

SM-47007

NOT RELEASED

139

tion Facility  
0740

MAY 1969

FACILITY FORM 602

**N70-34793**  
(ACCESSION NUMBER)

**701**  
(PAGES)

**CR-169941**  
(NASA CR OR TMX OR AD NUMBER)

(THRU) \_\_\_\_\_

(CODE) \_\_\_\_\_

**31**  
(CATEGORY)

[REDACTED]

[REDACTED]

[REDACTED]



**SATURN S-IVB-504N STAGE  
FLIGHT EVALUATION REPORT**

[REDACTED]

[REDACTED]

[REDACTED]

**MCDONNELL DOUGLAS ASTRONAUTICS COMPANY**

**MCDONNELL DOUGLAS**



[REDACTED]

# SATURN S-IVB-504N STAGE FLIGHT EVALUATION REPORT

SM-47007  
MAY 1969

PREPARED BY:  
SATURN S-IVB TEST PLANNING AND  
EVALUATION COMMITTEE AND  
COORDINATED BY: D. J. KATZ  
PROJECT OFFICE - TEST  
HUNTINGTON BEACH DEVELOPMENT ENGINEERING

PREPARED FOR:  
NATIONAL AERONAUTICS AND  
SPACE ADMINISTRATION  
UNDER NASA CONTRACT NAS7-101



APPROVED BY: A. P. O'NEAL  
HUNTINGTON BEACH DEVELOPMENT ENGINEERING DIRECTOR  
SATURN/APOLLO & APOLLO APPLICATIONS PROGRAMS

**MCDONNELL DOUGLAS ASTRONAUTICS COMPANY**  
**WESTERN DIVISION**

5301 Bolsa Avenue, Huntington Beach, California 92647 (714) 897-0311

ABSTRACT

This report presents the evaluation results of the prelaunch countdown, powered flight, and orbital phases of the S-IVB-504N stage which was launched 3 March 1969 as the third stage of the Saturn AS-504 vehicle.

The report is a contractual document as outlined in NASA Report MSFC-DRL-021, Contract Data Requirements, Saturn S-IVB Stage and GSE, dated 1 August 1968, Revision B. It was prepared by the Saturn S-IVB Test Planning and Evaluation Committee and coordinated by the Saturn S-IVB Project Office of the McDonnell Douglas Astronautics Company - Western Division.

DESCRIPTORS

Data Evaluation	S-IVB-504N
Flight Test	Saturn AS-504 Vehicle
Saturn V	Countdown

## PREFACE

The purpose of this report is to present the evaluation results of the prelaunch countdown, powered flight, and orbital phases of the S-IVB-504N stage which was launched on 3 March 1969 as the third stage of the Saturn AS-504 vehicle.

This report was prepared in compliance with the National Aeronautics and Space Administration Contract NAS7-101. It is published in accordance with NASA Report MSFC-DRL-021, Contract Data Requirements, Saturn S-IVB Stage and GSE, dated 1 August 1968, Revision B, which delineates the data required from the McDonnell Douglas Astronautics Company.

This document was prepared by the Saturn S-IVB Test Planning and Evaluation Committee and coordinated by the Saturn S-IVB Project Office of the McDonnell Douglas Astronautics Company - Western Division.



TABLE OF CONTENTS

PRECEDING PAGE BLANK NOT FILMED

<u>Section</u>		<u>Page</u>
1.	INTRODUCTION . . . . .	1-1
	1.1 General . . . . .	1-1
	1.2 History . . . . .	1-1
2.	SUMMARY . . . . .	2-1
	2.1 Flight Description . . . . .	2-1
	2.2 Mission Objectives . . . . .	2-4
	2.3 Test Operations . . . . .	2-5
	2.4 Cost Plus Incentive Fee . . . . .	2-5
	2.5 Trajectory . . . . .	2-6
	2.6 Mass Characteristics . . . . .	2-6
	2.7 Engine System . . . . .	2-6
	2.8 Solid Rockets . . . . .	2-6
	2.9 Oxygen-Hydrogen Burner System . . . . .	2-7
	2.10 Oxidizer System . . . . .	2-7
	2.11 Fuel System . . . . .	2-7
	2.12 Auxiliary Propulsion System (APS) . . . . .	2-7
	2.13 Pneumatic Control and Purge System . . . . .	2-8
	2.14 Propellant Utilization . . . . .	2-8
	2.15 S-II/S-IVB Separation . . . . .	2-8
	2.16 Data Acquisition System . . . . .	2-8
	2.17 Electrical System . . . . .	2-9
	2.18 Range Safety System . . . . .	2-10
	2.19 Flight Control . . . . .	2-10
	2.20 Hydraulic System . . . . .	2-10
	2.21 Aero/Thermo Environment . . . . .	2-11
	2.22 Stage Structure and Environment . . . . .	2-11
	2.23 Explosive Ordnance Equipment . . . . .	2-11
	2.24 Forward Skirt Therm conditioning . . . . .	2-12
	2.25 Stage Safing . . . . .	2-12
3.	TEST CONFIGURATION . . . . .	3-1
	3.1 General . . . . .	3-1
4.	SEQUENCE OF EVENTS . . . . .	4-1
	4.1 Predicted Times . . . . .	4-1
	4.2 Monitored Times . . . . .	4-2
	4.3 Time Bases . . . . .	4-2
	4.4 Data Omissions . . . . .	4-3
	4.5 Comments . . . . .	4-3
	4.6 Ground Sequence of Events . . . . .	4-4
5.	TEST OPERATIONS . . . . .	5-1
	5.1 Launch Vehicle Tests . . . . .	5-1
	5.2 AS-504 Launch Countdown . . . . .	5-2
	5.3 Redline Limits . . . . .	5-5
	5.4 Countdown Problems . . . . .	5-6
	5.5 Environmental Control Systems . . . . .	5-6
	5.6 Atmospheric Conditions . . . . .	5-7

TABLE OF CONTENTS (Continued)

<u>Section</u>		<u>Page</u>
6.	COST PLUS INCENTIVE FEE . . . . .	6-1
	6.1 Flight Mission Accomplishment . . . . .	6-1
	6.2 Telemetry Performance . . . . .	6-1
7.	TRAJECTORY . . . . .	7-1
	7.1 Comparison Between Actual and Preflight Predicted Trajectories . . . . .	7-1
	7.2 Powered Flight Simulated Trajectory Evaluation . . . . .	7-3
8.	MASS CHARACTERISTICS . . . . .	8-1
	8.1 Mass Property Uncertainties Analysis . . . . .	8-1
	8.2 Best Estimate Ignition and Cutoff Masses . . . . .	8-1
9.	ENGINE SYSTEM . . . . .	9-1
	9.1 Modifications . . . . .	9-1
	9.2 Sequence of Events . . . . .	9-2
	9.3 Engine Chilldown Conditioning . . . . .	9-3
	9.4 Start System Performance . . . . .	9-4
	9.5 Engine Control Sphere Performance . . . . .	9-6
	9.6 Engine Performance . . . . .	9-9
	9.7 Trajectory Simulation Analysis . . . . .	9-21
	9.8 Component Operation . . . . .	9-21
10.	SOLID ROCKETS . . . . .	10-1
	10.1 Retrockets . . . . .	10-1
	10.2 Ullage Rockets . . . . .	10-1
11.	OXIDIZER SYSTEM . . . . .	11-1
	11.1 LOX Tank Pressurization Control . . . . .	11-1
	11.2 Pressurization System Conditions During Coast . . . . .	11-6
	11.3 LOX Pump Chilldown . . . . .	11-8
	11.4 Engine LOX Supply . . . . .	11-9
12.	FUEL SYSTEM . . . . .	12-1
	12.1 LH2 Tank Pressurization . . . . .	12-1
	12.2 Pressurization System Conditions During Coast . . . . .	12-4
	12.3 LH2 Pump Chilldown . . . . .	12-5
	12.4 Engine LH2 Supply . . . . .	12-7
13.	OXYGEN-HYDROGEN BURN SYSTEM . . . . .	13-1
	13.1 Burner Performance . . . . .	13-1
	13.2 LH2 Tank Repressurization . . . . .	13-2
	13.3 Cold Helium Supply . . . . .	13-2
14.	AUXILIARY PROPULSION SYSTEM . . . . .	14-1
	14.1 APS Flight Operation . . . . .	14-1
	14.2 APS System Operation . . . . .	14-2
	14.3 Engine Performance . . . . .	14-5
15.	PNEUMATIC CONTROL AND PURGE SYSTEM . . . . .	15-1
	15.1 Pneumatic Control . . . . .	15-1
	15.2 Ambient Helium Purges . . . . .	15-3

TABLE OF CONTENTS (Continued)

<u>Section</u>		<u>Page</u>
16.	PROPELLANT UTILIZATION . . . . .	16-1
	16.1 PU Mass Sensor Calibration . . . . .	16-1
	16.2 Propellant Mass History . . . . .	16-2
	16.3 PU System Response . . . . .	16-5
	16.4 Anomalies . . . . .	16-6
17.	S-II/S-IVB STAGE SEPARATION . . . . .	17-1
	17.1 S-II/S-IVB Separation Dynamics . . . . .	17-1
18.	DATA ACQUISITION SYSTEM . . . . .	18-1
	18.1 Data Acquisition System Objective . . . . .	18-1
	18.2 Summary of Performance . . . . .	18-1
	18.3 Instrumentation System Performance . . . . .	18-2
	18.4 Telemetry System Performance . . . . .	18-2
19.	ELECTRICAL POWER AND CONTROL SYSTEM . . . . .	19-1
	19.1 Power System . . . . .	19-1
	19.2 Electrical Control System . . . . .	19-5
20.	RANGE SAFETY SYSTEM PERFORMANCE . . . . .	20-1
	20.1 Controllers . . . . .	20-1
	20.2 Firing Unit Monitors . . . . .	20-1
	20.3 Receivers Signal Strength . . . . .	20-1
21.	FLIGHT CONTROL . . . . .	21-1
	21.1 S-IVB Powered Flight Control System Evaluation . . . . .	21-1
	21.2 Attitude Control-Orbit . . . . .	21-6
22.	HYDRAULIC SYSTEM . . . . .	22-1
	22.1 Hydraulic System Operation . . . . .	22-1
23.	FORWARD SKIRT THERMOCONDITIONING SYSTEM . . . . .	23-1
	23.1 Temperature . . . . .	23-1
	23.2 Pressure . . . . .	23-1
	23.3 Flowrate . . . . .	23-1
24.	AERO/THERMODYNAMIC ENVIRONMENT . . . . .	24-1
	24.1 Compartment Venting . . . . .	24-1
	24.2 Thermodynamic Environment . . . . .	24-1
25.	STAGE SAFING . . . . .	25-1
	25.1 Propellant Dump . . . . .	25-1
	25.2 High-Pressure Sphere Passivation . . . . .	25-1

APPENDICES

Appendix

1.	GLOSSARY AND ABBREVIATIONS . . . . .	AP 1-1
	DISTRIBUTION LIST	

LIST OF TABLES

<u>Table</u>		<u>Page</u>
3-1	S-IVB-504N Stage and GSE Flight Orifices . . . . .	3-3
3-2	S-IVB-504N Stage Pressure Switch Data . . . . .	3-7
4-1	AS-504D Post Flight Sequence of Events . . . . .	4-5
4-2	Ground Commands . . . . .	4-52
4-3	Data Omissions (Reasons) . . . . .	4-54
4-4	Data Omissions (Times) . . . . .	4-54
4-5	Ground Sequence of Events . . . . .	4-55
5-1	S-IVB-504N Stage Propellant Loading Data . . . . .	5-8
5-2	APS Loading Data . . . . .	5-9
5-3	Sphere Pressurization Data . . . . .	5-10
5-4	AS-504N Terminal Countdown Sequence . . . . .	5-11
5-5	Atmospheric Conditions During AS-504 Launch . . . . .	5-12
6-1	S-IVB-504 Preconditions of Flight (PCF) (S-II/S-IVB Separation Command) . . . . .	6-2
6-2	S-IVB-504 End Conditions of Flight (ECF) MDAC-WD Position . . . . .	6-3
6-3	S-IVB End Conditions of Flight (ECF) MSFC Position . . . . .	6-5
6-4	Flight Telemetry Performance Summary . . . . .	6-7
7-1	AS-504 Conditions at Maximum Dynamic Pressure . . . . .	7-6
7-2	AS-504 Conditions at S-IC/S-II Separation Command . . . . .	7-7
7-3	AS-504 Conditions at S-II/S-IVB Separation Command . . . . .	7-8
7-4	AS-504 Conditions at S-IVB First Guidance Cutoff Command . . . . .	7-9
7-5	AS-504 Conditions at Parking Orbit Insertion . . . . .	7-10
7-6	AS-504 Condition at SC/LV Final Separation . . . . .	7-11
7-7	AS-504 Conditions at Time Base 6 . . . . .	7-12
7-8	AS-504 Conditions at S-IVB Second Engine Start Command . . . . .	7-13
7-9	AS-504 Conditions at S-IVB Second Cutoff Command . . . . .	7-14
7-10	AS-504 Conditions at Intermediate Orbit Insertion . . . . .	7-15
7-11	AS-504 Conditions at Time Base 8 . . . . .	7-16
7-12	AS-504 Conditions at S-IVB Ground Commanded Third Engine Start Command . . . . .	7-17
7-13	AS-504 Conditions at S-IVB Third Cutoff Command . . . . .	7-18
7-14	AS-504 Conditions at Escape Orbit Injection . . . . .	7-19
8-1	AS-504 Third Flight Stage Final Eval. Mass Summary . . . . .	8-3
9-1	Engine Sequence (504-First Burn) . . . . .	9-25
9-2	Engine Sequence (504-Second Burn) . . . . .	9-31
9-3	Engine Sequence (504-Third Burn) . . . . .	9-37
9-4	Fuel Lead Conditions . . . . .	9-43
9-5	Engine Start Sphere Data . . . . .	9-44
9-6	Control Sphere Data . . . . .	9-45
9-7	Start Bottle Refill Performance . . . . .	9-46
9-8	J-2 Engine Steady Performance Compared to Predicted (STDV +2.5 SEC to ECO) . . . . .	9-47
9-9	Data Inputs to Computer Programs . . . . .	9-48
9-10	J-2 Engine Start Transients . . . . .	9-52
9-11	S-IVB Total J-2 Propulsion Performance . . . . .	9-53
9-12	S-IVB Steady State Performance (STDV +60 Second Time Slice at Standard Altitude Conditions) . . . . .	9-54
9-13	S-IVB-504 Third Burn Anomaly . . . . .	9-55
9-14	J-2 Engine Cutoff Transients . . . . .	9-56
9-15	AS-504 S-IVB Cutoff Impulse . . . . .	9-57

LIST OF TABLES (Continued)

<u>Table</u>		<u>Page</u>
11-1	LOX Tank Prepressurization Data . . . . .	11-11
11-2	LOX Tank Pressurization Data . . . . .	11-12
11-3	Cold Helium Supply Data . . . . .	11-13
11-4	J-2 Heat Exchanger Performance Data . . . . .	11-14
11-5	LOX Chillover System Performance Data . . . . .	11-15
11-6	LOX Chillover Sequence - Third Burn . . . . .	11-18
11-7	LOX Pump Inlet Condition Data . . . . .	11-19
12-1	LH2 Tank Prepressurization Data . . . . .	12-10
12-2	LH2 Tank Pressurization Data . . . . .	12-11
12-3	LH2 Tank Repressurization Data . . . . .	12-12
12-4	LH2 Chillover System Performance Data . . . . .	12-13
12-5	LH2 Chillover - Third Burn . . . . .	12-16
12-6	LH2 Pump Inlet Condition Data . . . . .	12-17
13-1	O2-H2 Burner Performance Data . . . . .	13-3
14-1	Helium Bottle Conditions . . . . .	14-7
14-2	S-IVB-504N APS Propellant Consumption . . . . .	14-8
15-1	Pneumatic Control and Purge System Data . . . . .	15-4
16-1	Propellant Mass History . . . . .	16-7
17-1	AS-504 Separation Events . . . . .	17-2
18-1	Measurement Status . . . . .	18-6
18-2	Deleted Measurements . . . . .	18-9
18-3	Measurement Failures . . . . .	18-10
18-4	Measurement Anomalies . . . . .	18-16
18-5	RF System Performance . . . . .	18-20
21-1	Maximum Control Parameters During First Burn . . . . .	21-8
21-2	Maximum Control Parameters During Second Burn . . . . .	21-9
21-3	Maximum Control Parameters During S-IVB Third Burn . . . . .	21-10
21-4	"D" Mission Attitude Timeline Nominal Mission . . . . .	21-11
25-1	High-Pressure Sphere Passivation . . . . .	25-3
AP 1-1	Glossary and Abbreviations . . . . .	AP 1-1

LIST OF ILLUSTRATIONS

<u>Figure</u>		<u>Page</u>
1-1	S-IVB-504 Stage Checkout and Test History . . . . .	1-2
3-1	Schematic S-IVB/V Propulsion System Complete . . . . .	3-1
7-1	S-IC/S-II Stage Altitude History . . . . .	7-20
7-2	S-IC/S-II Stage Ground Range History . . . . .	7-21
7-3	S-IC/S-II Stage Crossrange Position History . . . . .	7-22
7-4	S-IC/S-II Stage Crossrange Velocity History . . . . .	7-23
7-5	S-IC/S-II Stage Inertial Velocity History . . . . .	7-24
7-6	S-IC/S-II Stage Axial Acceleration History . . . . .	7-25
7-7	S-IC/S-II Stage Inertial Flight Path Elevation Angle History . . . . .	7-26
7-8	S-IC/S-II Stage Inertial Flight Path Azimuth Angle History . . . . .	7-27
7-9	S-IC/S-II Stage Mach Number History . . . . .	7-28
7-10	S-IC Stage Dynamic Pressure History . . . . .	7-29
7-11	S-IC Stage Pitch Angle of Attack History . . . . .	7-30
7-12	S-IC Stage Yaw Angle of Attack History . . . . .	7-31
7-13	S-IC Stage Total Angle of Attack History . . . . .	7-32
7-14	Boost Phase Pitch Attitude Angle History . . . . .	7-33
7-15	Boost Phase Yaw Attitude Angle History . . . . .	7-34
7-16	Boost Phase Roll Attitude Angle History . . . . .	7-35
7-17	S-IVB Stage First Burn Altitude History . . . . .	7-36
7-18	S-IVB Stage First Burn Ground Range History . . . . .	7-37
7-19	S-IVB Stage First Burn Crossrange Position History . . . . .	7-38
7-20	S-IVB Stage First Burn Crossrange Velocity History . . . . .	7-39
7-21	S-IVB Stage First Burn Inertial Velocity History . . . . .	7-40
7-22	S-IVB Stage First Burn Axial Acceleration History . . . . .	7-41
7-23	S-IVB Stage First Burn Inertial Flight Path Elevation Angle History . . . . .	7-42
7-24	S-IVB Stage First Burn Inertial Flight Path Azimuth Angle History . . . . .	7-43
7-25	S-IVB Stage Second Burn Altitude History . . . . .	7-44
7-26	S-IVB Stage Second Burn Ground Range History . . . . .	7-45
7-27	S-IVB Stage Second Burn Crossrange Position History . . . . .	7-46
7-28	S-IVB Stage Second Burn Crossrange Velocity History . . . . .	7-47
7-29	S-IVB Stage Second Burn Inertial Velocity History . . . . .	7-48
7-30	S-IVB Stage Second Burn Axial Acceleration History . . . . .	7-49
7-31	S-IVB Stage Second Burn Inertial Flight Path Elevation Angle History . . . . .	7-50
7-32	S-IVB Stage Second Burn Inertial Flight Path Azimuth Angle History . . . . .	7-
7-33	S-IVB Stage Second Burn Pitch Attitude Angle History . . . . .	7-
7-34	S-IVB Stage Second Burn Yaw Attitude Angle History . . . . .	7-
7-35	S-IVB Stage Second Burn Roll Attitude Angle History . . . . .	7-54
7-36	S-IVB Stage Third Burn Altitude History . . . . .	7-55
7-37	S-IVB Stage Third Burn Ground Range History . . . . .	7-56
7-38	S-IVB Stage Third Burn Inertial Velocity History . . . . .	7-57
7-39	S-IVB Stage Third Burn Axial Acceleration History . . . . .	7-58
7-40	S-IVB Stage Third Burn Inertial Flight Path Elevation Angle History . . . . .	7-59
7-41	S-IVB Stage Third Burn Inertial Flight Path Azimuth History . . . . .	7-60
7-42	S-IVB Stage Third Burn Pitch Attitude Angle History . . . . .	7-61
7-43	S-IVB Stage Third Burn Yaw Attitude Angle History . . . . .	7-62
7-44	S-IVB Stage Third Burn Roll Attitude Angle History . . . . .	7-63

LIST OF ILLUSTRATIONS (Continued)

<u>Figure</u>		<u>Page</u>
7-45	Trajectory Simulation Deviations From Observed Trajectory - First Burn . . . . .	7-64
7-46	Trajectory Simulation Deviations From Observed Trajectory - Second Burn . . . . .	7-65
7-47	Trajectory Simulation Deviations From Observed Trajectory - Third Burn . . . . .	7-66
8-1	Third Flight Stage Vehicle Mass (First Burn) . . . . .	8-6
8-2	Third Flight Stage Vehicle Mass (Second Burn) . . . . .	8-7
8-3	Third Flight Stage Vehicle Mass (Third Burn) . . . . .	8-8
8-4	Third Flight Stage Vehicle Horizontal Center of Gravity (First Burn) . . . . .	8-9
8-5	Third Flight Stage Vehicle Horizontal Center of Gravity (Second Burn) . . . . .	8-10
8-6	Third Flight Stage Vehicle Horizontal Center of Gravity (Third Burn) . . . . .	8-11
8-7	Third Flight Stage Vehicle Roll Moment of Inertia (First Burn) . . . . .	8-12
8-8	Third Flight Stage Vehicle Roll Moment of Inertia (Second Burn) . . . . .	8-13
8-9	Third Flight Stage Vehicle Roll Moment of Inertia (Third Burn) . . . . .	8-14
8-10	Third Flight Stage Vehicle Pitch Moment of Inertia (First Burn) . . . . .	8-15
8-11	Third Flight Stage Vehicle Pitch Moment of Inertia (Second Burn) . . . . .	8-16
8-12	Third Flight Stage Vehicle Pitch Moment of Inertia (Third Burn) . . . . .	8-17
8-13	AS-504 Third Flight Stage Best Estimate Masses - First Burn . . . . .	8-18
8-14	AS-504 Third Flight Stage Best Estimate Masses - Second Burn . . . . .	8-19
8-15	AS-504 Third Flight Stage Best Estimate Masses - Third Burn . . . . .	8-20
9-1	J-2 Engine System and Instrumentation . . . . .	9-58
9-2	First Burn Tag Values . . . . .	9-59
9-3	Second and Third Burn Tag values . . . . .	9-61
9-4	Engine Start Sequence - First Burn . . . . .	9-63
9-5	Engine Start Sequence - Second Burn . . . . .	9-64
9-6	Engine Start Sequence - Third Burn . . . . .	9-65
9-7	Significant Events - Second and Third Burns . . . . .	9-66
9-8	Oxidizer Pump Discharge Pressure Versus Temperature . . . . .	9-67
9-9	Thrust Chamber Chillover - First Burn . . . . .	9-68
9-10	Fuel Lead - First Burn . . . . .	9-69
9-11	Fuel Lead - Second Burn . . . . .	9-70
9-12	Fuel Lead - Third Burn . . . . .	9-71
9-13	GH2 Start Sphere Critical Limits at Liftoff . . . . .	9-72
9-14	Engine Start Sphere Performance - First Burn . . . . .	9-73
9-15	Engine Control Sphere Performance - First Burn . . . . .	9-74
9-16	Start Sphere Refill Performance . . . . .	9-75
9-17	Start Sphere Conditions - Earth Orbit . . . . .	9-78
9-18	Start Sphere Conditions during Coast . . . . .	9-79
9-19	Start Sphere Refill . . . . .	9-80
9-20	Start Tank Safing (504N) . . . . .	9-83
9-21	Control Sphere Performance . . . . .	9-84
9-22	Control Sphere Conditions . . . . .	9-87
9-23	Engine Regulator Outlet Pressure . . . . .	9-90
9-24	Control Sphere Performance during Coast . . . . .	9-93
9-25	Control Sphere Pressure - Passivation . . . . .	9-94
9-26	Fuel Lead Characteristics - First Burn . . . . .	9-95
9-27	Fuel Lead Characteristics - Second Burn . . . . .	9-97
9-28	Fuel Lead Characteristics - Third Burn . . . . .	9-99
9-29	Engine Start Transient Characteristics . . . . .	9-101

LIST OF ILLUSTRATIONS (Continued)

	<u>Page</u>
LOX-LH2 Consumption during Burn Start Transient . . . . .	9-104
LOX and LH2 Pump Performance . . . . .	9-107
J-2 Engine Chamber Pressure . . . . .	9-110
PU Valve Operation . . . . .	9-113
J-2 Engine Flowrates . . . . .	9-116
J-2 Engine Pump Operating Characteristics . . . . .	9-120
J-2 Engine Injector Supply Conditions . . . . .	9-123
Turbine Operating Conditions . . . . .	9-126
Engine Steady-State Performance - First Burn . . . . .	9-129
Engine Steady-State Performance - Second Burn . . . . .	9-132
Engine Steady-State Performance - Third Burn . . . . .	9-135
Third Burn Anomaly Data - Fuel Turbine Inlet Temperature . . . . .	9-138
Third Burn Anomaly Data - Oxidizer Turbine Inlet Temperature . . . . .	9-139
Third Burn Anomaly Data - GG Valve Position . . . . .	9-140
S-IVB-504 Third Burn Sequence of Events . . . . .	9-141
S-IVB-504 Third Burn Anomaly Summary . . . . .	9-143
Third Burn Anomaly Data - Valve Positions . . . . .	9-146
Third Burn Anomaly Data - Thrust Structures and ECA Temperatures . . . . .	9-147
Third Burn Anomaly Data - GG Fuel Bleed Valve Temperature . . . . .	9-148
Third Burn Anomaly Data - Engine Area Ambient Temperature . . . . .	9-149
Engine Cutoff Transient Characteristics . . . . .	9-150
AS-504 S-IVB Change in Velocity due to Cutoff Impulse . . . . .	9-153
LH2 Pump Performance during Engine Start . . . . .	9-156
Gas Generator Performance . . . . .	9-159
Gas Generator Chamber Pressure - Third Burn . . . . .	9-162
Schematic, LOX Tank Pressurization and Repressurization System . . . . .	11-21
LOX Tank Conditions during Prepressurization . . . . .	11-22
LOX Tank Pressurization System Performance - First Burn . . . . .	11-24
Cold Helium Supply - Boost and First Burn . . . . .	11-26
J-2 Heat Exchanger Performance - First Burn . . . . .	11-27
LOX Tank Pressurization System Performance - Second Burn . . . . .	11-29
Cold Helium Supply - Second Burn . . . . .	11-31
J-2 Heat Exchanger Performance - Second Burn . . . . .	11-32
LOX Tank Pressurization System Performance - Third Burn . . . . .	11-34
Cold Helium Supply - Third Burn . . . . .	11-36
J-2 Heat Exchanger Performance - Third Burn . . . . .	11-37
LOX Tank Conditions - Earth Orbit and Solar Orbit Insertion . . . . .	11-39
LOX Tank Ullage Pressure - Earth Orbit and Solar Orbit Insertion . . . . .	11-43
LOX Nonpropulsive Vent System Performance - Solar Orbit Insertion . . . . .	11-45
Cold Helium Sphere Conditions - Earth Orbit . . . . .	11-46
Cold Helium Conditions - Intermediate Orbit and Dump . . . . .	11-48
LOX Pump Chilldown System Operation - Boost and First Burn . . . . .	11-49
LOX Pump Chilldown System Performance - Boost and First Burn . . . . .	11-51
LOX Pump Chilldown System Operation - Second Burn . . . . .	11-53
LOX Pump Chilldown System Performance - Second Burn . . . . .	11-55



LIST OF ILLUSTRATIONS (Continued)

<u>Figure</u>		<u>Page</u>
11-21	Schematic, LOX Fill and Feed System . . . . .	11-57
11-22	LOX Pump Inlet Conditions - First Burn . . . . .	11-58
11-23	LOX Pump Inlet Conditions during Firing - First Burn . . . . .	11-60
11-24	Effect of LOX Mass Level on LOX Pump Inlet Temperature . . . . .	11-61
11-25	LOX Pump Inlet Conditions - Second Burn . . . . .	11-62
11-26	LOX Pump Inlet Conditions during Firing - Second Burn . . . . .	11-64
11-27	LOX Pump Inlet Conditions - Third Burn . . . . .	11-65
11-28	LOX Supply Conditions during Extended Fuel Lead - Third Burn . . . . .	11-67
11-29	LOX Pump Inlet Conditions during Firing - Third Burn . . . . .	11-68
12-1	Schematic, LH2 Tank Pressurization and Repress System . . . . .	12-19
12-2	LH2 Tank Prepressurization System Performance . . . . .	12-20
12-3	LH2 Tank Pressurization System Performance - First Burn . . . . .	12-21
12-4	LH2 Tank Ullage Pressure during O <sub>2</sub> -H <sub>2</sub> Burner Repressurization . . . . .	12-23
12-5	LH2 Tank Pressurization System Performance - Second Burn . . . . .	12-24
12-6	LH2 Tank Ambient Helium Repressurization System Performance - Third Burn . . . . .	12-26
12-7	LH2 Tank Pressurization System Performance - Third Burn . . . . .	12-28
12-8	Nonpropulsive Vent System Operation - Solar Orbit Insertion . . . . .	12-30
12-9	LH2 Tank Continuous Vent System Performance - Earth Orbit . . . . .	12-31
12-10	LH2 Tank Continuous Vent System Operation - Earth Orbit . . . . .	12-35
12-11	LH2 Tank Continuous Vent System Performance - Intermediate Orbit . . . . .	12-39
12-12	LH2 Tank Continuous Vent System Operation - Intermediate Orbit . . . . .	12-40
12-13	LH2 Tank Continuous Vent System Performance - Solar Orbit Insertion . . . . .	12-41
12-14	LH2 Tank Continuous Vent System Operation - Solar Orbit Insertion . . . . .	12-42
12-15	LH2 Pump Chillover Performance - First Burn . . . . .	12-43
12-16	LH2 Pump Chillover - First Burn . . . . .	12-45
12-17	LH2 Pump Chillover System Performance - Second Burn . . . . .	12-47
12-18	LH2 Pump Chillover - Second Burn . . . . .	12-49
12-19	Schematic, LH2 Fill and Feed System . . . . .	12-50
12-20	LH2 Pump Inlet Conditions - First Burn . . . . .	12-51
12-21	LH2 Pump Inlet Conditions during Firing - First Burn . . . . .	12-53
12-22	Effect of LH2 Mass Level on LH2 Pump Inlet Temperature . . . . .	12-54
12-23	LH2 Pump Inlet Conditions - Second Burn . . . . .	12-55
12-24	LH2 Pump Inlet Conditions during Firing - Second Burn . . . . .	12-57
12-25	LH2 Supply Conditions during Extended Fuel Lead - Third Burn . . . . .	12-58
12-26	LH2 Pump Inlet Conditions - Third Burn . . . . .	12-59
12-27	LH2 Pump Inlet Conditions during Firing - Third Burn . . . . .	12-61
13-1	Schematic, Oxygen Hydrogen Burner . . . . .	13-4
13-2	O <sub>2</sub> -H <sub>2</sub> Burner Operation - First Restart Preparation . . . . .	13-5
13-3	O <sub>2</sub> -H <sub>2</sub> Burner Operation - Second Restart Preparation . . . . .	13-7
13-4	LH2 Tank Burner Repressurization . . . . .	13-9
13-5	Cold Helium Sphere Conditions during O <sub>2</sub> -H <sub>2</sub> Burner Operation . . . . .	13-10
14-1	System Schematic Auxiliary Propulsion Bladder System . . . . .	14-9
14-2	APS Module 1 Helium Bottle Temperature . . . . .	14-10
14-3	APS Module 1 Helium Bottle Pressure . . . . .	14-11
14-4	APS Module 2 Helium Bottle Temperature . . . . .	14-12
14-5	APS Module 2 Helium Bottle Pressure . . . . .	14-13
14-6	APS Helium Mass . . . . .	14-14

LIST OF ILLUSTRATIONS (Continued)

<u>Figure</u>		<u>Page</u>
14-7	APS Module No. 2 Helium Leakage . . . . .	14-15
14-8	APS Module No. 1 Propellant Temperatures . . . . .	14-16
14-9	APS Module 1 Propellant Masses . . . . .	14-17
14-10	APS Module 2 Propellant Temperatures . . . . .	14-18
14-11	APS Module 2 Propellant Masses . . . . .	14-19
14-12	APS Total Impulse (Module 1 Attitude Control Engines) . . . . .	14-20
14-13	APS Total Impulse (Module 2 Attitude Control Engines) . . . . .	14-21
14-14	APS Total Impulse Per Pulse (Module 1) . . . . .	14-22
14-15	APS Total Impulse Per Pulse (Module 2) . . . . .	14-23
14-16	APS Thrust (Module 1) . . . . .	14-24
14-17	APS Thrust (Module 2) . . . . .	14-25
15-1	Schematic, SV Pneumatic Control System . . . . .	15-6
15-2	Pneumatic Control and Purge System Performance - Boost and First Burn . . . . .	15-7
15-3	Pneumatic Control and Purge System Performance - Earth Orbit . . . . .	15-8
15-4	Pneumatic Control and Purge System Performance - Second Burn . . . . .	15-9
15-5	Pneumatic Control and Purge System Performance - Intermediate Orbit . . . . .	15-10
15-6	Pneumatic Control and Purge System Performance - Third Burn . . . . .	15-11
15-7	Pneumatic Control and Purge System Performance - Solar Orbit Insertion . . . . .	15-12
15-8	LOX Chilldown Pump Motor Container Purge Performance - First Burn . . . . .	15-13
15-9	LOX Chilldown Pump Motor Container Purge Performance - Second and Third Burn . . . . .	15-14
16-1	LOX S-IVB-504N Stage Total Volumetric Flight PU Mass Correction . . . . .	16-8
16-2	LH2 S-IVB-504N Stage Total Volumetric Flight PU Mass Correction . . . . .	16-9
16-3	LOX Mass Sensor Nonlinearity (Flow Integral Method) . . . . .	16-10
16-4	LH2 Mass Sensor Nonlinearity (Flow Integral Method) . . . . .	16-11
16-5	PU Valve Position History . . . . .	16-12
17-1	Longitudinal Acceleration . . . . .	17-3
17-2	Angular Velocity . . . . .	17-4
18-1	Ground Station Signal Strength - Tel 4 RH Boost Phase . . . . .	18-21
18-2	Ground Station Signal Strength - GBI RH Boost Phase . . . . .	18-22
18-3	Ground Station Signal Strength - GBI - LH . . . . .	18-23
18-4	Ground Station Signal Strength - Tex - RH Rev 3 PCM . . . . .	18-24
18-5	Ground Station Signal Strength - Tex - LH Rev 3 . . . . .	18-25
19-1	Forward Battery No. 1 Performance . . . . .	19-13
19-2	Forward Battery No. 2 Performance . . . . .	19-16
19-3	Aft Battery No. 1 Performance . . . . .	19-19
19-4	Aft Battery No. 2 Performance . . . . .	19-22
21-1	Pitch Attitude Control during S-IVB First Burn . . . . .	21-12
21-2	Yaw Attitude Control during S-IVB First Burn . . . . .	21-13
21-3	Roll Attitude Control during S-IVB First Burn . . . . .	21-14
21-4	S-IVB Slosh Frequency and Height for LOX during First Burn . . . . .	21-15
21-5	Pitch Attitude Control during S-IVB Second Burn . . . . .	21-16
21-6	Yaw Attitude Control during S-IVB Second Burn . . . . .	21-17
21-7	Roll Attitude Control during S-IVB Second Burn . . . . .	21-18
21-8	S-IVB Slosh Frequencies and Height during Second Burn . . . . .	21-19
21-9	Pitch Attitude Control during S-IVB Third Burn . . . . .	21-20
21-10	Yaw Attitude Control during S-IVB Third Burn . . . . .	21-21
21-11	Roll Attitude Control during S-IVB Third Burn . . . . .	21-22
21-12	Commanded and Actual Yaw Actuator Position . . . . .	21-23

LIST F ILLUSTRATIONS (Continued)

<u>Figure</u>		<u>Page</u>
12-13	Commanded and Actual Pitch Actuator Position . . . . .	21-24
21-14	504N Roll Torque - Third Burn . . . . .	21-25
21-15	S-IVB Slosh Frequencies and Heights during Third Burn . . . . .	21-26
21-16	Pitch Attitude Control during TD&E Maneuver . . . . .	21-27
21-17	Yaw Attitude Control during TD&E Maneuver . . . . .	21-28
21-18	Roll Attitude Control during TD&E Maneuver . . . . .	21-29
21-19	Pitch Attitude Control during S/C Separation . . . . .	21-30
21-20	Yaw Attitude Control during S/C Separation . . . . .	21-31
21-21	Roll Attitude Control during S/C Separation . . . . .	21-32
21-22	Pitch Attitude Control during Hard Dock . . . . .	21-33
21-23	Yaw Attitude Control during Hard Dock . . . . .	21-34
21-24	Roll Attitude Control during Hard Dock . . . . .	21-35
21-25	Pitch Attitude Control during LM Extraction . . . . .	21-36
21-26	Yaw Attitude Control during LM Extraction . . . . .	21-37
21-27	Roll Attitude Control during LM Extraction . . . . .	21-38
21-28	Pitch Attitude Control during Alignment of S-IVB to Local Horizontal prior to Second Burn . . . . .	21-39
21-29	Yaw Attitude Control during Alignment of S-IVB to Local Horizontal prior to Second Burn . . . . .	21-40
21-30	Roll Attitude Control during Alignment of S-IVB to Local Horizontal prior to Second Burn . . . . .	21-41
22-1	Hydraulic System Functional Sequence . . . . .	22-4
22-2	Hydraulic System Line Temperatures . . . . .	22-5
22-3	Hydraulic System Temperatures . . . . .	22-9
22-4	Hydraulic System - Boost and First Burn . . . . .	22-13
22-5	Hydraulic System - First Burn . . . . .	22-16
22-6	Hydraulic System - Second Burn . . . . .	22-17
22-7	Hydraulic System - Actuator Position . . . . .	22-20
22-8	Hydraulic System - Third Burn . . . . .	22-21
24-1	Saturn V-504N Aft Compartment Internal Pressure Minus Ambient Pressure Versus Time . . . . .	24-4
24-2	Saturn V-504N Forward Compartment Internal Pressure Minus Ambient Pressure Versus Time . . . . .	24-5
24-3	Saturn V-504N Aft Compartment Internal Pressure Minus Ambient Pressure Versus Mach Number . . . . .	24-6
24-4	Saturn V-504N Forward Compartment Internal Pressure Minus Ambient Pressure Versus Mach Number . . . . .	24-7
24-5	Saturn V Flight Trajectories Comparison . . . . .	24-8
24-6	Comparison of Predicted and Actual Battery Temperature History - Forward Battery No. 1 . . . . .	24-9
24-7	Comparison of Predicted and Actual Battery Temperature History - Forward Battery No. 2 . . . . .	24-10
24-8	Comparison of Predicted and Actual Battery Temperature History - Aft Battery No. 1 . . . . .	24-11
24-9	Comparison of Predicted and Actual Battery Temperature History - Aft Battery No. 2 . . . . .	24-12
24-10	Temperature Histories in the Vicinity of the O <sub>2</sub> -H <sub>2</sub> Burner . . . . .	24-13
24-11	Saturn V-504N Engine Bell Heat Fluxes during Third Engine Burn . . . . .	24-14
25-1	Ambient Repressurization Helium Dump . . . . .	25-4

## 1. INTRODUCTION

### 1.1 General

This report presents the results of analyses that were performed by McDonnell Douglas Astronautics Company - Western Division (MDAC-WD) personnel on the countdown, launch, and flight of the Saturn S-IVB-504N stage.

This report is authorized by NASA Contract NAS7-101, and is the final report on the S-IVB-504N stage by the MDAC-WD S-IVB Test Planning and Evaluation Committee, Huntington Beach, California.

### 1.2 History

The S-IVB-504N stage was assembled at MDAC-WD, Huntington Beach, California. A checkout was performed in the vehicle checkout laboratory (VCL) prior to shipping the stage to Sacramento Test Center (STC). The stage was delivered to STC on 15 June 1967 and installed at Complex Beta on test stand I on 7 July 1967. The S-IVB-504N stage was acceptance fired on 26 August 1967. No confidence firings of the two auxiliary propulsion system modules were scheduled. Evaluation and analysis of the acceptance firing is presented in MDAC-WD Report SM-47460, Saturn S-IVB-504N Stage Acceptance Firing Report.

The stage was then shipped to Kennedy Space Center, installed in the low bay of the vehicle assembly building and subjected to post transportation receiving inspections. After installation of the aft interstage the stage was installed in the high bay. The S-IVB-504N stage was then mated to AS-504. The AS-504 was launched from launch complex 39A on 3 March 1969 at 16:00:00.665 GMT. Figure 1-1 presents significant checkout and test history dates.

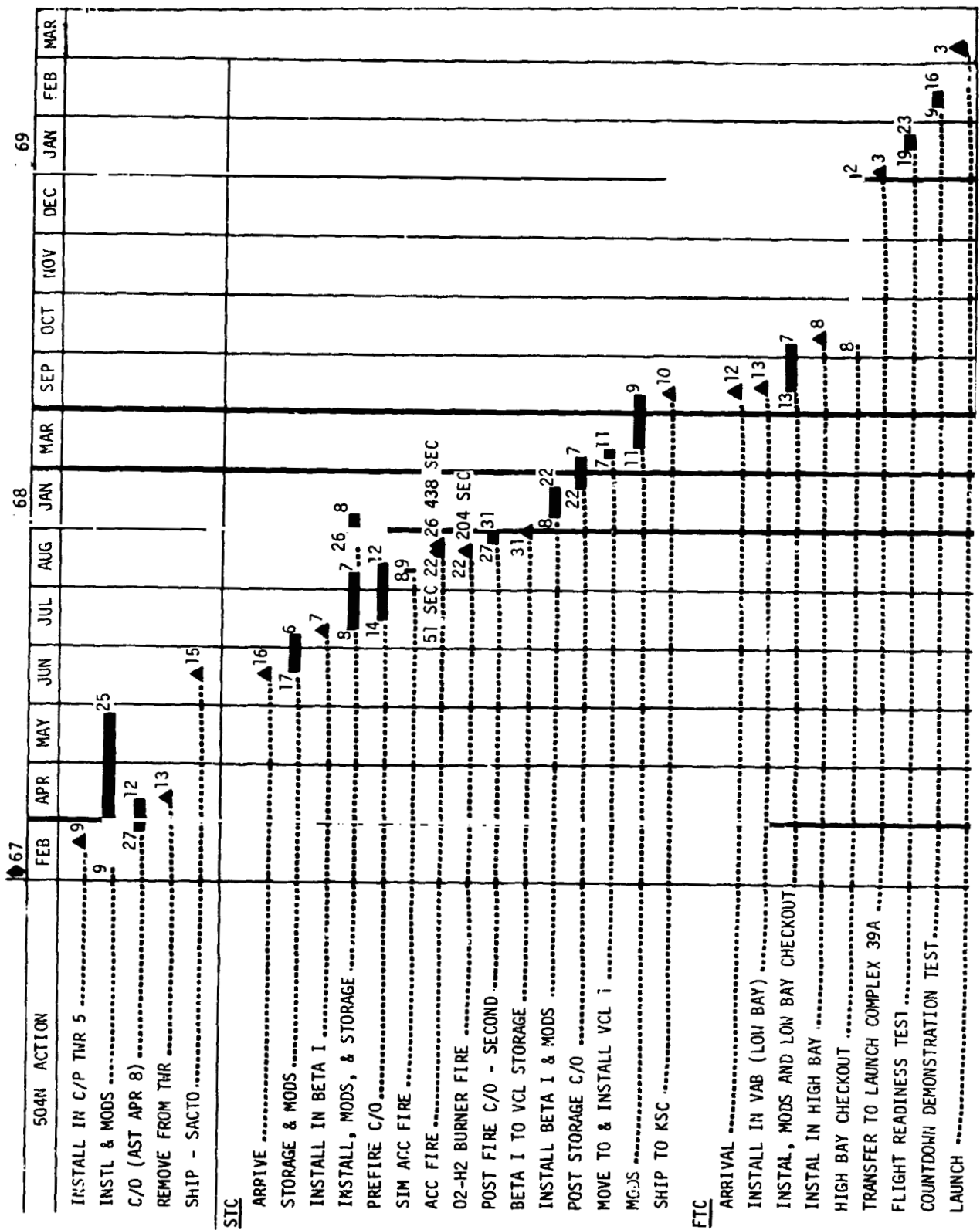

Figure 1-1. S-IV3-504 Stage Checkout and Test History

## 2. SUMMARY

### 2.1 Flight Description

#### 2.1.1 Launch Phase

##### 2.1.1.1 S-IC Flight

The AS-504 (Apollo 9) vehicle was launched from Kennedy Space Center (KSC), complex 39A, from a launch azimuth of 90 deg on March 3, 1969, at 16:00:00.675 GMT. Guidance Reference Release (GRR) occurred 16.968 sec before range zero. Umbilical disconnect and the corresponding establishment of time base one (TB1) occurred 0.67 sec after range zero. After tower clearance a tilt and roll maneuver was initiated to achieve the flight attitude and proper orientation for the 72 deg flight azimuth. At 85.5 sec after range zero, the vehicle encountered the maximum dynamic pressure of 617.9 lbf/ft<sup>2</sup>. At 134.28 sec after range zero, center engine cutoff occurred, and time base 2 (TB2) was established. The center engine cutoff was timed so that the vehicle acceleration did not exceed 4 g's. S-IC outboard engine cutoff occurred at 162.80 sec after range zero, establishing time base 3 (TB3). S-IC/S-II separation was commanded 0.653 sec after TB3.

##### 2.1.1.2 S-II Flight

S-II stage engine start command occurred 1.375 sec after TB3. The burn was characterized by low frequency oscillations similar to those encountered on AS-503 and were observed on the key center engine parameters on AS-504. The oscillations began at approximately 500 sec range time and damped at approximately 530 sec. Crossbeam frequency and engine No. 5 thrust chamber pressure frequency were coincident from about 505 to 522 sec. The structural frequency varied from about 16.3 hertz to 19 hertz. Maximum amplitude of chamber pressure oscillation was 80 psi peak-to-peak at 16.9 hertz occurring at 506 sec. The amplitude observed on AS-504 was greater than on AS-503, where 60 psi peak-to-peak oscillations were encountered in the chamber pressures. S-II engine cutoff which established time base 4 (TB4) occurred 536.243 sec after range zero (Ro). S-II/S-IVB separation was commanded at TB4 +0.923 sec.

### 2.1.1.3 S-IVB First Burn Operation

S-IVB first engine start command occurred at 537.264 sec after range zero. The engine mixture ratio for the S-IVB first burn was 5.5:1. S-IVB engine cutoff was commanded by guidance at TB4 +128.406 sec (Ro +664.649 sec) with a total burntime of 127.385 sec. Time base 5 (TB5) was initiated at Ro +664.868 sec. The stage was inserted into a nearly circular parking orbit with an apogee of 100.6 nmi and a perigee of 99.8 nmi.

### 2.1.2 S-IVB Orbital and Restart Operations

#### 2.1.2.1 Orbit and Second Burn Operations

Shortly after TB5 was initiated (approximately 20 seconds) a maneuver was initiated which aligned the S-IVB/spacecraft along the local horizontal. After this maneuver the flight vehicle maintained an orbital rate. LH2 continuous venting was initiated at TB5 +58.96 sec. At 9,240 sec from RO the S-IVB maneuvered to the transposition and docking attitude. The transposition and dock attitude was maintained for approximately 105 min. At 9900 sec from Ro the spacecraft command and service module (CSM) was separated from the S-IVB stage. At 10,928 sec from Ro the CSM transposed and docked with the S-IVB and lunar module. At 14,885 sec from Ro SC/LV final separation occurred. During the separation sequence an inhibit was programmed to prevent the initiation of any attitude maneuvers. After LM extraction was verified, the attitude inhibit was removed by ground command and the S-IVB maneuvered to a local horizontal attitude. When sufficient separation distance between the spacecraft and the S-IVB was obtained, a ground command removed the restart inhibit on the second S-IVB burn. Restart preparations (TB6) were initiated at 16,577.326 sec from Ro. The LH2 continuous vent was closed at TB6 +42.157 sec. Repressurization for second burn was accomplished by the O2-H2 burner. Second engine start command occurred at TB6 +569.953 sec. The engine mixture ratio for the S-IVB second burn was 5.0:1 after a start at 4:5.1. S-IVB engine cutoff was commanded by guidance at TB6 +640.357 sec with a total burntime of 70.397 sec. TB7 was established at Ro +17,217.898 sec. The S-IVB second burn inserted the stage into an elliptical orbit which had a perigee altitude of 105.8 nautical miles and apogee altitude of 1,671.6 nautical miles.

#### 2.1.2.2 S-IVB Intermediate Orbit and Third Burn Operation

At TB7 +0.366 sec the LH2 continuous vent was opened. At TB7 + approximately 20 sec a maneuver was initiated which aligned the S-IVB along the local horizontal. After this maneuver the flight vehicle maintained orbital rate. Restart preparations (time base 8 [TB8]) for the experimental S-IVB third restart were begun at RO +21,581.073 sec. The O<sub>2</sub>-H<sub>2</sub> burner was restarted and operated for 130 sec but was not used for repressurization for third burn. Repressurization was accomplished by the ambient helium repressurization system. Third burn restart operation was attempted without the benefit of recirculation chilldown as part of an experiment to demonstrate Flight Mission Rule 8-11. The second restart which occurred 80 min after second burn cutoff by ground command was characterized by a 52 sec fuel lead, 44 sec longer than normal. The restart was initiated with the PU valve at the low EMR stop (4.5:1) followed by a shift to the null (5.0:1) position.

Third burn mainstage did not perform as expected. Engine thrust was approximately 0.7 percent lower than expected during the initial period of third burn. The engine regulator pressure dropped to zero at RO +22,089 sec. This shut off the pneumatic supply to the engine valves. Subsequent suspected leakage caused the following: at STDV +92 sec the LH2 bleed valve cracked open and a reduction in thrust resulted. At STDV +98.8 sec the LOX bleed valve opened and another corresponding reduction in thrust occurred. At STDV +141.7 sec the LH2 bleed valve fully opened with a corresponding further reduction in thrust. The GG valve was still slowly closing for the remainder of third burn which corresponded to the gradual thrust reduction until engine cutoff command (ECC). Total burn time for third burn was 250.390 sec.

The extended fuel lead resulted in thrust chamber oscillations during third burn which imposed high vibration levels on the J-2 engine components and is considered the most probable cause of the third burn anomaly.

The yaw actuator data during the first 100 sec of third burn showed the actuator was oscillating at approximately 0.65 cps and reached a maximum amplitude of approximately 3 deg peak-to-peak. The time of oscillation on the actuator is that time that the J-2 engine was 0.7 percent low in thrust. This deviation is probably related to the J-2 engine third burn anomaly.



An unusually high number of pulses on the APS roll engines occurred during the third S-IVB burn. The APS roll engines were required to fire to give alternately clockwise and counterclockwise control at approximately 0.5 sec intervals. The roll disturbance diverged requiring pulses of increasing duration until the J-2 engine performance loss at which time the pulses were of 0.5 sec duration. Following S-IVB J-2 performance loss the APS pulsing requirements decreased to a constant clockwise roll correction (engines 1-1 and 2-1 firing). This deviation is probably related to the J-2 engine third burn anomaly. Engine cutoff was initiated by the instrument unit timer at TB8 +700.34 sec (Ro +22,281.319 sec). Time base 9 (TB9) was established at Ro +22,281.641 sec. Propellant dump was not accomplished due to loss of control of the engine valves. The LH2 CVS and NPV systems were opened to safe the LH2 tank; the LOX NPV system was utilized to safe the LOX tank. Stage pneumatics safing was also accomplished.

The APS ullage engines were fired to propellant depletion and a solar orbit of the S-IVB-504N stage was achieved.

## 2.2 Mission Objectives

MDAC-WD considers the MSFC Document I-V-8010.2, Revision A "Saturn Mission Implementation Plan, AS-504 Mission D/Apollo 9," dated November 8, 1968, as the official document for providing identification and control of launch vehicle mission requirements. The S-IVB-504N stage mission objectives are summarized and discussed as follows:

<u>Principle DTO's</u>	<u>Objective Accomplishment</u>
Demonstrate S-IVB/IU attitude control capability during transposition, docking, and LM ejection (TD&E) maneuver	Objective Achieved
<u>Secondary DTO's</u>	
Demonstrate S-IVB restart capability	Objective Achieved
Demonstrate O2-H2 burner repressurization system operation	Objective Achieved

<u>Secondary DTO's</u>	<u>Objective Accomplishment</u>
Demonstrate S-IVB propellant dump and safing	Objective partially accomplished; 1) Propellant dump not accomplished due to J-2 engine third burn anomaly, 2) Stage was safed.
Demonstrate 80 min restart capability	Objective Achieved
Demonstrate dual repressurization capability	Objective Achieved
Demonstrate O2-H2 burner restart capability	Objective Achieved

### 2.3 Test Operations

The AS-504 space vehicle was launched March 3, 1969, at 16:00:00 GMT from Launch Complex 39A. The overall performance of the S-IVB-504N stage was satisfactory during all phases of the countdown.

The only significant S-IVB stage problem occurred during the launch countdown when the pneumatic control and purge backup system cycled. MDAC-WD ground support equipment (GSE) sustained no significant damage during liftoff.

### 2.4 Cost Plus Incentive Fee

#### 2.4.1 Flight Mission Accomplishment

Performance of the S-IC and S-II stages provided PCF at S-II/S-IVB Separation Command, with the exception of inertial velocity, that were within allowable tolerances. Trajectory ECF, as defined in the MDAC-WD position and the MSFC position, were within allowable tolerances. Also, maximum flight values of attitude errors and rates for all phases of S-IVB operation (i.e., burn phase, parking orbit phase, and intermediate orbit phase) did not exceed the respective allowable tolerances. It was concluded for purposes of incentive achievement, therefore, that all ECF were achieved.

#### 2.4.2 Telemetry Performance

Evaluation of the telemetry performance indicated that the telemetry system operated at 99.3 percent efficiency during the telemetry performance period (TPEP) phase I (liftoff to first S-IVB engine cutoff +10 sec) and performed at 99.3 percent efficiency during the TPEP phase II (liftoff to planned LV/SC separation).

#### 2.5 Trajectory

The AS-504 trajectory showed low performance during the S-IC/S-II stage burn phase. S-IVB stage first and second burns were close to predicted. S-IVB stage third burn deviated from the predicted approximately 150 sec after third engine start command when the LOX bleed valve failed. Detailed comparison of actual and predicted trajectory parameters at key events may be found in tables 7-1 through 7-14.

#### 2.6 Mass Characteristics

The mass of the AS-504 vehicle was close to predicted and well within the mass tolerance until the end of the first burn. Because of the additional burntime required (10.5 sec more than predicted), to achieve orbital velocity, the mass of the vehicle was below the three sigma low tolerance until third engine start command plus 1<sup>st</sup> sec, at which time the LOX bleed valve opened reducing the engine flowrate. Subsequent events caused the vehicle mass to cross the tolerance band and exceed the three sigma high tolerance at third burn engine cutoff command.

#### 2.7 Engine System

The J-2 engine operated satisfactorily through first and second burns, and engine shutdowns were normal. During third burn, engine anomalies occurred as a result of the experimental nature of the engine restart. Because of these anomalies, the planned propellant dump through the engine was not accomplished.

#### 2.8 Solid Rockets

The solid rocket motors on the S-II and S-IVB stages performed satisfactorily. The S-II was separated from the S-IVB stage by the retrorockets, and the S-IVB propellants were settled prior to engine ignition by the village rockets.

## 2.9 Oxygen-Hydrogen Burner System

The S-IVB-504N stage utilized the O<sub>2</sub>-H<sub>2</sub> burner as the primary method of repressurization for the S-IVB second burn; LH<sub>2</sub> tank repressurization was satisfactorily accomplished; LOX tank repressurization was not required.

Although the burner was reignited prior to third burn and operated for 130 sec to demonstrate its restart capability, it was not used to repressurize the propellant tanks.

The burner performed satisfactorily and as expected during both periods of operation.

## 2.10 Oxidizer System

The oxidizer system performed adequately, supplying LOX to the engine pump inlet within the specified operating limits throughout J-2 engine operation. The available NPSP at the LOX pump inlet exceeded the engine manufacturer's minimum requirement at all times, except for the period from third engine start to 1.2 sec after third burn STDV. This behavior, however, was expected.

## 2.11 Fuel System

The fuel system supplied LH<sub>2</sub> to the engine as designed, and the NPSP exceeded minimum requirements except for three occasions: during second burn from engine start until STDV; and during third burn from engine start to ESC<sub>3</sub> +2 sec and again after the fuel bleed valve opened.

## 2.12 Auxiliary Propulsion System (APS)

The APS operation was nominal with the exception of a helium leak in Module 2. The leak continued from approximately Ro +4.5 hours to Ro +7 hours, but did not affect the ability of the APS to fulfill the attitude control, maneuvering, and ullaging requirements of the mission.

### 2.13 Pneumatic Control and Purge System

The pneumatic control and purge system adequately performed the actuations and purges required throughout the flight. The helium supply was adequate to meet all mission objectives.

The pneumatic control and purge backup system cycled during the countdown and again during third burn; however, the accomplishment of mission objectives was in no way endangered.

### 2.14 Propellant Utilization

The PU system successfully accomplished the requirements associated with propellant loading and management during burn. The best estimate propellant mass values at liftoff were 189,745 lbm LOX and 43,650 lbm LH<sub>2</sub>. These values are well within the required  $\pm 1.12$  percent stage loading accuracy.

### 2.15 S-II/S-IVB Separation

The AS-504 separation analysis was done by a comparison with the AS-501 and AS-503 separation data. The majority of the data compared closely for all three vehicles. The S-II stage longitudinal acceleration showed the effect of lighter S-II stage weight.

### 2.16 Data Acquisition System

Data acquisition system performance during the mission was excellent, and there were no system malfunctions.

System performance is summarized as follows:

Measurements assigned	299
Measurement inoperative due to stage configuration	1
Checkout measurements	7
Landline measurements	3
Measurements deleted prior to flight	3
Measurements active for flight	285
Phase I measurement failures	2
Phase I measurement efficiency	99.3 percent
Phase II measurement failures	2
Phase II measurement efficiency	99.3 percent

Measurement failures after Phase II	12
Measurement anomalies	15

The RF System blackout period data loss during S-IC/S-II separation was observed at Ro +163.4 for approximately one sec. Flame attenuation was not observed during S-II/S-IVB separation.

### 2.17 Electrical System

The electrical control system and the electrical power system performed satisfactorily from liftoff to third burn. All responses to switch selector commands were satisfactory and all event measurements verified that the engine control system had responded properly and occurred in the proper sequential order. The APS electrical control system performed within prescribed limitations. All batteries performed within expected limits. The chilldown inverters performed satisfactorily throughout the mission. All three 5V excitation modules performed satisfactorily and the PU Static Inverter-Converter operated within its design limits.

During third burn the Helium Control Solenoid de-energized causing the regulator outlet pressure to drop to zero. The solenoid also failed to operate properly during passivation. This failure caused the LOX and LH2 Main Valves to remain closed during the planned dump. The solenoid failure is attributed to damaged connectors or cabling from the ECA to the solenoid.

Third burn data from the Mainstage OK pressure switches, if valid, indicated that an engine cutoff should have been generated by the ECA. The problem apparently was caused by a short circuit in the measurement wiring which caused a diode in the signal line to open. This open diode caused a false data signal indication of the pressure OK. The short circuit also fused the pressure switch contacts in the pressurized state which gave a constant pressure OK indication to the ECA logic. This constant pressure OK indication prevented an engine cutoff from being initiated by the ECA and also prevented an Engine Ready signal from being received after engine cutoff.

The Engine Pneumatic Vent Solenoid failed to operate properly during passivation. Battery current data does not show any effect when the solenoid was commanded open or closed. The engine control helium pressure did start to decrease when the open command was given, but the decrease was much slower than if the valve had opened. The decrease in pressure occurred because the valve opened slightly when the open command was given or there is a leak in the system.

#### 2.18 Range Safety System

The range safety system was not required for propellant dispersion during the flight. All indications were that the system was operating properly and would have properly executed its function had it been called upon to do so.

#### 2.19 Flight Control

The attitude control system performance was adequate during the entire AS-504 mission. During third burn there was some anomalous performance of the yaw actuator detected which may have contributed to the oscillatory behavior of the stage; however, after one hundred sec into third burn the oscillations were damped and attitude control was maintained. Attitude control capability terminated as a result of the APS ullage motors having been fired (ground commanded) until depletion of APS propellants.

#### 2.20 Hydraulic System

The hydraulic system performance was within predicted limits and the system operated satisfactorily up to third burn. Immediately after 2nd restart the yaw actuator commenced to limit cycle at a maximum amplitude 3 deg peak-to-peak with a frequency of 0.65 Hz. This oscillatory motion continued for the first 100 sec of third burn. Cycling ceased soon after engine thrust degradation occurred during the burn. Hydraulic system pressure and temperature measurements indicated normal levels during the burn.

### 2.21 Aero/Thermo Environment

The mission profile of the AS-504N flight produced nominal thermal environments for the S-IVB stage components and structure. The boost trajectory was cooler than the thermal design (maximum heating) trajectory, being comparable to that of AS-503 and AS-501 and cooler than that of AS-502. There was no instrumentation from which structural temperatures could be obtained; however, it is apparent that the S-IVB stage structural temperatures were within the design limits.

Anomalous behavior of two J-2 engine calorimeters and a thrust structure mounted gas probe was noted during the second J-2 engine restart period.

### 2.22 Stage Structure and Environment

A review of AS-504 flight data revealed no structural anomalies. The structural integrities of the LH2 tank, LOX tank, and common bulkhead were verified by telemetry pressure data. From the time of LOX tank loading until the end of tank depressurizations in orbit, the common bulkhead internal pressure remained at 0.30 psia or less, indicating sound bulkhead.

After S-IVB stage third burn, the maximum reverse differential pressure of -9.6 psid occurred across the common bulkhead. At this time, the LOX ullage pressure had decreased to 11.1 psia and the LH2 ullage pressure had decreased to 20.7 psia. The LOX tank ullage pressure, however, was not decreased after first and second S-IVB stage burns, and no reverse pressure differentials occurred on the common bulkhead at these times.

The maximum measured acceleration during critical first stage launch was 3.84 g at S-IC OECO. This did not exceed the predicted axial load factor of 3.906 g.

### 2.23 Explosive Ordnance Equipment

All pertinent data has been reviewed to evaluate the performance of ordnance systems. Ullage Rocket Ignition, Stage Separation, Retrorocket Ignition, and Ullage Rocket Jettison occurred in response to commands from the instrument unit.



The explosive ordnance portion of the Range Safety System (the Propellant Dispersion System) was not required to function, since it was not necessary to destroy the stage during this mission.

#### 2.24 Forward Skirt Thermoconditioning

The forward skirt thermoconditioning system operated satisfactorily throughout launch and powered flight.

#### 2.25 Stage Safing

Due to loss of pneumatic control of the engine valves, the LH2 dump and the LOX dump could not be accomplished. The LH2 CVS and NPV systems were opened after third engine cutoff command, as programmed, to safe the LH2 tank; the LOX NPV system was utilized to safe the LOX tank.

Cold helium dump was accomplished by opening the LH2 cryogenic repressurization valves, which allowed the cold helium to flow through the O2-H2 burner into the LH2 tank and out the LH2 NPV and CVS systems.

To accomplish LOX and LH2 ambient repressurization helium dump, the LH2 ambient repressurization valve was opened to allow the helium to flow through the common manifold, into the LH2 tank, and out of the NPV and CVS.

The stage pneumatic control helium dump was accomplished by way of the engine pump purge module and followed predictions very closely.

### 3. TEST CONFIGURATION

#### 3.1 General

The S-IVB-504N stage was equipped with a Rocketdyne 230,000 lbf thrust engine, serial number 2094; additional stage information is presented in the following documents:

- a. MDAC-WD Report No. SM-47460, Saturn S-IVB-504N Stage Acceptance Firing Report, dated October 1967.
- b. MDAC-WD drawing 1B66684, S-IVB-V End Item Test Plan, dated 18 December 1968.
- c. MDAC-WD Report No. DAC-56561, Narrative End Item Report on Saturn S-IVB-504N (MDAC-WD S/N 1009), dated July 1967.

Table 3-1 presents the S-IVB-504N stage and GSE orifice data and table 3-2 presents the pressure switch checkout data.

Figure 3-1 is a schematic of the S-IVB-504N propulsion system.

#### 3.1.1 Electrical Configuration

The following paragraph delineates significant electrical configuration differences between S-IVB-503N and S-IVB-504N:

##### a. Data Acquisition System Changes

S-IVB-504N had an operational TM system compared to a modified operational system on S-IVB-503N. Assigned measurements on S-IVB-504N were 299. S-IVB-503N had a 453 assigned measurements. All of the measurements on S-IVB-504N were on S-IVB-503N except measurement D0248-425, Pressure - Cold Helium Spheres. This measurement is a backup measurement to D0016-425. The backup measurement to D0016-425 on S-IVB-503N was D0263-425, which was not on S-IVB-504N.

The following measurement types which were on S-IVB-503N were not installed on S-IVB-504N:

- |                 |              |
|-----------------|--------------|
| 1. Acceleration | 3. Vibration |
| 2. Acoustic     | 4. Strain    |

In addition, the number of pressure, temperature, event, and miscellaneous types of measurements were reduced on S-IVB-504N.

Deletion of these measurements resulted in the following TM system changes on S-IVB-504N:

1. Deletion of the FM/FM System
2. Deletion of the SS/FM System
3. Deletion of 3 Aft 20 Volt Excitation Modules
4. Deletion of 1 Forward 20 Volt Excitation Module
5. Routing of strain measurements to the CPIAO multiplexer not required.

The S-IVB-504N stage had one PCM/FM system for data acquisition.

TABLE 3-1 (Sheet 1 of 4)  
S-IVB-504N STAGE AND GSE FLIGHT ORIFICES

Description	Orifice Size or Nominal Flowrate	Coefficient of Discharge	Effective Area (in <sup>2</sup> )
<u>S-IVB-504N Stage</u>			
LH2 chilldown valve purge	14 scfm with 3,000 psid	--	Sintered
Continuous vent bypass valve bellows purge	300 scfm with 3,200 psid	--	Sintered
Continuous vent bypass valve switch cavity purge	15 scfm with 3,200 psid	--	Sintered
Continuous vent No. 1	1.090 in. dia	--	0.92
Continuous vent No. 2	1.090 in. dia	--	0.92
Continuous vent purge	1 scfm with 3,200 psid	--	Sintered
LH2 fill and drain valve purge	15 scfm with 3,200 psid	--	Sintered
LOX fill and drain valve purge	15 scfm with 3,200 psid	--	Sintered
LOX tank pressurization module, heat exchanger primary	0.219 in. dia	0.87	0.03294
LOX tank pressurization module, heat exchanger bypass	0.1849 in. dia	0.85	0.02266
LH2 tank pressurization module (Overcontrol - second burn)	0.2055 in. dia*	0.85	0.1141**
LH2 tank pressurization module (Undercontrol)	0.3552 in. dia	0.86	0.0854**
LH2 tank pressurization module control (Overcontrol - first burn)	0.2055 in. dia*	0.84	0.1123**
LH2 tank repressurization module outlet	0.3185 in. dia	0.82	0.065

\*Indicates diameter of overcontrol or step orifice only.

\*\*Discharge coefficient and effective area are calculated for overcontrol or step orifices in combination with the undercontrol orifice.

TABLE 3-1 (Sheet 2 of 4)  
S-IVB-504N STAGE AND GSE FLIGHT ORIFICES

Description	Orifice Size or Nominal Flowrate	Coefficient of Discharge	Effective Area (in <sup>2</sup> )
LH2 tank nonpropulsive vent purge	1 scfm with 3,200 psid	--	Sintered
LH2 tank nonpropulsive vent No. 1	2.180 in. dia	--	--
LH2 tank nonpropulsive vent No. 2	2.180 in. dia	--	--
LOX chilldown pump purge supply	200 scfm with 445 psid	--	--
LOX chilldown pump purge vent	200 scfm with 445 psid	--	--
LOX sensing line purge	1,728 scfm with 3,200 psid	--	Sintered
Burner LH2 tank press. coil outlet	0.221 in. dia	0.898	0.0344
LOX tank vent and relief valve	65 scfm with 3,200 psid	--	Sintered
Burner LH2 tank press. coil helium inlet balance	0.1200 in. dia	0.68	0.00985
Burner LOX tank press. coil outlet	0.089 in. dia	0.89	0.00554
LOX tank ambient repressurization	0.1109 in. dia	0.91	0.00881
Engine purge control module	0.0180 in. dia	--	--
<u>Pneumatic Console 432A</u>			
Stage 1 regulator dome vent	0.018 in. dia	--	--
Stage 1 regulator 3,100 psig dome loading	0.018 in. dia	--	--
APS helium supply and purge	0.027 in. dia	--	--
Console 432A GN2 inerting supply	0.031 in. dia	--	--
Mainstage OK pressure switch checkout, coarse (used with A12054)	0.025 in. dia	--	--
Mainstage OK pressure switch checkout, fine	0.025 in. dia	--	--

TABLE 3-1 (Sheet 3 of 4)  
S-IVB-504N STAGE AND GSE FLIGHT ORIFICES

Description	Orifice Size or Nominal Flowrate	Coefficient of Discharge	Effective Area (in <sup>2</sup> )
LH2 system checkout supply, fine	0.016 in. dia	--	--
LH2 system checkout supply, coarse (used with A11824)	0.016 in. dia	--	--
3200 Dome supply orifice	0.013 in. dia	--	--
LOX system checkout supply, fine	0.016 in. dia	--	--
LOX system checkout supply, coarse (used with A11837)	0.016 in. dia	--	--
Console 432A stage 1 bleed	--	--	Variable
Stage 4 regulator vent	--	--	Variable
Pressure switch checkout, low pressure, fine	0.025 in. dia	--	--
Pressure switch checkout, low pressure, coarse (used with A11793)	0.015 in. dia	--	--
Stage 2 regulator vent	--	--	Variable
750 psia helium purge supply	0.062 in. dia	--	--
<u>Pneumatic Console 433A</u>			
2000 psig cold purge valve supply	--	--	Variable
750 psig cold purge valve supply	--	--	Variable
Thrust chamber jacket purge and chilldown supply	0.072 in. dia	--	0.00347
Engine control helium sphere supply	0.125 in. dia	--	--
LOX tank prepressurization supply (located in model 315 aft umbilical kit)	0.0114 in. dia	--	--
Cold helium sphere pressurization supply (same orifice as above)	0.0114 in. dia	--	--
LOX umbilical purge supply	0.305 in. dia	--	--

TABLE 3-1 (Sheet 4 of 4)  
 S-IVB-504N STAGE AND GSE FLIGHT ORIFICES

Description	Orifice Size or Nominal Flowrate	Coefficient of Discharge	Effective Area (in <sup>2</sup> )
Umbilical purge supply vent	--	--	Variable
Stage regulator inlet	0.018 in. dia	--	--
LOX umbilical purge dome regulator inlet	0.180 in. dia	--	--
Stage 3 regulator outlet bleed	0.0022 lbm/min	--	Sinvered
<u>Heat Exchanger 438A</u>			
Circuit No. 1 upstream vent (primary)	0.081 in. dia	--	--
Circuit No. 1 downstream vent (secondary)	0.055 in. dia	--	--
LH2 fill valve closing control	0.013 in. dia	--	--
LH2 tank prepressurization supply	0.113 in. dia	--	0.00853
GH2 regulator dome bleed	3 scim at 750 psid	--	Sintered

TABLE 3-2

## S-IVB-504N STAGE PRESSURE SWITCH DATA

Name	Part No. and Serial No.	Specification* (psia)		Preflight Calibration** (psia)	
		Pickup	Dropout	Pickup	Dropout
LOX tank ullage	1B52624-515 S/N 029	41 max	37.5 min	40.4	39.2
LOX tank repressurization backup	1B52624-519 S/N 041	444 ±0	329 to 396	471	379
LOX tank regulator backup	1B52624-519 S/N 022	444 to 491	29 to 396	467	385
Engine pump purge	1B52623-515 S/N 015	136 max	99 min.	123	112
Control helium regulator backup	1B52624-517 S/N 029	579 to 621	459 to 521	619	485
LH2 tank repressurization control	1B52624-511 S/N 023	31.5 max	27.8 min	30.4	28.7
LH2 tank ullage-first burn	1B52624-511 S/N 028	31.5 max	27.8 min	30.4	28.7
LH2 tank repressurization backup	1B52624-519 S/N 043	444 to 491	329 to 396	470	371
Mainstage OK No. 1	308390 S/N 25478A	515 ±36	Pickup minus 75 +61, -31	484	411
Mainstage OK No. 2	308390 S/N 25421A	515 ±36	Pickup minus 75 +61, -31	502	432

\* Specifications are from the KSC specification and criteria document.

\*\* These values are the result of three actuations.



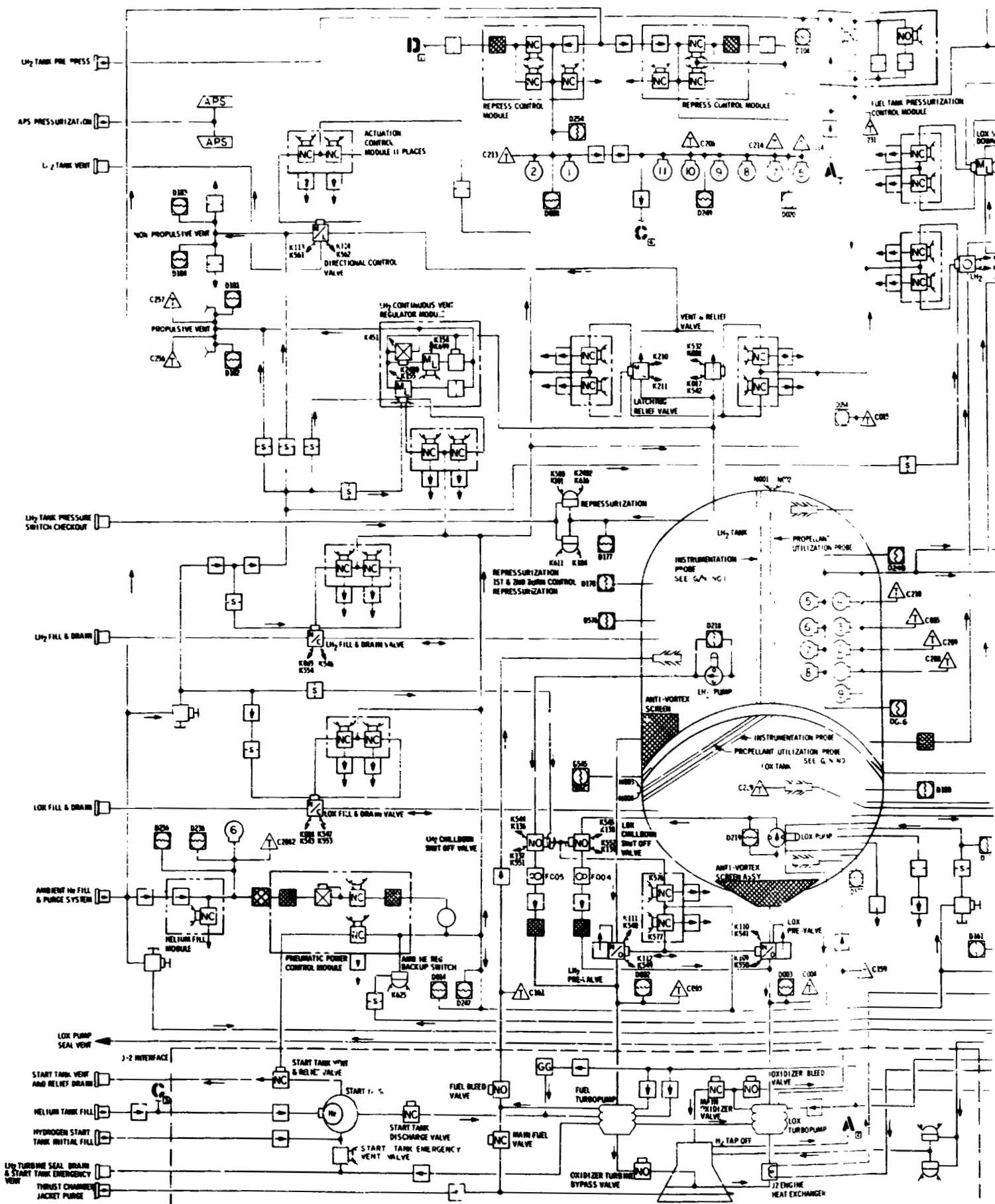
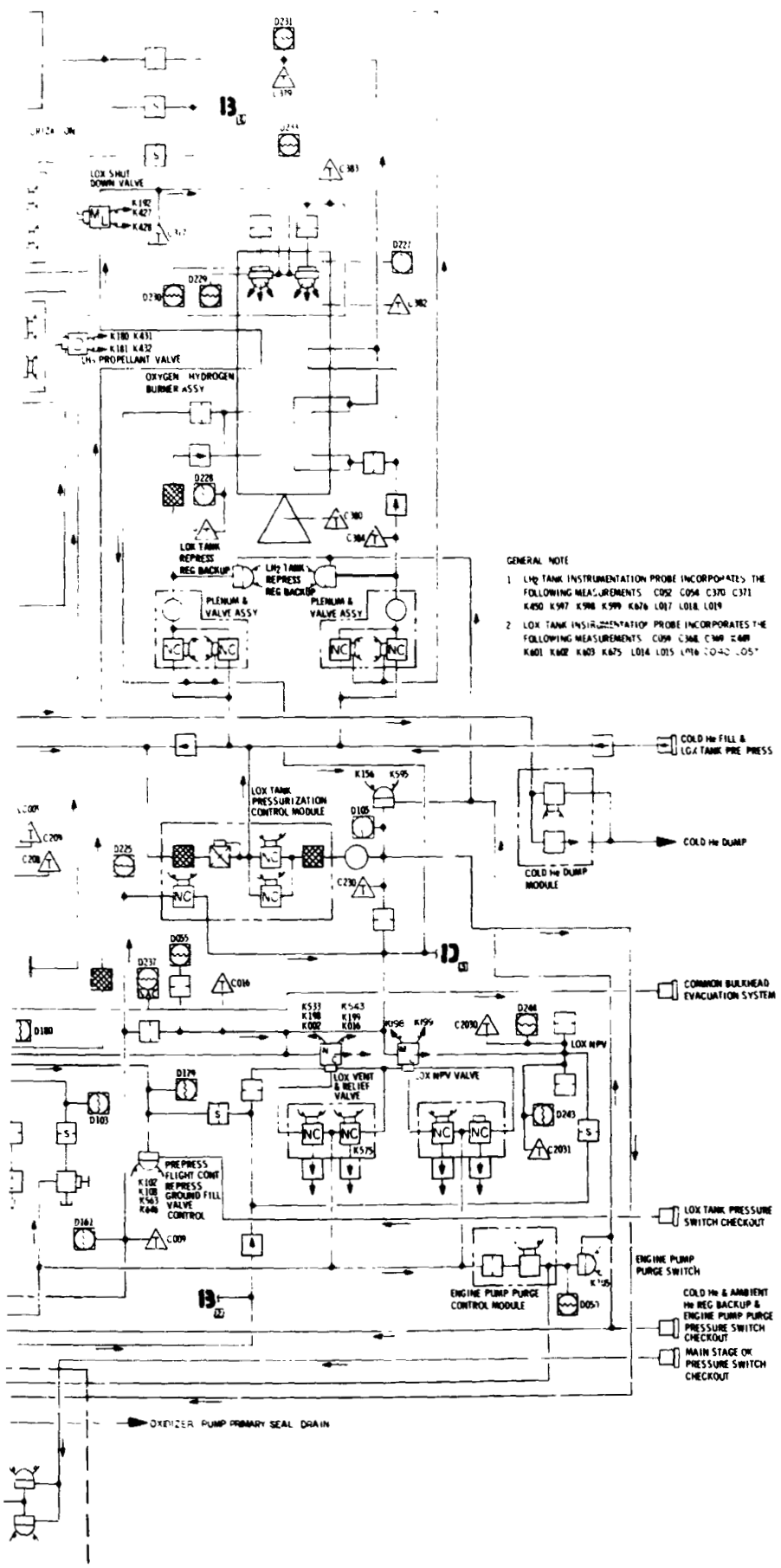

Figure 3-1. Schematic S-IVB/V Propulsion System Complete.

FOLDOUT FRAME 1



GENERAL NOTE

1. LOX TANK INSTRUMENTATION PROBE INCORPORATES THE FOLLOWING MEASUREMENTS: C02, C04, C37, C371, K450, K587, K598, K599, K676, L017, L018, L019
2. LOX TANK INSTRUMENTATION PROBE INCORPORATES THE FOLLOWING MEASUREMENTS: C099, C308, C309, C409, K601, K602, K603, K625, L014, L015, L016, L040, L057

#### 4. SEQUENCE OF EVENTS

Table 4-1 presents the AS-504 flight sequence of events. Four types of items are included in the sequence:

##### a. LVDC Commands

These items originate from the launch vehicle digital computer (LVDC) in the instrument unit (IU) and direct vehicle system actions.

##### b. Responses

These items are responses to commands that are issued from the IU and are monitored in the S-IVB.

##### c. Events

These items are monitored occurrences resulting from vehicle performance, e.g., the time of maximum dynamic pressure.

##### d. Ground Commands

These items are ground initiated changes, i.e., additions or modifications to the flight sequence of events.

In the sequence, all commands and events are preceded by an item number. Sequential series of related commands and responses are listed under the same event number with lower case letters distinguishing separate items.

A separate listing of the ground commands sent during this flight is presented in table 4-2.

#### 4.1 Predicted Times

Predicted times for events from guidance reference release (GRR) through time base four, (TB4) were obtained from MSFC's predicted operational trajectory, AS-504/D Mission Launch Vehicle Operational Trajectory Update, dated January 23, 1969; MSFC document Modification and Erratum to AS-504/D Mission Critical Sequence of Events, dated February 25, 1969; and the flight sequence ICD, Definition of Saturn SA-504 Flight Sequence Program, Saturn Interface Control Document 40M33624D, dated January 16, 1969. The remainder of predicted times were obtained from MDAC-WD predicted trajectory simulations, Definition of Saturn SA-504 Flight Sequence Program,

Saturn Interface Control Document 40M33624D, dated January 16, 1969 and from MSFC document, Apollo 9 Mission D Launch Vehicle Ground Support Plan, Report 1-MO-4-69, dated February 1969. Predicted times for S-IVB command responses could not be estimated and therefore are not shown. Predicted times for TB5, TB7, and TB9 were derived by adding 0.20 sec to the S-IVB cutoff times obtained from the MDAC-WD predicted trajectory simulation. Command times were not predicted for nonprogrammed telemetry calibrations made when passing over ground stations or for scheduled or unscheduled ground commands.

#### 4.2 Monitored Times

Commands issued from the LVDC to the S-IC, S-II, S-IVB, and IU were monitored at the LVDC. Times for these items were obtained from IBM document Saturn Instrument Unit S-IU-504 Final Flight Evaluation

Report for Apollo 9 Mission, dated May 2, 1969. Commands issued from the LVDC to the S-IVB were also monitored at the S-IVB switch selector. Times for these items were obtained from MDAC-WD, Sequence of Events for 504 Flight Vehicle. Monitored times for guidance parameters, S-IVB attitude maneuvers, prelaunch events, ground commands, and other special events were obtained from IBM document, Saturn Instrument Unit S-IU-504 Final Flight Evaluation Report for Apollo 9 Mission, dated May 2, 1969.

The time from range zero is provided for all items. Range zero, which is by definition the even second prior to liftoff, occurred at 16:00:00.0 GMT.

A time-from-base is given for all preprogrammed LVDC commands and for the monitored S-IVB command responses. A time-from-base is not applicable (N/A) for events which are not preprogrammed such as maximum dynamic pressure.

#### 4.3 Time Bases

Nine sequential series of preprogrammed commands were issued from the LVDC. Each sequential series was initiated by the establishment of its time base

in the LVDC. Listed below are the nine time bases with their respective originating events:

- a. Time Base One, TB1 - IU umbilical disconnect
- b. Time Base Two, TB2 - S-IC inboard engine cutoff
- c. Time Base Three, TB3 - S-IC outboard engine cutoff
- d. Time Base Four, TB4 - S-II J-2 engine cutoff
- e. Time Base Five, TB5 - First S-IVB engine cutoff
- f. Time Base Six, TB6 - Begin restart preparations for second burn (LVDC solves an equation)
- g. Time Base Seven, TB7 - Second S-IVB engine cutoff
- h. Time Base Eight, TB8 - Begin restart preparations for third burn (initiated by timer)
- i. Time Base Nine, TB9 - Third S-IVB engine cutoff

#### 4.4 Data Omissions

In the flight sequence table (table 4-1) a dash (--) has been inserted for item times which are not available. Monitored times missing for commands can be estimated from the last known time and the programmed time from base. Some items, such as command responses, had no predicted times. The S-IVB responses for which monitored times are missing are tabulated in table 4-3 with the cause of omission. The item numbers of those times for command issuance from the LVDC which are missing are listed in table 4-4. The times for command issuance from the LVDC are supplied to MDAC-WD by IBM and MSFC, and no explanation is available as to the cause of omission for these times.

#### 4.5 Comments

The accuracies listed in table 4-1 are related to the telemetry-channel sampling rates; therefore, the items occurred at the times indicated or earlier by the amount listed in the accuracy column. The accuracy of IU signals is not shown since this information is not available. The IU signal occurrence times were available only to the nearest 10 milli-

seconds in range zero times, thus making a detailed comparison between the time of command issuance from the LVDC and time of command receipt in the S-IVB difficult. These occurrence times were available to the nearest millisecond for time base times and are presented as such although perhaps they should be considered accurate only to the nearest 10 milliseconds. The difference between time of command receipt in the S-IVB and time of command from the LVDC varied from -15 milliseconds to +25 milliseconds for most of the preprogrammed commands in TB4, TB5, TB6, TB7, and TB8; however, these differences are considered within the accuracy tolerances of the IU and S-IVB telemetry systems. In TB9 a difference of up to 0.9 sec occurred for some commands. No explanations have been given for these differences.

#### 4.6 Ground Sequence of Events

Table 4-4 presents the ground sequence of events from approximately Ro-20 min to liftoff. These events are related to the S-IVB-504N and associated ground support equipment and are derived from the digital events evaluation.

TABLE 4-1 (Sheet 1 of 47)  
AS-504 D POST FLIGHT SEQUENCE OF EVENTS

ITEM NO.	EVENT	PREDICTED TIME		SIGNAL MONITORED AT	MONITORED TIME		DATA SOURCE	ACCURACY (ms)
		TIME FROM RANGE ZERO (hr:min:sec) (sec)	TIME FROM BASE (sec)		TIME FROM RANGE ZERO (hr:min:sec) (sec)	TIME FROM BASE (sec)		
1	Guidance Reference Release	-00:00:16.98 (-16.98)	N/A	IU	-00:00:16.97 (-16.97)	N/A	MSFC	--
2	S-IC Engine Start Sequence Command	N/A	N/A	IU	-00:00:08.89 (-8.89)	N/A	MSFC	--
3	Range Zero	00:00:00.0 (0.0)	N/A	IU	00:00:00.0 (0.0)	N/A	MSFC	--
4	Holddown Arms Release	N/A	N/A	IU	00:00:00.26 (0.26)	N/A	MSFC	--
5	First Motion	N/A	N/A	GSE	00:00:00.261 (0.261)	N/A	MSFC	--
6	<u>Time Base 1</u> AS-504 Liftoff; IU Umbilical Disconnect	00:00:00.652 (0.652)	TB1 +0.0	IU	00:00:00.67 (0.67)	TB1 +0.0	MSFC	--
7	Start Yaw Maneuver	00:00:01.6 (1.6)	N/A	N/A N/A	00:00:01.73 (1.73)	N/A	MSFC	--
8	Signal from LVDC for: Sensor Bias ON	00:00:05.6 (5.6)	TB1 +5.0	IU	00:00:05.62 (5.62)	TB1 +4.952	MSFC	--
9a	Signal from LVDC for: LOX Tank Pressurization Shutoff Valves Close	00:00:06.6 (6.6)	TB1 +6.0	IU	00:00:06.62 (6.62)	TB1 +5.953	MSFC	--
9b	Signal Received in S-IVB for: LOX Tank Pressurization Shutoff Valves Close	N/A	N/A	S-IVB	00:00:06.621 (6.621)	TB1 +5.956	MDAC	9
10	End Yaw Maneuver	00:00:09.6 (9.6)	N/A	N/A	00:00:09.69 (9.69)	N/A	MSFC	--
11	Begin Pitch and Roll Maneuver	00:00:11.8 (11.8)	N/A	N/A	00:00:13.26 (13.26)	N/A	MSFC	--
12	Signal from LVDC for: Multiple Engine Cutoff Enable	00:00:14.6 (14.6)	TB1 +14.0	IU	00:00:14.65 (14.65)	TB1 +13.977	MSFC	--
13	Signal from LVDC for: S-IC Outboard Engines Cant On "A"	00:00:20.4 (20.4)	TB1 +19.8	IU	00:00:20.43 (20.43)	TB1 +19.752	MSFC	--
14	Signal from LVDC for: S-IC Outboard Engines Cant On "B"	00:00:20.6 (20.6)	TB1 +20.0	IU	00:00:20.64 (20.64)	TB1 +19.965	MSFC	--
15	Signal from LVDC for: S-IC Outboard Engines Cant On "C"	00:00:20.8 (20.8)	TB1 +20.2	IU	00:00:20.83 (20.83)	TB1 +20.152	MSFC	--
16	Signal from LVDC for: Telemeter Calibrate ON	00:00:24.6 (24.6)	TB1 +24.0	IU	00:00:24.65 (24.65)	TB1 +23.973	MSFC	--
17	Signal from LVDC for: Telemetry Calibrator Inflight Calibrate ON	00:00:27.6 (27.6)	TB1 +27.0	IU	00:00:27.64 (27.64)	TB1 +26.974	MSFC	--

TABLE 4-1 (Sheet 2 of 47)  
AS-504 D POST FLIGHT SEQUENCE OF EVENTS

ITEM NO.	EVENT	PREDICTED TIME		SIGNAL MONITORED AT	MONITORED TIME		DATA SOURCE	ACCURACY (ms)
		TIME FROM RANGE ZERO (hr:min:sec) (sec)	TIME FROM BASE (sec)		TIME FROM RANGE ZERO (hr:min:sec) (sec)	TIME FROM BASE (sec)		
18	Signal from LVDC for: Telemeter Calibrate OFF	00:00:29.6 (29.6)	TB1 +29.0	IU	00:00:29.63 (29.63)	TB1 +28.953	MSFC	--
19	Signal from LVDC for: Launch Vehicle Engines EDS Cutoff Enable	00:00:30.6 (30.6)	TB1 +30.0	IU	00:00:30.63 (30.63)	TB1 +29.952	MSFC	--
20	Signal from LVDC for: Telemetry Calibrator Inflight Calibrate OFF	00:00:32.6 (32.6)	TB1 +32.0	IU	00:00:32.64 (32.64)	TB1 +31.968	MSFC	--
21	End Roll Maneuver	00:00:30.6 (30.6)	N/A	N/A	00:00:32.96 (32.96)	N/A	MSFC	--
22	Signal from LVDC for: Fuel Pressurizing Valve No. 2 Open	00:00:50.1 (50.1)	TB1 +49.5	IU	00:00:50.15 (50.15)	TB1 +49.473	MSFC	--
23	Signal from LVDC for: Start Data Recorders	00:01:14.6 (74.6)	TB1 +74.0	IU	00:01:14.63 (74.63)	TB1 +73.955	MSFC	--
24	Signal from LVDC for: Cooling System Electronic Assembly Power OFF	00:01:15.6 (75.6)	TB1 +75.0	IU	00:01:15.63 (75.63)	TP1 +74.953	MSFC	--
25	Maximum Dynamic Pressure	00:01:21.7 (81.7)	N/A	N/A	00:01:24.5 (85.5)	N/A	MSFC	--
26	Signal from LVDC for: Telemetry Calibrator Inflight Calibrate ON	00:01:30.6 (90.6)	TB1 +90.0	IU	00:01:30.63 (90.63)	TB1 +89.958	MSFC	--
27	Signal from LVDC for: Telemetry Calibrator Inflight Calibrate OFF	00:01:35.6 (95.6)	TB1 +95.0	IU	00:01:35.62 (95.62)	TB1 +94.953	MSFC	--
28	Signal from LVDC for: Fuel Pressurizing Valve No. 3 Open	00:01:35.9 (95.9)	TB1 +95.3	IU	00:01:35.95 (95.95)	TB1 +95.278	MSFC	--
29	Signal from LVDC for: Flight Control Computer Switch Point No. 1	00:01:45.6 (105.6)	TB1 +105.0	IU	00:01:45.63 (105.63)	TB1 +104.956	MSFC	--
30	Signal from LVDC for: Telemeter Calibrate ON	00:01:55.7 (115.7)	TB1 +115.1	IU	00:01:55.73 (115.73)	TB1 +115.053	MSFC	--
31a	Signal from LVDC for: TM Calibrate ON	00:01:59.8 (119.8)	TB1 +119.2	I	00:01:59.83 (119.83)	TB1 +119.161	MSFC	--
31b	Signal Received in S-IVB for: TM Calibrate ON	N/A	N/A	S-IVB	00:01:59.823 (119.823)	TB1 +119.158	MDAC	9
32	Signal from LVDC for: Telemeter Calibrate OFF	00:02:00.7 (120.7)	TB1 +120.1	IU	00:02:00.75 (120.75)	TB1 +120.075	MSFC	--
33a	Signal from LVDC for: TM Calibrate OFF	00:02:00.8 (120.8)	TB1 +120.2	IU	00:02:00.84 (120.84)	TB1 +120.172	MSFC	--
33b	Signal Received in S-IVB for: TM Calibrate OFF	N/A	N/A	S-IVB	00:02:00.840 (120.840)	TB1 +120.175	MDAC	9



TABLE 4-1 (Sheet 3 of 47)  
AS-504 D POST FLIGHT SEQUENCE OF EVENTS

ITEM NO.	EVENT	PREDICTED TIME		SIGNAL MONITORED AT	MONITORED TIME		DATE SOURCE	ACCURACY (ms)
		TIME FROM RANGE ZERO (hr:min:sec) (sec)	TIME FROM BASE (sec)		TIME FROM RANGE ZERO (hr:min:sec) (sec)	TIME FROM BASE (sec)		
34	Signal from LVDC for: Flight Control Computer Switch Point No. 2	00:02:10.6 (130.6)	TB1 +130.0	IU	00:02:10.62 (130.62)	TB1 +129.952	MSFC	--
35	Signal from LVDC for: Fuel Pressurizing Valve No. 4 Open	00:02:13.0 (133.0)	TB1 +132.4	IU	00:02:13.02 (133.02)	TB1 +132.353	MSFC	--
36	Signal from LVDC for: S-IC Two Engines Out Auto-Abort Inhibit Enable	00:02:13.2 (133.2)	TB1 +132.6	IU	00:02:13.22 (133.22)	TB1 +132.553	MSFC	--
37	Signal from LVDC for: S-IC Two Engines Out Auto-Abort Inhibit	00:02:13.4 (133.4)	TB1 +132.8	IU	00:02:13.44 (133.44)	TB1 +132.766	MSFC	--
38	Signal from LVDC for: Excess Rate (P,Y,R) Auto-Abort Inhibit Enable	00:02:13.6 (133.6)	TB1 +133.0	IL	00:02:13.62 (133.62)	TB1 +132.951	MSFC	--
39	Signal from LVDC for: Excess Rate (P,Y,R) Auto-Abort Inhibit & Switch Rate Gyro SC Indication "A"	00:02:13.8 (133.8)	TB1 +133.2	IU	00:02:13.82 (133.82)	TB1 +133.151	MSFC	--
40	Signal from LVDC for: Two Adjacent Outboard Engines Out Cutoff Enable	00:02:14.0 (134.0)	TB1 +133.4	IU	00:02:14.03 (134.03)	TB1 +133.356	MSFC	--
41	Start of Time Base No. 2	134.211	TB2 +0.0	IU	00:02:14.28 (134.28)	TB2 +0.0	MSFC	--
42	S-IC Inboard Engine Cutoff and Tape Recorder Record	00:02:14.261 134.261	TB2 +0.0	IU	00:02:14.33 (134.33)	TB2 +0.050	MSFC	--
43	Signal from LVDC for: Inboard Engine Cutoff Backup Enable	00:02:14.4 (134.4)	TB2 +0.2	IU	00:02:14.43 (134.43)	TB2 +0.152	MSFC	--
44	Signal from LVDC for: Start First PAM - FM/ FM Calibration	00:02:14.6 (134.6)	TB2 +0.4	IU	00:02:14.63 (134.63)	TB2 +0.351	MSFC	--
45	Signal from LVDC for: Auto-Abort Enable Relays Reset	00:02:14.8 (134.8)	TB2 +0.6	IU	00:02:14.84 (134.84)	TB2 +0.556	MSFC	--
46	Signal from LVDC for: Excessive Rate (Roll) Auto-Abort Inhibit Enable	00:02:15.0 (135.0)	TB2 +0.8	IU	00:02:15.04 (135.04)	TB2 +0.762	MSFC	--
47	Signal from LVDC for: Excessive Rate (Roll) Auto-Abort Inhibit & Switch Rate Gyro SC Indication "B"	00:02:15.2 (135.2)	TB2 +1.0	IU	00:02:15.23 (135.23)	TB2 +0.951	MSFC	--
48	Signal from LVDC for: Stop First PAM - FM/ FM Calibration	00:02:19.6 (139.6)	TB2 5.4	IU	00:02:19.64 (139.64)	TB2 +5.361	MSFC	--

TABLE 4-1 (Sheet 4 of 47)  
AS-504 D POST FLIGHT SEQUENCE OF EVENTS

ITEM NO.	EVENT	PREDICTED TIME		SIGNAL MONITORED AT	MONITORED TIME		DATA SOURCE	ACCURACY (ms)
		TIME FROM RANGE ZERO (hr:min:sec) (sec)	TIME FROM ASE (sec)		TIME FROM RANGE ZERO (hr:min:sec) (sec)	TIME FROM BASE (sec)		
49	Signal from LVDC for: S-II Ordnance Arm	00:02:28.7 (148.7)	TB2 +14.5	IU	00:02:28.75 (148.75)	TB2 +14.468	MSFC	--
50	Signal from LVDC for: Separation and Retro No. 1 EBW Firing Units Arm	00:02:28.9 (148.9)	TB2 +14.7	IU	00:02:28.94 (148.94)	TB2 +14.652	MSFC	--
51	Signal from LVDC for: Separation and Retro No. 2 EBW Firing Units Arm	00:02:29.1 (149.1)	TB2 +14.9	IU	00:02:29.15 (149.15)	TB2 +14.861	MSFC	--
52	Signal from LVDC for: Q-Ball Power OFF	00:02:31.5 (151.5)	TB2 +17.3	IU	00:02:31.54 (151.54)	TB2 +17.253	MSFC	--
53	Signal from LVDC for: Telemetry Measurement Switchover	00:02:31.7 (151.7)	TB2 +17.5	IU	00:02:31.74 (151.74)	TB2 +17.466	MSFC	--
54	Signal from LVDC for: Outboard Engines Cutoff Enable	00:02:31.9 (151.9)	TB2 +17.7	IU	00:02:31.94 (151.94)	TB2 +17.653	MSFC	--
55	Signal from LVDC for: Outboard Engines Cutoff Backup Enable	00:02:32.1 (152.1)	TB2 +17.9	IU	00:02:32.15 (152.15)	TB2 +17.569	MSFC	--
56	End Pitch Maneuver	00:02:36.8 (156.8)	N/A	N/A	00:02:38.00 (158.00)	N/A	MSFC	--
57	Time Base 3 S-IC Outboard Engines Cutoff	00:02:39.975 (159.975)	TB3 +0.0	IU	00:02:42.80 (162.80)	TB3 +0.0	MSFC	--
58	Signal from LVDC for: LH2 Tank High Pressure Vent Mode	00:02:40.1 (160.1)	TB3 +0.1	IU	00:02:42.88 (162.88)	TB3 +0.081	MSFC	--
59	Signal from LVDC for: S-II LH2 Recirculation Pumps OFF	00:02:40.2 (160.2)	TB3 +0.2	IU	00:02:42.98 (162.98)	TB3 +0.176	MSFC	--
60	Signal from LVDC for: S-II Ullage Trigger	00:02:40.5 (160.5)	TB3 +0.5	IU	00:02:43.27 (163.27)	TB3 +0.470	MSFC	--
61	Signal from LVDC for: S-IC/S-II Separation (No. 1)	00:02:40.7 (160.7)	TB3 +0.7	IU	00:02:43.45 (163.45)	TB3 +0.653	MSFC	--
62	Signal from LVDC for: S-IC/S-II Separation (No. 2)	00:02:40.8 (160.8)	TB3 +0.8	IU	00:02:43.58 (163.58)	TB3 +0.776	MSFC	--
63	Signal from LVDC for: S-II Engines Cutoff Reset	00:02:49.9 (160.9)	TB3 +0.9	IU	00:02:43.68 (163.68)	TB3 +0.878	MSFC	--
64	Signal from LVDC for: Engines Ready Bypass	00:02:41.0 (161.0)	TB3 +1.0	IU	00:02:43.76 (163.76)	TB3 +0.959	MSFC	--
65	Signal from LVDC for: Prevalves Lockout Reset	00:02:41.1 (161.1)	TB3 +1.1	IU	00:02:43.88 (163.88)	TB3 +1.083	--	--

TABLE 4-1 (Sheet 5 of 47)  
AS-504 D POST FLIGHT SEQUENCE OF EVENTS

ITEM NO.	EVENT	PREDICTED TIME		SIGNAL MONITORED AT	MONITORED TIME		DATA SOURCE	ACCURACY (ms)
		TIME FROM RANGE ZERO (hr:min:sec) (sec)	TIME FROM BASE (sec)		TIME FROM RANGE ZERO (hr:min:sec) (sec)	TIME FROM BASE (sec)		
66	Signal from LVDC for: Switch Engine Control to S-II & S-IC Outboard Engine Cant OFF "A"	00:02:41.2 (161.2)	TB3 +1.2	IU	00:02:43.98 (163.98)	TB3 +1.178	--	--
67	Signal from LVDC for: S-IC Outboard Engine Cant OFF "B"	00:02:41.3 (161.3)	TB3 +1.3	IU	00:02:44.07 (164.07)	TB3 +1.226	--	--
68	Signal from LVDC for: S-II Engine Start	00:02:41.4 (161.4)	TB3 +1.4	IU	00:02:44.17 (164.17)	TB3 +1.371	--	--
69	Signal from LVDC for: S-II Engine Out Indication "A" Enable; S-II Aft Interstage Separation Indication "A" Enable	00:02:41.5 (161.5)	TB3 +1.5	IU	00:02:44.27 (164.27)	TB3 +1.472	--	--
70	Signal from LVDC for: S-II Engine Out Indication "B" Enable; S-II Aft Interstage Separation Indication "B" Enable	00:02:41.7 (161.7)	TB3 +1.7	IU	00:02:44.47 (164.47)	TB3 +1.670	--	--
71	Signal from LVDC for: Engines Ready Bypass Reset	00:02:41.9 (161.9)	TB3 +1.9	IU	00:02:44.65 (164.65)	TB3 +1.854	--	--
72	Signal from LVDC for: S-II Hydraulic Accumulators Unlock	00:02:43.0 (163.0)	TB3 +3.0	IU	00:02:45.76 (165.76)	TB3 +2.960	MSFC	--
73	Signal from LVDC for: Chilldown Valves Close	00:02:46.4 (166.4)	TB3 +6.4	IU	00:02:49.15 (169.15)	TB3 +6.350	MSFC	--
74	Signal from LVDC for: S-II Start Phase Limiter Cutoff Arm	00:02:46.7 (166.7)	TB3 +6.7	IU	00:02:49.45 (169.45)	TB3 +6.652	MSFC	--
75	Signal from LVDC for: Activate PU System	00:02:46.9 (166.9)	TB3 +6.9	IU	00:02:49.67 (169.66)	TB3 +6.860	MSFC	--
76	Signal from LVDC for: S-II Start Phase Limiter Cutoff Arm Reset	00:02:47.7 (167.7)	TB3 +7.7	IU	00:02:50.46 (170.46)	TB3 +7.652	MSFC	--
77	Signal from LVDC for: Prevalves Close Arm	00:02:47.8 (167.8)	TB3 +7.8	IU	00:02:50.56 (170.56)	TB3 +7.753	MSFC	--
78	Signal from LVDC for: Stop Data Recorders	00:02:51.9 (171.9)	TB3 +11.9	IU	00:02:54.66 (174.66)	TB3 +11.858	MSFC	--
79	Signal from LVDC for: Water Coolant Valve Open	00:03:00.7 (180.7)	TB3 +20.7	IU	00:03:03.46 (183.46)	TB3 +20.660	MSFC	--
80	Signal from LVDC for: S-II Aft Interstage Separation	00:03:10.7 (190.7)	TB3 +30.7	IU	00:03:13.46 (193.46)	TB3 +30.664	MSFC	--
81	LET Jettison	Variable	N/A	N/A	00:03:18.30 (198.30)	N/A	MSFC	--

TABLE 4-1 (Sheet 6 of 47)  
AS-504 D POST FLIGHT SEQUENCE OF EVENTS

EVENT	PREDICTED TIME		SIGNAL MONITORED AT	MONITORED TIME		DATA SOURCE	ACCURACY (ms)
	TIME FROM RANGE ZERO (hr:min:sec) (sec)	TIME FROM BASE (sec)		TIME FROM RANGE ZERO (hr:min:sec) (sec)	TIME FROM BASE (sec)		
Signal from LVDC for: Flight Control Computer Switch Point No. 3	00:03:41.4 (221.4)	TB3 +61.4	IU	00:03:44.16 (224.16)	TB3 +61.351	MSFC	--
Signal from LVDC for: S-II LOX Step Pressurization	00:04:20.0 (260.0)	TB3 +100.0	IU	00:04:22.76 (262.76)	TB3 +99.951	MSFC	--
Signal from LVDC for: Start Second PAM - FM/ PM Calibration	00:04:45.0 (285.0)	TB3 +125.0	IU	00:04:47.76 (287.76)	TB3 +124.958	MSFC	--
Signal from LVDC for: Stop Second PAM - FM/ PM Calibration	00:04:50.0 (290.0)	TB3 +130.0	IU	00:04:52.76 (292.76)	TB3 +129.972	MSFC	--
Signal from LVDC for: Flight Control Computer Switch Point No. 4	00:05:51.4 (351.4)	TB3 +191.4	IU	00:05:54.17 (354.17)	TB3 +191.374	MSFC	--
Signal from LVDC for: Telemetry Calibrator In-Flight Calibrate ON	00:05:52.7 (362.7)	TB3 +202.7	IU	00:06:05.45 (365.45)	TB3 +202.653	MSFC	--
Signal from LVDC for: Telemetry Calibrator In-Flight Calibrate OFF	00:06:07.7 (367.7)	TB3 +207.7	IU	00:06:10.47 (370.47)	TB3 +207.671	MSFC	--
Signal from LVDC for: Start Third PAM - FM/ PM Calibration	00:06:25.0 (385.0)	TB3 +225.0	IU	00:06:27.77 (387.77)	TB3 +224.968	MSFC	--
Signal from LVDC for: Stop Third PAM - FM/ PM Calibration	00:06:30.0 (390.0)	TB3 +230.0	IU	00:06:32.76 (392.76)	TB3 +229.952	MSFC	--
1a Signal from LVDC for: TM Calibrate ON	00:07:30.7 (450.7)	TB3 +250.7	IU	00:07:33.45 (453.45)	TB3 +290.652	MSFC	--
1b Signal Received in S-IVB for: TM Calibrate ON	N/A	N/A	S-IVB	00:07:33.449 (453.449)	TB3 +290.657	MDAC	9
2 Signal from LVDC for: Telemetry Calibrator In-Flight Calibrate ON	00:07:30.9 (450.9)	TB3 +290.9	IU	00:07:33.66 (453.66)	TB3 +290.860	MSFC	--
3a Signal from LVDC for: TM Calibrate OFF	00:07:31.7 (451.7)	TB3 +291.7	IU	00:07:34.45 (454.45)	TB3 +291.652	MSFC	--
3b Signal Received in S-IVB for: TM Calibrate OFF	N/A	N/A	S-IVB	00:07:34.449 (454.449)	TB3 +291.657	MDAC	9
4 Signal from LVDC for: Telemetry Calibrator In-Flight Calibrate OFF	00:07:35.9 (455.9)	TB3 +295.9	IU	00:07:38.65 (458.65)	TB3 +295.853	MSFC	--
5 High (5.5) Engine Mixture Ratio OFF	Variable	Variable	IU	00:07:43.23 (463.23)	TB3 +300.428	MSFC	--

TABLE 4-1 (Sheet 7 of 47)  
AS-504 D POST FLIGHT SEQUENCE OF EVENTS

ITEM NO.	EVENT	PREDICTED TIME		SIGNAL MONITORED AT	MONITORED TIME		DATA SOURCE	ACCURACY (ms)
		TIME FROM RANGE ZERO (hr:min:sec) (sec)	TIME FROM BASE (sec)		TIME FROM RANGE ZERO (hr:min:sec) (sec)	TIME FROM BASE (sec)		
96	Signal from LVDC for: S-II LH2 Step Pressurization	00:07:40.0 (460.0)	TB3 +300.0	IU	00:07:42.76 (462.76)	TB3 +299.960	MSFC	--
97	Low (4.5) Engine Mixture Ratio ON	Variable	Variable	IU	00:07:43.23 (458.65)	TB3 +300.428	MSFC	--
98a	Signal from LVDC for: Charge Ullage Ignition ON	00:08:11.2 (491.2)	TB3 +331.2	IU	00:08:13.95 (493.95)	TB3 +331.152	MSFC	--
98b	Signal Received in S-IVB for: Charge Ullage Ignition ON	N/A	N/A	S-IVB	00:08:13.948 (493.948)	TB3 +331.156	MDAC	9
99	Signal from LVDC for: S-II/S-IVB Ordnance Arm	00:07:11.4 (491.4)	TB3 +331.4	IU	00:08:14.16 (494.16)	TB3 +331.362	MSFC	--
100a	Signal from LVDC for: LOX Tank Pressurization Shutoff Valves Open	00:07:12.0 (492.0)	TB3 +332.0	IU	00:08:14.75 (494.75)	TB3 +331.953	MSFC	--
100b	Signal Received in S-IVB for: LOX Tank Pressurization Shutoff Valves Open	N/A	N/A	S-IVB	00:08:14.748 (494.748)	TB3 +331.956	MDAC	9
101	Signal from LVDC for: Start Data Recorders	00:08:12.5 (492.5)	TB3 +332.5	IU	00:08:15.25 (495.25)	TB3 +332.452	MSFC	--
102	Signal from LVDC for: S-II LOX Depletion Sensors Cutoff Arm	00:08:18.9 (498.9)	TB3 +338.9	IU	00:08:21.66 (501.66)	TB3 +338.863	MSFC	--
103	Signal from LVDC for: S-II LH2 Depletion Sensors Cutoff Arm	00:08:19.1 (499.1)	TB3 +339.1	IU	00:08:21.88 (501.88)	TB3 +339.075	MSFC	--
104	Begin Chi-Freeze; End IGM Phase 2	00:08:50.0 (530.0)	N/A	N/A	00:08:47.12 (527.12)	N/A	MSFC	--
105	Time Base 4 S-II J-2 Engines Cutoff	00:08:51.1 (531.1)	TB4 +0.0	IU	00:08:56.25 (536.25)	TB4 +0.0	MSFC	--
106	Signal from LVDC for: Cutoff S-II J-2 Engines	00:08:51.1 (531.1)	TB4 +0.0	S-II	00:08:56.34 (536.34)	TB4 +0.085	MSFC	--
107	Signal from LVDC for: Start Recorder Timers	00:08:51.2 (531.2)	TB4 +0.1	IU	00:08:56.43 (536.43)	TB4 +0.177	MSFC	--
108a	Signal from LVDC for: Prevalves Close OFF	00:08:51.3 (531.3)	TB4 +0.2	IU	00:08:56.52 (536.52)	TB4 +0.270	MSFC	--
108b	Signal Received in S-IVB for: Prevalves Close OFF	N/A	N/A	S-IVB	00:08:56.514 (536.514)	TB4 +0.26	MDAC	9
109a	Signal from LVDC for: S-IVB Engine Cutoff OFF	00:08:51.4 (531.4)	TB4 +0.3	IU	00:08:56.62 (536.62)	TB4 +0.365	MSFC	--

TABLE 4-1 (Sheet 8 of 47)  
AS-504 D POST FLIGHT SEQUENCE OF EVENTS

ITEM NO.	EVENT	PREDICTED TIME		SIGNAL MONITORED AT	MONITORED TIME		DATA SOURCE	ACCURACY (ms)
		TIME FROM RANGE ZERO (hr:min:sec) (sec)	TIME FROM BASE (sec)		TIME FROM RANGE ZERO (hr:min:sec) (sec)	TIME FROM BASE (sec)		
109b	Signal Received in S-IVB for: S-IVB Engine Cutoff OFF	N/A	N/A	S-IVB	00:08:56.615 (536.615)	TB4 +0.36 MDAC	9	
110a	Signal from LVDC for: LOX Tank Flight Pressure System ON	00:08:51.5 (531.5)	TB4 +0.4	IU	00:08:56.74 (536.74)	TB4 +0.485 MSFC	--	
110b	Signal Received in S-IVB for: LOX Tank Flight Pressure System ON	N/A	N/A	S-IVB	00:08:56.731 (536.731)	TB4 +0.48 MDAC	9	
111a	Signal from LVDC for: Engine Ready Bypass	00:08:51.6 (531.6)	TB4 +0.5	IU	00:08:56.84 (536.84)	TB4 +0.580 MSFC	--	
111b	Signal Received in S-IVB for: Engine Ready Bypass	N/A	N/A	S-IVB	00:08:56.831 (536.831)	TB4 +0.58 MDAC	9	
112a	Signal from LVDC for: LOX Chilldown Pump OFF	00:08:51.7 (531.7)	TB4 +0.6	IU	00:08:56.96 (536.96)	TB4 +0.706 MSFC	--	
112b	Signal Received in S-IVB for: LOX Chilldown Pump OFF	N/A	N/A	S-IVB	00:08:56.956 (536.956)	TB4 +0.71 MDAC	9	
113a	Signal from LVDC for: Fire Ullage Ignition ON	00:08:51.8 (531.8)	TB4 +0.7	IU	00:08:57.08 (537.08)	TB4 +0.827 MSFC	--	
113b	Signal Received in S-IVB for: Fire Ullage Ignition ON	N/A	N/A	S-IVB	00:08:57.072 (537.072)	TB4 +0.82 MDAC	9	
114	Signal from LVDC for: S-II/S-IVB Separation	00:08:51.9 (531.9)	TB4 +0.8	IU	00:08:57.18 (537.18)	TB4 +0.923 MSFC	--	
115a	Signal from LVDC for: S-IVB Engine Start ON	00:08:52.1 (532.1)	TB4 +1.0	IU	00:08:57.27 (537.27)	TB4 +1.015 MSFC	--	
115b	Signal Received in S-IVB for: S-IVB Engine Start ON	N/A	N/A	S-IVB	00:08:57.264 (537.264)	TB4 +1.02 MDAC	9	
116	Signal from LVDC for: Flight Control Computer S-IVB Burn Mode ON "A"	00:08:52.3 (532.3)	TB4 +1.2	IU	00:08:57.40 (537.40)	TB4 +1.152 MSFC	--	
117	Signal from LVDC for: Flight Control Computer S-IVB Burn Mode ON "B"	00:08:52.4 (532.4)	TB4 +1.3	IU	00:08:57.50 (537.50)	TB4 +1.252 MSFC	--	
118a	Signal from LVDC for: Fuel Chilldown Pump OFF	00:08:53.3 (533.3)	TB4 +2.2	IU	00:08:58.41 (538.41)	TB4 +2.161 MSFC	--	
118b	Signal Received in S-IVB for: Fuel Chilldown Pump OFF	N/A	N/A	S-IVB	00:08:58.406 (538.406)	TB4 +2.16 MDAC	9	

TABLE 4-1 (Sheet 9 of 47)  
AS-504 D POST FLIGHT SEQUENCE OF EVENTS

ITEM NO.	EVENT	PREDICTED TIME		SIGNAL MONITORED AT	MONITORED TIME		DATA SOURCE	ACCURACY (ms)
		TIME FROM RANGE ZERO (hr:min:sec) (sec)	TIME FROM BASE (sec)		TIME FROM RANGE ZERO (hr:min:sec) (sec)	TIME FROM BASE (sec)		
119	Signal from LVDC for: S-IVB Engine Out Indication "A" Enable	00:08:53.6 (533.6)	TB4 +2.5	IU	00:08:58.71 (538.71)	TB4 +2.461	MSFC	--
120	Signal from LVDC for: S-IVB Engine Out Indicator "B" Enable	00:08:53.8 (533.8)	TB4 +2.7	IU	00:08:58.93 (538.93)	TB4 +2.674	MSFC	--
121a	Signal from LVDC for: Fuel Injector Temperature OK Bypass	00:08:55.1 (535.1)	TB4 +4.0	IU	00:09:00.20 (540.20)	TB4 +3.951	MSFC	--
121b	Signal Received in S-IVB for: Fuel Injector Temperature OK Bypass	N/A	N/A	S-IVB	00:09:00.196 (540.196)	TB4 +3.95	MDAC	9
122a	Signal from LVDC for: S-IVB Engine Start OFF	00:08:55.3 (535.3)	TB4 +4.2	IU	00:09:00.42 (540.42)	TB4 +4.166	MSFC	--
122b	Signal Received in S-IVB for: S-IVB Engine Start OFF	N/A	N/A	S-IVB	00:09:00.413 (540.413)	TB4 +4.17	MDAC	9
123a	Signal from LVDC for: First Burn Relay ON	00:08:56.9 (536.9)	TB4 +5.8	IU	00:09:02.03 (542.03)	TB4 +5.774	MSFC	--
123b	Signal Received in S-IVB for: First Burn Relay ON	N/A	N/A	S-IVB	00:09:02.021 (542.021)	TB4 +5.77	MDAC	9
124	IGM Initiation	N/A	N/A	N/A	00:09:10.96 (550.96)	N/A	MSFC	--
125a	Signal from LVDC for: PU Mixture Ratio 5.5 ON	00:09:00.1 (540.1)	TB4 +9.0	IU	00:09:05.20 (545.20)	TB4 +8.951	MSFC	--
125b	Signal Received in S-IVB for: PU Mixture Ratio 5.5 ON	N/A	N/A	S-IVB	00:09:05.195 (545.195)	TB4 +8.95	MDAC	9
126a	Signal from LVDC for: Charge Ullage Jettison ON	00:09:00.9 (540.9)	TB4 +9.8	IU	00:09:06.00 (546.00)	TB4 +9.752	MSFC	--
126b	Signal Received in S-IVB for: Charge Ullage Jettison ON	N/A	N/A	S-IVB	00:09:05.995 (545.995)	TB4 +9.75	MDAC	9
127a	Signal from LVDC for: Fire Ullage Jettison ON	00:09:03.9 (543.9)	TB4 +12.8	IU	00:09:09.01 (549.01)	TB4 +12.751	MSFC	--
127b	Signal Received in S-IVB for: Fire Ullage Jettison ON	N/A	N/A	S-IVB	00:09:09.004 (549.004)	TB4 +12.76	MDAC	9
128a	Signal from LVDC for: Ullage Charging Reset	00:09:04.9 (544.9)	TB4 +13.8	IU	00:09:10.01 (550.01)	TB4 +13.753	MSFC	--
128b	Signal Received in S-IVB for: Ullage Charging Reset	N/A	N/A	S-IVB	00:09:10.003 (550.003)	TB4 +13.76	MDAC	9

TABLE 4-1 (Sheet 10 of 47)  
AS-504 D POST FLIGHT SEQUENCE OF EVENTS

ITEM NO.	EVENT	PREDICTED TIME		SIGNAL MONITORED AT	MONITORED TIME		DATA SOURCE	ACCURACY (ms)
		TIME FROM RANGE ZERO (hr:min:sec) (sec)	TIME FROM BASE (sec)		TIME FROM RANGE ZERO (hr:min:sec) (sec)	TIME FROM BASE (sec)		
129a	Signal from LVDC for: Ullage Firing Reset	00:09:05.1 (545.1)	TB4 +14.0	IU	00:09:10.22 (550.22)	TB4 +13.964	MSFC	--
129b	Signal Received in S-IVB for: Ullage Firing Reset	N/A	N/A	S-IVB	00:09:10.211 (550.211)	TB4 +13.96	MDAC	9
130a	Signal from LVDC for: Fuel Injection Temperature OK Bypass Reset	00:09:05.3 (545.3)	TB4 +14.2	IU	00:09:10.40 (550.40)	TB4 +14.152	MSFC	--
130b	Signal Received in S-IVB for: Fuel Injection Temperature OK Bypass Reset	N/A	N/A	S-IVB	00:09:10.395 (550.395)	TB4 +14.15	MDAC	9
131	Signal from LVDC for: Telemetry Calibrator Inflight Calibrate ON	00:09:07.9 (547.9)	TB4 +16.8	IU	00:09:13.01 (553.01)	TB4 +16.752	MSFC	--
132	Signal from LVDC for: Telemetry Calibrator Inflight Calibrate OFF	00:09:12.9 (552.9)	TB4 +21.8	IU	00:09:18.02 (558.02)	TB4 +21.771	MSFC	--
133a	Signal from LVDC for: Heat Exchanger Bypass Valve Control Enable	00:09:15.1 (555.1)	TB4 +24.0	IU	00:09:20.20 (560.20)	TB4 +23.951	MSFC	--
133b	Signal Received in S-IVB for: Heat Exchanger Bypass Valve Control Enable	N/A	N/A	S-IVB	00:09:20.201 (560.201)	TB4 +23.95	MDAC	9
134a	Signal from LVDC for: TM Calibrate ON	00:09:17.3 (557.3)	TB4 +26.2	IU	00:09:22.42 (562.42)	TB4 +26.171	MSFC	--
134b	Signal Received in S-IVB for: TM Calibrate ON	N/A	N/A	S-IVB	00:09:22.417 (562.417)	TB4 +26.17	MDAC	9
135a	Signal from LVDC for: TM Calibrate OFF	00:09:18.3 (558.3)	TB4 +27.2	IU	00:09:23.42 (563.42)	TB4 +27.172	MSFC	--
135b	Signal Received in S-IVB for: TM Calibrate OFF	N/A	N/A	S-IVB	00:09:23.417 (563.417)	TB4 +27.17	MDAC	9
136	Chi Tilde Guidance Mode Initiation	00:10:13.4 (613.4)	C.O.-75.0	N/A	00:10:31.42 (631.42)	N/A	MSFC	--
137a	Signal from LVDC for: Engine Pump Purge Control Valve Enable ON	00:10:39.4 (639.4)	C.O.-9.0	IU	00:10:56.75 (656.75)	C.O.-7.898	MSFC	--
137b	Signal Received in S-IVB for: Engine Pump Purge Control Valve Enable ON	N/A	N/A	S-IVB	00:10:56.750 (656.750)	TB4 +120.50	MDAC	9
138	Chi Freeze	00:10:40.4 (640.4)	C.O.-8.0	N/A	00:10:57.8 (657.8)	N/A	MSFC	--
139a	Signal from LVDC for: S-IVB Engine Cutoff		N/A	IU	00:11:04.65 (664.65)	TB4 +128.399	MSFC	--



TABLE 4-1 (Sheet 11 of 47)  
AS-504 D POST FLIGHT SEQUENCE OF EVENTS

ITEM NO.	EVENT	PREDICTED TIME		SIGNAL MONITORED AT	MONITORED TIME		DATA SOURCE	ACCURACY (ms)
		TIME FROM RANGE ZERO (hr:min:sec) (sec)	TIME FROM BASE (sec)		TIME FROM RANGE ZERO (hr:min:sec) (sec)	TIME FROM BASE (sec)		
139b	Signal Received in S-IVB for: S-IVB Engine Cutoff	N/A	N/A	S-IVB	00:11:04.649 (664.649)	TB4 +128.40 MDAC	9	
140	<u>Time Base 5</u> LVDC Initiates TB5 Following Velocity Cutoff Signal	00:10:48.551 (648.551)	TB5 +0.0	IU	00:11:04.87 (664.87)	TB5 +0.000 MSFC	--	
141a	Signal from LVDC for: S-IVB Engine Cutoff	00:10:48.6 (648.6)	TB5 +0.1	IU	00:11:04.96 (664.96)	TB5 +0.086 MSFC	--	
141b	Signal Received in S-IVB for: S-IVB Engine Cutoff	N/A	N/A	S-IVB	00:11:04.958 (664.958)	TB5 +0.09 MDAC	9	
142a	Signal from LVDC for: Point Level Sensor Disarming	00:10:48.7 (648.7)	TB5 +0.2	IU	00:11:05.05 (665.05)	TB5 +0.178 MSFC	--	
142b	Signal Received in S-IVB for: Point Level Sensor Disarming	N/A	N/A	S-IVB	00:11:05.059 (665.059)	TB5 +0.19 MDAC	9	
143a	Signal from LVDC for: S-IVB Ullage Engine No. 1 ON	00:10:48.8 (648.8)	TB5 +0.3	IU	00:11:05.15 (665.15)	TB5 +0.272 MSFC	--	
143b	Signal Received in S-IVB for: S-IVB Ullage Engine No. 1 ON	N/A	N/A	S-IVB	00:11:05.149 (665.149)	TB5 +0.28 MDAC	9	
144a	Signal from LVDC for: S-IVB Ullage Engine No. 2 ON	00:10:48.9 (648.9)	TB5 +0.4	IU	00:11:05.27 (665.27)	TB5 +0.394 MSFC	--	
144b	Signal Received in S-IVB for: S-IVB Ullage Engine No. 2 ON	N/A	N/A	S-IVB	00:11:05.266 (665.266)	TB5 +0.39 MDAC	9	
145	Signal from LVDC for: S-IVB Ullage Thrust Present Indication ON	00:10:49.1 (649.1)	TB5 +0.6	IU	00:11:05.44 (665.44)	TB5 +0.565 MSFC	--	
146a	Signal from LVDC for: First Burn Relay (FF)	00:10:49.3 (649.3)	TB5 +0.8	IU	00:11:05.63 (665.63)	TB5 +0.752 MSFC	--	
146b	Signal Received in S-IVB for: First Burn Relay OFF	N/A	N/A	S-IVB	00:11:05.624 (665.624)	TB5 +0.75 MDAC	9	
147a	Signal from LVDC for: LOX Tank Flight Pressure System OFF	00:10:49.7 (649.7)	TB5 +1.2	IU	00:11:06.04 (660.04)	TB5 +1.168 MSFC	--	
147b	Signal Received in S-IVB for: LOX Tank Flight Pressure OFF	N/A	N/A	S-IVB	00:11:06.040 (666.040)	TB5 +1.17 MDAC	9	
148a	Signal from LVDC for: LOX Tank Pressurization Shutoff Valve Close	00:10:49.9 (649.9)	TB5 +1.4	IU	00:11:06.23 (666.23)	TB5 +1.351 MSFC	--	

TABLE 4-1 (Sheet 12 of 47)  
AS-504 D POST FLIGHT SEQUENCE OF EVENTS

ITEM	EVENT	PREDICTED TIME		SIGNAL MONITORED AT	MONITORED TIME		DATA SOURCE	ACCURACY (ms)
		TIME FROM RANGE ZERO (hr:min:sec) (sec)	TIME FROM BASE (sec)		TIME FROM RANGE ZERO (hr:min:sec) (sec)	TIME FROM BASE (sec)		
148b	Signal Received in S-IVB for: LOX Tank Pressurization Shutoff Valves Close	N/A	N/A	S-IVB	00:11:06.223 (666.223)	TB5 +1.35 MDAC		9
149a	Signal from LVDC for: Engine Pump Purge Control Valve Enable ON	00:10:50.1 (650.1)	TB5 +1.6	IU	00:11:06.44 (666.44)	TB5 +1.562 MSFC		--
149b	Signal Received in S-IVB for: Engine Pump Purge Control Valve Enable ON	N/A	N/A	S-IVB	00:11:06.440 (666.440)	TB5 +1.57 MDAC		9
150a	Signal from LVDC for: PU Programmed Mixture Ratio OFF	00:10:50.3 (650.3)	TB5 +1.8	IU	00:11:06.64 (666.64)	TB5 +1.769 MSFC		--
150b	Signal Received in S-IVB for: PU Programmed Mixture Ratio OFF	N/A	N/A	S-IVB	00:11:06.640 (666.640)	TB5 +1.77 MDAC		9
151a	Signal from LVDC for: PU Fuel Boiloff Bias Cutoff ON	00:10:50.5 (650.5)	TB5 +2.0	IU	00:11:06.83 (666.83)	TB5 +1.951 MSFC		--
151b	Signal Received in S-IVB for: PU Fuel Boiloff Bias Cutoff ON	N/A	N/A	S-IVB	00:11:06.823 (666.823)	TB5 +1.95 MDAC		9
152	Signal from LVDC for: Flight Control Computer S-IVB Burn Mode OFF "A"	00:10:52.0 (652.0)	TB5 +3.5	IU	00:11:08.35 (668.35)	TB5 +3.474 MSFC		--
153	Signal from LVDC for: Flight Control Computer S-IVB Burn Mode OFF "B"	00:10:52.2 (652.2)	TB5 +3.7	IU	00:11:08.53 (668.53)	TB5 +3.651 MSFC		--
154a	Signal from LVDC for: Aux. Hydraulic Pump Flight Mode OFF	00:10:52.6 (652.6)	TB5 +4.1	IU	00:11:08.95 (668.95)	TB5 +4.074 MSFC		--
154b	Signal Received in S-IVB for: Aux. Hydraulic Pump Flight Mode OFF	N/A	N/A	S-IVB	00:11:08.948 (668.948)	TB5 +4.08 MDAC		9
155	Signal from LVDC Telemetry Calibrator Inflight Calibrate ON	00:10:52.7 (652.7)	TB5 +4.2	IU	00:11:09.05 (669.05)	TB5 +4.170 MSFC		--
156a	Signal from LVDC for: TM Calibrate ON	00:10:53.1 (653.1)	TB5 +4.6	IU	00:11:09.43 (669.43)	TB5 +4.552 MSFC		--
156b	Signal Received in S-IVB for: TM Calibrate ON	N/A	N/A	S-IVB	00:11:09.423 (669.423)	TB5 +4.55 MDAC		9
157	Signal from LVDC for: SC Control of Saturn Enable	00:10:53.5 (653.5)	TB5 +5.0	IU	00:11:09.84 (669.84)	TB5 +4.969 MSFC		--

TABLE 4-1 (Sheet 13 of 47)  
AS-504 D POST FLIGHT SEQUENCE OF EVENTS

ITEM NO.	EVENT	PREDICTED TIME		SIGNAL MONITORED AT	MONITORED TIME		DATA SOURCE	ACCURACY (ms)
		TIME FROM RANGE ZERO (hr:min:sec) (sec)	TIME FROM BASE (sec)		TIME FROM RANGE ZERO (hr:min:sec) (sec)	TIME FROM BASE (sec)		
158a	Signal from LVDC for: TM Calibrate OFF	00:10:54.1 (654.1)	TB5 +5.6	IU	00:11:10.44 (670.44)	TB5 +5.558	MSFC	--
158b	Signal Received in S-IVB for: TM Calibrate OFF	N/A	N/A	S-IVB	00:11:10.432 (670.432)	TB5 +5.57	MDAC	9
159	Signal from LVDC for: Telemetry Calibration Inflight Calibrate OFF	00:10:57.7 (657.7)	TB5 +9.2	IU	00:11:14.03 (674.03)	TB5 +9.152	MSFC	--
160	Maneuver to Local Horizontal and Hold	00:11:08.5 (668.5)	TB5 +20.0	N/A	00:11:25.0 (585.0)	TB5 +20.2	MSFC	--
161a	Signal from LVDC for: LH2 Tank Continuous Vent Orifice Shutoff Valve Open ON	00:11:47.5 (707.5)	TB5 +59.0	IU	00:12:03.83 (723.83)	TB5 +58.952	MSFC	--
161b	Signal Received in S-IVB for: LH2 Tank Continuous Vent Orifice Shutoff Valve Open ON	N/A	N/A	S-IVB	00:12:03.831 (723.831)	TB5 +58.96	MDAC	9
162a	Signal from LVDC for: LH2 Tank Continuous Vent Relief Override Shutoff Valve Open ON	00:11:47.6 (707.6)	TB5 +59.1	IU	00:12:03.96 (723.96)	TB5 +59.078	MSFC	--
162a	Signal received in S-IVB for: LH2 Tank Continuous Vent Relief Override Shutoff Valve Open ON	N/A	N/A	S-IVB	00:12:03.955 (723.955)	TB5 +59.08	MDAC	9
163a	Signal from LVDC for: LH2 Tank Continuous Vent Orifice Shutoff Valve Open OFF	00:11:49.5 (709.5)	TB5 +61.0	IU	00:12:05.85 (725.85)	TB5 +60.973	MSFC	--
163b	Signal Received in S-IVB for: LH2 Tank Continuous Vent Orifice Shutoff Valve Open OFF	N/A	N/A	S-IVB	00:12:05.847 (725.847)	TB5 +60.97	MDAC	9
164a	Signal from LVDC for: LH2 Tank Continuous Vent Relief Override Shutoff Valve Open OFF	00:11:49.6 (709.6)	TB5 +61.1	IU	00:12:05.95 (725.95)	TB5 +61.071	MSFC	--
164b	Signal Received in S-IVB for: LH2 Tank Continuous Vent Relief Override Shutoff Valve Open OFF	N/A	N/A	S-IVB	00:12:05.947 (725.947)	TB5 +61.07	MDAC	9
165a	Signal from LVDC for: S-IVB Ullage Engine No. 1 OFF	00:12:15.5 (735.5)	TB5 +87.0	IU	00:12:31.83 (751.83)	TB5 +86.953	MSFC	--
165b	Signal Received in S-IVB for: S-IVB Ullage Engine No. 1 OFF	N/A	N/A	S-IVB	00:12:31.826 (751.826)	TB5 +86.95	MDAC	9

TABLE 4-1 (Sheet 14 of 47)  
AS-504 D POST FLIGHT SEQUENCE OF EVENTS

ITEM NO.	EVENT	PREDICTED TIME		SIGNAL MONITORED AT	MONITORED TIME		DATA SOURCE	ACCURACY (ms)
		TIME FROM RANGE ZERO (hr:min:sec) (sec)	TIME FROM BASE (sec)		TIME FROM RANGE ZERO (hr:min:sec) (sec)	TIME FROM BASE (sec)		
166a	Signal from LVDC for: S-IVB Ullage Engine No. 2 OFF	00:12:15.6 (735.6)	TB5 +87.1	IU	00:12:31.96 (751.96)	TB5 +87.021	MSFC	--
166b	Signal Received in S-IVB for: S-IVB Ullage Engine No. 2 OFF	N/A	N/A	S-IVB	00:12:31.958 (751.958)	TB5 +87.09	MDAC	9
167	Signal from LVDC for: S-IVB Ullage Thrust Present Indication OFF	00:12:15.7 (735.7)	TB5 +87.2	IU	00:12:32.05 (752.05)	TB5 +87.175	MSFC	--
168a	Signal from LVDC for: PU Inverter and DC Power OFF	00:15:48.5 (948.5)	TB5 +300.0	IU	--	TB5 +	MSFC	--
168b	Signal Received in S-IVB for: PU Inverter and DC Power OFF	N/A	N/A	S-IVB	00:16:04.822 (964.822)	TB5 +299.95	MDAC	9
169a	Signal from LVDC for: Engine Pump Purge Control Valve Enable OFF	00:20:51.1 (1,251.1)	TB5 +602.6	IU	00:21:07.42 (1,267.42)	TB5 +602.55	--	--
169b	Signal Received in S-IVB for: Engine Pump Purge Control Valve Enable OFF	N/A	N/A	S-IVB	00:21:07.419 (1,267.419)	TB5 +602.55	MDAC	9
170	Signal from LVDC for: Telemetry Calibrate Inflight Calibrate ON	N/A	N/A	IU	00:38:06.23 (2,286.23)	TB5+1621.369	MSFC	--
171a	Signal from LVDC for: TM Calibrate ON	N/A	N/A	IU	00:38:06.43 (2,286.43)	TB5+1621.570	MSFC	--
171b	Signal Received in S-IVB for: TM Calibrate ON	N/A	N/A	S-IVB	00:38:06.436 (2,286.436)	TB5 +1621.57	MDAC	9
172a	Signal from LVDC for: TM Calibrate OFF	N/A	N/A	IU	00:38:07.43 (2,287.43)	TB5+1622.570	MSFC	--
172b	Signal Received in S-IVB for: TM Calibrate OFF	N/A	N/A	S-IVB	00:38:07.437 (2,287.437)	TB5 +1622.57	MDAC	9
173	Signal from LVDC for: Telemetry Calibrate Inflight Calibrate OFF	N/A	N/A	IU	00:38:11.23 (2,291.23)	TB5+1626.370	MSFC	--
174	Signal from LVDC for: Telemetry Calibrate Inflight Calibrate ON	N/A	N/A	IU	00:53:18.15 (3,198.15)	TB5+2533.290	MSFC	--
175a	Signal from LVDC for: TM Calibrate ON	N/A	N/A	IU	00:53:18.35 (3,198.35)	TB5+2533.490	MSFC	--
175b	Signal Received in S-IVB for: TM Calibrate ON	N/A	N/A	S-IVB	00:53:18.348 (3,198.348)	TB5 +2533.48	MDAC	9

TABLE 4-1 (Sheet 15 of 47)  
AS-504 D POST FLIGHT SEQUENCE OF EVENTS

ITEM	EVENT	PREDICTED TIME		SIGNAL MONITORED AT	MONITORED TIME		DATA SOURCE	ACCURACY (ms)
		TIME FROM RANGE ZERO (hr:min:sec) (sec)	TIME FROM BASE (sec)		TIME FROM RANGE ZERO (hr:min:sec) (sec)	TIME FROM BASE (sec)		
176a	Signal from LVDC for: TM Calibrate OFF	N/A	N/A	IU	00:53:19.35 (3,199.35)	TB5+2534.491	MSFC	--
176b	Signal Received in S-IVB for: TM Calibrate OFF	N/A	N/A	S-IVB	00:53:19.356 (3,199.356)	TB5 +2534.49	MDAC	9
177	Signal from LVDC for: Telemetry Calibrate Inflight Calibrate OFF	N/A	N/A	IU	00:53:23.14 (3,203.14)	TB5+2538.289	MSFC	--
178a	Signal from LVDC for: Auxiliary Hydraulic Pump Flight Mode ON	00:54:08.5 (3,248.5)	TB5+2600.0	IU	00:54:24.81 (3,264.81)	TE5+2599.952	MSFC	--
178b	Signal Received in S-IVB for: Auxiliary Hydraulic Pump Flight Mode ON	N/A	N/A	S-IVB	00:54:24.808 (3,264.808)	TB5 +2599.94	MDAC	9
179a	Signal from LVDC for: Auxiliary Hydraulic Pump Flight Mode OFF	00:54:56.5 (3,296.5)	TB5+2648.0	IU	00:55:12.81 (3,312.81)	TB5+2647.952	MSFC	--
179b	Signal Received in S-IVB for: Auxiliary Hydraulic Pump Flight Mode OFF	N/A	N/A	S-IVB	00:55:12.807 (3,312.807)	TE5 +2647.94	MDAC	9
180	Signal from LVDC for: Telemetry Calibrate Inflight Calibrate ON	N/A	N/A	IU	01:29:26.13 (5,366.13)	TB5+4701.284	MSFC	--
181a	Signal from LVDC for: TM Calibrate ON	N/A	N/A	IU	01:29:26.33 (5,366.33)	TB5+4701.485	MSFC	--
181b	Signal Received in S-IVB for: TM Calibrate ON	N/A	N/A	S-IVB	01:29:26.334 (5,366.334)	TE5 +4701.46	MDAC	9
182a	Signal from LVDC for: TM Calibrate OFF	N/A	N/A	IU	01:29:27.33 (5,367.33)	TB5+4702.484	MSFC	--
182b	Signal Received in S-IVB for: TM Calibrate OFF	N/A	N/A	S-IVB	01:29:27.333 (5,367.333)	TB5 +4702.46	MDAC	9
183	Signal from LVDC for: Telemetry Calibrate Inflight Calibrate OFF	N/A	N/A	IU	01:29:31.13 (5,371.13)	TB5+4706.286	MSFC	--
184a	Signal from LVDC for: Auxiliary Hydraulic Pump Flight Mode ON	01:40:48.5 (6,048.5)	TB5+5400.0	IU	01:41:04.80 (6,064.80)	TB5+5399.949	MSFC	--
184b	Signal Received in S-IVB for: Auxiliary Hydraulic Pump Flight Mode ON	N/A	N/A	S-IVB	01:41:04.795 (6,064.795)	TB5 +5399.93	MDAC	9
185a	Signal from LVDC for: Auxiliary Hydraulic Pump Flight Mode OFF	01:41:36.5 (6,096.5)	TB5+5448.0	IU	01:41:52.80 (6,112.80)	TB5+5447.952	MSFC	--

TABLE 4-1 (Sheet 16 of 47)  
AS-504 D POST FLIGHT SEQUENCE OF EVENTS

ITEM NO.	EVENT	PREDICTED TIME		SIGNAL MONITORED AT	MONITORED TIME		DATA SOURCE	ACCURACY (ms)
		TIME FROM RANGE ZERO (hr:min:sec) (sec)	TIME FROM BASE (sec)		TIME FROM RANGE ZERO (hr:min:sec) (sec)	TIME FROM BASE (sec)		
185b	Signal Received in S-IVB for: Auxiliary Hydraulic Pump Flight Mode OFF	N/A	N/A	S-IVB	01:41:52.794 (6,112.794)	TB5 +5447.93	MDAC	9
186	Signal from LVDC for: Telemetry Calibrate Inflight Calibrate ON	N/A	N/A	IU	02:10:22.18 (7,822.18)	TB5+7157.349	MSFC	--
187a	Signal from LVDC for: TM Calibrate ON	N/A	N/A	IU	02:10:22.38 (7,822.38)	TB5+7157.550	MSFC	--
187b	Signal Received in S-IVB for: TM Calibrate ON	N/A	N/A	S-IVB	02:10:22.384 (7,822.384)	TB5 +7157.51	MDAC	9
188a	Signal from LVDC for: TM Calibrate OFF	N/A	N/A	IU	02:10:23.38 (7,823.38)	TB5+7158.550	MSFC	--
188b	Signal Received in S-IVB for: TM Calibrate OFF	N/A	N/A	S-IVB	02:10:23.384 (7,823.384)	TB5 +7158.51	MDAC	9
189	Signal from LVDC for: Telemetry Calibrate Inflight Calibrate OFF	N/A	N/A	IU	02:10:27.18 (7,827.18)	TB5+7162.350	MSFC	--
190	Signal from LVDC for: Telemetry Calibrate Inflight Calibrate ON	N/A	N/A	IU	02:26:30.13 (8,790.13)	TB5+8125.299	MSFC	--
191a	Signal from LVDC for: TM Calibrate ON	N/A	N/A	IU	02:26:30.33 (8,790.33)	TB5+8125.499	MSFC	--
191b	Signal Received in S-IVB for: TM Calibrate ON	N/A	N/A	S-IVB	02:26:30.332 (8,790.332)	TB5 +8125.46	MDAC	9
192a	Signal from LVDC for: TM Calibrate OFF	N/A	N/A	IU	02:26:31.33 (8,791.33)	TB5+8126.500	MSFC	--
192b	Signal Received in S-IVB for: TM Calibrate OFF	N/A	N/A	S-IVB	02:26:31.332 (8,791.332)	TB5 +8126.46	MDAC	9
193	Signal from LVDC for: Telemetry Calibrate Inflight Calibrate OFF	N/A	N/A	IU	02:26:35.13 (8,795.13)	TB5+8130.299	MSFC	--
194	Signal from LVDC for: EDS Cutoff No. 1 Disable	N/A	N/A	IU	02:26:35.61 (8,795.61)	N/A	MSFC	--
195	Signal from LVDC for: IU Command System Enable	02:39:08.5 (9,548.5)	TB5+8900.0	IU	02:39:24.79 (9,564.79)	TB5+8899.952	MSFC	--
196	CSM Separation	02:45:00 (9780)	N/A	--	02:07:56 (9,676.0)	N/A	MSFC	--
197	Signal from LVDC for: Telemetry Calibrate Inflight Calibrate ON	N/A	N/A	IU	02:51:58.13 (10,318.13)	TB5+9653.311	MSFC	--
198a	Signal from LVDC for: TM Calibrate ON	N/A	N/A	IU	02:51:58.33 (10,318.33)	TB5+9653.512	MSFC	--

TABLE 4-1 (Sheet 17 of 47)  
AS-504 D POST FLIGHT SEQUENCE OF EVENTS

ITEM NO.	EVENT	PREDICTED TIME		SIGNAL MONITOR'D AT	MONITORED TIME		DATA SOURCE	ACCURACY (ms)
		TIME FROM RANGE ZERO (hr:min:sec) (sec)	TIME FROM BASE (sec)		TIME FROM RANGE ZERO (hr:min:sec) (sec)	TIME FROM BASE (sec)		
198b	Signal Received in S-IVB for: TM Calibrate ON	N/A	N/A	S-IVB	02:51:58.331 (10,318.331)	TB5 +9653.46	MDAC	9
199a	Signal from LVDC for: TM Calibrate OFF	N/A	N/A	IU	02:51:59.34 (10,319.34)	TB5 +9654.516	MSFC	--
199b	Signal Received in S-IVB for: TM Calibrate OFF	N/A	N/A	S-IVB	02:51:59.339 (10,319.339)	TB5 +9654.47	MDAC	9
200	Signal from LVDC for: Telemetry Calibrate Inflight Calibrate OFF	N/A	N/A	IU	02:51:03.13 (10,323.13)	TB5 +9658.310	MSFC	--
201	GSM Docking	03:00:00 (10,800)	N/A	--	03:02:08 (10,928)	N/A	MSFC	--
202	Signal from LVDC for: Telemetry Calibrate Inflight Calibrate ON	N/A	N/A	IU	03:02:38.14 (10,958.14)	TB5+10293.323	MSFC	--
203a	Signal from LVDC for: TM Calibrate ON	N/A	N/A	IU	03:02:38.34 (10,958.34)	TB5+10293.523	MSFC	--
203b	Signal Received in S-IVB for: TM Calibrate ON	N/A	N/A	S-IVB	03:02:38.343 (10,958.343)	TB5 +10293.47	MDAC	9
204a	Signal from LVDC for: TM Calibrate OFF	N/A	N/A	IU	03:02:39.34 (10,959.34)	TB5+10294.524	MSFC	--
204b	Signal Received in S-IVB for: TM Calibrate OFF	N/A	N/A	S-IVB	03:02:39.342 (10,959.342)	TB5 +10294.47	MDAC	9
205	Signal from LVDC for: Telemetry Calibrate Inflight Calibrate OFF	N/A	N/A	IU	03:02:43.14 (10,963.14)	TB5+10294.324	MSFC	--
206a	Signal from LVDC for: Auxiliary Hydraulic Pump Flight Mode ON	03:05:48.5 (11,148.5)	TB5+10500.0	IU	03:06:04.76 (11,164.76)	TB5+10499.951	MSFC	--
206b	Signal Received in S-IVB for: Auxiliary Hydraulic Pump Flight Mode ON	N/A	N/A	S-IVB	03:06:04.770 (11,164.770)	TB5 +10499.90	MDAC	9
207a	Signal from LVDC for: Auxiliary Hydraulic Pump Flight Mode OFF	03:13:48.5 (11,628.5)	TB5+10980.0	IU	03:14:04.77 (11,644.77)	TB5+10979.950	MSFC	--
207b	Signal Received in S-IVB for: Auxiliary Hydraulic Pump Flight Mode OFF	N/A	N/A	S-IVB	03:14:04.762 (11,644.762)	TB5 +10979.80	MDAC	9
208	Signal from LVDC for: Telemetry Calibrate Inflight Calibrate ON	N/A	N/A	IU	--	TB5+	MSFC	--
209a	Signal from LVDC for: TM Calibrate ON	N/A	N/A	IU	--	TB5+	MSFC	--

TABLE 4-1 (Sheet 18 of 47)  
AS-504 D POST FLIGHT SEQUENCE OF EVENTS

ITEM NO.	EVENT	PREDICTED TIME		SIGNAL MONITORED AT	MONITORED TIME		DATA SOURCE	ACCURACY (ms)
		TIME FROM RANGE ZERO (hr:min:sec) (sec)	TIME FROM BASE (sec)		TIME FROM RANGE ZERO (hr:min:sec) (sec)	TIME FROM BASE (sec)		
209b	Signal Received in S-IVB for: TM Calibrate ON	N/A	N/A	S-IVB	03:29:18.338 (12,558.338)	TB5 +11893.47	MDAC	9
210a	Signal from LVDC for: TM Calibrate OFF	N/A	N/A	IU	--	TB5 +	MSFC	--
210b	Signal Received in S-IVB for: TM Calibrate OFF	N/A	N/A	S-IVB	02:29:19.338 (12,559.338)	TB5 +11894.47	MDAC	9
211	Signal from LVDC for: Telemetry Calibrate Inflight Calibrate OFF	N/A	N/A	IU	--	TB5 +	MSFC	--
212a	Signal from LVDC for: PU Inverter and DC Power ON	03:40:48.5 (13,248.5)	TB5+12600.0	IU	--	TB5 +	MSFC	--
212b	Signal Received in S-IVB for: PU Inverter and DC Power ON	N/A	N/A	S-IVB	--	TB5 +	MDAC	9
213	Signal from LVDC for: Telemetry Calibrate Inflight Calibrate ON	N/A	N/A	IU	03:59:34.09 (14,374.09)	TB5+13709.293	MSFC	--
214a	Signal from LVDC for: TM Calibrate ON	N/A	N/A	IU	03:59:34.29 (14,374.29)	TB5+13709.493	MSFC	--
214b	Signal Received in S-IVB for: TM Calibrate ON	N/A	N/A	S-IVB	03:59:34.295 (14,374.295)	TB5 +13709.50	MDAC	9
215a	Signal from LVDC for: TM Calibrate OFF	N/A	N/A	IU	03:59:35.30 (14,375.30)	TB5+13710.503	MSFC	--
215b	Signal Received in S-IVB for: TM Calibrate OFF	N/A	N/A	S-IVB	03:59:35.295 (14,375.295)	TB5 +13710.50	MDAC	9
216	Signal from LVDC for: Telemetry Calibrate Inflight Calibrate OFF	N/A	N/A	IU	03:59:39.09 (14,379.09)	TB5+13714.292	MSFC	--
217	SC/LV Final Separation	04:09:00 (14,940)	N/A	--	04:08:05 (14,885)	N/A	MSFC	--
218	Signal from LVDC for: Telemetry Calibrate Inflight Calibrate ON	N/A	N/A	IU	04:24:30.07 (15,870.07)	TB5+15205.283	MSFC	9
219a	Signal from LVDC for: TM Calibrate ON	N/A	N/A	IU	04:24:30.27 (15,870.27)	TB5+15205.483	MSFC	9
219b	Signal Received in S-IVB for: TM Calibrate ON	N/A	N/A	S-IVB	04:24:30.273 (15,870.273)	TB5 +15205.40	MDAC	--
220a	Signal from LVDC for: TM Calibrate OFF	N/A	N/A	IU	04:24:31.28 (15,871.28)	TB5+15206.492	MSFC	9
220b	Signal Received in S-IVB for: TM Calibrate OFF	N/A	N/A	S-IVB	04:24:31.282 (15,871.282)	TB5 +15206.41	MDAC	--



TABLE 4-1 (Sheet 19 of 47)  
AS-504 D POST FLIGHT SEQUENCER OF EVENTS

ITEM NO.	EVENT	PREDICTED TIME		SIGNAL MONITORED AT	MONITORED TIME		DATA SOURCE	ACCURACY (ms)
		TIME FROM RANGE ZERO (hr:min:sec) (sec)	TIME FROM BASE (sec)		TIME FROM RANGE ZERO (hr:min:sec) (sec)	TIME FROM BASE (sec)		
221	Signal from LVDC for: Telemetry Calibrate Inflight Calibrate OFF	N/A	N/A	IU	04:24:35.07 (15,875.07)	TB5 +15210.20	MSFC	9
222	Signal from LVDC for: S-IVB Restart Enable	N/A	N/A	IU	04:34:11 (16,451)	N/A	MSFC	--
223	Signal from LVDC for: Telemetry Calibrate Inflight Calibrate ON	N/A	N/A	IU	--	TB5 +	MSFC	9
224a	Signal from LVDC for: TM Calibrate ON	N/A	N/A	IU	--	TB5 +	MSFC	9
224b	Signal Received in S-IVB for: TM Calibrate ON	N/A	N/A	S-IVB	04:36:14.360 (16,574.360)	TB5 +15909.49	MDAC	--
225a	Signal from LVDC for: TM Calibrate OFF	N/A	N/A	IU	04:36:15.38 (16,575.38)	TB5+15910.594	MSFC	9
225b	Signal Received in S-IVB for: TM Calibrate OFF	N/A	N/A	S-IVB	04:36:15.376 (16,575.376)	TB5 +15910.51	MDAC	--
226	Signal from LVDC for: Telemetry Calibrate Inflight Calibrate OFF	N/A	N/A	IU	--	TB5 +	MSFC	9
227	Time Base 6 Begin Restart Preparations	04:36:09.261 (16,569.261)	TB6 +0.0	--	04:36:17.24 (16,577.24)	TB6 +0.000	MSFC	--
228	Signal from LVDC for: SC Control of Saturn Disable	04:36:09.5 (16,569.5)	TB6 +0.2	IU	--	TB6 +	MSFC	--
229	Signal from LVDC for: EDS Cutoff No. 1 Disable	04:36:09.7 (16,569.7)	TB6 +0.4	IU	04:36:17.59 (16,577.59)	TB6 +0.353	MSFC	--
230a	Signal from LVDC for: EDS Cutoff NO. 2 Disable	04:36:09.9 (16,569.9)	TB5 +0.6	IU	04:36:17.81 (16,577.81)	TB6 +0.566	MSFC	--
230b	Signal Received in S-IVB for: EDS Cutoff No. 2 Disable	N/A	N/A	S-IVB	04:36:17.810 (16,577.810)	TB6 +0.57	MDAC	9
231	Signal from LVDC for: Telemetry Calibration Inflight Calibrate ON	04:36:10.3 (16,570.3)	TB6 +1.0	IU	04:36:18.19 (16,578.19)	TB6 +0.951	MSFC	--
232a	Signal from LVDC for: TM Calibrate ON	04:36:10.5 (16,570.5)	TB6 +1.2	IU	04:36:18.40 (16,578.40)	TB6 +1.164	MSFC	--
232b	Signal Received in S-IVB for: TM Calibrate ON	N/A	N/A	S-IVB	04:36:18.409 (16,578.409)	TB6 +1.74	MDAC	9
233a	Signal from LVDC for: TM Calibrate OFF	04:36:11.5 (16,571.5)	TB6 +2.2	IU	04:36:19.41 (16,579.41)	TB6 +2.165	MSFC	--
233b	Signal Received in S-IVB for: TM Calibrate OFF	N/A	N/A	S-IVB	04:36:19.409 (16,579.409)	TB6 +2.17	MDAC	9

TABLE 4-1 (Sheet 20 of 47)  
AS-504 D POST FLIGHT SEQUENCE OF EVENTS

ITEM NO.	EVENT	PREDICTED TIME		SIGNAL MONITORED AT	MONITORED TIME		DATE SOURCE	ACCURACY (ms)
		TIME FROM RANGE ZERO (hr:min:sec) (sec)	TIME FROM BASE (sec)		TIME FROM RANGE ZERO (hr:min:sec) (sec)	TIME FROM BASE (sec)		
234	Signal from LVDC for: Telemetry Calibration Inflight Calibrate OFF	04:36:15.3 (16,575.3)	TB6 +6.0	IU	04:36:23.19 (16,583.19)	TB6 +5.953	MSFC	--
235a	Signal from LVDC for: S-IVB Engine Cutoff OFF	04:36:19.3 (16,579.3)	TB6 +10.0	IU	04:36:27.19 (16,587.19)	TB6 +9.952	MSFC	--
235b	Signal Received in S-IVB for: S-IVB Engine Cutoff OFF	N/A	N/A	S-IVB	04:36:27.190 (16,587.190)	TB6 +9.95	MDAC	9
236a	Signal from LVDC for: LH2 Tank Vent and Latching Relief Valve Boost Close ON	04:36:45.6 (16,605.6)	TB6 +36.3	IU	04:36:53.52 (16,673.52)	TB6 +36.275	MSFC	--
236b	Signal Received in S-IVB for: LH2 Tank Vent and Latching Relief Valve Boost Close ON	N/A	N/A	S-IVB	04:36:53.519 (16,613.519)	TB6 +36.28	MDAC	9
237a	Signal from LVDC for: LOX Tank Vent and NPV Valves Boost Close ON	04:36:45.8 (16,605.8)	TB6 +36.5	IU	04:36:53.69 (16,613.69)	TB6 +36.451	MSFC	--
237b	Signal Received in S-IVB for: LOX Tank Vent and NPV Valves Boost Close ON	N/A	N/A	S-IVB	04:36:53.714 (16,613.714)	TB6 +36.47	MDAC	9
238a	Signal from LVDC for: LH2 Tank Vent and Latching Relief Valve Boost Close OFF	04:36:47.6 (16,607.6)	TB6 +38.3	IU	04:36:55.5 (16,615.50)	TB6 +38.26	MSFC	--
238b	Signal Received in S-IVB for: LH2 Tank Vent and Latching Relief Valve Boost Close OFF	N/A	N/A	S-IVB	04:36:55.502 (16,615.502)	TB6 +38.262	MDAC	9
239a	Signal from LVDC for: LOX Tank Vent NPV Valves Boost Close OFF	04:36:47.8 (16,607.8)	TB6 +38.5	IU	04:36:55.69 (16,615.69)	TB6 +38.45	MSFC	--
239b	Signal Received in S-IVB for: LOX Tank Vent and NPV Valves Boost Close OFF	N/A	N/A	S-IVB	04:36:55.694 (16,615.694)	TB6 +38.45	MDAC	9
240a	Signal from LVDC for: Repressurization System Mode Selector OFF (AMB)	04:36:50.4 (16,610.4)	TB6 +41.1	IU	04:36:58.29 (16,618.29)	TB6 +41.052	MSFC	--
240b	Signal Received in S-IVB for: Repressurization System Mode Select - OFF (AMB)	N/A	N/A	S-IVB	04:36:58.293 (16,618.293)	TB6 +41.052	MDAC	9
241a	Signal from LVDC for: Burner LH2 Propellant Valve Open ON	04:36:50.6 (16,610.6)	TB6 +41.3	IU	04:36:58.51 (16,618.51)	TB6 +41.272	MSFC	--

TABLE 4-1 (Sheet 21 of 47)  
AS-504 D POST FLIGHT SEQUENCE OF EVENTS

ITEM NO.	EVENT	PREDICTED TIME		SIGNAL MONITORED AT	MONITORED TIME		DATA SOURCE	ACCURACY (ms)
		TIME FROM RANGE ZERO (hr:min:sec) (sec)	TIME FROM BASE (sec)		TIME FROM RANGE ZERO (hr:min:sec) (sec)	TIME FROM BASE (sec)		
241b	Signal received in S-IVB for: Burner LH2 Propellant Valve Open ON	N/A	N/A	S-IVB	04:36:58.518 (16,618.518)	TB6 +41.28	MDAC	9
242a	Signal from LVDC for: Burner Exciters ON	04:36:50.9 (16,610.9)	TB6 +41.6	IU	04:36:58.81 (16,618.81)	TB6 +41.570	MSFC	--
242b	Signal received in S-IVB for: Burner Exciters ON	N/A	N/A	S-IVB	04:36:58.810 (16,618.810)	TB6 +41.570	MDAC	9
243a	Signal from LVDC for: Burner LOX Shutdown Valve Open ON	04:36:51.3 (16,611.3)	TB6 +42.0	IU	04:36:59.20 (16,619.20)	TB6 +41.955	MSFC	--
243b	Signal received in S-IVB for: Burner LOX Shutdown Valve Open ON	N/A	N/A	S-IVB	04:36:59.201 (16,619.201)	TB6 +41.96	MDAC	9
244a	Signal from LVDC for: LH2 Tank Continuous Vent Valve Close ON	04:36:51.5 (16,611.5)	TB6 +42.2	IU	04:36:59.40 (16,619.40)	TB6 +42.157	MSFC	--
244b	Signal received in S-IVB for: LH2 Tank Continuous Vent Valve Close ON	N/A	N/A	S-IVB	04:36:59.409 (16,619.409)	TB6 +42.17	MDAC	9
245a	Signal from LVDC for: Burner LH2 Propellant Valve Open OFF	04:36:52.1 (16,612.1)	TB6 +42.8	IU	04:37:00.00 (16,620.00)	TB6 +42.759	MSFC	--
245b	Signal received in S-IVB for: Burner LH2 Propellant Valve Open OFF	N/A	N/A	S-IVB	04:37:00.001 (16,620.001)	TB6 +42.76	MDAC	9
246a	Signal from LVDC for: Burner LOX Shutdown Valve Open OFF	04:36:52.8 (16,612.8)	TB6 +43.5	IU	04:37:00.71 (16,620.71)	TB6 +43.473	MSFC	--
246b	Signal received in S-IVB for: Burner LOX Shutdown Valve Open OFF	N/A	N/A	S-IVB	04:37:00.718 (16,620.718)	TB6 +43.48	MDAC	9
247a	Signal from LVDC for: LH2 Tank Continuous Vent Valve Close OFF	04:36:53.5 (16,613.5)	TB6 +44.2	IU	04:37:01.39 (16,621.39)	TB6 +44.153	MSFC	--
247b	Signal received in S-IVB for: LH2 Tank Continuous Vent Valve Close OFF	N/A	N/A	S-IVB	04:37:01.392 (16,621.392)	TB6 +44.15	MDAC	9
248a	Signal from LVDC for: Second Burn Relay ON	04:36:54.5 (16,614.5)	TB6 +45.2	IU	04:37:02.39 (16,622.39)	TB6 +45.153	MSFC	--
248b	Signal received in S-IVB for: Second Burn Relay ON	N/A	N/A	S-IVB	04:37:02.392 (16,622.392)	TB6 +45.15	MDAC	9
249a	Signal from LVDC for: Burner Exciters OFF	04:36:54.7 (16,614.7)	TB6 +45.4	IU	04:37:02.60 (16,622.60)	TB6 +45.363	MSFC	--

TABLE 4-1 (Sheet 22 of 47)  
AS-504 D POST FLIGHT SEQUENCE OF EVENTS

ITEM NO.	EVENT	PREDICTED TIME		SIGNAL MONITORED AT	MONITORED TIME		DATA SOURCE	ACCURACY (ms)
		TIME FROM RANGE ZERO (hr:min:sec) (sec)	TIME FROM BASE (sec)		TIME FROM RANGE ZERO (hr:min:sec) (sec)	TIME FROM BASE (sec)		
24yb	Signal received in S-IVB for: Burner Exciters OFF	N/A	N/A	S-IVB	04:37:02.608 (16,622.608)	TB6 +45.37	MDAC	9
250a	Signal from LVDC for: Burner Automatic Cutoff System Arm	04:36:57.3 (16,617.3)	TB6 +48.0	IU	04:37:05.20 (16,625.20)	TB6 +47.958	MSFC	--
250b	Signal received in S-IVB for: Burner Automatic Cutoff System Arm	N/A	N/A	S-IVB	04:37:05.200 (16,625.200)	TB6 +47.96	MDAC	9
251a	Signal from LVDC for: LH2 Tank Repressurization Control Valve Open ON	04:36:57.4 (16,617.4)	TB6 +48.1	IU	04:37:05.33 (16,625.33)	TB6 +48.089	MSFC	--
251b	Signal received in S-IVB for: LH2 Tank Repressurization Control Valve Open ON	N/A	N/A	S-IVB	04:37:05.333 (16,625.333)	TB6 +48.089	MDAC	9
252a	Signal from LVDC for: LOX Tank Repressurization Control Valve Open ON	04:36:57.6 (16,617.6)	TB6 +48.3	IU	04:37:05.50 (16,625.50)	TB6 +48.260	MSFC	--
252b	Signal received in S-IVB for: LOX Tank Repressurization Control valve Open ON	N/A	N/A	S-IVB	04:37:05.500 (16,625.500)	TB6 +48.26	MDAC	9
253a	Signal from LVDC for: Auxiliary Hydraulic Pump Flight Mode ON	04:39:48.3 (16,788.3)	TB6 +219.0	IU	04:39:56.19 (16,796.19)	TB6 +218.952	MSFC	--
253b	Signal received in S-IVB for: Auxiliary Hydraulic Pump Flight Mode ON	N/A	N/A	S-IVB	04:39:56.193 (16,796.193)	TB6 +218.95	MDAC	9
254a	Signal from LVDC for: Chilldown Shutoff Valve Close OFF	04:40:08.3 (16,808.3)	TB6 +239.0	IU	04:40:16.20 (16,816.20)	TB6 +238.964	MSFC	--
254b	Signal Received in S-IVB for: Chilldown Shutoff Valve Close OFF	N/A	N/A	S-IVB	04:40:16.206 (16,816.206)	TB6 +238.96	MDAC	9
255a	Signal from LVDC for: LOX Chilldown Pump ON	04:40:18.3 (16,818.3)	TB6 +249.0	IU	04:40:26.18 (16,826.18)	TB6 +248.951	MSFC	--
255b	Signal received in S-IVB for: LOX Chilldown Pump ON	N/A	N/A	S-IVB	04:40:26.187 (16,826.187)	TB6 +248.95	MDAC	9
256a	Signal from LVDC for: Fuel Chilldown Pump ON	04:40:23.3 (16,823.3)	TB6 +254.0	IU	04:40:31.19 (16,831.19)	TB6 +253.952	MSFC	--
256b	Signal received in S-IVB for: Fuel Chilldown Pump ON	N/A	N/A	S-IVB	04:40:31.194 (16,831.194)	TB6 +253.95	MDAC	9

TABLE 4-1 (Sheet 23 of 47)  
AS-504 D POST FLIGHT SEQUENCE OF EVENTS

ITEM NO.	EVENT	PREDICTED TIME		SIGNAL MONITORED AT	MONITORED TIME		DATA SOURCE	ACCURACY (ms)
		TIME FROM RANGE ZERO (hr:min:sec) (sec)	TIME FROM BASE (sec)		TIME FROM RANGE ZERO (hr:min:sec) (sec)	TIME FROM BASE (sec)		
257a	Signal from LVDC for: Prevalves Close ON	04:40:28.3 (16,828.3)	TB6 +259.0	IU	04:40:36.20 (16,836.20)	TB6 +258.960	MSFC	--
257b	Signal received in S-IVB for: Prevalves Close ON	N/A	N/A	S-IVB	04:40:36.202 (16,836.202)	TB6 +258.96	MDAC	9
258	Signal from LVDC for: Telemetry Calibration Inflight Calibrate ON	04:42:49.3 (16,969.3)	TB6 +400.0	IU	04:42:57.20 (16,977.20)	TB6 +399.952	MSFC	--
259a	Signal from LVDC for: TM Calibrate ON	04:42:49.5 (16,969.5)	TB6 +400.2	IU	04:42:57.41 (16,977.41)	TB6 +400.163	MSFC	--
259a	Signal received in S-IVB for: TM Calibrate ON	N/A	N/A	S-IVB	04:42:57.406 (16,977.406)	TB6 +400.163	---	--
260a	Signal from LVDC for: TM Calibrate OFF	04:42:50.5 (16,970.5)	TB6 +401.2	IU	04:42:58.41 (16,978.41)	TB6 +401.161	MSFC	--
260b	Signal received in S-IVB for: TM Calibrate OFF	N/A	N/A	S-IVB	04:42:58.406 (16,978.406)	TB6 +401.16	---	--
261	Signal from LVDC for: Telemetry Calibration Inflight Calibrate OFF	04:42:54.3 (16,974.3)	TB6 +405.0	IU	04:43:02.21 (16,982.21)	TB6 +404.962	MSFC	--
262a	Signal from LVDC for: PU Mixture Ratio 4.5 ON	04:43:39.5 (17,019.5)	TB6 +450.2	IU	04:43:47.40 (17,027.40)	TB6 +450.152	MSFC	--
262b	Signal received in S-IVB for: PU Mixture Ratio 4.5 ON	N/A	N/A	S-IVB	04:43:47.397 (17,027.397)	TB6 +450.15	MDAC	9
263a	Signal from LVDC for: S-IVB Ullage Engine No. 1 ON	04:44:25.6 (17,065.6)	TB6 +496.3	IU	04:44:53.50 (17,073.50)	TB6 +496.252	MSFC	--
263b	Signal received in S-IVB for: S-IVB Ullage Engine No. 1 ON	N/A	N/A	S-IVB	04:44:33.495 (17,073.495)	TB6 +496.25	MDAC	9
264a	Signal from LVDC for: S-IVB Ullage Engine No. 2 ON	04:44:25.7 (17,065.7)	TB6 +496.4	IU	04:44:53.60 (17,073.60)	TB6 +496.351	MSFC	--
264b	Signal received in S-IVB for: S-IVB Ullage Engine No. 2 ON	N/A	N/A	S-IVB	04:44:33.595 (17,073.595)	TB6 +496.35	MDAC	9
265a	Signal from LVDC for: LOX Tank Repressurization Control Valve Open OFF	04:44:25.9 (17,065.9)	TB6 +496.6	IU	04:44:33.81 (17,073.81)	TB6 +496.561	MSFC	--

TABLE 4-1 (Sheet 24 of 47)  
AS-504 D POST FLIGHT SEQUENCE OF EVENTS

ITEM NO.	EVENT	PREDICTED TIME		SIG. AL MONITORED AT	MONITORED TIME		DATA SOURCE	ACCURACY (ms)
		TIME FROM RANGE ZERO (hr:min:sec) (sec)	TIME FROM BASE (sec)		TIME FROM RANGE ZERO (hr:min:sec) (sec)	TIME FROM BASE (sec)		
265b	Signal received in S-IVB for: LOX Tank Repressurization Control Valve Open OFF	N/A	N/A	S-IVB	04:44:33.803 (17,073.803)	TB6 +496.56	MDAC	9
266a	Signal from LVDC for: LH2 Tank Repressurization Control Valve Open OFF	04:44:26.0 (17,065.0)	TB6 +496.7	IU	04:44:33.93 (17,073.93)	TB6 +495.687	MSFC	--
266b	Signal received in S-IVB for: LH2 Tank Repressurization Control Valve Open OFF	N/A	N/A	S-IVB	04:44:33.928 (17,073.928)	TB6 +496.69	MDAC	9
267a	Signal from LVDC for: Burner LH2 Propellant Valve Close ON	04:44:26.1 (17,066.1)	TB6 +496.8	IU	04:44:34.03 (17,074.03)	TB6 +496.783	MSFC	--
267b	Signal received in S-IVB for: Burner LH2 Propellant Valve Close ON	N/A	N/A	S-IVB	04:44:34.028 (17,074.028)	TB6 +496.78	MDAC	9
268a	Signal from LVDC for: Burner Automatic Cutoff System Disarm	04:44:26.3 (17,066.3)	TB6 +497.0	IU	04:44:34.20 (17,074.20)	TB6 +496.954	MSFC	--
268b	Signal received in S-IVB for: Burner Automatic Cutoff System Disarm	N/A	N/A	S-IVB	04:44:34.196 (17,074.196)	TB6 +496.95	MDAC	9
269a	Signal from LVDC for: LH2 Tank Continuous Vent Valve Close ON	04:44:26.5 (17,066.5)	TB6 +497.2	IU	04:44:34.41 (17,074.41)	TB6 +497.164	MSFC	--
269b	Signal received in S-IVB for: LH2 Tank Continuous Vent Valve Close ON	N/A	N/A	S-IVB	04:44:34.403 (17,074.403)	TB6 +497.25	MDAC	9
270a	Signal from LVDC for: Repressurization System Mode Selector ON (AMB)	04:44:26.9 (17,066.9)	TB6 +497.6	IU	04:44:34.80 (17,074.80)	TB6 +497.553	MSFC	--
270b	Signal received in S-IVB for: Repressurization system Mode Selector ON (AMB)	N/A	N/A	S-IVB	04:44:34.795 (17,074.795)	TB6 +497.55	MDAC	9
271a	Signal from LVDC for: LH2 Tank Continuous Vent Valve Close OFF	04:44:28.5 (17,068.5)	TB6 +499.2	IU	04:44:36.40 (17,076.40)	TB6 +499.158	MSFC	--
271b	Signal received in S-IVB for: LH2 Tank Continuous Vent Valve Close OFF	N/A	N/A	S-IVB	04:44:36.403 (17,076.403)	TB6 +499.16	MDAC	9
272a	Signal from LVDC for: Burner LH2 Propellant Valve Close OFF	04:44:29.1 (17,069.1)	TB6 +499.8	IU	04:44:37.00 (17,077.00)	TB6 +499.752	MSFC	--

TABLE 4-1 (Sheet 25 of 47)  
AS-504 D POST FLIGHT SEQUENCE OF EVENTS

ITEM NC.	EVENT	PREDICTED TIME		SIGNAL MONITORED AT	MONITORED TIME		DATA SOURCE	ACCURACY (ms)
		TIME FROM RANGE ZERO (hr:min:sec) (sec)	TIME FROM BASE (sec)		TIME FROM RANGE ZERO (hr:min:sec) (sec)	TIME FROM BASE (sec)		
272b	Signal received in S-IVB for: Burner LH2 Propellant Valve Close OFF	N/A	N/A	S-IVB	04:44:36.995 (17,076.995)	TB6 +499.75	MDAC	9
273a	Signal from LVDC for: LOX Tank Repressurization Control Valve Open ON	04:44:29.3 (17,069.3)	TB6 +500.0	IU	04:44:37.21 (17,077.21)	TB6 +499.967	MSFC	--
273b	Signal received in S-IVB for: LOX Tank Repressurization Control Valve Open ON	N/A	N/A	S-IVB	04:44:37.212 (17,077.212)	TB6 +499.97		9
274a	Signal from LVDC for: Burner LOX Shutdown Valve Close ON	04:44:30.6 (17,070.6)	TB6 +501.3	IU	04:44:38.50 (17,078.50)	TB6 +501.253	MSFC	--
274b	Signal received in S-IVB for: Burner LOX Shutdown Valve Close ON	N/A	N/A	S-IVB	04:44:38.494 (17,078.494)	TB6 +501.25	MTAC	9
275a	Signal from LVDC for: Burner LOX Shutdown Valve Close OFF	04:44:33.6 (17,073.6)	TB6 +504.3	IU	04:44:41.50 (17,081.50)	TB6 +504.254	MSFC	--
275b	Signal received in S-IVB for: Burner LOX Shutdown Valve Close OFF	N/A	N/A	S-IVB	04:44:41.494 (17,081.494)	TB6 +504.25	MDAC	9
276a	Signal from LVDC for: LH2 Tank Repressurization Control Valve Open ON	04:44:99.3 (17,089.3)	TB6 +520.0	IU	04:44:57.21 (17,097.21)	TB6 +519.963	MSFC	--
276b	Signal received in S-IVB for: LH2 Tank Repressurization Control Valve Open ON	N/A	N/A	S-IVB	04:44:57.208 (17,097.208)	TB6 +519.96	MDAC	9
277a	Signal from LVDC for: Prevalves Close OFF	04:45:28.7 (17,128.7)	TB6 +559.4	IU	04:45:36.59 (17,136.59)	TB6 +559.352	MSFC	--
277b	Signal received in S-IVB for: Prevalves Close OFF	N/A	N/A	S-IVB	04:45:36.592 (17,136.592)	TB6 +559.35	MDAC	9
278a	Signal from LVDC for: Engine Ready Bypass	04:45:37.9 (17,137.9)	TB6 +568.6	IU	04:45:45.82 (17,145.82)	TB5 +568.574	MSFC	--
278b	Signal received in S-IVB for: Engine Ready Bypass	N/A	N/A	S-IVB	04:45:45.815 (17,145.815)	TB6 +568.58	MDAC	9
279a	Signal from LVDC for: Fuel Chilldown Pump OFF	04:45:38.7 (17,138.7)	TB6 +569.4	IU	04:45:46.61 (17,146.61)	TB6 +569.366	MSFC	--
279b	Signal received in S-IVB for: Fuel Chilldown Pump Off	N/A	N/A	S-IVB	04:45:46.607 (17,146.607)	TB6 +569.37	MDAC	9

TABLE 4-1 (Sheet 26 of 47)  
AS-504 D POST FLIGHT SEQUENCE OF EVENTS

ITEM NO.	EVENT	PREDICTED TIME		SIGNAL MONITORED AT	MONITORED TIME		DATA SOURCE	ACCURACY (ms)
		TIME FROM RANGE ZERO (hr:min:sec) (sec)	TIME FROM BASE (sec)		TIME FROM RANGE ZERO (hr min:sec) (sec)	TIME FROM BASE (sec)		
280a	Signal from LVDC for: LOX Chilldown Pump OFF	04:45:38.9 (17,138.9)	TB6 +569.6	IU	04:45:46.82 (17,146.82)	TB6 +569.570	MSFC	--
280b	Signal received in S-IVB for: LOX Chill-down Pump OFF	N/A	N/A	S-IVB	04:45:46.815 (17,146.815)	TB6 +569.57	MDAC	9
281a	Signal from LVDC for: S-IVB Engine Start ON	04:45:39.3 (17,139.3)	TB6 +570.0	IU	04:45:47.20 (17,147.20)	TB6 +569.95	MSFC	--
281b	Signal received in S-IVB for: S-IVB Engine Start ON	N/A	N/A	S-IVB	04:45:47.199 (17,147.199)	TB6 +569.95	MDAC	9
282a	Signal from LVDC for: S-IVB Ullage Engine No. 1 OFF	04:45:42.3 (17,142.3)	TB6 +573.0	IU	04:45:50.20 (17,150.20)	TB6 +572.955	MSFC	--
282b	Signal received in S-IVB for: S-IVB Ullage Engine No. 1 OFF	N/A	N/A	S-IVB	04:45:50.19 (17,150.198)	TB6 +572.96	MDAC	9
283a	Signal from LVDC for: S-IVB Ullage Engine No. 2 OFF	04:45:42.4 (17,142.4)	TB6 +573.1	IU	04:45:50.30 (17,150.30)	TB6 +573.053	MSFC	9
283b	Signal received in S-IVB for: S-IVB Ullage Engine No. 2 OFF	N/A	N/A	S-IVB	04:45:50.298 (17,150.298)	TB6 +573.05	MDAC	9
284a	Signal from LVDC for: Flight Control Computer Switch Point No. 5	04:45:46.3 (17,146.3)	TB6 +577.0	IU	04:45:54.22 (17,154.22)	TB6 +576.98	MSFC	--
285a	Signal from LVDC for: LOX Tank Repressurization Control Valve Open OFF	04:45:46.6 (17,146.6)	TB6 +577.3	IU	-----	TB6 +-----	MSFC	--
285b	Signal received in S-IVB for: LOX Tank Repressurization Control Valve Open OFF	N/A	N/A	S-IVB	04:45:54.507 (17,154.507)	TB6 +577.27	MDAC	9
286a	Signal from LVDC for: LH2 Tank Repressurization Control Valve Open OFF	04:45:46.8 (17,146.8)	TB6 +577.5	IU	-----	TB6 +-----	MSFC	--
286b	Signal received in S-IVB for: LH2 Tank Repressurization Control Valve Open OFF	N/A	N/A	S-IVB	04:45:54.698 (17,154.698)	TB6 +577.46	MDAC	9
287	Signal from LVDC for: Flight Control Computer S-IVB Burn Mode ON "A"	04:45:46.9 (17,146.9)	TB6 +577.6	IU	-----	TB6 +-----	MSFC	--
288	Signal from LVD for: Flight Control Computer S-IVB Burn Mode ON "B"	04:45:47.1 (17,147.1)	TB6 +577.8	IU	04:45:55.08 (17,155.08)	TB6 +577.836	MSFC	--



TABLE 4-1 (Sheet 27 of 47)  
AS-504 D POST FLIGHT SEQUENCE OF EVENTS

ITEM NO.	EVENT	PREDICTED TIME		SIGNAL MONITORED AT	MONITORED TIME		DATA SOURCE	ACCURACY (ms)
		TIME FROM RANGE ZERO (hr:min:sec) (sec)	TIME FROM BASE (sec)		TIME FROM RANGE ZERO (hr:min:sec) (sec)	TIME FROM BASE (sec)		
289a	Signal from LVDC for: Fuel Injection Temperature OK Bypass	04:45:47.3 (17,147.3)	TB6 +578.0	IU	04:45:55.20 (17,155.20)	TB6 +577.952	MSFC	--
289b	Signal received in S-IVB for: Fuel Injection Temperature OK Bypass	N/A	N/A	S-IVB	04:45:55.197 (17,155.197)	TB6 +577.95	MDAC	9
290a	Signal from LVDC for: LOX Tank Flight Pressurization System ON	04:45:47.5 (17,147.5)	TB6 +578.2	IU	04:45:55.41 (17,155.41)	TB6 +578.164	MSFC	--
290b	Signal received in S-IVB for: LOX Tank Flight Pressure System ON	N/A	N/A	S-IVB	04:45:55.405 (17,155.405)	TB6 +578.17	MDAC	9
291a	Signal from LVDC for: LOX Tank Pressurization Shutoff Valves OPEN	04:45:47.7 (17,147.7)	TB6 +578.4	IU	04:45:55.60 (17,155.60)	TB6 +578.353	MSFC	--
291b	Signal received in S-IVB for: LOX Tank Pressurization Shutoff Valves Open	N/A	N/A	S-IVB	04:45:55.597 (17,155.597)	TB6 +578.35	MDAC	9
292a	Signal from LVDC for: S-IVB Engine Start OFF	04:45:47.9 (17,147.9)	TB6 +578.6	IU	04:45:55.81 (17,155.81)	TB6 +578.562	MSFC	-
292b	Signal received in S-IVB for: S-IVB Engine Start OFF	N/A	N/A	S-IVB	04:45:55.805 (17,155.805)	TB6 +578.57	MDAC	9
293a	Signal from LVDC for: PU Programmed Mixture Ratio OFF	04:45:52.3 (17,152.3)	TB6 +583.0	IU	04:45:00.20 (17,160.20)	TB6 +582.961	MSFC	--
293b	Signal received in S-IVB for: PU Programmed Mixture Ratio OFF	N/A	N/A	S-IVB	04:46:00.137 (17,160.197)	TB6 +582.96	MDAC	9
294a	Signal from LVDC for: Fuel Injection Temperature OK Bypass Reset	04:45:57.3 (17,157.3)	TB6 +588.0	IU	04:46:05.21 (17,165.21)	TB6 +587.953	MSFC	--
294b	Signal received in S-IVB for: Fuel Injection Temperature OK Bypass Reset	N/A	N/A	S-IVB	04:46:05.205 (17,165.205)	TB6 +587.97	MDAC	9
295a	Signal from LVDC for: Engine Pump Purge Control Valve Enable ON	04:46:42.7 (17,202.7)	TB6 +633.4	IU	04:46:50.62 (17,210.62)	TB6 +633.372	MSFC	--
295b	Signal Received in S-IVB for: Engine Pump Purge Control Valve Enable ON	N/A	N/A	S-IVB	04:46:50.614 (17,210.614)	TB6 +633.37	MDAC	9
296a	Signal from LVDC for: S-IVB Engine Cutoff	04:46:49.7 (17,209.7)	TB6 +690.4	I-IVB	04:46:57.60 (17,217.60)	TB6 +640.36	MSFC	--

TABLE 4-1 (Sheet 28 of 47)  
AS-504 D POST FLIGHT SEQUENCE OF EVENTS

ITEM NO.	EVENT	PREDICTED TIME		SIGNAL MONITORED AT	MONITORED TIME		DATA SOURCE	ACCURACY (ms)
		TIME FROM RANGE ZERO (hr:min:sec) (sec)	TIME FROM BASE (sec)		TIME FROM RANGE ZERO (hr:min:sec) (sec)	TIME FROM BASE (sec)		
296b	Signal received in S-IVB for: S-IVB Engine Cutoff	N/A	N/A	S-IVB	04:46:57.596 (17,217.596)	TB6 +640.36	MDAC	9
297a	Signal from LVDC for: Point Level Sensor Arming	04:47:09.7 (17,229.7)	TB6 +660.4	IU	-----	TB6 +-----	MSFC	--
297b	Signal received in S-IVB for: Point Level Sensor Arming	N/A	N/A	S-IVB	-----	TB6 +-----	MDAC	9
298	Time Base 7 LVDC initiates TB7 following Timer Cutoff Signal	04:46:49.661 (17,209.661)	TB7 +0.0	IU	04:46:57.82 (17,217.82)	TB7 +0.0	MSFC	--
299a	Signal from LVDC for: S-IVB Engine Cutoff	04:46:49.8 (17,209.8)	TB7 +0.1	IU	04:46:57.91 (17,217.91)	TB7 +0.086	MSFC	--
299b	Signal received in S-IVB for: S-IVB Engine Cutoff	N/A	N/A	S-IVB	04:46:57.904 (17,217.904)	TB7 +0.08	MDAC	9
300a	Signal from LVDC for: S-IVB Ullage Engine No. 1 ON	04:46:49.9 (17,209.9)	TB7 +0.2	IU	04:46:58.00 (17,218.00)	TB7 +0.179	MSFC	--
300b	Signal received in S-IVB for: S-IVB Ullage Engine No. 1 ON	N/A	N/A	S-IVB	04:46:57.996 (17,217.996)	TB7 +0.18	MDAC	9
301a	Signal from LVDC for: S-IVB Ullage Engine No. 2 ON	04:46:50.0 (17,210.0)	TB7 +0.3	IU	04:46:58.09 (17,218.09)	TB7 +0.273	MSFC	--
301b	Signal received in S-IVB for: S-IVB Ullage Engine No. 2 ON	N/A	N/A	S-IVB	04:46:58.088 (17,218.088)	TB7 +0.27	MDAC	9
302a	Signal from LVDC for: LH2 Tank Continuous Vent Orifice Shutoff Valve Open ON	04:46:50.1 (17,210.1)	TB7 +0.4	IU	04:46:58.18 (17,218.18)	TB7 +0.366	MSFC	--
302b	Signal received in S-IVB for: LH2 Tank Continuous Vent Orifice Shutoff Valve Open ON	N/A	N/A	S-IVB	04:46:58.179 (17,218.179)	TB7 +0.36	MDAC	9
303a	Signal from LVDC for: LH2 Tank Continuous Vent Relief Orifice Shutoff Valve Open ON	04:46:50.2 (17,210.2)	TB7 +0.5	IU	04:46:58.28 (17,218.28)	TB7 +0.460	MSFC	--
303b	Signal received in S-IVB for: LH2 Tank Continuous Vent Relief Override Shutoff Valve Open ON	N/A	N/A	S-IVB	04:46:58.270 (17,218.270)	TB7 +0.45	MDAC	9
304a	Signal from LVDC for: Point Level Sensor Disarming	04:46:50.4 (17,210.4)	TB7 +0.7	IU	04:46:58.49 (17,218.49)	TB7 +0.674	MSFC	--
304b	Signal received in S-IVB for: Point Level Sensor Disarming	N/A	N/A	S-IVB	04:46:58.487 (17,218.487)	TB7 +0.67	MDAC	9

TABLE 4-1 (Sheet 29 of 47)  
AS-504 D POST FLIGHT SEQUENCE OF EVENTS

ITEM NO.	EVENT	PREDICTED TIME		SIGNAL MONITORED AT	MONITORED TIME		DATA SOURCE	ACCURACY (ms)
		TIME FROM RANGE ZERO (hr:min:sec) (sec)	TIME FROM BASE (sec)		TIME FROM RANGE ZERO (hr:min:sec) (sec)	TIME FROM BASE (sec)		
305a	Signal from LVDC for: Second Burn Relay OFF	04:46:50.5 (17,210.5)	TB7 + 0.8	IU	04:46:58.61 (17,218.69)	TB7 + 0.800	MSFC	--
305b	Signal received in S-IVB for: Second Burn Relay OFF	N/A	N/A	S-IVB	04:46:53.612 (17,218.612)	TB7 + 0.79	MDAC	9
306a	Signal from LVDC for: LOX Tank Flight Pressure System OFF	04:46:50.7 (17,210.7)	TB7 + 1.0	IU	04:46:58.79 (17,218.79)	TB7 + 0.973	MSFC	--
306b	Signal received in S-IVB for: LOX Tank Flight Pressure System OFF	N/A	N/A	S-IVB	04:46:58.787 (17,218.787)	TB7 + 0.97	MDAC	9
307a	Signal from LVDC for: LOX Tank Pressurization Shutoff Valves Close	04:46:51.1 (17,211.1)	TB7 + 1.4	IU	04:46:59.17 (17,219.17)	TB7 + 1.351	MSFC	--
307b	Signal received in S-IVB for: LOX Tank Pressurization Shutoff Close	N/A	N/A	S-IVB	04:46:59.171 (17,219.171)	TB7 + 1.35	MDAC	9
308a	Signal from LVDC for: Engine Pump Purge Control Valve Enable ON	04:46:51.3 (17,211.3)	TB7 + 1.6	IU	04:46:59.38 (17,219.38)	TB7 + 1.562	MSFC	--
308b	Signal received in S-IVB for: Engine Pump Purge Control Valve Enable ON	N/A	N/A	S-IVB	04:46:59.378 (17,219.378)	TB7 + 1.56	MDAC	9
309a	Signal from LVDC for: LH2 Continuous Vent Orifice Shutoff Valve Open OFF	04:46:52.1 (17,212.1)	TB7 + 2.4	IU	04:47:00.17 (17,220.17)	TB7 + 2.357	MSFC	--
309b	Signal received in S-IVB for: LH2 Tank Continuous Vent Orifice Shutoff Valve Open OFF	N/A	N/A	S-IVB	04:47:00.171 (17,220.171)	TB7 + 2.35	MDAC	9
310a	Signal from LVDC for: LH2 Tank Continuous Vent Relief Override Shutoff Valve Open OFF	04:46:52.2 (17,212.2)	TB7 + 2.5	IU	04:47:00.27 (17,220.27)	TB7 + 2.456	MSFC	--
310b	Signal received in S-IVB for: LH2 Tank Continuous Vent Relief Override Shutoff Valve Open OFF	N/A	N/A	S-IVB	04:47:00.270 (17,220.270)	TB7 + 2.45	MDAC	9
311	Signal from LVDC for: Flight Control Computer S-IVB Burn Mode OFF "A"	04:46:53.2 (17,213.2)	TB7 + 3.5	IU	04:47:01.27 (17,221.27)	TB7 + 3.452	MSFC	--

TABLE 4-1 (Sheet 30 of 47)  
AS-504 D POST FLIGHT SEQUENCE OF EVENTS

ITEM NO.	EVENT	PREDICTED TIME		SIGNAL MONITORED AT	MONITORED TIME		DATA SOURCE	ACCURACY (ms)
		TIME FROM RANGE ZERO (hr:min:sec) (sec)	TIME FROM BASE (sec)		TIME FROM RANGE ZERO (hr:min:sec) (sec)	TIME FROM BASE (sec)		
312	Signal from LVDC for: S/C Control of Spacecraft Enable	N/A	N/A	IU	04:47:01.50 (17,221.50)	N/A	MSFC	--
313	Signal from LVDC for: Flight Control Computer S-IVB Burn Mode OFF "B"	04:46:53.5 (17,213.5)	TB7 + 3.7	IU	04:47:01.47 (17,221.47)	TB7 + 3.654	MSFC	--
314a	Signal from LVDC for: Auxiliary Hydraulic Pump Flight Mode OFF	04:46:53.9 (17,213.9)	TB7 + 4.1	IU	04:47:01.88 (17,221.88)	TB7 + 4.064	MSFC	--
314b	Signal received in S-IVB for: Auxiliary Hydraulic Pump Flight Mode OFF	N/A	N/A	S-IVB	04:47:01.878 (17,221.878)	TB7 + 4.07	MDAC	9
315a	Signal from LVDC for: S-IVB Ullage Engine No. 1 OFF	04:47:08.7 (17,228.7)	TB7 + 19.0	IU	04:47:16.79 (17,236.79)	TB7+18.973	MSFC	--
315b	Signal received in S-IVB for: S-IVB Ullage Engine No. 1 OFF	N/A	N/A	S-IVB	04:47:16.785 (17,236.785)	TB7 + 18.96	MDAC	9
316a	Signal from LVDC for: S-IVB Ullage Engine No. 2 OFF	04:47:08.8 (17,228.8)	TB7 + 19.1	IU	04:45:16.89 (17,236.89)	TB7+19.068	MSFC	--
316b	Signal received in S-IVB for: S-IVB Ullage Engine No. 2 OFF	N/A	N/A	S-IVB	04:45:16.885 (17,236.885)	TB7 + 19.06	MDAC	9
317	Maneuver to Local Horizontal	04:47:09.7 (17,229.7)	TB7 + 20.0	--	04:47:17.82 (17,237.82)	N/A	MSFC	--
318	Signal from LVDC for: Water Coolant Valve Open	N/A	N/A	IU	04:48:34.28 (17,314.28)	N/A	MSFC	--
319a	Signal from LVDC for: Engine Pump Purge Control Valve Enable OFF	04:56:51.7 (17,811.7)	TB7 + 602.6	IU	--	TB7 + ---	MSFC	--
319b	Signal received in S-IVB for: Engine Pump Purge Control Valve Enable OFF	N/A	N/A	S-IVB	--	TB7 + ---	MDAC	9
320	Signal from LVDC for: Water Coolant Valve Closed	N/A	N/A	IU	04:53:35.76 (17,615.76)	N/A	MSFC	--
321	S-IVB Restart Enable	N/A	N/A	IU	05:40:16 (20,416)	N/A	MSFC	--
322	Signal from LVDC for: Water Coolant Valve Open	N/A	N/A	IU	05:58:46.86 (21,526.86)	N/A	MSFC	--

TABLE 4-1 (Sheet 31 of 47)  
AS-504 D POST FLIGHT SEQUENCE OF EVENTS

ITEM NO.	EVENT	PREDICTED TIME		SIGNAL MONITORED AT	MONITORED TIME		DATA SOURCE	ACCURACY (ms)
		TIME FROM RANGE ZERO (hr:min:sec) (sec)	TIME FROM BASE (sec)		TIME FROM RANGE ZERO (hr:min:sec) (sec)	TIME FROM BASE (sec)		
323	Signal from LVDC for: Begin Second Restart Preparations-Start of Time Base 8 (T8)	05:59:32.261 (21,572.261)	TB8 + .0	IU	05:59:40.98 (21,580.98)	TB8 + 0.000	MSFC	--
324	Signal from LVDC for: Telemetry Calibrator In-Flight Calibrate ON	05:59:33.3 (21,573.3)	TB8 + 1.0	IU	05:59:41.93 (21,581.93)	TB8 + 0.951	MSFC	--
325a	Signal from LVDC for: TM Calibrate ON	05:59:33.5 (21,573.5)	TB8 + 1.2	IU	05:59:42.14 (21,582.14)	TB8 + 1.162	MSFC	--
325b	Signal received in S-IVB for: TM Calibrate ON	N/A	N/A	S-IVB	05:59:42.142 (21,582.142)	TB8 + 1.16	MDAC	9
326a	Signal from LVDC for: TM Calibrate OFF	05:59:34.5 (21,574.5)	TB8 + 2.2	IU	05:59:43.13 (21,583.13)	TB8 + 2.153	MSFC	--
326b	Signal received in S-IVB for: TM Calibrate OFF	N/A	N/A	S-IVB	05:59:43.133 (21,583.133)	TB8 + 2.15	MDAC	9
327	Signal for LVDC for: Telemetry Calibrator In-Flight Calibrate OFF	05:59:38.3 (21,578.3)	TB8 + 6.0	IU	05:59:46.93 (21,586.93)	TB8 + 5.952	MSFC	--
328a	Signal from LVDC for: LH2 Tank Vent and Latching Relief Valve Boost Close ON	06:00:10.3 (21,610.3)	TB8 + 38.0	IU	06:00:18.95 (21,618.95)	TB8+37.976	MSFC	--
328b	Signal received in S-IVB for: LH2 Tank Vent and Latching Relief Valve Boost Close ON	N/A	N/A	S-IVB	06:00:18.951 (21,618.151)	TB8 + 37.97	MDAC	9
329a	Signal from LVDC for: LOX Tank Vent and NPV Valves Boost Close ON	06:00:10.5 (21,610.5)	TB8 + 38.2	IU	06:00:19.13 (21,619.13)	TB8+38.153	MSFC	--
329b	Signal received in S-IVB for: LOX Tank Vent and NPV Valves Boost Close ON	N/A	N/A	S-IVB	06:00:19.135 (21,619.135)	TB8 + 38.15	MDAC	9
330a	Signal from LVDC for: LH2 Tank Vent and Latching Relief Valve Boost Close OFF	06:00:12.3 (21,612.3)	TB8 + 40.0	IU	06:00:20.94 (21,620.94)	TB8+39.961	MSFC	--
330b	Signal received in S-IVB for: LH2 Tank Vent and Latching Relief Valve Boost Close OFF	N/A	N/A	S-IVB	06:00:20.943 (21,620.943)	TB8 + 39.96	MDAC	9
331a	Signal from LVDC for: LOX Tank Vent and NPV Valves Boost Close OFF	06:00:12.5 (21,612.5)	TB8 + 40.2	IU	06:00:21.13 (21,621.13)	TB8+40.152	MSFC	--
331b	Signal received in S-IVB for: LOX Tank Vent and NPV Valves Boost Close OFF	N/A	N/A	S-IVB	06:00:21.135 (21,621.135)	TB8 + 40.15	MDAC	9

TABLE 4-1 (Sheet 32 of 47)  
 S-04 D POST FLIGHT SEQUENCE OF EVENTS

ITEM NO.	EVENT	PREDICTED TIME		SIGNAL MONITORED AI	MONITORED TIME		DATA SOURCE	ACCURACY (ms)
		TIME FROM RANGE ZERO (hr: in:sec) (sec)	TIME FROM BASE (sec)		TIME FROM RANGE ZERO (hr:min:sec) (sec)	TIME FROM BASE (sec)		
332a	Signal from LVDC for: Second Burn Relay ON	06:00:17.5 (21,617.5)	TB8 + 45.2	IU	06:00:26.14 (21,626.14)	TB8+45.165	MSFC	--
332b	Signal received in S-IVB for: Second Burn Relay ON	N/A	N/A	S-IVB	06:00:26.142 (21,626.142)	TB8 + 45.16	MDAC	9
333a	Signal from LVDC for: Aux Hydraulic Pump Flight Mode On	06:01:11.3 (21,671.3)	TB8 + 99.0	IU	06:01:19.93 (21,679.93)	TB8+98.954	MSFC	--
333b	Signal received in S-IVB for: Aux Hydraulic Pump Flight	N/A	N/A	S-IVB	06:01:19.931 (21,679.931)	TB8 + 98.95	MDAC	9
334a	Signal from LVDC for: Chilldown Shutoff Valve Close OFF	06:01:36.3 (21,696.3)	TB8 + 124.0	IU	06:01:44.94 (21,704.94)	TB8+123.965	MSFC	--
334b	Signal received in S-IVB for: Chilldown Shutoff Valve Close OFF	N/A	N/A	S-IVB	06:01:44.944 (21,704.944)	TB8+123.96	MDAC	9
335a	Signal from LVDC for: Chilldown Shutoff Valve Close ON	N/A	N/A	IU	06:01:50.02 (21,710.02)	TB8 + N/A	MSFC	--
335b	Signal received in S-IVB for: Chilldown Shutoff Valve Close ON	N/A	N/A	S-IVB	06:01:50.026 (21,710.026)	TB8 + N/A	MDAC	9
336a	Signal from LVDC for: LOX Chilldown Pump ON	06:01:41.3 (21,701.3)	TB8 + 129.0	IU	06:01:49.93 (21,709.93)	TB8+128.952	MSFC	--
336b	Signal received in S-IVB for: LOX Chilldown Pump ON	N/A	N/A	S-IVB	06:01:49.926 (21,709.926)	TB8+128.95	MDAC	9
337a	Signal from LVDC for: Fuel Chilldown Pump ON	06:01:46.3 (21,706.3)	TB8 + 134.0	IU	06:01:54.93 (21,714.93)	TB8+133.952	MSFC	--
337b	Signal received in S-IVB for: Fuel Chilldown Pump ON	N/A	N/A	S-IVB	06:01:54.933 (21,714.933)	TB8+133.95	MDAC	9
338a	Signal from LVDC for: Prevalves Close ON	06:01:51.3 (21,711.3)	TB8 + 139.0	IU	06:01:59.95 (21,719.95)	TB8+138.969	MSFC	--
338b	Signal received in S-IVB for: Prevalves Close ON	N/A	N/A	S-IVB	06:01:59.949 (21,719.949)	TB8+138.97	MDAC	9
339a	Signal from LVDC for: Fuel Chilldown Pump OFF	N/A	N/A	IU	06:02:09.16 (21,729.16)	TB8 + N/A	MSFC	--
339b	Signal received in S-IVB for: Fuel Chilldown Pump OFF	N/A	N/A	S-IVB	06:02:09.166 (21,729.166)	TB8 + N/A	MDAC	9
340a	Signal from LVDC for: LOX Chilldown Pump OFF	N/A	N/A	IU	06:02:09.96 (21,729.96)	TB8 + N/A	MSFC	--
340b	Signal received in S-IVB for: LOX Chilldown Pump OFF	N/A	N/A	S-IVB	06:02:09.966 (21,729.966)	TB8 + N/A	MDAC	9

TABLE 4-1 (Sheet 33 of 47)  
AS-504 D POST FLIGHT SEQUENCE OF EVENTS

ITEM NO.	EVENT			SIGNAL MONITORED AT			DATA SOURCE	ACCURACY (ms)
		TIME FROM RANGE ZERO (hr:min:sec) (sec)	TIME FROM BASE (sec)		TIME FROM RANGE ZERO (hr:min:sec) (sec)	TIME FROM BASE (sec)		
341a	Signal from LVDC for: PU Mixture Ratio 4.5 ON	06:02:52.6	TB8 + 200.2	IU	06:03:01.15 (21,781.15)	TB8+200.168	MSFC	--
341b	Signal received in S-IVB for: PU Mixture Ratio 4.5 ON	N/A	N/A	S-IVB	06:03:01.146 (21,781.146)	TB8+200.17	MDAC	9
342a	Signal from LVDC for: Burner LH2 Propellant Valve Open ON	06:03:38.3 (21,818.3)	TB8 + 246.0	IU	06:03:46.93 (21,826.93)	TB8+245.952	MSFC	--
342b	Signal received in S-IVB for: Burner LH2 Propellant Valve Open ON	N/A	N/A	S-IVB	06:03:46.929 (21,826.929)	TB8+245.95	MDAC	9
343a	Signal from LVDC for: Burner Exciters ON	06:03:38.6 (21,818.6)	TB8 + 246.3	IU	06:03:47.23 (21,827.23)	TB8+246.253	MSFC	--
343b	Signal received in S-IVB for: Burner Exciters ON	N/A	N/A	S-IVB	06:03:47.229 (21,827.229)	TB8+245.25	MDAC	9
344a	Signal from LVDC for: Burner LOX Shutdown Valve Open ON	06:03:39.0 (21,819.0)	TB8 + 246.7	IU	06:03:47.63 (21,827.63)	TB8+246.654	MSFC	--
344b	Signal received in S-IVB for: Burner LOX Shutdown Valve Open ON	N/A	N/A	S-IVB	06:03:47.630 (21,827.630)	TB8+246.65	MDAC	9
345a	Signal from LVDC for: Burner LH2 Propellant Valve Open OFF	06:03:39.8 (21,819.8)	TB8 + 247.5	IU	06:03:48.45 (21,828.45)	TB8+247.472	MSFC	--
345b	Signal received in S-IVB for: Burner LH2 Propellant Valve Open OFF	N/A	N/A	S-IVB	06:03:48.446 (21,828.446)	TB8+247.472	MDAC	9
346	Signal from LVDC for: Water Coolant Valve Closed	N/A	N/A	IU	06:03:48.55 (21,828.55)	N/A		
347a	Signal from LVDC for: Burner LOX Shutdown Valve Open OFF	06:03:40.5 (21,820.5)	TB8 + 248.2	IU	06:03:49.14 (21,829.14)	TB8+248.159	MSFC	--
347b	Signal received in S-IVB for: Burner LOX Shutdown Valve Open OFF	N/A	N/A	S-IVB	06:03:49.137 (21,829.137)	TB8+248.16	MDAC	9
348a	Signal from LVDC for: Burner Exciters OFF	06:03:42.4 (21,822.4)	TB8 + 250.1	IU	06:03:51.03 (21,831.03)	TB8+250.056	MSFC	--
348b	Signal received in S-IVB for: Burner Exciters OFF	N/A	N/A	S-IVB	06:03:51.028 (21,831.028)	TB8+250.05	MDAC	9
349a	Signal from LVDC for: Burner Automatic Cutoff System Arm	06:03:44.9 (21,824.9)	TB8 + 252.6	IU	06:03:53.54 (21,833.54)	TB8+252.561	MSFC	--
349b	Signal received in S-IVB for: Burner Automatic Cutoff System Arm	N/A	N/A	S-IVB	06:03:53.536 (21,833.536)	TB8+252.56	MDAC	9

TABLE 4-1 (Sheet 34 of 47)  
AS-504 D POST FLIGHT SEQUENCE OF EVENTS

ITEM NO.	EVENT			SIGNAL MONITORED AT			DATA SOURCE	ACCURACY (ms)
		TIME FROM RANGE ZERO (hr:min:sec) (sec)	TIME FROM BASE (sec)		TIME FROM RANGE ZERO (hr:min:sec) (sec)	TIME FROM BASE (sec)		
350a	Signal from LVDC for: Chilldown Shutoff Valve Close OFF	N/A	N/A	IU	06:05:52.75 (21,952.75)	TB8 + N/A	MSFC	--
350b	Signal received in S-IVB for: Chill-down Shutoff Valve Close OFF	N/A	N/A	S-IVB	06:05:52.752 (21,952.752)	TB8 + N/A	MDAC	9
351a	Signal from LVDC for: Prevalves Close OFF	N/A	N/A	IU	06:05:53.53 (21,953.53)	TB8 + N/A	MSFC	--
351b	Signal received in S-IVB for: Prevalves Close OFF	N/A	N/A	S-IVB	06:05:53.535 (21,953.535)	TB8 + N/A	MDAC	9
352a	Signal from LVDC for: S-IVB Engine Cutoff OFF	N/A	N/A	IU	06:05:54.32 (21,954.32)	TB8 + N/A	MSFC	--
352b	Signal received in S-IVB for: S-IVB Engine Cutoff OFF	N/A	N/A	S-IVB	06:05:54.318 (21,954.318)	TB8 + N/A	MDAC	9
353a	Signal from LVDC for: Engine Ready Bypass	N/A	N/A	IU	06:05:55.10 (21,955.10)	TB8 + N/A	MSFC	--
353b	Signal received in S-IVB for: Engine Ready Bypass	N/A	N/A	S-IVB	06:05:55.102 (21,955.102)	TB8 + N/A	MDAC	9
354a	Signal from LVDC for: S-IVB Ullage Engine No. 1 ON	06:05:48.3 (21,948.3)	TB8 + 376.0	IU	06:05:56.95 (21,956.95)	TB8+375.972	MSFC	--
354b	Signal received in S-IVB for: S-IVB Ullage Engine No. 1 ON	N/A	N/A	S-IVB	06:05:56.951 (21,956.951)	TB8+375.9	MDAC	9
355a	Signal from LVDC for: S-IVB Ullage Engine	06:05:48.4 (21,948.4)	TB8 + 376.1	IU	06:05:57.04 (21,957.04)	TB8+376.068	MSFC	--
355b	Signal received in S-IVB for: S-IVB Ullage Engine No. 2 ON	N/A	N/A	S-IVB	06:05:57.042 (21,957.042)	TB8+376.07	MDAC	9
356a	Signal from LVDC for: Burner LH2 Propellant Valve Close ON	06:05:48.8 (21,948.8)	TB8 + 376.5	IU	06:05:57.42 (21,957.42)	TB8+376.465	MSFC	--
356b	Signal received in S-IVB for: Burner LH2 Propellant Valve Close ON	N/A	N/A	S-IVB	06:05:57.426 (21,957.426)	TB8+376.47	MDAC	9
357a	Signal from LVDC for: Burner Automatic Cutoff System Disarm	06:05:49.0 (21,949.0)	TB8 + 376.7	IU	06:05:57.63 (21,957.63)	TB8+376.661	MSFC	--
357b	Signal received in S-IVB for: Burner Automatic Cutoff System Disarm	N/A	N/A	S-IVB	06:05:57.634 (21,957.634)	TB8+376.66	MDAC	9



TABLE 4-1 (Sheet 35 of 47)  
AS-504 D POST FLIGHT SEQUENCE OF EVENTS

ITEM NO.	EVENT			SIGNAL MONITORED AT			DATA SOURCE	ACCURACY (ms)
		TIME FROM RANGE ZERO (hr:min:sec) (sec)	TIME FROM BASE (sec)		TIME FROM RANGE ZERO (hr:min:sec) (sec)	TIME FROM BASE (sec)		
358a	Signal from LVDC for: Burner LH2 Propellant Valve Close OFF	06:05:51.8 (21,951.8)	TB8 + 379.5	IU	06:06:00.44 (21,960.44)	TB8+379.466	MSFC	--
358b	Signal received in S-IVB for: Burner LH2 Propellant Valve Close OFF	N/A	N/A	S-IVB	06:06:00.442 (21,960.442)	TB8+379.47	MDAC	9
359a	Signal from LVDC for: LOX Tank Repressurization Control Valve Open ON	06:05:52.3 (21,952.3)	TB8 + 380.3	IU	06:06:00.94 (21,960.94)	TB8+379.967	MSFC	--
359b	Signal received in S-IVB for: LOX Tank Repressurization Control Valve Open ON	N/A	N/A	S-IVB	06:06:00.941 (21,960.941)	TB8+379.97	MDAC	9
360a	Signal from LVDC for: Burner LOX Shutdown Valve Close ON	06:05:53.3 (21,953.3)	TB8 + 381.0	IU	06:06:01.95 (21,961.95)	TB8+380.969	MSFC	--
360b	Signal received in S-IVB for: Burner LOX Shutdown Valve Close ON	N/A	N/A	S-IVB	06:06:01.950 (21,961.950)	TB8+380.97	MDAC	9
361a	Signal from LVDC for: Burner LOX Shutdown Valve Close OFF	06:05:56.3 (21,956.3)	TB8 + 384.0	IU	06:06:04.93 (21,964.93)	TB8+383.952	MSFC	--
361b	Signal received in S-IVB for: Burner LOX Shutdown Valve Close OFF	N/A	N/A	S-IVB	06:06:04.925 (21,964.925)	TB8+383.95	MDAC	9
362a	Signal from LVDC for: LH2 Tank Continuous Vent Valve Close ON	06:05:56.7 (21,956.7)	TB8 + 384.4	IU	06:06:05.33 (21,965.33)	TB8+384.355	MSFC	--
362b	Signal received in S-IVB for: LH2 Tank Continuous Vent Valve Close ON	N/A	N/A	S-IVB	06:06:05.334 (21,965.334)	TB8+384.36	MDAC	9
363a	Signal from LVDC for: LH2 Tank Continuous Vent Valve Close OFF	06:05:58.7 (21,958.7)	TB8 + 386.4	IU	06:06:07.33 (21,967.33)	TB8+386.352	MSFC	--
363b	Signal received in S-IVB for: LH2 Tank Continuous Vent Valve Close OFF	N/A	N/A	S-IVB	06:06:07.333 (21,967.333)	TB8+386.35	MDAC	9
364a	Signal from LVDC for: LH2 Tank Repressurization Control Valve Open ON	06:06:12.3 (21,972.3)	TB8 + 400.0	IU	06:06:20.93 (21,980.93)	TB8+399.952	MSFC	--
364b	Signal received in S-IVB for: LH2 Tank Repressurization Control Valve Open ON	N/A	N/A	S-IVB	06:06:20.930 (21,980.930)	TB8+399.95	MDAC	9

TABLE 4-1 (Sheet 36 of 47)  
AS-504 D POST FLIGHT SEQUENCE OF EVENTS

ITEM NO.	EVENT			SIGNAL MONITORED AT			DATA SOURCE	ACCURACY (ms)
		TIME FROM RANGE ZERO (hr:min:sec) (sec)	TIME FROM BASE (sec)		TIME FROM RANGE ZERO (hr:min:sec) (sec)	TIME FROM BASE (sec)		
365	Signal from LVDC for: Telemetry Calibrator In-Flight Calibrate ON	06:06:13.3 (21,973.3)	TB8 + 401.0	IU	06:06:21.93 (21,987.93)	TB8+400.952	MSFC	--
366a	Signal from LVDC for: TM Calibrate ON	06:06:13.5 (21,973.5)	TB8 + 401.2	IU	06:06:22.15 (21,982.15)	TB8+401.166	MSFC	--
366b	Signal received in S-IVB for: TM Calibrate ON	N/A	N/A	S-IVB	06:06:22.147 (21,982.147)	TB8+401.17	MDAC	9
367a	Signal from LVDC for: TM Calibrate OFF	06:06:14.5 (21,974.5)	TB8 + 402.2	IU	06:06:23.13 (21,983.13)	TB8+402.154	MSFC	--
367b	Signal received in S-IVB for: TM Calibrate OFF	N/A	N/A	S-IVB	06:06:23.130 (21,983.130)	TB8+402.15	MDAC	9
368	Signal from LVDC for: Telemetry Calibrator Inflight Calibrate OFF	06:06:18.3 (21,978.3)	TB8 + 406.0	IU	06:06:26.93 (21,986.93)	TB8+405.955	MSFC	--
369a	Signal from LVDC for: Engine Start ON	N/A	N/A	IU	06:06:27.34 (21,987.34)	TB8 + N/A	MSFC	--
369b	Signal received in S-IVB for: Engine Start ON	N/A	N/A	S-IVB	06:06:27.338 (21,987.338)	TB8 + N/A	MDAC	9
370a	Signal from LVDC for: Prevalves Close OFF	06:06:51.7 (22,011.7)	TB8 + 439.4	IU	06:07:00.35 (22,020.35)	TB8+439.375	MSFC	--
370b	Signal received in S-IVB for: Prevalves Close OFF	N/A	N/A	S-IVB	06:07:00.349 (22,020.349)	TB8+439.37	MDAC	9
371a	Signal from LVDC for: S-IVB Engine Cutoff OFF	06:07:00.7 (22,020.7)	TB8 + 448.4	IU	06:07:09.33 (22,029.33)	TB8+448.352	MSFC	--
371b	Signal received in S-IVB for: S-IVB Engine Cutoff OFF	N/A	N/A	S-IVB	06:07:09.331 (22,029.331)	TB8+448.35	MDAC	9
372a	Signal from LVDC for: Engine Ready Bypass	06:07:00.9 (22,020.9)	TB8 + 448.6	IU	06:07:09.54 (22,029.54)	TB8+448.562	MSFC	--
372b	Signal received in S-IVB for: Engine ready Bypass	N/A	N/A	S-IVB	06:07:09.539 (22,029.539)	TB8+448.56	MDAC	9
373a	Signal from LVDC for: Fuel Chilldown Pump OFF	06:07:01.7 (22,021.7)	TB8 + 449.4	IU	06:07:10.33 (22,030.33)	TB8+449.353	MSFC	--
373b	Signal received in S-IVB for: Fuel Chilldown Pump OFF	N/A	N/A	S-IVB	06:07:10.330 (22,030.330)	TB8+449.35	MDAC	9
374a	Signal from LVDC for: LOX Chilldown Pump OFF	06:07:01.9 (22,021.9)	TB8 + 449.6	IU	06:07:10.55 (22,030.55)	TB8+449.571	MSFC	--
374b	Signal received in S-IVB for: LOX Chilldown Pump OFF	N/A	N/A	S-IVB	06:07:10.546 (22,030.546)	TB8+449.57	MDAC	9

TABLE 4-1 (Sheet 37 of 47)  
AS-504 D POST FLIGHT SEQUENCE OF EVENTS

ITEM NO.	EVENT	PREDICTED TIME		SIGNAL MONITORED AT	MONITORED TIME		DATA SOURCE	ACCURACY (ms)
		TIME FROM RANGE ZERO (hr:min:sec) (sec)	TIME FROM BASE (sec)		TIME FROM RANGE ZERO (hr:min:sec) (sec)	TIME FROM BASE (sec)		
375a	Signal from LVDC for: S-IVB Engine Start ON	06:07:02.3 (22,022.3)	TB8 + 450.0	IU	06:07:10.93 (22,030.93)	TB8+449.952	MSFC	--
375b	Signal received in S-IVB for: S-IVB Engine Start ON	N/A	N/A	S-IVB	06:07:10.929 (22,030.929)	TB8+449.95	MDAC	9
376a	Signal from LVDC for: S-IVB Ullage Engine No. 1 OFF	06:07:05.3 (22,025.3)	TB8 + 453.0	IU	06:07:13.93 (22,033.93)	TB8+452.955	MSFC	--
376b	Signal received in S-IVB for: S-IVB Ullage Engine No. 1 OFF	N/A	N/A	S-IVB	06:07:13.929 (22,033.929)	TB8+452.96	MDAC	9
377a	Signal from LVDC for: S-IVB Ullage Engine No. 2 OFF	06:07:05.4 (22,025.4)	TB8 + 453.1	IU	06:07:14.03 (22,034.03)	TB8+453.055	MSFC	--
377b	Signal received in S-IVB for: S-IVB Ullage Engine No. 2 OFF	N/A	N/A	S-IVB	06:07:14.029 (22,034.029)	TB8+453.05	MDAC	9
378a	Signal from LVDC for: LOX Tank Repressurization Control Valve Open OFF	06:07:09.6 (22,029.6)	TB8 + 457.3	IU	06:07:18.23 (22,038.23)	TB8+457.254	MSFC	--
378b	Signal received in S-IVB for: LOX Tank Repressurization Control Valve Open OFF	N/A	N/A	S-IVB	06:07:18.228 (22,038.228)	TB8+457.25	MDAC	9
379a	Signal from LVDC for: LH2 Tank Repressurization Control Valve Open OFF	06:07:09.8 (22,029.8)	TB8 + 457.5	IU	06:07:18.44 (22,038.44)	TB8+457.469	MSFC	--
379b	Signal received in S-IVB for: LH2 Tank Repressurization Control Valve Open OFF	N/A	N/A	S-IVB	06:07:18.445 (22,038.445)	TB8+457.469	MDAC	9
380	Signal from LVDC for: Flight Control Computer S-IVB Burn Mode ON "A"	06:07:09.9 (22,029.9)	TB8 + 457.6	IU	06:07:18.54 (22,038.54)	TB8+457.566	MSFC	--
381	Signal from LVDC for: Flight Control Computer S-IVB Burn Mode ON "B"	06:07:10.1 (22,030.1)	TB8 + 457.8	IU	06:07:18.73 (22,038.73)	TB8+457.753	MSFC	--
382a	Signal from LVDC for: Fuel Injection Temperature OK Bypass	06:07:10.3 (22,030.3)	TB8 + 458.0	IU	06:07:18.93 (22,038.93)	TB8+457.952	MSFC	--
382b	Signal received in S-IVB for: Fuel Injection Temperature OK Bypass	N/A	N/A	S-IVB	06:07:18.928 (22,038.928)	TB8+457.95	MDAC	9

TABLE 4-1 (Sheet 38 of 47)  
AS-504 D POST FLIGHT SEQUENCE OF EVENTS

ITEM NO.	EVENT	PREDICTED TIME		SIGNAL MONITORED AT	MONITORED TIME		DATA SOURCE	ACCURACY (ms)
		TIME FROM RANGE ZERO (hr:min:sec) (sec)	TIME FROM BASF (sec)		TIME FROM RANGE ZERO (hr:min:sec) (sec)	TIME FROM BASE (sec)		
383a	Signal from LVDC for: LOX Tank Flight Pressure System ON	06:07:10.5 (22,030.5)	TB8 + 458.2	IU	06:07:19.14 (22,039.14)	TB8+458.156	MSFC	--
383b	Signal received in S-IVB for: LOX Tank Flight Pressure System ON	N/A	N/A	S-IVB	06:07:19.137 (22,039.137)	TB8+458.16	MDAC	9
384a	Signal from LVDC for: LOX Tank Pressurization Shutoff Valves Open	06:07:10.7 (22,030.7)	TB8 + 458.4	IU	06:07:19.35 (22,039.35)	TB8+458.373	MSFC	--
384b	Signal received in S-IVB for: LOX Tank Pressurization Shutoff Valves Open	N/A	N/A	S-IVB	06:07:19.354 (22,039.354)	TB8+458.37	MDAC	9
385a	Signal from LVDC for: S-IVB Engine Start OFF	06:07:10.9 (22,030.9)	TB8 + 458.6	IU	06:07:19.53 (22,039.53)	TB8+458.553	MSFC	--
385b	Signal received in S-IVB for: S-IVB Engine Start OFF	N/A	N/A	S-IVB	06:07:19.528 (22,039.528)	TB8+458.55	MDAC	9
386a	Signal from LVDC for: PU Programmed Mixture Ratio OFF	06:07:15.2 (22,035.3)	TB8 + 463.0	IU	06:07:23.93 (22,043.93)	TB8+462.953	MSFC	--
386b	Signal received in S-IVB for: PU Programmed Mixture Ratio OFF	N/A	N/A	S-IVB	06:07:23.927 (22,043.927)	TB8+462.95	MDAC	9
387a	Signal from LVDC for: Fuel Injection Temperature OK Bypass Reset	06:07:20.3 (22,040.3)	TB8 + 468.0	IU	06:07:28.93 (22,048.93)	TB8+467.952	MSFC	--
387b	Signal received in S-IVB for: Fuel Injection Temperature OK Bypass Reset	N/A	N/A	S-IVB	06:07:28.920 (22,048.920)	TB8+467.94	MDAC	9
388a	Signal from LVDC for: S-IVB Engine Cutoff	06:11:12.7 (22,272.7)	TB8 + 700.4	IU	06:11:21.32 (22,281.32)	TB8+700.34	MSFC	--
388b	Signal received in S-IVB for: S-IVB Engine Cutoff	N/A	N/A	S-IVB	06:11:21.319 (22,281.319)	TB8+700.34	MDAC	9
389a	Signal from LVDC for: Point Level Sensor Arming	06:11:12.9 (22,272.9)	TB8 + 700.6	IU	06:11:21.54 (22,281.54)	TB8+700.573	MSFC	--
389b	Signal received in S-IVB for: Point Level Sensor Arming	N/A	N/A	S-IVB	---	TB8 + ---	MDAC	9
390a	Signal from LVDC for: Start of Time Base No. 9 (TB9)	06:11:12.661 (22,272.661)	TB9 + 0.0	IU	06:11:21.53 (22,281.53)	TB9+0.000	MSFC	--
391a	Signal from LVDC for: S-IVB Engine Cutoff	06:11:12.8 (22,272.8)	TB9 + 0.1	IU	06:11:21.62 (22,281.62)	TB9+0.086	MSFC	--

TABLE 4-1 (Sheet 39 of 47)  
AS-504 D POST FLIGHT SEQUENCE OF EVENTS

ITEM NO.	EVENT			SIGNAL MONITORED AT			DATA SOURCE	ACCURACY (ms)
		TIME FROM RANGE ZERO (hr:min:sec) (sec)	TIME FROM BASE (sec)		TIME FROM RANGE ZERO (hr:min:sec) (sec)	TIME FROM BASE (sec)		
391b	Signal received in S-IVB for: S-IVB Engine Cutoff	N/A	N/A	S-IVB	06:11:21.619 (22,281.619)	TB9 + 0.09	MDAC	9
392a	Signal from LVDC for: LH2 Tank Continuous Vent Orifice Shutoff Valve Open ON	06:11:12.9 (22,272.9)	TB9 + 0.2	IU	06:11:21.74 (22,281.74)	TB9+0.209	MSFC	--
392b	Signal received in S-IVB for: LH2 Tank Continuous Vent Orifice Shutoff Valve Oper. ON	N/A	N/A	S-IVB	06:11:21.744 (22,281.744)	TB9 + 0.21	MDAC	9
393a	Signal from LVDC for: LH2 Tank Continuous Vent Relief Override Shutoff Valve Open ON	06:11:13.0 (22,273.0)	TB9 + 0.3	IU	06:11:21.83 (22,281.83)	TB9+0.302	MSFC	--
393b	Signal received in S-IVB for: LH2 Tank Continuous Vent Relief Override Shutoff Valve Open ON	N/A	N/A	S-IVB	06:11:21.836 (22,281.836)	TB9 + 0.31	MDAC	9
394a	Signal from LVDC for: Point Level Sensor Disarming	06:11:13.1 (22,273.1)	TB9 + 0.4	IU	06:11:21.93 (22,281.93)	TB9 + 0.41	MSFC	--
394b	Signal received in S-IVB for: Point Level Sensor Disarming	N/A	N/A	S-IVB	06:11:21.927 (22,281.927)	TB9 + 0.41	MDAC	9
395a	Signal from LVDC for: Aux Hydraulic Pump Flight Mode ON	06:11:13.2 (22,273.2)	TB9 + 0.5	IU	06:11:22.05 (22,282.05)	TB9+0.517	MSFC	--
395b	Signal received in S-IVB for: Aux Hydraulic Pump Flight Mode ON	N/A	N/A	S-IVB	06:11:22.053 (22,282.053)	TB9 + 0.52	MDAC	9
396a	Signal from LVDC for: Second Burn Relay OFF	06:11:13.5 (22,273.5)	TB9 + 0.8	IU	06:11:22.30 (22,282.30)	TB9+0.772	MSFC	--
396b	Signal received in S-IVB for: Second Burn Relay OFF	N/A	N/A	S-IVB	06:11:22.303 (22,282.303)	TB9 + 0.77	MDAC	9
397a	Signal from LVDC for: LOX Tank Flight Pressure System OFF	06:11:13.7 (22,273.7)	TB9 + 1.0	IU	06:11:22.48 (22,282.48)	TB9+0.952	MSFC	--
397b	Signal received in S-IVB for: LOX Tank Flight Pressure System OFF	N/A	N/A	S-IVB	06:11:22.486 (22,282.486)	TB9 + 0.96	MDAC	9
398a	Signal from LVDC for: LOX Tank Pressurization Shutoff Valves Close	06:11:14.1 (22,274.1)	TB9 + 1.4	IU	06:11:22.90 (22,282.90)	TB9+1.366	MSFC	--
398b	Signal received in S-IVB for: LOX Tank Pressurization Shutoff Valves Close	N/A	N/A	S-IVB	06:11:22.902 (22,282.902)	TB9 + 1.37	MDAC	9

TABLE 4-1 (Sheet 40 of 47)  
AS-504 D POST FLIGHT SEQUENCE OF EVENTS

ITEM NO.	EVENT	TIME FROM RANGE ZERO	TIME FROM BASE	SIGNAL MONITORED AT	TIME FROM RANGE ZERO	TIME FROM BASE	DATA SOURCE	ACCURACY (ms)
		(hr:min:sec) (sec)	(sec)		(hr:min:sec) (sec)	(sec)		
399a	Signal from LVDC for: Repressurization System Mode Selector OFF (AMB)	06:11:14.3 (22,274.3)	TB9 + 1.6	IU	06:11:23.08 (22,283.08)	TB9+1.553	MSFC	--
399b	Signal received in S-IVB for: Repressurization System Mode Selector OFF (AMB)	N/A	N/A	S-IVB	06:11:23.085 (22,283.085)	TB9 + 1.56	MDAC	9
400a	Signal from LVDC for: Passivation Enable	06:11:14.4 (22,274.4)	TB9 + 2.0	IU	06:11:23.49 (22,283.49)	TB9+1.957	MSFC	--
400b	Signal received in S-IVB for: Passivation Enable	N/A	N/A	S-IVB	06:11:23.493 (22,283.493)	TB9 + 1.96	MDAC	9
401	Signal from LVDC for: LH2 Tank Continuous Vent Orifice Shutoff Valve Open OFF	06:11:14.6 (22,274.6)	TB9 + 2.2	IU	06:11:23.71 (22,283.71)	TB9+2.173	MSFC	--
401b	Signal received in S-IVB for: LH2 Tank Continuous Vent Orifice Shutoff Valve Open OFF	N/A	N/A	S-IVB	06:11:23.710 (22,283.710)	TB9 + 2.18	MDAC	9
402a	Signal from LVDC for: LH2 Tank Continuous Vent Relief Override Shutoff Valve Open OFF	06:11:14.7 (22,274.7)	TB9 + 2.3	IU	06:11:23.80 (22,283.80)	TB9+2.271	MSFC	--
402b	Signal received in S-IVB for: LH2 Tank Continuous Vent Relief Override Shutoff Valve Open OFF	N/A	N/A	S-IVB	06:11:23.802 (22,283.802)	TB9 + 2.27	MDAC	9
403a	Signal from LVDC for: LH2 Tank Repressurization Control Valve Open ON	06:11:15.4 (22,275.4)	TB9 + 3.0	IU	06:11:24.48 (22,284.48)	TB9+2.952	MSFC	--
403b	Signal received in S-IVB for: LH2 Tank Repressurization Control Valve Open ON	N/A	N/A	S-IVB	06:11:24.485 (22,284.485)	TB9 + 2.96	MDAC	9
404	Signal from LVDC for: Flight Control Computer S-IVB Burn Mode OFF "A"	06:11:16.9 (22,276.9)	TB9 + 4.5	IU	06:11:26.00 (22,286.00)	TB9+4.469	MSFC	--
405	Signal from LVDC for: Flight Control Computer S-IVB Burn Mode OFF "B"	06:11:17.0 (22,277.0)	TB9 + 4.6	IU	06:11:26.10 (22,236.10)	TB9+4.565	MSFC	--
406	Signal from LVDC for: Maneuver to Local Horizontal	06:11:32.7 (22,292.7)	TB9 + 20.0	IU	06:11:41.53 (22,301.53)	N/A	MSFC	--
407a	Signal from LVDC for: Start Bottle Vent Control Valve Open ON	06:12:12.7 (22,332.7)	TB9 + 60.0	IU	06:12:21.48 (22,341.48)	TB9+59.95	MSFC	--

TABLE 4-1 (Sheet 41 of 47)  
AS-504 D POST FLIGHT SEQUENCE OF EVENTS

ITEM NO.	EVENT	PREDICTED TIME		SIGNAL MONITORED AT	MONITORED TIME		DATA SOURCE	ACCURACY (ms)
		TIME FROM RANGE ZERO (hr:min:sec) (sec)	TIME FROM BASE (sec)		TIME FROM RANGE ZERO (hr:min:sec) (sec)	TIME FROM BASE (sec)		
407b	Signal received in S-IVB for: Start Bottle Vent Control Valve Open ON	N/A	N/A	S-IVB	06:12:21.483 (22,341.483)	TB9+59.95	MDAC	9
408a	Signal from LVDC for: Engine Mainstage Control Valve Open ON	06:12:42.7 (22,362.7)	TB9 + 90.0	IU	06:12:51.50 (22,371.50)	TB9+89.97	MSFC	--
408b	Signal received in S-IVB for: Engine Mainstage Control Valve Open ON	N/A	N/A	S-IVB	06:12:51.503 (22,371.503)	TB9+89.97	MDAC	9
409a	Signal from LVDC for: Engine Helium Control Valve Open ON	06:12:42.9 (22,362.9)	TB9 + 90.2	IU	06:12:51.69 (22,371.69)	TB9+90.16	MSFC	--
409b	Signal received in S-IVB for: Engine Helium Control Valve Open ON	N/A	N/A	S-IVB	06:12:51.694 (22,371.694)	TB9+90.16	MDAC	9
410a	Signal from LVDC for: Start Bottle Vent Control Valve Open OFF	06:14:42.7 (22,482.7)	TB9 + 210.0	IU	06:14:51.48 (22,491.48)	TB9+209.95	MSFC	--
410b	Signal received in S-IVB for: Start Bottle Vent Control Valve Open OFF	N/A	N/A	S-IVB	06:14:51.483 (22,491.483)	TB9+209.95	MDAC	9
411a	Signal from LVDC for: Engine Pump Purge Control Valve Enable ON	06:16:12.7 (22,572.7)	TB9 + 300.0	IU	06:16:21.48 (22,581.48)	TB9+299.95	MSFC	--
411b	Signal received in S-IVB for: Engine Pump Purge Control Valve Enable ON	N/A	N/A	S-IVB	06:16:21.484 (22,581.484)	TB9+299.95	MDAC	9
412	Signal from LVDC for: Telemetry Calibrate Inflight Calibrate ON	N/A	N/A	IU	06:18:18.05 (22,698.05)	TB9+416.52	MSFC	--
413a	Signal from LVDC for: TM Calibrate ON	N/A	N/A	IU	06:18:18.25 (22,698.25)	TB9+416.72	MSFC	--
413b	Signal received in S-IVB for: TM Calibrate ON	N/A	N/A	S-IVB	06:18:18.249 (22,698.249)	TB9+416.72	MDAC	9
414a	Signal from LVDC for: TM Calibrate OFF	N/A	N/A	IU	06:18:19.25 (22,699.25)	TB9+417.72	MSFC	--
414b	Signal received in S-IVB for: TM Calibrate OFF	N/A	N/A	S-IVB	06:18:19.249 (22,699.249)	TB9+417.72	MDAC	9
415	Signal from LVDC for: Telemetry Calibrate Inflight Calibrate OFF	N/A	N/A	IU	06:18:23.05 (22,703.05)	TB9+421.52	MSFC	--

TABLE 4-1 (Sheet 42 of 47)  
AS-504 D POST FLIGHT SEQUENCE OF EVENTS

ITEM NO.	EVENT	PREDICTED TIME		SIGNAL MONITORED AT	MONITORED TIME		DATA SOURCE	ACCURACY (ms)
		TIME FROM RANGE ZERO (hr:min:sec) (sec)	TIME FROM BASE (sec)		TIME FROM RANGE ZERO (hr:min:sec) (sec)	TIME FROM BASE (sec)		
416a	Signal from LVDC for: Engine Mainstage Control Valve Open OFF	N/A	N/A	IU	06:22:56.89 (22,976.89)	TB9 + N/A	MSFC	--
416b	Signal received in S-IVB for: Engine Mainstage Control Valve Open OFF	N/A	N/A	S-IVB	06:22:56.782 (22,976.782)	TB9 + N/A	MDAC	9
417a	Signal from LVDC for: Engine He Control Valve Open OFF	N/A	N/A	IU	06:22:57.71 (22,977.71)	TB9 + N/A	MSFC	--
417b	Signal received in S-IVB for: Engine He Control Valve Open OFF	N/A	N/A	S-IVB	06:22:57.607 (22,977.607)	TB9 + N/A	MDAC	9
418a	Signal from LVDC for: Passivation Enable	N/A	N/A	IU	06:23:13.64 (22,993.64)	TB9 + N/A	MSFC	--
418b	Signal received in S-IVB for: Passivation Enable	N/A	N/A	S-IVB	06:23:13.538 (22,993.538)	TB9 + N/A	MDAC	9
419a	Signal from LVDC for: Engine Mainstage Control Valve Open ON	N/A	N/A	IU	06:23:14.42 (22,994.92)	TB9 + N/A	MSFC	--
419b	Signal received in S-IVB for: Engine mainstage Control Valve Open ON	N/A	N/A	S-IVB	06:23:14.313 (22,994.313)	TB9 + N/A	MDAC	9
420a	Signal from LVDC for: Engine He Control Valve Open ON	N/A	N/A	IU	06:23:13.21 (22,993.21)	TB9 + N/A	MSFC	--
420b	Signal received in S-IVB for: Engine He Control Valve Open ON	N/A	N/A	S-IVB	06:23:15.130 (22,995.130)	TB9 + N/A	MDAC	9
421a	Signal from LVDC for: Engine Mainstage Control Valve Open OFF	06:23:52.5 (23,032.5)	TB9 + 759.8	IU	06:24:01.29 (23,041.29)	TB9+759.76	MSFC	--
421b	Signal received in S-IVB for: Engine Mainstage control Valve Open OFF	N/A	N/A	S-IVB	06:24:01.290 (23,041.290)	TB9+759.76	MDAC	9
422a	Signal from LVDC for: Engine Helium Control Valve Open OFF	06:23:52.7 (23,032.7)	TB9 + 760.0	IU	06:24:01.49 (23,041.49)	TB9+759.957	MSFC	--
422b	Signal received in S-IVB for: Engine Helium Control Valve Open OFF	N/A	N/A	S-IVB	06:24:01.498 (23,041.498)	TB9+759.97	MDAC	9
423a	Signal from LVDC for: LOX Tank NPV Valve Open ON	06:23:52.9 (23,032.9)	TB9 + 760.2	IU	06:24:01.69 (23,041.69)	TB9+760.16	MSFC	--
423b	Signal received in S-IVB for: LOX Tank NPV Valve Open ON	N/A	N/A	S-IVB	06:24:01.698 (23,041.698)	TB9+760.17	MDAC	9



TABLE 4-1 (Sheet 43 of 47)  
AS-504 D POST FLIGHT SEQUENCE OF EVENTS

ITEM NO.	EVENT	PREDICTED TIME		SIGNAL MONITORED AT	MONITORED TIME		DATA SOURCE	ACCURACY (ms)
		TIME FROM RANGE ZERO (hr:min:sec) (sec)	TIME FROM BASE (sec)		TIME FROM RANGE ZERO (hr:min:sec) (sec)	TIME FROM BASE (sec)		
424a	Signal from LVDC for: LOX Tank NPV Valve Latch Open ON	06:23:54.9 (23,034.9)	TB9 + 762.2	IU	06:23:43.69 (23,043.69)	TB9+762.16	MSFC	--
424b	Signal received in S-IVB for: LOX Tank NPV Valve Latch Open ON	N/A	N/A	S-IVB	06:24:03.689 (23,043.689)	TB9+762.16	MDAC	9
425a	Signal from LVDC for: LOX Tank NPV Valve Open OFF	06:23:55.9 (23,035.9)	TB9 + 763.2	IU	06:24:04.69 (23,044.69)	TB9+763.17	MSFC	--
425b	Signal received in S-IVB for: LOX Tank NPV Valve Open OFF	N/A	N/A	S-IVB	06:24:04.689 (23,044.689)	TB9+763.17	MDAC	9
426a	Signal from LVDC for: LOX Tank NPV Valve Latch Open OFF	06:23:56.9 (23,036.9)	TB9 + 764.2	IU	06:24:05.69 (23,045.69)	TB9+764.170	MSFC	--
426b	Signal received in S-IVB for: LOX Tank NPV Valve Latch Open OFF	N/A	N/A	S-IVB	06:24:05.689 (23,045.689)	TB9+764.17	MDAC	9
427a	Signal from LVDC for: Engine Ignition Phase Control Valve Open ON	06:24:02.5 (23,042.5)	TB9 + 765.8	IU	06:24:11.29 (23,051.29)	TB9+769.75	MSFC	--
427b	Signal received in S-IVB for: Engine Ignition Phase Control Valve Open ON	N/A	N/A	S-IVB	06:24:11.288 (23,051.288)	TB9+769.76	MDAC	9
428a	Signal from LVDC for: Engine Helium Control Valve Open ON	06:24:02.7 (23,042.7)	TB9 + 770.0	IU	06:24:11.49 (23,051.49)	TB9+769.96	MSFC	--
428b	Signal received in S-IVB for: Engine Helium Control Valve Open ON	N/A	N/A	S-IVB	06:24:11.488 (23,051.488)	TB9+769.96	MDAC	9
429a	Signal from LVDC for: Engine Ignition Phase Control Valve Open OFF	N/A	N/A	IU	06:25:56.23 (23,156.23)	TB9 + N/A	MSFC	9
429b	Signal received in S-IVB for: Engine Ignition Phase Control Valve Open OFF	N/A	N/A	IU	06:25:56.132 (23,156.132)	TB9 + N/A	MDAC	--
430a	Signal from LVDC for: Engine He Control Valve Open OFF	N/A	N/A	IU	06:25:57.05 (23,157.05)	TB9 + N/A	MSFC	9
430b	Signal received in S-IVB for: Engine He Control Valve Open OFF	N/A	N/A	S-IVB	06:25:56.947 (23,156.947)	TB9 + N/A	MDAC	--
431a	Signal from LVDC for: Passivation Enable	N/A	N/A	IU	06:26:12.49 (23,172.49)	TB9 + N/A	MSFC	9
431b	Signal received in S-IVB for: Passivation Enable	N/A	N/A	S-IVB	06:26:12.395 (23,172.395)	TB9 + N/A	MDAC	--

TABLE 4-1 (Sheet 44 of 47)  
AS-504 D POST FLIGHT SEQUENCE OF EVENTS

ITEM NO.	EVENT	PREDICTED TIME		SIGNAL MONITORED AT	MONITORED TIME		DATA SOURCE	ACCURACY (ms)
		TIME FROM RANGE ZERO (hr:min:sec) (sec)	TIME FROM BASE (sec)		TIME FROM RANGE ZERO (hr:min:sec) (sec)	TIME FROM BASE (sec)		
432a	Signal from LVDC for: Engine Ignition Phase Control Valve Open ON	N/A	N/A	IU	06:26:13.24 (23,173.24)	TB9 + N/A	MSFC	9
432b	Signal received in S-IVB for: Engine Ignition Phase Control Valve Open ON	N/A	N/A	S-IVB	06:26:14.145 (23,174.145)	TB9 + N/A	MDAC	--
433a	Signal from LVDC for: Engine He Control Valve Open ON	N/A	N/A	IU	06:26:15.06 (23,175.06)	TB9 + N/A	MSFC	--
433b	Signal received in S-IVB for: Engine HE Control Valve Open ON	N/A	N/A	S-IVB	06:26:14.961 (23,174.961)	TB9 + N/A	MDAC	--
434a	Signal from LVDC for: Engine Ignition Phase Control Valve Open OFF	N/A	N/A	IU	---	TB9 + N/A	MSFC	--
434b	Signal received in S-IVB for: Engine Ignition Phase Control Valve Open OFF	N/A	N/A	S-IVB	06:41:25.854 (24,075.854)	TB9 + N/A	MDAC	9
435a	Signal from LVDC for: Engine HE Control Valve Open OFF	N/A	N/A	IU	---	TB9 + N/A	MSFC	--
435b	Signal received in S-IVB for: Engine HE Control Valve Open OFF	N/A	N/A	S-IVB	06:41:26.762 (24,076.762)	TB9 + N/A	MDAC	9
436a	Signal from LVDC for: Passivation Enable	N/A	N/A	IU	---	TB9 + N/A	MSFC	--
436b	Signal received in S-IVB for: Passivation Enable	N/A	N/A	S-IVB	06:41:44.558 (24,094.558)	TB9 + N/A	MDAC	9
437a	Signal from LVDC for: Engine Ignition Phase Control Valve Open ON	N/A	N/A	IU	---	TB9 + N/A	MSFC	--
437b	Signal received in S-IVB for: Engine Ignition Phase Control Valve Open ON	N/A	N/A	S-IVB	06:41:45.466 (24,095.466)	TB9 + N/A	MDAC	9
438a	Signal from LVDC for: Engine He Control Valve Open ON	N/A	N/A	IU	---	TB9 + N/A	MSFC	--
438b	Signal Received in S-IVB for: Engine He Control Valve Open ON	N/A	N/A	S-IVB	06:41:46.366 (24,096.366)	TB9 + N/A	MDAC	9
439a	Signal from LVDC for: Engine Ignition Phase Control Valve Open OFF	06:42:17.7 (24,137.7)	TB9+1865.0	IU	---	TB9 + ---	MSFC	--

TABLE 4-1 (Sheet 45 of 47)  
AS-504 D POST FLIGHT SEQUENCE OF EVENTS

ITEM NO.	EVENT	PREDICTED TIME		SIGNAL MONITORED AT	MONITORED TIME		DATA SOURCE	ACCURACY (ms)
		TIME FROM RANGE ZERO (hr:min:sec) (sec)	TIME FROM BASE (sec)		TIME FROM RANGE ZERO (hr:min:sec) (sec)	TIME FROM BASE (sec)		
439b	Signal Received in S-IVB for: Engine Ignition Phase Control Valve Open OFF	N/A	N/A	S-IVB	06:42:26.501 (24,146.501)	TB9+1864.97	MDAC	9
440a	Signal from LVDC for: Engine Helium Control Valve Open OFF	06:42:17.9 (24,137.9)	TB9+1865.2	IU	---	TB9 + ---	MSFC	--
440b	Signal Received in S-IVB for: Engine Helium Control Valve Open OFF	N/A	N/A	S-IVB	06:42:26.700 (24,146.700)	TB9+1865.17	MDAC	9
441a	Signal from LVDC for: Aux. Hydraulic Pump Flight Mode OFF	06:42:18.7 (24,138.7)	TB9+1866.0	IU	---	TB9 + ---	MSFC	--
441b	Signal Received in S-IVB for: Aux Hydraulic Pump Flight Mode OFF	N/A	N/A	S-IVB	06:42:27.501 (24,147.501)	TB9+1865.97	MDAC	9
442a	Signal from LVDC for: Passivation Disable	06:42:19.7 (24,139.7)	TB9+1867.0	IU	---	TB9 + ---	MSFC	--
442b	Signal Received in S-IVB for: Passivation Disable	N/A	N/A	S-IVB	06:42:28.501 (24,148.501)	TB9+1866.97	MDAC	9
443a	Signal from LVDC for: LH2 Tank Latching Relief Valve Open ON	06:42:21.7 (24,141.7)	TB9+1869.0	IU	---	TB9 + ---	MSFC	--
443b	Signal Received in S-IVB for: LH2 Tank Latching Relief Valve Open ON	N/A	N/A	S-IVB	06:42:30.500 (24,150.500)	TB9+1868.97	MDAC	9
444a	Signal from LVDC for: LH2 Tank Latching Relief Valve Latch ON	06:42:23.7 (24,143.7)	TB9+1871.0	IU	---	TB9 + ---	MSFC	--
444b	Signal received in S-IVB for: LH2 Tank Latching Relief Valve Latch ON	N/A	N/A	S-IVB	06:42:32.508 (24,152.508)	TB9+1870.98	MDAC	9
445a	Signal from LVDC for: LH2 Tank Latching Relief Valve Open OFF	06:42:24.7 (24,144.7)	TB9+1872.0	IU	---	TB9 + ---	MSFC	--
445b	Signal Received in S-IVB for: LH2 Tank Latching Relief Valve Open OFF	N/A	N/A	S-IVB	06:42:33.508 (24,153.508)	TB9+1872.32	MDAC	9
446a	Signal from LVDC for: LH2 Tank Latching Relief Valve Latch OFF	06:42:25.7 (24,145.7)	TB9+1873.0	IU	---	TB9 + ---	MSFC	--
446b	Signal received in S-IVB for: LH2 Tank Latching Relief Valve Latch OFF	N/A	N/A	S-IVB	06:42:34.524 (24,154.524)	TB9+1872.99	MDAC	9

TABLE 4-1 (Sheet 46 of 47)  
AS-504 D POST FLIGHT SEQUENCE OF EVENTS

ITEM NO.	EVENT	PREDICTED TIME		SIGNAL MONITORED AT	MONITORED TIME		DATA SOURCE	ACCURACY (ms)
		TIME FROM RANGE ZERO (hr:min:sec) (sec)	TIME FROM BASE (sec)		TIME FROM RANGE ZERO (hr:min:sec) (sec)	TIME FROM BASE (sec)		
447a	Signal from LVDC for: PU Inverter and D.C. Power OFF	06:42:25.9 (24,145.9)	TB9+1873.2	IU	---	TB9 + ---	MSFC	--
447b	Signal Received in S-IVB for: PU Inverter and D.C. Power OFF	N/A	N/A	S-IVB	06:42:34.716 (24,154.716)	TB9+1873.19	MDAC	9
448a	Signal from LVDC for: Repressurization System Mode Selector ON (AMB)	06:42:27.7 (24,147.7)	TB9+1875.0	IU	---	TB9 + --	MSFC	--
448b	Signal Received in S-IVB for: Repressurization System Mode Selector ON (AMB)	N/A	N/A	S-IVB	06:42:36.507 (24,156.507)	TB9+1874.98	MDAC	9
449a	Signal from LVDC for: Engine Pneumatic System Vent Open	06:42:28.7 (24,148.7)	TB9+1876.0	IU	---	TB9 + ---	MSFC	--
449b	Signal Received in S-IVB for: Engine Pneumatic System Vent Open	N/A	N/A	S-IVB	06:42:37.507 (24,157.507)	TB9+1875.98	MDAC	9
450a	Signal from LVDC for: Passivation Enable	N/A	N/A	IU	---	TB9 + N/A	MSFC	--
450b	Signal Received in S-IVB for: Passivation Enable	N/A	N/A	S-IVB	06:45:28.853 (24,328.853)	TB9 + N/A	MDAC	9
451a	Signal from LVDC for: Engine HE Control Valve Open ON	N/A	N/A	IU	---	TB9 + N/A	MSFC	--
451b	Signal Received in S-IVB for: Engine He Control Valve Open ON	N/A	N/A		06:45:29.770 (24,329.770)	TB9 + N/A	MDAC	9
452a	Signal from LVDC for: Repressurization System Mode Selector OFF (AMB)	06:45:47.7 (24,347.7)	TB9+2075.0	IU	---	TB9 + ---	MSFC	--
452b	Signal Received in S-IVB for: Repressurization System Mode Selector OFF	N/A	N/A	S-IVB	06:47:36.507 (24,356.507)	TB9+2074.98	MDAC	9
453a	Signal from LVDC for: Engine Pneumatic System Vent Close	N/A	N/A	IU	06:52:37.50 (24,757.50)	TB9 + N/A	MSFC	--
453b	Signal Received in S-IVB for: Engine Pneumatic System Vent Close	N/A	N/A	S-IVB	06:52:37.508 (24,757.508)	TB9 + N/A	MDAC	9
454a	Signal from LVDC for: S-IVB Engine Cutoff OFF	N/A	N/A	IU	06:52:49.97 (24,769.97)	TB9 + N/A	MSFC	--

TABLE 4-1 (Sheet 47 of 47)  
AS-504 D POST FLIGHT SEQUENCE OF EVENTS

ITEM NO.	EVENT	PREDICTED TIME		SIGNAL MONITORED AT	MONITORED TIME		DATA SOURCE	ACCURACY (ms)
		TIME FROM RANGE ZERO (hr:min:sec) (sec)	TIME FROM BASE (sec)		TIME FROM RANGE ZERO (hr:min:sec) (sec)	TIME FROM BASE (sec)		
454b	Signal Received in S-IVB for: S-IVB Engine Cutoff OFF	N/A	N/A	S-IVB	06:52:49.973 (24,769.973)	TB9 + N/A	MDAC	9
455a	Signal from LVDC for: Engine Ready Bypass	N/A	N/A	IU	06:52:50.93 (24,770.93)	TB9 + N/A	MSFC	--
455b	Signal Received in S-IVB for: Engine Ready Bypass	N/A	N/A	S-IVB	06:52:50.931 (24,770.931)	TB9 + N/A	MDAC	9
456a	Signal from LVDC for: Prevalves Close OFF	N/A	N/A	IU	06:52:51.88 (24,771.88)	TB9 + N/A	MSFC	--
456b	Signal Received in S-IVB for: Prevalves Close OFF	N/A	N/A	S-IVB	06:52:51.882 (24,771.882)	TB9 + N/A	MDAC	9
457a	Signal from LVDC for: S-IVB Engine Start ON	N/A	N/A	IU	06:52:52.83 (24,772.83)	TB9 + N/A	MSFC	--
457b	Signal Received in S-IVB for: S-IVB Engine Start ON	N/A	N/A	S-IVB	06:52:52.831 (24,772.831)	TB9 + N/A	MDAC	9
458	Signal from LVDC for: Water Coolant Valve Open	N/A	N/A	IU	06:54:43.43 (24,833.43)	TB9 + N/A	MSFC	--
459	Signal from LVDC for: Water Coolant Valve Close	N/A	N/A	IU	06:58:54.94 (25,134.94)	TB9 + N/A	MSFC	--
460a	Signal from LVDC for: LH2 Tank Repressurization Control Valve Open OFF	07:14:35.9 (26,075.9)	TB9+3803.2	IU	07:14:44.72 (26,084.72)	TB9+3803.157	MSFC	--
460b	Signal Received in S-IVB for: LH2 Tank Repressurization Control Valve Open OFF	N/A	N/A	S-IVB	07:14:44.721 (26,084.721)	TB9+3803.16	MDAC	9
461a	Signal from LVDC for: Engine Pump Purge Control Valve Enable OFF	07:14:52.9 (26,092.9)	TB9+3820.2	IU	07:15:00.72 (26,101.72)	TB9+3820.162	MSFC	--
461b	Signal Received in S-IVB for: Engine Pump Purge Control Valve Enable OFF	N/A	N/A	S-IVB	07:15:00.728 (26,101.728)	TB9+3820.17	MDAC	9
462a	Signal from LVDC for: S-IVB Ullage Engine No. 1 ON	N/A	N/A	IU	07:34:04.62 (27,244.62)	TB9 + N/A	MSFC	--
462b	Signal Received in S-IVB for: S-IVB Ullage Engine No. 1 ON	N/A	N/A	S-IVB	07:34:04.626 (27,244.626)	TB9 + N/A	MDAC	9
463a	Signal from LVDC for: S-IVB Ullage Engine No. 2 ON	N/A	N/A	IU	07:34:05.76 (27,245.76)	TB9 + N/A	MSFC	--
463b	Signal Received in S-IVB for: S-IVB Ullage Engine No. 2 ON	N/A	N/A	S-IVB	07:34:05.768 (27,245.768)	TB9 + N/A	MDAC	9

TABLE 4-2 (Sheet 1 of 2)

## GROUND COMMANDS

<u>Item No.</u>	<u>Time from Range Zero</u>	<u>Event</u>
194	8,795.61*	EDS Cutoff No. 1 Disable
318	17,315.19*	Water Coolant Valve Open
321	20,416 *	S-IVB Restart Enable
322	21,526.86*	Water Coolant Valve Open
335	21,710.02	Chiltdown Shutoff Valve Close ON
339	21,729.16	Fuel Chiltdown Pump OFF
340	21,729.96*	LOX Chiltdown Pump OFF
350	21,952.75*	Chiltdown Shutoff Valve Close OFF
351	21,953.53*	Prevalves Close OFF
352	21,954.32*	S-IVB Engine Cutoff OFF
353	21,955.10*	Engine Ready Bypass
369	21,987.34*	Engine Start ON
416	22,976.89*	Engine Mainstage Control Valve Open OFF
417	22,977.71*	Engine He Control Valve Open OFF
418	22,993.64	Passivation Enable
419	22,994.42*	Engine Mainstage Control Valve Open ON
420	22,994.10*	Engine He Control Valve Open ON
429	23,156.23*	Engine Ignition Phase Control Valve Open OFF
430	23,157.05*	Engine He Control Valve Open OFF
431	23,172.49*	Passivation Enable
432	23,173.24*	Engine Ignition Phase Control Valve Open ON

TABLE 4-2 (Sheet 2 of 2)

## GROUND COMMANDS

<u>Item No.</u>	<u>Time from Range Zero</u>	<u>Event</u>
433	23,175.06*	Engine He Control Valve Open ON
434	24,075.854**	Engine Ignition Phase Control Valve Open OFF
435	24,076.762**	Engine He Control Valve Open OFF
436	24,094.559**	Passivation Enable
437	24,095.466**	Engine Ignition Phase Control Vavle Open ON
438	24,096.366**	Engine He Control Valve Open ON
450	24,328.853**	Passivation Enable
451	24,329.770**	Engine He Control Valve Open ON
453	24,757.50*	Engine Pneumatic System Vent Close
454	24,769.97*	S-IVB Engine Cutoff OFF
455	24,770.93*	Engine Ready Bypass
456	24,771.88*	Prevalves Close OFF
457	24,772.83*	S-IVB Engine Start ON
458	24,833.43*	Water Coolant Valve Open
459	25,134.94*	Water Coolant Valve Close
462	27,244.62*	S-IVB Ullage Engine No. 1 ON
463	27,245.76*	S-IVB Ullage Engine No. 2 ON

\* Time of command issuance from LVDC.

\*\* Time of command receipt in S-IVB.

TABLE 4-3

DATA OMISSIONS (REASONS)

<u>Predicted Time from Base (Sec)</u>	<u>Commands</u>	<u>Reason for Loss of Monitored Times</u>
TB5 +12,660.0	PU Inverter and DC Power ON (Item 212)	Monitored by insertion ship and data is not available.
TB6 +660.4	Point Level Sensor Arming (Item 297)	TB7 was initiated before this command was scheduled to be sent.
TB7 +602.6	Engine Pump Purge Control Valve Enable OFF (Item 319)	Event occurred between ground station coverage.
TB8 +700.6	Point Level Sensor Arming (Item 387)	TB9 was initiated before this command was scheduled to be sent.

TABLE 4-4

DATA OMISSIONS (TIMES)

Item numbers for missing times for command issuance from the LVDC.

168*	228***	437 *	446 *
208***	285*	438 *	447 *
209*	286*	439 *	448*
210*	287***	440 *	449*
211***	297**	441 *	450*
212**	319**	442 *	451*
223***	434 *	443 *	452*
224*	435*	444 *	
226***	436*	445 *	

\* - Signal was received in S-IVB.

\*\* - Signal was not received in S-IVB.

\*\*\* - IU command only.



TABLE 4-5 (Sheet 1 of 3)

## GROUND SEQUENCE OF EVENTS

<u>Min Sec</u>	<u>Event</u>
-19:58.270	Eng. St Tk Purge Sup Vlv Close
58.266	Eng. St Tk Purge Sup Vlv Open
18.564	Prelaunch C/O Grp Pwr ON
-18:20.340	Prelaunch C/O Grp Pwr OFF
-17:50.338	Aux Hyd Pump Pwr ON
-14:59.380	TC Purge Sup Vlv Open
59.314	TC Purge Sup Vlv Close
29.166	Eng St Tk Purge Sup Vlv Open
29.158	Eng. St Tk Purge Sup Vlv Close
28.518	St Tk Supply Vlv Open
28.514	St Tk Supply Vlv Close
-11:01.425	LOX Vent Close
01.253	LOX Vent Open
-10:55.694	LH2 Tk Vent Vlv Open
55.430	LH2 Tk Vent Vlv Close
54.798	LH2 Tk Vent Vlv Open
-9:59.570	TC Purge Sup Vlv Close
59.570	TC Purge Sup Vlv Open
58.758	TC Chilloverdown Sup Vlv Close
58.754	TC Chilloverdown Sup Vlv Open
-5:43.106	Safe and Arm Safe
43.088	E and A Armed
43.080	Ordnance OK Ind
35.992	S-IVB DC Pwr Sup Commit
-4:59.458	LH2 Chilloverdown Pump ON
58.272	St Tk Sup Vlv Open
58.268	St Tk Sup Vlv Close
58.222	St Tk Sup Vent Vlv Close
58:218	St Tk Vent Vlv Open
57.428	Cont Bot Sup Vlv Close
57.412	Cont Bot Sup Vlv Open

TABLE 4-5 (Sheet 2 of 3)

## GROUND SEQUENCE OF EVENTS

<u>Min Sec</u>	<u>Events</u>
-4:57.346	Cont Bot Sup Vent Vlv Close
57.344	Cont Bot Sup Vent Vlv Open
49.304	LCX Chillover Pump ON
44.096	LH2 Prevalve Open
44.080	LOX Prevalve Open
43.846	LH2 Prevalve Close
43.794	LOX Prevalve Close
35.714	APS No. 2 Eng Vlv Pwr ON
35.710	APS No. 1 Eng Vlv Pwr ON
35.704	S-IVB Prep Complete
29.458	Cold He XOver Vlv Open
29.456	Cold He XOver Vlv Close
05.996	Firing Command (T-186)
05.592	LH2 Fill & Drain Vlv Open
05.428	LOX Fill & Drain Vlv Open
05.098	LH2 Fill & Drain Vlv Close
04.724	LOX Fill & Drain Vlv Close
-3:03.938	Gn LOX Umb Purg Sup Close
03.934	Gn LOX Umb Purg Sup Open
-2:46.562	LOX Vent Close
46.554	LOX Tk Press Cmd
31.990	Time for LOX Press + 15 sec
25.286	LOX Tk Pressurized
25.286	LOX Min Liftoff Press ON
-1:36.324	LH2 Tk Vent Vlv Close
36.320	LH2 Tk Press Cmd
36.238	LH2 Tk Prepress SV Close
36.130	LH2 Tk Gnd Prepress SV Open
26.290	LH2 Min Liftoff Press OK
23.990	LH2 Tk Pressurized
23.922	LH2 Tk Gnd Prepress SV Open

TABLE 4-5 (Sheet 3 of 3)

## GROUND SEQUENCE OF EVENTS

<u>Min Sec</u>	<u>Events</u>
23.914	LH2 Tk Prepress SV Close
21.990	Time for LH2 Press + 15 sec
-1:19.766	LH2 100 PC Flight Mass
-00:49.912	Stage ON Internal Power
49.512	Power Transfer Complete
39.848	LH2 Directional Vent Gnd Pos
39.786	LH2 Directional Vent Flt Pos
39.780	S-IVB Ready for Launch
08.832	Start Ignition Sequence
08.888	Status T - 8.9 sec Ign Cmd
08.836	LH2 Tk Prepress Sup Vent Cl
08.832	LH2 Tk Gnd Prepress Slv Open
08.820	TC Chillover Sup Vlv Open
08.816	TC Chillover Sup Vlv Close
08.796	Cold He Bottle Sup Open
08.794	Cold He Bottle Sup Close
08.704	Cold He Bottle Sup Line V Open
08.662	Cold He Bottle Sup Vent Close
08.554	LH2 Gnd Cont Repress Sup Open
08.538	LH2 Gnd Cont Repress Close
01.350	All Engines Running
+00:00.006	Time for Commit
00.091	LH2 Nozz Prg Sup Open
00.091	LH2 Nozz Prg Sup Close
00.631	LIFTOFF
01.212	LH2 Debris Vlv Close
01.646	LOX Debris Vlv Close

## 5. TEST OPERATIONS

The AS-504 space vehicle was launched at 16:00:00 GMT on 3 March 1969 from Launch Complex 39A. Although the launch was delayed for 72 hours because of flight crew health problems, the overall performance of the S-IVB-504N stage was satisfactory during all phases of the countdown.

No significant S-IVB stage or equipment problems occurred during the launch countdown, and MDAC ground support equipment (GSE) sustaining no serious damage during liftoff. The precountdown and countdown activities are reviewed and evaluated in the following paragraphs which include discussions of the prelaunch checkouts, purges, propellant and pneumatic loadings, and the terminal countdown. Significant events occurred at the following times:

<u>Event</u>	<u>Time</u>
LOX loading initiated	07:41:00 GMT
LH2 loading initiated	11:15:00 GMT
Terminal countdown initiated	15:30:00 GMT
Liftoff	16:00:00 GMT

### 5.1 Launch Vehicle Tests

The S-IVB-504 stage was subjected to launch vehicle tests to determine that switch selector, interfaces, etc. were functional for launch. The two major tests, Flight Readiness and Countdown Demonstration, are discussed in the following paragraphs.

#### 5.1.1 Flight Readiness Test

The space vehicle Flight Readiness Test was accomplished at launch complex 39A in accordance with KSC procedure V-20017, revision 009. The testing was started on 21 January, and initial MDAC activities included power up operations and functional testing. During the S-IVB preparations complete test, an abnormal shutdown of the LOX chilldown pump

inverter was noted. After investigation, the inverter was replaced on a non-interference basis during EDS testing, after which a short hold was called to complete S-IVB retest activities. Several other holds of non-MDAC origin were called, and the test was terminated at the start of Time Base No. 1, with 7-hours plus count time still to be accomplished. The test was rerun on 22 January.

#### 5.1.2 Countdown Demonstration Test

The Countdown Demonstration Test (Wet) was initiated at 0930 GMT on 12 February with a count of T -130 hours. Because of numerous spacecraft problems, all the built-in hold time was absorbed, and the final portion of the test was rescheduled. Although another hold was built in, additional problems delayed cutoff to approximately 2151 GMT on 18 February.

The CDDT (Dry) began at 1115 GMT on 19 February with a count of T -4 hours 45 minutes. Temporary loss of range support because of an ETR launch necessitated a hold at T -5 minutes; T -0 occurred at 1654 GMT on 19 February.

The following S-IVB problems were encountered during the CDDT:

- a. The 3200 psi helium supply increased from 1400 to 1600 psi in 5 minutes. The 1A66985-509 dome regulator in the pneumatic console was removed and replaced.
- b. During flight battery activation, battery 1A59741-507N, S/N 41 failed to pass the case isolation check and was replaced with S/N 43.
- c. A wet indication from the LH2 tank overfill sensor executed a revert to the PTCS during slow fill at approximately 100 percent flight mass. This was attributed to LH2 sloshing.
- d. Several erratic and off-scale vehicle measurements were observed.

#### 5.2 AS-504 Launch Countdown

The launch countdown activities began on 22 February 1969 with a count of T -130 hours and continued without interruption until T -15 hours

30 minutes on 27 February when the test was scrubbed, and the launch delayed 72 hours because of launch crew health problems. The launch was rescheduled for 1600 GMT on 3 March and the countdown was recycled to T -42 hours with the course pickup at 0730 GMT on 1 March.

The concluding portion of the countdown began at 0700 GMT on 3 March 1969. After LOX loading was completed, the 1A58345-523 pneumatic power control module failed to regulate control helium pressure properly. The decision was made to leave the unit installed for flight.

The final portion of the countdown progressed without incident to space vehicle launch which occurred exactly on time at 1600:00 GMT.

#### 5.2.1 Prelaunch Preparations and Purges

The prelaunch preparations consisted of leak checks, verification of purges and valve actuations, and analysis of the helium supply for purity and moisture content. The preparations and purges were accomplished in accordance with MDAC countdown procedure V-30539 and LOX/LH2 preloading tank purge procedure V-35015.

#### 5.2.2 Loading Operations

Propellant tank and APS module loading and prepressurization, thrust chamber chardown, and helium and GH2 sphere loading were all satisfactorily accomplished.

##### 5.2.2.1 Propellant Loading

S-IVB stage LOX and LH2 loadings were uninterrupted and smoothly accomplished. Pressures, temperatures, and flowrates at significant times are presented in table 5-1.

#### 5.2.2.2 APS Loading

The APS propellant loading was completed on 8 February; helium pressurization for the leak check was completed the same day. No major problems or anomalies occurred. Loading data are presented in table 5-2.

#### 5.2.2.3 Helium and GH2 Loading

Final pressurization of all S-IVB stage spheres, both cold and ambient, was accomplished without difficulty. Sphere pressurization data are presented in table 5-3.

#### 5.2.3 Terminal Count

The terminal count was initiated at T -30 minutes and was completed without any significant problems. During this period, final engine and stage conditioning were accomplished. The sequence of terminal count events is presented in table 5-4.

##### 5.2.3.1 Engine Conditioning

The J-2 engine conditioning was initiated at T -20 minutes with a 50-psig ambient helium purge through the start sphere. After the purge was terminated, the start sphere was chilled and pressurized with cold GH2. The engine control sphere was also pressurized to meet redlines at liftoff. No problems occurred during start and control sphere conditioning for launch.

The J-2 engine thrust chamber jacket conditioning was initiated at T -15 minutes with a 50-psig ambient helium purge. The purge was terminated at T -10 minutes, and thrust chamber chilldown was initiated. Fuel injection temperature (C0200) was used as the redline criteria in place of thrust chamber jacket temperature (C0199) because of erratic behavior seen on C0199 earlier in the count. However, both transducers were well within redline limits at liftoff.

#### 5.2.3.2 Stage Conditioning

LOX turbopump chilldown was performed with a LOX flowrate of 40.0 gpm unpressurized and 42.5 gpm pressurized. LH2 turbopump chilldown was performed at an LH2 flowrate of 98 gpm unpressurized and 138 gpm pressurized. The chilldowns were normal and provided satisfactory pump inlet conditions for launch. Chilldown is further discussed in sections 11 and 12.

LOX and LH2 tank prepressurization were normal, but LOX prepressurization was longer than usual because of the low LOX load; however, the tank ullage pressures were satisfactory at liftoff. Three LOX tank ullage pressure makeup cycles were accomplished between T -143 and T -113 seconds.

The stage pneumatic power control module was replaced after the count-down scrub. During the final countdown the regulator in the new module failed after LOX loading, and the backup pressure switch terminated flow.

#### 5.3 Redline Limits

All redlines were satisfied for launch; however, two were changed before the launch. Because of the erratic nature of C0199-501, thrust chamber temperature, it was replaced by C0200-501, fuel injection temperature. In addition, the maximum redline for stage control helium regulator discharge pressure was raised from 585 psia to 630 psia to allow for system operation in the backup mode. As a result of the relaxation of the regulator redline and in light of existing regulator performance, the backup pressure switch not picked up function was removed from the terminal count logic.

The redline limits for launch vehicle parameters are presented in report K-V-05.10/4: Apollo/Saturn V Launch Mission Rules Apollo 9 (SA-504/CSM-103) Final, dated 3 February 1969 with revisions in the A41 Redline Monitoring Brief.



#### 5.4 Countdown Problems

The only hold other than those built into the countdown sequence was called because of flight crew health; however, the following S-IVB problems occurred.

- a. During requalification of the pneumatic power control module on 28 February, the 6000 psi dome regulator failed and was replaced. The new regulator failed after two cycles, and the 3200 psi ambient helium relief valve failed at the same time. The new regulator and the relief valve were removed and replaced. The seat material of the replacement regulator was nylon in lieu of Kel-F in the original.
- b. During final propulsion preparations at T -23 hours, the solenoid valve in the stage pneumatic power control module that controls the start tank vent appeared sluggish. The module was removed and replaced after the preparations were complete.
- c. After LOX loading, the regulator in the stage pneumatic power control module discussed in item b. failed to regulate properly. The engine pump purge was enabled to put a demand on the system and lower the regulator discharge pressure until T -5 minutes 33 seconds. The decision was made to leave the unit installed for launch and rely upon the backup pressure switch to prevent regulator discharge overpressure.

#### 5.5 Environmental Control Systems

##### 5.5.1 Aft Interstage Thermoconditioning and Purge System

The thermoconditioning and purge system functioned properly during countdown, maintaining the APS fuel and oxidizer temperatures constant up to liftoff within the design limits of  $87 \pm 5^{\circ}\text{F}$ . The module 1 oxidizer and module 2 fuel temperatures were maintained at  $91.5^{\circ}\text{F}$ , and the module 1 fuel and module 2 oxidizer temperatures were constant at  $88^{\circ}\text{F}$ .

##### 5.5.2 Common Bulkhead Vacuum Monitor System

At 0702 GMT on 27 February a gas sample of the common bulkhead was taken. The sample gas composition (listed below) indicated a satisfactory internal atmosphere. The vacuum supply valves were opened at 1.5 psia. Evacuation of the bulkhead continued until 1630 GMT, at which time the vacuum supply valves were closed because of a scrub in the count. Evacuation of the bulkhead was resumed at 0715

on 2 March, at which time the internal pressure was 1.50 psia, and continued until the start of LOX loading (0815 on 3 March) when the vacuum supply valves were closed with an internal pressure of 0.3 psia. At the completion of LH2 loading, the internal pressure was 0.2 psia; and at liftoff the pressure was essentially zero (0.05 psia).

Gas Sample Composition

O2	2.2%
Ar	85.1%
CO2	0.7%
H2	None
He	0.014%
N2	11.9%

5.6 Atmospheric Conditions

The atmospheric conditions for the AS-504 launch on 3 March are presented in table 5-5.

TABLE 5-1

## S-IVB-504N STAGE PROPELLANT LOADING DATA

Parameter	LOX	LH2
Chilldown initiated (GMT)	0741	1115
Slow fill		
Levels (percent)	0 to 5	0 to 5
Initiation time (GMT)	0815:50	1205:25
Maximum swing arm pressure (psia)	48.0	52.0
Maximum ullage pressure (psia)	22.7	20.0
Fast fill		
Levels (percent)	5 to 96	5 to 96
Initiation time (GMT)	0816:40	1212:24
Flowrate (gpm)	900 to 950	2,500 to 3,000
Swing arm pressure		
Maximum (psia)	50.0	37.0
Stabilized (psia)	50.0	31.0
Maximum ullage pressure (psia)	17.0	17.0
Final slow fill		
Level at initiation (percent)	96	94
Initiation time (GMT)	0836:21	1236:15
Swing arm pressure (psia)	25.0	18.0
Maximum ullage pressure (psia)	16.4	16.0
Total time required (min)	22	38

TABLE 5-2

## APS LOADING DATA

Item	Volume (in <sup>3</sup> )	Temperature (deg R)
Module 1		
Oxidizer system		
Loaded	4,102	536
Off loaded	280	536
Final mass (lbm)	198	---
Fuel system		
Loaded	4,102	534
Offloaded	100	534
Final mass (lbm)	125.5	---
Module 2		
Oxidizer system		
Loaded	4,102	536
Offloaded	280	536
Final mass (lbm)	198	---
Fuel system		
Loaded	4,102	530
Offloaded	100	530
Final mass (lbm)	126.2	---

TABLE 5-3

## SPHERE PRESSURIZATION DATA

Sphere	Volume (ft <sup>3</sup> )	Final Pressurization		Initial Pressure (psia)	Final Pressure (psia)	Pressure at Liftoff (psia)	Temperature at Liftoff (deg R)	Mass at Liftoff (lbm)
		Initiation Time	Required Time					
Ambient Helium								
LOX Tank Repress	9.0	T -7 hrs	6 min	1,580	3,035	3,125	470	20.1
LH2 Tank Repress	27.0	T -7 hrs	6 min	1,580	3,030	3,110	477	59.2
Control	4.5	T -7 hrs	6 min	1,560	3,025	3,080	532	3.8
Cold Helium	31.5	74% LH2	19 min	1,370	3,050	3,100	39.0	379
APS Helium								
Module 1	0.535	T -7 hrs	3 min	80	2,995	3,070	548	1.02
Module 2	0.535	T -7 hrs	3 min	60	2,995	3,060	549	1.01
Engine Control	0.578	T -7 hrs	10 sec	1,615	3,050	3,100	281	2.04
Engine GH2 Start	4.224	T -5 min 30 sec	Approx 5 sec	1,127	1,260	1,308	275	3.55

TABLE 5-4  
AS-504N TERMINAL COUNTDOWN SEQUENCE

Time From Liftoff	Sequence
-1198.3	Engine start sphere purge initiated
-899.4	Engine thrust chamber purge initiated
-869.2	Engine start sphere purge terminated
-868.5	Engine start sphere chilldown initiated
-599.6	Engine thrust chamber purge terminated
-598.8	Engine thrust chamber chilldown initiated
-299.5	LH2 chilldown initiated
-298.4	Engine start sphere fill terminated
-297.4	Engine control sphere supply closed
-287.3	LOX chilldown initiated
-284.1	LH2 prevalve closed
-284.1	LOX prevalve closed
-269.5	Cold helium crossover valve closed
-185.1	LH2 fill and drain valve closed
-184.7	LOX fill and drain valve closed
-166.6	LOX tank vent closed
-166.6	LOX tank prepressurization initiated
-145.3	LOX tank prepressurization terminated
-96.6	LH2 tank vent closed
-96.2	LH2 tank prepressurization initiated
-84.0	LH2 tank prepressurization terminated
-39.8	LH2 directional vent to flight position
-8.8	Engine thrust chamber chilldown terminated
0	Commit and liftoff (16:00:00 GMT)

TABLE 5-5  
ATMOSPHERIC CONDITIONS DURING AS-504 LAUNCH

TIME (GMT)	AMBIENT TEMPERATURE (deg R.)	DEW POINT (deg F)	WIND DIRECTION (deg from N)	WIND VELOCITY (kno's)	ATMOSPHERIC PRESSURE (inches of Mercury)
0700	55	46	360	11	29.83
0800	55	47	350	13	29.83
0900	55	48	350	10	29.82
1000	55	49	350	13	29.83
1100	55	49	360	12	29.82
1200	55	49	10	13	29.81
1300	58	52	10	12	29.82
1400	62	54	20	7	29.80
1500	66	54	10	12	29.81
1600	67	54	140	12	29.80

## 6.0 COST PLUS INCENTIVE FEE

### 6.1 Flight Mission Accomplishment

Flight data evaluated to establish Preconditions of Flight (PCF) and End Conditions of Flight (ECF) were obtained from observed trajectory and attitude data transmitted by magnetic tape and printout to MDAC-WD from MSFC as requested in Douglas Report DAC-56334B, Douglas S-IVB Stage Data Acquisition Requirements Document for Saturn V Flights, June 1968 revision.

AS-504 predicted and actual PCF are presented in table 6-1. All PCF with the exception of inertial velocity were within allowable tolerances. Tables 6-2 and 6-3 compare actual End Conditions of Flight (ECF) with allowable tolerances as defined for the MDAC-WD position (Parking orbit injection) and MSFC position (Intermediate orbit injection). All ECF parameters are within the allowable tolerances of both positions.

### 6.2 Telemetry Performance

Evaluation of the telemetry performance indicated that the telemetry system operated at 99.3 percent efficiency during the telemetry performance evaluation period (TPEP) phase I (liftoff to first S-IVB engine cutoff plus 10 sec) and phase II (liftoff to planned LV/SC separation).

The results of the telemetry performance analysis are shown in table 6-4.



TABLE 6-1

S-IVB-504 PRECONDITIONS OF FLIGHT (PCF)  
(S-II/S-IVB SEPARATION COMMAND)

<u>PARAMETER</u>	<u>UNITS</u>	<u>NOMINAL</u>	<u>ACTUAL</u>	<u>ALLOWABLE DEVIATION</u>	<u>ACTUAL DEVIATION</u>
Range	KM	1,544.0	1,544.2	+59.8 -71.3	0.2
Crossrange	KM	24.0	24.45	+3.1 -3.5	0.45
Altitude	KM	189.2	186.67	+4.6 -4.8	-2.53
Velocity Vector Magnitude	M/S	7,022.0	6,937.9	+53.6 -72.5	-84.1*
Velocity Vector Direction (Path Angle from Local Horizontal)	deg	0.46	0.906	+0.55 -0.45	0.446
Velocity Vector Direction (Heading Azimuth from True North)	deg	81.90	81.907	+0.43 -0.50	0.007
Pitch Attitude	deg	-99.3	-96.3	+6.0	3.0
Pitch Rate	deg/sec	0.0	0.0	+1.5	0.0
Yaw Attitude	deg	0.2	0.1	+5.0	-0.1
Yaw Rate	deg/sec	0.0	0.0	+1.5	0.0
Roll Attitude	deg	0.0	-0.04	+5.0	-0.04
Roll Rate	deg/sec	0.0	0.0	+1.5	0.0

\* Out of Tolerance PCF Parameter.

TABLE 6-2 (Sheet 1 of 2)  
 S-IVB-504 END CONDITIONS OF FLIGHT (ECF)  
 MDAC-WD POSITION

A. Trajectory Parameters (Evaluated at Parking Orbit Insertion)

<u>PARAMETER</u>	<u>UNITS</u>	<u>NOMINAL</u>	<u>ACTUAL</u>	<u>ALLOWABLE DEVIATION</u>	<u>ACTUAL DEVIATION</u>
Velocity Vector Magnitude	M/S	7,793.059	7,793.933	+4.331 -4.723	0.874
Velocity Vector Direction (Path Angle from Local Horizontal)	deg	-0.0009	-0.0058	+0.0704 -0.0686	-0.0049
Altitude	KM	191.362	191.047	+1.418 -1.557	-0.315
Node	deg	123.1742	123.1416	+0.0935 -0.0953	-0.0326
Inclination	deg	32.5611	32.5517	+0.0607	-0.0094

TABLE 6-2 (Sheet 2 of 2)

S-IVB-504 END CONDITIONS OF FLIGHT  
MDAC-WD POSITION

B. Attitude Control Parameters

<u>PARAMETER</u>	<u>UNITS</u>	<u>ALLOWABLE ENVELOPE</u>	<u>MAXIMUM FLIGHT VALUE</u>
S-IVB First Burn Phase			
Pitch Attitude Error	deg	<u>+7.0</u>	2.1
Yaw Attitude Error	deg	<u>+7.0</u>	-1.1
Roll Attitude Error	deg	<u>+5.0</u>	0.9
Pitch Attitude Rate	deg/sec	<u>+3.0</u>	-1.25
Yaw Attitude Rate	deg/sec	<u>+3.0</u>	0.35
Roll Attitude Rate	deg/sec	<u>+1.5</u>	0.1
Orbital Phase from GCS to LM Physical Separation			
Pitch Attitude Error	deg	<u>+4.0</u>	2.74
Yaw Attitude Error	deg	<u>+4.0</u>	-2.28
Roll Attitude Error	deg	<u>+5.0</u>	1.06
Pitch Attitude Rate	deg/sec	<u>+1.5</u>	0.34
Yaw Attitude Rate	deg/sec	<u>+1.5</u>	0.32
Roll Attitude Rate	deg/sec	<u>+1.5</u>	0.24

TABLE 6-3 (Sheet 1 of 2)

S-IVB END CONDITIONS OF FLIGHT (ECF)

MSFC POSITION

A. Trajectory Parameters (Evaluated at Intermediate Orbit Injection)

<u>PARAMETER</u>	<u>UNITS</u>	<u>NOMINAL</u>	<u>ACTUAL</u>	<u>ALLOWABLE DEVIATION</u>	<u>ACTUAL DEVIATION</u>
Inclination	deg	32.490	32.302	+0.378 -0.374	-0.188
Node	deg	121.875	122.261	+0.885 -0.876	0.386
$C_3$	$M^2/S^2$	-49,978,997	-49,676,548	+718,011 -648,541	302,449
Eccentricity		0.1757	0.1807	+0.01183 -0.01065	0.0050

TABLE 6-3 (Sheet 2 of 2)

S-IVB-504 END CONDITIONS OF FLIGHT (ECF)  
MSFC POSITION

B. Attitude Control Parameters

<u>PARAMETERS</u>	<u>UNITS</u>	<u>ALLOWABLE ENVELOPE</u>	<u>MAXIMUM FLIGHT VALUE</u>
S-IVB First Burn Phase			
Pitch Attitude Error	deg	<u>+7.0</u>	2.1
Yaw Attitude Error	deg	<u>+7.0</u>	-1.1
Roll Attitude Error	deg	<u>+5.0</u>	0.9
Pitch Attitude Rate	deg/sec	<u>+3.0</u>	-1.25
Yaw Attitude Rate	deg/sec	<u>+3.0</u>	0.35
Roll Attitude Rate	deg/sec	<u>+1.5</u>	0.1
Parking and Intermediate Orbit Coast Phases (to Time Base 8)			
Pitch Attitude Error	deg	<u>+4.0</u>	2.79
Yaw Attitude Error	deg	<u>+4.0</u>	2.74
Roll Attitude Error	deg	<u>+5.0</u>	1.24
Pitch Attitude Rate	deg/sec	<u>+1.5</u>	0.34
Yaw Attitude Rate	deg/sec	<u>+1.5</u>	-0.38
Roll Attitude Rate	deg/sec	<u>+1.5</u>	0.24
S-IVB Second Burn Phase			
Pitch Attitude Error	deg	<u>+11.0</u>	-1.7
Yaw Attitude Error	deg	<u>+11.0</u>	-4.9
Roll Attitude Error	deg	<u>+2.5</u>	0.85
Pitch Attitude Rate	deg/sec	<u>+3.5</u>	1.8
Yaw Attitude Rate	deg/sec	<u>+3.5</u>	-1.6
Roll Attitude Rate	deg/sec	<u>+1.5</u>	0.15

TABLE 6-4 (Sheet 1 of 3)

FLIGHT TELEMETRY PERFORMANCE SUMMARY

<u>ITEM</u>	<u>DESCRIPTION</u>	<u>TOTAL</u>
1.	Total number of measurements listed in the S-IVB-504 Instrumentation Program and Components List, Drawing 1B43570, "AK" Change.	299
2.	Measurements known to be inoperative at start of automatic launch sequence.	8

The function of the following measurements is to monitor the output voltage of exploding bridge-wires (EBW) by means of pulse sensors during checkout. The pulse sensors are removed prior to launch, thus making the measurements inoperative during flight.

- K0141-411 Event - R/S 1 Pulse Sensor
- K0142-411 Event - R/S 2 Pulse Sensor
- K0149-404 Event - Ullage Jettison 1 P/S
- K0150-404 Event - Ullage Jettison 2 P/S
- K0169-404 Event - EBW Pulse Sensor OFF Indication
- K0176-404 Event - Ullage Rocket Ignition P/S 1 Ind.
- K0177-404 Event - Ullage Rocket Ignition P/S Ind.

The following measurement was listed in the IP&CL, and the capability to make the measurements existed on the stage. MSFC did not require the associated rate gyro installation; therefore, the measurement is inoperative.

- K0152-404 Event - Rate Gyro Wheel Speed OK Ind.

TABLE 6-4 (Sheet 2 of 3)

FLIGHT TELEMETRY PERFORMANCE SUMMARY

<u>ITEM</u>	<u>DESCRIPTION</u>	<u>TOTAL</u>
3.	Measurement failures prior to start of Automatic Launch Sequence.	0
	C0001-401 Temp - LH2 Turbine Inlet C0007-401 Temp - Engine Control Helium C0159-424 Temp - LOX Circ Rtn Line Tank Inlet	
4.	Measurements wholly transmitted landline to the Launch Control Center (LCC):	3
	D0545-407 Press - Common Bulkhead Internal H/W D0576-408 Press - Fuel Tank Ullage Umbilical H/W D0577-406 Press - Oxid Tank Ullage Umbilical H/W	
5.	The total number of measurements to be evaluated for incentive performance for both TPEP phase I and phase II is item 1 minus the sum of items 2, 3, and 4.	
6.	Measurements which were failures during TPEP phase I (Liftoff to first S-IVB engine cutoff plus 10 sec). Details regarding these measurement failures may be obtained in section 18 of this report.	2
	C0133-401 Temp - LOX Pump Discharge K0005-401 Event - Mainstage Control Solenoid	
7.	Measurements which were failures during TPEP phase II (Liftoff to planned LV/SC separation).	2

Both measurements which were failures during TPEP phase I are included as phase II failures because phase II encompasses phase I.

Calculation of phase I performance:

Item 5 minus item 6, divided by item 5, multiplied by 100, and rounded off to the nearest one-tenth of one percent.

$$\frac{285-2}{285} \times 100 = 99.3 \text{ percent}$$

TABLE 6-4 (Sheet 3 of 3)

FLIGHT TELEMETRY PERFORMANCE SUMMARY

<u>ITEM</u>	<u>DESCRIPTION</u>	<u>TOTAL</u>
-------------	--------------------	--------------

7. (continued)

Calculation of phase II performance:

Item 5 minus item 7, divided by item 5, multiplied by 100, and rounded off to the nearest one-tenth of one percent.

$$\frac{285-2}{285} \times 100 = 99.3 \text{ percent}$$

8. In addition to the failures noted above, a total of twelve measurements failed after the end of phase II. Nine of these failures occurred during third burn.

C0010-403	Temp - Engine Area Ambient
C0199-401	Temp - Thrust Chamber Jacket
C0200-401	Temp - Fuel Injection
C0392-403	Temp - Helium Heater Support 1
C2015-401	Temp - Crossover Duct External Wall #1
C2016-401	Temp - Crossover Duct External Wall #2
D0003-403	Press - Oxidizer Pump Inlet
D0104-403	Press - LH2 Press Module Inlet
G0003-401	Posit - Main Oxidizer Valve
G0004-401	Posit - Main Fuel Valve
K0157-401	Event - Mainstage OK Press Sw 2
K0159-401	Event - Mainstage OK Press Sw 2 Depress



## 7. TRAJECTORY

### 7.1 Comparison Between Actual and Preflight Predicted Trajectories

This section presents a comparison between the actual trajectory (based on tracking and telemetry data) and the preflight predicted trajectory. The predicted trajectory for the S-IC and S-II stages is the same as that presented in the Boeing launch vehicle operational trajectory. The S-IVB stage portion of the predicted trajectory is the same as that presented in the MDAC-WD final predicted trajectory (Memorandum No. A3-250-KACA-M-31). Tables 7-1 through 7-14 present a comparison of conditions at certain significant event times. Figures are presented comparing the actual and predicted values of attitude, surface range, crossrange position, crossrange velocity, inertial velocity, axial acceleration, inertial flight path evaluation angle, and inertial flight path azimuth angle for the S-IC/S-II, S-IVB first burn, S-IVB second burn, and S-IVB third burn phases of the mission. Figures 7-1 through 7-44 compare the actual and predicted histories for each trajectory parameter.

The AS-504 D mission actual trajectory showed low performance during the S-IC/S-II stage burns. At S-II/S-IVB separation command the trajectory can be characterized as being low, short, slow, and to the right, as presented in table 7-3. The lower-than-predicted S-IC and S-II stage performance caused the S-IVB stage to burn 11.24 sec longer than predicted in order to obtain the desired parking orbit. Trajectory conditions at parking orbit insertion are presented in table 7-5. SC/LV final separation occurred 97.5 sec earlier than predicted. Table 7-6 presents the conditions at SC/LV final separation. The comparison of conditions at S-IVB second engine start command and S-IVB second cutoff command are presented in tables 7-8 and 7-9, respectively. Conditions at S-IVB third engine start command are presented in table 7-12. Approximately 150 sec after S-IVB third engine start command the S-IVB stage LOX bleed valve failed to the open position, which resulted in a

partial loss of thrust for the remainder of the third burn. A corresponding failure of the LH2 bleed valve at approximately 193 sec after S-IVB third engine start command further deteriorated S-IVB stage engine performance for the duration of third burn. However, the third burn impulse was sufficient to accelerate the S-IVB to escape velocity and to inject the stage onto the desired solar orbit. Conditions at S-IVB third cutoff command are presented in table 7-13.

## 7.2 Powered Flight Simulated Trajectory Evaluation

A five-degrees-of-freedom trajectory simulation program employing a differential correction technique was used to find control parameter adjustments which would yield a trajectory simulation most closely fitting the observed trajectory in the least squares sense. The control parameters selected were engine thrust and weight flow data obtained from the engine system analysis and pitch and yaw thrust misalignment angles.

The deviations between the observed and simulated trajectories are shown in figures 7-45, 7-46, and 7-47 for first, second, and third burns, respectively. Thrust from the propulsion tape was increased by 0.54 percent for the first burn and by 1.26 percent for the second burn. For both first and second burns weight flow was constrained to match the propellant consumption of the best estimate mass simulation. Listed below is a table of predicted and actual thrust, weight flow, and specific impulse averages for all three burns.

<u>First Burn</u>	<u>Predicted*</u> <u>Average Value</u>	<u>Simulated*</u> <u>Average Value</u>
Thrust (lbf)	230,620	232,441
Weight Flow (lbm/sec)	541.02	546.46
Specific Impulse (sec)	426.44	425.45
<u>Second Burn</u>		
Thrust (lbf)	201,535	202,421
Weight Flow (lbm/sec)	469.25	474.31
Specific Impulse (sec)	429.59	427.05
<u>Third Burn</u>		
Thrust (lbf)	203,451	155,125
Weight Flow (lbm/sec)	474.00	373.09
Specific Impulse (sec)	429.25	414.30

\*Averages from 90 percent thrust to cutoff.

As can be seen from the above table, there are large deviations between predicted and actual thrust and weight flow during the third burn. These deviations were caused primarily by a large drop in thrust and weight flow

at the time of LOX bleed valve failure. The following table presents the average values of thrust, weight flow, and specific impulse for the periods of 90 percent thrust to LOX bleed valve failure and from 10X bleed valve failure to cutoff.

<u>Third Burn</u>	<u>Before LOX Bleed Valve Failure</u>	<u>After LOX Bleed Valve Failure</u>
Thrust (lbf)	199,483	129,142
Weight Flow (lbm/sec)	470.61	315.97
Specific Impulse (sec)	424.57	408.31

Due to the shape of the third burn thrust and weight flow profile, a unique solution for weight flow was not determined. The trajectory simulation analysis determined the level of third burn thrust before and after LOX bleed valve failure which most closely matched the observed trajectory using the shape of the flowrate profile as determined by engine analysis. The initial and final vehicle weights were constrained to best-estimate values. Thrust from the propulsion tape was increased by 1.63 percent before LOX bleed valve failure and decreased by 0.29 percent after LOX bleed valve failure. Weight flow from the propulsion tape was increased by 0.54 percent throughout the third burn.

The pitch and yaw thrust misalignment angles established by control system and trajectory analyses are shown below.

	<u>Control System Analysis</u>	<u>Trajectory Simulation</u>
<u>First Burn</u>		
Pitch Thrust Misalignment (deg)	0.30	-0.03
Yaw Thrust Misalignment (deg)	0.48	0.55
<u>Second Burn</u>		
Pitch Thrust Misalignment (deg)	0.26	0.01
Yaw Thrust Misalignment (deg)	0.55	0.67
<u>Third Burn</u>		
Pitch Thrust Misalignment (deg)	0.41	0.18
Yaw Thrust Misalignment (deg)	0.40	0.20

A positive thrust vector misalignment in the pitch plane causes a nose-above-commanded attitude, and a positive misalignment in the yaw plane causes a nose-left-of-commanded attitude, looking downrange.

The total vehicle weights as determined by trajectory best estimate mass simulation are compared with predicted at engine start command and engine cutoff command in the following table.

	<u>Predicted</u>	<u>Simulated*</u>
<u>First Burn</u>		
Engine Start Command	358,047 lbm	359,306 lbm
Engine Cutoff Command	297,540 lbm	292,249 lbm
<u>Second Burn</u>		
Engine Start Command	199,745 lbm	194,685 lbm
Engine Cutoff Command	171,158 lbm	166,129 lbm
<u>Third Burn</u>		
Engine Start Command	169,664 lbm	164,889 lbm
Engine Cutoff Command	55,328 lbm	75,411 lbm

\*Best estimate mass

The results of the postflight trajectory simulation can be applied to explain the deviation from predicted in the duration of the first burn. The table below itemizes the contributions of the various performance parameter deviations to the observed deviation of 11.24 sec in burn time.

<u>Parameter</u>	<u>Contribution to Burn Time Deviation (sec)</u>
Lower Stage Performance	10.0
Vehicle Weight at S-II/S-IVB Separation	1.8
S-IVB Engine Performance	-0.7
Total Explained	11.1
Total Unexplained	0.1

TABLE 7-1  
AS-504  
CONDITIONS AT MAXIMUM DYNAMIC PRESSURE

<u>Parameter</u>		<u>Unit</u>	<u>Predicted</u>	<u>Actual</u>	<u>Deviation</u>
Time from Range Zero	(t)	sec	81.39	85.5	+4.11
Dynamic Pressure	(q)	lbf/ft <sup>2</sup>	686.2	617.9	-68.3
Altitude	(h)	ft	43,701	45,137	+1,436
Earth-Fixed Velocity	(V <sub>E</sub> )	ft/sec	1,666.1	1,737.7	+71.6
Mach Number	(M)	--	1.66	1.68	+0.02
Ambient Pressure	(Pa)	lbf/ft <sup>2</sup>	354.4	314.4	-40.0
Pitch Angle of Attack	(α)	deg	0.71	-0.91	-1.62
Yaw Angle of Attack	(β)	deg	0.05	4.52	+4.47

TABLE 7-2  
AS-504  
CONDITIONS AT S-IC/S-II SEPARATION COMMAND

<u>Parameter</u>		<u>Unit</u>	<u>Predicted</u>	<u>Actual</u>	<u>Deviation</u>
Time from Range Zero	(t)	sec	160.66	163.45	+2.79
Altitude	(h)	ft	223,145	213,540	-9,605
Surface Range	(S)	ft	312,246	318,452	+6,206
Crossrange Distance	( $Y_E$ )	ft	755	1,431	+676
Crossrange Velocity	( $\dot{Y}_E$ )	ft/sec	24.8	32.6	+7.8
Earth-Fixed Velocity	( $V_E$ )	ft/sec	7,929.4	7837.9	-91.5
Inertial Velocity	( $V_I$ )	ft/sec	9,142.0	9059.3	-82.7
Inertial Flight Path Elevation Angle	( $\gamma'_{1I}$ )	deg	19.508	18.449	-1.059
Inertial Flight Path Azimuth Angle	( $\gamma'_{2I}$ )	deg	75.268	75.337	+0.069
Dynamic Pressure	(q)	lbf/ft <sup>2</sup>	7.1	9.8	+2.7
Pitch Angle of Attack	( $\alpha$ )	deg	0.20	1.19	+0.99
Yaw Angle of Attack	( $\beta$ )	deg	0.01	1.41	+1.40

TABLE 7-3  
AS-504  
CONDITIONS AT S-II/S-IVB SEPARATION COMMAND

<u>Parameter</u>		<u>Unit</u>	<u>Predicted</u>	<u>Actual</u>	<u>Deviation</u>
Time from Range Zero	(t)	sec	531.95	537.18	+5.23
Altitude	(h)	ft	620,681	612,430	-8,251
Surface Range	(S)	ft	5,071,310	5,066,230	-5,080
Crossrange Distance	( $y_E$ )	ft	78,901	80,231	+1,330
Crossrange Velocity	( $\dot{y}_E$ )	ft/sec	561.3	555.9	-5.4
Earth-Fixed Velocity	( $V_E$ )	ft/sec	21,715.6	21,440.5	-275.1
Inertial Velocity	( $V_I$ )	ft/sec	23,037.9	22,762.3	-275.6
Inertial Flight Path Elevation Angle	( $\gamma'_{1I}$ )	deg	0.457	.906	+0.449
Inertial Flight Path Azimuth Angle	( $\gamma'_{2I}$ )	deg	81.901	81.907	+0.006



TABLE 7-4  
AS-504  
CONDITIONS AT S-IVB FIRST GUIDANCE CUTOFF COMMAND

<u>Parameter</u>		<u>Unit</u>	<u>Predicted</u>	<u>Actual</u>	<u>Deviation</u>
Time from Range Zero	(t)	sec	648.31	664.66	+16.35
Altitude	(h)	ft	627,468	626,776	-692
Surface Range	(S)	ft	7,652,996	7,879,354	+226,358
Crossrange Distance	( $Y_E$ )	ft	158,678	169,219	+10,541
Crossrange Velocity	( $\dot{Y}_E$ )	ft/sec	822.5	853.4	+30.9
Inertial Velocity	( $V_I$ )	ft/sec	25,561.4	25,564.0	+2.6
Inertial Flight Path Elevation Angle	( $\gamma'_{1I}$ )	deg	-0.001	0.000	+0.001
Inertial Flight Path Azimuth Angle	( $\gamma'_{2I}$ )	deg	86.531	86.979	+0.448

TABLE 7-5  
AS-504  
CONDITIONS AT PARKING ORBIT INSERTION

<u>Parameter</u>		<u>Unit</u>	<u>Predicted</u>	<u>Actual</u>	<u>Deviation</u>
Time from Range Zero	(t)	sec	658.31	674.66	+16.35
Altitude	(h)	ft	627,509	626,775	-734
Surface Range	(S)	ft	7,888,348	8,114,746	+226,398
Crossrange Distance	(Y <sub>E</sub> )	ft	166,989	177,836	+10,847
Crossrange Velocity	(Y' <sub>E</sub> )	ft/sec	839.7	870.6	+30.9
Inertial Velocity	(V <sub>I</sub> )	ft/sec	25,566.6	25,569.8	+3.2
Inertial Flight Path Elevation Angle	(γ' <sub>1I</sub> )	deg	-0.001	0.000	+0.001
Inertial Flight Path Azimuth Angle	(γ' <sub>2I</sub> )	deg	86.963	87.412	+0.449
Apogee Altitude*	(h <sub>a</sub> )	nmi	99.9	100.6	+0.7
Perigee Altitude*	(h <sub>p</sub> )	nmi	99.1	99.8	+0.7
Apogee Velocity	(V <sub>a</sub> )	ft/sec	25,572.4	25563.9	-8.5
Perigee Velocity	(V <sub>p</sub> )	ft/sec	25,569.3	25570.1	+0.8
Eccentricity	(e)	--	0.0001	0.0001	0.0000
Inclination	(i)	deg	32.561	32.552	-0.009
Period	(P)	min	88.18	88.20	+0.02
Descending Node	(θ <sub>n</sub> )	deg	123.174	123.142	-0.032
Orbit Energy	(C <sub>3</sub> )	m <sup>2</sup> /sec <sup>2</sup>	-60,738,898	-60,727,984	+10,914

\*Measured with respect to mean earth radius of 3,443.94 nmi.

TABLE 7-6  
AS-504  
CONDITION AT SC/LV FINAL SEPARATION

<u>Parameter</u>		<u>Unit</u>	<u>Predicted</u>	<u>Actual</u>	<u>Deviation</u>
Time from Range Zero	(t)	sec	14,982.51	14,885.00	-97.5
Altitude	(h)	ft	628,544	639,416	+10,872
Surface Range	(S)	ft	49,801,593	52,409,752	+2,608,159
Crossrange Distance	( $Y_E$ )	ft	-8,333,890	-7,126,402	+1,207,488
Crossrange Velocity	( $\dot{Y}_E$ )	ft/sec	-10,525.6	-11,529.7	-1,004.1
Inertial Velocity	( $V_I$ )	ft/sec	25,573.7	25,565.0	-8.9
Inertial Flight Path Elevation Angle	( $\gamma_{1I}^i$ )	deg	0.042	0.028	-0.014
Inertial Flight Path Azimuth Angle	( $\gamma_{2I}^i$ )	deg	58.948	60.373	+1.425
Apogee Altitude*	( $h_a$ )	nmi	113.3	112.5	-0.8
Perigee Altitude*	( $h_p$ )	nmi	102.4	104.1	+1.7
Apogee Velocity	( $V_a$ )	ft/sec	25,500.1	25,507.5	+7.4
Perigee Velocity	( $V_p$ )	ft/sec	25,579.0	25,568.0	-11.0
Eccentricity	(e)	--	0.0015	0.0011	-0.0004
Inclination	(i)	deg	32.597	32.584	-0.013
Period	(P)	min	88.49	88.51	+0.02
Descending Node	( $\theta_n$ )	deg	121.887	121.860	-0.017
Orbit Energy	( $C_3$ )	$m^2/sec^2$	-60,597,422	-60,589,118	+8,304

\*Measured with respect to a mean earth radius of 3,443.94 nmi.

TABLE 7-7  
AS-504  
CONDITIONS AT TIME BASE 6

<u>Parameter</u>	<u>Unit</u>	<u>Predicted</u>	<u>Actual</u>	<u>Deviation</u>
Time from Range Zero	(t) sec	16,569.26	16,577.24	+7.98
Altitude	(h) ft	664,842	663,829	-1,013
Surface Range	(S) ft	12,498,040	12,638,627	+140,587
Crossrange Distance	( $Y_E$ ) ft	-6,960,697	-7,032,176	-71,479
Crossrange Velocity	( $\dot{Y}_E$ ) ft/sec	12,390.0	12,348.7	-41.3
Inertial Velocity	( $V_I$ ) ft/sec	25,544.3	25,549.1	+4.8
Inertial Flight Path Elevation Angle	( $\gamma'_{1I}$ ) deg	0.006	0.000	-0.006
Inertial Flight Path Azimuth Angle	( $\gamma'_{2I}$ ) deg	88.834	88.623	-0.211
Apogee Altitude*	( $h_a$ ) nmi	106.1	107.2	+1.1
Perigee Altitude*	( $h_p$ ) nmi	105.2	106.0	+0.8
Apogee Velocity	( $V_a$ ) ft/sec	25,544.5	25,539.4	-5.1
Perigee Velocity	( $V_f$ ) ft/sec	25,550.6	25,548.3	-2.3
Eccentricity	(e) --	0.0001	0.0002	+0.0001
Inclination	(i) deg	32.560	32.551	-0.009
Period	(P) min	88.41	88.44	+0.03
Descending Node	( $\theta_n$ ) deg	121.774	121.743	-0.031
Orbit Energy	( $C_3$ ) $m^2/sec^2$	-60,635,348	-60,618,132	+17,216

\*Measured with respect to a mean earth radius of 3,443.94 nmi.

TABLE 7-8  
AS-504  
CONDITIONS AT S-IVB SECOND ENGINE START COMMAND

<u>Parameter</u>		<u>Unit</u>	<u>Predicted</u>	<u>Actual</u>	<u>Deviation</u>
Time from Range Zero	(t)	sec	17,139.26	17,147.20	+7.94
Altitude	(h)	ft	657,463	655,100	-2,363
Surface Range	(S)	ft	1,216,358	1,126,045	-90,313
Crossrange Distance	( $Y_E$ )	ft	1,236,598	1,158,293	-78,305
Crossrange Velocity	( $\dot{Y}_E$ )	ft/sec	15,351.9	15,367.5	+15.6
Inertial Velocity	( $V_I$ )	ft/sec	25,551.8	25,556.1	+4.3
Inertial Flight Path Elevation Angle	( $\gamma'_{1I}$ )	deg	-0.006	0.000	+0.006
Inertial Flight Path Azimuth Angle	( $\gamma'_{2I}$ )	deg	110.999	110.846	-0.153

TABLE 7-9  
AS-504  
CONDITIONS AT S-IVB SECOND CUTOFF COMMAND

<u>Parameter</u>		<u>Unit</u>	<u>Predicted</u>	<u>Actual</u>	<u>Deviation</u>
Time from Range Zero	(t)	sec	17,209.66	17,217.60	+7.94
Altitude	(h)	ft	660,180	657,154	-3,026
Surface Range	(S)	ft	2,753,585	2,627,188	-126,397
Crossrange Distance	( $Y_E$ )	ft	2,351,431	2,271,265	-80,166
Crossrange Velocity	( $\dot{Y}_E$ )	ft/sec	16,508.7	16,489.7	-19.0
Inertial Velocity	( $V_I$ )	ft/sec	27,666.9	27,742.0	+65.1
Inertial Flight Path Elevation Angle	( $\gamma'_{1I}$ )	deg	0.476	0.384	-0.093
Inertial Flight Path Azimuth Angle	( $\gamma'_{2I}$ )	deg	112.894	112.544	-0.350

TABLE 7-10  
AS-504  
CONDITIONS AT INTERMEDIATE ORBIT INSERTION

<u>Parameter</u>		<u>Unit</u>	<u>Predicted</u>	<u>Actual</u>	<u>Deviation</u>
Time from Range Zero	(t)	sec	17,219.66	17,227.60	+7.94
Altitude	(h)	ft	662,490	659,066	-3,424
Surface Range	(S)	ft	2,999,019	2,871,915	-127,104
Crossrange Distance	( $Y_E$ )	ft	2,516,469	2,436,419	-80,050
Crossrange Velocity	( $\dot{Y}_E$ )	ft/sec	16,494.7	16,480.3	-13.8
Inertial Velocity	( $V_I$ )	ft/sec	27,672.3	27,753.6	+81.3
Inertial Flight Path Evaluation Angle	( $\gamma'_{1I}$ )	deg	0.586	0.498	-0.088
Inertial Flight Path Angle	( $\gamma'_{2I}$ )	deg	113.188	112.841	-0.347
Apogee Altitude*	( $h_a$ )	nmi	1,602.4	1,671.6	+69.2
Perigee Altitude*	( $h_p$ )	nmi	106.0	105.8	-0.2
Apogee Velocity	( $V_a$ )	ft/sec	19,472.4	19,262.4	-210.0
Perigee Velocity	( $V_p$ )	ft/sec	27,680.6	27,759.4	+78.8
Eccentricity	(e)	---	0.1741	0.1807	+0.0066
Inclination	(i)	deg	32.446	32.302	-0.144
Period	( $\tau$ )	min	117.80	119.22	+1.42
Descending Node	( $\vartheta_n$ )	deg	121.975	122.261	+0.286
Orbit Energy	( $C_3$ )	$m^2/sec^2$	-50,075,375	-49,676,548	+399,371

\*Measured with respect to a mean earth radius of 3,445.94 nmi.

TABLE 7-11  
AS-504  
CONDITIONS AT TIME BASE 8

<u>Parameter</u>		<u>Unit</u>	<u>Predicted</u>	<u>Actual</u>	<u>Deviation</u>
Time from Range Zero	(t)	sec	21,572.26	21,580.98	+8.72
Altitude	(h)	ft	8,757,509	9,280,532	+523,023
Surface Range	(S)	ft	57,103,119	57,915,574	+812,455
Crossrange Distance	( $Y_E$ )	ft	-11,028,921	-10,395,223	+633,698
Crossrange Velocity	( $\dot{Y}_E$ )	ft/sec	-11,315.2	-11,432.9	-117.7
Inertial Velocity	( $V_I$ )	ft/sec	20,246.5	19,944.4	-302.1
Inertial Flight Path Elevation Angle	( $\gamma'_{1I}$ )	deg	-6.202	-6.018	+0.184
Inertial Flight Path Azimuth Angle	( $\gamma'_{2I}$ )	deg	58.946	59.507	+0.561
Apogee Altitude*	( $h_a$ )	nmi	1,600.7	1,670.0	+69.3
Perigee Altitude*	( $h_p$ )	nmi	114.2	113.6	-0.6
Apogee Velocity	( $V_a$ )	ft/sec	19,490.7	19,279.7	-211.0
Perigee Velocity	( $V_p$ )	ft/sec	27,633.6	27,714.6	+81.0
Eccentricity	(e)	---	0.1728	0.1795	+0.0067
Inclination	(i)	deg	32.457	32.312	-0.145
Period	(P)	min	117.93	119.35	+1.42
Descending Node	( $\theta_n$ )	deg	121.806	122.086	+0.280
Orbit Energy	( $C_3$ )	m <sup>2</sup> /sec <sup>2</sup>	-50,037,363	-49,640,805	+396,558

\*Measured with respect to a mean earth radius of 3,443.94 nmi.



TABLE 7-12

AS-504

CONDITIONS AT S-IVB GROUND COMMANDED THIRD  
ENGINE START COMMAND

<u>Parameter</u>		<u>Unit</u>	<u>Predicted</u>	<u>Actual</u>	<u>Deviation</u>
Time from Range Zero	(t)	sec	21,977.26	21,987.35	+10.09
Altitude	(h)	ft	7,686,331	8,235,624	+549,293
Surface Range	(S)	ft	51,863,336	52,890,589	+1,027,253
Crossrange Distance	( $Y_E$ )	ft	-15,143,254	-14,627,274	+515,980
Crossrange Velocity	( $\dot{Y}_E$ )	ft/sec	-8,820.9	-9,203.8	-382.9
Inertial Velocity	( $V_I$ )	ft/sec	21,106.4	20,766.0	-340.4
Inertial Flight Path Elevation Angle	( $\gamma'_{1I}$ )	deg	-8.357	-8.353	+0.004
Inertial Flight Path Azimuth Angle	( $\gamma'_{2I}$ )	deg	57.565	57.817	+0.252

TABLE 7-13  
AS-504  
CONDITIONS AT S-IVB THIRD CUTOFF COMMAND

<u>Parameter</u>		<u>Unit</u>	<u>Predicted</u>	<u>Actual</u>	<u>Deviation</u>
Time from Range Zero	(t)	sec	22,272.66	22,281.32	+8.66
Altitude	(h)	ft	6,995.993	7,491,466	+495,473
Surface Range	(S)	ft	46,560,168	47,969,707	+1,409,539
Crossrange Distance	( $Y_E$ )	ft	-18,165,730	-17,701,064	+464,666
Crossrange Velocity	( $\dot{Y}_E$ )	ft/sec	-14,294.9	-12,738.6	-1,556.3
Inertial Velocity	( $V_I$ )	ft/sec	36,620.1	31,589.2	-5,030.9
Inertial Flight Path Elevation Angle	( $\gamma'_{1I}$ )	deg	1.323	-1.007	-2.330
Inertial Flight Path Azimuth Angle	( $\gamma'_{2I}$ )	deg	56.574	56.509	-0.065

TABLE 7-14  
AS-504  
CONDITIONS AT ESCAPE ORBIT INJECTION

<u>Parameter</u>		<u>Unit</u>	<u>Predicted</u>	<u>Actual</u>	<u>Deviation</u>
Time from Range Zero	(t)	sec	22,282.66	22,291.32	+8.66
Altitude	(h)	ft	7,006,124	7,485,441	+479,317
Surface Range	(S)	ft	46,301,711	47,753,602	+1,451,891
Crossrange Distance	( $Y_E$ )	ft	-18,308,318	-17,826,894	+481,424
Crossrange Velocity	( $\dot{Y}_E$ )	ft/sec	-14,211.9	-12,665.3	-1,546.6
Inertial Velocity	( $V_I$ )	ft/sec	36,635.8	31,619.8	5,016.1
Inertial Flight Path Elevation Angle	( $\gamma'_{1I}$ )	deg	1.799	-0.678	-2.477
Inertial Flight Path Azimuth Angle	( $\gamma'_{2I}$ )	deg	56.654	56.555	-0.099
Perigee Altitude*	( $h_p$ )	nmi	1,149.2	1,231.2	+82.0
Perigee Velocity	( $V_p$ )	ft/sec	36,646.7	31,622.0	-5,024.7
Geocentric Radius	( $r_c$ )	ft	27,930,611	28,410,561	+479,950
Eccentricity	(e)	---	1.6626	1.0179	-0.6447
Inclination	(i)	deg	34.116	33.825	-0.291
Descending Node	( $\theta_n$ )	deg	122,176	122,228	+0.052
Orbit Energy	( $C_3$ )	$m^2/sec^2$	31,050,142	824,685	-30,225,457

\*Measured with respect to a mean earth radius of 3,443.94 nmi.

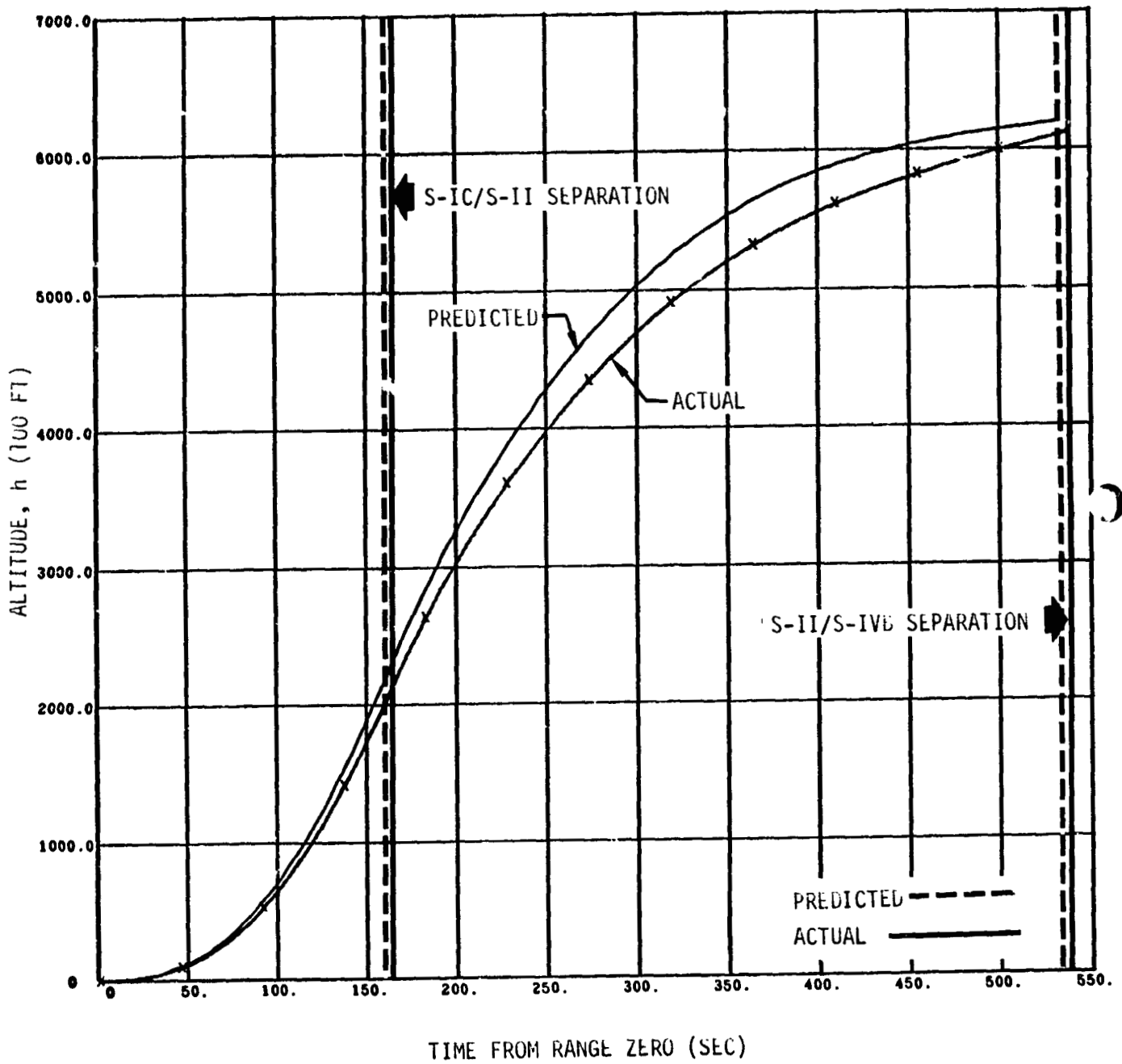

Figure 7-1 S-IC/S-II Stage Altitude History

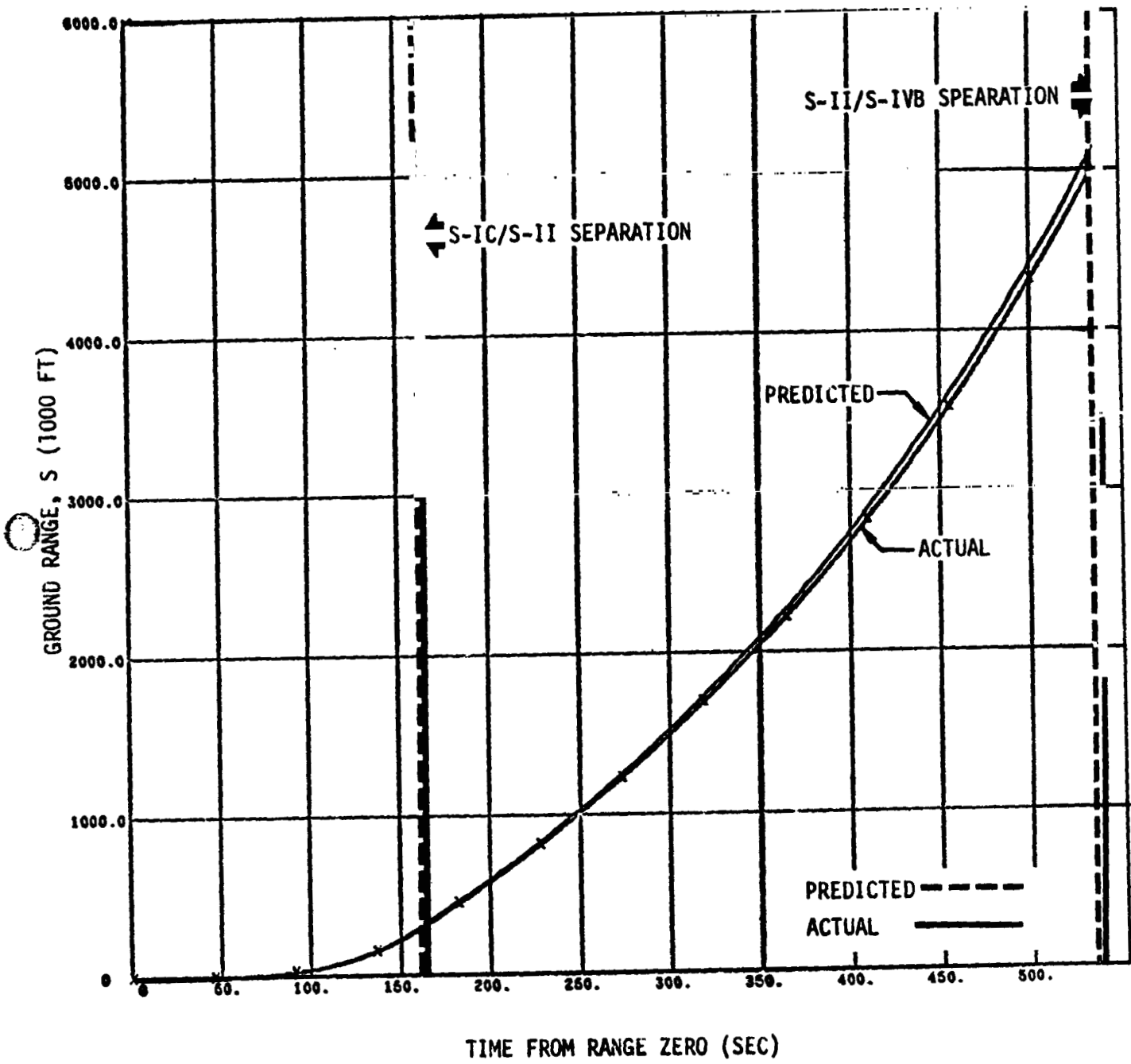

Figure 7-2 S-IC/S-II Stage Ground Range History

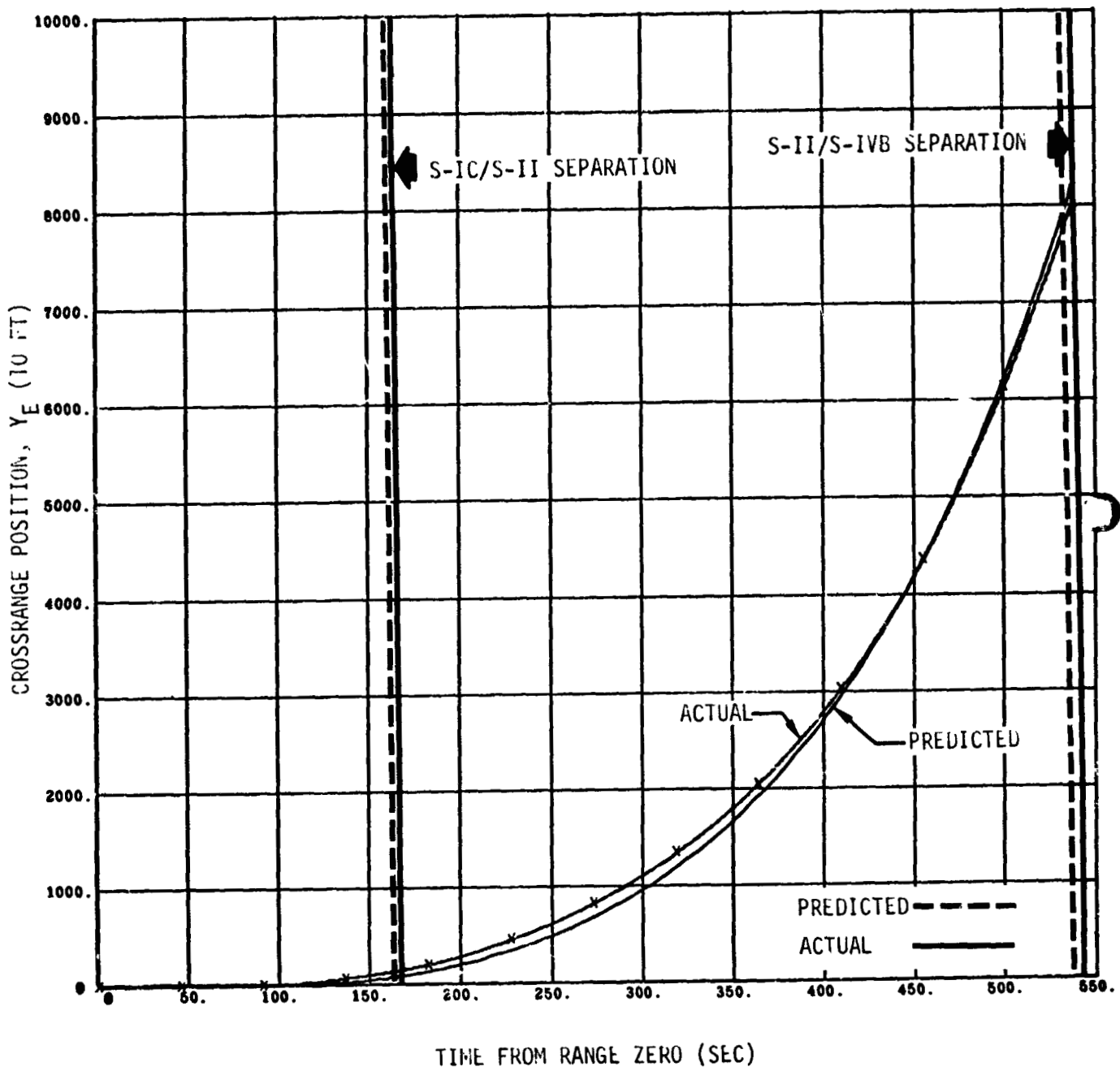

Figure 7-3 S-IC/S-II Stage Crossrange Position History

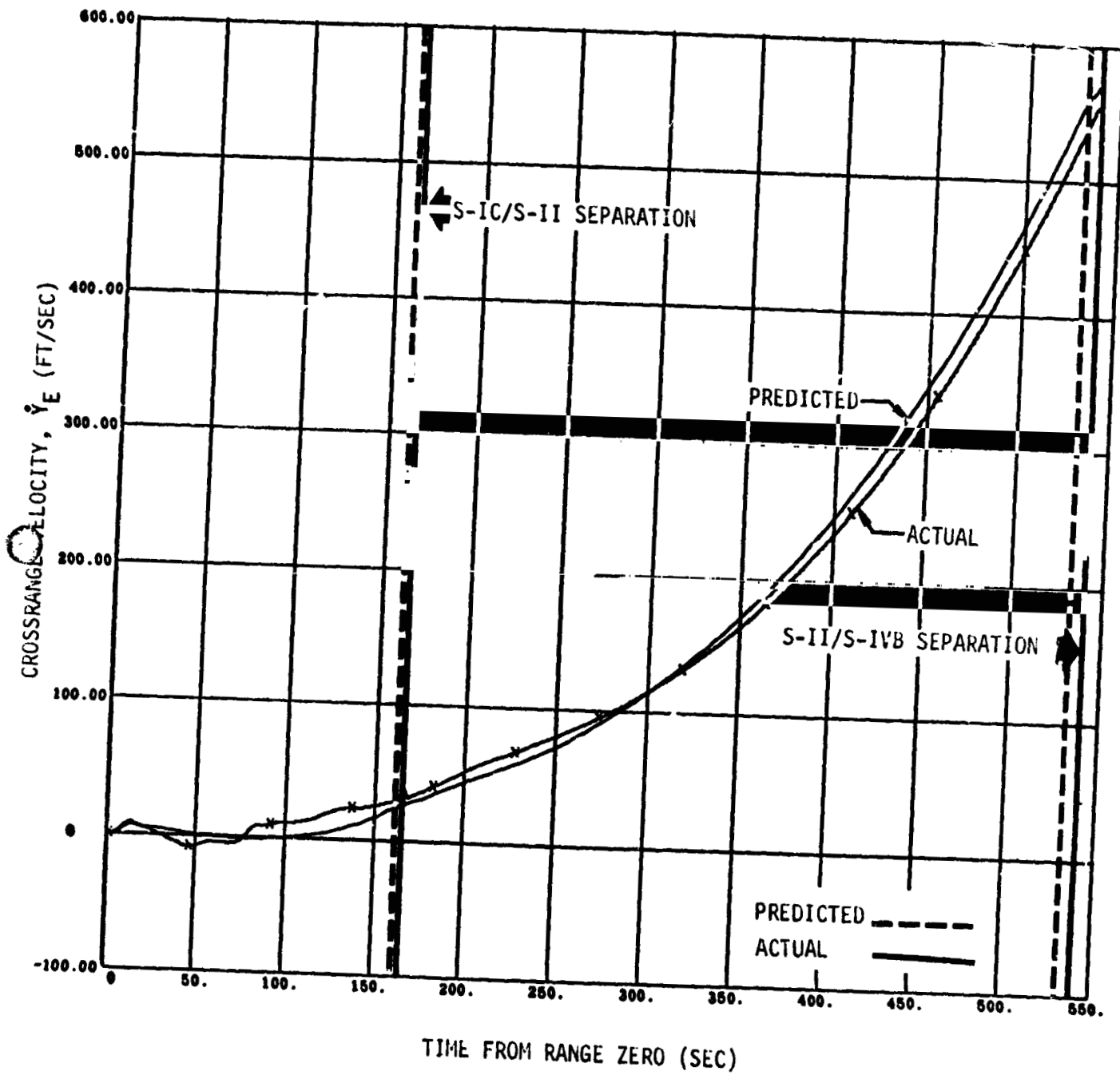

Figure 7-4 S-IC/S-II Stage Crossrange Velocity History

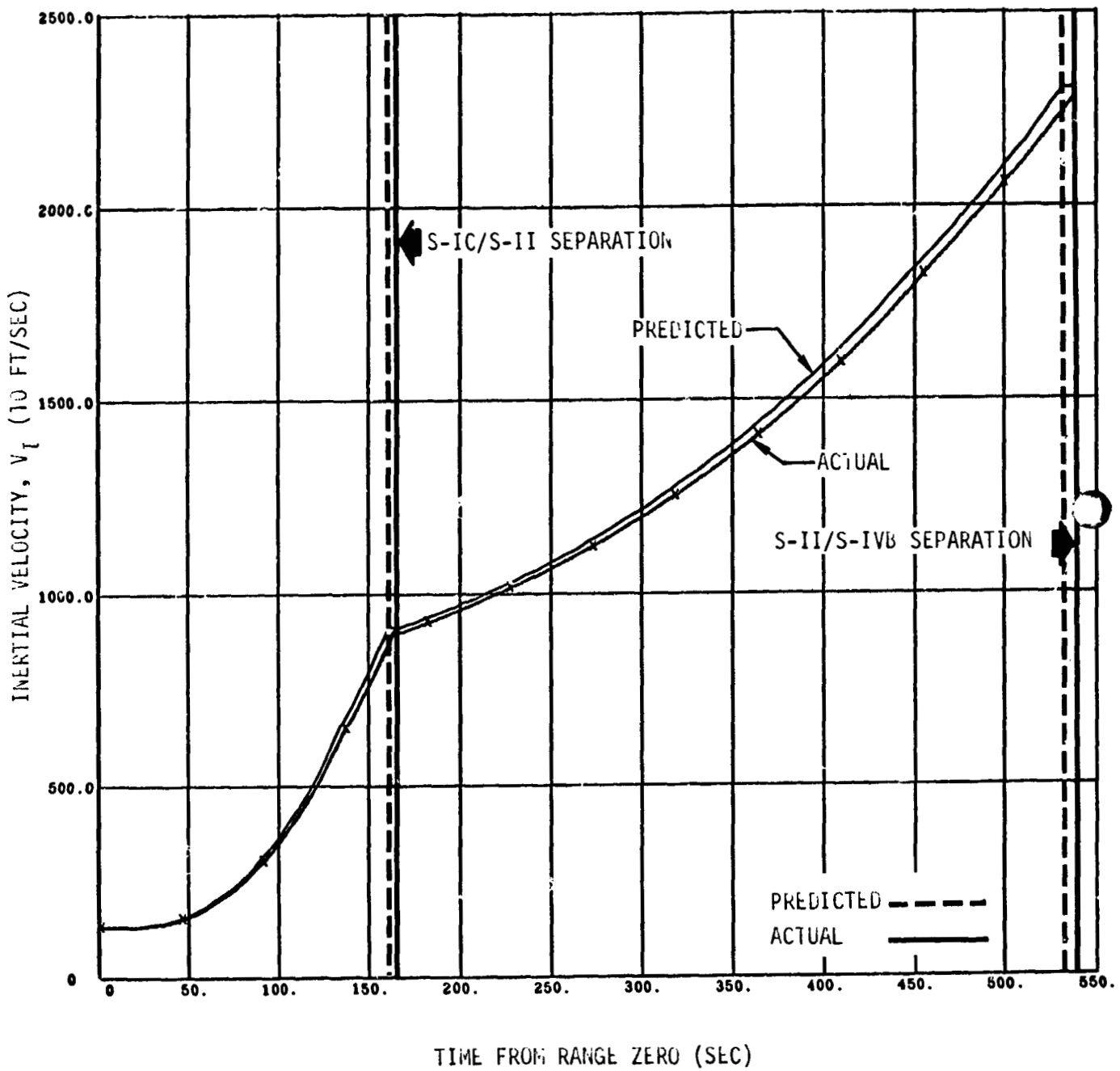

Figure 7-5 S-IC/S-II Stage Inertial Velocity History



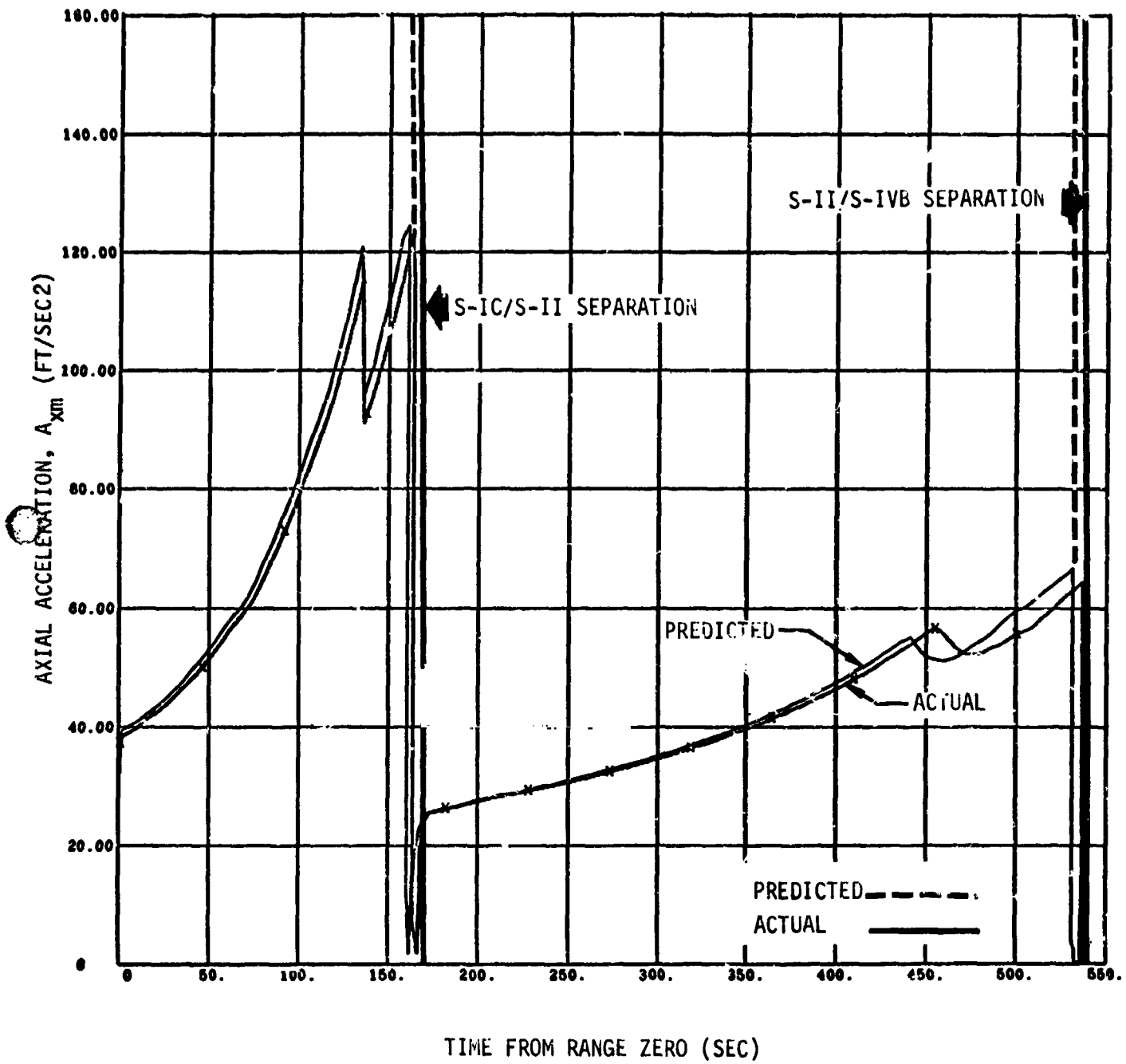

Figure 7-6 S-IC/S-II Stage Axial Acceleration History

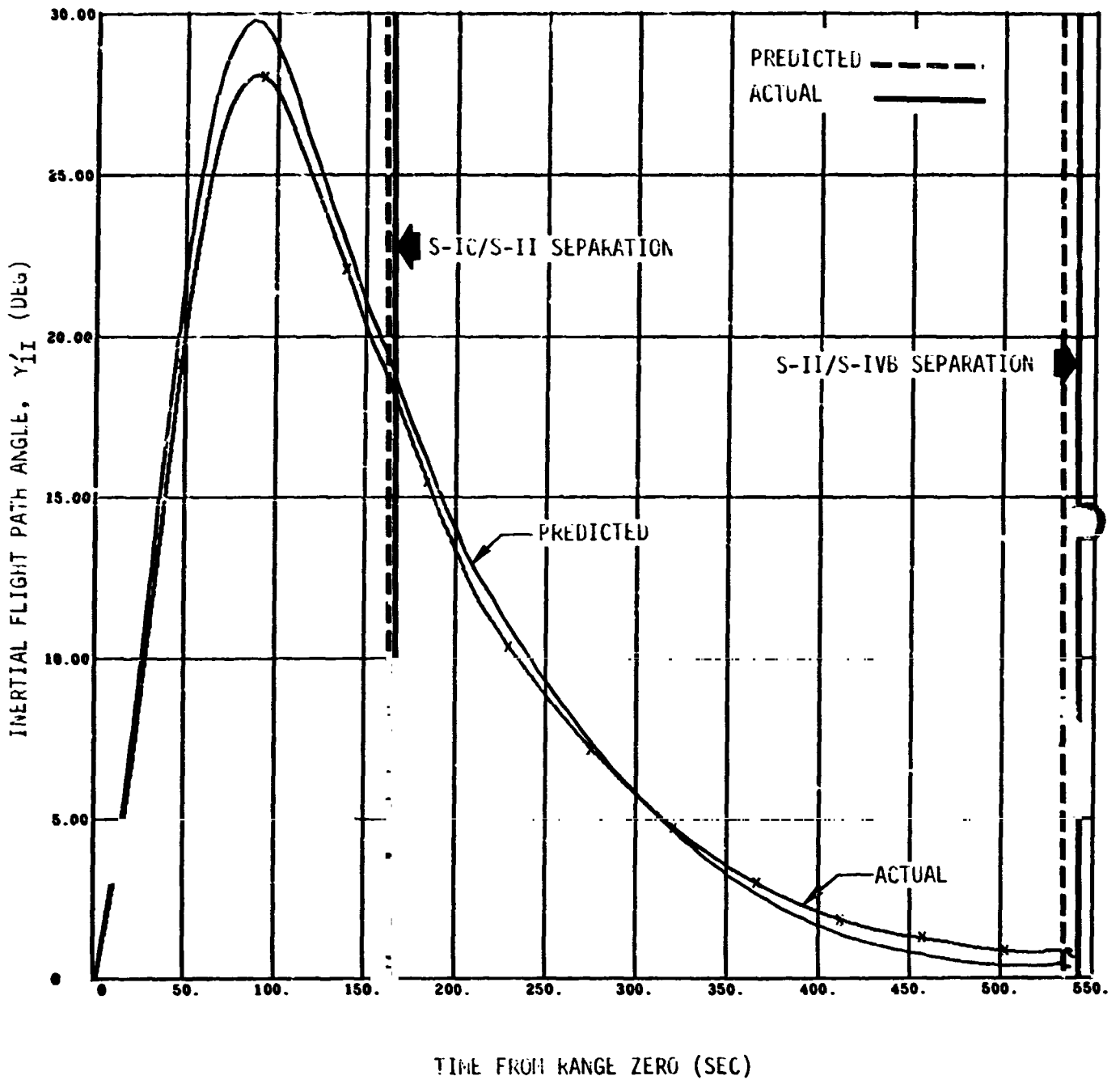

Figure 7-7 S-IC/S-II Stage Inertial Flight Path Elevation Angle History

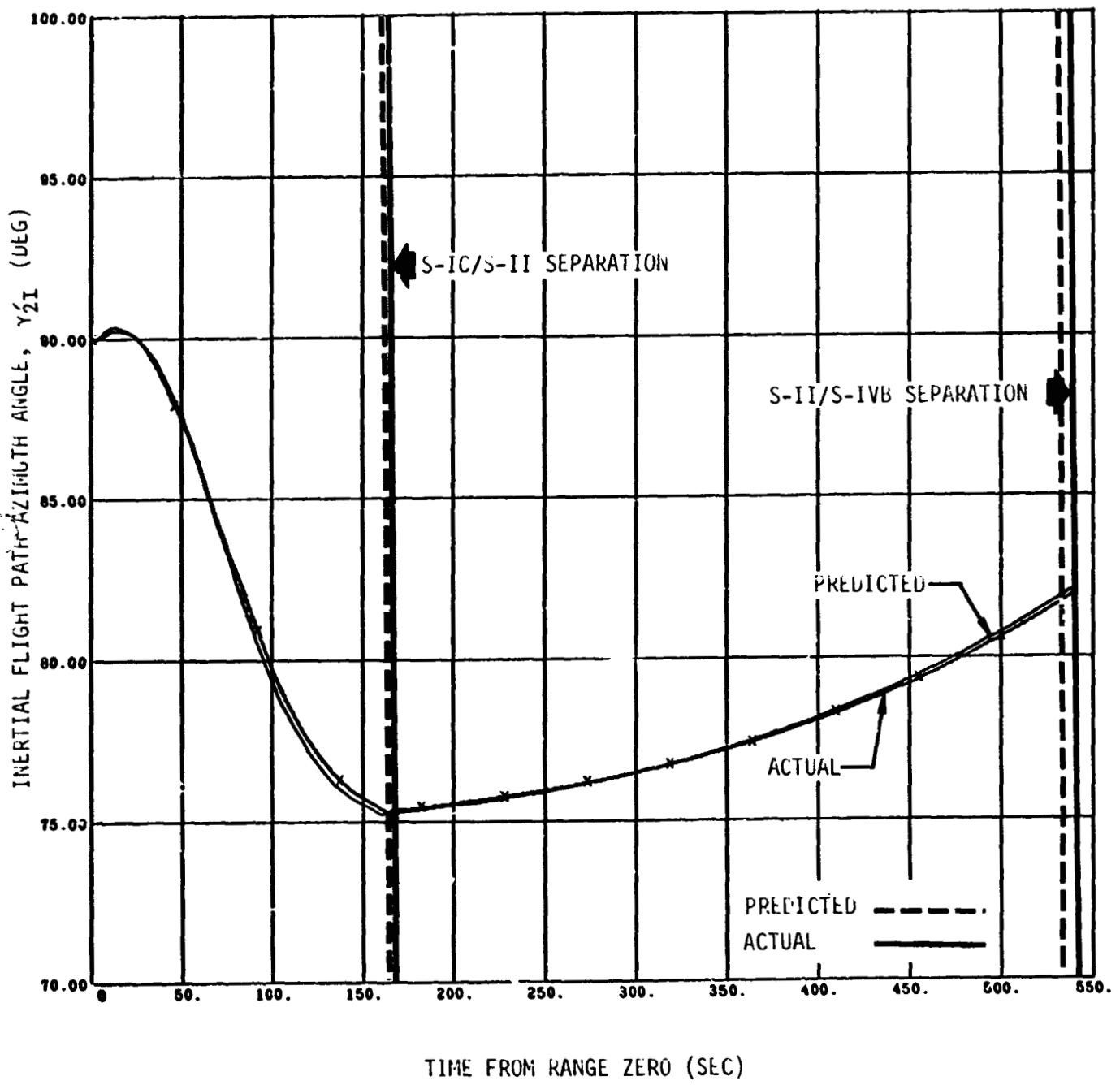

Figure 7-b S-IC/S-II Stage Inertial Flight Path Azimuth Angle History

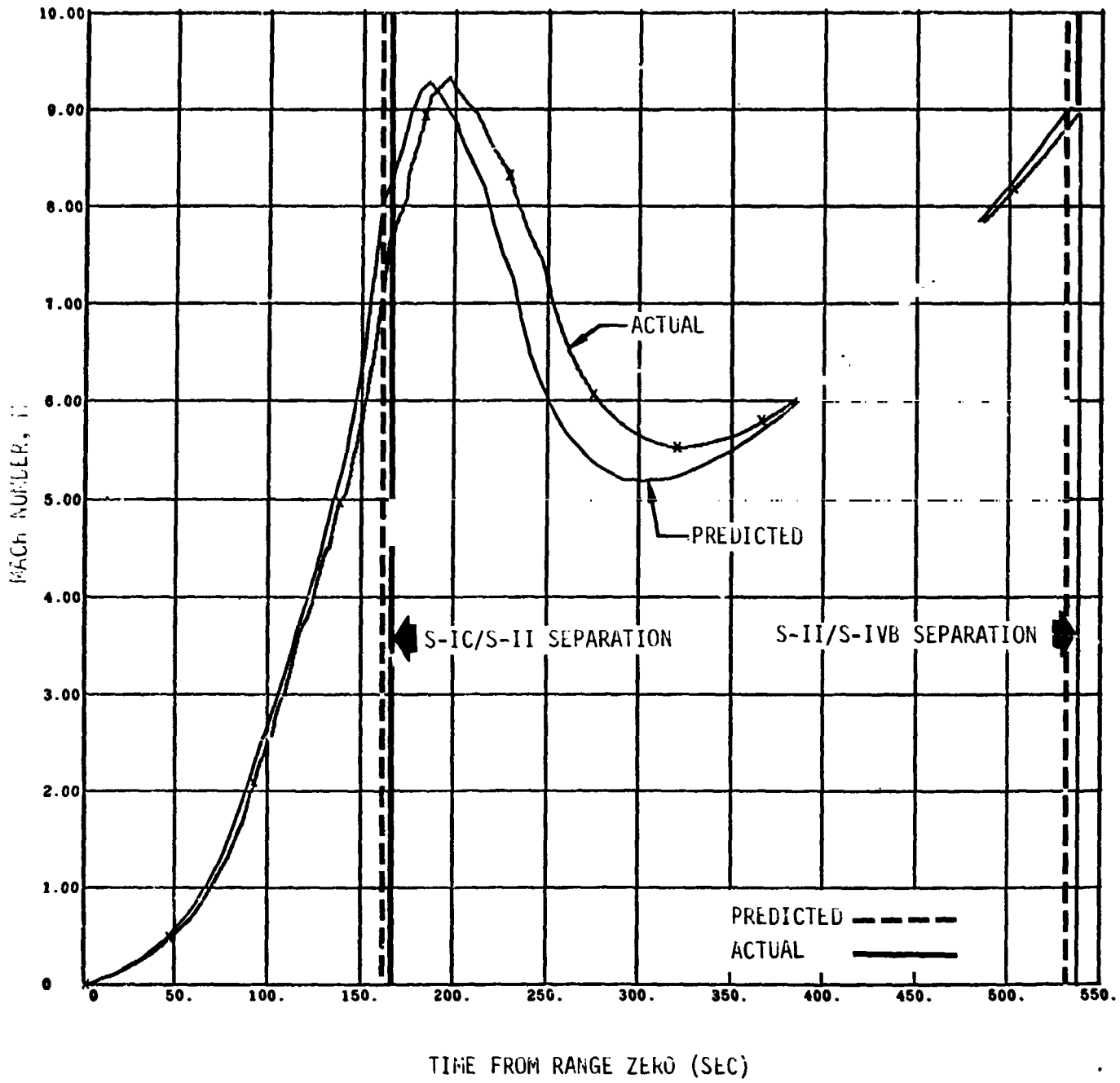

Figure 7-9 S-IC/S-II Stage Mach Number History

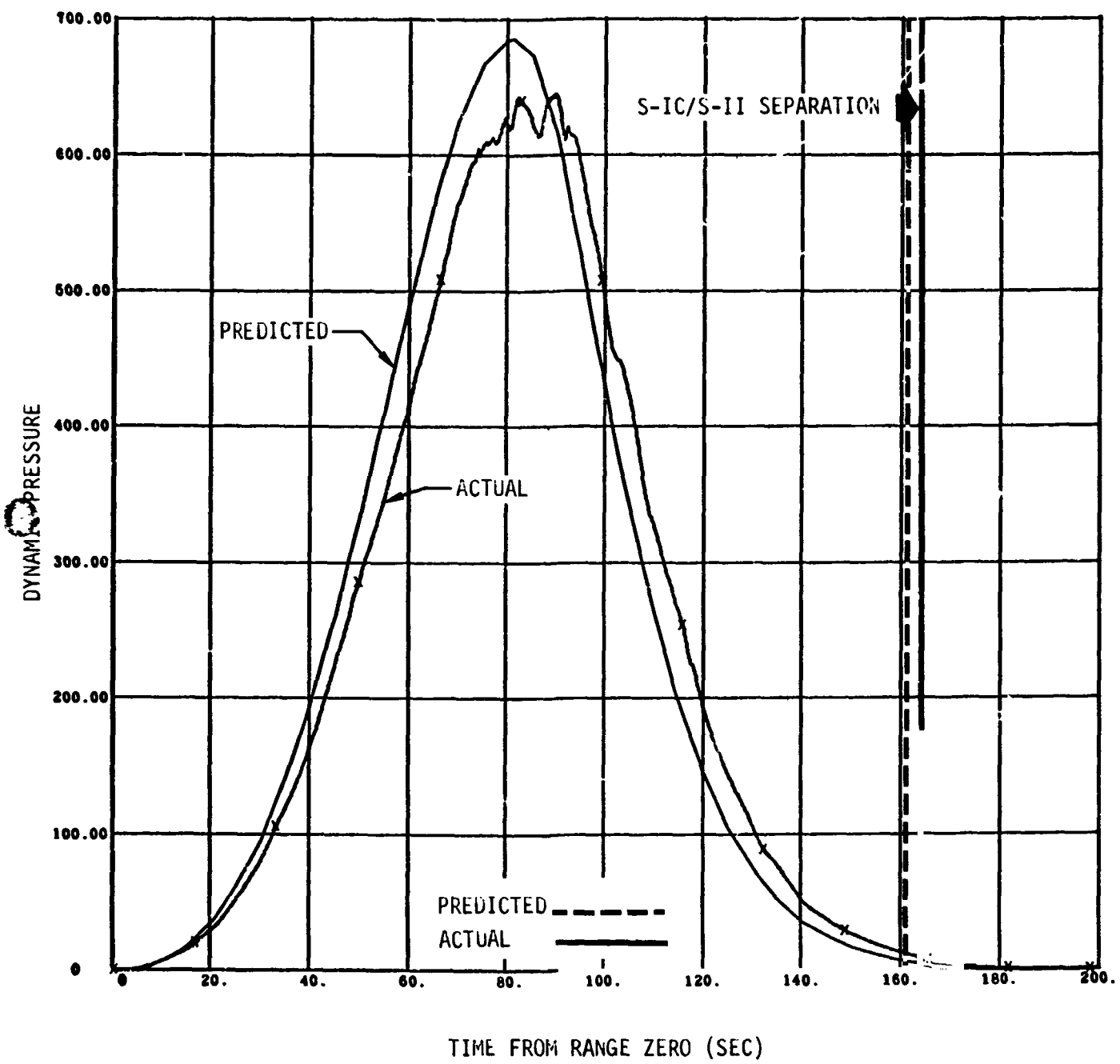

Figure 7-10 S-IC Stage Dynamic Pressure History

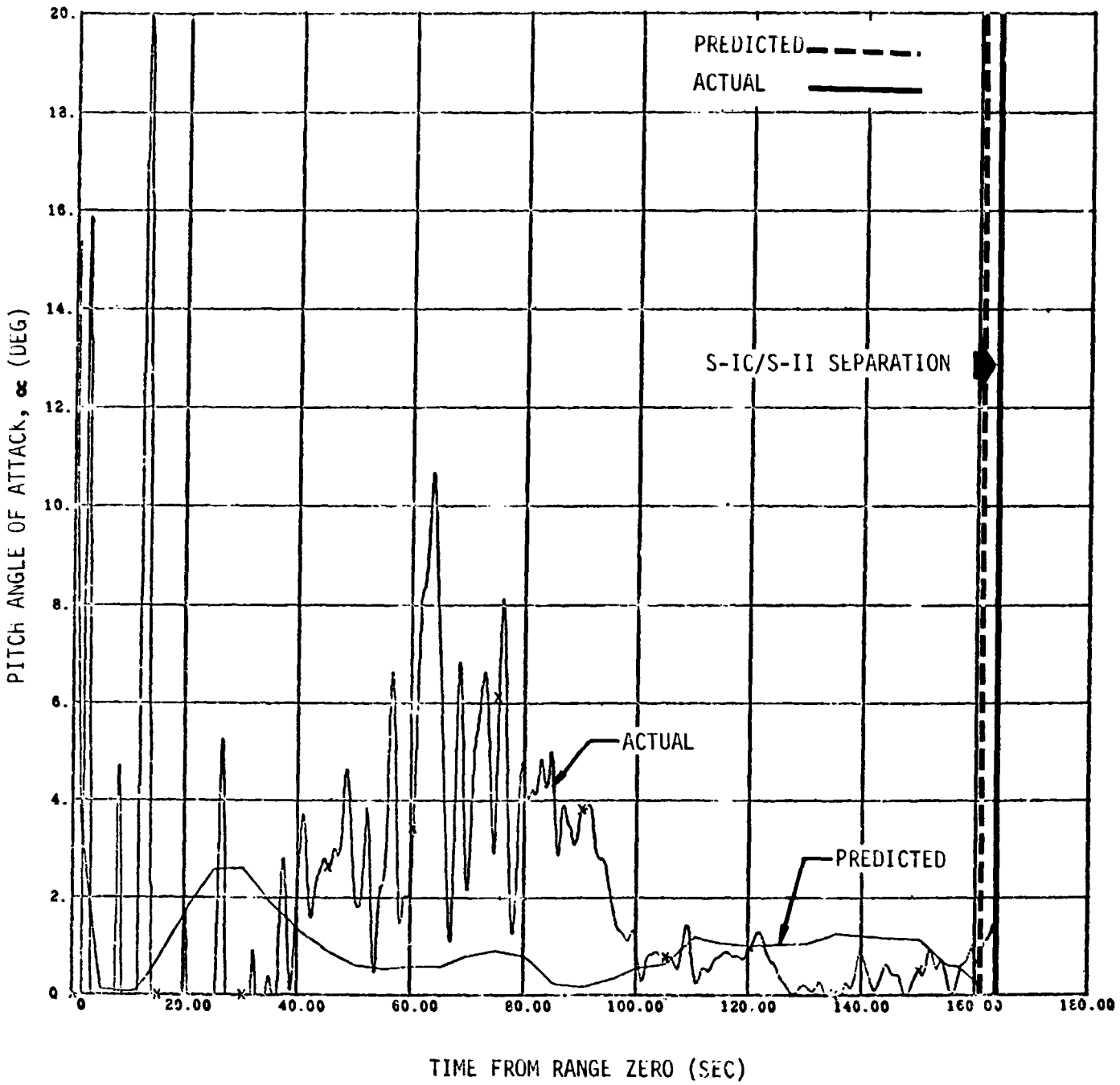

Figure 7-11 S-IC Stage Pitch Angle of Attack History

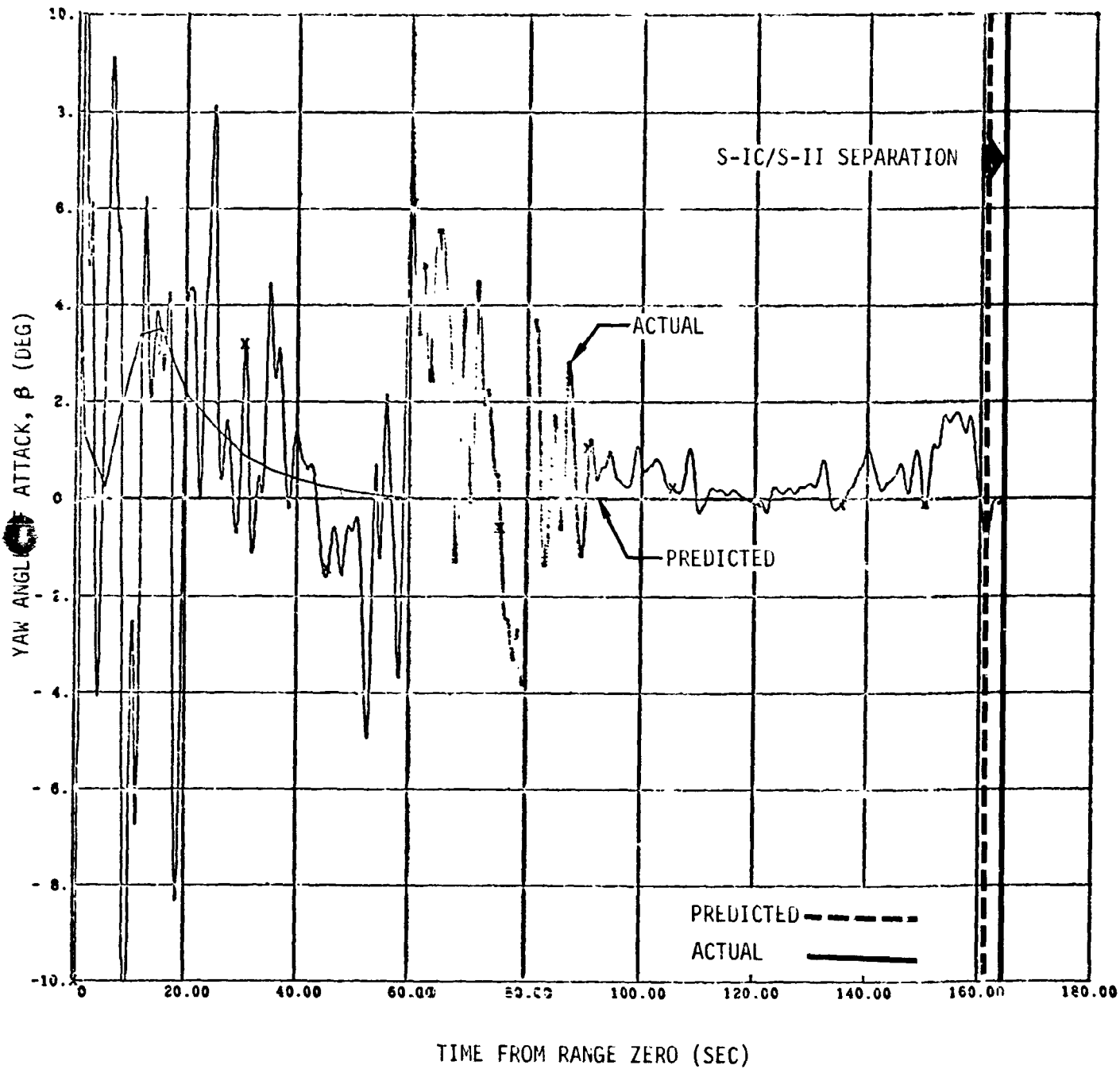

Figure 7-12 S-IC Stage Yaw Angle of Attack History

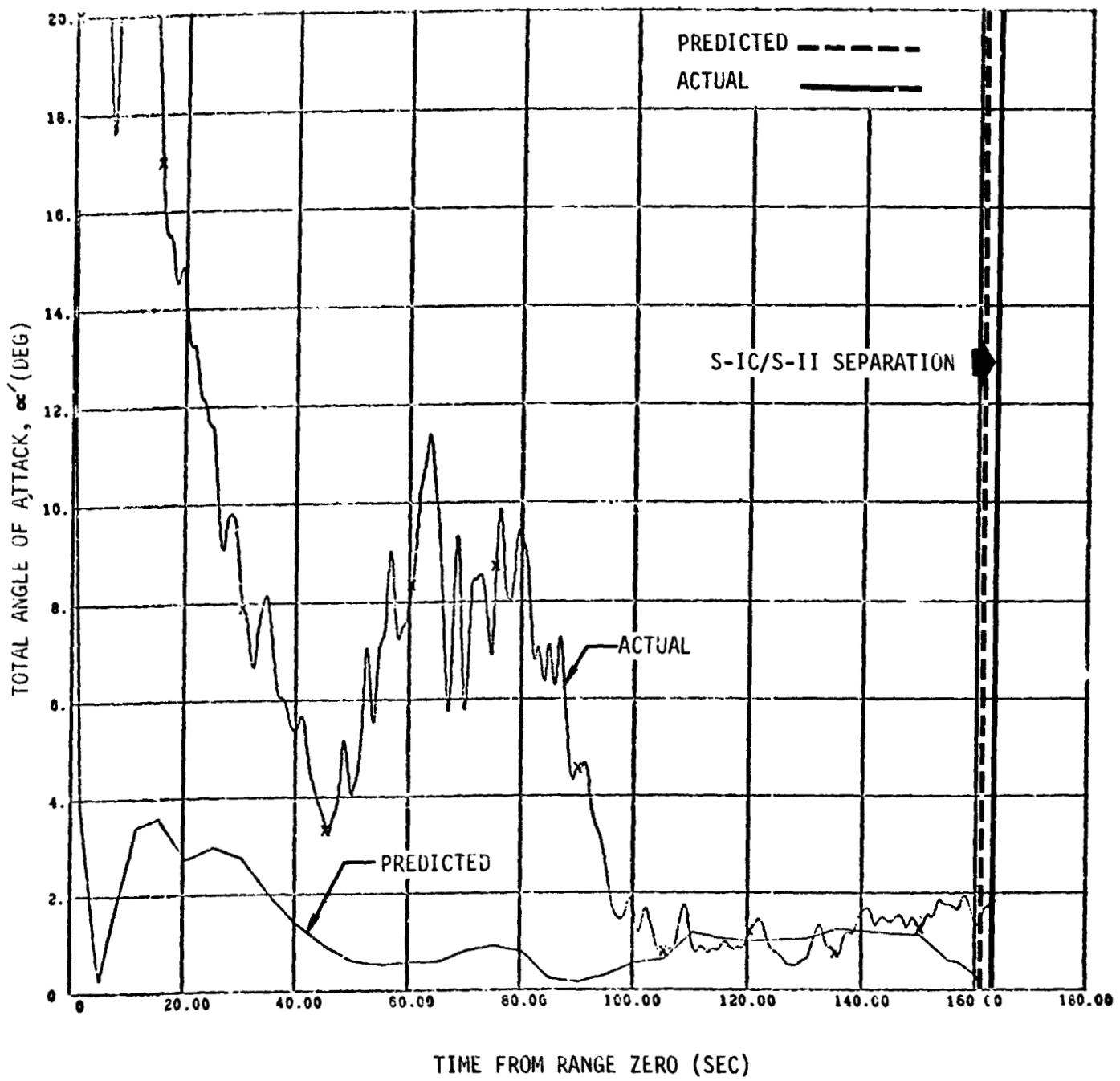

Figure 7-13 S-IC Stage Total Angle of Attack History



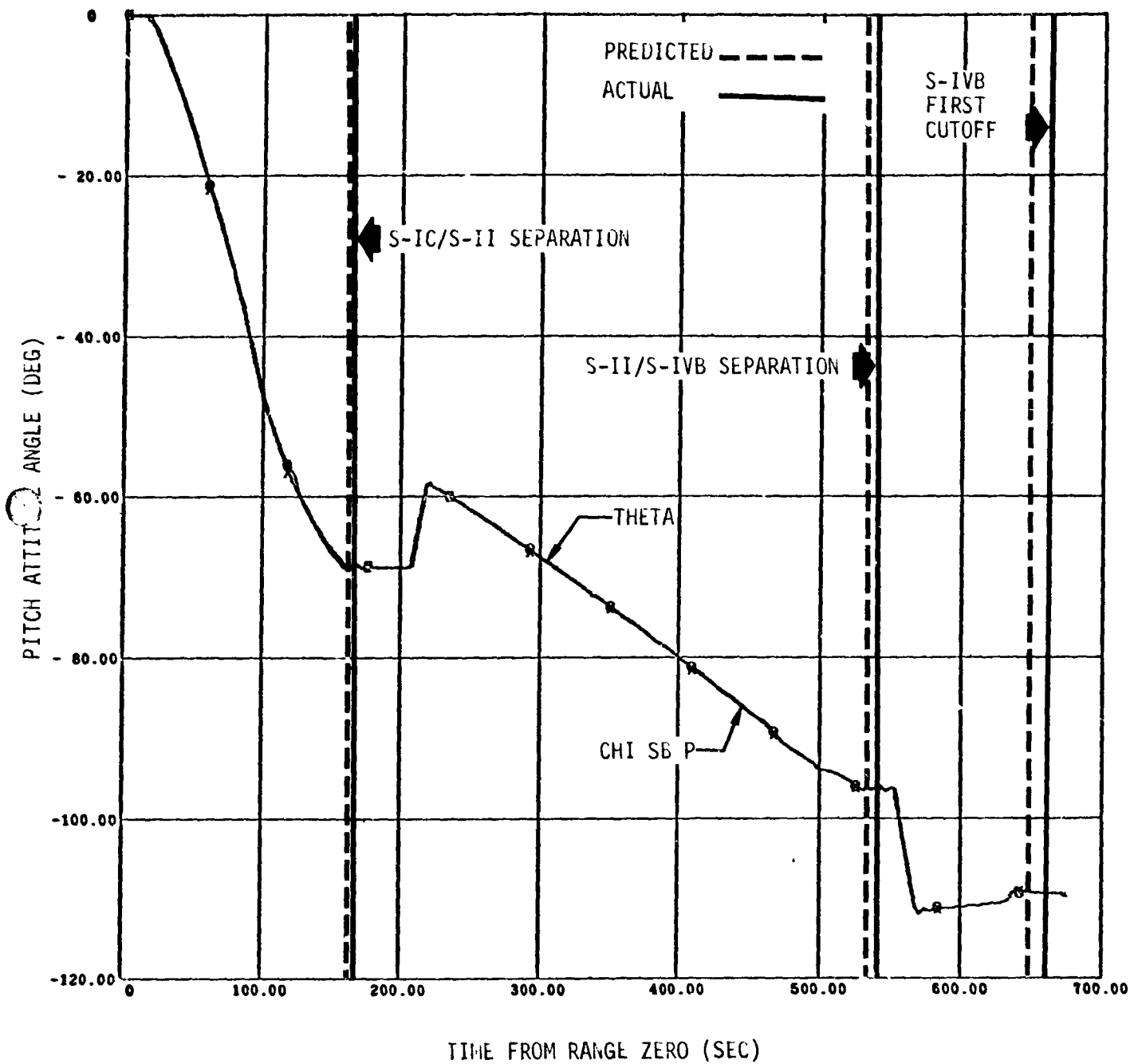

Figure 7-14 Boost Phase Pitch Attitude Angle History

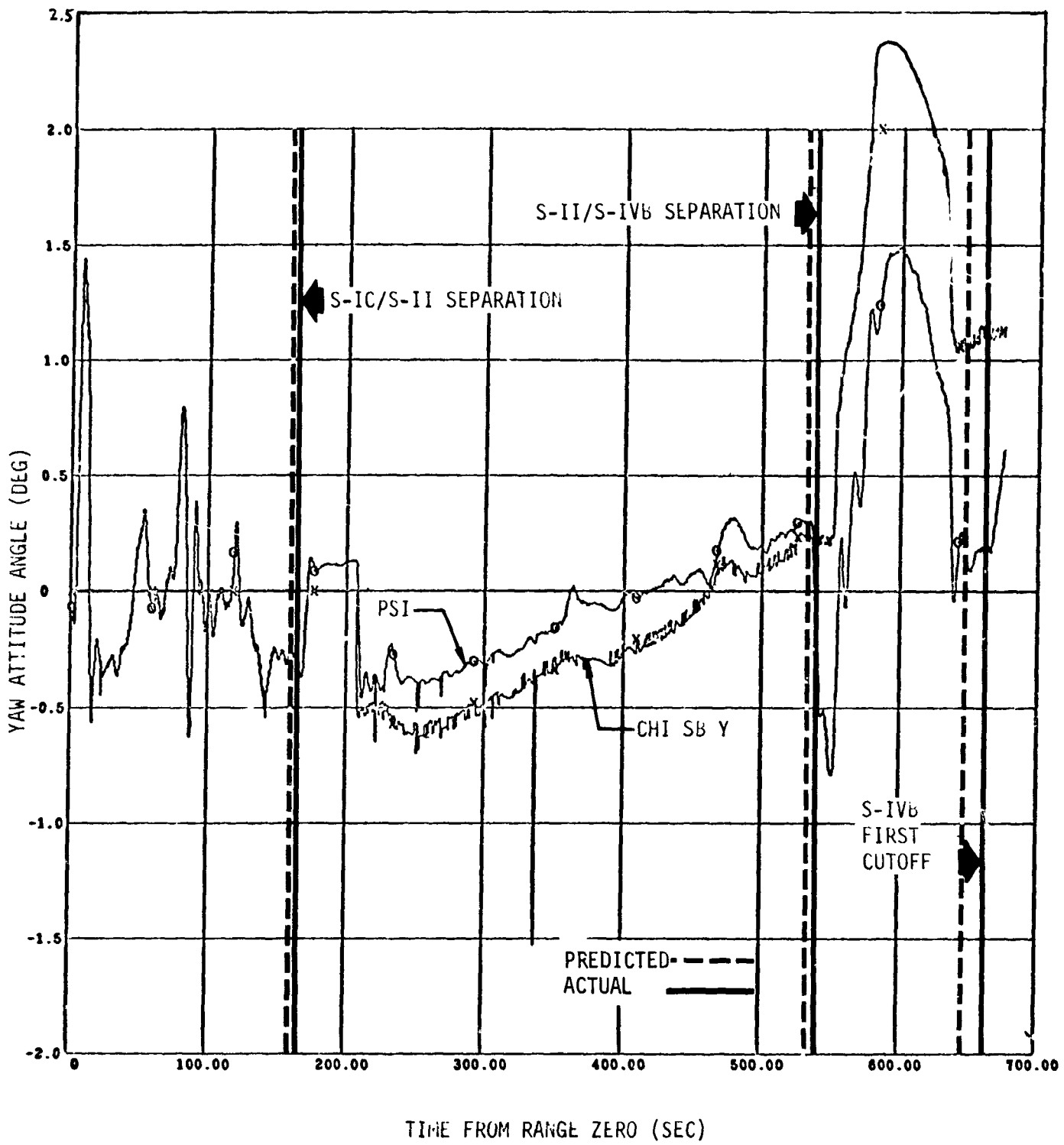

Figure 7-15 Boost Phase Yaw Attitude Angle History

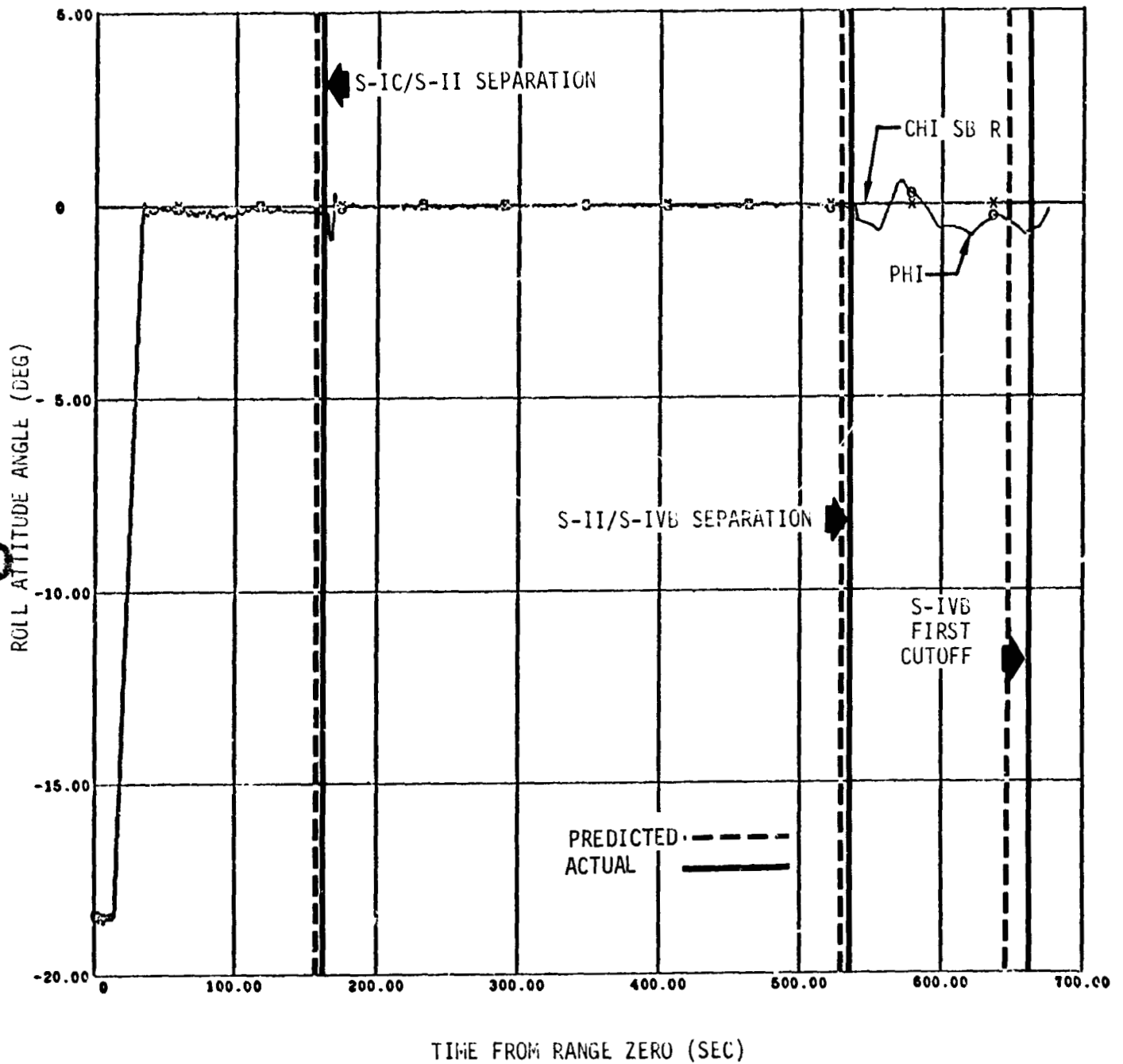

Figure 7-16 Boost Phase Roll Attitude Angle History

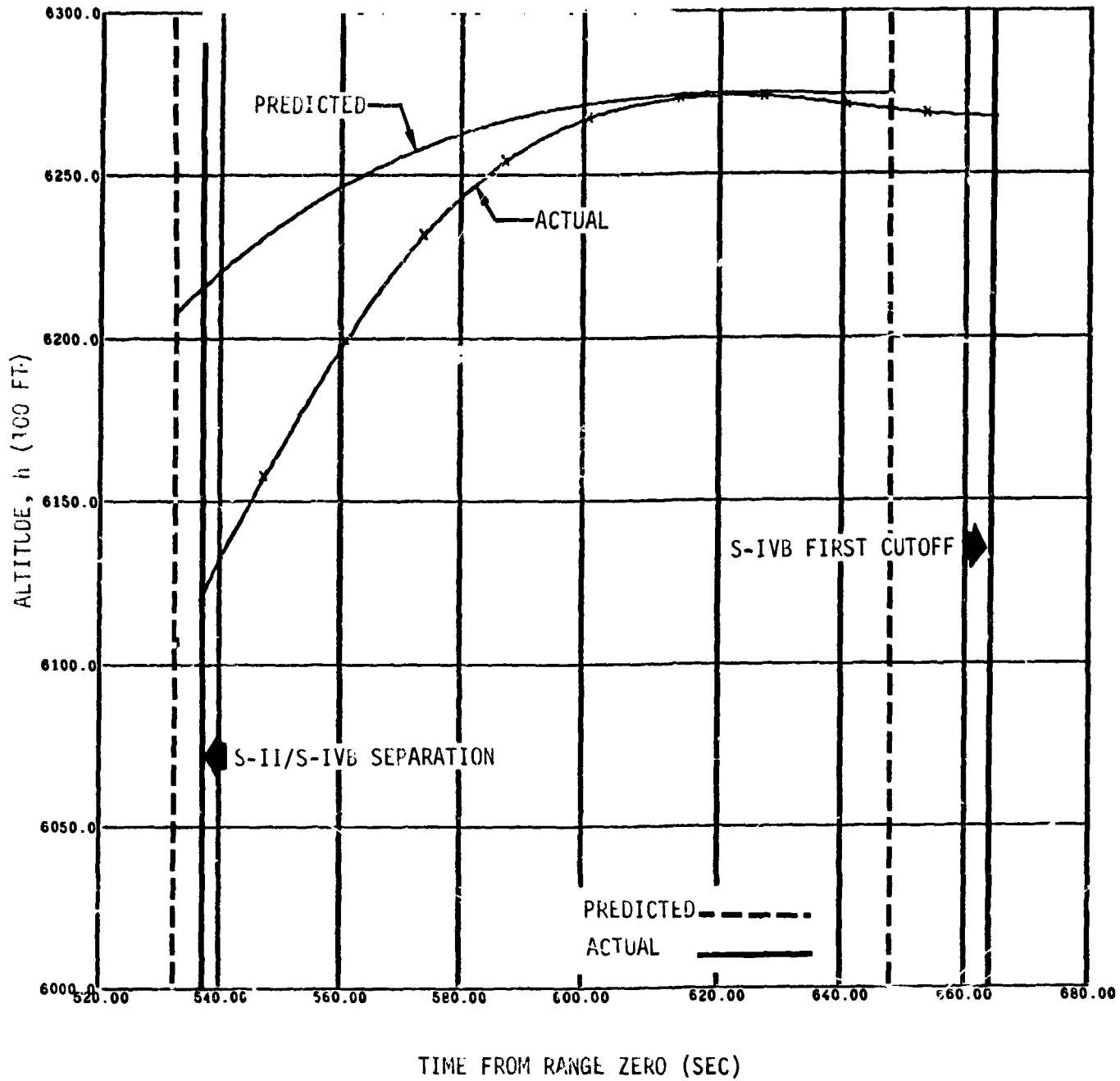

Figure 7-17 S-IVB Stage First Burn Altitude History

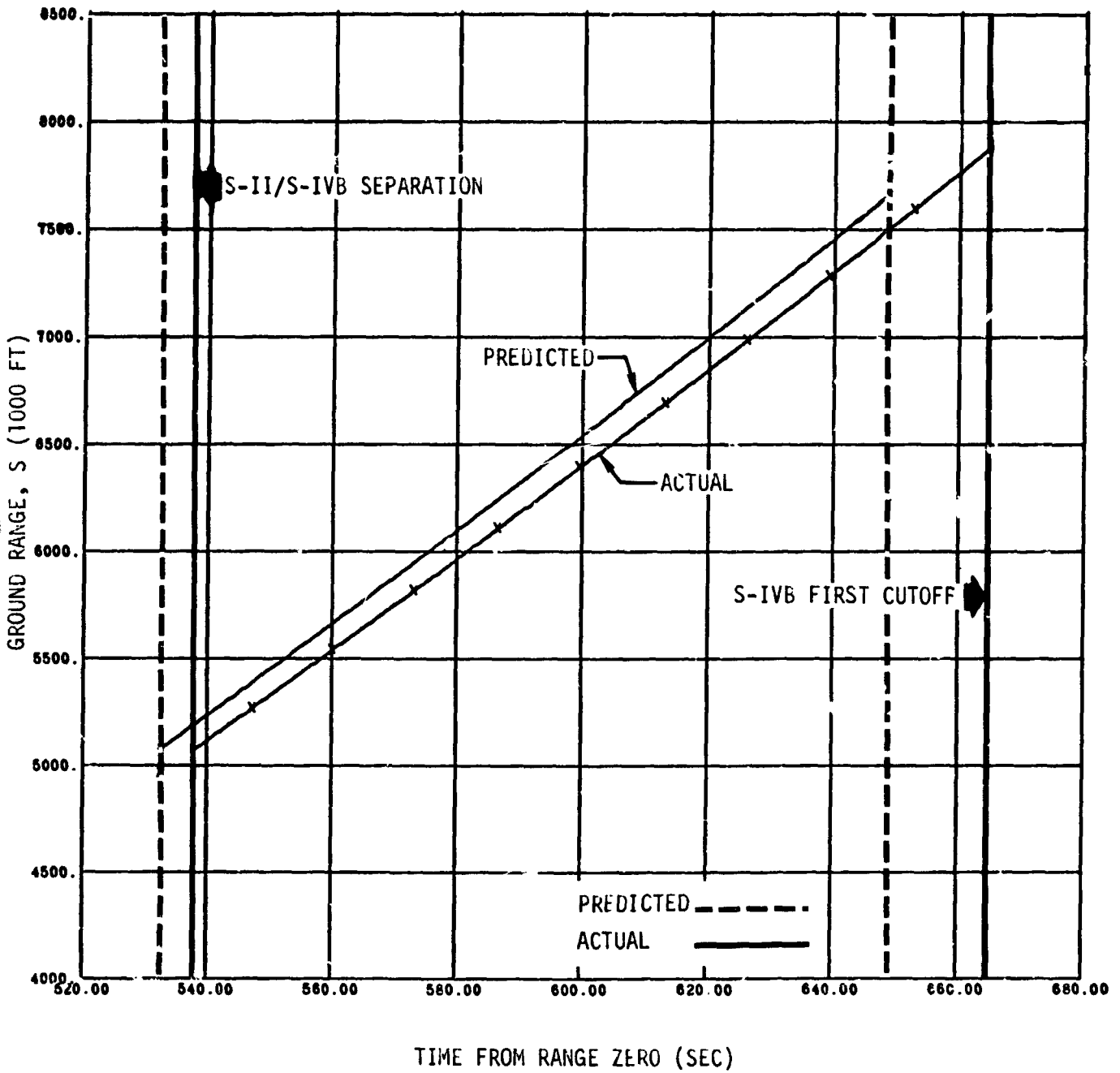

Figure 7-18 S-IVB Stage First Burn Ground Range History

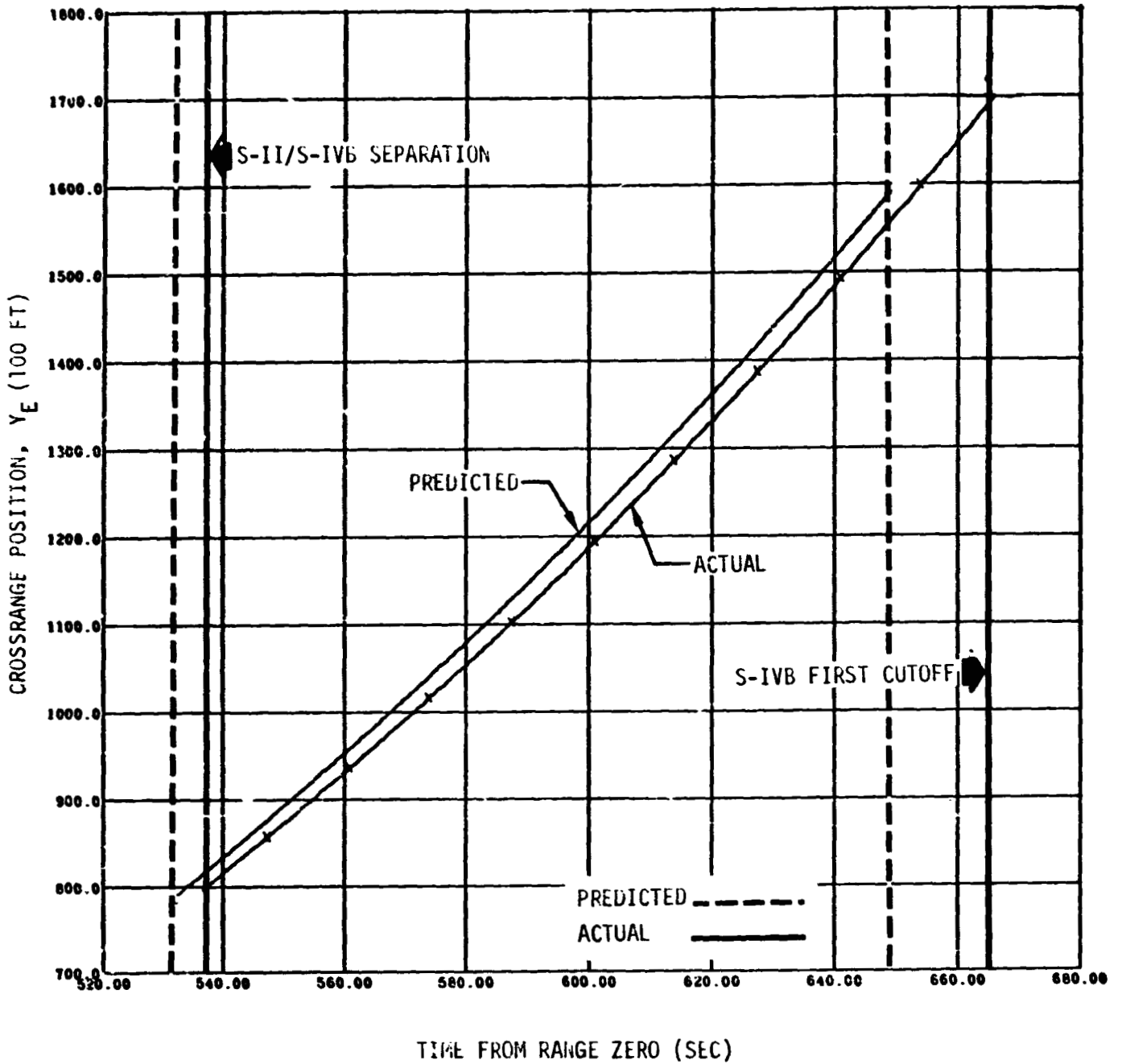

Figure 7-19 S-IVB Stage First Burn Crossrange Position History

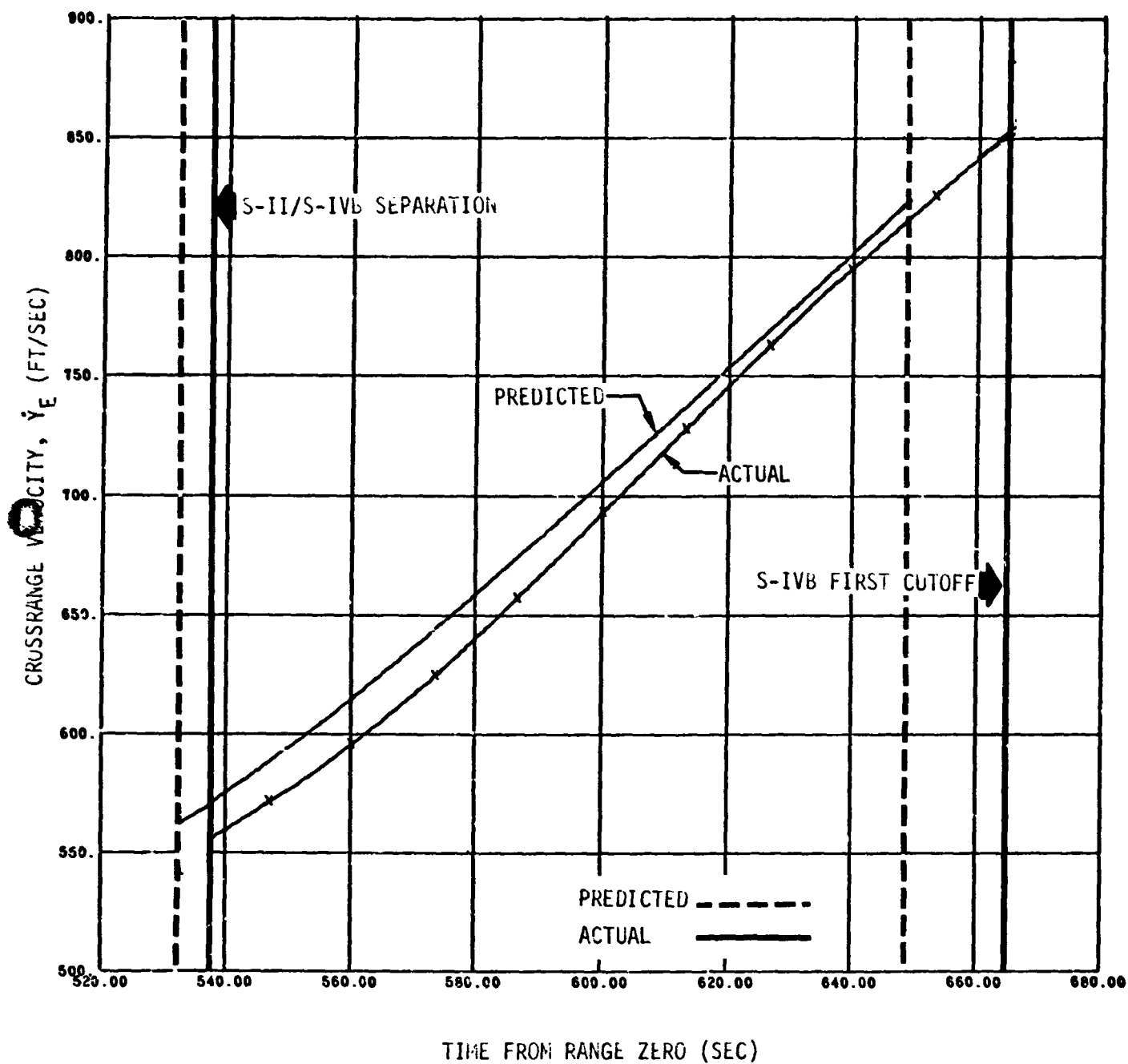

Figure 7-20 S-IVB Stage First Burn Crossrange Velocity History

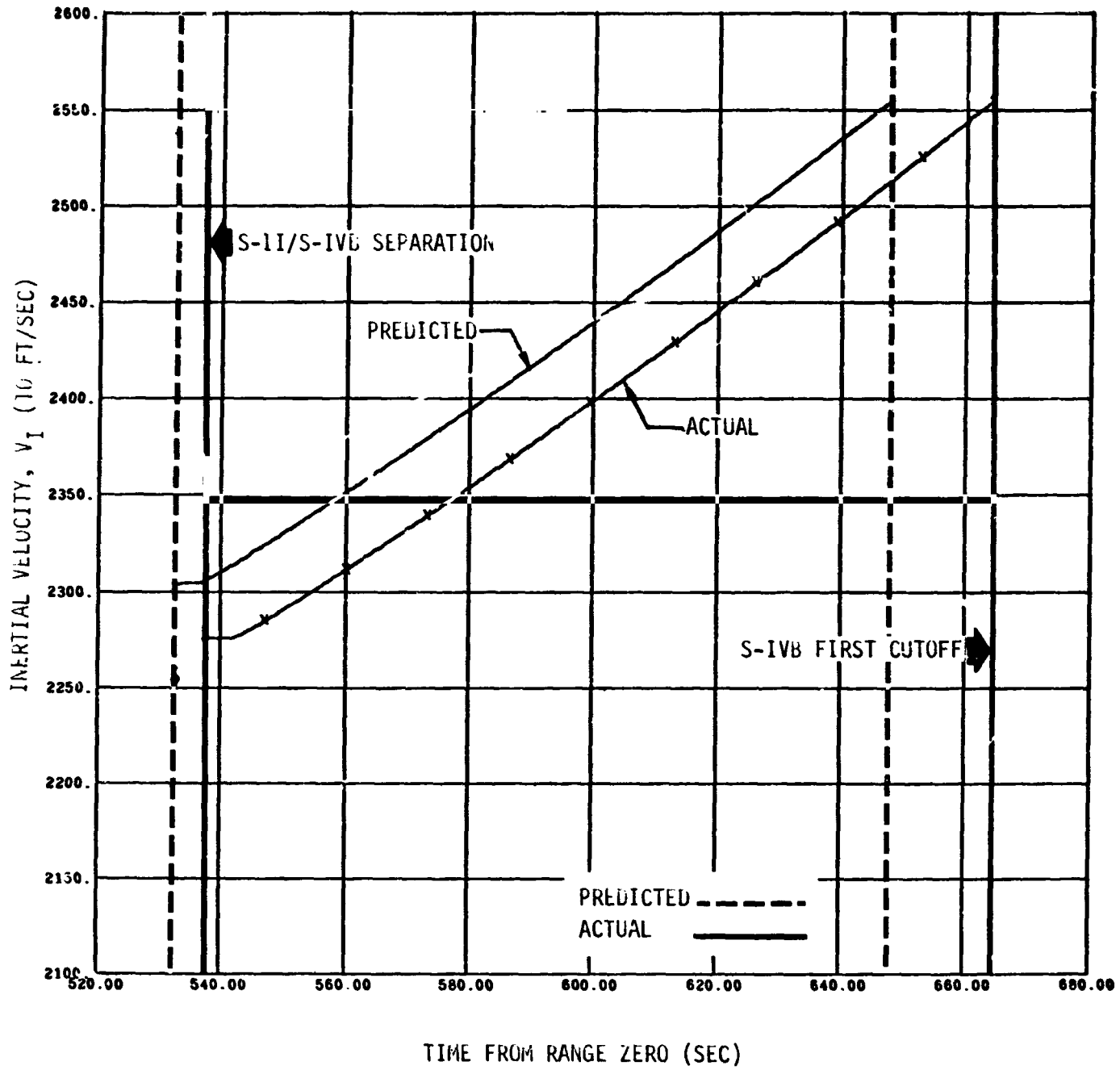

Figure 7-21 S-IVB Stage First Burn Inertial Velocity History



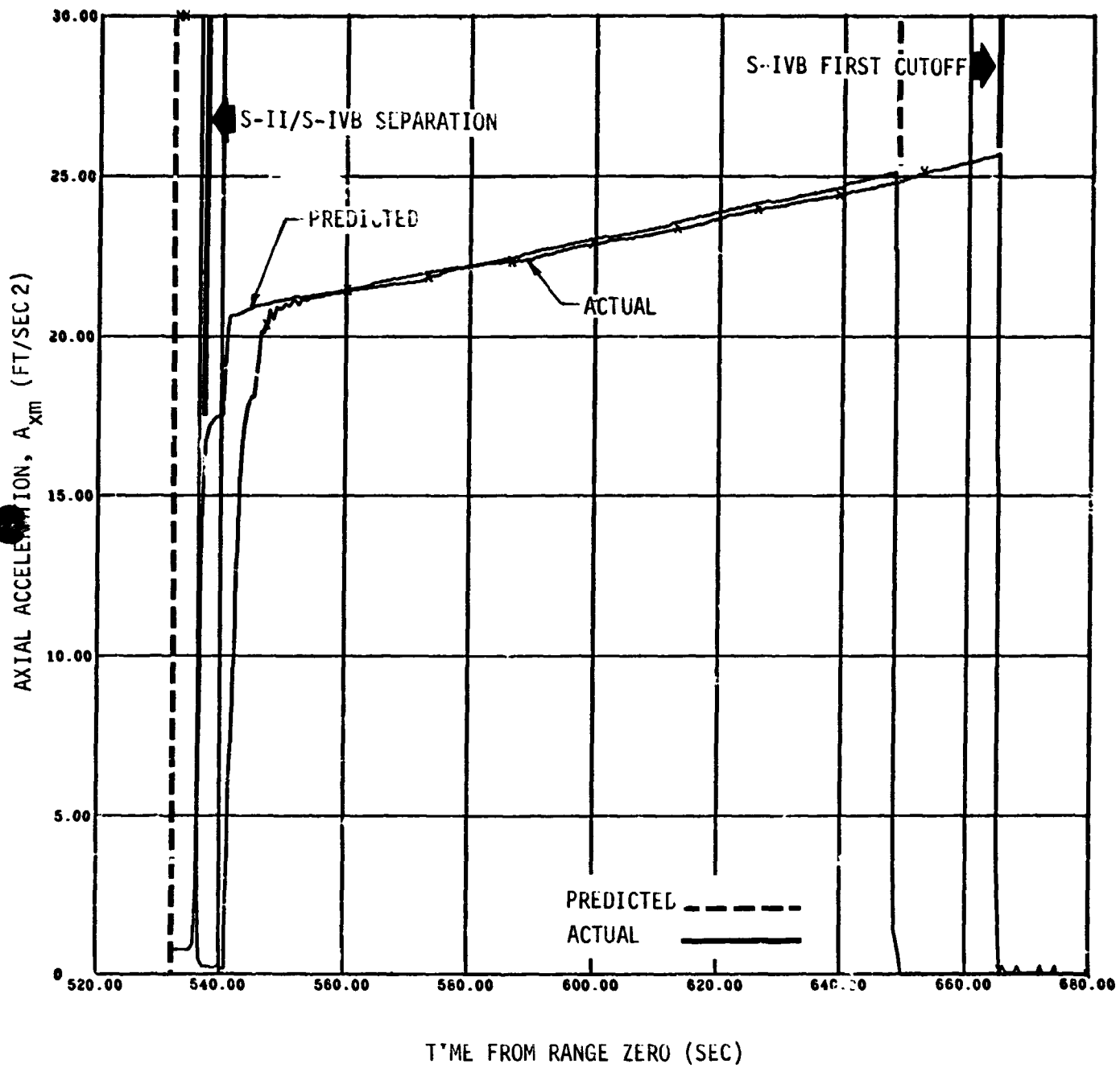

Figure 7-22 S-IVB Stage First Burn Axial Acceleration History

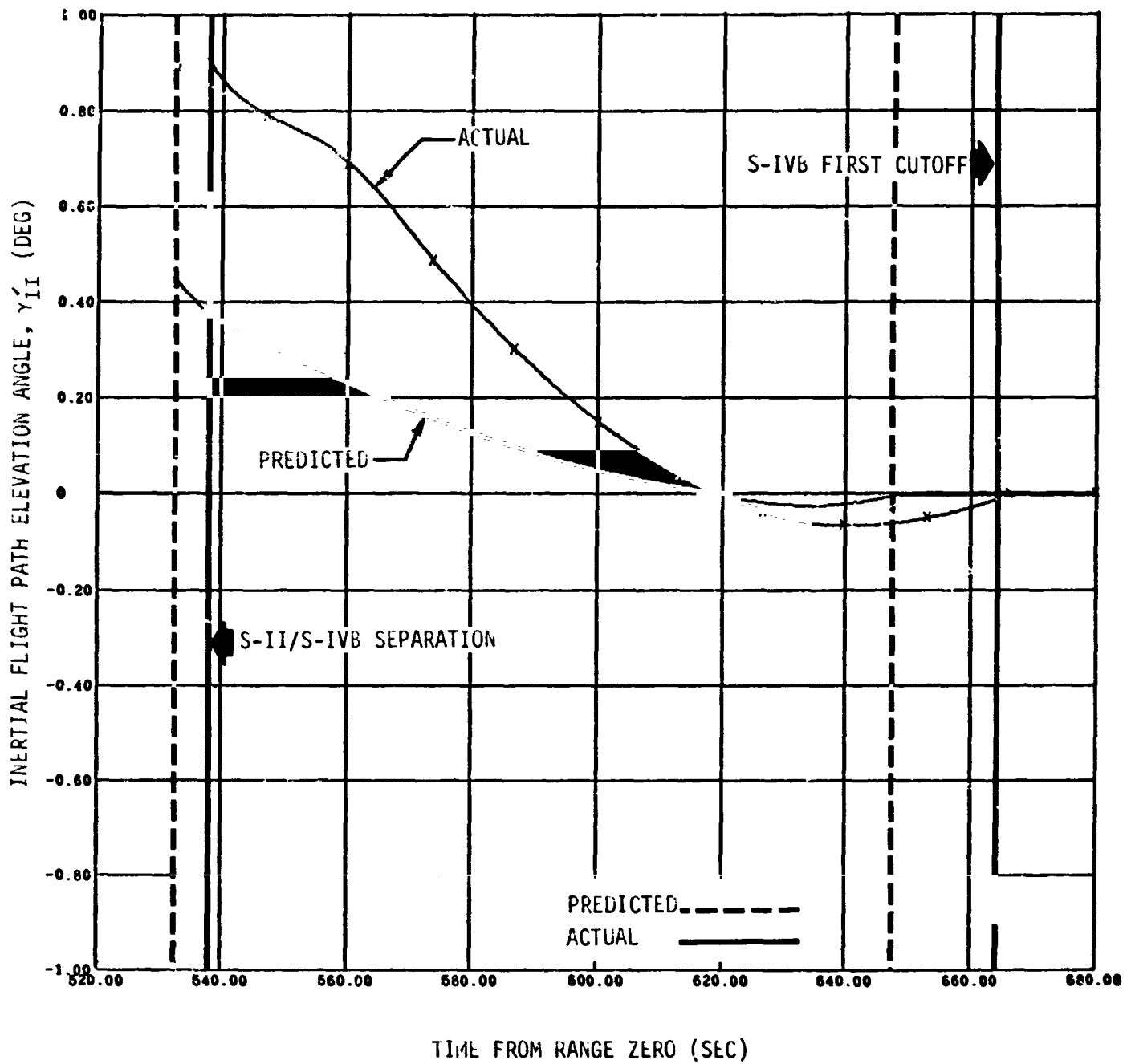

Figure 7-23 S-IVB Stage First Burn Inertial Flight Path Elevation Angle History

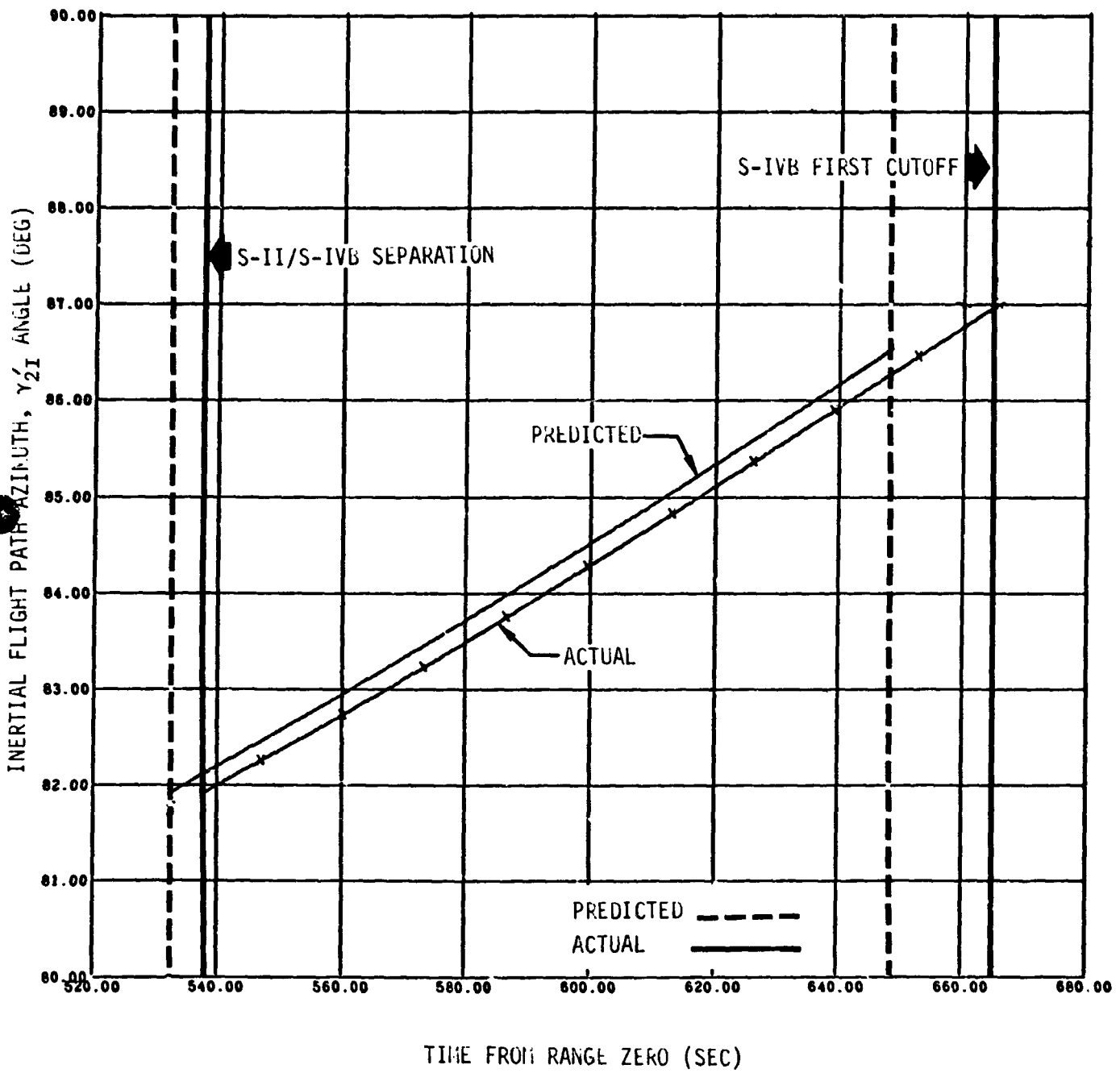

Figure 7-24 S-IVB Stage First burn Inertial Flight Path Azimuth Angle History

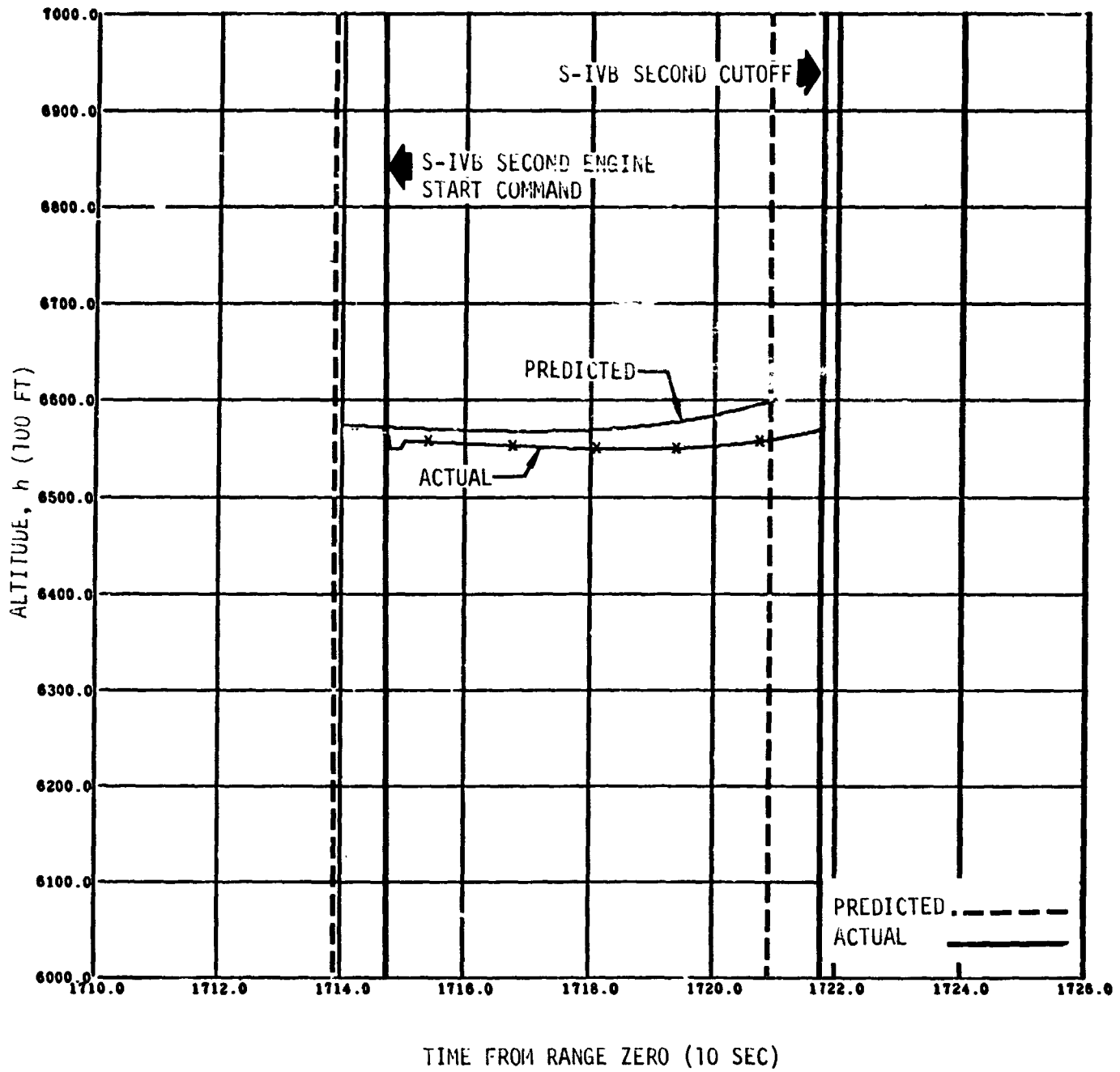

Figure 7-25 S-IVB Stage Second Burn Altitude History

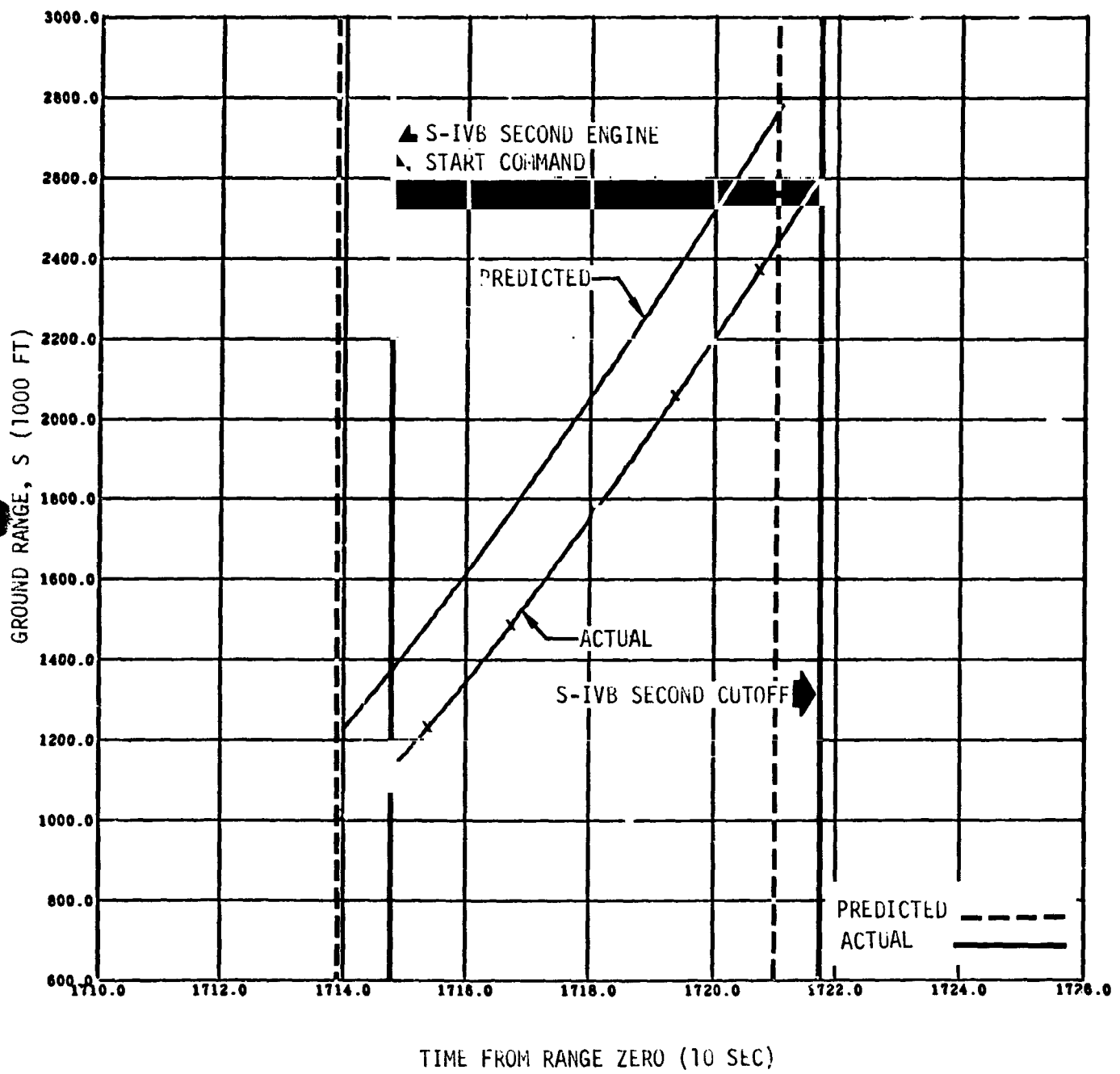

Figure 7-26 S-IVB Stage Second Burn Ground Range History

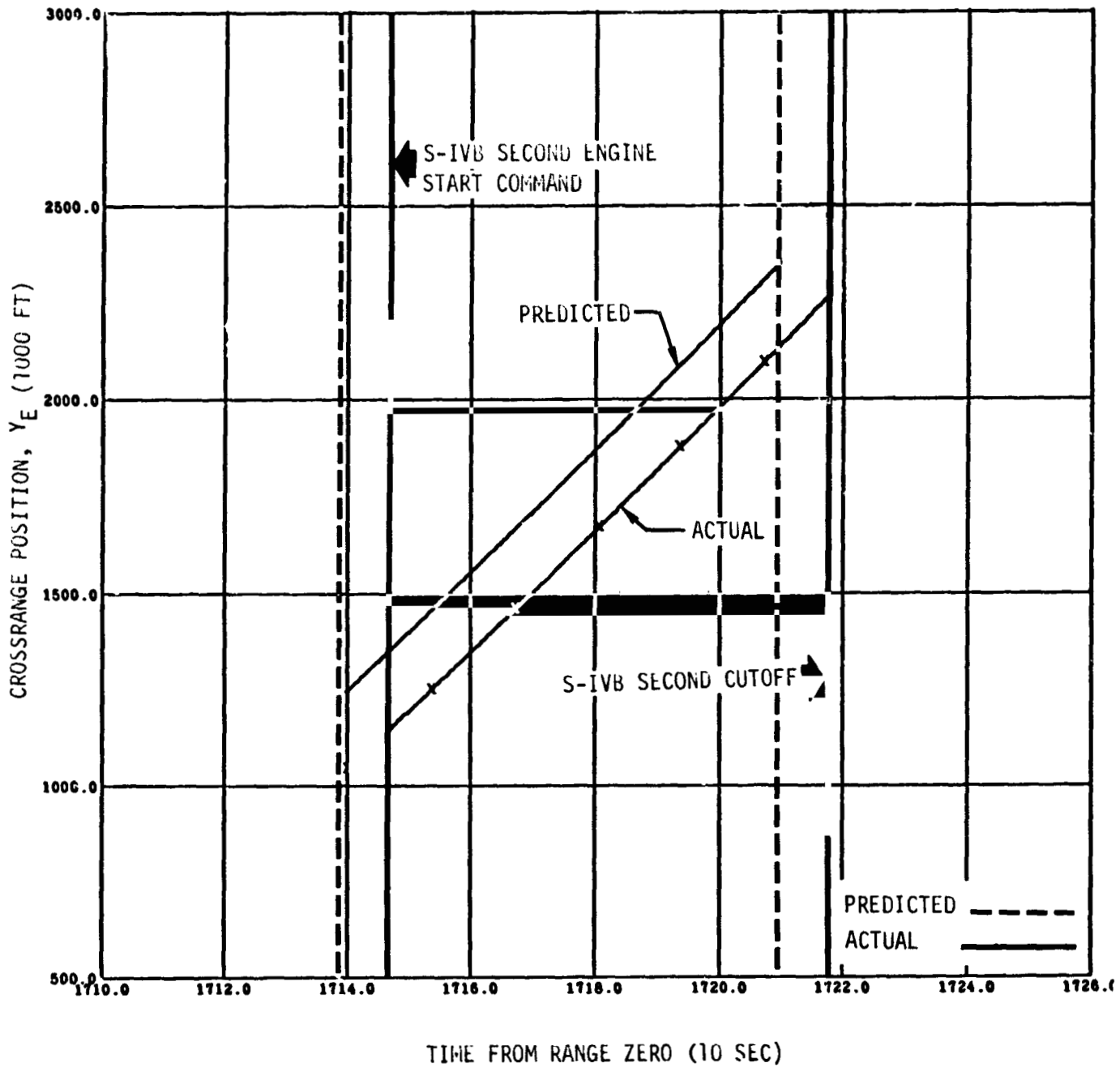

Figure 7-27 S-IVB Stage Second Burn Crossrange Position History

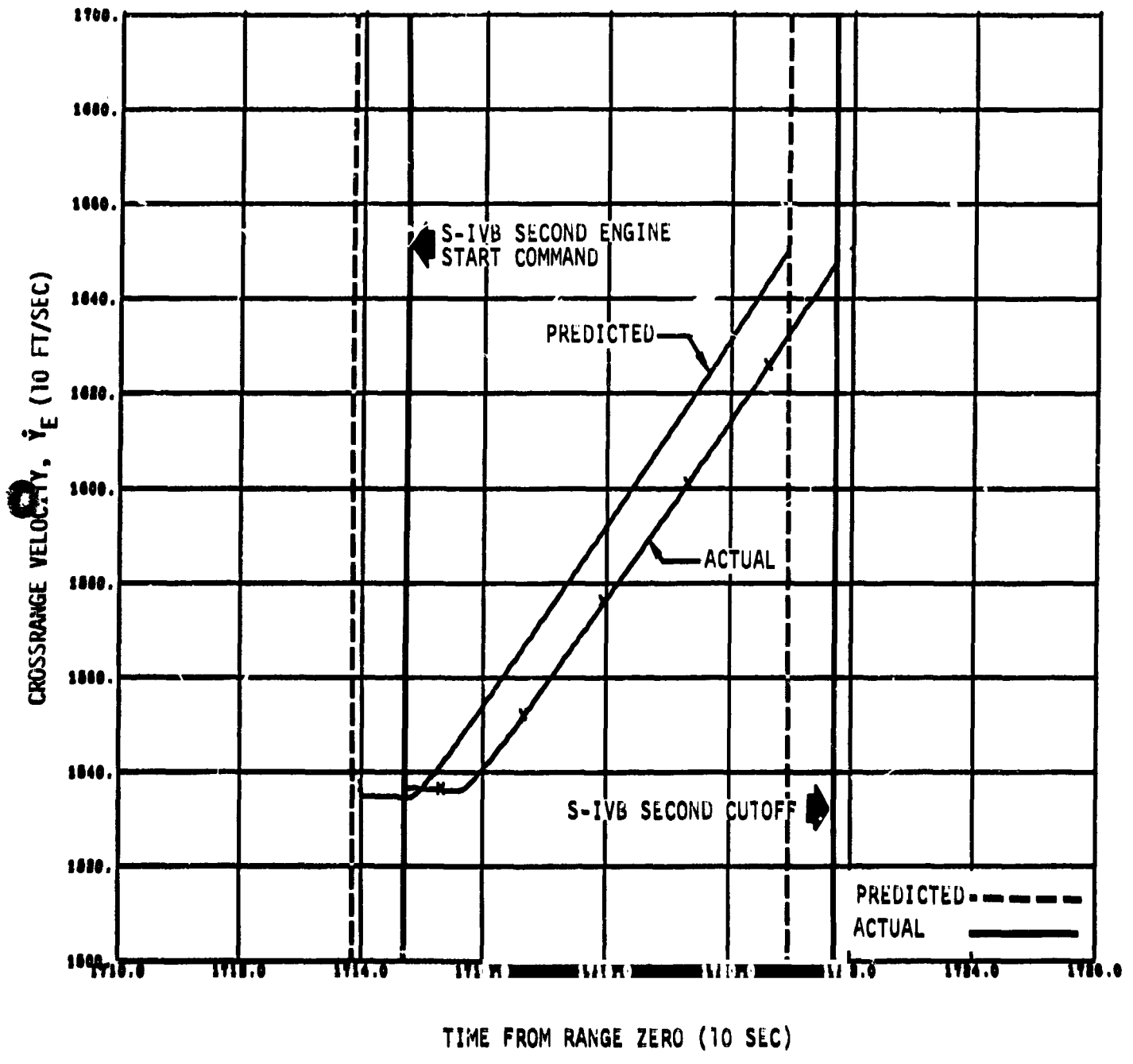

Figure 7-28 S-IVB Stage Second Burn Crossrange Velocity History

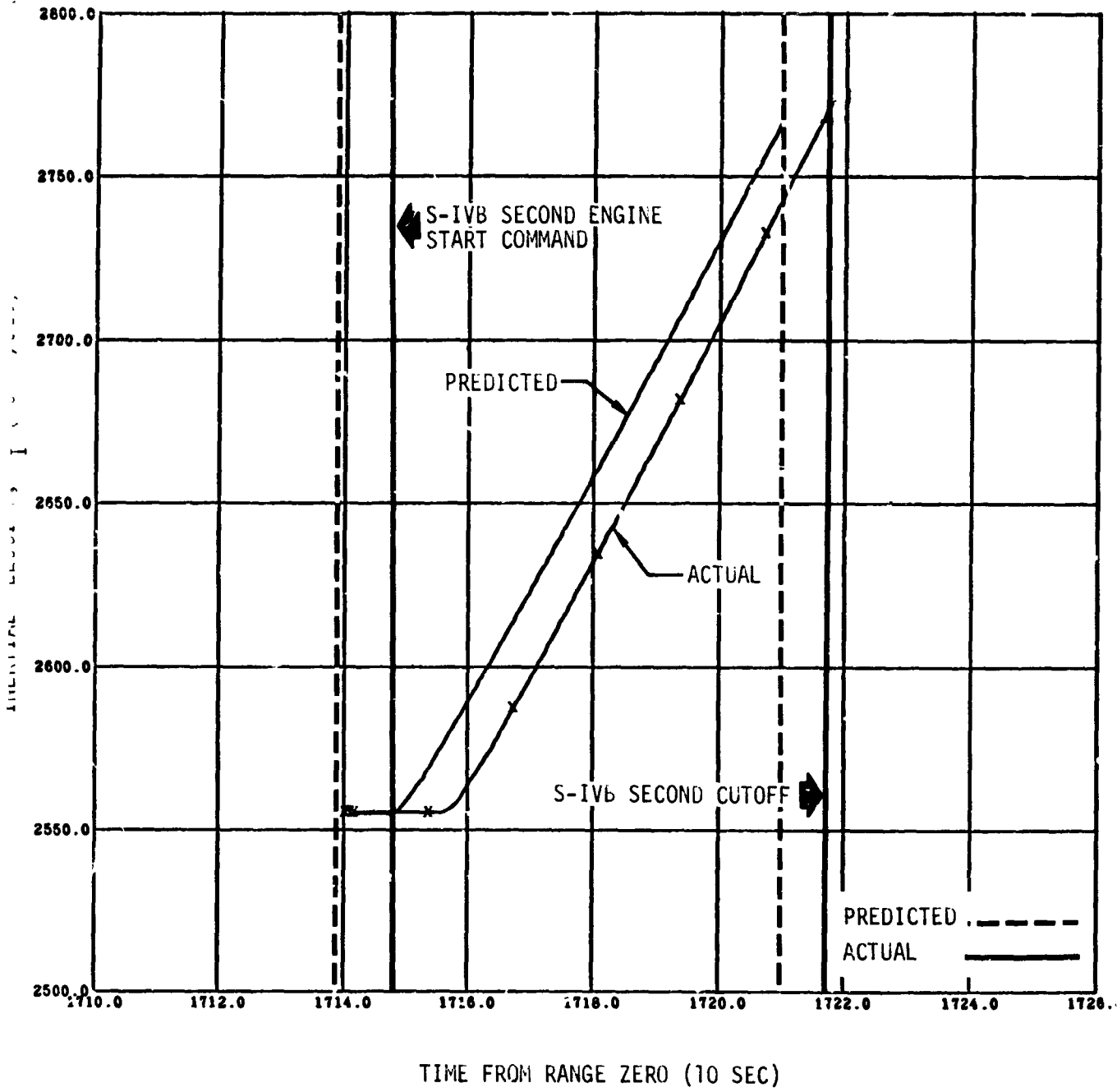

Figure 7-29 S-IVB Stage Second burn Inertia Velocity History



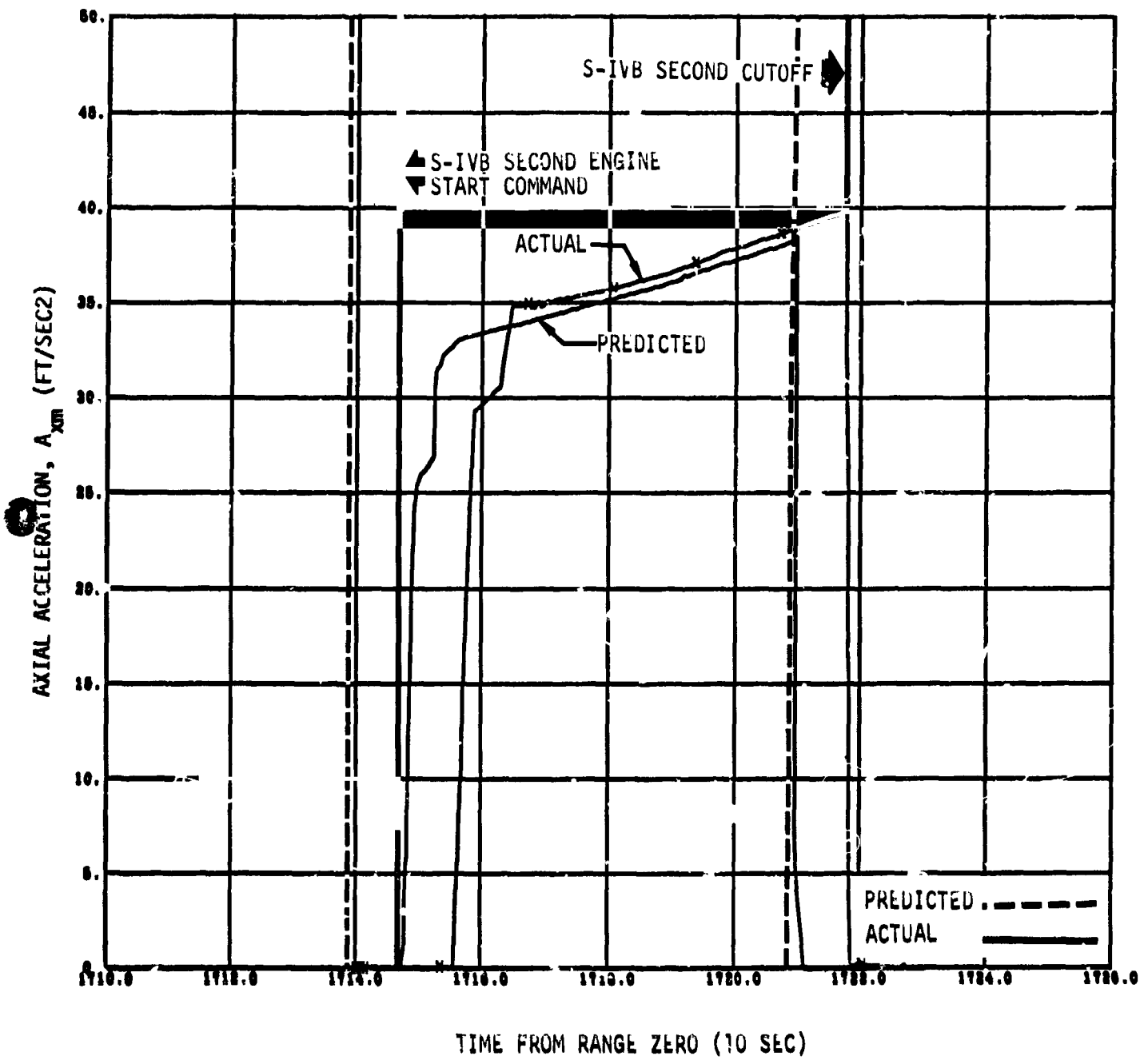

Figure 7-30 S-IVB Stage Second Burn Axial Acceleration History

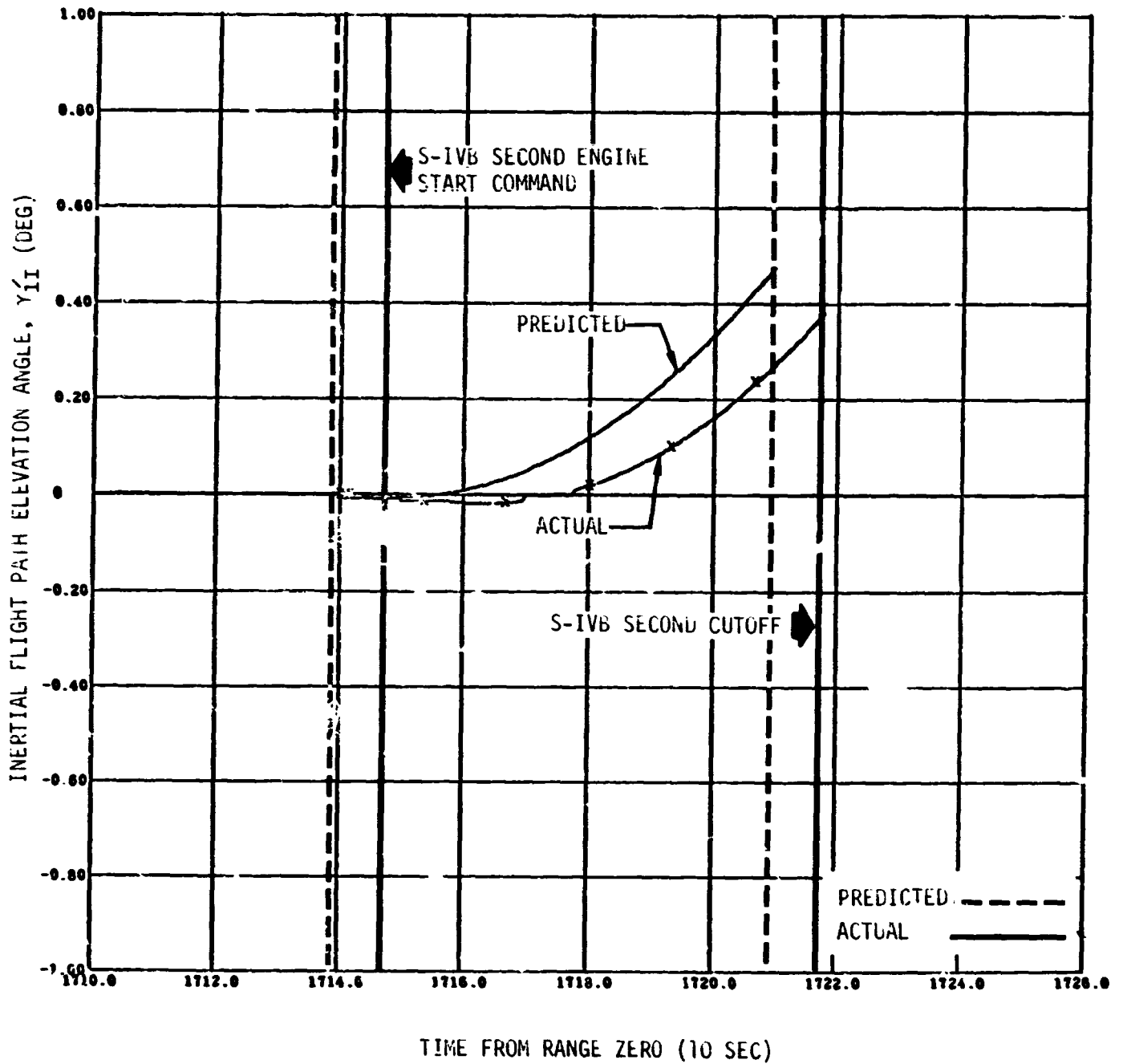

Figure 7-31 S-IVB Stage Second burn Inertial Flight Path Elevation Angle History

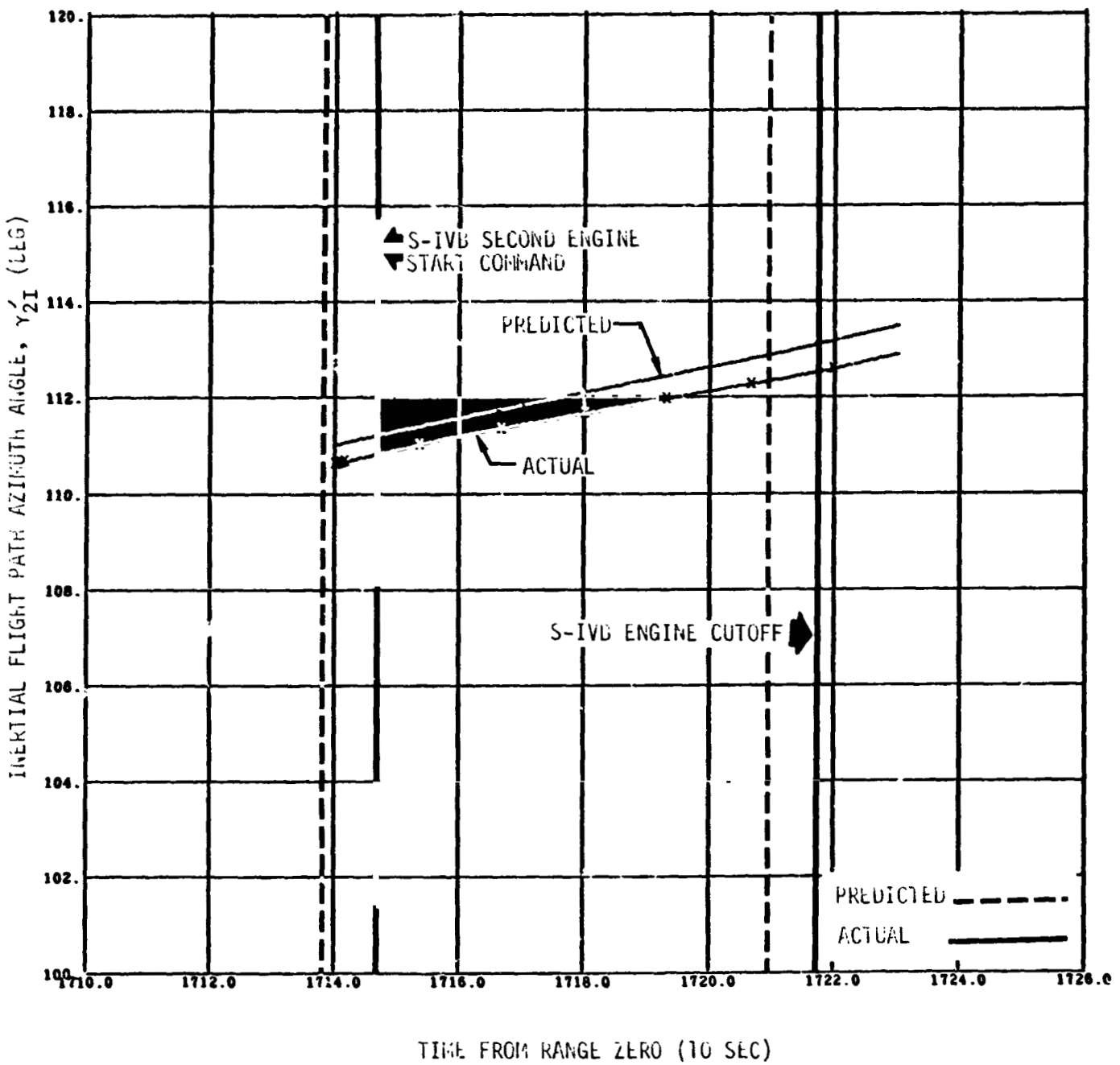

Figure 7-32 S-IVB Stage Second Burn Inertial Flight Path Azimuth Angle history

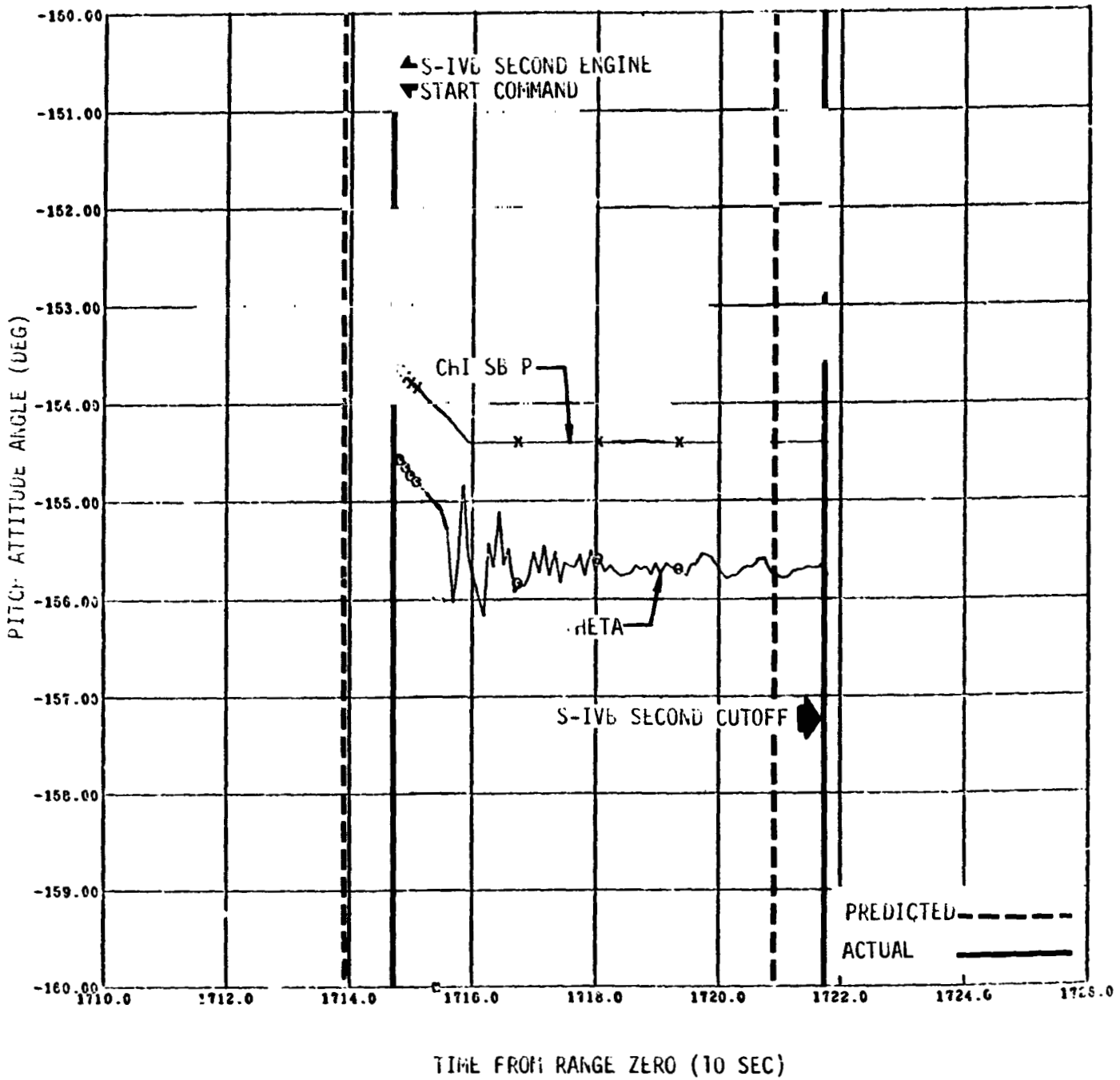

Figure 7-33 S-IVB Stage Second Burn Pitch Attitude Angle history

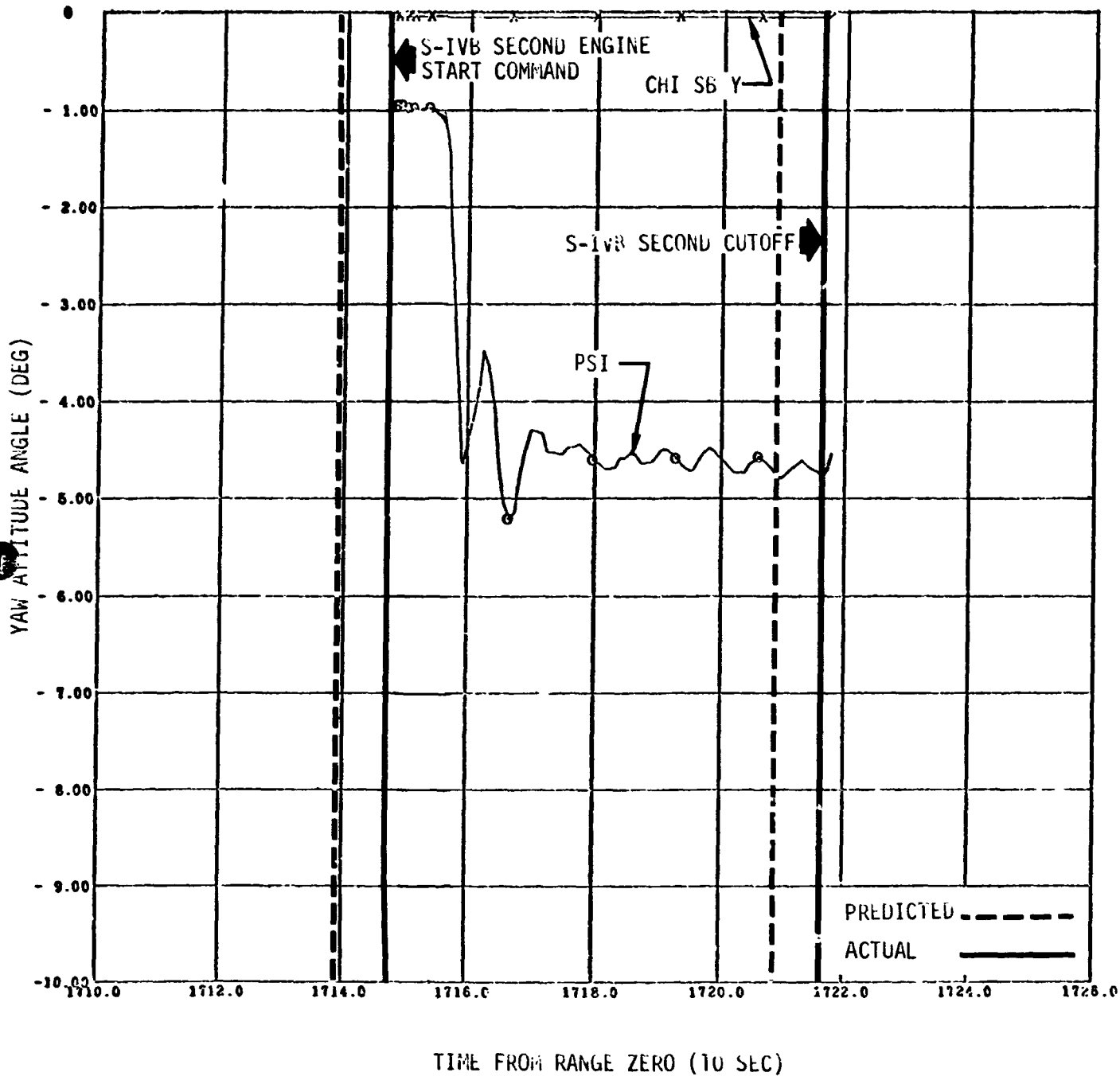

Figure 7-34 S-IVB Second Burn Yaw Attitude Angle history

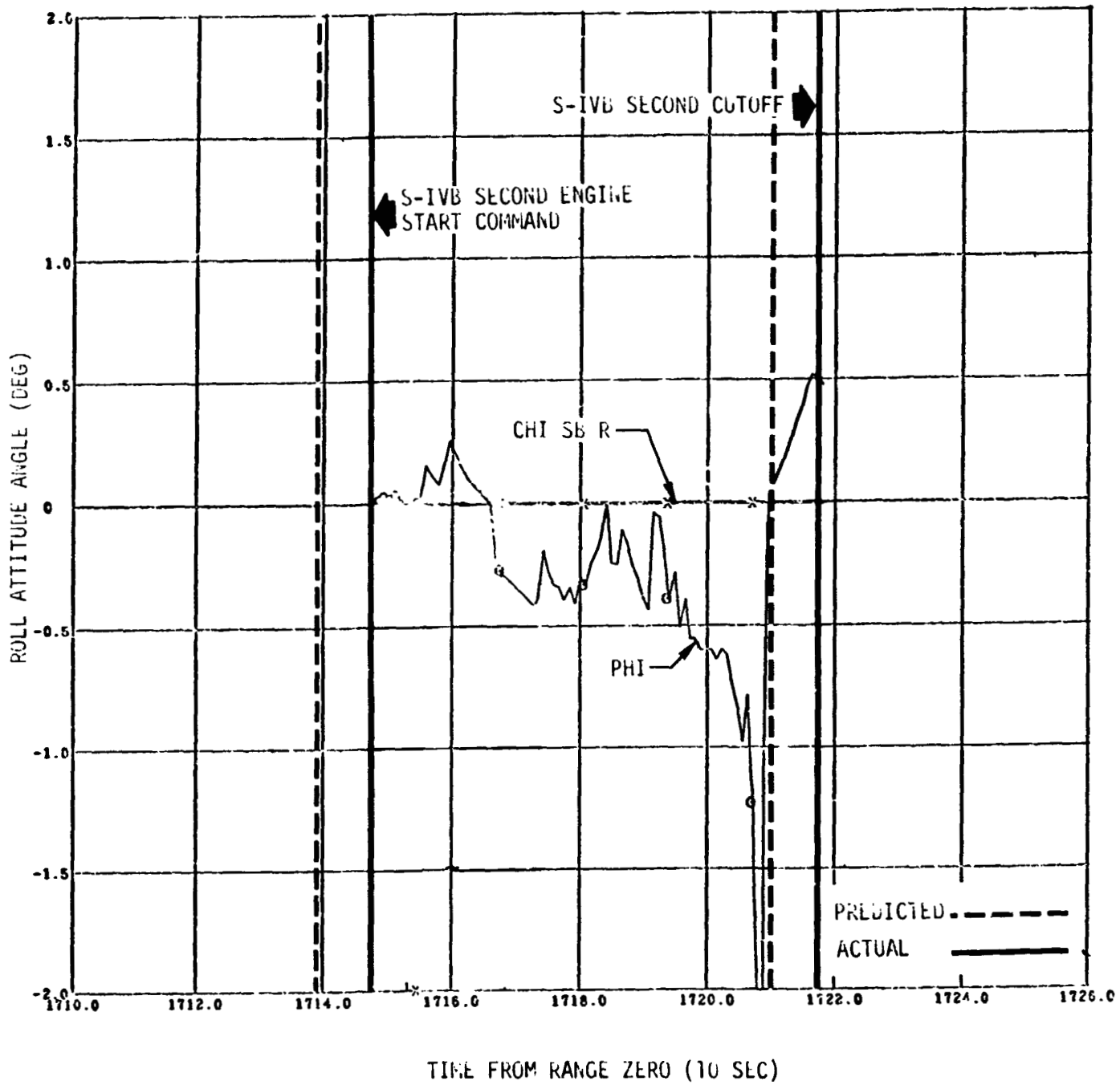

Figure 7-35 S-IVb Stage Second Burn Roll Attitude Angle History

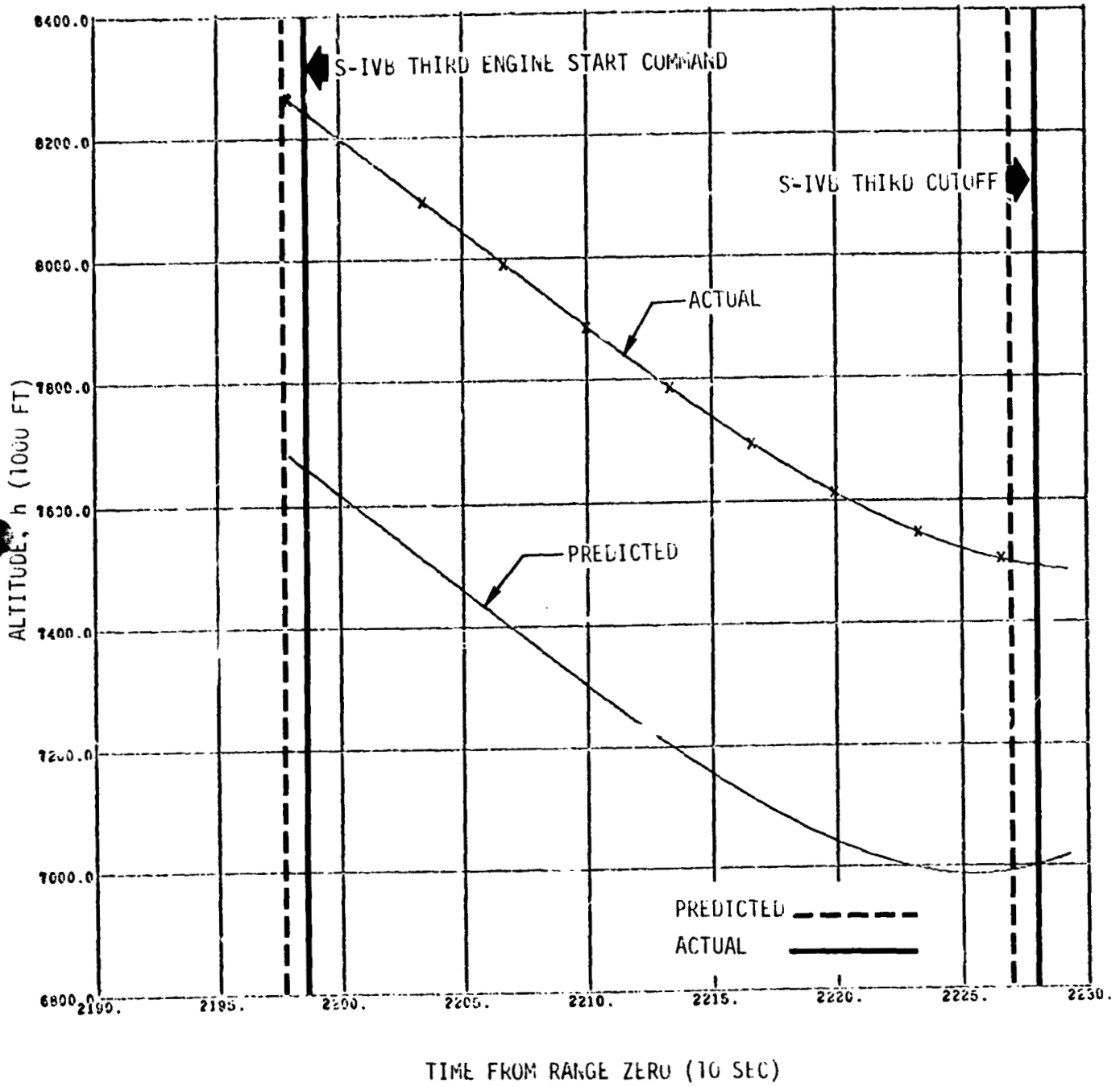

Figure 7-36 S-IVB Stage Third burn Altitude History

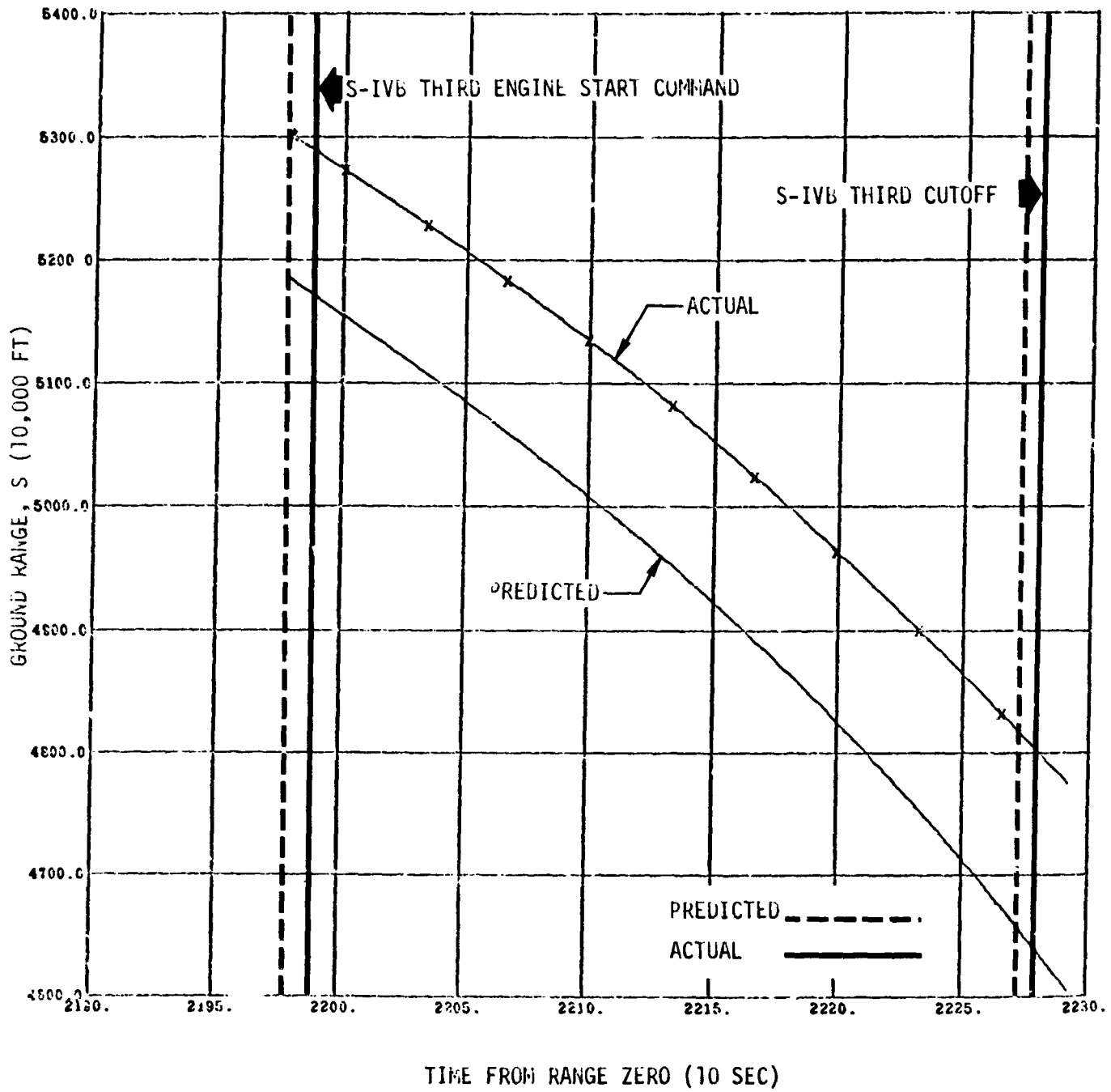

Figure 7-37 S-IVB Stage Third Burn Ground Range History



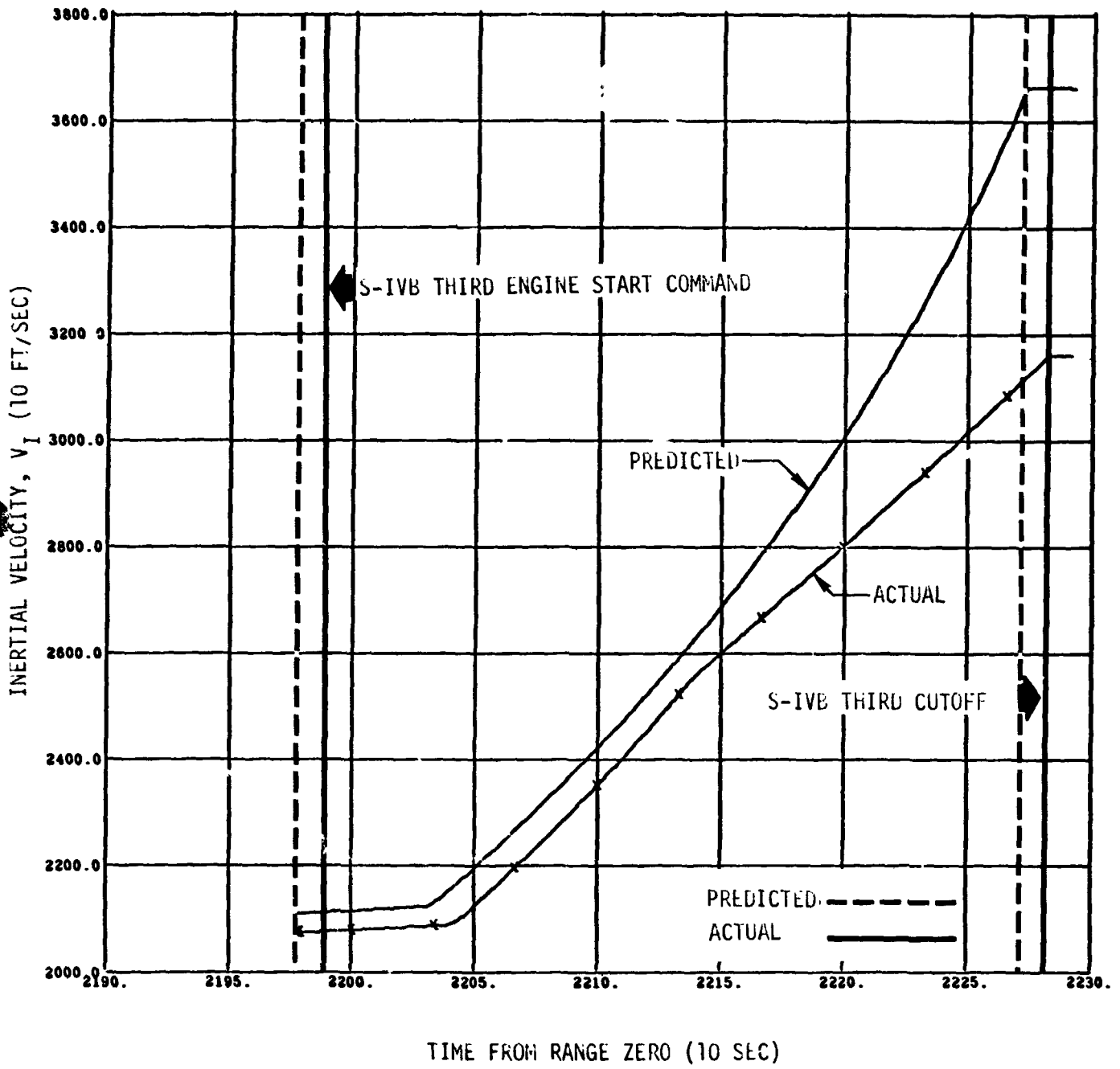

Figure 7-38 S-IVB Third Burn Inertial Velocity History

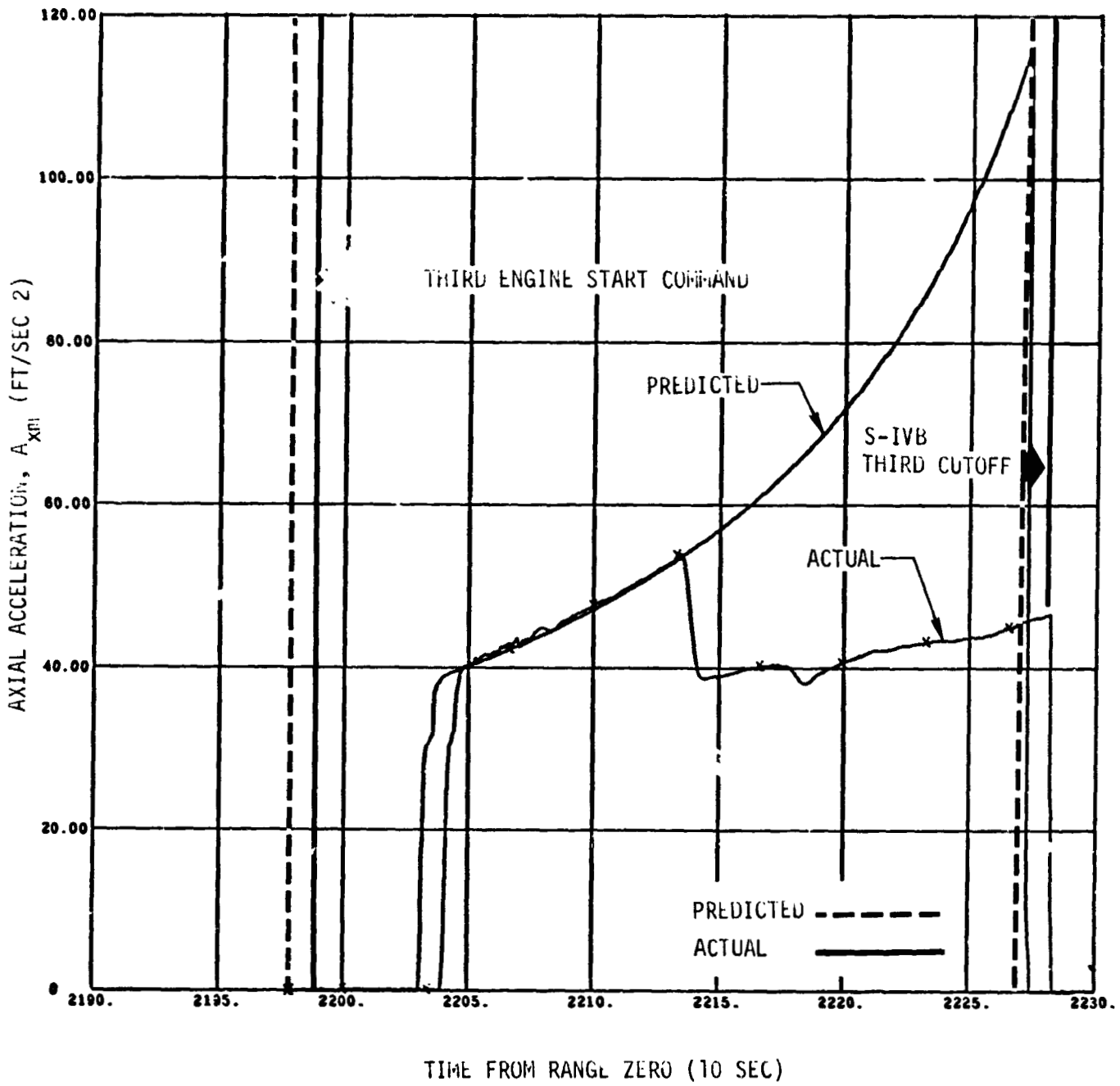

Figure 7-39 S-IVB Stage Third Burn Axial Acceleration History

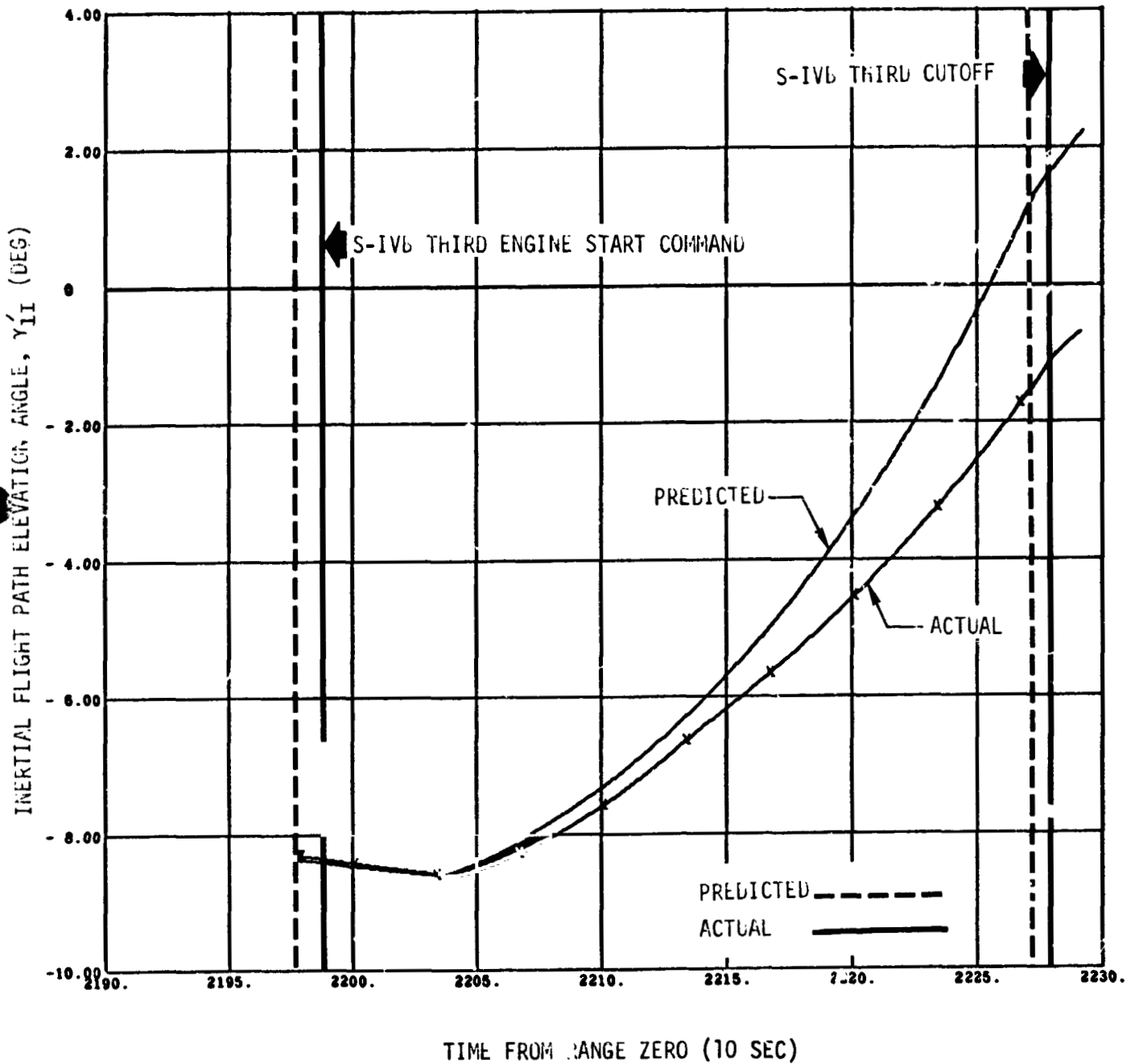

Figure 7-40 S-IVB Stage Third Burn Inertial Flight Path Elevation Angle History

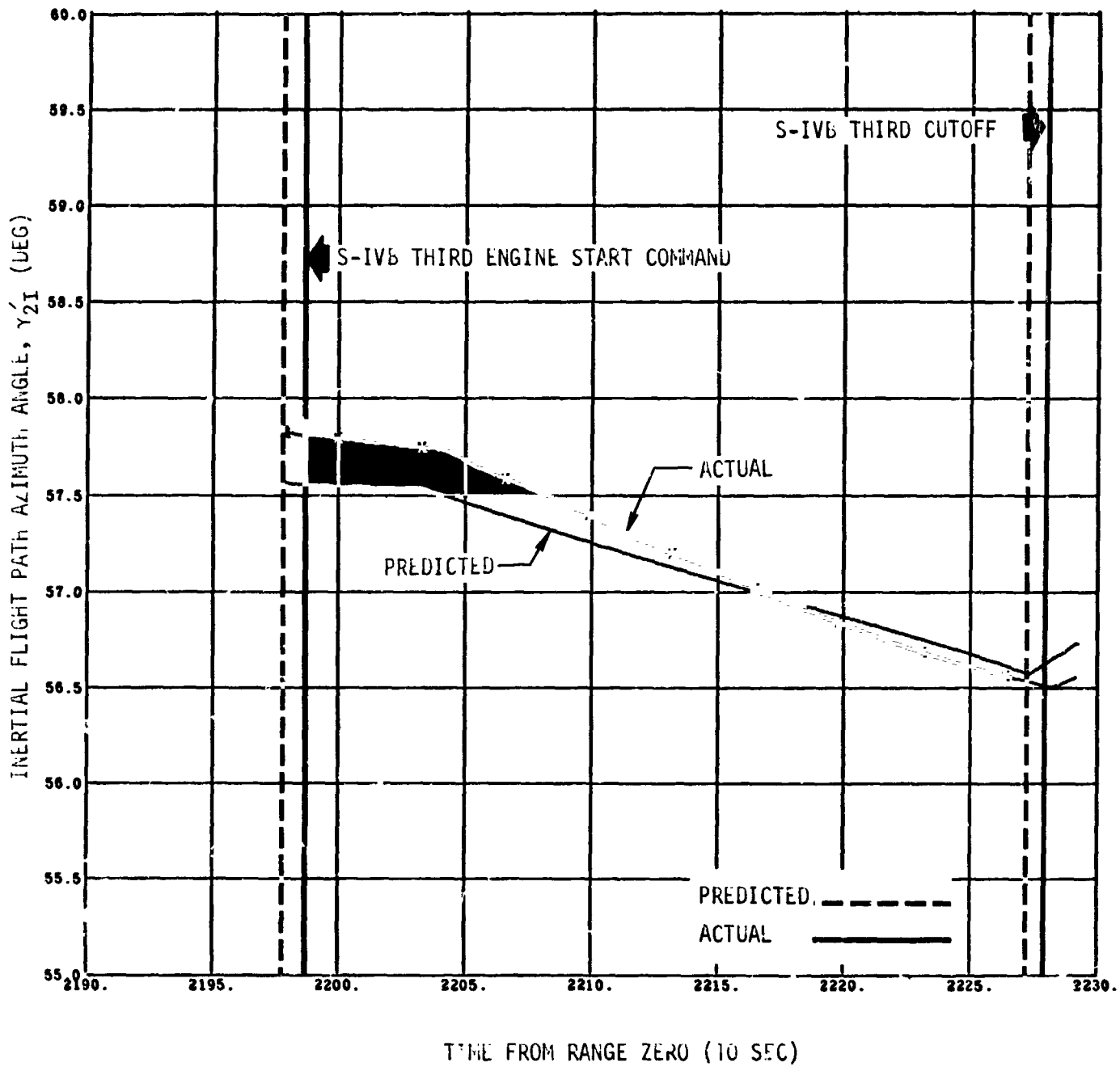

Figure 7-41 S-IVb Stage Third Burn Inertial Flight Path Azimuth History

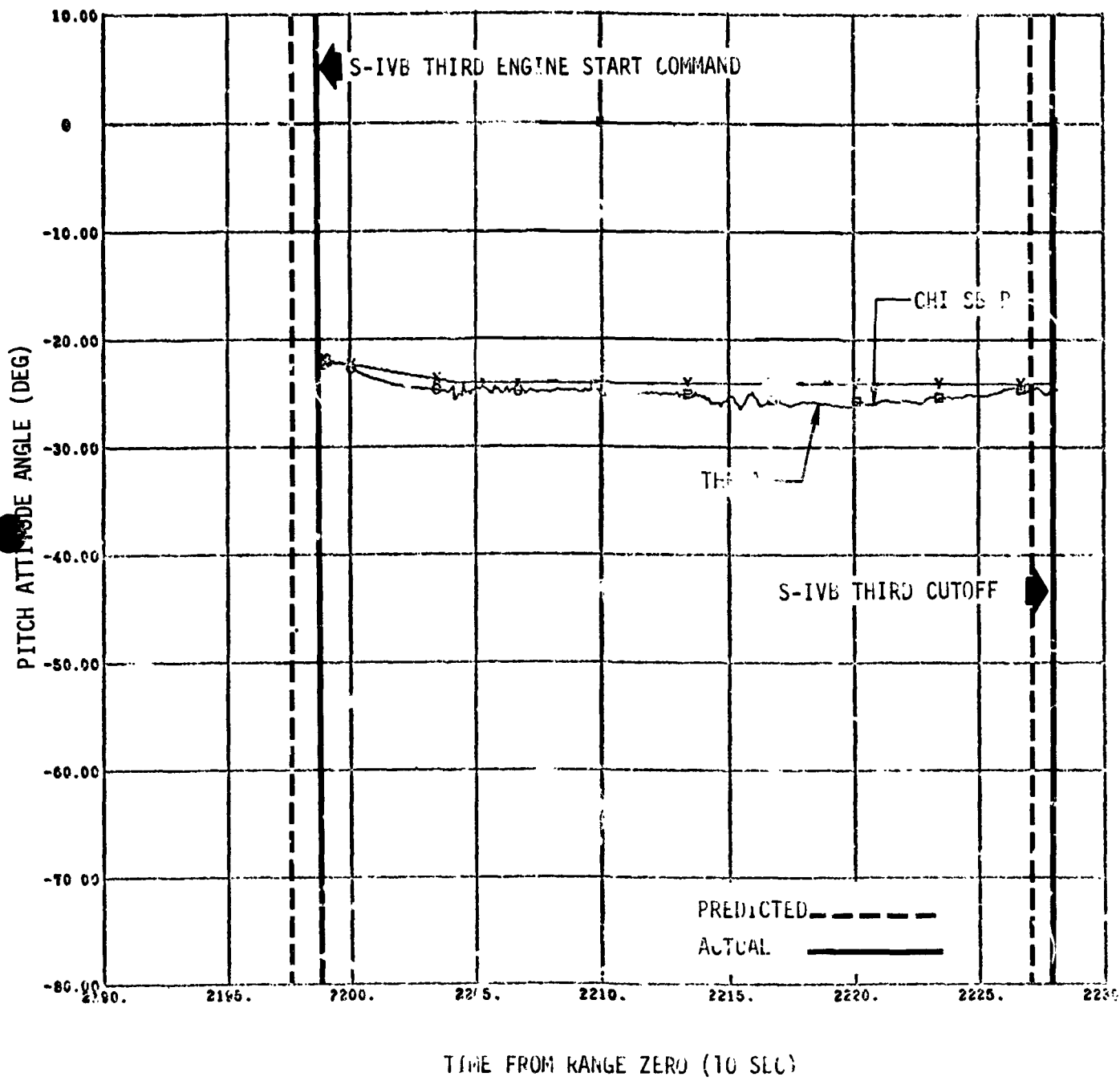

Figure 7-42 S-IVB Third Burn Pitch Attitude Angle History

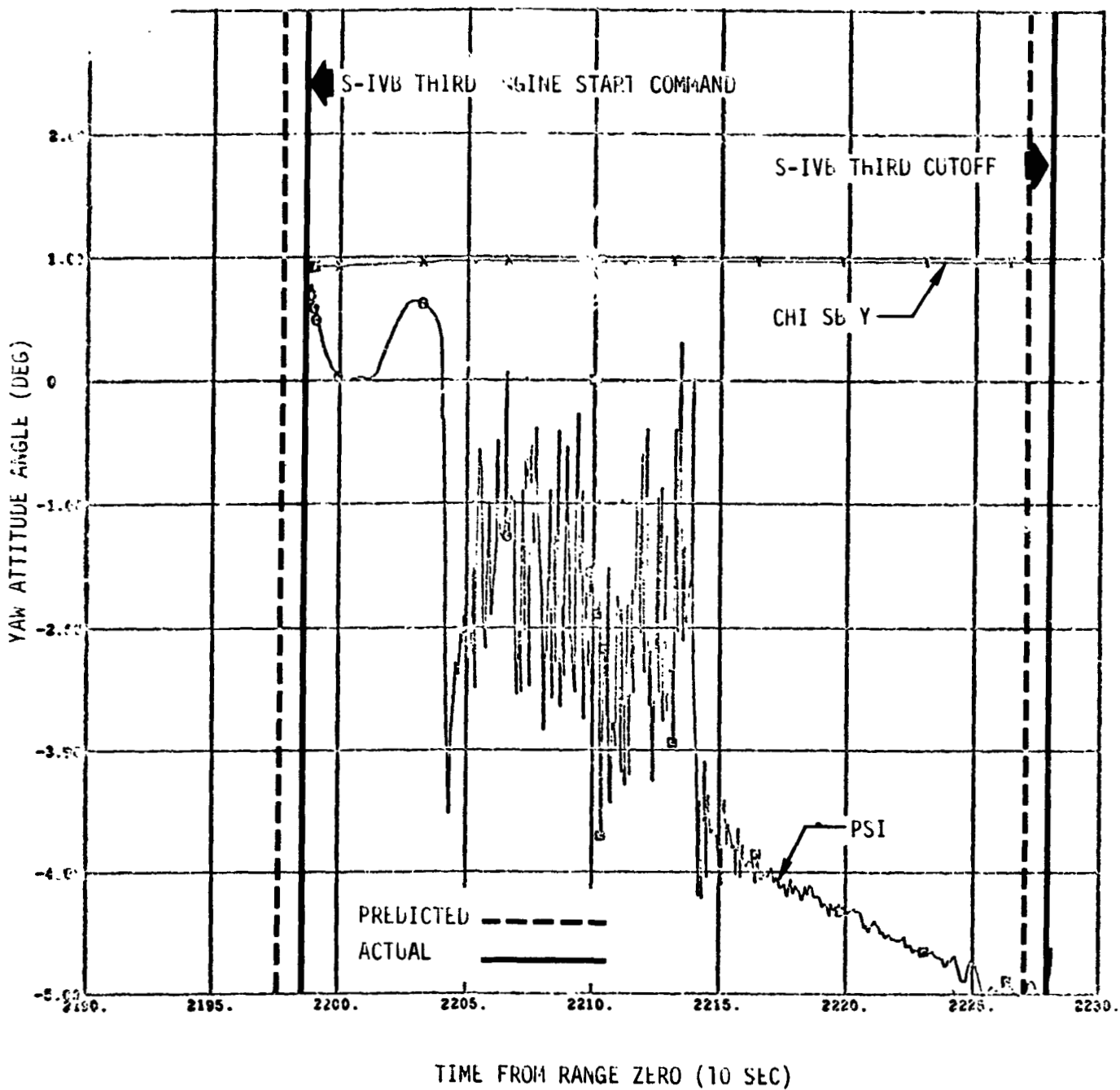

Figure 7-43 S-IVB Stage third burn Yaw Attitude Angle History

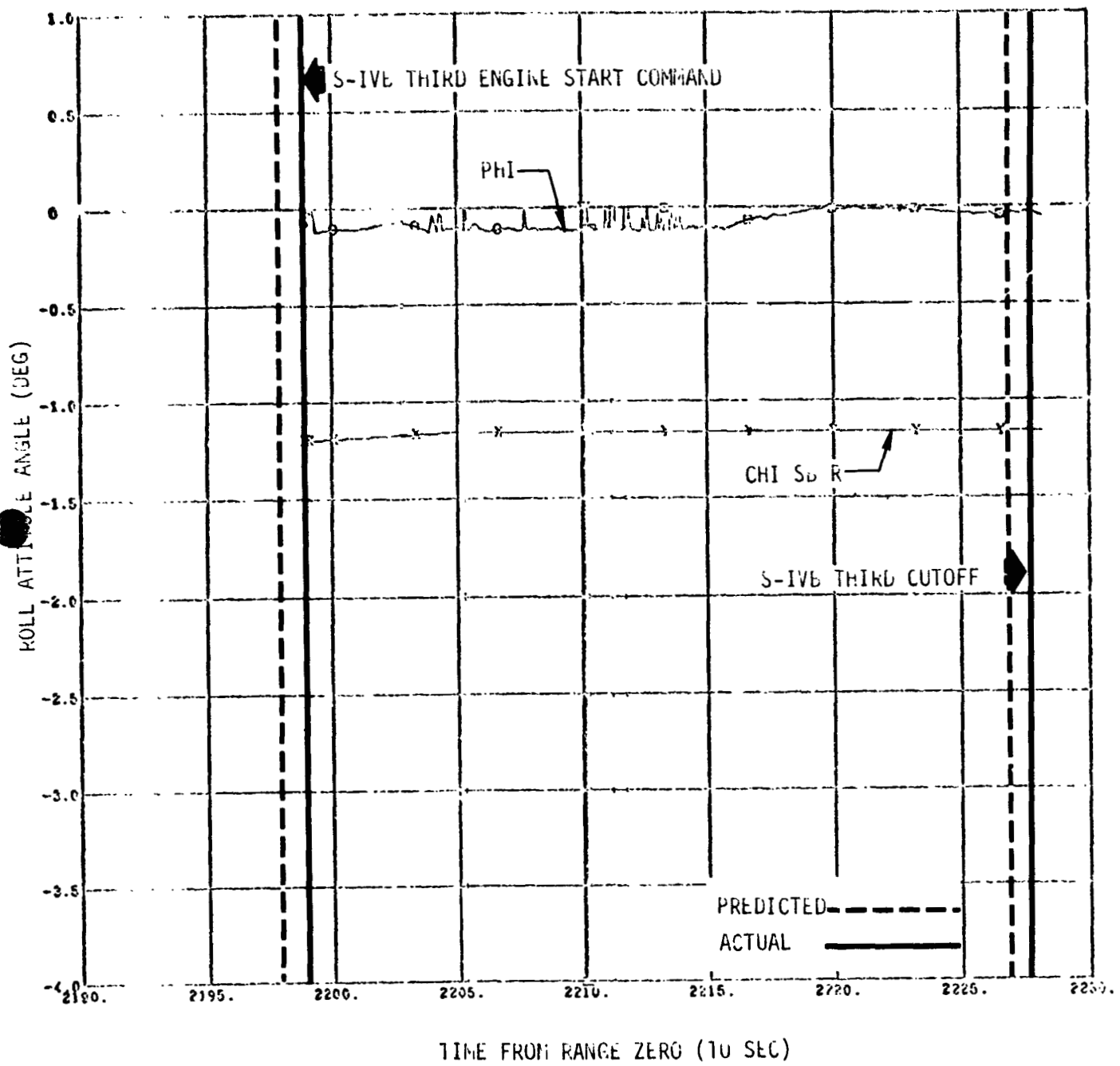

Figure 7-44 S-IVb Stage Third Burn Roll Attitude Angle History

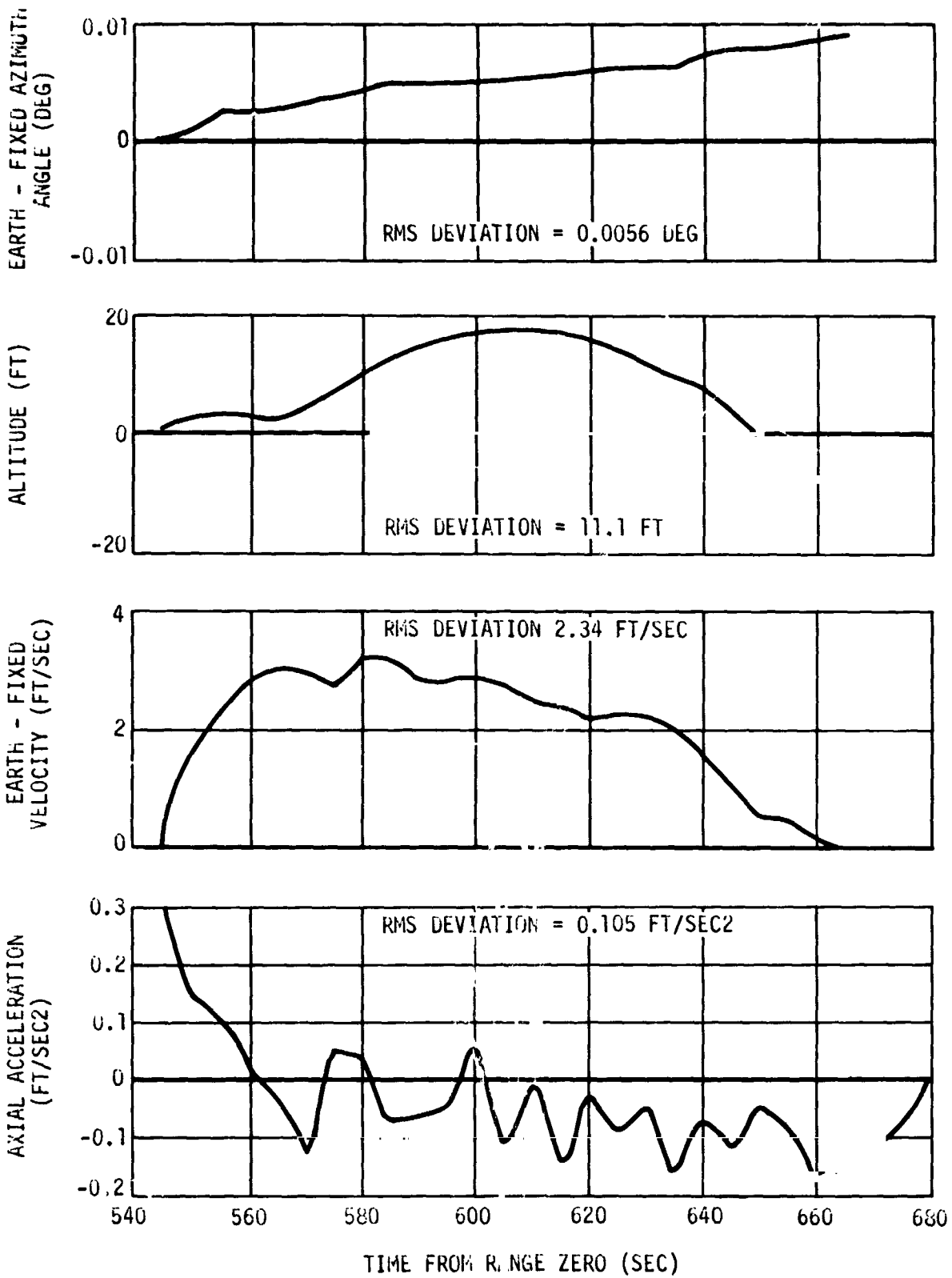

Figure 7-45 Trajectory Simulation Deviations From Observed Trajectory - First Burn



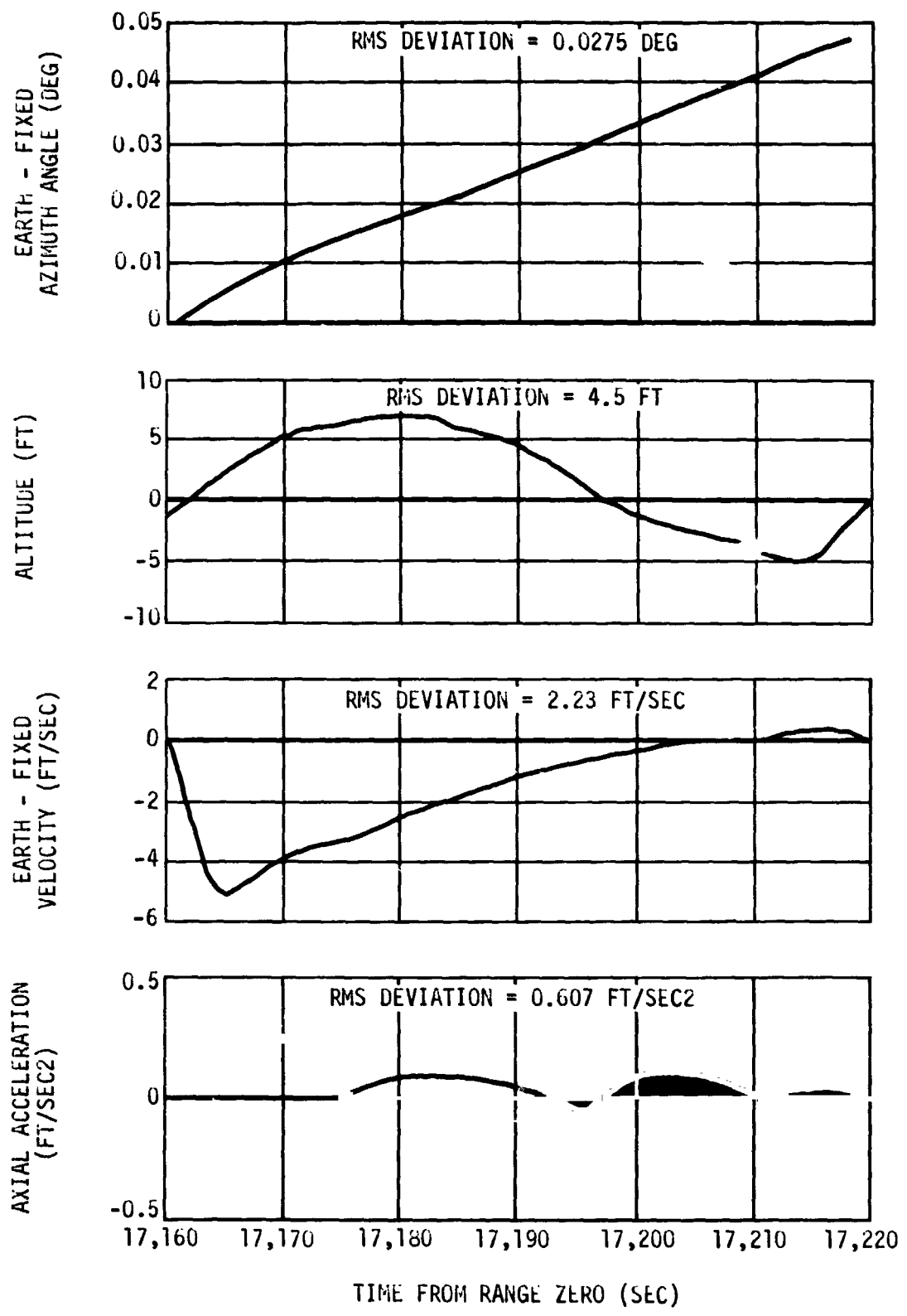

Figure 7-46 Trajectory Simulation Deviations From Observed Trajectory - Second Burn

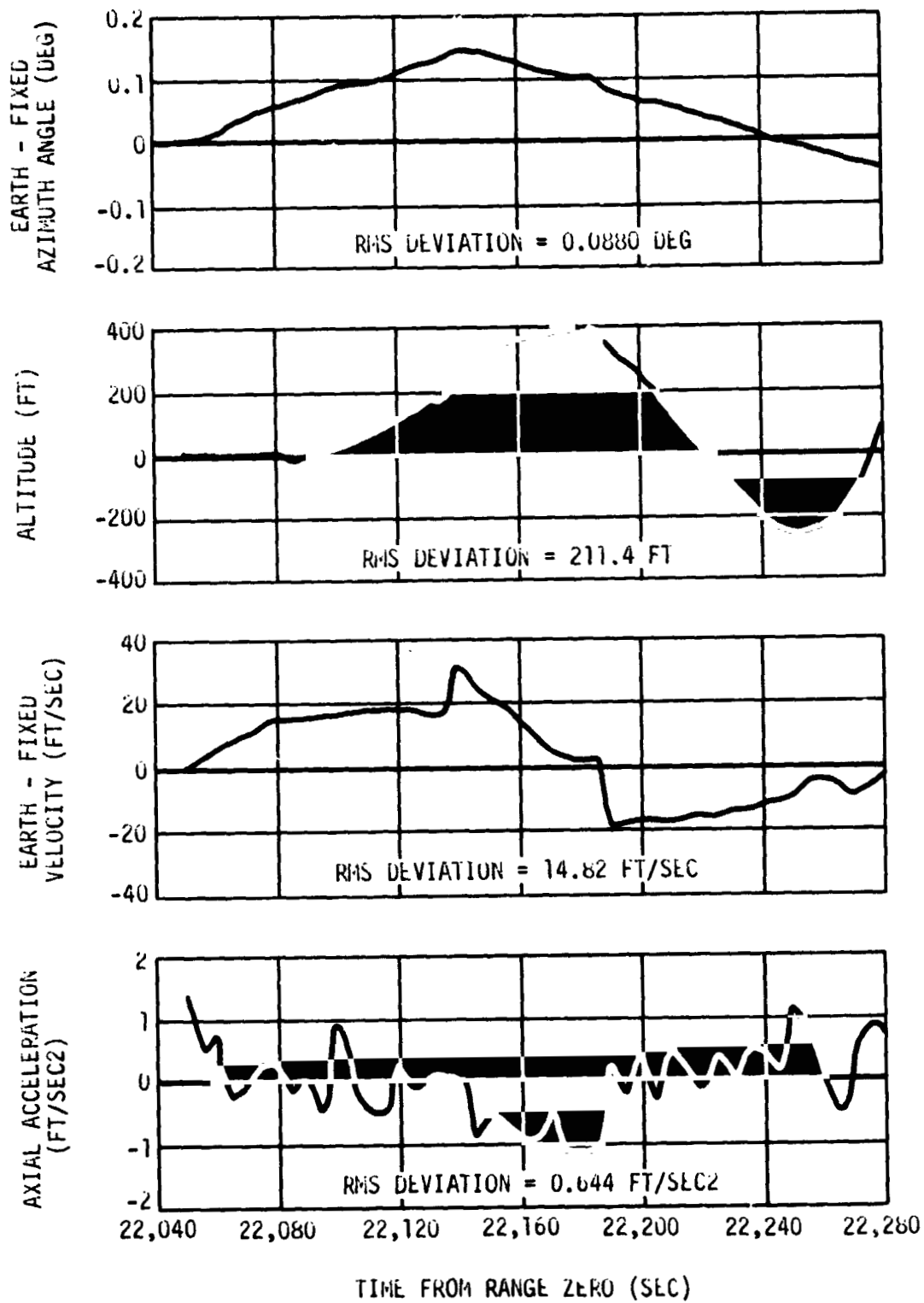

Figure 7-47 Trajectory Simulation Deviations From Observed Trajectory - Third burn

## 8. MASS CHARACTERISTICS

The AS-504 Third Flight Stage (S-IVB-504, I.U. and Payload) mass characteristics presented in table 8-1 are "best estimate" values.

### 8.1 Mass Property Uncertainties Analysis

Figures 8-1 through 8-12 present a comparison of the predicted vehicle mass characteristics and three sigma uncertainties versus the actual flight mass characteristics during S-IVB powered flight. The predicted uncertainties were determined from a statistical analysis of component mass properties uncertainties and are referenced relative to time from S-IVB Engine Start Command.

The mass of the vehicle was close to predicted and well within the mass tolerance until the end of the first burn. Because of the additional (10.5 sec) burntime required to achieve orbital velocity, the mass of the vehicle was below the three sigma low tolerance until third engine start command plus 150 sec, at which time the LOX bleed valve opened reducing the engine flow rate. Subsequent events caused the vehicle mass to cross the tolerance band and exceed the three sigma high tolerance at third burn engine cutoff command.

### 8.2 Best Estimate Ignition and Cutoff Masses

The "best estimate method" is a three dimensional statistical analysis of data from various measurement systems. This method develops a joint probability density function for each of the three burns from which the most probable ignition and cutoff masses and their associated accuracies are determined.

For all three burns, three measurement systems were utilized to compute the best estimate masses:

1. Flow Integral Propellant Consumption
2. Volumetric P.U. Ignition and Cutoff Masses
3. P.U. Indicated (Corrected) Ignition and Cutoff masses.

## 8.2 Best Estimate Ignition and Cutoff Masses (continued)

Two other data sources, usually utilized, were not available for this analysis. The trajectory reconstruction ratio of ignition mass over cutoff mass was not used because the short burn time (for the first two burns) and the anomalies (on the third burn) rendered the accuracy of the trajectory reconstruction insufficient to be of value for the best estimate analysis.

Level Sensor Data was not available because of the large residual propellants.

A brief description of the various measurement systems is presented in Section 16.

Figures 8-13 through 8-15 show graphical presentations of the best estimate analysis for first, second, and third burns respectively.

TABLE 8-1 (Sheet 1 of 3)  
AS-504 THIRD FLIGHT STAGE FINAL EVAL. MASS SUMMARY

EVENT	FIRST BURN				SECOND BURN				THIRD BURN				C S M SEPAR				
	SIC LIFT OFF	S2=543 SEPAR	FIRST S=IVB E S C	FIRST STOV	90 PCT. TRUST	FIRST S=IVB E C C	FIRST S=IVB E T C	TIME FRJM RVG. ZERJ	SIC LIFT OFF	S2=543 SEPAR	FIRST S=IVB E S C	FIRST STOV		90 PCT. TRUST	FIRST S=IVB E C C	FIRST S=IVB E T C	TIME FRJM RVG. ZERJ
TOTAL SECJNDS	0	537	537	540	542	542	542	542	542	542	542	542	542	542	542	542	542
LAUNCH ESCAPE	8869	0	0	0	0	0	0	0	0	0	0	0	0	0	0	0	0
SEPARATION PKG	51	0	0	0	0	0	0	0	0	0	0	0	0	0	0	0	0
ULLAGE ROCKETS	252	248	244	134	134	134	134	134	134	134	134	134	134	134	134	134	134
ADAPTER-PANELS	2510	2510	2510	2510	2510	2510	2510	2510	2510	2510	2510	2510	2510	2510	2510	2510	2510
COMMAND MODULE	12447	12447	12447	12447	12447	12447	12447	12447	12447	12447	12447	12447	12447	12447	12447	12447	12447
SERVICE MODULE	10587	10587	10587	10587	10587	10587	10587	10587	10587	10587	10587	10587	10587	10587	10587	10587	10587
SPS PROPELLANT	35984	35984	35984	35984	35984	35984	35984	35984	35984	35984	35984	35984	35984	35984	35984	35984	35984
ADAPTER RING	98	98	98	98	98	98	98	98	98	98	98	98	98	98	98	98	98
LUNAR MODULE	32034	32034	32034	32034	32034	32034	32034	32034	32034	32034	32034	32034	32034	32034	32034	32034	32034
ADAPTER-FIXED	1502	1502	1502	1502	1502	1502	1502	1502	1502	1502	1502	1502	1502	1502	1502	1502	1502
INSTRUMENT UNIT	4258	4258	4258	4258	4258	4258	4258	4258	4258	4258	4258	4258	4258	4258	4258	4258	4258
FROST	300	100	100	100	100	100	100	100	100	100	100	100	100	100	100	100	100
S&B504 DRY STG	24904	24904	24904	24904	24904	24904	24904	24904	24904	24904	24904	24904	24904	24904	24904	24904	24904
LX IN TANK	189378	189378	189378	189378	189378	189378	189378	189378	189378	189378	189378	189378	189378	189378	189378	189378	189378
LX ULLAGE GAS	50	50	50	50	50	50	50	50	50	50	50	50	50	50	50	50	50
LX BELT TANK	367	367	367	367	367	367	367	367	367	367	367	367	367	367	367	367	367
LX IN TANK	43602	43602	43602	43602	43602	43602	43602	43602	43602	43602	43602	43602	43602	43602	43602	43602	43602
LX ULLAGE GAS	40	40	40	40	40	40	40	40	40	40	40	40	40	40	40	40	40
LX BELT TANK	48	48	48	48	48	48	48	48	48	48	48	48	48	48	48	48	48
COLD HELIUM	372	372	372	372	372	372	372	372	372	372	372	372	372	372	372	372	372
APS PROPELLANT	648	648	648	648	648	648	648	648	648	648	648	648	648	648	648	648	648
AMB HE-REPRESS	72	72	72	72	72	72	72	72	72	72	72	72	72	72	72	72	72
GHZ IN STARTNK	5	5	5	5	5	5	5	5	5	5	5	5	5	5	5	5	5
SERVICE ITEMS	56	56	56	56	56	56	56	56	56	56	56	56	56	56	56	56	56
TOTAL MASS	368433	359310	359305	359189	358819	292249	291518	228152	228152	228152	228152	228152	228152	228152	228152	228152	228152

TABLE 8-1 (Sheet 2 of 3)  
AS-504 THIRD FLIGHT STAGE FINAL EVAL. MASS SUMMARY

EVENT	SECOND BURN									
	C S M DOCK T J L M	LUNAR MODULE EXTRACT	FIRST RESTRY PREPS	SECOND S-IVB E S C	SECOND STDV	3D PCT. THRUJST	SECOND S-IVB E C C	SECOND S-IVB E T D		
TIME FRJM	00 34 2M	00 4H 84	00 4H35M	00 4-145M	00 4H45M	00 4-145M	00 4H45M	00 4-145M		
RNG. ZERO	8,0005	5,0005	17,3005	47,2005	55,2005	57,7005	57,6005	59,0005		
TOTAL SECONDS	10928 ,000	14895 ,000	16577 ,300	17147 ,200	17155 ,200	17157 ,700	17217 ,600	17219 ,000		
LAUNCH ESCAPE	0	0	0	0	0	0	0	0		
SEPARATION PKG	0	0	0	0	0	0	0	0		
ULLAGE SOCKETS	0	0	0	0	0	0	0	0		
ADAPTER-PANELS	0	0	0	0	0	0	0	0		
COMMAND MODULE	12447	0	0	0	0	0	0	0		
SERVICE MODULE	10587	0	0	0	0	0	0	0		
SPS PROPELLANT	35984	0	0	0	0	0	0	0		
ADAPTER RING	98	0	0	0	0	0	0	0		
LUNAR MODULE	32034	0	0	0	0	0	0	0		
ADAPTER-FIXED	1502	1502	1502	1502	1502	1502	1502	1502		
INSTRUMENT UNIT	4258	4258	4258	4258	4258	4258	4258	4258		
FRJST	100	100	100	100	100	100	100	100		
S68504 DRY STG	24904	24904	24904	24904	24904	24904	24904	24904		
L1X IN TANK GAS	132713	132697	132593	132593	132561	131512	108883	109744		
L2X ULLAGE GAS	250	300	317	317	320	322	348	348		
L2X BELTAN TANK	367	357	357	367	367	397	357	357		
LH2 IN TANK	30685	29731	29409	29370	29342	29250	24437	24437		
L-12 ULLAGE GAS	300	324	324	344	350	352	397	397		
L-12 BELTAN TANK	48	68	68	48	56	58	58	68		
COLD HELIUM	318	318	318	293	295	294	255	254		
APS PROPELLANT	537	525	511	454	452	452	446	446		
AYB HE-REPRESS	72	72	72	72	72	72	72	72		
G-12 IN STARTNK	7	7	7	7	7	7	7	7		
SERVICE ITEMS	56	55	56	56	56	56	56	56		
TOTAL MASS	287067	195190	194639	196687	194642	193629	166129	165319		

TABLE 8-1 (Sheet 3 of 3)  
AS-504 THIRD FLIGHT STAGE FINAL EVAL. MASS SUMMARY

EVENT	THIRD BURN													
	SECJND RESTR PREPS	THIRD S-IVB E S C	THIRD STOV	90 PCT, THRJST	LOX BLEED OPEN	LH2 BLEED OPEN	THIRD S-IVB E C C	THIRD S-IVB E T D	TIME FRJN RVG. ZERO	OD 6H 7M 11,1005	OD 6H 7M 18,9005	OD 6H 8M 21,4005	OD 6H 9M 20,5005	OD 6H 11M 22,8005
TOTAL SECJNDS	21581 .100	22031 .100	22038 .900	22041 .400	22137 .700	22180 .500	22291 .400	22292 .800						
LAUNCH ESCAPE	0	0	0	0	0	0	0	0						
SEPARATION PKG	0	0	0	0	0	0	0	0						
ULLAGE ROCKETS	0	0	0	0	0	0	0	0						
ADAPTER-PANELS	0	0	0	0	0	0	0	0						
COMMAND MODULE	0	0	0	0	0	0	0	0						
SERVICE MODULE	0	0	0	0	0	0	0	0						
SPS PROPELLANT	0	0	0	0	0	0	0	0						
ADAPTER RING	0	0	0	0	0	0	0	0						
LJNAR MODULE	0	0	0	0	0	0	0	0						
ADAPTER-FIXED	1502	1502	1502	1502	1502	1502	1502	1502						1502
INSTRUMENT UNIT	4258	4258	4258	4258	4258	4258	4258	4258						4258
FRJST	100	100	100	100	100	100	100	100						100
S4B504 DRY STG	24904	24904	24904	24904	24904	24904	24904	24904						24904
LJX IN TANK	108609	108595	108573	108294	70832	59457	33652	33523						33523
LJX ULLAGE GAS	398	402	402	402	435	449	482	492						492
LJX BELJW TANK	367	357	357	397	397	397	397	357						357
LH2 IN TANK	23627	23515	23502	23395	15679	13156	8879	8849						8849
LH2 ULLAGE GAS	660	484	484	484	535	558	608	509						509
LH2 BELJW TANK	48	58	58	58	58	58	58	48						48
COLD HELIUM	264	264	264	264	232	217	183	193						193
APS PROPELLANT	417	365	363	362	330	319	312	312						312
A4B HE-REPRESS	72	54	54	54	54	54	54	54						54
G42 IN STARTNK	7	7	7	7	7	7	7	7						7
SERVICE ITEMS	56	55	56	56	55	56	55	56						56
TOTAL MASS	165089	164923	164893	164530	119378	105502	75452	75253						75253

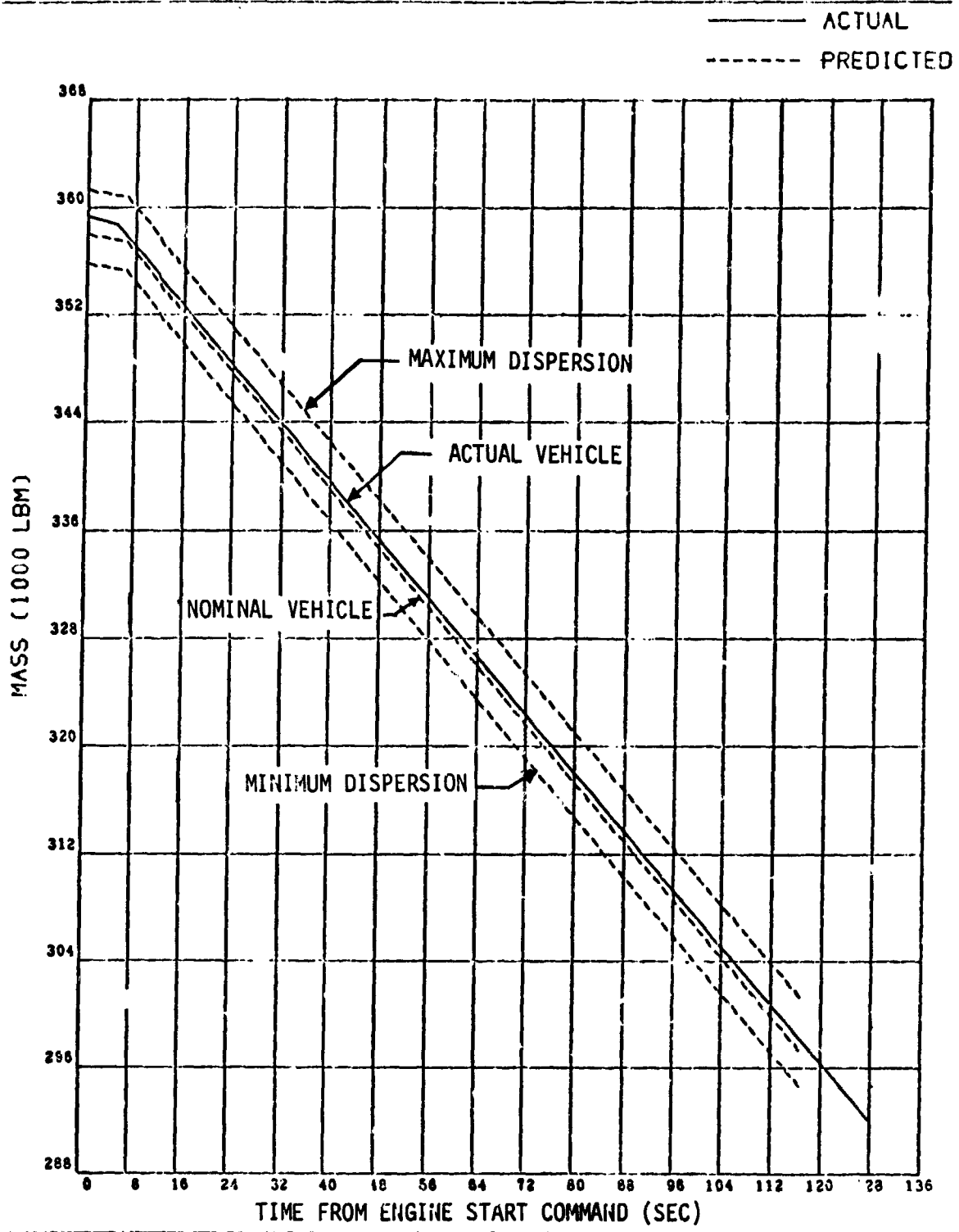

Figure 8-1. Third Flight Stage Vehicle Mass (First Burn)



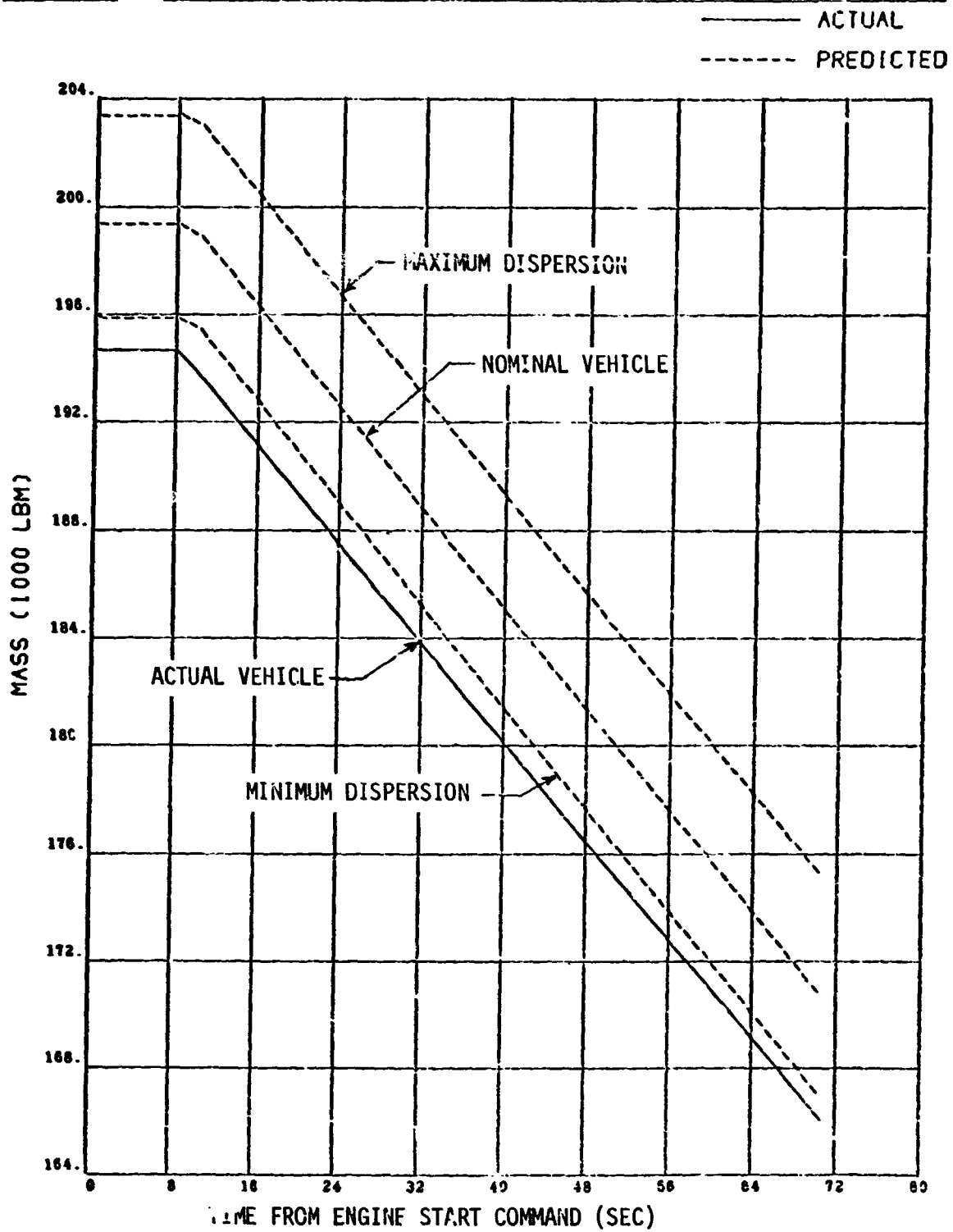

Figure 8-2. Third Flight Stage Vehicle Mass (Second Burn)

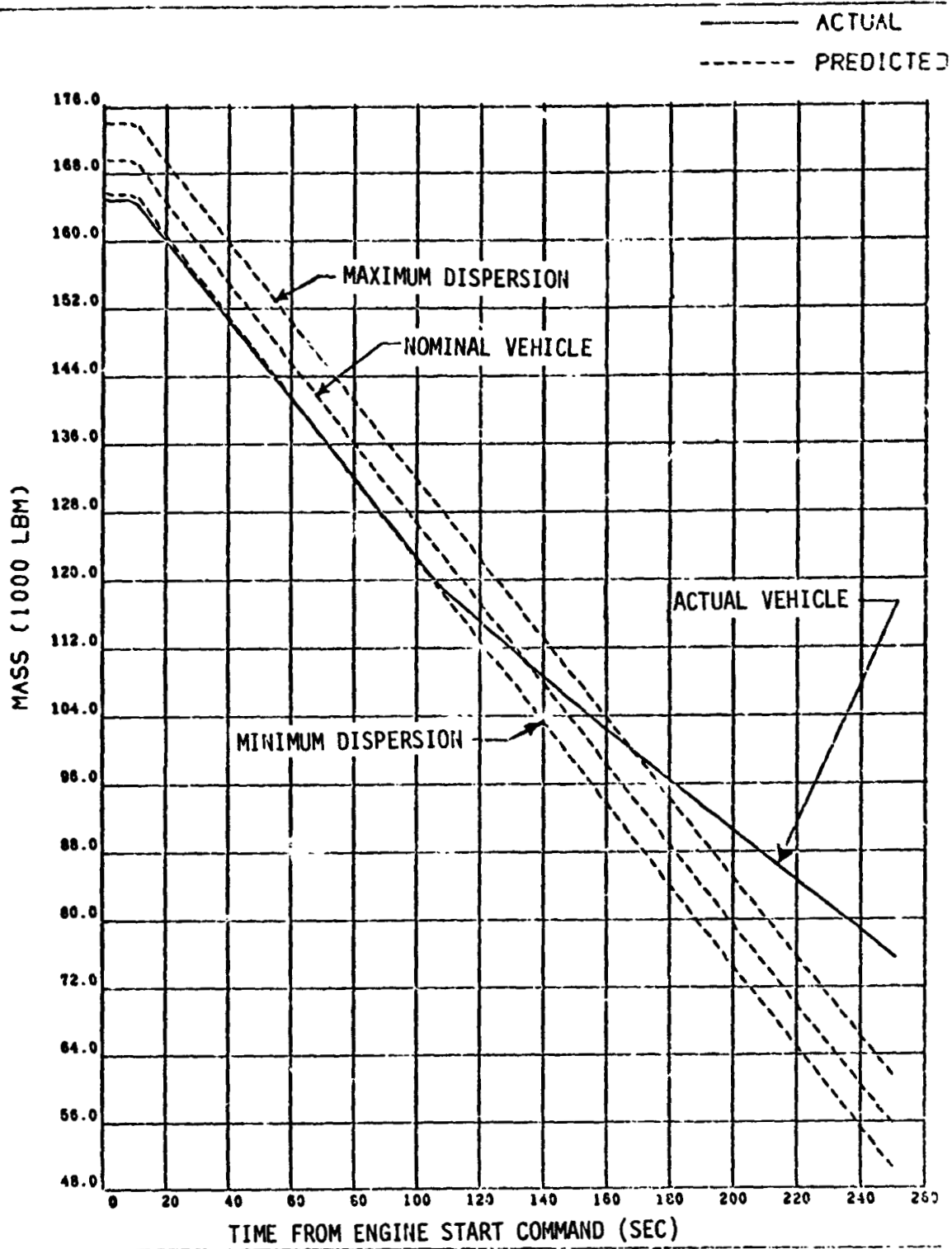

Figure 8-3. Third Flight Stage Vehicle Mass (Third Burn)

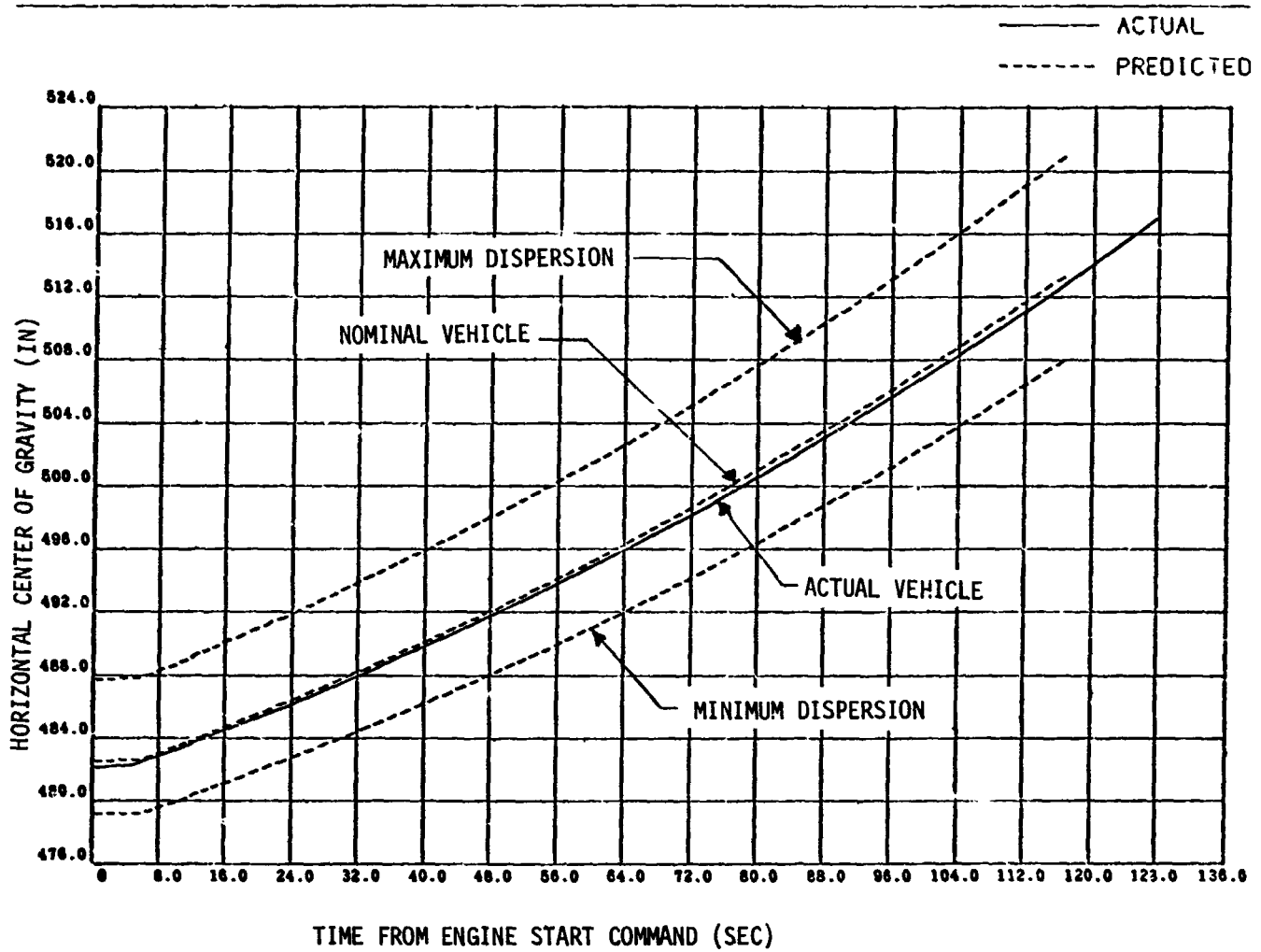

Figure 8-4. Third Flight Stage Vehicle Horizontal Center of Gravity (First Burn)

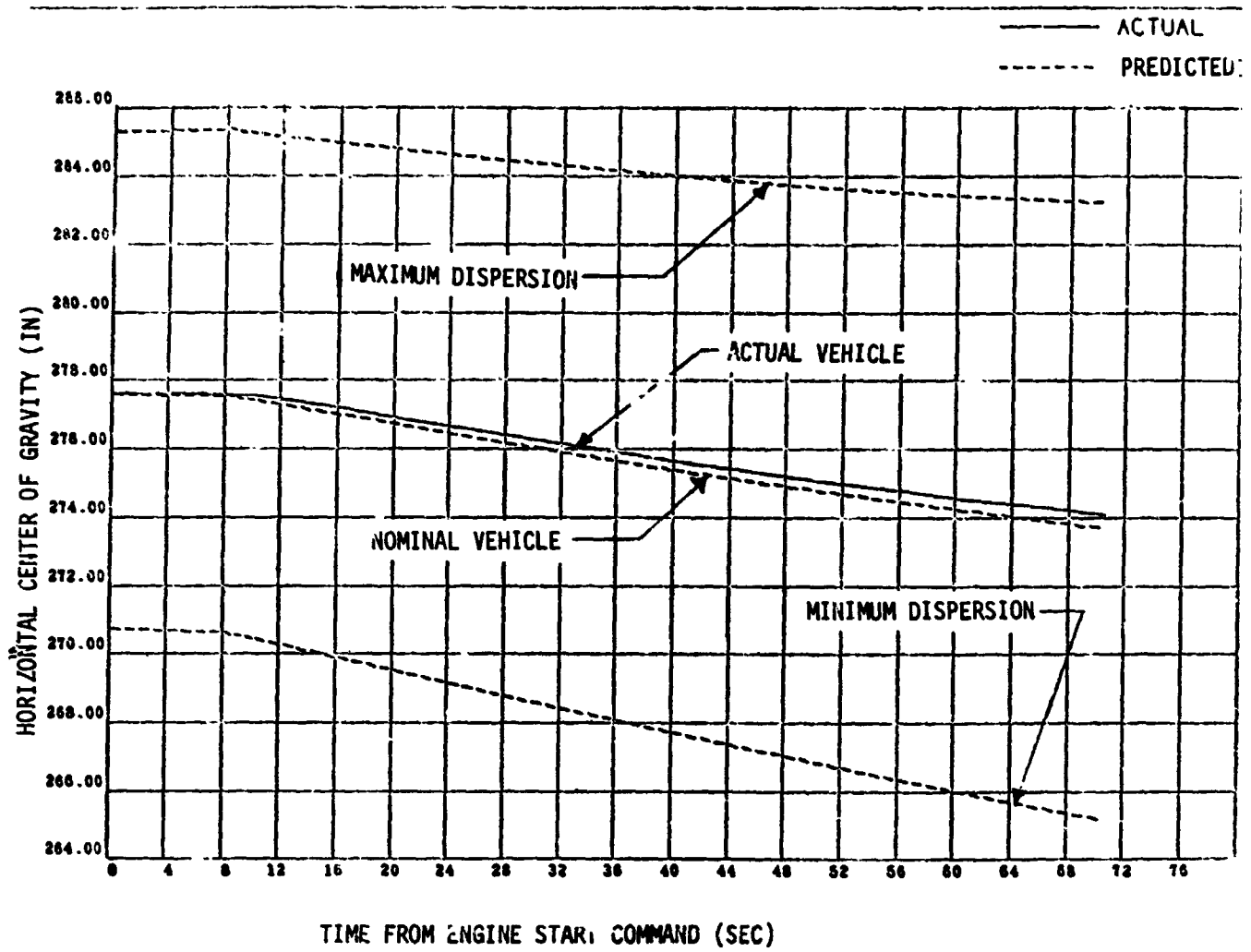

Figure 8-5. Third Flight Stage Vehicle Horizontal Center of Gravity (Second Burn)

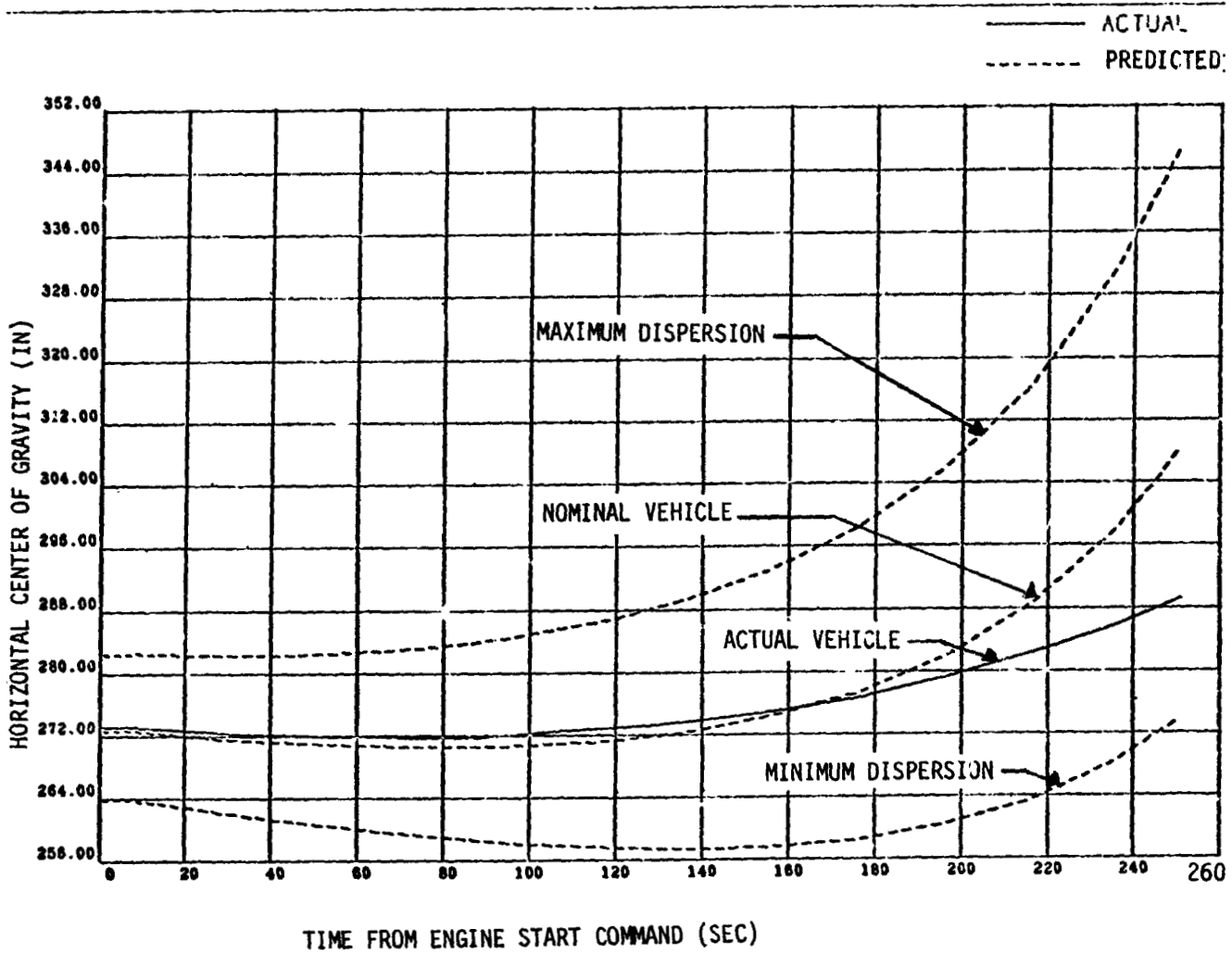

Figure 8-6. Third Flight Stage Vehicle Horizontal Center of Gravity (Third Burn)

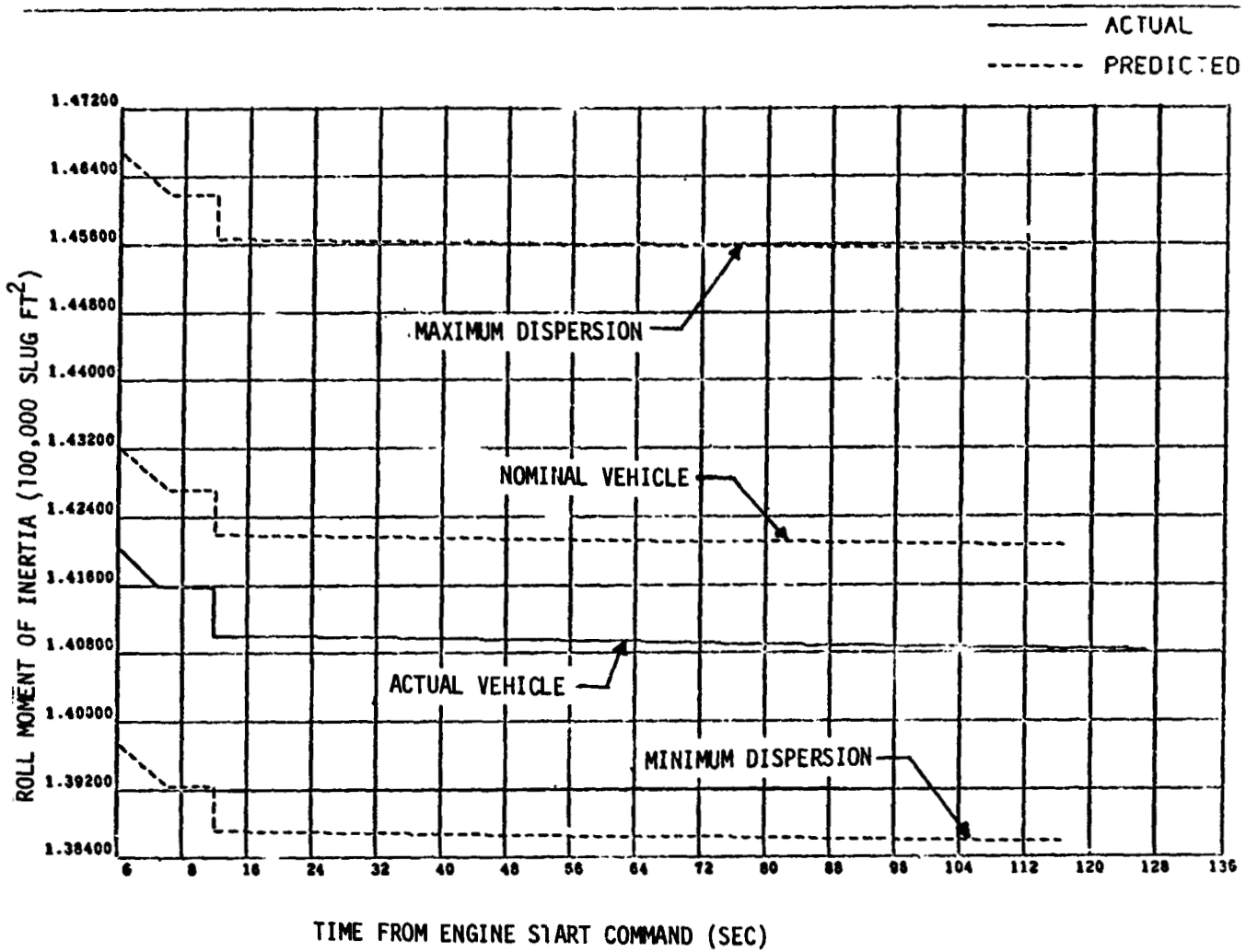

Figure 8-7. Third Flight Stage Vehicle Roll Moment of Inertia (First Burn)

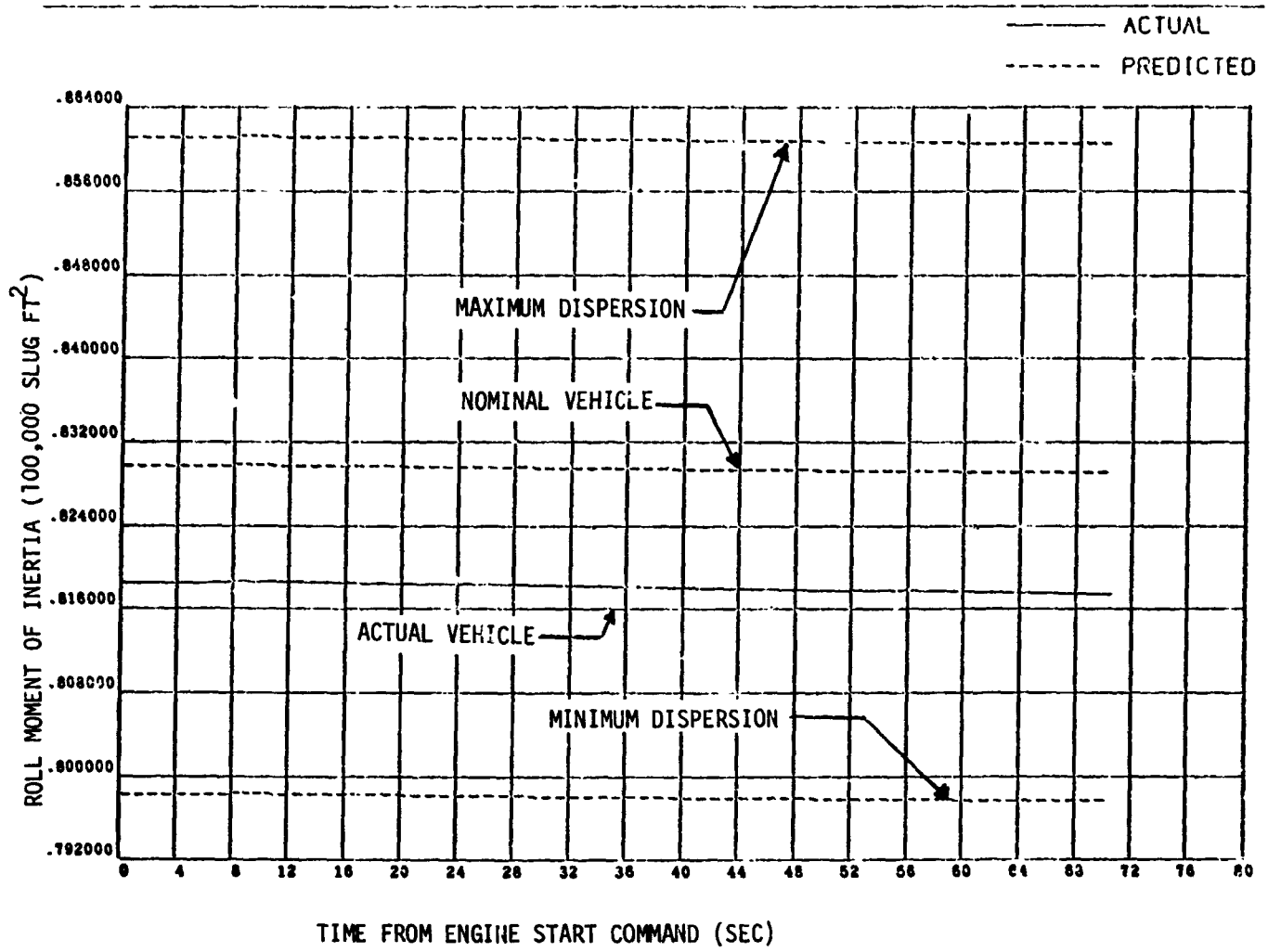

Figure 8-8. Third Flight Stage Vehicle Roll Moment of Inertia (Second Burn)

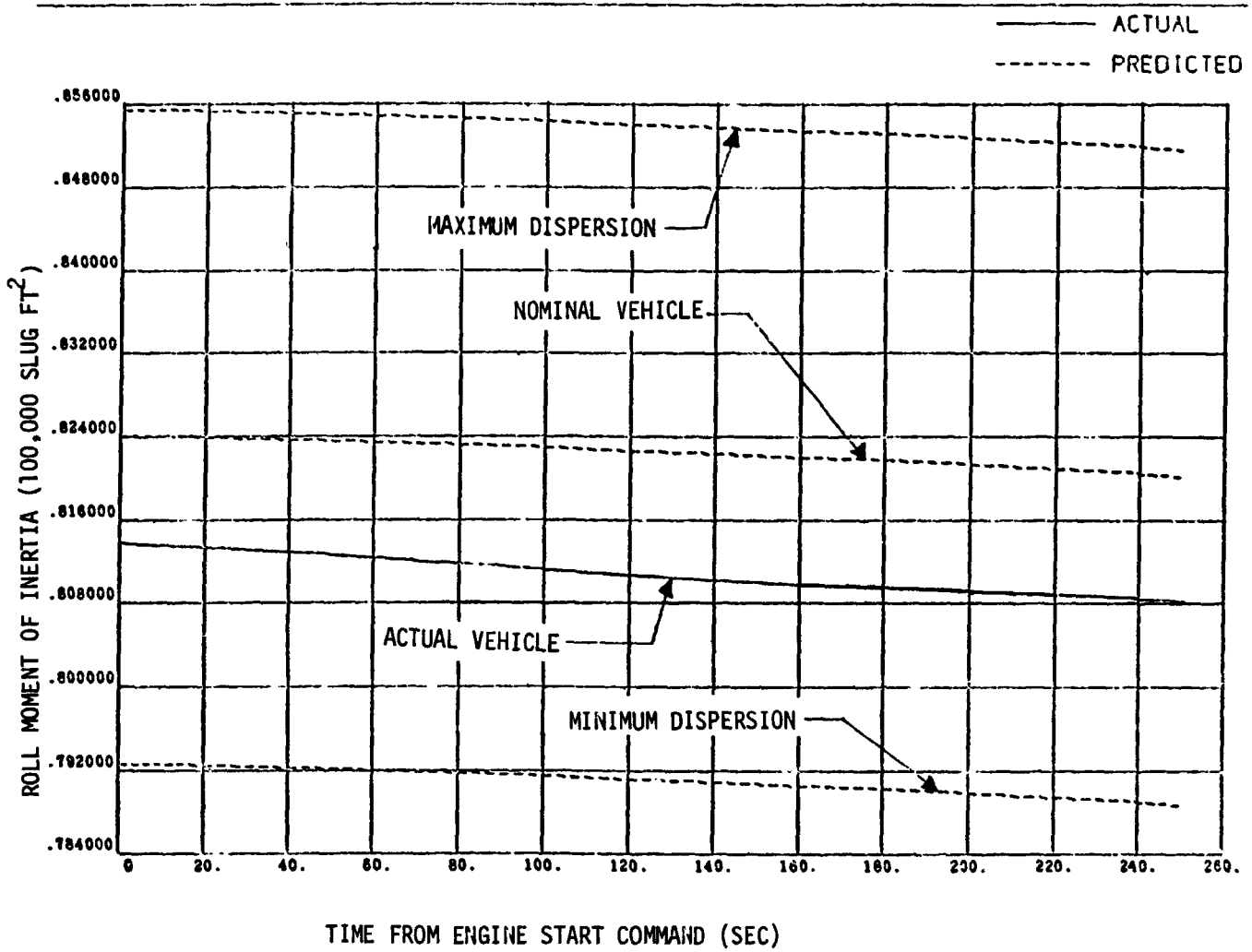

Figure 8-9. Third Flight Stage Vehicle Roll Moment of Inertia (Third Burn)



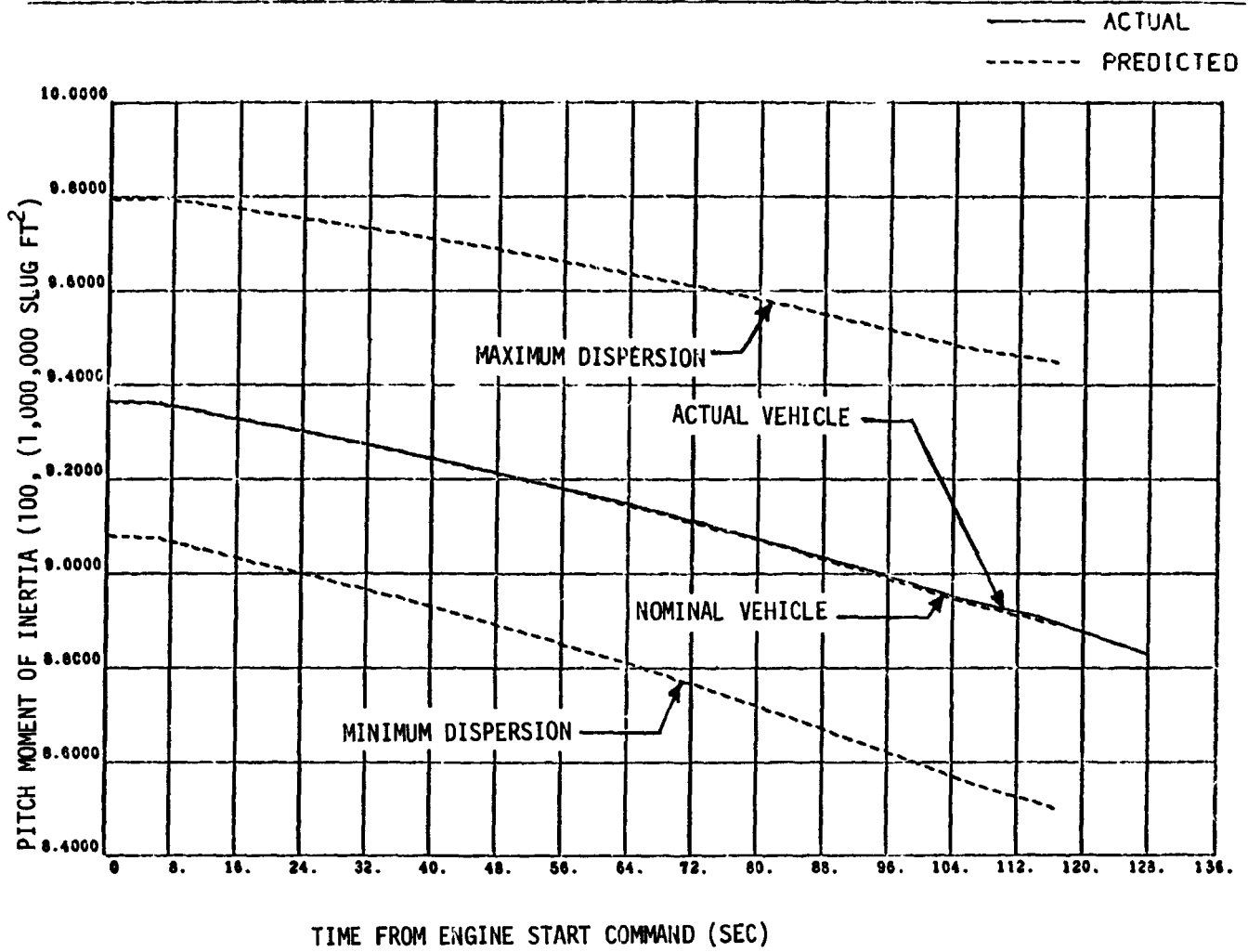

Figure 8-10. Third Flight Stage Vehicle Pitch Moment of Inertia (First Burn)

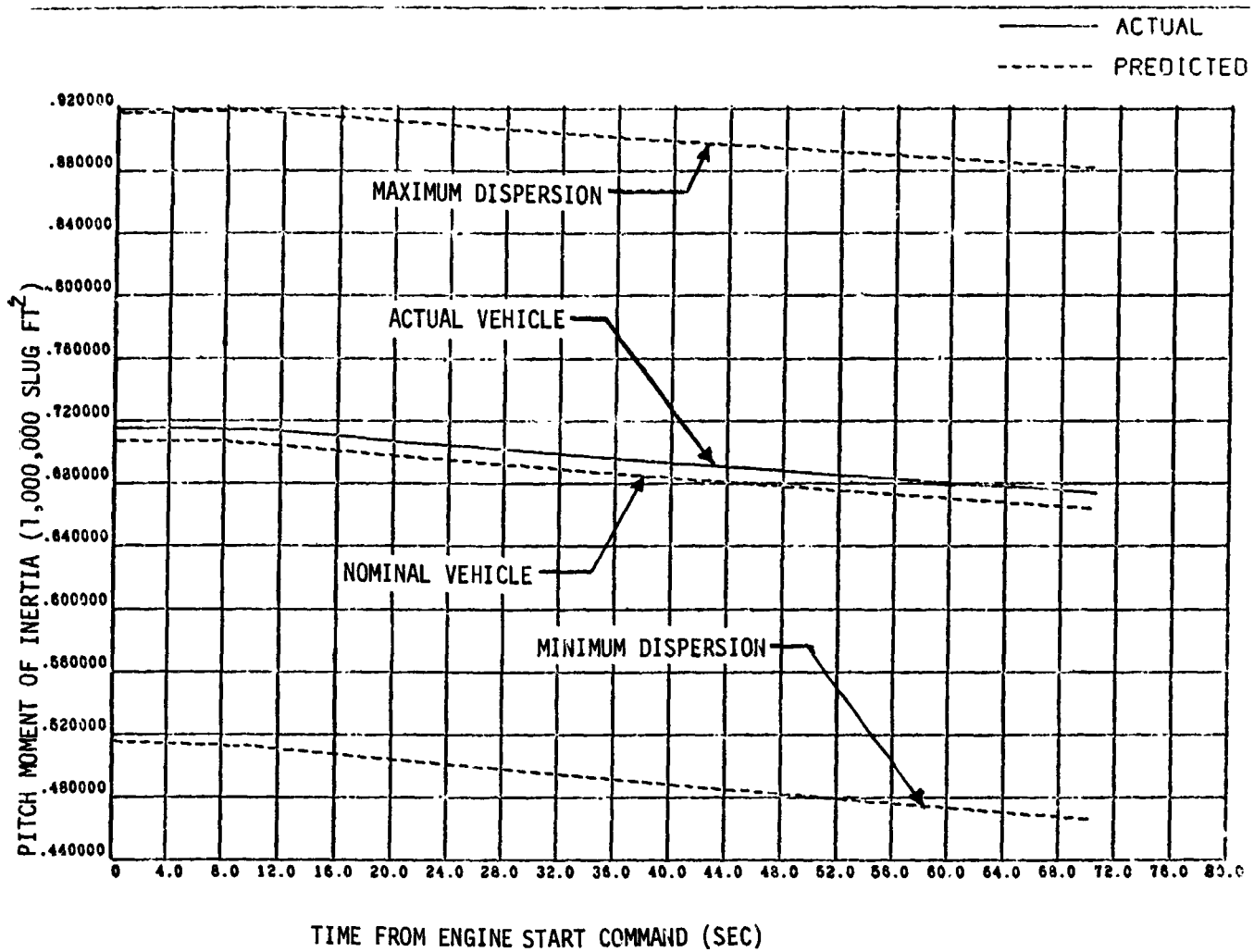

Figure 8-11. Third Flight Stage Vehicle Pitch Moment of Inertia (Second Burn).

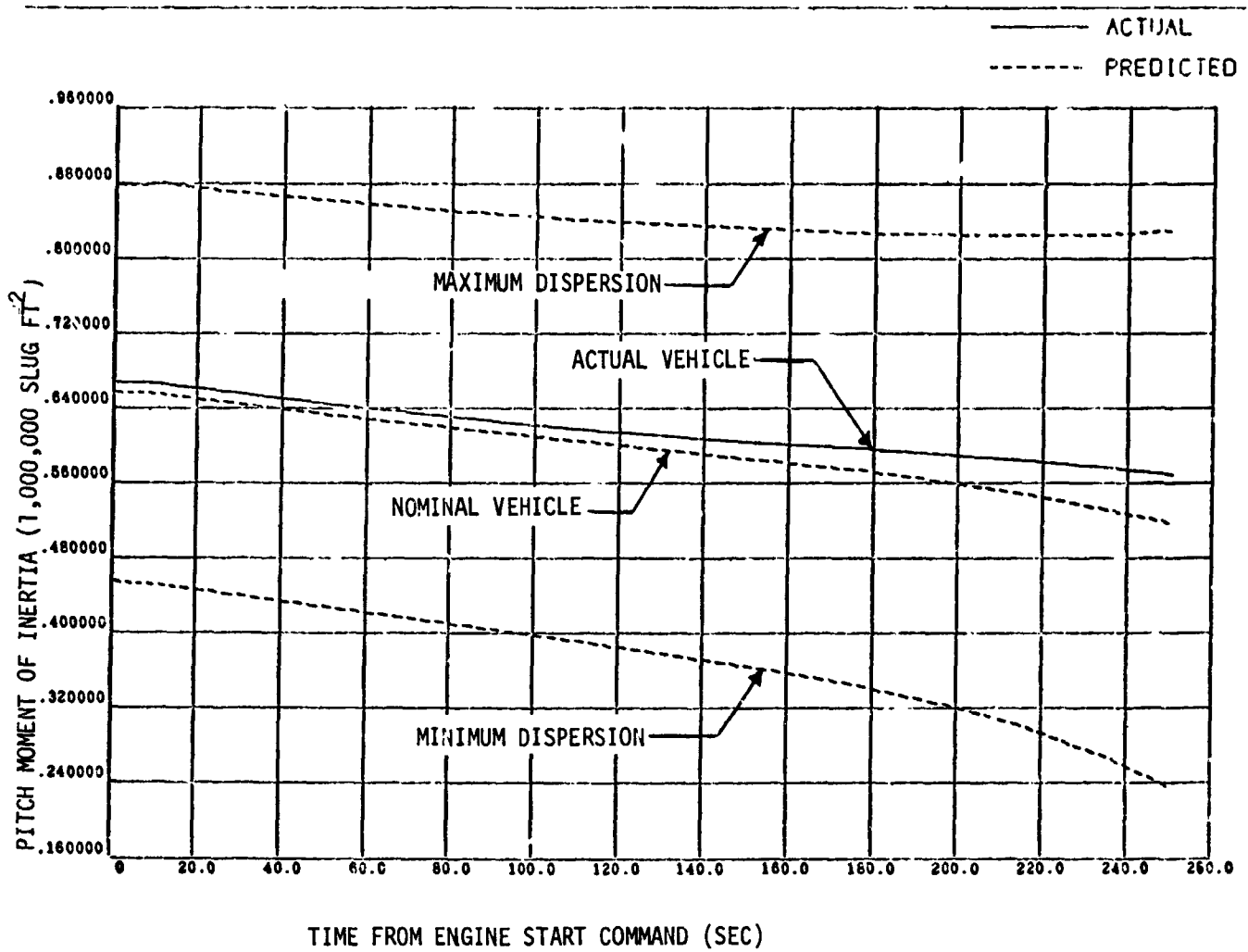

Figure -12. Third Flight Stage Vehicle Pitch Moment of Inertia (Third Burn).

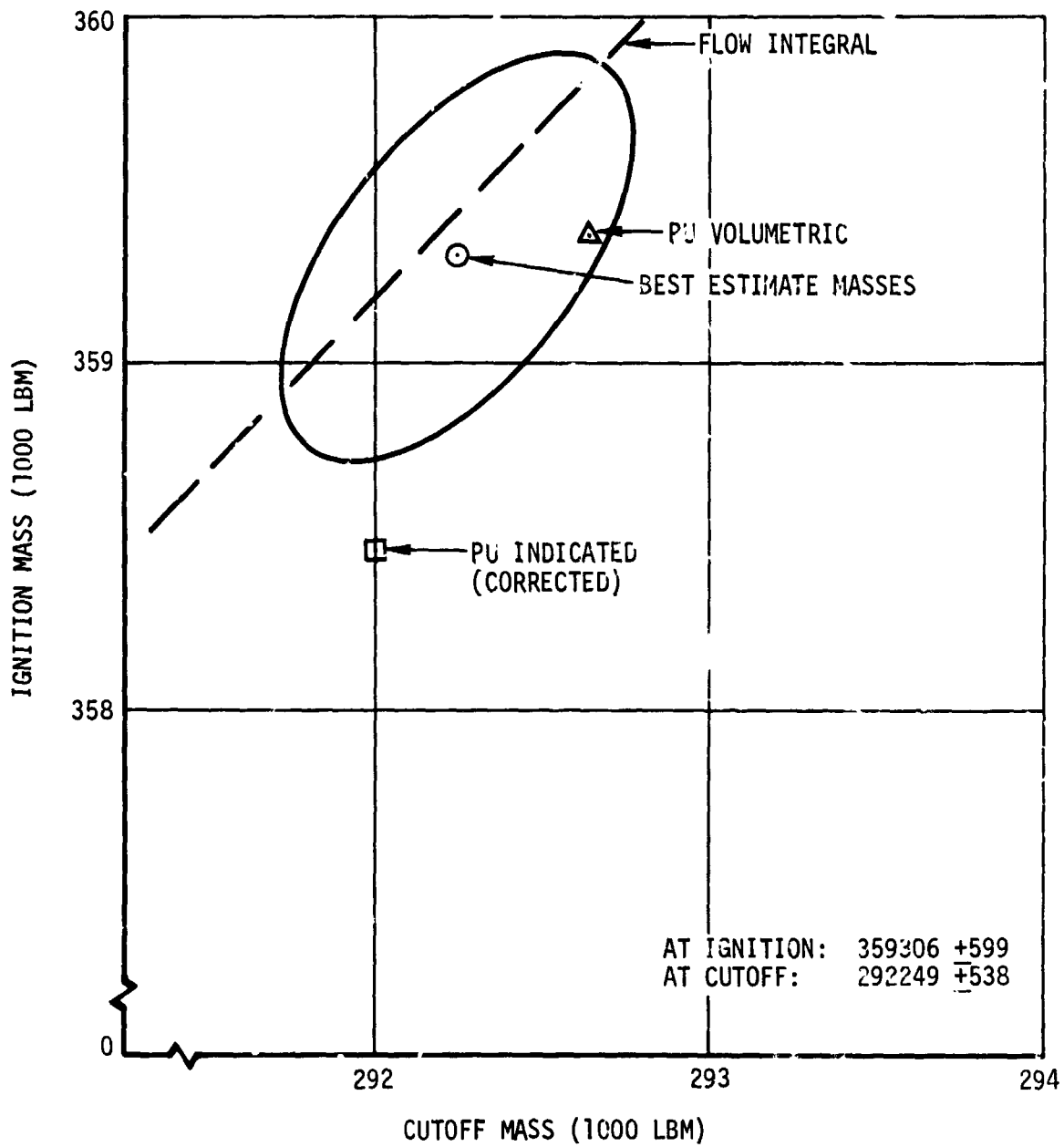

Figure 8-13. AS-504 Third Flight Stage Best Estimate Masses-First Burn

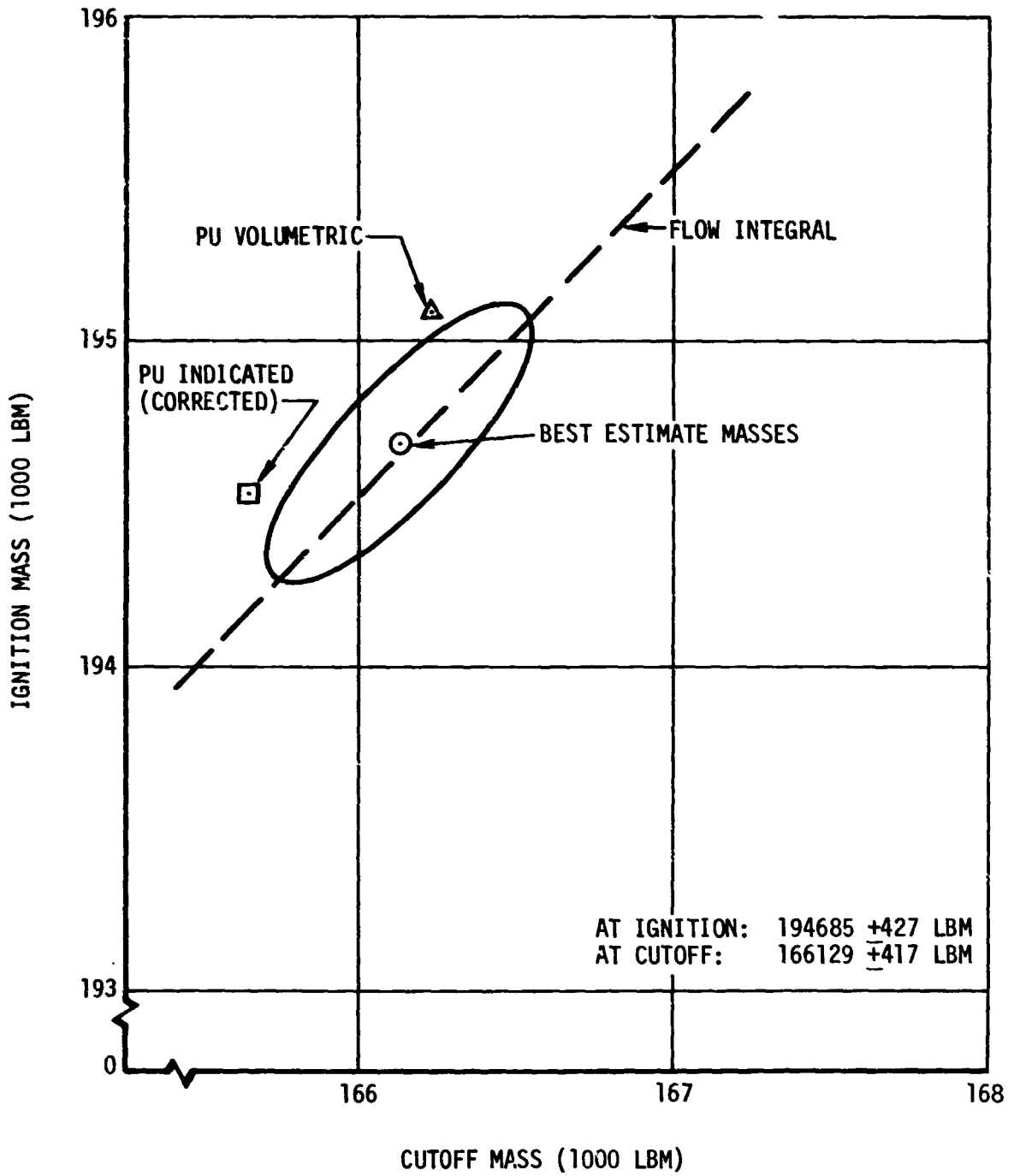

Figure 8-14. AS-504 Third Flight Stage Best Estimate Masses-Second Burn

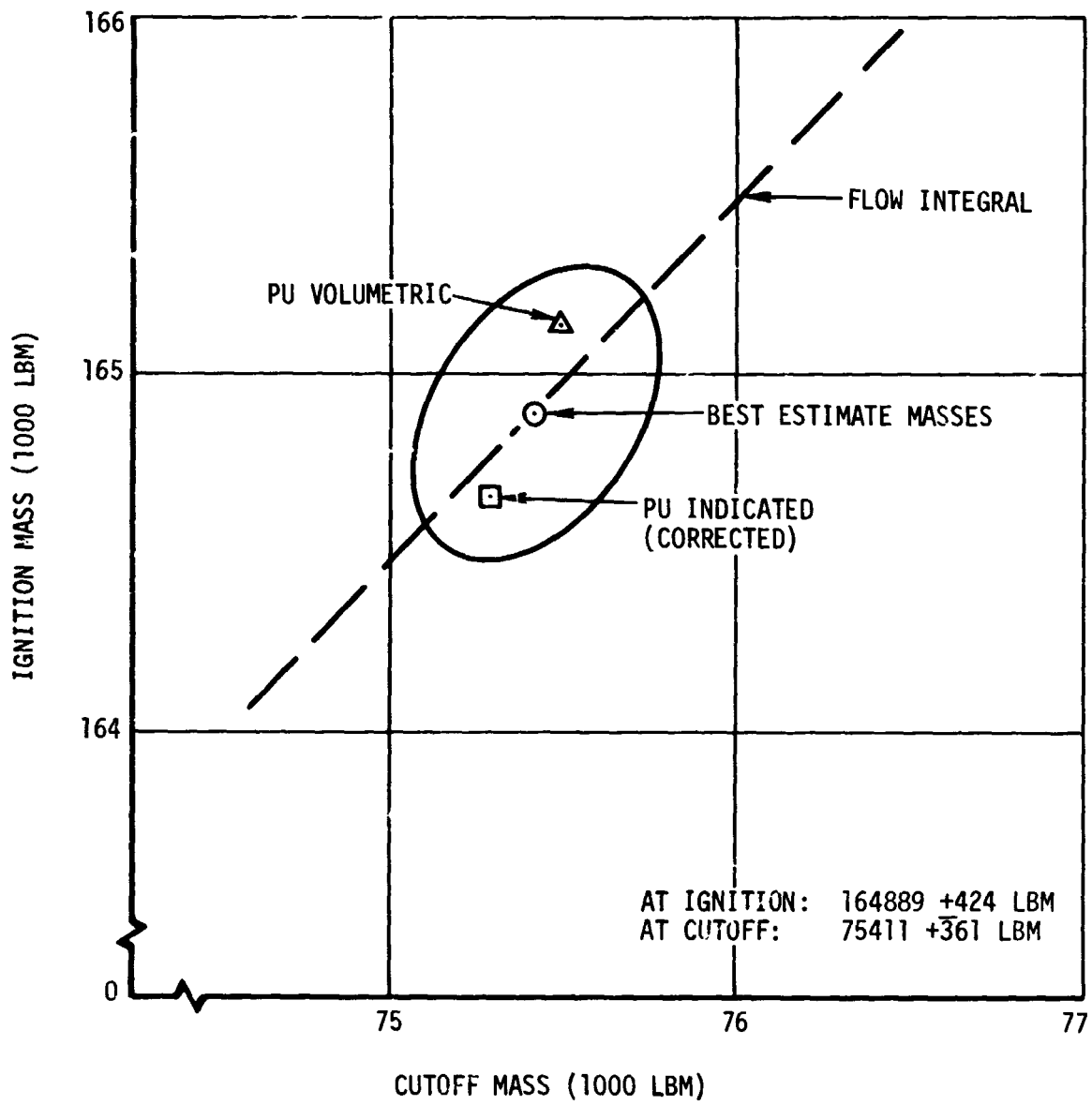

Figure 8-15. AS-504 Third Flight Stage Best Estimate Masses-Third Burn

9. ENGINE SYSTEM

The main propulsion system of the S-IVB stage of the AS-504 launch vehicle consisted of a Rocketdyne J-2 engine (S/N J-2094), shown schematically in figure 9-1, and the associated propellant ducting and conditioning systems. The engine was rated to operate at 230,000 lbf thrust. As a result of the analysis of the engine and stage acceptance tests, a set of variable tags (figures 9-2 and 9-3) were established using the following engine constants:

Engine Constants

LOX flowmeter	5.5384 cycles/gal
LH2 flowmeter	1.8504 cycles/gal
LOX bootstrap orifice	0.275 in. <sup>2</sup>
LH2 bootstrap orifice	0.486 in. <sup>2</sup>
Oxidizer turbine bypass nozzle	1.347 in. <sup>2</sup>

The engine was equipped with a 1.0-sec start tank discharge valve (STDV) timer in the engine control circuit; however, actuation of the STDV, which determines the fuel lead duration, was controlled from the stage through the fuel injection temperature bypass circuit. Using this control, the fuel leads were 2.924, 8.007, and 51.588 sec for the first, second, and third burns, respectively.

9.1 Modifications

The engine was modified to improve restart capability. These modifications included retiming the main oxidizer valve (MOV) opening rate, reducing the augmented spark ignitor (ASI) LOX orifice size, and painting the crossover duct black. The stage PU system was modified to provide for a second burn engine start with the PU valve full open. The engine control bottle was connected with the stage ambient repressurization bottles (figure 3-1). The ASI system was modified by removing the bellows in the fuel and LOX ASI feedlines and replacing them with rigid tubular lines as in 503N flight stage.

The PU valve was modified to reduce engine performance shifts. Other modifications were made involving instrumentation, but are not discussed here as they do not affect performance. Details of these modifications are presented in the Rocketdyne configuration report (R-5788).

## 9.2 Sequence of Events

The engine start and cutoff sequences were satisfactory in providing smooth transient operation and were compatible with the engine logic. The opening and closing times for the valves were obtained from potentiometer readings as there were no closed microswitch indications for the main engine valves on S-IVB-504N. The mainstage control solenoid energized time was not available on any burn due to erroneous signals. There were no major deviations from specifications at any engine events in the first two burns.

Third burn had significant deviations from nominal. As discussed in paragraph 9.6.4, an extended fuel lead initiated by Houston command was used rather than the normal 8-sec fuel lead. The LOX bleed valve fully opened 98.802 sec from STDV and the LH2 bleed valve opened fully 141.735 sec from STDV. From STDV +66.740 to STDV +67.845 sec both mainstage pressure switches dropped out for short periods but not long enough to cause IU cutoff. This condition should have initiated electrical control assembly (ECA) engine cutoff. However, it is believed that mainstage pressure switch No. 2 remained fused in the yes position to the ECA package, thereby not allowing engine cutoff. This would also account for the absence of the engine ready signal at engine cutoff. Engine ready requires both pressure switches in the depressed position with the ECA package. At Engine Cutoff Command mainstage No. 1 was indicating OK and mainstage No. 2 was indicating both OK and NOT OK. The gas generator (GG) started to close at 92.564 sec from STDV and at Engine Cutoff Command was approximately 52 percent open. These occurrences are attributed to the reduction in engine pneumatic pressure as discussed in paragraph 9.5.

At third engine cutoff the main valves took longer than nominal to begin closing, but once started, their closing times were faster than normal. This was due to low pneumatic pressure and also lower overall flow resistance.

Significant engine events during the start transients are shown in figures 9-4, 9-5, and 9-6. Figure 9-7 shows a comparison of significant events between second and third burn cutoff. Tables 9-1, 9-2, and 9-3 list the engine events for each burn.



### 9.3 Engine Chillover Conditioning

#### 9.3.1 Turbopump Chillover

Chillover in conjunction with the fuel lead adequately conditioned the LOX and LH2 turbopumps for a proper engine start for both first and second burns. For third burn restart, there was no chillover conditioning of the turbopumps. Fuel lead was used to condition the LH2 turbopump. Figure 9-8 shows the condition of the LOX pump.

#### 9.3.2 Thrust Chamber Chillover

##### 9.3.2.1 Ground Conditioning and Boost

Thrust chamber chillover was initiated at  $t_0 - 6.11$  sec and terminated at  $t_0 - 8.8$  sec (figure 9-9) with a main fuel injector temperature (C0200) that satisfied the maximum allowable redline limits of 340 deg R at liftoff. The temperature rise rate just prior to Engine Start Command was calculated to be 2.3 deg/min for S-IVB-504N flight and 0.7 deg/min for S-IVB-503N flight, whereas the average temperature rise rate during boost was 11.8 deg R/min for S-IVB-504N flight and 10.0 deg R/min for S-IVB-503N flight.

Engine start requirements for C0200 were obtained by adding the average difference between the thrust chamber jacket temperature (C0199) and C0200 (81 deg R) to C0199 engine start requirements. C0199 was a questionable measurement and hence was not used.

##### 9.3.2.2 Inflight Conditioning

Inflight conditioning of the thrust chamber was accomplished by the fuel lead which allowed hydrogen to flow through the thrust chamber jacket prior to mainstage operation. The time used for this fuel lead period is defined as the time between Engine Start Command and STDV solenoid energize.

Fuel lead times were 2.924 and 8.007 sec, respectively, for the first and second burns. The conditions and characteristics of these fuel lead operations are summarized in table 9-4. Flight measurements are presented in figures 9-10, 9-11, and 9-12.

Both fuel lead operations (first and second burns) were satisfactory. Engine performance during the fuel lead periods is presented in paragraphs 9.6.2, 9.6.3, and 9.6.4. Third burn fuel lead is discussed in paragraph 9.6.4.

### 9.3.3 Engine Start Sphere Chillover and Loading

Start sphere liftoff requirements are shown in figure 9-13 along with the actual. Sphere conditions at liftoff are compared to S-IVB-502 and S-IVB-503N flight conditions in table 9-5. The sphere warmup rate from sphere pressurization to blowdown was 1.3 deg/min; the S-IVB-503N warmup rate was also 1.3 deg/min. The difference between the GH2 start sphere and engine control helium sphere temperatures on S-IVB-503N and S-IVB-504N after pressurization was 30 deg R and 25 deg R, respectively. At liftoff, the respective differences had decreased to 10 and 4 deg R. The S-IVB-503N and S-IVB-504N warmup rates from pressurization to liftoff were 2.4 deg/min. From liftoff to sphere blowdown, the respective warmup rates were 0.6 and 0.7 deg/min. These warmup rates reflect the temperature differences before and after liftoff and are within the previous band of experience (figure 9-14).

### 9.3.4 Engine Control Sphere Chillover and Loading

Control sphere performance data during loading are presented in figure 9-15. Control sphere conditions at liftoff are compared with S-IVB-502 and S-IVB-503N flight conditions in table 9-6. The increase in pressure during boost is the result of boost-induced heating; similar pressure increases occurred during the boost periods of previous flights. The engine control sphere temperature (C0007) became erratic. Prior to liftoff, C0007 was constructed during its period of erratic behavior (figure 9-15).

## 9.4 Start System Performance

### 9.4.1 First Burn

The J-2 engine start system performed as expected during the first burn. The refill conditions are shown in table 9-7 and figure 9-16. The times for topping initiation and completion of 504N first burn were similar to those of S-IVB-502 first burn, which were also at an EMR of 5.5.

Following topping, heat input from the system environment caused a temperature increase and a corresponding pressure increase as shown in figure 9-16.

#### 9.4.2 Orbital Coast

It was predicted that the relief setting would be reached by first burn cutoff. However, the pressure at cutoff was 1259 psia and the relief setting was actually reached at ECC1 +73 min resulting in a mean pressure rise rate of 1.18 psi/min. The expected relief and cutoff pressure was 1320 psi. The actual cutoff pressure was lower because topping completion occurred at a lower pressure than expected so that the normal heatup during the remainder of burn was not sufficient to raise the pressure to the relief setting. The low topping completion pressure was due to a 44 psi difference between the start tank pressure and fuel pump discharge pressure at topping completion. This was the  $\Delta P$  required across the check valve to maintain flow.

Also, the relief pressure was 1346 psi instead of the expected 1320 psi and it required more time to reach the higher pressure after engine cutoff. The start bottle conditions were within the required restart envelope at ESC1 +65.7 sec at a pressure of 1200 psia. As noted on all previous flights, the measured temperature during the orbital coast is invalid. Corrected temperature data are compared to 502 and 503 data in figure 9-17.

#### 9.4.3 Second Burn

The J-2 engine start system also performed as expected during second burn. The refill conditions are shown in table 9-7 and figure 9-16. Following topping, heat input from the system again caused the expected temperature and pressure increases shown in figure 9-16.

#### 9.4.4 Second Coast Period

During second coast the start tank pressure never reached the relief setting due to the short burn and resulting low cutoff pressure and the relatively short coast period. However, the start tank conditions were within the required restart envelope at ECC2 +40 min. Pressure and temperature data are compared to first coast data in figure 9-18.

#### 9.4.5 Third Burn and Safing

The start system performance was again as expected. The start tank conditions are shown in table 9-7 and figure 9-16. At ESC3 +8.004 sec STDV Command Open was given and the pressure decay initiated at ESC3 +8.245 sec. STDV closure occurred at ESC3 +8.865 sec. Approximately 3.33 lbm of hydrogen was discharged during blowdown. The gaseous portion of refill was completed when the start tank pressure reached 806 psia at ESC3 +17.6 sec. Topping was completed with a start tank pressure of 1080 psia at ESC3 +68.4 sec. Refill and topping is shown in figure 9-19 for all three burns.

At the beginning of topping, the same temperature reversal condition was noted during third burn as was seen on 503 flight.

This condition is believed to be a characteristic of the start tank temperature transducer and its environment at this time and the data is considered misleading during these excursions.

At engine cutoff the pressure had risen to 1176 psi as shown in table 9-7 due to environmental heating.

The start tank was safed at approximately ECC3 +60 sec. The pressure decrease is shown in figure 9-20. At the last receipt of S-IVB data at ECC3 +25,739 sec, the start bottle pressure D0017 was reading 46 psia.

### 9.5 Engine Control Sphere Performance

#### 9.5.1 First Burn

During the AS-504 flight, the J-2 engine helium control sphere was connected to the eight stage ambient helium repress bottles. Two check valves between the control sphere and repress bottles insure that the direction of helium flow was always into the control sphere.

Table 9-6 shows pressure and temperature data and calculated mass for significant times throughout the mission. During both burns the ambient repress spheres replenished the control sphere. Figure 9-21 is a plot of bottle pressure versus temperature. Pressure and temperature versus time during the burn is shown in figure 9-22. A drop in temperature due to heat transfer with the start bottle caused more mass to flow into the

control bottle resulting in a slight increase in mass and pressure at first Engine Cutoff Command. A slight pressure decrease was noted in the ambient bottles due to the intermediate seal cavity purge during mainstage. The usage was within required limits. Pressure during the burn was within the band but slightly higher than the nominal prediction due to a high repress sphere pressure. The predicted value was 2935  $\pm$ 180 psia.

Due to friction in the lines, check valve flow resistance and spring forces, the pressure difference between the ambient bottles and the control bottle was approximately 45 psi.

Helium usage was estimated from purge flowrates and burn times. The fuel lead time for the first burn engine start was 2.929 sec, but the ignition phase control timer extended the period of high helium usage associated with the fuel lead to 2.929  $\pm$ (0.450  $\pm$ 0.03) sec which was normal. Approximately 0.350 lbm was consumed during first burn.

Figure 9-23 is a plot of regulator outlet pressure during the burn.

#### 9.5.2 First Orbital Coast

Pressure buildup due to heatup was as expected during the coast period. Figure 9-24 is a plot of pressure versus time during the coast.

#### 9.5.3 Second Burn

The pressure during the burn was higher than the nominal prediction due to higher than anticipated pressure in the repressurization spheres. Orbital heating effects were not included in the predictions of repress sphere pressure; therefore, the control sphere pressure approaches the maximum predicted for second burn. Figure 9-21 is a plot of bottle pressure versus temperature for second burn. Pressure and temperature versus time during second burn are shown in figure 9-22. A slight normal decrease in pressure in the repressurization spheres was again noted due to the intermediate seal cavity purge.

The ignition phase control timer extended the period of high helium usage from 7.999 sec associated with fuel lead to 7.999  $\pm$ (0.430  $\pm$ 0.03) sec. The mass usage during the burn was estimated from flowrates and was approximately 0.168 lbm. The temperature and pressure agreed with the prediction. Engine regulator outlet pressure is shown in figure 9-23.

#### 9.5.4 Second Orbital Coast

Pressure buildup due to heatup was within required limits during the coast period. Figure 9-24 is a plot of pressure versus time during the coast period.

#### 9.5.5 Third Burn

Prior to the initiation of the extended fuel lead for third burn, the stage ambient repress bottles were used to repressurize the fuel tank. There was sufficient helium for the repressurization and fuel lead. At STDV the engine regulator outlet pressure experienced a shift downward of 10 psi. It recovered 5 psi during the following 36 sec and then experienced a second shift downward of 10 psi<sup>(1)</sup> at STDV +50 sec.

Control sphere pressure dropped rapidly until the pressure was low enough for flow to once again occur between the ambient spheres and the control bottle. No further pressure decay was noted in the control sphere after the regulator outlet pressure dropped to zero.

The regulator outlet pressure dropped to zero and remained there throughout the remainder of the burn.<sup>(2)</sup> Accumulator pressure should have maintained the valves in their proper positions. There was an indication of a loss in accumulator pressure when the bleed valves came open and the GG valve started to close. Figure 9-23 is a plot of regulator outlet pressure and estimated accumulator pressure based on the valve closing pressure levels.<sup>(3)</sup> Accumulator pressure would be lost through the intermediate seal cavity purge if the check valve failed to remain closed or floated due to vibrations. Additional sources of possible leakage within the accumulator system include the purge control, fast shutdown, and low pressure relief valves.

- 
- (1) Such shifts have occurred during vibration tests made by Rocketdyne.
  - (2) Since the helium control solenoid could not be energized during the planned passivation sequence, the indication is an electrical failure.
  - (3) The closing pressure band for the GG valve is 220  $\pm$ 50 psig; for the ASI LOX valve it is 210  $\pm$ 50 psia; for the LOX bleed valve it is 245  $\pm$ 50 psia; for the LH2 bleed valve it is 210  $\pm$ 50 psia; for the purge control valve it is 200 to 225 psia, and for the fast shutdown valve it is 200 psia.

Figure 9-21 is a plot of control bottle pressure versus temperature for third burn. Pressure and temperature versus time are plotted in figure 9-22.

Approximately 2.1 lbm was consumed during the burn.

#### 9.5.6 Passivation

The programmed propellant dumps did not occur due to a failure of the helium control solenoid to energize. A slight decrease in control bottle pressure was noticed at the initiation of the repress sphere dump and the sequenced control bottle dump through the helium vent solenoid. Repress sphere dumping occurred at ECC +1875 sec and control sphere dumping occurred at ECC +1876 sec. The decay rate was slower than would be anticipated through the vent solenoid, indicating a possible failure to open all the way. An Engine Start Command signal sent during the planned 10-min dump failed to produce any change in the decay rate. At the end of the planned dump period, no change in decay rate was noticed indicating a failure of the helium vent valve to close. Since there was no indication of an electrical command received by the helium vent solenoid, the pressure loss may have been due to leakage. However, there was no loss in pressure noticed between the third Engine Cutoff Command and initiation of the bottle dump. Figure 9-25 is a plot of control bottle pressure after third burn engine cutoff. Figure 9-25 also shows that the stage ambient repress spheres recovered to a pressure level higher than the engine control sphere indicating that the pneumatic system leakage was not through the stage isolation check valves.

### 9.6 Engine Performance

#### 9.6.1 J-2 Engine Performance Analysis Methods and Instrumentation

The performance of the engine start tank and helium control sphere was analyzed by applying thermodynamic relationships to the measured data. Start and cutoff transient thrust and impulse were determined by computer program PA53. Flowrates and consumption during the transients were determined by computer program G105. Computer program UT23A was used to investigate internal engine performance. Third burn steady-state performance was calculated by use of computer program G105. The results

of G105 program were also used in determining the best estimate of stage propellant consumption. Steady-state performance and tag values, based on flight data, were generated by computer program PA63 (Rocketdyne PAST 641); the results are presented in table 9-8. Data inputs to the computer programs with the applicable biases are shown in table 9-9.

#### 9.6.2 Fuel Lead - First Burn

The S IVB-504N temperature and pressure data are compared with 503 data in figure 9-10. Data from 501 is also presented where applicable. The 502 data is similar to 501 data and is not presented. The AS-504 first burn data correlates well with 503 data except for thrust chamber jacket temperature (C0199) which is slow to react and fuel injector pressure (D0004) which is lower than 503. The C0199 anomaly was apparent all through the flight and is considered an instrumentation error. Injector pressure is also shown compared to 501 data. The AS-504 D0004 data correlates better with 501 data, since conditions for 501 and 504 first burns were similar. AS-503 starting conditions were hotter than the other flights thus producing the lower injector pressure. Table 9-4 shows that total impulse was similar to 501 and 502 due to the similarity presented above. Flowrates, total flow, thrust, and total impulse data presented in figure 9-26 were calculated using flowmeter, temperature, and pressure data.

#### 9.6.3 Fuel Lead - Second Burn

Temperature and pressure data from S-IVB-504N flight are compared to AS-503 data and also AS-501 data where applicable.

Data from AS-504 appear to correlate well with AS-503 data except for thrust chamber jacket temperature (C0199) and fuel injector temperature (C0200). The C0199 measurement is slow to react as explained in paragraph 9.6.2. The C0200 measurement is shown compared to AS-501 because of its similar starting condition. The difference between 504 and 503 is due to the higher ullage pressure for AS-503.

Table 9-4 shows that 504 used more fuel during the fuel leak period than AS-501, thus producing a higher impulse. The data shown in figure 9-27 of flowrates, total flow, thrust, and total impulse were calculated using the same method as for first burn analysis.



#### 9.6.4 Fuel Lead - Third Burn

In the event of a chardown pump failure, an extended fuel lead was to have been used to cool the fuel inlet duct and the thrust chamber to cryogenic conditions. This particular failure was simulated prior to third burn with a 51.6 sec fuel lead to examine the engine start achieved with this type of preconditioning.

Although engine startup appeared satisfactory, combustion instability occurred during burn as a probable result of the long duration fuel lead. Unsteady combustion has also been observed in Rocketdyne tests with similar extended fuel leads.

Figure 9-12 shows the fuel injection temperature along with the thrust chamber jacket temperature. These temperatures decreased at a slower rate than normal due to additional heat transferred to the fuel from the hot inlet duct and the fuel turbopump; however, after 16 sec liquid conditions were reached at the injector. From ESC -25 sec until STDV a relatively steady flow of low quality liquid existed at approximately 14 lbm/sec, leading to the expulsion of 555 lbm of LH2 during the fuel lead (figure 9-28).

As seen in figure 9-28, during steady-state liquid flow, the pressure in the system decreased from 29.4 psia at the pump inlet to nearly 0 psia at the engine exit. The fuel, which was subcooled at the pump inlet, became saturated at the pump discharge and began to flash so that a quality of .08 (8 percent gas by mass) occurred at the injector. As the two phase fluid flowed into the thrust chamber and toward the nozzle throat, the quality increased until the mixture changed from a liquid-gas to a solid-gas phase, after which the quality decreased toward the nozzle exit. A thrust of approximately 480 lbf was realized from this two phase flow during steady-state, which resulted in a total impulse of 19,500 lbf/sec

#### 9.6.5 Start Transients

Engine performance during the first and second burn start transients was satisfactory. A summary of this performance is presented in table 9-10. First burn thrust buildup occurred at a null PU valve position following a 3 sec fuel lead while second burn thrust buildup occurred with the PU

valve fully open after an 8 sec fuel lead. During first and second starts the PU valve position and MOV operation were satisfactory and good starts were obtained.

Thrust buildup to the 90 percent performance level (STDV Command +2.5 sec) was within the maximum and minimum thrust limits for first and second burns as shown in figure 9-29. Since these limits were established for a null PU valve position at start and the second start occurred with a full open PU valve, the thrust approaches the minimum limit near the end of the second burn start transient.

Third burn start transient performance, also occurring with a full-open PU valve, was lower than the second start performance, and fell out of the three sigma start envelope (figure 9-29). Failure to remain within the envelope may be attributed to two factors. First, the envelope is for a 5.0 EMR start and the third burn start was at 4.5. And second, the absence of a LOX system chilldown caused a slight cavitation of the LOX pump and a reduction of the LOX pump discharge pressure. The lower than normal pressure against the MOV allowed the latter to open earlier. Because the gas generator bootstraps upstream of the MOV, the early opening of the MOV starved the gas generator of some of its oxidizer, thus causing a slower than normal buildup of the gas generator and engine.

The thrust and total impulse at the 90 percent performance level were very similar to the S-IVB-501 and 503 flight values for first and second burns. Third burn start performance was lower than second burn for the reason mentioned above. The total impulse values were greater than those reported in the log book. Figure 9-29 shows the thrust chamber pressure, the thrust buildup, and total impulse during the start transients. Figures 9-30 and 9-31 show the measured flowrates, consumptions and pump speeds during the three start transients.

#### 9.6.6 J-2 Engine Steady-State Performance

##### 9.6.6.1 First and Second Burns

The S-IVB stage J-2 engine met all objectives during the 504N mission for the first and second burn. Plots of selected data showing engine

characteristics are presented in figures 9-32 through 9-37 for first and second burns. The engine propellant inlet conditions are discussed in sections 11 and 12. The average stage performance and propellant consumption summary is presented in tables 9-8 and 9-11. Computer engine performance parameters of thrust, ISP, EMR, LOX flow, fuel flow, and total flow for all burns are shown in figures 9-38 through 9-40.

The standard attitude performance level at approximately STDV +60 sec as determined by computer program PA63 (PAST-641 DECK) is shown in table 9-12.

Engine tag values for steady-state performance as compared to predicted are shown in figures 9-2 and 9-3. All tag parameters were within the three sigma run-to-run deviations except for EMR during first burn. It should be noted that mixture ratio variation between Rocketdyne engine acceptance test and MDAC stage acceptance firing was approximately 0.05 at the 60 sec point.

Satisfactory performance of the J-2 engine was observed throughout the first and second burn periods. First burn time was, however, approximately 11 sec longer than predicted. This was due to lower performance of the lower stages. Also, during second burn, the engine did experience performance shifts of 1500 lbf of thrust caused by 6 psia shifts in gas generator chamber pressure and 20 deg change in fuel turbine inlet temperature during second burn. These shifts are attributed to changes in the gas generator system flow resistance on the LOX side.

Coordination with the flight dynamics and control section indicates that the variations were sensed and corrected by the guidance computer.

Table 9-11 shows total impulse generated during mainstage operation. This provided sufficient velocity gain to complete orbital insertion during the first burn.

#### 9.6.6.2 S-IVB Third-Burn Mainstage Performance

The propulsion reconstruction analysis indicates that the stage performance during mainstage operation was lower than expected prior to the major power level changes. A comparison of predicted and actual performance of thrust, total flowrate, specific impulse, and mixture ratio versus time is shown in figure 9-40. Table 9-12 shows the specific impulse, flowrates and mixture ratio deviation from the predicted at the 60-sec slice. This time slice performance is the standardized altitude performance which is comparable to engine logbook data at the null PU position and second-burn performance. The 60-sec time slice performance for third-burn thrust was 0.664 percent lower than predicted and specific impulse performance 0.676 percent lower than predicted. This level of performance, which was attributed to the presence of thrust chamber pressure oscillations, was maintained until the loss of pneumatics caused the closing of the GG valve and the opening of the LOX and fuel bleed valves. Figures 9-32, 34 through 37, and 40 through 43 show the loss in performance due to this abnormal condition. The LOX injection pressure was approximately 470 psia at cutoff, which was within the pressure switch dropout points of 410 and 420 from test data had they been operative.

Table 9-13 is a comparison of AS-504 third-burn results and Rocketdyne instability tests.

Table 9-8 compares the S-IVB stage flight reconstruction performance with that predicted for third burn.

#### 9.6.6.3 Third-Burn Engine Performance (Anomalies)

Abnormal engine performance was observed throughout third burn. Figure 9-44 presents a sequence of events during third burn. The abnormal events in the sequence are attributed to a vibrational problem. Figure 9-45 is a flow diagram of the anomalies which occurred during third burn. Main chamber pressure exhibited pressure oscillations (up to 50 psi peak-to-peak) through the start phase and during most of third-burn operation. The effect of the pressure oscillations was to lower

main chamber pressure by about 20 psi during the first 93 sec. According to the reconstructed trajectory, this effect caused only a small reduction in the actual thrust performance.

A J-2 firing was conducted at Rocketdyne on 5-8-69 in an attempt to simulate the sustained pressure oscillations that occurred on the 504 flight third burn.

Results of the test duplicated most of the flight failures with mainstage pressure switch cutoff at approximately 120 sec. A PU excursion test was conducted early in the mainstage with no obvious effects on the pressure oscillations. A summary of significant events follows:

<u>504N FLIGHT</u>		<u>ROCKETDYNE J022-5 TEST</u>
Sustained Instability	Induced by start conditions	Induced by bomb at 90 percent
Fuel Injector Temp Fails	STDV +2	STDV +5
Erratic MOV Trace	STDV +17	STDV +18
Erratic MFV Trace	STDV +45	(None Noted)
Regulator Pressure Shift	STDV +3	STDV +3
Erratic M/S Pressure Switch No. 1	STDV +60	STDV +60
Regulator Failure	STDV +51	STDV +17
GG Valve Closing	STDV +96 (Reg fail +45)	STDV +47 (Reg fail +30)
ASI LOX Valve Close	Reg fail +46	Reg fail +30
LOX Bleed Valve Open	Reg fail +48	Reg fail +56
Fuel Bleed Valve Open	Ref fail +90	(Did not fail)
Engine Cutoff	250 sec by IU	120 sec by M/S P.S.

Other significant data on the Rocketdyne test:

- a. Following ECC actuation of the helium control solenoid would not vent the control bottle similar to flight experience. The bottle was vented using the ground vent solenoid.

- b. Several indications of external fire were noted around the thrust chamber; however, the ASI and gas generator appeared intact on post test inspection. Possibly caused by old test instrumentation installations in tubes.
- c. Injector face was "blue" from overtemp but no obvious damage was noted.
- d. About 80 tubes were split in the thrust chamber area allowing GH2 to flow into the chamber.
- e. Some external leakage of GH2 occurred near the thrust chamber skin temperature measurement (C0199)

During third burn seven distinct performance shifts occurred as noted.

1. STDV +3- sec - a change in performance occurred (figures 9-34, 9-41 and 9-42). This shift in performance is under investigation.
2. STDV +62 sec - a loss in performance occurred (figures 9-34

through 9-36, 9-41 through 9-42). This reduction in performance is attributed to a reduction in gas generator performance.

During the start phase the observed ignition spike could have caused either a rupture of a GG ignitor or an instrumentation port, burnthrough of the GG body or damage to the ASI or the ignition detection probe. In addition to these possible conditions, the LOX bleed valve cracking open would also cause a reduction in GG performance. As shown in figure 9-43, at this time the GG valve position exhibits a closing trend. Localized cooling could cause such an instrumentation response. However, if this was not the case and there was actual valve movement, it had negligible effect on performance. The GG valve is designed so that only a negligible change in performance will occur until the valve is less than 60 percent open.

Also, during this same time period, several measured parameters shown on figures 9-46 and 9-47 began to react to an increased vibrational condition or the effect of heating. The main oxidizer valve position, although indicating the valve was not fully open which is believed to have little effect on performance, began to respond to some increased vibrational or heating

condition, and the main fuel valve position also responded. The actuator pitch position which exhibited a response to vibrations or heating following STDV began to react to a definite change in its signal command. The reason for the increased unusual activity during this period correlates only as an effect and not a cause.

Also, during this period the thrust chamber jacket temperature (figure 9-36) exhibited a cooling trend, but the electrical control assembly temperature (figure 9-47) and thrust structure temperature (figure 9-47) both indicated a heating effect.

3. STDV +92 sec - a gradual decrease in performance began to occur. This is caused by the fuel bleed valve cracking open, or by a small crack occurring in the line upstream of the valve. This is substantiated by a typical loss in performance with an increase in turbine temperatures and fuel injection temperature and a decrease in fuel bleed valve temperature. See figures 9-32, 9-34 through 9-37, 9-40 through 9-42, and 9-48. Since the fuel injector temperature failed shortly after STDV, it was reconstructed using the LH2 pressurization module inlet temperature as shown in figure 12-7.

The slight opening of the fuel bleed valve, if it did occur, was not sufficient to be picked up by the microswitch.

4. STDV +99.8 sec - a very rapid decrease in performance occurred when the LOX bleed valve went fully open as indicated by its microswitch. Turbine temperature and speeds, GG pressure and main chamber, and flowrates all showed a drop characteristic of a LOX bleed valve opening fully. See figures 9-32, 9-34 through 9-37, 9-40 through 9-42.
5. STDV +128 sec - A gradual decrease in performance began to occur similar to that which occurred at STDV +92 sec. This was caused by the fuel bleed valve opening slightly more or to an increase in a hole in the line.

The fuel bleed valve open indication by the microswitch had still not occurred.

See figures 9-32, 9-34 through 9-37, and 9-40 through 9-42.

6. STDV +141.7 sec - a very rapid decrease in performance occurred when the fuel bleed valve went fully open as indicated by its microswitch. As shown in figures 9-32, 9-34 through 9-37, and 9-40 through 9-42, the observed drops in pressures, propellant flows, and turbopump speeds are characteristic of a fuel bleed valve going full open. The increase in turbine temperature is also characteristic and caused by reduced fuel flow to the GG.
7. STDV +170 sec - performance continued to decrease as the GG valve continued to close. During this time the effective flow area through the GG valve was controlling the loss in performance and at cutoff the valve was only 5 percent from closing the oxidizer poppet portion of the valve. See figures 9-32, 9-34 through 9-39, and 9-40 through 9-43.

#### Engine Environment

No abnormal heating was observed during first and second burn. During third burn, however, primary instrumentation package and ECA internal temperatures increased steadily as shown in figure 9-47.

The GG valve position (figure 9-43) indicator showed the valve to be opening slowly. This opening trend of the measurement can be correlated to a localized heating. Subsequent indicated valve closing could be actual valve motion due to pneumatic loss or localized cooling similar to 502 results.

Stage mounted engine area ambient temperature measurement (figure 9-49) after indicating a slight cooling for a few seconds following STDV, increased abruptly and failed off-scale high.

The behavior of these measurements can be attributed to a condition of hot gases escaping from the gas generator, thrust chamber or ASI. The last two situations are not believed because the observed changes in engine performance do not fully correlate the observed phenomena.



#### 9.6.7 Cutoff Transients

Engine performance during both first and second burn cutoff transients was satisfactory. The time lapse between engine cutoff, as received at the engine, and thrust decrease to 11,500 lbf (5 percent thrust) was within the maximum allowable time of 800 ms for first and second burns. Engine performance during the cutoff transients is shown in table 9-14.

The total impulse values determined for the flight were adjusted to standard conditions (null PU and 460 deg R MOV temperature) to compare them to the logbook values. Because MOV actuator skin temperature was not measured on this flight, cutoff impulse was corrected to predicted temperatures. The adjusted first burn cutoff impulse was 5,025 Lbf-sec lower than the log book value while the second burn impulse was 5,975 Lbf-sec lower. These variations were outside the specified limits since the total impulse to 5 percent thrust given in the J-2 engine log book (35,852 Lbf-sec) was incorrect. The log book value was 2,400 Lbf-sec high and more than accounts for the deviations between predicted and actual impulses.

Figure 9-50 shows the thrust chamber pressure, the thrust decrease, and total impulse for the first and second cutoff transients. The plot of cutoff transient thrust for third burn shows two small spikes. A study of the data for third burn suggests the spikes are the result of an irregular closing of the main propellant valves, caused by low pneumatic pressure at cutoff.

The first and second burn cutoff impulses to zero thrust determined from engine thrust data were 48,952 lbf-sec and 43,652 lbf-sec, respectively.

All deviations from predicted were within the expected three-sigma tolerance. Figure 9-51 presents a comparison of predicted and actual change in velocity caused by cutoff impulse based on engine and trajectory data. Table 9-15 presents a comparison of predicted and actual cutoff impulses for first, second and third burns.

Because of the above mentioned mainstage problems (see paragraph 9.6.6), thrust at third cutoff command was only 102,205 lbf. Also, because of the low pneumatic pressure available to the valves, the valves began to close later than normal. Consequently, although the thrust at cutoff was lower than normal, the delay in closing the valves gave a higher than normal cutoff impulse to zero thrust of 46,891 lbf-sec. This out-of-spec value may be attributed entirely to the delay in closing the main propellant valves. Figure 9-50 shows the chamber pressure, thrust, and total impulse for the third burn cutoff transient.

The cutoff impulse to zero thrust computed from actual trajectory data for the S-IVB first burn was 50,094 lb-sec, S-IVB second burn was 64,464 lb-sec, and the S-IVB third burn was 60,859 lb-sec. The first, second, and third burn cutoff impulse determined from actual engine thrust data were 48,952 lb-sec, 43,652 lb-sec, and 46,891 lb-sec respectively. Table 9-15 presents a comparison of the predicted, actual engine, and actual trajectory cutoff impulse for all three burns. First burn cutoff impulse deviation from predicted was within the expected three-sigma tolerance. A comparison of the predicted actual change in velocity due to cutoff impulse for the first burn is presented in figure 9-51. Second burn cutoff impulse derived from the actual trajectory data was higher than the three-sigma tolerance. Figure 9-51 presents the comparison of cutoff impulse for the second burn.

Third burn cutoff impulse derived from the actual trajectory data was higher than the three-sigma tolerance. Due to the reduction in thrust and propellant flowrate which occurred during third burn the mass at cutoff was larger than predicted, and with the higher than predicted cutoff impulse resulted in a change in velocity which appears to place it within the tolerances for a nominal third burn. Figure 9-51 presents the comparison of change in velocity for the third burn cutoff. A shift in the trajectory data sequence of 0.13 sec would be required to place the second and third burn cutoff impulse within tolerances.

Values of cutoff impulse obtained from trajectory analysis were derived from IU data transmitted to MDAC-WD from MSFC. Results agree with those derived by MSFC and IBM through analysis of the same data. No

explanation has been obtained for the differences in second and third burn cutoff impulse values occurring between engine analysis results and trajectory analysis results.

### 9.7 Trajectory Simulation Analysis

A five-degrees-of-freedom trajectory simulation program was used to adjust propulsion system parameter histories so that an S-IVB trajectory could be generated which closely matched the observed trajectory. To obtain this match of the observed trajectory a differential correction technique was used to adjust the levels of thrust and weight flow from those determined by engine analysis. These adjustments are summarized in the table below:

	<u>First Burn</u>	<u>Second Burn</u>	<u>Third Burn Before LOX Bleed Valve Failure</u>	<u>Third Burn After LOX Bleed Valve Failure</u>
Thrust	0.54 percent	1.26 percent	1.63 percent	-0.29 percent
Weight Flow	*	*	0.54 percent	0.54 percent

\*The weight flow for first and second burns was constrained to match the propellant consumption of the best estimate mass simulation.

These adjustments minimize, in a least squares sense, the weighted differences in earth-fixed azimuth angle, altitude, earth-fixed velocity, and axial acceleration between the observed and simulated trajectories. Average values of thrust and weight flow for the three burns are presented in Section 7.

### 9.8 Component Operation

#### 9.8.1 Main LOX Valve

The main LOX valve opened and closed satisfactorily for first and second burns.

The valve opening time data were as follows:

Item	Ambient Dry Nominal	S-IVB-503N Flight			Acceptance Test
		1st Burn	2nd Burn	3rd Burn	
First Stage Travel Time	50 <u>+25</u>	115	95	80	66
First Stage Plateau	510 <u>+70</u>	424	415	340	598
Second Stage Travel	1,825 <u>+75</u>	1,763	1,686	1,580	1,913
TOTAL	2,385 <u>+170</u>	2,302	2,196	2,000	2,577

The flight data acquisition accuracy is probably responsible for the deviations in first stage travel and first stage plateau times from the specification limits. The accuracy level is a result of the 10 sample/sec data sampling rate.

The main oxidizer valve opened very quickly during third start because of the low LOX pump discharge pressure. (The discharge pressure tends to hold the MOV closed.) The low discharge pressure was caused by a slight cavitation of the LOX pump, resulting from absence of LOX chill-down before third burn.

#### 9.8.2 Engine Driven Hydraulic Pump

The engine driven hydraulic pump performed satisfactorily during first and second burn periods. The average power required by the pump was 5.23 hp during these periods. These power levels were determined by hydraulics flight reconstruction computer program.

At ESC +84 sec of third burn the yaw actuator experienced a transitory cyclic extension and contraction of 0.65 cps maximum, lasting 25 sec and consuming 10.6 hp. The actuation was commanded by the guidance system.

#### 9.8.3 Pumps and Turbines

The LH2 and LOX pumps and turbines performed satisfactorily during first and second burns. The pump speeds, discharge pressures and temperatures during these burns responded to the engine inlet conditions, changes in GG bootstrap resistance to flow as described in paragraph 9.8.5 and the

opening of both bleed valves. The pressure and temperature drops across the turbines were nominal. The LH2 and LOX pump and turbine data are shown in figures 9-34, 9-35, and 9-37. The LH2 pump performance during all start transients is shown on the H-Q curves (figure 9-52) which indicates no severe trends toward the stall lines. During third start, however, there was a slight cavitation of the LOX pump caused by absence of LOX system chilldown. This resulted in low start LOX pump discharge pressure, but resulted in no overspin.

#### 9.8.4 PU Valve

The PU valve overall level of performance during both starts and burns was satisfactory. At first burn Engine Start Command the PU valve was at the null (-2 deg) position. The valve was commanded at ESC +8 sec to the 5.5 PU position for the remainder of first burn. Both restarts at the full open PU valve position were successful. At second and third burn Engine Start Commands -120 sec, the PU valve was commanded fully open. It responded properly going to the fully opened position (- deg) where it remained during the start transient of both burns until ESC +13 sec when the full-open command was removed. The valve was then commanded to the null position for the remainder of second and third burn. There was a slight drifting of the PU valve at null during both second and third burns as discussed in Section 16.

#### 9.8.5 Gas Generator

The gas generator performance was satisfactory during first and second burns. During second burn the gas generator performance responded normally to changes that occurred in GG LOX system resistance. Also, at about ESC2 +28 sec and ESC2 +47 sec, a shift in GG performance occurred, apparently because of changes in GG LOX system resistance to flow. The precise mechanism is not known. Plots of GG performance are shown in figure 9-53.

A pressure spike can be seen during third start (figure 9-54). This was caused by a LOX-rich start resulting from a low liquid quality fuel in GG (The result of no recirculation chilldown). Although figure 9-54 shows the spike to be 100 psi, it was probably much higher and occurred too fast to be accurately read by the transducer.

At approximately 70 sec after ESC3, the GG control valve began to close due to insufficient pneumatic pressure. At 100 sec, due to the increased loss of pneumatic pressure, the GG valve began to close more rapidly, dropping to 58 percent open at ESC3 +110 sec. When the LOX bleed valve went full open, the pressure inside the GG control valve bellows dropped causing the GG valve to open to 68 percent (a positive pressure in the bellows tends to stretch bellows, tending to close poppets). From this point, the drop in pneumatic pressure caused the valve to close further, until engine cutoff, when the GG valve was 50 percent open. Due to insufficient pneumatic pressure at ECC the GG control valve closing time was out of spec, 2,110 ms to full closed as opposed to the spec value of 500 ms. See figure 9-43.

At approximately ESC3 +72 sec a shift occurred in the GG performance. At this time the exact cause is unknown but may have been a hole in the GG, a leak past the LOX bleed valve, or a leak in the GG LOX bootstrap line.

TABLE 9-1 (Sheet 1 of 6)  
ENGINE SEQUENCE (504-FIRST BURN)

Control Events		Contingent Events		Nominal Time From Specified Reference	Actual Time (ms)	
Meas No.	Event and Comment	Meas No.	Event and Comment		From ESC	From Specified Reference
K0021 (K0621)	*Engine Start Command P/U			0	0	
		K0007 (K0531)	Helium Control Solenoid Engr P/U	Within 10 ms of K0021	0	0
		K0010 (K0454)	Thrust Controller Spark on P/U	Within 10 ms of K0021	0	0
		K0011 (K0455)	Gas Generator Spark on P/U	Within 10 ms of K0021	0	0
		K0006 (K0535)	Ignition Phase Control Solenoid Engr P/U	Within 20 ms of K0021	0	0
		K0012 (K0530)	Engine Ready D/O	Within 20 ms of K0006	13	13
		K0126 (K0558)	LOX Bleed Valve Closed P/U	Within 130 ms of K0007	190	190
		K0127 (K0557)	LH2 Bleed Valve Closed P/U	Within 130 ms of K0007	135	135
		K0020 (K0627)	ASI LOX Valve Open P/U	Within 20 ms of K0006	110	110

(K0XXX) Actual number from acceptance firing event recorder.

\*Engine ready and stage separation signals (or simulation) are required before this command will be executed. This command also actuates a 640 ±30 ms timer which controls energizing of the start tank discharge solenoid valve (K0096).

P/U - Pickup

D/O - Dropout

TABLE 9-1 (Sheet 2 of 6)  
ENGINE SEQUENCE (504-FIRST BURN)

Control Events		Contingent Events		Nominal Time From Specified Reference	Actual Time (ms)	
Meas No.	Event and Comment	Meas No.	Event and Comment		From ESC	From Specified Reference
		K0119 (G506)	Main Fuel Valve Closed D/O	60 ±30 ms from K0006	45	45
		K0118 (G506)	Main Fuel Valve Open P/U	80 ±50 ms from K0119	109	64
K0008 (K0537)	*Ignition Detected			Within 250 ms of K0021	N/A	
K0021 (K0021)	**Engine Start D/O			Approx 200 ms from K0021 P/U	N/A	
K0096 (K0536)	***Start Tank Disc Control Solenoid Engr			3,000 ±40 ms from K0021 P/U	2924	2924
		K0123 (G508)	Start Tank Disc Valve Closed D/O	100 ±20 ms from K0096	3169	245
		K0122 (G508)	Start Tank Disc Valve Open P/U	105 ±20 ms from K0123	3209	40
K0005 (K0538)	Mainstage Control Solenoid Engr			450 ±30 ms from K0096	N/A	

\*This signal must be received within 1,110 ±60 ms of K0021 P/U or cutoff will be initiated.

\*\*This signal drops out after a time sufficient to lock in the engine electrical.

\*\*\*An indication of fuel injection temperature of -150 ±40 deg F (or simulation) is required before this command will be executed. This command also actuates a 450 ±30 ms timer which controls the start of mainstage.

P/U - Pickup

D/O - Dropout



TABLE 9-1 (Sheet 3 of 6)  
ENGINE SEQUENCE (504-FIRST BURN)

Control Events		Contingent Events		Nominal Time From Specified Reference	Actual Time (ms)	
Meas No.	Event and Comment	Meas No.	Event and Comment		From ESC	From Specified Reference
		K0096 (K0536)	Start Tank Disc Control Solenoid Engr D/O	450 ±30 ms from K0096	3374	450
		K0121 (G507)	Main LOX Valve Closed D/O	50 ±20 ms from K0005	3370	N/A
		K0116 (G509)	Gas Generator Valve Closed D/O	140 ±10 ms from K0005	3568	N/A
		K0122 (G508)	Start Tank Disc Valve Open D/O	95 ±20 ms from K0096	3598	224
		K0117 (G509)	Gas Generator Valve Open P/U	50 ±30 ms from K0116	3756	188
		K0124 (G510)	LOX Turbine Bypass Valve Open D/O		3724	
			LOX Turbine Bypass Valve 80% Closed	400 +150 -50 ms from K0122	3942	344
		K0123 (G508)	Start Tank Disc Valve Closed P/U	250 ±40 ms from K0122	3863	265
		K0125 (G510)	*LOX Turbine Bypass Valve Closed P/U		4002	
K0158 (K0572)	Mainstage Press Switch #1 Depress D/O				5734	

\*Within 5,000 ms of K0005 (Normally = 500 ms)

P/U - Pickup

D/O - Dropout

TABLE 9-1 (Sheet 4 of 6)  
ENGINE SEQUENCE (504-FIRST BURN)

Control Events		Contingent Events		Nominal Time From Specified Reference	Actual Time (ms)	
Meas No.	Event and Comment	Meas No.	Event and Comment		From ESC	From Specified Reference
K0159	Mainstage Press Switch #2 Depress D/O				5734	
K0191 (K0610)	*Mainstage OK					
		K0120 (G507)	Main Lox Valve Open P/U	2,435 ±145 ms from K0005	5816	
		K0010 (K0454)	Thrust Chamber Spark on D/O	3,300 ±200 ms from K0005 P/U	6675	6358
		K0011 (K0455)	Gas Generator Spark On D/O	3,300 ±200 ms from K0005 P/U	6675	6358
K0507 CSS-22	PU Activate Switch P/U		Not on		N/A	

\*One of these signals must be received within 4,410 ±260 ms from K0021 P/U, or cutoff will be initiated. Signal occurs when LOX injection pressure is 500 ±30 psig.

P/U - Pickup

D/O - Dropout

TABLE 9- 1 (Sheet 5 of 6)  
ENGINE SEQUENCE (504-FIRST BURN)

Control Events		Contingent Events		Nominal Time From Specified Reference	Actual Time (ms)	
Meas No.	Event and Comment	Meas No.	Event and Comment		From ECC	From Specified Reference
K0140 (K0522)	Engine Cutoff P/U (New time reference)			0	0	
		K0005 (K0538)	Mainstage Control Solenoid Engr D/O	Within 10 ms of K0013	6	6
		K0006 (K0535)	Ignition Phase Control Solenoid Engr D/O	Within 10 ms of K0013	6	6
		K0020 (K0622)	ASI LOX Valve Open D/O		66	
		K0120 (G507)	Main Oxidizer Valve Open D/O	50 ±15 ms from K0005	131	125
		K0117 (G509)	Gas Generator Valve Open D/O	75 +25 ms from K0006 -35	95	89
		K0118 (G506)	Main Fuel Valve Open D/O	90 ±25 ms from K0006	187	181
		K0121 (G507)	Main Oxidizer Valve Closed P/U	120 ±15 ms from K0120	333	167
		K0116 (G509)	Gas Generator Valve Closed P/U	500 ms from K0006	445	439
		K0119 (G506)	Main Fuel Valve Closed P/U	225 ±25 ms from K0118	511	324

P/U - Pickup  
D/O - Dropout

TABLE 9-1 (Sheet 6 of 6)  
ENGINE SEQUENCE (504-FIRST BURN)

Control Events		Contingency Events		Nominal Time From Specified Reference	Actual Time (ms)	
Meas No.	Event and Comment	Meas No.	Event and Comment		From ECC	From Specified Reference
K0158 (K0572)	*Mainstage Press Switch A Depress P/U				275	
K0159 (K0573)	Mainstage Press Switch B Depress P/U			*	275	
K0191 (K0610)	Mainstage OK D/O			*	N/A	
K0007 (K0531)	Helium Control Solenoid Engr D/O			1,000 ±110 ms from K0013	956	956
SS-22 K0507	P/U Activate Switch D/O			N/A	N/A	
		K0125 (G510)	Oxidizer Turbine By- pass Valve Closed D/O		362	
		K0124 (G510)	Oxidizer Turbine Bypass Valve Open F/U	10,000 ms from K0005	1435	1429
K0126 (K0558)	LOX Bleed Valve Closed D/O			30,000 ms from K0005	4880	4874
K0127 (K0557)	LH2 Bleed Valve Closed D/O			30,000 ms from K0005	4880	4874

\*Signal drops out when pressure reaches 75 psi lower than pickup.

P/U - Pickup

D/O - Dropout

TABLE 9.2 (Sheet 1 of 6)  
ENGINE SEQUENCE (504-SECOND BURN)

Control Events		Contingent Events		Nominal Time From Specified Reference	Actual Time (ms)	
Meas No.	Event and Comment	Meas No.	Event and Comment		From ESC	From Specified Reference
K0021 (K0021)	*Engine Start Command P/U			0	0	
		K0007 (K0531)	Helium Control Solenoid Engr P/U	Within 10 ms of K0021	8	8
		K0010 (K0454)	Thrust Chamber Spark on F/U	Within 10 ms of K0021	8	8
		K0011 (K0455)	Gas Generator Spark on P/U	Within 10 ms of K0021	8	8
		K0006 (K0535)	Ignition Phase Control Solenoid Engr P/U	Within 20 ms of K0021	8	8
		K0012 (K0530)	Engine Ready D/O	Within 20 ms of K0006	86	78
		K0126 (F0558)	LOX Bleed Valve Closed P/U	Within 130 ms of K0007	178	170
		K0127 (K0557)	LH2 Bleed Valve Closed P/U	Within 130 ms of K0007	178	170
		K0020 (K0627)	ASI LOX Valve Open P/U	Within 20 ms of K0006	77	69

(K0XXX) Actual number from acceptance firing event recorder.

\*Engine ready and stage separation signals (or simulation) are required before this command will be executed. This command also actuates a 640 ±30 ms timer which controls energizing of the start tank discharge solenoid valve (K0096).

P/U - Pickup

D/O - Dropout

TABLE 9-2 (Sheet 2 of 6)  
ENGINE SEQUENCE (504-SECOND BURN)

Control Events		Contingent Events		Nominal Time From Specified Reference	Actual Time (ms)	
Meas No.	Event and Comment	Meas No.	Event and Comment		From ESC	From Specified Reference
		K0119 (G506)	Main Fuel Valve Closed D/O	60 ±30 ms from K0006	146	38
		K0118 (G506)	Main Fuel Valve Open P/U	80 ±50 ms from K0119	218	172
K0008 (K0537)	*Ignition Detected			Within 250 ms of K0021 P/U		
K0021 (K0021)	**Engine Start D/O			Approx 8,200 ms from K0021 P/U	8616	8616
K0096 (K0536)	**Start Tank Disc Control Solenoid Engr			8,000 ±40 ms from K0021 P/U	8007	8007
		K0123 (G508)	Start Tank Disc Valve Closed D/O	100 ±20 ms from K0096	8219	212
		K0122 (G508)	Start Tank Disc Valve Open P/U	105 ±20 ms from K0123	8364	145
K0005 (K0538)	Mainstage Control Solenoid Engr			450 ±30 ms from K0096	N/A	

\*This signal must be received within 1,110 ±60 ms of K0021 P/U or cutoff will be initiated.

\*\*This signal drops out after a time sufficient to lock in the engine electrical.

\*\*\*An indication of fuel injection temperature of -150 ±40 deg F (or simulation) is required before this command will be executed. This command also actuates a 450 ±30 ms timer which controls the start of mainstage.

P/U - Pickup

D/O - Dropout

TABLE 9-2 (Sheet 3 of 6)  
ENGINE SEQUENCE (504-SECOND BURN)

Control Events		Contingent Events		Nominal Time From Specified Reference	Actual Time (ms)	
Meas No.	Event and Comment	Meas No.	Event and Comment		From ESC	From Specified Reference
		K0096 (K0536)	Start Tank Disc Control Solenoid Engr D/O	450 ±30 ms from K0096	8457	450
		K0121 (G507)	Main LOX Valve Closed D/O	50 ±20 ms from K0005	8514	N/A
		K0116 (G509)	Gas Generator Valve Closed D/O	140 ±10 ms from K0005	8570	N/A
		K0122 (G508)	Start Tank Disc Valve Open D/O	95 ±20 ms from K0096	8591	134
		K0117 (G509)	Gas Generator Valve Open P/U	50 ±30 ms from K0116	8652	82
		K0124 (G510)	LOX Turbine Bypass Valve Open D/O		8638	
			LOX Turbine Bypass Valve 80% Closed	400 +150 -50 ms from K0122	8884	293
		K0123 (G508)	Start Tank Disc Valve Closed P/U	250 ±40 ms from K0122	8858	267
		K0125 (G510)	*LOX Turbine Bypass Valve Closed P/U		8943	
K0158 (K0572)	Mainstage Press Switch #1 Depress D/O				9868	

\*Within 5,000 ms of K0005 (Normally = 500 ms)

P/U - Pickup

D/O - Dropout

TABLE 9-2 (Sheet 4 of 6)  
ENGINE SEQUENCE (504-SECOND BURN)

Meas No.	Control Events		Contingent Events		Nominal Time From Specified Reference	Actual Time (ms)	
	Event and Comment	Meas No.	Event and Comment	From ESC		From Specified Reference	
K059	Mainstage Press Switch #2 Depress D/O					9868	
K0191 (K0G10)	*Mainstage OK						
		K0120 (K0507)	Main LOX Valve Open P/U		2,435 ±145 ms from K0005	10710	N/A
		K0010 (K0454)	Thrust Chamber Spark on D/O		3,300 ±200 ms from K0005 P/U	11744	N/A
		K0011 (K0455)	Gas Generator Spark On D/O		3,300 ±200 ms from K0005 P/U	11749	N/A
K0507 (K05-22)	PU Activate Switch P/U		Not on				

\*One of these signals must be received within 4,410 ±260 ms from K0021 P/U, or cutoff will be initiated. Signal occurs when LOX injection pressure is 500 ±30 psig.

P/U -- Pickup

D/O -- Dropout



TABLE 9-2 (Sheet 5 of 6)  
ENGINE SEQUENCE (504-SECOND BURN)

Control Events		Contingent Events		Nominal Time From Specified Reference	Actual Time (ms)	
Meas No.	Event and Comment	Meas No.	Event and Comment		From ECC	From Specified Reference
K0140 (K0522)	Engine Cutoff PU (New time reference)			0	0	
		K0005 (K0538)	Mainstage Control Solenoid Engr D/O	Within 10 ms of K0013	9	9
		K0006 (K0535)	Ignition Phase Control Solenoid Engr D/O	Within 10 ms of K0013	9	9
		K0020 (K0622)	ASI LOX Valve Open D/O		86	
		K0120 (G507)	Main Oxidizer Valve Open D/O	50 ±15 ms from K0005	125	116
		K0117 (G509)	Gas Generator Valve Open D/O	75 +25 ms from K0006 -35	34	25
		K0118 (G506)	Main Fuel Valve Open D/O	90 ±25 ms from K0006	161	152
		K0121 (G507)	Main Oxidizer Valve Closed P/U	120 ±15 ms from K0120	281	156
		K0116 (G509)	Gas Generator Valve Closed P/U	500 ms from K0006	363	354
		K0119 (G506)	Main Fuel Valve Closed P/U	225 ±25 ms from K0118	429	268

P/U - Pickup  
D/O - Dropout

TABLE 9-2 (Sheet 6 of 6)  
ENGINE SEQUENCE (504-SECOND BURN)

Control Events		Contingent Events		Nominal Time From Specified Reference	Actual Time (ms)	
Meas No.	Event and Comment	Meas No.	Event and Comment		From ECC	From Specified Reference
K0156 (K0572)	*Mainstage Press Switch A Depress P/U				212	
K0159 (K0573)	Mainstage Press Switch B Depress P/U			*	212	
K0191 (K0610)	Mainstage OK D/O		Not on	*	N/A	
K0007 (K0531)	Helium Control Solenoid Engage D/O			1,000 ±110 ms from K0013	960	
SS-22 K0507	PU Activate Switch D/O		Not on	N/A	N/A	
		K0125 (G510)	Oxidizer Turbine Bypass Valve Closed D/O		290	
		K0124 (G510)	Oxidizer Turbine Bypass Valve Open P/U	10,000 ms from K0005	1001	992
K0126 (K0558)	LOX Bleed Valve Closed D/O			30,000 ms from K0005	18761	18752
K0127 (K0557)	LH2 Bleed Valve Closed D/O			30,000 ms from K0005	19677	19668

\*Signal drops out when pressure reaches 75 psi lower than pickup.

P/U - Pickup

D/O - Dropout

TABLE 9-3 (Sheet 1 of 6)  
ENGINE SEQUENCE (504-THIRD BURN)

Control Events		Contingent Events		Nominal Time From Specified Reference	Actual Time (ms)	
Meas No.	Event and Comment	Meas No.	Event and Comment		From ESC	From Specified Reference
K0021 (K0021)	*Engine Start Command P/U			0	0	0
		K0007 (K0531)	Helium Control Solenoid Engr P/U	Within 10 ms of K0021	0	0
		K0010 (K0454)	Thrust Chamber Spark on P/U	Within 10 ms of K0021	0	0
		K0011 (K0455)	Gas Generator Spark on P/U	Within 10 ms of K0021	0	0
		K0006 (K0535)	Ignition Phase Control Solenoid Engr P/U	Within 20 ms of K0021	0	0
		K0012 (K0530)	Engine Ready D/O	Within 20 ms of K0006	2	2
		K0126 (K0558)	LOX Bleed Valve Closed P/U	Within 130 ms of K0007	173	173
		K0127 (K0557)	LH2 Bleed Valve Closed P/U	Within 130 ms of K0007	173	173
		K0020 (K0627)	ASI LOX Valve Open P/U	Within 20 ms of K0006	152	152

(K0XXX) Actual number from acceptance firing event recorder

\*Engine ready and stage separation signals (or simulation) are required before this command will be executed. This command also actuates a 640 ±30 ms timer which controls energizing of the start tank discharge solenoid valve (K0096).

P/U - Pickup

D/O - Dropout

TABLE 9-3 (Sheet 2 of 6)  
ENGINE SEQUENCE (504-THIRD BURN)

Control Events		Contingent Events		Nominal Time From Specified Reference	Actual Time (ms)	
Meas No.	Event and Comment	Meas No.	Event and Comment		From ESC	From Specified Reference
		K0119 (G506)	Main Fuel Valve Closed D/O	60 ±30 ms from K0006	N/A	
		K0118 (G506)	Main Fuel Valve Open P/U	80 ±50 ms from K0119	169	
K0008 (K0537)	*Ignition Detected			Within 250 ms of K0021 P/U		
K0021 (K0021)	**Engine Start D/O			Approx 200 ms from K0021 P/U		
K0096 (K0536)	***Start Tank Disc Control Solenoid Engr				51588	
		K0123 (G508)	Start Tank Disc Valve Closed D/O	100 ±20 ms from K0096	51829	241
		K0122 (G508)	Start Tank Disc Valve Open P/U	105 ±20 ms from K0123	51925	86
K0005 (K0538)	Mainstage Control Solenoid Engr			450 ±30 ms from K0096	N/A	

\*This signal must be received within 1,110 ±60 ms of K0021 P/U or cutoff will be initiated.

\*\*This signal drops out after a time sufficient to lock in the engine electrical.

\*\*\*An indication of fuel injection temperature of -150 ±40 deg F (or simulation) is required before this command will be executed. This command also actuates a 450 ±30 ms timer which controls the start of mainstage.

P/U - Pickup

D/O - Dropout

TABLE 9-3 (Sheet 3 of 6)  
ENGINE SEQUENCE (504-THIRD BURN)

Control Events		Contingent Events		Nominal Time From Specified Reference	Actual Time (ms)	
Meas No.	Event and Comment	Meas No.	Event and Comment		From ESC	From Specified Reference
		K0096 (K0536)	Start Tank Disc Control Solenoid Engr D/O	450 ±30 ms from K0096	52046	458
		K0121 (G507)	Main LOX Valve Closed D/O	50 ±30 ms from K0005	52121	N/A
		K0116 (G509)	Gas Generator Valve Closed D/O	140 ±10 ms from K0005	52168	N/A
		K0122 (G508)	Start Tank Disc Valve Open D/O	95 ±20 ms from K0096	52176	130
		K0117 (G509)	Gas Generator Valve Open P/U	50 ±30 ms from K0116	52366	198
		K0124 (G510)	LOX Turbine Bypass Valve Open D/O		52222	
			LOX Turbine Bypass Valve 80% Closed	400 +150 ms from K0122 -50	52461	285
		K0123 (G508)	Start Tank Disc Valve Closed P/U	250 ±40 ms from K0122	52449	273
		K0125 (G510)	*LOX Turbine Bypass Valve Closed P/U		52516	
K0158 (K0572)	Mainstage Press Switch #1 Depress D/O				53357	

\*Within 5,000 ms of K0005 (Normally = 500 ms)

P/U - Pickup

D/O - Dropout

TABLE 9-3 (Sheet 4 of 6)  
ENGINE SEQUENCE (504-THIRD BURN)

Control Events		Contingent Events		Nominal Time From Specified Reference	Actual Time (ms)	
Meas No.	Event and Comment	Meas No.	Event and Comment		From ESC	From Specified Reference
K0159	Mainstage Press Switch #2 Depress D/O				53440	
K0191 (K0610)	*Mainstage OK					
		K0120 (G507)	Main LOX Valve Open P/U	2,435 ±145 ms from K0005	54121	N/A
		K0010 (K0454)	Thrust Chamber Spark on D/O	3,300 ±200 ms from K0005 P/U	55330	N/A
		K0011 (K0455)	Gas Generator Spark On D/O	3,300 ±200 ms from K0005 P/U	55330	N/A
K0507 CSS-22	PU Activate Switch P/U		Not on			

\*One of these signals must be received within 4,410 ±260 ms from K0021 P/U, or cutoff will be initiated.  
Signal occurs when LOX injection pressure is 500 ±30 psig.

P/U - Pickup

D/O - Dropout

TABLE 9-3 (Sheet 5 of 6)  
ENGINE SEQUENCE (504-THIRD BURN)

Control Events		Contingent Events		Nominal Time From Specified Reference	Actual Time (ms)	
Meas No.	Event and Comment	Meas No.	Event and Comment		From ECC	From Specified Reference
K0140 (K0522)	Engine Cutoff PU (New time reference)			0	0	
		K0005 (K0538)	Mainstage Control Solenoid Engr D/O	Within 10 ms of K0013	0	
		K0006 (K0535)	Ignition Phase Control Solenoid Engr D/O	Within 10 ms of K0013	0	
		K0020 (K0622)	ASI LOX Valve Open D/O			
		K0120 (G507)	Main Oxidizer Valve Open D/O	50 ±15 ms from K0005	235	235
		K0118 (G506)	Main Fuel Valve Open D/O	90 ±25 ms from K0006	244	244
		K0121 (G507)	Main Oxidizer Valve Closed F/U	120 ±15 ms from K0120	315	80
		K0116 (G509)	Gas Generator Valve Closed P/U	500 ms from K0006	2115	2115
		K0119 (G506)	Main Fuel Valve Closed P/U	225 ±25 ms from K0118	335	91

P/U - Pickup  
D/O - Dropout

TABLE 9-3 (Sheet 6 of 6)  
ENGINE SEQUENCE (504-THIRD BURN)

Control Events		Contingent Events		Nominal Time From Specified Reference	Actual Time (ms)	
Meas No.	Event and Comment	Meas No.	Event and Comment		From ECC	From Specified Reference
K0158 (K0572)	*Mainstage Press Switch A Depress P/U				186	
K0159 (K0573)	Mainstage Press Switch B Depress P/U		*			
K0191 (K0610)	Mainstage OK D/O		Not on			
K0007 (K0531)	Helium Control Solenoid Engr D/O			1,000 ±110 ms from K0013	959	959
SS-22 K0507	PU Activate Switch D/O		Not on	N/A		
		K0125 (G510)	Oxidizer Turbine Bypass Valve Closed D/O		415	
		K0124 (G510)	Oxidizer Turbine Bypass Valve Open P/U	10,000 ms from K0005	2209	2209

\*Signal drops out when pressure reaches 75 psi lower than pickup.

P/U - Pickup

D/O - Dropout



TABLE 9-4  
FUEL LEAD CONDITIONS

	S-IVB-501 Flight		S-IVB-502 Flight		S-IVB-503 Flight		S-IVB-504 Flight		
	First Start	Second Start	First Start	Second Start	First Start	Second Start	First Start	Second Start	Third Start
Estimated Thrust Chamber Bulk Temp.* at Fuel Lead Start (Deg R)	242	443	265	411	278	433	285**	528**	575**
Fuel Lead Duration (sec)	3	8	3	8	3	8	3	8	52
Fuel Temp. at the Injector at Fuel Lead Termination (Deg R)	40	165	55	34	60	30	Off scale low	Off scale low	Off scale low
Fuel Passing Through MFV During Fuel Lead (lbm)	15	25	14	39	11	35	11	30	540
Fuel Between Injector and MFV at Fuel Lead Termination (lbm)	4	8	4.5	14.5	6	9	2	9	15
Total Effective Impulse During Fuel Lead (lbf-sec)	1,400	3,200	1,250	3,050	770	3,650	1,470	4,210	19,500
Fuel Passing Through Injector During Fuel Lead (lbm)	11	17	9.5	24.5	5	26	9	21	555

\*This is the average of the temperature measurements C0199, C0385, and C0386.

\*\*C0385 and C0386 were removed for 504N flight. This is only C0199.

TABLE 9-5  
ENGINE START SPHERE DATA

Parameter	Temperature (°R)			Pressure (psia)			Mass (lbm)		
	504N Flight	503N Flight	502 Flight	504N Flight	503N Flight	502 Flight	504N Flight	503N Flight	502 Flight
Liftoff	275	269	279	1,310	1,300	1,303	3.54	3.62	3.47
Liftoff Requirements	See liftoff box								
First Engine Start Command	281	273	284	1,310	1,301	1,267	3.70	3.78	3.31
After First Start Sphere Blowdown	184	173	180	130	115	120	0.56	0.50	0.50
First Engine Cutoff Command	205	208	197	1,259	1,130	1,242	4.87	4.30	4.75
Total GH2 Usage During First Start	--	--	--	--	--	--	3.14	3.23	2.84
Second Engine Start Command	280	263	253	1,312	1,310	1,327	3.72	3.95	3.88
After Second Start Sphere Blowdown	192	164	--	150	140	--	0.62	0.68	--
Second Engine Cutoff Command	186	211	162	1,068	1,175	182	4.56	4.41	0.89
Total GH2 Usage During Second Start	--	--	--	--	--	--	3.10	3.27	--
Third Engine Start Command	242	--	--	1,263	--	--	4.14	--	--
After Third Start Sphere Blowdown	160	--	--	164	--	--	0.81	--	--
Third Engine Cutoff Command	198	--	--	1,176	--	--	4.71	--	--
Total GH2 Usage During Third Start	--	--	--	--	--	--	3.33	--	--

TABLE 9-6

## CONTROL SPHERE DATA

Parameter	Temperature (°R)			Pressure (psia)			Mass (lbm)*		
	504N Flight	503N Flight	502 Flight	504N Flight	503N Flight	502 Flight	504N Flight	503N Flight	502 Flight
Required at Liftoff	290 ±30**	290 ±30**	279 ±30**	2,800 to 3,200			--	--	--
Actual at Liftoff	279	278	290	3,095	2,930	2,963	1.96	1.89	1.87
Before First Burn Engine Start	270	273	288	3,141	2,960	3,000	2.09	1.91	1.90
After First Burn Engine Cutoff	225	240	210	3,043	2,820	1,679	2.10	2.06	1.51
Before Second Burn Engine Start	262	252	247	3,380	3,079	1,918	2.27	2.13	1.48
After Second Burn Engine Cutoff	240	217	186	3,098	2,947	903	2.27	2.35	0.97
Before Third Burn Engine Start	232	--	--	3,215+	--	--	2.41	--	--
After Third Burn Engine Cutoff	216	--	--	1,636+	--	--	1.42	--	--
Mass Used - First Burn	--	--	--	--	--	--	0.35	0.48++	0.39
Mass Used - Second Burn	--	--	--	--	--	--	0.168	0.99++	0.37
Mass Used - Third Burn	--	--	--	--	--	--	2.1	--	--

\*As calculated from measured temperature and pressure.

\*\*Actual requirement is start sphere temperature ±30 deg R.

+Backup measurement D3242

++Mass used by engine from control sphere and stage repressurization spheres was estimated from flowrates and burntime.

TABLE 9-7  
START BOTTLE REFILL PERFORMANCE

FIRST BURN

	Time From ESC (sec)	Actual Data			Predicted		
		Pressure	Temperature	Mass	Pressure	Temperature	Mass
ESC <sub>1</sub>	0	1,310	281	3.70	1,320	273	3.84
End of Blowdown	3.70	130	164.5	0.56	180	174	0.97
Topping Initiation	14.0	909	231	3.12	900	225	3.17
Topping Completion	89.0	1,232	198	4.95	1,234	195	5.02
ECC <sub>1</sub>	127.4	1,259	205	4.87	1,320	210	4.99

SECOND BURN

	Time From ESC (sec)	Actual Data			Predicted		
		Pressure	Temperature	Mass	Pressure	Temperature	Mass
ESC <sub>2</sub>	0	1,312	280	3.72	1,320	256	4.09
End of Blowdown	8.75	150	191.5	0.62	160	167	0.76
Topping Initiation	16.6	801.6	230	2.77	750	221	2.69
Topping Completion	69.6	1,069	185	4.59	1,095	185	4.70
ECC <sub>2</sub>	70.4	1,068	186	4.56	1,110	188	4.68

THIRD BURN

	Time From ESC (sec)	Actual Data			Predicted		
		Pressure	Temperature	Mass	Pressure	Temperature	Mass
ESC <sub>3</sub>	0	1,262.5	242	4.14	1,315	224	4.66
End of Blowdown	9.40	164	160.4	0.811	160	167	0.76
Topping Initiation	17.6	806	203	3.15	750	221	2.69
Topping Completion	68.4	1,080	175.8	4.874	1,095	185	4.70
ECC <sub>2</sub>	294.0	1,000	198	4.712	1,270	191	5.28

TABLE 9-8

J-2 ENGINE STEADY PERFORMANCE COMPARED TO PREDICTED  
(STDV +2.5 SEC TO ECO)

Parameter	Overall Performance			
	Actual	Predicted	Actual Deviation	Percent Deviation
Thrust (lbf)				
1st Burn	232,686	230,774	+1912	+0.828
2nd Burn	201,990	200,612	+1378	+0.687
3rd Burn	154,093	203,309	-49,216	-24.21
Total Flowrate (lbm/sec)				
1st Burn	545.59	541.35	+4.24	+0.783
2nd Burn	470.06	469.74	+0.32	+0.068
3rd Burn	375.28	474.30	-99.02	-20.88
LOX Flowrate (lbm/sec)				
1st Burn	461.46	457.61	+3.85	+0.841
2nd Burn	390.34	390.81	-0.47	-0.120
3rd Burn	315.64	394.25	-78.61	-19.94
LH2 Flowrate (lbm/sec)				
1st Burn	84.13	83.74	+0.39	+0.466
2nd Burn	79.72	78.93	+0.79	+1.001
3rd Burn	59.64	80.06	-20.42	-25.5
Engine Mixture Ratio				
1st Burn	5.484	5.462	+0.022	+0.403
2nd Burn	4.892	4.949	-0.057	-1.152
3rd Burn	5.398	4.924	+0.474	+9.63
Specific Impulse				
1st Burn	426.56	426.45	+0.11	+0.0258
2nd Burn	429.94	426.85	+2.44	+0.572
3rd Burn	406.96	428.58	-21.62	-5.04

TABLE 9-9 (Sheet 1 of 4)  
DATA INPUTS TO COMPUTER PROGRAMS

Parameter	Program	Selection	Bias			Reason
			First Burn	Second Burn	Third Burn	
Chamber Pressure	PA53 (Start)	D0001	-15	-15	-15	Rocketdyne estimation of purge effect
		Total	-2.56	-2.36	+0.65	Zero shift correction of transducer
	PA53 (Cutoff)	D0001	-15	-15	-15	Rocketdyne estimation of purge effect
		Total	-3.73	-2.85	+12.66	Zero shift correction of transducer
	LOX Flowrate	G105-1	D0001	-15	-15	-15
Total			-18.73	-17.85	-2.34	Correction to agree with trajectory analysis
PA63		D0001	-15	-15	-15	Rocketdyne estimation of purge effect
		F0001	None	None	Overridden with table input	Correction for LOX bleed valve opening
PA63		F0001	None	None	Program not used	Program not used

TABLE 9-9 (Sheet 2 of 4)  
DATA INPUTS TO COMPUTER PROGRAMS

Parameter	Program	Selection	Bias			Reason
			First Burn	Second Burn	Third Burn	
Fuel Flowrate	G105-1	F0002	-82.4 gpm	None	None	Correction to agree with rated Isp
	PA63	F0002	-82.4 gpm	None	Program not used	Same as for G105-1
	PA63	C0004	None	None	Program not used	
LOX Pump Inlet Temp.	G105-1	C0133		+0.61°R		To correct temperature drop across pump
		C0004	+5.7°R		+5.7°R	C0133 offscale for 1st and 3rd burn
LOX Pump Speed	PA63	C0133		+0.61°R		Same as for G105-1
		C0004	+5.7°R		Program not used	Same as for G105-1
LOX Pump Inlet Press.	PA63	T0001	None	None	Program not used	
		D0003	None	None	Program not used	
LOX Pump Outlet Press.	G105-1	D0009	None	None	None	
		PA63	D0009	None	None	Program not used

TABLE 9-9 (Sheet 3 of 4)  
DATA INPUTS TO COMPUTER PROGRAMS

Parameter	Program	Selection	Bias			Reason
			First Burn	Second Burn	Third Burn	
Fuel Pump Inlet Temp.	PA63	C0003	None	None	Program not used	To correct temperature drop across pump Same as for G105-1
Fuel Pump Outlet Temp.	G105-1	C0134	None	-0.51°R	None	
	PA63	C0134	None	-0.51°R	Program not used	
Fuel Pump Speed	PA63	T0002	None	None	Program not used	
Fuel Pump Inlet Press.	PA63	D0002	None	None	Program not used	
Fuel Pump Outlet Press.	G105-1	D0008	None	None	None	
	PA63	D0008	None	None	None	
LOX Turbine Inlet Temp.	PA63	C0002	None	None	Program not used	
LOX Turbine Outlet Temp.	PA63	C0215	None	None	Program not used	
LOX Turbine Inlet Press.	PA63	D0007	None	None	Program not used	
LOX Turbine Outlet Press.	PA63	D0086	None	None	Program not used	



TABLE 9-9 (Sheet 4 of 4)  
DATA INPUTS TO COMPUTER PROGRAMS

Parameter	Program	Selection	Bias			Reason
			First Burn	Second Burn	Third Burn	
Fuel Turbine Inlet Temp.	G105-1	C0001	None	None	None	C0013 not on vehicle 504N. LOX pump outlet temp. used in place of LOX bleed temp.
	PA63	C0001	None	None	Program not used	
Gas Generator Chamber Pressure	G105-1	D0010	None	None	None	
	PA63	D0010	None	None	Program not used	
Gas Generator LOX Bleed Temp.	PA63	C0004	+5.7°R	+0.61°R	Program not used	
		C0133				
Thrust Chamber Fuel Injection Temp.	PA63	C0200	None	None	Program not used	
Thrust Chamber Fuel Injection Press.	PA63	D0004	None	None	Program not used	
Thrust Chamber LOX Injection Press.	PA63	D0005	None	None	Program not used	
PU Valve Position	PA63	G0010	None	None	Program not used	

TABLE 9-10  
J-2 ENGINE START TRANSIENTS

Parameter	504N Log Book	501 Flight		503N Flight		504N Flight		
		1st Burn	2nd Burn	1st Burn	2nd Burn	1st Burn	2nd Burn	3rd Burn
Time of STDV Command (SEC from ESC)	1.0	3.008	7.998	2.983	7.991	2.924	8.007	7.997***
Thrust at 90 percent performance level (lbf)	185,000**	183,125	166,364	183,862	165,686	191,211	159,035	146,433
Total Impulse from engine start command to 90 percent performance level* (lbf-sec)	--	188,864	192,634	185,332	188,245	192,327	177,724	N/A
Total Impulse from STDV command to 90 percent performance level* (lbf-sec)	165,700**	187,464	189,444	184,562	184,596	190,857	173,514	167,767

\*Defined as STDV command +2.5 seconds.

\*\*Based on stabilized thrust at null PU and standard altitude conditions.

\*\*\*Time from I.U. engine start command; 43.591 seconds after ground (Houston) engine start command.

TABLE 9-11  
S-IVB TOTAL J-2 PROPULSION PERFORMANCE

PARAMETER	FIRST BURN			SECOND BURN			ACTUAL
	ACTUAL	PREDICTED	% DEV	ACTUAL	PREDICTED	% DEV	
Impulse (lbf-sec) (1) Mainstage	28.94x10 <sup>6</sup>	25.69x10 <sup>6</sup>	+12.65	12.10x10 <sup>6</sup>	12.04x10 <sup>6</sup>	+0.498	3.96x10
Impulse (lbf-sec) to Depletion (3)	DNA	DNA		DNA	DNA		49.49x10
Burntime (sec) (1) Mainstage	-124.385	111.4	+11.65	59.897	60.0	-0.172	239.894
Burntime (sec) to Depletion (1)	DNA	DNA		DNA	DNA		369.9
Consumption (1) (2)							
LOX (lbm)	57,399	50,951	+12.66	23,380	23,451	-0.303	75,220
LH2 (lbm)	10.464	9,322	+12.25	4,775	4,736	+0.823	14,307

- (1) STDV +2.5 seconds to engine cutoff command.  
(2) Propellants exhausted through J-2 engine only.  
(3) Engine performance degradation was occurring during third burn.  
Performance based on last operating point.

DNA - Does not apply

TABLE 9-11  
J-2 PROPULSION PERFORMANCE

SECOND BURN		THIRD BURN			TOTAL		
PREDICTED	% DEV	ACTUAL	PREDICTED	% DEV	ACTUAL	PREDICTED	% DEV
12.04x10 <sup>6</sup>	+0.498	3.96x10 <sup>6</sup>	48.79x10 <sup>6</sup>	-24.25	78.0x10 <sup>6</sup>	98.77x10 <sup>6</sup>	-21.03
DNA		49.49x10 <sup>6</sup>	58.08x10 <sup>6</sup>	14.79	--	--	--
60.0	-0.172	239.894	240.0	-0.044	424.176	411.40	+3.105
DNA		369.9	285.497	29.56	--	--	--
23,451	-0.303	75,220	94,623	-19.98	156,499	169,025	-7.41
4,736	+0.823	14,307	19,113	-25.14	29,546	33,171	-10.93

urn.

TABLE 9-12  
S-IVB STEADY STATE PERFORMANCE  
(STDV +60 SECOND TIME SLICE AT STANDARD ALTITUDE CONDITIONS)

PARAMETER	FLIGHT FIRST BURN	STAGE ACCEPTANCE (FLIGHT PREDICTED)	FLIGHT			STAGE* ACCEPTANCE (FLIGHT PREDICTED)	ACTUAL MINUS FLIGHT PREDICTED			30 I-I 2ND & 3RD BURNS
			SECOND BURN	THIRD BURN	THIRD BURN		FIRST BURN	SECOND BURN	THIRD BURN	
Thrust	232,306	230,605	203,568	203,411	204,771	+1,761	-1,203	-1,360	+2,216	+2,955
EMR	5.487	5.440	4.905	5.049	4.898	+0.047	+0.007	0.151	+0.03	+0.04
ISP	425.6	426.1	428.3	426.2	429.1	-0.5	-0.78	-2.9	+2.5	+3.33

\*For second and third burns the same tag value was used.

TABLE 9-13  
S-IVB-504 THIRD BURN ANOMALY

PARAMETER	STDV +60-SECOND DATA SLICE			DIFFERENCE	RKD 5-SECOND STABILITY TEST		
	SECOND	THIRD	THIRD		UNSTABLE	STABLE	DIFFERENCE
Chamber pressure (psia)	700.8	682.9	682.9	-17.9	711.8	734.2	-22.4
Engine Mixture Ratio	4.91	5.05	5.05	+0.14	5.39	5.25	+0.14
LOX Flowrate (lb/sec)	394.8	397.7	397.7	+2.9	424.7	422.4	+2.3
LH2 Flowrate (lbm/sec)	80.5	78.7	78.7	-1.8	78.7	80.5	-1.8
LOX Pump Speed (rpm)	7,806	8,021	8,021	+115	8,313	8,261	+52
LH2 Pump Speed (rpm)	25,707	25,646	25,646	-61	25,903	25,887	+16
LH2 Turbine Inlet Temp (°F)	1,106	1,083	1,083	-23	1,219	1,247	-20

TABLE 9-14  
J-2 ENGINE CUTOFF TRANSIENTS

	Unit	Flight			Predicted	
		First Burn	Second Burn	Third Burn	First Burn	Second Burn
Time for thrust decrease to 11,500 lbf	ms	400	442	1,150	800*	800*
PU valve position at engine cutoff	deg	31.6	-1.35	-2.0	31.6	-2.0
Thrust at cutoff	lbf	232,912	204,124	102,205	232,400	205,600
Actual total impulse						
To 5% thrust	lbf-sec	42,461	37,596	38,738	49,756 +4200 -4000	44,018 +4200 -4000
To zero thrust	lbf-sec	48,952	43,652	46,891	56,156 +4200 -4000	50,418 +4200 -4000
Total impulse to 5% thrust adjusted to null PU valve position and 460 deg R mov actuator temperature	lbf-sec	30,877	29,877	69,211	35,852 <u>+3,700</u>	35,852 <u>+3,700</u>

\*Allowable

FOLDOUT FRAME 1

TRANSIENTS

Predicted			Deviation			J-2 Engine Log Book
First Burn	Second Burn	Third Burn	First Burn	Second Burn	Third Burn	
800*	800*	800*	-400	-358	+750	302
31.6	-2.0	-2.0	0	+0.65	+0.35	-2.0
232,400	205,600	204,200	+512	-1476	+1,420	201,998
9,756 +4200 -4000	14,018 +4200 -4000	43,718 +4200 -4000	-7,295	-6,422	-4,980	--
5,156 +4200 -4000	50,418 +4200 -4000	50,118 +4200 -4000	-7,204	-6,766	-3,227	--
35,852 <u>+3,700</u>	35,852 <u>+3,700</u>	35,852 <u>+3,700</u>	-5,025	-5,975	+33,359	35,852

ENGINE FRAME



TABLE 9-15  
AS-504 S-IVB CUTOFF IMPULSE

	<u>PREDICTED</u>	<u>ACTUAL-ENGINE DATA</u>	<u>ACTUAL TRAJECTORY DATA</u>
<u>FIRST BURN</u>			
Cutoff Impulse (lb-sec)	56,156 <sup>+4,200</sup> -4,000	48,952	50,094 (2)
Velocity Change (ft/sec)	5.4 <sup>+0</sup> -0.4	5.4 (1)	5.5
<u>SECOND BURN</u>			
Cutoff Impulse (lb-sec)	50,418 <sup>+4,200</sup> -4,000	43,652	64,464 (2)
Velocity Change (ft/sec)	8.3 <sup>+0.8</sup> -0.8	8.5 (1)	12.5
<u>THIRD BURN</u>			
Cutoff Impulse (lb-sec)	50,118 <sup>+4,200</sup> -4,000	46,891	60,856 (2)
Velocity Change (ft/sec)	25.0 <sup>+2.4</sup> -2.2	19.9 (1)	25.9

(1) Velocity change derived from cutoff impulse (propulsion data).

(2) Cutoff impulse derived from velocity change (trajectory data).

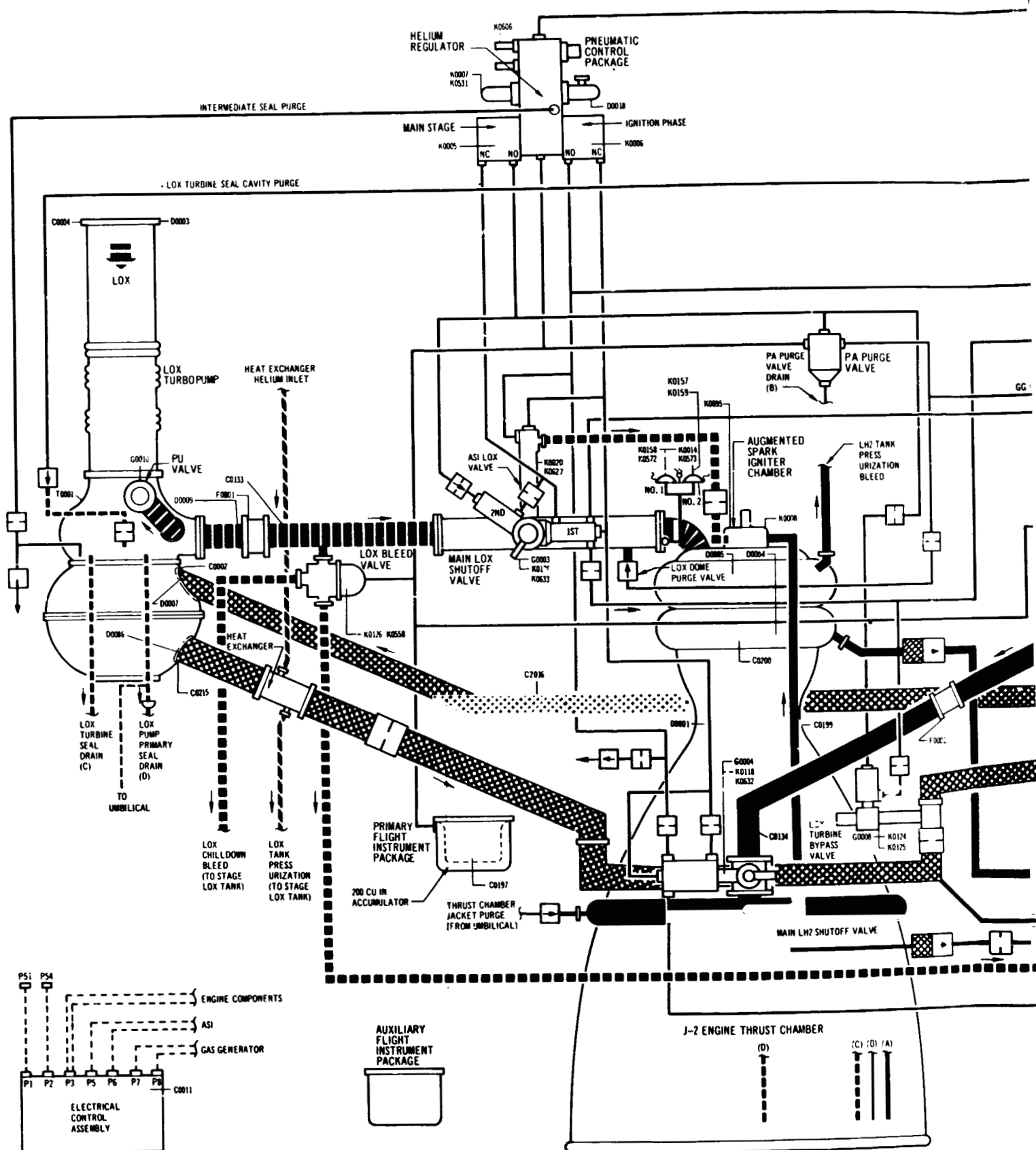
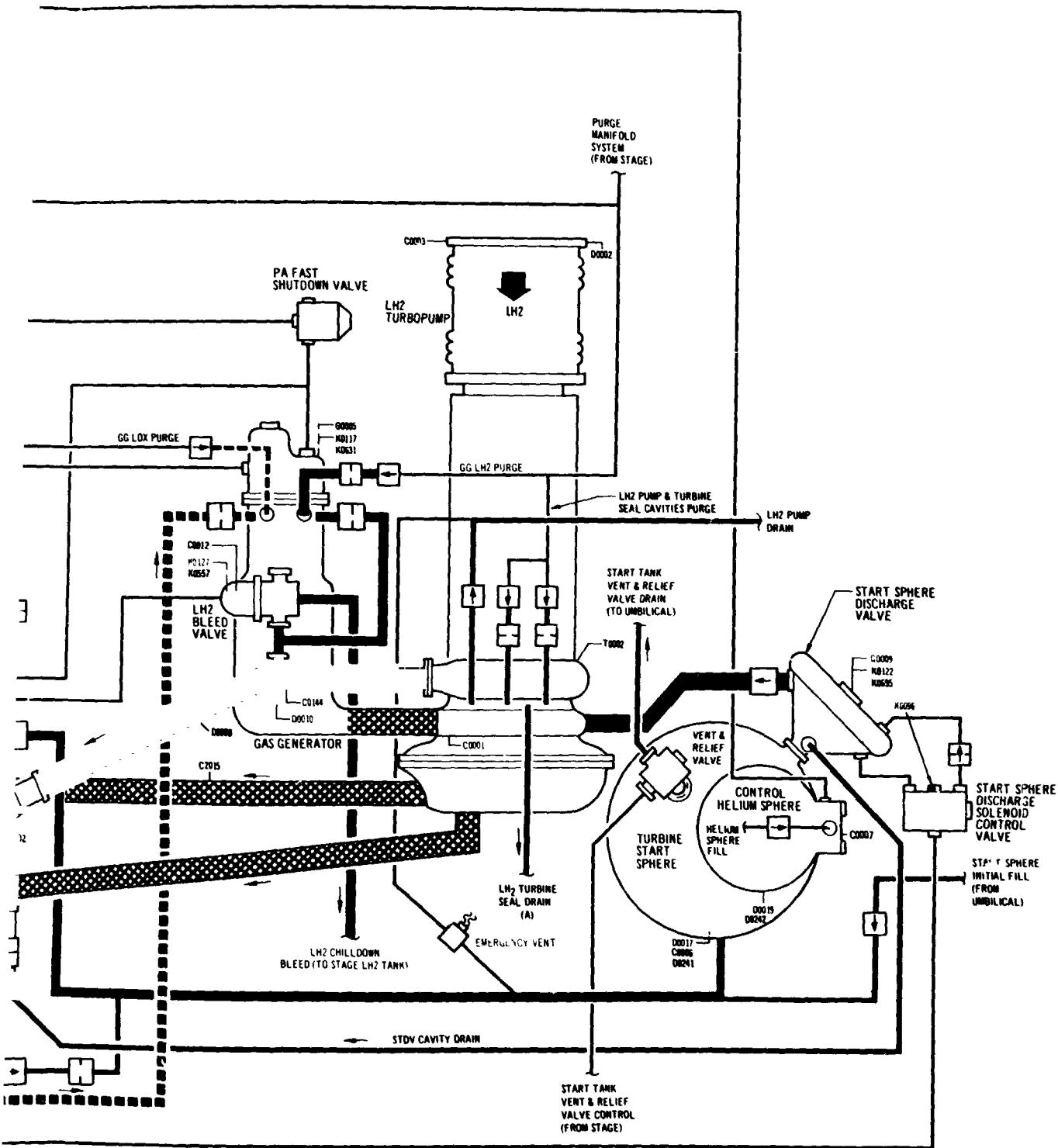

Figure 9-1. J-2 Engine System and Instrumentation



ENGINE AREA AMBIENT  
C0010

S-IVB STAGE - 504 ENGINE - J2004

FOLDOUT FRAME 2

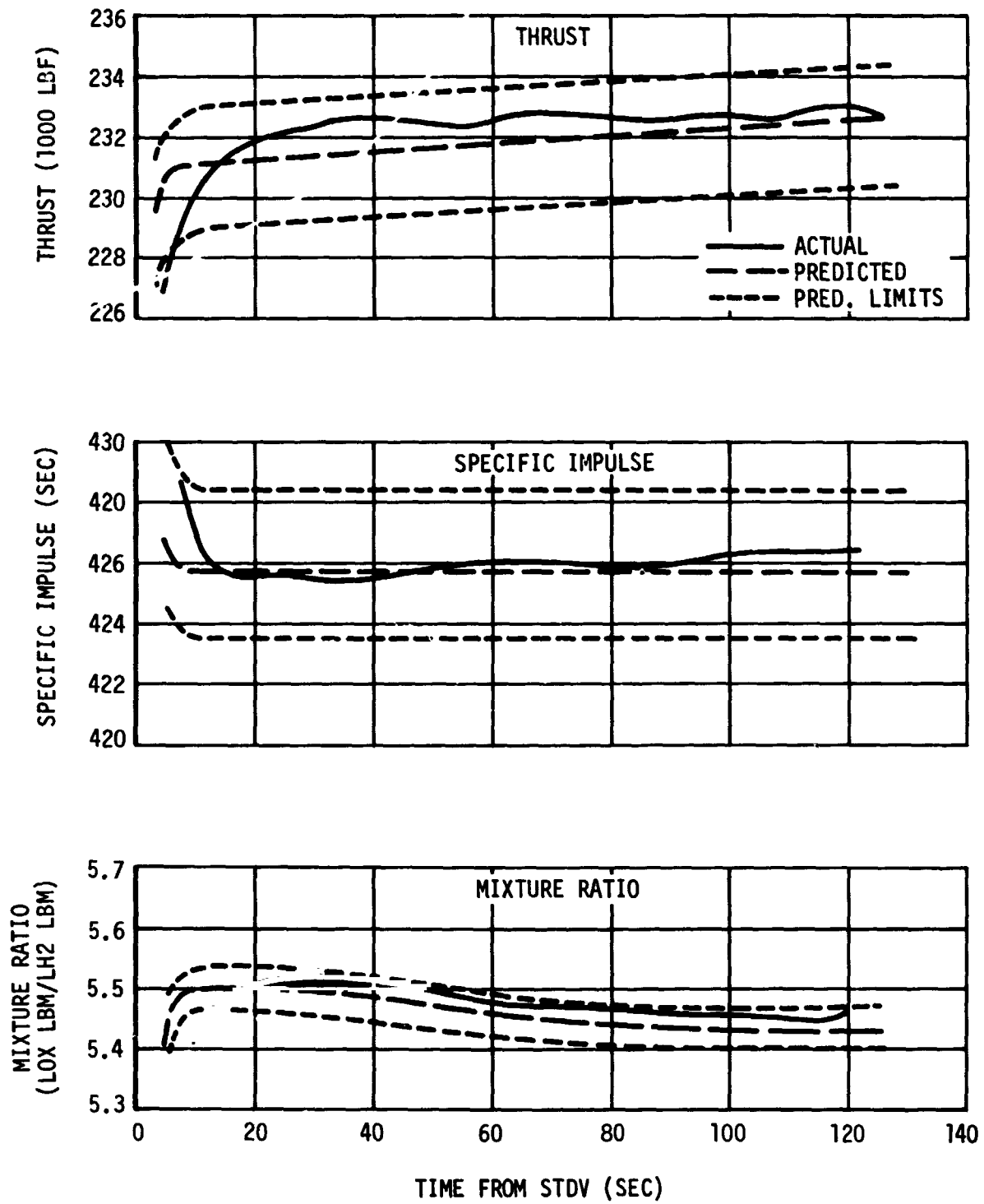

Figure 9-2. First Burn Tag Values (Sheet 1 of 2)

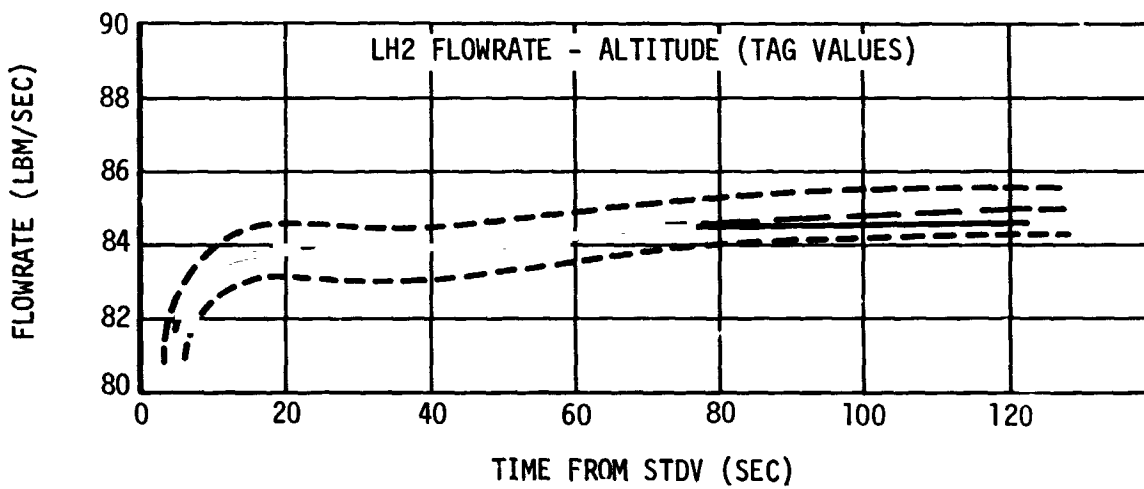
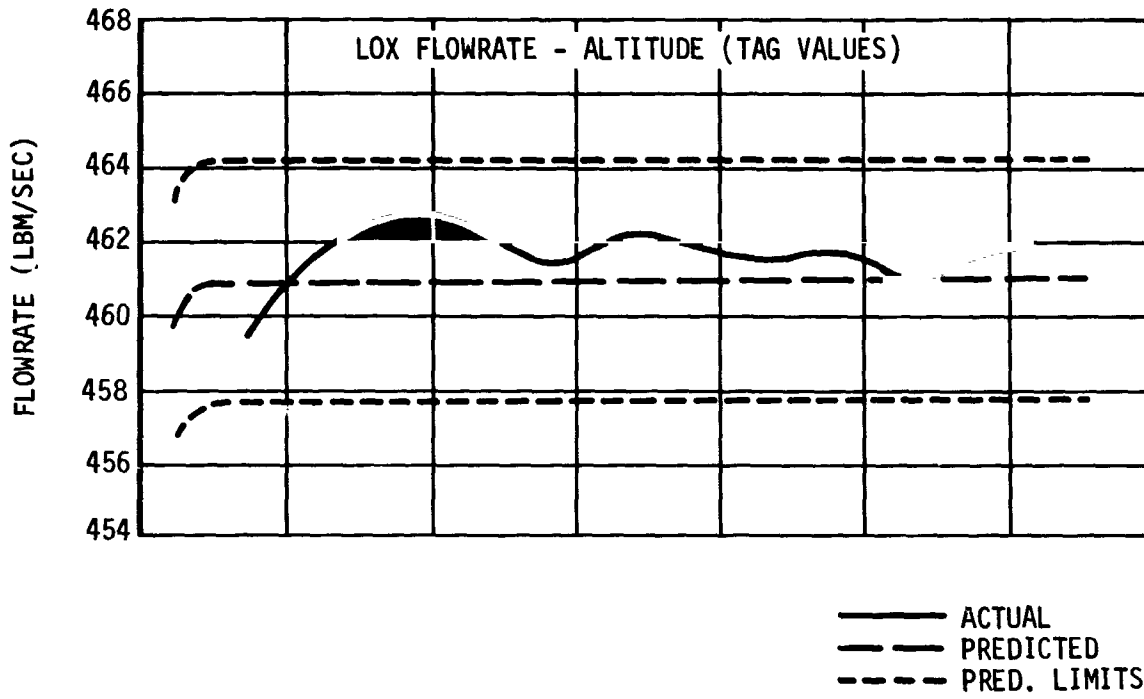

Figure 9-2. First Burn Tag Values (Sheet 2 of 2)

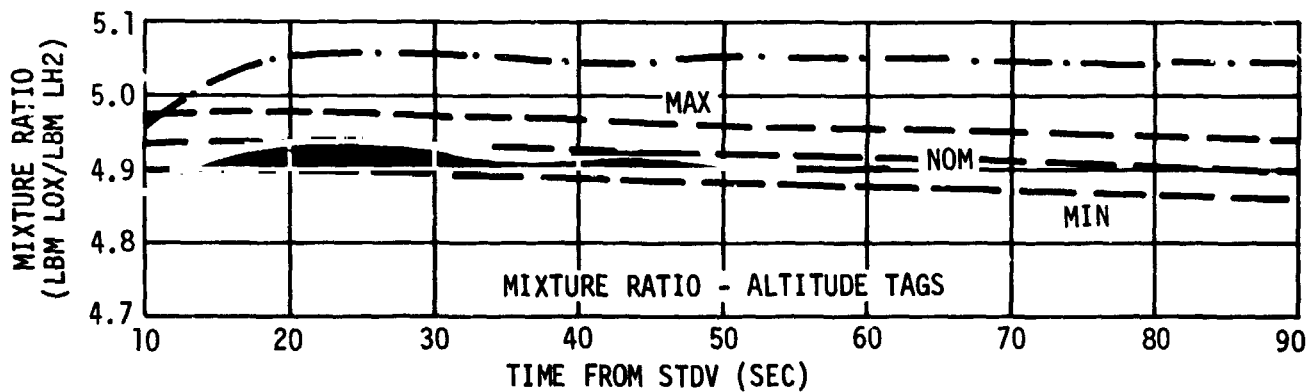
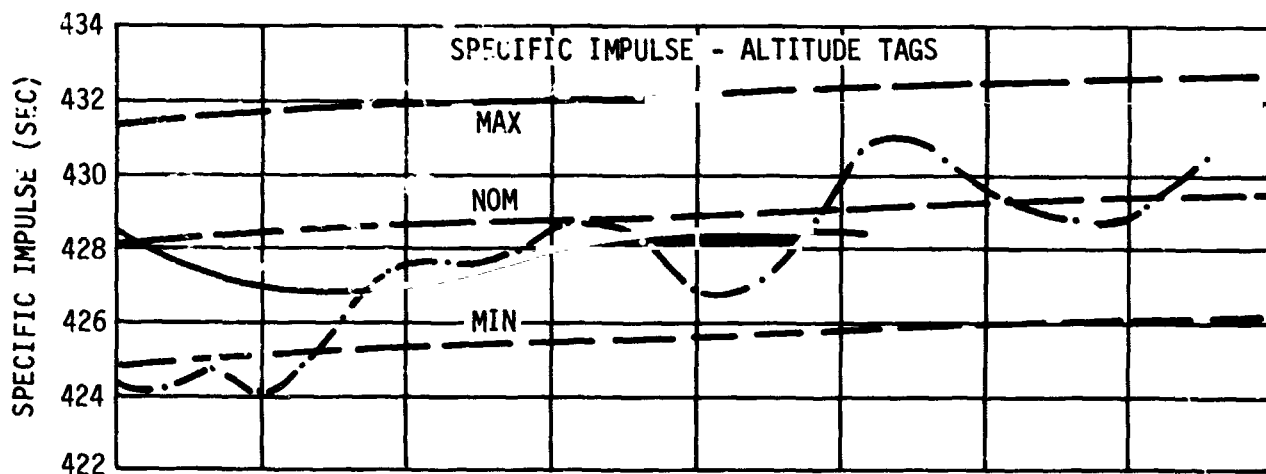
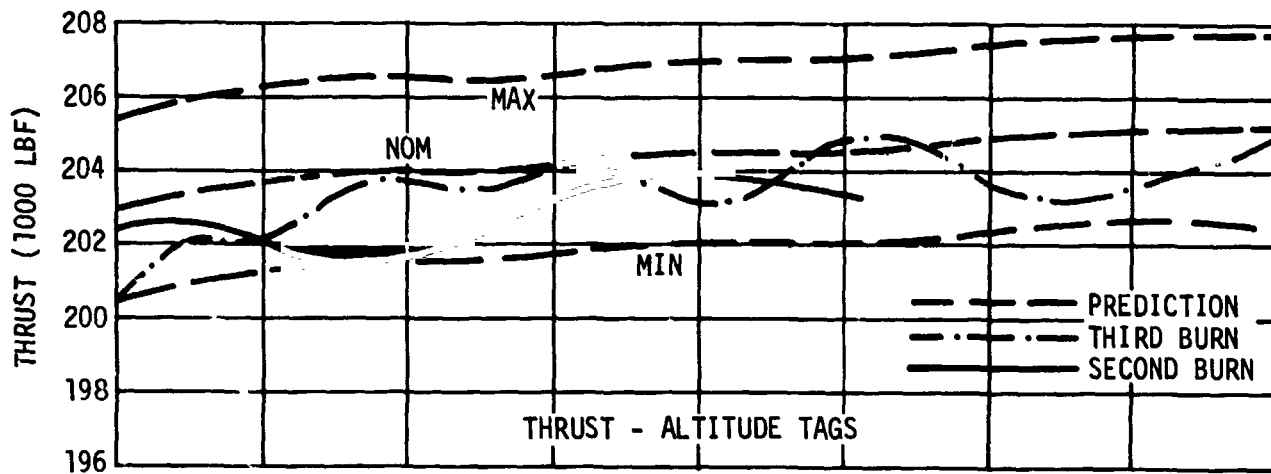

Figure 9-3. Second and Third Burn Tag Values (Sheet 1 of 2)

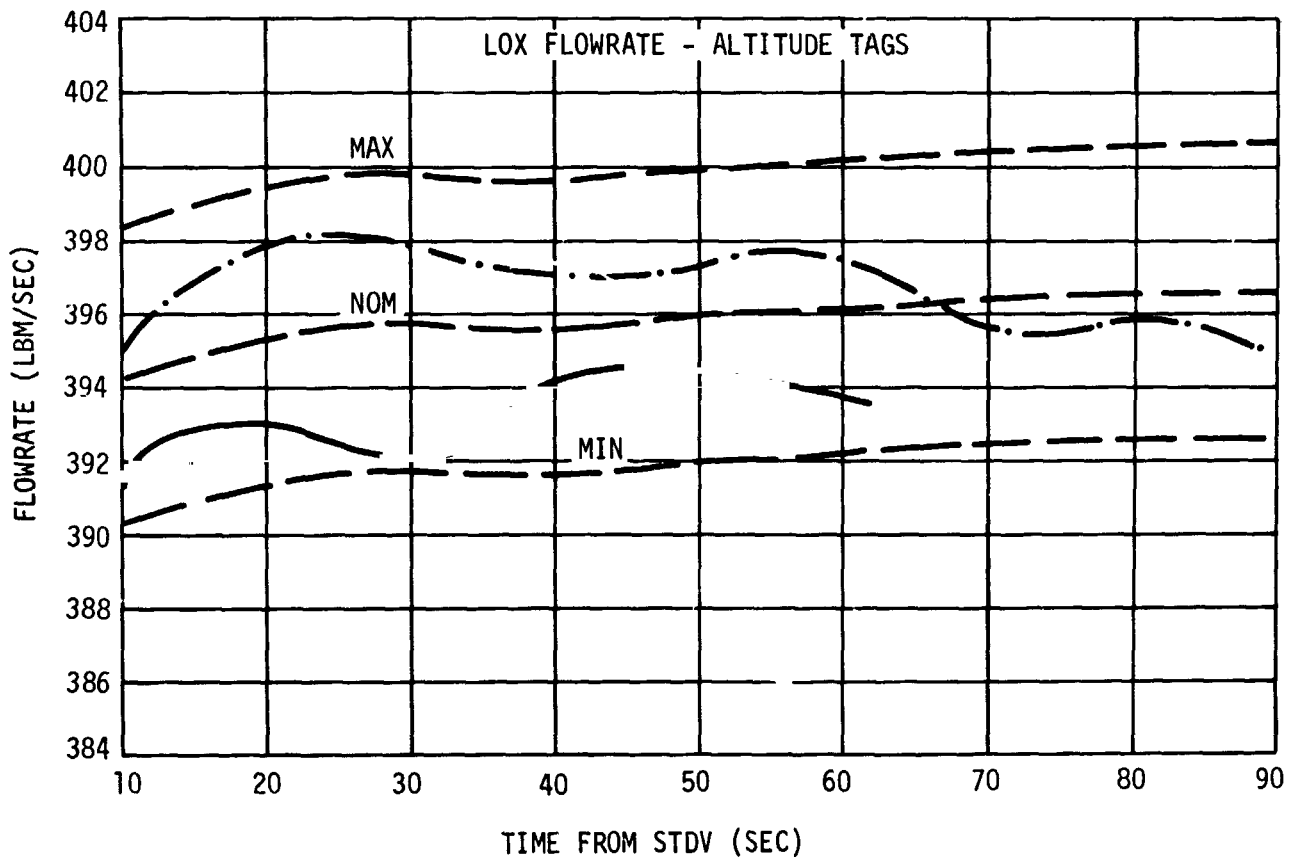
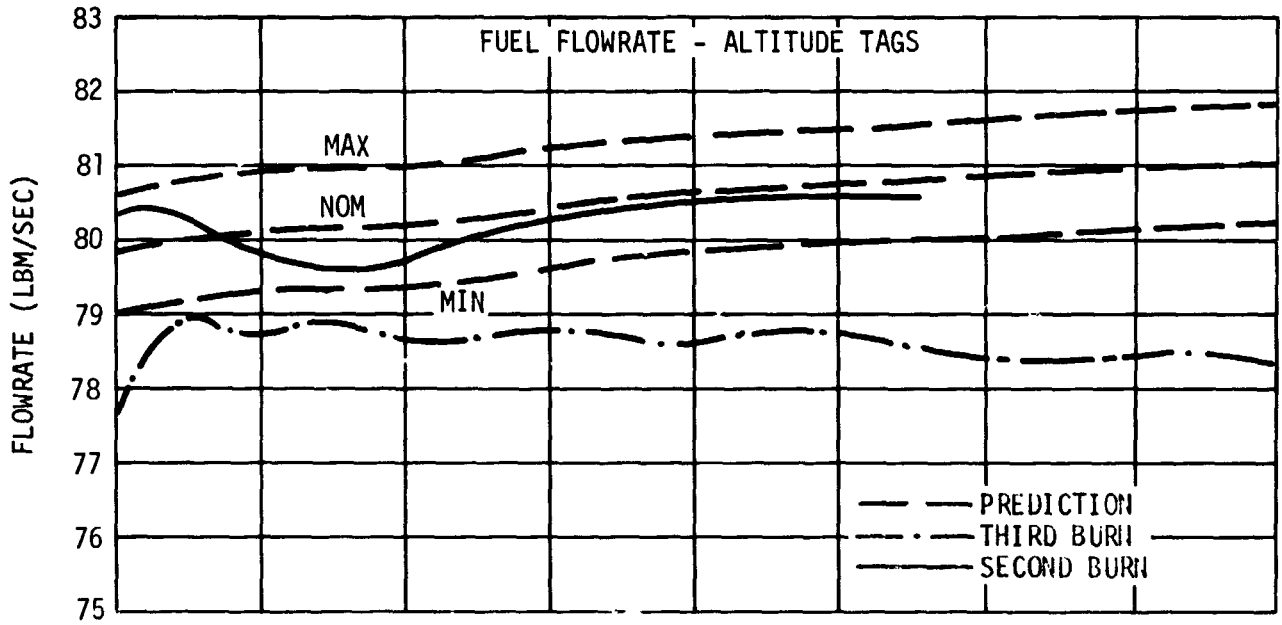

Figure 9-3. Second and Third Burn Tag Values (Sheet 2 of 2)

EVENTS

IGNITION PHASE  
 ENGINE START COMMAND P/U  
 HELIUM CONTROL SOLENOID ENERGIZE P/U  
 THRUST CHAMBER SPARK ON P/U  
 GAS GENERATOR SPARK ON P/U  
 IGNITION PHASE CONT SOLENOID ENERG P/U  
 ASI LOX VALVE OPEN P/U  
 LOX BLEED VALVE CLOSED P/U  
 LH2 BLEED VALVE CLOSED P/U  
 MAIN FUEL VALVE CLOSED D/O  
 MAIN FUEL VALVE OPEN P/U  
 ENGINE START COMMAND D/O  
 PUMP SPIN PHASE  
 START TANK DISCH CONT SOLENOID ENERG P/U  
 START TANK DISCHARGE VALVE CLOSED D/O  
 START TANK DISCHARGE VALVE OPEN P/U  
 MAINSTAGE PHASE  
 START TANK DISCH CONT SOLENOID ENERG D/O  
 MAIN LOX VALVE CLOSED D/O  
 GAS GENERATOR VALVE CLOSED D/O  
 START TANK DISCHARGE VALVE OPEN D/O  
 GAS GENERATOR VALVE OPEN P/U  
 LOX TURBINE BYPASS VALVE OPEN D/O  
 START TANK DISCHARGE VALVE CLOSED P/U  
 LOX TURBINE BYPASS VALVE CLOSED P/U  
 MAINSTAGE PRESS. SWITCH NO. 1 PRESS. P/U  
 MAINSTAGE PRESS. SWITCH NO. 2 PRESS. P/U  
 MAIN LOX VALVE OPEN P/U  
 THRUST CHAMBER SPARK ON D/O  
 GAS GENERATOR SPARK ON D/O

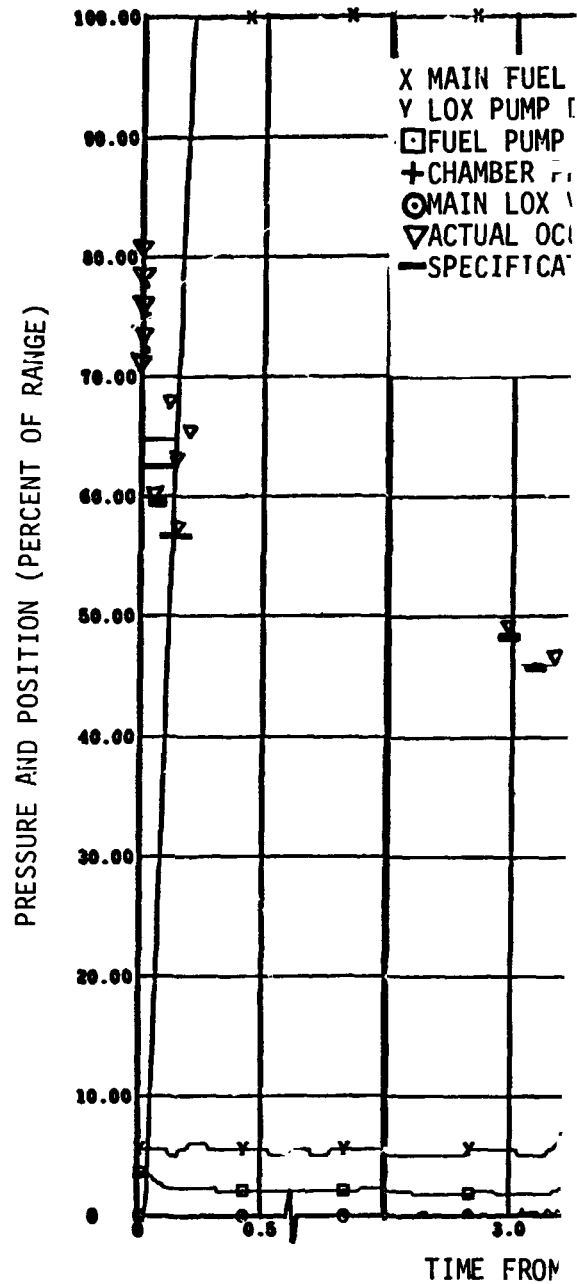

Figure 5



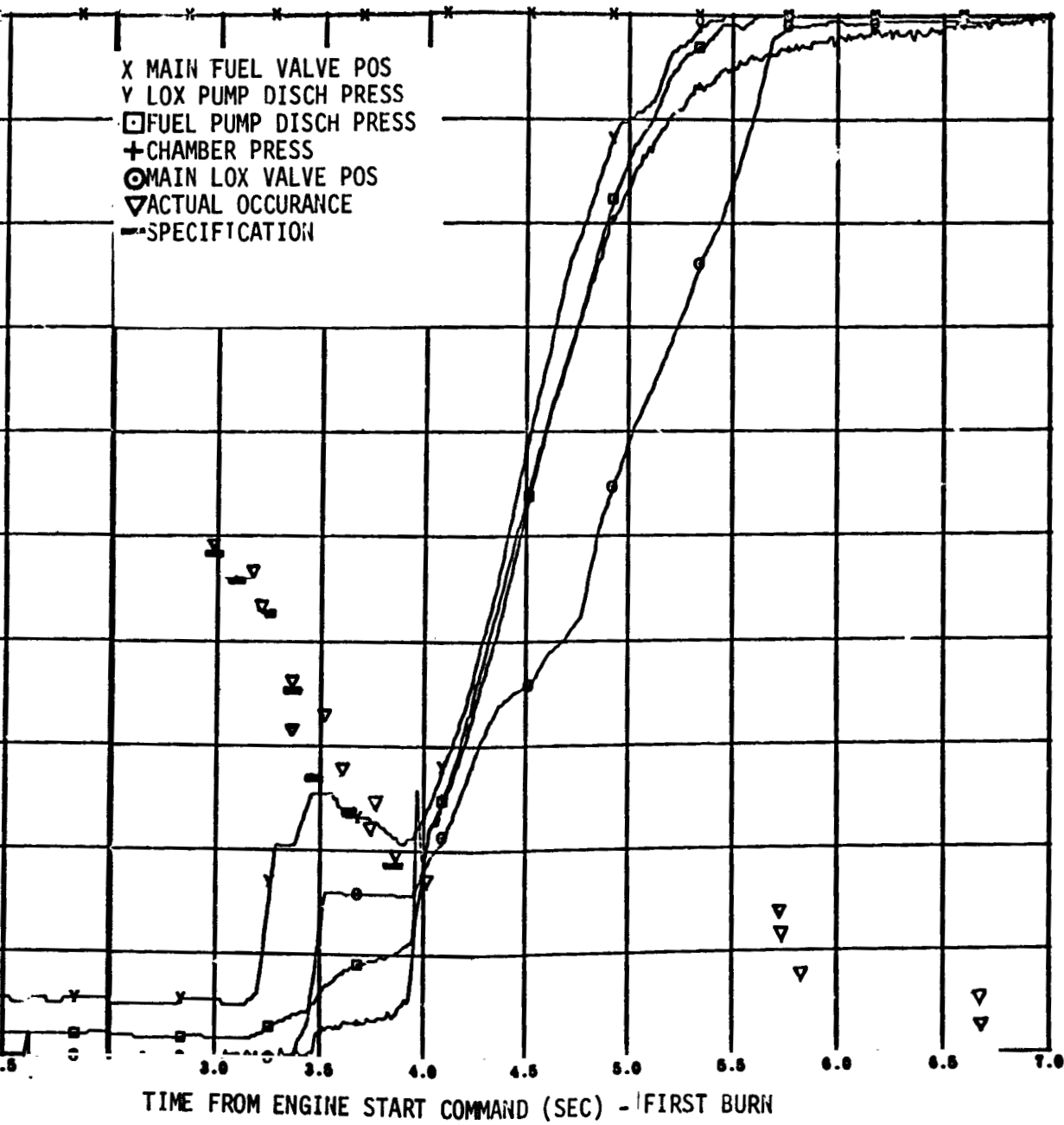

Figure 9-4. Engine Start Sequence - First Burn

EVENTS

IGNITION PHASE

ENGINE START COMMAND P/U  
 HELIUM CONTROL SOLENOID ENERGIZE P/U  
 THRUST CHAMBER SPARK ON P/U  
 GAS GENERATOR SPARK ON P/U  
 IGNITION PHASE CONT SOLENOID ENERG P/U  
 ASI LOX VALVE OPEN P/U  
 LOX BLEED VALVE CLOSED P/U  
 LH2 BLEED VALVE CLOSED P/U  
 MAIN FUEL VALVE CLOSED D/O  
 MAIN FUEL VALVE OPEN P/U  
 ENGINE START COMMAND D/O

PUMP SPIN PHASE

START TANK DISCH CONT SOLENOID ENERG P/U  
 START TANK DISCHARGE VALVE CLOSED D/O  
 START TANK DISCHARGE VALVE OPEN P/U

MAINSTAGE PHASE

START TANK DISCH CONT SOLENOID ENERG D/O  
 MAIN LOX VALVE CLOSED D/O  
 GAS GENERATOR VALVE CLOSED D/O  
 START TANK DISCHARGE VALVE OPEN D/O  
 GAS GENERATOR VALVE OPEN P/U  
 LOX TURBINE BYPASS VALVE OPEN D/O  
 START TANK DISCHARGE VALVE CLOSED P/U  
 LOX TURBINE BYPASS VALVE CLOSED P/U  
 MAINSTAGE PRESS. SWITCH NO. 1 PRESS. P/U  
 MAINSTAGE PRESS. SWITCH NO. 2 PRESS. P/U  
 MAIN LOX VALVE OPEN P/U  
 THRUST CHAMBER SPARK ON D/O  
 GAS GENERATOR SPARK ON D/O

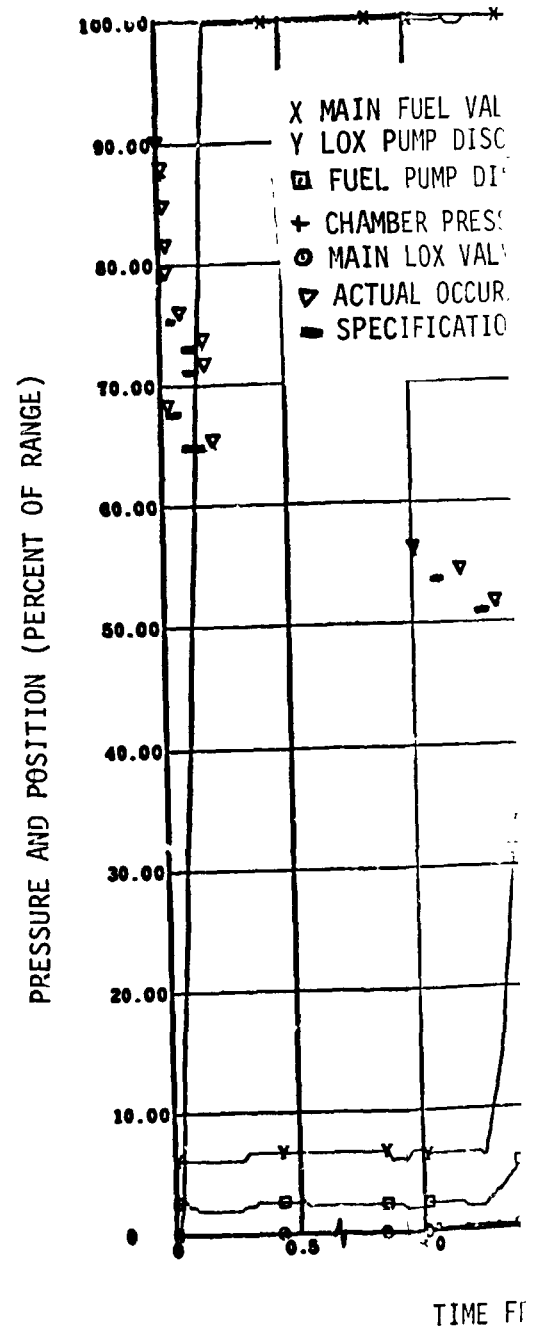
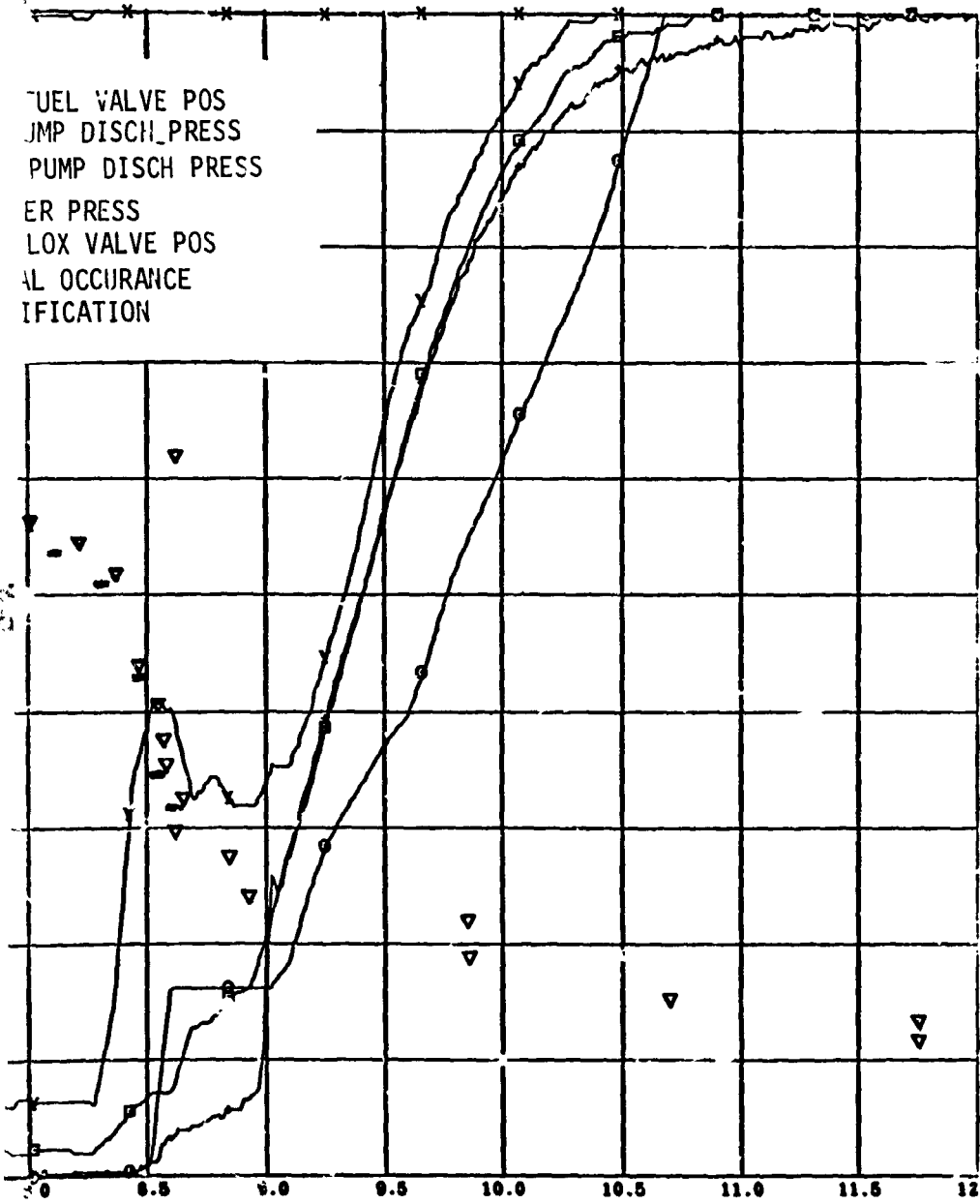

Figure 9--

SERIAL 057

FUEL VALVE POS  
JMP DISCH PRESS  
PUMP DISCH PRESS  
ER PRESS  
LOX VALVE POS  
AL OCCURANCE  
IFICATION



TIME FROM ENGINE START COMMAND - SECOND BURN (SEC)

Figure 9-5 Engine Start Sequence - Second Burn

EVENTS

PUMP SPIN PHASE  
START TANK DISCH CONT SOLENOID ENERG P/U  
START TANK DISCHARGE VALVE CLOSED D/O  
START TANK DISCHARGE VALVE OPEN P/U  
MAINSTAGE PHASE  
START TANK DISCH CONT SOLENOID ENERG D/O  
MAIN LOX VALVE CLOSED D/O  
GAS GENERATOR VALVE CLOSED D/O  
START TANK DISCHARGE VALVE OPEN D/O  
GAS GENERATOR VALVE OPEN P/U  
LOX TURBINE BYPASS VALVE OPEN D/O  
START TANK DISCHARGE VALVE CLOSED P/U  
LOX TURBINE BYPASS VALVE CLOSED P/U  
MAINSTAGE PRESS. SWITCH NO. 1 PRESS. P/U  
MAINSTAGE PRESS. SWITCH NO. 2 PRESS. P/U  
MAIN LOX VALVE OPEN P/U  
THRUST CHAMBER SPARK ON D/O  
GAS GENERATOR SPARK ON D/O

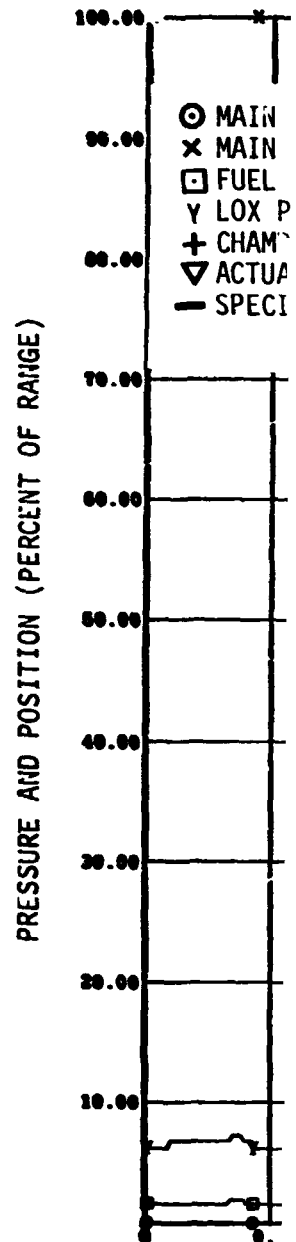

FOLDOUT FRAME \

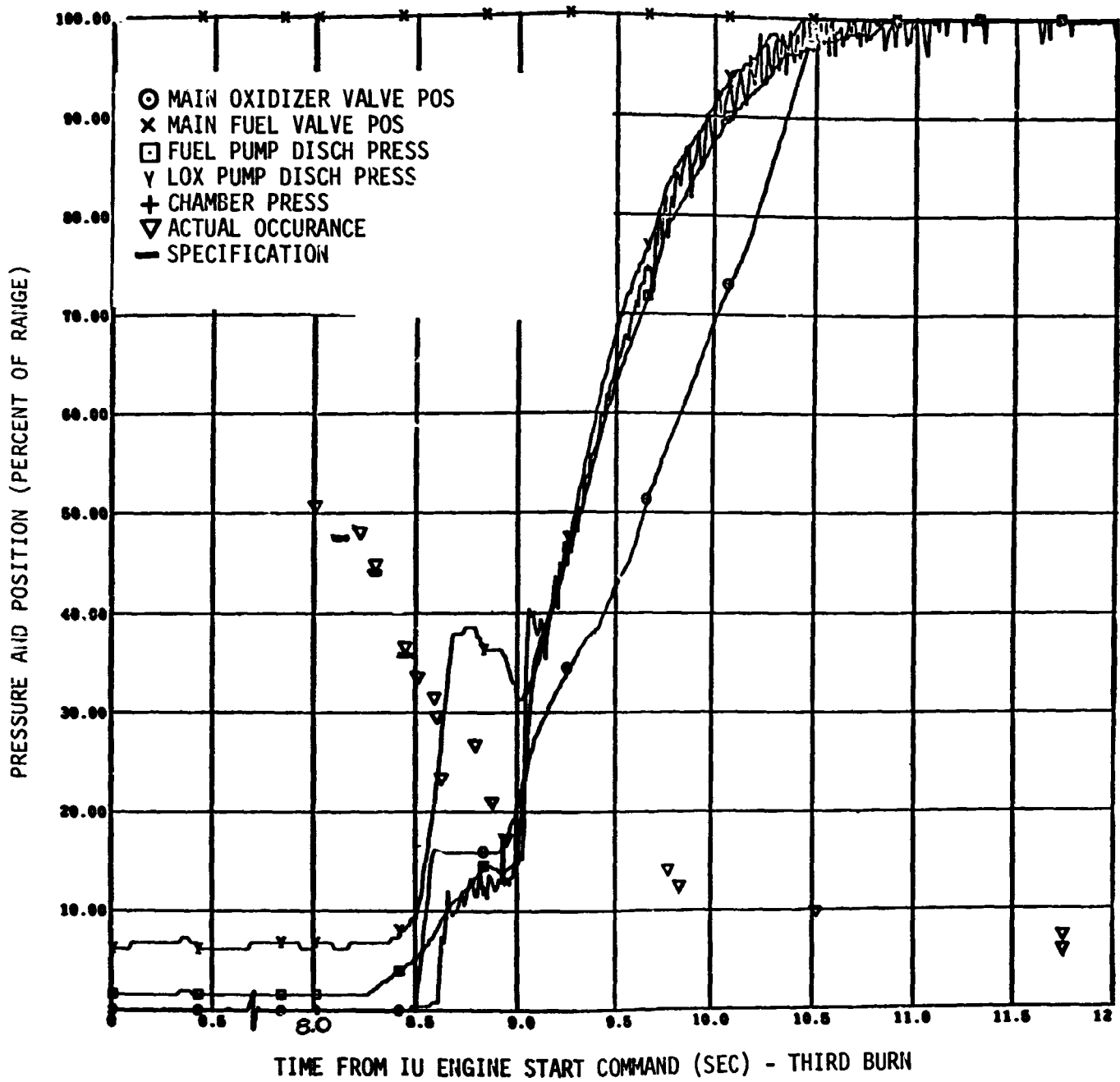

Figure 9-6. Engine Start Sequence - Third Burn

- EVENT
- MAIN OXIDIZER VALVE (OPEN D/O-CLOSED P/U)
  - 1 SECOND BURN CUTOFF
  - 2 THIRD BURN CUTOFF
  - MAIN FUEL VALVE (OPEN D/O-CLOSED P/U)
  - 3 SECOND BURN CUTOFF
  - 4 THIRD BURN CUTOFF
  - GAS GENERATOR VALVE (OPEN D/O-CLOSED P/U)
  - 5 SECOND BURN CUTOFF
  - 6 THIRD BURN CUTOFF
  - OXIDIZER TURBINE BYPASS VALVE (CLOSED D/O-OPEN P/U)
  - 7 SECOND BURN CUTOFF
  - 8 THIRD BURN CUTOFF

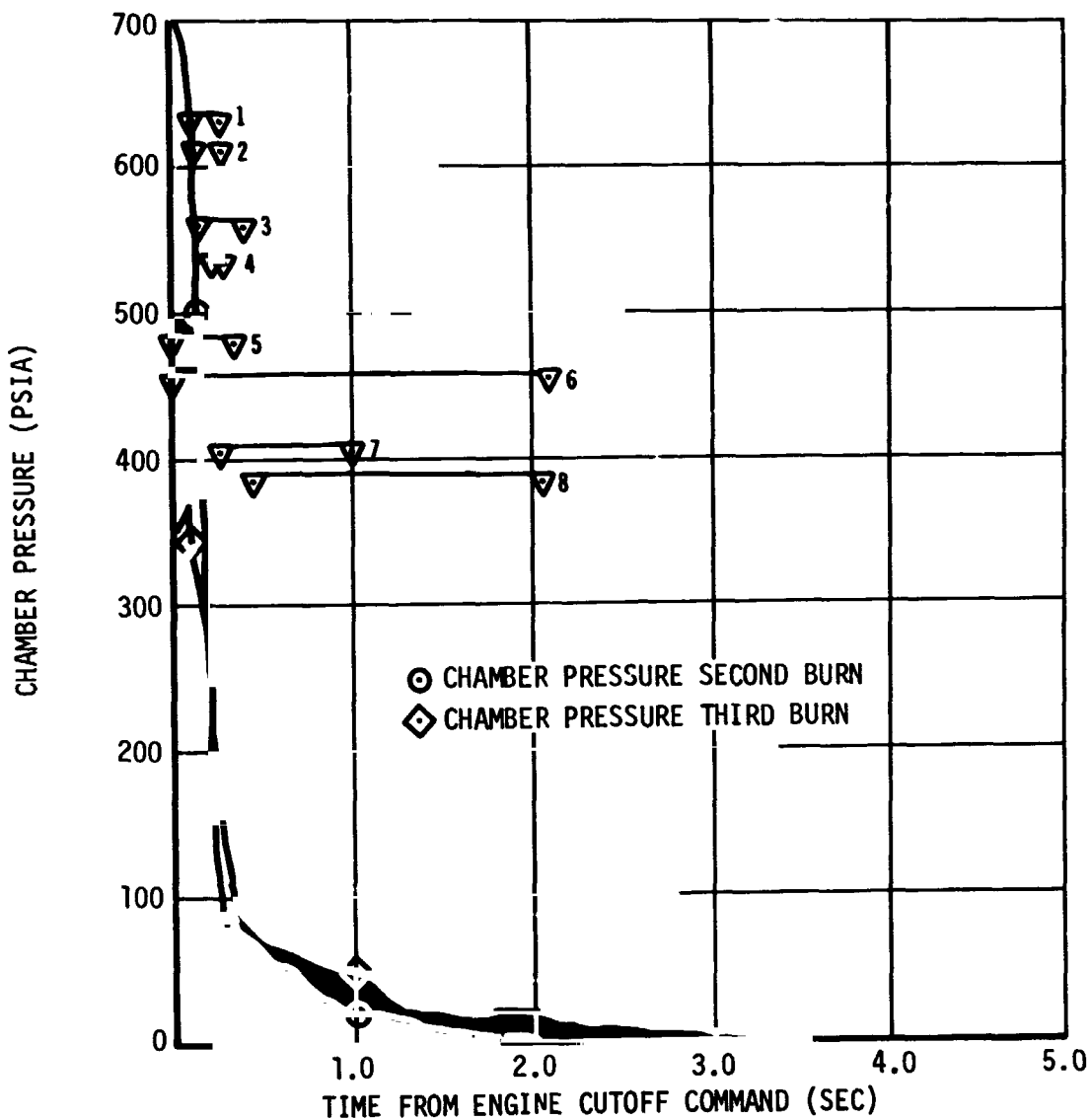
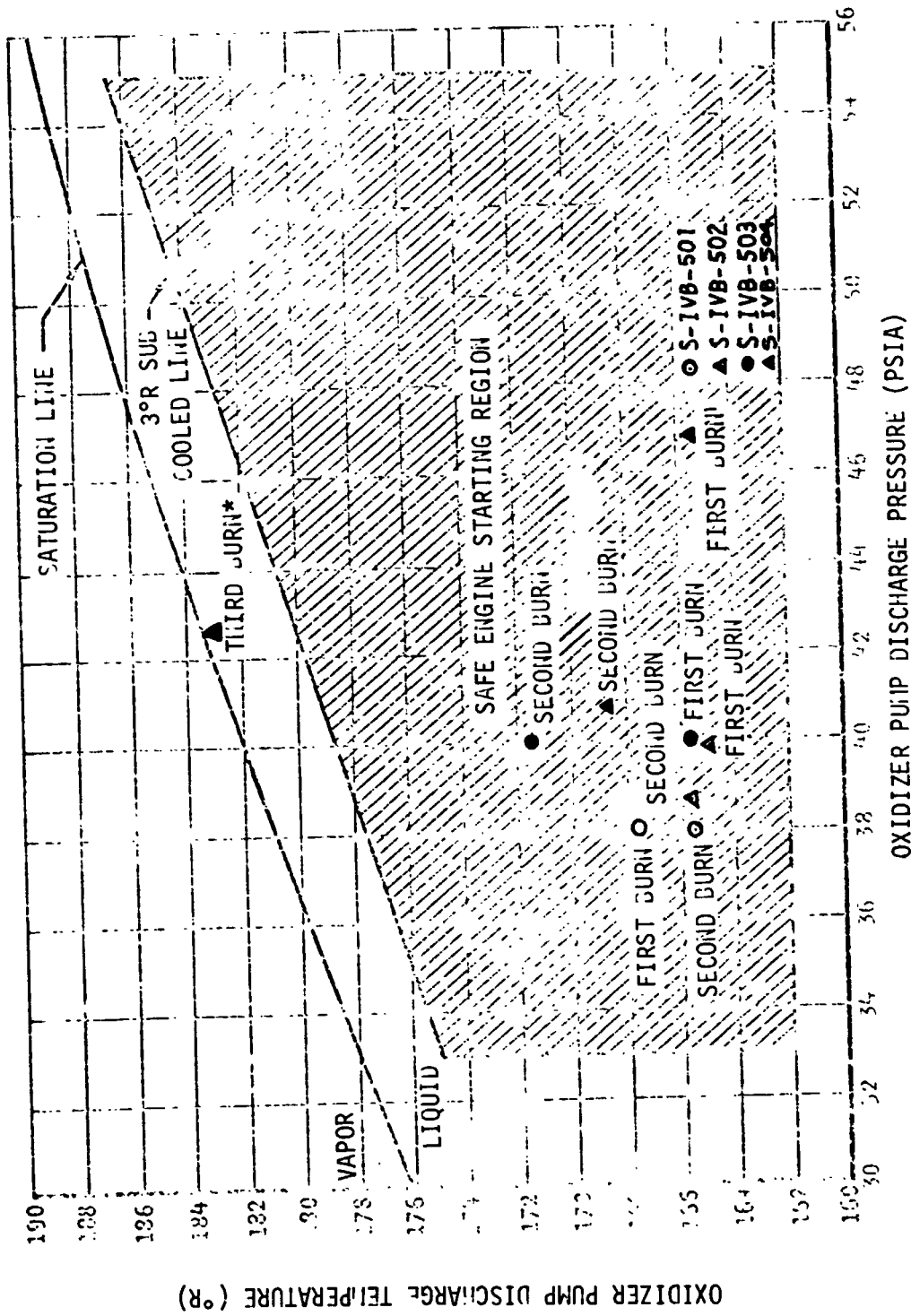

Figure 9-7. Significant Events - Second and Third Burns



\*DUE TO LACK OF OXIDIZER CHILLDOWN, TEMPERATURE AT START IS BELIEVED TO BE THAT OF SATURATED VAPOR

Figure 9-8. Oxidizer Pump Discharge Pressure Versus Temperature

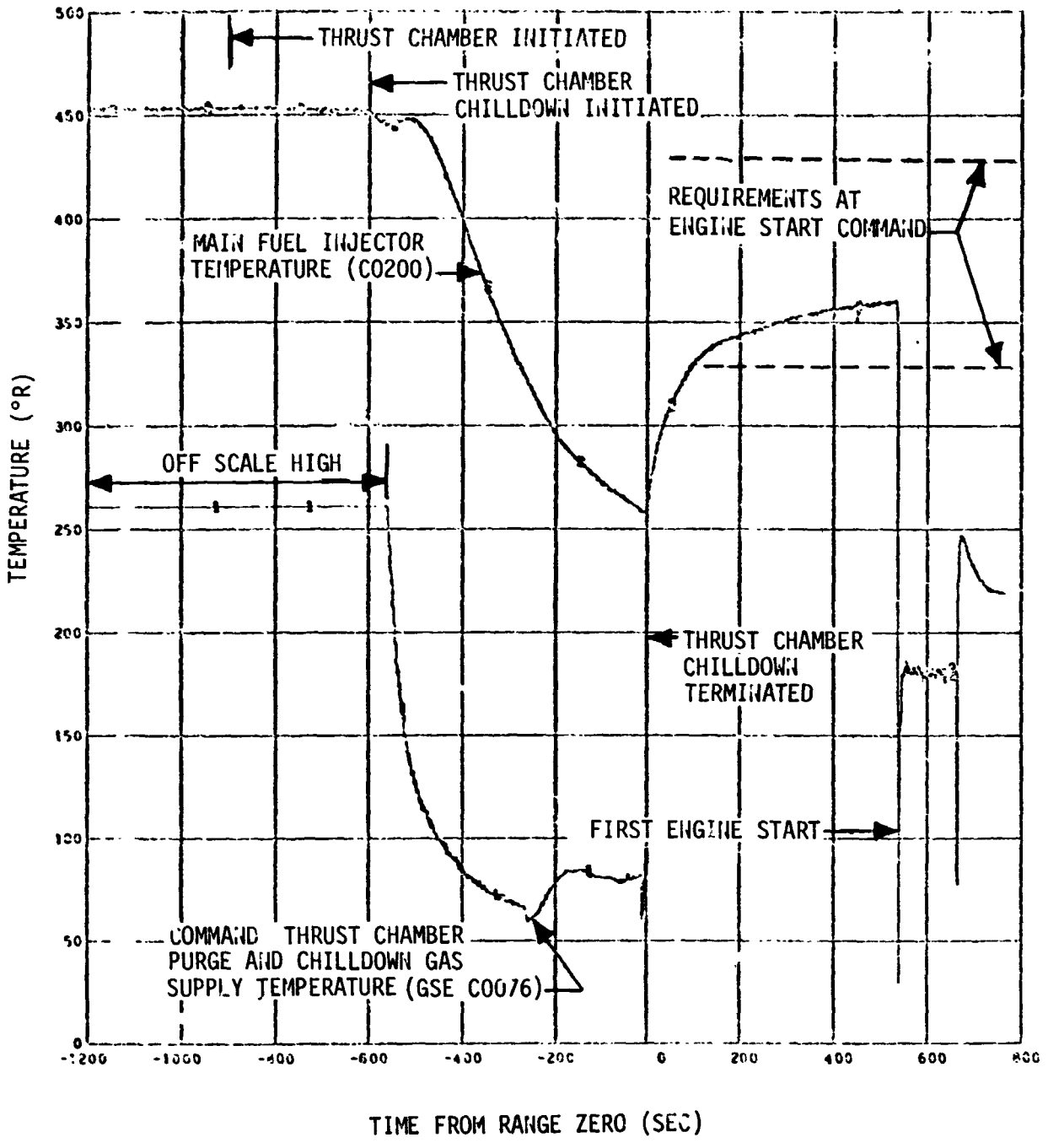

FIGURE 9-9. THRUST CHAMBER CHILLDOWN -- FIRST BURN



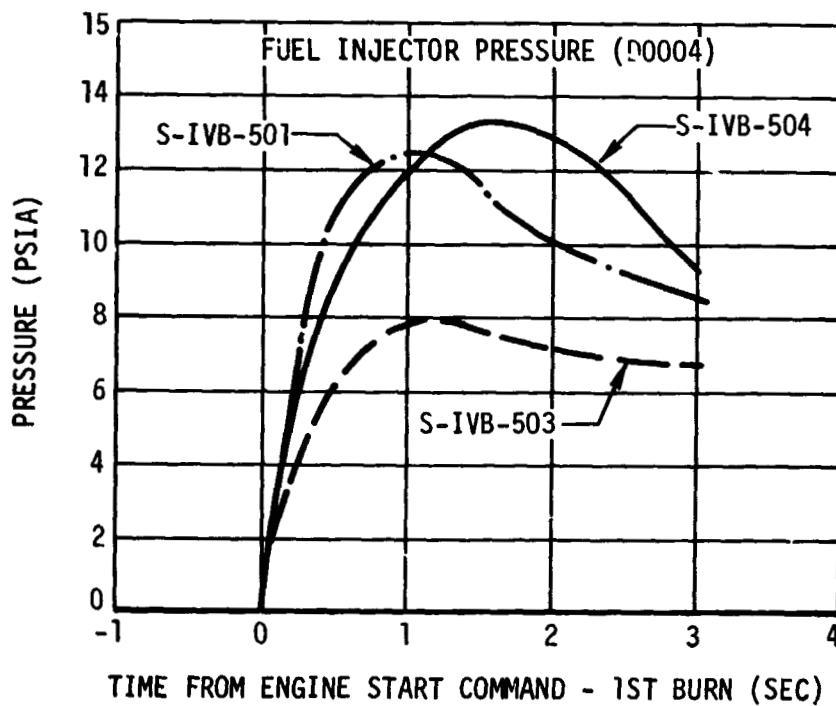
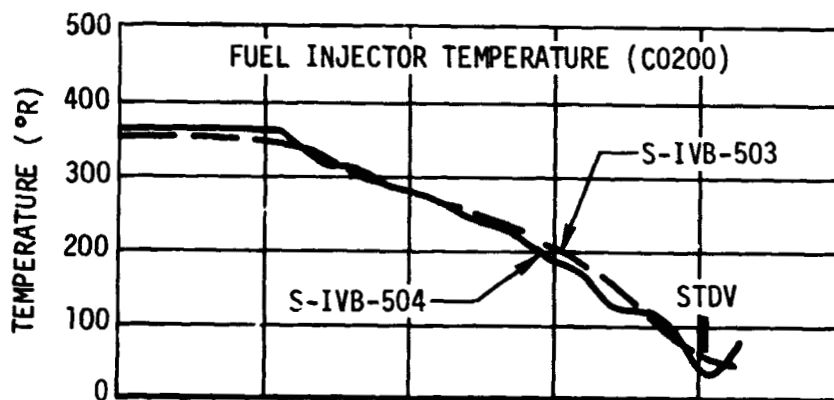
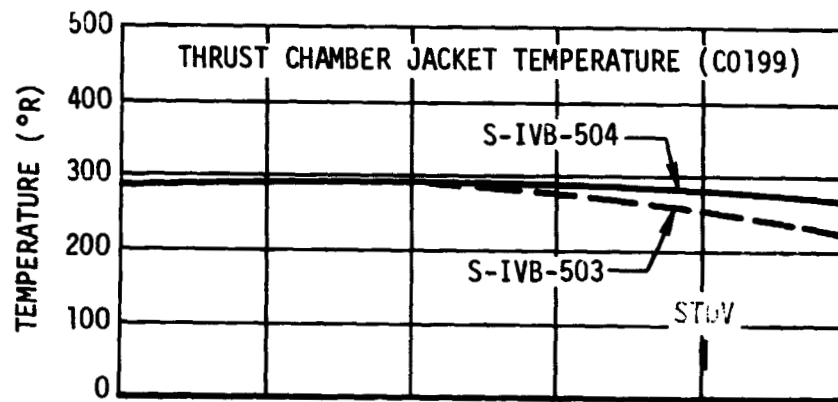

Figure 9-10. Fuel Lead - First Burn

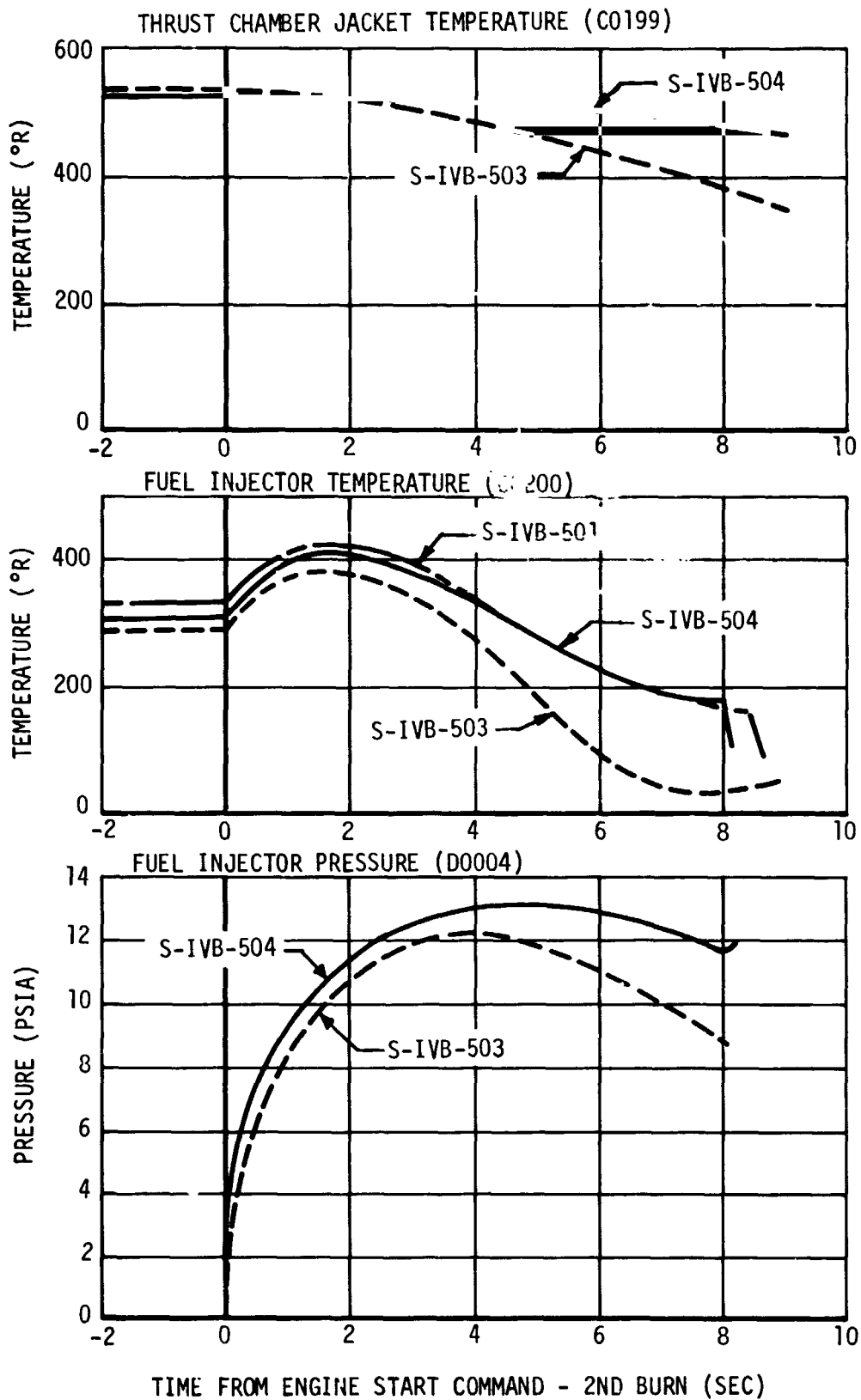

Figure 9-11. Fuel Lead - Second Burn

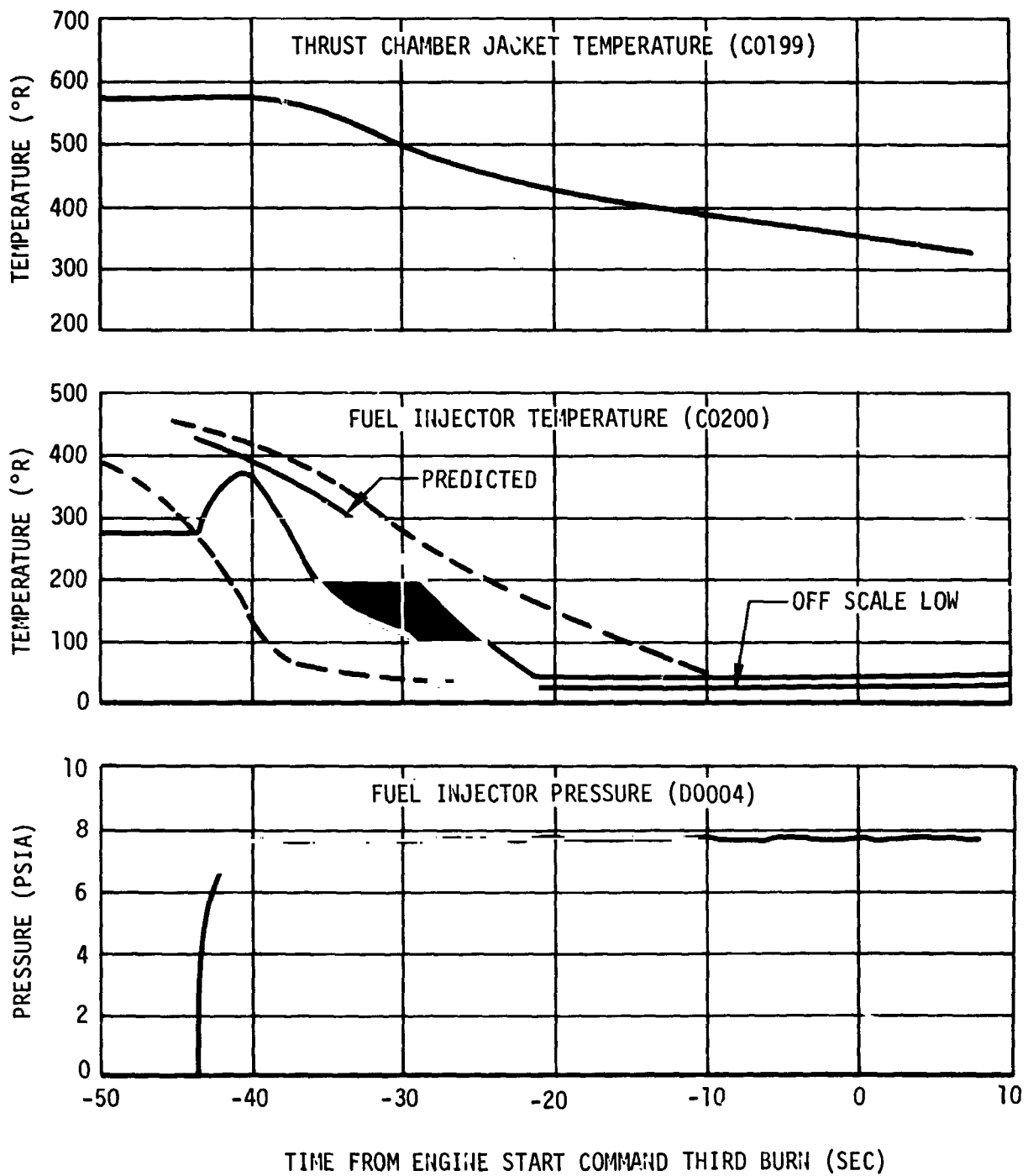

FIGURE 9-12. FUEL LEAD -- THIRD BURN

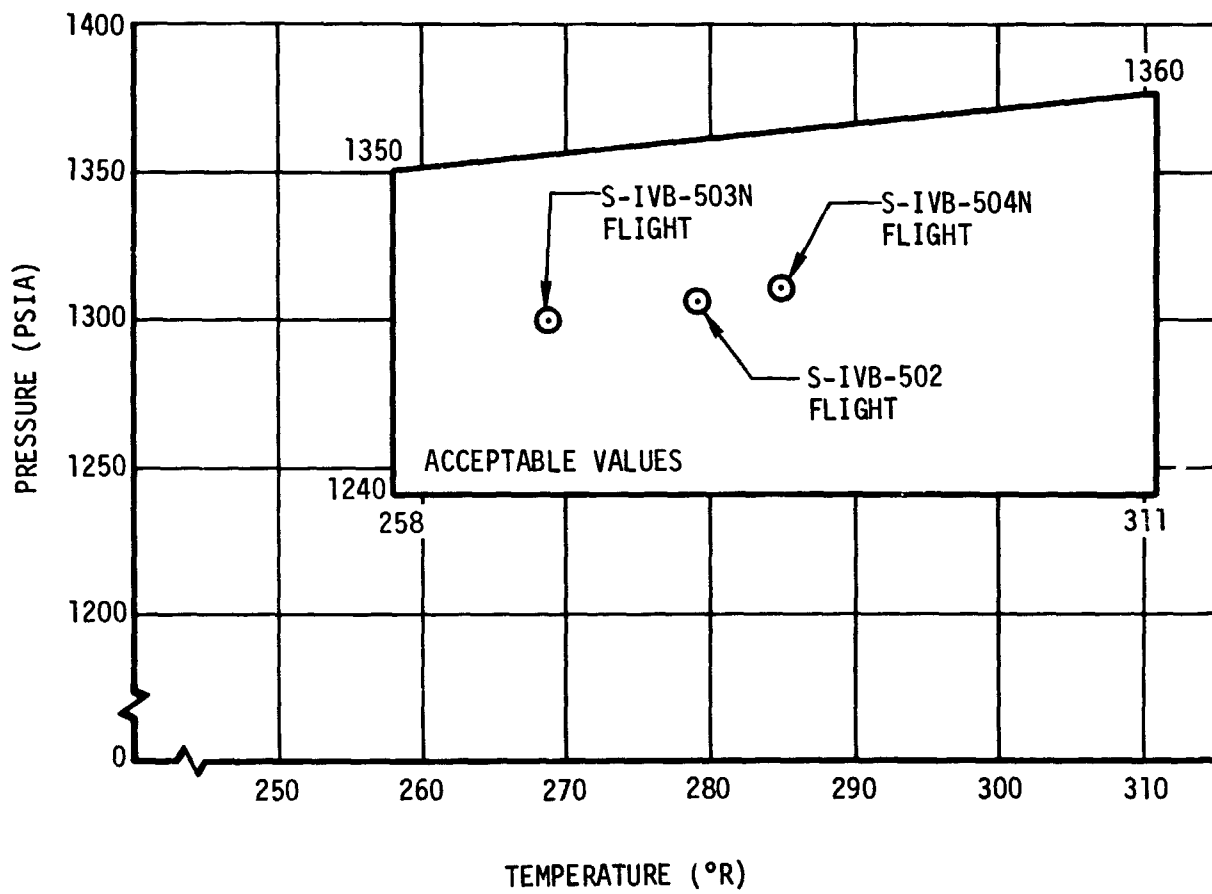

Figure 9-13. GH2 Start Sphere Critical Limits at Liftoff

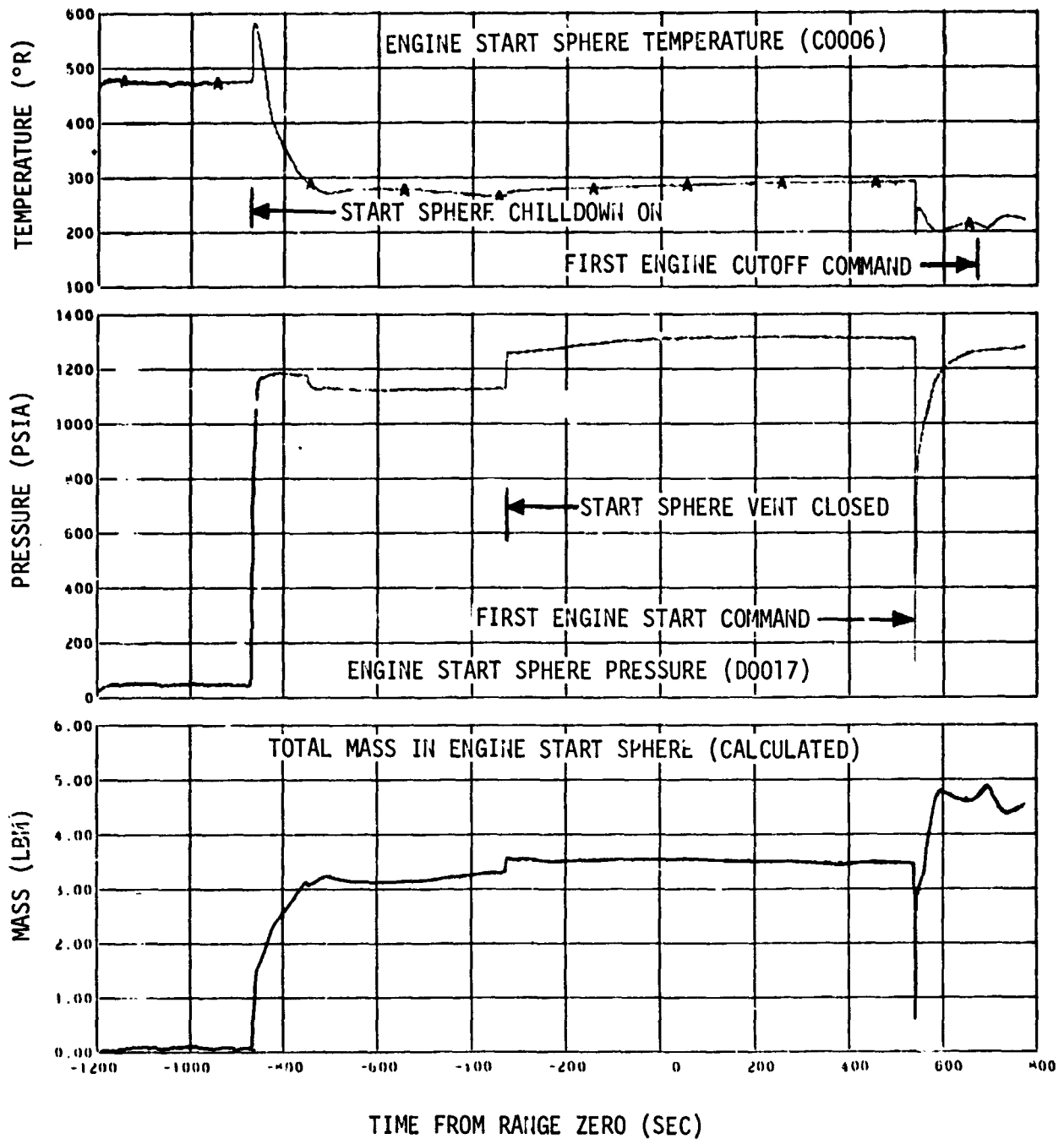

FIGURE 9-14. ENGINE START SPHERE PERFORMANCE-FIRST BURN

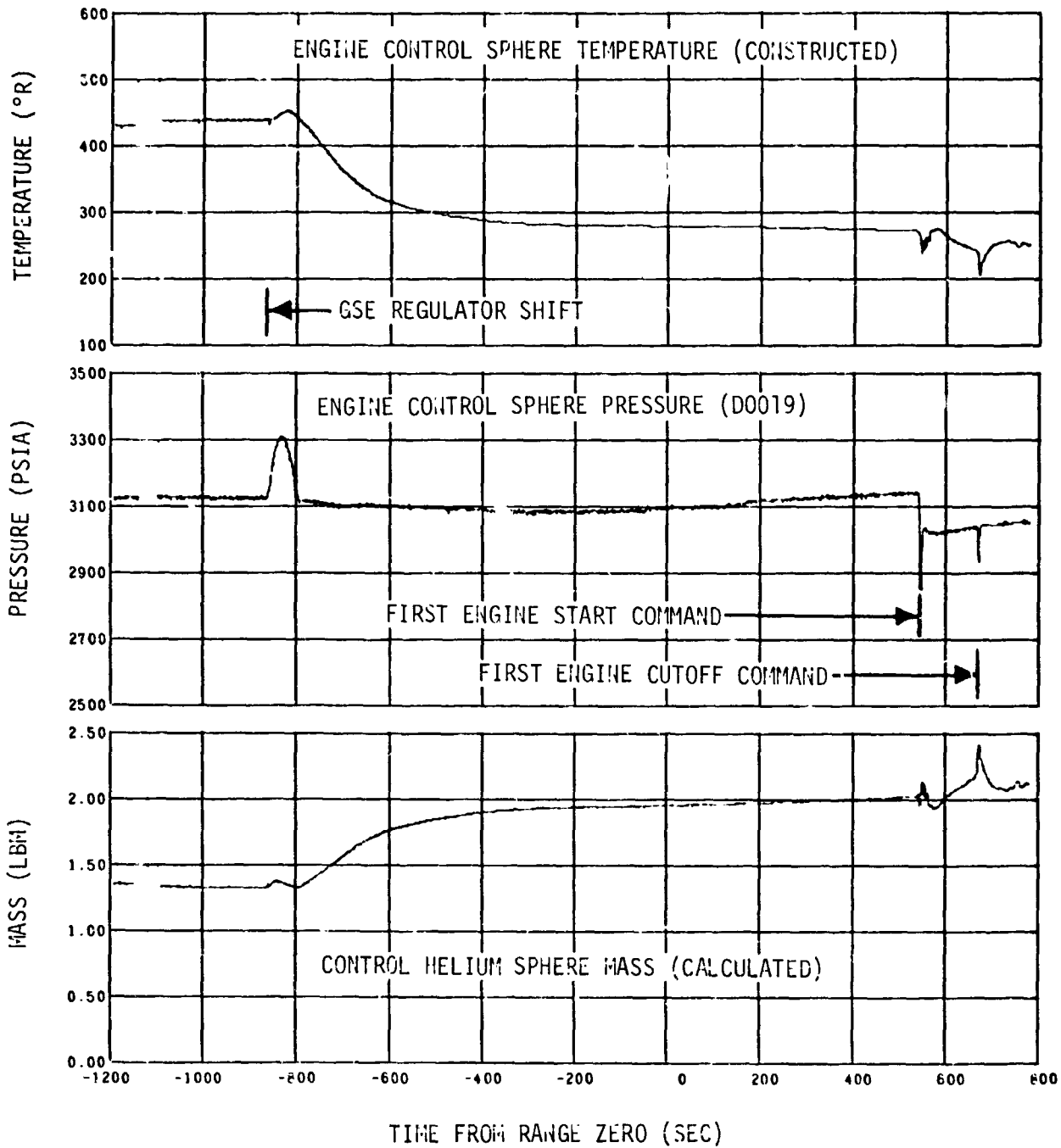

Figure 9-15. Engine Control Sphere Performance -- First Burn

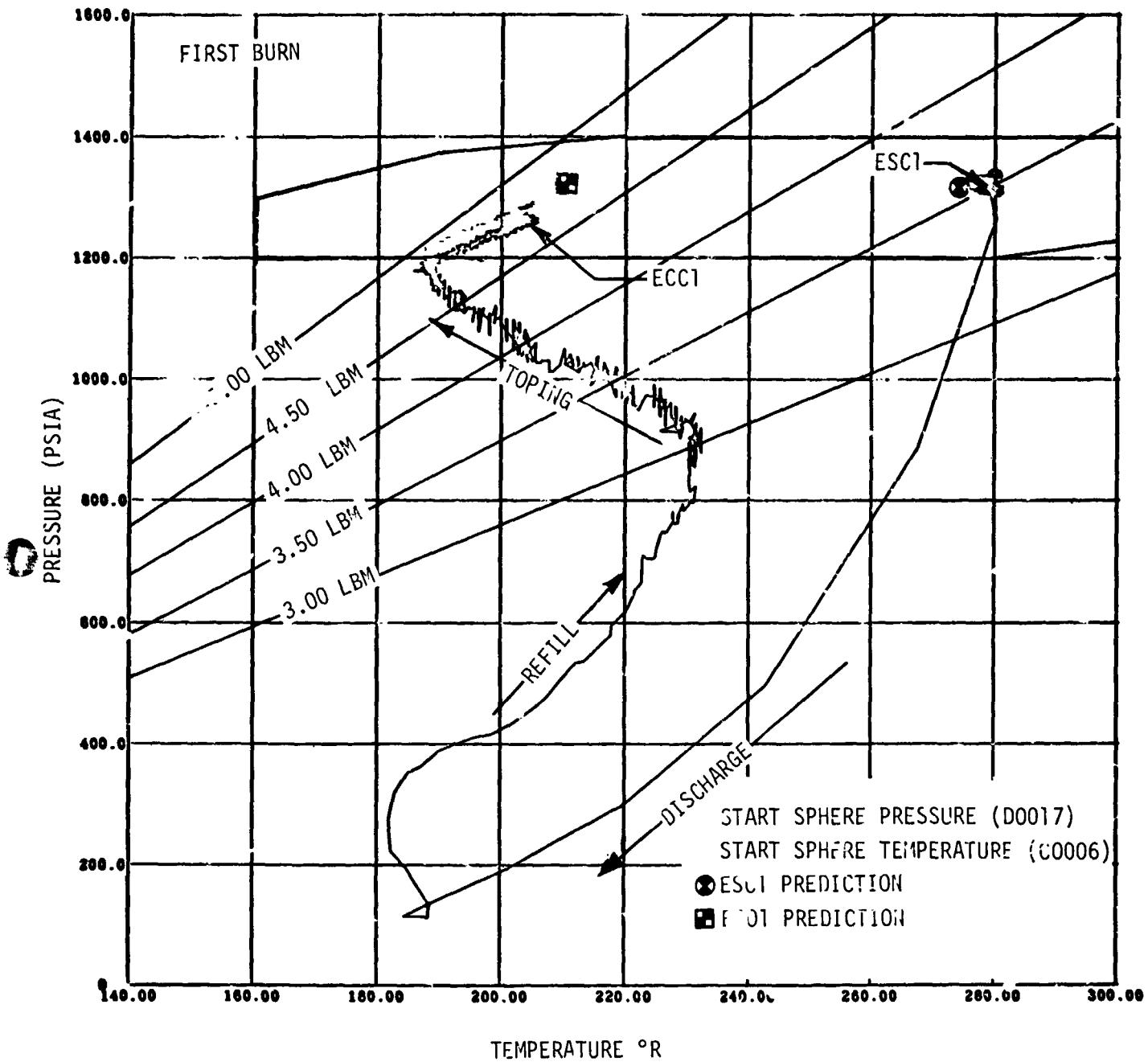

Figure 9-16. Start Sphere Refill Performance (Sheet 1 of 3)

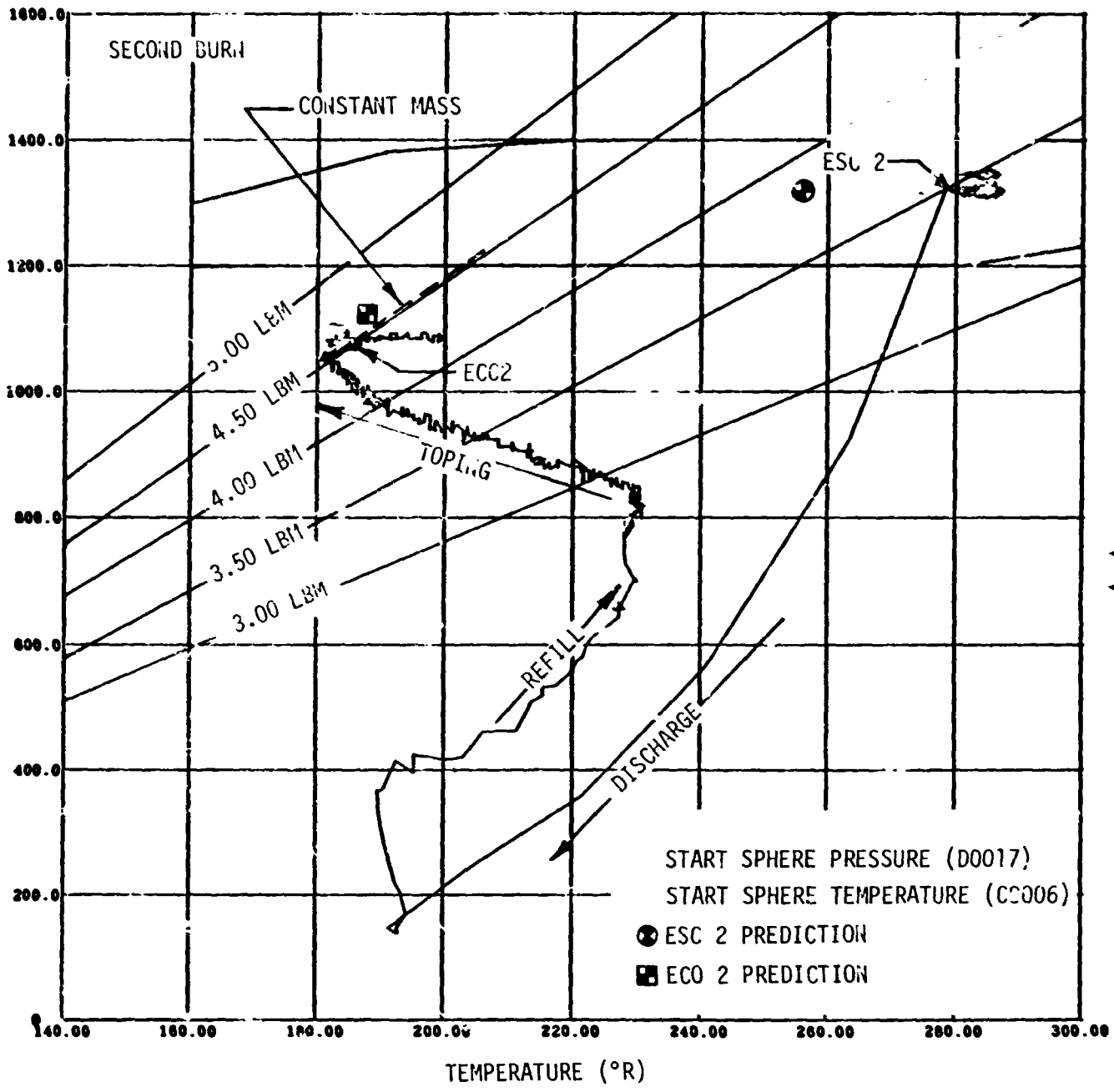

Figure 9-16. Start Sphere Refill Performance (Sheet 2 of 3)



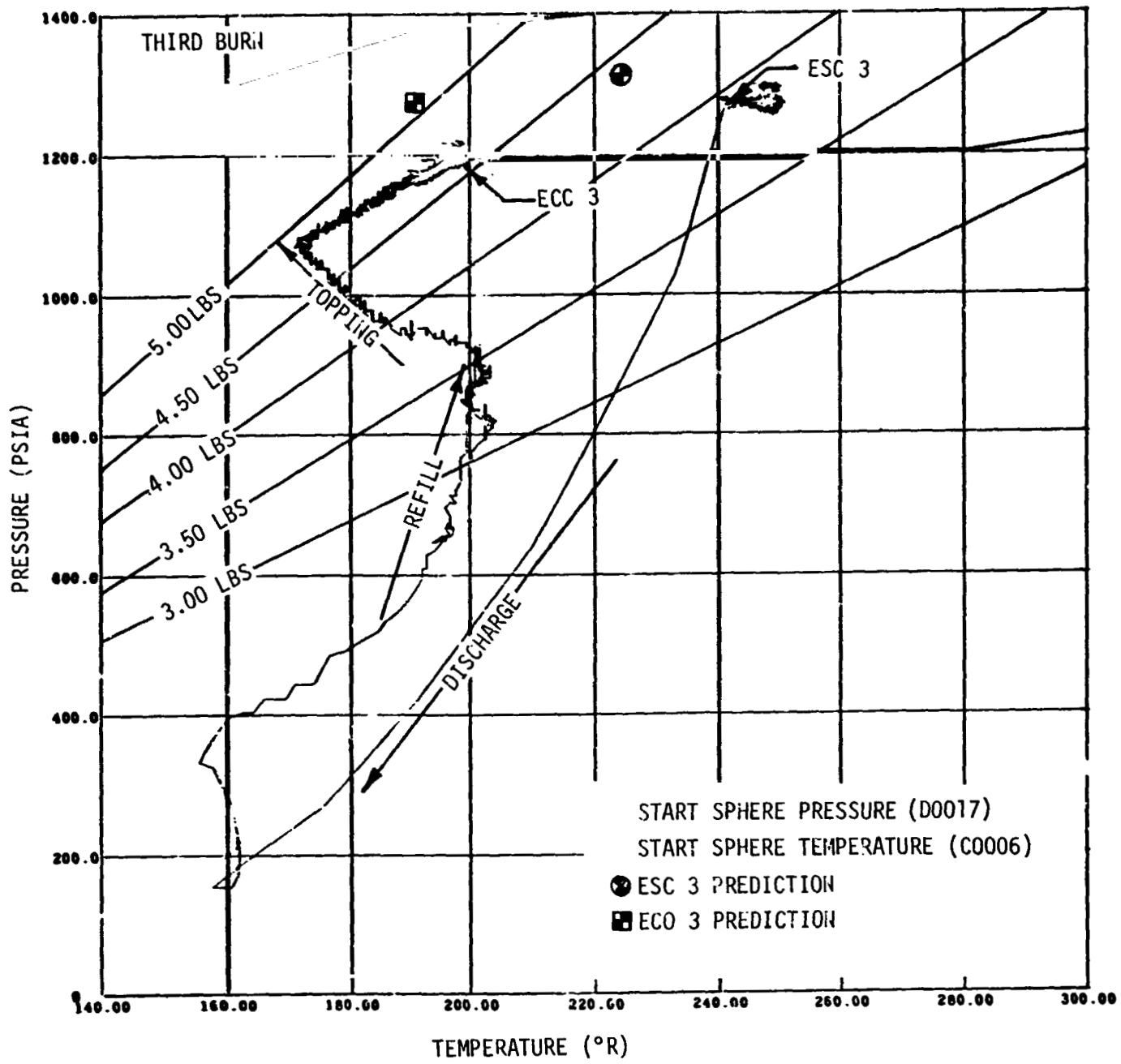

Figure 9-16. Start Sphere Refill Performance (Sheet 3 of 3)

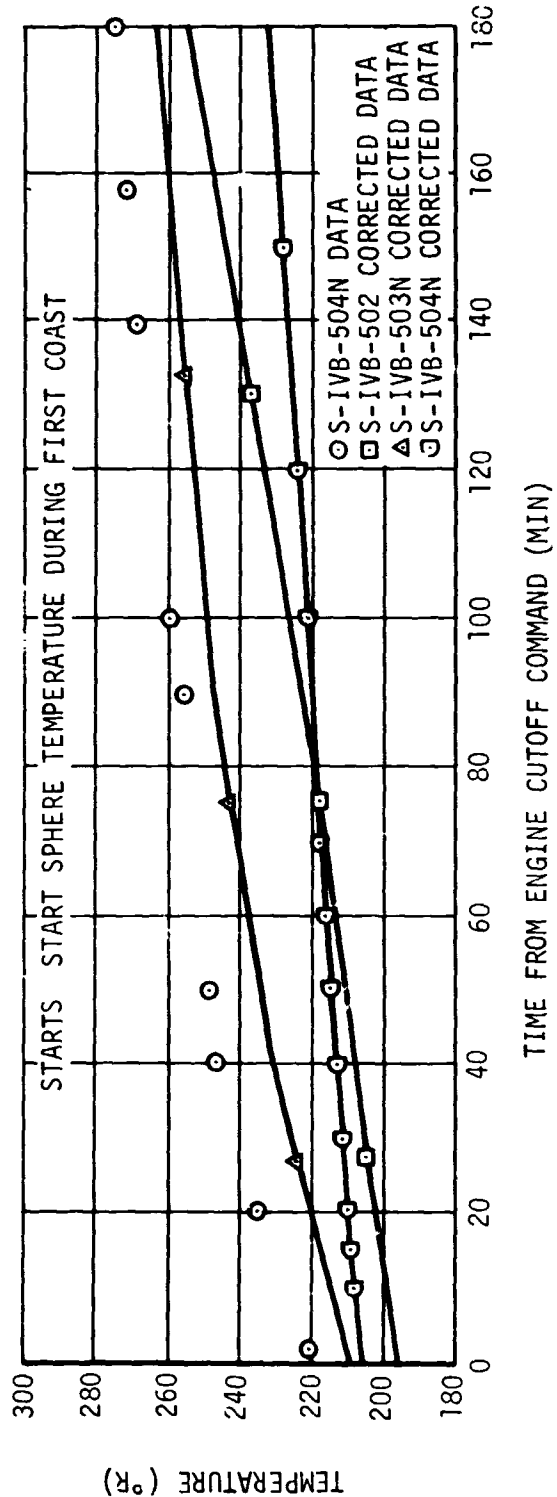
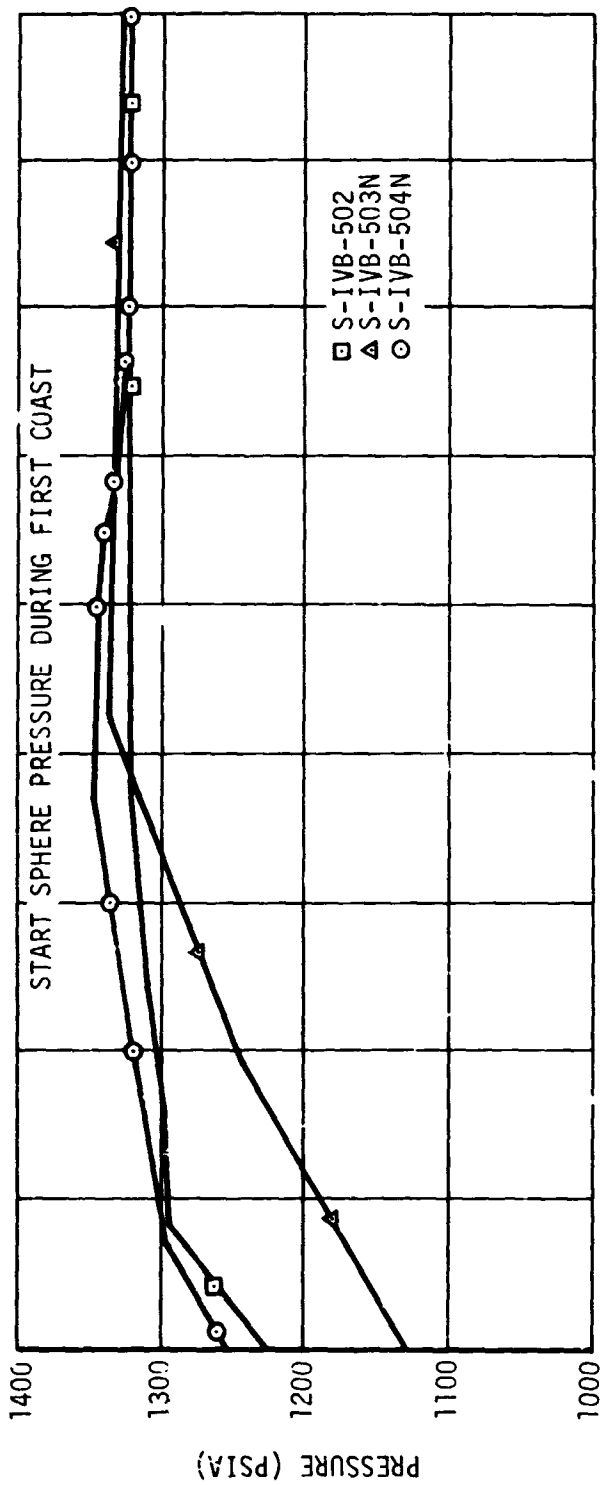

Figure 9-17. Start Sphere Conditions - Earth Orbit

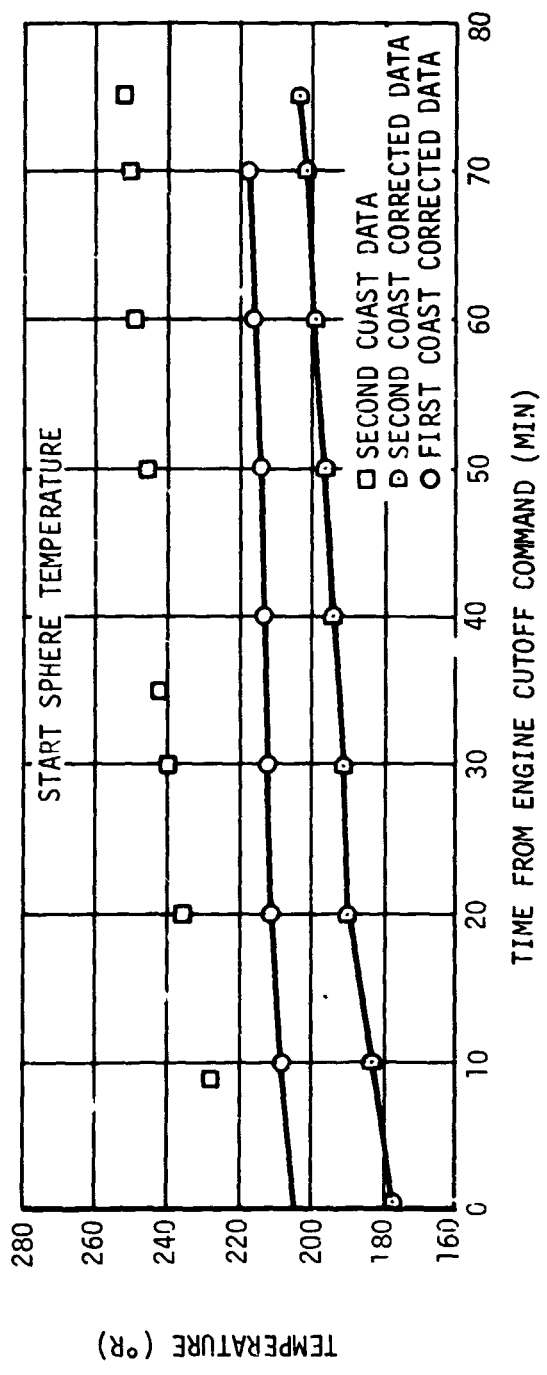
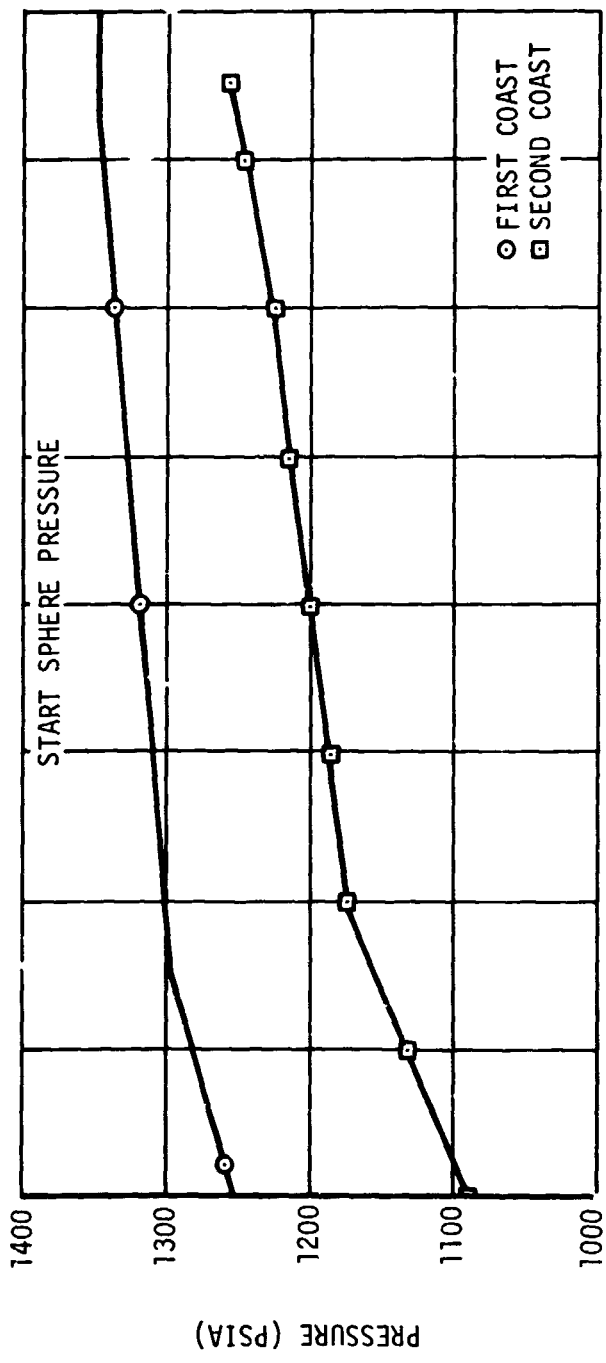

Figure 9-18. Start Sphere Conditions during Coast

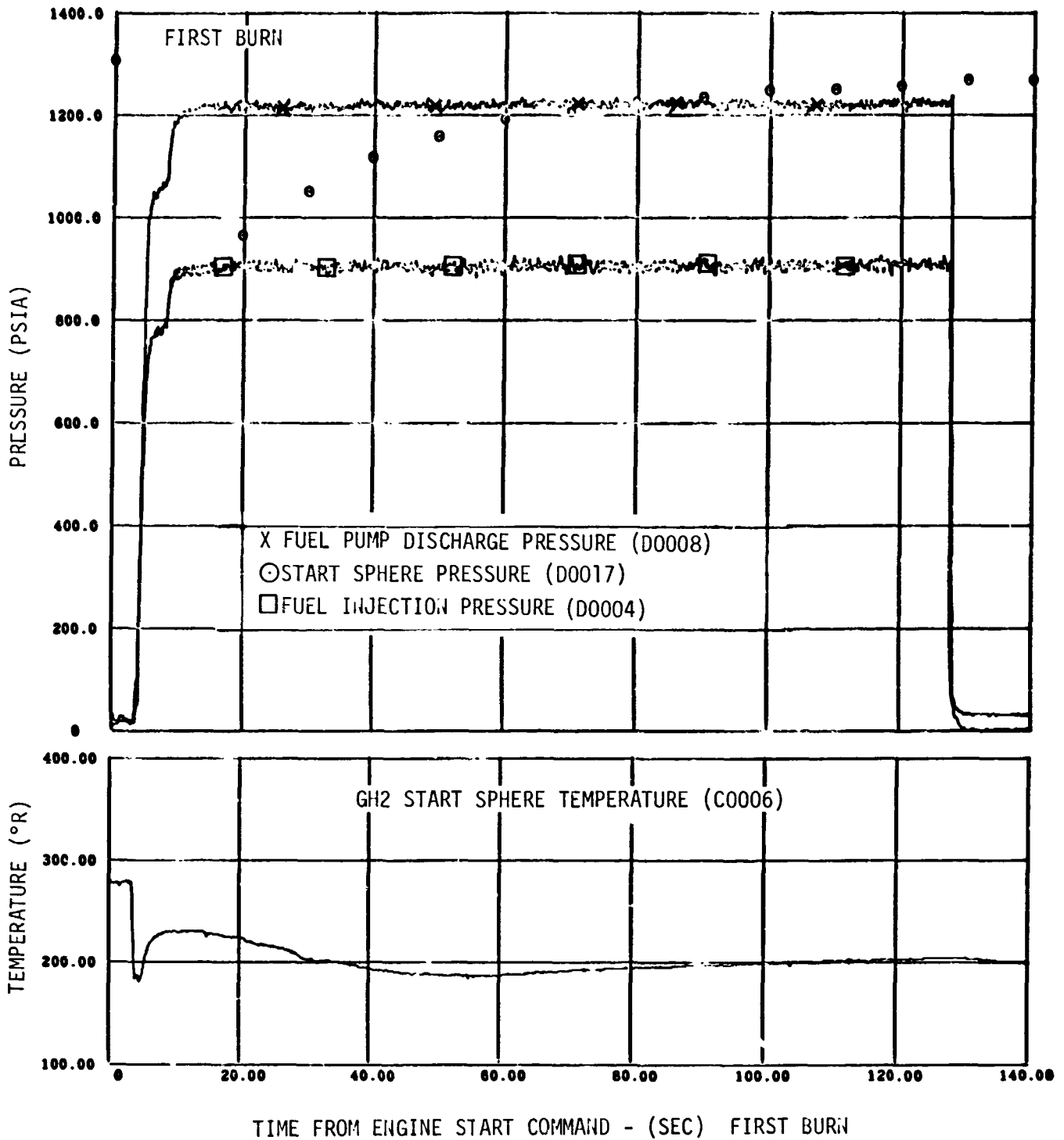

Figure 9-19. Start Sphere Refill (Sheet 1 of 3)

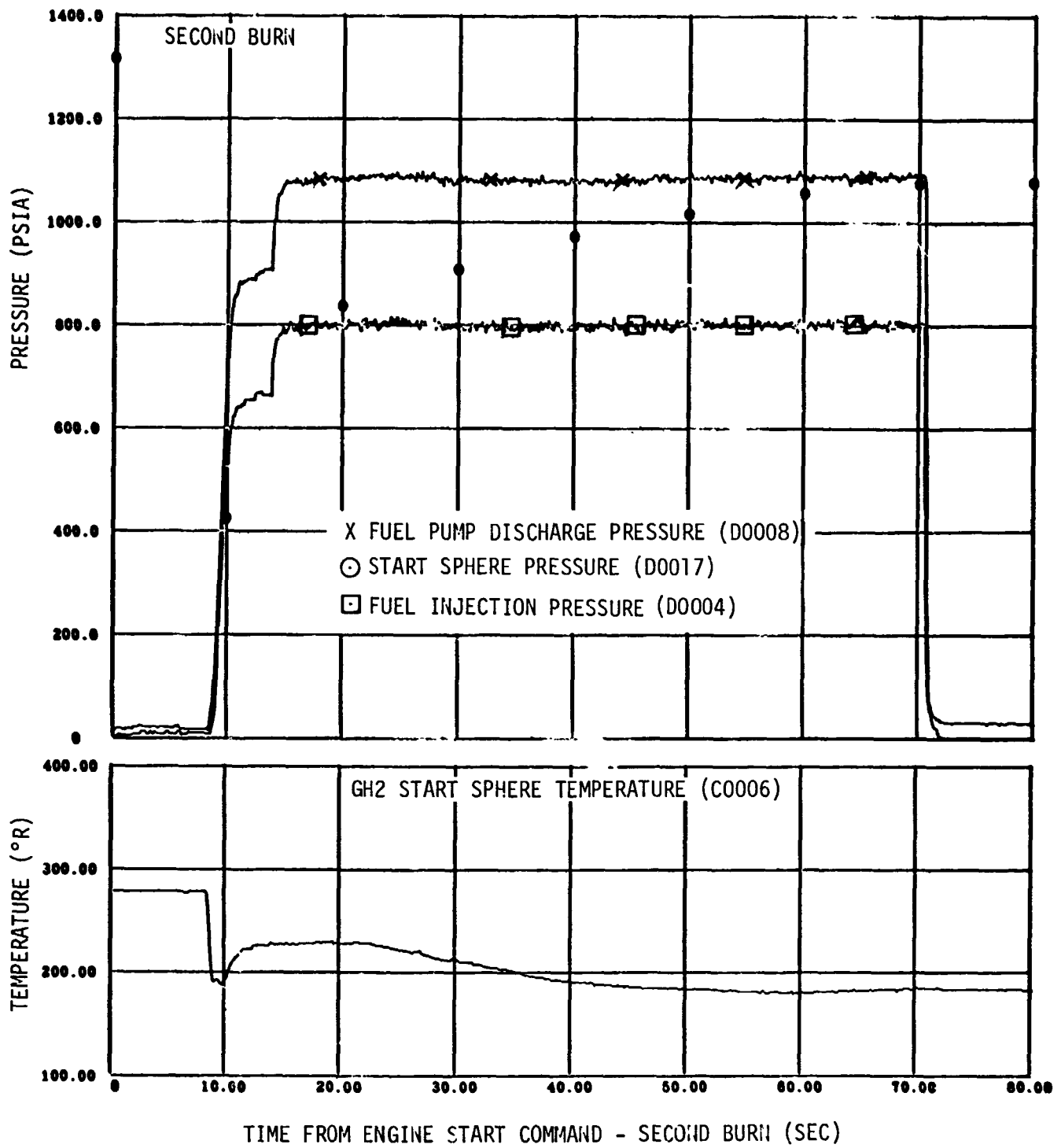

Figure 9-19. Start Sphere Refill (Sheet 2 of 3)

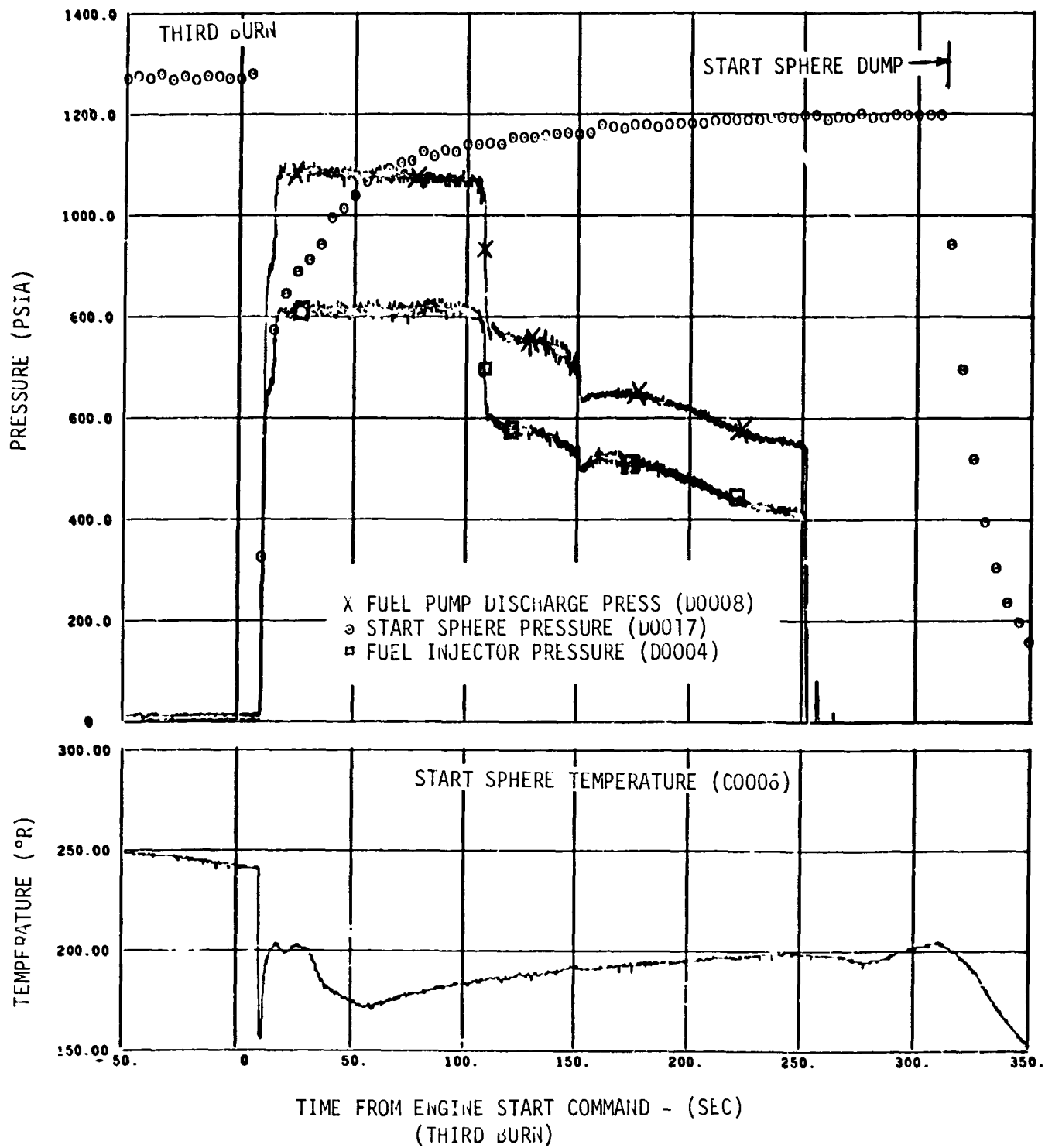

Figure 9-19. Start Sphere Refill (Sheet 3 of 3)

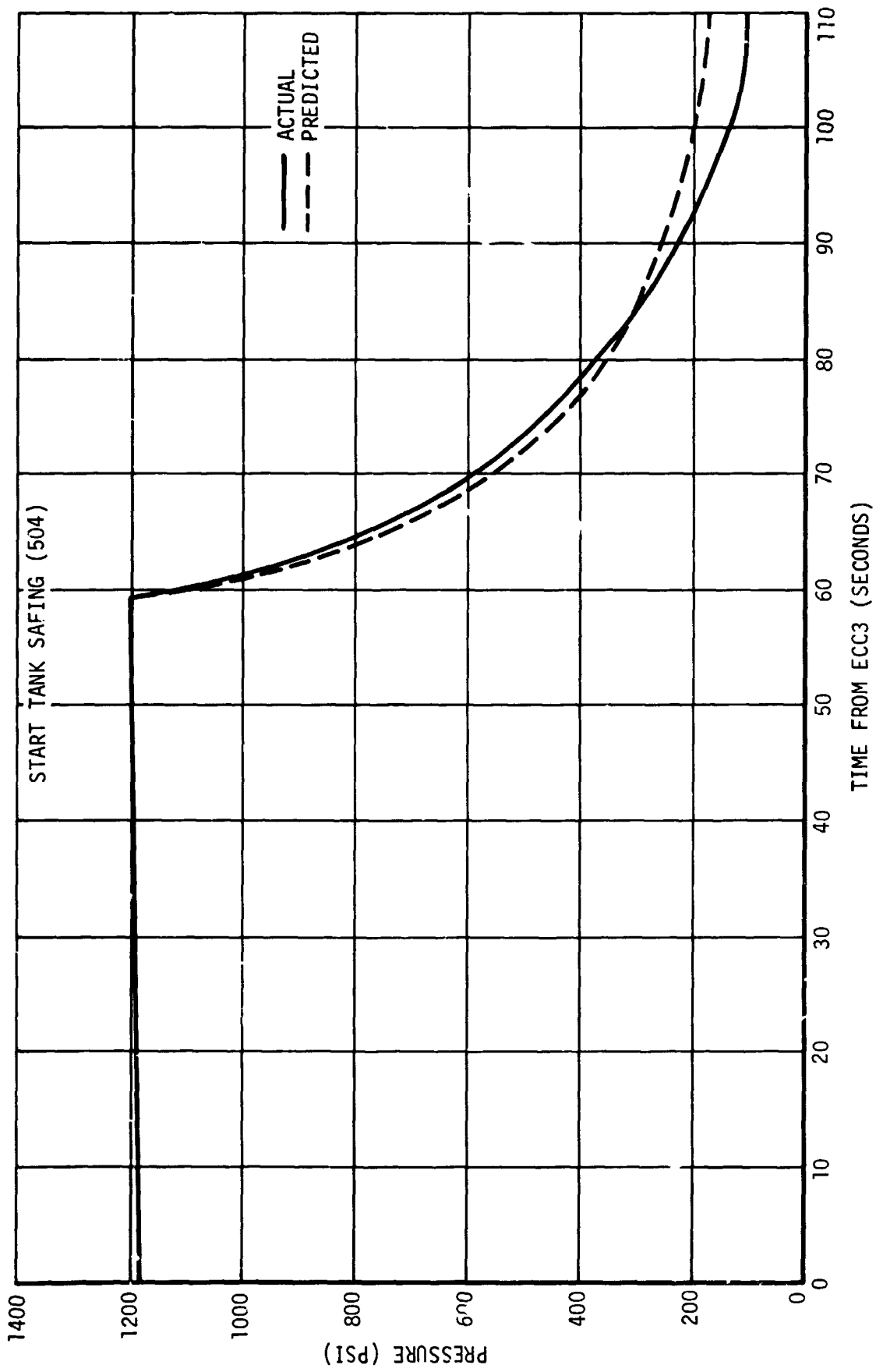

Figure 9-20. Start Tank Safing (504N)

FIRST BURN

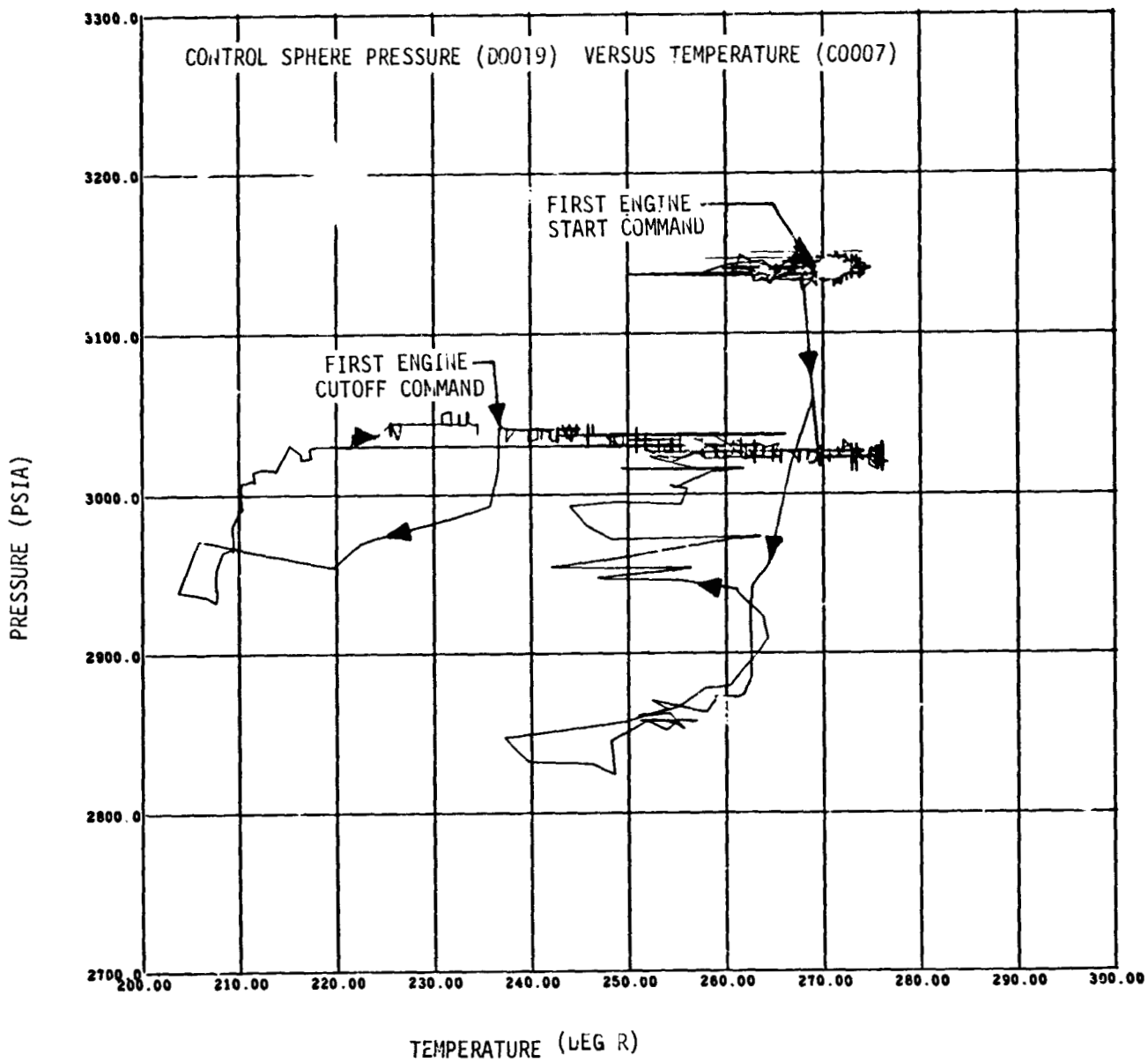

Figure 9-21. Control Sphere Performance (Sheet 1 of 3)



SECOND BURN

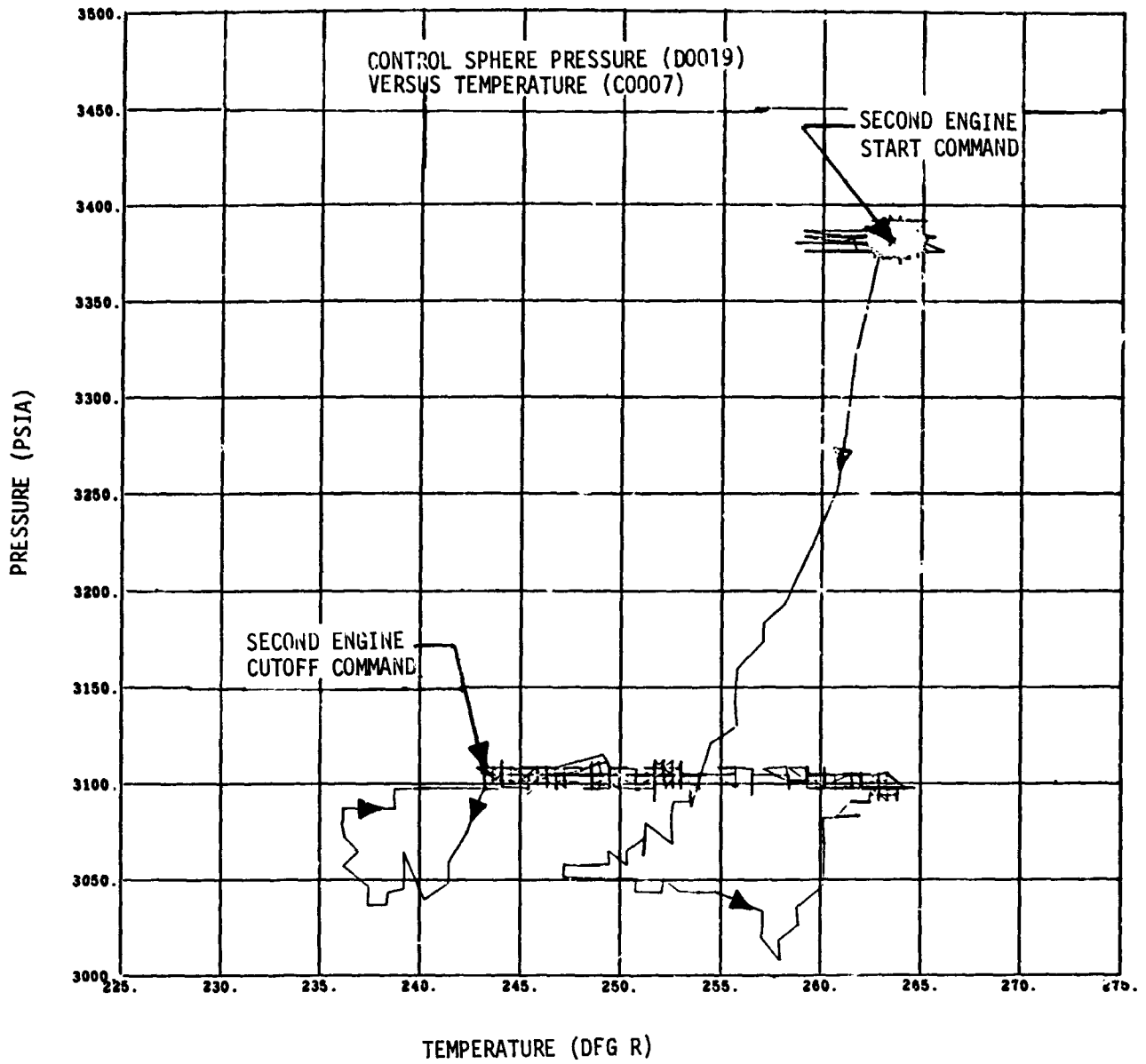

Figure 9-21. Control Sphere Performance (Sheet 2 of 3)

THIRD BURN

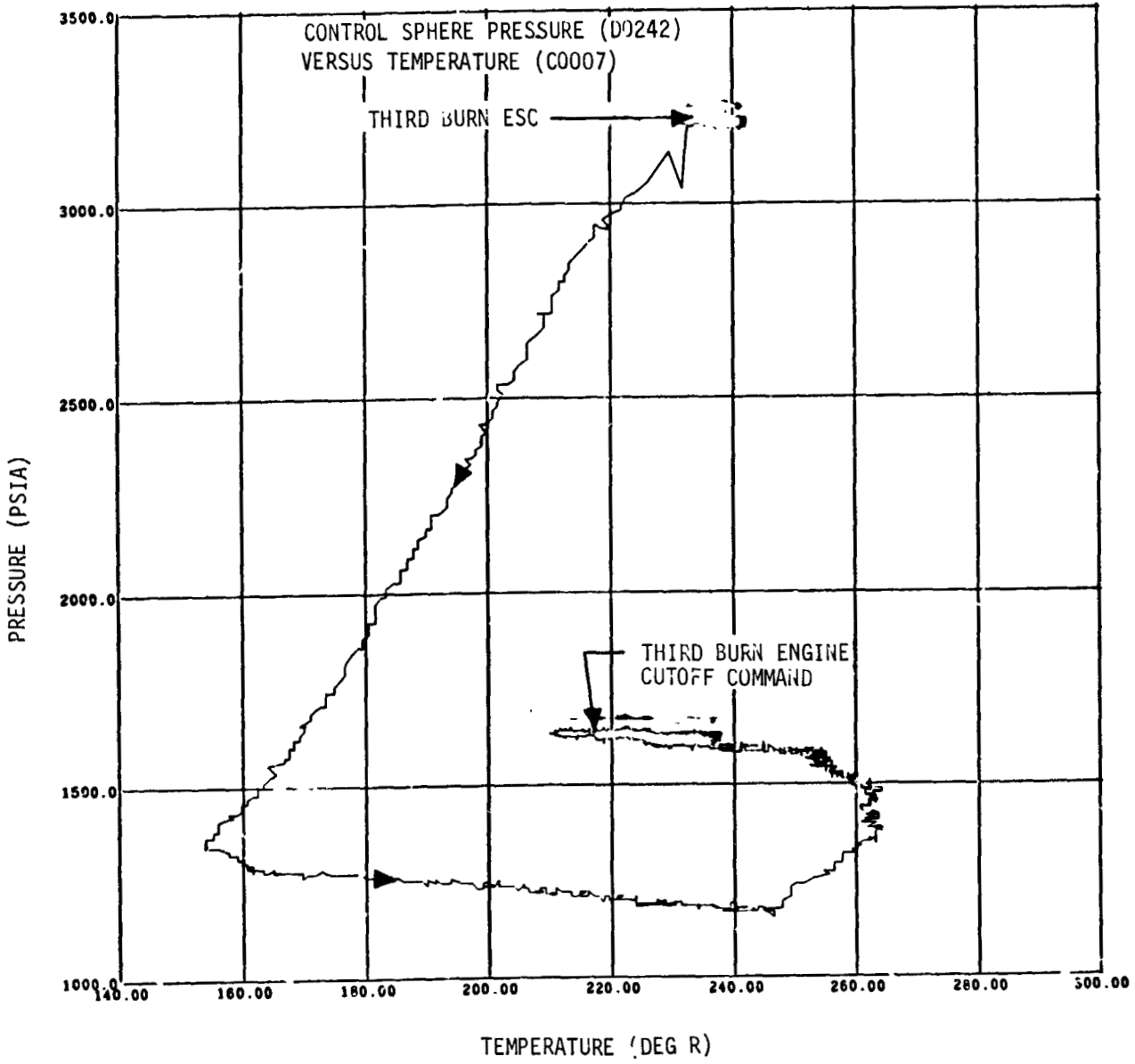

Figure 9-21 Control Sphere Performance (Sheet 3 of 3)

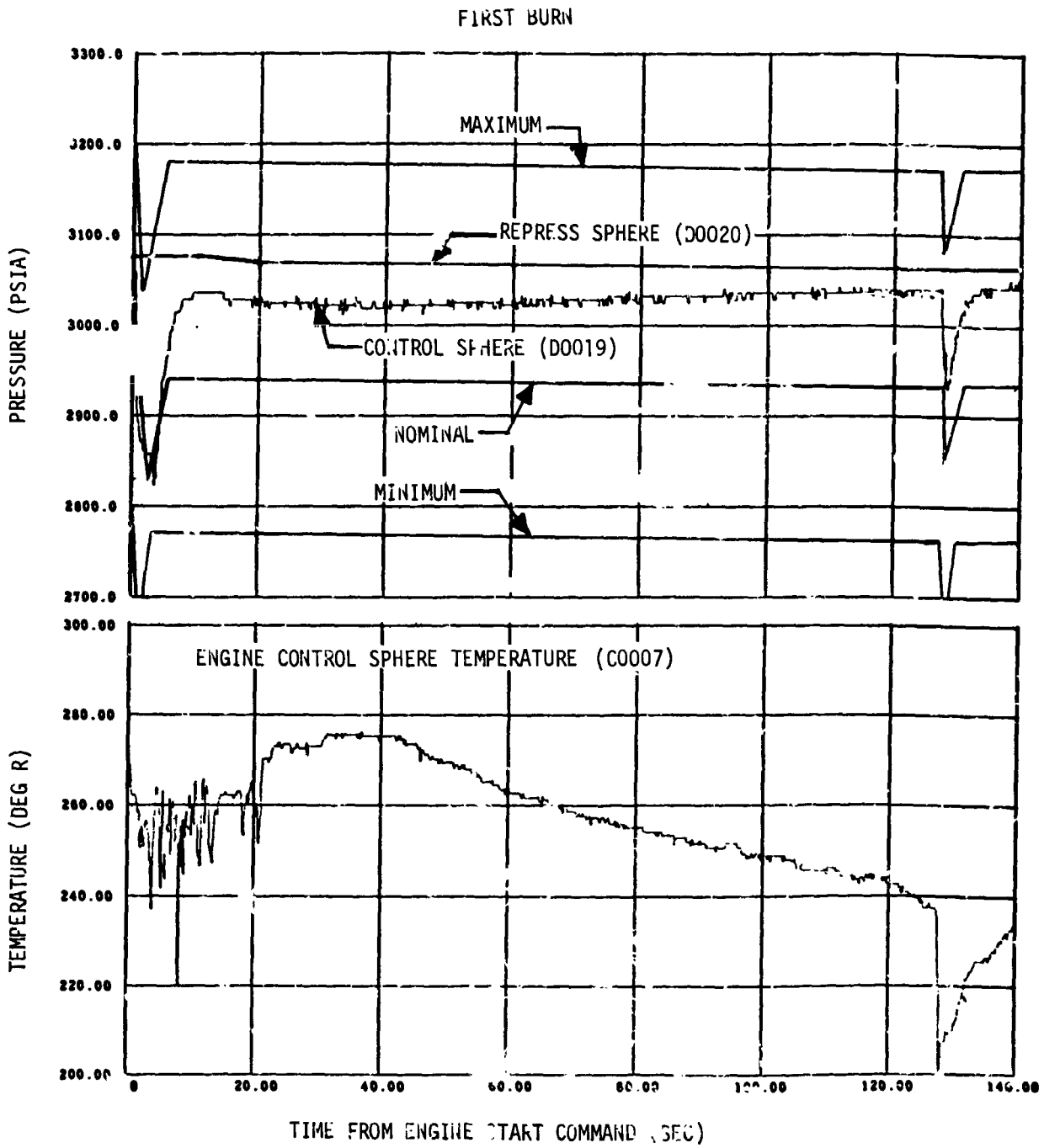

Figure 9-22 Control Sphere Conditions (Sheet 1 of 3)

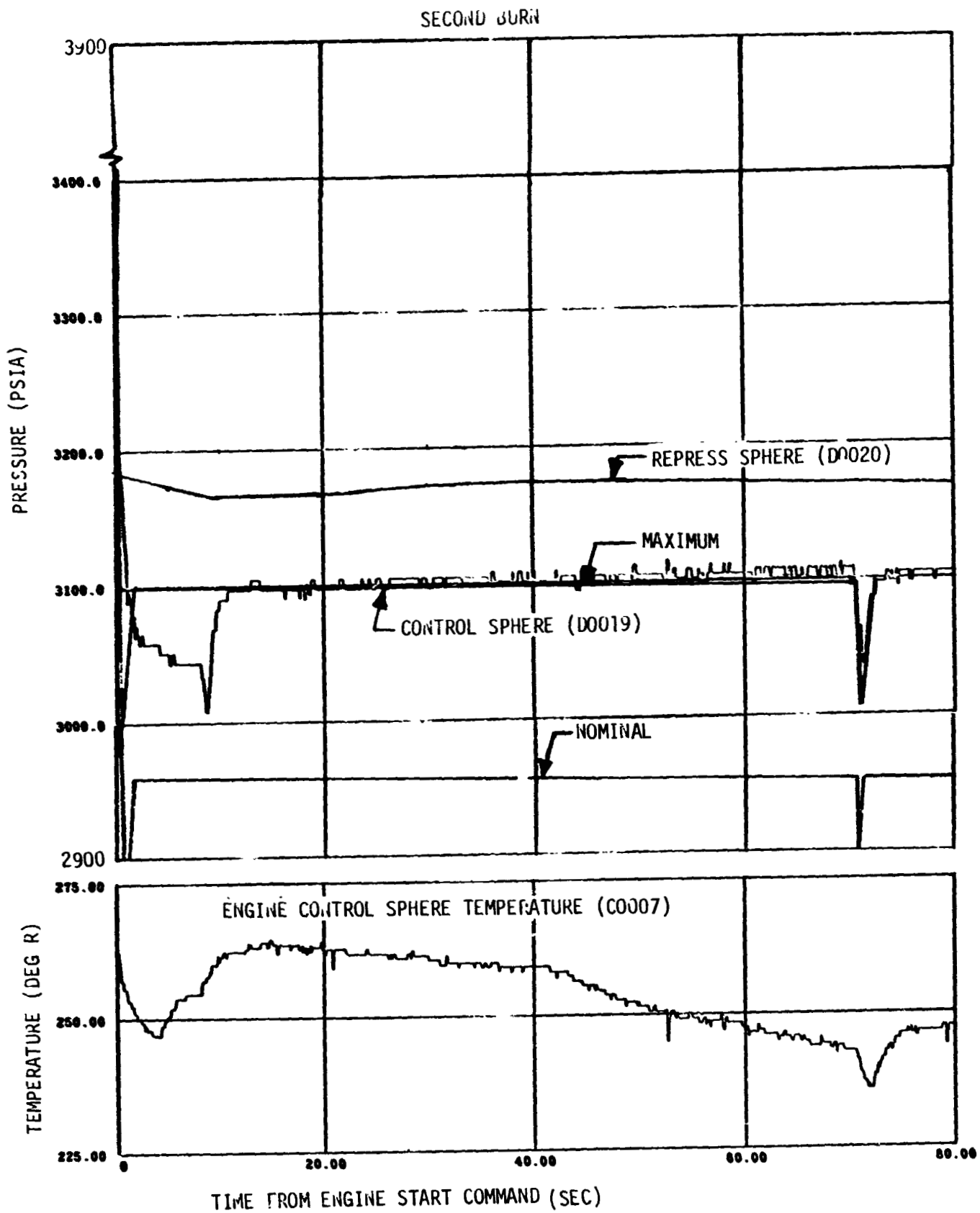

Figure 9-22 Control Sphere Conditions (Sheet 2 of 3)

THIRD BURN

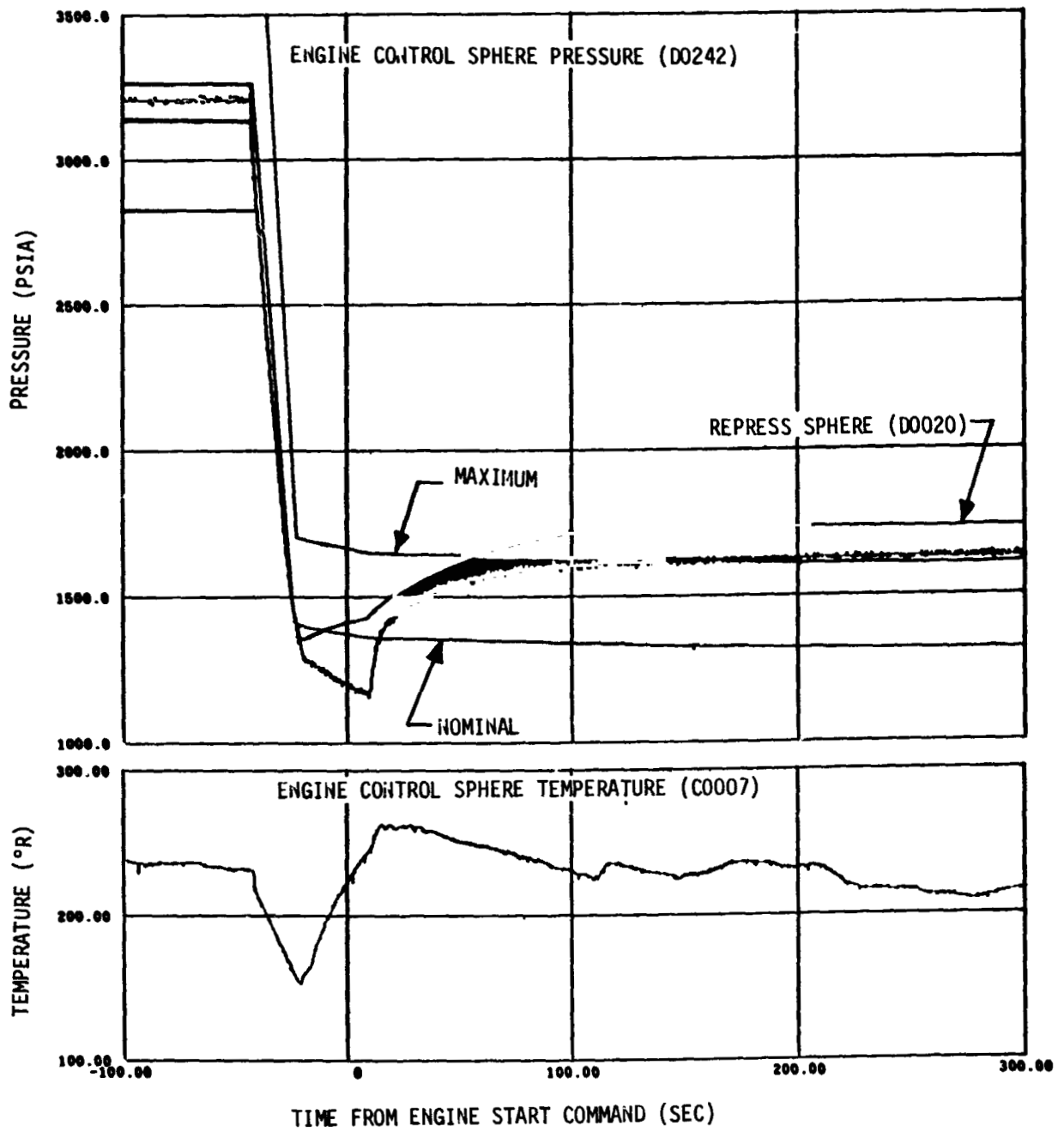

Figure 9-22 Control Sphere Conditions (Sheet 3 of 3)

FIRST BURN

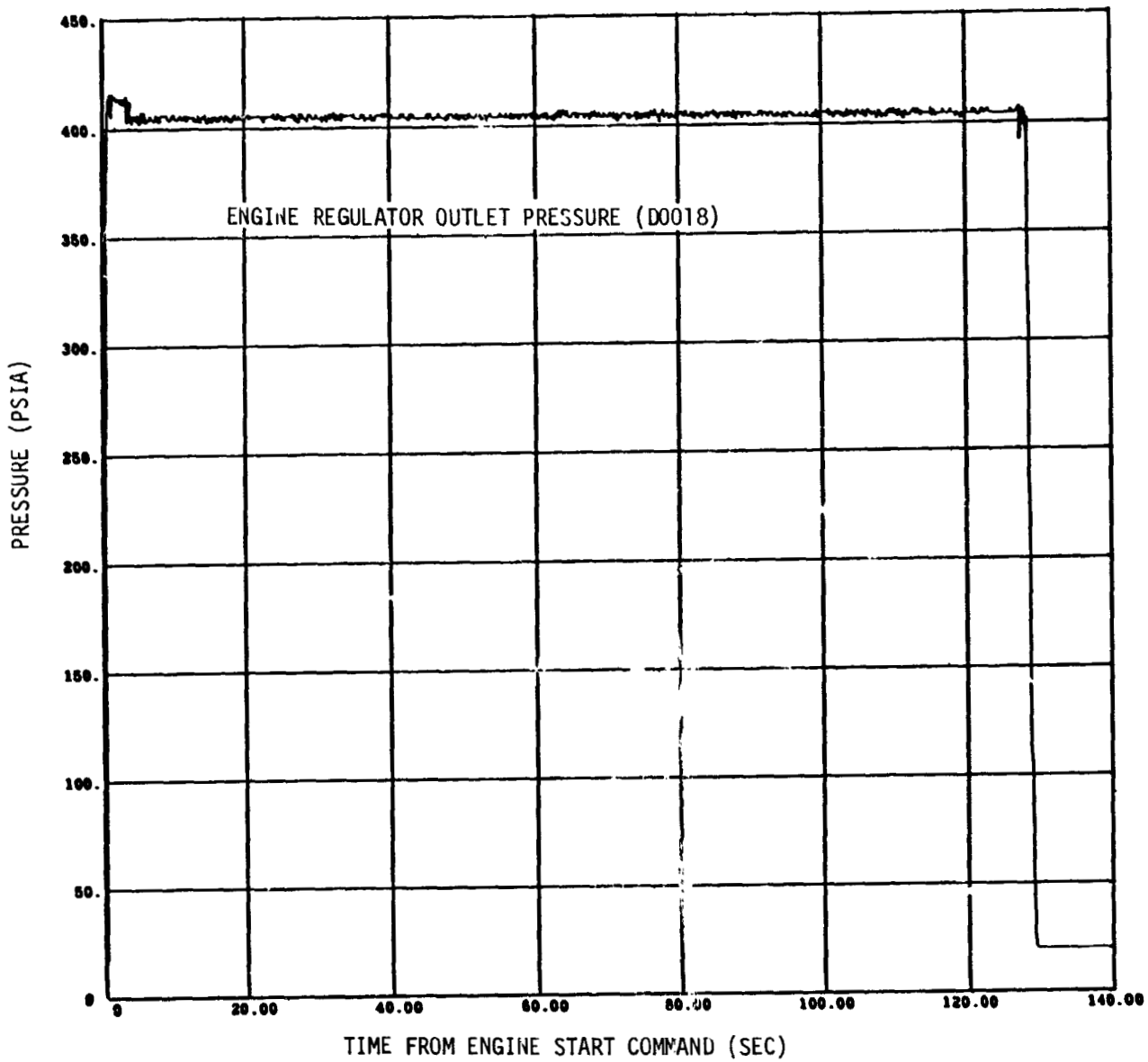

Figure 9-23 Engine Regulator Outlet Pressure (Sheet 1 of 3)

SECOND BURN

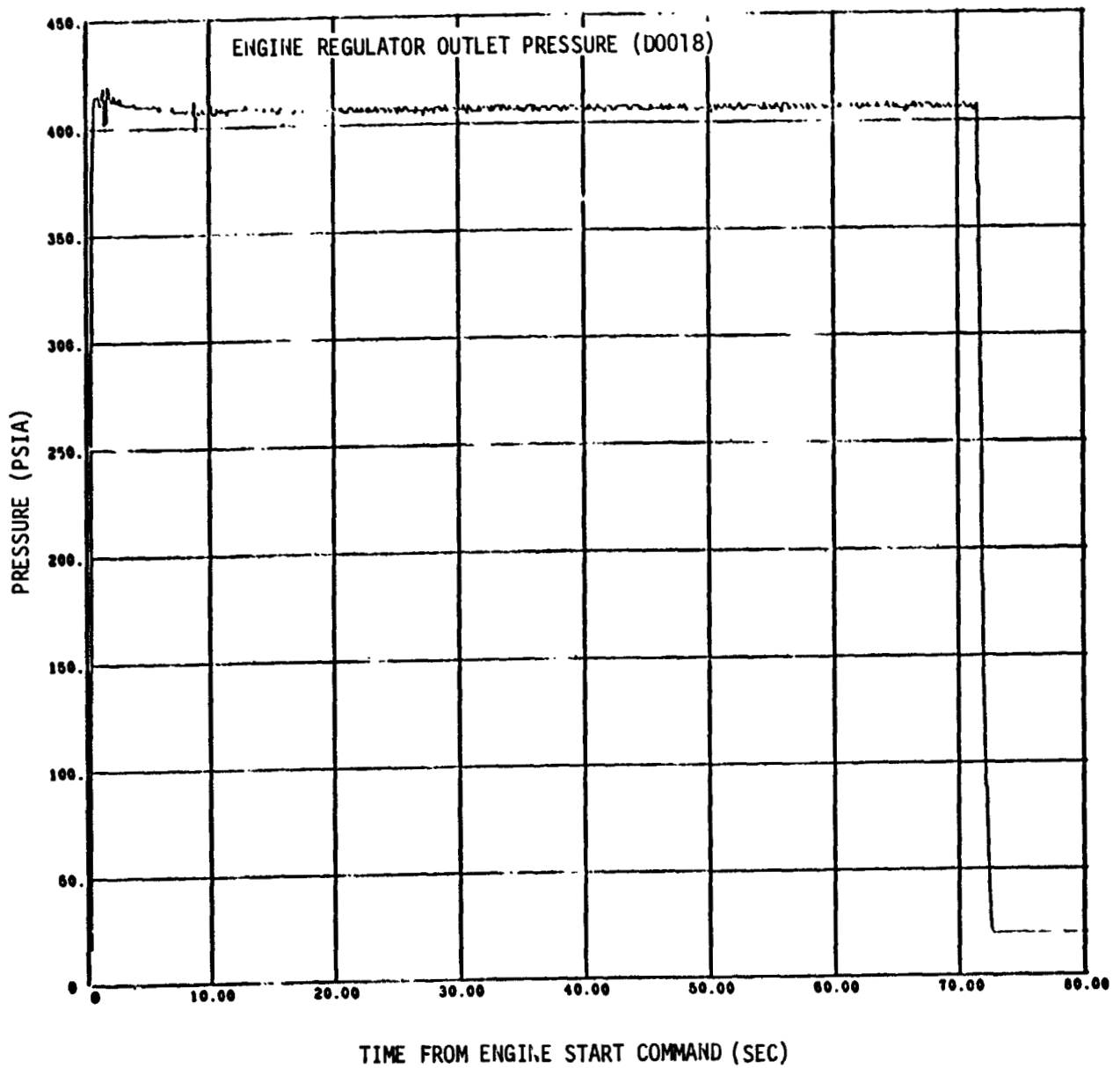

Figure 9-23 Engine Regulator Outlet Pressure (Sheet 2 of 3)

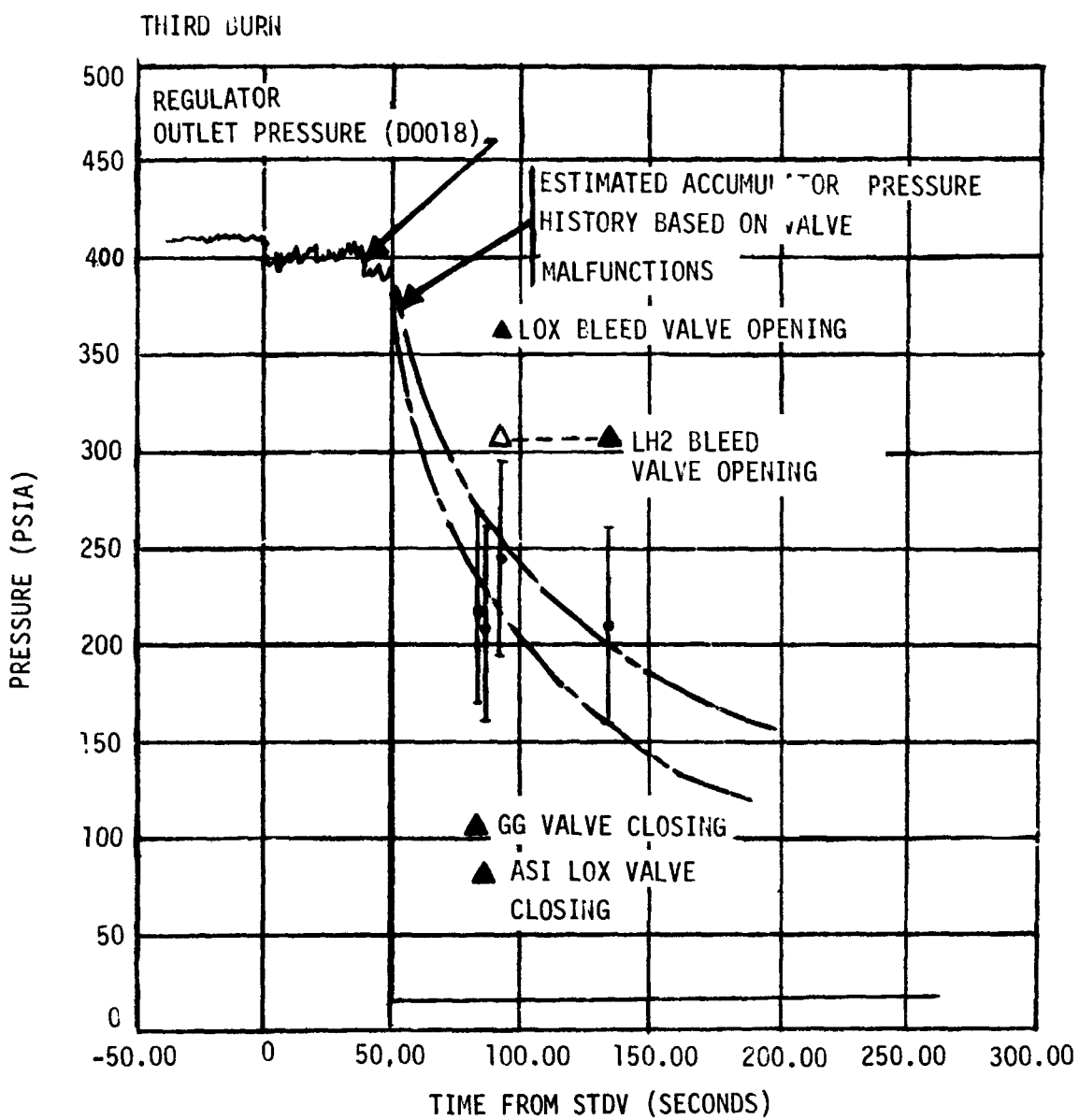

Figure 9-23. Engine Regulator Outlet Pressure (Sheet 3 of 3)



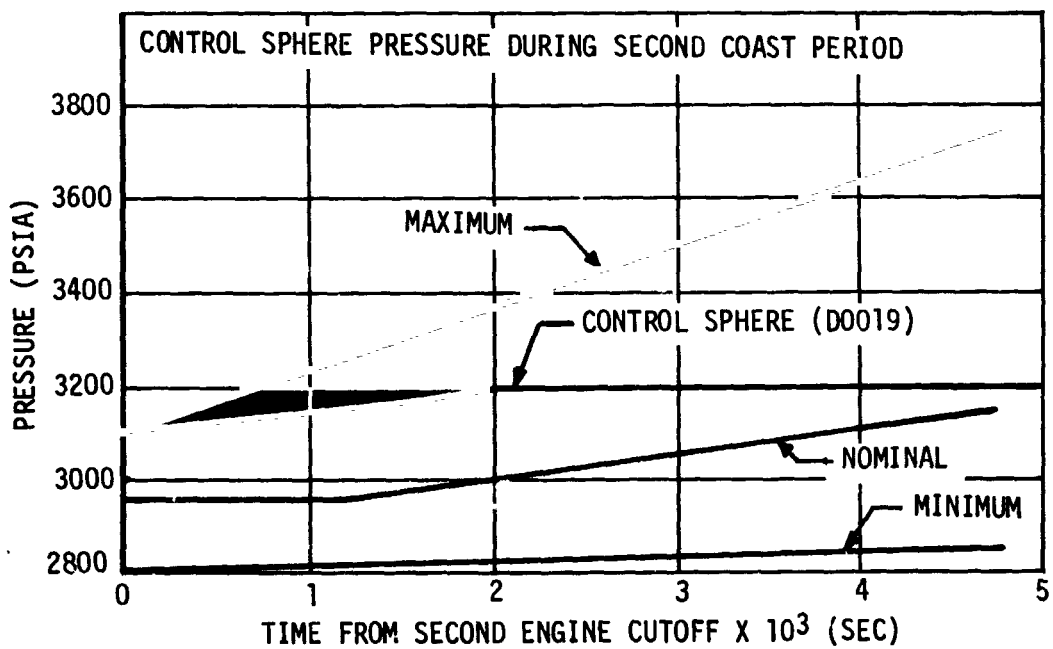
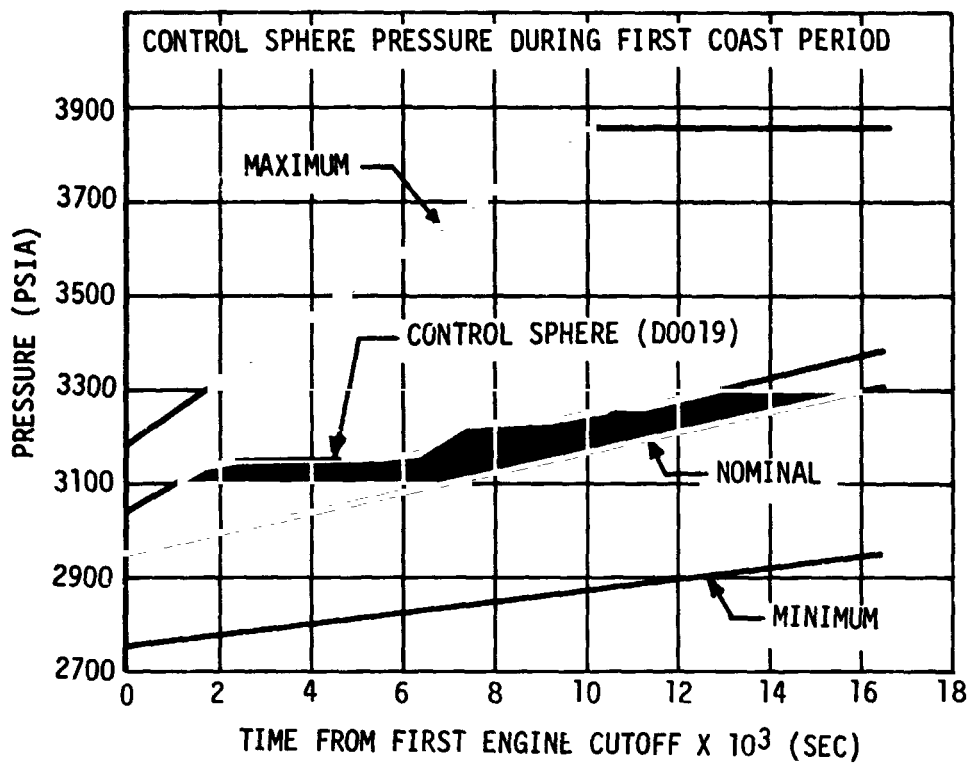

Figure 9-24. Control Sphere Performance during Coast

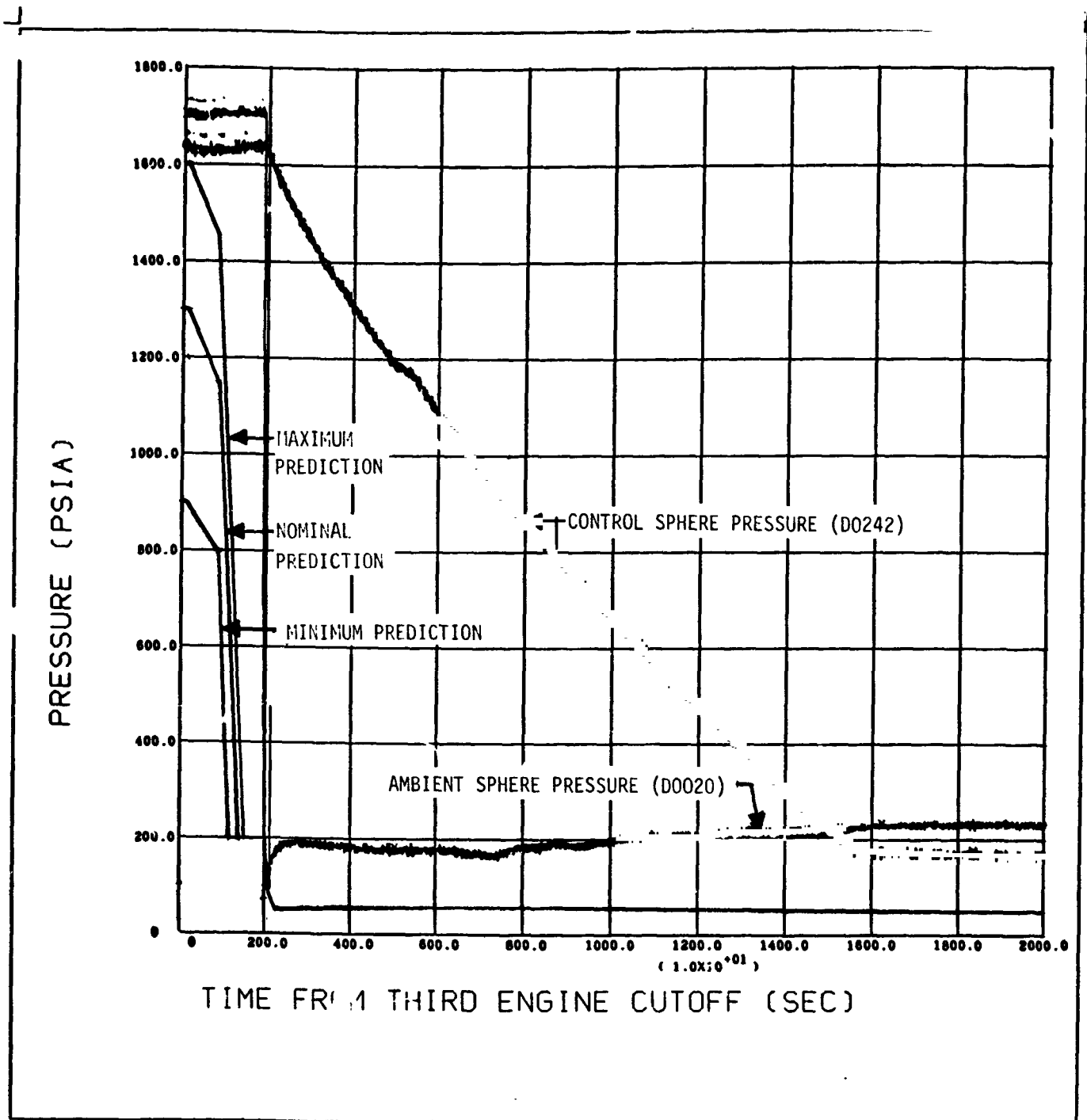

Figure 9-25. Control Sphere Pressure -- Passivation

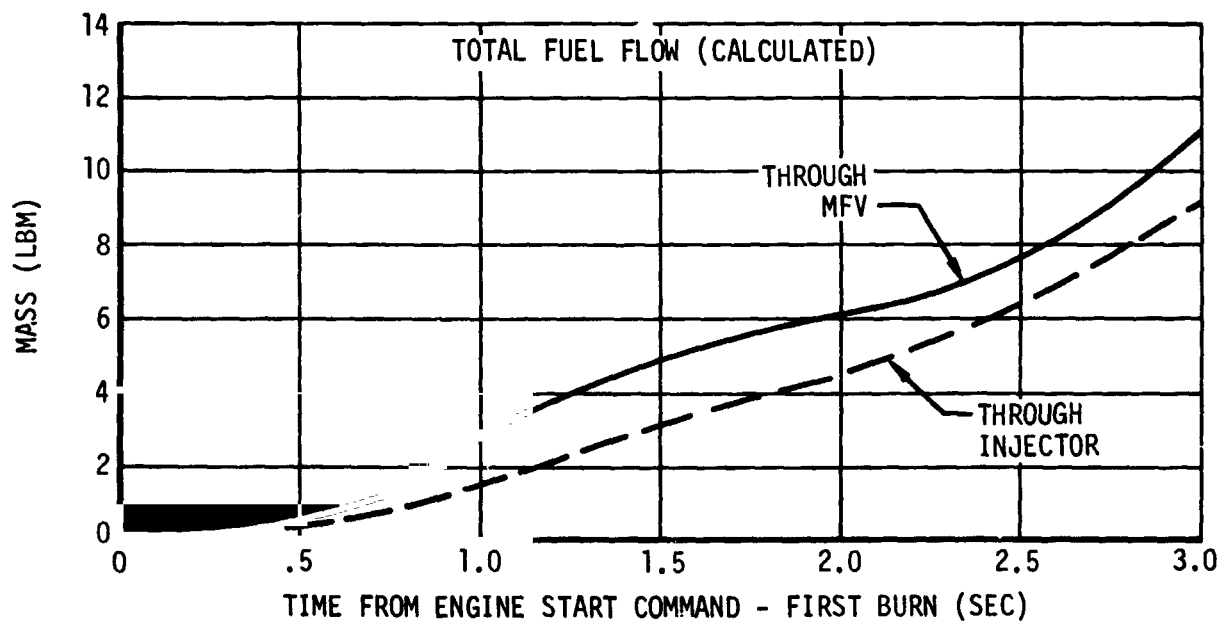
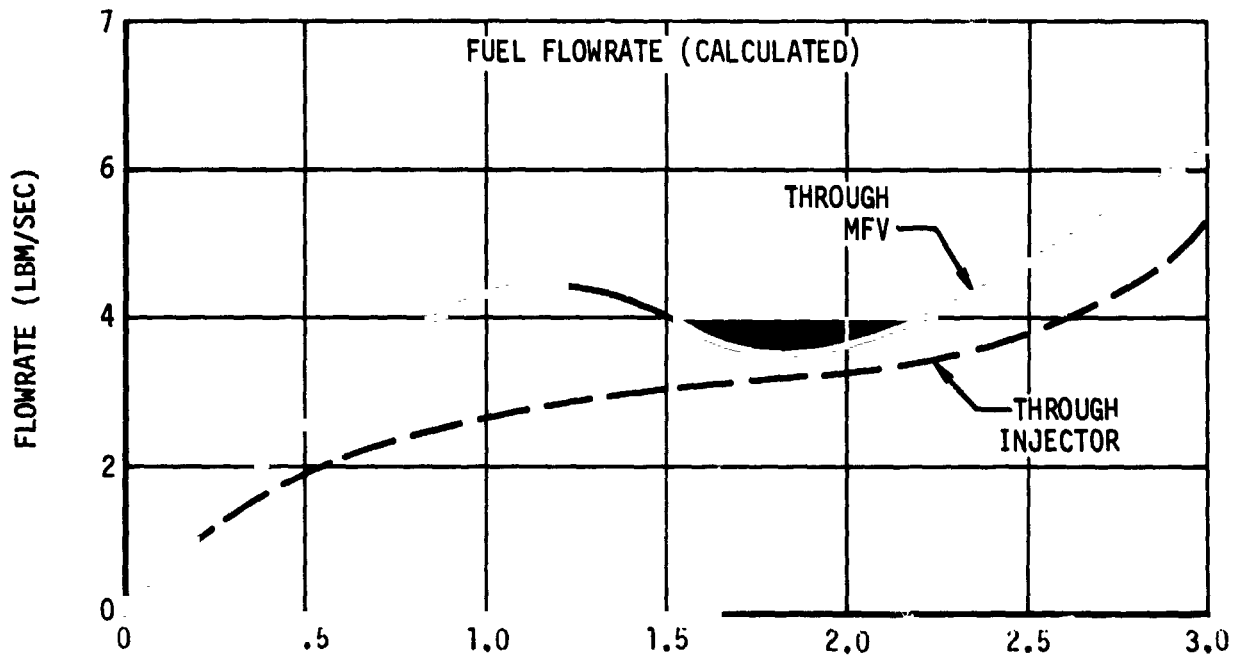

Figure 9-26. Fuel Lead Characteristics - First Burn (Sheet 1 of 2)

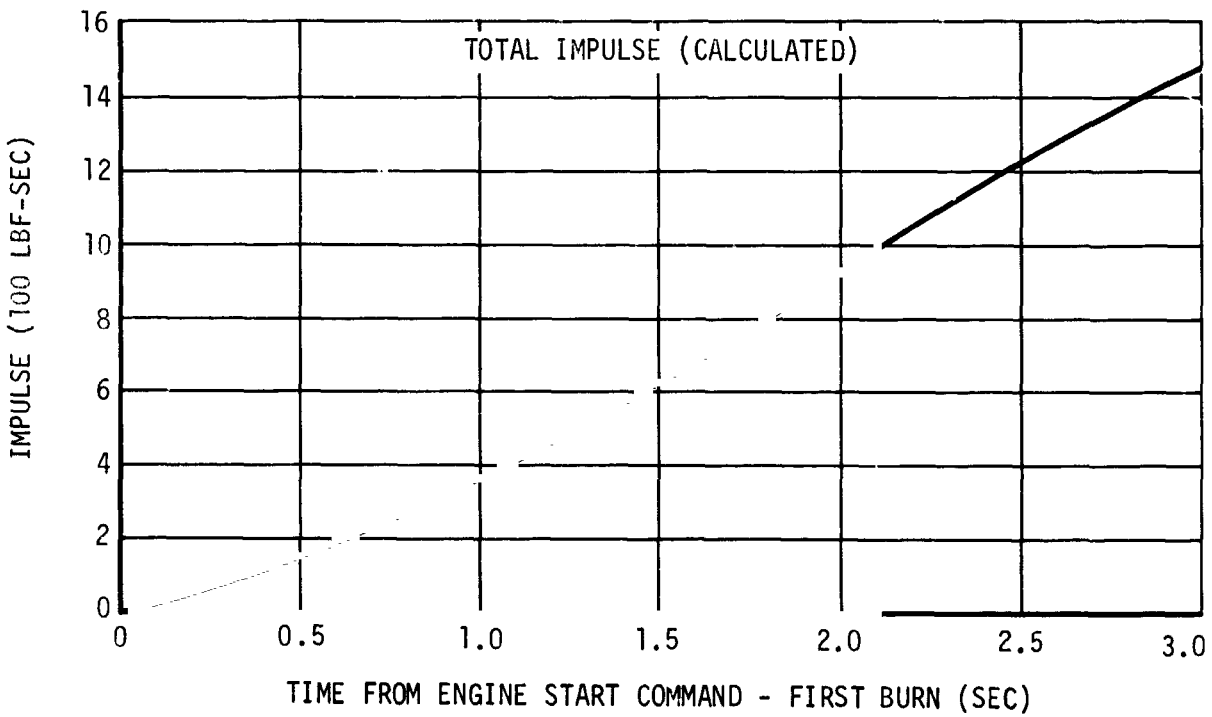
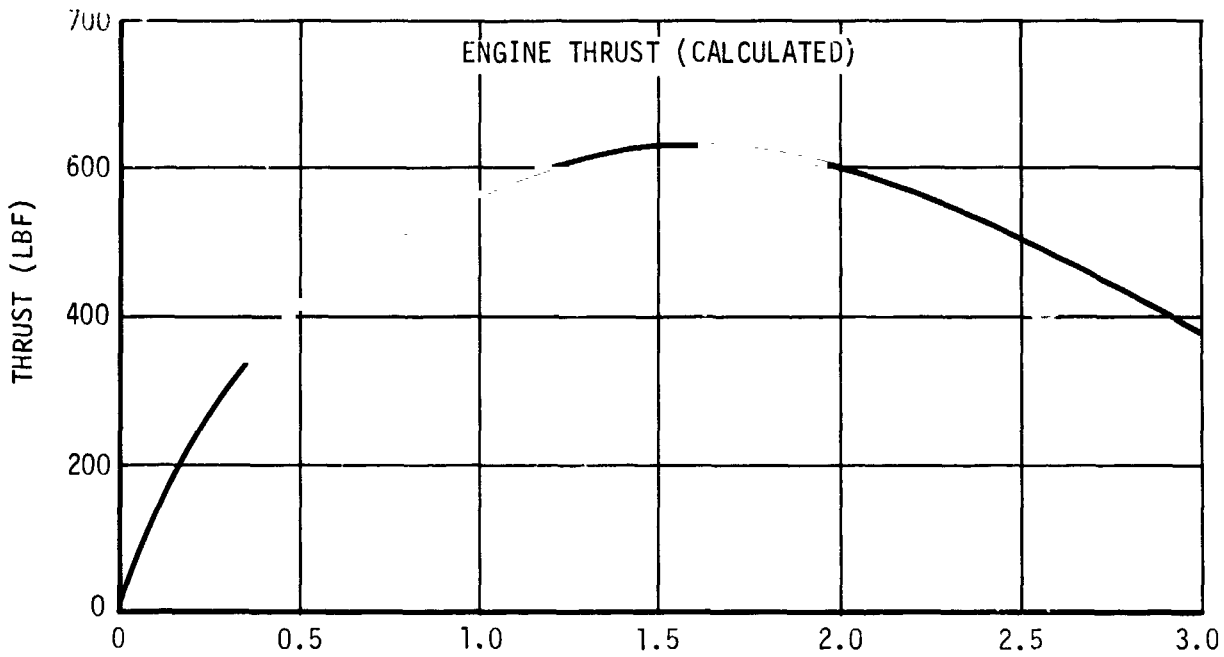

Figure 9-26. Fuel Lead Characteristics - First Burn (Sheet 2 of 2)

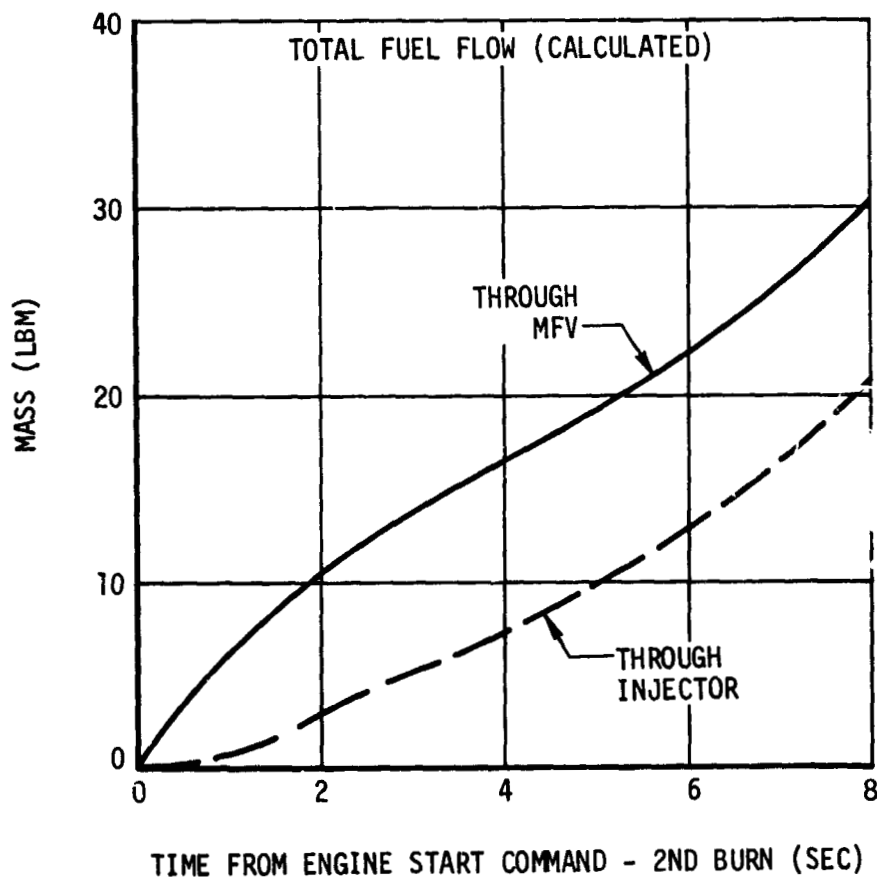
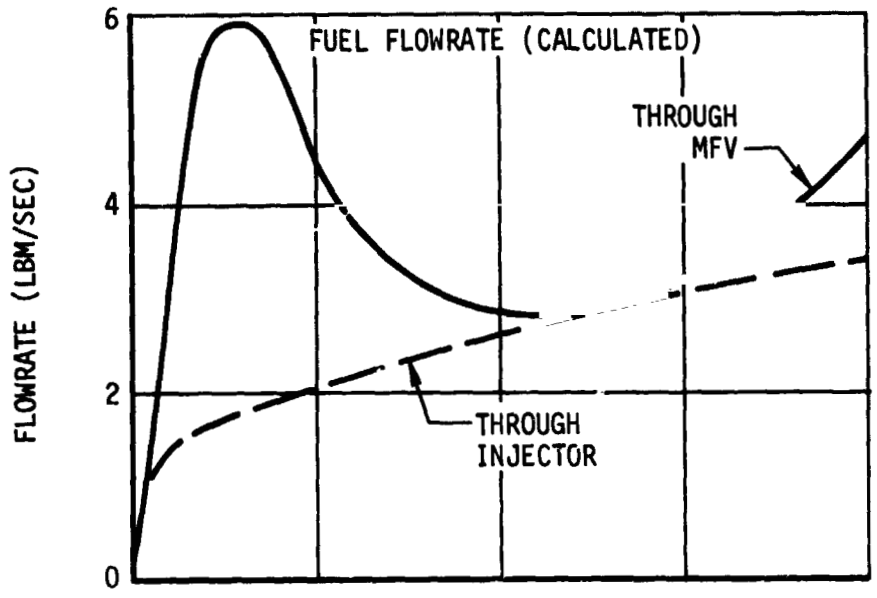

Figure 9-27. Fuel Lead Characteristics - Second Burn (Sheet 1 of 2)

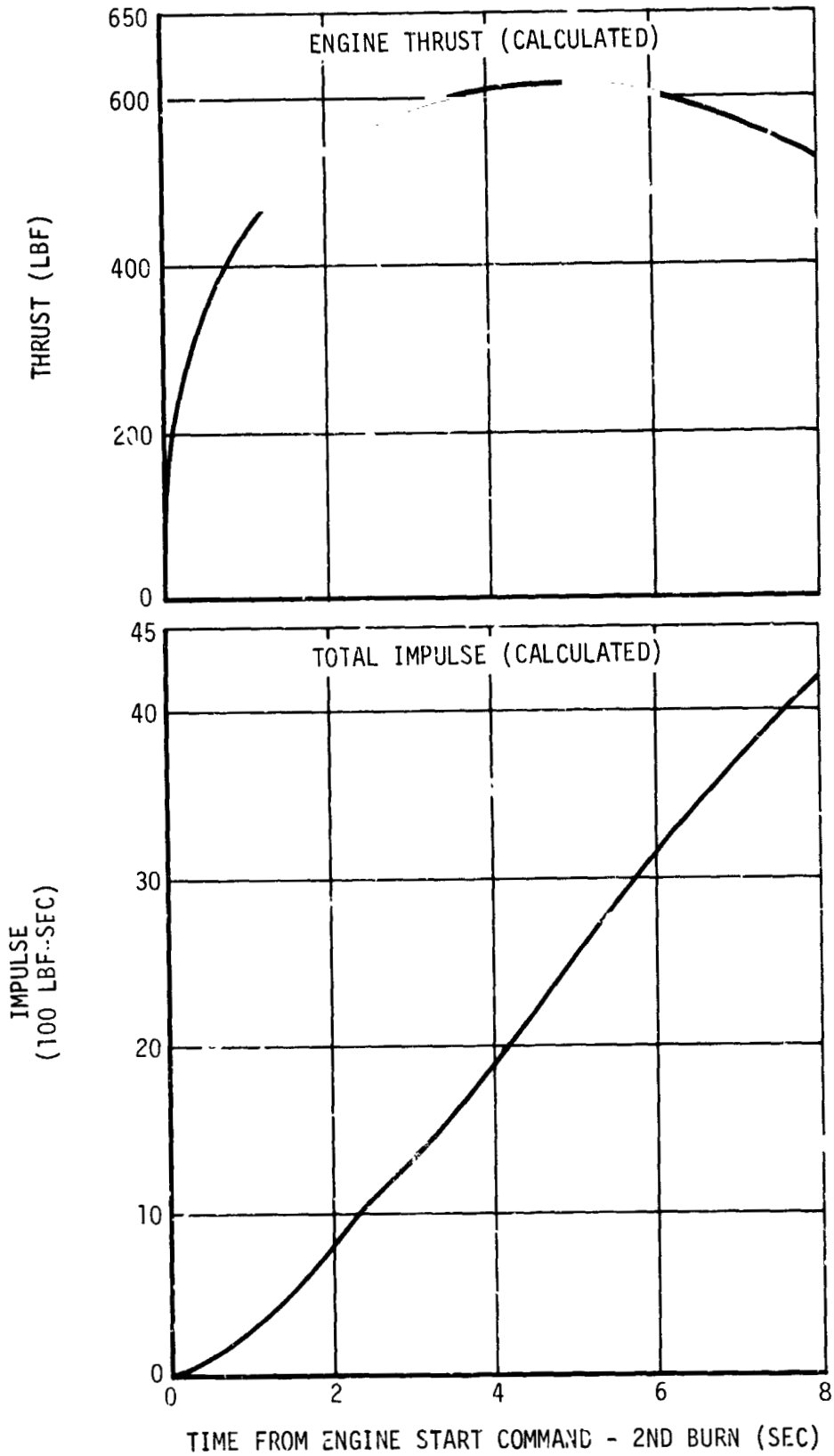

Figure 9-27. Fuel Lead Characteristics - Second Burn (Sheet 2 of 2)

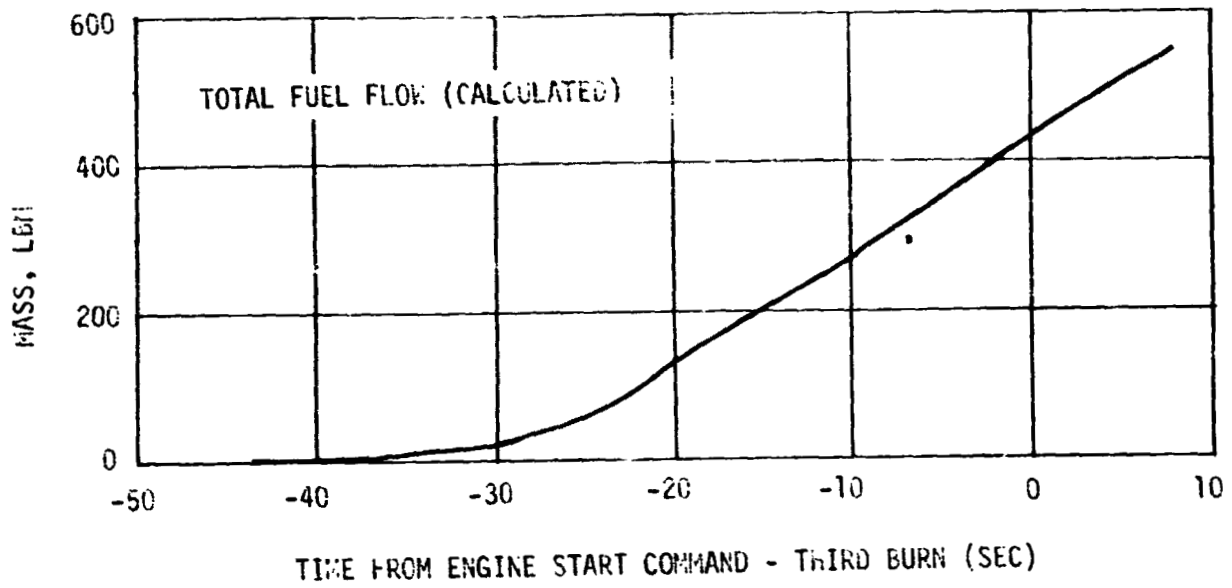
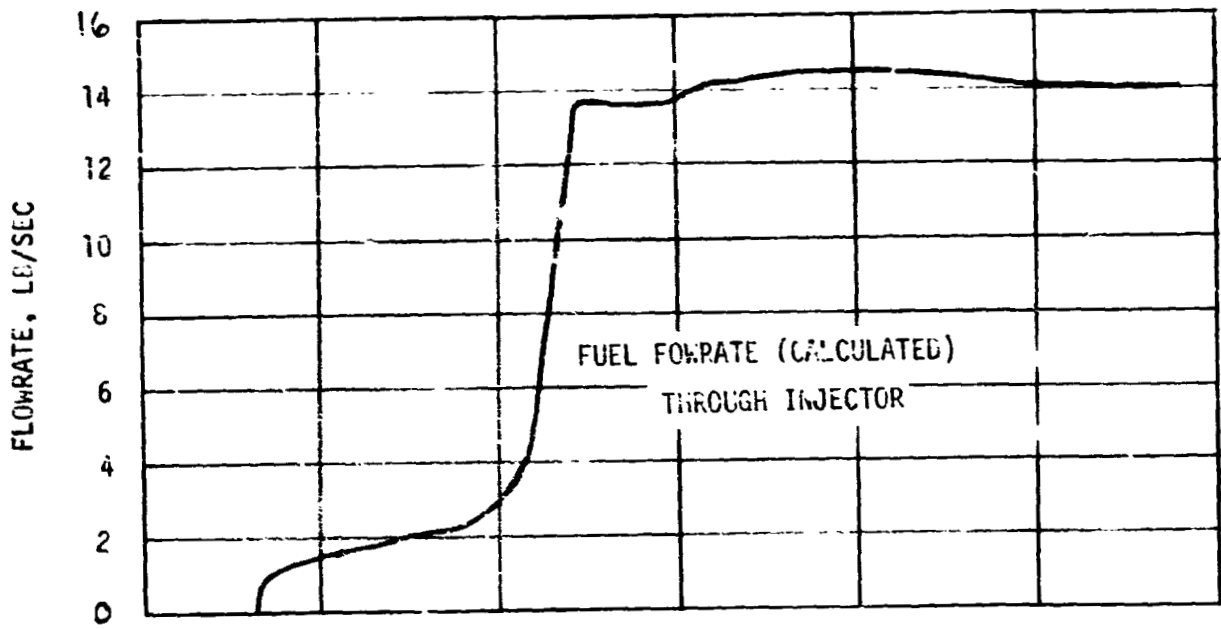

Figure 9-28. Fuel Lead Characteristics - Third Burn (Sheet 1 of 2)

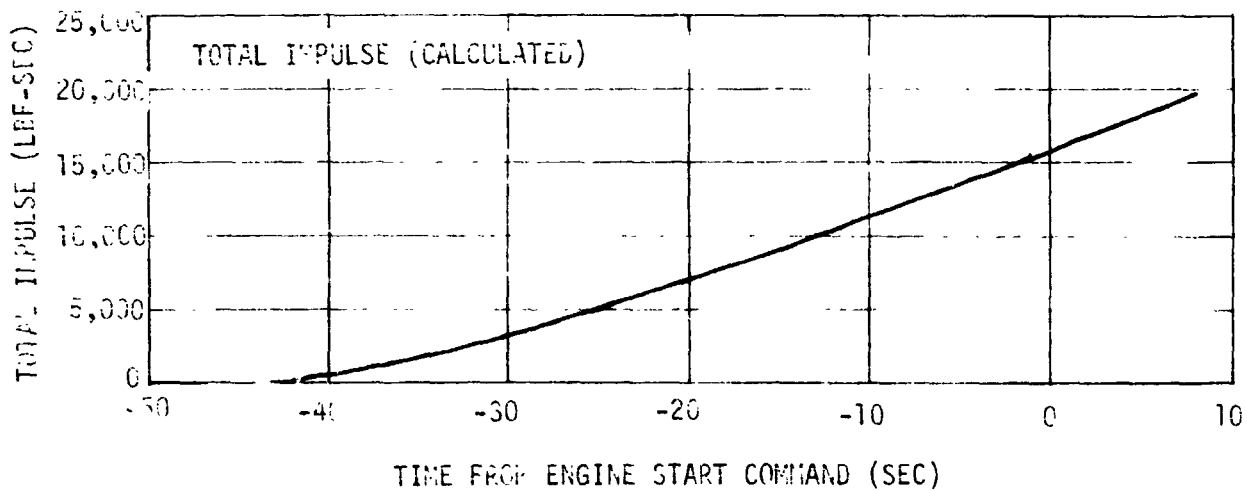
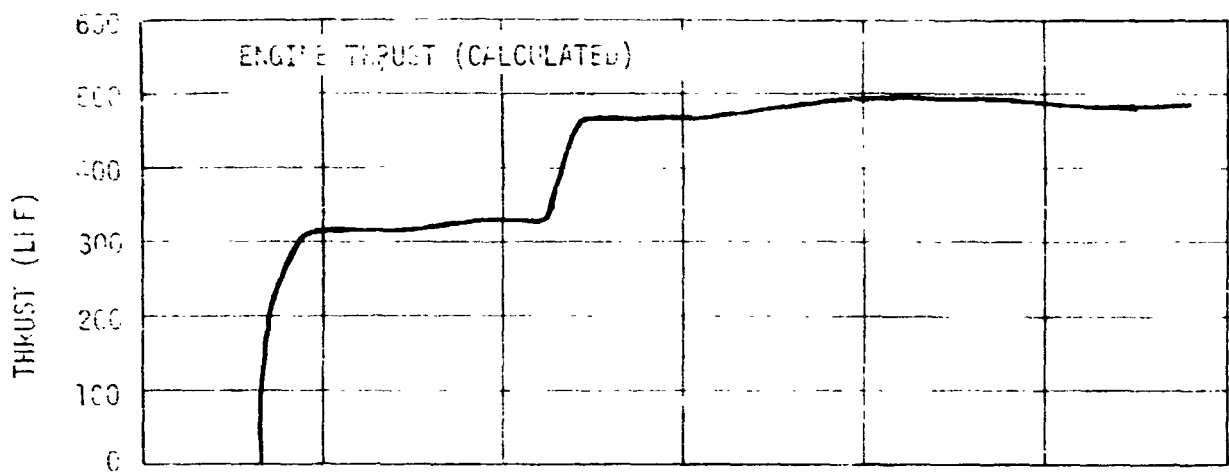
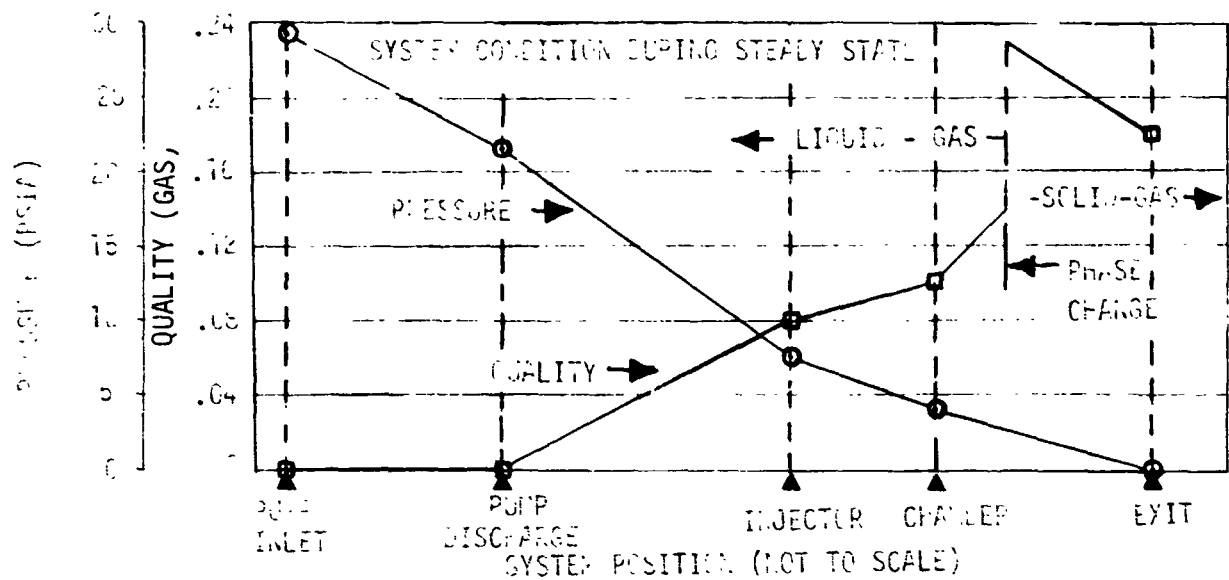

Figure 9-28. Fuel Leak Characteristics - Third Burn (Sheet 2 of 2)



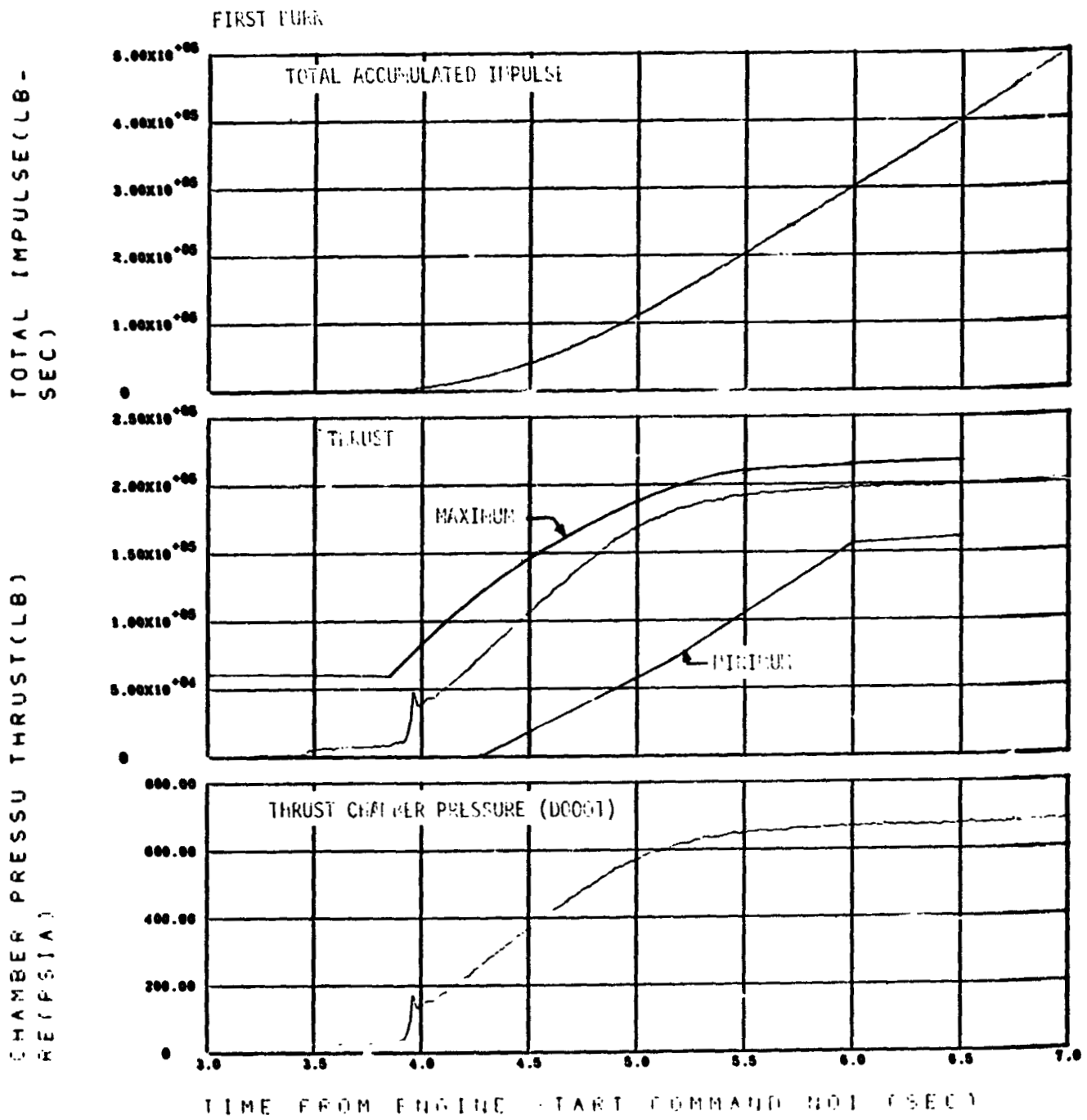

Figure 9-29. Engine Start Transient Characteristics (Sheet 1 of 3)

SECOND BURN

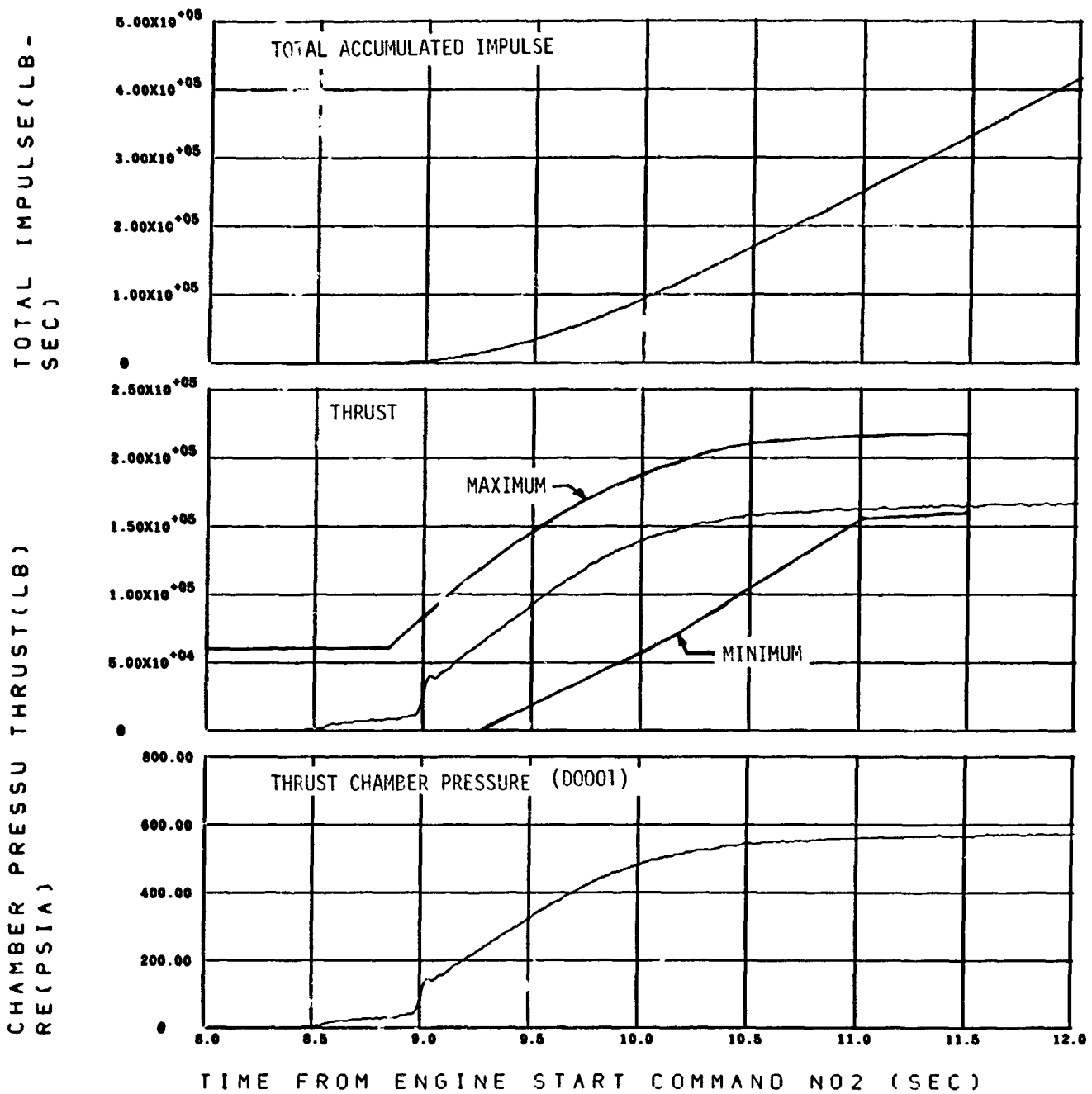

Figure 9-29. Engine Start Transient Characteristics (Sheet 2 of 3)

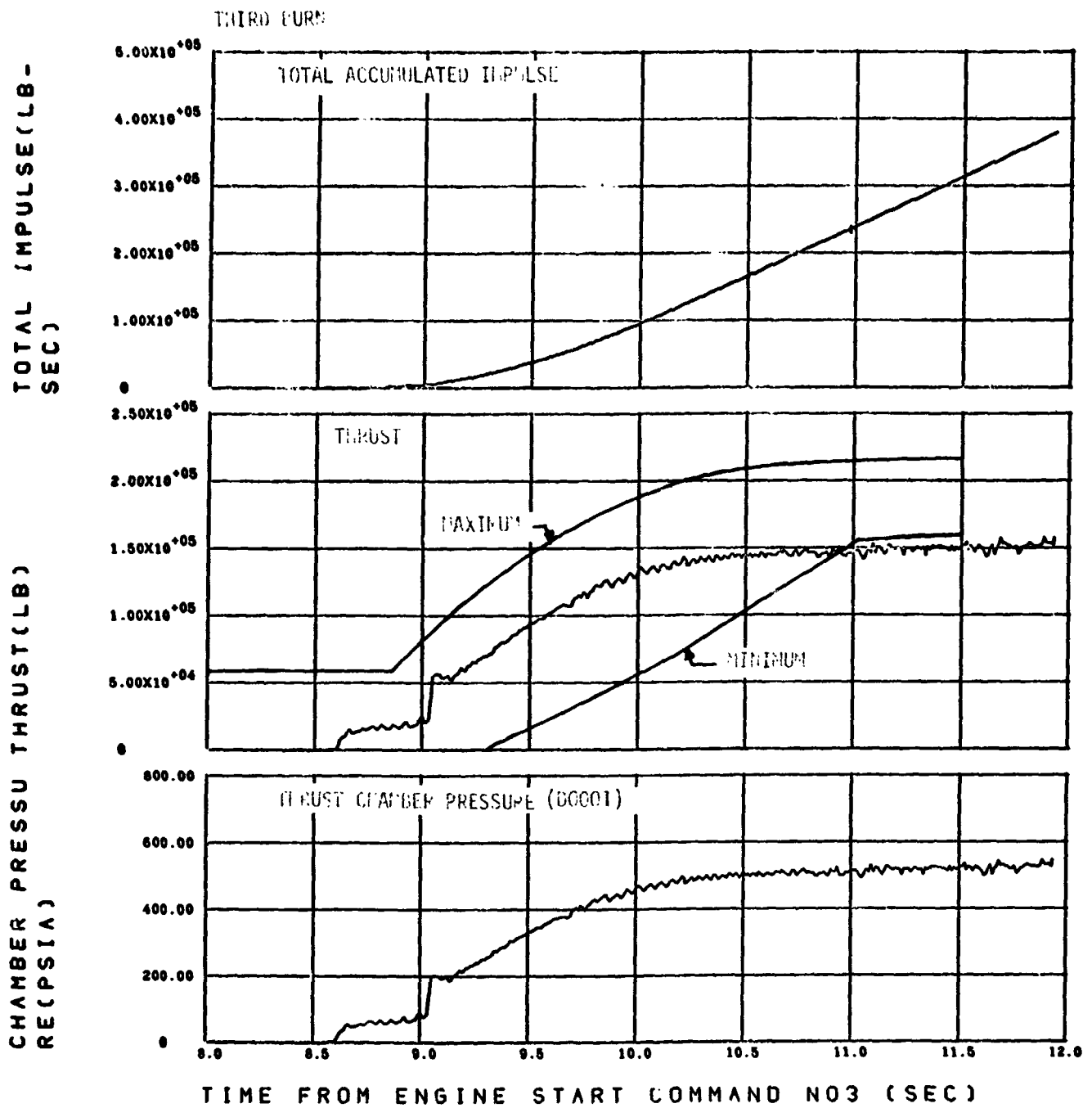

Figure 9-29. Engine Start Transient Characteristics (Sheet 3 of 3)

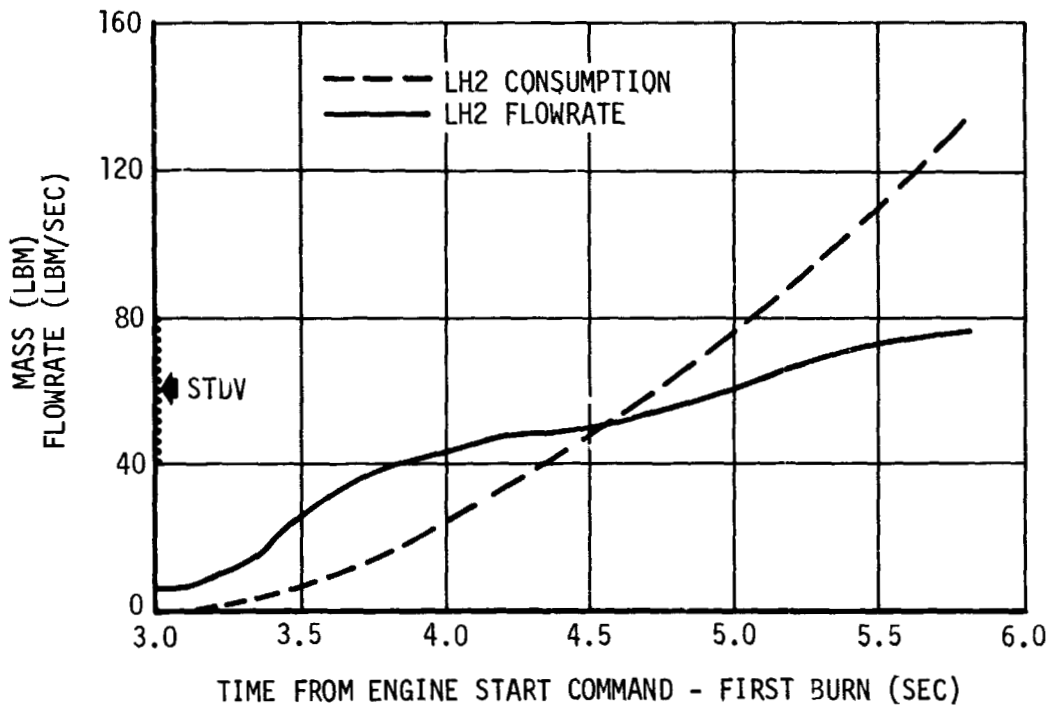
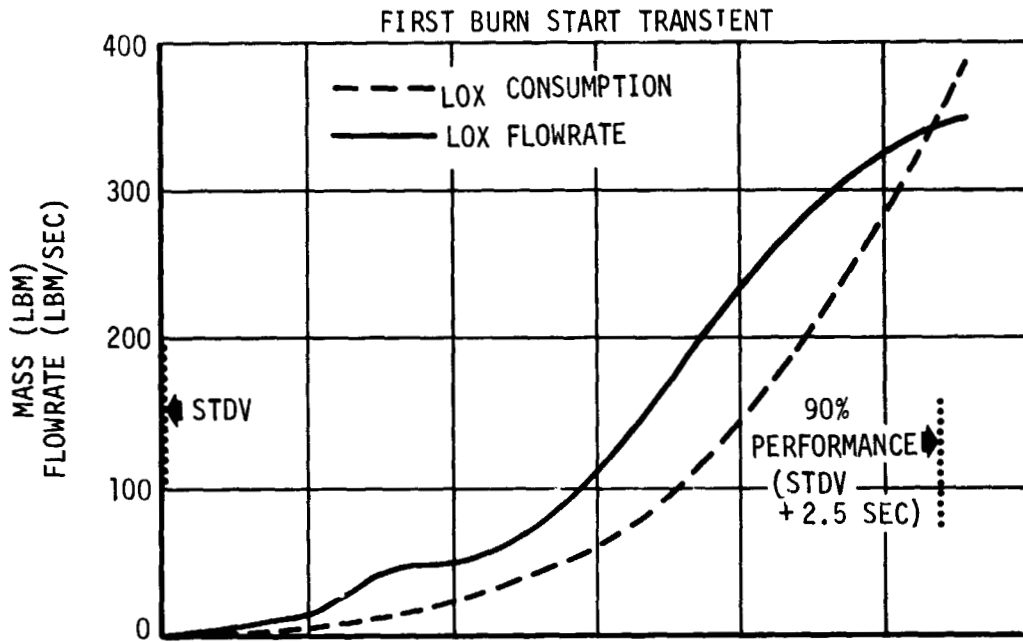

Figure 9-30. LOX - LH2 Consumption--during Burn Start Transient (Sheet 1 of 3)

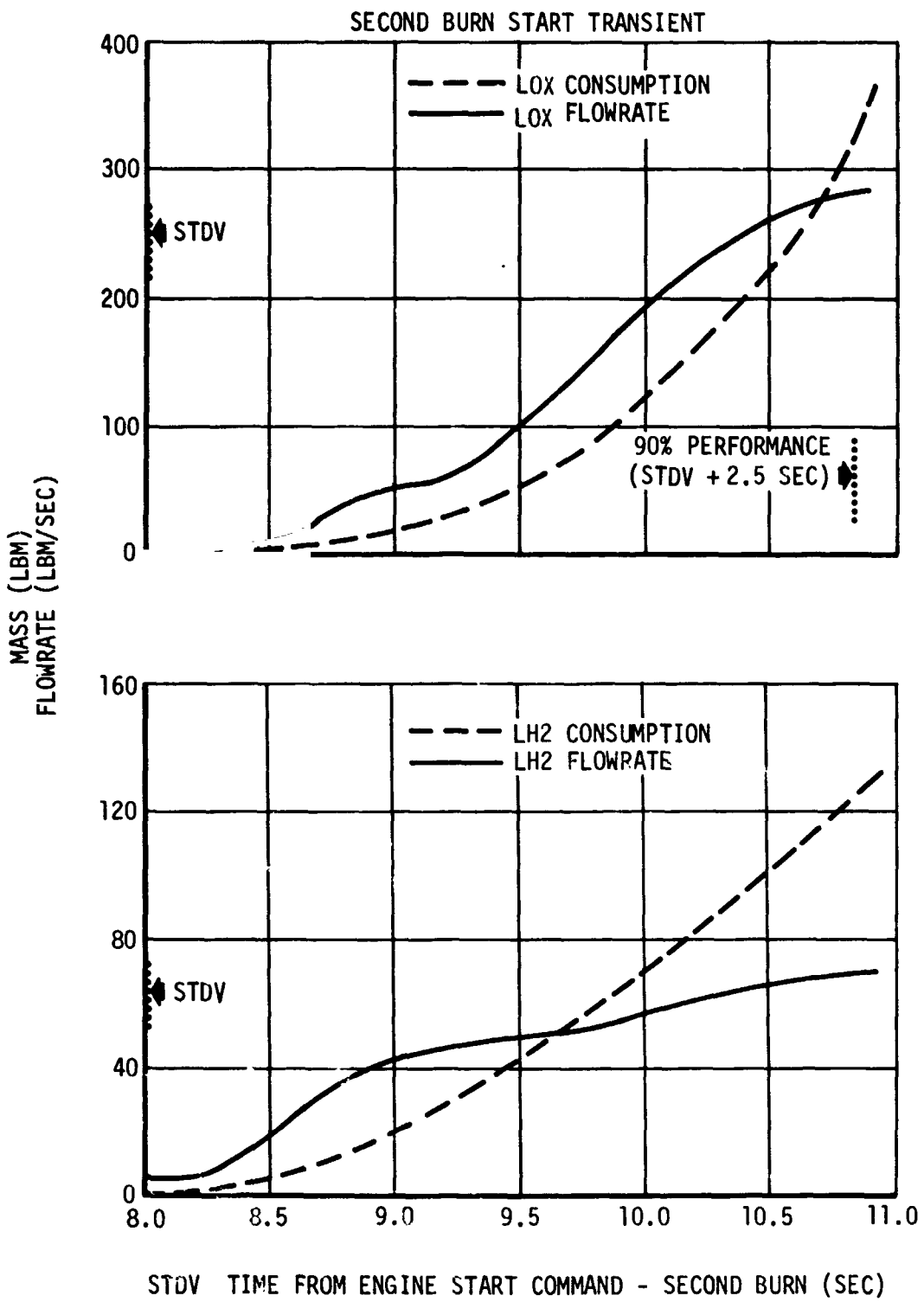

Figure 9-30. LOX - LH2 Consumption--during Burn Start Transient (Sheet 2 of 3)

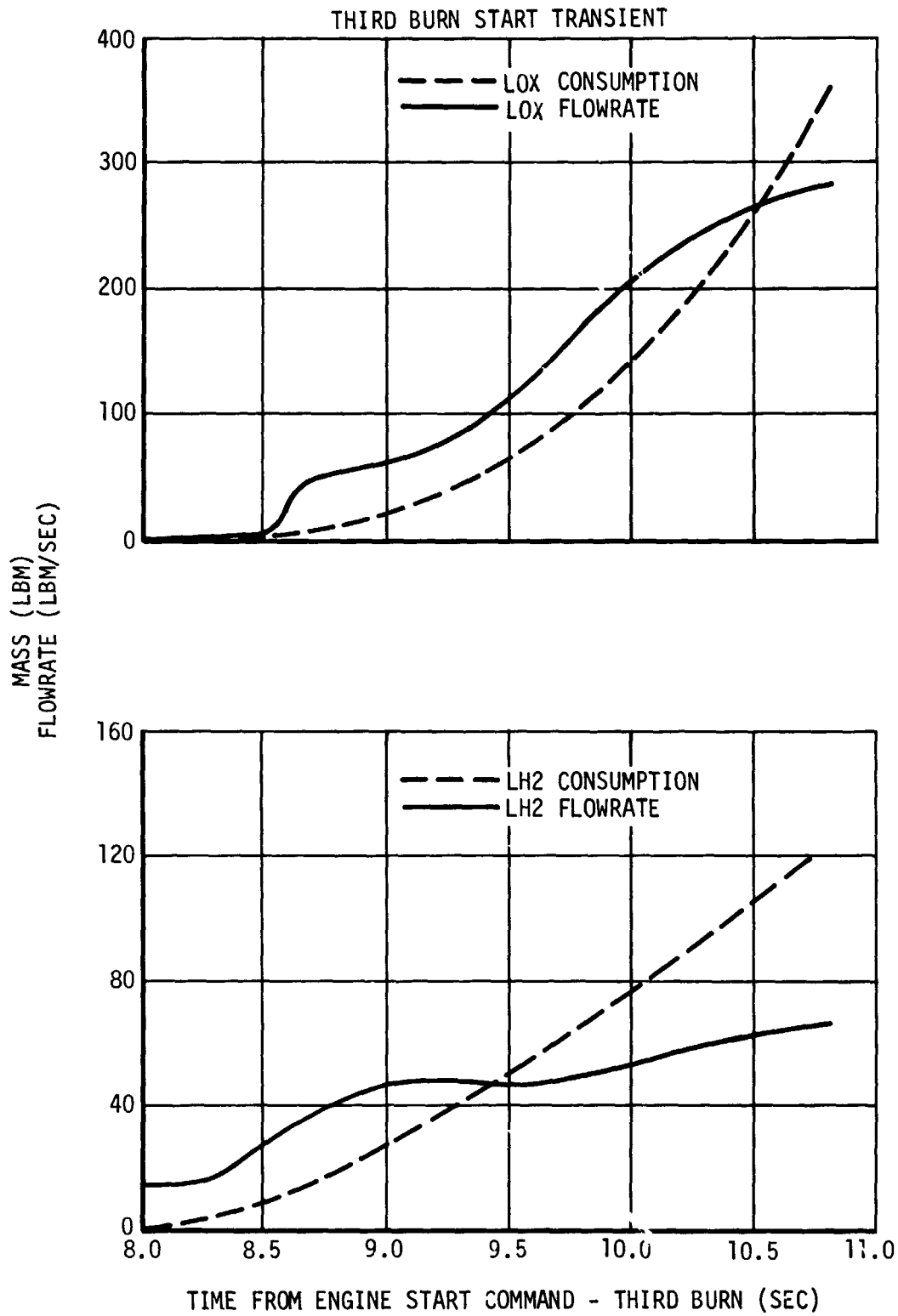

Figure 9-30. LOX - LH2 Consumption--during Burn Start Transient (Sheet 3 of 3)

FIRST LURN

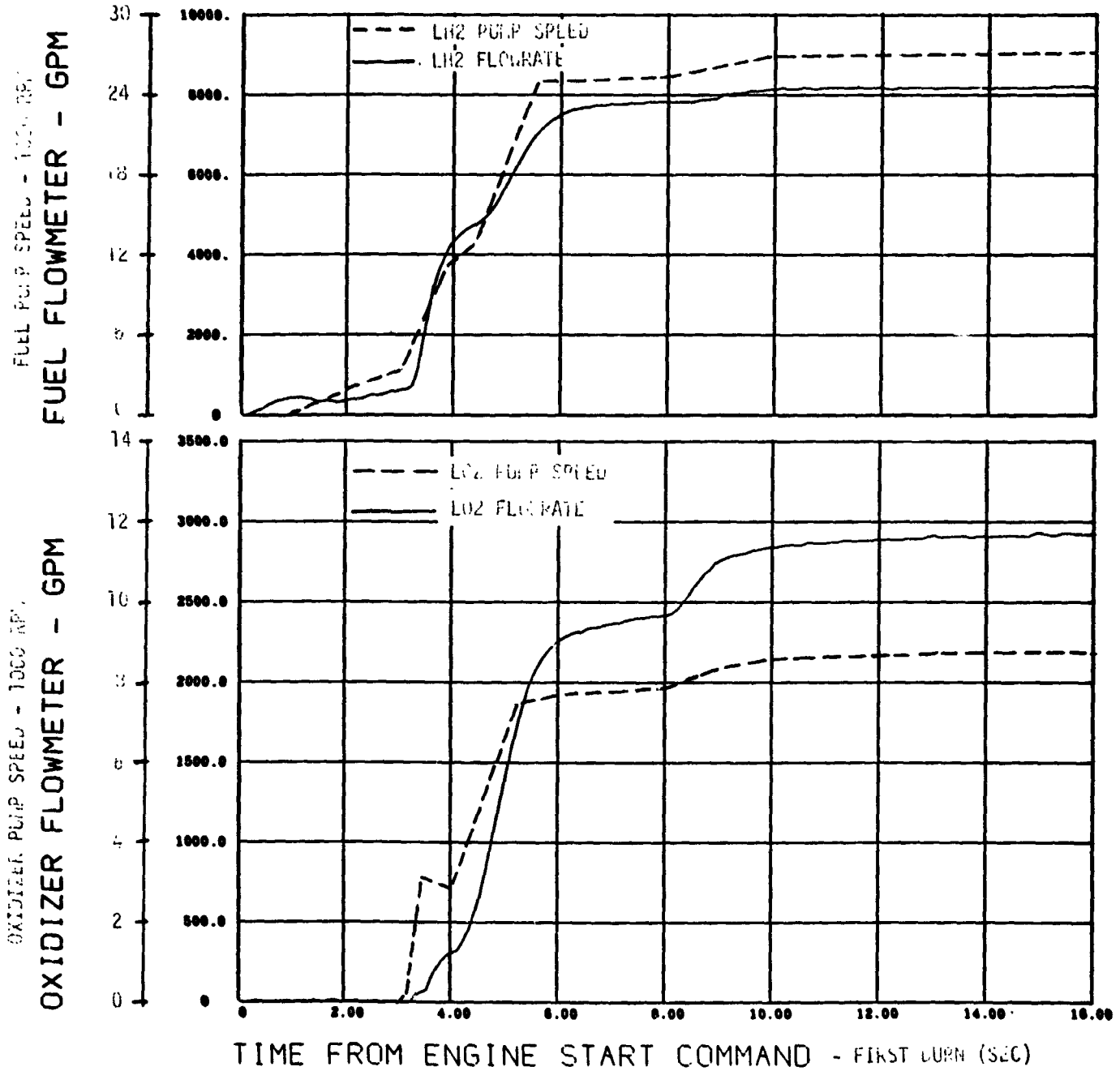

Figure 9-31. LOX and LH2 Pump Performance (Sheet 1 of 3)

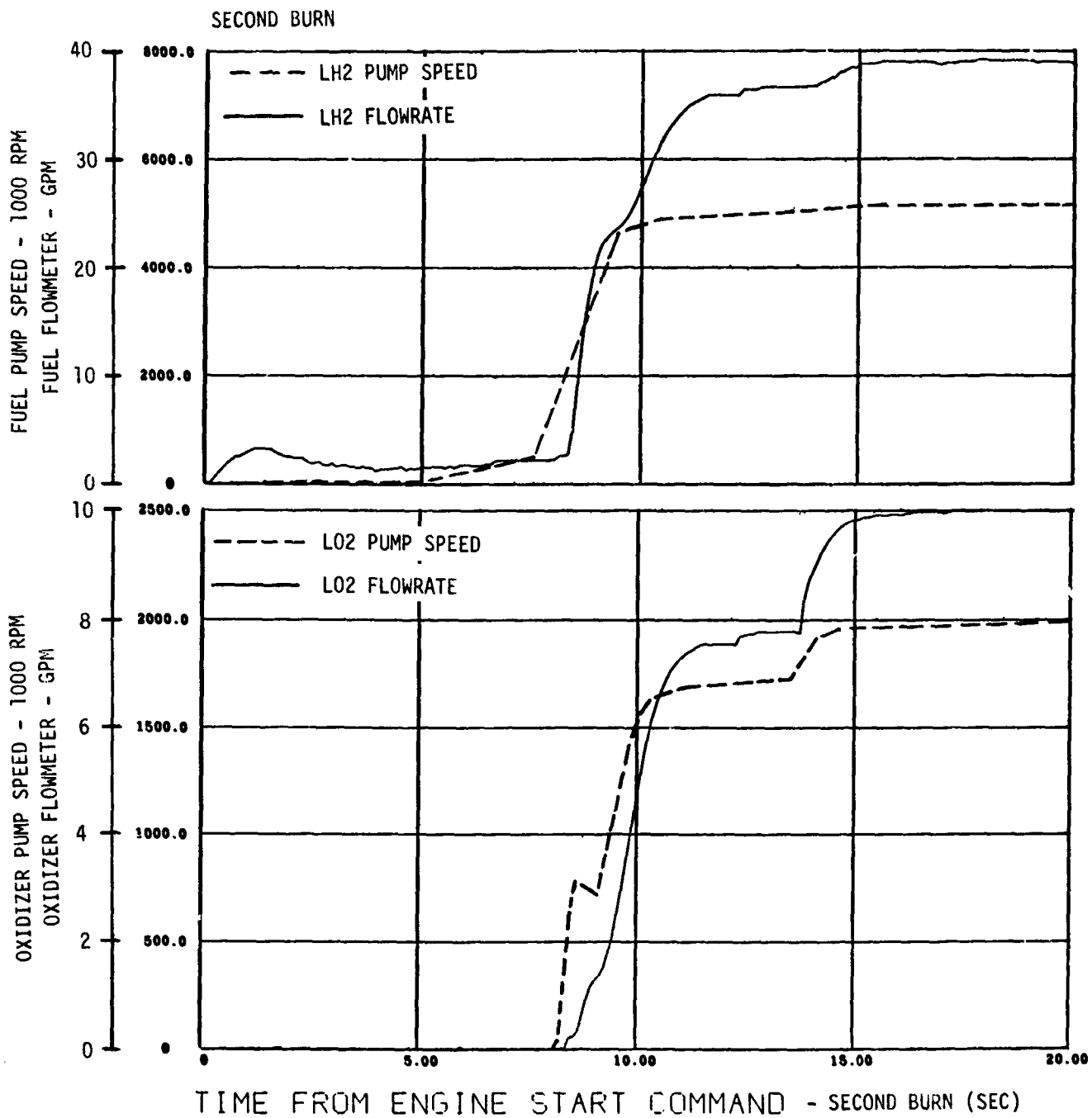

Figure 9-3i. LOX and LH2 Pump Performance (Sheet 2 of 3)



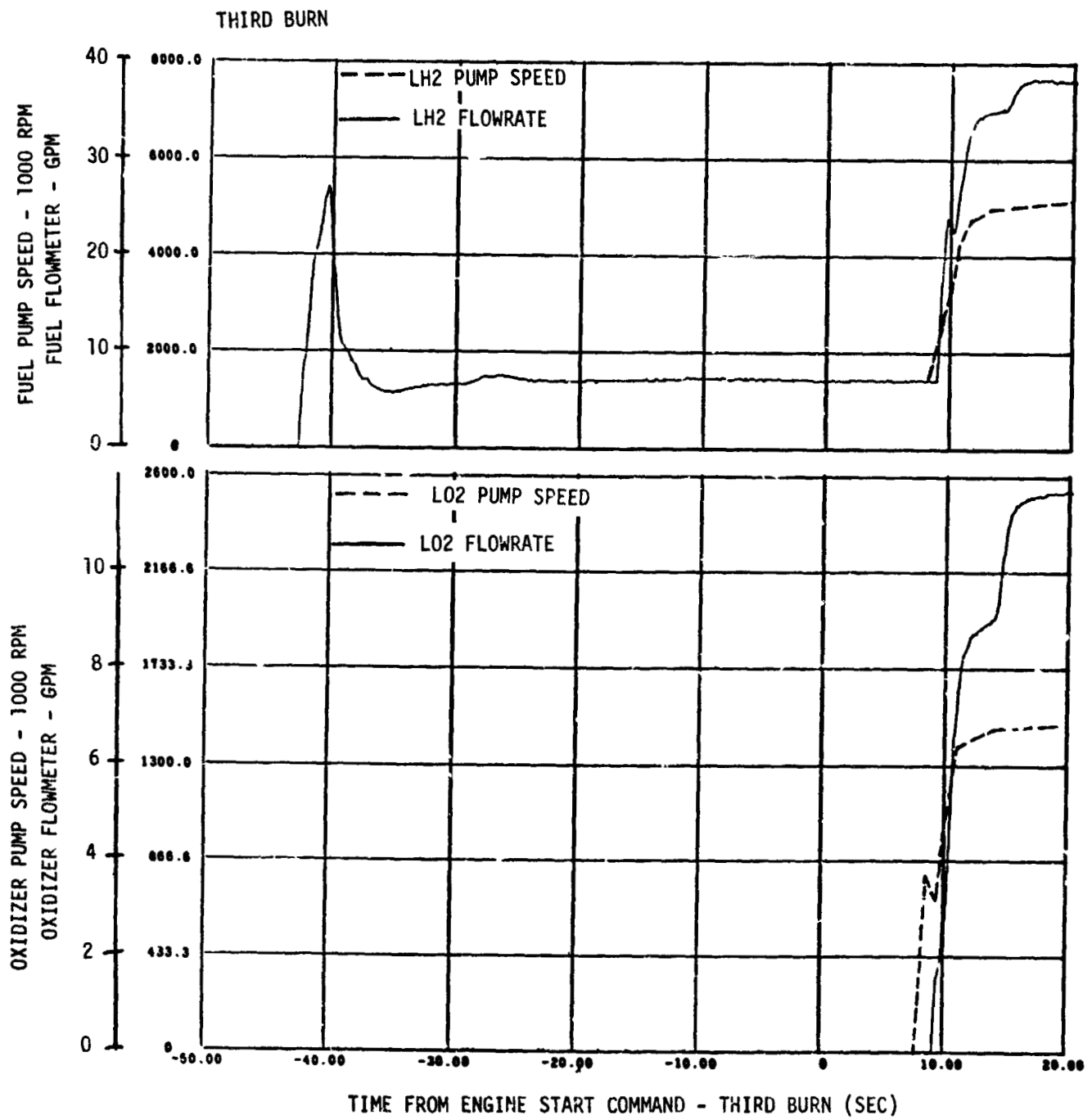

Fig. 9-31. LOX and LH2 Pump Performance (Sheet 3 of 3)

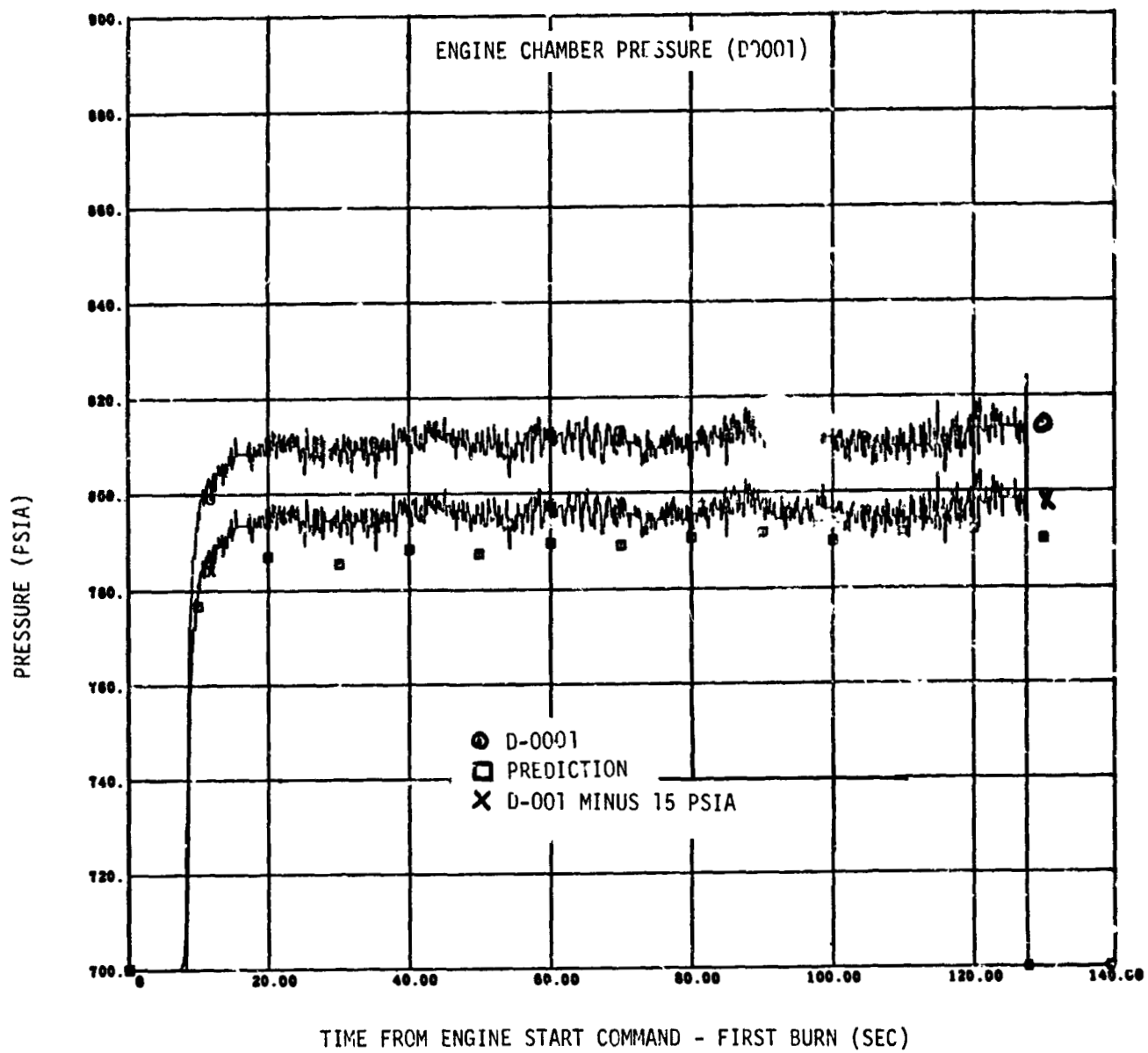

Figure 9-32. J-2 Engine Chamber Pressure (Sheet 1 of 3)

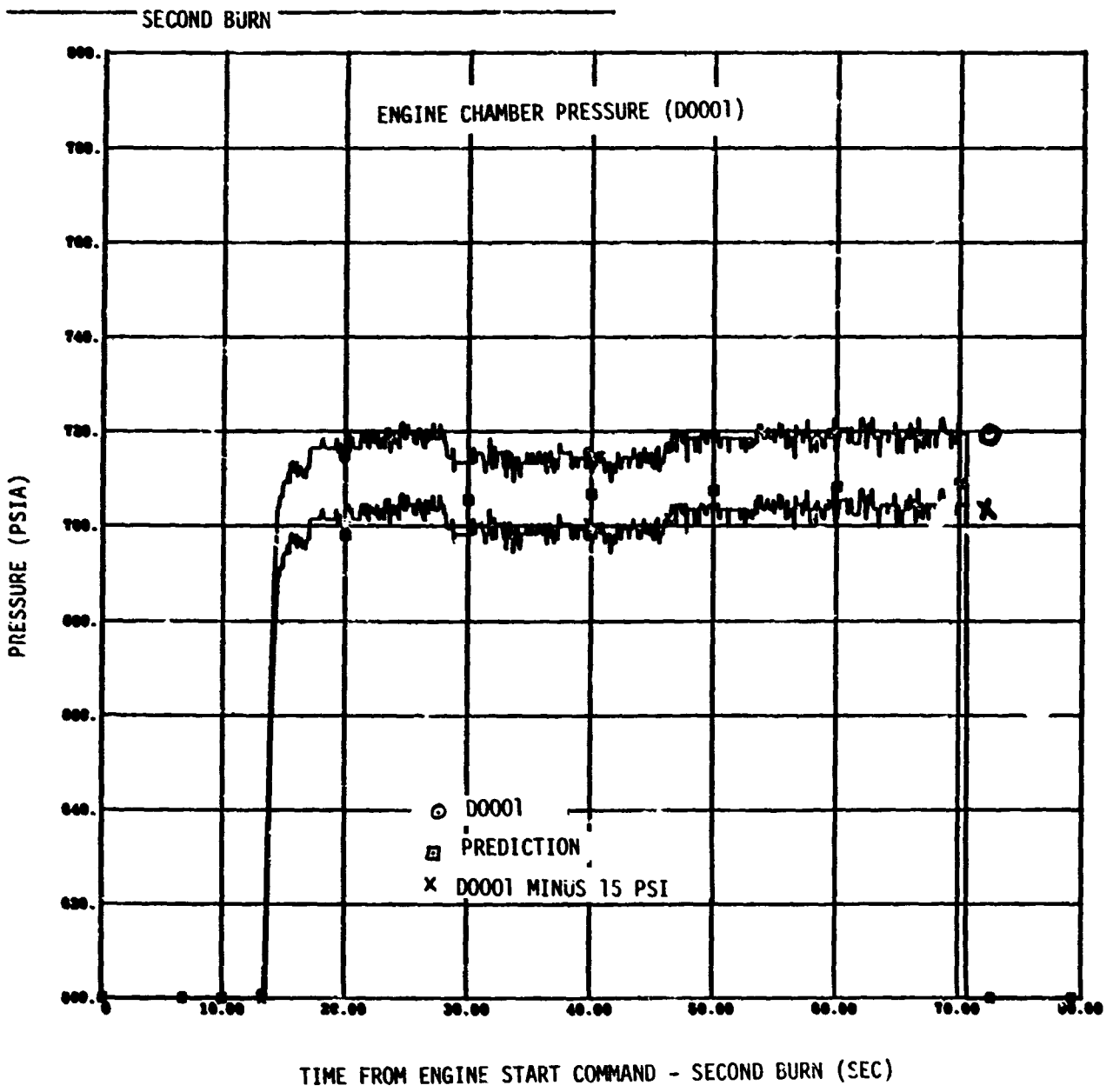

Figure 9-32. J-2 Engine Chamber Pressure (Sheet 2 of 3)

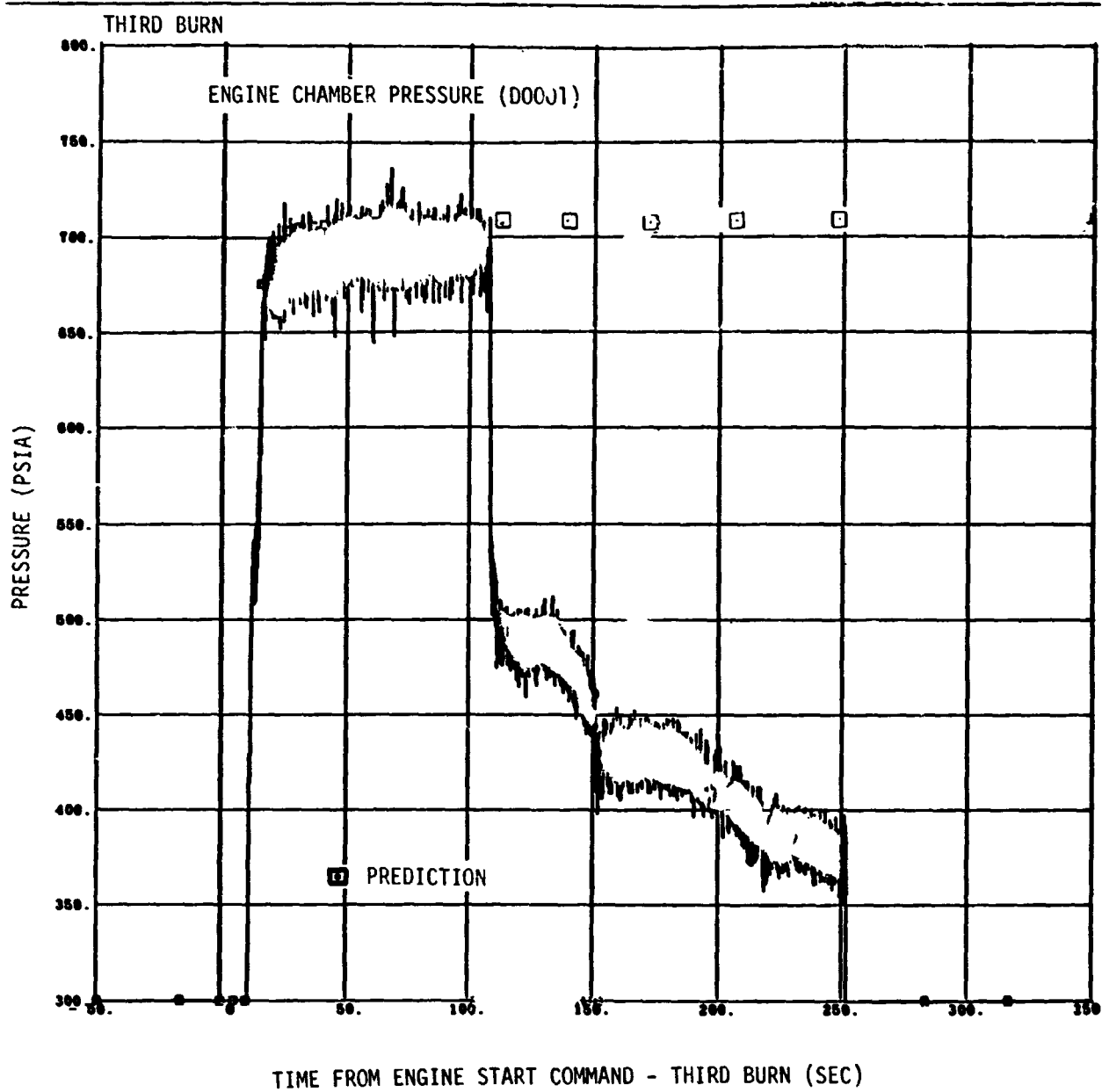

Figure 9-23. J-2 Engine Chamber Pressure (Sheet 3 of 3)

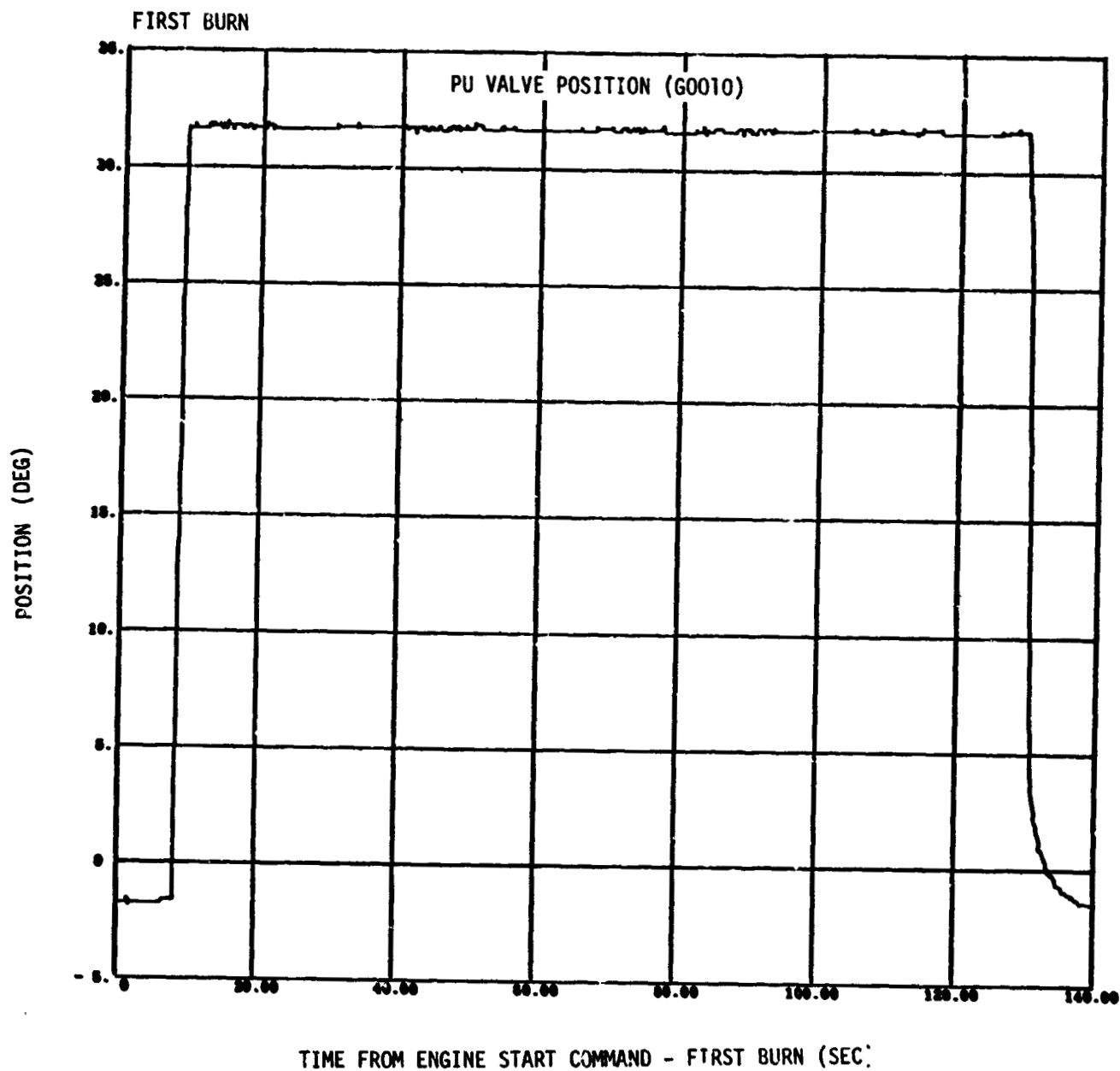

Figure 9-33. PU Valve Operation (Sheet 1 of 3)

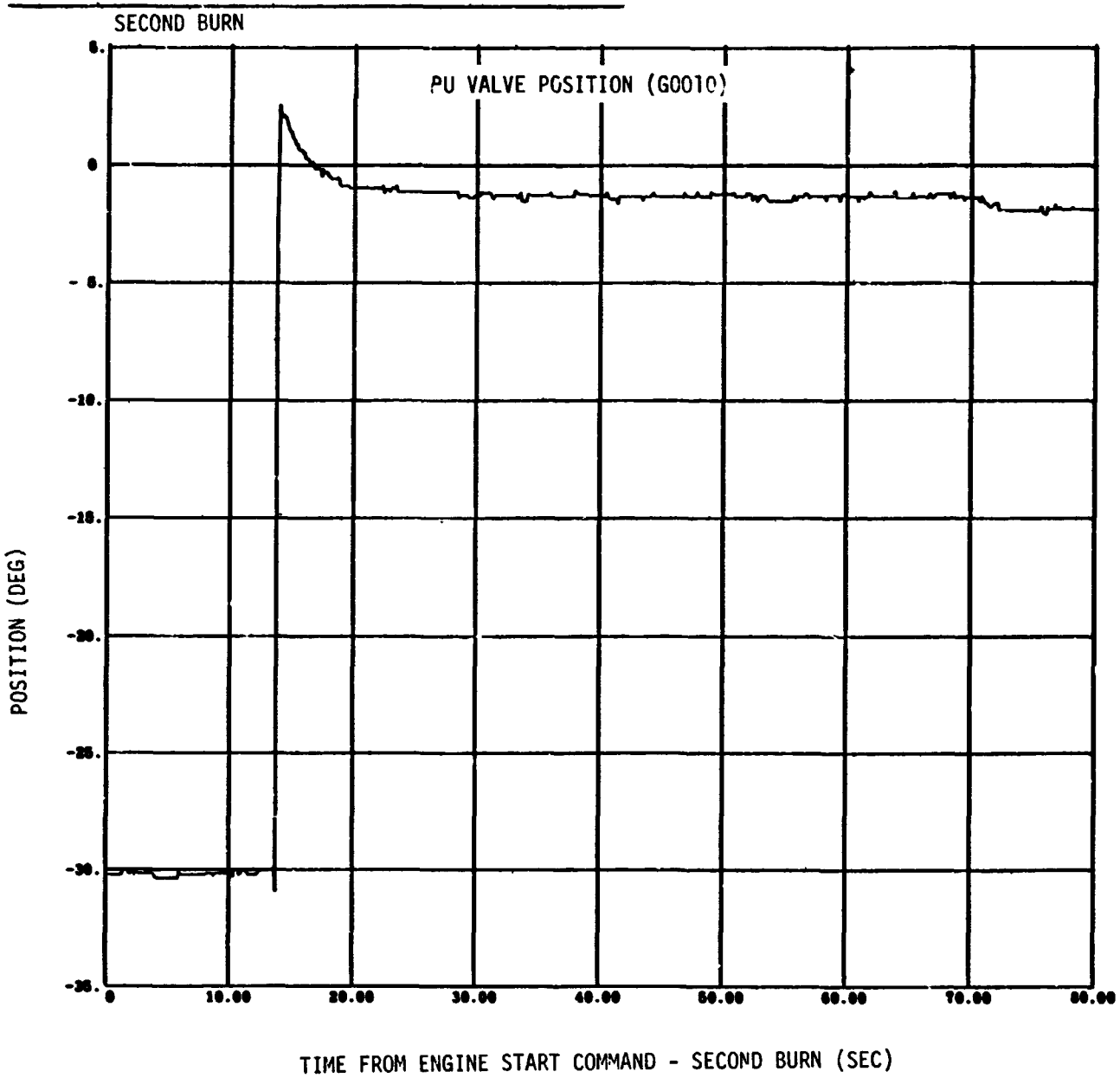

Figure 9-33. PU Valve Operation (Sheet 2 of 3)

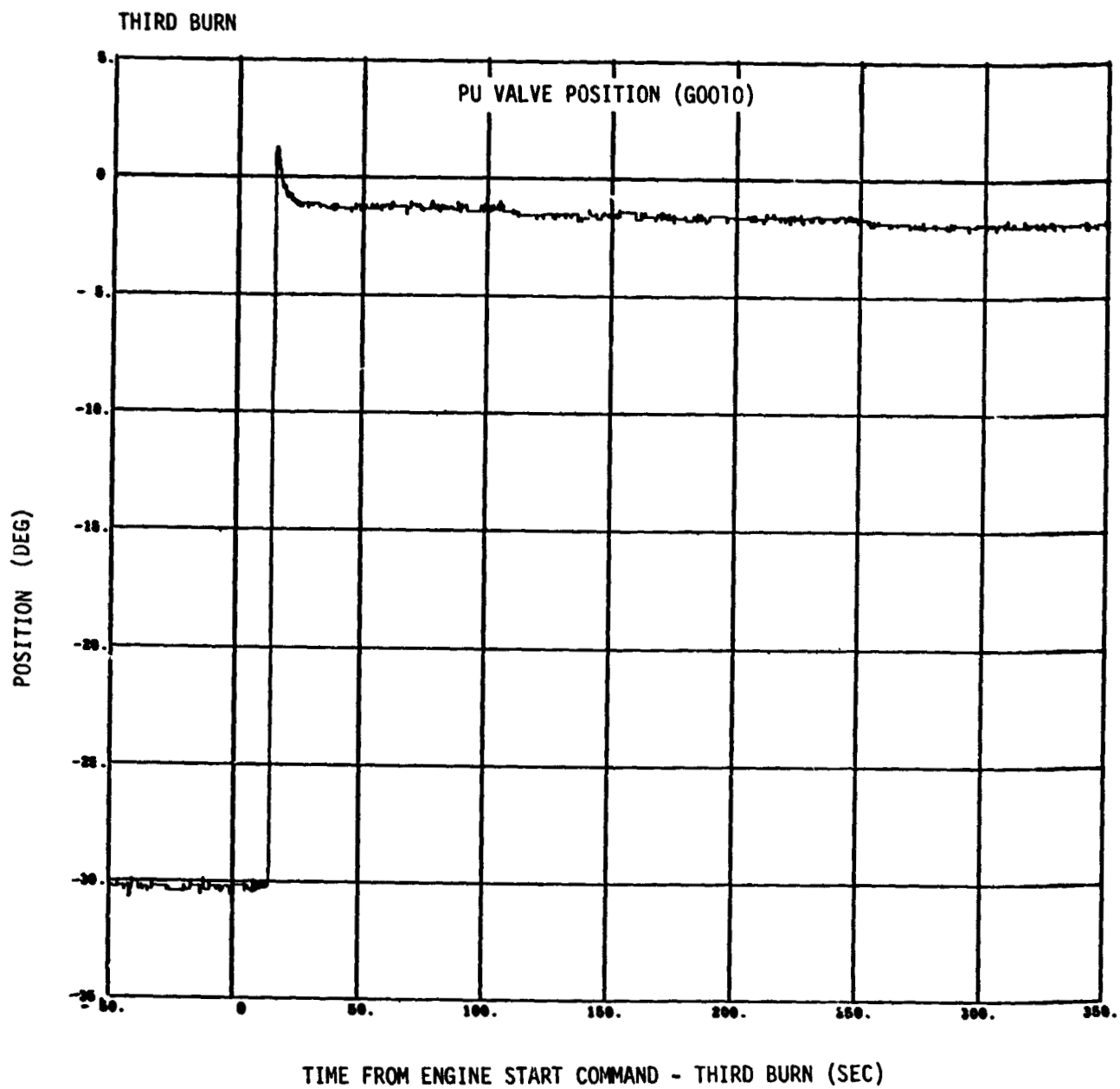

Figure 9-33. PU Valve Operation (Sheet 3 of 3)

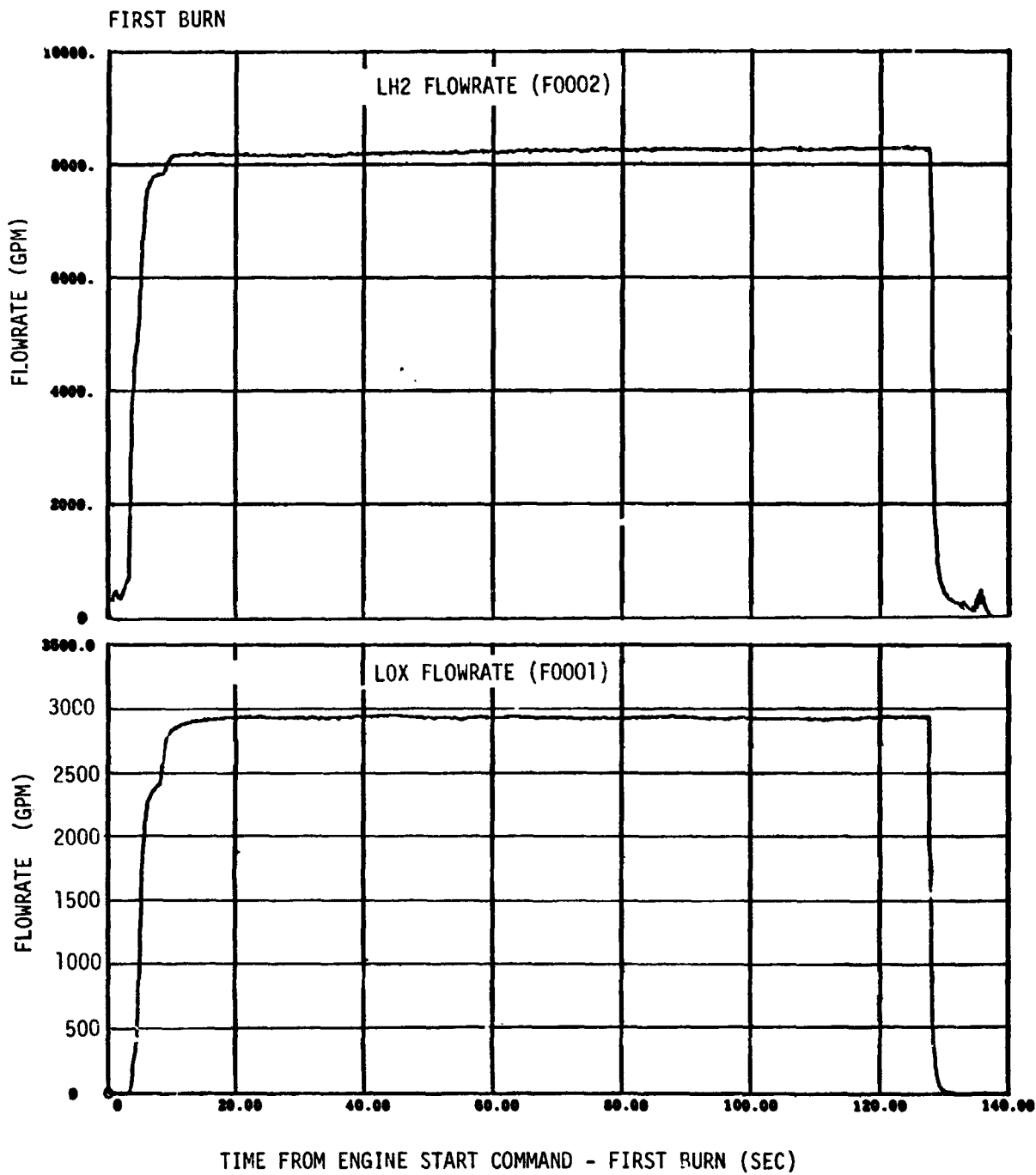

Figure 9-34. J-2 Engine Flowrates (Sheet 1 of 4)



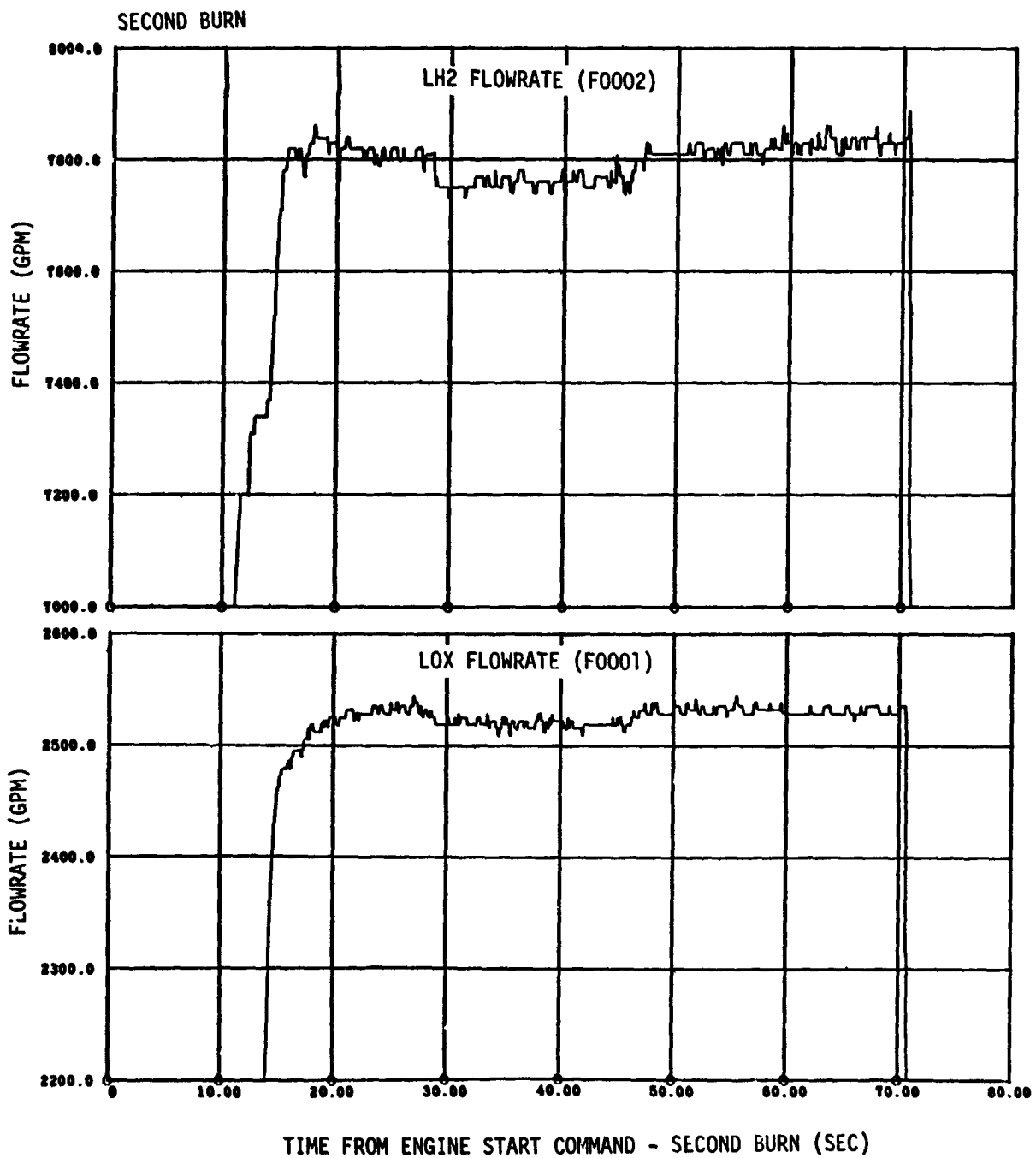

Figure 9-34. J-2 Engine Pump Flowrates (Sheet 2 of 4)

THIRD BURN

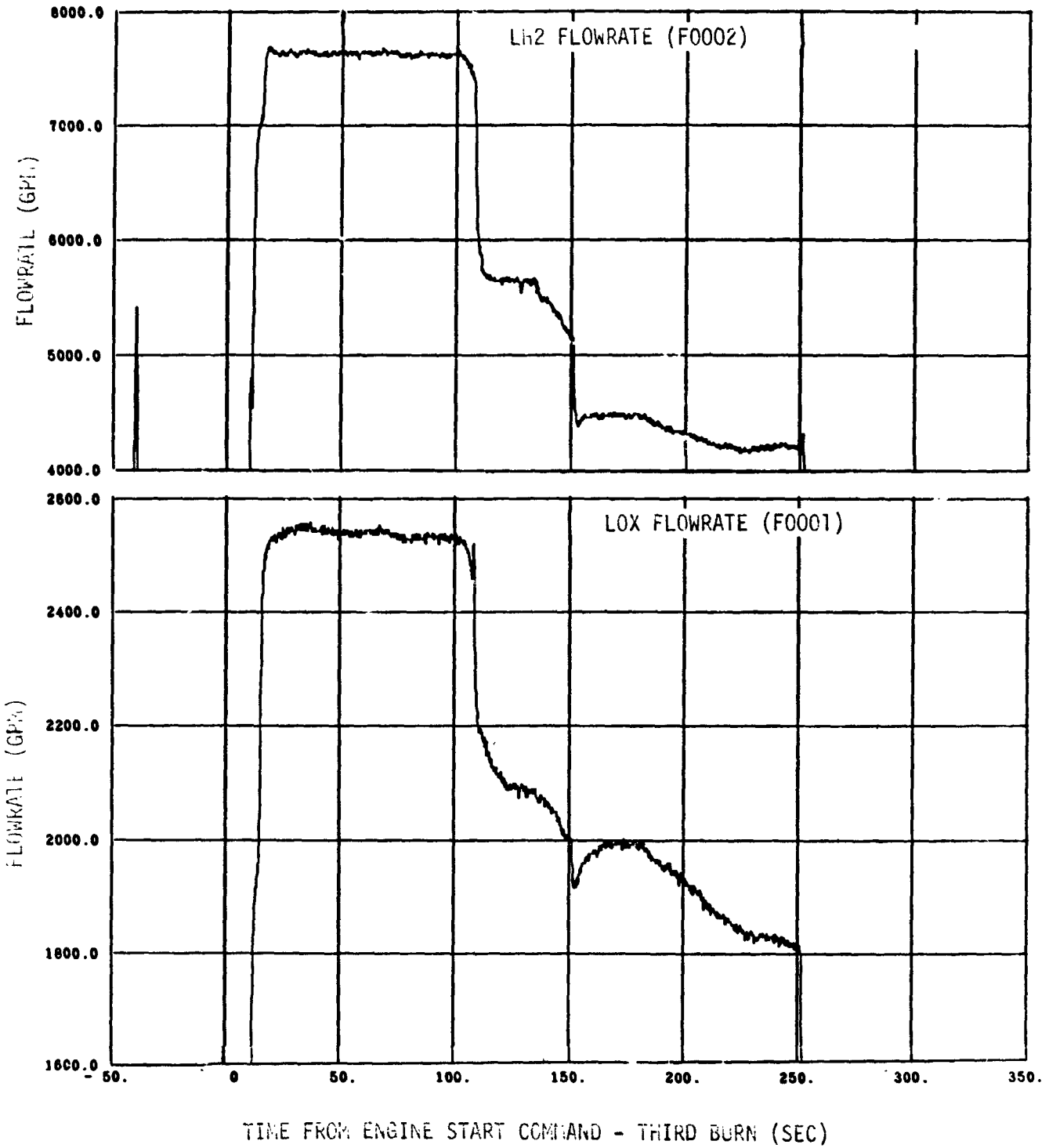

Figure 9-34. J-2 Engine Pump Flowrates (Sheet 3 of 4)

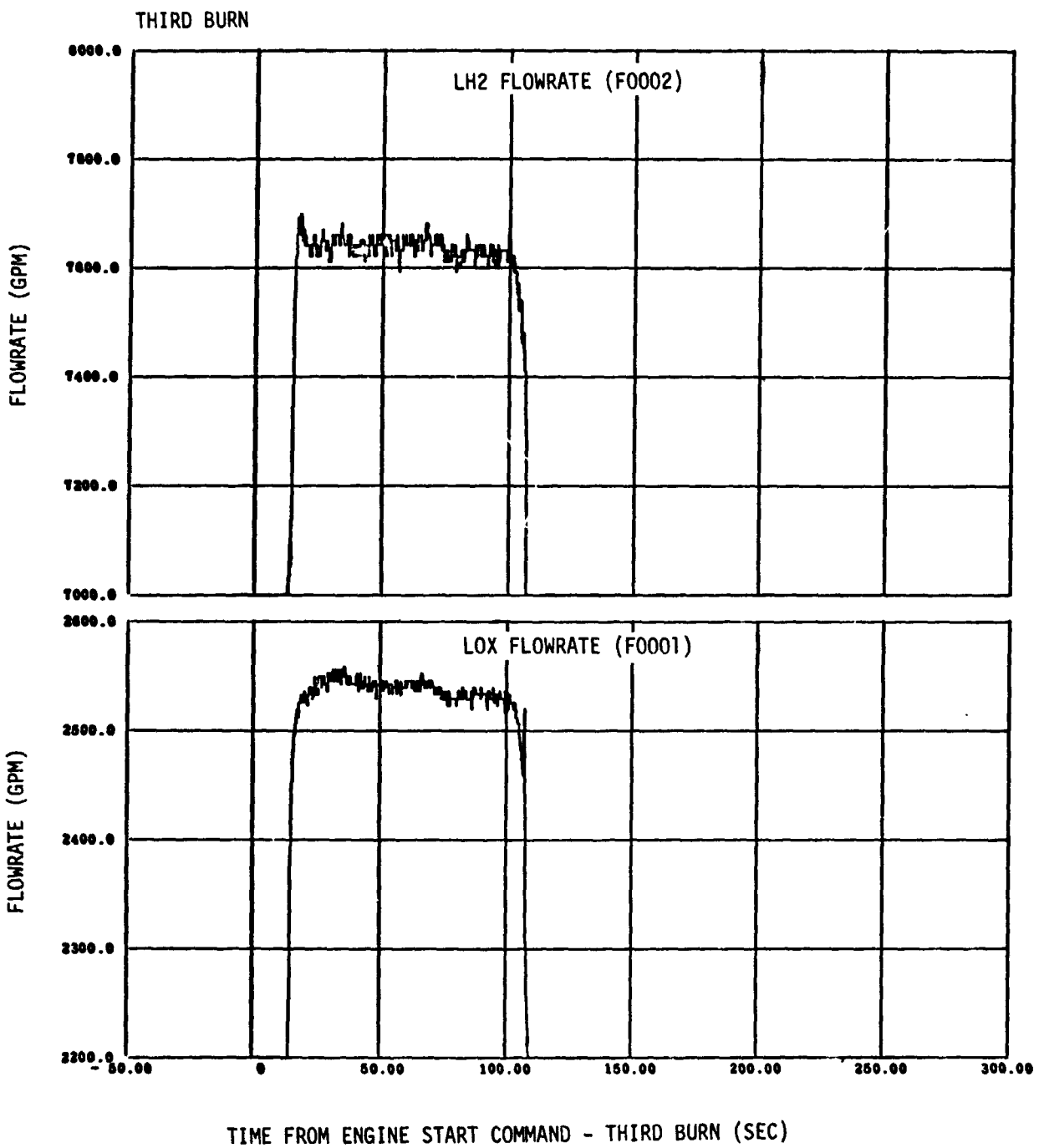

Figure 9-34. J-2 Engine Pump Flowrates (Sheet 4 of 4)

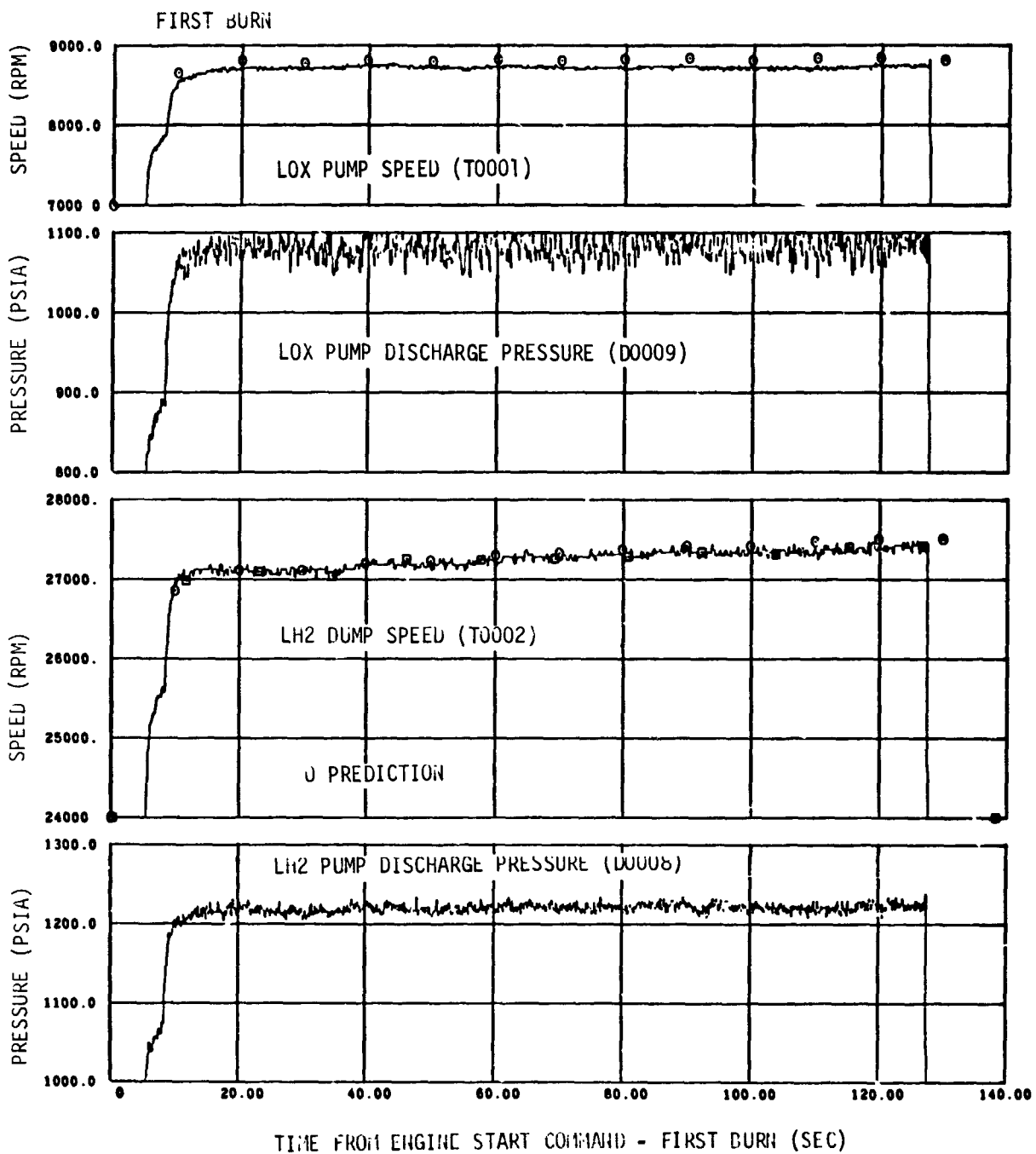

Figure 9-35. J-2 Engine Pump Operating Characteristics (Sheet 1 of 3)

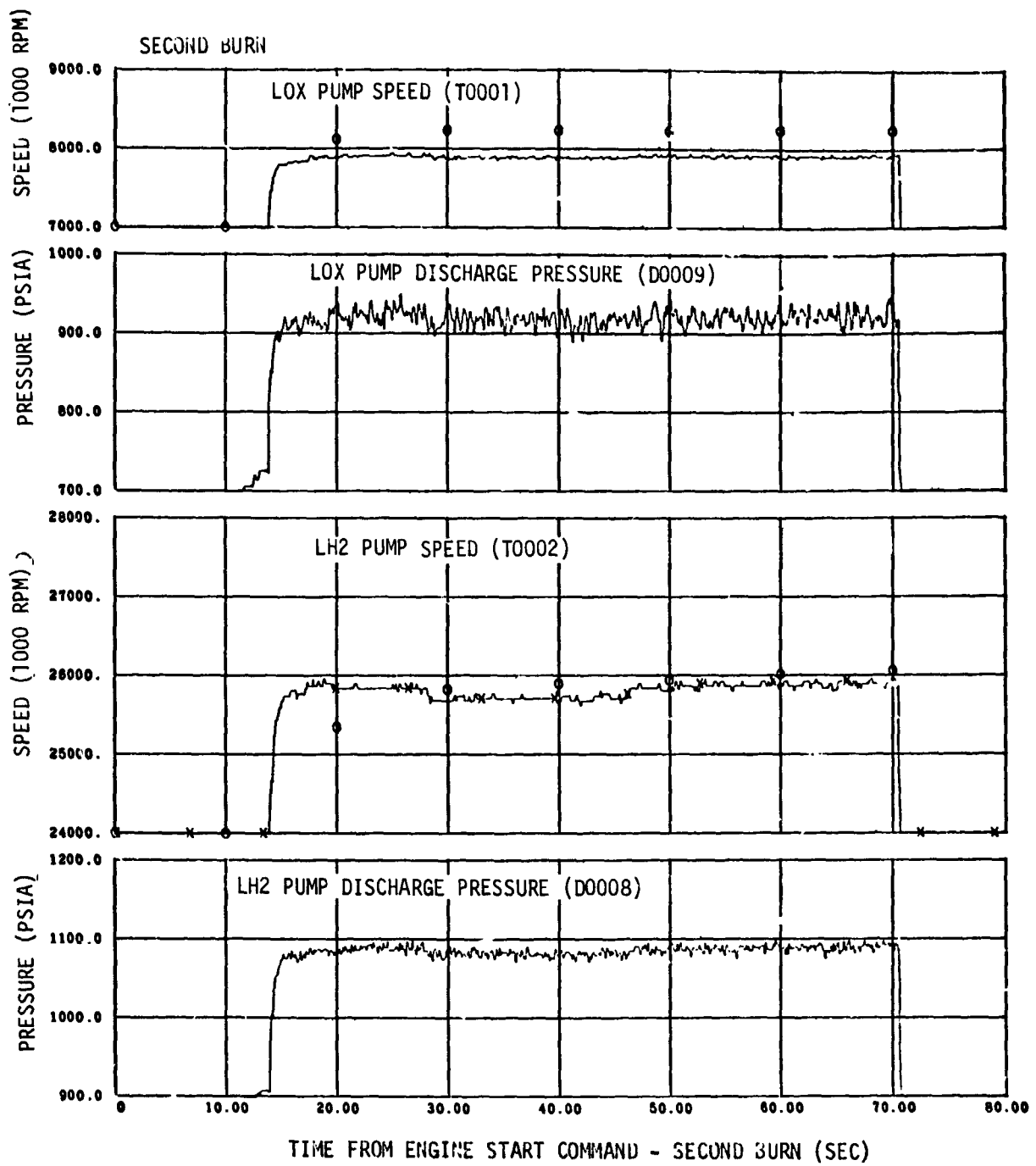

Figure 9-35. J-2 Engine Pump Operating Characteristics (Sheet 2 of 3)

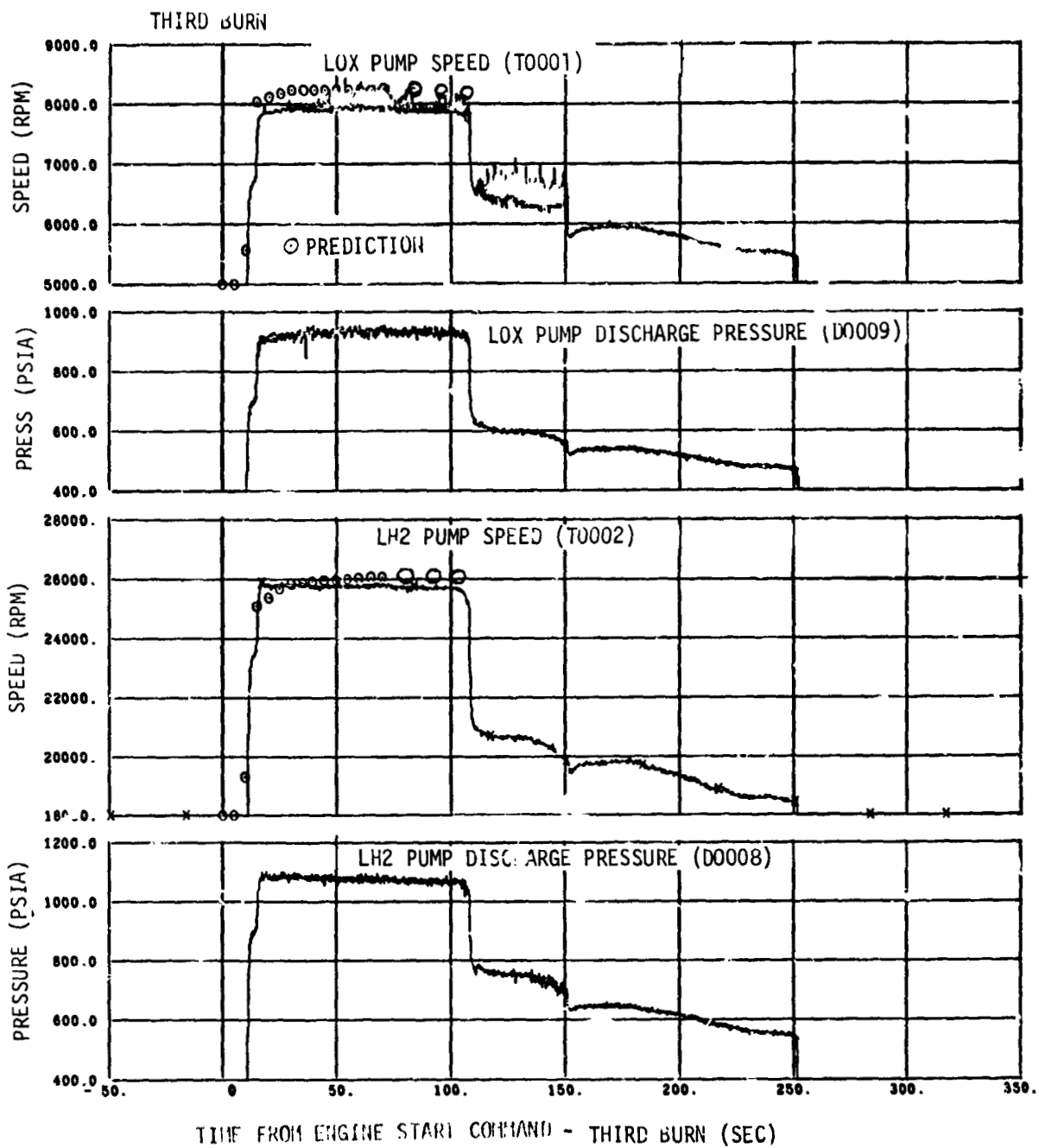

Figure 9-35. J-2 Engine Pump Operating Characteristics (Sheet 3 of 3)

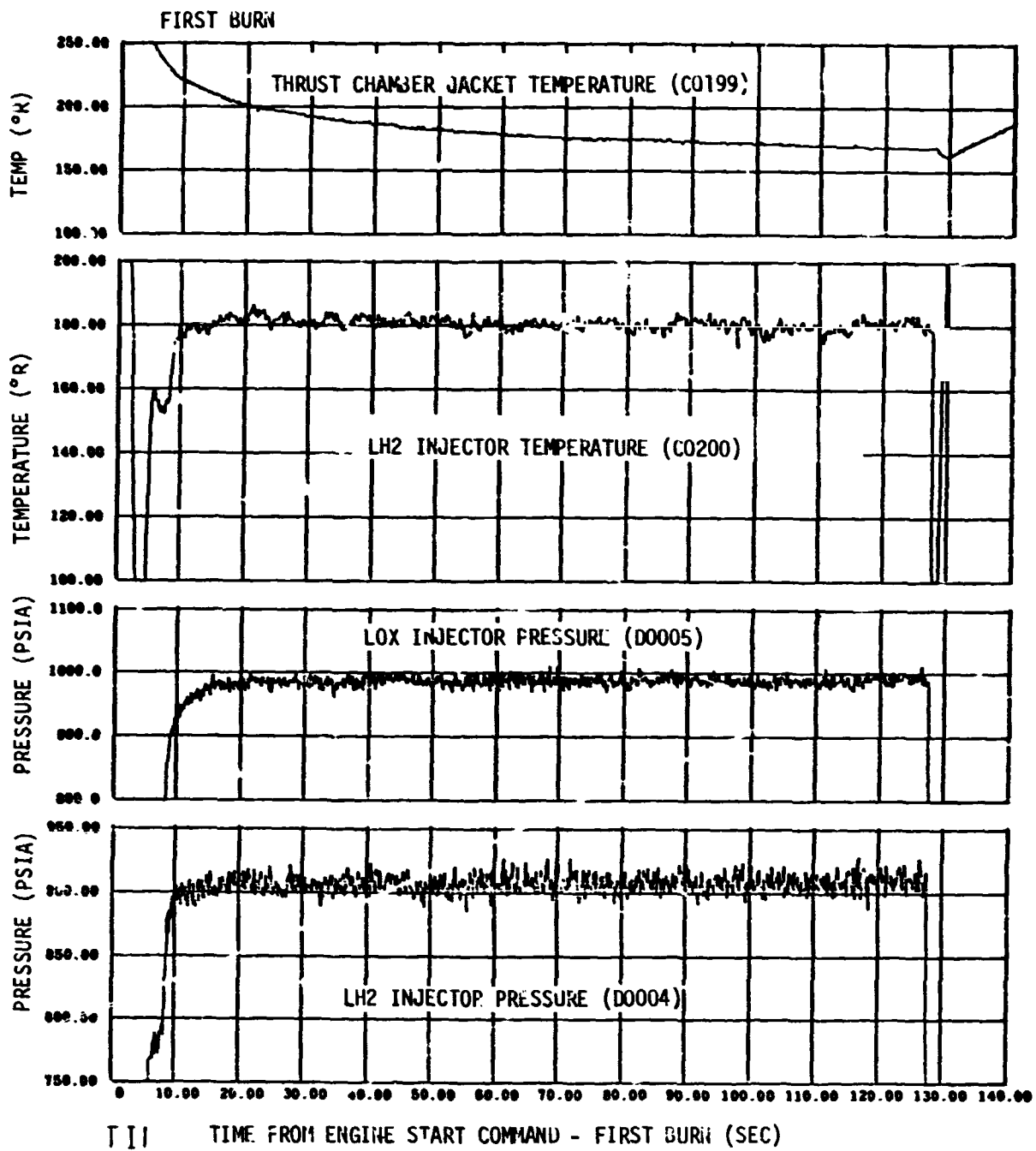

Figure 9-36 J-2 Engine Injector Supply Conditions (Sheet 1 of 3)

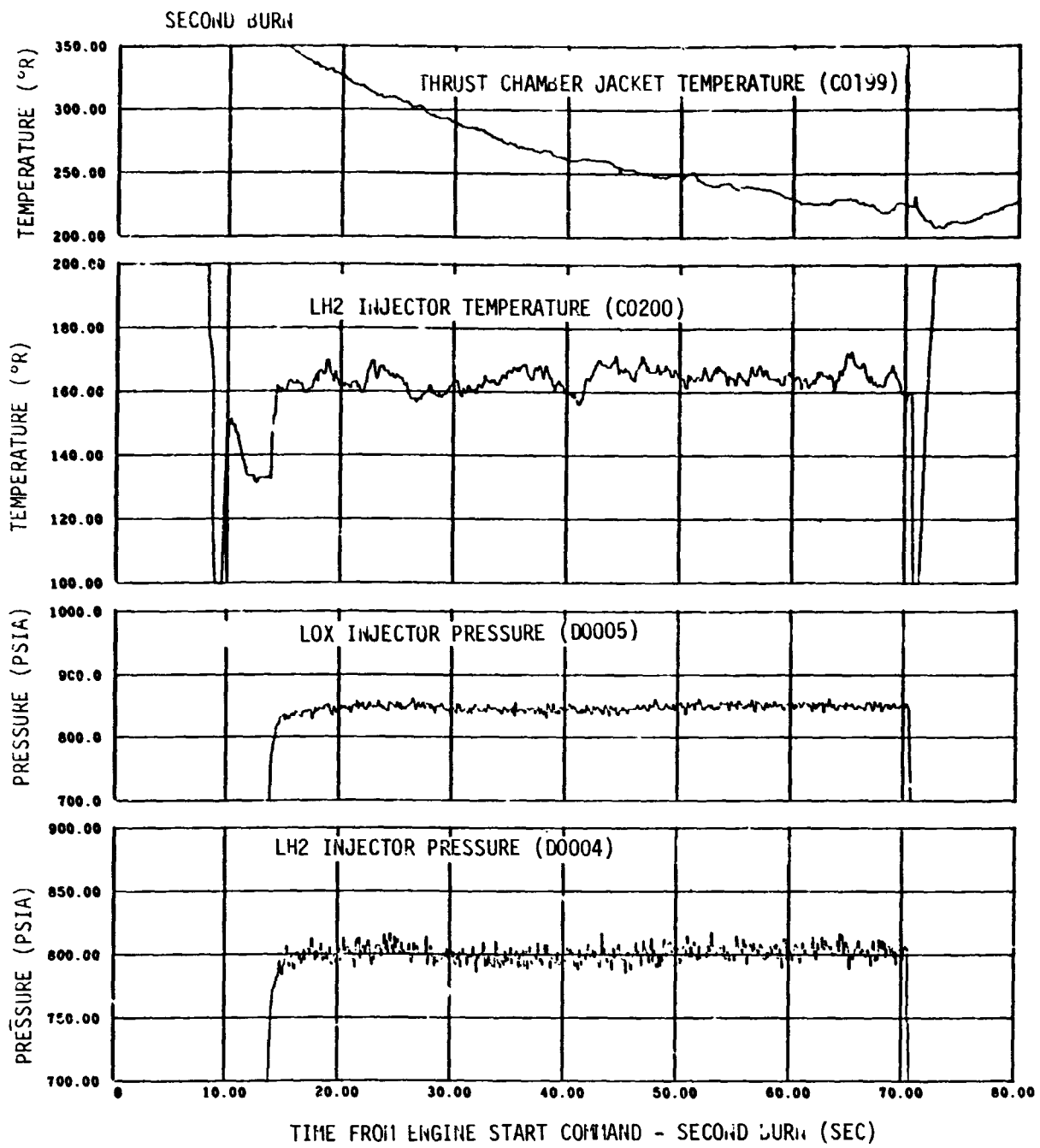

Figure 9-36 J-2 Engine Injector Supply Conditions (Sheet 2 of 3)



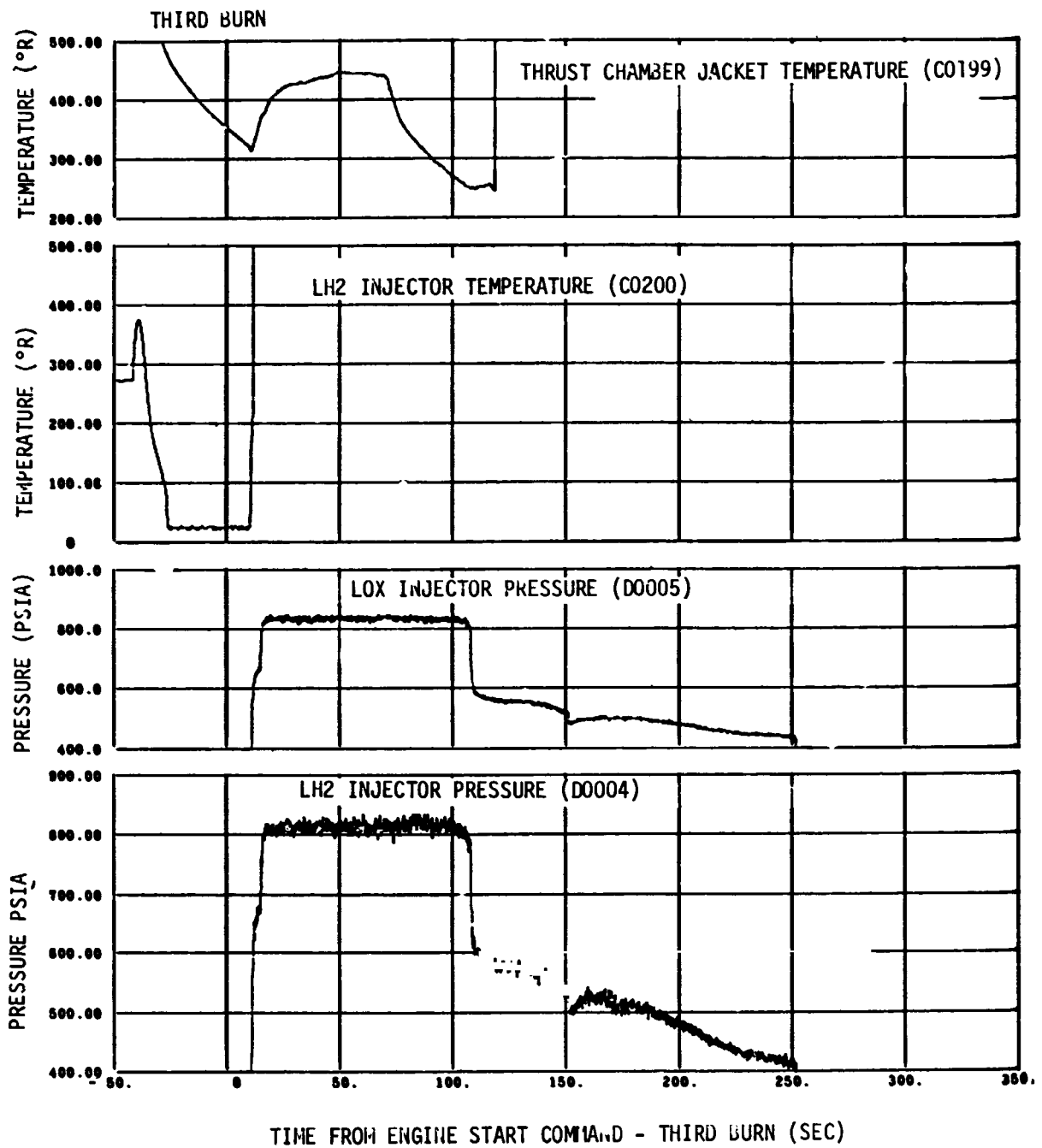

Figure 9-36. J-2 Engine Injector Supply Conditions 9 (sheet 3 of 3)

FIRST BURN

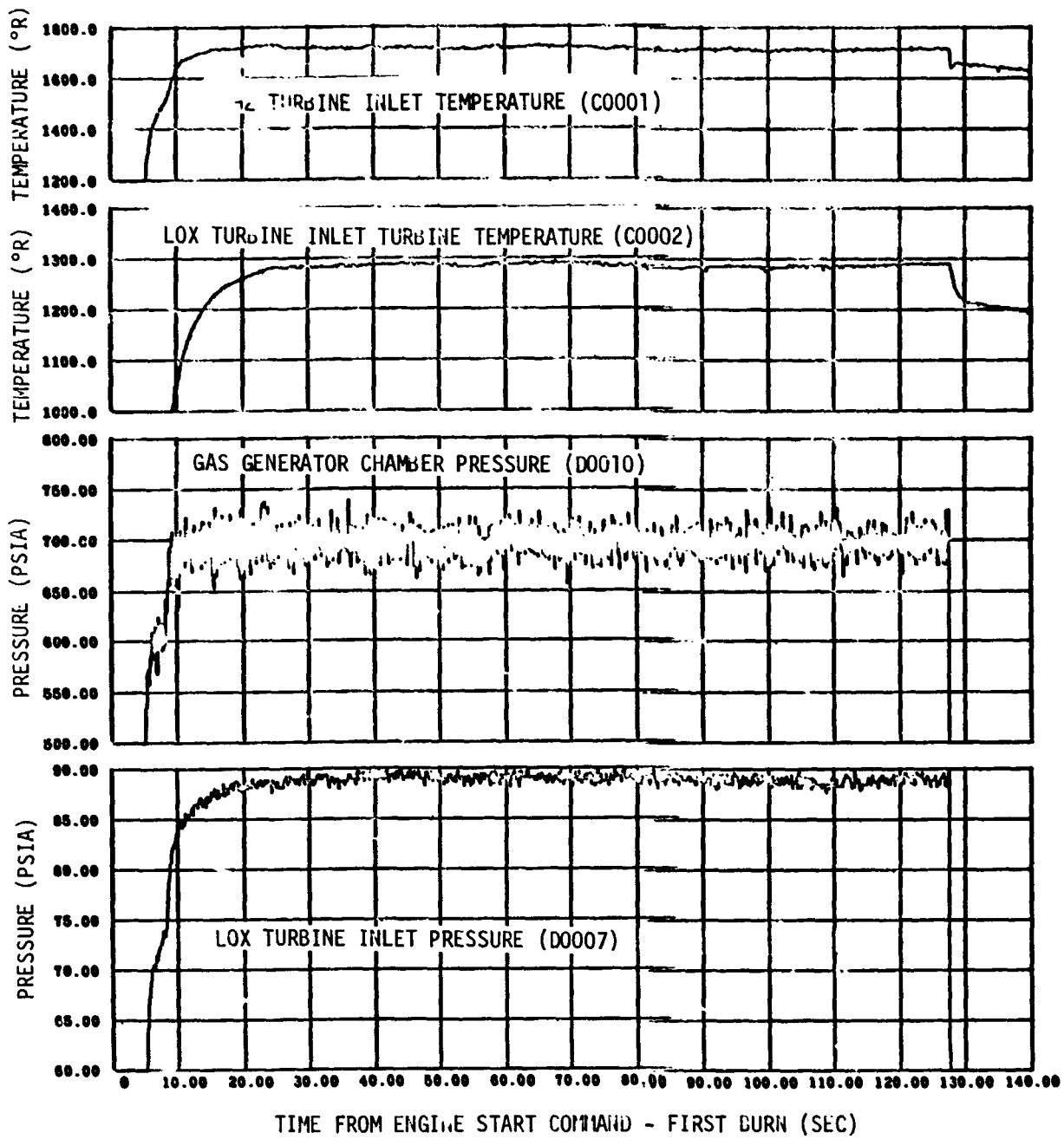

Figure 9-37 Turbine Operating Conditions (Sheet 1 of 3)

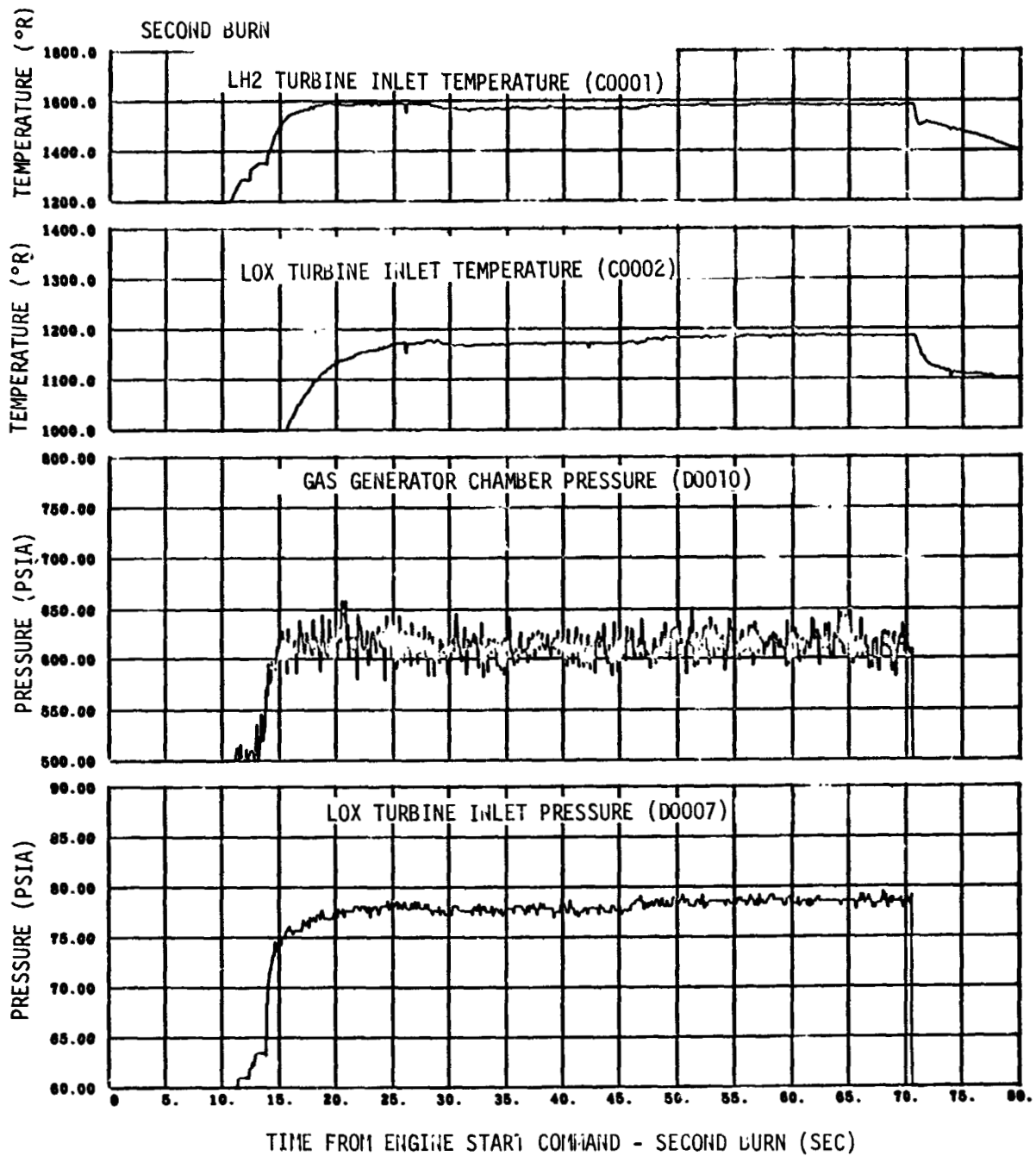

Figure 9-37 Turbine Operating Conditions (Sheet 2 of 3)

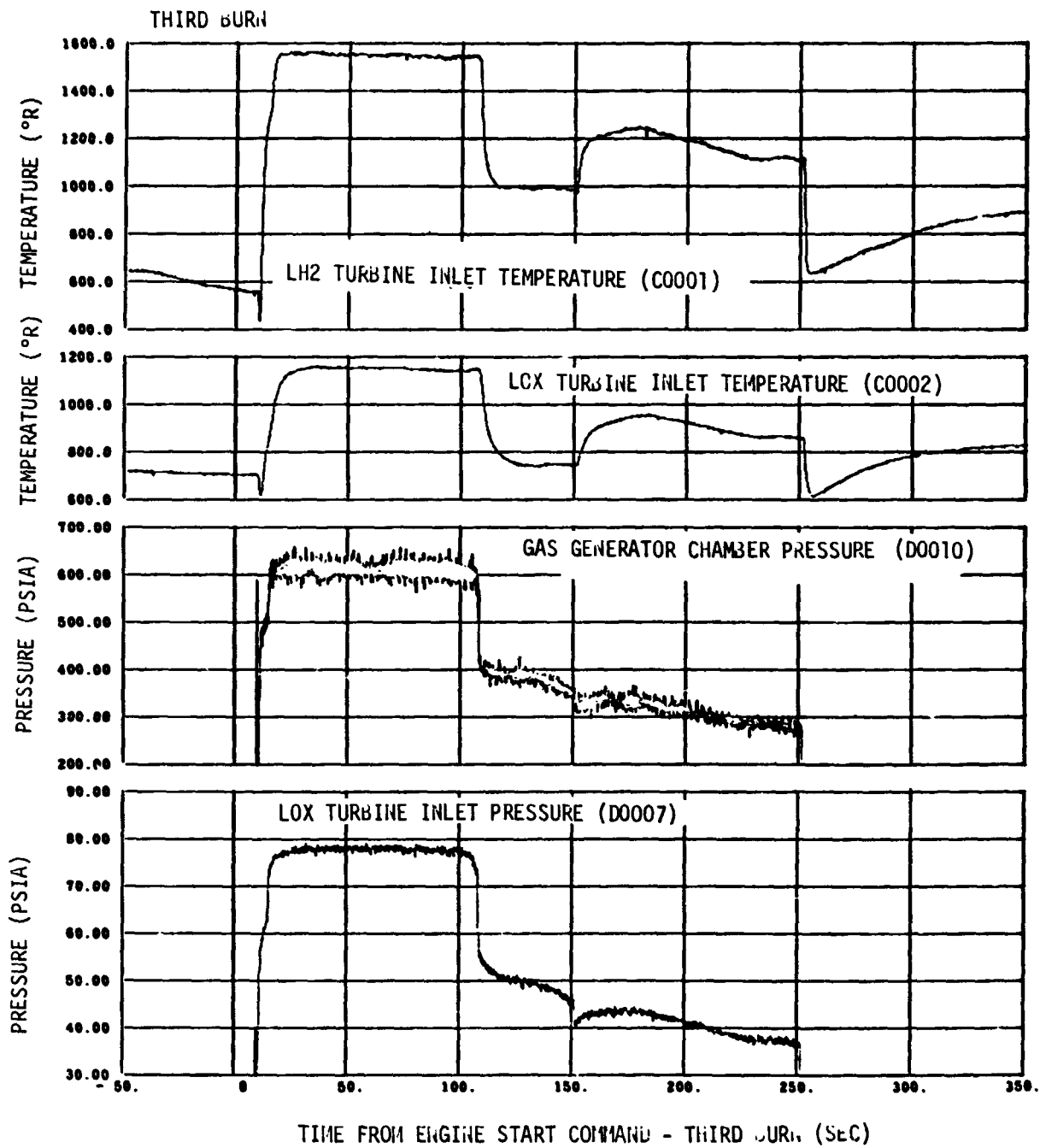

Figure 9-37. Turbine Operating Conditions (Sheet 3 of 3)

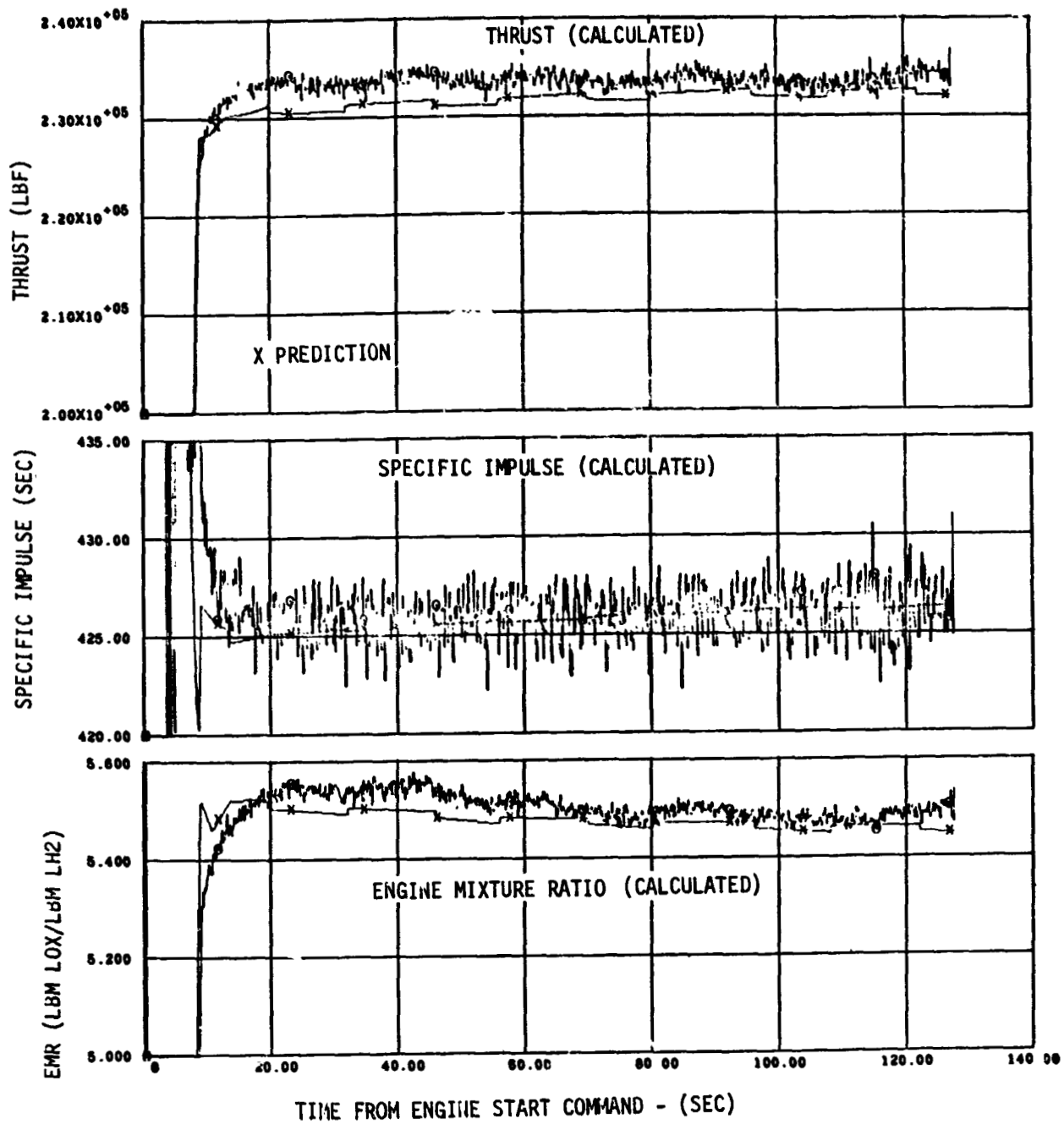

Figure 9-38. Engine Steady-State Performance-First Burn (Sheet 1 of 3)

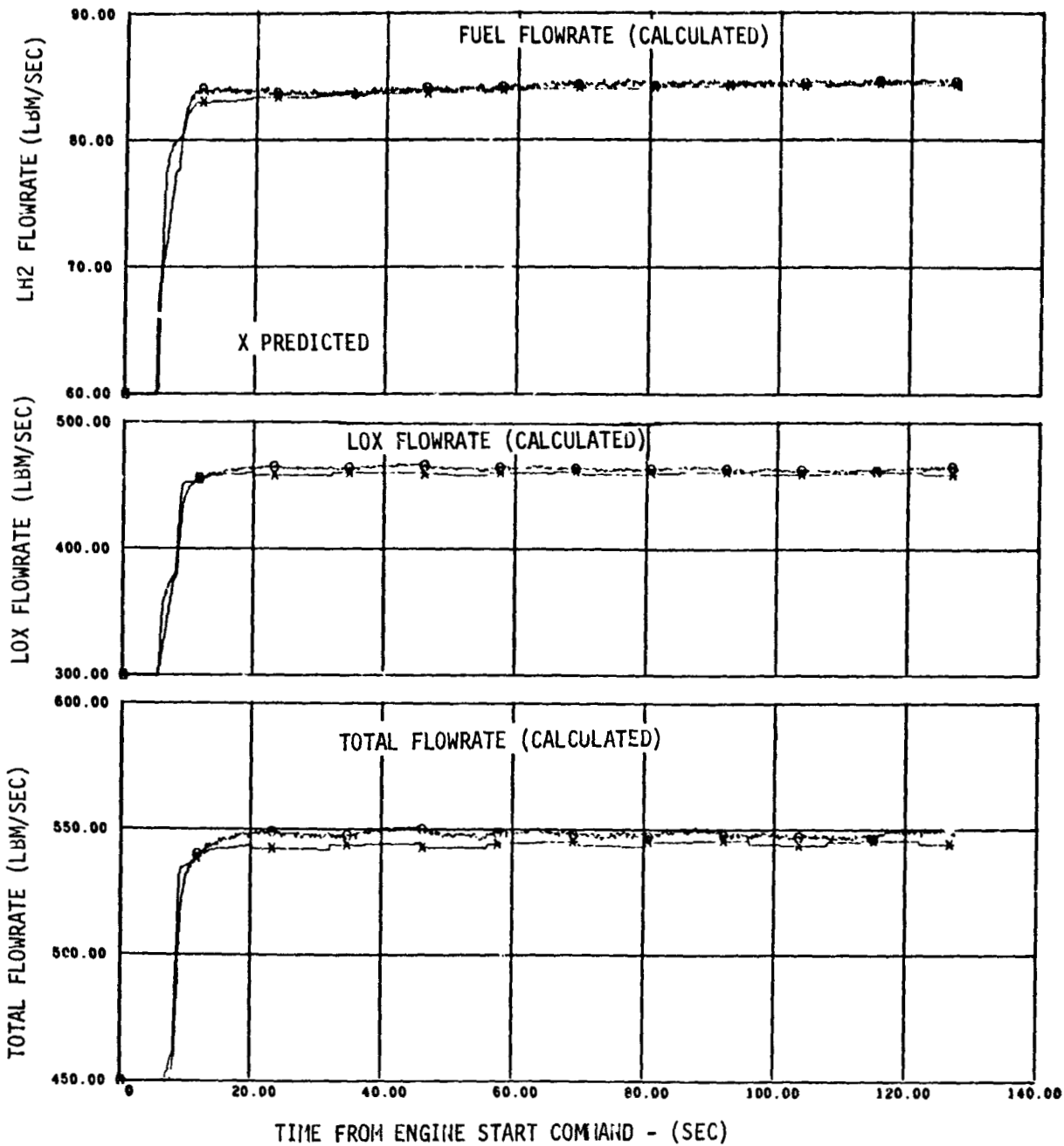

Figure 9-38. Engine Steady-State Performance - First Burn (Sheet 2 of 3)

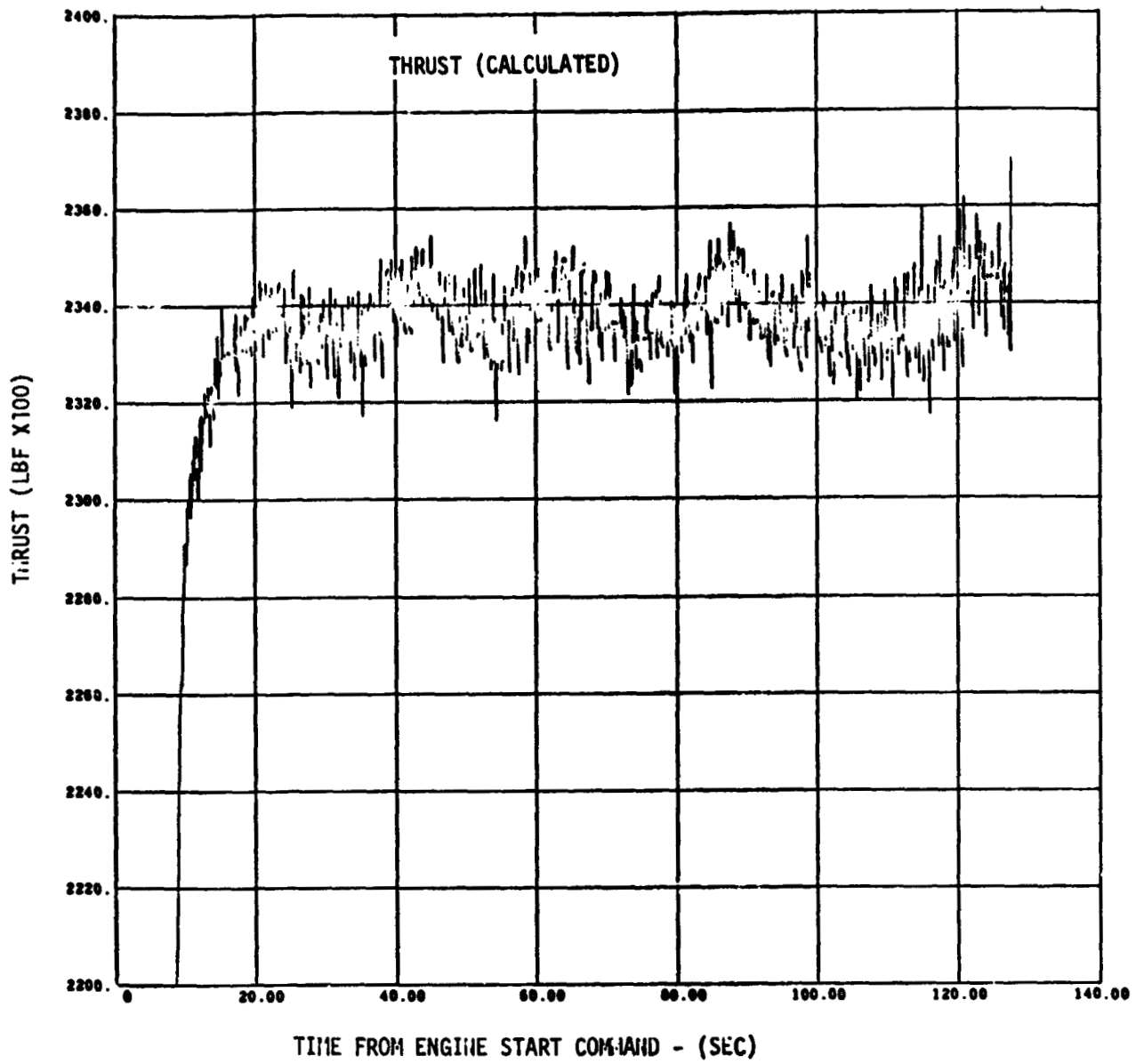

Figure 9-38. Engine Steady-State Performance - First Burn (Sheet 3 of 3)

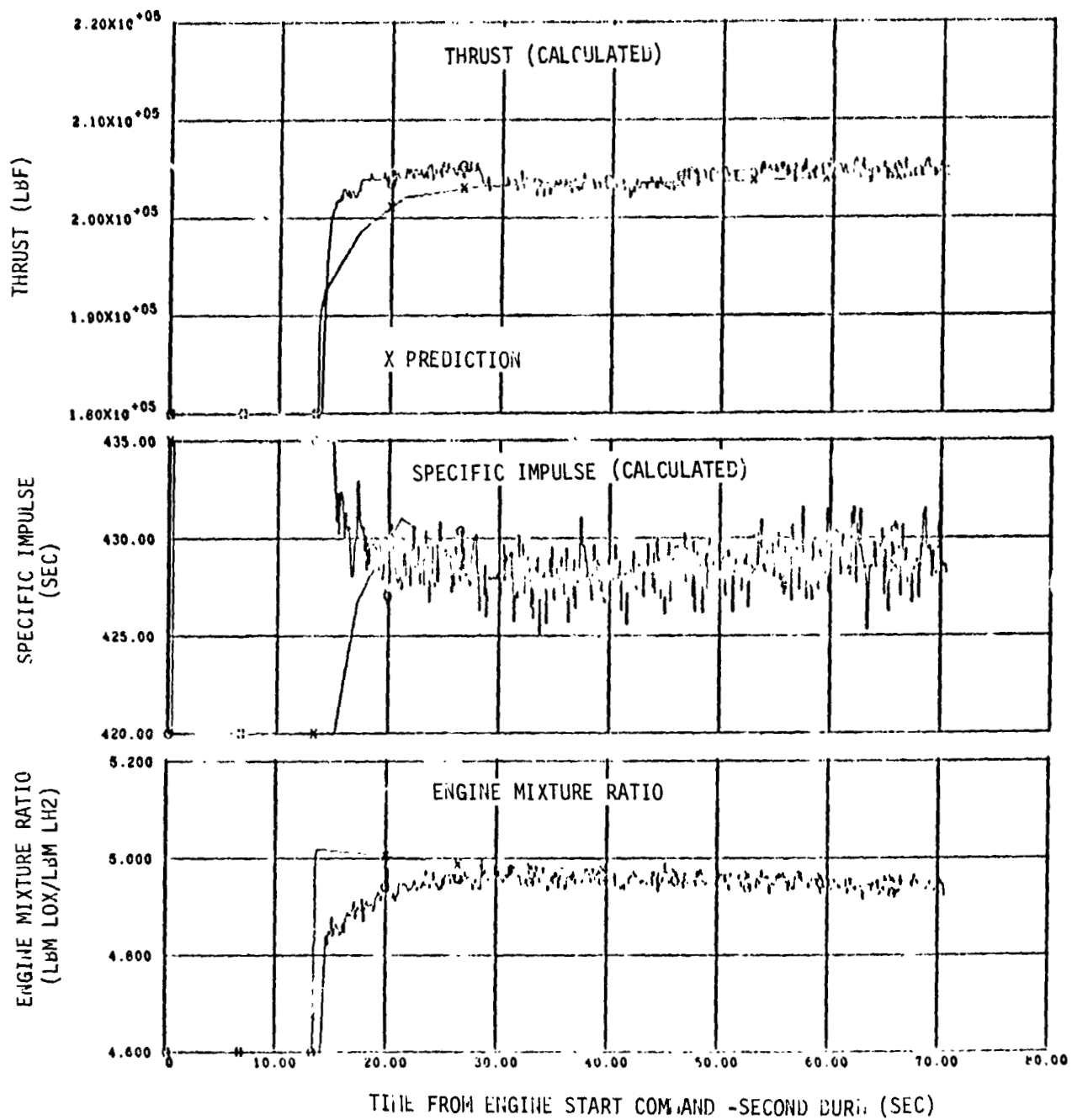

Figure 9-39 Engine Steady-State Performance - Second Burn (Sheet 1 of 3)



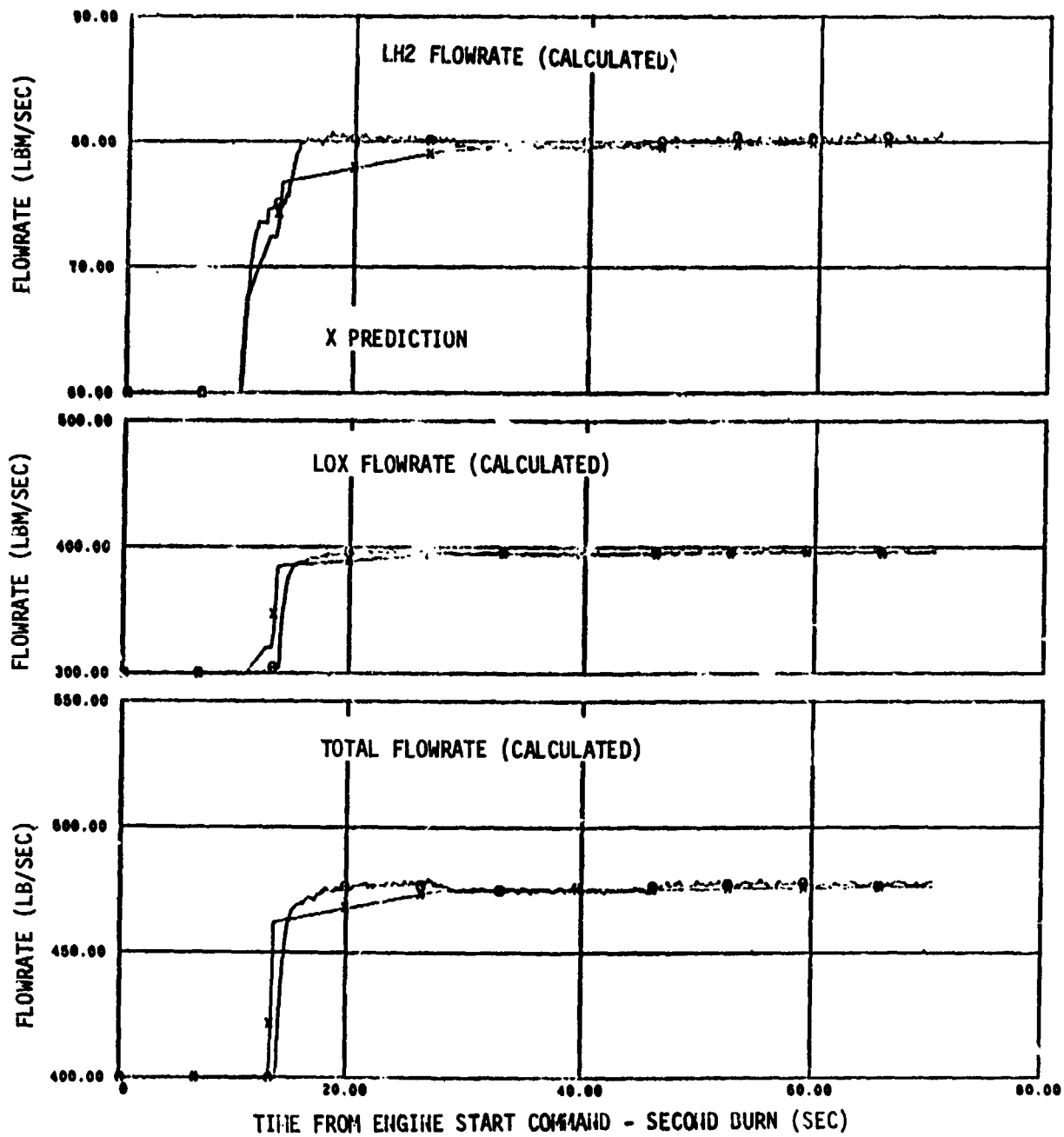

Figure 9-39 Engine Steady-State Performance - Second Burn (Sheet 2 of 3)

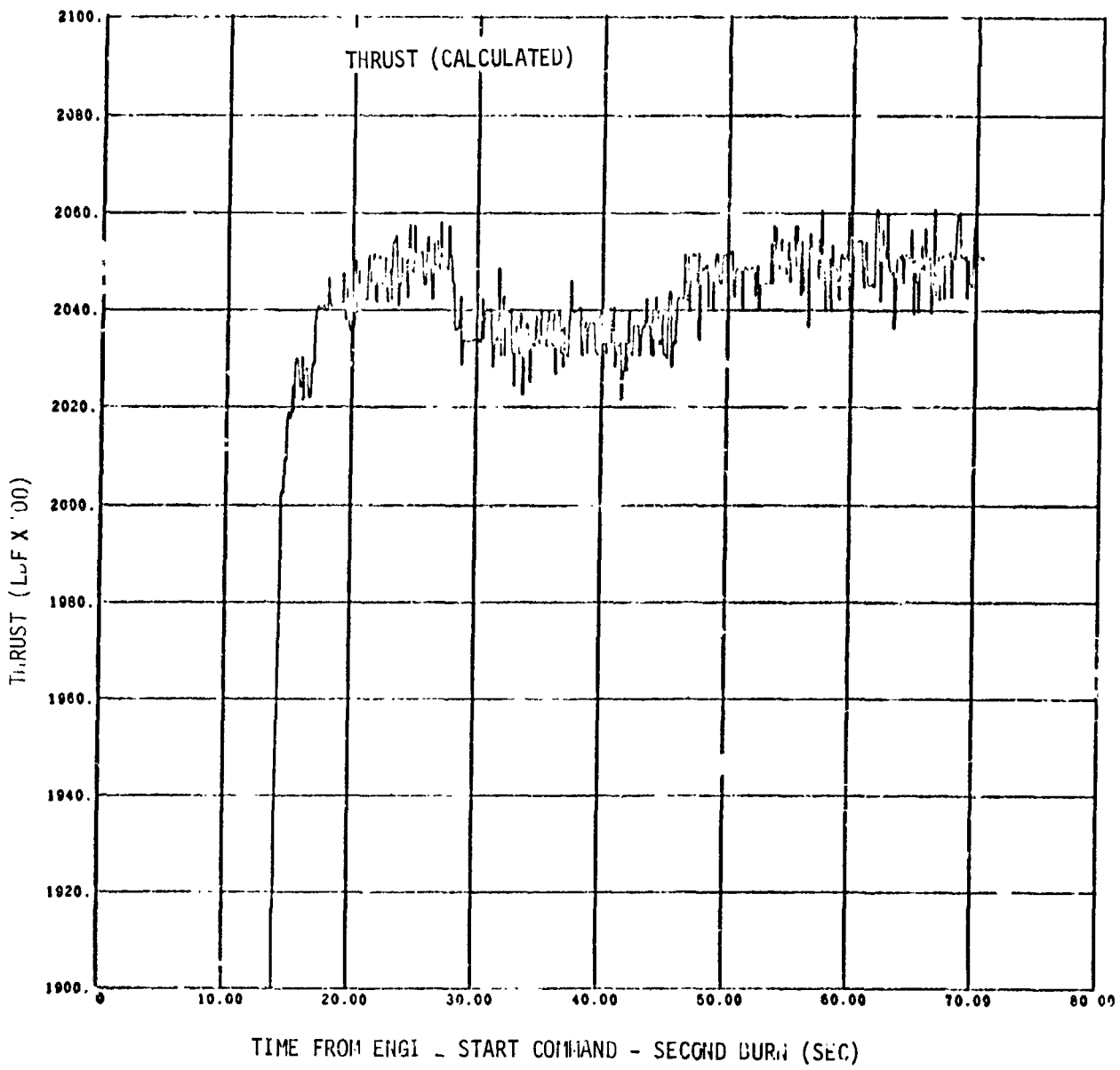

Figure 9-39 Engine Steady-State Performance - Second Burn - (Sheet 3 of 3)

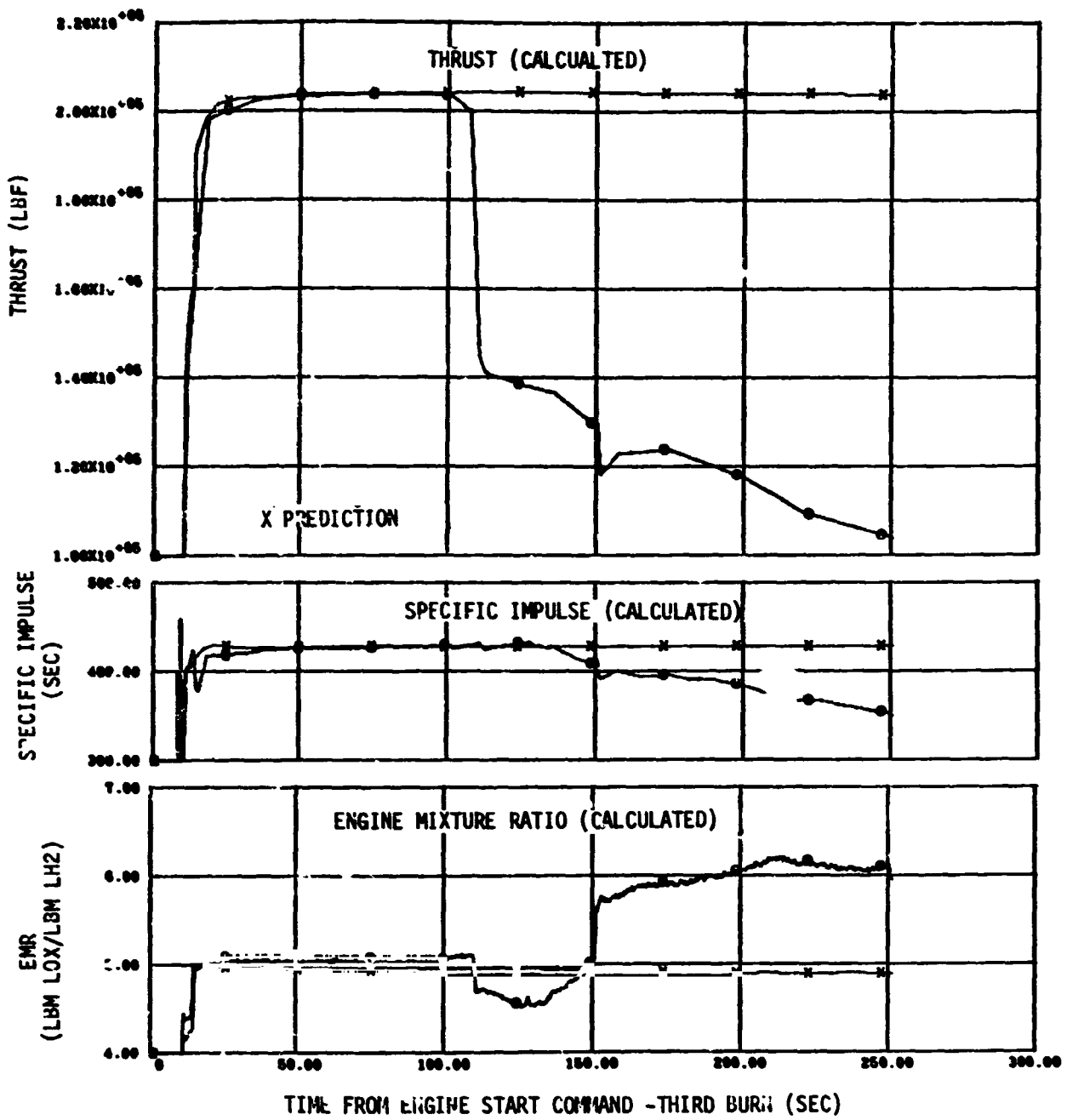

Figure 9-40 Engine Steady-State Performance - Third Burn (Sheet 1 of 3)

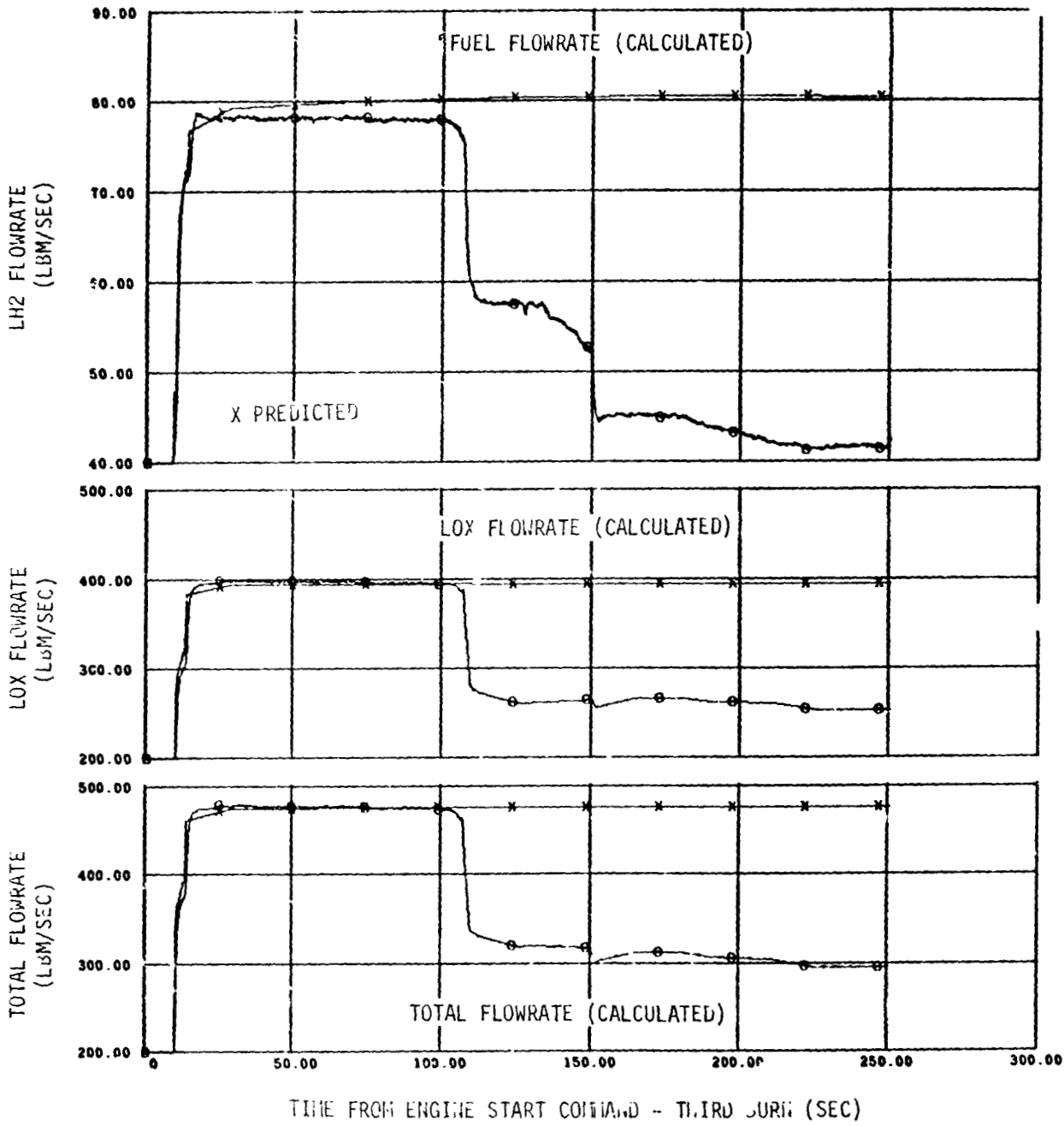

Figure 9-40 Engine Steady-State Performance - Third burn (Sheet 2 of 3)

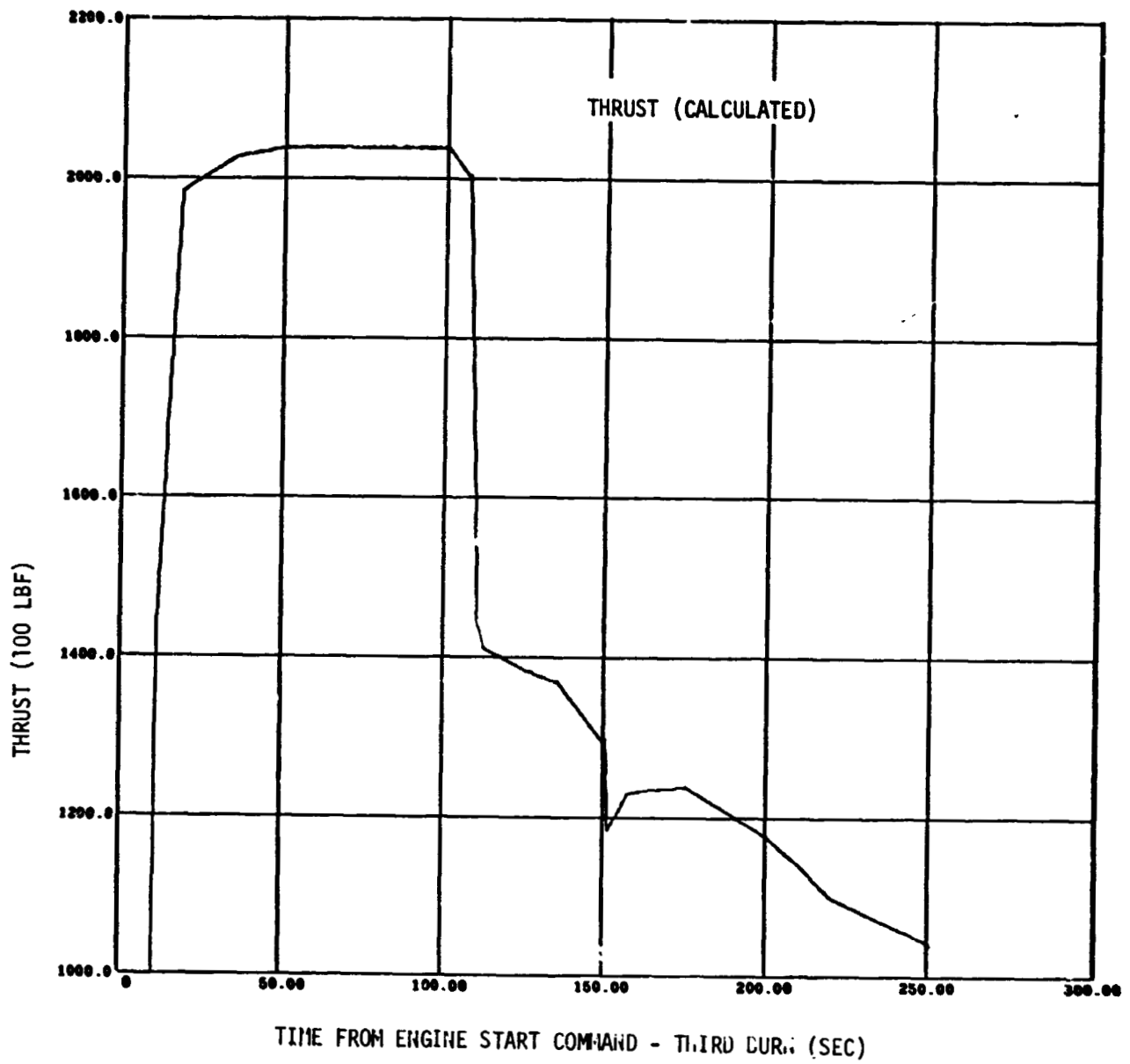

Figure 9-40 Engine Steady-State Performance - Third Burn (Sheet 3 of 3)

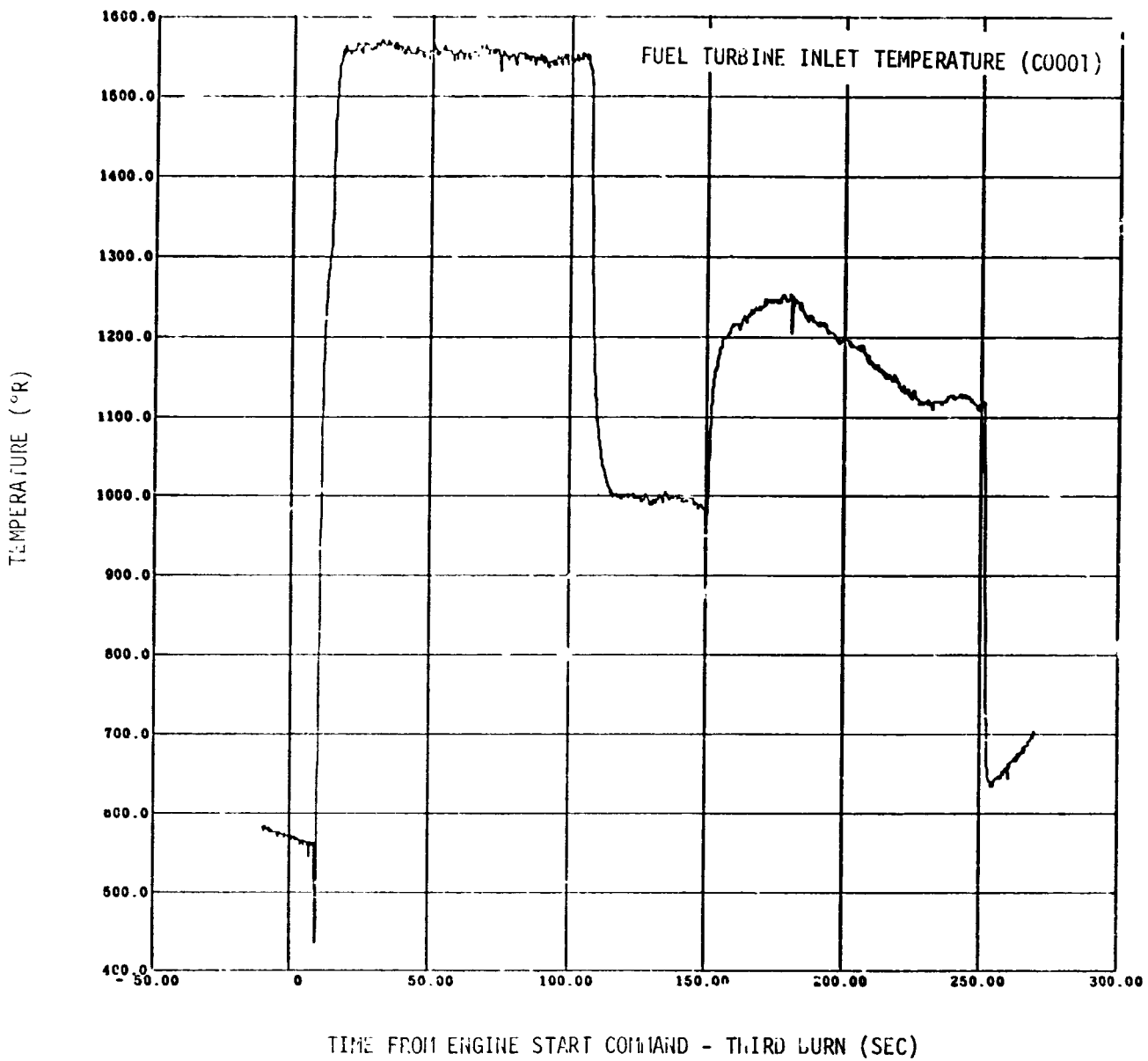

Figure 9-41 Third Burn Anomaly Data - Fuel Turbine Inlet Temperature

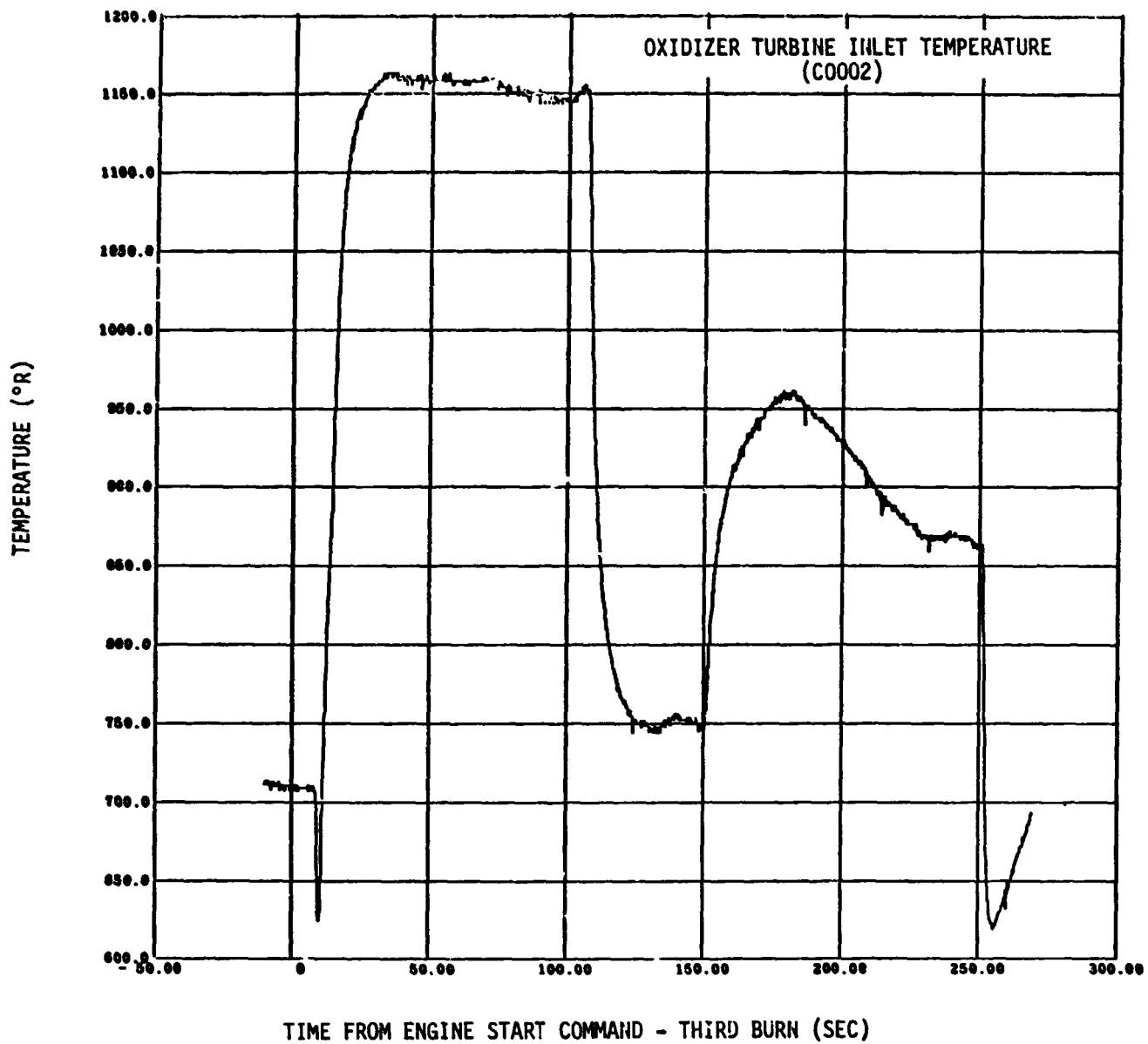

Figure 9-42. Third Burn Anomaly Data - Oxidizer Turbine Inlet Temperature

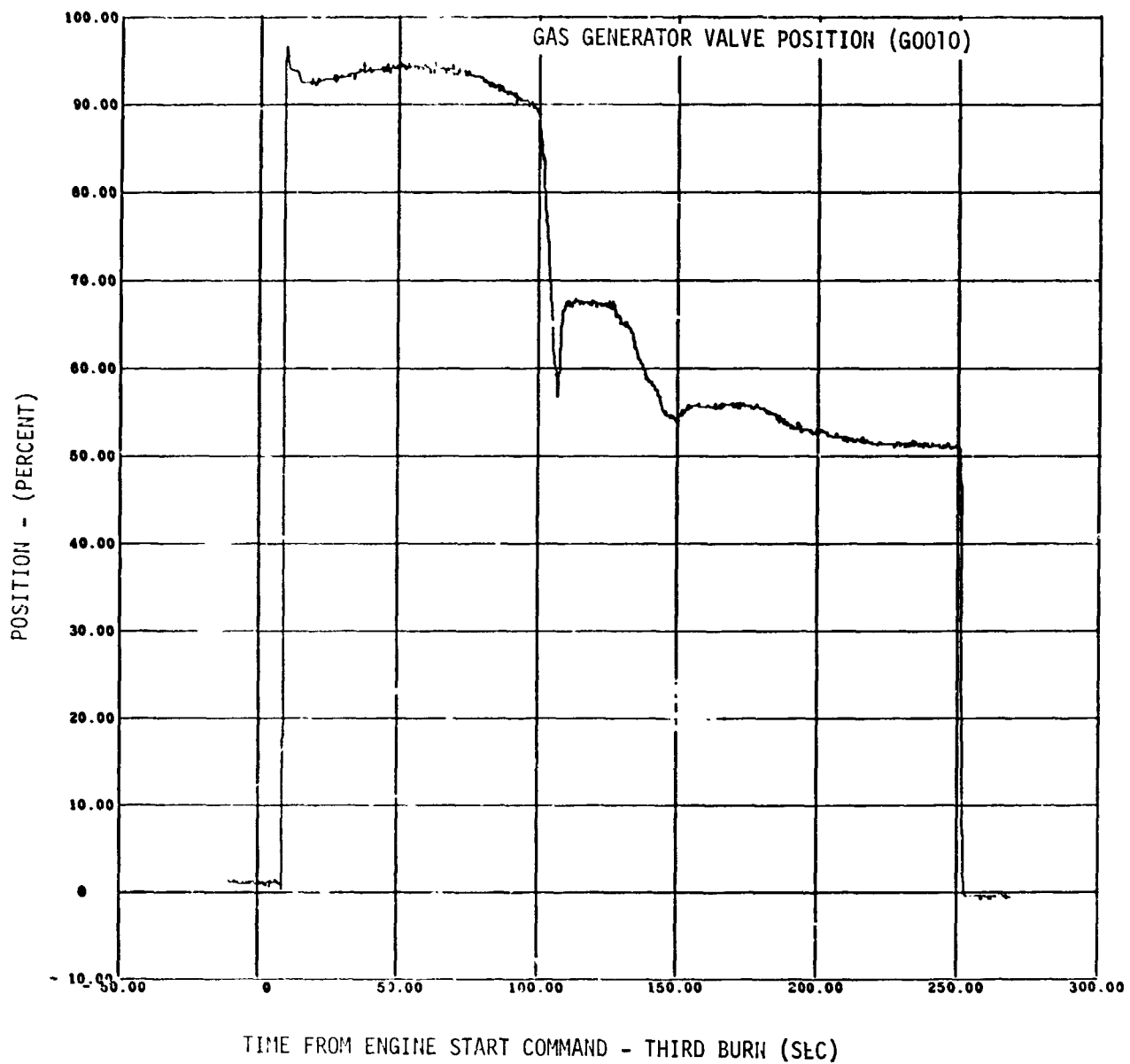

Figure 9-43. Third Burn Anomaly Data - GG Valve Position



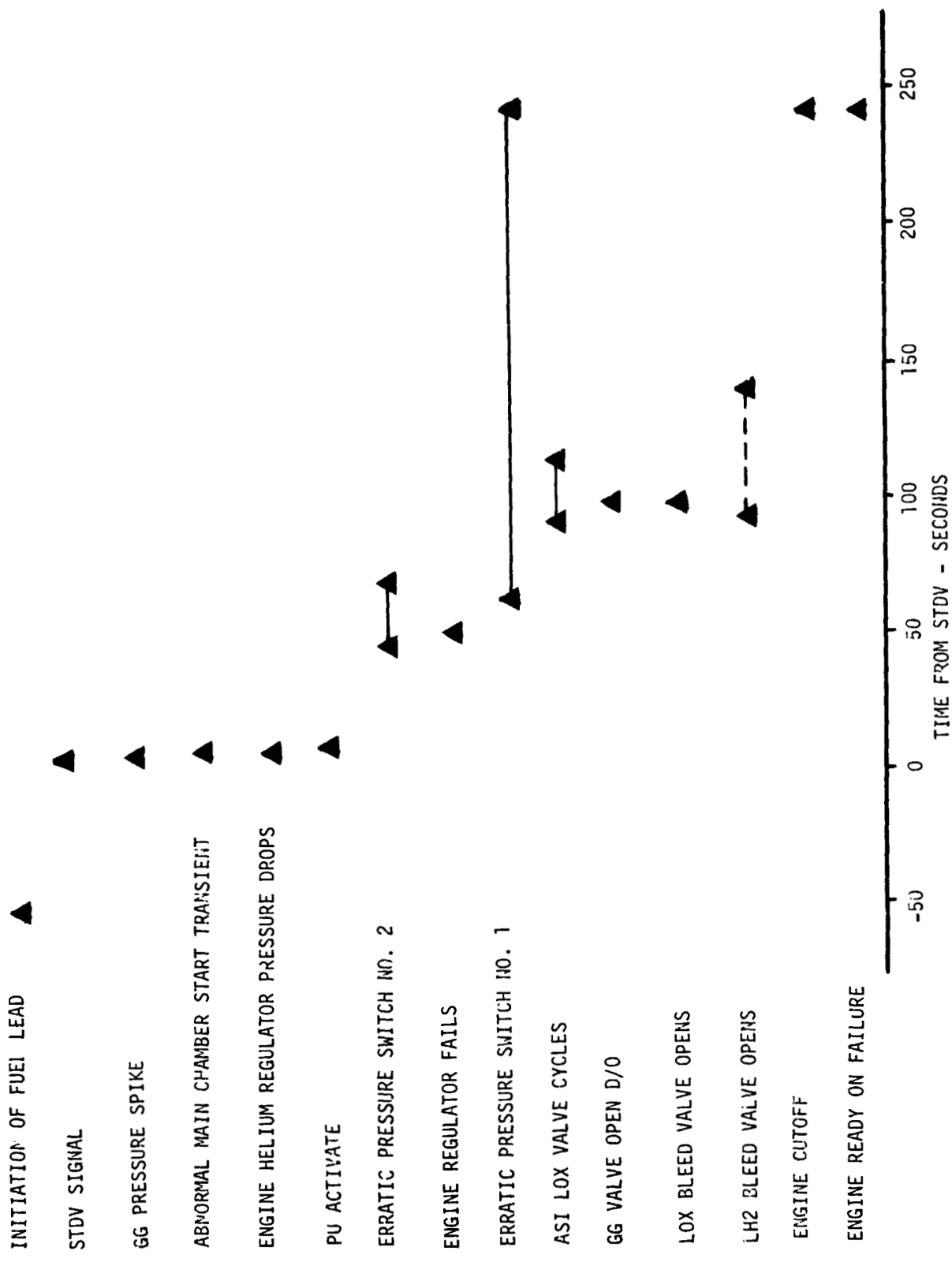

Figure 9-44. S-IVB-504 Third Burn Sequence of Events (Sheet 1 of 2)

GROUND ELAPSED TIME		21,987.345		22,027.345		22,047.345		22,067.345		22,087.345		22,107.345		22,127.345		22,147.345		22,167.345																			
TIME FROM ESC		0		40		50		60		70		80		90		100		110		120		130		140		150		160		170		180					
TIME FROM STDV		0		10		20		30		40		50		60		70		80		90		100		110		120		130		140		150		160			
<b>LOX FEED SYSTEM</b>		△ P SLIGHTLY HIGH COMPARED TO 2ND BURN △ T SLIGHTLY HIGH COMPARED TO 2ND BURN						▲ STDV + 30 LOX PUMP DISCHARGE PRESS INCREASES 13 PSI DUE TO UNKNOWN PERFORMANCE SHIFT				STDV + 92 LOX PUMP DISCHARGE PRESS BEGINS TO DECREASE DUE TO LH2 BLEED VALVE CRACKING OPEN																									
<b>LOX PUMP</b>																																					
<b>HIGH PRESS LINE (PUMP OUT TO INJ)</b>																																					
<b>LOX INJECTOR</b>																																					
<b>LH2 FEED SYSTEM</b>				▲ ESC(U) LH2 PUMP DISCHARGE PRESS BEGINS GRAD DELAY OF 15 PSI TO STDV + 92										STDV + 92 LH2 PUMP DISCHARGE PRESS BEGINS TO DECREASE DUE TO LH2 BLEED VALVE CRACKING OPEN																							
<b>LH2 PUMP</b>		△ P SLIGHTLY LOW COMPARED TO 2ND BURN △ T SLIGHTLY LOW COMPARED TO 2ND BURN																																			
<b>HIGH PRESS LINE (PUMP OUT TO INJ)</b>																																					
<b>LH2 TUBES</b>																																					
<b>FUEL INJECTOR</b>				ESC + 14 INJ △ P A MINIMUM OF 20 PSI HIGH THROUGHOUT BURN PROB DUE TO COMBUSTION INSTABILITY																																	
<b>THRUST CHAMBER</b>		SLOWER THAN NORMAL COOLING TREND		CO199 THRUST CHAMBER SKIN TEMP SHOWS LARGE RISE INSTEAD OF NORMAL CONTINUED COOLING DATA SEEMS GOOD 1ST POSSIBLE CAUSE - SPLIT TUBE CAUSES REDUCTION IN COOLING IN SKIN PATCH AREA ABOVE THE BREAK 2ND POSSIBLE CAUSE INSTRUMENTATION FAILURE SUCH AS SKIN PATCH CONNECTIONING LOOSE 3RD POSSIBLE CAUSE OVER TEMP DUE TO COMBUSTION INSTABILITY ▲ STDV + 7. THRUSTR CHAMBER SKIN TEMP LEVEL OFF																																	
<b>GG SYSTEM</b>																																					
<b>LOX FEED (INJ) (LOX BLEED VALVE)</b>																																					
<b>FUEL FEED (INJ) (FUEL BLEED VALVE)</b>																																					
<b>GG CHAMBER</b>																																					
<b>FUEL TURBINE</b>																																					
<b>LOX TURBINE</b>																																					
<b>TURBINE DUCTING (HEAT EXCHANGER)</b>		30° HOTTER THAN 2ND BURN		ESC(U) C2015 & C2016 CROSSOVER DUCT TEMPS HIGHER TEMP DUE TO SHORTER COAST TIME																																	
<b>PNEUMATIC SYSTEM</b>																																					
<b>ENVIRONMENT</b>																																					
<b>ELECTRICAL</b>																																					

FOLDOUT FRAME

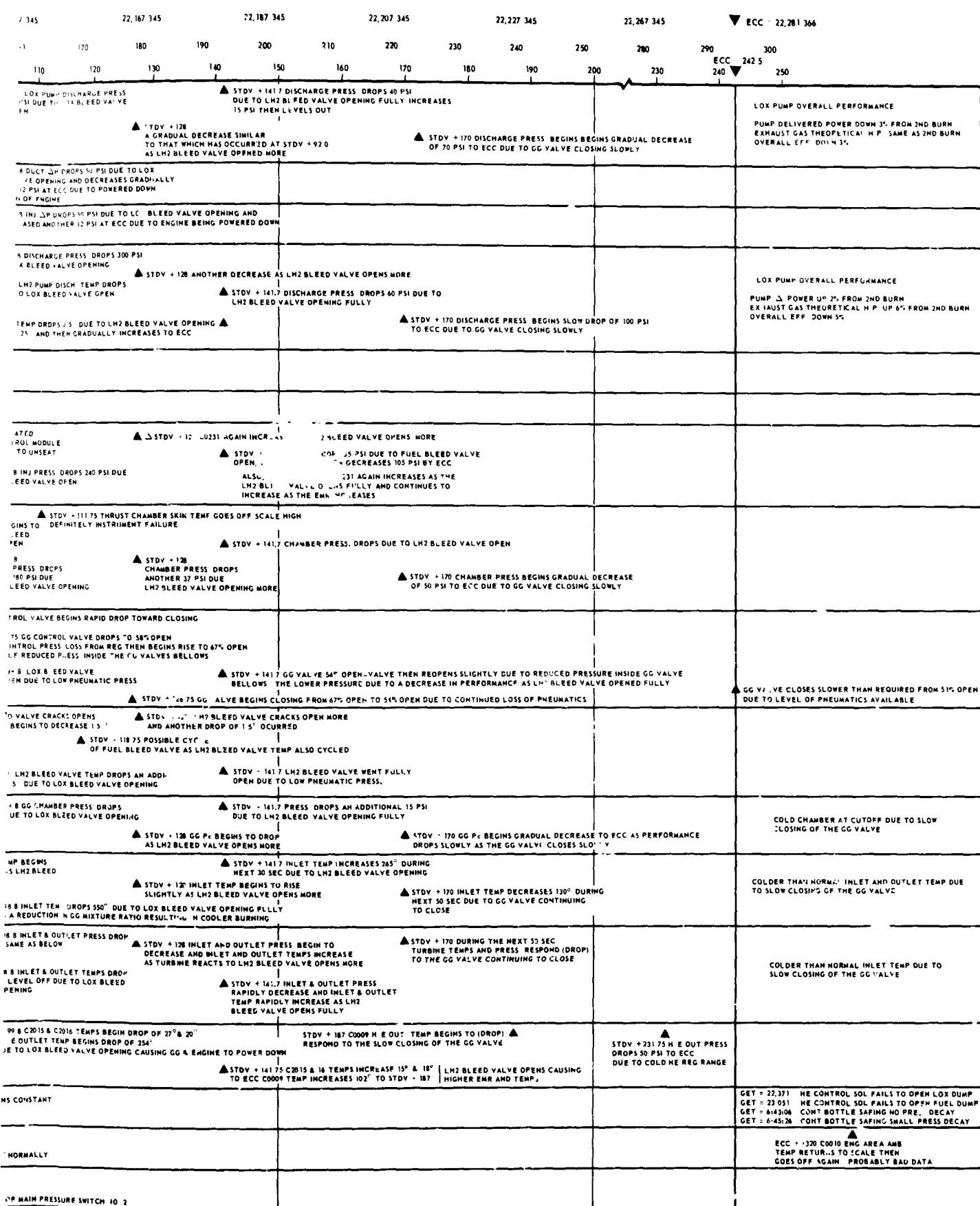

Figure 9-44 S-IVB Sequence Of Events (Sheet 2 Of 2)

FOLDOUT FRAME 2

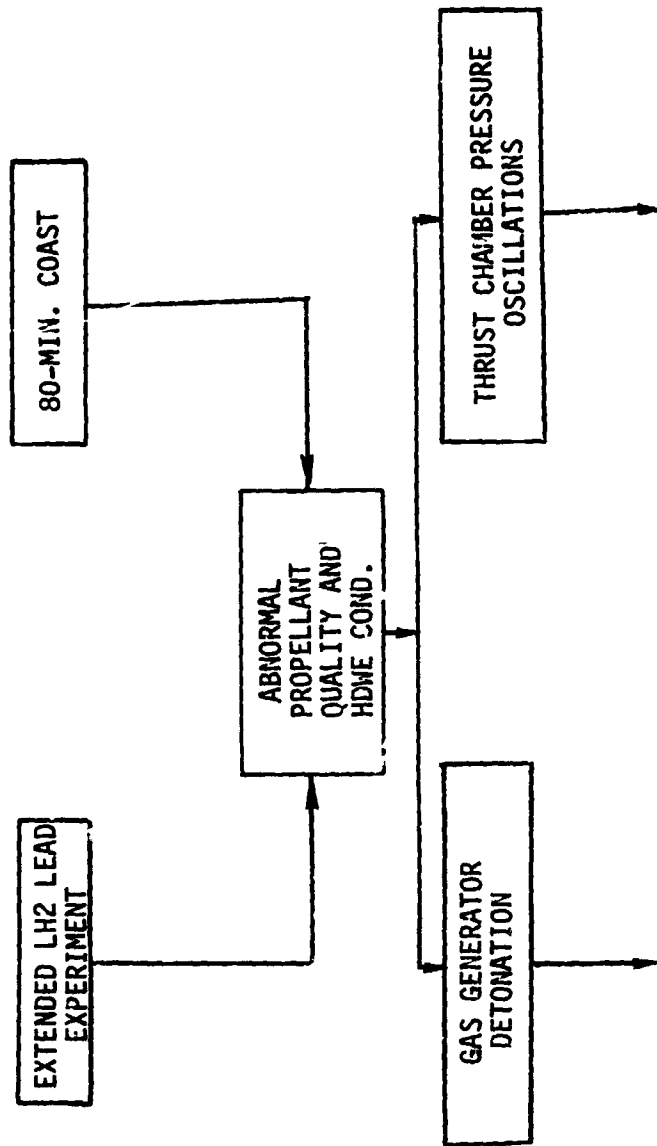

Figure 9-45. S-IVB-504 Third Burn Anomaly Summary (Sheet 1 of 3)

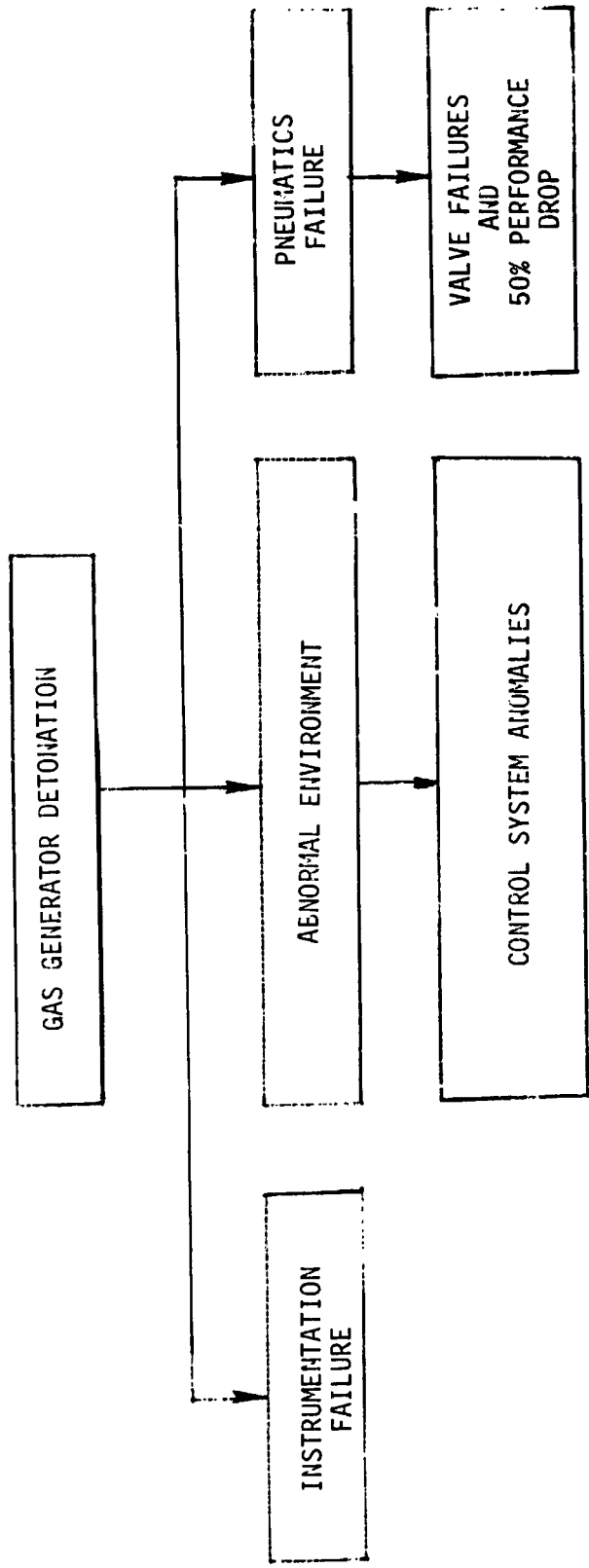

Figure 9-45. S-IVB-504 Third Burn Anomaly Summary (Sheet 2 of 3)

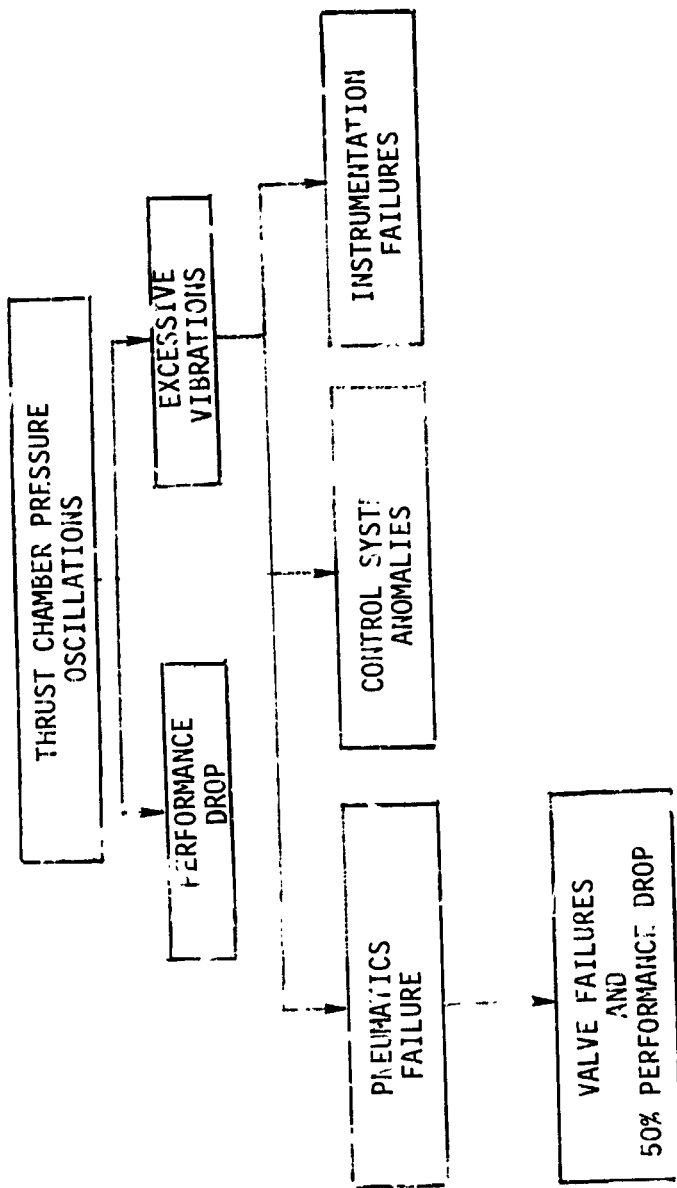

Figure 9-45. S-IVB-504 Third Burn Anomaly Summary (Sheet 3 of 3)

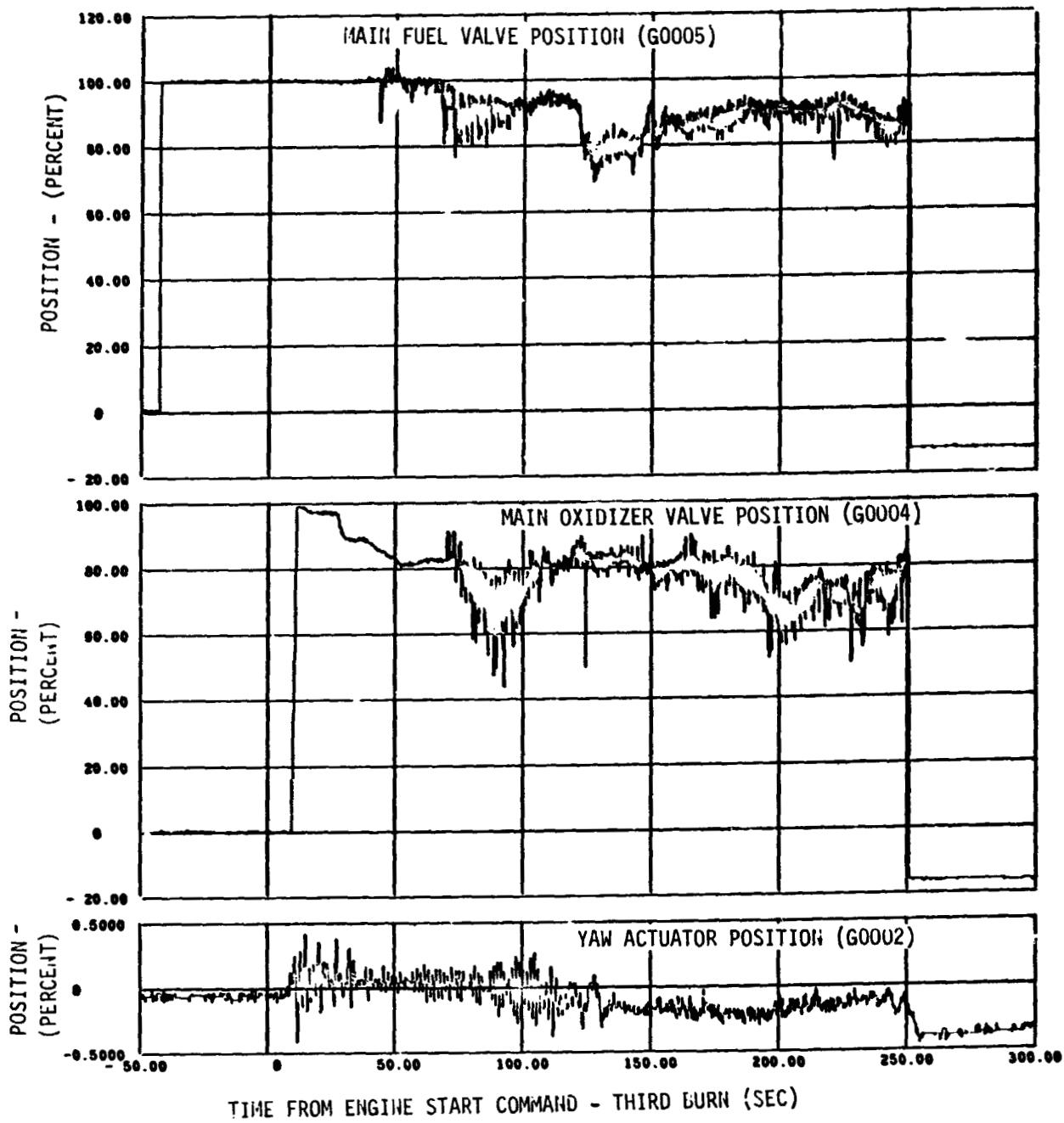

Figure 9-46. Third Burn Anomaly Data - Valve Positions

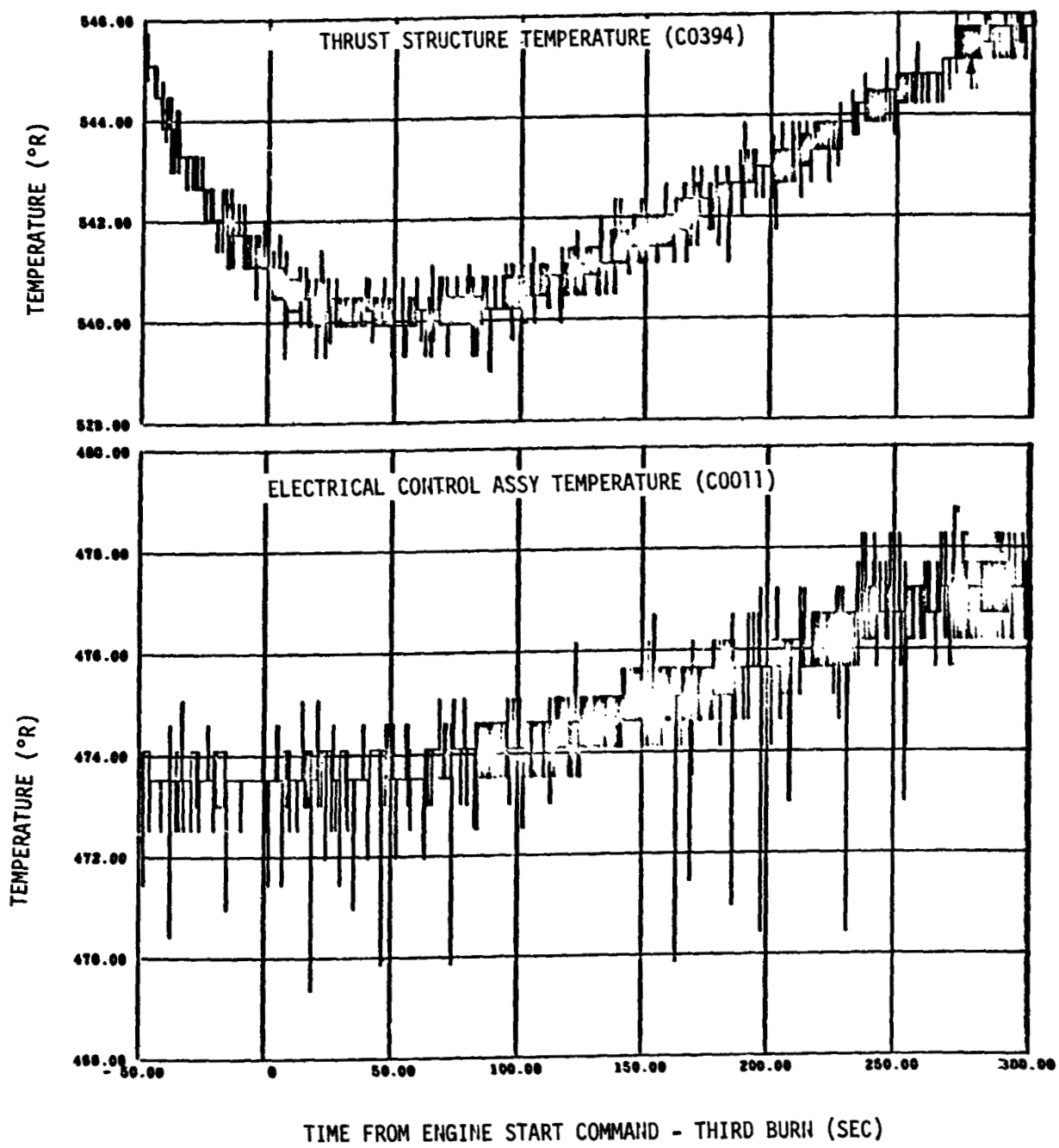

Figure 9-47. Third Burn Anomaly Data - Thrust Structures and ECA Temperatures



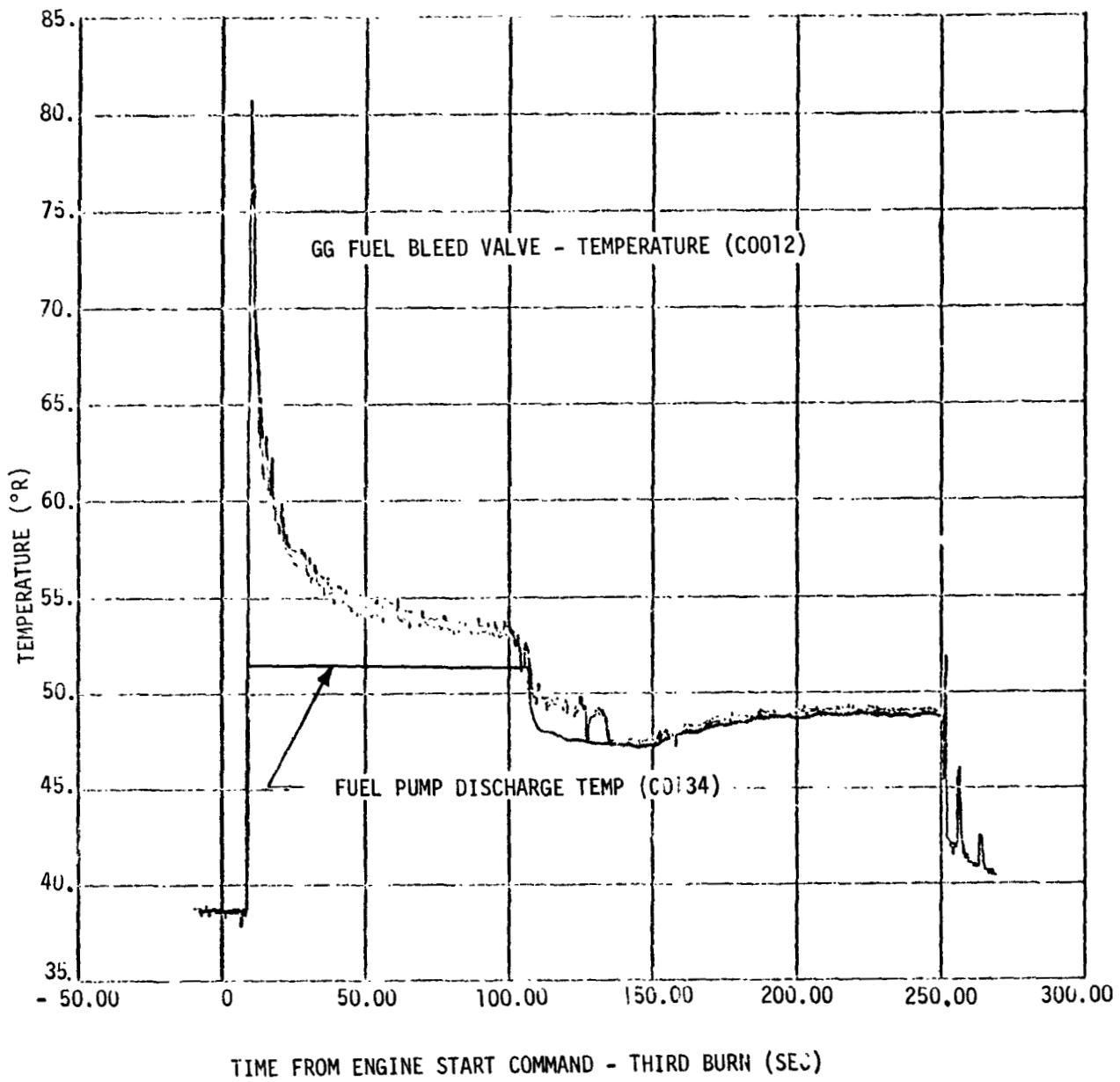

Figure 9-48. Third burn Anomaly Data - GG Fuel Bleed Valve Temperature

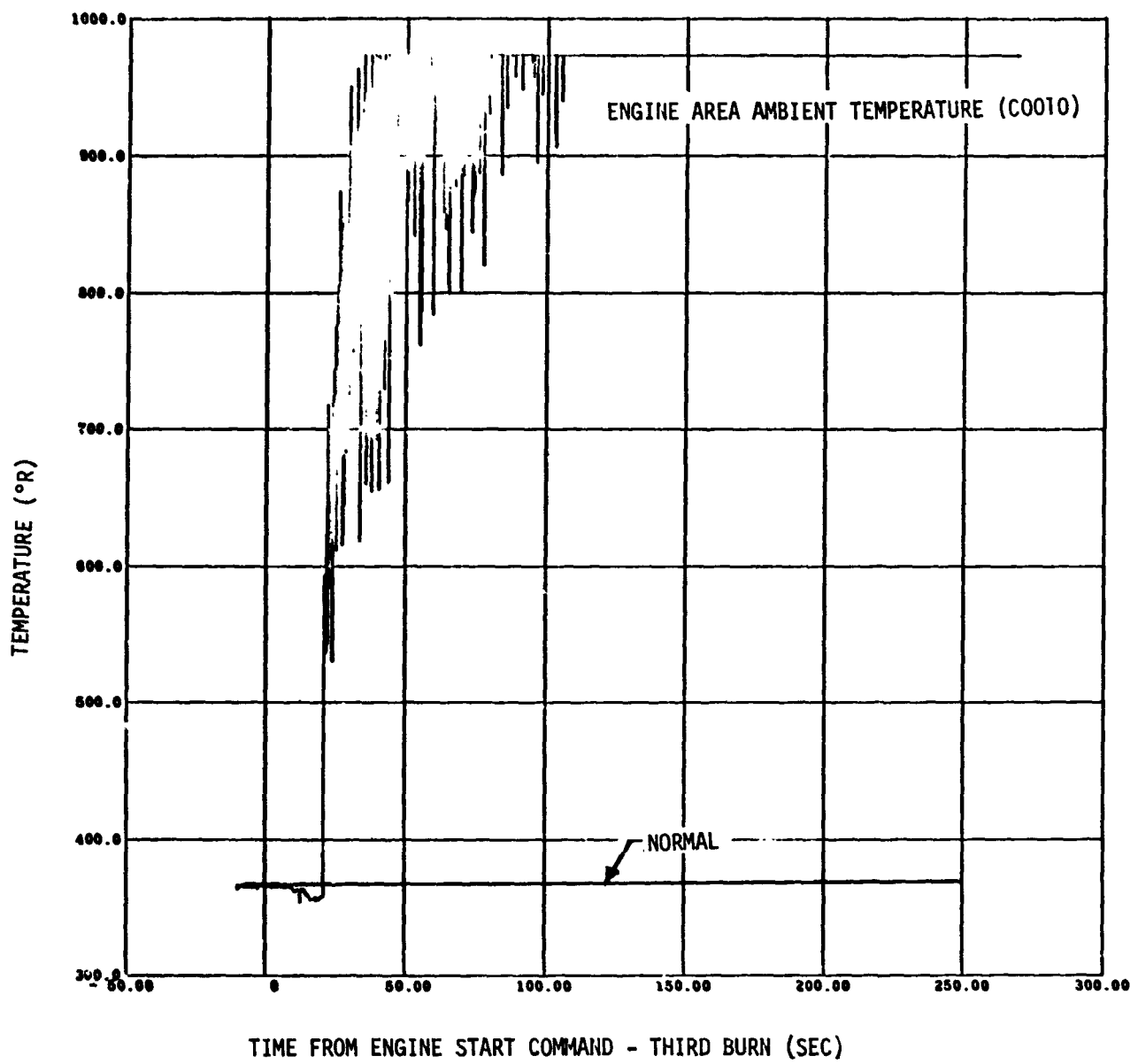

Figure 9-49. Third Burn Anomaly Data - Engine Area Ambient Temperature

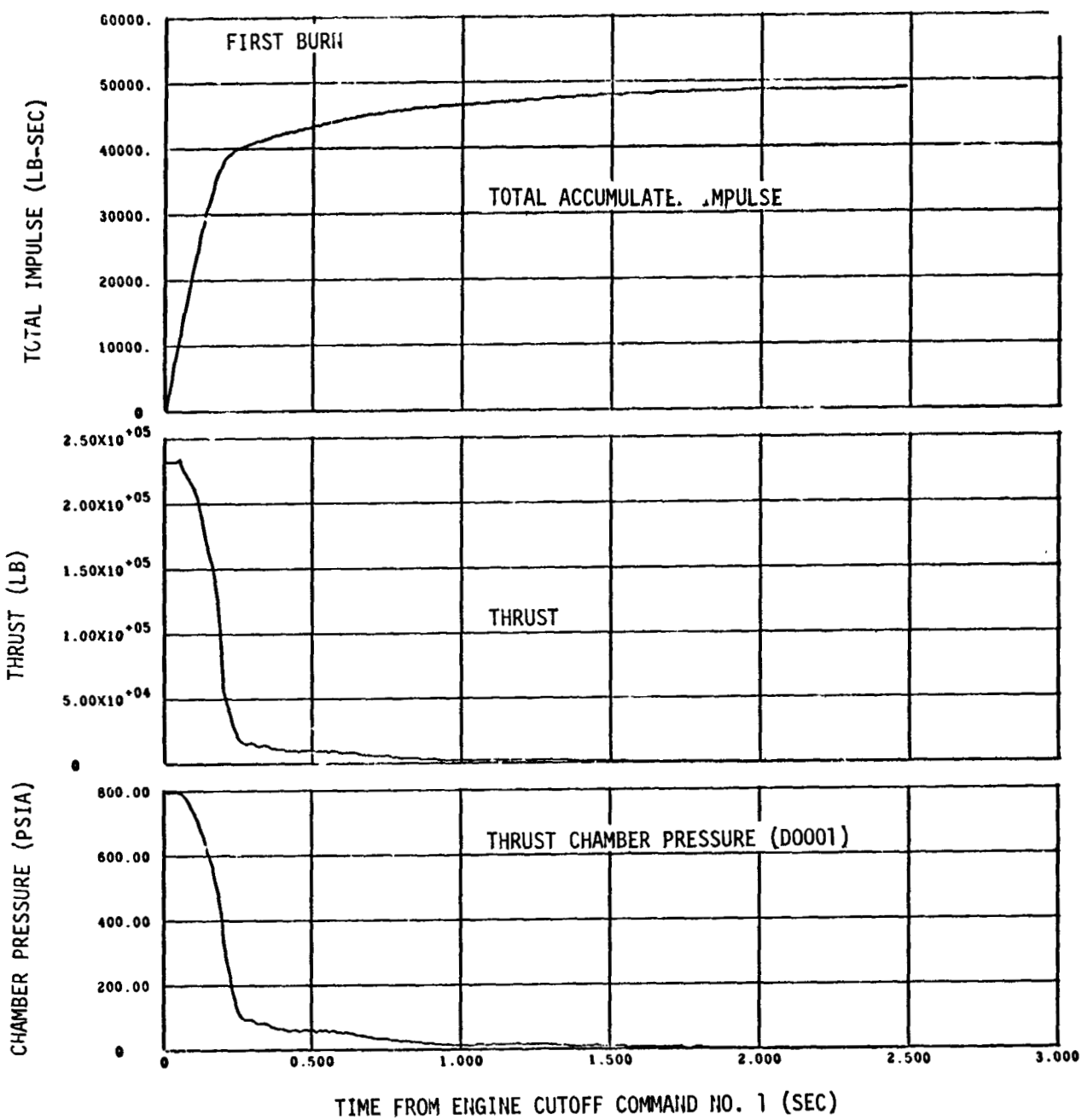

Figure 9-50. Engine Cutoff Transient Characteristics (Sheet 1 of 3)

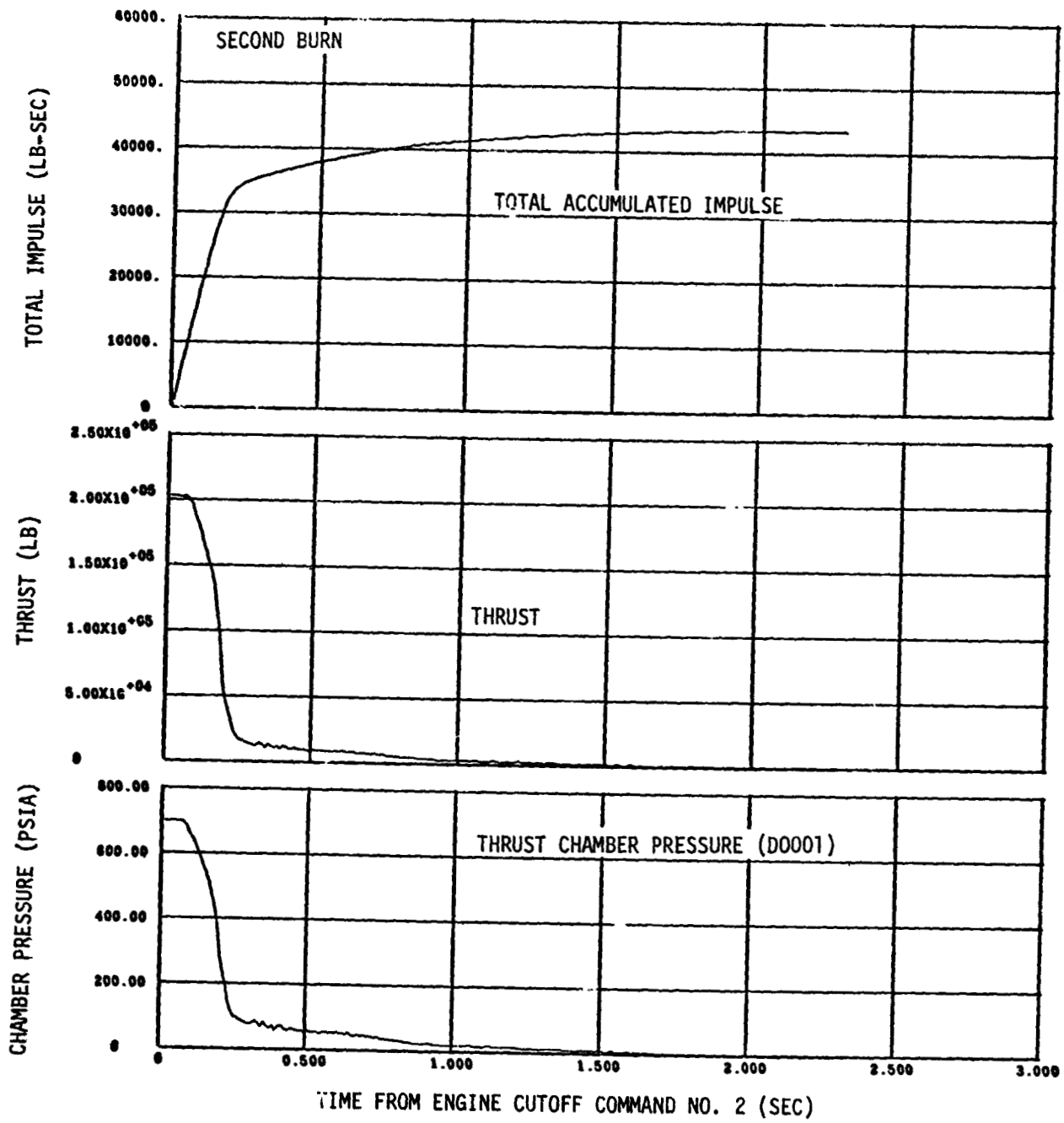

Figure 9-50. Engine Cutoff Transient Characteristics (Sheet 2 of 3)

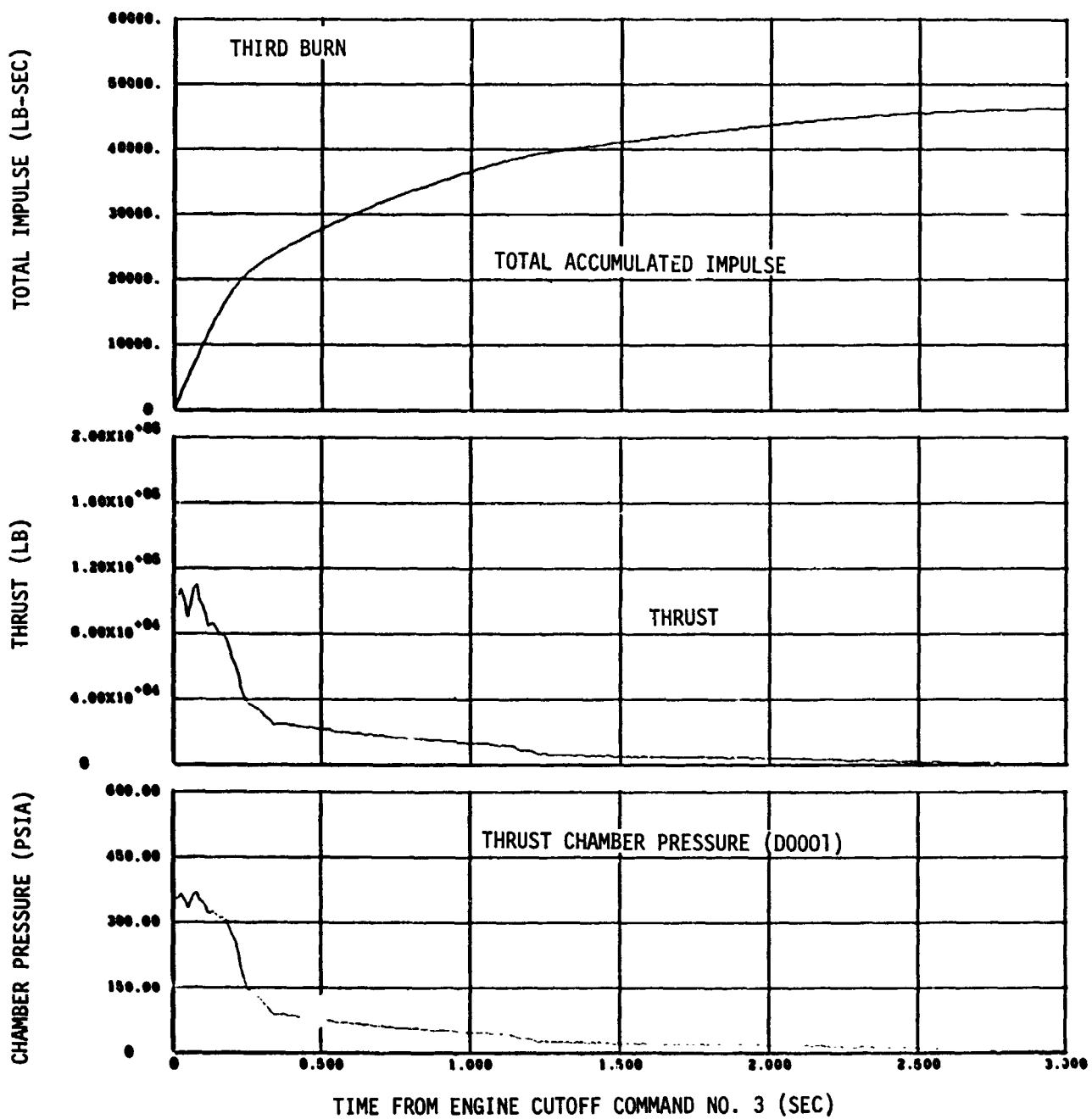

Figure 9-50. Engine Cutoff Transient Characteristics (Sheet 3 of 3)

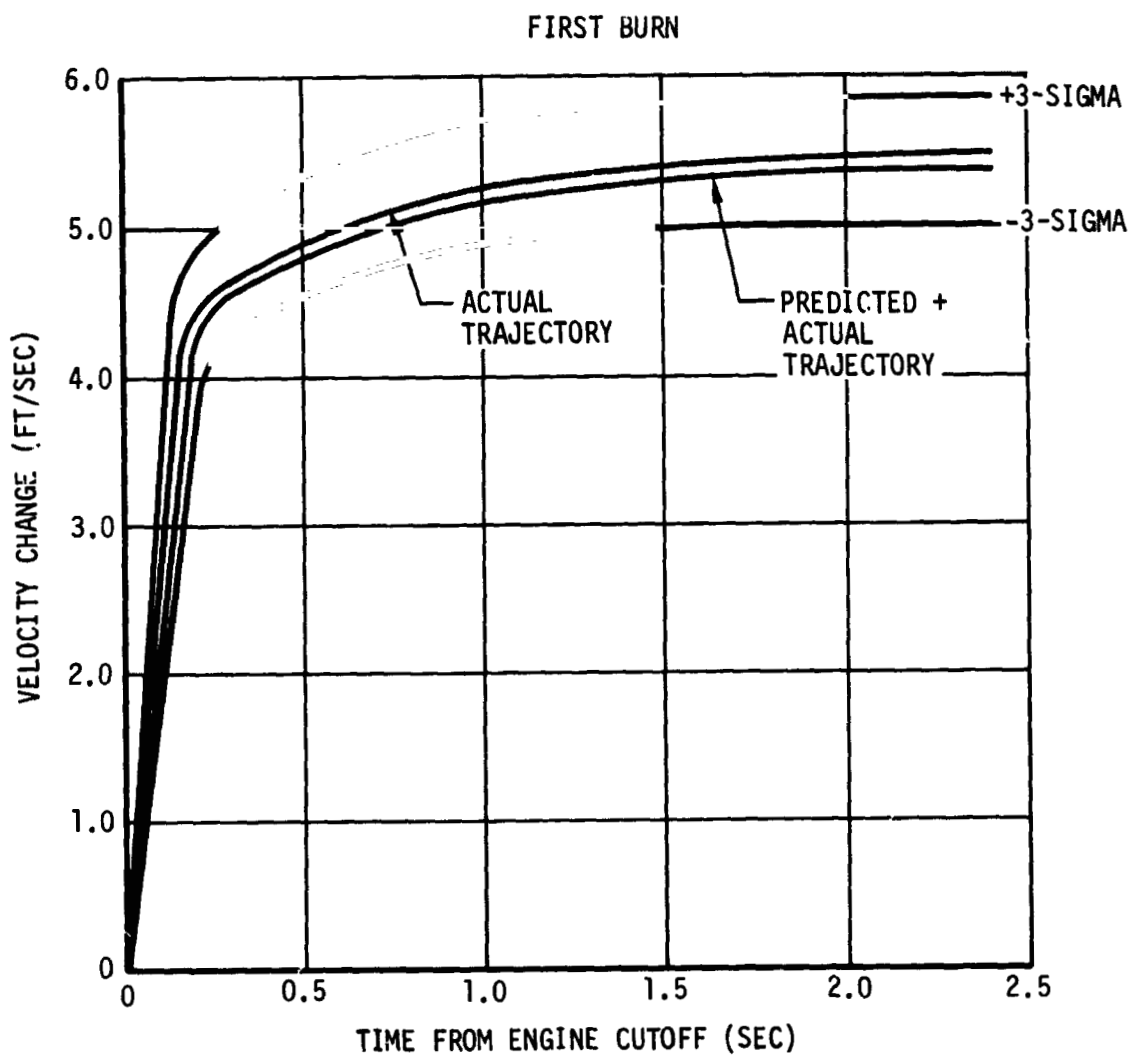

Figure 9-51. AS-504 S-IVB Change in Velocity Due to Cutoff Impulse (Sheet 1 of 3)

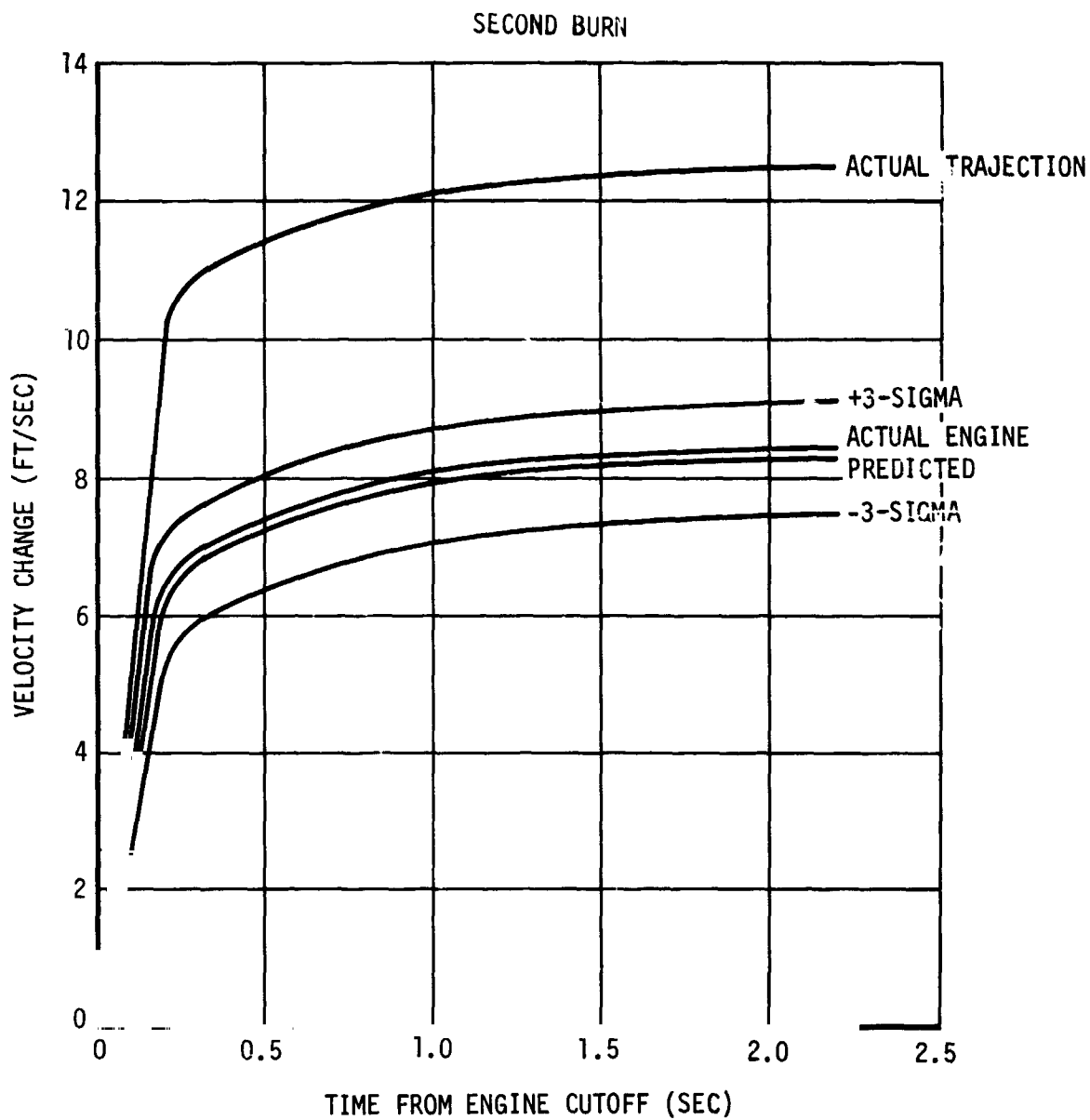

Figure 9-51. AS-504 S-IVB Change in Velocity Due to Cutoff Impulse (Sheet 2 of 3)

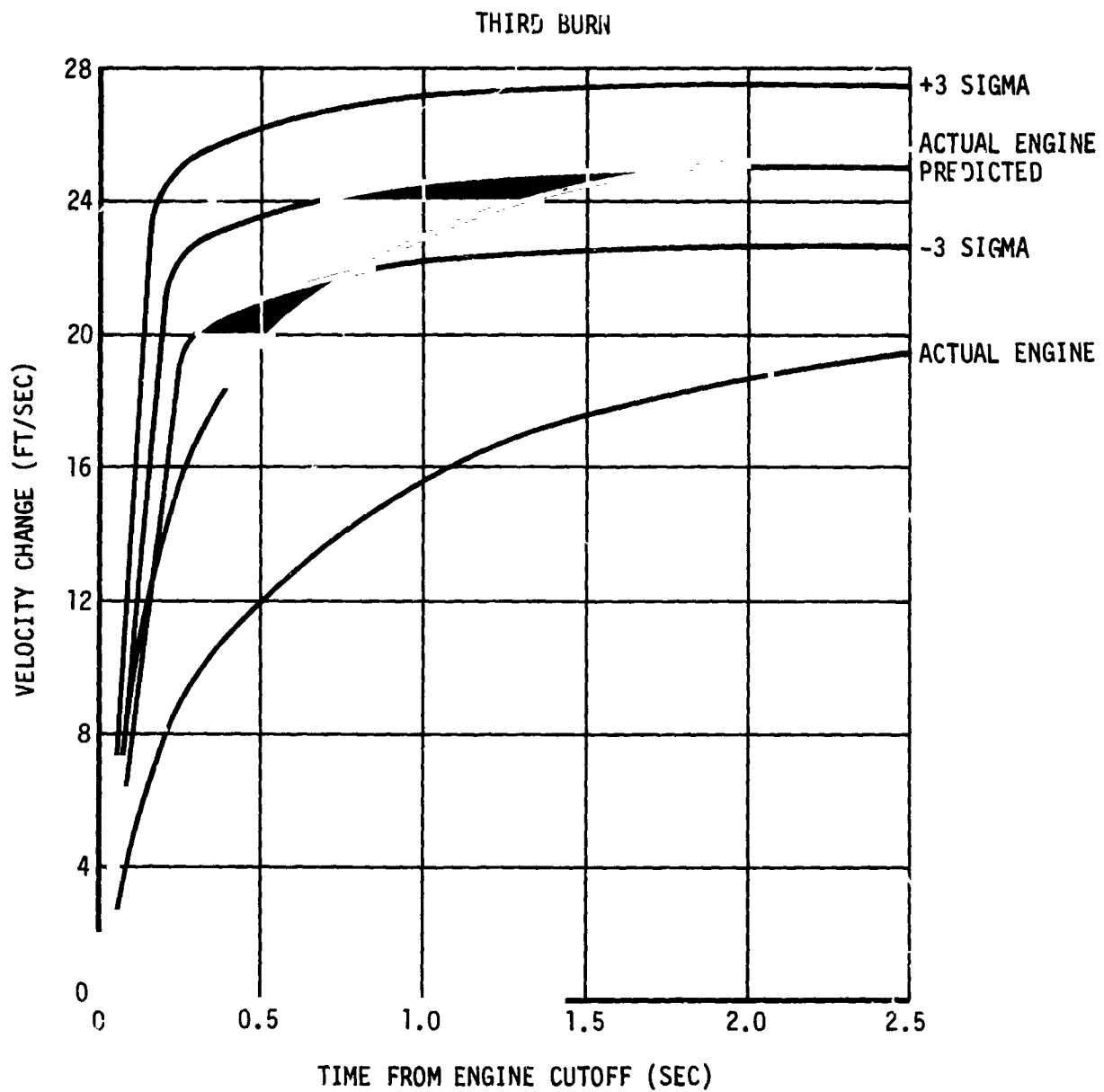

Figure 9-51. AS-504 S-IVB Change in Velocity Due to Cutoff Impulse (Sheet 3 of 3)



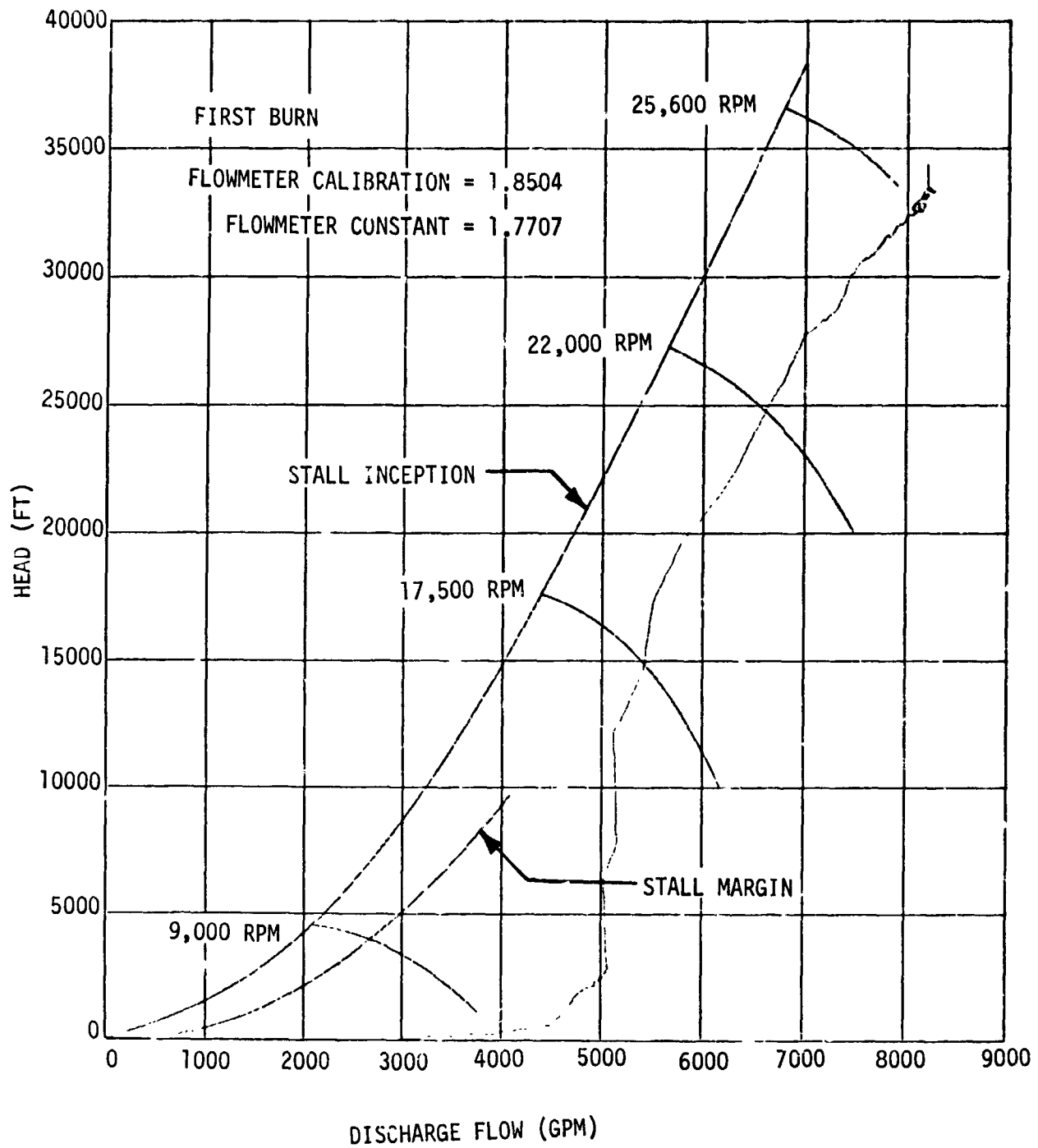

Figure 9-52. LH2 Pump Performance During Engine Start (Sheet 1 of 3)

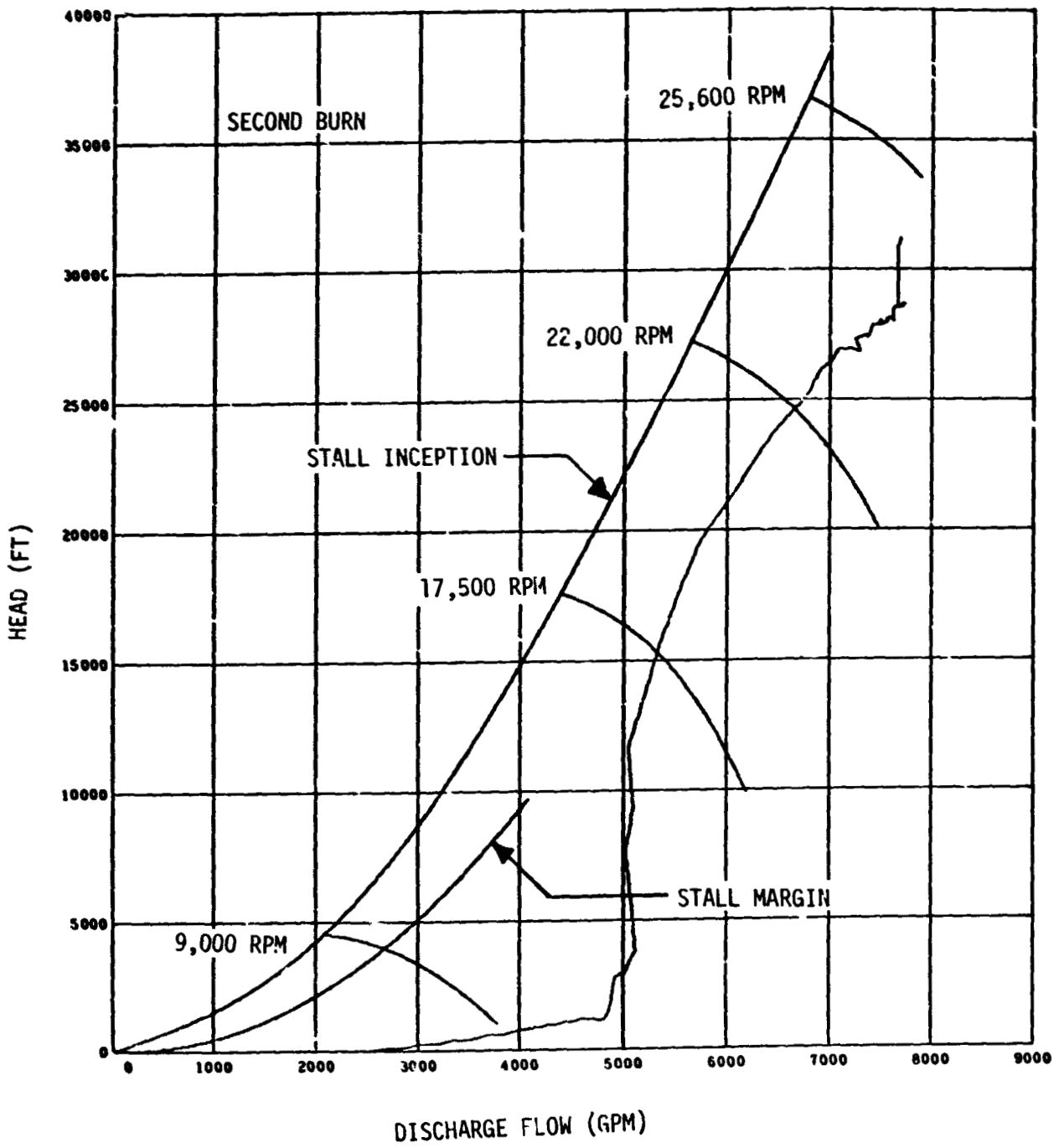

Figure 9-52. LH2 Pump Performance During Engine Start (Sheet 2 of 3)

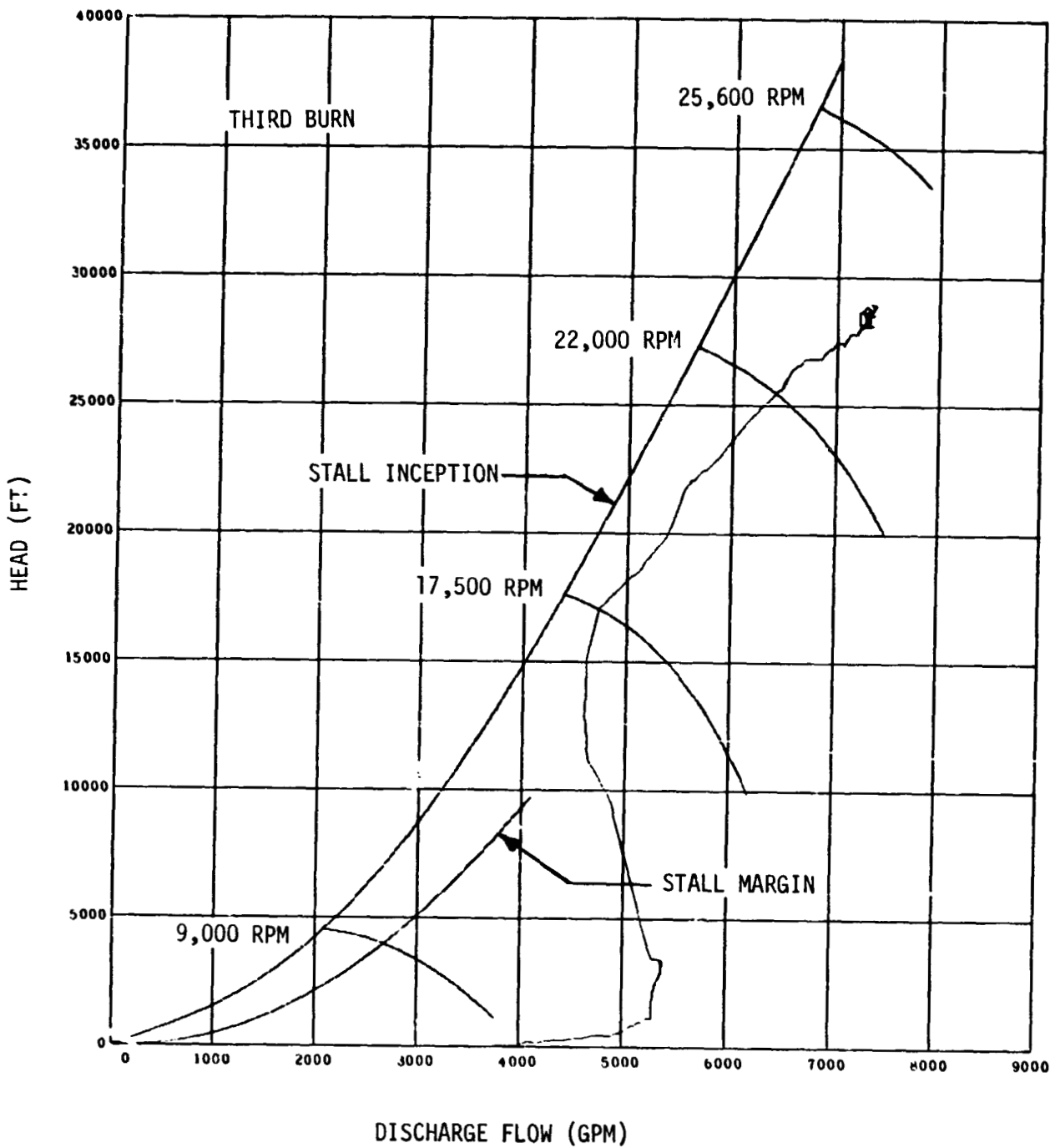

Figure 9-52. LH2 Pump Performance During Engine Start (Sheet 3 of 3)

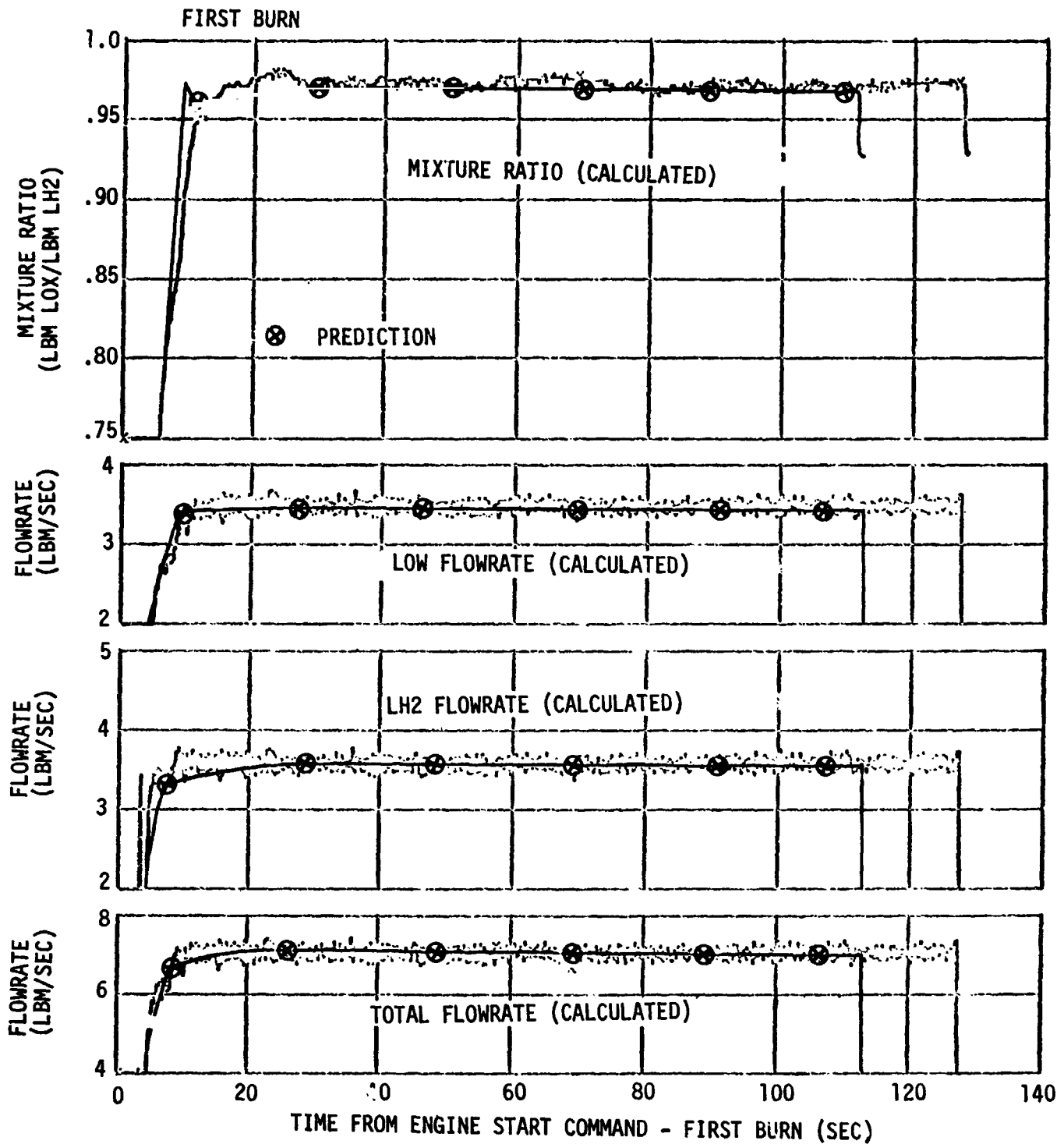

Figure 9-53. Gas Generator Performance (Sheet 1 of 3)

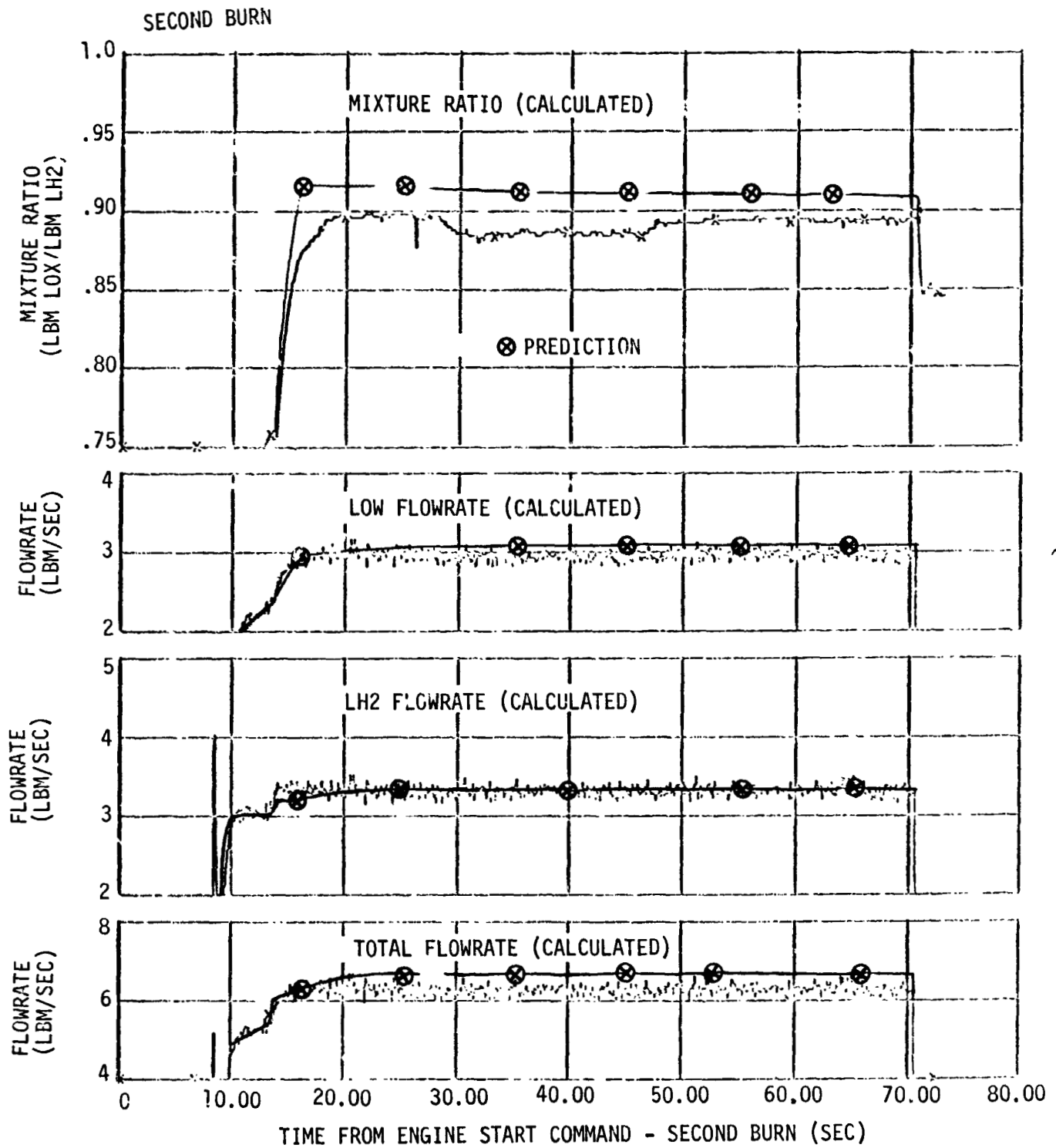

Figure 9-53. Gas Generator Performance - Second Burn (Sheet 2 of 3)

THIRD BURN

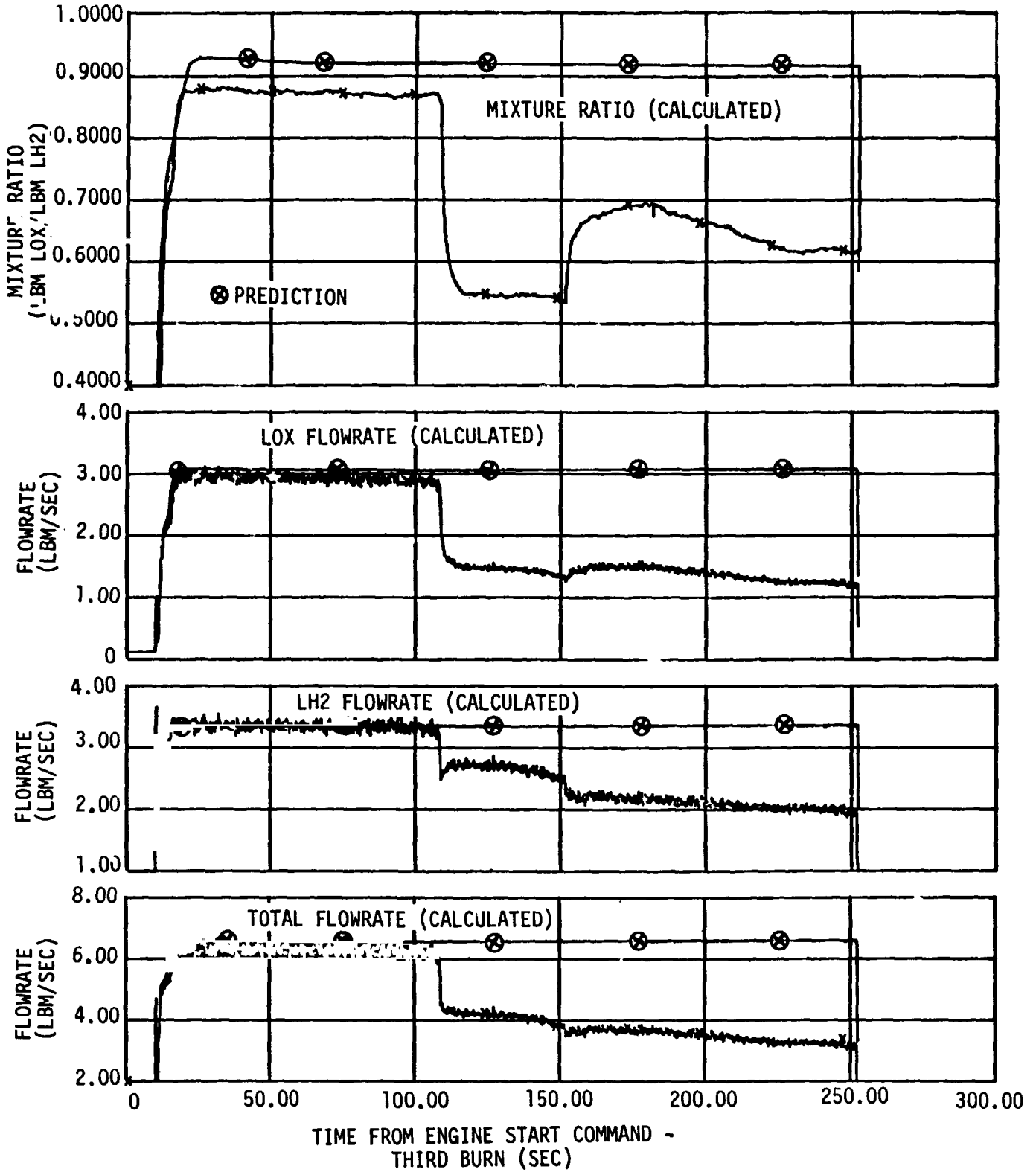

Figure 9-53. Gas Generator Performance (Sheet 3 of 3)

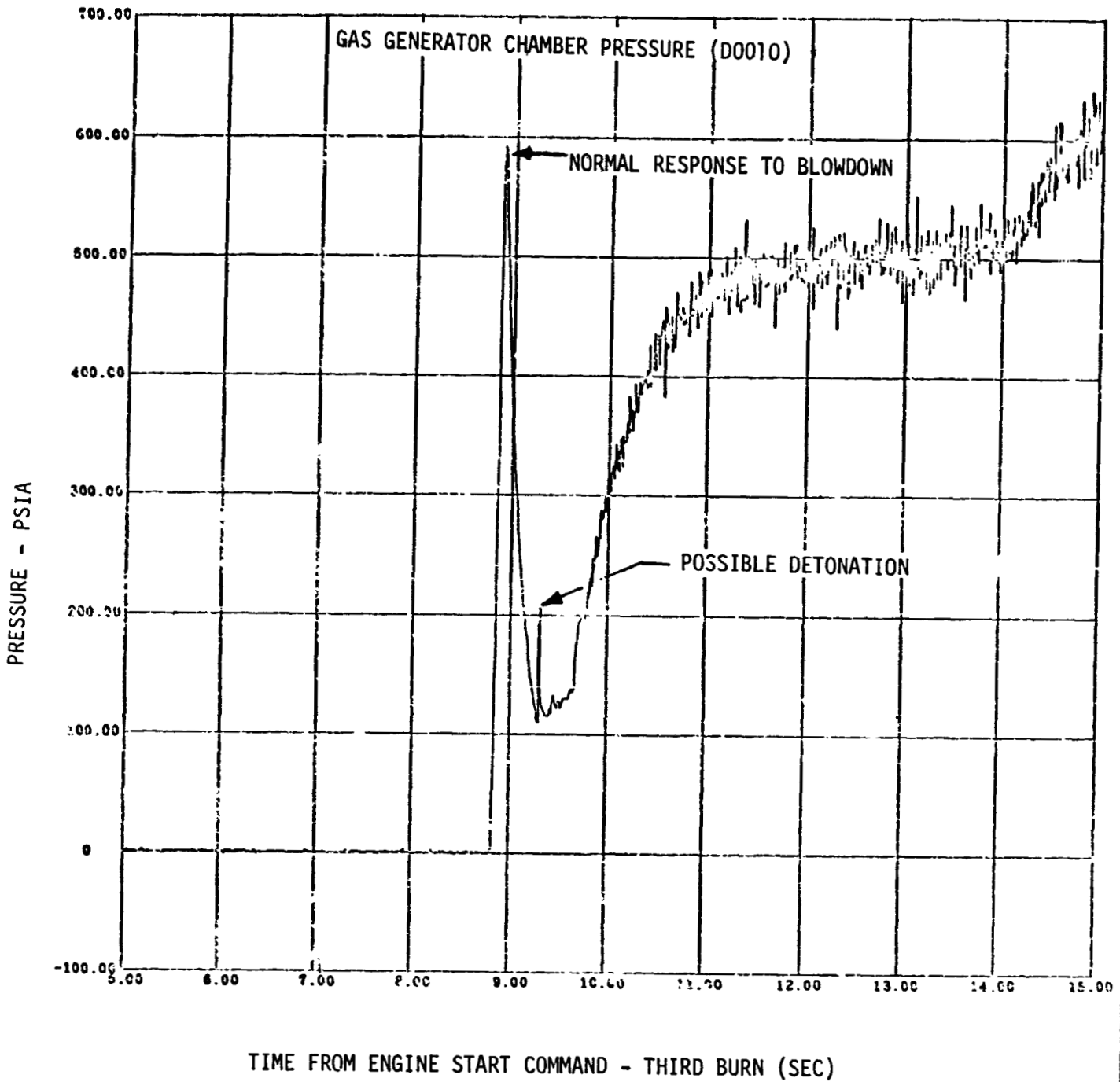

Figure 9-54. Gas Generator Chamber Pressure - Third Burn

## 10. SOLID ROCKETS

The solid rocket motors on the S-II and S-IVB stages performed satisfactorily. The S-II was separated from the S-IVB stage by the retrorockets, and the S-IVB propellants were settled prior to engine ignition by the ullage rockets.

### 10.1 Retrorockets

The four retrorocket motors on the S-II stage performed satisfactorily and separated the S-II stage from the S-IVB stage. The retrorockets were initiated at RO +537.10 seconds.

### 10.2 Ullage Rockets

Ullage rocket performance was satisfactory. The ullage rocket ignition command was given at RO +537.072 seconds with the jettison command at RO +549.004 seconds. These times were within 0.139 and 0.039 seconds respectively of predicted times relative to engine start command. No instrumentation existed to measure the chamber pressure of the ullage rockets.



## 11. CXIDIZER SYSTEM

The oxidizer system performed adequately, supplying LOX to the engine pump inlet within the specified operating limits throughout J-2 engine operation. The available NPSP at the LOX pump inlet exceeded the engine manufacturer's minimum requirement at all times.

### 11.1 LOX Tank Pressurization Control

The LOX tank pressurization system (figure 11-1) satisfactorily maintained pressure in the LOX tank during all periods of the flight. The LOX tank pressurization control module regulator performed as expected. The LOX tank pressurization system operated normally during first, second, and third burns. A reduced LOX usage rate during third burn (caused by engine anomalies) caused the LOX ullage pressure to increase to the relief setting.

As predicted, four overcontrol cycles were required for first burn pressurization. None was required during second burn, compared to one predicted. No overcontrol cycles were required for third burn, as predicted.

LOX tank repressurization was not required during either restart preparation period. Due to the third burn engine anomaly, no propellant dump occurred; however, the LOX tank was adequately safed by latching open the LOX NPV valves.

#### 11.1.1 First Burn

##### 11.1.1.1 Prepressurization and Boost

The LOX tank was satisfactorily prepressurized within 22 sec (figure 11-2). Three makeup cycles were required to maintain the LOX tank ullage pressure above the lower pressure switch setting before

The ullage temperature stabilized. Table 11-1 compares prepressurization data of the 502 and 503N flights with that of the 504N flight. S-IVB-504N required a longer prepressurization period than 502 and 503N because the ullage volume was larger. The ullage pressure increased from 38.7 psia at T-96 sec to 41.0 psia at liftoff due to stage geometric change during LH<sub>2</sub> tank prepressurization and to the LOX vent valve and LOX pressure sense line purges.

The LOX ullage pressure decreased during S-IC and S-II boost because of the stage geometric change caused by axial acceleration and because of ullage collapse. The average decay rate was 1.1 and 0.18 psia/min during S-IC and S-II boosts, respectively. At S-IC and S-II cutoffs, the abrupt termination of acceleration caused sharp pressure increases.

A modified pressurization sequence which inhibits makeup cycles during boost was utilized for the first time on 504N. The sequence eliminates the possibility of cold helium depletion prior to first burn which could be caused by a shutoff valve failing open during a boost makeup cycle. The minimum ullage pressure during boost was 38.0 psia. When the inhibit was removed at RO +495 sec, a makeup cycle occurred which increased the ullage pressure from 38.0 to 41.0 psia.

#### 11.1.1.2 Pressurization--First Burn

The LOX tank ullage pressure was 40.8 psia at first engine start command, satisfying the engine start requirements, and was sufficient throughout S-IVB powered flight to meet the minimum NPSP requirements. The ullage pressure, pressurant flowrate, and related pressurization system parameters are shown in figure 11-3. Table 11-2 compares the pressurization system performance of 504N flight to that of 502 and 503N flights.

The ullage pressure dip during the start transient was eliminated, as it was on 503N flight, by employing a 3.5-sec cold helium lead and a programmed overcontrol cycle until  $ESC_1 + 23$  sec. The resulting high initial helium flowrate caused the LOX nonpropulsive vent (NPV) and relief valve to crack twice while holding the ullage pressure at 42.0 psia. No pressure dip occurred. As predicted, four additional overcontrol cycles were required during first burn. The pressurization sequence permits helium flow to continue for 1.4 sec after first engine cutoff command, with the heat exchanger bypass valve programmed open at  $ECC_1 + 1.2$  sec. The helium added to the LOX tank after first engine cutoff increased the ullage pressure from 39.8 to 40.9 psia.

#### 11.1.1.3 Cold Helium Supply--First Burn

The cold helium supply was adequate to meet boost and first burn requirements. Due to a preprogrammed inhibit there was only one makeup cycle, just prior to engine start, using approximately 0.4 lbm of cold helium. Mass calculations based upon sphere temperature and pressure during burn were comparable to the results obtained from flow integration. The cold helium supply system data are presented in table 11-3 and figure 11-4.

#### 11.1.1.4 J-2 Heat Exchanger--First Burn

The J-2 heat exchanger performance data are presented in figure 11-5 and compared to 502 and 503N flight data in table 11-4. A spike was observed in the heat exchanger helium flowrate at  $ECC_1 + 1.2$  sec when the heat exchanger bypass valve was programmed open. The spike, a result of increasing the controlling flow area, is normal for the pressurization sequenced used and has been observed on previous flights.

## 11.1.2 Second Burn

### 11.1.2.1 Repressurization

LOX tank repressurization was not required because the LOX tank ullage pressure was above the lower pressure switch setting. The ullage pressure was 42.3 psia at second engine start command.

### 11.1.2.2 Pressurization--Second Burn

The LOX tank pressurization system performed satisfactorily during second burn. The ullage pressure was sufficient to meet minimum NPSP requirements throughout the burn. The ullage pressure and related pressurization system data are shown in figure 11-6. The system performance for 504N flight is compared to that of 502 and 503N flights in table 11-2.

Due to the high ullage pressure at second engine start command (paragraph 11.2.1), no overcontrol cycles were required during second burn. One overcontrol cycle was predicted because the high initial ullage pressure was not anticipated. As on first burn, a sharp increase in helium flow occurred when the heat exchanger bypass valve was opened at  $ECC_2 + 1.2$  sec; the ullage pressure increased from 40.6 to 41.2 psia before the cold helium flow was terminated.

### 11.1.2.3 Cold Helium Supply--Second Burn

The cold helium supply was adequate to meet second burn requirements. Mass calculations based upon sphere temperature and pressure during burn were comparable to the results obtained from flow integration. The cold helium supply system data are presented in table 11-3 and figure 11-7.

### 11.1.2.4 J-2 Heat Exchanger--Second Burn

The J-2 heat exchanger performed satisfactorily during second burn. The performance data are presented in figure 11-8 and compared to 502 and

503N flight data in table 11-4. As on first burn, a spike in the heat exchanger helium flowrate occurred during the cutoff sequence because the heat exchanger bypass valve was programmed open before the cold helium flow was terminated. This spike, verified by pressure and temperature increases at the LOX vent inlet, is normal.

### 11.1.3 Third Burn

#### 11.1.3.1 Repressurization

LOX tank repressurization was not required because the LOX tank ullage pressure never dropped below the lower pressure switch setting during the coast period preceding third burn.

#### 11.1.3.2 Pressurization - Third Burn

At third engine start command, the LOX tank ullage pressure was 41.5 psia. Because there was no LOX chilldown, the LOX pump inlet temperature was off scale high at STDV. Approximately 5 sec after start tank discharge valve (STDV) command, the NPSP requirements were met and remained sufficiently high to meet minimum NPSP requirements throughout third burn.

Pressurization system performance was satisfactory during third burn and, as predicted, no overcontrol cycles occurred; however, the pressurization system responded to engine anomalies which affected the otherwise normal operation. When the engine LOX bleed valve opened at STDV +98.8 sec, approximately 60 lb./sec of LOX were returned to the LOX tank. This resulted in lower than normal net usage of LOX and also added heat to the LOX bulk. Since the pressurizing helium flow continued at a slightly increased rate, LOX ullage pressure increased rapidly and reached relief pressure within 50 sec. Five NPV cycles occurred before cutoff. Helium flowrate reached a maximum of 0.43 lb/sec. Flow integration disclosed that 93 lbm of helium were added to the LOX ullage during third burn.

The pressurization system performance data during third burn are presented in figure 11-9 and compared to S-IVB-502 and -503 flight test data in table 11-2.

#### 11.1.3.3 Cold Helium Supply--Third Burn

The cold helium supply was adequate to meet third burn requirements. Mass calculations based upon sphere temperature and pressure during burn agreed closely with the results obtained from flow integration. The cold helium supply system data are presented in table 11-3 and figure 11-10.

#### 11.1.3.4 J-2 Heat Exchanger--Third Burn

Heat exchanger performance was satisfactory but deviated somewhat from normal because of engine anomalies. Heat exchanger outlet temperature decreased in response to LOX bleed valve opening at STDV +98.8 sec and then increased again after the LH<sub>2</sub> bleed valve opened at STDV +141.7 sec. These temperature changes occurred in response to LOX turbine exhaust gases in the heat exchanger which vary with turbine power level and mixture ratio changes caused by the opening of the bleed valves. The performance data are presented in figure 11-11 and compared to S-IVB-502 and -503 flight test data in table 11-4.

### 11.2 Pressurization System Conditions During Coast

#### 11.2.1 LOX Tank Conditions During Coast

The LOX tank pressure and temperatures exhibited normal profiles during earth orbit, intermediate orbit and insertion into solar orbit (figures 11-12 and 11-13). During all three phases a temperature gradient gradually developed in the LOX tank; ullage temperatures decreased in the forward end of the tank, and liquid temperatures increased in the aft end. The liquid remained subcooled until LOX tank venting during passivation.

Twice during the earth parking orbit, the ullage pressure increased significantly because of attitude pitch maneuvers. At approximately RO +9,240 sec, the stage was maneuvered to transposition and docking (T&D) attitude, and the resulting slosh wave increased the temperature of the ullage gas by mixing it with the warmer LOX. The GOX component of the ullage was no longer saturated, and evaporation of LOX occurred until a saturated condition was regained. The ullage temperature increase and the mass increase due to evaporation resulted in an ullage pressure rise from 38.9 to 42.7 psia. This increase (3.8 psi) was greater than the 1.8 psi rise predicted. A similar ullage pressure increase (0.6 psi) occurred at approximately RO +15,900 sec when the stage was aligned with the local horizontal in preparation for second burn.

#### 11.2.2 LOX Tank Venting During Coast

The LOX tank nonpropulsive vent (NPV) system performed satisfactorily in relieving and safing the LOX tank during coast.

The NPV valve relieved after the pitch maneuver to transposition and docking attitude significantly increased the ullage pressure (paragraph 11.2.1). Although the relief venting occurred during a data gap, it was verified by a temperature recovery of the NPV nozzles, first observed at approximately RO +9, ) sec. Another relief vent, which occurred 20 sec after third engine cutoff command, removed approximately 15 lbm of ullage gas from the LOX tank.

At RO +23,042 sec the LOX NPV valve was latched permanently open in order to safe the LOX tank. LOX NPV nozzle conditions and flowrate are shown in figure 11-14. The ullage pressure decreased from 41.7 to 1 psia in approximately 4 hours. The ullage pressure and temperatures decreased rapidly during the first 240 sec of venting. During this period the liquid residual remained subcooled. At about RO +23,280 sec the LOX reached a saturated condition and began to boil off. The ullage pressure decay rate decreased and the ullage temperatures (figure 11-9) increased slightly as GOX was added to the ullage through boiloff. The gradual pressure decay continued, and safing was accomplished.

### 11.2.3 Cold Helium Supply System During Coast

The cold helium sphere conditions for earth orbit, intermediate orbit, and solar orbit insertion are presented in figures 11-15 and 11-16. No leakage was evident during earth orbit or intermediate orbit. The cold helium spheres were passivated during solar orbit insertion by dumping cold helium into the LH2 tank. The cold helium dump is discussed in section 27.

### 11.3 LOX Pump Chilldown

#### 11.3.1 First Burn

First burn chilldown performance was acceptable. Significant data are presented in table 11-5. Plots of stage parameters and calculated values of interest are presented in figures 11-17 and 11-18.

The steady state heat input calculated for section 1 was noticeably higher than on previous flights because the LOX bulk temperature (C0040) was used in the calculation in place of the LOX chilldown pump outlet temperature (C0163). Since 504N was an operational vehicle, C0163 was not installed on the stage. Had bulk temperatures been used in the heat input calculations for section 1 of previous flight stages, these results would have been similar to the 504N heat input.

The LOX pump inlet temperature response during the few seconds preceding and following liftoff appeared unusual; however, close comparison with previous flight data indicated that it was unusual in magnitude only.

#### 11.3.2 Second Burn

Second burn chilldown performance was nominal in all respects and did not reflect the apparent deviation noted for prelaunch and boost in the previous paragraphs. Significant data are presented in table 11-5; plots of stage parameters and calculated values of interest are presented in figures 11-19 and 11-20.



### 11.3.3 Third Burn

#### 11.3.3.1 Simulated Chillover System Failure

As part of an extended fuel lead experiment, a chillover system failure was simulated. Immediately after the LOX chillover pump was spun up, the chillover shutoff valves were closed preventing flow through the chillover pump into the LOX feed duct. This, in effect, precluded chillover conditioning of the LOX pump inlet. Third engine start command and STDV occurred therefore with no preconditioning of the LOX supply system. A sequence is presented in table 11-6.

#### 11.3.3.2 Bleed Valve Opening (Engine Anomaly Effect)

An unbalanced moment was produced on the stage during third burn by the action of the chillover return line flow when the LOX and LH2 bleed valves opened. Further discussion is presented in paragraph 12.3.3.2.

### 11.4 Engine LOX Supply

The engine LOX supply system (figure 11-21) delivered the necessary quantity of LOX to the engine during first and second burns. During third burn the LOX supply to the engine was also satisfactory (table 11-7) except for the first 1.2 sec after STDV.

#### 11.4.1 First Burn

The NPSP at the LOX pump inlet was well above that required at first engine start command and throughout first burn. The pump inlet conditions are presented in figure 11-22. A correlation between the inlet temperature and pressure indicates that pump inlet conditions were within the LOX pump operating region (figure 11-23). The effect of decreasing mass in the LOX tank on pump inlet temperature is shown in figure 11-24.

#### 11.4.2 Second Burn

The NPSP at the LOX pump inlet was well above that required at second engine start command and throughout second burn. The pump inlet

conditions are presented in figure 11-25. A correlation between the inlet temperature and pressure indicates that pump inlet conditions were within the LOX pump operating region (figure 11-26). The effect of decreasing mass in the LOX tank on pump inlet temperature is shown in figure 11-24.

#### 11.4.3 Third Burn

Due to the simulated chilldown system failure (paragraph 11.3.3), the LOX pump inlet was not conditioned prior to third engine start command. This lack of conditioning resulted in the LOX pump inlet temperature being offscale high from engine start command until STDV +1.2 sec. Data indicated that the LOX pump inlet condition requirements were violated at both engine start command and STDV, and this was substantiated by J-2 performance during the start transient. By STDV +1.2 sec, however, the NPSP was above the minimum requirement and remained above it for the duration of third burn. Pump inlet conditions during third burn are presented in figure 11-27. Supply and chilldown system parameter data during extended fuel lead are presented in figure 11-28. A correlation between the inlet temperature and pressure indicates that pump inlet conditions were within the LOX pump operating region from STDV +1.2 sec through engine cutoff command (figure 11-29).

At ESC +150 sec, the LOX bleed valve opened diverting a portion of the engine LOX supply back into the LOX tank. A gradual rise in the LOX bulk temperature resulted from the flow of this high energy liquid into the LOX tank. This rise in bulk temperature led to a corresponding increase in pump inlet temperature. However, the rise in inlet temperature did not cause any violation of NPSP requirements. The effect of return flow bulk heating and decreasing mass in the LOX tank on pump inlet temperature is shown in figure 11-24.

TABLE 11-1  
LOX TANK PREPRESSURIZATION DATA

Parameter	S-IVB-504N Flight	S-IVB-503N Flight	S-IVB-502 Flight
Prepressurization duration (sec)	22	17	17
Number of makeup cycles from GSE	3	3	2
Number of makeup cycles during boost	1*	2	2
Pressurization helium			
Flowrate (lbm/sec)	0.33	0.28**	0.28**
Mass added to LOX tank during prepressurization (lbm)	7.2	4.7**	4.8**
Mass added to LOX tank during GSE makeup cycles (lbm)	2.6	1.3	0.9
Ullage pressure			
At prepressurization initiation (psia)	15.2	15.3	15.2
At prepressurization termination (psia)	40.8	40.5	40.5
At liftoff (psia)	41.0	41.8	42.1
At pressurization initiation (psia)	40.0	39.2	40.3
Events (sec from liftoff)			
Prepressurization initiation	-167	-167	-167
Prepressurization termination	-145	-150	-150
Engine start command	537.3	525.0	577.3
Pressurization initiation	536.7	524.5	580.1

\* Makeup cycles were inhibited during boost until 42 seconds before engine start command.

\*\* These values are approximately 10 percent high because the orifice temperatures were off scale high throughout the prepressurization period.

TABLE 11-2

## LOX TANK PRESSURIZATION DATA

Parameter	S-IVB-504N Flight			S-IVB-503N Flight		S-IVB-502 Flight	
	First Burn	Second Burn	Third Burn	First Burn	Second Burn	First Burn	Second Burn
Number of overcontrol cycles	5	0	0	1	0	4	N/A
Pressure control band							
Minimum (psia)	38.2	N/A	N/A	38.2	N/A	38.6	N/A
Maximum (psia)	40.0	N/A	N/A	39.6	N/A	40.3	N/A
Ullage pressure							
At engine start command (psia)	40.8	42.3	41.5	40.4	39.0	40.3	41.6
At engine cutoff command (psia)	40.1	40.7	42.2	39.8	38.4	39.0	42.1
Pressurant total flowrate							
During undercontrol (lbm/sec)	0.26 to 0.32	0.22 to 0.33	0.30 to 0.43	0.27 to 0.36	0.35 to 0.45	0.25 to 0.31	N/A
During overcontrol (lbm/sec)	0.36 to 0.42	N/A	N/A	0.40 to 0.42	N/A	0.37 to 0.41	N/A
Maximum LOX tank vent inlet temperature (°R)	458	369	340	420	237	506	N/A

N/A Not applicable

\* Includes the programmed overcontrol cycle during the start transient.

TABLE 11-3  
COLD HELIUM SUPPLY DATA

Parameter	S-IVB-504N Flight			S-IVB-503N Flight		S-IVB-502 Flight	
	First Burn	Second Burn	Third Burn	First Burn	Second Burn	First Burn	Second Burn
Pressure							
At liftoff (psia)	3,090	N/A	N/A	2,990	N/A	2,966	N/A
At engine start command (psia)	3,010	1,550	1,393	2,970	1,350	2,939	860
At engine cutoff command (psia)	1,850	1,213	608	1,500	560	1,378	830
Average Temperature							
At liftoff (deg R)	39.3	N/A	N/A	37.9	N/A	38.9	N/A
At engine start command (deg R)	38.8	34.0	36.1	38.1	33.2	39.1	35.3
At engine cutoff command (deg R)	32.1	30.8	31.8	31.0	41.0	30.8	34.8
Helium Mass							
At engine start command (lbm)	379	309	286.9	376	297	332	201.0
At engine cutoff command (lbm)	332	291.6	207.0	320	184	275	198.5
Usage calculated from sphere conditions (lbm)	47	17.4	79.9	56	113	57	2.5
Usage calculated by integration of flowrate (lbm)	41.9	19.3	93	53	124	55	2.9

N/A Not applicable

TABLE 11-4

## J-2 HEAT EXCHANGER PERFORMANCE DATA

Parameter	S-IVB-504N Flight			S-IVB-503N Flight		S-IVB-502 Flight	
	First Burn	Second Burn	Third Burn	First Burn	Second Burn	First Burn	Second Burn
Flowrate through heat exchanger							
During overcontrol (lbm/sec)	0.20	N/A	N/A	0.21	N/A	0.185	N/A
During undercontrol (lbm/sec)	0.085	0.095	0.085 to 0.105	0.09	0.09	0.065	N/A
Heat exchanger inlet temperature							
During overcontrol (°R)	78	N/A	N/A	65	N/A	*	N/A
During undercontrol (°R)	86	75	53	60	40	*	N/A
Minimum (°R)	76	72	48	48	35	*	N/A
Heat exchanger outlet temperature							
At end of 50-sec transient (°R)	965	900	900	875	865	965	N/A
During overcontrol (°R)	1,005	N/A	N/A	870	N/A	990	N/A
During undercontrol (°R)	1,020	925	930	925	930	1,005	N/A
At engine cutoff command (°R)	1,010	925	740	930	940	1,000	N/A
Heat exchanger outlet pressure							
During overcontrol (psia)	340	N/A	N/A	335	N/A	330	N/A
During undercontrol (psia)	390	400	400	400	405 to 320	380	N/A
Average LOX vent inlet pressure							
During overcontrol (psia)	63	N/A	N/A	60	N/A	69	N/A
During undercontrol (psia)	50	50	51	51	50	52	N/A
Maximum LOX vent inlet temperature (°R)	458	369	340	420	370	506	N/A

\* Measurement failed.  
N/A Not applicable.

TABLE 11-5 (Sheet 1 of 3)

## LOX CHILLDOWN SYSTEM PERFORMANCE DATA

Parameter	S-IVB-504N Flight		S-IVB-503N Flight		S-IVB-502 Flight	
	First Burn	Second Burn	First Burn	Second Burn	First Burn	Second Burn
NPSP						
At engine start command						
With chill pump head (psi)	25.0	N/A	25.8	N/A	24.9	N/A
Without chill pump head (psi)	23.0	24.0	23.8	22.0	22.8	24.7
Minimum required at engine start (psi)	12.8	12.8	12.8	12.8	12.8	12.8
At prevalve open command (psi)	41.2	32.5	45.2	32.0	42.23	27.1
Pump inlet conditions						
Pressure at engine start command						
With chill pump head (psia)	43.5	N/A	41.7	N/A	41.7	N/A
Without chill pump head (psia)	41.5	42.3	39.7	39.8	40.5	41.6
Temperature at engine start command (deg R)	165.0	166.2	164.5	165.5	164.7	165.0
Average flow coefficient (sec <sup>2</sup> /in <sup>2</sup> ft <sup>2</sup> )	17.6	17.6	17.9	17.9	18.3	18.3
Heat absorption rate (Btu/hr)						
Section 1 (tank to pump inlet)						
Ground	2,700	N/A	2,500	N/A	3,000	N/A
Boost-Orbit	9,000	6,200	0	0	500	500

N/A Not applicable

TABLE 11-5 (Sheet 2 of 3)  
LOX CHILLDOWN SYSTEM PERFORMANCE DATA

Parameter	S-IVB-504N Flight		S-IVB-503N Flight		S-IVB-502 Flight	
	First Burn	Second Burn	First Burn	Second Burn	First Burn	Second Burn
Section 2 (pump inlet to bleed valve)						
Ground	42,000*	N/A	25,000	N/A	20,000	N/A
Boost-Orbit	19,500*	5,000*	7,000	12,500	4,000	100
Section 3 (bleed valve to tank inlet)						
Ground	*	*	2,500	N/A	7,000	N/A
Boost-Orbit	*	*	500	1,000	500	0
Total						
Ground	44,700	N/A	30,000	N/A	30,000	N/A
Boost-Orbit	28,500	11,200	7,500	13,500	5,000	600
Chilldown flowrate						
Unpressurized (gpm)	40.0	N/A	39.9	N/A	39.5	N/A
Pressurized (gpm)	42.0	42.0	41.7	42.0	42.5	42.5
Chilldown system pressure drop						
Unpressurized (psi)	9.5	N/A	10.2	N/A	10.0	N/A
Pressurized (psi)	10.0	10.0	10.8	12.0	11.5	12.4

N/A Not applicable

\*Heat inputs for sections 2 and 3 were combined because temperature transducer C0013, LOX bleed valv temperature, was not on the stage.



TABLE 11-5 (Sheet 3 of 3)

LOX CHILLDOWN SYSTEM PERFORMANCE DATA

Parameter	S-IVB-504N Flight		S-IVB-503N Flight		S-IVB-502 Flight	
	First Burn	Second Burn	First Burn	Second Burn	First Burn	Second Burn
Events (sec from range zero)						
Chilldown initiation	-289.306	-321.012	-289.062	-321.021	-284.152	-742.466
Prevalve closed	-283.794	-310.398	-284.064	-310.399	-274.909	-727.146
Prepressurization initiation*	-166.554		-166.590		-166.602	-227.001
Prevalve open command	536.514	- 10.067	524.315	- 10.615	576.596	- 10.79
Prevalve closed signal dropout	537.481	- 9.421	525.162	- 9.418	577.596	- 9.256
Prevalve open signal pickup	539.064	- 7.504	526.745	- 7.630	579.421	- 7.117
Chilldown pump off	536.956	- 0.384	524.690	- 0.416	576.872	- 0.602
Engine start command	537.264	0	524.998	0	577.270	0

N/A Not applicable

\*Repressurization on second burn

TABLE 11-6  
LOX CHILLDOWN SEQUENCE--THIRD BURN

Time from LO (sec)	Meas. No.	Event
21704.944		Chilldown shutoff valve close off (CMD)
21709.926		LOX chillpump on (CMD)
21710.026		Chilldown shutoff valve close on (CMD)
21710.252	K138	Oxidizer chilldown valve open (DO)
21710.335	K139	Oxidizer chilldown valve close (PU)
21719.949		Prevalves close on (CMD)
21720.108	K109	Oxidizer prevalve open (DO)
21720.441	K110	Oxidizer prevalve close (PU)
21729.966		LOX chilldown pump off (CMD)
21952.752		Chilldown shutoff valve close off (CMD)
21953.650	K136	Oxidizer chilldown valve close (DO)
21953.817	K137	Oxidizer chilldown valve open (PU)
21954.318		Prevalves close off (CMD)
21954.590	K109	Oxidizer prevalve close (DO)
21956.421	K110	Oxidizer prevalve open (PU)
21987.338		S-IVB engine start command on (CMD)

TABLE 11-7 (Sheet 1 of 2)

LOX PUMP INLET CONDITION DATA

Parameter	S-IVB-504N Flight			S-IVB-503N Flight		S-IVB-502 Flight	
	First Burn	Second Burn	Third Burn	First Burn	Second Burn	First Burn	Second Burn
Pump Inlet Conditions							
Static pressure at engine start command*							
With chilldown pump head (psi)	43.5	N/A	N/A	41.7	N/A	41.7	N/A
Without chilldown pump head (psi)	41.5	42.3	41.7	39.7	39.8	40.3	41.6
Temperature at engine start command (deg R)	165.0	166.2	**	164.5	165.5	164.7	165.0
Temperature at engine cutoff command (deg R)	164.8	165.8	167.0	164.4	165.7	164.7	165.2
NPSP Requirements							
Minimum at engine start command (psi)	12.8	12.8	12.8	12.8	12.8	12.8	12.8
At high EMR (psi)	20.3***	N/A	N/A	N/A	N/A	20.96***	20.96***
After EMR cutback (psi)	N/A	15.2***	15.2***	15.2	15.1	14.93***	14.93***
NPSP Available							
At engine start command* (psi)							
With chilldown pump head (psi)	25.0	N/A	N/A	25.8	N/A	24.9	N/A
Without chilldown pump head (psi)	23.0	24.0	**	23.8	22.0	22.8	24.7

N/A Not applicable

\*The NPSP and pump inlet pressure are high at this time because the prevalves were slow in opening.

\*\*LOX pump inlet temperature off scale high until STDV +1.2 seconds

\*\*\*These requirements are variable with acceleration. The values presented are maximum. Figures 11-10 and 11-11 graphically display the requirement.

TABLE 11-7 (Continued)  
 TABLE 11-7 (Sheet 2 of 2)  
 LOX PUMP INLET CONDITION DATA

Parameter	S-IVB-504N Flight			S-IVB-503N Flight		S-IVB-502 Flight	
	First Burn	Second Burn	Third Burn	First Burn	Second Burn	First Burn	Second Burn
At start tank discharge valve open command (psi)	25.3	23.8	*	27.0	21.7	23.4	25.5
Maximum during firing (psi)	29.6	29.8	28.5	29.7	26.8	27.3	25.7
Time of maximum (sec from ESC)	8	30	145	18	30	6	15
Minimum during firing (psi)	24.0	22.9	*	24.5	22.8	21.1	24.6
Time of minimum (sec from ESC)	34	9	0.0	52	324	26	3
At engine cutoff command (psi)	25.5	27.4	27.5	26.5	22.8	25.3	25.5
LOX Feed Duct							
At high EMR							
Pressure drop (psi)	2.0	N/A	N/A	N/A	N/A	2.0	0.8
Flowrate (lbm/sec)	464	N/A	N/A	N/A	N/A	453	250
After EMR cutback							
Pressure drop (psi)	N/A	2.1	2.0	1.9	2.0	N/A	N/A
Flowrate (lbm/sec)	N/A	399	400	393	391	N/A	N/A

N/A Not applicable

\*LOX pump inlet temperature off scale high until STDV +1.2 seconds



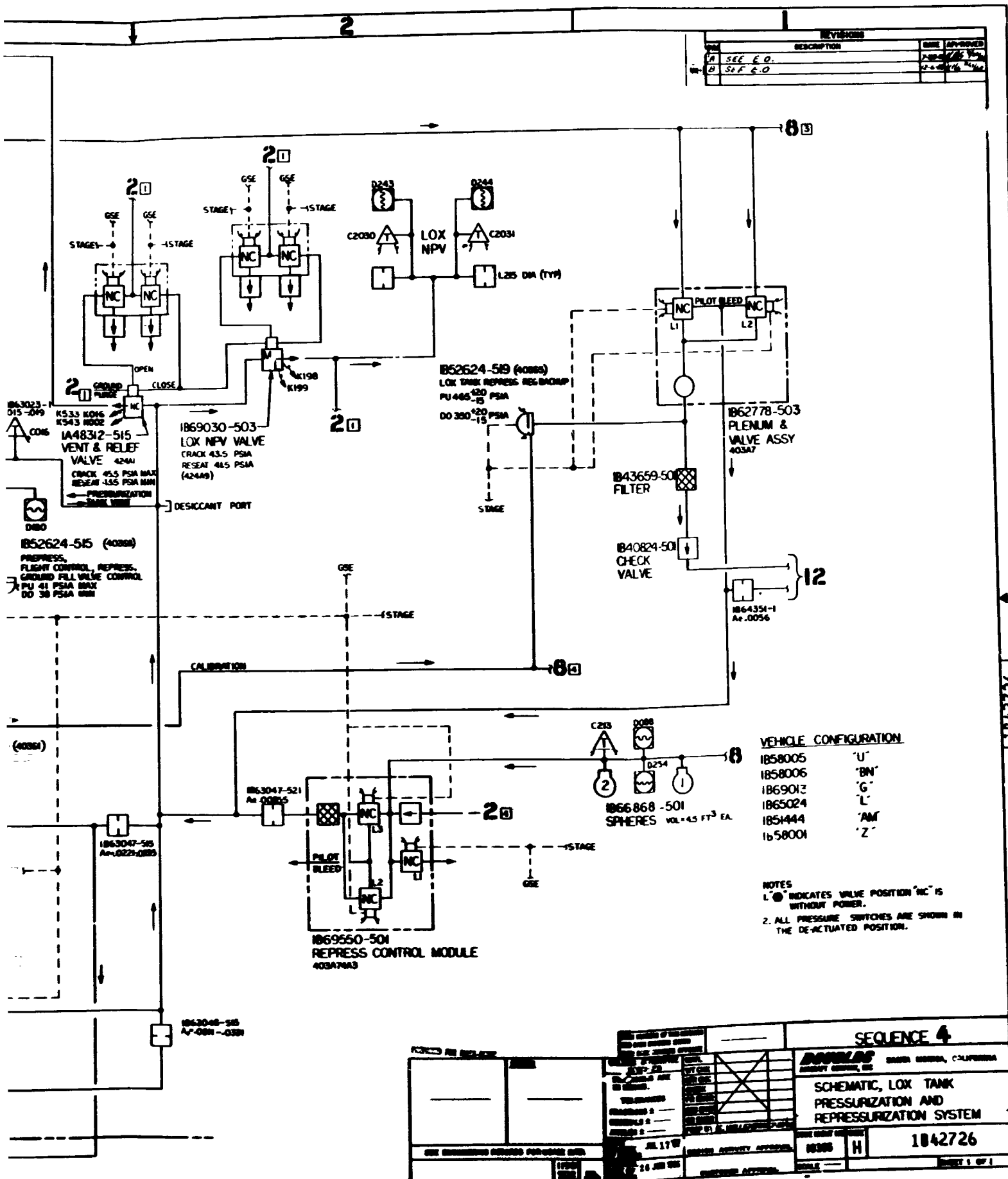

2 Figure 11-1. Schematic, LOX Tank Pressurization and Repressurization System

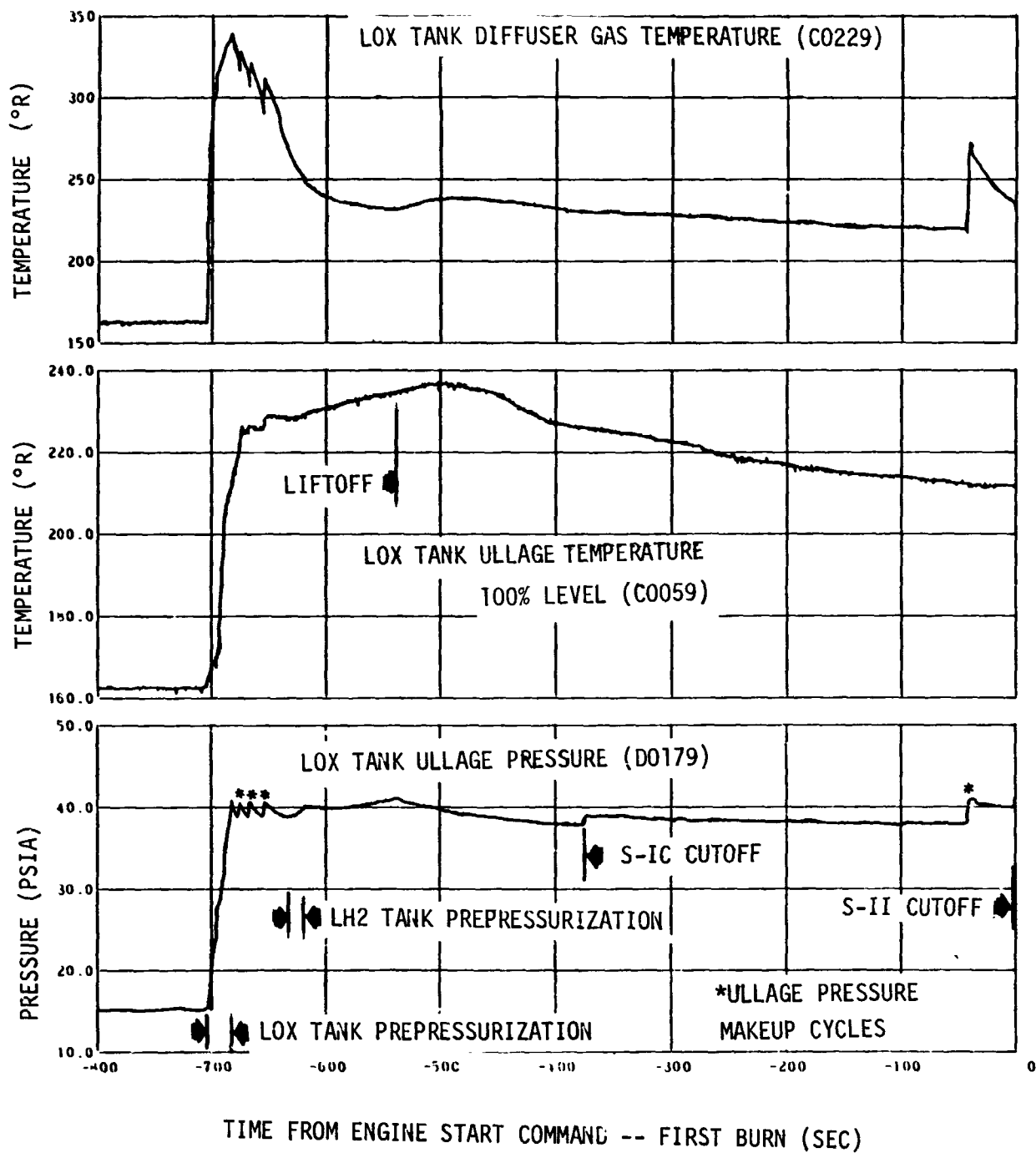

Figure 11-2. LOX Tank Conditions During Prepressurization and Boost (Sheet 1 of 2)

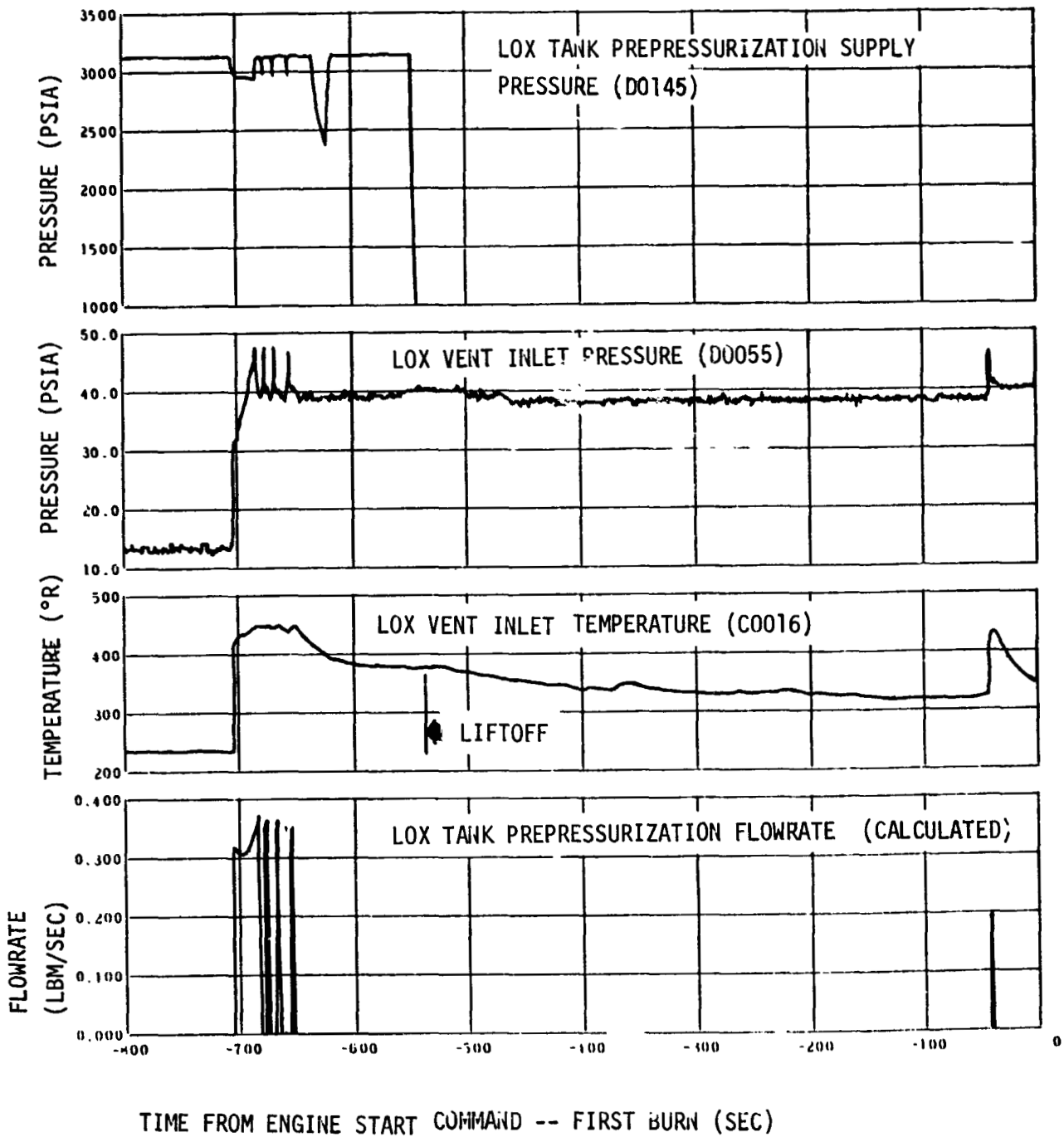

Figure 11-2. LOX Tank Conditions During Prepressurization and Boost  
(Sheet 2 of 2)



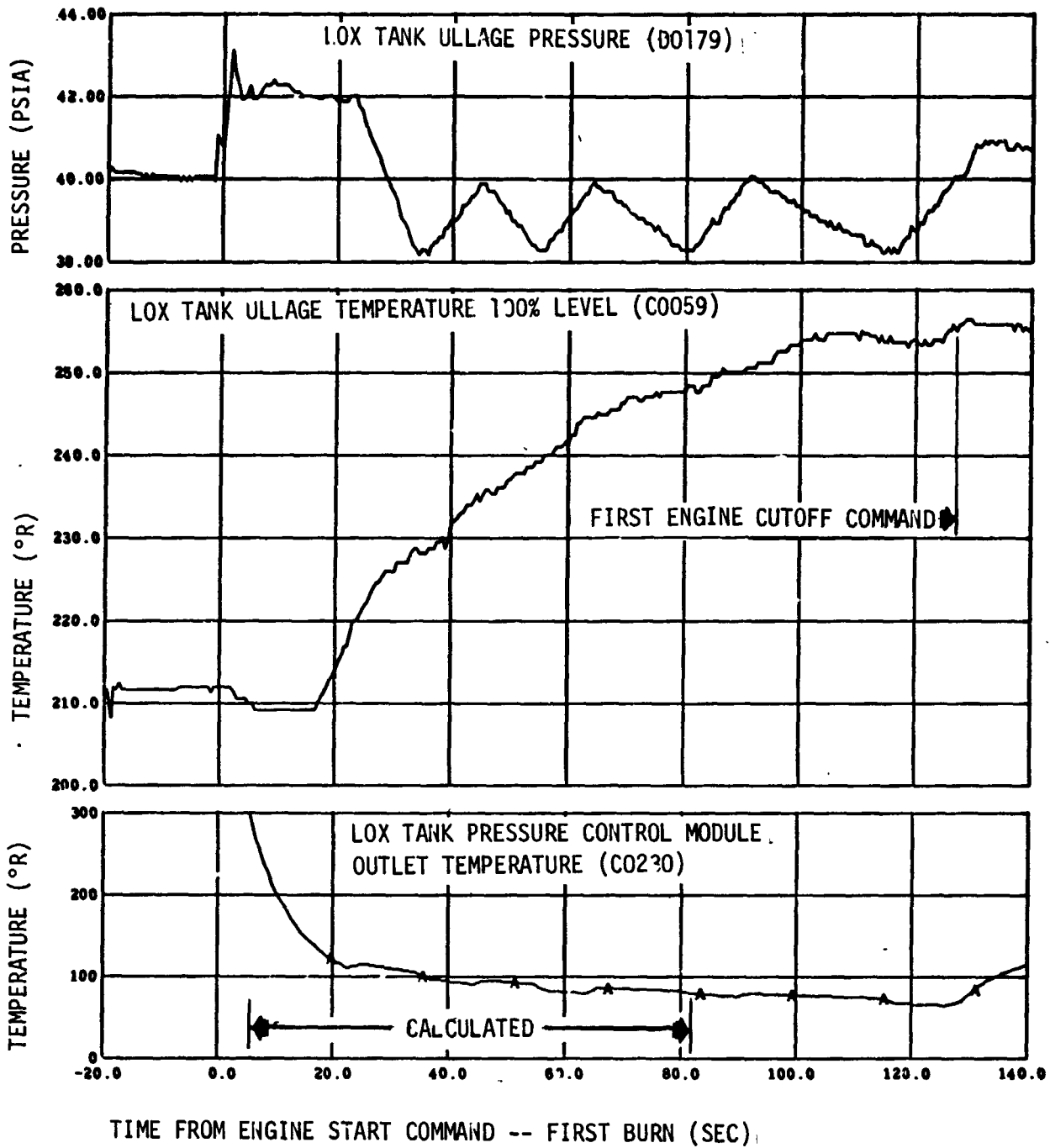

Figure 11-3. LOX Tank Pressurization System Performance --  
 First Burn (Sheet 1 of 2)

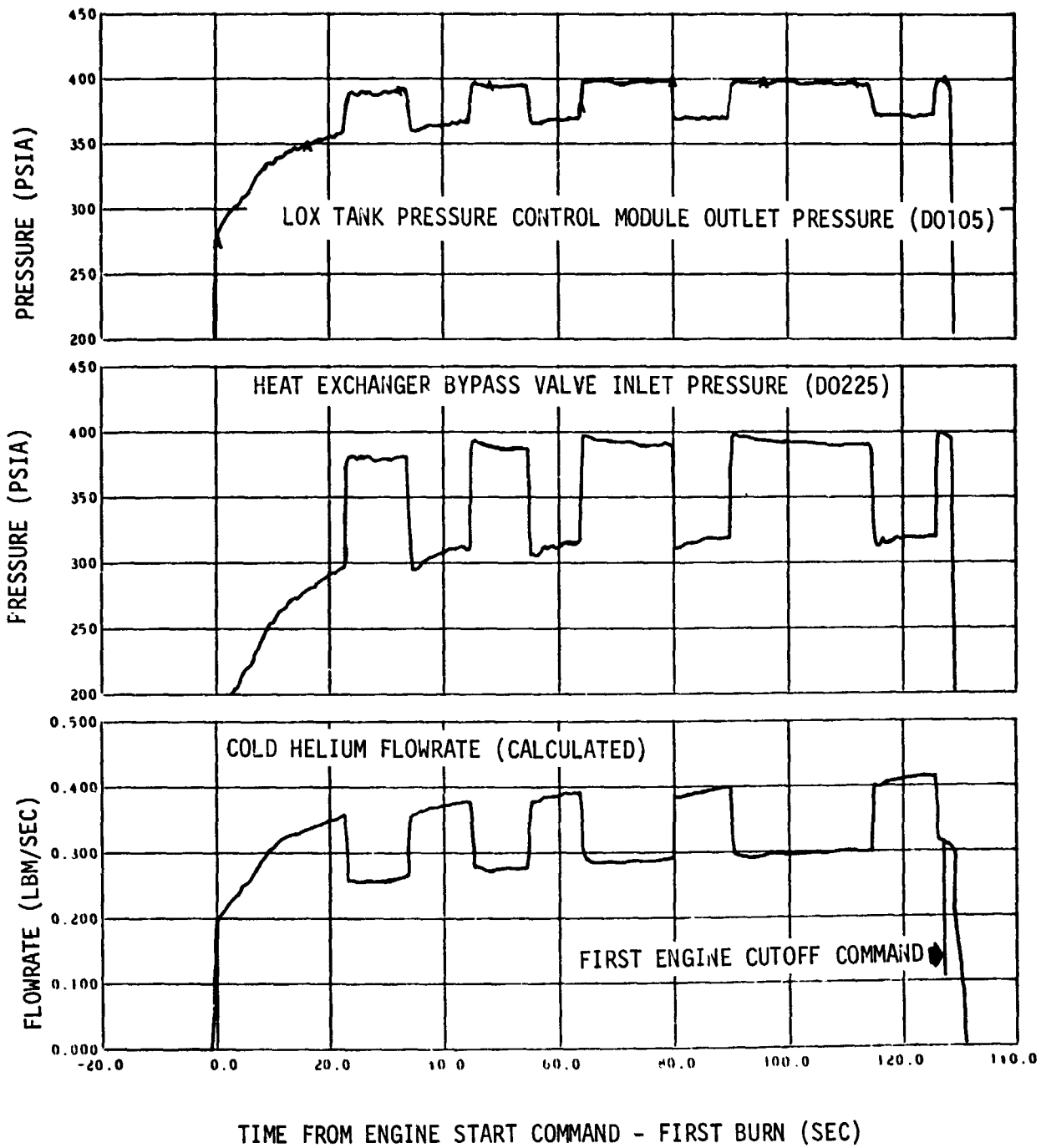

Figure 11-3. LOX Tank Pressurization System Performance --  
First Burn (Sheet 2 of 2)

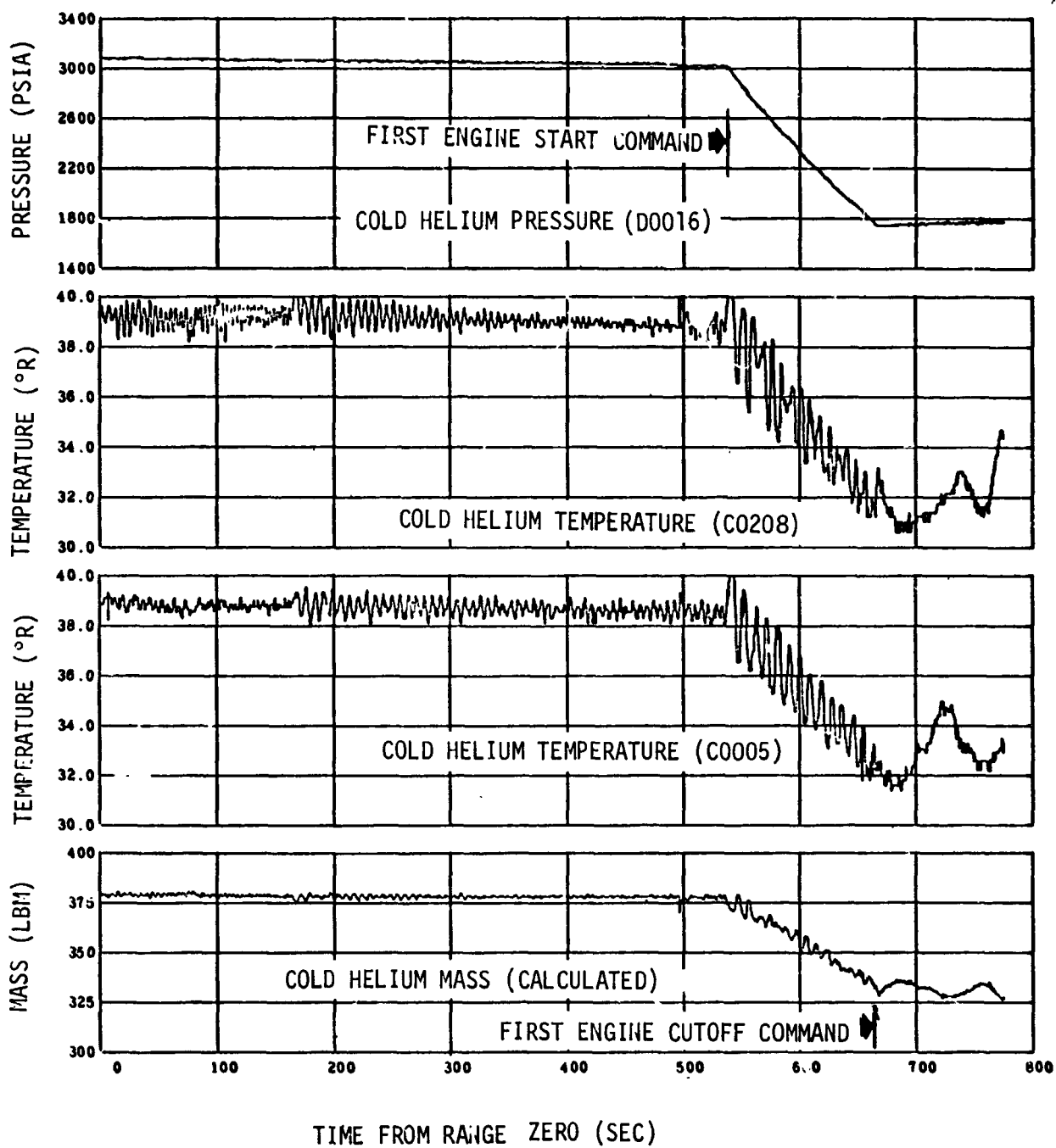

Figure 11-4. Cold Helium Supply - Boost and First Burn

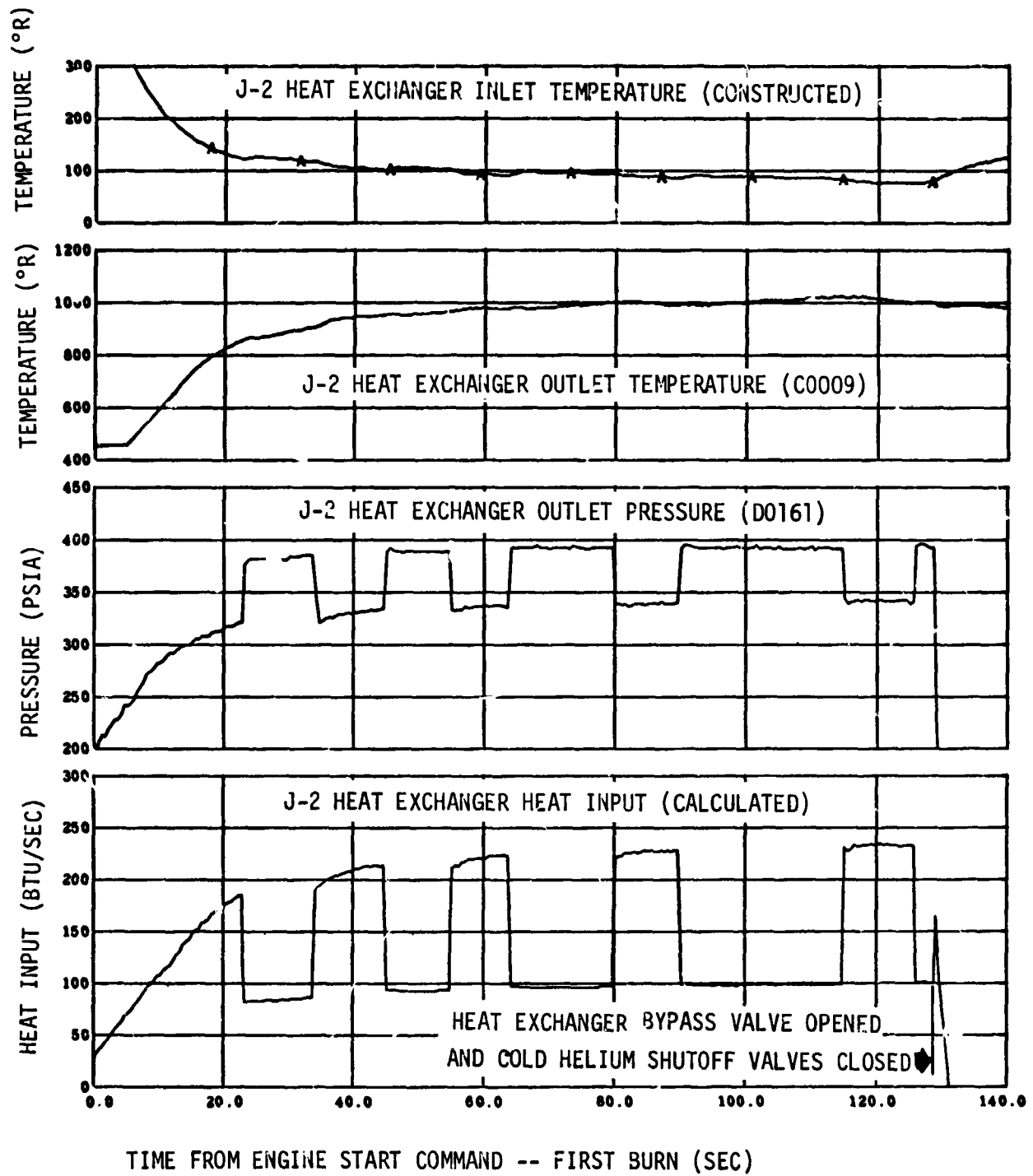

Figure 11-5. J-2 Heat Exchanger Performance -- First Burn (Sheet 1 of 2)

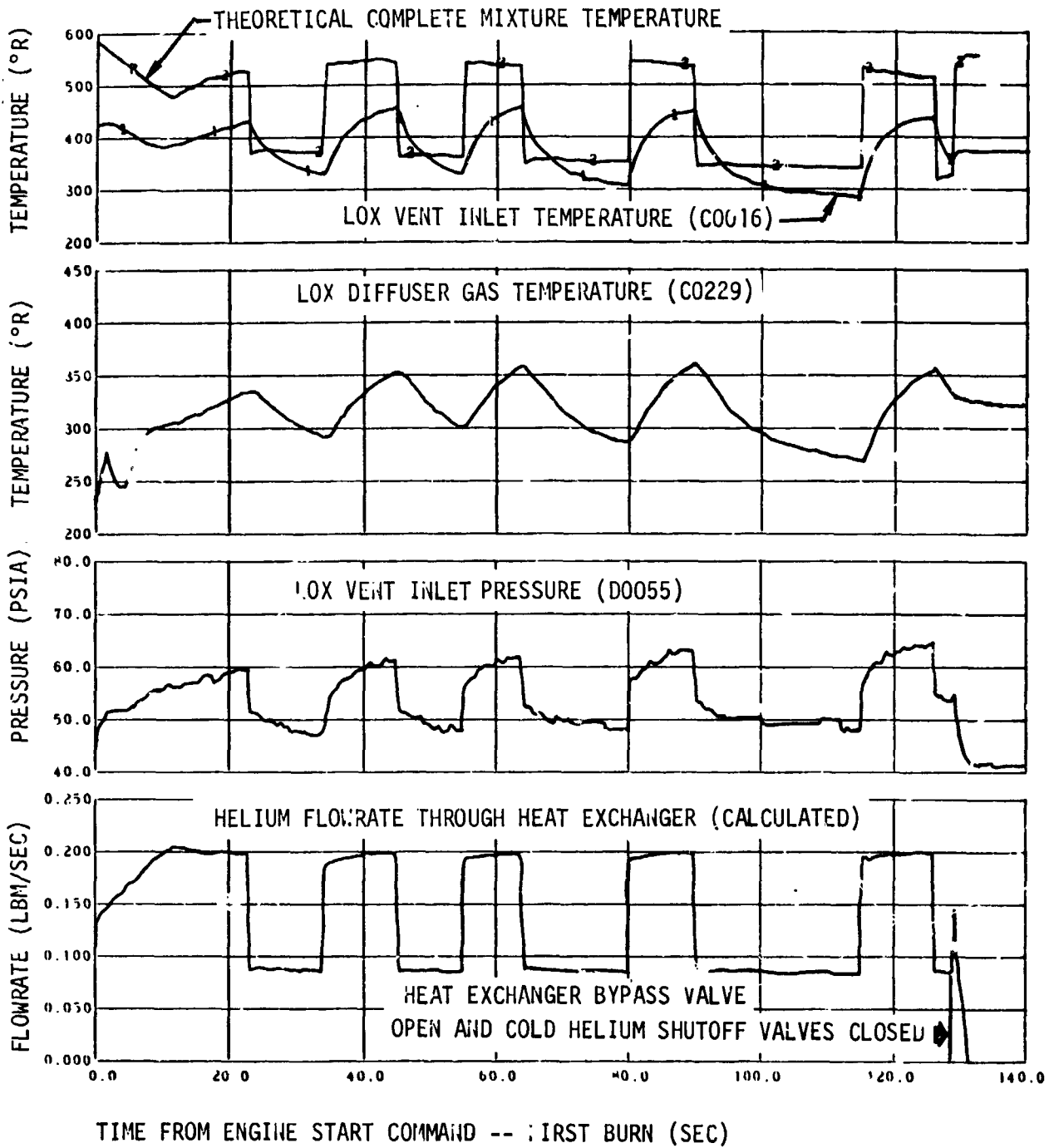

Figure 11-5. J-2 Heat Exchanger Performance -- First Burn (Sheet 2 of 2).

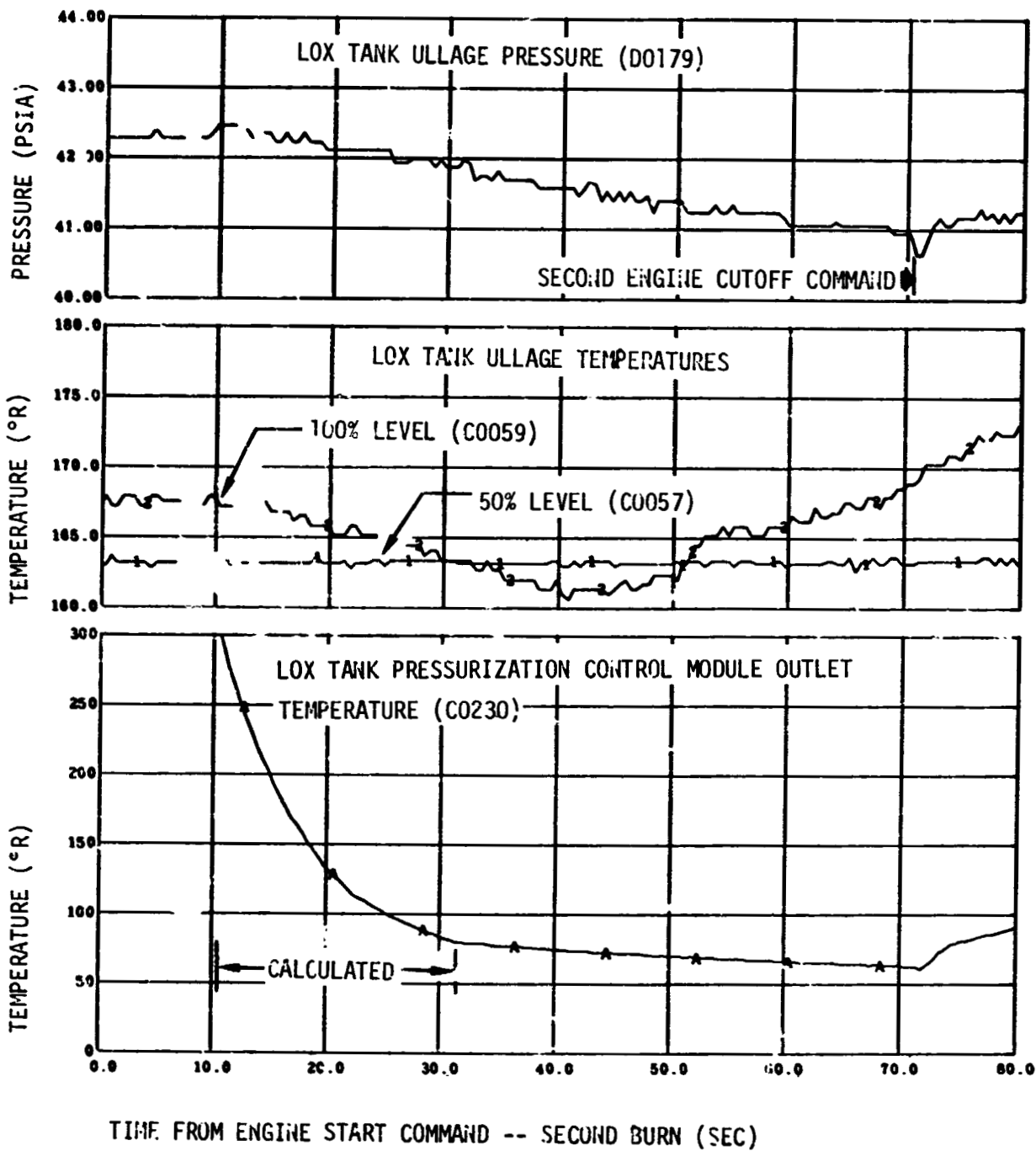

Figure ii-6. LOX Tank Pressurization System Performance --  
 Second Burn (Sheet 1 of 2)

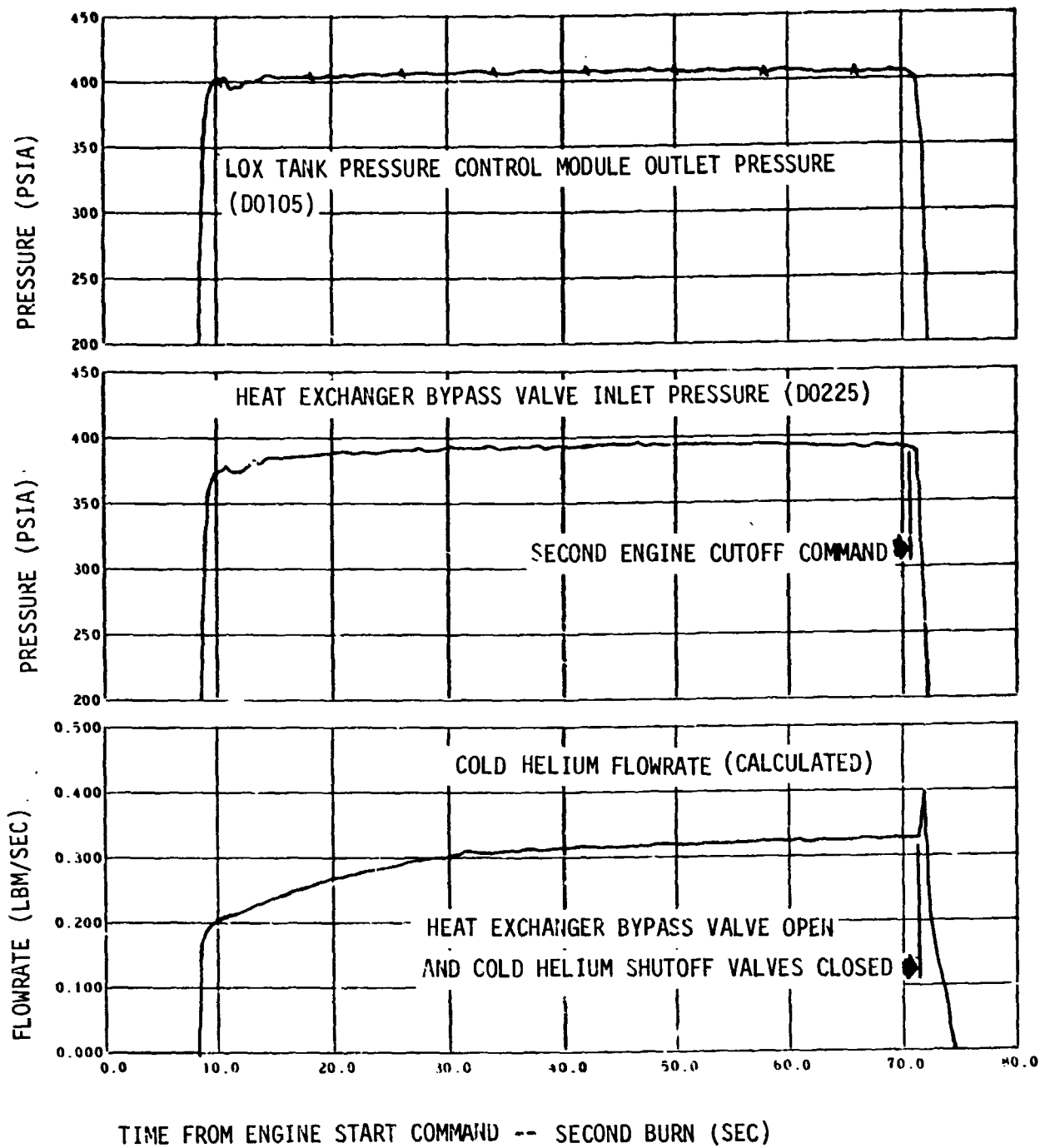

Figure 11-6. LOX Tank Pressurization System Performance --  
Second Burn (Sheet 2 of 2)

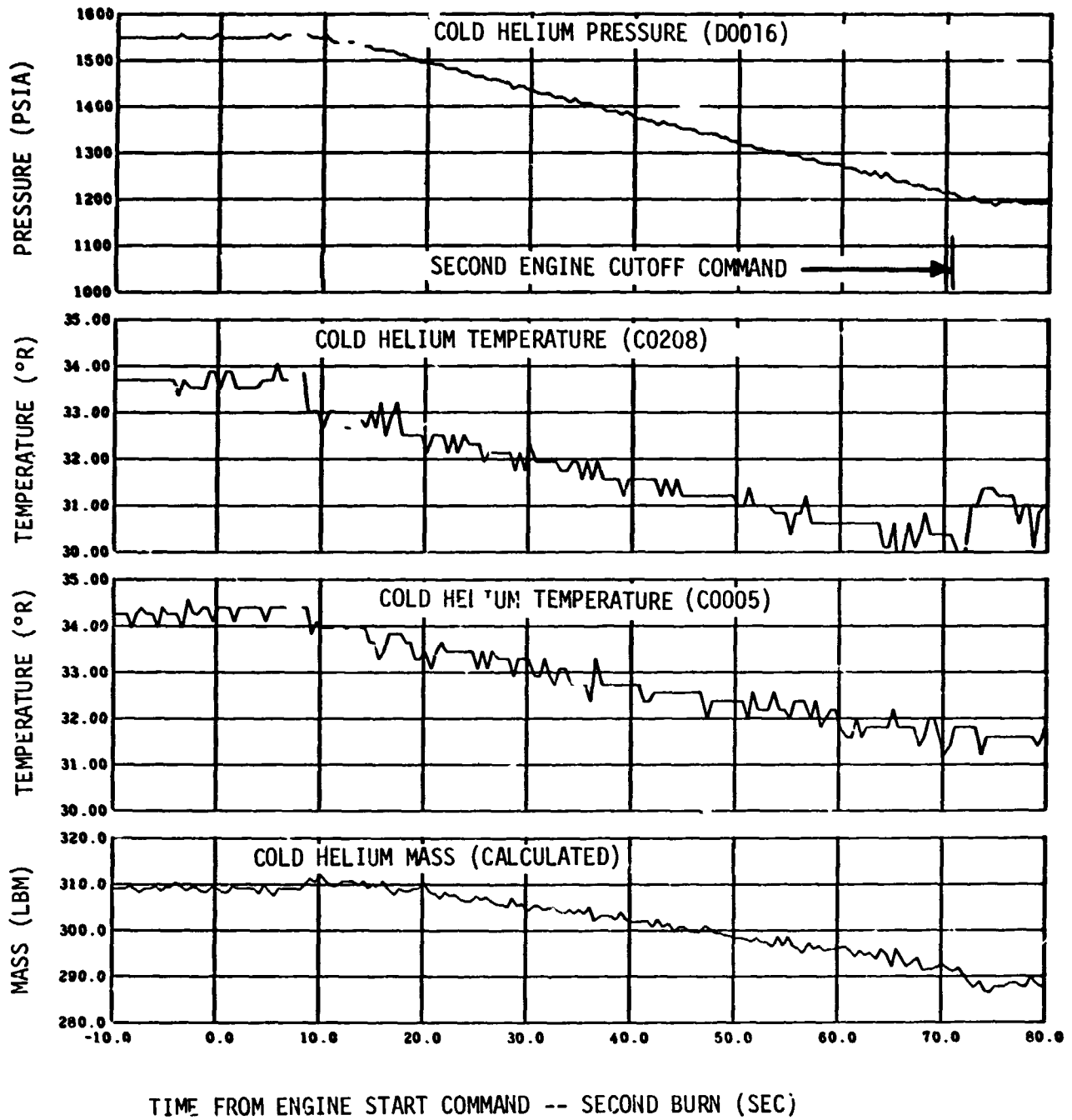

Figure 11-7. Cold Helium Supply -- Second Burn



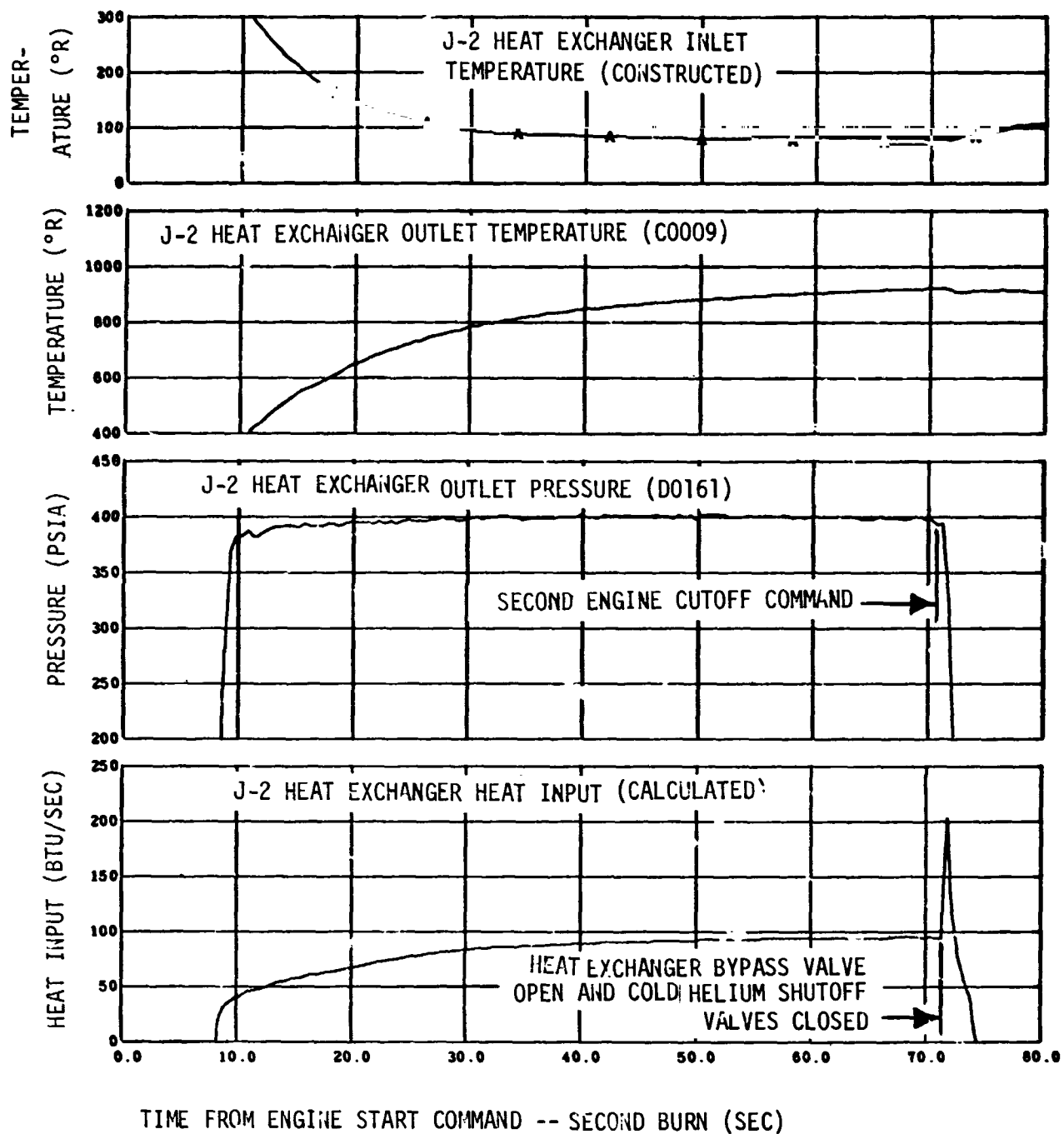

Figure 11-8. J-2 Heat Exchanger Performance -- Second Burn (Sheet 1 of 2)

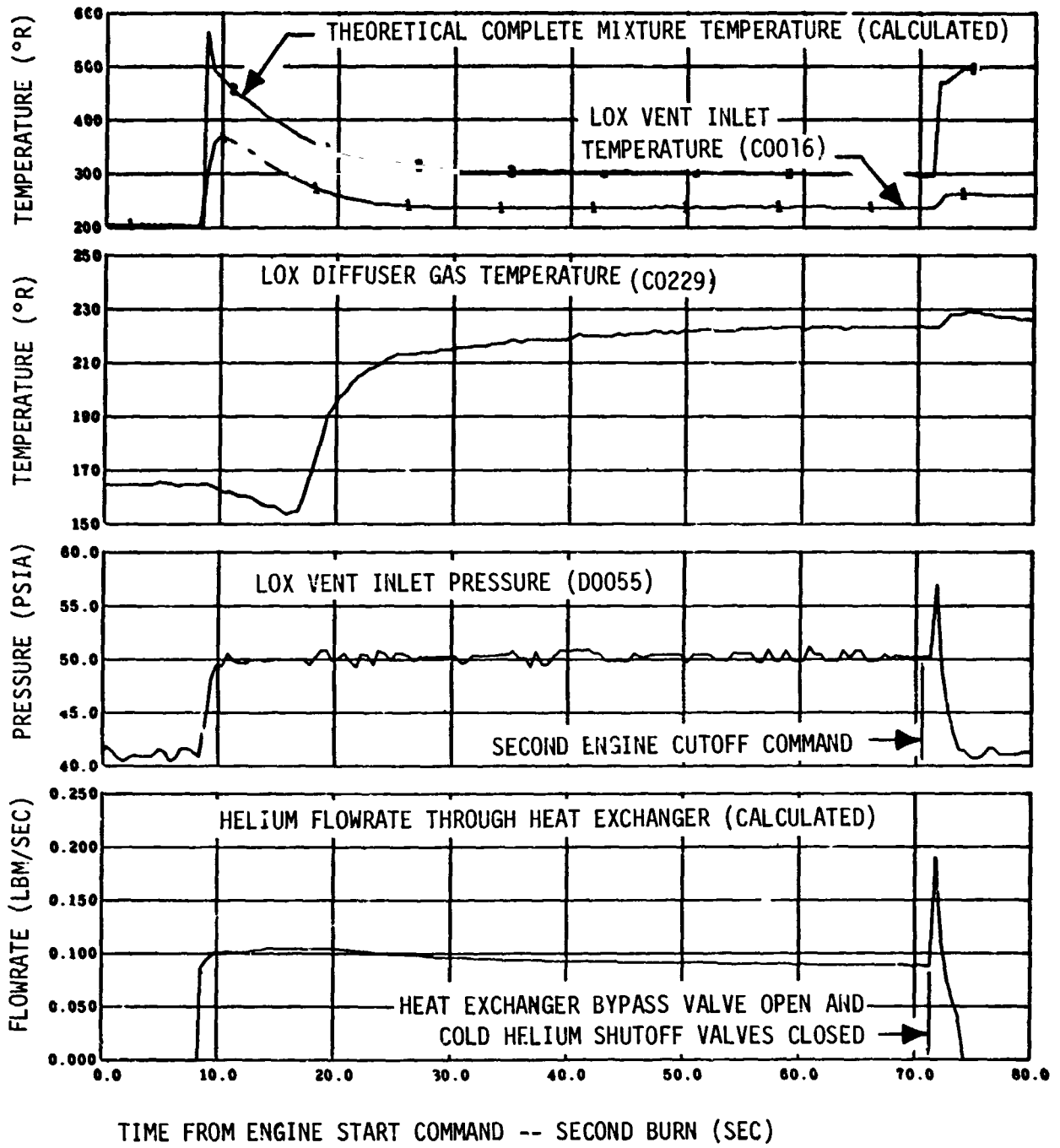

Figure 11-8. J-3 Heat Exchanger Performance -- Second Burn (Sheet 2 of 2)

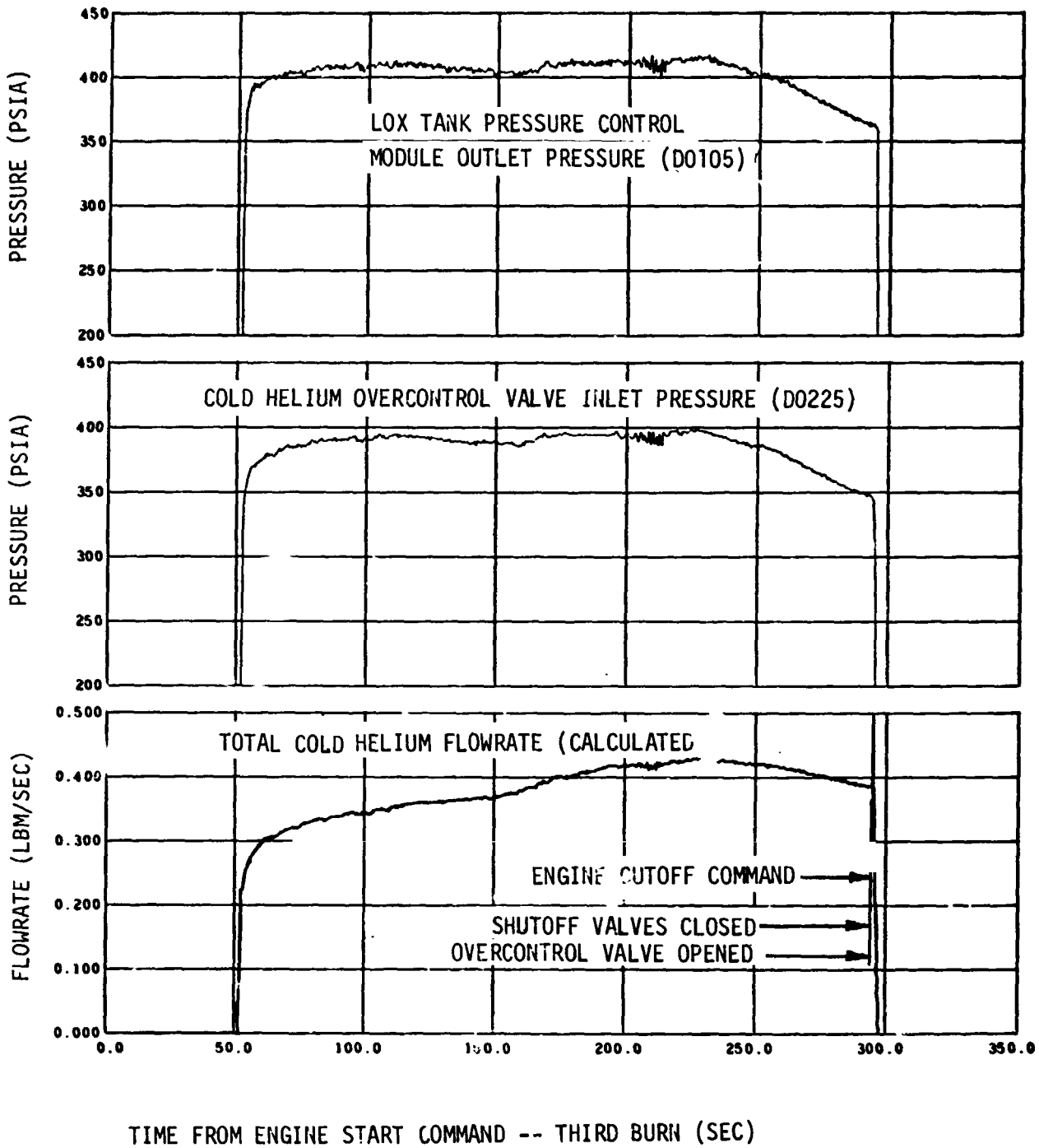

Figure 11-9. LOX Tank Pressurization System Performance --  
Third Burn (Sheet 1 of 2)

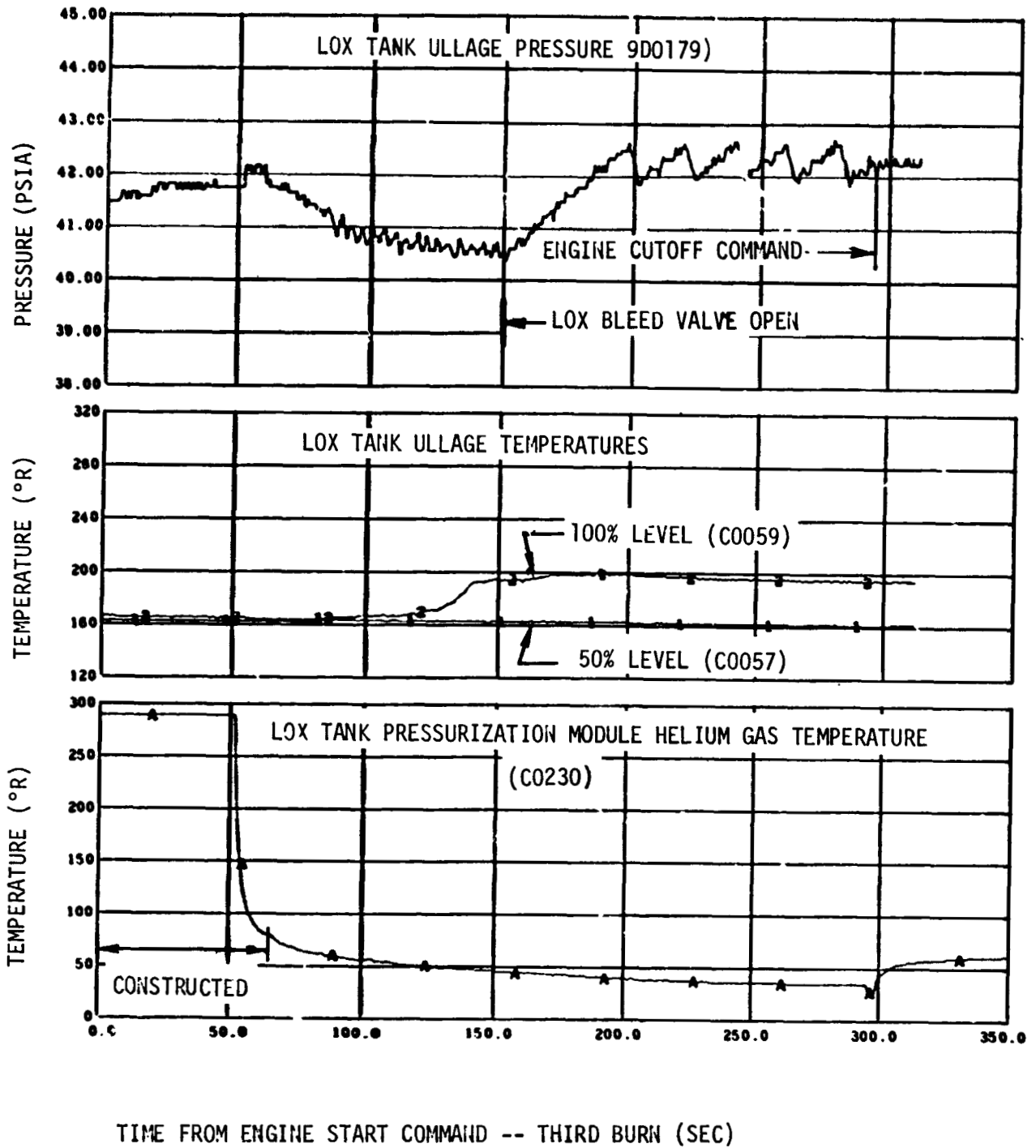

Figure 11-9. LOX Tank Pressurization System Performance --  
 Third Burn (Sheet 2 of 2)

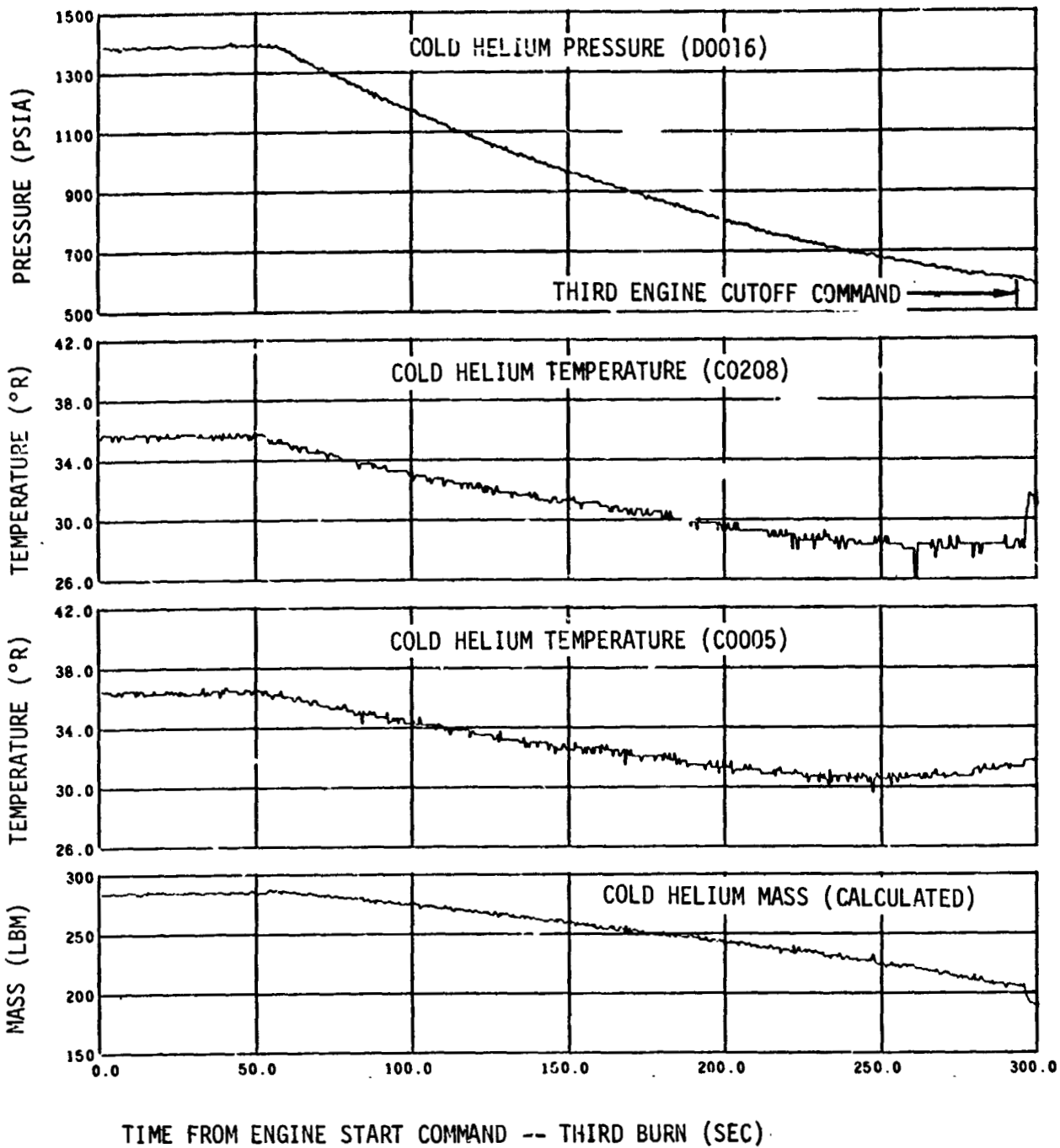
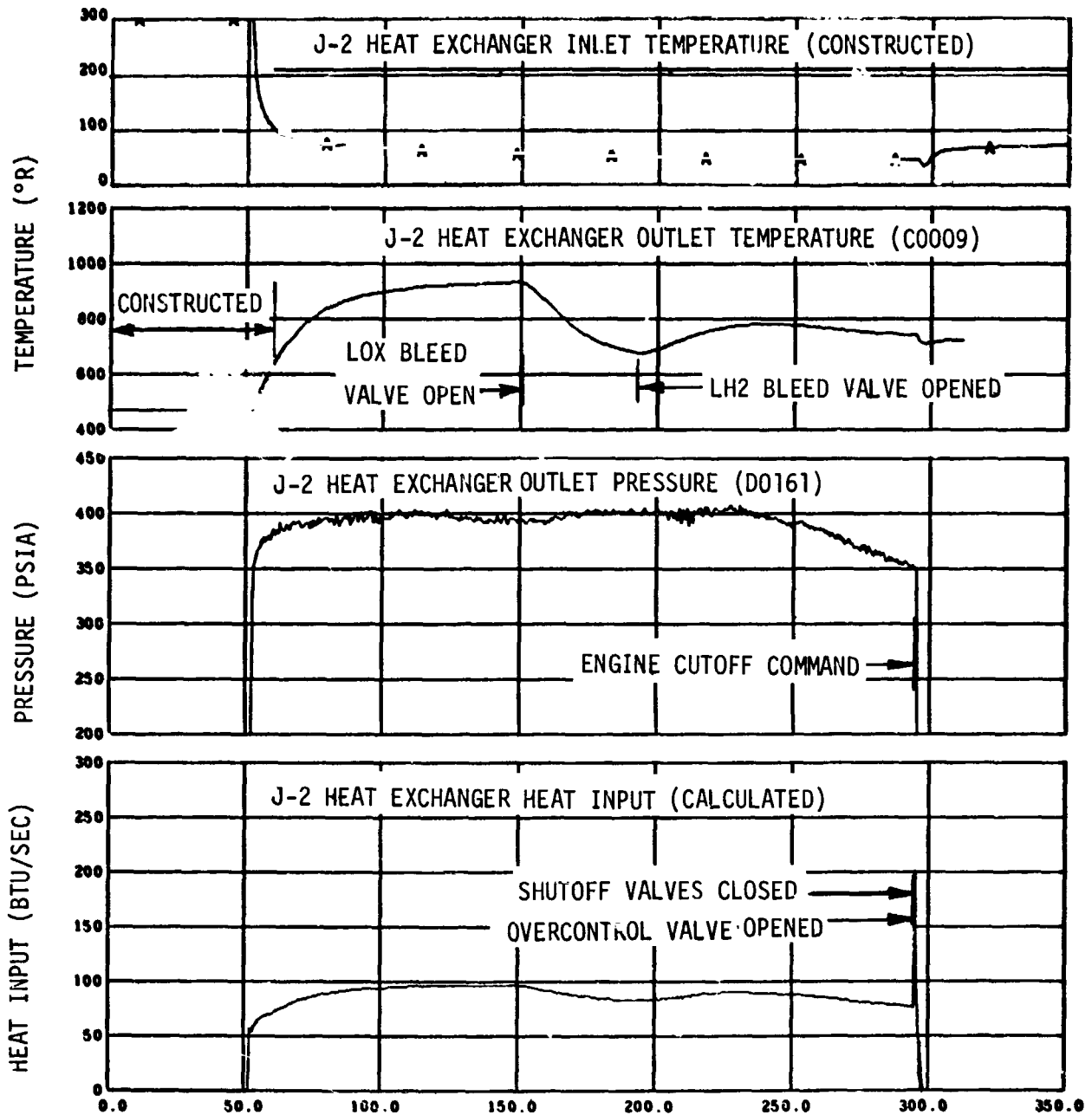

Figure 11-10. Cold Helium Supply -- Third Burn



TIME FROM ENGINE START COMMAND -- THIRD BURN (SEC)

Figure 11-11. J-2 Heat Exchanger Performance --  
 Third Burn (Sheet 1 of 2)

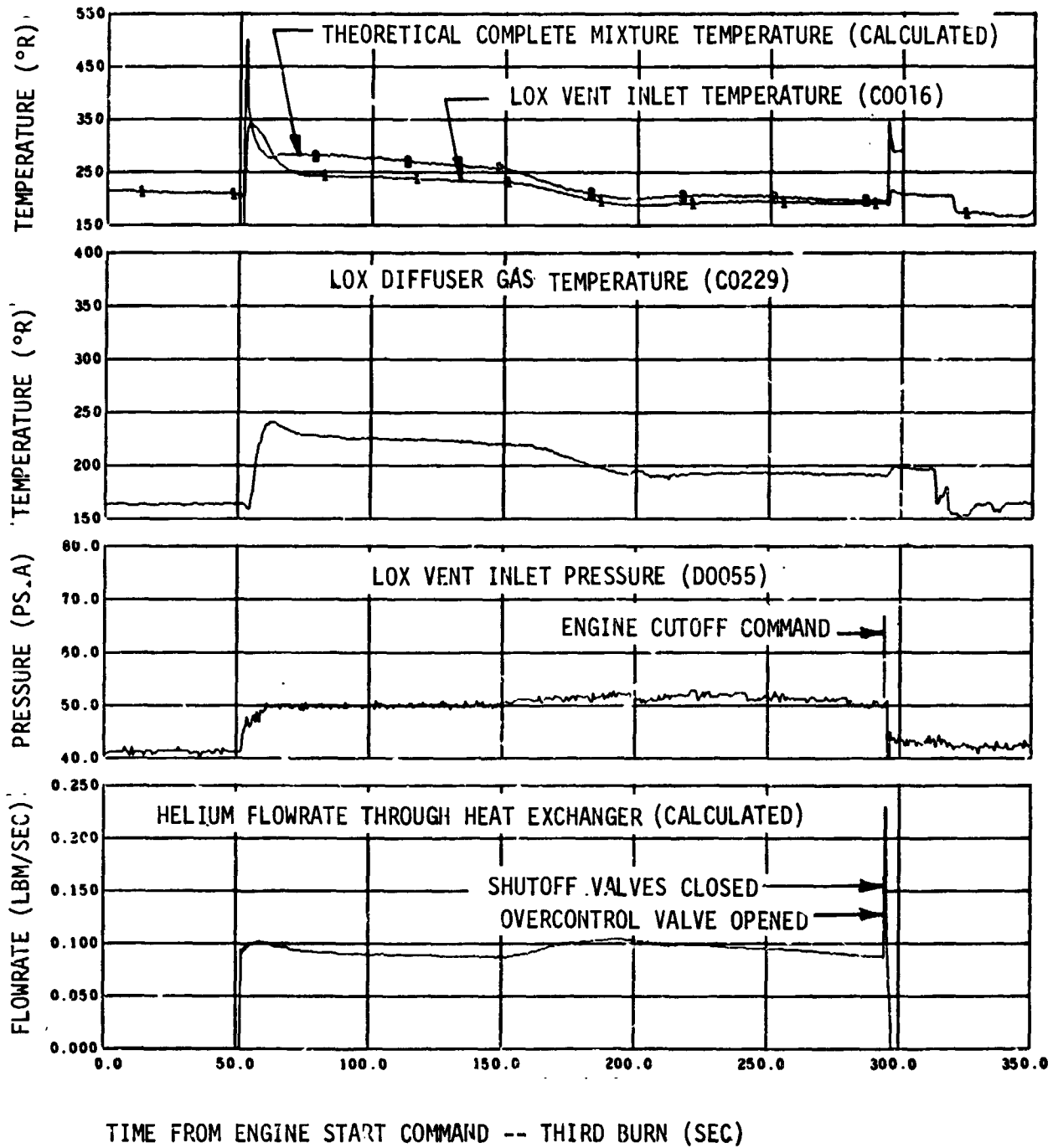

Figure 11-11. J-2 Heat Exchanger Performance -- Third Burn  
(Sheet 2 of 2)

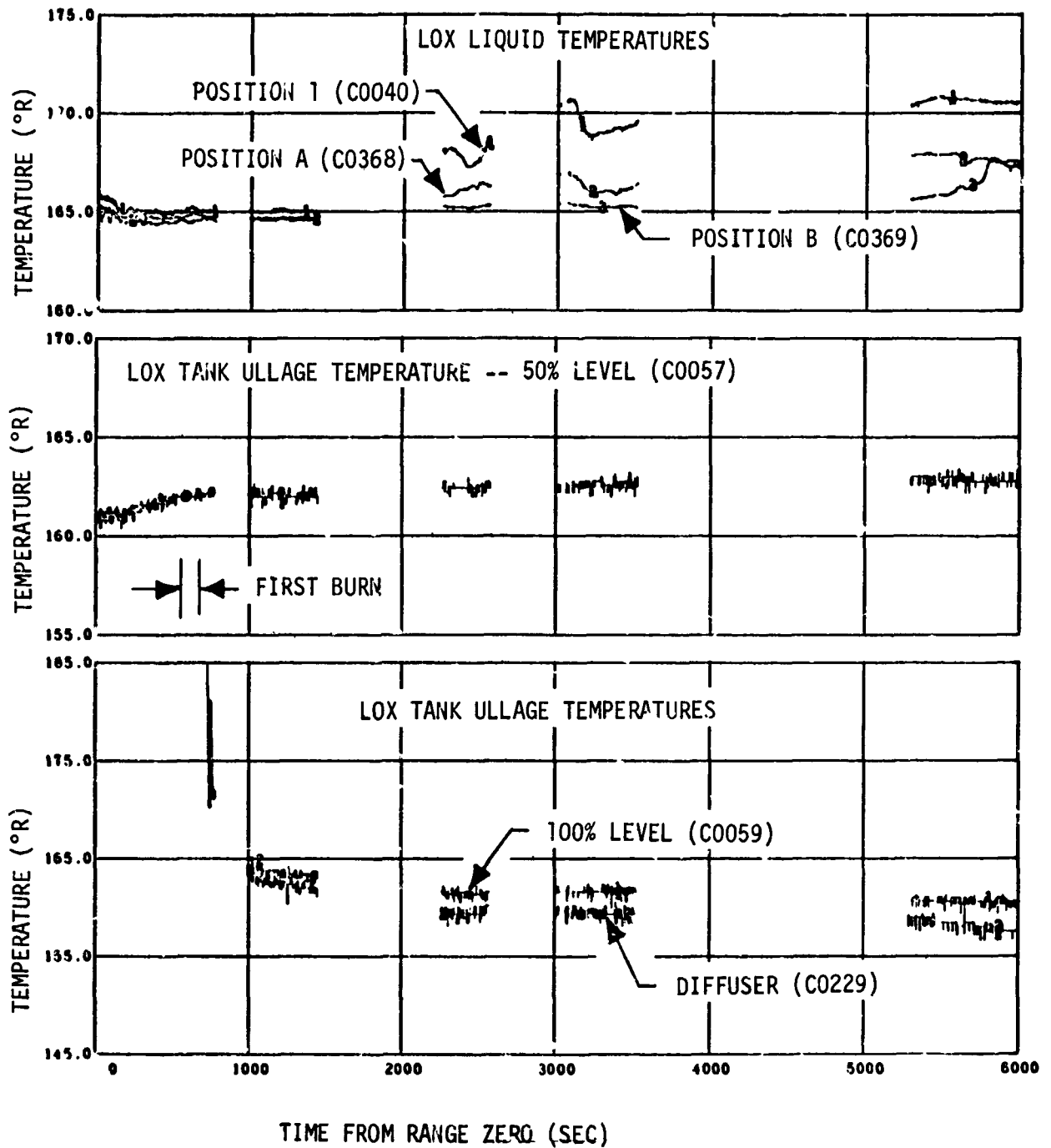

Figure 11-12. LOX Tank Conditions -- Earth Orbit and Solar Orbit Insertion (Sheet 1 of 4)



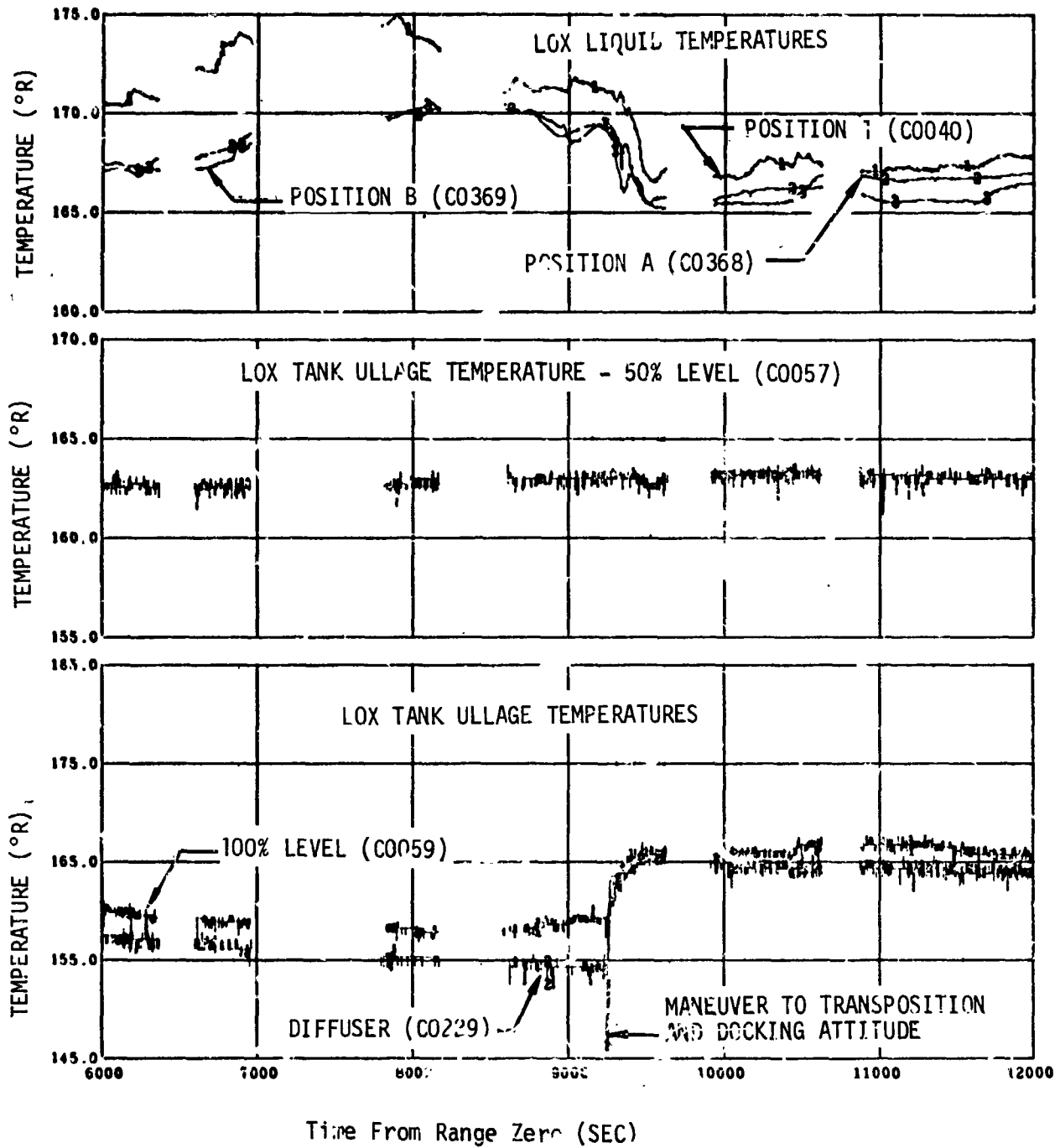

Figure 11-12. LOX Tank Conditions - Earth Orbit and Solar Orbit Insertion (Sheet 2 of 4)

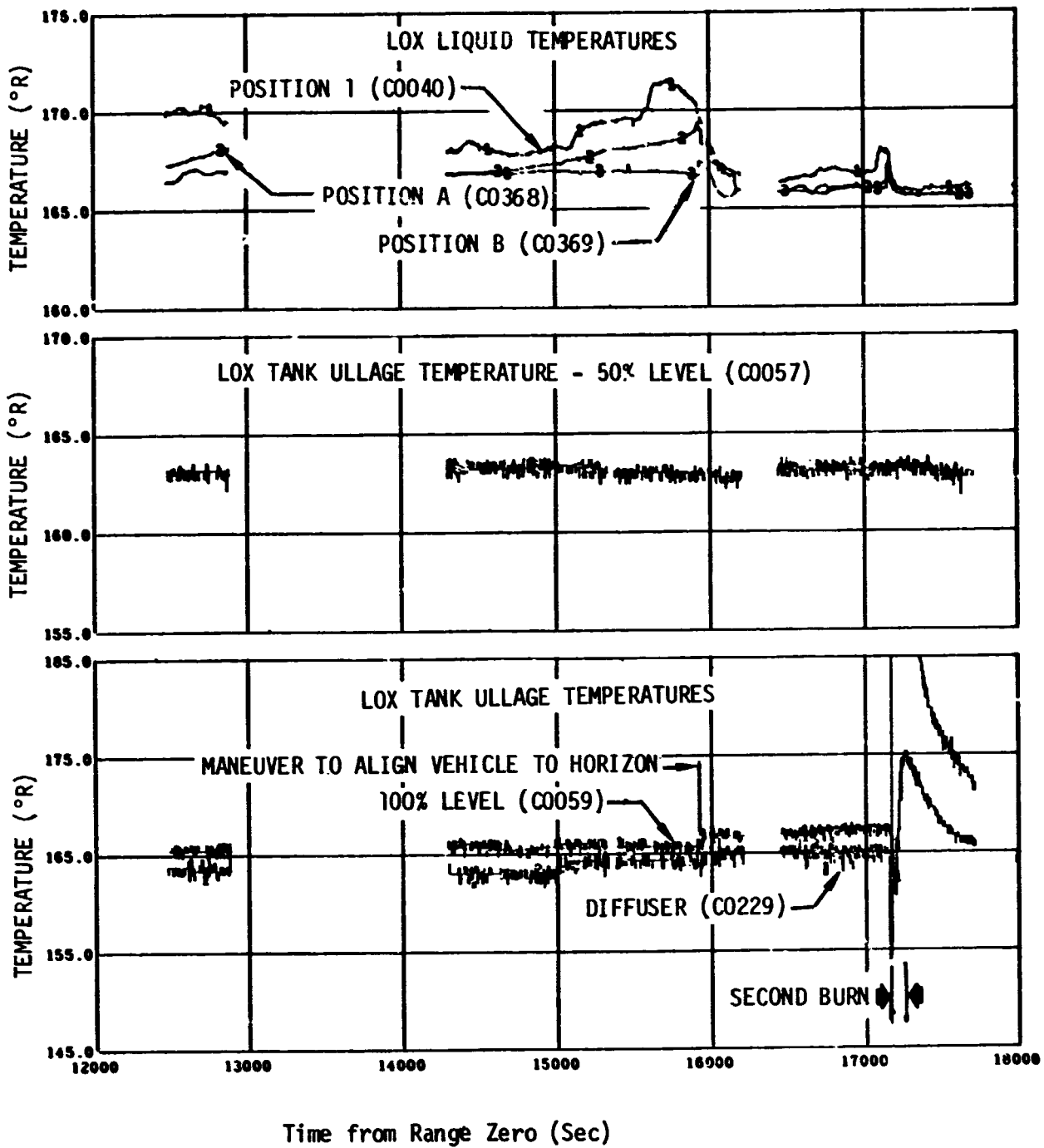

Figure 11-12. LOX Tank Conditions - Earth Orbit and Solar Orbit Insertion (Sheet 3 of 4)

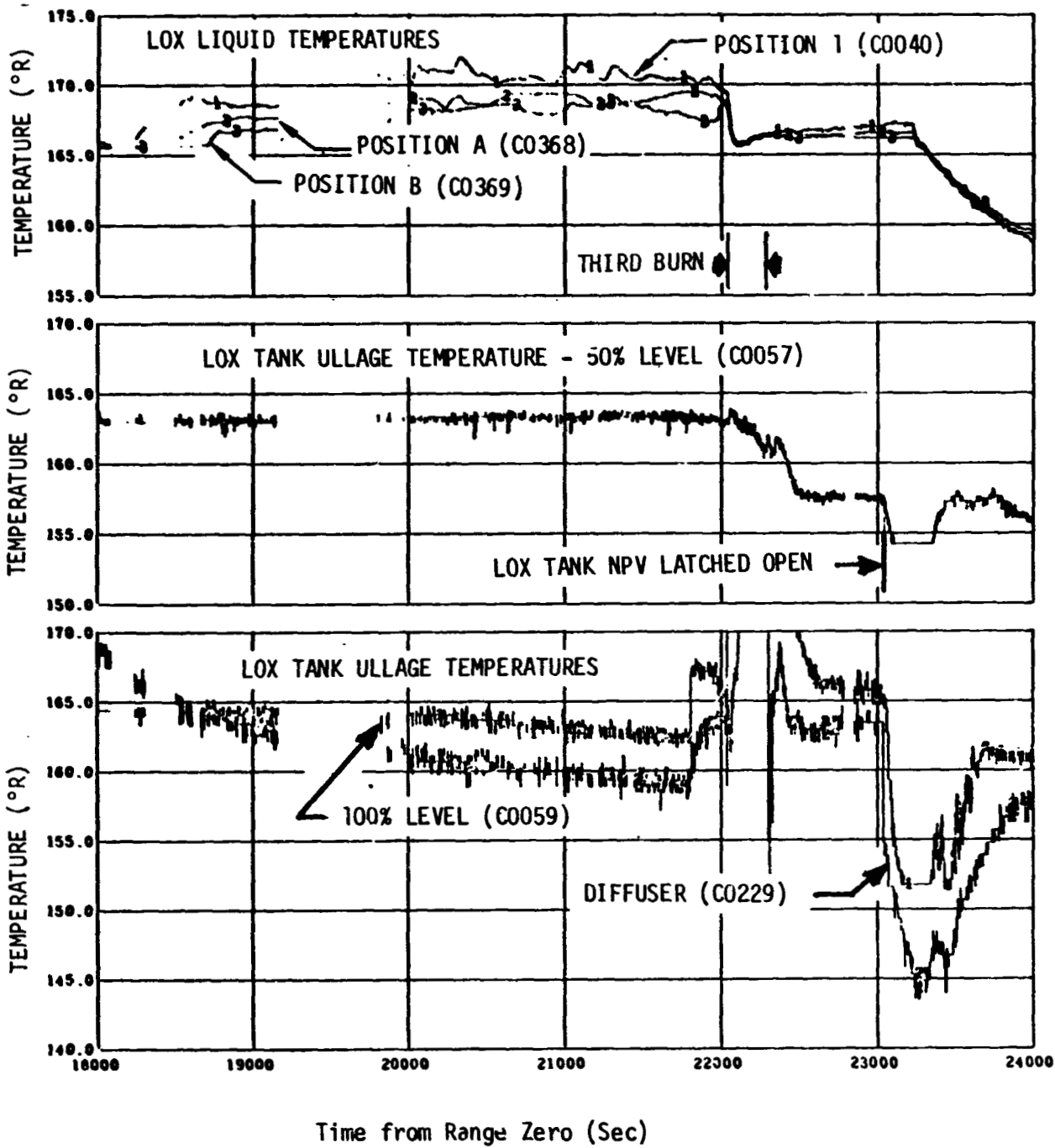

Figure 11-12. LOX Tank Conditions - Earth Orbit and Solar Orbit Insertion (Sheet 4 of 4)

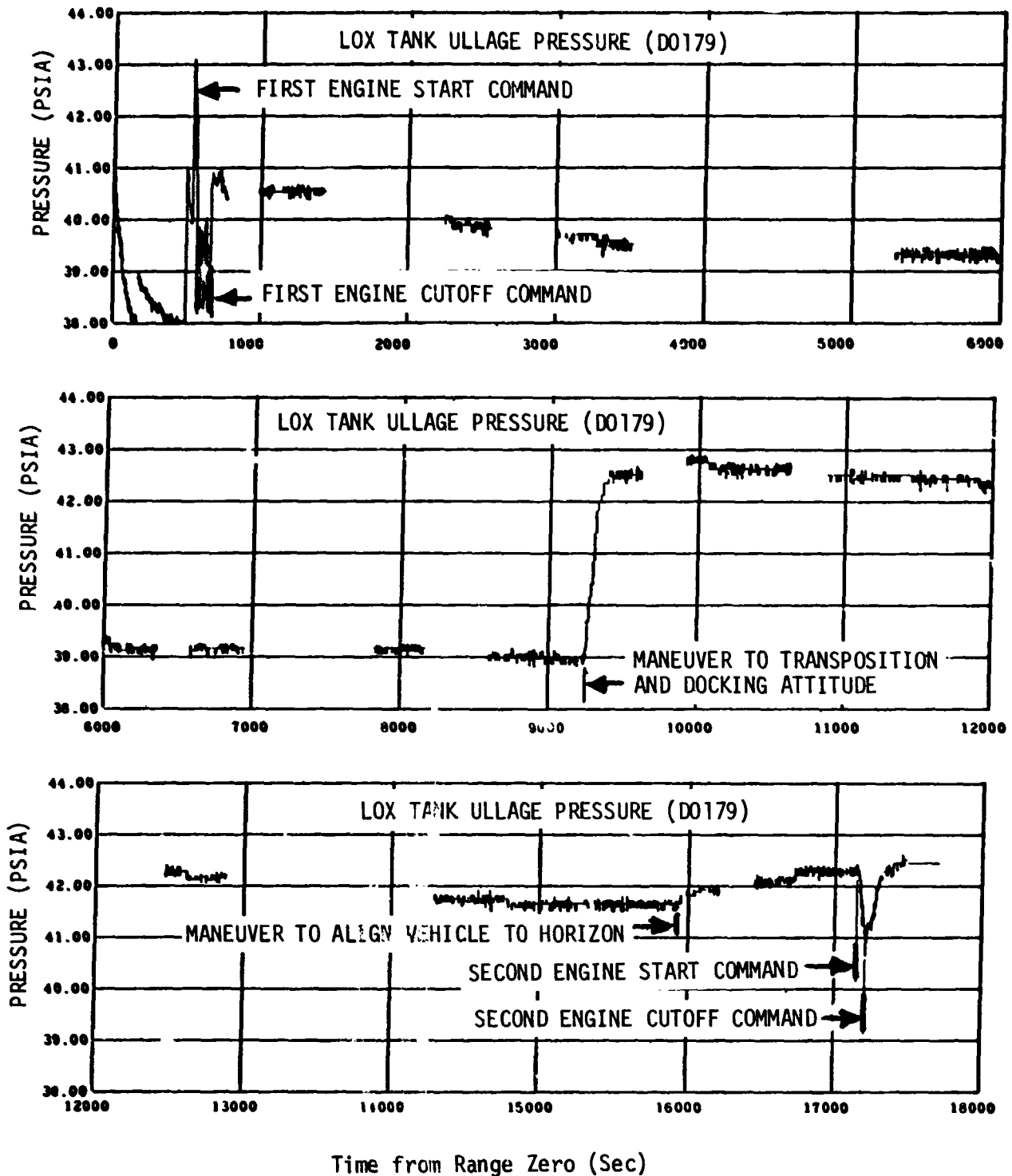

FIGURE 11-13. LOX Tank Ullage Pressure - Earth Orbit and Solar Orbit Insertion (Sheet 1 of 2)

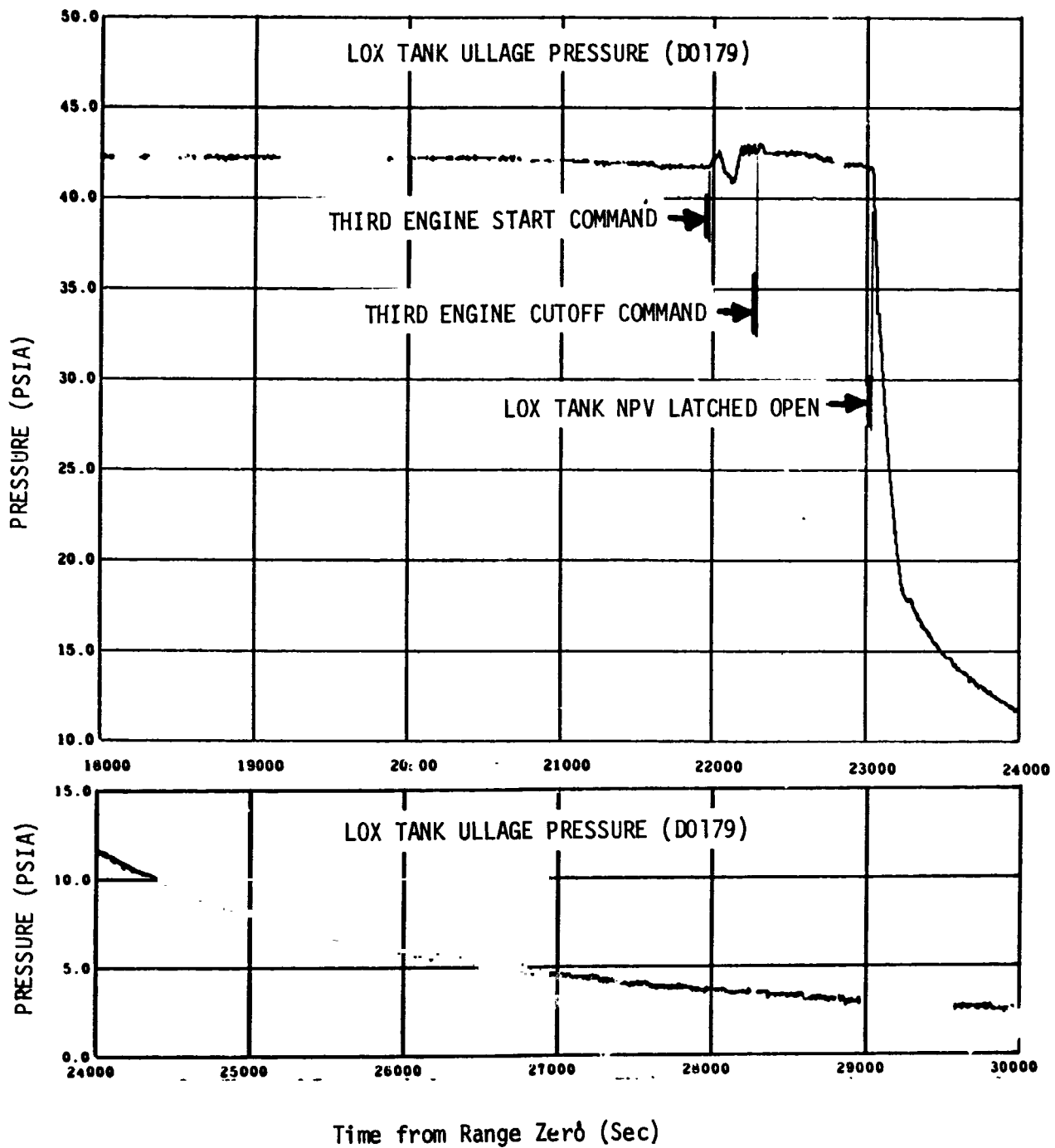

Figure 11-13. LOX Tank Ullage Pressure - Earth Orbit and Solar Orbit Insertion (Sheet 2 of 2)

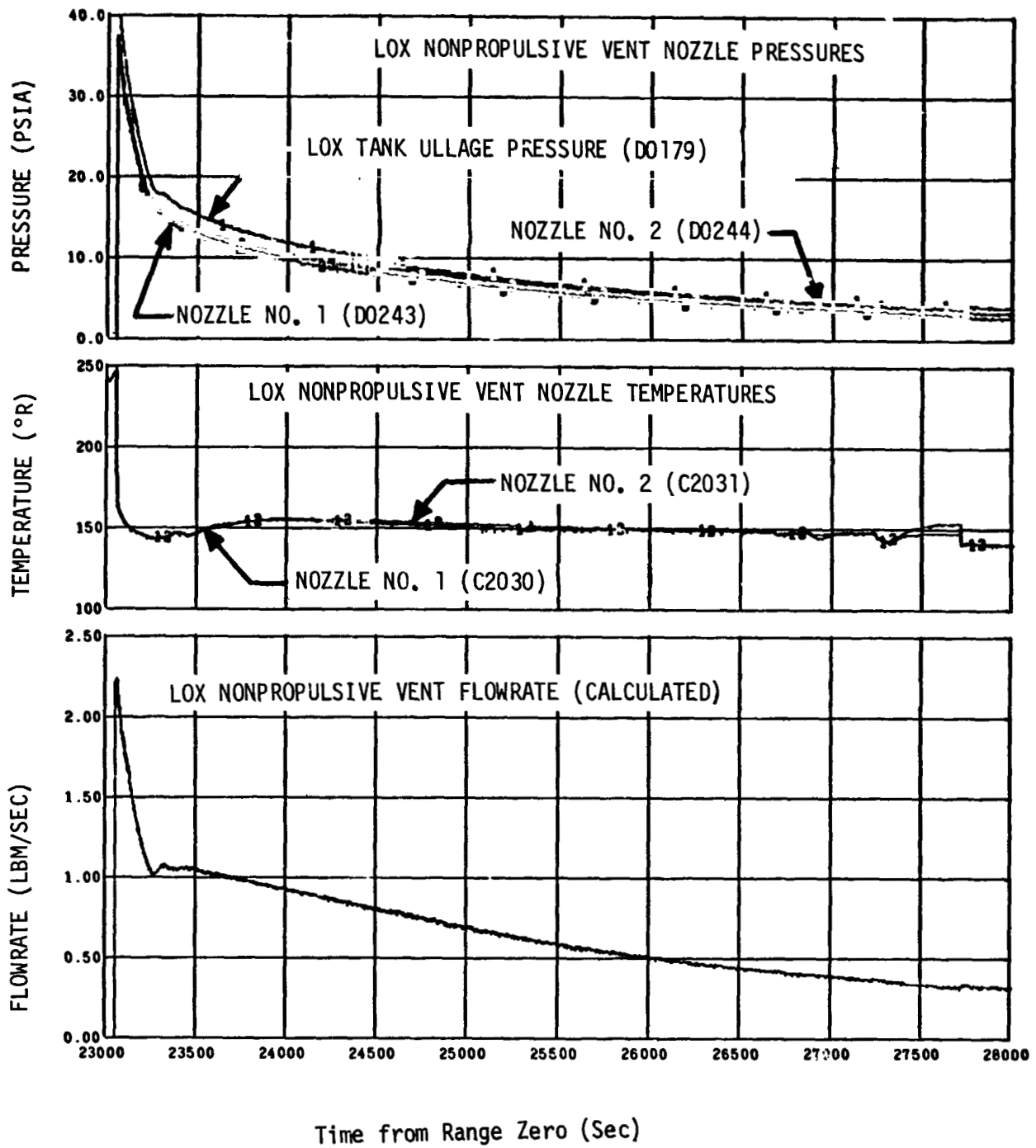

Figure 11-14. LOX Nonpropulsive Vent System Performance - Solar Orbit Insertion

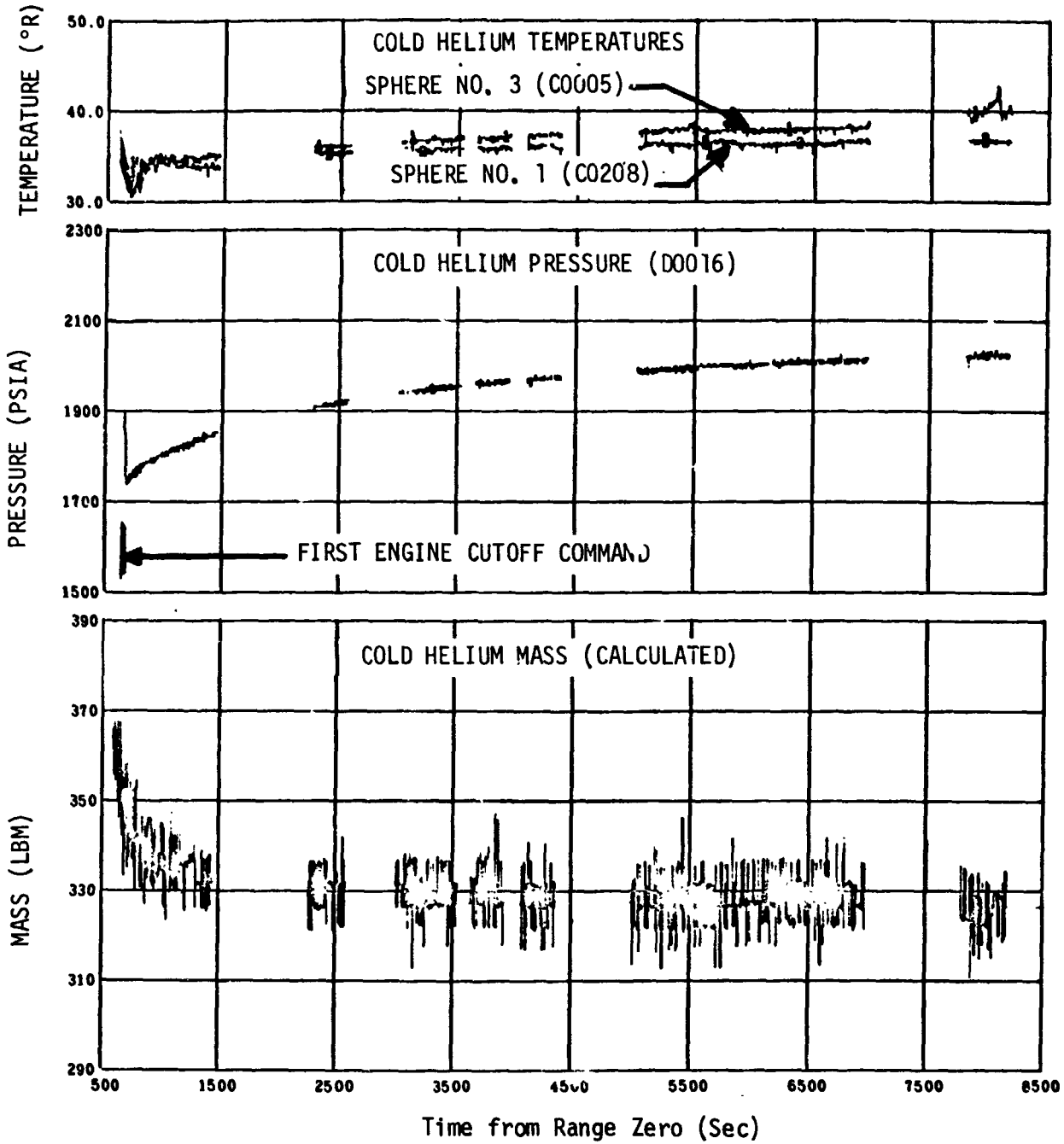

Figure 11-15. Cold Helium Sphere Conditions - Earth Orbit  
 (Sheet 1 of 2)

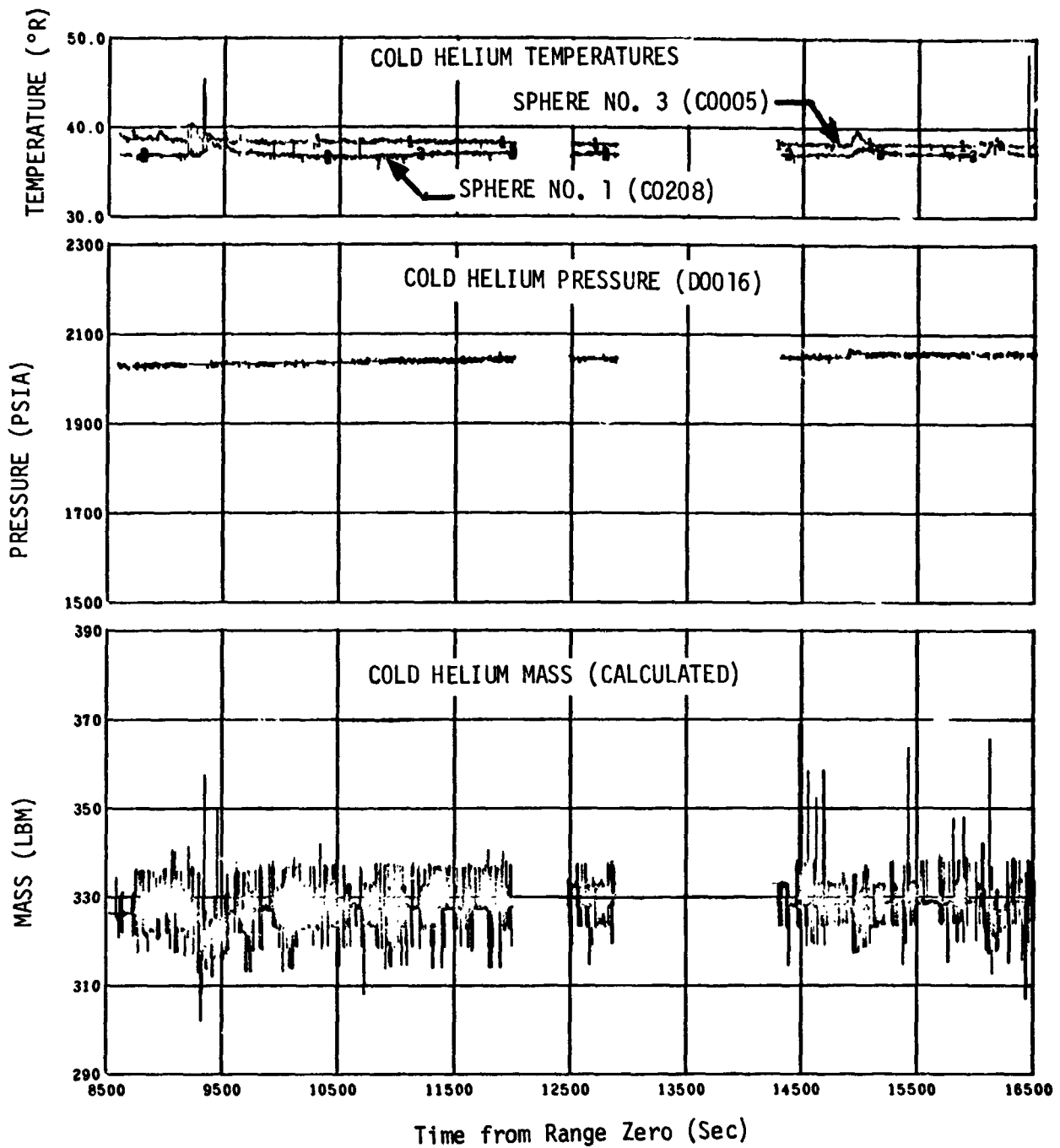

Figure 11-15. Cold Helium Sphere Conditions - Earth Orbit  
(Sheet 2 of 2)



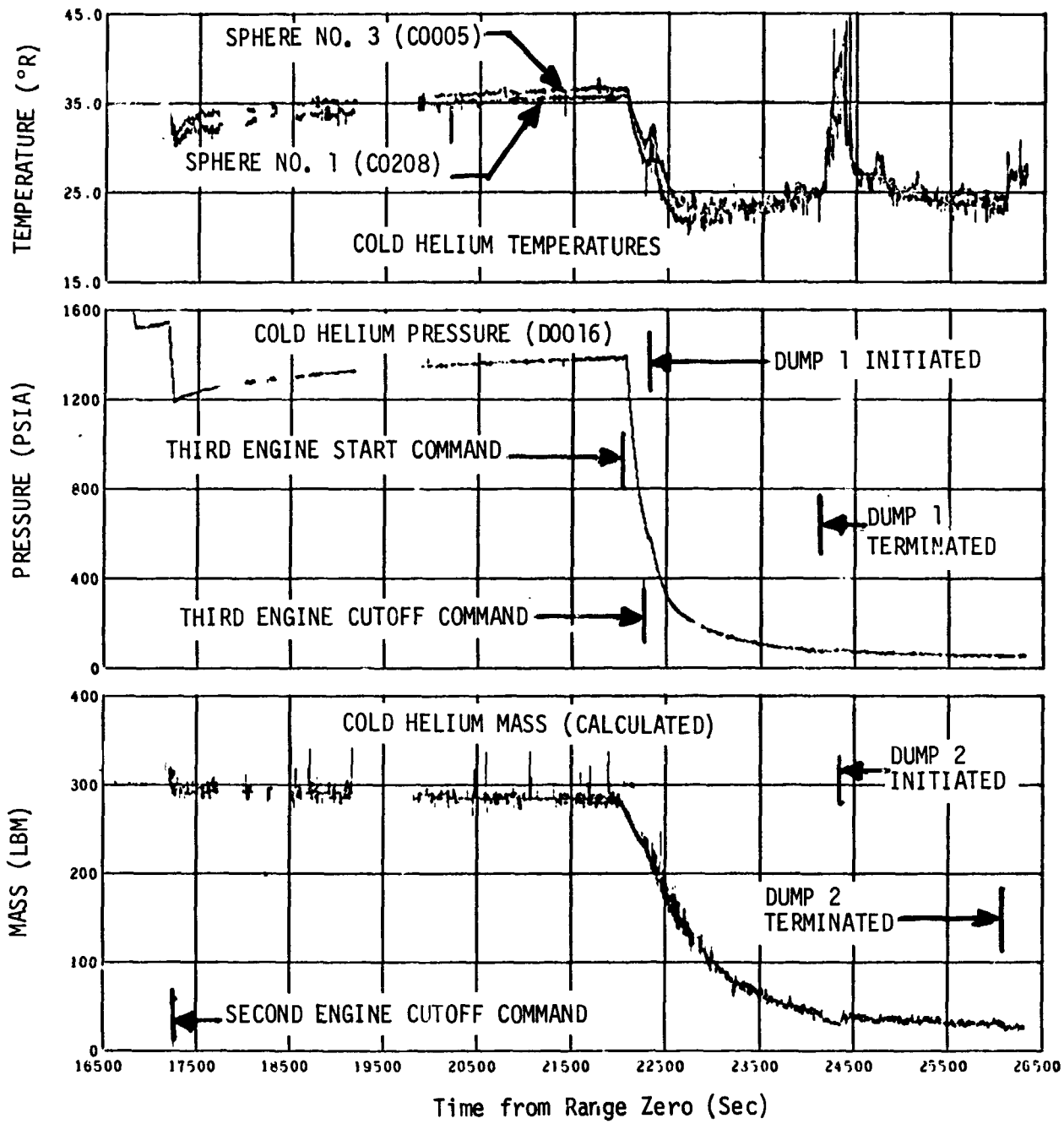

Figure 11-16. Cold Helium Conditions - Intermediate Orbit and Dump

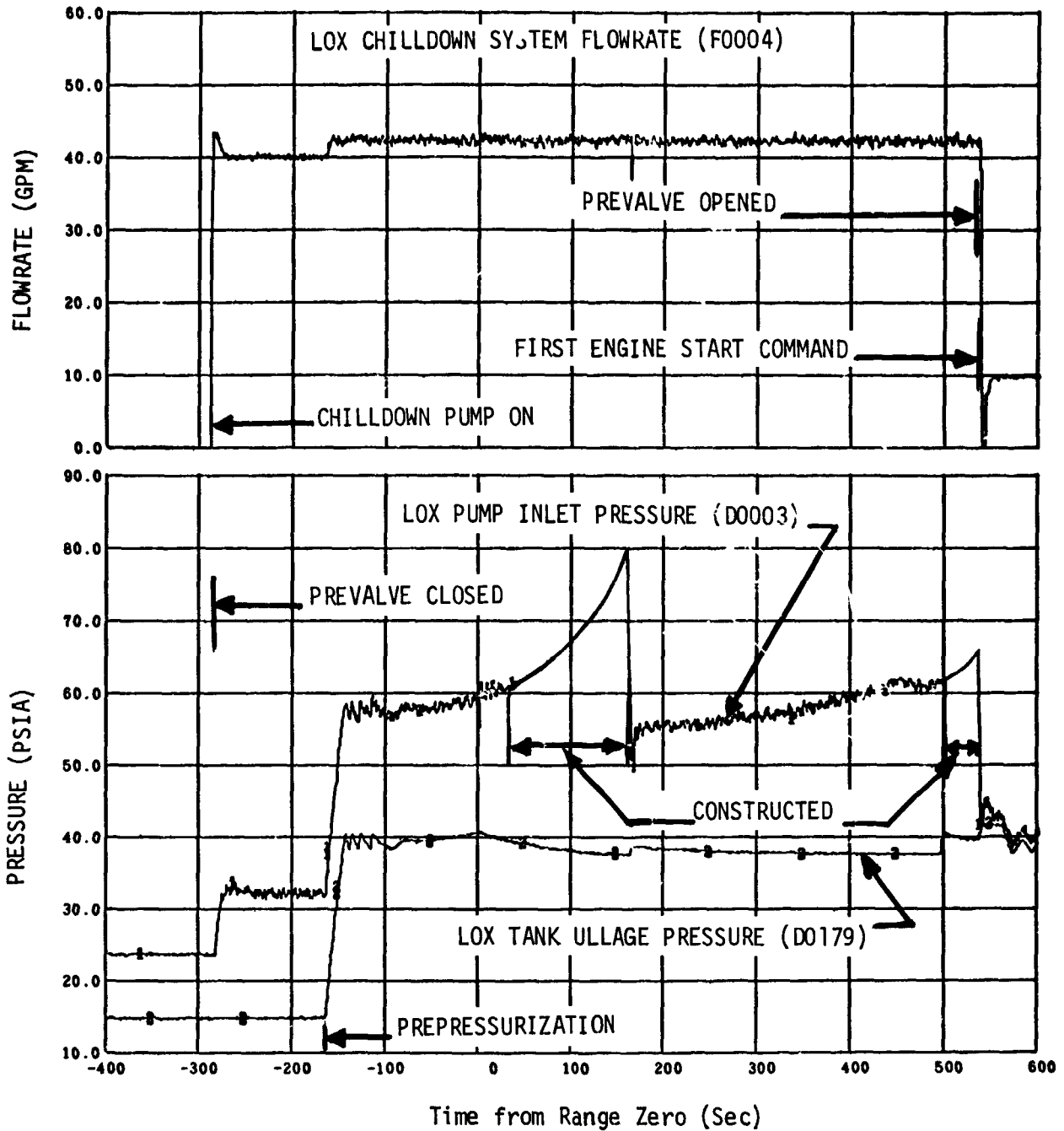

Figure 11-17. LOX Pump Chilldown System Operation - Boost and First Burn (Sheet 1 of 2)

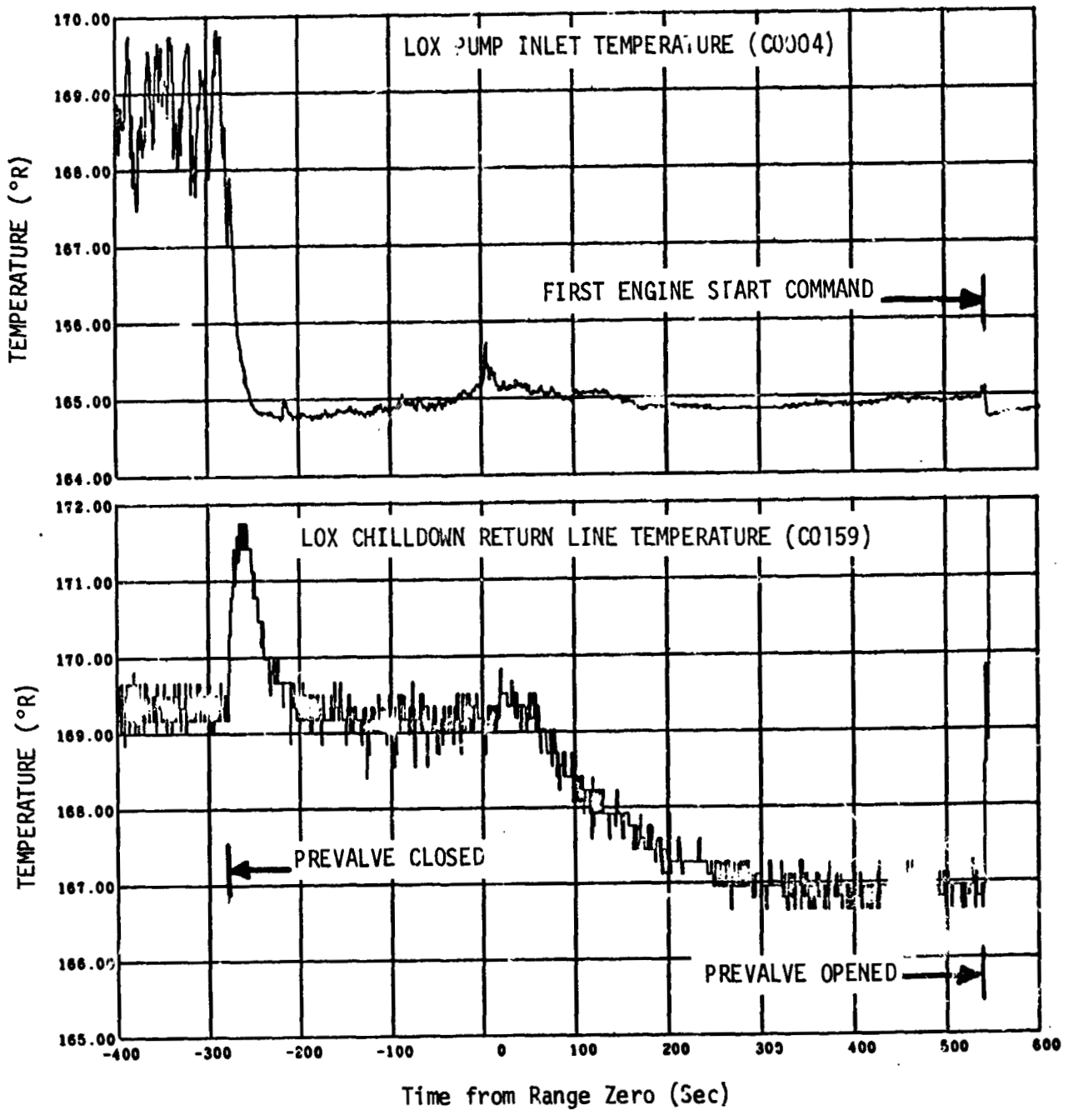

Figure 11-17. LOX Pump Chilldown System Operation - Boost and First Burn (Sheet 2 of 2)

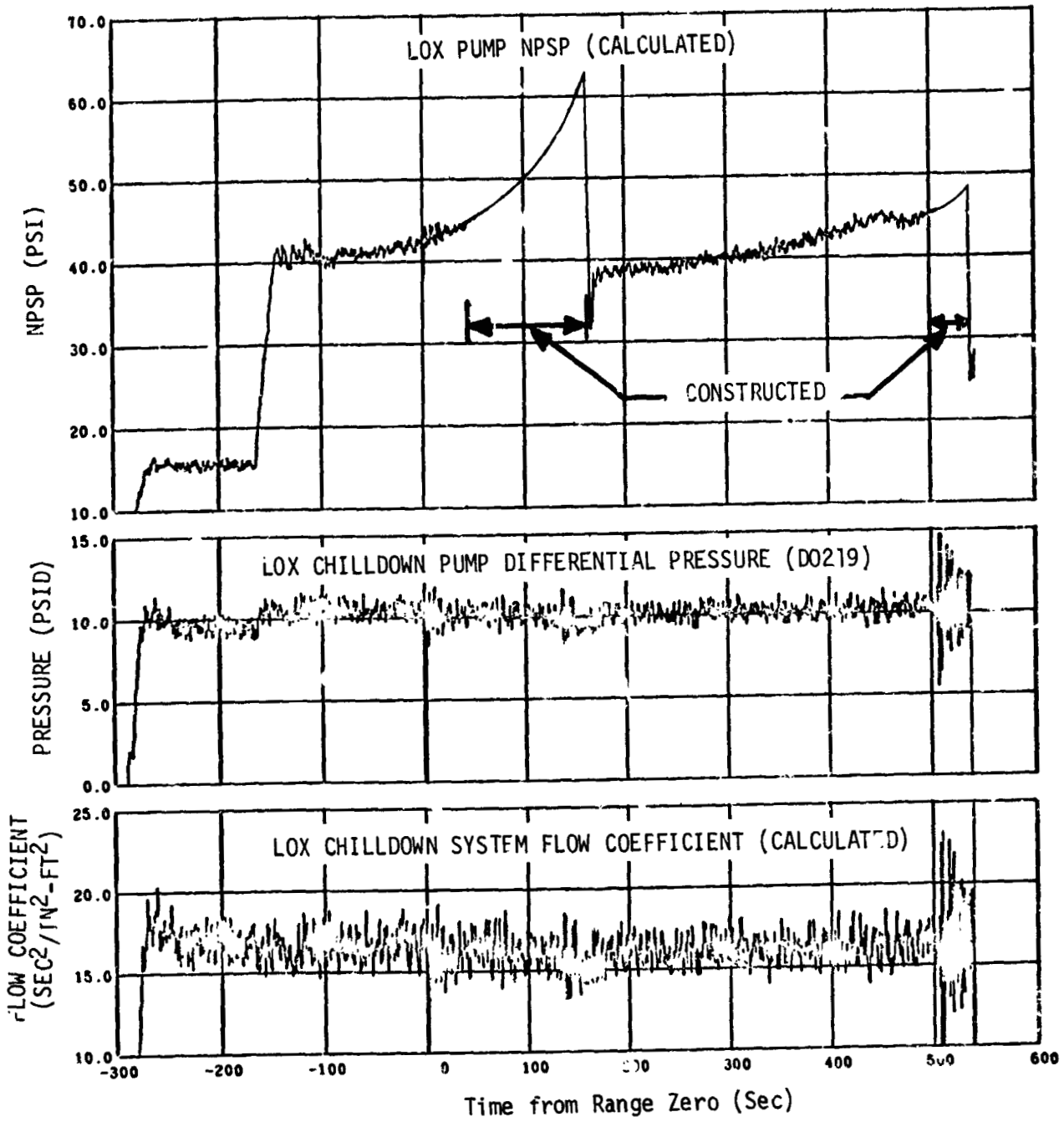

Figure 11-18. LOX Pump Chillover System Performance - Boost and First Burn (Sheet 1 of 2)

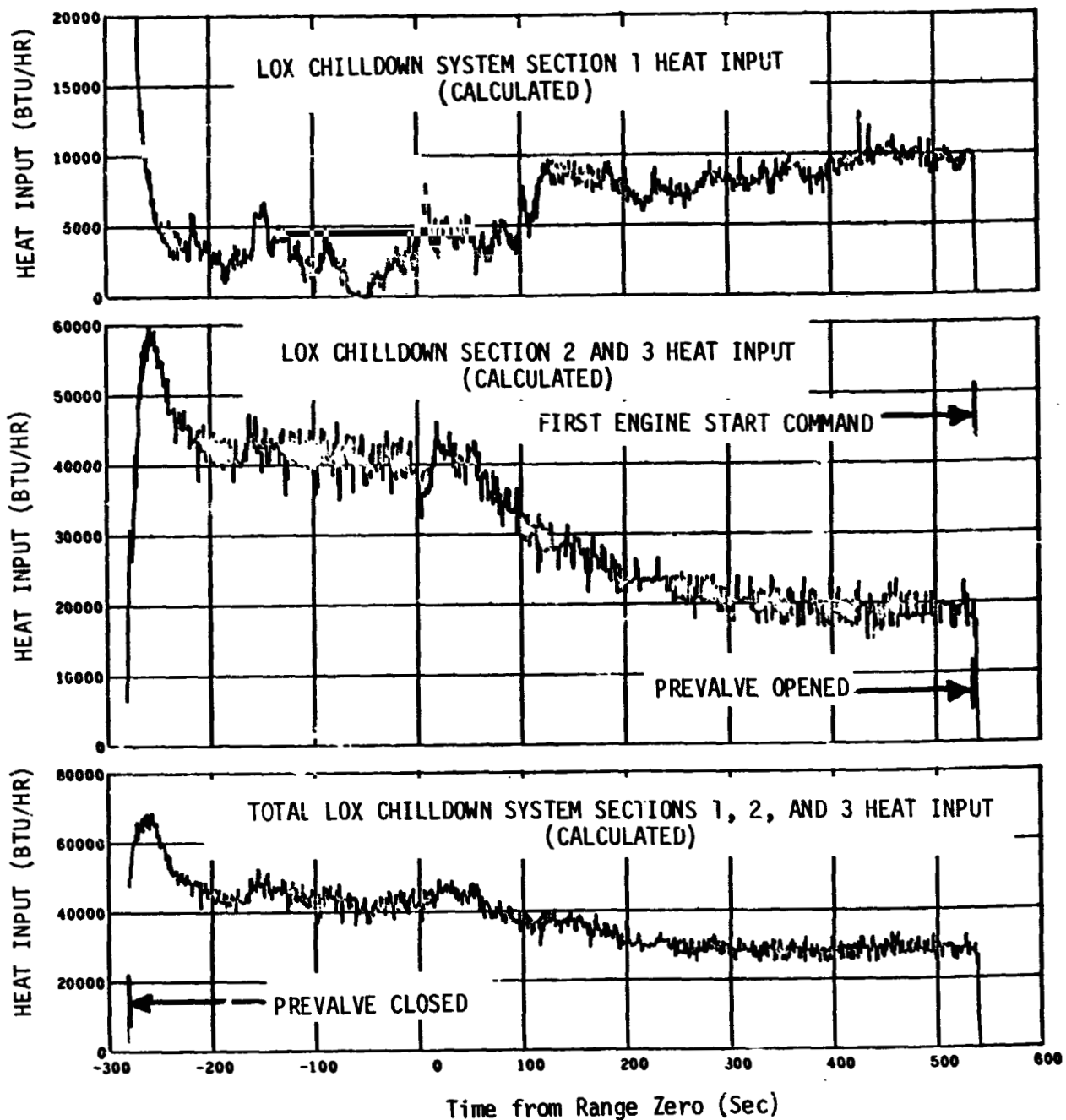

Figure 11-18. LOX Pump Chilldown System Performance - Boost and First Burn (Sheet 2 of 2)

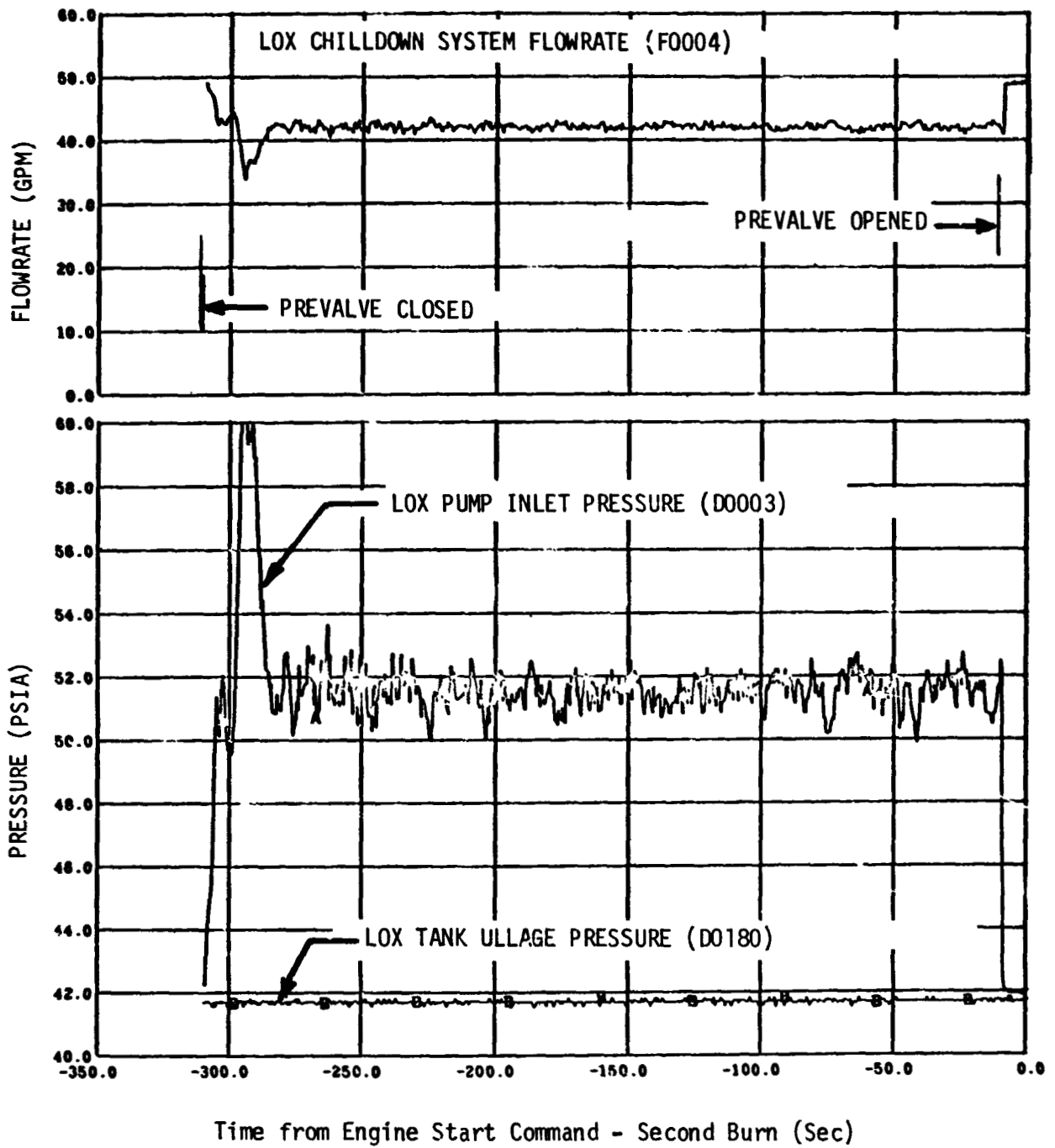

Figure 11-19. LOX Pump Chilldown System Operation - Second Burn (Sheet 1 of 2)

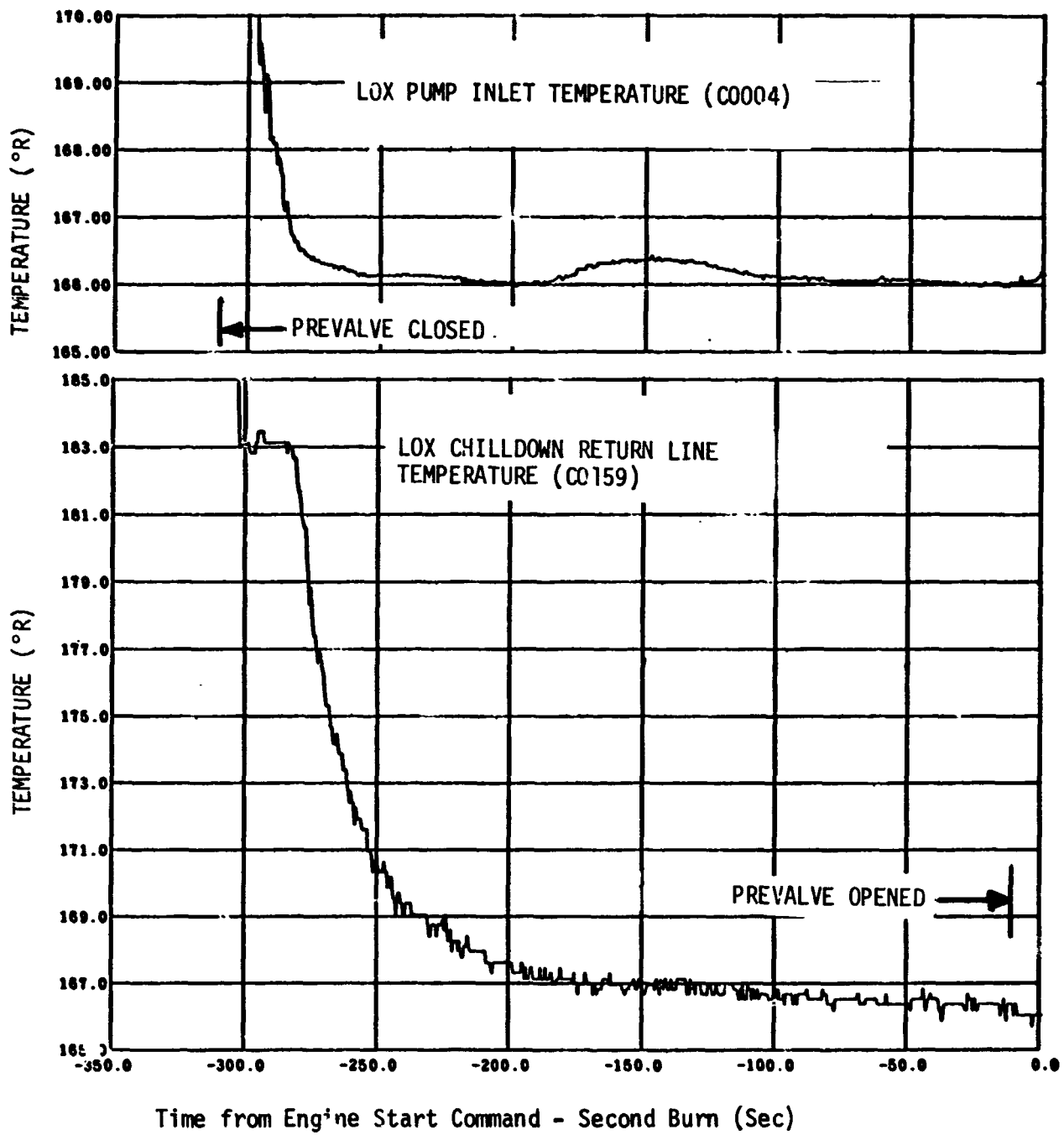

Figure 11-19. LOX Pump Chilldown System Operation - Second Burn (Sheet 2 of 2)

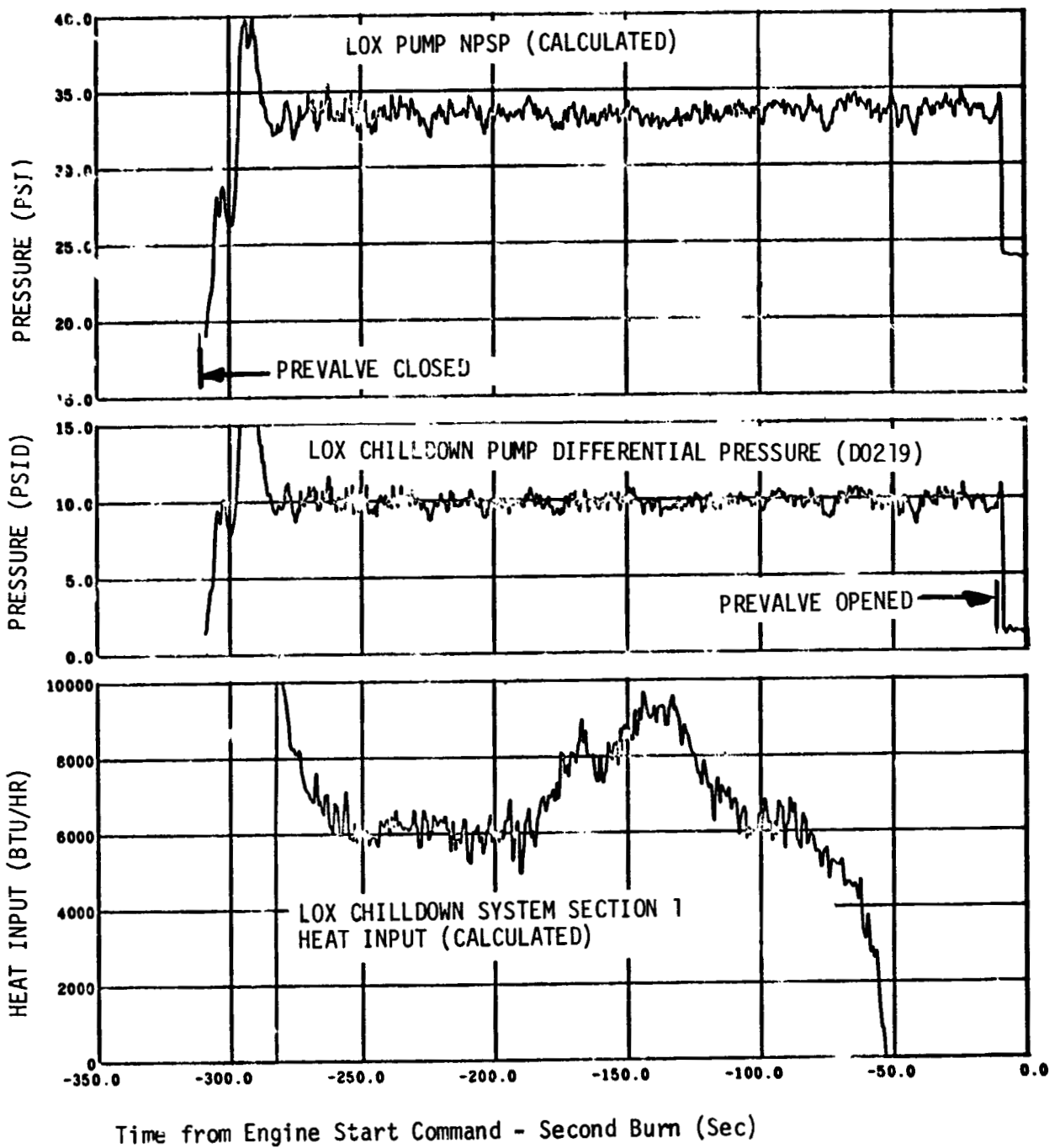

Figure 11-20. LOX Pump Chilldown System Performance - Second Burn (Sheet 1 of 2)



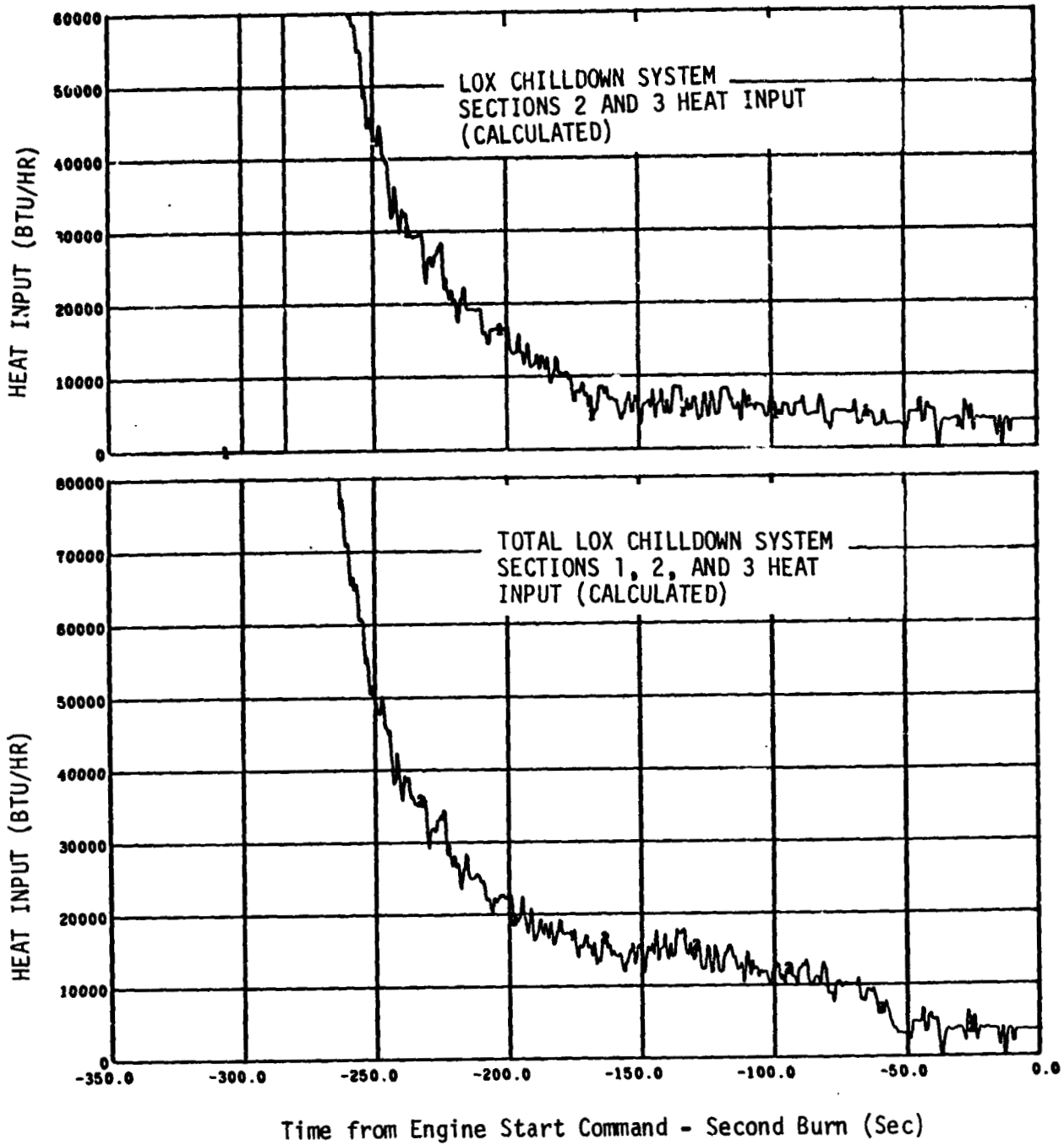
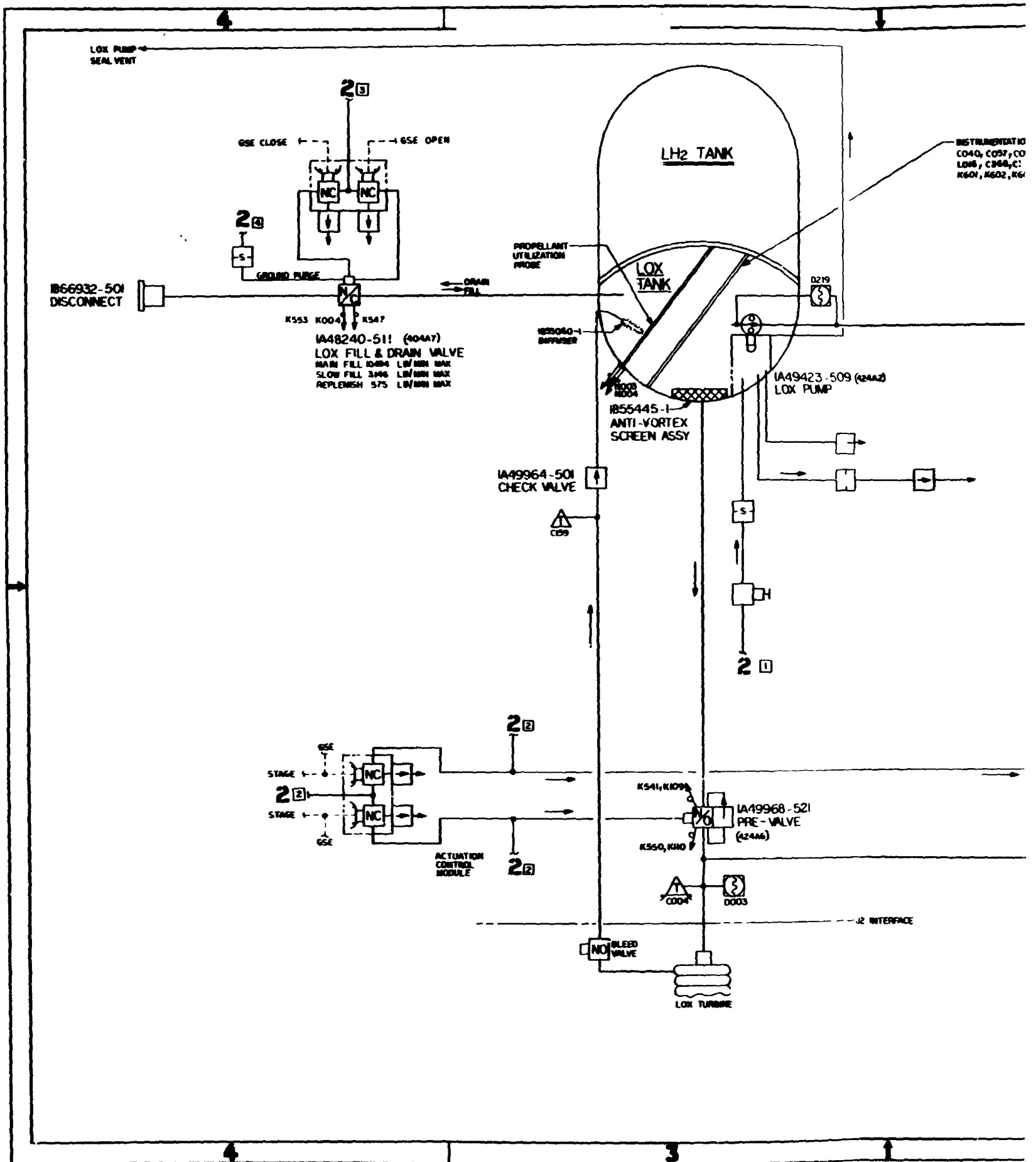

Figure 11-20. LOX Pump Chilldown System Performance - Second Burn (Sheet 2 of 2)



FOLDOUT FRAME

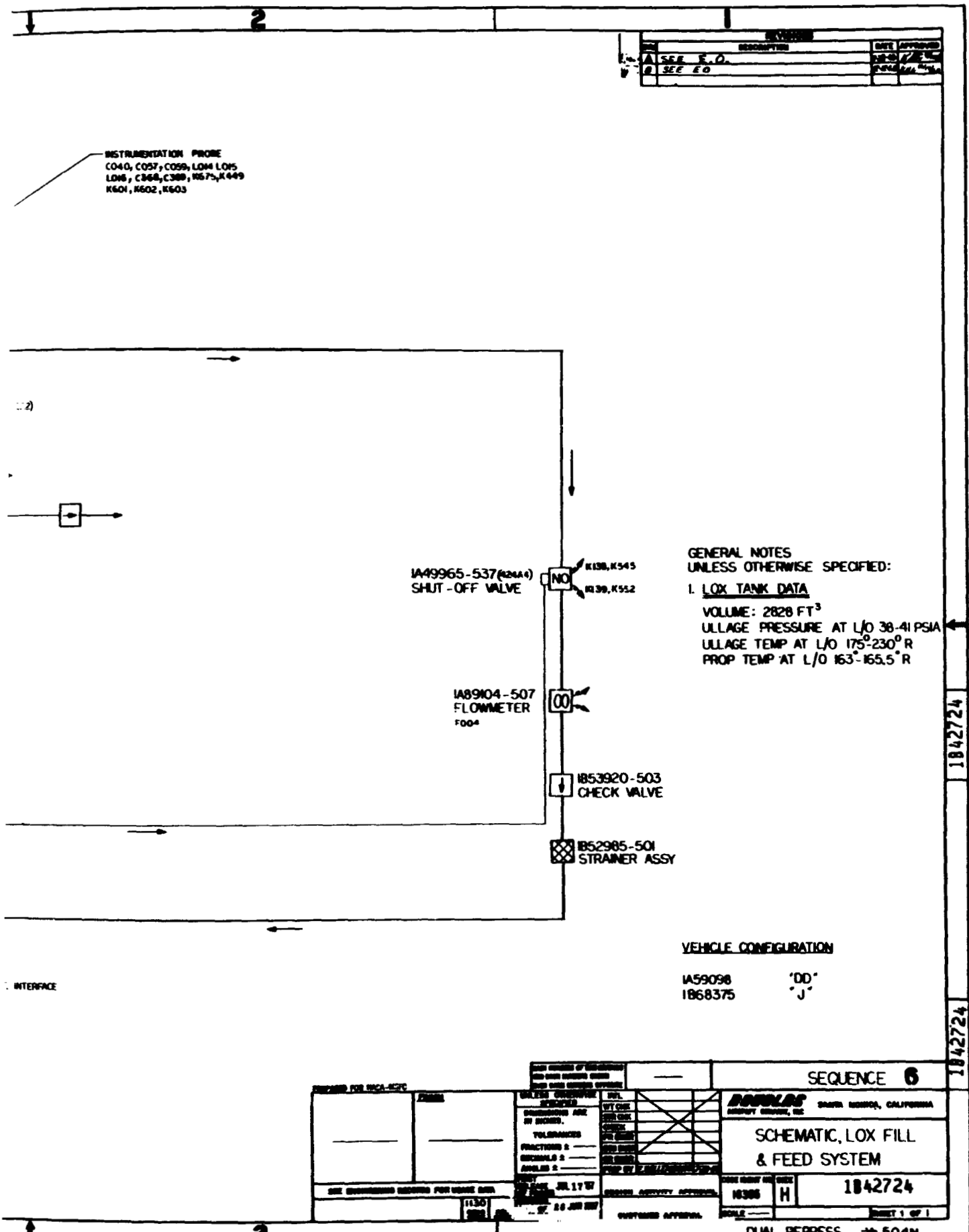

Figure 11-21. Schematic, LOX Fill and Feed System

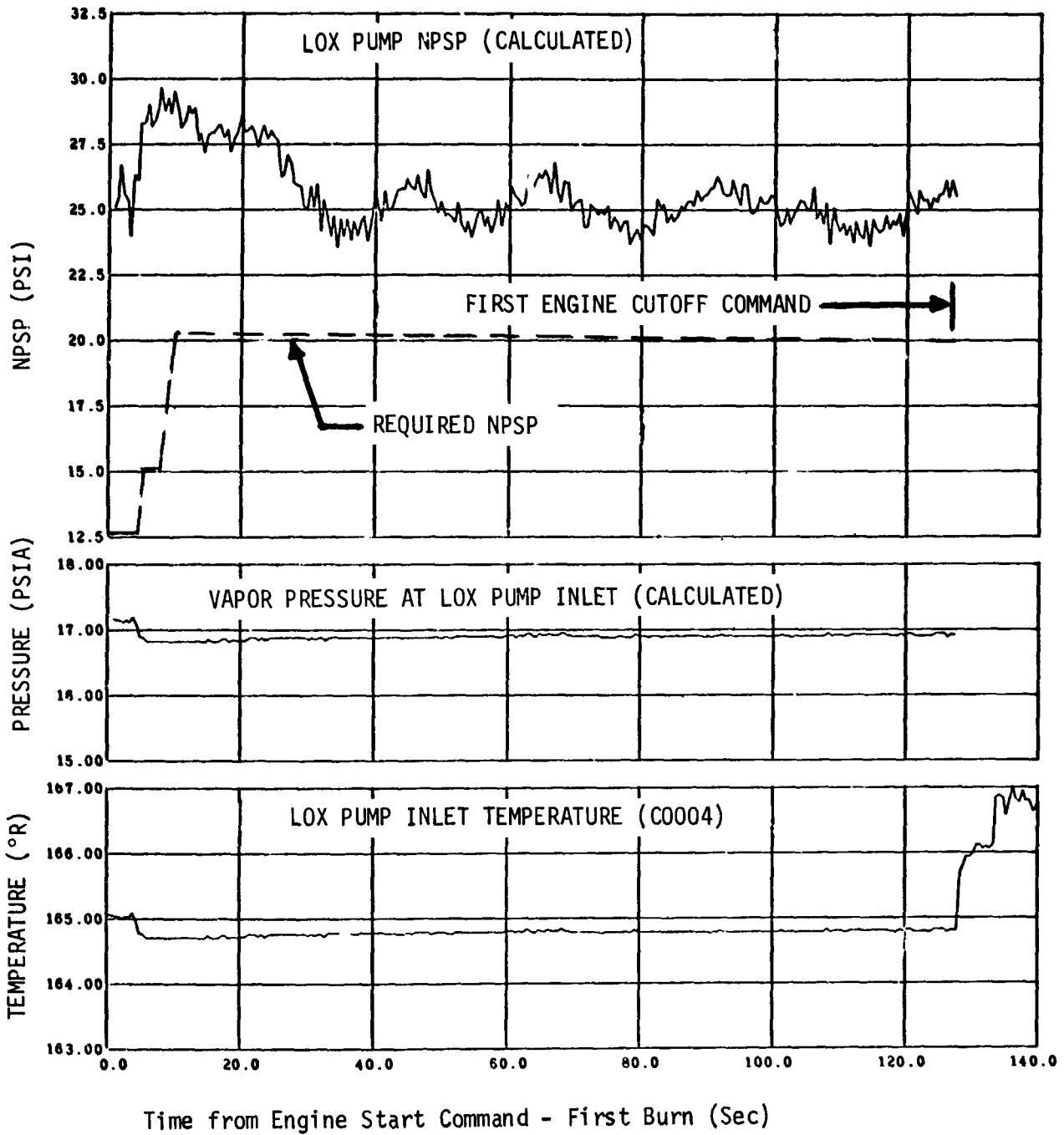

Figure 11-22. LOX Pump Inlet Conditions - First Burn (Sheet 1 of 2)

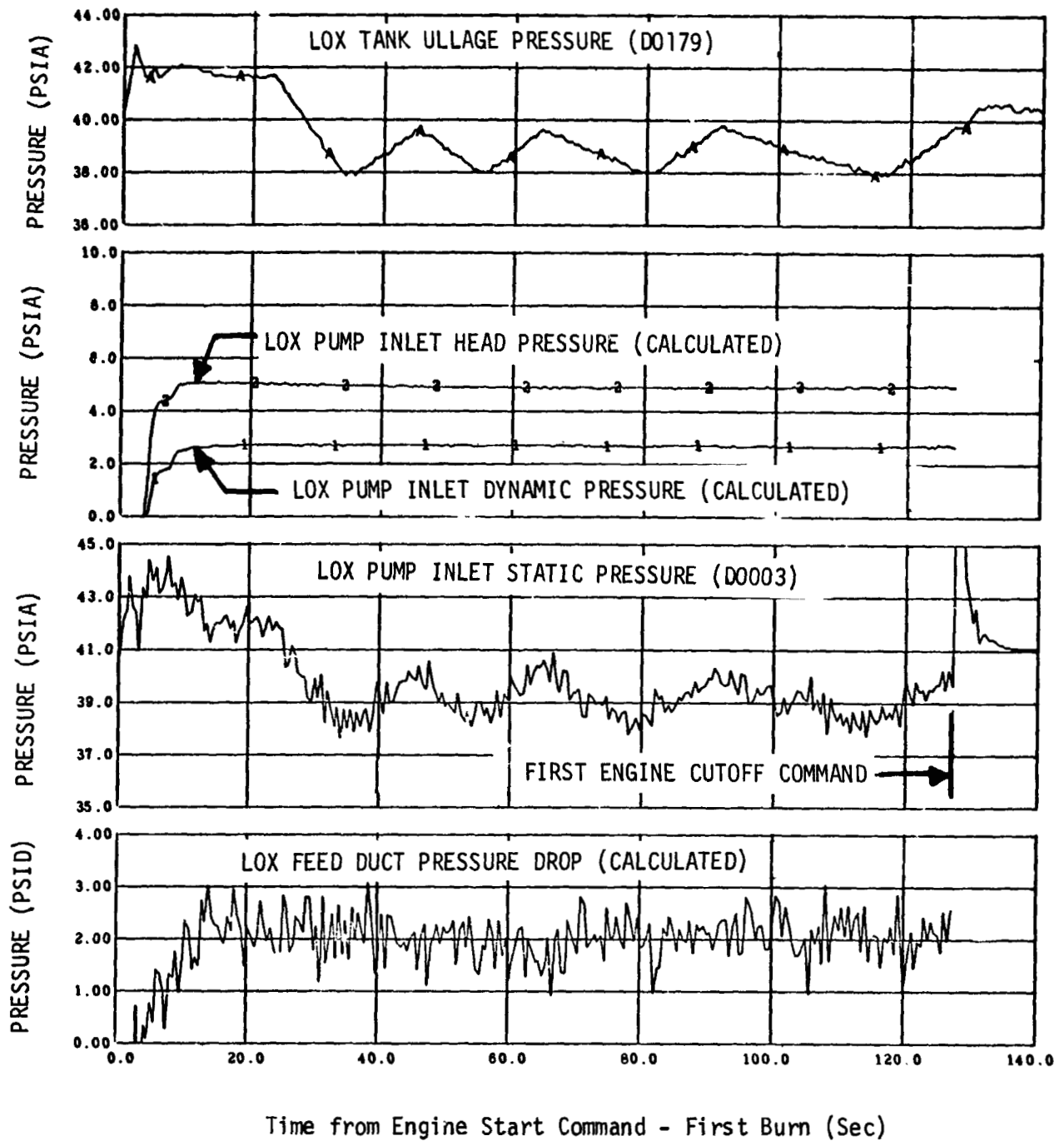

Figure 11-22. LOX Pump Inlet Conditions - First Burn (Sheet 2 of 2)

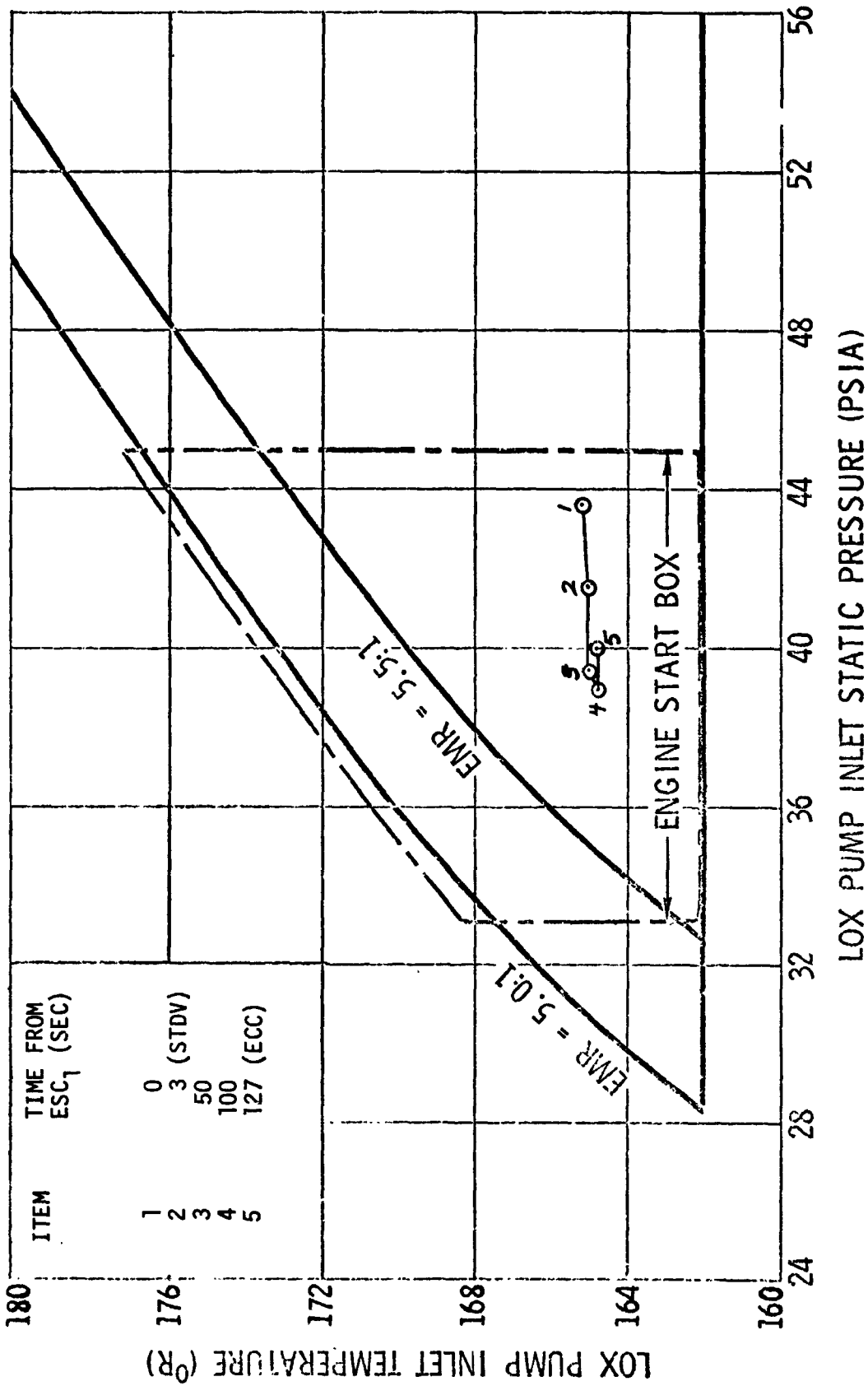

Figure 11-23. LOX Pump Inlet Conditions During Firing - First Burn

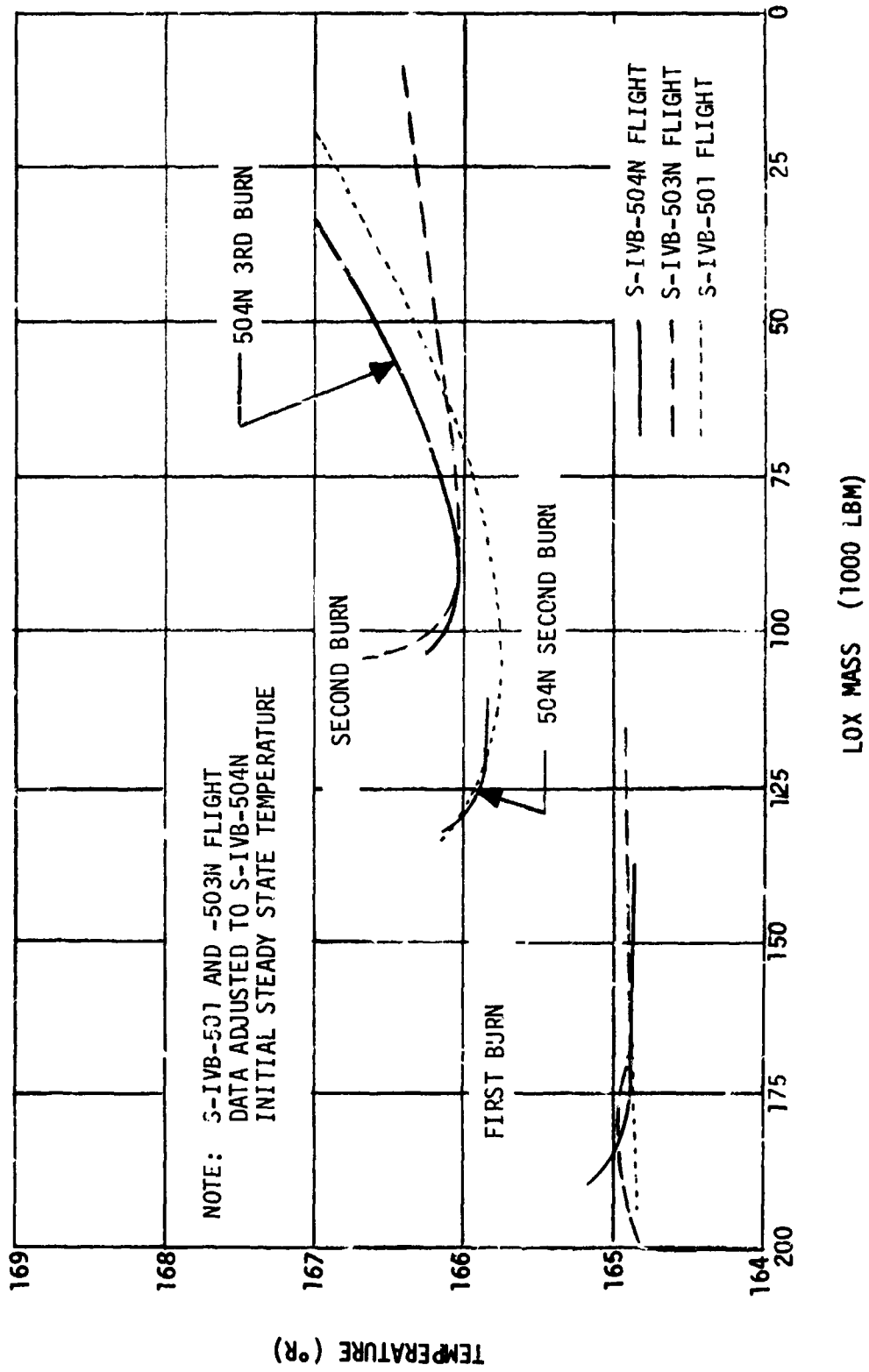

Figure 11-24. Effect of LOX Mass Level on LOX Pump Inlet Temperature

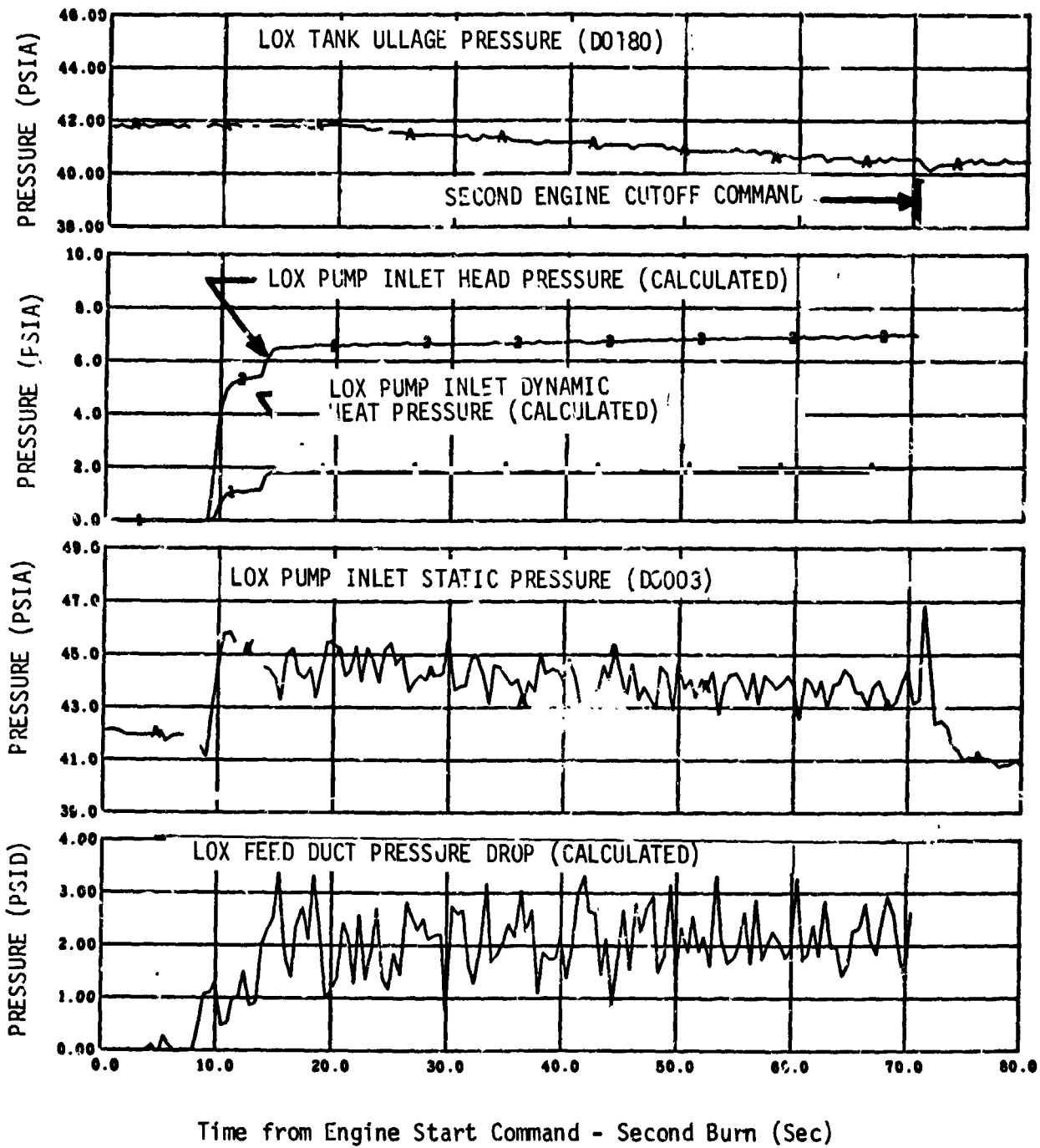

Figure 11-25. LOX Pump Inlet Conditions - Second Burn (Sheet 1 of 2)



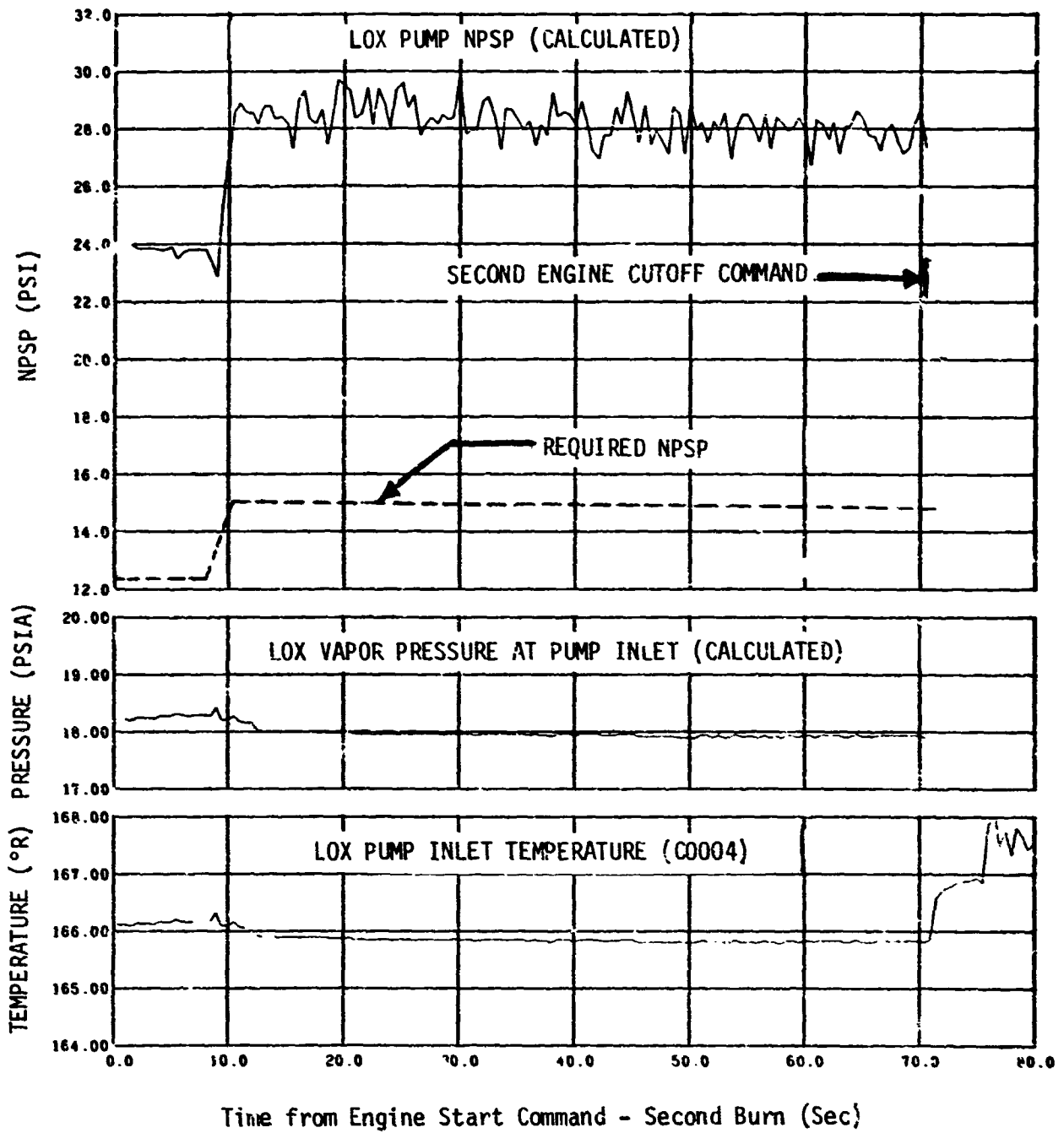

Figure 11-25. LOX Pump Inlet Conditions - Second Burn (Sheet 2 of 2)

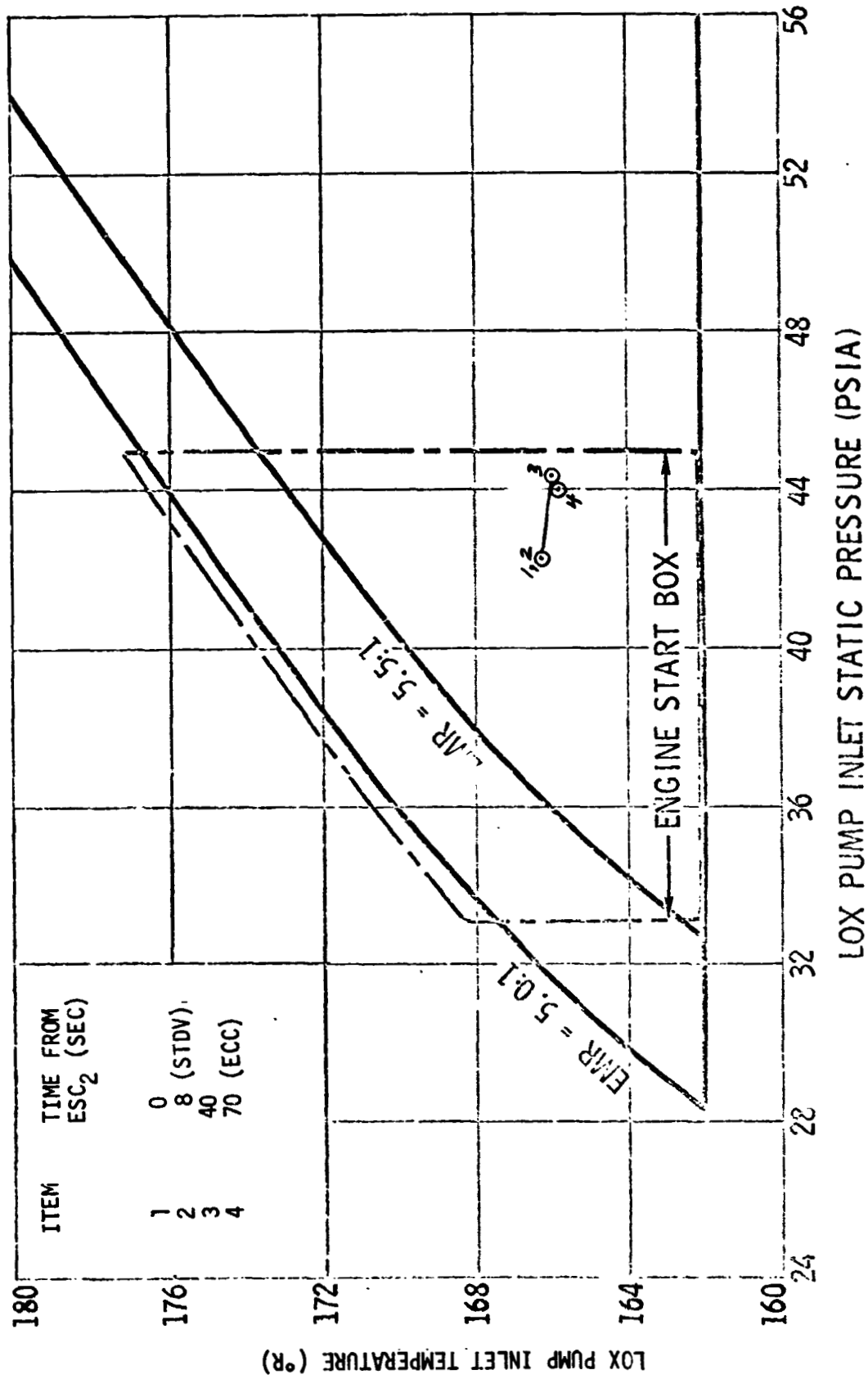
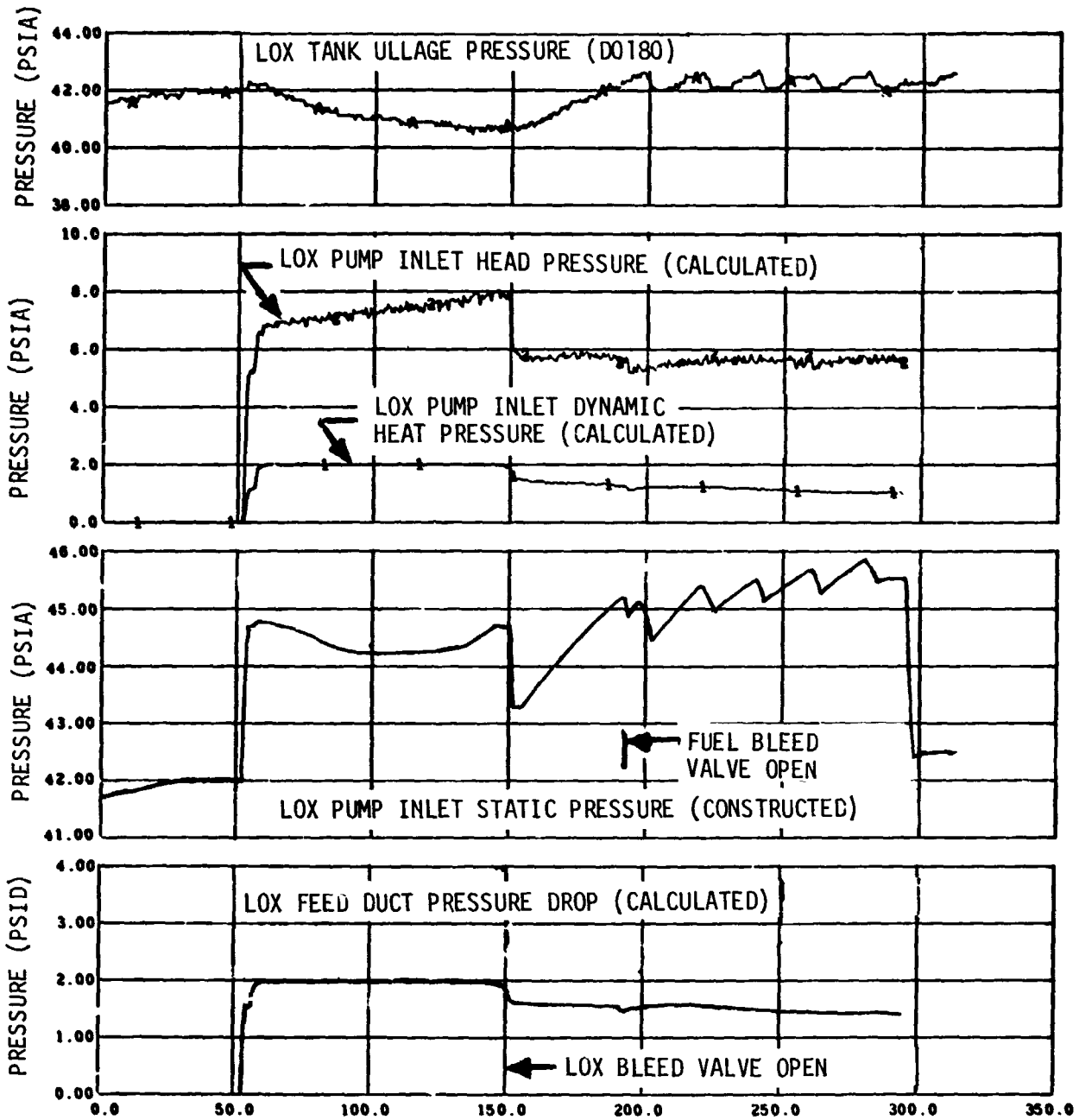

Figure 11-26. LOX Pump Inlet Conditions During Firing - Second Burn



Time from Engine Start Command - Third Burn (Sec)

Figure 11-27. LOX Pump Inlet Conditions - Third Burn (Sheet 1 of 2)

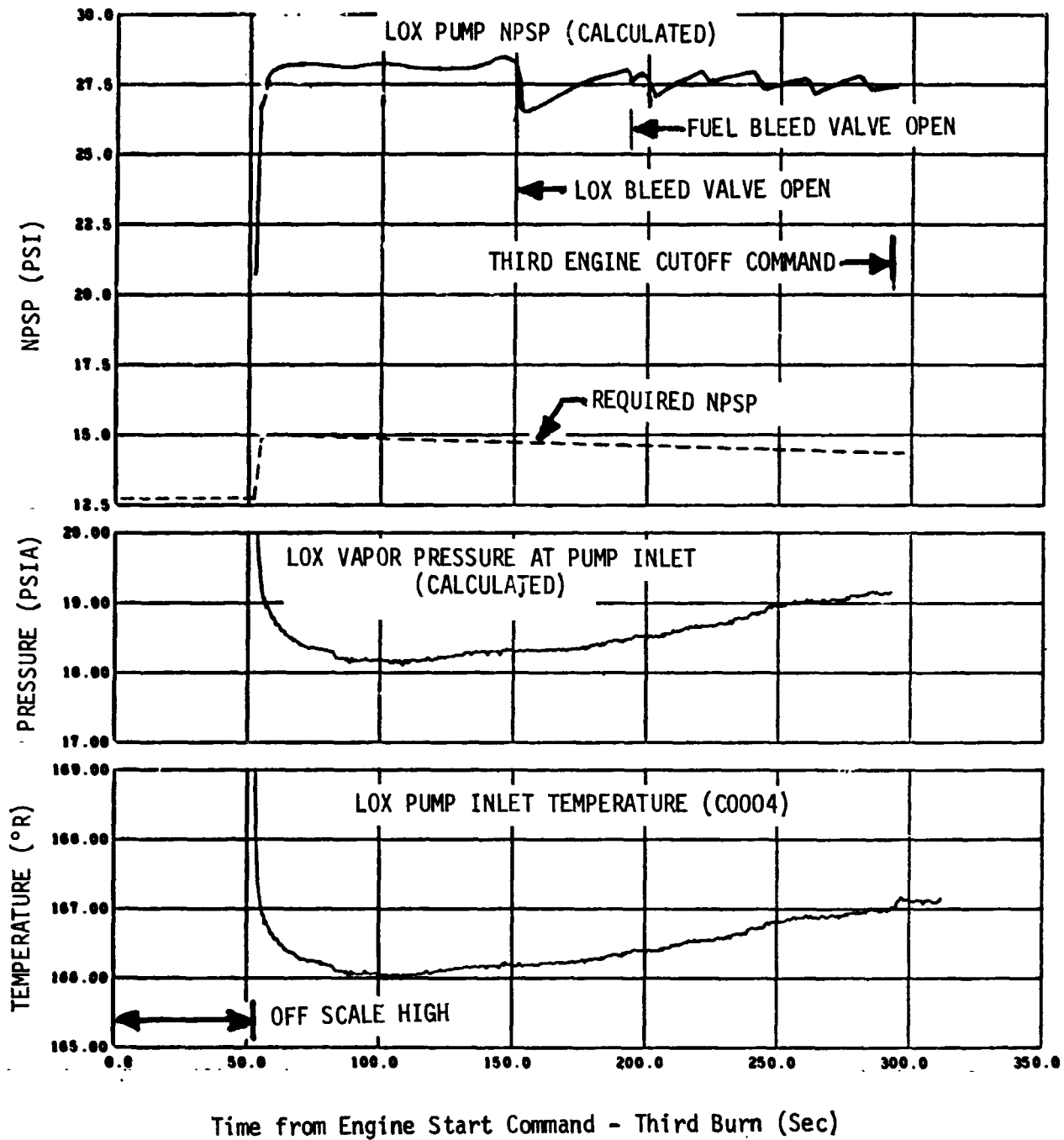

Figure 11-27. LOX Pump Inlet Conditions - Third Burn (Sheet 2 of 2)

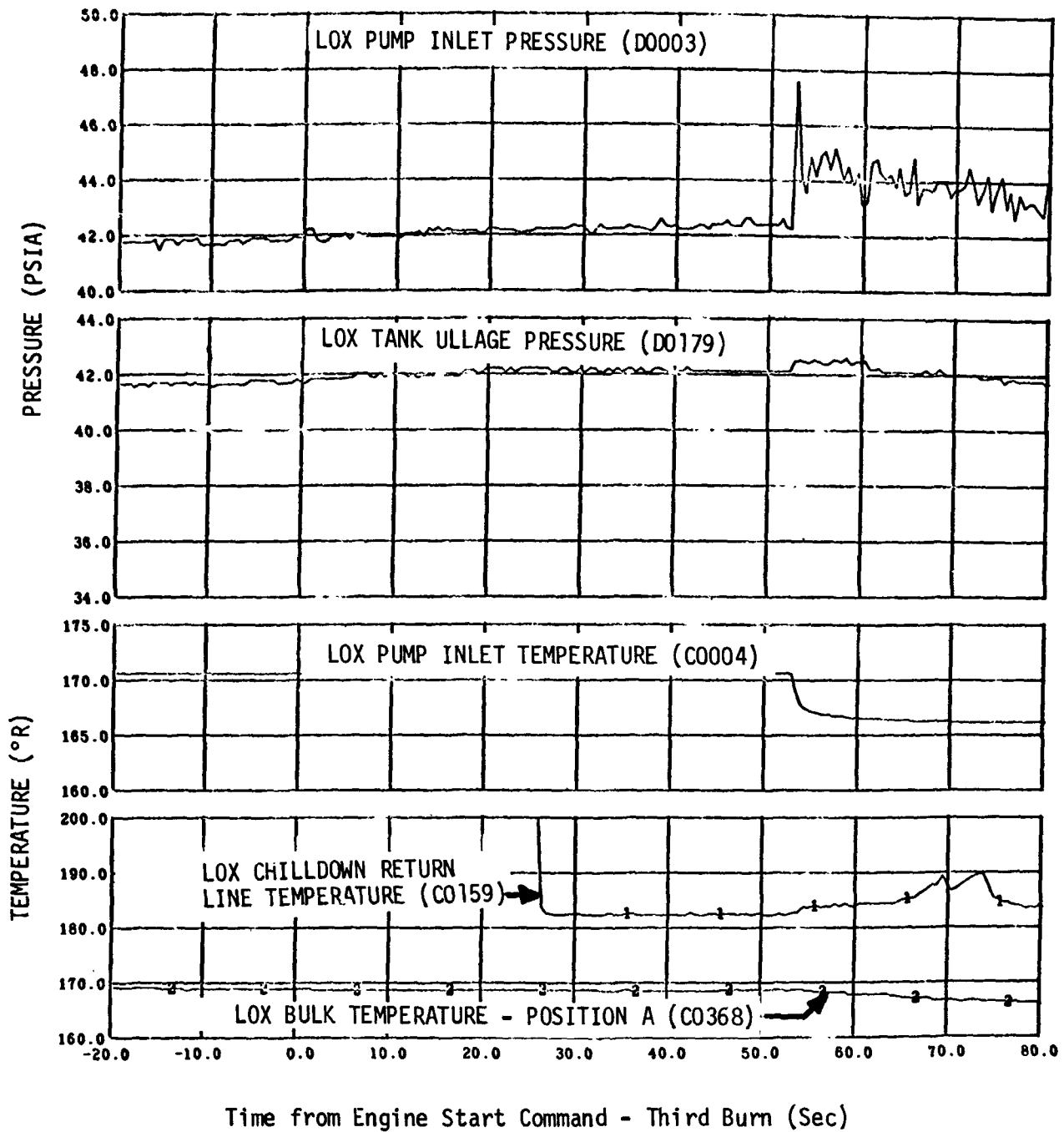

Figure 11-28. LOX Supply Conditions During Extended Fuel Lead - Third Burn

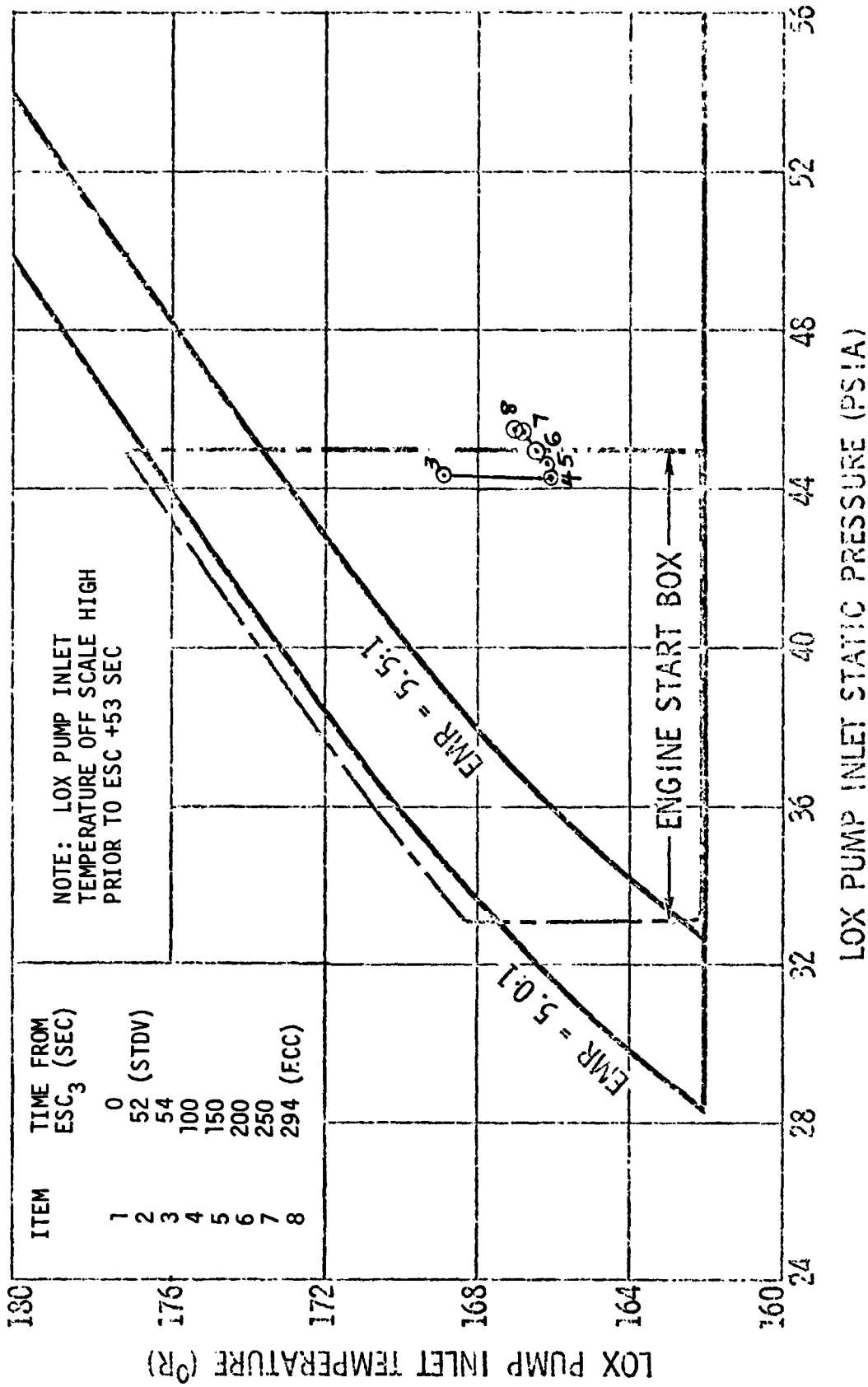

Figure 11-29. LOX Pump Inlet Conditions During Firing - Third Burn

## 12. FUEL SYSTEM

The fuel system supplied LH2 to the engine as designed. The minimum NPSP requirements were exceeded during first and second burns, although they were not met at second engine start command. The NPSP was zero for third engine start because a chilldown failure was simulated; however, the 52-sec fuel lead raised the NPSP to acceptable levels by start tank discharge valve (STDV) opening. The NPSP remained satisfactory until approximately ESC<sub>3</sub> +250 sec, at which time it decreased below minimum requirements because of the anomalous engine performance.

### 12.1 LH2 Tank Pressurization

The LH2 tank pressurization system (figure 12-1) satisfactorily accomplished the following: first, second, and third-burn GH2 pressurization, O2-H2 burner repressurization, and ambient repressurization.

#### 12.1.1 First Burn

##### 12.1.1.1 Prepressurization

The LH2 tank was satisfactorily prepressurized. Pertinent data are presented in table 12-1 and figure 12-2. A minor decay and subsequent recovery in the LH2 tank ullage pressure occurred during the 100 sec following liftoff. This effect was noted again during the period from RO +505 sec to engine start command (RO +537 sec). These decays were probably the result of ullage gas cooling due to surface agitation of the liquid: the first period by the launch vehicle vibrating because of the forces exerted at liftoff; the second period caused by the S-II center engine prior to its cutoff. The effect of this ullage cooling was accentuated by the small ullage volume, as compared to previous flights. The LH2 tank ullage pressure was at relief conditions, 31.1 psia, for the remainder of boost.

#### 12.1.1.2 Pressurization -- First Burn

At first burn engine start command, the LH2 tank ullage pressure was 31.4 psia. The GH2 pressurization system performance was nominal during first burn, and tank pressurization was accomplished as predicted.

The LH2 tank ullage pressure was at relief conditions during the burn, resulting in approximately 17.6 lbm of vented ullage gas. Conditions during first burn LH2 tank pressurization are summarized in figure 12-3 and compared with S-IVB-502 and 503N flight data in table 12-2.

#### 12.1.2 Second Burn

##### 12.1.2.1 O2-H2 Burner Repressurization

The O2-H2 burner was utilized to repressurize the LH2 tank in preparation for S-IVB second burn. Burner start command was followed by a 6.70-sec lag before initiation of repressurization in order to provide higher burner chamber pressure (and improved combustion stability) during the start transient. The LH2 tank conditions are shown in figure 12-4; significant data are compared to 503N flight data in table 12-3.

The LH2 tank ullage pressure rise rate was 3.72 psi/min. During the S-IVB 504N flight burner operation, the actual total energy in the helium at the burner outlet was 7 percent higher than the theoretical total energy calculated by assuming the temperature of the helium at the burner inlet to be 40 deg R. The 7 percent increase was due to the heating that occurs between the cold helium spheres and the O2-H2 burner inlet.

##### 12.1.2.2 Pressurization -- Second Burn

At second burn engine start command, the LH2 tank ullage pressure was 30.7 psia. The GH2 pressurant flowrate was adequate to satisfactorily accomplish LH2 tank second burn pressurization. Conditions during second burn LH2 tank pressurization are summarized in figure 12-5 and compared with S-IVB-502 and 503N flight data in table 12-2.



### 12.1.3 Third Burn

#### 12.1.3.1 Ambient Repressurization

The ambient helium repressurization system was utilized to repressurize the LH2 tank in preparation for third S-IVB burn. The LH2 tank was satisfactorily repressurized from eight ambient helium spheres, all of which were available for LH2 tank repressurization since LOX tank repressurization was not required. Data and performance levels are presented in figure 12-6 and compared to S-IVB-507 and 508 acceptance tests in table 12-3.

#### 12.1.3.2 Pressurization - Third Burn

The ullage pressure at STDV<sub>3</sub> was 29.5 psia. The GH2 pressurization system performance was normal in view of the engine operation, and tank pressurization was accomplished adequately.

The ullage pressure profile was as predicted until approximately ESC<sub>3</sub> +150 sec at which time it dropped 1 psi (figure 12-7, sheet 1). Subsequent to this drop, the ullage pressure recovered and continued to increase during the remainder of the burn.

Analysis of the pressurization system and tank ullage, presuming a nearly constant ullage temperature, indicated that the ullage pressure should have remained at the relief level throughout burn. With the pressurant flowrate recorded, an ullage collapse would have had to occur between ESC<sub>3</sub> +150 and ESC<sub>3</sub> +160 sec to explain the ullage pressure during that period. Although no data are available to confirm this possibility, the pressure drop was coincident with the initial opening of the LOX gas generator bleed valve (section 9).

Considering the initial pressure and the pressurant flowrate during the period, the ullage pressure response from ESC<sub>3</sub> +160 sec until engine cut-off was what would be expected with a relatively constant ullage temperature.

The average GH2 pressurant flowrate was 0.69 lbm/sec until the LOX bleed valve opened at ESC<sub>3</sub> +150.4 sec, when it began to reflect the changes in engine performance caused by opening of the LOX and LH2 bleed valves.

Conditions during third burn LH2 tank pressurization are summarized in figure 12-7 and compared with S-IVB-502 and 503N flight data in table 12-2.

The LH2 injector temperature (C0200) failed at third burn STDV. During the analysis of the LH2 tank pressurization system, the LH2 injector temperature was reconstructed using the assumptions that a constant heat source was available in the aft interstage area and that any unusual change in GH2 pressurant temperature occurred before the GH2 left the injector. The reconstructed data are shown in figure 12-7.

## 12.2 Pressurization System Conditions During Boost

### 12.2.1 LH2 Tank NPV and Relief Valve Operation

The nonpropulsive vent (NPV) and relief valve operated satisfactorily during boost. At the termination of prepressurization, the ullage pressure was at relief conditions, approximately 31.6 psia. A small ullage collapse occurred during the first 20 sec of boost, and the pressure then returned to the relief level at liftoff + 60 sec due to self-pressurization.

Another ullage collapse occurred prior to first engine start command (ESC<sub>1</sub>) due to LH2 surface agitation induced by the S-II center engine vibration period (R0 +505 to R0 +537 sec). The ullage pressure again reached relief level at ESC<sub>1</sub> +5 sec and continued to vent throughout first burn.

The NPV was permanently latched open at R0 +24,150.6 sec for the purpose of safing the LH2 tank. LH2 tank NPV data are presented in figure 12-8.

### 12.2.2 LH2 Tank Continuous Vent

The continuous vent system (CVS) regulated below specification, maintaining the LH2 tank ullage pressure at an average level of 19.2 psia. A 15,955.2-sec continuous vent was initiated at R0 +664.6 sec and maintained an average acceleration of  $5 \times 10^{-5}$  G's for propellant settling with a peak in acceleration of  $10.8 \times 10^{-5}$  G's immediately following completion of a 4.6 deg pitch to transposition, docking, and extraction (TD&E)

attitude. CVS data during earth orbit are presented in figures 12-9 and 12-10.

A 4,746.8-sec programmed continuous vent was initiated at RO +17,218.2 sec which maintained an average acceleration of  $9 \times 10^{-5}$  G's for propellant settling. CVS data for intermediate orbit are presented in figures 12-11 and 12-12.

The CVS was permanently latched open at RO +22,281.7 sec which was 2.7 sec prior to the cold helium dump. Prior to the opening of the LH2 tank nonpropulsive vent (NPV) at RO +24,150.6 sec, the CVS maintained an average acceleration of  $32.2 \times 10^{-5}$  G's which decreased with ullage pressure after NPV initiation. CVS data during solar orbit insertion are presented in figures 12-13 and 12-14.

### 12.2.3 LH2 Tank Passivation

The loss of pneumatic control to the engine valves prevented the programmed LH2 dump. Therefore, the passivation was accomplished via the LH2 continuous vent system (CVS) and the LH2 nonpropulsive vent.

At third engine cutoff command (ECC<sub>3</sub>), at RO +22,281.3 sec, the LH2 tank ullage pressure (D0177) was 31.6 psia and the residual LH2 was 8,939 lbm. The CVS was initiated at ECC<sub>3</sub> +2.7 sec, and D0177 decayed to 20 psia. The NPV was initiated at RO +24,150.6 sec and D0177 decayed to 1.1 psia at RO +41,800 sec. The mass remaining at this time was 5,912 lbm. At approximately RO +43,700 sec the LH2 tank ullage pressure (D0177) began to increase from 1.1 psia to a high of 3.2 psia at RO +45,900 sec. At the end of data (RO +48,010 sec) D0177 was indicating 2.5 psia and was holding constant. The cause of the pressure rise was determined to be a series of LH2 tank NPV and CVS partial blockages which resulted in LH2 tank self-pressurization from boiloff and ullage heating. A thermodynamic analysis determined that all residual LH2 would have been boiled off  $\approx$  15 hr from third CVS initiation (RO +22,281.7 sec).

### 12.3 LH2 Pump Chilldown

#### 12.3.1 First Burn

The LH2 pump chilldown system performed adequately. Table 12-4 compares

significant LH2 chilldown system performance data with that from S-IVB-503N and 500 flights. The chilldown system temperatures, pressures, and calculated performance are presented in figures 12-5 and 12-16.

### 12.3.2 Second Burn

Although the LH2 chilldown system failed to adequately condition the LH2 pump inlet for restart, the 8-sec fuel lead subsequent to engine start command was sufficient to complete conditioning (paragraph 12.4.2). Chilldown system operation and performance are shown in figures 12-17 and 12-18. Significant data are compared to previous flight data in table 12-4.

At second engine start command, the NPSP requirement at the pump inlet was not met. Several factors led to this violation. The chilldown flow-rate reached a steady-state level later in the chilldown than on the only previous flight (503N) with a comparable chilldown sequence. Also, the heat transfer rate in section 1 of the chilldown system reached a steady-state condition at a level well above those observed on previous orbital restart attempts, but within past experience with ground heat transfer rates in section 1. As a result, the high pump inlet temperature together with a further increase due to heatup after pre valve opening caused a high vapor pressure at the LH2 pump inlet. The high vapor pressure reduced the available NPSP to a value below the requirement at second engine start command.

### 12.3.3 Third Burn

#### 12.3.3.1 Simulated Chilldown System Failure

In order to perform a fuel lead experiment, a chilldown system failure was simulated; therefore, the LH2 chilldown system was not used to pre-condition the LH2 pump inlet prior to third engine start command. The sequence of the simulated failure and the fuel lead preparations is presented in table 12-5.

The third engine start command (ESC<sub>3</sub>) was ground commanded 45 sec prior to the programmed command initiating the extended engine start fuel lead. By ESC<sub>3</sub> +2 sec the pump inlet temperature came on scale. The available NPSP increased above the minimum requirement 13 sec later. By STDV, the pump inlet conditions were well within the acceptable region. The extended fuel lead (paragraph 9.6.4) proved to be more than adequate to condition the LH2 pump inlet in the event of a chilldown system failure.

#### 12.3.3.2 Bleed Valve Opening (Engine Anomaly Effect)

An unbalanced counterclockwise (looking forward) moment on the stage started at approximately STDV +95 sec. A maximum moment of 290 lb-ft occurred shortly after the LH2 chilldown return bleed valve opened at STDV +142 sec and thereafter decreased steadily to a near zero value at engine cutoff command. Previous cracking of the LH2 chilldown return line bleed valve was inferred from data that started at approximately STDV +95 sec.

The roll moment during third burn was caused by the action of the LH2 chilldown return line flow to the LH2 tank and to a very minor extent by the LOX chilldown return line flow to the LOX tank. The unsymmetrical location of the return line in the LH2 tank with respect to the outlet was responsible for torque creation by angular momentum effects. Additional torque was caused by return flow drag on internal tank members.

#### 12.4 Engine LH2 Supply

The LH2 supply system (figure 12-19) delivered an acceptable quantity of LH2 to the engine during all three burns. During third burn, the LH2 bleed valve opened, resulting in the LH2 pump inlet conditions deviating from the allowable engine operating region. Supply data are compared to 503N and 502 flight data in table 12-6.

##### 12.4.1 First Burn

The NPSP at the LH2 pump inlet was well above the required at first engine start command and throughout first burn. The pump inlet conditions

are presented in figure 12-20. A correlation between the inlet temperature and pressure indicates that the inlet conditions were within the LH2 pump operating region throughout the burn (figure 12-21). The relationship between the mass in the tank and the pump inlet temperature is shown in figure 12-22.

#### 12.4.2 Second Burn

The NPSP requirement at second engine start command was not met because the chilldown system was unable to lower the pump inlet temperature to a steady-state level (paragraph 12.3.2). The NPSP requirement at engine start command was developed to ensure proper pump inlet conditions at STDV when the possibility of pump cavitation occurs. Although the requirement at engine start command was not met, the normal programmed fuel lead between engine start command and STDV sufficiently conditioned the pump inlet to eliminate the possibility of pump cavitation at STDV. Subsequent to STDV, the NPSP remained above the minimum requirement. The LH2 supply to the engine was therefore adequate during second burn. The pump inlet conditions are presented in figures 12-23 and 12-24. The relationship between the mass in the LH2 tank and the pump inlet temperature is shown in figure 12-22.

#### 12.4.3 Third Burn

Due to the fuel lead experiment the NPSP requirement at engine start command was not met. At engine start command, the pump inlet temperature was off-scale high, but by STDV the extended fuel lead had chilled the LH2 pump inlet sufficiently to increase the NPSP above requirements (figure 12-25). Following engine pneumatic system failure, the LH2 bleed valve opened at STDV +141.7 sec allowing high energy LH2 to return to the LH2 tank through the chilldown return line. As a result the LH2 bulk temperature increased, correspondingly increasing the pump inlet temperature. This increase in inlet temperature caused a significant reduction in available NPSP, and after ESC<sub>3</sub> +243 sec the NPSP was below requirements. Normally not meeting the NPSP requirements would lead to pump cavitation, but opening the LOX and LH2 bleed valves diverted a

portion of the gas generator propellant supply. This, in turn, caused a reduction in pump speed and, therefore, in the probability of cavitation. Engine performance indicated that LH2 supply to the engine was adequate at all times during third burn.

The pump inlet conditions are presented in figure 12-26. A correlation between the pump inlet temperature and pressure indicates that the inlet conditions were within the established LH2 pump operating region until the bleed valve opened (figure 12-27). The relationship between the mass in the tank and the pump inlet temperature is shown in figure 12-22.

TABLE 12-1

## LH2 TANK PREPRESSURIZATION DATA

Parameter	S-IVB-504N Flight	S-IVB-503N Flight	S-IVB-502 Flight
Prepressurization duration (sec)	12.3	12.8	21.3
Ullage volume (cu ft)	495	540	719
Helium added (lbm)	4.66	4.85	7.1
Ullage Pressure			
At prepressurization initiation (psia)	15.3	15.3	16.0
At prepressurization termination (psia)	31.7	32.1	33.8
At liftoff (psia)	31.1	31.3	36.2
At engine start command (psia)	31.4	31.7	36.2
Events (sec from liftoff)			
Prepressurization initiation	-96.3	-96.3	-96.3
Prepressurization termination	-84.0	-83.5	-75.0
Engine start command	537.3	524.9	577.3



TABLE 12-2

## LH2 TANK PRESSURIZATION DATA

Parameter	S-IVB-504N Flight			S-IVB-503N Flight		S-IVB-502 Flight	
	First Burn	Second Burn	Third Burn	First Burn	Second Burn	First Burn	Second Burn
Pressure switch setting							
Lower (psia)	28.6	28.6	28.6	28.7	28.7	28.7	32.2
Upper (psia)	30.3	30.3	30.3	30.6	30.6	30.2	33.8
Ullage pressure							
At engine start command (psia)	31.4	30.7	29.5 <sup>+</sup>	31.7	31.5	36.2	32.8
At engine cutoff command (psia)	31.6	30.8	31.6	31.6	32.0	32.6	30.0
GH2 pressurant flowrate							
Undercontrol--high EMR (lbm/sec)	0.76	--	--	--	--	0.62	--
Undercontrol--low EMR (lbm/sec)	--	0.72	0.69 <sup>++</sup>	0.69	0.67	--	--
Overcontrol--high EMR (lbm/sec)	--	--	--	--	--	--	--
Overcontrol--low EMR (lbm/sec)	--	--	--	--	--	--	--
Step**--low EMR (lbm/sec)	--	--	--	--	1.06	--	--
Total GH2 added (lbm)	93.2	43.3	120.6	107.5	234.2	102	*

\* GH2 pressurant added during S-IVB-502 second-burn start attempt was negligible.

\*\* Average GH2 pressurant flowrate during last 46 seconds of S-IVB 503N second burn.

+ Ullage pressure 8 seconds prior to STDV<sub>3</sub>

++ Pressurization flowrate during first 150 seconds of third burn.

TABLE 12-3  
LH2 TANK REPRESSURIZATION DATA

BURNER REPRESSURIZATION

Parameter	S-IVB-504N Flight	S-IVB-503N Flight
Repressurization duration (sec)*	180.4	168.4
Ullage volume (ft <sup>3</sup> )	3,690	3,887
Ullage pressure		
At repressurization initiation (psia)	19.2	19.4
At repressurization termination (psia)	30.4	30.2
Rise rate (psi/min)	3.72	3.85
Repressurization helium usage (lbm)	24.6	25.0

\*Does not include the lag in repressurization initiation following burner start command.

AMBIENT REPRESSURIZATION

Parameter	S-IVB-504N Flight	S-IVB-508 Accept.	S-IVB-507 Accept.
Repressurization duration (sec)	28.8	25	28.9
Ullage volume (ft <sup>3</sup> )	4,975	4,663	4,519
Ullage pressure			
At repressurization initiation (psia)	19.5	22.0	21.4
At repressurization termination (psia)	30	30.3	30.3
Rise rate (psi/min)	21.9	19.8	18.4
Repressurization helium usage (lbm)	28.9	20.5	24.6

TABLE 12-4 (Sheet 1 of 3)

LH2 CHILLDOWN SYSTEM PERFORMANCE DATA

Parameter	S-IVB-504N Flight		S-IVB-503N Flight		S-IVB-502 Flight	
	First Burn	Second Burn	First Burn	Second Burn	First Burn	Second Burn
NPSP						
At engine start command (psi)						
With chill pump head	13.7	N/A	19.16	N/A	22.8	N/A
Without chill pump head	6.2	2.0	11.06	4.86	15.9	9.5
Minimum required at engine start (psi)	4.53	4.53	4.53	4.53	6.3	6.3
Maximum during chilldown (psi)	23.7	8.3	24.7	15.0	29.0	18.9
Average Flow coefficient (sec <sup>2</sup> /in <sup>2</sup> ft <sup>3</sup> )	17.6	17.6	18.1	18.1	19.0	19.0
Fuel quality in sections* 2 and 3 (lb gas/lb mixture)						
Maximum during unpressurized chilldown	0.036	N/A	0.036	N/A	0.050	N/A
At prepressurization	0.034	N/A	0.033	N/A	0.045	N/A
Fuel pump inlet conditions						
Static pressure at engine start command (psi)	35.0	N/A	38.1	N/A	42.5	N/A
With chill pump head	27.5	30.4	30.0	31.8	35.6	32.6
Without chill pump head	38.4	40.9	38.1	40.5	38.3	39.4
Temperature at engine start command (deg R)	4.1	0.5	5.1	1.2	5.7	2.5
Amount of subcooling at engine start (deg R) (degrees below saturation at pump inlet)						

\*Section 1 is tank to pump inlet; section 2 is pump inlet to bleed valve exit; section 3 is bleed valve exit to tank.

N/A = Not applicable

LH2 CHILLDOWN SYSTEM PERFORMANCE DATA

Parameter	S-IVB-504N Flight		S-IVB-503N Flight		S-IVB-502 Flight	
	First Burn	Second Burn	First Burn	Second Burn	First Burn	Second Burn
Heat absorption rate during unpressurized chilldown						
Section 1* (Btu/hr)	19,500	N/A	22,000	N/A	22,000	0.0**
Section 2 and 3* (Btu/hr)	26,500	N/A	23,000	N/A	29,000	28,000**
Total (Btu/hr)	46,000	N/A	45,000	N/A	51,000	28,000**
Heat absorption rate during pressurized chilldown						
Section 1* (Btu/hr)	8,000	27,000	2,500	1,000	2,500	500
Section 2* (Btu/hr)	4,500	7,500	7,500	22,000	7,000	23,000
Section 3* (Btu/hr)	3,000	7,500	7,500	23,000	7,500	23,500
Total (Btu/hr)	15,500	34,500	17,500	23,000	17,000	23,500
Chilldown flowrate						
Unpressurized (gpm)	98	N/A	100	N/A	92	10 to 100
Pressurized (gpm) After Prepressurization+	139	140	141	140	133	134
Chilldown pump pressure differential						
Unpressurized (psi)	9.2	N/A	9.2	N/A	9.0	2 to 8.5
Pressurized (psi)	7.4	7.2	8.0	7.7	6.4	7.2

\*Section 1 is tank to pump inlet; section 2 is pump inlet to bleed valve exit; section 3 is bleed valve exit to tank

\*\*Values at repressurization initiation

N/A - Not Applicable

TABLE 12-4 (Sheet 3 of 3)

LH2 CHILDDOWN SYSTEM PERFORMANCE DATA

Parameter	S-IVB-504N Flight		S-IVB-503N Flight		S-IVB-502 Flight	
	First Burn	Second Burn	First Burn	Second Burn	First Burn	Second Burn
Events (seconds*)						
Childdown initiation	-299.542	-316.005	-299.450	-315.991	-299.008	-737.446
Prevalve closed	-283.846	-310.709	-284.410	-310.399	-275.076	-727.446
CVS closed	N/A	-527.390	N/A	-527.650	N/A	-325.696
Prepressurization**	-96.320	-521.866	-96.316	-521.872	-96.506	-126.993
Prevalve open command	536.514	-10.607	524.315	-10.615	576.596	-10.79
Prevalve closed signal dropout	537.481	-9.421	525.162	-9.668	577.429	-9.839
Prevalve open signal pickup	539.146	-7.254	526.828	-7.713	579.671	-5.909
Childdown pump off	538.406	-0.592	526.215	-0.608	578.470	-0.791
Engine start command	537.264	0	524.998	0	577.270	0

\*All first burn data are referenced to liftoff; all second burn data are referenced to second engine start command.

\*\*Repressurization for second burn

N/A - Not Available

TABLE 12-5

## LH2 CHILLDOWN -- THIRD BURN

Time	Meas. No.	Event
21704.944		Chilldown Shutoff Valve Close Off (CMD)
21710.026		Chilldown Shutoff Valve Close On (CMD)
21710.243	K137	Fuel Chilldown Valve Open (DO)
21710.243	K136	Fuel Chilldown Valve Close (PU)
21714.933		Fuel Chilldown Pump On (CMD)
21719.949		Prevalves Close On (CMD)
21720.191	K111	Fuel Prevalve Open (DO)
21721.108	K112	Fuel Prevalve Close (PU)
21729.166		Fuel Chilldown Pump Off (CMD)
21952.752		Chilldown Shutoff Valve Close Off (CMD)
21953.808	K136	Fuel Chilldown Valve Close (DO)
21954.058	K137	Fuel Chilldown Valve Open (PU)
21954.318		Prevalves Close Off (CMD)
21954.507	K112	Fuel Prevalve Close (DO)
21956.424	K111	Fuel Prevalve Open (PU)
21987.338		S-IVB Engine Start Command On (CMD)

TABLE 12-6 (Sheet 1 of 2)

LH2 PUMP INLET CONDITION DATA

Parameter	S-IVB-504a Flight			S-IVB-503N Flight		S-IVB-502 Flight	
	First Burn	Second Burn	Third Burn	First Burn	Second Burn	First Burn	Second Burn
<b>Pump Inlet Conditions</b>							
Static pressure at engine start command (psia)							
With chill pump head*	35.0	N/A	N/A	38.1	N/A	42.5	N/A
Without chill pump head	27.5	30.4	25.4	30.0	31.8	35.6	32.6
Static pressure at engine cutoff (psia)	31.8	29.8	32.4	30.2	32.0	30.5	28.2
Temperature at engine start (deg R)	38.4	40.9	**	38.1	40.5	38.3	39.4
Temperature at engine cutoff (deg R)	38.0	38.5	41.4	38.1	39.3	38.5	38.5
<b>NPSP Requirements</b>							
Minimum at engine start command (psi)	4.53	4.53	4.53	4.53	4.53	6.3	6.3
At 5.5 EMR (psi)	5.30	N/A	N/A	N/A	N/A	6.37	6.37
At 5.0 EMR (psi)	N/A	4.98	4.98	5.0	5.0	N/A	5.8
<b>NPSP Available</b>							
At engine start command (psi)	13.7	N/A	N/A	19.2	N/A	22.8	N/A
With chill pump head*	6.2	2.0	0.0	11.1	4.9	15.9	9.5
Without chill pump head							

N/A Not applicable

\*The NPSP and pump inlet pressure are high at this time because the prevalves were slow in opening.

\*\*Off-scale high

LH2 PUMP INLET CONDITIONS DATA

Table 12-6 (Continued)

Parameter	S-IVB-504 Flight			S-IVB-503N Flight		S-IVB-502 Flight	
	First Burn	Second Burn	Third Burn	First Burn	Second Burn	First Burn	Second Burn
At start tank discharge valve open cmd (psi)	9.8	4.8	7.4	13.9	8.6	16.5	11.2
Maximum during engine burn (psi)	14.4	12.2	12.4	14.2	11.8	16.5	11.5
Minimum during engine burn (psi)	12.4	2.0	0.0	12.8	9.1	11.8	7.7
At engine cutoff command (psi)	14.4	12.2	3.0	13.5	9.8	11.8	7.7
LH2 Feed Duct							
At 5.5 EMR	0.7	N/A	N/A	N/A	N/A	1.0	1.25
Pressure drop (psi)							
Flowrate (lbm/sec)	85.6	N/A	N/A	N/A	N/A	82.5	60.0
At 5.0 EMR							
Pressure drop (psi)	N/A	0.7	0.5	0.9	0.9	N/A	N/A
Flowrate (lbm/sec)	N/A	80.5	78.6	80.1	79.8	N/A	N/A

N/A Not applicable



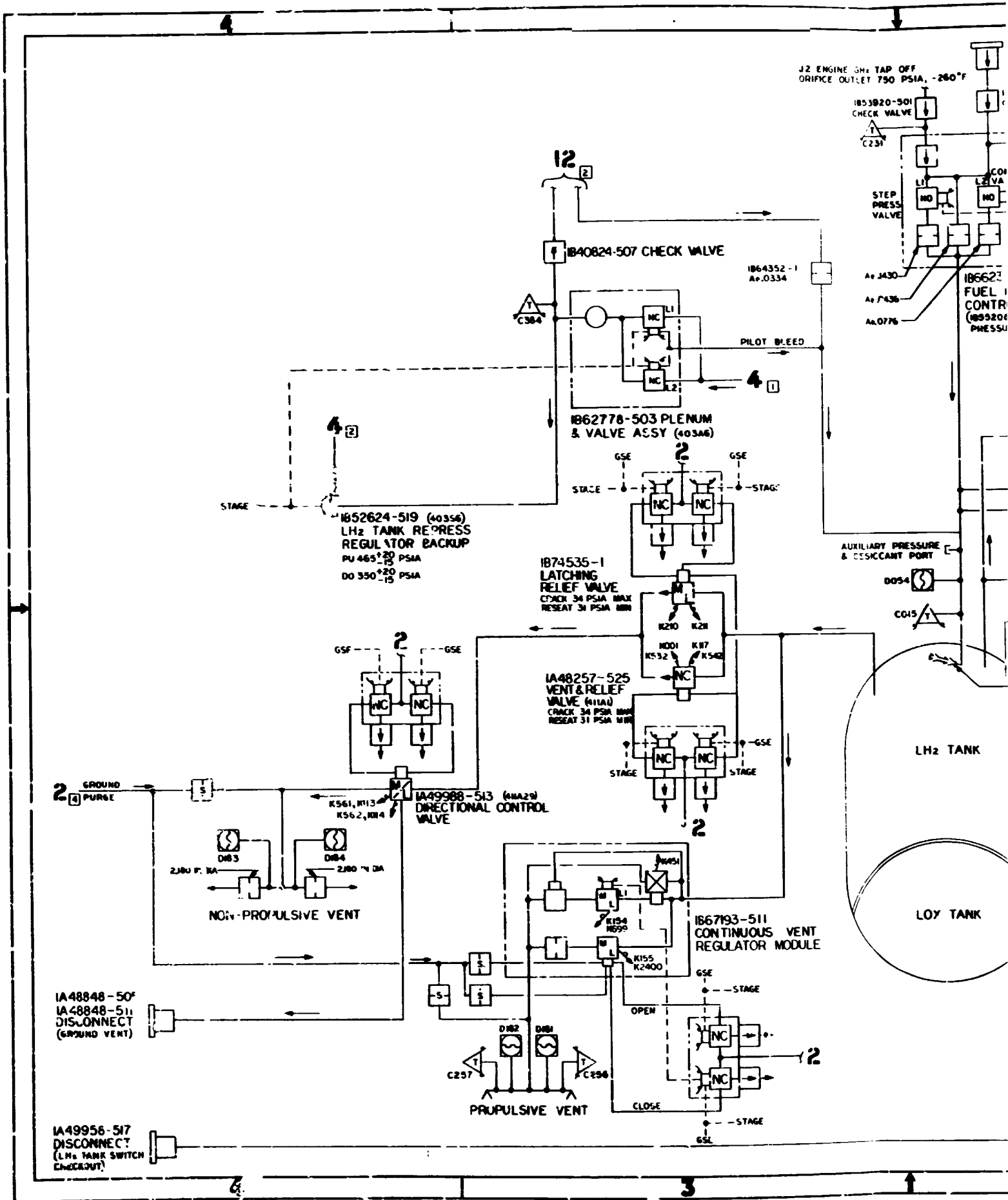

FOLDOUT FRAME 1

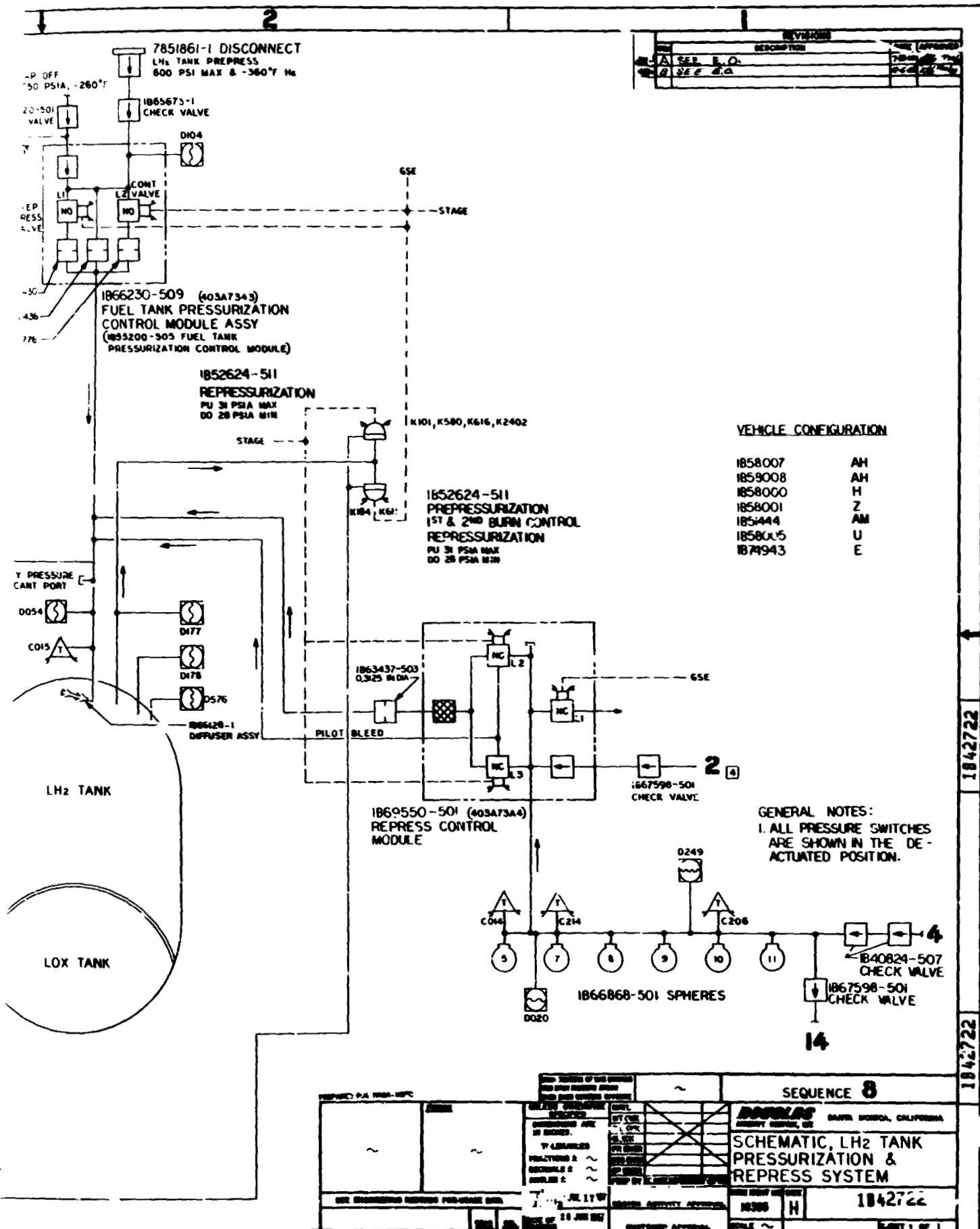

Figure 12-1. Schematic, LH2 Tank Pressurization and Repress System

FOLDOUT FRAME 2

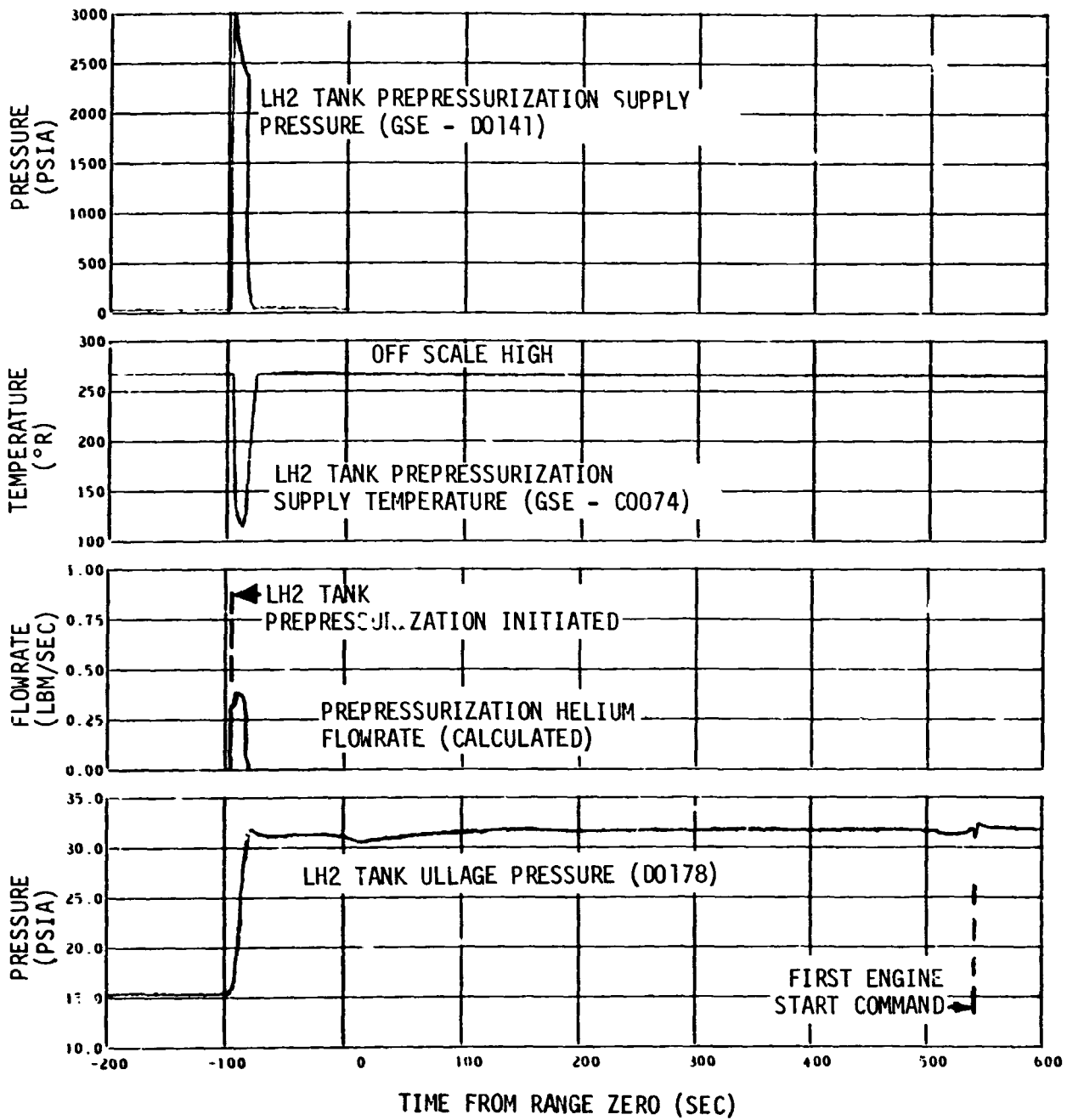

Figure 12-2. LH2 Tank Prepressurization System Performance

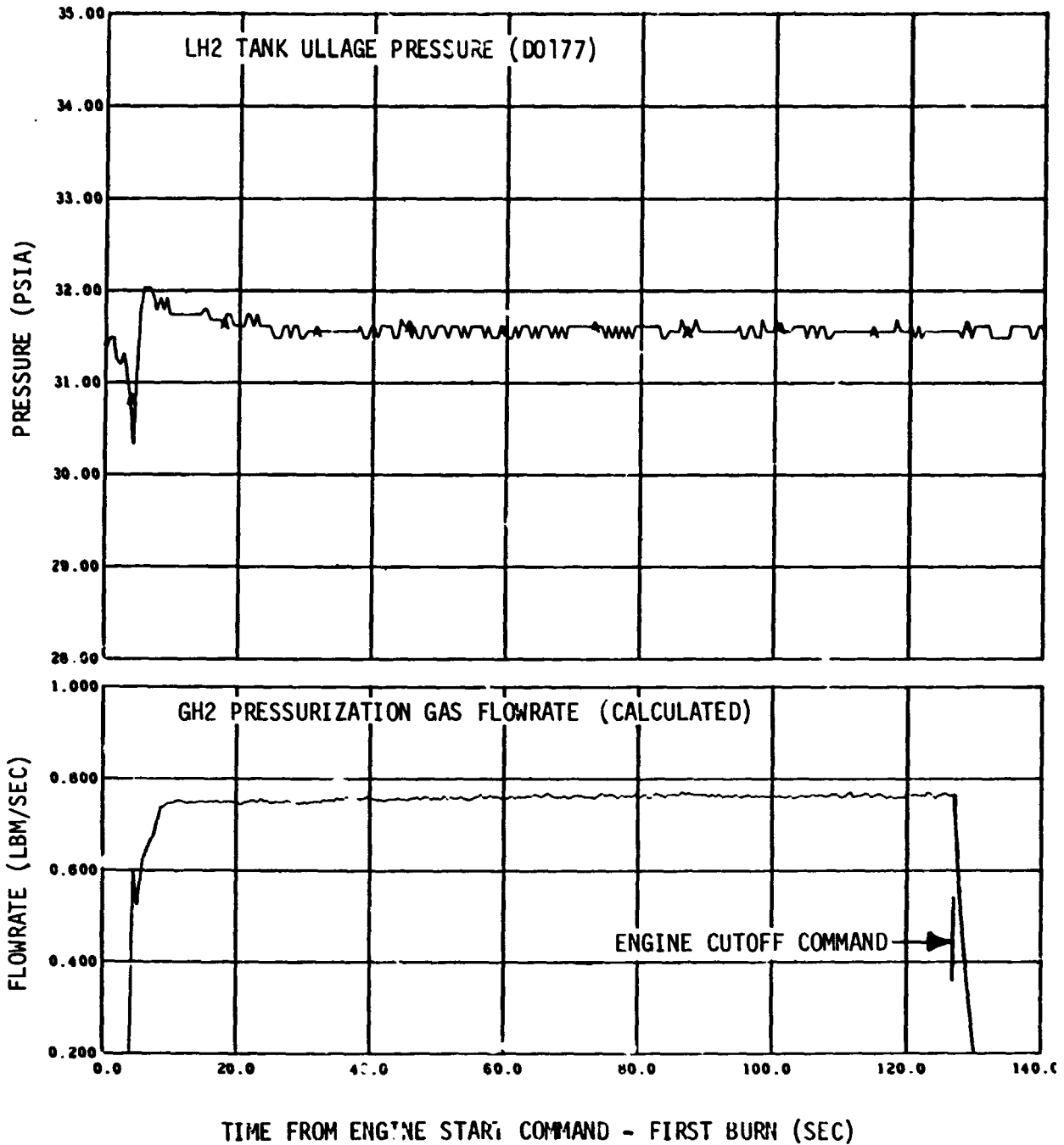

Figure 12-3. LH2 Tank Pressurization System Performance - First Burn (Sheet 1 of 2)

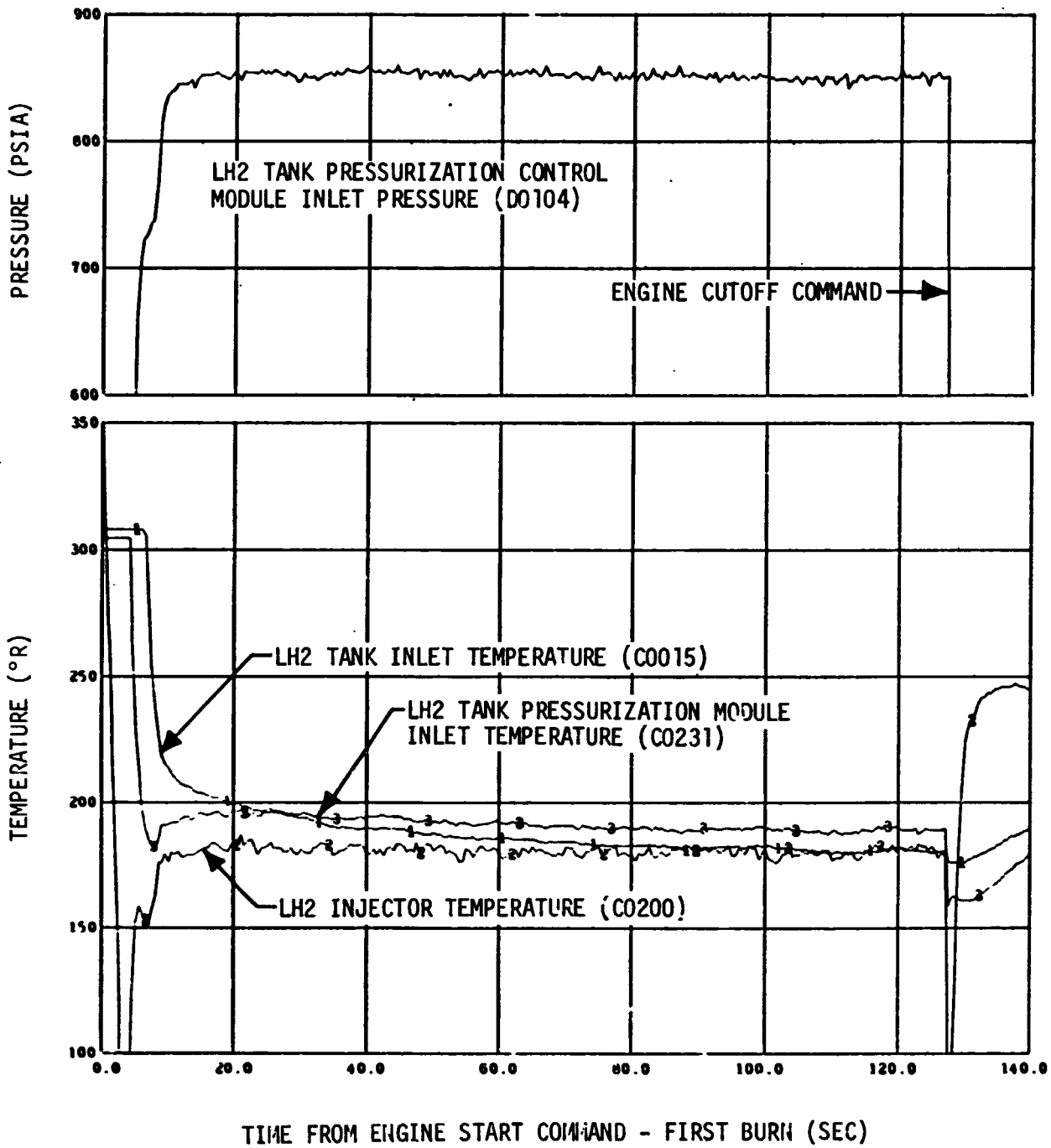

Figure 12-3. LH2 Tank Pressurization System Performance - First Burn (Sheet 2 of 2)

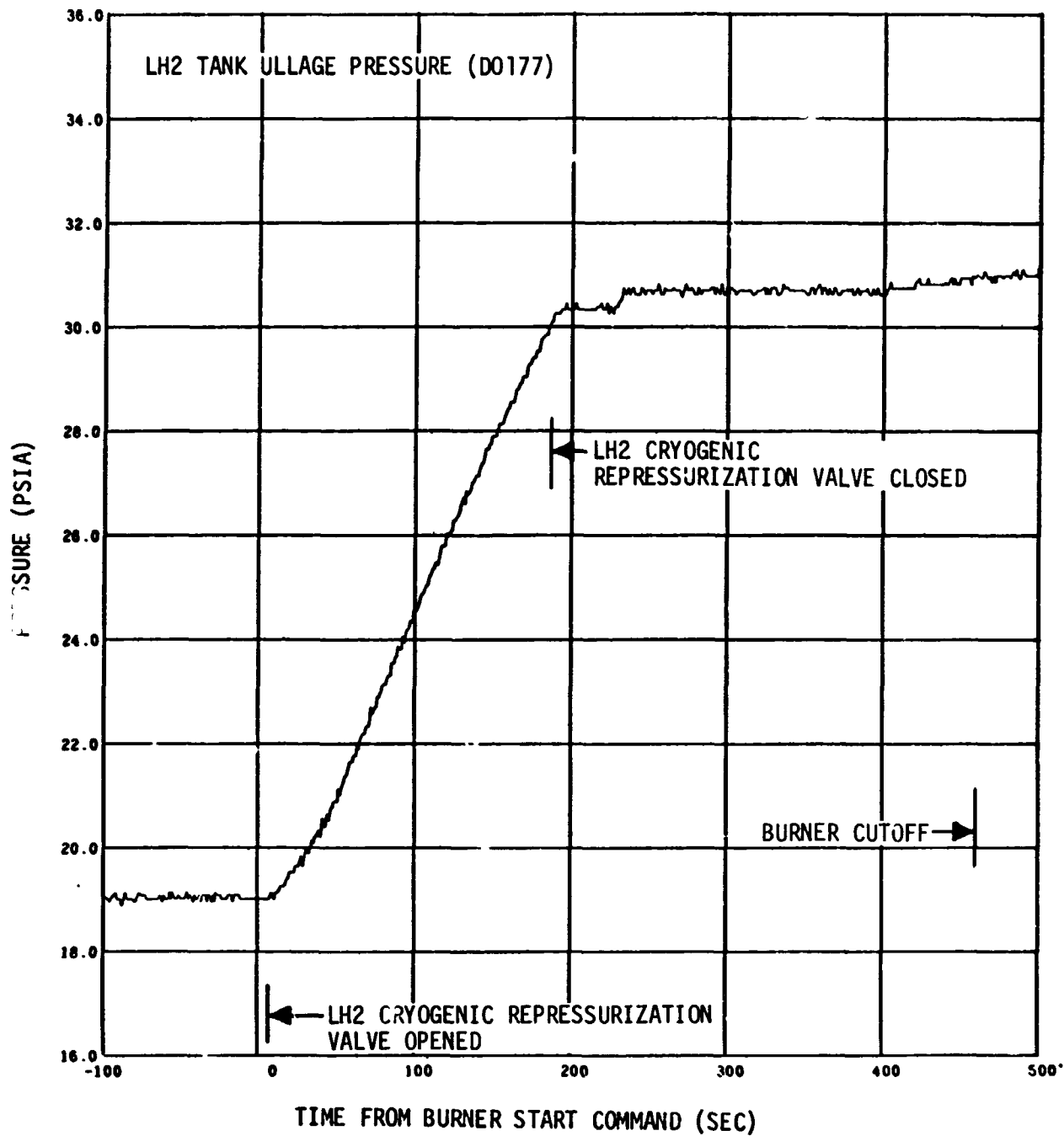

Figure 12-4. LH2 Tank Ullage Pressure During O2-H2 Burner Repressurization

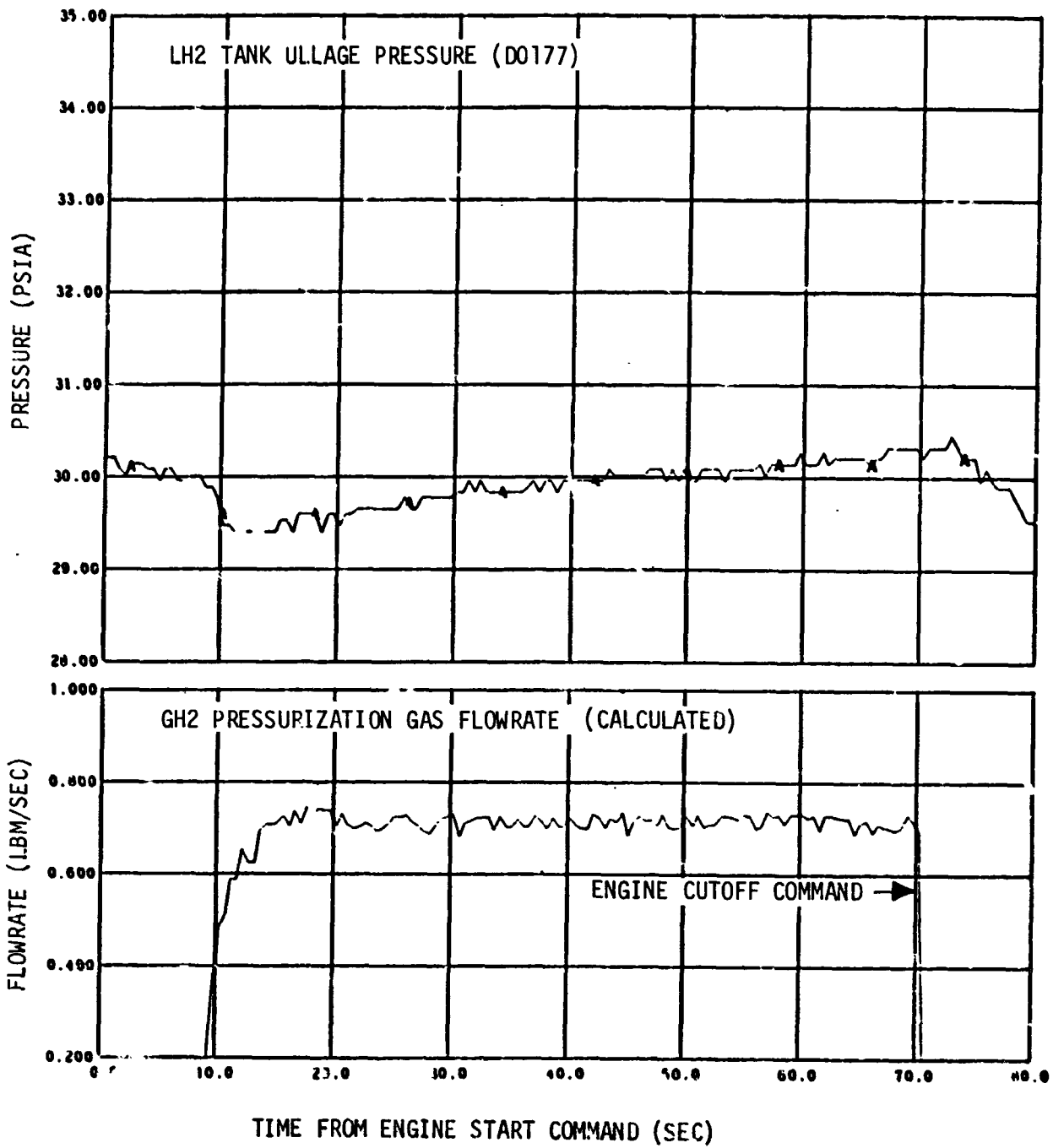

Figure 12-5. LH2 Tank Pressurization System Performance - Second Burn (Sheet 1 of 2)

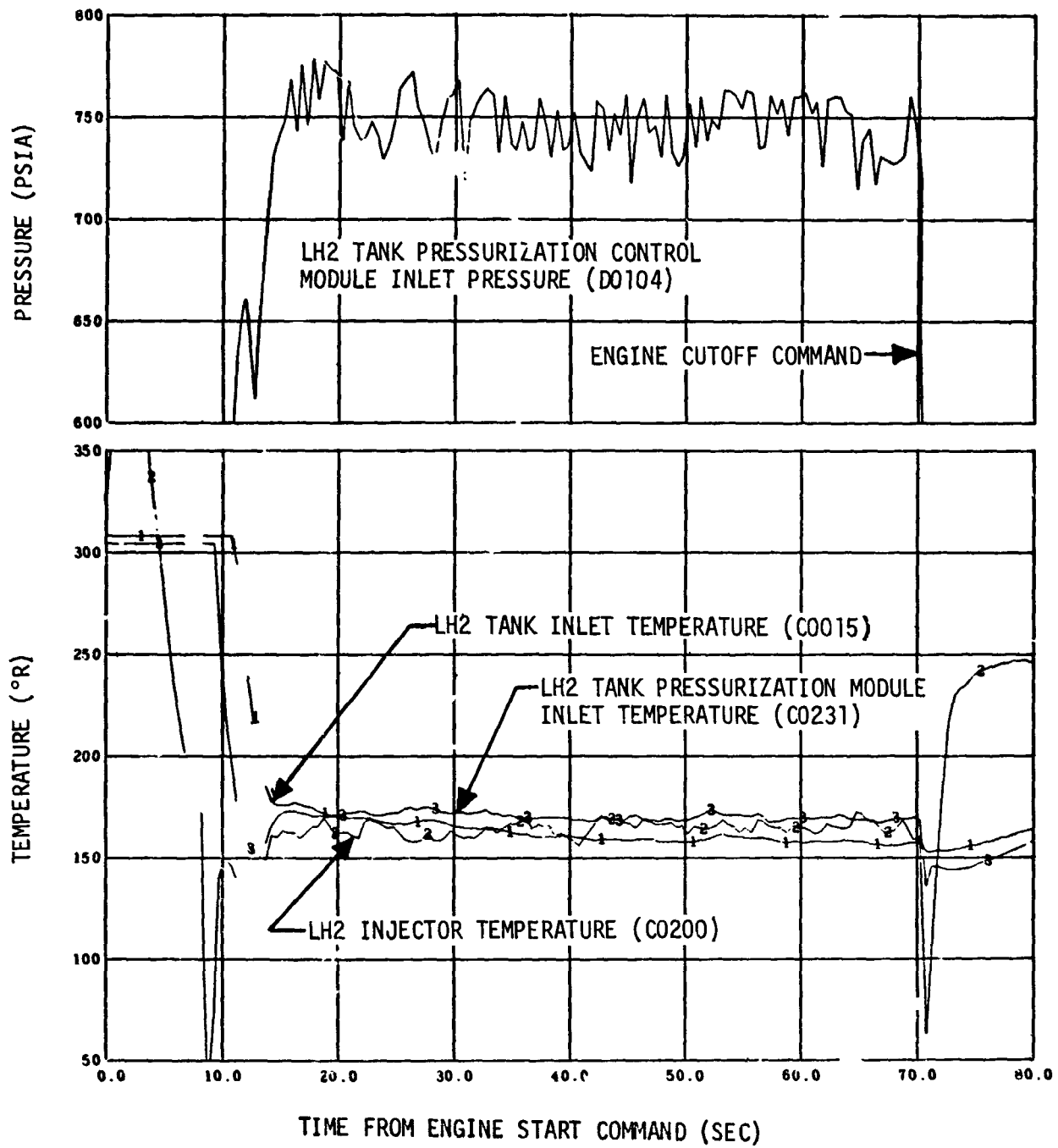

Figure 12-5. LH2 Tank Pressurization System Performance -  
Second Burn (Sheet 2 of 2)



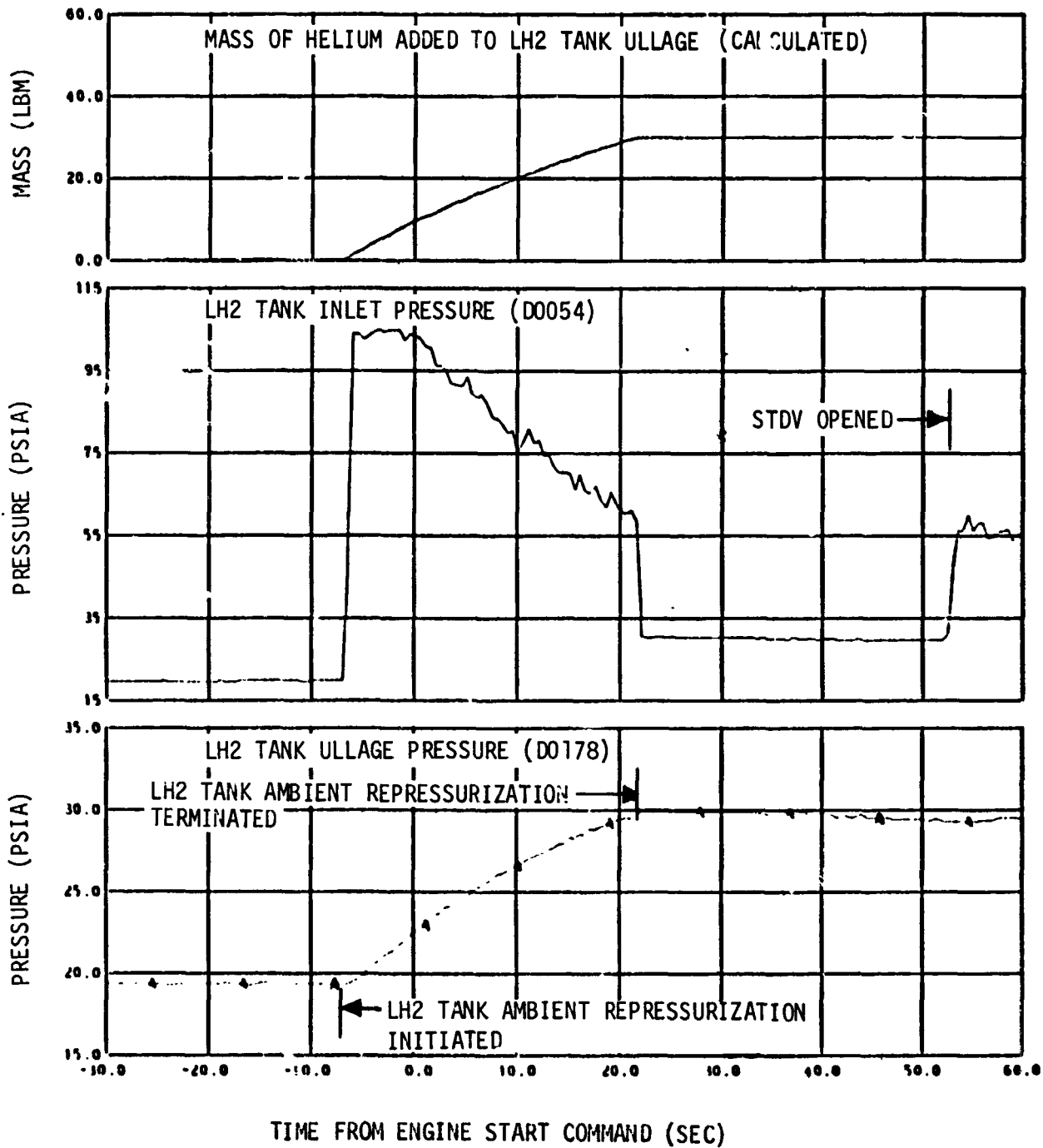

Figure 12-6. LH2 Tank Ambient Helium Repressurization System Performance - Third Burn (Sheet 1 of 2)

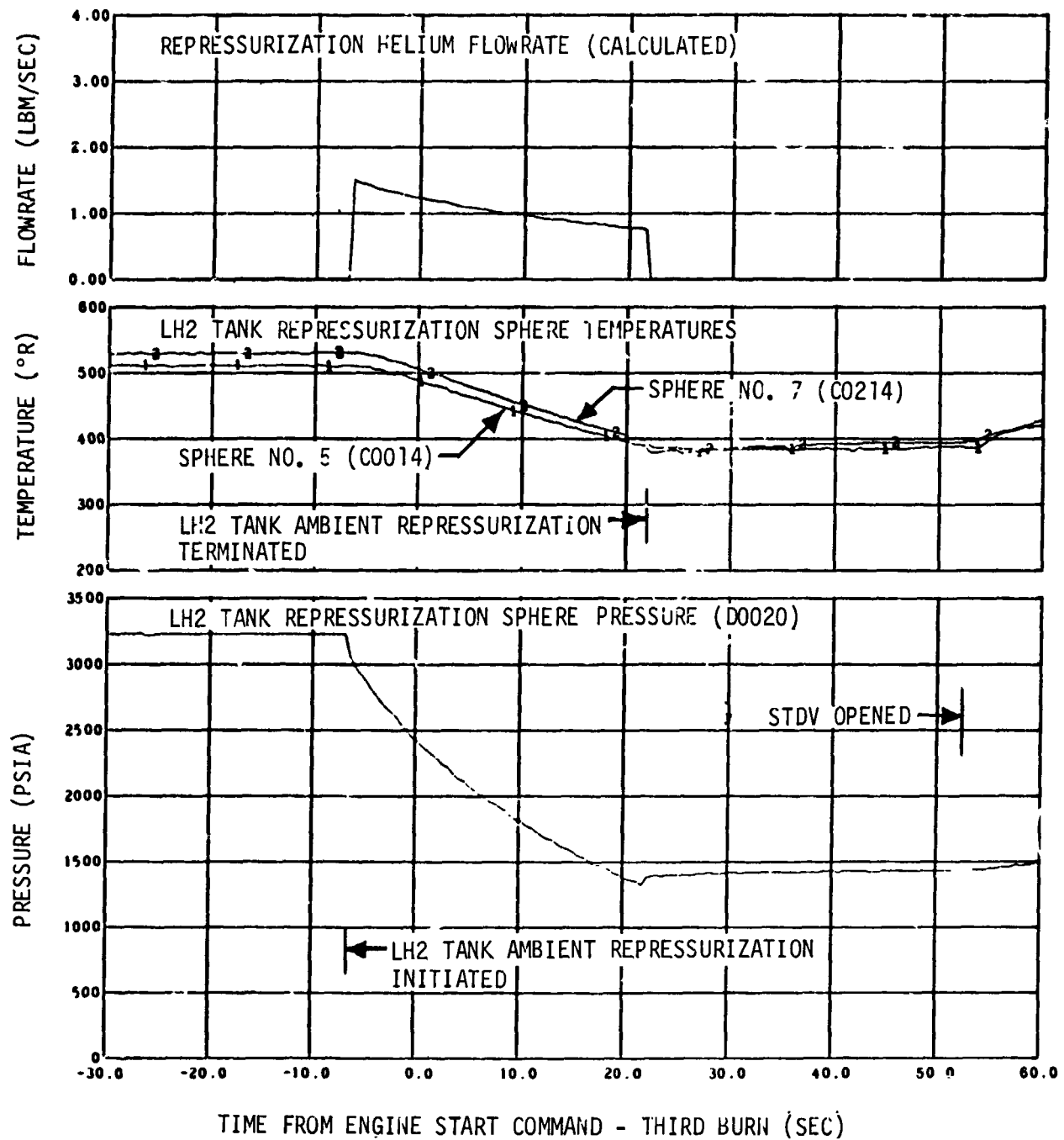

Figure 12-6. LH2 Tank Ambient Helium Repressurization System Performance - Third Burn (Sheet 2 of 2)

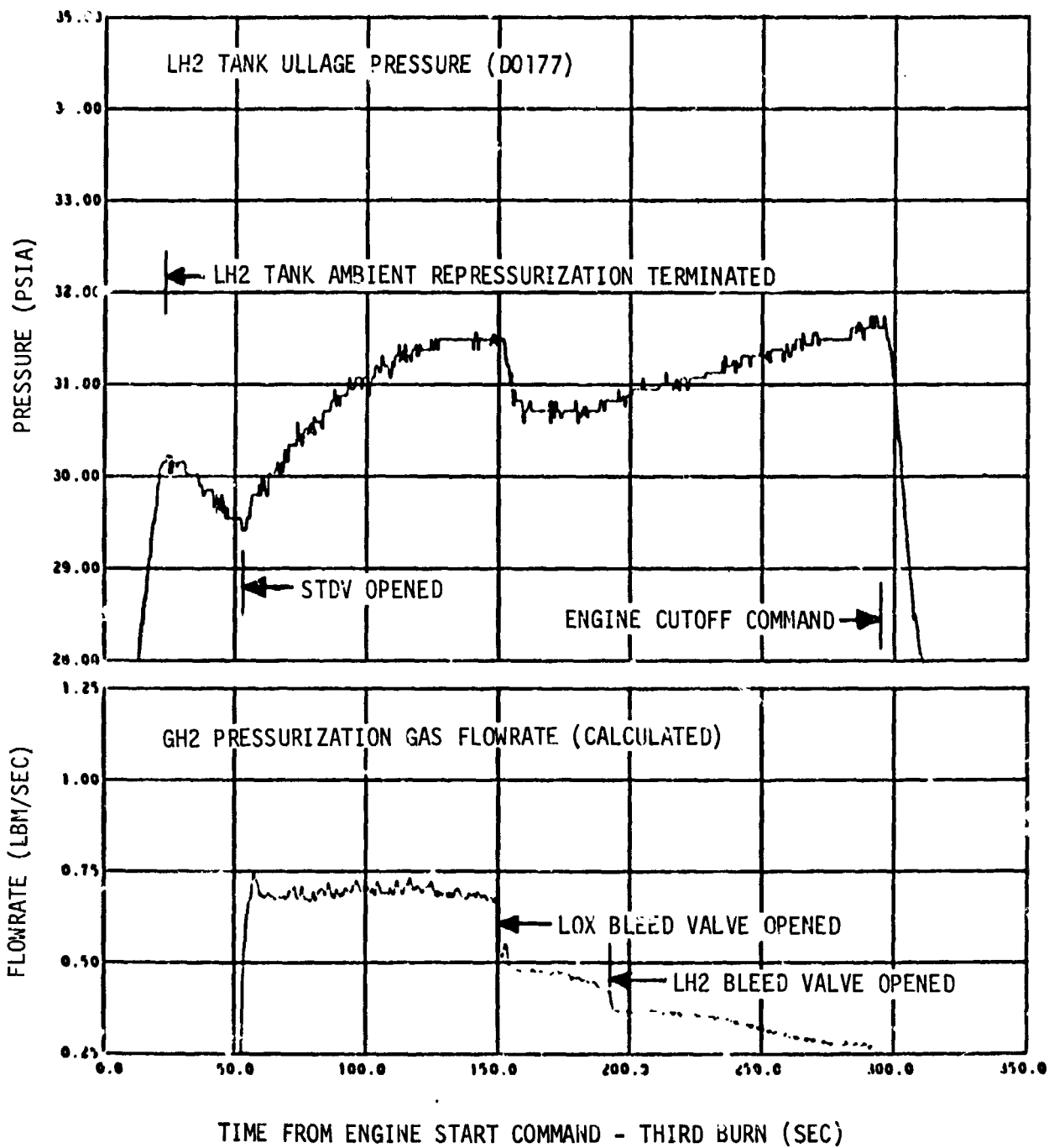

Figure 12-7. LH2 Tank Pressurization System Performance - Third Burn (Sheet 1 of 2)

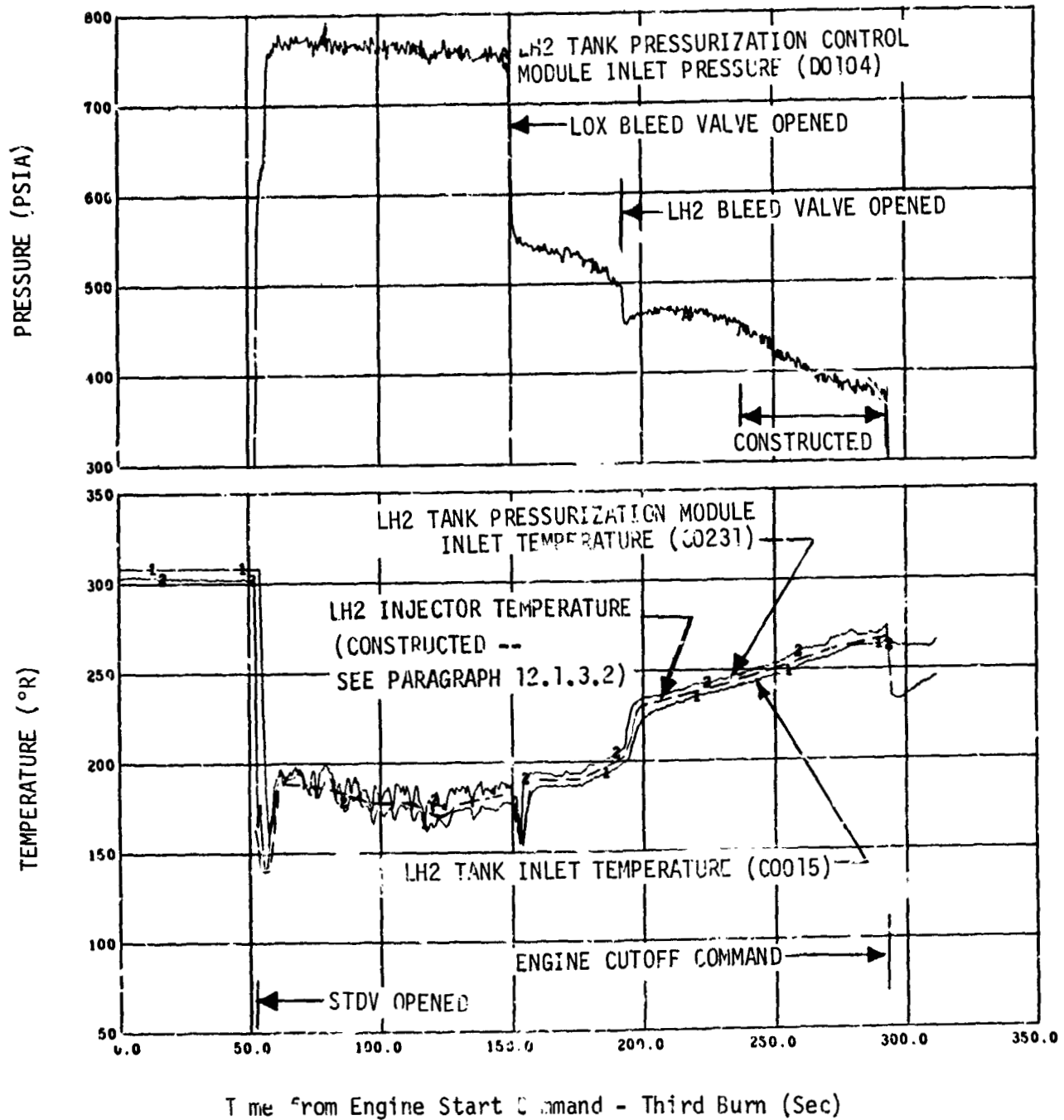

Figure 12-7. LH2 Tank Pressurization System Performance - Third Burn (Sheet 2 of 2)

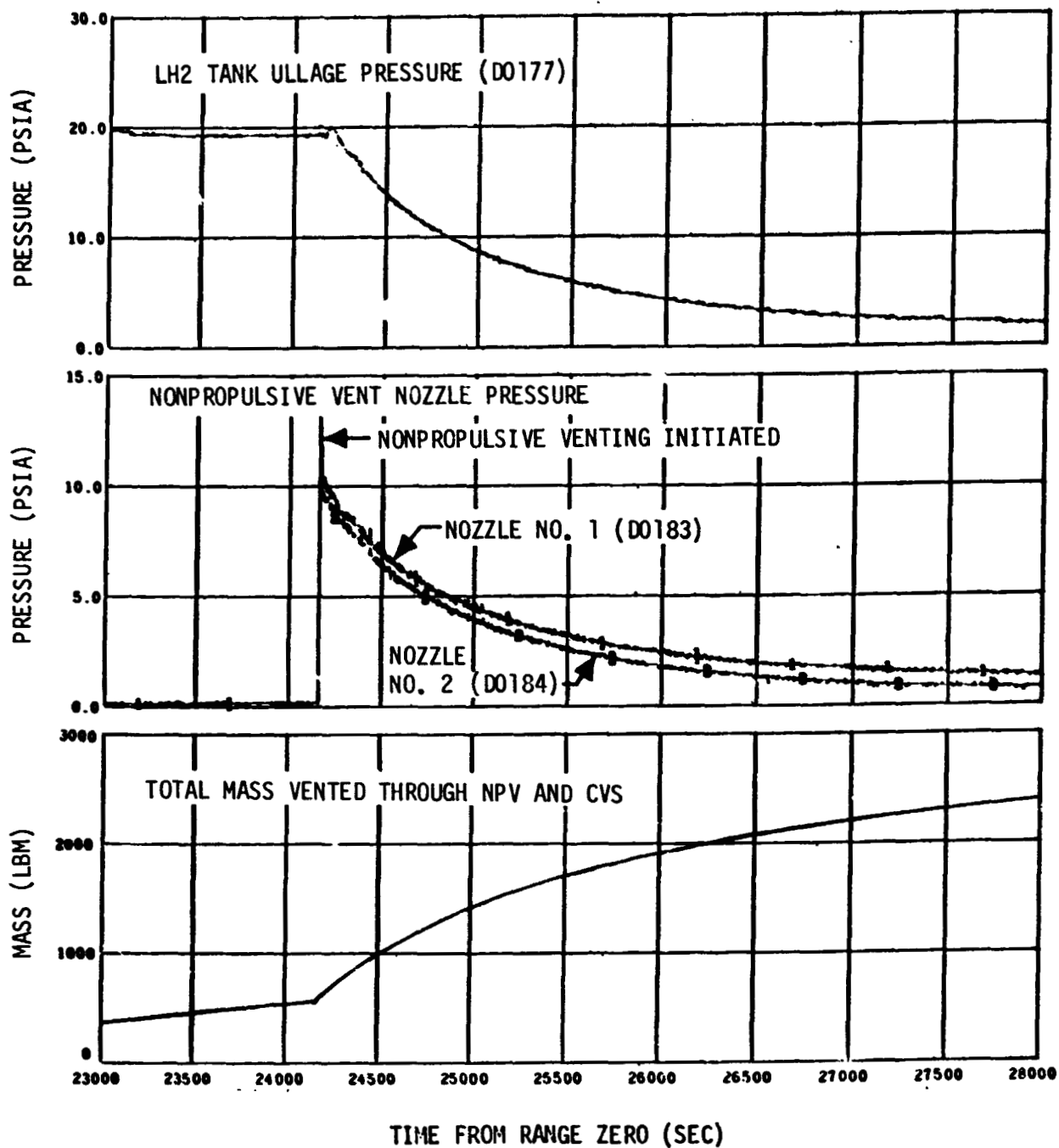

Figure 12-8. Nonpropulsive Vent System Operation - Solar Orbit Insertion

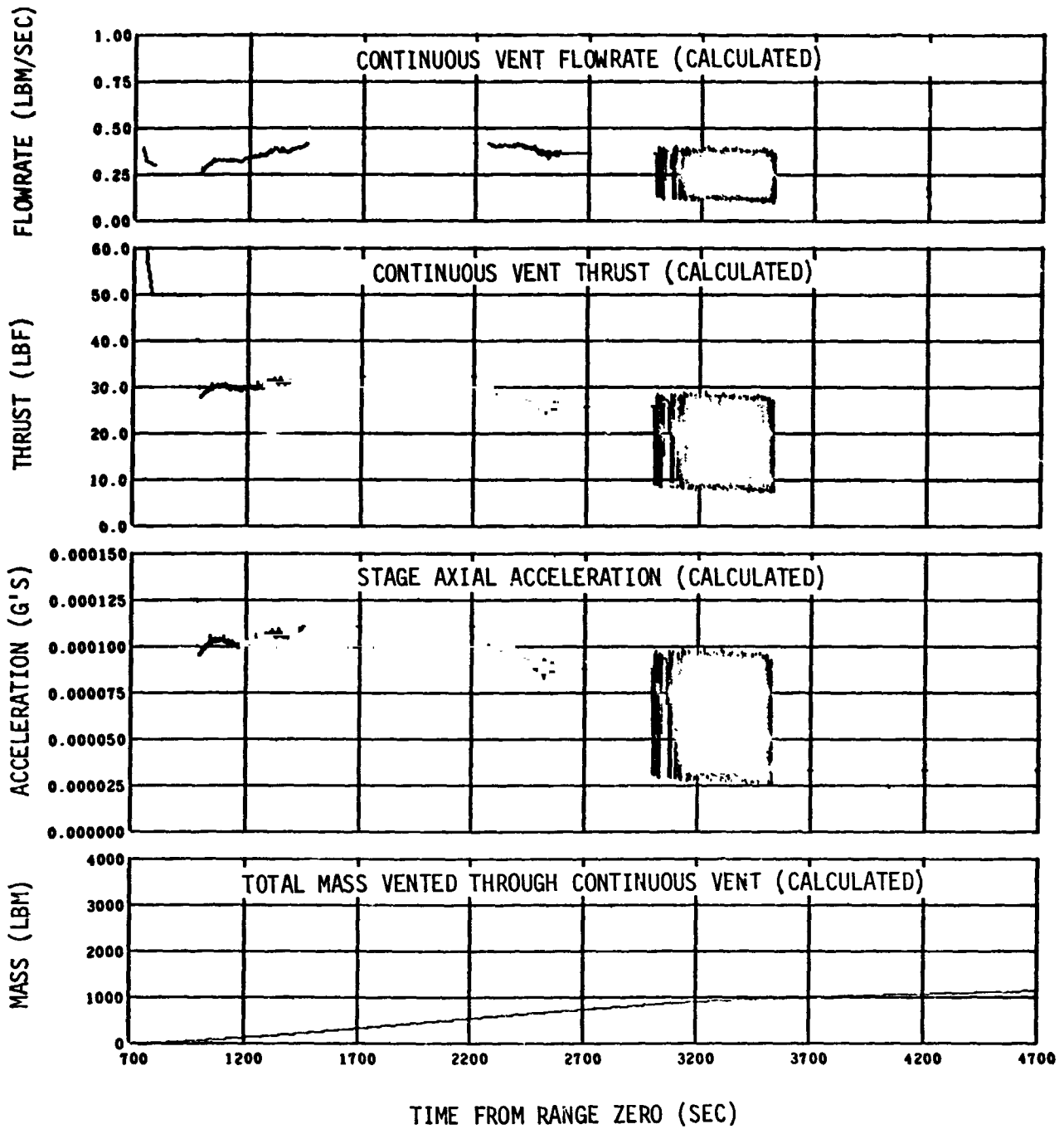

Figure 12-9. LH2 Tank Continuous Vent System Performance - Earth Orbit (Sheet 1 of 4)

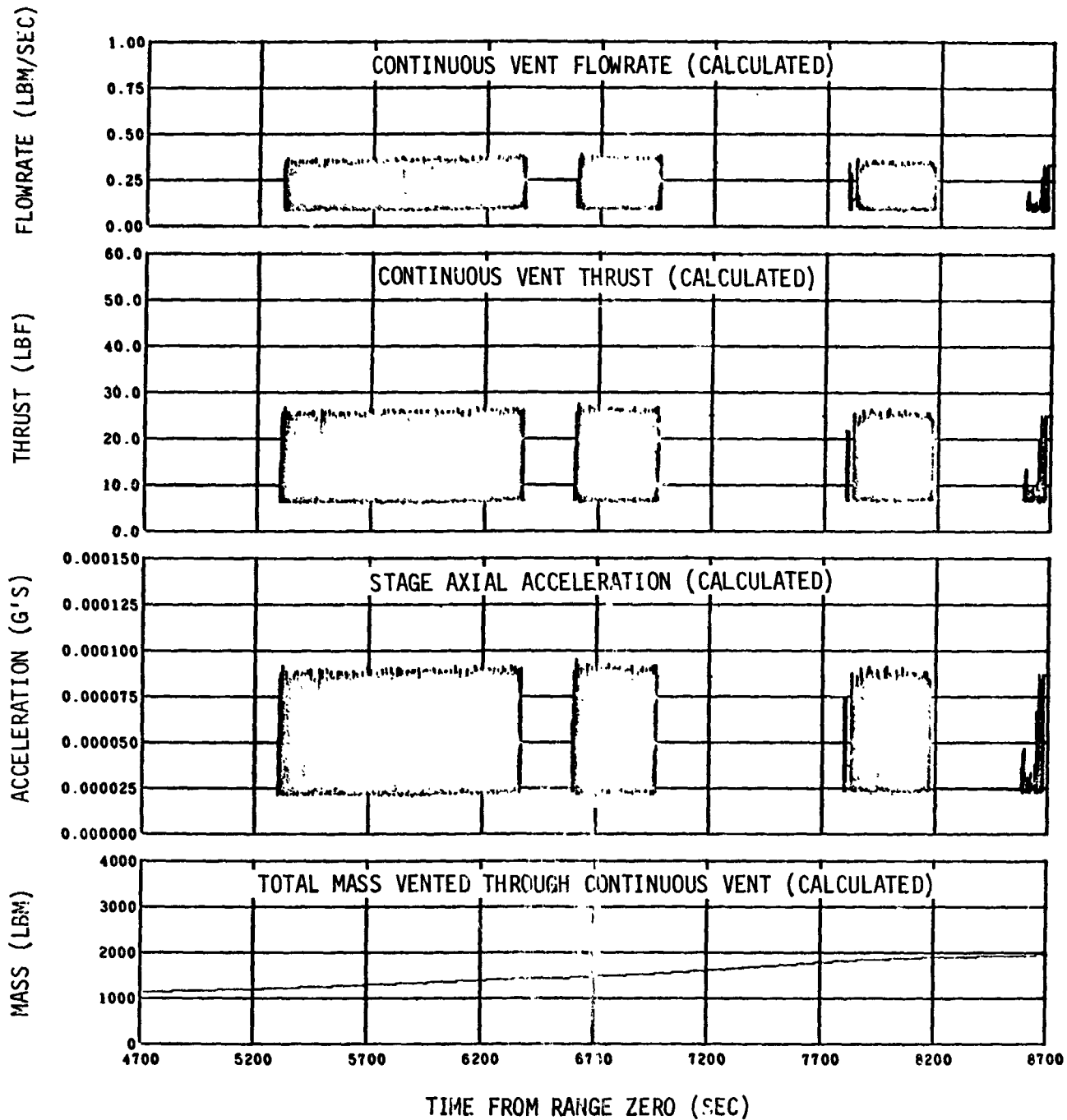

Figure 12-9. LH2 Tank Continuous Vent System Performance - Earth Orbit (Sheet 2 of 4)

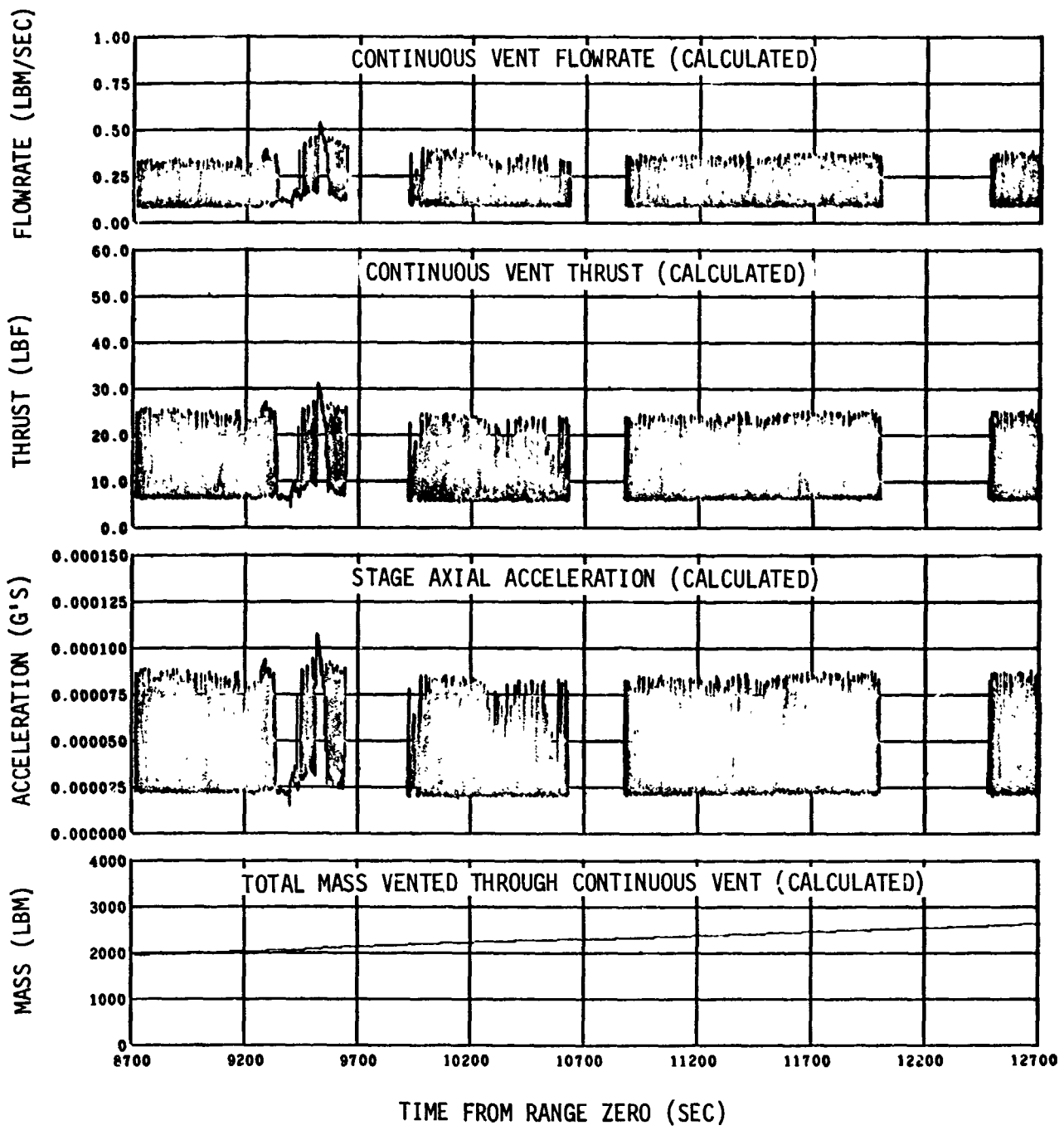

Figure 12-9. LH2 Tank Continuous Vent System Performance - Earth Orbit (Sheet 3 of 4)



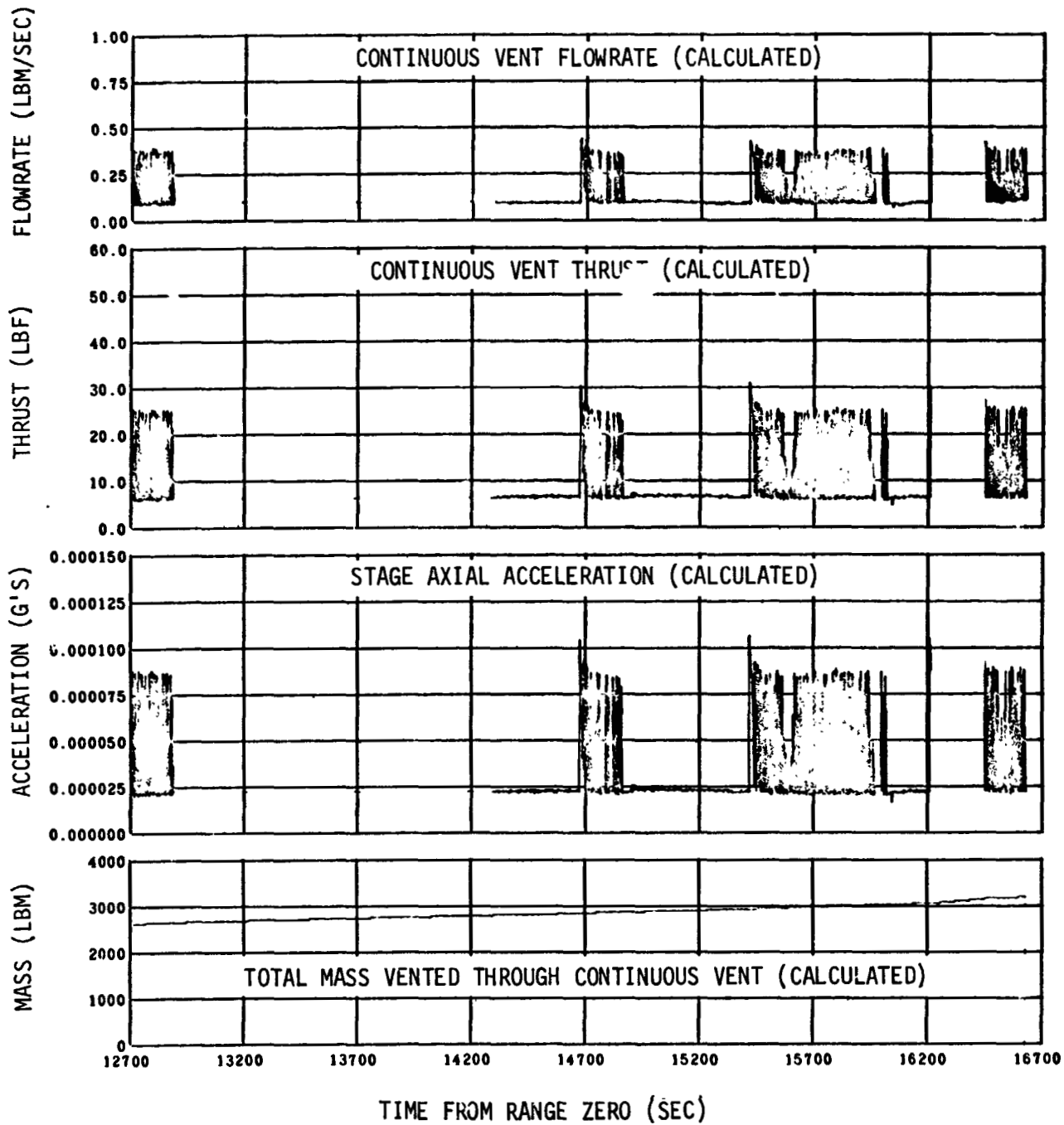

Figure 12-9. LH2 Tank Continuous Vent System Performance - Earth Orbit (Sheet 4 of 4)

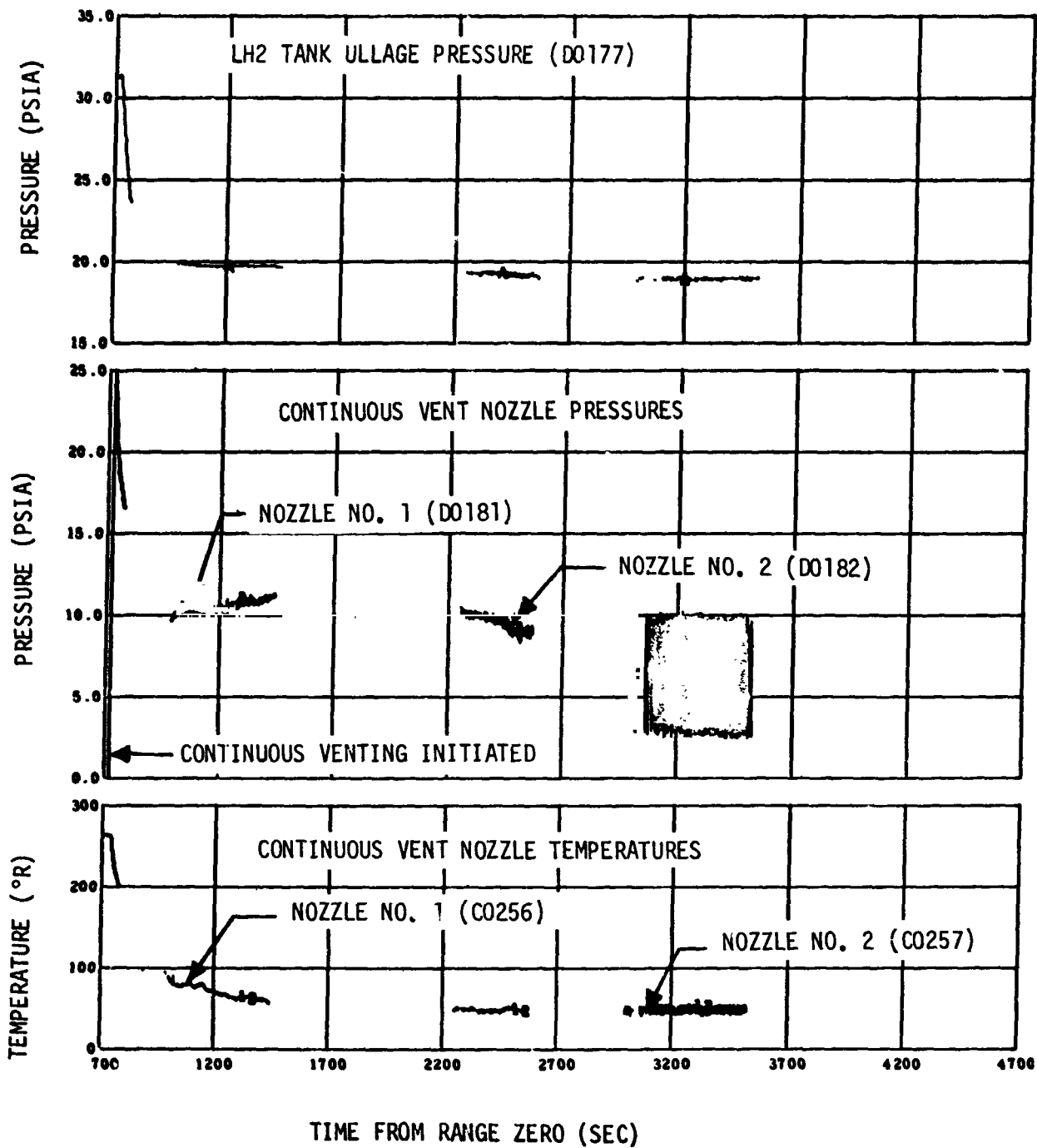

Figure 12-10. LH2 Tank Continuous Vent System Operation - Earth Orbit (Sheet 1 of 4)

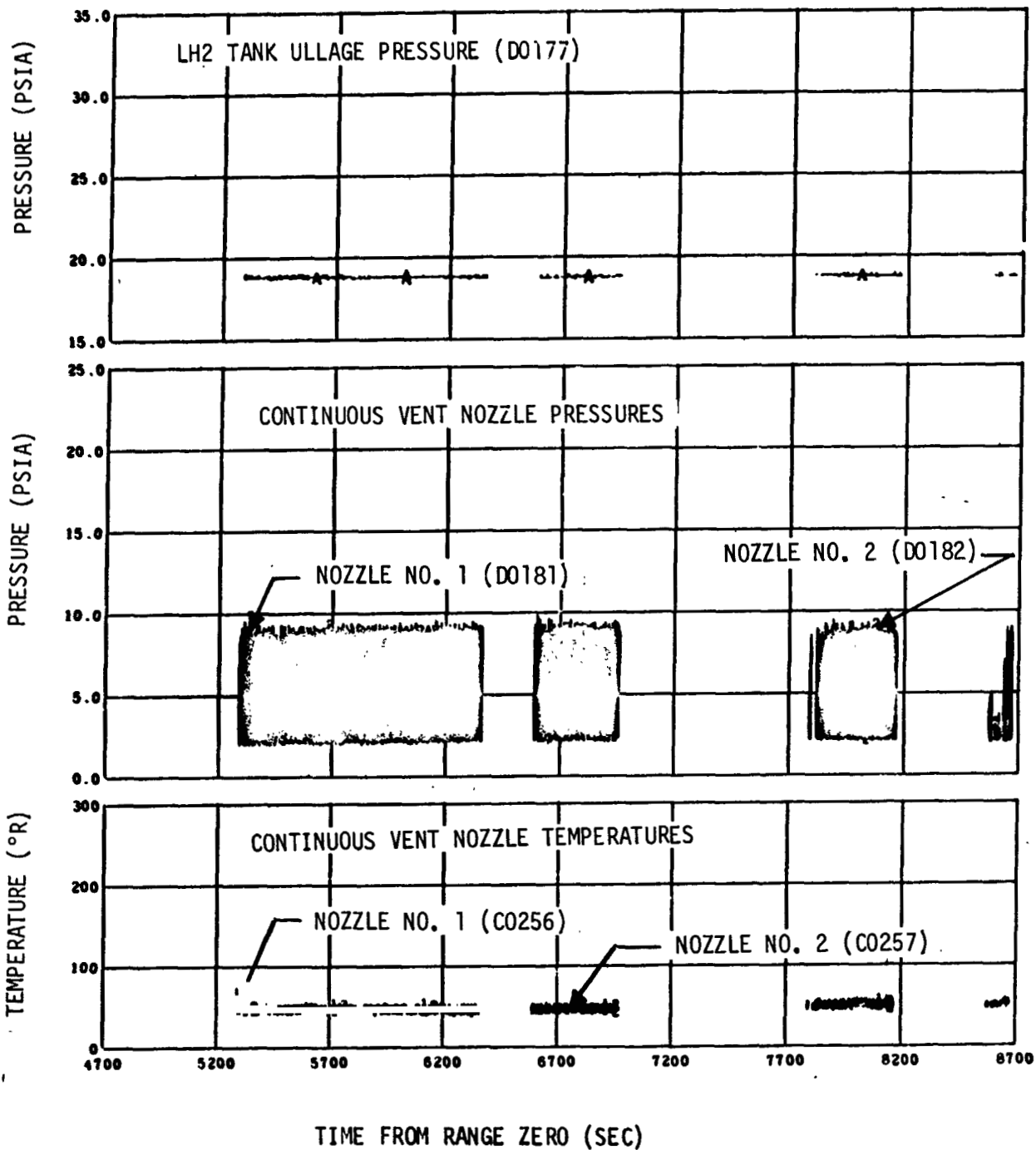

Figure 12-10. LH2 Tank Continuous Vent System Operation - Earth Orbit (Sheet 2 of 4)

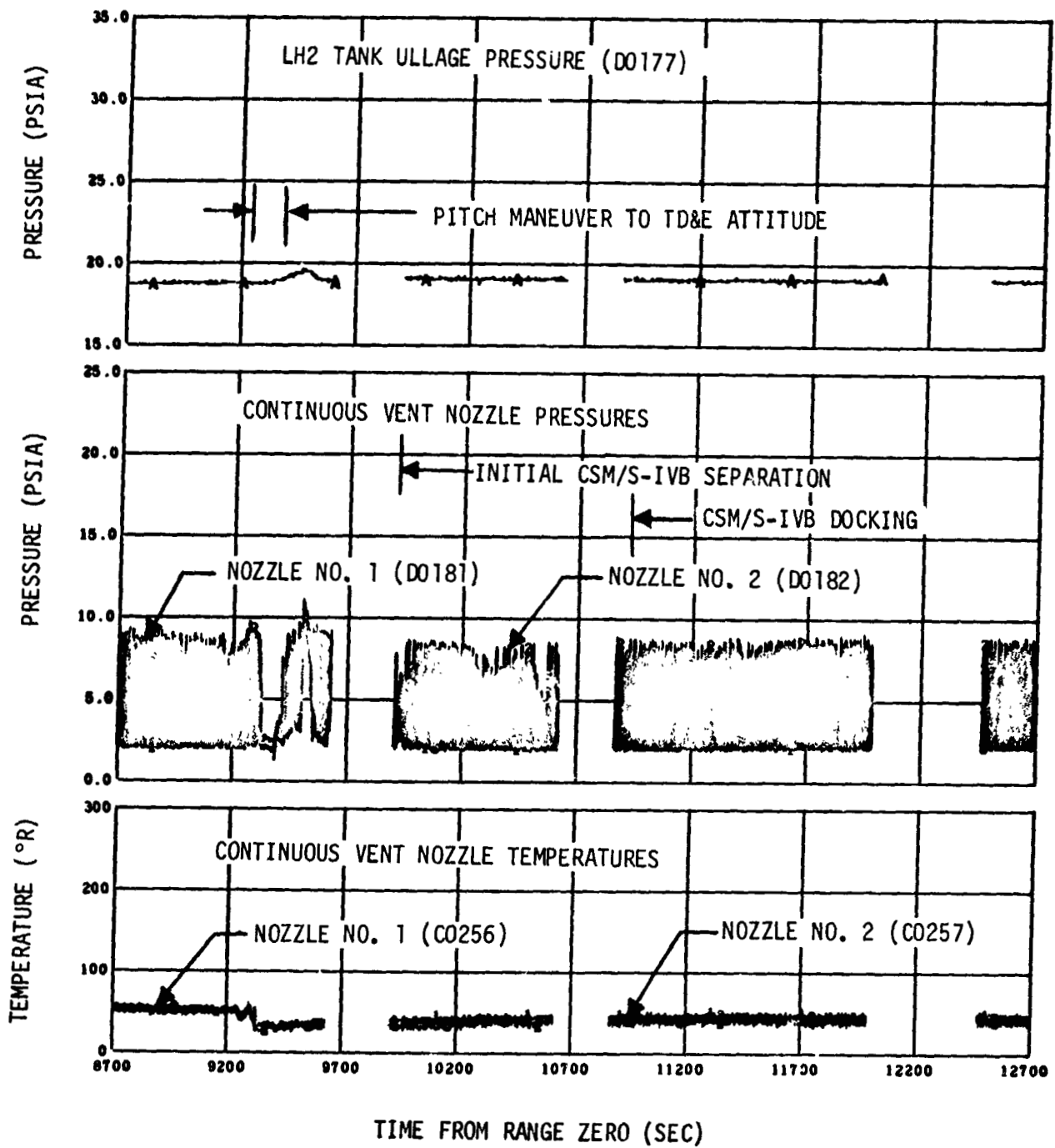

Figure 12-10. LH2 Tank Continuous Vent System Operation - Earth Orbit (Sheet 3 of 4)

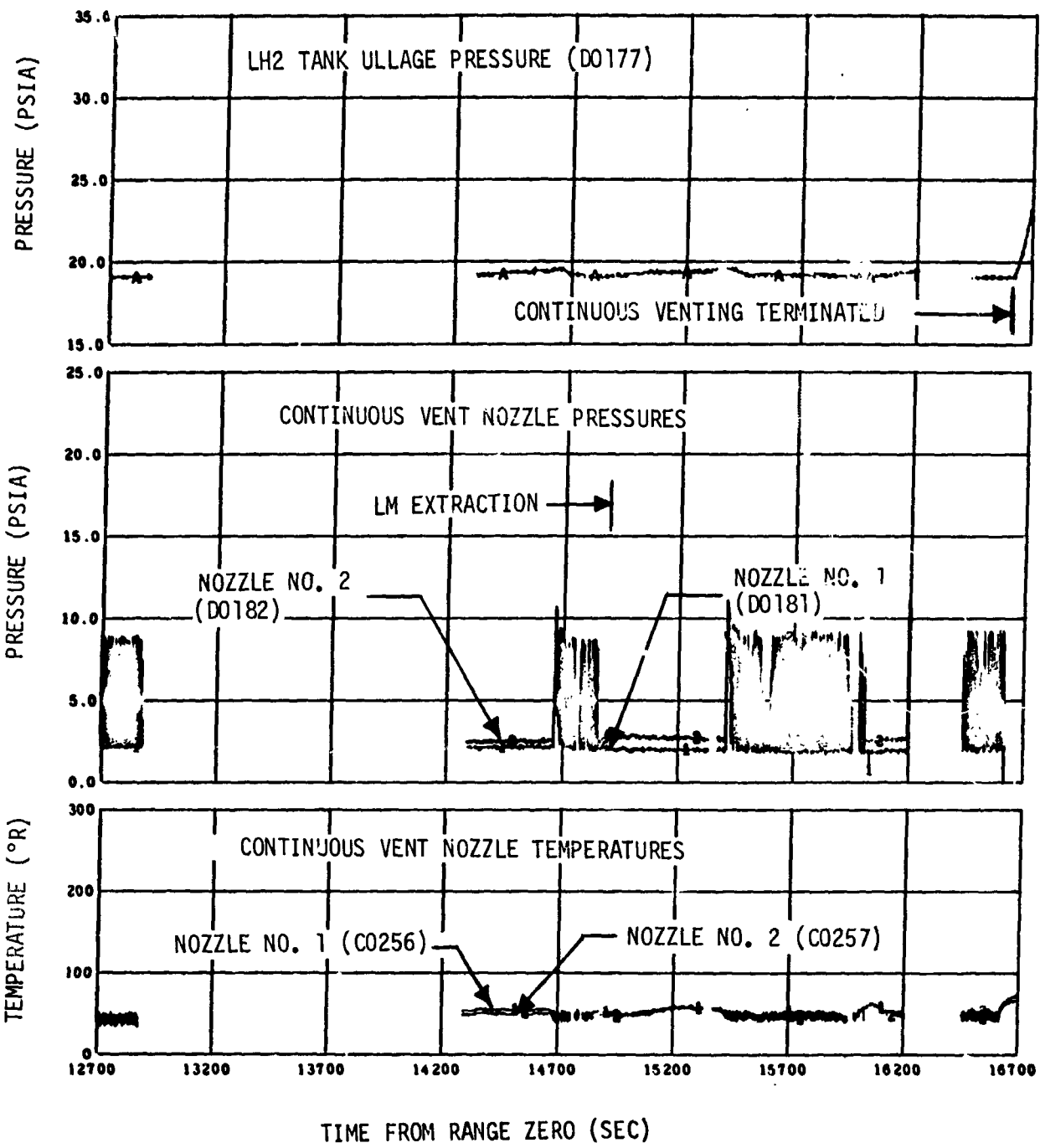

Figure 12-10. LH2 Tank Continuous Vent System Operation - Earth Orbit (Sheet 4 of 4)

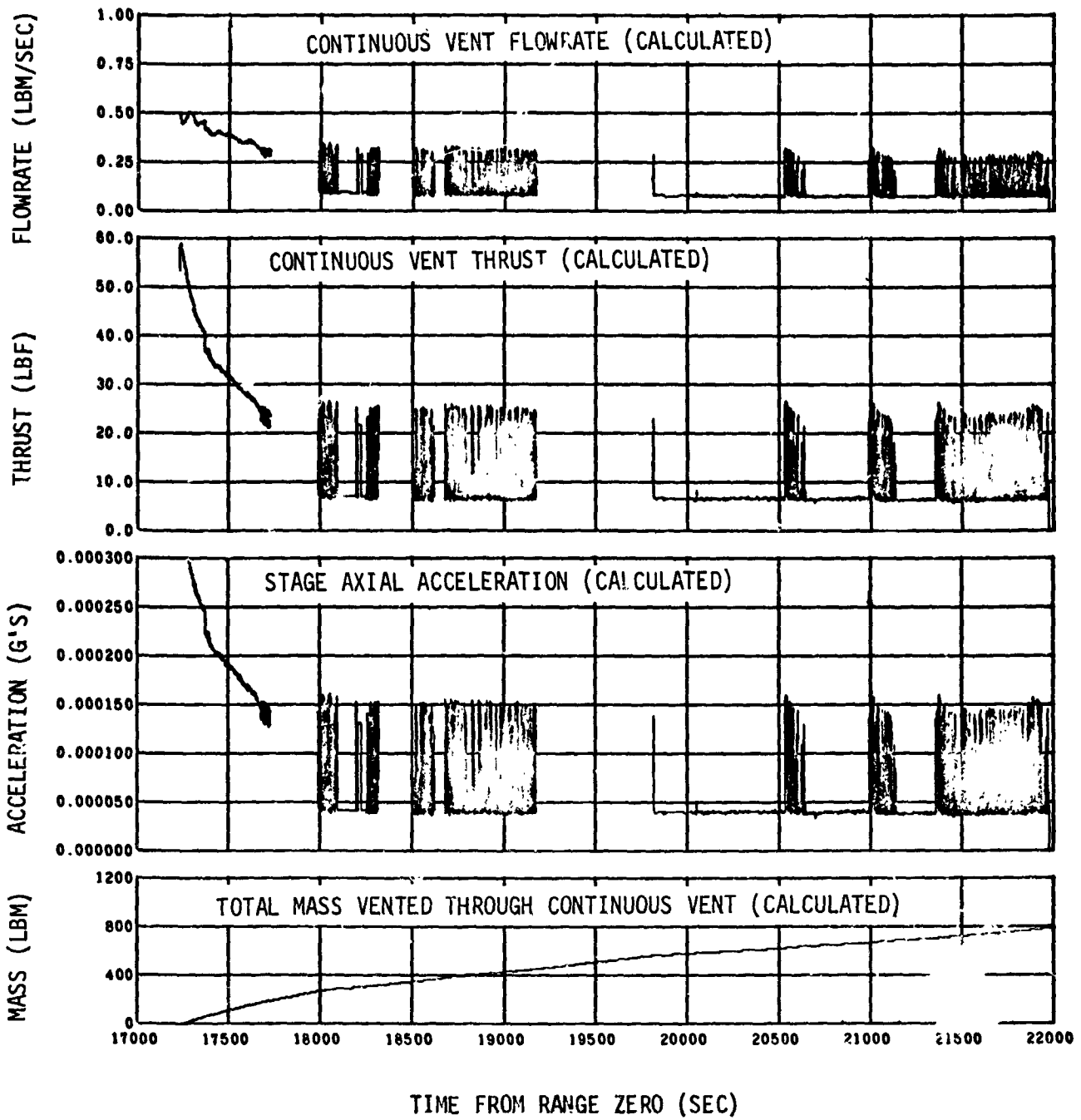

Figure 12-11. LH2 Tank Continuous Vent System Performance - Intermediate Orbit

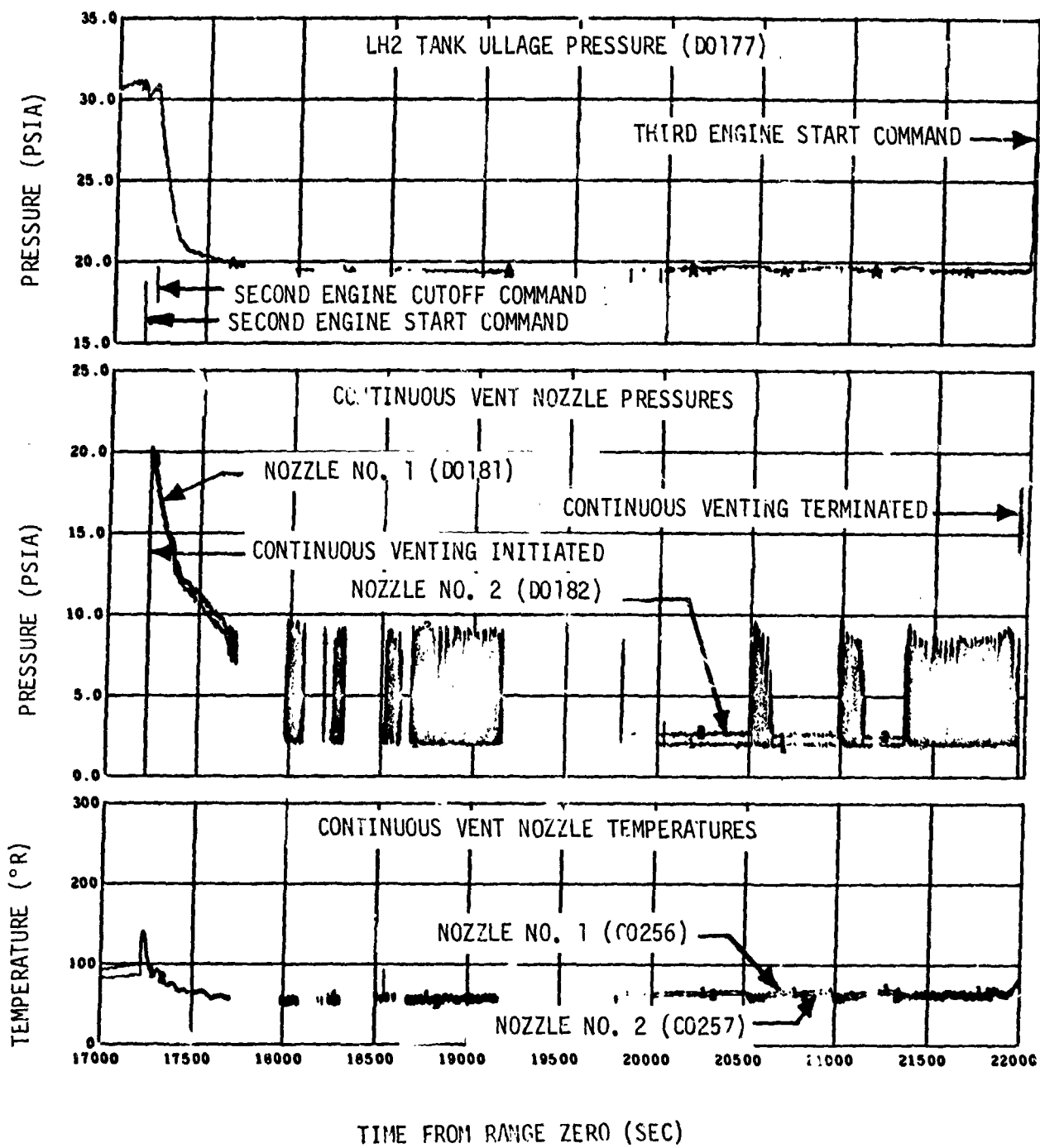

Figure 12-12. LH2 Tank Continuous Vent System Operation - Intermediate Orbit

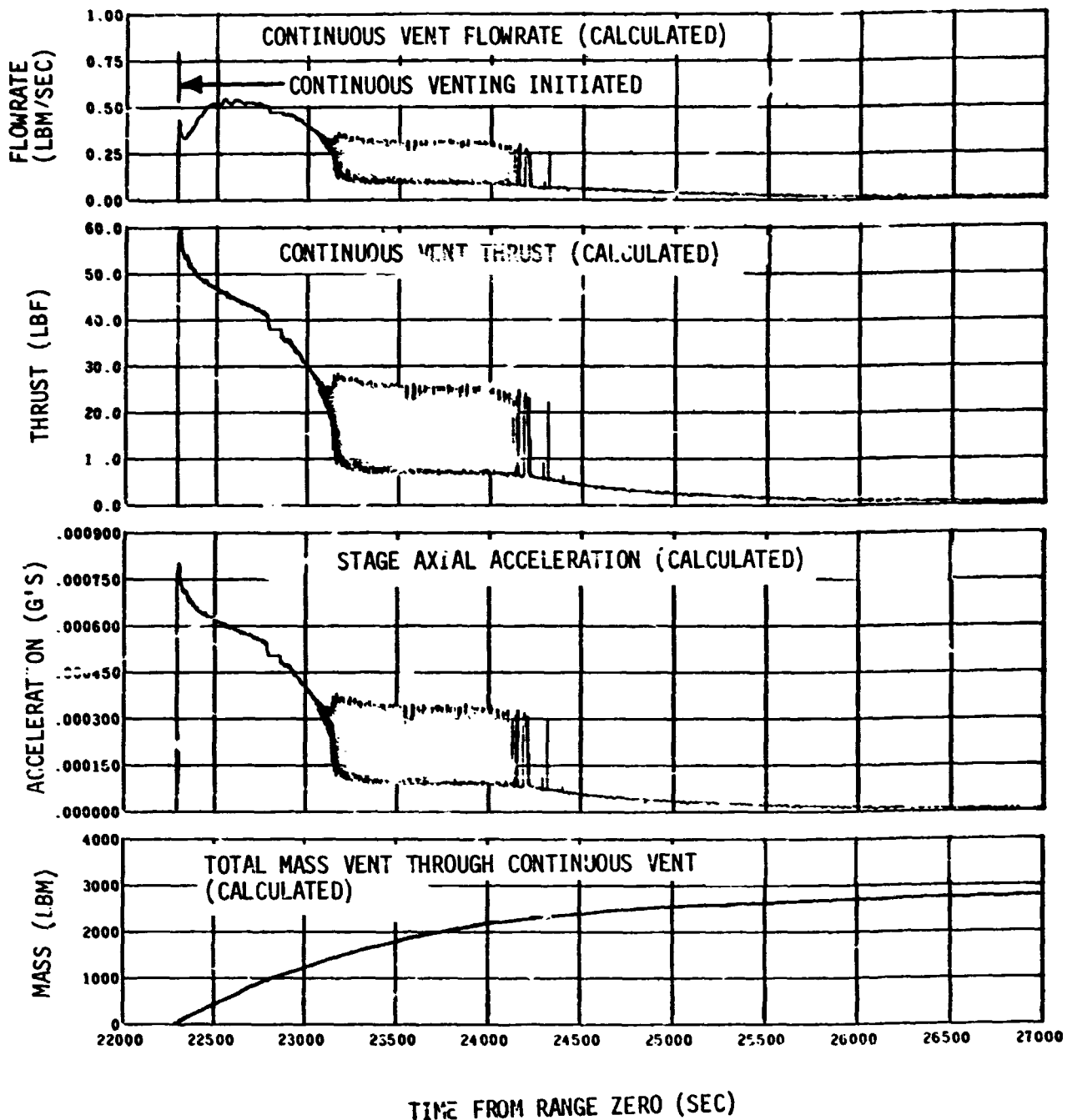

Figure 12-13. LH2 Tank Continuous Vent System Performance - Solar Orbit Insertion



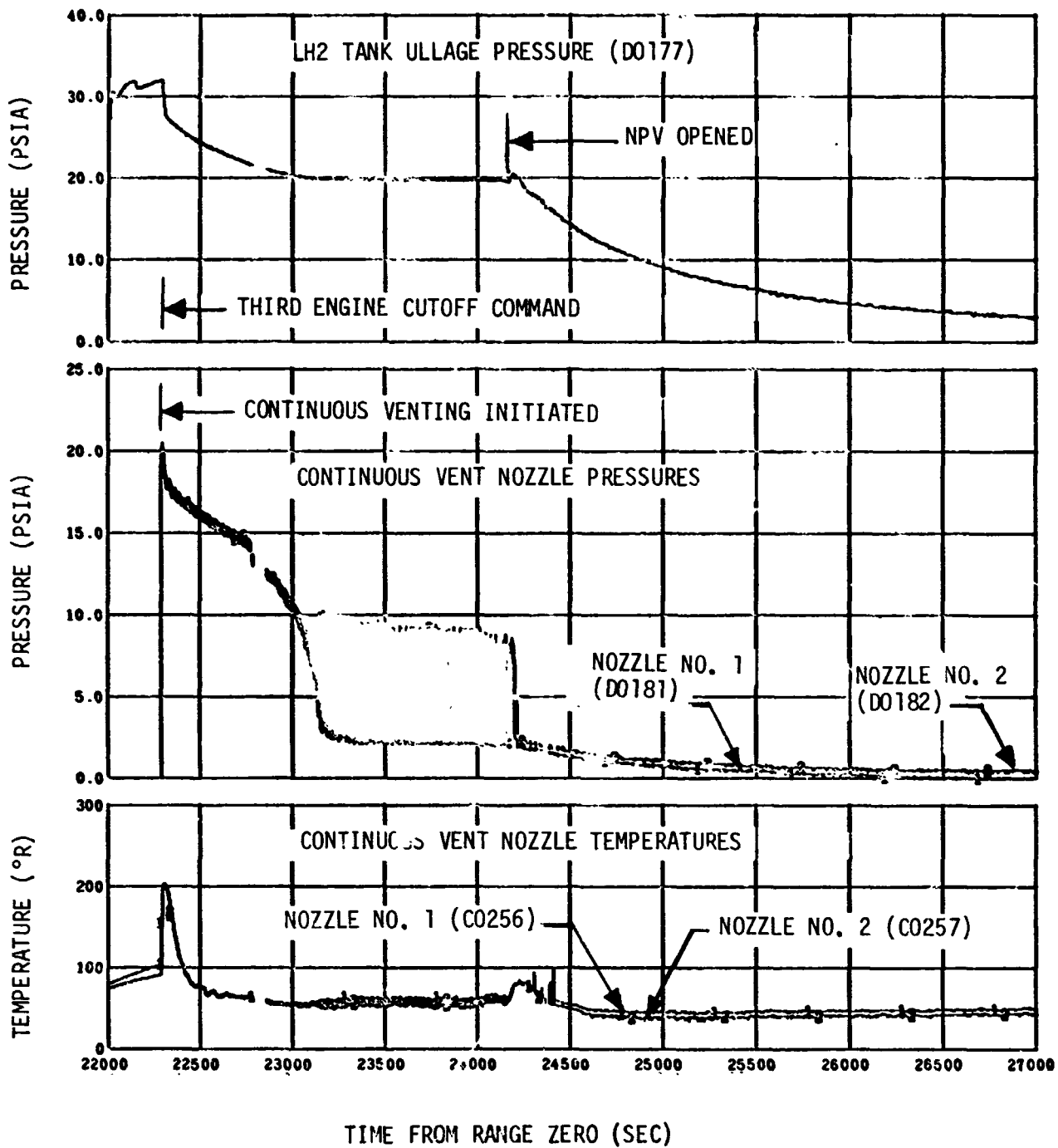

Figure 12-14. LH2 Tank Continuous Vent System Operation - Solar Orbit Insertion

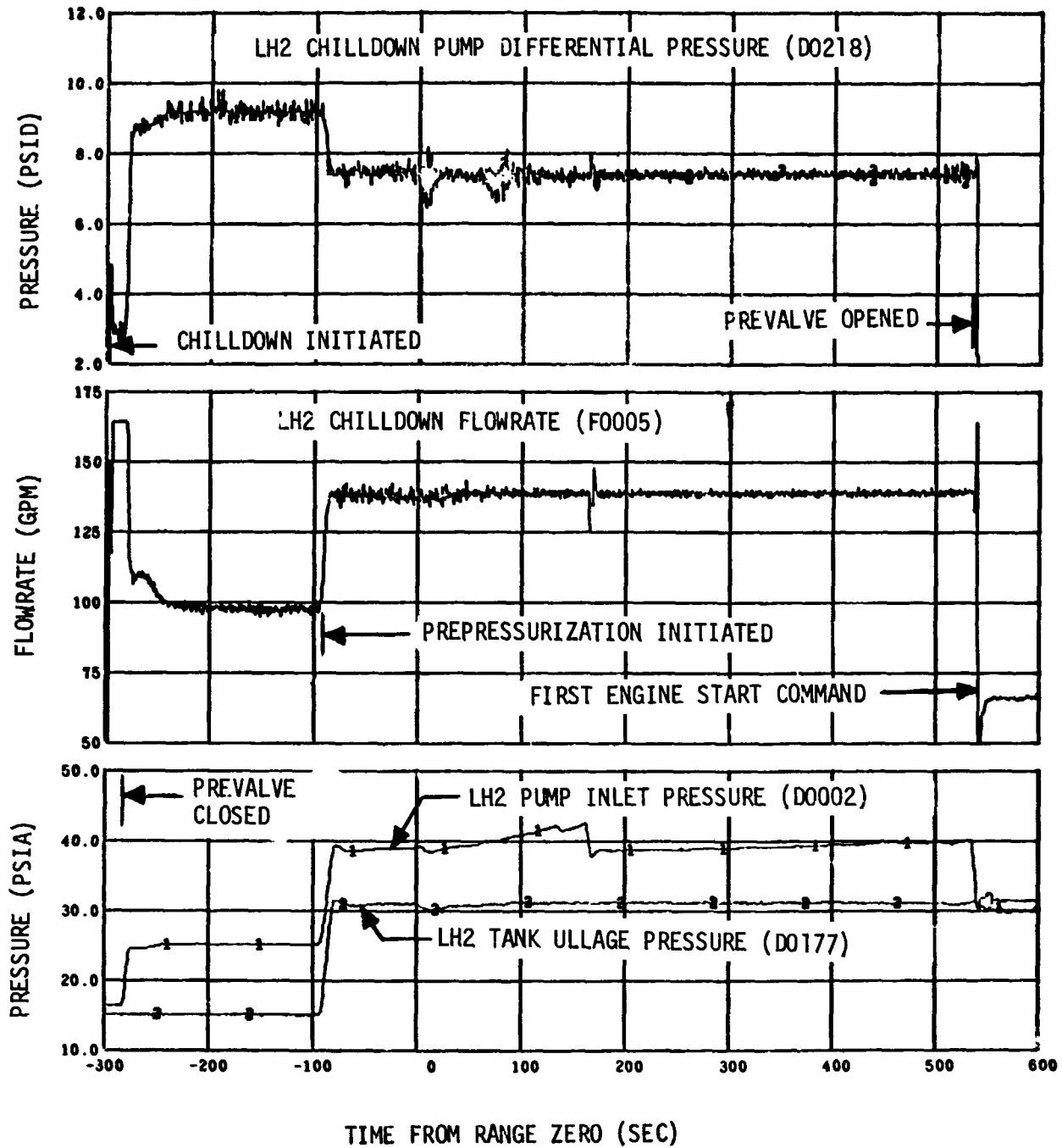

Figure 12-15. LH2 Pump Chilldown Performance - First Burn (Sheet 1 of 2)

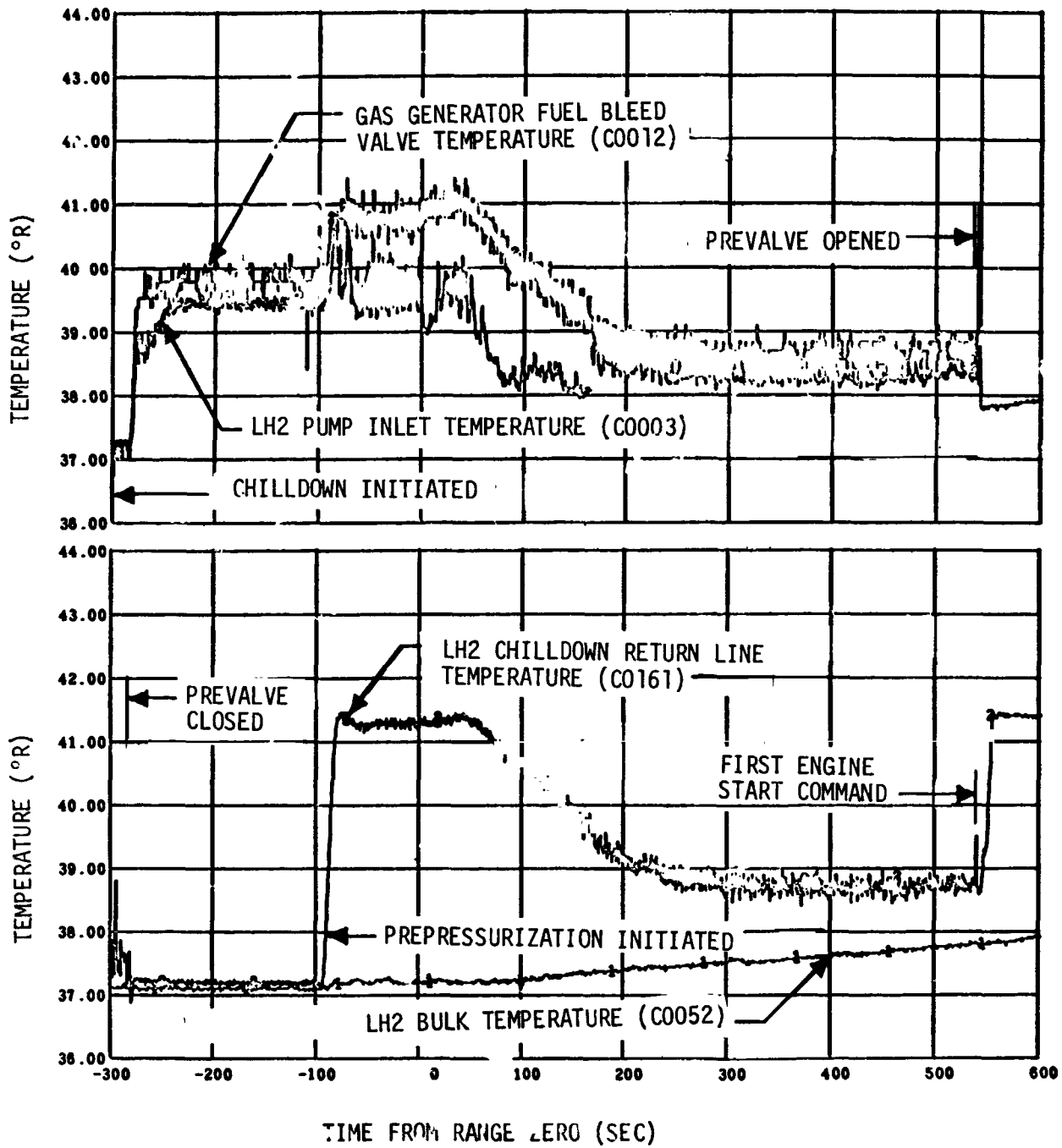

Figure 12-15. LH2 Pump Chilldown Performance - First Burn (Sheet 2 of 2)

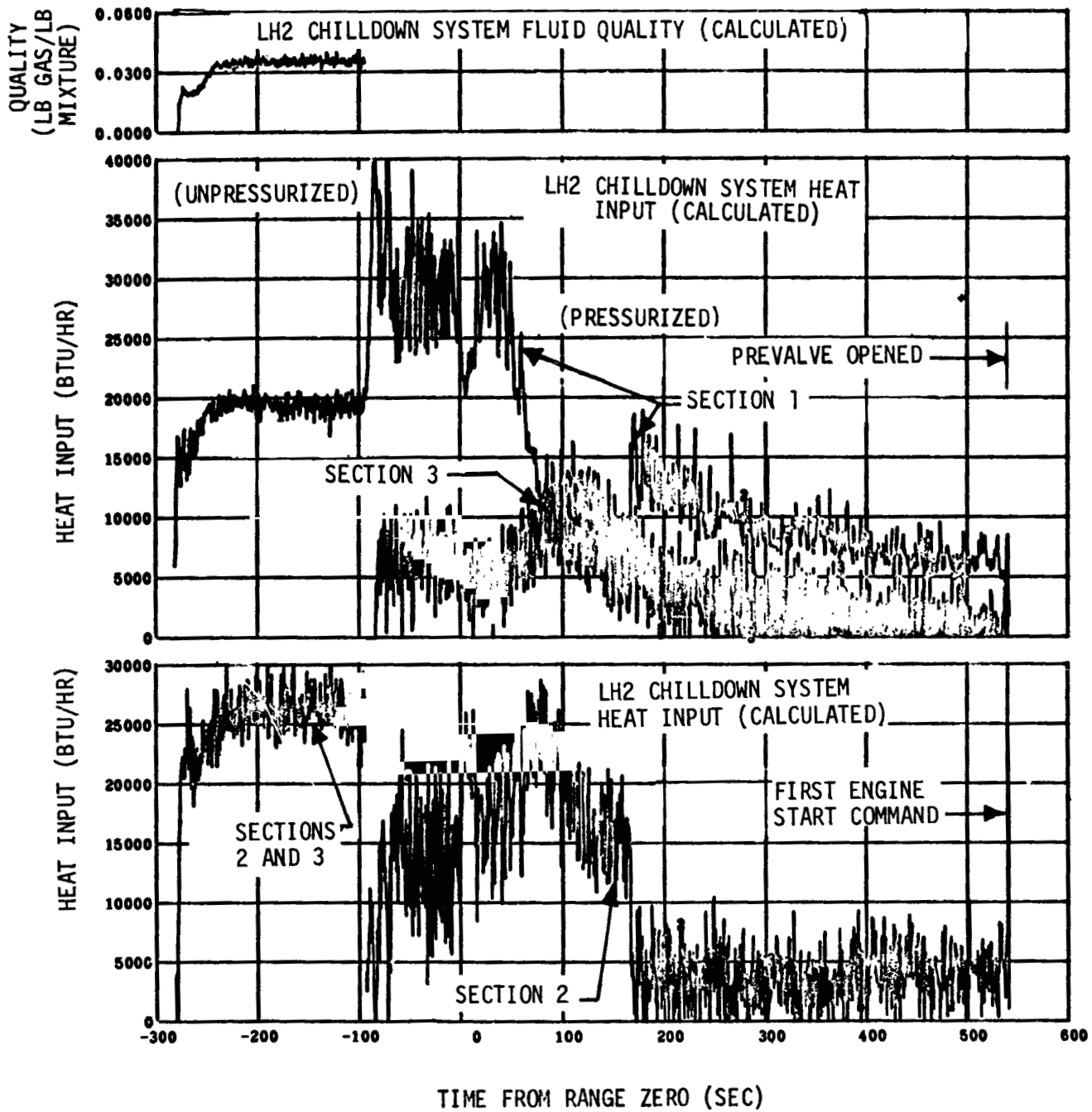

Figure 12-16. LH2 Pump Chilldown - First Burn  
(Sheet 1 of 2)

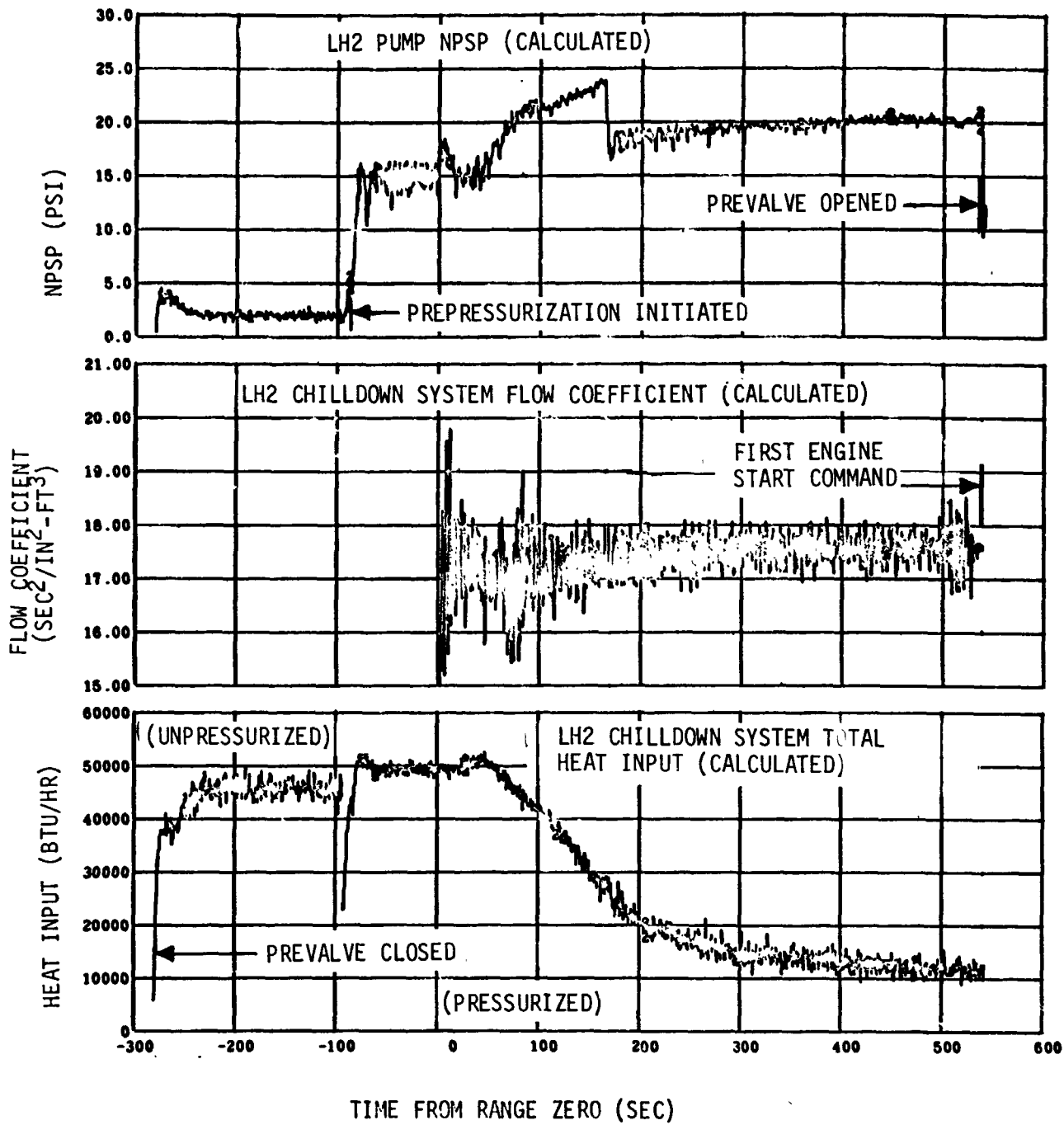

Figure 12-16. LH2 Pump Chilldown - First Burn (Sheet 2 of 2)

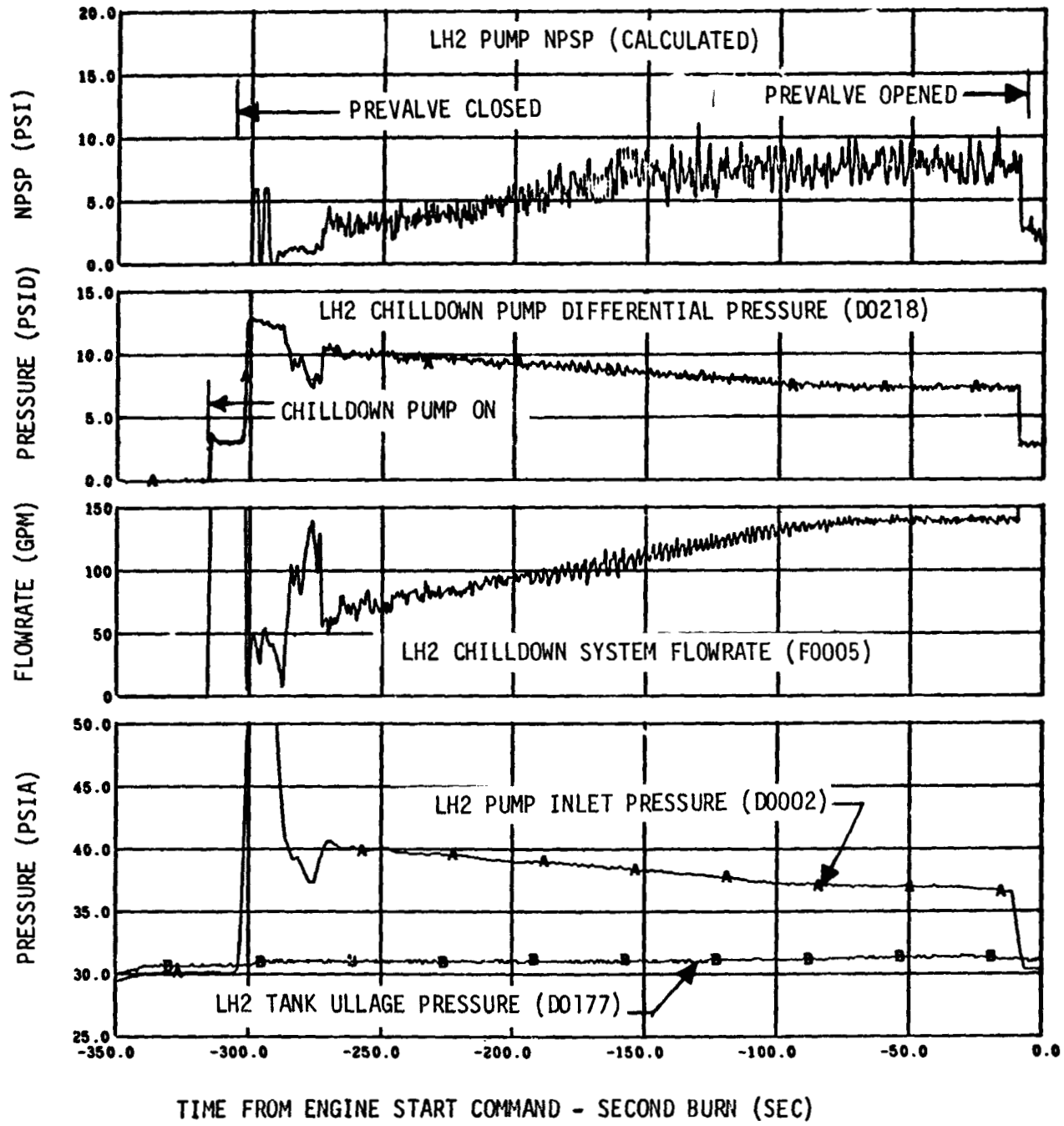

Figure 12-17. LH2 Pump Chilldown System Performance - Second Burn (Sheet 1 of 2)

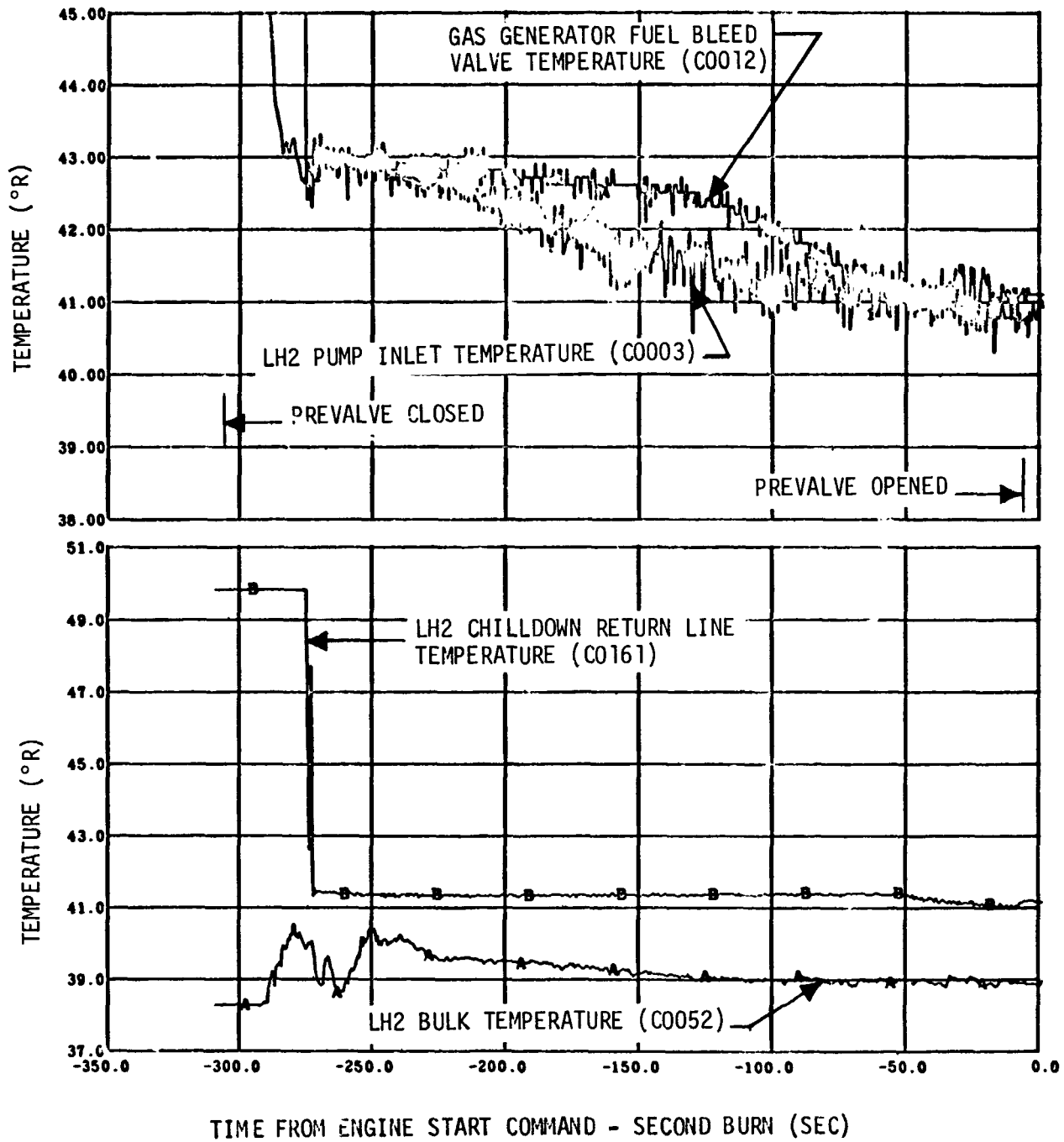

Figure 12-17. LH2 Pump Chilldown System Performance - Second Burn (Sheet 2 of 2)

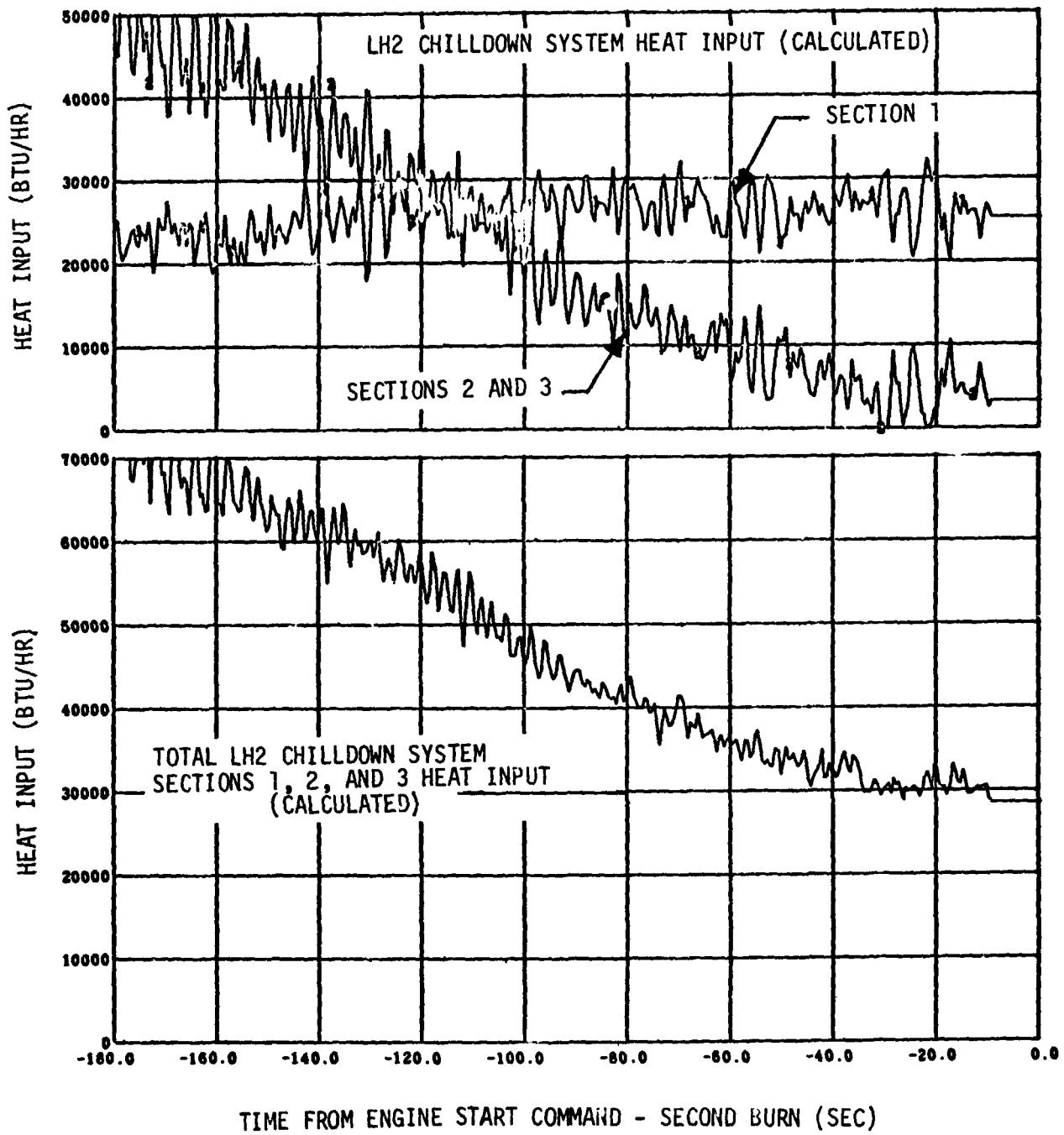

Figure 12-18. LH2 Pump Chilldown - Second Burn



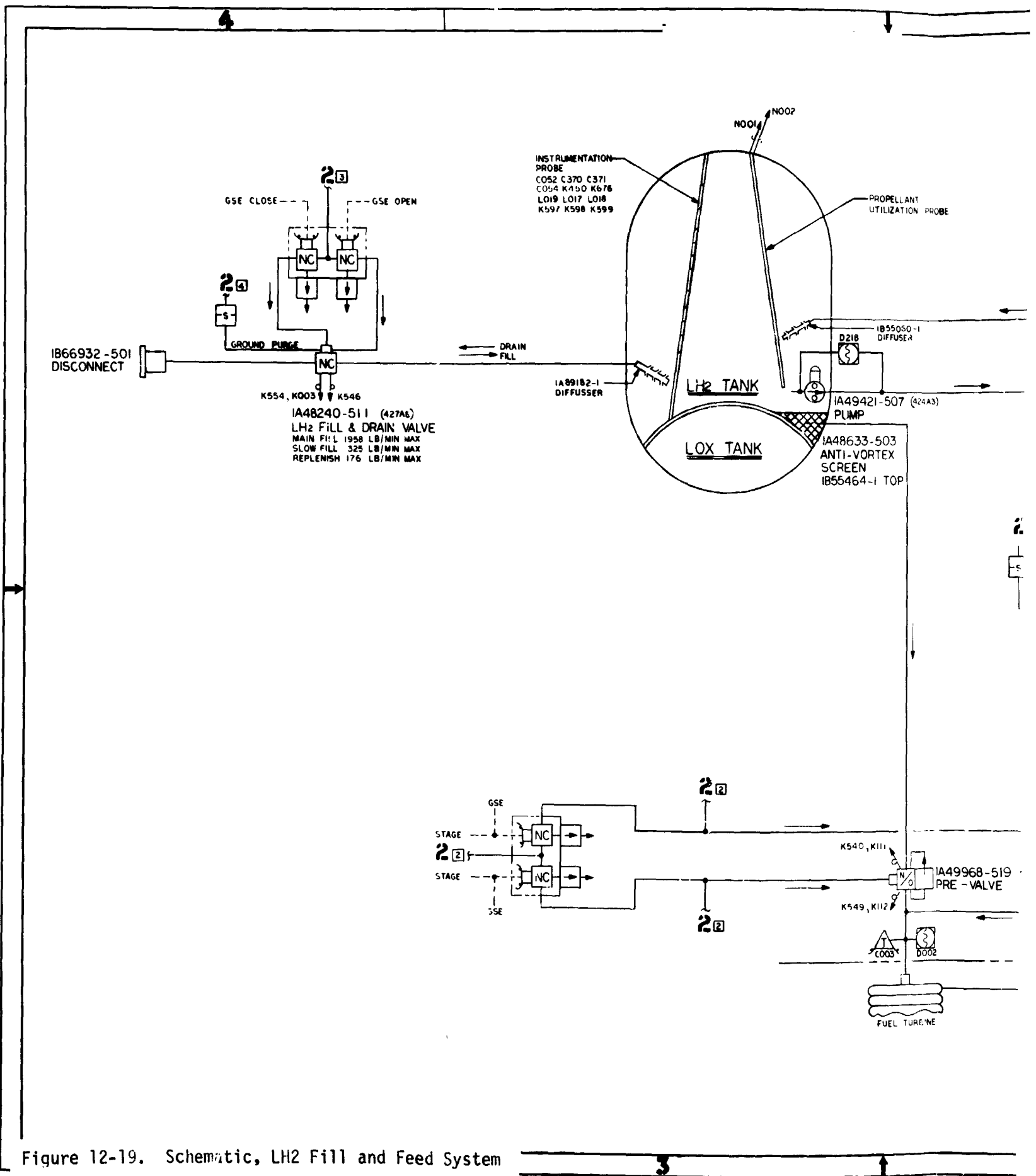
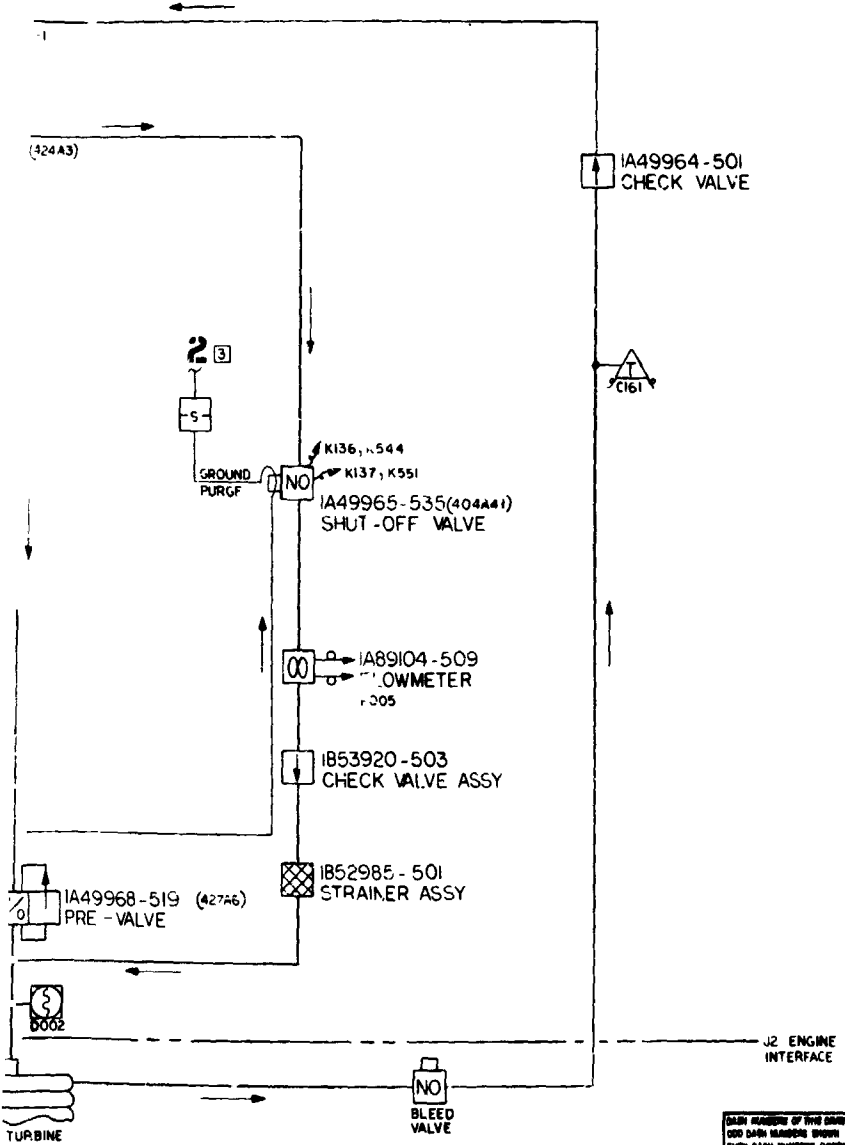

Figure 12-19. Schematic, LH2 Fill and Feed System

2

REVISIONS		DATE	APPROVED
A	SEE E.O.		
B	SEE E.O.		

PROBE



GENERAL NOTES  
UNLESS OTHERWISE SPECIFIED:

- 1. LH<sub>2</sub> TANK DATA
  - VOLUME 10,409.5 FT<sup>3</sup>
  - ULLAGE PRESSURE AT L/O 31-34 PSIA
  - ULLAGE TEMP AT L/O 150°-200°R
  - PROPELLANT TEMP AT L/O 37°-38°R

VEHICLE CONFIGURATION

1B74477 "L"  
1A59098 "DD"

1866037

SEQUENCE 10

PREPARED FOR NACA USE		UNLESS OTHERWISE SPECIFIED		MATERIAL		<b>DOUGLAS</b> AIRCRAFT COMPANY, INC. SANTA MONICA, CALIFORNIA	
DIMENSIONS ARE IN INCHES.		DIMENSIONS ARE IN INCHES.		WT LHM		SCHEMATIC, LH <sub>2</sub> FILL & FEED SYSTEM	
TOLERANCES		TOLERANCES		STR. CHK		1866037	
FRACTIONS 2		FRACTIONS 2		CHK		H	
DECIMALS 2		DECIMALS 2		PR. ENGR		1866037	
ANGLES 2		ANGLES 2		GR. ENGR		1866037	
DATE		DATE		DESIGN ACTIVITY APPROVAL		1866037	
30		26 JUN 58		CUSTOMER APPROVAL		1866037	
SEE ENGINEERING RECORD		DATE		SCALE		1866037	
						1866037	

FOLDOUT

2

DUAL REPRESS

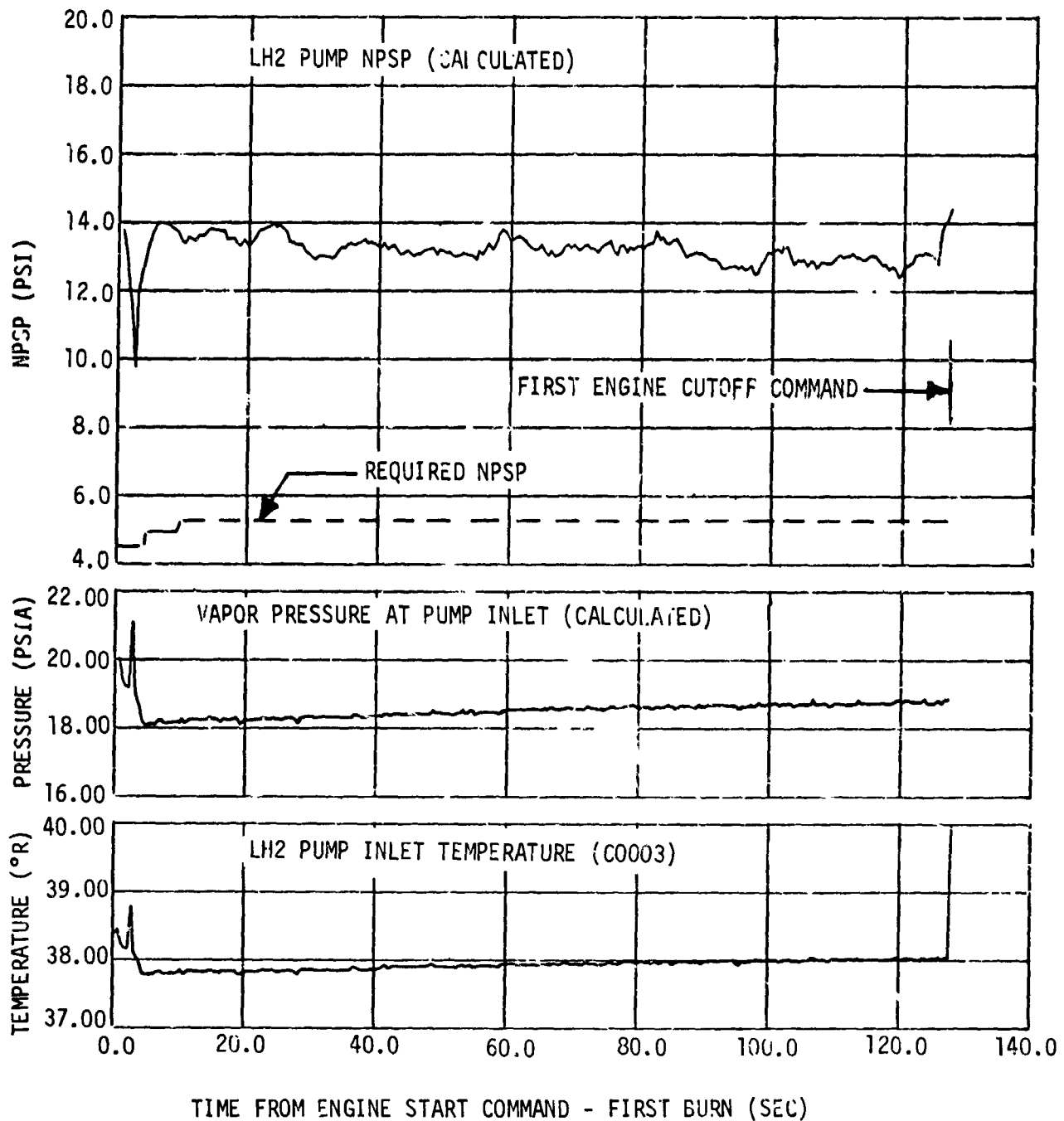

Figure 12-20. LH2 Pump Inlet Conditions--First Burn  
(Sheet 1 of 2)

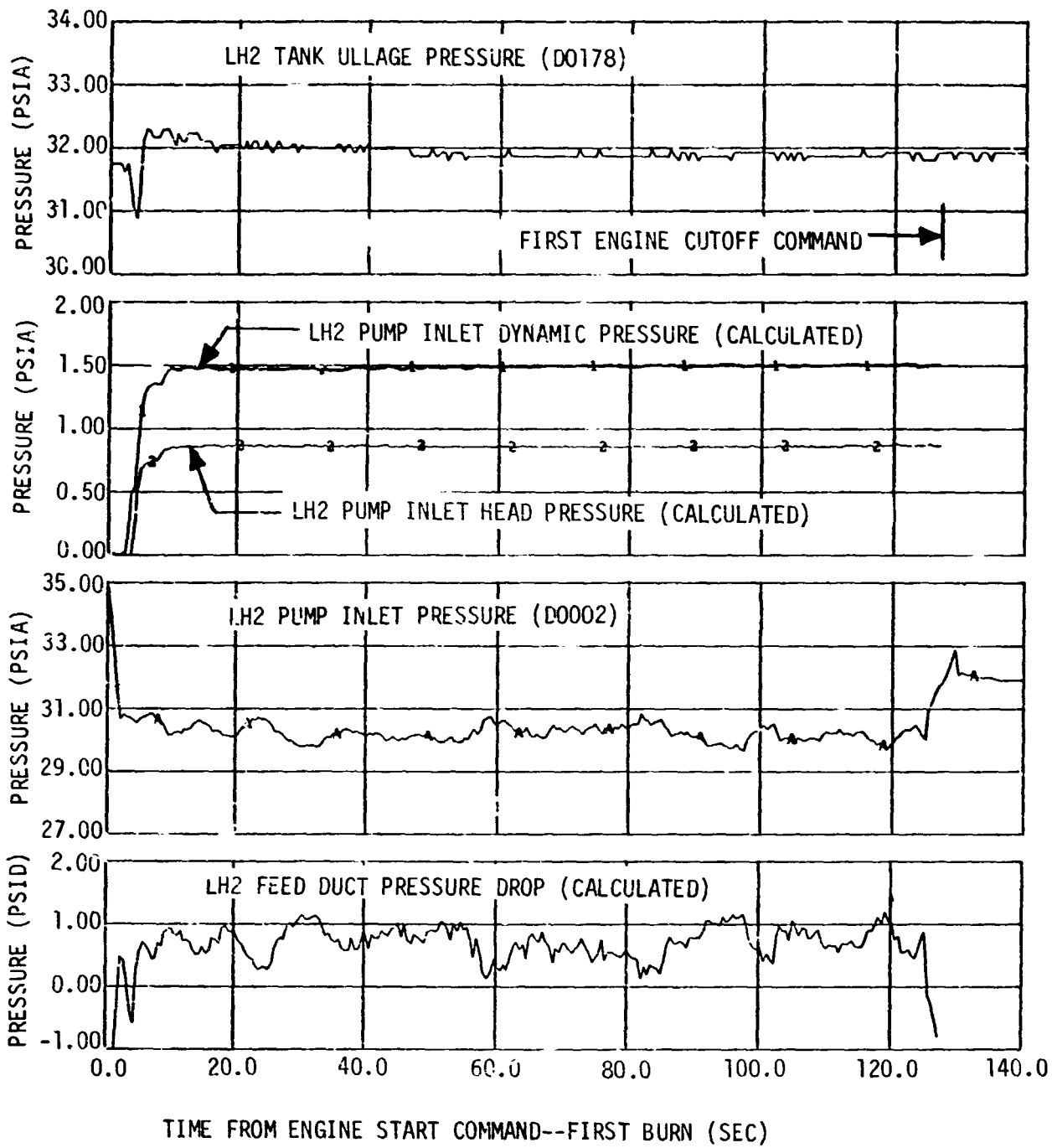

Figure 12-20. LH2 Pump Inlet Conditions--First Burn  
(Sheet 2 of 2)

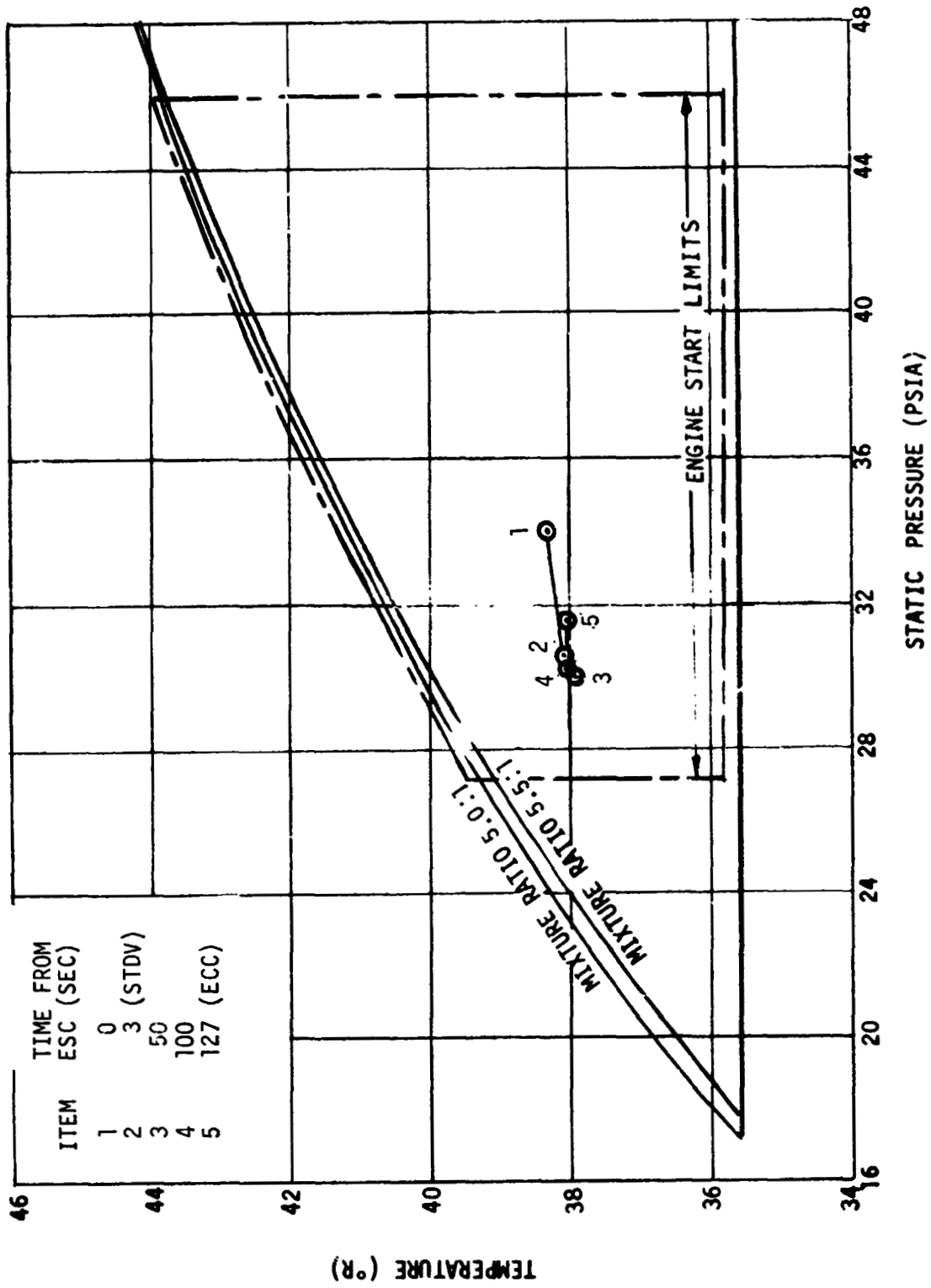

Figure 12-21. LH2 Pump Inlet Conditions During Firing - First burn

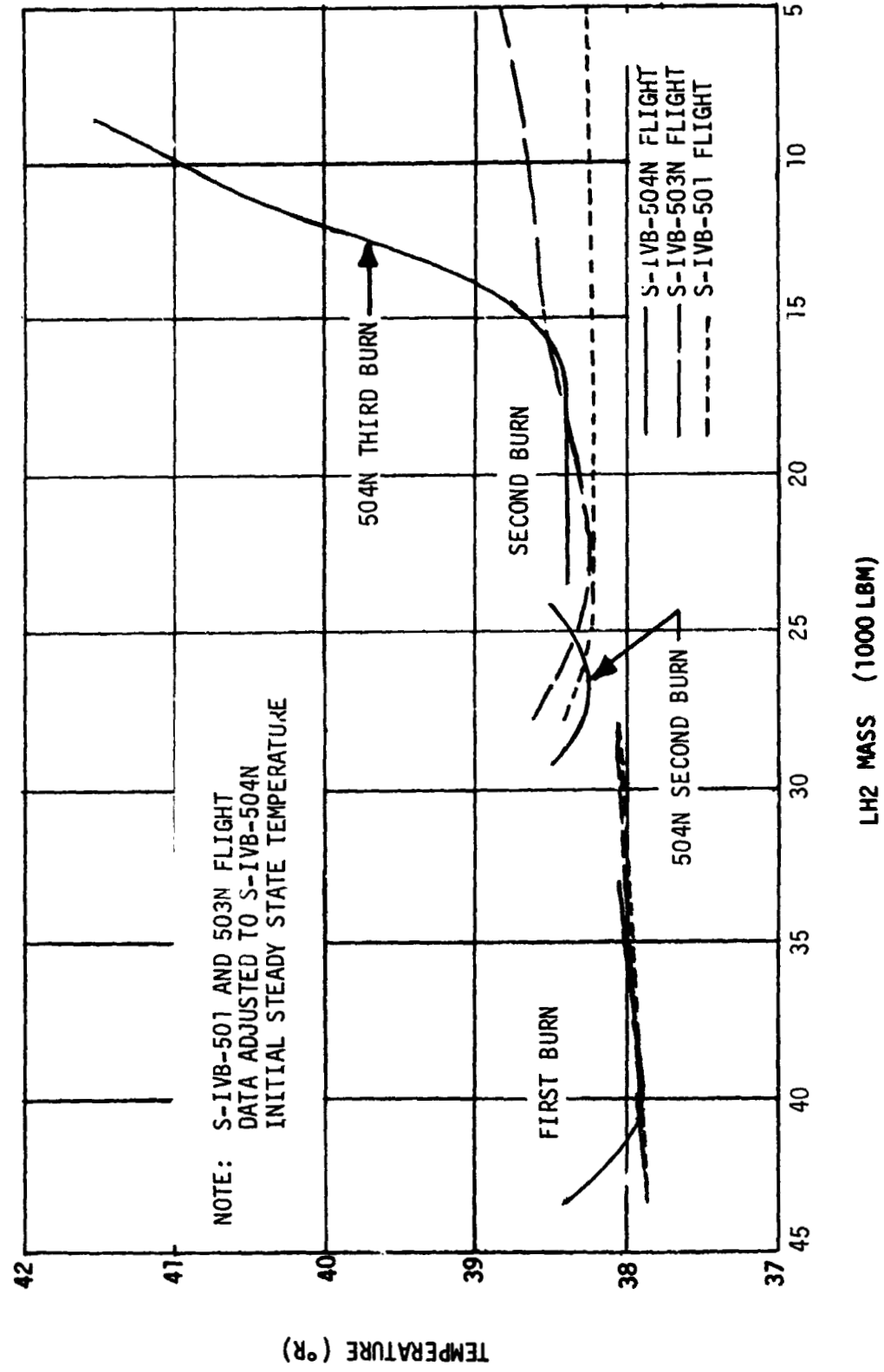

Figure 12-22. Effect of LH2 Mass Level on LH2 Pump Inlet Temperature

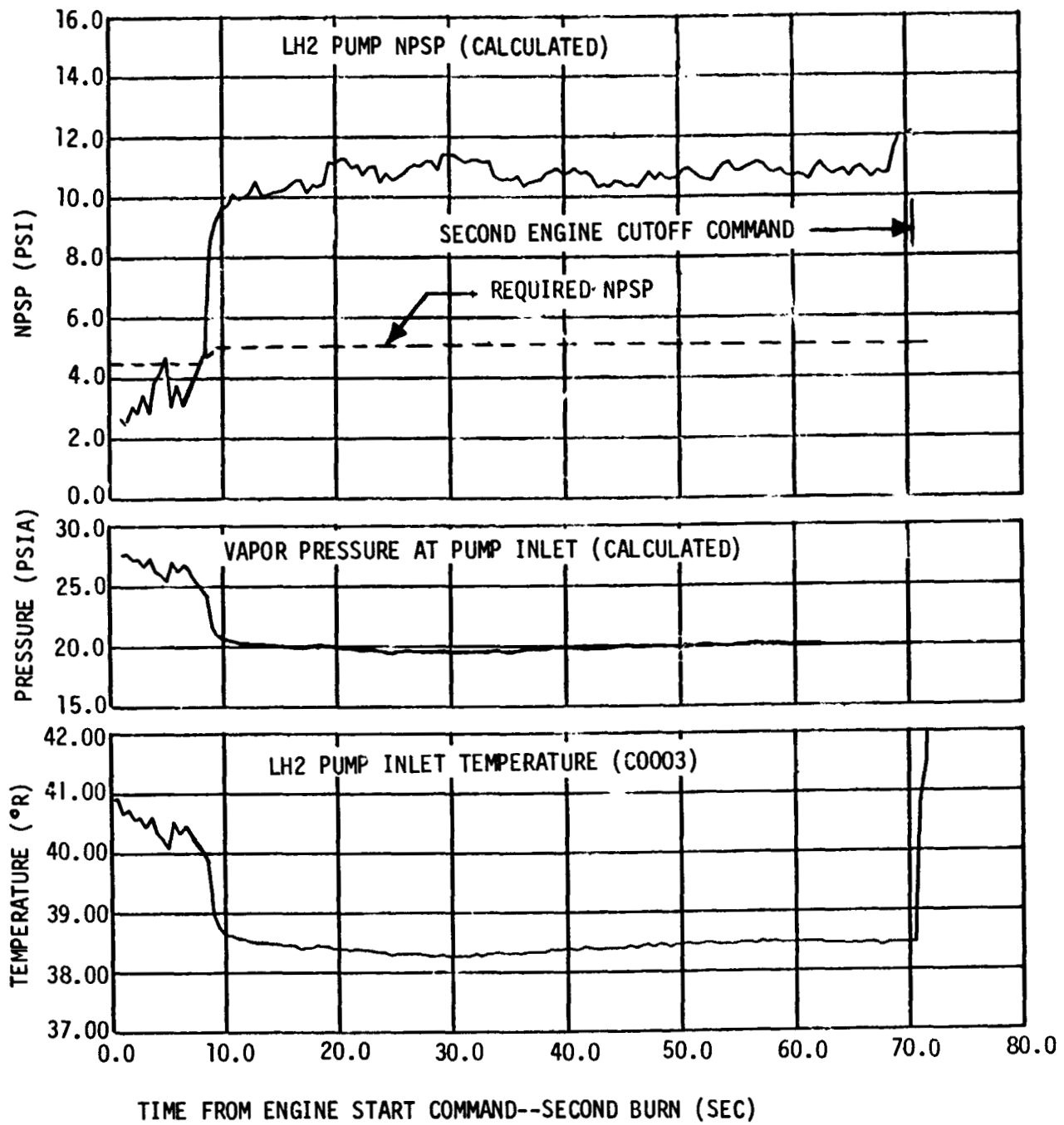

Figure 12-23. LH2 Pump Inlet Conditions--Second Burn  
(Sheet 1 of 2)

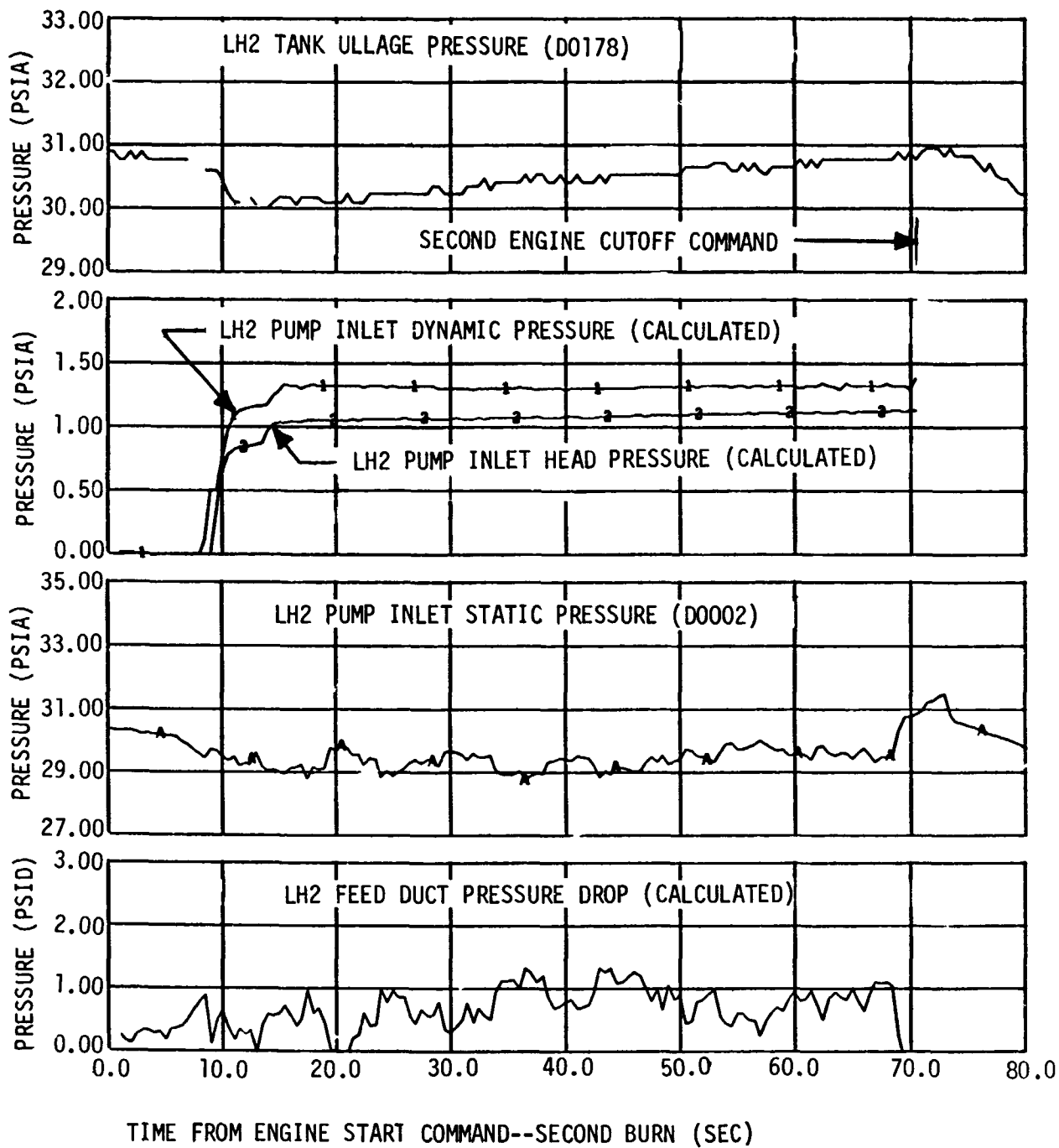

Figure 12-23. LH2 Pump Inlet Conditions--Second Burn  
(Sheet 2 of 2)



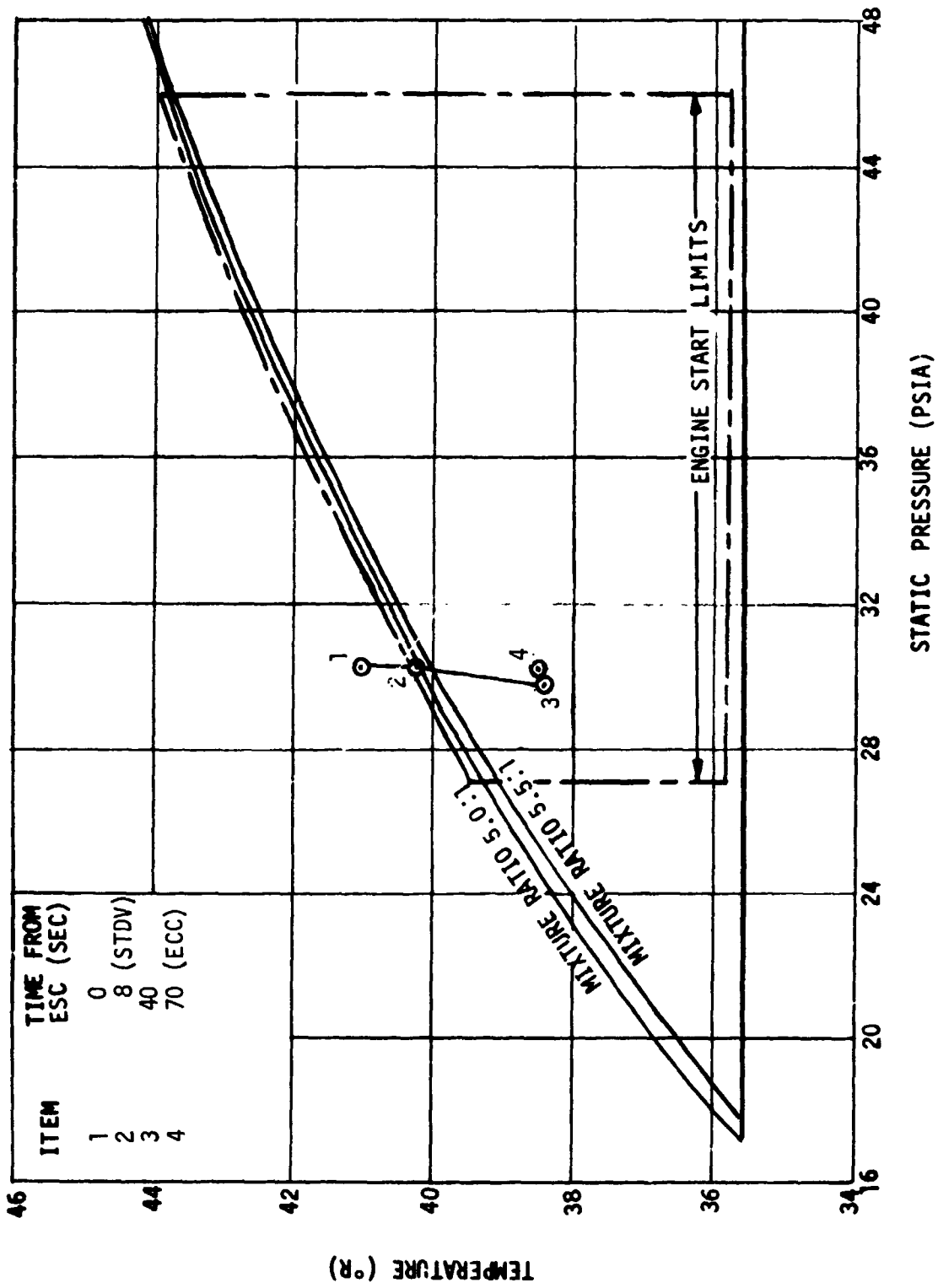

Figure 12-24. LH2 Pump Inlet Conditions During Firing - Second Burn

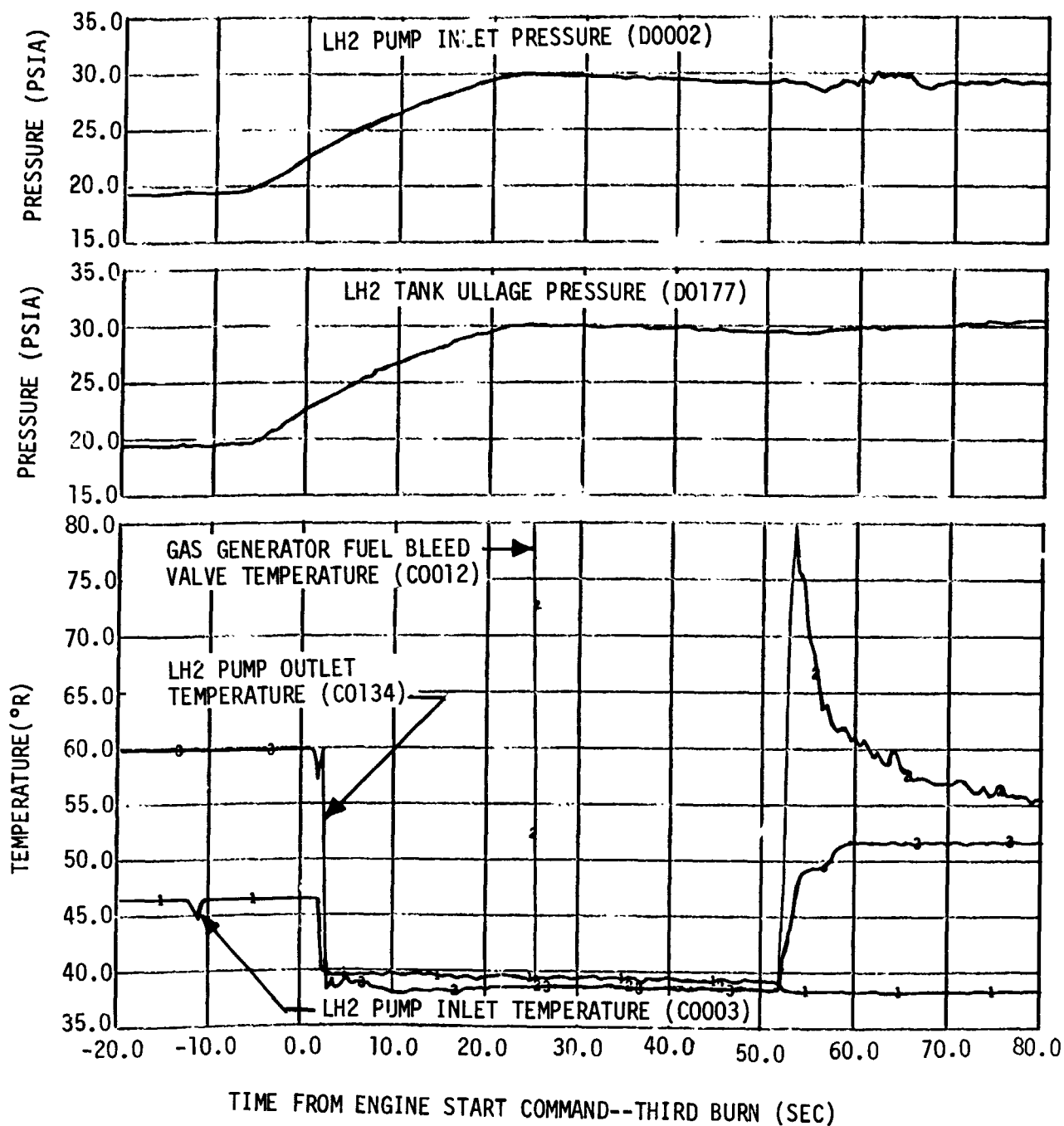

Figure 12-25. LH2 Supply Conditions During Extended Fuel Lead--Third Burn

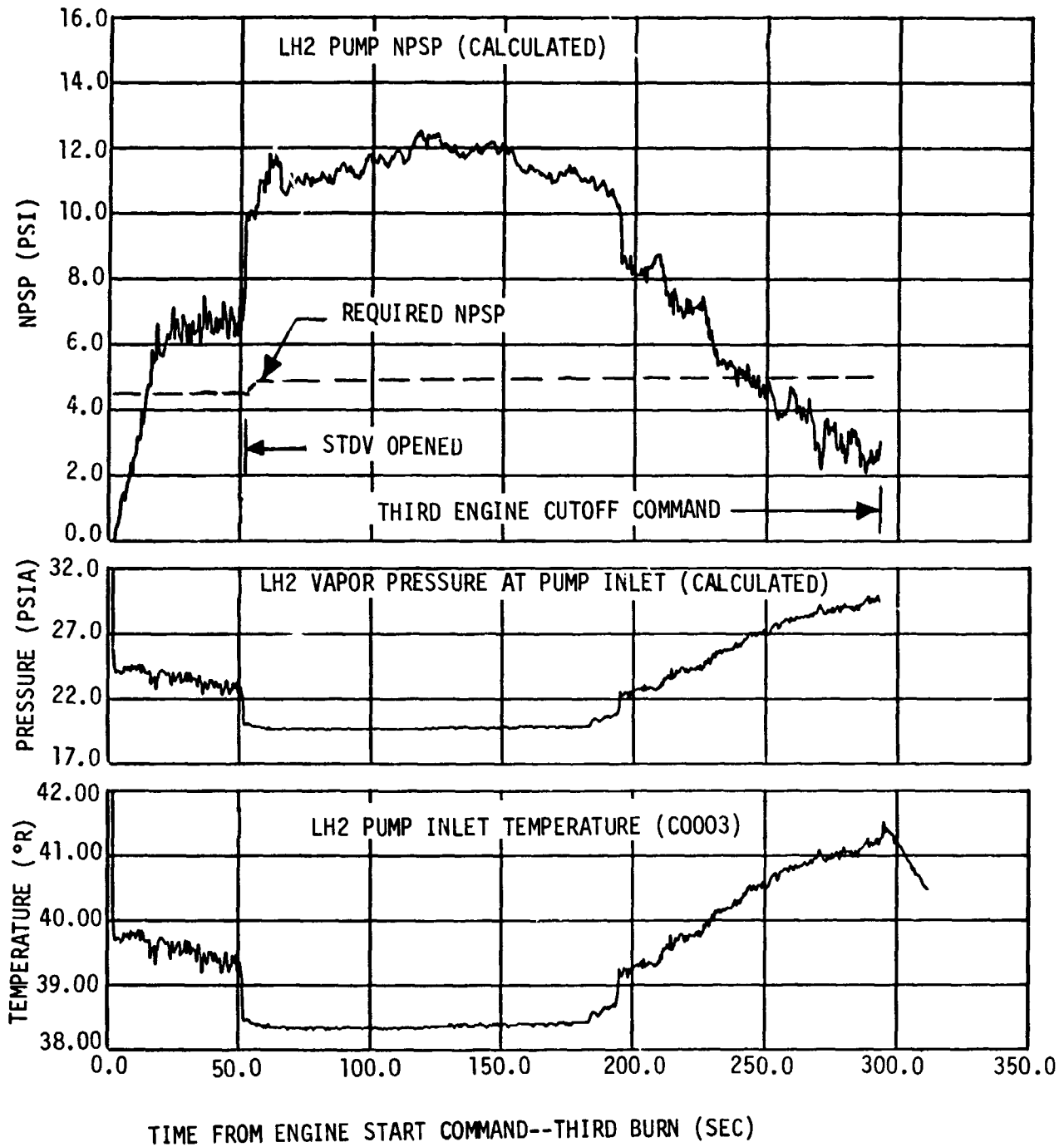

Figure 12-26. LH2 Pump Inlet Conditions--Third Burn  
(Sheet 1 of 2)

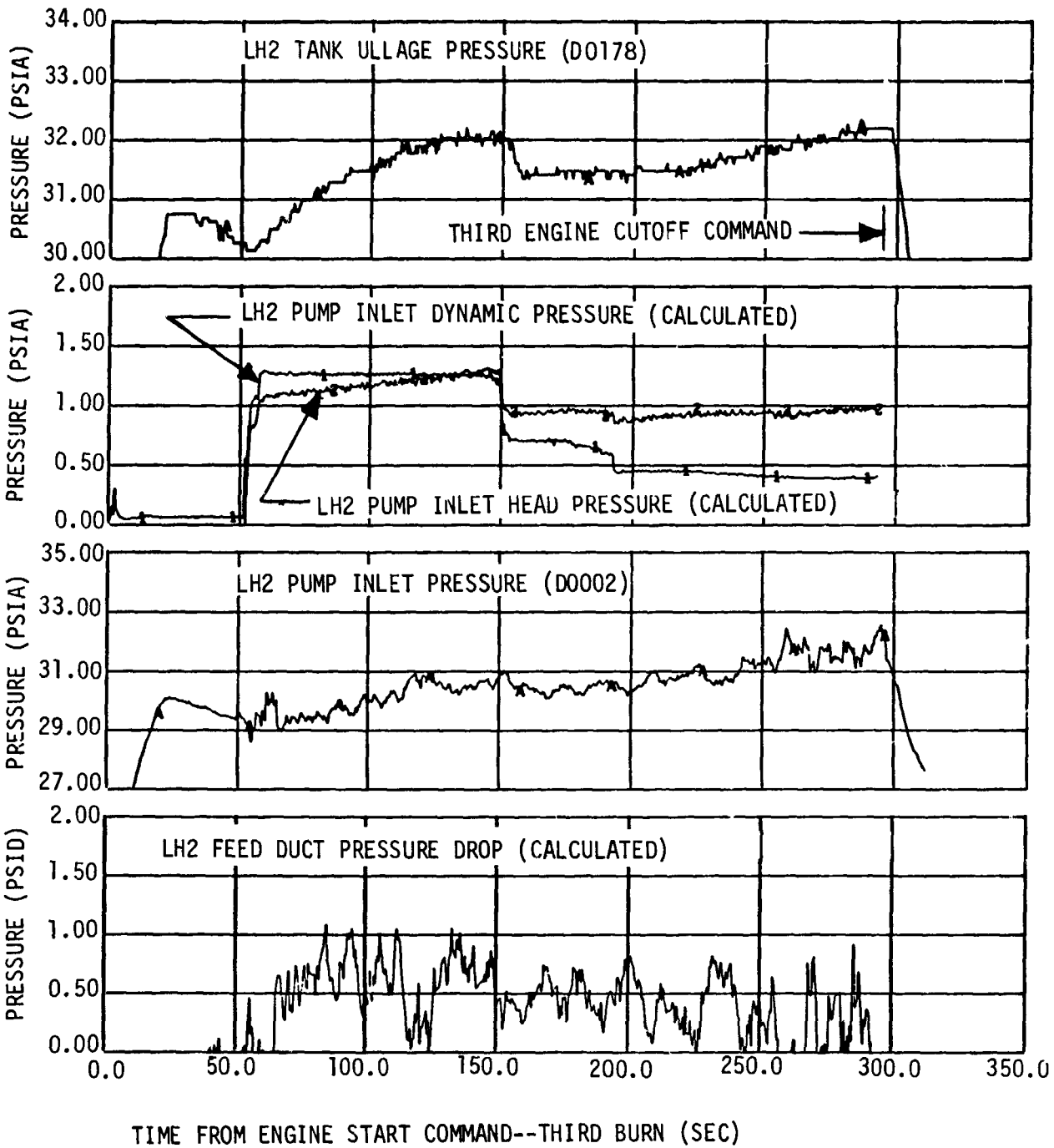

Figure 12-26. LH2 Pump Inlet Conditions--Third Burn  
(Sheet 2 of 2)

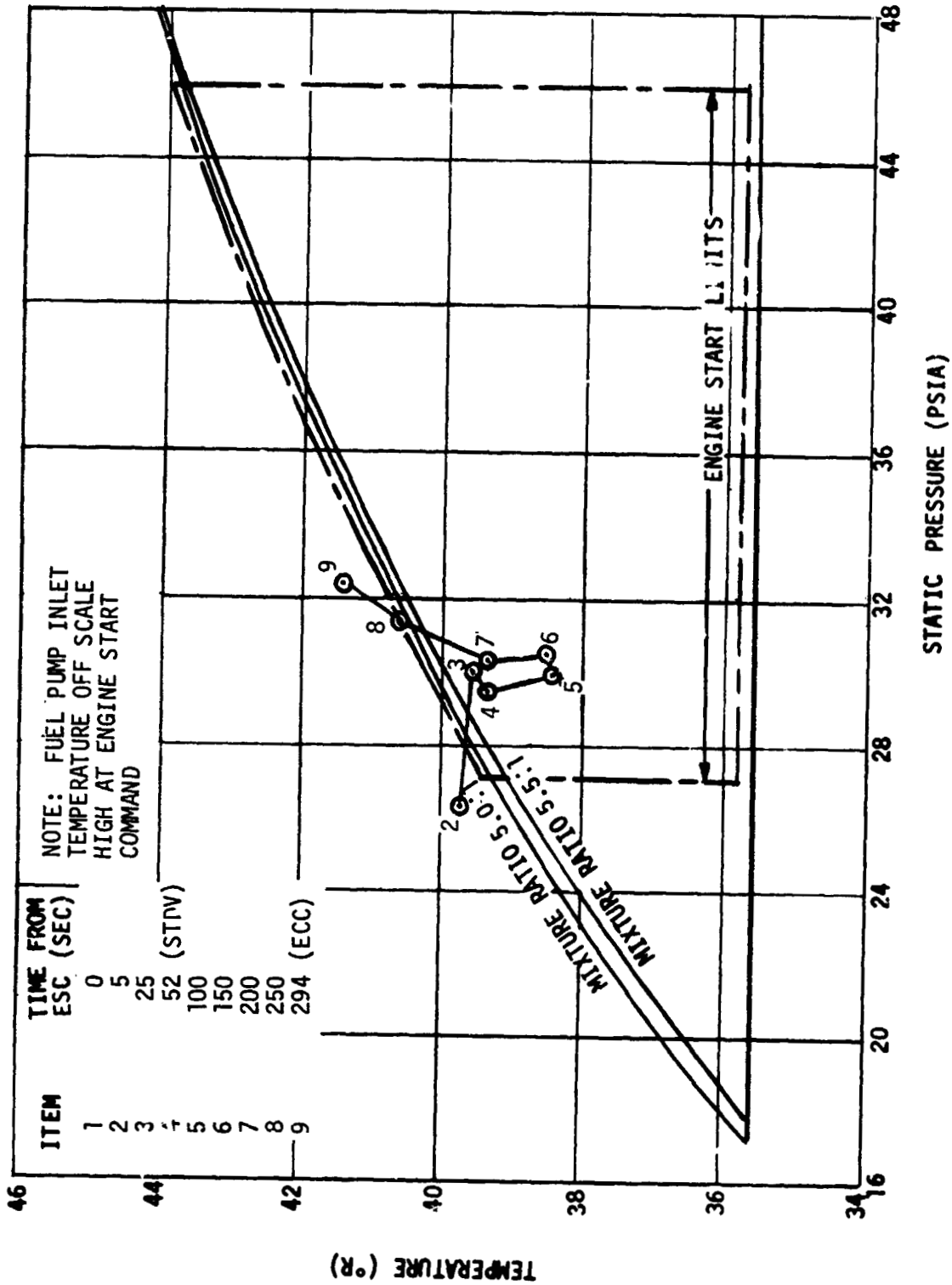

Figure 12-27. LH2 Pump Inlet Conditions During Firing - Third Burn

### 13. OXYGEN-HYDROGEN BURN SYSTEM

The S-IVB-504N stage utilized the O<sub>2</sub>-H<sub>2</sub> burner (figure 13-1) as the primary method of repressurization for the S-IVB second burn. Prior to the third burn, the burner was reignited and operated for 130 seconds in an effort to demonstrate its restart capability; however, it was not used to repressurize the propellant tanks during this operation.

LH<sub>2</sub> tank repressurization was satisfactorily accomplished by the O<sub>2</sub>-H<sub>2</sub> burner prior to second burn; LOX tank repressurization was not required. The burner performed satisfactorily and as expected during both periods of operation.

#### 13.1 Burner Performance

##### 13.1.1 First Restart Preparations

The performance of the burner during preparations for first restart was satisfactory. Data profiles (figure 13-2) were all typical of previous ground tests; however, as compared to 503N flight, temperature levels were generally 100 to 200 degrees R higher. These higher temperatures were the result of a more LOX-rich mixture ratio which occurred because the LOX supply pressure (LOX ullage pressure) to the burner was approximately 2.6 psi higher than it was on 503N flight. Performance data are presented in figure 13-2 and summarized in table 13-1.

The burner chamber pressure and temperature increases were moderate after termination of LH<sub>2</sub> tank repressurization and were very comparable to acceptance test results. This is in contrast to the sharp rises noted on AS-503, the only previous operation of the burner in flight. The 503N response was attributed to a brief period of two-phase oxidizer flow into the combustion chamber. It is apparent that this did not occur during the 504N mission.

### 13.1.2 Second Restart Preparation

The burner installed on this stage was of the restartable configuration the restart capability, however, had not previously been demonstrated in a total space environment. To verify and demonstrate this capability, the burner was restarted at ESC<sub>3</sub> -160 seconds and operated for 130 seconds, although the burner was not utilized for tank repressurization at this time. Performance was nominal and very comparable to the ground tests performed under the same conditions. Data are presented in figure 13-3.

### 13.2 LH2 Tank Repressurization

Repressurization of the LH2 tank by the O<sub>2</sub>-H<sub>2</sub> burner was satisfactory and as expected. Pertinent data are presented in figure 13-4 and compared to AS-503 flight data in table 13-1. The only notable deviation from the 503 performance is in the increased level of the average total heat flux. This is a direct result of the higher combustion chamber temperature levels discussed in paragraph 13.1.1.

### 13.3 Cold Helium Supply

The cold helium spheres provided adequate helium (24.6 lbm) for cryogenic repressurization. The quantity of helium used for repressurization during 504N flight was very near that used for 503N flight.

The cold helium supply temperature and pressure profiles after burner start command were as expected and are shown in figure 13-5. The system performance is compared to that on 503N flight in table 13-1.

TABLE 13-1  
O2-H2 BURNER PERFORMANCE DATA

Parameter	S-IVB-504N Flight	S-IVB-503N Flight
Duration of burner operation (sec)	460	460
Lag in pressurant flow after burner start (sec)	6.70	6.74
Cold helium supply		
Initial pressure (psia)	2,060	1,860
Initial average temperature (deg R)	37.6	38
Initial mass (lbm)	332	319
Consumption during burner operation (lbm)	24.6	25.0
Burner propellant supply during repressurization period		
LH2 supply pressure range (psia)	19.2-31.0	19.4-31.2
LOX supply pressure range (psia)	42.0-42.2	39.1
LH2 tank pressurization*		
Ullage volume (cu ft)	3,690	3,887
Initial pressure (psia)	19.2	19.4
Final pressure (psia)	30.4	30.2
Duration (sec)	180.4	168.4
Average pressurization rate (psi/min)	3.72	3.85
Average total heat flux** (Btu/hr)	245,000	223,000
Ambient heating rate** of pressurant gas (Btu/hr)	16,100	15,200
Pressurant helium through burner (lbm)	23.5	24.0
Pressurant helium through valve pilot bleed (lbm)	1.15	0.99
Total helium required (lbm)	24.6	25.0

\* LOX tank pressurization was not required for either flight.  
\*\* Measured from 40 deg R reference base.



00000000 1860030

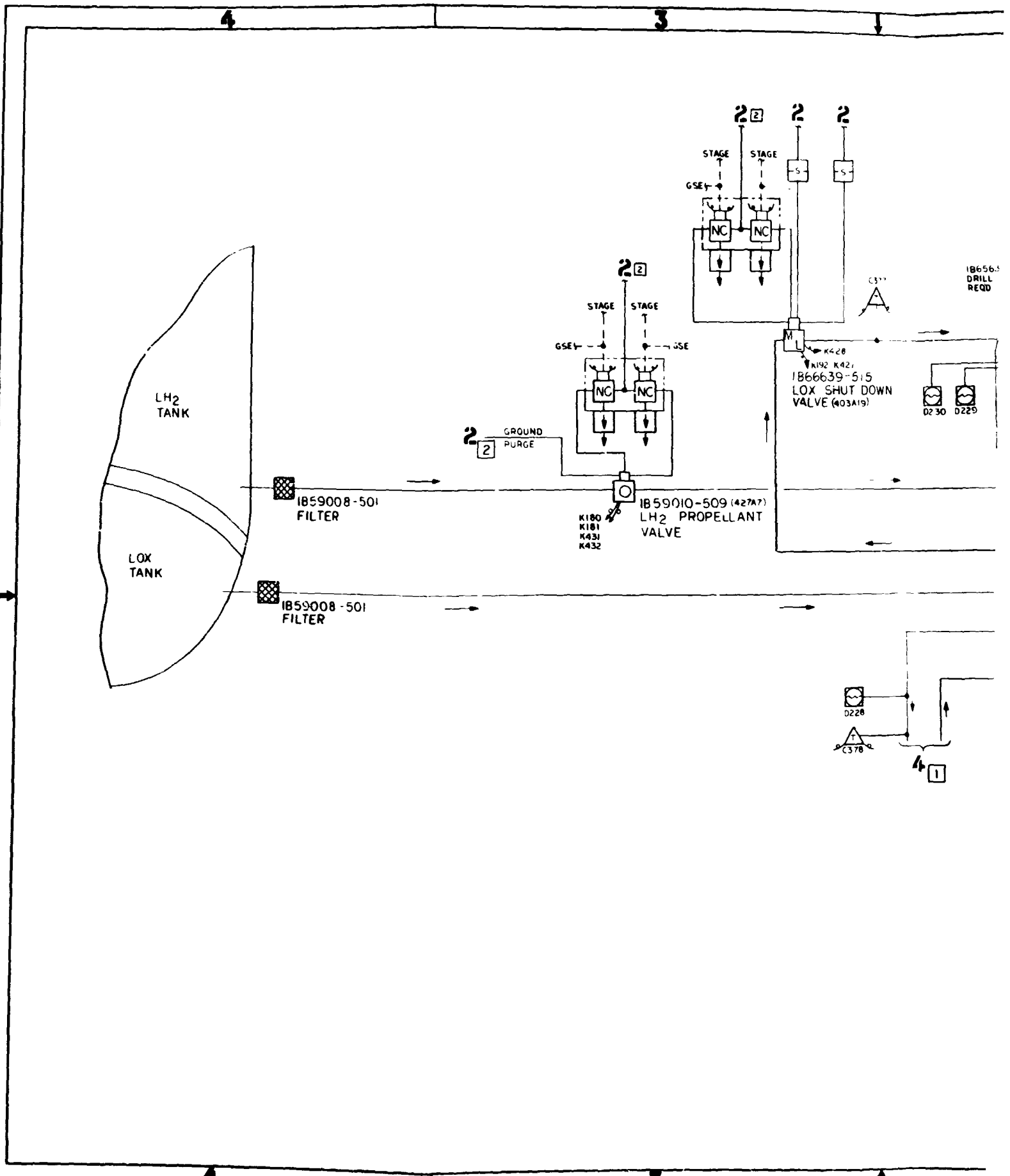
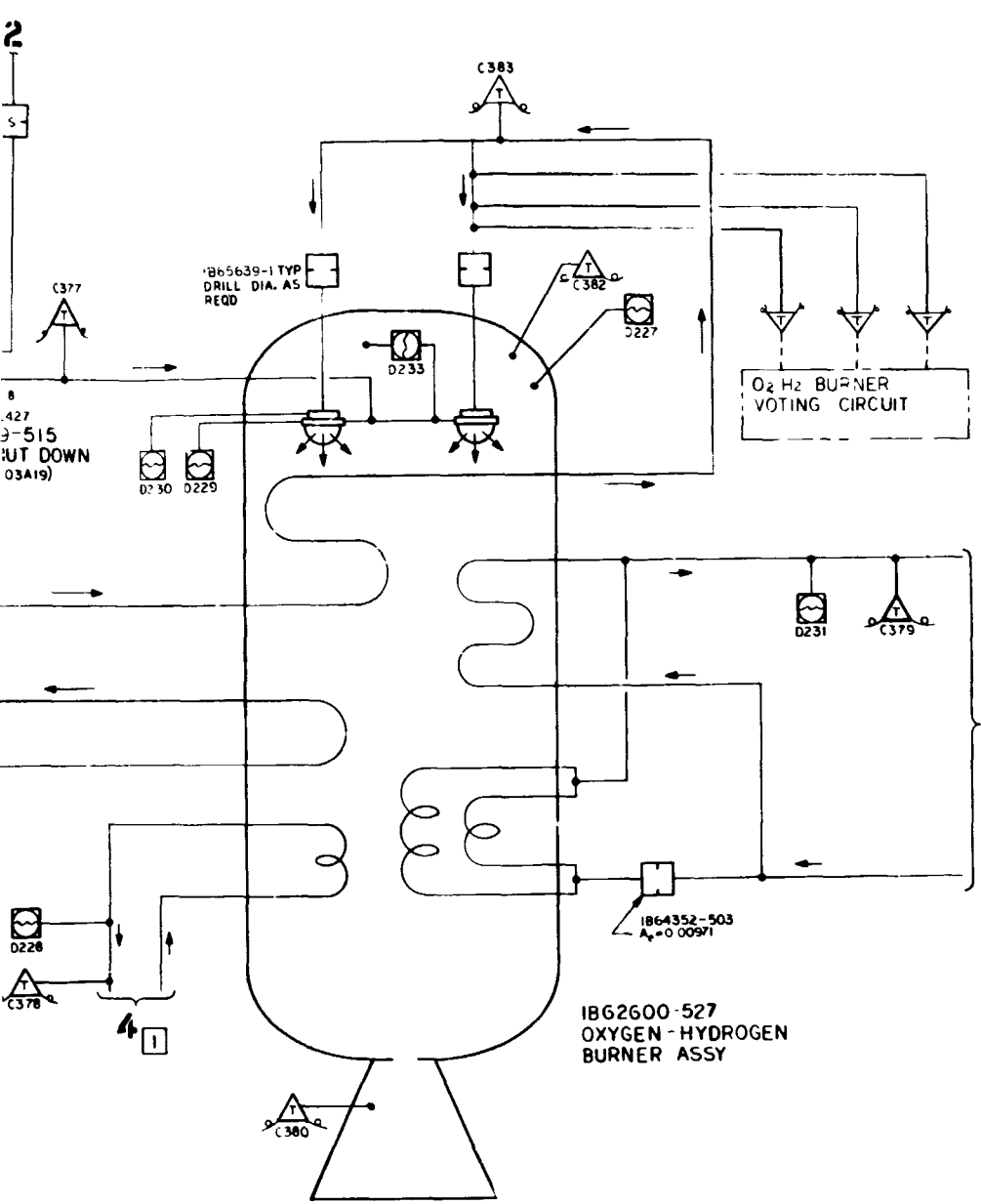

Figure 13-1. Schematic, Oxygen Hydrogen Burner

FOLDOUT FRAME

REVISIONS		
NO.	DESCRIPTION	DATE APPROVED
1	SEE E.O.	7-29-62
2	SEE E.O.	8-1-62



IB62600-527  
OXYGEN-HYDROGEN  
BURNER ASSY

VEHICLE CONFIGURATION  
IB62600 AN  
IB62675 Z

IB66039

PREPARED FOR NASA-MSFC		SEQUENCE 12	
DIMENSIONS ARE IN INCHES. TOLERANCES: FRACTIONS ± .005 DECIMALS ± .001 ANGLES ± .01		<b>DOUGLAS</b> SANTA MONICA, CALIFORNIA AIRCRAFT COMPANY, INC.	
SEE DIMENSIONS REQUIRED FOR USAGE DATA JUL 19 1962 1700		SCHEMATIC, OXYGEN HYDROGEN BURNER 18385 H 1866039 SHEET 1 OF 1	

FOLDOUT FRAME 2

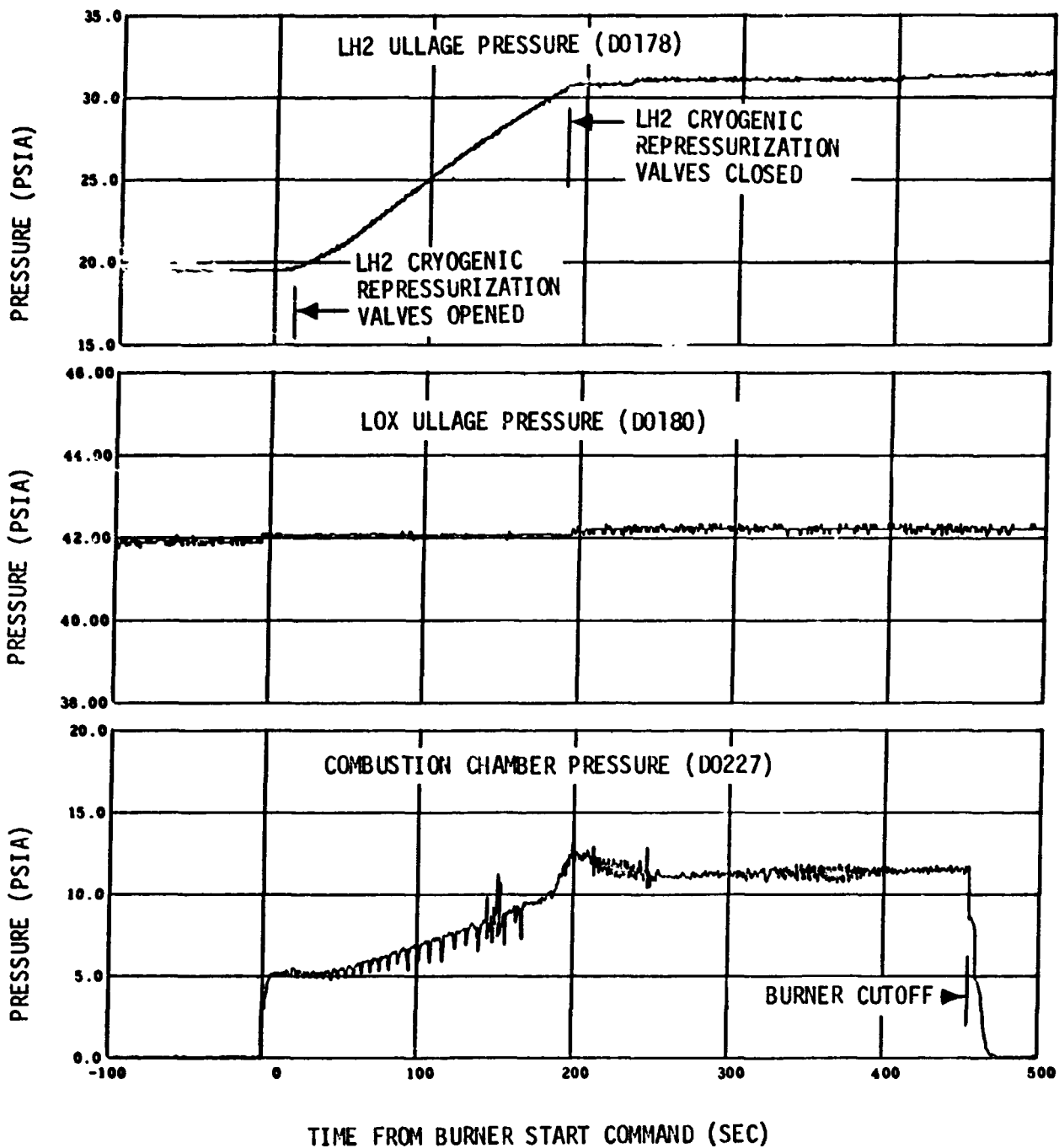

Figure 13-2. O<sub>2</sub>-H<sub>2</sub> Burner Operation -- First Restart Preparation (Sheet 1 of 2)

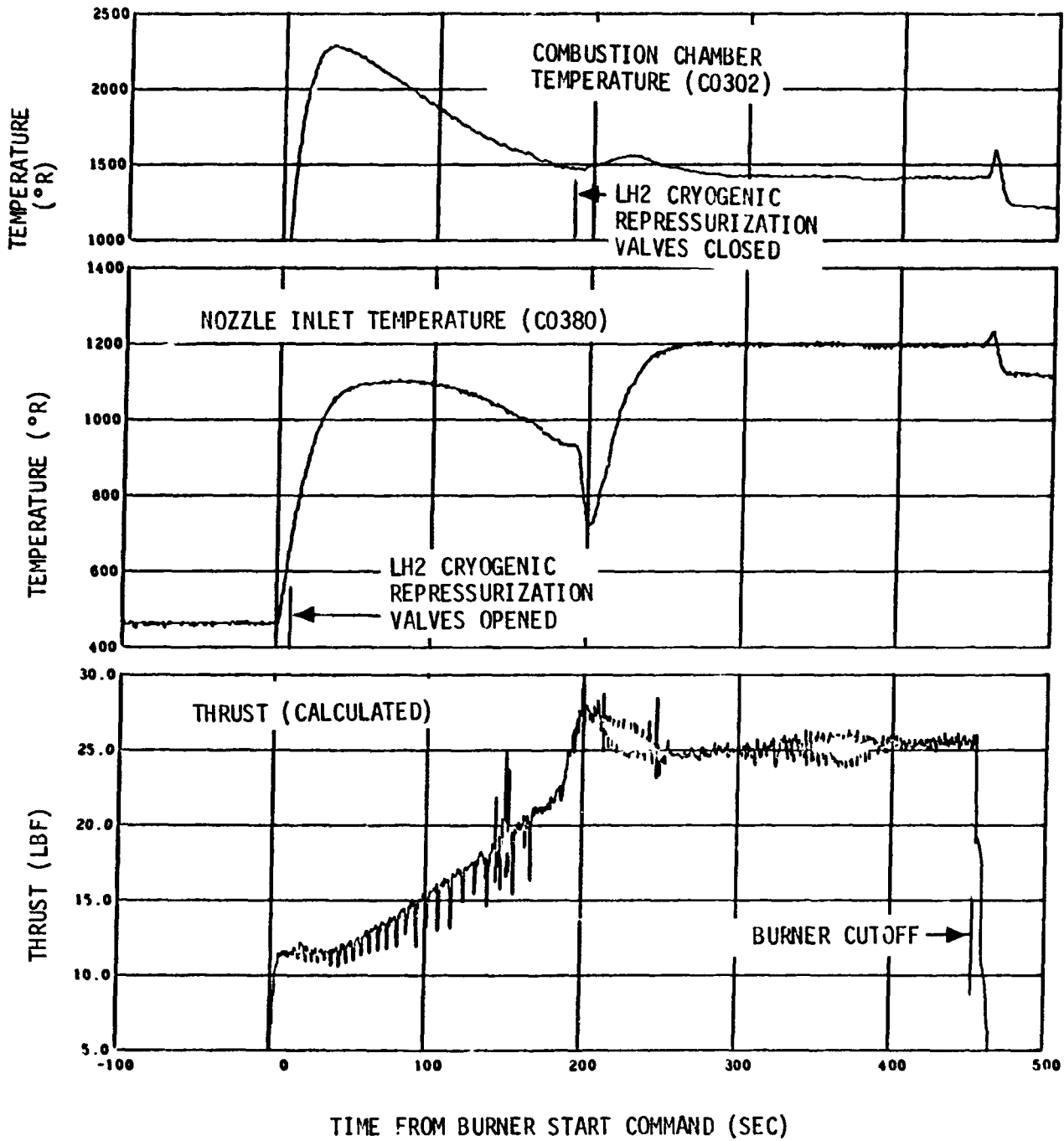

Figure 13-2. O<sub>2</sub>-H<sub>2</sub> Burner Operation -- First Restart Preparation (Sheet 2 of 2)

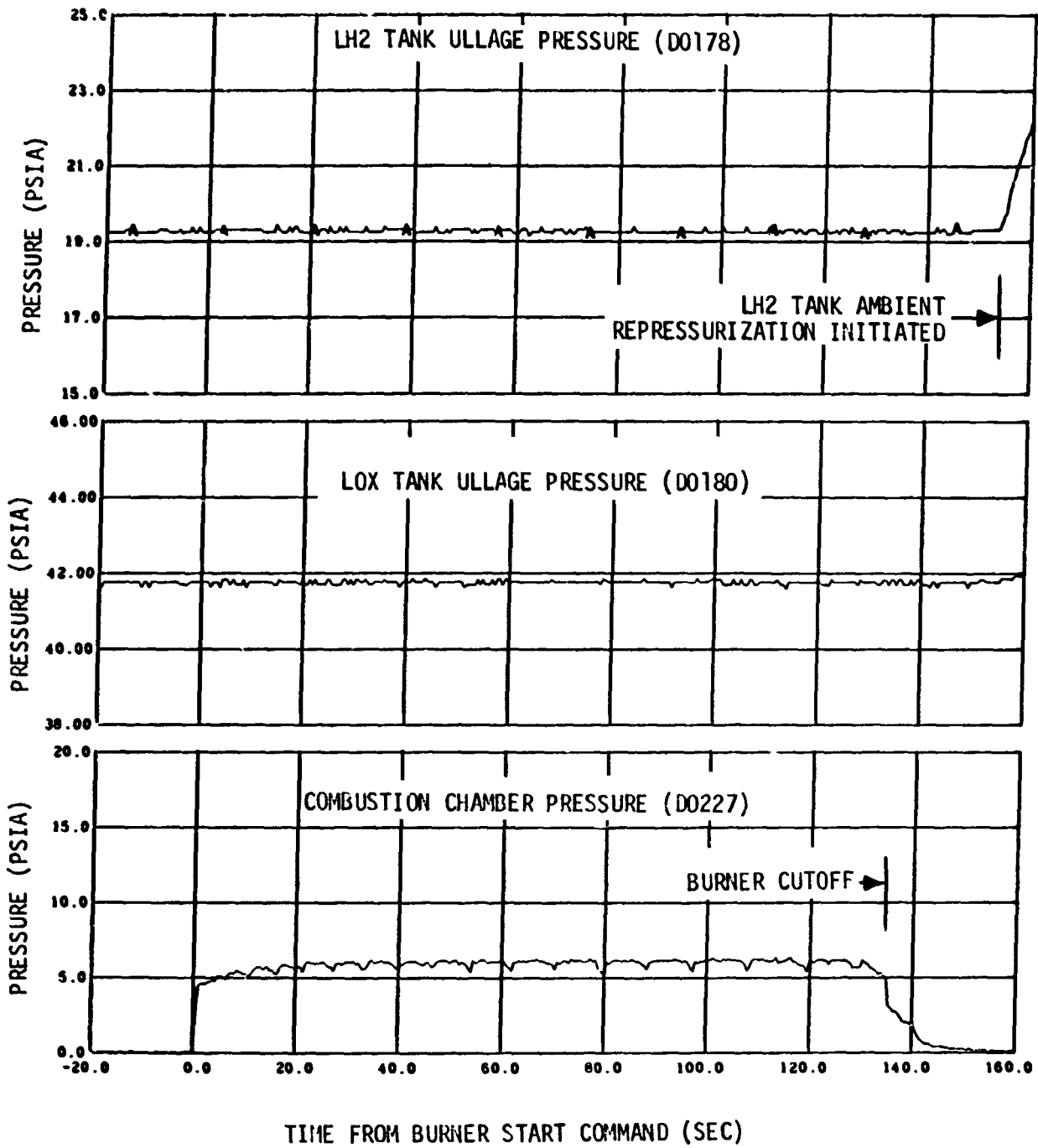

Figure 13-3. O<sub>2</sub>-H<sub>2</sub> Burner Operation -- Second Restart Preparation (Sheet 1 of 2)

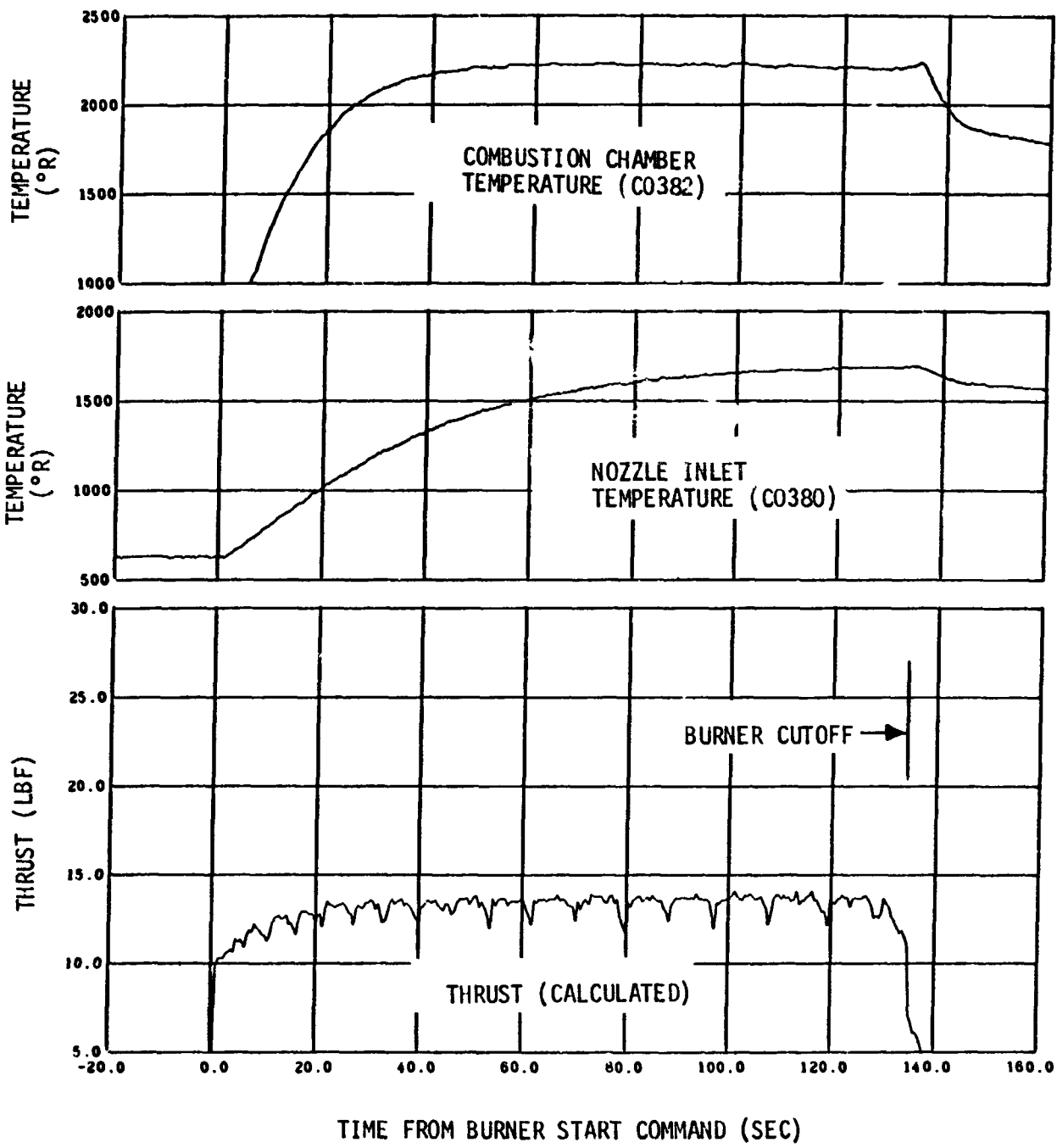

Figure 13-3. O<sub>2</sub>-H<sub>2</sub> Burner Operation -- Second Restart Preparation (Sheet 2 of 2)

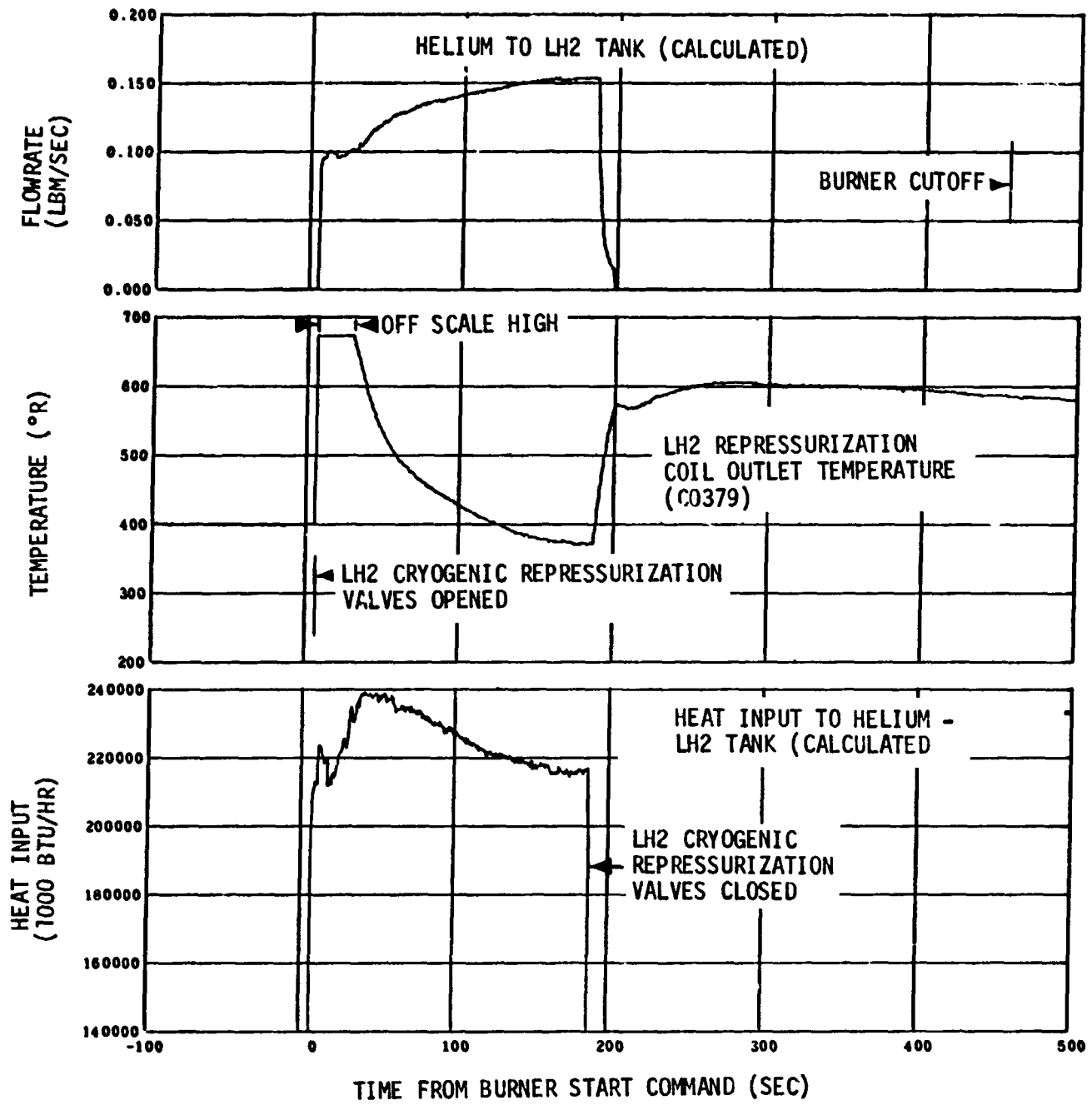

Figure 13-4. LH2 Tank Burner Repressurization

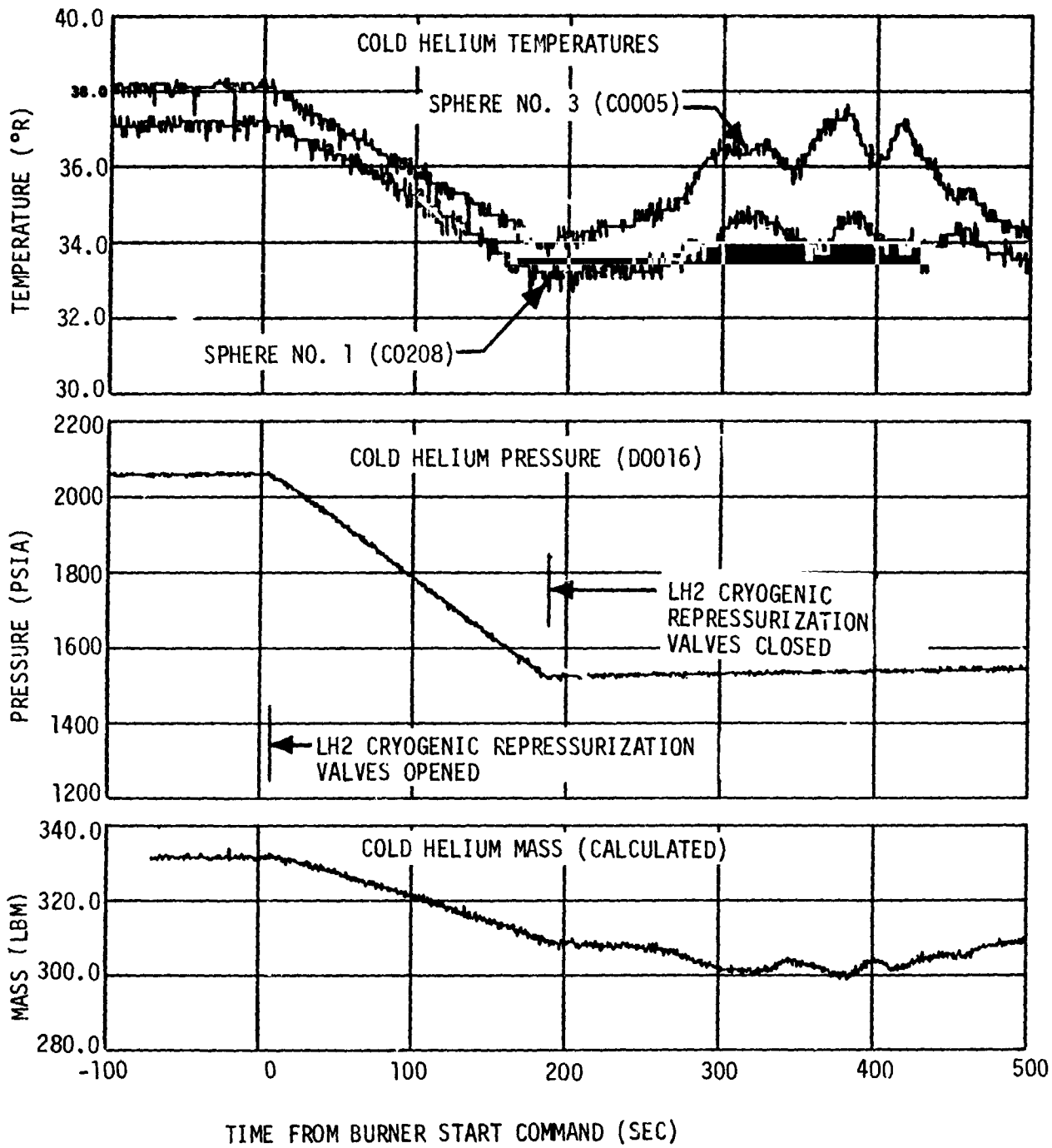

Figure 13-5. Cold Helium Sphere Conditions During O<sub>2</sub>-H<sub>2</sub> Burner Operation



#### 14. AUXILIARY PROPULSION SYSTEM

The attitude of the S-IVB stage is controlled by two auxiliary propulsion system (APS) modules (figure 14-1) mounted 180 degrees apart on the aft skirt of the stage. Each module is a self-contained unit composed of four basic systems: (1) the oxidizer system; (2) the fuel system; (3) the helium pressurization system; and (4) the engines. The instrumentation unit, mounted above the S-IVB stage, provides signals for the operation of the APS modules.

Each module contains two 150-pound-thrust engines which provide roll control during S-IVB powered flight, and yaw and roll control during the coast periods. A third 150-pound-thrust engine in each module provides pitch control during coast periods. Each module also contains a 72-pound-thrust engine which supplied axial thrust on the vehicle to provide propellant slosh control and settling.

##### 14.1 APS Flight Operation

The APS operation was nominal with the exception of a helium leak in Module 2. The attitude control, maneuvering, and ullaging requirements of the mission were all fulfilled.

##### 14.1.1 APS Flight Objectives

The APS flight objectives were to verify the ability of the APS to provide thrust on demand for roll control during the S-IVB J-2 engine first, second, and third burns; for roll, pitch, and yaw control after J-2 engine cutoff; and for propellant settling. These objectives were successfully met during the flight.

##### 14.1.2 APS Flight Description

Approximately 1 second after S-II engine cutoff, the APS was activated to provide roll control during S-IVB J-2 first burn.

Following S-IVB J-2 engine cutoff, APS pitch and yaw control was activated to maintain the vehicle in the desired attitude. The APS ullage engines fired 86.7 seconds following J-2 first burn to provide slosh control and

propellant settling. The ullage engines were fired a second time for 76.7 seconds to provide a positive acceleration on the vehicle from burner cutoff until J-2 res. rt. The ullage engines were started approximately 5 seconds before O2-H2 burner shutdown and were cut off 3 seconds after second J-2 engine start command.

During the second J-2 engine burn the APS pitch and yaw control was deactivated, and the APS provided roll control only. Following J-2 cutoff the APS pitch and yaw control was reactivated, and the APS ullage engines were fired for 18.9 seconds for slosh control and propellant settling.

The ullage engines were fired a fourth time for 87 seconds, extending from 5 seconds prior to burner cutoff until 3 seconds after S-IVB third J-2 engine start command. The APS again provided only roll control during the third S-IVB J-2 engine burn, and pitch, yaw, and roll control after J-2 cutoff.

A fifth unscheduled APS ullage engine burn to propellant depletion was initiated at RO +27,245 seconds. Module 2 depleted after 425 seconds of burn while Module 1 depleted after 469 seconds.

#### 14.2 APS System Operation

The operation of all APS systems was satisfactory with the exception of the Module 2 helium leak. The Module 1 helium pressurization system, the fuel and oxidizer systems, and the attitude control and ullage engines all performed nominally.

##### 14.2.1 Helium Pressurization System

The Module 1 helium pressurization system operation was normal. The helium bottle conditions are presented as a function of time in figures 14-2 through 14-6. The nominal and 3-sigma helium bottle pressure predictions are included for comparison. Helium bottle initial and final conditions are presented in table 14-1.

Module 2 developed a helium leak approximately 4 hours 25 minutes after liftoff. The leak terminated at approximately 7 hours after liftoff (figure 14-7). The average leakage rate was 235 scim. The leakage was determined by comparing the change in the mass of helium in the high pressure bottle with the change that should occur in displacing propellant for the impulse supplied by the APS during this portion of the mission.

The cause of the leak has not been determined; however, based on past experience and the results of Sacramento checkouts, prime sources of such leakage are the teflon "O" rings used for sealing the APS helium bottle temperature transducer mounting flange and several "MC" type fittings. For future vehicles, the teflon "O" rings are being replaced with MS-28778 "O" rings. This fix has been very effective in eliminating leakage problems. Another possible source of leakage is the low pressure helium module vent valves, which have been known to leak during vibration. The AS-504 leakage, however, does not seem to correlate with periods of high vibration.

Another factor which tends to indicate a sealing problem is the temperature recorded by the Module 2 helium bottle temperature transducer. The leak started as this temperature dropped below 525 deg R and continued as long as the temperature remained below 520 deg R. As the temperature increased from a low of 492 deg R to 515 deg R, the leak terminated. These data indicate that the leak was temperature sensitive. Again, the change of "O" rings should eliminate this problem.

The Module 1 regulator outlet pressure was maintained at approximately 199 psia throughout the APS operation. Module 2 regulator outlet pressure was 190 to 195 psia which was below the  $196 \pm 3$  psia regulation band, but within instrumentation accuracy. Other system pressures verified proper regulator operation. The APS ullage pressures in the tanks were acceptable, ranging from 188 to 192 psia, which is within the 188 to 203 psia required.

#### 14.2.2 APS Propellant System

Both the fuel and oxidizer systems of Modules 1 and 2 performed as expected during the flight. The propellant quantities remaining and the propellant temperatures are presented as a function of mission time in figures 14-8 through 14-11. The nominal and 3-sigma predicted usages are included in the propellant mass figures for comparison. From this it can be seen that the propellant usage was slightly less than predicted. The propellant temperatures remained within the required range of 480 to 585 deg R. The maximum temperatures recorded in the propellant control module prior to propellant depletion was the Module 2 fuel temperature of 581 deg R. The bulk temperatures of the propellant in the bladder ranged from 548 to 555 deg R, as shown in figures 14-8 and 14-10, following times of high propellant usage.

The propellant usage during significant periods of the mission are presented in table 14-2. As in previous flights when propellant depletion was observed, the fuel was depleted first. The fuel in Module 2 was depleted at RO +27,671 seconds; the fuel in Module 1 was depleted at RO +27,713 seconds. Module 2 oxidizer was depleted at RO +27,782 seconds, while Module 1 oxidizer was depleted at RO +27,850 seconds. These times of propellant depletion were obtained from propellant manifold pressures which drop rapidly when depletion occurs.

As in previous flights, no apparent problems were associated with the depletion. The fuel was depleted first in both modules because the propellants were loaded for a 1.65 to 1.00 mixture ratio (EMR) while the attitude control engines normally operate at a 1.60 to 1.00 EMR during minimum impulse bit pulsing. Also, the oxidizer was not off-loaded to account for the fifth ullage burn to propellant depletion at the ullage engine EMR of 1.27 to 1.00. The fuel load for this flight was maximum.

The helium pressure, volume, temperature method (PVT) used in determining propellant usage for Saturn V APS modules was accurate for Module 1. At the time of fuel depletion, the PVT program indicated minus 3 pounds of fuel, which is within 2 percent accuracy.

Because of the helium leakage in Module 2, the PVT program could not be used directly in determining propellant usage once the leakage occurred. The PVT program was modified to account for the helium leakage as shown in figure 14-7. The resulting plot of Module 2 propellant usage is presented in figure 14-11. With the modification, the PVT program indicated that 5 pounds of fuel remained when fuel depletion actually occurred; this is within 4 percent accuracy. As previously mentioned, actual depletion was determined from the manifold pressure.

The propellant supply pressures were normal during the flight and ranged from 188 to 196 psia, which is within the 188 to 203 psia required.

#### 14.3 Engine Performance

The performance of the APS engines was satisfactory throughout the mission. The engine chamber pressure ranged from 90 to 100 psia with the exception of two pulses on engine 2-2 (Module 2 pitch engine). At approximately  $RO +23,660$  sec, a series of three pulses had chamber pressures of 82, 88, and 94 psia, respectively. Series of pulses of increasing chamber pressure were previously observed during the AS-502 flight and were attributed to high injector temperatures. As the cooler propellants from the tank reached the engine and cooled the injector, the chamber pressure increased. The chamber pressures recorded were obtained from minimum impulse pulses from which it is difficult to obtain an accurate steady state chamber pressure value.

The longest attitude control engine steady state burn time was 9.6 sec on engine No. 5 during the pitch maneuver to separation attitude at  $RO +9,301.6$  sec. The majority of pulses during the flight were of minimum pulse width as shown in figures 14-14 through 14-17.

Unusually high roll control activity was observed during the third S-IVB J-2 engine burn. From  $RO +22,040$  to 22,153 sec, the APS roll engines corrected for alternately clockwise then counterclockwise roll disturbances at approximately 1 to 1.5 sec intervals. The pulse widths increased

progressively from 0.1 sec to greater than 0.5 sec duration at R0 +22,138 sec, then decreased to approximately 0.15 sec at R0 +22,153 sec. From this time until J-2 engine cutoff, the APS roll engines 1-1 and 2-1 continued to correct for a higher than normal, but decreasing, negative roll disturbance. Immediately after J-2 engine cutoff, the APS corrected for a small positive roll disturbance.

The total APS impulse for the attitude control engines in each module is presented as a function of mission in figures 14-12 and 14-13. Module 1 supplied a total impulse of 25,346 lbf-sec for attitude control. The quantity of propellant for attitude control to this time was 109.2 lbm; therefore, the average specific impulse was 232 seconds. The Module 2 attitude control total impulse was 28,626 lbf-sec. The quantity of propellant used for attitude control to this time was 118.2 lbm; therefore, the average specific impulse of module 2 attitude control engines was 242 seconds.

Figures 14-14 through 14-17 show that the engine performance agreed closely with the engine manufacturer's test data obtained at simulated altitude conditions. The variation from the TRW 2-sigma variation can be attributed to the methods used in determining the performance and to the fact that some of the pulses were recorded during fuel depletion. The pulse width was determined from the time the chamber pressure increased to 10 psia until it dropped to 10 psia. Since the engine chamber pressures were only sampled at 120 samples per second, an accurate pulse width could not be obtained. The pulse width determined by this method could be longer than actual, and the resulting thrust value obtained by dividing the impulse by pulse width would then be lower than actual.

The ullage engine chamber pressures were normal during the five ullage engine burns, ranging from 93 to 100 psia. The final unscheduled ullage engine burns to depletion were 469 seconds duration for Module 1 and 425 seconds for Module 2. This final ullage burn was performed to determine whether the decrease in Module 2 helium bottle pressure during the flight was a helium leak or a propellant leak. The length of the final Module 2 ullage engine burn proved it to be a helium leak.

TABLE 14-1

## HELIUM BOTTLE CONDITIONS

Parameter	Module 1		Module 2	
	Initial	Final (RO +28,400 sec)	Initial	Final (RO +28,400 sec)
Pressure (psia)	3,063	1,120	3,069	560
Temperature (deg R)	548	498	550	524
Mass (lbm)	1.0184	0.4344	1.0175	0.2100
Usage (lbm)	--	0.5840	--	0.8075

TABLE 14-2. S-IVB-504N AF3 PROPELLANT CONSUMPTION\*

Time Period	Module 1		Module 2	
	Oxidizer (lbm)	Fuel (lbm)	Oxidizer (lbm)	Fuel (lbm)
Initial load	198.0	125.6	198.0	126.2
First J-2 burn roll control	1.0	0.4	0.9	0.6
J-2 engine cutoff to end of first APS ullaging	16.1	12.4	15.4	11.6
End of first ullaging to S-IVB/LM/CSM separation	20.6	13.0	18.8	12.0
From separation to start of second ullage burn	10.5	6.5	14.5	9.0
Start of second ullage burn to second engine start command	11.1	8.7	12.0	9.6
Second J-2 burn roll control	0.8	0.4	2.8	1.6
J-2 engine cutoff to end of third APS ullaging	2.2	1.7	3.4	2.2
End of third ullage to start of fourth ullage burn	5.9	3.8	1.9	1.4
Start of fourth ullage burn to third engine start command	10.6	8.4	13.1	10.2
Third J-2 burn roll control	15.4	9.8	18.2	11.6
Third burn engine cutoff to ullage depletion burn	11.8	7.1	10.3	6.3
Ullage depletion burn	92.7	54.0	86.7	49.7

\*The propellant usage presented in this table was obtained by the helium bottle pressure, volume, temperature program.



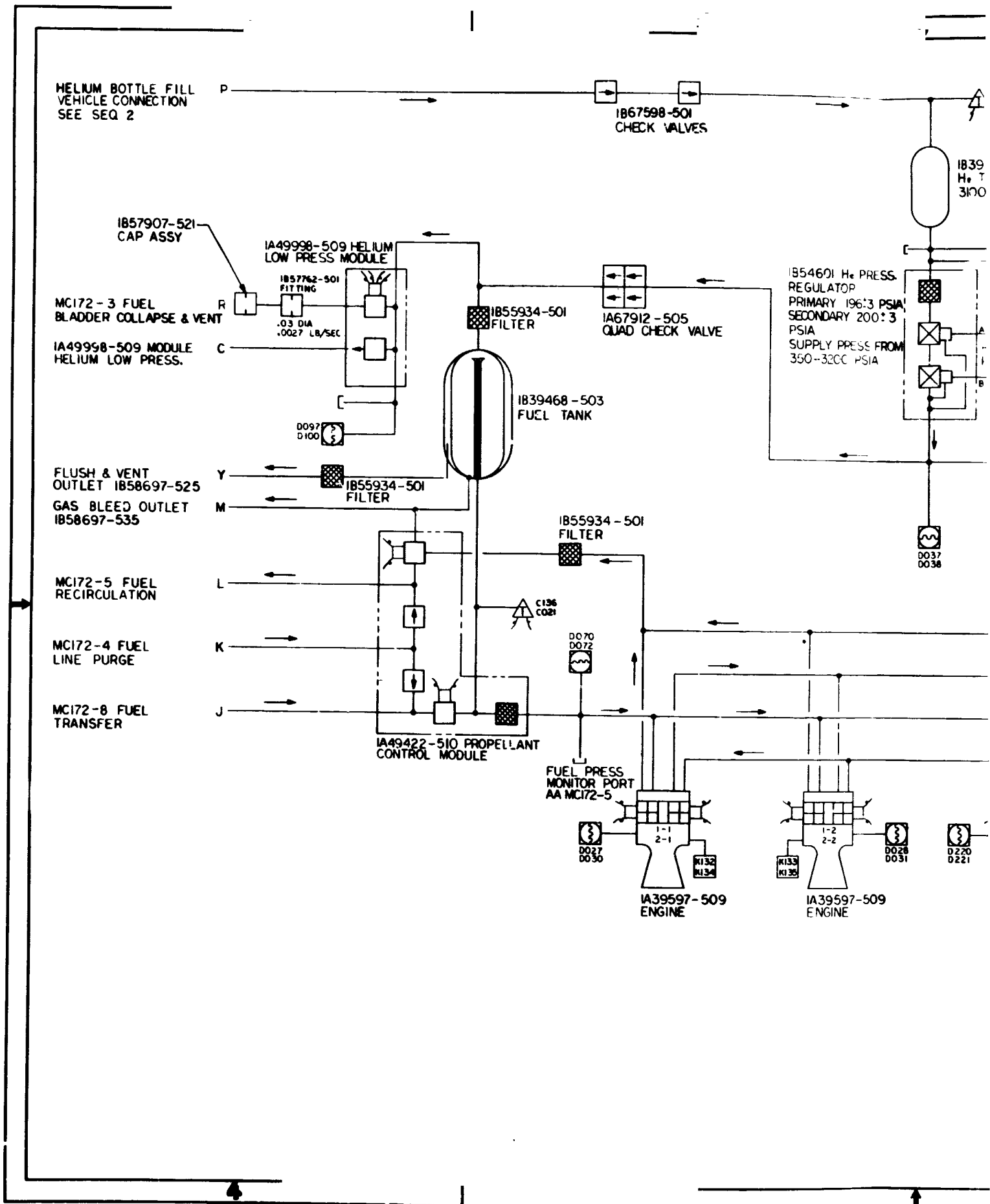

FOLDOUT FRAME 1

2

REV	DESCRIPTION	DATE	APPROVED
A	SEE EO	7-2-7	
B	SEE EO	7-2-7	
C	SEE EO	7-2-7	
D	SEE EO	7-2-7	
E	SEE EO	7-2-7	

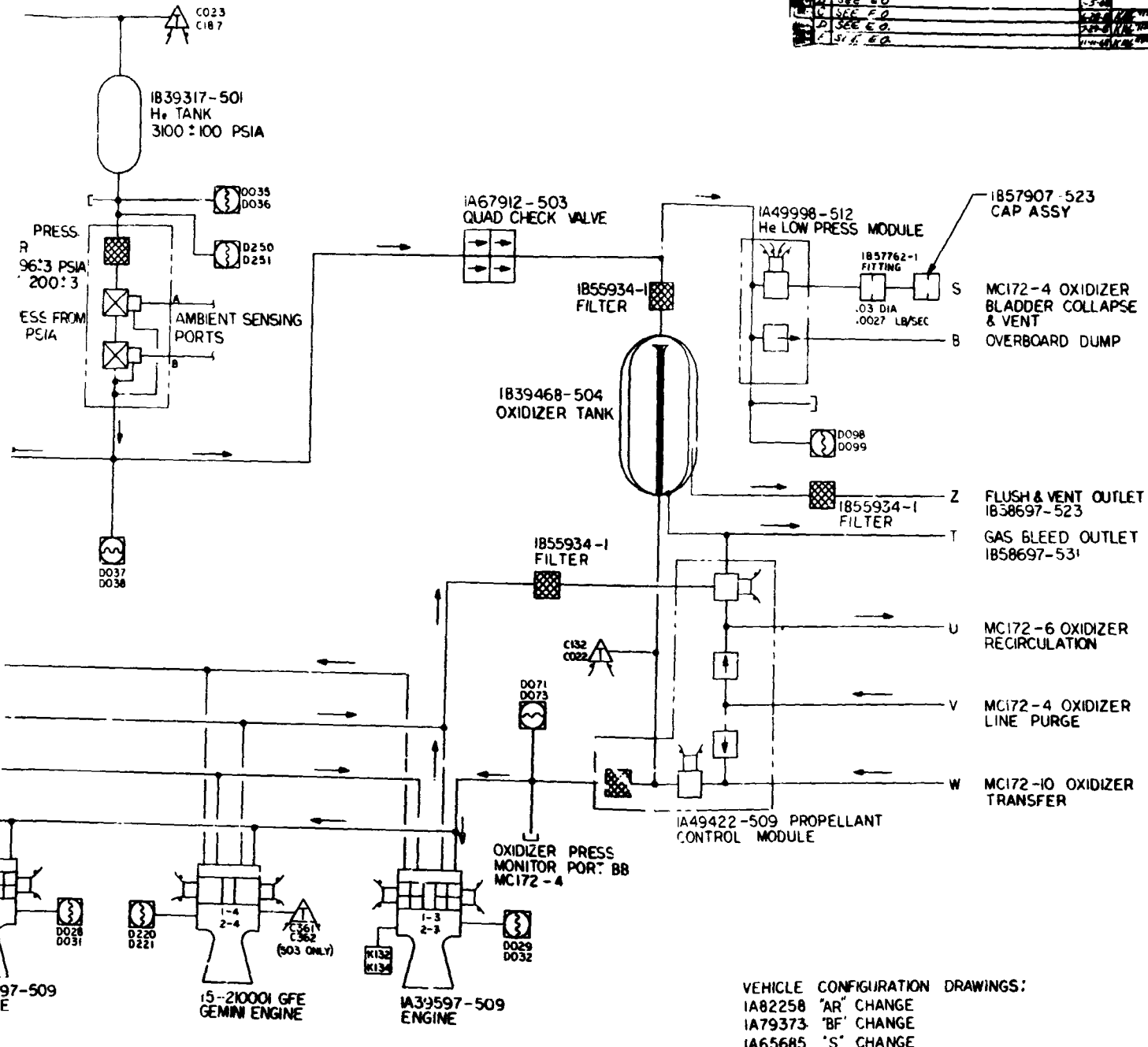

1B66126

VEHICLE CONFIGURATION DRAWINGS:  
 IA82258 'AR' CHANGE  
 IA79373 'BF' CHANGE  
 IA65685 'S' CHANGE

PREPARED FOR NASA-MSFC		DATE: 8 JUN 68		SEQUENCE 16	
DRAWN BY: [ ]		CHECKED BY: [ ]		DUNLAP SANTA MONICA, CALIFORNIA AEROSPACE SYSTEMS, INC.	
DESIGNED BY: [ ]		APPROVED BY: [ ]		SYSTEM SCHEMATIC AUXILIARY PROPELLION BLADDER SYSTEM	
PART NUMBER: [ ]		REV: H		1B66126	
DATE: [ ]		SCALE: [ ]		PAGE 1 OF 1	

Figure 14-1. System Schematic Auxiliary Propulsion Bladder System

FOLDOUT FRAME 2

HELIUM BOTTLE TEMPERATURE (DEG R)

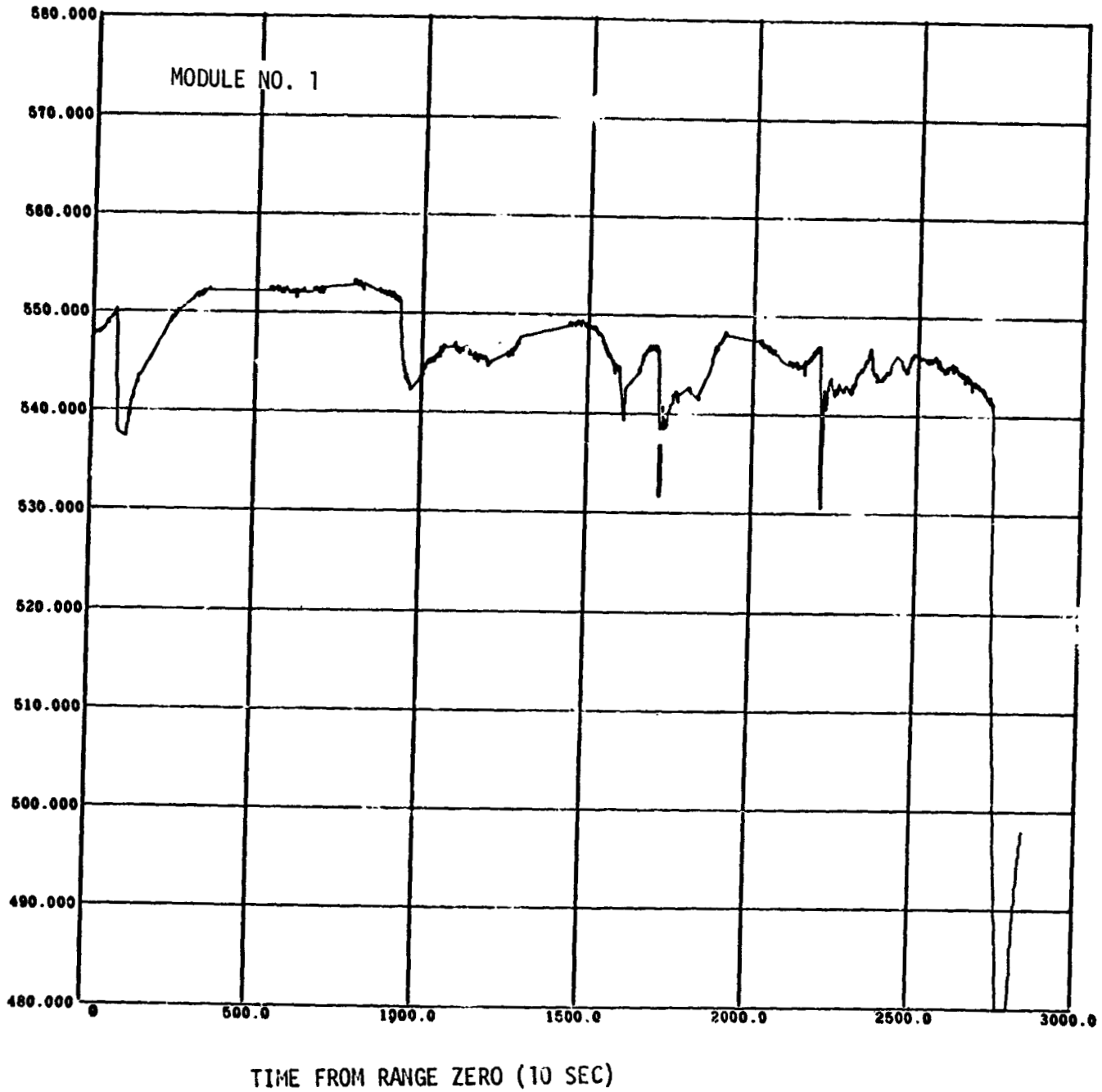

Figure 14-2. APS Module 1 Helium Bottle Temperature

HELIUM BOTTLE PRESSURE (PSIA)

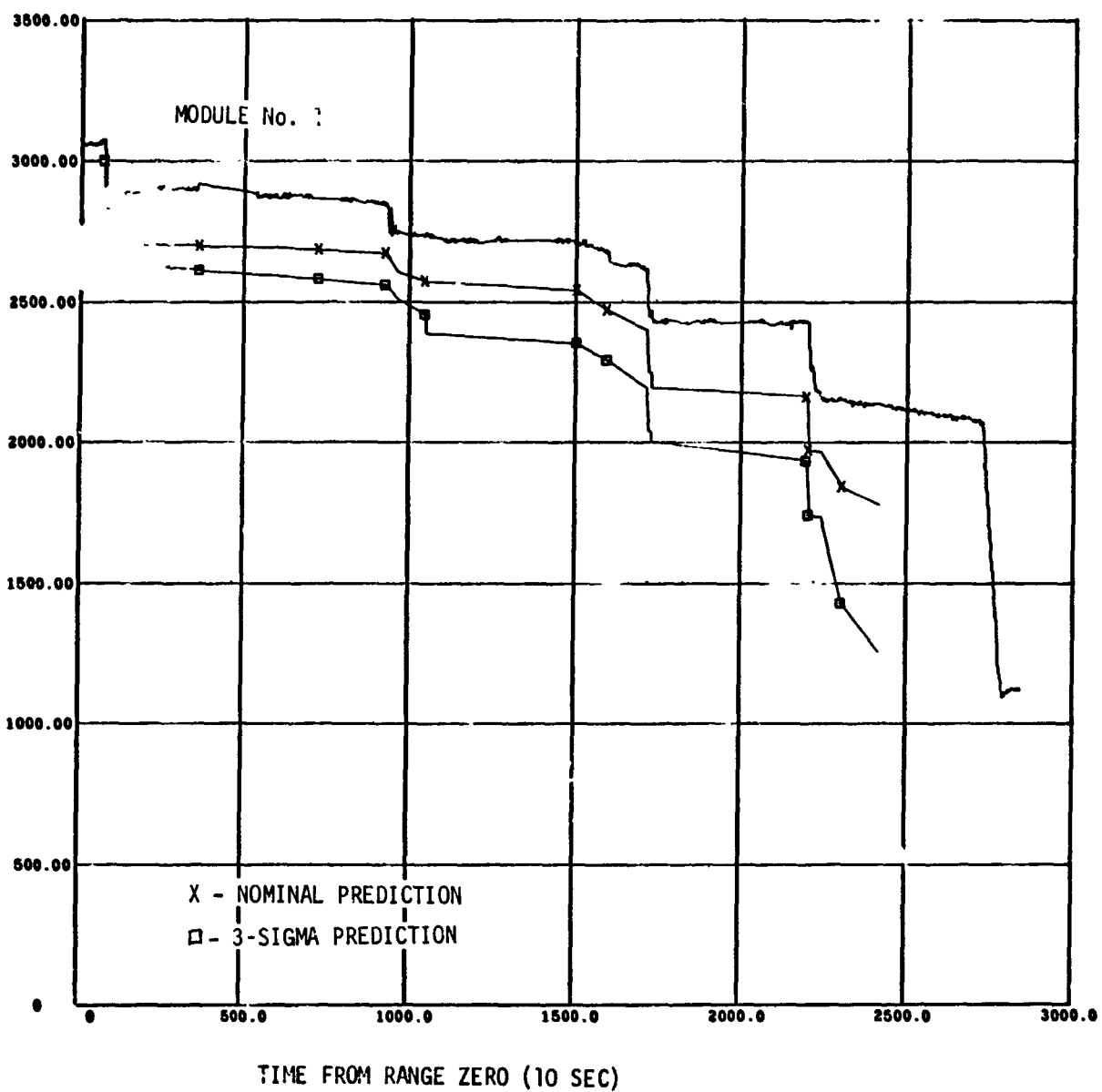

Figure 14-3. APS Module 1 Helium Bottle Pressure

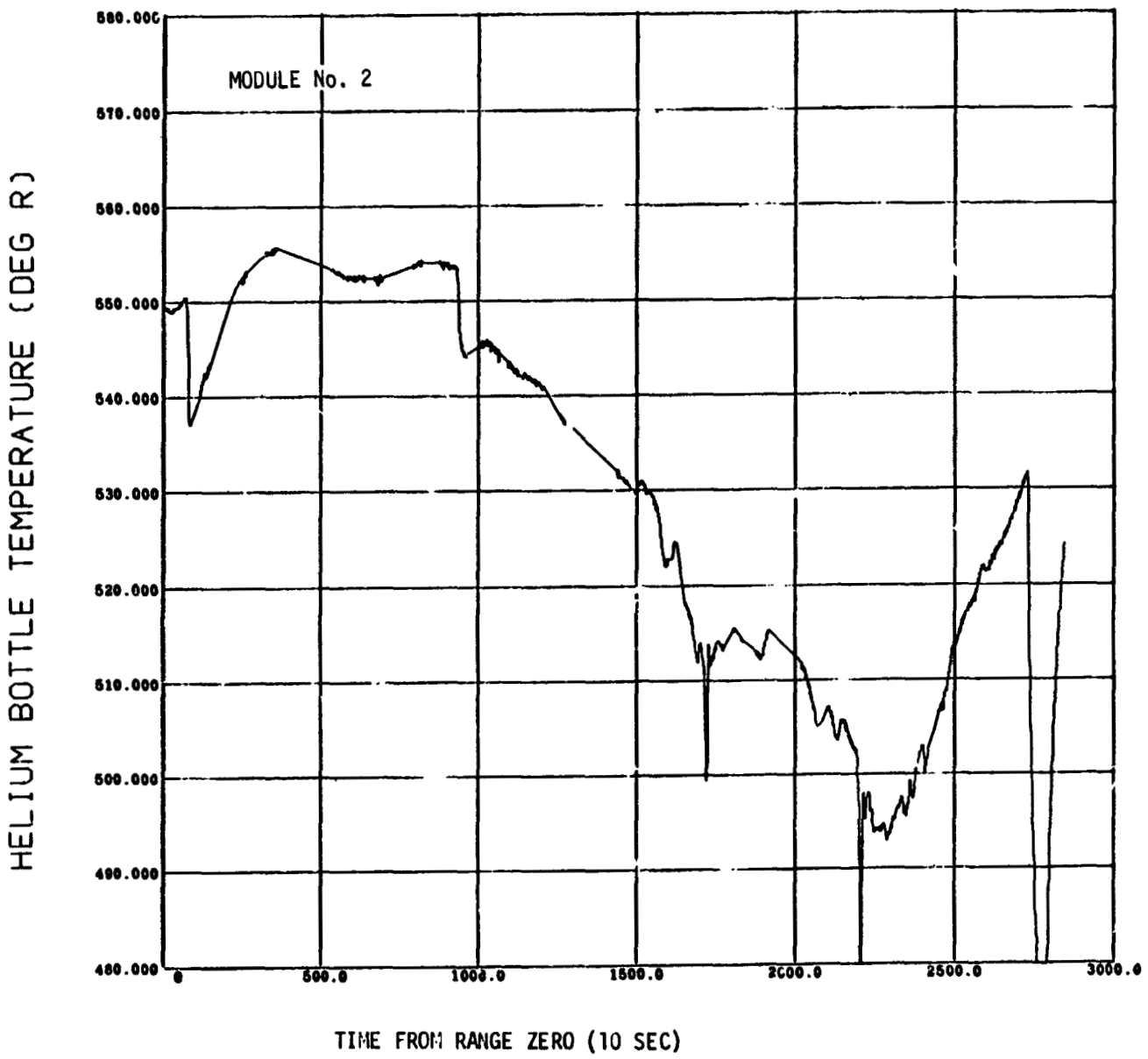

Figure 14-4. APS Module 2 Helium Bottle Temperature

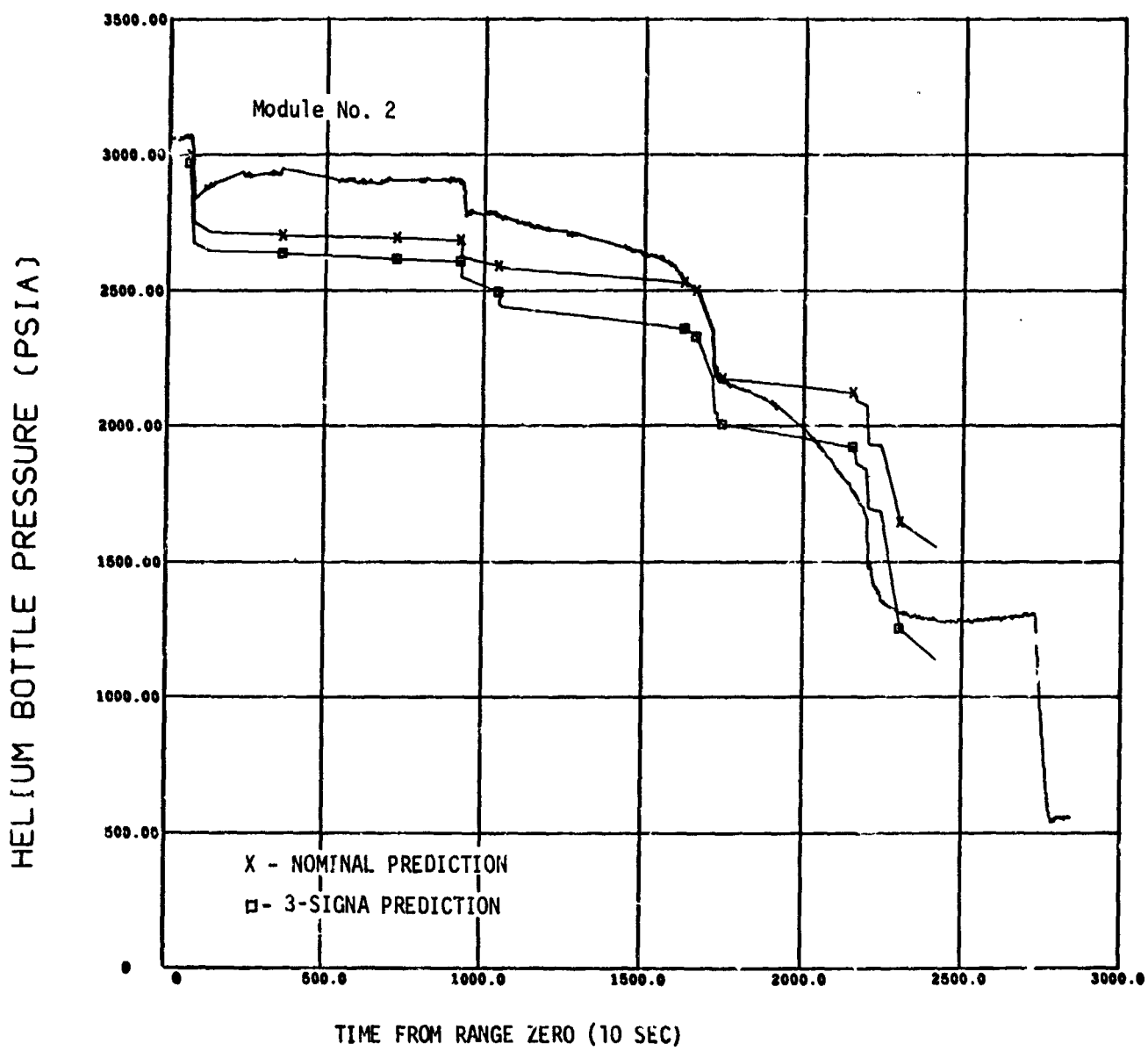

Figure 14-5. APS Module 2 Helium Bottle Pressure

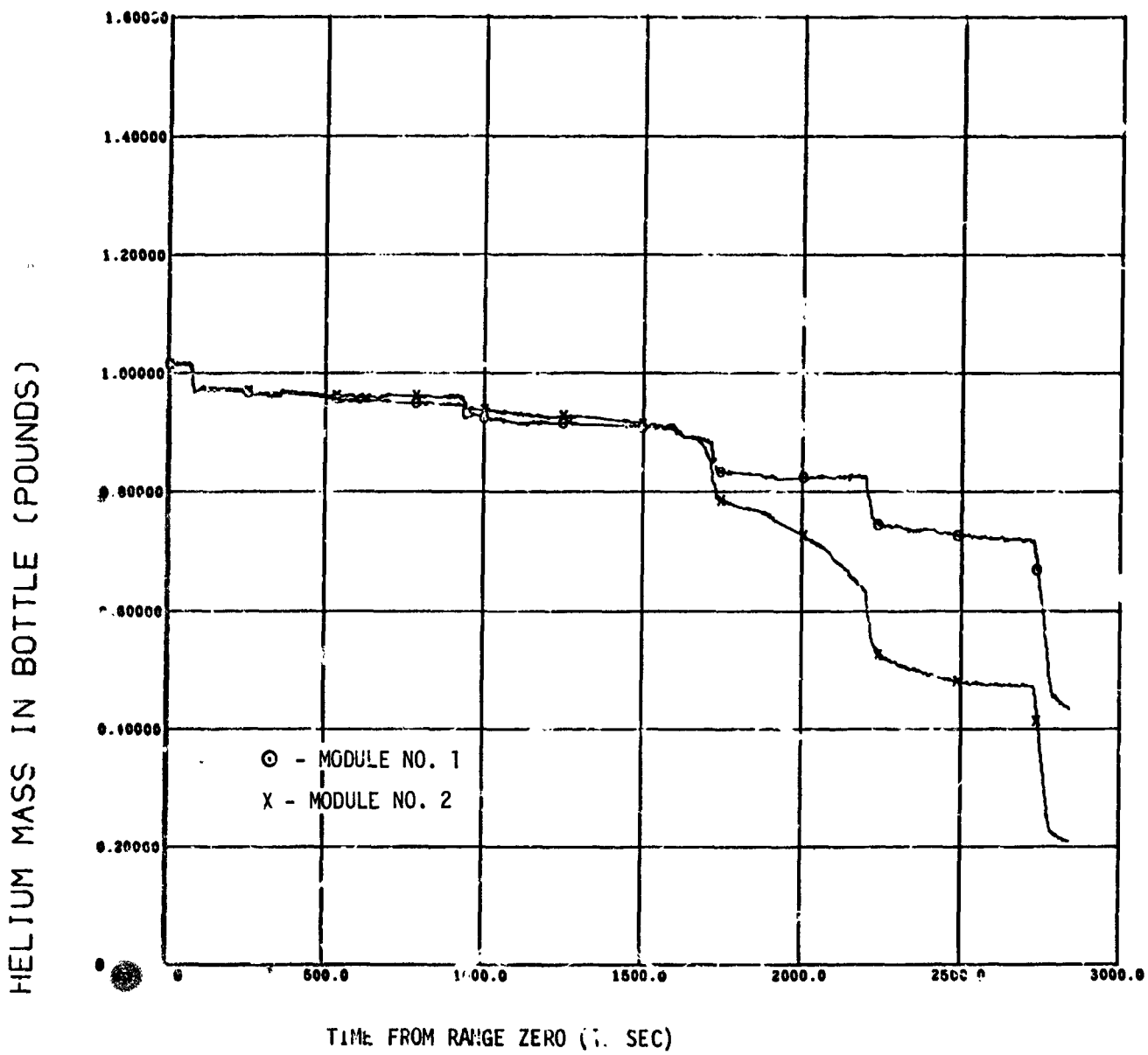

Figure 14-6. APS Helium Mass

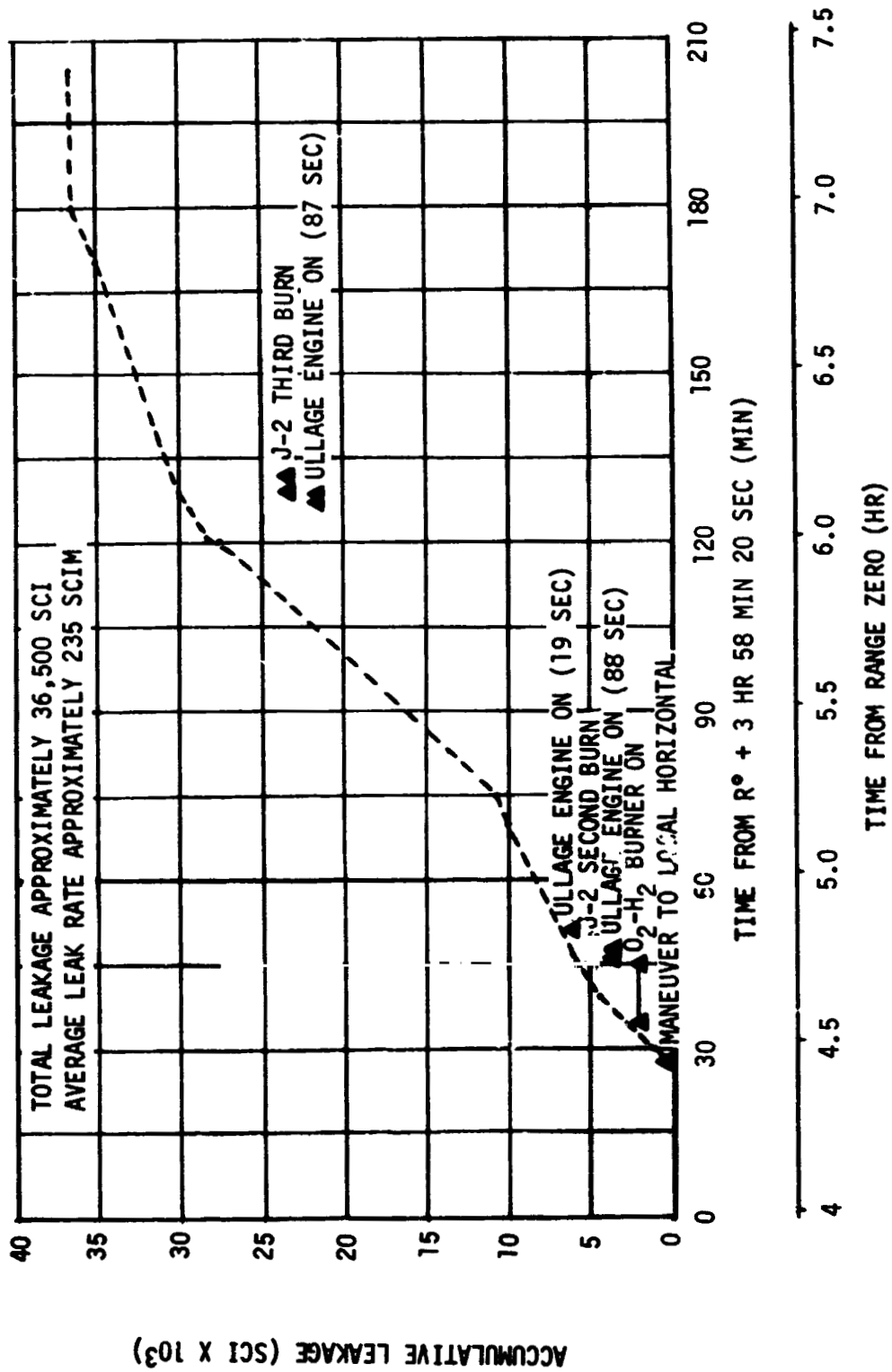

Figure 14-7. APS Module No. 2 Helium Leakage



MODULE FUEL AND OXIDIZER TEMP. (DEG R)

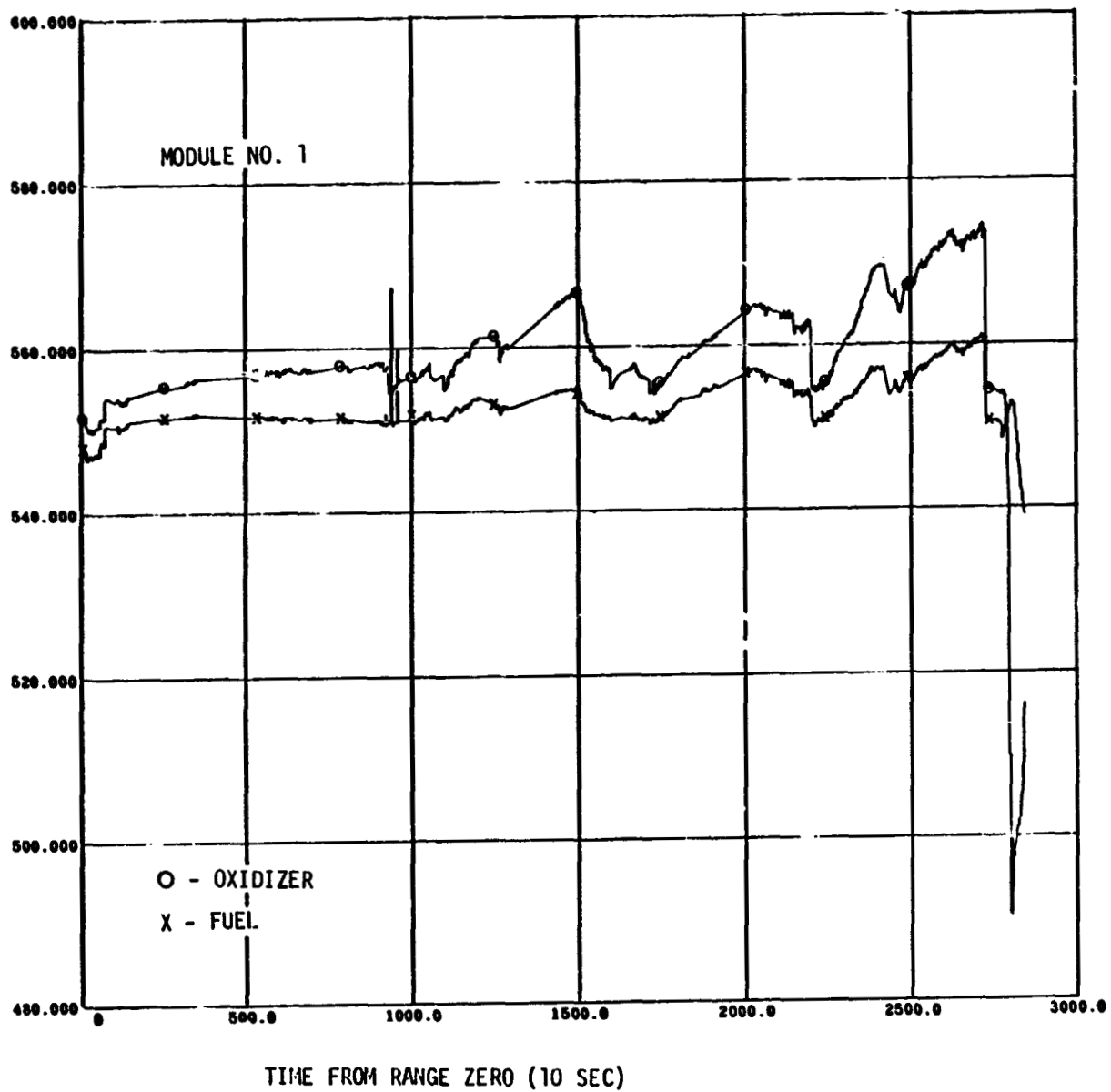

Figure 14-8. APS Module No. 1 Propellant Temperatures

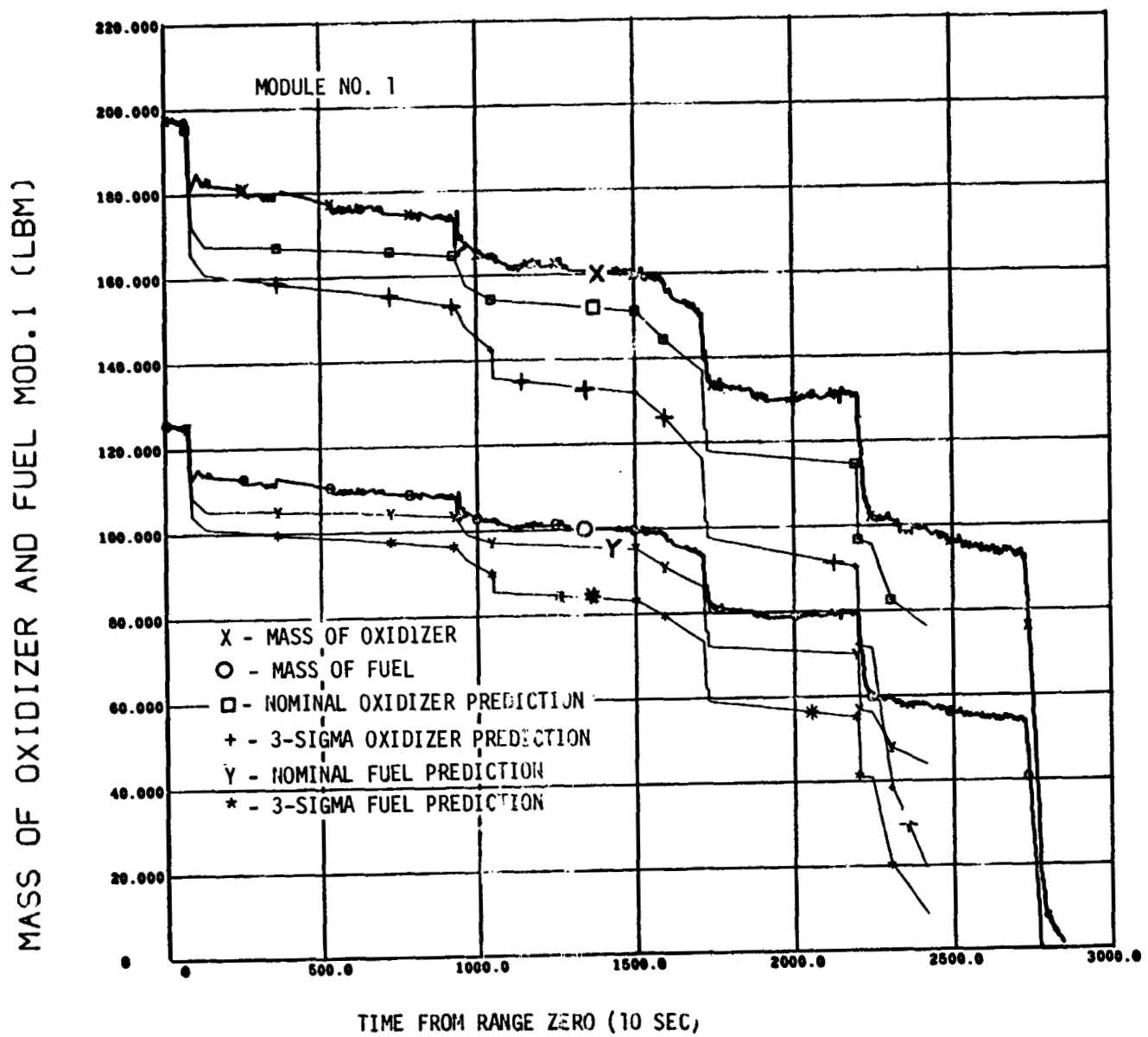

Figure 14-9. APS Module 1 Propellant Masses

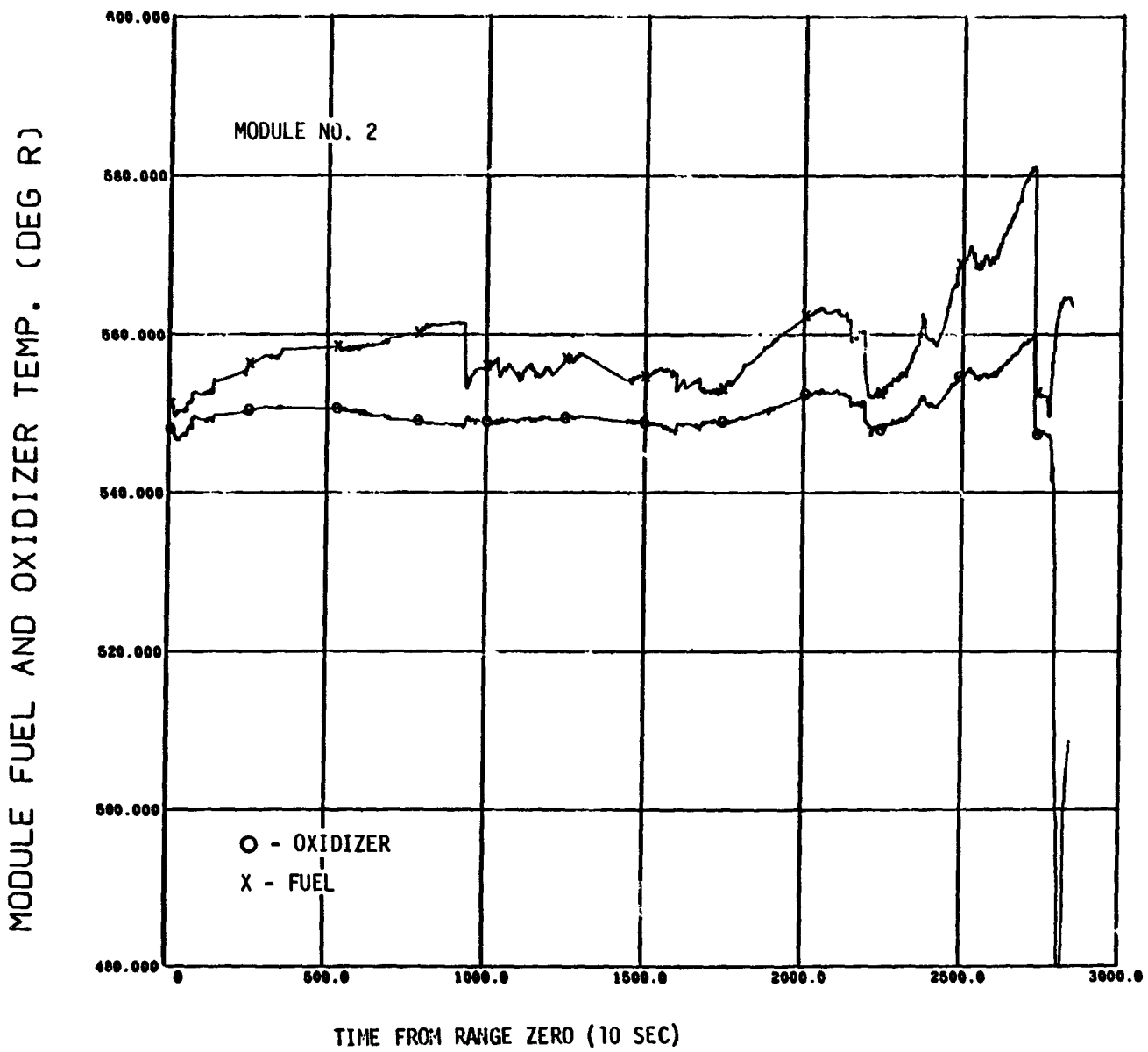

Figure 14-10. APS Module 2 Propellant Temperatures

MASS OF OXIDIZER AND FUEL MOD.2 (LBM)

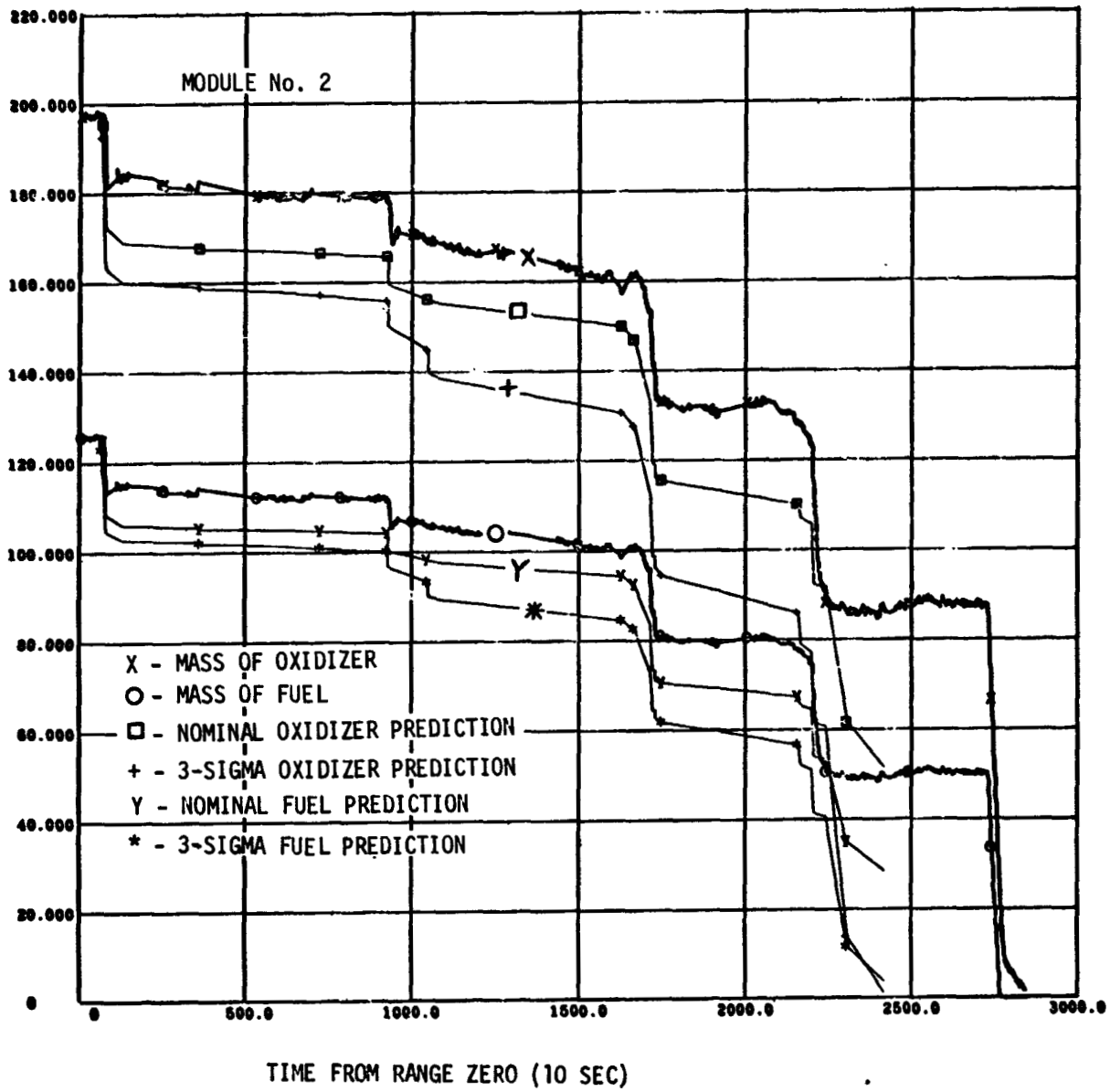

Figure 14-11. APS Module 2 Propellant Masses

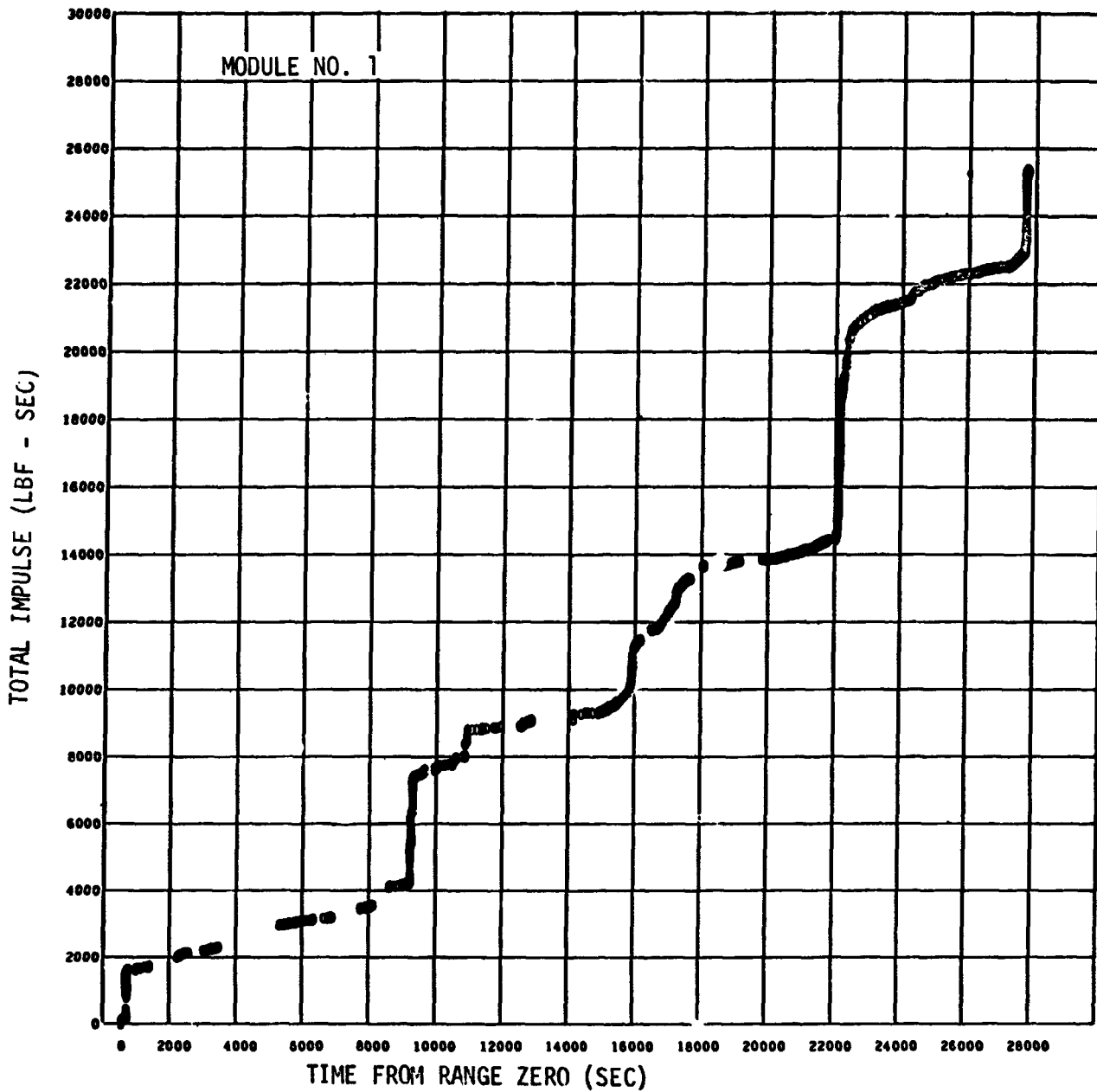

Figure 14-12. APS Total Impulse (Module 1 Attitude Control Engines)

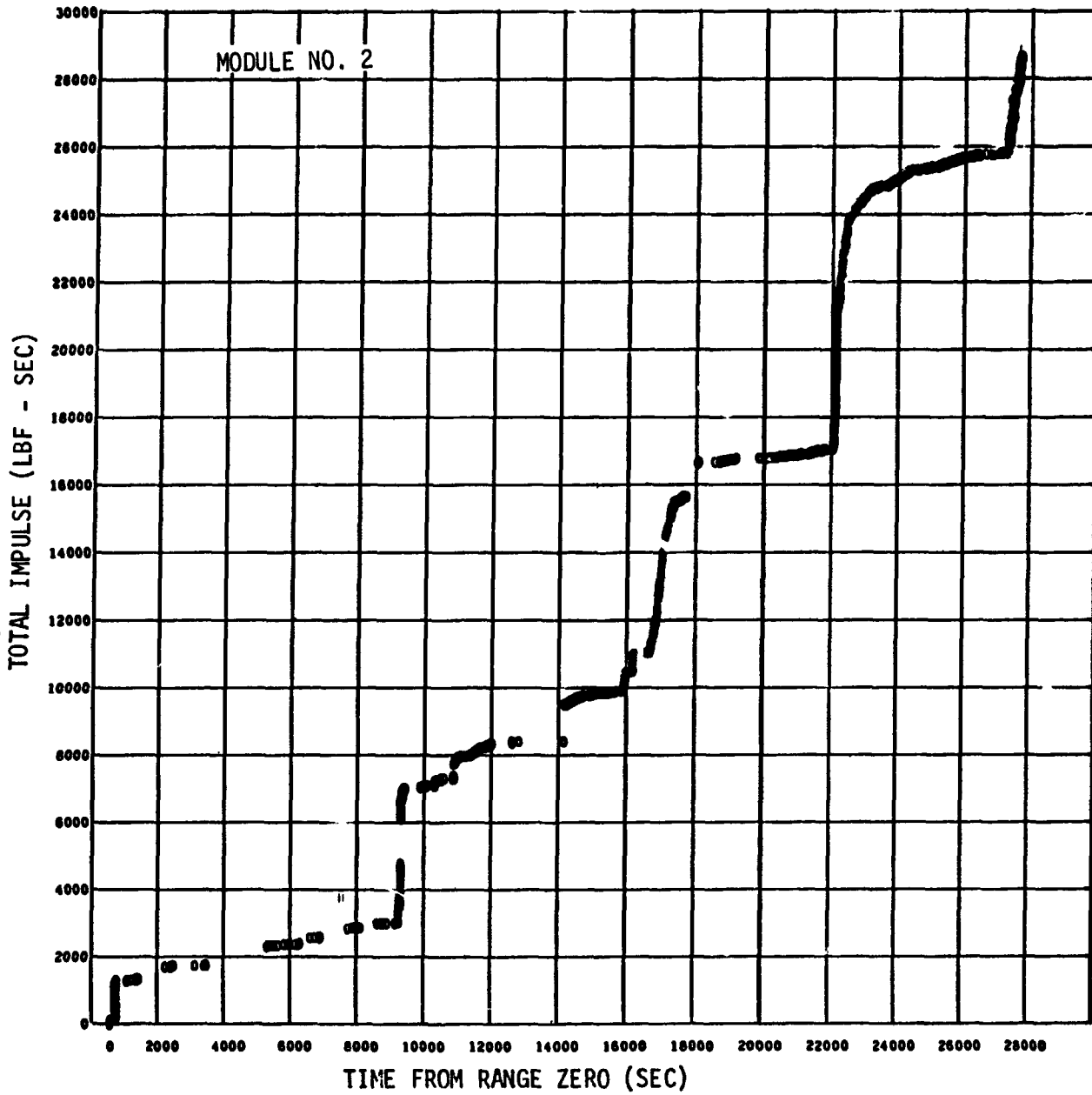

Figure 14-13 APS Total Impulse (Module 2 Attitude Control Engines)

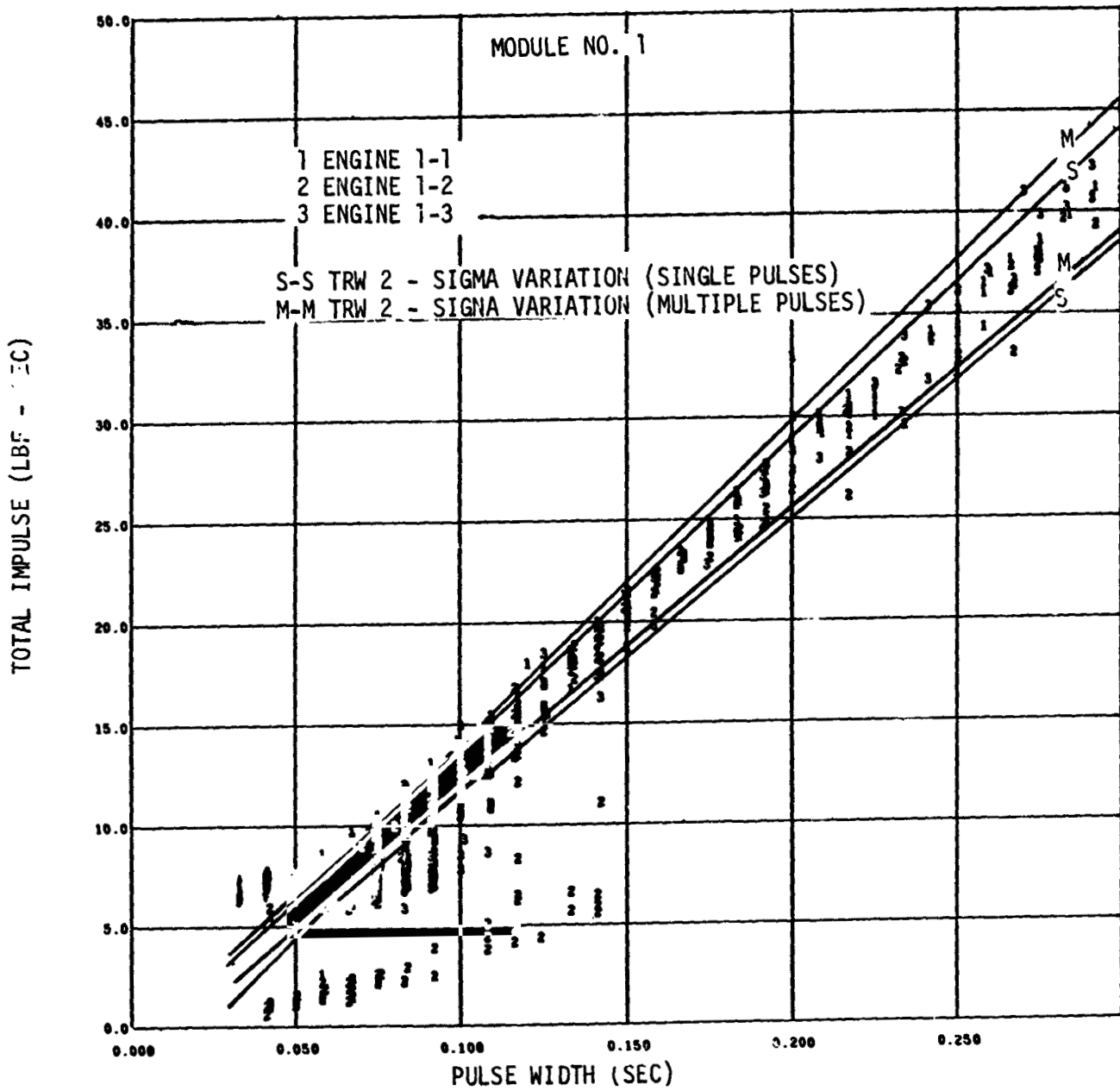

Figure 14-14. APS Total Impulse Per Pulse (Module 1)

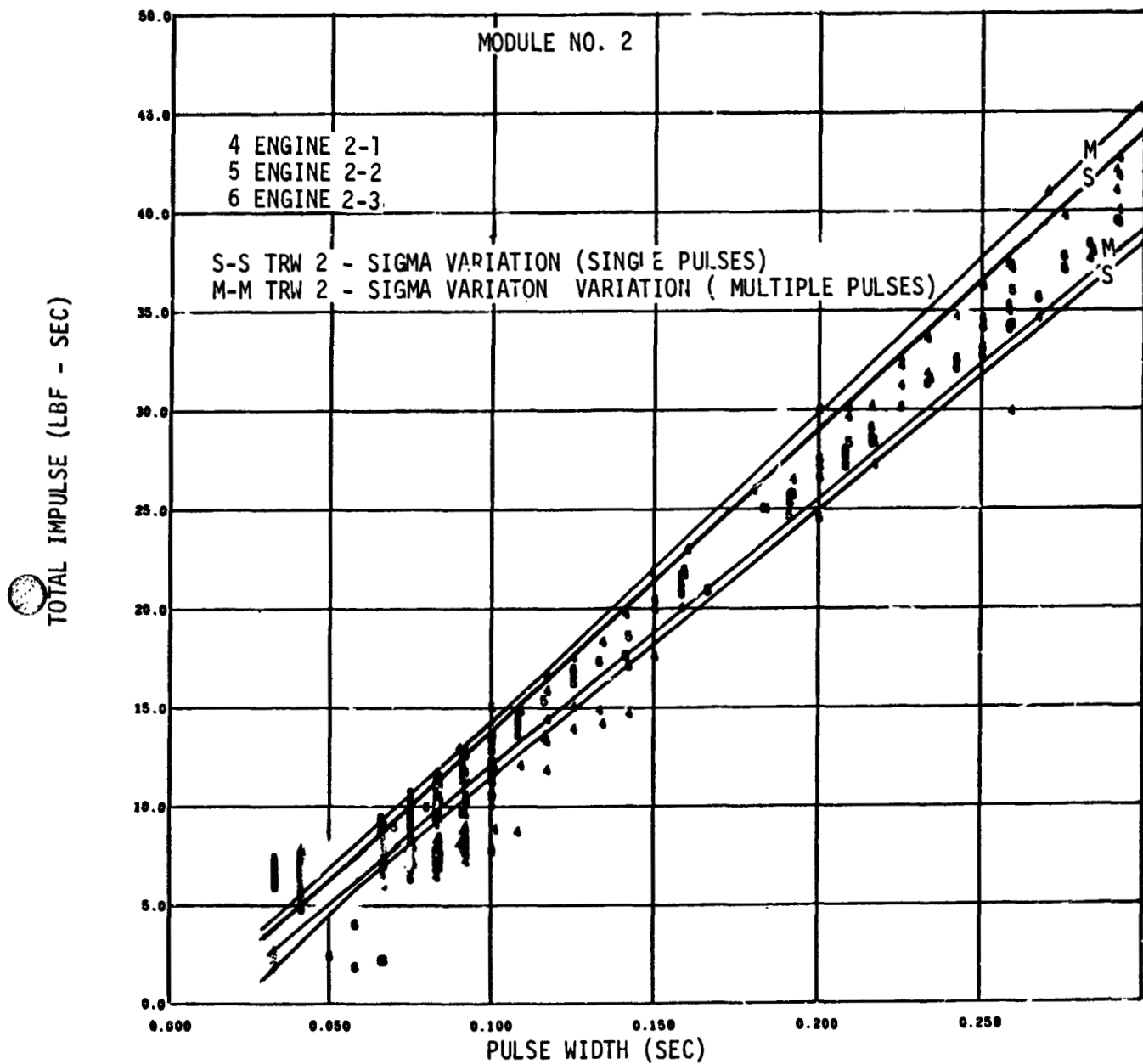

Figure 14-15. APS Total Impulse Per Pulse ( Module 2 )



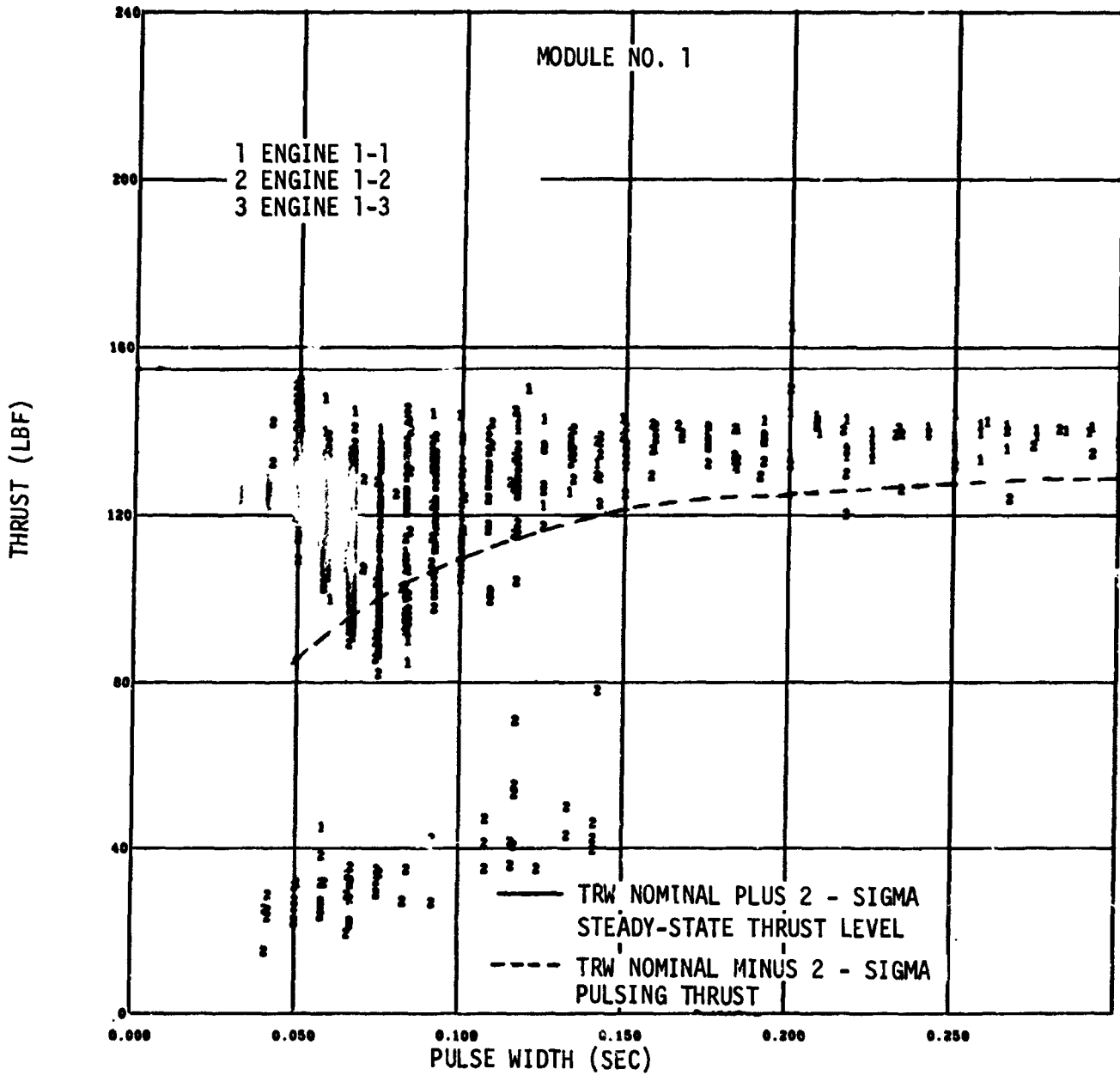

Figure 14-16. APS Thrust (Module 1)

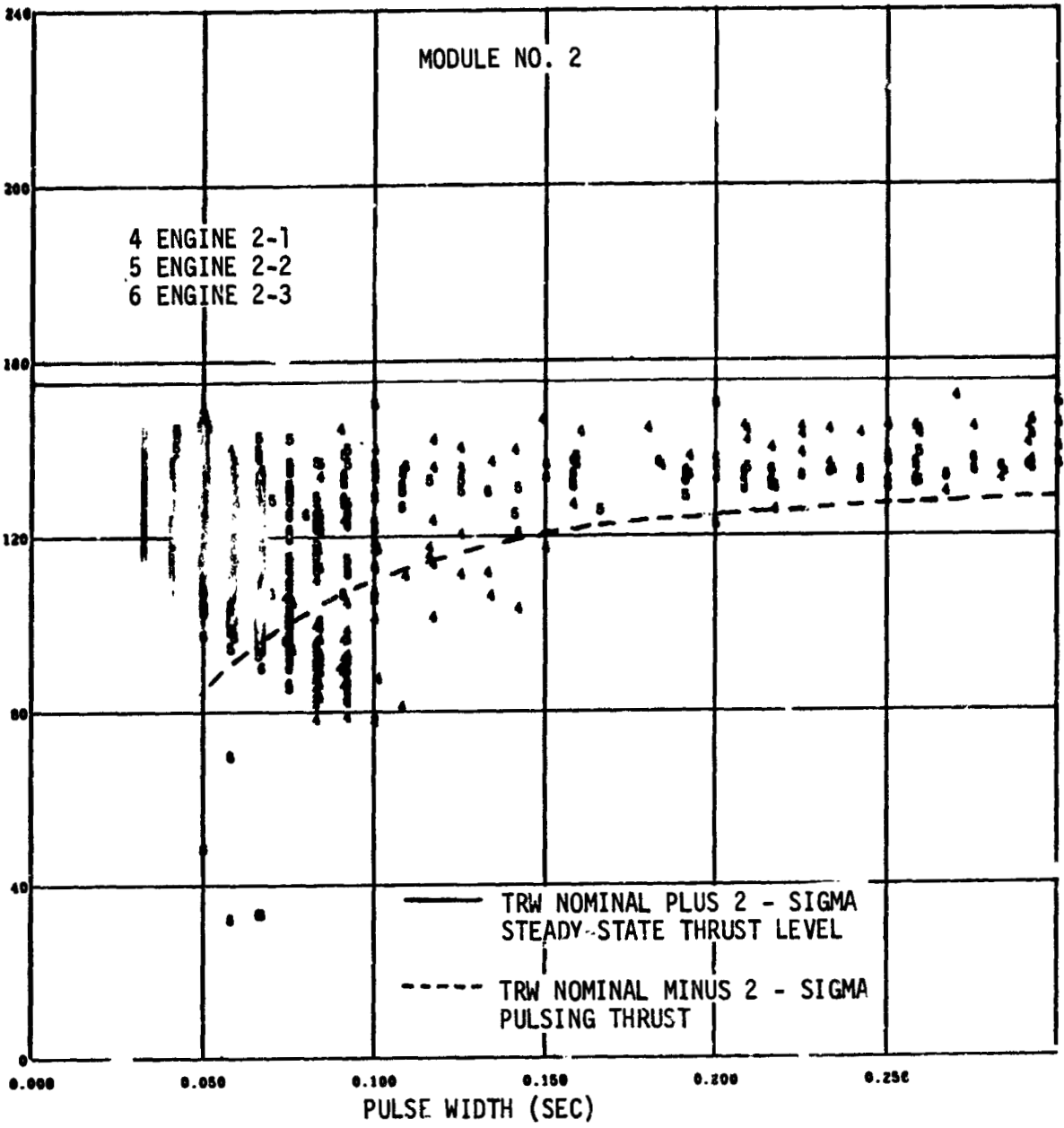
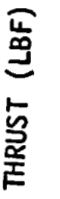

Figure 14-17. APS Thrust ( Module 2 )

## 15. PNEUMATIC CONTROL AND PURGE SYSTEM

The pneumatic control and purge system (figure 15-1) adequately performed the actuations and purges required throughout the flight. The helium supply was adequate to meet all mission objectives. No helium leakage was evident during orbital periods.

### 15.1 Pneumatic Control

During the countdown, the regulator discharge pressure rose to a level that caused the sensing pressure switch to cycle the pneumatic control and purge backup system. The engine pump purge was initiated to increase the demand on the pneumatic control and purge system allowing the regulator to resume normal regulation. During the engine pump purge, the regulator maintained the discharge pressure at 542 psia, about 17 psia higher than the normal pump purge level. Approximately 330 seconds prior to liftoff the engine pump purge was terminated. The regulator discharge pressure then rose to 620 psia before the prevalues were actuated closed after which the regulator continued to regulate high for the remainder of countdown, boost, and first burn; the regulation band was 615 to 598 psia during these periods (figure 15-2).

In order to permit launch to occur with this high regulator discharge pressure, the maximum redline limit was raised from 585 psia to 630 psia. This redline relaxation required the stage pneumatic backup pressure -itch launch interlock to be by-passed in order to allow launch in the elevated pressure region.

During earth orbit, the pneumatic regulator outlet pressure drifted from 600 to 585 psia. A drift also occurred during intermediate coast when the outlet pressure declined from 575 to 565 psia. These drifts in regulator discharge pressure, together with changes due to valve actuation usage, caused the regulator lockup pressure to vary continually throughout the flight within a band from 615 to 540 psia (figures 15-3 through 15-7).

Following CVS closure, in preparation for the second restart, the regulator discharge pressure recovery raised the pressure to 622 psia causing the pressure switch to pickup. The pneumatic control and purge system, therefore, went to the backup mode for 211 seconds starting 8 seconds prior to third burn. After this single cycle of the regulator backup system, normal regulation was again obtained. The regulator performed normally for the remainder of the flight. During the interval ESC<sub>3</sub> +250 to ESC<sub>3</sub> +282 seconds, two apparent responses occurred in the regulator discharge pressure; however, careful analysis and comparison with the backup pressure measurement (D0247) indicates that no change in pressure level actually occurred.

In order to eliminate the recurrence of this type of behavior by the pneumatic control regulator, changes are being made in the regulator system hardware. The changes being incorporated are vendor installed redundant filter, chrome plating of the regulator poppet, and establishment of the regulation band under lower flow conditions.

## 15.2 Ambient Helium Purges

A manually commanded engine pump purge was initiated during the countdown. The purge was used to increase the demand on the pneumatic control and purge system as discussed previously. It was manually terminated before liftoff.

To prepare the pumps and gas generator for restart, the engine pump purge was initiated 8 seconds prior to first engine cutoff command and 7 seconds prior to second engine cutoff command. Both purges were nominal and lasted 10 minutes.

The LOX chilldown pump motor container purge system consisted of a sintered inlet orifice and a sharp edged outlet orifice. The nominal flowrate of the motor container purge was 200 scim. The motor case pressure remained within acceptable limits (figures 15-8 and 15-9).

TABLE 15-1 (Sheet 1 of 2)  
PNEUMATIC CONTROL AND PURGE SYSTEM DATA

Parameter	S-IVB-504N Flight			S-IVB-503N Flight		S-IVB-502 Flight	
	First Burn	Second Burn	Third Burn	First Burn	Second Burn	First Burn	Second Burn
Sphere Volume (cu ft)	4.5	4.5	4.5	4.5	4.5	4.5	4.5
Sphere Pressure (psia)							
At liftoff	3,152	--	--	2,997	--	3,063	--
At engine start command	3,135	2,400	1,884	2,884	2,185	3,003	2,429
At engine cutoff command	3,128	2,400	1,886	2,874	2,215	3,010	2,429
Sphere Temperature (deg R)							
At liftoff	532	--	--	534	--	545	--
At engine start command	528	483	460	527	497	541	496
At engine cutoff command	528	482	464	527	503	541	496
Helium Mass (lbm)							
At liftoff	8.8	--	--	8.36	--	8.54	--
At engine start command	8.8	7.55	6.32	8.21	6.74	8.49	7.56
At engine cutoff command	8.8	7.55	6.27	8.16	6.74	8.49	7.56
Usage during engine operation	0	0	0.05	0.05	0	0	0
Usage during 10-minute postfiring engine pump purge	0.97	1.00	--	0.79*	--	0.72	--

\*Exact value could not be determined due to the nature of the data.

TABLE 15-1 (Sheet 2 of 2)  
 PNEUMATIC CONTROL AND PURGE SYSTEM DATA

Parameter	S-IVB-504N Flight			S-IVB-503N Flight			S-IVB-502 Flight	
	First Burn	Second Burn	Third Burn	First Burn	Second Burn	First Burn	Second Burn	
Regulator Outlet Pressure								
Maintained pressure band (psia)	605 to 608	550 to 558	484 to 622	522 to 535	520 to 540	525 to 560	525 to 560	483 to 43
Minimum system pressure during start and cutoff transient (psia)	598	550	563	495	472	510	483	43
Average LOX chilldown motor container purge pressure (psia)	50	44	54	54	49.5	42	43	

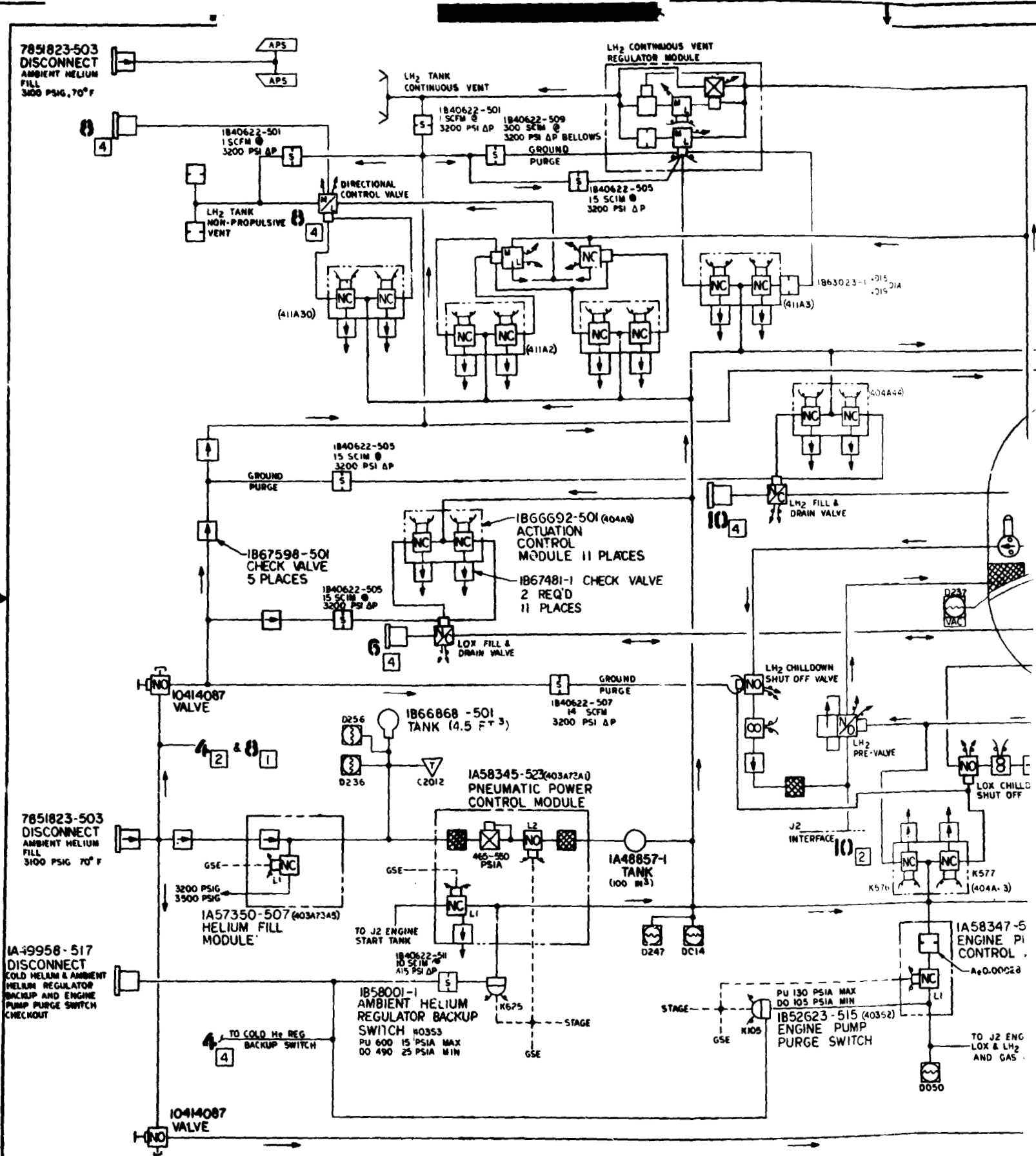
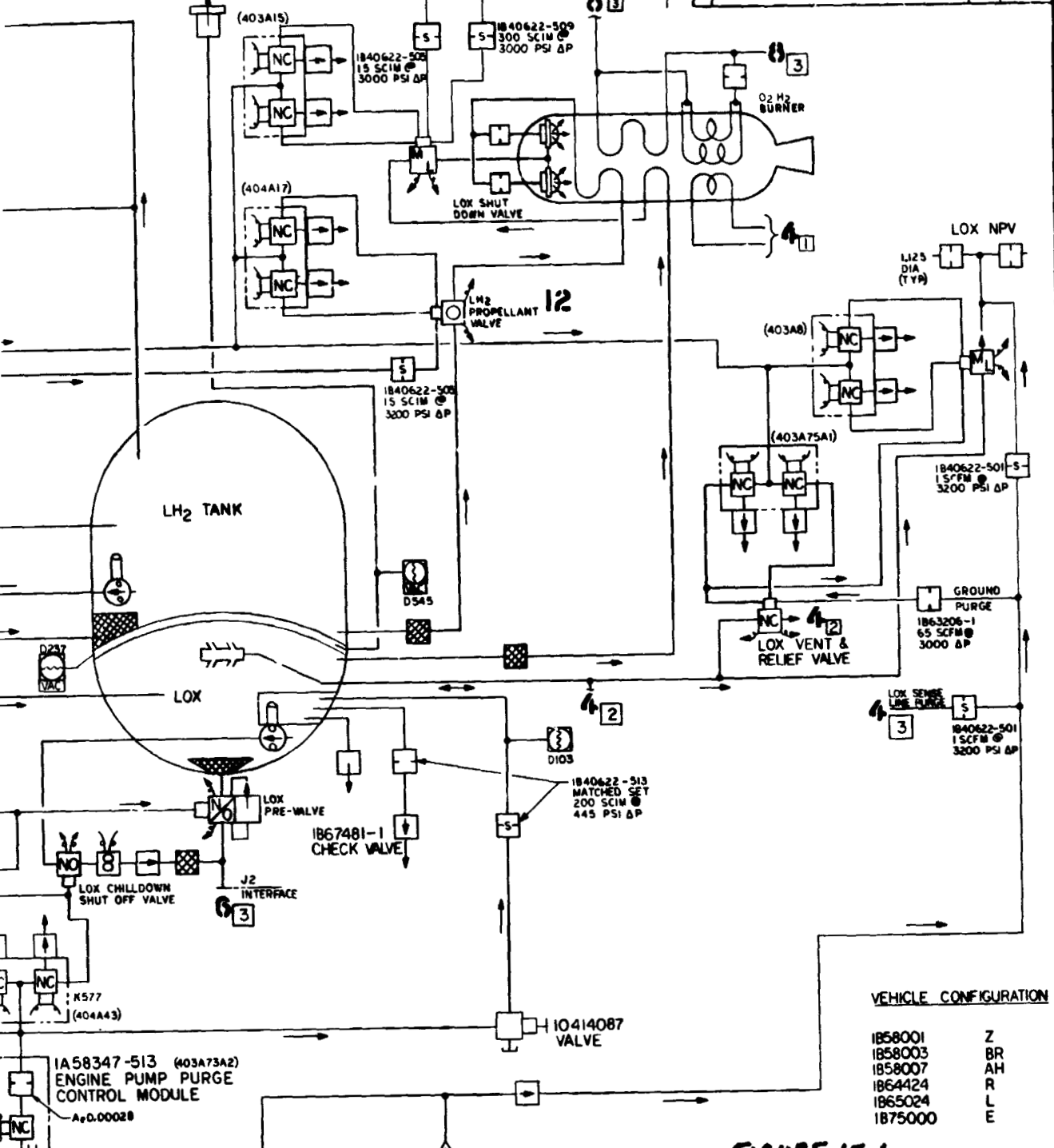

Figure 15-1. Schematic, SV Pneumatic Control System



IB41065-1 DISCONNECT  
COMMON BULKHEAD  
VACUUM MONITORING SYSTEM

VISIONS		DATE	APPROVED
1	SEE F.O.	3-20-68	[Signature]
2	SEE F.O.	3-22-68	[Signature]



VEHICLE CONFIGURATION

IB58001	Z
IB58003	BR
IB58007	AH
IB64424	R
IB65024	L
IB75000	E

FIGURE 15-1.  
SEQUENCE 2

PREPARED FOR NASA-MSC	DATE: JUL 17 68	BY: [Signature]	1842728
DESIGNER: [Signature]	CHECKER: [Signature]	DATE: 24 JUN 68	1842728
ENGINEER: [Signature]	DATE: 24 JUN 68	1842728	1842728
DATE: 24 JUN 68	1842728	1842728	1842728

SCHEMATIC, SV PNEUMATIC CONTROL SYSTEM

1842728

1842728

1842728

1842728

DUAL RE-PRESSURIZATION

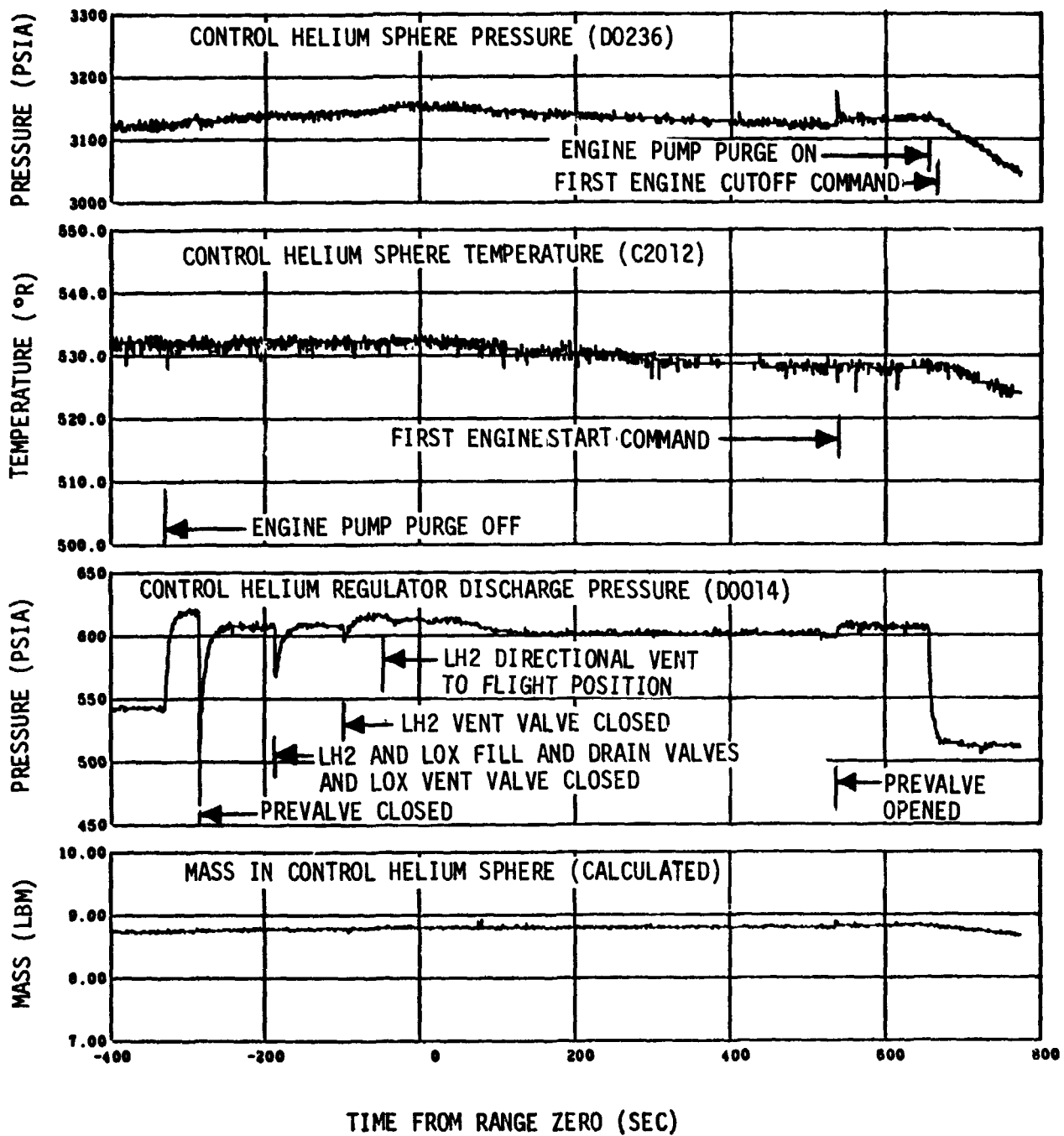

Figure 15-2. Pneumatic Control and Purge System Performance--Boost and First Burn

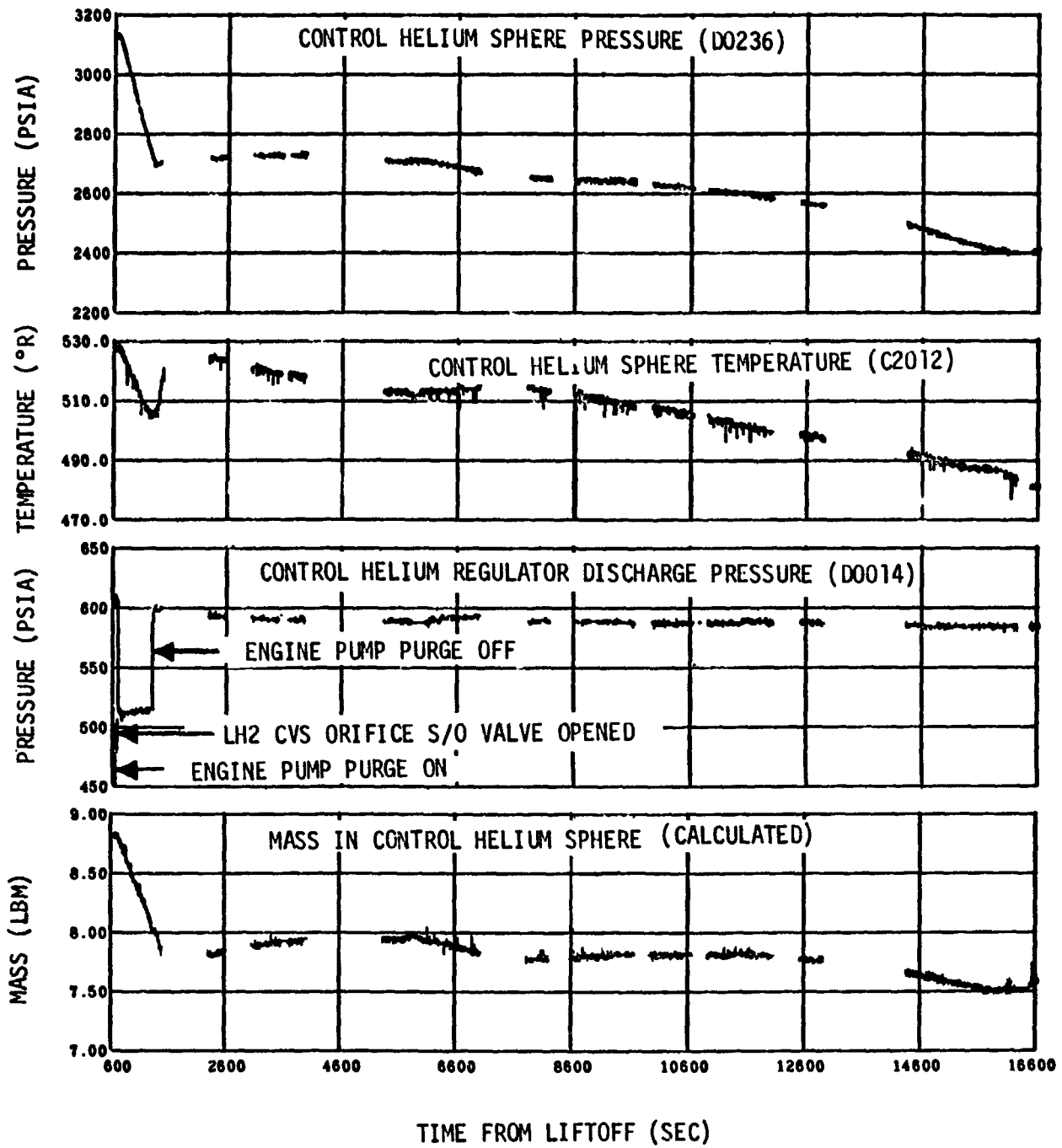

Figure 15-3. Pneumatic Control and Purge System Performance -- Earth Orbit

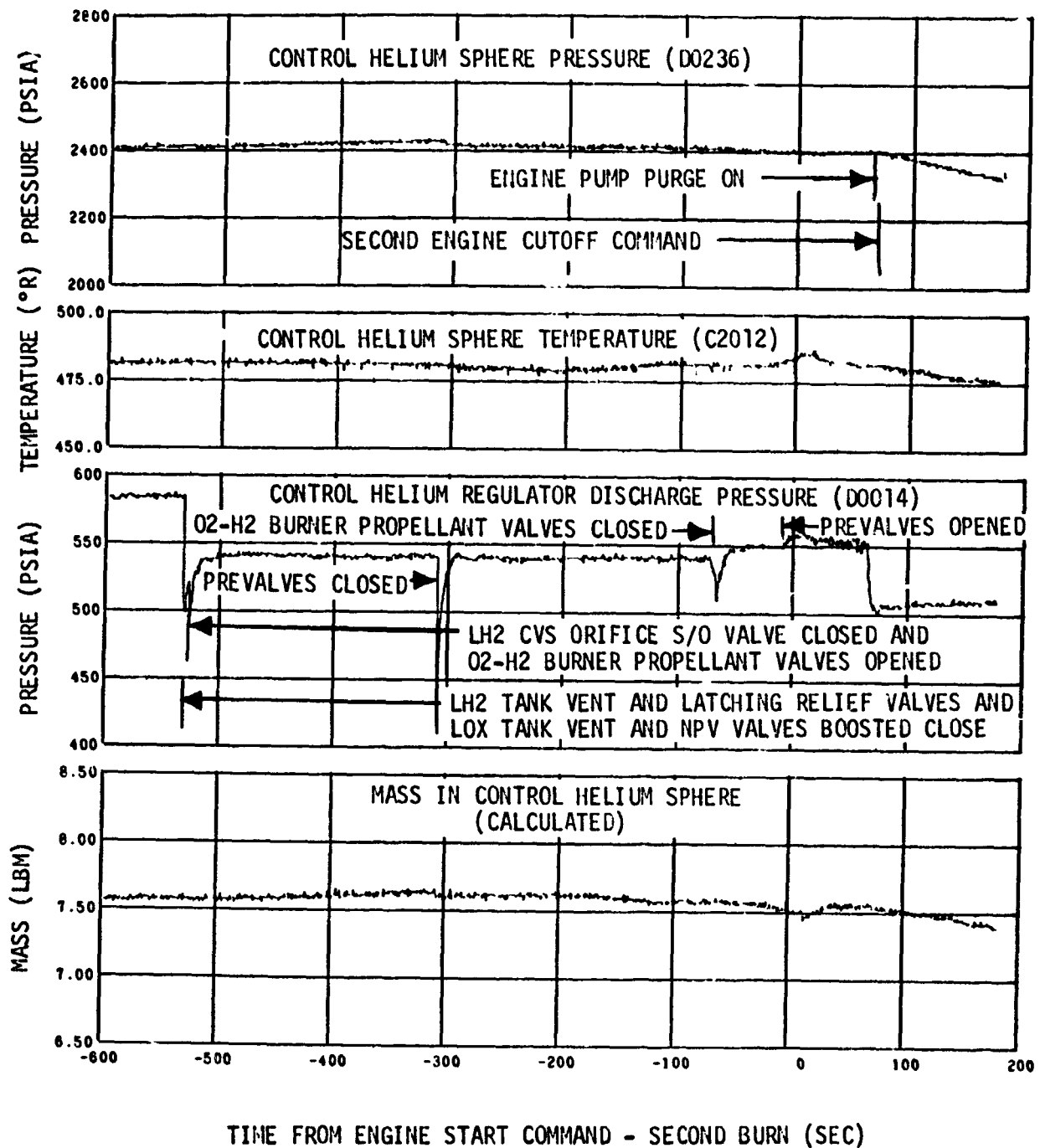

Figure 15-4. Pneumatic Control and Purge System Performance -- Second Burn

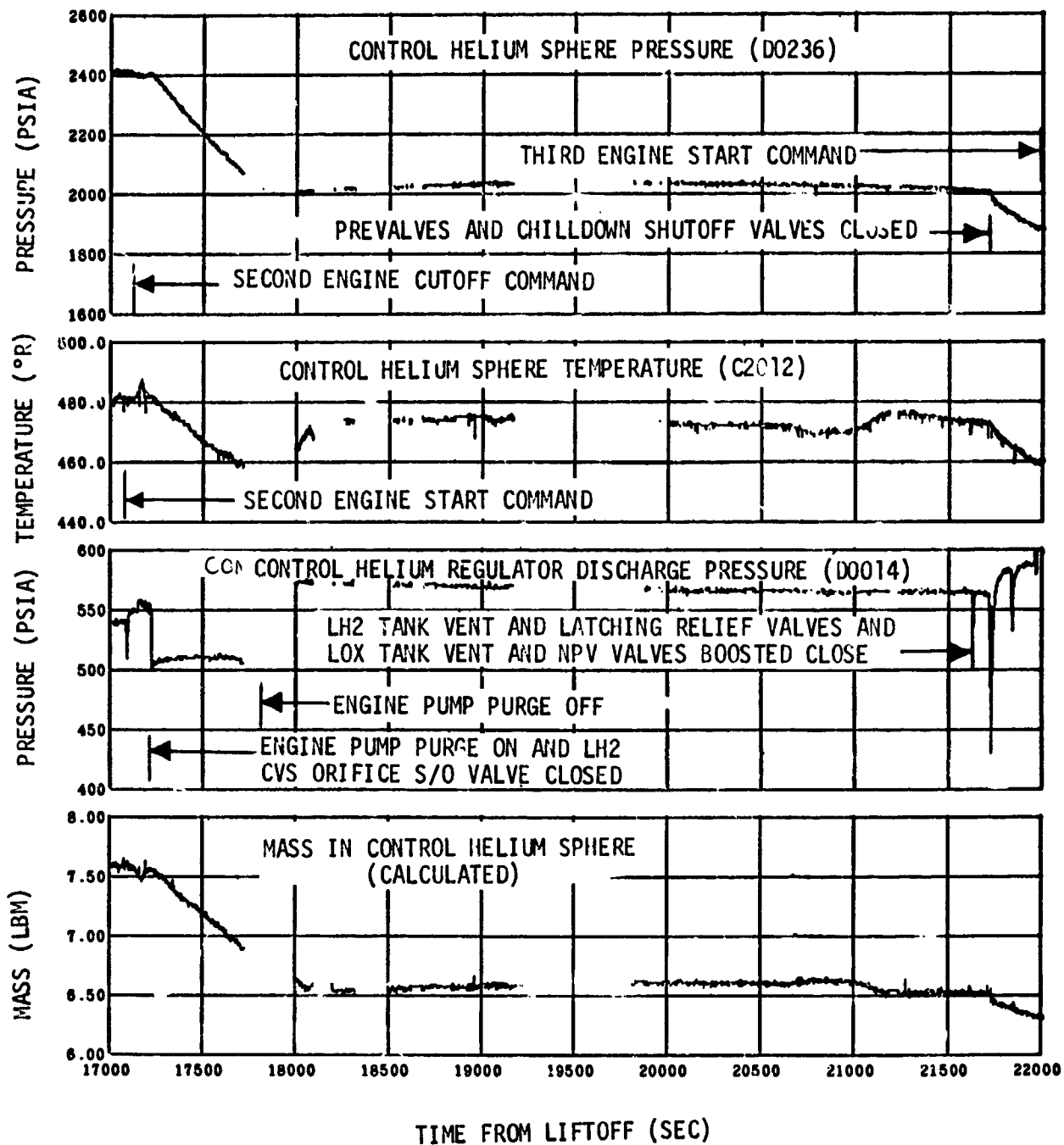

Figure 15-5. Pneumatic Control and Purge System Performance -- Intermediate Orbit

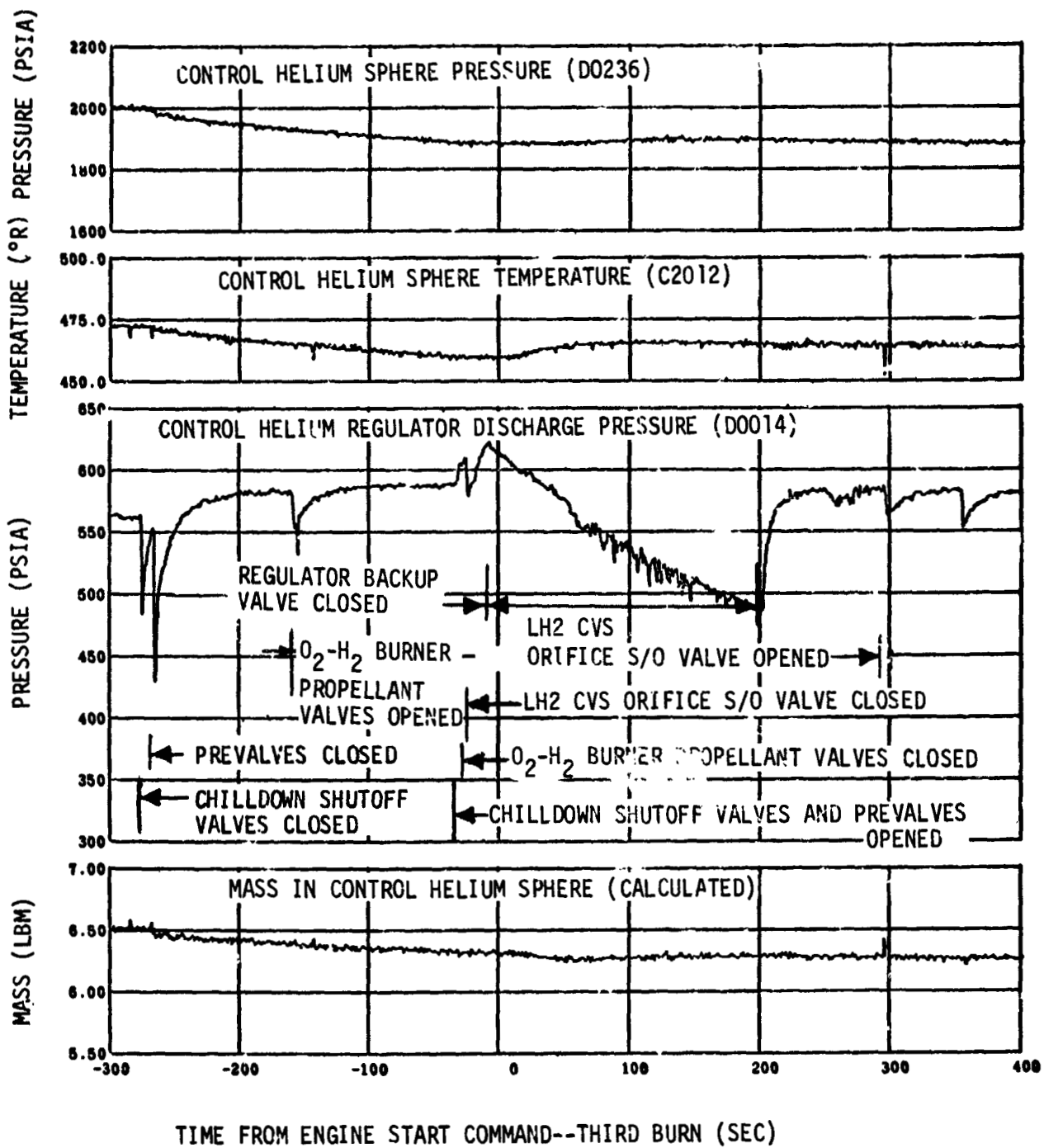

Figure 15-6. Pneumatic Control and Purge System Performance--Third Burn

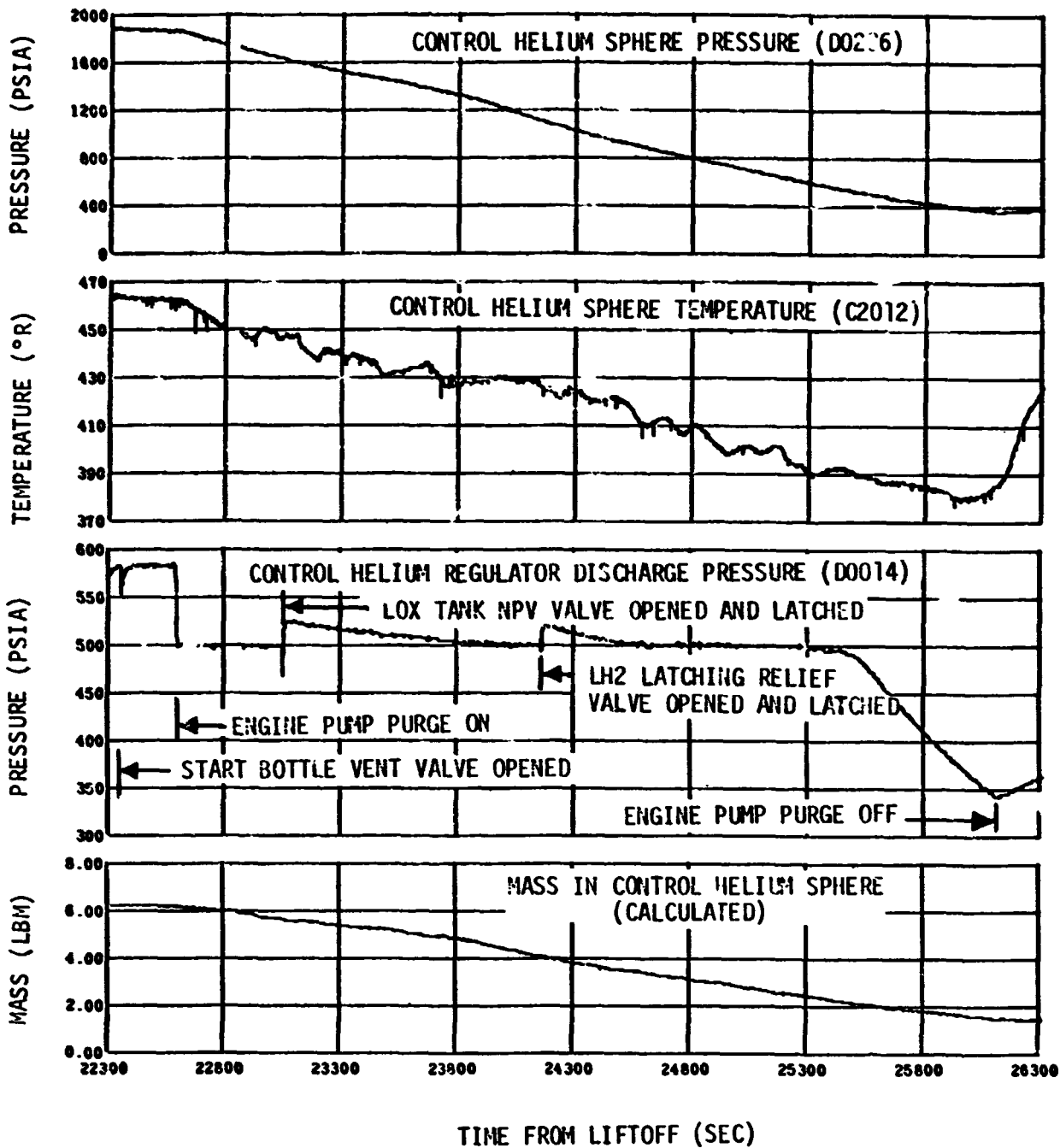

Figure 15-7. Pneumatic Control and Purge System Performance--Solar Orbit Insertion

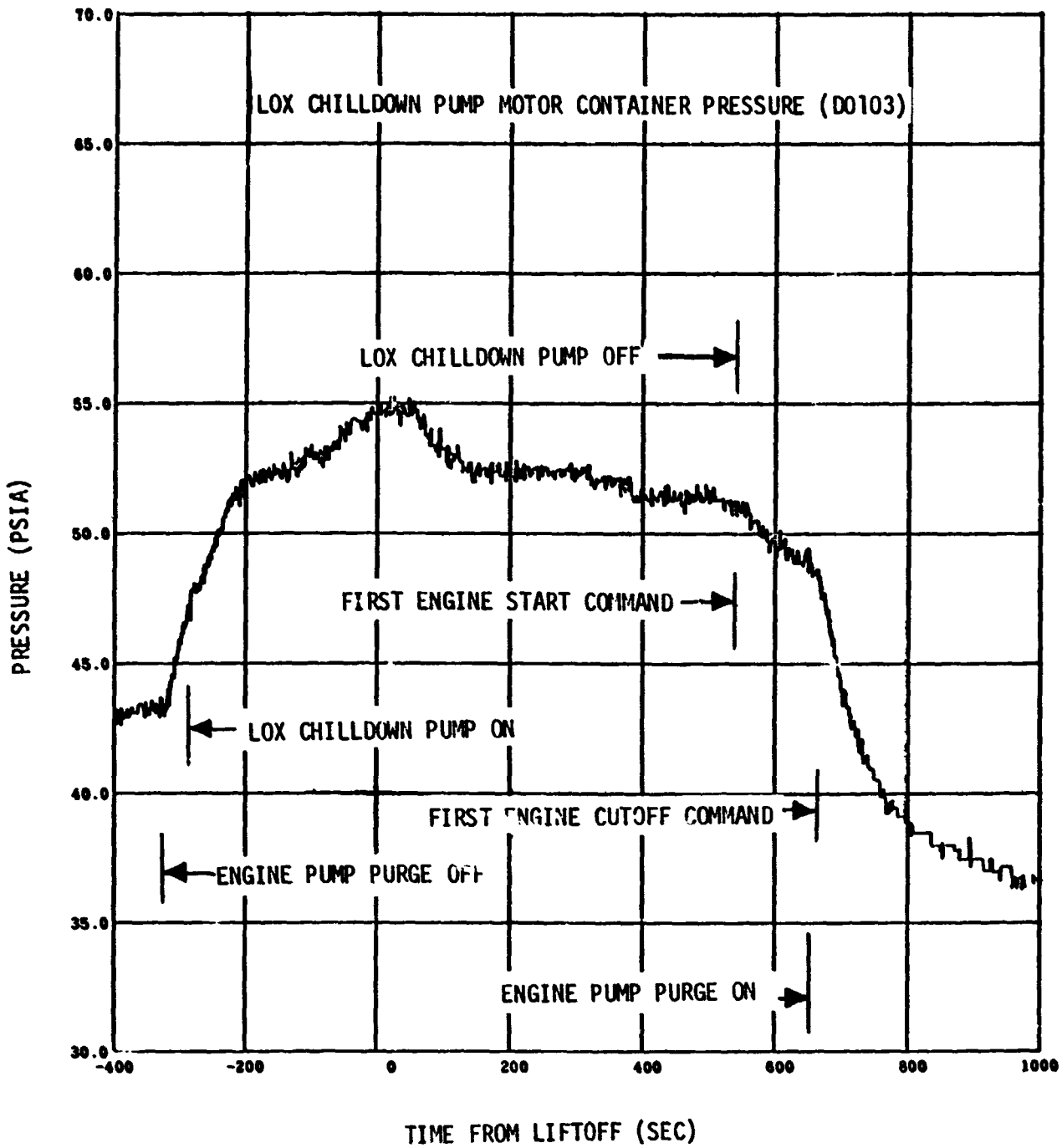

Figure 15-8. LOX Chilldown Pump Motor Container Purge Performance--First Burn



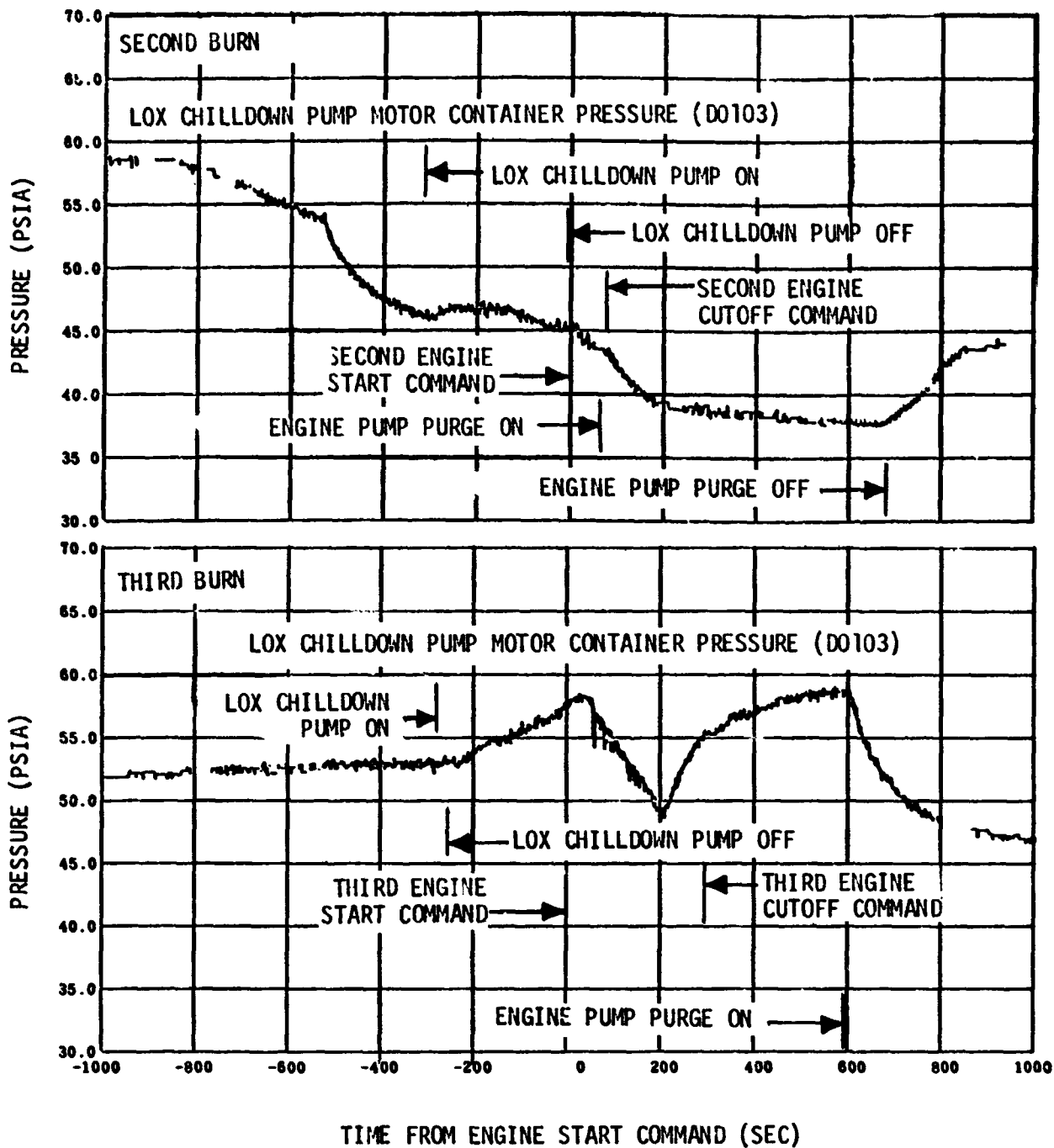

Figure 15-9. LOX Chilldown Pump Motor Container Purge Performance--Second and Third Burn

## 16. PROPELLANT UTILIZATION

The propellant utilization (PU) system successfully accomplished the requirements associated with propellant loading and management during burn. The best estimate propellant mass values at liftoff were 189,745 lbm LOX and 43,650 lbm LH2. These values are well within the required +1.12 percent stage loading accuracy.

The total propellant residuals at third Engine Cutoff Command (ECC3) were 34,112 lbm LOX and 8,917 lbm LH2. The usable masses at ECC3 were 8,157 lbm LH2 and 33,627 lbm LOX.

The PU system was operated inflight in the open loop mode. The PU valve operation was controlled in response to launch vehicle digital computer (LVDC) issued commands. The PU valve was positioned at null for start and shifted to the high EMR position throughout the entire first burn mode. At time base 6 (TB6) +450.152 sec the PU valve was positioned at the low EMR stop for restart. At ESC2 +12.998 sec the PU valve was commanded to the null position. By ESC2 +14.298 sec the valve had arrived at the null position where it remained for the duration of the second burn operation.

Similarly, the PU valve was commanded to the low EMR stop for second restart and commanded to the null position at ESC3 +12.998 sec where it remained for the duration of the third burn.

The rise of propellants within the mass sensors due to capillary action during the low acceleration coast period was noted as on previous Saturn V flight stages. The capillary action had no effect upon the PU system operation due to the open loop mode of operation.

### 16.1 PU Mass Sensor Calibration

The preflight propellant masses at the full point calibration points were determined from the S-IVB-504 acceptance firing full load data. The acceptance firing full load masses were determined by the flow integral analysis method. The capacitance values corresponding to the full load masses were actual measured test data.

The propellant masses at the lower calibration point were computed from unique tank volumes and predicted propellant density data. The corresponding capacitance values were determined from the fast drain data obtained during the S-IVB stage acceptance firing.

The following table presents a summary of the PU mass sensor calibration data:

SENSOR	FULL POINT		EMPTY POINT	
	MASS (lbm)	CAPACIT. (pf)	MASS (lbm)	CAPACIT. (pf)
LOX	191,797	411.20	1,384	281.77
LH2	37,774	1,152.53	201	970.76

## 16.2 Propellant Mass History

The predicted, measured and best estimate propellant masses at significant flight events are presented in table 16-1. The best estimate propellant masses are derived by subtracting nonpropellants (dry stage, ullage gases, etc.) from the AS-504 third stage best estimate masses presented in section 8. The remaining propellant mass is then divided into LOX and LH2 according to the prevailing mixture ratio at the specific flight event.

The propellant mass measurement systems represented in table 16-1 are:

- a. PU indicated
- b. PU indicated corrected
- c. PU volumetric
- d. Flight flow integral

A brief description of each measurement system is as follows:

- a. The PU indicated method measures propellant mass from the raw PU probe output which is reduced according to the preflight flow integral calibration slope.

- b. The PU indicated corrected method is constituted in a manner similar to item (a) above but it also includes adjustments for acceptance firing flow integral non-linearity and PU flight dynamics effects.
- c. The PU volumetric masses are derived from raw PU probe output data which are reduced according to volumetric calibration slopes and adjusted for flight dynamics effects and volumetric tank to sensor mismatch. The calibration slopes (lbm/pf) were computed from the capacitance-propellant mass relationships at the upper and lower probe active element extremities. Propellant masses at the extremities were calculated from unique tank volume determined from tank measurements and propellant density.
- d. The flight flow integral method consists of determining the LOX and LH2 mass flowrates and integrating as a function of time to obtain total consumed propellant masses during engine burn. The flow integral propellant masses at first Engine Start Command (ESC1) are determined by adding propellant at third Engine Cutoff Command (ECC3) to the total propellant consumed by the engine during all three burns, the fuel pressurant added to the ullage, and the propellant lost to boiloff.

The results of the four methods of propellant evaluation are presented in table 16-1. The desired and best estimate values are shown in addition to the mass values determined by the various measurement systems. The deviation of each value from the best estimate is also shown.

The best estimate total propellant mass at liftoff was 233,395 lbm which is 989 lbm greater than desired. Both LOX and LH2 masses were well within the guaranteed loading accuracy of  $\pm 1.12$  percent. The liftoff mass, as determined by each individual measurement system compared to the best estimate, is within the accuracy constraints for each system.

The best estimate total propellant mass at third Engine Cutoff Command (ECC3) is 42,956 lbm which is 20,153 lbm greater than predicted. No significant differences exist in total propellant consumption between measurement systems. The best estimate total consumption through the engine is 185,218 lbm which is 19,157 lbm less than predicted.

Propellant loading was accomplished automatically by the loading computer.

The loading computer values at liftoff were 86.55 percent for LOX and 95.92 percent for LH2 which were well within the 0.5 percent loading computer accuracy.

#### 16.2.1 Orbital Boiloff

The LOX usage between first burn Engine Cutoff Command (ECC1) and second Engine Start Command (ESC2) as determined by ullage gas mass analysis was 369 lbm including first engine burn thrust decay, orbital boiloff, O2-H2 burner usage and second burn engine chilldown. The LOX usage between second burn Engine Cutoff Command (ECC2) and third burn Engine Start Command (ESC3) was 178 lbm. This included LOX boiloff, O2-H2 burner and recirculation chilldown usage.

The total LH2 usage between ECC1 and ESC2 was 3,619 lbm and included the effects of orbital boiloff (3,557 lbm), first burn engine thrust decay, O2-H2 burner usage and second burn engine chilldown. Similarly the total LH2 usage between ECC2 and ESC3 was 891 lbm which included 790 lbm of LH2 boiloff and an aggregate of 101 lbm LH2 used for second burn thrust decay, O2-H2 burner operation, recirculation chilldown and extended fuel lead consumption.

#### 16.2.2 Propellant Residuals

Propellant residuals are normally computed at final engine cutoff by means of the residual point level sensors and the PU mass sensors. Because of the nature of the engine related malperformance, the resulting cutoff propellant levels were higher than that required to activate the LOX or LH2 level sensors.

As a result the total masses at third Engine Cutoff Command were determined solely by the PU mass sensors and consisted of 34,112 lbm LOX and 8,917 lbm LH2. The usable masses at third Engine Cutoff Command were 33,627 lbm LOX and 8,157 lbm LH2.

### 16.2.3 Total PU Volumetric Method Mass Sensor Flight Correction

Figures 16-1 and 16-2 present a comparison of the predicted and post-flight evaluation total correction to the indicated propellant mass, as determined by the PU volumetric method, for the LOX and LH2 mass sensors. The total predicted mass correction is the sum of the predicted effects due to CG offset, changing tank shape inflight, volumetric tank-to-sensor mismatch, and the difference in preflight flow integral and volumetric calibration slopes.

### 16.2.4 PU Nonlinearity Analysis

The LOX and LH2 mass sensor nonlinearities as determined by the flow integral method is presented in figures 16-3 and 16-4. The flow integral actual data are smoothed nonlinearities from the flight flow integral analysis which include inflight dynamics effect.

### 16.3 PU System Response

Since the system was flown open loop, there were no cutback dispersions experienced. Similarly, there were no PU system induced thrust variations at any time during engine burn as a result of operating in an open loop fashion.

As a result of an S-II PU valve slew test problem during the 503 CDDT the S-II and S-IVB PU electronics assembly have been adjusted on 504 and subs. This adjustment allows maximum torque voltage to move the PU valve from the high or low stop to the null position however, this is done at the expense of the available torque voltage around null. As a result if a PU valve has a high breakaway torque characteristic the valve may be expected to exhibit minor difficulty in achieving null.

During the second and third burn operation the PU valve responded correctly to the Hardover Off Command in shifting from low EMR to null, displayed a typical overshoot and then displayed a 1/2 deg offset from the desired null position. This offset gradually decreased with time.

It is concluded the offset observed on 504 was the result of the re-adjusted PU electronics assembly operating in conjunction with a valve

that has a high breakaway torque. The PU valves on 505 and 506 have been measured and found to exhibit very low breakaway torque characteristics, therefore it is not anticipated the 504 valve position non-conformity will repeat on AS-505 or AS-506.

Figure 16-5 presents the PU valve position history. The small overshoot noted when the valve returns to null during second and third burn is nominal for this type of operation of the PU ratio valve.

#### 16.4 Anomalies

No PU system anomalies occurred during the S-IVB-504 flight.

TABLE  
PROPELLANT

EVENT		PREDICTED MASS	PU INDICATED MASS	PU INDICATED MASS (CORRECTED)	PU VOLUMETRIC MASS	FLOW INTEGRAL MASS	BL ESTIMATE
Liftoff	LOX	188,906	189,099	189,204	189,659	189,900	189
	LH2	43,500	43,462	43,522	43,807	43,538	43
	Total	232,406	232,561	232,726	233,466	233,430	233
First Engine Start Command (ESC1)	LOX	188,906	188,984	189,089	189,654	189,900	189
	LH2	43,500	43,407	43,467	43,807	43,538	43
	Total	232,406	232,391	232,556	233,461	233,438	233
First Engine Cutoff Command (ECC1)	LOX	137,542	133,372	133,257	133,632	133,232	133
	LH2	33,985	32,810	32,870	33,135	33,071	33
	Total	171,527	166,182	166,127	166,767	166,303	166
First Burn Prop Cons (ECC1 - ESC1)	LOX	51,364	55,612	55,832	56,022	56,668	56
	LH2	9,515	10,597	10,597	10,672	10,467	10
	Total	60,879	66,209	66,429	66,694	67,135	67
Second Engine Start Command (ESC2)	LOX	137,207	133,153	132,923	133,263	132,913	132
	LH2	30,109	29,366	29,305	29,516	29,486	29
	Total	167,316	162,519	162,228	162,779	162,399	162
Second Engine Cutoff Command (ECC2)	LOX	113,469	109,345	108,930	109,295	109,257	109
	LH2	25,203	24,420	24,323	24,540	24,531	24
	Total	138,672	133,765	133,253	133,835	133,788	133
Second Burn Prop Cons	LOX	23,738	23,808	23,993	23,968	23,656	23
	LH2	4,906	4,946	4,982	4,976	4,955	4
	Total	28,644	28,754	28,975	28,944	28,611	28
Third Engine Start Command	LOX	113,208	109,197	108,772	109,117	109,005	108
	LH2	24,398	23,599	23,514	23,649	23,533	23
	Total	137,606	132,796	132,286	132,766	132,538	132
Third Engine Cutoff Command	LOX	18,315	34,822	33,877	34,112	34,112	34
	LH2	4,488	9,247	8,950	8,917	8,917	8
	Total	22,803	44,069	42,827	43,029	43,029	42
Third Burn Prop Cons	LOX	94,893	74,375	74,895	75,005	74,893	74
	LH2	19,959	14,352	14,564	14,732	14,616	14
	Total	114,852	88,727	89,459	99,737	89,509	89

FOLDOUT FRAME



TABLE 16-1  
PROPELLANT MASS HISTORY

FLOW INTEGRAL MASS	BEST ESTIMATE MASS	DEVIATION FROM BEST ESTIMATE MASS				
		PREDICTION	PU INDICATED	PU INDICATED (CORRECTED)	PU VOLUMETRIC	FLOW INTEGRAL
189,900	189,745	-839 (0.44%)	-646 (0.34%)	-541 (0.29%)	-86 (0.05%)	+155 (0.08%)
43,538	43,650	-150 (0.34%)	-188 (0.43%)	-128 (0.29%)	+157 (0.36%)	-112 (0.26%)
233,430	233,395	-989 (0.42%)	-834 (0.36%)	-669 (0.29%)	+71 (0.03%)	+43 (0.02%)
189,900	189,745	-839 (0.44%)	-761 (0.40%)	-656 (0.35%)	-91 (0.05%)	+155 (0.08%)
43,538	43,650	-150 (0.34%)	-243 (0.56%)	-183 (0.42%)	+157 (0.36%)	-112 (0.26%)
233,438	233,395	-989 (0.42%)	-1,004 (0.43%)	-839 (0.36%)	+66 (0.03%)	+43 (0.02%)
133,232	133,362	+4,180 (2.20%)	+10 (0.01%)	-105 (0.06%)	+270 (0.14%)	-130 (0.07%)
33,071	33,018	+967 (2.22%)	-208 (0.48%)	-148 (0.34%)	+117 (0.26%)	+53 (0.12%)
166,513	166,380	+5,147 (2.21%)	-198 (0.08%)	-253 (0.11%)	+387 (0.17%)	-77 (0.03%)
56,668	56,383	-5,019 (2.65%)	-771 (0.41%)	-551 (0.29%)	-361 (0.19%)	+285 (0.15%)
10,467	10,632	-1,117 (2.56%)	-35 (0.08%)	-35 (0.08%)	+40 (0.09%)	-165 (0.38%)
67,135	67,015	-6,136 (2.63%)	-806 (0.35%)	-586 (0.25%)	-321 (0.14%)	+120 (0.05%)
132,913	132,960	+4,247 (2.24%)	+193 (0.10%)	-37 (0.02%)	+303 (0.16%)	-47 (0.02%)
29,486	29,418	+691 (1.58%)	-52 (0.12%)	-113 (0.05%)	+98 (0.22%)	+68 (0.16%)
162,399	162,378	+4,938 (2.12%)	+141 (0.06%)	-150 (0.06%)	+401 (0.17%)	+21 (0.01%)
109,257	109,250	+4,219 (2.22%)	+95 (0.05%)	-320 (0.17%)	+45 (0.02%)	+7 (0.0%)
24,531	24,485	+718 (1.64%)	-65 (0.15%)	-162 (0.37%)	+55 (0.13%)	+46 (0.11%)
133,788	133,735	+4,937 (2.12%)	+30 (0.01%)	-482 (0.21%)	+100 (0.04%)	+53 (0.02%)
23,656	23,710	+28 (0.01%)	+98 (0.05%)	+283 (0.15%)	+258 (0.14%)	-54 (0.03%)
4,955	4,933	-27 (0.06%)	+13 (0.03%)	+49 (0.11%)	+43 (0.10%)	+22 (0.05%)
28,611	28,643	+1 (0.00%)	+111 (0.05%)	+332 (0.14%)	+301 (0.13%)	-32 (0.01%)
109,005	108,953	+4,255 (2.24%)	+244 (0.13%)	-181 (0.10%)	+164 (0.09%)	+52 (0.03%)
23,533	23,563	+835 (1.91%)	+36 (0.08%)	-49 (0.11%)	+86 (0.20%)	-30 (0.07%)
132,538	132,516	+5,090 (2.18%)	+280 (0.12%)	-230 (0.10%)	+250 (0.11%)	+22 (0.01%)
34,112	34,029	-15,714 (8.28%)	+793 (0.42%)	-152 (0.08%)	+83 (0.04%)	+83 (0.04%)
8,917	8,927	-4,439 (10.17%)	+320 (0.73%)	+23 (0.05%)	-10 (0.02%)	-10 (0.02%)
43,029	42,956	-20,153 (8.64%)	+1,113 (0.48%)	-129 (0.06%)	+73 (0.03%)	+73 (0.03%)
74,893	74,924	+19,969 (10.52%)	-549 (0.29%)	-29 (0.02%)	+81 (0.04%)	-31 (0.02%)
14,616	14,636	+5,323 (12.19%)	-284 (0.65%)	-72 (0.16%)	+96 (0.22%)	-20 (0.05%)
89,509	89,560	+25,292 (10.84%)	-833 (0.36%)	-101 (0.04%)	+177 (0.08%)	-51 (0.02%)

FOUR POINT FRAME 2

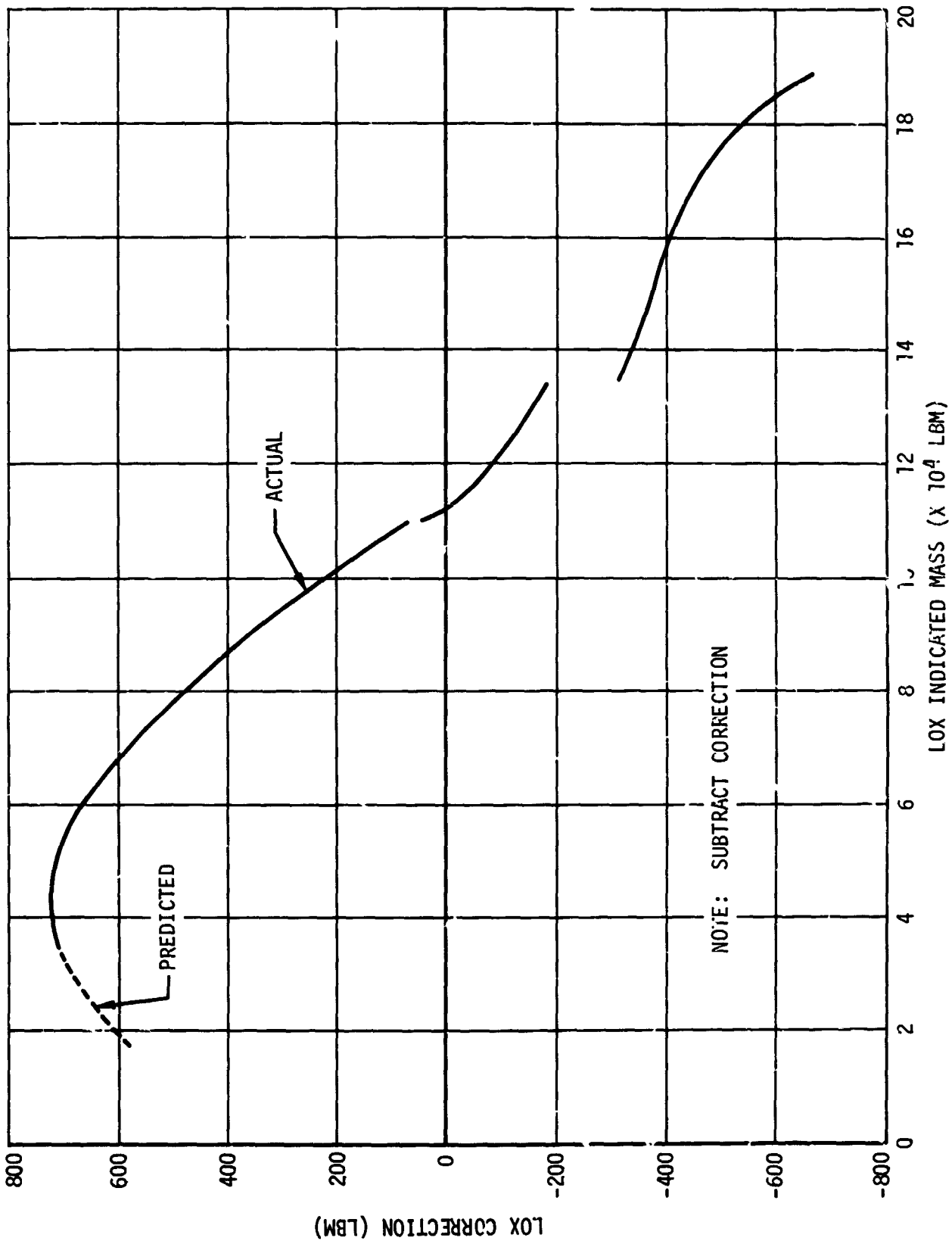

Figure 16-1. LOX S-IVB-504H Stage Total Volumetric Flight PU Mass Correction

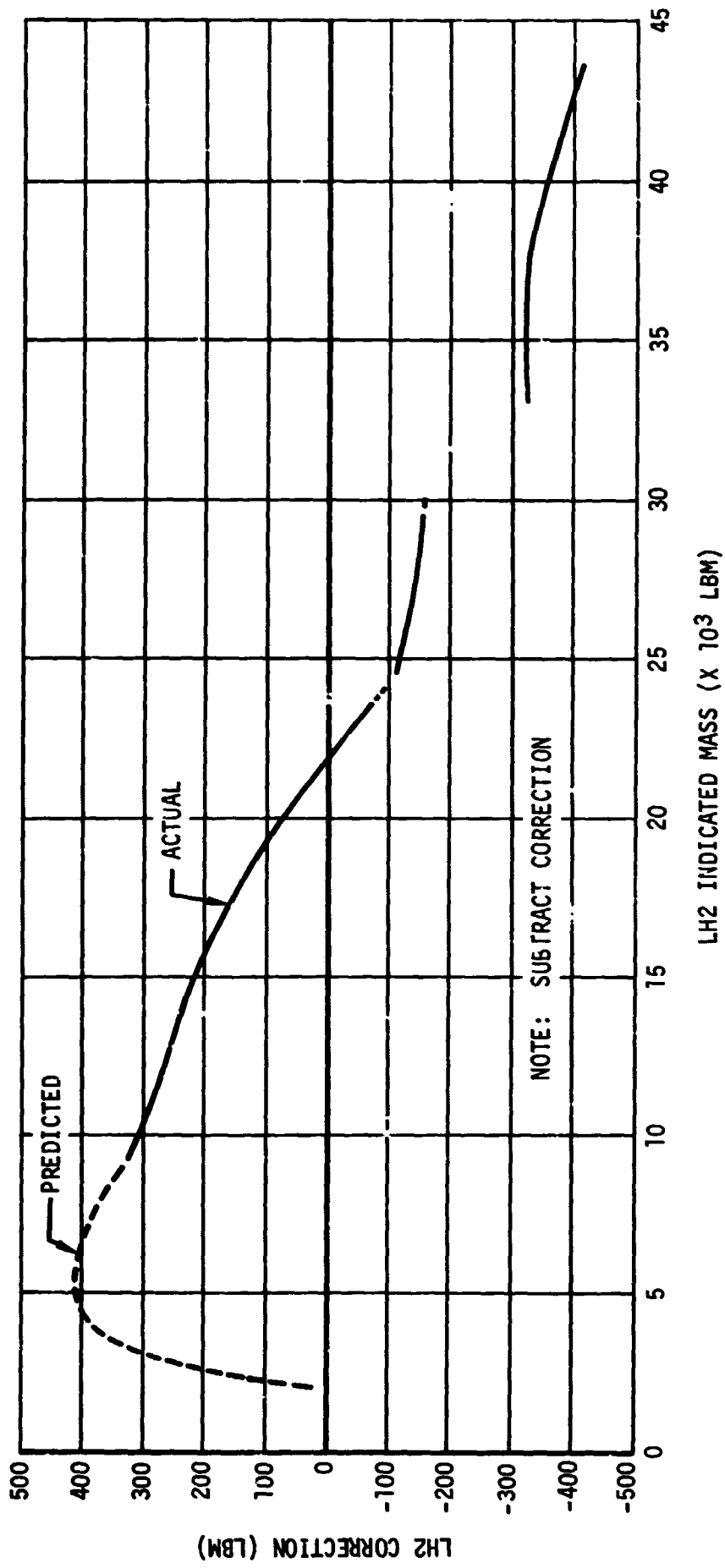

Figure 16-2. LH2 S-IVB-504N Stage Total Volumetric Flight PU Mass Correction

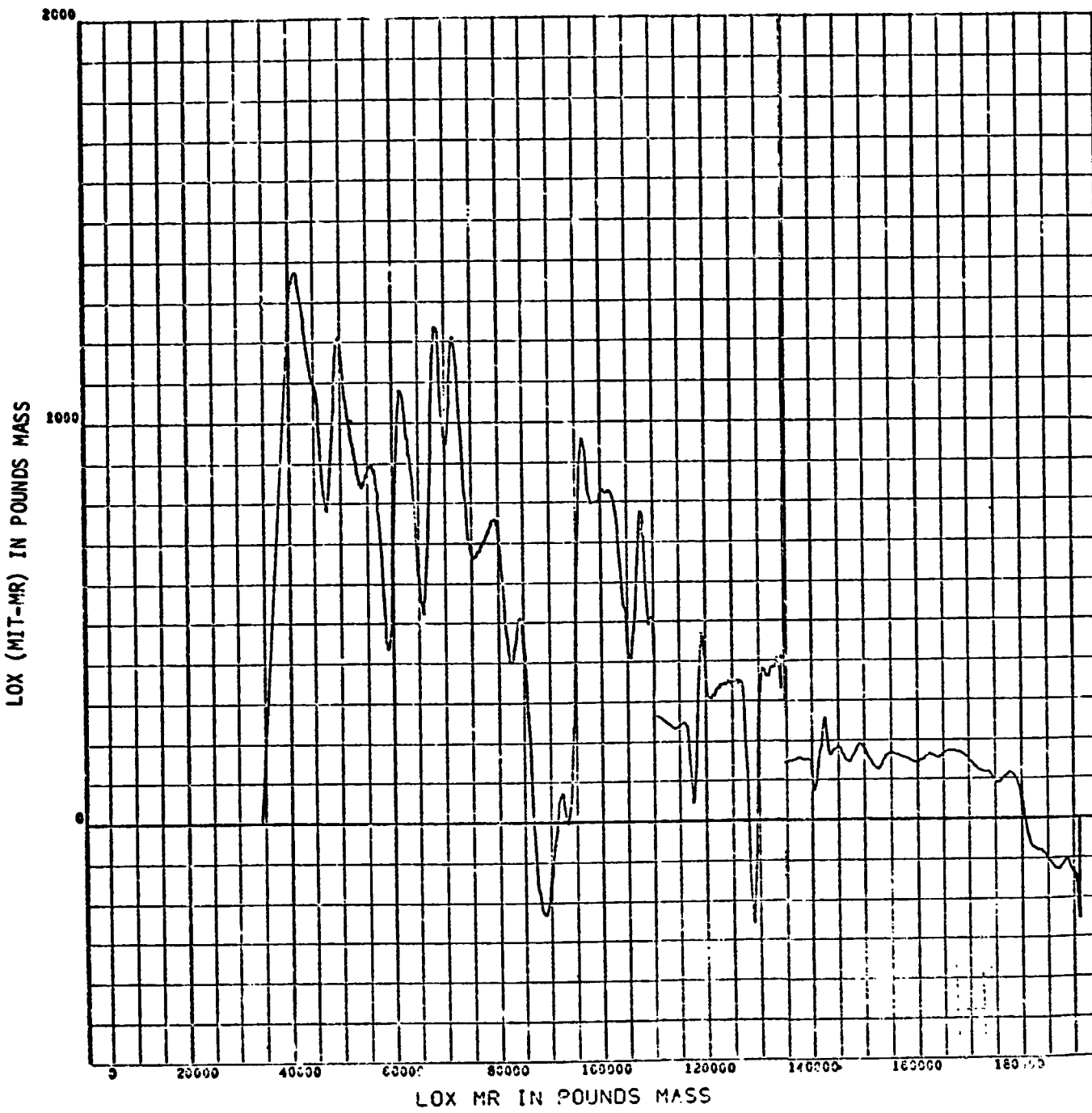

Figure 16-3. LOX Mass Sensor Nonlinearity  
(Flow Integral Method)

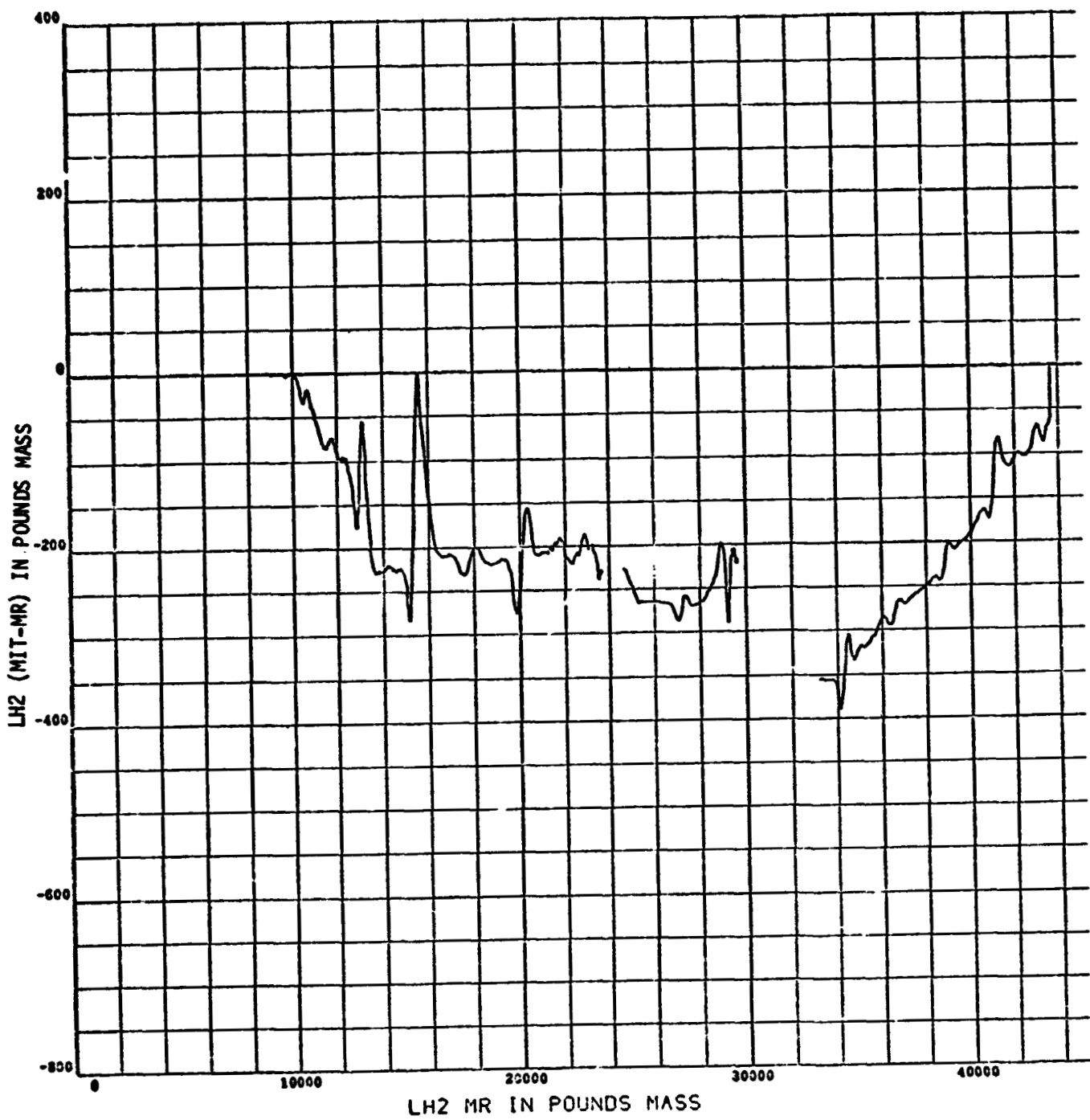

Figure 16-4. LH2 Mass Sensor Nonlinearity (Flow Integral Method)

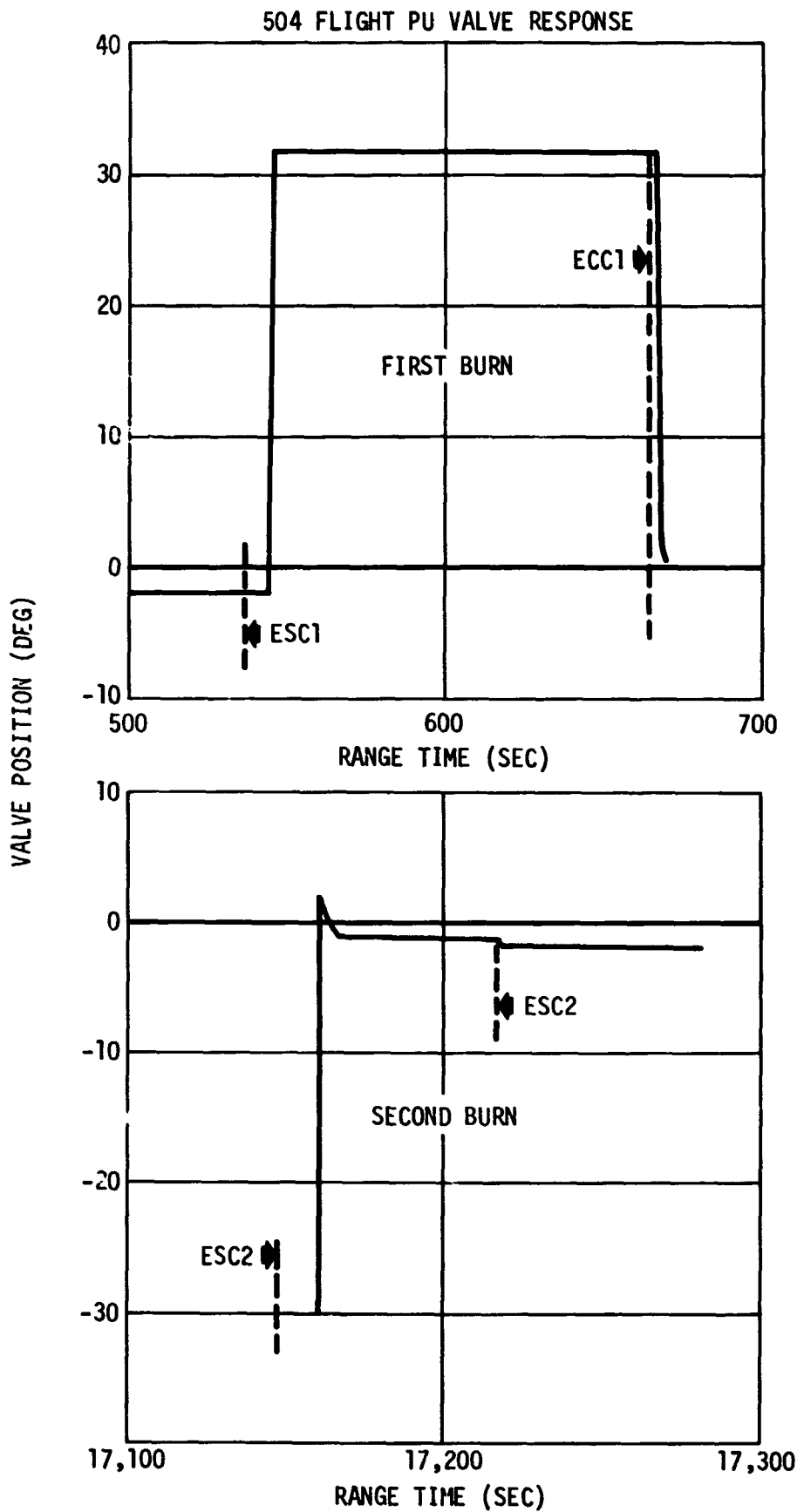
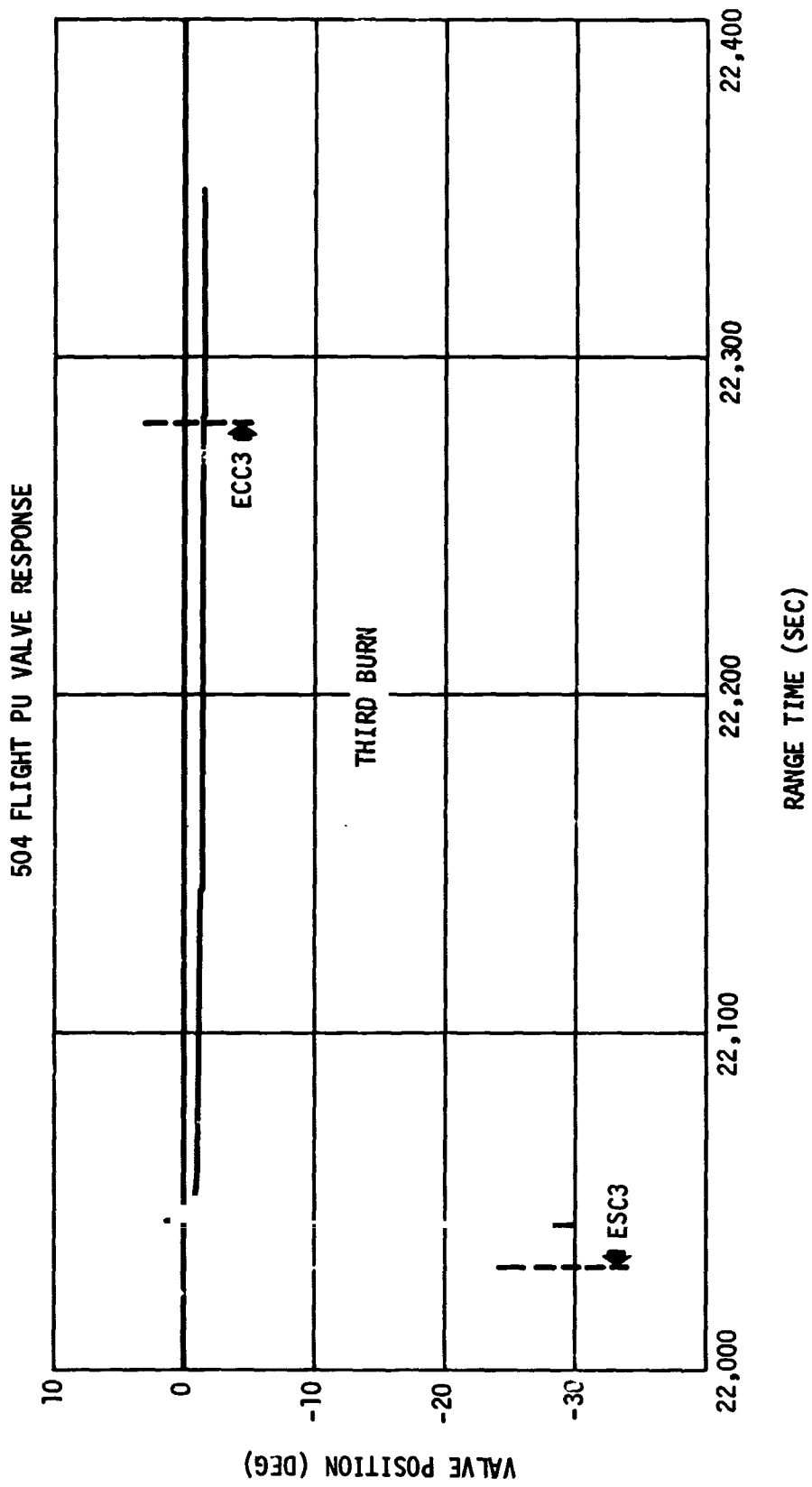

Figure 16-5. PU Valve Position History (Sheet 1 of 2)



**Figure 16-5 PU Valve Position History (Sheet 2 of 2)**

## 17. S-II/S-IVB STAGE SEPARATION

### 17.1 S-II/S-IVB Separation Dynamics

The analysis of separation dynamics was done by comparing the data from the AS-504 flight to that of AS-503 and AS-501. Since the data compared very closely, detailed reconstruction was not performed to determine precisely the lateral clearance used and the separation completion time. From the comparative analysis performed it can be estimated that a detailed reconstruction would yield a separation completion time of approximately 1.0 sec and a lateral clearance utilization of less than 5 in.

Table 17-1 contains significant times and events for the S-II/S-IVB separation.

Figure 17-1 shows the longitudinal accelerometer data for the S-II and S-IVB stages. The S-II stage showed a low tailoff thrust level and a light stage weight. The angular rates for both the S-II and S-IVB stages are presented in figure 17-2. The S-IVB rates were all small with pitch and yaw rates less the +0.2 deg/sec.



TABLE 17-1

## AS-504 SEPARATION EVENTS

	AS-504		AS-501	AS-502	AS-503
	S-II Engine Cutoff	536.25	-0.92?	-0.77	-0.766
S-IVB Ullage Rocket Ignition	537.080	-0.096	-0.091	-0.12	-0.119
Separation Command	537.18	0	0	0	0
S-II Retrorocket Ignition	537.166	0	0	0	0
First Axial Motion			0.052	0.049	
S-IVB Engine Start Command	537.27	0.092	0.189	0.192	0.096
Separation Complete			1.044	.99	

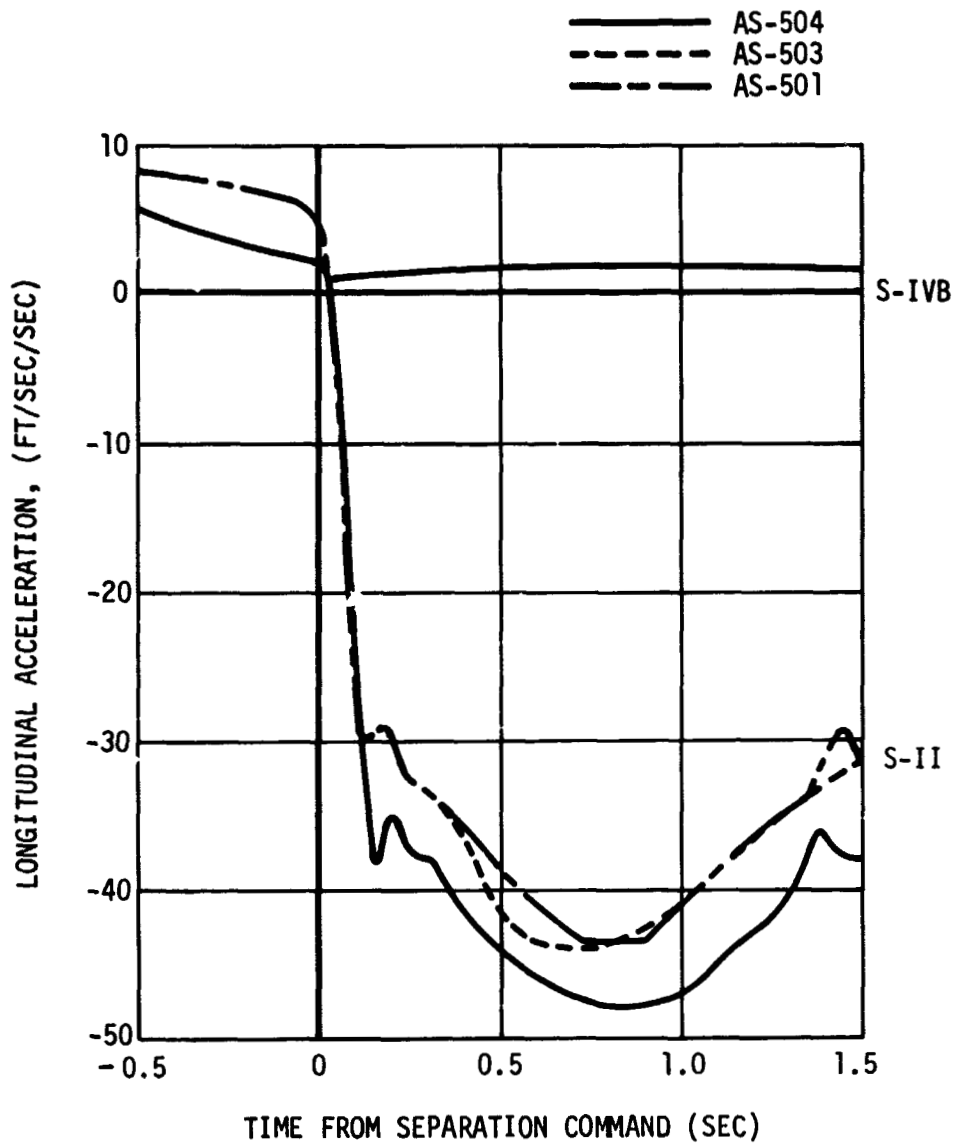

Figure 17-1. Longitudinal Acceleration

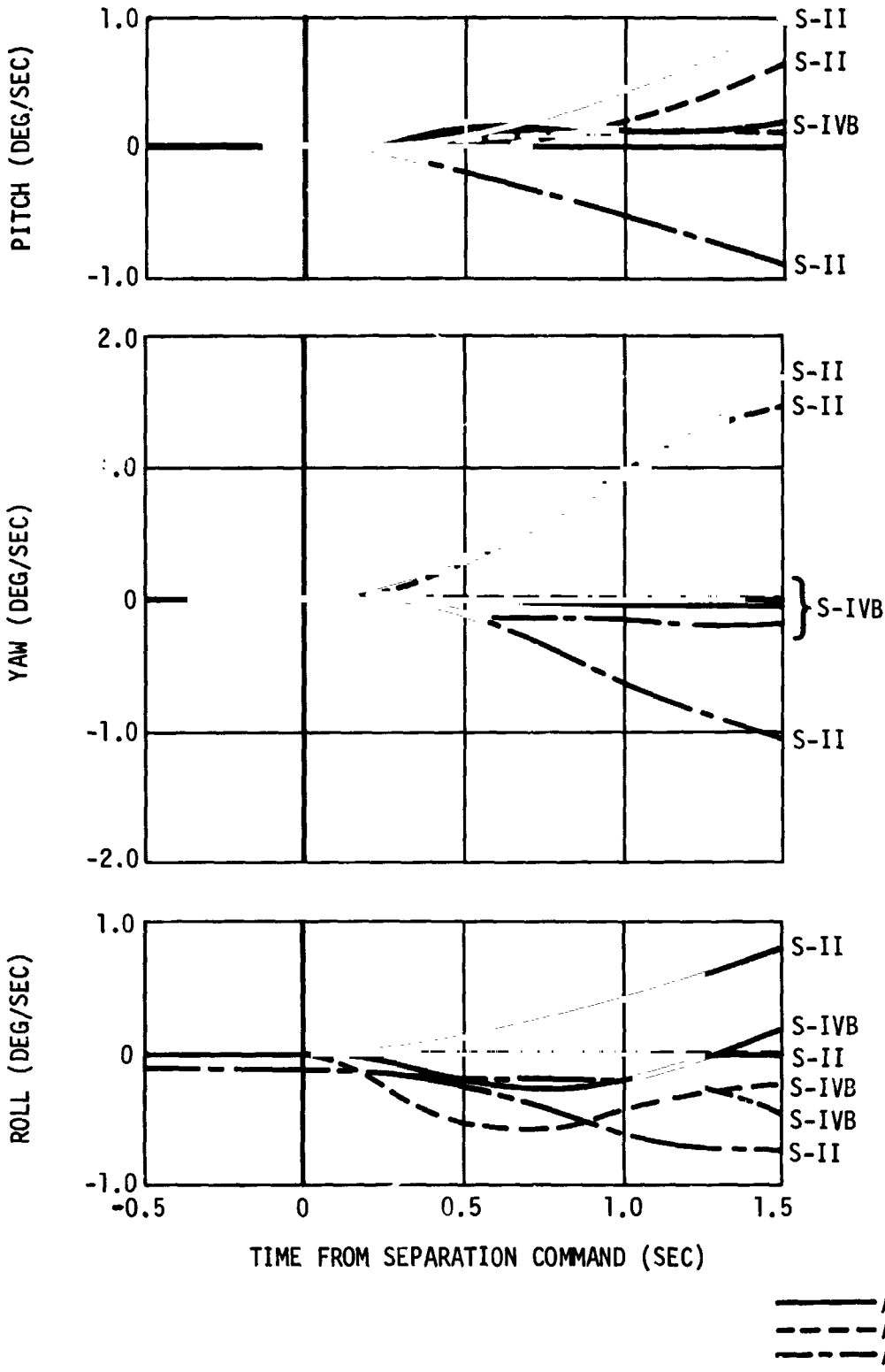

Figure 17-2. Angular Velocity

## 18. DATA ACQUISITION SYSTEM

### 18.1 Data Acquisition System Objective

The objective of the data acquisition system was to gather information describing stage environments and the performance of stage system. The measurements so utilized are specified in the Instrumentation Program and Components List (MDAC-WD Drawing 1B43570, "AK" change). The information acquired from the measurements was converted into a telemetry format, transmitted to ground stations located throughout the flight path, and recorded on magnetic tape.

The data reduced and processed from the recorded magnetic tape was evaluated to requirements specified in the Instrumentation Program and Components List. The evaluation period was from the start of automatic sequence to the loss of telemetry data. The incentive areas of data acquisition system evaluation are defined as Phase I and Phase II. Phase I encompasses liftoff to S-IVB Engine Cutoff Command (ECC) plus 10 sec, and Phase II includes Phase I and the time period from S-IVB ECC plus 10 sec to S-IVB/Lunar Module separation. The nonincentive phase of flight test is subsequent to S-IVB/Lunar Module separation and encompasses the second and third burns.

### 18.2 Summary of Performance

The performance of the data acquisition system was very good throughout the S-IVB stage flight mission. Measurement data from the PCM subsystem was reduced without difficulty. The system performed as designed and there were no system malfunctions. Summarization of the evaluations for Phases I and II is presented below:

Total Measurements Assigned	299
Checkout Only Measurements	7
Landline Measurements	3
Measurements inoperative due to stage configuration	1
Measurements deleted prior to start of automatic launch sequence	3

Total Active Measurements	285
Phase I Measurement Failures	2
Phase II Measurement Failures	2
Phase I Measurement Efficiency	99.3%
Phase II Measurement Efficiency	99.3%
Failures After Phase II	12
Measurement Anomalies	15

A detailed measurement flight status is presented in table 18-1.

### 18.3 Instrumentation System Performance

The performance of the S-IVB-504N instrumentation system was good throughout the flight evaluation period. Two measurements were considered as Phase I evaluation period failures. No additional measurements failed during the Phase II evaluation period. Twelve measurements failed during the post payload separation period, most of which failed during third burn. Table 18-2 discusses those measurements deleted from CPIF consideration. Table 18-3 elaborates each measurement failure. Measurements which were not failures, but considered as anomalies, are covered in table 18-4.

The Remote Automatic Calibration System (RACS) calibration levels were evaluated at RO -1,144 sec. All measurements were within system tolerances.

### 18.4 Telemetry System Performance

The airborne S-IVB telemetry system was composed of one PCM subsystem. Performance of the telemetry system was satisfactory throughout the flight.

#### 18.4.1 Pulse Code Modulation Subsystem

Both the CP1B0 and the DP1B0 model 270 multiplexers were properly synchronized to their respective PCM/DDAS assembly. The PCM wave train was properly serialized and sync words properly coded. Analog-to-digital conversion was uniform throughout the life of the stage.

The evaluation of the PCM system in-flight calibration verified all channels were within system tolerances.

#### 18.4.2 Calibration Subsystem

The Remote Automatic Calibration System (RACS), used for instrumentation system evaluation, was exercised at 1540:56 GMT, (RO -1,144 sec). High mode, low mode, and return to run mode were initiated at 1540:56, 1541:17, and 1541:37 GMT, respectively. Calibration levels were verified on all channels having RACS calibration capabilities.

The PCM system in-flight programmed and non-programmed calibration commands were received by the PCM/DDAS assembly.

#### 18.4.3 Radio Frequency Subsystem

The performance of the RF subsystem is presented in table 18-5. RF black-out due to flame attenuation was observed during S-IC/S-II separation for a period of approximately one second of MILA data. No loss of data was noted during S-II/S-IVB separation.

The data from the S-IVB RF link was noted at threshold at RO +29,020 sec. At that time, the altitude of the stage was approximately 14100 NM above the local horizontal.

The DP1 PCM data passes through the Instrument Unit (IU) and is transmitted on VHF as well as on S-Band. Data has been reviewed through RO +48,100 sec from the Goldstone ground station on the S-Band data link. Loss of Instrument Unit (IU) S-Band data was observed to occur at RO +48,100 sec.

#### 18.4.4 Signal Strength

Five actual signal strength plots from telemetry ground stations were available and reviewed. These plots are as follows:

1. TEL-4 Right Hand Circular Polarized (RHCP) (figure 18-1)
2. Grand Bahama Island RHCP (figure 18-2)
3. Grand Bahama Island LHCP (figure 18-3)
4. Texas RHCP (figure 18-4)
5. Texas LHCP (figure 18-5).

The TEL-4 RHCP actual signal was generally as predicted during the launch phase except at the start and at the end of the pass. During this time the actual signal was up to 20db higher than predicted. The Grand Bahama Island actual signal strength received during the launch phase for both RHCP and LHCP signal was from 15 to 20db higher than predicted. The actual signal strength measured at Texas during the second burn was 8db to 30db lower than predicted with degraded data indicated at approximately 16717 and 16750 sec and data dropout at approximately 16880 sec. The discrepancy between the predicted and actual T/M signal strength may be due to a lack of understanding of the calibration and operating procedures used at the tracking stations.

Meaningful comparisons of predicted and actual range safety RF signal strength cannot be made, due to the non existence of received signal strength data as is available from tracking stations for telemetry links. The stage range safety receivers do however have a low level signal strength indication on T/M (N0057-411 Misc-Secure R/S Receiver 1 Low Level Sig Strength, N0062-411 Misc-Secure R/S Receiver 2 Low Level Sig Strength). These measurements have a very limited dynamic range and are uncalibrated. They can be used for indications of complete or nearly complete loss of signal. One complete loss of signal was observed on N0057-411 and N0062-411 at RJ +161 sec due to ground transmitter antenna change over from the omni directional antenna to the quad helix. The transmitter power is interrupted for 300-500 ms while this switchover takes place.

#### 18.4.5 Electromagnetic Compatibility

A review of S-IVB-504M telemetry flight data revealed no significant data degradation due to EMI except for measurement K0005-401, Event - Mainstage Control Solenoid Energized.

This event measurement cycled many times at engine start during the periods when the engine spark igniters were ON. Similar erroneous cyclings were observed during checkout at KSC. Tests were conducted at Huntington Beach VCL on 510 stage and at KSC on the 504 stage to determine if a possible J-2 engine problem existed. The tests indicated the cyclings were not an

engine control problem; the problem was the measurement system was susceptible to EMI during engine sparks activity.

Additionally, flight data from S-IVB-503 had revealed approximately 2 percent chillover inverter noise on measurements D0001-401, Press - Thrust Chamber; D0010-401, Press - Gas Generator Chamber; D0011-401, Press - Gas Generator Fuel Inj; D0012-401, Press - Gas Generator Oxid Inj. and 3 percent chillover inverter noise on M0069-404, Volt - Aft TM Full Scale Ref. Measurements D0001, D0010 and M0069 showed no discernible noise due to chillover inverter operation on 504. (D0011-401 and D0012-401 are not 504 measurements). This is attributed to the effectiveness of ECP 2763 R1 in reducing or eliminating chillover inverter noise.



TABLE 18-1 (Sheet 1 of 3)

MEASUREMENT STATUS

<u>Measurements Assigned by IPCL (MDAC-WD Dwg 1B43570, "AK" Change)</u>		299
<u>Checkout Only Measurements</u>		7
K0141-411	Event - R/S 1 Pulse Sensor	
K0142-411	Event - R/S 2 Pulse Sensor	
K0149-404	Event - Ullage Jettison 1 P/S	
K0150-404	Event - Ullage Jettison 2 P/S	
K0169-404	Event - EBW Pulse Sensor OFF Ind	
K0176-404	Event - Ullage Rkt Ign P/S 1 Ind	
K0177-404	Event - Ullage Rkt Ign P/S 2 Ind	
<u>Landline Measurements</u>		3
D0545-407	Press - Common Bulkhead Int - H/W	
D0576-408	Press - Fuel Tank Ullage Umb - H/W	
D0577-406	Press - Oxid Tank Ullage Umb - H/W	
<u>Measurements Inoperative Due to Stage Configuration</u>		1
K0152-404	Event - Rate Gyro Wheel Speed OK Indication	
<u>Measurements Deleted Prior to Start of Automatic Launch Sequence</u>		3
C0001-401*	Temp - LH2 Turbine Inlet	
C0007-401	Temp - Engine Control Helium	
C0159-424*	Temp - LOX Circ Rtn Line Tank Inlet	
*Although Deleted from CPIF, measurement provided valid data.		
<u>Total Active Measurements</u>		285

TABLE 18-1 (Sheet 2 of 3)

MEASUREMENT STATUS

<u>Phase I Failures</u>	2
C0133-401      Temp - LOX Pump Discharge	
K0005-401      Event - Mainstage Control Solenoid	
 <u>Phase II Failures</u>	 2
(Same as Phase I)	
 <u>Phase I Measurement Efficiency</u>	 99.3%
 <u>Phase II Measurement Efficiency</u>	 99.3%
 <u>Failures after Phase II</u>	 12
C0010-403    Temp - Engine Area Ambient	
C0199-401    Temp - Thrust Chamber Jacket	
C0200-401    Temp - LH2 Injection	
C0392-403    Temp Burner Support, Location 2	
C2015-401    Temp - Crossover Duct Ext Wall 1	
C2016-401    Temp - Crossover Duct Ext Wall 2	
D0003-403    Press - LOX Pump Inlet	
D0104-403    Press - LH2 Press Module Inlet	
G0003-401    Posit - Main Oxidizer Valve	
G0004-401    Posit - Main Fuel Valve	
K0157-401    Event - Mainstage OK Press Sw 2	
K0159-401    Event - Mainstage OK Press Sw 2 Depress	
 <u>Measurement Anomalies</u>	 15
C0005-405    Temp - Cold Helium Sphere No. 3 Gas	
C0208-405    Temp - Cold Helium Sphere No. 1 Gas	
D0002-403    Press - Fuel Pump Inlet	
D0071-414    Press - Oxidizer Supply Manifold Mod 1 (APS)	

TABLE 18-1 (Sheet 3 of 3)

MEASUREMENT STATUS

Measurement Anomalies (Continued)

D0073-414 Press - Oxidizer Supply Manifold Mod 2 (APS)  
D0088-403 Press - Ambient Helium Pneumatic Sphere  
K0014-401 Event - Mainstage OK Press Sw 1  
K0020-401 Event - ASI LOX Valve Open  
M0024-411 Volt - 5 Volt Excitation Module, Forward 1  
M0024-411 Volt - 5 Volt Excitation Module, Aft  
M0068-411 Volt - 5 Volt Excitation Module, Forward 2  
N0018-411 Misc - PCM/FM Transmitter Output Power  
N0055-411 Misc - T/M RF System Reflected Power  
T0001-401 Speed - LOX Pump

TABLE 18-2

DELETED MEASUREMENTS

C0001-401 Temp - LH2 Turbine Inlet

The measurement presented valid data throughout the flight. During CDDT, an erratic behavior was observed. The engine interface connector was cleaned; the transducer was not replaced. Since the data was off-scale-low during launch countdown, and with no assurance the CDDT behavior would not repeat itself, the measurement was deleted from the flight active list.

C0007-401 Temp - Engine Control Helium

This measurement was erratic on CDDT. The same procedure as measurement C1 was used to eliminate the problem; however, it was deleted due to lack of measurement confidence. C7 uses the same interface connector as C1; therefore, a common problem was suspected.

The flight data indicated noise from R0 -520 sec to S-IVB engine start, apparently the reoccurrence of the CDDT problem. Subsequent to first engine start, the data appears usable.

The possible malfunction was attributed to contamination of the interface connector appearing as a short circuit temperature probe.

C0159-424 Temp - LOX Circ Return Lin. Tank Inlet

The measurement was deleted from the active measurement list prior to liftoff. However, the data evaluated during the engine burn periods were considered valid. The measurement performance compared favorably with S-IVB-503 flight for both first and second engine burn. No degradation of the measurement was noted during the third burn or subsequent to it. Although the measurement was deleted from the incentive list, it provided useful data throughout flight.

TABLE 18-3 (Sheet 1 of 6)

MEASUREMENT FAILURES

PHASE I FAILURES

C0133-401 Temp - LOX Pump Discharge

The measurement was erratic from LOX pressurization (RO -280) to first engine start (RO +537). At engine start, the measurement decreased to off-scale-low instead of indicating normal temperature increase. This condition persisted to engine cutoff. Second burn data appears normal; however, third burn data was questionable.

The malfunction was attributed to the engine interface connector. During CDDT, the measurement was erratic. The transducer was replaced; however, the problem still existed during the launch period. The problem may either be a shunt impedance of the sensor or a high ohmic contact resistance of the sensor electrical common line.

K0005-401 Event - Mainstage Control Solenoid Energized

The event measurement cycled many times at engine start during the periods when the engine spark igniters were ON. Similar erroneous cyclings were observed during checkout at KSC. Tests were conducted at Huntington Beach VCL on 510 stage and at KSC on the 504 stage to determine if a possible J-2 engine problem existed. The tests indicated the cyclings were not an engine control problem; the problem was that the measurement system was susceptible to EMI during engine sparks activity.

MEASUREMENT FAILURES AFTER PHASE II

C0010-403 Temp - Engine Area Ambient

The measurement failed at RO +22050 sec, eleven seconds after third burn engine ignition, indicating a rapid rise of temperature in an erratic manner. The response appears as a real temperature rise, but since the magnitude of temperature increase was not possible at that particular time, it was deemed an instrumentation malfunction. A possible failure mode is an ohmic open circuit of the sensor circuitry induced by engine vibration.

TABLE 18-3 (Sheet 2 of 6)

MEASUREMENT FAILURES

The process of failure may have started 10 sec prior to RO +22,050 sec when the data indicated a temperature decrease. At the present time, this response is unexplained. The data then started increasing at RO +22,050 sec until an off-scale indication was initially attained nine seconds later. Due to the erratic nature of the data, a constant off-scale-high state was not attained until 14 sec after the initial temperature rise.

C0199-401 Temp - Thrust Chamber Jacket

The measurement failed at RO +22,148 sec, approximately 109 sec after third burn engine ignition. The sensor malfunctioned in the open circuit mode. The failure was probably the result of a damaged surface sensing probe which was brought about by the prolonged rapid engine oscillation.

The data also exhibited erratic information from prepressurization to shortly after liftoff, and at the max Q area. This type of response was also observed on CDDT and the transducer was replaced. A possible interface connector problem was suspected during CDDT and the connector was cleaned. However, the flight failure could be caused by discontinuity at the interface connector.

C0200-401 Temp - LH2 Injection

The measurement failed at RO +22,041 sec, approximately at the time of third engine ignition, by abruptly increasing to off-scale high. The failure appears as an open circuit sensor; however, a remote possibility is open circuitry in the sensor line due to connector problems. The failure was probably the result of a "hard" start condition.

C0392-403 Temp - Burner Support, Location 2

The measurement initially failed in an off-scale-high mode at approximately RO +18,100 sec, 900 sec after second burn cutoff. The failure was probably the result of thermal stresses in the bonding material causing a fracture of

TABLE 18-3 (Sheet 3 of 6)

MEASUREMENT FAILURES

sensor electrical continuity. The temperature patch appears to be temperature sensitive in the region of 700°R, as shown by the following:

- 1) Initial failure (RO +18,100) occurred at 665°R on a cooling trend.
- 2) Fifty seconds after engine ignition (RO +22,090), valid data was indicated at 698°R on a warming trend.
- 3) Finally at 710°R (RO +22,890), the data failed in the off-scale-high mode, on a cooling trend. The data remained off-scale-high, as the temperature did not again rise above 700°R.

C2015-401 Temp - Crossover Duct Ext Wall 1

C2016-401 Temp - Crossover Duct Ext Wall 2

The temperature increase indicated during second and third burn was far below the expected values. A debonding of the sensors from the duct surface was the probable malfunction. The time of malfunction occurred between first burn cutoff and second burn engine start. These patch-type sensors are bonded to the duct on the LOX turbine side and are four inches apart on the same cross-sectional plane. They are cemented and then held in place with metal straps spot-welded to the duct. The debonding probably occurred due to dissimilar expansion rates between the bonding material and the duct.

D0003-403 Press - LOX Pump Inlet

The measurement showed a drop in pressure from 43 psia to 10 psia at RO +22,069 sec, 30 sec after third burn engine ignition. The data indicates off-scale-low at engine cutoff which occurs at RO +22,281 sec.

The measurement utilizes a potentiometer-type pressure transducer which is located at the input to the oxidizer pump. Damage to the transducer wiper arm is suspected as a result of unusual engine vibrations, based upon the yaw actuator performance, during the above mentioned time period. This possibility is also supported by the high peak-to-peak data variations during the time period.

TAB<sup>L</sup>E 18-3 (Sheet 4 of 6)

MEASUREMENT FAILURES

D0104-403 Press - LH2 Press Module Inlet

The measurement indicated an abrupt shift in data level from 450 psia to off-scale-high at RO +22,237 sec during the third burn period. The transducer is a split-package, strain gage type instrumentation system and an open circuit in the bridge circuitry is suspected. The transducer was located on the thrust structure area where engine vibrations during the third burn was believed a contributing factor to the measurements deterioration. No significant events were occurring at that time which could have adversely affected the transducer, although the related temperature measurements C0015-410 (fuel tank GH2 inlet) and C0231-403 (fuel tank press cont mod GH2) did show unusual temperature changes. This measurement failure is considered random

G0003-401 Posit - Main Oxidizer Valve

The measurement was erratic during the third burn period between RO +22,040 and RO +22,282 sec. A critical evaluation of the data indicated that the measurement started to decrease from its full-open position of 97 percent to a partially closed position of 90 percent at RO +22,057 sec. At RO +22,101 sec the measurement indicated 83 percent and began exhibiting erratic peak-to-peak perturbations until engine cutoff at RO +22,281 sec. Indications as low as 50 percent valve open were observed during this period. The corresponding event measurement, K0120-401 (event-main LOX valve open), did not reflect any indications of the valve going closed. Both measurements, G0003-401 and K0120-401, are in the same transducer package and coupled together and are expected to operate in unison. A failure of the potentiometer wiper of measurement G0003-401 is suspected. This is substantiated by the failure of the measurement to return to its pre-engine start close position at engine cutoff. The cause of the failure is attributed to a high engine vibration environment during the third engine burn period.

G0004-401 Posit - Main Fuel Valve

The measurement was erratic during the third burn period between RO +22,040 and RO +22,282 sec. Detailed evaluation of the data revealed that the



TABLE 18-3 (Sheet 5 of 6)

MEASUREMENT FAILURES

measurement was at 100 percent open after engine start, then began exhibiting erratic position indications, dropping to as much as 70 percent open, until engine cutoff at RO +22,281 sec. Measurement K0118-401 (event-main LH2 valve open) did not indicate the valve leaving the full open position until engine cutoff. Failure analysis is the same as for G0003-401.

K0157-401 Event - Mainstage OK Press Sw 2

K0159-401 Event - Mainstage OK Press Sw 2 Depress

Measurement K0157-401 started cycling at RO +22,103.025 sec and continued to cycle randomly until RO +22,107.774 sec when a steady Off state occurred. The Off state remained throughout the rest of the burn except for one cycle at RO +22,138.688 sec. This cycle was for only one sample period and is not considered valid data.

Measurement K0159-401 began cycling erratically at RO +22,083.859 sec and continued to cycle until RO +22,100.608 sec. At this time the event was on and remained ON until RO +22,107.607 sec when it went off. It remained off throughout the rest of the burn. The measurement was expected to go to the on state at engine cutoff but did not change state.

The pressurized (K0157-401) and depressurized (K0159-401) measurements operate from the same single-pole double-throw pressure switch in one assembly. The pressurized event, which had been cycling, and the depressurized event, which had been erroneously indicating on, terminate activity at the same time that a 55 amp current spike was observed on aft bus No. 1 (RO +22,107.5 sec). Aft bus No. 1 provides power to the pressure switches as well as other control functions on the J-2 engine, such as the engine control bus. The engine control bus provides power to the switch and for the signal to the RDSM. The voltage decrease at the time of the current spike was greater at the engine control bus (4.5 V) than at aft bus No. 1 (2.5 V).

It is suspected that the measurements wiring between the Engine Control Assembly (ECA) package and the input to the Remote Digital Sub-Multiplexer (RDSM) was damaged, causing a short circuit of mainstage OK press switch 2

TABLE 18-3 (Sheet 6 of 6)

MEASUREMENT FAILURES

(K0157-401). This short circuit caused the high current spike which in turn fused the pressure switch contacts in the pressurized condition. The high current surge also failed open the isolation diode in the signal output line in the ECA package, preventing the pressurized signal from reaching the RDSM. The fused contacts will prevent the depressurized event from coming on at engine cutoff.

The cycling of the pressure switches is believed to be caused by the switch contacts bouncing. This was caused by the vibration in the engine area. Other event measurements, K0014-401 event-mainstage OK press Sw 1 and K0020 event-ASI LOX valve open, exhibited the same erratic cycling. The behavior of these switches is also attributed to vibration. The possibility of a data problem at the RDSM was considered but discounted. Other event measurements not associated with the engine would have responded in an erratic manner. The mainstage pressure switch event measurements operated normally at all other times in the flight. No measurements other than those in the engine area which were subject to vibrations responded in an erratic manner. The effects of the pressure switch malfunctions on the electrical control system is contained in Section 19.2.1.

TABLE 18-4 (Sheet 1 of 4)

MEASUREMENT ANOMALIES

C0005-405 Temp - Cold Helium Sphere No. 3 Gas

C0208-405 Temp - Cold Helium Sphere No. 1 Gas

Although these measurements are considered as acceptable, they exhibited an unusual indication of temperature cycling from liftoff until S-IVB cutoff at RO +664 sec. This phenomenon has also been observed to a lesser degree on S-IVB stages 501, 502, 503N, 204 and 205. The measurement performances do not indicate an instrumentation hardware anomaly but additional study to determine the cause of the apparent temperature phenomenon will be done.

D0002-403 Press - Fuel Pump Inlet

The measurement indicated a pressure drop from 40 psia to 8 psia at liftoff on the DP1B0 multiplexer data link. The data from the CP1B0 multiplexer data link did not indicate the drop in pressure. The measurement is considered valid on the CP1B0 multiplexer data link and the data loss on the DP1B0 multiplexer data link is attributed to a multiplexer channel gating problem. The CP1B0 data compared favorably with AS-503.

D0071-414 Press - Ox Supply Manifold Mod 1 (APS)

D0073-415 Press - Ox Supply Manifold Mod 2 (APS)

These measurements exhibited noise at liftoff and Max Q. These measurements use potentiometer type pressure transducers which are known to be susceptible to a high vibration environment. Since the APS is not exercised during the boost period, no loss of data occurred. The measurements are considered valid except for the anomalous periods during boost.

D0088-403 Press - LOX Tank Repress Spheres

D0236-403 Press - Ambient Helium Pneumatic Sphere

The data exhibited spikes and negative level shifts of less than one percent at S-II/S-IVB separation. The level shifts are within tolerance and the data are acceptable for use. These measurement anomalies were due to RFI. Similar

TABLE 18-4 (Sheet 2 of 4)

MEASUREMENT ANOMALIES

problems were observed on AS-503 at S-II/S-IVB separation. Corrective action for the RFI problem has been incorporated and transducers with RFI filters will be used on S-IVB-506N and subs.

K0014-401 Event - Mainstage OK Press Switch 1

The measurement cycled once at R0 +22,103 sec. From R0 +22,106 to R0 +22,135 sec, it cycled 18 times. Several additional random cycles (8 times) were observed before engine cutoff. However, K0014-401 and its depressurized indication complement K0158-401, operated properly at engine cutoff.

The problem appears to be related to a high engine vibration environment during third burn. The cycling is attributed to bouncing of the contacts of the switch.

K0020-401 Event - ASI LOX Valve Open

The measurement exhibited frequent cycling from R0 +22,131 to R0 +22,155 sec. At R0 +22,155 sec the measurement indicated closed and remained closed for the remainder of the engine burn period.

The cycling of the measurement appears to be caused by vibration in the engine area. An analysis of the engine parameters indicates the valve left the open position at R0 +22,155 sec.

M0024-411 Volt - 5 Volt Excitation Mod - Forward 1

M0068-411 Volt - 5 Volt Excitation Mod - Forward 2

These measurements experienced a 10 mv level shift upward at liftoff. This anomaly has been encountered on previous stages and appears to be caused by a ground reference shift of signal conditioning for the measurements when the umbilicals were disconnected. Both measurements remained within tolerance throughout the flight.

TABLE 18-4 (Sheet 3 of 4)

MEASUREMENT ANOMALIES

M0025-404 Volt - 5 Volt Excitation Module, Aft

Although the measurement was in tolerance, a shift of approximately one percent, 4.970 vdc to 4.980 vdc, was observed at engine start. The shift is due to a common ground problem of the 5 volt excitation module signal conditioning and the chilldown inverters. Relocation of instrumentation ground wires was proposed with ECP 2898 but it was disapproved by the customer. The shift is an expected anomaly.

N0018-411 Misc - PCM/FM Transmitter Output Power

The measurement was drifting throughout the flight. The measurement started to increase at R0 -50 sec (power transfer internal) and went from 95 mv to 110 mv at R0 +1,400 sec. The measurement drifted between 95 mv and 115 mv several times during the flight. The maximum shift observed was 115 mv at R0 +26,200 sec.

The reflected power measurement, N0055-411, did not indicate a similar trend during this period. Therefore, it is believed that the transmitter output power remained constant during this time. The measurement was susceptible to environmental changes which were believed to occur during flight. Temperature data of the cold-plates will be analyzed to determine if environmental changes did occur.

N0055-411 Misc - T/M RF System Reflected Power Channel 1

The measurement started to fluctuate at approximately R0 +14,885 sec at S-IVB/LM separation, and stopped at R0 +14,915 sec. The maximum fluctuation was 10.7 mv and occurred at R0 +14,893 sec.

The measurement was susceptible to RFI and the anomaly occurred when RF was reflected off the LM into the forward skirt area during separation.

T0001-401 Speed - LOX Turbine

The measurement became noisy at R0 +22,072 sec, 33 sec after third engine ignition, and remained noisy until R0 +22,179 sec. The measurement was

TABLE 18-4 (Sheet 4 of 4)

MEASUREMENT ANOMALIES

noisier from RO +22,137 to RO +22,179 sec. From RO +22,179 sec until engine cutoff, the measurement performed in a normal manner with no noise present.

The noise observed on the measurement was not considered engine performance data. This was based upon observing the characteristics of the noise, analyzing the design of the measurement system, and lack of corresponding data from the LOX flowrate.

It is suspected that noise was induced between the magnetic pickup on the pump and the frequency-to-dc converter signal conditioning on the aft skirt. The noise appears primarily as positive excursions with respect to the nominal level of 7,900 rpm which suggests that spurious noise was seen as data pulses.

The probable cause would be a loose connector or a damaged signal lead shorting to the shield during high engine vibration periods.

TABLE 18-5

RF SYSTEM PERFORMANCE

	<u>RO -10</u>	<u>RO +500</u>	<u>RO +1,700</u>	<u>RO +22,000</u>
PCM/FM XMTR OUTPUT PWR (WATTS) (MINIMUM ALLOWED - 15 WATTS)	19.1	20.0	20.1	19.3
RF SYSTEM VSWR (MAXIMUM ALLOWED - 1.7:1)	1.24:1	1.25:1	1.27:1	1.26:1

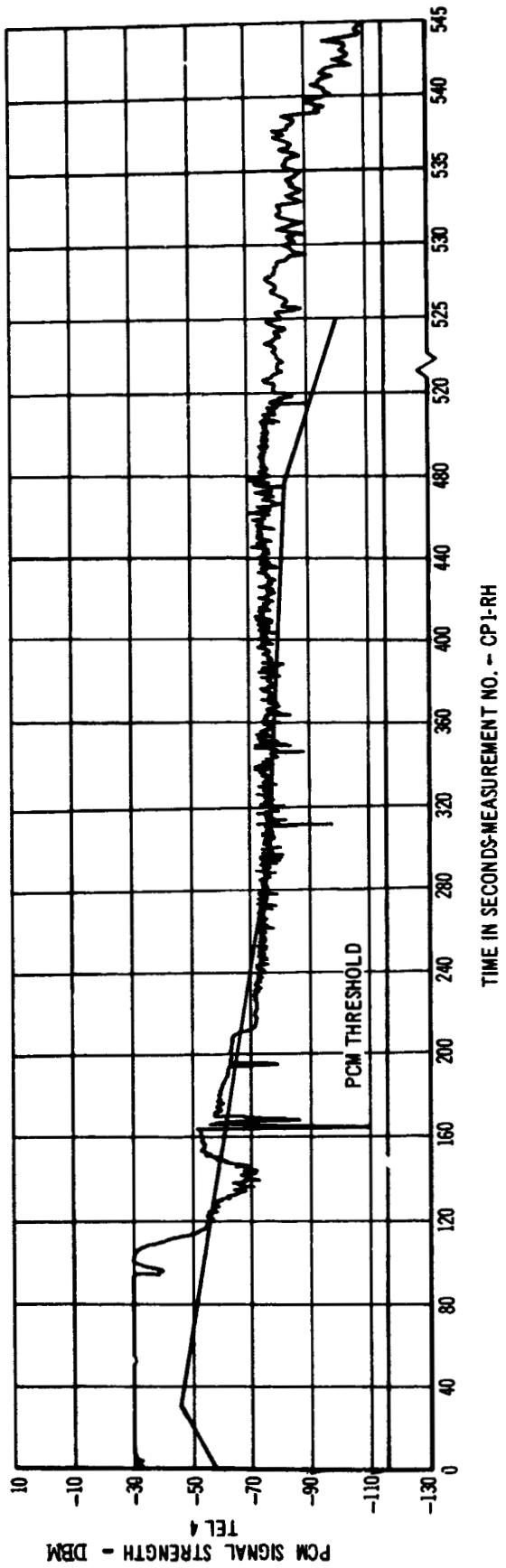

Figure 18-1. Ground Station Signal Strength - Tel 4 RH Boost Phase



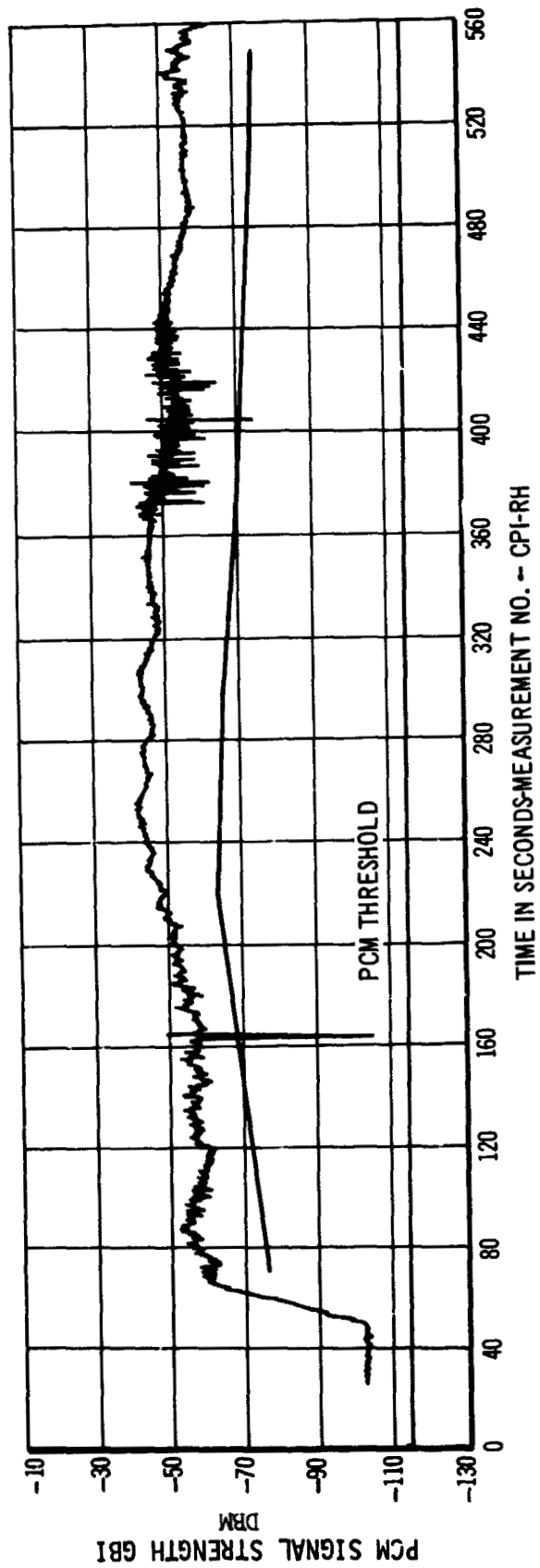

Figure 18-2. Ground Station Signal Strength - GBI RH Boost Phase

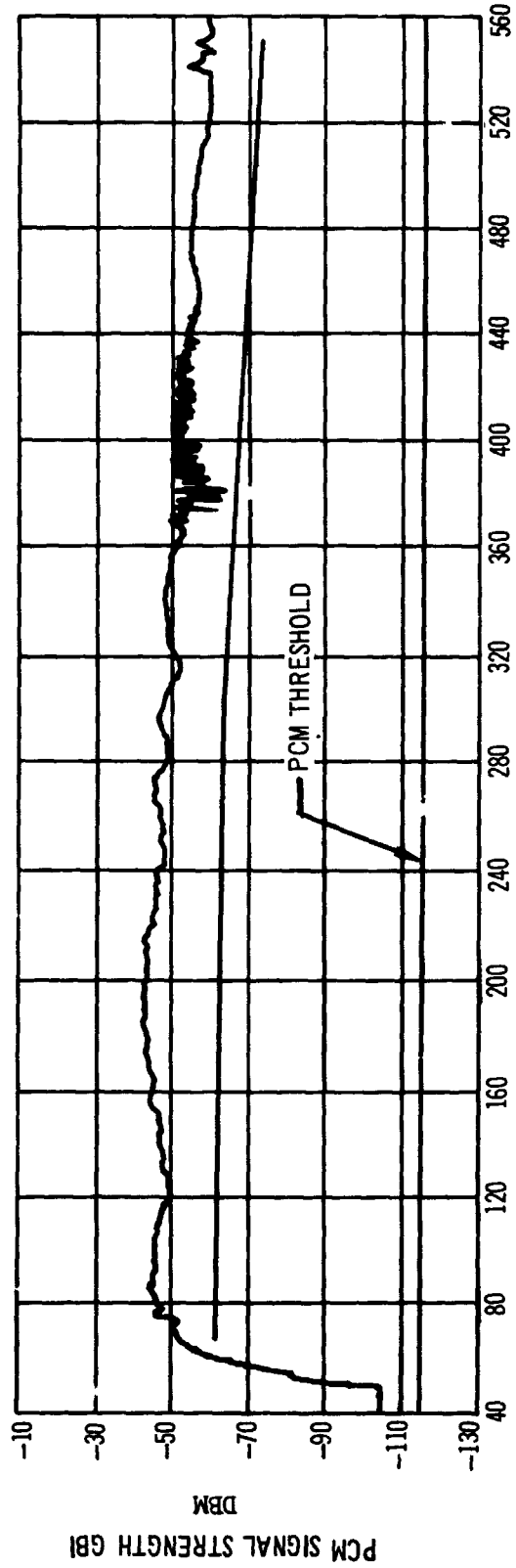
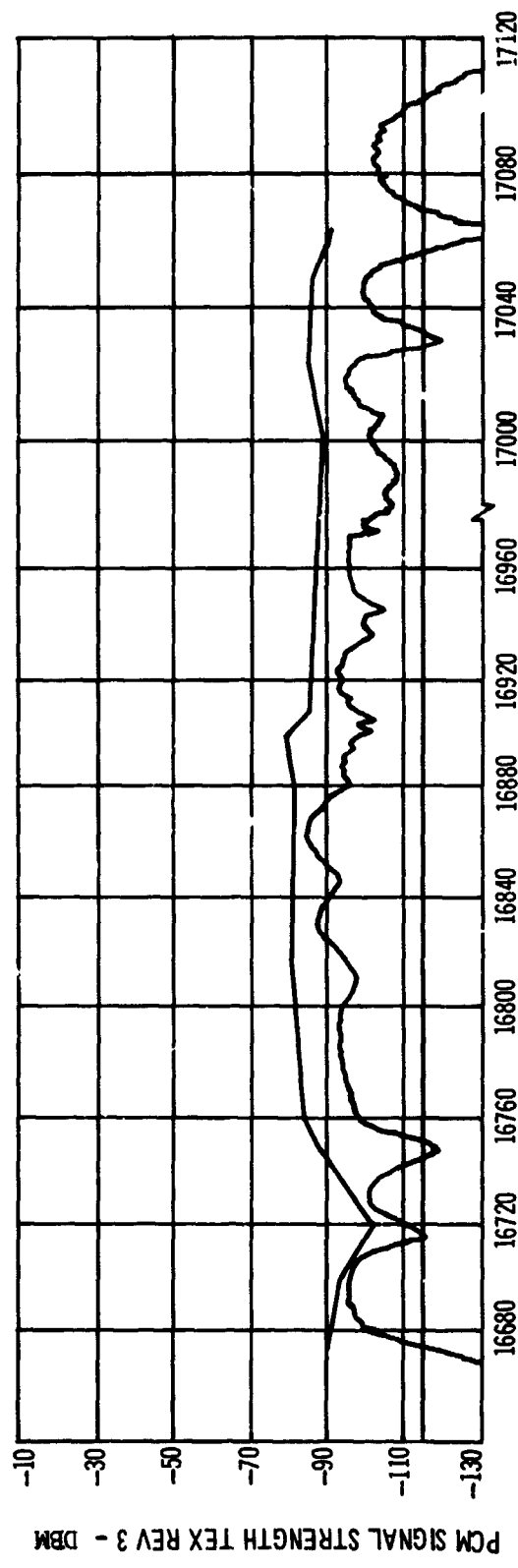

Figure 18-3. Ground Station Signal Strength - GBI - LH



TIME IN SECONDS-MEASUREMENT NO. -- 1-RH  
 Figure 18-4. Ground Station Signal Strength -- Tex - RH Rev 3 PCM

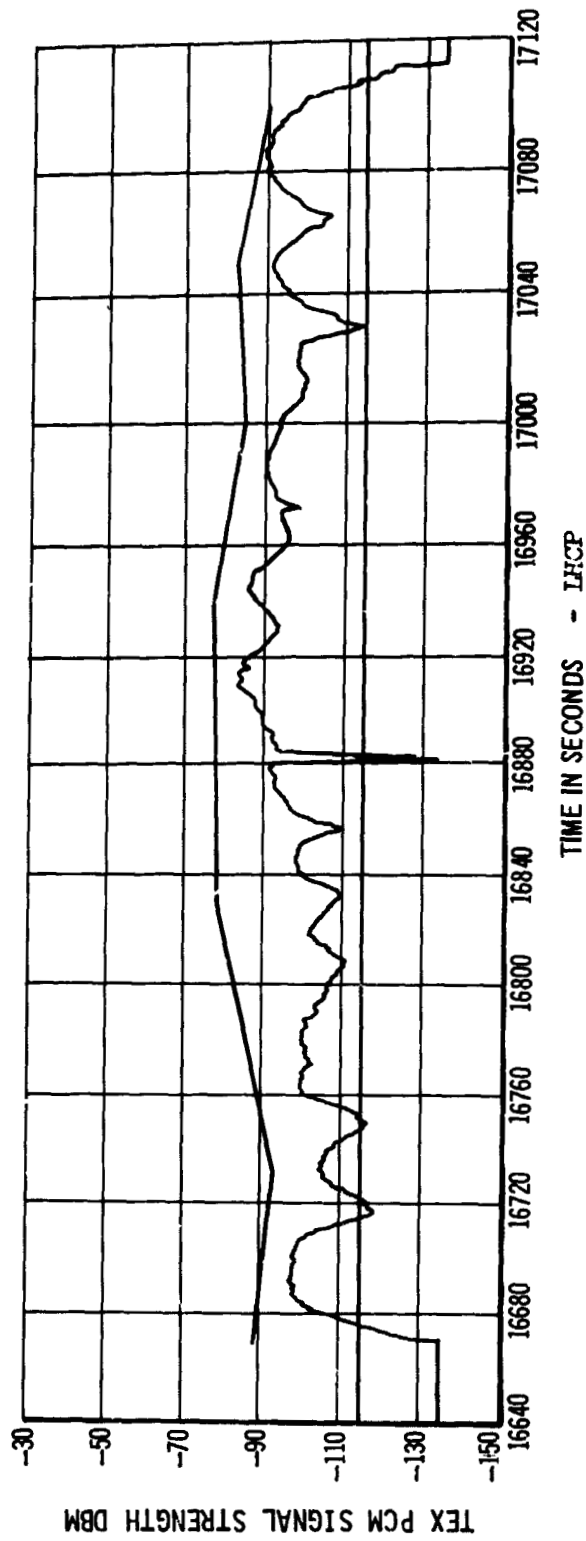

Figure 18-5. Ground Station Signal Strength - Tex - LH Rev 3

## 19. ELECTRICAL POWER AND CONTROL SYSTEM

### 19.1 Power System

The Electrical Power System performed satisfactorily throughout the S-IVB mission, for all three engine burns and for passivation.

#### 19.1.1 Flight Batteries

All batteries performed within the expected limits as verified from the load profiles and temperature data shown in figures 19-1 to 19-4. However, two anomalies did occur, a battery heater failure and two abnormal current spikes during third burn.

At RO +11,170 sec, forward battery No. 1 unit 1 heater came on and remained on for only 50 sec. A "time-on" cycle for this heater is normally 300 to 400 sec. Prior to RO +11,170 sec the heater cycled on once at RO +6,150 sec for a duration of 300 sec. But after RO +11,170 sec, the heater did not cycle again, and the temperature decreased to a low of 513 deg R at RO +48,000 sec. This type of failure has not been observed on any previous flight, but during AS-503 CDDT, a similar failure was caused by a faulty thermostat. The cause of the failure during flight has not been determined. The time of failure probably occurred when the heater cycled off at RO +11,220 sec. The heater cycle was shorter than normal, and the temperature of the battery unit was too low for the heater to be cycled off if it had been functioning properly (see figure 19-1).

Two abnormal spikes in current were observed on aft battery No. 1 during third burn period. The first spike had an amplitude of 19 amp at RO +22,107.4 sec, and the second spike had an amplitude of 55 amp at RO +22,107.5 sec. The spikes are actual current changes because there is a corresponding voltage drop for each current spike.

The current spikes were related to the mainstage OK pressure switch measurement failure. The spikes were caused by a short circuit in the measurement circuitry. A detailed description of the measurement failure is contained in table III of Section 18.

All batteries were operating at the proper voltage when data was lost at 13 hr 20 min (RO +48,000 sec). Battery consumption for aft No. 1 and aft No. 2 batteries was higher than predicted because the load test requirements during battery activation consumed more amp-hr than expected.

	<u>Actual</u>	<u>Predicted</u>	<u>Preflight Usage</u>
Fwd No. 1	95.3 A-H	105.6 A-H	5.5 A-H
Fwd No. 2	17.1 A-H	17.0 A-H	3.0 A-H
Aft No. 1	70.3 A-H	63.0 A-H	21.9 A-H
Aft No. 2	68.8 A-H	67.9 A-H	10.1 A-H

The consumption for forward No. 1 battery is less than predicted because a heater failed during the flight at approximately 3 hr after liftoff. The lack of subsequent heater cycles caused the actual consumption to be less than predicted.

#### 19.1.2 PU Static Inverter Converter

The PU static inverter converter operated within the design limits during the boost and both restart flight evaluation periods. The modifications included in ECP 2008 minimized the level shifts seen on the PU 5 vdc (M0004-411) and the 400 Hz frequency (M0012-411) measurements when the PU mixture ratio 4.5 on command was sent. Positive level shifts of less than 1 percent were noted at that time.

Voltage and frequency levels during the flight are given as follows:

MEASUREMENT	ACCEPTABLE RANGE	ACTUAL VALUES			
		FIRST BURN		SECOND & THIRD BURN	
		MIN	MAX	MIN	MAX
M0001-411 Volt-PU Inv/Conv	115 $\pm$ 3.45 VRMS	116.2	116.9	116.8	117.0
M0004-411 Volt-PU Inv/Conv 5 vdc	4.9 $\pm$ 0.2 vdc	4.97	5.03	4.98	5.01
M0012-411 Freq-PU Inv/Conv	400 $\pm$ 6 Hz	399.2	400.1	399.3	400.2
M0023-411 Volt-PU Inv/Conv 21 vdc	21.0 $\pm$ 1.5 -1.0 vdc	21.66	21.68	21.71	21.79

### 19.1.3 Chiltdown Inverters

The LOX and LH2 chiltdown inverters operated as expected during boost and both restart periods. For the second restart, ground commands turned the LOX chiltdown inverter off 20 sec after turn on and the LH2 chiltdown inverter off 15 sec after it was turned on.

Voltage and frequency levels during the flight are given below.

#### LOX Chiltdown Inverter

MEASUREMENT	ACCEPTABLE RANGE	ACTUAL					
		FIRST BURN		SECOND BURN		THIRD BURN	
		MIN	MAX	MIN	MAX	MIN	MAX
M0027-404 Volt-LOX C/D Inv Phase A-B	55 $\pm$ 5 vac	53.3	55.9	55.5	56.1	55.8	56.6
M0040-404 Volt-LOX C/D Inv Phase A-C	55 $\pm$ 5 vac	53.2	55.6	55.5	56.1	56.0	56.8
M0029-404 Freq-LOX C/D Inv	400 $\pm$ Hz	400.3	401.7	402.0	402.8	400.6	401.1

LH2 Chilldown Inverter

MEASUREMENT	ACCEPTABLE RANGE	ACTUAL					
		FIRST BURN		SECOND BURN		THIRD BURN	
		MIN	MAX	MIN	MAX	MIN	MAX
M0026-404 Volt-LH2 C/D Inv Phase A-B	55 <u>+5</u> vac	53.8	56.1	55.3	55.5	55.1	55.9
M0041-404 Volt-LH2 C/D Inv Phase A-C	55 <u>+5</u> vac	53.2	56.1	55.3	55.5	55.7	56.4
M0028-404 Freq-LH2 C/D Inv	400 <u>+4</u> Hz	400.3	401.7	402.0	402.8	402.3	402.9

19.1.4 5 Volt Excitation Modules

The 5 volt excitation modules operated within the design limits during all phases of the mission. However, the measurement for the 5 vdc from the aft 5 volt excitation module, M0025-404, was at the low tolerance level. This condition is caused by different grounds for the 5 volt module and the multiplexer reference measurement (M0069-404). A calibration curve shift will be made on future stages to correct the problem.

Voltage and frequency levels during flight are given below.

MEASUREMENT	ACCEPTABLE RANGE	ACTUAL	
		MIN	MAX
M0024-411 Volt-5 Volt Excit Mod, Fwd 1	5 <u>+0.030</u> vdc	5.000	5.011
M0043-411 Freq-5 Volt Excit Mod, Fwd 1	2,000 <u>+200</u> Hz	2,030	2,130
M0068-411 Volt-5 Volt Excit Mod, Fwd 2	5 <u>+0.030</u> vdc	4.993	5.009
M0042-404 Freq-5 Volt Excit Mod, Aft	2,000 <u>+200</u> Hz	1,967	1,982
M0025-404 Volt-5 Volt Excit Mod, Aft	5 <u>+0.030</u> vdc	4.970	4.980



## 19.2 Electrical Control System

The sequence of events, which is in Section 4, details the times of occurrence for significant events during the S-IVB-504N flight. Discrete and analog data responses to the switch selector commands sent to the stage are furnished in this sequence, and this data was used to evaluate the operational integrity of the electrical control system.

### 19.2.1 I-2 Engine

The data verified that the engine control system responded properly to the start and cutoff commands sent for all three burns. The Engine Start Command (ESC), Engine Cutoff Command (ECO), and total burn times for all three burns are as follows:

	<u>ESC</u>	<u>ECO</u>	<u>Burn Time</u>
First Burn	RO +537.264	RO +664.649	127.385 sec
Second Burn	RO +17,147.199	RO +17,217.596	70.397 sec
Third Burn	RO +22,030.929	RO +22,281.319	250.390 sec

Third burn performance of the engine was abnormal with several of the engine parameters exhibiting unusual behavior after engine start. Two third burn electrical control system problems were investigated.

#### 1. Failure of the Engine Pneumatic Regulator

At RO +22,089 sec, the regulator output pressure suddenly decreased to 0 psia. This probably was caused by a failure in the wiring to the helium control solenoid in the regulator.

Detailed examination of aft battery 1 current data indicates that a current shift occurred simultaneously with the drop in helium regulator pressure at approximately 22,089 sec. The magnitude of the shift was sufficient (0.6A) to indicate removal of the helium control solenoid load from the bus. Measurement K0007-401 (event-helium control solenoid energized), did not drop out until the helium control de-energized timer expired one second after third burn engine cutoff.

This event measurement originates in the ECA package, not at the solenoid. There are several events occurring approximately one second after engine cutoff which caused a current decrease. These events and the relatively small magnitude of current required by the helium control solenoid made it impossible to determine which events caused the current decrease. Since K0007-401 did not drop out until the command was removed, the problem would have been in the connectors or cabling from the ECA to the helium control solenoid. The helium control solenoid energized command was sent six times during the remainder of the flight. Measurement K0007-401 responded properly each time indicating the command was received in the ECA but other data indicates the helium control solenoid was never activated.

## 2. Mainstage OK Pressure Switch Failure

Measurements K0157-401 event-mainstage OK press Sw 2 and K0159-401 event-mainstage OK press Sw depress began to cycle erratically early in the third burn. The measurements failed 67 sec into third burn at R0 +22,107.6 sec. At approximately the same time these measurements failed, measurement K0014-401 event-mainstage OK press Sw 1 began to cycle erratically. These random cycles continued throughout the remainder of third burn.

Since mainstage OK pressure switch 2 failed off at approximately R0 +22,107 sec, when mainstage OK pressure switch 1 cycled to the off state both measurements indicated off. Such a condition would result in a J-2 engine shutdown by the engine cutoff logic in the ECA. Also a signal would go to the flight computer which would initiate a new time base and engine cutoff. Since no cutoff was given, at least one OK pressure signal existed at the ECA throughout third burn.

It is believed that the mainstage OK press switch 2 (K0157-401) was short circuited between the ECA package and the input to the RDSM. This short circuit caused a fusing of the pressure switch contacts in the pressurized condition and an open failure of the

isolation diode in the signal output line in the ECA package. Such a condition would enable the engine logic to have a constant pressure OK indication while the open diode would prevent the RDSM from receiving the signal. Such a condition would prevent the engine logic from causing an engine cutoff and have the data indicate K0157-401 is OFF. The fused contacts of pressure switch 2 would prevent an engine ready signal (K0012-401) and mainstage OK press Sw 2 depressurized (K0159-401) from being received after engine cutoff. Data indicates that neither of these events came on after engine cutoff.

Engine cutoff did not occur through the IU flight computer because the mainstage OK pressure switches were not simultaneously in the off state long enough to drop out the relays which send the pressure OK signal to the IU.

#### 19.2.2 Stage Control Pressure Switches

Evaluation of the event and pressure measurements associated with the stage pressure switches verified that from an electrical control standpoint, they operated as expected during the flight.

- a. The LOX tank ground fill valve control, prepress, flight control, and repress pressure switch operated within the range of 38 to 41 psia as required.

K0102-404 Event - LOX Prepress and Flight Control Switch - En

K0108-404 Event - LOX Prepress Flight Switch - De-energized

D0179-406 Press - LOX Tank Ullage EDS 1

D0180-406 Press - LOX Tank Ullage EDS 2

- b. The LH2 ground fill valve control, prepress, flight control, and step-pressure pressure switch operated as expected to maintain the LH2 ullage pressure within the limits of 28 to 31 psia.

K0184-404 Event - LH2 Flight Control Pressure Switch - En

K0101-404 Event - LH2 Repress Control Switch - De-energized

- K0177-410 Press - LH2 Tank Ullage EDS 1
- D0178-410 Press - LH2 Tank Ullage EDS 2
- c. The LH2 tank repress pressure switch also operated as required within the range of 28 to 31 psia.
- K0101-404 Event - LH2 Repress Control Switch - De-energized
- D0177-410 Press - LH2 Tank Ullage EDS 1
- D0178-410 Press - LH2 Tank Ullage EDS 2
- d. The engine pump purge control module pressure switch operated at the end of first engine burn to maintain the engine pump purge pressure between 105 and 130 psia, as expected.
- K0105-404 Event - Pump Purge Regulator Backup - De-energized
- D0050-403 Press - Engine Pump Purge Regulator
- e. The LOX tank regulator backup pressure switch did not actuate during the flight since the LOX tank regulator was able to maintain the cold helium pressure at the required level, which is below the actuation level of this backup pressure switch (465 +20, -15 psia).
- K0156-404 Event - LOX Tank Regulator Backup Pressure switch - Energized
- D0105-403 Press - LOX Tank Pressurization Module He Gas
- f. The LOX tank repress regulator backup pressure switch remained in its de-actuated position during the O2/H2 burner repressurization phase since the cold helium regulator maintained the cold helium supply pressure to the burner at the required level (385 +25 psia).
- D0228-403 Press - LOX/LH2 Burner LOX Press Coil
- g. The LH2 tank repress regulator backup pressure switch also remained in its de-actuated position during the O2/H2 burner repressurization phase because of the normal operation of the cold helium regulator.
- D0231-403 Press - LOX/LH2 Burner LH2 Press Coil

### 19.2.3 Control Valves

- a. The LOX and LH2 fill and drain valves were commanded close through the umbilicals prior to liftoff, and they remained closed throughout flight, as verified by the following measurements:

K0003-427 Event - LH2 Fill Valve - Close

K0004-404 Event - LOX Fill Valve - Close

- b. The LOX and LH2 chilldown shutoff valves were commanded open prior to liftoff and remained open throughout first and second burn; they were cycled open and close during the chilldown pump test prior to third burn. The following measurements verified the proper operation of these valves:

K0136-409 Event - LH2 SOV Chill System - Close

K0137-409 Event - LH2 SOV Chill System - Open

K0138-424 Event - LOX SOV Chill System - Open

K0139-424 Event - LOX SOV Chill System - Close

- c. The LOX and LH2 prevalues were commanded close for chilldown operations and were commanded open prior to the engine burns. They operated properly as verified by the following measurements:

K0109-403 Event - LOX Prevalve - Open

K0110-403 Event - LOX Prevalve - Close

K0111-404 Event - LH2 Prevalve - Open

K0112-404 Event - LH2 Prevalve - Close

- d. A review of the following measurements showed that the various valves in the LOX and LH2 tank venting systems responded to switch selector commands and operated properly from an electrical controls standpoint. These valves were: the LOX and LH2 tank vent & relief valves; the LOX nonpropulsive vent valve; the LH2 latching relief valve; the LH2 tank continuous vent relief override and orifice bypass shutoff valves; and the LH2 tank directional vent valve.

K0001-410 Event - LH2 Tank Vent Valve - Close  
 K0002-424 Event - LOX Tank Vent Valve - Close  
 K0016-404 Event - LOX Tank Vent Valve 1 - Open  
 K0017-410 Event - LH2 Tank Vent Valve 1 - Open  
 K0113-411 Event - LH2 Tank Vent Valve C - Close  
 K0114-411 Event - LH2 Tank Vent Valve D - Close  
 K0154-411 Event - Relief Override SOV LH2 Tank - Close  
 K0155-411 Event - Orifice SOV Continuous Vent LH2 Tank -  
 Close  
 K0198-424 Event - LOX Non Propulsive Vent (NPV) Valve -  
 Open  
 K0199-424 Event - LOX Non Propulsive Vent (NPV) Valve -  
 Close  
 K0210-410 Event - LH2 Latch Relief Valve - Close  
 K0211-410 Event - LH2 Latch Relief Valve - Open

#### 19.2.4 Auxiliary Propulsion System (APS)

An evaluation of the event measurements on the engine feed valves verified that the stage electrical control system operated as expected to send commands to these valves.

	<u>Value</u>
K0132-404 Event - APS Eng 1-1/1-3 Feed Valves Open	3.8 vdc
K0133-404 Event - APS Eng 1-2 Feed Valves Open	3.8 vdc
K0134-404 Event - APS Eng 2-1/2-3 Feed Valves Open	3.8 vdc
K0135-404 Event - APS Eng 2-2 Feed Valves Open	3.8 vdc

### 19.2.5 Exploding Bridgewire (Ullage Rocket EBW) System

The measurements listed below verified the operational integrity of the stage electrical control system in providing the commands necessary to ignite and jettison the ullage rockets.

		<u>Specified*</u> <u>Min Value</u>	<u>Actual</u> <u>Value</u>
M0064-404	Volts - Ullage Rocket Ign, EBW F/U 1	3.9 vdc	4.25 vdc
M0065-404	Volts - Ullage Rocket Ign, EBW F/U 2	3.9 vdc	4.28 vdc
M0066-404	Volts - Ullage Rocket Jett, EBW F/U 1	3.9 vdc	4.25 vdc
M0067-404	Volts - Ullage Rocket Jett, EBW F/U 2	3.9 vdc	4.20 vdc

\*The specified minimum value necessary to ignite an EBW detonator.

### 19.2.6 O2/H2 Burner

The stage electrical control system functioned properly to send commands to the burner and to provide power for the operation of the burner. This was verified by the fact that the O2/H2 burner was successfully used to repressurize the stage for second burn and that it was successfully test fired prior to third burn.

### 19.2.7 Passivation System

The requirements for propellant dumping and stage safing in the terminal phase of the mission involved maintaining electrical control over various S-IVB stage and J-2 engine valves. Evaluation of passivation associated parameters verified that the stage valves operated as required. Therefore, passivation of the cold helium spheres, the ambient helium repressurization spheres, and the S-IVB stage pneumatic control helium sphere was accomplished. The engine start tank was passivated by stage supplied pneumatics and was carried out successfully. In addition, the LOX and LH2

tank latching vent valves were permanently opened. However, problems were encountered with passivation procedures that required the use of the engine pneumatic control regulator. This regulator failed during the third burn. In particular, the helium control solenoid, which must be energized for the regulator to function, failed to activate. This failure is discussed in Section 19.2.1 of this report. The failure of this solenoid prevented the opening of the main LOX and LH2 valves for propellant dumping through the engine. A means of venting the engine helium control sphere was provided on this stage. Switch selector channels 14 (engine pneumatic vent open) and 15 (engine pneumatic vent close) were connected to open and close the ground helium vent solenoid in the engine regulator. The open command was sent at RO +24,157.507 sec. The data shows a corresponding decrease in the sphere pressure, although the rate of decrease was much less than expected. The close command at RO +24,757.508 sec did not stop this decrease. At this time, the bottle still contained about 1,400 to 1,500 psia of helium. However, the bottle pressure continues to decrease and reaches a level of approximately 100 to 200 psia at about T +37,800 sec. The current data from aft bus No. 1, which supplies current to the solenoid, does not show an increase at the open command or a decrease at the close command. Since there is no indication of the solenoid affecting the current, the solenoid apparently did not actuate. The cause of the failure to actuate could be the failure of a latching relay in the sequencer or damage to the connectors or cabling from the ECA to the solenoid.



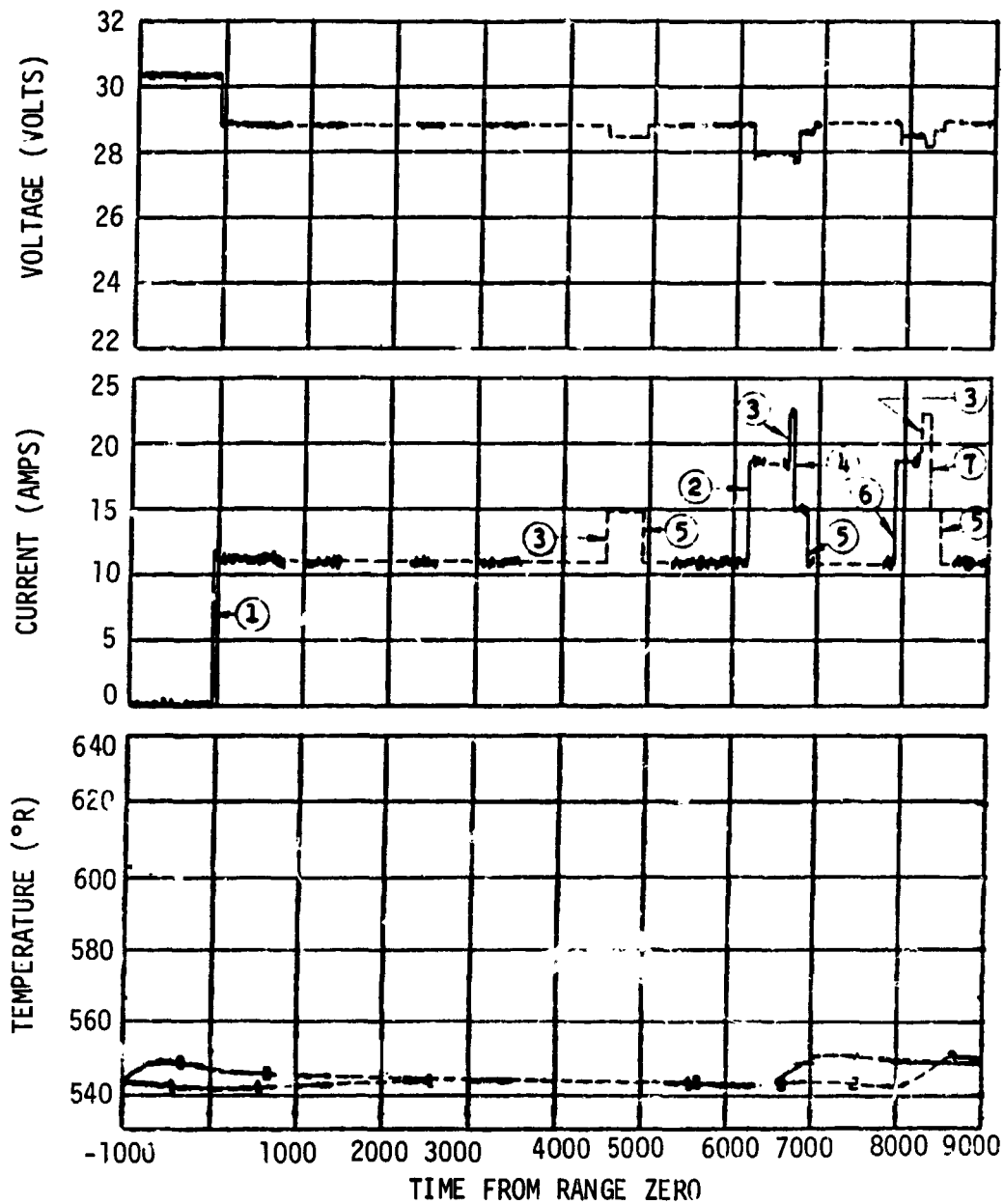

- |                            |  |
|----------------------------|--|
| ① TRANSFER TO INTERNAL     | ⑤ FWD BAT 2 HTR OFF                                  |
| ② FWD BAT 1 UNIT 1 HTR ON  | ⑥ FWD BAT 1 UNIT 2 HTR ON                            |
| ③ FWD BAT 2 HTR ON         | ⑦ FWD BAT 1 UNIT 2 HTR OFF                           |
| ④ FWD BAT 1 UNIT 1 HTR OFF | - - - - EXPECTED VALUE DURING PERIODS OF NO COVERAGE |

Figure 19-1. Forward Battery No. 1 Performance (Sheet 1 of 3)

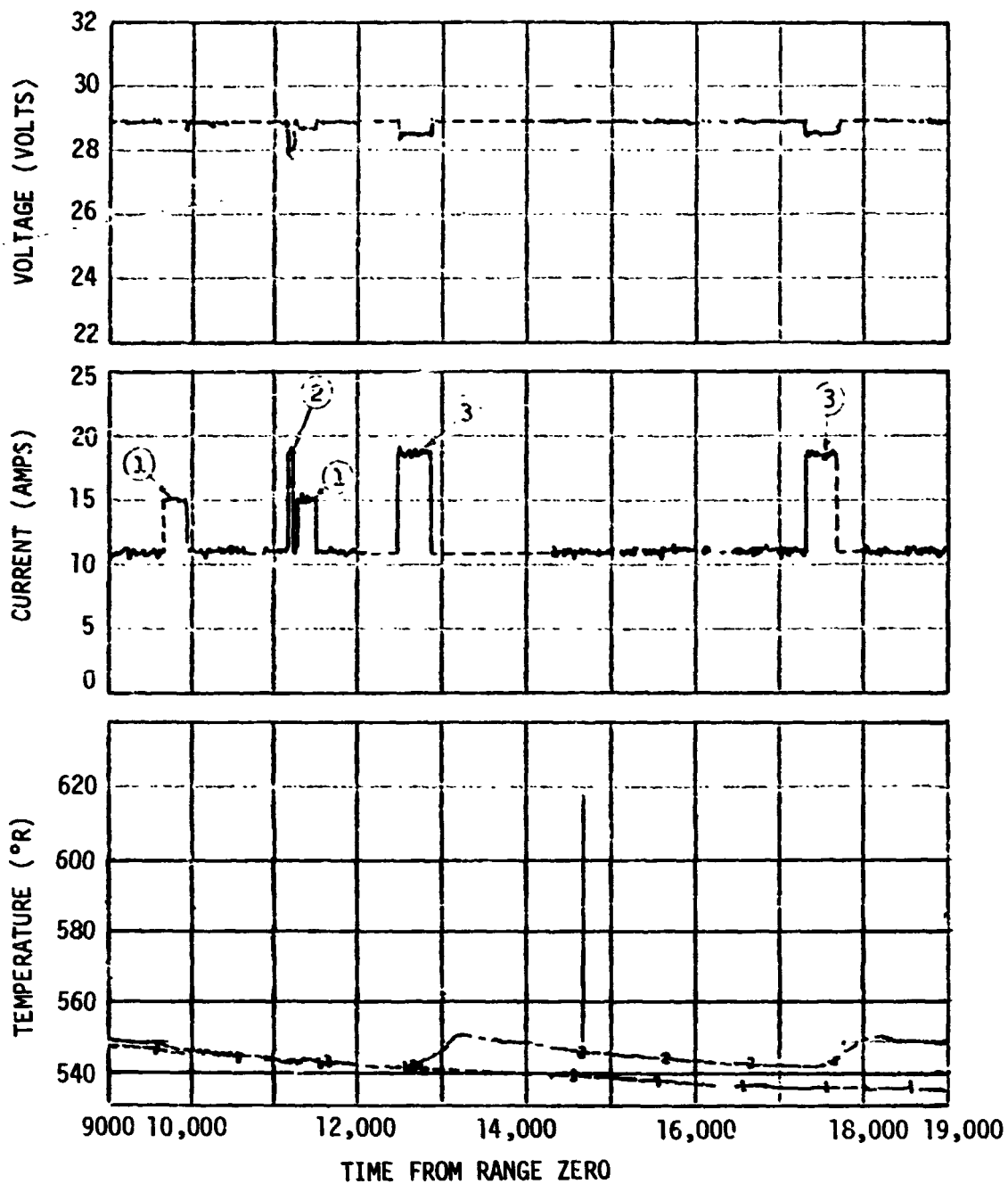

- ① FWD BAT 2 HTR CYCLE
- ② FWD BAT 1 UNIT 1 CYCLE
- ③ FWD BAT 1 UNIT 2 CYCLE

- - - - EXPECTED VALUE DURING PERIODS OF NO COVERAGE

Figure 19-1. Forward Battery No. 1 Performance (Sheet 2 of 3)

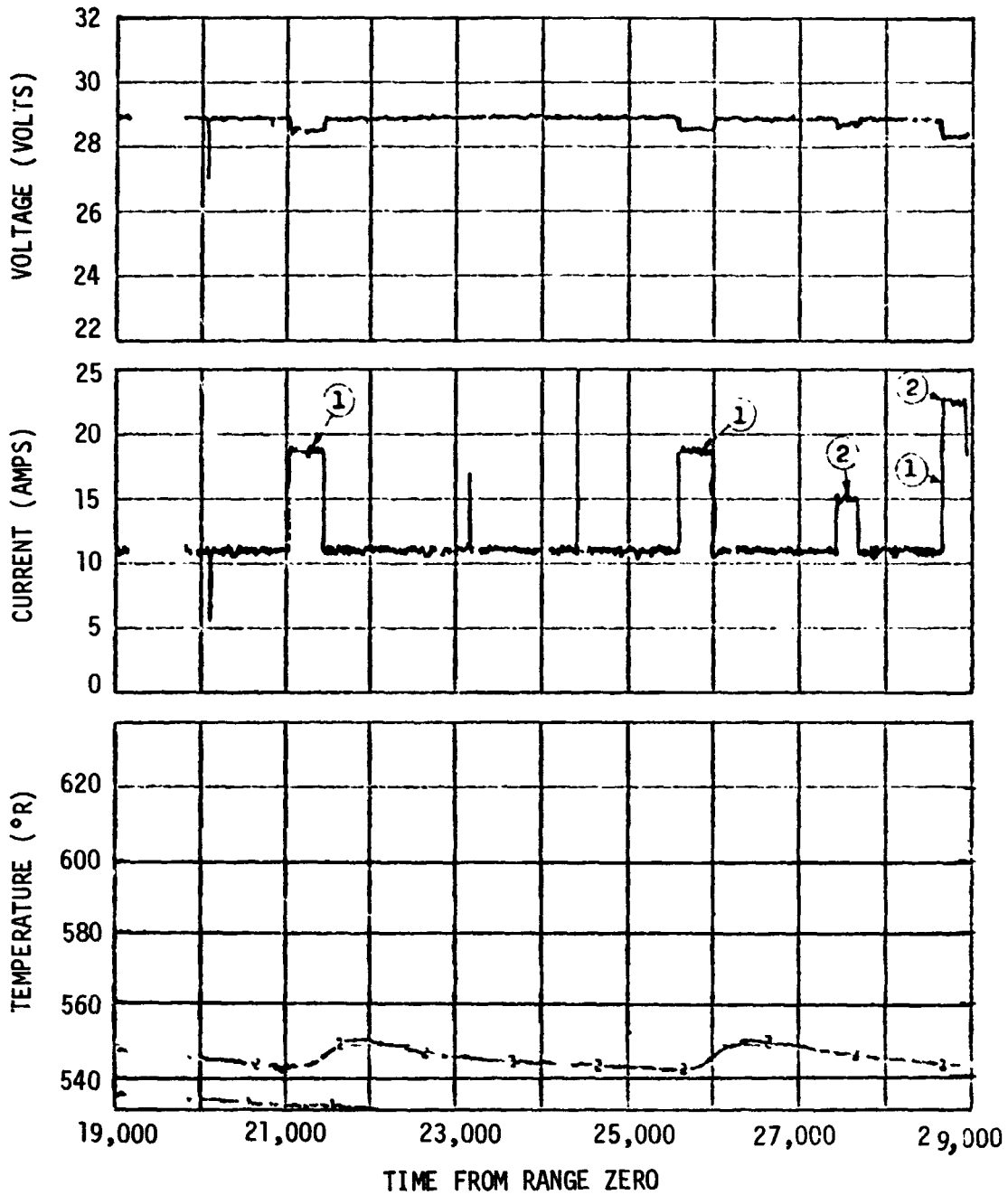

- ① FWD BAT 1 UNIT 2 HEATER CYCLE
- ② FWD BAT 2 HEATER CYCLE
- - - - EXPECTED VALUE DURING PERIODS OF NO COVERAGE

Figure 19-1. Forward Battery No. 1 Performance (Sheet 3 of 3)

- ① TRANSFER TO INTERNAL
  - ② PU MIXTURE RATIO 5.5 ON
  - ③ PU PROGRAMMED MIXTURE RATIO OFF
  - ④ PU INVERTER AND DC POWER OFF
- - - - EXPECTED VALUE DURING PERIODS OF NO COVERAGE

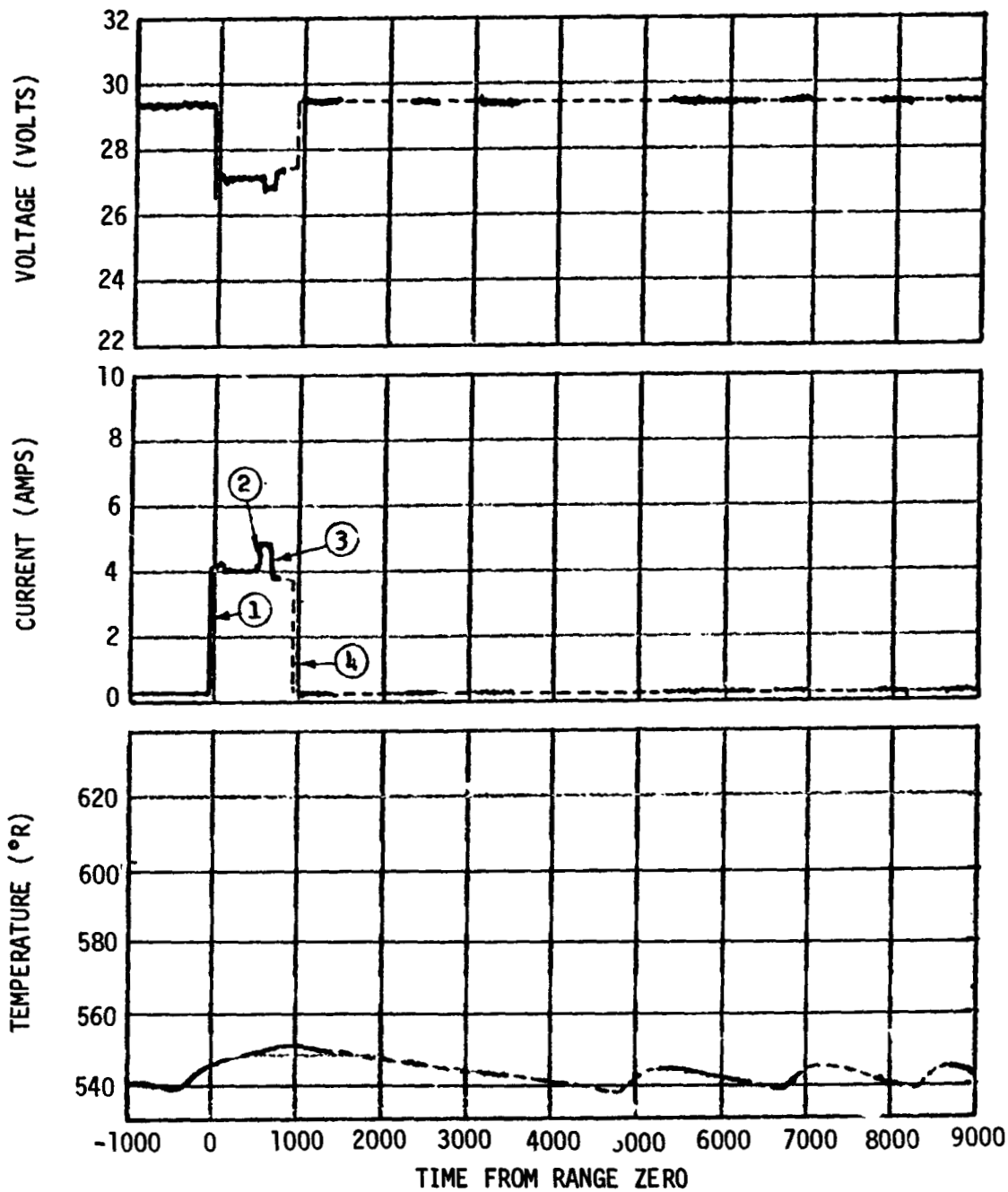
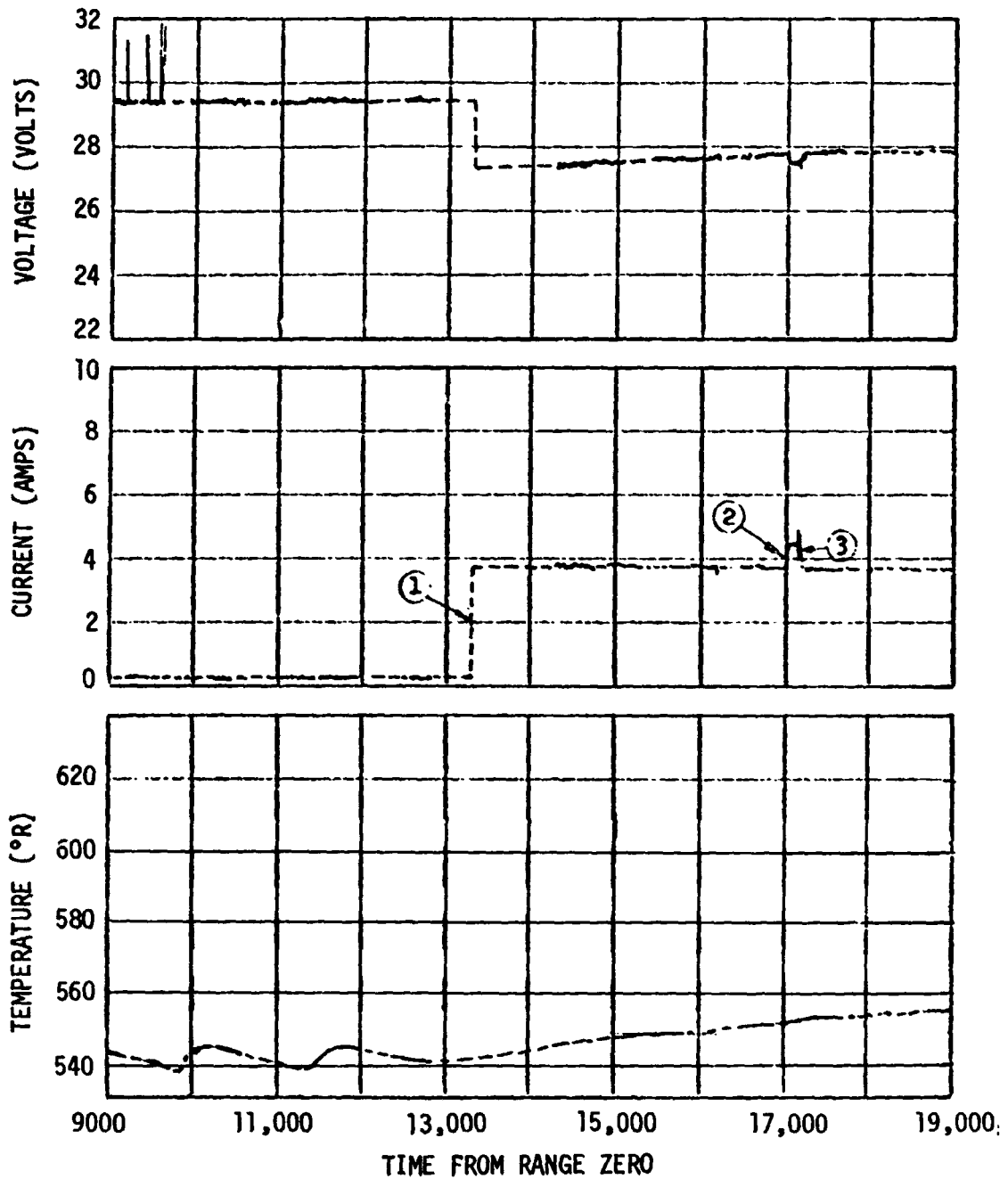

Figure 19-2. Forward Battery No. 2 Performance (Sheet 1 of 3)



- ① PU INVERTER AND DC POWER ON
- ② PU MIXTURE RATIO 4.5 ON
- ③ PU PROGRAMMED MIXTURE RATIO OFF
- - - - EXPECTED VALUE DURING PERIODS OF NO COVERAGE

Figure 19-2. Forward Battery No. 2 Performance (Sheet 2 of 3)

- ① PU MIXTURE RATIO 4.5 ON
- ② PU PROGRAMMED MIXTURE RATIO OFF
- ③ PU INVERTER AND DC POWER OFF
- - - - EXPECTED VALUE DURING PERIODS OF NO COVERAGE

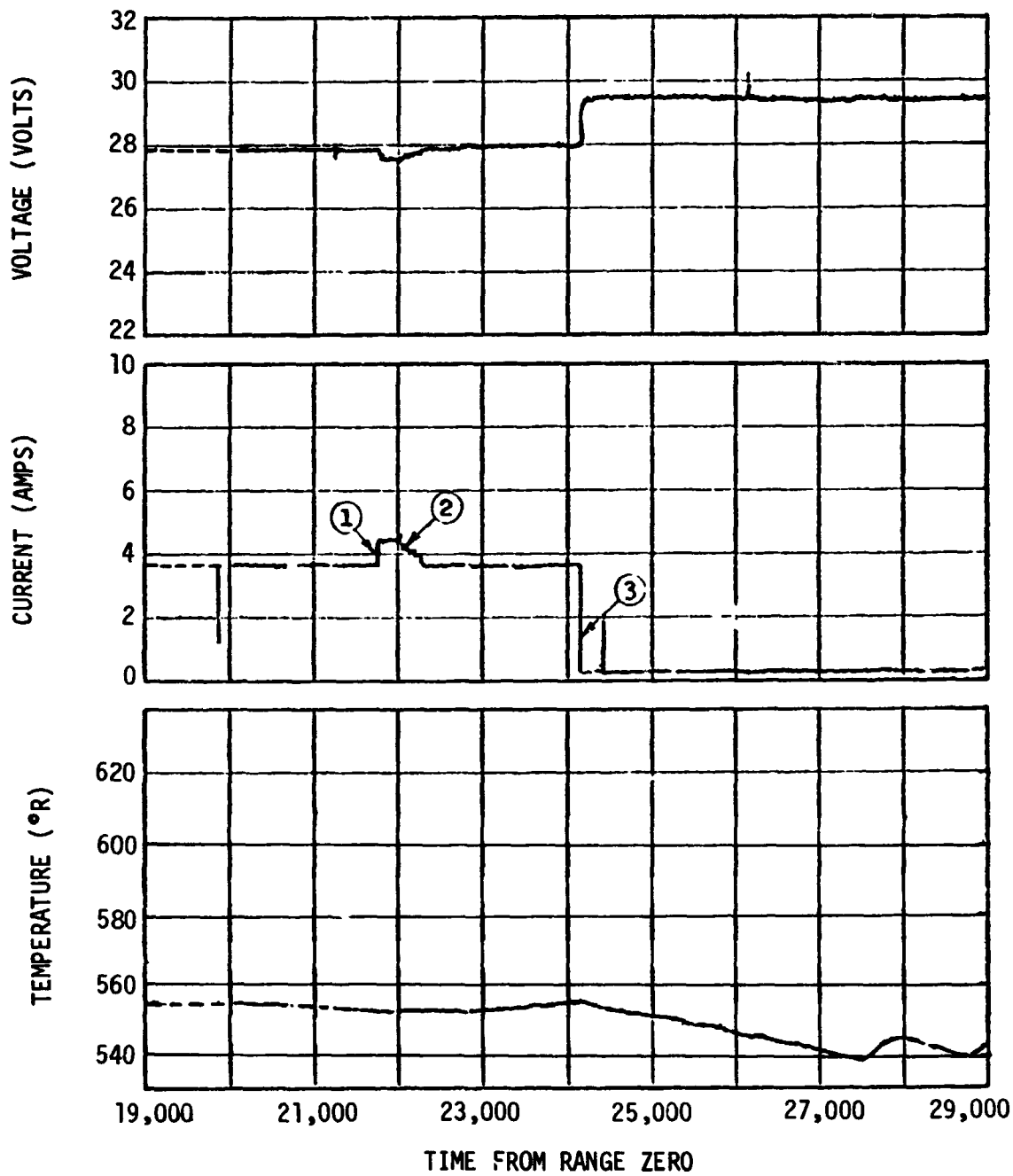

Figure 19-2. Forward Battery No. 2 Performance (Sheet 3 of 3)

- ① TRANSFER TO INTERNAL; AFT 1 UNIT 2 HEATER CYCLE
- ② ENGINE START; ULLAGE ENGINES ON
- ③ ENGINE CUTOFF
- ④ ULLAGE ENGINE OFF
- ⑤ AFT BAT 1 UNIT 1 HTR CYCLE
- ⑥ AFT BAT 1 UNIT 2 HTR CYCLE
- - - - EXPECTED VALUE DURING PERIODS OF NO COVERAGE

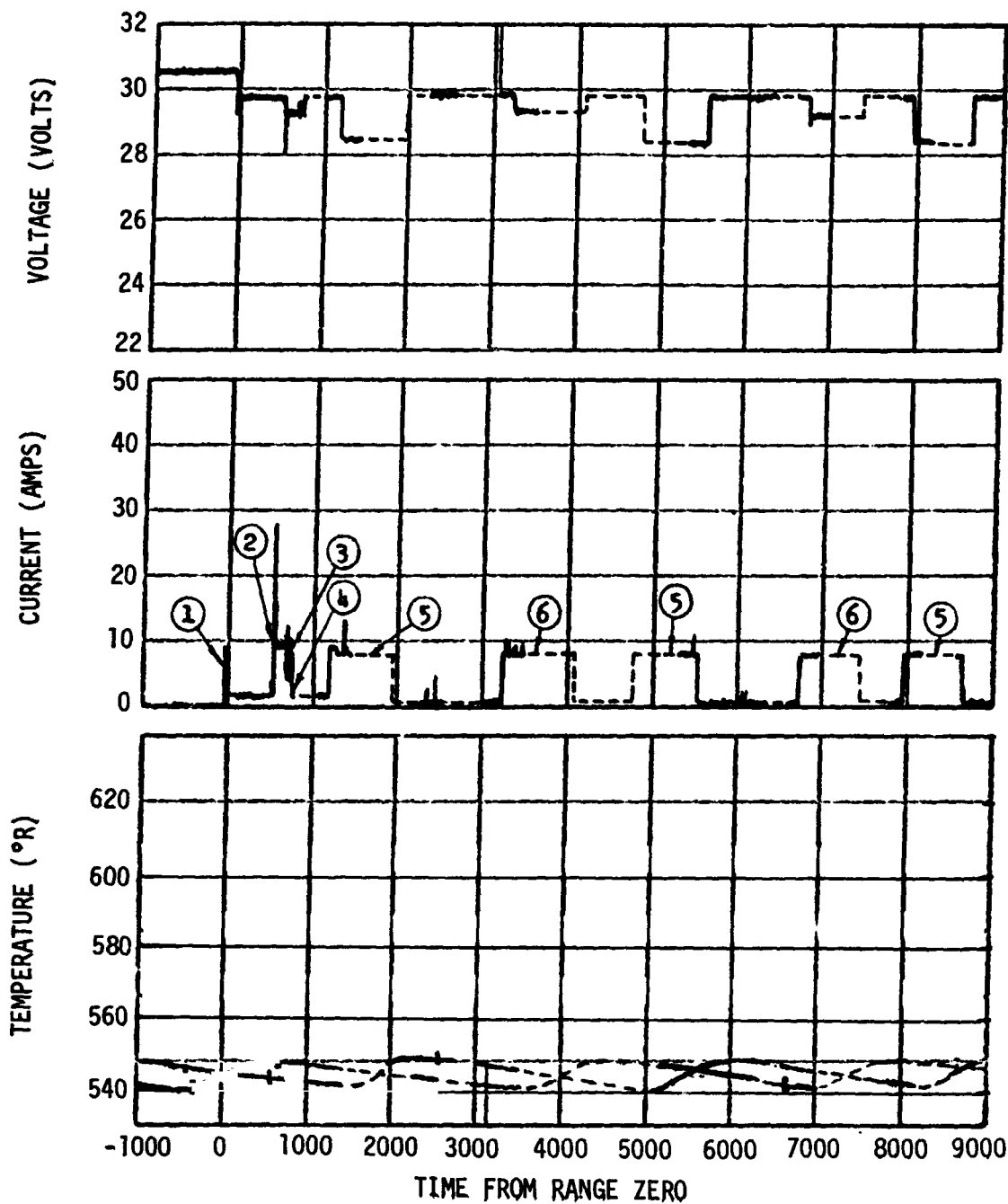
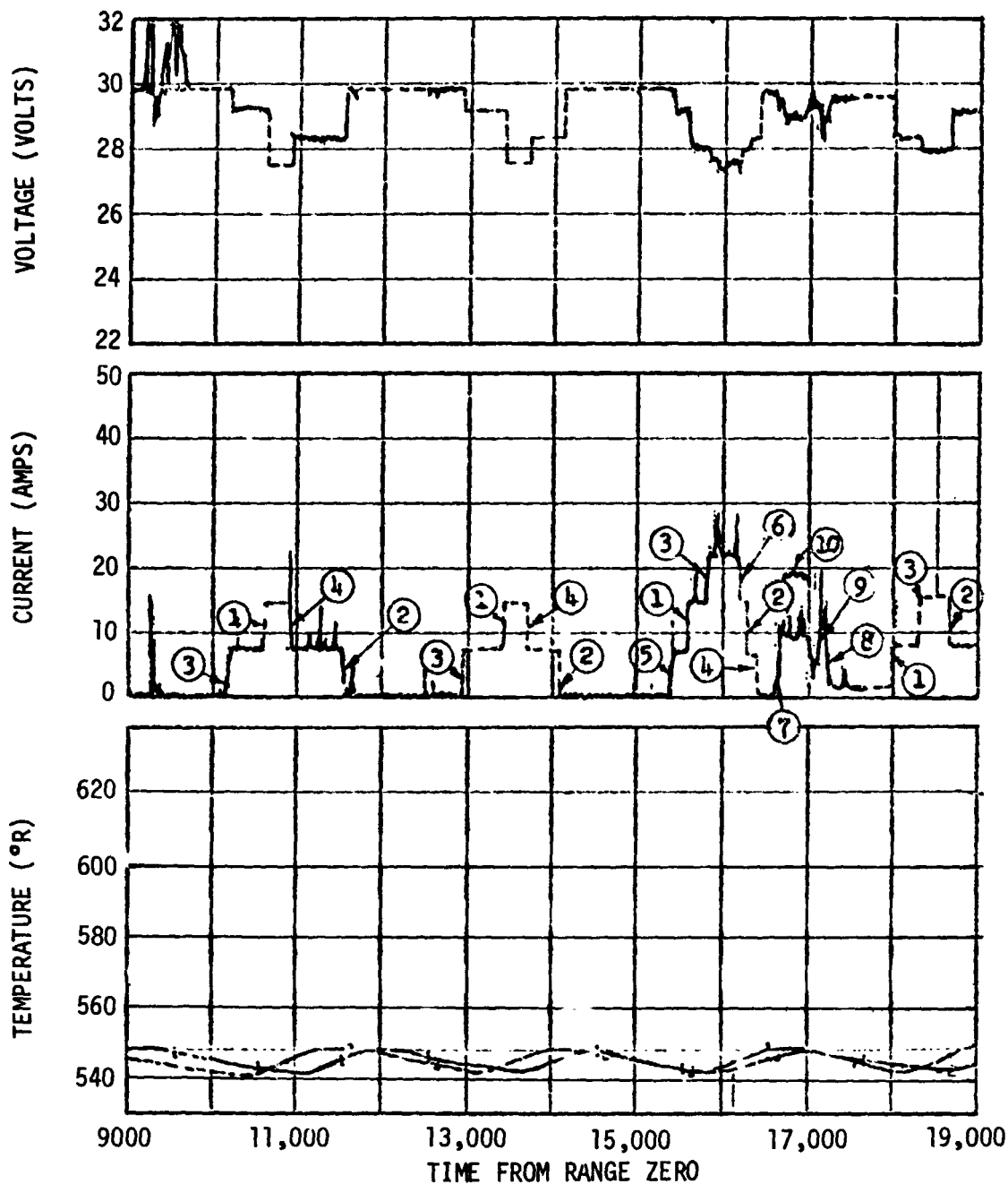

Figure 19-3. Aft Battery No. 1 Performance (Sheet 1 of 3)



- |                            |  |
|----------------------------|--|
| ① AFT BAT 1 UNIT 1 HTR ON  | ⑦ ULLAGE ENGINES ON                                  |
| ② AFT BAT 1 UNIT 1 HTR OFF | ⑧ ENGINE CUTOFF AND ULLAGE ENGINES OFF               |
| ③ AFT BAT 1 UNIT 2 HTR ON  | ⑨ ENGINE START                                       |
| ④ AFT BAT 1 UNIT 2 HTR OFF | ⑩ AFT BAT 2 UNIT 1 HTR CYCLE                         |
| ⑤ AFT BAT 2 UNIT 2 HTR ON  | - - - - EXPECTED VALUE DURING PERIODS OF NO COVERAGE |
| ⑥ AFT BAT 2 UNIT 2 HTR OFF |  |

Figure 19-3. Aft Battery No. 1 Performance (Sheet 2 of 3)



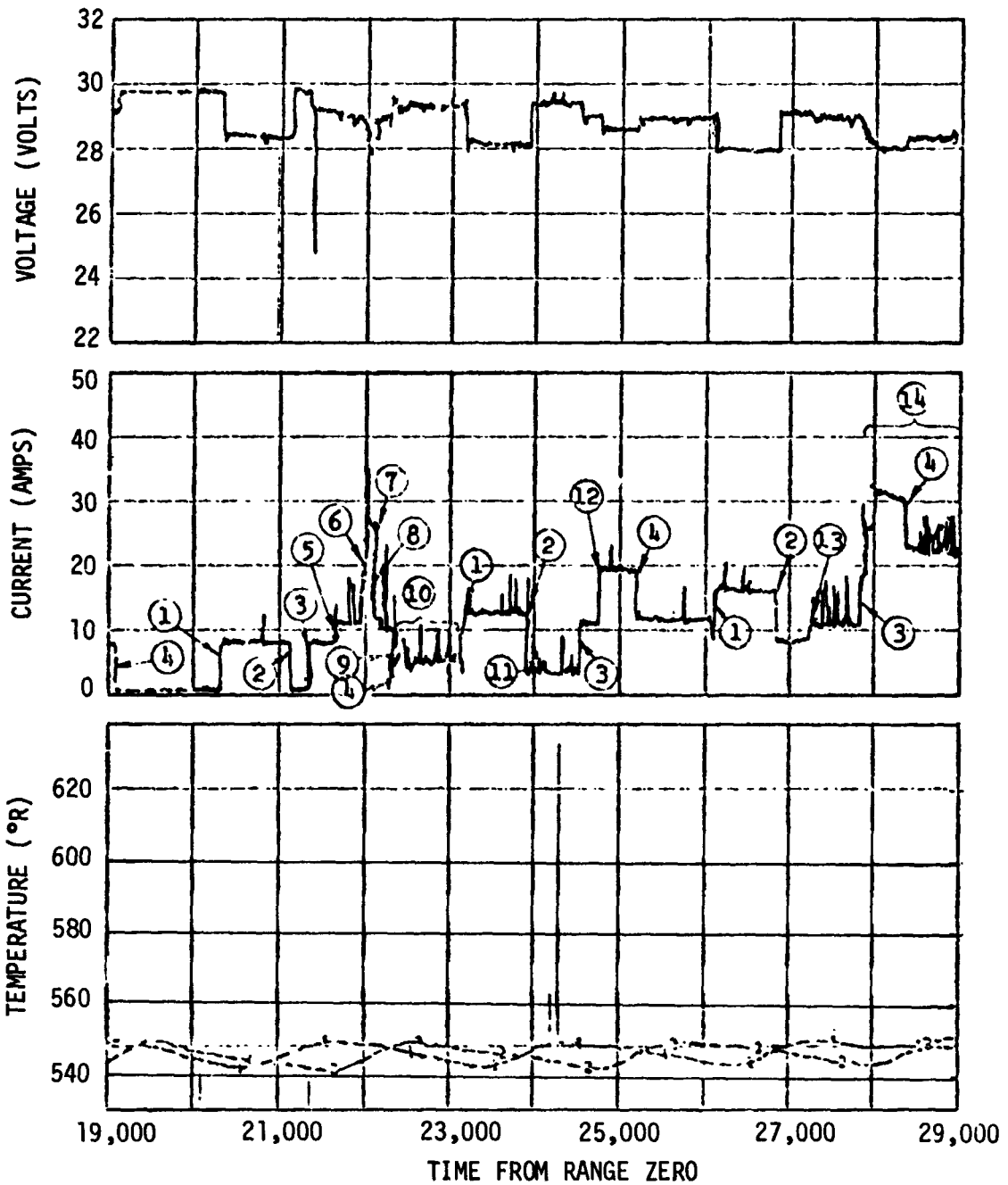

- |   |   |    |   |
|---|---|----|---|
| 1 | AFT BAT 1 UNIT 1 ON                     | 8  | AFT BAT 1 UNIT 2 HTR OFF                    |
| 2 | AFT BAT 1 UNIT 1 OFF                    | 9  | ENGINE CUTOFF                               |
| 3 | AFT BAT 1 UNIT 2 ON                     | 10 | APS CYCLING; LH2 REPRESS VLVS OPEN          |
| 4 | AFT BAT 1 UNIT 2 OFF                    | 11 | MAINSTAGE & HE CONTROL SOLENOID VALVE CLOSE |
| 5 | S-IVB ULLAGE ENGINES ON                 | 12 | ENGINE START ON                             |
| 6 | ENGINE START                            | 13 | ULLAGE ENGINES 1 & 2 ON                     |
| 7 | S-IVB ULLAGE ENGINES OFF;<br>SPARKS OFF | 14 | CONTINUOUS APS OPERATION                    |
- - - - EXPECTED VALUE DURING PERIODS OF NO COVERAGE

Figure 19-3. Aft Battery No. 1 Performance (Sheet 3 of 3)

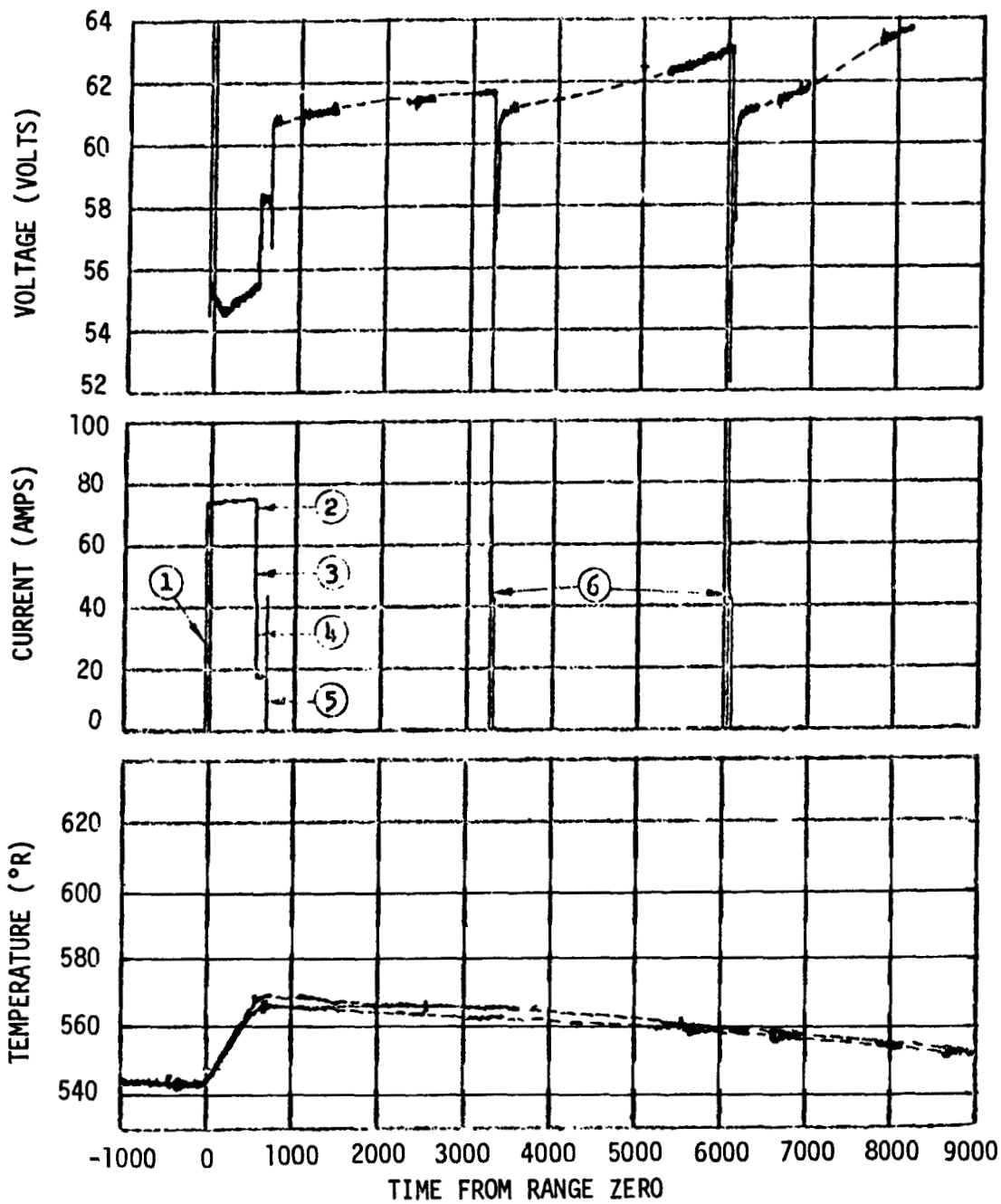

- 1 TRANSFER TO INTERNAL
- 2 LOX CHILLDOWN PUMP OFF
- 3 LH2 CHILLDOWN PUMP OFF
- 4 ENGINE SHARING THE GIMBAL LOAD
- 5 AUXILIARY HYDRAULIC PUMP OFF
- 6 AUXILIARY HYDRAULIC PUMP CYCLE
- - - - EXPECTED VALUE DURING PERIODS OF NO COVERAGE

Figure 19-4. Aft Battery No. 2 Performance (Sheet 1 of 3)

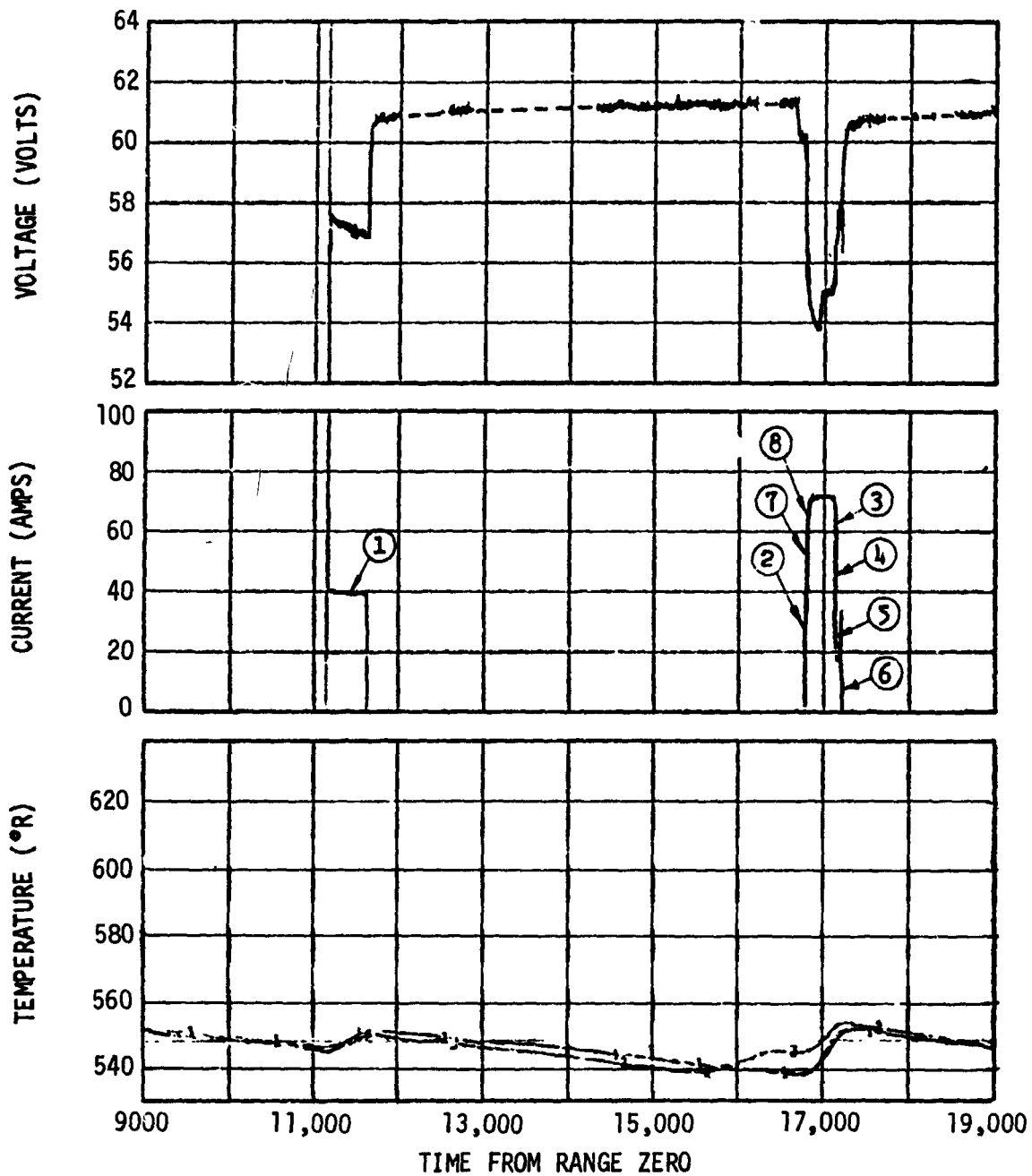

- |                               |  |
|-------------------------------|--|
| ① AUXILIARY HYDRAULIC PUMP    | ⑥ AUXILIARY HYDRAULIC PUMP OFF                       |
| ② AUXILIARY HYDRAULIC PUMP ON | ⑦ LOX CHILLDOWN PUMP OFF                             |
| ③ LH2 CHILLDOWN PUMP OFF      | ⑧ LH2 CHILLDOWN PUMP ON                              |
| ④ LOX CHILLDOWN PUMP OFF      | - - - - EXPECTED VALUE DURING PERIODS OF NO COVERAGE |
| ⑤ ENGINE SHARING GIMBAL MODE  |  |

Figure 19-4. Aft Battery No. 2 Performance (Sheet 2 of 3)

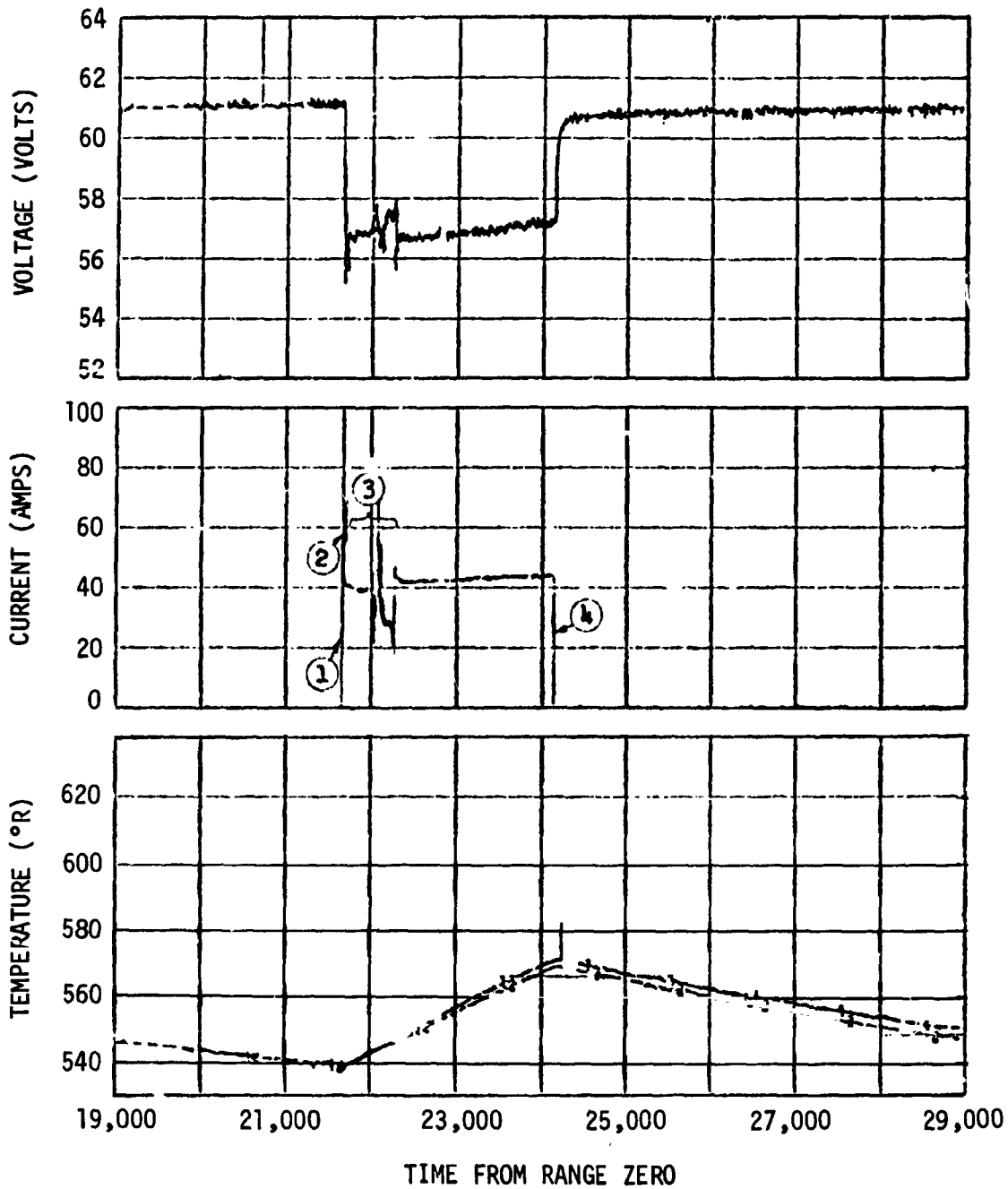

Figure 19-4. Aft Battery No. 2 Performance (Sheet 3 of 3)

20. RANGE SAFETY SYSTEM PERFORMANCE

The range safety system was not required for propellant dispersion during the flight. All indications are that it operated properly and would have satisfactorily terminated an abnormal flight.

20.1 Controllers

The controllers are designed to distribute command signals for engine cutoff, exploding bridgewire (EBW) charge and fire, and to distribute power to the range safety components. No abnormal conditions were evident.

20.2 Firing Unit Monitors

The following measurements indicate that the EBW firing units were not charged throughout the flight

MOO30-411 Volt - F/U 1 EBW Range Safety

MOO31-411 Volt - F/U 2 EBW Range Safety

20.3 Receivers Signal Strength

An Rf carrier was received by the stage until the Range Safety System was safed at  $R_0 + 685.25$  sec. Range safety receiver 1 low level signal strength (NOO57-411) was 3.6 v and range safety receiver 2 low level signal strength (NOO62-411) was 3.7 v. A momentary signal strength decrease of 0.5 sec duration was observed on both receivers at  $R_0 + 161.2$  sec. This was due to the range safety control transfer from the omni-directional to a directional antenna. The slight signal strength perturbation prior to the switch-over was due to low signal strength and vehicle look angle of the omni-directional antenna. The switch point was originally predicted at approximately  $R_0 + 113$  sec.; however, later changed to approximately  $R_0 + 160$  sec.

### 20.3 Receivers Signal Strength (Continued)

Several other perturbations were observed that were minor or not indicated on both receivers.

- a) Slight perturbation noticed on both receivers at  $R_0 + 195$ ; possibly due to S-II second plane separation disturbance.
- b) One data sample (83 ms) decrease at  $R_0 + 208$  on receiver 2 only.
- c) Four one-data sample decrease between  $R_0 + 288$  and  $R_0 + 296$  sec on receiver 1 only.
- d) Slight one data sample decrease at  $R_0 + 377$  on receiver 2 only.
- e) Slight perturbation during S-II Retrorocket operation on receiver 2 only.

These disturbances were attributed to RF phenomena that are not predictable. At no time, except for the switch-over point and at S-IC/S-II separation, was the range safety system not prepared for flight termination.

During S-IVB burn, no perturbation of signal strengths were observed until range safety "safe" indication.

## 21. FLIGHT CONTROL

### 21.1 S-IVB Powered Flight Control System Evaluation

The S-IVB Thrust Vector Control system (TVC) provided satisfactory pitch and yaw control during first and second burn. Control was maintained during third burn although abnormal performance was observed in both the pitch and yaw actuators and an abnormal roll torque was observed during the last 150 sec of the burn. The auxiliary propulsion system (APS) provided satisfactory roll control during the three burns.

During S-IVB first burn, control system transients were experienced at S-II/S-IVB separation, guidance initiation, chi tilde guidance mode, and J-2 engine cutoff. During second burn control system transients occurred at engine start and engine cutoff. These transients were expected and were well within the capabilities of the control system.

During third burn high amplitude yaw oscillations due to abnormal actuator performance occurred during the first 100 sec of burn. The oscillations were also evident in the pitch and roll planes but to a much smaller degree. After 145 sec of third burn an unexpectedly large roll torque developed. The sources of the abnormal actuator performance and the large roll torque have not been definitely determined.

#### 21.1.1 Control System Evaluation During First Burn

The S-IVB first burn attitude control system response to guidance commands for pitch, yaw, and roll are presented in figures 21-1, 21-2, and 21-3, respectively. The significant events related to control system operation are indicated on each figure. Maximum attitude errors and rates during first burn occurred at separation and guidance initiation and are presented in table 21-1.

The pitch and yaw thrust vector misalignments during first burn were +0.3 and -0.48 deg, respectively.

As experienced on previous flights, a steady-state roll torque of 5.8 ft-lb counter clockwise looking forward, was experienced during first burn. The roll torque experienced on AS-503 was 6.3 ft-lb.

The PU sensors indicated that only LOX sloshing occurred during first burn. The propellant slosh amplitudes and frequencies were comparable to those experienced on previous flights and did not have an appreciable effect on the control system. The LOX slosh amplitudes and frequencies during first burn are presented in figure 21-4.

#### 21.1.2 Control System Evaluation During Second Burn

The S-IVB second burn attitude control system response to guidance commands for pitch, yaw, and roll are presented in figure 21-5, 21-6, and 21-7, respectively. The effect of LOX propellant sloshing is very pronounced on the pitch attitude, attitude error, angular rate, and actuator position as seen in figure 21-5. The maximum attitude errors and rates occurred at S-IVB ignition. A summary of the second burn maximum values of critical flight control parameters is presented in table 21-2.

The pitch and yaw effective thrust vector misalignments during second burn were +0.26 and -0.55 deg, respectively. The steady-state roll torque was negligible during the short (70 sec) burn. LOX and LH2 slosh parameters are presented in figure 21-8. The LH2 slosh frequency was found to be higher than predicted. Its observed frequency during the first part of second burn agrees closely with the LOX slosh frequency. This indicates that the LOX slosh mass is driving the LH2.

#### 21.1.3 Control System Evaluation During Third Burn

Normal control system operation was observed during the first and second burns of the AS-504 Mission. During third burn, however, abnormal control system performance was observed in three areas:

- a. The yaw actuator developed an erratic negative shift (retract) with respect to valve current during the first 30 sec of the burn. The yaw attitude control system then broke into 0.65 to 0.7 hz oscillations. The pitch control system also oscillated at this frequency but at a lower amplitude. When main engine thrust increased at ESC3 +100 sec, the oscillations in both the pitch and yaw axes ceased.



- b. The pitch actuator gradually developed a  $-0.35$  deg bias (extend) with respect to valve current during the last 80 sec of the burn.
- c. The roll control system firings indicate an abnormally high roll torque during the last 150 sec of the burn.

The S-IVB third burn attitude control system responses to guidance commands for pitch, yaw, and roll are presented in figures 21-9, 21-10, and 21-11, respectively. The maximum control system parameters are tabulated in table 21-3.

#### 21.3.1 Yaw Attitude Control

Erratic yaw actuator behavior, consisting of random spikes in the retract direction, developed several seconds after STDV Open and continued for approximately 30 sec at which time the control system began to oscillate at a frequency of 0.65 to 0.7 hz. The attitude error oscillations reached 1.5 deg (O-P) and the actuator position oscillations reached 1.3 deg (O-P) prior to the thrust decrease. The control system oscillations then damped to expected steady-state values for the remainder of the burn.

Figure 21-12 presents the yaw actuator response during the oscillatory period. The response demonstrates a 1.6 db gain increase and a large phase lag as the actuator moves in the extended direction. The response also shows a shift in the average actuator position with respect to the average commanded position. The value of this shift was approximately  $-0.4$  deg (retract). The shift disappeared when the thrust decreased and the oscillations damped. This change correlates with a sudden shift in attitude error at thrust decrease.

The abnormal increase in the yaw actuator gain and phase lag for frequencies near 0.6 hz decreased the control system phase margin near LOX slosh. This reduction in phase margin decreased the damping of the control loop. Therefore, the high amplitude yaw oscillations are attributed to abnormal actuator behavior. When the thrust decreased, the excessive phase lag decrease and the control system oscillations terminated.

The cause of the abnormal yaw actuator behavior has not been definitely determined. However, possible causes are excessive loads or abnormal actuator vibration environment. Abnormal vibration could result from rough engine combustion. The average value of the yaw actuator position indicates a thrust vector misalignment of nearly  $-0.4$  deg. This value is consistent with second burn yaw misalignment.

#### 21.1.3.2 Pitch Attitude Control

The initial transient oscillations in pitch occurred at a frequency near the yaw plane oscillation frequency instead of at the rigid body control frequency. However, the control system reduced the initial  $0.5$  deg (O-P) attitude error oscillations to less than  $0.15$  deg (O-P). The attitude rate and actuator position oscillations were also low and were consistent with the attitude oscillations. It is currently felt that the pitch oscillations are the result of coupling with the yaw plane activity. The pitch oscillations were at a much lower amplitude than yaw.

Pitch thrust vector misalignment was  $+0.4$  deg for the first 100 sec of burn, suddenly decreased to  $+0.3$  deg at thrust decrease and remained there for the remainder of the burn. This sudden shift in thrust vector misalignment is to be expected at thrust cutback due to thrust structure relaxation.

During the last 80 sec of third burn the pitch actuator gradually developed a  $-0.35$  deg bias (extend) with respect to its commanded position. The null position then drifted to  $-0.20$  deg over a period of several minutes following cutoff and remained there. This behavior is indicative of an abnormal thermal environment.

A close comparison of commanded and actual actuator position during the first 100 sec of oscillations (figure 21-13) indicates abnormal phase lag and slightly increased gain. The larger phase lag occurs as the actuator retracts. An erratic negative null shift (extend) of small magnitude results from the abnormal behavior. Although the actuator performance is abnormal, it should not result in control system instability.

#### 21.1.3.3 Roll Attitude Control

Roll attitude control oscillations in the same frequency range as the pitch and yaw oscillations (0.65 to 0.7 Hz) occurred during the first 100 sec of burn. These oscillations were low in amplitude, and were caused by large amplitude oscillations in the pitch and yaw planes. The average of steady-state roll disturbing torque during the oscillatory period was within the expected range of 50 foot-pounds maximum. The exact value is difficult to determine due to extensive roll control activity in both directions. After the chamber pressure decrease the oscillations stopped, allowing a more confident determination of the "steady-state" roll torque. A summary of the roll torque during third burn is given in figure 21-14. The maximum roll torque was 285 foot-pounds whereas the maximum experienced on previous flights was 40 foot-pounds. The cause of the abnormally high roll torque has been attributed to the LH2 bleed valve opening as explained in section 12.3.3.1.

#### 21.1.3.4 Propellant Sloshing

The sloshing parameters during third burn are presented in figure 21-15. The LOX slosh frequency was near the predicted values throughout the burn. The LH2 slosh frequency was near the LOX slosh frequency instead of the predicted LH2 slosh frequency. Therefore, the LH2 slosh mass was driven by the larger LOX slosh mass.

The LOX slosh height at the PU probe was higher than expected. It was approximately twice the amplitude seen on vehicle AS-503. The slosh height indicated at the PU probe increased with burntime after the surface level went below the tank centerline (forward-aft dome intersection). The height increased from about 2.75 cm (0 to peak) at the probe to 4.8 cm (0 to peak) at the probe at cutoff.

The LH2 slosh height was very erratic but its average height appeared to decrease toward the end of flight. The oscillations were caused by LOX/LH2 coupling.

## 21.2 Attitude Control - Orbit

The AACS provided satisfactory orientation and stabilization during orbital coast. Some of the more significant events in the attitude timeline presented in table 4 are discussed in the following paragraphs.

### TD&E Maneuvers

A maneuver to achieve the desired transposition, docking, and ejection (TD&E) attitude was initiated at approximately 9230 sec GET. The TD&E inertial attitude was pitch (4.36 deg), yaw (14.78 deg), and roll (1.43 deg). The control system responses during this period are presented in figure 21-16, 21-17, and 21-18.

### Spacecraft Separation

The control system responses during and immediately following spacecraft separation are presented in figures 21-19, 21-20, and 21-21. The data indicated that extremely small disturbances were impacted on the S-IVB stage during spacecraft separation. This is consistent with normal control system response prediction during this time period.

### Spacecraft Docking

The control system responses during and immediately following spacecraft docking are presented in figures 21-22, 21-23, and 21-24. The APS engine firing histories indicated small yaw and roll disturbances imparted on the S-IVB stage at spacecraft docking. Pitch disturbances were negligible. Propellant consumption resulting from docking were well within the three sigma predictions. Based on the inactivity of the APS engines following docking, it is apparent that no significant sloshing activity resulted from spacecraft docking.

### LM Ejection

The control system responses at and following LM extraction are presented in figures 21-25, 21-26, and 21-27. The data indicated negligible disturbances resulted from LM ejection. This is consistent with the nominal predicted results.

Maneuver from TD&E Attitude to Second Burn Attitude

Prior to second burn the S-IVB was maneuvered from the TD&E attitude back to a local horizontal, in-plane attitude. Control system responses for this maneuver are presented in figures 21-28, 21-29, and 21-30.

Loss of Attitude Control

Attitude control capability was terminated upon depletion of APS propellants (APS ullage engines intentionally fired to depletion) at approximately 7:41:40 GET. APS usage is presented in section 14.

TABLE 21-1. MAXIMUM CONTROL PARAMETERS DURING FIRST BURN

PARAMETER	IGNITION AND GUID INITIATION	CHI TILDE	CHI FREEZE	S-IVB CUTOFF
Pitch Attitude Error, Deg	+2.1	+0.5	+0.3	+0.3
Yaw Attitude Error, Deg	-1.1	-0.85	-0.6	-0.7
Roll Attitude Error, Deg	+0.9	0	-0.5	-0.35
Pitch Rate, Deg/Sec	-1.25	+0.5	+0.25	0
Yaw Rate, Deg/Sec	+0.35	-0.25	0.0	0
Roll Rate, Deg/Sec	+0.1	0	0.0	0
Pitch Actuator Position, Deg	+1.15	+0.8	+0.3	+0.35
Yaw Actuator Position, Deg	-0.85	-0.85	-0.55	-0.5

TABLE 21-2. MAXIMUM CONTROL PARAMETERS DURING SECOND BURN

PARAMETER	IGNITION	S-IVB CUTOFF
Pitch Attitude Error, Deg	-1.7	-1.6
Yaw Attitude Error, Deg	-4.9	-4.5
Roll Attitude Error, Deg	+0.6	+0.85
Pitch Rate, Deg/Sec	+1.8	+0.25
Yaw Rate, Deg/Sec	-1.6	-0.3
Roll Rate, Deg/Sec	+0.15	+0.05
Pitch Actuator Position, Deg	+0.4	-0.15
Yaw Actuator Position, Deg	+1.25	+0.45

TABLE 21-3. MAXIMUM CONTROL PARAMETERS DURING S-IVB THIRD BURN

PARAMETER	IGNITION	S-IVB CUTOFF
Pitch Attitude Error, Deg	-1.4	0
Yaw Attitude Error, Deg	-4.2	-5.7
Roll Attitude Error, Deg	+0.55	-0.35
Pitch Rate, Deg/Sec	-1.8	+0.3
Yaw Rate, Deg/Sec	-2.0	0
Roll Rate, Deg/Sec	+0.3	0
Pitch Actuator Position, Deg	+0.5	-0.2
Yaw Actuator Position, Deg	-1.2	-1.2



TABLE 21-4  
 'D' MISSION ATTITUDE TIMELINE  
 NOMINAL MISSION

MANEUVER	GROUND ELAPSED TIME	
	PREDICTED HR:MIN:SEC	MONITORED HR:MIN:SEC
1. MAINTAIN COMMANDED CUTOFF INERTIAL ATTITUDE.	00:10:51.4	00:11:04.87
2. INITIATE MANEUVER TO ALIGN S-IVB/SC +X AXIS ALONG LOCAL HORIZONTAL (CSM FORWARD, POSITION I DOWN) AND MAINTAIN ORBITAL RATE.	00:11:11.4	00:11:24.87
3. INITIATE MANEUVER TO TRANSPOSITION AND DOCKING INERTIAL ATTITUDE. ATTITUDE IS DEFINED BY THE FOLLOWING GIMBAL ANGLES: $X_{PITCH} = 4.36^\circ$ , $X_{YAW} = 14.78^\circ$ , $X_{ROLL} = 1.43^\circ$ . MAINTAIN ATTITUDE WITH RESPECT TO INERTIAL REFERENCE.	02:34:00	02:34:00
4. SPACECRAFT SEPARATION	02:40:00	02:45:00
5. LM EXTRACTION	04:10:00	04:08:05
6. INITIATE MANEUVER TO ALIGN THE S-IVB/IU + X AXIS ALONG THE LOCAL HORIZONTAL (IU FORWARD, POSITION I DOWN) AND MAINTAIN ORBITAL RATE. THIS MANEUVER WAS PROGRAMMED WITH THE INHIBIT ON. INHIBIT WAS REMOVED BY GROUND COMMAND AFTER LM EXTRACTION WAS CONFIRMED.	04:24:51	04:25:04.87*
7. INITIATE TIME BASE 6. MAINTAIN LOCAL HORIZONTAL ATTITUDE.	04:36:11	04:36:17.24
8. FREEZE S-IVB ATTITUDE INERTIALLY.	04:45:51	04:45:57.54*
9. MAINTAIN COMMANDED CUTOFF INERTIAL ATTITUDE.	04:46:51	04:46:57.82
10. INITIATE MANEUVER TO ALIGN THE S-IVB/IU +X AXIS ALONG THE LOCAL HORIZONTAL (IU FORWARD, POSITION I DOWN) AND MAINTAIN ORBITAL RATE.	04:47:11	04:47:17.82
11. INITIATE TIME BASE 8. MAINTAIN LOCAL HORIZONTAL ATTITUDE.	05:58:25	05:59:40.98
12. FREEZE S-IVB ATTITUDE INERTIALLY.	06:06:05	06:07:21.28*
13. MAINTAIN COMMANDED CUTOFF INERTIAL ATTITUDE.	06:10:04	06:11:21.53
14. INITIATE MANEUVER TO ALIGN THE S-IVB/IU +X AXIS ALONG THE LOCAL HORIZONTAL. (IU FORWARD, POSITION I DOWN).	06:10:24	06:11:41.53

\* COMPUTED USING PREDICTED  $\Delta t$  FROM THE TIME BASE.

- ① S-IVB BURN MODE ON, 537.4
- ② GUIDANCE INITIATION, 551.0
- ③ CHI TILDE, 631.4
- ④ CHI FREEZE, 656.9
- ⑤ S-IVB ENGINE CUTOFF COMMAND, 665.0

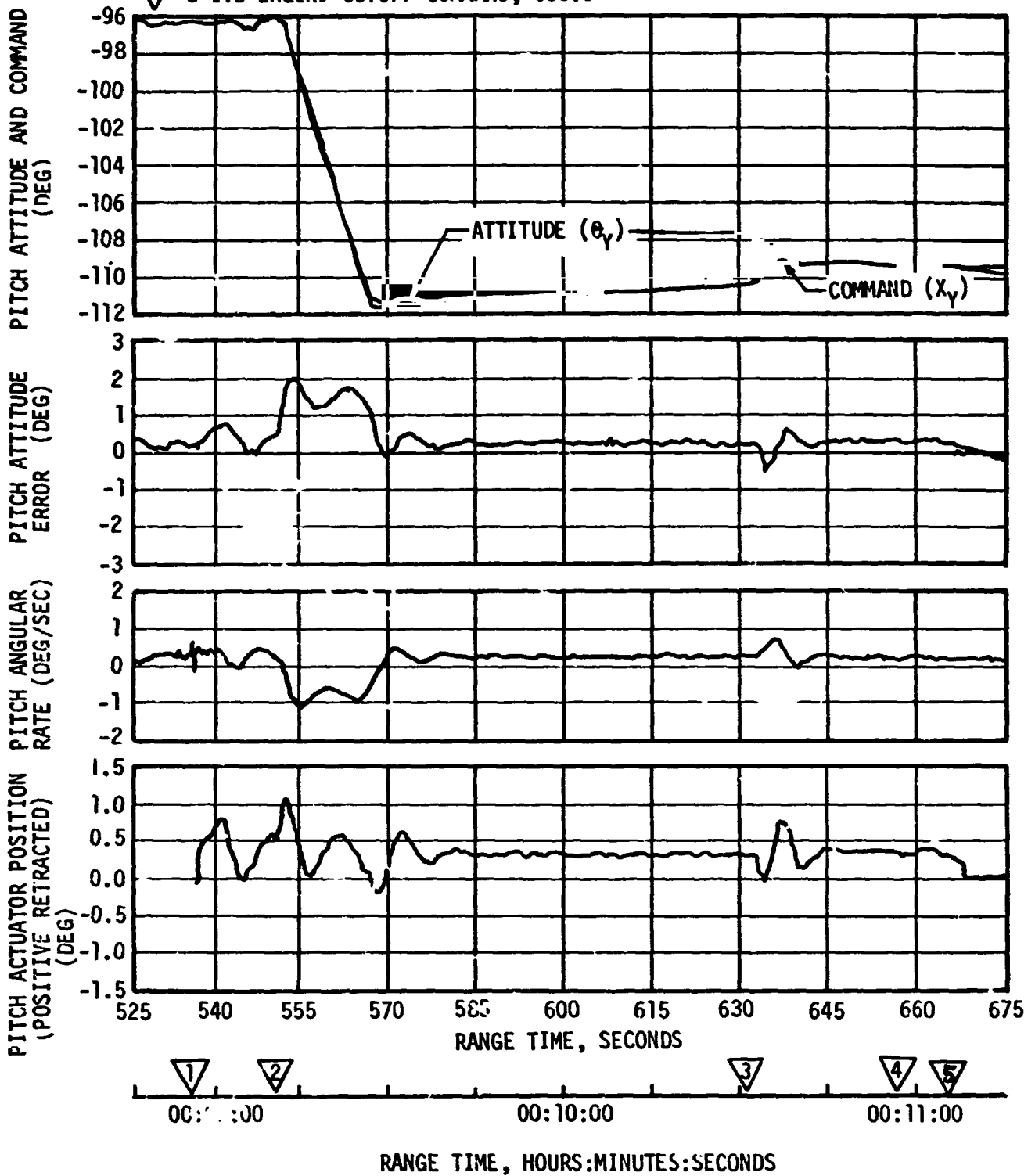

Figure 21-1. Pitch Attitude Control During S-IVB First Burn

- ▽ 1 S-IVB BURN MODE ON, 537.4
- ▽ 2 GUIDANCE INITIATION, 551.0
- ▽ 3 CHI TILDE, 631.4
- ▽ 4 CHI FREEZE, 656.9
- ▽ 5 S-IVB ENGINE CUTOFF COMMAND, 665.0

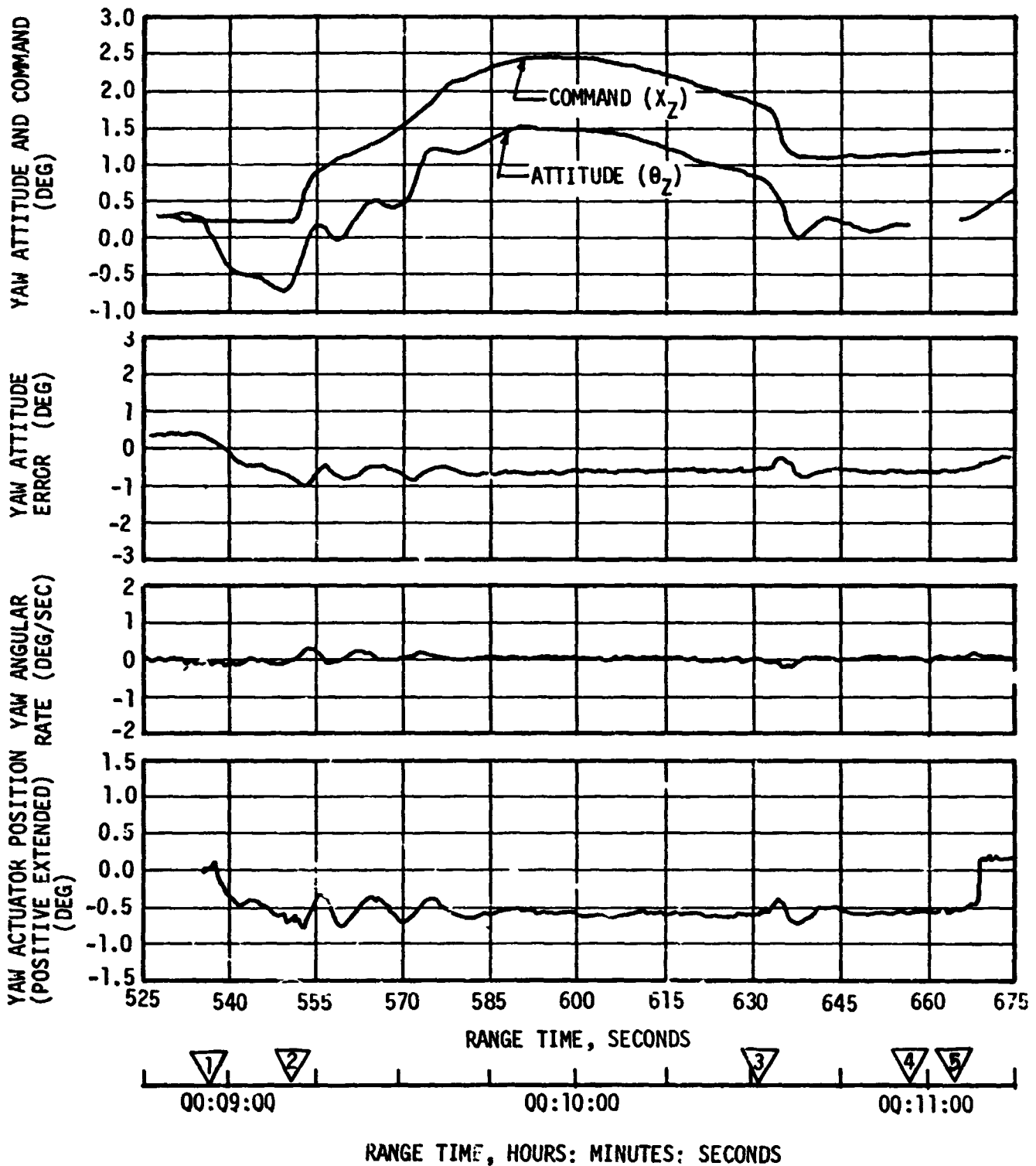

Figure 21-2. Yaw Attitude Control during S-IVB First Burn 21-13

- 1 S-IVB BURN MODE ON, 537.4
- 2 GUIDANCE INITIATION, 551.0
- 3 CHI TILDE, 631.4
- 4 CHI FREEZE, 656.9
- 5 S-IVB ENGINE CUTOFF COMMAND, 665.0

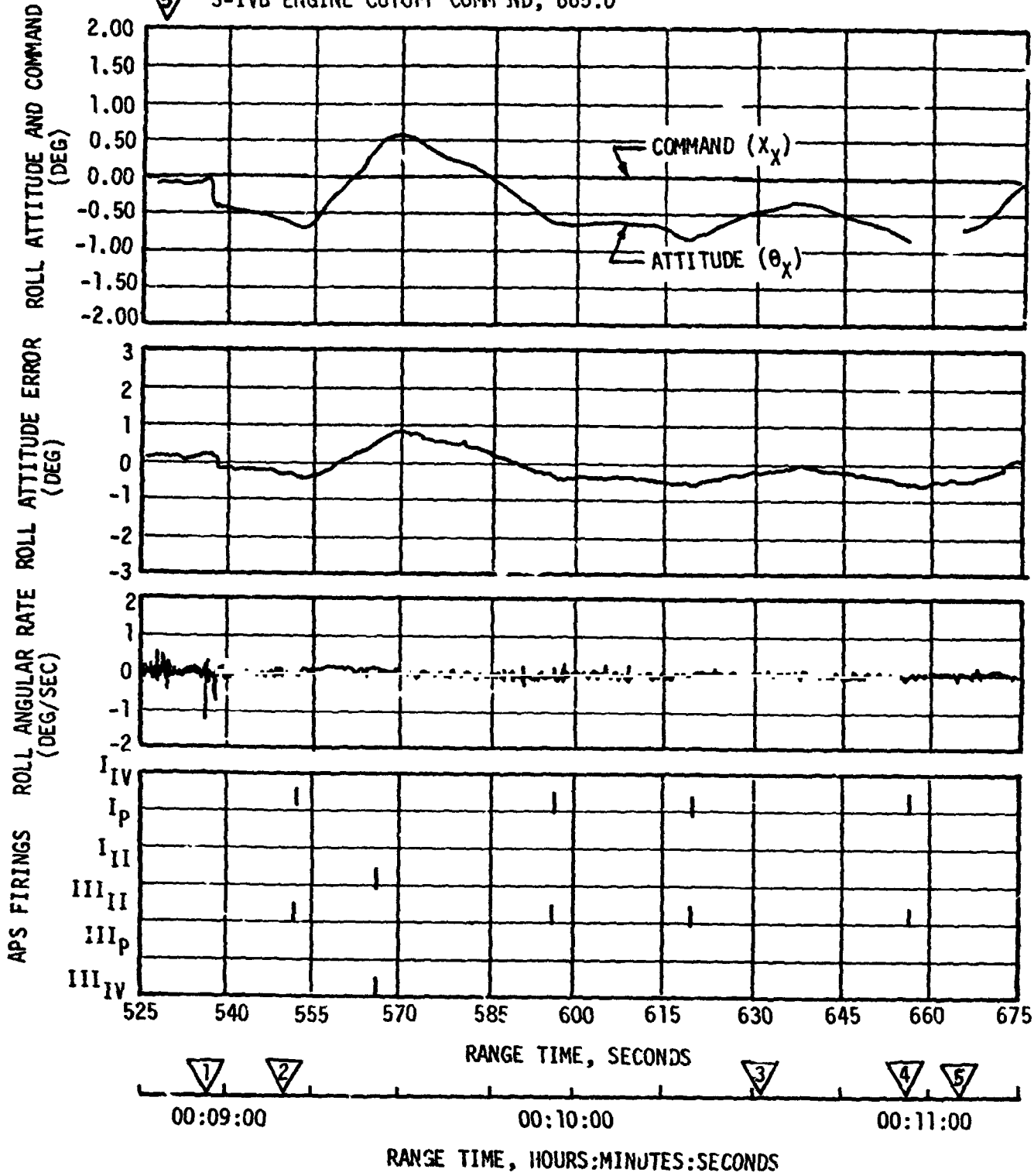
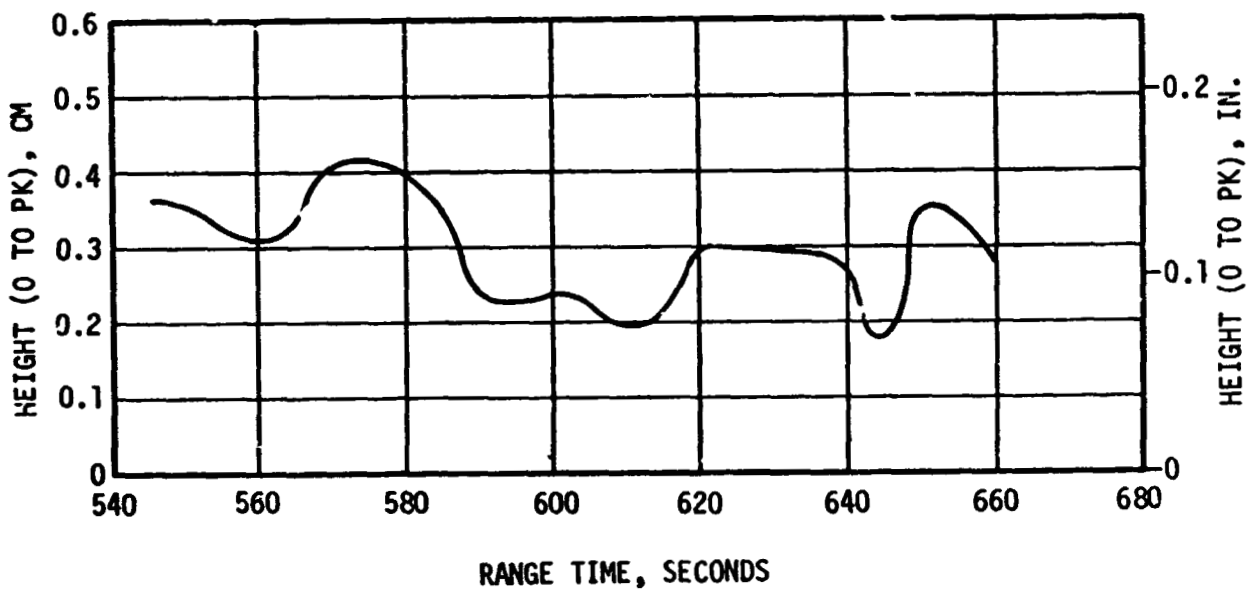
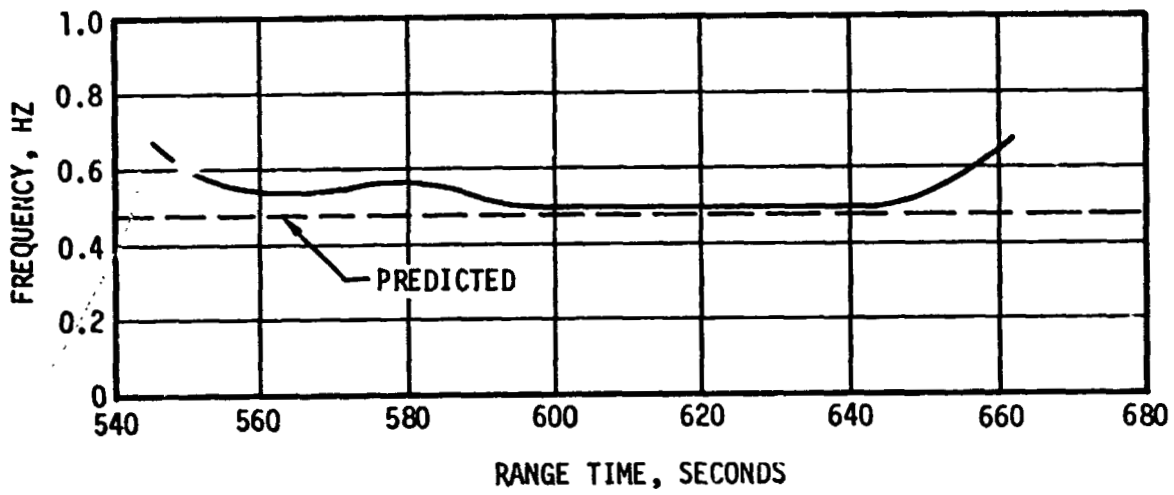

Figure 21-3. Roll Attitude Control during S-IVB First Burn



NOTE: NO SIGNIFICANT LH2 SLOSH OCCURRED

Figure 21-4. S-IVB Slosh Frequency and Height for LOX during First Burn

- ▽ 1 S-IVB ENGINE START COMMAND, 17147.3
- ▽ 2 S-IVB ENGINE CUTOFF COMMAND, 17217.7

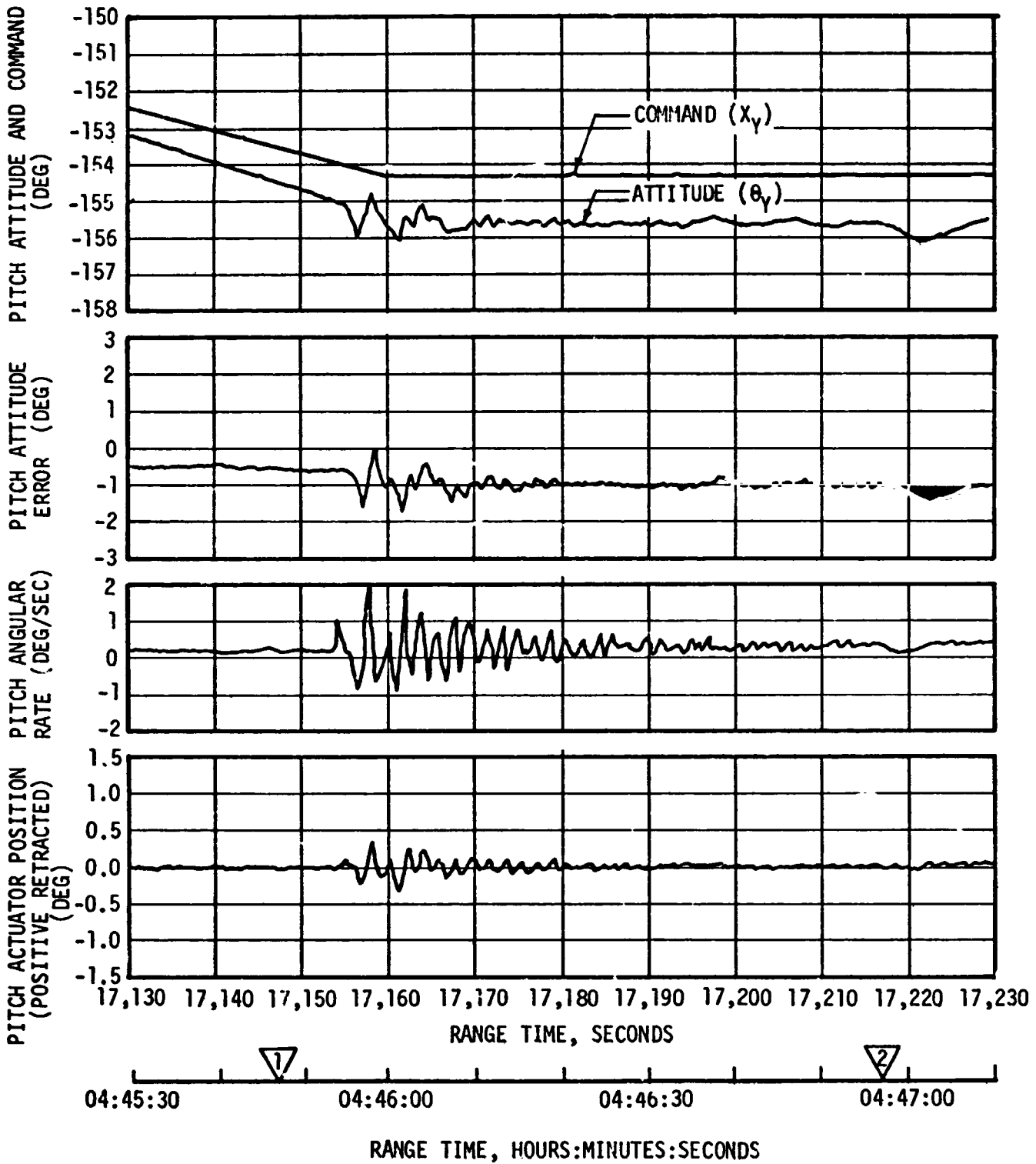

Figure 21-5. Pitch Attitude Control during S-IVB Second Burn

- 1 S-IVB ENGINE START COMMAND 17147.3
- 2 S-IVB ENGINE CUTOFF COMMAND, 17217.7

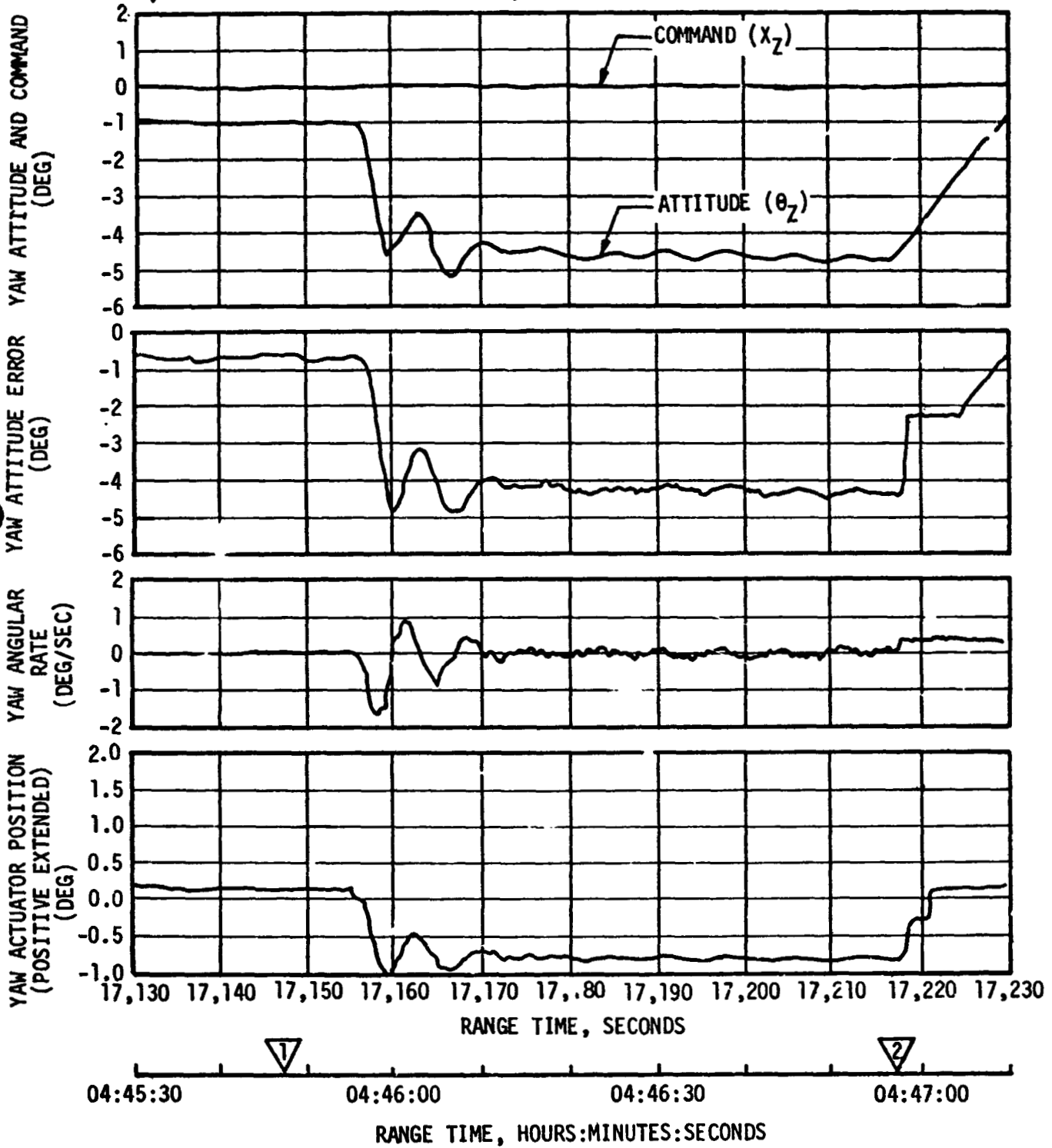

Figure 21-6. Yaw Attitude Control during S-IVB Second Burn

- ▽ S-IVB ENGINE START COMMAND, 17147.3
- ▽ S-IVB ENGINE CUTOFF COMMAND, 17217.7

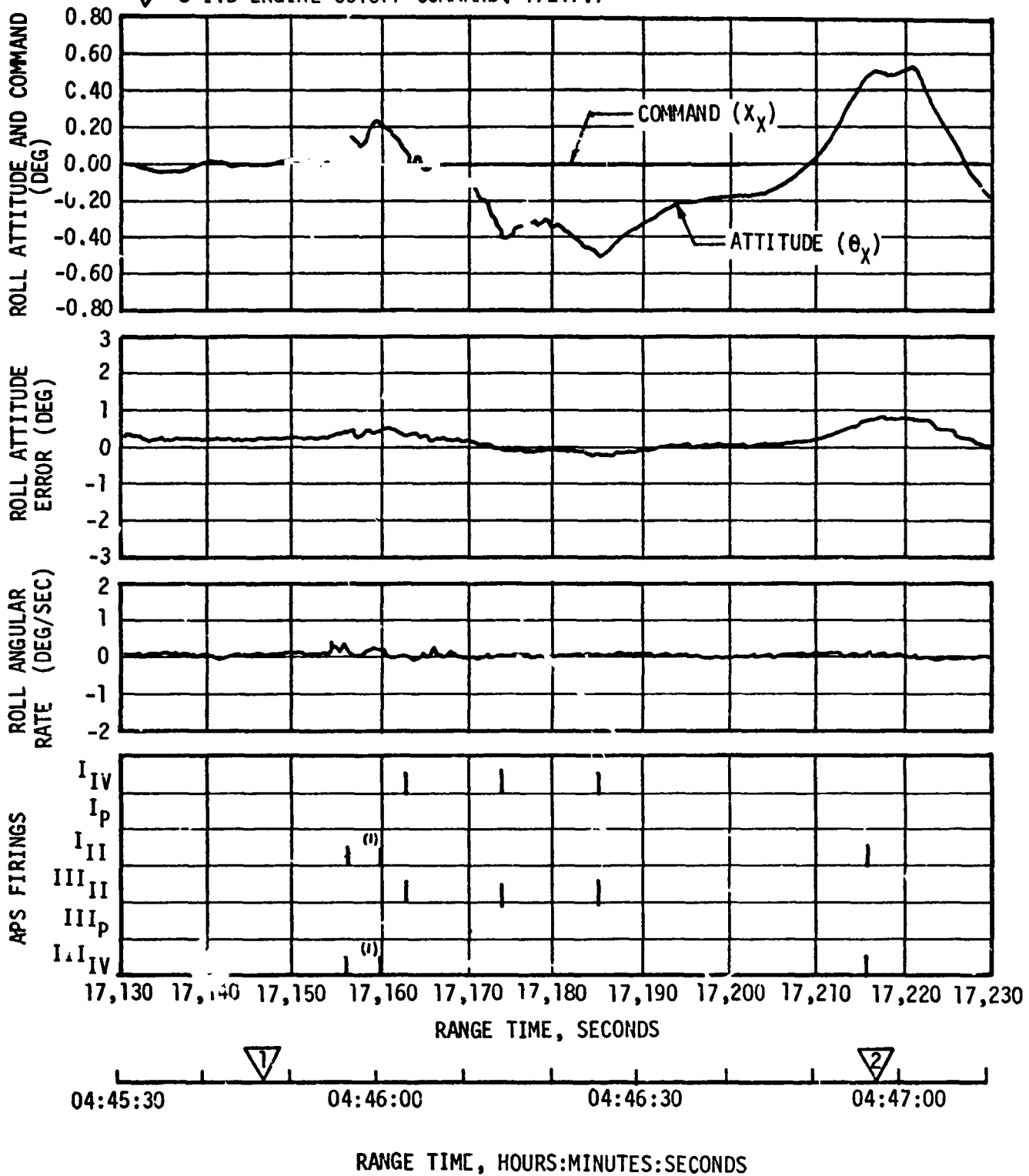

Figure 21-7. Roll Attitude Control During S-IVB Second Burn



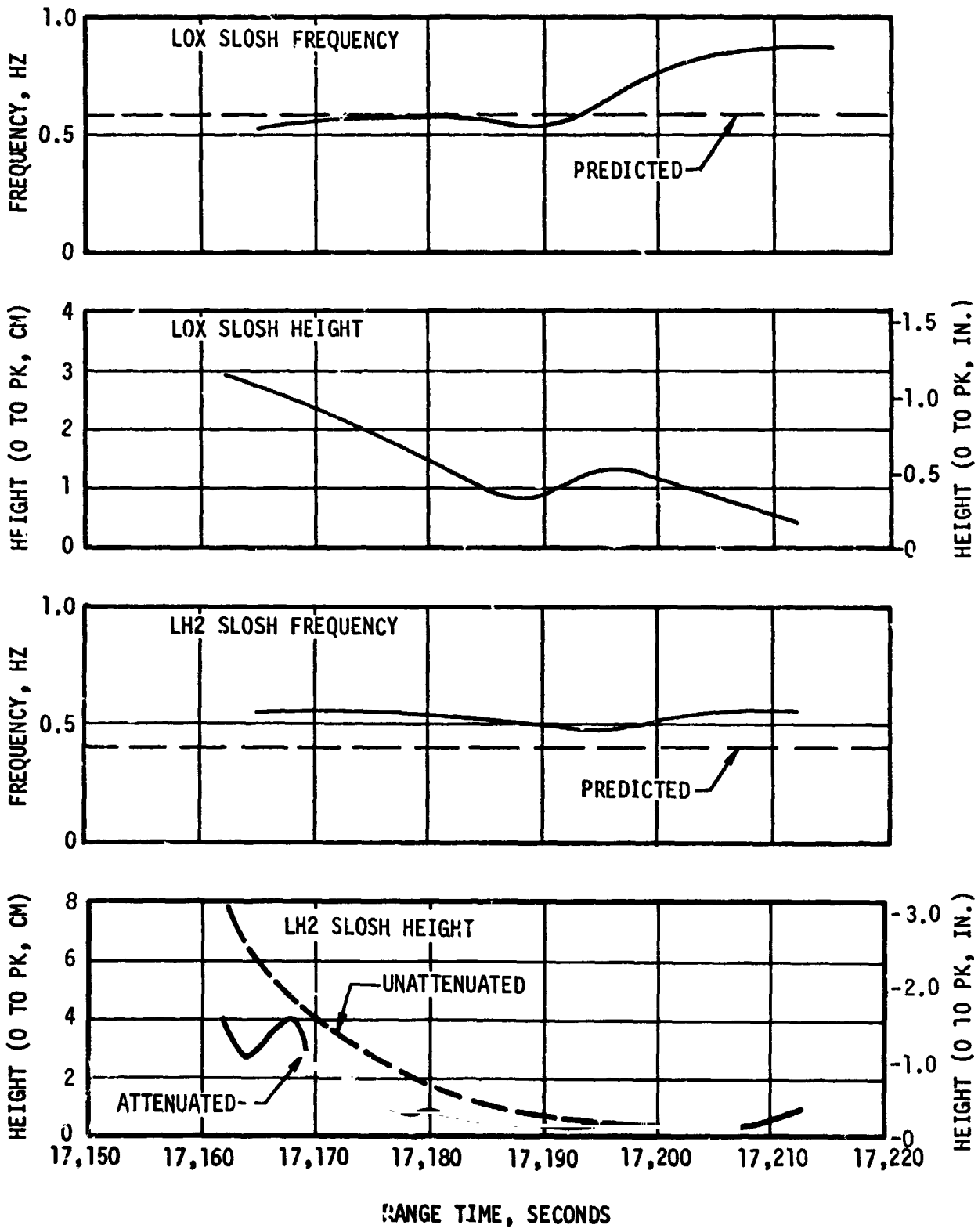

Figure 21-8. S-IVB Slosh Frequencies and Height during Second Burn

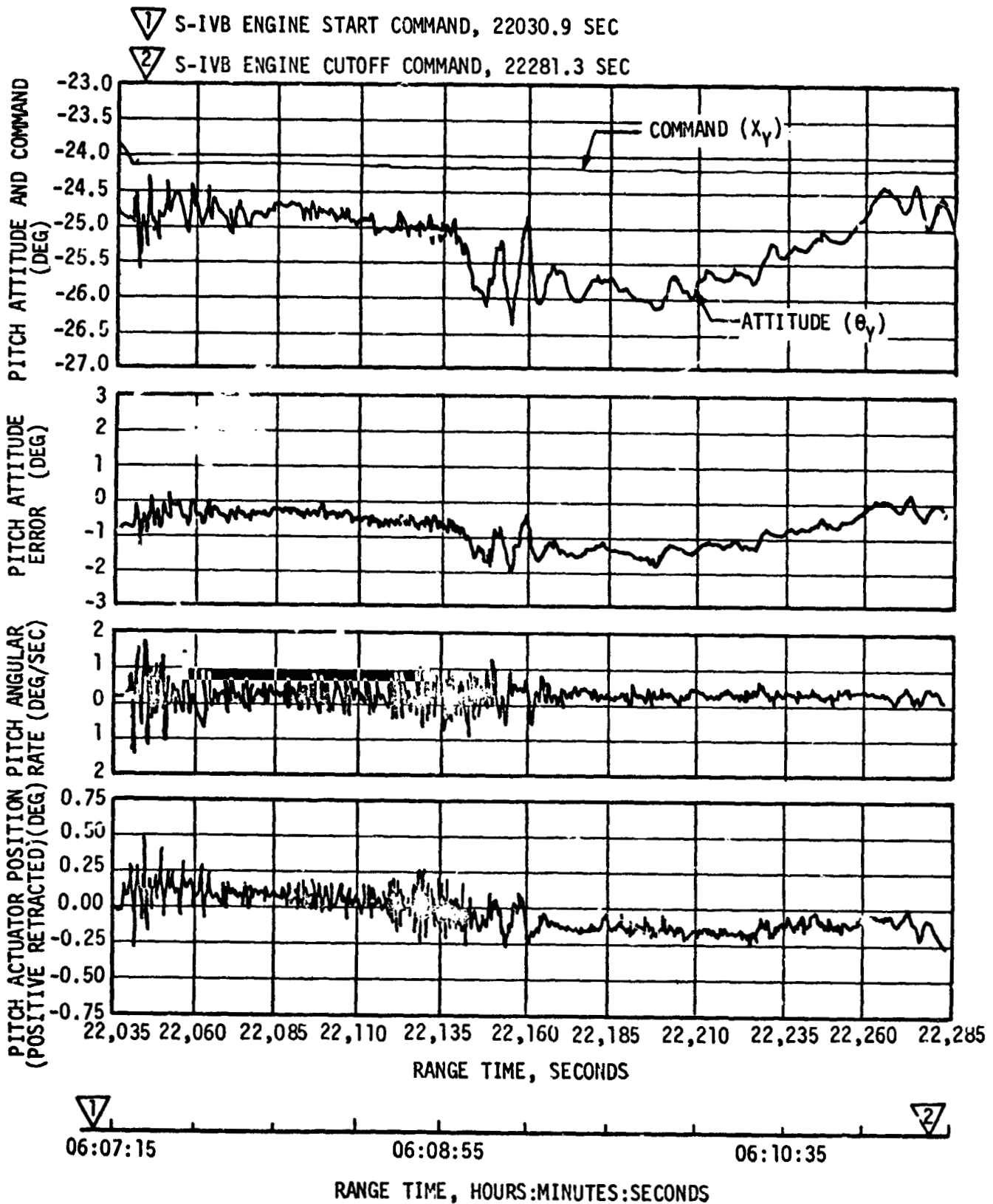
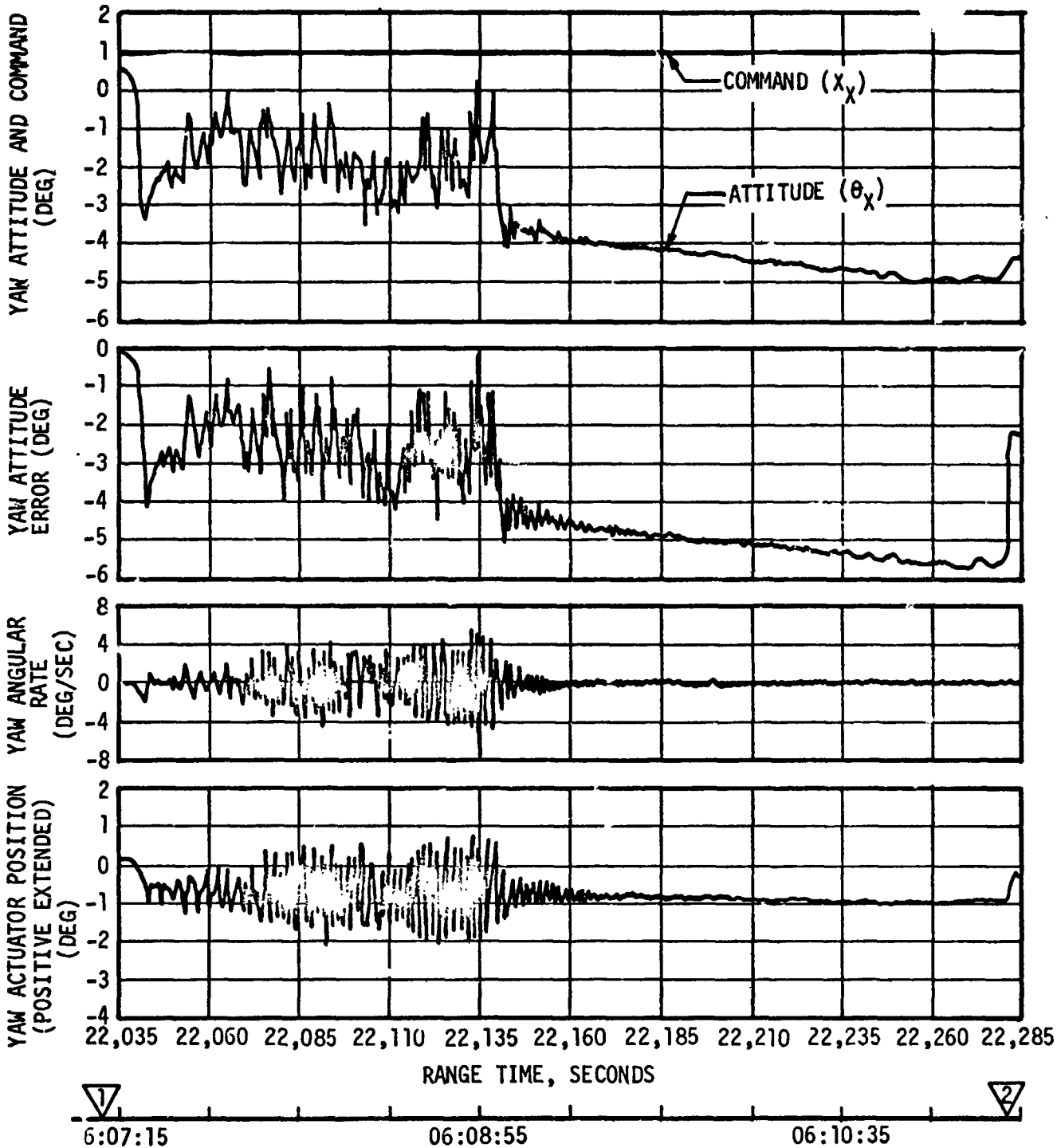

Figure 21-9. Pitch Attitude Control During S-IVB Third Burn

1 S-IVB ENGINE START COMMAND, 22030.9 SEC  
 2 S-IVB ENGINE CUTOFF COMMAND, 22281.3 SEC



RANGE TIME, HOURS:MINUTES:SECONDS

Figure 21-10. Yaw Attitude Control during S-IVB Third Burn

- ▽ 1 S-IVB ENGINE START COMMAND, 22030.9 SEC
- ▽ 2 S-IVB ENGINE CUTOFF COMMAND, 22281.3 SEC

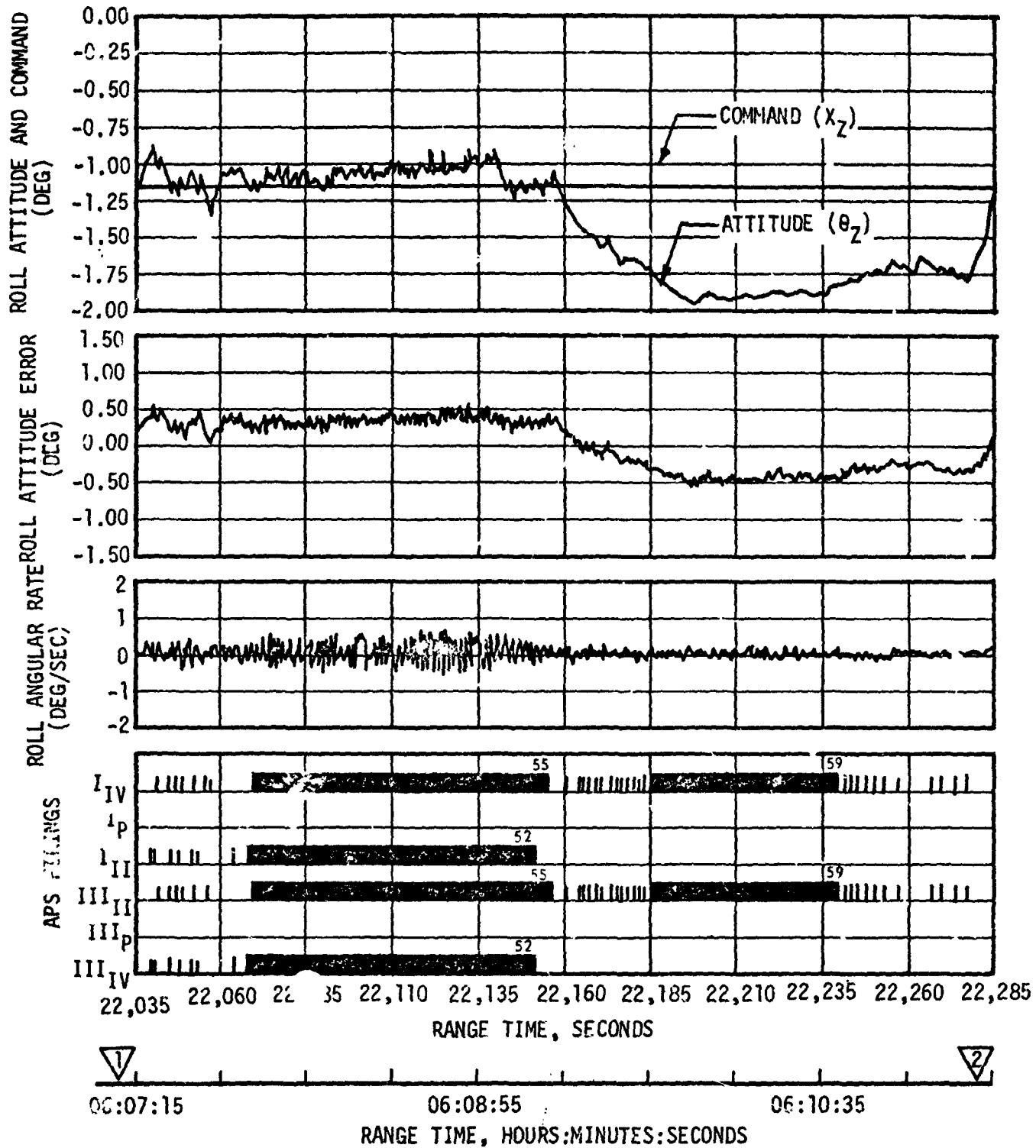

\*INDICATES NUMBER OF PULSES

Figure 21-11. Roll Attitude Control during S-IVB Third Burn

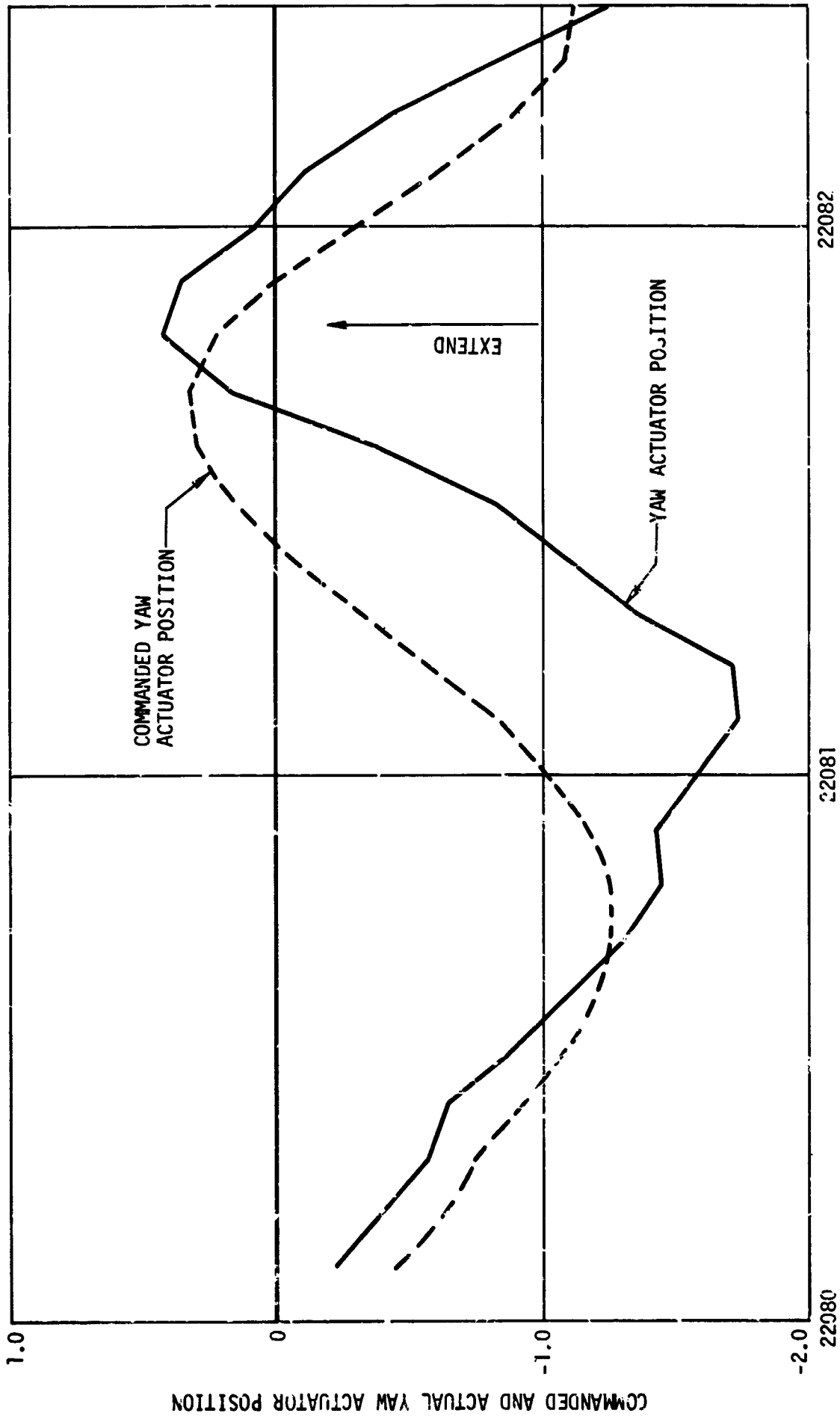

Figure 21-12. Comanded and Actual Yaw Actuator Position

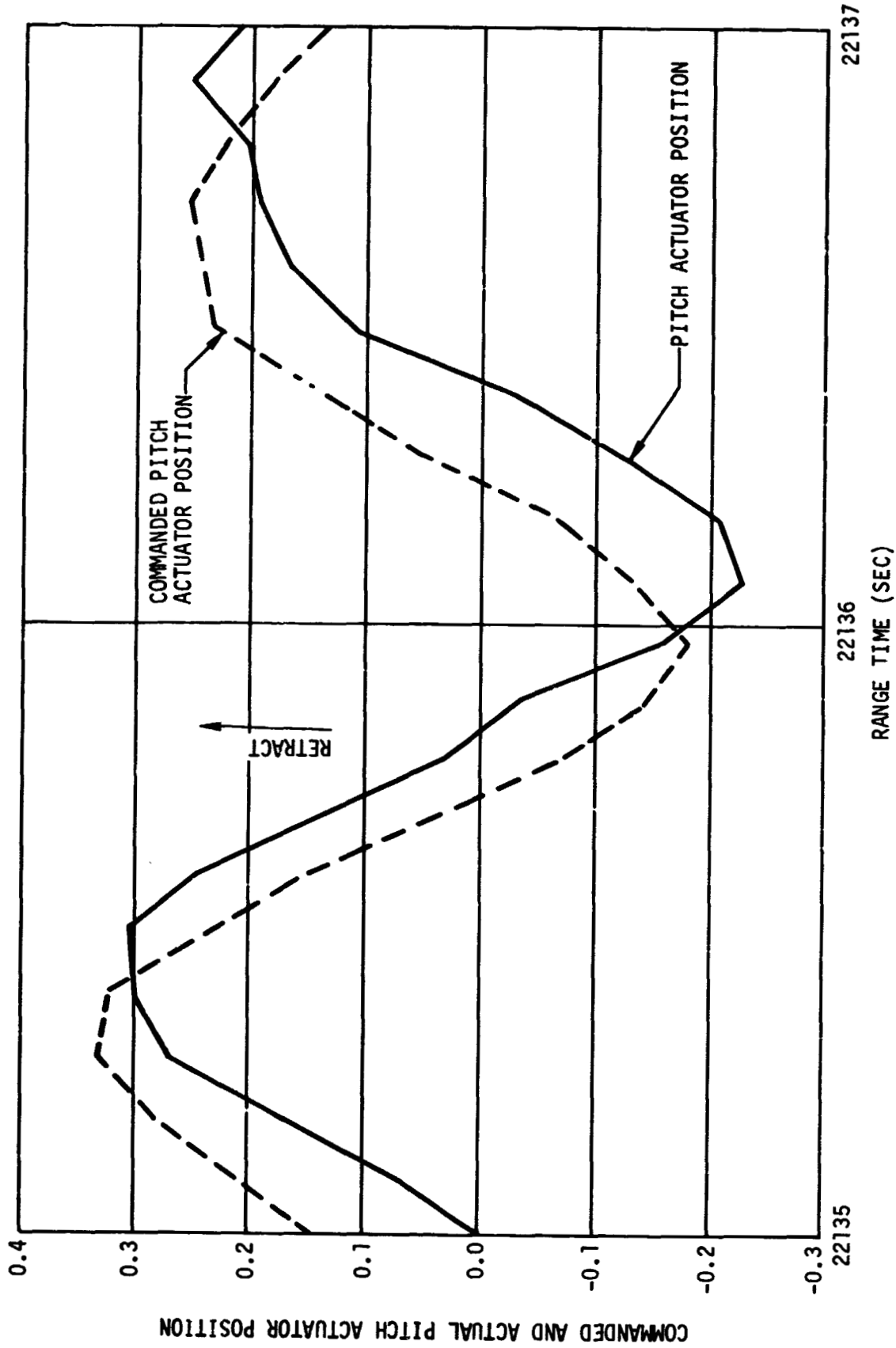

Figure 21-13. Comanded and Actual Pitch Actuator Position

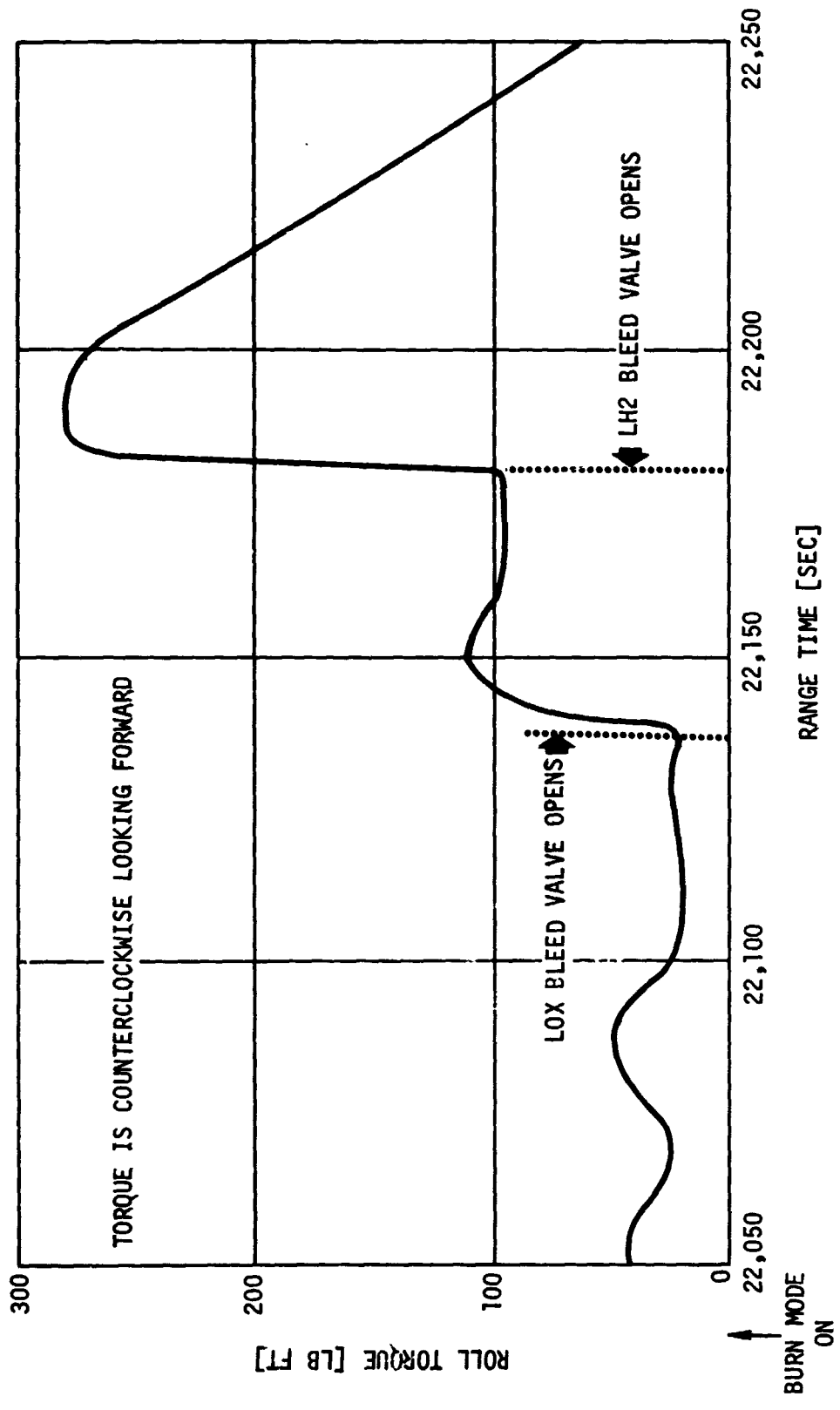

Figure 21-14 504N Roll Torque-3RD Burn

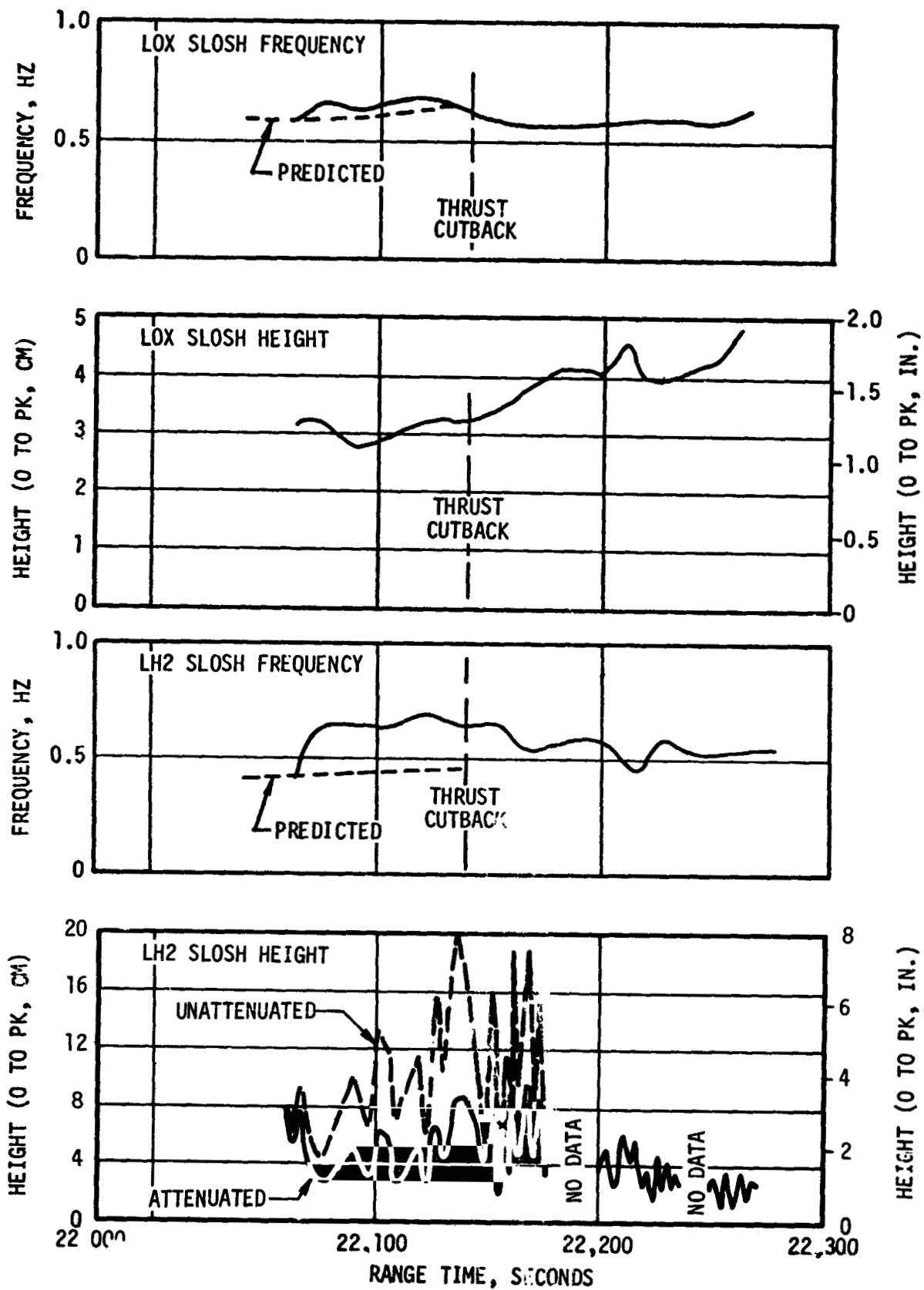

Figure 21-15. S-IVB Slosh Frequencies and Heights during Third Burn



▽ BEGIN MANEUVER TO TRANSPOSITION, DOCKING AND EXTRACTION ATTITUDE

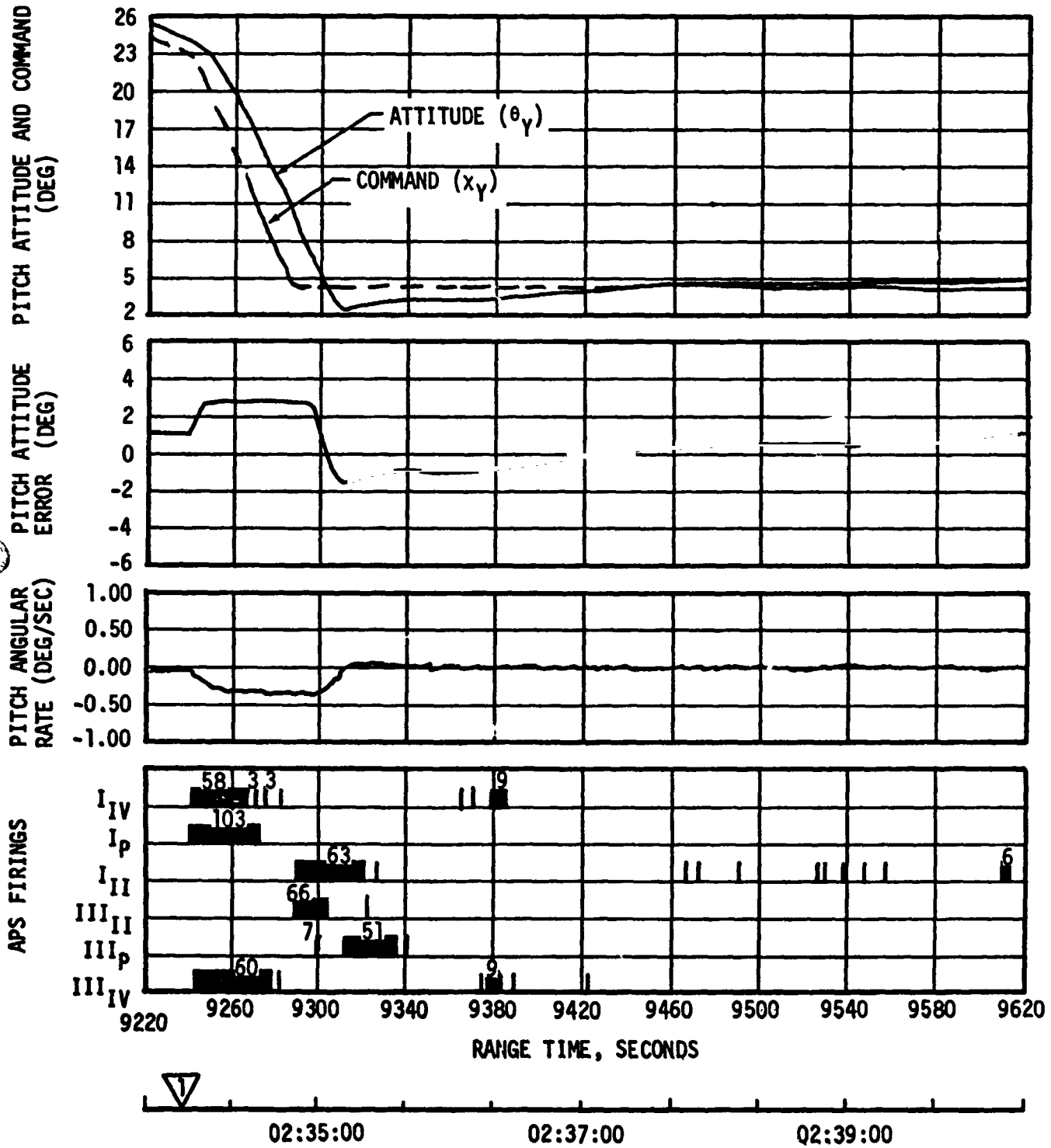

Figure 21-16. Pitch Attitude Control during TD&E Maneuver

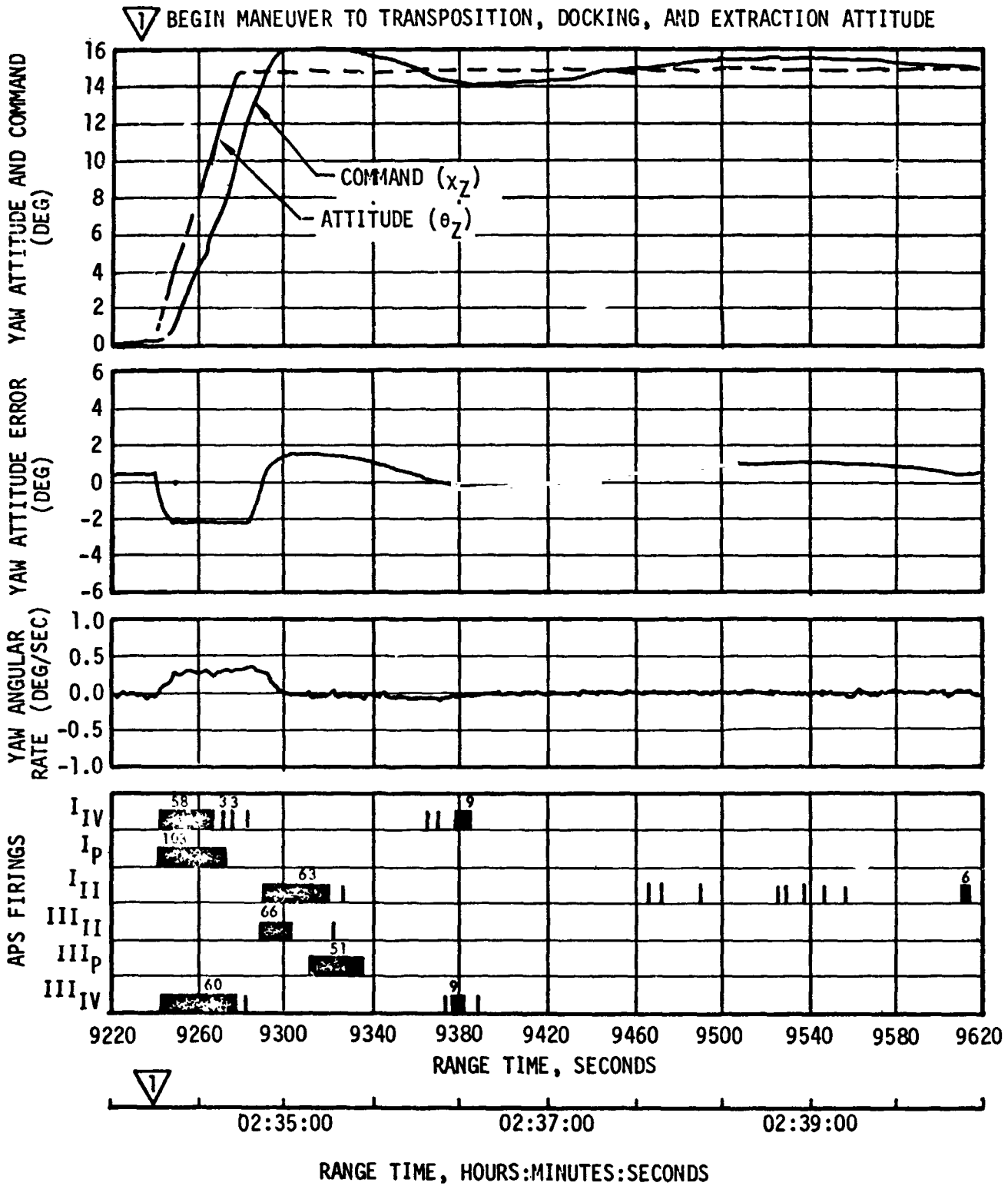

Figure 21-17. Yaw Attitude Control during TD&E Maneuver.

ROLL ATTITUDE AND COMMAND (DEG)  
 ROLL ATTITUDE ERROR (DEG)  
 ROLL ANGULAR RATE (DEG/SEC)

▽ BEGIN MANEUVER TO TRANSPOSITION, DOCKING, AND EXTRACTION ATTITUDE

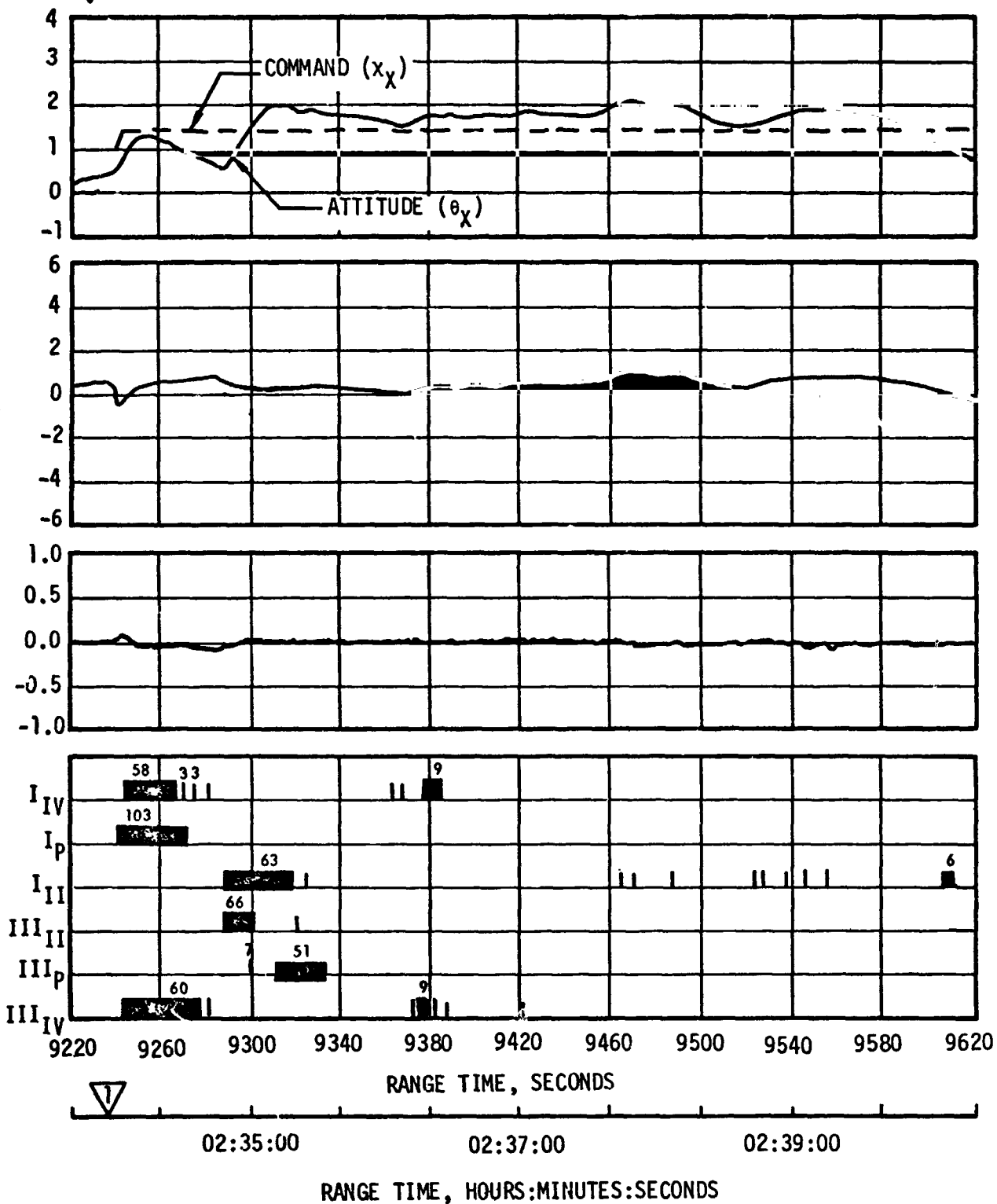

Figure 21-18. Roll Attitude Control during TD&E Maneuver

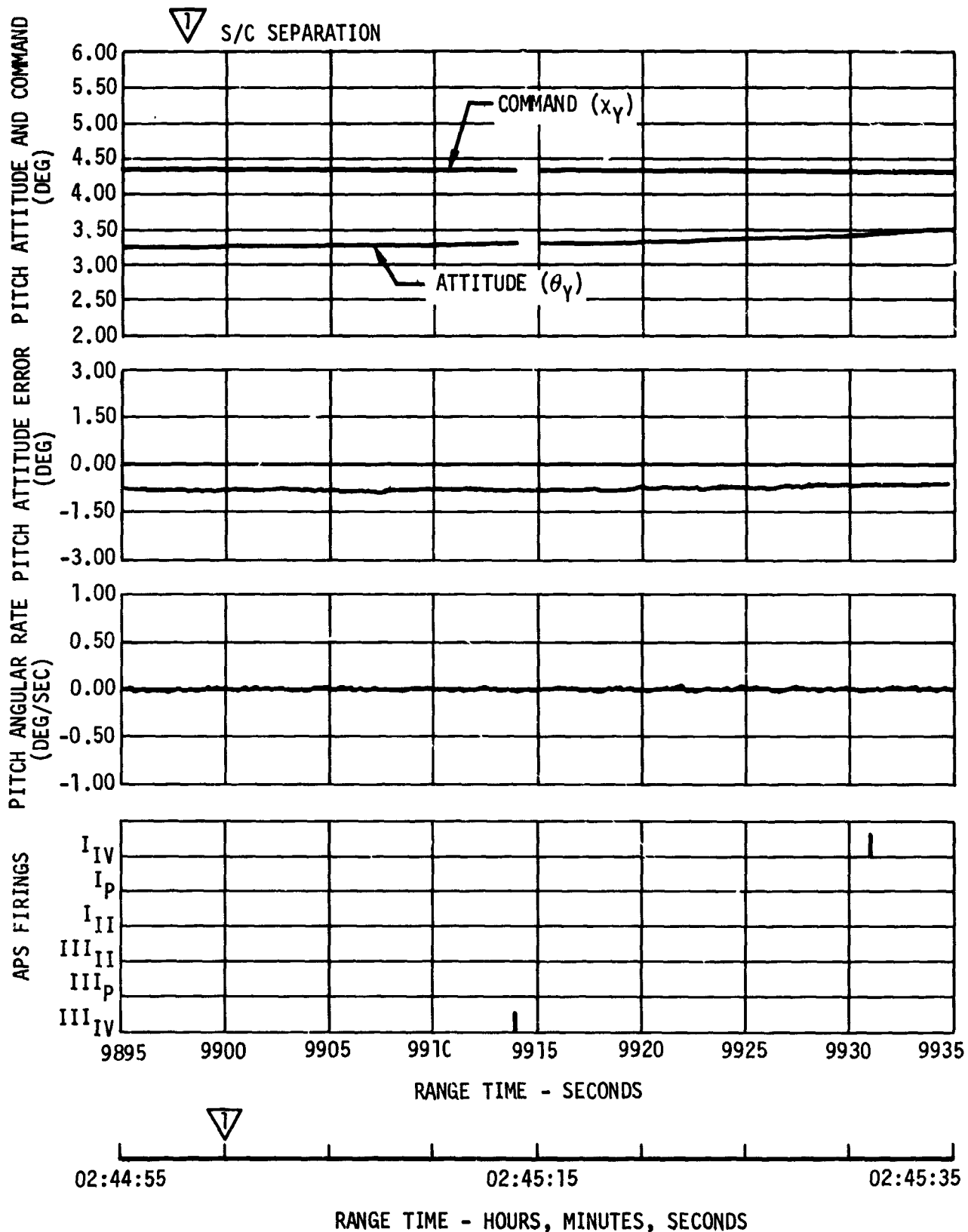

Figure 21-19, Pitch Attitude Control During S/C Separation

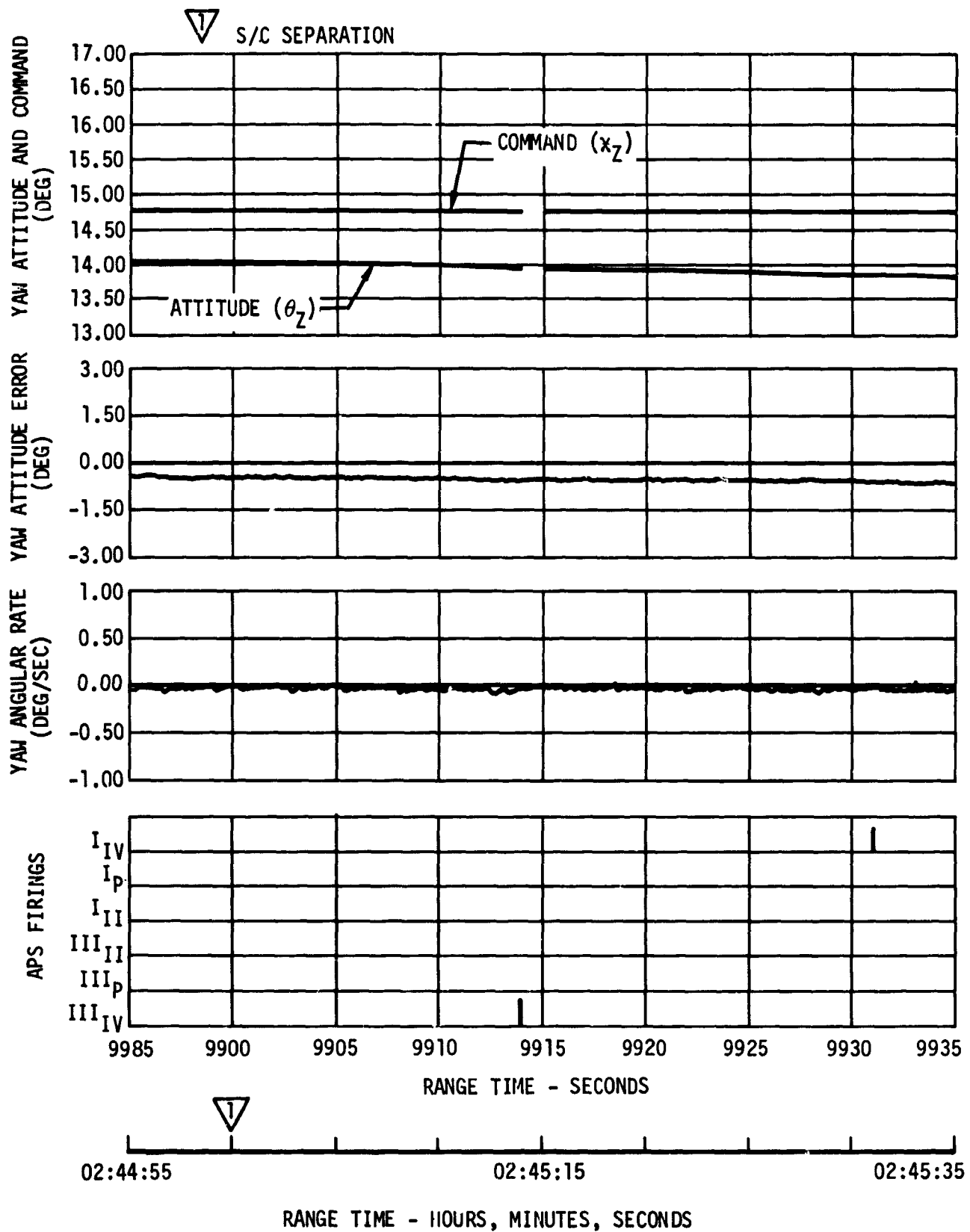

Figure 21-20, Yaw Attitude Control During S/C Separation

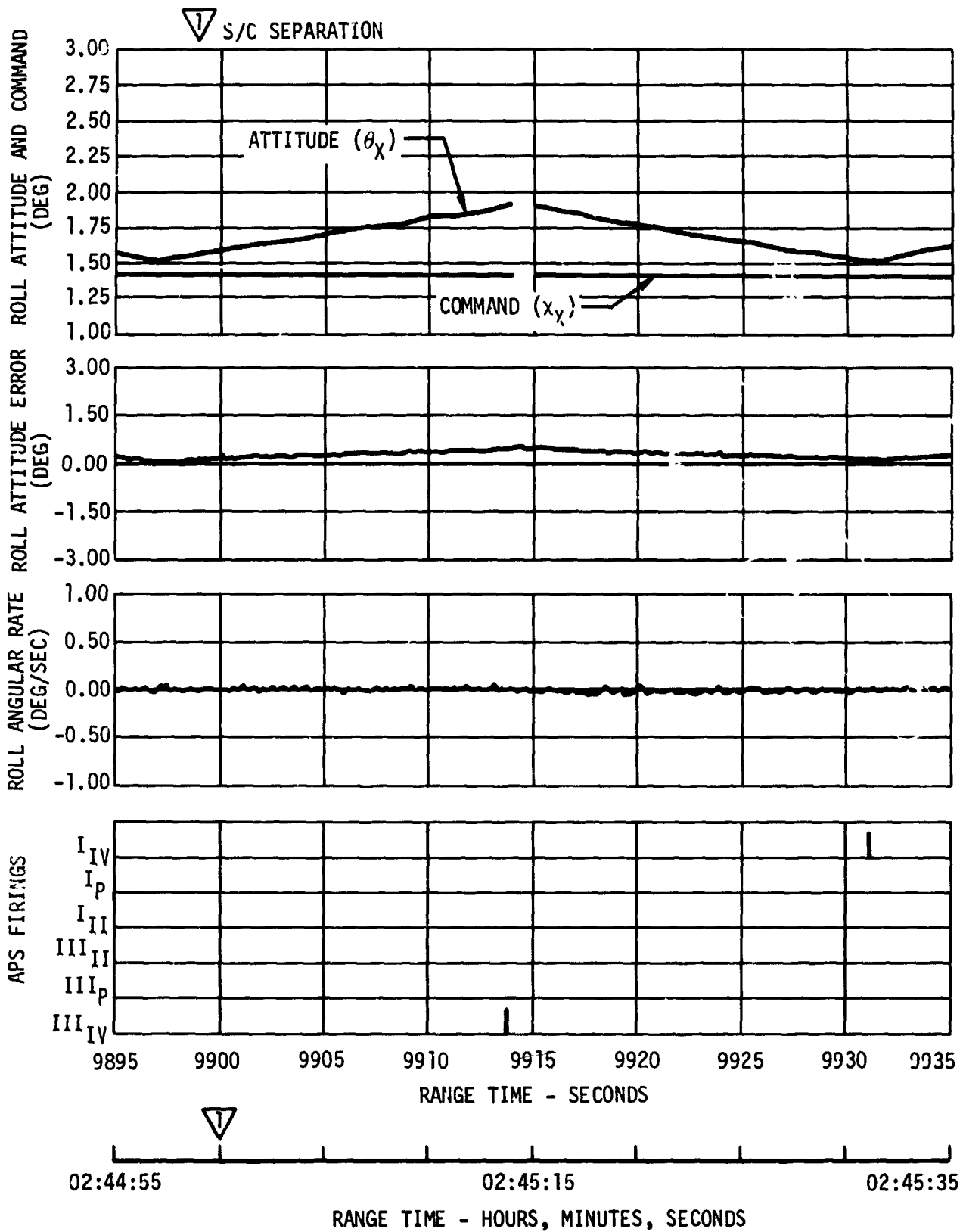

Figure 21-21, Roll Attitude Control During S/C Separation

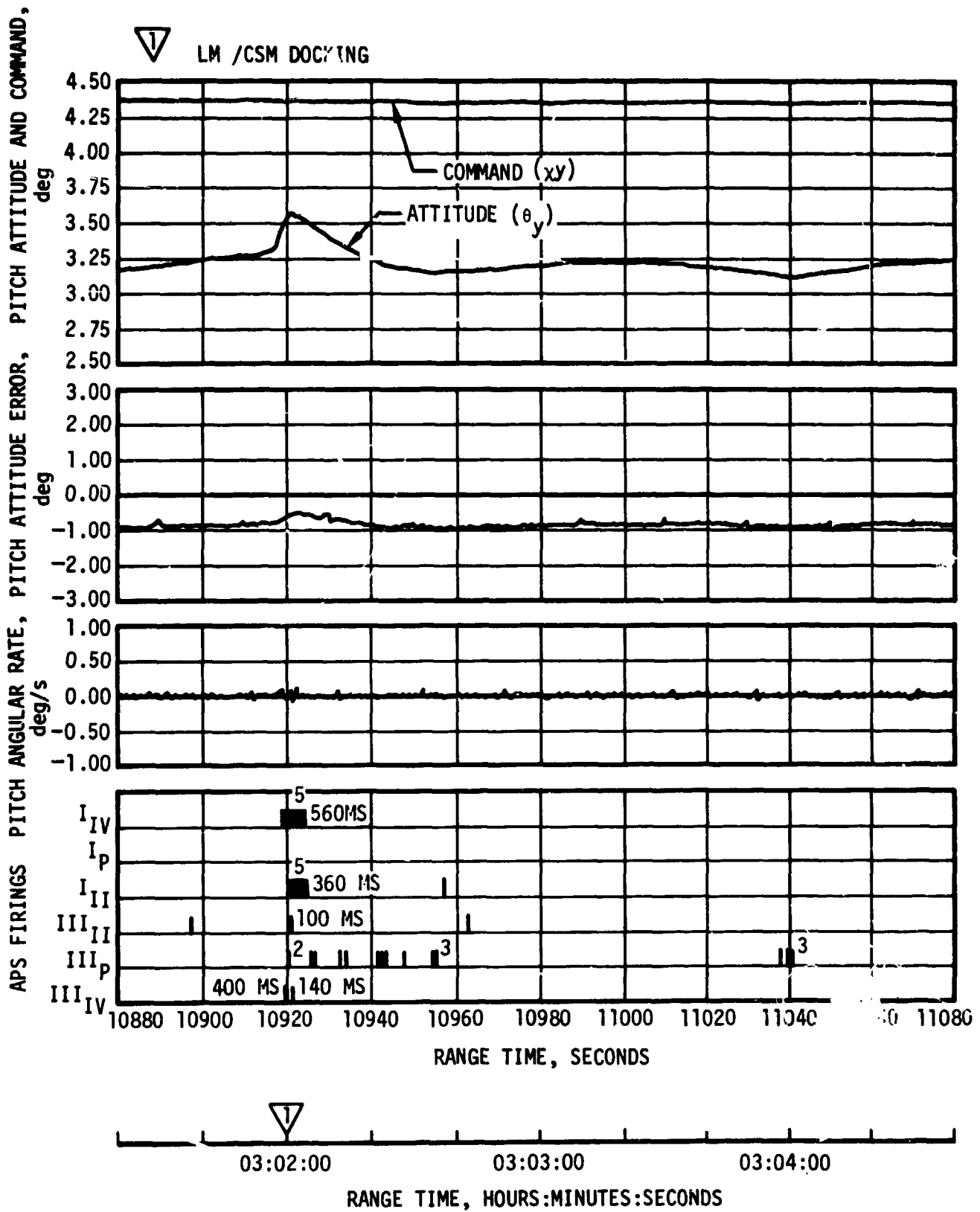

Figure 21-22. Pitch Attitude Control During Hard Dock

▽ LM/CSM DOCKING

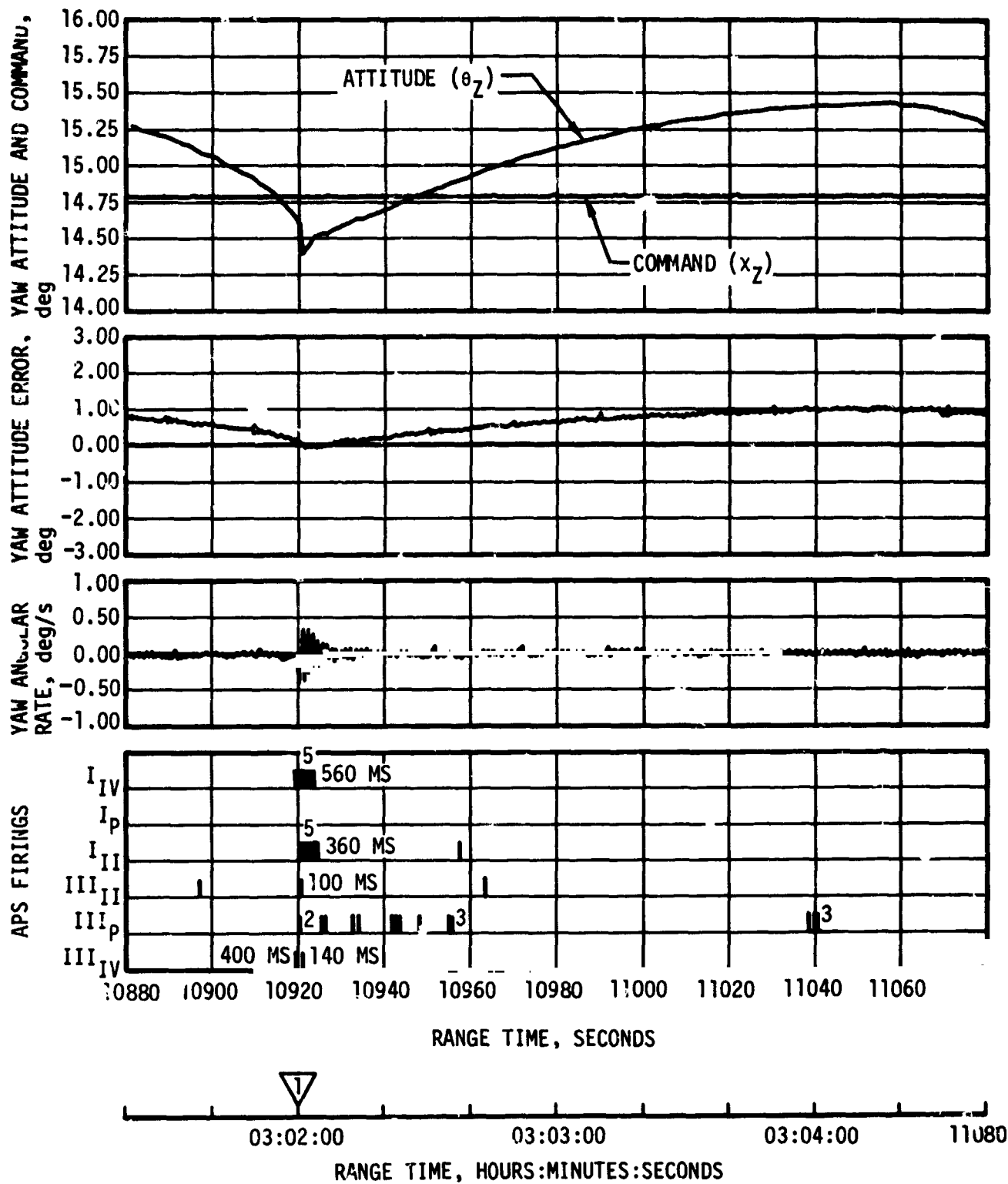

Figure 21-23. Yaw Attitude Control During Hard Dock



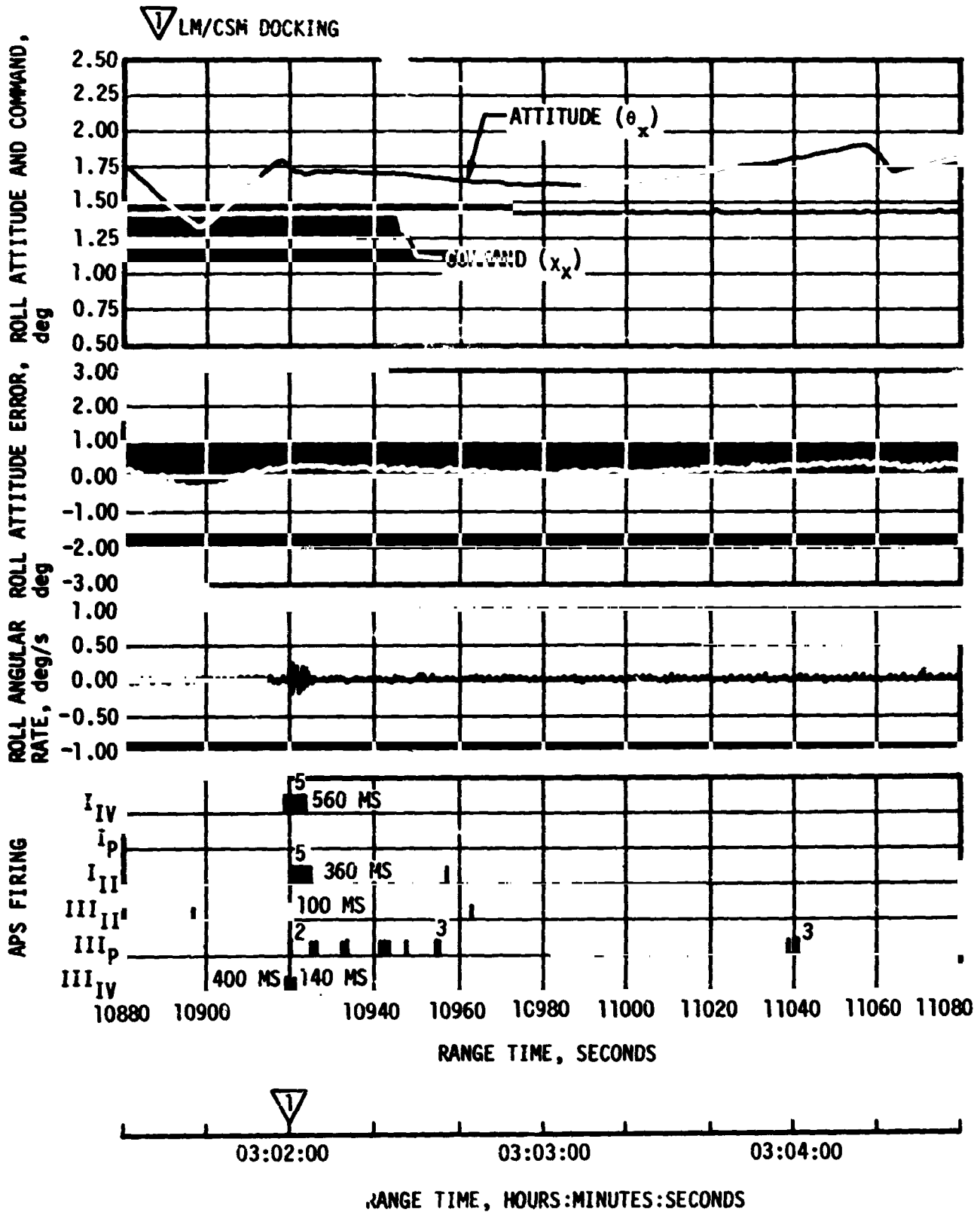

Figure 21-24. Roll: Attitude Control During Hard Dock

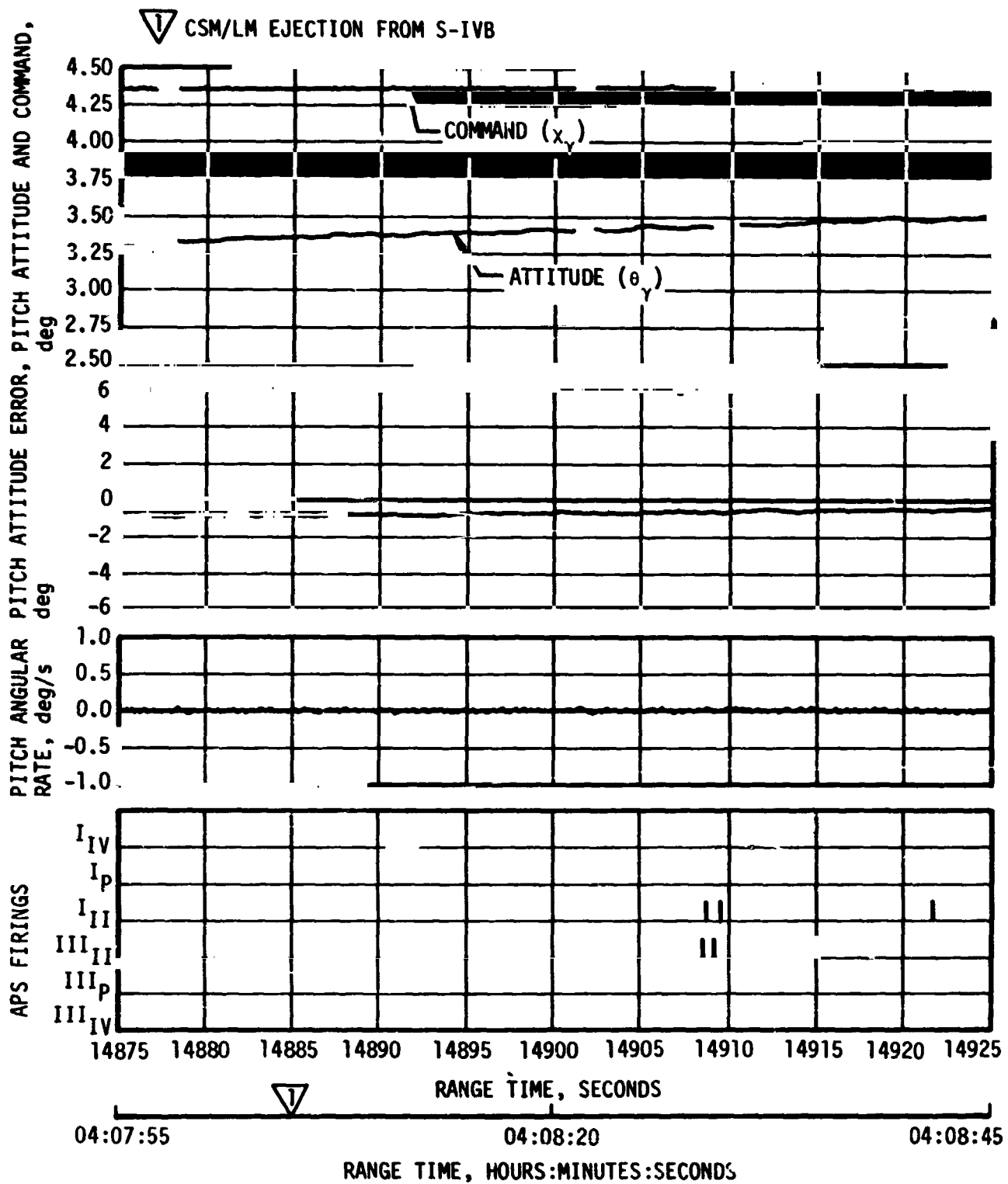

Figure 21-25. Pitch Attitude Control During LM Extraction

▽ CSM/LM EJECTION FROM S-IVB

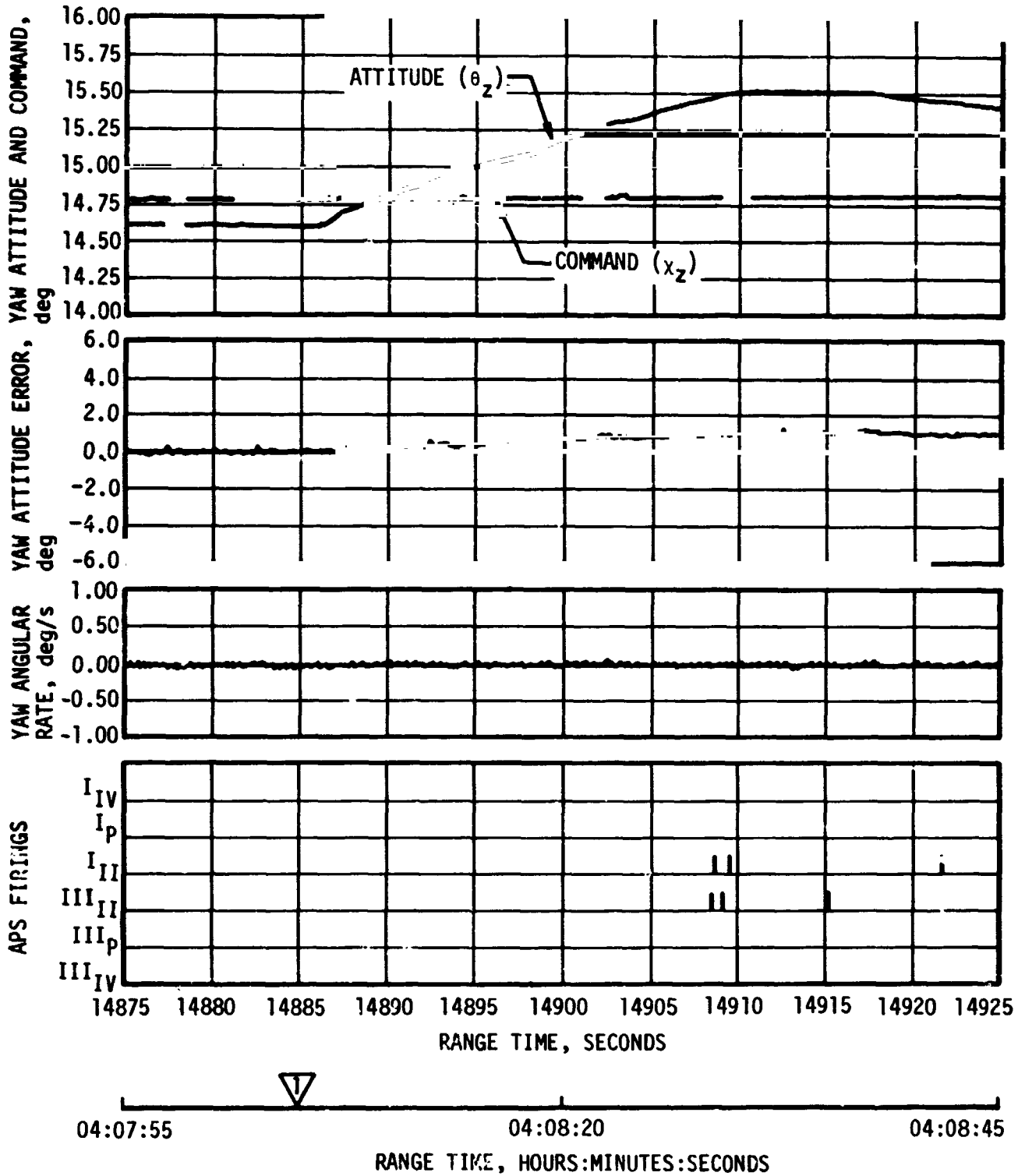

Figure 21-26. Yaw Attitude Control During LM Extraction

▽ CSM/LM EJECTION FROM S-IVB

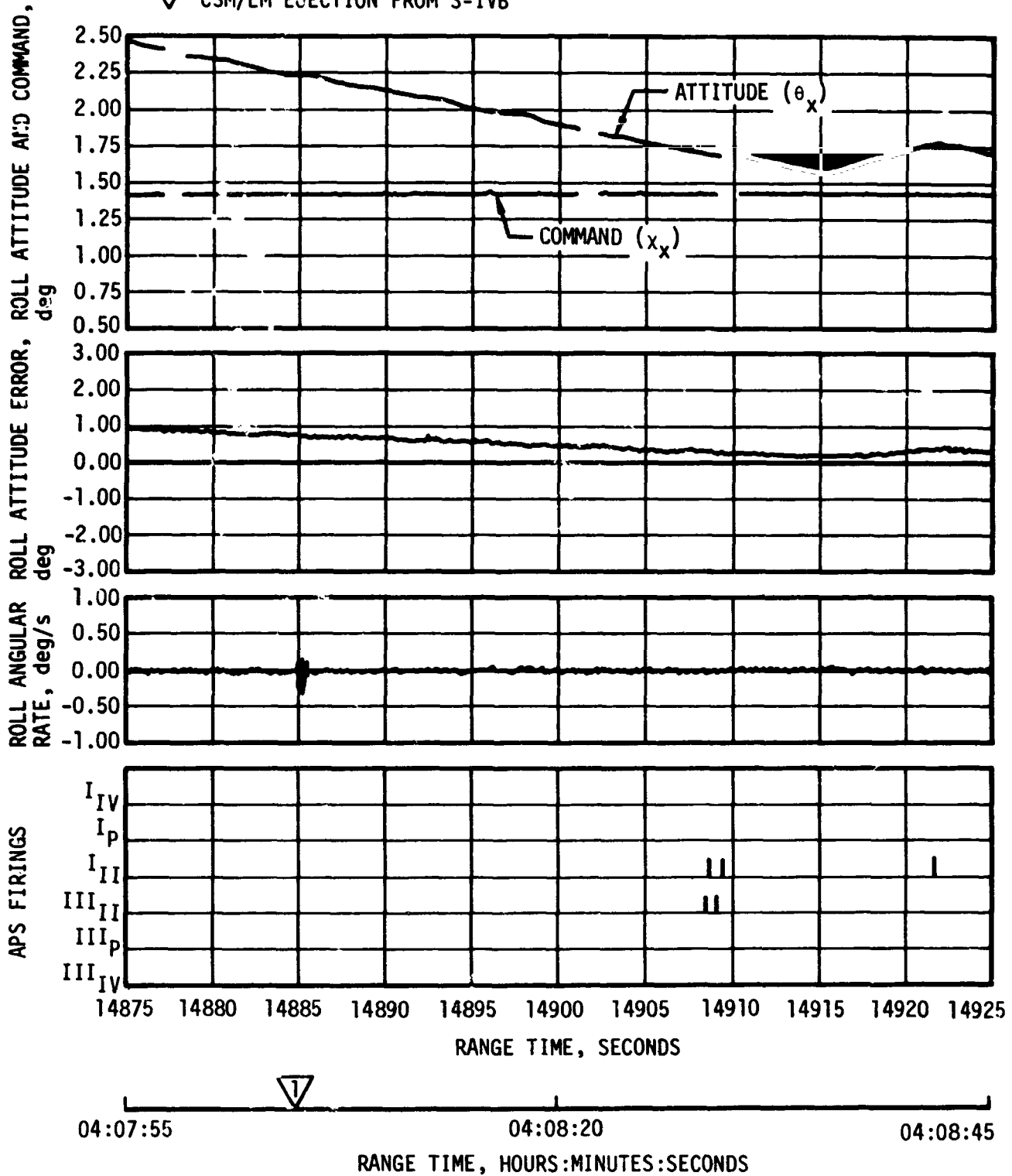

Figure 21-27. Roll Attitude Control During LM Extraction

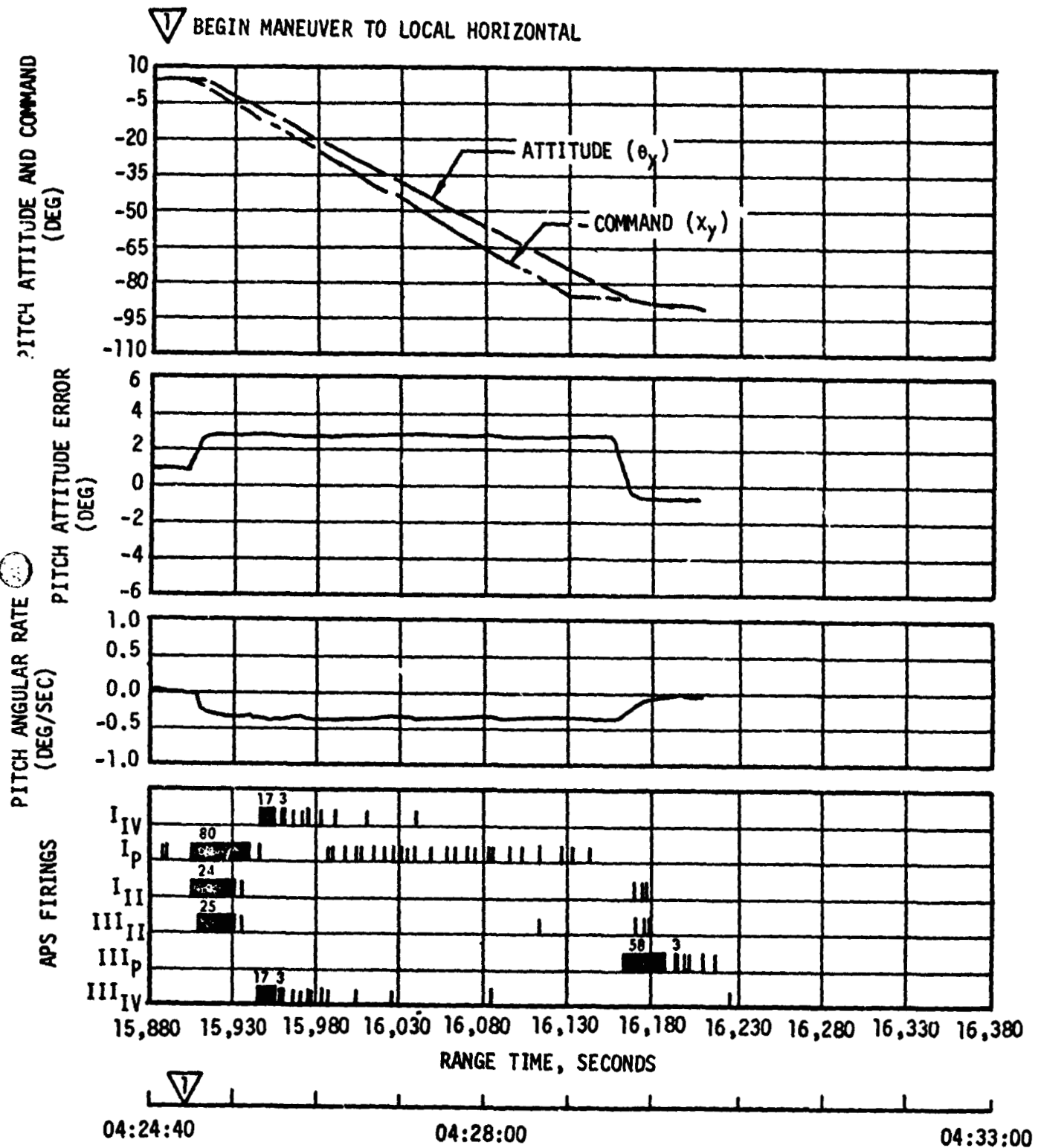

Figure 21-28. Pitch Attitude Control during Alignment of S-IVB to Local Horizontal prior to Second Burn

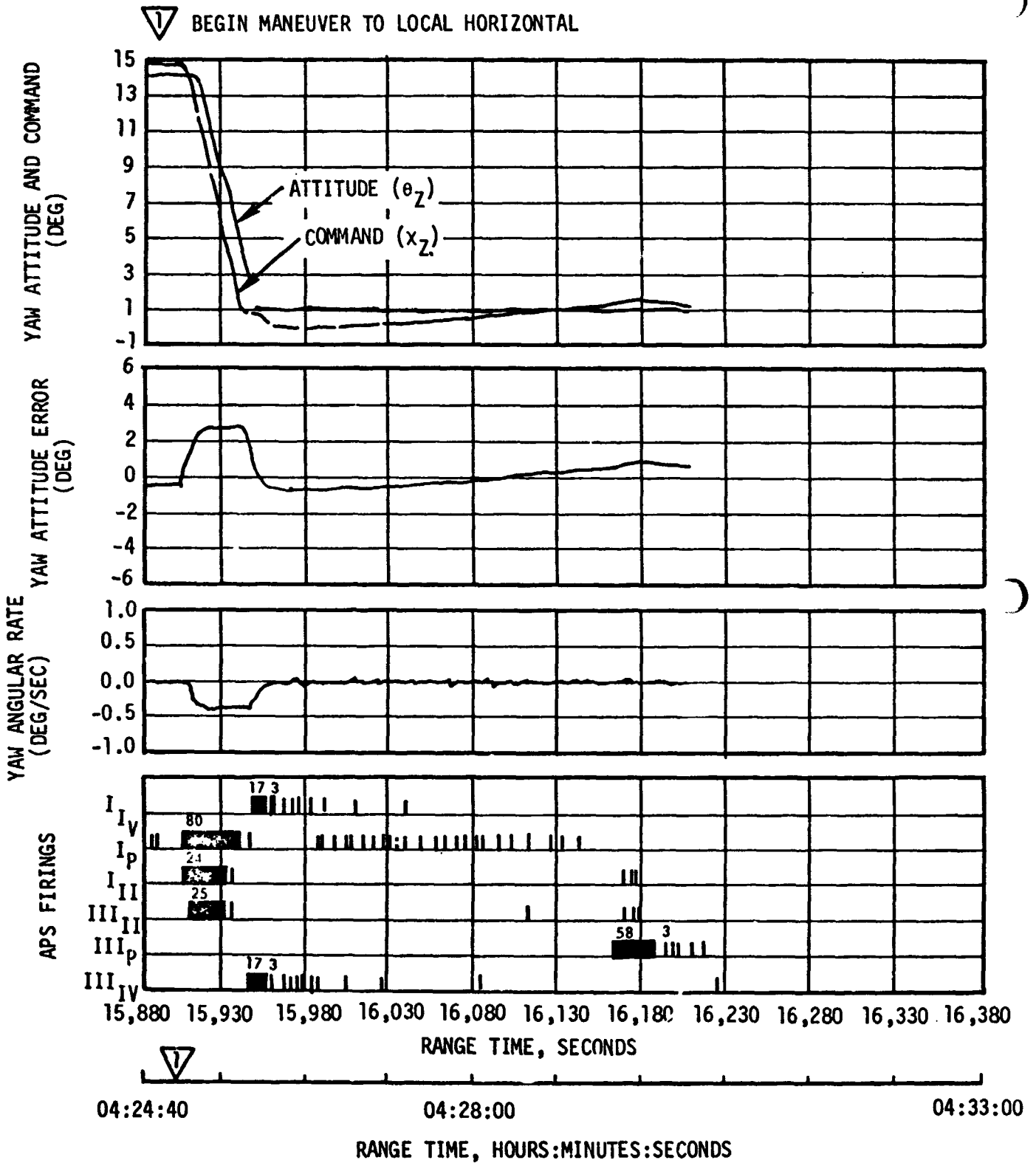

Figure 21-29. Yaw Attitude Control during Alignment of S-IVB to Local Horizontal prior to Second Burn

▽ BEGIN MANEUVER TO LOCAL HORIZONTAL

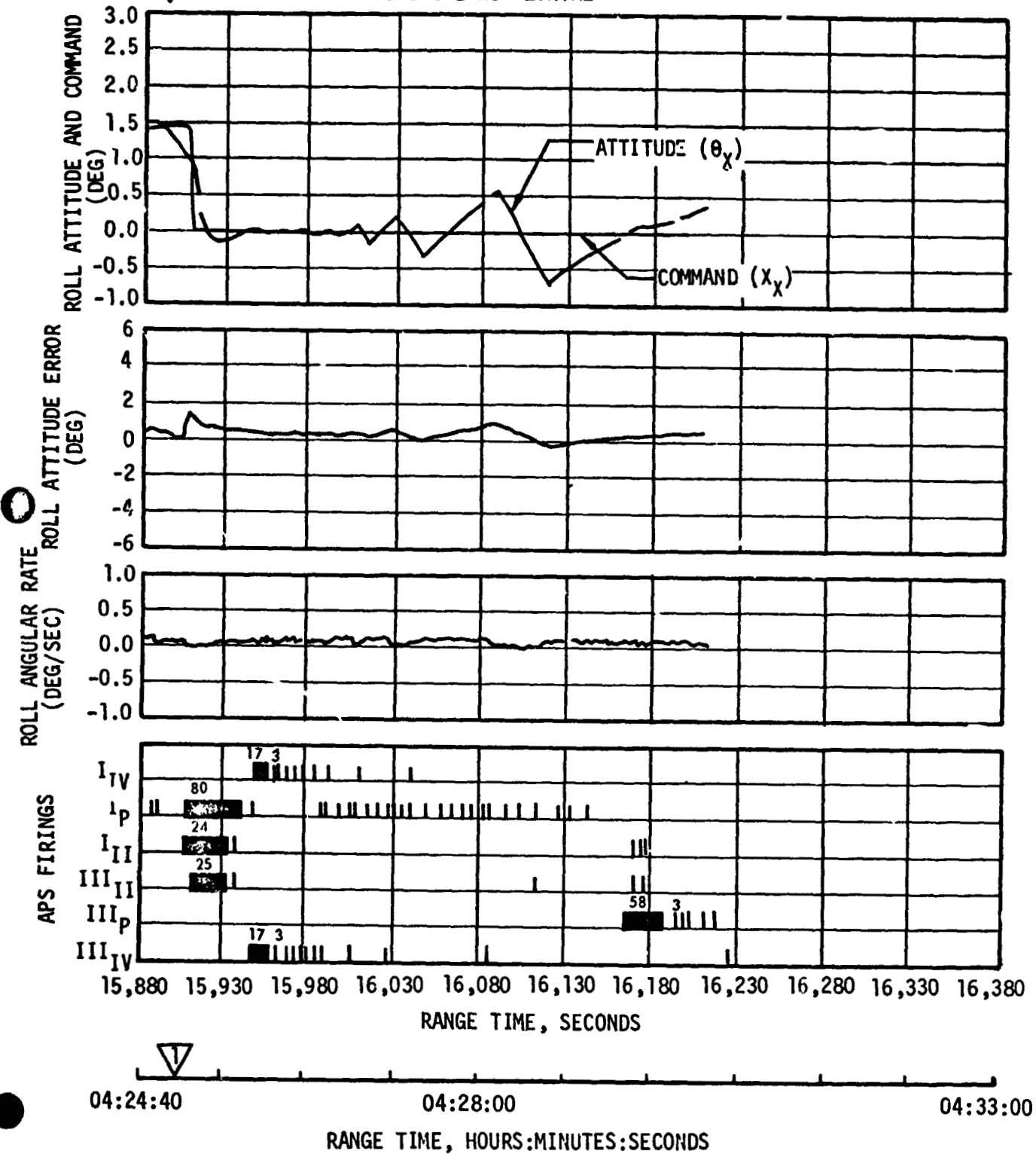

Figure 21-30. Roll Attitude Control during Alignment of S-IVB to Local Horizontal prior to Second Burn

## 22. HYDRAULIC SYSTEM

### 22.1 Hydraulic System Operation

#### 22.1.1 General

The hydraulic system performance was within predicted limits and the system operated satisfactorily up to the third burn. During the third burn the pitch and yaw actuator response traces appeared irregular. There were three thermal cycles during the first orbital coast period as shown in figure 22-1. System internal leakage was .58 gpm which is within the allowable leakage range of 0.4 to 0.8 gpm. There was no overboard venting of reservoir fluid due to thermal expansion. Continuous system temperature flight history is shown in figures 22-2 and 22-3.

#### 22.1.2 Boost and First Burn (figures 22-4 to 22-5)

During S-IC/S-II boost all system fluid temperatures rose steadily as the auxiliary pump operation warmed the hydraulic oil. The system pressure during burn was nearly constant at 3655 psia compared to the allowable of 3615 to 3665 psia.

After ignition the system internal leakage rate of 0.58 gpm was delivered by the engine driven pump as indicated by a 15 psi system pressure increase and auxiliary pump motor current load reduction to 18 amp at engine start. Power extracted from the engine by the main pump during burn was 5.23 bf.

#### 22.1.3 Parking Orbit and Second Burn (figures 22-6 and 22-7)

After engine cutoff, the pump inlet oil temperature continued to increase due to heat transfer from the LOX turbine dome to the main pump manifold. During the orbital coast period the auxiliary hydraulic pump was thermally cycled for 48 sec at TB5 +2600 and at TB5 +5400 sec. A third thermal cycle of 480 sec was performed at TB5 +10,800 sec.

The auxiliary pump was activated to the flight mode ON at TB6 +219 sec, 380 sec prior to second burn. System operation was normal through restart operation and second burn. Pump inlet and reservoir oil temperatures rose at a rate of 8.6 and 3.2°F/min, respectively during second burn. System pressure stabilized at 3653 psia. After cutoff reservoir oil pressure stabilized at 70 psia following a 40 sec bleeddown.



#### 22.1.4 Third Burn (figure 22-8)

The auxiliary hydraulic pump was turned on approximately 300 sec prior to second restart command and the hydraulic system operated normally through the restart transient.

Hydraulic system pressure and temperature measurements indicated normal levels during the burn. Low amplitude pressure oscillations were present during the actuator cyclic activity which is normal for the resultant flow demand.

The response of the pitch and yaw actuators at third burn engine start appeared normal. At time 22046.4 sec after liftoff, the yaw actuator response appeared irregular. Later in the burn the command signals to the pitch and yaw hydraulic servos started to cycle at the LOX slosh frequency of approximately 0.65 cps. Non-linearities continued to appear during the rest of the burn at the higher thrust level but to a lesser extent in the pitch plane. After thrust cutback, the slosh oscillations as seen by the autopilot dampened out. During the period of high oscillations the pitch actuator's maximum excursion was 1/2 deg (peak-to-peak) with a maximum apparent amplitude gain of 1.3. The pitch actuator appeared to lag the signal to a greater extent when retracting than when extending. The opposite is true of the yaw actuator. The amplitude of the yaw oscillations approached 3 deg (peak-to-peak) with a maximum apparent amplitude gain of 1.6.

The pitch actuator motion lead the yaw actuator by approximately 61 deg during the period of high thrust, indicating engine motion was following an elliptical path.

The static gains of the actuators were normal prior to third burn and after the engine thrust had cut back and the oscillations had dampened out. This indicates the mechanical feedback networks within the actuators were operating properly.

At time 22200 sec from liftoff the pitch actuator response started to appear noisy and produce an offset. At engine cutoff the offset was -0.34 deg. Actuator position drifted back to null over an extended period of time.

Although there was insufficient instrumentation to define the exact cause(s) of the above noted irregularities in actuator performance, it is suspected that they resulted from the abnormal engine conditions known to have existed at the time.

\*AHP - AUXILIARY HYDRAULIC PUMP, MOTOR DRIVEN

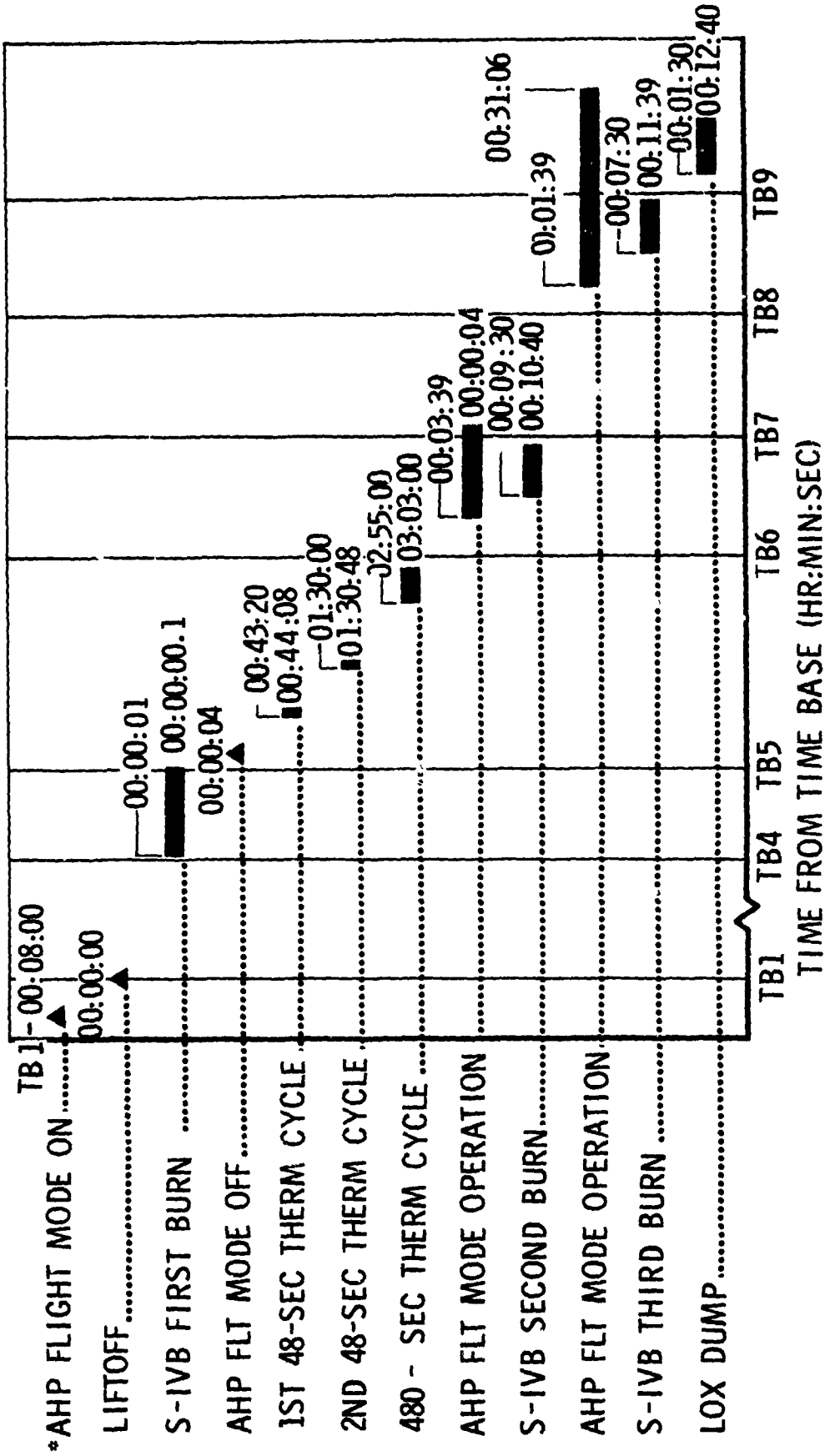

Figure 22-1. hydraulic System Functional Sequence

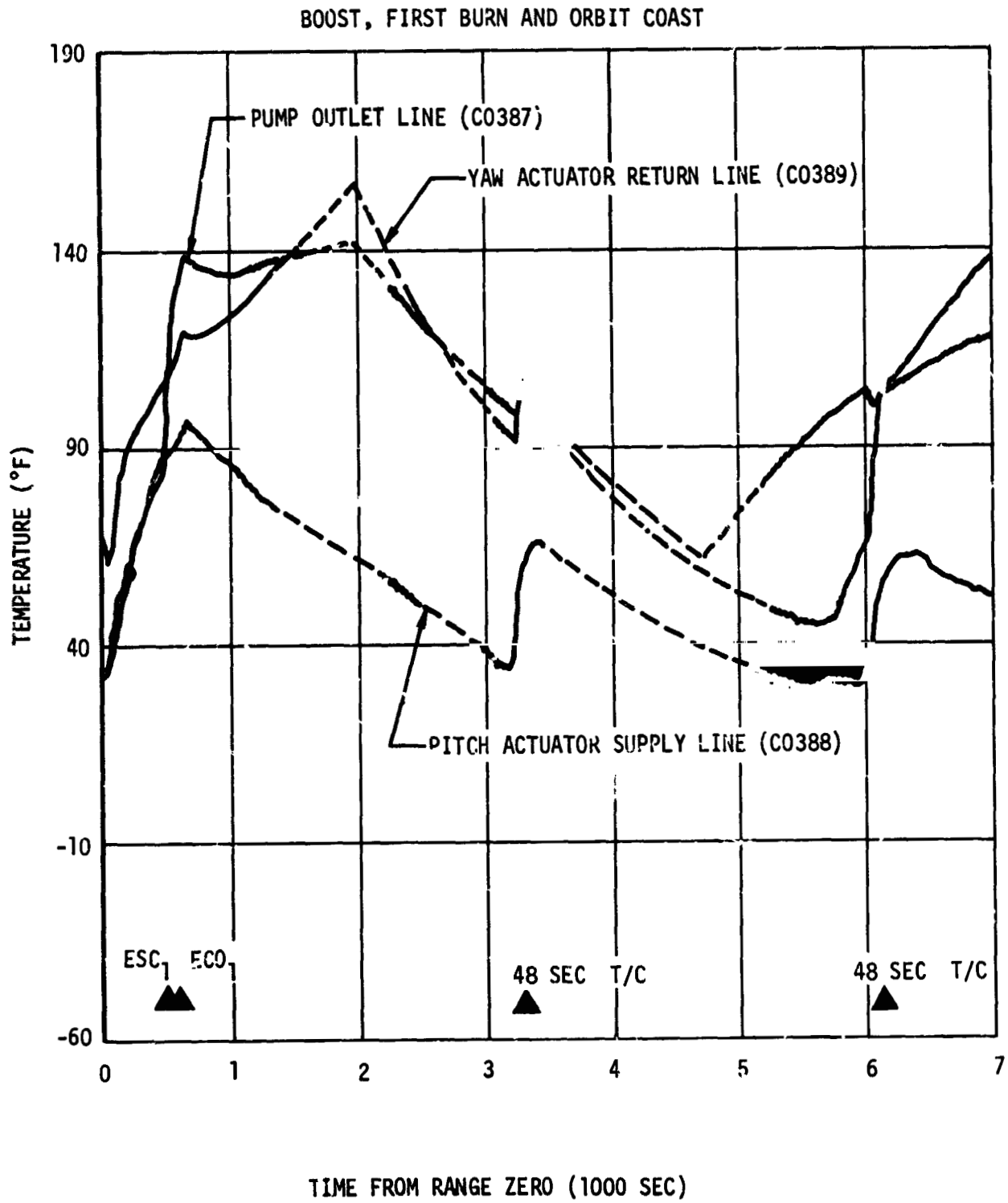

Figure 22-2. Hydraulic System Line Temperatures (Sheet 1 of 4)

ORBITAL COAST

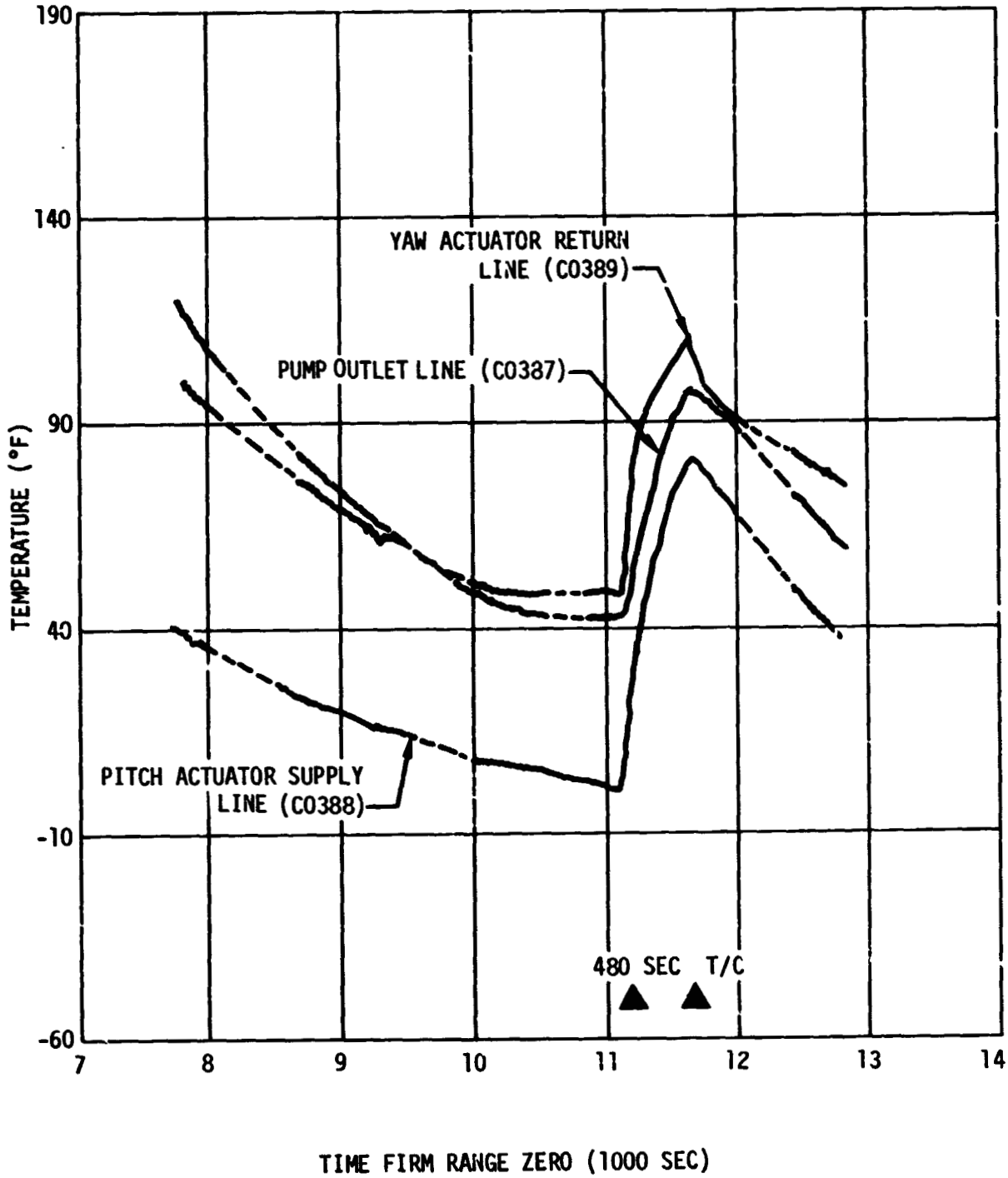

Figure 22-2. Hydraulic System Line Temperatures (Sheet 2 of 4)

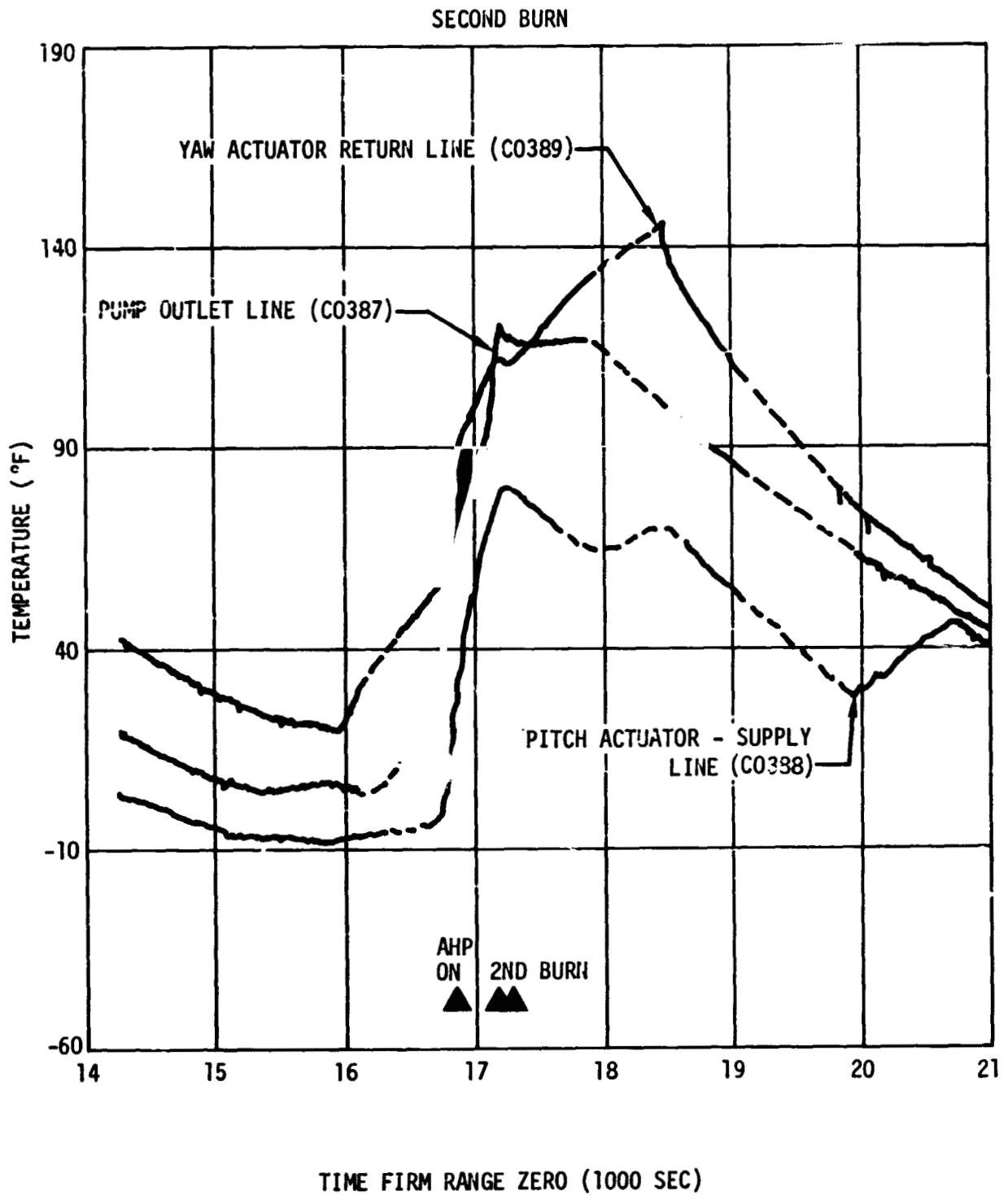

Figure 22-2. Hydraulic System Line Temperatures (Sheet 3 of 4)

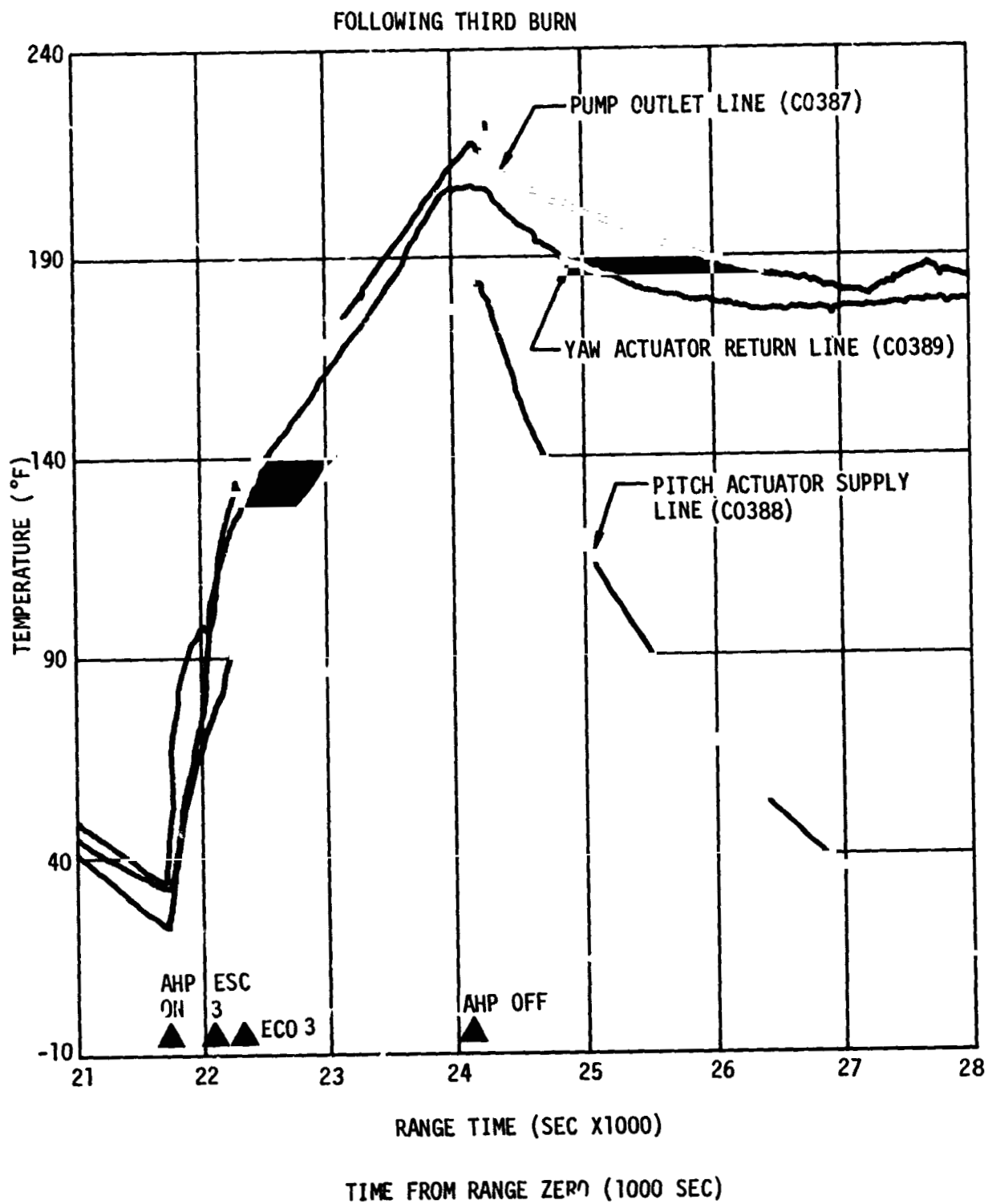

Figure 22-2. Hydraulic System Line Temperatures (Sheet 4 of 4)

BOOST, 1ST BURN, AND ORBITAL COAST

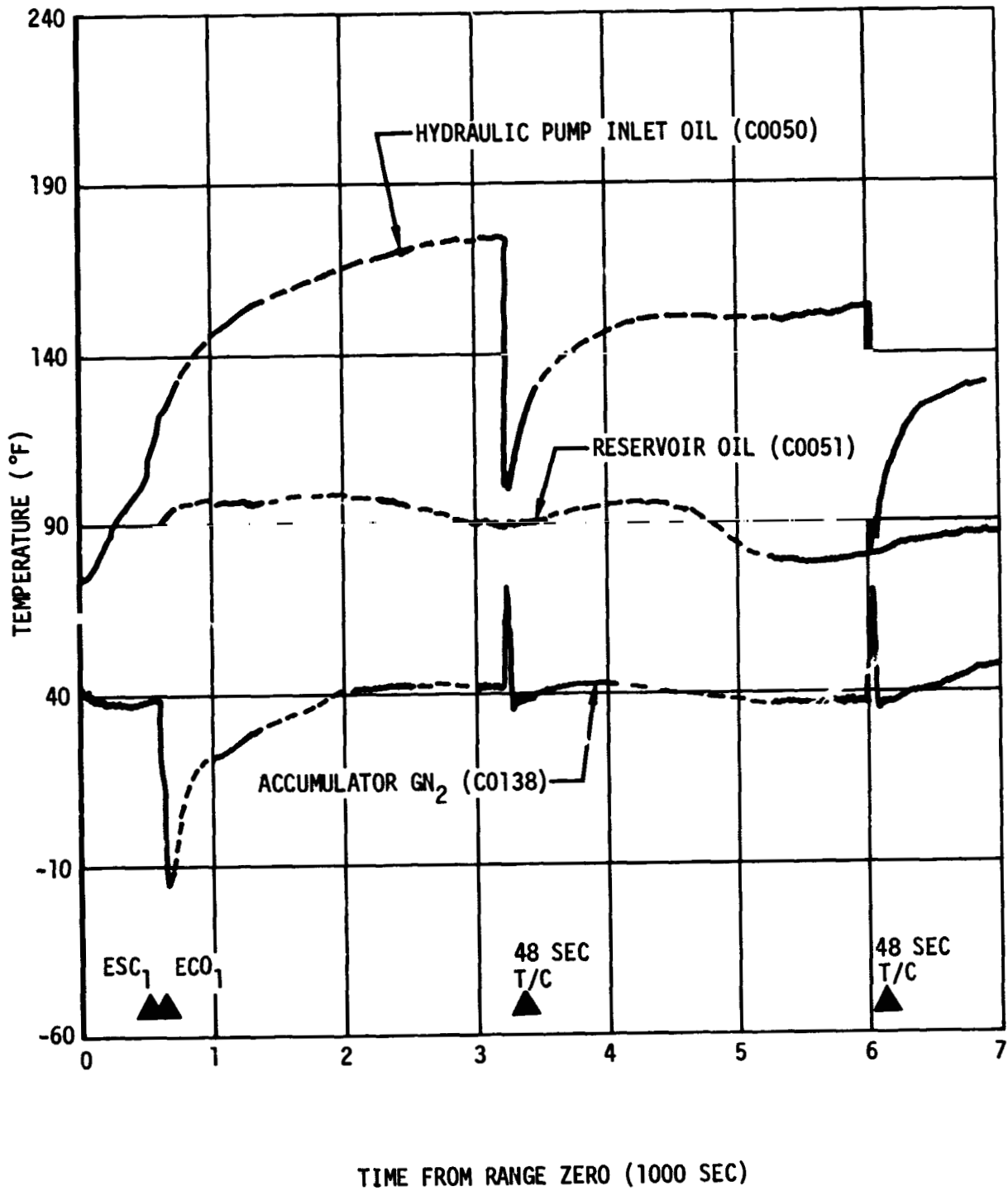

Figure 22-3. Hydraulic System Temperatures (Sheet 1 of 4)



ORBITAL COAST

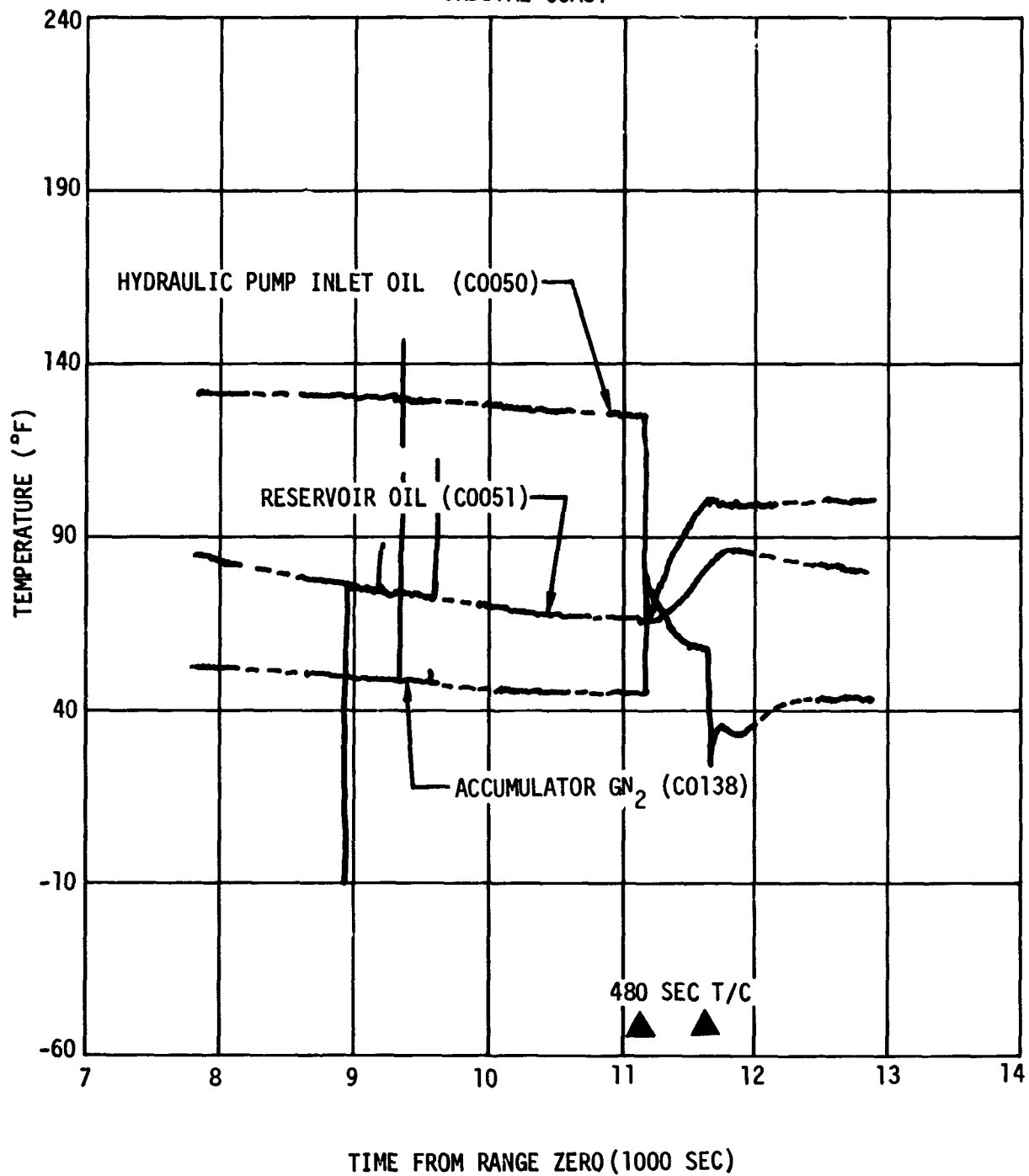

Figure 22-3. Hydraulic System Temperatures (Sheet 2 of 4)

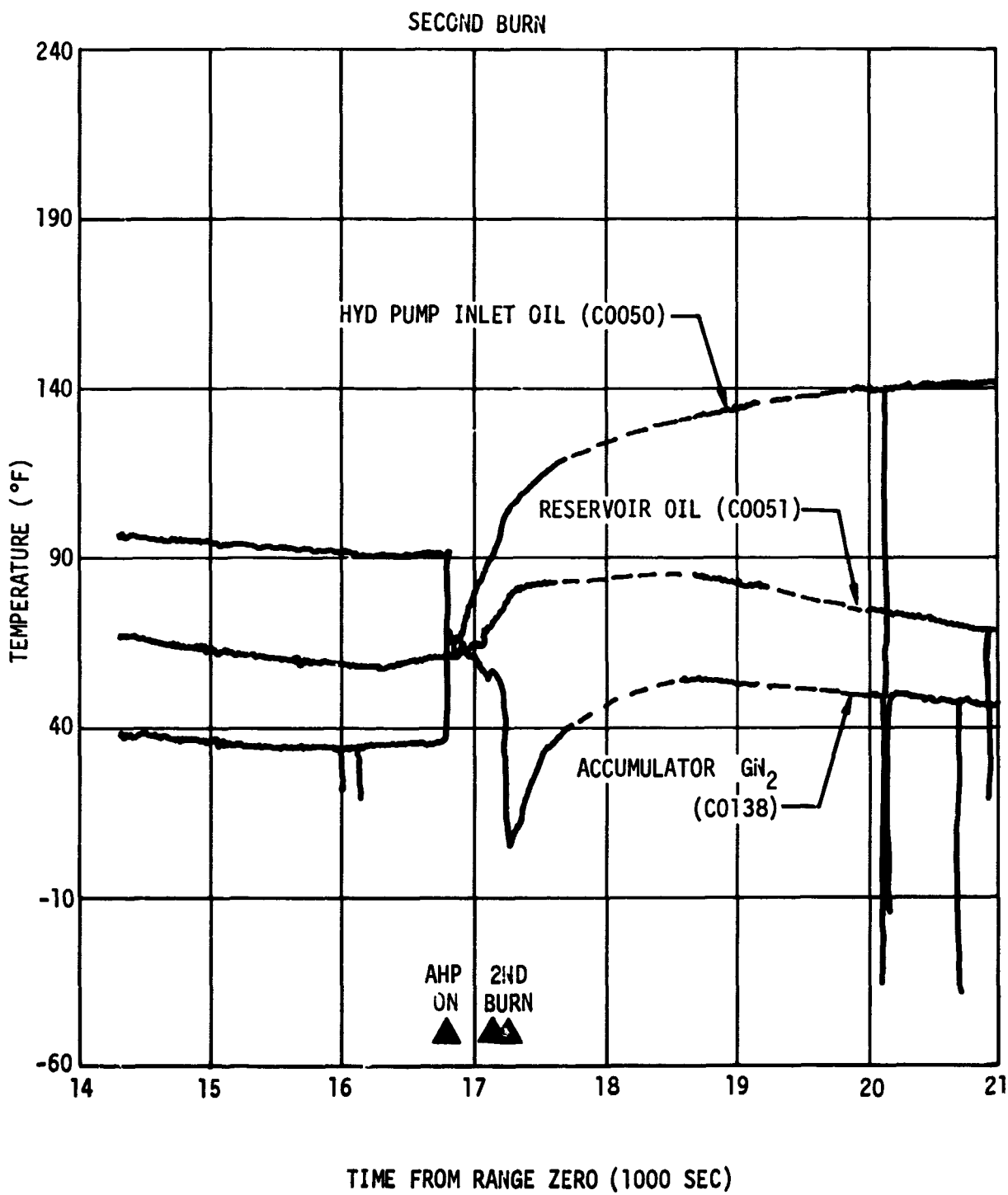

Figure 22-3. Hydraulic System Temperatures (Sheet 3 of 4)

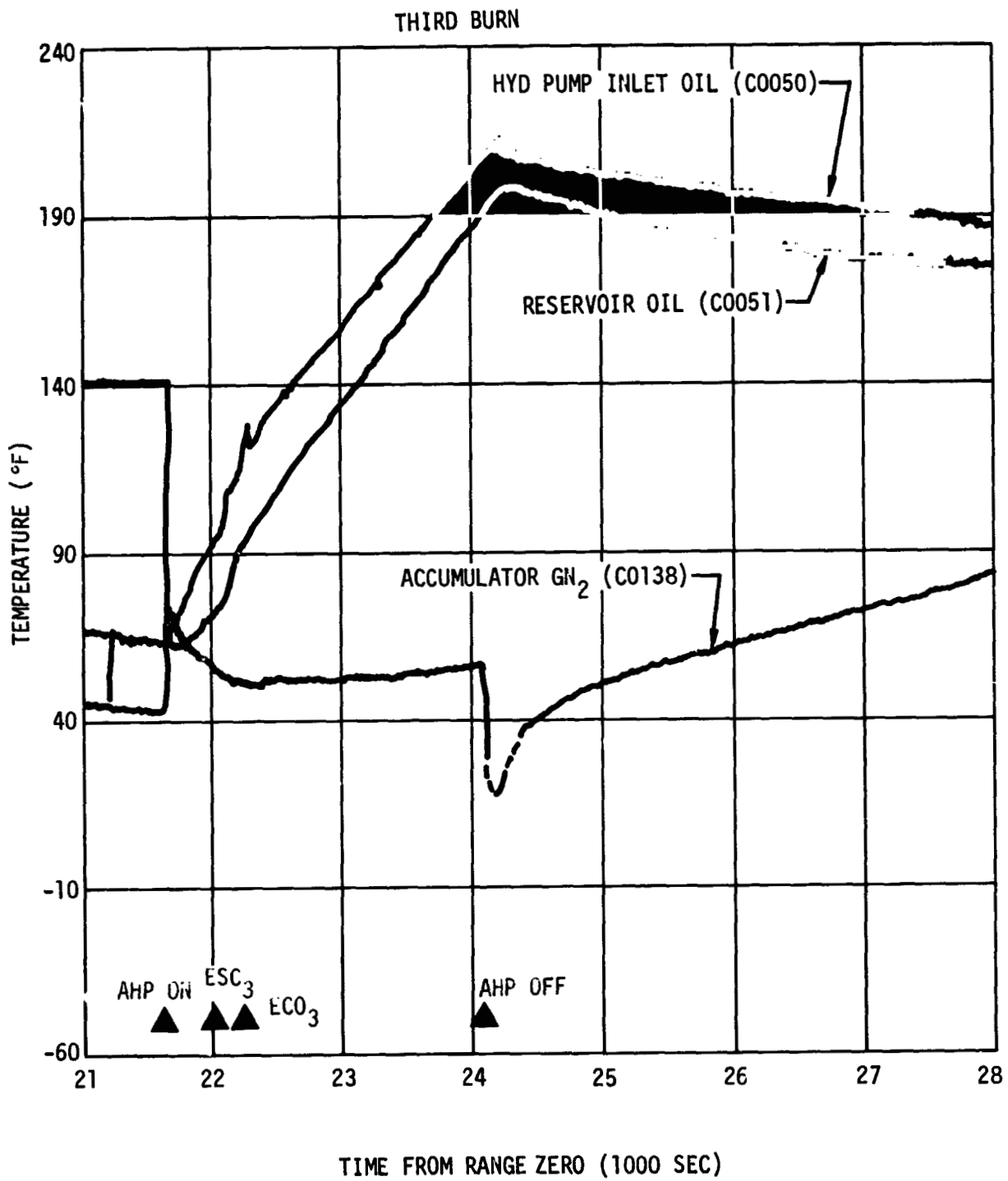

Figure 22-3. Hydraulic System Temperatures (Sheet 4 of 4)

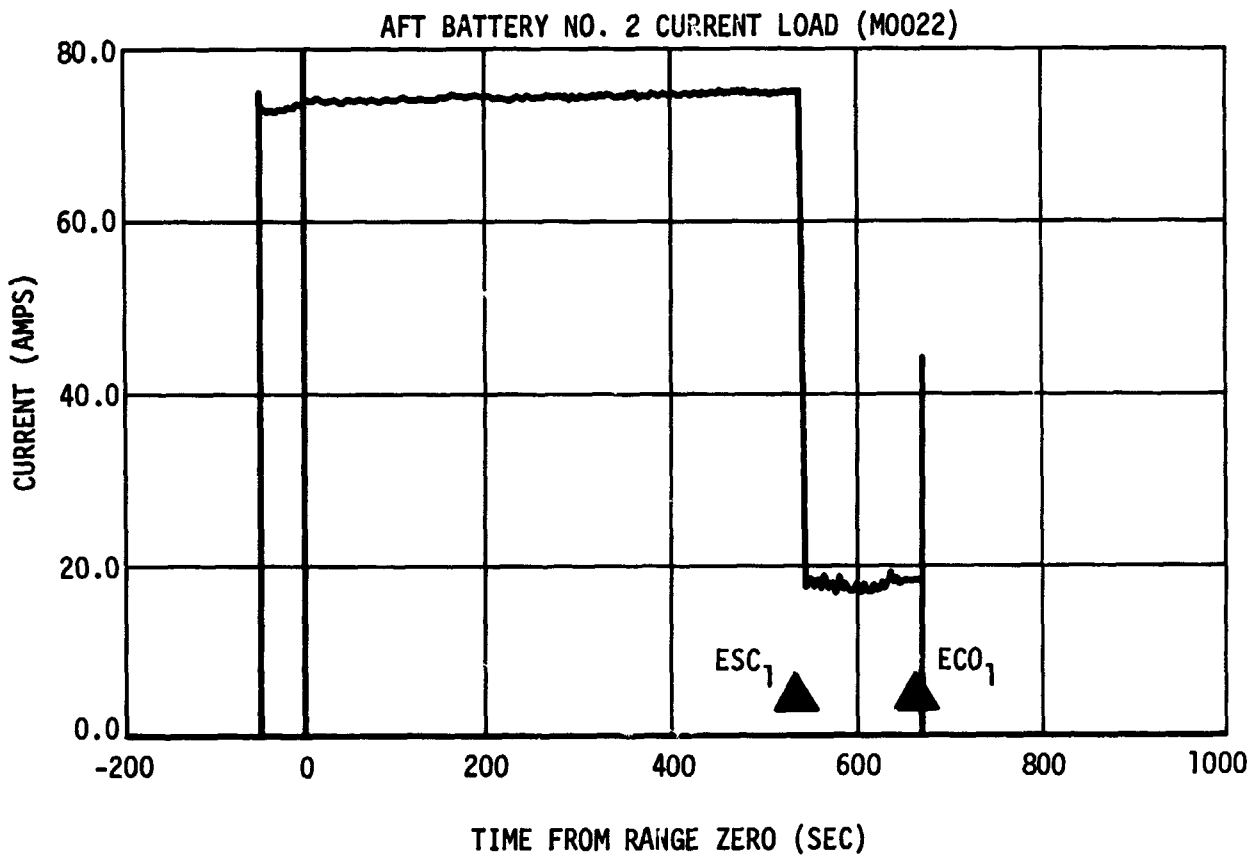
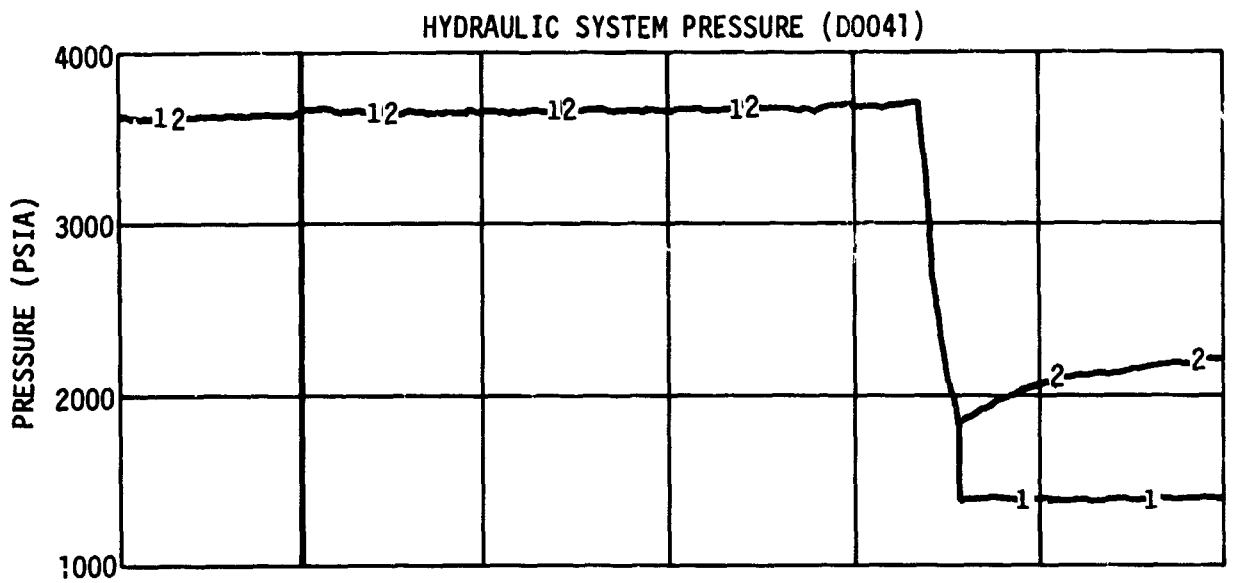

Figure 22-4. Hydraulic System - Boost and First Burn (Sheet 1 of 3)

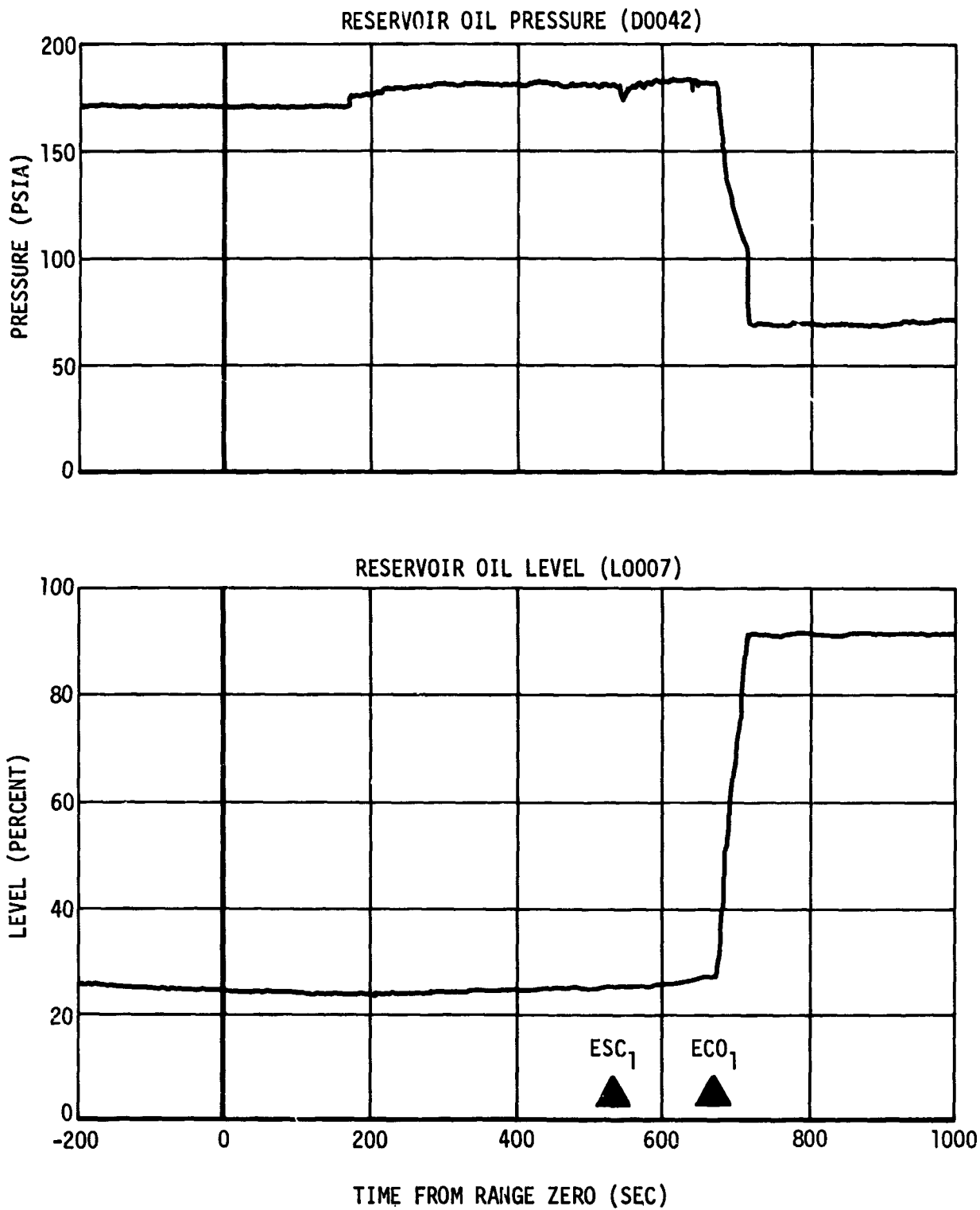

Figure 22-4. Hydraulic System - Boost and First Burn (Sheet 2 of 3)

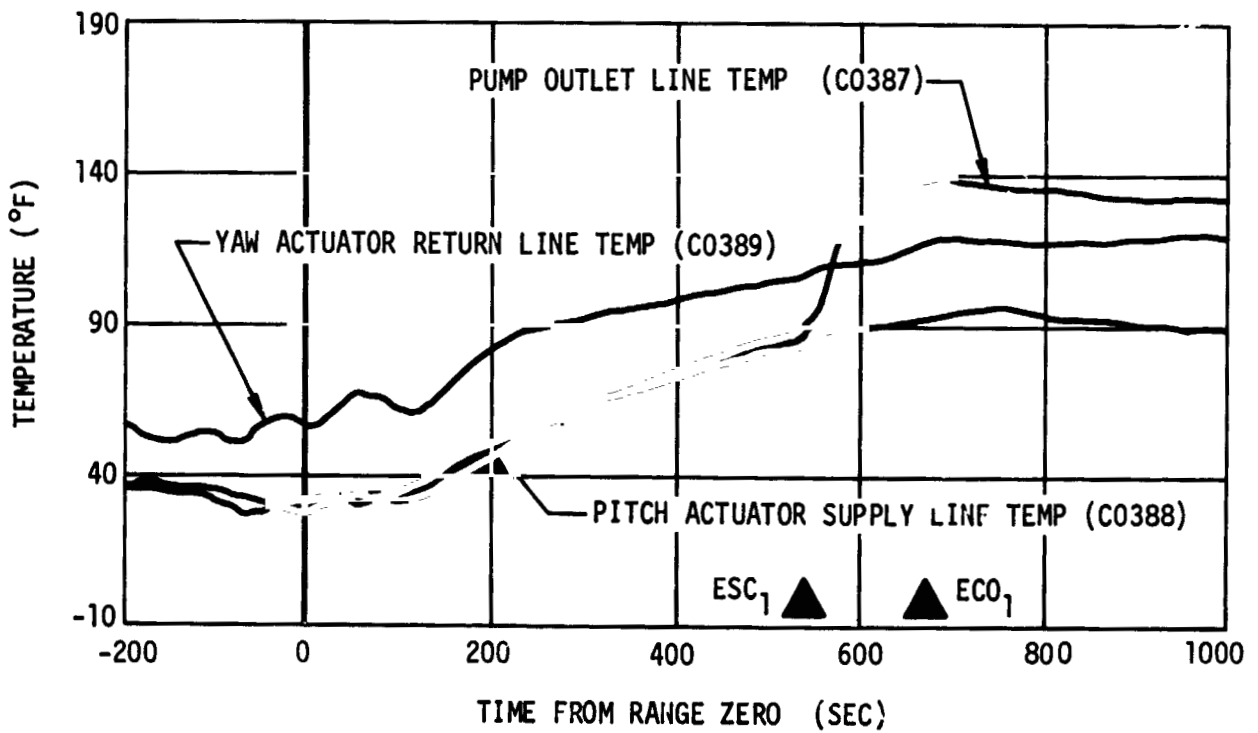
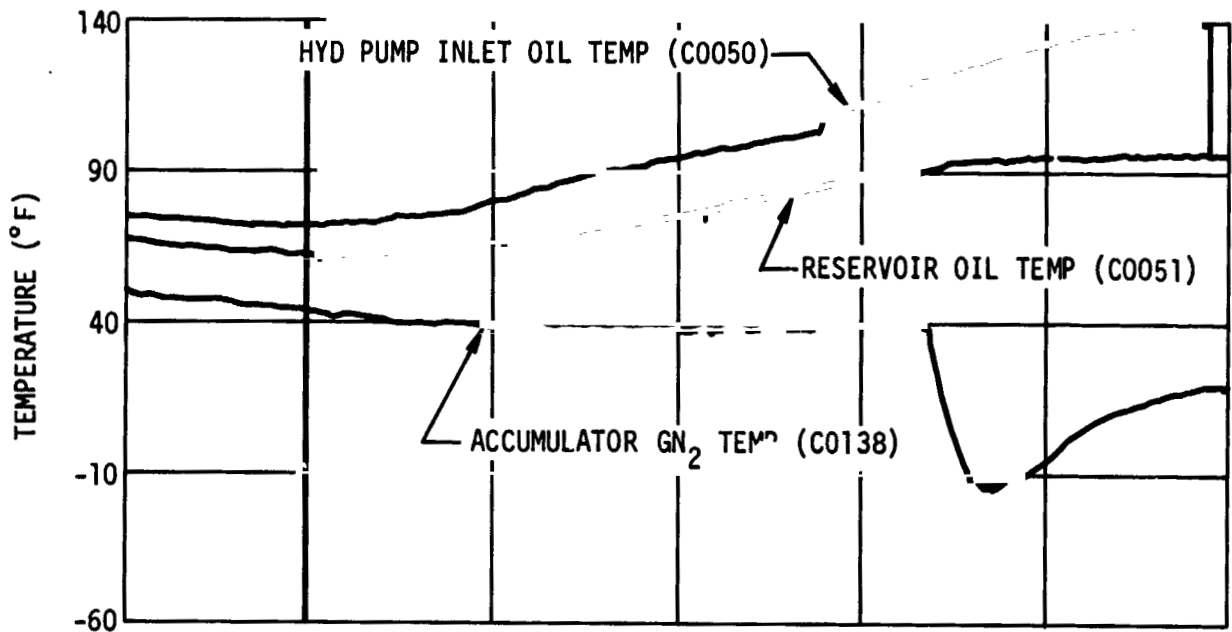

Figure 22-4. Hydraulic System - Boost and First Burn (Sheet 3 of 3)

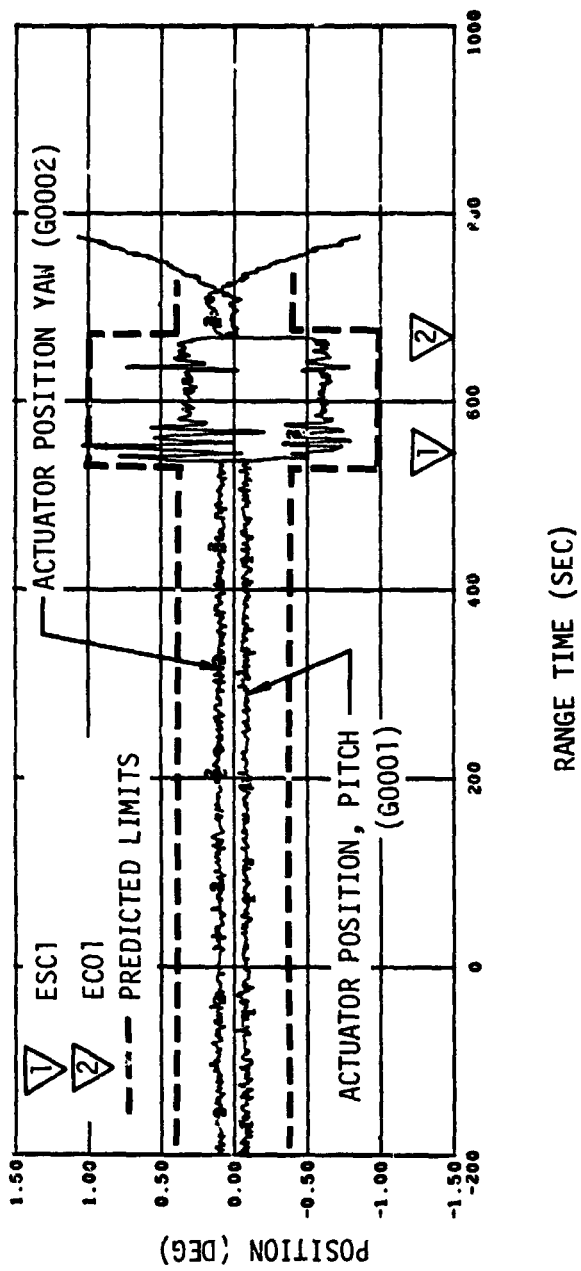

Figure 22-5. Hydraulic System - First Burn

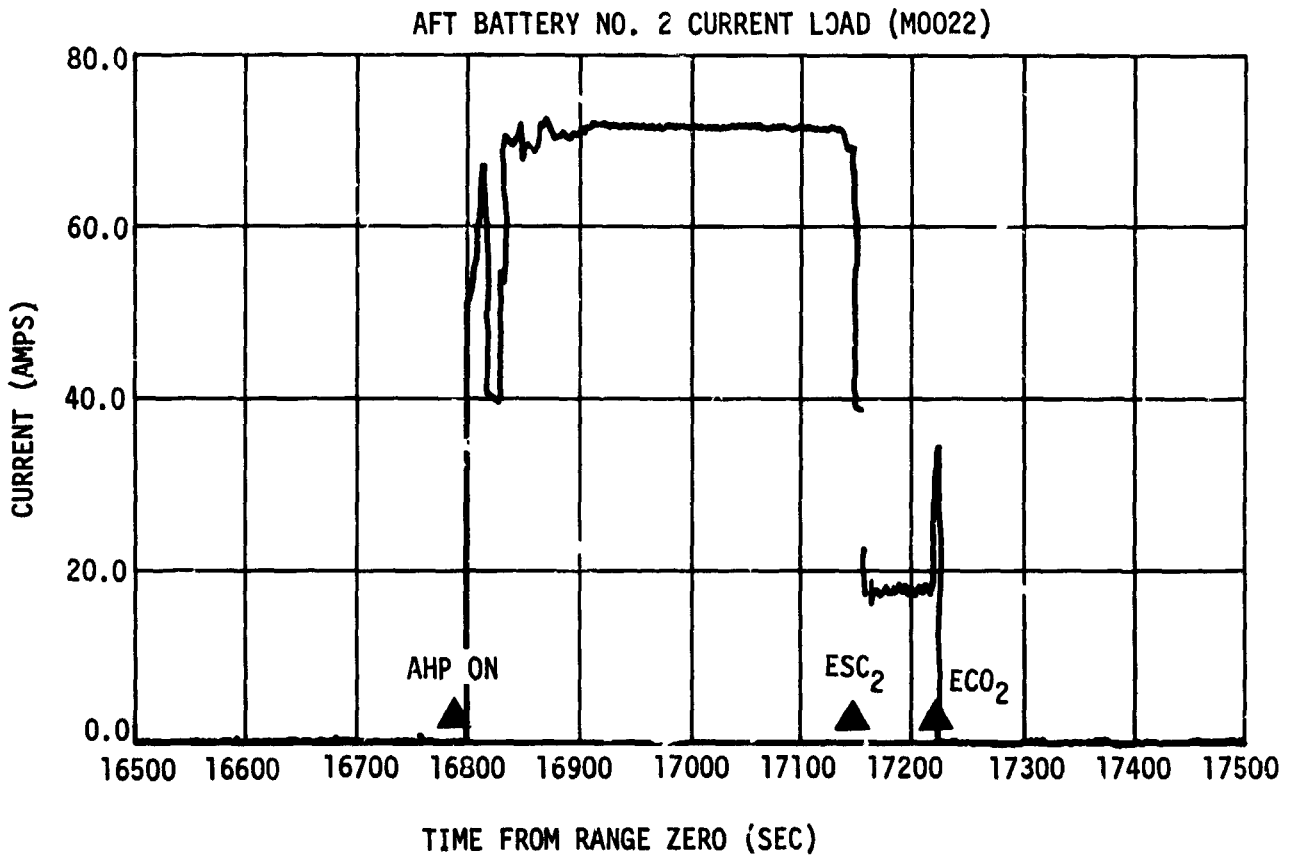
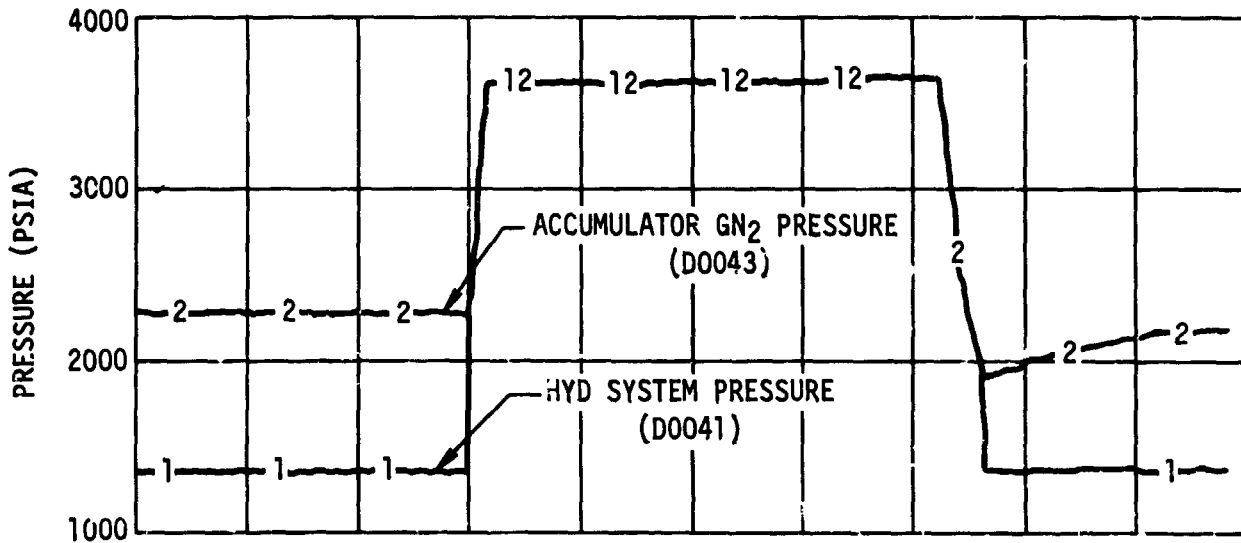

Figure 22-6. Hydraulic System - Second Burn (Sheet 1 of 3)



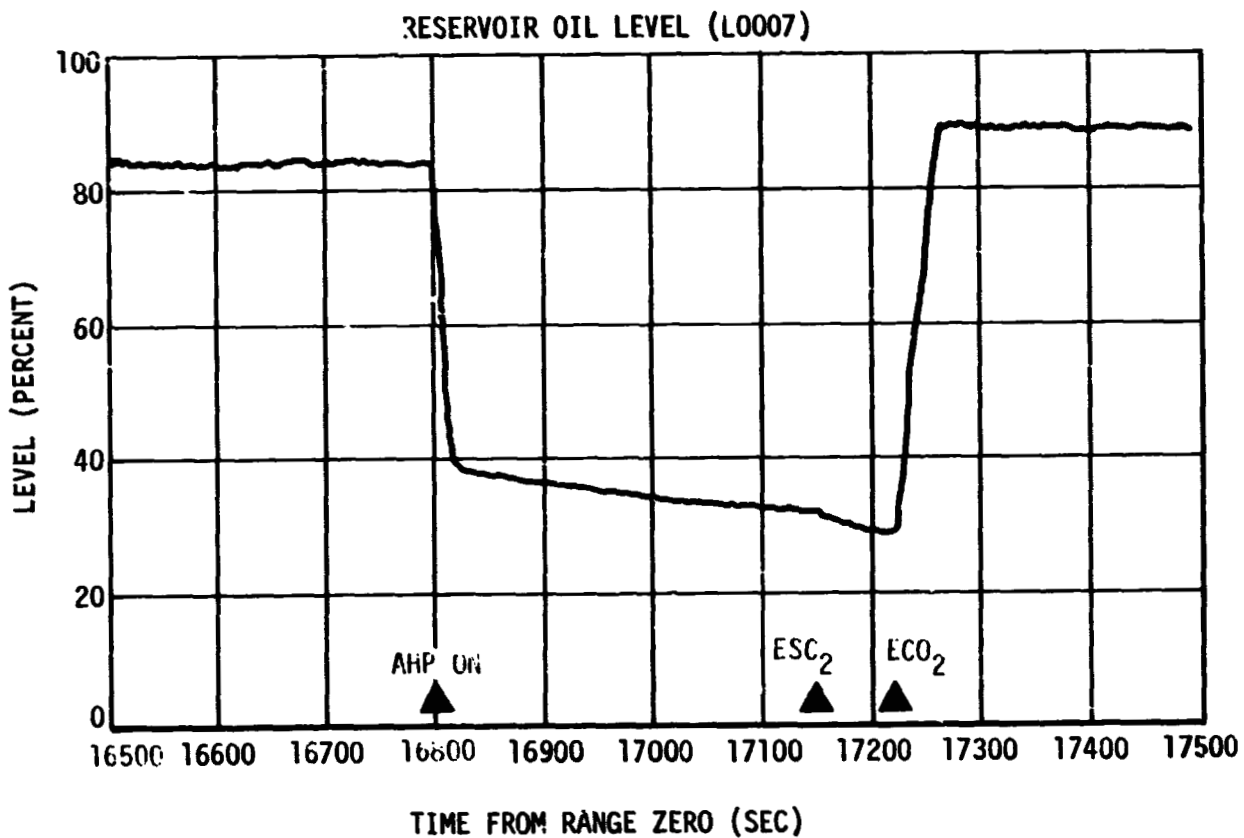
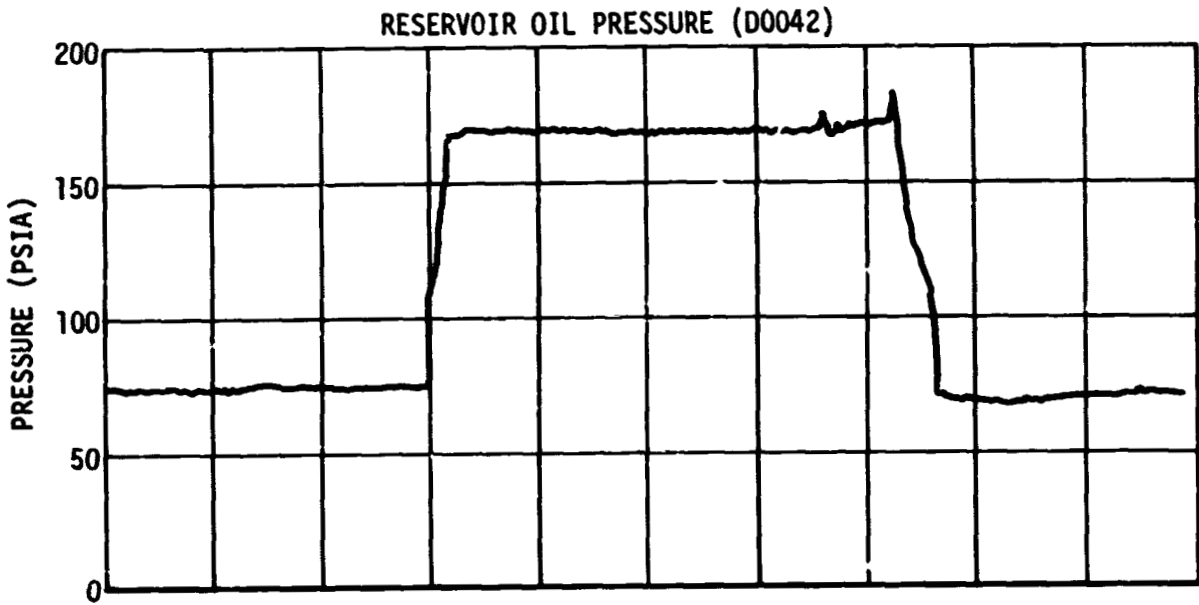

Figure 22-6. Hydraulic System - Second Burn (Sheet 2 of 3)

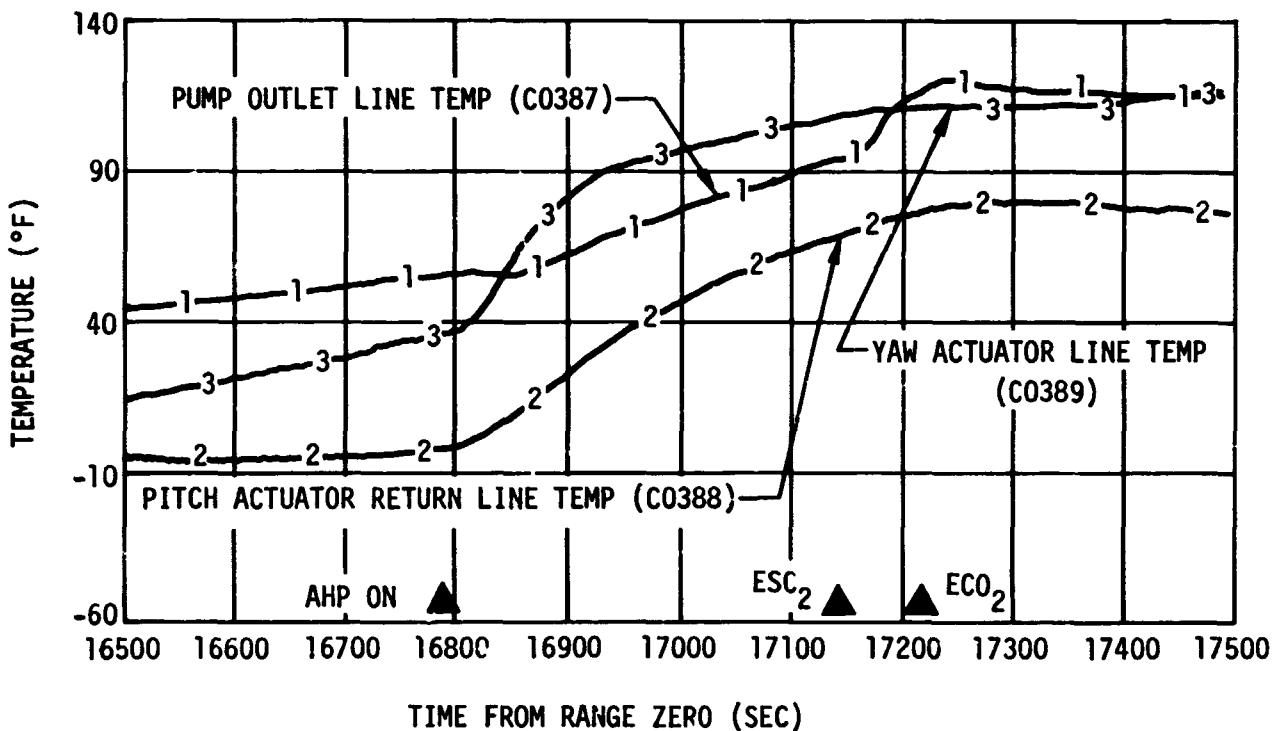
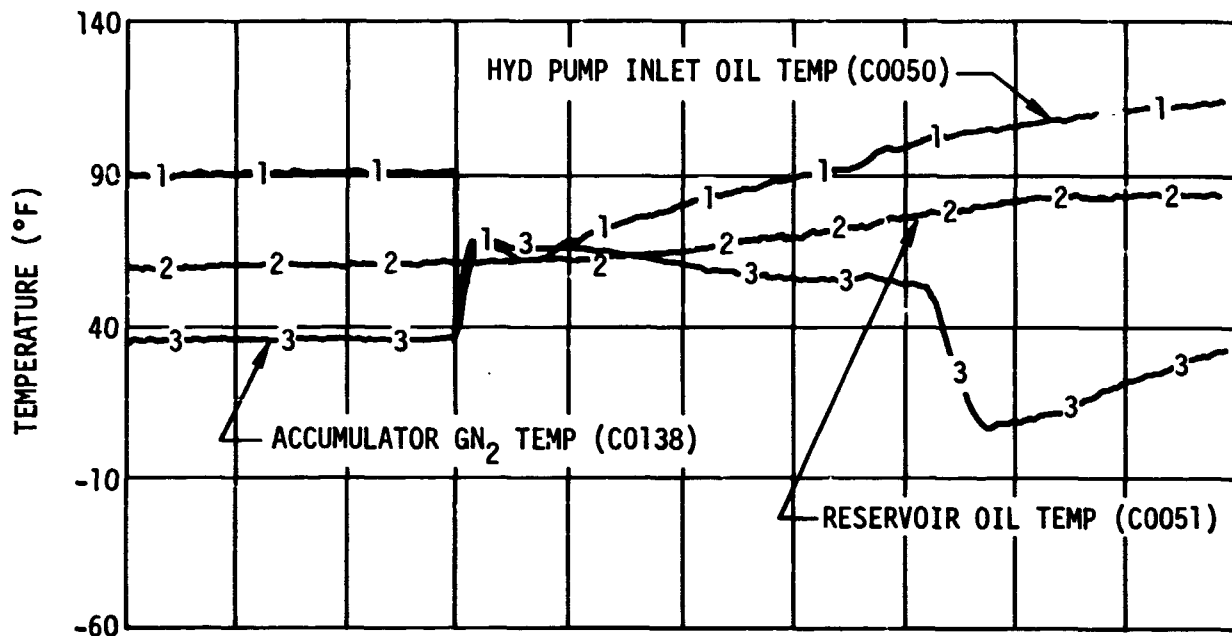

Figure 27-6. Hydraulic System - Second Burn (Sheet 3 of 3)

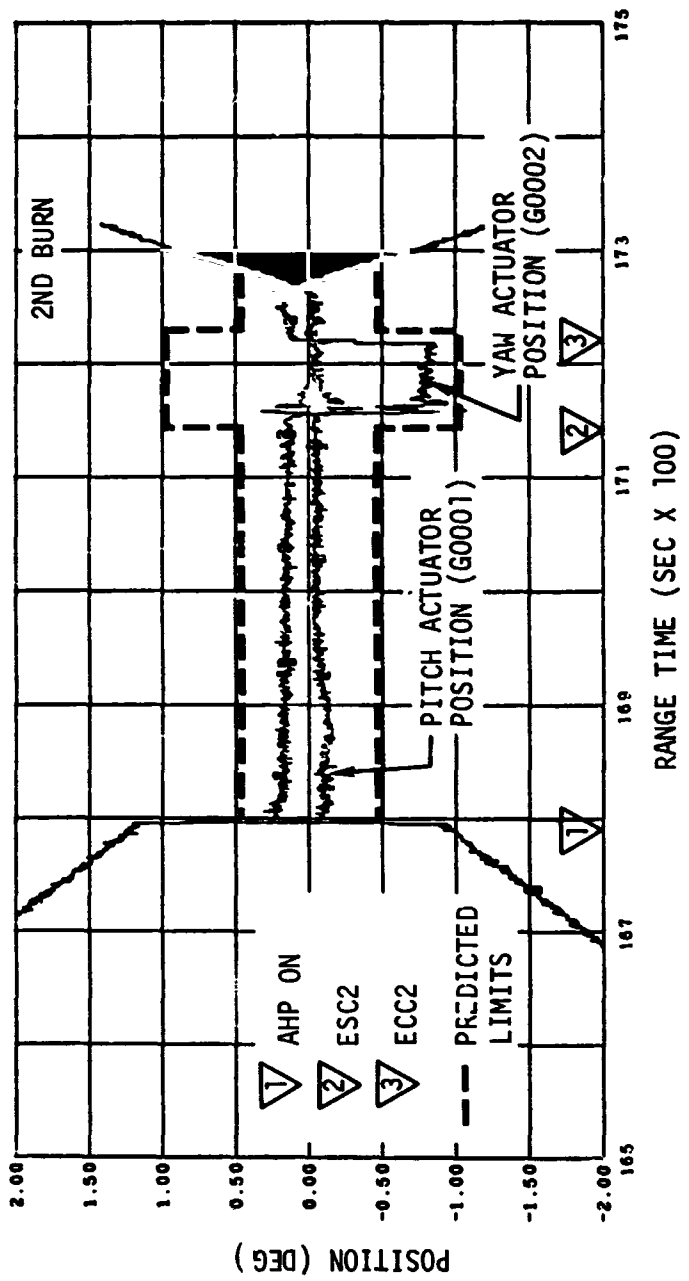

Figure 22-7. Hydraulic System - Actuator Position

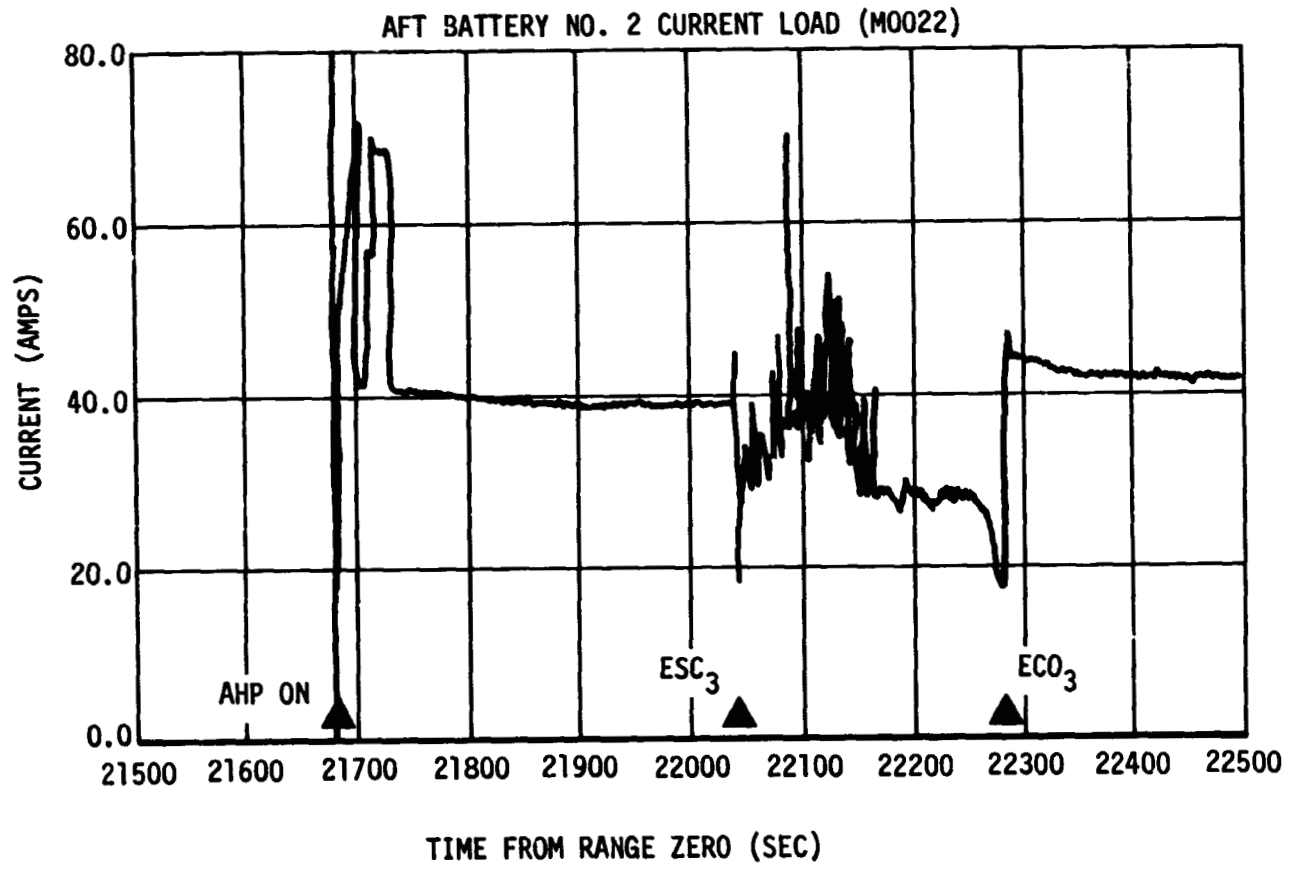
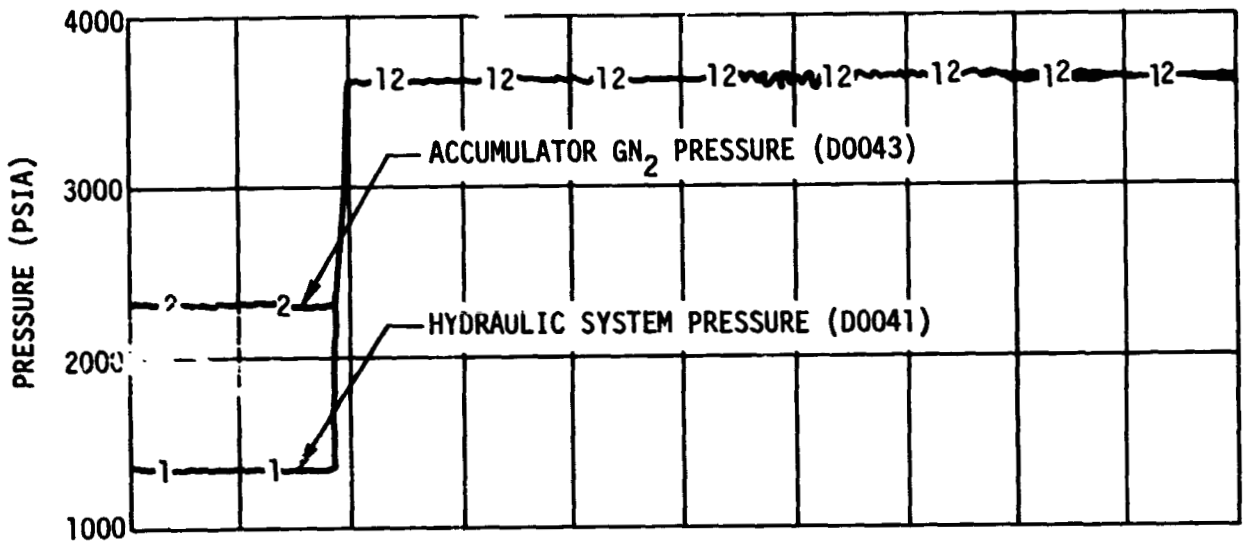

Figure 22-8. Hydraulic System - Third Burn (Sheet 1 of 4)

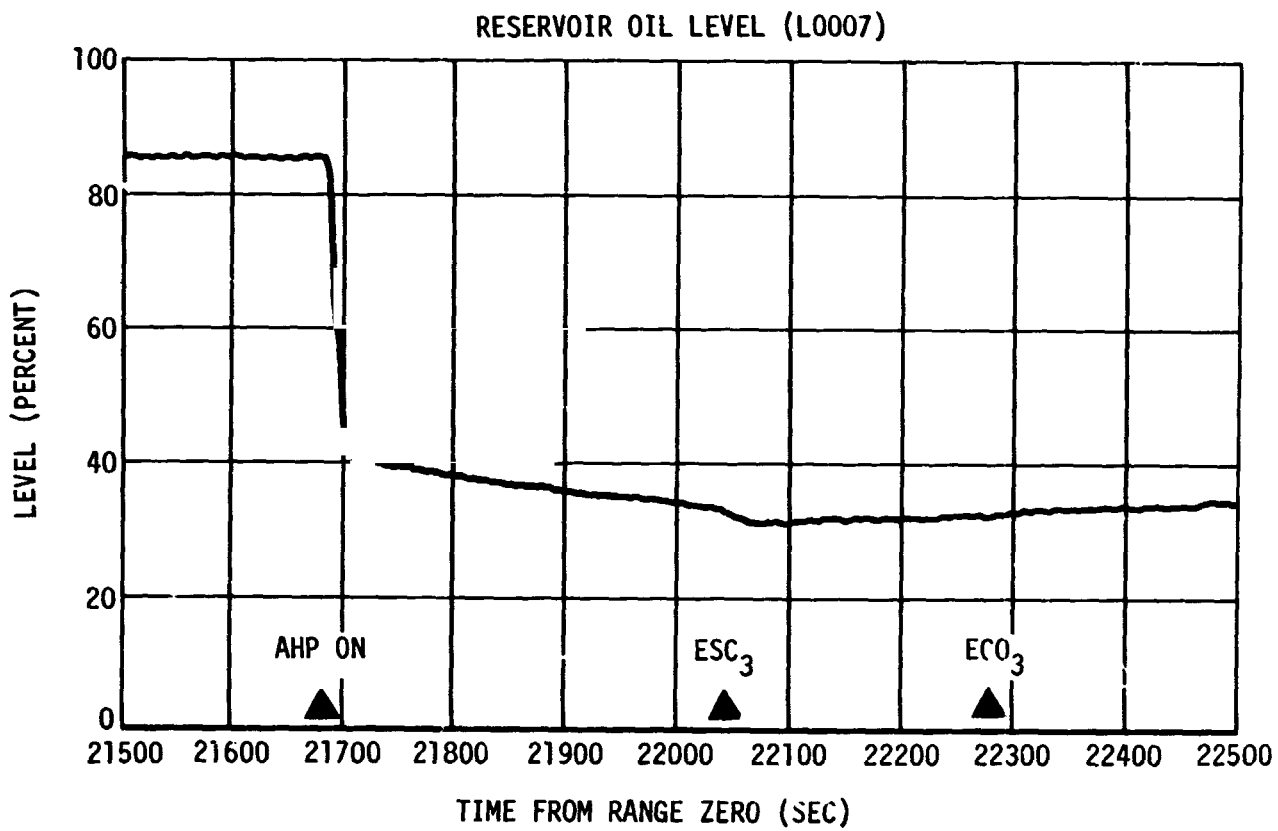
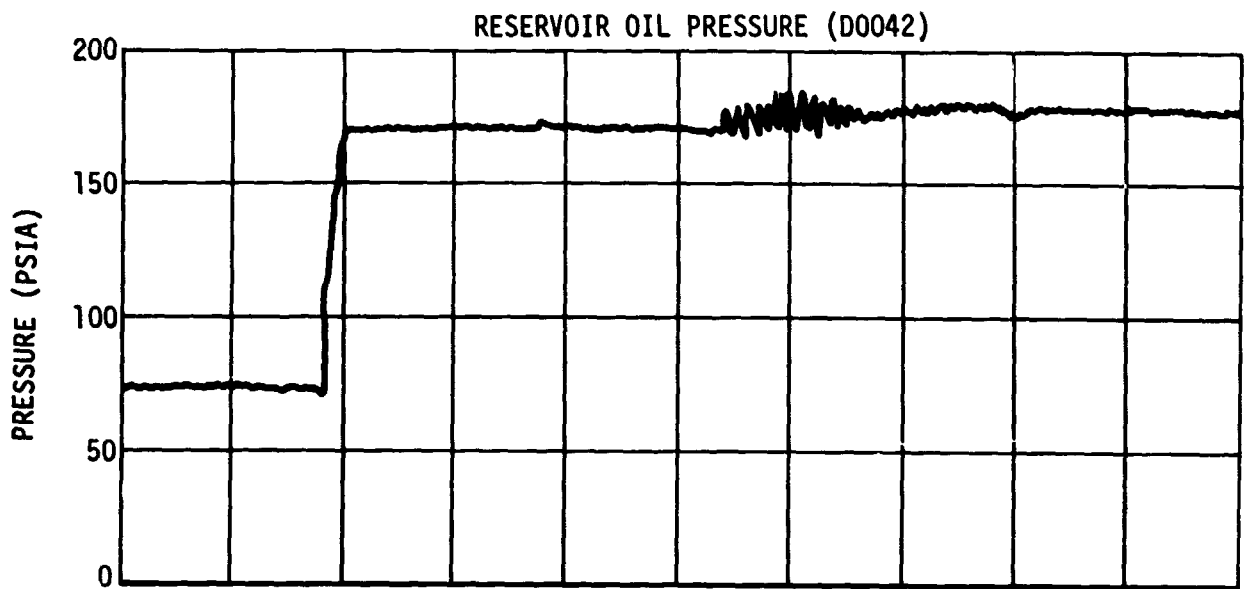

Figure 22-8. Hydraulic System - Third Burn (Sheet 2 of 4)

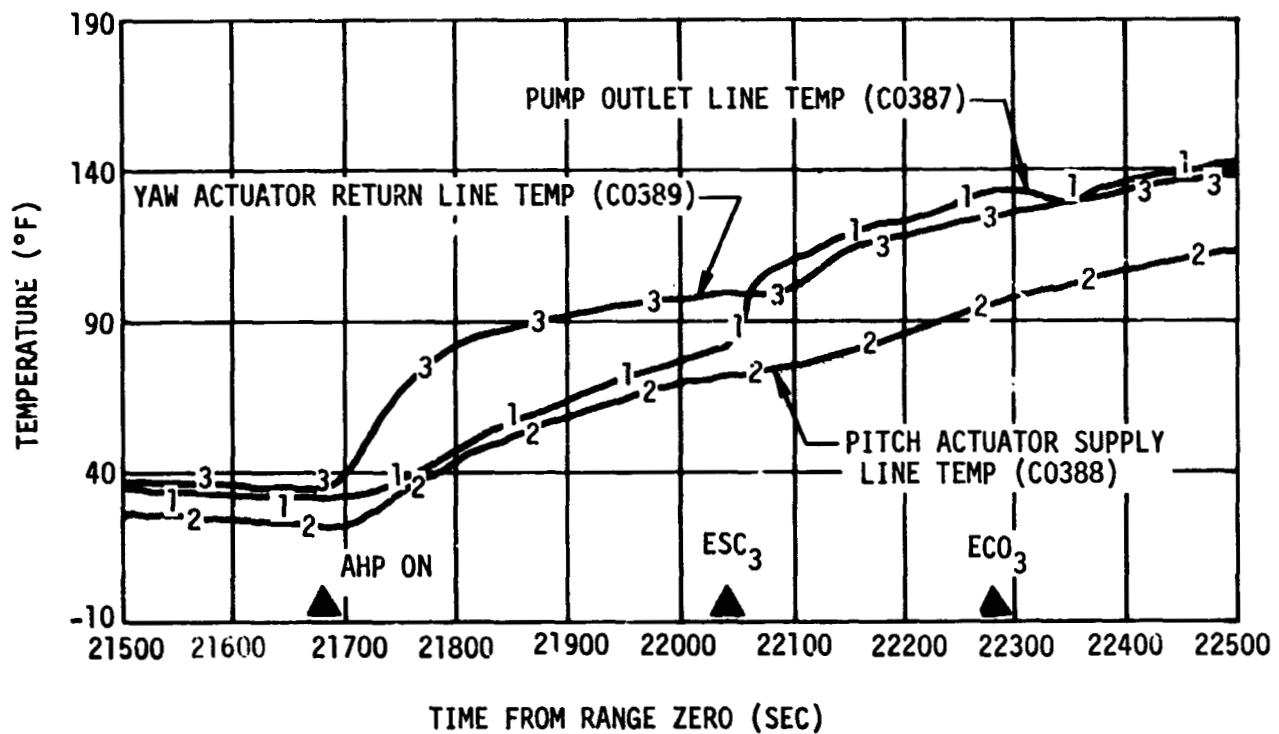
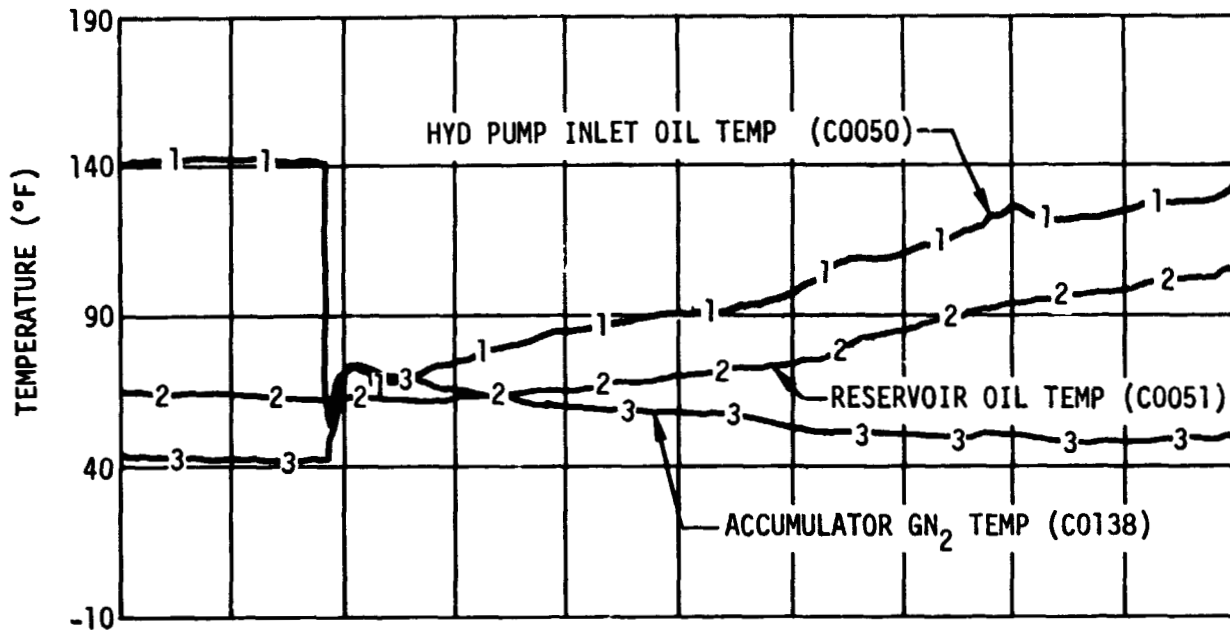
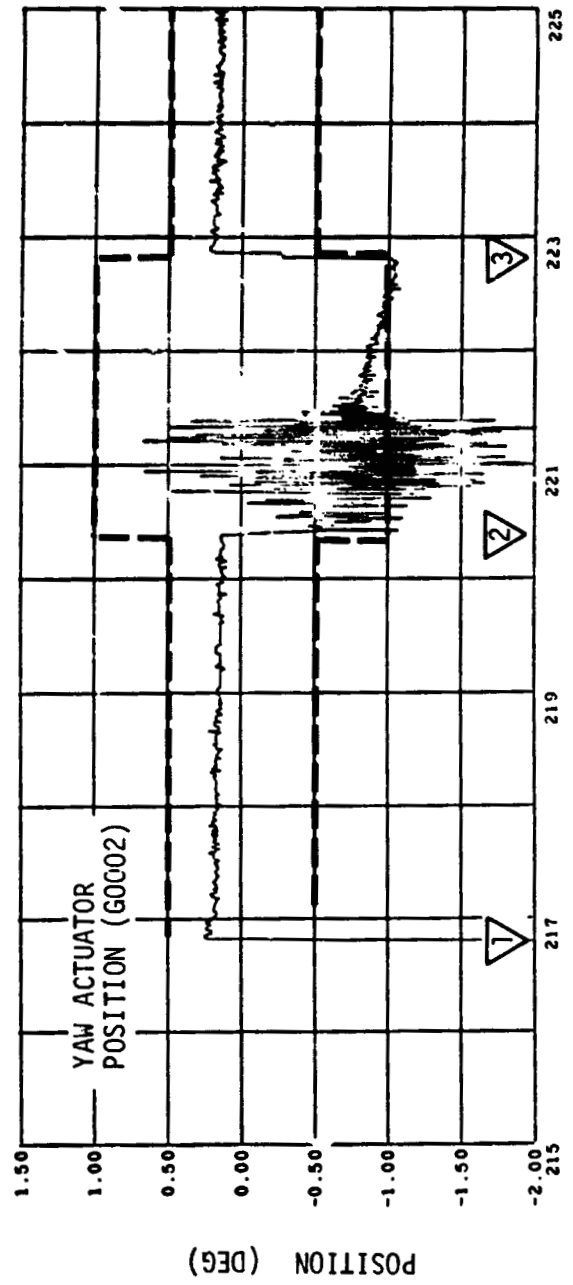
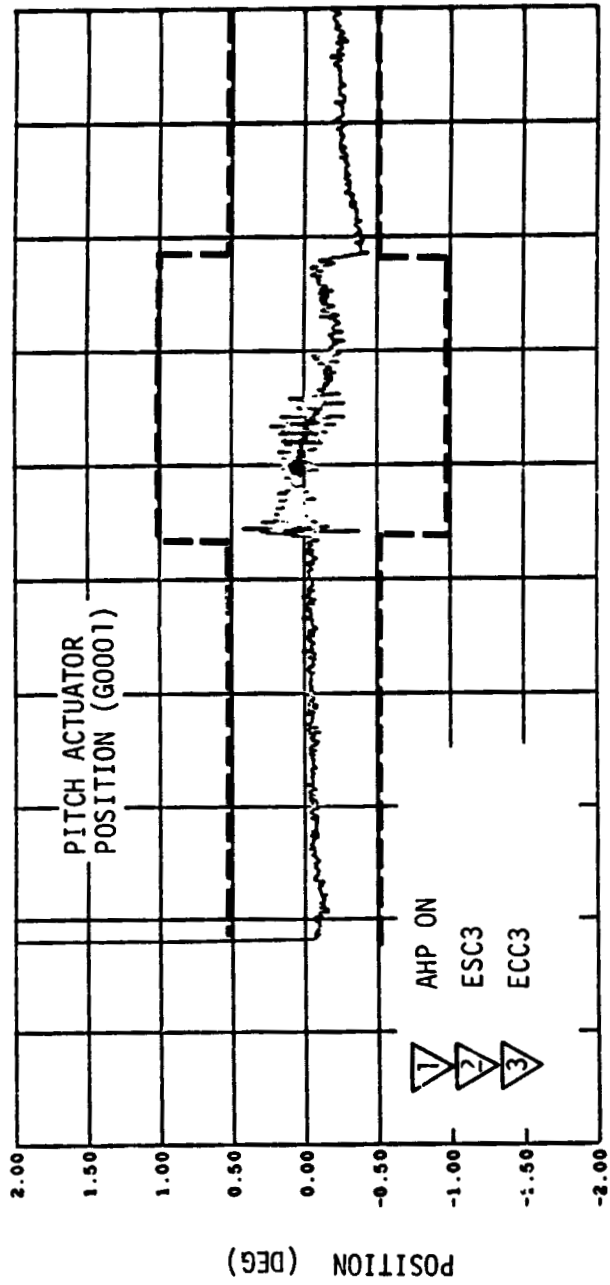

Figure 22-8. Hydraulic System - Third Burn (Sheet 3 of 4)



RANGE TIME (SEC X 100)

Figure 22-8. Hydraulic System - Third Burn (Sheet 4 of 4)

## 23. FORWARD SKIRT THERMOCONDITIONING SYSTEM

The thermoconditioning system operated normally during boost and flight. All parameters were within their design limits with respect to temperature, pressure, and flow.

### 23.1 Temperature

The temperature of the heat transfer fluid exiting from the S-IVB (measurement C0026-601) was maintained essentially constant at 59.0°F. The temperature of the fluid supplied (measurement C0015-601) varied between 50 and 60°F, which is within the interface limits of 45 to 70°F.

### 23.2 Pressure

The inlet pressure (measurement D0017-601) to the S-IVB thermoconditioning system was controlled to 45 psia.

### 23.3 Flowrate

The flowrate through the S-IVB thermoconditioning system (measurement F0010-601) remained essentially constant at 7.9 gallons per min throughout the flight.



## 24. AERO/THERMODYNAMIC ENVIRONMENT

### 24.1 Compartment Venting

Aft compartment pressures on the S-IVB stage were measured by one internal transducer. No pressure measurements were located in the forward compartment. Figure 24-1 shows internal pressure minus ambient pressure for the aft compartment. Presented are simulations based on the Saturn V design trajectory, the AS-504N flight trajectory, and the actual AS-504N flight data. Figure 24-2 shows internal pressure minus ambient pressure calculated for the forward compartment based on design trajectory and AS-504N flight trajectory. The S-IVB-502, S-IVB-503N, and S-IVB-504N stages had identical vent areas of  $0.097 \text{ m}^2$  ( $150 \text{ in}^2$ ) in the forward compartment and  $0.103 \text{ m}^2$  ( $160 \text{ in}^2$ ) in the aft compartment. The internal pressure minus ambient pressure for the aft and forward compartments are shown as a function of Mach number in figures 24-3 and 24-4, respectively. Critical structural loading during this flight occurred between Mach 1 and Mach 1.68. In this Mach number range, flight pressures fell within the predicted pressure range.

### 24.2 Thermodynamic Environment

#### 24.2.1 Structural Heating

The mission profile of the AS-504N flight produced nominal thermal environments for the S-IVB stage components and structure. The boost trajectory was cooler than the thermal design (maximum heating) trajectory, being comparable to that of AS-503 and AS-501, and cooler than that of AS-502 (figure 24-5). There was no instrumentation from which structural temperatures could be obtained; however, it is apparent that the S-IVB stage structural temperatures were within the design limits.

#### 24.2.2 Propellant Heating

Propellant heating could not be determined from the existing temperature sensors in either the LH2 or LOX tanks. However, boiloff data obtained from the propellant utilization (PU) probe readings indicate that propellant heating was within predicted limits.

### 24.2.3 Propellant Behavior

No unusual propellant behavior could be detected from the limited instrumentation in either the LH2 or LOX tanks.

### 24.2.4 Electrical Components

The predicted and the flight recorded forward and aft battery temperatures are shown in figures 24-6 through 24-9. There is good correlation between the battery temperature preflight predictions and the flight data except for forward battery No. 1, Unit 1. During the first 1.7 hr of flight the forward battery No. 1, Unit 1 temperature ranged between 82 deg F and 85 deg F. The heater was activated for 330 sec at R0 +1.7 hr and the battery temperature increased to 90 deg F. It started to cool at R0 +2.5 hr and the heater was again activated for 48 sec at R0 +3.1 hr. The temperature continued to decrease, reaching 70 deg F at R0 +6.5 hr and 63 deg F at R0 +8 hr. There is no evidence of heater activation after R0 +3.1 hrs. (Since the temperature control system of the battery is set to activate the battery heater at a minimum temperature of 70 deg F, this temperature control system is considered to have failed.)

### 24.2.5 O<sub>2</sub>-H<sub>2</sub> Burner

Four temperature sensors were located on the O<sub>2</sub>-H<sub>2</sub> burner support struts, two on an aft strut and two on the forward cone strut. The aft strut sensor C0391 was off-scale low throughout the flight.

Data from sensors C0392, C0393, and C0394 are shown in figure 24-10 along with analytical simulations of the sensors for both periods of burner operation. The temperature responses of all three sensors were as expected during both burner operations. However, the signal from C0392 appeared to go off-scale high approximately 0.5 hr after the beginning of the first burner operation and return shortly after the start of second burner operation.

#### 24.2.6 Auxiliary Propulsion System (APS)

Temperatures of the fuel and oxidizer were measured by 4 transducers. No anomalies were noted and all temperatures were within design limits during the contractually defined mission.

#### 24.2.7 Third Burn Anomaly

Anomalous behavior of two J-2 engine calorimeters and a thrust structure mounted gas probe was noted during the second J-2 engine restart period. The heat flux response from J-2 calorimeter C0395 indicates the following:

- a. A peak heat flux of approximately  $0.05 \text{ Btu/sec-ft}^2$  (at approximately 21,850 sec) during  $\text{O}_2\text{-H}_2$  burner operation, corresponding to the normal expected value.
- b. The flux dropped off and then was followed by a peak heat flux of approximately  $0.08 \text{ Btu/sec-ft}^2$  (at approximately 21,980 sec) during APS ullage rocket operation, corresponding to the normal expected value.
- c. At the termination of the ullage rocket burn, the heat flux dropped as expected and then a peak of  $0.08 \text{ Btu/sec-ft}^2$  occurred at approximately 22,043 sec. This flux indicated the unexpected presence of a hot gas source. Another J-2 engine calorimeter (C0397) had a lesser peak of  $0.01 \text{ Btu/sec-ft}^2$  at approximately the same time. These anomalous peaks are shown in figure 24-11 on an expanded time scale.

Anomalous behavior was also noted in the output of the base region gas temperature probe C0010 which indicated a steady temperature of approximately 360 deg F (expected response) up to engine start (approximately 22,030 sec) and then (1) showed a dip of approximately 10 deg F indicating the unexpected presence of a cold gas source followed by (2) a sharp rise to 950 deg F within 25 sec and shortly thereafter went off-scale high. The sharp rise in temperature is indicative of a hot gas source. The response of the gas probe and the calorimeters occurred at approximately the same time period.

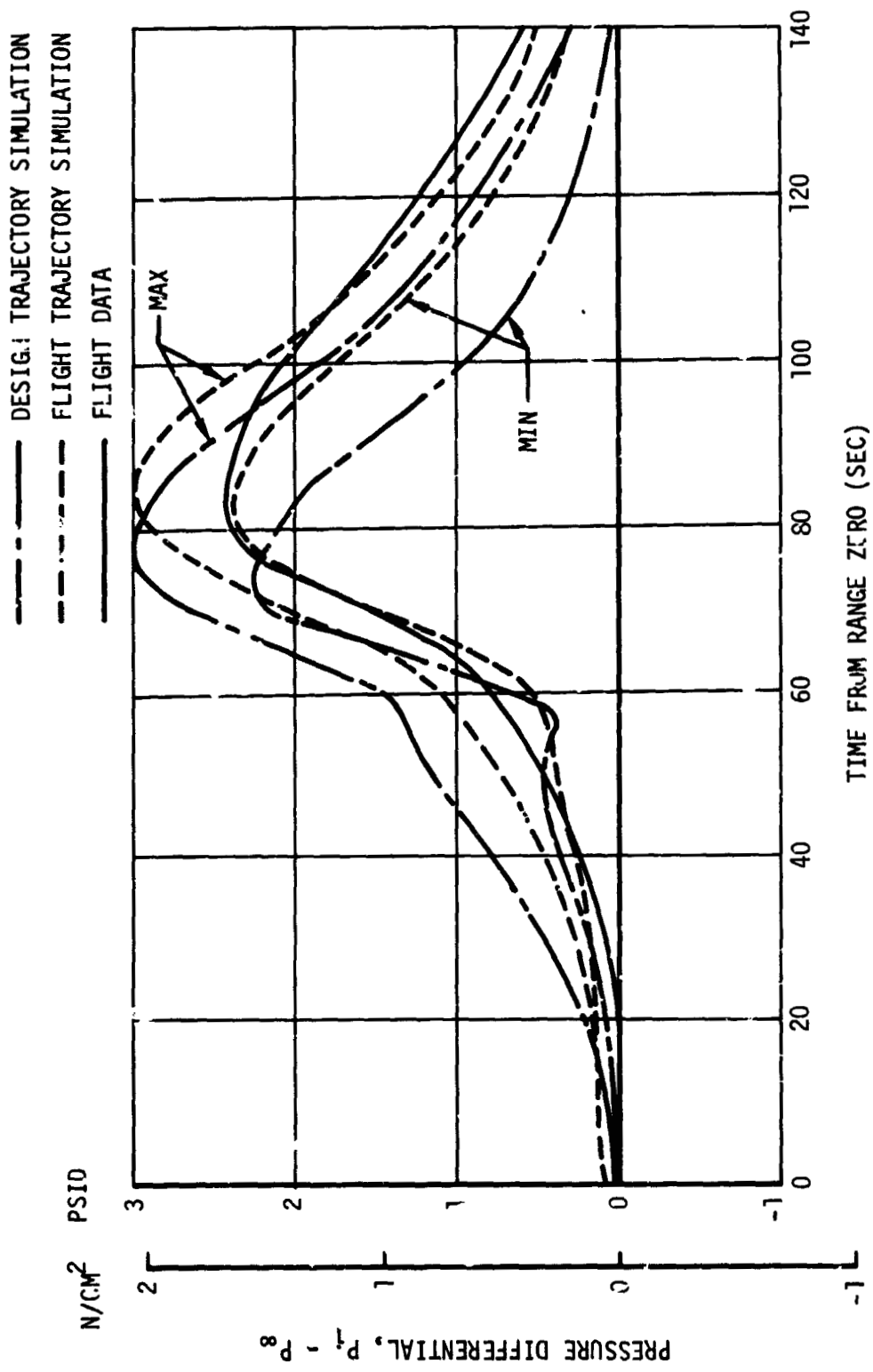

Figure 24-1. Saturn V - 504-N Aft Compartment Internal Pressure Minus Ambient Pressure Versus Time

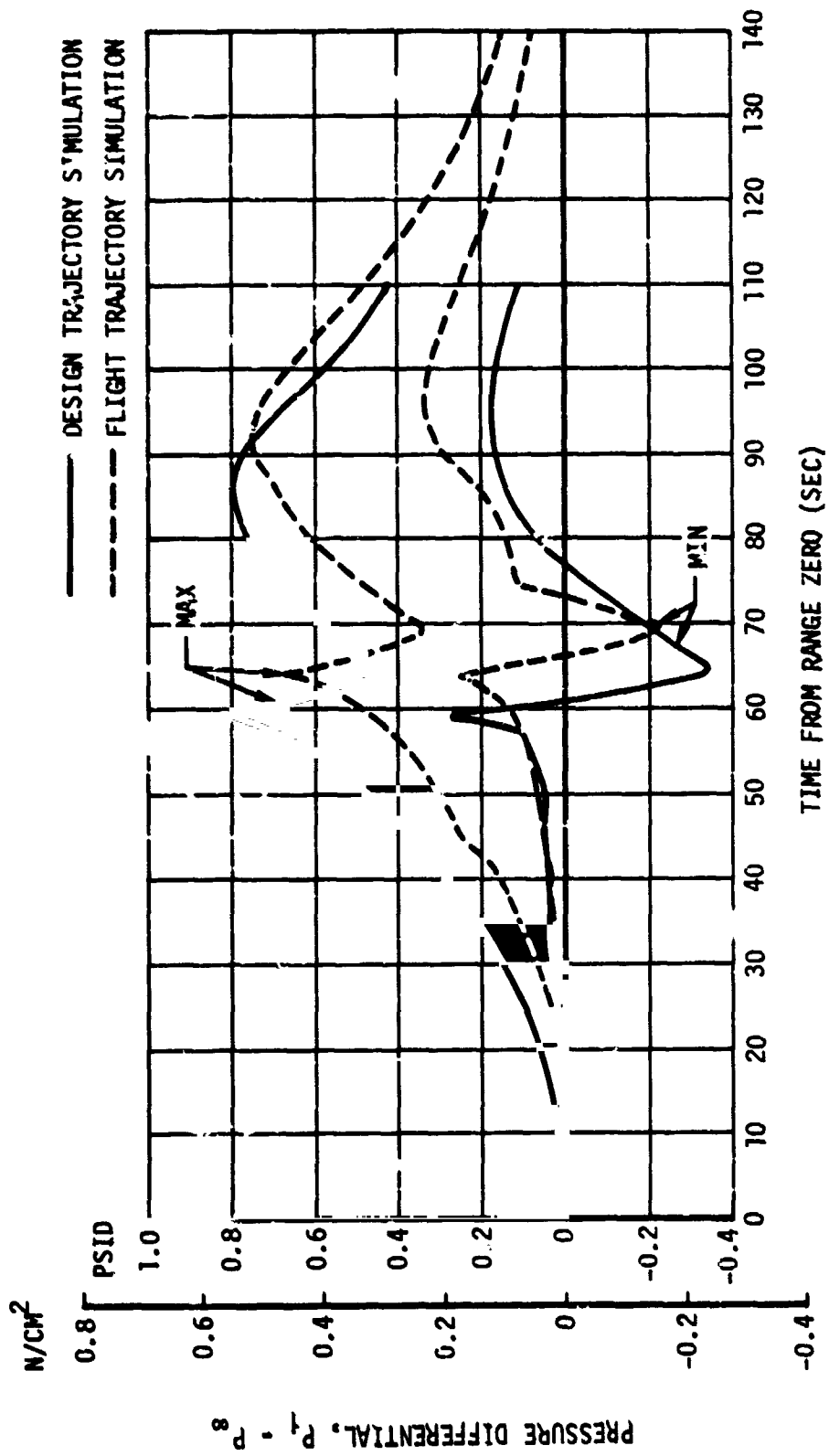

Figure 24-2. Saturn V - 504N Forward Compartment Internal Pressure Minus Ambient Pressure Versus Time

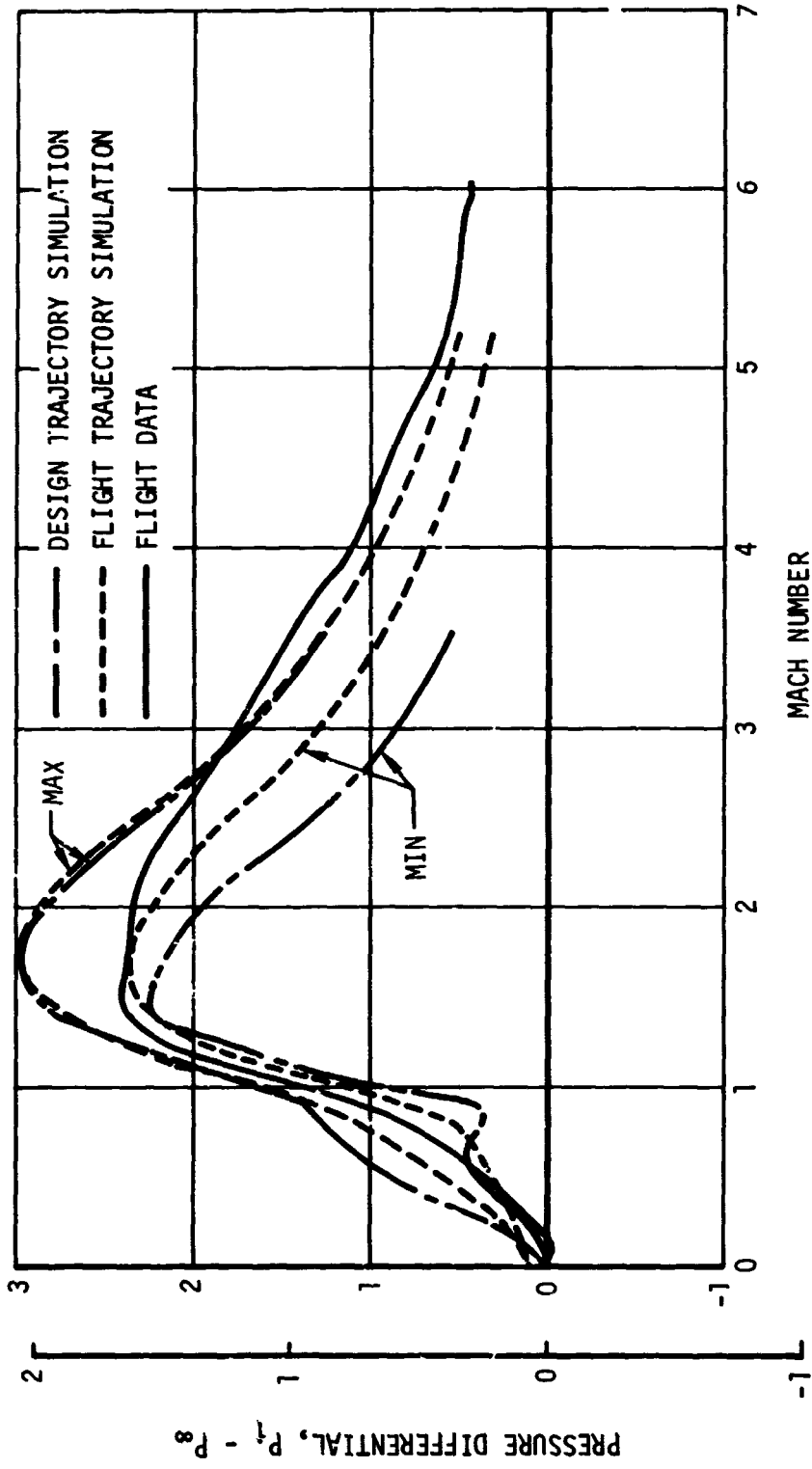

Figure 24-3. Saturn V - 504N Aft Compartment Internal Pressure Minus Ambient Pressure Versus Mach Number

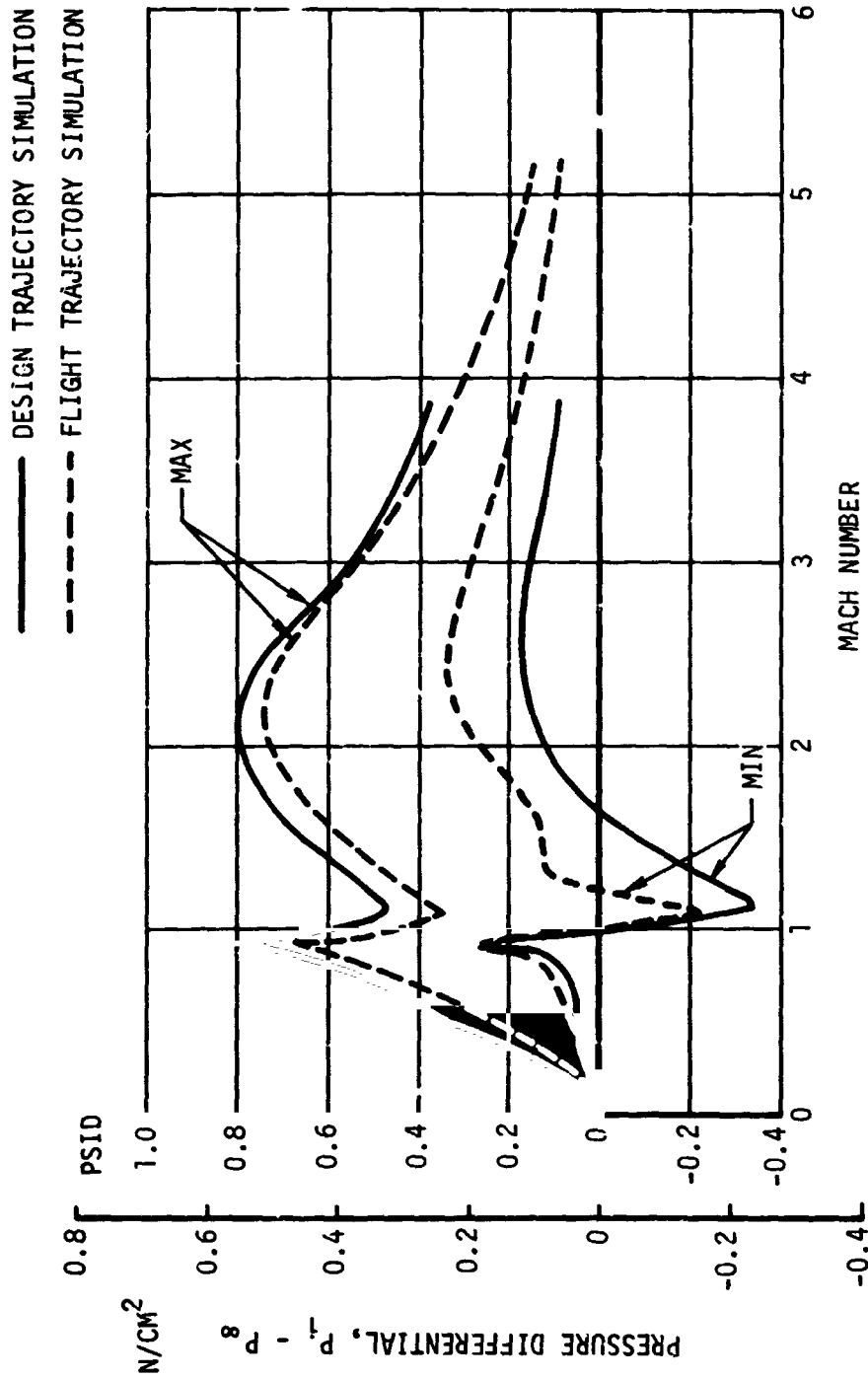

Figure 24-4. Saturn V - 504N Forward Compartment Internal Pressure Minus Ambient Pressure Versus Mach Number

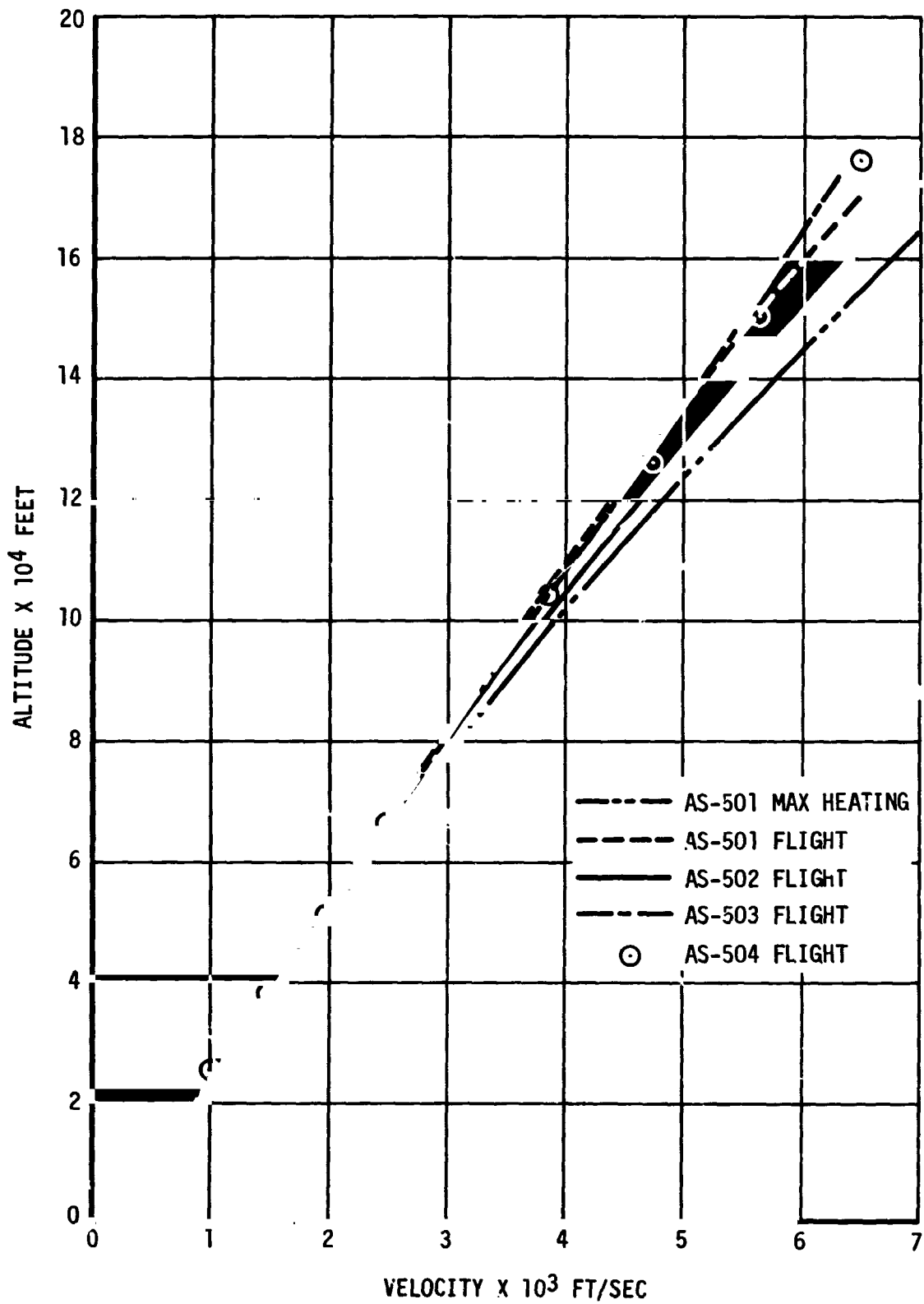

Figure 24-5. Saturn V Flight Trajectories Comparison



FLIGHT DATA:  
 ○ UNIT ONE  
 □ UNIT TWO

FORWARD BATTERY NO. 1 AS-504N "D" MISSION

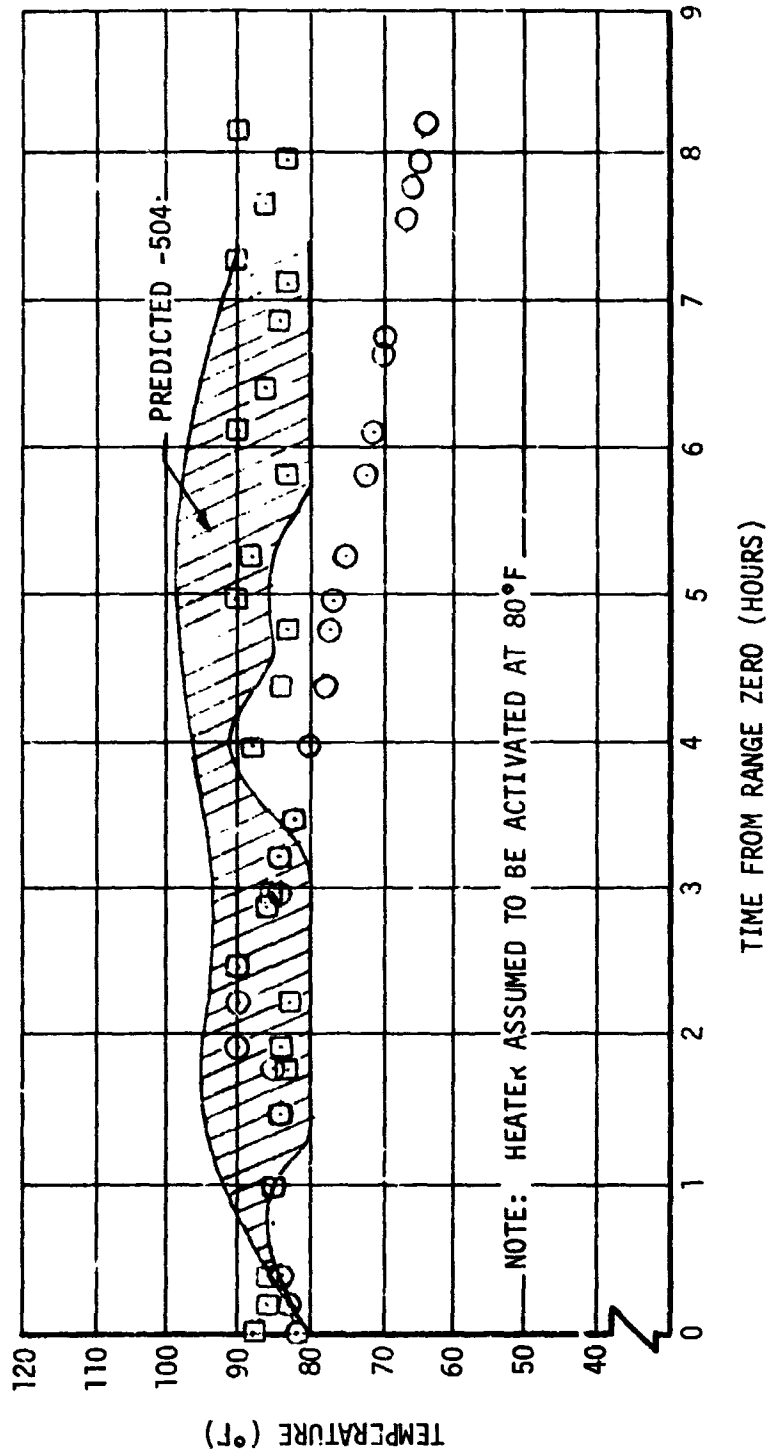

Figure 24-6. Comparison of Predicted and Actual Battery Temperature History  
 - Forward Battery No. 1

FORWARD BATTERY NO. 2 AS-504N "D" MISSION

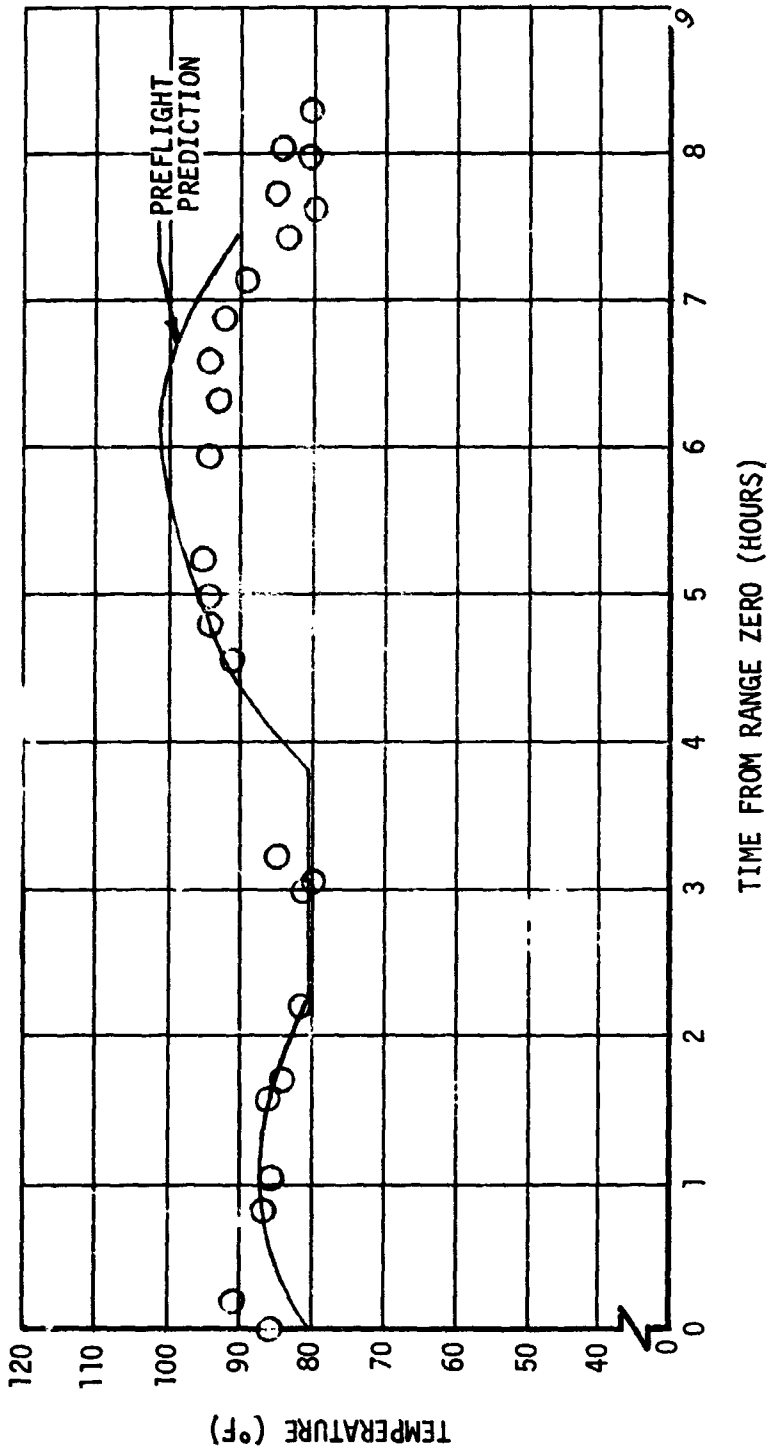

Figure 24-7. Comparison of Predicted and Actual Battery Temperature History  
- Forward Battery No. 2

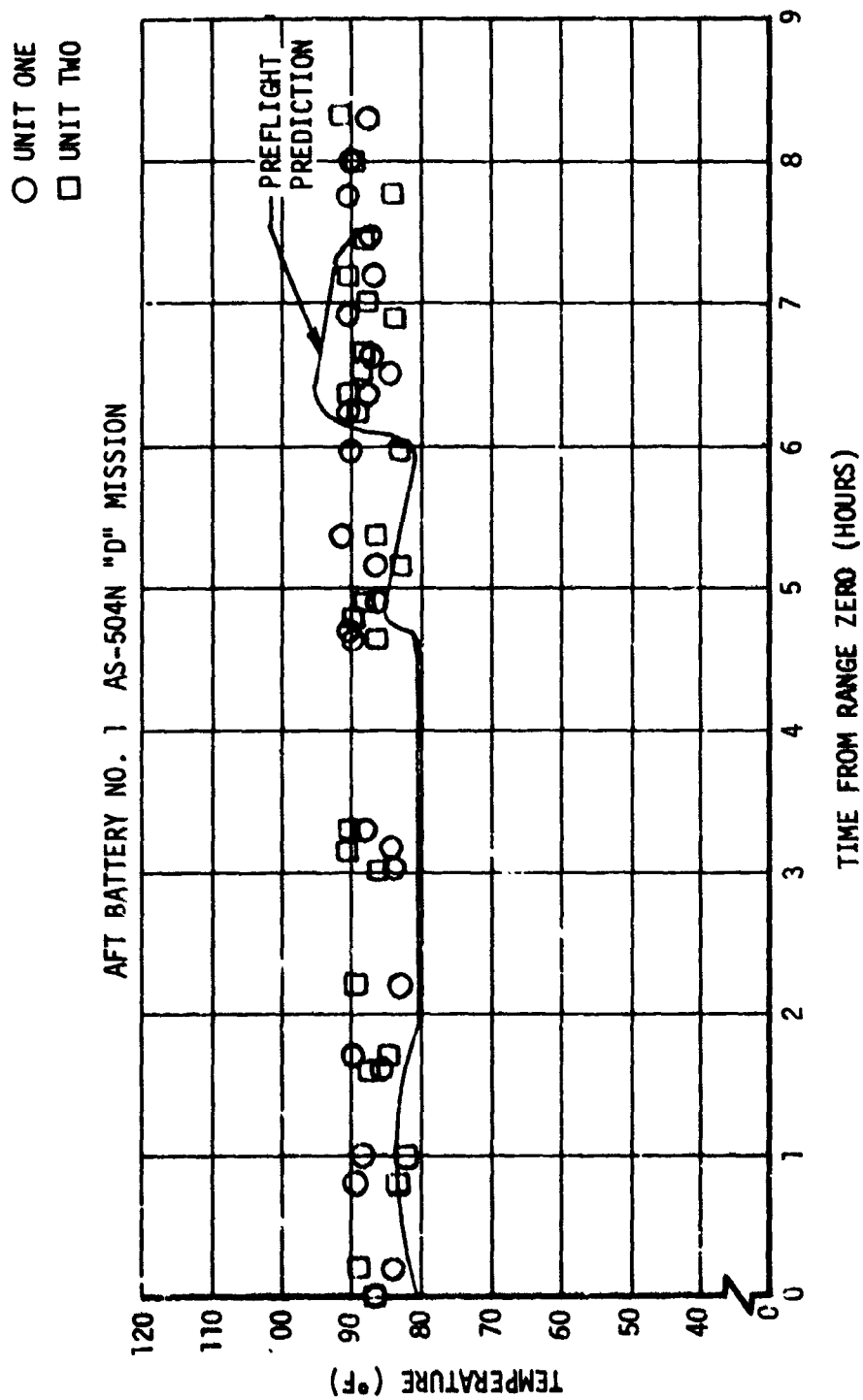

Figure 24-8. Comparison of Predicted and Actual Battery Temperature History  
- Aft Battery No. 1

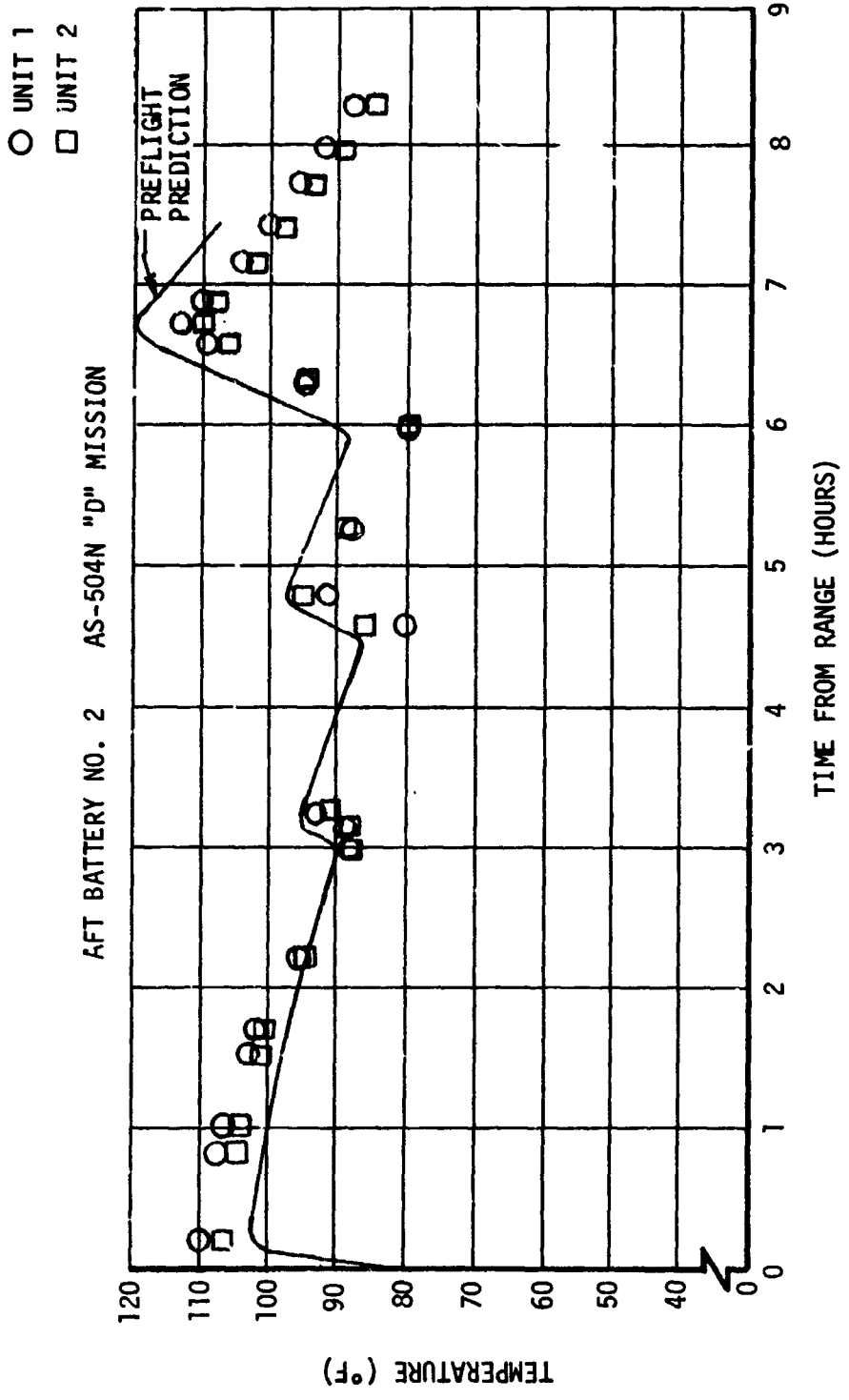

Figure 24-3. Comparison of Predicted and Actual Battery Temperature History  
- Aft Battery No. 2

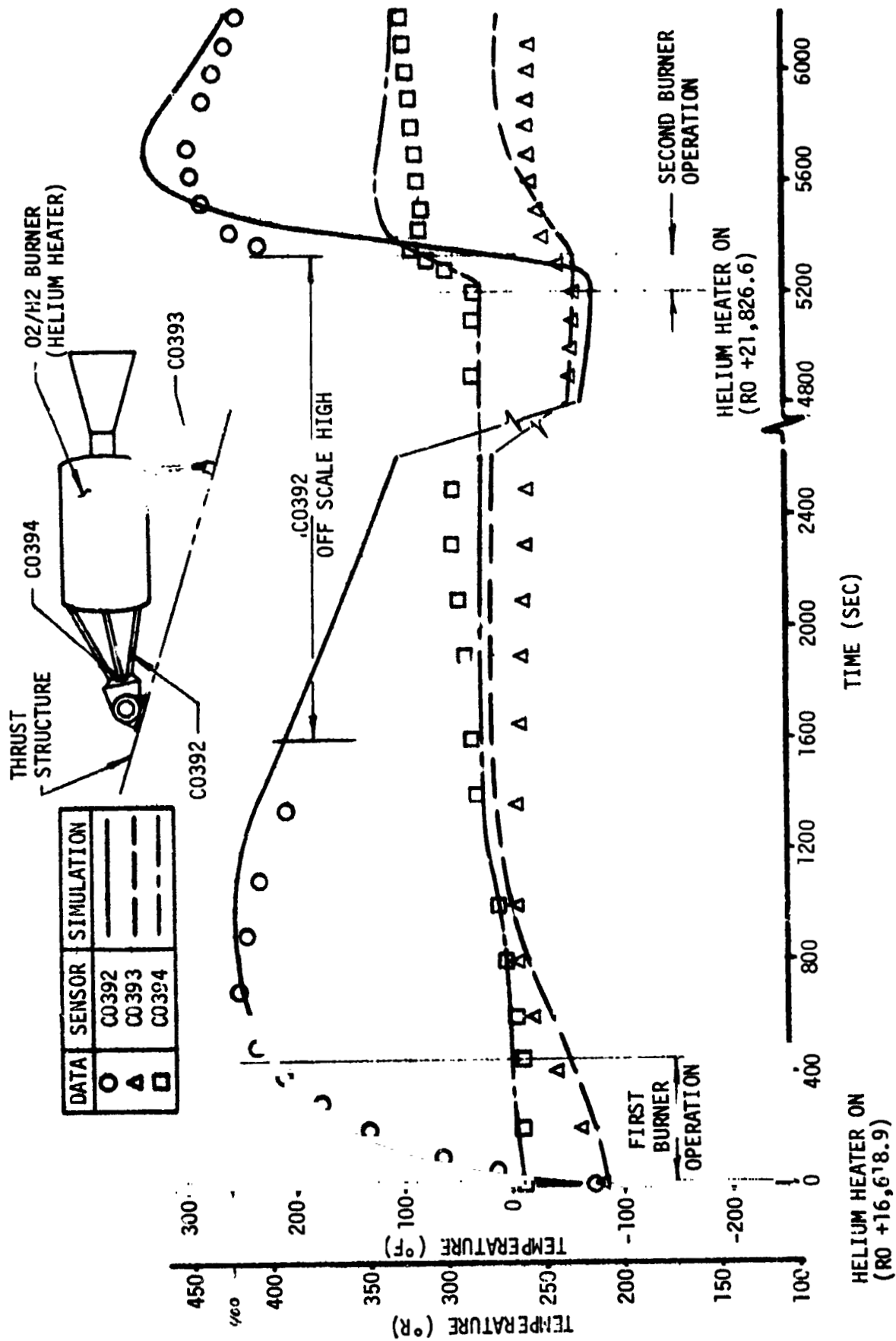

Figure 24-10. Temperature Histories in the Vicinity of the O<sub>2</sub>-H<sub>2</sub> Burner

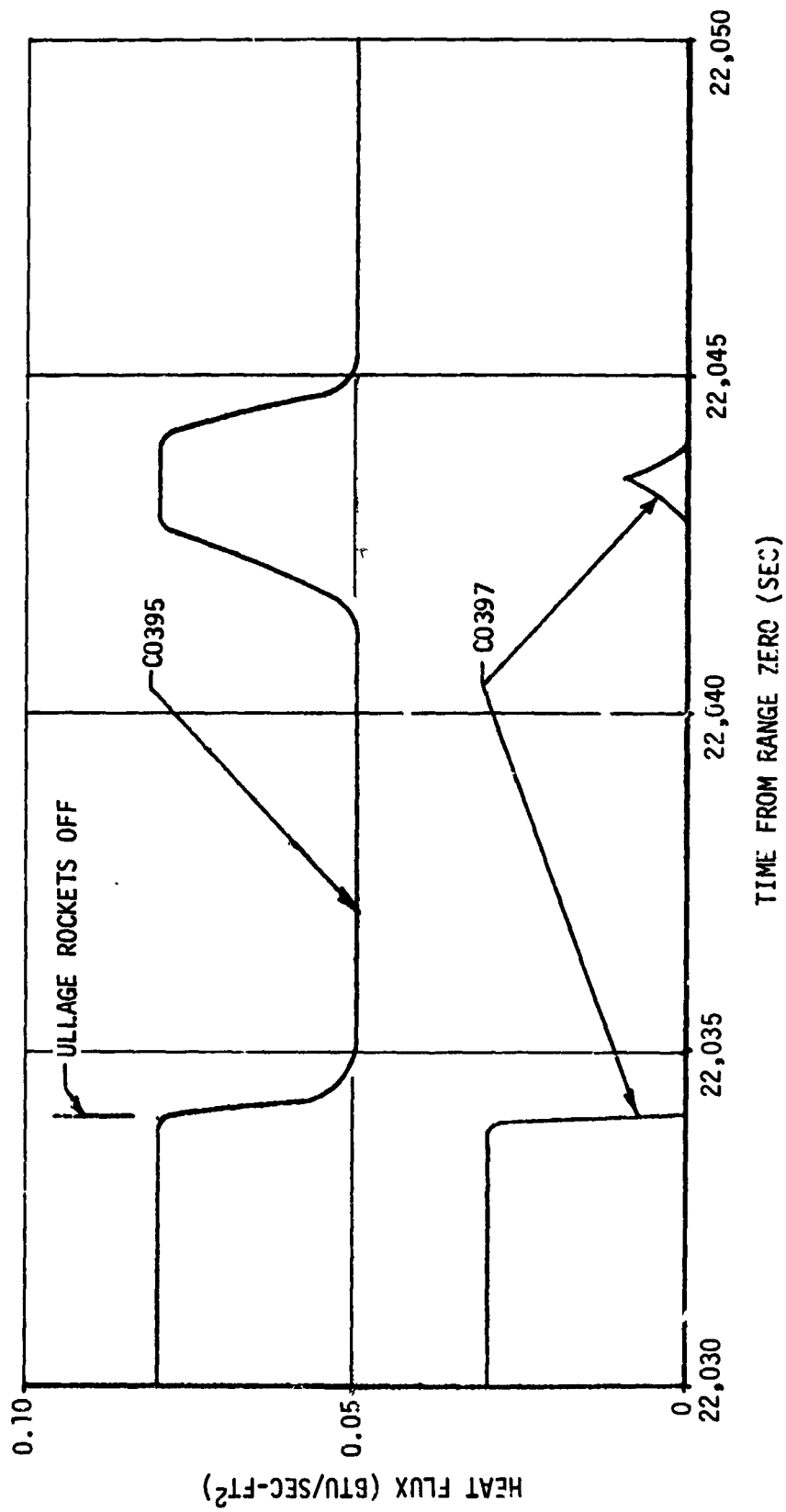

Figure 24-11. Saturn V-504N Engine Bell Heat Fluxes During Third Engine Burn

## 25. STAGE SAFING

### 25.1 Propellant Dump

Execution of the programmed LOX and LH2 dumps was prevented by the loss of main propellant valve control, a result of the engine pneumatic system electrical failure that occurred during third burn (section 9).

Several ground commands failed to open the main oxidizer valve, therefore precluding LOX dump. During a period estimated to be 15 days, the residual LOX was vented through the nonpropulsive vent system.

Like the LOX dump, the LH2 dump could not be executed. Several ground commands failed to actuate the main fuel valve. Based on NPV and CVS performance through the end of data acquisition, the period required to vent the residual LH2 was estimated to be 15 hr.

### 25.2 High-Pressure Sphere Passivation

#### 25.2.1 Cold Helium Dump

The cold helium spheres were passivated during two programmed cold helium dumps. This was accomplished by opening the LH2 cryogenic repressurization valves which allow the cold helium to flow through the O2-H2 burner, into the LH2 tank, and out the LH2 NPV and CVS. The cold helium supply system data are presented in figure 11-16 and table 25-1.

#### 25.2.2 Ambient Repressurization Helium Dump

Ambient repressurization helium dump was adequately accomplished by opening the LH2 ambient repressurization valves as on 503N. The LOX and LH2 tank ambient repressurization helium flowed through the interconnected system into the LH2 tank and was vented overboard through the NPV and CVS systems. Dump data are presented in figure 25-1 and table 25-1.

### 25.2.3 Pneumatic Control and Purge Helium Dump

The pneumatic control and purge helium was dumped through the engine pump purge module. At approximately  $R_0 + 25,450$  sec, the control and purge sphere pressure became equal to the regulator discharge pressure and the two pressures subsequently decreased together. Safing was terminated at  $R_0 + 26,094$ . Pertinent system data are presented in figure 15-7 and table 25-1.



TABLE 25-1  
HIGH-PRESSURE SPHERE PASSIVATION

Parameter	Cold Helium		Ambient Repressurization Helium	Pneumatic Control and Purge Helium
	First Dump	Second Dump		
Initiation (sec from Ro)	22,284.5	24,356.5	24,156	22,581
Duration (sec)	1,872	1,728	200	3,513
helium pressure				
At dump initiation (psia)	608	90	1,710	1,850
At dump termination (psia)	90	50	90	340
Helium mass dumped (lbm)	167	10	39	4.7

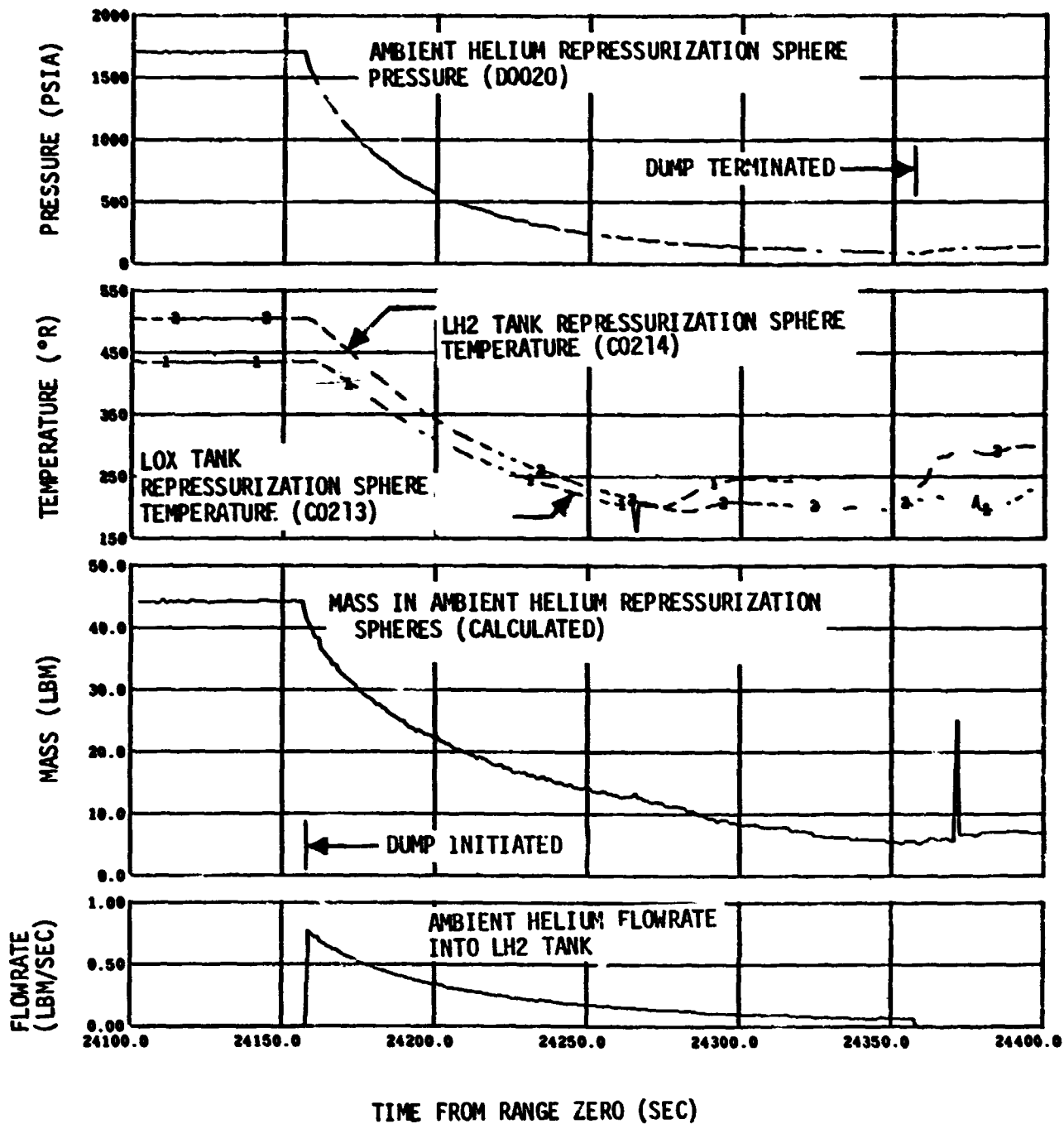

Figure 25-1. Ambient Repressurization Helium Dump

1. GLOSSARY AND ABBREVIATIONS

This appendix (table AP 1-1) lists the commonly used S-IVB-504 stage flight evaluation terms and abbreviations together with their definitions.

TABLE AP 1-1 (Sheet 1 of 11)  
GLOSSARY AND ABBREVIATIONS

<u>Abbreviation</u>	<u>Terms</u>	<u>Definition</u>
AACS	--	Auxiliary attitude control system (see APS)
ac	--	Alternating current
AEDC	--	Arnold Engineering Development Center
--	Aerodynamically induced vibration	The oscillation of a mechanical system when set into motion by the turbulent boundary layer during flight. It is dependent on the shape and velocity of the body
AHF	--	Auxiliary hydraulic pump
amp	--	Ampere
ANT	--	AFETR Station on Antigua Island
APS	--	Auxiliary propulsion system (see AACS)
AS	--	Apollo Saturn
ASC	--	AFETR Station on Ascension Island
ASI	--	Augmented spark igniter
AST	--	All systems test
$A_t$	--	Throat area
aux	--	Auxiliary
--	Average mixture ratio	The time average of the propellant mixture ratio over 1-sec time intervals between 90 percent thrust buildup and Engine Cutoff Command
--	Average thrust or specific impulse	Determined between the time of 90 percent thrust and Engine Cutoff Command
$A_w$	--	Wind azimuth (deg)
$A_{ax}$	--	Axial acceleration (ft/sec <sup>2</sup> )
BDA	--	Bermuda
BGR	--	Bridge gain ratio
Btu	--	British thermal unit
BSC	--	Burner Start Command
$C_3$	--	Orbit energy
CCS	--	Command communication system
CCW	--	Counterclockwise
CDDT	--	Countdown demonstration test
CECO	--	S-IC stage Center Engine Cutoff Command
C	--	Contract end item
CDF	--	Confine detonating fuse

TABLE AP 1-1 (Sheet 2 of 11)  
GLOSSARY AND ABBREVIATIONS

<u>Abbreviation</u>	<u>Terms</u>	<u>Definition</u>
$C_F$	--	Thrust coefficient
$C_f$	Collapse factor	A measure of the effectiveness of pressurization defined as: $C_f = \frac{M_{\text{actual}}}{M_{\text{theoretical}}}$ , where M actual: is the mass necessary to pressure the propellant tank (lbm) $M_{\text{theoretical}}$ : is the mass necessary to pressurize the propellant tank if heat and mass transfer across the ullage boundaries are neglected (lbm)
CHI	--	Major loop guidance command
CHIX	--	Major loop guidance command in roll (axis)
CHIY	--	Major loop guidance command in pitch (axis)
CHIZ	--	Major loop guidance command in yaw (axis)
--	Composite data (acoustic and vibration)	The total energy of the oscillatory phenomenon, consisting of all frequencies and amplitudes sensed by the transducers, and represents the phenomenon at the point of measurement within the limitations of the data acquisition and reduction systems
CIF	--	Central instrumentation facility
CPIF	--	Cost plus incentive fee
cpm	--	Cycles per minute
cps	--	Cycles per second (Hz)
CRO	--	Carnarvon
CSM	--	Command service module
cu in.	--	Cubic inches
CVS	--	Continuous vent system
CW	--	Clockwise
CYI	--	Grand Canary Island
db	--	Decibel
dbm	--	10 log P (milliwatts) where p = power
dbw	--	10 log P (watts)
dc	--	Direct current
DCS	--	Digital command system
DDAS	--	Digital data acquisition
deg	--	Degree
--	Depletion Engine Cutoff Command	The time that engine cutoff was, or would be, initiated by the depletion level sensors
DNA	--	Does not apply
D/O	--	Dropout
e	--	Eccentricity
EA	--	Electronics assembly

TABLE AP 1-1 (Sheet 3 of 11)  
GLOSSARY AND ABBREVIATIONS

<u>Abbreviation</u>	<u>Terms</u>	<u>Definition</u>
EBW	--	Exploding bridgewire
ECA	--	Electrical control assembly
ECC	--	Engine Cutoff Command
ECF	--	End conditions of flight
ECP	--	Engineering change proposal
ECS	--	Environmental control system
EDS	--	Emergency detection system
--	Effective burntime	The engine burntime from 90 percent thrust buildup to Engine Cutoff Command
E/I	--	External/internal
EMC	--	Electromagnetic compatibility
EMI	--	Electromagnetic interference
EMR	Engine propellant mixture ratio	The ratio of engine LOX mass flowrate to LH2 mass flowrate includes gas generator operations
eng	--	Engine
--	Engine cutoff transient	Engine operation during the period from the Engine Cutoff Command until the end of thrust decay
ESC	--	Engine Start Command
EST	--	Eastern standard time
--	Engine start transient	Engine operation during the period from the Engine Start Command until the time of 90 percent thrust (approximately a 3-sec period)
--	Engine steady-state operation	Engine operation during the period from the time of 90 percent thrust until Engine Cutoff Command
ETD	--	End of thrust decay
ETR	--	Eastern test range
*F	--	Degree Fahrenheit
F	Stage longitudinal thrust	Thrust (lbf) developed by the J-2 engine. Ullage rocket thrust is not included
F <sub>a</sub>	--	Ullage rocket thrust (lbf)
--	Flow integral propellant mass history	That propellant mass history determined by combining independent engine analyses by a statistical method
F/B	--	Feedback
FCC	--	Flight control computer
FIOR	--	Flight Information and Operations Report
FM	--	Frequency modulation
fps	--	Feet per second
ft	--	Foot
FTC	--	Florida Test Center
F/U	--	Firing unit

TABLE AP 1-1 (Sheet 4 of 11)  
GLOSSARY AND ABBREVIATIONS

<u>Abbreviation</u>	<u>Terms</u>	<u>Definition</u>
fwd	--	Forward
g	Gravitational acceleration	The acceleration produced by the force of gravity, which varies with the altitude and elevation of the point of observation. The value 32.1739 ft/sec <sup>2</sup> has been chosen as the standard by international agreement for sea level at 45° north latitude
GBI	--	AFETR Station on Grand Bahama Island
GCC	--	Guidance Cutoff Command
G.E.T.	--	Ground elapsed time
GG	--	Gas generator
GH2	--	Gaseous hydrogen
GMT	--	Greenwich mean time
GN2	--	Gaseous nitrogen
GOK	--	Gaseous oxygen
gpm	--	Gallons per minute
grms	--	Gravity root mean square
GRR	--	Guidance reference release
GSE	--	Ground support equipment
GYM	--	Gusynas
h	--	Altitude
h <sub>a</sub>	--	Apogee altitude
HAW	--	Hawaii
He	--	Helium
HF	--	High frequency
Hg	--	Mercury
hr	--	Perigee Altitude
hr	--	Hour
H/W	--	Hardwire
Hz	Hertz	Cycles per second
i	--	Inclination
IAS	--	Initiation of automatic sequence
IECO	--	S-IC stage Inboard Engine Cutoff Command
IGM	--	Iterative guidance mode
in.	--	Inches
in./in.	--	Inches per inch (strain)
IP&CL	--	Instrumentation Program and Components List
ips	--	Inches per second
IRIG	--	Inter range instrumentation group

TABLE AP 1-1 (Sheet 5 of 11)  
GLOSSARY AND ABBREVIATIONS

<u>Abbreviation</u>	<u>Terms</u>	<u>Definition</u>
$I_{sp}$	--	Specific Impulse
IU	--	Instrument unit
k	--	Insulation thermal conductivity
km	--	Kilometer
kc	--	Kilocycles
KSC	--	Kennedy Space Center
kai	--	1,000 lb/in. <sup>2</sup>
L	--	Trajectory fit parameter
lbf	--	Pounds force
lbm	Pounds mass	1/32.1739 slug
lbm/hr	--	Pounds mass, hour
lbm/sec	--	Pounds mass, second
lb/pf	--	Pounds per picofarad
LC	--	Launch Complex
L/C	--	Loading Computer
LCC	--	Launch control center
LES	--	Launch escape system
LET	--	Launch escape tower
--	Level sensor residuals	Those propellant residuals above the main propellant valves determined by combining data from one or more level sensors by a statistical method and extrapolating to Engine Cutoff Command
LH2	--	Liquid hydrogen
LM	--	Lunar module
LO	--	Vehicle liftoff time
--	Look angle	Angle between the vehicle centerline and the line of sight, measured from the rear of the vehicle (deg)
LOS	--	Loss of signal
LOX	--	Liquid oxygen
L/S	--	Level sensor
LTA	--	Lunar test article (Structural representation of LM)
LV	--	Launch vehicle
LVDC	--	Launch vehicle digital computer
M	--	Mach number
$\dot{M}$	Stage propellant mass flowrate (lbm/sec)	Engine propellant mass flowrate (includes propellant flowrate for gas generator operation)
$\dot{M}_2$	Stage LH2 mass flowrate (lbm/sec)	Engine LH2 mass flowrate (includes LH2 flowrate for gas generator operation)
$\dot{M}_O$	Stage LOX mass flowrate (lbm/sec)	Engine LOX mass flowrate (includes LOX flowrate for gas generator operation)

TABLE AP 1-1 (Sheet 6 of 11)  
GLOSSARY AND ABBREVIATIONS

<u>Abbreviation</u>	<u>Terms</u>	<u>Definition</u>
ma	--	Milliampere
M&A	--	Manufacturing and assembly building (STC)
max q	--	Maximum dynamic pressure
mbars	--	Millibars
MC <sup>c</sup>	--	Mission control center
MDAC-WD	--	McDonnell Douglas Astronautics Company - Western Division
MDAC-WD/FTC	--	McDonnell Douglas Astronautics Company - Western Division/ Florida Test Center
MDAC-WD/HE	--	McDonnell Douglas Astronautics Company - Western Division/ Huntington Beach
MDAC-WD/STC	--	McDonnell Douglas Astronautics Company - Western Division/ Sacramento Test Center
MDF	--	Mild detonating fuse
MFV	--	Main fuel valve
MHz	--	Millihertz
MILA	--	Merritt Island Florida
μin./in.	Micro inch per inch	Millionth of an inch per inch
min	--	Minute(s)
ML CHI	--	Minor loop guidance command
ML CHIX	--	Minor loop guidance command in roll (axis)
ML CHIY	--	Minor loop guidance command in pitch (axis)
ML CHIZ	--	Minor loop guidance command in yaw (axis)
MOI	--	Moment of inertia
MOV	--	Main oxidizer valve
MR	--	Mixture ratio
ms	Millisecond	Thousandth of a sec
MSC	--	Manned Spacecraft Center, Houston, Texas
MSFC	--	Marshall Space Flight Center
MSFN	--	Manned space flight network
MSL	--	Mean sea level
mv	--	Millivolt
mxr	--	Multiplexer
N/A	--	Not applicable
NASA	--	National Aeronautics and Space Administration
NC	--	Normally closed
--	Ninety percent thrust buildup	Time from Engine Start Command until the last engine chamber pressure (injector end) reaches 618 psia



TABLE AP 1-1 (Sheet 7 of 11)  
GLOSSARY AND ABBREVIATIONS

<u>Abbreviation</u>	<u>Terms</u>	<u>Definition</u>
nmi	--	Nautical miles
NO	--	Normally open
No.	--	Number
N <sub>2</sub> O <sub>4</sub>	NTO	Nitrogen Tetroxide
NPSP	--	Net positive suction pressure
NPV	--	Nonpropulsive vent
OAT	--	Overall test
OECCO	--	S-IC stage Outboard Engine Cutoff Command
O-P	--	Zero to peak
P	--	Geodetic latitude
P	--	Period (time of one orbit)
P	--	Pitch
P <sub>a</sub>	--	Ambient pressure
P <sub>c</sub>	--	Combustion chamber pressure measured at the injector
PA	--	Pressure actuated
PAM	--	Pulse amplitude modulation
PCF	--	Preconditions of flight
PCM	--	Pulse code modulation
pf	--	Picofarad
--	Phase I	Time from liftoff to ECC1 +10 sec
--	Phase II	Time from liftoff to planned LV/SC separation
PMR	Programmed mixture ratio	A method of controlling the PU valve mixture ratio to obtain maximum efficiency of the stage. The propellant loading is provided to cause the PU system to command the PU valve against the LOX rich stop for the initial portion of flight and then decrease to a lower mixture ratio during the final portion of flight
P/N	--	Part number
P-P	--	Peak to peak
PP	--	Position planes
ppm	--	Parts per million
--	Propellant residuals	The sum of LOX and LH2 remaining onboard at Engine Cutoff Command. The residuals include both usable and trapped propellants.
PS	--	Pressurization system
P/S	--	Pulse sensor
PSD	--	Power spectral density
psi	--	Pounds per square inch
psia	--	Pounds per square inch absolute

TABLE A. 1-1 (Sheet 8 of 11)  
GLOSSARY AND ABBREVIATIONS

<u>Abbreviation</u>	<u>Terms</u>	<u>Definition</u>
psid	--	Pounds per square inch differential
psig	--	Pounds per square inch gauge
PTCS	--	Propellant tanking computer system
P/U	--	Pickup
PU	--	Propellant utilization
--	PU system propellant mass history	That propellant mass history determined for flight by the PU system
--	PU system residuals	Those propellant residuals above the main propellant valves determined by the PU system
q	--	Dynamic pressure
R	--	Rankine
R <sub>A</sub>	--	Radius of apogee
RACS	--	Remote analog calibration system
RASH	--	Remote analog sub-multiplexer
R&D	--	Research and development
RCS	--	Reaction control system
RDSM	--	Remote digital sub-multiplexer
reg	--	Regulator
RF	--	Radio frequency
RFI	--	Radio frequency interference
RMR	--	Reference mixture ratio
rms	--	Root mean square
R/NAA	--	Rocketdyne, North American Aviation
RO	--	An event time used as reference for S-IVB stage flight evaluation sequence of events. Defined as the first Greenwich mean time second prior to vehicle liftoff
rpm	--	Revolutions per minute
R/S	--	Range safety
RSCR	--	Range safety command receiver
rsa	--	Root sum square
S	--	Surface range (ft)
SC	--	Spacecraft
scfm	--	Standard cubic ft/min
scim	--	Standard cubic in./min
sco	--	Subcarrier oscillator
sec	--	Seconds
S-IB	--	First stage of the Saturn IB (200) series of vehicles
S-IC	--	First stage of the Saturn V (500) series of vehicles

TABLE AP 1-1 (Sheet 9 of 11)  
GLOSSARY AND ABBREVIATIONS

<u>Abbreviation</u>	<u>Terms</u>	<u>Definition</u>
S-II	--	Second stage of the Saturn V (500) series of vehicles
S-IVB	--	Second stage of the Saturn IB (200) series of vehicles and third stage of Saturn V (500) series of vehicles
SLA	--	Spacecraft LM adapter
--	Slug	English system unit of mass
SLV	--	Saturn launch vehicle
SM	--	Santa Monica
SM	--	Service module
SMC	--	Steering misalignment correction
S/N	--	Serial number
SPC	--	Service propulsion system
aps	--	Samples per second
SOV	--	Shutoff valve
SSB	--	Single sideband
SSS	--	Stage switch selector
sta	--	Station
--	Statistical weighted average loaded propellants	The most accurate determination of actual propellant load at liftoff as derived from the statistically weighted average mass
--	Statistical weighted average mass determination	A statistical combination of the PU system, engine system, flight simulation, and propellant level sensors at Engine Start Command and Engine Cutoff Command
--	Statistical weighted average residual propellants	The most accurate determination of actual propellant residual at Engine Cutoff Command as derived from the statistically weighted average mass determination method
STC	--	Sacramento Test Center
STD	--	Start tank discharge
STDV	--	Start tank discharge valve
S/V	--	Space vehicle
sw	--	Switch
Sw sel	--	Switch selector
T	--	Countdown time from prospective liftoff or as specifically defined in the text
TB	--	Time base
T/C	--	Thermal cycle
Tel 2	--	Telemetry station at KSC
Tel 3	--	Cape Kennedy Telemetry Station IV
Tel 4	--	Merritt Island Telemetry Station IV
TEX	--	Corpus Christi, Texas
tk	--	Tank

TABLE AP 1-1 (Sheet 10 of 11)  
GLOSSARY AND ABBREVIATIONS

<u>Abbreviation</u>	<u>Terms</u>	<u>Definition</u>
	--	Translunar injection
	--	Telemetry
--	Total depletion burntime	The engine burntime from Engine Start Command to the time that the Depletion Engine Cutoff Command would have been initiated
--	Total propellants consumed	That amount of liquid propellants consumed from Engine Start Command to Engine Cutoff Command includes engine consumption, boiloff, and LH2 tank pressurant
EP	--	Telemetry performance evaluation period
--	Total stage burntime	The engine burntime from Engine Start Command to Engine Cutoff Command
--	Total stage mass history	A compilation of all final hardware, propellant, and gas masses. The measured and computed mass of each constituent is adjusted within its accuracy band so that the total stage mass at Engine Start Command and Engine Cutoff Command agrees with the total stage mass as determined by the Statistical Weighted Average mass determination method
P&E	--	Test Planning and Evaluation
VCS	--	Thrust vector control system
--	Unusable propellants	Those propellants remaining for a propellant depletion cutoff. This includes the propellant in the tank below the depletion sensor, propellant in the feed duct, and trapped propellants. It does not include sensor lag time or the propellant consumed during engine cutoff but does include sensor time delay
U/R	--	Ullage rocket
--	Usable residual	Propellants in excess of trapped propellants left onboard a stage after powered flight has been terminated by some specified cutoff criteria
USB	--	Unified S-band
	--	Volt
A	--	Apogee velocity
E	--	Relative velocity
I	--	Inertial velocity
V <sub>P</sub>	--	Perigee velocity
V <sub>∞</sub>	--	Freestream velocity
V <sub>W</sub>	--	Wind velocity (speed)
VAB	--	Vehicle Assembly Building, KSC, Florida
vac	--	Voltage, alternating current
VCL	--	Vehicle checkout laboratory
VCO	--	Voltage controlled oscillator
vdc	--	Voltage, direct current
VHF	--	Very high frequency
V <sub>I</sub>	--	Initial velocity
VSE	--	Vehicle support equipment

TABLE AP 1-1 (Sheet 11 of 11)  
GLOSSARY AND ABBREVIATIONS

<u>Abbreviations</u>	<u>Terms</u>	<u>Definition</u>
VSWR	--	Voltage standing wave ratio
W	--	Watt
WRD	--	DAC work release order
wt	--	Weight
$\dot{W}_T$	--	Time rate of change of total vehicle weight
$X_E$	--	Downrange distance
$\dot{X}_E$	--	Downrange velocity
Y	--	Yaw
$Y_E$	--	Vertical distance
$\dot{Y}_E$	--	Vertical velocity
$Y_E$	--	Crossrange distance
$\dot{Y}_E$	--	Crossrange velocity
$\alpha$	--	Angle of attack
$\alpha_P$	--	Pitch angle of attack
$\alpha_q$	--	Product of angle of attack and dynamic pressure
$\alpha_Y$	--	Yaw angle of attack
$\beta$	--	Yaw angle of attack
$\gamma_1$	--	Earth fixed flight path elevation angle
$\Delta w$	--	Delta weight
$\theta_r$	--	Descending node
$\gamma_{1I}$	--	Inertial flight path elevation angle
$\gamma_{2I}$	--	Inertial flight path azimuth angle
$\lambda$	--	Longitude
$\mu v$	--	Microvolt

TABLE 25-1  
HIGH-PRESSURE SPHERE PASSIVATION

Parameter	Cold Helium		Ambient Repressurization Helium	Pneumatic Control and Purge Helium
	First Dump	Second Dump		
Initiation (sec from Ro)	22,284.5	24,356.5	24,156	22,581
Duration (sec)	1,972	1,728	2.0	3,513
helium pressure				
At dump initiation (psia)	608	90	1,710	1,850
At dump termination (psia)	90	50	90	340
Helium mass dumped (lbm)	167	10	39	4.7

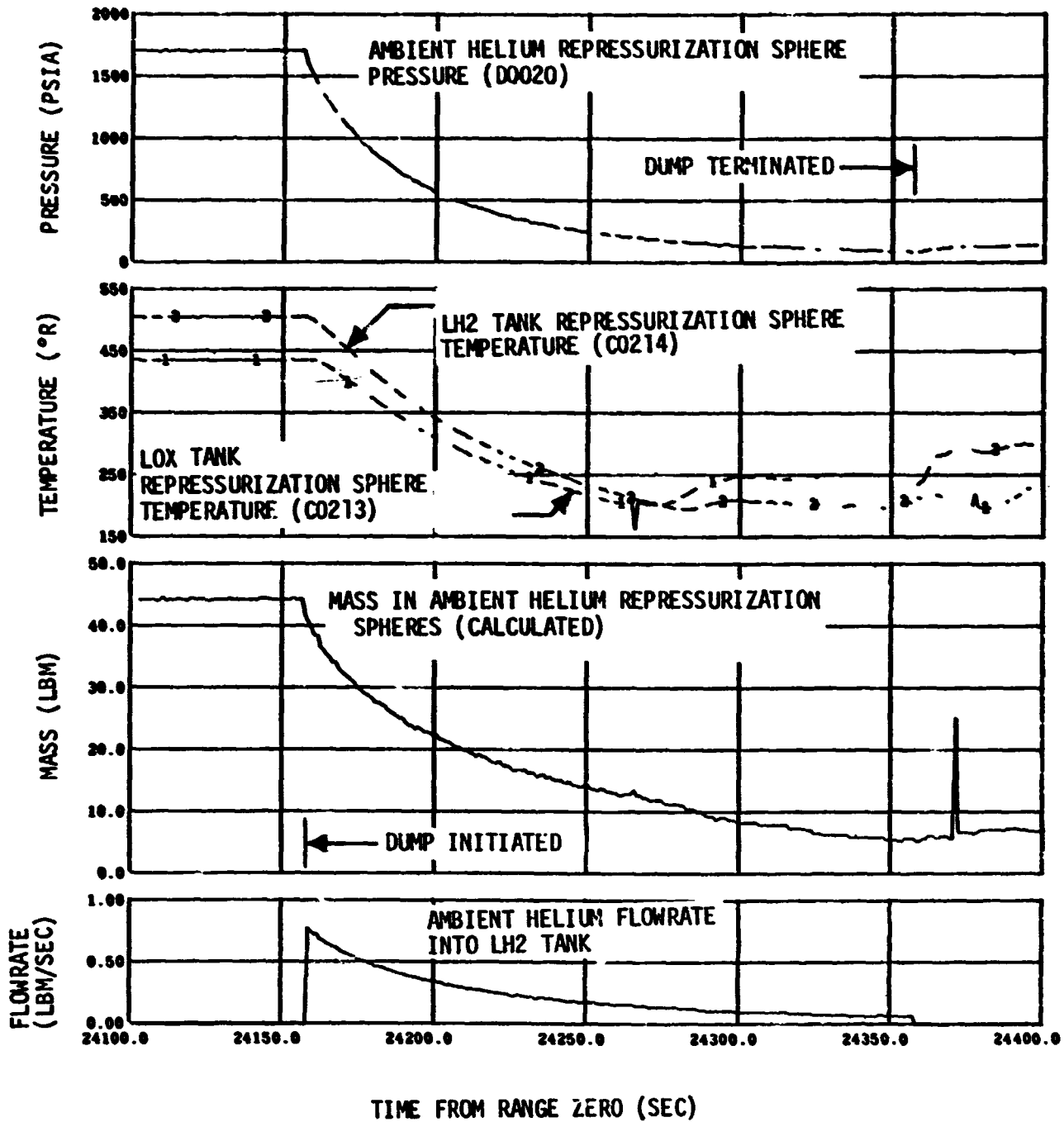

Figure 25-1. Ambient Repressurization Helium Dump

1. GLOSSARY AND ABBREVIATIONS

This appendix (table AP 1-1) lists the commonly used S-IVB-504 stage flight evaluation terms and abbreviations together with their definitions.

TABLE AP 1-1 (Sheet 1 of 11)  
GLOSSARY AND ABBREVIATIONS

<u>Abbreviation</u>	<u>Terms</u>	<u>Definition</u>
AACS	--	Auxiliary attitude control system (see APS)
ac	--	Alternating current
AEDC	--	Arnold Engineering Development Center
--	Aerodynamically induced vibration	The oscillation of a mechanical system when set into motion by the turbulent boundary layer during flight. It is dependent on the shape and velocity of the body
AHF	--	Auxiliary hydraulic pump
amp	--	Ampere
ANT	--	AFETR Station on Antigua Island
APS	--	Auxiliary propulsion system (see AACS)
AS	--	Apollo Saturn
ASC	--	AFETR Station on Ascension Island
ASI	--	Augmented spark igniter
AST	--	All systems test
$A_t$	--	Throat area
aux	--	Auxiliary
--	Average mixture ratio	The time average of the propellant mixture ratio over 1-sec time intervals between 90 percent thrust buildup and Engine Cutoff Command
--	Average thrust or specific impulse	Determined between the time of 90 percent thrust and Engine Cutoff Command
$A_w$	--	Wind azimuth (deg)
$A_{XM}$	--	Axial acceleration (ft/sec <sup>2</sup> )
BDA	--	Bermuda
BGR	--	Bridge gain ratio
Btu	--	British thermal unit
BSC	--	Burner Start Command
$C_3$	--	Orbit energy
CCS	--	Command communication system
CCW	--	Counterclockwise
CDDT	--	Countdown demonstration test
CECO	--	S-IC stage Center Engine Cutoff Command
C'	--	Contract end item
CDF	--	Confined detonating fuse



TABLE AP 1-1 (Sheet 2 of 11)  
GLOSSARY AND ABBREVIATIONS

<u>Abbreviation</u>	<u>Terms</u>	<u>Definition</u>
C <sub>F</sub>	--	Thrust coefficient
C <sub>f</sub>	Collapse factor	A measure of the effectiveness of pressurization defined as: $C_f = \frac{M_{\text{actual}}}{M_{\text{theoretical}}}$ , where M actual: is the mass necessary to pressure the propellant tank (lbm) M <sub>theoretical</sub> : is the mass necessary to pressurize the propellant tank if heat and mass transfer across the ullage boundaries are neglected (lbm)
CHI	--	Major loop guidance command
CHIX	--	Major loop guidance command in roll (axis)
CHIY	--	Major loop guidance command in pitch (axis)
CHIZ	--	Major loop guidance command in yaw (axis)
--	Composite data (acoustic and vibration)	The total energy of the oscillatory phenomenon, consisting of all frequencies and amplitudes sensed by the transducers, and represents the phenomenon at the point of measurement within the limitations of the data acquisition and reduction systems
CIF	--	Central instrumentation facility
CPIF	--	Cost plus incentive fee
cpm	--	Cycles per minute
cps	--	Cycles per second (Hz)
CRO	--	Carnarvon
CSM	--	Command service module
cu in.	--	Cubic inches
CVS	--	Continuous vent system
CW	--	Clockwise
CYI	--	Grand Canary Island
db	--	Decibel
dbm	--	10 log P (milliwatts) where p = power
dbw	--	10 log P (watts)
dc	--	Direct current
DCS	--	Digital command system
DDAS	--	Digital data acquisition
deg	--	Degree
--	Depletion Engine Cutoff Command	The time that engine cutoff was, or would be, initiated by the depletion level sensors
DNA	--	Does not apply
D/O	--	Dropout
e	--	Eccentricity
EA	--	Electronics assembly

TABLE AP 1-1 (Sheet 3 of 11)  
GLOSSARY AND ABBREVIATIONS

<u>Abbreviation</u>	<u>Terms</u>	<u>Definition</u>
EBW	--	Exploding bridgewire
ECA	--	Electrical control assembly
ECC	--	Engine Cutoff Command
ECF	--	End conditions of flight
ECP	--	Engineering change proposal
ECS	--	Environmental control system
EDS	--	Emergency detection system
--	Effective burntime	The engine burntime from 90 percent thrust buildup to Engine Cutoff Command
E/I	--	External/internal
EMC	--	Electromagnetic compatibility
EMI	--	Electromagnetic interference
EMR	Engine propellant mixture ratio	The ratio of engine LOX mass flowrate to LH2 mass flowrate includes gas generator operations
eng	--	Engine
--	Engine cutoff transient	Engine operation during the period from the Engine Cutoff Command until the end of thrust decay
ESC	--	Engine Start Command
EST	--	Eastern standard time
--	Engine start transient	Engine operation during the period from the Engine Start Command until the time of 90 percent thrust (approximately a 3-sec period)
--	Engine steady-state operation	Engine operation during the period from the time of 90 percent thrust until Engine Cutoff Command
ETD	--	End of thrust decay
ETR	--	Eastern test range
°F	--	Degree Fahrenheit
F	Stage longitudinal thrust	Thrust (lbf) developed by the J-2 engine. Ullage rocket thrust is not included
F <sub>a</sub>	--	Ullage rocket thrust (lbf)
--	Flow integral propellant mass history	That propellant mass history determined by combining independent engine analyses by a statistical method
F/B	--	Feedback
FCC	--	Flight control computer
FIOR	--	Flight Information and Operations Report
FM	--	Frequency modulation
fps	--	Feet per second
ft	--	Foot
FTC	--	Florida Test Center
F/U	--	Firing unit

TABLE AP 1-1 (Sheet 4 of 11)  
GLOSSARY AND ABBREVIATIONS

<u>Abbreviation</u>	<u>Terms</u>	<u>Definition</u>
fwd	--	Forward
g	Gravitational acceleration	The acceleration produced by the force of gravity, which varies with the altitude and elevation of the point of observation. The value 32.1739 ft/sec <sup>2</sup> has been chosen as the standard by international agreement for sea level at 45° north latitude
GBI	--	AFETR Station on Grand Bahama Island
GCC	--	Guidance Cutoff Command
G.E.T.	--	Ground elapsed time
GG	--	Gas generator
GH2	--	Gaseous hydrogen
GMT	--	Greenwich mean time
GN2	--	Gaseous nitrogen
GOX	--	Gaseous oxygen
gpm	--	Gallons per minute
grms	--	Gravity root mean square
GRR	--	Guidance reference release
GSE	--	Ground support equipment
GYM	--	Guyanas
h	--	Altitude
h <sub>a</sub>	--	Apogee altitude
HAW	--	Hawaii
He	--	Helium
HF	--	High frequency
Hg	--	Mercury
hp	--	Perigee Altitude
hr	--	Hour
H/W	--	Hardwire
Hz	Hertz	Cycles per second
i	--	Inclination
IAS	--	Initiation of automatic sequence
IECO	--	S-IC stage Inboard Engine Cutoff Command
IGM	--	Iterative guidance mode
in.	--	Inches
in./in.	--	Inches per inch (strain)
IP&CL	--	Instrumentation Program and Components List
ips	--	Inches per second
IRIG	--	Inter range instrumentation group

TABLE AP 1-1 (Sheet 5 of 13)  
GLOSSARY AND ABBREVIATIONS

<u>Abbreviation</u>	<u>Terms</u>	<u>Definition</u>
$I_{sp}$	--	Specific impulse
IU	--	Instrument unit
k	--	Insulation thermal conductivity
km	--	Kilometer
kc	--	Kilocycles
KSC	--	Kennedy Space Center
ksi	--	1,000 lb/in. <sup>2</sup>
L	--	Trajectory fit parameter
lbf	--	Pounds force
lbm	Pounds mass	1/32.1739 slug
lbm/hr	--	Pounds mass, hour
lbm/sec	--	Pounds mass, second
lb/pf	--	Pounds per picofarad
LC	--	Launch Complex
L/C	--	Loading Computer
LCC	--	Launch control center
LES	--	Launch escape system
LET	--	Launch escape tower
--	Level sensor residuals	Those propellant residuals above the main propellant valves determined by combining data from one or more level sensors by a statistical method and extrapolating to Engine Cutoff Command
LH2	--	Liquid hydrogen
LM	--	Lunar module
LO	--	Vehicle liftoff time
--	Look angle	Angle between the vehicle centerline and the line of sight, measured from the rear of the vehicle (deg)
LOS	--	Loss of signal
LOX	--	Liquid oxygen
L/S	--	Level sensor
LTA	--	Lunar test article (Structural representation of LM)
LV	--	Launch vehicle
LVDC	--	Launch vehicle digital computer
M	--	Mach number
$\dot{M}$	Stage propellant mass flowrate (lbm/sec)	Engine propellant mass flowrate (includes propellant flowrate for gas generator operation)
$\dot{M}_f$	Stage LH2 mass flowrate (lbm/sec)	Engine LH2 mass flowrate (includes LH2 flowrate for gas generator operation)
$\dot{M}_o$	Stage LOX mass flowrate (lbm/sec)	Engine LOX mass flowrate (includes LOX flowrate for gas generator operation)

TABULAR AP 1-1 (Sheet 6 of 11)  
GLOSSARY AND ABBREVIATIONS

<u>Abbreviation</u>	<u>Terms</u>	<u>Definition</u>
ma	--	Milliampere
M&A	--	Manufacturing and assembly building (STC)
max q	--	Maximum dynamic pressure
mbar	--	Millibars
MC	--	Mission control center
MDAC-WD	--	McDonnell Douglas Astronautics Company - Western Division
MDAC-WD/FTC	--	McDonnell Douglas Astronautics Company - Western Division/ Florida Test Center
MDAC-WD/HB	--	McDonnell Douglas Astronautics Company - Western Division/ Huntington Beach
MDAC-WD/STC	--	McDonnell Douglas Astronautics Company - Western Division/ Sacramento Test Center
MDF	--	Mild detonating fuse
MFV	--	Main fuel valve
MHz	--	Millihertz
MILA	--	Merritt Island Florida
μin./in.	Micro inch per inch	Millionth of an inch per inch
min	--	Minute(s)
ML CHI	--	Minor loop guidance command
ML CHIX	--	Minor loop guidance command in roll (axis)
ML CHIY	--	Minor loop guidance command in pitch (axis)
ML CHIZ	--	Minor loop guidance command in yaw (axis)
MOI	--	Moment of inertia
MOV	--	Main oxidizer valve
MR	--	Mixture ratio
ms	Millisecond	Thousandth of a sec
MSC	--	Manned Spacecraft Center, Houston, Texas
MSFC	--	Marshall Space Flight Center
MSFN	--	Manned space flight network
MSL	--	Mean sea level
mv	--	Millivolt
mrx	--	Multiplexer
N/A	--	Not applicable
NASA	--	National Aeronautics and Space Administration
NC	--	Normally closed
--	Ninety percent thrust buildup	Time from Engine Start Command until the last engine chamber pressure (injector end) reaches 618 psia

TABLE AP 1-1 (Sheet 7 of 11)  
GLOSSARY AND ABBREVIATIONS

<u>Abbreviation</u>	<u>Terms</u>	<u>Definition</u>
nmi	--	Nautical miles
NO	--	Normally open
No.	--	Number
N <sub>2</sub> O <sub>4</sub>	NTO	Nitrogen Tetroxide
NPSP	--	Net positive suction pressure
NPV	--	Nonpropulsive vent
OAT	--	Overall test
OECO	--	S-IC stage Outboard Engine Cutoff Command
O-P	--	Zero to peak
P	--	Geodetic latitude
P	--	Period (time of one orbit)
P	--	Pitch
P <sub>a</sub>	--	Ambient pressure
P <sub>c</sub>	--	Combustion chamber pressure measured at the injector
PA	--	Pressure actuated
PAM	--	Pulse amplitude modulation
PCF	--	Preconditions of flight
PCM	--	Pulse code modulation
pf	--	Picofarad
--	Phase I	Time from liftoff to ECC1 +10 sec
--	Phase II	Time from liftoff to planned LV/SC separation
PMR	Programmed mixture ratio	A method of controlling the PU valve mixture ratio to obtain maximum efficiency of the stage. The propellant loading is provided to cause the PU system to command the PU valve against the LOX rich stop for the initial portion of flight and then decrease to a lower mixture ratio during the final portion of flight
P/N	--	Part number
P-P	--	Peak to peak
PP	--	Position planes
ppm	--	Parts per million
--	Propellant residuals	The sum of LOX and LH2 remaining onboard at Engine Cutoff Command. The residuals include both usable and trapped propellants.
PS	--	Pressurization system
P/S	--	Pulse sensor
PSD	--	Power spectral density
psi	--	Pounds per square inch
psia	--	Pounds per square inch absolute

TABLE A-1-1 (Sheet 8 of 11)  
GLOSSAR. AND ABBREVIATIONS

<u>Abbreviation</u>	<u>Terms</u>	<u>Definition</u>
psid	--	Pounds per square inch differential
psig	--	Pounds per square inch gauge
PTCS	--	Propellant tanking computer system
P/U	--	Pickup
PU	--	Propellant utilization
--	PU system propellant mass history	That propellant mass history determined for flight by the PU system
--	PU system residuals	Those propellant residuals above the main propellant valves determined by the PU system
q	--	Dynamic pressure
R	--	Rankine
R <sub>A</sub>	--	Radius of apogee
RACS	--	Remote analog calibration system
RASM	--	Remote analog sub-multiplexer
R&D	--	Research and development
RCS	--	Reaction control system
RDSM	--	Remote digital sub-multiplexer
reg	--	Regulator
RF	--	Radio frequency
RFI	--	Radio frequency interference
RMR	--	Reference mixture ratio
rms	--	Root mean square
R/NAA	--	Rocketdyne, North American Aviation
RO	--	An event time used as reference for S-IVB stage flight evaluation sequence of events. Defined as the first Greenwich mean time second prior to vehicle liftoff
rpm	--	Revolutions per minute
R/S	--	Range safety
RSCR	--	Range safety command receiver
rss	--	Root sum square
S	--	Surface range (ft)
SC	--	Spacecraft
scfm	--	Standard cubic ft/min
scin	--	Standard cubic in./min
sco	--	Subcarrier oscillator
sec	--	Seconds
S-IB	--	First stage of the Saturn IB (200) series of vehicles
S-IC	--	First stage of the Saturn V (500) series of vehicles

TABLE AP 1-1 (Sheet 9 of 11)  
GLOSSARY AND ABBREVIATIONS

<u>Abbreviation</u>	<u>Terms</u>	<u>Definition</u>
S-II	--	Second stage of the Saturn V (500) series of vehicles
S-IVB	--	Second stage of the Saturn IB (200) series of vehicles and third stage of Saturn V (500) series of vehicles
SLA	--	Spacecraft LM adaptor
--	Slug	English system unit of mass
SLV	--	Saturn launch vehicle
SM	--	Santa Monica
SM	--	Service module
SMC	--	Steering misalignment correction
S/N	--	Serial number
SPs	--	Service propulsion system
sp/s	--	Samples per second
SOV	--	Shutoff valve
SSB	--	Single sideband
SSS	--	Stage switch selector
sta	--	Station
--	Statistical weighted average loaded propellants	The most accurate determination of actual propellant load at liftoff as derived from the statistically weighted average mass
--	Statistical weighted average mass determination	A statistical combination of the PU system, engine system, flight simulation, and propellant level sensors at Engine Start Command and Engine Cutoff Command
--	Statistical weighted average residual propellants	The most accurate determination of actual propellant residual at Engine Cutoff Command as derived from the statistically weighted average mass determination method
STC	--	Sacramento Test Center
STD	--	Start tank discharge
STDV	--	Start tank discharge valve
S/V	--	Space vehicle
sw	--	Switch
Sw sel	--	Switch selector
T	--	Countdown time from prospective liftoff or as specifically defined in the text
TB	--	Time base
T/C	--	Thermal cycle
Tel 2	--	Telemetry station at KSC
Tel 3	--	Cape Kennedy Telemetry Station IV
Tel 4	--	Merritt Island Telemetry Station IV
TEX	--	Corpus Christi, Texas
tk	--	Tank



TABLE AP 1-1 (Sheet 10 of 11)  
GLOSSARY AND ABBREVIATIONS

<u>Abbreviation</u>	<u>Terms</u>	<u>Definition</u>
TLI	--	Translunar injection
T/M	--	Telemetry
--	Total depletion burntime	The engine burntime from Engine Start Command to the time that the Depletion Engine Cutoff Command would have been initiated
--	Total propellants consumed	That amount of liquid propellants consumed from Engine Start Command to Engine Cutoff Command includes engine consumption, boiloff, and LH2 tank pressurant
TPEP	--	Telemetry performance evaluation period
--	Total stage burntime	The engine burntime from Engine Start Command to Engine Cutoff Command
--	Total stage mass history	A compilation of all final hardware, propellant, and gas masses. The measured and computed mass of each constituent is adjusted within its accuracy band so that the total stage mass at Engine Start Command and Engine Cutoff Command agrees with the total stage mass as determined by the Statistical Weighted Average mass determination method
TP&E	--	Test Planning and Evaluation
TVCS	--	Thrust vector control system
--	Unusable propellants	Those propellants remaining after a propellant depletion cutoff. This includes the propellant in the tank below the depletion sensor, propellant in the feed duct, and trapped propellants. It does not include sensor lag time or the propellant consumed during engine cutoff but does include sensor time delay
U/R	--	Ullage rocket
--	Usable residual	Propellants in excess of trapped propellants left onboard a stage after powered flight has been terminated by some specified cutoff criteria
USB	--	Unified S-band
V	--	Volt
V <sub>A</sub>	--	Apogee velocity
V <sub>E</sub>	--	Relative velocity
V <sub>I</sub>	--	Inertial velocity
V <sub>P</sub>	--	Perigee velocity
V <sub>∞</sub>	--	Freestream velocity
V <sub>W</sub>	--	Wind velocity (speed)
VAB	--	Vehicle Assembly Building, KSC, Florida
vac	--	Voltage, alternating current
VCL	--	Vehicle checkout laboratory
VCO	--	Voltage controlled oscillator
vdc	--	Voltage, direct current
VHF	--	Very high frequency
V <sub>I</sub>	--	Inertial velocity
VSE	--	Vehicle support equipment

TABLE AP 1-1 (Sheet 11 of 11)  
GLOSSARY AND ABBREVIATIONS

<u>Abbreviations</u>	<u>Terms</u>	<u>Definition</u>
VSWR	--	Voltage standing wave ratio
W	--	Watt
WBO	--	DAC work release order
wt	--	Weight
$\dot{W}_T$	--	Time rate of change of total vehicle weight
$X_E$	--	Downrange distance
$\dot{X}_E$	--	Downrange velocity
Y	--	Yaw
$Y_E$	--	Vertical distance
$\dot{Y}_E$	--	Vertical velocity
$Y_E$	--	Crossrange distance
$\dot{Y}_E$	--	Crossrange velocity
$\alpha$	--	Angle of attack
$\alpha_P$	--	Pitch angle of attack
$\alpha_Q$	--	Product of angle of attack and dynamic pressure
$\alpha_Y$	--	Yaw angle of attack
$\beta$	--	Yaw angle of attack
$\gamma_1$	--	Earth fixed flight path elevation angle
$\Delta w$	--	Delta weight
$\theta_r$	--	Descending node
$\gamma_{II}$	--	Inertial flight path elevation angle
$\gamma_{ZI}$	--	Inertial flight path azimuth angle
$\mu$	--	Longitude
$\mu V$	--	Microvolt