

A REAL-TIME SPECTRUM-TO-DOSE CONVERSION SYSTEM

B. J. Farmer, J. H. Johnson, and R. G. Bagwell

ADVANCED TECHNOLOGY CENTER, INC.

The Research Center for LTV Aerospace and LTV ElectroSystems

A system has been developed which will permit the determination of dose in real time or near real time directly from the pulse-height output of a radiation spectrometer. The technique has been demonstrated in the laboratory using the output of a NaI(Tl) anticoincidence gamma-ray spectrometer and a beta-gamma spectrometer which was flown on Gemini XII and also in space with the electron-proton spectrometer on the Radiation and Meteoroid Satellite.

The technique involves the use of the resolution matrix of a spectrometer, the radiation energy-to-dose conversion function, and the geometrical factors, although the order of matrix operations is reversed. The usual method requires that a complete pulse-height spectrum (which is reasonably accurate statistically) be accumulated. The instrument resolution is then removed from this distribution giving the true radiation energy spectrum. This step requires the use of an inverted instrument resolution matrix or a more accurate but more time-consuming iterative process. A geometric function and the radiation energy-to-dose function must then be applied to obtain dose. This requires the use of a significant remote or on-board computer and unnecessary and time-consuming computer operations if only the dose is required.

The new technique yields a result which is mathematically identical to the standard method while requiring no matrix manipulations or resolution matrix storage in the remote computer. It utilizes only a single function for each type dose required (e.g., physical dose, biological dose) and each geometric factor involved (e.g., surface dose at a specific location inside a space vehicle). The dose functions are generated using the same resolution functions, geometric factors, and dose curves that would be used in the standard technique; however, the matrix manipulations are made only once for each function instead of each time a new pulse-height spectrum is obtained. Also, the dose may be calculated and accumulated while the data is being received, since it is not necessary to have a complete instrument spectrum before making a calculation.

For many years attempts have been made to measure physical dose (energy deposited per unit mass) in radiation fields in order to relate and predict radiation effects. For simplicity, developments have tended toward integrating devices so that a single number, dose, could be read directly from the device. Direct reading dosimeters are usually based on ionization measurements and have utilized both ionization chambers and solid state detectors. The reliability of the measurements from these devices is dependent upon the assumption that the system is wholly responsive to energy deposited, exclusive of radiation quality and/or the equivalence of the calibration and measured fields. These devices yield a single value, physical dose, which when applied to biological effect, must be converted to biological dose. Since it is generally accepted that biological dose is a function of radiation type and energy, no relationship can be established between a measured physical dose and a biological dose unless the radiation types and spectra are considered. No system is currently available which does distinguish particle type and spectra and yield a direct dose readout.

The technique to be described in this paper permits the determination of dose in real time or near real time directly from the pulse-height output of a spectrometer. The technique has been applied in the laboratory to the Beta-Bremsstrahlung

Spectrometer which was flown on Gemini XII (refs. 1 and 2) and a NaI(Tl) anticoincidence gamma-ray spectrometer (ref. 3). A system based on the technique was flown on the Radiation and Meteoroid Satellite late in 1970 (ref. 4).

THEORETICAL DISCUSSION

The technique involves the use of the instrument resolution matrix, the radiation energy-to-dose conversion function, and the necessary geometrical factors, although the order of matrix operations is reversed from the standard procedure. The dose D is related to a source spectrum S by the following matrix equation:

$$D = CGS \quad (1)$$

Where C is a row matrix representing the dose per unit flux as a function of energy for a specific type of radiation and G represents the geometrical effects such as vehicle shielding. The source spectrum S is related to the pulse-height spectrum P from the radiation spectrometer by the following equation:

$$P = RS \quad (2)$$

Where R represents the response function of the spectrometer. Solving for S gives,

$$S = R^{-1}P. \quad (3)$$

Combining eqs. (1) and (3) gives,

$$D = C[G(R^{-1}P)] \quad (4)$$

It is customary to solve for D in the order of matrix operations indicated. In this order each step has physical meaning. For example, an instrument on the outside of a space vehicle would obtain a pulse-height spectrum P. The operation $R^{-1}P$ would yield S, the source spectrum outside the ship. The operation GS would yield the spectrum S' at the point where the dose is desired and the final operation CS' would yield the dose. Thus, at each step there is a physically meaningful parameter to consider. The new technique involves the calculation of a function, which when applied directly to P will yield the dose. Consider eq. (4) in which the order of matrix operations is reversed.

$$D = [(C G)R^{-1}]P \quad (5)$$

The product CG becomes a row matrix C' which is a dose conversion function modified to include geometric factors. The product $C'R^{-1}$ defines the pulse-height spectrum to dose conversion function F,

$$F = C' R^{-1} \quad (6)$$

Then we have

$$D = FP \quad (7)$$

Thus, if dose is required immediately, the only computation required is F times the pulse-height spectrum. Perhaps the most important point, however, is that it is not necessary to have a complete pulse-height spectrum to determine the dose. One may think of F as a set of weighting values $F_1, F_2 \dots F_n$ where n is the number of pulse-height channels. Then as each pulse is analyzed the appropriate weighting value may be applied and the resulting values summed, giving

$$\sum_{i=1}^n F_i P_i = D \quad (8)$$

As soon as D is statistically significant, one has a reliable dose. Using the standard technique one must wait until a statistically accurate spectrum is accumulated before dose can be determined. This virtually eliminates the ability to make remote or on-board dose calculations, since a rather large computer capability is required.

BETA-BREMSSTRAHLUNG SPECTROMETER

As mentioned earlier the technique has been applied to the Beta-Bremsstrahlung Spectrometer (refs. 1 and 2) which had been flown on Gemini XII. The instrument consisted of a 3/4-inch diameter by 1/2-inch long CsI(Tl) crystal with a thin plastic scintillator behind the electron collimator. By utilizing the different decay time constants in CsI and plastic the instrument could differentiate between electrons and gammas. Examples of the response of the instrument to gamma rays and electrons are given in figures 1 and 2, respectively. These response curves indicate that the studies using this instrument represented a very severe test for the method. It is apparent, due to the complex interactions of particles in the small

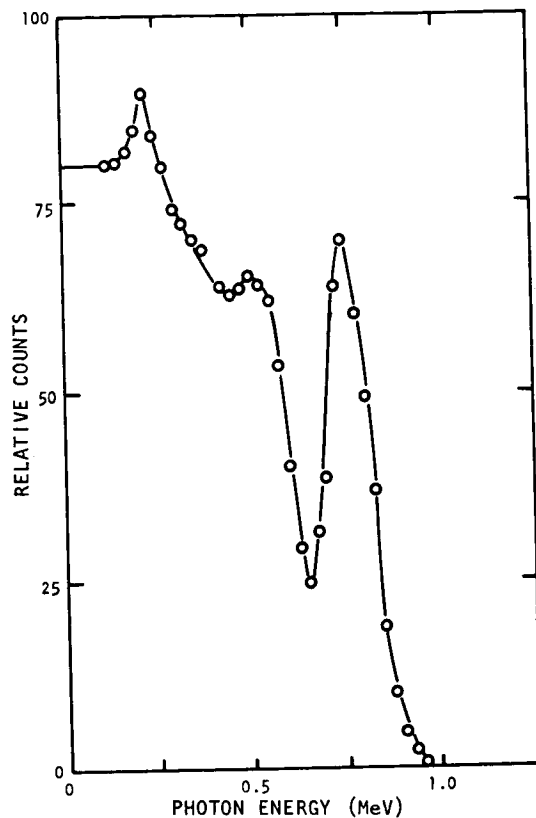

FIGURE 1. - Response of Beta-Bremsstrahlung Spectrometer to 0.83-MeV gamma rays.

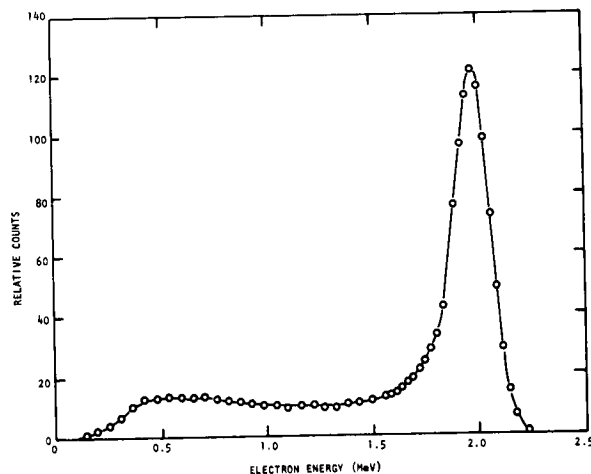

FIGURE 2. - Response of Beta-Bremsstrahlung Spectrometer to 2-MeV electrons.

crystal, that the response functions are irregular in shape and do not lend to description by analytic means. Another factor influencing the severe nature of the test was that large grid elements with energy widths of 200 keV were utilized in the computation. (This is somewhat arbitrary and can be increased to give higher resolution; however, in this test, the previously determined response matrices for electrons R_e and gammas R_γ were employed without modification). The dimensions of the response matrices were 15 x 15 with R_γ extending over the range from 0.1 to 3.1 MeV and R_e from 0.3 to 3.3 MeV. The

inversion to obtain R_e^{-1} and R_γ^{-1} was accomplished with the aid of an IBM 7090 matrix inversion routine. The energy to dose conversion values C_e and C_γ were obtained from the literature (ref. 1 and 2) and are consistent with those being used in the national laboratories. Gamma conversion to roentgen exposure dose was used to allow comparison with the R-Meter measurements. The electron conversion chosen was to rad in carbon, which is the most common absorbed dose reference. It may be noted, however, that at this point the actual dose unit is irrelevant and any one may be used to satisfy a given requirement.

The above matrices were then multiplied to give the products $R_e^{-1}C_e$ and $R_\gamma^{-1}C_\gamma$ which correspond to F_e and F_γ , respectively. Each function contained 15 terms. Inspection of these functions revealed not only an erratic nature, but some of the values were even found to be negative. This is a common characteristic of the solutions of matrix equations where the inverse is used to solve for an unknown matrix. This characteristic comes about from several causes:

- (a) uncertainties in the response matrix,
- (b) nature of the inverse (many large positive and negative terms),
- (c) tendency of the inverse to magnify small fluctuations, and
- (d) finite number of terms in the matrix (grid size).

After a detailed inspection verified the accuracies of the matrices and their inverses, and the product $R R^{-1}$ was shown to produce the unit matrix to within 0.1%, this technique was abandoned and an alternate approach was taken to determine F. The method is based on rewriting eq. (6) as

$$F = CR^{-1} \quad (9)$$

where the geometric factor is considered to be unity. If we multiply both sides by R, we get

$$FR = C. \quad (10)$$

This equation lends itself to a solution using a standard iterative process. We must first write R as

$$R = N\epsilon \quad (11)$$

where ϵ represents the efficiency of the spectrometer and N is a normalized response matrix. Then

$$FN = C\epsilon^{-1}. \quad (12)$$

Eq. (12) states that there exists a function (or matrix) F that when multiplied by the response matrix N, gives $C\epsilon^{-1}$. Since $C\epsilon^{-1}$ and N are well known, by making an intelligent estimate of F (which we will refer to as F_1) and multiplying the estimate by N, which has been suitably normalized, it is possible to compare the result with $C\epsilon^{-1}$. The degree of agreement between F_1N and $C\epsilon^{-1}$ is a direct measure of the degree of agreement between F_1 and F. Thus, by successively correcting F_1 by the difference between F_1N and $C\epsilon^{-1}$ and remultiplying the corrected F_1 by N, an iterative method is arrived at which generates a function F_n which approaches F when $(F_n - C\epsilon^{-1}) = 0$. Since it is known that the response normalized functions N_e and N_γ are such that the

pulse-height and true-energy spectra are not drastically different, the first estimate of F for each radiation was taken as the respective $C\epsilon^{-1}$. Throughout the iterations F_1N was compared to $C\epsilon^{-1}$ on the rms basis with the average rms difference computed after each iteration. When the average rms difference reached a minimum the computation was stopped. The function determined for the gammas had an rms difference of 1.2% while the same for the electrons was 2.6%. The resulting functions were then smoothed with a three point average routine. Plots of these functions are shown in figures 3 and 4. It is seen that these functions are smoothly varying and non-negative. This is the result of working directly with N_e and N_γ instead of their inverses.

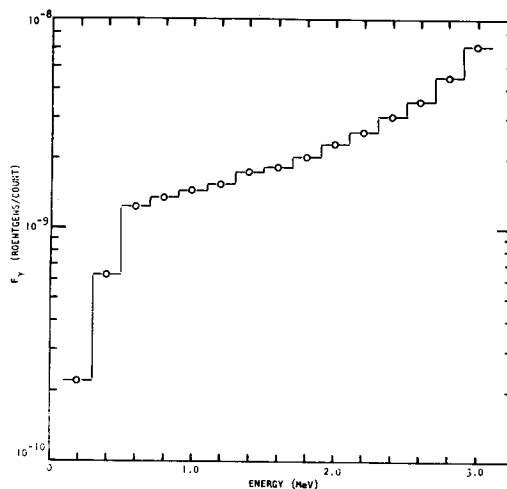

FIGURE 3. - Pulse-height spectrum-to-dose conversion function for gamma-rays.

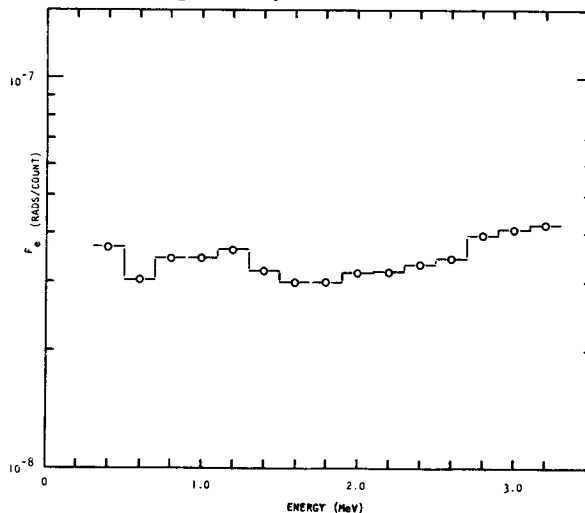

FIGURE 4. - Pulse-height spectrum-to-dose conversion function for electrons.

For electrons the experimental verification of the accuracy of the function was made using a 3-MeV Van de Graaff accelerator. The electron beam was scattered by a series of aluminum foils and allowed to pass into the air. At this point the beam was approximately 2 inches in diameter. After passing approximately one foot through air the beam was mapped with a solid state detector and found to be uniform in intensity for a distance of 2 inches on

either side of centerline. The Beta-Bremsstrahlung Spectrometer was placed in this beam and a series of runs was taken at various energies. Using electron dose values calculated from the energy loss curves for electrons in ref. 5, the pulse-height spectrum-to-dose measurements were compared to those calculated (true dose) from the electron flux as measured with a collimated solid-state detector, the results are shown in table 1.

TABLE 1. - Pulse-height spectrum-to-dose comparisons for monoenergetic electrons.

Electron Energy (Mev)	True Dose (Rad)	Measured Spectrum-to-Dose (Rad)	Error (Percent)
0.40	7.47(-3)*	7.06(-3)	-5.5
0.50	7.06(-3)	6.93(-3)	-1.8
0.75	6.62(-3)	6.61(-3)	-0.1
1.00	6.43(-3)	6.32(-3)	-1.7
1.25	6.35(-3)	6.06(-3)	-4.6
1.50	6.32(-3)	5.85(-3)	-7.4
2.0	5.28(-3)	5.18(-3)	-1.8
2.5	3.05(-3)	2.90(-3)	-4.9

*Denotes 10⁻³

For gammas a number of radioactive sources and a bremsstrahlung spectrum produced by a Van de Graaff Accelerator were used. Results of these measurements compared to calculated values are given in table 2.

TABLE 2. - Pulse-height spectrum-to-dose comparisons for gamma- and x-rays.

Source	Energy (Mev)	True Dose (R)	Measured Dose (R)	Error (Percent)
Cs-137	0.662	1.14(-4)*	1.04(-4)	-8.0
Mn-54	0.835	1.17(-4)	1.17(-4)	0.0
Hg-203	0.279	8.23(-5)	7.72(-5)	-6.1
Na-22	1.28	1.85(-4)		
	0.511	1.62(-4)		
		3.47(-4)	3.10(-4)	-10.7
Y-88	0.9	8.50(-5)		
	1.8	17.00(-5)		
	2.76	0.12(-5)		
		2.56(-4)	2.26(-4)	-12.0
X-Ray Spectrum	2.0	4.40(-5)	4.66(-5)	+ 6.1

*Denotes 10⁻⁴

The above tests were performed to show the accuracy of the technique; however, the actual dose calculations from the F functions were made after all the data had been taken. As a next step in the studies, a real-time system was assembled (figure 5) which used the Gemini XII Beta-Bremsstrahlung Spectrometer as the sensing head. The same pulse-height spectrum-to-dose functions determined above were used for dose conversion.

In operation the linear signal from the spectrometer was pulse-height analyzed and a binary channel number produced. This binary number, along with the radiation identification binary bit, produced an address for the computer. An interrupt was produced and the computer acquired the address for processing in buffer storage. The computer then processed the radiation event in real time by adding a number representing the

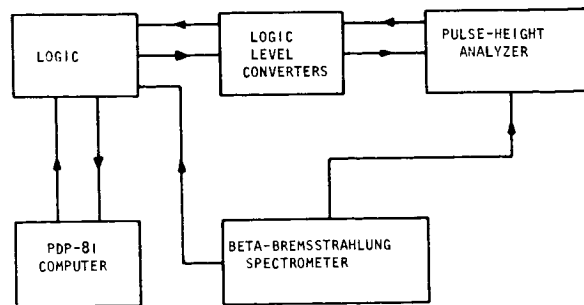

FIGURE 5. - Block diagram of real-time dose conversion system using the Beta-Bremsstrahlung Spectrometer as the sensing head.

single event dose for the particular pulse-height channel to a dose accumulator. The value in this accumulator then represented the integrated dose for the period of time the data was accumulated. In addition by properly setting the switch register of the computer, pulse-height spectra were also accumulated in the computer for comparison purposes. The pulse-height analyzer also produced a clock pulse that interrupted the computer and caused termination of the run when the end of the requested data period had been reached. The system was compensated for computer and analyzer busy time.

The gamma sources, cesium-137, cobalt-60, and sodium-22 were placed individually at various distances from the spectrometer. In addition, the spectrometer was exposed to the same cesium and cobalt sources simultaneously. Dose was integrated over a 10 second period and then displayed in rad/hr by the computer. These results were compared to the doses calculated from the known curie strength of the sources and the use of the gamma radiation levels specified in ref. 7. These levels were corrected for source strength and distance and are shown in table 3 along with the measured values. The errors shown are well within the limits anticipated considering the large grid size of the resolution matrix which was used. This system embodied the basic features of a space radiation monitoring device by providing the capability for measurements in separate or mixed radiation fields and providing both dose rate and total dose measurements.

TABLE 3. - Real-time spectrum-to-dose comparisons.

Source	Strength (Micro curies)	Calculated Dose Rate at 0.5 Meters (MR/HR)	Measured Dose Rate at 0.5 Meters (MR/HR)	Error (Percent)
Cs-136	91.2±1.0	.120	.119	-0.8
Co-60	41.2±0.8	.218	.203	-6.9
Na-22	21.3±1.0	.102	.100	-2.0
Cs-137 and Co-60	±2%	.338	.321	-5.0

ICL

LABORATORY NaI(Tl) ANTICOINCIDENCE SPECTROMETER

To further substantiate the uniqueness of the pulse-height to dose function F , a set of measurements was made using a NaI(Tl) crystal spectrometer which was surrounded by an anti-Compton coincidence annulus. The response of this system is very good as seen from the response curve for 1.28 MeV gamma rays which is shown in figure 6. The pulse-height spectrum-to-dose function F as obtained by the iterative process discussed above and the corresponding first guess, $C\epsilon^{-1}$, are shown in figure 7.

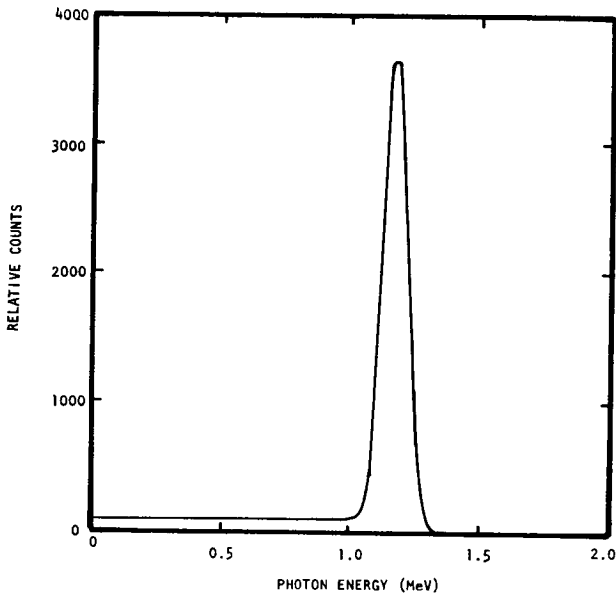

FIGURE 6. - Response of a 2" x 6" NaI(Tl) anti-coincidence spectrometer to 1.28-MeV gamma rays.

As a test of F , bremsstrahlung spectra were observed from thick aluminum targets which were bombarded with monoenergetic electrons. The total dose due to each spectrum was obtained in two different ways for comparison. In one case the pulse-height spectrum P was multiplied by the pulse-height spectrum-to-dose function F , the terms then being summed to give the dose. In the other case, the pulse-height spectrum was converted to an energy spectrum as described in ref. 8. The energy spectrum was converted to a dose spectrum and the terms summed to give the total dose. Comparisons were made for photon end point energies of 1.0 and 2.5 MeV. In both cases the total dose agreed to within two percent. Figure 8 contains a plot of one of the pulse-height spectra used and the corresponding bremsstrahlung energy spectrum. This is a typical shape for the spectra used from a thick target and represents a somewhat ideal spectral shape for the type of comparison made. It is seen that there is very little distortion in the pulse-height spectrum at low energies. This is due to the rapidly increasing shape of the spectrum at low energies. This shape makes the tail contributions at low energies, due to the high energy photons, insignificant. Also, it is seen in figure 6 that F and $C\epsilon^{-1}$ practically coincide at low energies. Thus, spectra of this shape

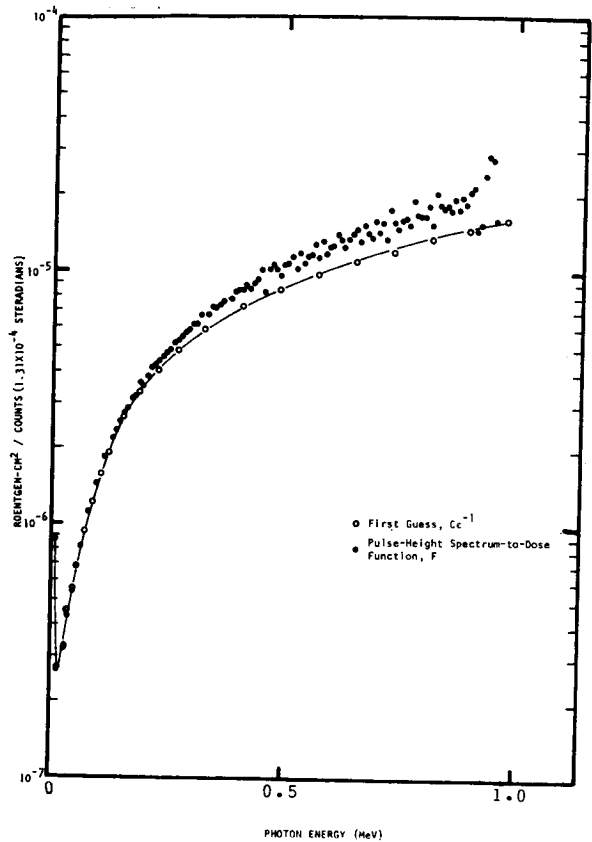

FIGURE 7. - Pulse-height to dose function and $C\epsilon^{-1}$.

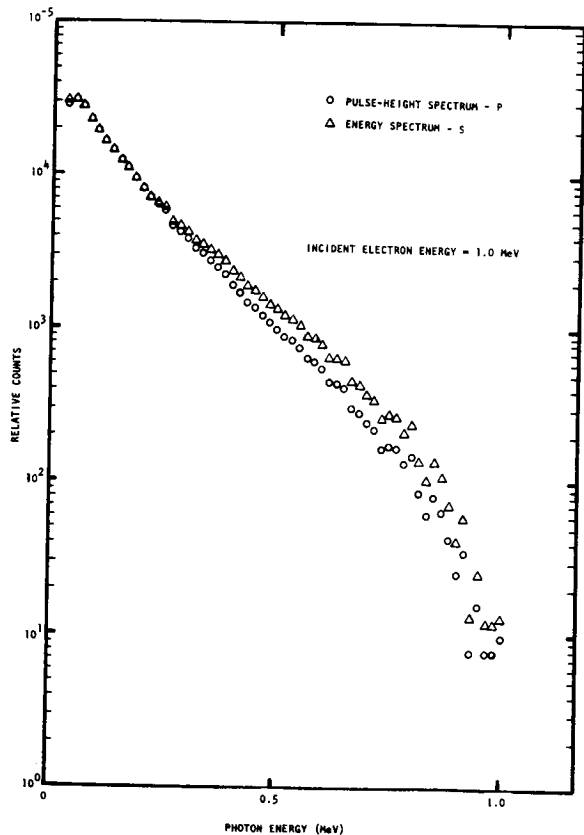

FIGURE 8. - Detector distortion produced in a typical bremsstrahlung spectrum.

test only the low-energy portion of F, since the dose contribution is weighted very heavily at low energies.

To test F over a greater range of its values and specifically in the region of higher energies, a series of hypothetical "true" spectra were smeared with N and ϵ to produce "theoretical" pulse-height spectra. Doses were then calculated from the curves by the two methods. This was accomplished for four

cases and the total doses for each case agreed within 1%. The cases chosen are shown in figures 9, 10, 11, and 12. In each figure the "true" spectrum and the resulting "theoretical" pulse-height spectrum are shown. The cases chosen represent the most extreme cases which would be encountered. The results of these mathematical tests and those of the actual data are considered to be sufficient to establish the validity of the technique as a simple and accurate method for converting pulse-height spectra to dose.

RADIATION AND METEOROID SATELLITE

The most extensive test of the pulse-height spectrum-to-dose concept was made with the proton-

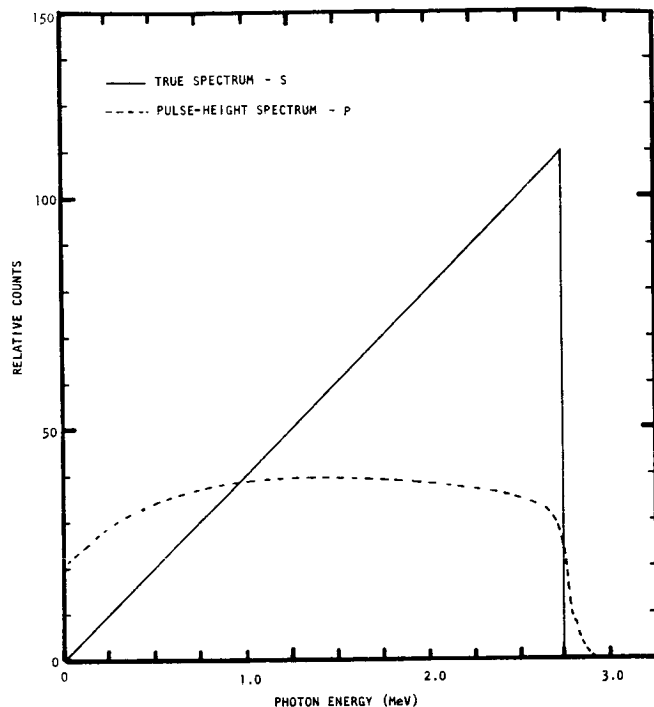

FIGURE 9. - Effect of smearing an increasing ramp with the response matrix.

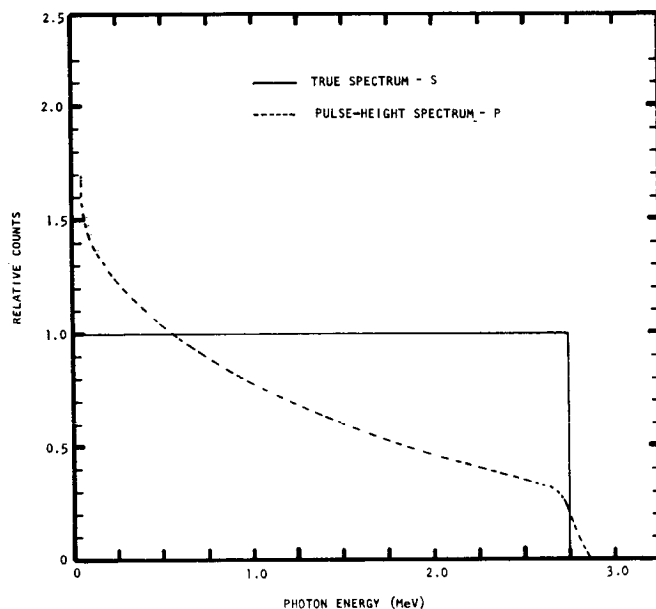

FIGURE 11. - Effect of smearing a flat distribution with the response matrix.

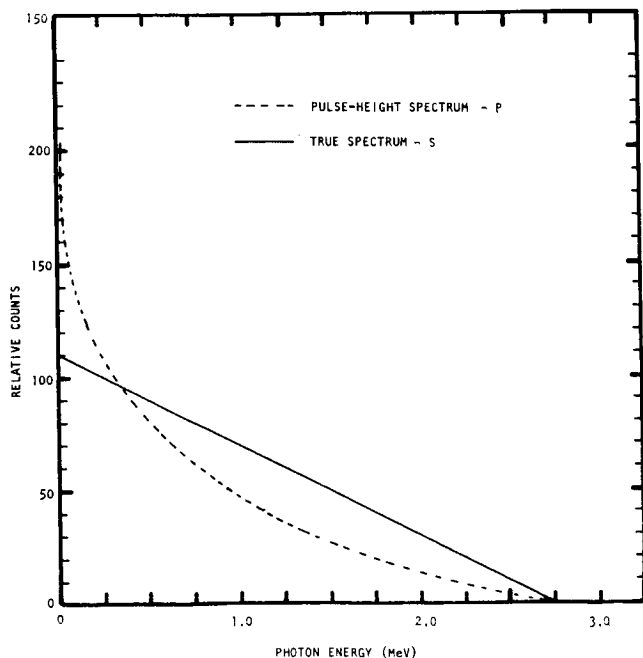

FIGURE 10. - Effect of smearing a decreasing ramp with the response matrix.

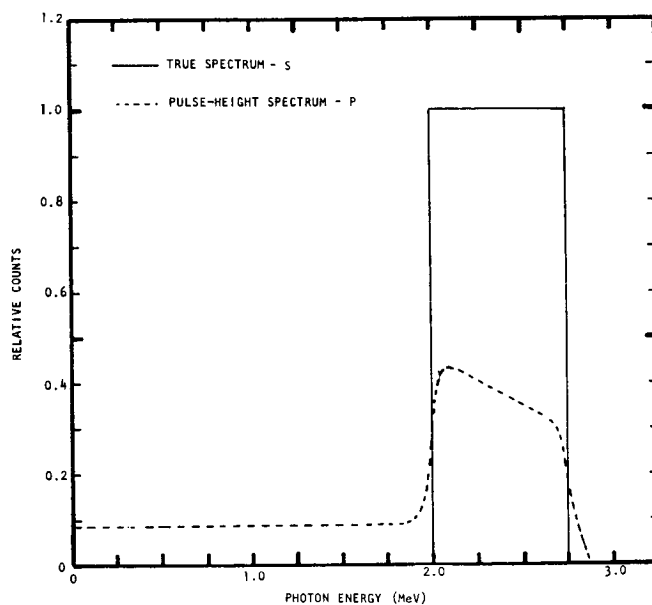

FIGURE 12. - Effect of smearing square plateau with the response matrix.

electron spectrometer on the Radiation and Meteoroid Satellite (RMS). The system is discussed in detail in the final report of the satellite program (ref. 4). A preliminary look at data obtained during the satellite mission indicates general verification of the dose-conversion system capabilities; however, the reduction of the data is in a very early state and system accuracies are yet to be determined.

CONCLUSIONS

This new technique yields a result which is mathematically identical to previous standard methods while requiring no matrix manipulations or resolution matrix storage in a remote computer. It utilizes only a single function for each type

dose required (e.g., physical dose, biological dose) and each geometric factor involved (e.g., surface dose at a specific location inside a space vehicle). The dose functions are generated using the same resolution functions, geometric factors, and dose curves that would be used in the standard technique; however, the matrix manipulations are made only once for each function instead of each time a new pulse-height spectrum is obtained. Also, the dose may be calculated and accumulated while the data is being received, since it is not necessary to have a complete instrument spectrum before making a calculation. The application of this technique can be made to any monitoring system which functions as a spectrometer. Further, if any remote computations are made, the technique may be employed by the addition of software only.

REFERENCES

1. Farmer, B. J.; Chappel, N.E.; Bagwell, R. G.; and Rainwater, W. J.: "LTV Beta-Bremsstrahlung Spectrometer for Gemini XII", Contract NAS9-5765, Final Report, LTV Report No. O-71000/7R-1, 1967.
2. Farmer, B. J.; and Rainwater, W. J.: "Study to Determine the Utility of Spectrum-to-Dose Conversion", Contract NAS9-7565, Final Report, LTV Report No. O-71100/8R-5, 1968.
3. Rainwater, W. J.: "Derivation of a Pulse-Height Spectrum to Dose Function for a 2" x 6" NaI Crystal Spectrometer", LTV Report No. O-71100/9R-5, 1969.
4. Farmer, B. J.; Johnson, J. H.; Bagwell, R. G.; and King, B. R.: "Radiation and Meteoroid Satellite", Contract NAS9-9195, Final Report, LTV Report No. B-95000/1CR-11, 1971.
5. Nelms, A. T.: "Energy Loss and Range of Electrons and Positrons", National Bureau of Standards Circular 583, 1957.
6. Rockwell, III, Theodore: "Reactor Shielding Design Manual", McGraw-Hill Book Co., Inc., 1956.
7. Jaeger, R. G., et al: "Engineering Compendium on Radiation Shielding", Vol. 1, New York, Springer-Verlog, 1968, pp. 21-30.
8. Rester, D. H. and Dance, W. E.: NASA CR-759, April 1967.