

Methods of Quantitative and Qualitative Analysis of Bird Migration with a Tracking Radar

BRUNO BRUDERER

Zoologische Anstalter Universität Basel

PETER STEIDINGER

Zoologisch-Vergl. Anatomisches Institute der Universität Zürich

THE AIM OF OUR WORK with a tracking radar was not primarily orientation research, but a study of intensity and height of migration under the influence of changing weather conditions and an examination of the different groups of birds and other animals involved in these migratory movements. Nevertheless we think that a presentation of the methods we have developed and of some of the results attained may be a valuable contribution to this symposium, because of their possible application in orientation research.

The present paper is based on two observation periods of three weeks each (March 19

to April 10, 1968 and April 3 to 25, 1969) in northern Switzerland near the Zurich airport (~ 430 m above sea level). In the first part of the paper we describe our method of assessing the rate of bird passage and discuss three topics—the grouping of nocturnal migrants, their velocity of flight, and the identification of species by radar echoes. Finally we will deal with height and volume of migration under different weather situations. The second part outlines the methods of studying the directions of migration and discusses the correlation between winds and the height and direction of migrating birds.

Part I by B. Bruderer

RADAR EQUIPMENT AND ITS APPLICATION

The equipment used in our studies (fig. 1) was a fire-control radar of the type "Superfledermaus" (produced by Contraves AG, Zurich) with a wavelength of 3 cm and

a peak pulse power >150 kW. The narrow pencilbeam and extremely short pulse length allowed us to localize the smallest birds with an accuracy of a few meters in all three dimensions and to track them to ranges of more than 4 km. Further technical details may not be given because of military security.

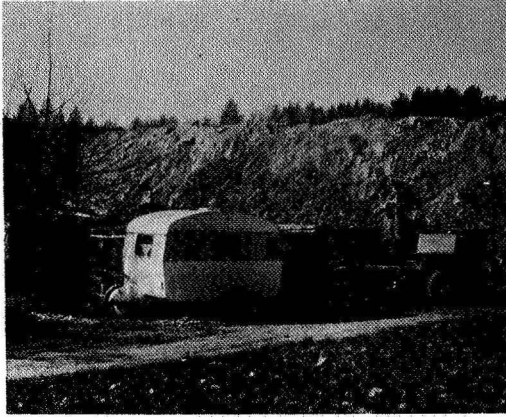

FIGURE 1. By operating the tracking radar "Superfledermaus" in a hollow, ground clutter may be avoided without applying MTI circuits.

One of the most important conditions for ornithological work with a tracking radar is a suitable site in a hollow, which reduces ground clutter. The application of moving target indicator (MTI) circuits is not recommended because birds that fly at low speeds (against the wind) will often be eliminated (ref. 1). We employed two main techniques: quantitative and qualitative. The qualitative methods inform us about direction, speed, and height of automatically tracked targets; simultaneous recording of AGC-signals (voltage of the automatic gain control) gives us the possibility of analyzing the echo signatures produced by these targets. The quantitative methods inform us about height and volume of migration.

QUANTITATIVE METHODS

The basic technique of our quantitative measurements was an improved vertical-beam method (fig. 2). The narrow beam, widened by conical scanning, was pointed vertically upwards for 20 minutes. In a second phase the beam was directed at low elevation perpendicular to a supposed principal

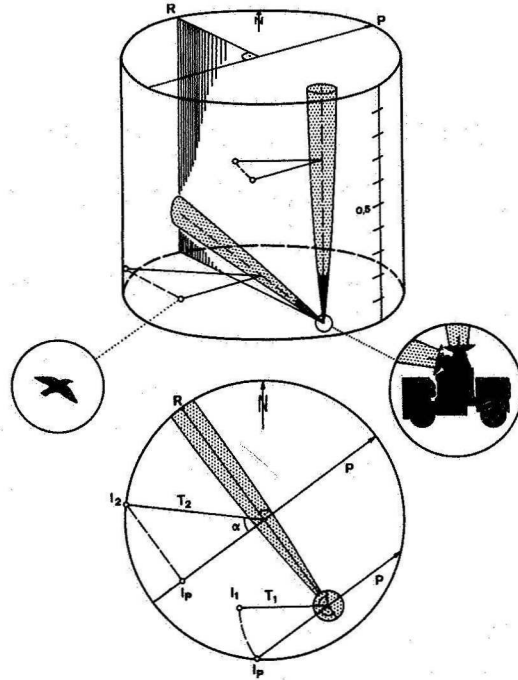

FIGURE 2. Principle of improved vertical-beam method: Beam is pointed vertically upward in the first phase, so ranges up to 4000 m above ground could be surveyed. Levels next to the ground are surveyed in second phase with low antenna elevation. Graph above shows volume of a cylinder with a height of 1 km and the radar site to the SE. Diagram beneath is the ground plan for the figure above. In both drawings *P* gives the supposed principal direction of migration and *R* is the plane of registration for low-elevation counts. Small circles mark position of single birds: *I_p* marking an individual with principal direction; *I₁* and *I₂* are individuals with the track directions *T₁* and *T₂*. α is angle between actual and supposed migration direction.

direction of migration ($\sim 55^\circ$) over the edge of the hollow. It was thus possible to reach birds flying as low as 30 m above ground. Objects crossing the beam could be counted on the A-scope (range indicator) and were registered according to their ranges. The A-scope trace could also be displayed on a separate oscilloscope in Z-modulation (i.e., in-

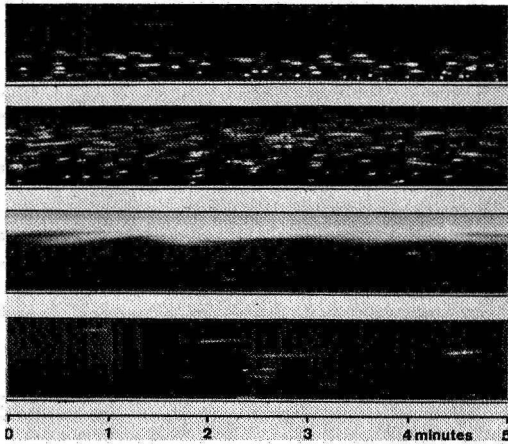

FIGURE 3. Z-scan film records of the passage of birds in heavy migration (A, B) and in low density migration (C, D). Film movement was 1/2 mm per sec. Height of film strip corresponds to range of 4 km: A, C with vertical beam; C with rain clouds above 2500 m; B, D with low elevation.

tensity modulation) and recorded on continuously moving 36 mm film (fig. 3). The width of the film corresponds to the surveyed range of 4 km; the longitudinal axis shows the time of passage for each target.

In the case of the low-elevation beam, attention must be paid to the fact that the number of echoes appearing within the surveyed range intervals depends on the flight directions of the birds. To diminish this influence, the number of echoes was divided by the cosine of the angle α between the supposed principal direction and the mean of the actually measured tracks (fig. 2). After having eliminated the echoes of insects and bats (ref. 2),¹ the frequency of migration Q (i.e., number of bird transits through a cylinder of 100 m in height and 100 m in diameter during 1 hour) was calculated by dividing the number of bird echoes in a certain height

¹ Also, BRUDERER, B.: Radarbeobachtungen über den Frühlingszug im Schweizerischen Mittelland (to be published).

interval by the corresponding area of the performance diagram of the beam.² If the spread of the flight directions is low, this frequency corresponds to the rate of passage of birds through a vertical area of 100×100 m normal to the mean direction of migration per hour. The density of migration D (number of birds in an air volume with a base of 2 km^2 and a height of 250 m) was calculated by dividing frequency Q by mean ground-speed of bird targets in the height interval considered and multiplication by factor 50.

Because the size of the surveyed space is very small and provides only the local flight frequencies, all samples taken during a night (normally between 2100 and 0300 hours) were summed. This is considered a useful estimate of the flight activity in northeast Switzerland.

GROUPING OF NOCTURNAL MIGRANTS

The analysis of echo signatures shows whether there are 1, 1 or 2, 2 or 3, or more birds in the pulse volume considered (see fig. 4). This permits us to establish the number of birds that fly in one pulse volume at various times of day. The pulse volume at medium ranges may be thought of as a cube with side lengths of 100 m. Figure 5 shows that in spring migration we have recorded almost exclusively single birds during the night, while flocks prevailed in the daytime.

The possible existence of some sort of loose groups during night migration was examined by measuring the distances between neighboring echoes on the films from the Z-scan display.³ The frequency of the various

² Because small passerines make up the biggest part of the migrating birds (~ 82 percent), we took $\sigma = 8 \text{ cm}^2$ as the standard radar cross section to calculate the performance diagram.

³ BRUDERER, B.: Radarbeobachtungen über den Frühlingszug im Schweizerischen Mittelland (to be published).

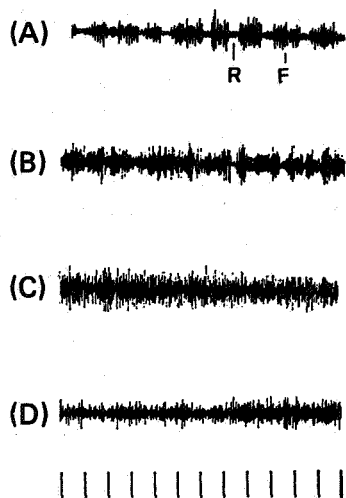

FIGURE 4. Four echo signatures showing difference between single birds and flocks of different size. To eliminate strong slow signal fluctuations, low frequencies were reduced by a high-pass filter, while wing-beat frequencies (above ~ 6 Hz) pass optimally. Vertical lines at bottom mark intervals of 1 sec. (A) Wing-beat pattern of a single starling (*Sturnus vulgaris*) with typical change of flapping (F) and resting (R) periods; (B) Signal of two sky larks (*Alauda arvensis*) with interfering beating and quiescent phases of the two birds; (C) Echo signature of six starlings, with continuous fluctuations; (D) Signature of 12 starlings with continuous fluctuations of less amplitude.

distances was plotted in histograms (fig. 6). These diagrams show that minimum distances between birds are about 50 m and that distances of 150 to 300 m are most frequent. This peak of the distribution persists even when the density of migration decreases; this means that, on nights with light migration, only some of the distances between birds grow larger, while a noticeable fraction remains constant. This fraction may be interpreted as a hint of the existence of loose bird groups in addition to a large number of individuals flying alone. We estimate that the number of individuals within such a formation in low density migration is 2 to 25, most

frequently 2 to 10; with high density of migration the number of birds per flock may increase (refs. 3 and 4).

PROBLEMS OF FLIGHT VELOCITY

Bellrose (ref. 5) pointed out that ground-speeds are not influenced in an additive way by the following component of the wind. Our own measurements have, in a general sense, confirmed this statement. Yet our results show—with much better correlation—an alteration of groundspeed by $\frac{2}{3}$ of the component of the wind vector along the birds' track direction, while in Illinois Bellrose found an increase of only $\frac{1}{3}$ of the (favorable) wind component. As an example (fig. 7) we give the optimally correlated data from 64 chaffinches (*Fringilla coelebs*). If the difference between track and heading is low (sidewind component negligible), as in these cases, the decrease of airspeed is about $\frac{1}{3}$ of the corresponding wind component. Our results indicate that birds must recognize accurately the speed and direction of the wind and that they seem to know and to actively choose an appropriate airspeed under different wind conditions.

Another striking phenomenon is the increase of the average airspeed with height. It is, according to our measurements, 2 to 3 km/hr per 500 m of height or about 10 percent per km (see fig. 8). The theoretical rise in speed due to the decreasing density of the air is only about 5 percent per km of height. This leads us to the conclusion that fast-flying birds (ducks, waders) prefer higher flight levels than most of the small passerines with low speed capabilities.

IDENTIFICATION OF BIRD ECHOES

The recorded signals of the AGC allow determination of wing-beat frequency as

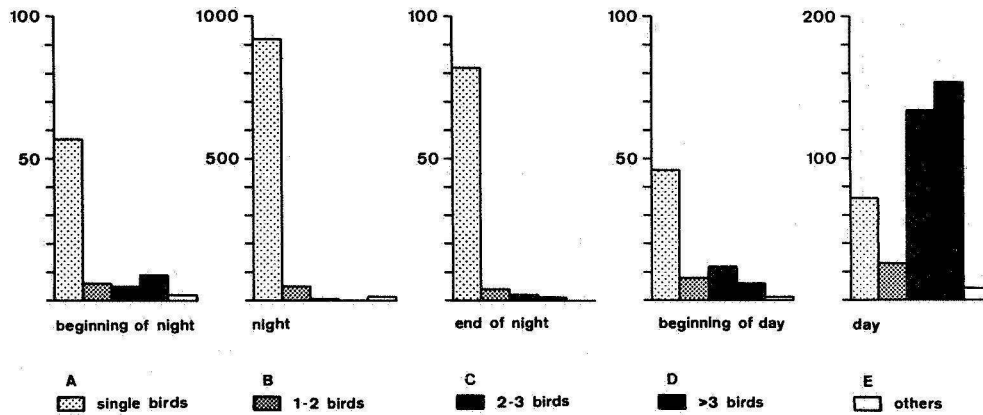

FIGURE 5. Distribution of echo signatures of single birds and flocks in day and night migration (classes A to D). Class E (others) includes signatures of bats and insects (main mass of insects being eliminated already in advance by a sensitivity time control, STC). The beginning of the night (sunset until 1 hr after sunset) contains some groups which are mostly caused by roosting starlings (*Sturnus vulgaris*) and black-headed gulls (*Larus ridibundus*). Night migration (1 hr after sunset to 1 hr before sunrise) comprises scarcely any flocks. End-of-night migration (1 hr before sunrise until 1/2 hr before sunrise) shows a similar composition as night migration. Beginning-of-day migration (1/2 hr before sunrise until sunrise) shows that formation of flocks begins fairly late. In daytime migration (after sunrise) the flocks prevail. (Autumn migration shows even fewer single birds.)

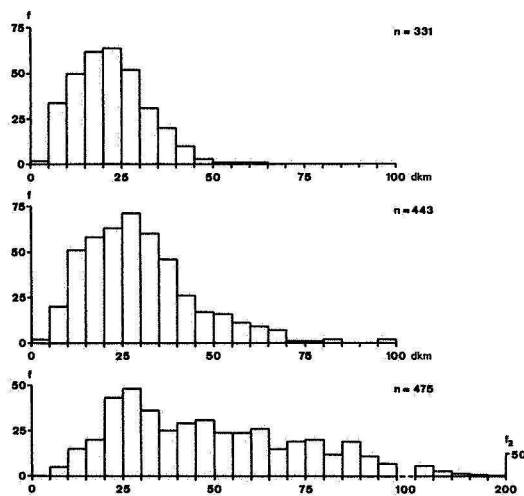

FIGURE 6. Distribution of distances between birds in night migration; the abscissa giving the measured distances in dekameters (1 dkm = 10 m) the height of the columns (ordinate) representing the frequency of each distance. Upper diagram for heaviest migration, middle diagram for medium to high frequency of migration, and lowest diagram for light migration. The fact that in light migration a considerable fraction of distances between birds remains in the same size category as in heavy migration may be interpreted as a hint of formations with spaces between individual birds of 100 to 300 m, independent of migration volume.

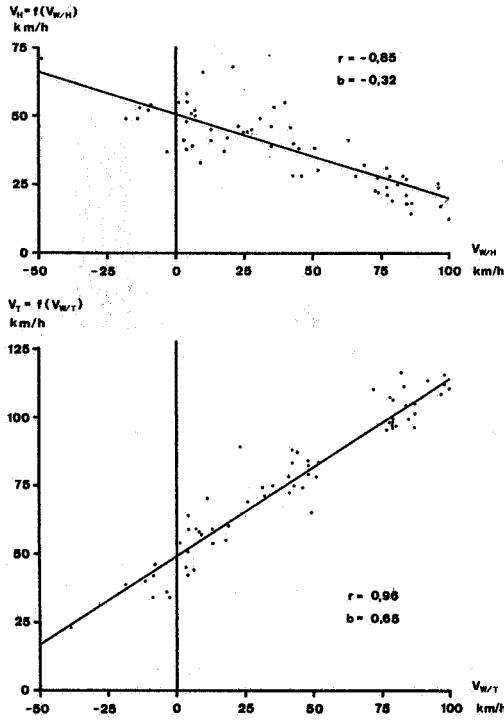
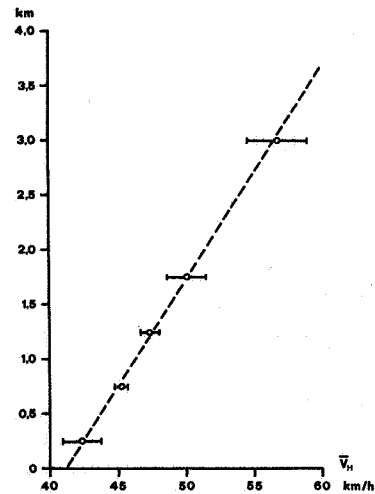

FIGURE 7. Wind influence on flight speeds of chaffinches (*Fringilla coelebs*). Top diagram shows correlation between calculated airspeed (V_H) and wind vector in the direction of heading ($V_{W/H}$). r is correlation coefficient; b is regression coefficient (slope of regression line). Lower diagram shows correlations between groundspeed (V_T) and wind component in the direction of track ($V_{W/T}$). Night migration showed correlations similar to this example of day migration.

FIGURE 8. Increase of average airspeed (\bar{V}_H) with height. Circles mark the mean of the airspeeds for five intervals of height (four comprising 500 m each and one summing up heights between 2000 and 4000 m). Horizontal lines show the standard error (s/\sqrt{N}). Differences between the five means are—in spite of the large spread of the single dates—statistically significant on levels of $p = 0.07$ to 0.01.



well as the duration of flapping and quiescent periods within the wing-beat patterns of a bird (see fig. 9). Additional information of less diagnostic value may be obtained by calculating the typical flight velocity of a particular species (airspeed plus $\sim 1/3$ of the wind component in the direction of heading)⁴ and by measuring its radar cross section (ref. 6).

In daytime migration the species belonging to a certain echo signature can be identified with the help of a telescope mounted parallel to the optical axis of the antenna. For night migration we need much more film material showing flight of night migrants in daytimes; this is needed to establish a correlation between taxonomic classification and the "radar" or "echo" species determined from echo-signatures (ref. 7). In order to make the sampled echo signatures available for immediate use we have established a provisional radar classification without attempting a zoological one (fig. 10). An example of the application of this radar classification is given in part II.

VOLUME AND HEIGHT OF SPRING MIGRATION UNDER DIFFERENT WEATHER CONDITIONS

In all graphs of figures 11 to 14 the length of the horizontal columns indicates the frequency (Q) of migration; the position of the circles marks the corresponding density (D) of migration (an average groundspeed of 50 km/hr leading to the same values in both frequency and density).

Figure 11 shows the average altitude distribution of spring migration derived from two periods of 3 weeks (1968 and 1969). The distribution agrees fairly well with the results

⁴The sign \sim is necessary because the value of $1/3$ is somewhat too high in cases with large components of wind normal to the heading.

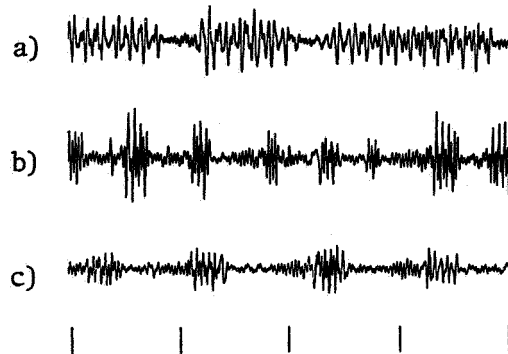

FIGURE 9. Echo signatures of visually identified day migrants: (A) Mistle thrush (*Turdus viscivorus*); (B) Chaffinch (*Fringilla coelebs*); (C) White wagtail (*Motacilla alba*). The three species can be distinguished by wing-beat frequency and by length of flapping and quiescent periods within their flight; vertical lines at the bottom mark intervals of 1 sec. Echo signatures of night migrants may be classified according to the same parameters (fig. 10), but to date we have not established a correlation with ornithological classification.

published by Eastwood and Rider (ref. 8). Altitude distribution as well as the intensity of migration vary on a large scale according to weather development. In figure 12, 40 nights of observation were divided into nine typical weather situations. They show volume and height of migration during a weather development comprising five situations with anticyclonic character (1 to 5) and four situations in which cyclonic influences prevail (6 to 9):

- (1) East side of a high pressure area (with cold northerly winds)
- (2) Central part of a meteorological high (with light and variable winds)
- (3) Flat pressure areas with anticyclonic character (winds light, in the cases considered, mostly from W to SW)
- (4) Southern part of a high (NE to E winds, partly with Foehn winds in the Alps)

ANIMAL ORIENTATION AND NAVIGATION

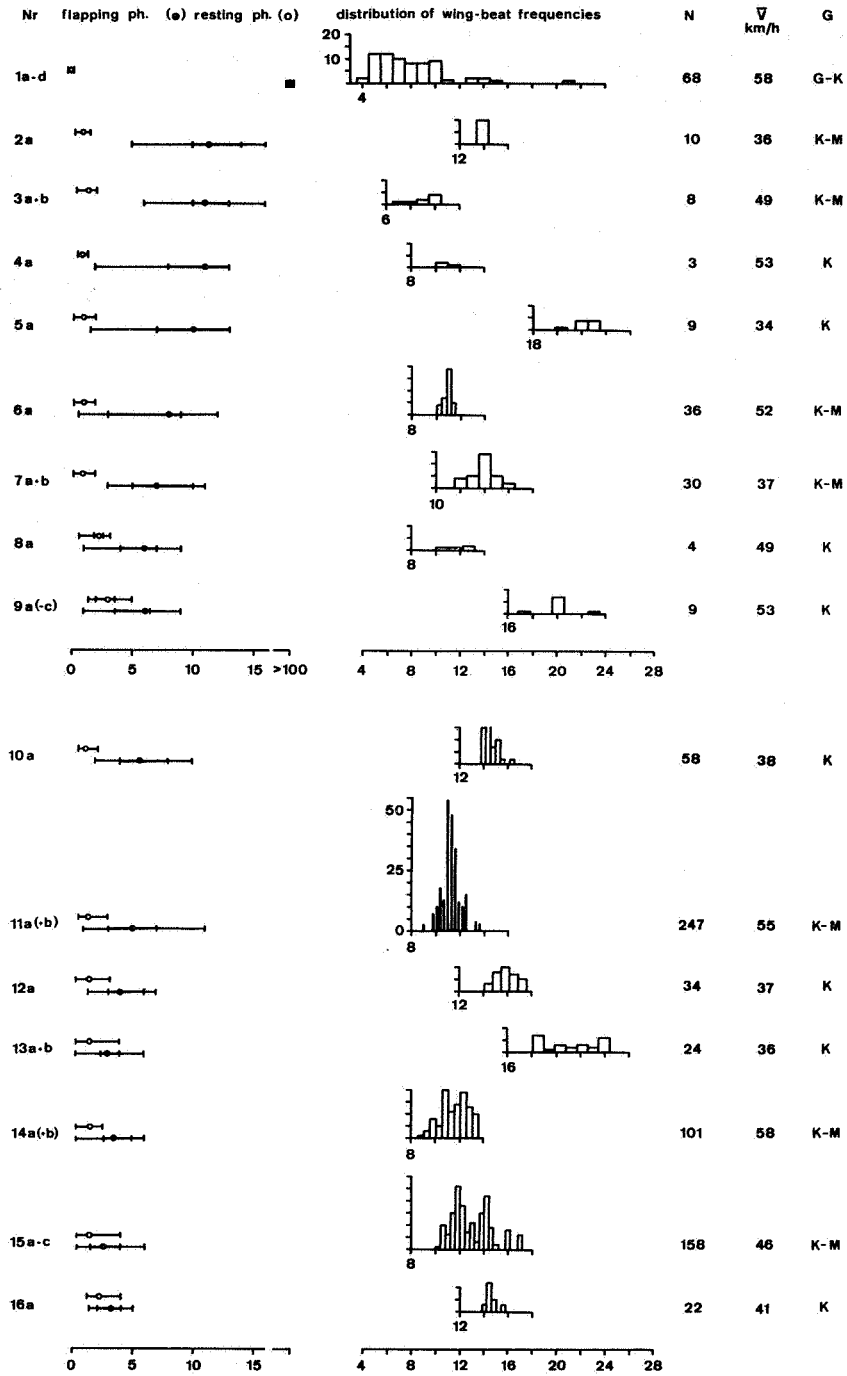
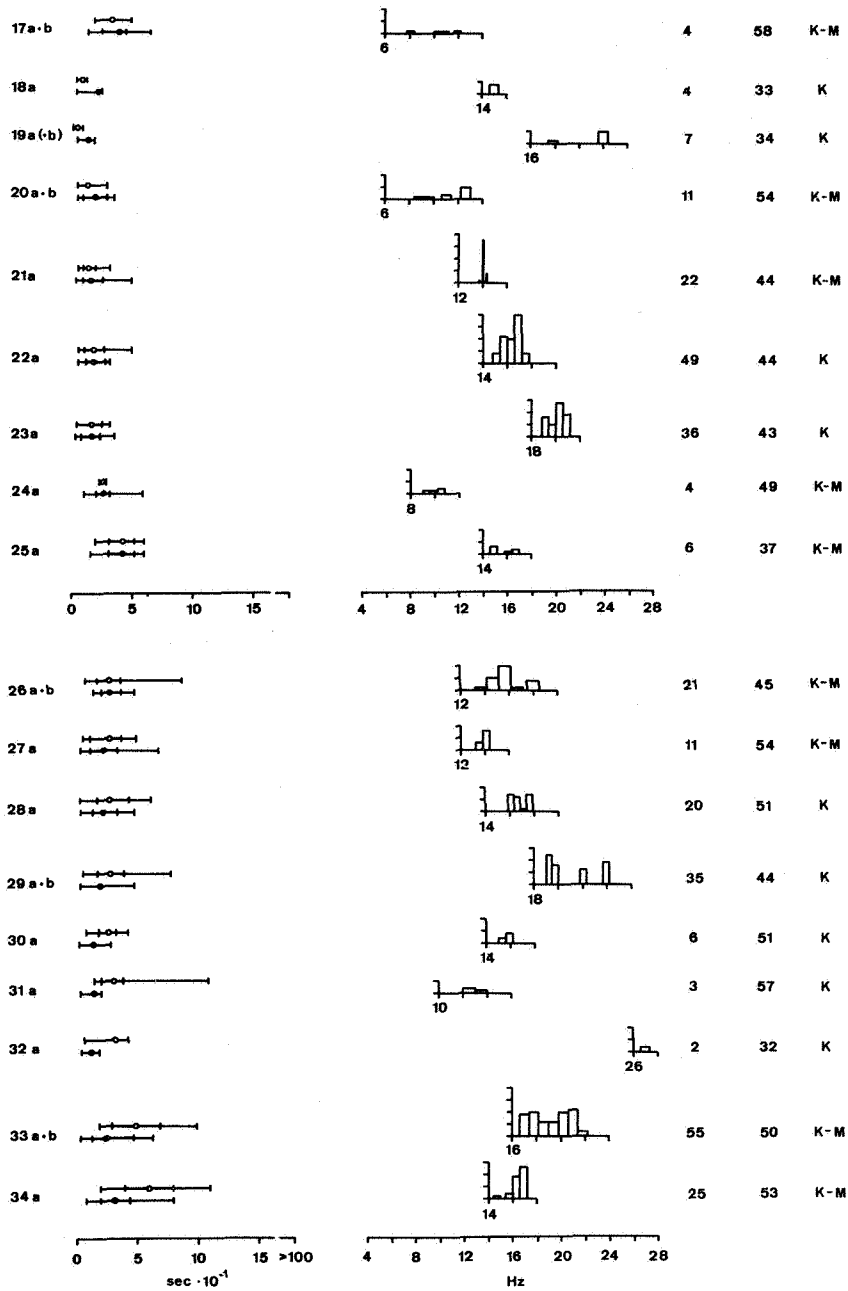

FIGURE 10. Provisional classification of "echo types" and "echo species" recorded during April 1969. A first arrangement according to the length of flapping periods (●) and quiescent



phases (O) and their spreads (—) leads to 34 echo types, each of which may be divided into one, two, or more (a , $a + b$, or $a - z$) echo species with the help of wing-beat frequencies. N marks the number of individuals in every type; V is mean of calculated velocities of species ($V_H + \sim 1/3 (V_{WH})$); G may give a hint to the size of the birds contained in one type ($G =$ large; $M =$ medium; and $K =$ small).

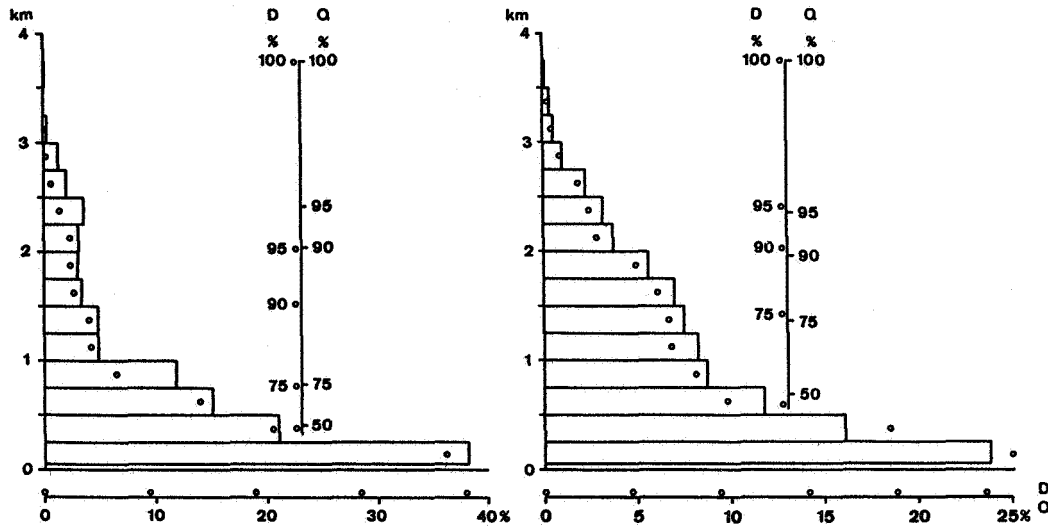

FIGURE 11. Average altitude distribution of spring migration. On the abscissa the percentage of frequency (columns) and density (circles) of migration is indicated for height intervals of 250 m. At the left—day migration; at the right—night migration.

(5) W to SW side of an anticyclone (E to SE winds, often Foehn winds in the Alps)

(6) Approaching warm front (all cases after the passage of a previous low pressure area)

(7) Warm sector (could be interpreted in some cases also as the NW edge of a warm high pressure cell; SW winds)

(8) Central regions and disturbance zones of low pressure areas (wind variable in direction, often strong)

(9) Rear side of low pressure areas (in the present cases mostly with winds from sector north to west). This situation leads back to situation 1.

In the cases we could examine, heaviest migration occurred in the warm sectors of cyclones (not too near the frontal systems) and on the W to SW side of anticyclones. Lightest migration was observed in zones of precipitation (center of low and fronts) and on the rear side of the low pressure areas, as well

as on the east side of the high pressure areas.

With respect to the question whether the level of migration might be higher with tail winds than with head winds, we believe that the reality is much more complex than the question. Perhaps the question should be restricted to anticyclonic conditions, because we have noticed several cases with low migration in the neighborhood of frontal systems in spite of tail winds (fig. 13). On the other hand topographic features may induce wind distributions differing from the normal case (i.e., windspeeds increasing with height), so that anticyclonic situations with opposed winds may give rise to quite a similar distribution of migrating birds as situations with tail winds, whenever windspeeds are favorable at the same levels (see fig. 14). Furthermore the facts may often be blurred by differences in behavior of different species or even by alterations of flight levels by the same species during one night (see part II).

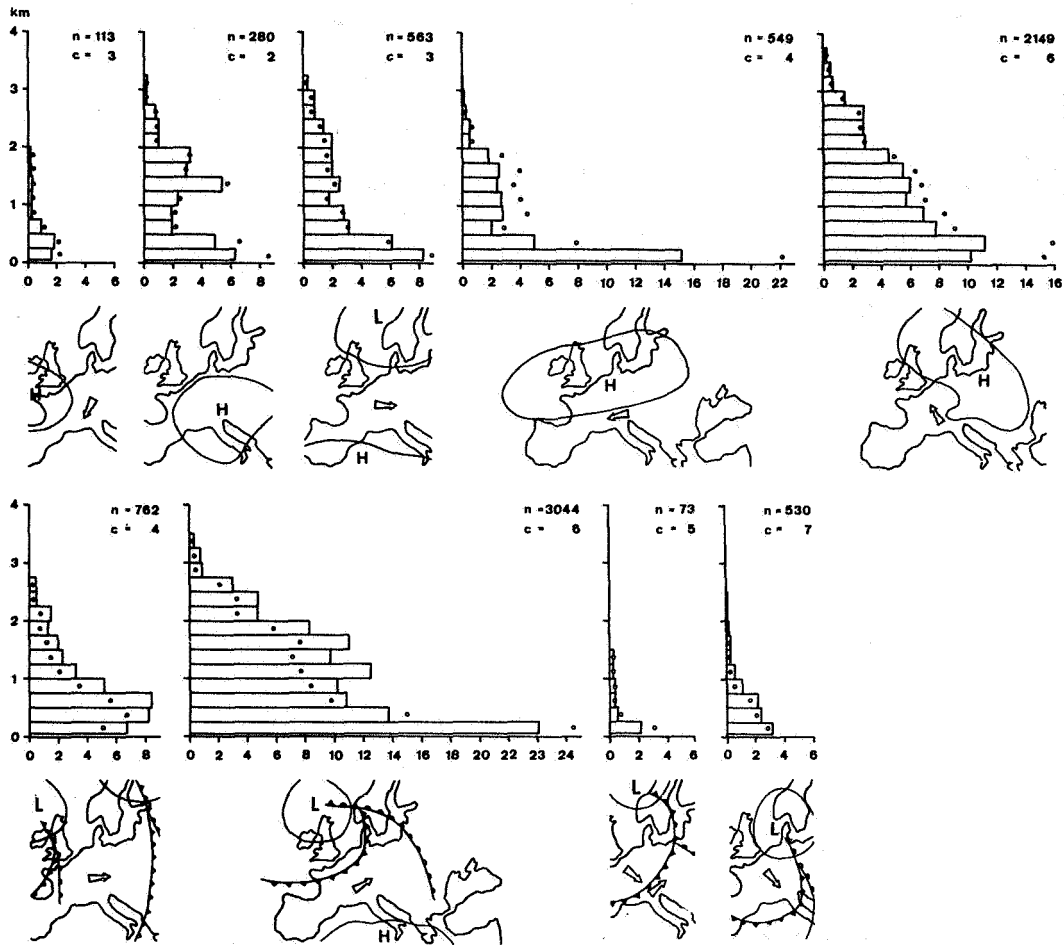

FIGURE 12. Intensity and height of migration derived from 40 nights of observation with respect to nine different weather situations. Number of nights within each situation is indicated as *c*, the number of the counted echoes as *n*. Below each migration diagram, a sketch indicates the appropriate weather situation with the prevailing wind direction. Altitude distribution (ordinate) is given for height intervals of 250 m. The abscissa gives frequency (columns) and density (circles) of migration as defined in the text.

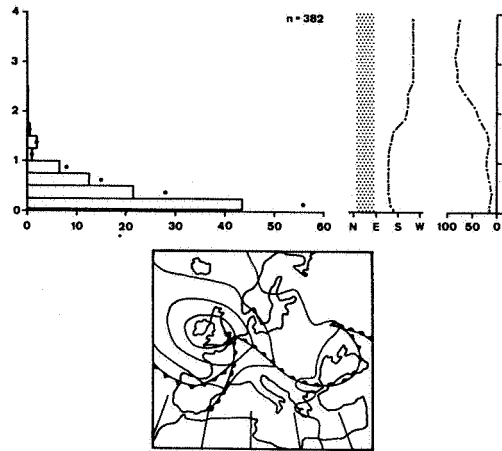

FIGURE 13. Low level of migration in the neighborhood of a frontal system (April 21 and 22, 1969) in spite of tail winds. Diagram on the right shows windspeeds in km/h. Middle diagram indicates direction from which wind is blowing and main sector toward which birds are migrating (dotted area). The weather situation at midnight is shown below. Diagram on the left corresponds to those in figure 12.

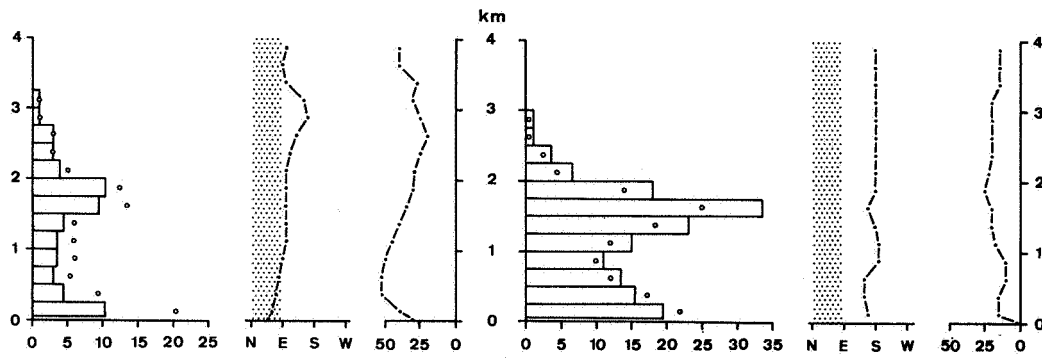

FIGURE 14. Altitude distribution of migration and wind conditions in nights of March 23 and 24, 1968 (with a strong tail wind component) and in nights of April 5 and 6, 1969 (with a head wind component); same mode of diagrams as in figure 13. In the case of tail wind, the height with lightest wind shows lightest migration; in the case of head wind, lightest migration occurred at levels with highest windspeeds.

*Part II by P. Steidinger**DEPENDENCE OF MIGRATION
FLIGHT DIRECTIONS UPON
WIND DIRECTIONS*

Taking as an example one of the most interesting nights in our radar observation period in the spring of 1969, we will show one of the potentialities of our tracking radar in orientation research.

Ceiling balloons with a metallic reflector, tracked with our radar up to a height of 4000 m above ground informed us about wind directions and windspeeds at all altitudes we needed. At intervals of 30 seconds we photographed the measuring instruments of the radar which showed us the positions of the balloon. From the different positions we computed wind directions and windspeeds. Figure 15 shows graphs of the three wind measurements we carried out on the night of April 19 and morning of April 20. Note that at lower levels the wind blew from SE or S and higher up from SW.

We tracked the birds with our radar in the same manner as the balloons. We normally observed each bird during 2 minutes and took five pictures of the measuring instruments at intervals of 30 seconds. From these five positions we computed height, track direction, and track speed. The possibility of computing the exact altitude of migration with the information from the tracking radar is an important advantage when compared to our investigation with the surveillance radar of Zurich Airport (refs. 1, 9, 10, and 11).

Figure 16 shows the height and the tracks of the birds observed between 2010 and 2340 hours on April 19. We computed heading and airspeed based on the wind measurements closest to a bird observation (fig. 17). Note that tracks and headings of high flying

birds in this first part of the night show quite a similar distribution to those of low flying birds.

Figures 18 and 19 demonstrate tracks and headings between 0130 hours and 0530 hours. The high flying birds observed in this second part of the night show distributions of tracks and headings similar to those of birds observed in the first part of the night (compare fig. 18 with fig. 16 and fig. 19 with fig. 17).

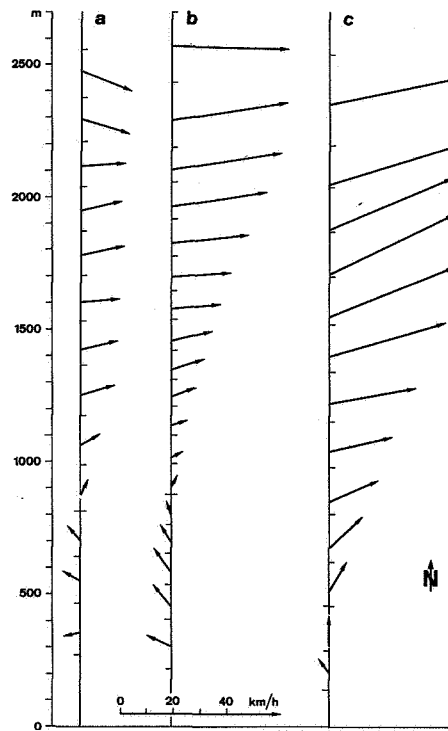

FIGURE 15. Wind measurements: (A) April 19, 1969, 1751 to 1813; (B) April 20, 1969, 0053 to 0109; (C) April 20, 1969, 0809 to 0821. Ordinate: meters above ground. Direction of arrows shows wind direction in the corresponding height. Length of arrows indicates windspeeds in km/h (compare with windspeed scale).

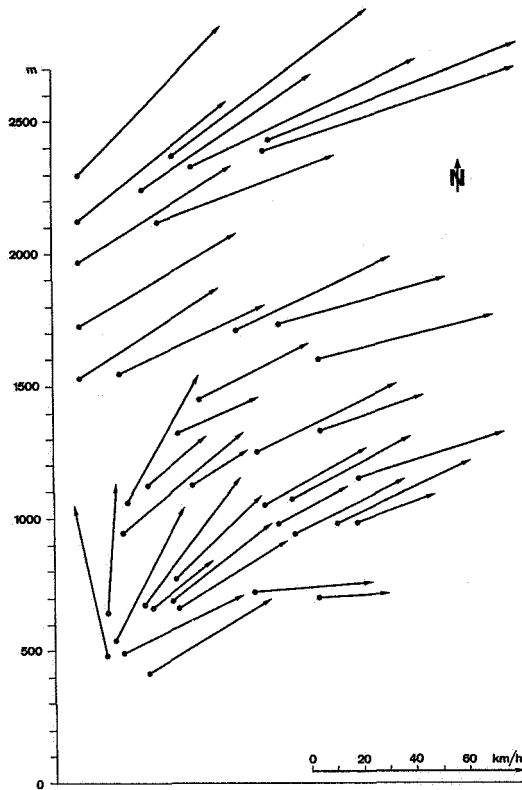

FIGURE 16. Tracks of birds observed between 2010 and 2340 on April 20, 1969. Ordinate: meters above ground. Each point at the end of an arrow shows migration height of individual bird. Direction and length of arrow indicate track direction and track speed.

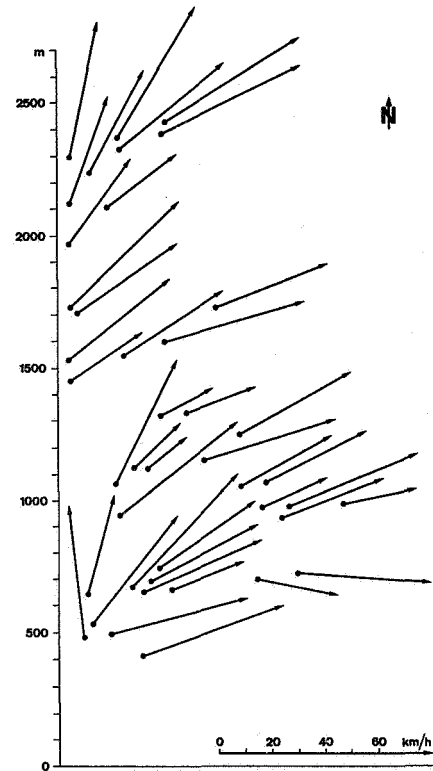

FIGURE 17. Headings of birds observed between 2010 and 2340 on April 19, 1969. Ordinate: meters above ground. Each point at the end of an arrow shows migration height of individual bird. Direction and length of arrow indicate heading direction and airspeed.

Tracks and headings of the low flying birds in this second part of the night point mainly to the north. The distribution of tracks and headings below 850 m above ground is statistically different at the 0.001 level from the distribution of tracks and headings above 850 m (Wilcoxon test). These northerly flight directions occurred more often during the second part of this night than at any other time during our observations.

Comparing tracks and headings of low flying and high flying birds (figs. 18 and 19)

with the appropriate wind directions during the night (fig. 15), we see that the birds, at least in this case, migrate at such a height that they have favorable winds. Birds migrating to the north fly lower than those migrating to the northeast. This finding is in good agreement with Bellrose (ref. 1), who reported, on the basis of his radar observation in the midwestern United States: "Our radar findings demonstrate that birds have a phenomenal understanding of winds. They select nights and altitudes having favorable directional winds and favorable windspeeds."

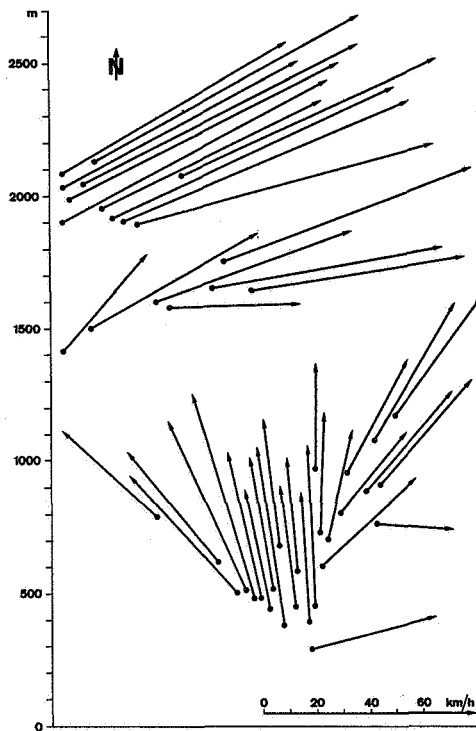

FIGURE 18. Tracks of birds observed between 0127 and 0526 on April 20, 1969. For explanation see figure 16.

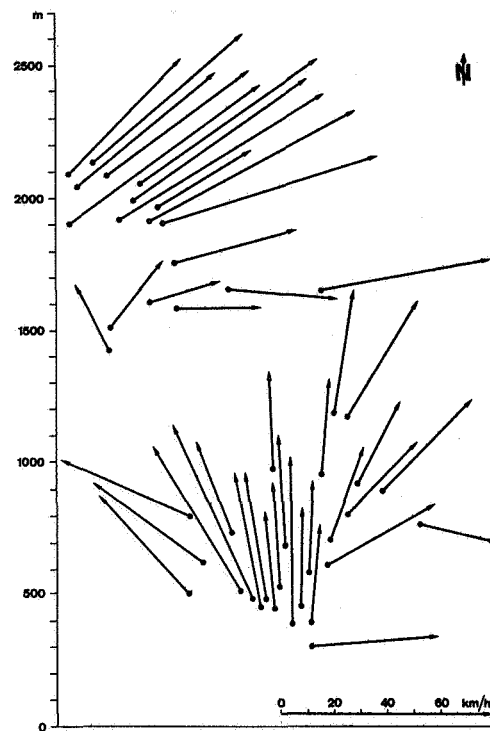

FIGURE 19. Headings of birds observed between 0127 and 0526 on April 20, 1969. For explanation see figure 17.

Our analysis of echo signatures (refs. 2 and 6) indicates that species traveling at different heights during the first part of the night change altitudes to fly at one particular height in the second part. It is possible that migration calls could help the birds to find a height with favorable winds. For example, a bird may hear the calls of another bird of the same species flying at a higher altitude. If the wind higher up is more favorable, the higher flying bird will move ahead faster. Realizing this, the lower bird might climb up and thus will find a height with more favorable winds.

The observation that in the first part of the night there were only few birds with a northerly track raises another question: Where and when did all the low flying birds

that were seen migrating to the north in the second part of the night take off? We see two possibilities:

- (1) They started late at night, north of the Alps.
- (2) They took off early at night, south of the Alps.

But we may ask: After crossing the mountains at a height of about 2500 m above sea level, do night migrants lose so much height that after a further flight of 150 kilometers they are only at about 1000 m above sea level? Perhaps they do, especially if the winds near the ground are more favorable than higher up. We are not able to answer all the questions raised in this paper. But we hope to have shown some possibilities of using a

tracking radar in migration research. For this purpose we have discussed a few specific problems, some of which we will try to solve in the near future.

SUMMARY

1. With the help of an X-band (3 cm) tracking radar, data on spring migration in northern Switzerland were collected during two periods of 3 weeks in 1968 and 1969.

2. A vertical beam method, improved by counts with low elevation of the beam, allowed quantitative recording of the frequency of migration at all heights between about 30 and 4000 m above ground. Density of migration was calculated with the help of the measured speed of migration.

3. The qualitative analysis of migration was based on automatic tracking of single targets and comprised: (a) measurements of groundspeed, height and track, (b) recording of echo signatures based on AGC signals, (c) measurements of local upper winds with radar-tracked balloons, (d) calculation of airspeed and heading with the help of the measured wind data.

4. In night migration loose groups of birds seem to exist in addition to large numbers of individuals flying alone, the distances between grouped birds being in the order of 100 to 300 m. The airspeed of night migrants increases with height. Airspeed decreases in tail winds and increases in head winds.

5. Heaviest migration was observed in warm sectors and on the W to SW side of high pressure areas.

6. The question of the relationship between height of flight and wind direction is a very complex one, and must be considered at least in relation to the prevailing weather situations and the local topography.

7. In the second part of the paper we discuss the dependence of track and heading

directions upon wind directions on a night with particularly interesting winds. Our finding is that birds migrated most frequently at heights of favorable winds.

ACKNOWLEDGMENT

We are very grateful to the firm Contraves AG and to the Swiss Army for making available to us the radar equipment and for the active assistance they gave us during our work. Financial support by the Dr. Fritz Hoffmann—La Roche Foundation is gratefully acknowledged, as well as the kind support and encouragement of our study by A. Portmann and G. Wagner. We wish to thank the Meteorological Office of Zurich Airport for supplying weather data and to A. Urfer for summarizing these data in daily reports. All further cooperation and help which made possible our research is heartily acknowledged.

DISCUSSION

QUESTION: What is the range of flock size in the passerines? Do the nocturnal migrants break up in flocks at the beginning of darkness?

BRUDERER: In spring the flocks number from 2 to 20, normally from 3 to 10. In autumn migration they are in the order of 5 to 30 or even larger.

The flocks occasionally observed visually at the beginning of darkness were mostly those of roosting starlings and black-headed gulls; thus, we are not able to say if there are any night migrants breaking up into flocks. We know only that starlings migrate closely flocked in the daytime and that we have no echo signatures of flocks recorded during the night. Yet we know from captures in the alps that starlings do migrate during the night, and we have several echo signatures of night migrants which are similar to those of singly flying starlings.

MADISON: How do you distinguish between migrant and nonmigrant starlings?

BRUDERER: Nonmigrants normally do not fly at night. At twilight, roosting starlings can be recognized because we know the direction of their roosts which are not the same as the direction of migration. Furthermore, the roosting birds flew relatively low at our observation point. In the daytime only, the direction of migration and the constancy of the flight tracks can give some indications for distinction.

GWINNER: You have presented data indicating that the groundspeed is kept constant if the birds are exposed to back winds. To what extent does it remain constant?

BRUDERER: The groundspeed doesn't remain constant; it was only said that it was not influenced in an additive way by the wind vector along the birds' track. In our measurements about two-thirds of the wind component in question were added to the groundspeed of the birds, so that in a tail wind the birds seem to lower and in a head wind to increase their own effort. A possible mathematical explanation to these observations is given by Pennyquick (ref. 12).

EVANS: Your analysis suggests that the groundspeed of a bird is not the vector sum of the wind with a constant airspeed. Could this result be explained by differences in airspeed according to the weight of the bird? According to Pennyquick's calculations, one would expect a bird of a certain weight to maintain a certain airspeed to achieve maximum range. As that bird gets lighter during a long flight, so its airspeed should decrease.

BRUDERER: To answer your question it would be necessary to measure the weight of a bird with high accuracy so as to recognize the decrease of the bird's weight according to the utilization of fat. With our methods we were only able to say to which of three size categories a bird belongs. Perhaps with better methods it will be possible to show if the average weight of a species during a night decreases until sunrise. If it would be so (and it should), you are right in thinking that the airspeed of a species should slow down if the birds don't raise their flight level. However, the speed changes shown in this paper can't be explained in terms of weight changes because we excluded this problem by treating all the data of one night or even the data of several nights (or days) as a whole; speed differences arising from weight changes during a night are so eliminated statistically.

WILLIAMS: Perhaps it would be interesting to add another point of view to this problem with an example of a track of a single bird target descending through a wind shear having a variety of winds. We were able to show that it makes considerable difference what a bird can see. If the birds can see and it is clear, they compensate both for direction and the speed of the wind. In other words, the airspeed and the heading of the birds both change. If they can see either the stars or the Earth, neither

the airspeed nor the heading of the birds change even though they descend through considerable wind shear. They do not compensate for either.

REFERENCES

1. STEIDINGER, P.: Radarbeobachtungen über die Richtung und deren Streuung beim nächtlichen Vogelzug im Schweizerischen Mittelland. *Orn. Beob.*, vol. 65, 1968, pp. 197-226.
2. BRUDERER, B.: Zur Registering und Interpretation von Echosignaturen an einem 3-cm Zielverfolgungsradar. *Orn. Beob.*, vol. 66, 1969, pp. 70-88.
3. NISBET, I. C. T.: Measurements with Radar of the Height of Nocturnal Migration Over Cape Cod, Massachusetts. *Bird Banding*, vol. 34, 1963, pp. 57-67.
4. EASTWOOD, E.; AND RIDER, G. C.: The Grouping of Nocturnal Migrants. *Nature*, vol. 211, 1966, pp. 1143-1146.
5. BELLROSE, F. C.: Radar in Orientation Research. *Proc. 14th Intern. Ornithol. Congr.*, 1967, pp. 281-309.
6. BRUDERER, B.; UND JOSS, J.: Methoden und Probleme der Bestimmung von Radarquerschnitten frei fliegender Vögel. *Rev. Suisse Zool.*, vol. 76, 1969, pp. 1106-1118.
7. SCHAEFER, G. W.: Radar Echo Signatures of Birds, Insects and Bats. *The Radio and Electronic Engineer*, vol. 37, 1969, p. 13.
8. EASTWOOD, E.; AND RIDER, G. C.: Some Radar Measurements of the Altitude of Bird Flight. *Brit. Birds*, vol. 58, 1965, pp. 393-426.
9. SUTTER, E.: Radar als Hilfsmittel der Vogelzugforschung. *Orn. Beob.*, vol. 54, 1957, pp. 70-96.
10. SUTTER, E.: Radar-Beobachtungen über den Verlauf des nächtlichen Vogelzuges. *Rev. Suisse Zool.*, vol. 64, 1957, pp. 294-303.
11. GEHRING, W.: Radar- und Feldbeobachtungen über den Verlauf des Vogelzuges im Schweizerischen Mittelland: Der Tagzug im Herbst (1957-1961). *Orn. Beob.*, vol. 60, 1963, pp. 35-68.
12. PENNYQUICK, C. J.: The Mechanics of Bird Migration. *Ibis*, vol. 111, 1969, pp. 525-556.