

Visual Direction Finding by Fishes

TALBOT H. WATERMAN
Yale University

DIRECTION FINDING is a fundamental aspect of spatial orientation and navigation. Broadly it can relate to an animal's position in space, to its posture, and to the steering component controlling its locomotion. Sensory information about direction, which may be determined from a single external clue, is usually obtained by "distance receptors" as opposed to "contact receptors." Thus olfaction, hearing, vision, and mechanoreception mediated by gravity receptors are well known direction-finding modalities; electroreception and magnetoreception are less well known ones,¹ and in the latter case even problematical because no corresponding physiological receptor-transducer has yet been identified except in certain fishes.

The present review will consider only a limited aspect of direction-finding by restricting itself to underwater vision and to fishes. Furthermore, attention will be focused mainly on orientation in the absence of local landmarks and will also exclude general components like the dorsal light reflex.

Motivation for such a circumscribed approach is both practical and personal: practical in the sense of attaining a reasonable

¹ See Bullock, Lindauer, elsewhere in this volume.

compromise between depth and scope, personal in terms of relating to our current research on polarized light perception in fishes (ref. 1) and the possibility that underwater polarization patterns in nature could provide an indirect Sun compass if the animals are able to use it (refs. 2 and 3).

Before dealing specifically with fish orientation, a brief review will be made of those characteristics of submarine optics that are particularly distinctive for seeing underwater. These mainly make visual direction-finding much more difficult than in air; hence, visual orientation is a challenge for aquatic animals. Nevertheless, the large, well developed eyes of most pelagic species in the photic zone attest to the adaptive importance of their vision.

UNDERWATER OPTICS

Except for bioluminescence, light in the sea (and other natural bodies of water) originates mainly from the Sun and to a much less extent from other celestial bodies as well as the sky. The air-water interface establishes two important features of underwater illumination. First, the difference in refractive index bends the rays of entering light and

causes total reflection in upward lines of sight beyond the critical angle. Thus the 180° horizon to horizon hemisphere of the sky is reduced to 97° (taking the water's refractive index to be 1.333) for an underwater eye; hence, all celestial clues to direction occur within this refraction cone, and the Sun rises and sets at apparent zenith distances of 48.5° instead of 90° as in air. Furthermore, as dictated by Snell's law, the apparent zenith distance is a nonlinear function of its real zenith distance in the sky.

Second, the fact that natural water surfaces are rarely flat calm means that ripples and waves will further distort, often markedly, the image of the celestial hemisphere. Thus the refracted Sun's disc usually appears as a more or less extensive glitter pattern comparable to, but much brighter near the surface and not subtending so large an angle, as the reflected glitter pattern observed looking down at the Sun's reflection on the water surface in air (refs. 4 and 5).

Once in the aqueous medium itself, radiant energy is then subject to absorption and scattering much more intense than in a clear atmosphere. As a result incident light becomes rapidly attenuated and less directional as it penetrates the water. For instance in Jerlov's type I clear oceanic water like the Sargasso Sea, surface irradiance (at 465 nm) is reduced to 1 percent at just over 140 m depth; in clear coastal water (Jerlov type 1) this 100-fold reduction occurs just above 30 m (ref. 6).

For the clearest deep oceanic water reported (at depths of 300 to 800 m in certain areas of the Indian Ocean (ref. 7), the 1 percent depth would be 219 m at the most penetrating λ , 475 nm Crater Lake (Oregon) approaches ideal clarity, and extrapolating the shallow measurements actually made would have its 1 percent depth at 292 m for 420 to 425 nm its most penetrating λ

(ref. 8). Actually Crater Lake's transmittance at 475 nm is not as great as the Indian Ocean water cited.

Visibility

As a result of both absorption and scattering, visibility underwater is sharply reduced from that of clear air where 14 000 m of troposphere attenuate the incident solar radiation only to about 60 percent (ref. 9). In contrast to atmospheric visual ranges of 300 to 400 k, submarine ranges for large high contrast objects against a water background rarely exceed 100 m in very transparent water, while 40 m is more usual for quite clear water and 5 to 6 m typical for moderately turbid coastal waters (refs. 10 to 12).

At high light intensities the maximum range (in meters) for the human visibility of a large dark object viewed horizontally under water is roughly given by $4/c$ (ref. 13) where c is the total attenuation coefficient per meter (varies from 0.0158 to 0.033 for extremely clear natural water). Since contrast between object and background is crucial for visibility, depth will in fact be another parameter underwater. As depth increases overall irradiance decreases rapidly as cited above and scotopic contrast threshold for man is only about 0.1 as good as photopic (ref. 14).

The limiting case for submarine visibility would come at the depth where the Sun's rays are no longer detectable by an eye looking upward. If the attenuation coefficient were constant throughout the water column the irradiance at 840 m depth would be only 10^{-12} that at the surface even in Jerlov type I oceanic water. Depending of course on the eye and the detailed visual conditions, this could well be a plausible absolute threshold since estimates for maximum depths for eyes to detect sunlight in the clearest waters range from about 800 to 1500 m (refs. 7, 15, and

16). The deepest human daylight sighting from an experimental submersible is 700 m in quite clear water in the Bahamas (ref. 12). Since the world ocean averages nearly 4000 m in depth, three quarters or more of this huge living space is devoid of sunlight.

Directionality of Light

Both theory and field observations indicate that some directionality of the Sun's penetrating rays is maintained all the way down to the extinction depth. However, scattering and absorption cause the radiance distribution to become less directional than near the surface where it can be represented by a quasi-ellipsoid with its major axis parallel to the initial direction of the refracted ray. In deeper water the ellipticity decreases until the distribution resembles a prolate spheroid (ref. 6).

Perceiving the direction of maximal brightness, of course, requires discrimination between the visible intensities in neighboring areas of the radiance distribution. Thus, as the ellipticity of the latter is reduced and approaches a spheroidal shape, the potential accuracy of direction finding by this means will be significantly reduced. Again the rapid reduction of intensity with depth will have a marked additional effect since in general brightness discrimination deteriorates as illumination decreases. For man the minimum discriminable $\Delta I/I$ at scotopic light intensities is more than 10 times that at moderate photopic levels.

Despite the absence of appropriate data on fish visual physiology and behavior, Harden Jones (ref. 17) has made some interesting relevant calculations. Correlating measurements of underwater radiance distribution (for a fresh water lake) and estimates of the accuracy of human spatial localization and brightness discrimination, he calculates

the Sun's bearing discrimination (within $\pm 20^\circ$) would reach threshold at a depth of 54 m; whereas Sun's altitude discrimination (within $\pm 10^\circ$) would similarly reach threshold at about 59 m. If these figures are of the right order magnitude, direction finding from the radiance distribution can be useful at best only in a shallow superficial layer.

In addition the combined action of scattering and absorption causes the zenith angle of the major axis of the radiance distribution to decrease from the angle of refraction at the surface to 0° at the so-called asymptotic or equilibrium depth. At this level the transmitted light distribution becomes symmetrical around the vertical. This occurs at various depths depending on the water's absorptance and scatterance (in turn strongly dependent on λ), e.g., at 100 m for green light in the Baltic and at 400 m for blue light in the Sargasso Sea (ref. 6).

Obviously when the angle between the main axis of the radiance distribution and the vertical falls below the threshold for an animal's discrimination, no azimuth directional information can be obtained from this factor at the corresponding depth and below. Even above the asymptotic depth, radiance distributions symmetrical around the vertical occur with the Sun below the horizon at sunrise and sunset, with the zenith Sun at noon and with a heavily and uniformly overcast sky.

Spectral Distribution

Whereas thin layers of clear water have little apparent effect on the visible spectral energy distribution of sunlight, thick layers have marked selective absorption reducing its bandwidth. In pure water or very clear seawater, this finally results in a narrow monochromatic band with a peak at 475 nm. In coastal waters and various fresh waters, "yel-

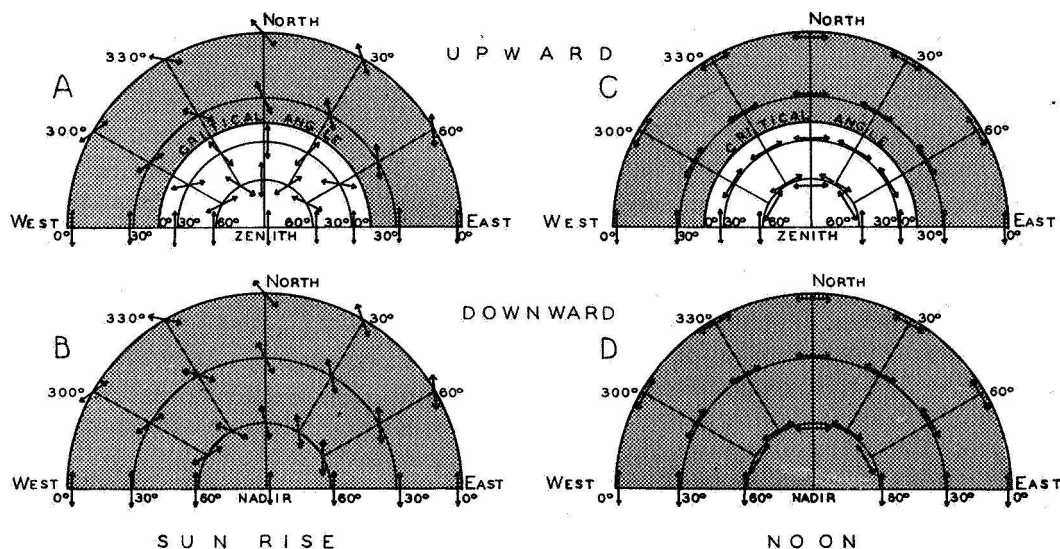

FIGURE 1. E-vector patterns (double-headed arrows) in natural underwater illumination at sunrise (A, B) and noon (C, D). In upper hemisphere (A, C), sky polarization (as shown in the unstippled area) is visible in shallow water. Radial coordinate represents elevation (A, C) or depression (B, D) of the line of sight from horizontal; angular coordinate is the sight line's compass bearing. Within the critical angle (A, C), refracted apparent positions of the horizon as well as 30° and 60° elevation angles in the sky are shown (ref. 2).

low substance" and other colored material in the water may alter the most penetrating λ to green, brown, or even yellow, orange, or red (refs. 6 and 18).

Clearly these wavelength characteristics of underwater light may affect contrast and have a powerful interaction with the λ_{\max} of an eye's visual pigment. The wide range of λ_{\max} shown by the visual pigments of various aquatic animals (refs. 14, 19, and 20) is no doubt a reflection of the adaptive importance of these light transmitting properties of the environment. Very marked effects on the maximum depth for seeing may be involved here (ref. 21).

Polarization

One interesting consequence of the scattering of light by water is the development of

an underwater polarization pattern resulting from primary (Rayleigh) scattering of directional light (refs. 2, 22, and 23). Unlike the absorbance and the other results of scatterance, this optical feature of submarine illumination may increase the possibilities of direction finding by providing an index of the Sun's position down to depths of at least 200 m (ref. 24)—far beyond those where the Sun's disc is ordinarily visible as such and perhaps well in excess of those where the radiance distribution can be used to determine the Sun's bearing. (See Harden Jones' estimates cited above.)

In contrast to the situation in air where only the hemisphere including the blue sky is polarized by scattering of the Sun's rays, underwater light is polarized throughout the whole 360° solid angle, including near the surface the sky polarization visible above the

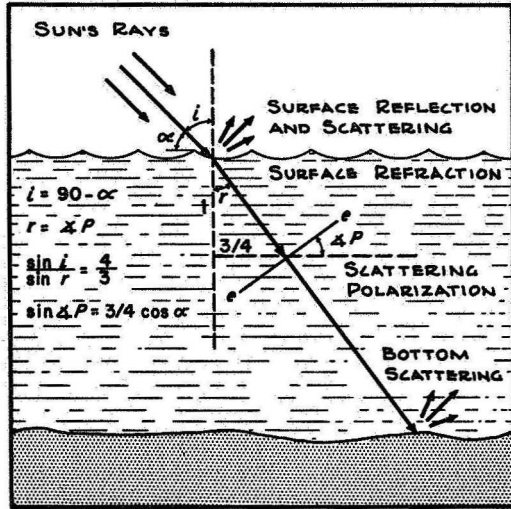

FIGURE 2. Origin of underwater polarization by primary scattering of directional light in the water. The overall e -vector pattern (fig. 1) arises from the interaction of this basic geometry with the Sun's altitude (fig. 4) and the relation of the lines of sight to the Sun's bearing (ref. 23).

critical angle (ref. 2) (fig. 1). The e -vector everywhere is normal to the Sun's rays in the medium (ref. 23) (fig. 2), and the degree of polarization ($p = I_{\max} - I_{\min} / I_{\max} + I_{\min}$) is maximal perpendicular to the Sun's direction (fig. 3). In this direction the tilt of the e -vector from horizontal is a simple function of the Sun's elevation angle (fig. 4).

As depth increases the changes in the radiance distribution toward the equilibrium depth condition can be directly observed by measuring the e -vector tilt in horizontal lines of sight perpendicular to the Sun's bearing (ref. 24). Theoretically at the asymptotic depth and below, the plane of polarization would be horizontal and 20 to 30 percent polarized in horizontal lines of sight while the vertical radiance from the surface would be unpolarized (refs. 25 and 26). However, polarization measurements to support this directly have yet to be made in deep water.

The effect of depth on the degree of polarization has been measured only down to 115 m (ref. 27) (fig. 5) and as mentioned above, the e -vector orientation to a maximum of 200 m (ref. 24).

The degree of scattering polarization in pure water has a theoretical maximum of somewhat greater than 80 percent (ref. 6). *In situ* determinations of p due to scattering of the natural light have shown maxima near 60 percent for clear seawater west of Corsica and near Bermuda (refs. 27 and 28). Generally the values of p obtained with artificial light sources *in situ* are significantly greater than this presumably due to the stricter directionality of the artificial light (ref. 29).

Since polarotactic orientation in *Daphnia* has been demonstrated in the laboratory consistently for partial polarization of 20 percent and sometimes at 10 percent (Waterman and Jander, unpublished, cited in ref. 30), the naturally occurring polarized light underwa-

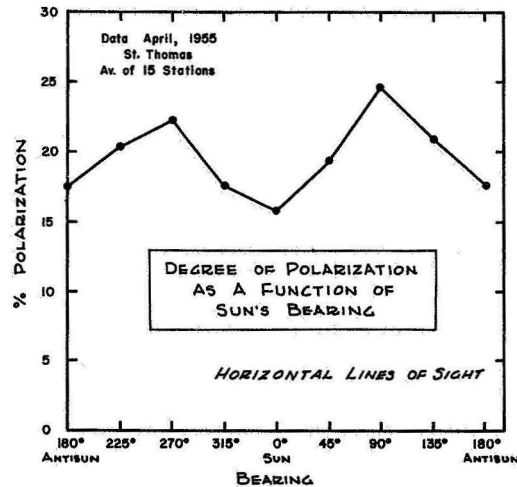

FIGURE 3. Dependence of the degree of underwater polarization (p) on the relation of the Sun's bearing to the line of sight. Obviously p is maximal normal to the Sun's direction. Lack of symmetry is due to the large variance in the field data plotted (ref. 23).

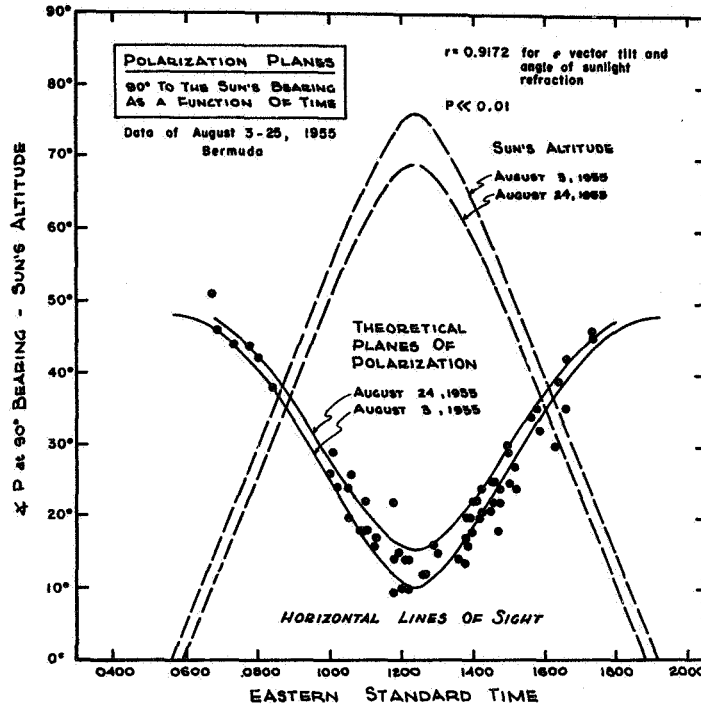

FIGURE 4. Effect of the Sun's altitude on the tilt of e -vector observed 90° to the Sun's bearing. Points represent the underwater measurements made at different times of day. Broken lines indicate the Sun's altitudes. Solid lines represent the corresponding angles τ between the vertical and the refracted rays of the Sun predicted from figure 2; these are closely matched by the observed e -vector orientations (ref. 23).

ter has considerable biological interest as a possible Sun compass (ref. 3). Both the azimuth and altitude of the Sun could be determined rather easily from the e -vector tilt in horizontal lines of sight. The azimuth indication would be simple at all depths down to equilibrium, but altitude would of course show an interaction with depth as mentioned above.

Resumé

The net effect of these various features of underwater optics on visual direction finding may be briefly summarized as follows. Pilotage, i.e., steering by means of visible landmarks, is feasible only for littoral animals or benthic and parabenthic forms in the photic zone during the day. Since the water mass itself provides almost no aids to pilotage [but thermoclines and turbid strata are often

visible (ref. 31)], other means of visual direction finding must be used throughout the great preponderance of the hydrosphere. As indicated above these will be either (1) celestial directional clues observed directly near the surface or observed indirectly through the radiance distribution down to levels no greater than the asymptotic depth or (2) alternatively the underwater polarization. The evidence for their use, as yet quite incomplete, is reviewed below.

CELESTIAL ORIENTATION

There are at least five different kinds of visual celestial cues which various animals can use for direction finding: the Sun (ref. 32), the Moon² (refs. 33 to 35), the stars (refs. 35 to 37), differential brightness of various parts of the sky (refs. 38 to 40) and the

polarization of the clear sky and natural waters (refs. 2 and 41). Because of lack of information on the likely significance of the other three clues for animals underwater only the first and last of the five are considered here.

The Sun Compass

Fishes, like many animals (refs. 17 and 42 to 46), are capable of finding a given azimuth by establishing and maintaining a fixed angular relation to the Sun's bearing. In so doing they are using the Sun's disc as a light compass as first proved in homing ants (ref. 32). At any given moment or for short intervals of time, this compass could function as a rather simple direction finder. The behavior involved would be like the transverse orientation of photomenotaxis (= light compass reaction) to an artificial light source (refs. 47 to 49).

However, over longer time intervals and for general use, a Sun compass must be much more sophisticated than a menotaxis because the movement of the Sun through the sky has to be taken into account. Also there is evidence that in some cases the Sun's altitude especially at local noon affects the direction finding (refs. 50 to 52). Therefore, knowledge of the Sun's path and a chronometer to measure its time course are required.

Time Compensation

In a variety of cases the Sun's course is compensated for not only during the day but at night when it cannot be observed, a capacity demonstrated when the animal is systematically orienting over 24 hr and allowing for the expected displacement of a stationary artificial Sun (refs. 50 and 53). For animals in

² Compass orientation using the Moon has been recently reported for the mosquitofish *Gambusia* (Goodyear, 1971, in press).

the tropics where the Sun changes its direction of apparent movement with the season and for migratory forms which move from one hemisphere to the other the information required is particularly elaborate (for general discussion see ref. 54, ch. 8).

Time compensated orientation to the Sun was originally demonstrated for the honey bee and the starling by von Frisch (ref. 55) and Kramer (ref. 38), respectively. Similar solar direction finding was reported for the first time in fish (two species of centrarchids, *Lepomis gibbosus* and *L. machrochirus*) by Hasler, Horrall, Wisby and Braemer (ref. 56). Two types of training experiments in an experimental vessel exposed to the Sun and sky showed that these fish could use the solar disc to find a given geographical direction at different times of day.

Obviously the trained direction was a learned component of this behavior pattern, but was the Sun's path through the sky learned or genetically determined? Subse-

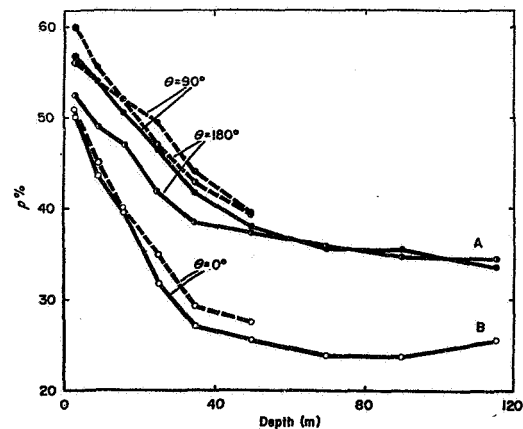

FIGURE 5. Effect of depth on degree of submarine polarization (p) in clear Sargasso Sea water near Bermuda (Secchi disc reading 50 m). Measurements were made in three lines of sight relative to the Sun's bearing (θ). Solid curves: measurements taken without filter; broken lines: with 500 nm narrow band filter (ref. 27).

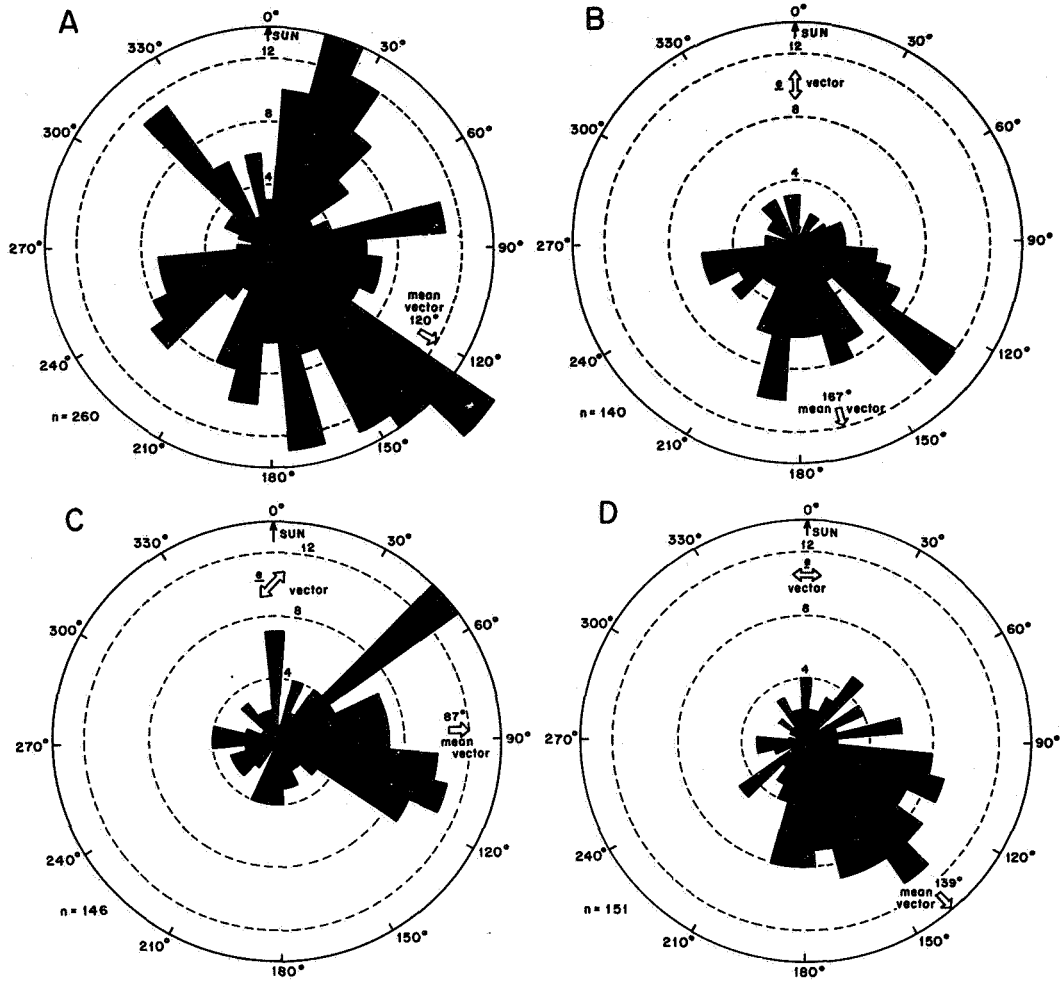

FIGURE 6. Directional orientation of the fish *Zenarchopterus* exposed to natural illumination underwater (A) and to this modified by an overhead polarizer with different e -vector orientations relative to the Sun's bearing at 0° . (B) e -vector 0 and 180° . (C) e -vector 45° and 235° . (D) e -vector 90° and 270° . Radial coordinate represents the number of observations grouped in 10° intervals. Mean vectors for the circular distributions are shown by single-headed broad arrows. The polarizer significantly modified these vectors in (B) and (C) compared to that with no polarizer added (A) (ref. 1).

quent work showed that fish raised without seeing the Sun were nevertheless able to compensate for its movement; therefore, the basic ability must be inherent. Furthermore, the compensation was appropriate to the season and latitude represented by artificial

light-dark cycles under which the fish were kept (ref. 57).

Comparisons between the compensatory capacities of Northern temperate centrarchids and tropical cichlids demonstrated that the former always allowed for clockwise Sun

displacement which is all that is apparent in northern latitudes above the Tropic of Cancer. But the latter could compensate either clockwise or anticlockwise as would be required at different times of year within the tropics (ref. 52).

Occurrence in Fishes

Such direction-finding abilities have been demonstrated in fish orienting in experimental vessels or enclosures for *Lepomis* (3 spp.) (refs. 53 and 56), *Aequidens* (ref. 53), *Oncorhynchus* (refs. 53 and 58), *Cichlaurus*, *Uaru* (ref. 52), *Anableps* (ref. 59), *Anguilla* (ref. 60), *Gambusia* (ref. 61) and *Fundulus* (ref. 62).

Field experiments have also shown that displaced fish in lakes and marine reef areas can find the direction of their usual haunts by similar means (*Roccus*, refs. 56 and 63; *Scarus* (2 spp.), ref. 64; *Oncorhynchus*, ref. 65; *Salmo*, ref. 66). In some of these cases, complete sky overcast produced little deterioration in the orientation (*Anguilla* and *Salmo*), but in most instances orientation became random under this condition although the probability that there may have been other direction-finding modalities was usually not eliminated.

Thus there is no doubt that a wide range of fishes can use a Sun compass for direction finding. However, the field data, due to the difficulties of obtaining them are still rather thin, and the details of the relevant sensory and behavioral mechanisms remain largely to be discovered. For example, most of the experiments have been done in flat calm, very shallow experimental vessels where the shortcomings of submarine optics, discussed above, are minimal if not negligible. This has obviously been important in making it possible to prove the animals' basic capabilities but leaves open many real questions regarding

their specific contributions to the overall functions of orientation and migration.

POLARIZED LIGHT COMPASS

If the preceding statement is true of the intensively studied Sun compass, how much more strongly does it apply to the possibilities of direction finding by underwater polarized light! Here even the basic capacity of fishes to perceive and respond to polarized light has been difficult to demonstrate. Indeed the failure to obtain strong behavioral or physiological responses has so far blocked progress towards understanding the sensory basis and biological significance of this visual capability. Nevertheless, we have recently begun field and laboratory experiments in this area which are making some headway.

Field work carried out in Palau in the Western Caroline Islands during the summer of 1969 showed that *Zenarchopterus* (a tropical West Pacific halfbeak) changed its orientation to Sun and sky when a Polaroid filter was oriented with the *e*-vector in directions different from the plane of polarization in the zenith sky (ref. 1). When the filter's *e*-vector was parallel to that of the zenith, i.e., perpendicular to the Sun's bearing, the spontaneous orientation behavior of the halfbeaks was not different from that without a polarizing filter (fig. 6).

Previous Evidence

Although we were somewhat surprised to find polarized light perception in a fish, there were several inchoate lines of earlier evidence which had suggested it. One of these stemmed from experiments done more than 10 years earlier on several fresh water and marine tropical fish. These were tested for azimuth preferences when exposed to a vertical beam of polarized light. For an animal

like *Daphnia* (refs. 67 to 69) or young cephalopods (ref. 70), which respond strongly to polarized light, the experimental procedure used produces marked peaks in the distribution of the animal's directions around a circle (fig. 7).

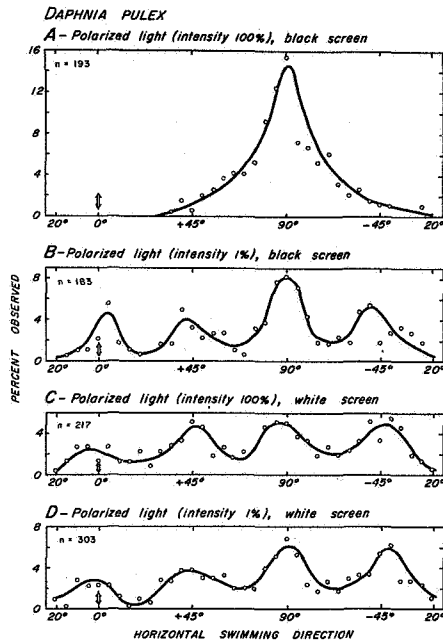

FIGURE 7. Polarotactic responses shown in the laboratory by *Daphnia* swimming in a vertical beam of polarized light. (A) Strong single-peaked orientation 90° to the e -vector observed with high light intensities and a black surround. Weaker responses with four peaks at 0° , 45° , 90° , 135° occur at reduced light intensities with the black surround (the light intensity effect) (B) or at both high and low light intensities with a white surround (the light contrast effect) (C, D). (Ref. 68).

In the fish tested, however, such marked orientation preferences to e -vector orientation were not found. Yet in some cases (e.g., the cichlid *Pterophyllum*), there was marginal evidence for a polarotactic response (ref. 71).

But as rather extensive exploratory experiments failed to elicit stronger responses in this and other species, fishes were then abandoned by the author in favor of arthropods and cephalopods. Soon afterward the fact that some fish trained to use a Sun compass could continue to orient properly for some minutes after sunset was mentioned by Braemer in the discussion of his paper presented to the Deutsche Zoologische Gesellschaft (ref. 53). The fact that sky polarization arising from the primary scattering of the Sun's rays is at its maximum at such times was considered, but apparently no experiments to test its relevance were carried out.

Groot's Data

Somewhat later this same line of thought led to evidence in favor of a polarized light compass in the sockeye salmon (*Onchorhynchus nerka*). While studying the migration of smolts towards the outlet to the sea from Babine Lake and some other British Columbia lakes, Groot's interest was drawn to the fact that these fish were found to be migrating primarily during twilight when the zenith sky is strongly polarized (up to 90 percent) and the Sun's disc is not visible (ref. 58). In addition transposing the apparent position of patches of blue sky with a mirror appeared to have similar effects on salmon orientation to those found in *Apis* (ref. 72) for which the sky polarization pattern had definitely been proven to be important in direction finding.

Experiments on individual smolts exposed to the natural sky in 30 cm diameter by 30 cm tall cylinders of clear plastic were carried out by Groot at noon, afternoon, and twilight. No effects were noted except at twilight. Then rotating a polarizer placed over the vessel through 90° usually was followed by approximately the same angular direction change in the fish's headings. These headings,

however, were at various menotactic angles and not at 0° , 45° , 90° , 135° to the e -vector as in some arthropod and cephalopod basitactic responses to polarized light (refs. 70 and 68).

Also behavior with the polarizer present was different than with it absent. Thus with the e -vector perpendicular to the Sun's bearing the difference in behavior from the control (no polarizer) was greater than it was with the filter e -vector parallel to the Sun's bearing. This seems curious since in the zenith and, indeed, all along the great circle through the Sun and at sunset or sunrise the great circle perpendicular to that, the sky's e -vector is perpendicular to the Sun's bearing. Hence one might expect the least change from the no-filter condition with such an orientation of the imposed polarization. No explanation for this anomaly is available.

Dill's Experiments

Further support for a polarized light sensitivity in *Oncorhynchus* is provided by an unpublished master's thesis by Dill (ref. 73) who worked with Groot. Two kinds of laboratory experiments were done, again with smolts. One test was to see whether the fish's directional preferences were related to e -vector orientation when it was exposed to a vertical beam of polarized light. Comparison of the heading distributions shows that on the basis of a χ^2 test significant differences ($p < 0.01$) from random orientation occurred with a peak located at 22.5° relative to the e -vector when the polarizer was present but not when it was absent ($p > 0.05$). However, an explanation for this persistent menotactic orientation relative to the e -vector in a considerable number of fish tested at different times of day is not obvious.

On the other hand, although more individual fish showed a preferred direction of

orientation with a polarizer present, this was not significantly different from the number of controls which had a preferred direction also. But the "concentration" of headings around the preferred direction was greater with the polarizer than without. Thus while the data are neither unequivocal nor completely explainable, the balance of evidence from this kind of experiment supports polarized light perception. However, the possibility was not checked that light intensity artifacts were involved (refs. 68 and 69).

In a second type of experiment, smolts were trained by Dill to distinguish vertical from horizontal e -vectors with food as a reward. After an initial training period, the cumulative rate of response to the reinforced e -vector (one target with vertical polarization) was clearly greater than that to the nonreinforced plane of polarization (three targets with horizontal polarization.) When the reinforcement was discontinued for the fourth target (now oriented like the others), the rates became the same showing that secondary clues of some sort were not producing the previous results.

While this series of experiments may indeed prove polarized light sensitivity in sockeyes, no control was established on possible reflection artifacts in the setup. This consisted of an octagonal clear plastic experimental vessel with four small square polarizers mounted vertically on alternate faces of the octagon and illuminated from behind. As the vessel was shallow and the polarizers near the bottom, a sharp difference in the bottom reflection would be expected with vertical (dark, due to minimal reflection) vs horizontal (bright, due to maximal reflection) e -vectors. However, no check on this artifact seems to have been made; hence the sceptic might well attribute the fish's learning to intensity differences rather than directly to e -vector perception.

*CURRENT WORK ON
HEMIRHAMPHIDS*

Since our 1969 field experiments on *Zenarchopterus* (ref. 1), we have had during 1970 a second period of extensive field work as well as laboratory experiments on this genus in Palau. These data have been only partly analyzed and so cannot be reported here. However, we have meanwhile undertaken laboratory experiments at Yale on available related fishes. Again their analysis is not complete, and indeed the experiments themselves are not finished, but a preliminary report can be made on results already obtained with the fresh water halfbeak *Dermogenys* from South East Asia.

As mentioned above, finding an experimental procedure to evoke strong *e*-vector responses from fishes has so far proved rather difficult. However, a particular technique worked out by Richard B. Forward, Jr., in collaboration with the author, is proving reasonably productive. As employed with *Dermogenys* tests are being run as follows:

Mature *Dermogenys pusillus* Van Hasselt were obtained from commercial aquarists and kept on a 12 hr light-dark cycle with the light phase starting at 9 a.m. For the experiments individual fish are placed in a shallow cylindrical clear plastic vessel, screened laterally with a white surround and exposed to a downward vertical beam of light. This light beam has in its path a Polaroid filter (white light between 99 to 100 percent polarized) mounted together with two sheets of wax paper acting as a depolarizer (fully polarized white light scrambled to about 4 percent polarized). For testing the effect of *e*-vector, the depolarizer precedes the polarizer in the beam and randomly selected *e*-vector orientations were tested at 10° intervals over 180°. For control runs the polarizer precedes the depolarizer in the optic train, and the polar-

izer-depolarizer is again randomly oriented in 10° steps to eliminate possible artifacts relating to any unsuspected asymmetry it might have.

After a 5 min wait in the light for the fish to calm down, the light is turned off. Following 1 min in the dark, the vertical beam is turned on again and a sequence of 13 pictures taken at a rate of 1/sec by a camera viewing the experimental vessel from below. Polarized and depolarized tests are run alternately and eight sequences carried out on each individual fish. In the data here reported, 38 fish are included.

The directional behavior has been analyzed by measuring the direction of the fish's heading in each frame and correlating the number of "pauses" (counted as angular changes of 0° or 10° between successive frames) with the *e*-vector orientation in which they occurred.

While some of the runs look highly correlated with the polarization, others do not. Correspondingly the total data do not show significant preferential orientation. However, if the runs done in the morning are separated from afternoon runs, a significant difference does appear. Consequently, four categories need to be considered: AM polarized, AM depolarized, PM polarized and PM depolarized.

Only the first of these shows significant deviation from a random orientation (figs. 8 and 9). In the morning polarizer-present case peaks are present at 40° and 130° oblique to the *e*-vector. A χ^2 test shows that in this case the distribution is nonrandom ($p > 0.01$), but that the 40° individual peak does not differ significantly from the mean. However, since these data were obtained in the spring of 1970, 14 more *Dermogenys* have been run in the same way with similar results. Consequently the N's are now sufficiently large so that both the 40° and 130°

peaks can be shown to differ from the mean of all the angles tested at the $p > 0.005$ level.

Polarotaxis with 45° and 135° preferred directions has been observed previously in insects (refs. 73 and 74). Multiple peak basitaxes with preferred directions at 0° , 90° or 0° , 45° , 90° , 135° have been widely demonstrated in one water mite, a considerable range of crustaceans and insects as well as in cephalopods (ref. 75). Their occurrence implies interesting trigonometric processing of the visual information and the consequent motor output (ref. 76), but relatively little is known about this. One exception to such general ignorance is that the input for polarized light perception is known to be organ-

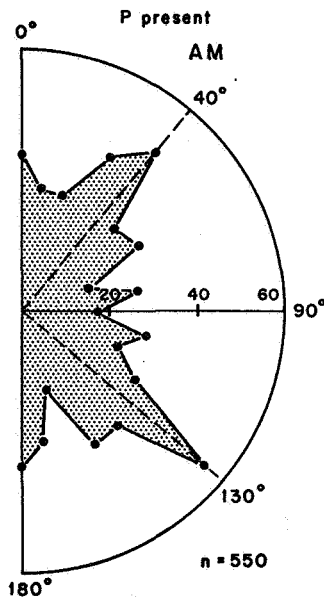

FIGURE 8. Polarotactic responses of the fish *Dermogenys* exposed in the laboratory to a vertical beam of polarized light. Clear maxima occurred at oblique angles to the e -vector (40° , 130°). This data was taken in morning experiments. Compare figure 9 (R. B. Forward, Jr., and the author, unpublished).

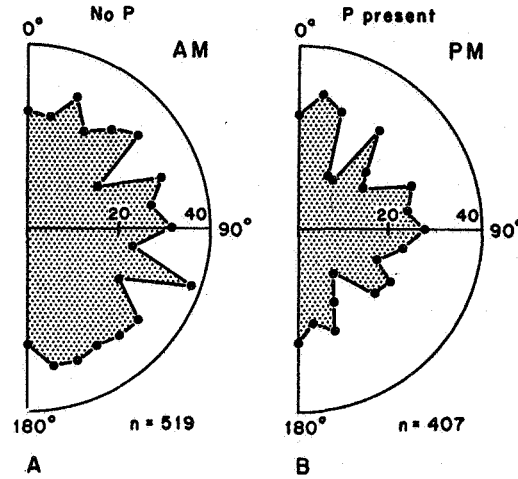

FIGURE 9. Absence of significant preferential orientation of the fish *Dermogenys* in control experiments in the laboratory using an unpolarized vertical light beam as well as in afternoon experiments with the beam polarized. (A) Not polarized, AM experiments. (B) Polarized, PM experiments. Compare figure 8 (R. B. Forward, Jr., and the author, unpublished).

ized in two orthogonal channels in decapod crustaceans at least (refs. 77 to 83).

PROBLEM OF MECHANISM

The similarity of the fish and insect oblique polarotactic pattern is an interesting parallelism particularly since the vertebrates in general lack the fine structural details that endow the rhabdom-bearing eyes of arthropods and cephalopods with their e -vector sensitivity. The critical matter here is the construction of the photoreceptor organelle (the rhabdom) out of a large number of regularly arranged microvilli that contain all or most of the visual pigment (refs. 82 and 84). For the single photoreceptor cell of which they are an elaboration of the cell membrane, all the microvilli are parallel to one another and perpendicular to the local optic axis of the

receptor. Direct microspectrophotometric measurement has shown in isolated crustacean rhabdoms that dichroism of the visual pigment, presumably effective because of the regularity of its molecular arrangement in the receptor membranes, allows individual cells to be differentially sensitive to e -vector orientation (refs. 82, 83, and 85) (fig. 10).

In contrast fish eyes, like those of other vertebrates, lack rhabdoms entirely and have their photoreceptor membranes organized in stacks of plates that are isotropic to polarized light traversing the outer segment axially as in normal vision. Consequently a retinal mechanism for e -vector sensitivity would appear to be lacking although the widespread occurrence of regularly arranged twin cones in teleost retinas (refs. 86 and 87) might somehow be involved.³

Retinal Mechanism

Fairly extensive measurements of receptor potentials, s -potentials, and ganglion cell spike frequencies in isolated fragments of goldfish retina have failed to disclose any significant polarized light discrimination.⁴ The goldfish has not been proved behaviorally to respond to e -vector orientation, so perhaps our failure to record retinal responses to polarization is not surprising; yet if we accept the provisional evidence that cichlids, salmonids, and hemirhamphids can see polarized light, the capacity seems rather widespread in teleosts.

Indeed our negative results so far with the fish retina should not be considered definitive because repeated earnest attempts to record polarized light discriminating fibers in the optic nerve of decapod crustaceans did

not produce convincing results on this point (refs. 88 and 89). Subsequently extensive data of various kinds were obtained for e -vector discrimination at the retinal level (in addition to the earlier behavioral evidence); and, recently in fact successful recordings from two categories of optic nerve fibers, maximally sensitive to orthogonal e -vectors, have been achieved in the crayfish.⁵

Extraretinal Mechanism

Of course, there is the possibility that polarized light responses in fish depend on some extraretinal mechanism. In man the perception of polarized light depends on the dichroism of the yellow macular pigment on the surface of the central retina, but this alternative is quite unlikely in teleosts since macular pigment is limited to primates (ref. 87). However, there is some evidence that the adipose eyelid present in many fishes is both birefringent and dichroic (ref. 90).

For example in the Pacific herring *Clupea pallasii* 40 percent less linearly polarized light is transmitted by the fresh adipose eyelid when the e -vector is vertical (i.e., parallel to the dorso-ventral axis) than when it is horizontal (ref. 90). Hence fish with such a structure over their cornea may be able to use it as an e -vector analyzer; but even if this were so, it does not solve the general problem. For one thing the e -vector discrimination found in *Oncorhynchus* was unaffected by adipose eyelid removal (ref. 73). However, only a small portion of the posterior adipose eyelid of salmonids (which is reduced compared to clupeids and some other teleosts) overlies the eye (ref. 90), so that Dill's experiment may not be a critical test of the general visual significance of this structure.

Furthermore the alternative that the *On-*

³ G. D. Bernard, personal communication, 1969.

⁴ H. Hashimoto, in collaboration with the author, unpublished, 1970.

⁵ Yamaguchi, in press, 1971.

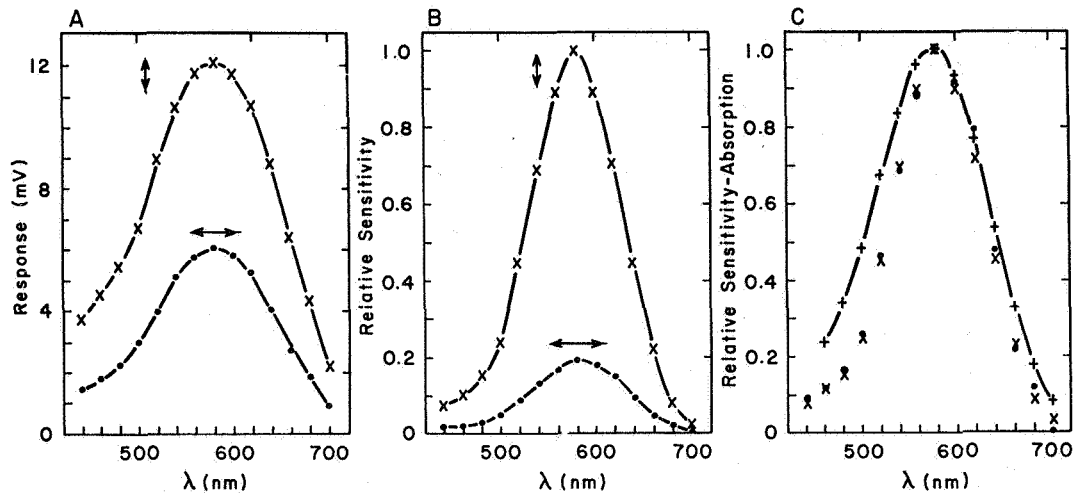

FIGURE 10. Differential sensitivity to polarized light in a single reticular cell of the compound eye of the crayfish *Procambarus*. This receptor cell had a λ_{\max} at 580 nm and was 5.25 \times more sensitive to vertical (dorso-ventral) than horizontal e -vectors (shown by double-headed arrows). (A) Spectral response curves obtained from intracellular receptor potentials. (B) Relative spectral sensitivities calculated from A and the response energy curve. (C) Normalized relative spectral sensitivities for the two e -vector directions compared with the absorption spectrum calculated from the Dartnall nomogram for a vertebrate visual pigment with λ_{\max} at 580 nm (ref. 83).

corhynchus adipose eyelid is too small to act in e -vector discrimination indicates that some other mechanism is responsible for the salmon's apparent perception of polarized light. This is certainly true of *Pterophyllum*, *Zenarchopterus*, and *Dermogenys* which lack adipose eyelids altogether. Nevertheless further study of possible polarized light responses in fish which do have well developed adipose eyelids seems highly desirable.

Another intriguing possibility is that some sort of extraocular sensory perception of light (EOP) might be involved in fish polarized light sensitivity. We know that in certain copepods their median naupliar eye can effectively analyze polarized light (refs. 91 and 92); but there, as in the arthropod lateral eye, regularly arranged microvilli are apparently involved in the mechanism (ref. 93). As possible analogs of the naupliar eye, the mid-

brain region, and its associated appendages, the parapineal (parietal) and pineal bodies may provide likely sites of EOP in fishes since all these are known to be light sensitive (ref. 94).

Yet no rhabdom-like membrane systems have been reported. Instead stacked lamellar elements resembling cone outer segments have been widely found, more specifically in the pineal (e.g., ref. 95). Although such structures in the retina are well known to be isotropic along their normal optic axis, rod outer segments are strongly dichroic for light transmitted perpendicularly to that axis (see discussion and references in ref. 82). However, no data on the occurrence and possible significance of these properties are available for fish pineal photoreceptor cells.

Alternatively the possibility that dichroism of the skin or skull over this region might

confer polarized light sensitivity on certain fishes has been considered.⁶ But at least in *Zenarchopterus* no evidence for significant dichroism was found in the appropriate regions of freshly dissected specimens (ref. 1).

However, amphibians (*Acris* and *Ambystoma*) have recently been demonstrated to be capable of celestial orientation after their eyes have been removed but not when the midbrain region of the skull was covered by an opaque subdermal screen in blinded specimens (refs. 96 and 97). Also phototaxis and photokinesis in some fishes are affected by the pineal (e.g., refs. 94 and 98) but in other species are not (ref. 99). Thus there are several intriguing lines of research that need to be systematically followed up for their real relevance to the problems of visual direction finding by fishes.

SUMMARY

The particular conditions of underwater vision sharply restrict the scope of visual direction finding potentially available to fishes and other aquatic animals. These restrictions stem both from the rapid absorption of sunlight by the water which leaves 75 percent or more of the sea's volume without daylight and from the marked scattering of light even in the clearest of water which rapidly results in image deterioration.

One consequence of this scattering may, however, be of use in underwater direction finding, namely the Sun-dependent polarization patterns in the water. These can reach maxima of at least 60 percent polarization and have been proved photographically to provide clear evidence for the Sun's azimuth at depths down to 200 m which are considerably greater than estimates of maximum depths at which the Sun's disc or the subma-

rine radiance distribution could be used for this purpose. The feasibility of such a time-compensated celestial compass has been repeatedly supported by the demonstration of a direct Sun compass in a wide variety of fishes (as well as other animals).

However, the relevance of the natural polarization pattern as a potential underwater Sun compass for fishes is problematic for several reasons. To begin with, demonstrating that fish can discriminate the plane of linearly polarized light has proved difficult because the behavior patterns used as evidence have been rather weak and the possibility of intensity artifacts has not yet been adequately controlled. Nevertheless there is an accumulating body of data supporting polarization perception in fish—more particularly our continuing field and laboratory experiments on tropical hemirhamphid teleosts. These should soon permit the testing of differential intensity effects and the demonstration of sensory mechanisms.

ACKNOWLEDGMENT

The author's research program is supported by grants from the National Institutes of Health, the National Geographic Society, and the National Aeronautic and Space Administration.

DISCUSSION

GWINNER: Is it correct that the altitude of the Sun could enter into the orientation pattern through polarized light?

WATERMAN: Yes. Braemer and Schwassmann showed that cichlids would change their behaviorally conditioned direction if the apparent altitude of the Sun was modified without altering its bearing. They used a mirror to reverse the Sun's apparent direction by 180° and then changed its apparent altitude by tilting the mirror. They did get a significant shift in the fishes' directional behavior. Since the Sun's altitude, as well as its bearing, affects the underwater polarization pattern, it could also influence orientation there.

⁶T. Kuroki, personal communication, 1968.

REFERENCES

1. WATERMAN, T. H.; AND FORWARD, R. B., JR.: Field Evidence for Polarized Light Sensitivity in the Fish *Zenarchopterus*. *Nature*, vol. 228, 1970, pp. 85-87.
2. WATERMAN, T. H.: Polarization Patterns in Submarine Illumination. *Science*, vol. 120, 1954, pp. 927-932.
3. WATERMAN, T. H.: Polarized Light and Plankton Navigation. *In: Perspectives in Marine Biology*, A. A. Buzzati-Traverso, ed., University of California Press, 1958, pp. 429-450.
4. COX, C. S.; AND MUNK, W. H.: Statistics of the Sea Surface Derived from Sun Glitter. *J. Mar. Res.*, vol. 13, 1954, pp. 198-227.
5. COX, C. S.; AND MUNK, W. H.: Slopes of the Sea Surface Deduced from Photographs of Sun Glitter. *Bull. Scripps Inst. Oceanog.*, Univ. Calif., vol. 6, 1956, pp. 401-488.
6. JERLOV, N. G.: *Optical Oceanography*. Elsevier, 1968.
7. CLARKE, G. L.; AND KELLY, M. G.: Variation in Transparency and in Bioluminescence on Longitudinal Transects in the Western Indian Ocean. *Bull. Inst. Oceanog.*, vol. 1319, 1964, pp. 1-20.
8. SMITH, R. C.; AND TYLER, J. E.: Optical Properties of Clear Natural Water. *J. Opt. Soc. Am.*, vol. 57, 1967, pp. 589-595.
9. COLLINGBOURNE, R. H.: General Principles of Radiation Meteorology. *In: Light as an Ecological Factor*, R. Bainbridge, G. C. Evans and O. Rackham, eds., Blackwell, 1966, pp. 1-39.
10. HEMMINGS, C. C.: Factors Influencing the Visibility of Objects Underwater. *In: Light as an Ecological Factor*, R. Bainbridge, G. C. Evans and O. Rackham, eds., Blackwell, 1966, pp. 359-374.
11. LYTHGOE, J. N.: Visual Pigments and Underwater Vision. *In: Light as an Ecological Factor*, R. Bainbridge, G. C. Evans and O. Rackham, eds., Blackwell, 1966, pp. 375-391.
12. BUSBY, R. F.: Undersea Penetration by Ambient Light, and Visibility. *Science*, vol. 158, 1967, pp. 1178-1180.
13. DUNTLEY, S. Q.: Underwater Visibility. *In: The Sea*, vol. 1, M. N. Hill, ed., Interscience, 1962, pp. 452-455.
14. LYTHGOE, J. N.: Visual Pigments and Visual Range Underwater. *Vision Res.*, vol. 8, 1968, pp. 997-1012.
15. WATERMAN, T. H.; NUNNEMACHER, R. F.; CHACE, F. A., JR.; AND CLARKE, G. L.: Diurnal Vertical Migrations of Deep-Water Plankton. *Biol. Bull.*, vol. 76, 1939, pp. 256-279.
16. CLARKE, G. L.; AND DENTON, E. J.: Light and Animal Life. *In: The Sea*, vol. 1, M. N. Hill, ed., Interscience, 1962, pp. 456-468.
17. HARDEN JONES, F. R.: *Fish Migration*. St. Martin's Press, 1968.
18. HUTCHINSON, G. E.: *A Treatise on Limnology*. Vol. 1, Wiley, 1957.
19. BRIDGES, C. D. B.: Absorption Properties, Interconversions and Environmental Adaptation of Pigments from Fish Photoreceptors. *Cold Spr. Hrbr. Symp. Quant. Biol.*, vol. 30, 1965, pp. 317-334.
20. DARTNALL, H. J. A.; AND LYTHGOE, J. N.: The Spectral Clustering of Visual Pigments. *Vision Res.*, vol. 5, 1965, pp. 81-100.
21. NICOL, J. A. C.: Some Aspects of Photoreception and Vision in Fishes. *In: Advances in Marine Biology*, vol. 1, F. S. Russell, ed., Academic, 1963, pp. 171-208.
22. IVANOFF, A.: Au sujet du facteur de polarisation de la lumière solaire dans la mer. *Compt. Rend. Acad. Sci. Paris*, vol. 241, 1955, pp. 1809-1811.
23. WATERMAN, T. H.; AND WESTELL, W. E.: Quantitative Effect of the Sun's Position on Submarine Light Polarization. *J. Mar. Res.*, vol. 15, 1956, pp. 149-169.
24. WATERMAN, T. H.: Polarization of Scattered Sunlight in Deep Water. *Deep Sea Res.*, vol. 3, suppl., 1955, pp. 426-434.
25. TYLER, J. E.: Estimation of Percent Polarization in Deep Oceanic Water. *J. Mar. Res.*, vol. 21, 1963, pp. 102-109.
26. BEARDSLEY, G. F., JR.: The Polarization of the Near Asymptotic Light Field in Sea Water. Thesis, Massachusetts Institute of Technology, 1966.
27. IVANOV, A.; AND WATERMAN, T. H.: Factors, Mainly Depth and Wavelength, Affecting Underwater Polarized Light. *J. Mar. Res.*, vol. 16, 1958, pp. 283-307.
28. IVANOFF, A.: Contribution à l'étude des propriétés optiques de l'eau de mer en Bretagne et en Corse, et la théorie de la polarisation sousmarine. *Ann. Géophys.*, vol. 13, 1957, pp. 22-53.

29. IVANOFF, A.; JERLOV, N.; AND WATERMAN, T. H.: A Comparative Study of Irradiance, Beam Transmittance and Scattering in the Sea near Bermuda. *Limnol. Oceanog.*, vol. 6, 1961, pp. 129-153.
30. WATERMAN, T. H.: Polarotaxis and Primary Photoreceptor Events in Crustacea. *In: The Functional Organization of the Compound Eye*, C. G. Bernhard, ed., Pergamon, 1966, pp. 493-511.
31. NEUYMIN, H. G.: Inhomogeneities of Optical Properties in Deep Ocean Waters. *J. Opt. Soc. Am.*, vol. 60, 1970, pp. 690-693.
32. SANTSCHI, F.: Observations et remarques critiques sur le mécanisme de l'orientation chez les fourmis. *Rev. Suisse Zool.*, vol. 19, 1911, pp. 303-338.
33. ENRIGHT, J. T.: Lunar Orientation of *Orchestoidea corniculata* Stout. *Biol. Bull.*, vol. 120, 1961, pp. 148-156.
34. PAPI, F.; AND PARDI, L.: On the Lunar Orientation of Sandhoppers (Amphipoda Talitridae). *Biol. Bull.*, vol. 124, 1963, pp. 97-105.
35. FERGUSON, D. E.; LANDRETH, H. F.; AND TURNPISEED, M. R.: Astronomical Orientation of the Southern Cricket Frog, *Acris gryllus*. *Copeia*, vol. 1965, 1965, pp. 58-66.
36. SAUER, F.: Die Sternorientierung nächtlich ziehender Grasmücken (*Sylvia atricapilla borin* und *curruca*). *Z. Tierpsychol.*, vol. 14, 1957, pp. 29-70.
37. EMLEN, S. T.: Celestial Rotation: Its Importance in the Development of Migratory Orientation. *Science*, vol. 170, 1970, pp. 1198-1201.
38. KRAMER, G.: Orientierte Zugaktivität gekäfigter Singvögel. *Naturwiss.*, vol. 37, 1950, p. 188.
39. EHRENFELD, D. W.; AND CARR, A.: The Role of Vision in the Sea-Finding Orientation of the Green Turtle (*Chelonia mydas*). *Anim. Behav.*, vol. 15, 1967, pp. 25-36.
40. EHRENFELD, D. W.: The Role of Vision in the Sea-Finding Orientation of the Green Turtle (*Chelonia mydas*). 2. Orientation Mechanism and Range of Spectral Sensitivity. *Anim. Behav.*, vol. 16, 1968, pp. 281-287.
41. VON FRISCH, K.: Gelöste und ungelöste Rätsel der Bienensprache. *Naturwiss.*, vol. 35, 1948, pp. 38-43.
42. FRAENKEL, G. S.; AND GUNN, D. L.: *The Orientation of Animals*. Dover, 1961.
43. AUTRUM, H.-J. (ed.): *Orientierung der Tiere*. *Ergbn. Biol.*, vol. 26, Springer, 1963.
44. LINDAUER, M.: Kompassorientierung. *Ergbn. Biol.*, vol. 26, 1963, pp. 158-181.
45. STORM, R. M. (ed.): *Animal Orientation and Navigation*. Oregon State University Press, 1966.
46. ADLER, H. E.: Ontogeny and Phylogeny of Orientation. *In: Development and Evolution of Behavior: Essays in Memory of T. C. Schneirla*. L. R. Aronson, E. Tobach, D. S. Lehrman and J. S. Rosenblatt, eds., Freeman, 1970, pp. 303-336.
47. VON BUDDENBROCK, W.: Die Lichtkompassbewegungen bei den Insekten, insbesondere den Schmetterlingsraupen. *Sitz.-Bericht Heidelberger Akad. Wiss.*, vol. 8B, 1917, pp. 1-26.
48. VON BUDDENBROCK, W.: Beiträge zur Lichtkompassbewegung (Menotaxis) der Arthropoden. *Z. vergl. Physiol.*, vol. 15, 1931, pp. 597-612.
49. JANDER, R.: Grundleistungen der Licht- und Schwereorientierung von Insekten. *Z. vergl. Physiol.*, vol. 47, 1963, pp. 381-430.
50. BRAEMER, W.: A Critical Review of the Sun-Azimuth Hypothesis. *Cold Spr. Hrbr. Symp. Quant. Biol.*, vol. 25, 1960, pp. 413-427.
51. BRAEMER, W.; AND SCHWASSMANN, H. O.: Vom Rhythmus der Sonnenorientierung am Äquator (bei Fischen). *Ergbn. Biol.*, vol. 26, 1963, pp. 182-201.
52. SCHWASSMANN, H. O.; AND HASLER, A. D.: The Role of the Sun's Altitude in Sun Orientation of Fish. *Physiol. Zool.*, vol. 37, 1964, pp. 163-178.
53. BRAEMER, W.: Versuche zu der im Richtungsgehen der Fische enthaltenen Zeitschätzung. *Verh. Deut. Zool. Ges. Zool. Anz.*, vol. 23, suppl., 1959, pp. 276-288.
54. HASLER, A. D.: *Underwater Guideposts*. University of Wisconsin Press, 1966.
55. VON FRISCH, K.: Die Sonne als Kompass im Leben der Bienen. *Experientia*, vol. 6, 1950, pp. 210-221.
56. HASLER, A. D.; HERRALL, R. M.; WISBY, W. J.; AND BRAEMER, W.: Sun-Orientation and Homing in Fishes. *Limnol. Oceanog.*, vol. 3, 1958, pp. 353-361.
57. SCHWASSMANN, H. O.; AND BRAEMER, W.: The Effect of Experimentally Changed Pho-

- toperiod on the Sun-Orientation Rhythm of Fish. *Physiol. Zool.*, vol. 34, 1961, pp. 273-286.
58. GROOT, C.: On the Orientation of Young Sockeye Salmon (*Oncorhynchus nerka*) During Their Seaward Migration out of the Lakes. *Behaviour*, suppl., vol. 14, Brill., Leiden, 1965.
 59. SCHWASSMANN, H. O.: Orientation of Amazonian Fishes to the Equatorial Sun. *Atas Symp. Biota Amazónica*, vol. 3 (*Limnologia*), 1967, pp. 201-220.
 60. MILES, S. G.: Laboratory Experiments on the Orientation of the Adult American Eel, *Anguilla rostrata*. *J. Fish. Res. Bd., Canada*, vol. 25, 1968, pp. 2143-2155.
 61. GOODYEAR, C. P.; AND FERGUSON, D. E.: Sun-Compass Orientation in the Mosquitofish, *Gambusia affinis*. *Anim. Behav.*, vol. 17, 1969, pp. 636-640.
 62. GOODYEAR, C. P.: Terrestrial and Aquatic Orientation in the Starhead Topminnow, *Fundulus nottii*. *Science*, vol. 168, 1970, pp. 603-605.
 63. HASLER, A. D.; GARDELLA, E. S.; HERRALL, R. M.; AND HENDERSON, H. F.: Open-Water Orientation of White Bass, *Roccus chrysops*, as Determined by Ultrasonic Tracking Methods. *J. Fish. Res. Bd., Canada*, vol. 26, 1969, pp. 2173-2192.
 64. WINN, H. E.; SALMON, M.; AND ROBERTS, N.: Sun-Compass Orientation by Parrot Fishes. *Z. Tierpsychol.*, vol. 21, 1964, pp. 798-812.
 65. GROOT, C.; AND WILEY, W. L.: Time-Lapse Photography of an ASDIC Echo-Sounder PPI-Scope as a Technique for Recording Fish Movements During Migration. *J. Fish. Res. Bd., Canada*, vol. 22, 1965, pp. 1025-1034.
 66. McCLEAVE, J. D.; AND HERRALL, R. M.: Ultrasonic Tracking of Homing Cutthroat Trout (*Salmo clarki*) in Yellowstone Lake. *J. Fish. Res. Bd., Canada*, vol. 27, 1970, pp. 715-730.
 67. BAYLOR, E. R.; AND SMITH, F. E.: The Orientation of Cladocera to Polarized Light. *Am. Naturalist*, vol. 87, 1953, pp. 97-101.
 68. JANDER, R.; AND WATERMAN, T. H.: Sensory Discrimination Between Polarized Light and Light Intensity Patterns by Arthropods. *J. Cell. Comp. Physiol.*, vol. 56, 1960, pp. 137-160.
 69. WATERMAN, T. H.: Interaction of Polarized Light and Turbidity in the Orientation of *Daphnia* and *Mysidium*. *Z. vergl. Physiol.*, vol. 43, 1960, pp. 149-172.
 70. JANDER, R.; DAUMER, K.; AND WATERMAN, T. H.: Polarized Light Orientation by Two Hawaiian Decapod Cephalopods. *Z. vergl. Physiol.*, vol. 46, 1963, pp. 383-394.
 71. WATERMAN, T. H.: The Problem of Polarized Light Sensitivity. (Abstr.) *Proc. XV Internat. Congr. Zool., London, 1958-1959*, pp. 537-539.
 72. VON FRISCH, K.: Die Polarisation des Himmelslichtes als orientierender Faktor bei den Tänzern der Bienen. *Experientia*, vol. 5, 1949, pp. 142-148.
 73. DILL, P. A.: Polarized Light Perception by Yearling Sockeye Salmon (*Oncorhynchus nerka*). Master's Thesis, University of British Columbia, 1965.
 74. JACOBS-JESSEN, U.: Zur Orientierung der Hummeln und einiger anderer Hymenopteren. *Z. vergl. Physiol.*, vol. 41, 1959, pp. 597-641.
 75. WATERMAN, T. H.: Specific Effects of Polarized Light on Organisms. *In: Environmental Biology*, P. L. Altman and D. S. Dittmer, eds., *Fed. Am. Soc. Exptl. Biol.*, 1966, pp. 155-165.
 76. WATERMAN, T. H.: Systems Analysis and the Visual Orientation of Animals. *Am. Scientist*, vol. 54, 1966, pp. 15-45.
 77. SHAW, S. R.: Polarized Light Responses from Crab Retinula Cells. *Nature (London)*, vol. 211, 1966, pp. 92-93.
 78. SHAW, S. R.: Sense-Cell Structure and Interspecies Comparisons of Polarized Light Absorption in Arthropod Compound Eyes. *Vision Res.*, vol. 9, 1969, pp. 1031-1040.
 79. WATERMAN, T. H.: Information Channeling in the Crustacean Retina. *In: Proc. Symp. Information Processing in Sight Sensory Systems*, P. W. Nye, ed., *National Institutes of Health and California Institute of Technology*, 1966, pp. 48-56.
 80. WATERMAN, T. H.; AND HORCH, K. W.: Mechanism of Polarized Light Perception. *Science*, vol. 154, 1966, pp. 467-475.
 81. EGUCHI, E.; AND WATERMAN, T. H.: Cellular Basis for Polarized Light Perception in the

- Spider Crab, *Libinia*. Z. Zellforsch., vol. 84, 1968, pp. 87-101.
82. WATERMAN, T. H.; FERNANDEZ, H. R.; AND GOLDSMITH, T. H.: Dichroism of Photosensitive Pigment in Rhabdoms of the Crayfish *Orconectes*. J. Gen. Physiol., vol. 54, 1969, pp. 415-432.
 83. WATERMAN, T. H.; AND FERNÁNDEZ, H. R.: E-Vector and Wavelength Discrimination by Reticular Cells of the Crayfish *Procambarus*. Z. vergl. Physiol., vol. 68, 1970, pp. 154-174.
 84. EGUCHI, E.: Rhabdom Structure and Receptor Potentials in Single Crayfish Reticular Cells. J. Cell. Comp. Physiol., vol. 66, 1965, pp. 411-429.
 85. HAYS, D.; AND GOLDSMITH, T. H.: Microspectrophotometry of the Visual Pigment of the Spider Crab *Libinia emarginata*. Z. vergl. Physiol., vol. 65, 1969, pp. 218-232.
 86. ENGSTROM, K.: Cone Types and Cone Arrangements in Teleost Retinae. Acta Zool. (Stockholm), vol. 44, 1963, pp. 179-243.
 87. WALLS, G. L.: The Vertebrate Eye and its Adaptive Radiation. Hafner, 1963.
 88. WATERMAN, T. H.; AND WIERSMA, C. A. G.: Electrical Responses in Decapod Crustacean Visual Systems. J. Cell. Comp. Physiol., vol. 61, 1963, pp. 1-16.
 89. WATERMAN, T. H.; WIERSMA, C. A. G.; AND BUSH, B. M. H.: Afferent Visual Responses in the Optic Nerve of the Crab, *Podophthalmus*. J. Cell. Comp. Physiol., vol. 63, 1964, pp. 135-156.
 90. STEWART, K.: Observations on the Morphology and Optical Properties of the Adipose Eyelid of Fishes. J. Fish. Res. Bd., Canada, vol. 19, 1962, pp. 1161-1162.
 91. UMMINGER, B. L.: Polarotaxis in Copepods. I. An Endogenous Rhythm in Polarotaxis in *Cyclops vernalis* and its Relation to Vertical Migration. Biol. Bull., vol. 135, 1968, pp. 239-251.
 92. UMMINGER, B. L.: Polarotaxis in Copepods. III. A Light Contrast Reaction in *Diaptomus shoshone* Forbes. Crustaceana, vol. 16, 1969, pp. 202-204.
 93. UMMINGER, B. L.: Polarotaxis in Copepods. II. The Ultrastructural Basis and Ecological Significance of Polarized Light Sensitivity in Copepods. Biol. Bull., vol. 135, 1968, pp. 252-261.
 94. FENWICK, J. C.: The Pineal Organ. In: Fish Physiology, vol. IV, W. S. Hoar and D. J. Randall, eds., Academic, 1970, pp. 91-108.
 95. RÜDEBERG, C.: Structure of the Pineal of the Sardine, *Sardina pilchardus sardina* (Russo), and Some Further Remarks on the Pineal Organ of *Mugil* spp. Z. Zellforsch., vol. 84, 1968, pp. 219-237.
 96. TAYLOR, D. H.: Biological Clock Control and Extraoptic Photoperception in the Tiger Salamander, *Ambystoma Tigrinum*. (Abstr.) Am. Zoologist, vol. 10, 1970, p. 474.
 97. TAYLOR, D. H.; AND FERGUSON, D. E.: Extraoptic Celestial Orientation in the Southern Cricket Frog *Acris gryllus*. Science, vol. 168, 1970, pp. 390-392.
 98. BREDER, C. M.; AND RASQUIN, P.: Comparative Studies in the Light Sensitivity of Blind Characins from a Series of Mexican Caves. Am. Museum Novitates, vol. 89, 1947, pp. 325-351.
 99. HAFEEZ, M. A.; AND QUAY, W. B.: The Role of the Pineal Organ in the Control of Phototaxis and Body Coloration in the Rainbow Trout (*Salmo gairdneri* Richardson). Z. vergl. Physiol., vol. 68, 1970, pp. 403-416.