

# THE BOEING 747 FATIGUE INTEGRITY PROGRAM

By Max M. Spencer  
The Boeing Company  
Everett, Washington, U.S.A.

1072-29898

## INTRODUCTION

3

The Boeing 747 is designed and certified as a fail-safe airplane. (See ref. 1.) The fatigue integrity program was established to insure economic operations and to provide foundation data for inspection and maintenance. Significant features of the 747 fatigue integrity program are

1. Fatigue analyses which are continually updated to reflect design changes, fatigue test results, and static and flight load survey measurements
2. Material selection and detail design by using initial fatigue analyses, service experience, and testing
3. Fatigue testing to check detail design quality and to verify the analyses, culminated by the test of a structurally complete airframe

These three features are interrelated during all program phases of conception, design, design check, production, and operation.

Desired fatigue reliability levels are established by using data from statistical studies on military as well as commercial fleets. Appropriate fatigue reliability factors (scatter factors) are considered in the fatigue life evaluations. Essential fatigue analysis factors are fatigue loading environment, load-stress relationships, fatigue performance data (S-N curves), and cumulative damage theory.

The 747 fatigue loading environments were established by using NASA, military, and Boeing data, in conjunction with aircraft aerodynamics and loads data, customer route structure analyses, and flight load surveys. Because of the airplane size and the complex landing-gear system, the 747 ground-handling and landing load spectra received special attention.

Fatigue stress analyses were performed with the aid of experimental as well as analytical procedures. Extensive application was made of the stress severity factor, developed at Boeing, for evaluating peak stresses in complex joints.

A frame of reference was established by families of structural fatigue performance curves (S-N curves) encompassing the range of materials and fatigue qualities anticipated for the 747 airplane design. Modifications to the endurance limit and the low-stress region of the curves were made by using service experience and structural

component and full-scale fatigue tests. These modifications were necessary to account for the inherent shortcoming of Miner's method for predicting fatigue life for spectrum-loaded structures by using constant-amplitude generated S-N curves.

Each family of fatigue performance curves was assigned a fatigue quality identified by a fatigue performance index (FPI). The FPI of structural details was estimated by a semiempirical relationship.

The most significant factors in attaining satisfactory fatigue quality are detail design and material selection. From previous airplane experience and initial fatigue analyses, material was selected which satisfied the static, fatigue, and fail-safe requirements. Careful consideration to detail design with respect to fatigue and fail safety was given to all primary structural components.

All major details on the airplane were analyzed by using the technique outlined above. These analyses were verified by extensive full-scale and component tests. Fatigue developmental and verification tests conducted specifically for the 747 airplane included

- Quonset-hut tests

- Wing, body, and nose landing-gear tests

- Outboard-flap functional and fatigue tests

- Full-scale horizontal-tail tests

- Fuselage crown stringer splice tests

- Side-of-body rib-component tests

- Numerous small-scale specimen tests concerning –

  - Shot peening

  - Fastener development

  - Cold working

  - Wing—side-of-body joint configuration

  - Window forging configurations

In addition, a full-scale airplane fatigue test is in progress. This test utilizes a flight-by-flight load spectrum including pressure cycles applied in a manner to represent the fatigue loading during a typical flight. The test objectives are to

1. Locate any fatigue-critical areas early in production
2. Provide test data for analytical service-life prediction

3. Help develop inspection and maintenance procedures

4. Evaluate fail-safe characteristics of major structural components and assemblies

The 747 fatigue integrity program provides a high degree of confidence in the ability of the structure to withstand service loads. Safe and economic operation is insured by the continual updating of analyses to reflect design changes and fatigue test results.

#### SYMBOLS

D	drag load
d	diameter, inches
$F_{MEAN}$	mean stress
g	acceleration due to gravity
$K_t$	stress concentration factor
$K_{t,b}$	bearing stress concentration factor
$K_{t,g}$	gross-area stress concentration factor
$\Delta P$	load transferred
$P - \Delta P$	bypass load
S	side load
T	torque
t	thickness, inches
V	vertical load
w	width, inches
$\alpha$	hole condition factor

$\beta$	hole filling factor
$\eta$	semispan station measured from root (see fig. 6)
$\theta$	bearing distribution factor
$\sigma$	stress

#### ABBREVIATIONS

AIRP, A/P	airplane
BS	body station
$\zeta$	center line
DMF	dynamic magnification factor
FLT	flight
FPI	fatigue performance index
FRF	fatigue reliability factor
FWD	forward
GAG	ground air ground
GRND	ground
IHL	intermittent high loads
INBD	inboard
LE	leading edge
MED	medium
ML	marker loads

OUTBD	outboard
SL	sea level
SSF	stress severity factor
TE	trailing edge
W/O	without
FS	forward spar
STA	station
UNSYM	unsymmetrical

## APPROACH

The service-life objective of current Boeing commercial airplanes is 20 years. In pursuing this objective on the 747, a program consisting of analysis, material selection and detail design, and testing has been followed. There is an obvious overlap and interdependence of these elements in design, development, and maintenance of aircraft. Delineation of specific subelements, such as analysis or testing, is done simply to affirm that many techniques may be used in designing for fatigue and to emphasize that several techniques have been applied in parallel as a check-and-balance approach on the 747.

### Analysis

Essential fatigue analysis factors include fatigue loading environment, load-stress relationships, fatigue performance data (S-N curves), and a cumulative damage theory. In defining expected aircraft fatigue loading, both usage (flight profiles) and environment (gust, maneuver, etc.) are required (table 1). Fatigue loadings were established by using military, NASA, and Boeing data for taxi, gust, maneuver, landing, and ground-handling environments. A peak-to-peak definition of the ground-air-ground cycle was used.

Extensive route structure analysis of expected 747-100 operation resulted in the flight length distribution illustrated in figure 1 and a 20-year usage goal of 60 000 hours for each airplane. To encompass the wide range of flight lengths from this study, the flight profiles shown in figure 2 were developed. The average flight length of the three simulated commercial flights is 3 hours, the average expected over a 20-year service

life. Four percent of the total 60 000 hours usage is expected to be consumed in training and is represented for analysis by 600 4-hour, zero-payload flights, also shown in figure 2.

Fuel consumption data are applied to all flight profiles to determine gross-weight variation within each flight. Each flight is subsequently divided into appropriate segments as shown in figure 3. Climb and descent portions of the flight are actually covered by numerous altitude segments to account for the very large variation in gust environment statistics with altitude. Flight mean loads, dynamic response to gust, and response to maneuver are determined from aeroelastic analysis for each flight segment.

Analytical techniques include engineering theory and finite-element methods; experimental techniques include photostress and strain gages. These analytical and experimental techniques are used to convert external airplane loads into the stresses required for fatigue analysis: 1g stress, stress response to gust, and stress response to maneuver. In addition to conventional stress analysis, the stress-severity-factor technique is used (ref. 2). This technique was developed primarily to evaluate load and stress distributions in multfastened joints. It is also used to locate fatigue-critical locations, establish fatigue performance estimates, and evaluate possible design improvements. The stress severity factor includes the effects of geometric stress concentration factor  $K_t$ , fastener load distribution, type of fastener, bearing stress distribution, hole surface condition, and residual stresses. The equation for the stress severity factor is

$$\begin{aligned} \text{SSF} &= \frac{\sigma_{\text{peak}}}{\sigma_{\text{ref}}} \\ &= \frac{1}{\sigma_{\text{ref}}} \left[ \sigma_{\text{load transfer}} + \sigma_{\text{bypass}} \right]^{\alpha\beta} \\ &= \frac{1}{\sigma_{\text{ref}}} \left[ \frac{\Delta P}{td} K_{t,b}^{\theta} + \frac{P - \Delta P}{tw} K_{t,g} \right]^{\alpha\beta} \end{aligned}$$

Because of its ease of application and relatively good agreement in analyzing airplane structure (ref. 3), Miner's theory of cumulative damage is used. Two shortcomings of Miner's method have been observed in laboratory testing. One is the inability to account for damage from stress amplitudes below the constant-amplitude endurance limit; the other is the so-called sequence effect where in block-type loading, a substantial difference in life has been observed in some tests in which the order of application of high and low load blocks has been varied. The second shortcoming is somewhat academic for

evaluating flight structure since relatively few parts, if any, are subjected to two-step high-low or low-high block loads in service. The sequence effect is of course very real in simulated flight testing and is the primary reason that flight-by-flight testing is preferred.

To correct Miner's method to account for damage below the constant-amplitude endurance limit, two techniques are available. One is simply to translate (reduce) the S-N curve linearly on life at each alternating stress level (ref. 4). The other is to reshape (change the slope of) the S-N curve. The latter course has been followed in this work and is illustrated in figure 4. The level to which the S-N curves have been reduced at infinite life is the nonpropagating crack threshold stress. The shape and location of the upper portion of the S-N curve are essentially unaltered, which retains the advantage of fatigue quality determination from constant-amplitude testing. The resulting curves, which are then termed fatigue performance curves, are mathematically defined with a Stuessi type equation (ref. 5) and verified with fleet analysis and flight-by-flight spectrum tests.

In the early stages of airplane configuration development (prior to built-up structure tests), the fatigue quality of a given design may not be known with high confidence. To preclude having to rerun fatigue analysis whenever a slight change in detail geometry is made, as well as to provide a frame of reference for fleet analysis, a family of fatigue performance curves was developed for each of the materials used on the 747. The reference curve for each was that for basic structure (which is defined as skin-stringer construction having no significant load transfer between skin and stringer). The basic-structure curve was based on built-up structure fatigue performance data which were available for the material and type of construction in question. It should be noted that simple coupon ( $K_t$ ) data are not used to estimate life of aircraft structure directly (refs. 6 to 9). With the basic-structure curve as a reference, the remainder of the family of fatigue performance curves for each material was developed by using the variation of life with quality from past tests (refs. 10, 11, and 12).

The term used to identify fatigue quality is the fatigue performance index (FPI), and each of the many curves is identified with a fraction corresponding to the familiar  $1/K_t$  form. (Basic structure, for example, was initially identified as  $FPI = 1/2.5$ .) An example of curves used for analysis of a given detail is shown in figure 5. Fatigue analyses conducted in this manner are essentially parametric studies of life as a function of quality. A sufficient number of analyses are conducted to bracket the expected fatigue quality. Curves developed in this way, for fatigue performance indices of 0 to 1, and for each material, were mathematically defined and programed for computerized fatigue analysis.

Techniques for estimating fatigue quality involved stress-severity-factor analysis, previous airplane tests, or fleet data. The factors accounted for in the estimating tech-

nique are geometric stress concentration, load transfer, type of fastener (interference, design, and modulus of elasticity), bearing stress distribution, hole surface condition, residual stresses, and material. Constants were determined which provided the best fit of estimated life versus test- or fleet-demonstrated life from approximately 2000 assessments. The sequence of analysis, test, and fatigue performance estimation is discussed in the section entitled "Typical Results."

Figure 6 illustrates the scope of the fatigue analyses conducted on basic structures, and figure 7 illustrates typical details selected for analysis.

Fatigue reliability factors (scatter factors) accounting for fatigue performance variability, possible load environment variability, and the number of tests conducted on representative built-up structures are included in each basic structure or detail fatigue analysis. The magnitudes of the fatigue reliability factors varied from 2 to 4, with 4 being used in preliminary analysis when the least built-up structure data were available, and 2 being used when large numbers of representative built-up structure tests were completed.

#### Materials Selection and Detail Design

This facet of the 747 fatigue integrity program is intended to cover fatigue improvement activities which parallel the basic analysis. Fleet experience, for example, can play a major role in complementing preliminary fatigue analysis, that is, as a check and balance. Fleet experience with similar parts can augment conventional fatigue analysis, provide positive assessment of detail design quality, even derive new model fatigue performance providing usage, stress, and detail design are not substantially different.

During the design stage, guides for satisfactory fatigue design (or at least guides for identification of possible problems such as given in ref. 13) are of value. The best experience of course is fleet experience, and listings of previous industry airplane problems (cause and effect) were used as design background on the 747. These types of activities, together with preliminary fatigue analysis, resulted in numerous design improvements, a few of which are shown in figures 8, 9, and 10, and in the following materials section:

Wing lower surface - 2024 skin and stiffeners

Wing upper surface - 7075 skin and stiffeners

Body skin - primarily 2024

Body frames and stiffeners - 7075

Empennage - 7075



Landing gear – primarily 4340 steel heat-treated to yield an ultimate strength varying from 270 to 300 ksi

Forgings – 7075-T73 (stress corrosion is a prime consideration)

### Testing

Analysis and past experience are very important in establishing preliminary design geometries, materials, and allowable stress levels. The proof of fatigue quality, however, must come from test or flight experience. Since the objective of the fatigue integrity program is to minimize early flight fatigue experience (i.e., cracks), early testing is a key element (refs. 14 and 15). An extensive verification test program was conducted on representative sections of the entire airplane (figs. 11 to 17). All these test structures were constructed with the same finishes, fasteners, and geometries as were planned for production airplanes. Both constant-amplitude and flight-by-flight spectrum tests were run. In addition to the panel and pressurized fuselage test program summarized in figures 11 to 17, numerous small-scale development-type tests were conducted. Major-component tests, including landing gears, trailing-edge flaps, and horizontal stabilizer, are discussed in the section entitled "Tests of Major Components." The culmination of the 747 fatigue test program is the full-scale fatigue test, which is discussed subsequently.

### TYPICAL RESULTS

Typical of the analyses conducted on the airplane is that shown in figure 18. This particular analysis was conducted for three fatigue qualities and included a fatigue reliability factor (FRF) of 4.0. The analysis illustrates variation of life with spanwise and chordwise location as well as the approximate quality required to achieve the fatigue life goal of 60 000 hours.

Typical test quality determination is illustrated in figure 19, where fatigue quality is plotted against cycles to first crack. The quality associated with the number of cycles endured at the listed stress state is 0.361, or in  $1/K_t$  form,  $FPI = 1/2.77$ . This quality, incidentally, is very near the initial quality estimated for basic structure  $FPI = 0.4$  or  $1/2.5$  and is near the upper end of the qualities for which the analysis in figure 17 was conducted.

Application of test-determined quality and a revised fatigue reliability factor  $FRF = 2.95$  (which is appropriate after additional testing) results in the estimated fleet fatigue performance of stringer runouts shown in figure 20.

Additional examples of the type of data available from fatigue analyses are shown in figures 21, 22, and 23. Since several flights were included in the basic definition of usage,

parametric-type analyses illustrating the influence of flight length on fatigue life are available. These particular analyses have been useful in assessing fatigue life of 747 derivatives for different kinds of usage, especially short-range operation. Zones of life deficiencies and stress reductions or quality improvements required to achieve appropriate life goals for 1-hour average flight operation, for instance, are also fallouts of basic airplane analysis.

## TESTS OF MAJOR COMPONENTS

Major-component tests include: nose, wing, and body landing gears, horizontal stabilizer, and outboard trailing-edge flap. Photographs and descriptions of landing-gear test specimens are given in figure 24. In order to represent flight airplane structure, test specimens are production parts and jig structure is designed to simulate the flexibility of airplane support structure. These specimens are subjected to block-type loadings shown in figures 25, 26, and 27. Each block consists of loadings equivalent to 1000 flights, 5 percent of the one lifetime goal of 20 000 flights. The numerous environmental conditions included in analysis and test of each gear are also listed on the respective figures.

The outboard-flap test is illustrated in figure 28. The test consisted of stress surveys, functional testing in which the flap was raised and lowered 5000 times, and fatigue testing the outboard flap in the fully extended position. The inboard flap and leading-edge flaps are tested in the fatigue test on the full-scale airplane.

The horizontal stabilizer is tested separately from the full-scale airplane fatigue test primarily to avoid the complication of meshing with fin load systems (fig. 29). Since the stabilizer is mounted in a determinate manner on two hinges and a jackscrew, a fully representative load spectrum can be applied in both the full-scale test, through dummy stabilizer structure, and the separate test. An added advantage is that the stabilizer test can then be conducted at a faster rate. To allow for the fin-empennage airload interaction with the stabilizer, the vertical gust loads are applied in both separate and full-scale tests with a  $\pm 20$ -percent asymmetry. Derived spectrum loads are applied to the inboard and outboard elevators on the left side and through dummy elevators on the right side. Additional elevator loads representing take-off rotation and climb rotation are applied in the take-off phase, and loads representing spoiler trim and landing flare are applied in the landing phase.

## FATIGUE TEST OF FULL-SCALE AIRPLANE

### General Description of Specimen and Test Rig

The culmination of the test phase of the fatigue integrity program is the fatigue test of the full-scale airplane (fig. 30). The test specimen is a structurally complete airframe

of typical production configuration. Omitted are main and nose landing gears, trailing-edge flaps except left-hand inboard, leading-edge flaps except left-hand flap numbers 3, 7, and 12, ailerons, spoilers, engine pod, and the horizontal stabilizer, which is tested separately. Loads are applied through representative dummy structures for the major components omitted from the test.

Loads are applied to the airplane by using 86 hydraulic actuators, which are controlled by an automatic closed-loop electro-hydraulic servo system. The command or program signal is supplied to the servo systems by a digital programmer. This programmer and the data acquisition functions for the test are controlled by a Digital Equipment Corporation PDP-8 computer. The computer is also used to automate many of the operating functions of the test.

To prevent the test specimen from being loaded to levels that are outside defined tolerances, a lockup manifold is installed on each hydraulic actuator. When the lockup system is actuated, the actuator holds the load at the limit of present tolerances until problem correction. Stainless-steel safety links are included in all load systems attached to the airplane. These are designed to yield before local airplane structure is damaged by inadvertent overloading. There is also a two-way relief valve installed in each load system to limit actuator pressure and thereby prevent an overload.

#### Load Spectrum Derivation

The main purpose of the airplane fatigue test is to better determine the true structural fatigue performance by eliminating most of the assumptions which are necessary in the analysis. The specific objectives of the test are to locate as quickly as possible any fatigue-critical areas with a program accurately representing typical service loads, to provide test data for analytical service life predictions, to help develop inspection and maintenance procedures for the airlines, and to evaluate fail-safe characteristics of major structural parts. Criteria considered in developing the load spectrum are

Flight-by-flight testing

Average of mixture of flights used as base

Match upper surface ground-air-ground stresses

Match upper surface taxi damage

Match lower surface flight segment damage distribution

Match 1g stresses in 3-hour flight

Equivalent gust and maneuver cycles

One lateral cycle for one vertical cycle in flight segments

Lateral-load cycles quarter of a cycle out of phase with vertical-load cycles  
Representative cabin pressurization and depressurization  
Average flap utilization  
Mean engine thrust in each flight segment  
Equivalent landing-gear loads in ground-handling phase  
Intermittent high loads and marker loads

To give the correct combination of spectrum loads, cabin pressure, and ground-air-ground cycle loads, the test is conducted on a flight-by-flight basis. An average flight based on the mixture of four analysis flights is used for deriving the test program. For convenience, damage in the average flight is factored by  $19\,800/20\,000 = 0.99$  to give 20 000 average flights in 60 000 hours of service. Therefore, each test spectrum represents 3 hours of flying in the mixture of flights.

From the derived gust, maneuver, and taxi damage in each flight segment, the required test cycles are found by using the appropriate stresses from the 3-hour flight (fig. 2).

Incremental stresses due to gust or maneuver and the relationship between gust speed and airplane acceleration differ for each component. Therefore, the damage due to gust and maneuvers is considered independently and is applied to each component with representative loads. Equivalent gust loads are factored by appropriate dynamic magnification factors.

On the basis of aircraft industry experience, both wing upper and wing lower surfaces are of fatigue concern. Therefore, a load program is derived which is representative for both surfaces. The wing upper surface GAG cycle (which is given by the cycle from the maximum once-per-flight tension stress on the ground, to the maximum once-per-flight compression stress in the air, to the maximum once-per-flight tension stress on the ground) damage is matched by a slightly modified GAG cycle for the 3-hour flight. This modification limits the maximum allowable tension stress in the taxi segment. To reduce the number of cycles, the mean stress in the taxi is reduced below the 1g level allowing a higher alternating stress. With this additional variable the required number of cycles, which was fixed at five, can be matched. Having fixed the upper surface GAG cycle stresses and matched the taxi damage, 97 percent of the total upper surface damage is matched.

For the wing lower surface, the GAG cycle gives approximately 30 percent of the total damage. The lower surface taxi damage corresponds to the cycles already determined for the upper surface. The small difference between the analysis and test taxi damage is corrected in the GAG cycle damage to give the correct total damage. The

lower surface GAG stresses are determined by the same method used for the upper surface. With a representative 1g stress in each flight segment, the maximum allowable alternating stress, and hence the maximum equivalent alternating cycle, is limited by the GAG cycle stresses. To achieve the best damage match at other locations, the maximum GAG stresses are fixed in the same flight segments as the analysis. Maximum upper surface tension and lower surface compression stresses occur in the taxi segments. The maximum upper surface compression stress occurs in the hold segment, and the maximum lower surface tension stress occurs during flaps-down climb. Gust and maneuver damage is matched in each segment by finding the minimum number of cycles based on the 1g and GAG stress limitations.

Figure 31 illustrates the vertical-load program derived for the wing. Fuselage vertical loads correspond to the gust, maneuver, and taxi loads derived similarly to those for the wing. Since it is impractical to load all the passenger and cargo floor, representative loads are applied in fore, mid, and aft body locations. The numerous other load spectra and the approximate phasing with vertical loads are shown in figure 32. For reference purposes, the average 3-hour flight is subdivided into eleven phases, shown by Roman numerals.

For the lateral-load program, the load magnitude is found by matching the damage in each segment with the same number of cycles as the vertical-load program. In the segments with an even number of cycles, half the cycles are applied with a gust load distribution and half with maneuver load distribution. The cycles in the other segments are arranged so that the total flight damage is half gust and half maneuver.

Additional discrete rudder loads which occur during take-off, flap extension, approach, and landing roll-out are applied during phase I for convenience. It is considered unlikely that the maximum lateral loads generally occur at the same time as the maximum vertical loads. Therefore, the lateral-load cycles are applied one-quarter of a cycle out of phase with the vertical-load cycles. This means the peak lateral load occurs with 1g vertical load and the maximum and minimum vertical loads occur with zero lateral load.

Cabin pressure differential varies from zero to 0.6 psi in phase IV, from 0.6 linearly to 9.0 psi in phase V, is constant at 9.0 psi in phases VI and VII, varies from 9.0 linearly to 0.6 psi in phase VIII, is constant at 0.6 psi in phase IX, and varies from 0.6 psi to zero in phase X.

Loads representing an average utilization are applied to the leading-edge (LE) and trailing-edge (TE) flaps. On the leading edge the loads are applied to flaps 3, 7, and 12 on the left-hand side. The remaining flap loads are applied through dummy flaps with representative loads on the support structure. Loads on trailing-edge flaps are applied to the inboard flap on the left side with the remaining loads applied to the tracks through

dummy flaps. Most of the damage to TE flaps occurs during approach with the flaps fully extended. Therefore, the test loads are applied with the flaps in the extended position. An equivalent load cycle is applied in phase III to represent the damage in the most critical track and carriage sections during take-off with flaps at 15°. In the analysis of the primary structure on the LE flaps, most of the damage occurs during take-off. The maximum flap load during take-off occurs with the flaps extended at the end of the take-off rotation. Therefore, the test loads are applied with the flaps in the extended position. An equivalent cycle is applied during the approach in phase X. When the LE flaps are retracted, the uplock load exceeds all the 1g, gust, and maneuver airloads. Therefore no loads are applied on the leading-edge flaps during the remaining flight stages. To represent the uplock stress which occurs during flight and the two cycles during ground handling, three equivalent load cycles are applied in phase I.

Mean fore and aft nacelle loads in the 3-hour flight are applied in each phase. Maximum gross thrust during take-off and reverse thrust during landing are applied in phases III and IX, respectively.

Landing-gear loads in an average flight are applied through dummy gears to the landing-gear support structure. The dummy gear has a representative relative stiffness to give a true load distribution. In phase I ground handling the vertical, fore and aft, and side loads are based on the same criteria used to derive the separate landing-gear test program. The main difference between the two tests is the block loading in the gear test, which has 1000 flights in each test spectrum and flight-by-flight loading in the airplane fatigue test. Vertical loads in phase II taxi correspond to the loads derived for the wing. Average spinup and springback loads are applied in phase XI landing.

The spectrum applied on the airplane fatigue test represents typical loads which occur in an average flight. In addition to these loads, the airframe is subjected to infrequent high loads during the 60 000-hour life of the airplane. These loads have a negligible effect on the cumulative fatigue damage but affect the damage rate and crack initiation and propagation. Therefore, to include this effect in the program, the loads which occur three times in 60 000 hours flying are applied. These loads are termed intermittent high loads (IHL).

Since any cabin pressure differential higher than the normal 9.0 psi is unlikely to occur, no intermittent high cabin pressure is applied.

In previous fatigue tests it has been difficult to establish crack initiation times, crack propagation rates, and crack life prior to rapid fracture in inaccessible areas, and for cracks which were not found until the test was completed. To help in establishing crack data, unique loads, termed marker loads (ML), are applied during the test. These marker loads are arranged in sequence with the intermittent high loads so that a definite test time can be determined from the striations (table 2).

In the test spectrum the cabin pressure is cycled from zero to 9.0 psi to zero once per flight. This gives a representative cycle for a typical flight. In the training flight the airplane climbs to a varying altitude three times. To represent these pressure cycles and concurrently provide a ML pattern for pressure-critical components, those additional pressure cycles from the training flights are applied.

The present status of the major-component and full-scale airplane fatigue tests is given in table 3. The differing test goals specified in this table are an outgrowth of the fatigue reliability factor criteria discussed in the section entitled "Approach." In general, critical details in landing-gear structure are single-detail-type items, for example, a fillet radius. For these types of tests, a larger statistical factor is required to achieve desired reliability levels in service.

In built-up structure tests such as the outboard flap, horizontal stabilizer, and full-scale airplane, several points usually are identically stressed and therefore constitute a larger sample and require lower statistical factors. All major components have been subjected to loads exceeding the planned requirements for the basic passenger airplane. Many of the tests have been continued beyond the original test goals in order to substantiate derivative airplane requirements. Pending identification of requirements more severe than those currently estimated, some tests have been suspended.

#### CONCLUDING REMARKS

The Boeing 747 fatigue integrity program provides a high degree of confidence in the ability of the structure to withstand service loads. Safe and economic operation is insured through fail-safe design augmented with a continually updated program reflecting past experience, analysis, and test-demonstrated fatigue performance.

## REFERENCES

1. Anon.: Airworthiness Standards: Transport Category Airplane. Federal Aviation Regulations - Part 25, Federal Aviation Agency, Nov. 1968.
2. Jarfall, L. E.: Optimum Design of Joints: The Severity Factor Concept. The Aero Research Institute of Sweden, May 1967.
3. Chrichlow, W. J.; Young, Louis; McCulloch, A. J.; and Melcon, M. A.: An Engineering Evaluation of Methods for the Prediction of Fatigue Life in Airframe Structures. Technical Report ASD-TR-61-434, Mar. 1962.
4. Smith, James M.: Extended Service Life Wing Design F-8 Crusader. Aerospace Structures Design Conference, Seattle, Washington, Aug. 1969.
5. Stuessi, F.: Theory and Test Results on the Fatigue of Metals. ASCE Proceedings, Vol. 85 (Jrle, Structural Div. #ST8), Paper #2222, pp. 65-90, Oct. 1959.
6. Hyler, W. S.; et al.: Fatigue Behavior of Aircraft Structural Beams. NACA TN 4137, Jan. 1958, p. 59.
7. Sines, G.; and Waisman, J. L., eds.: Metal Fatigue. McGraw-Hill, New York, 1959, pp. 319-320.
8. Harris, W. J.: Metallic Fatigue. Pergamon Press, 1961, p. 166.
9. Barrois, W.; and Ripley, E. L.: Symposium on Fatigue of Aircraft Structures. Pergamon Press, 1963, p. 88.
10. Grover, H. J.; Bishop, S. M.; and Jackson, L. R.: Fatigue Strength of Aircraft Materials-Axial-Load Fatigue Tests on Unnotched Sheet Specimens of 24S-T3 and 75S-T6 Aluminum Alloys and of SAE 4130 Steel. NACA TN 2324, Mar. 1951.
11. Grover, H. J.; Bishop, S. M.; and Jackson, L. R.: Fatigue Strengths of Aircraft Materials-Axial-Load Fatigue Tests on Notched Sheet Specimens of 24S-T3 and 75S-T6 Aluminum Alloys and of SAE 4130 Steel With Stress-Concentration Factors of 2.0 and 4.0. NACA TN 2389, June 1951.
12. Grover, H. J.; Bishop, S. M.; and Jackson, L. R.: Fatigue Strengths of Aircraft Materials-Axial-Load Fatigue Tests on Notched Sheet Specimens of 24S-T3 and 75S-T6 Aluminum Alloys and SAE 4130 Steel With Stress-Concentration Factor of 5.0. NACA TN 2390, June 1951.
13. Smith, C. R.: Tips on Fatigue. Navweeps 00-25-559, 1963.
14. Illg, W.: Factors in Evaluating Fatigue Life of Structural Parts. NASA TN D-725, Apr. 1961.



15. Schijve, J.: Cumulative Damage Problems in Aircraft Structures and Materials.  
The Aeronautical Journal of the Royal Aeronautical Society, vol. 74, no. 714,  
June 1970.

TABLE 1.- FATIGUE ANALYSIS DETAILS

- ENVIRONMENT
  - Gust
  - Ground Handling Loads
  - Landing Loads
  - Miscellaneous
- FLIGHT PROFILES
- FLIGHT SEGMENTATION
- STRESS DETERMINATION
- FATIGUE PERFORMANCE DATA
  - Built-Up Structure Panel Tests
  - Full-Scale Cyclic Tests
  - Fleet Service
- APPLY PRINCIPLES OF MINER'S METHOD TO  
PRODUCE CALCULATED FATIGUE PERFORMANCE

TABLE 2.- LOAD SEQUENCE OF MARKER LOADS AND INTERMITTENT HIGH LOADS

PROGRAM NUMBER	EQUIVALENT FLYING TIME	NUMBER OF ML CYCLES	NUMBER OF IHL CYCLES	TOTAL CYCLES
6,667	20,000 HR	2	1	3
13,333	40,000 HR	3	1	4
20,000	60,000 HR	4	1	5
26,667	80,000 HR	5	1	6
33,333	100,000 HR	3	1	4
40,000	120,000 HR	2	1	3

One Marker Load Is As Follows :

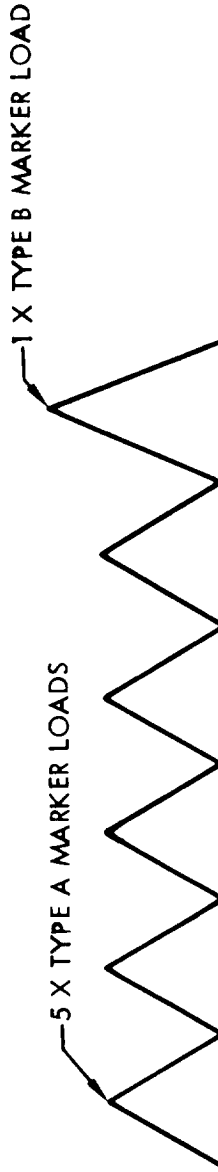

- FOR EACH MARKER LOAD CYCLE APPLY FIVE TYPE "A" ML CYCLES FOLLOWED BY ONE TYPE "B" ML CYCLE.

NOTE :

- MINIMUM LOAD IS ZERO UNLESS OTHERWISE STATED.
- THE ML'S AND IHL'S ARE TO BE APPLIED CONSECUTIVELY WITH THE TOTAL NUMBER OF ML'S APPLIED FIRST.
- THE ML AND IHL GUST CYCLES MUST INCLUDE THE APPROPRIATE DYNAMIC MAGNIFICATION FACTORS.

TABLE 3.- FATIGUE TEST STATUS

ITEM TESTED	TEST GOAL (LIFETIMES) <sup>①</sup>	BASIC A/P LIFETIMES COMPLETED	CURRENT STATUS
● LANDING GEAR ● NOSE	4	4.6	SUSPENDED
● WING	4	5.5	SUSPENDED
● BODY	4	5.1	SUSPENDED
● HORIZONTAL STABILIZER	2	5.8	TEST IN PROGRESS
● OUTBOARD FLAP	2	2.2	SUSPENDED
● AIRFRAME CYCLING	2	0.64	STOPPED FOR INSPECTION

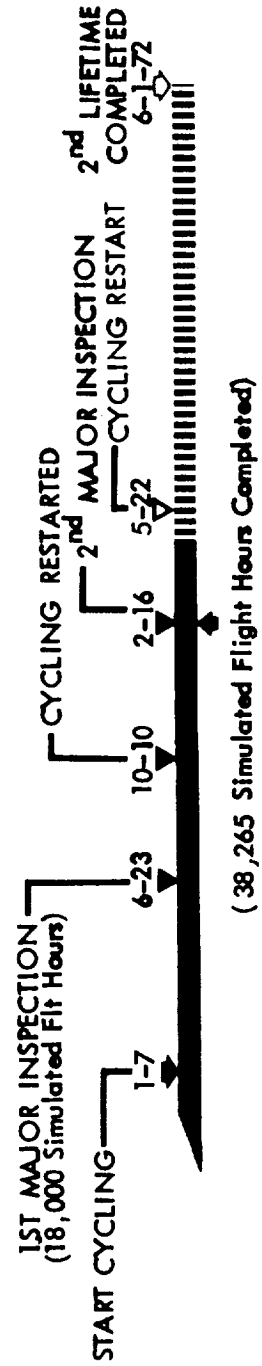
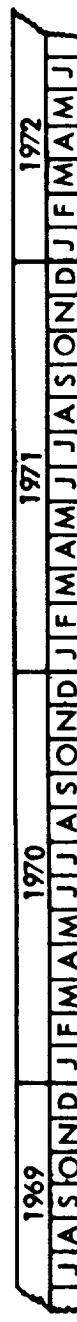

① 1 LIFETIME = 20 YEARS OF EXPECTED SERVICE (APPROX 20,000 FLIGHTS)

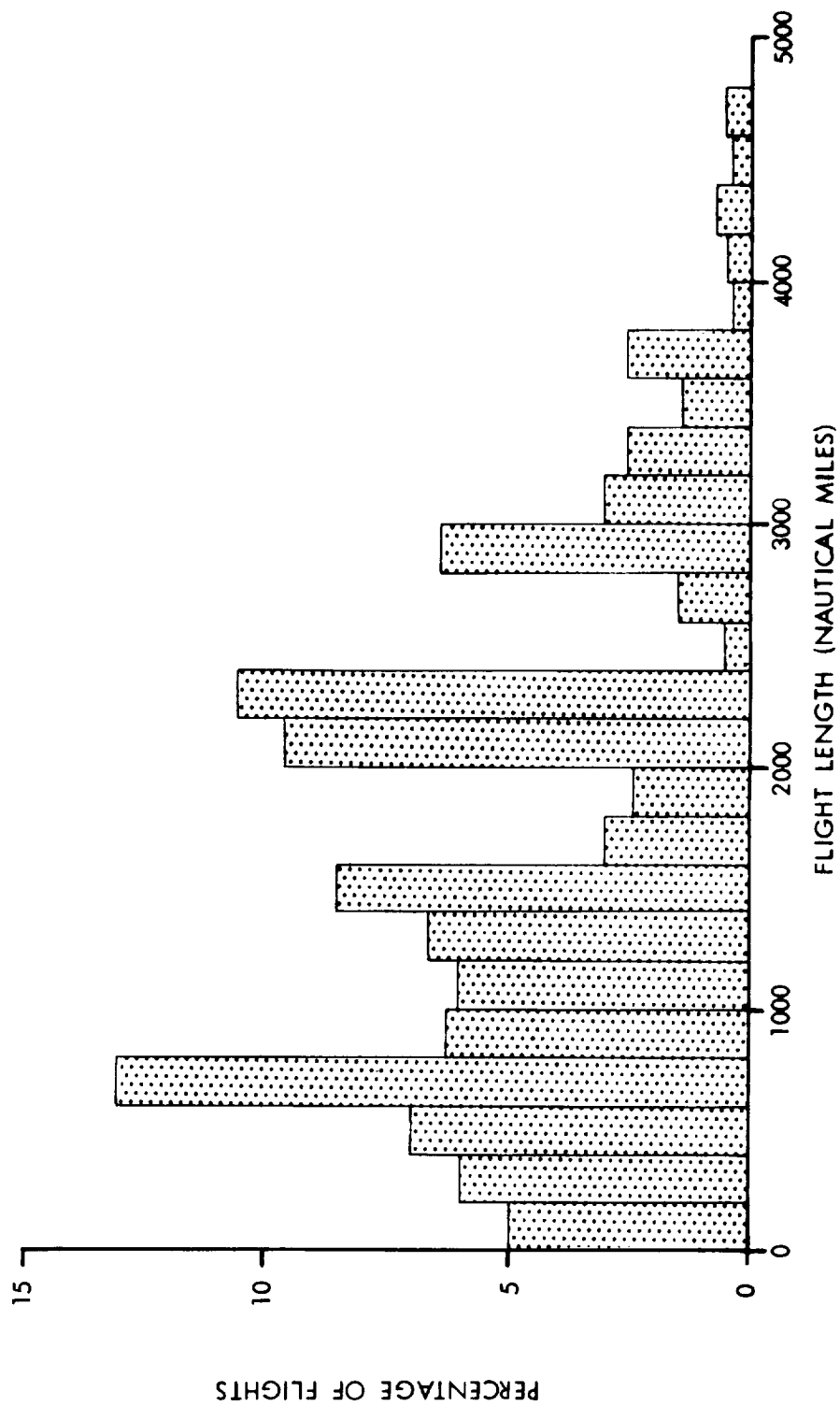
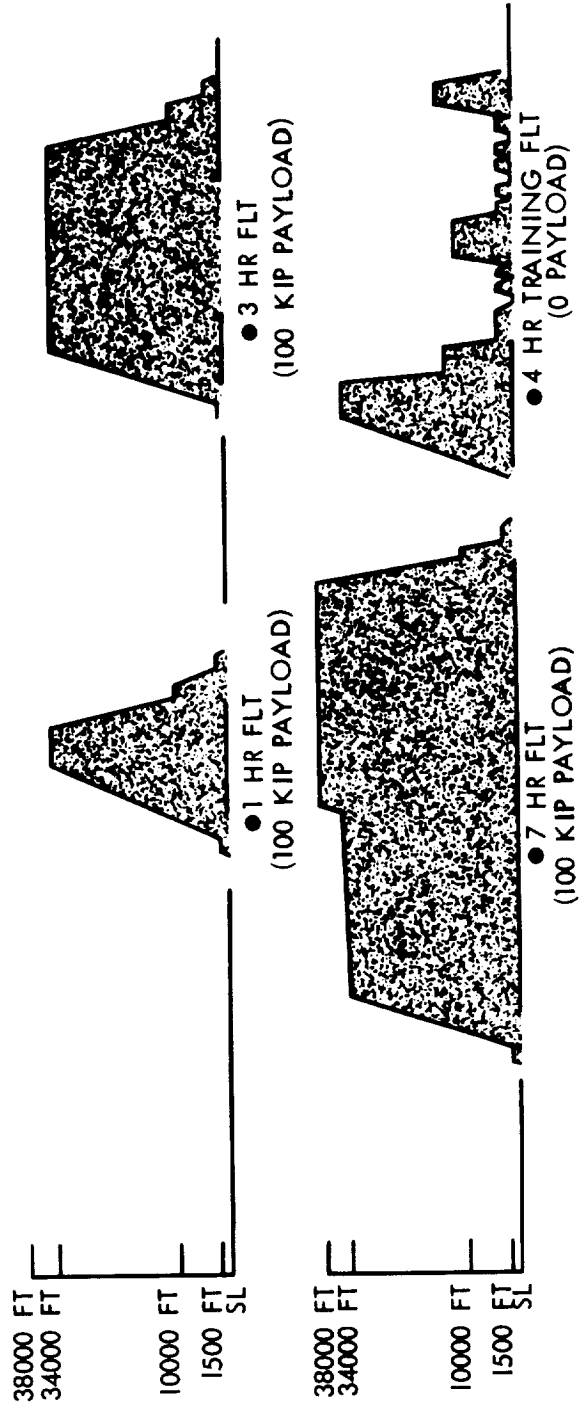

Figure 1.- Flight length distribution for Boeing 747-100 passenger airplane.



NOTE: IN 60,000 HOURS OF SERVICE OPERATION, THE FOLLOWING DISTRIBUTION OF FLIGHTS IS USED:

- 9600 - ONE HOUR
- 4800 - THREE HOUR
- 4800 - SEVEN HOUR
- 600 - TRAINING

Figure 2.- Flight profiles. Operating empty weight, 360 000 lb.

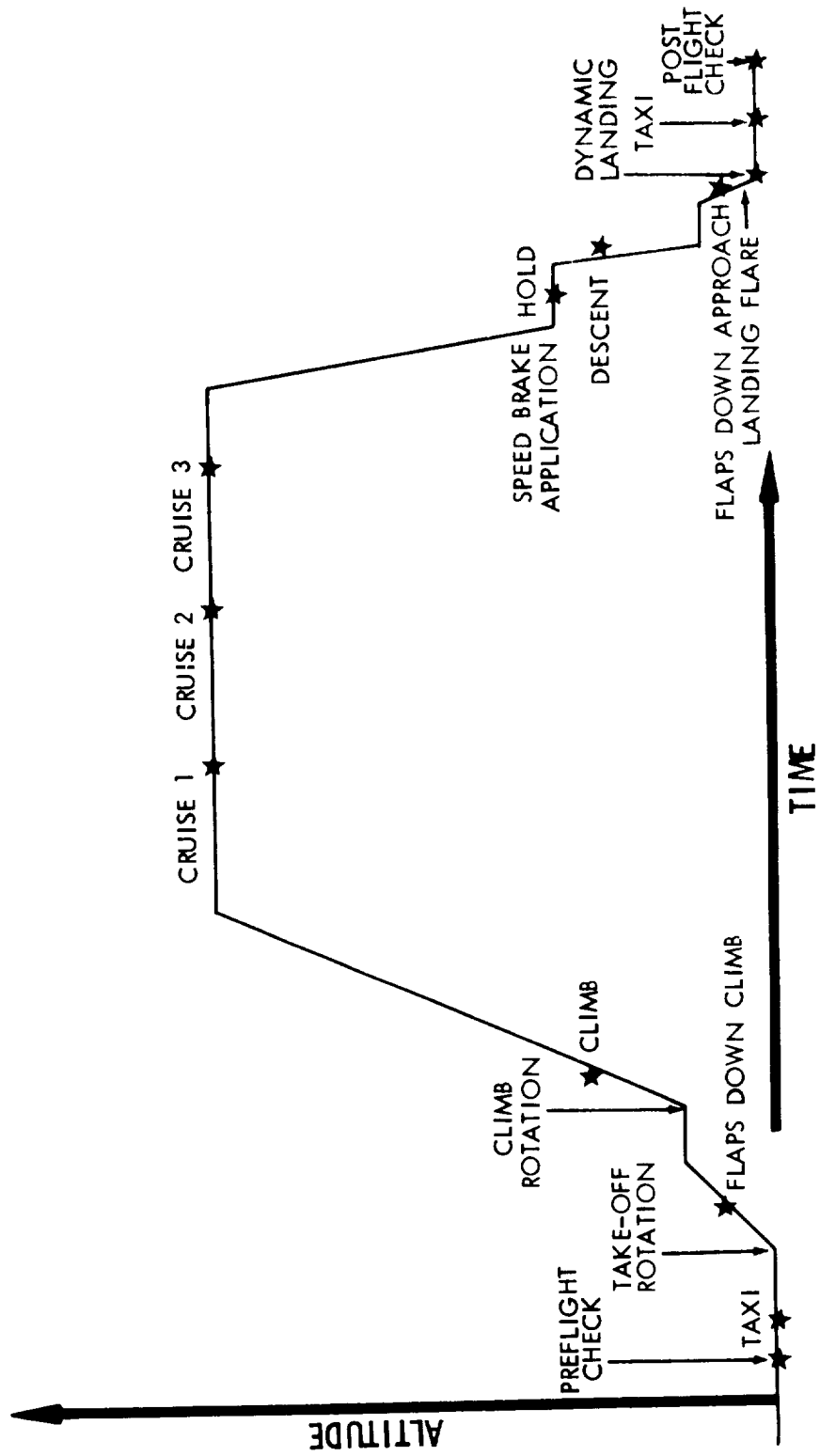

Figure 3.- Typical flight segmentation.

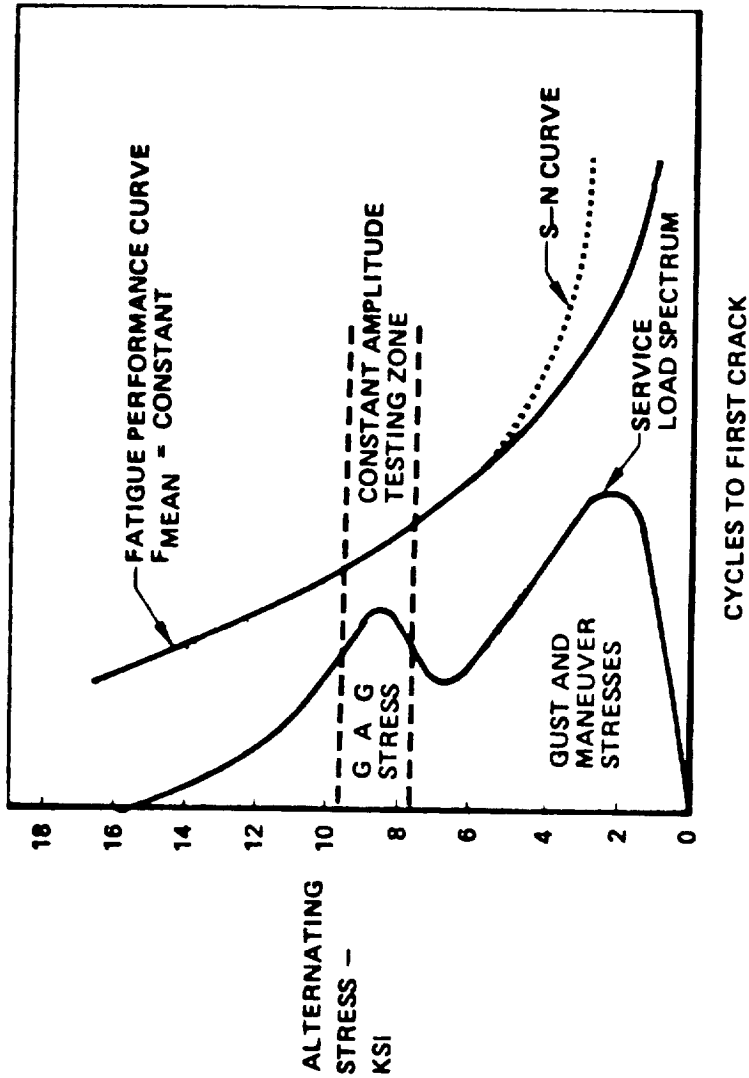

Figure 4.- Modified Miner's method.



FATIGUE PERFORMANCE INDEX (FPI)  
 DETERMINED BY ONE OF THE FOLLOWING:

- FPI = 1.0 / k SSF
- FLEET DATA
- TEST OF ACTUAL STRUCTURE

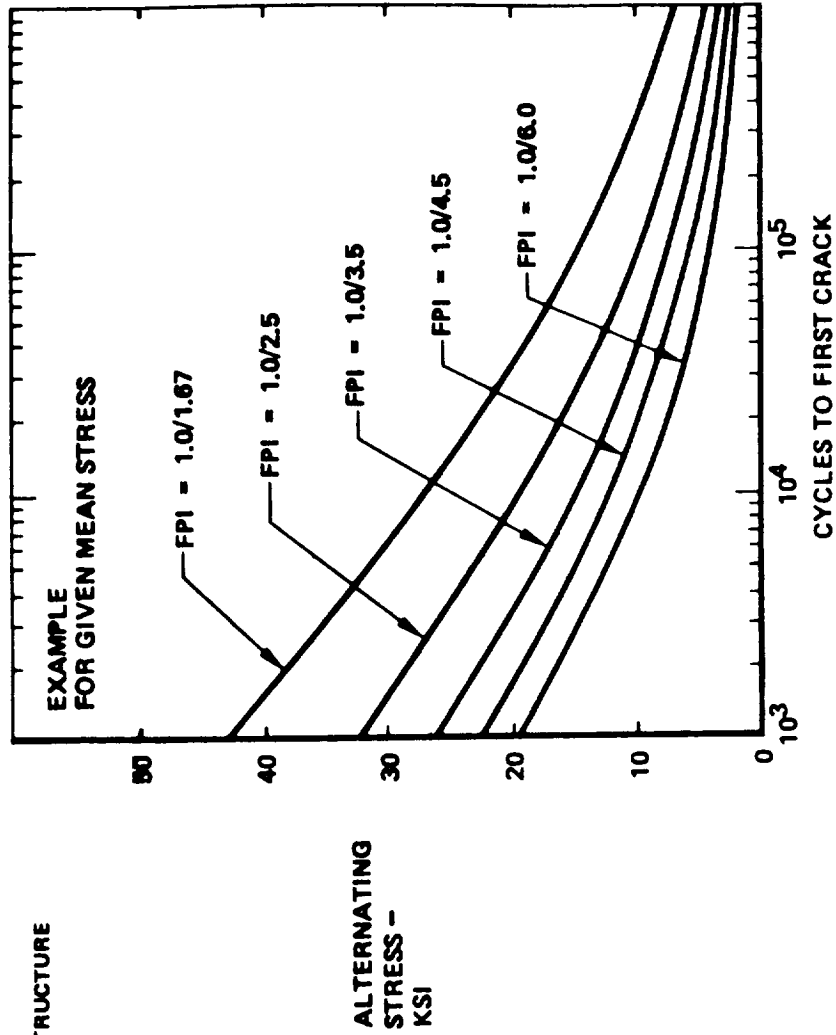

Figure 5.- Fatigue performance curves.

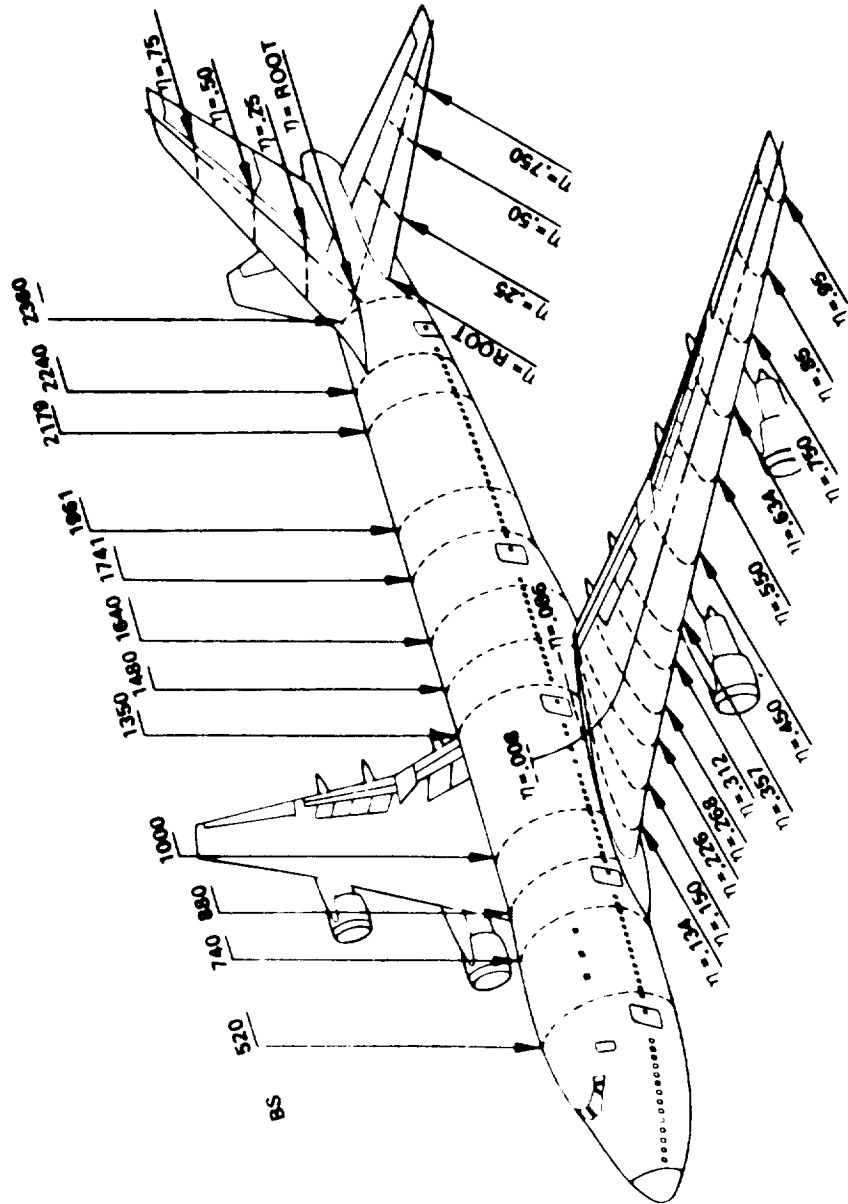
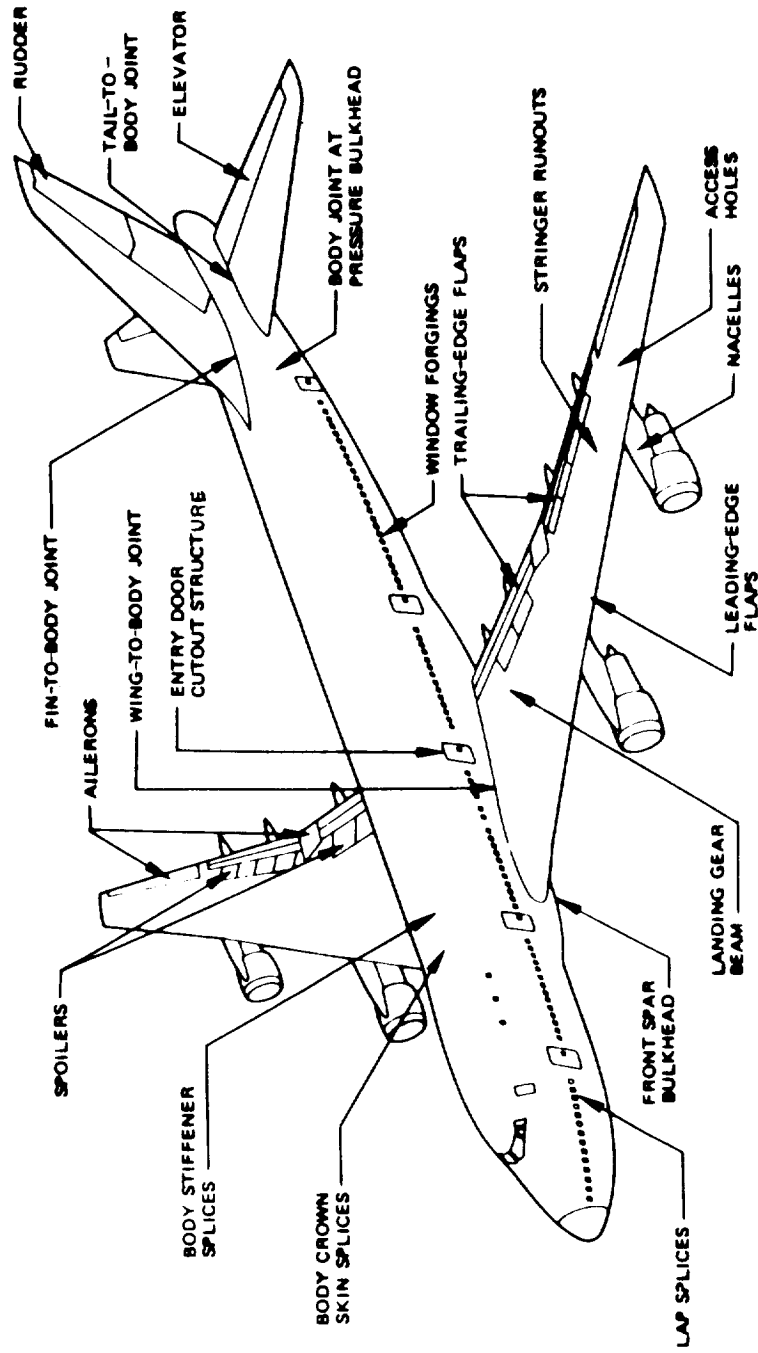

Figure 6.- Analysis locations on basic structure.



● ALSO DETAILS ON NOSE, WING, AND FUSELAGE LANDING GEARS

Figure 7.- Typical detail analysis locations.

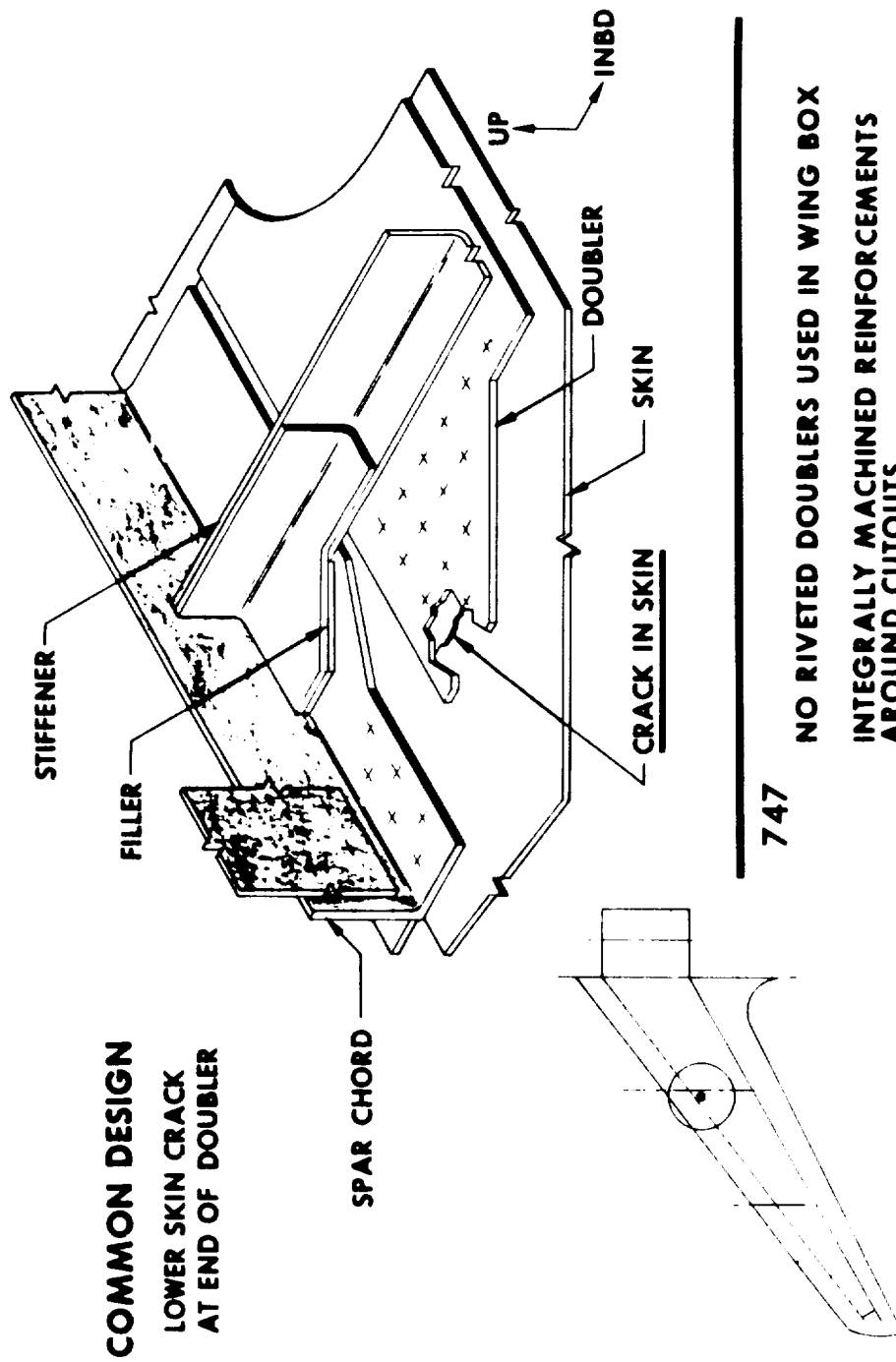

Figure 8.- Tension-critical design.

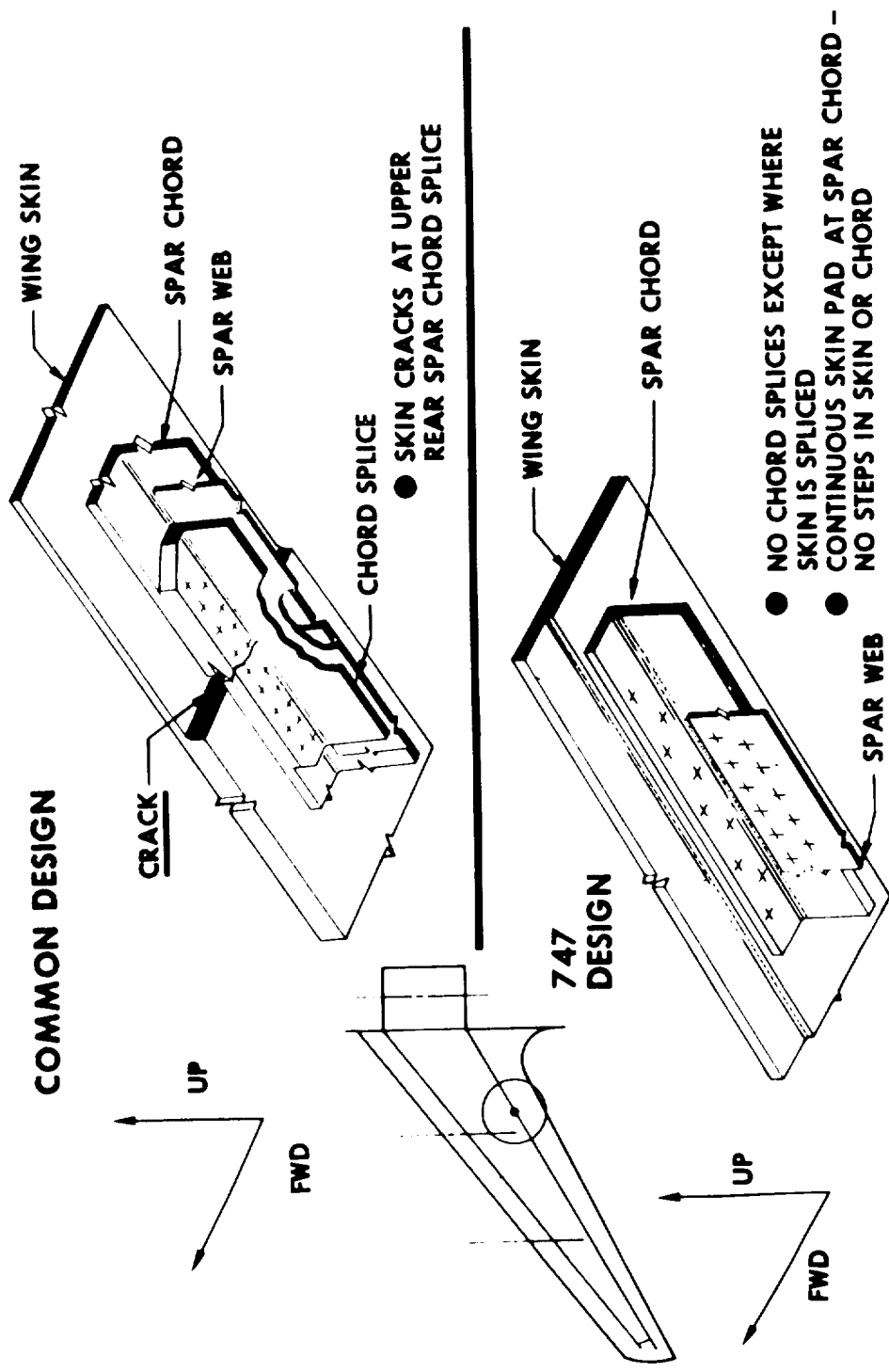

Figure 9.- Tension-critical design.

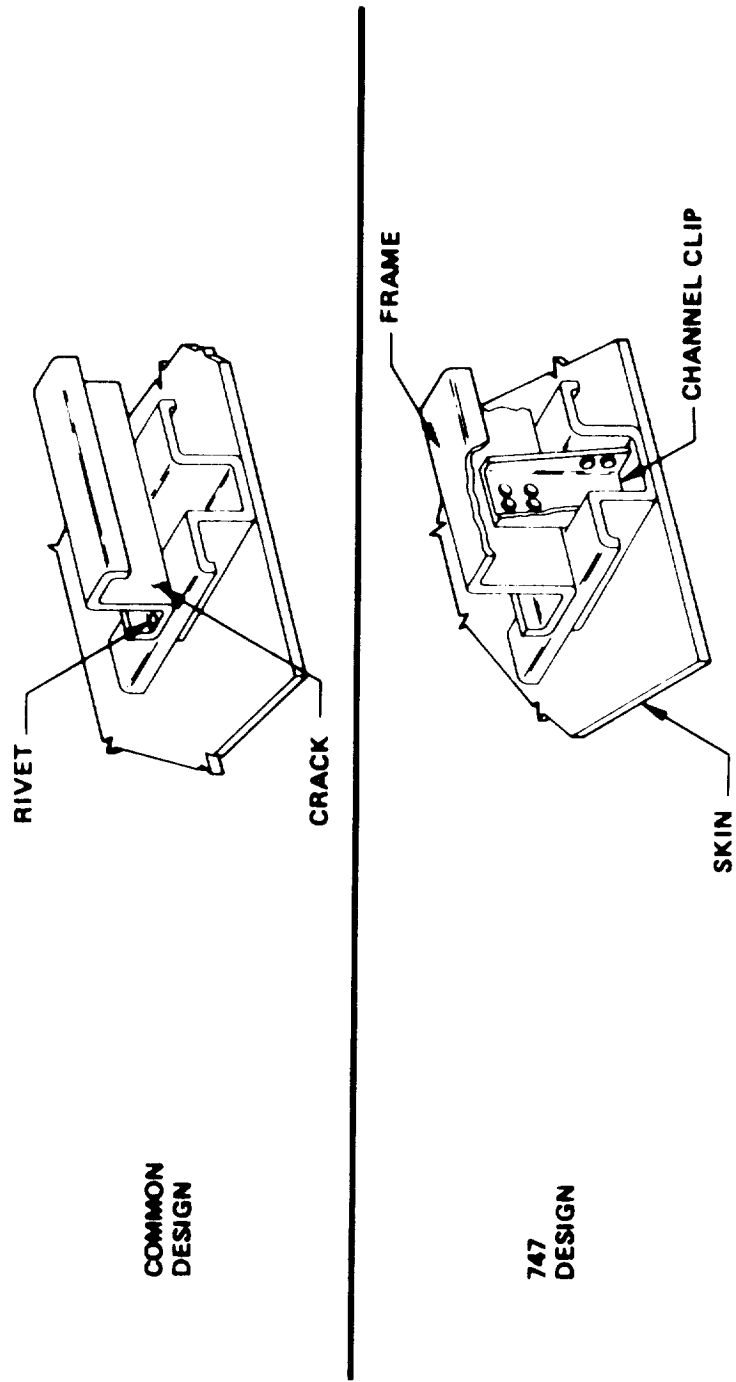

Figure 10.- Attachment of fuselage stiffener to frame.

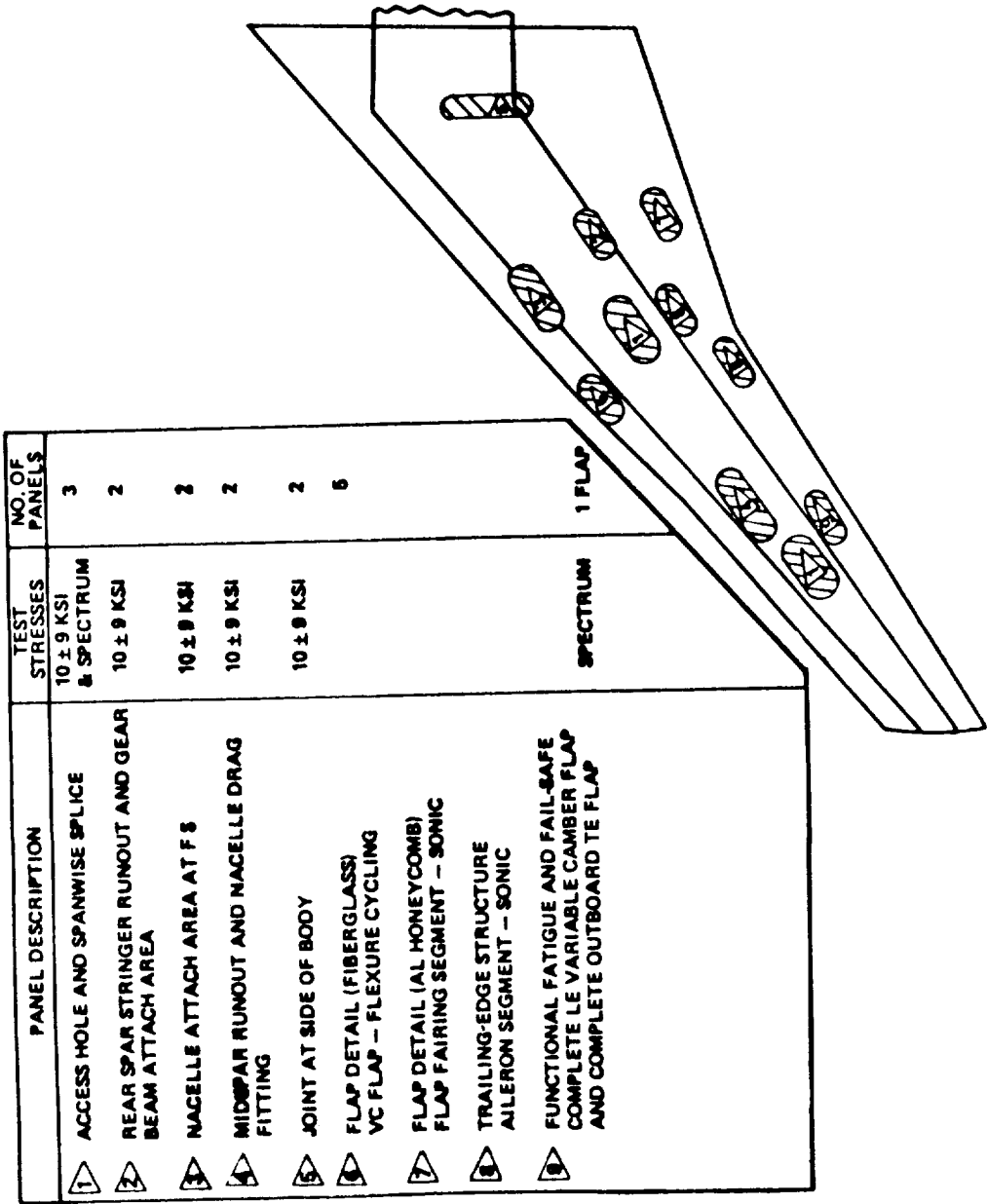

Figure 11.- Testing of wing lower surface.

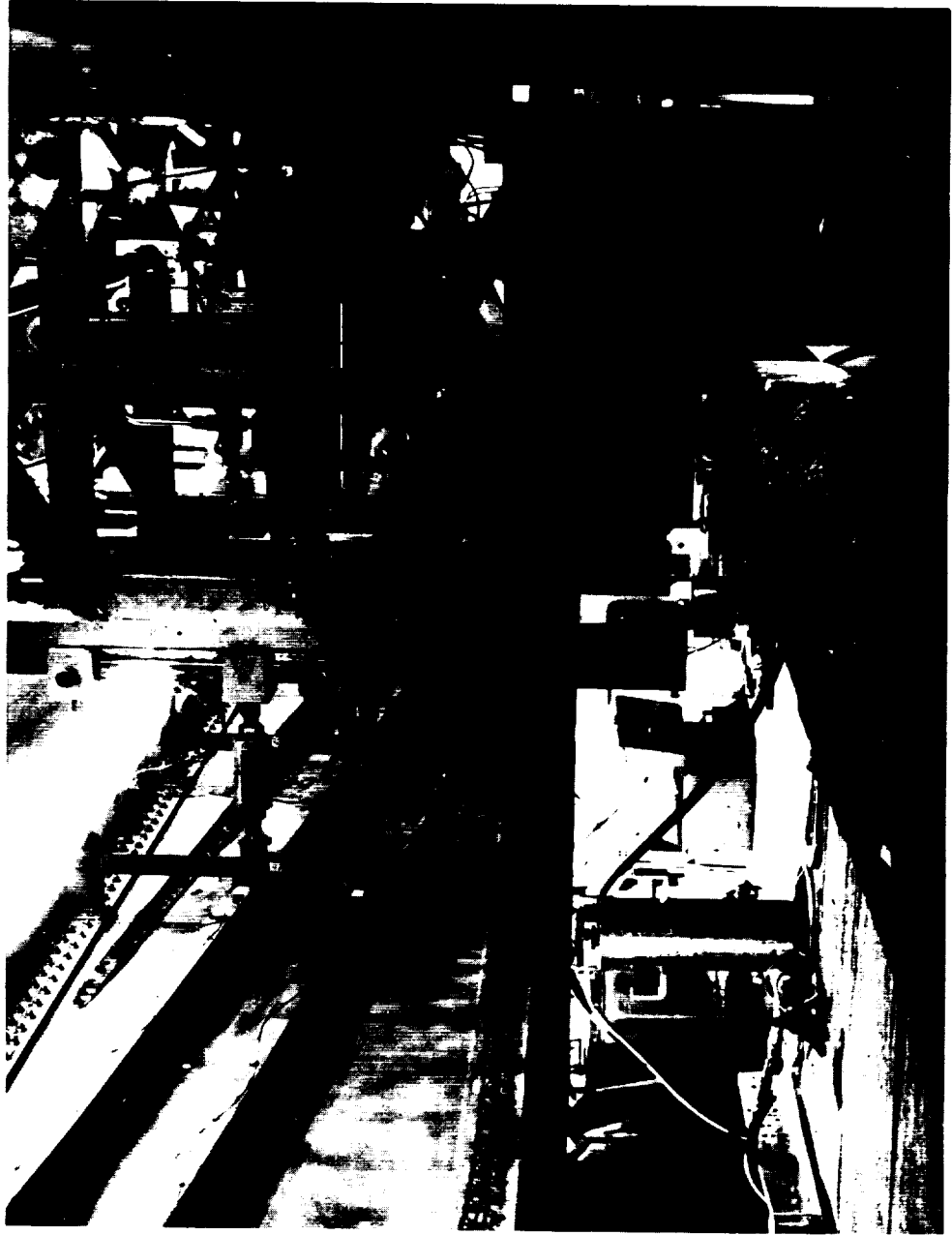

Figure 12.- Wing lower surface stringer runout.



PANEL DESCRIPTION		TEST STRESSES	NO. OF PANELS
1	BASIC SKIN-STRINGER (OUTBD)	-5 ± 18.5 KSI	3
2	BASIC SKIN-STRINGER (INBD)		
3	JOINT AT SIDE OF BODY	-5.5 ± 14.5	1
4	BASIC SKIN-STRINGER (CENTER)	-5.5 ± 14.5	1

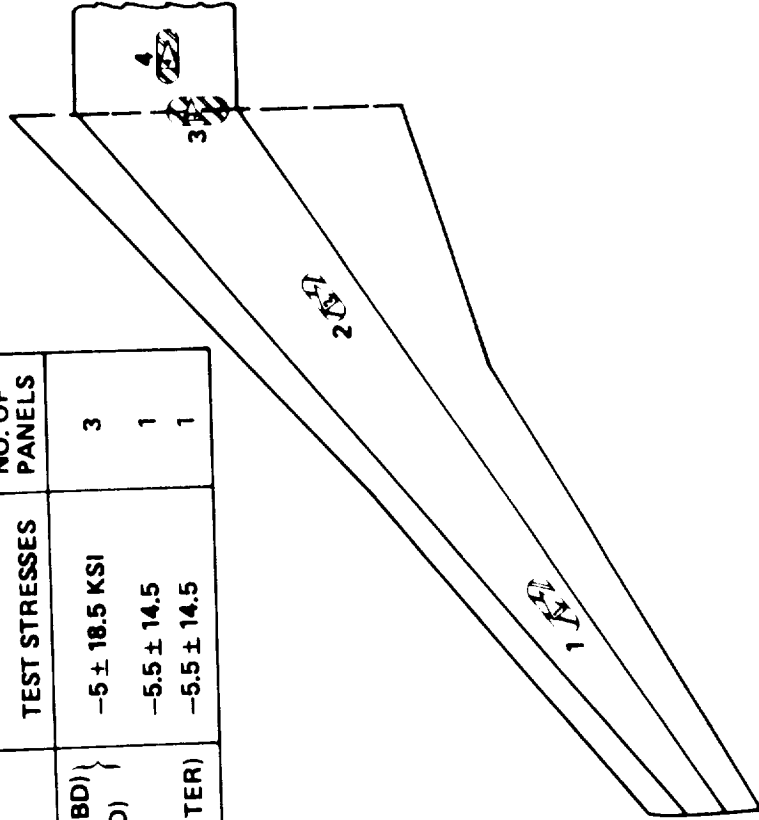

Figure 13.- Upper surface fatigue test panels.

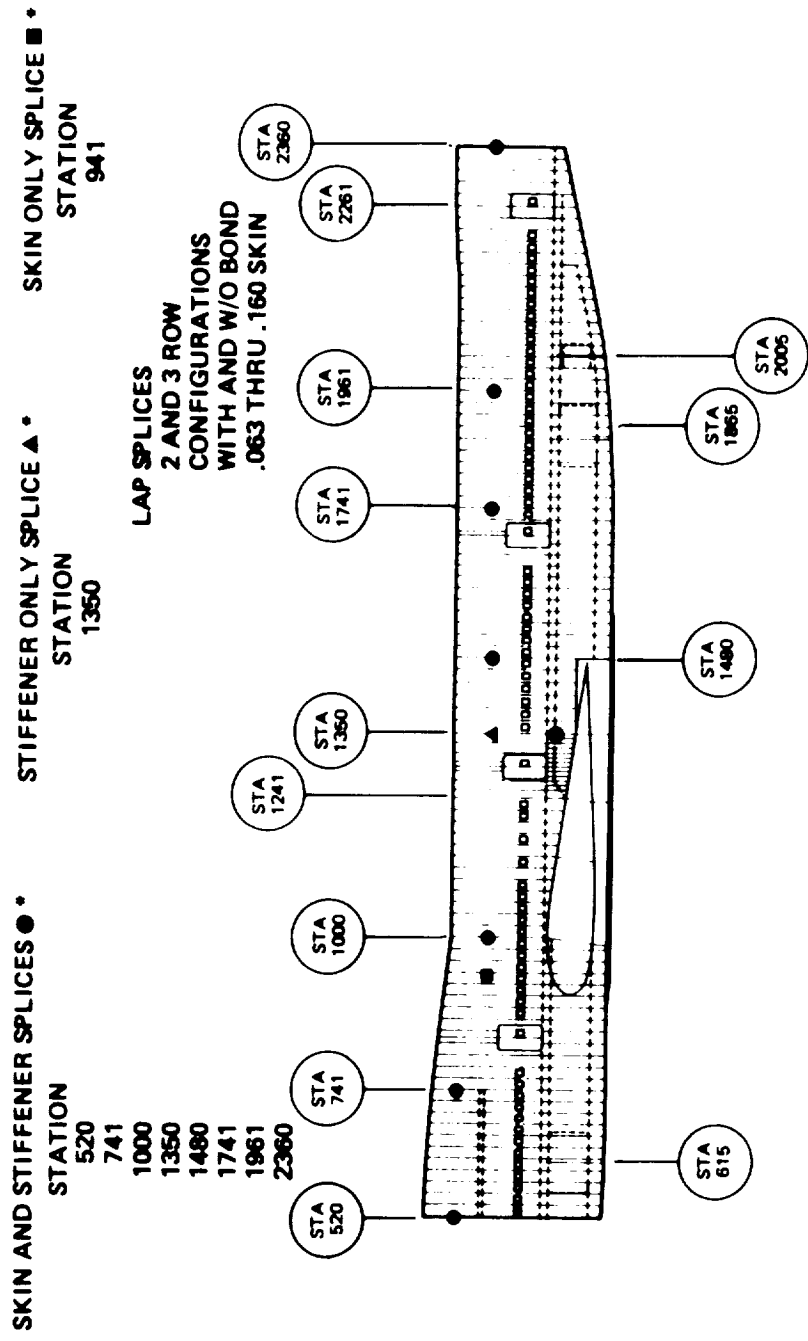

Figure 14.- Fuselage testing.

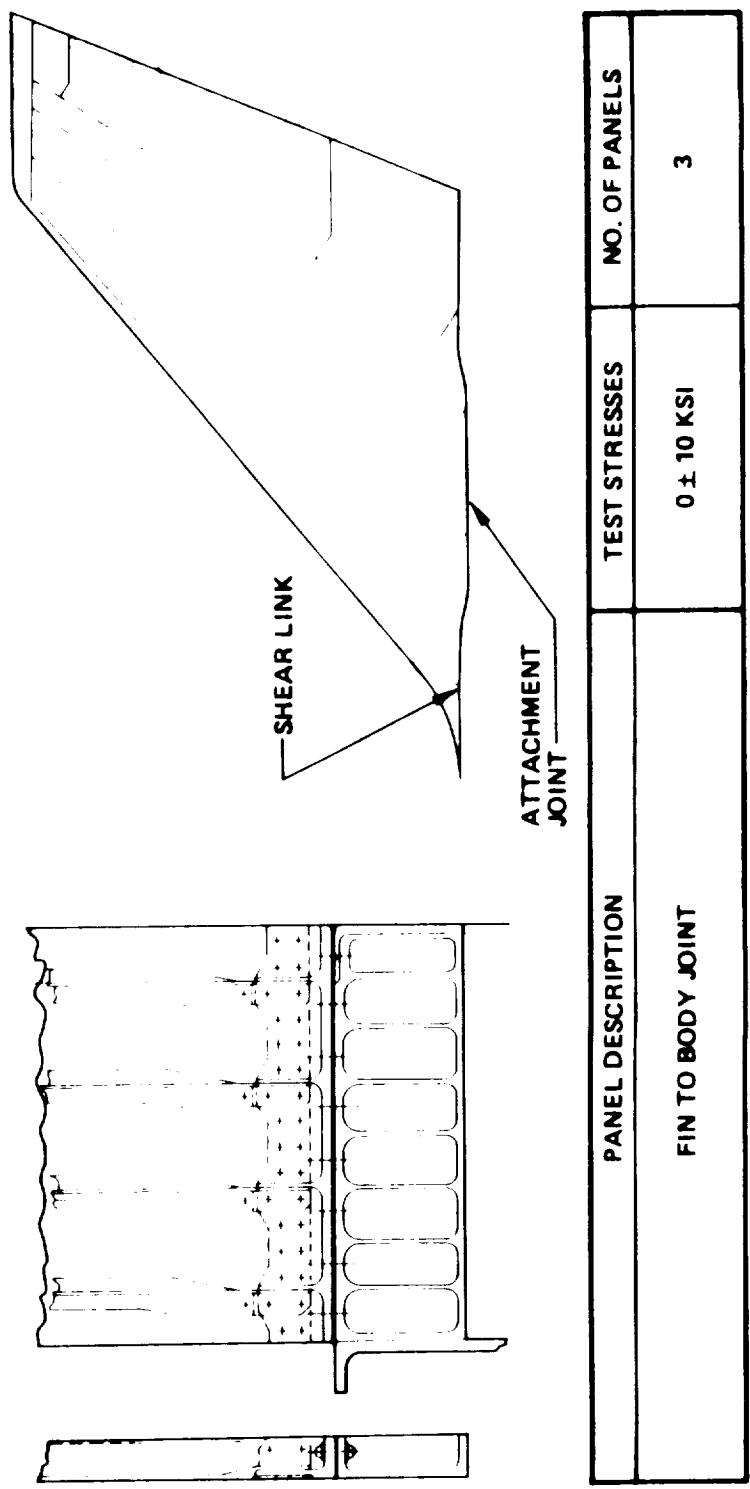

Figure 15: Vertical-tail testing.

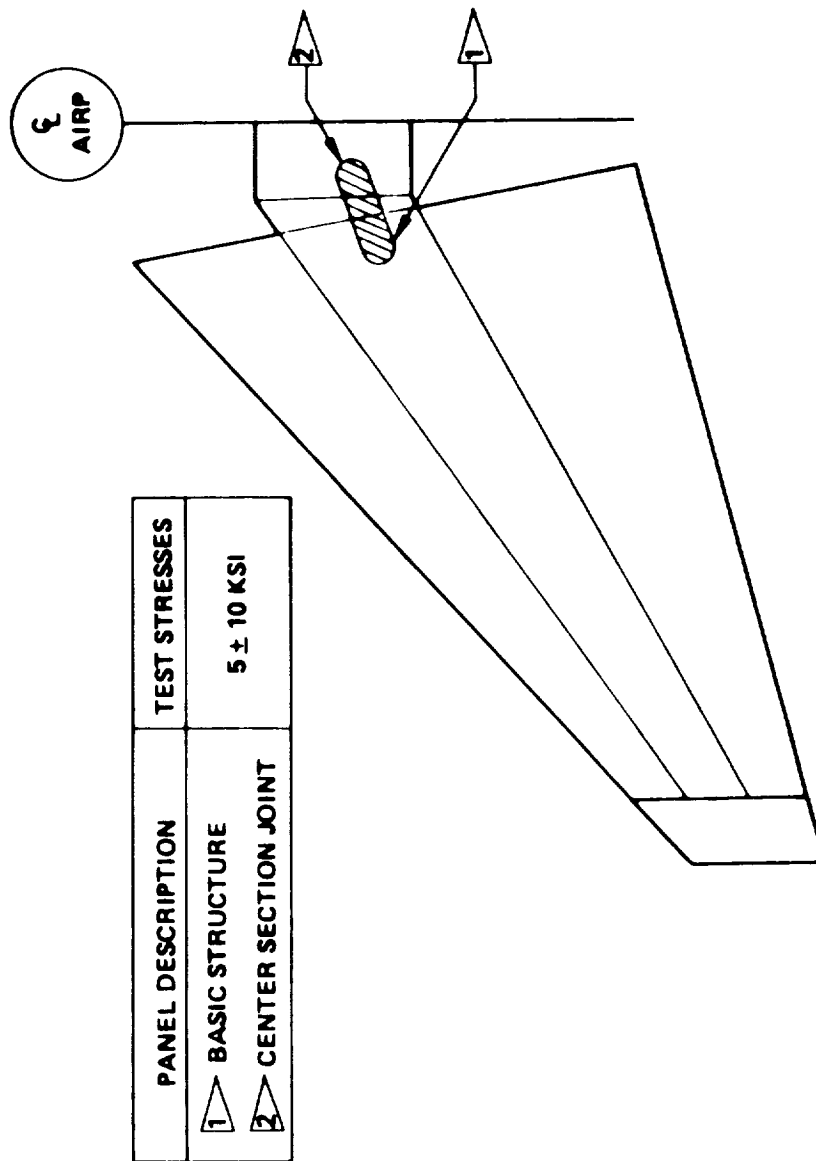

Figure 16.- Horizontal-tail testing (3 panels tested).

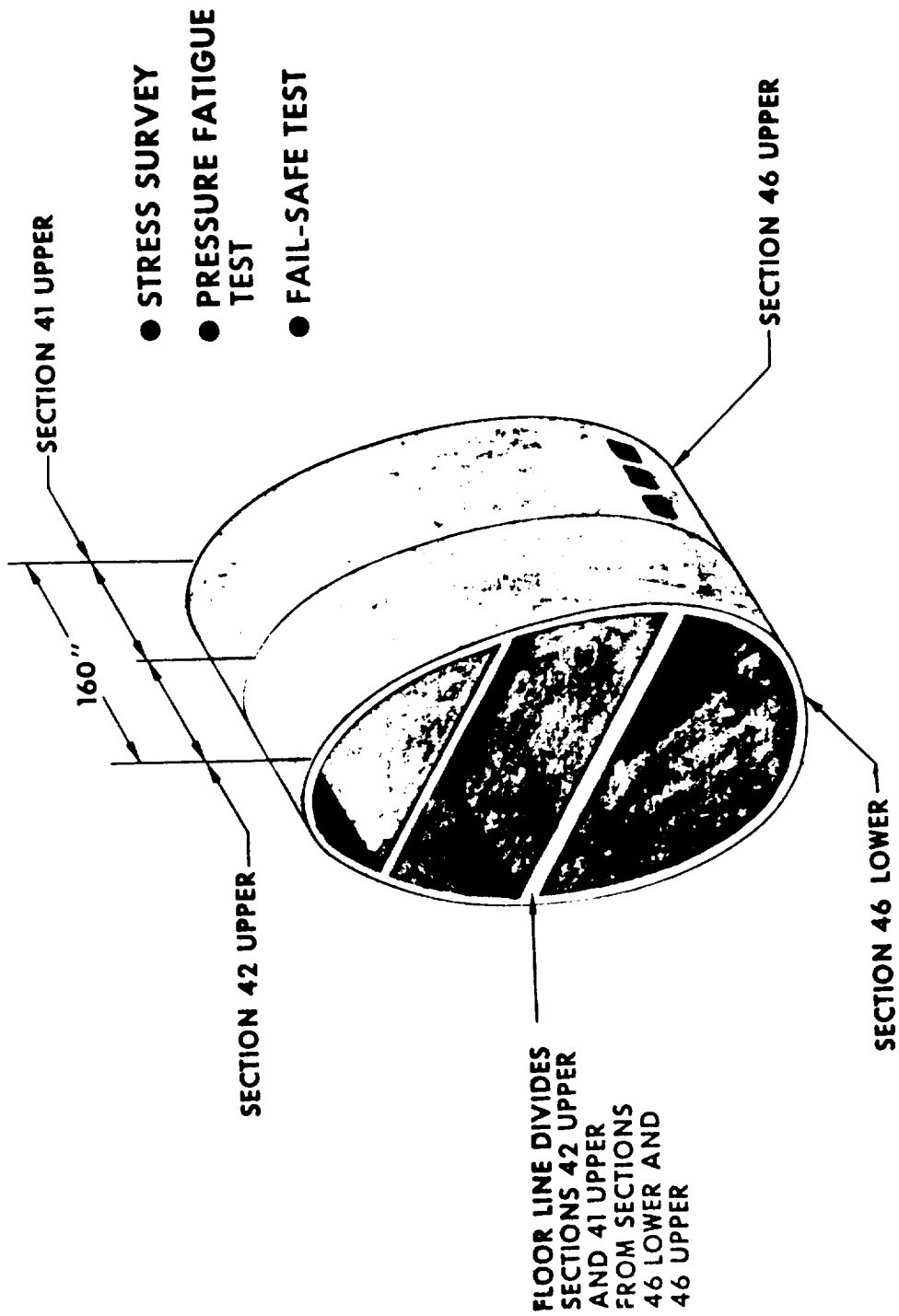
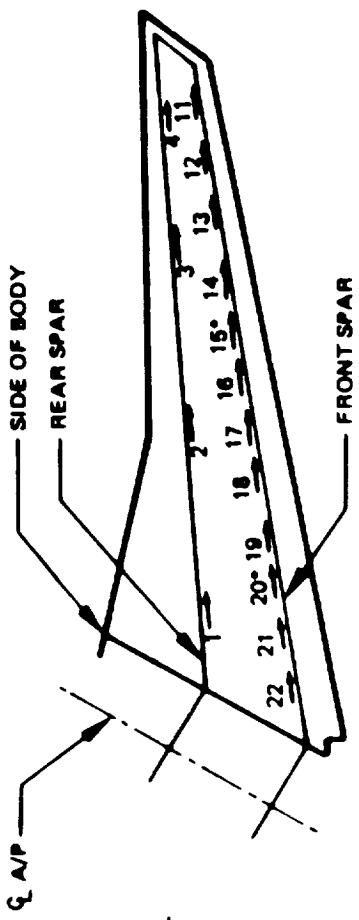

Figure 17.- Pressurized fuselage test.



- NOTES:**
- (1) 2024-T3 MATERIAL
  - (2) FRF = 4.0
  - (3) BASED ON 3-HR FLIGHT
  - (4) \*INDICATES SKIN SPLICE RUNOUT
- CODE**
- .....FPI = 1/2.5
  - FPI = 1/3.5
  - FPI = 1/4.5

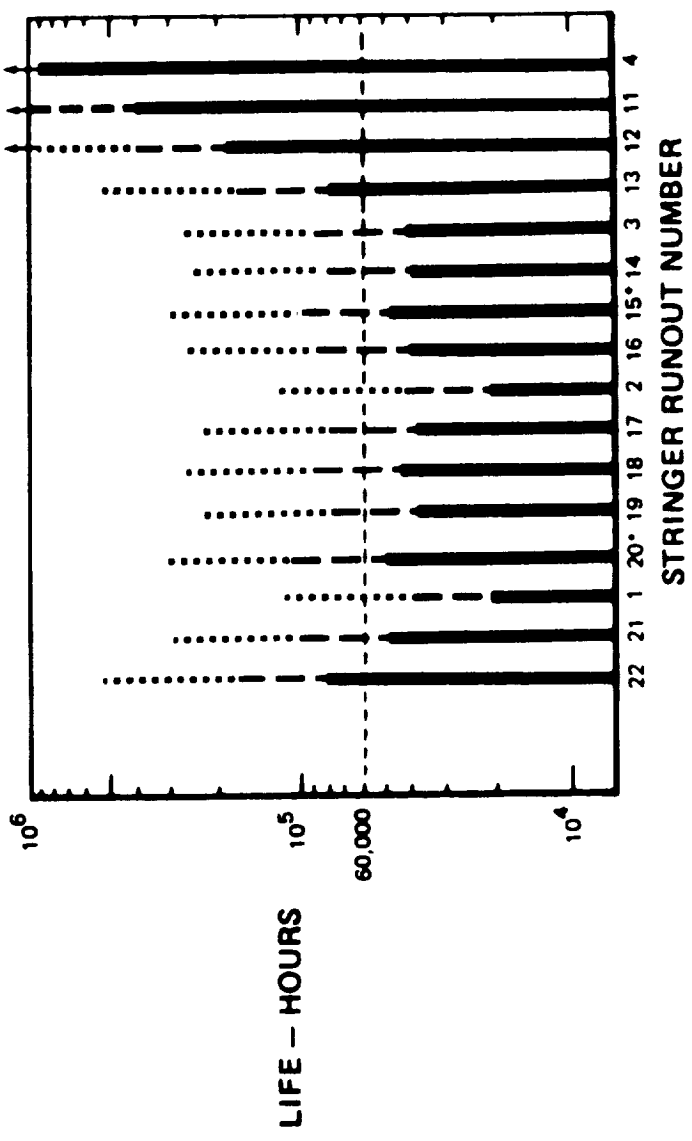

Figure 18.- Fatigue analysis example. Wing lower surface; stringer runouts.

● MATERIAL — 2024-T3

● TEST DATA

REFERENCES	TEST STRESS KSI	APPLICABLE TEST CYCLES
EWA 21-110012, PANEL NO. 2	10 ± 9	327,200

● DEMONSTRATED FPI = .361 = 1/2.77

● FATIGUE PERFORMANCE RELIABILITY FACTOR (FRF)

FRF = 2.95

TEST DEMONSTRATED F.P.I.

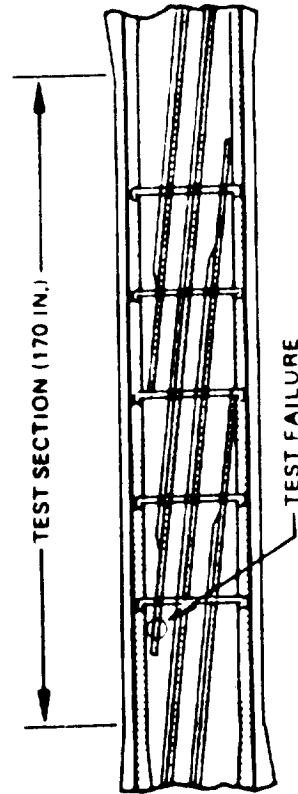
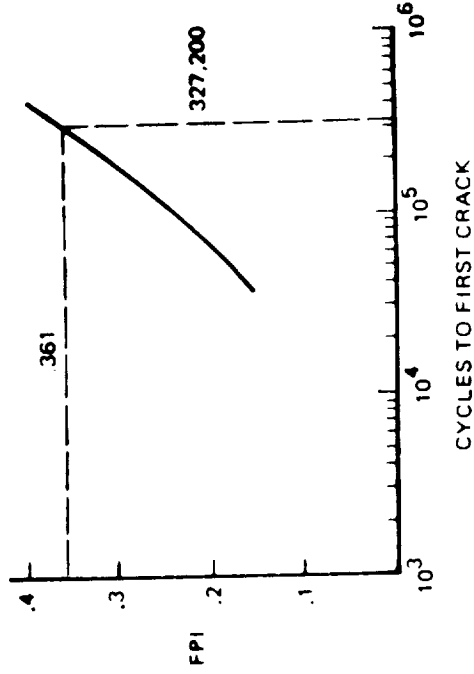
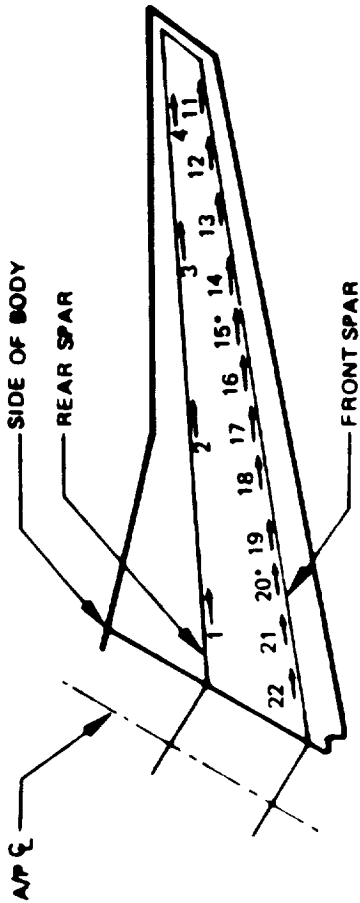

Figure 19.- Panel test data example. Wing lower surface; typical stringer runout.



**NOTES:**

- (1) 2024-T3 MATERIAL
- (2) FRF = 2.96
- (3) FPI = 1/2.77 FOR TYPICAL
- (4) FPI = 1/3.14 FOR SKIN SPLICE
- (5) \*INDICATES SKIN SPLICE RUNOUT
- (6) BASED ON 3-HOUR FLIGHT

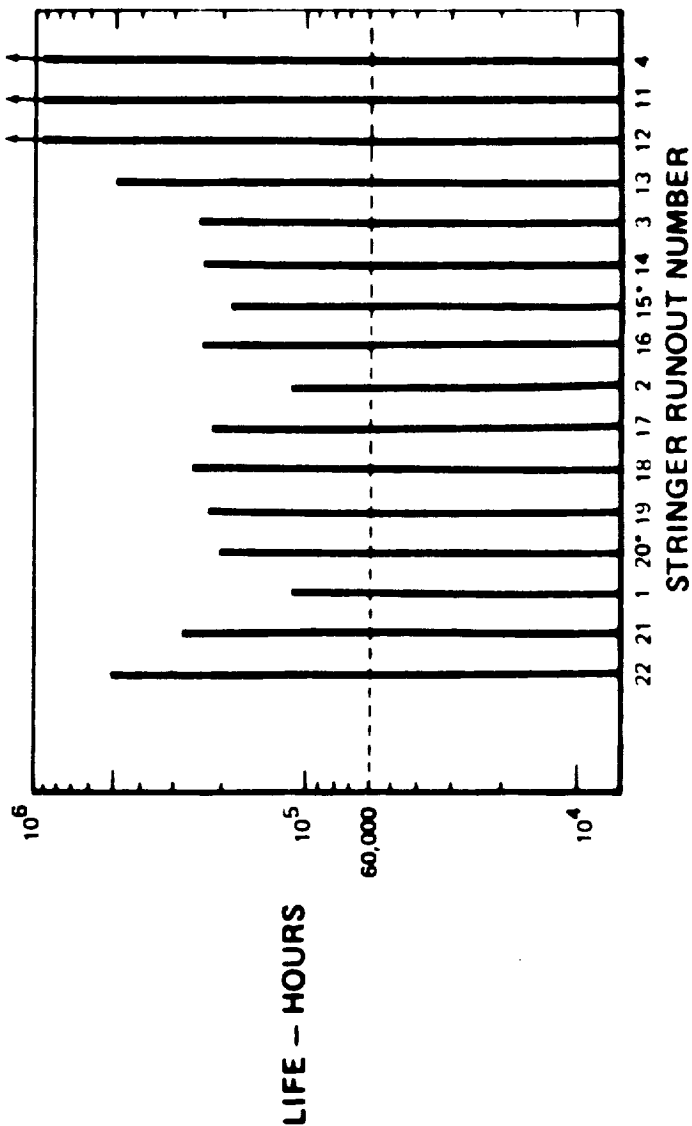

Figure 20.- Fatigue performance example. Wing lower surface; stringer runouts.



2024-T3 MATERIAL  
 FRF = 2.76  
 FPI = 1/2.9

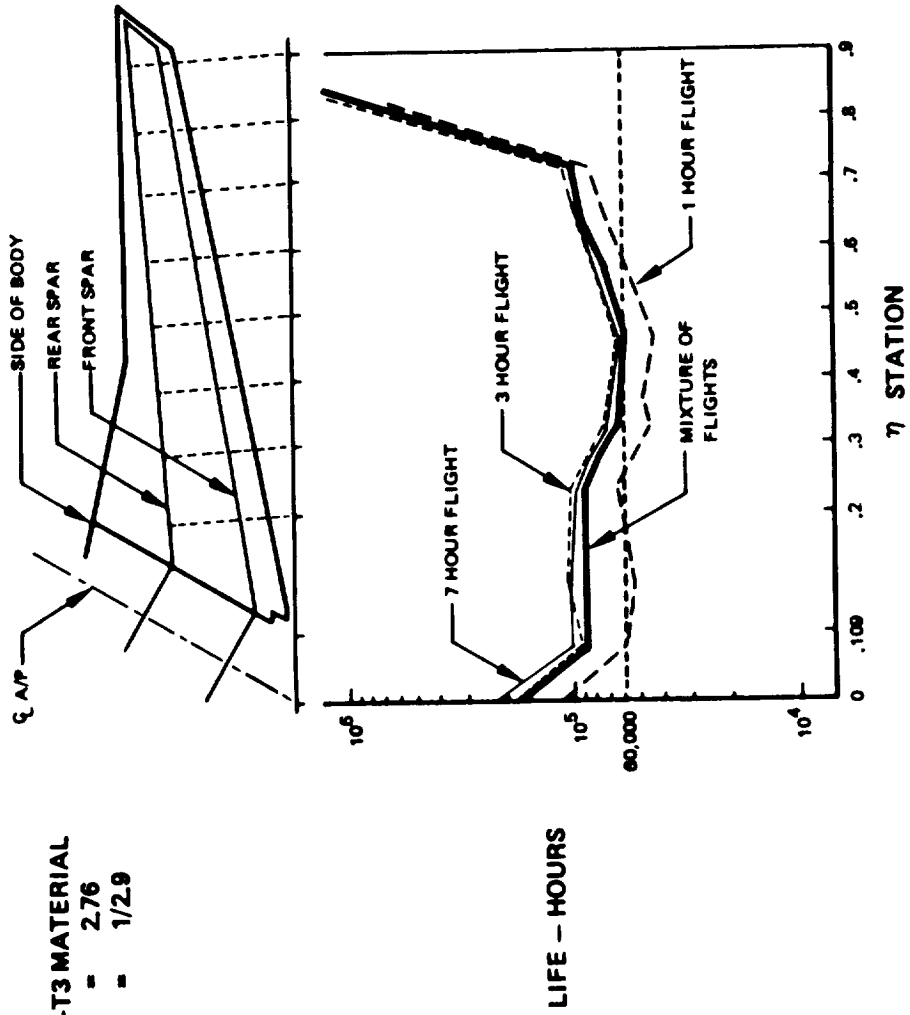

Figure 21.- Fatigue performance of wing lower surface on 747 basic passenger airplane.

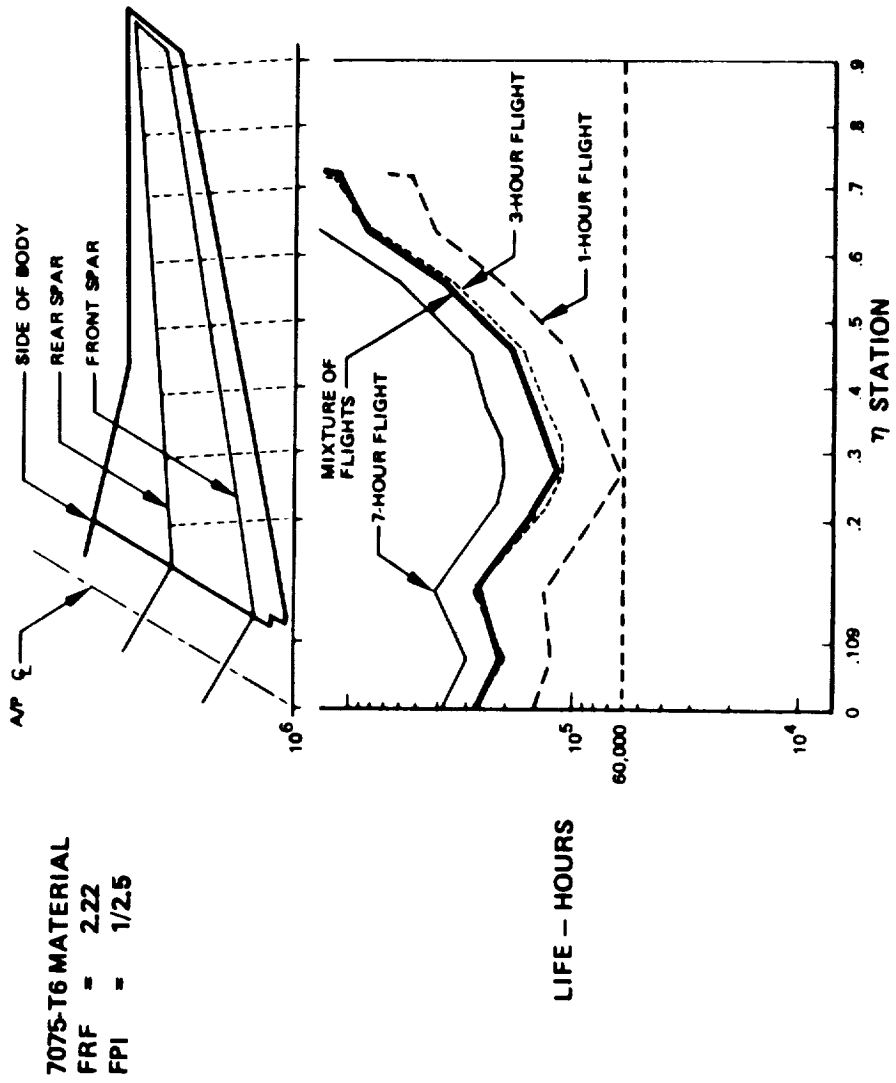

Figure 22.- Fatigue performance of wing upper surface on 747 basic passenger airplane.

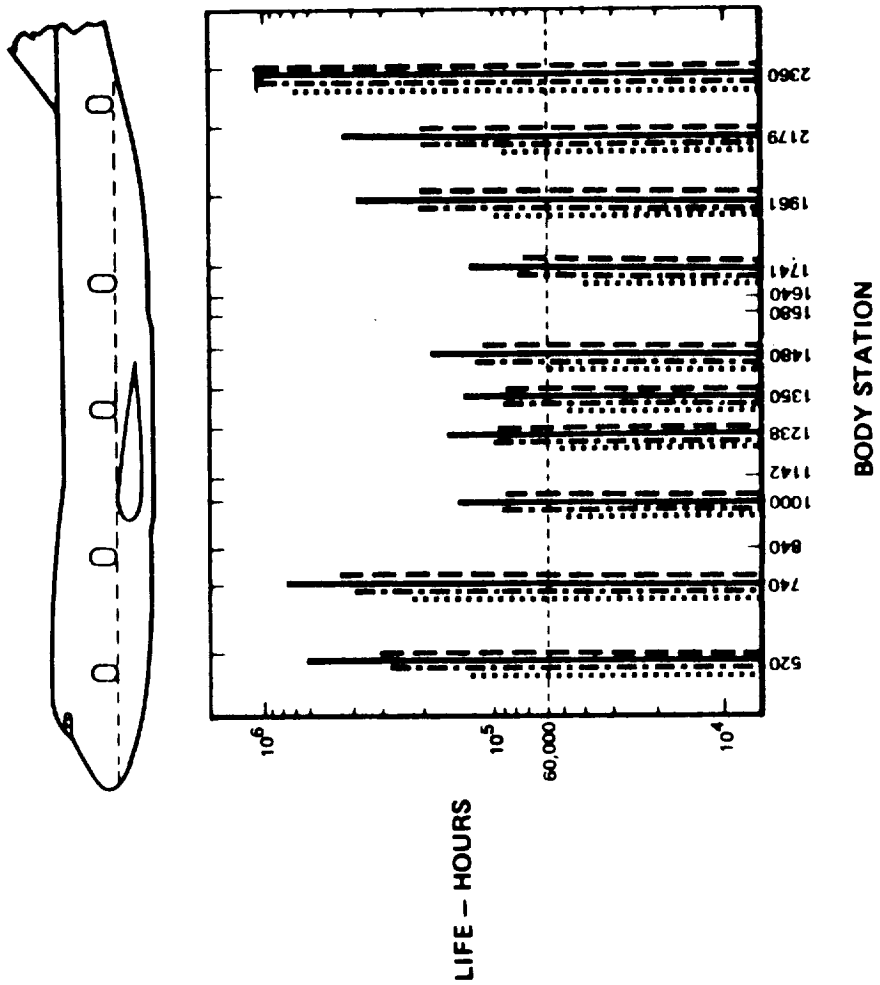
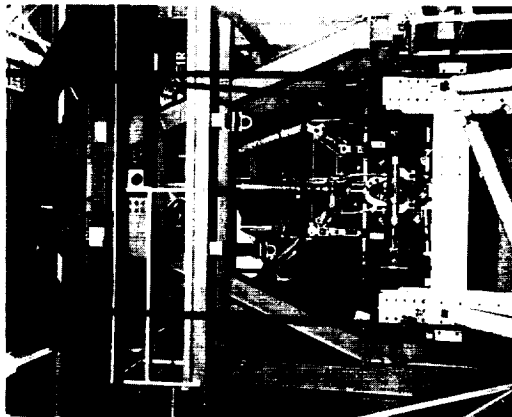

Figure 23.- Fatigue performance of fuselage crown stringer splices on 747 basic passenger airplane.

DESCRIPTION

1. TEST SPECIMEN IS A PRODUCTION GEAR, EXCLUDING WHEELS, TIRES AND THREE BRAKES
2. JIG SIMULATES THE AIRPLANE SUPPORT STRUCTURE.
3. LOADS ARE APPLIED IN A MANNER TO SIMULATE ACTUAL GROUND LOADING.
4. TEST SCHEDULED FOR EQUIVALENT OF 4x60000 = 240000 HOURS IN MIXTURE OF FLIGHTS.



WING GEAR

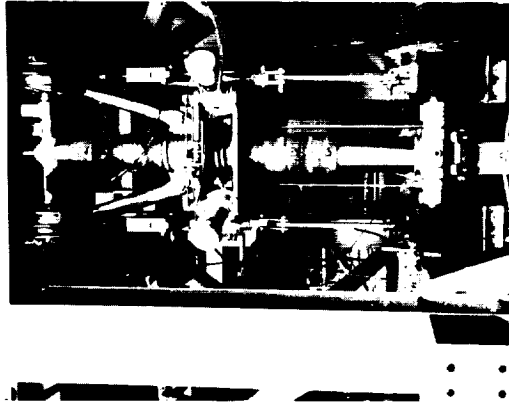

NOSE GEAR

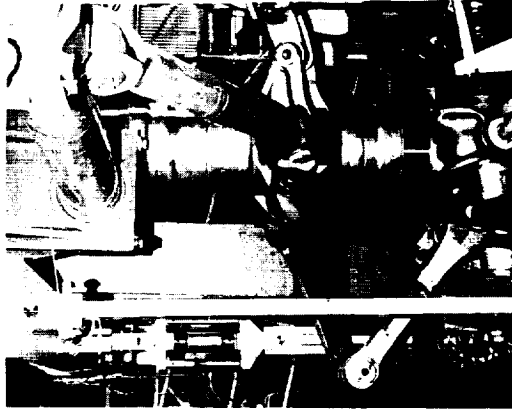

BODY GEAR

Figure 24.- Landing-gear fatigue test.



C.4.

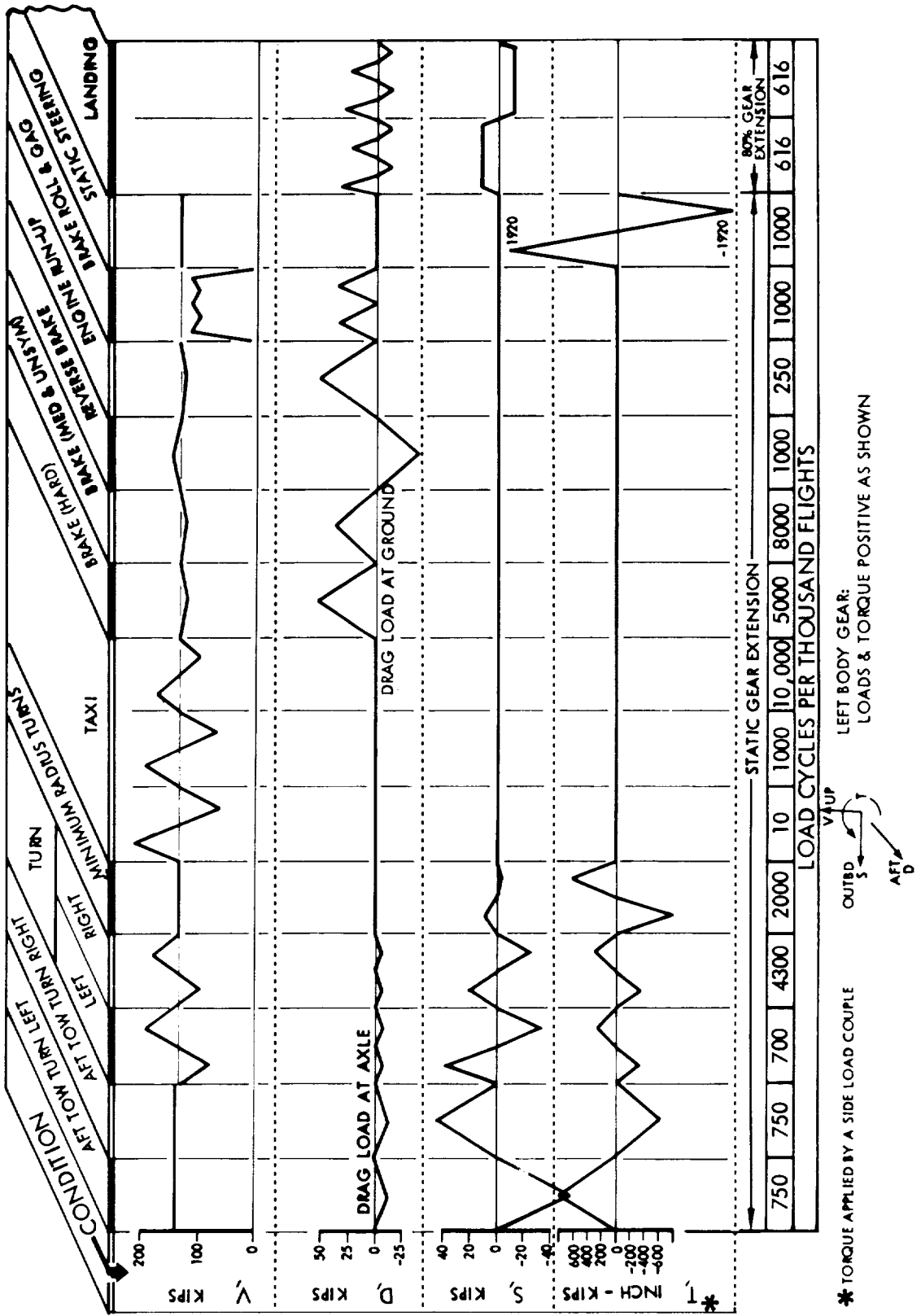

Figure 26.- 747 body gear fatigue test. Loading block.

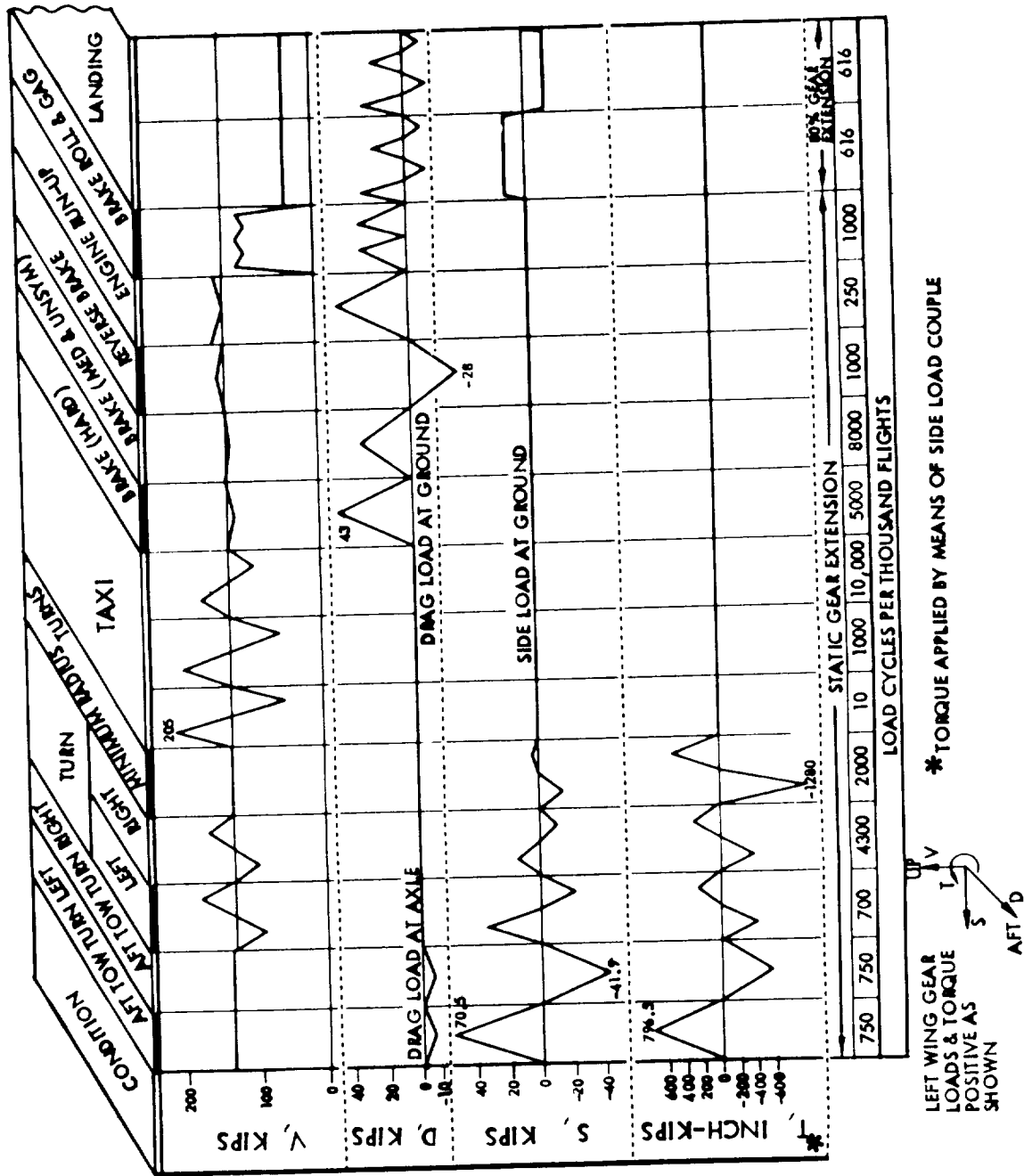
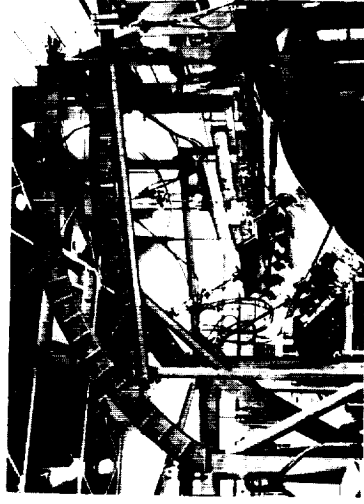

Figure 27.- 747 wing gear fatigue test. Loading block.

- TEST SPECIMEN CONSISTS OF COMPLETE PRODUCTION FLAP AND DRIVE SYSTEM
- TESTING INCLUDES STRESS SURVEY, SYSTEM CYCLIC TESTING, STRUCTURAL FATIGUE TESTING AND FAILSAFE TESTING
- SIMULATED AIRLOADS ARE APPLIED DIRECTLY TO THE FLAP SURFACES
- TEST IS SCHEDULED FOR EQUIVALENT OF 2 X 60,000 (120,000) HOURS IN MIXTURE OF FLIGHTS



**OUTBOARD FLAP SYSTEM**

Figure 28.- Tests of trailing-edge flap and flap drive system.



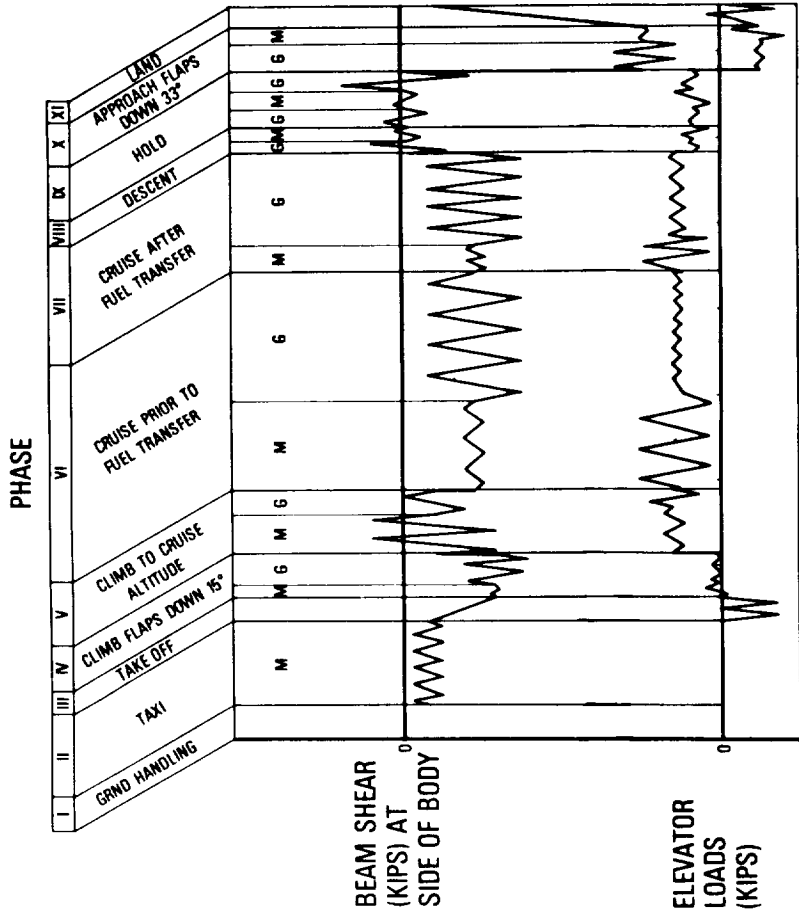

STABILIZER TEST SET-UP

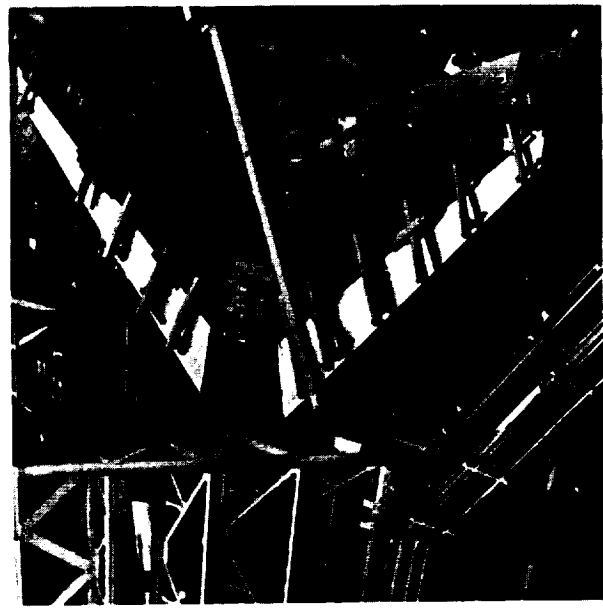

- NOTE:
- M = MANEUVER CYCLES
  - G = GUST CYCLES
  - TEST IS SCHEDULED FOR EQUIVALENT OF 2 X 120,000 (240,000) HOURS IN MIXTURE OF FLIGHTS

Figure 29. - Fatigue test of horizontal stabilizer.

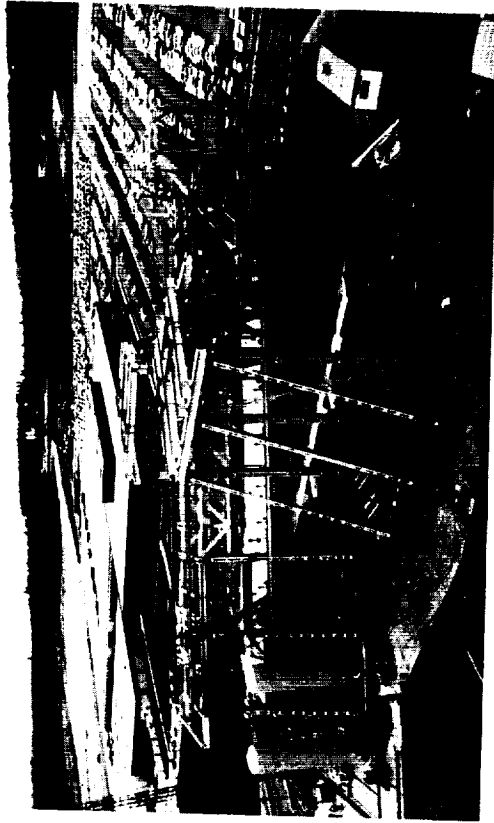
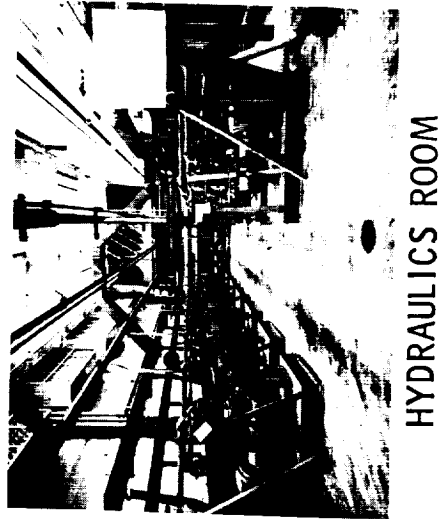

NOTE: TEST IS SCHEDULED FOR 2 X 60,000 (120,000) HOURS IN MIXTURE OF FLIGHTS.

Figure 30.- Airplane fatigue test.

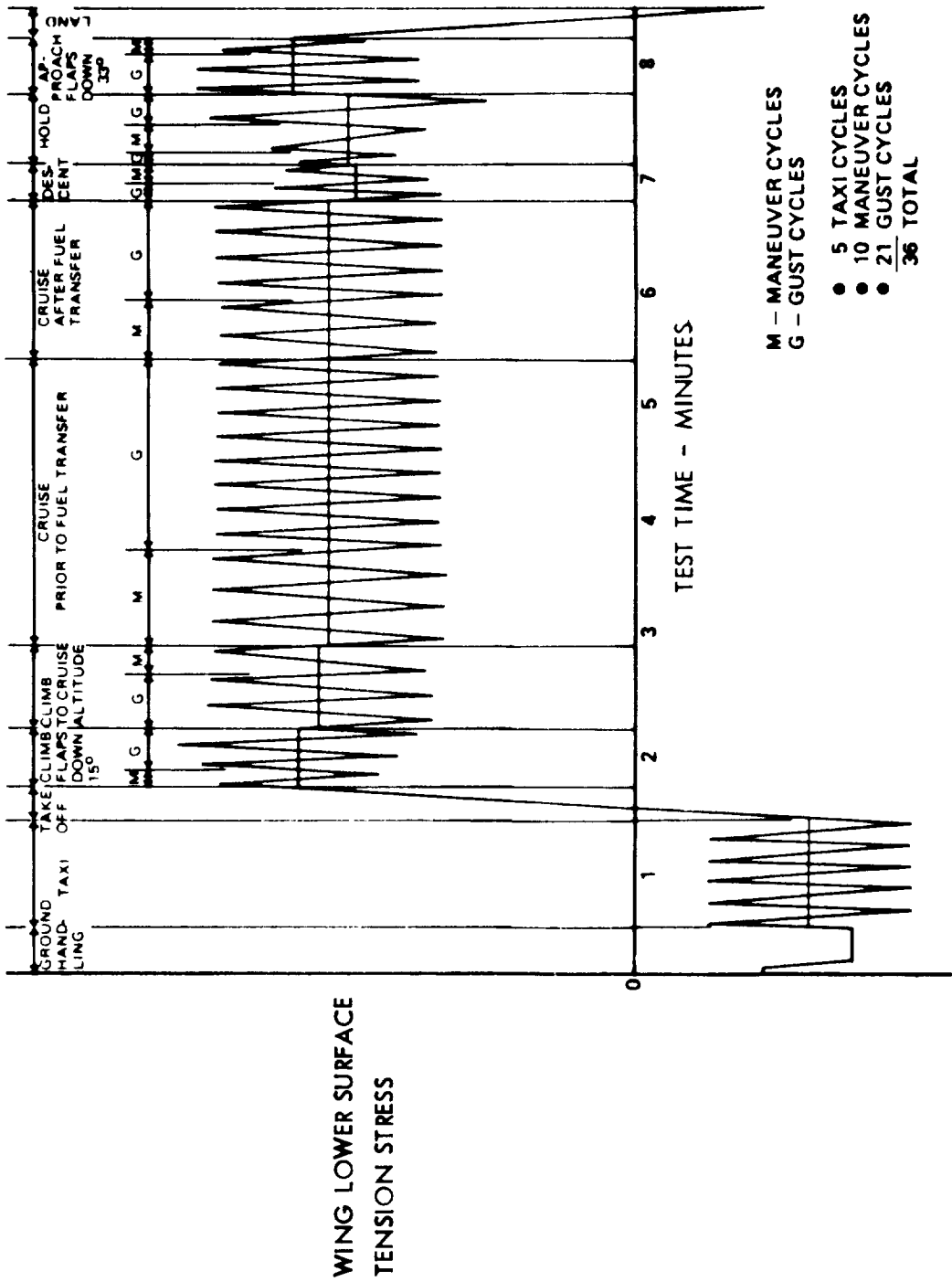

Figure 31.- Vertical-load program of 747 full-scale fatigue test.

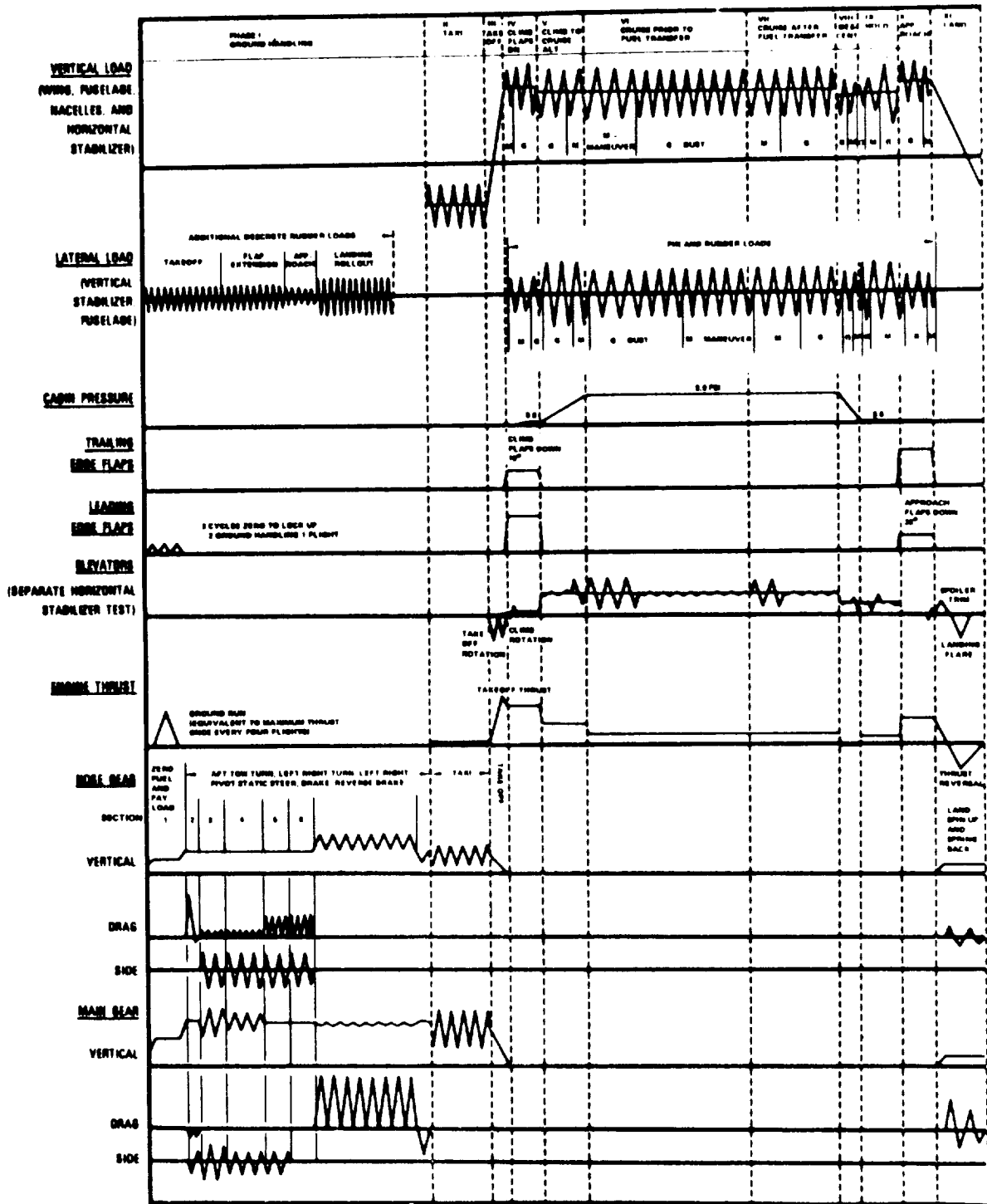

Figure 32.- 747 full-scale fatigue test.