

**NASA TECHNICAL
MEMORANDUM**

NASA TM X-64672

**CASE FILE
COPY**

FLAT CONDUCTOR CABLE APPLICATIONS

By W. Angele

Process Engineering Laboratory

March 1972

NASA

*George C. Marshall Space Flight Center
Marshall Space Flight Center, Alabama*

1. REPORT NO. TM X- 64672		2. GOVERNMENT ACCESSION NO.		3. RECIPIENT'S CATALOG NO.	
4. TITLE AND SUBTITLE Flat Conductor Cable Applications				5. REPORT DATE March 1972	
				6. PERFORMING ORGANIZATION CODE	
7. AUTHOR(S) W. Angele				8. PERFORMING ORGANIZATION REPORT #	
9. PERFORMING ORGANIZATION NAME AND ADDRESS George C. Marshall Space Flight Center Marshall Space Flight Center, Alabama 35812				10. WORK UNIT NO.	
				11. CONTRACT OR GRANT NO.	
12. SPONSORING AGENCY NAME AND ADDRESS National Aeronautics and Space Administration Washington, D.C. 20546				13. TYPE OF REPORT & PERIOD COVERED Technical Memorandum	
				14. SPONSORING AGENCY CODE	
15. SUPPLEMENTARY NOTES This report was reviewed and edited by the Process Engineering Laboratory, Science and Engineering. The information in this report was provided by Hayes International Corporation, under Contract NAS8-21809, with technical inputs from MSFC.					
16. ABSTRACT This report contains brief descriptions, supplemented with artwork, of some of the numerous applications of flat conductor cable (FCC) systems. Both Government and commercial uses have been considered, with described applications designated as either aerospace, military, or commercial. The document is designed to illustrate the number and variety of ways in which FCC is being applied and considered for future designs. EDITOR'S NOTE Use of trade names or names of manufacturers in this report does not constitute an official endorsement of such products or manufacturers, either express or implied, by the National Aeronautics and Space Administration or any other agency of the United States government.					
17. KEY WORDS			18. DISTRIBUTION STATEMENT unclassified - unlimited <i>W.K. Vandenberg</i>		
19. SECURITY CLASSIF. (of this report) Unclassified		20. SECURITY CLASSIF. (of this page) Unclassified		21. NO. OF PAGES 114	22. PRICE \$3.00

PREFACE

This document was designed and prepared under the direction and with the assistance of Mr. W. Angele of NASA. He was supported in this effort by Candace Swanson, Hayes International Corporation, in fulfillment of requirements specified in a Technical Directive issued by the Process Engineering Laboratory, NASA/MSFC.

In this effort to further the development of flat conductor cable technology by making facts available to the interested public, many known producers of FCC systems were mailed requests for assistance. Unfortunately, response was negligible; often a result of various company policies.

Special thanks must be extended to the many individuals within NASA and private industry who gave generously of their time and knowledge, providing the necessary data and artwork for this document. These people, and the organizations they represent, realize the gains to the field and to themselves which must ultimately result when the unrestricted dissemination of knowledge occurs.

TABLE OF CONTENTS

	Page
SUMMARY	vii
SECTION I. INTRODUCTION	1
Purpose	3
Definition of Terms	3
History	4
Report Format	4
SECTION II. AEROSPACE APPLICATIONS	7
Advanced Action Manipulator System (ADAMS)	10
Agena Space Booster	12
Apollo Lunar Surface Experiments Package (ALSEP)	14
Apollo Telescope Mount (ATM)	16
Electronics Control Equipment for Neutral Buoyancy System	20
Experiment Package for Zero-G Studies	22
KC-135 Aircraft Experiment Platform	24
Lunar Portable Magnetometer (LPM)	26
Lunar Surveyor	28
Pegasus Meteoroid-Detection Satellite	30
Research Space Vehicle Program	32
Saturn V Optical Tracking System GSE	34
Saturn 201 Instrumentation Unit	36
Saturn IVB Study	38
Solar Array for Skylab Orbital Workshop	40
Space Station Power System	42
SECTION III. MILITARY APPLICATIONS	45
Cryptographic Equipment	48
E2C Airplane	50
F-111 Airplane GSE	52
F-111 Airplane: Mark II Avionics	54
F-14 Airplane	56
MK 48 Torpedo Fire Control System (FCS)	58
Naval Shipboard Equipment	60
Pershing Missile	62
Poseidon Missile Flight Programmer	64
Poseidon Missile GSE	66
Poseidon Missile Tunnel Wiring	68

TABLE OF CONTENTS (Concluded)

	Page
Standard Missile	69
Ships Inertial Navigation Systems (SINS)	70
Spartan Missile	72
Upstage Missile	74
Minuteman II and III Missiles	76
Mark 17 Reentry Vehicle, Minuteman III Missile	80
SECTION IV. COMMERCIAL APPLICATIONS	81
Boeing 747 Aircraft	84
Ceiling Lights	86
High Intensity Picture Light	88
Microcircuit Prober	90
CONCLUSION	92
APPENDIX. SOURCES OF ADDITIONAL INFORMATION	93
BIBLIOGRAPHY OF SELECTED GOVERNMENT AND INDUSTRY DOCUMENTS	95

SUMMARY

Flat conductor cable (FCC) has been selected or proposed for use in a wide variety of projects, aerospace and military fields of effort as well as industrial-commercial programs. In numerous cases, FCC has been able to provide definite advantages over conventional round wire cable. Several applications were such that no other cabling system could practically meet specifications.

In the body of this report, applications have been grouped according to type user, Government (aerospace or military) or commercial, a method quite useful for individual treatment of FCC uses. However, another way of obtaining an overall view of FCC applications is to consider a selected sampling according to type program requirements and advantages of use. This latter method has been chosen for the following summation.

Volume Reduction

As a result of its flat configuration and flexibility, FCC has a higher packaging density than conventional round wire cable. Because of this fact, FCC often is the only practical cable for a particular project. For example, the Apollo Telescope Mount's (ATM) gimbal system (see page 16) includes a cable arch which cannot house the required amount of round wire cable. In many complex shipboard instrumentation systems, such as the Ships Inertial Navigation System (SINS) (see page 70) and the MK 48 Torpedo Fire Control System (see page 58), space for required wiring is extremely limited. Again, FCC is uniquely able to meet specifications. Space is often a major consideration in airborne applications. The Navy's Standard and Poseidon missiles as well as E2C and F14 airplanes (described on pages 69, 64, 50 and 56) use FCC for some electronics equipment.

Weight Reduction

In aircraft as well as shipboard applications, weight is often a critical factor in cable selection. When McDonnell Douglas, under contract to NASA, replaced a 180-degree portion of a Saturn IVB aft skirt mockup cabling harness with flat cable (refer to page 38), they realized a weight savings of 76 percent. Boeing confirmed the weight savings advantages of FCC in a laboratory installation of the 747 airplane Auxiliary Power Unit (see page 84). Librascope uses FCC in numerous naval shipboard systems (noted on pages 58 and 60) largely because of resulting weight savings.

Cost Savings

In many instances, lower manufacturing costs and savings resulting from ease in installation of FCC systems has been a major basis for use. An assembly developed by ABT Associates and Non-Linear Systems (refer to page 86) can be simply installed for numerous low-voltage uses, such as home lighting, and result in considerable savings. Conversion to FCC for the Inertial Reference Unit in the Mark II avionics on the F-111 airplane (refer to page 54) actually saved 800 labor hours per assembly.

In the previously mentioned Saturn IVB aft skirt mockup fabricated in 1966 by McDonnell Douglas (see page 38), savings in materials were conservatively estimated at 33 percent. Using 1971 cable prices, material savings for this same mockup would be closer to 72 percent.

Movement

LINEAR MOTION

The configuration of FCC makes it extremely well suited to applications where two or more pieces of electrically interconnected hardware must move in a linear direction in relation to each other. Some of the FCC assemblies which have been employed to meet this requirement are discussed below.

Corrugated Cable

In the Hughes Lunar Surveyor spacecraft (refer to page 28), a cable permanently corrugated for elasticity was used which allowed an experiment package to be dropped onto the lunar surface. Numerous naval projects, such as the MK 48 Torpedo Fire Control System and the SINS (described on pages 58 and 70) have used permanently corrugated FCC to enable equipment drawers to be moved for servicing.

Another way of interconnecting moving drawer assemblies to a stationary console is through use of a temporary corrugated FCC configuration. In the closed drawer position, the cable forms corrugations in a minimum of space. When the drawer is extended, these straighten. Several consoles used in the operation of NASA/MSFC's Neutral Buoyancy Tank (see page 20) have this type FCC assembly for smooth drawer movement.

Reels

FCC can also be stowed on a reel and used to deploy equipment in an efficient and reliable manner. This type system has been used most successfully in the Apollo

Lunar Surface Experiments Package (refer to page 14) for deploying equipment packages up to 60 feet from the central data package, as well as the Lunar Portable Magnetometer (described on page 26). Military programs, like the Air Force GSE for the F-111 airplane (described on page 52) have also made use of FCC reel assemblies.

LIMITED ROTARY MOTION

Various configurations of FCC are used to maintain electrical connections between two pieces of electronic equipment which must rotate in relation to each other. The high flex life and low torque property of flat cable are definite assets for this type cable use.

Torque Compensating Loop

This configuration of interconnection is used in a gimbal system where electrical energy and signals must be conveyed at a minimum of torque. When applied to the ATM gimbal system (see page 16), the torque will be 90 percent less than that of a conventional round wire system, a considerable reduction.

Spring Coil

In NASA's Advanced Action Manipulator System (see page 10), a remotely operated electromechanical manipulator for performing work, flexible coils of FCC in the shoulder and elbow joints enable ± 170 degrees rotation, as well as bending movement.

HINGE-LINE APPLICATIONS

FCC is ideally suited for use as a medium to convey electrical signals across a hinge line. Flat cable was used for this purpose in the wings of the highly successful Pegasus meteoroid-detection satellite (refer to page 30) and has been proposed for similar aerospace applications. In a ground test unit for the Navy's Poseidon missile (see page 66), FCC assemblies provide door to cabinet and door to door connections.

Invisible Wiring

The flat, thin profile of FCC enables it to be applied to surfaces by an adhesive backing, painted or papered over, and thus provide almost invisible circuitry. Because of this feature, FCC has recently been selected for several low-voltage home wiring applications. The New York State Urban Development Corporation will use an FCC assembly, which includes a special switching device, for wiring to ceiling lights in an

experimental housing project (see page 86). This extremely promising innovation may well result in vast construction and installation cost reductions. Hobby Hill, Inc., of Chicago markets an FCC picture-light assembly (refer to page 88) which does not have the bulky, unsightly appearance of round wire cable. This system has numerous additional household uses.

Reliability

The reliability of FCC is attested to by the inclusion of FCC assemblies in numerous projects where severe operating conditions exist and high reliability is a critical requirement.

For example, a submarine environment, with its special conditions of shock, vibration, and temperature, makes its demands on a cabling system. Reliability was, thus, a major consideration when FCC was selected as an interconnecting medium in the Mark 48 Torpedo Fire Control System and in the SINS (described on pages 58 and 70). In addition, both applications presented severe mechanical and electrical problems because of the requirement that the circuitry must carry consistent electrical signals regardless of console drawer position.

Airborne applications also place severe operating conditions on cabling systems and demand high reliability. Vibration effects often associated with bulky, stiff, round wire cables can be sharply reduced through the use of FCC systems. Flat conductor jumper cables used in the Mark II avionics in the Air Force F-111 airplane (see page 54) are corrugated, and thus provide float for vibration isolation. In an experiment platform for use in a KC-135 research aircraft (refer to page 24), the thin, flat configuration of FCC allows it to be fastened firmly to the structure. This results in less chances of destructive vibration between cable and connector.

SECTION I. INTRODUCTION

PURPOSE

Flat conductor cable (FCC) systems have been used extensively in both Government and commercial designs. This document presents some of the ways in which FCC has been successfully used or proposed for use. No attempt has been made to cover even a majority of examples in this rapidly expanding field but merely to show representative designs as well as some of the more innovative ideas.

Most of the applications described in this document do not represent optimum uses of FCC. Because FCC systems are just beginning to be used in production items, the full advantages of FCC application have not yet been realized. In several of the described applications, FCC is used to replace round wire cable (RWC) in an existing system, and thus some of the RWC design limits are automatically imposed on the new matrix. In other examples, only limited use of FCC has been made, often the result of insufficient development time and money, or perhaps a desire to first use FCC on a trial basis. The reader will also notice that many different cable systems have been developed for similar uses, for example electronic drawer applications. This is a natural consequence of different designers looking for the best ways of applying a relatively new system.

Although the benefits to be gained through use of FCC are well known, greater application of flat cable systems will occur as potential users become more familiar with existing uses and comprehensive application studies. As the awareness of these FCC systems increases, so will the usage of FCC, and as greater quantities of FCC are used, production costs will inevitably decline. The end result will be a system which not only is more suitable than other wiring for many projects, but which can be obtained at costs competitive with or substantially lower than those of other systems.

It is hoped that this document will add to the knowledge of the reader, and thus further the growth of FCC application.

DEFINITION OF TERMS

Flat conductor cable consists of flat parallel conductors laminated between thin flexible plastic insulating films, or otherwise held in a rectangular flat configuration. For the purposes of this report, the terms "FCC" and "flat cable" are considered to be synonymous with "flat conductor cable." Flat ribbon cable, containing round wires and sometimes referred to as flat cable, is not within the scope of this document and is not implied by the term "flat cable."

HISTORY

Efforts by Government and private industry have brought FCC technology to a highly advanced state. Since the earliest investigative work, initiated in 1956 at the Guidance and Control Laboratory of the Army Ballistic Missile Agency (now part of the Marshall Space Flight Center), FCC systems have been continually refined. Hardware has been developed, systems subjected to stringent testing, and military specifications have been written for both cables and connecting hardware. Much of this work has been accomplished at NASA Marshall Space Flight Center under the direction of Mr. Wilhelm Angele, recognized throughout the aerospace industry as the leading designer of FCC systems. In more recent years, private industry has done much to advance flat cable technology: designing simple and effective terminations, developing competitive production methods and designs for cable harnesses, and investigating unique packaging concepts.

The benefits of using FCC in many interconnecting systems have long been recognized. In a growing number of instances, highly flexible FCC is more compatible than round wire with modern circuit designs, component miniaturization trends, and new packaging techniques. Certainly FCC should always be considered in electrical system design where weight, space, cost reduction, flexibility, reliability, and uniform electrical characteristics are of prime importance. In case after case, results of carefully designed tests and comparative studies have lent strong support to merits attributed to FCC systems.

Nonetheless, even with the abundance of supportive evidence, the relative newcomer to the field is not completely convinced of the utility of FCC. He wants to see examples, actual cases of successful utilization.

REPORT FORMAT

The primary purpose of this document is to present varied and successful applications of flat conductor cable systems and to illustrate the numerous ways in which FCC can be used to great advantage. These include Government and commercial projects in which FCC was selected either because it met a requirement which no other interconnecting system could meet or because the benefits of use outweighed merits of other systems. To give some ideas as to future possibilities, descriptions of proposed applications and major studies have also been included.

Subject matter has been divided into three main sections:

Section II. Aerospace Applications

Section III. Military Applications

Section IV. Commercial Applications

Each section contains brief descriptions of applied and proposed FCC uses as well as major application studies. These descriptions are supplemented with photos and illustrations and with references to additional sources of information.

At the end of this document, a bibliography of selected Government and industry documents relating to FCC systems has been included for further study.

SECTION II. AEROSPACE APPLICATIONS

UNCLASSIFIED

Page Intentionally Left Blank

SECTION II. AEROSPACE APPLICATIONS

Advanced Action Manipulator System (ADAMS)

Agena Space Booster

Apollo Lunar Surface Experiments Package (ALSEP)

Apollo Telescope Mount (ATM)

Electronics Control Equipment for Neutral Buoyancy System

Experiment Package for Zero-g Studies

KC-135 Aircraft Experiment Platform

Lunar Portable Magnetometer (LPM)

Lunar Surveyor

Pegasus Meteoroid-Detection Satellite

Research Space Vehicle Program

Saturn-V Optical Tracking System GSE

Saturn 201 Instrumentation Unit

Saturn IVB Study

Solar Array for Skylab Orbital Workshop

Space Station Power System

ADVANCED ACTION MANIPULATOR SYSTEM (ADAMS)

FCC is used for electrical circuits which cross the shoulder and elbow axes.

The ADAMS (Fig. 1) is one of a group of low cost, electromechanical manipulators which are under development for the performance of tasks such as handling, loading, transferring, stacking, and assembling in space and in other harsh environments. The basic system will be coordinated with various MSFC and other NASA organizations to comprise ultimate systems. FCC was selected to replace original round wire cables because of greater flexibility, reliability, and packaging density factors.

Two FCC flexible spring coil assemblies, provided by NASA/MSFC, are used in the manipulator. The center coil of one is located in the shoulder joint (Fig. 2), allowing ± 170 degrees rotation and an elevation of +200 degrees from the vertical down position of the upper arm. The second coil is centered in the elbow joint, and again allows rotation of ± 170 degrees. Elbow pitch of -60 degrees to +140 degrees is also possible. Each cable assembly consists of two layered cables, terminated at one end to a standard NASA circular 1/2-inch plug, and at the other end to an FCC to round wire transition. Plugs of both assemblies connect to a feed-through receptacle below the shoulder joint, thus enabling quick disconnect of the ADAMS from the base structure. The flat cable used is Kapton/Teflon insulated, 1/2 inch wide, and contains six 4×40 mil conductors on a 75-mil baseline center to center spacing.

For additional information, refer to the Appendix, item number 1.

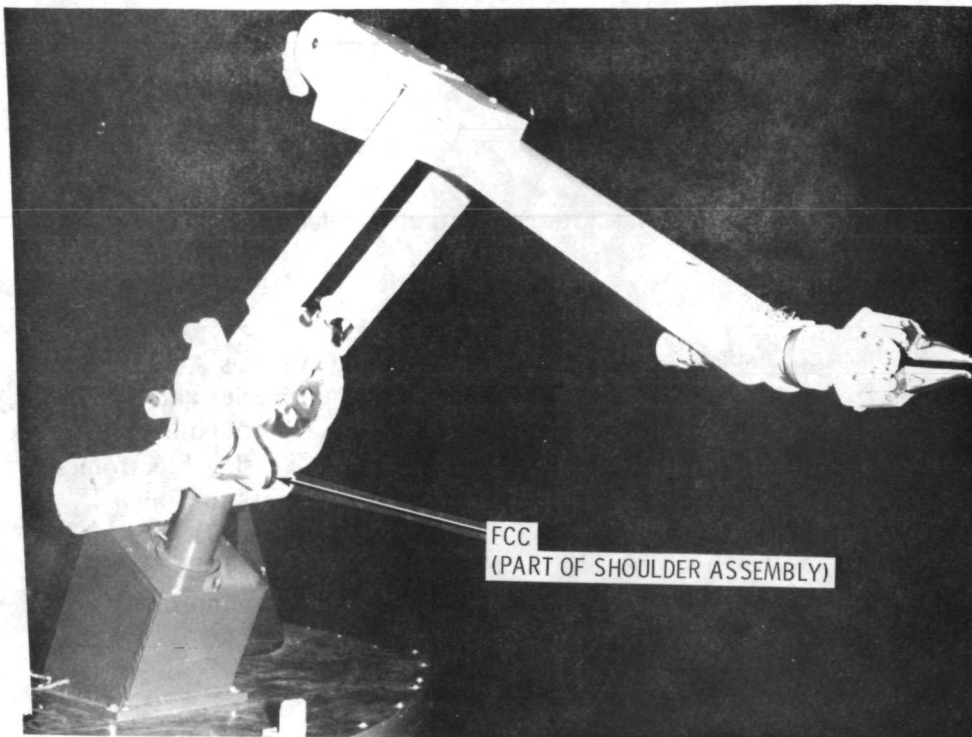

Figure 1. Overall view of ADAMS.

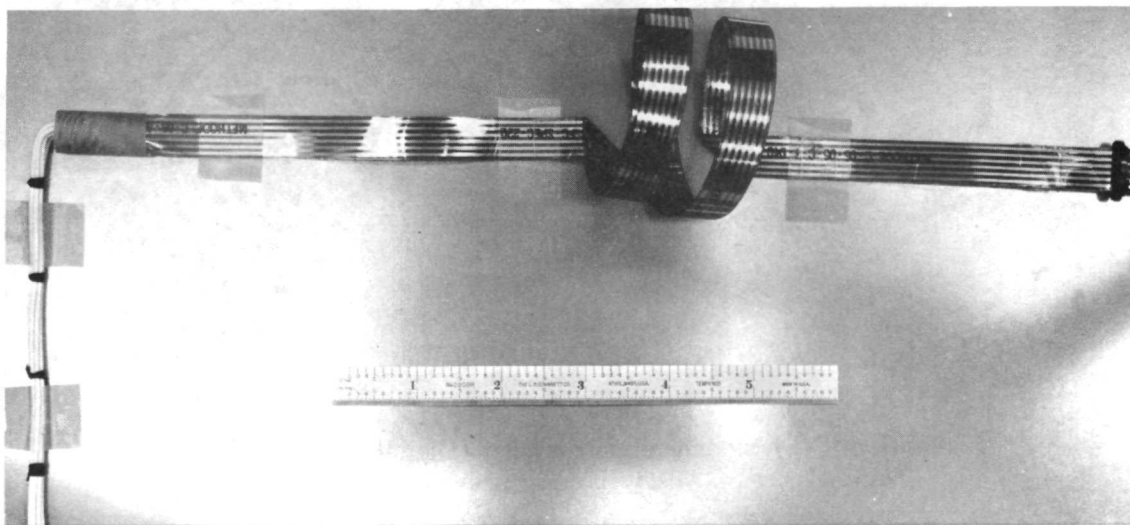

Figure 2. ADAMS shoulder spring coil assembly.

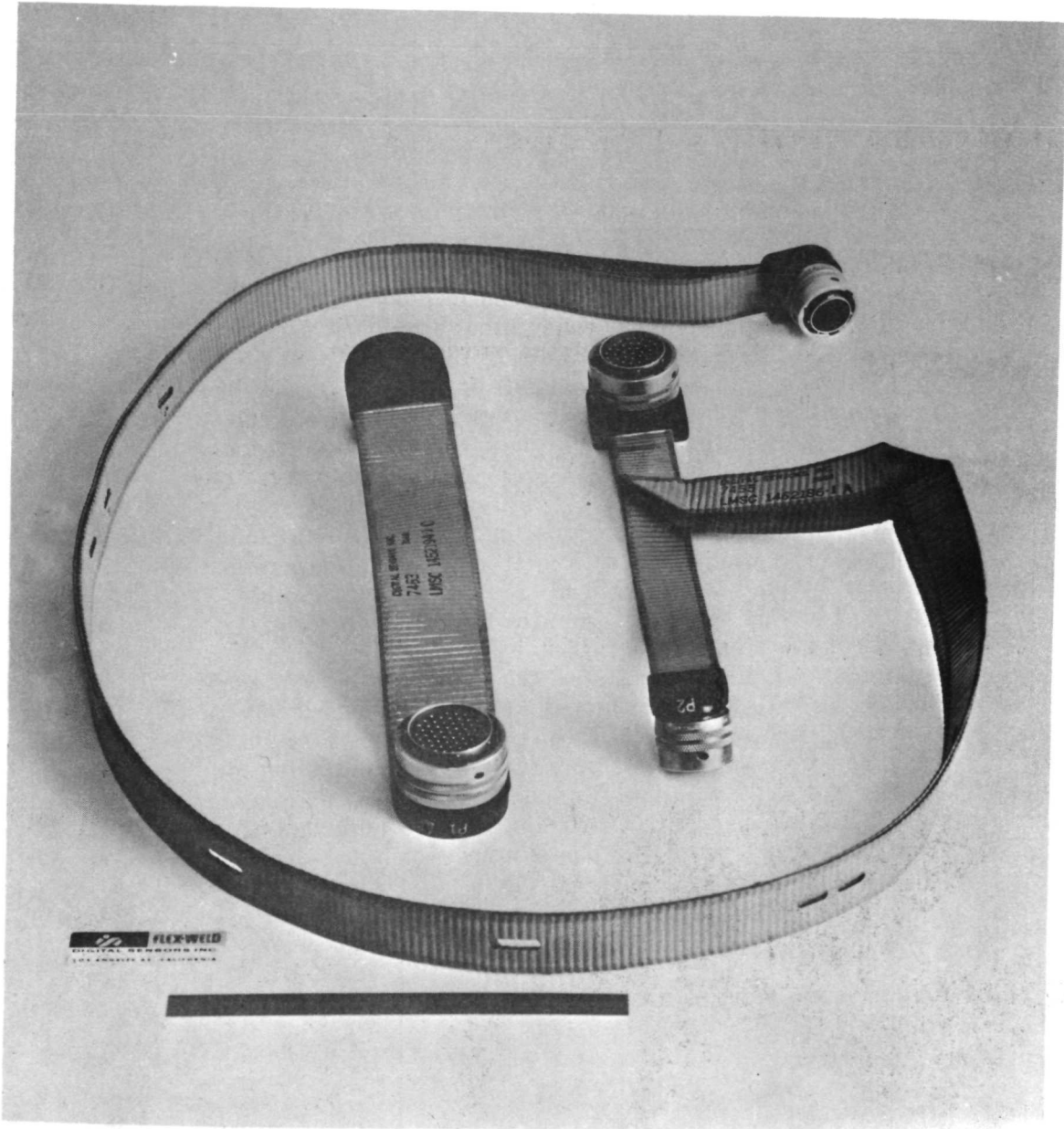

Figure 4. Shielded and corrugated FCC assemblies (Digital Sensors, Inc., is now part of Ansley Electronics Corporation).

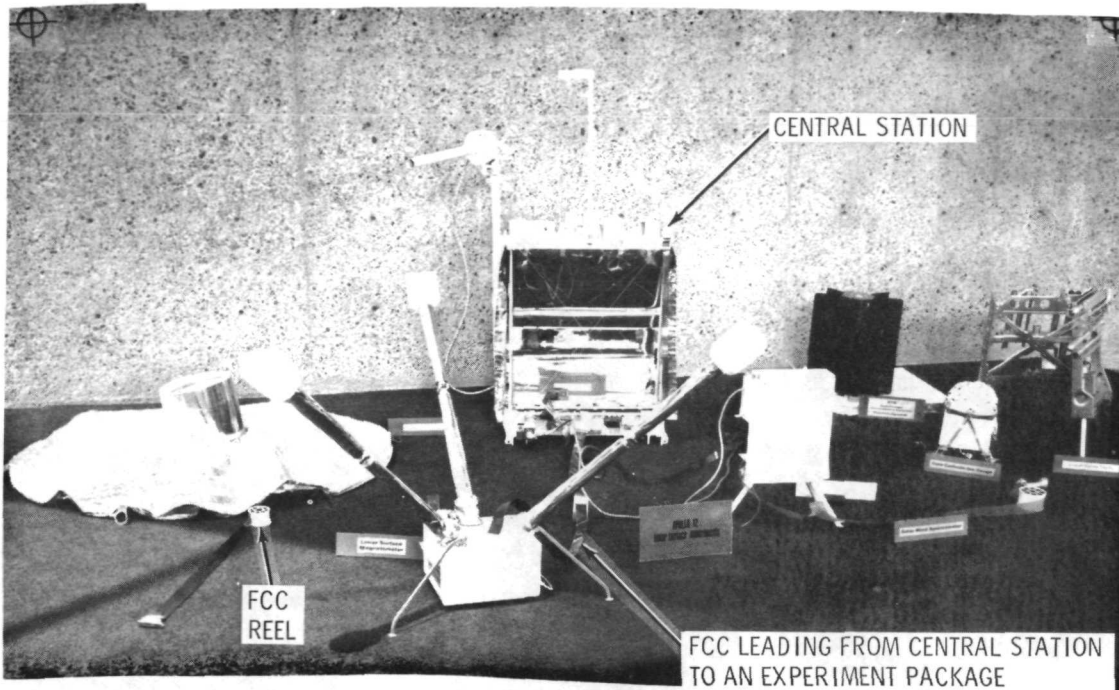

Figure 5. Model of ALSEP system.

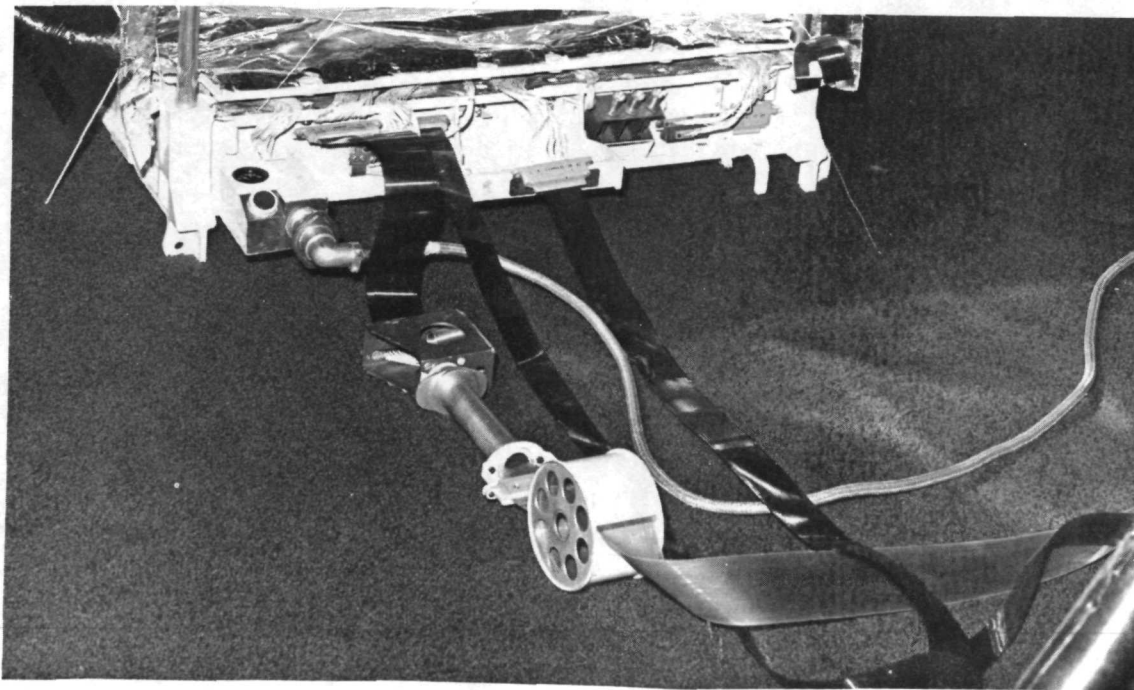

Figure 6. Model of ALSEP central station (lower portion shown).

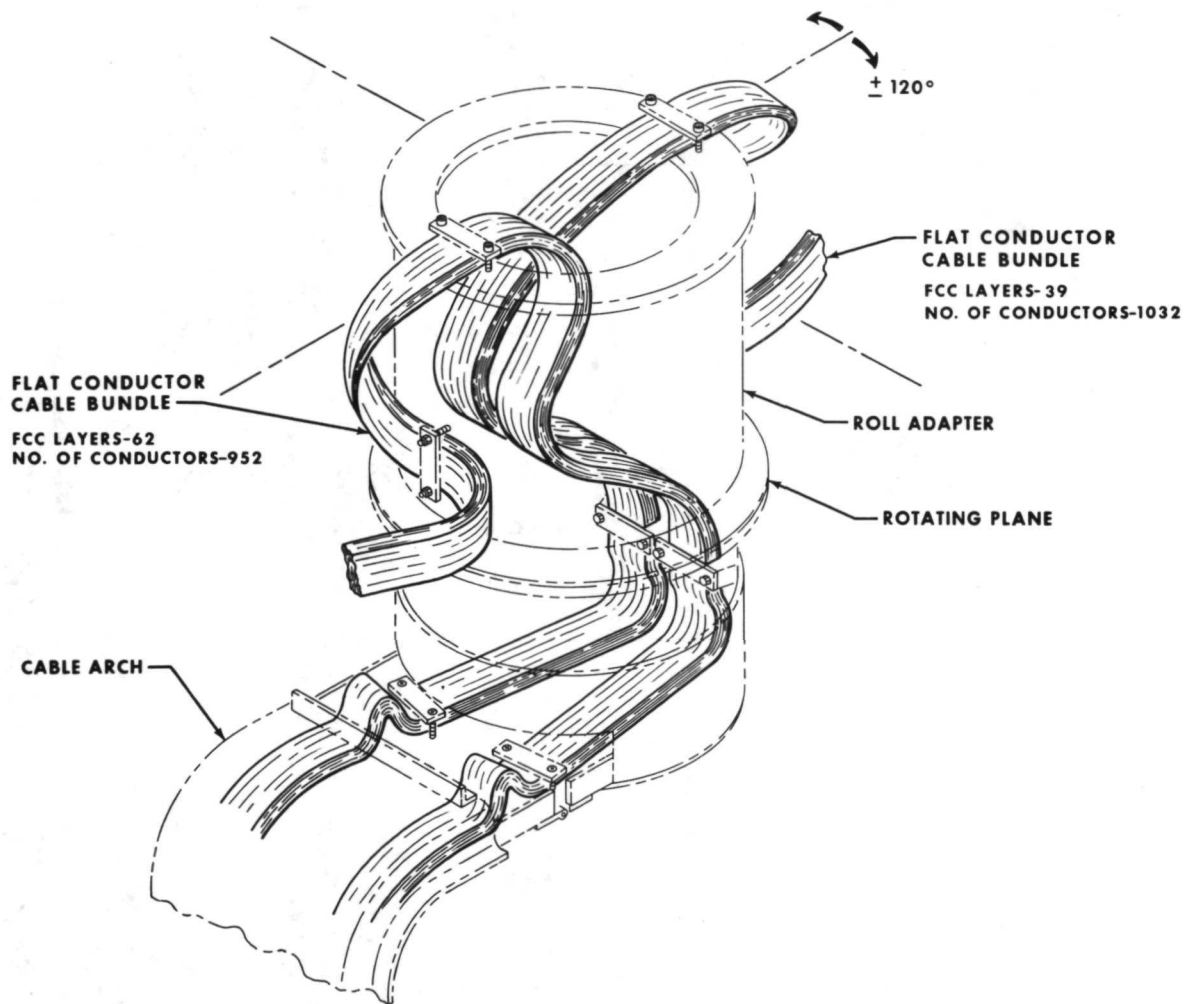

Figure 7. FCC routing and securing in the ATM roll adapter.

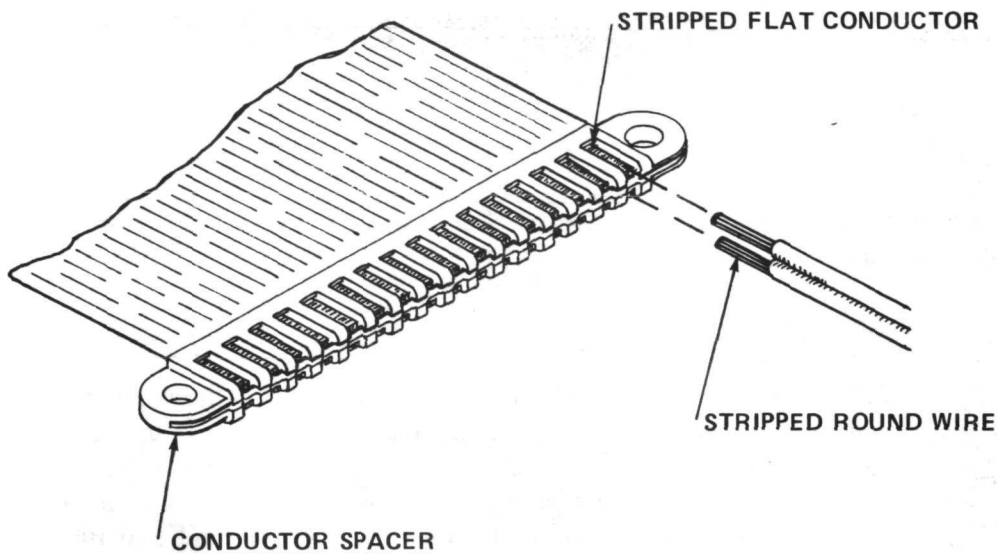

Figure 10. Fabrication of ATM transition (only one of the two layers is shown).

In the basic ATM FCC to round wire transition, two layers of unshielded 32-conductor signal cable are threaded through the back of a conductor spacer, the stripped conductors are folded into the spacer groove, and an insulator is inserted. Round wires (#20 AWG) are then laid on and soldered to the flat conductors, and the soldered assembly is potted. The standard conductor spacer (shown above) is used in all of the ATM's transitions, both shielded and unshielded, signal cable and power cable. The transition spacer is modified to accommodate 8 conductors for power FCC to round wire (#12, #16, or #20 AWG) transitions.

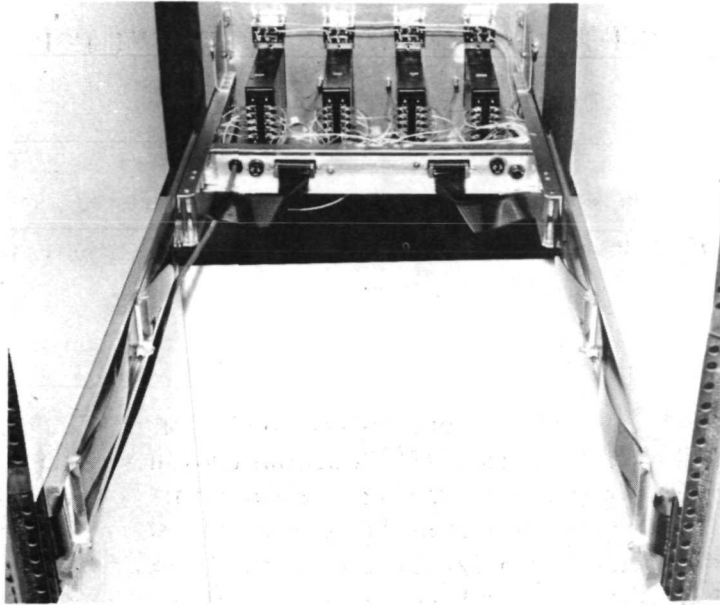

Figure 11. Panel Assembly in Open Position.

Observe that all of the drawer movement occurs in the FCC, thus allowing electrical components and panel round wire to remain in a fixed position.

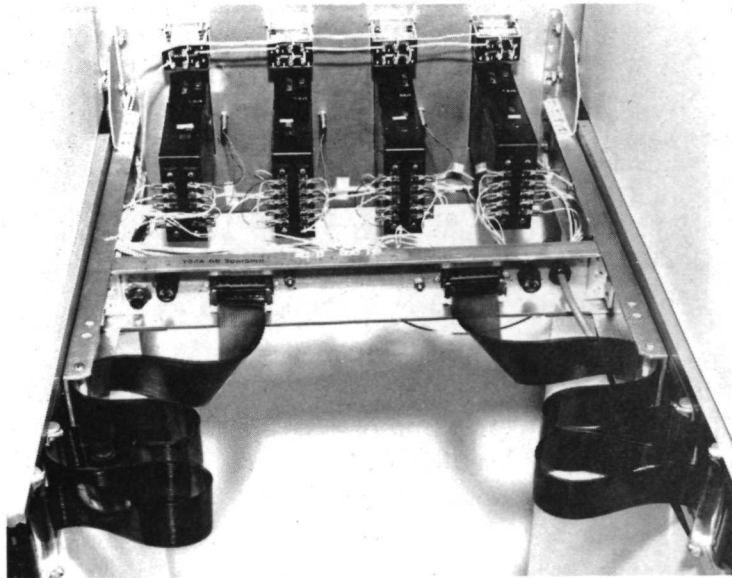

Figure 12. Panel assembly in closed position.

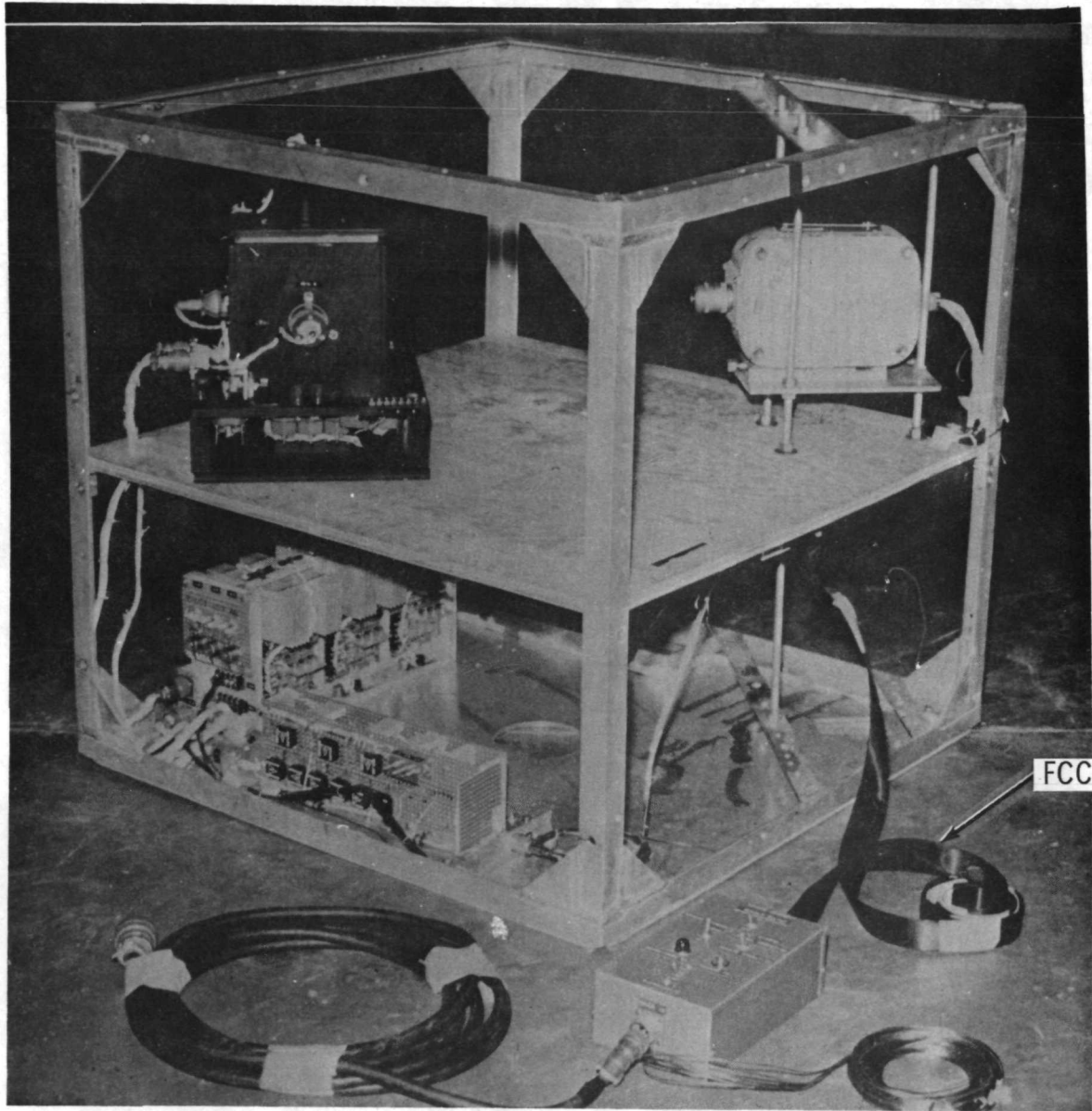

Figure 13. Experiment package prepared for use in the KC-135 aircraft.

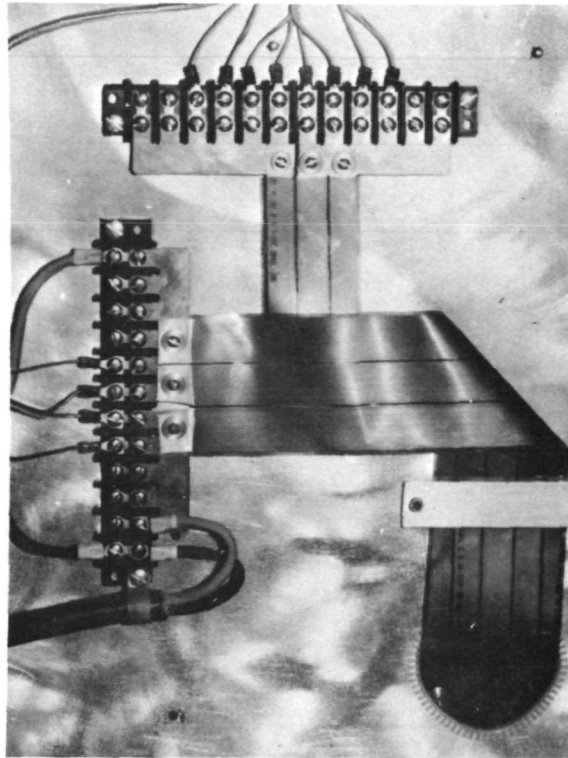

Figure 14. Flat conductor power cable terminations to bus bars.

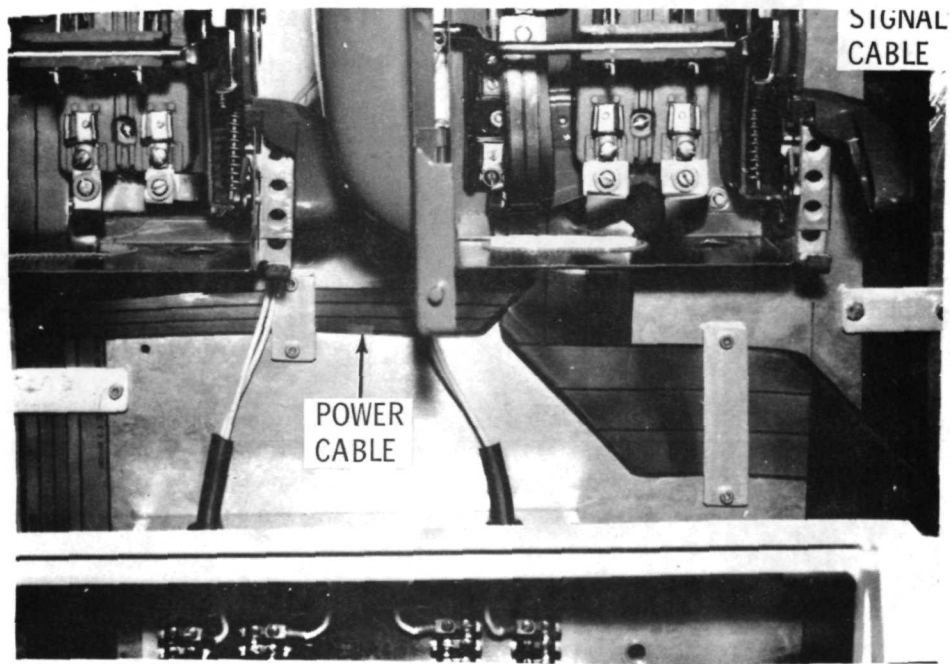

Figure 15. FCC power circuitry in fuse boxes. (Note simple bracket wall fixtures and ease with which FCC is folded to form required angles.)

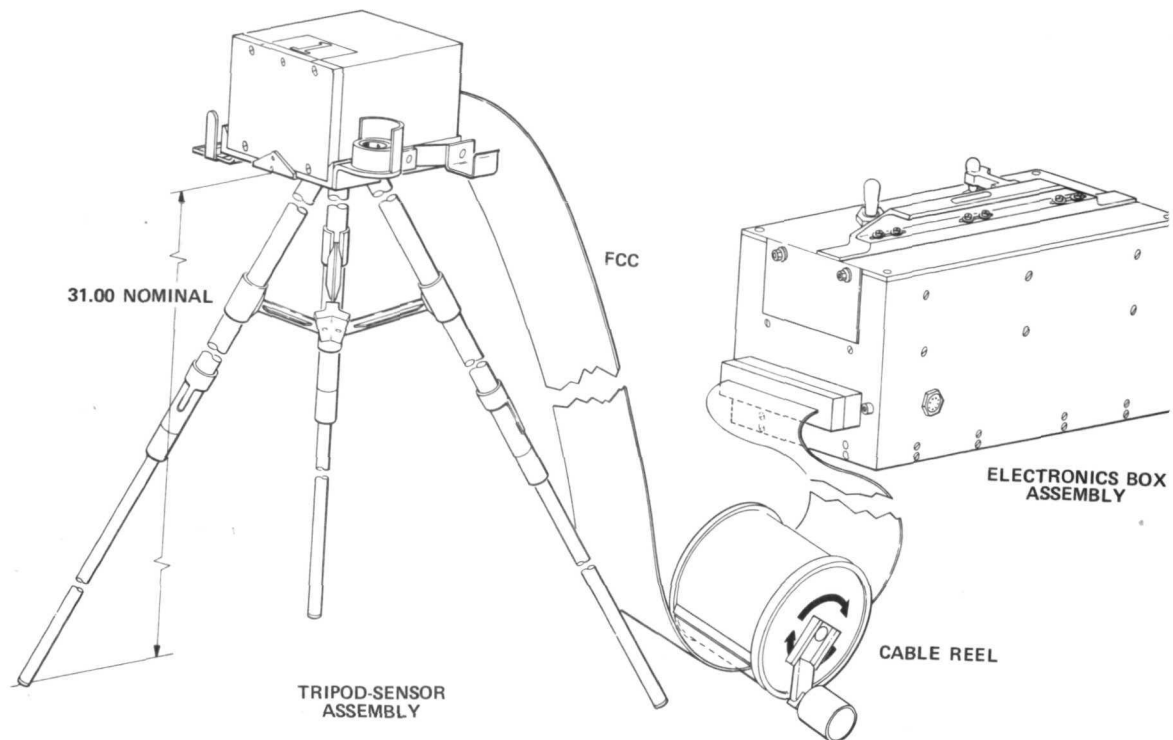

Figure 16. Portable magnetometer and stowage assemblies.

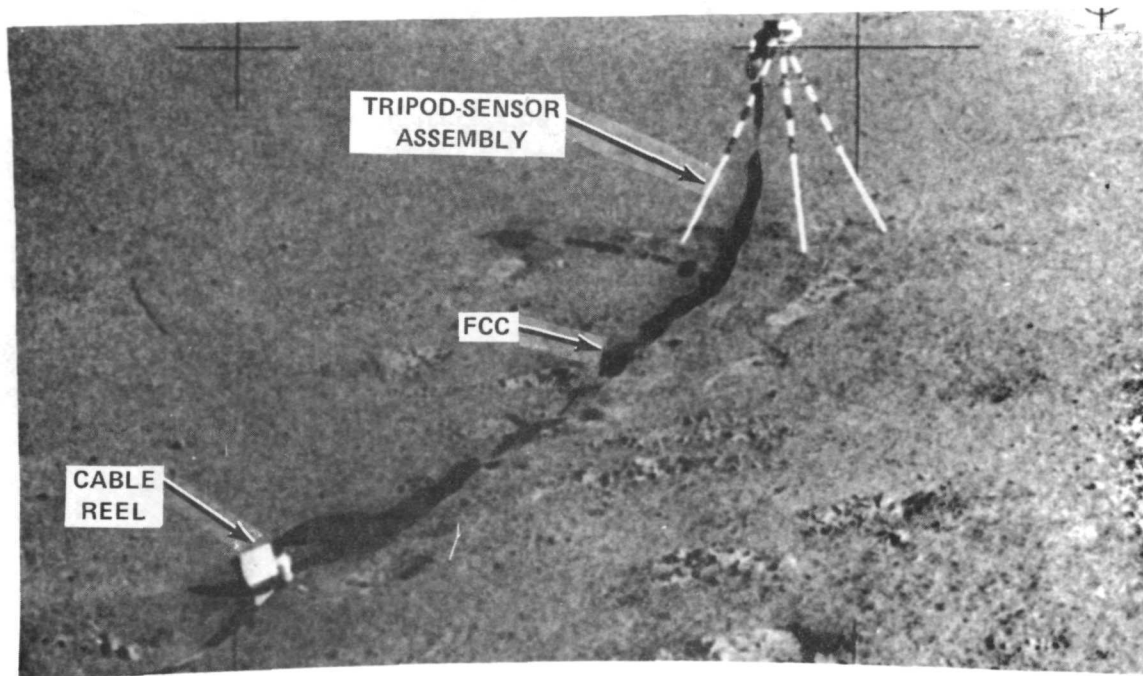

Figure 17. Apollo 14 portable magnetometer on the moon.

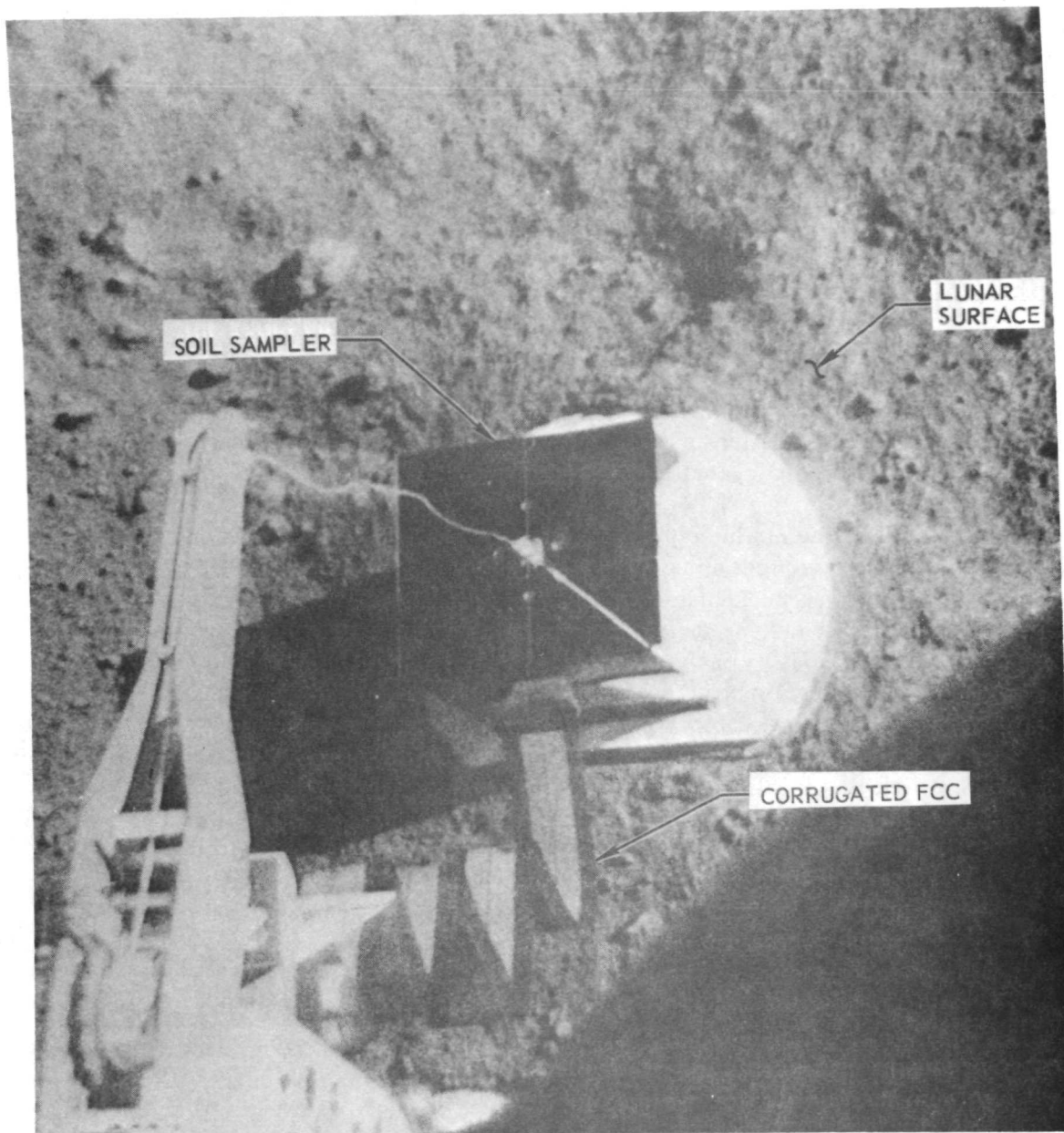

Figure 18. FCC harness on Hughes Lunar Surveyor V Spacecraft, flown in 1967.

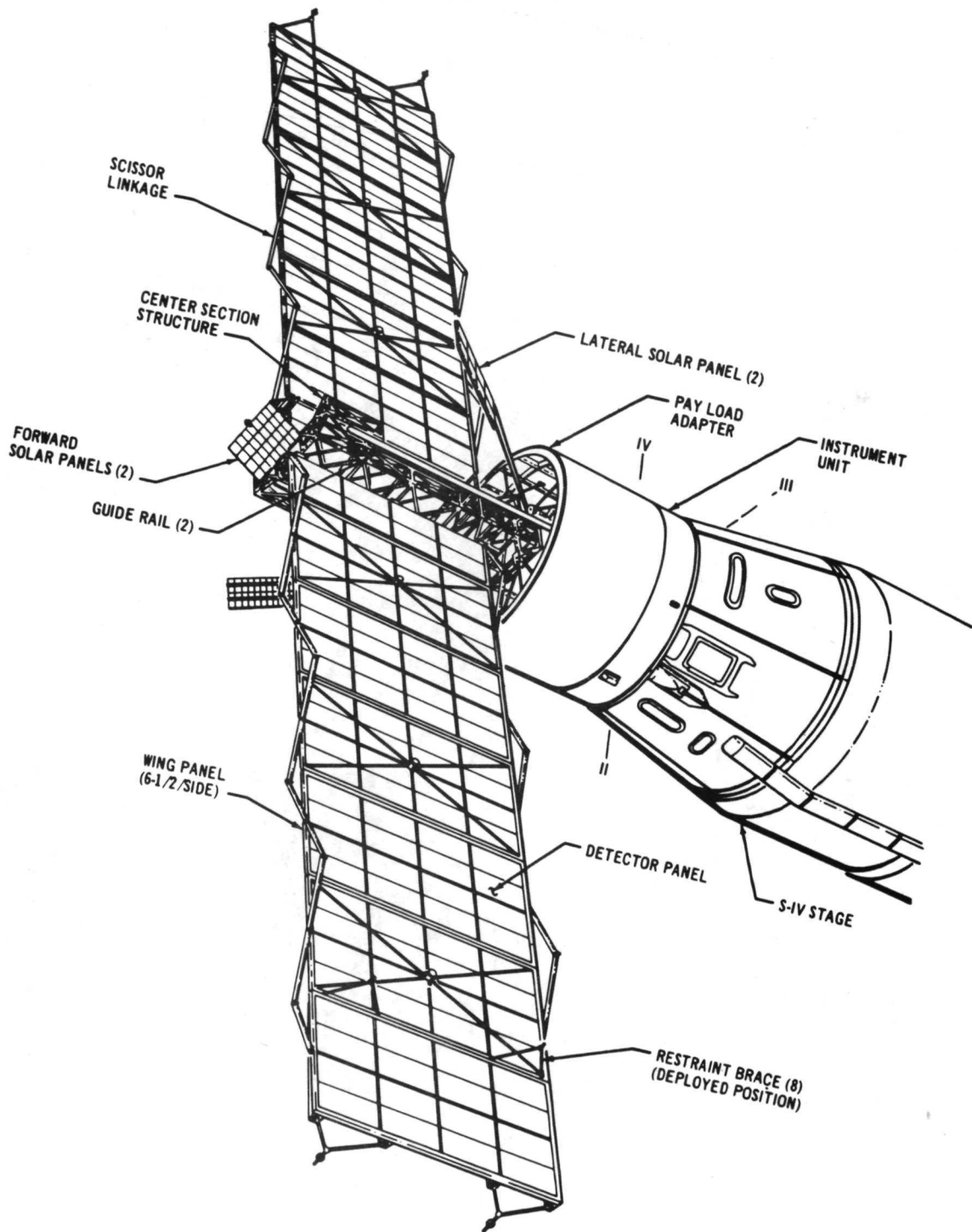

Figure 19. Pegasus spacecraft.

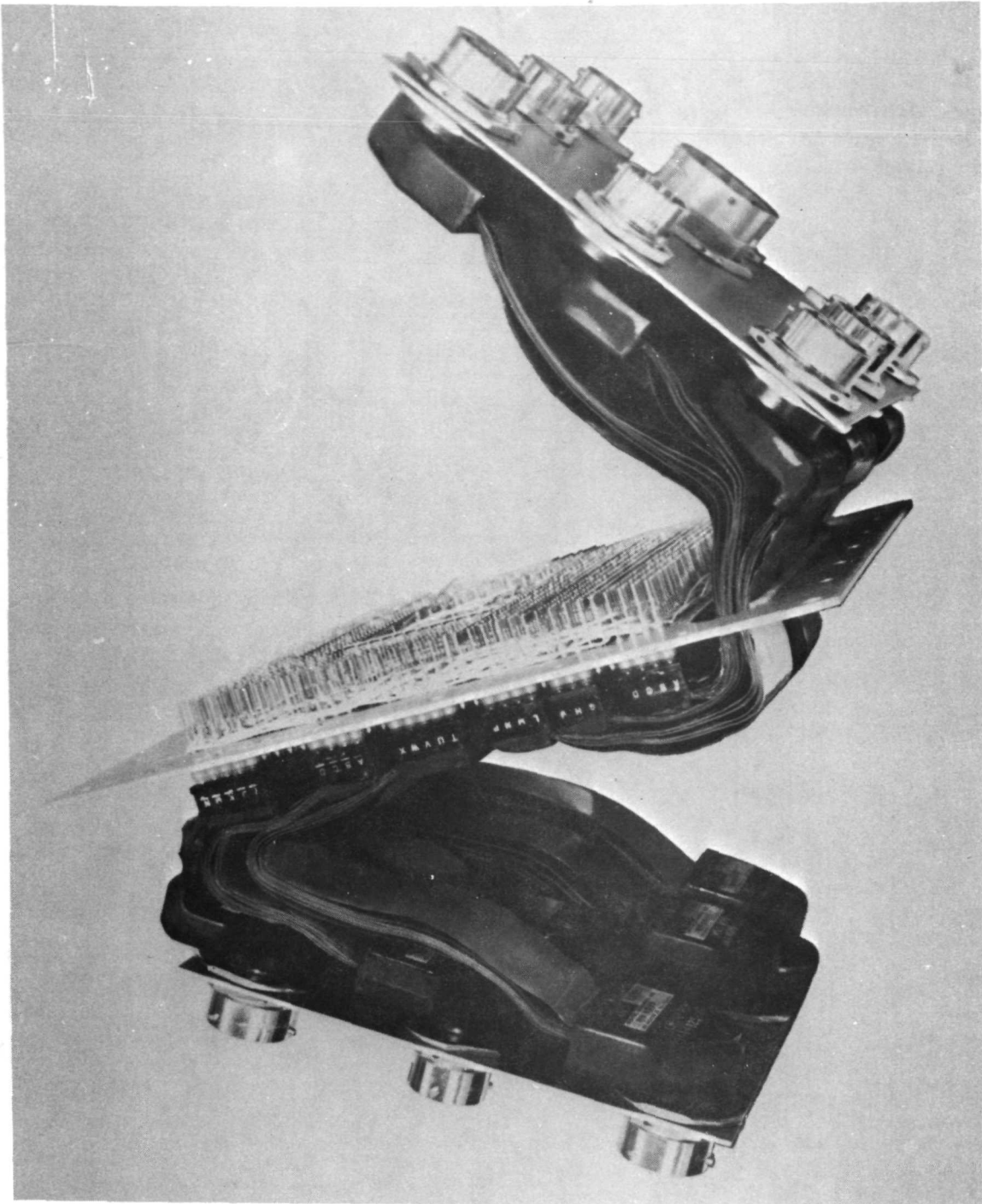

Figure 20. FCC wire-wrap distributor (Digital Sensors, Inc., is now part of Ansley Electronics Corporation).

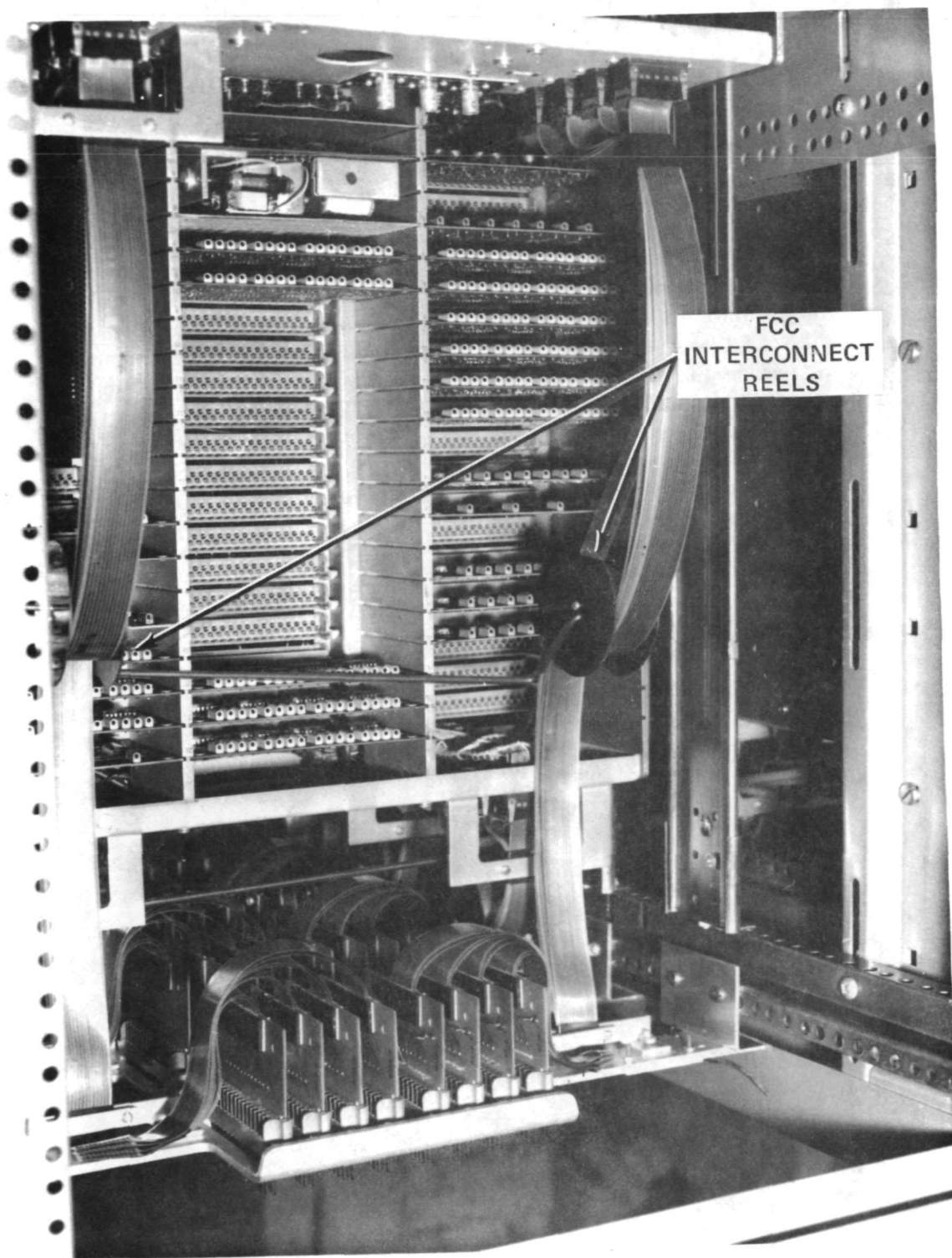

Figure 21. FCC interconnect reels on Saturn V GSE (closed position).

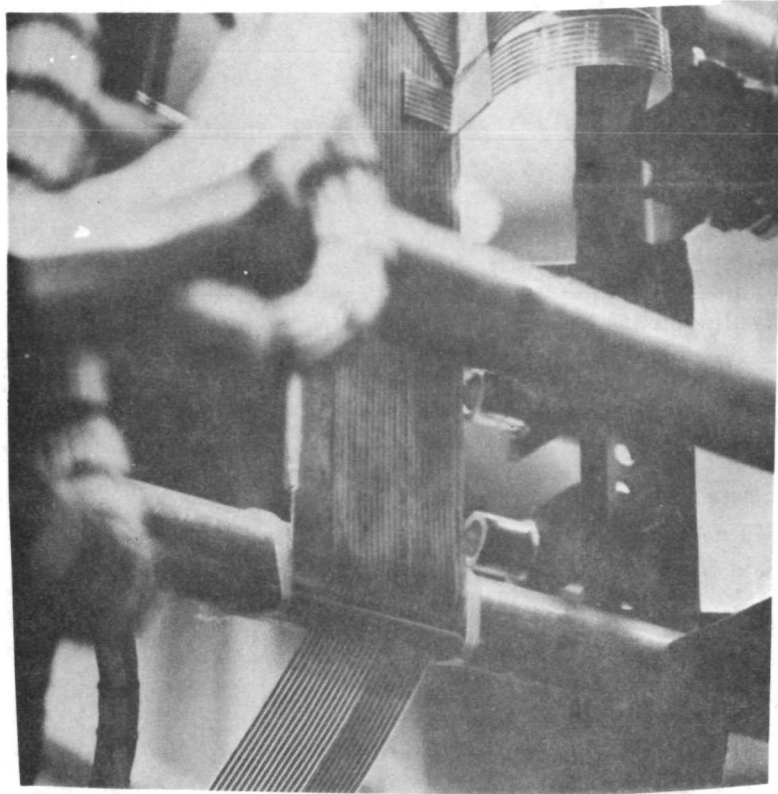

Figure 22. Flat cable on measuring rack. (Note simple cable-folding techniques.)

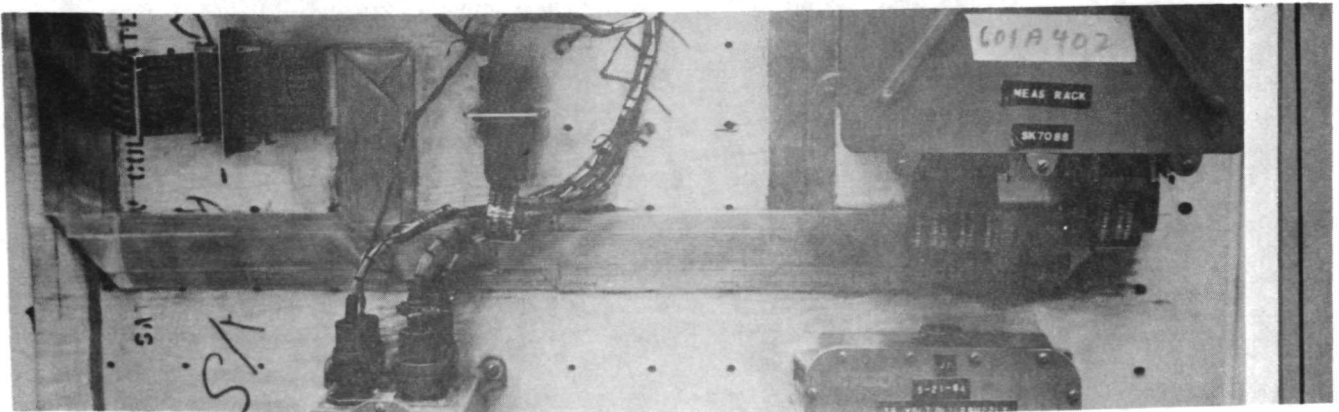

Figure 23. Flat cable connection to black box.

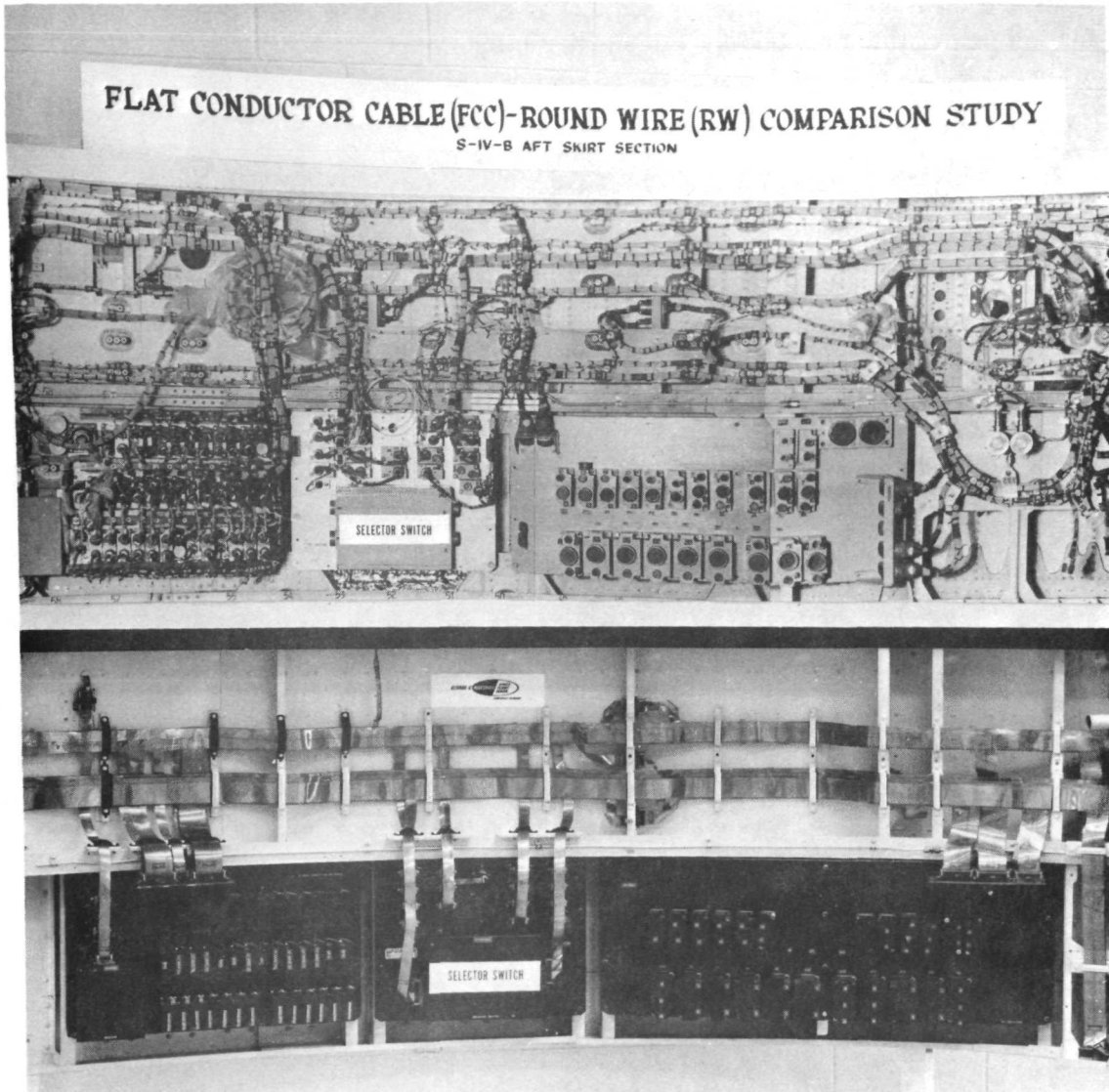

Figure 24. FCC versus RWC comparison, Saturn IVB aft skirt mockup.

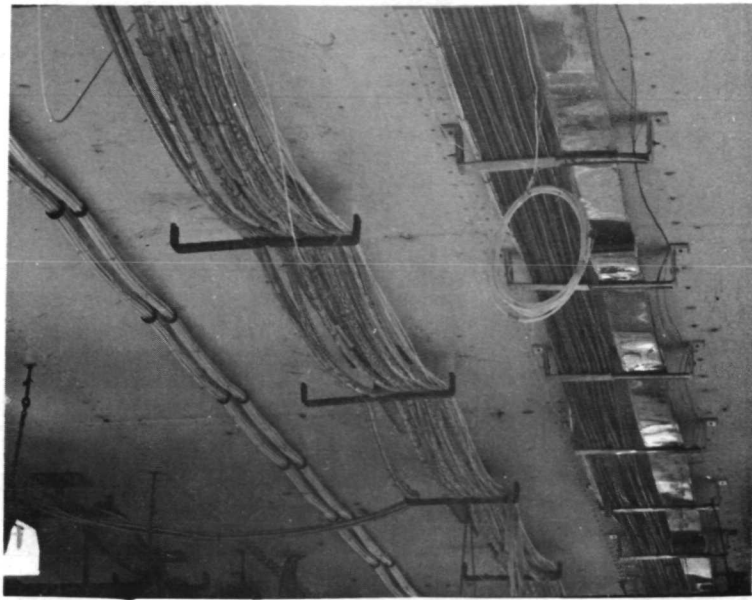

Figure 25. Solar array 16-connector wing junction box.

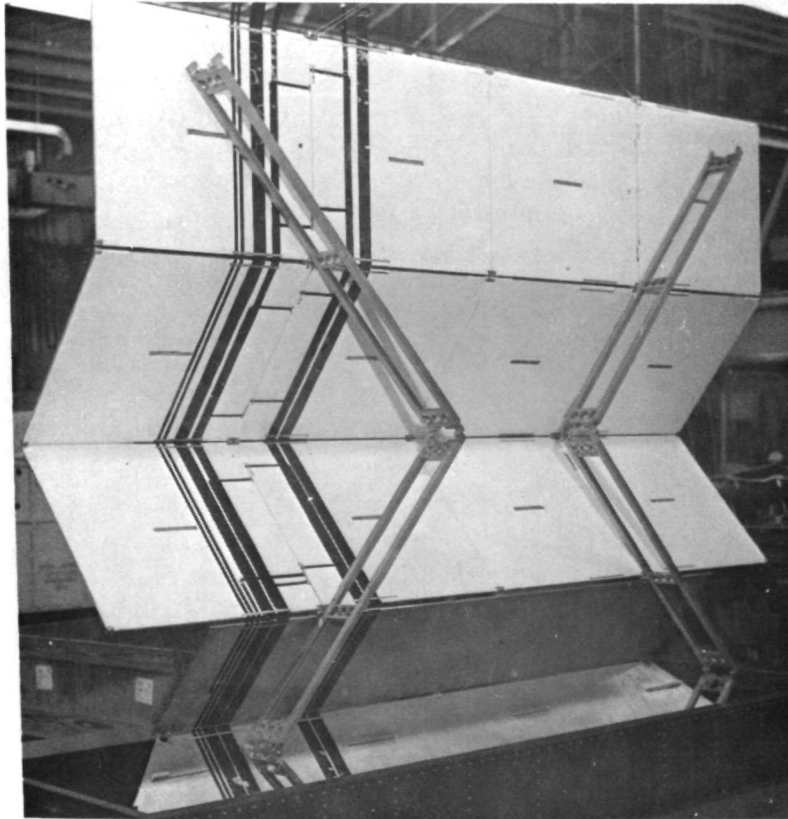

Figure 26. Model of wing portion depicting typical cable routing during deployment.

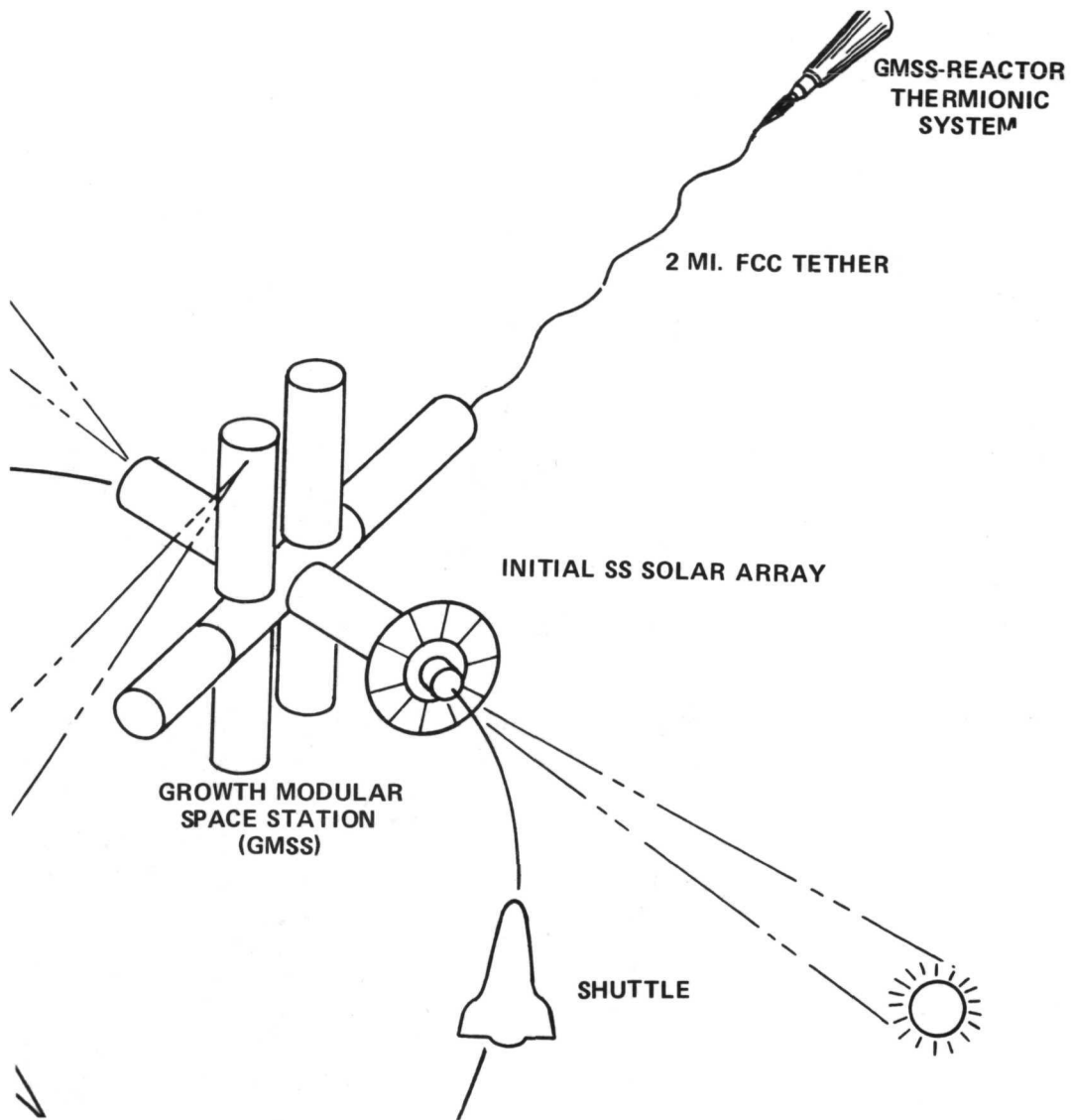

Figure 27. Conceptual drawing of space station attached to power system by flat cable.

SECTION III. MILITARY APPLICATIONS

SECTION III. MILITARY APPLICATIONS

Cryptographic Equipment

E2C Airplane

F-111 Airplane GSE

F-111 Airplane: Mark II Avionics

F-14 Airplane

MK 48 Torpedo Fire Control System (FCS)

Naval Shipboard Equipment

Pershing Missile

Poseidon Missile Flight Programmer

Poseidon Missile GSE

Poseidon Missile Tunnel Wiring

Standard Missile

Ships Inertial Navigation Systems (SINS)

Spartan Missile

Upstage Missile

Minuteman II and III Missiles

Mark 17 Reentry Vehicle, Minuteman III Missile

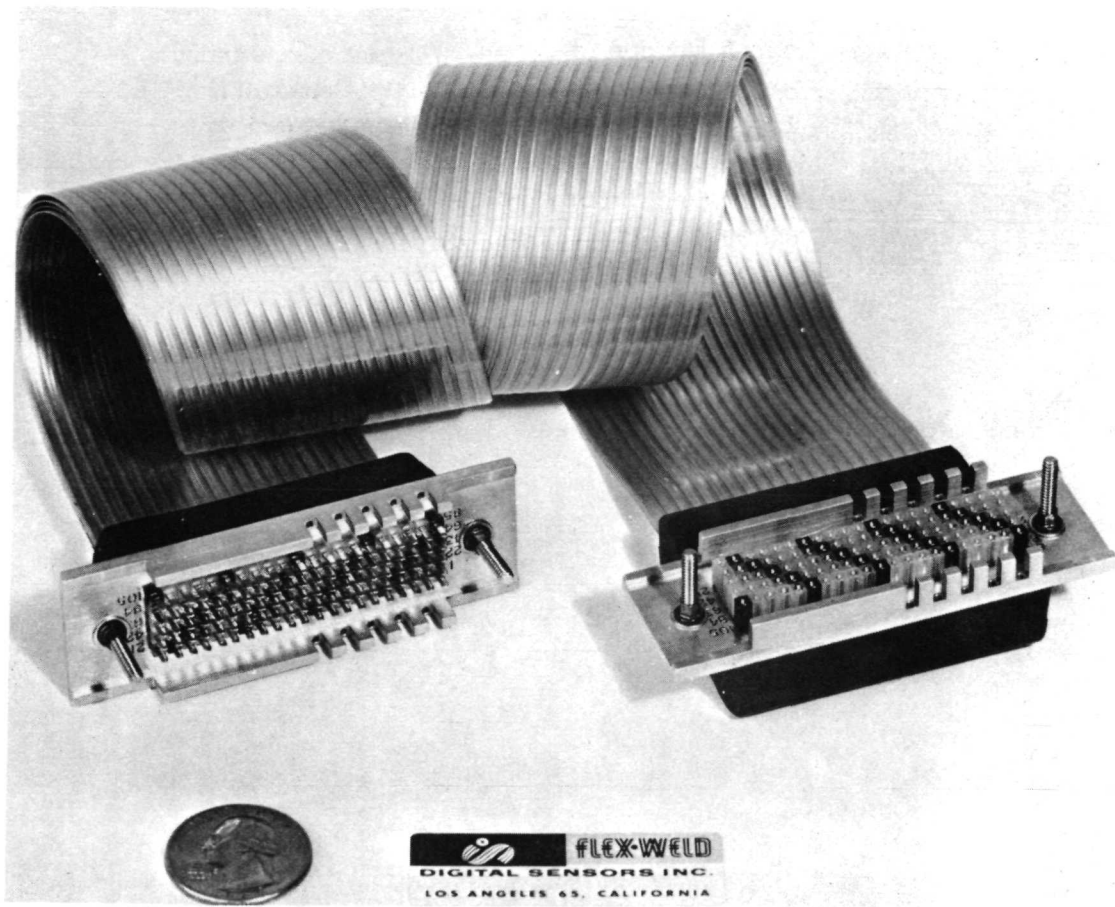

Figure 28. Flat conductor cable with plate and insert type connectors (Digital Sensors, Inc., is now part of Ansley Electronics Corporation).

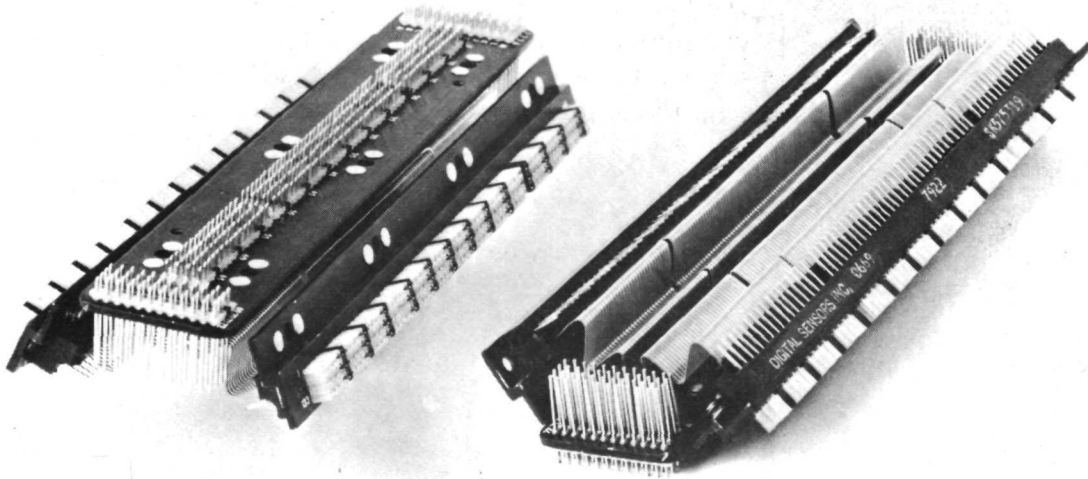

Figure 29. Flat conductor jumper assembly for computer interconnectors
(Digital Sensors, Inc., is now part of Ansley Electronics Corporation).



Figure 30. Self-retracting flat cable assembly
(Digital Sensors, Inc., is now part of Ansley Electronics Corporation).

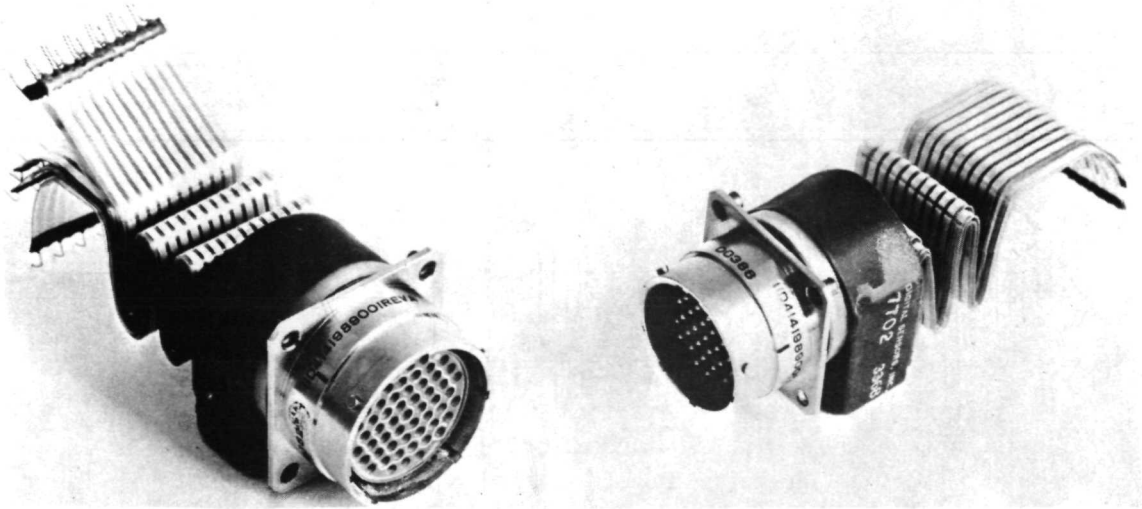

Figure 31. Jumper cable assemblies (Digital Sensors, Inc., is now part of Ansley Electronics Corporation).

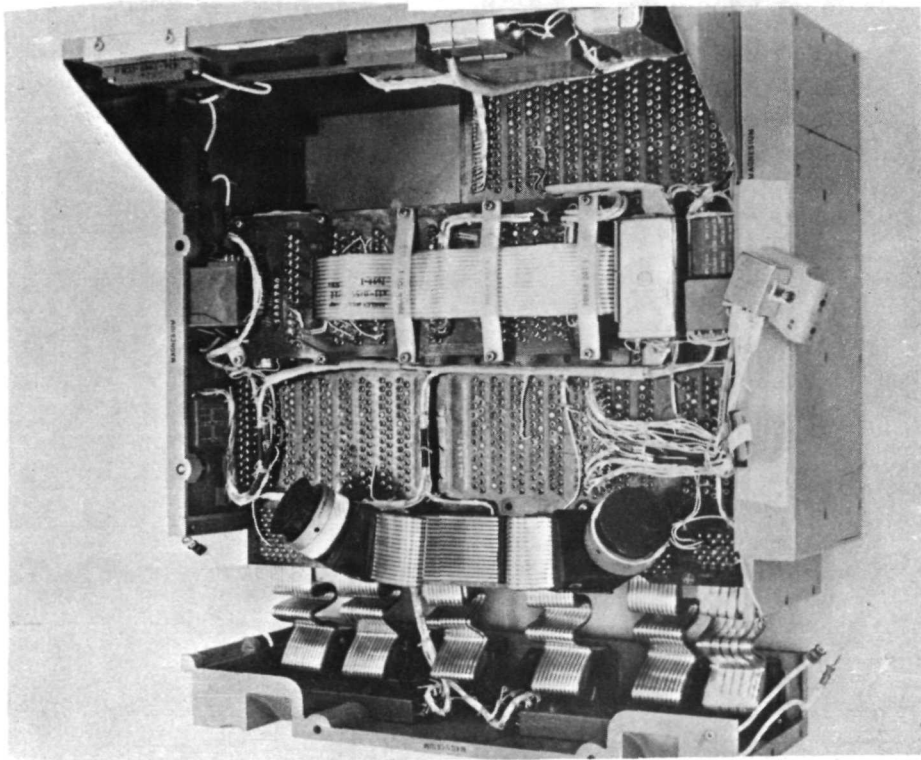

Figure 32. Inertial navigation assembly with flat conductor cable (Ansley Electronics Corporation).

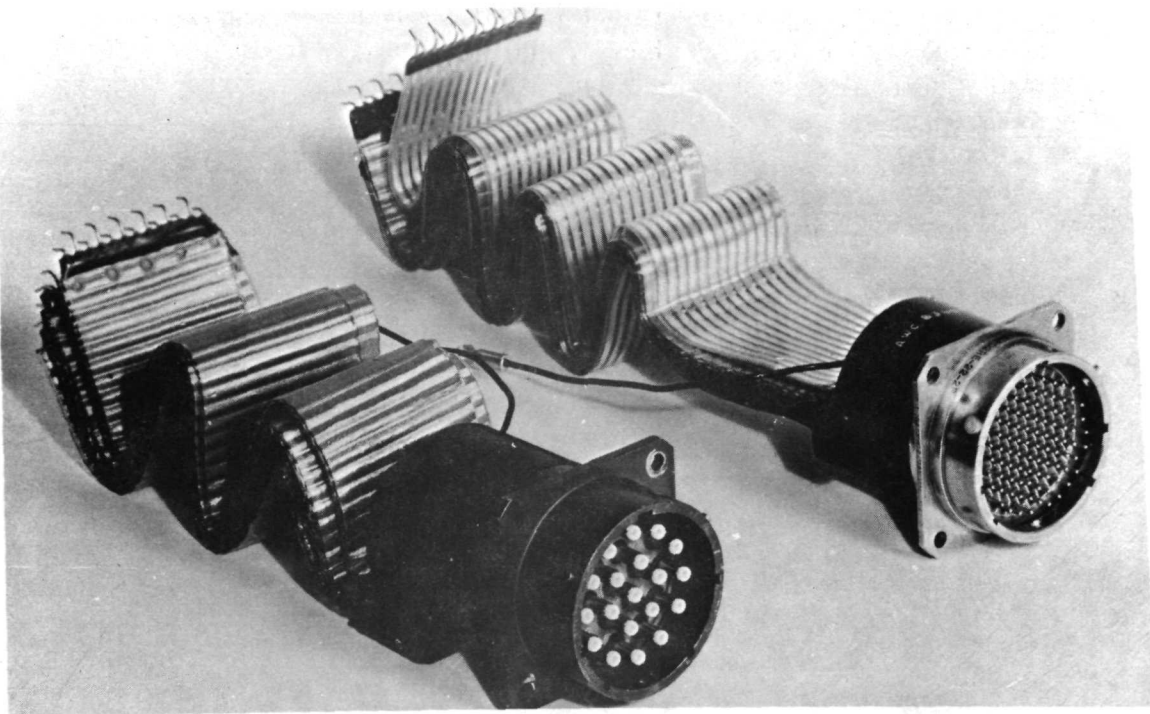

Figure 33. Flat conductor jumper cable assemblies for electronic equipment interconnections (Digital Sensors, Inc., is now part of Ansley Electronics Corporation).

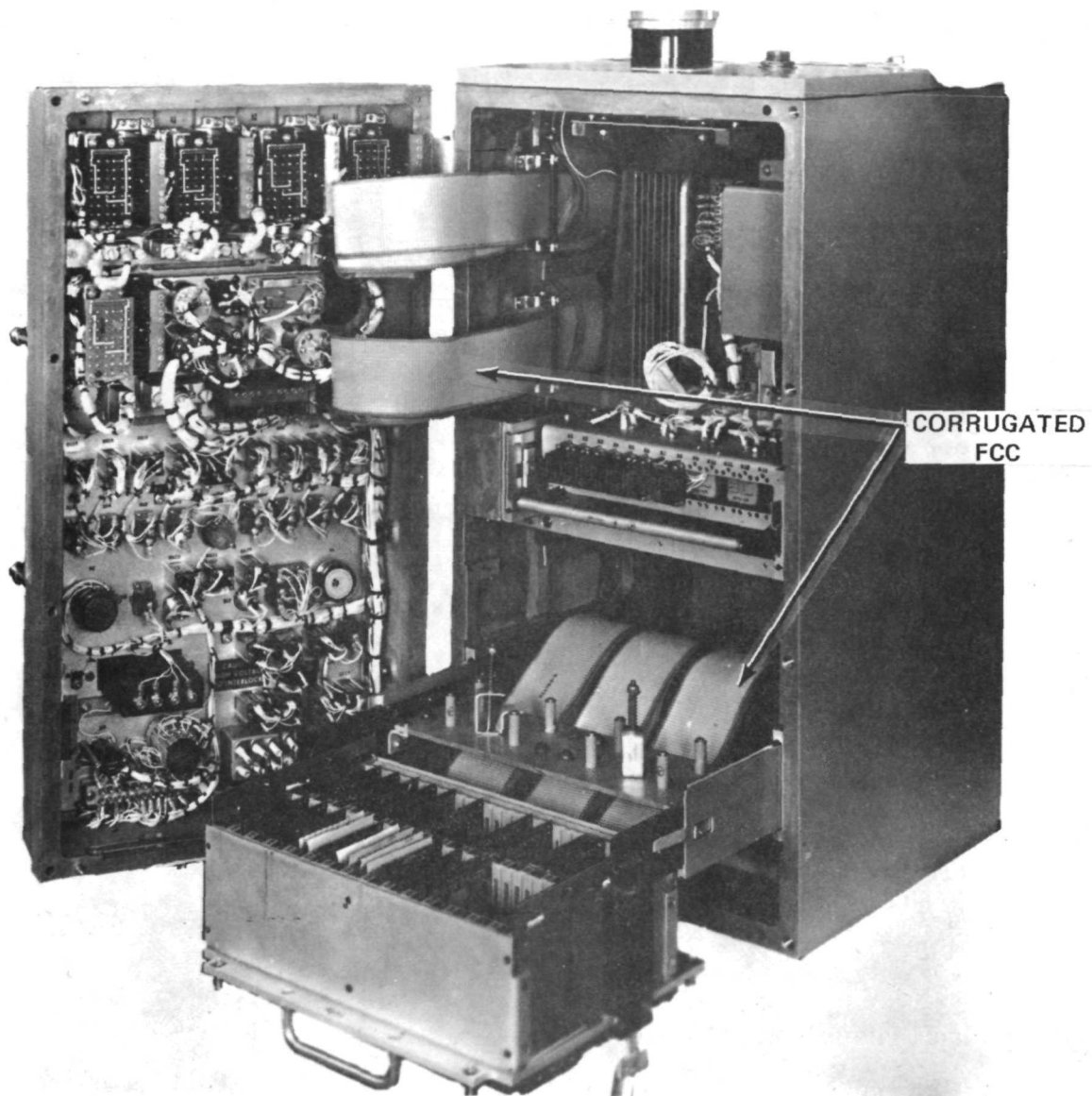

Figure 34. MK 48 Torpedo Fire Control System
(Librascope Division of the Singer Company).

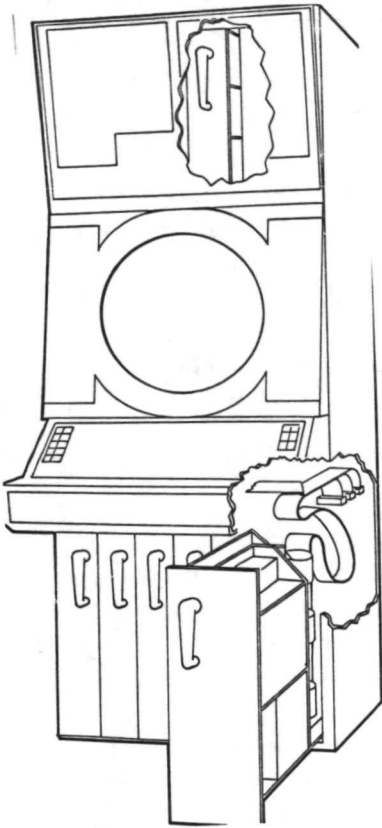

Figure 35. Conceptual packaging drawing.



Figure 37. A completed 6-foot long 80-layer FCC harness 100 percent shielded.

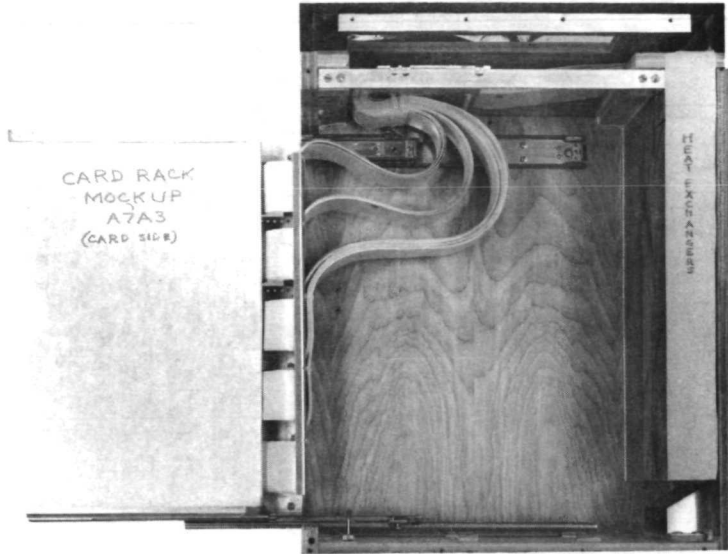

Figure 36. Mockup of a typical drawer in service position.

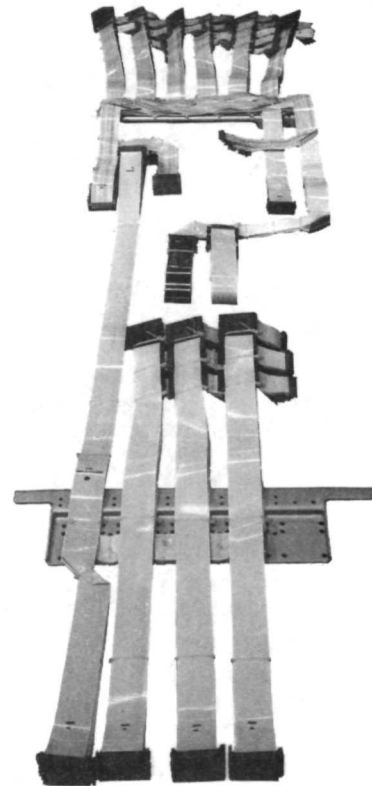

Figure 38. A completed 9-foot long 180-layer FCC harness.

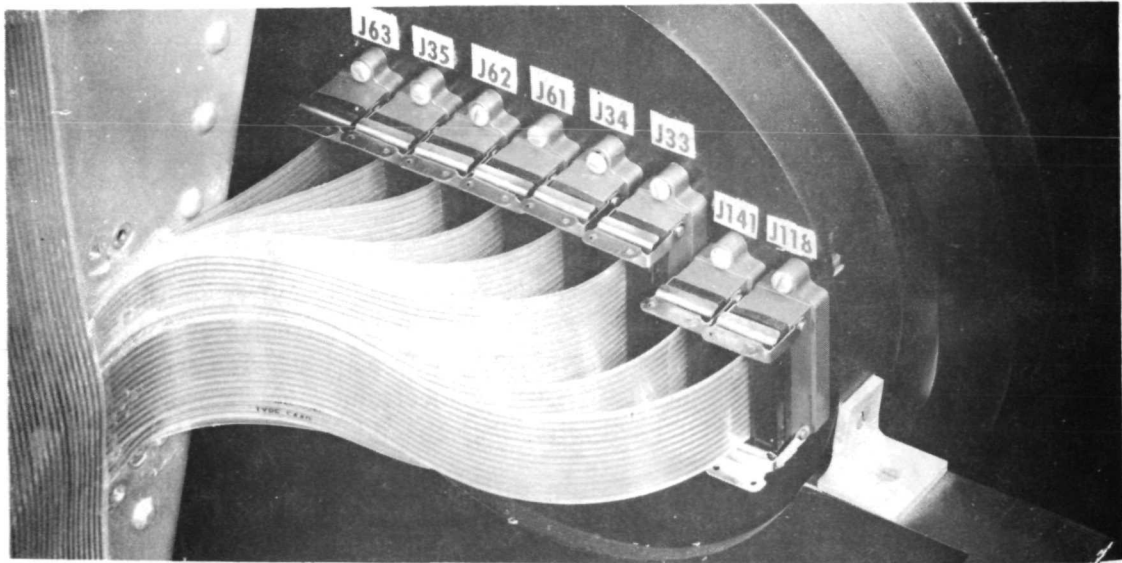

Figure 40. Installation of flat cable on vehicle gyro platform.

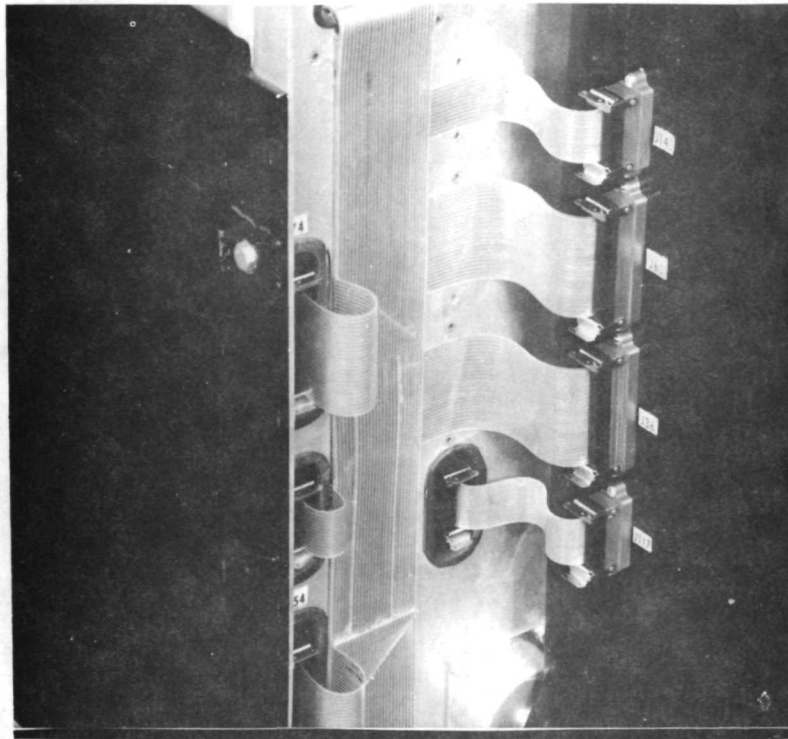

Figure 41. A flat cable installation.

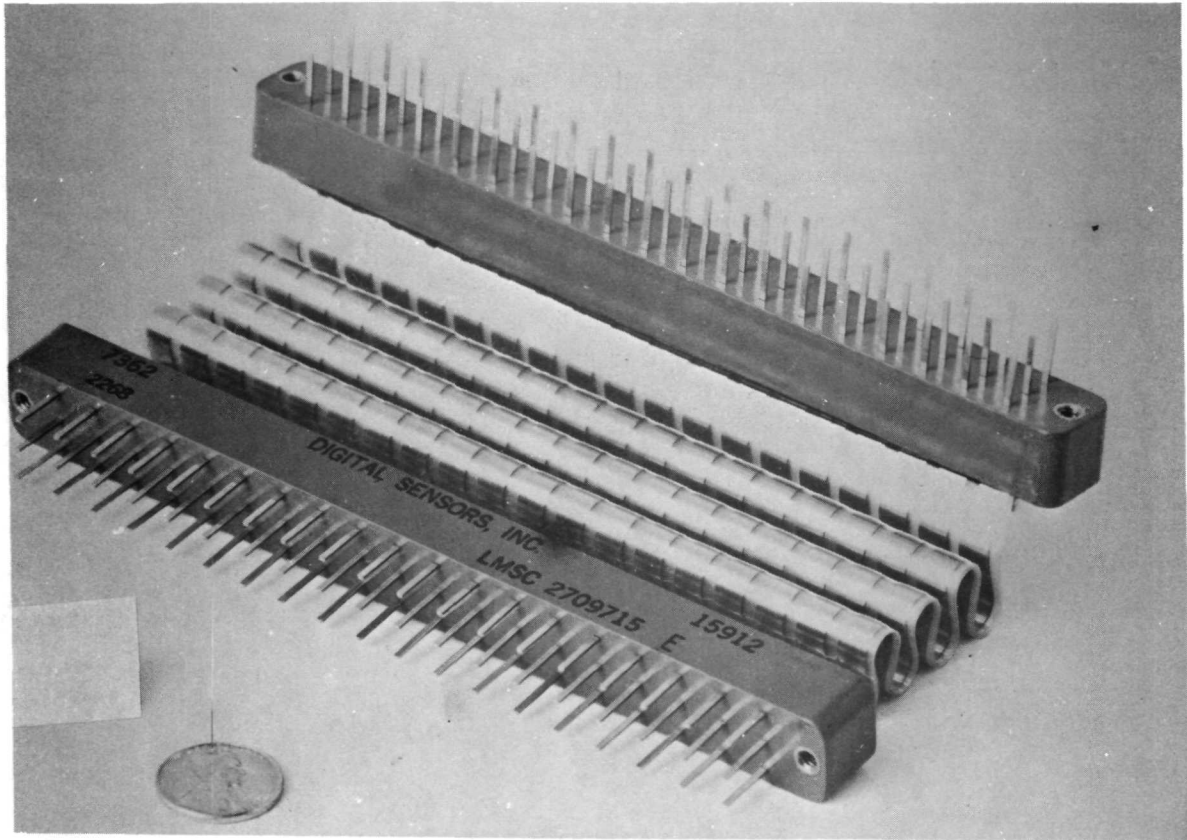

Figure 42. Heavy duty FCC power-handling assembly
(Digital Sensors, Inc., is now part of Ansley Electronics Corporation).

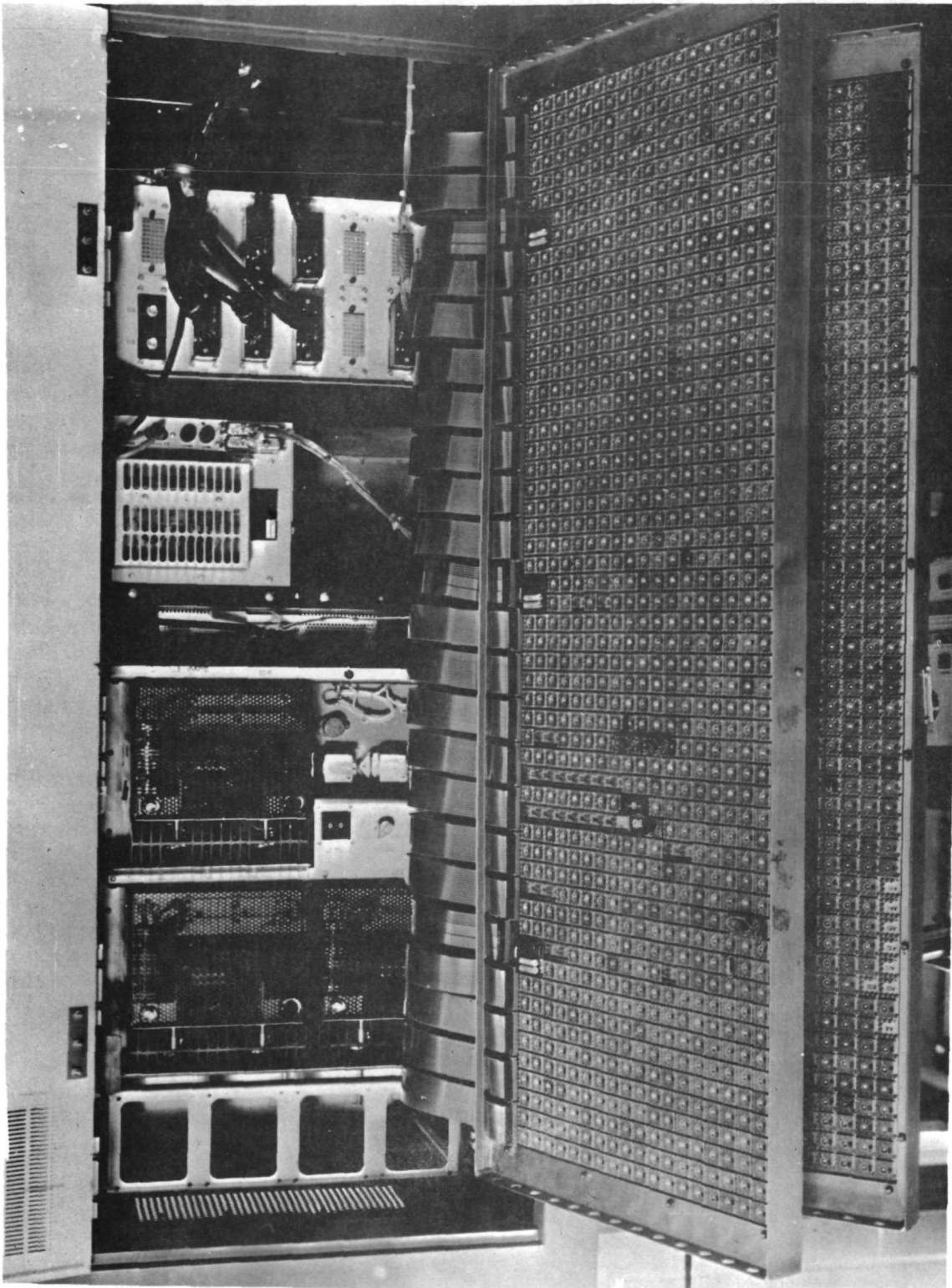

Figure 43. Digital test and checkout equipment with FCC hinges (Ansley Electronics Corporation).

STANDARD MISSILE

FCC interconnecting harnesses are used in the ordnance section.

General Dynamics used FCC harnesses (Fig. 44) in the ordnance section of the Navy's Standard Missile. Kapton/Teflon-insulated, shielded and unshielded cables were terminated through transition devices to Hughes Aircraft miniature center-lock screw connectors. Flat cable was used to reduce to a minimum the diametrical space required for the interconnecting harnesses.

For additional information, refer to the Appendix, item number 19.

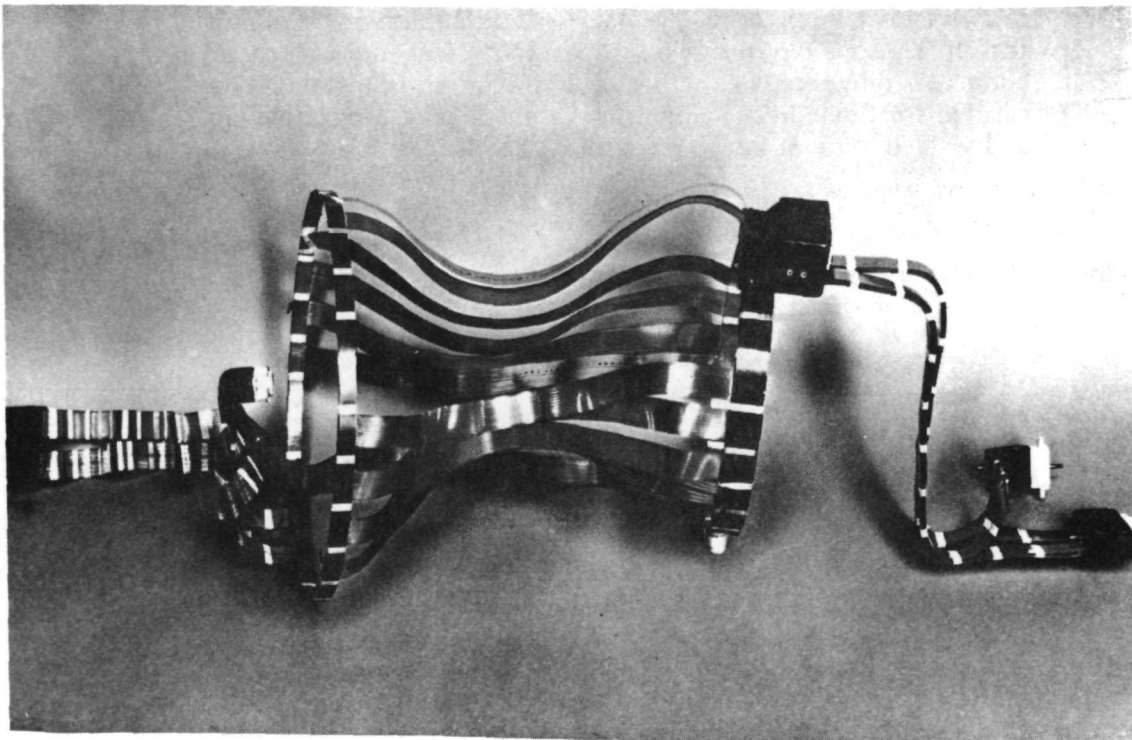

Figure 44. FCC harness for the Standard Missile (General Dynamics).



Figure 46. Crimped flat conductor to round wire transition using Thomas and Betts copper molded splices.

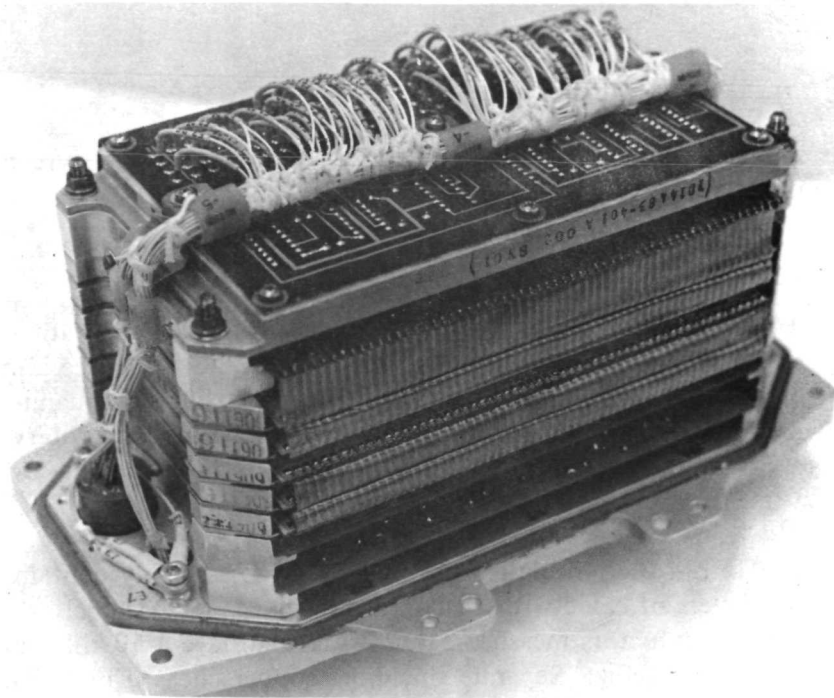

Figure 47. 6-inch flat jumper cable in Upstage Guidance Command Unit (McDonnell Douglas).

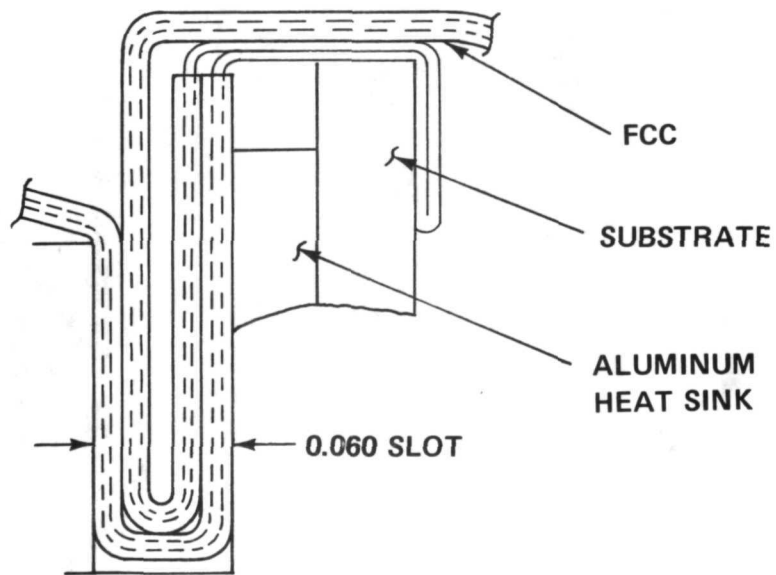

Figure 48. Detail of a typical 6-inch jumper cable interconnection (McDonnell Douglas).



Figure 49. Gyro harness assembly (Digital Sensors, Inc., is now part of Ansley Electronics Corporation).

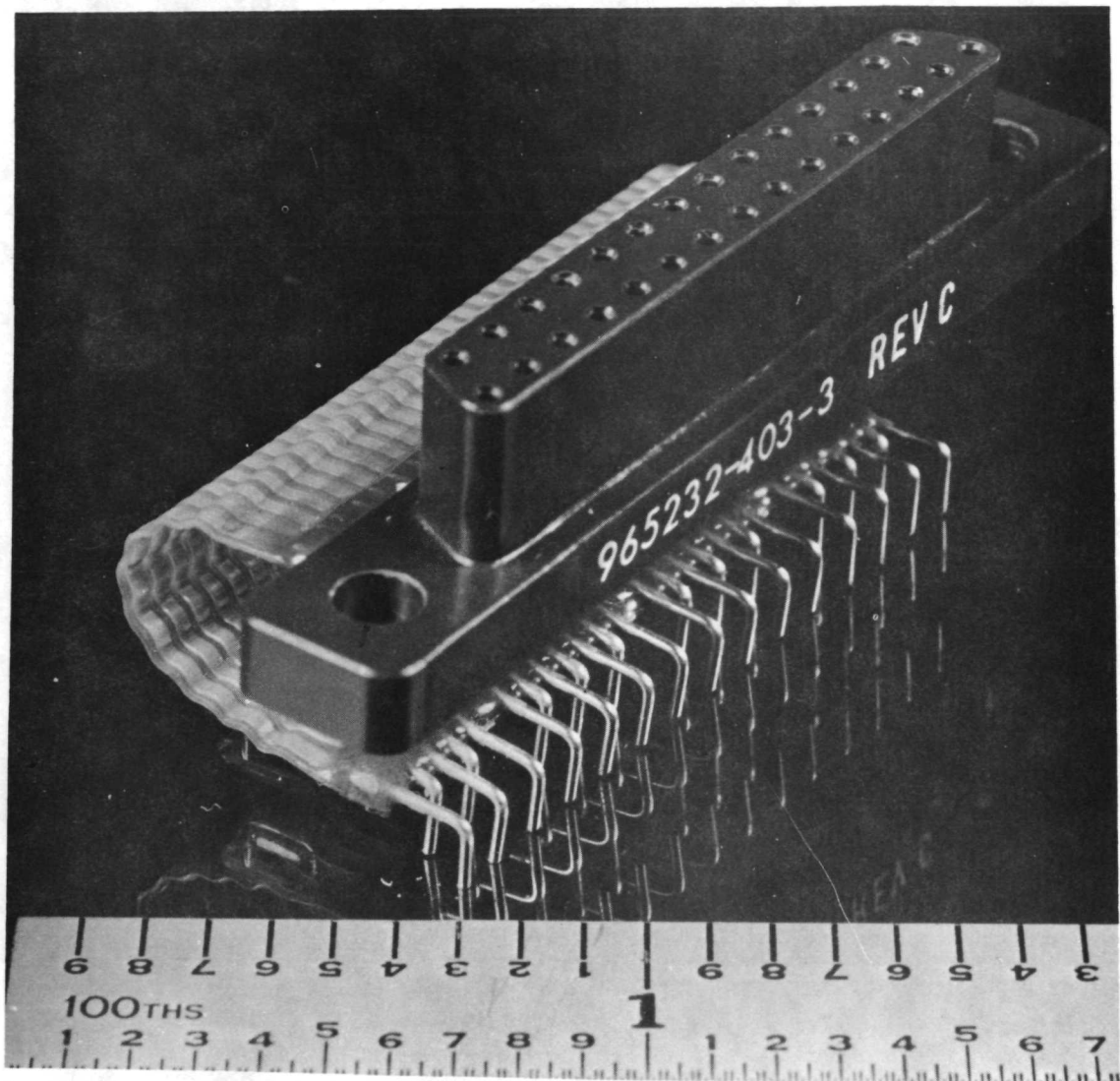

Figure 50. Miniature cable assembly (Ansley Electronics Corporation).

SECTION IV. COMMERCIAL APPLICATIONS

SECTION IV. COMMERCIAL APPLICATIONS

Boeing 747 Aircraft

Ceiling Lights

High Intensity Picture Light

Microcircuit Prober

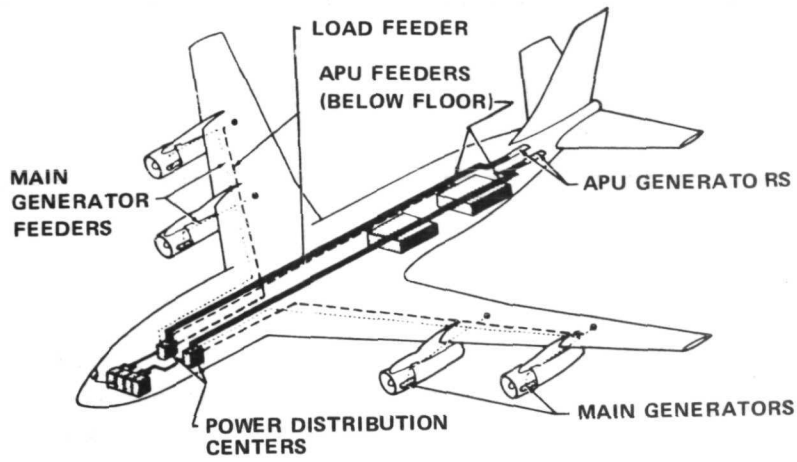

Figure 51. Airplane power feeder system (The Boeing Company).

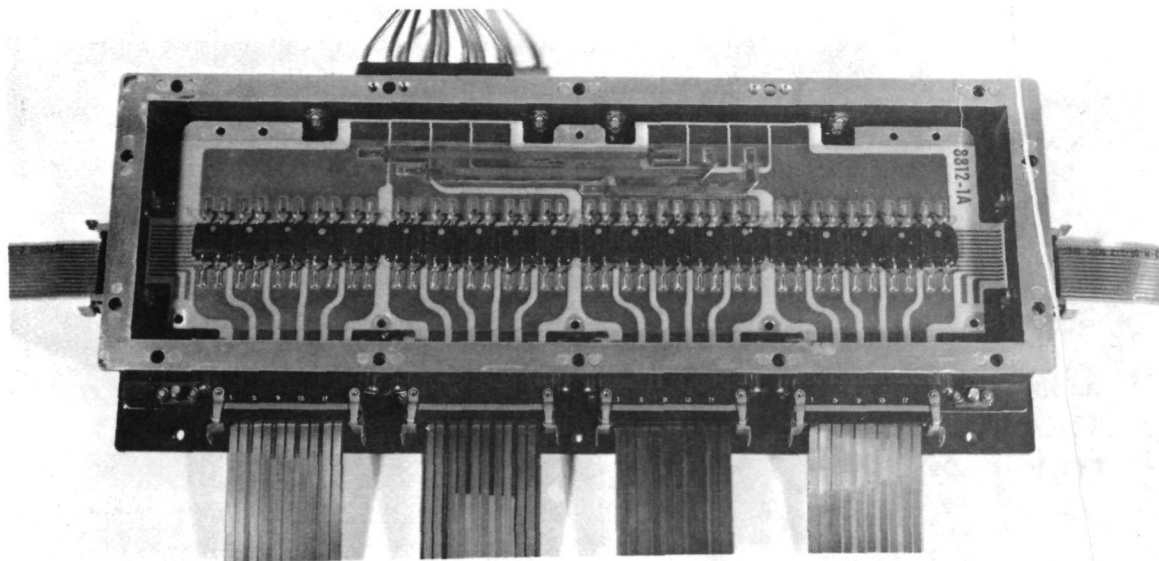

Figure 52. FCC feeder installation (The Boeing Company).

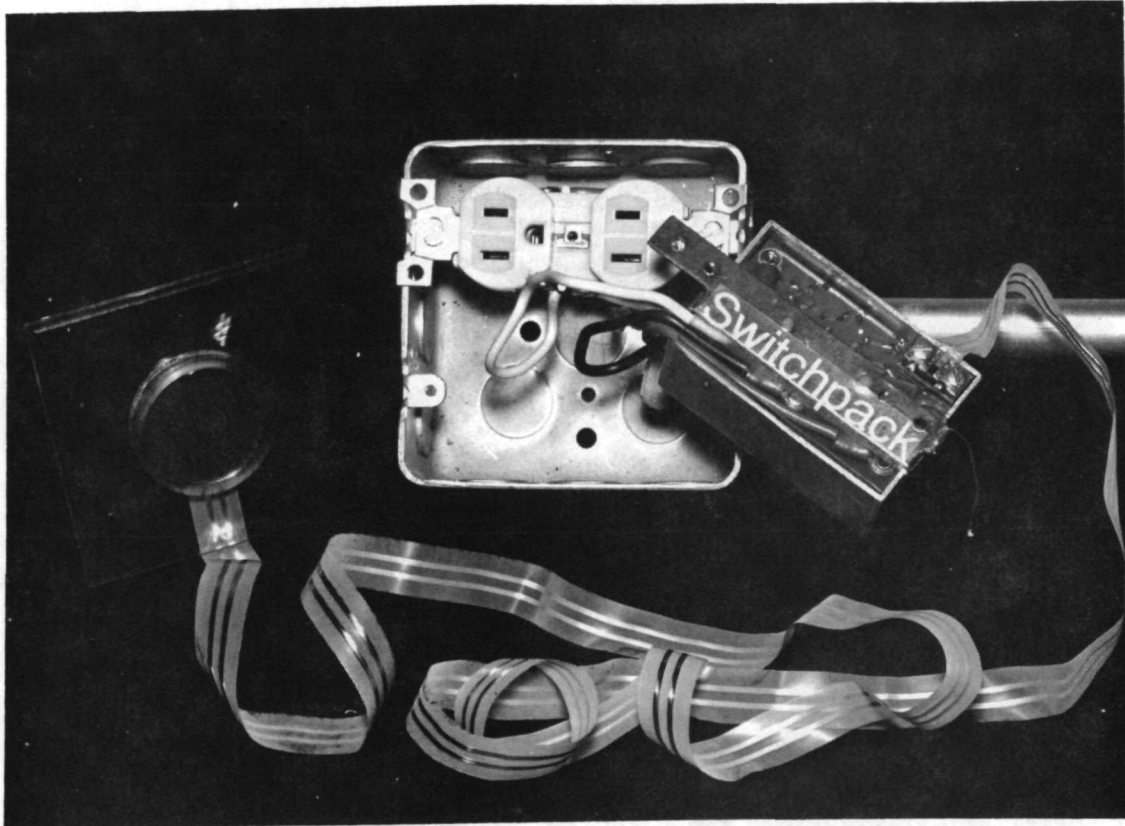
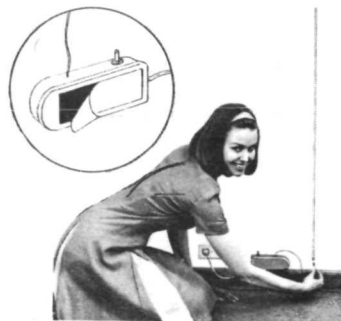

Figure 53. FCC-Switchpack System (ABT Associates and Non-Linear Systems).

*** ATTACH CONNECTOR TO WALL**
 Strip release paper from connector
 Attach to wall back of picture
 Strip release paper from CONDUCT-O-TAPE

from picture lamp
 scotch tape across
 insert into connectors
 from transformer
 scotch tape across
 insert into connectors

CONDUCT-O-TAPE can be painted or papered over.*



ATTACH TRANSFORMER TO BASEBOARD OR WALL
 Strip off green release paper.* Press to wall — It will hold.
 Insert thin wire into bottom connectors.

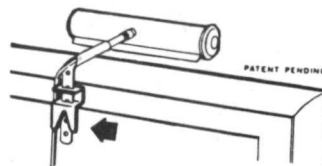

ATTACH HANG-O-BRACKET TO FRAME



CONNECT WIRE TO TOP CONNECTOR
 Hang up picture and picture light.

PLUG IVORY WIRE INTO OUTLET
 Press switch on top of transformer.
 Press again to turn light off.

Figure 54. Installation of high intensity picture light assembly.

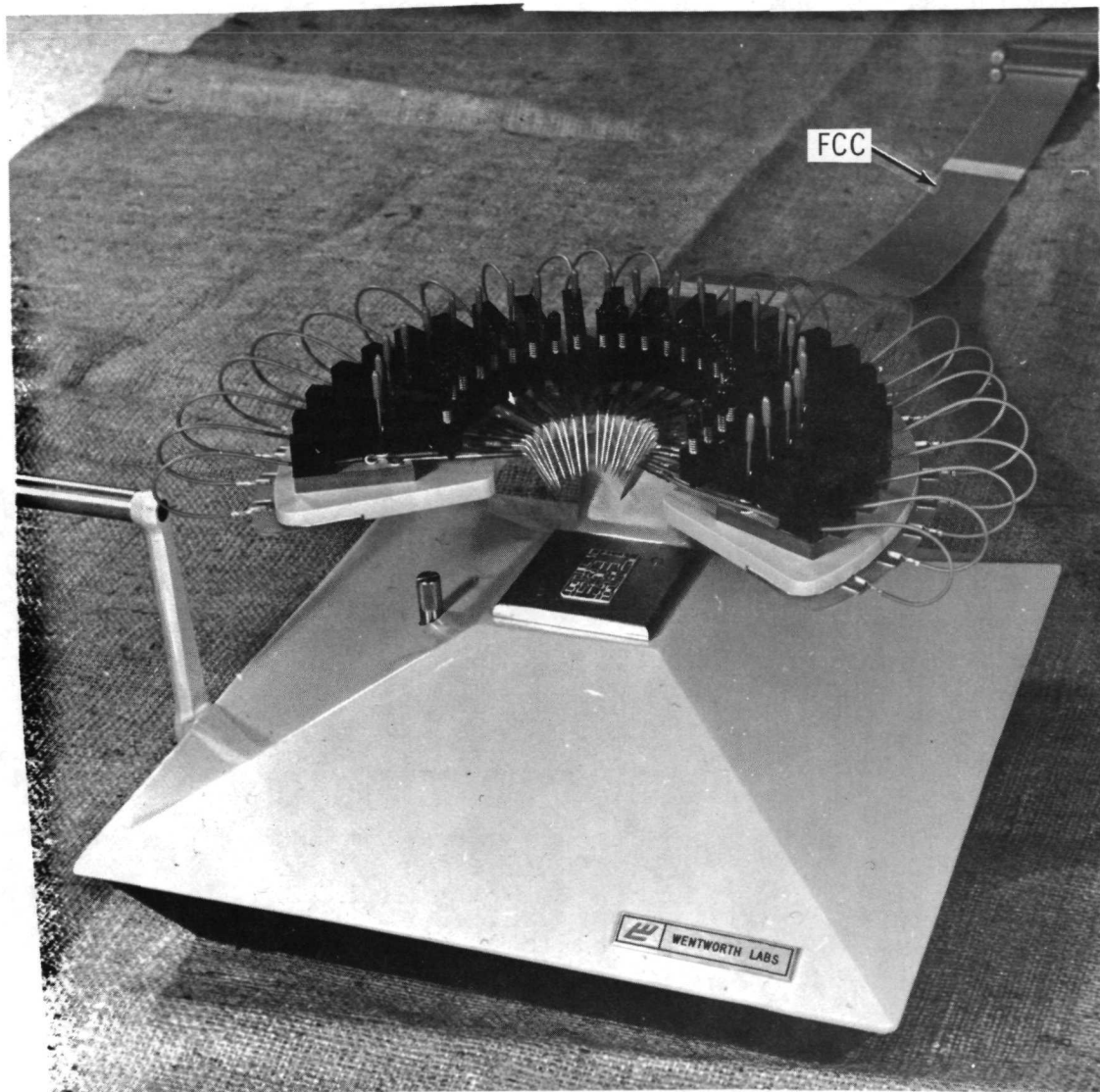

Figure 55. Microcircuit Prober Model MP-0200 with FCC.

APPENDIX
SOURCES OF ADDITIONAL INFORMATION

1. Wilhelm Angele, Process Engineering Laboratory, NASA-Marshall Space Flight Center, Alabama 35812.
2. Ansley Electronics Corporation, 4100 N. Figueroa St., Los Angeles, California 90065.
3. Lockheed Missiles and Space Company, Sunnyvale, California.
4. Bendix Corporation, Aerospace Systems Division, 3300 Plymouth Road, Ann Arbor, Michigan 48107.
5. Final Report for ATM/Rack Flex Cable Interconnect Wiring Study. LMSC-A842239. Prepared for NASA/MSFC by Lockheed Missiles and Space Company, Sunnyvale, California, June 1967.
6. Palmer Dyal and Curtis W. Parkin: The Magnetism of the Moon. Scientific American, August 1971.
7. NASA/Ames Research Center: Technical Specification for Lunar Portable Magnetometer. D-34-101A, September 1970.
8. Hughes Aircraft, Centinela Ave. and Teak St., Culver City, California 90230.
9. Sperry Rand Corporation, Space Support Division, 716 Arcadia Circle, N.W., Huntsville, Alabama.
10. McDonnell Douglas Corporation: Saturn-IVB/V Aft-Skirt Mockup, Flat-cable Development Program. SM-53175, May 1966.
11. Progress Review: Thermionic Reactor Power System for Growth Modular Space Station Conceptual Design and Integration. Joint study by NASA-Marshall Space Flight Center, Huntsville, Alabama, and Gulf Energy and Environmental Systems, San Diego, California.
12. Scope Inc., 2816 Fallfax Dr., Falls Church, Virginia 22042.
13. Guidance and Control Systems Div., Litton Systems, Inc., 5500 Canoga Ave., Woodland Hills, California 91364.
14. Convair Division of General Dynamics, Fort Worth, Texas.
15. Autonetics, Division of North American Rockwell, 3370 E. Miraloma Ave., Anaheim, California 92803.
16. Norden Division of United Aircraft Corp., Norwalk, Connecticut.

BIBLIOGRAPHY OF SELECTED GOVERNMENT AND INDUSTRY DOCUMENTS

SPECIFICATIONS AND STANDARDS

IPC-FC-218A, General Specification for Connectors, Electrical, Flexible FC Type, September 1968.

IPC-FC-220, Specification for FCC, Unshielded, May 1970.

IPC-FC-230, Handbook for FCC and Flexible Printed Wiring, April 1969.

MIL-C-55543, Cable, Electrical, Flat Multiconductor, Flexible, Unshielded, November 15, 1968.

MIL-C-55544, Connectors, Electrical, Environment Resistant, For Use With Flexible, Flat Conductor Cable, General Specification for, December 26, 1968.

MSFC-SPEC-219A, Connectors, Flat Conductor, Flexible Electrical Cable, May 5, 1966.

MSFC-SPEC-220B, Cable, Flat Conductor, Flexible, Electrical Copper, January 28, 1966.

REPORTS

Angele, W.: Flat Conductor Cable Manufacture and Installation Techniques. NASA TM X-53586, March 1967.

Angele, W.: Measuring the Conductor Spacing in Flat Conductor Cables. NASA TM X-53843, June 13, 1969.

Angele, W. and Hankins, J.D.: Flat Conductor Cable Design, Manufacture, and Installation. NASA TM X-53975, January 9, 1970.

Angele, W., Martineck, Hans G., Bennight, J D , and Hankins, J.D.: Flat Conductor Cable Connector Survey of 1970. NASA TM X-64613, July 1971.

Astrionics Laboratory: Flat Conductor Technology Exemplified. NASA TM X-53584, March 1967.

FLAT CONDUCTOR CABLE APPLICATIONS

By W. Angele

The information in this report has been reviewed for security classification. Review of any information concerning Department of Defense or Atomic Energy Commission programs has been made by the MSFC Security Classification Officer. This report, in its entirety, has been determined to be unclassified.

This document has also been reviewed and approved for technical accuracy.

M.P.L. Siebel 5/30/72
M.P.L. SIEBEL
Director, Process Engineering Laboratory

DISTRIBUTION

INTERNAL

DIR
 DEP-T
 AD-S

 A&TS-MS-H

 A&TS-MS-IL (8)

 A&TS-MS-IP (2)

 A&TS-PAT
 L. Wofford, Jr.

 A&TS-TU
 James Wiggins (6)

 PD-RV-MGR
 Roy E. Godfrey

 PD-RV-V
 Hermon Hight

 PD-SA-DIR
 W.G. Huber

 PD-SS-MGR
 W.A. Brooksbank

 PM-HE-I
 H. Fichtner

 PM-SAT-IU
 Friedrich Duerr

 PM-SAT-S-II
 William LaHatte (4)

 PM/SE-ATM
 E. Cagle

 S&E-DIR
 H.K. Weidner

S&E-ASTN-DIR
 K. Heimburg

S&E-ASTN-EAS
 E. Deuel (4)
 H. Thayer
 A.E. West

S&E-ASTR-DIR
 F. Moore

S&E-ASTR-CSE
 H. Vick

S&E-ASTR-E
 R. Aden
 P. Youngblood

S&E-ASTR-EAA
 J. Burson

S&E-ASTR-EB
 E. Baggs

S&E-ASTR-EBC
 W. Shockley (10)
 B. McPeak

S&E-ASTR-EBF
 J. Fuller
 R. Milner
 C. Crowell

S&E-ASTR-EP
 C. Graff

S&E-ASTR-EPN
 J. Miller

S&E-ASTR-G
 C. Mandel

S&E-ASTR-GM
 C. Cornelius

S&E-PE-M
 W. Angele (100)
 V. Caruso
 W. Wilson
 J. Williams

S&E-PE-ME
 J D Bennight
 J. Hankins (100)

S&E-PE-MES
 R. Herndon
 J. Willis
 J. Carden (100)

S&E-PE-MS
 J. Splawn (1)

S&E-PE-MW
 P. Parks

S&E-PE-MX
 P. Schuerer
 E. Van Orden

S&E-PE-P
 W. Potter (1)

S&E-PE-RC
 W. Vardaman

S&E-PE-T
 W. Crumpton (1)

S&E-PE-TC
 J. Lands (1)

S&E-QUAL-DIR
 D. Grau

S&E-QUAL-A
 R. Henritze

S&E-ASTR-M
 J. Boehm

S&E-ASTR-SE
 J. Stroud

S&E-ASTR-SM
 R. V. Allen

S&E-COMP-DIR
 H. Hoelzer

S&E-CSE-DIR
 W. Haeussermann
 O. Hoberg
 J. Mack
 F. Weber

S&E-CSE-G
 R. Currie
 S.A. Johns

S&E-CSE-H
 F.C. Hammers

S&E-CSE-I
 L.L. McNair

S&E-CSE-S
 J.O. Aberg

S&E-CSE-V
 C.O. Brooks

S&E-P-DIR
 H.W. Kroeger

S&E-PE-DIR
 M. Siebel (2)

S&E-PE-D
 F. Weckwarth (1)

S&E-QUAL-AF
 J. D. Calhoun

S&E-QUAL-AFC
 W. Fenner, Jr.

S&E-QUAL-AFR
 W. Reynolds
 B. Futral
 R. Sturgill

S&E-QUAL-AR
 J. Bates

S&E-QUAL-ARM
 R. Neuschaefer
 B. Tannehill
 G. McDaniel
 B. Parker

S&E-QUAL-QP
 A. Carr

S&E-QUAL-QPA
 Q. Soprano
 H. Ricketts

S&E-QUAL-QT
 B. Corder

S&E-R-DIR
 W. G. Johnson

S&E-SSL-DIR
 G. B. Heller