

ADVANCES IN HIGH ENERGY ASTRONOMY FROM SPACE

By Dr. Riccardo Giacconi
Senior Vice President
American Science and Engineering

INTRODUCTION

In the life of the modern city it is rare for us today to turn our sight to the night sky and contemplate the stars. A thousand physical and emotional stimuli prevent us from doing it; thus, in the age of space travel, the stars seem to have receded farther away from our consciousness than in the past. The question is often asked: why X-ray astronomy, or astronomy in general?

For our remote ancestors the contemplation of the heavens was an important part of life. From the practical point of view, the orderly movement of the celestial bodies was used to regulate the time for sowing, for the harvest, for the hunt, and then for market. The position of the stars was used as the only compass for the traveler on land and on sea. Later, the study of the orderly and cyclical nature of the heavenly notions became interwoven with myth, legend, and religion. When today's astronomer looks back to his colleagues of the past, he does not find men like himself, with the same outlook on life and from the same backgrounds, but rather poets, philosophers, priests, and princes with intellects quite as powerful as our own, who had realized several thousand years ago a powerful synthesis of their cosmological views and the life of their society.

In the stupendous accomplishments of these predecessors, such as the construction of the astronomical observatory of Stonehenge, and possibly the understanding of the precession of the equinox, which implied the oral transmission and knowledge of cyclic phenomena with periods of hundreds and thousands of years, we encounter an interest and desire for pure knowledge, with no possible practical application. This has made astronomy the intellectual adventure it has remained to this day.

While the study of the universe by means of astronomical observations has traditionally played a large role in the advances of knowledge of the physical sciences, its central impact and appeal have been in the deeper knowledge man obtains of himself by studying the universe in which he lives. The

cultural and social impacts of the Copernican, Keplerian, and Newtonian revolutions are only now beginning to be fully realized. Primarily because of the development of new techniques for exploring regions of the electromagnetic spectrum outside the optical window, a spectacular series of discoveries has occurred in the past two decades. These were so surprising and enigmatic that they provided a powerful stimulus for further exploration and forced a reappraisal of astrophysical theories.

First, through radio astronomy, came the realization that explosive phenomena in stars (supernovae) released tremendous amounts of energy, a large fraction of which appears in the form of high-energy particles. Then followed the discovery of radio galaxies and quasars, leading to the conclusion that explosive phenomena are taking place on a very large scale in galaxies as a whole. The recent discoveries of the microwave background radiation, X-ray sources, and pulsars have strengthened the conclusion that in our universe high-energy processes (i.e., processes in which the energy released per gram is much greater than for normal stellar matter, ~ 1 erg/gm-sec) play a major and quite possibly a decisive role. The study of these processes defines a new field, high-energy astrophysics, the central problem of which is an understanding of the source of the tremendous amounts of energy released in X-ray sources, supernovae, radio galaxies, quasars, etc., and the processes by which the high-energy particles responsible for the radiation from these objects are produced. It is no overstatement to say that the resolution of these problems constitutes one of the most important and fascinating tasks in all of physics.

Since the production of high-energy photons is to be expected whenever high-energy particles collide with a magnetic or photon or particle field, and whenever high temperature plasmas are present, it is not surprising that X-ray astronomy has made significant contribution to the development of the field of high-energy astrophysics, despite the fact that the total amount of observing time has been

small compared to that in other fields. We can expect this contribution to be much greater in the future, when increased observing time becomes available, because a number of crucial observations can be made only in the X-ray band.

Since high-energy photons from a few electron volts to several million electron volts do not penetrate the earth's atmosphere, observations in this energy range became possible only by the development of balloons, rockets, and satellites (Fig. 1). This development made it possible for the first time in man's history to observe the sky unimpeded by the atmospheric blanket that surrounds us on earth. While this opportunity was of some importance in improving "seeing" conditions for traditional observational techniques, its true significance was in permitting the observation of regions of the spectrum for which the atmosphere is an opaque barrier. In one stroke, space astronomy could extend the range of observable wavelengths by as many decades as had been until then available.

In retrospect, it is easy to understand why X-ray observations, rather than ultraviolet or gamma rays, should have provided us the first major surprises in space astronomy. First, the existence of a diffuse interstellar gas produces a sharp increase in absorption at 13.5 eV, the energy corresponding to the ionization potential of atomic hydrogen. While photons from the visible through the ultraviolet up to this energy can traverse the interstellar medium relatively unattenuated, photons with energy greater than 13.5 eV are completely absorbed over extremely short distances, in astronomical terms. The interstellar medium does not again become transparent until we reach energies of a few hundred electron volts in the X-ray range. On the low-energy side of this barrier, the processes we can observe are mainly the same ones that give rise to the visible light spectrum we observe. It is only on the high-energy side of the barrier that the photons we observe may carry information about vastly different physical processes and states of matter (Fig. 2). Photons in the X-ray range of energy are the lowest energy and, therefore, the most abundant photons beyond this barrier that can penetrate galactic distances. Thus, it is not surprising that the first discoveries in high-energy astronomy occurred in the X-ray rather than in the gamma-ray range of energy.

In the short 8 years since the first detection of cosmic X-ray sources, a number of significant observations have been made which have revealed to

us a different aspect of the cosmos. We have discovered the existence of a class of stellar objects whose main mechanism of electromagnetic energy loss is through emission of high-energy photons. A well-known example is Sco X-1, the first of the cosmic X-ray sources to be detected. The name "xstar" which was proposed for this object finds some justification in the fact that while in main sequence, stars emission in the visible light range of wavelengths exceeds, by orders of magnitude, the emission in X-rays. In Sco X-1 this ratio is reversed.

The pulsar in the Crab Nebula, which has been first detected through its radio pulsations, has been also shown to emit most of its radiative energy in the X-rays' range of wavelengths. Also, its rotational energy which is believed to be expended in accelerating particles to relativistic energy may ultimately be dissipated by energy loss of the electrons through synchrotron emission, mainly in the X-ray range of wavelengths. We have observed X-ray emission from exploding galaxies, such as M-87, where again the energy emitted in X-rays equals or exceeds all other forms of radiative dissipation. We have perhaps detected the emission from intergalactic gases, whose existence and density play an essential role in determining closure or openness of our universe. The existence of these gases can only be detected through their X-ray emission if they are as hot as presently believed.

A general discussion which pretends to encompass all X-ray astronomy would be as hopeless a task today as would be the case for optical astronomy. The sheer richness and variety of the field prevents completeness. I will, therefore, endeavor only to mention briefly the observational techniques and then to give an example of what we learn through X-ray observations of a few objects, such as the sun, a stellar object, and a galactic object, followed by a few comments about what we can expect from future developments.

Instrumentation

The essential elements of an X-ray experiment are a detection device, such as photon counter or film, and a collimating device to define the direction from which the X-rays are coming. These units must be rigidly mounted on a carrier (rocket or satellite), and some means must be provided to maneuver or point the carrier in order to acquire

or sweep interesting regions in the sky. Some means to determine instantaneous celestial coordinates for the instrumentation must be provided. Finally, there is the problem of signal conditioning and return of the data to the ground.

Rather than discussing in detail each element of instrumentation, I will mention two examples of complete instrument systems presently in use.

Uhuru is the first satellite entirely devoted to X-ray astronomy (Fig. 3). It was launched in an equatorial orbit of 500 km from Kenya, Africa, on December 12, 1970. This day is the anniversary of Kenyan independence, hence the Swahili name for freedom, Uhuru. Data are stored onboard on a tape recorder during a 9-min period and then transmitted to the ground when the satellite passes over a ground station at Quito, Ecuador.

The satellite's fields of view and scanning mode are shown in Figures 4 and 5. As the satellite slowly rotates about its axis, the detectors scan a band in the sky 5 deg wide and 360 deg long. By magnetic torquing against the earth's magnetic field, we can change the orientation of the spin axis and thus observe any desired part of the sky. A typical sample of data is shown in Figure 6.

This satellite is the most sensitive X-ray instrument yet at our disposal. The relatively large area of detection, 1 ft², and, most important, the long time of observation available, make it some 10 000 times more sensitive to weak extrasolar X-ray sources than the crude rocket experiment, with which the first X-ray star was discovered in 1962. Most of the data I will discuss today come from this satellite.

A totally different system which up to now has only been used for solar X-ray studies is shown in Figure 7. It is mentioned here both to introduce the observations of the sun in X-rays (which I will discuss briefly), and because of its importance for stellar X-ray astronomy in the future. The system consists of an X-ray grazing incidence mirror which forms a high-quality real image in the focal plane. The mirror consists of a highly polished glass or metal surface on which X-rays impinge at very small angles of grazing incidence, about 1 deg. Under these conditions, X-rays of a few tenths to a few kilovolts reflect with efficiencies of the order of 1.

The X-rays undergo two reflections from a paraboloid and a hyperboloid of revolution (Fig. 8), and

the image formed at the focus is then recorded on film or on a television camera. Images with angular resolutions of a few arc seconds, comparable to the ones achieved in visible light, can be obtained for intense sources, such as our own sun, during exposures of a few seconds. Thus, a rocket flight of only 300 sec provides the opportunity of obtaining several photographs of the sun during one flight. The flux of X-rays from the sun is of about 10^5 photons/cm² sec. Even the nearest and most powerful stars are so distant that the X-ray flux reaching us at earth is many orders of magnitude smaller, so that the much longer observation times provided by satellites and much larger telescopes of this type will be needed before the technique can be applied to extrasolar sources.

The Sun as an X-ray Star

X-ray emission from the quiet sun originates in the upper chromosphere and corona. Low density and high-temperature plasmas are created in these regions by heating from sound or hydromagnetic waves originating from below the atmosphere. The details of this heating mechanism whereby a million-degree temperature region is created surrounding the very cool surface of the sun (a few thousand degrees) are not fully understood. Independent of their origin, the thin (10^{10} particles per cm³) and hot ($T > 10^6$ °K) gases thus created become almost completely ionized. Emission in X-rays can occur as free-free collision between particles (thermal bremsstrahlung continuum), as free bound (recombination continuum), or line emission. Most of the emission from the quiet corona takes place at temperatures of the order of 1 or 2 million degrees and, therefore, appears mainly as line emission. During flares or from active regions the temperature can reach two or three times that value. The hot plasmas which generate the observed X-rays are contained by the sun's magnetic field. Thus, we would expect to observe X-ray structures reflecting the configuration of the coronal magnetic field. This is precisely what one observes, as shown in Figure 9 (obtained with a grazing incidence telescope during a rocket flight on March 7, 1970, shortly after the solar eclipse).

The striking feature of Figure 9 is the absence of the solar disk, much too cold to be observed in X-rays, and the appearance of a complex and varied structure reflecting the presence of plasmas and the configuration of the magnetic field. Tubular arches and loops of enhanced density and

temperature rise to heights of more than 10^5 km above the photosphere. X-ray observations are thus two-dimensional projections of these structures.

Rather than discussing in detail the significance of the various small- and large-scale structures, I would like to conclude this discussion of the X-ray sun by quoting some energetics. The sun emits about 4×10^{33} ergs/sec in all wavelengths. In X-rays, its luminosity is only of about 10^{25} to 10^{26} erg/sec. Thus, at the most, one-millionth of the sun's total energy is emitted as X-rays. We will see in what follows that although this ratio is fortunate for us, it is by no means true for every stellar object. In fact, if all stars emitted at the same rate as our own sun, we could not have discovered their existence. We will see that stars exist in which the central object emits a negligible amount of the total energy dissipated by electromagnetic radiation; its importance is to provide, by nuclear burning or release of rotational or gravitational energy, the energy that is expended in the radiative process and to serve as an anchor to gravitationally or magnetically contain the plasmas or high-energy particles that emit the bulk of the radiation.

Extrasolar Sources

The X-ray Sky. When we analyze the information that Uhuru is sending us about the night sky, we observe the following main features:

1. Many stellar objects, now 80 or so, are observed to emit copious amounts of X-rays. They appear to be strung throughout the disk of our galaxy at great distances from us (Fig. 10). They emit most of the radiation in X-rays (typically $L_x/L_v = 1000$) and they are among the most powerful emitters in the galaxy at 10^{36} to 10^{38} erg/sec, some 10^3 to 10^5 times our own sun.

2. These X-ray sources appear to be associated with a variety of stellar objects, such as:

a. Identified

- Supernova remnants Type I - Crab, Tycho
- Supernova remnants Type II - Cas A
- Pulsar - NP-5032
- Blue varying star - Sco X-1, Cyg X-2

b. Not identified

- Pulsating white dwarfs - Cen X-3 ?
- Neutron stars - 340 + 0 ?
- Black holes - Cyg X-1 ?

3. There exists a large number (40) of extragalactic sources of which about 12 have been identified. They include:

- | | |
|----------------------------------|----------------------|
| a. Galaxies of our own | LMC |
| b. Local cluster (50-100 kpc) | SMC |
| c. Radio galaxies (10 Mpc) | M87, NGC 5128 |
| d. Seyfert galaxies (10-70 Mpc) | NGC 1275
NGC 4151 |
| e. Clusters of galaxies (100 Mp) | Coma Cluster |
| f. QSO (600 Mpc) | 3C273 |

The intrinsic luminosity of these objects ranges from about 10^{39} erg/sec for LMC to about 10^{46} erg/sec for 3C273.

4. A diffused intense background, partly originating in our own galaxy and partly outside, possibly at cosmological distances from us, is observed. This background could be due to a number of unresolved discrete weak sources or to emission by gas or particles in interstellar or intergalactic space.

I would like to give two examples of study in stellar and galactic astronomy to illustrate the detailed nature of these observations and their significance.

Cen X-3. Cen X-3 is not one of the most intense sources. Its intensity at earth is of about 10^{-1} photons/cm² sec or some 500 times less than the strongest known X-ray source, Sco X-1. It is, however, an extremely interesting source due to its variability, pulsations, and level of detail in which we can study it. It was first observed during rocket experiments exploring the region of Centaurus. It is called Cen X-3 because it was the third X-ray source discovered in this constellation. Uhuru has observed it since January 1971, and

is still observing it as of now. Figure 11 shows a plot of the observed intensity of the source in the 2- to 8-keV-energy range during a day. We observe a tremendous change in its intensity occurring in a 1-hr period. This vast change in emitted X-ray energy is a common characteristic of X-ray sources. The time in which such changes occur and the amount of change vary from source to source.

If we observe the emission of this source in more detail, as in Figure 12, we find an even more striking fact. The dotted envelope shows what we would expect to be the response to a constant point source through our instrument as we scan through it. The very large fluctuations we observe, 70 or 80 percent in intensity, occurring during 100 sec are then occurring at the source. The source is thus pulsating in X-rays. If we examine these data in greater detail we find that we can fit them with a sine wave function, including the first and second harmonic. The period is of 4.832 ± 0.004 sec. An important question is the stability of the period. If these X-ray pulsations are due to rapid rotation of a stellar object, we would expect them to be maintained for a long time. When we examine this question in detail (Fig. 13), we find that relatively large changes of the period occur in short times of the order of 1 hour. From the rapid change in X-ray emission, we are driven to postulate small regions from which X-ray emission occurs, of the size of earth, or smaller.

Since the source is quite close to the galactic equator, we believe it is quite distant. At 1 kpc its intrinsic luminosity is 10^{36} erg/sec. Thus, we have an object one-hundredth the size of the sun, presumably with the same mass, and thus with incredibly high density, emitting some 10^3 times more energy.

What type of star are we confronted with?

The small radius requires that it be a collapsed star near the endpoint of stellar evolution. Of the three states, white dwarf, neutron stars, and black hole, in which a star is conceived to end, perhaps the white dwarf is more conventional. It turns out that a recent theoretical model, based on a pulsating white dwarf, where a dense atmosphere is heated by shock waves produced by nuclear burning of the shell or accretion, seems to satisfy all observational data. The model makes detailed predictions about the energy spectrum of the source as a function of phase of the pulse (Fig. 14). Detailed comparisons are presently being done to establish the validity of the

model. A search is underway to discover a possible optical or radio counterpart to this object. None has as yet been found. One should stress that such violent behavior of white dwarfs had not been understood to take place prior to the observations. In fact, the validity of the model is by no means generally accepted and could be completely destroyed if several other objects of the same type, but shorter period, should be discovered.

A few weeks ago, another object with a period of about 1.3 sec was observed. Shorter periods would strain the white-dwarf hypothesis even further. Many other X-ray sources exhibit pulsations, for instance, the Crab pulsars NP0532 of a 30-msec period, which is interpreted as a rotating neutron star whose gigantic magnetic field dissipates the star's rotational energy by accelerating particles to high energy with consequent emission of X-rays via the synchrotron process.

These observations are so new that they have outrun theory. It is clear, however, that X-rays give us a powerful new tool with which to study the physical processes taking place at the end point of stellar evolution.

Extragalactic Sources

Leaving now the confines of our own galaxy and the local group, I would like to focus on a recent measurement of X-ray emission from the Coma Cluster of galaxies (Fig. 15). The Coma Cluster at a distance of 90 Mpc, that is some 10 000 times more remote from us than the center of our own galaxy, contains some 800 galaxies emitting a 100-by-100-arc min area of the sky. We find an X-ray source centered very closely to the kinematically determined center of the cluster. If this is not a chance coincidence, which we think we can exclude, the luminosity of the source is 3×10^{44} erg/sec, some 10^6 times the luminosity of our own galaxy. We find that the region of X-ray emission is extended by about 45 arc min and that, contrary to what has occurred for other extragalactic sources, no galaxy with very peculiar optical or radio characteristics coincides with the source location.

We are then led to consider several possible hypotheses:

1. A single galaxy which for some reason (local obscuration) is not conspicuous optically.

2. A large number of individual galaxies in the cluster, too faint to be resolved. This would require galactic luminosity of $10^{41} - 10^{42}$ erg/sec which would be in itself peculiar.

3. Last, the source is due to emission via thermal bremsstrahlung from a hot intergalactic gas in the cluster. The data can be fit by a temperature of 70×10^6 K with particle velocity of 1000 km sec^{-1} in agreement with the velocity of the individual galaxies in the cluster.

The mass of the gas would be about $3 \times 10^{13} M$, which is very large — about 100 galaxies similar to our own, but much too small by a factor of 100 to prevent indefinite expansion of the galaxies in the cluster. In fact, the most significant aspect of this observation was recently pointed out; the amazing fact being not that the emission from the cluster is too large, but that it is too little. If large amounts of intergalactic gas existed, they would have fallen into the cluster and would have been heated to very high temperatures. If one assumes that the mass required to close the universe is in this form, we should have observed an emission of a factor of about 10 times greater from this effect alone.

Conclusion

I would like to conclude my remarks by mentioning the new observational tools that are planned in X-ray astronomy for the coming decade. With Uhuru, we have achieved angular resolutions of about 0.25 deg, positional accuracies of a few arc minutes, spectral resolution of 10 to 20 percent. In the High Energy Astronomy Observatory Program of NASA, much larger instruments will be made available. The first and second missions, due in 1975, will perform higher sensitivity surveys of the type of instrumentation that Uhuru has pioneered with — similar, though much improved. The third

mission will see the first use of a large focusing X-ray telescope from a pointed platform (Fig. 16). This will make it possible to analyze the angular structure and position of sources with resolution comparable to one obtained in visible light. Figures 17 and 18 show the type of improvement one can expect. From this observatory, it will also be possible to analyze in detail the presence of emission lines superimposed on the continuum spectra, to study in great detail the time variations and the polarization of the sources, and to extend the observations to the farthest objects in our universe. It will be possible to study in detail the nature of the X-ray background and perhaps to detect the presence of a hot intergalactic gas, thus contributing to the choice of cosmological models.

While it may yet be too early to completely define the role of X-ray stars and other X-ray emitting objects in stellar and galactic evolution, the wide range of observable phenomena mentioned above and the large energies involved show that the study of X-ray emission is essential to an understanding of the physical processes occurring in many of the objects of greatest astrophysical interest. In addition, the mere notion that high-energy photons could be detected from various extrasolar sources has compelled a rethinking of astrophysical theories.

After a few years of X-ray observations, we have glimpsed a different and important aspect of the universe surrounding us. From the vantage point of this new perspective we have a better understanding of the role and importance of high-energy phenomena in astrophysics. We believe that this new awareness will not be lost in the future. X-ray observations have been an unexpected gift to astronomy from space exploration. So long as space endeavors continue, X-ray astronomy will maintain its rapid rate of progress and take its place beside visible and radio techniques as one of the powerful tools with which to explore the universe.

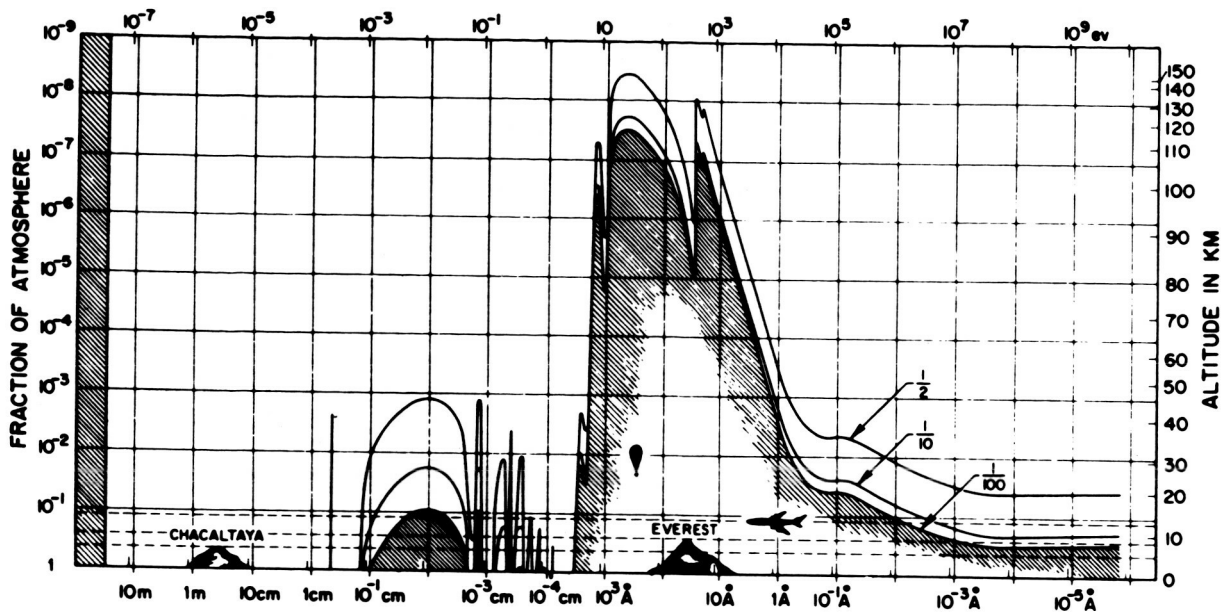

Figure 1. Energy ranges, outside the earth's atmosphere, now observable through balloon, rocket, and satellite development.

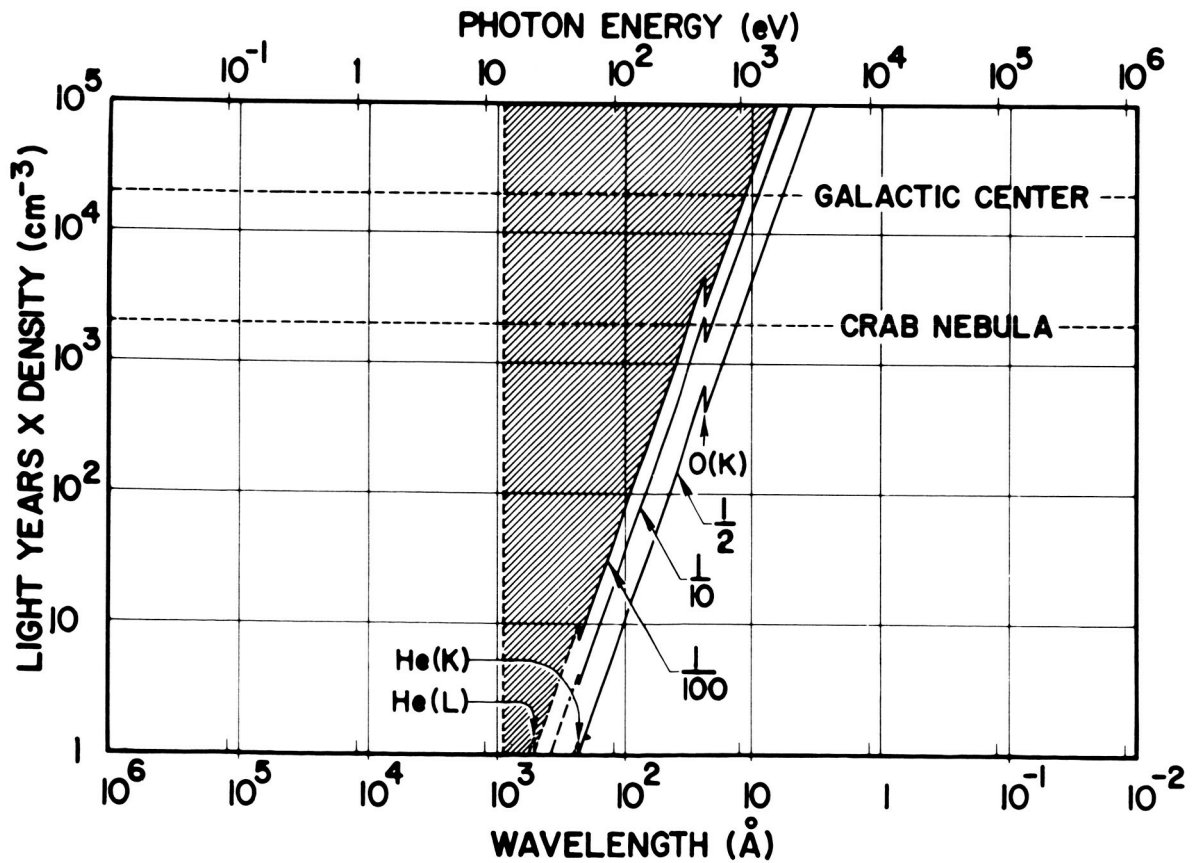

Figure 2. Attenuation of radiation in interstellar space.

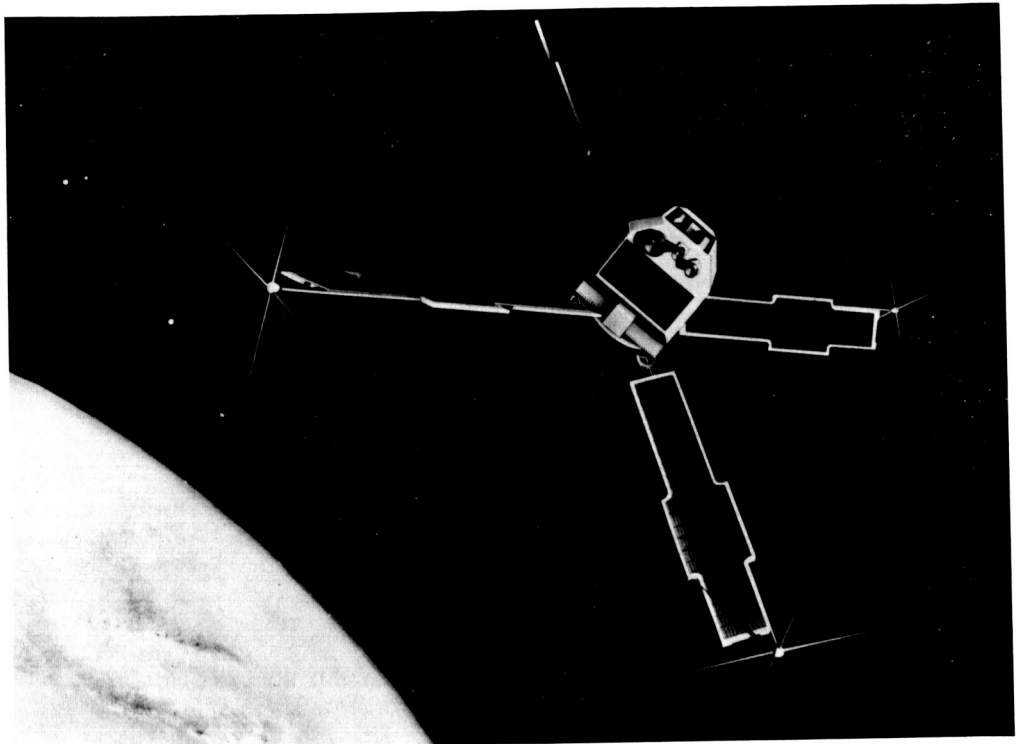

Figure 3. Uhuru.

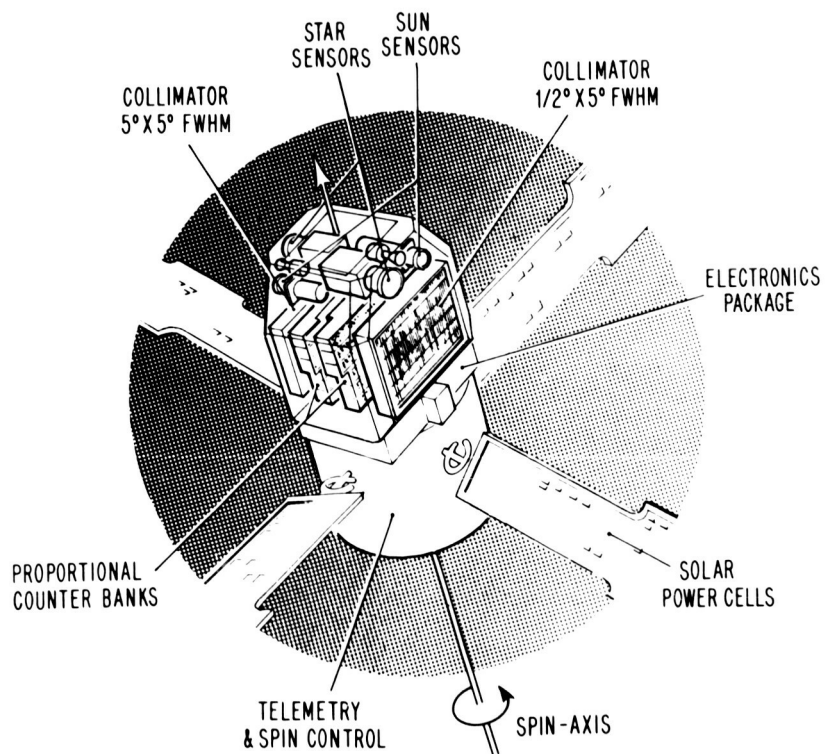

Figure 4. Uhuru's fields of view and scanning mode.

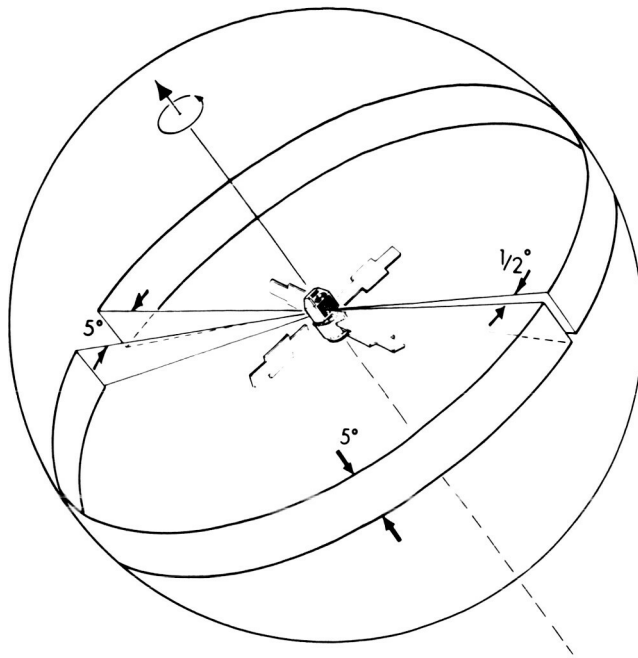

Figure 5. Scanning mode.

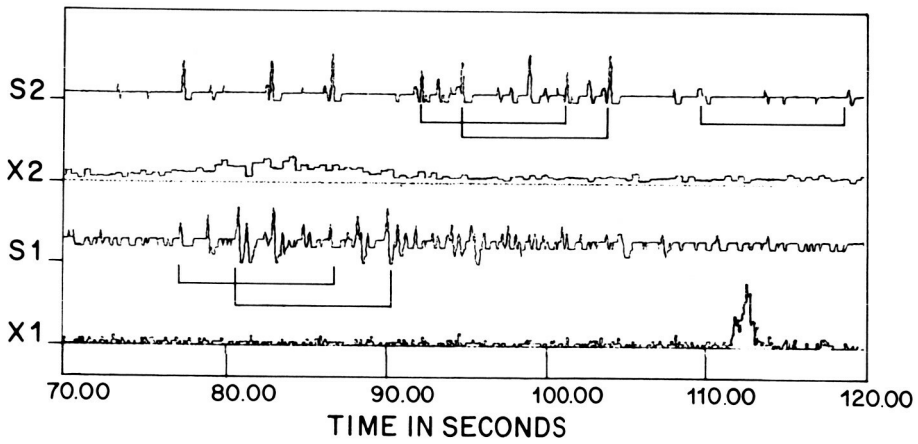

Figure 6. Raw data — day 381.

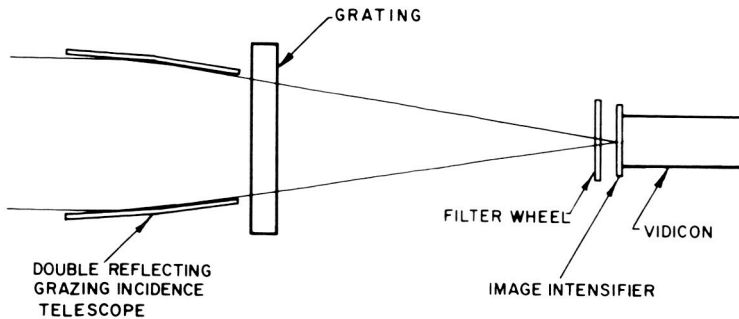

Figure 7. New method for solar X-ray studies.

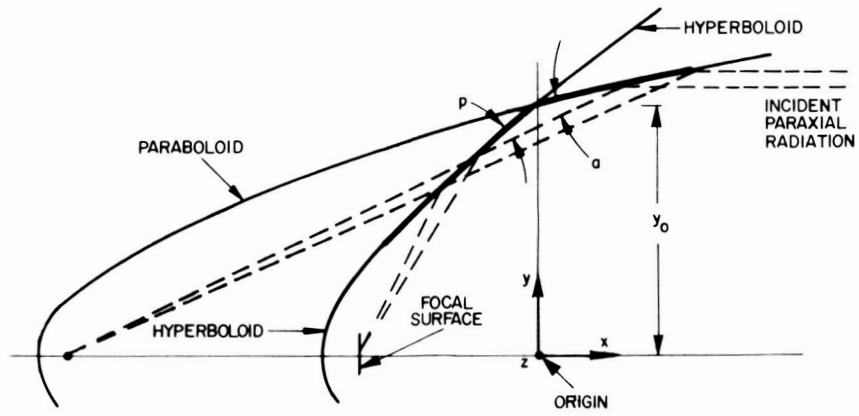

Figure 8. Two reflections from a paraboloid and hyperboloid of resolution.

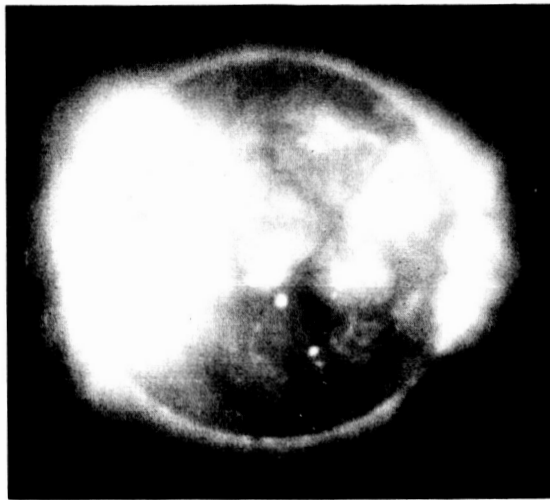

Figure 9. Photograph of the sun obtained with a grazing incidence telescope.

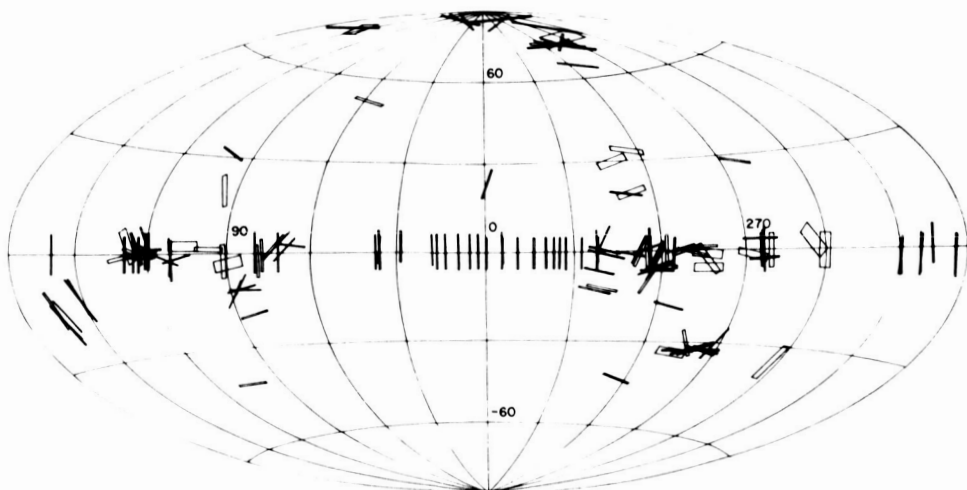

Figure 10. X-ray sky from Uhuru — March 29, 1971.

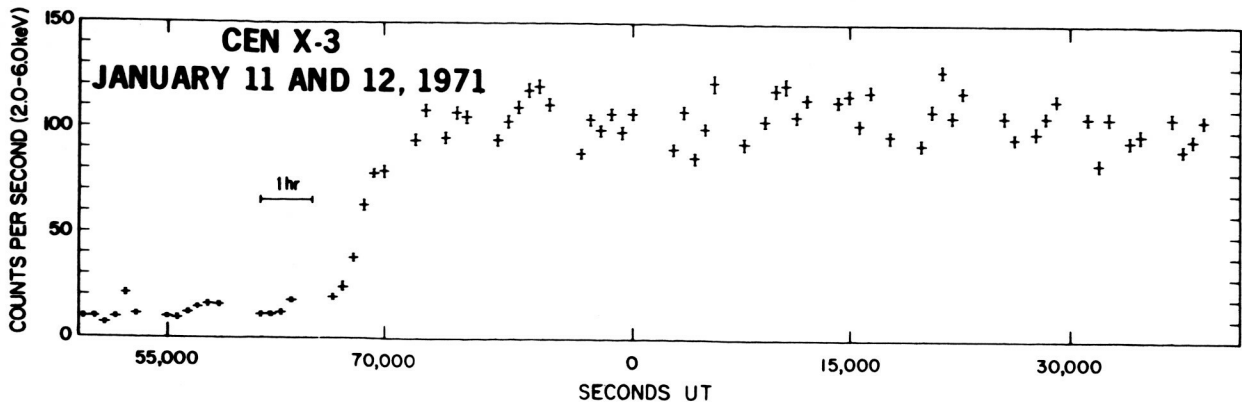

Figure 11. Plot of observed intensity of the Cen X-3 in the 2- to 8-keV energy range during a day.

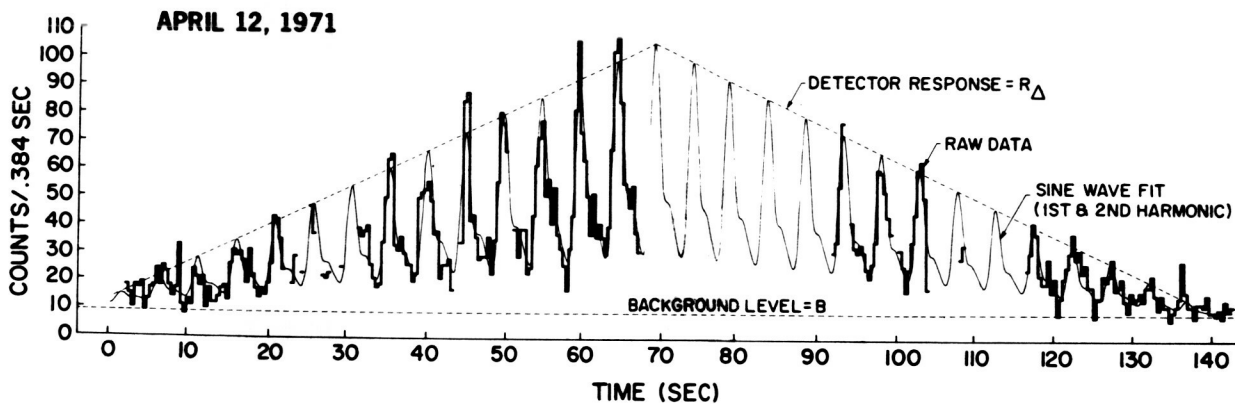

Figure 12. Detail of Cen X-3 emissions.

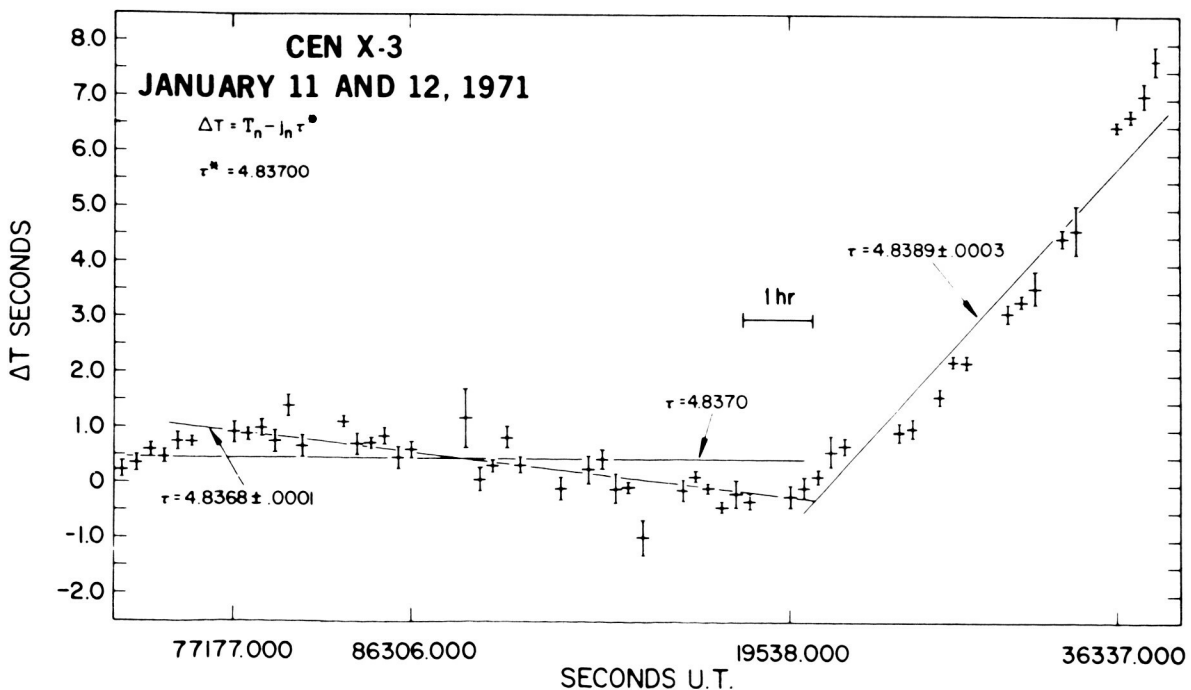

Figure 13. Rapid change in X-ray emission.

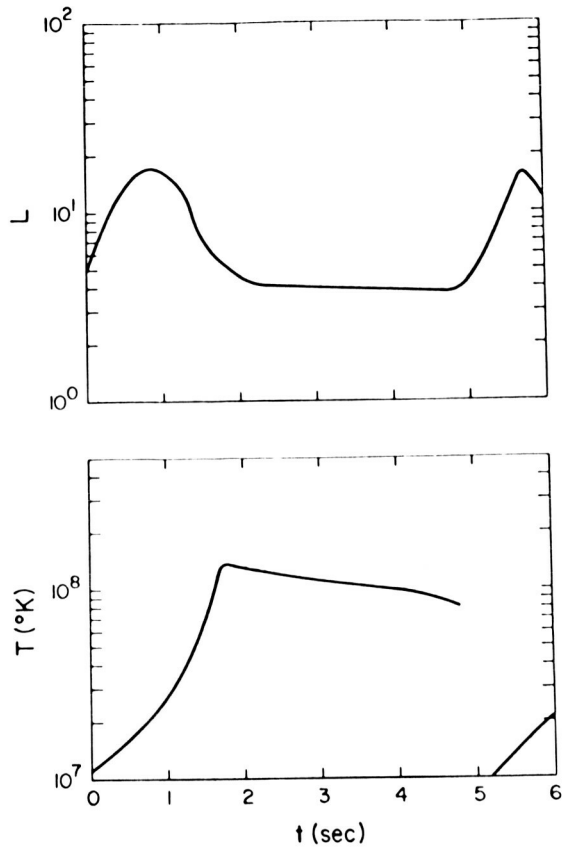

Figure 14. X-ray luminosity and temperature for a pulsating white dwarf.

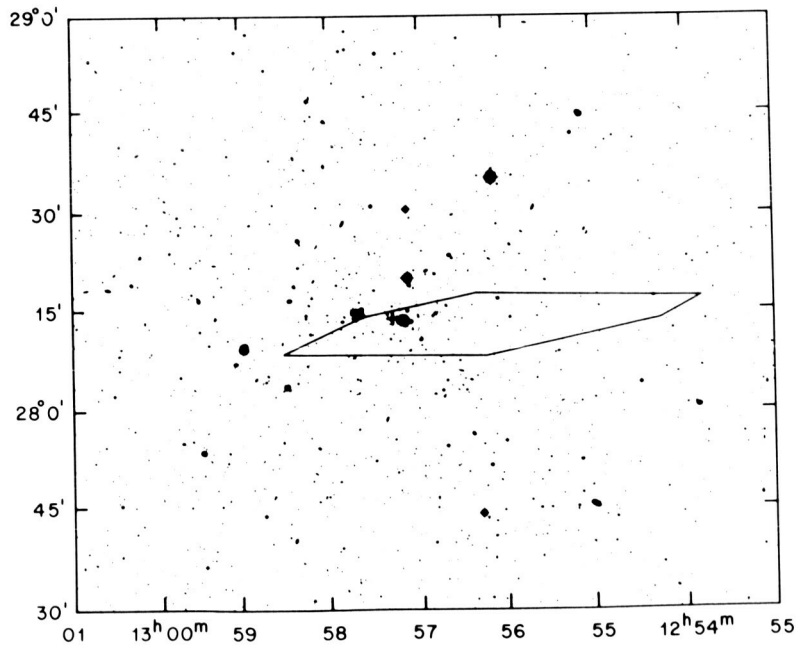

Figure 15. X-ray source in Coma Cluster.

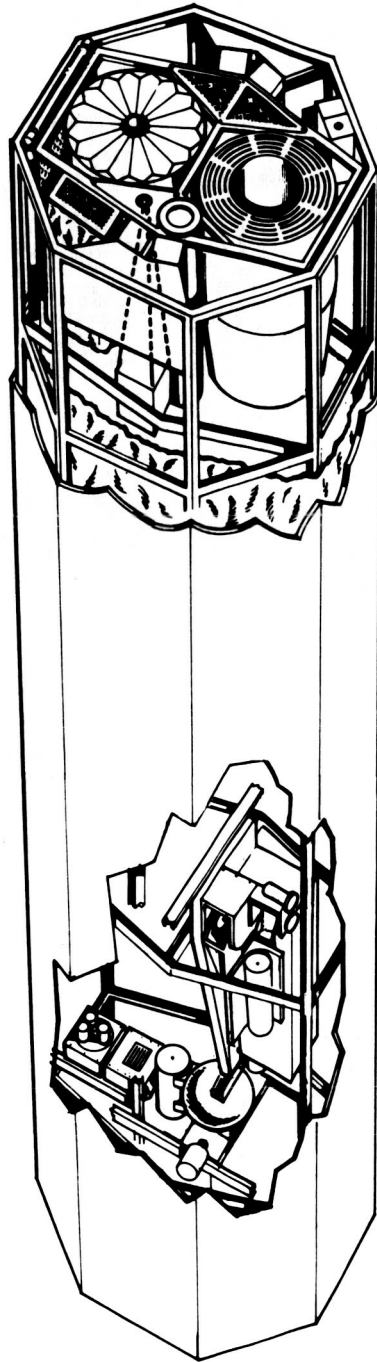

Figure 16. Large focusing X-ray telescope to be used in NASA's High Energy Astronomy Observatory program's third mission.

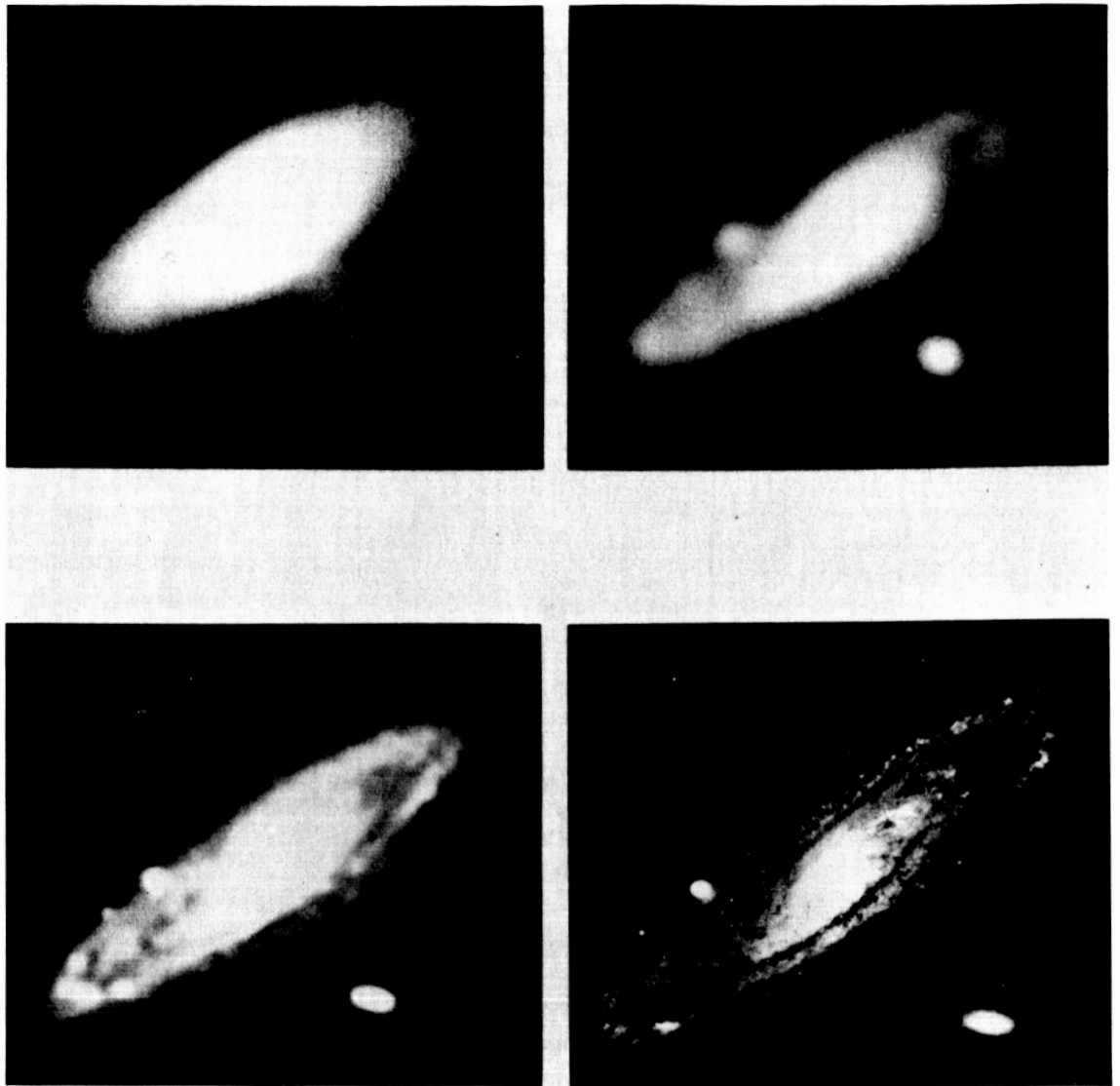

Figure 17. Improvements seen from use of the telescope shown in Figure 16.

Crab Nebula

Distance 1700 pc
 $m_v - A = +7$
 $m_x(1 - 10\text{keV}) = 3 \times 10^{-8} \text{ergs/cm}^2\text{-sec}$
 $f_v(100 \text{mc}) = 1700 \text{ f.u.}$
Angular Size = 3 arc-minutes

NP0532 (PULSAR)

$m_v = +17$
 $m_x(1 - 10\text{keV}) = 10^{-9} \text{ergs/cm}^2\text{-sec}$

AA-264

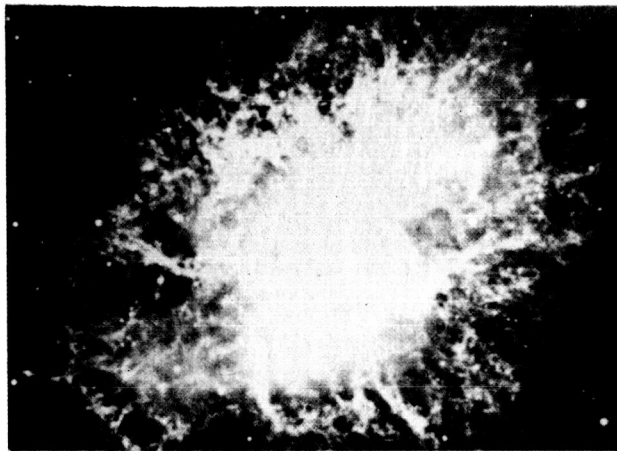

Large Magellanic Cloud

Distance 55,000 pc
Crab-Like Object
 $m = +14.5$
 $m_x = 3 \times 10^{-11} \text{ergs/cm}^2\text{-sec}$
 $f_v(100 \text{mc}) = 1.7 \text{ f.u.}$
Angular Size = 6 arc-seconds

NP0532-like object

$m_v = +24.5$
 $M_x = 10^{-12} \text{ergs/cm}^2\text{-sec}$

DT-041



M-31

Distance 500,000 pc
Crab-Like Object
 $m_v = +20.5 \text{ mag}$
 $m_x = 3 \times 10^{-13} \text{ergs/cm}^2\text{-sec}$
 $f_v(100 \text{mc}) = 0.017 \text{ f.u.}$

NP0532-like object

$m_v = +30.5$
 $m_x = 10^{-14} \text{ergs/cm}^2\text{-sec}$

DT-036



Figure 18. Improvements seen from use of the telescope shown in Figure 16.