

NASA TECHNICAL NOTE

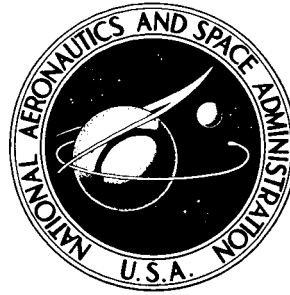

NASA TN D-7610

NASA TN D-7610

**APOLLO EXPERIENCE REPORT -
MANNED THERMAL-VACUUM
TESTING OF SPACECRAFT**

by James C. McLane, Jr.

*Lyndon B. Johnson Space Center
Houston, Texas 77058*



1. Report No. NASA TN D-7610		2. Government Accession No.		3. Recipient's Catalog No.	
4. Title and Subtitle APOLLO EXPERIENCE REPORT MANNED THERMAL-VACUUM TESTING OF SPACECRAFT				5. Report Date March 1974	
				6. Performing Organization Code	
7. Author(s) James C. McLane, Jr., JSC				8. Performing Organization Report No. JSC S-388	
9. Performing Organization Name and Address Lyndon B. Johnson Space Center Houston, Texas 77058				10. Work Unit No. 951-15-00-00-72	
				11. Contract or Grant No.	
12. Sponsoring Agency Name and Address National Aeronautics and Space Administration Washington, D.C. 20546				13. Type of Report and Period Covered Technical Note	
				14. Sponsoring Agency Code	
15. Supplementary Notes The JSC Director waived the use of the International System of Units (SI) for this Technical Note, because, in his judgment, the use of SI Units would impair the usefulness of the report or result in excessive cost.					
16. Abstract Manned thermal-vacuum tests of the Apollo spacecraft presented many first-time problems in the areas of test philosophy, operational concepts, and program implementation. The rationale used to resolve these problems is explained and examined critically in view of actual experience. The series of 12 tests involving 1517 hours of chamber operating time resulted in the disclosure of numerous equipment and procedural deficiencies of significance to the flight mission. Test experience and results in view of subsequent flight experience confirmed that thermal-vacuum testing of integrated manned spacecraft provides a feasible, cost-effective, and safe technique with which to obtain maximum confidence in spacecraft flight worthiness early in the program.					
17. Key Words (Suggested by Author(s)) · Thermal-Vacuum Tests · Test Chambers · Solar Simulation · Manned Testing · Thermal Simulation · Space Simulators				18. Distribution Statement Subject Category 31: Space Vehicles	
19. Security Classif. (of this report) None		20. Security Classif. (of this page) None		21. No. of Pages 67	22. Price \$3.50

* For sale by the National Technical Information Service, Springfield, Virginia 22151

NASA — MSC

CONTENTS

Section	Page
SUMMARY	1
INTRODUCTION	1
TEST-PHILOSOPHY DEVELOPMENT	2
Purposes of the Tests	2
Selection of Spacecraft to be Tested	4
Facility Capability and Limitations	6
Test Configuration and Time Lines	11
TEST OPERATIONS	23
Management Coordination	23
Test-Team Concept	24
Documentation and Configuration Control	28
Safety and Readiness Reviews	31
SPECIAL GROUND TEST PROBLEMS	32
Ground Test Safety Criteria	32
Materials Control	33
Failure Modes and Effects Analysis	34
Facility and Spacecraft Fire Protection	34
Safety Instrumentation Package and Circuit Protection	36
Ground Support Equipment Fluid Lines	37
Facility Environmental Control System	38
Mercury Contamination of the Environmental Control System	41
Work-Rest Cycles	42

Section	Page
TEST RESULTS AND FLIGHT-SIGNIFICANT ANOMALIES	42
Block I Command and Service Module Tests	42
Block II Command and Service Module Tests	47
Lunar Module Tests Supporting Earth-Orbital Flight	53
Lunar Module Tests Supporting Lunar Flight	55
Summary of Corrective Actions	58
CONCLUDING REMARKS	59

TABLES

Table	Page	
I	NUMERICAL SUMMARY OF CORRECTIVE ACTIONS RESULTING FROM DEFICIENCIES DETECTED DURING THERMAL-VACUUM TESTS	58
II	NUMERICAL SUMMARY OF CONTRIBUTIONS TO MISSION PLANNING FROM PERFORMANCE EVALUATION OF THERMAL- VACUUM SPACECRAFT	59

FIGURES

Figure	Page	
1	Space environment simulation laboratory	2
2	Thermal-vacuum test spacecraft	
	(a) Spacecraft 008	5
	(b) Spacecraft 2TV-1	6
	(c) Spacecraft LTA-8	6
3	Chamber A	7
4	General features of chamber A	7
5	Chamber B	8
6	General features of chamber B	9
7	Block schematic of SESL ACE systems	10
8	Orientation of CSM in chamber A	11
9	Ingress-egress ramp, chamber A	
	(a) View from manlock (ramp closed)	12
	(b) View from above (ramp open)	12
10	Typical block simulation time line for CSM testing	13
11	Chamber A pumpdown curve	13
12	Typical mission-simulation time line	15

Figure		Page
13	Section of the LM skin heater control consoles	16
14	Electrically heated RCS engines on the LM	17
15	Spacecraft LTA-8 installed in chamber B.	18
16	Lunar module access platform	19
17	Stairs to access platform	19
18	Foldaway slide deployed for simulated rescue	19
19	Falling restraint system and umbilical connections	20
20	Schematic diagram, LO ₂ dump system	22
21	Test-team organization	25
22	Chamber A control room during test	25
23	Crew-support conductor duty station at chamber B	25
24	Timed rescue drill in LM test setup	28
25	Typical page from CSM development test procedure	30
26	Typical page from LM development test procedure	30
27	Typical page from test rules	31
28	Chamber fogging following a practice emergency repressurization and water deluge	36
29	Safety instrumentation package	37
30	Some of the GSE fluid lines in the CSM test installation	37
31	Simplified schematic of facility open-loop ECS module	39
32	Facility ECS module	40
33	Facility ECS flow distribution panel	40
34	Mercury recovered from the body and stem of contaminated facility ECS valve	41
35	Crew ingress for first manned test	43

Figure		Page
36	Side-solar hot-soak and radiator-mode testing on spacecraft 008 . . .	46
37	Cracks in the CM heat shield	47
38	Command module window fogging	47
39	Spacecraft 2TV-1 being installed in chamber A	48
40	Crew ingress	48
41	Open-hatch operation	50
42	Service module paint blistering	50
43	Spacecraft LTA-8 being installed in chamber B	53
44	Crewmen prebreathing for manned LM test	54
45	Ingress for manned operations	54
46	Crew ingress through side hatch	57

APOLLO EXPERIENCE REPORT

MANNED THERMAL-VACUUM TESTING OF SPACECRAFT

By James C. McLane, Jr.
Lyndon B. Johnson Space Center

SUMMARY

The Apollo Program included a series of thermal-vacuum tests of the command and service module and the lunar module in the large chambers A and B of the Space Environment Simulation Laboratory at the NASA Lyndon B. Johnson Space Center (formerly the Manned Spacecraft Center). Because these were the first tests known to involve manned operation of large integrated spacecraft in high-fidelity simulated thermal-vacuum environments, many special first-time problems were presented. Whenever possible, precedents for various facets of the operation were drawn from procedures used during similar mission checkouts and operations and from analogous commercial practice. In many instances, there was no precedent; methods and procedures used in tests at the end of the series were the result of cumulative experience, which began with the first test planning in 1963. Changes and improvements resulted from almost every new study, operations review, dry run, and test during the next 6 years. Test experience and results considered relative to subsequent flight experience confirmed that thermal-vacuum testing of integrated manned spacecraft provides a feasible, cost-effective, and safe technique with which to obtain maximum confidence in spacecraft flight worthiness early in the program.

INTRODUCTION

During the late 1950's and early 1960's, major efforts were expended by industry, the Department of Defense, and the National Advisory Committee for Aeronautics (and its successor, the National Aeronautics and Space Administration (NASA)) toward the definition of a new combined-environments testing discipline to support development and checkout of spacecraft. Originally called space environment simulation testing, this area of primary supporting activity subsequently came to be known as thermal-vacuum testing because of the predominance of the thermal and vacuum environments in most tests. A large number of Government and industry facilities for thermal-vacuum testing were designed and constructed during this period. These facilities were used for tests of materials; components; subsystems; and complete, small, unmanned spacecraft. However, time and effort were necessary to develop the very large, high-quality simulation facilities that were needed to accommodate full-size manned spacecraft; for this reason, facilities were not available for complete environmental tests on the two American manned space programs, Project Mercury and the

Gemini Program. Some manned environmental ground tests of these spacecraft were accomplished; however, the tests involved considerable compromises in simulation fidelity, and it was not possible to exercise many of the flight systems in a true simulated thermal-vacuum environment. Design of two large man-rated chambers at the NASA Lyndon B. Johnson Space Center (JSC) (formerly the Manned Spacecraft Center (MSC)) Space Environment Simulation Laboratory (SESL) (fig. 1) was begun in 1962. Construction was completed in 1965. These chambers made it possible to include high-fidelity environmental tests for the first time on large spacecraft with manned occupancy. In this report, some of the more important technical engineering problems that were unique to thermal-vacuum testing, and management innovations that were developed and used to carry out this specialized activity will be emphasized.

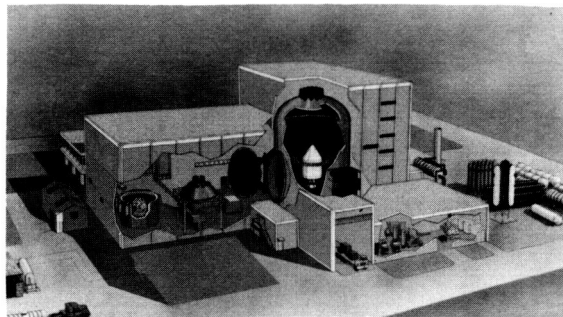

Figure 1. - Space environment simulation laboratory.

The author gratefully acknowledges the assistance of the staff of the MSC Space Environment Test Division in providing technical and historical information that is included in this report. The special efforts of P. B. Campbell and A. B. McIntyre of the Test Management Office are particularly appreciated.

TEST-PHILOSOPHY DEVELOPMENT

The development of a general philosophy for conducting manned or unmanned integrated spacecraft thermal-vacuum tests presented an early issue, with major differences in opinion. In considering the principal elements of this philosophy, a number of alternative approaches were proposed. In each case, the approach adopted represented a realistic compromise that could result in maximum benefit to the program. Some of the most important elements of the test philosophy are discussed in the following sections of this report.

Purposes of the Tests

Originally, it was presumed that there would be no major design issues to be resolved in the integrated thermal-vacuum tests. This premise was based on plans for very extensive testing at the subsystem and lower levels before integrated thermal-vacuum testing, and the integrated tests were viewed primarily as a final man-rating and flight-worthiness demonstration of the spacecraft before committing it to manned flight. However, as the program progressed, it became evident that there were many areas of uncertainty regarding specific performance of subsystems, which could only be determined in flight or in integrated systems thermal-vacuum ground tests. Many of these uncertainties were related to off-nominal or emergency operating modes of spacecraft systems, and the thermal-vacuum tests presented a number of practical

advantages over flight tests for such performance investigation. Among the advantages were lower cost, expanded instrumentation, better safety, accessibility of hardware for post-test (postflight) inspection and analysis, and the ability to repeat a test (flight) quickly and economically to obtain a missed objective or to confirm correction of an anomalous condition. Therefore, it was decided that, in addition to the demonstration of spacecraft capability to perform nominal missions, a number of off-nominal operations would be included that would benefit flight planning, especially in areas of contingent operations.

It was also recognized that the design margin in some spacecraft elements was such that the subtle influence of final production or manufacturing techniques and integration with other spacecraft elements could result in out-of-limits performance not identified previously in nonintegrated subsystems tests. An example of this circumstance was the lunar module (LM) passive thermal control system, in which the efficiency of the extensive multilayer reflective insulation was a function of vacuum level within the insulation layups. This interlayer vacuum was dependent on the integrated venting scheme, the influence of outgassing and leaks from components within the LM structure, and the details of workmanship in manufacturing and installing the insulation. The combined influence of these factors could be determined only by means of integrated systems thermal-vacuum tests (or development flights); therefore, the test data were considerably more significant than a simple demonstration of final flight readiness.

A basic requirement for design and operation of almost every spacecraft system was a detailed knowledge of heat flow and temperatures within the spacecraft. Analytical thermal models of the integrated spacecraft were developed for this purpose, and these models received approximate experimental verification from thermal-vacuum tests of mockups of representative areas of the spacecraft and early full-scale mockups of the entire spacecraft. These relatively simple tests were conducted in smaller, less complex commercial facilities early in the program. As in all mathematical analyses, the thermal models were limited by the input data on the thermal properties of materials, configurations, and so forth, and many simplifying assumptions had to be made. The high-fidelity thermal-vacuum test data were used to verify or correct these assumptions and to provide data relating to detail excluded in the network. Thus, flight configuration verification and fine tuning of the spacecraft thermal models were recognized as primary test objectives in the final thermal-vacuum tests.

In considering the inherent nature of an integrated thermal-vacuum test operation that has as primary objectives the verification of systems performance and thermal models, it became obvious that additional benefits could be derived at little or no additional cost simply by the identification of secondary objectives and the introduction of procedures and reporting techniques to ensure attention to these objectives. Thus, it was decided that ground-based spacecraft-checkout procedures which were developed for preflight spacecraft checkout at the launch site would be used wherever possible in similar test-preparation activities. Because in most cases the test preceded similar operations at the launch site, a valuable early procedure checkout was provided under a somewhat less time-critical situation than would be presented subsequently at the launch site. Also, any initial checkout-procedure deficiency that resulted in damage to the spacecraft could be accommodated with less program impact by the test spacecraft than by a flight spacecraft. Similar rationale was used in adopting, wherever possible, crew operating procedures for use by the onboard test crewmen. The major difference between flight and ground test was that, in flight, most of the procedural

steps were performed individually by the astronaut without detailed, documented confirmation; in the tests, most steps were performed on command from the test director and, when executed, were confirmed by the crewman so that a precise record of actions and configuration was obtained that could be correlated closely with the test data.

The test provided opportunities for a realistic evaluation of many crew-support items in a flight-like environment. Because test times would approximate the length of actual missions and would require full real-time dependency on these items by the crewmen, subjective evaluation was added as a secondary objective.

The early tests of the series confirmed that there would be completely unexpected flight-significant occurrences during test operations. These occurrences had not been recognized specifically in the test objectives. Therefore, it was essential that procedures be adopted to ensure that such occurrences were recognized, identified, documented, and investigated, and that proper action was taken, whether the occurrences related directly to a formal test objective or not. In practice, this philosophy was not implemented as rigorously as it might have been, and several flight-significant anomalies were not identified and investigated promptly and thoroughly when first manifested during the test. These significant anomalies will be discussed elsewhere in this report.

Selection of Spacecraft To Be Tested

In keeping with the original plan that the thermal-vacuum testing would be primarily a final man-rating and flight-worthiness demonstration, early proposals were made to subject each flight spacecraft to a thermal-vacuum test before delivery to the launch site. Because these proposals were impractical, a compromise was devised. It was decided that less elaborate facilities would be constructed at the launch site, enabling checkout of flight spacecraft under modest vacuum conditions at ambient temperature as a part of normal launch preparation. These tests were adequate to confirm operational status of all essential systems but did not involve the full thermal-vacuum environment, which might degrade thermal coatings and life-limited components to the point at which refurbishment would be necessary before launch. Moreover, these relatively simple tests could be performed at the launch site at considerably less cost and schedule impact than would have been required in a thermal-vacuum chamber at MSC.

Three alternatives were presented concerning the choice of spacecraft to undergo full thermal-vacuum testing. First, production spacecraft, which would be refurbished after testing and flown on a late Apollo mission, could be used. Because the test data were required as early as possible and always before the first manned flight, the spacecraft would have to be one of the first in the production run, and a very selective early cut-off date for design and manufacturing changes would be required to ensure timely delivery. Moreover, some deviations from flight configuration would be required so that the spacecraft could be adapted to perform special simulations (such as rocket firings) and to accept the special test instrumentation. These factors would result in the test spacecraft being considerably out of configuration for downstream flight missions. This situation, together with the necessary replacement of life-limited equipment, escalated the cost of refurbishment to such an extent that the use of the test

spacecraft for a subsequent flight mission was uneconomical. A second alternative was the fabrication of a simplified test spacecraft with thermal simulators for much of the expensive, long-lead-time equipment. This approach was not considered seriously because of the obvious potential for inaccurate test results when even subtle differences from flight configuration exist. Also, this approach would effectively negate the philosophy of qualifying flight spacecraft by similarity to the test spacecraft. For a third alternative, certain production spacecraft could be dedicated to the thermal-vacuum test program. This approach was adopted, and it had many advantages. First, late design and production changes to the spacecraft could be evaluated individually and foregone where the change would not clearly influence the forthcoming test. Early delivery of the spacecraft could be ensured further by selectively permitting the use of prototype or non-flight-qualified hardware when cost and expediency dictated and when evaluation showed that the component was not critical to the test. The increased safety of the ground test compared with the flight test made this substitution feasible in many instances. An additional attractive feature of this approach was that the use of test-dedicated spacecraft left the test program essentially open ended to account for contingencies; that is, contingency retests could be added to the program without a cut-off date forced by refurbishment-schedule requirements, as would be necessary if the spacecraft were to be used on a later flight. To make this approach more cost effective, the test spacecraft were also used for many secondary non-thermal-vacuum tests (cabin-noise studies, radiological shielding surveys, biological sterilization demonstrations, and many others). Three spacecraft were dedicated to the program (fig. 2). Spacecraft (SC) 008 was the first man-rated Block I command and service module (CSM) to be produced and was the first Apollo spacecraft tested. Spacecraft 2TV-1 was the first production Apollo Block II CSM. Spacecraft LTA-8 was the first production man-rated lunar module, although it was preceded by two lunar modules that were designated for unmanned development flights and were not equipped with all flight systems. Tests of these three spacecraft comprised the program, with major manufacturing effort, to update Earth-orbital configuration to lunar-mission configuration, being performed onsite at MSC on spacecraft 2TV-1 and LTA-8 between the initial and final tests.

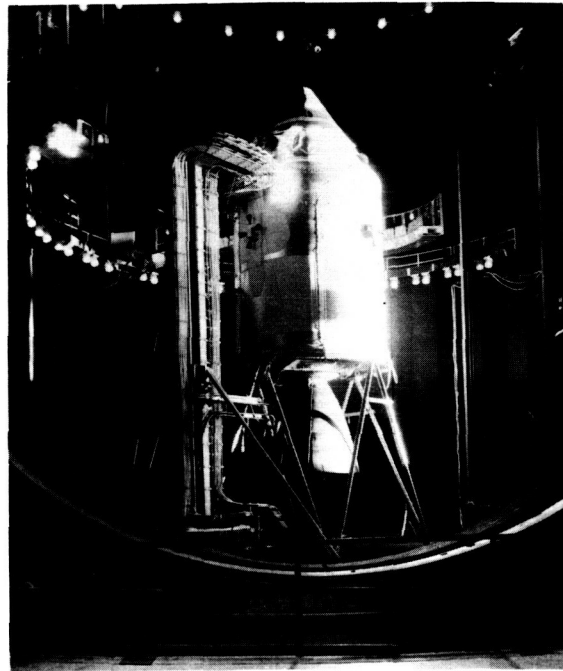

(a) Spacecraft 008.

Figure 2. - Thermal-vacuum test spacecraft.

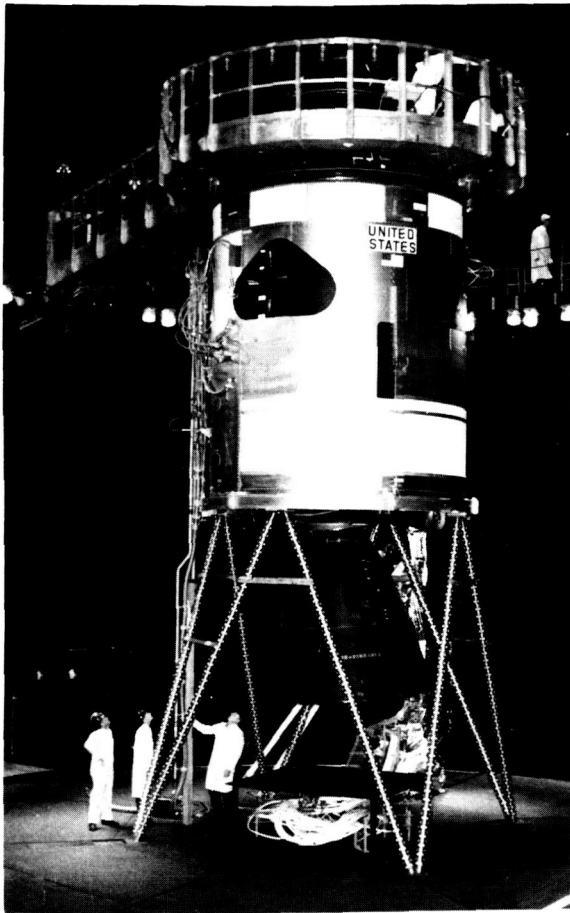

(b) Spacecraft 2TV-1.



(c) Spacecraft LTA-8.

Figure 2. - Concluded.

Facility Capability and Limitations

Facility design was essentially complete and construction well underway before the final decision to perform thermal-vacuum tests of Apollo spacecraft at MSC. Although the original design provided general capability for tests of this sort, the facility was by no means designed uniquely for specified Apollo test requirements because, obviously, the requirements were not known when design was undertaken.

Chamber A (fig. 3), the largest of the two thermal-vacuum chambers, was intended to be used for tests of large manned spacecraft and clusters of spacecraft (such as the mated CSM/LM). The chamber has external dimensions of 65 feet in diameter by 120 feet in height, and a nominal upright test volume of approximately 25 feet in diameter and 75 feet in height was provided for spacecraft that weighed as much as 150 000 pounds (fig. 4). For tests requiring high-quality solar simulation, this test volume was limited to 20 feet in diameter by 65 feet in height, because penetration ports were not available for the modular system of carbon-arc-source solar-simulator

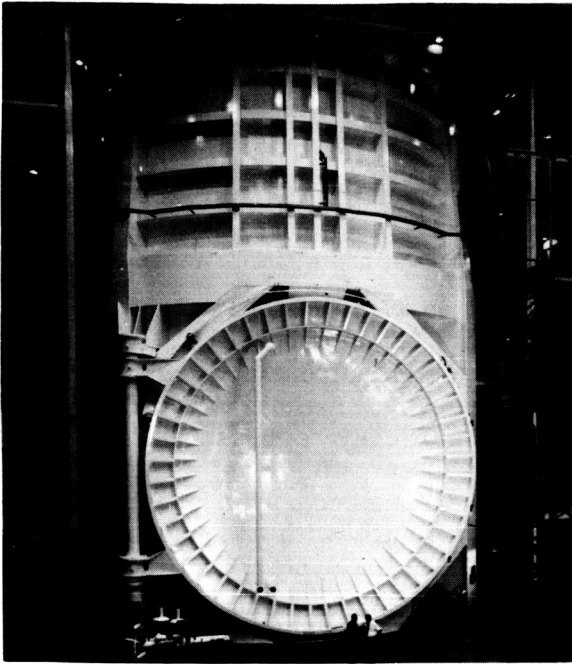

Figure 3. - Chamber A.

units. In fact, solar-simulator modules sufficient to irradiate the full test volume were never manufactured; procurement was limited to the number actually required for the Apollo tests that were finally derived. Solar-simulator modules were in fixed locations on top of the chamber (projected down vertically) and on the side of the chamber (projected horizontally). Directional cycling of the side Sun was achieved by rotating the floor of the chamber, to which the spacecraft mounting fixture was attached, at whatever rate was desired during the test. The heat sink of space was simulated by cooling almost all internal chamber surfaces to approximately 90° K by the use of circulating liquid nitrogen (LN₂). Coincidentally, the heat sink also functioned as a vacuum cryopump, providing an almost unlimited pumping capacity for water vapor and other gases that were condensable at its temperature.

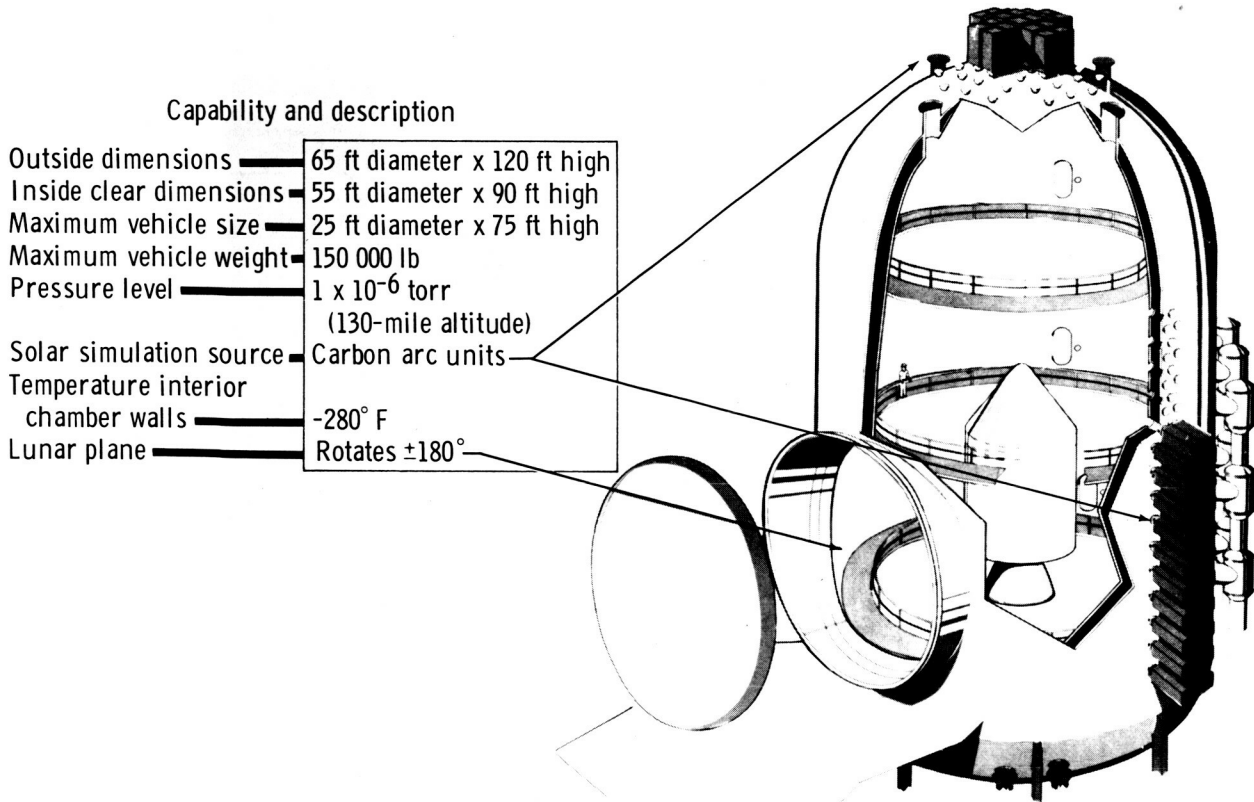

Figure 4. - General features of chamber A.

Other gases, including oxygen and nitrogen and excluding only helium, hydrogen, and neon, were pumped at the rate of 15 torr-liters/sec by cryocondensing surfaces arranged around the chamber walls and maintained at 17° K. The three noncondensable gases were pumped at the rate of approximately 0.4 torr-liter/sec by 18 large oil-diffusion pumps. Atmospheric leakage from the more than 300 vacuum feedthroughs usually required about half of the available pumping capacity, leaving the other half to account for the gas load generated by leakage and outgassing from the spacecraft under test. A chamber pressure of 1×10^{-6} torr was attainable with these gas loads present. A double manlock, one for maintaining inside safety and rescue observers at intermediate rescue pressures and the other to permit hard-vacuum ingress and egress by test crewmen, was located at the ground level of the chamber. A single manlock for inside observers was located 31 feet above floor level. An emergency repressurization system was provided that could bring the chamber to a rescue working level of 6 psia in 30 seconds with a mixture of dry oxygen and nitrogen. Repressurization from that level to full atmospheric pressure was accomplished originally with unconditioned atmospheric air; however, after the initial tests of the CSM, the system was modified to permit full repressurization in 90 seconds by the use of a dry oxygen-nitrogen mixture to avoid the heavy chamber fogging that would occur if small amounts of atmospheric water vapor were present when the cryogenic heat-sink shroud was still cold.

Chamber B (fig. 5) was provided to perform tests on smaller spacecraft such as the Apollo command module (CM), on space suits and other extravehicular activity (EVA) equipment, and on subsystems and intermediate-size equipment. Chamber B systems were similar to those of the larger chamber A but generally reduced in size. The 35-foot-diameter by 43-foot-high external chamber dimensions resulted in a useful test volume of approximately 13 feet in diameter by 27 feet in height for spacecraft that weighed as much as 75 000 pounds (fig. 6). Fixed penetrations for a 20-foot-diameter top Sun were provided, but the actual initial installation of solar modules provided an irradiated area only 5.6 feet in diameter. Because there was no side solar simulator, rotation of the floor was not provided. Chamber B was also equipped to present only 90° K heat-sink surfaces to the test volume. Originally, the design vacuum level was 1×10^{-4} torr, and this level was attained by the use of a system of oil-diffusion pumps. Before Apollo testing was undertaken, a 17° K cryopumping system was added, providing a final pumping capacity of 12 torr-liters/sec for condensable gases and 0.25 torr-liter/sec for the noncondensable gases at a chamber pressure of

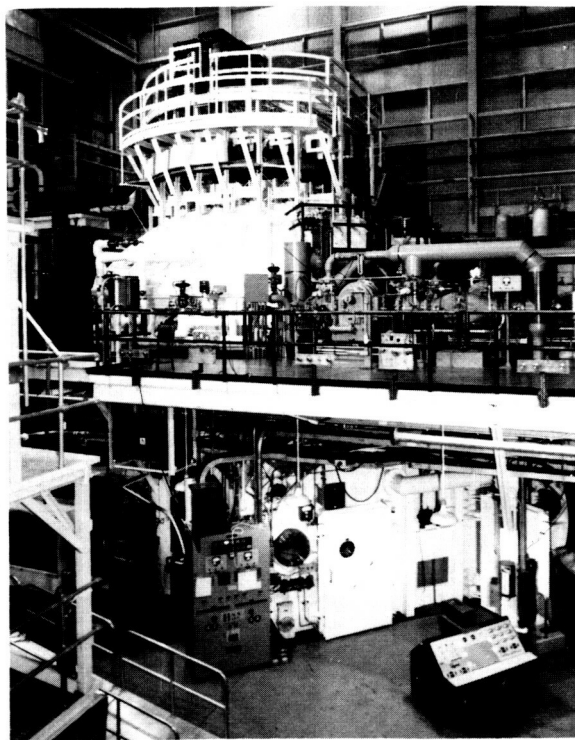

Figure 5. - Chamber B.

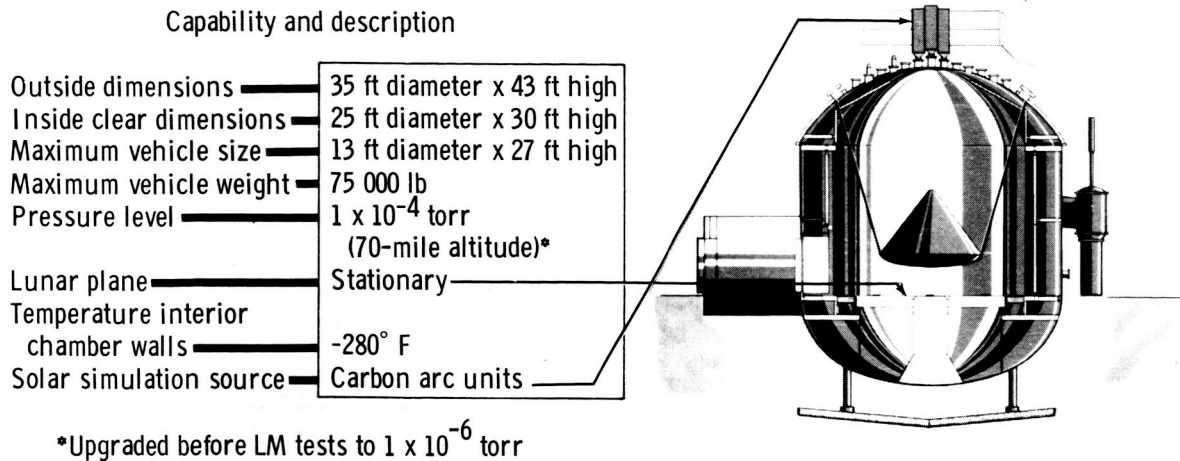

Figure 6. - General features of chamber B.

1×10^{-6} torr. Because of fewer vacuum penetrations in chamber B, atmospheric in-leakage was limited to approximately 3 torr-liters/sec, leaving approximately the same capability for spacecraft gas load as was available in chamber A. The emergency re-pressurization systems in chambers A and B had essentially identical performance.

The original facility design did not include the basic capability to meet several specific Apollo test requirements that were identified subsequently. These deficiencies were a major influence in deriving concepts for test configuration, and decisions had to be made to accept them as restraints or to modify the facility to upgrade performance. Three deficiencies that required major consideration were (1) no basic capability to handle significant amounts of hazardous spacecraft fluids (such as hydrogen and cryogenic oxygen), (2) no universal capability to simulate albedo and planetary thermal emissions, and (3) no universal capability to simulate oblique solar angles. The special problems posed by these deficiencies and the approach adopted in each case will be discussed elsewhere in this report. A fourth deficiency was that the original design provided no universal system for acquiring and processing data from the spacecraft under test. The facility itself had been designed for manual operation, and the data necessary for its operation were displayed by means of conventional instruments. Where necessary, facility measurements were recorded on strip charts; no complex computer operations were involved. Apollo Program management provided an ideal solution to this problem by designating two acceptance checkout equipment (ACE) computer systems for installation in the laboratory. These special-purpose computer systems were designed specifically to provide up-link and down-link command and data-acquisition capability for Apollo spacecraft checkout at the manufacturing plants and at the launch site. With the addition of a relatively small amount of peripheral equipment, the computer systems were ideally suited to performing the same functions in pretest buildup of the spacecraft and ground support equipment (GSE) at the

thermal-vacuum facility and were also used for up-link command and down-link data-acquisition functions during the test (fig. 7). Data-acquisition capability included real-time processing of some 500 of the approximately 2000 total test-article measurements to assist the test team during performance of the test. A few essential facility measurements also were handled by the system. During thermal-vacuum tests, one ACE station was designated as prime, and the other station was maintained in backup status in order to assume all control and data-acquisition functions within 5 minutes of a failure of the prime station, thus avoiding test abort. By maintaining these computer systems in common configuration with those at other Apollo sites, the maximum experience benefit was obtained by similarity to the other operations.

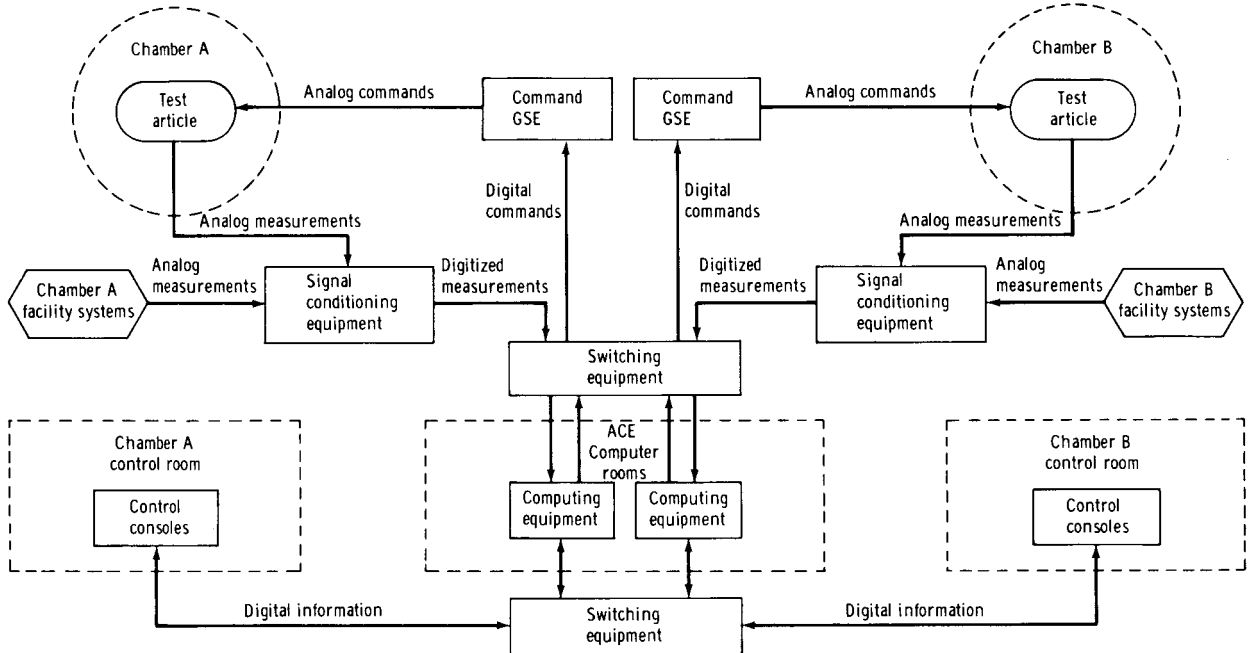

Figure 7. - Block schematic of SESL ACE systems.

Apollo-common GSE was, as a matter of policy, used to the maximum at the SESL in support of the tests. This feature provided an advantage in operational shake-down of the equipment and associated procedures. However, in practice, it was seen that the peculiarities of the test and of the test site resulted in much of the equipment not being ideally useful. In some cases, it was necessary to modify the equipment or even to substitute alternate equipment to accomplish the necessary functions. Considerable effort was expended in continuous updating of this equipment to maintain it in Apollo-common configuration, even in instances where the modification was of no consequence in its use for the thermal-vacuum test program. It was also observed that, for the thermal-vacuum test, special GSE (usually simpler and less expensive) could have performed much better in this application than did some of the Apollo-common equipment.

Test Configuration and Time Lines

Block I command and service module tests. - Factors that influenced the development of a specific test configuration included test objectives, facility capability, spacecraft design mission, and characteristics of spacecraft systems. Initial attention was focused on configuring the tests of the Block I CSM (SC 008). These tests, which were planned to precede all others by at least 12 months, were particularly critical because, in addition to the objectives relating to spacecraft performance, the tests would also serve to verify the overall concepts derived for conducting integrated systems manned testing in the new facility. Chamber A was selected for the test. The location of the top and side Suns in the chamber, and the desire to provide directional cycling of the Sun as the vehicle rotated on its longitudinal axis, dictated that the spacecraft be placed near the center of the test volume, with its longitudinal axis aligned vertically (fig. 8). The exact height of the vehicle was determined by aligning the CM side hatch approximately opposite the chamber manlock, which was located at the 31-foot elevation. A walkway, extending from this manlock and encircling the CM, provided the crewmen and rescue observers with access to the side hatch at all rotational positions of the spacecraft. The walkway was split along its centerline, and the two sections could be folded back against the chamber wall when not in use (fig. 9). This vertical orientation of the spacecraft also was optimum in accommodating the crew for extended one-g stay times in the spacecraft. Another concession to gravity and crew mobility was made by removing the center couch from the CM and providing non-flight-configuration floor pads and couch pads for crew comfort.

In the construction of a test time line (that is, the selection of operational and environmental sequences to be used for the test), two general alternatives were available. The first method, referred to as mission simulation, consisted of duplicating in real time, insofar as possible, the exact sequence of events planned for the spacecraft design mission. The second method, called block simulation, involved designing a number of interchangeable test sequences or modes, each aimed at specific performance demonstrations under environments selected to stress the systems of interest to the extremes required for full evaluation. Of the two methods, block simulation offered distinct advantages if the characteristics of the spacecraft thermal control systems met the following two criteria: (1) spacecraft temperatures had to stabilize within a reasonably short time after establishment of a new operating mode or external environment and (2) after any operating mode, suitable initial temperature conditions had to be reestablished within a reasonable time to permit initiation of a new mode. The CSM was designed with many active thermal control systems that responded quickly to changing operating

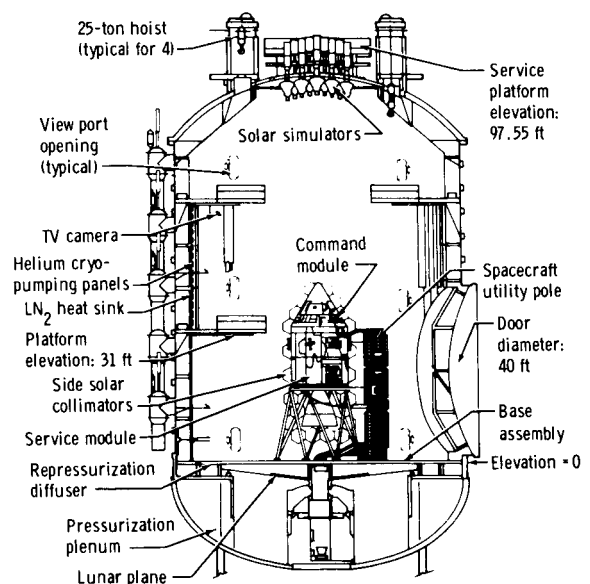
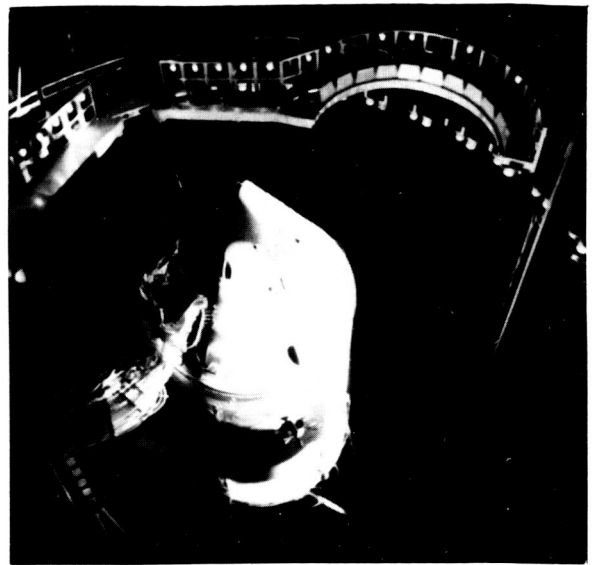
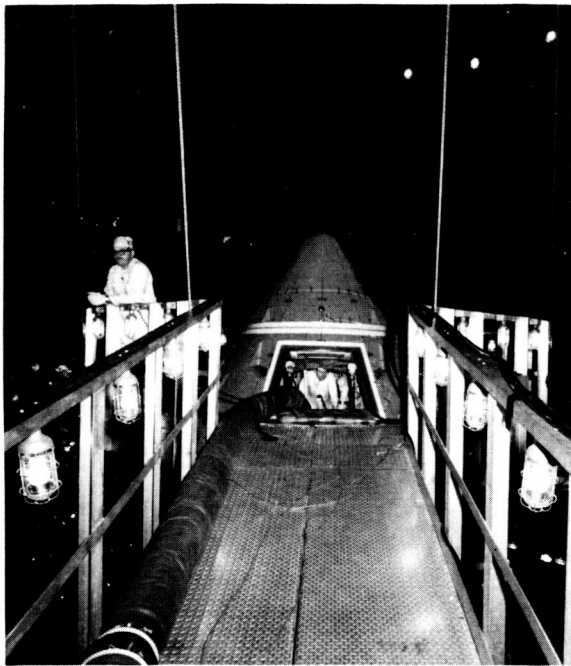

Figure 8. - Orientation of CSM in chamber A.



(a) View from manlock (ramp closed).

(b) View from above (ramp open).

Figure 9. - Ingress-egress ramp, chamber A.

conditions. Moreover, in those CSM areas in which passive thermal control was used, only a few hours were needed to reach stable conditions in any changed environment. Thus, the CSM was ideally adapted to a block simulation time line (fig. 10), which offered maximum opportunity for investigating off-nominal operations and for exploring performance limits of various systems. An additional advantage was that, if difficulties arose during a particular test sequence because of malfunction of a spacecraft or facility system, the test could be diverted quickly to one of the other modes not requiring the system while repairs or workarounds were performed. Even with the block-time-line concept, it was still desirable to run the test for a total time that was approximately equal to the full length of the spacecraft design mission in order to obtain data related to consumables usage, life-limited equipment, and habitability.

The importance of albedo and planetary-emission thermal radiations was not overlooked in the SC 008 tests. Early planning included a considerable engineering effort to investigate concepts for adding these environments to the existing heat sink and solar simulations. A small albedo simulator, which was based on the principles and design features derived from this study, was constructed and subsequently used in several manned tests of space suits. A major practical problem in adapting this design concept to the spacecraft was that there appeared to be no easy way to integrate the design with the CM personnel-access platform; the platform was mandatory for safety reasons. In addition, the estimate of construction cost was prohibitive. Fortunately, by the use of the block-time-line concept, it was possible to alter solar-irradiance periods to provide partial compensation for this deficiency; the remaining correction was made in the analytical thermal model.

(108 hr total)										
Phase	Chamber pumpdown	A	B	C	D	E	F	G	H	I
Duration, hr	19	9	9	10	5	15	6	15	15	5
Crew sleep										

Planned time line

(120 hr total)											
Phase	Chamber pumpdown	D	P	A	B	C	E	F	G	H	I
Duration, hr	24	9	6	9	9	10	15	6	15	15	3
Crew sleep											

As-run time line

- A. Bay 4 hot soak, side Sun
- B. Bay 6 hot soak, side Sun
- C. Bay 3 hot soak, side Sun
- D. Open hatch, side Sun
- E. Translunar coast, side Sun, 1 rotation per hour
- F. RCS quad D hot soak, side Sun
- G. Cold soak, no Sun, 1 rotation per hour
- H. CM hot soak, top Sun
- I. Chamber warmup and repressurization
- P. Special overboard water dump test

Figure 10. - Typical block simulation time line for CSM testing.

Real-time ascent-pressure-change simulation was beyond the capability of the facility. It required approximately 3 hours to bring the chamber pressure from atmospheric pressure to 1 torr, the range of greatest interest as far as rate effects were concerned. Even though this rate of change did not correspond to the flight value where transition to vacuum is accomplished in only a few minutes, valuable data relating to the ability of many systems to adapt to vacuum were still obtained during the pumpdown phase (fig. 11). Approximately 16 additional hours were needed to complete chamber heat-sink cooldown and to reach the ultimate operating vacuum level. No attempt was made to simulate ascent aerodynamic heating or booster-induced vibration; so the CM boost protective cover and the launch escape rocket, which are jettisoned in flight during the launch phase, were not included in the test configuration.

The effects of thermal soakback from firings of the service propulsion system (SPS) and reaction control system (RCS) rockets were not considered to be significant to the extent that special provisions for simulations should be included, as would be done later in tests of the LM. However, when the fuel and oxidizer were used, simulations were devised for the changes in thermal mass of the main propulsion tanks. The tanks were loaded with a dummy propellant, water/glycol, which was dumped to other tanks outside the vacuum chamber when propellant usage was to be simulated.

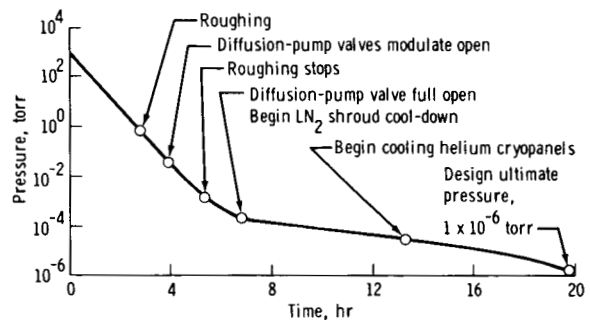

Figure 11. - Chamber A pumpdown curve.

Hydrogen and oxygen, required for fuel cells, and oxygen, required for the environmental control system (ECS), posed a more difficult problem. It was considered essential that the fuel cells and the ECS function in flight configuration during the tests. However, a leaking oxygen or hydrogen system could pose a much more severe fire and explosion hazard in the chamber than on the launch pad or in flight because of the containment characteristics of the chamber. Studies were conducted to determine the safe quantity limits of these gases within the chamber; the findings were that, if the full flight load were to leak into the chamber, an explosive safety hazard of unacceptable magnitude would exist. However, quantities in the chamber could be limited to acceptable values by locating the supply of these gases outside and piping them in directly to the spacecraft distribution systems rather than filling the flight tanks with cryogenic fluids. Quick-acting valves outside the chamber were provided to isolate the gaseous supplies in case a significant in-chamber leak occurred. Hydrogen detectors were located in the facility roughing-pump train and in the diffusion-pump backing system. If concentrations of hydrogen exceeded limits in these systems, nitrogen ballast gas could be introduced into the pumping trains to avoid an explosive mixture of hydrogen and oxygen or air.

A functional demonstration of the spacecraft waste water dump system under various flight conditions was identified as a mandatory test requirement. This spacecraft system was designed to vent urine and excess fuel-cell-generated water to space through a heated orifice on the side of the CM. During tests of the Block I spacecraft, simulated dumps were conducted in full flight configuration using both fuel-cell water and urine; however, concern about undesirable corrosion of chamber elements (principally the very expensive collimating mirrors of the solar simulators) on exposure to urine salts resulted in the dumps, during Block II tests, being limited to fuel-cell water. In these later tests, urine was removed from the spacecraft through a special pipe connected to an evacuated tank outside the chamber.

Lunar module tests. - Configuring the tests of the LM posed many new problems that did not exist when CSM tests were considered. First, the spacecraft had few active thermal control systems. Great dependence was placed on a rather complex system of passive thermal control that involved extensive vacuum-dependent multilayer reflective insulation and approximately 32 different thermal coatings to control radiant heat exchange at various locations on the surface of the spacecraft. Because of the spacecraft design, it was not possible to reach complete thermal equilibrium during the mission. In a general sense, the spacecraft underwent a slow cooling process from the time of launch until mission completion. Of course, there were many exceptions to this generalization if specific systems and components are considered. The sequence and duration of operational events such as engine firings, cabin pressurizations, and so forth, had a profound influence on temperatures, as did the timing of the great variety of natural thermal environments that were encountered in the design mission. The effects of these factors were cumulative, making it difficult to establish initial test conditions at will that would correspond to intermediate times in the mission. These factors dictated a mission-simulation-type test time line rather than the block simulation that was used with the CSM. Even with a mission-simulation time line, operational options existed within the spacecraft design mission that could hasten or retard the general spacecraft cooldown. Therefore, two separate test time lines were devised (fig. 12); the first, in which options were combined that would result, generally, in the warmest conditions at the end of the mission, was called the "hot-case test"; the second, in which options were combined to result in coldest conditions at the end of the mission, was called the "cold-case test."

Phase	A	B	C	D	E			
Duration, hr	101	23	5	12	312			
Manning			3	12				
	Cold-case test				Turnaround			
	F		G	H	I	J	K	L
	64		5	9	39	45	36	11
			12			8		11
	Hot-case test and abort situations							

- A. Translunar coast
- B. Lunar orbits and crew ingress and descent
- C. Lunar touchdown and crew exits LM
- D. Crew ingress, lunar lift-off, crew exits LM
- E. Turnaround activities to configure for hot-case lunar stay
- F. Translunar coast
- G. Lunar orbits and crew ingress and descent
- H. Lunar touchdown, crew egress and stay time for thermal stabilization
- I. Turnaround for subsolar lunar stay, crew ingress
- J. Subsolar lunar stay and crew egress
- K. Turnaround for thermal mission simulation
- L. Crew ingress and thermal mission simulation

Figure 12. - Typical mission-simulation time line.

The design of a test configuration that would provide accurate thermal simulations for the different mission environments seemed at first to be an insurmountable problem because of facility limitations. Conditions to be simulated included (1) translunar flight in docked mode with the CSM, (2) lunar orbit in docked mode with the CSM, (3) lunar orbit in the undocked configuration, (4) descent to the lunar surface, (5) lunar-surface stay, and, finally, (6) solo ascent-stage operation from the lunar surface to lunar orbit and in lunar orbit. The combinations of solar angles and lunar-albedo and planetary-radiation view angles and intensities that had to be simulated were practically unlimited.

An additional complexity was that, in the ground test, it would be necessary to maintain the LM in an upright position to make manned operations in the unit-gravity field of the Earth feasible. Because docking of the LM and CSM results in the respective floors of the two spacecraft being located in opposing directions, concurrent manned testing in the docked configuration was not feasible. Therefore, the LM and CSM were tested separately, and the radiative and conductive heat paths at the interface were simulated.

A new approach to simulating thermal inputs was required because of the fixed orientation of the facility solar simulator, the restrictions against tilting the spacecraft to oblique solar angles, and the lack of albedo-simulator design concepts that would satisfy the diversity of mission conditions. This requirement was met by the design of a special conformal-skin-heater system. The concept necessitated that the thermal-absorptance characteristics of the external spacecraft surfaces be known from previous tests of the thermal coatings. Considering the vehicle location and orientation in various parts of the mission, the thermal energy absorption by each spacecraft surface at any time could be calculated. During testing, this energy was imposed directly on the exposed surfaces of the spacecraft by means of electric heaters that were bonded to the inside of these surfaces. The spacecraft was then free to assume natural thermal balance by its own internal thermal mechanisms and by radiation to the cold chamber walls.

Implementation of the conformal-skin-heater concept involved dividing the external spacecraft surfaces into approximately 300 separately controllable zones. The complexity of continuously controlling the amount of heat to these zones for long test times immediately led to considering automation of the system. However, automation was considered to be too expensive, and the system was operated manually by approximately 23 technicians who manipulated control potentiometers according to preplanned operating procedures (fig. 13). Real-time modification of the procedures was needed for special conditions; this modification was directed by a team of thermal analysts who were monitoring test data.

In addition to the skin heaters that were used for simulation of solar and albedo energy, several special-purpose "guard" heaters were installed at GSE connections to the spacecraft. These heaters provided a neutral thermal interface at points where nonflight equipment (cables, gas-sample lines, propellant-detanking piping, and so forth) penetrated the spacecraft.

Thermal soakback from the rocket engines and nozzle extensions of the RCS, ascent propulsion system, and descent propulsion system were important factors in the LM thermal model. Because of this fact, rocket firings were simulated thermally by electric heater elements that were installed on the engines and rocket nozzles. These heaters were activated at the appropriate times in the mission to simulate conditions during and after engine burns. For the descent-engine-burn and ascent-engine-burn simulations, the soakback lasted 5 to 10 hours after a 10- to 15-minute engine burn, and the heaters were operated at temperatures as great as 700° F. The descent-engine-base heat shield was similarly heated to as much as 950° F to simulate conditions associated with descent-engine firings. Typical simulations of reaction control system injector soakbacks involved the heaters operating for 15 to 30 minutes at temperatures as great as 300° F (fig. 14). As in the tests of the CSM, the main propulsion tanks were loaded with dummy propellant (in this case Freon TF) and were offloaded to tanks outside the chamber during the tests to simulate changes in thermal mass during engine firings. Changes in the thermal mass of the RCS tankage were not very significant; the tanks were loaded with dummy propellant for the duration of the mission.

The mission-simulation-type time line for LM testing required that solo-ascent-stage phases of the mission be simulated immediately after the lunar-stay-time phases that involved the mated ascent-descent stages. To avoid the complexities of removing the LM descent stage from the chamber for these operations, a thermal-conditioning

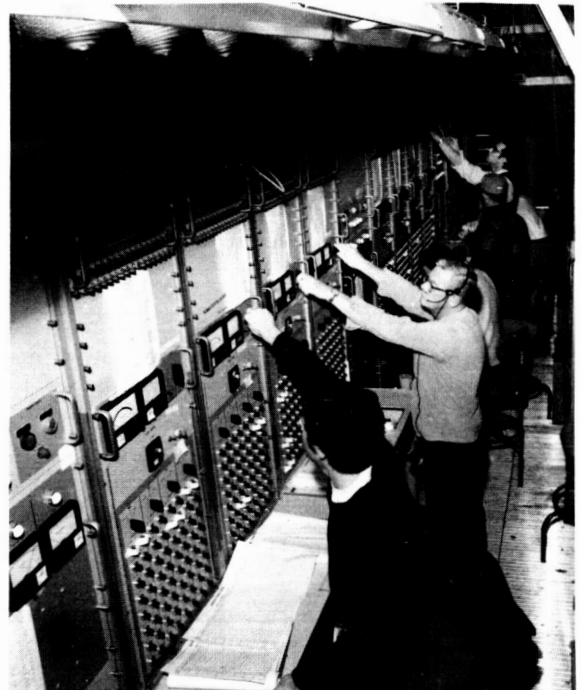

Figure 13. - Section of the LM skin heater control consoles.

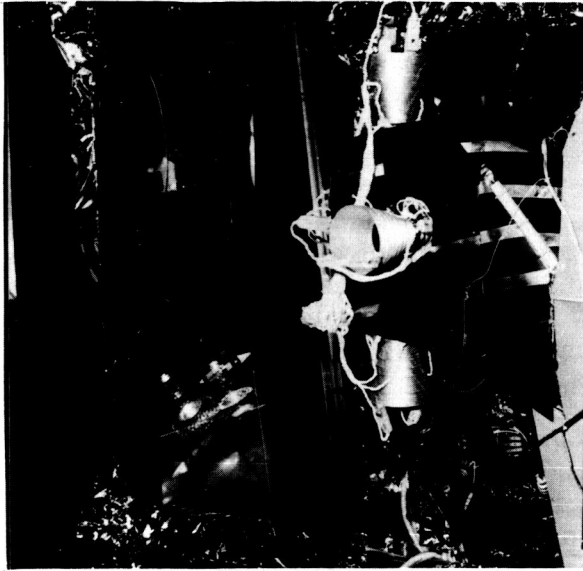

Figure 14. - Electrically heated RCS engines on the LM.

volume requirements for LM testing were minimal; it was determined that the LM could be tested conveniently in the smaller chamber B, even though it was a comparatively tight fit. The principal requirements were a heat sink, a high vacuum-pumping speed, and man-rating provisions, all of which were available in chamber B (fig. 15). As mentioned previously, it was necessary to upgrade the pumping capability by the addition of a 17° K cryopumping system. Space limitations prevented full deployment of the landing gear, but this was not significant when using the skin-heater thermal-simulation technique.

The mission-simulation time line that was selected for LM testing necessitated that the spacecraft be entered and manned during discrete periods without interrupting the established environmental conditions. Accommodations for crewmember rest and sleep during the quiet periods between lunar-surface extravehicular excursions were considered to be barely acceptable for $1/6$ -g lunar conditions, and completely unacceptable under Earth one-g conditions. It was determined that engineering data would not be compromised if the crewmen were permitted to leave the spacecraft and the chamber for rest and sleep during these times, provided that the spacecraft hatches were left closed, the cabin was pressurized, and all systems were left configured as if the crewmen were still on board. There was some concern about metabolic moisture that would be generated by the crewmen during sleep periods. It was believed that the moisture might condense on some cool components that had working mechanisms (such as the hand controllers) and, when the cabin was depressurized to vacuum, the moisture might freeze and interfere with mechanism operation. This condition was simulated during one of the tests by evaporating the correct amount of moisture into the cabin before depressurizing for crew ingress after a sleep period. No adverse conditions resulted.

plate was installed between the ascent and descent stages. During simulations of mated operations, this plate was conditioned to a neutral temperature that did not inhibit the normal thermal interface between the two spacecraft elements. To simulate the operation of the ascent stage alone, the plate was cooled with LN_2 , providing the bottom of the ascent stage with a simulated space heat sink similar to that viewed by the other spacecraft surfaces.

Schedule developments resulted in requirements to conduct tests of the Block II CSM (spacecraft 2TV-1) and the LM (spacecraft LTA-8) during the same approximate time period. As a result of the previous tests of spacecraft 008, chamber A was already configured for the CSM, including an extensive installation of GSE. Therefore, it was logical that the Block II CSM testing be continued in that chamber. Using the conformal-skin-heater technique, chamber

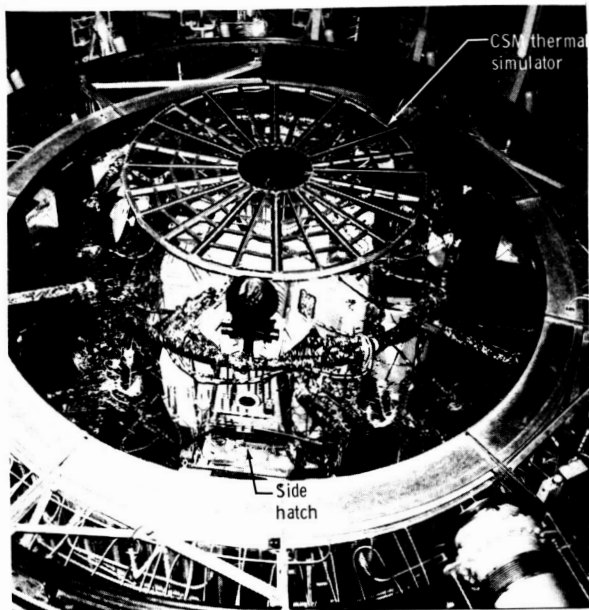

Figure 15.- Spacecraft LTA-8 installed in chamber B.

The technique to be used for crew ingress-egress under the thermal-vacuum conditions was probably the most difficult conceptual problem presented by the test. The spacecraft top hatch was obstructed by a special apparatus that was provided to simulate CM albedo and thermal emissions in docked flight phases. In addition, the facility double manlock that was required for inside observer/rescue personnel and crew ingress was located at the chamber ground-floor level, a considerable distance from the top hatch. These two factors forced the decision that all ingress-egress operations should involve the side hatch rather than the top hatch of the spacecraft. This situation still posed a formidable problem because the side hatch was located 13.5 feet above the floor level and, because of the dimensions of the hatch, the crewmen would have to crawl in on hands and knees. The problem was to devise a practical, safe scheme that would permit the two crewmen

to move from the ground-floor manlock to and through the elevated side hatch, and to return. Mobility in the pressurized suit in one-g conditions and the complexity of rescue operations ruled out the use of a ladder (such as the one built onto the landing gear strut and used in the lunar-gravity environment). Two alternatives were investigated in detail. The first alternative was an elevator concept. This idea was abandoned because of mechanical complexity and a multitude of failure modes that would make emergency rescue operations difficult or impossible. The approach that was adopted was to construct a platform opposite the spacecraft side hatch that was large enough to accommodate the crewmen and rescue personnel (fig. 16). This platform was connected by stairs to the chamber floor near the manlock (fig. 17). To facilitate rescue of incapacitated crewmen, a foldaway slide was mounted on the stairs (fig. 18). Incapacitated crewmen could be brought down the stairs quickly and safely by using the slide and a rope tether dropped down by the rescue observer at the top of the platform.

Two other features of the ingress-egress scheme needed innovation. First, there was the requirement to provide a positive restraint against falling in case a crewman slipped or became unconscious during any part of the operation. Closely associated with this was the requirement to provide breathable oxygen at the correct pressure, temperature, and flow rate to the pressurized suit while the crewman was in the chamber. The first concept attempted involved the use of the flight EVA portable life support system (PLSS) and an overhead suspension block and tackle as a mobility assist and falling restraint. Dry runs using the block and tackle were proof that this approach was impractical because the weight and bulk of the PLSS made it extremely difficult to climb the stairs and enter the side hatch in a kneeling position. This factor resulted in the use of an umbilical to supply breathing oxygen from a controlled facility source and to provide electrical service to bioinstrumentation and communication equipment in the suit. The umbilical consisted of two 1.25-inch flexible hoses, a 37-conductor electrical cable, and a Beta-cloth cover for thermal and mechanical protection. The

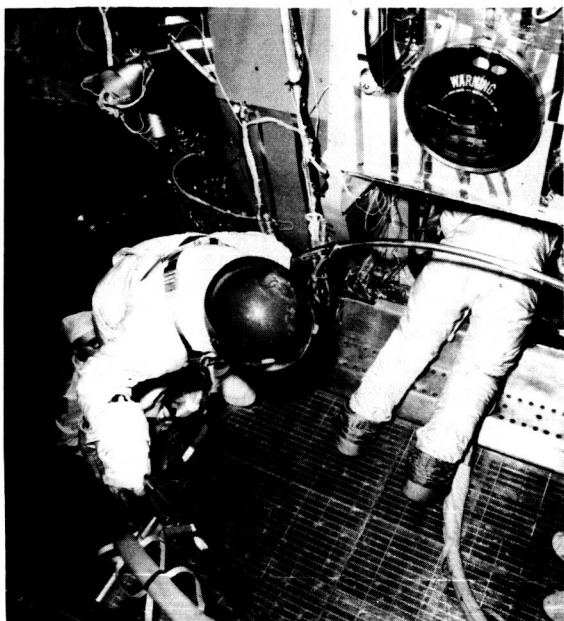

Figure 16. - Lunar module access platform.



Figure 17. - Stairs to access platform.



Figure 18. - Foldaway slide deployed for simulated rescue.

umbilical weighed 2 lb/ft and was relatively stiff, the bend radius being limited to approximately 1.5 feet. Thus, the umbilical was somewhat difficult to pull around and to stow when not in use. Fortunately, the dual set of connectors on the Apollo space suit made it possible to change from one set of umbilicals to another, so that the length of any one umbilical could be kept to a manageable size by switching umbilicals at appropriate times. Thus, one umbilical was used for initial pumpdown in the manlock and for movement between the manlock and the chamber, and another umbilical was used to move up and down the stairs and into the spacecraft. Once in the spacecraft, the crewmen switched to the regular LM flight umbilicals, which were cross-connected to the spacecraft and facility breathing systems, and shoved the facility umbilicals through the side hatch to the access platform before closing the hatch. An open trough was mounted alongside the stair to provide for convenient routing of the umbilical while the crewmen went up or down. When not attached to a space suit, the supply and

return hoses of the facility oxygen umbilicals were shunted together with a bypass fixture at the suit end. Oxygen flow was maintained to keep temperature up and to prevent any moisture that may have accumulated from freezing.

With the elimination of the heavy backpack, falling restraints were required only while crewmen were on the stairs and elevated platform. Concepts for automatic falling restraints, which would remain oriented directly over the crewman, were complicated by the large range of elevations and translations involved in climbing the stairs. Thus, a pair of chest-high restraining straps were developed that were attached to a special harness on the crewman at one end and, at the other end, to movable pipe clamp devices that slid freely on pipe rails on each side of the stairs when a slight pressure was exerted on the extension handles (fig. 19). The crewman could move the clamp along the pipe rail quite easily as he ascended or descended. If the crewman's hand moved away from the rail for any reason, the device would clamp firmly, and the attachment strap would limit his movement. The straps were attached to the web-belt chest harness by means of hook snaps and D-rings that could be connected and disconnected easily at the bottom of the stairs and on the upper platform.

The operating details for hard-vacuum ingress and egress and for emergency rescue from all possible locations were worked out by means of dry runs on a dimensionally correct mockup of the test installation; the details were finally confirmed by means of additional dry runs using the actual test installation. All special hardware (such as the folding stairs slide and the falling restraint devices) were prequalified for use by functional tests that involved operation through the full range of temperatures from ambient to 80° K.

Several special provisions were necessary in the ground tests of the LM as a result of design limitations on cabin pressure. Because the LM was intended strictly for space operations, the cabin was designed to withstand internal pressure only. Vents used to depressurize the cabin during flight operations were not capable of passing sufficient gas flow into the cabin to prevent substantial negative pressure during emergency repressurization of the test chamber. To prevent structural collapse of the cabin under this emergency contingency situation, the hinge pins of the cabin side hatch (which opened into the cabin) were redesigned to act as shear pins during the test. This would permit the side hatch to open automatically during emergency repressurization, providing a large flow area and preventing negative cabin pressure. The shear-pin design also made it easier for rescue personnel to remove the hatch and enter the cabin in case an



Figure 19. - Falling restraint system and umbilical connections.

incapacitated crewman obstructed normal hatch opening. As additional assurance that the hatch would come open with minimum negative-pressure differential, the hinge pins were removed each time the cabin was pressurized and were replaced before each depressurization. In practice, the fragile shear-type hinge pins were a nuisance because they were difficult to remove and replace without breaking, necessitating that the hatch be opened and closed with extra care. On one occasion, a pin broke as the hatch was being closed after crew egress. Rather than abort the test, the crewmen waited until the next regular manning to replace the pin under hard-vacuum conditions by the use of a special tool that was quickly designed and fabricated for that purpose.

Normal flight dumps of LM cabin pressure directly to the chamber would have overwhelmed the chamber high-vacuum-pumping systems to the extent that the required thermal-vacuum test conditions would have been violated. Because of this fact, the cabin pressure was dumped through a pipe to the facility roughing system, which had the capacity to handle the flow but at a higher pressure ($\approx 1 \times 10^{-3}$ torr) than that in the chamber volume. This pipe was connected to the cabin by a metal plate, which replaced the left-hand flight window. As the cabin pressure approached the low pressure limit of the facility roughing system and as discharge flow came within range of the facility high-vacuum-pumping system, the regular cabin valve permitted dumping the remaining cabin pressure directly to the chamber.

Block II command and service module tests. - The experience gained in tests of the Block I CSM in chamber A confirmed the desirability of the block simulation time line and the validity of the basic test configuration. Tests of the Block II CSM spacecraft 2TV-1, therefore, were also planned with a block simulation time line with minimum changes in test configuration from that proven previously. Freon TF was substituted as the dummy propellant for the water/glycol mixture that was used previously to eliminate a remote flammability hazard. Admittedly, there were special hazards associated with Freon TF in this application, particularly the possibility of generating toxic gases if the Freon was exposed to a gross conflagration; however, the advantages of Freon TF outweighed the disadvantages of the water/glycol mixture.

The most significant change to the test configuration was the addition of the full 640-pound flight load of cryogenic oxygen on board the spacecraft for use during testing. This change resulted from an urgent need to confirm integrated thermal conditions and proper functioning in areas where cold oxygen from the tanks was routed. A new review of special safety hazards was undertaken because of this quantity of high-pressure liquid oxygen (LO_2) in the confined chamber. A gross rupture of either of the two tanks was considered to be very unlikely. The most probable mode of failure that might produce a real hazard was a small or medium leak in the oxygen system that could build up locally an oxygen-rich atmosphere in a poorly vented compartment to an extent sufficient to sustain combustion. The top deck of the service module (SM), where oxygen piping was close to a large amount of electronic equipment that had potential ignition sources, was a typical suspect area. In postulating such a leak and subsequent ignition, it was believed that the principal threat to crew safety and catastrophic destruction of the spacecraft could be relieved by quickly removing the large stored quantity of LO_2 from the spacecraft to a remote location where the supply of oxygen could be isolated. For this purpose, a stainless-steel dump tank was located within the chamber, suspended underneath the rotating floor. Special piping and valves were installed to permit dumping the LO_2 from the flight tanks through the fill-line inverted standpipes to the tank (fig. 20). Forcing pressure was maintained in the flight tanks during the dump

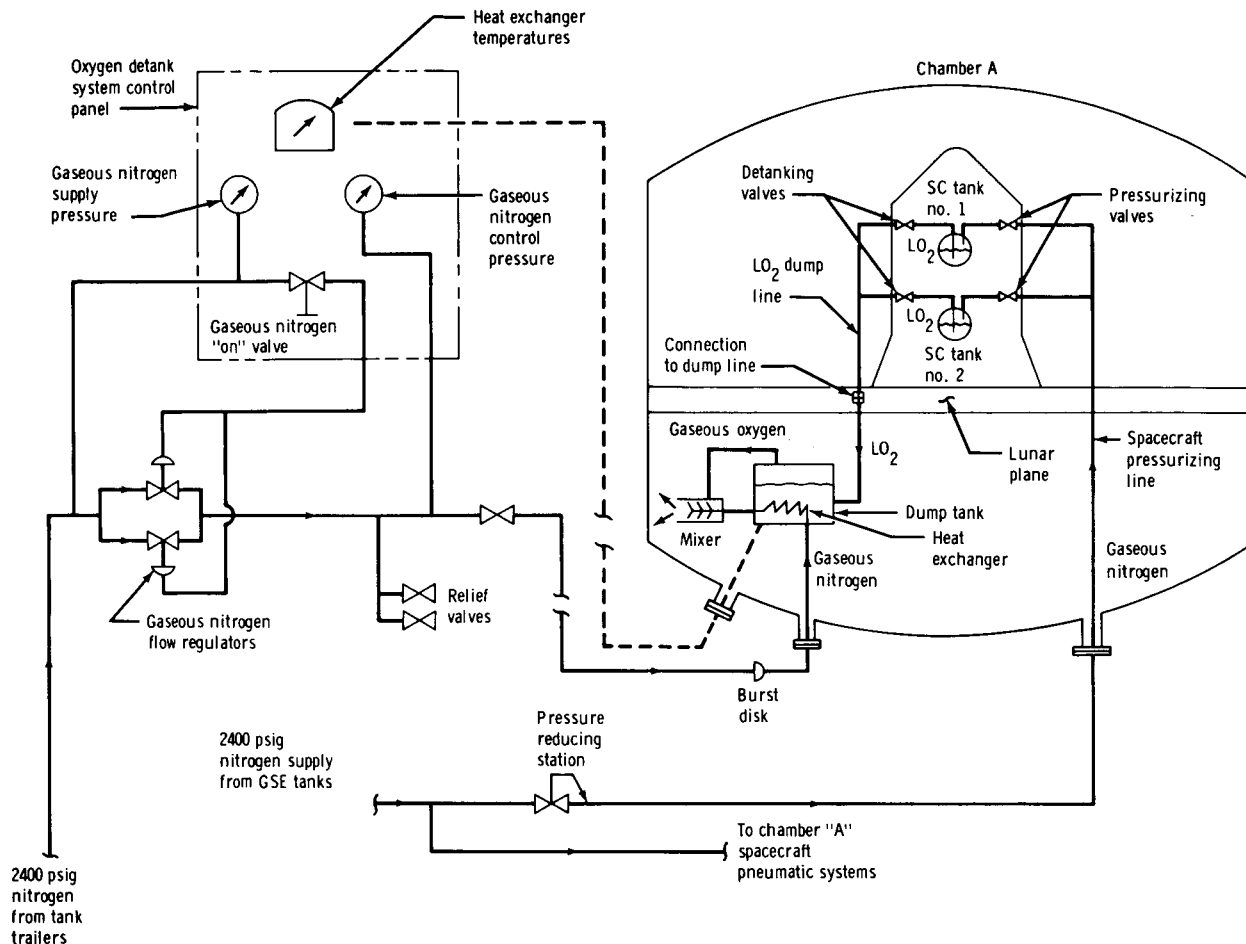

Figure 20. - Schematic diagram, LO₂ dump system.

by pressurizing the vent line with gaseous nitrogen. After the tanks were emptied, the nitrogen flow through the vent line was maintained to purge the system. The system was designed to accomplish the transfer of liquid to the dump tank in 3 minutes or less, although, as will be discussed elsewhere in this report, this time was exceeded in all tests of the system. Once the liquid was in the dump tank, it was vaporized slowly and was mixed with nitrogen in such a way that the gas mixture discharged to the chamber approximated the normal oxygen/nitrogen mixture of natural air. Thus, there were no special flammability or asphyxiation hazards posed for other activities in the chamber.

An additional precaution was taken that was related to the special flammability hazards posed by the LO₂ load. The facility water-deluge fire-suppression system was extended to provide water spray nozzles that covered the cryotank shelf area in the service module. It was believed that, in event of an oxygen-fed fire, this water deluge could delay gross structural damage to the SM long enough to detank the oxygen supply.

TEST OPERATIONS

The obvious similarity between major thermal-vacuum tests and actual flight operations led to the adoption of as many of the flight program management concepts and techniques as were feasible. The first tests conducted on the Block I CSM in 1966 identified many of the strong points and weaknesses in these adaptations. By the time that final preparations for Block II CSM and LM testing were in full swing in the last quarter of 1967, several improvements had been made that smoothed these operations considerably. Another major factor in shaping the overall operation was the general safety review of ground test activity, which was undertaken by MSC after the fire during check-out of spacecraft 204 at the NASA John F. Kennedy Space Center (KSC) in early 1967. The general effect of this review was to formalize requirements for detailed attention to many of the test planning and operational areas that had lacked specific and uniform guidelines previously.

Management Coordination

The scope of the activity and the large number of different organizations directly involved in the tests made the development of an adequate management concept a particularly demanding task. The Apollo Spacecraft Program Office (ASPO), which was the source of all programmatic direction and support, was given the overall responsibility for the test program. However, the detailed planning and implementation of the program outlined by ASPO fell primarily to the Engineering and Development (E&D) Directorate facility operating staff and support contractors, to the spacecraft prime contractors, and to the E&D spacecraft subsystem managers and supporting institutional staffs. In addition, elements of many other organizations played key roles in biomedical services, quality engineering and control, safety surveillance, data reduction, and many institutional supportive services. At the peak of activity in mid-1968, approximately 1200 persons, representing over a dozen MSC directorate- or company-level organizations, were engaged full time on the thermal-vacuum test program at MSC. To facilitate local operations, ASPO delegated authority to the SESL laboratory manager for within-scope direction of the onsite spacecraft contractors. The SESL laboratory manager also was authorized to arrange and coordinate services of all other elements contributing to the program. Written management plans were developed and published for each test series; in these plans, the responsibilities and coordinating mechanisms peculiar to that series were delineated. This general scheme was strengthened further for the Block II CSM and LM tests by the appointment of a test manager for each test series. The test manager reported directly to the Apollo Program manager and the SESL laboratory manager, and was delegated full authority to act for both in all matters relating to preparation and performance of the assigned test series.

A major area of activity was the coordination of test plans and procedures through all of the different organizations that had a special interest or responsibility. Because of the requirement to act quickly, this coordination problem was greatly compounded when it came to review of changes to procedures and time lines that were proposed while a test was underway. Each test generated proposals for changes to account for real-time contingencies (for example, equipment or instrumentation failure, unexpected spacecraft performance, and so forth). The NASA test director had the ultimate authority to direct such real-time changes as he considered necessary to obtain test objectives

and ensure safety; however, when time permitted, a thorough analysis of proposed changes by a board of experts provided advantages. A test review board, which was on short-notice call throughout the test, was established to review and authorize proposed changes. The test review board consisted of senior representatives of ASPO, the spacecraft contractor, the facility operations staff, and the medical and safety offices, who could evaluate each proposed change for impact on all aspects of the operation.

Test-Team Concept

A test team of approximately 85 facility and data system operations personnel, approximately 65 spacecraft and GSE operations personnel, and 15 to 20 miscellaneous personnel for medical surveillance, quality assurance, safety monitoring, and so forth, was required at any given time on officially designated duty stations to conduct a test. Most of these test-team members were on 12-hour shifts; however, certain key personnel on safety-critical stations were limited to 8-hour shifts. In addition, an engineering support team of approximately 35 people per shift evaluated data in real time and advised the test director and test review board concerning unanticipated problems. Thus, a total complement of more than 400 persons was needed for real-time operations.

The test team (fig. 21) was formally organized into appropriate sections that were disciplined to carry out the operation in strict accordance with the preestablished procedures and test rules. Twenty intercom channels were available to link this team by means of voice communication; the tests usually involved approximately 10 of these channels. The major sections of the test team were (1) those sections required to operate the facility (which reported to the facility test conductor), (2) those sections required to operate the spacecraft and associated GSE (which reported to the spacecraft test conductor), and (3) the biomedical support section (which reported to the medical monitor). Each of these sections was divided further, where necessary, into systems groups headed by a lead technician or engineer. The test director was in overall control of real-time activities, and all sections of the test team reported to him through the channels described previously.

Communications with the test crewmen were handled by the test director, except for medical matters, which were handled directly between the crewmen and the flight surgeon serving as medical monitor. To expedite anomaly investigation and to troubleshoot special problems, occasionally the test director authorized direct communications between the crewmen and the appropriate systems engineer. Drawing on earlier flight experience, an unrecorded "private line" communications channel was installed (for the first tests) between the crewmen and the medical monitor for uninhibited discussion of confidential medical matters. Although special efforts were made to restrict the use of this voice channel to that purpose, on several occasions the private line was used for off-the-record preliminary discussion of nonmedical problems, which resulted in confusing the record of several significant events and in incomplete coordination of activities. For this reason, the private line was omitted from later tests.

During the tests, the test director, test conductors, medical monitors, and most of the lead systems engineers and technicians were located in one of two central control rooms (fig. 22) that were somewhat remote from the chambers. The other test-team members were at local control stations throughout the facility. One such station was that of the crew-support conductor (fig. 23), whose console was directly in front of the

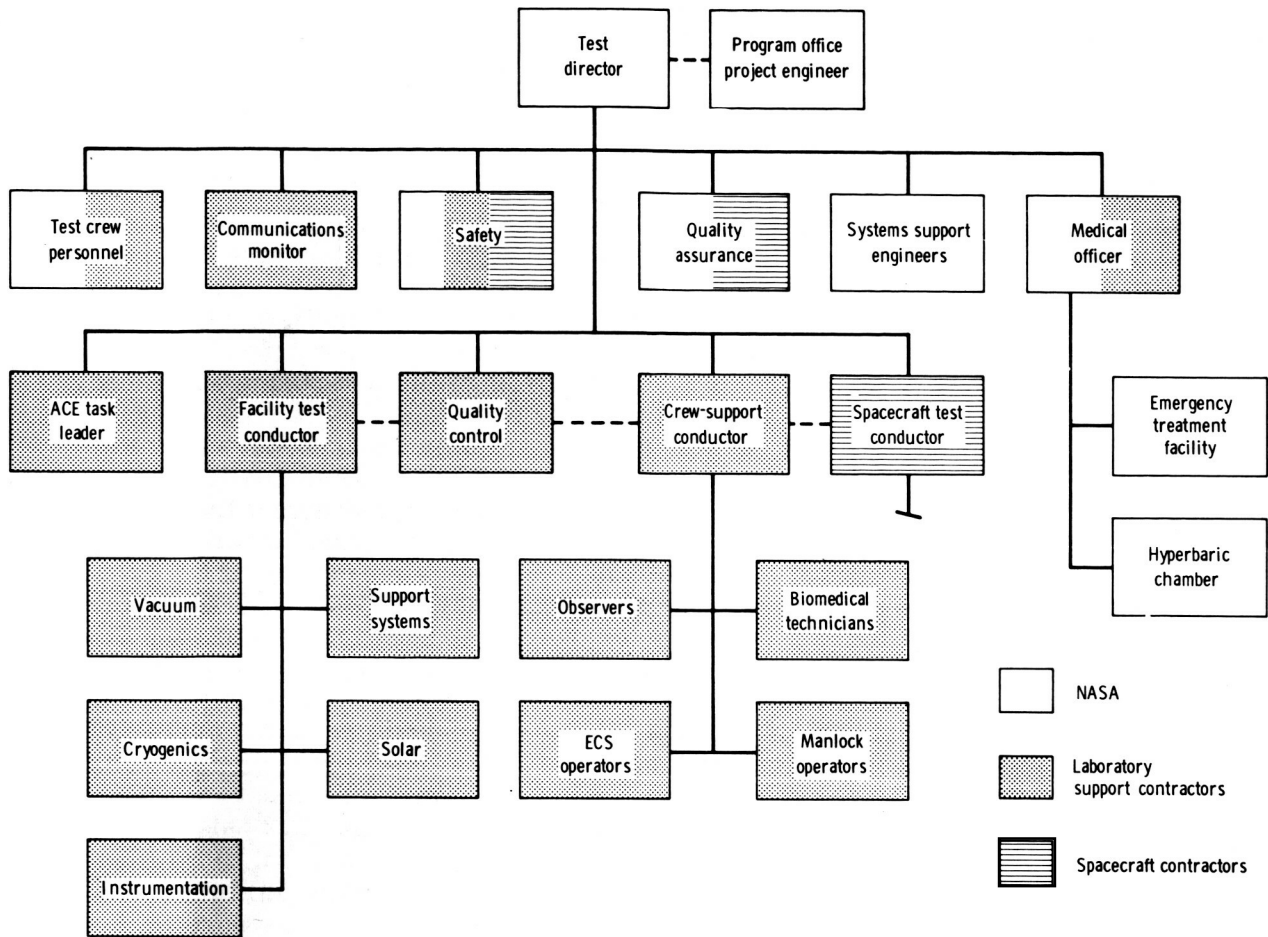

Figure 21. - Test-team organization.



Figure 22. - Chamber A control room during test.

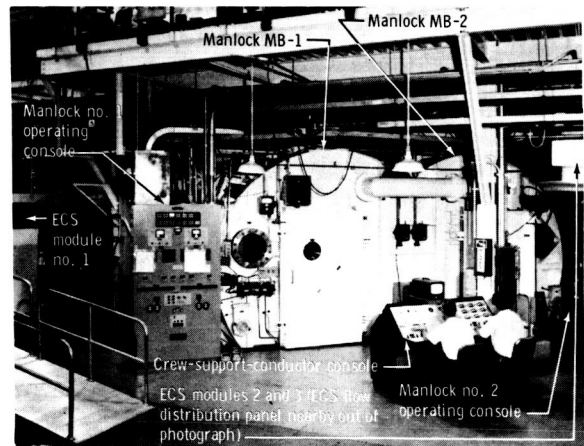

Figure 23. - Crew-support conductor duty station at chamber B.

chamber manlocks. There, he could maintain close visual contact with the crewmen in EVA and with his team of inside observers, manlock operators, and facility ECS operators. Crew ingress-egress operations required mutual cooperation within this team; therefore, during those segments of the tests, control of crew action was transferred temporarily from the test director to the crew-support conductor.

Emergency repressurization of the chamber represented a powerful tool with which to cope rapidly with a variety of in-chamber emergencies. No precise parallel for this capability existed in the flight operation, although there was some operational similarity between initiating emergency repressurization and actuation of the flight launch escape system. As with the flight launch escape system, initiation of chamber emergency repressurization irrevocably committed the test to traumatic events, which should be risked only in case of a compelling, overriding situation posing an immediate, severe threat to crew safety. Among the contingencies involved were possible rupture of eardrums, structural damage to the spacecraft by rapidly changing pressure loads, electrical corona or arc discharge if interlocks failed to work, rapid cooling of spacecraft and other components in the chamber as a result of convective heat transfer to the cold walls, and back contamination of the spacecraft by water and other chamber cold-wall cryogen deposits caused by uncontrolled release. In addition, if the crewmen were in pressurized space suits at the time that emergency repressurization occurred, the possibility existed that they would encounter dangerous negative pressure on the suit if equipment built into the ECS to prevent this condition failed. During manned activity in the manlocks or chamber, a capability was available to automatically initiate emergency repressurization of either, in event of loss of space-suit pressure. This capability consisted of three barostats mounted on a biomedical instrumentation harness that was worn by the crewman. The barostats were wired to the chamber-repressurization circuit in such a manner that a pressure less than 2.2 psia measured by any two of the sensors would initiate the emergency repressurization. Philosophical questions were raised regarding responsibility and capability for manual initiation of emergency repressurization. Considerable discussion and negotiations were needed before a completely satisfactory scheme could be determined. There was no doubt that the test director, who had the ultimate responsibility for real-time test operations and crew safety, should have the authority to initiate emergency repressurization when he deemed it necessary. In addition, because of the time-critical nature of hypobaric medical emergencies, it was deemed necessary to provide the medical monitor with unilateral authority to initiate emergency repressurization. Systems technicians checked out and armed the system before chamber manning was performed; however, the primary control for initiation of emergency repressurization was on the console of the medical monitor. A controversy arose because the crewmen wanted to have a switch that would give them independent capability to initiate emergency repressurization. Many parallels in the flight operation for independent crew action in event of emergency were cited in support of this request. Opposing arguments centered around the fact that one of the early symptoms of hypoxia is loss of judgment. It was feared that a crewman suffering from a mild case of hypoxia might initiate emergency repressurization solely because of confusion at a time when a less traumatic repressurization rate would be safer and much more desirable. This matter was resolved by the issuance of a mission rule that required immediate, mandatory chamber repressurization whenever the crewmen called for it. The question of repressurization rate was left unanswered, with the responsibility for final determination left to the medical monitor and the test director. In practice, the mutual respect and confidence in test-team proficiency, which was developed during the many planning conferences and test dry runs with crewmember participation, relegated this controversy to insignificance.

Because of the large number of organizations involved, it was not practicable to devise a completely unified, standardized program for proficiency training of test-team members. Instead, each organization was held separately responsible for training and certification of its own personnel. The SESL laboratory management audited the several programs for adequacy and accepted certification from the various organizations for specific team members before each test. Proficiency in special systems and specialty areas was obtained by a combination of classroom and on-the-job training. In addition, all test-team members were required to complete standardized formal courses in first aid and firefighting (with emphasis on oxygen-rich fires), in SESL facility familiarization, and in high-altitude physiology. There were three different courses in high-altitude physiology, and detail was appropriate to the test-team position in each individual case. Crewmembers and inside observers who were required to work in a reduced-pressure environment were given a physiology training course equivalent to that given to U.S. Air Force crewmembers who fly at high altitudes. This course included a training run in an altitude chamber. Other test-team members who were involved directly in crew activity and support (for example, test directors, crew-support conductors, ECS operators, and so forth) received the same training except that an actual run in an altitude chamber was not required. Based on the premise that general familiarity with the hazards to be experienced by the crewmen and inside observers might provide excellent motivation for anyone involved in the test, all other test-team members were required to participate in a very short course in high-altitude physiology.

A very important aspect of test-team training was the dry runs. These dry runs were conducted at many levels and served not only to familiarize test-team members with the operations and to improve proficiency, but also to correct or improve the procedures and to develop intercom discipline. For some test-team members, such as the crew-support team of inside observers, manlock operators, and ECS operators, repetitive timed dry runs of the various normal, off-normal, and emergency procedures were a major activity for months before the test (fig. 24). At another level, key members of the test team participated in early around-the-table read-throughs of the integrated test procedure as soon as it became available in each circumstance. These read-throughs were aimed primarily at identifying discrepancies in the procedures, but also served as familiarization exercises for the participants. At least one on-station dry run with almost all of the test-team members participating was held before each new test. Many times it was possible to power up some of the spacecraft and GSE systems and have them operating during the ambient dry runs. This practice provided late operational verification of the system before going into the test, and added realism to the exercise. Simulated emergencies were included in the dry runs. In several of the early dry runs, test-team proficiency was considered substandard and, after detailed critiques, the dry runs were repeated.

News-media interest in the test operations performed in 1968 was unusually high for a nonflight activity. This interest probably resulted from the striking similarity to flight operations and the involvement of astronauts as test crewmen, combined with the fact that there had been no manned flight activity since the end of the Gemini Program, and public interest was focused on any key events leading to the first manned Apollo flights. Pretest and post-test news conferences involving the crewmen and key laboratory and program-office personnel were well attended and widely reported in the news media. A duty station for the Public Affairs Office (PAO) representative was established in the control room, and facilities were provided for him to make real-time voice reports on progress to an area set aside for the press. In addition, real-time



Figure 24. - Timed rescue drill in LM test setup.

post-test activities. Interface control documents (ICD), which were a feature of this system, were prepared to define the limits of responsibility where the spacecraft or GSE interfaced with the facility. An ICD contained not only data relative to location, dimensions, tolerances, and loads, but also, when appropriate, information concerning fluid-flow conditions and electrical characteristics. Work-authorization procedures for the facility were similar to those used on the spacecraft and GSE except that the authorization of configuration changes was the responsibility of the laboratory staff rather than the ASPO. The configuration of many facility systems was not controlled as rigorously as the configuration of the spacecraft and GSE systems. Instead, certain facility systems that were considered to be safety critical (environmental control, emergency repressurization, electrical power, biomedical instrumentation, and fire-suppression systems) were designated as needing complete, detailed configuration control. It was known that the remaining systems had inaccuracies in the engineering drawings of record, and the operation of these systems was verified primarily by means of functional checkouts. This was a practical matter dictated by the construction history of the facility and limitations on the resources that were available for configuration verification.

The test plan was the overall basic document that specified the requirements for the test and defined such primary items as what spacecraft would be used, where the test would be conducted, what GSE would be involved, and so forth. The integrating contractor for the Apollo Program prepared a ground operation test plan that covered, in general terms, the thermal-vacuum tests on the CSM and LM and other tests (such as structural, acoustical, vibrational, and so forth) which together comprised the total ground test program. Later, the prime contractor for the LM compiled a more detailed test plan that covered the SESL tests of the LM exclusively.

The specific objectives of the test were contained in Certification Test Requirement (CTR) documents. Timely and successful accomplishment of each CTR was a

voice from the communication loop of the test director and closed circuit television pictures from the test chamber or from inside the spacecraft were fed to this newsroom during periods of special activity. This practice proved to be an excellent method of training and familiarization with Apollo spacecraft operation for personnel who served subsequently at the PAO console in the Mission Control Center during Apollo flights.

Documentation and Configuration Control

Insofar as the test spacecraft and GSE were concerned, the work authorization and configuration control system designed and implemented by the ASPO for program-wide use was enforced rigorously during the site activation, test preparation, and test and

contractual requirement and was directly associated with contract incentives. A CTR was issued only for the most essential and crucial spacecraft performance demonstrations; attention to secondary objectives and to many anomalies of an unanticipated nature was somewhat inhibited because these factors did not receive the same contractual emphasis. Nevertheless, CTR documents served an essential function by providing the specific mechanism whereby the test activity could be integrated directly into master Apollo Program plans.

A procedure for performing checkout of various spacecraft systems and GSE, either individually or as integrated units, was called an Operational Checkout Procedure (OCP). Wherever possible, commonality was maintained in these procedures for operations at the manufacturing plant, at the test site, and at the launch site, although peculiarities at the various sites (mainly associated with the local facility interfaces or minor differences in local GSE installations) made some deviations inevitable. Checkout and operation of facility systems were accomplished by using standard operating procedures (SOP), which were, by and large, independent of the vagaries of the instant test program.

Real-time test operations were performed according to a Development Test Procedure (DTP), which comprised a detailed procedural document that was unique to each test. The DTP contained step-by-step commands and responses to be executed by the test team from the beginning to the end of the test (figs. 25 and 26). Routine operation of a subsystem was explained by reference to the appropriate OCP or SOP rather than by reprinting the complete established procedure in the DTP. Even with these attempts at abbreviation, each DTP was a voluminous document, typically consisting of approximately 2000 pages in 9 volumes and containing more than 35 000 discrete procedural steps. Preparing, editing, and updating each DTP was a major undertaking. To assist in this activity, computer card decks containing the various steps were prepared, and programs for printout were designed, which permitted late editing. Copies of the final printed DTP reproduced by means of offset printing were distributed to each test-team member. Safety regulations required that the final updated version of the DTP be delivered to each test-team member no later than 24 hours before dry runs and no later than 48 hours before an actual test. After those times, changes could be made only with specific approval from the level of the MSC Director.

Decisions as to what course of action to take in the event of off-nominal or emergency conditions were preplanned and printed in a section of the DTP called "test rules" (fig. 27). The off-nominal and emergency procedures, if peculiar to the test, were also contained in the DTP. If the procedures were standard, they were contained in the OCP or SOP and were distinguished from routine procedures by being printed on a fold-out page or on contrasting-color paper.

As each test progressed, quality-control personnel monitored the communications network and stamped each procedural step complete as it was accomplished. Each unauthorized deviation from the procedure, nonconformance with the procedure, or malfunction of equipment was documented by the quality-control monitors on an Interim Discrepancy Report (IDR) form. Subsequently, each IDR was reviewed by the engineers responsible for the system involved, who made a determination of the significance of the event or condition noted. If further investigation, procedural changes, equipment modification, or repair were needed, the IDR was converted to an official Discrepancy Report and entered in the quality-control logs for tracking until final disposition was made; otherwise, the IDR was canceled.

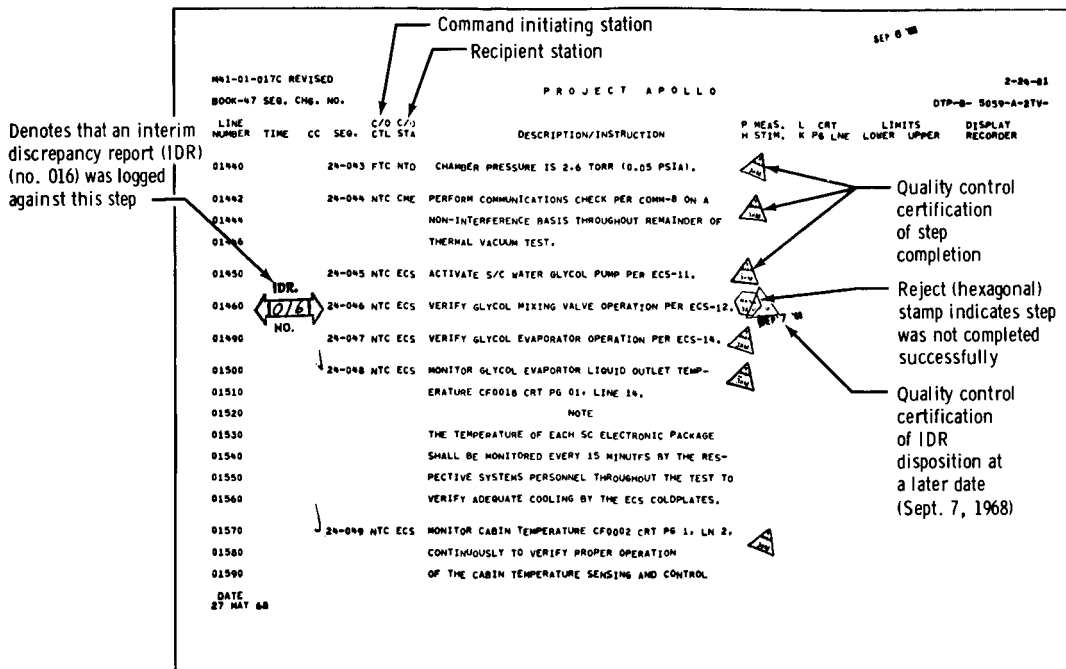

Figure 25. - Typical page from CSM development test procedure.

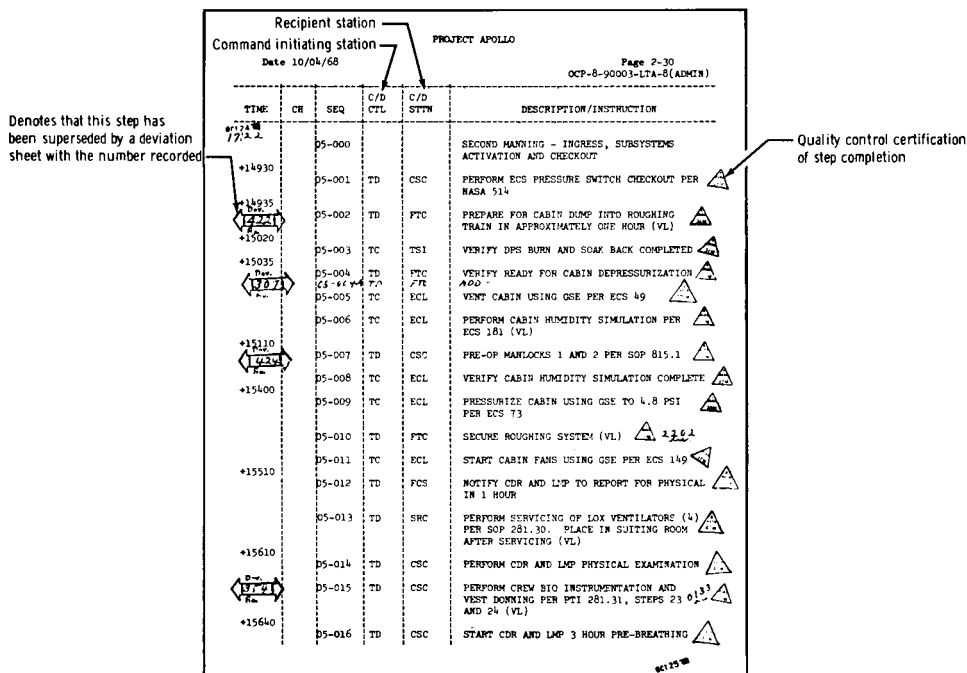

Figure 26. - Typical page from LM development test procedure.

SPACE ENVIRONMENT SIMULATION LABORATORY
THERMOVACUUM TEST RULES

REV	ITEM	CONDITION/MALFUNCTION	PHASE	RULING	CUES/NOTES/COMMENTS
3	6-1	1. LOSS OF BOTH PRIMARY AND SECONDARY COOLING LOOPS	ALL	1. POWER S/C DOWN TO MINIMUM POWER AND ABORT - MODE III	CREW DON O ₂ MASKS
		2. RUPTURED GLYCOL LINE IN CABIN		2. ABORT - MODE III	
	6-2	FAILURE OF BOTH SUIT COMPRESSORS	ALL	ABORT - MODE 1	
		1. CREW SUITED, CABIN DEPRESSURIZED		ABORT - MODE II CREW DOFF HELMETS IMMEDIATELY	
		2. CREW SUITED, CABIN PRESSURIZED		ABORT - MODE DEPENDING UPON RISING LEVEL OF CO ₂	
6-3	FAILURE OF BOTH WATER CYCLIC ACCUMULATORS	ALL	HOLD AND EVALUATE; ABORT IF CONDITION CANNOT BE CORRECTED AND CABIN ENVIRONMENT BECOMES INTOLERABLE.	CO ₂ LEVEL DETECTED BY GSE GAS SAMPLING	
6-4	FAILURE OF BOTH REGULATORS IN THE FOLLOWING VALVES:	ALL	HOLD AND EVALUATE IF ANY ONE OF TWO SIDES OF THE LISTED VALVES FAILS. FAILURE OF BOTH SIDES OF ANY ONE OF THE 5, <u>ABORT</u> .		
	1. MAIN OXYGEN PRESSURE REGULATOR				
	2. EMERGENCY CABIN PRESSURE REGULATOR VALVE				
	3. CABIN PRESSURE REGULATOR				
	4. TANK PRESSURE REGULATOR				
	5. DEMAND PRESSURE REGULATOR				
TEST SC 2TV-1	REV 3	DATE 5/15/68	SECTION 6 SPACECRAFT ENVIRONMENTAL CONTROL SYSTEMS	GROUP SAFETY	PAGE 6-1

MSC Form 2382 (Apr 68) (87)

Figure 27. - Typical page from test rules.

The reporting of testing activity and results was done by each group that had specialized interests in the tests. The problem was not that sectors of the activity went unreported, but rather that there were too many reports, each prepared from the viewpoint of a narrow interest that frequently ignored the potential value of the report to other interests. A unified report that covered all aspects of facility and spacecraft performance was never issued. As a result, no in-depth integrated analysis to correlate the subtleties of facility performance with spacecraft performance was prepared.

Safety and Readiness Reviews

Much of the credit for the successful accomplishment of these complicated test operations and for the outstanding safety record associated with them in view of the unusual safety hazards involved must go to the system of readiness review. This system was developed to provide management overview of test planning and to ensure detailed attention to all critical areas. Early in the construction phase of MSC, a need was identified for formal certification of new major test facilities for initial operation.

By the time that SESL was near completion, this procedure had evolved into a formal operational readiness inspection (ORI), whereby a committee of senior management personnel, who were representative of several primary disciplines (for example, engineering, test, quality control, safety, occupational medicine, and so forth), performed an in-depth review of the facility and all operational planning to determine its readiness for activation. The first SESL ORI was performed in 1965, and resulted in identification of 127 discrepant conditions or deficiencies that had to be corrected before the first test. Facility changes and procedural upgrading, which resulted from the new formal safety requirements that were inaugurated early in 1967, were considered to be sufficiently extensive to warrant another ORI before continuing test operations. In this instance, 73 discrepant items and deficiencies were identified and corrected. In addition to these very broad general reviews, immediate readiness to undertake a specific test was, in each case, reviewed and certified by a Test Readiness Review Board (TRRB). This activity roughly paralleled the flight readiness reviews that were held before each flight, from which precedent was drawn. Generally, the boards were composed of division-chief level or higher personnel; also, the boards had varied disciplinary representation that was similar to ORI committees. The ORI committees and the TRR boards consisted of knowledgeable people who were not ordinarily involved in the routine operation of the laboratory; therefore, these reviews afforded a very meaningful, impartial judgment that was completely additional to the normal efforts of the facility staff, and these reviews were instrumental in carrying over the experience of the board and committee members from other similar or related operations.

SPECIAL GROUND TEST PROBLEMS

During the course of the thermal-vacuum test program, a large number of special problems were encountered that were more or less unique to this type of specialized activity. This section of the report will deal with a few of these problems, which were selected primarily on the basis that discussion may be of benefit to others undertaking similar tests. No attempt has been made to present them in an order of significance.

Ground Test Safety Criteria

Before 1967, there were no generally accepted safety criteria governing the design and operation of man-rated high-vacuum chambers. In laboratories engaged in this and similar activities, the practices were based mainly on the judgment and experience of each individual laboratory staff, along with the normal information exchange afforded by the literature and technical symposia of interested agencies and technical societies. Uniform, mandatory requirements for most design and operational features were completely lacking, and this void placed a burden (which sometimes was insurmountable) on the facility operator to justify the time and expense involved in providing many of the high-quality safety features that subsequently have been recognized as "minimum." Attention was focused sharply on this problem in early 1967 by the fire in spacecraft 204 while it was undergoing preflight checks at KSC. Shortly thereafter, another fire occurred that involved an oxygen-rich atmosphere in a chamber at the U. S. Air Force School of Aviation Medicine in San Antonio, Texas. As a corollary to the investigation of these accidents, a survey of practices used in man-rated ground test facilities was undertaken, and the variances immediately became apparent. As a

result, a special task team was formed at MSC to develop a set of minimum safety standards, and these standards were issued as requirements in a special section of the MSC safety manual. These safety requirements were imposed immediately on all ground test activities involved in the NASA manned space programs, and, subsequently, the requirements served as the basis for an industry-wide standard issued by the American Society for Testing Materials. In general, the minimum requirements were written in broad terms that were suitable for a variety of detailed implementation methods, which allowed flexibility for variable laboratory needs. Emphasis was placed on ensuring adequate expert attention to each of the various facets of design and operation, as opposed to a rigid specification of detail. However, in a few matters, it was considered necessary to specify detailed restrictions; for example, the unequivocal requirement for Teflon in-chamber wiring insulation to the exclusion of others. Other, less specific design requirements were directed toward such items as communications, electric-circuitry protection, emergency-repressurization provisions, breathing systems, and so forth. Additional sections of the standards dealt with test-team training, qualification, and certification; quality control; safety monitoring; test documentation; single-point failure analyses; medical surveillance; material control; and test-checkout operations. The final determination of whether the specific implementations of these general requirements were adequate was left to the ORI committees that were required to review each facility and major test setup.

Materials Control

As mentioned previously, configuration control of the spacecraft and the Apollo-common GSE involved in the tests was vested with the ASPO. Of course, this control included a closely governed inventory of all materials used in the spacecraft. As a result, the test spacecraft received the same careful attention as the flight spacecraft, with identical restrictions being imposed with regard to flammability, toxicity, and odor. Materials on the spacecraft that were to be exposed to the space environment (as opposed to the cabin environment) were selected primarily on the basis of satisfactory physical properties that would not degrade to an unacceptable level during the mission. Flammability was a consideration, but requirements were not as restrictive as with materials that were exposed to the oxygen-rich cabin atmosphere. As long as the functional properties of these external materials were not affected, weight loss because of vacuum exposure was not a consideration. However, vacuum outgassing of spacecraft materials was of great concern to the facility operator because it could be a major constituent of the gas load that had to be processed by the facility pumping system; also, some outgassing constituents could plate out and permanently degrade critical chamber components (such as solar-simulator collimating mirrors). Nevertheless, it seemed unrealistic to attempt to impose additional material specification restrictions on the spacecraft for the sole purpose of minimizing chamber damage; thus, no such attempts were made.

Although configuration control of the facility was a separate responsibility of the facility operator, the selection and control of materials in the facility ECS, which provided breathable oxygen to EVA crewmen in the chamber, exactly conformed to the standards established for the spacecraft cabins and breathing systems. In addition to normal functional specifications, other in-chamber materials had special requirements imposed for vacuum compatibility that were designed to minimize chamber back contamination. All nonmetallic materials were reviewed by a special facility materials review

board, and certain metallic materials that had borderline vapor pressures at nominal temperatures (such as cadmium and zinc) were prohibited unconditionally from in-chamber use.

Failure Modes and Effects Analysis

The safety requirements written in 1967 required that systems-failure-mode analyses be performed on the facility, the test article, the GSE, and the integrated combination of these three. A special note stated that, "One basic criterion that must be maintained inviolate in manned testing is as follows: Test personnel shall not be subjected to a test environment wherein a credible single-point failure will result in injury." Satisfactory implementation of this requirement was difficult initially because of varying opinions as to what exactly constituted a failure modes and effects analysis in the context of the requirement. Techniques for analysis to determine failure modes and to identify potential single-point failure sources were, of course, well developed at this time and had been used previously in reviewing spacecraft systems. Most analyses of this type had involved an examination of systems down to the individual component level (resistors, transistors, seals, connectors, valve components, and so forth) and were very time consuming and very expensive. Because of the time and expense considerations, it seemed impractical to apply the same philosophy to the extensive facility systems. Therefore, a much more generalized but effective technique was adopted. In simple terms, it was postulated that major facility components, systems, and services would fail in gross, credible modes; and the effects upon operation were examined. If something could fail, it was assumed to do so without the detailed studies necessary to identify every possible cause for such failure. Then, the rule was applied that there must be redundancy, operational alternatives, or backout procedures so that the failure would not jeopardize crew safety. Although not required specifically by the safety standards, the analyses were extended to the failure modes that would result in significant damage to the spacecraft or facility; where possible, changes were made to avoid such damage. The failure modes and effects analyses of the spacecraft developed for flight operational purposes were more than adequate for this purpose and required only that deviations from flight configuration, which were peculiar to the ground test spacecraft, be considered further. Then, the spacecraft and facility analyses were considered together to determine the interrelated effects of single-point failures in either. In practice, this technique permitted performance of an effective analysis at nominal cost. Most of the unacceptable conditions disclosed by the analyses could be corrected by procedural changes, although a few hardware changes also were involved.

Facility and Spacecraft Fire Protection

The ground test fire incidents of early 1967 resulted in extensive studies of fire-suppression systems for use in reduced pressure, oxygen-rich, habitable areas. The extraordinary measures that were taken to minimize the use of combustible materials, to limit fire-propagation paths, and to eliminate ignition sources were complemented by the provision of fire-suppression apparatus for use if the other precautions failed and a conflagration occurred. The primary candidates for consideration as extinguishing elements were water, foam, carbon dioxide (CO₂), and Freon. The use of foam extinguishers that could be discharged into the sectionalized cabin compartments was

adopted for the CM. Also, this flight system was considered to be adequate for the ground test operation and was accepted without special modification for that purpose. The LM depended on water spray from the in-cabin potable-water drinking nozzle for fire extinguishing. This same system was used in the ground test, except that an external facility water supply was connected to the nozzle to provide an unlimited amount of water to be used in an emergency.

In considering what type of fire-suppression system would be best for in-chamber use (external to the spacecraft), it was first noted that oxygen-rich environments would not be encountered, except possibly at highly localized spots where a leak in an oxygen system might exist. Moreover, the vacuum in the chamber during test operations would, in itself, constitute an effective fire-suppression agent. Therefore, the greatest fire hazards were recognized to exist during the pretest buildup and checkout phases in the confined chamber areas at atmospheric pressure. Hazards also existed during the pumpdown and repressurization phases of test operation, when chamber pressure was still high enough to support combustion. Of the possible extinguishing elements considered in detail, water delivered by deluge nozzles was determined to be the most effective and to have no unacceptable operational disadvantages. A foam system was too expensive, required too much time to fill the chamber volume, and presented severe visibility problems for condition assessment and rescue operations. Carbon dioxide was extremely expensive and presented toxicity hazards to the test crewmen, rescue personnel, and operations personnel. Except in very high concentrations, Freon was ineffective against fires that were well established, and Freon generated highly toxic fumes upon exposure to a major conflagration. In small concentrations, Freon had been shown to be very effective in the suppression of fires in oxygen-rich atmospheres if applied within a very few seconds of initial ignition, but this did not seem to be feasible operationally for the chamber and spacecraft configuration involved in these tests. In addition, a Freon system for the large chamber was estimated to be very expensive. A water-deluge system for in-chamber use was estimated to cost less than any of the other systems considered, and the effectiveness of water deluge for the types of fires likely to occur in the chamber was equal to or better than any of the other systems. The principal disadvantages of the water-deluge system were that its use would unquestionably result in major damage to the spacecraft because the spacecraft contained many components and materials that were highly susceptible to water damage; also, a visibility problem from cold fog (fig. 28) would exist to hamper rescue operations if the system were used during or immediately after a chamber repressurization, when the cryogenically cooled walls of the chamber were still cold. To assure vacuum compatibility, the in-chamber piping for the deluge system was maintained dry and was vented continuously through the deluge nozzles to the chamber volume. The piping was isolated from the external water supply by means of valves and vacuum-tight rupture disks. The rupture disks were designed to relieve and admit water to the chamber piping when the water-control valves opened and applied full line pressure to the disks. To ensure that the in-chamber piping would not cool during testing to a temperature that would result in water freezing in the line if flow were initiated, the piping was traced with thermostatically controlled electric-resistance heaters and was insulated thermally by a covering of sheet Teflon.

Because of the consequences of spacecraft damage from water deluge in the event of inadvertent operation of the system, it was decided to include no automatic initiation devices. During nontest operational phases, control of the system was from stations



Figure 28. - Chamber fogging following a practice emergency repressurization and water deluge.

that were adjacent to the chamber manlocks. With the manning of duty stations for test operations, control of the in-chamber systems was transferred from the local stations at the manlocks to the test director console in the control room. During manlock operations, crewmen and manlock inside observers were always under direct observation through the viewports by outside personnel at the manlocks. Control of manlock deluge systems under these circumstances was maintained active at the test director console and at the local stations at the manlock.

Safety Instrumentation Package and Circuit Protection

Because the tests were developmental, it was considered that special precautions to ensure crew safety were warranted over and above those taken on flight missions which involved fully developed and qualified hardware. One such precaution was the use of much more biomedical instrumentation to monitor physiological status than was used in flight. This extra instrumentation was feasible in the ground tests because the instrument signals could be brought out to displays and recorders by means of hardline electrical umbilical cables without regard to the restricted number of telemetry channels that were needed to obtain such data in flight. It was decided to measure partial pressure of oxygen (O_2) and CO_2 , sternal and axillary electrocardiogram (ECG), respiration rate, deep body temperature, breathing-gas temperature, and total pressure. Sensors for partial pressure of O_2 and CO_2 were mounted inside the helmet area. Total gas pressure was sensed in the torso area. Breathing-gas temperature was sensed at the inlet to the suit. The impedance pneumograph (for sensing respiratory rate), the ECG sensors, and the deep body-temperature sensor were mounted directly on the crewman.

Signal conditioners for the instruments and the associated wiring harnesses were mounted on a vest-like supporting garment that was made of Teflon fabric; this vest was worn over the undergarment (fig. 29). The three barostats, which triggered chamber emergency repressurization when a lower safe limit of total pressure was sensed, also were mounted near the signal conditioners. All signals were brought out by means of a connector that could be mated directly to the electrical umbilical in the cabin or, if the crewman was garbed in a pressure suit, the connector could be mated to another hermetically sealed connector on the pressure garment and then to the umbilical. This entire assembly was referred to as the safety instrumentation package (SIP).

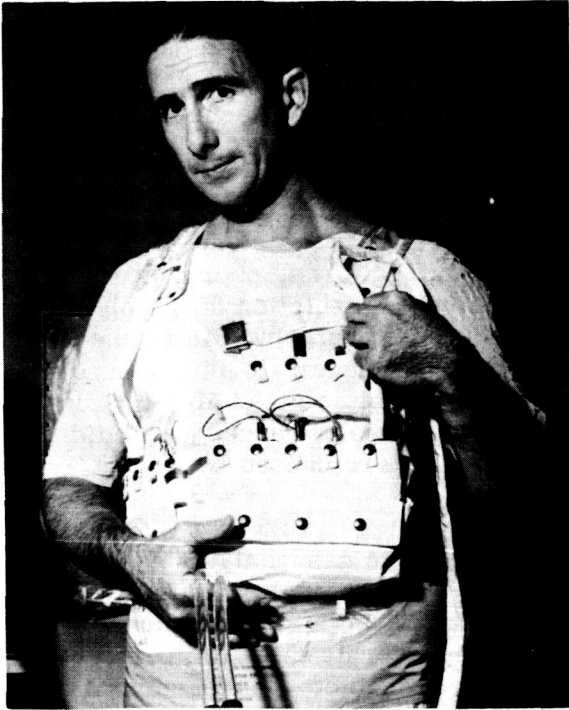

Figure 29. - Safety instrumentation package.

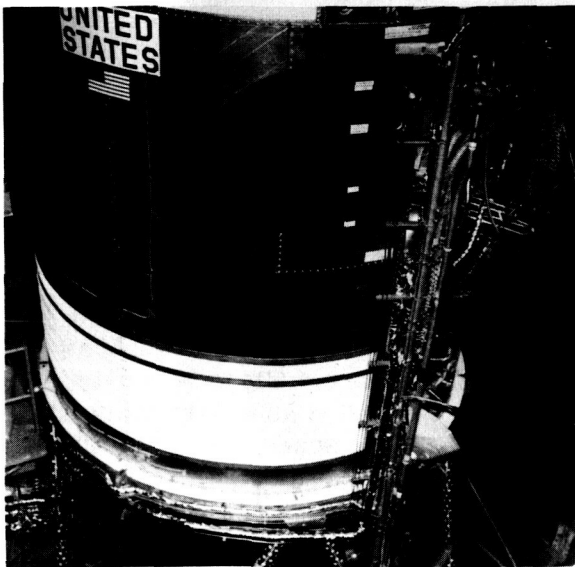

Figure 30. - Some of the GSE fluid lines in the CSM test installation.

Protection against arcing or overheating of the bioinstrumentation equipment in the oxygen-rich space-suit or cabin environment was provided by fuses rated at 250 milliamperes in each conductor at the point of electrical penetration of the chamber. In addition, protection against inadvertent dangerous electrical shock to the crewman through the ECG leads was provided by adding a 200-kilohm resistance in series with each lead.

Ground Support Equipment Fluid Lines

Nonflight piping and tubing was used extensively inside the chambers to provide for fluid flow between the spacecraft and the GSE that was outside the chamber (fig. 30). During the test, these lines were used for a variety of purposes, including off-loading dummy propellants to simulate changes in thermal mass, providing gaseous hydrogen for fuel-cell operation, providing emergency means of detanking LO_2 , dumping crew

liquid wastes, and sampling cabin atmospheres. Problems with these fluid lines were one of the most persistent threats to operational success during most of the test program. Problems were of two types. First, there were leaks in the lines, which usually occurred only under full thermal-vacuum conditions. Second, there were difficulties in maintaining line temperatures at desired values, which resulted in lines being blocked by frozen fluids.

In original test installations, extensive use was made of mechanical connections in the fluid lines. In spite of the greatest care in installation and thorough leak checking (using best state-of-the-art helium leak-detection techniques), all of the early tests proceeded with marginal chamber vacuum because of the high gas loads imposed on the chamber pumping systems from leaks in these connections. Because of the relatively limited pumping capacity for "noncondensables" and because of the explosion

hazards associated with hydrogen in the chamber and pumping systems, leaks in the hydrogen supply line to the spacecraft fuel cells were particularly troublesome. The use of improved washers in the piping connections and attempts to encapsulate the connections in vacuum-compatible epoxy proved to be inadequate for high-vacuum service. For the final tests in the series, all mechanical piping connections were replaced with welded connections, which proved to be adequate.

The fluid lines were protected against freezing by electrical resistance heaters. Problems were encountered because of frequent open-circuit failures, poor heat transfer between the heaters and the piping, and inadequate thermal insulation of the piping-heater configuration. These problems were solved in later test runs by tracing the lines with redundant heaters, using a thermoset plastic for the heater-to-piping bond in some instances, and wrapping each line with a double layer of aluminized Mylar reflective insulation held in place by glass tape. These measures greatly reduced, but did not completely eliminate, instances of fluid-line failure that were caused by low temperature.

Attempts to sample cabin gases through lines connected to gas-analysis equipment outside the chamber were marginally successful. Again, the principal problem was in maintaining proper line temperatures. If the temperature in even a small segment of the sampling line was permitted to become less than the spacecraft cabin temperature, condensation of some sample fractions within the line was probable. Conversely, if the line was operated at too high a temperature, the chemical structure of the gases that were being sampled was likely to be altered. A sample-line temperature of approximately 155° F was considered to be optimum; however, limited temperature measurements and other indirect evidence indicated that this was seldom achieved. In several instances, the sample lines were completely plugged by frozen water. Cabin gases were collected through the lines by two methods: by cryodeposition on LN₂-cooled plates for analysis at a much later date, and by collection in evacuated bottles for analysis in near real time (within approximately 20 minutes). Analyses of samples collected by use of the two different techniques correlated well.

Facility Environmental Control System

Tests of the CSM did not require the use of a facility ECS because the crewmen entered and left the chamber at atmospheric pressure. A facility ECS was required, however, for tests of the LM because ingress and egress operations were performed under hard-vacuum conditions and it was not feasible to use flight equipment (such as the PLSS) to maintain suit pressurization and habitable atmosphere. Closed-loop-type environmental control systems were provided for chambers A and B as a part of the original facility design and were used in 1966 for manned tests of space suits. In these units, metabolized oxygen was replaced from a stored supply, and the resulting CO₂ was absorbed in barium hydroxide canisters. Because the process loop operated at sub-atmospheric pressure and the units were, of necessity, located outside the vacuum chambers, even very small inleaks of atmospheric air over a significant period of time resulted in a gradual dilution of gas in the system to the point at which unacceptable nitrogen (N₂) levels were present; there was no way to purge the system of N₂ during operation. Moreover, the systems had been designed, in general, to commercial

standards, and the design included several marginal fire hazards and several theoretical failure modes for which no satisfactory redundancy or procedural alternate existed. An indepth review of the systems, conducted as a part of the general safety review of ground test operations in early 1967, resulted in the systems being condemned and replaced with new open-loop systems that included detailed consideration of all of the rigid standards that were developed at that time.

In the new system, which was used in tests of the LM, the flow of O₂ to each of the two crewmen was regulated by the use of an individual control module (figs. 31 and 32). A third module was maintained in operational status on standby and could be valved into the circuit instantly in case of failure of either of the other modules (fig. 33). The pneumatic control system of these modules was designed to permit precise variable control of suit gas pressure and flow rate over the full range of manlock and chamber operating pressures. A major point of concern was the ability of the system to maintain suit pressure at or above the chamber or manlock pressure during an emergency-repressurization event. If, for any reason, the suited crewman was subjected to an external pressure load (referred to as negative pressure), the general effect would be to collapse the suit and apply force that would tend to move the crewman into the hard-helmet area of the assembly. At best, this condition would be very uncomfortable for the crewman, and could cause cardiac arrest in extreme circumstances. To preclude this possibility, a large check valve that was vented to the chamber atmosphere and that was calibrated to open at 0.02 psi negative suit pressure was installed inside the chamber in each ECS supply line. This check valve would admit air to the suit loop and, thus, to the pressure garment automatically in adverse circumstances.

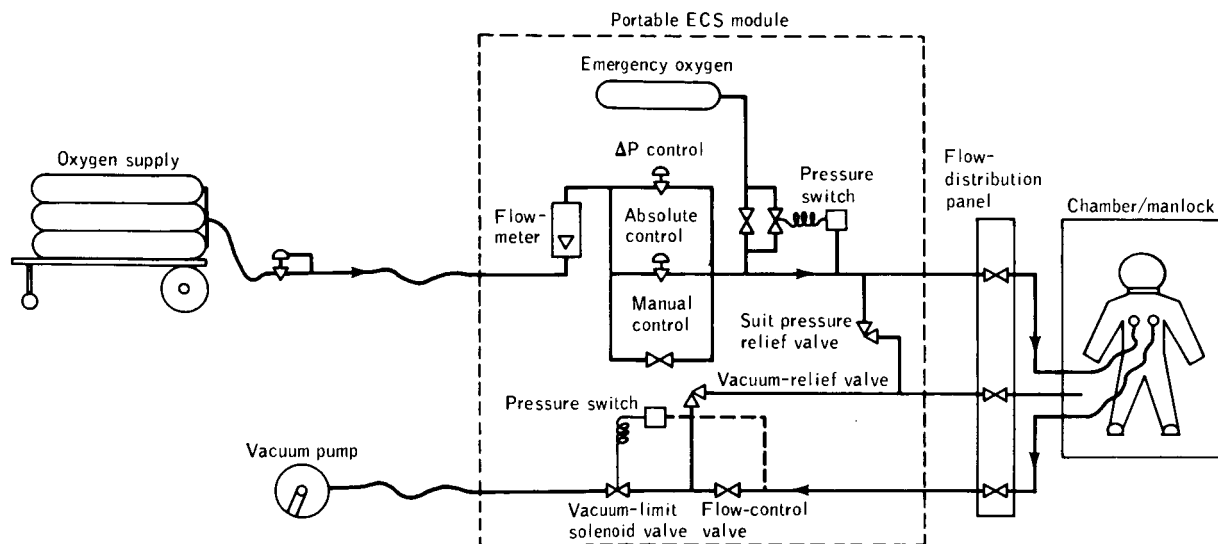

Figure 31. - Simplified schematic of facility open-loop ECS module.

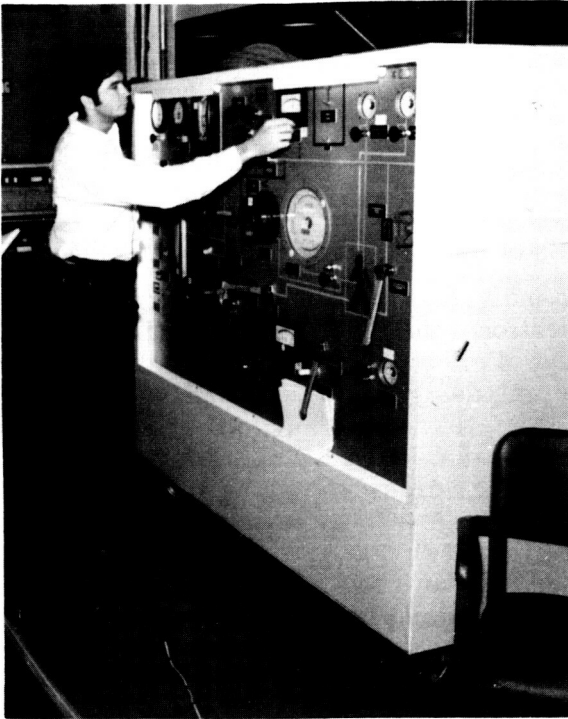

Figure 32. - Facility ECS module.

In planning for the hard-vacuum ingress-egress operation that was required for LM testing, the problem of adequate cooling of the crewman was overshadowed by mechanical details associated with developing an acceptable maneuver concept. Chilled-water-to-oxygen heat exchangers were provided near the point at which the ECS supply lines penetrated the chamber walls in an attempt to regulate the temperature of gas entering the space suits. At the full rated flow of $15 \text{ ft}^3/\text{min}$ through the suit, the net effective cooling capacity for the crewman was approximately 800 Btu/hr. Reliable estimates of crewman workload involved in the exercise were not available until the operational concept was well developed and dry runs using the actual EVA hardware had been performed. It turned out that, in original estimates, the work that was involved in manipulating the bulky umbilicals and climbing the access stairs in the pressurized space suit had not been considered fully. It was determined that sustained metabolic rates of approximately 1500 to 2000 Btu/hr could be involved, and that short-time peaks could be 2500 Btu/hr. Analysis also disclosed that very little could be gained by lowering the suit-inlet-gas temperature to the medically permissible limit, which was approximately 32° F . The addition of chilled-water supply and return lines to the umbilicals to service a water-cooled undergarment was considered to be undesirable because it would add bulk to the umbilical and would introduce additional complexities and failure points to an already complex operation. In practice, this deficiency in cooling capacity was compensated for (not

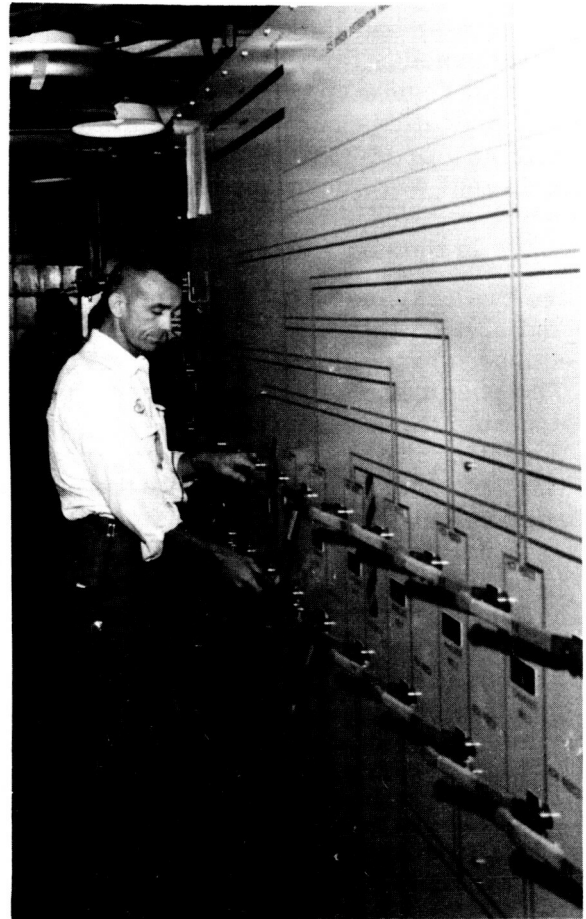

Figure 33. - Facility ECS flow distribution panel.

without considerable forbearance of the crewmen) by monitoring the metabolic load and body temperature of the crewmen closely and by pacing their activity carefully during ingress and egress to avoid overheating.

Mercury Contamination of the Environmental Control System

During final preparation for LM testing, routine leak checks were made on the facility ECS distribution piping. This involved evacuating sections of the system and monitoring the evacuated volume with a sensitive leak detector while spraying suspect connections with helium. After one such operation, a technician was replacing the LN₂-cooled cold finger that was used in conjunction with the vacuum pump and called attention to a suspicious deposit that was determined to be mercury. The ensuing investigation disclosed no immediately apparent source of mercury contamination and brought to light the absence of standard techniques to analyze and locate the trace mercury contamination in such systems.

It was decided to open the ECS distribution system at convenient piping flanges, thereby dividing it into separate sections. This permitted checking for mercury in steps that would avoid spreading the contamination to other uncontaminated sections of the system. Three basic techniques for mercury detection were used. First, hot gaseous nitrogen was flowed through the isolated piping section, and the effluent was monitored by the use of an ultraviolet-absorption spectrometer. This method was considered to be the primary detection method; however, spot samples of the nitrogen effluent also were checked for mercury vapor by the use of selenium sulfide decoloration apparatus. If no trace of mercury was discovered, final assurance of noncontamination was obtained by evacuating the line and sequentially heating all elements during the evacuation with a hand-held heat gun. An LN₂-cooled trap (or cold finger) was installed between the line to be evacuated and the vacuum pump. Afterward, the line was repressurized and the cold-finger surface was analyzed carefully for traces of mercury. Using these techniques, it was determined that the mercury contamination was isolated in the piping section where it was discovered, and the source was determined to be a valve that apparently had been contaminated at the vendor's before delivery (fig. 34). As a result of this incident, prohibitions against the use of mercury in the laboratory were strengthened, and standard procedures for initial and periodic checks of environmental control systems for mercury contamination were instituted.

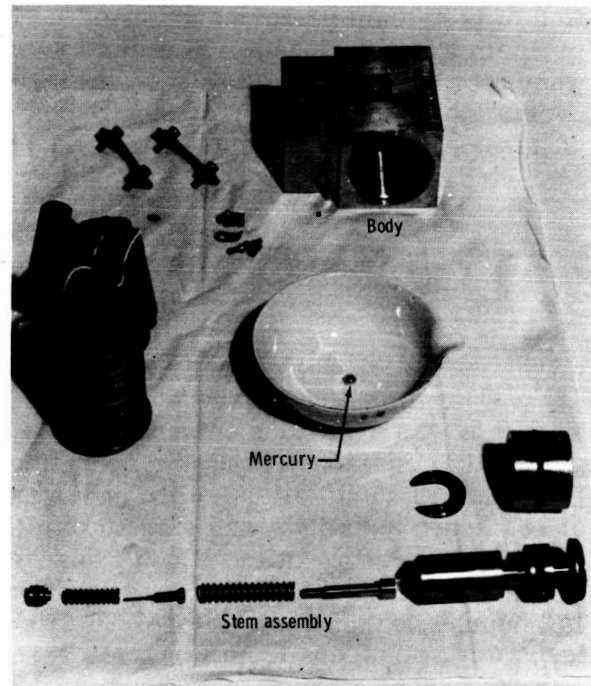

Figure 34. - Mercury recovered from the body and stem of contaminated facility ECS valve.

Work-Rest Cycles

Several factors combined to result in an extraordinarily high workload for SESL personnel in late 1967 and throughout 1968. These factors included late delivery of test spacecraft and the manifestation of a large number of late-identified problems in readying the facility and spacecraft for test. This situation became apparent after it was too late to hire and train the supplementary personnel that were needed to maintain the required schedule. As a result, large numbers of laboratory personnel were required to work extended hours of overtime. Work weeks with more than double normal hours, sometimes for as long as 4 to 6 weeks consecutively without a single day off, were not unusual during nontest periods. As the dates for actual test operations approached, those people who were responsible for medical surveillance and laboratory management became concerned about the mounting evidence of fatigue among test-team personnel. To minimize the possibility of adverse incidents resulting from fatigue during the test, rigid regulations regarding work-rest cycles for duty-station personnel during testing were formulated and enforced. It was required that all test-team members be given at least one full 24-hour day off from any work duty immediately before the initial manning of a duty station. Most test-team members were permitted to man stations on 12-hour shifts, with a minimum of 12 hours between shifts; occasional exceptions were made, reducing the minimum time between shifts to 10 hours whenever test-essential activities demanded. Personnel manning duty stations that were particularly critical to crew safety were limited to 8-hour shifts. These personnel included the test directors, test conductors, medical monitors, and those people who operated the manlocks and environmental control system. Inside observers were limited to working 4 hours at altitude and 4 hours at other tasks, for a maximum of 8 hours per shift. These limitations proved to be satisfactory in the aggregate, as there was no noticeable degradation of test-team performance over the long periods of test operations. One persistent problem was the chronic inflammation of the nasal passages of the inside observers when they were required to stay at altitude breathing pure, dry oxygen for 4 hours daily over a long period of time. This problem resulted in an occasional temporary shortage of physically qualified inside observers during some of the more extended test time.

TEST RESULTS AND FLIGHT-SIGNIFICANT ANOMALIES

Block I Command and Service Module Tests

Operational summary. - There were three tests of the Block I CSM (spacecraft 008). The first was a 94-hour unmanned test that began on July 26, 1966. This test was aimed primarily at demonstrating the operational capability of the combined spacecraft, facility, and GSE installation before undertaking the manned test. The first manned test, of 183 hours duration, was started on August 2, 1966. This test was designed to demonstrate the adequacy of the Block I spacecraft for manned Earth-orbital missions; however, anomalies during this test resulted in a second manned test, which lasted for 173 hours, beginning on October 26, 1966. The crewmembers for the first manned test were volunteers from MSC; all were career military pilots on assignment to NASA. For the second manned test, two astronauts were joined by a military pilot.

Unmanned test. - Two major operational problems were encountered during the first unmanned test. The spacecraft side hatch would not seal properly, apparently

because of the slow rate of pressure change in the chamber test volume during initial pumpdown. After the abortive start and on all subsequent tests, this problem was overcome by pressurizing the spacecraft cabin to between 0.5 to 1.0 psid after hatch closure before chamber pumpdown. Later in the test, the spacecraft steam duct through which cabin air is vented became blocked with ice, and it was necessary to thaw the duct by exposure to the side solar simulator and by raising the chamber pressure to permit convective heating. A procedural change in the operation of the ECS water boiler was implemented to avoid blocking the steam duct during subsequent operations.

First manned test. - The "block simulation" type time line used for CSM testing proved its value on the first manned test (fig. 35) and on subsequent tests. There were 13 individual phases or "blocks," and, during the test, it was necessary to change the sequence of these phases several times to circumvent holds caused by problems in facility or spacecraft equipment. The scheduled 19-hour pumpdown was doubled because of necessary repairs to the chamber emergency-repressurization system and to the gas chromatograph cabin-atmosphere sampling system. After pumpdown and cold-wall stabilization, the chamber pressure stabilized at 6.2×10^{-6} torr. Several holds were experienced during the course of the test because of the erratic performance of the chamber solar-simulator modules. These modules were being used for the first time in a major test, and, because it was a newly activated system, many real-time adjustments were necessary before the desired high reliability could be achieved. On August 4, a leak developed in a GSE helium line that supported proper operation of a quick-disconnect fitting in the line which supplies gaseous hydrogen to the fuel cells. Warming the quick-disconnect fitting with side solar simulators reduced the leak and eliminated the threat of a wet shutdown, which would have caused the fuel cells to fail.

After the first manned test, a concerted review of the test results was undertaken. Some of the principal findings are given as follows.

Regarding thermal response, the structural temperature did not respond as predicted in all circumstances, partly because of difficulties with the thermal environment provided during the test. Difficulty in maintaining consistent solar-module operation and chamber-pressure increases because of leaks in vehicle ground support hardlines made it necessary to attempt verification of the Block I thermal model by using spacecraft-surface-temperature histories as a boundary condition rather than using data directly from the solar-simulator radiation intensity measurement system (RIMS). Also, it was determined that the CM heat leak was much higher than was predicted. This difference was believed to be caused by an excessive amount of moisture in the CM superinsulation.

Thermal data from the SPS test phases indicated a definite need for insulating and heating the propellant lines from the sump tanks to the engine interface and

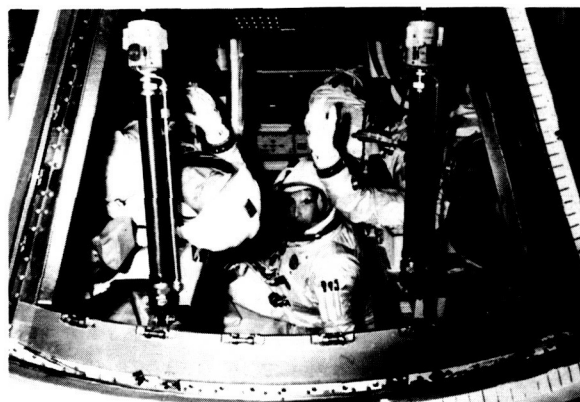

Figure 35. - Crew ingress for first manned test.

for modifying flight heater circuits on other portions of the system. An unsatisfactory bonding technique for RCS quad heaters was disclosed, which necessitated establishing an improved bonding technique.

Evaluation of the ECS operation during testing disclosed that the suit-circuit evaporator did not function. Also of concern was the difficulty in attaining a 100-percent-oxygen level in the cabin during early test phases. It was thought that this problem was caused by poor purging procedures during cabin closeout; it was necessary to upgrade purge techniques to eliminate trapped nitrogen from the cabin interior before future pumpdowns or flights.

During the test, water froze in the fuel-cell hydrogen purge line and at the hydrogen vent. This problem required the addition of heaters and the insulation of spacecraft 008 and flight vehicles to preclude freezing, which prevents required periodic purges of fuel cells and which could cause degraded fuel-cell powerplant operation.

These anomalies, when considered together with many minor deficiencies, resulted in a decision to make corrections and to conduct a retest. Modifications included the replacement of two fuel cells in the SM, the installation of heaters on the fuel-cell hydrogen vent line, the relocation of many instrumentation end-items, the rework of quad heaters, and the rework of the ECS and CM side hatch. The environmental control unit and many of the critical environmental controls were replaced with updated equipment. A modification was made to the side crew hatch to incorporate a scientific airlock that was scheduled for use on later Block I missions. Minor changes were made in other systems to ensure that spacecraft 008 was in the latest spacecraft 012 configuration before the retest.

Second manned test. - While the fuel cells were powered up during final preparations for the second manned test, they ceased to maintain an output load. All three fuel cells were shut down, and drying procedures were initiated. Only one fuel cell could be recovered. A backup of water in the potable-water line, caused by an operational error, resulted in flooding of the cells. A decision was made to revise the test for operation with one fuel cell only, and closeout operations were continued. Crew insertion was accomplished as scheduled on October 25. However, during an ECS wick-wetting operation, a critical total water flowmeter became inoperative. The ingress was terminated to replace the flowmeter. On October 26, the crewmen again ingressed the CM, and cabin purge and closeout procedures were completed. The following major objectives were established for the retest.

1. Demonstration of the Block I ECS performance in modes planned for the CSM 012 mission using flight electrical power profiles
2. Investigation of anomalies that occurred during the first thermal-vacuum test
3. Demonstration of the effectiveness of the cabin and heat-shield purge procedures for minimizing cabin nitrogen content and heat-shield condensation
4. Demonstration of the Block I experimental airlock and canister mechanism operation in a thermal-vacuum environment

Chamber pumpdown was initiated on October 26 and was continued through October 28. Pumping time was longer than normal because of leaks in GSE lines. During pumpdown, performance of the ECS and suit integrity were demonstrated satisfactorily. At a chamber pressure of 1×10^{-5} torr, with chamber cold walls stable at 90° K, operations proceeded with a top-solar hot-soak phase.

The 25-hour top-solar hot-soak test of the CM progressed without major incidents. Operation of the experiments airlock in a hot environment was accomplished and data obtained on CM thermal response that determined the effectiveness of the heat-shield-purge procedures adopted before the retest. Also, a successful fuel-cell hydrogen purge into the chamber environment was demonstrated. An attempt to accomplish a simulated urine dump through the spacecraft zero-g urine nozzle failed during this phase. Post-test analysis revealed that the urine nozzle had become blocked with crystals of urine salts, which had formed in the urine lines after the first manned test. Later attempts to dump simulated urine failed and precluded attainment of test objectives in the zero-g urine-dump system. The top-solar hot-soak phase was completed on October 29, and a cold-soak phase was initiated.

The cold-soak period was accomplished successfully with the exception of an unsatisfactory demonstration of the experiments airlock operation. The airlock ablative plug failed to lock in place after completion of airlock operations and fell back into the airlock cavity. Troubleshooting was not attempted because additional problems might have ensued and forced early test termination. The ability of the cabin emergency oxygen-supply system to maintain a safe cabin pressure after a 0.5-inch meteorite puncture in the cabin wall was demonstrated successfully during this phase. Also, operation of the fuel-cell hydrogen vent line was demonstrated again and data were obtained that established satisfactory ECS performance and acceptable thermal response of the cabin structure and insulation. The cold soak was terminated on October 30, and SM quad D hot-soak testing was begun. During the 10-hour quad D hot-soak test period, satisfactory operation of the quad thermal control system was demonstrated. An investigation of steam-duct operation by means of a simulated failure of duct heaters also proved to be successful; no freezing was observed at the duct outlet or inlet.

Early on the evening of October 30, the only operational fuel cell failed as a result of a damaged hydrogen pump and was shut down; the test was continued on ground power alone. Shortly after the fuel-cell failure, an attempt to transfer potable water from the SM storage tank to the CM storage tank was unsuccessful. This imposed a severe time constraint on the test time line. Conservative estimates indicated only 1.5 days of test time remaining because of crew water shortage.

Side-solar hot-soak and radiator-mode testing was begun late on October 30 (fig. 36). This test phase was used for investigating transient and off-nominal modes of radiator operations, and several off-nominal modes of ECS operation were tested to determine operational limits that could be applied to mission rules. On October 31, another attempt was made to transfer potable water to the CM. This attempt was successful, and the water-shortage constraint was removed from the test time line. In addition to the successful demonstration of a multitude of off-nominal radiator modes, successful operation of the ECS suit loop was demonstrated, without problems, in a single lithium hydroxide canister mode. Late in the test phase, the ECS water/glycol pump circuit breakers were tripped, indicating abnormal operation. Manually resetting



Figure 36. - Side-solar hot-soak and radiator-mode testing on spacecraft 008.

the circuit breakers restored normal operation. This condition occurred periodically throughout the remainder of the test. After a demonstration of suit boiler operation with the water/glycol coolant loop deactivated, chamber repressurization was initiated on October 31.

Warmup and repressurization to ambient was completed on November 1. During descent, entry sequencing and barostat operations were demonstrated, and suit loop and cabin negative-pressure-relief operation were verified. After a brief investigation of the experiments-airlock ablative plug problem, which disclosed that the plug had been unlocked inadvertently during the airlock-securing procedure, the crew egressed the CM, and the vehicle was powered down after post-test troubleshooting of test anomalies.

The spacecraft 008 retest was successful in lifting certification-test-requirement constraints for the spacecraft 012 mission. However, as during the initial test series, operational problems with top and side solar simulation and leaks in GSE hardlines made analysis of thermal-response data difficult. The test data did allow updating of the Block I thermal model for improving the capability to predict mission thermal response, and showed improved performance by the CM heat-shield insulation. This improvement indicated the effectiveness of using dry-gas continuous purges of insulation areas during ground checkout. Even though data indicated improvement in heat-shield thermal response, the CM heat leak was still higher than expected and was attributed to structural heat shorts between the heat shield and the inner cabin structure. Considerable attention was given to determining the effects of thermal-vacuum environments on the structural integrity of the heat shield. Although visible cracks were observed (fig. 37), the basic structural integrity was maintained. The addition of heaters to the fuel-cell hydrogen vent line was successful in preventing the freezing of water vapor at the vent exits. Rework of the quad D heater system proved to be beneficial in the restoration of predicted thermal response to the RCS quads. The problems experienced with the ECS suit water-boiler operation did not recur on the retest and, in general, the ECS performed nominally except for minor problems that were, in most instances, peculiar to spacecraft 008.

Throughout both manned tests of spacecraft 008, the spacecraft crews noted an excessive amount of condensation (fogging) of spacecraft view windows (fig. 38). It was thought that this condition was not a program problem at this point, and the problem recurred in subsequent tests of the Block II spacecraft and in early Apollo flights.

Off-nominal testing of subsystems modes and radiator configurations contributed to mission-rule and real-time evaluation criteria for use during subsequent Apollo

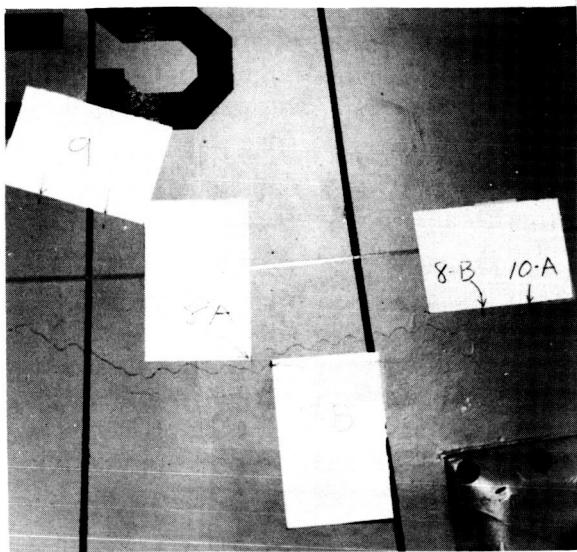

Figure 37. - Documentary photograph of cracks in the CM heat shield.



Figure 38. - Command module window fogging.

flights. Analysis of cabin atmosphere during all phases of the test program resulted in the determination that no toxic products were outgassed by cabin materials; thus, this concern for future manned flights was relieved. Satisfactory performance of the SPS thermal control was demonstrated during the retest, permitting improvements to be incorporated in future vehicles to ensure that propellant-feedline temperatures would remain above freezing during manned orbital missions.

Block II Command and Service Module Tests

Operational summary. - Four tests were conducted on the Block II CSM (spacecraft 2TV-1, fig. 39). The first was an unmanned vacuum test of 29 hours duration that was begun on June 10, 1968. The primary test objectives were (1) the verification of the pressure integrity of the cabin and suit loop, (2) the oxygen compatibility of the powered spacecraft systems, and (3) the performance of the system provided for emergency dump of the onboard cryogenic oxygen. The second test of 170 hours duration was a full thermal-vacuum test with an astronaut crew. The test was begun on June 16, and there was a great variety of test objectives associated with certification-test requirements that had to be satisfied prior to the first manned Earth-orbital flight (Apollo 7). After this second test, the spacecraft was modified while still in the chamber to a configuration matching that intended for lunar flights. Another unmanned test, lasting 61 hours, was begun on August 24, 1968, under full thermal-vacuum conditions. In this test, a suit-loop stimuli generator was installed to satisfy calibration requirements for the environmental control systems. Other objectives dealt with verification of the adequacy of modifications made since the last test but before commitment to another manned test. On September 4, 1968, the last thermal-vacuum test of the series was started. Military pilots assigned to the NASA served as the crew for this 102-hour test. The numerous objectives were based on satisfying certification-test requirements that were restraining on the first manned lunar mission.

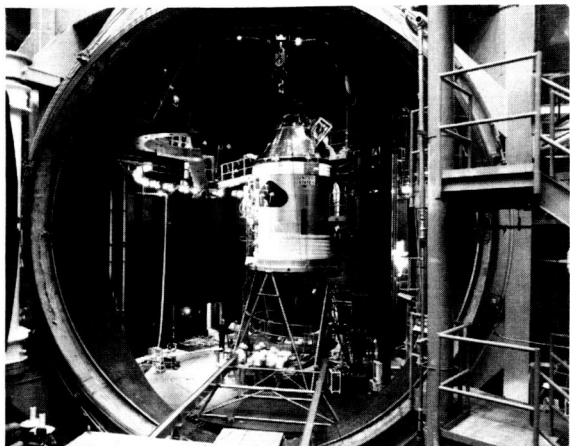

Figure 39. - Spacecraft 2TV-1 being installed in chamber A.

in hydrogen, oxygen, and nitrogen lines and connectors. Thus, it was shown that many fluid leaks are highly dependent on thermal conditions, and a vacuum test alone at ambient temperature does little to provide assurance of leak-tight performance in a fully simulated space environment.

First manned test. - Facility and vehicle turnaround activity in preparation for the first manned test (fig. 40) began immediately after completion of the unmanned test phase. After fuel-cell powerplant activation and vehicle and facility closeouts, pump-down for the manned test phase began on June 16, 1968, and the thermal-vacuum test time line was started. After 15 hours of CM hot soak and 2 hours of cold soak, significant nitrogen, oxygen, and hydrogen leakage occurred in the facility supply systems to the spacecraft. In addition, several waterlines outside the chamber burst, shorting out a major section of the side solar simulator. An alternate test sequence, including cabin depressurization and repressurization, was then accomplished to make constructive use of the necessary hold time. As a result of the cabin pressure dump and the continued presence of hydrogen in the chamber, the facility gaseous-helium cryogenic pumping panels released their gas load, which drove the chamber pressure to a level of 5×10^{-2} torr. This pressure level was maintained for approximately 15 hours because of the exceedingly heavy hydrogen and oxygen gas loads that were imposed on the chamber roughing- and diffusion-pump systems. Vacuum recovery was achieved only after warming the vehicle with side solar simulators,

First unmanned test. - The first unmanned test was accomplished routinely except that, during the demonstration of the emergency LO₂ dump system, the detanking took much longer than the design time. Because this anomaly was subsequently shown to be significant relative to the failure in flight of the Apollo 13 LO₂ tank, it will be discussed elsewhere in this report. Also, it is significant to note that one of the main objectives of this vacuum test was to demonstrate the pressure integrity of the spacecraft, its systems, and the GSE piping in the chamber before undertaking the major manned test. No leaks were evident during the test; yet, in the following manned thermal-vacuum test, the operation was jeopardized continually by massive leaks



Figure 40. - Crew ingress.

which effectively improved the cold-leak condition that caused high gas loads. The chamber recovered nominal test conditions, and the test time line was completed successfully after revision to make full use of remaining test time. All major objectives of the test were accomplished satisfactorily in spite of the difficulties. A review of the test data indicated that the anomalies were isolated to the extent that they could be investigated on a component or subsystem basis and would not require thermal-vacuum retest before the Apollo 7 mission.

Configuration changes between tests. - After the first manned test, the spacecraft was modified to a configuration similar to that to be used in early lunar-landing flights, and extensive rework of all communications hardlines and connections with the vehicle was accomplished in several areas. The heavyweight, unified side hatch was replaced with the lightweight side hatch; the forward tunnel was modified to the CSM 103 configuration by the installation of a docking probe; the CM upper deck was modified to include the thrust augmentation system; and the high-gain steerable-antenna system was installed on the SM. Also during this time, a specially designed hot-cold gas-shroud apparatus was installed over and around the new lightweight hatch, and a series of thermal tests was conducted at ambient pressure to qualify the Block II side hatch for missions. The thermal test revealed the necessity for minor structural modification. Retesting then verified satisfactory performance of the hatch configuration, and the shroud apparatus was removed.

Second unmanned test. - Because of the fluid leaks that caused so much trouble on the previous test, it was decided to verify the revised configuration for the next manned test by performing a thermal-vacuum unmanned test. During the test, several fluid lines leaked again in spite of improvements in their mechanical connectors, and the very thorough ambient-temperature pressure and leak checks that had been made in the interim. All other objectives, including a calibration of the ECS using a suit-loop stimuli generator, were met successfully.

Second manned test. - A major overhaul of the GSE fluid lines inside the chamber was accomplished before beginning the test. All mechanical connectors were replaced with welded connections. The flight-type disconnect fittings by which the oxygen and hydrogen fill and vent lines were connected to the spacecraft were reworked to minimize the possibility of leakage. As a result, this was the only test of the entire CSM series that was not jeopardized sporadically by massive leaks in these lines. Chamber pumpdown began on September 4, 1968, and operation during the thermal-vacuum test proceeded in a nominal manner, except for delays in starting the SM hot-soak phase that was scheduled immediately after pumpdown completion. Real-time requirements to evaluate the flow characteristics of the urine nozzle in a cold environment caused a hold between pumpdown and initiation of side-solar operations. To minimize impact to the overall test time line, the cabin depressurization and open-hatch EVA operation (fig. 41) were accomplished concurrently with the zero-g urine-nozzle evaluations. The original test time line was begun again on September 6, and all test phases were completed successfully in a nominal manner. The chamber vacuum was maintained at a level of approximately 2.5×10^{-6} torr throughout the test, except when the vacuum was interrupted intentionally because of specific test objectives.

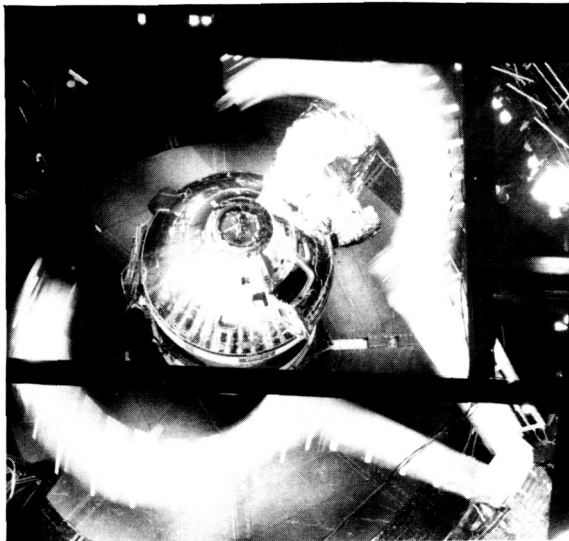

Figure 41. - Open-hatch operation.

an inoperative RIMS heater system and erratic RIMS bar movement instrumentation; and miscellaneous disturbances of the thermal environment that were caused by cryo-deposits, television lamps and floodlamps, and blistering of the CM thermal control coating and of the SM paint (fig. 42). The thermal-vacuum tests disclosed inadequate bay venting that required redesign of thermal blankets. Also as a result of the tests, passive-thermal-control attitudes were developed to prevent extreme temperature excursions during flight.

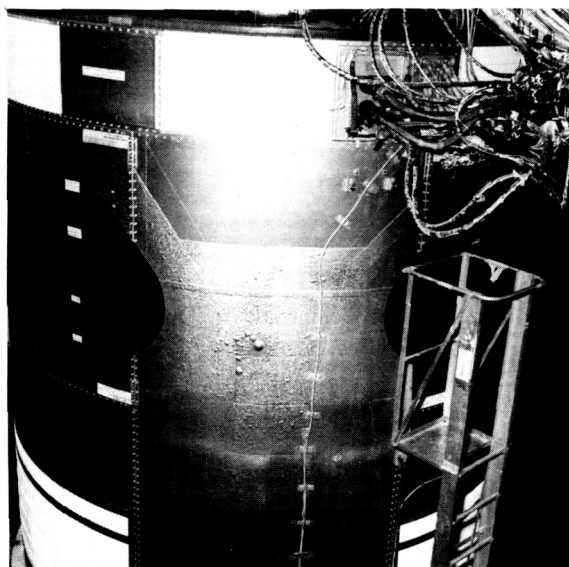

Figure 42.- Service module paint blistering.

Test results and anomalies. - The tests were satisfactory in achieving the integrated system and subsystem operating objectives; however, significant problems did develop in determining the thermal characteristics of the integrated vehicle. Test results and anomalies for each major system are discussed as follows.

Thermal control systems: Successful operation of the CSM integrated thermal control systems in extreme space environments was verified during the tests. Determination of thermal control systems thermal characteristics was hampered by several anomalies: a warmer lunar plane than was planned (indicated temperatures between -80° and -150° F); infrared and reflected solar flux and blockage of cold walls from chamber equipment; errors in determining intensity of the solar simulation because of

Crew equipment: The tests demonstrated the design adequacy of crew equipment of the Apollo Block II spacecraft to accomplish Earth-orbital and lunar missions. However, the tests also identified the need for redesign of the biomed cables and SIP because of failures, and the need for material changes in the constant-wear garment because of skin and eye irritation experienced by the crewmen. As a result of the 2TV-1 crew recommendations, numerous other changes were made in such items as food packaging and storage, water chlorination, and window-shade fit.

Environmental control system: In general, the test verified the operational capability of the Apollo Block II ECS under simulated-space-condition extremes with crewmen on board. However, the test indicated major problems in two areas: the radiator proportioning valve and the zero-g

urine-dump system. Sometimes the radiator proportioning valve had improper switches that were caused by inadequate mixing of fluid upstream of the temperature sensor. Hardware changes were not implemented because this was determined to be a system characteristic and could be controlled in flight with a switch operation. The zero-g urine-dump system repeatedly froze during dumps because of latent heat required for vaporization, probably aggravated by water collecting in a low spot in the line under the one-g environment. This problem was resolved before flight by the addition of a backup urine-dump outlet in the side hatch and a procedural change that provided large manual dumps of the waste-water tank instead of small automatic dumps. In addition to these major problems, two other significant problems were demonstrated that dictated redesign. Excessive water condensation was prevented on the CM flight configuration by increased insulation of cold lines. Test results also provided data on equipment response after loss of coolant and provided an evaluation of frozen radiators, which resulted in development of flight procedures for thawout and recovery of frozen radiators. Window fogging during the test was erroneously assumed to be caused by moisture condensation between the panes. After similar fogging occurred on the Apollo 7 and 8 flights, the windows on the test spacecraft were dismantled, and the fogging was identified correctly as consisting of silicone outgassing products. A change in the material and curing process minimized this problem on subsequent flights.

Communications: The operational integrity of communication systems under thermal-vacuum conditions was demonstrated; however, blackouts and background noise led to changes in ground network and vehicle communications network to prevent this problem on flight vehicles. The test also demonstrated satisfactory SM high-gain-antenna operation at extreme conditions contrary to qualification limits, and provided an evaluation of CM acoustic modifications under thermal-vacuum conditions.

Service module reaction control system: The test verified the redesigned SM RCS secondary-heater operation and its capability to maintain engine components above minimum redline temperatures in case of primary-heater failure. Several other factors were determined during the test: the temperature differential between the engine and the nozzle during the cold-soak and rolling phases; the temperature response of engine components to realistic simulation of rolling mode (1 revolution/hr and 2.5 revolutions/hr); and the SM RCS engine-component temperatures during a full solar hot soak. The test also provided verification that the engine package operational sensor gave a satisfactory reading for the package temperature. One shortcoming of the test was in the SM RCS area where Block I RCS tanks and components were used. The Block I RCS tank configuration was significantly different from the Block II configuration, and most of the test data in the SM RCS area could not be used to verify or improve the mathematical thermal models. The 2TV-1 test data were not considered to be adequate for verification of Block II RCS, so a separate panel was run in a different facility for this purpose.

Command module reaction control system: The thermal response of the CM RCS to extreme space-environment conditions was determined as was the heater-warmup response under varying initial conditions.

Guidance and navigation: The test demonstrated the performance of the guidance and navigation system in combined systems operation in a simulated space environment, including systems operation in normal and backup modes, operation with secondary ECS glycol loop only, and operation during a simulated coolant-loop failure.

Stabilization and control system and entry monitor system: Operation of the stabilization and control system (SCS) and the entry monitor system (EMS) in the normal and backup modes was demonstrated. There were no major problems in the SCS; however, the EMS failed to operate repeatedly in V mode. This failure prevented accurate null adjustment of the EMS, which affected the performance of subsequent EMS self-tests. Because this was a prototype unit with a known weakness, no corrective action was required.

Electrical power system: Vehicle procedures for one-fuel-cell operation were developed from test data; five- and eight-panel radiator performance was demonstrated satisfactorily over a wide range of loads and environments.

Service propulsion system: The primary test objective for the SPS (that is, performance of the SPS thermal control heaters under normal side-Sun conditions) was not met because of an unscheduled 19-hour cold soak and operation of the heaters at lower-than-design power because of line losses from the facility power supply. The unscheduled cold soak caused a large decline in all spacecraft temperatures; as a result, internal spacecraft temperatures did not approach normal values until near the end of the side-Sun operation. The secondary objective of obtaining thermal-response data to use in the evaluation of SPS heater capability was met satisfactorily. Since then, analysis has been indicative that the SPS heaters are adequate for all flight environments.

Command module hatches: The test demonstrated the operational capability of the Block II CM lightweight unified crew hatch under extreme hot and cold space environments. An evaluation was made of opening and operating procedures; the hatch performed satisfactorily during simulated launch conditions, one cycle in a simulated space environment, and during postlanding simulation. After the first test, the forward hatch was replaced with a single pressure/ablative configuration and was successfully tested thermally but not functionally.

Liquid oxygen dump system: The LO₂ dump system, a nonflight innovation provided specifically for this test, was designed to transfer the 640 pounds of LO₂ in the SM flight tanks to a GSE tank suspended below the floor of chamber A in 3 minutes or less. In an initial trial run at ambient chamber pressure using LN₂ instead of LO₂, this procedure required more than 30 minutes. An analysis of this operation, hampered by limited instrumentation, produced no conclusive reason for this slow transfer. During the first unmanned vacuum test, a demonstration LO₂ detanking resulted in depletion of tank 2 in 11 minutes and depletion of tank 1 in 21 minutes. Again, analysis of the data was inconclusive. Because the detank system was provided as a special ground-based safety device, this performance was reviewed by the TRRB and was judged satisfactory for proceeding with the manned test. Further analysis of the anomaly was not undertaken. Subsequently, a slow LO₂ detank on the Apollo 13 spacecraft at the launch site was experienced. During the postflight investigation of the Apollo 13 inflight tank explosion, the slow detank of spacecraft 2TV-1 was reviewed again, and one of the tanks was sectioned for examination. This examination disclosed that an adverse accumulation of manufacturing tolerances had occurred on the fill-line inverted-standpipe fitting in the tank, resulting in a leak path between the tank and the standpipe near the top of the tank. When pressure was applied through the tank vent line to force liquid up through

the fill-line standpipe, some of the pressurizing gas was leaked into the top of the standpipe, delaying the discharge of LO_2 . A similar condition was postulated to have existed on the Apollo 13 tank, which contributed to the series of events leading to the flight failure of that tank. This incident emphasizes the need to thoroughly investigate and completely explain all anomalies that occur during the test and that even remotely involve the spacecraft, whether they appear to be flight related or not.

Lunar Module Tests Supporting Earth-Orbital Flight

Operational summary. - Spacecraft LTA-8 (fig. 43) was delivered in late September 1967, configured to support tests that were restraining on the first manned Earth-orbital flight (LM-3, Apollo 9). Two major late changes to production-run lunar modules had not been incorporated on LTA-8 because of cost and schedule considerations. These major late changes were a modification of propellant fluid-distribution-system fittings and a change in electrical-system minimum wire size from 22 to 18 gage. After delivery, trouble with fluid-distribution-system leaks and wire breaks compounded general problems that arose from first-time field use of operational checkout procedures, and delayed the start of the first test until April 1968.

Five tests were conducted. The first was an unmanned test of 193 hours 32 minutes duration, which began on April 1, 1968. The test was designed to be a thermal-vacuum shakedown of all GSE and the spacecraft. During the test, the conformal skin heaters were operated and exercised to simulate various thermal conditions; the cabin was pressurized and depressurized; simulated propellant was detanked; and all other equipment that could be operated from outside the chamber was activated. Numerous deficiencies in the test setup were discovered, principally guard-heater failures or inadequacies and leaks in the fluid lines.

The second test was designed to man-rate the overall test setup. The test began on May 5, 1968, and continued for 84 hours 25 minutes, of which 13 hours were manned operation. Test activity revolved around demonstrating successful activation of all spacecraft systems with a 100-percent-oxygen cabin atmosphere. Special precautions were observed during the first manned systems activation in that the chamber was pumped to 5.8 psia, and inside observers (wearing aviation breathing masks) with fire extinguishers were stationed directly outside the spacecraft hatch during the operation. Every circuit breaker, switch, and knob was exercised during this phase of the test to make sure that no adverse effects would result. When this activity was completed successfully, the inside observers removed the safety equipment from the chamber and located themselves in the chamber manlock while the chamber shroud was cooled to simulated space heat-sink temperatures, and the chamber was pumped to hard vacuum. Again, all

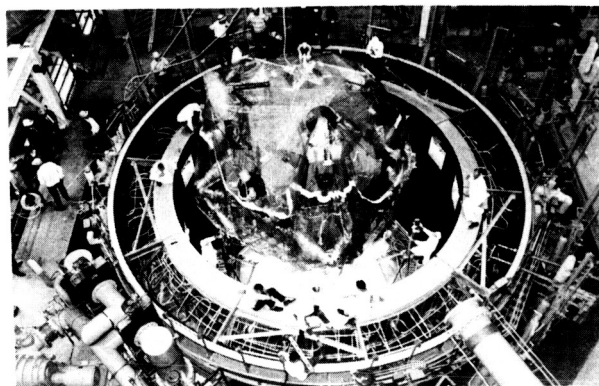

Figure 43. - Spacecraft LTA-8 being installed in chamber B.

circuit breakers, switches, and knobs were actuated successfully, and the crewmen egressed the chamber after it was repressurized to 5.8 psia.

The cold-case thermal-vacuum test was started on May 24, 1968, and continued for 288 hours. Two spacecraft mannings by the crewmen, lasting 10.5 and 12 hours, were conducted on May 27 and May 29, respectively. The first manning was devoted to cabin checkout and system operations, and the second manning was devoted to simulated CSM/LM separation, LM maneuvering, and docking operations. As in all of the LM and CSM manned testing, each manning was preceded by at least 3 hours of pure oxygen prebreathing by the crew, to assure denitrogenation (fig. 44).

At the conclusion of the cold-case test, the condition of the spacecraft appeared to be excellent; therefore, it was decided to dispense with the scheduled 11-day turnaround between that test and the planned hot-case test. Instead of warming the chamber and repressurizing, the chamber was maintained cold and the pressure was raised to 5.8 psia. Two crewmen replenished the spacecraft cabin consumables by entering the chambers in thermal-protective garments and aviation breathing masks with backpack oxygen supplies. The spacecraft was recycled thermally to initial test conditions by use of the conformal skin heaters, and the hot-case test was started on May 30, 1968. It had been estimated originally that approximately 3 days would be needed to warm the vehicle to the initial conditions for starting the second test; however, by maintaining the chamber pressure at approximately 1×10^{-2} torr instead of hard vacuum, convective heat transfer accelerated the spacecraft warmup so that initial conditions were established in approximately 12 hours.

The hot-case test lasted 118 hours and featured two mannings with operations similar to those of the cold-case test. The first manning by the two crewmen lasted for 9 hours on May 31 (fig. 45). As they egressed the spacecraft, a shear pin on the



Figure 44. - Crewmen prebreathing for manned LM test.

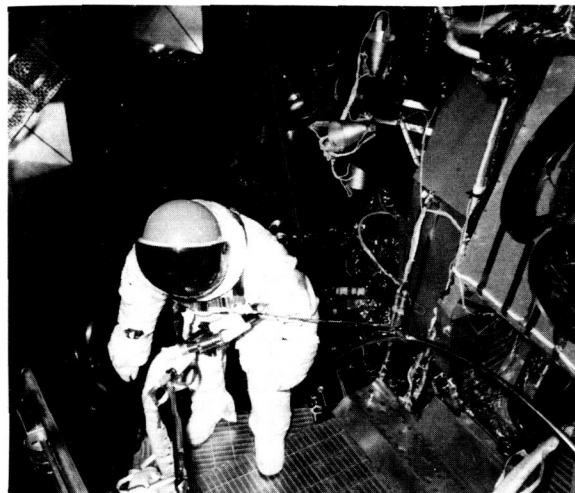

Figure 45. - Ingress for manned operations.

spacecraft side hatch was broken accidentally. The shear pin was repaired by two crewmen early in the second 14-hour manning on June 1, demonstrating the feasibility of making limited repairs in hard-vacuum conditions. An additional feature of this manning was the attempted activation of the PLSS in the LM cabin. This was not completed satisfactorily because of low PLSS battery voltage.

Because of the importance of the PLSS-activation demonstration, a special 21-hour test for that purpose was started on June 5 with two crewmen. During the 7 hours of manned operations, one crewman was attached to the PLSS; then, he secured the spacecraft ECS and accomplished some general cabin activity while supported by the PLSS. All objectives were accomplished successfully.

Test results and anomalies. - The results of these tests were considered to be satisfactory; 57 of the 62 certification-test requirements were satisfied outright, and the remaining requirements necessitated anomaly analysis for subsequent disposition. In general, the vehicle structural temperatures resulting from each test were well within allowable margins for the Earth-orbital mission. The vehicle life support system also worked well, and the heat transport system maintained equipment temperatures satisfactorily during all phases of operation. The significant anomalies that were encountered are as follows.

1. A water-sublimator breakthrough was experienced when the secondary water/glycol heat transport system was activated by puncturing the isolation valve between it and the water management system. It had not been recognized previously that glycol contamination of the sublimator water in this operational circumstance would be sufficient to cause breakthrough. As a result, an accumulator was added to all flight secondary water/glycol systems, and procedures were revised to maintain isolation.
2. The rendezvous radar gave improper range displays. The problem was traced to a solder crack in the rendezvous-radar electronics assembly.
3. No ground receiver backup was given when S-band signals were generated. The trouble was found to be in a diplexer, suspected to have been damaged by radio-frequency breakdown in the output isolator of the power amplifier.
4. The abort electronics assembly sustained memory loss because of high temperature. This loss resulted from use of the wrong mounting bolts for attaching the assembly to the cold rails.
5. The water-quantity-measuring device failed because of a cracked solder fillet between a pad and a terminal that was swaged improperly to the printed circuit board.
6. Pitch control of the S-band steerable antenna was lost because of a broken wire in the pitch slew synchronization transmitter. Excessive insulation had been stripped from the wire at its crimped connector, leaving it susceptible to damage.

Lunar Module Tests Supporting Lunar Flight

Operational summary. - There were several configuration differences between the LTA-8 spacecraft used for Earth-orbital flight-test support and the spacecraft

intended for use on lunar missions. The most significant change involved the venting scheme for the multilayer insulation that was used extensively through the spacecraft. The original scheme involved venting the spaces between the layers to various internal spacecraft bays, thence through an opening into space. Later, more detailed analysis showed that the vacuum conductance of this system was inadequate to lower the inter-layer pressure to a value that would result in the necessary insulation efficiency for the lunar mission. This deficiency was confirmed during the first Earth orbit tests of spacecraft LTA-8, which was configured with the original insulation scheme. The design of spacecraft to be used on lunar missions was revised to permit venting the insulation more directly to space. There were also significant changes to the cooling loops of the ECS (called the atmospheric revitalization system on the LM). Three choices existed regarding site selection for the modification of LTA-8 to incorporate the changes: (1) the spacecraft could be sent back to the factory, (2) the spacecraft could be removed from the chamber and modified at MSC, or (3) the spacecraft could remain in the chamber and be modified in place. Studies showed a large economic and schedule advantage for in-place modification because of the great number of cables and GSE fluid lines that would not have to be removed and reinstalled. The in-place method was adopted, even though the limited working space in the chamber meant foregoing some of the details of the modifications. These configuration differences were taken into account analytically in the subsequent tests. Other configuration changes from the previous test included upgrading the gas-sampling system, replacing the spacecraft batteries with less expensive thermal simulators, deactivating several unreliable spacecraft circuit breakers that would have been too costly to replace, and provisioning drinking water for crewmember use in the spacecraft because of possible biological contamination of the normal spacecraft supply.

Cold-case testing began on October 14, 1968. The 280-hour test mission simulated translunar flight, descent from lunar orbit, lunar landing, lunar stay, and ascent to lunar orbit. There were two mannings. The first, on October 18, was by two crewmen and lasted 9 hours. The second manning was 13.75 hours in duration and occurred on October 25 with two crewmen. During the simulated lunar stay, it became necessary to apply additional heat to the interstage area to avoid freezing of the interstage waterline (an unexpected event); however, there were no significant breakdowns of equipment, and time to refurbish the setup for the following hot-case test was minimized.

The countdown for the hot-case test was started on November 4; however, a 30-hour hold was necessary to troubleshoot and repair a problem in the facility communications and biomedical instrumentation system. Stable initial test conditions were established on November 7, and the test lasted 270 hours. The test time line included simulation of translunar flight, descent from lunar orbit, lunar stay, and ascent to lunar orbit. These events were followed by a second descent from lunar orbit, a second lunar subsolar stay, and another ascent to lunar orbit. The first and second mannings were on November 10 and 12, and lasted 14.75 and 13.75 hours, respectively. The third manning (fig. 46) on November 14 lasted 13 hours. The third manning involved operation of the ECS redundant loop during simulation of an ascent propulsion system burn to depletion, followed by a 5.5-hour soakback, making the hottest possible cabin conditions.

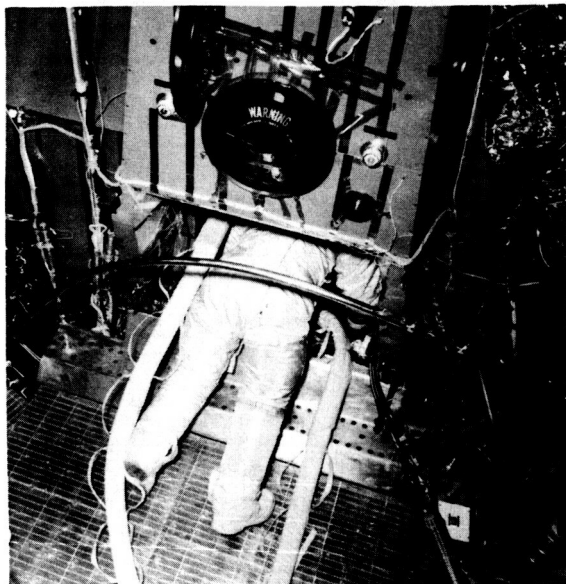

Figure 46. - Crew ingress through side hatch.

Test results and anomalies. - The successful conclusion of these tests marked the end of thermal-vacuum constraints to the lunar-landing mission. Although no requirement for integrated systems thermal-vacuum retest resulted, a number of anomalies that occurred during the test required considerable additional investigation and, sometimes, confirmation of the correction at the component or subsystem level. Some of the most significant anomalies are listed as follows.

1. During the hot-case mission simulation, the descent-engine throttle-valve actuator failed after a 580-second firing of the descent engine. The failure was caused by a shorting of capacitors in the amplifiers; the short was caused by high-temperature conditions.

2. During the cold-case simulation with the vehicle on the lunar terminator, the temperature of the waterline from as-

cent water tank 1 reached 39° F and was still dropping. The simulated Sun was raised to 15° above the horizon to prevent freezing.

3. The cabin-temperature-control valve failed to regulate properly because of degradation of an O-ring in the sensing element.

4. The cabin indication was not observed when the data storage electronics assembly was in the voice-operated mode in the first test. The assembly did not operate during the following test series.

5. The tracking light failed 25 minutes before it was scheduled to be turned off. The failure resulted from corona discharge from a potting void between a high voltage lead and the ground.

6. The S-band steerable antenna did not respond to yaw commands. After the test, it was determined that the antenna had been caught in GSE wiring; however, even after the antenna was freed it was still sluggish. It was found that the socket leads from a power transistor in a servoamplifier were not soldered to the printed circuit board.

7. The quantity measurement on ascent water tank 1 indicated a decrease with no water usage. Post-test examination showed the correct amount of water in the tank; the gaging error was caused by leakage of the nitrogen gas that was used to pressurize the tank.

8. The suit outlet pressure continued to decrease beyond the normal backup pressure after the cabin was depressurized. Leakage was determined to be 30 percent over the specification limit of 0.0006 lb/min. Subsequently, the leak was located between

the heat exchanger and the water separators; however, the anomaly emphasized the difficulty of quantitative leak checks on this system under ambient (nonvacuum) conditions.

9. During simulated firing of the RCS jets, no firing indication was obtained. Investigation revealed a need to modify the positive positioning of the attitude-controller assembly during manufacturing.

10. The glass cover over the display and keyboard in the cabin failed, resulting in a change to the manufacturing glass specification for flight spacecraft.

Summary of Corrective Actions

Table I is a numerical summary of corrective actions taken because of anomalous performance disclosed by the tests. Most of these changes were to the design of the spacecraft or to the operating procedures. The remainder, approximately 18 percent of the total, were changes to the manufacturing processes of the spacecraft components involved. Table II shows a numerical summary of specific performance investigations that contributed to mission planning by providing a more accurate definition of actual performance limits and constraints on systems operation.

In evaluating the results of these ground tests, the presumed advantages of lower costs, greater safety, and better corrective actions were intuitively confirmed by engineering judgment. However, no post-test attempt was made to assess the cost-effectiveness of trade-offs between flight tests and ground tests.

TABLE I. - NUMERICAL SUMMARY OF CORRECTIVE ACTIONS RESULTING FROM DEFICIENCIES DETECTED DURING THERMAL-VACUUM TESTS

Vehicle	Design	Procedure	Process
Block I CSM	10	8	5
Block II CSM	12	12	2
LM	5	5	4
Subtotal	27	25	11
Total	63		

TABLE II. - NUMERICAL SUMMARY OF CONTRIBUTIONS TO MISSION PLANNING
FROM PERFORMANCE EVALUATION OF THERMAL-VACUUM SPACECRAFT

Vehicle	Thermal-vacuum tests	Ambient tests
Block I CSM	20	7
Block II CSM	25	9
LM	11	6
Subtotal	56	22
Total	78	

CONCLUDING REMARKS

Manned testing of complete spacecraft in thermal-vacuum conditions was conducted with a wide range of objectives. Primary objectives included man-rating the spacecraft, overall demonstration of flight worthiness, investigation of performance in off-nominal and emergency modes of operation, determination of the effects of interaction between subsystems in the integrated configuration, and verification and fine tuning of mathematical thermal models. Among the secondary objectives were the verification of prelaunch ground checkout and flight crew operating procedures, and evaluation of crew-support items. Special safety provisions for test personnel were designed into the tests. When necessary, calculations or simulations or special test conditions were used where some unusually hazardous materials were concerned.

Overall management of the test program was exercised by the Apollo Spacecraft Program Office, with detailed and operational authority delegated to the test organization; this arrangement worked well. Major emphasis was placed on training the test-team members. Special reviews were held to assure safety of operations, and the readiness of facilities, spacecraft, and personnel to enter into test phases. Special attention was given to protection against fires and related hazards.

Test results for nominal subsystem operation showed spacecraft thermal deficiencies, pressure venting deficiencies, and subsystem performance problems that required design or procedural changes. Additional results from off-nominal subsystem operations provided data for later use in mission rules and real-time performance evaluation.

Overall, the test results provided verification that the spacecraft would be acceptable for manned space flight after necessary design and procedural changes were made. In evaluating the results of these ground tests, the presumed advantages of lower costs, greater safety, and better corrective actions were intuitively confirmed by engineering

judgment. However, no post-test attempt was made to assess the cost-effectiveness trade-offs between flight tests and ground tests. A summary report of the results of all facets of the tests would have been of value to highlight the performance, problems, and problem resolutions of this test program.

Lyndon B. Johnson Space Center
National Aeronautics and Space Administration
Houston, Texas, November 26, 1973
951-15-00-00-72