

"THE ALCOA RAM FASTENER - A REUSABLE BLIND RIVET"

by

W. J. Dewalt

N74 30950

N74 30956

Presented at the Symposium on Welding, Bonding  
and Fastening at Williamsburg, Virginia, on  
May 30 - June 1, 1972

Alcoa Research Laboratories  
Aluminum Company of America  
New Kensington, Pennsylvania  
July 26, 1972

711<

"THE ALCOA RAM FASTENER - A REUSABLE BLIND RIVET"

ABSTRACT

Results of tensile, shear, fatigue and accelerated weathering tests are presented for the Alcoa Ram Fastener, a reusable, single-unit blind rivet. The effects of variations in hole size, grip length and sheet thickness on strength properties of the fastener were determined. The test results show these fasteners to have strength characteristics suitable for light structural applications. Exposure to accelerated weathering did not impair their performance.

# "THE ALCOA RAM FASTENER - A REUSABLE BLIND RIVET"

## I. Introduction

The Alcoa Ram Fastener is a drive-pin or push-stem type of blind rivet consisting of a nylon plastic jacket and an aluminum alloy locking stem. One outstanding feature of this fastener is that, after being installed, it can be easily removed with simple tools. Another feature, which is unique, is that it can be used over and over again. The fastener, therefore, should be ideal for applications where frequent disassembly and reassembly of a unit are necessary, but where high structural strength is not a requirement.

This paper describes the Alcoa Ram Fastener and recommends installation procedures. It also provides engineering data to assist designers in the consideration and evaluation of this fastener. Results of tensile, shear and fatigue tests of joints are shown. Data are also presented on the effects of accelerated weathering tests on the performance of the fastener.

## II. Description of Fastener

Figure 1 shows the two components of the Alcoa Ram Fastener: The aluminum locking stem and the nylon jacket. The stem is made of aluminum alloy 2024-T4, a high-strength alloy commonly used for threaded fasteners. The jacket is made of Dupont Zytel 71G, a 33% glass reinforced nylon. Figure 1 shows the Alcoa Ram Fastener in both the "open" and

"installed" positions. It is supplied to the user with the stem and jacket assembled, in the open position. At this point it is a single-unit blind rivet; the stem and jacket cannot be separated without destroying one or the other. In the open position the fastener is either ready for installation or, after it has been installed, ready for removal from the workpiece.

Figure 1 shows several additional features of the Alcoa Ram Fastener. The contours of the split or expansion end of the jacket, and the bulb machined on the end of the stem, are designed to facilitate insertion into the hole. After the fastener is placed in a hole, it is driven by pushing the stem with either thumb pressure or a hammer. In this position the disc on the head of the stem is seated in a recess molded in the head of the jacket, and the slotted end of the jacket has been expanded to form the blind head. The purpose of the disc on the stem is to remove the fastener from its installed position. The groove molded into the head of the jacket provides access for a plier-like tool (or even a small screwdriver) to grasp the disc and pull the stem until the fastener is in the open position. The fastener can now be removed, intact and ready for reuse, since with a slight time delay the nylon jacket recovers its initial shape.

Current production of the Alcoa Ram Fastener is confined to two diameters, 3/16 and 1/4-in., and, for both sizes, lengths to accommodate grips ranging from 0.100 to

0.600 in., in increments of 0.050-in. As indicated in Fig. 1, it is recommended that a fastener made to accommodate a nominal grip thickness be used in joint thicknesses within  $\pm 0.025$  in. of the nominal value. For the tests described herein, fasteners designed for grip thicknesses considered as short (0.150 in.), medium (0.350 in.) and long (0.600 in.) were used.

The suggested or "recommended" hole diameters for the Alcoa Ram Fasteners are: 0.187 to 0.192 in. for the 3/16-in. size and 0.250 to 0.255 in. for the 1/4-in. size. The initial development work and evaluations indicated that best overall performance, from the standpoints of clamping action and strength, was obtained when these hole sizes were used. To show the effect of hole diameter on tensile and shear strength, tests were made with "oversize" holes, nominally 0.010-in. larger than the fastener nominal diameter. Actual diameters of the oversize holes were from 0.197 to 0.202 in. for the 3/16-in. size and 0.260 to 0.265 in. for the 1/4-in. size.

### III. Engineering Properties

Figure 2 illustrates some types of applications envisioned for the Alcoa Ram Fastener. Quite often there is a strength requirement attendant to such applications. The tests conducted at the Alcoa Research Laboratories were made to provide basic information that would be helpful to an engineer or designer.

The results of tests to determine the tensile load carrying capacity of 3/16 and 1/4-in. diameter Alcoa Ram Fasteners are summarized in Figs. 3, 4 and 5. At least five tests were made for each test condition plotted in these figures. In all of the tensile tests failure occurred in the nylon jacket, not in the aluminum stem. Two kinds of failures occurred. In some cases the expanded, slotted end of the nylon jacket was sheared off by the test fixture. In other cases the failure was at the juncture of the head and the body of the jacket.

The results plotted in Fig. 3 are for tensile tests made using recommended hole diameters. The average tensile breaking loads for the 3/16 and 1/4-in. diameter Alcoa Ram Fasteners were about 100 lb and 180 lb, respectively. For both diameters the fasteners with the shortest (0.150 in.) grip length gave the lowest tensile breaking loads. Included in the results shown in Fig. 4 are tests of fasteners that were reused fifty times before testing. No difference was observed in the strength of these fasteners and of those used only once.

Figures 4 and 5 compare the tensile strengths of fasteners tested with recommended and oversize holes. For both sizes the use of oversize holes tended to decrease tensile strength. The average loss, however, was much greater for the 3/16-in. size than for the 1/4-in. size, 43 lb or 43 per cent versus only 15 lb or 8 per cent, respectively.

Results of the shear tests made of Alcoa Ram Fasteners using steel fixtures are summarized in Figs. 6, 7, 8 and 9. Not less than five tests were made for each condition shown in these figures. All failures were by shearing of the nylon jacket. When this occurred, the compressive clamping action was released and the joined members spread apart. There were no shear failures of the aluminum stem.

The shear strength results shown in Figs. 6 and 7 were obtained using steel test fixtures prepared with recommended hole diameters. Average single-shear values obtained at the three grip lengths ranged from 185 lb to 370 lb for the 3/16-in. size and from 265 lb to 560 lb for the 1/4-in. size fastener. The wide variance in single-shear strengths for both sizes is the result of having to use different thicknesses of plate for the different fastener grip lengths. Figure 7 shows that the effect was not nearly so drastic in tests where the fastener was in double shear.

The data plotted in Figs. 9 and 10 show that over-size holes also tend to reduce shear strength of Alcoa Ram Fasteners. On the average, the loss from the shear strength values obtained using recommended hole sizes for both fastener diameters was about 10 per cent for the 0.150-in. grip length fasteners and about 20 per cent for the 0.600-in. grip length fasteners.

Fatigue strength data were obtained using single-lap specimens joined with 3/16-in. diameter Alcoa Ram Fasteners. The

specimens were made of 0.080-in. thick aluminum alloy 3003-H14 sheet and employed the recommended hole size. The fasteners were designed to accommodate a nominal 0.150-in. grip thickness. The test setup and joint dimensions are shown in Figs. 10 and 11. Fatigue tests were made of ten specimens, two of which were subjected to 500 hours of continuous salt spray prior to testing. The tests were made in a 5 kip Krouse fatigue testing machine. In these tests, a specimen was considered to have failed, even though still intact, when it could not maintain the initial test load because of wear of the nylon jacket. The results plotted in Fig. 11 show that the specimens loaded to half the static failure load gave fatigue lives on the order of 5 million cycles. This compares favorably with data obtained at Alcoa Research Laboratories for other types of fasteners under similar conditions of test. It should be noted that the exposure to salt spray prior to testing had no adverse effect on fatigue strength.

Both accelerated and long-time corrosion test programs are being employed to determine the effects of "weathering" on the performance of Alcoa Ram Fasteners. For the accelerated tests, two kinds of exposures were used. One was a Weather-O-Meter and the other a Salt Spray Test. For the long-time tests, exposures will be outdoors for several years at two locations: New Kensington, Pa. (industrial atmosphere) and Point Judith, R. I. (seacoast atmosphere).



The Weather-O-Meter test consists of ten two-hour exposure cycles per 24-hour period. In each cycle the specimens are exposed to ultraviolet light for the two-hour period, with a de-ionized water spray during the last 18 minutes. The test temperature is a constant 145°F. In this test individual fasteners (in both the open and installed positions) and fasteners installed in lap joints of aluminum alloy 3003-H14 sheet were exposed for total periods of 100 and 500 hours. After exposure for up to 500 hours, the individual fasteners were installed and removed 50 times without any indication of failure. Only a slight whitening of the black nylon plastic indicated some mild surface degradation, but this had no adverse effect on performance.

The salt spray test consists of a continuous spray of 5 per cent NaCl solution at 95°F for 500 or 1000 hours. In this test the fasteners were installed in lap joints of either aluminum alloy 3003-H14 or painted steel sheet. Examination of specimens after 500 and 1000 hours exposure revealed only mild corrosive attack on the 2024-T4 locking stems inside the nylon sleeves, which were unaffected. As mentioned previously, 500 hours exposure time had no adverse effect on the fatigue strength of lap joints made with alloy 3003-H14 sheet.

#### IV. Summary

The information in this paper shows that the Alcoa Ram Fastener has strength characteristics suitable for

light structural applications. The tensile and shear strength values given should serve as a guide to the designer for his particular strength requirements. Optimum strengths, as would be expected, are obtained when hole clearance is kept to a minimum and the ratio of the fastener diameter to the least thickness of sheet being joined is about 1. Excellent resistance to loosening by vibration was demonstrated by the long fatigue lives obtained in the lap joints tested at a maximum load equal to half the static strength. The accelerated corrosion test results confirmed the re-usability feature, even after exposure to rather severe environments.

720<

# ALCOA RAM FASTENER ASSEMBLY

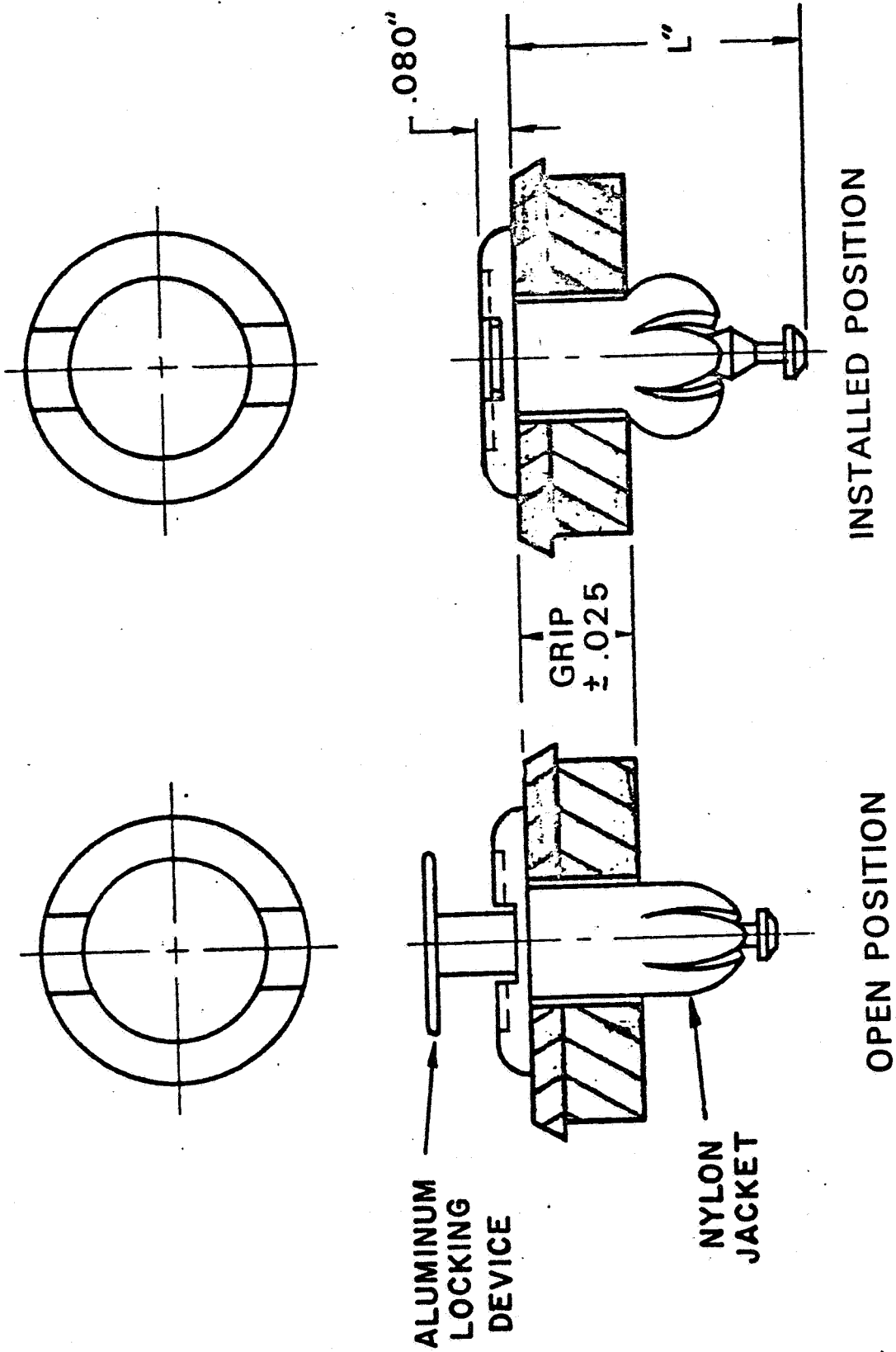

721

Fig. 1

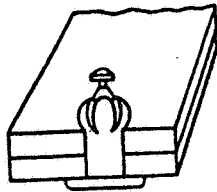

**Ram Fasteners in sheet applications**  
Jacket expands beyond metal, grips by compression.

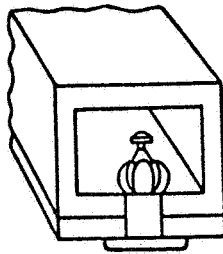

**Ram Fasteners in blind applications**  
Installs easily from one side.

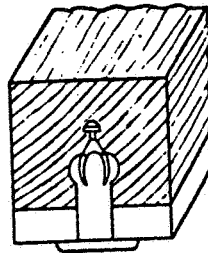

**Ram Fasteners in wood, plastics and composites**  
Special design permits fastening in these materials.

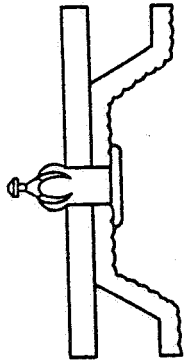

**Fragile or delicate materials**  
Reduces danger of distortion or fracturing of material.

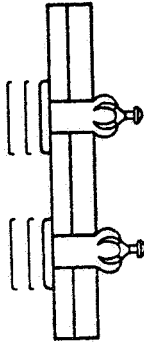

**Shake-proof**

Holds securely under vibration.

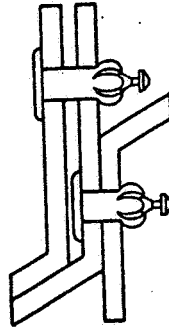

**Flexible in assembly**

Ram Fasteners offer a solution in complicated designs.

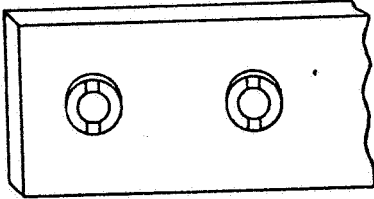

**No blemished surfaces**

Ease of installation eliminates tool damage to finished surfaces.

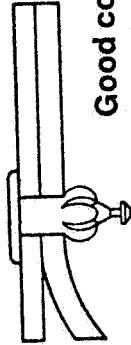

**Good compression**

Alcoa Ram Fasteners will connect materials without distorting even the thinnest materials.

722<

# SOME TYPICAL APPLICATIONS FOR THE ALCOA RAM FASTENER

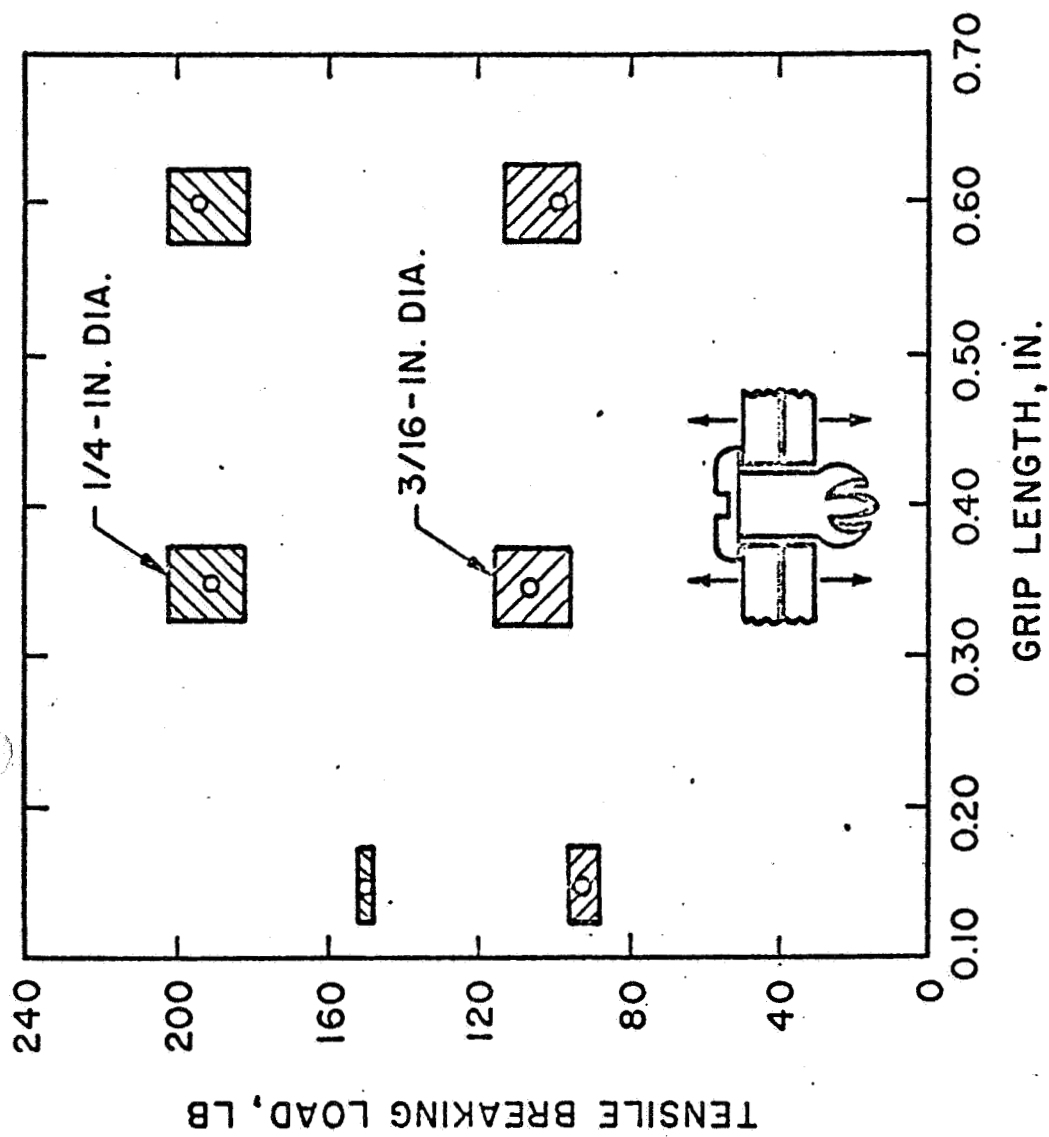

TENSILE STRENGTH OF ALCOA RAM FASTENERS

723<

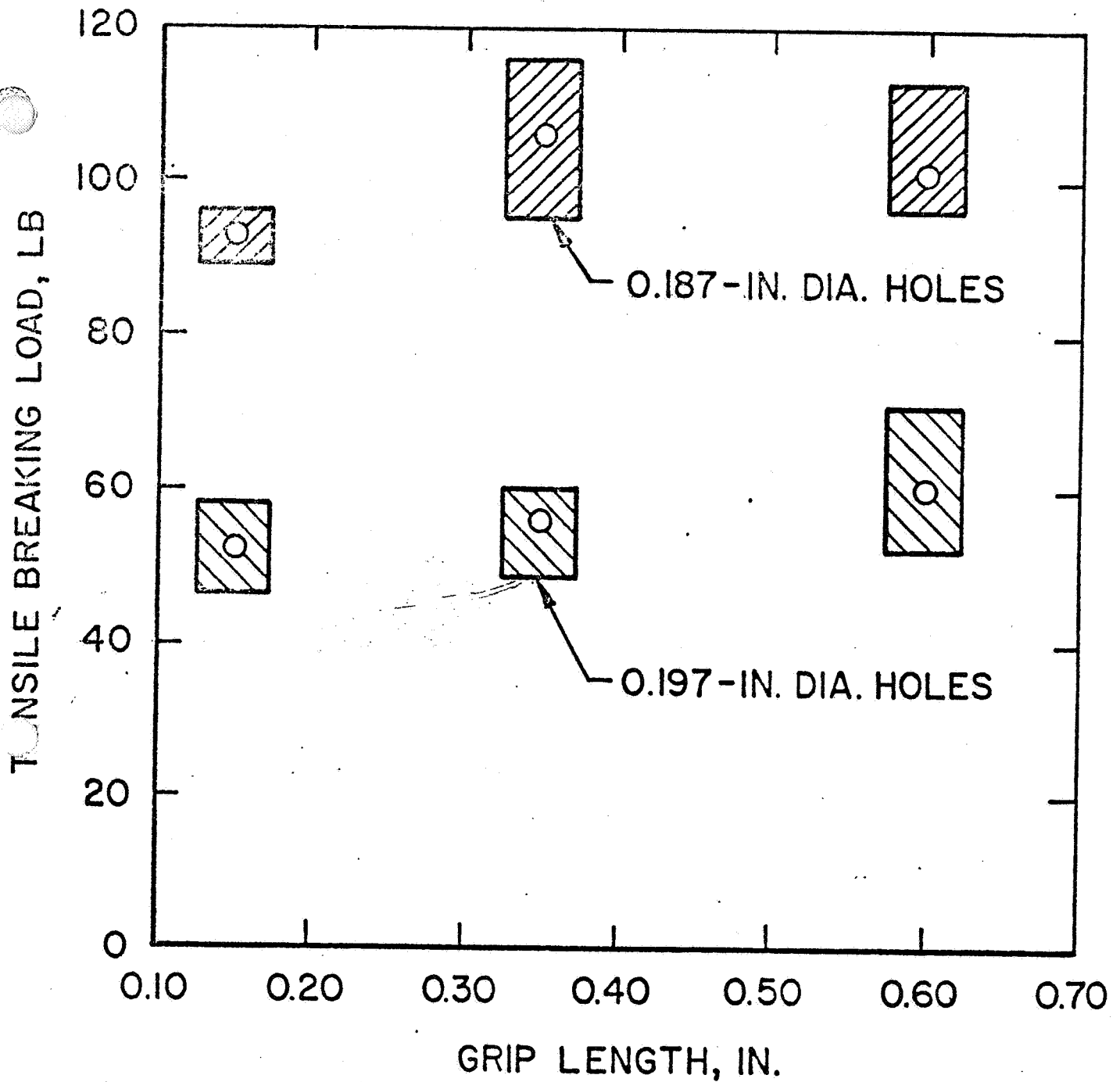

EFFECT OF HOLE SIZE ON TENSILE STRENGTH OF  
3/16-IN. DIAMETER ALCOA RAM FASTENERS

724<

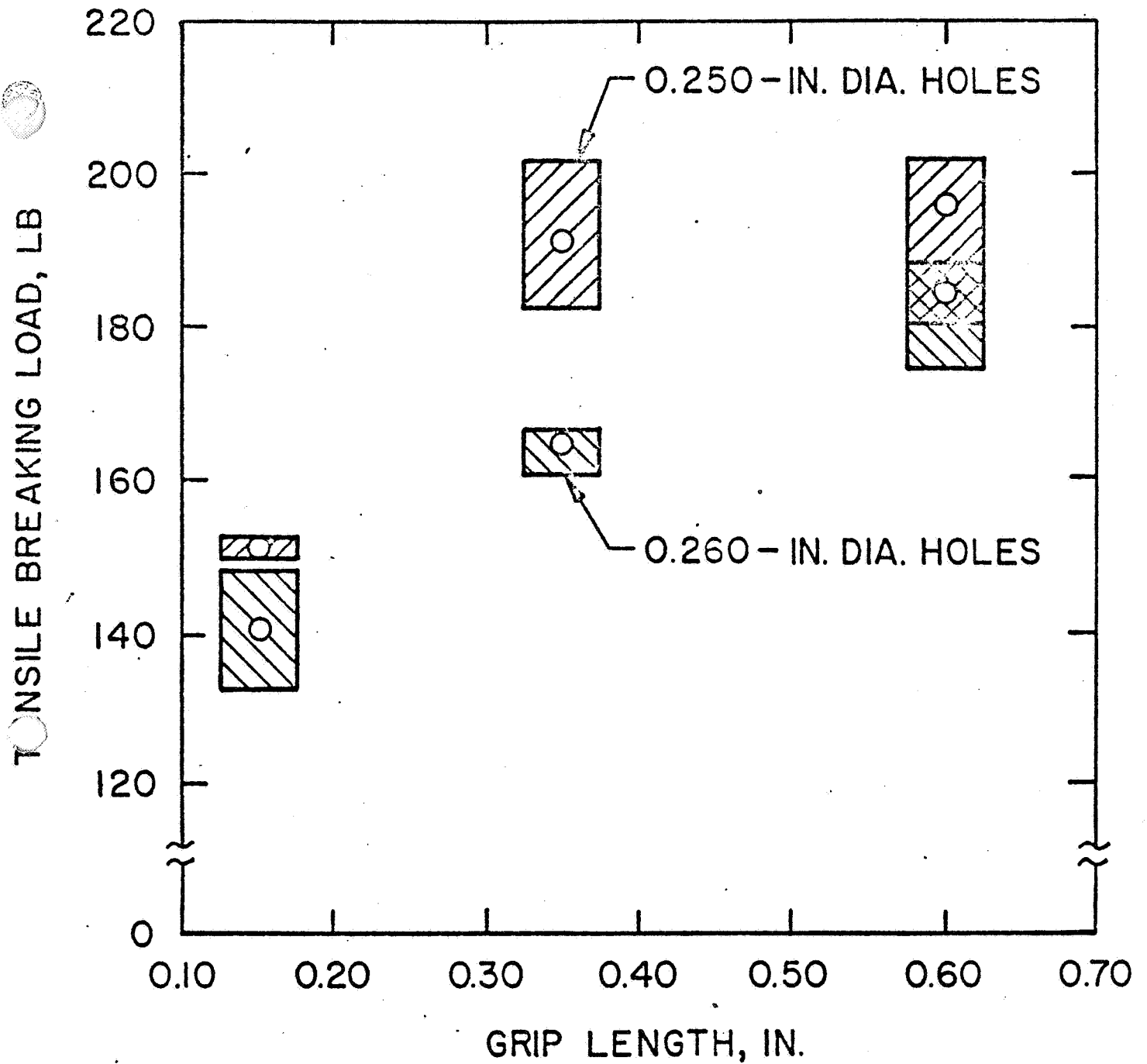

EFFECT OF HOLE SIZE ON TENSILE STRENGTH OF  
1/4 -IN. DIAMETER ALCOA RAM FASTENERS

725<

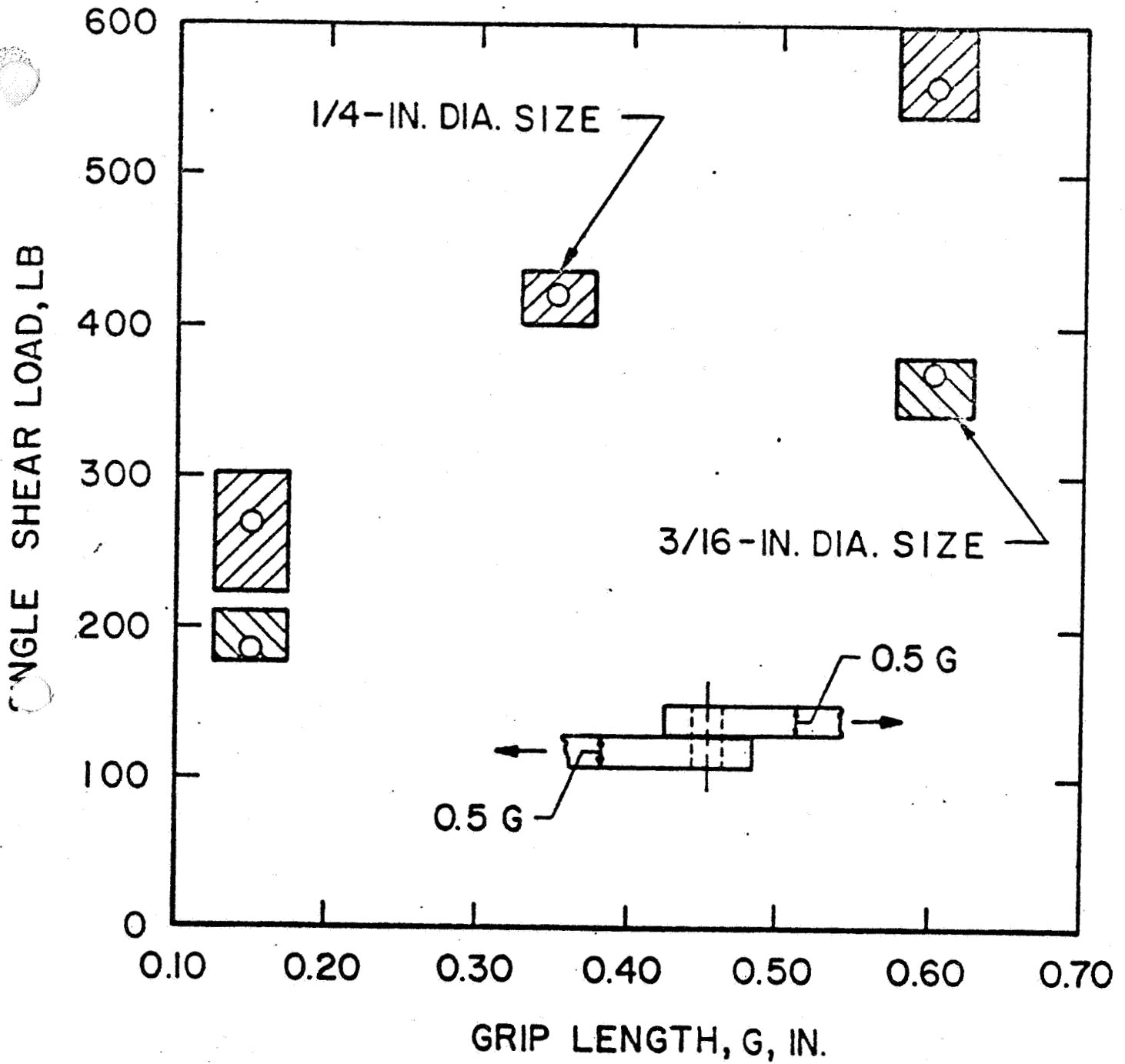

SINGLE - SHEAR STRENGTH OF ALCOA RAM FASTENERS

726<



727<

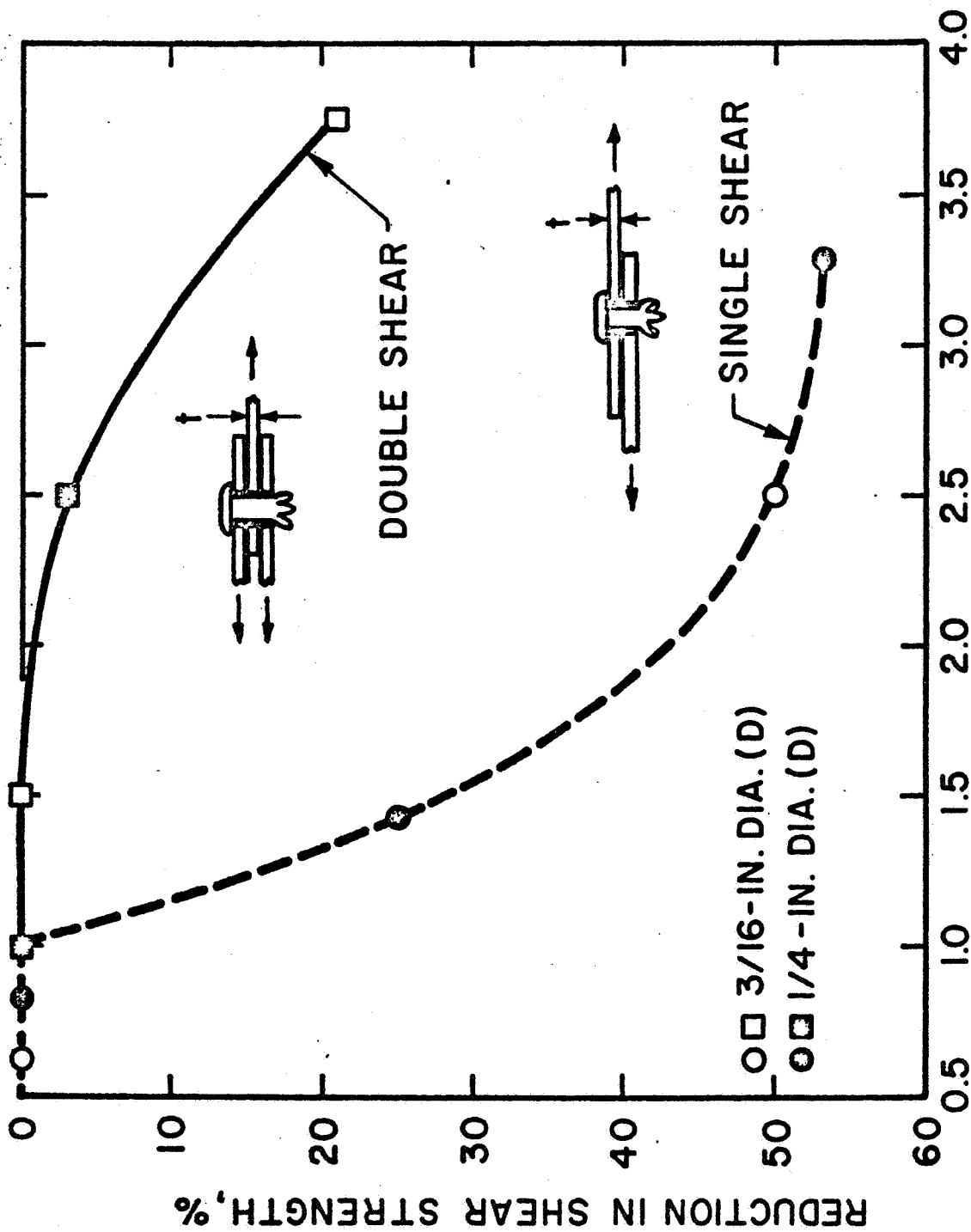

RATIO OF FASTENER DIAMETER TO SHEET THICKNESS, D/t

DOUBLE SHEAR

SINGLE SHEAR

○ 3/16-IN. DIA. (D)  
● 1/4-IN. DIA. (D)

EFFECT OF SHEET THICKNESS ON SHEAR STRENGTH OF ALCOA RAM FASTENERS.

Fig. 7

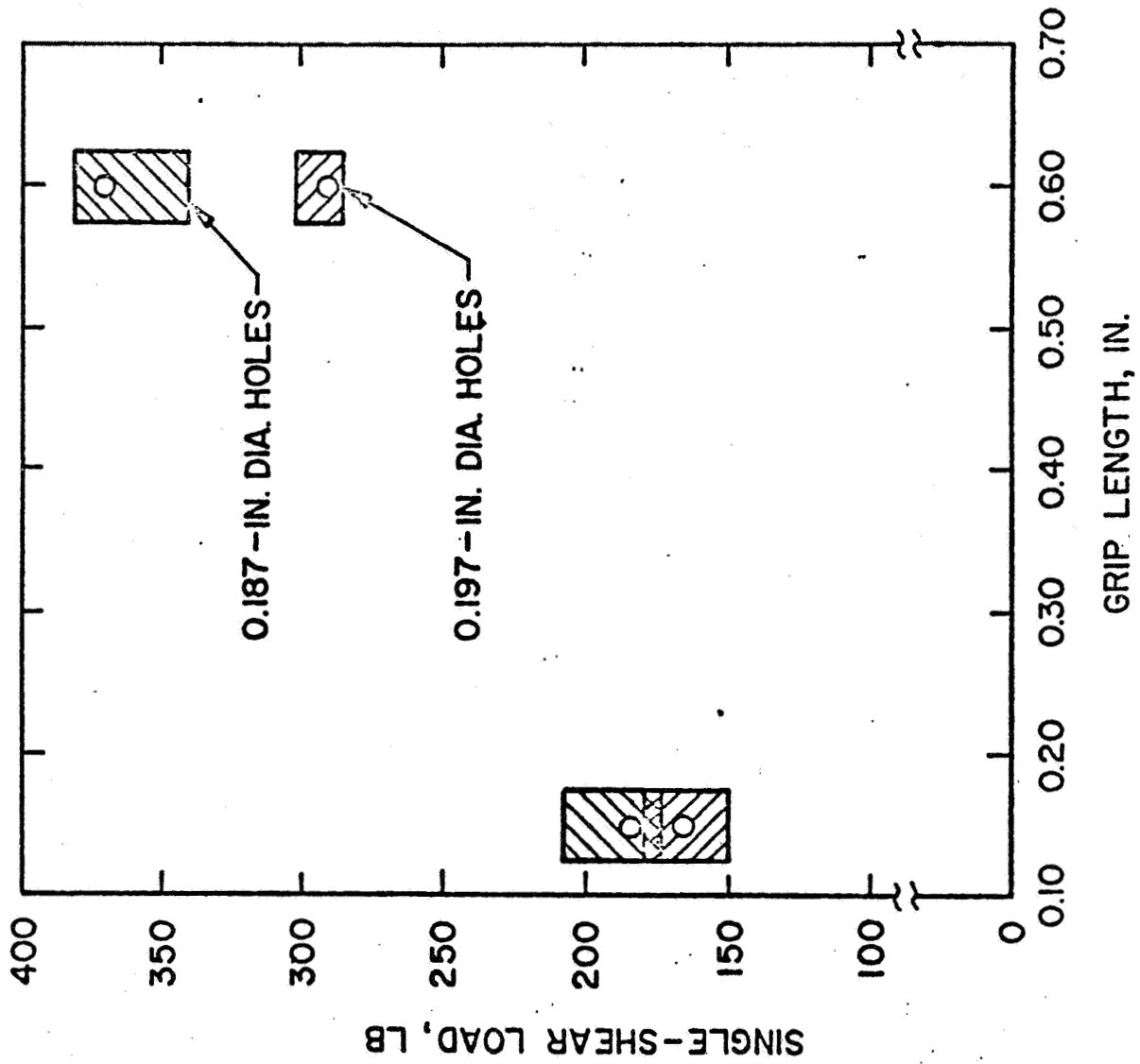

EFFECT OF HOLE SIZE ON SHEAR STRENGTH OF  
3/16-IN. DIAMETER ALCOA RAM FASTENERS

728<

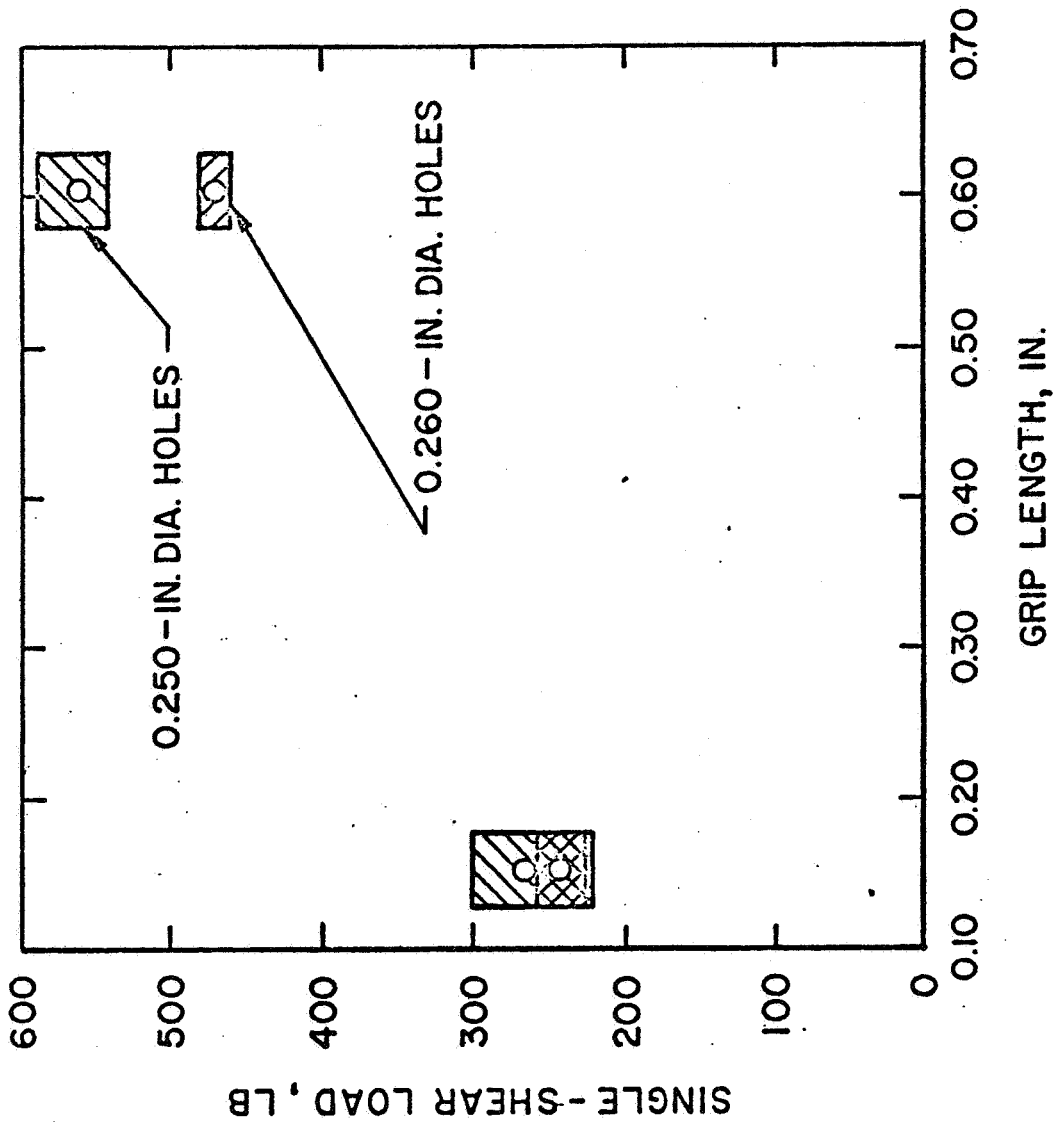

EFFECT OF HOLE SIZE ON SINGLE-SHEAR STRENGTH OF  
 1/4-IN. DIAMETER ALCOA RAM FASTENERS

729<

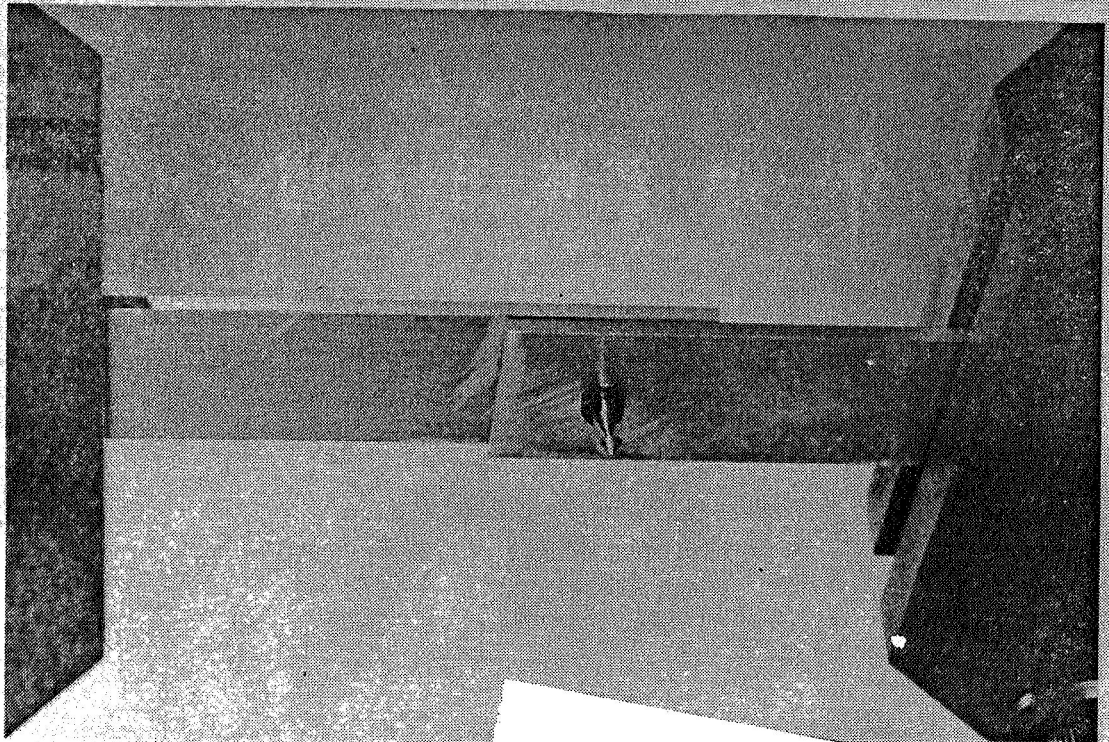
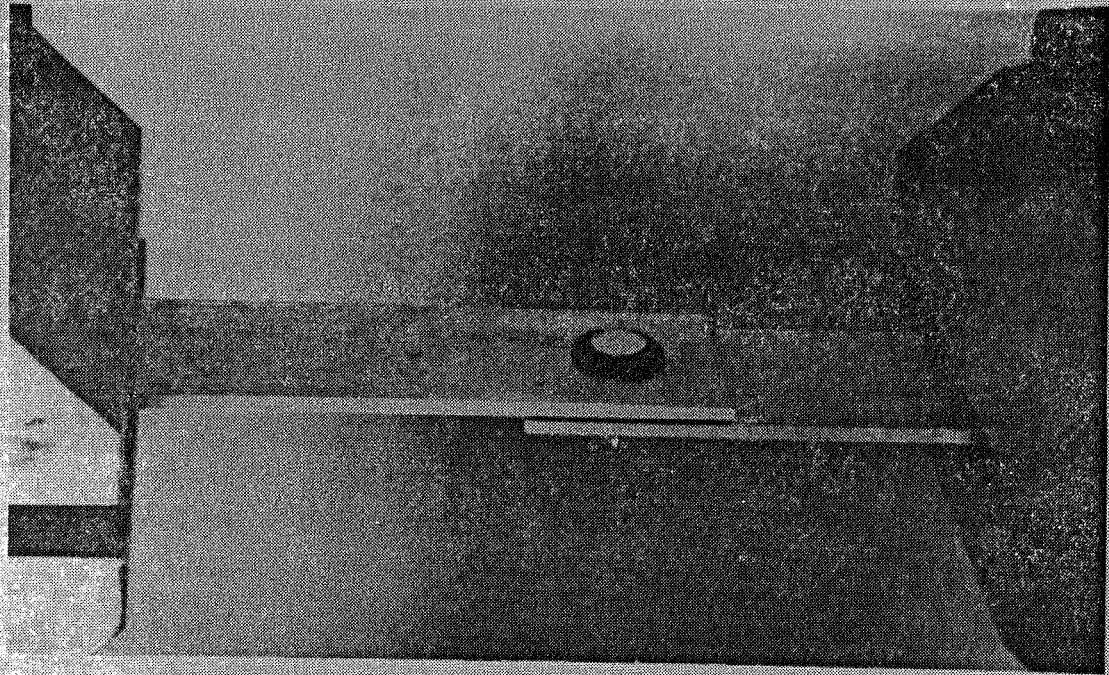

FATIGUE TEST SPECIMENS

Fig. 19

730<

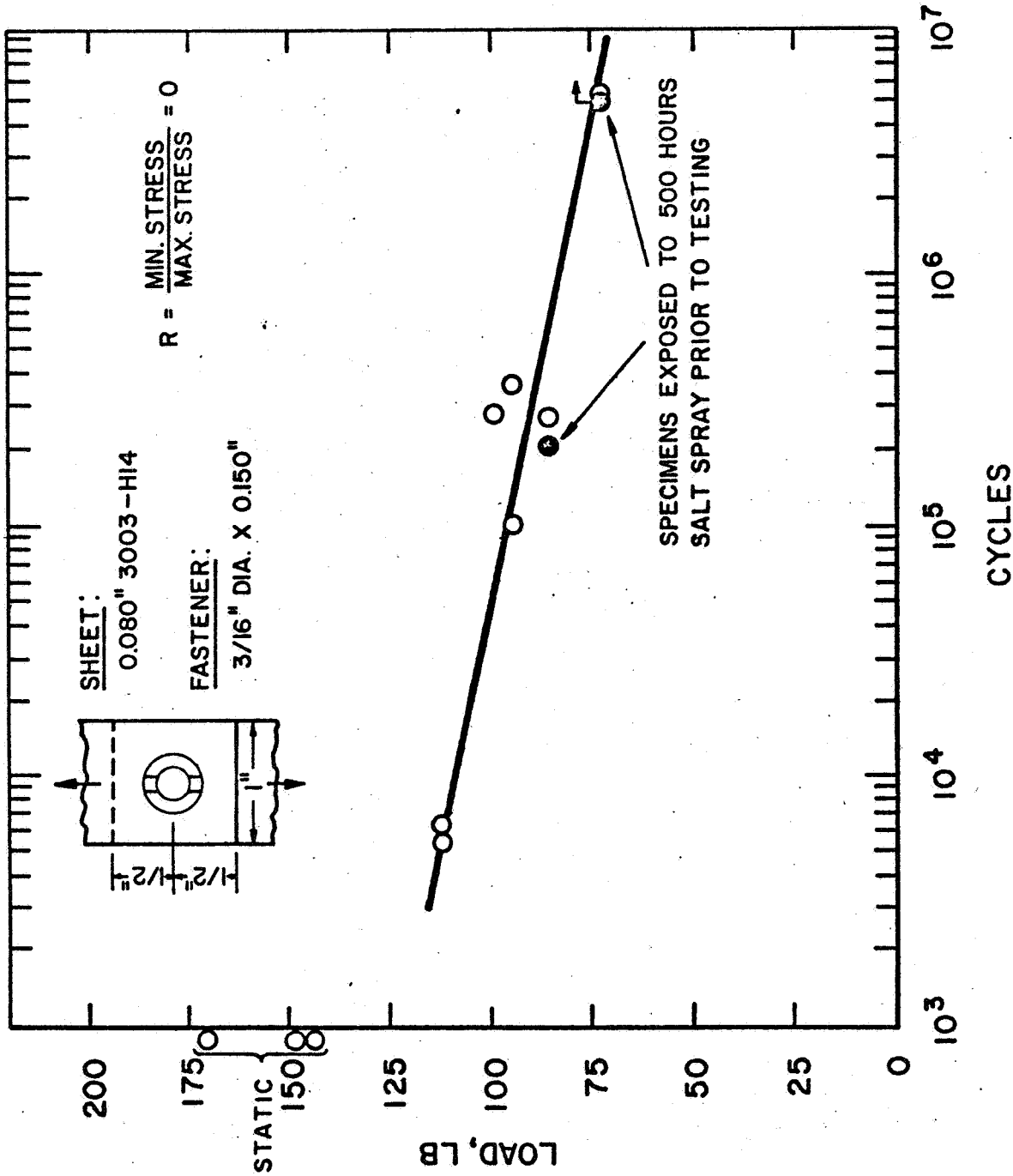

731

FATIGUE TESTS OF LAP JOINTS CONTAINING ALCOA RAM FASTENERS