

# WAVE CLIMATE MODEL OF THE MID-ATLANTIC SHELF AND SHORELINE (VIRGINIAN SEA)

## Model Development, Shelf Geomorphology, and Preliminary Results

Goldsmith

Morris

Byrne

Whitlock

NATIONAL AERONAUTICS AND SPACE ADMINISTRATION



VIRGINIA INSTITUTE OF MARINE SCIENCE

(NASA-SP-358) WAVE CLIMATE MODEL OF THE  
MID-ATLANTIC SHELF AND SHORELINE (VIRGINIAN  
SEA): MODEL DEVELOPMENT, SHELF  
GEOMORPHOLOGY, AND PRELIMINARY RESULTS  
(NASA) 153 n HC \$6.25

N75-23072

Unclas

21106

CSCI ORC H1/48

WAVE CLIMATE MODEL OF THE  
MID-ATLANTIC SHELF AND SHORELINE  
(VIRGINIAN SEA)

Model Development,  
Shelf Geomorphology,  
and Preliminary Results

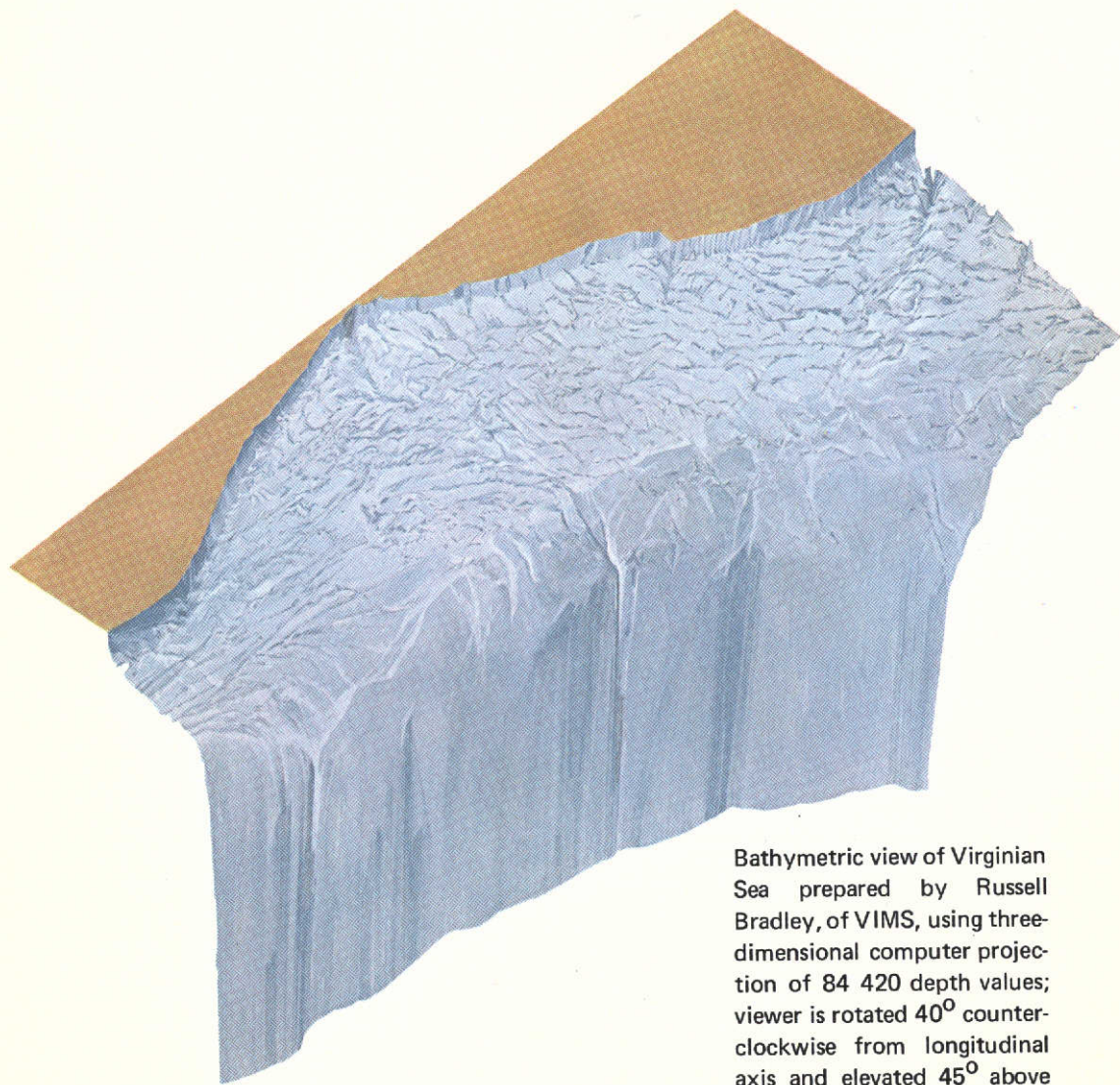

Bathymetric view of Virginian Sea prepared by Russell Bradley, of VIMS, using three-dimensional computer projection of 84 420 depth values; viewer is rotated  $40^{\circ}$  counterclockwise from longitudinal axis and elevated  $45^{\circ}$  above surface; vertical exaggeration is 600 to 1.

# WAVE CLIMATE MODEL OF THE MID-ATLANTIC SHELF AND SHORELINE (VIRGINIAN SEA)

## Model Development, Shelf Geomorphology, and Preliminary Results

Victor Goldsmith, *Virginia Institute of Marine Science*  
W. Douglas Morris, *NASA Langley Research Center*  
Robert J. Byrne, *Virginia Institute of Marine Science*  
Charles H. Whitlock, *NASA Langley Research Center*



*Scientific and Technical Information Office* 1974  
NATIONAL AERONAUTICS AND SPACE ADMINISTRATION  
Washington, D.C.

## PREFACE

A description is presented of the development and preliminary results of the Wave Climate Model of the Mid-Atlantic Continental Shelf and Shoreline (Virginian Sea), a joint effort of the Virginia Institute of Marine Science (VIMS) and the Langley Research Center (LaRC). A review of the shelf geomorphology is also presented, since the most important influence on the wave climate of this shelf is the interaction between the ocean waves and the various shelf relief elements.

This Wave Climate Model resulted from extensive modifications made by Victor Goldsmith and Joseph M. Colonell of a wave refraction program developed by Dobson (Stanford Univ. Tech. Rep. No. 80). The resulting analytical model was adapted to the Control Data 6000 computer systems at the Langley Research Center by Vincent R. Roland and James R. Schiess. The map projection constructed at the Clark University Cartography Laboratory is described by Norman T. Carpenter in appendix A. The 84 420 depths on this grid were accumulated through the efforts of Carolyn H. Sutton and Gaynor Williams. Joseph M. Colonell of the University of Massachusetts, George Grant and Maynard M. Nichols of VIMS, and Theodore A. Talay and Andrew R. Wineman of LaRC reviewed the manuscript.

This research was supported by Sea Grant Project No. 5-72 to VIMS from the Office of Sea Grant Programs, National Oceanic and Atmospheric Administration, Department of Commerce, under Public Law 89-688, and the Commonwealth of Virginia.

~~MISSING~~ PAGE BLANK NOT REPRODUCED

## CONTENTS

PREFACE . . . . .	v
INTRODUCTION . . . . .	1
SYMBOLS . . . . .	5
ANALYTICAL MODEL . . . . .	6
Development History . . . . .	6
Theoretical Review . . . . .	6
Wave refraction diagrams . . . . .	8
Validity and limitations . . . . .	9
Map Projection . . . . .	13
Theoretical development . . . . .	13
Virginian Sea map projection . . . . .	13
Data Input . . . . .	14
Depths . . . . .	14
Wave conditions . . . . .	20
Data Output . . . . .	26
Special Computer Requirements . . . . .	27
SHELF GEOMORPHOLOGY - A REVIEW . . . . .	28
Large-Scale Morphogeometry . . . . .	30
Terraces . . . . .	30
Subaqueous stream drainage . . . . .	31
Virginia Beach Massif . . . . .	33
Small-Scale Shelf Relief Elements . . . . .	33
Linear ridges . . . . .	33
Arcuate shoals . . . . .	34
STUDY RESULTS . . . . .	34
Variations in Wave Behavior With Different Combinations of Input Parameters . . . . .	34
Ocean-Wave—Continental-Shelf Interaction . . . . .	35
Shelf-edge canyons . . . . .	35
Shelf valleys . . . . .	36
Ridge and swale bathymetry . . . . .	36
Shoals, banks, and massifs . . . . .	37
Shoreline Wave Energy Distribution . . . . .	37
Shore-connected linear ridges . . . . .	37
Inlets and wave energy concentrations . . . . .	38
Prediction of Shoreline Changes . . . . .	39
Tidal Effects . . . . .	41

APPLICATIONS . . . . .	41
Advanced Coastal Wave Forecasting . . . . .	42
Improved Environmental Quality . . . . .	43
Data Supply for Government, Industry, and Other Scientific Disciplines . . . . .	44
CONCLUDING REMARKS . . . . .	45
APPENDIX A - SUMMARY OF MAP PROJECTION CONSTRUCTION . . . . .	46
APPENDIX B - WAVE REFRACTION DIAGRAMS . . . . .	48
REFERENCES . . . . .	119
BIBLIOGRAPHY . . . . .	133

## INTRODUCTION

As man has increased his usage of the continental shelves of the world, the need to understand those physical processes affecting his planning and operations has grown concomitantly. For example, as population pressures have increased shoreline recreational demands, the need for design criteria information for shoreline defenses has grown. As the need for offshore power plants or port facilities has grown, so has grown the need for that environmental information required for site selection and design. In both of the cited examples and others, one of the most urgently needed information elements is that of surface wave behavior on the continental shelf and fringing coastline.

In most engineering activities on the coastline and shelf, the designer needs to know the temporal and spatial variations in wave energy so that he may select a site or design a structure. Experience has shown that the acquisition of sufficiently verified statistical information on waves in the open ocean is an enormously expensive and technically difficult undertaking. Even if adequate wave information is available for the deep-ocean regions, it is necessary to manipulate this information so that the transformations which waves experience in transit over the shelf are accounted for. Recent and future theoretical advances in our understanding of wave generation, coupled with advances in remote sensing technology, foster the expectation that adequate deep-sea wave information will, in the near future, be routinely observed. The purpose of this report is to supply a detailed description of the development of a methodology to investigate the expected behavior of waves as they pass over the continental shelf and the resulting wave energy distribution along the coastline. This Virginia Institute of Marine Science (VIMS)-Langley Research Center (LaRC) Wave Climate Model supplies the interfacing function whereby shelf and shoreline wave behavior may be calculated for any specified ocean wave input.

The model applies linear wave theory and shelf depth information so that a first-order approximation of the varying wave path and other parametric changes is obtained. Because of the advent of high-speed digital computers such models have become increasingly common within the last few years (refs. 1 to 21). Basically all these models move shoreward a single wave ray at a time across a grid of depths. Wave behavior is determined for a number of rays for each specific wave condition (i.e., wave period, height, direction, and tide). In fact, Bascom (ref. 22, p. 11) has correctly observed, ". . . the theoreticians have become so bold as a result of the success of their complicated equations that there is danger the study of waves will fall entirely into the hands of men who have never seen the sea." An attempt is being made to avoid this failing (discussed by Bascom) in the present studies through comparisons of the results of the Wave Climate



Model with vertical aerial photographs of the complex sea surface (e.g., Saco Bay, Maine), wide application of the data to real-life problems, and adaptation of this model to future developments in space technology (e.g., linking the Wave Climate Model to an Earth satellite storm warning system).

The Virginian Sea Wave Climate Model differs from previous models in the following important elements:

(1) The model covers a very large geographic area of the continental shelf and shoreline, Cape Henlopen, Del., to Cape Hatteras, N.C., an area of 20 000 square n. mi. within a single large grid.<sup>1</sup> The importance of this approach is that the resulting graphical display allows the investigator to visually integrate patterns of wave behavior which would escape detection when smaller areas are used; as a result, regional differences in behavior within the grid stand out. More detailed studies can then be made on a finer-mesh grid in specific subareas by using the wave information from the large grid as input to the smaller grid.

(2) Distortions due to flat representations of the spherical Earth and problems resulting from the fact that waves travel great circle paths were overcome by constructing a Transverse Mercator map projection tangent to the Earth along the center of the grid.

(3) An improved understanding of wave behavior in the area of crossed wave rays is now available from the theoretical studies of Chao (ref. 13) and Pierson (ref. 23). These studies have been applied to the interpretation of such wave phenomena as curved caustics (which occur over continental shelf ridge and swale bathymetry) and straight caustics (which occur directly over the margins of the deeply incised channels off the mouths of the Delaware and Chesapeake Bays).

The depth grid used utilized an input of 84 420 depths with a unit cell of 0.5 n. mi. on a side. The specified wave input conditions considered nine initial directions for six different wave frequencies, two wave heights, and two tidal conditions (for three approach directions). In all, 122 separate wave conditions were used with 19 different wave parameters computed as output for the whole shelf and adjacent shoreline.

These wave data, which encompass waves propagated shoreward from deep water using a 0.5 n. mi. depth grid, are being used (not reported herein) as input to four smaller grids in order to illustrate the usefulness of these data to specific problems.

---

<sup>1</sup>All shoreline and shelf geographic locations mentioned in the text are shown on the bathymetric map in figure 1.

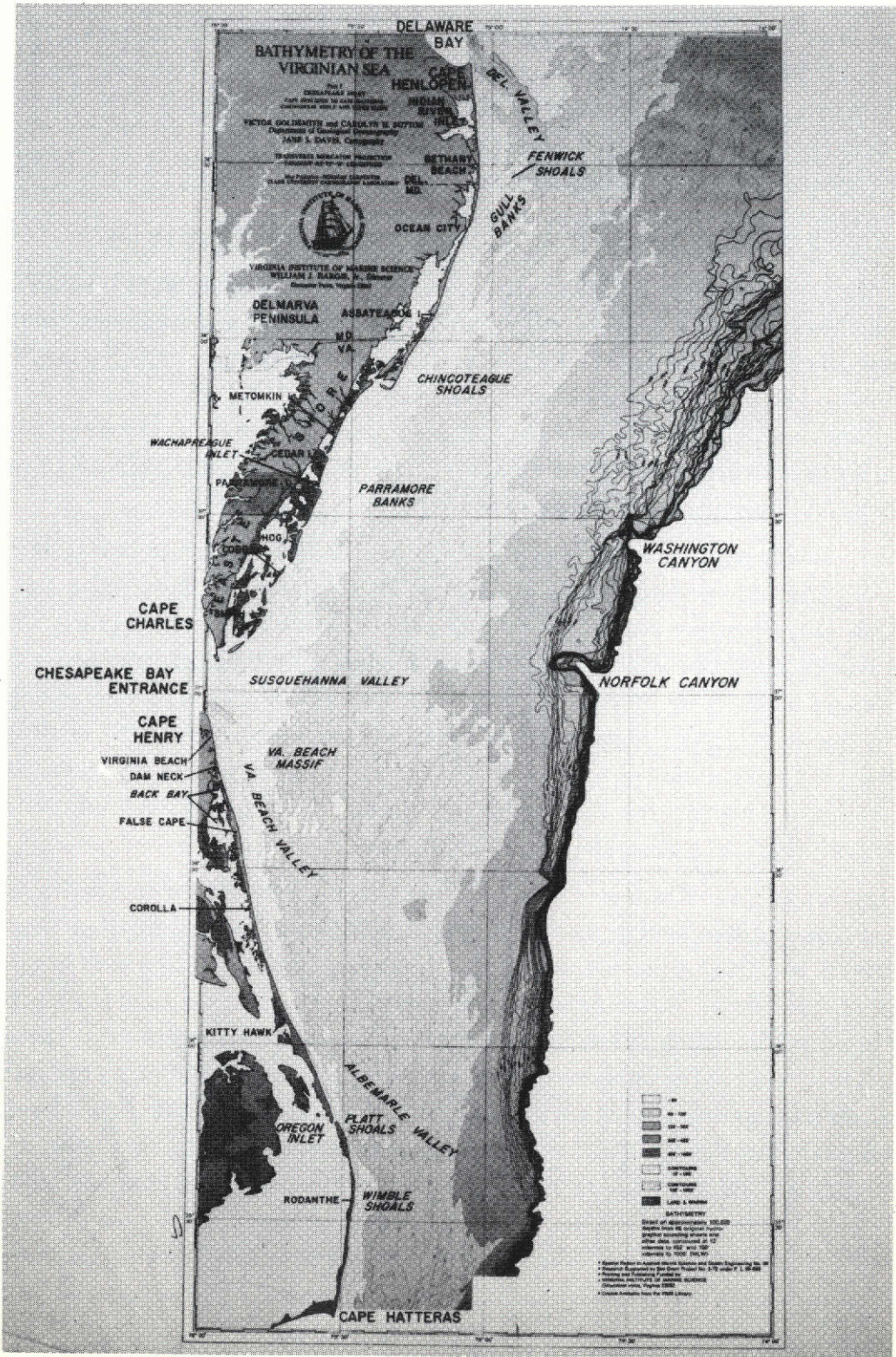

ORIGINAL PAGE IS  
OF POOR QUALITY

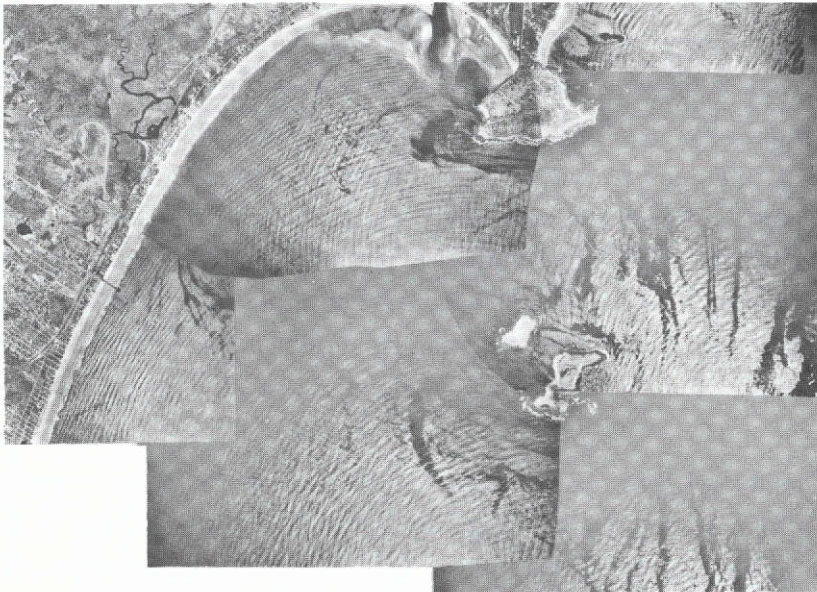

SACO BAY AZ =  $135^{\circ}$  T = 8.0 sec HT = 0.3 m (1 ft) TIDE = 0.0

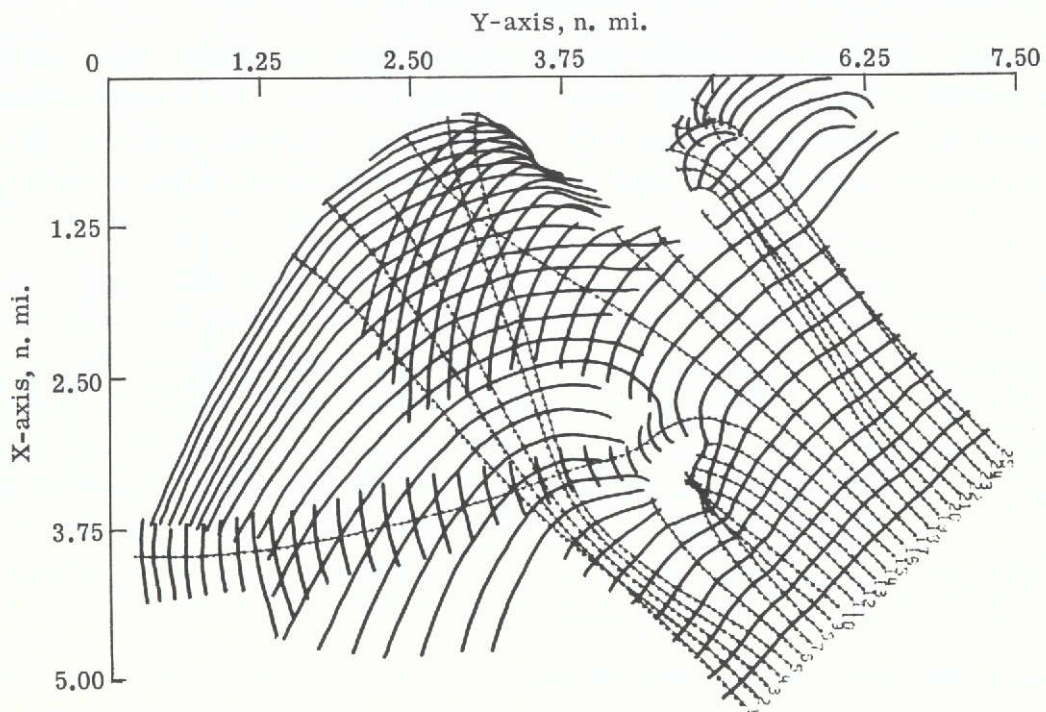

Figure 2.- Comparison of vertical aerial photograph of Saco Bay, Maine, and wave refraction diagram computed for T = 8.0 sec and AZ =  $135^{\circ}$ . (From ref. 12.)

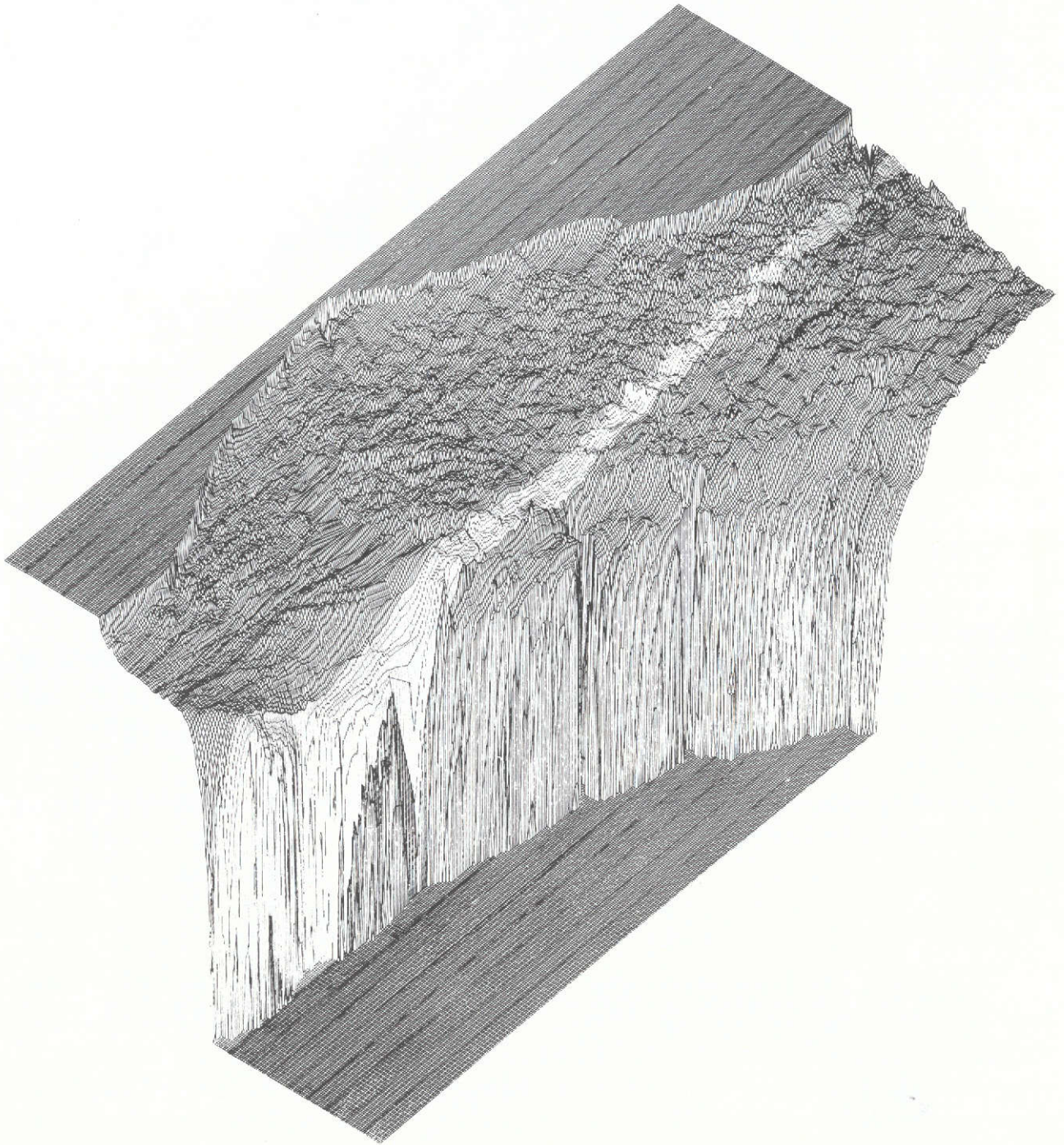
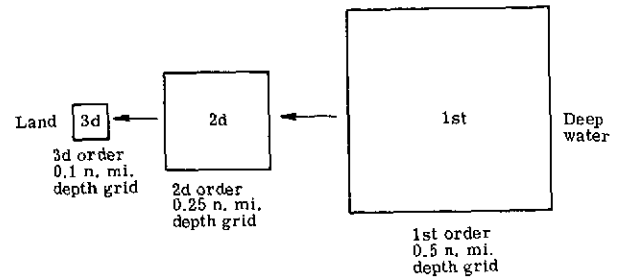

Figure 9.- Three-dimensional computer projection of depth data.  
(Used in preparation of frontispiece.)

These grids, consisting of three "second order" and one "third order," are described schematically in sketch (a). Output from the first-order grid is used as input to the second-order grid, and so on, the result being an increasing density of depths as the waves approach shallower depths.



Sketch (a)

The three second-order grids are located in the vicinity of Wachapreague Inlet (1852 and 1934 bathymetry) on the Eastern Shore of Virginia and adjacent to the area from Cape Henry, Va., to the Virginia-North Carolina state line. A third-order grid encompasses 6 n. mi. of shoreline along the resort area of Virginia Beach, Va. This method allows sufficient detail of wave behavior along relatively short stretches of coastline without overburdening the computer with the voluminous depth input information required to propagate the waves shoreward from deep water.

Still another application of this Wave Climate Model conducted during the present study is to delineate the importance of shifting wave patterns on the growth and development of the largely offset coastal inlets along the Eastern Shore of Virginia. Two identically sized second-order depth grids have been made up for the area adjacent to Wachapreague Inlet. One of these grids contains depths acquired in the 1852 offshore survey of the area. The companion grid contains depths acquired in the most recent survey (1934). The question then raised (to be discussed later) is, did the wave climate in 1852, derived by inputting the 1852 bathymetric data, drive the barrier island-inlet system towards its greatly changed present configuration (ref. 25).

This report presents a description of the VIMS-LaRC Virginian Sea Wave Climate Model, a review of the geomorphology of the Mid-Atlantic Continental Shelf, the wave computations resulting from 122 wave input conditions, and a preliminary analysis of these voluminous data. After detailed analyses of these data, the information will be applied to problems which are either currently pressing or soon will be. The computed wave information is being summarized by contouring the shelf and shoreline for important computed parameters such as wave height, wave energy, bottom orbital velocity, shoreline power gradient, and other parameters for important and commonly occurring wave conditions. Shelf areas of "confused seas" are being highlighted and shoreline areas of wave energy noted. Thus, several techniques and methods will probably be developed and evaluated for using the voluminous output from the Wave Climate Model in order to increase its usefulness to managers of continental shelf and shoreline resources.

## SYMBOLS

AZ	azimuth, deg
$b, \beta$	distance between adjacent wave rays
C	wave celerity
d	water depth
g	acceleration due to gravity
H	wave height
$K_r$	coefficient of refraction
$K_s$	coefficient of shoaling
k	wave number, $2\pi/L$
L	wave length
T	wave period
$\alpha$	angle between successive wave-front positions (or ray orientations) and respective adjacent bottom contours
MLW	mean low water
SSMO	summary of synoptic meteorological observation
UTM	Universal Transverse Mercator
Subscript:	
o	initial

## ANALYTICAL MODEL

### Development History

Early adaptations of computerized techniques to the study of waves refracting over nonbreaking regions were made by Mehr (ref. 26) and Griswold (ref. 27). Harrison and Wilson (ref. 28) expanded Griswold's work into a computer program which produced a wave orthogonal trace based upon a grid of wave speed in a study of the area off Virginia Beach, Va. Such a grid of wave speeds is awkward because it requires a new grid to be computed in the area of interest for each wave period, as well as for each wave direction. Also, computations of wave intensities are difficult from a grid of wave speeds. Wilson (ref. 2) used a grid of depths which fitted a linear surface computed from four adjacent depths to calculate the path of the wave orthogonal. Again wave heights were not calculated. Roberts (ref. 29) and Keulegan and Harrison (ref. 9) applied refraction techniques to the study of tsunamis in order to explain the intense concentrated destruction from a tsunami at Crescent City, Calif.

Dobson (ref. 4) fitted a quadratic surface to a grid of 12 adjacent depths to calculate wave heights. A refraction program based on Dobson's program was adapted to the CDC 3600 computer and associated CalComp plotter at the University of Massachusetts (refs. 7 and 30). These studies showed a strong correlation between the calculated ocean wave refraction patterns, observed wave patterns, and short-term shoreline erosion measured in the field over a 3-year interval (ref. 31). The spatial variation in shoreline wave energy patterns was determined from wave orthogonal spacing along the shoreline and wave height variations for important wave approach directions. However, because the effects of bottom friction were not included in the wave intensity calculations, the calculated wave heights were found to be reasonable in some cases but too large in others. This aspect was improved by adopting routines developed by Coleman and Wright (ref. 11) based upon equations for calculating bottom friction developed by Putnam and modified by Bretschneider and Reid (refs. 32 and 33). This resulting program, with some additional improvements, has been adapted to the Control Data (CDC) 6000 computer systems at the Langley Research Center and associated software.

### Theoretical Review

Wave theory applied to wave refraction and its limitations has been succinctly summarized by Colonell, Farrell, and Goldsmith (ref. 18), from which this section has been largely drawn.

The process by which waves are slowed, shortened, and steepened as they travel into progressively shallower water is called shoaling. Typically, shoaling does not occur uniformly along a wave front so that, as the wave celerity decreases in accordance with

its shorter wave length, the wave front bends as a result of the variations in celerity along the front. This combination of shoaling and wave-front bending is called refraction and, for purposes of analysis, is regarded as analogous to its optical counterpart in the refraction of light rays. With the assumption of small wave steepness (amplitude/wave length), linear water wave theory (ref. 34) provides the following expression for the celerity of a progressive sinusoidal wave traveling through water:

$$C^2 = \frac{gL}{2\pi} \tanh \frac{2\pi d}{L} \quad (1)$$

Rearrangement of equation (1), with  $C = L/T$ , gives the following familiar expression for wave length:

$$L = \frac{gT^2}{2\pi} \tanh \frac{2\pi d}{L} \quad (2)$$

Because the hyperbolic tangent tends toward unity for large arguments (i.e., "deep" water), it is apparent that for sufficiently large depths the wave length (and consequently, wave celerity) is a function only of the wave period. It is easy to show that deep water can be assumed with a maximum computational error of less than 0.4 percent when the depth exceeds only one-half wave length. For all conditions except those along the top boundaries of the study area, the one-half wave-length criteria would have been sufficient. However, because of the shallow shelf in this boundary region, deep water was assumed to be greater than one-fourth wave length; thereby, the initial maximum possible computation error was increased to 8 percent.

The effects of shoaling and refraction can be estimated by linear wave theory. For example, the propagation of surface waves into shallow water is analyzed by consideration of the wave energy between two vertical planes which are orthogonal to the wave crests and which intersect with the surface to produce wave rays. Energy is assumed not to be transmitted along the wave crest; thus, it is not transmitted across wave rays. If it is also assumed that the wave period is constant and that there is no loss or gain of energy from reflection, percolation, or bottom friction, then linear wave theory provides the well-known result,

$$\frac{H}{H_0} = K_R K_S \quad (3)$$

The coefficients of refraction and shoaling are given by

$$K_R = \left( \frac{b_0}{b} \right)^{1/2} \quad (4)$$



and

$$K_s = \left( \frac{2 \cosh^2 kd}{2kd + \sinh 2kd} \right)^{1/2} \quad (5)$$

In this report, the effects of bottom friction are incorporated in H. Koh and Le Méhauté (ref. 35) have calculated the transformation of progressive waves from deep water to shore using first-, third-, and fifth-order theory, with results differing by only 5 percent.

Wave refraction diagrams. - As a surface wave travels into shallower water the bottom exerts an ever greater influence on it, because of the effect of depth in the determination of wave celerity (eq. (1)). For example, at a depth equal to one-eighth wave length, the wave is slowed down to 65.6 percent of its deep-water velocity. When the crests of a train of waves are not parallel to the bottom contours (lines of constant depth), the forward portions of the wave crest decrease in speed in such a way that the crests tend to become alined with the bottom contours. (See sketch (b).) Wave refraction diagrams are used to determine the way in which a wave of given period will respond to the bottom topography.

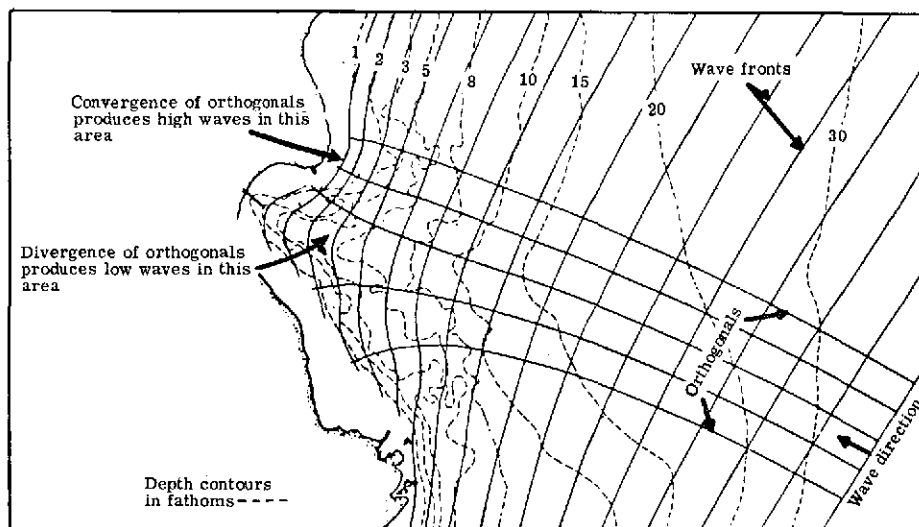

Sketch (b)

The primary objective in wave refraction analysis is to compute the shoaling and refraction coefficients (eqs. (4) and (5)) and thus to determine the variation of wave heights (eq. (3)) in shoaling water and to deduce therefrom the specific kinematic or dynamic property of the waves that is required for any given application. For example, wave particle velocities and accelerations are required for wave force computations, whereas variations in wave energy along the shoreline are utilized for sediment transport

and coastal process investigations. In most cases, such deductions of wave properties are made by utilizing the results of linear wave theory.

According to Wiegel (ref. 36, p. 155), the procedures for the preparation of wave refraction diagrams have existed at least since 1937. A good example of such an early effort is reference 37. The diagrams are constructed in either of two ways:

(1) Wave-front method: This method is essentially a map of the successive positions of a wave front at given time intervals as it moves shoreward. To determine wave height variations along the fronts, it is necessary to construct wave rays (or orthogonals) which are everywhere perpendicular to the wave fronts.

(2) Wave-ray (orthogonal) method: This method is a technique which allows the wave rays to be drawn directly, without benefit of the wave fronts, by determination of the trajectories of selected points on a wave front.

Both methods are based on the premise that the water wave refraction phenomenon is analogous to optical refraction to the extent that Snell's law is applicable; consequently, it is assumed that

$$\frac{\sin \alpha_2}{\sin \alpha_1} = \frac{C_2}{C_1} \tag{6}$$

where  $\alpha_1$  and  $\alpha_2$  are the angles between successive wave-front positions (or ray orientations) and the respective adjacent bottom contours, and wave celerities (function of depth and wave period) for these positions are denoted by  $C_1$  and  $C_2$ . Preparation of a wave refraction diagram by either method is basically a step-by-step application of equations (1), (2), and (6) to a wave of prescribed period and initial deep water direction over a specified bottom topography. Waves are terminated as they reach the shoreline, that is, when the wave height reaches a value of 0.78 water depth.

The advent of modern digital computational facilities has made manual construction of wave refraction diagrams virtually obsolete. Although the wave-front method is the usual technique for manual construction, the wave-ray method is generally regarded as more amenable to the automated preparation made possible by the digital computer. Wave refraction diagrams for the investigations reported herein were computed by means of a program based on the Stanford University wave refraction program (ref. 4), which was adapted for use on the CDC 6400 and 6600 computer systems and the associated CalComp plotter at the Langley Research Center. This program utilizes the wave-ray method and requires as input information a grid of bathymetric data for the area of interest as well as definitive wave characteristics such as height, period, and initial direction.

Validity and limitations.- Although there is reasonable confidence in the general validity of wave refraction analysis procedures just briefly described, it should be empha-

sized that the underlying theory has bounds to its validity which are exceeded in most routine wave refraction computations. As noted previously, linear wave theory is predicated with such assumptions as sinusoidal wave forms, small wave steepness, and constant water depth. Casual observation is sufficient to verify that ocean waves are not sinusoidal and that they become steep as they approach the shore. However, the "irregular" sea surface may be looked upon as a complex combination of sinusoidal waves. Also, the assumption of constant depth for application of linear theory is not strictly correct.

Another aspect, the proper interpretation of crossed wave rays (or fronts) in the refraction diagrams (i.e., caustics), such as those in many of the wave refraction diagrams, does not appear to be the problem it was once thought to be. Chao, in a thorough series of theoretical (refs. 38 and 39), wave tank (refs. 40 and 41), and continental shelf (refs. 13 and 42) refraction studies of this caustic phenomena, has made the following conclusion for such wave refraction studies (ref. 42, p. 20): "The rays, after escaping from the caustic regions, eventually follow the continued ray path and the wave conditions are determined by the  $\beta$  factor just as if no caustic had occurred except that there has been a phase shift, which is unobservable because of the randomness of waves in nature. These conditions eliminate the necessity of the evaluations of the waves near a caustic . . . ." Although some wave height changes may occur in the waves that pass through a caustic region, theoretical and wave tank studies (ref. 41) suggest that such changes seaward of the zone of breaking waves may be minimal and well within the bounds set by other limiting factors such as depth information. Farrell (ref. 43) was able to perform an impromptu field evaluation of the wave refraction computations that he had performed in conjunction with his research on the mechanisms which are dominant in determining the geomorphology of Saco Bay, Maine. Figure 2 provides a direct comparison of a wave pattern observed in a vertical aerial photograph in Saco Bay and the computed refraction diagram. The input for the diagram was based on the actual wave conditions as closely as they could be determined from the photograph. The qualitative correlation between photograph and diagram suggests that the computational procedure is reasonably valid for this situation which is characterized by a complex shoreline and irregular bathymetry. Field measurements of wave directions and heights need to be made downwave from the region of caustics in order to verify these and other qualitative observations and the theoretical considerations of Chao. One must also recognize that this comparison is for a single wave condition at a single site over a relatively small geographic region. Higher order wave interactions may possibly cause significant effects in the far-field region. However, very little field data on the effects from caustics and other wave interaction phenomena are available in the literature.

Steady-state conditions are assumed for the present model. Calculations are made for two tide heights, mean low water and spring high tide, which are assumed constant

ORIGINAL PAGE IS  
OF POOR QUALITY



SACO BAY AZ =  $135^{\circ}$  T = 8.0 sec HT = 0.3 m (1 ft) TIDE = 0.0

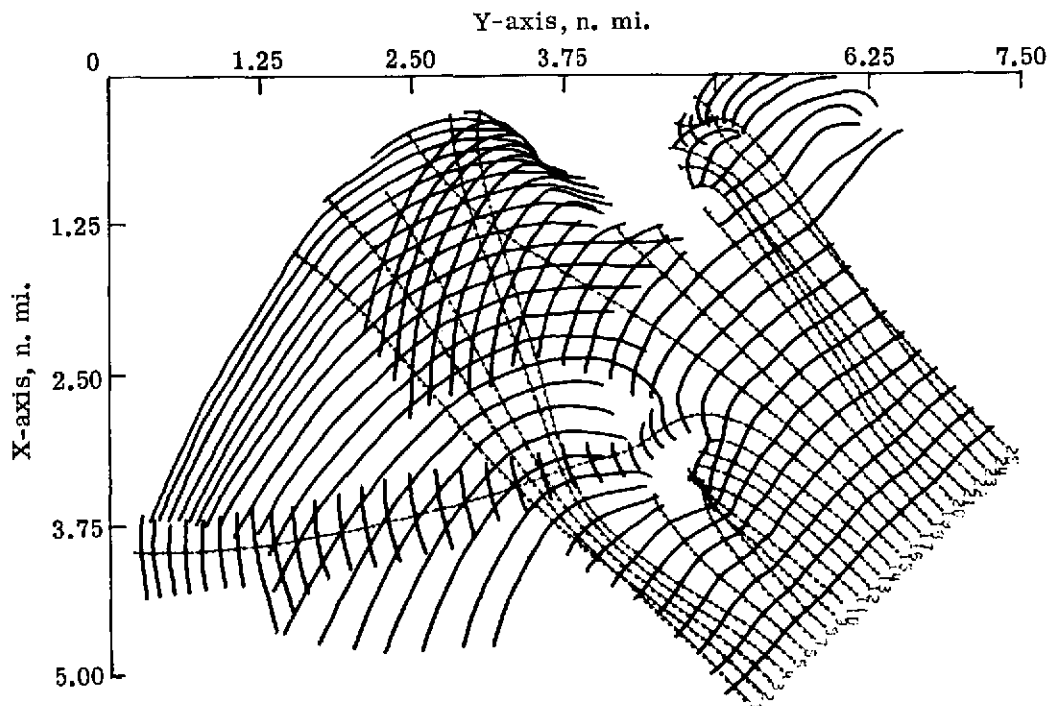

Figure 2.- Comparison of vertical aerial photograph of Saco Bay, Maine, and wave refraction diagram computed for T = 8.0 sec and AZ =  $135^{\circ}$ . (From ref. 12.)

over the region of the model. Constant tide height is a traditional assumption for wave refraction models of small geographical regions where wave transient time across the region is small compared to a tidal cycle. For wide shallow continental shelves, waves approaching at an angle may travel 100 n. mi. in areas with depths less than  $\frac{1}{4} L$ ; the transient time for these longer waves may be as much as 2 hours. In such cases, a time-variable tide height may be required to correctly represent the wave climate. Such a complication may be unnecessary from a practical viewpoint, however, if tide changes cause only small effects on the wave patterns. For example, in most of the Virginian Sea, where the mean tide range is approximately 1.1 meters (3.5 feet) the change in sea-level elevation would be about 0.3 meter (1 foot) during the maximum time of wave transit across the shelf. This study examines the magnitude of change in wave patterns for the maximum tidal range of 1.2 meters (4 feet) in an effort to provide guidance for future research.

The present model follows traditional practice in that no winds are assumed over the region. For small regions where short wave transient times prevail, wave perturbations caused by surface winds are small. For larger regions with longer wave transient times, "headwinds" may possibly have a significant effect on the dissipation of wave height. However, very little is known about the effects of winds on waves; neither the effects of winds nor currents are considered in this study.

The theoretical foundation to combat the inherent shortcomings of linear wave theory for refraction computations is provided by Stoker (ref. 44) and an excellent review of higher order wave theories by Dean (refs. 45 and 46) and Bretschneider (ref. 32) can provide guidance for selection of a more suitable theoretical base for any specific problem.

Despite these and other valid criticisms of conventional wave refraction computations, it can be argued that the uncertainties associated with the input data required for these computations (i.e., depth and wave information) are large enough that the incorporation of such theoretical refinements is generally not warranted for most practical applications. However, there remains a need for field verification of computational results, especially for problems involving fairly irregular bathymetry. The considerable expense of such an undertaking is of course the major deterrent to its performance. Nevertheless, there are occasional qualitative field verifications that serve to inspire confidence in the analytical procedures (refs. 31, 43, and 25).

Clearly, substantial caution must be exercised in the interpretation of wave refraction diagrams that are subject to these limitations; however, the limitations themselves should not be regarded as implacable obstacles to achieving a better understanding of coastal hydraulics through the utilization of wave refraction diagrams. Although these diagrams are not data in the usual sense, they can provide information on wave behavior

that is a useful complement to actual field investigation. This information is essentially qualitative in value but, within the limits imposed by linear wave theory, some quantitative information is also gained without the expense of costly field collection of wave data.

Other problems to which a wave analyst must be alerted include the role of Earth curvature in determining ray travel directions (ref. 13), the shortcomings of representing actual ocean waves by theoretically uniform wave trains of distinct period (refs. 47 and 48), and the problem of extending waves landward of the breaker zone (refs. 49 to 51).

### Map Projection

Theoretical development. - The definitive mathematical work on map projections was computed by Tissot (ref. 52). This work was applied to standard map projections by Adams (ref. 53), Deetz and Adams (ref. 54), and Army Map Service (ref. 55). A qualitative description of map projections can be found in references 56 to 58, and a more mathematical description in reference 59. Application of map projections to problems of ocean wave propagation have been discussed by Hardy (ref. 60) and Adamo, Baer, and Hosmer (ref. 61). The Transverse Mercator map projection specifically constructed for this study used a computer program developed by the U.S. Central Intelligence Agency (ref. 62).

Virginian Sea map projection. - Ocean waves travel great circle paths across the spherical Earth. Since wave refraction diagrams are flat representations of portions of the round Earth, a certain amount of distortion is normally represented in such presentations. Where the areas involved are small and close to the equator such distortions are minimal. However, for a large area (e.g., Virginian Sea) such distortions can be quite critical. For example,  $1^{\circ}$  of longitude is approximately  $1\frac{1}{2}$  n. mi. wider at latitude  $35^{\circ}$  N than at  $39^{\circ}$  N.

Whereas Chao (ref. 38) chose to use spherical coordinates based upon latitude and longitude instead of Cartesian coordinates for computing the path of the wave ray, the present study employed a specially constructed Transverse Mercator map projection for solving the round Earth problem. The projection, which has a square grid superimposed on it, was chosen because of the need for a common grid in assembling the voluminous but detailed depth information from many sources.

The Mercator projection takes the form of a cylinder which contacts the surface of the Earth along the equator. Latitude, longitude, and surface features are transferred to the cylinder in such a way that the angular relationships around each point are preserved without deformation. Such a projection is called conformal. The cylinder is then unwrapped to form a flat map. The Universal Transverse Mercator has the same characteristics as the standard Mercator except that a meridian has been made the standard line instead of the equator. The extreme areal exaggerations that occur with increasing distance from the standard line are avoided by limiting the extent of the standard Mercator

projection to  $3^{\circ}$  of longitude on either side of the standard line and using a separate projection for each of 60 zones which cover the whole circumference of the Earth. As a result the maximum areal exaggeration is one in a thousand over the whole width of one zone.

The projection prepared herein differs from the standard UTM in three ways: First, to simplify computation it is based on the sphere of equal area rather than the spheroid (which is an ellipsoid of rotation and a closer mathematical approximation of the somewhat irregular shape of the Earth). Although the diameter of the spheroid is smaller at the poles and larger at the equator than that of the sphere, they approximate each other quite closely, within  $1/4$  of 1 percent, in the middle latitude for which the Virginian Sea projection was constructed. Second, the nominal scale of this projection is true at the central meridian of  $75^{\circ}$ . Third, the rectangular coordinate system superimposed on the UTM has its origin on the equator 500 000 meters (1 640 420 feet) to the west of the central meridian, whereas this coordinate system is in feet with an origin in the northwest corner of the area plotted. Not one of these differences has any effect on the use for which this particular projection is intended.

A detailed description, including the strengths and limitations, of this map projection constructed at the Clark University Cartography Laboratory by Norman T. Carpenter is given in appendix A.

#### Data Input

Depths.- The most important input to the Wave Climate Model is the depth information. The depth information used in this study was taken directly from original Hydrographic Sounding Sheets (i.e., boat sheets). These are charts with depths written along the survey lines (refs. 63 and 64). Though these depths have all been tidally corrected to depth at the time of mean low water, no interpretation or interpolation has been used; that is, these are the original surveyed depths. A location map of 60 U.S. National Ocean Survey (formerly Coast and Geodetic Survey) Hydrographic Sounding Sheets and other data used in this study are given in figure 3.

Despite the wide usage of these original sounding sheets, few sources of written information exist on the accuracy criteria desired and met in these surveys as well as the corrections employed or not employed and their justifications. In order to fill this critical information gap a study on the accuracy of the depth and navigational positioning has been made by Sallenger, Goldsmith, and Sutton (ref. 65). Figure 4 which is from this study illustrates the different criteria set by the U.S. Coast Survey and its successor agencies for surveys of different dates. The depths at which waves of the periods used in this study are first significantly refracted by the sea floor irregularities are plotted over the Coast Survey accuracy criteria to give an indication of the depth errors influencing the wave climate model. Only four of the charts which were used in the depth

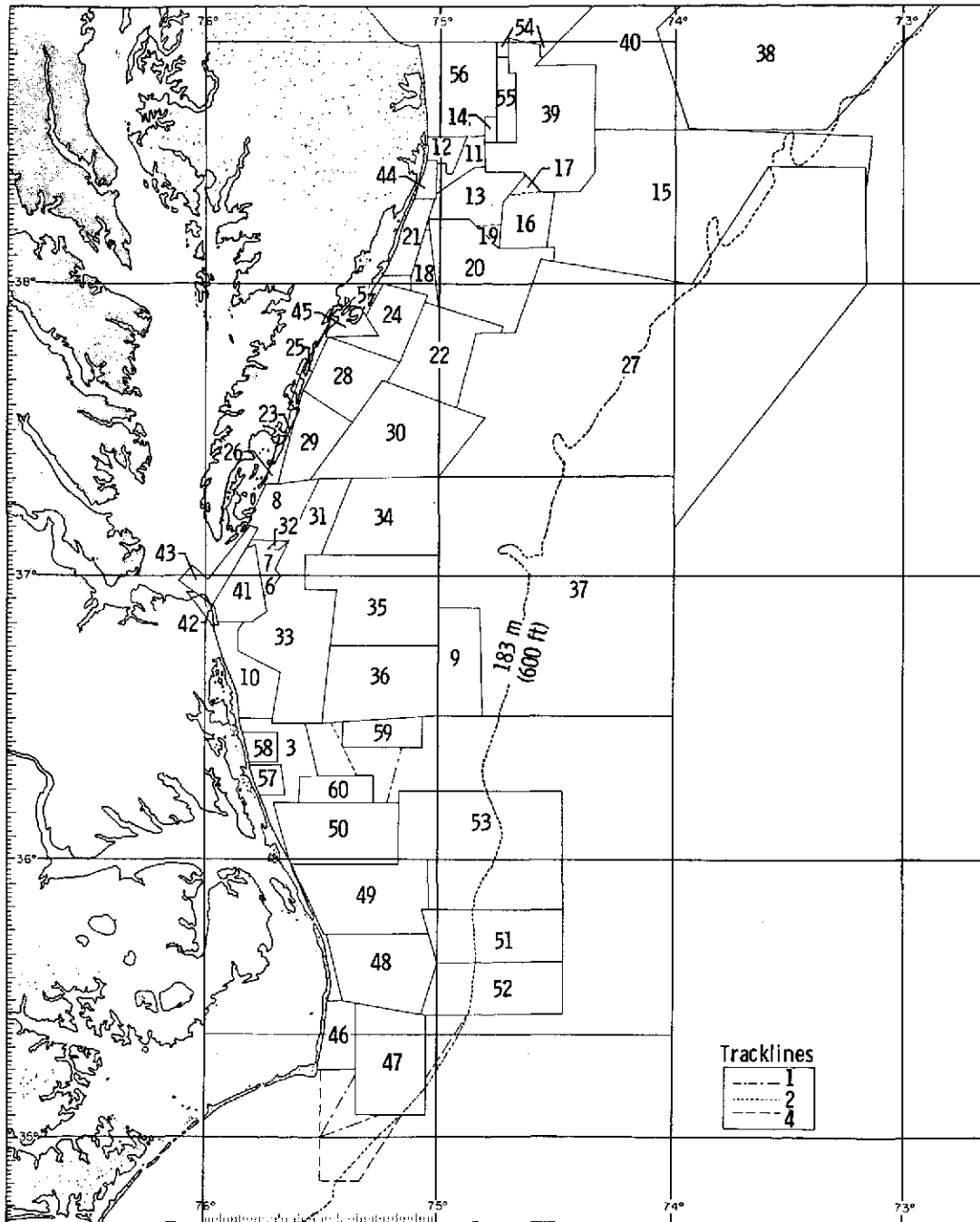

(a) Location map. Numbers refer to sounding sheets.

Figure 3.- Location map and index of U.S. National Ocean Survey hydrographic sounding sheets of Virginia Continental Shelf used in preparing depth data.



Identification in Fig. 3(a)	Number	Date	Scale	Comments
	Map			
1	237	1850	1: 400 000	Soundings only along lines indicated; soundings in fathoms (MLW)
2	674	1859	1: 200 000	Soundings only along lines indicated; soundings in fathoms (MLW)
3	965	1868	1: 40 000	Soundings appear to be in fathoms; age and numerical system used confirm this
4	1721	1886	1: 200 000	Soundings in fathoms, only along lines indicated (MLW)
5	3774	1915	1: 20 000	Soundings in feet (MLW)
6	4089	1919	1: 40 000	Soundings in feet (MLW); 76° west, soundings are barely readable
7	4193	1921	1: 40 000	Soundings in feet (MLW); soundings decrease by a factor of 2 eastward of 75°30'
8	4194	1921	1: 40 000	Soundings in feet (MLW); discontinued at 75°30' east because area is covered by more recent map
9	4255	1922	1: 120 000	Depth in fathoms (MLW); soundings diminish toward east
10	4286	1922	1: 40 000	Soundings in feet (MLW)
11	4944	1922	1: 120 000	Soundings in fathoms (MLW)
12	4951	1929	1: 20 000	Soundings in feet (MLW); shoreline soundings
13	5348	1933	1: 40 000	Soundings in feet (MLW)
14	5349	1933	1: 20 000	Soundings in feet (MLW)
15	5350	1933	1: 120 000	Depth in fathoms (MLW); soundings become sparse past 74°50'
16	5351	1933	1: 40 000	Soundings in feet (MLW)
17	5352	1933	1: 10 000	Soundings in feet (MLW)
18	5353	1933	1: 40 000	Soundings in feet (MLW)
19	5354	1933	1: 20 000	Soundings in feet (MLW); becomes sparse toward edges
20	5355	1934	1: 40 000	Soundings in feet (MLW)
21	5357	1933	1: 20 000	Soundings in feet (MLW)
22	5673	1934	1: 40 000	Soundings in feet (MLW)
23	5674	1934	1: 40 000	Soundings in feet (MLW)
24	5702	1934	1: 40 000	Soundings in feet (MLW)
25	5703	1934	1: 20 000	Soundings in feet (MLW)
26	5704	1934	1: 20 000	Soundings in feet (MLW)
27	5713	1927	1: 120 000	Soundings in fathoms (MLW)
28	5715	1934	1: 40 000	Soundings in feet (MLW)
29	5770	1935	1: 40 000	Soundings in feet (MLW)
30	5771	1934	1: 40 000	Soundings in feet (MLW)
31	5988	1935	1: 40 000	Soundings in feet (MLW)
32	5989	1935	1: 40 000	Soundings in feet (MLW)
33	5990	1935	1: 80 000	Soundings in feet (MLW)
34	5991	1935	1: 40 000	Soundings in feet (MLW)
35	5992	1935	1: 40 000	Soundings in feet (MLW)
36	5993	1935	1: 40 000	Soundings in feet (MLW)
37	5995	1935	1: 120 000	Soundings in fathoms (MLW)
38	6219	1937	1: 120 000	Soundings in feet (MLW)
39	6344	1938	1: 40 000	Soundings in feet (MLW)
40	6345	1938	1: 80 000	Soundings in fathoms (MLW)
41	6595	1940	1: 40 000	Soundings in feet (MLW)
41	6976	1947	1: 40 000	Soundings in feet (MLW)
42	7703	1948	1: 10 000	Soundings in feet (MLW)
43	8218	1954	1: 25 000	Soundings in feet (MLW)
44	8711	1962	1: 10 000	Soundings in feet (MLW)
45	8784	1927	1: 40 000	Soundings in feet (MLW)
46	8809	1963	1: 20 000	Soundings in feet (MLW)
47	8810	1963	1: 40 000	Soundings in fathoms (MLW)
48	9137	1970	1: 40 000	Soundings in feet at 2-foot intervals
49	9155	1970	1: 40 000	Soundings in feet at 2-foot intervals
50	9171	1970	1: 40 000	Soundings in feet at 2-foot intervals
51	9231(B)	1971	1: 80 000	Soundings in fathoms (MLW)
52	9231(C)	1971	1: 80 000	Soundings in fathoms (MLW)
53	9243	1971	1: 80 000	Soundings in fathoms (MLW)
	Bathymetric Map			
54	0807N-55	1967	1: 125 000	Soundings in fathoms (MLW)
55	0807N-56	1967	1: 125 000	Soundings in fathoms (MLW)
56	0807N-57	1967	1: 125 000	Soundings in fathoms (MLW)
	Archive			
57	715025.007	1971	1: 40 000	Soundings in feet (MLW)
58	715025.008	1971	1: 40 000	Soundings in feet (MLW)
59	715025.009	1971	1: 40 000	Soundings in feet (MLW)
60	71504.010	1971	1: 40 000	Soundings in feet (MLW)

(b) Index.

Figure 3.- Concluded.

accumulation were surveyed prior to 1915, and only three of these charts were surveyed prior to 1870. These charts (prior to 1915) used for the model were surveyed where the depths did not exceed 85 feet.

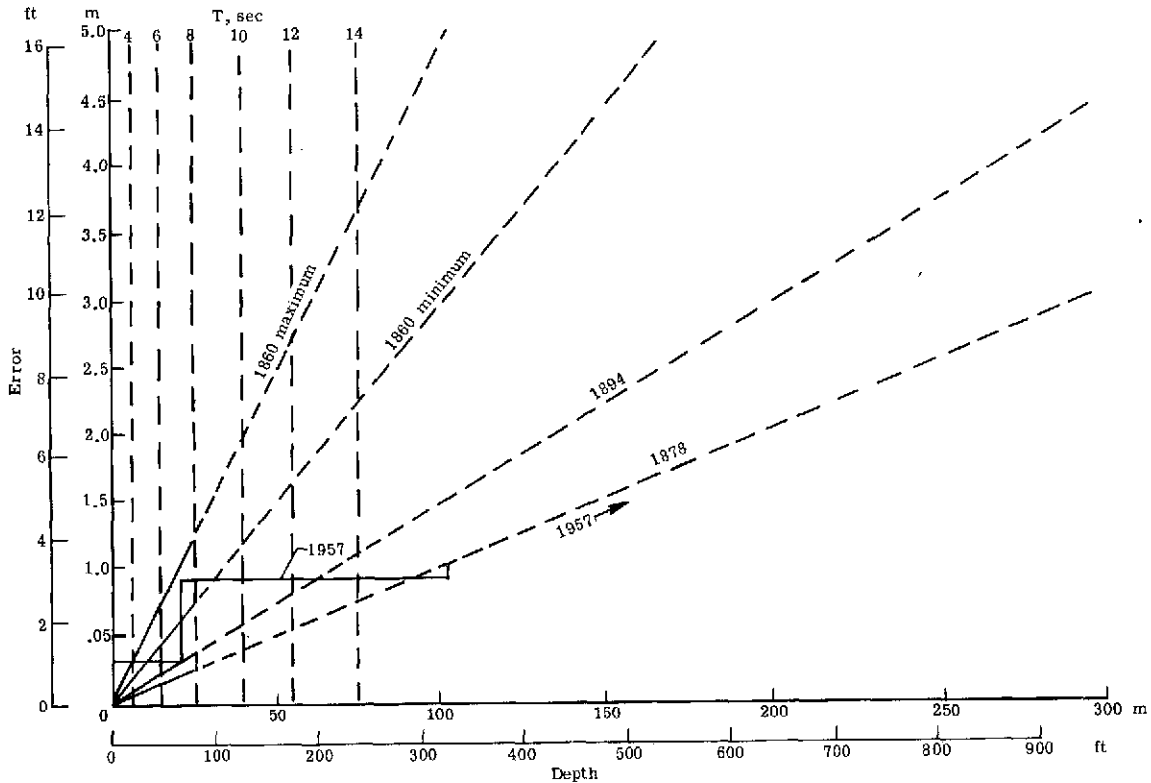

(a) Error criteria chart.

Year	Criteria
Circa 1844	None
Circa 1860	"The allowable error at sounding-line crossings was not to be more than 3 percent of the depth, with a limiting error of 5 percent." (See ref. 64, p. 218.)
1878/1883	"Lines of soundings at their crossings were not to exceed 'in depths of 15 feet and under, two-tenths of a foot; between depths of 15 and 30 feet, three-tenths; 30 and 48 feet, five-tenths; between 48 and 72 feet, three-fourths of a foot; between 72 and 96, one foot and a half; and between 96 and 150 feet, two feet. In the sea-depths the limit of error should not exceed 1 percent . . .'" (from instructions to surveyors 1878 and continued in 1883, as given in ref. 64, p. 221).
1894	". . . the admissible percent of error at sounding-line crossings was a maximum of 1.5 percent of the depth at that point." (See ref. 64, p. 224.)
1957	"Maximum errors: (1) 0 to 11 fm. (0 to 20 m.): 1.0 ft. (0.3 m.); (2) 11 to 55 fm. (20 to 100 m.): 0.5 fm. (1.0 m.); (3) 55 fm. (100 m.) and deeper: one percent of depth." (See ref. 63, p. 20.)

(b) Accuracy criteria.

Figure 4.- Sounding error criteria for NOS (C&GS) Sounding Sheets from references 64 and 63 as compiled in reference 65. Depths at 1/4 wave length for wave periods used in this study are also shown.

Approximately 100 000 of these original uninterpolated depths were transferred from the 61 sounding sheets and other data, using latitude and longitude, onto a Transverse Mercator map projection 2.4 by 1.2 meters (8 by 4 feet), specially constructed for the present study.<sup>2</sup> Then 84 420 of these depths were read from the map grid in lines at 0.5 n. mi. intervals spaced 0.5 n. mi. apart and punched on cards.

In order to provide a check on this depth accumulation process, a computer program was written which plotted 420 east-west bathymetric profiles. Seven typical profiles are illustrated in figure 5. By adjusting the spacing between the profiles it was

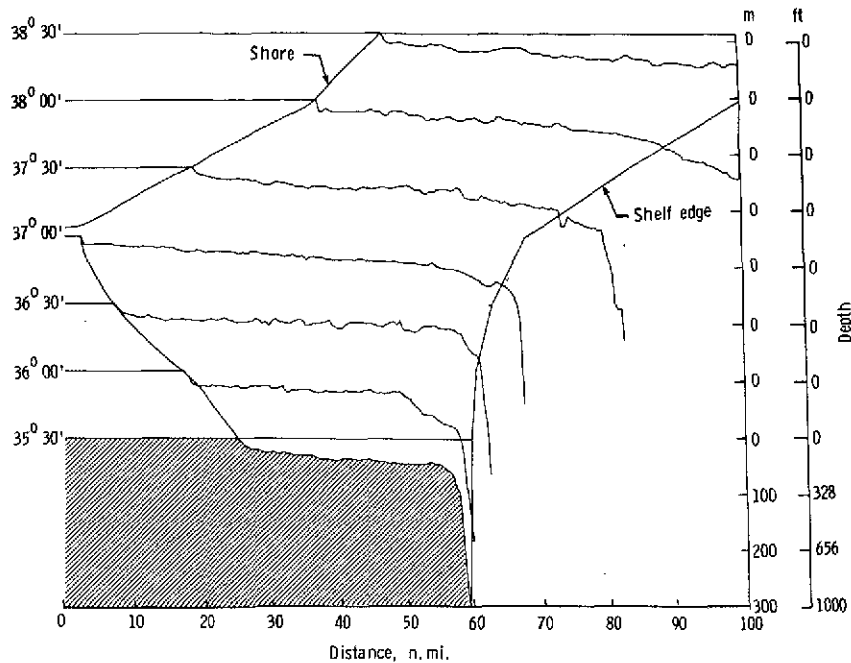

Figure 5.- Seven of the 420 computer-plotted east-west bathymetric profiles selected at intervals of 30 minutes of latitude.

possible to compare both adjacent data points and adjacent profiles. Thus, misspelled numbers, computer cards out of place, and incorrectly read depths, which may be expected to occur within a large 84 420 depth array, could be visually located. Corrections were then made on a point-by-point basis by reference to the original Hydrographic Sounding Sheets. This comparison was repeated until all the depths on the tape were determined to be correct.

<sup>2</sup>An addendum to this study, a detailed map of the Virginian Sea, was made from these accumulated depths which were contoured at 3.7-meter (12 foot) intervals out to 150 meters (492 feet) and at 30.5-meter (100 foot) intervals out to 305 meters (1000 feet). (See ref. 24.) A black-and-white copy of this 1.22- by 0.61-meter (4 by 2 foot) multicolored map, with the location names used in this report, is shown as figure 1.

Once the data had been checked, they were input on punch cards, but the number of errors that occurred due to the necessary handling of these 5628 cards indicated that a more reliable system was necessary. The data were then transferred to magnetic tape, but even the tapes were subject to handling errors. The system finally chosen was to record the bathymetry on a data cell; this proved to be the most reliable of the three techniques.

An additional test was performed to determine whether the density of depths (i.e., 0.5 n. mi. spacing) was sufficient to accurately portray a region of this bathymetric complexity with respect to the regional refraction patterns. It was determined that, by using an existing grid (ref. 31) on a much smaller region, very little difference would exist in refraction patterns between this depth density and one of approximately half the spacing (which would require approximately four times as many depths). (However, since more detailed studies in shallow depths and along the shore require an increase in depth density, additional small grids are being used in areas of such studies. The output from the larger, regional, first-order grid is used as input at the seaward intersection with the smaller grids.)

The equations used in propagating the wave ray across the grid of depths is described by Dobson (ref. 4, pp. 14 to 16) in terms of Cartesian coordinates and time. Essentially, the ray is propagated forward as a function of the celerity, which in turn is related to the depth coordinates. Start from a known point in a given initial direction and propagate the ray forward in a series of small steps by using a complex iteration procedure that keeps the ray curvature within arbitrary set bounds. If the curvature falls outside these bounds, such as in areas of complex high-relief bathymetry, the ray is terminated and a message printed. Since the likelihood of many of these small steps falling exactly on the grid points is small, a depth interpolation procedure is required. Dobson (ref. 4) used a second-degree polynomial employing the method of least squares to describe the local surface of fit for 12 adjacent depths. This method is an improvement over a linear surface fit (computed by Wilson (ref. 2), May and Tanner (ref. 20), and others) in that the ray separation factor  $b$  can be calculated;  $b$  is needed for determining the wave intensity. A statistical test is run on the fit of the quadratic surface to the local depth configuration. An unrelated test of the ability of such surfaces to accurately portray the original configuration determined that 12 depths was the optimum number and configuration to use in such a quadratic surface. (See ref. 66.)

These complex mathematical routines are only as good as the input depth information and there are still numerous U.S. coastal areas (including much of the depth data used in this study) whose latest depth information predates electronic navigation and precision depth records. (See ref. 65.)

Wave conditions. - The second major input to the Wave Climate Model was a wide variety of wave conditions. Approximately 200 to 250 wave orthogonals were propagated shoreward from deep water<sup>3</sup> for each of 122 wave conditions. The wide variety of wave conditions, shown in table I, was chosen in order to model as many different combinations as possible of wave period, direction, height, and tidal conditions from amongst the infinite variety of conditions that occur in real life.

TABLE I.- INITIAL DEEP-WATER WAVE CONDITIONS

Tide		Wave direction, deg	Wave periods, sec	Wave height	
m	ft			m	ft
0	0	0	4, 6, 8, 10	0.61, 1.83	2, 6
		22.5	4, 6, 8, 10, 12, 14	.61, 1.83	2, 6
		45 NE	4, 6, 8, 10, 12, 14	.61, 1.83	2, 6
		67.5	4, 6, 8, 10, 12, 14	.61, 1.83	2, 6
		90 E	4, 6, 8, 10, 12, 14	.61, 1.83	2, 6
		112.5	4, 6, 8, 10, 12, 14	.61, 1.83	2, 6
		135 SE	4, 6, 8, 10, 12, 14	.61, 1.83	2, 6
		167.5	4, 6, 8, 10, 12, 14	.61, 1.83	2, 6
		180 S	4, 6, 8, 10, 12, 14	.61, 1.83	2, 6
+1.22	+4.0	45	4, 6, 8, 10, 12, 14	.61	2
		90	4, 6, 8, 10, 12, 14	.61	2
		135	4, 6, 8, 10, 12, 14	.61	2

Thus, a "library file" of a wide variety of wave conditions is accumulated that can be used in conjunction with other geological, biological, and chemical studies of the shelf and shoreline and as an aid to resource managers charged with choosing sites for off-shore ports and shoreline defense structures.

One might well ask the question as to why this "scatter-gun" approach with respect to wave input conditions. Why not zero in on just the most significant waves for calculating the wave parameters? There are two reasons why a wide variety of wave conditions is calculated. First, anyone can testify to the almost infinite variety of wave conditions that may occur over a long span of time. Second, data for determining the precise percentage of time that a given wave condition will occur are presently unavailable in most areas. The large frequency of conditions is also needed in order to calculate

---

<sup>3</sup>Waves propagating landward from deep water will be slowed to  $0.996C_0$  at  $d = \frac{1}{2} L_0$ . Similarly, at  $d = \frac{1}{4} L_0$ , the waves are traveling at  $0.92C_0$ , and at  $d = \frac{1}{8} L_0$ , they are traveling at  $0.66C_0$ . Therefore, the slowing down of the wave is a gradual process, and for the purpose of starting the 14-second waves, deep water was considered to be where the waves were not appreciably affected by the bottom or at depths  $\cong \frac{1}{4} L_0$ .

parameters such as the mean wave height at a shelf location and the total shoreline wave energy along a stretch of coast during an average year. This could be easily calculated by summing up, based on frequency of occurrence, the data for a given location from each of the calculated wave parameters. Also, in order to determine the effects of storm waves along a shoreline, the sequence of weather fronts and resulting storm-generated waves is needed (ref. 67).

Such data come from one of four sources: (1) wave measurements by instruments in deep water, (2) wave measurements by instruments in shallow water and along the shoreline (i.e., on piers, anchored buoys, etc.), (3) ship wave observations compiled by U.S. Naval Oceanographic Office by  $10^0$  squares called Marsden squares, and (4) wave hindcast calculations. None of these methods has produced data considered adequate for this area.

Data from source (1) are quite rare and, where available, are generally of insufficient duration to be statistically valid. Summaries of shallow water wave measurements calculated from coastal wave gages were found to bear little relationship to individual shipboard wave height and period observations off the east coast of the United States (ref. 68, p. II-679), as shown in figure 6. These authors further concluded that if adequate data were available from shipboard wave observations, wave refraction methods would be useful in determining shallow water and shoreline wave parameters. Furthermore, no procedures presently exist for propagating waves seaward, which use wave parameters determined from coastal gages as input.

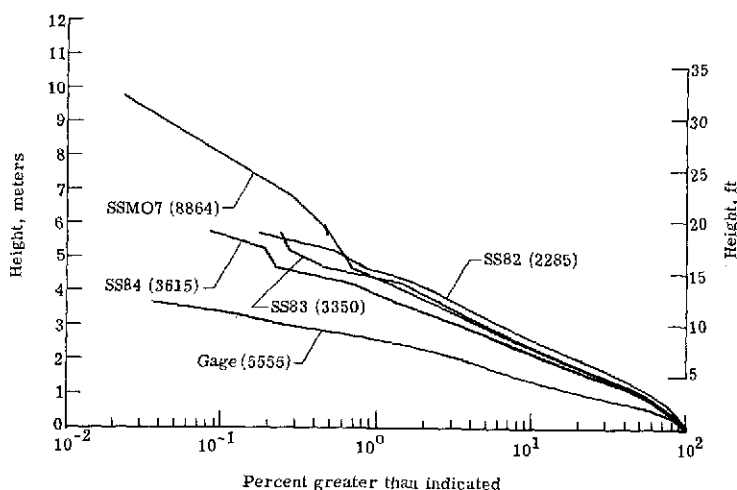
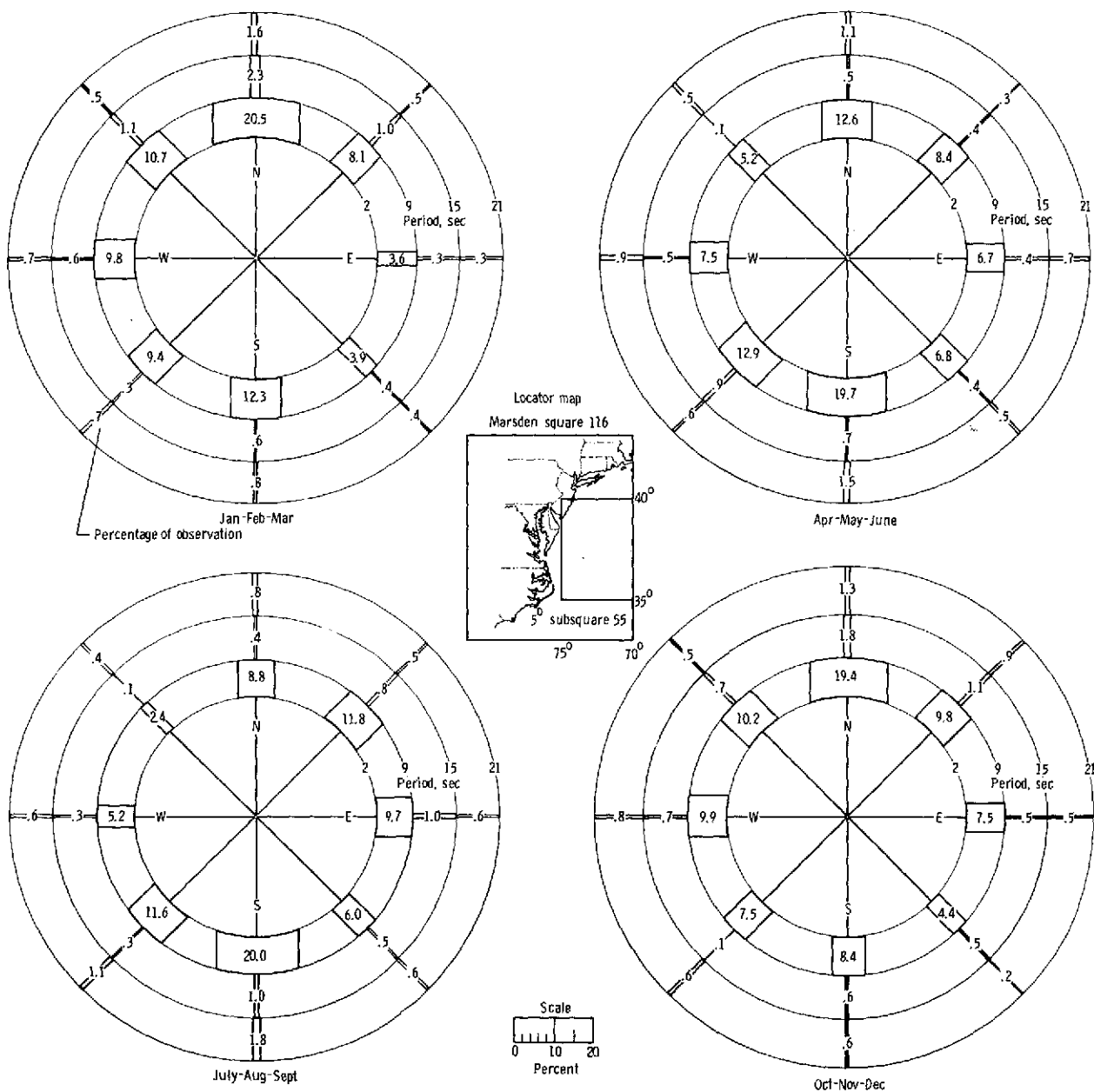

Figure 6.- Comparison of cumulative shipboard wave height distribution (Marsden square) with Atlantic City, N.J., gage data. Numbers in parentheses are number of observations in that subsquare (SS). (From ref. 68.)

Ship wave observation data are not the final answer either for determining the percentage frequency of occurrence for a given wave condition, as there are several inherent biases built into the present data collection system. Several of these biases, such as the

awkward computer forms, are discussed by Harris (ref. 69). Another bias is suspected from the interpretation of summary graphs of ship wave observations from the Marsden squares adjacent to Cape Cod, Mass. (ref. 31) and the southern portion of the Virginian Sea (fig. 7). In these two area summaries, the dominant waves on an annual basis appear to approach from the west, despite the proximity of land to the west and more than 3000 n. mi. of ocean to the east. One possible explanation for this suspected bias is related to the fact that the ship wave observations are recorded as part of a voluntary



(a) Direction as a function of period.

Figure 7.- Marsden square wave information from Marsden 5° subsquare 116-55.

program; ships tend to avoid extreme wave conditions, and when they do encounter severe conditions, the assigned observer might find that he has more important duties to perform than filling out wave forms. Nevertheless, ship wave observations appear to be the best information available at present for summing up individual wave conditions. These data have been used with some success in making littoral drift calculations along the coast of Florida (ref. 70).

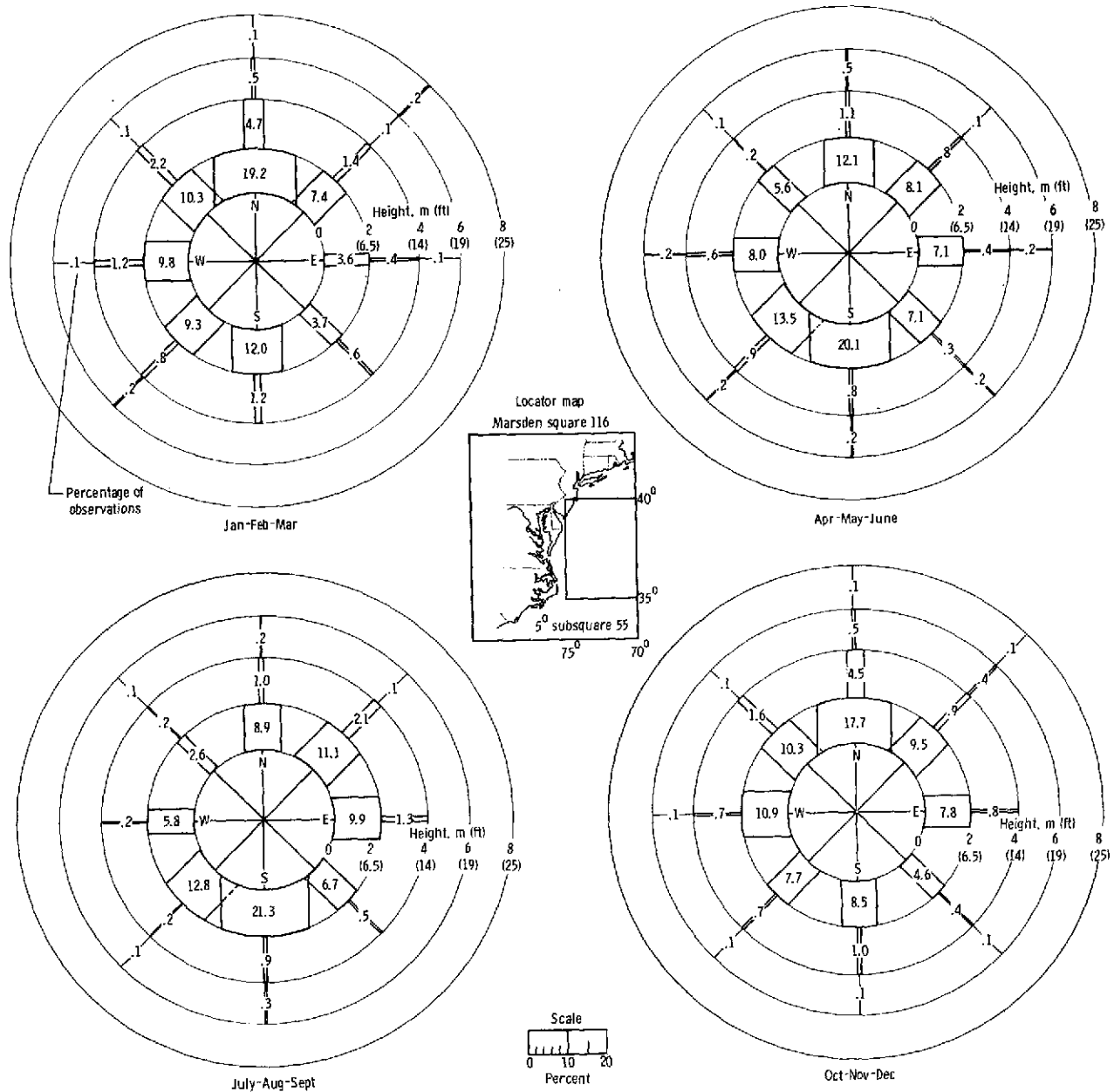

(b) Direction as a function of height.

Figure 7.- Concluded.



The final method used in summarizing wave conditions is wave hindcast calculations. All these methods are discussed elsewhere (refs. 32 and 71). Hindcast calculations using the Bretschneider-revised Sverdrup-Munk (significant wave) method has been computed for four stations along the U.S. East Coast, including one adjacent to the Chesapeake Bay entrance (fig. 8), by using data from weather stations for the 3-year period, 1948-1950 (ref. 72). Note the large discrepancy between the ship wave observations and this wave hindcast data (figs. 7(b) and 8). Important considerations in this discrepancy are the two major assumptions used in wave hindcasting: (1) deep water for 360° around the hindcast station and (2) the meteorological conditions in the 3-year period, 1948-1950, are representative of long-term weather conditions.

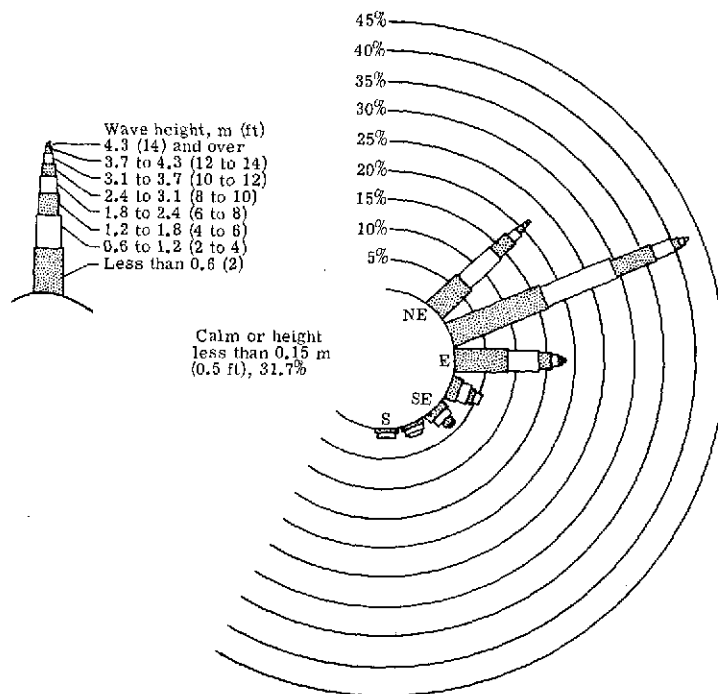

Figure 8.- Deep-water wave hindcast data adjacent to Chesapeake Bay entrance. (From ref. 72.) Wave rose showing percent of time waves of different heights occur from each direction.

In order to determine the range of parameters used in this study, the wave conditions in table I were checked against the hindcast and Marsden square data and were found to represent 99.11 percent of the hindcasted wave conditions calculated for the Virginian Sea area by Saville in reference 72 (table II) and greater than 59.4 percent of the ship wave observations reported in the Marsden square summary for Marsden subsquare 116-55 which covers the Virginian Sea area (table III). Most of the remaining observed wave conditions (29.2 percent) were from the west; therefore they were not deemed significant for this study because of the limiting fetch and other assumptions in this study.

TABLE II. - HINDCAST WAVE DATA FOR OCEAN ADJACENT TO  
CHESAPEAKE BAY ENTRANCE

[3-year period, 1948-1950; from reference 72]

AZ	Percent frequency of occurrence at -						Total
	T = 4, 5 sec	T = 6, 7 sec	T = 8, 9 sec	T = 10, 11 sec	T = 12, 13 sec	T = 14 sec	
N	0.03						0.03
NNE	.182	0.334	0.182	0.046	0.06		.804
NE	.958	1.81	5.81	7.0	3.85	3.25	22.678
ENE	1.25	5.61	11.37	12.6	7.2	5.26	43.29
E	1.49	5.58	5.35	3.52	1.32	1.26	18.52
ESE	.87	2.13	1.11	.62	.56	.55	5.84
SE	.44	1.32	.59	.53	.55	.85	4.28
SSE	.32	.85	.30	.17	.24	.21	2.09
S	.45	.64	.09	.14	.03	.23	1.58
Totals	5.99	18.274	24.802	24.626	13.81	11.61	99.112

TABLE III. - SHIP WAVE OBSERVATIONS

[Marsden Subsquare 116-55]

Direction	Percent frequency of occurrence at -						Total
	T = <5 sec	T = 5 to 7 sec	T = 7 to 9 sec	T = 9 to 11 sec	T = 11 to 13 sec	T = 13 to 15 sec	
N	8.2	5.1	1.8	0.7	0.4	1.3	17.5
NE	5.5	2.9	1.15	.45	.3	.6	10.9
E	4.2	2.0	.7	.35	.15	.55	7.95
SE	3.4	1.4	.6	.3	.1	.5	6.3
S	9.65	3.8	1.4	.5	.15	1.25	16.75
Total	30.95	15.2	5.65	2.30	1.10	4.20	59.40
Total calm . . . . .							7.9
Total west . . . . .							29.2
Total unknown . . . . .							3.3
Total . . . . .							99.8

## Data Output

For each of the 122 wave conditions (e.g., combinations of wave directions, periods, heights, and lunar and storm tides), two kinds of computer output are generated:

(1) The wave refraction diagrams show the directions of the waves as they are propagated landward under specific wave input and depth conditions. Instead of wave fronts, these diagrams display wave rays (i.e., orthogonals) which are everywhere perpendicular to the wave fronts. Seventy of these wave diagrams are presented in appendix B (figs. B1 to B70).

(2) The computer printout gives the computations of different wave parameters at intervals of 609.6 to 914.4 meters (2000 to 3000 feet) along each wave ray. The rays were input in deep water at a spacing of 1 n. mi.; approximately 200 to 250 wave rays were used in the wave computations for each condition. The parameters printed for each of the conditions in table I are

- (1) Angle of wave approach
- (2) Depth
- (3) Wave length
- (4) Wave celerity
- (5) Refraction coefficient
- (6) Shoaling coefficient
- (7) Wave height (including effects of bottom friction)
- (8) Maximum horizontal component of wave orbital velocity at the bottom
- (9) Maximum horizontal component of wave orbital velocity at middepth
- (10) Total wave energy
- (11) Longshore wave energy
- (12) Wave steepness
- (13) Group velocity
- (14) Total wave power
- (15) Longshore wave power

and the parameters printed when the wave reaches shore are

- (16) Total wave power gradient
- (17) Longshore wave power gradient
- (18) Longshore drift current velocity
- (19) Longshore sediment drift (five different equations)

Parameters (1) to (7) were computed based on reference 4, parameters (8) to (17) were from reference 36, and parameter (18) is from reference 34. These computations may generate as many as 50 000 values for each wave parameter along each ray for each wave condition. These data may be used to contour the sea floor in order to delineate areas of high wave-induced current motion and wave energy as well as areas of "confused seas." Parameters (8) and (9) are used in computing the drag and inertial components of wave forces, and parameters (16) and (17) are used in delineating areas of wave energy concentration (i.e., areas which may experience larger rates of wave scour or beach erosion).

Longshore sediment drift was calculated by five different equations taken from references 73 to 78. There was an extremely large scatter in longshore drift values as calculated by the different equations, with most results appearing to be many times too large. These results support the widely recognized need for a significantly greater understanding of longshore processes.

### Special Computer Requirements

The application of the refraction model to such a large geographic area is unique and was made possible by the capacity to store a large amount of data. Storage requirements for this study were 330 000 octal locations. Of these, approximately 300 000 locations were required for the bathymetric data, and the remaining 30 000 locations were required for the program, plotting, and tape generation routines.

The data were run in sets with a set consisting of one tidal height, one wave direction, and six wave periods. The approximate computer requirements for a set were

Total computer storage field length (octal) . . . . .	330 000
Computer time for the CDC 6600 computer, sec . . . . .	1 250
Operating system calls . . . . .	47 000
LaRC computer system cost . . . . .	\$650

A total of 21 sets were run. A total cost including program adaptation and checking was approximately \$30 000.

A number of subsequent modifications have been made to the computer model but were not incorporated at the time this study was made. Among these was a method which can reduce the computer storage requirements to one-fourth of that presently required. This method is called the random-access method, and a peripheral disk is used to store the data in modules which can then be retrieved individually; thus, data not required are bypassed (ref. 79). This method also reduces cost by approximately 65 percent and should allow greater use of the program with computers of more limited storage capacity.

## SHELF GEOMORPHOLOGY – A REVIEW

Ever since Uchupi's detailed studies of the continental shelf along the east coast of the United States (ref. 80), an increasing number of studies have focused attention on the various shelf relief elements. Much of this work is discussed in reference 81. References 82 to 117 are examples of studies which are of direct interest to the Virginian Sea area. Also, references 118 to 139 are studies of significance to the origin of the shelf geomorphology of the Virginian Sea area. A classic study on the shoreline effects resulting from offshore changes is Jordaan (ref. 140).

Many of these studies are aimed primarily at shedding light on the controversy concerning the origin of the shelf relief elements – that is, are these features relict or presently hydraulically active, or a combination? If relict, how much have they been modified? It is not the direct purpose of this study to explore this controversy, but merely to point out the importance of complex interactions between the ocean waves passing over the shelf and many of these shelf relief elements, which result in a nonuniform wave energy distribution over the shelf and along the shoreline. This relationship is discussed in detail in the section "Study Results." In this section, the purpose is merely to elaborate on those geomorphic features which are significant to the wave climate of the Mid-Atlantic Continental Shelf and Shoreline. These features are shown in the bathymetric map of the Virginian Sea (fig. 1) and also in figure 9, a three-dimensional computer projection of the depth data.

Seven east-west bathymetric profiles at intervals of 30 minutes of latitude taken from the 0.5 n. mi. depth grid is shown in figure 5. Two important aspects of the profiles for this study are the great width and relatively shallow nature of this portion of the continental shelf. The abrupt increase in gradient at the shelf edge is between depths of 61 and 91 meters (200 and 300 feet) and is located as much as 60 n. mi. from shore. The distance from shore at which the ocean waves of different period begin to be appreciably affected by the sea floor is shown in figure 10. Thus, a great expanse of the continental shelf, and superimposed relief elements, is available for influencing ocean wave behavior.

A closer examination of these profiles (fig. 5) and the detailed bathymetric map of the sea floor (fig. 1) reveals that the shelf surface is not a smooth plain but instead consists of numerous irregularities. These irregularities may be divided into two groups:

- (1) Large-scale morphogeometry consists mainly of erosional forms cut into the shelf such as terraces, channels and valleys, and shelf-edge canyons
- (2) Small-scale shelf relief elements consist of low relief features (i.e., less than 9.144 meters (30 feet)) of probable depositional origin, most notably ridge and swale bathymetry and arcuate (e.g., cape-associated) shoals

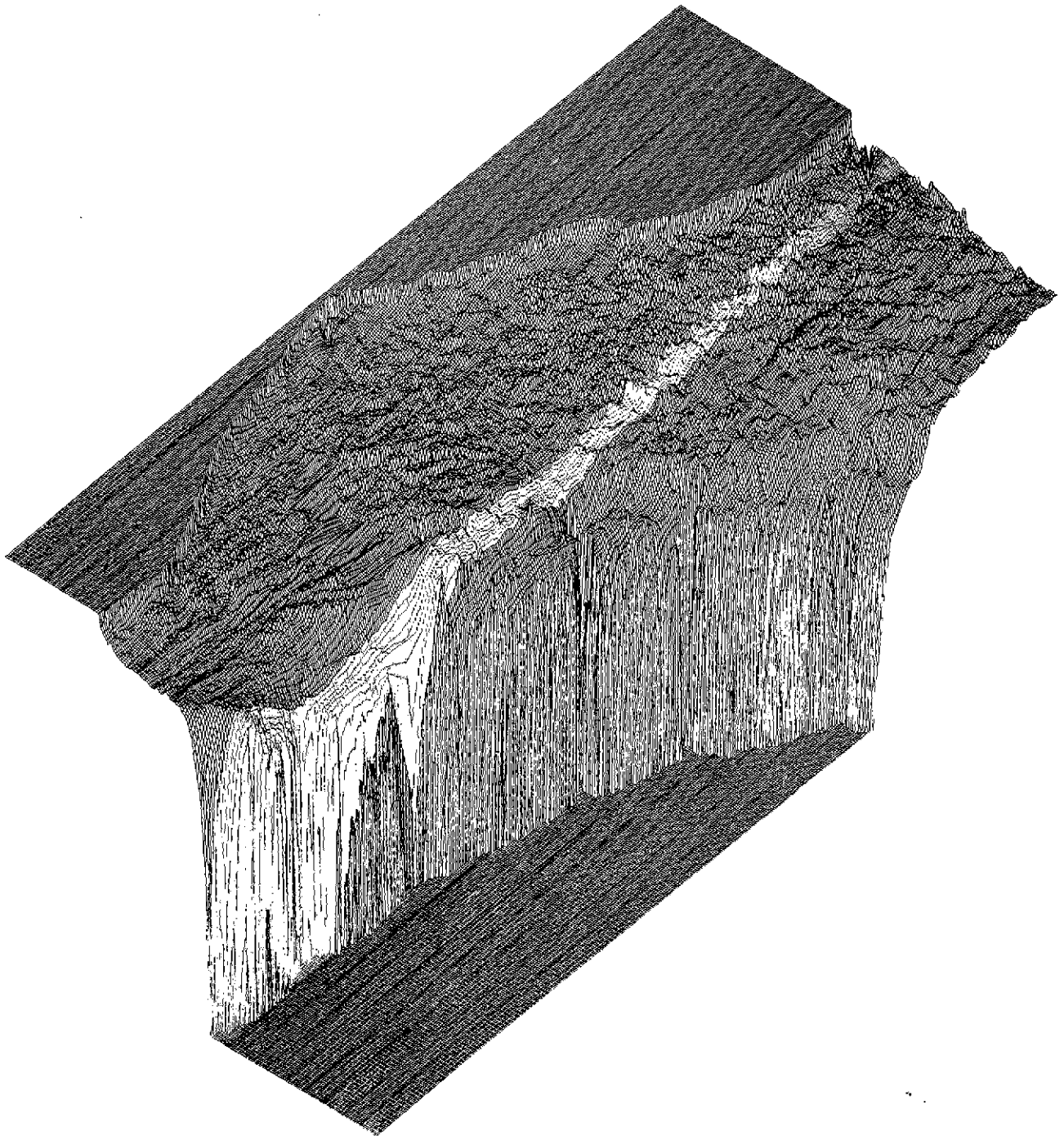

Figure 9.- Three-dimensional computer projection of depth data.  
(Used in preparation of frontispiece.)

ORIGINAL PAGE IS  
OF POOR QUALITY

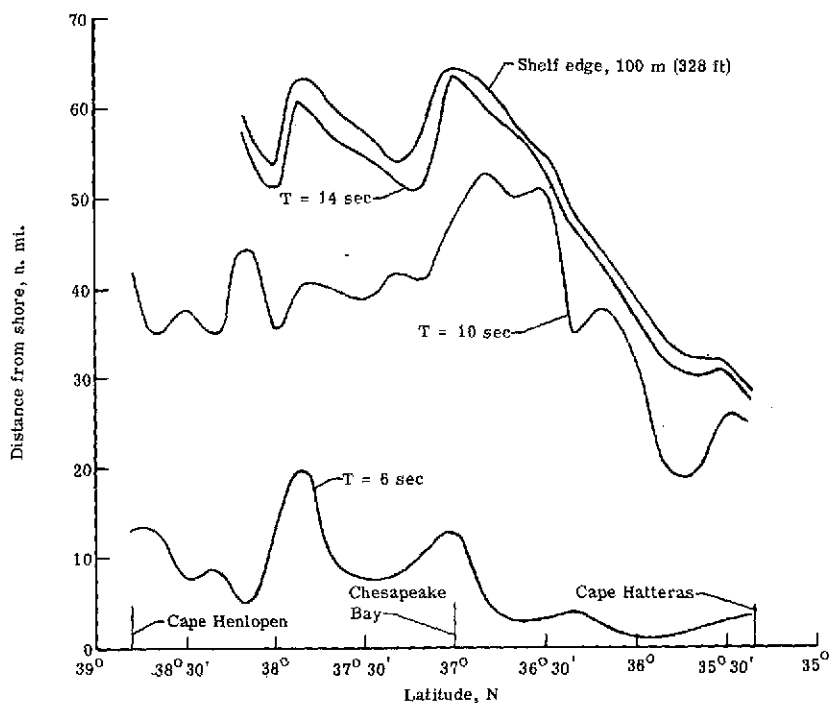

Figure 10.- Depths at which waves of different periods begin to be appreciably affected by Virginian Sea Floor.

Whereas the origin of group (1) features is directly related to a lowered sea level, group (2) features probably formed since the last rise in sea level under the present shelf hydraulic conditions. The most recent eustatic sea level lowering reached its maximum extent approximately 15 000 years ago on the Atlantic Continental Shelf. Eustatic sea level has been within 1.8 meters (6 feet) of its present level approximately 30 000 to 35 000 years ago and for the last 4000 years (ref. 128). However, tectonic events may have severely altered this sequence of sea level changes in this area. (See refs. 141 to 143.)

#### Large-Scale Morphogeometry

Terraces.- The depths of the outer edge of the prominent shelf terraces determined from an east-west profile along  $37^{\circ}$  latitude from the mouth of Chesapeake Bay out across the shelf to Norfolk Canyon (from ref. 24) are given in table IV and depths of these terraces are compared with the depths of other prominent terraces along the East Coast shelf given in reference 80. The most pronounced terraces adjacent to Chesapeake Bay are at 24, 30, 40, and 86 meters (78, 100, 132, and 282 feet).

The presence of these terraces on the sea floor indicate a step-like bathymetric profile. The effect of the steeper portions of the profiles on the incoming waves will depend primarily on the angle of wave approach to these rises. However, even the steepest rises have relatively low-gradient slopes. The slope is  $0^{\circ}07'19''$  for the rise between

TABLE IV. - DEPTH TO OUTER EDGE OF TERRACES ON  
THE CONTINENTAL SHELF AND SLOPE

Depth of outer edge of terraces, m (ft), at -						
Chesapeake Bay, Va. (a)	Martha's Vineyard, Mass. (b)	Atlantic City, N.J. (b)	Onslow Bay, N.C. (b)	Savannah, Ga. (b)	Cape Kennedy, Fla. (b)	Miami, Fla. (b)
-----	-----	-----	-----	-----	-----	10 (33)
7 to 18 (24 to 60)	-----	-----	-----	-----	-----	15 (49)
16 (54)	-----	20 (66)	20 (66)	-----	20 (66)	18 (59)
24 (78)	-----	-----	-----	25 (82)	25 (82)	-----
30 (100)	-----	-----	30 (98)	-----	30 (98)	-----
-----	35 (115)	-----	-----	33 (108)	-----	33 (108)
-----	-----	40 (131)	40 (131)	40 (131)	40 (131)	-----
40 (132)	43 (141)	-----	45 (148)	45 (148)	-----	-----
-----	-----	-----	-----	50 (164)	50 (164)	-----
57 (188)	55 (180)	-----	-----	55 (180)	-----	-----
-----	63 (207)	-----	63 (207)	-----	-----	62 (203)
-----	-----	-----	-----	67 (220)	65 (213)	-----
-----	-----	-----	70 (230)	-----	-----	70 (230)
86 (282)	80 (262)	83 (272)	80 (262)	80 (262)	-----	80 (262)
-----	-----	95 (312)	-----	-----	-----	-----
106 (348)	-----	-----	100 (328)	-----	-----	-----
-----	-----	120 (394)	120 (394)	-----	-----	-----
-----	125 (410)	-----	-----	-----	-----	-----
-----	-----	130 (426)	-----	-----	-----	-----
-----	-----	140 (459)	-----	-----	-----	-----
-----	158 (518)	-----	-----	-----	-----	-----
-----	-----	-----	170 (558)	-----	-----	-----
-----	-----	175 (574)	-----	-----	-----	-----
183 (600)	-----	-----	200 (656)	-----	-----	-----
244 (800)	210 (689)	-----	-----	-----	-----	-----

<sup>a</sup>Reference 24.

<sup>b</sup>Reference 80, table 2.

depths of 87.8 and 62.2 meters (288 and 204 feet) as compared with a slope of 0°01'58" for the total shelf landward of the depth contour of 62.2 meters (204 feet). (See ref. 24.)

Subaqueous stream drainage. - Generally oriented perpendicular to the strike of the terraces, the major relief features remaining from the Pleistocene stream drainage are the shelf valleys at the mouths of Delaware and Chesapeake Bays. (However, Swift (ref. 115) has suggested that the Delaware shelf valley is an estuary retreat path and not a drowned river valley.) Both these southeast-oriented valleys have a pronounced influence on the wave refraction patterns, with areas of confused seas forming over the seaward rim of the shelf valleys.

Most of the relict Pleistocene river channel network has been filled in with sediments. However, subtle changes in relief in some areas of the shelf surface of the



Virginian Sea are suggestive of former channels. Examples of these transverse shelf valleys are found between the mouth of Chesapeake Bay and Norfolk Canyon (Susquehanna Valley), from the Delaware Bay shelf valley to the shelf edge (Delaware Valley), from the Chesapeake Bay shelf valley southeastward to the shelf edge (Virginia Beach Valley), from the Oregon Inlet, N.C., vicinity southeastward to the shelf edge (Albemarle Valley), and from the Metomkin-Assawoman Island vicinity east-southeastward to Washington Canyon. The valley names are adopted from reference 99. The dimensions and gradients of these submarine canyons (from ref. 144) are compared in table V with subaerial canyons.

TABLE V.- COMPARISON OF DIMENSIONS AND GRADIENTS OF CANYONS ABOVE AND BELOW SEA LEVEL

[Data from reference 144, pp. 122-123]

(a) Dimensions

Canyon	Mapped total length, n. mi. (a)	Length of part invading shelf, n. mi.	Maximum width, n. mi.	Maximum depth below adjacent ridges		Greatest mapped depth of floor below sea level (a)		Mean longitudinal gradient in shelf area	Mean longitudinal gradient in belt of continental slope
				meters	feet	meters	feet		
Hudson . . . . .	43	15	7	1219	4000	2256	7 400	1:33	1:40
Wilmington . . . . .	56	9	6	1097	3600	2865	9 400	1:18	1:53
Baltimore . . . . .	74	9	5	823	2700	3048	10 000	1:18	1:66
Washington . . . . .	56	6	3	732	2400	2499	8 200	1:20	1:53
Norfolk . . . . .	52	10	3	914	3000	2743	9 000	1:19	1:48
Colorado River . . . . .	---	---	13	1859	6100	----	----	1:530 (mean gradient)	
Snake River . . . . .	---	---	9	2408	7900	----	----	1:400 (mean gradient)	

<sup>a</sup>Actual dimension is greater.

(b) Average longitudinal gradients of canyons (by groups)

Regional group	Average number of canyons	Gradient of canyon as a whole			Gradient at head of canyon		
		percent	meters/n. mi.	feet/mile	percent	meters/n. mi.	feet/mile
Eastern United States . . . . .	14	5.5	102	290	7.3	135	385
Western United States . . . . .	29	4.83	89	255	9.96	184	525
Eastern Asia . . . . .	28	7.0	130	370	14.4	267	760
Indian Ocean . . . . .	5	9.8	181	517	20.0	377	1075
Mediterranean Sea . . . . .	12	10.9	202	575	15.2	281	800
Oceanic Islands . . . . .	4	13.8	266	759	21.0	395	1125
Off large rivers . . . . .	9	1.7	32	90	3.24	60	170
Colorado River . . . . .	---	0.2	4	10	----	---	----
Snake River . . . . .	---	0.25	5	13	----	---	----

Virginia Beach Massif.- Virginia Beach Massif, between the Susquehanna Valley and the Virginia Beach Valley, is an extensive shallow, relatively level-topped topographic high lying approximately between the depth contours of 18.3 and 21.9 meters (60 and 72 feet). (See fig. 1.) This imposing large-scale relict feature, of probable interfluvial origin, contains a superimposed irregular ridge and swale bathymetry, which is delineated by the depth contour of 18.3 meters (60 feet). The Virginia Beach Valley, flanked to the northeast by the Virginia Beach ridges on the topographic high and to the southeast by the False Cape ridges, is indeed suggestive of a series of relict ebb-tidal deltas formed as the sea level rose and the estuary mouth retreated, as hypothesized by Swift, Kofoed, Saulsbury, and Sears (ref. 99).

This complex topographic high, originating as an interfluvial feature, with subsequent superimposed tidal-delta-associated ridges, that have been modified under the present shelf hydraulic regime, has been named the Virginia Beach shoal retreat massif by Swift, Kofoed, Saulsbury, and Sears (ref. 99); this name has been adopted for this study.

#### Small-Scale Shelf Relief Elements

Linear ridges.- Superimposed on the larger relief elements is an undulating ridge and swale bathymetry composed of shoals with less than 9.1 meters (30 feet) of relief, with the long axis generally extending from 1 to 10 miles and oriented such that they form a small angle (peak at  $35^{\circ}$ ) with the present shoreline (ref. 145). These shoals are thought to have formed under the present shelf hydraulic regime because marked seismic and grain-size discontinuities exist between the shoals and the underlying strata which are generally older than 7000 years (refs. 145 and 146). Moreover, the mineralogy and granulometric characteristics of many of the shoals are often directly related to the beaches along the adjacent shoreline (ref. 145).

Linear ridges, separated by valleys called swales (ref. 80), are most prominent opposite the shorelines of Delaware and Maryland, the southern Delmarva Peninsula, the Virginia-North Carolina state line, and Oregon Inlet to Rodanthe, N.C.

The depth and orientation of over 200 of the linear ridges on the U.S. East Coast Continental Shelf is shown in figure 11 (data from ref. 145). Note the bimodal depth distribution with clusters of shoals at depths of 6.1 to 9.1 meters (20 to 30 feet) and 12.2 to 16.8 meters (40 to 55 feet) (and possibly a third mode at depths greater than 24.4 meters (80 feet)). These depths do not appear to be related to depths of prominent terraces; instead, they may be related to depths at which the most frequent waves begin to appreciably interact with the sea floor. (Compare fig. 11 with figs. 5, 7, 8, and 10.) The right histogram in figure 11 shows the azimuth distribution of the same 200 linear ridges, with

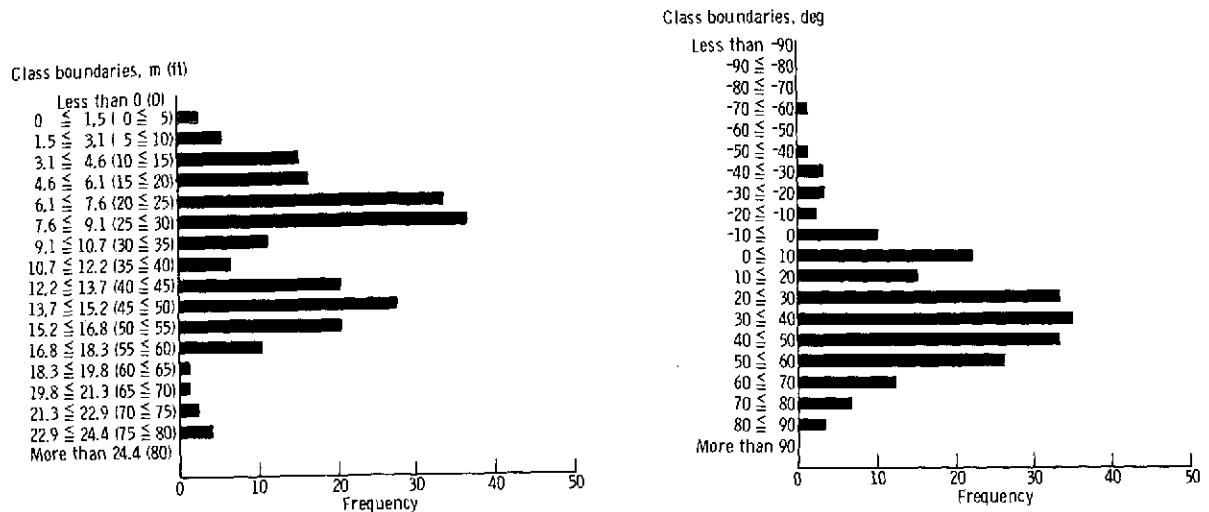

Figure 11.- Depth and orientation of shelf linear ridges. (From ref. 145.)

major axis of the shoals having a mean azimuth (i.e., compass direction) of  $32^{\circ}$ . Two modes are suggested at approximately  $5^{\circ}$  and  $35^{\circ}$ , with a third mode possibly at  $-30^{\circ}$  (i.e.,  $330^{\circ}$ ).

Arcuate shoals.- The arcuate shoals are most prominent when associated with capes such as within Chincoteague Shoals opposite the south end of Assateague Island, Md. They are even more extensive immediately south of the study area, within Diamond Shoals opposite Cape Hatteras, N.C. Arcuate shoals are also located opposite the mouths of nearly all the inlets along the coast of the Virginian Sea. The formation of the inlet shoals (i.e., ebb-tidal deltas) is related to the tidal-current-wave interaction, and they often have an important effect on the nearshore wave refraction patterns (ref. 25).

Probably the largest arcuate shoal in the study area is one associated with the entrance to Chesapeake Bay. Though highly bisected and cut by tidal channels, the distinct convex-seaward arcuate shape of this intermittent sand body, encompassing the mouth of the Bay, can be delineated from the detailed bathymetry. This huge sand body, suggestive of an ebb-tidal delta, may also be directly related to the origin of linear ridges adjacent to False Cape. Indeed, many of the linear ridges, especially those attached to shore, as well as many of the arcuate shoals may owe their origin, in part, to the formation of now relict ebb-tidal deltas.

## STUDY RESULTS

### Variations in Wave Behavior With Different Combinations of Input Parameters

Because of the very large number of combinations of wave direction, period, tide and height input conditions, large variations in wave behavior may result in any particular

portion of the shelf and along the shoreline. Also the large areal extent of the study adds to the complexity of the voluminous data. (A detailed analysis of these data is in progress.)

However, in spite of the complexity of the computer-generated data, certain definite features and patterns of wave behavior are clearly displayed by the wave refraction diagrams (figs. B1 to B70). One of the most notable of these patterns is a definite spatial periodicity in wave energy distribution over the shelf and along the shoreline. This periodicity results from the interaction of the ocean waves with the numerous relief elements on the continental shelf. These shelf relief elements include the shelf-edge canyons (for 12-second or longer waves) such as Washington and Norfolk Canyons; shelf valleys such as at the entrances to Delaware and Chesapeake Bays; ridge and swale bathymetry, most notably adjacent to the Delmarva Peninsula and Virginia Beach, Va.; and shore-connected northeast-oriented ridge systems such as Bethany Beach, Del.; False Cape, Va.; and Rodanthe, north of Cape Hatteras, N.C.

The resultant shoreline wave energy distribution varies with wave approach direction, wave period, stage of the tide, and changes in sea level from the inverse barometric effect associated with moderate to severe storms. This spatial variation in wave energy distribution (i.e., alternate zones of wave energy concentration and diminution) also varies directly with the period of the incoming waves. For waves of 6 to 8 seconds, these periodic zones are 1 to 5 n. mi. in length along the shoreline, and for waves of 12 to 14 seconds, these zones may be 15 to 25 n. mi. in length. The variations in the widths of these zones appear to be related to the distance from shore that the waves begin to interact with the shelf relief elements. This spatial wave energy distribution along the shoreline will affect the morphology and the long-term erosional history of the shoreline. Obviously, documentation of these trends needs to be undertaken in any shoreline planning.

#### Ocean-Wave—Continental-Shelf Interaction

Shelf-edge canyons.— Norfolk and Washington Canyons head at depths of approximately 87.8 and 73.2 meters (288 and 240 feet), respectively. They, therefore, appear to have an important effect on waves with periods of 12 seconds or greater. These effects are twofold:

- (1) Relatively decreased concentration of wave energy downwave from the canyons and the creation of a shadow zone of low wave energy along the shore about 20 n. mi. in length due to a divergence of the wave rays
- (2) Greater wave energy on either side of this shadow zone as a result of the convergence of the wave rays refracted away from the shadow zone

These effects have been noted by Munk and Traylor (ref. 147) along the California shoreline where, because of the closeness of the canyons to shore, the effects are more

discernible. Though apparent for 12- and 14-second waves from all directions (see diagrams in appendix B), the effects of the canyons on the waves will vary with wave approach direction because of additional wave-shelf interaction in the downwave direction. An example of this is the shoreline effect of Norfolk Canyon, which for northeast waves is slight because of additional refraction but much more noticeable for east-northeast and east waves. The shadow zone moves north along the shoreline as the wave approach direction moves south; the Norfolk Canyon shadow zone moves from the False Cape vicinity to Virginia Beach and then to the Chesapeake Bay entrance and Smith Island, with the wave approach direction changing from northeast to east-northeast to east, respectively.

Shelf valleys.- Two of the larger shelf valleys are located adjacent to the mouths of Delaware and Chesapeake Bays and display a southeast orientation. The Delaware Shelf Valley has appreciably more relief and steeper sides than the Susquehanna Shelf Valley (fig. 1). Like the shelf-edge canyons at the seaward side of the shelf, these relict features were probably formed by subaqueous stream processes when sea level was lower. Present interaction with the shelf valleys results in one of the most important effects of wave-shelf interaction, that is, the development of confused seas over the seaward margin of these valleys. This effect is due to landward moving waves encountering an abrupt increase in depth and is most dramatically illustrated for the Delaware Valley by 12-second waves from the south-southeast. As can be readily seen in the diagrams (appendix B), subtle changes in wave approach direction and wavelength will drastically alter the "strength" of the confused sea, which is referred to technically as a straight caustic. Straight caustics have been demonstrated in a wave tank and described theoretically by Chao and Pierson (ref. 41). The concentration of wave energy from southeast swell (as exemplified by increased wave heights) along the seaward side of the Delaware Valley may have been observed and photographed by LaRC personnel in August 1973.

Ridge and swale bathymetry.- Originally described by Uchupi (ref. 80), the detailed morphology and suggested processes of origin and maintenance of these ridges has been recently summarized by Duane, Field, Meisburger, Swift, and Williams (ref. 145). A mechanism for maintenance of these ridges by present wave processes has been suggested by Goldsmith (ref. 31), in which wave refraction around a topographic high would cause the sediment to be redeposited downwave from the high (fig. 12). Thus, such ridges would have their long axis oriented parallel to the wave rays from the dominant wave approach direction, as is the case for most of the ridges on the shelf.

Irrespective of the genetic mechanism of this ridge and swale bathymetry, an examination of the wave refraction diagrams clearly shows that this bathymetry has the most significant overall effect of any of the shelf relief elements on the ocean waves. As a result of wave refraction over this regular ridge and swale bathymetry, alternating

zones of relative wave energy concentration and diminution are produced downwave from this bathymetry, both over portions of the shelf and along the shoreline.

Shoals, banks, and massifs.- Extensive shoal areas, forming topographic highs on the shallow continental shelf, will also greatly affect incoming wave patterns. Such areas are found offshore from Ocean City, Md. (Gull Banks and Fenwick Shoals), the south end of Assateague Island, Md. (Chincoteague Shoals), Parramore Island, Va. (Parramore Banks), Virginia Beach to False Cape, Va. (Virginia Beach Massif), and Oregon Inlet and Rodanthe, N.C. (Platt and Wimble Shoals, respectively).

An example of the effects of these offshore shoal areas on nearshore circulation patterns can be seen in the vicinity of Virginia Beach, Va., which is

greatly affected by the adjacent, extensive Virginia Beach Massif. Here, the waves with periods of 10 seconds or shorter from the north-northeast, northeast, and east-northeast are, for the most part, refracted away from the resort area by the Virginia Beach Massif to the Chesapeake Bay entrance and the Back Bay-False Cape area. In a similar manner waves from the east-southeast, southeast, and south-southeast are concentrated in the Virginia Beach and adjacent offshore area. These phenomena result in the dominant northward longshore drift observed in the Virginia Beach area; this might be because greater wave energy reaches the area from the southern quadrants than from the north, resulting in a net nearshore sediment transport to the north. Harrison, Brehmer, and Stone (ref. 148) suggested that the observed northward sediment transport in the Virginia Beach area was due to a large nontidal eddy related to the circulation originating at the mouth of the Chesapeake Bay. It should therefore be noted that both effects may be occurring and that neither the wave or current-induced circulation patterns are mutually exclusive.

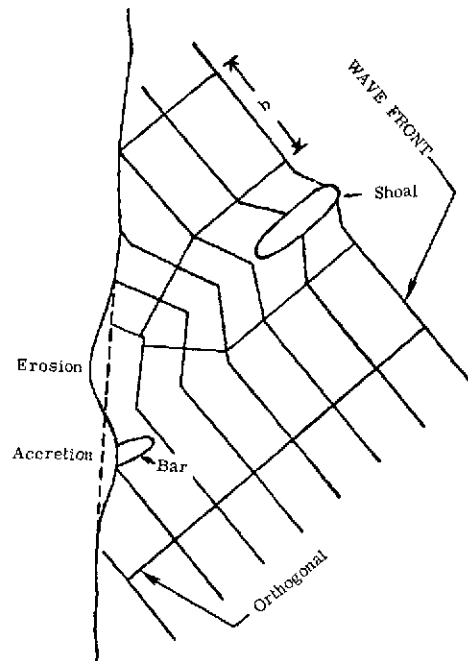

Figure 12.- Schematic illustrating a mechanism proposed to explain growth and maintenance of linear ridge on shelf and its effect on wave energy distribution along shoreline. (From ref. 31.)

### Shoreline Wave Energy Distribution

Shore-connected linear ridges.- Of critical importance to the final shoreline wave energy distribution and intimately related to shoreline changes, are the several series of

shore-connected linear sand ridges, which, like the linear ridges offshore, generally have their long axes alined to the northeast. Extensive shore-connected ridge systems are found off Bethany Beach, Del.; False Cape, Va.; and Oregon Inlet to Cape Hatteras, N.C.

Moody's hand-drawn refraction diagrams for the Delaware ridges (ref. 149) indicated shoreline wave energy concentrations over the ridge crests for all common wave approach directions. These concentrations were apparently substantiated by Moody with measurements of the irregular beach changes at Bethany Beach following the March 1962 storm.

Vincent (ref. 150), in a very detailed statistical analysis of shoreline meanders along the Rodanthe-Cape Hatteras shoreline, found a definite relationship between the Rodanthe shoreline rhythms and the adjacent ridge and swale bathymetry, which could be related through the wave refraction patterns.

Though the detailed wave refraction patterns over these ridge systems are smaller than the scale of these diagrams, it is significant with respect to hypotheses advanced concerning the origin of these shoals in reference 100 to note that the shorelines of all three of these ridge systems are areas of above average wave energy concentrations from many different directions. These concentrations are most apparent for waves with periods of 8 seconds from the northeast and southeast and to a lesser extent for waves with periods of 6 and 10 seconds from these and other directions.

A second-order grid of the area offshore from southeast Virginia is now being examined in some detail at VIMS to determine the wave refraction patterns over the False Cape ridge system.

Inlets and wave energy concentrations.- There are definite shoreline areas with pronounced wave energy concentrations for several wave approach directions. Two of the most obvious examples are the False Cape area and the Chesapeake Bay entrance. This concentration appears to be a direct result of the extensive Virginia Beach Massif which is relatively shallow, 18.3 meters (60 feet) deep, and close to shore (10 n. mi.). Present studies are following these waves into Chesapeake Bay in order to study the resulting refraction patterns and delineate the contribution of these ocean waves to the wave climate of the Bay.

One of the more intriguing results of the present study is the close proximity of the coastal inlets and the shoreline areas of wave energy concentration; this suggests a causal relationship. This relationship is especially true for the numerous inlets of the southern Delmarva Peninsula (e.g., Wachapreague Inlet) and for Oregon Inlet; thus, the inlets may owe their existence, in part, to wave action because the inlets are in areas of wave energy concentration. Also related to this is the apparent spacing of wave energy concentrations for waves with periods of 8 and 10 seconds for various directions, which is remarkably close to the spacing of the inlets. This shoreline spacing, as indicated by

the convergences of wave rays, is directly related both to the depth and relief of the various shelf elements and the length of the waves that would be most directly influenced by these relief elements. The relatively shallow, wide shelf helps to emphasize these relief elements. The slight wave refraction of waves with periods of 4 and 6 seconds and the abrupt increase in refraction for waves with periods of 8 seconds and longer, for all wave approach directions, is clearly related to this morphogeometry of the shelf.

An excellent example of the regular periodicity that can result from the ridge and swale bathymetry is shown in the wave refraction diagrams (figs. B38, B20, and B26) for waves with periods of 10 seconds from the southeast for the North Carolina shoreline and from the east-northeast and east for the Eastern Shore of Virginia. Here, shoreline zones of wave ray divergences and convergences alternate at approximately intervals of 5 n. mi. A detailed study has been made of such alternating zones of wave energy along 20 n. mi. of shoreline off the southern Delmarva Peninsula (ref. 25). A noteworthy correlation was observed between observed rates of shoreline erosion since 1852 and areas of wave energy concentrations as computed in this second-order Virginian Sea Wave Climate Model (fig. 13).

Other areas of relatively high shoreline wave energy concentrations for specific wave conditions are between Indian River Inlet, Del., and Ocean City, Md.; the south end of Assateague Island near the Virginia-Maryland state line; Cobb Island to Smith Island, Va.; and Corolla to Kitty Hawk, N.C.

Thus, shoreline wave energy concentrations are formed by wave refraction over the various shelf relief elements. The location and spacing of these shoreline zones of wave ray convergences and divergences will depend on

- (1) The wave approach angle
- (2) The size and extent of the adjacent shelf relief elements
- (3) The distance from shore and depth of these relief elements
- (4) The regularity and rhythmic nature of the relief elements
- (5) The interaction of wave refraction patterns from more than one set of relief elements

#### Prediction of Shoreline Changes

Figure 13 illustrates the surprisingly strong correlation near Wachapreague Inlet, Va. (between Cedar and Parramore Islands) between shoreline variations in measured rates of erosion between 1852 and 1934 and areas of wave energy concentrations in 1852 determined by using 1852 bathymetry as input data. The three wave energy peaks for the 1852 erosional waves with periods of 4 seconds show a strong correlation in both location



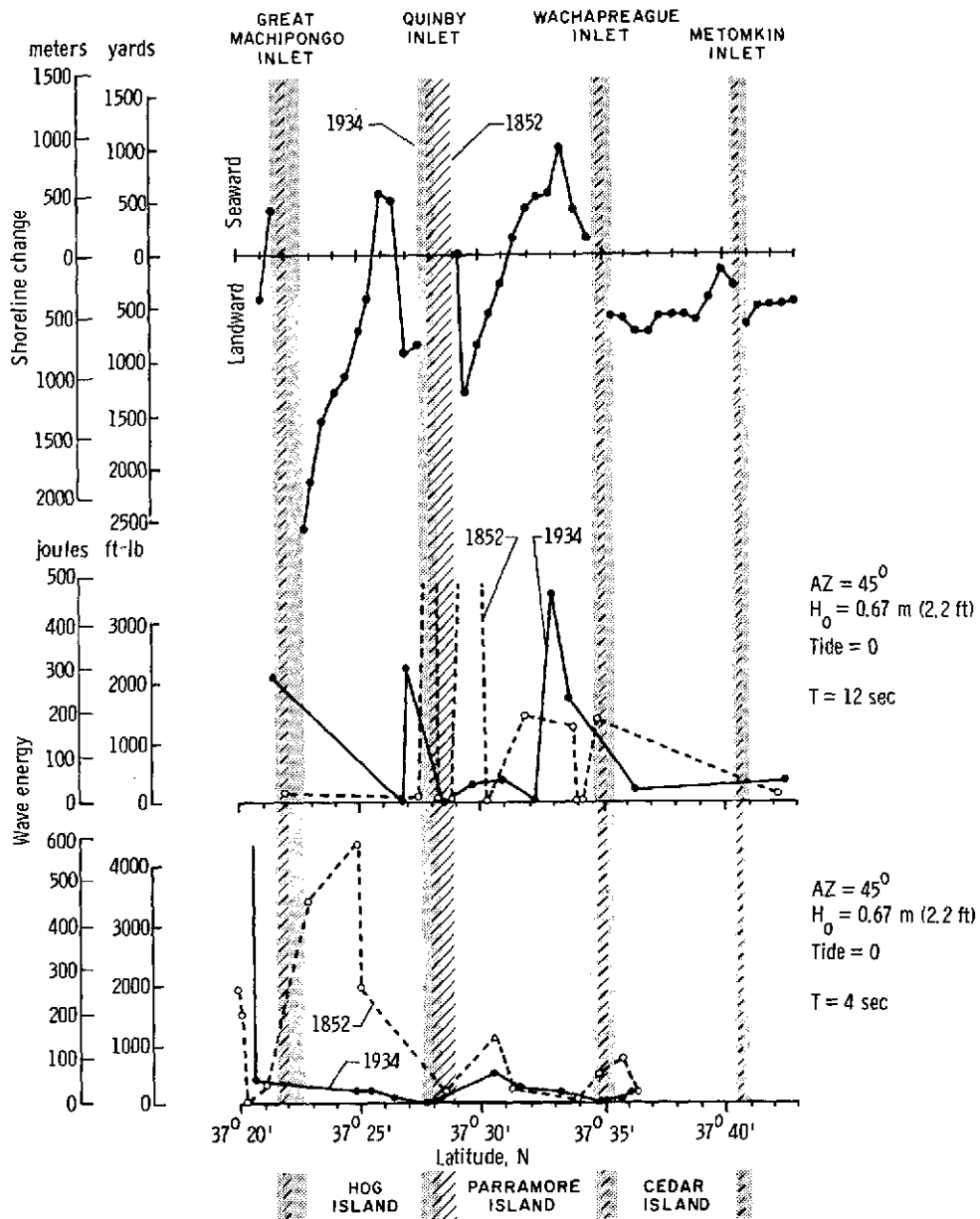

Figure 13.- Historical shoreline changes along the Eastern Shore of Virginia compared with changes in shoreline wave energy distributions. 1852 to 1934.

and magnitude with the three areas of shoreline erosion. Also, the three wave energy peaks for the 1934 accretional waves with periods of 12 seconds show a similar correlation with the three areas of shoreline accretion. In each of these two cases, the amounts of erosion are also directly related to the magnitude of the computed wave energy. Coincident with the irregular shoreline changes that resulted in the increased development of the offset inlets, the shoreline wave energy for the waves with periods of 4 seconds tended to become more evenly distributed along the shoreline between 1852 and 1934. Therefore,

one might be emboldened to predict that when the alongshore shoreline wave energy distribution becomes evenly distributed, the inlet offsets will cease growing and rates of shoreline erosion and accretion will become more evenly distributed along the shore.

Thus, by this evaluation of historical wave conditions based upon historical shoreline and bathymetric data, changing shoreline wave energy distributions with time (as a reflection of offshore bathymetric changes) can be delineated, and predictions can then be made of future shoreline and nearshore changes. Therefore, the usefulness of the VIMS-LaRC Wave Climate Model is not limited to present conditions, but the model is a valuable tool which can also be utilized in understanding the past in order to predict the future wave energy distribution over the shelf and along the shoreline.

### Tidal Effects

In order to test the effect of changing water level on these refraction patterns, 1.2 meters (4 feet)<sup>4</sup> were added to each of the depths and the waves from the northeast, east, and southeast were recomputed.

In general, for the east and southeast directions the wave rays are less concentrated along the shore for high-tide conditions, though the areas of wave energy concentration are not significantly different for equivalent low- and high-tide conditions. For waves from the northeast the situation is more complex, with some significant changes between low- and high-tide conditions involving focusing of wave ray convergences and changes in the locations of this focusing of up to 2 or 3 n. mi. along the shore.

### APPLICATIONS

An important aspect of this applied research supported in part by the NOAA Sea Grant Program is the concomitant development of applications for the new research technology.

The presentation and analysis of the data derived from the VIMS-LaRC Wave Climate Model further substantiate the general recognition that ocean wave refraction plays a dominant role in controlling the distribution of wave energy over the continental shelf and along our coasts; furthermore, these data illustrate how knowledge of a specific refracted wave input at a site is critical to the successful implementation of shoreline defense programs, knowledge of continental shelf sedimentation processes, and construction and maintenance of coastal and offshore structures. Thus, a number of agencies have interests in the continental shelf waters (e.g., VIMS, NASA, U.S. Army Corps of Engineers, NOAA, Environmental Protection Agency, Geological Survey, Fish and Wildlife Service, Virginia Marine Resources Commission, Commonwealth Division of Planning and

---

<sup>4</sup>Equivalent to a spring tide over most of the area.

Community Affairs, and Virginia Highway Department) and are potential users of information from analytical wave models such as the VIMS-LaRC Wave Climate Model. Also, industries which may benefit from wave predictions on the shelf include shipping, oil, fishing, and recreation.

Although the present model is limited to a first-order linear approach, it is an invaluable tool for the scientific understanding of a number of shelf processes. Additional experimental verification of this model (or an improved version) offers the opportunity for a variety of additional potential uses.

Advances in analytical modeling may be expected to interact with technology advances from other areas of science. Although all potential uses cannot be defined, major categories of specific long-term applications discussed in this section are (1) advanced coastal wave forecasting, (2) improved environmental quality, and (3) data supply for government, industry, and other scientific disciplines.

#### Advanced Coastal Wave Forecasting

Considerable potential exists for the application of continental shelf wave refraction modeling for the improvement of marine forecasts of wave heights over the continental shelf. Two major approaches to this problem are discussed: (1) the continental shelf modeling may be incorporated into existing Weather Service forecast techniques or (2) it could become part of the data analysis procedure for future satellite systems.

The present NOAA marine forecasting technique (ref. 151) utilizes the National Meteorological Center (NMC) 1977-point grid system for the prediction of wind-generated waves and swell. Computations are made at each grid point spaced 180 n. mi. apart. Wave forecasting techniques applicable to the deep ocean are used in these computations. Wave-height contour charts are then derived based on values at each grid point over the entire North Atlantic Ocean. Because of the large grid spacing and utilization of deep-ocean computational methods, the present forecast system has limited application to the continental shelf regions where bottom topography modifies ocean swell characteristics. It is reasonable to expect that wave refraction models of small areas of the continental shelf could be incorporated within the large-scale NMC grid squares in coastal regions. Output (height, period, and direction) from the NMC grid could be smoothed and input to the refraction model which in turn would predict height distribution in finer detail over the continental shelf region. This same procedure is essentially followed for a smaller geographic region in reference 42.

An alternative approach to more accurate wave forecasts would be to utilize a system similar to the prospective Seasat oceanography satellite (ref. 152) coupled to the wave refraction model by using microwave instrumentation for all-weather capability. Deep-ocean wave directional spectrum data could be input to the refraction model for

prediction of continental shelf swell conditions. Wave spectra and/or wind data could be used to predict wind-generated wave height distribution. Recent successes in monitoring wave and wind characteristics with microwave instrumentation (refs. 153 to 155) give encouragement that such advances are possible. Harrison and Green (ref. 156) show that satellite orbits are possible which maximize oceanographic and wind observations in the coastal zone.

As the continental shelf regions of the United States are subject to increased utilization, there will be a need for more detailed wave forecasts over the region just as detailed meteorological forecasts are now required around airports. A study by Pierson in 1972 (ref. 23) has shown that wave refraction effects over high-relief bathymetry in the North Sea could have been directly related to the sinking of two fishing boats. A similar experience may have been encountered by Florida fishermen off Cape Charles, Va., in December 1973 (ref. 157). Coping with the natural weather and sea environment is probably the largest single problem in offshore operations (ref. 158). It is clear that as advanced marine prediction systems are developed, large-scale analytical wave refraction modeling will play an increasingly important role.

#### Improved Environmental Quality

Although prediction of surface wave conditions is of obvious value to offshore operations, this same capability has important impact on the ability to analyze a number of environmental problems. The ability to analyze and predict shoreline changes caused by either natural or manmade bathymetry changes on the shelf has been discussed in the section "Study Results." Prediction of surface wave conditions also has potential impact on ocean dumping operations. For products categorized as liquid wastes, it has been suggested that disposal sites be selected which allow rapid dispersal near the surface. This implies that it may be desirable to dump these products in a region with high sea state where turbulent mixing is high. Thus prediction of weather and wave conditions could be used to vector dumping vessels to high energy regions of the shelf.

A theoretical study utilizing second-order Stokes wave theory (ref. 159) suggests that wave-induced currents may, under some conditions, be the same order of magnitude as wind-driven currents on the Mid-Atlantic Continental Shelf. This suggestion has important implications concerning the transport of pollutants both on the surface and at depth in shelf waters. Predictive capability of the bottom currents is particularly important to site selection for disposal of both inert and degradable solid wastes. Surface current conditions are important for prediction of oil-spill movement. Close to land, wave-induced longshore currents are important to the transport of effluents of sewage outfalls. One method for monitoring shelf circulation (noted in ref. 159) may be the application of wind, wave, and Gulf Stream data from remote sensors to analytical circulation models

which would calculate both surface and subsurface currents. Such modeling should include wave refraction calculations as well as geostrophic balance, wind stress, salt balance, thermal balance, and fresh-water runoff.

#### Data Supply for Government, Industry, and Other Scientific Disciplines

As frequent, all-weather wave observations become available from systems such as the planned Seasat satellite, a greater scientific understanding of wave conditions on the continental shelf will evolve. This understanding will enable more sophisticated analytical models. For example, it may be possible one day to transform wave directional spectra statistics taken at one location to another location through a series of verified refraction calculations. Such operations could reduce the need for wave gage installation and long duration measurement periods at sites of proposed offshore construction (such as is now underway on the New Jersey coast).

With respect to direct application of the Virginian Sea Wave Climate Model to oil-spill problems, recent studies indicate that the spread of oil on the sea surface is a complex problem, with the oil movement mainly a function of the direction and velocity of the surface winds and tidal currents (ref. 160). Sonu, Murray, and Smith suggested in reference 161 on pages 17 and 18 that wave action was an important factor in the spread of oil under sea conditions inasmuch as wave action affected mixing in the water layer which in turn influenced vertical eddy viscosity and, hence, the vertical velocity profile. Therefore, although this model may be somewhat limited in its ability to predict the movement of oil, it could be combined with other models (discussed previously) and contribute basic data on swell conditions and areas of potential confused seas, especially in crisis situations.

If data derived from either the present VIMS-LaRC Wave Climate Model or more sophisticated versions are used, more rapid definition of engineering specifications, appropriate legislation, insurance actuarial data, and environmental impact effects may be possible. Such information is necessary for the correct management of environmental resources. For example, accurate knowledge of shoreline wave energy distributions is a must in defining coastal setback lines such as that legislated in 1971 in Florida (ref. 162).

By using deep-water wave conditions from Marsden square or hindcasted storms, data from the VIMS-LaRC Wave Climate Model for specific wave conditions can be put into a statistical representation of shoreline wave energy distribution. Risk factors can then be developed by combining these data with probabilistic descriptions of storms (i.e., frequency and intensity). Such data should be of great interest to insurance companies and aid in the formulation of setback lines.

These wave data may be used specifically to assist in the analysis of the distribution of the sediments of the sea floor of the Virginian Sea. In a detailed study conducted by Nichols (ref. 104), these sediments displayed large grain-size variations on the shelf. Comparison of a detailed grain-size distribution map prepared by Nichols, with a shelf wave energy and bottom wave scour "map," contoured for a variety of wave conditions, should provide valuable information as to the causes of the grain-size distribution (i.e., relict processes and/or modern hydraulic processes). If a comparison suggests a relationship between the grain-size and wave energy distributions, then the wave data can be used to suggest areas for future sediment sampling in order to further test the hypothesis. Thus, it is clear that regional-size banks of data concerning wave orbital velocities and wave-induced currents will provide beneficial information to scientists in other disciplines.

### CONCLUDING REMARKS

A Wave Climate Model for the Mid-Atlantic Continental Shelf and shoreline encompassing 20 000 square n. mi. and 200 n. mi. of shoreline has been computed for 122 distinct wave and tidal conditions. Computations of 19 wave parameters along more than 30 000 wave rays have resulted in the generation of over one million pieces of useful data, which will be used as

- (a) A data bank of useful wave information available at the Virginia Institute of Marine Science (Gloucester Point, Va. 23062) to user agencies, other officials, and companies involved with the development and use of the continental shelf and shoreline
- (b) A source for additional, more detailed analyses, such as testing of proposed modifications prior to initiation of projects
- (c) Input to smaller closer spaced near-shore grids
- (d) The nucleus for an early warning system from severe storm events for coastal areas

The most important wave process on the continental shelf is the interaction between the ocean waves and the various shelf relief elements. This process results in nonuniform wave energy distributions over the shelf and along the shoreline. Detailed analyses of these ocean-wave—shelf interactions for specific shelf and shoreline areas should provide valuable input for the understanding of the present processes, the past development, and future changes of the continental shelf and coastal geomorphology.

## APPENDIX A

### SUMMARY OF MAP PROJECTION CONSTRUCTION

By Norman T. Carpenter  
Clark University Cartography Laboratory  
Worcester, Massachusetts

#### Construction of the Map Projection

For the construction of the map projection, a grid of 0.0508-meter (2-inch) squares was scribed on Keuffel & Esser 0.127-millimeter (0.005-inch) scribing film, 2.74 meters (108 inches) long and 1.016 meters (40 inches) wide. The measurements were made by surveyor's metal tape for intervals of 0.3048 meter (1 foot) or more and by draftsman's scale for shorter intervals.

The center intersection on the grid was designated the origin of a rectangular coordinate system, with the ordinate parallel to the long dimension of the grid. The origin was designated lat.  $37^{\circ}$  N, long.  $75^{\circ}$  W in the geographic grid. A computer program (ref. 62) calculated abscissa and ordinate values in inches for intersections at 10-minute intervals of latitude and longitude, based on the sphere of equal area, radius equals 6 370 997 meters (3440 n. mi.). The intersections were plotted by hand and connected by scribed interrupted lines. The estimated accuracy of location of all intersections is within 0.508 millimeter (0.02 inch).

A positive contact print made from the original scribe coat was measured. The grid on this print, made on a stable-base material, is 2.75 meters (108.1 inches) long and 1.0168 meters (40.03 inches) wide, an expansion of about 1/10 of 1 percent. The diagonals of the grid were equal: no deviation from rectangularity could be measured.

The nominal scale of the projection is 2.54 centimeters (1 inch) equals 2.5 n. mi.,<sup>5</sup> or 1:180000. Variations in this scale are discussed in the following section.

The map extends from latitude  $35^{\circ}$  to  $39^{\circ}$  N and from longitude  $74^{\circ}$  to  $76^{\circ}$  W. With no change in the present map, the projection can be extended in any direction.

#### Scale Factor

Scale factor is the term used to define the variation in areal exaggeration of a projection. Since the scale of the projection is 1:180000, it corresponds to a globe 1/180000 the size of the sphere of equal area to the Earth. All distances along the standard line

---

<sup>5</sup>For the map projection construction, 1 n. mi. = 1852 meters (6076 feet); for the example in this discussion, 1 n. mi. = 1829 meters (6000 feet).

## APPENDIX A

are exactly the same on both globe and map. Leaving the standard line, distances are slightly greater on the map than on the globe, so that in the actual scale, the denominator is slightly less than 180 000. The scale factor is equal to the denominator of the nominal scale, or 180 000, divided by the denominator of the actual scale. The difference in scale is not great on this map. On the standard line,  $75^{\circ}$ , the scale factor is 1.0000 and 2.54 centimeters (1 inch) equals 4572 meters (15 000 feet); 50 n. mi. east or west from the standard line, the scale factor is 1.0001 and 2.54 centimeters (1 inch) equals 4571.5 meters (14 998.5 feet). (See fig. 1 of ref. 55.)

### Convergence

A projection is conformal when the angular relationships are the same at any point on the map as at the corresponding point on the Earth; therefore, conformal maps are used in navigation and surveying. The price of conformality is area exaggeration, but that is no problem in the limited extent of the UTM. However, it should be understood that while all directions are true at a point on the UTM, they vary from one point to the next. There are two characteristics of the projection to consider in connection with direction and the measurement of azimuth.

First, on this map the latitude and longitude lines have been superimposed on a square grid, which is more convenient to use, since locations can be expressed in Cartesian coordinates and directions expressed in plane trigonometry. The grid direction parallel to the central meridian is called grid north GN. However, grid north is the same as true north only on the central meridian and on the equator. The angle between grid north and true north is called the convergence, and it increases with distance from the central meridian and with distance from the equator. On this map it amounts to less than  $1^{\circ}$ .

Second, except for the central meridian and great circles at right angles to it, a straight line on the Earth's surface is not a straight line when projected on the UTM, and a straight line on the UTM does not pass through the same intermediate points as a great circle between the corresponding end points on Earth. This difference is greatest for north-south lines, increasing with distance from the central meridian, but it is slight on this projection. Take the two points  $35^{\circ}$  N,  $74^{\circ}$  W and  $39^{\circ}$  N,  $74^{\circ}$  W. A straight line on the Earth's surface between these points is, of course, the meridian  $74^{\circ}$  itself. The meridian is a curve on the map and at its midpoint,  $37^{\circ}$  N, it deviates from a straight line by 0.302 millimeter (0.0119 inch) or 54.5 meters (178.5 feet) on the Earth. Also, a straight line drawn on the map tangent to the meridian at  $39^{\circ}$  N,  $74^{\circ}$  W would cross  $35^{\circ}$  N about 1.21 millimeters (0.0478 inch) from the meridian (218.5 meters (717 feet) on the Earth's surface).



## APPENDIX B

### WAVE REFRACTION DIAGRAMS

Included in this appendix are 70 wave refraction diagrams (figs. B1 to B70) computed for the 122 wave input conditions listed in table I. Because linear wave theory was used, computations for initial wave heights of 0.6 and 1.8 meters (2 and 6 feet), with otherwise identical input conditions, will give identical refraction diagrams; therefore, the initial wave height was 0.6 meter (2 feet) for all diagrams shown. (To convert values of depth contour from feet to meters, multiply by 0.3048.) The conditions for the 70 refraction diagrams are given in the following index:

Figure	Azimuth, AZ, deg	Wave period, T, sec	Tide		Page	Figure	Azimuth, AZ, deg	Wave period T, sec	Tide		Page
			m	ft					m	ft	
B1	0	4	0	0	49	B36	135	6	0	0	84
B2	0	6	0	0	50	B37	135	8	0	0	85
B3	0	8	0	0	51	B38	135	10	0	0	86
B4	0	10	0	0	52	B39	135	12	0	0	87
B5	22.5	4	0	0	53	B40	135	14	0	0	88
B6	22.5	6	0	0	54	B41	157.5	4	0	0	89
B7	22.5	8	0	0	55	B42	157.5	6	0	0	90
B8	22.5	10	0	0	56	B43	157.5	8	0	0	91
B9	22.5	12	0	0	57	B44	157.5	10	0	0	92
B10	22.5	14	0	0	58	B45	157.5	12	0	0	93
B11	45	4	0	0	59	B46	157.5	14	0	0	94
B12	45	6	0	0	60	B47	180	4	0	0	95
B13	45	8	0	0	61	B48	180	6	0	0	96
B14	45	10	0	0	62	B49	180	8	0	0	97
B15	45	12	0	0	63	B50	180	10	0	0	98
B16	45	14	0	0	64	B51	180	12	0	0	99
B17	67.5	4	0	0	65	B52	180	14	0	0	100
B18	67.5	6	0	0	66	B53	45	4	*1.2	*4	101
B19	67.5	8	0	0	67	B54	45	6	*1.2	*4	102
B20	67.5	10	0	0	68	B55	45	8	*1.2	*4	103
B21	67.5	12	0	0	69	B56	45	10	*1.2	*4	104
B22	67.5	14	0	0	70	B57	45	12	*1.2	*4	105
B23	90	4	0	0	71	B58	45	14	*1.2	*4	106
B24	90	6	0	0	72	B59	90	4	*1.2	*4	107
B25	90	8	0	0	73	B60	90	6	*1.2	*4	108
B26	90	10	0	0	74	B61	90	8	*1.2	*4	109
B27	90	12	0	0	75	B62	90	10	*1.2	*4	110
B28	90	14	0	0	76	B63	90	12	*1.2	*4	111
B29	112.5	4	0	0	77	B64	90	14	*1.2	*4	112
B30	112.5	6	0	0	78	B65	135	4	*1.2	*4	113
B31	112.5	8	0	0	79	B66	135	6	*1.2	*4	114
B32	112.5	10	0	0	80	B67	135	8	*1.2	*4	115
B33	112.5	12	0	0	81	B68	135	10	*1.2	*4	116
B34	112.5	14	0	0	82	B69	135	12	*1.2	*4	117
B35	135	4	0	0	83	B70	135	14	*1.2	*4	118

\* Equivalent to a spring tide.



APPENDIX B

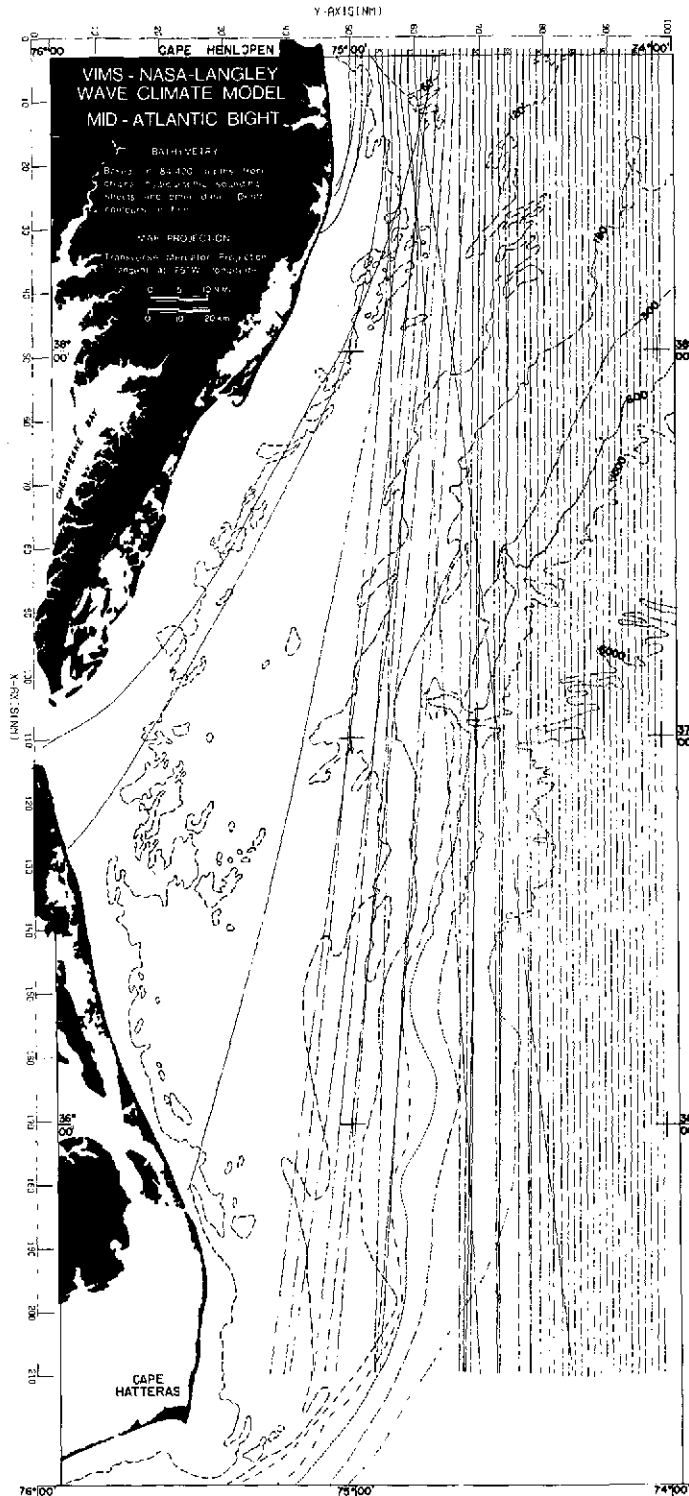

ORIGINAL PAGE IS  
OF POOR QUALITY

Figure B2.- Wave rays computed with following input conditions:  
AZ = 0°; T = 6 sec; Tide = 0.

# APPENDIX B

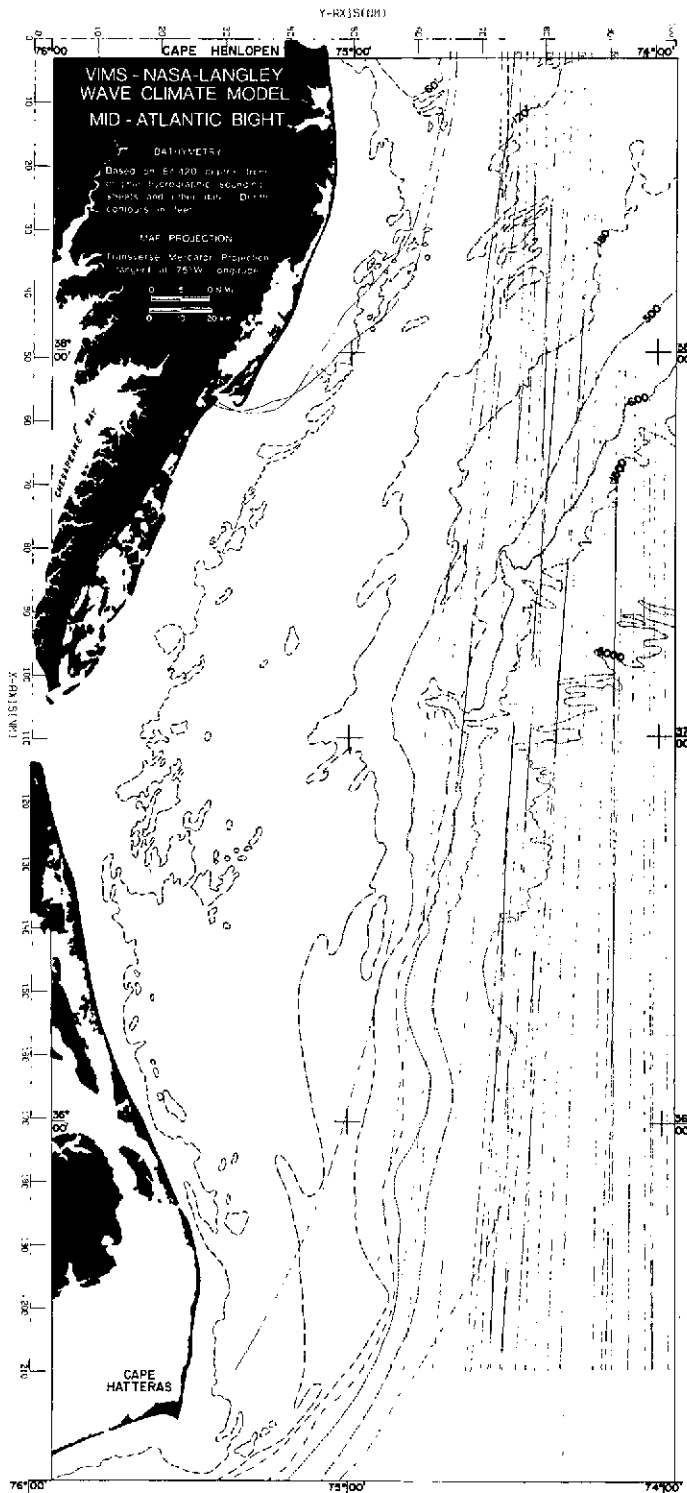

Figure B3.- Wave rays computed with following input conditions:  
 AZ = 0°; T = 8 sec; Tide = 0.

ORIGINAL PAGE IS  
 OF POOR QUALITY

# APPENDIX B

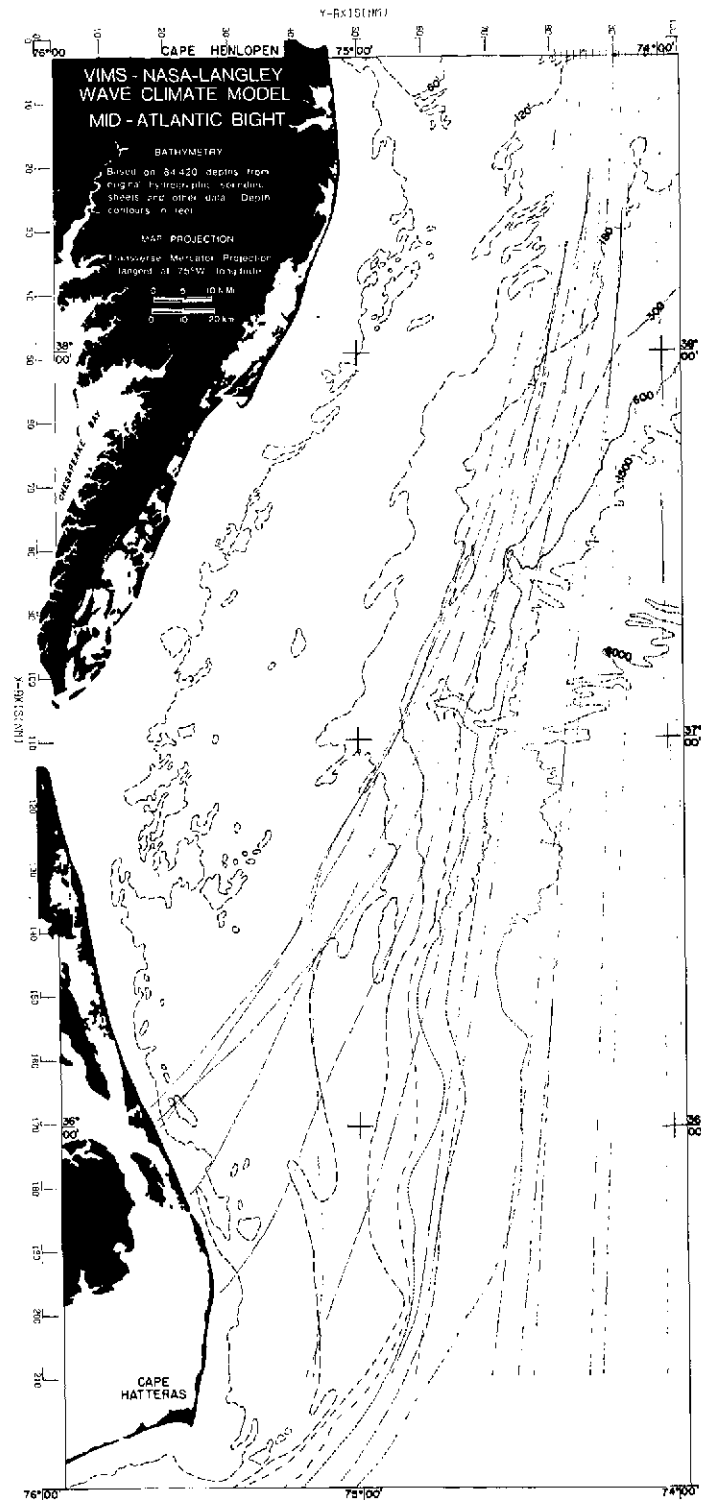

Figure B4.- Wave rays computed with following input conditions:  
 AZ = 0°; T = 10 sec; Tide = 0.

# APPENDIX B

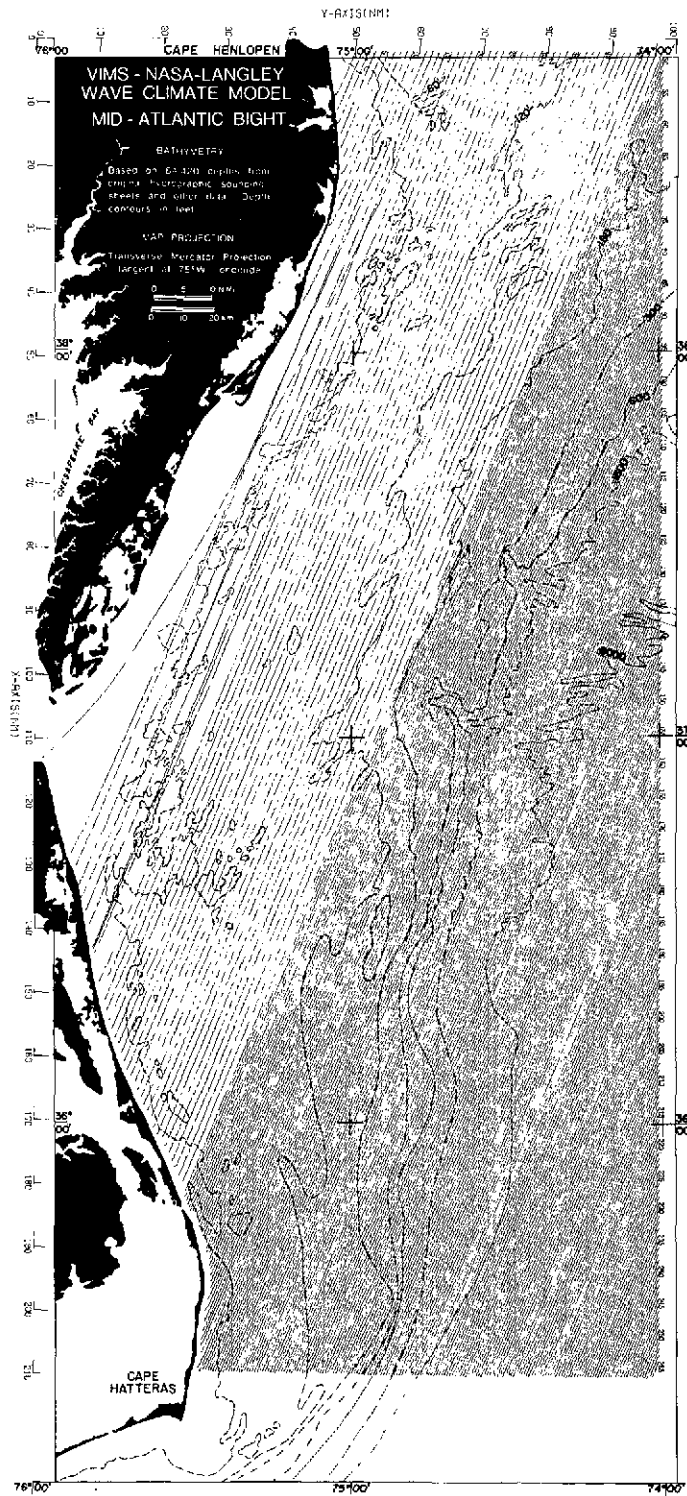

Figure B5.- Wave rays computed with following input conditions:  
 AZ = 22.5°; T = 4 sec; Tide = 0.

APPENDIX B

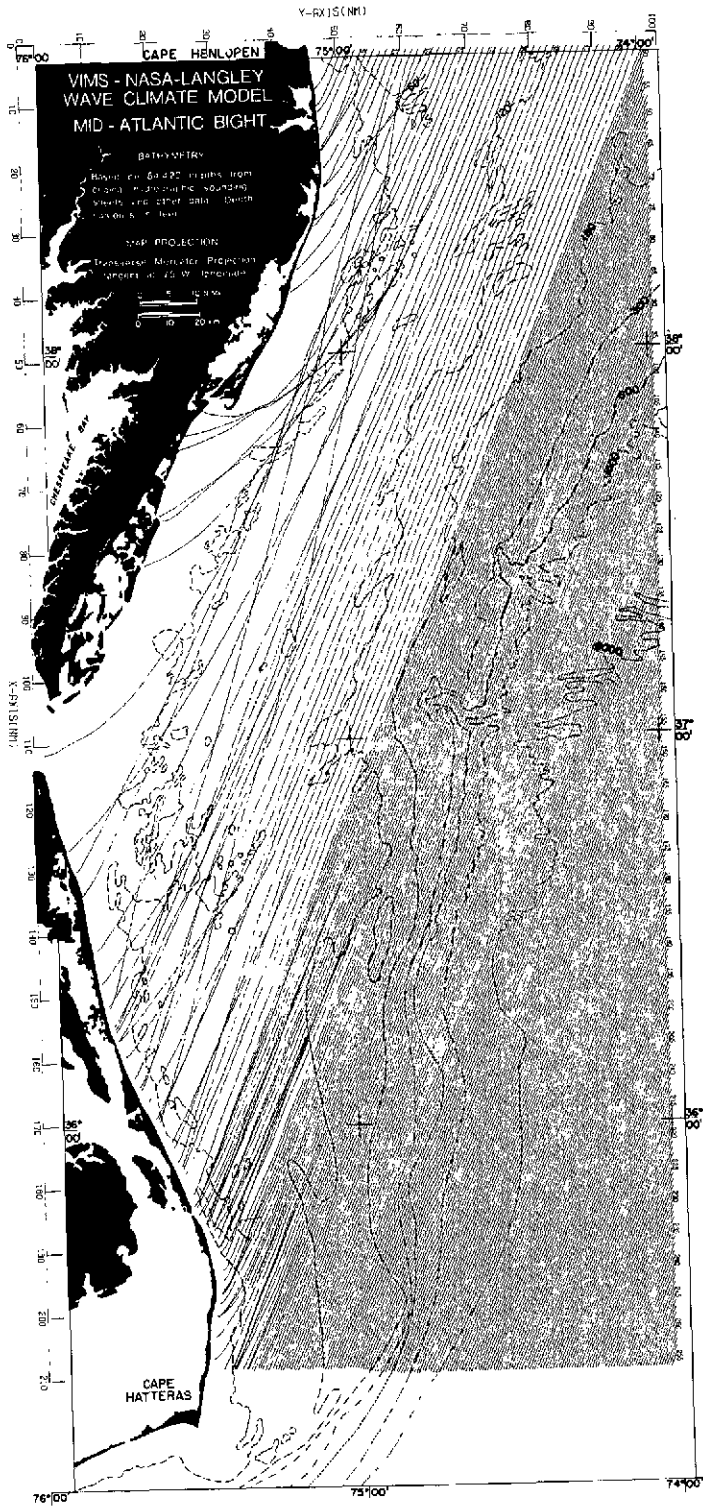

Figure B6.- Wave rays computed with following input conditions:  
 AZ = 22.5°; T = 6 sec; Tide = 0.

# APPENDIX B

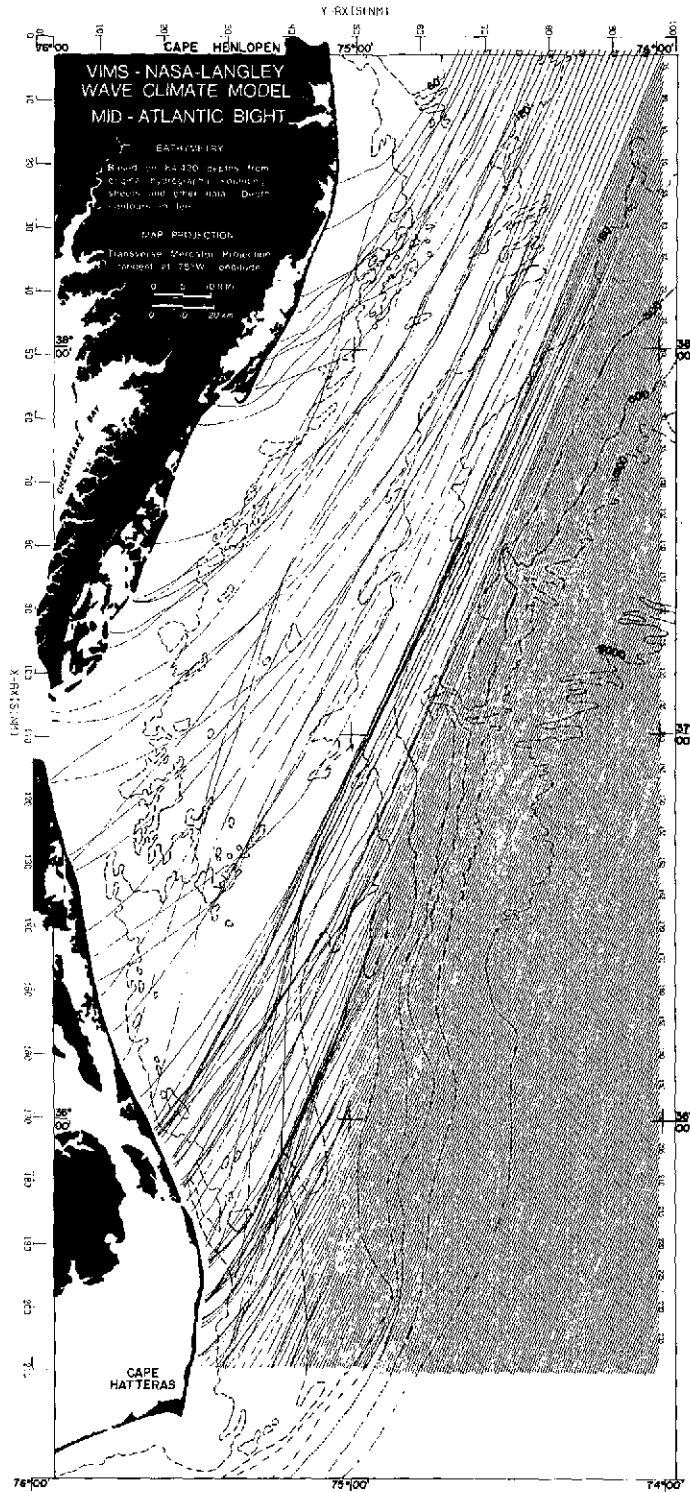

Figure B7.- Wave rays computed with following input conditions:  
AZ = 22.5°; T = 8 sec; Tide = 0.



APPENDIX B

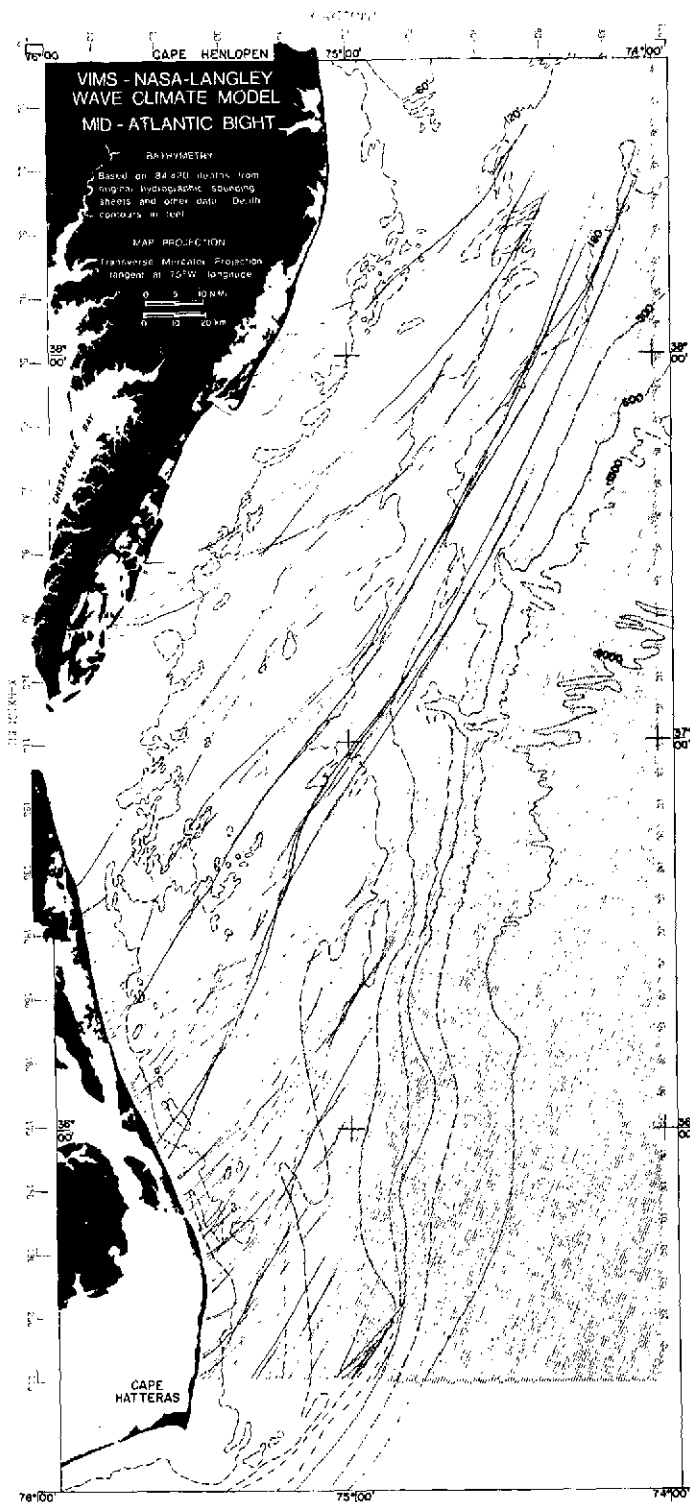

Figure B8.- Wave rays computed with following input conditions:  
AZ = 22.5°; T = 10 sec; Tide = 0.

# APPENDIX B

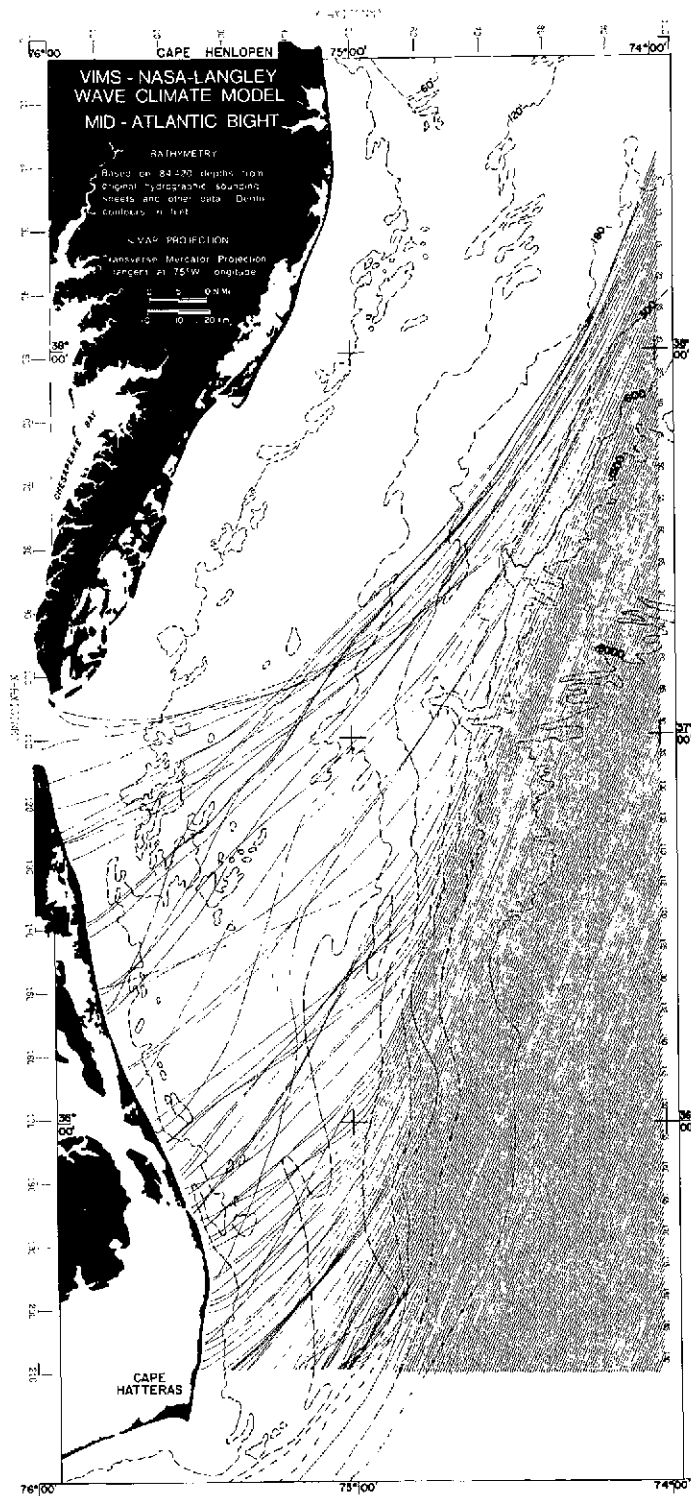

Figure B9.- Wave rays computed with following input conditions:  
AZ = 22.5°; T = 12 sec; Tide = 0.

# APPENDIX B

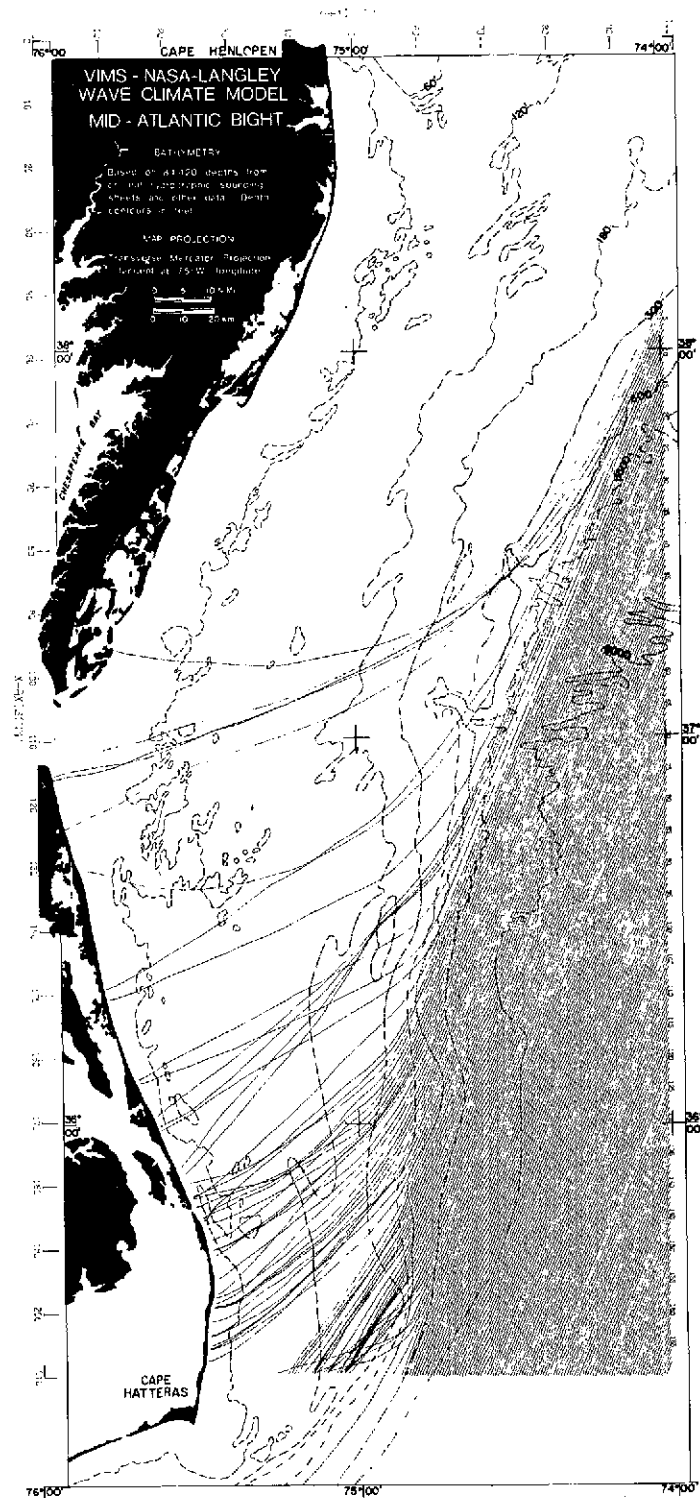

Figure B10.- Wave rays computed with following input conditions:  
 AZ = 22.5°; T = 14 sec; Tide = 0.

# APPENDIX B

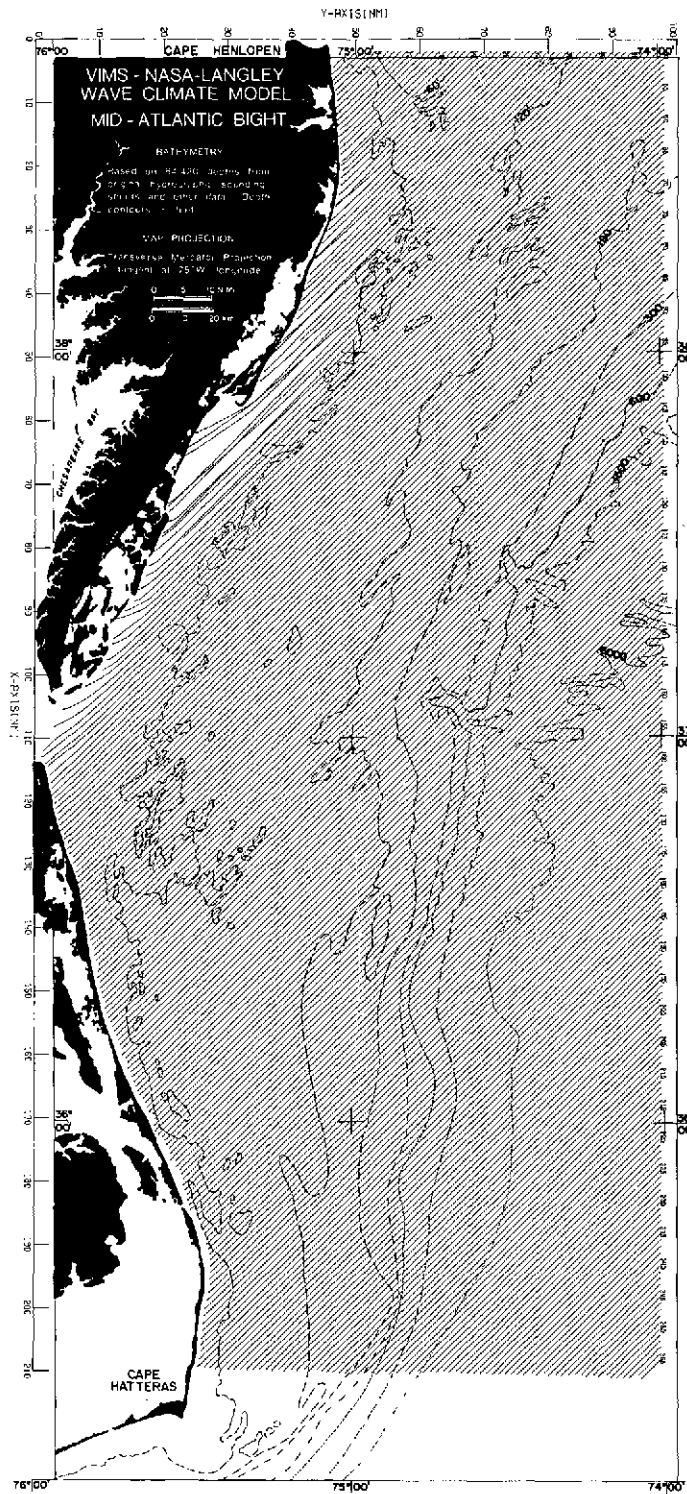

Figure B11.- Wave rays computed with following input conditions:  
 AZ = 45°; T = 4 sec; Tide = 0.

# APPENDIX B

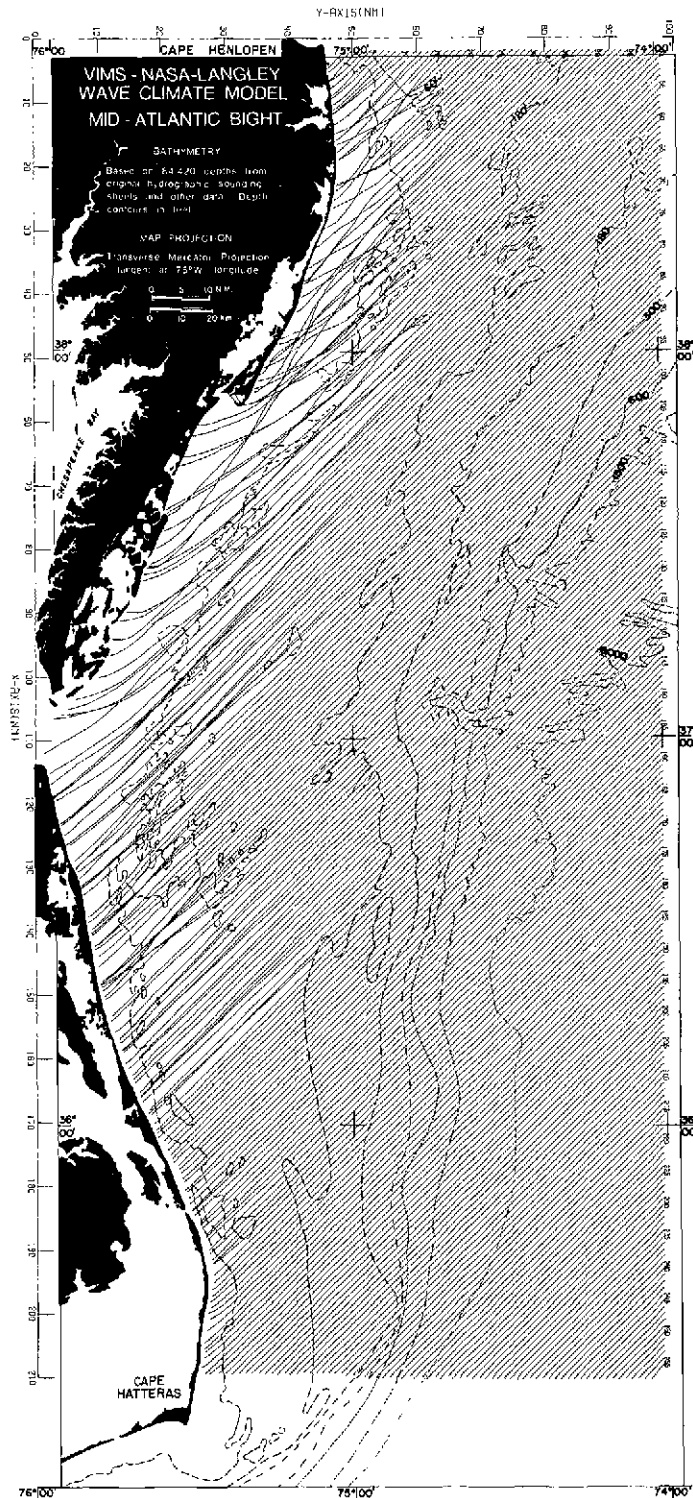
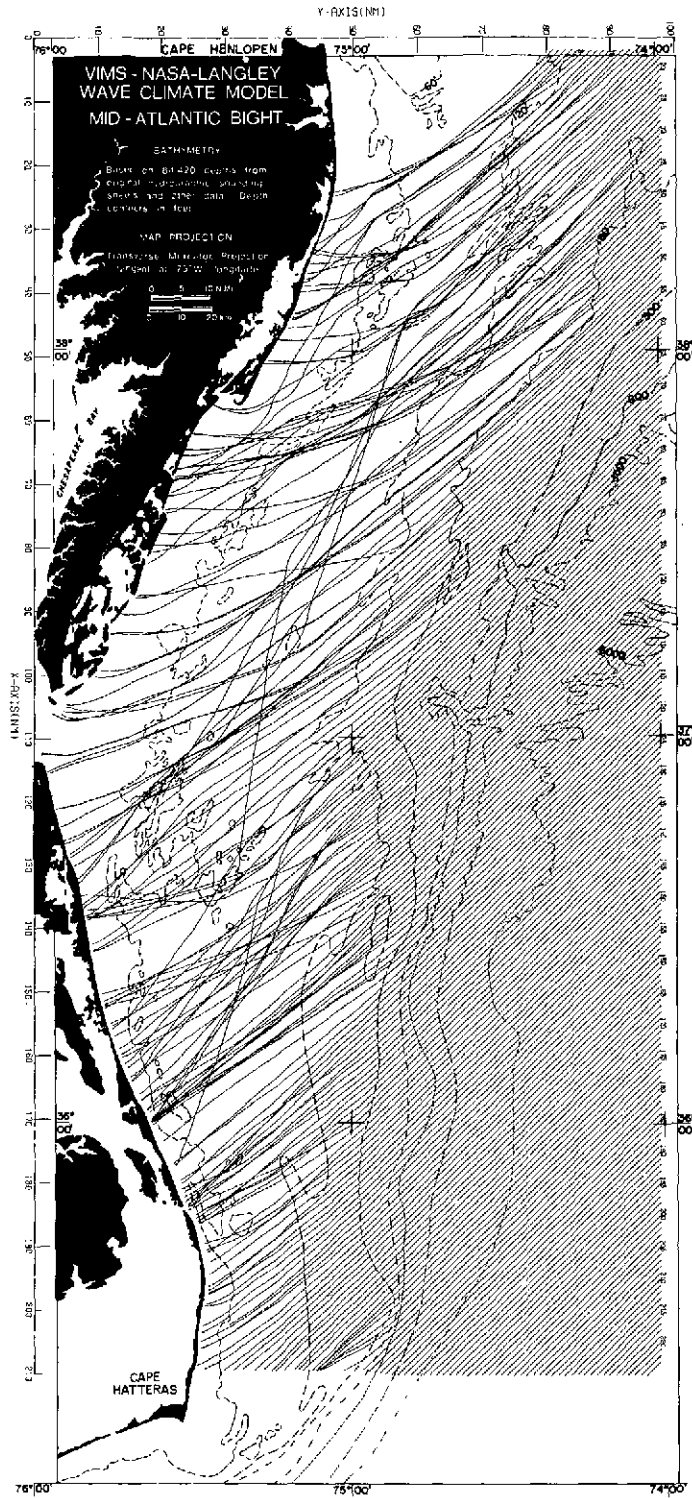

Figure B12.- Wave rays computed with following input conditions:  
 AZ = 45°; T = 6 sec; Tide = 0.



APPENDIX B



ORIGINAL PAGE IS  
OF POOR QUALITY

Figure B14.- Wave rays computed with following input conditions:  
AZ = 45°; T = 10 sec; Tide = 0.

APPENDIX B

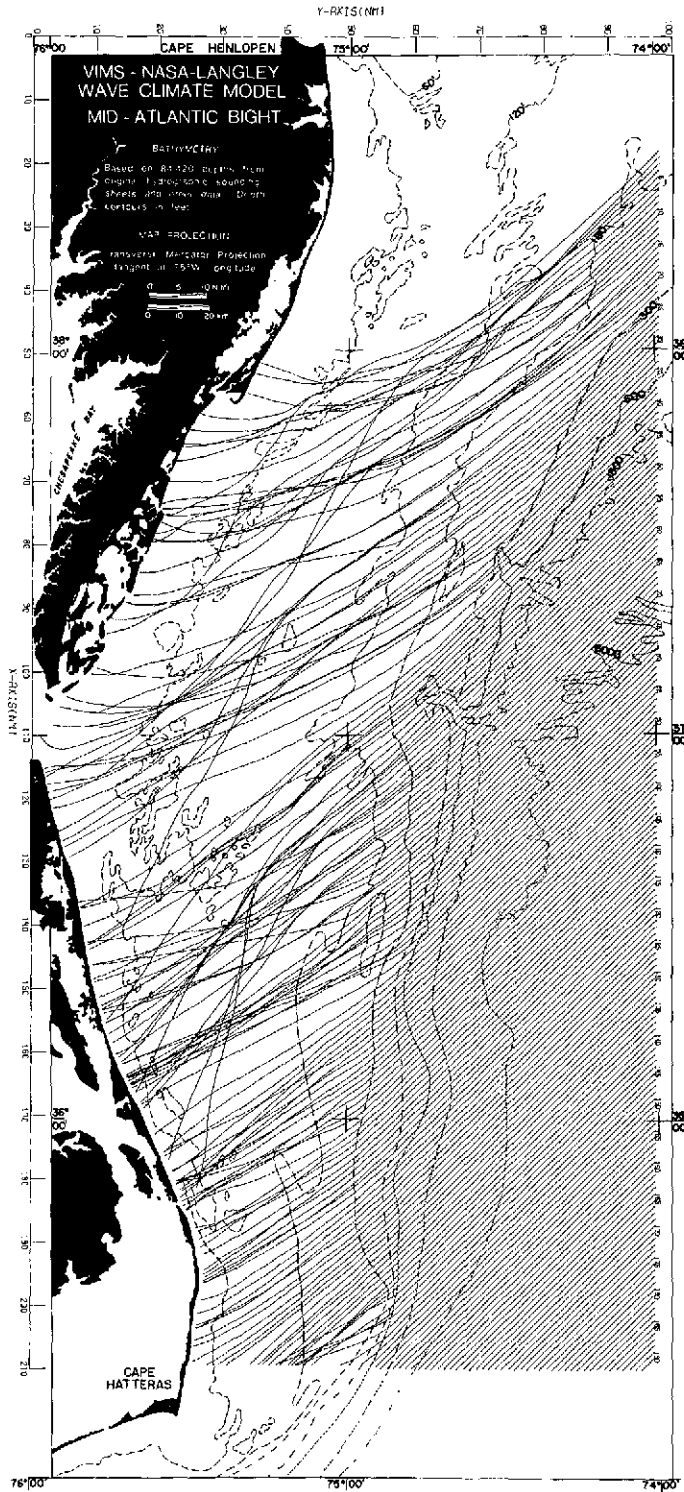

Figure B15.- Wave rays computed with following input conditions:  
AZ = 45°; T = 12 sec; Tide = 0.

ORIGINAL PAGE IS  
OF POOR QUALITY



# APPENDIX B

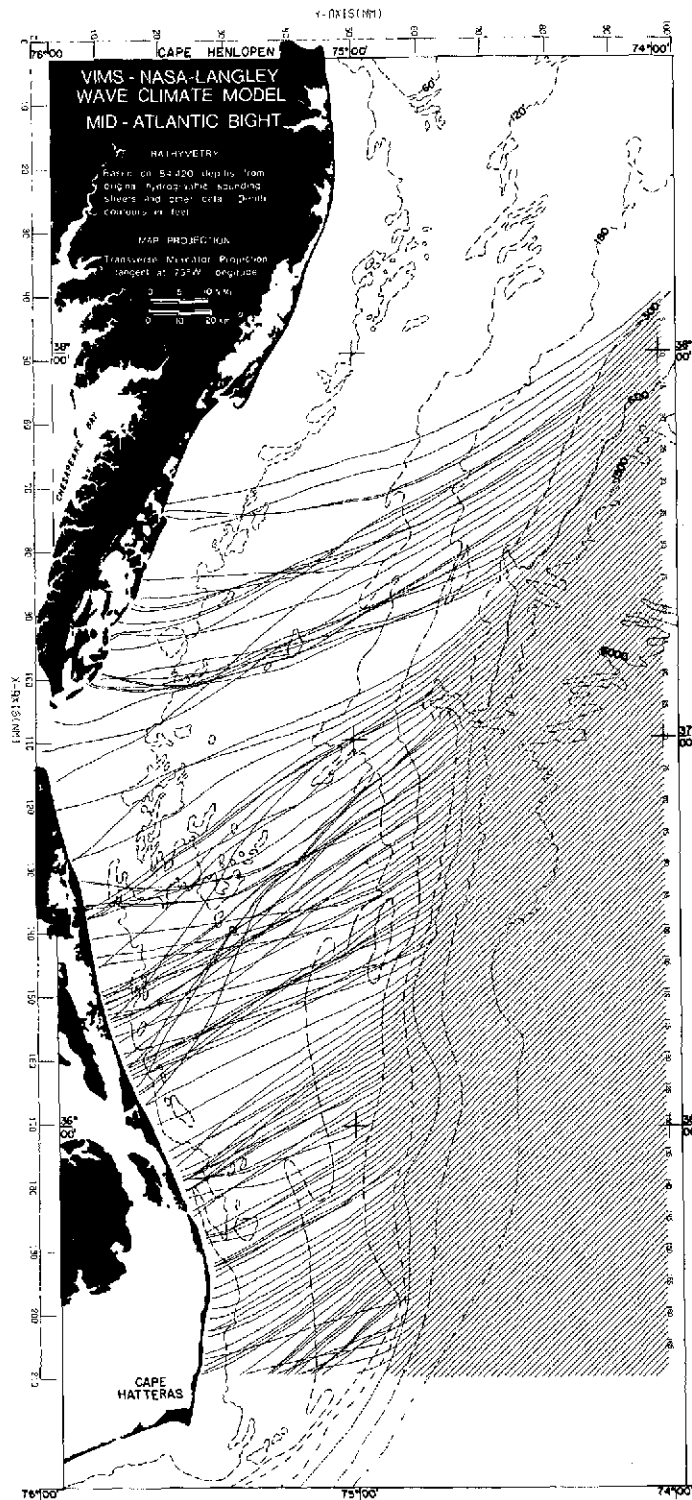

Figure B16.- Wave rays computed with following input conditions:  
 $AZ = 45^{\circ}$ ;  $T = 14$  sec; Tide = 0.

# APPENDIX B

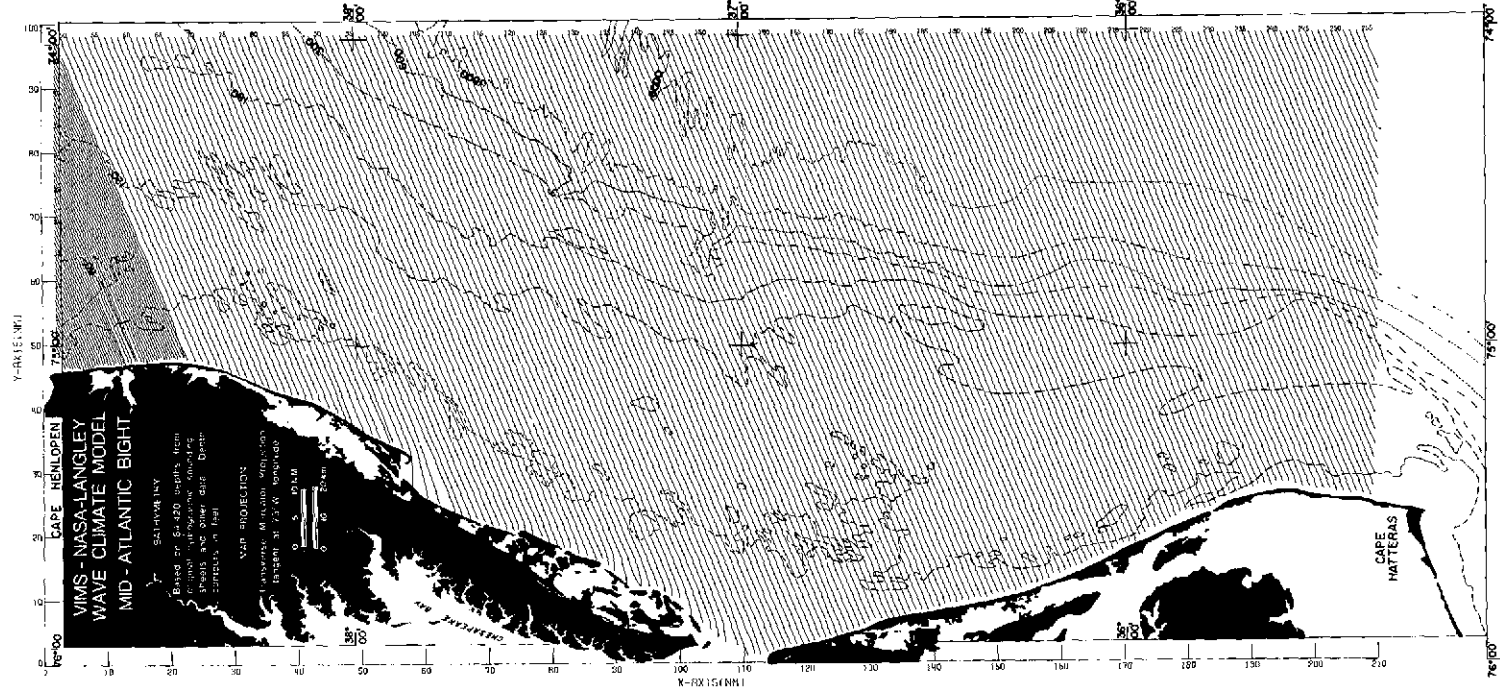

Figure B17.- Wave rays computed with following input conditions:  
 AZ = 67.5°; T = 4 sec; Tide = 0.

ORIGINAL PAGE IS  
 OF POOR QUALITY

# APPENDIX B

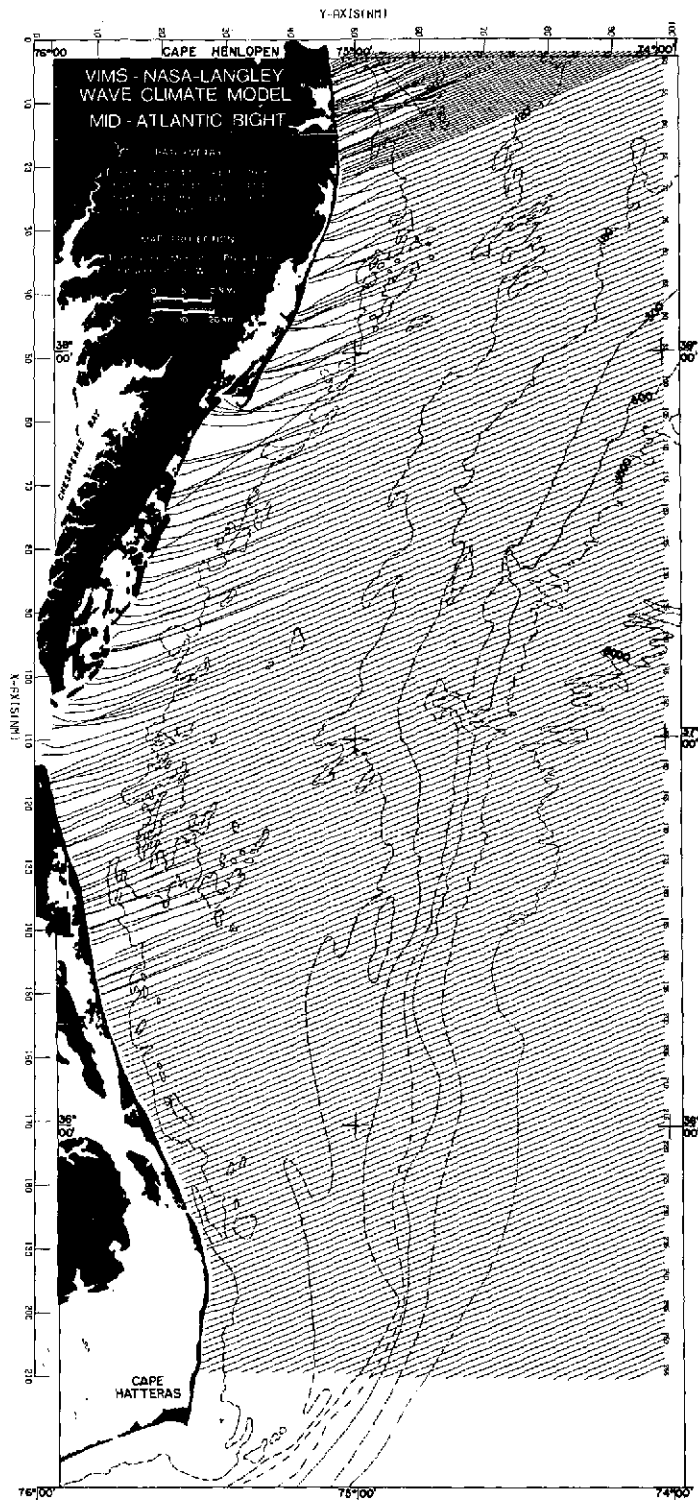

Figure B18.- Wave rays computed with following input conditions:  
 AZ = 67.5°; T = 6 sec; Tide = 0.

# APPENDIX B

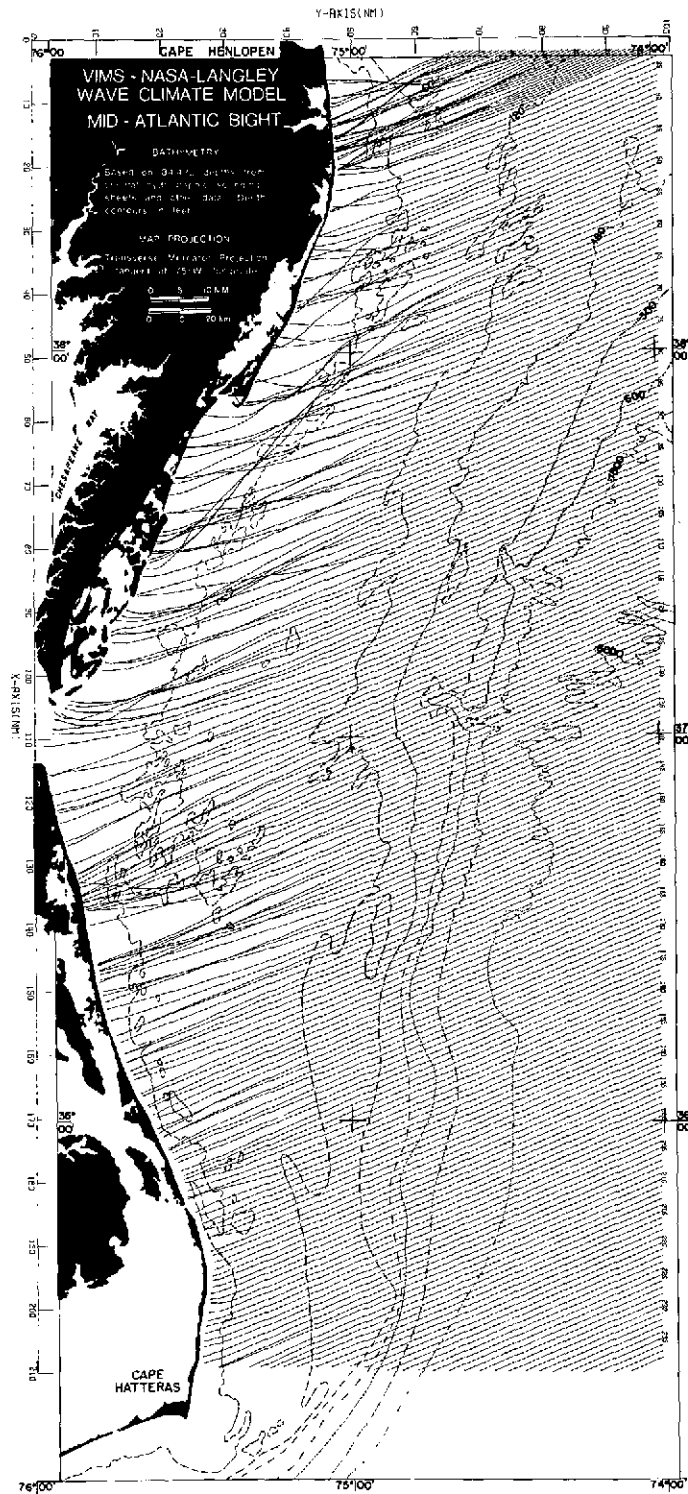

Figure B19.- Wave rays computed with following input conditions:  
 $AZ = 67.5^\circ$ ;  $T = 8 \text{ sec}$ ;  $Tide = 0$ .

# APPENDIX B

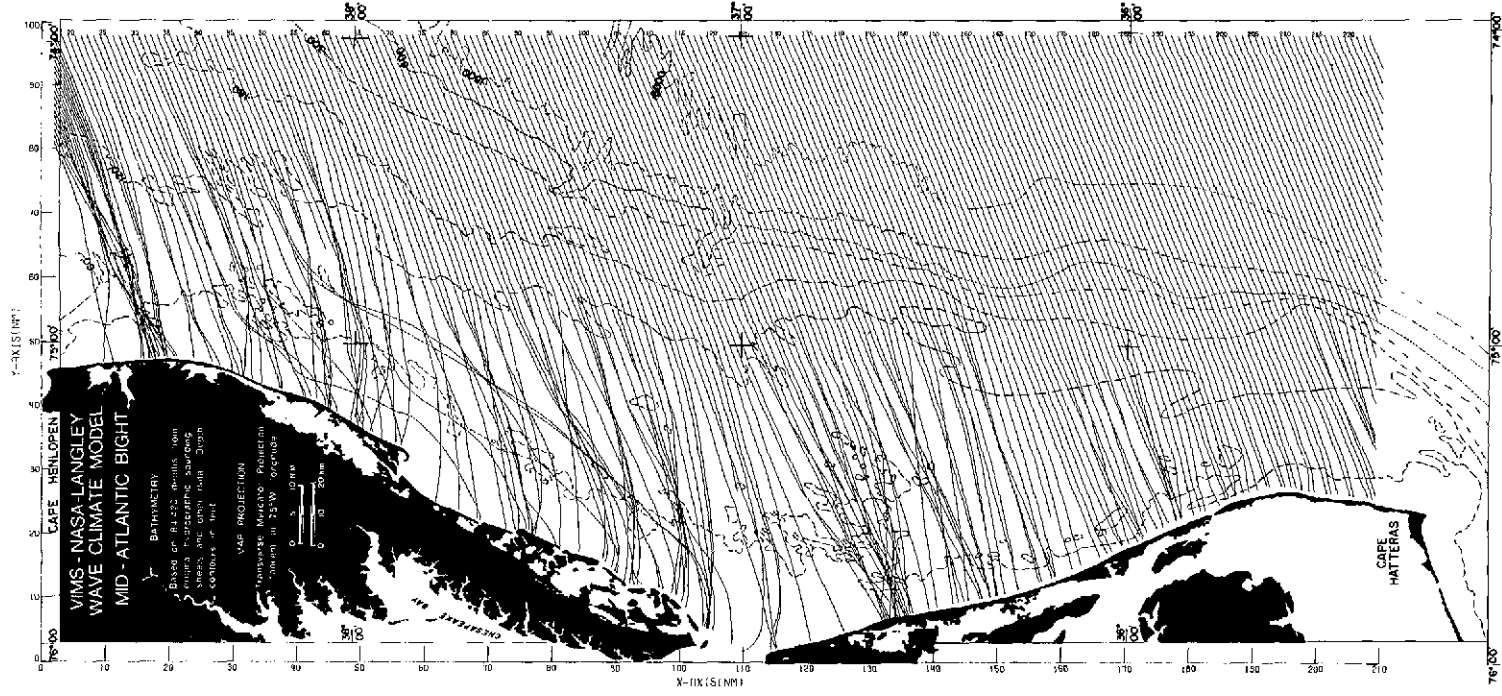

Figure B20.- Wave rays computed with following input conditions:  
AZ = 67.5°; T = 10 sec; Tide = 0.

# APPENDIX B

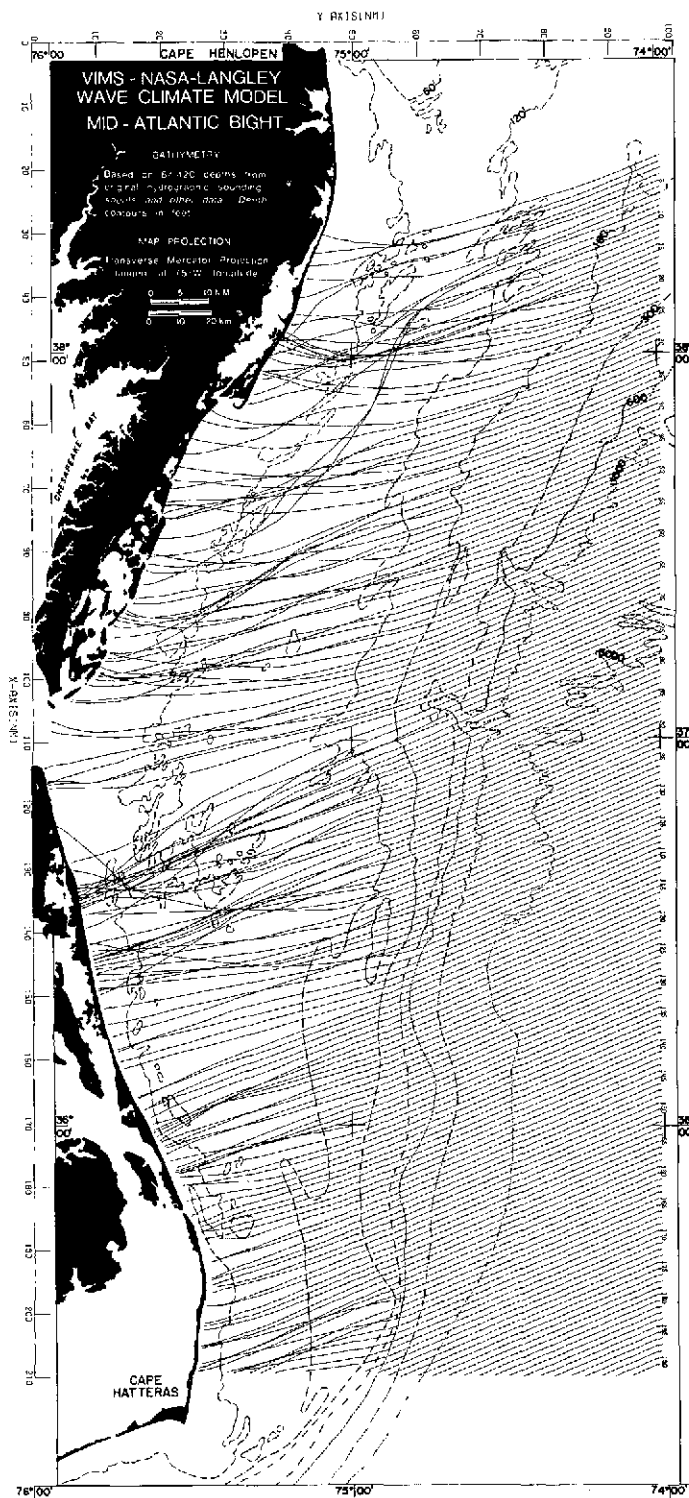

Figure B21.- Wave rays computed with following input conditions:  
 $AZ = 67.5^\circ$ ;  $T = 12 \text{ sec}$ ;  $Tide = 0$ .



APPENDIX B

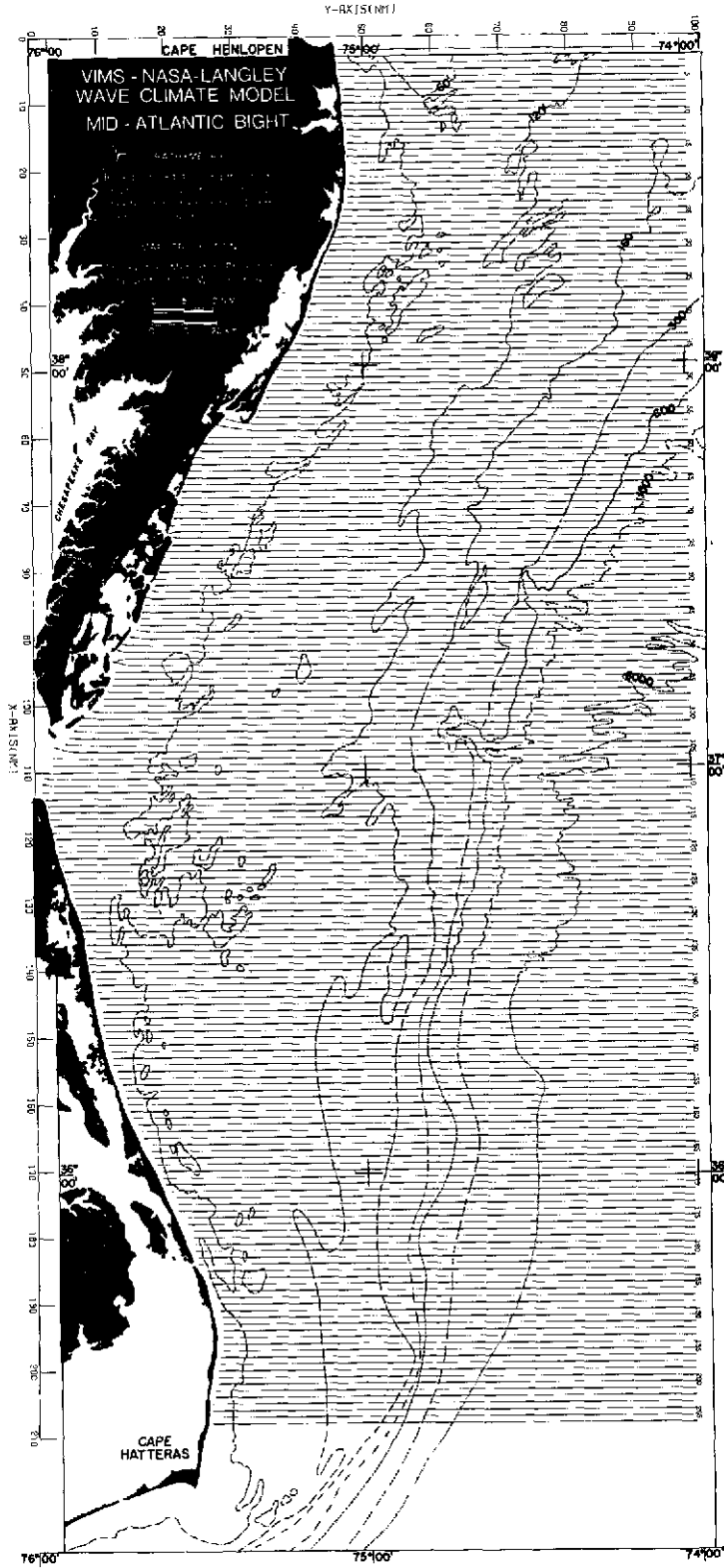

Figure B23.- Wave rays computed with following input conditions:  
AZ = 90°; T = 4 sec; Tide = 0.



APPENDIX B



Figure B24.- Wave rays computed with following input conditions:  
AZ = 90°; T = 6 sec; Tide = 0.

APPENDIX B

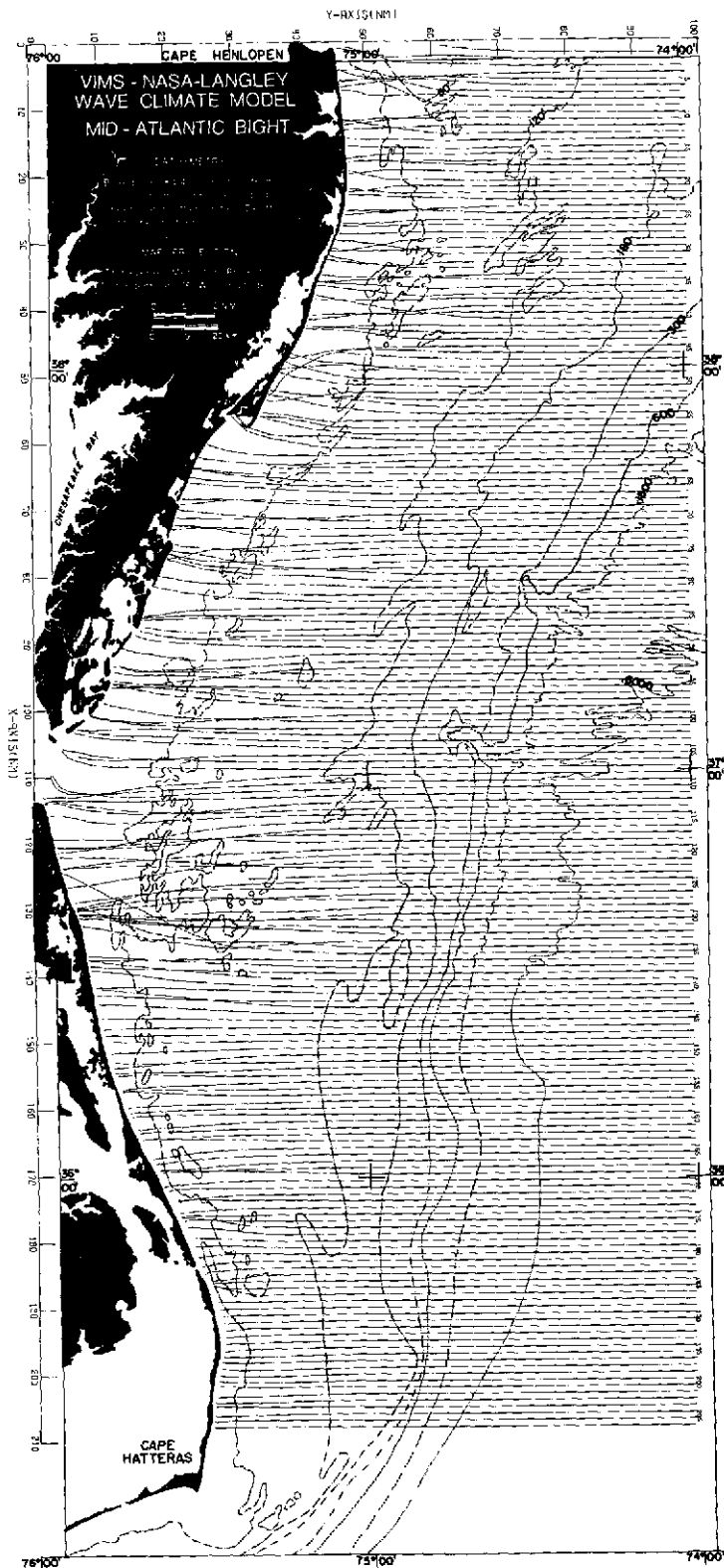

Figure B25.- Wave rays computed with following input conditions:  
AZ = 90°; T = 8 sec; Tide = 0.

# APPENDIX B



Figure B26.- Wave rays computed with following input conditions:  
AZ = 90°; T = 10 sec; Tide = 0.

APPENDIX B

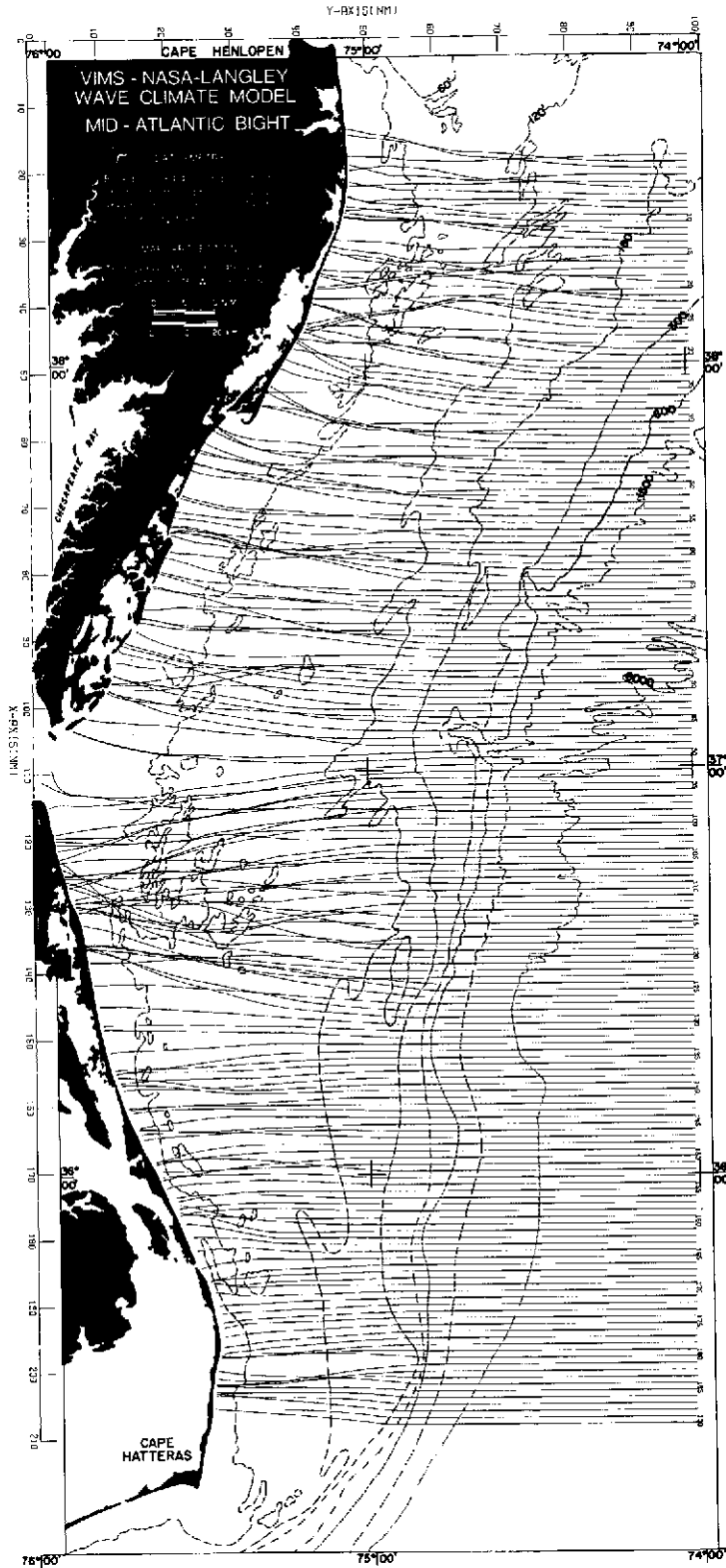

Figure B27.- Wave rays computed with following input conditions:  
AZ = 90°; T = 12 sec; Tide = 0.

# APPENDIX B

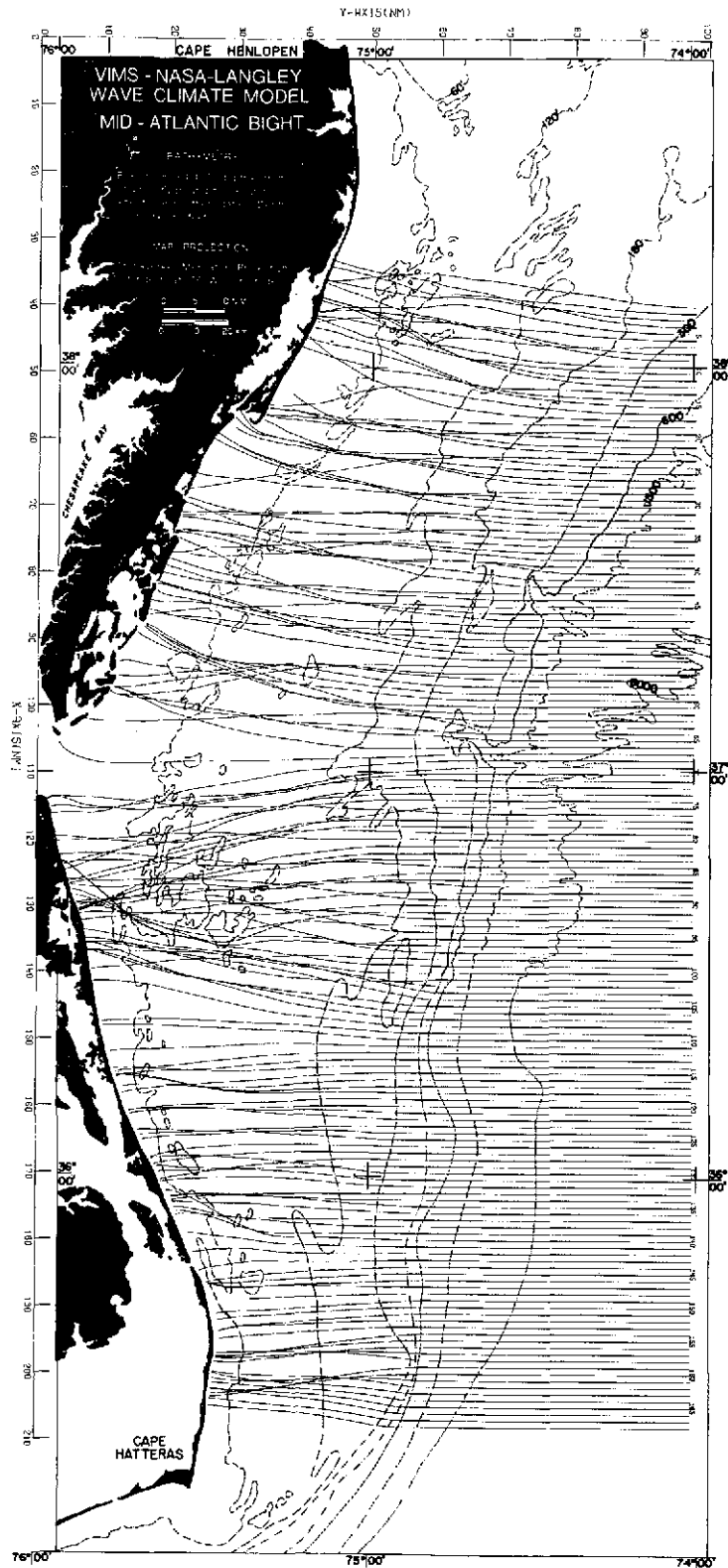

Figure B28.- Wave rays computed with following input conditions:  
 AZ = 90°; T = 14 sec; Tide = 0.

APPENDIX B

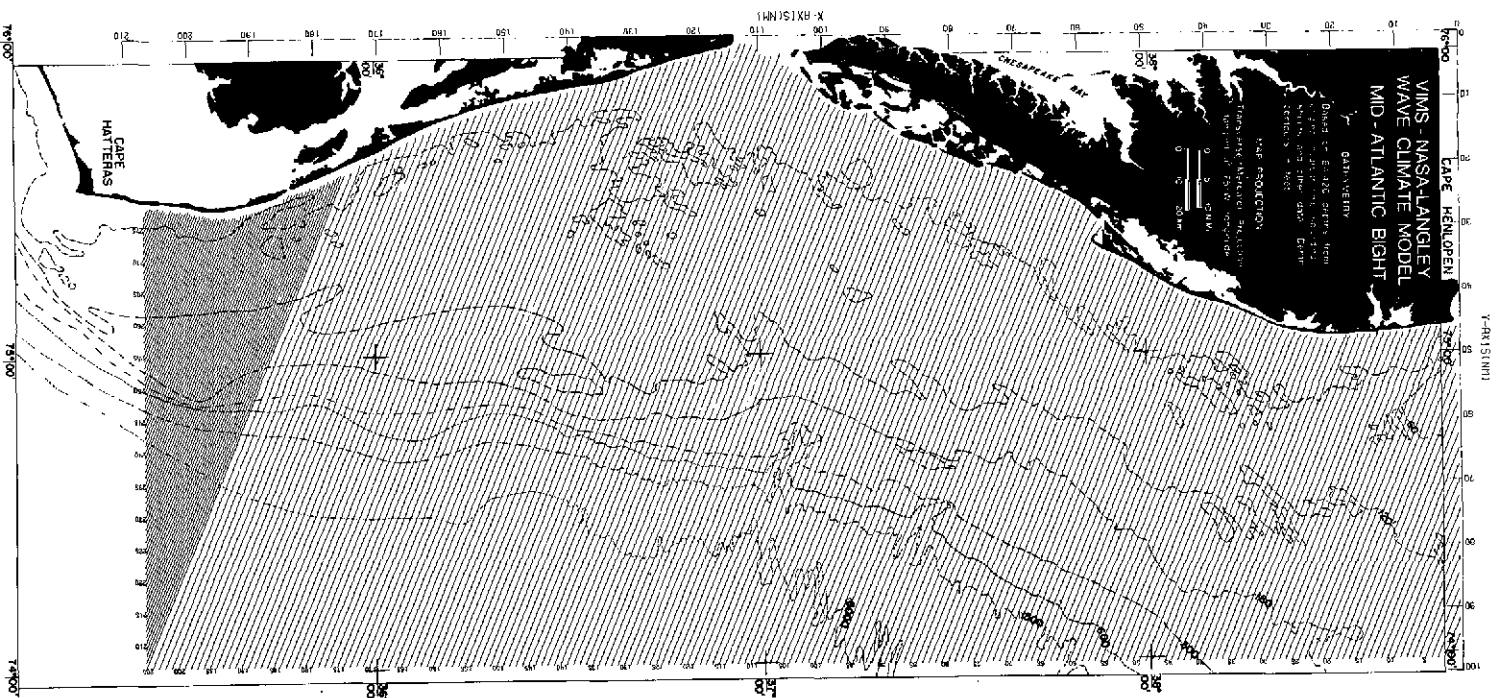

Figure B29.- Wave rays computed with following input conditions:  
AZ = 112.5°; T = 4 sec; Tide = 0.

APPENDIX B

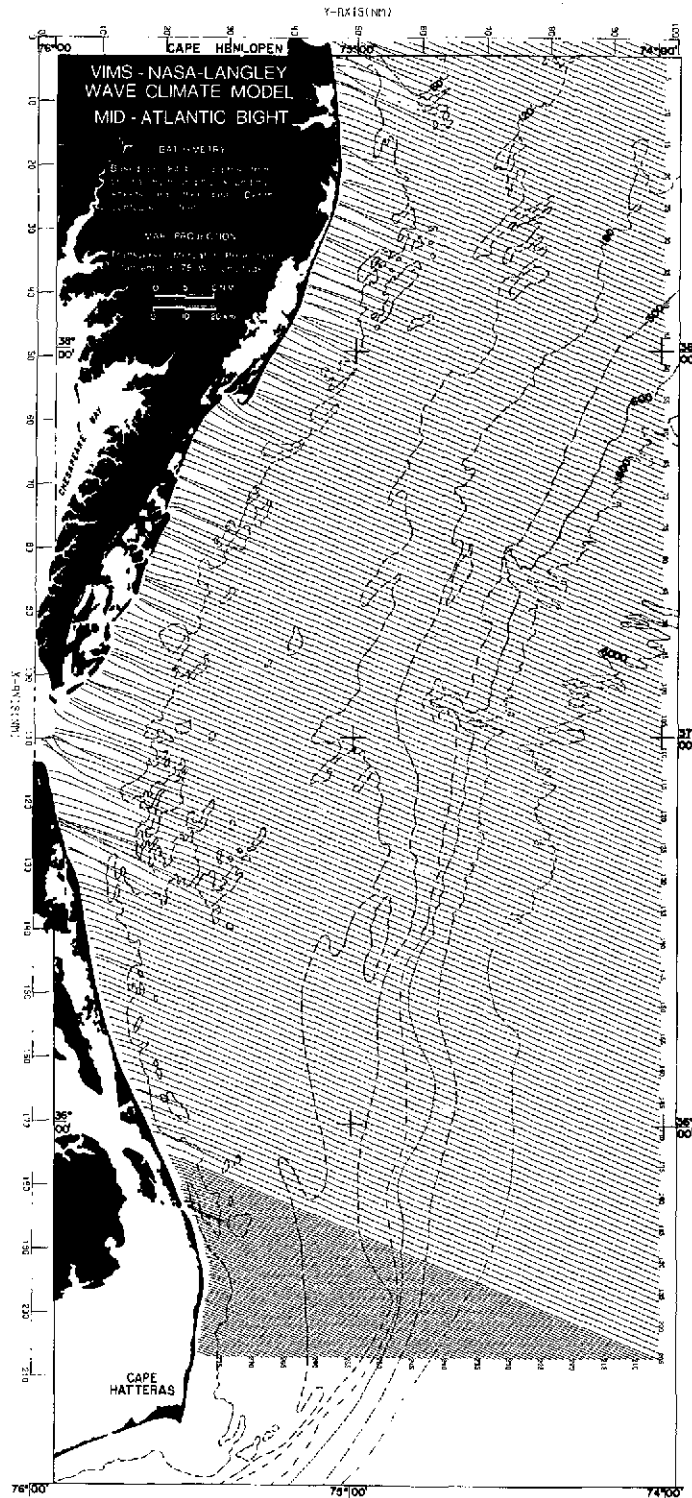

Figure B30.- Wave rays computed with following input conditions:  
AZ = 112.5°; T = 6 sec; Tide = 0.





# APPENDIX B

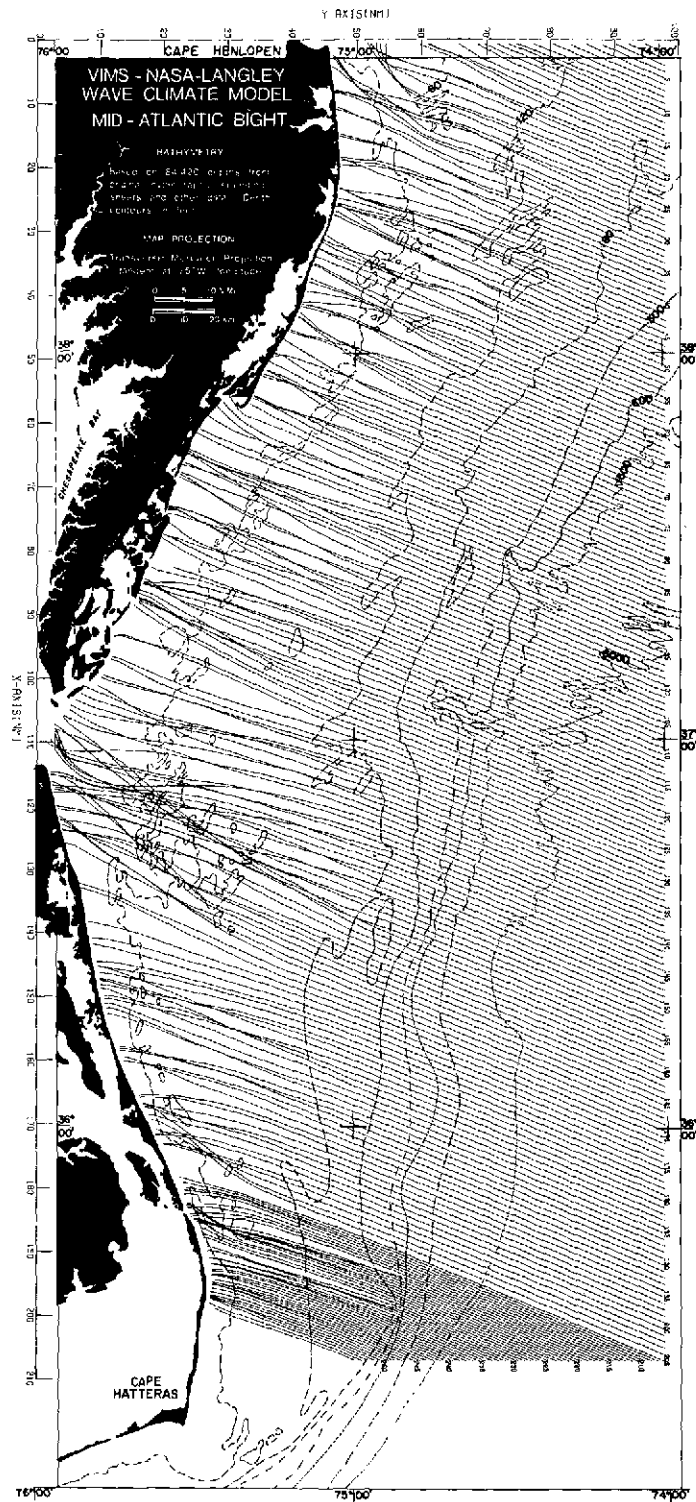

Figure B32.- Wave rays computed with following input conditions:  
 AZ = 112.5°; T = 10 sec; Tide = 0.

# APPENDIX B

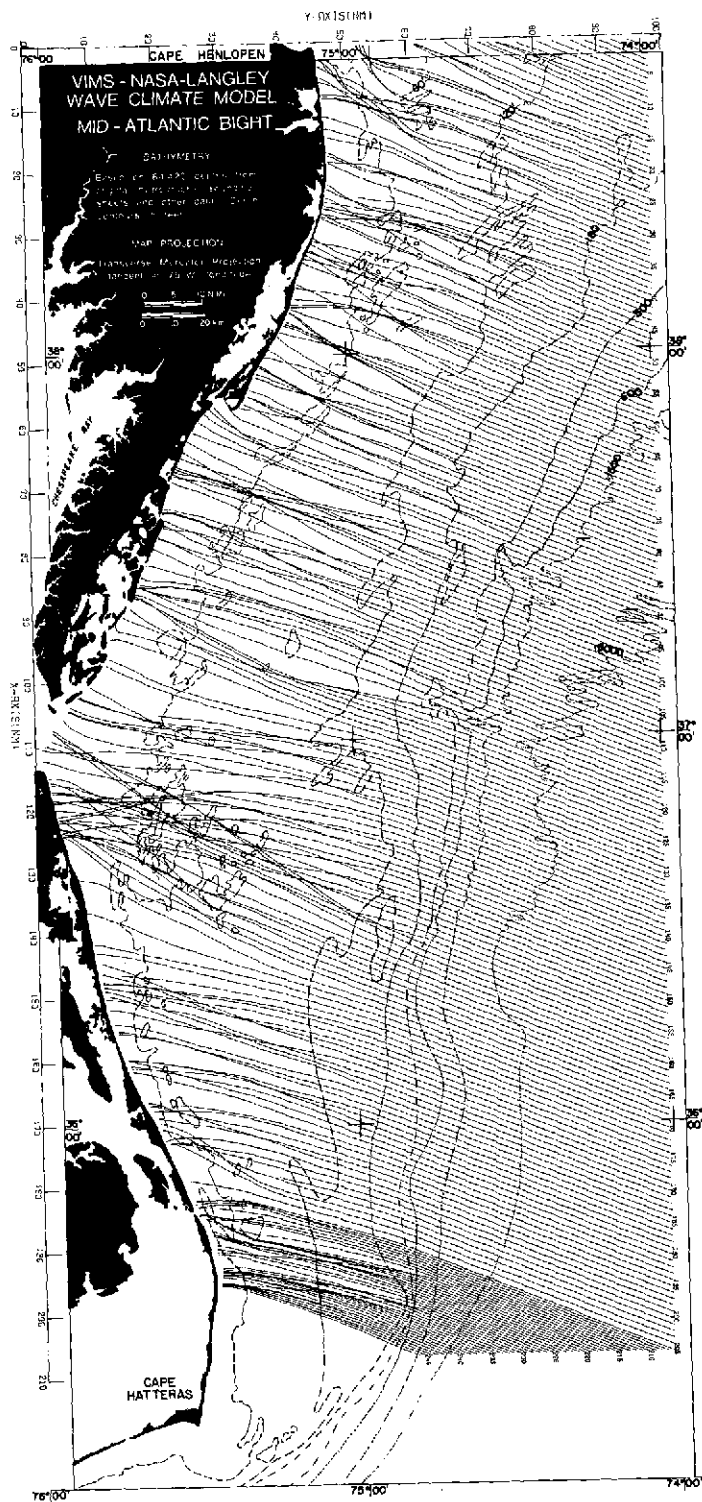

Figure B33.- Wave rays computed with following input conditions:  
 AZ = 112.5°; T = 12 sec; Tide = 0.

# APPENDIX B

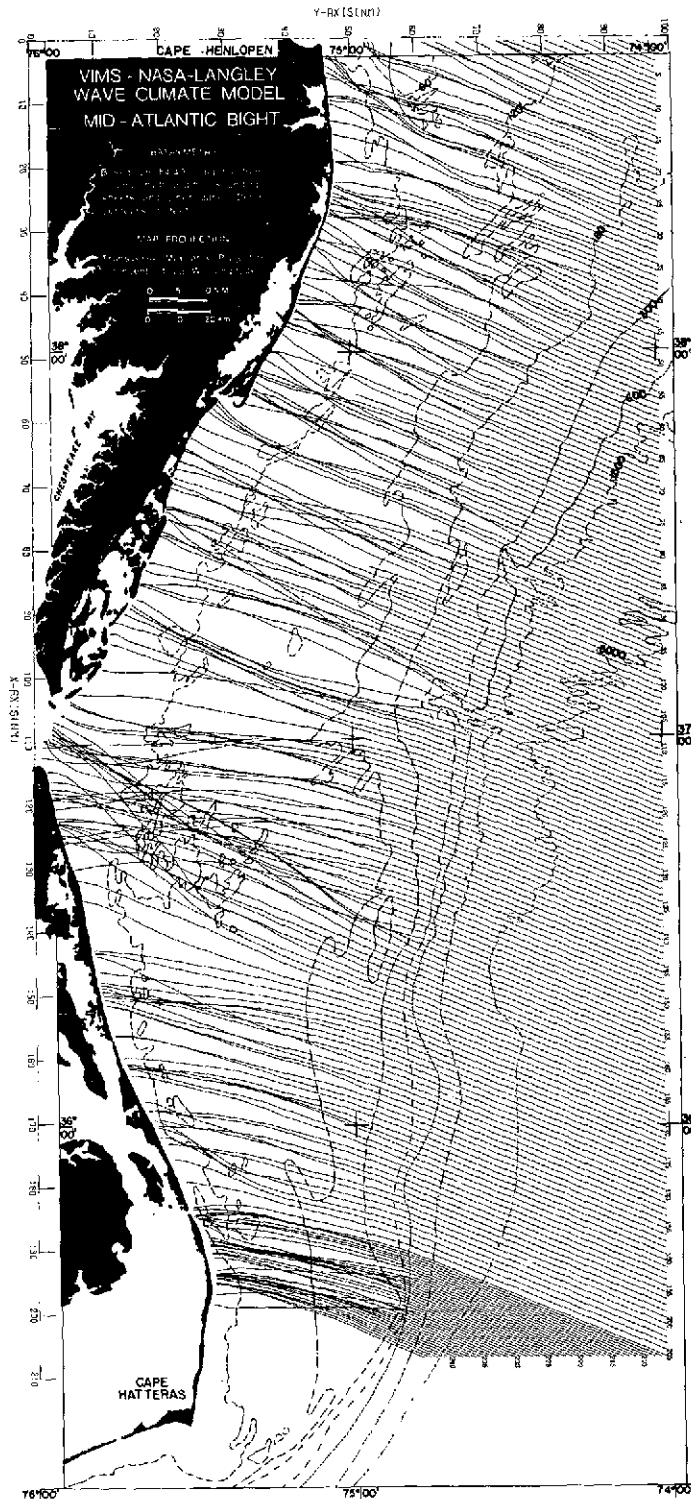

Figure. B34.- Wave rays computed with following input conditions:  
 AZ = 112.5°; T = 14 sec; Tide = 0.

# APPENDIX B

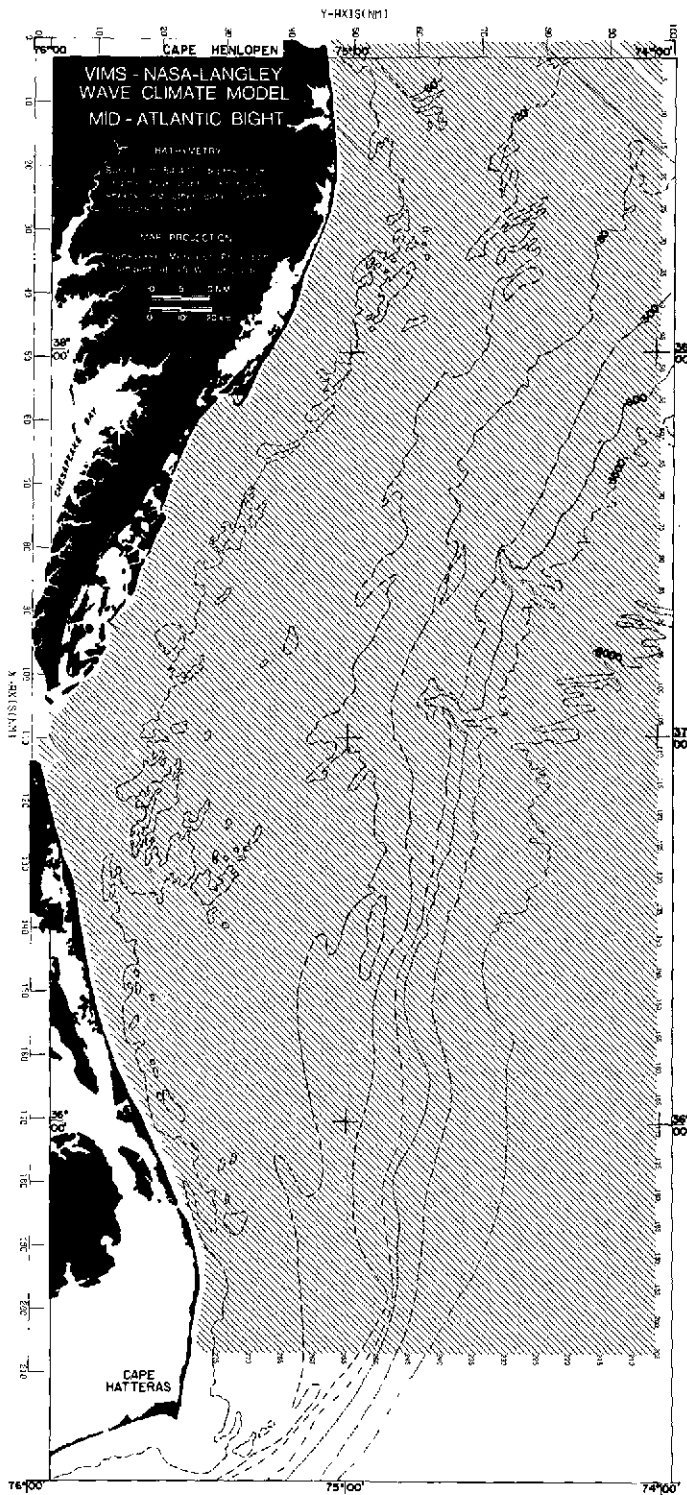

Figure B35.- Wave rays computed with following input conditions:  
 AZ = 135°; T = 4 sec; Tide = 0.

APPENDIX B

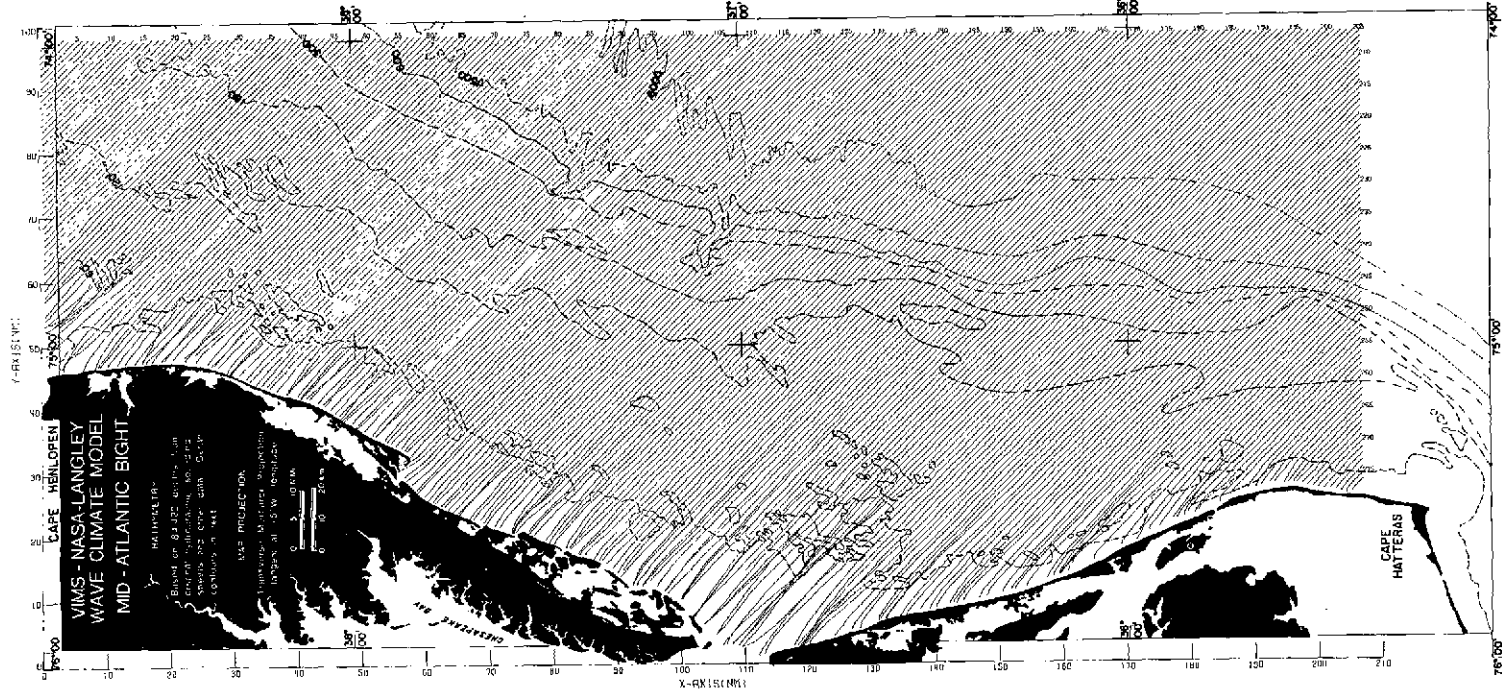

Figure B36.- Wave rays computed with following input conditions:  
AZ = 135°; T = 6 sec; Tide = 0.

# APPENDIX B

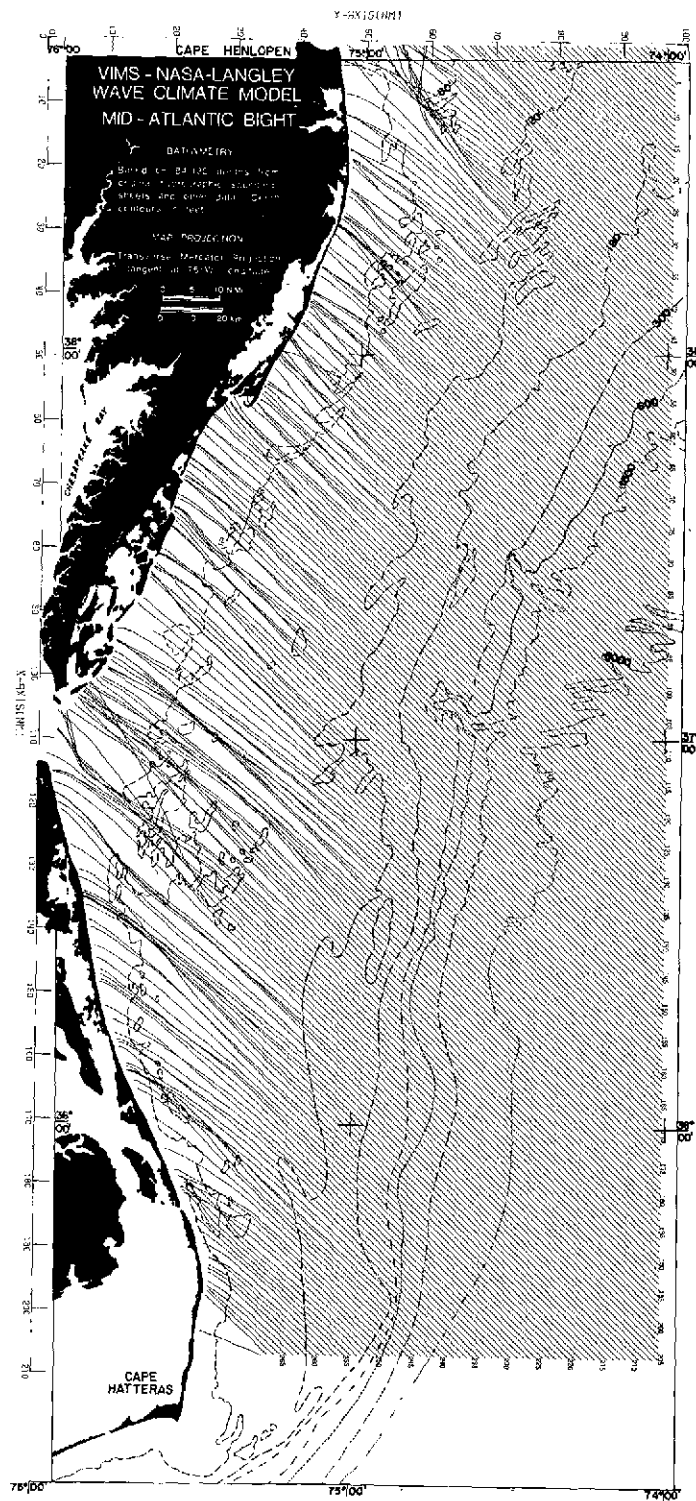

Figure B37.- Wave rays computed with following input conditions:  
AZ = 135°; T = 8 sec; Tide = 0.

APPENDIX B

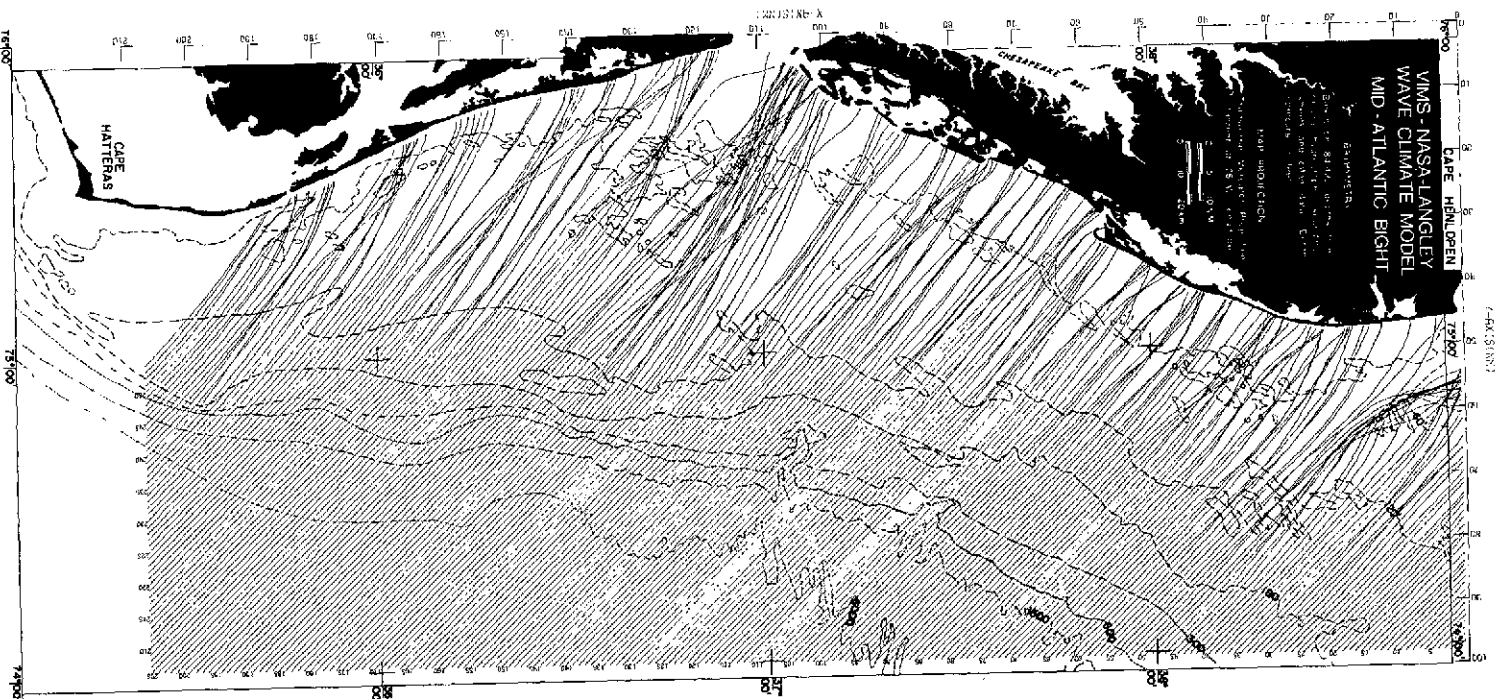

Figure B38. - Wave rays computed with following input conditions:  
AZ = 135°; T = 10 sec; Tide = 0.

# APPENDIX B

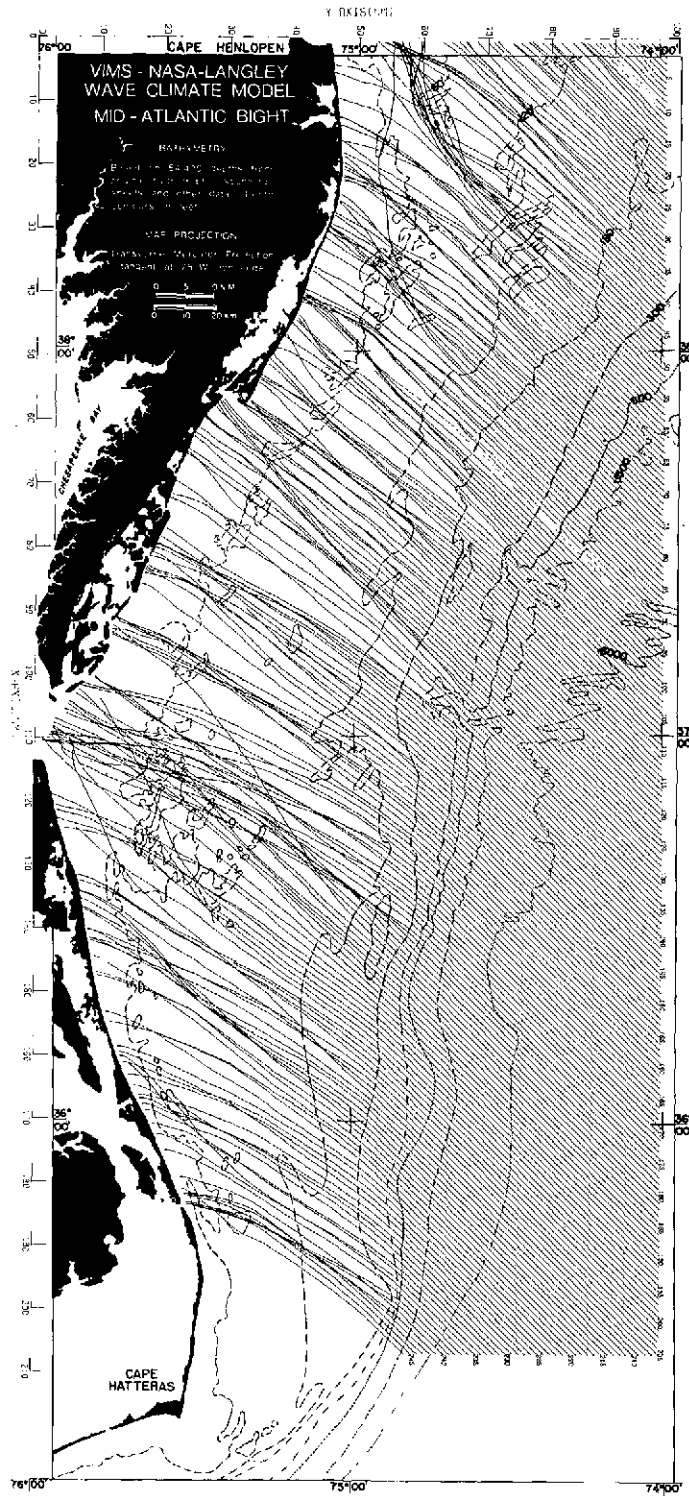

Figure B39.- Wave rays computed with following input conditions:  
AZ = 135°; T = 12 sec; Tide = 0.



APPENDIX B

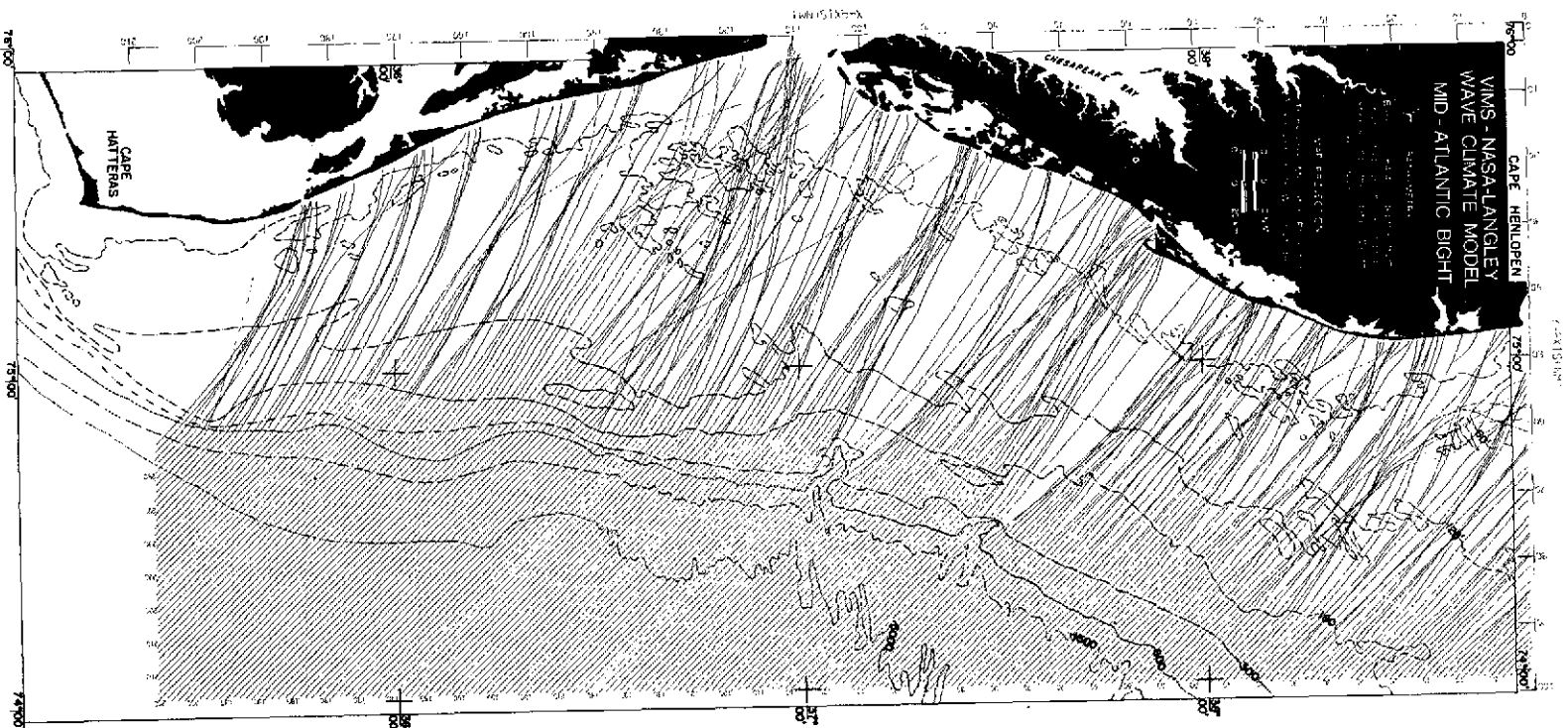

Figure B40.- Wave rays computed with following input conditions:  
AZ = 135°; T = 14 sec; Tide = 0.

# APPENDIX B

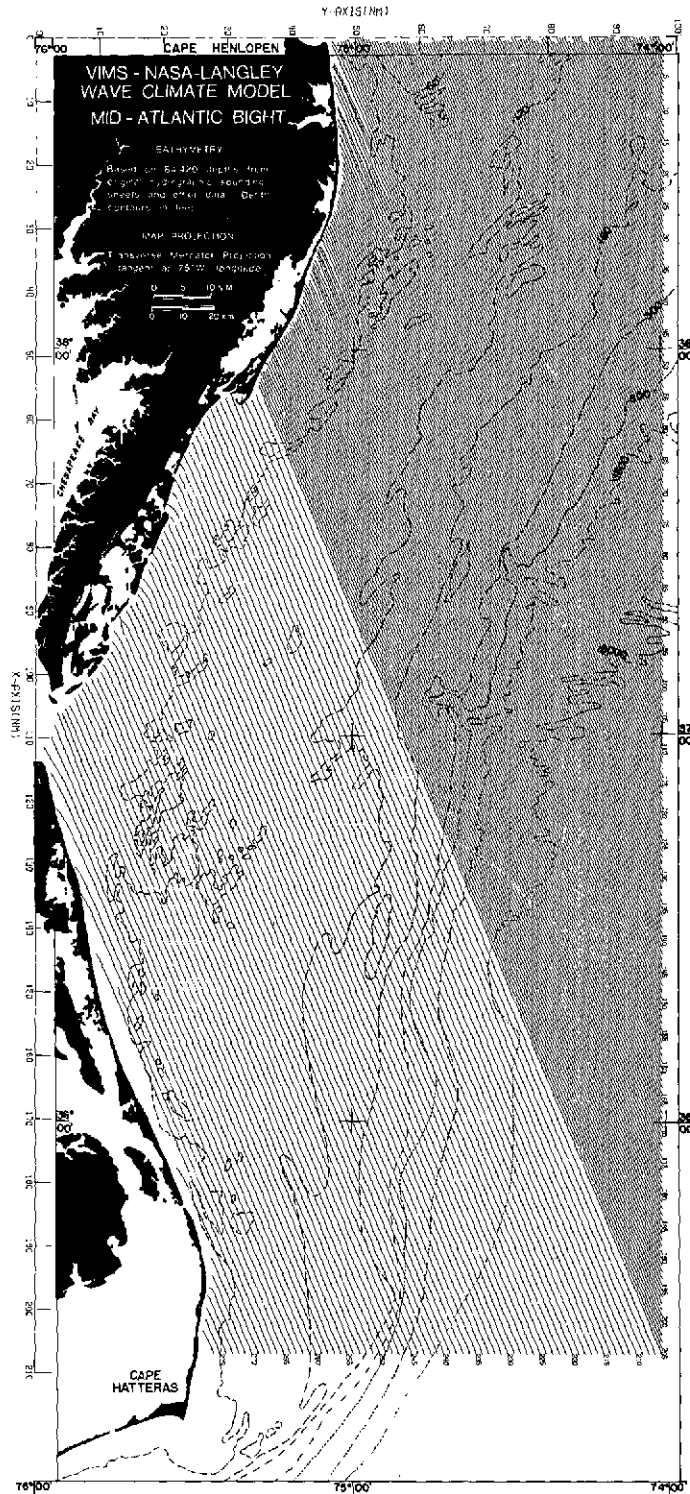

Figure B41.- Wave rays computed with following input conditions:  
 AZ = 157.5°; T = 4 sec; Tide = 0.



APPENDIX B

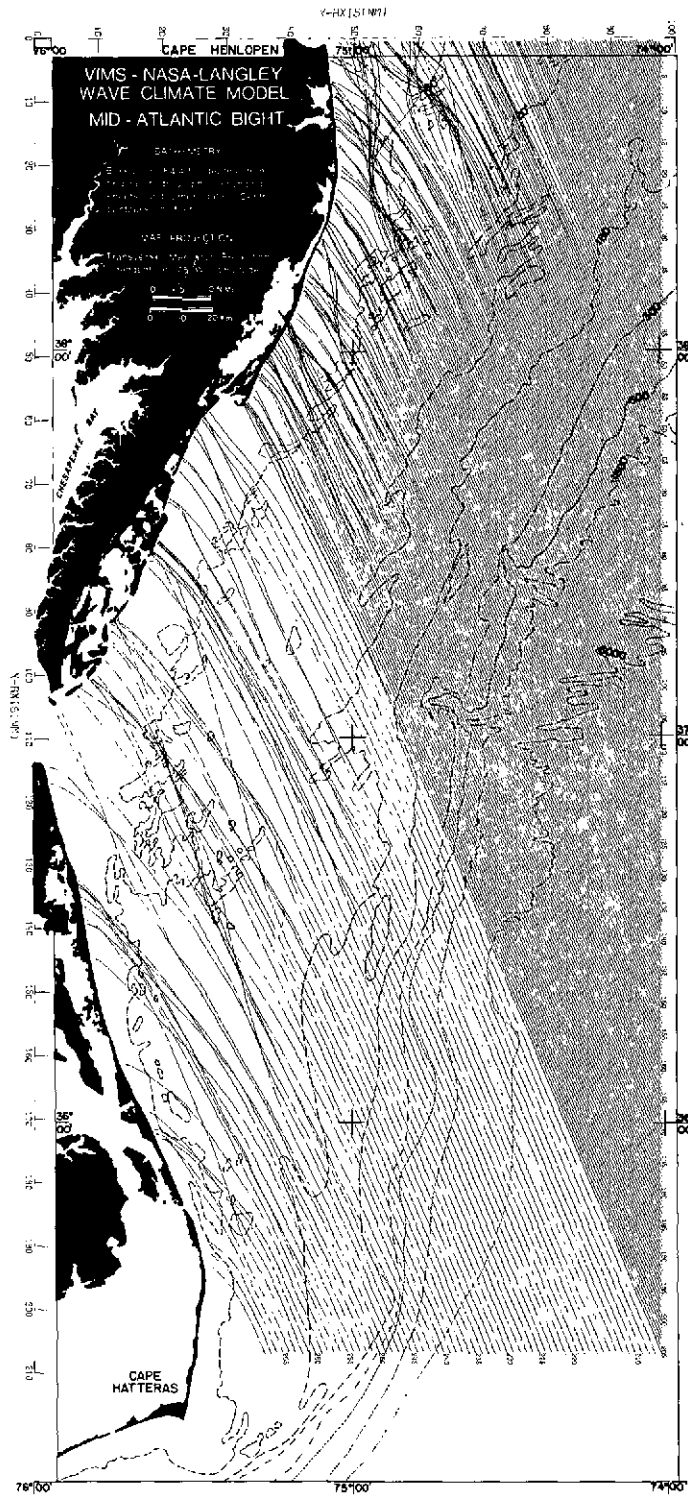

Figure B43.- Wave rays computed with following input conditions:  
AZ = 157.5°; T = 8 sec; Tide = 0.

cd

APPENDIX B

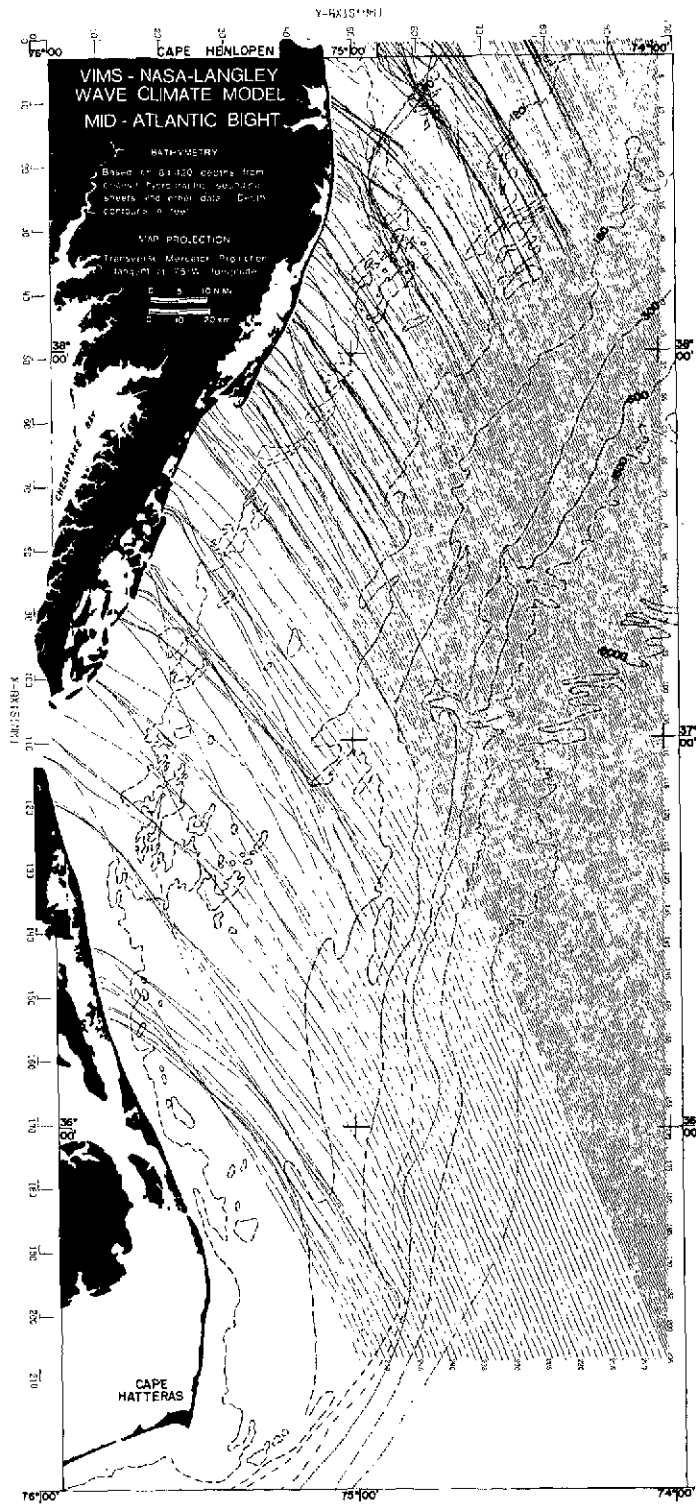

Figure B44.- Wave rays computed with following input conditions:  
 $AZ = 157.5^{\circ}$ ;  $T = 10 \text{ sec}$ ;  $Tide = 0$ .

# APPENDIX B

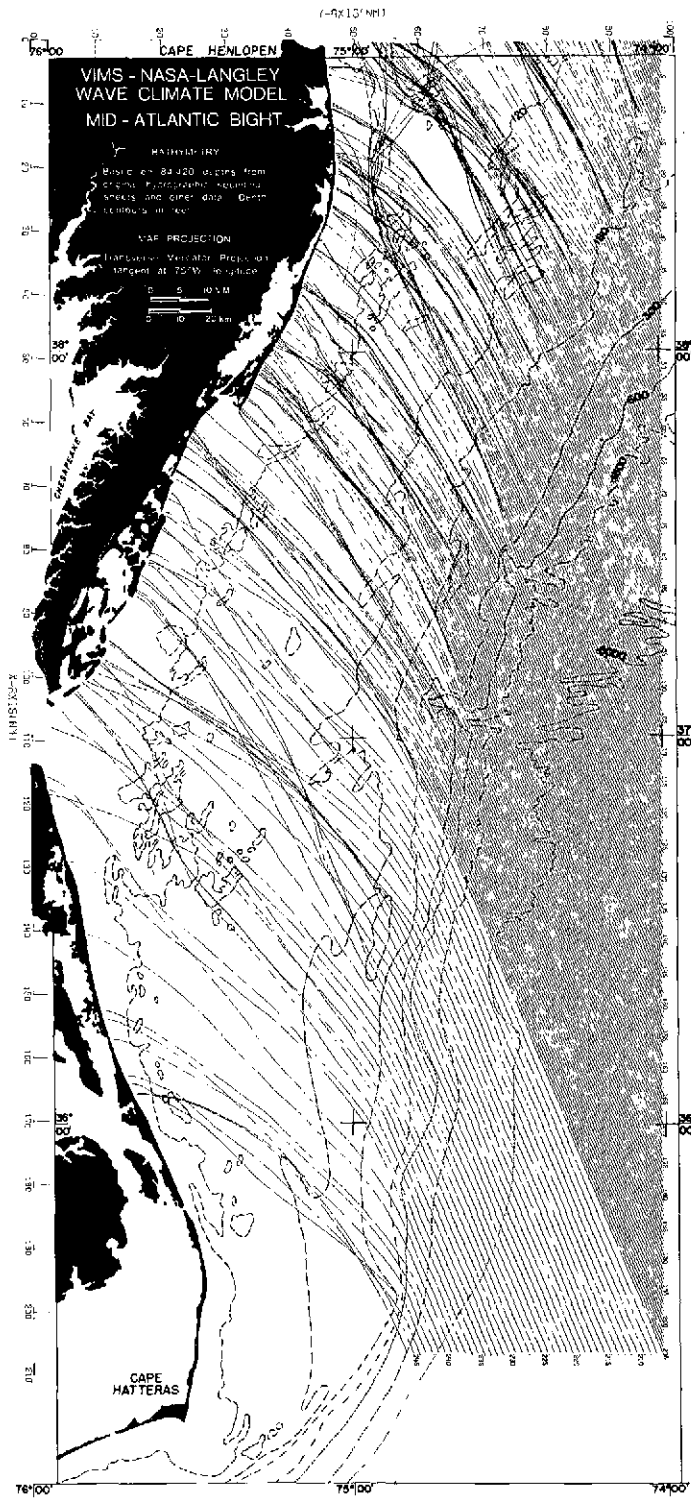

Figure B45.- Wave rays computed with following input conditions:  
 AZ = 157.5°; T = 12 sec; Tide = 0.

APPENDIX B

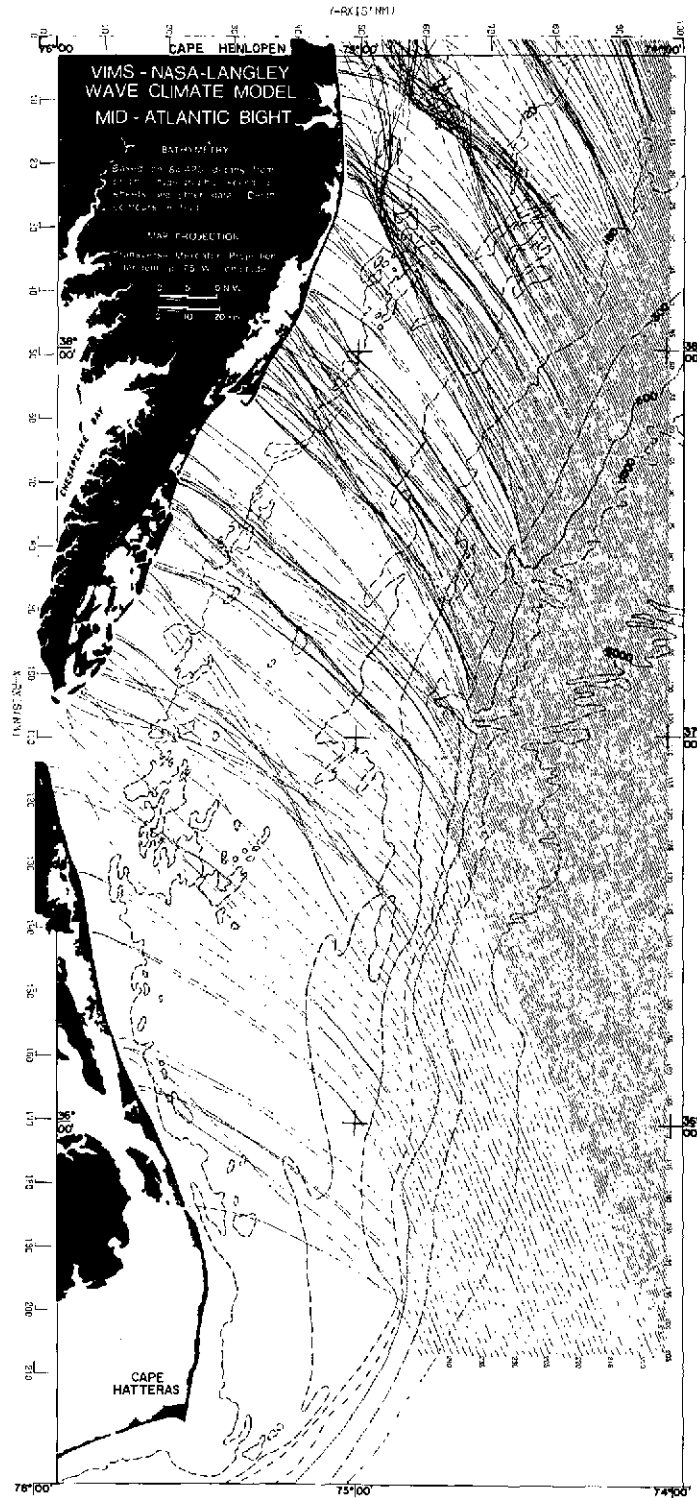

Figure B46.- Wave rays computed with following input conditions:  
 AZ = 157.5°; T = 14 sec; Tide = 0.

# APPENDIX B

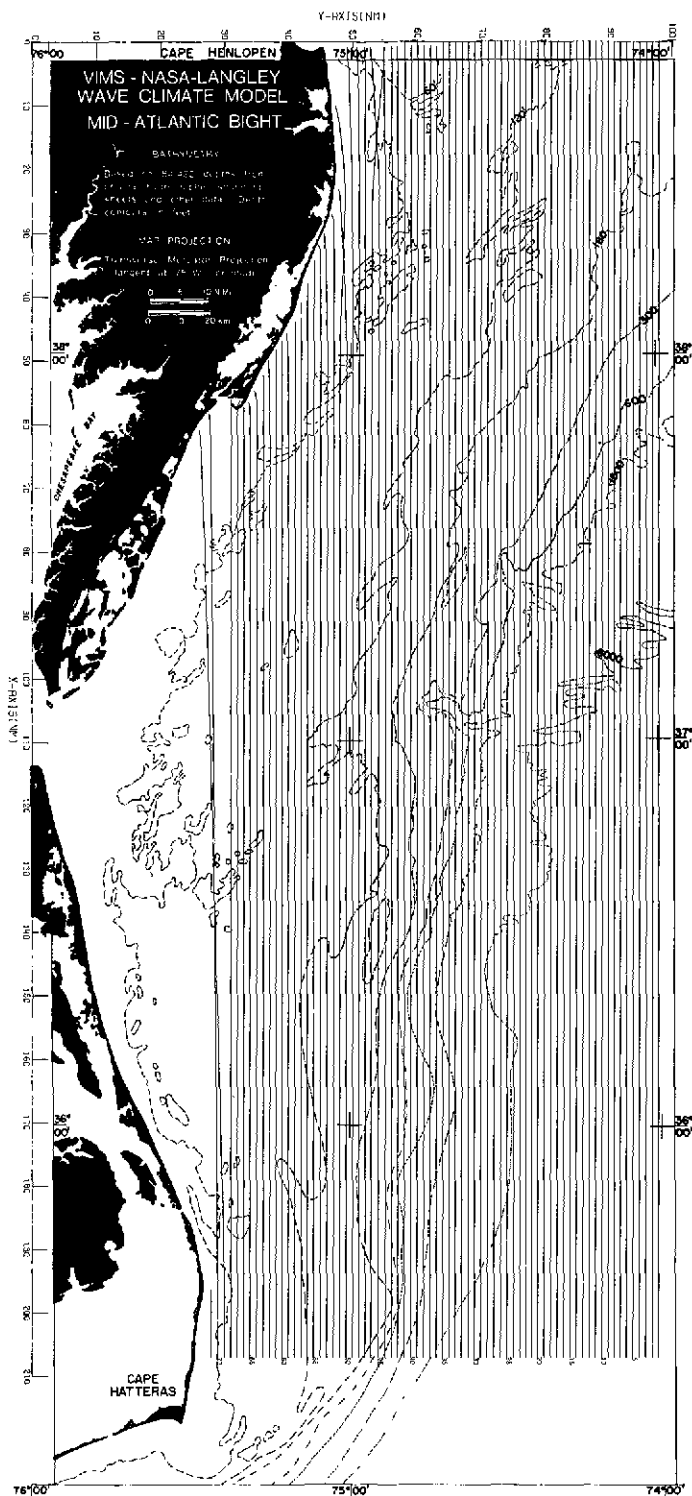

Figure B47.- Wave rays computed with following input conditions:  
 AZ = 180°; T = 4 sec; Tide = 0.



APPENDIX B



Figure B48.- Wave rays computed with following input conditions:  
 AZ = 180°; T = 6 sec; Tide = 0.

# APPENDIX B

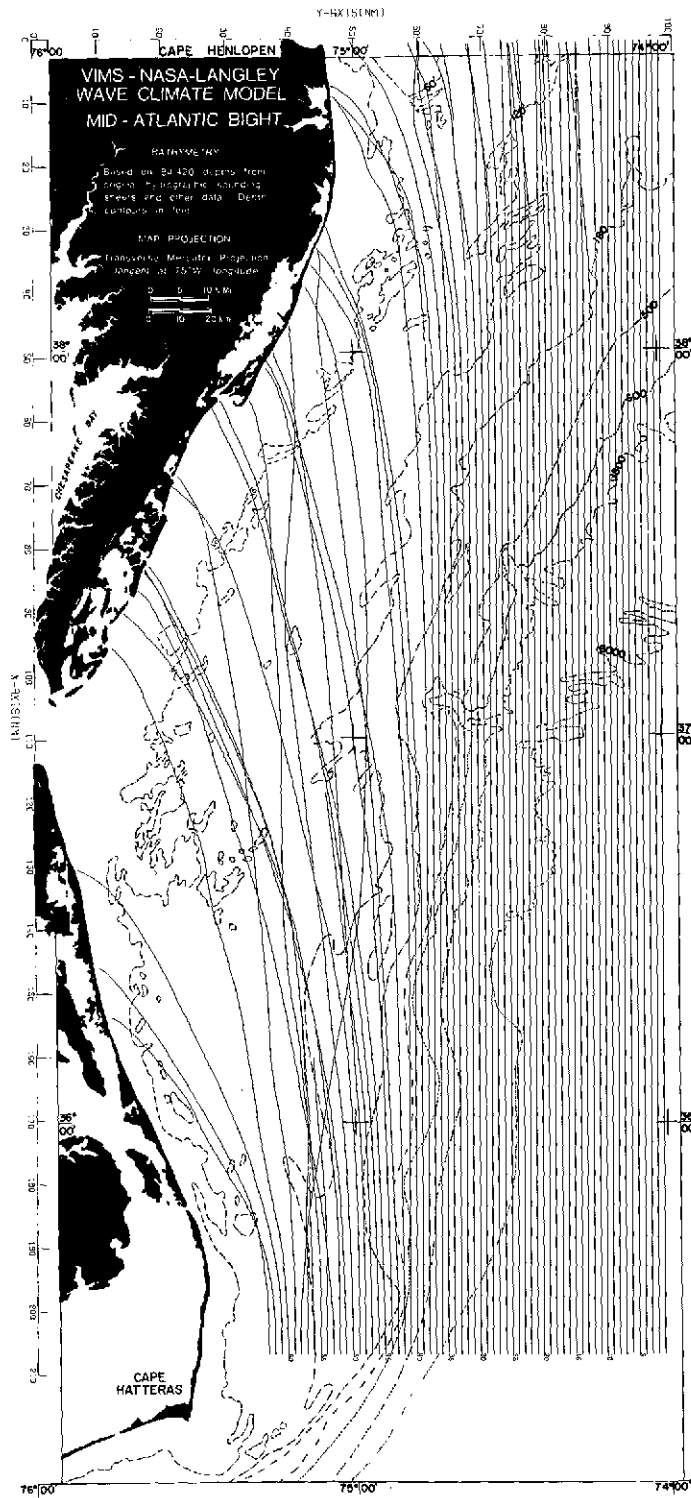

Figure B49.- Wave rays computed with following input conditions:  
 AZ = 180°; T = 8 sec; Tide = 0.

# APPENDIX B

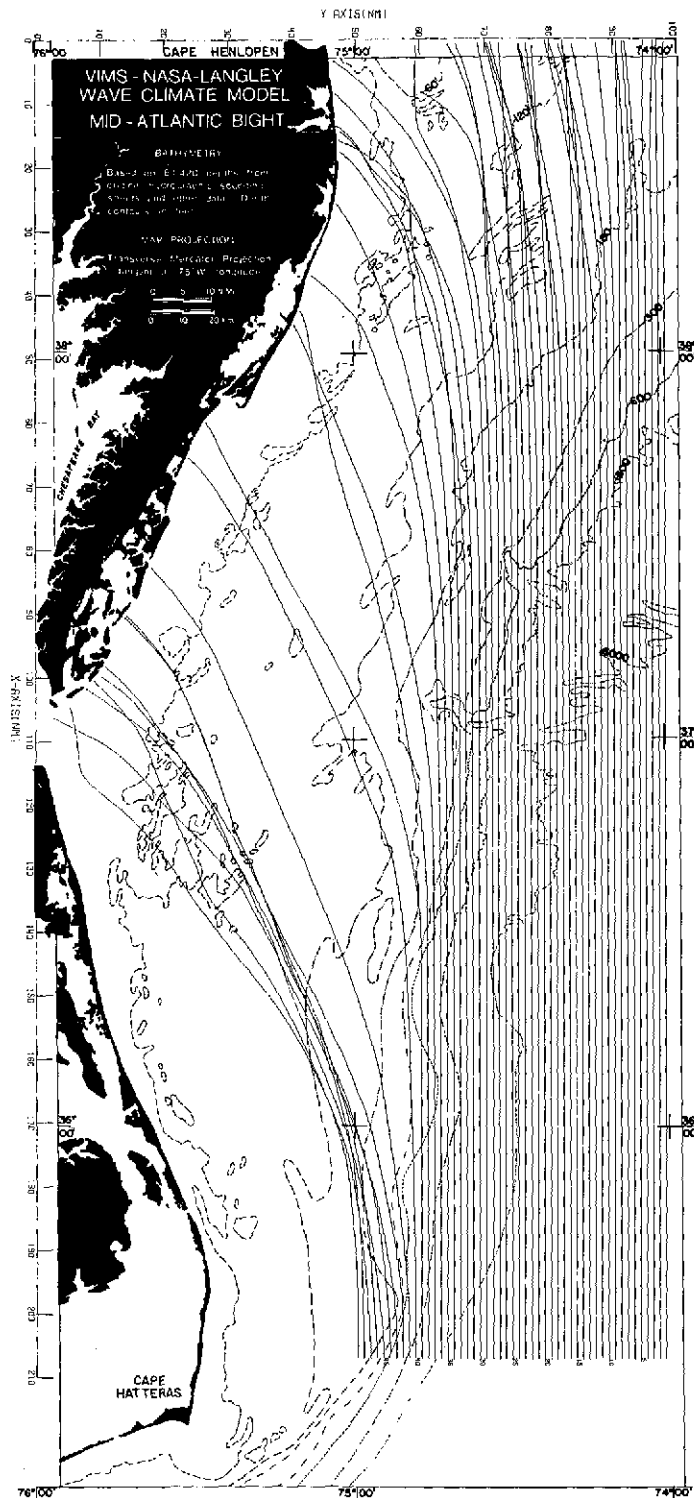

Figure B50.- Wave rays computed with following input conditions:  
 AZ = 180°; T = 10 sec; Tide = 0.

# APPENDIX B

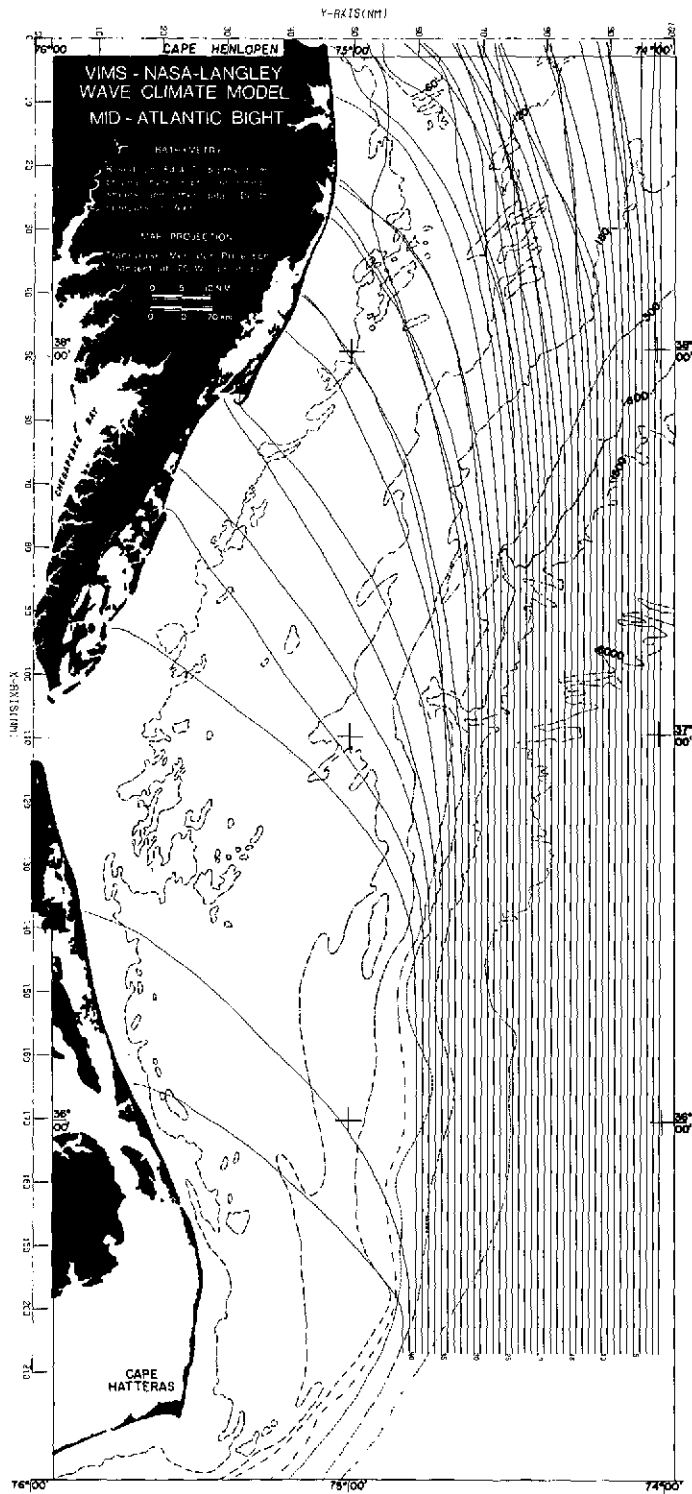

Figure B51.- Wave rays computed with following input conditions:  
 AZ = 180°; T = 12 sec; Tide = 0.

# APPENDIX B

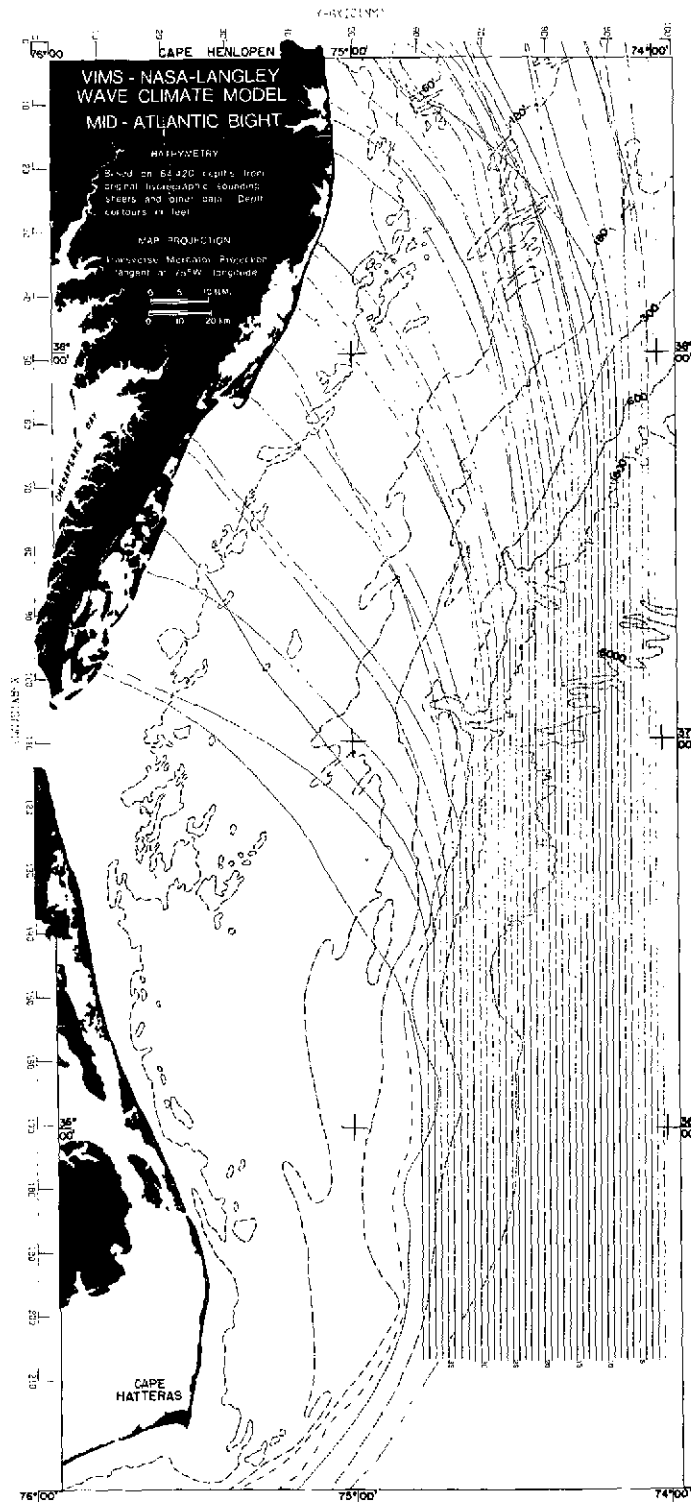

Figure B52.- Wave rays computed with following input conditions:  
 AZ = 180°; T = 14 sec; Tide = 0.

APPENDIX B

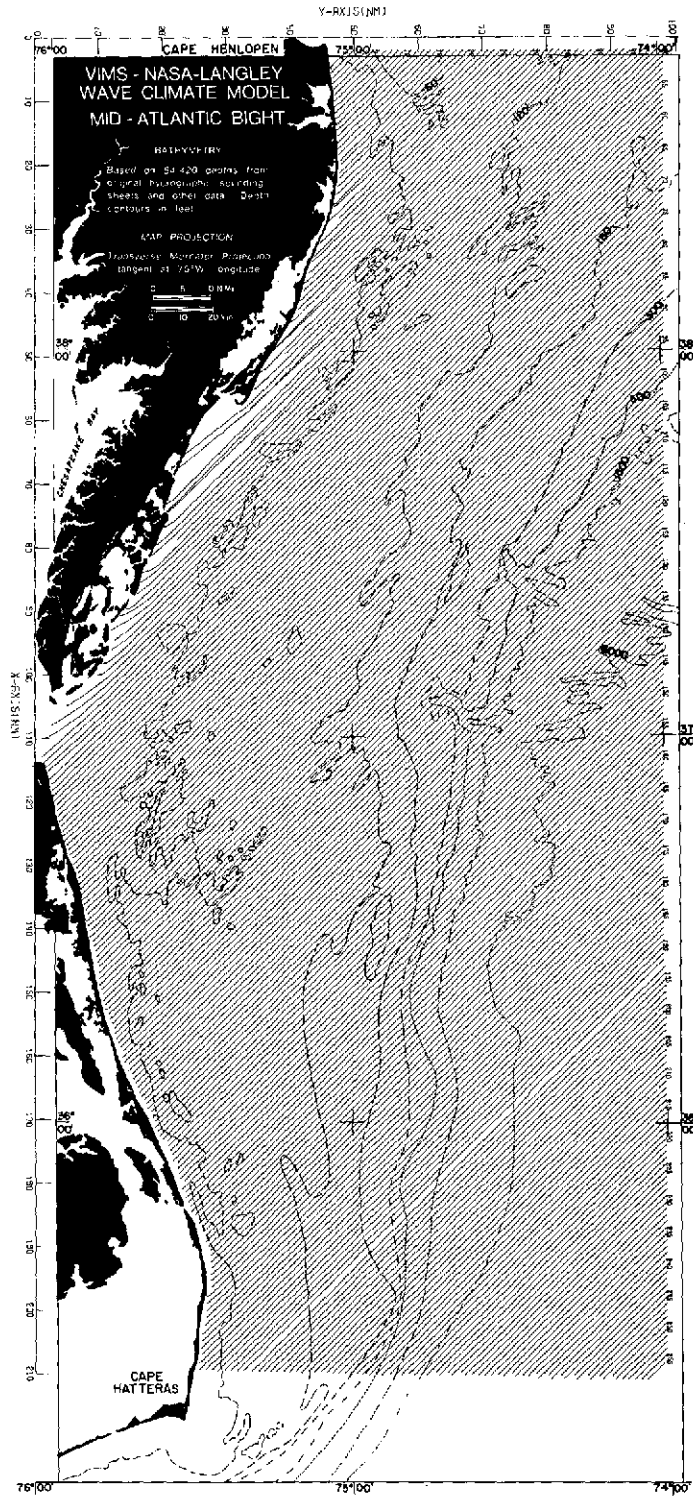

Figure B53.- Wave rays computed with following input conditions:  
 $AZ = 45^\circ$ ;  $T = 4$  sec; Tide = 1.2 m (4 ft).

# APPENDIX B

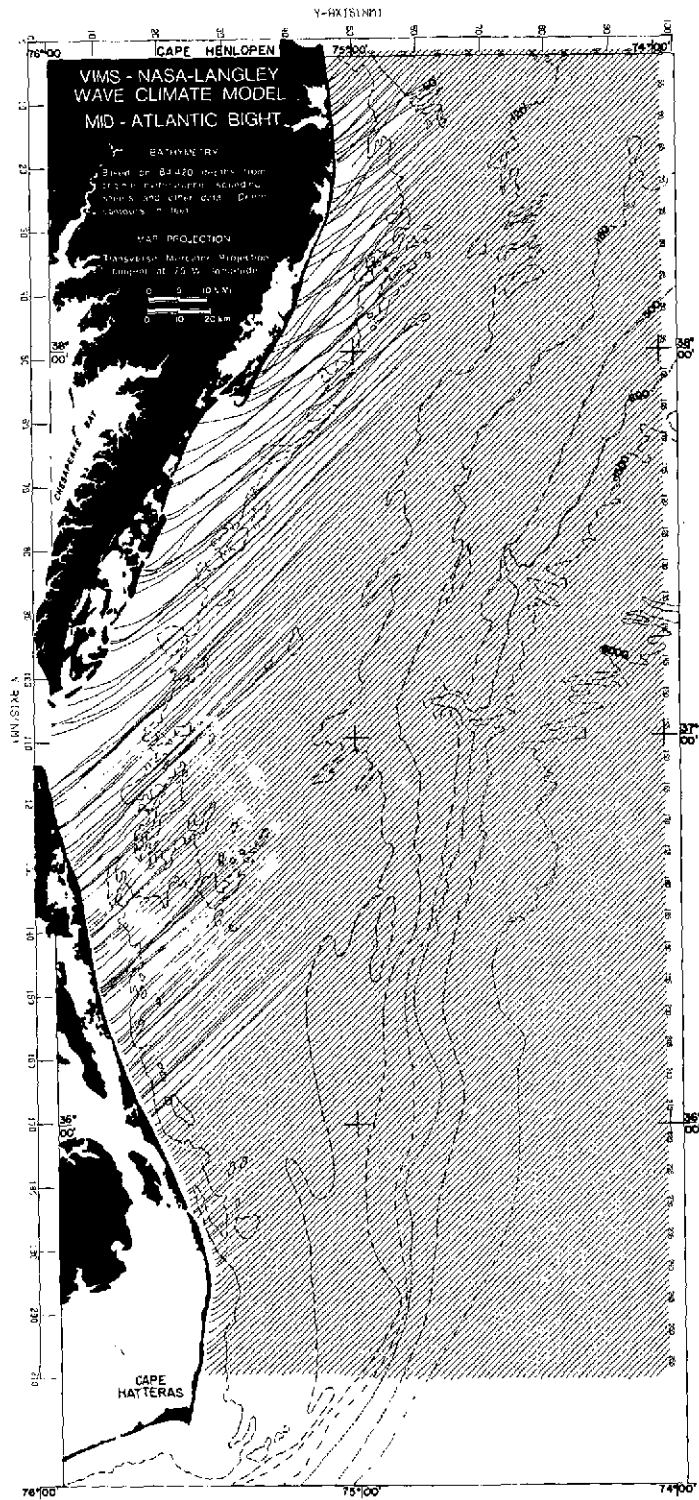

Figure B54.- Wave rays computed with following input conditions:  
 AZ = 45°; T = 6 sec; Tide = 1.2 m (4 ft).

# APPENDIX B

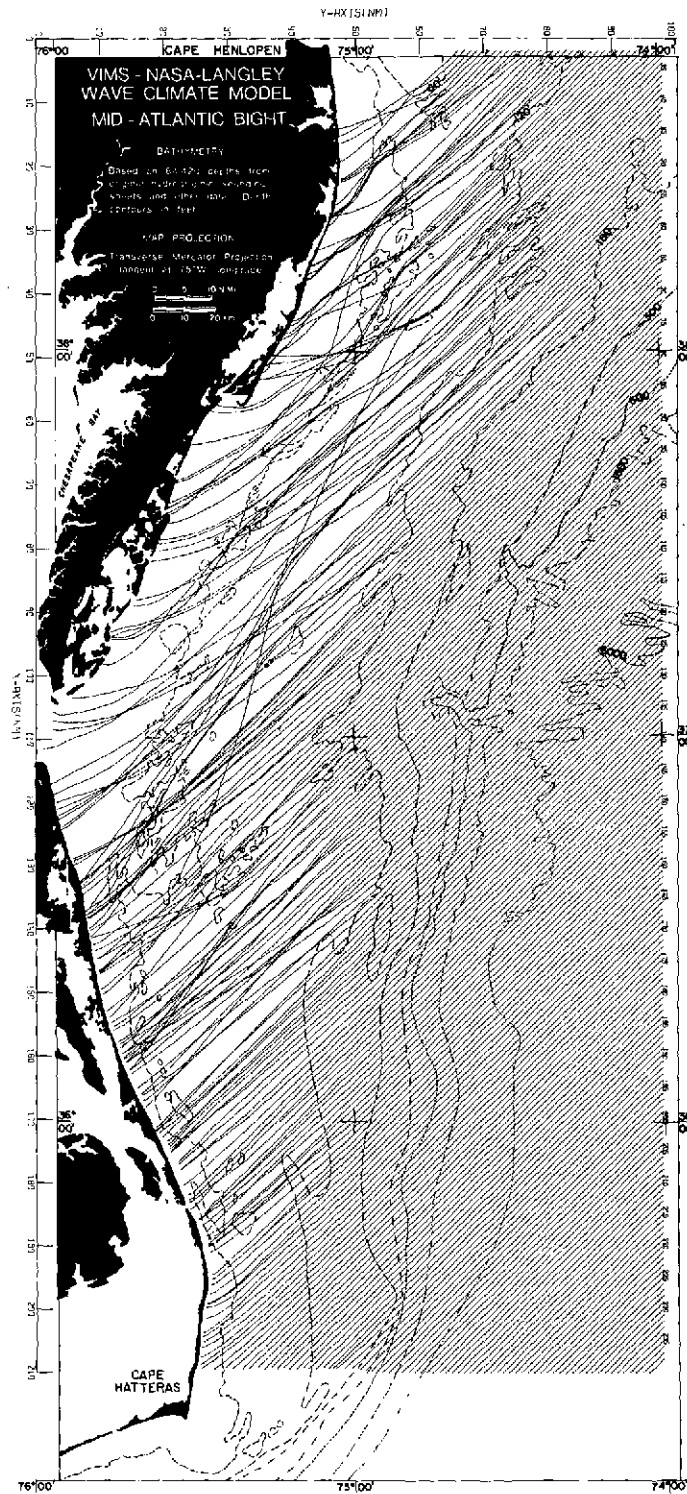

Figure B55.- Wave rays computed with following input conditions:  
 AZ = 45°; T = 8 sec; Tide = 1.2 m (4 ft).



APPENDIX B

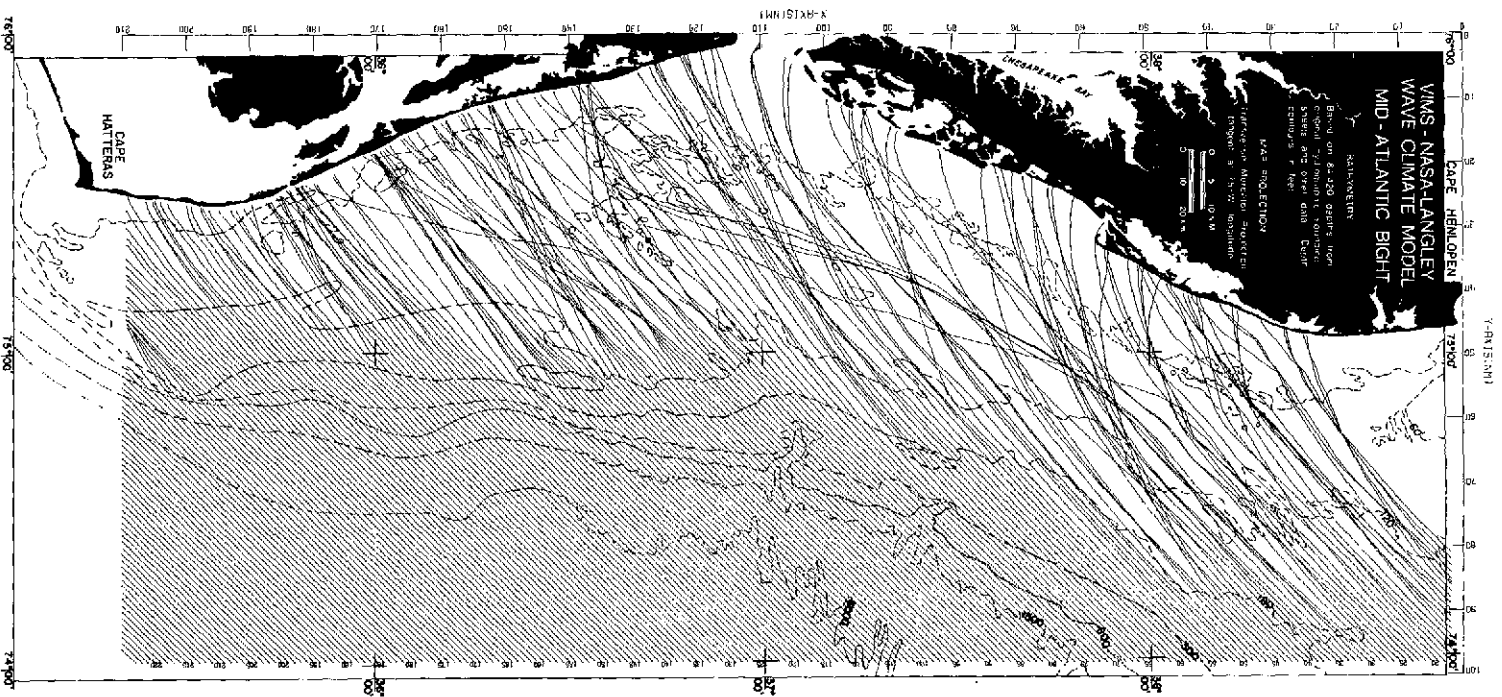

Figure B56.- Wave rays computed with following input conditions:  
AZ = 45°; T = 10 sec; Tide = 1.2 m (4 ft).



# APPENDIX B

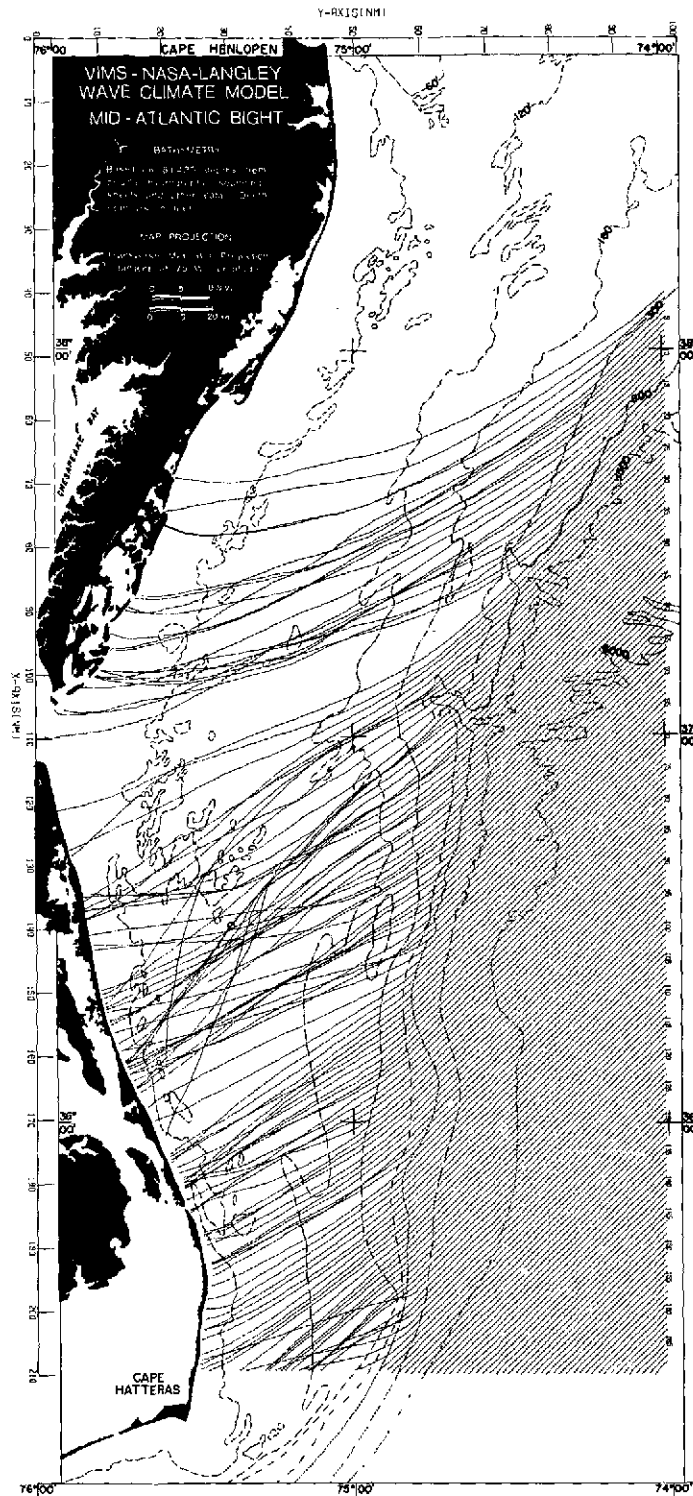

Figure B58.- Wave rays computed with following input conditions:  
 AZ = 45°; T = 14 sec; Tide = 1.2 m (4 ft).

# APPENDIX B

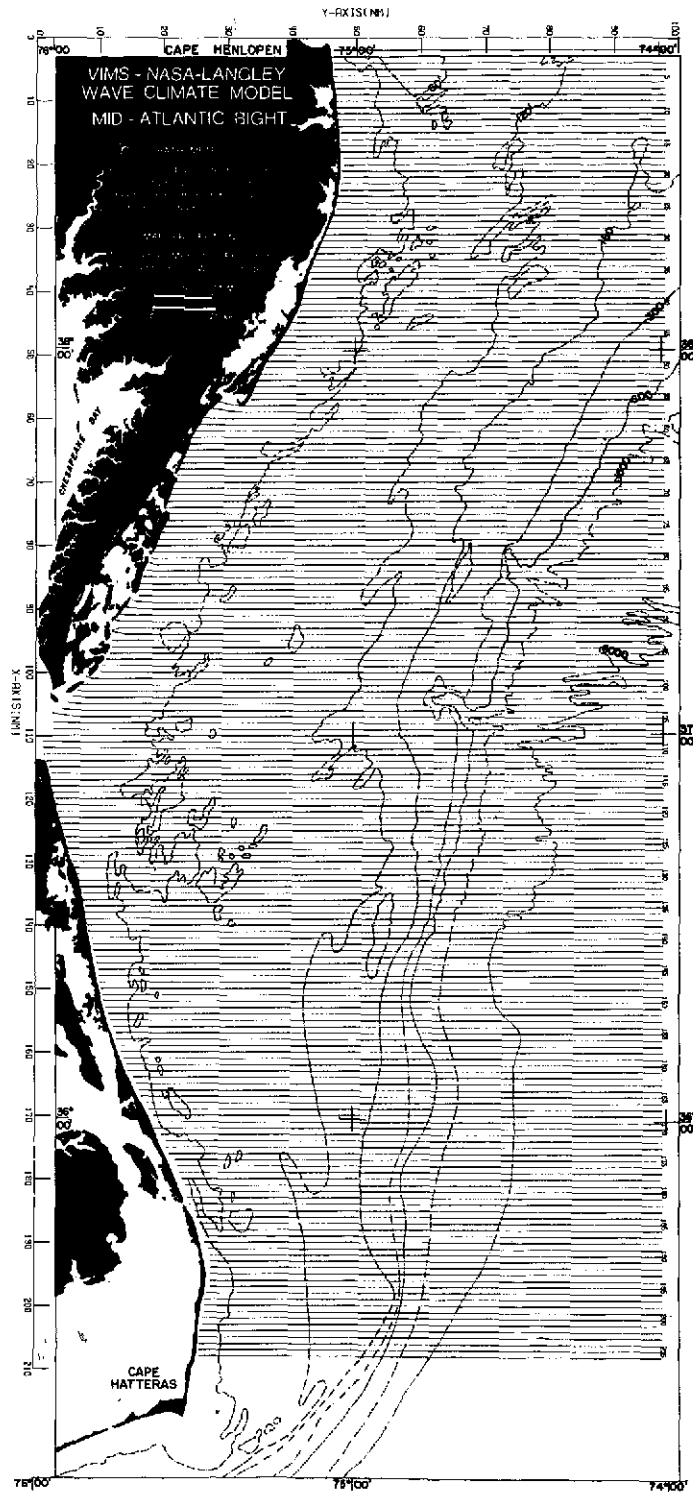

Figure B59.- Wave rays computed with following input conditions:  
AZ = 90°; T = 4 sec; Tide = 1.2 m (4 ft).

# APPENDIX B

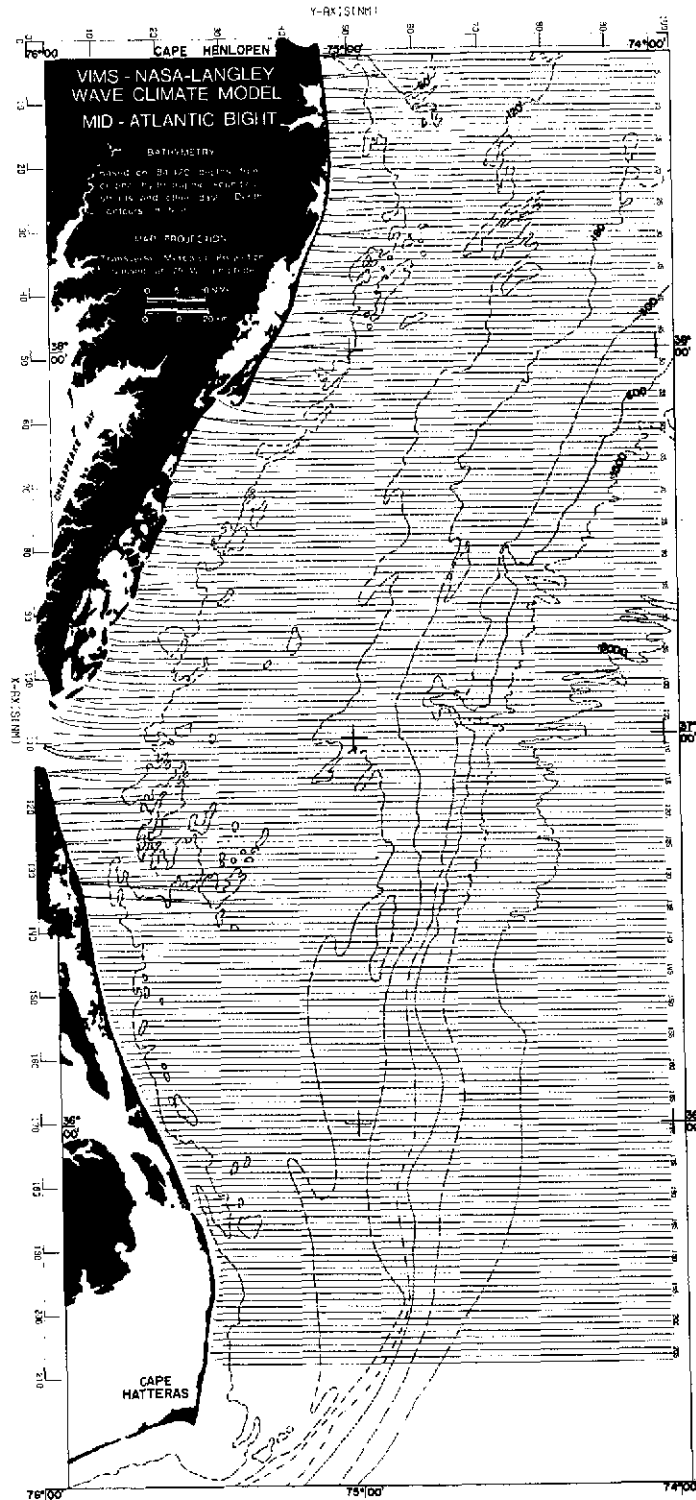

Figure B60.- Wave rays computed with following input conditions:  
 AZ = 90°; T = 6 sec; Tide = 1.2 m (4 ft).



# APPENDIX B

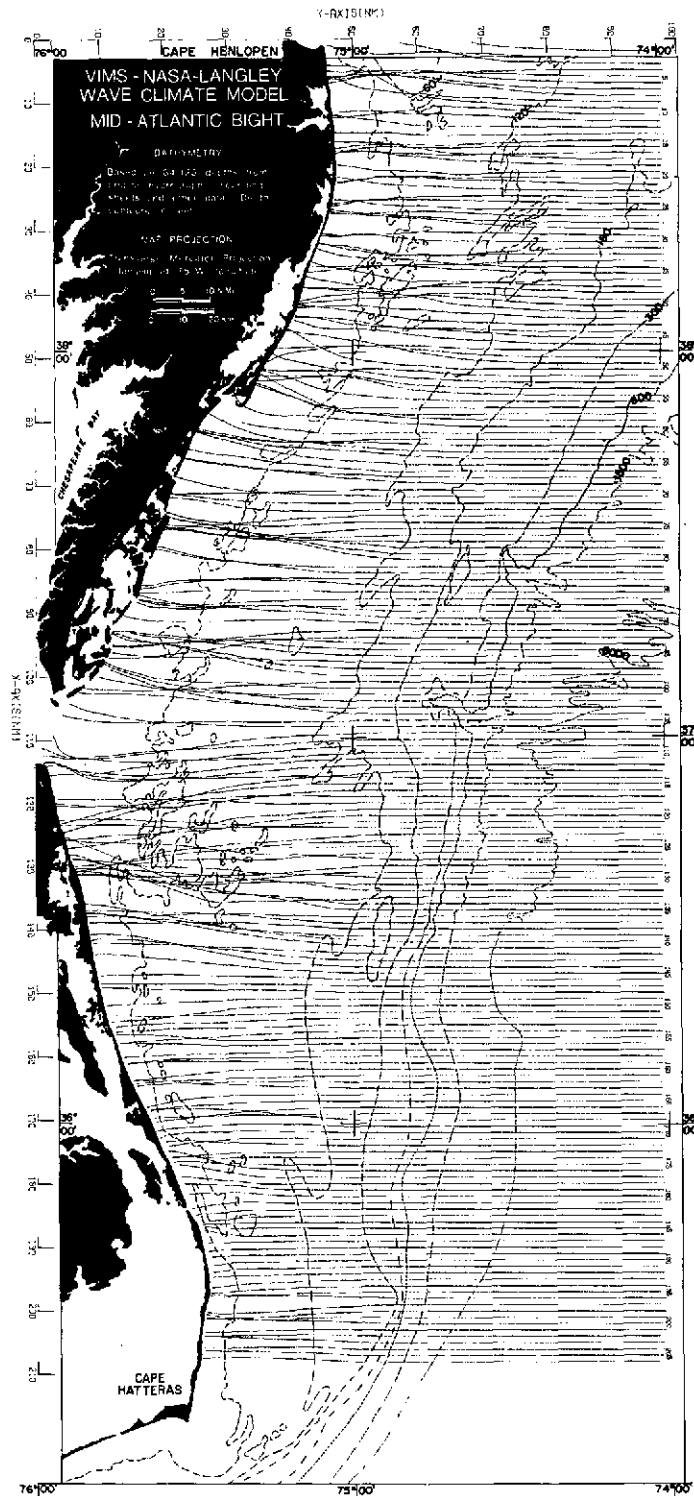

Figure B62.- Wave rays computed with following input conditions:  
 AZ = 90°; T = 10 sec; Tide = 1.2 m (4 ft).

APPENDIX B

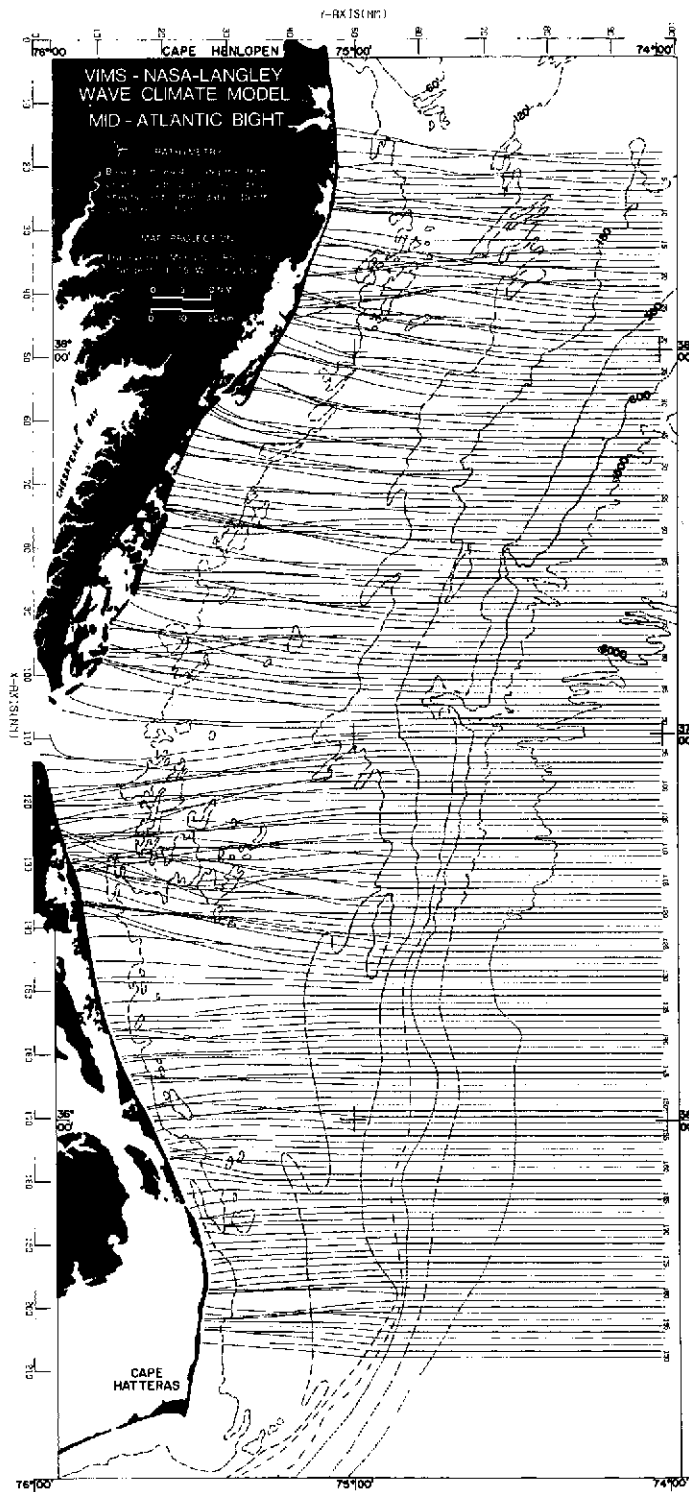

Figure B63.- Wave rays computed with following input conditions:  
 AZ = 90°; T = 12 sec; Tide = 1.2 m (4 ft).



# APPENDIX B

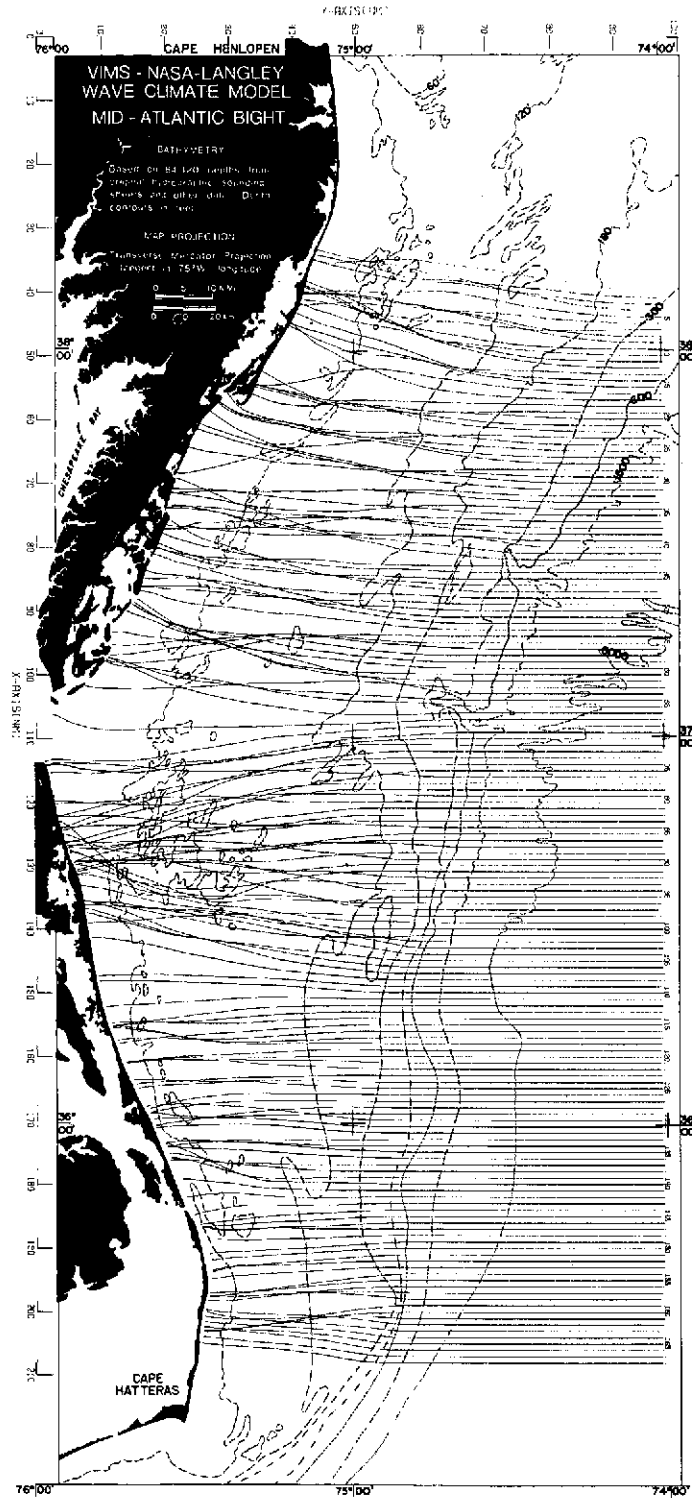

Figure B64.- Wave rays computed with following input conditions:  
 AZ = 90°; T = 14 sec; Tide = 1.2 m (4 ft).

# APPENDIX B

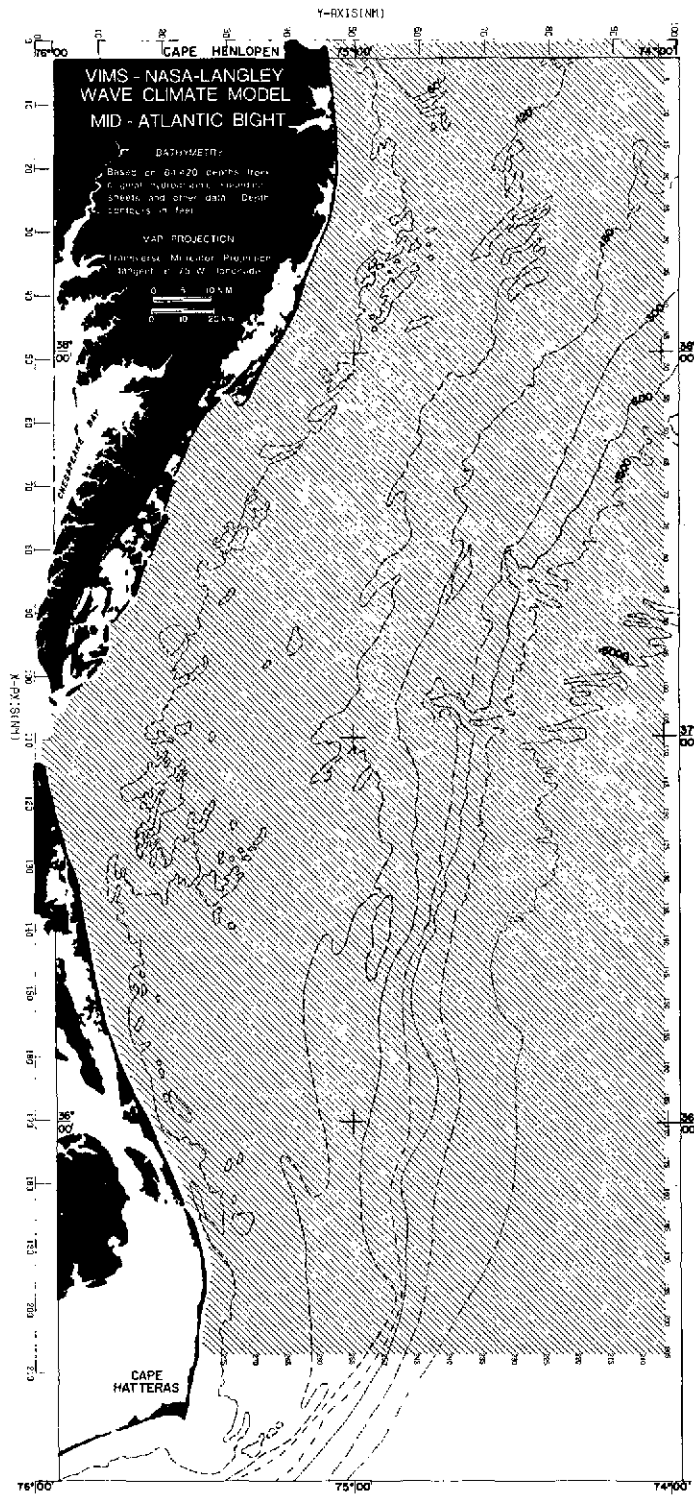

Figure B65.- Wave rays computed with following input conditions:  
 AZ = 135°; T = 4 sec; Tide = 1.2 m (4 ft).

## APPENDIX B

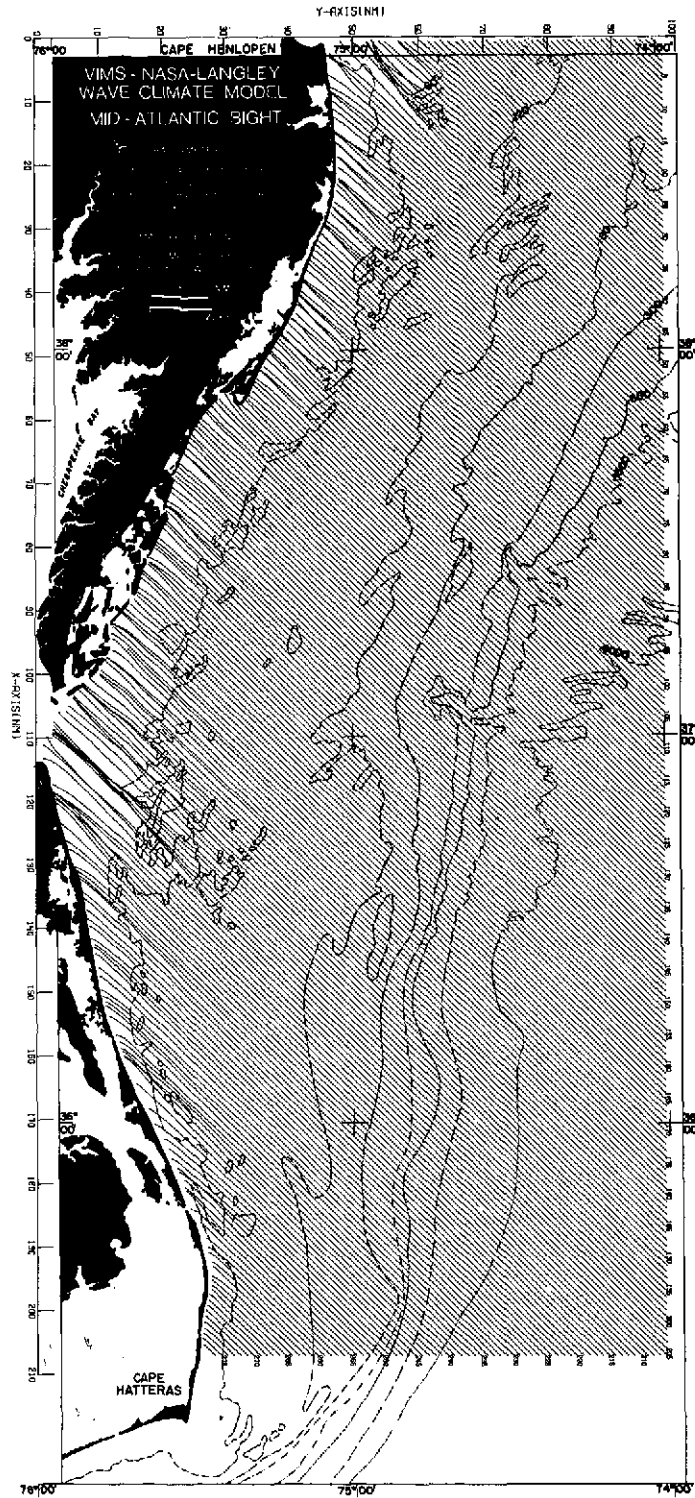

Figure B66.- Wave rays computed with following input conditions:  
AZ = 135°; T = 6 sec; Tide = 1.2 m (4 ft).

APPENDIX B

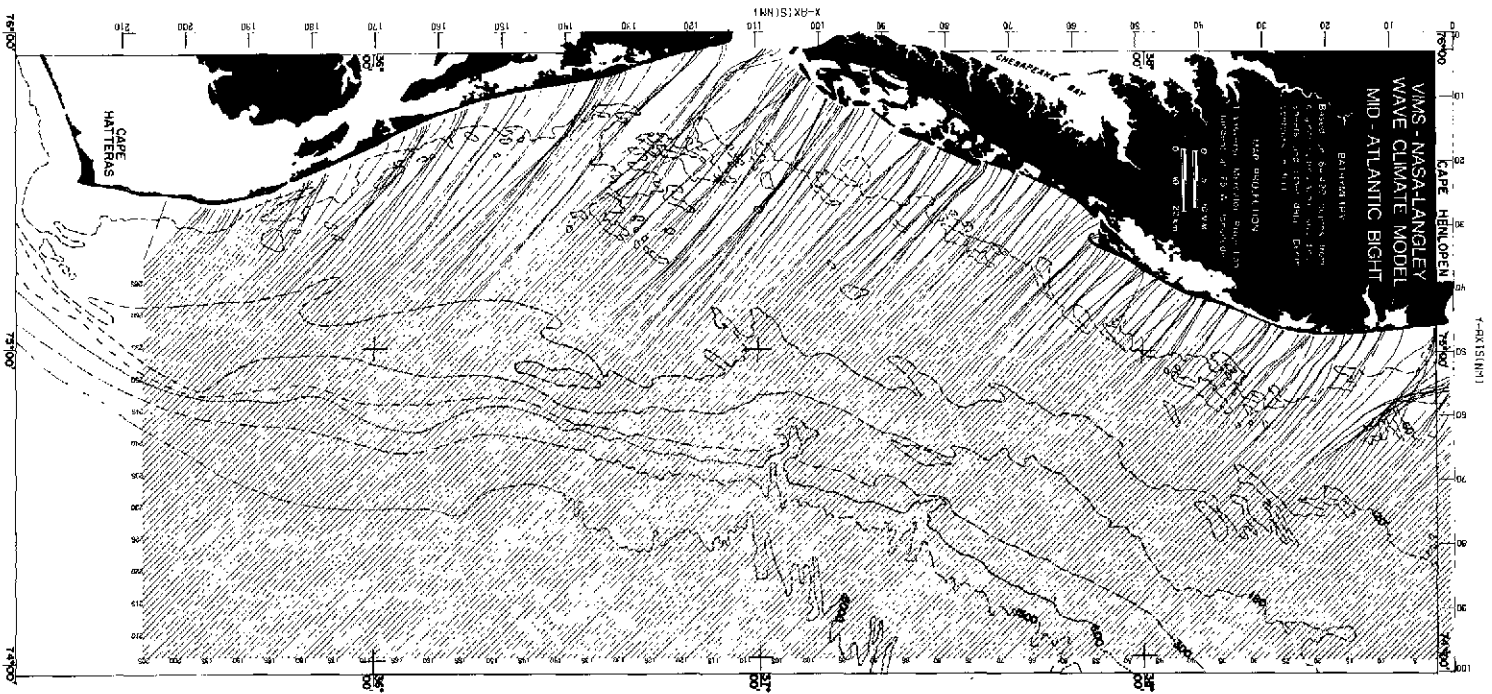
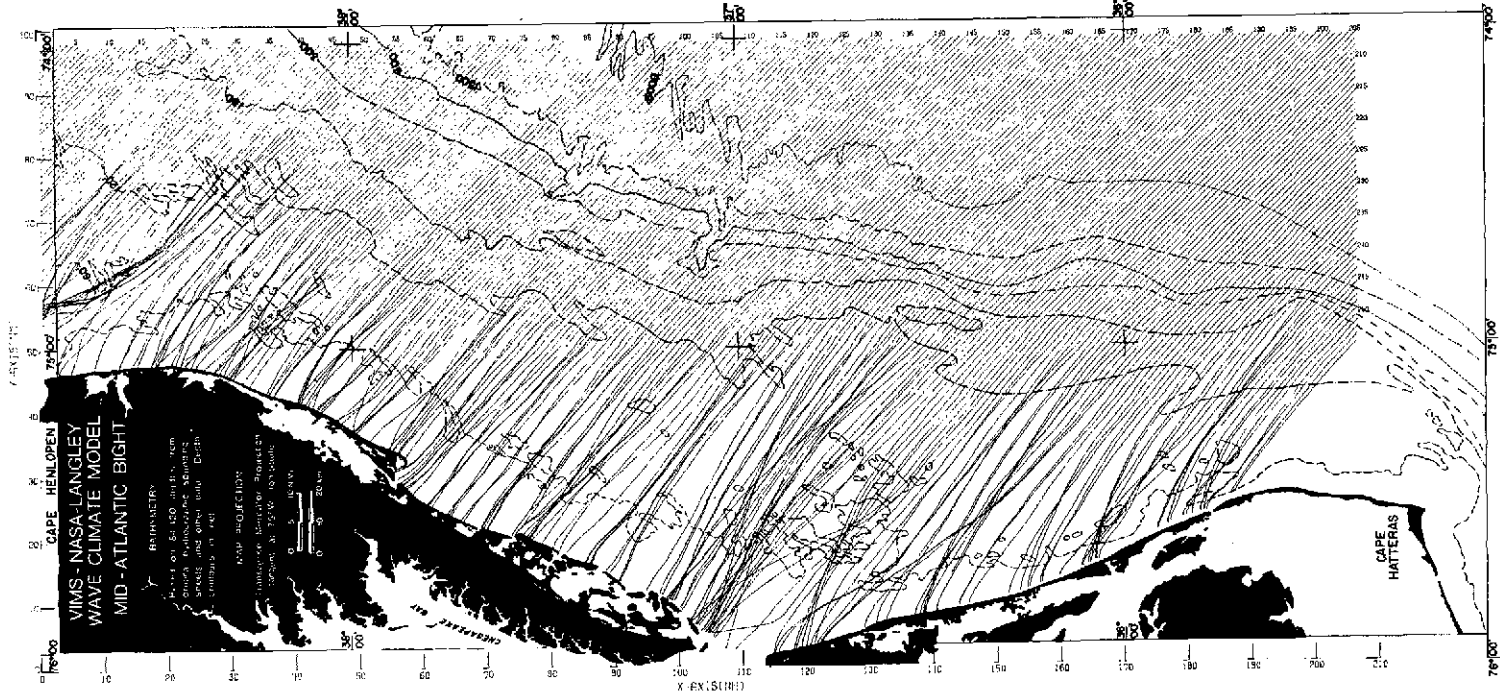

Figure B67.- Wave rays computed with following input conditions:  
AZ = 135°; T = 8 sec; Tide = 1.2 m (4 Ft).

APPENDIX B



ORIGINAL PAGE IS  
OF POOR QUALITY

Figure B68.- Wave rays computed with following input conditions:  
AZ = 135°; T = 10 sec; Tide = 1.2 m (4 ft).

# APPENDIX B

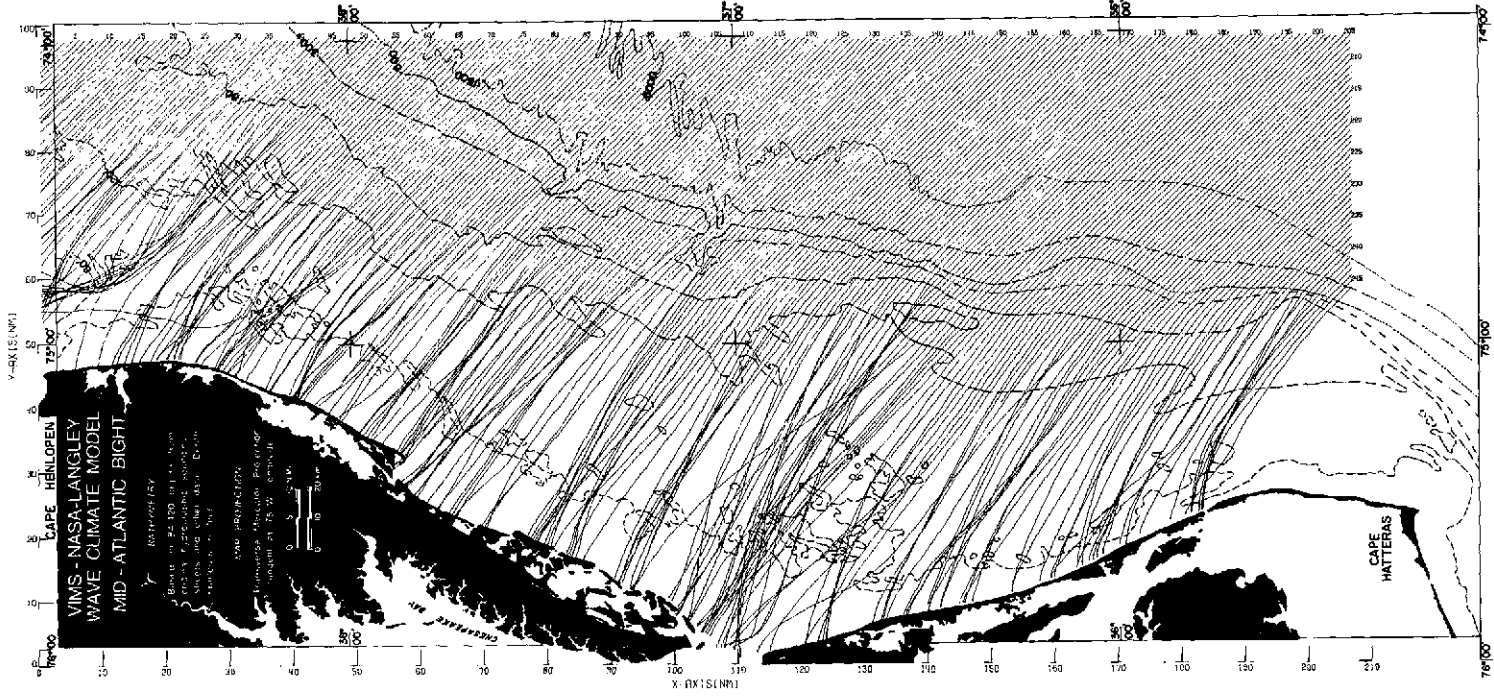

Figure B69.- Wave rays computed with following input conditions:  
AZ = 135°; T = 12 sec; Tide = 1.2 m (4 ft).

APPENDIX B

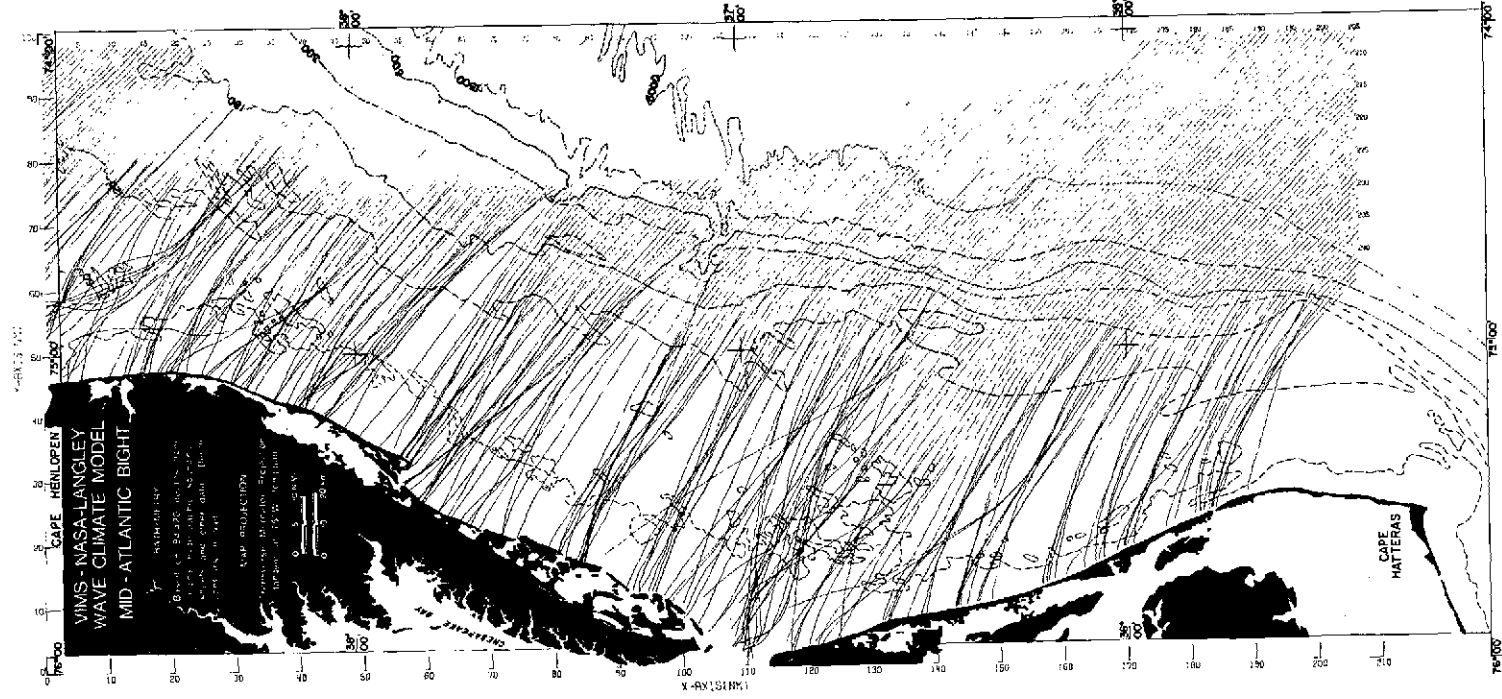

Figure B70.- Wave rays computed with following input conditions:  
AZ = 135°; T = 14 sec; Tide = 1.2 m (4 ft).

## REFERENCES

1. Lepetit, J. P.: Étude de la Réfraction de la Houle Monochromatique par le Calcul Numérique. Bull. Centre Recher. & Essais de Chatou, no. 9, Oct. 1964, pp. 3-25.
2. Wilson, W. Stanley: A Method for Calculating and Plotting Surface Wave Rays. Tech. Mem. No. 17, Coastal Eng. Res. Center, U.S. Army Corps Eng., Feb. 1966. (Available from DDC as AD 636 771.)
3. Stoupe, David Edward: Ocean Wave Crest and Ray Refraction in Shoaling Water by Computer. M.S. Thesis, U.S. Naval Postgraduate School, 1966.
4. Dobson, R. S.: Some Applications of a Digital Computer to Hydraulic Engineering Problems. Tech. Rep. No. 80 (Contract Nonr 225(85)), Dep. Civil Eng., Stanford Univ., June 1967. (Available from DDC as AD 659 309.)
5. Orr, Terry E.; and Herbich, John B.: Numerical Calculation of Wave Refraction by Digital Computer. C.O.E. Rep. No. 114 (Sea Grant Publ. No. 209), Texas A & M Univ., Dec. 1969.
6. Jen, Yuan: Wave Refraction Near San Pedro Bay, California. J. Waterways & Harbors Div., American Soc. Civil Eng., vol. 95, no. WW3, Aug. 1969, pp. 379-393.
7. Goldsmith, Victor; and Colonell, Joseph M.: Effects of Nonuniform Wave Energy in the Littoral Zone. Proceedings of the Twelfth Coastal Engineering Conference, Volume II, American Soc. Civil Eng., 1970, pp. 767-798.
8. Mogel, Theodor R.; Street, Robert L.; and Perry, Byrne: Computation of Alongshore Energy and Littoral Transport. Proceedings of the Twelfth Coastal Engineering Conference, Volume II, American Soc. Civil Eng., 1970, pp. 899-917.
9. Keulegan, Garbis H.; and Harrison, John: Tsunami Refraction Diagrams by Digital Computer. J. Waterways & Harbors Div., American Soc. Civil Eng., vol. 96, no. WW2, May 1970, pp. 219-233.
10. Langfelder, L. J.; Stafford, D. B.; and Amein, M.: Coastal Erosion in North Carolina. J. Waterways & Harbors Div., American Soc. Civil Eng., vol. 96, no. WW2, May 1970, pp. 531-545.
11. Coleman, James M.; and Wright, Lynn D.: Analysis of Major River Systems and Their Deltas: Procedures and Rationale, With Two Examples. Tech. Rep. No. 95 (Contract N00014-69-A-0211-0003), Coastal Stud. Inst., Louisiana State Univ., Apr. 15, 1971. (Available from DDC as AD 723 575.)
12. Farrell, Stewart C.; Rhodes, Eugene G.; and Colonell, Joseph M.: Saco Bay, Maine, A Test of Computer Models for Wave Forecasting and Refraction. Geol. Soc. of America Abstr. With Programs, vol. 3, no. 7, Oct. 1971, pp. 562-563.



13. Chao, Yung-Yao: Refraction of Ocean Surface Waves on the Continental Shelf. Fourth Annual Offshore Technology Conference – Preprints, Volume I, Paper No. OTC 1616, c.1972, pp. I-965 – I-976.
14. McCann, S. Brian; and Bryant, Edward A.: Beach Changes and Wave Conditions, New Brunswick. Proceedings of the Thirteenth Coastal Engineering Conference, Volume II, American Soc. Civil Eng., c.1973, pp. 1293-1304.
15. Walker, James R.; Palmer, Robert Q.; and Kukea, Joseph K.: Recreational Surfing on Hawaiian Reefs. Proceedings of the Thirteenth Coastal Engineering Conference, Volume III, American Soc. Civil Eng., c.1973, pp. 2609-2628.
16. Smith, Benjamin S. L.; and Camfield, Frederick E.: A Refraction Study and Program for Periodic Waves Approaching a Shoreline, and Extending Beyond the Breaking Point. Tech. Rep. No. 16 (Contract No. N00014-69-A0407), Coll. Mar. Stud., Univ. of Delaware, Nov. 1972.
17. Thrall, David E.: Development of a Computer Program To Simulate Wind Wave Generation, Refraction, and Shoaling in the Gulf of Maine. EDAL Rep. No. 113 (Rep. No. UNH-SG-106), Univ. of New Hampshire, Mar. 1973.
18. Colonell, Joseph M.; Farrell, Stewart C.; and Goldsmith, Victor: Wave Refraction Analysis: Aid to Interpretation of Coastal Hydraulics. Hydraulic Engineering and the Environment, Proceedings of the Hydraulic Division Specialty Conference, American Soc. Civil Eng., 1973, pp. 131-140.
19. Anon.: Hurricane-Wave Protection – Beach-Erosion Control, Brunswick County, N.C., Beach Projects (Yaupon Beach and Long Beach Segments). General Design Memorandum – Phase I, Eng. District, Wilmington, U.S. Army Corps Eng., July 1973.
20. May, James P.; and Tanner, William F.: The Littoral Power Gradient and Shoreline Changes. Coastal Geomorphology, Donald R. Coates, ed., Publ. in Geomorphology, State Univ. of New York, 1972, pp. 43-60.
21. Wilson, W. Stanley; Wilson, Donald G.; and Michael, Jeffrey A.: Analysis of Swell Near the Island of Aruba. J. Geophys. Res., vol. 78, no. 33, Nov. 20, 1973, pp. 7834-7844.
22. Bascom, Willard: Waves and Beaches – The Dynamics of the Ocean Surface. Anchor Books, c.1964.
23. Pierson, Willard J.: The Loss of Two British Trawlers – A Study in Wave Refraction. J. Navigation, vol. 25, no. 3, July 1972, pp. 291-304.
24. Goldsmith, Victor; Sutton, Carolyn H.; and Davis, Jane S.: Bathymetry of the Virginian Sea. Part 1 – Chesapeake Bight (Cape Henlopen to Cape Hatteras, Continental Shelf and Upper Slope). SRAMSOE No. 39 (Sea Grant Project No. 5-72), Virginia Inst. Mar. Sci., [1973].

25. Goldsmith, Victor; Byrne, Robert J.; Sallenger, Asbury H.; and Drucker, David M.: The Influence of Waves on the Origin and Development of the Offset Coastal Inlets of the Southern Delmarva Peninsula, Virginia. VIMS Contrib. No. 579 to the Second International Estuarine Research Conference: Geology Section – Coarse-Grained Sediment Transport and Accumulation in Estuaries (Myrtle Beach, S.C.), Oct. 1973.
26. Mehr, Emanuel: Surf Refraction – Computer Refraction Program. NWRP 36-0962-068, U.S. Navy, Sept. 1962.
27. Griswold, Gale M.: Numerical Calculation of Wave Refraction. *J. Geophys. Res.*, vol. 68, no. 6, Mar. 15, 1963, pp. 1715-1723.
28. Harrison, W.; and Wilson, W. S.: Development of a Method for Numerical Calculation of Wave Refraction. Tech. Mem. No. 6, Coastal Eng. Res. Center, U.S. Army Corps Eng., Oct. 1964. (Available from DDC as AD 453 226.)
29. Roberts, James A.: The Reshaping of South Beach, Crescent City, California, After the Tsunami of 27-28 March 1964. MRI64 Pa-202 presented to the Beach Erosion Control Conference (Santa Monica, Calif.), Dec. 2, 1964.
30. Colonell, Joseph M.; and Goldsmith, Victor: Computational Methods for Analysis of Beach and Wave Dynamics. Quantitative Geomorphology: Some Aspects and Applications, Marie Morisawa, ed., Publ. in Geomorphology, State Univ. of New York, 1971, pp. 199-222.
31. Goldsmith, Victor: Coastal Processes of a Barrier Island Complex and Adjacent Ocean Floor: Monomoy Island – Nauset Spit, Cape Cod, Massachusetts. Ph. D. Diss., Univ. of Massachusetts, 1972.
32. Bretschneider, C. L.: Wave Generation by Wind, Deep and Shallow Water. *Estuary and Coastline Hydrodynamics*, Arthur T. Ippen, [ed.], McGraw-Hill Book Co., Inc., c.1966, pp. 133-196.
33. Bretschneider, C. L.; and Reid, R. O.: Modification of Wave Height Due to Bottom Friction, Percolation, and Refraction. Tech. Mem. No. 45, Beach Erosion Board, U.S. Army Corps Eng., Oct. 1954. (Available from DDC as AD 48 974.)
34. Eagleson, P. S.; and Dean, R. G.: Small Amplitude Wave Theory. *Estuary and Coastline Hydrodynamics*, Arthur T. Ippen, [ed.], McGraw-Hill Book Co., Inc., c.1966, pp. 1-92.
35. Koh, Robert C. Y.; and Le Méhauté, Bernard: Wave Shoaling. *J. Geophys. Res.*, vol. 71, no. 8, Apr. 15, 1966, pp. 2005-2012.
36. Wiegel, Robert L.: *Oceanographical Engineering*. Prentice-Hall, Inc., c.1964.

37. O'Brien, M. P.: Wave Refraction at Long Beach and Santa Barbara, California. Bull. Beach Erosion Board, vol. 4, no. 1, Jan. 1, 1950, pp. 1-14.
38. Chao, Yung-Yao: The Theory of Wave Refraction in Shoaling Water, Including the Effects of Caustics and the Spherical Earth. Geophys. Sci. Lab. TR-70-7 (Contracts N62306-67-C-0124 and N62306-70-A-0075), Dep. Meteorol. & Oceanogr., New York Univ., June 1970. (Available from DDC as AD 711 304.)
39. Chao, Yung-Yao: An Asymptotic Evaluation of the Wave Field Near a Smooth Caustic. J. Geophys. Res., vol. 76, no. 30, Oct. 20, 1971, pp. 7401-7408.
40. Chao, Yung-Yao; and Pierson, Willard J., Jr.: An Experimental Study of Gravity Wave Behavior Near a Straight Caustic. Geophys. Sci. Lab. TR-70-17 (Contract N00014-67-A-0467-001), Dep. Meteorol. & Oceanogr., New York Univ., Dec. 1970. (Available from DDC as AD 721 437.)
41. Chao, Yung-Yao; and Pierson, Willard J.: Experimental Studies of the Refraction of Uniform Wave Trains and Transient Wave Groups Near a Straight Caustic. J. Geophys. Res., vol. 77, no. 24, Aug. 20, 1972, pp. 4545-4554.
42. Chao, Yung-Yao: Wave Refraction Phenomena Over the Continental Shelf Near the Chesapeake Bay Entrance. Geophys. Sci. Lab. Contrib. No. 134 (Contract Nos. N62306-70-0075 and DACW 72-71-C-0012), Dep. Meteorol. & Oceanogr., New York Univ., Sept. 1972.
43. Farrell, Stewart C.: Present Coastal Processes, Recorded Changes, and the Post-Pleistocene Geologic Record of Saco Bay, Maine. Ph. D. Thesis, Univ. of Massachusetts, 1972.
44. Stoker, J. J.: Water Waves - The Mathematical Theory With Applications. Interscience Publ., Inc., 1957.
45. Dean, Robert G.: Relative Validities of Water Wave Theories. J. Waterways & Harbors Div., American Soc. Civil Eng., vol. 96, no. WW1, Feb. 1970, pp. 105-119.
46. Dean, R. G.: Evaluation and Development of Water Wave Theories for Engineering Application. Volume I - Presentation of Research Results. Tech. Rep. No. 14 (Contract No. DACW 72-67-0009), Coastal & Oceanogr. Eng. Lab., Univ. of Florida, Dec. 1972.
47. Battjes, Jurjen A.: Refraction of Water Waves. J. Waterways & Harbors Div., American Soc. Civil Eng., vol. 94, no. WW4, Nov. 1968, pp. 437-451.
48. Karlsson, Thorbjorn: Refraction of Continuous Ocean Wave Spectra. J. Waterways & Harbors Div., American Soc. Civil Eng., vol. 95, no. WW4, Nov. 1969, pp. 437-448.

49. Byrne, Robert J.: Field Occurrences of Induced Multiple Gravity Waves. *J. Geophys. Res.*, vol. 74, no. 10, May 15, 1969, pp. 2590-2596.
50. Galvin, Cyril J., Jr.: Wave Breaking in Shallow Water. *Waves on Beaches and Resulting Sediment Transport*, R. E. Meyer, ed., Academic Press, Inc., 1972, pp. 413-456.
51. Chandler, Pierce L., Jr.; and Sorensen, Robert M: Transformation of Waves Passing a Submerged Bar. *Proceedings of the Thirteenth Coastal Engineering Conference, Volume I*, American Soc. Civil Eng., c.1973, pp. 385-404.
52. Tissot, M. A.: *Mémoire sur la Représentation des Surfaces et les Projections des Cartes Géographiques*. Gauthier-Villars, Imprimeur (Paris), 1881.
53. Adams, Oscar S.: Latitude Developments Connected With Geodesy and Cartography – Lambert Equal Area Meridional Projection. *Spec. Publ. No. 67*, Coast & Geod. Surv., U.S. Dep. Com., 1949.
54. Deetz, Charles H.; and Adams, Oscar S.: *Elements of Map Projection With Applications to Map and Chart Construction*. *Spec. Publ. No. 68*, Fifth Ed., Coast & Geod. Surv., U.S. Dep. Com., Rev. 1944.
55. Anon.: Universal Transverse Mercator Grid. Army Map Serv., U.S. Army Corps Eng.
56. O'Keefe, John A.: The Universal Transverse Mercator Grid and Projection. *Prof. Geogr.*, vol. 4, 1952, pp. 19-24.
57. Greenwood, David: *Mapping*. Univ. of Chicago Press, c.1964.
58. Robinson, Arthur H.; and Sale, Randall D.: *Elements of Cartography*. Third ed. John Wiley & Sons, Inc., c.1969.
59. Richardus, Peter; and Adler, Ron K.: *Map Projections for Geodesists, Cartographers and Geographers*. American Elsevier Pub. Co., Inc., 1972.
60. Hardy, J. R.: Some Grid and Projection Problems in the Numerical Calculation of Wave Refraction. *J. Geophys. Res.*, vol. 73, no. 22, Nov. 15, 1968, pp. 7083-7087.
61. Adamo, Louis C.; Baer, Ledolph; and Hosmer, Jean P.: Icosahedral-Gnomonic Projection and Grid of the World Ocean for Wave Studies. *J. Geophys. Res.*, vol. 73, no. 16, Aug. 15, 1968, pp. 5125-5132.
62. Anon.: *Cartographic Automatic Mapping Program (CAM) Documentation*. CIA/BGI-CD-70-2, Cent. Intel. Agency, May 4, 1970.
63. Jeffers, Karl B.: *Hydrographic Manual*. Third ed. *Publ. 20-2*, Coast & Geod. Surv., U.S. Dep. Com., 1960.

64. Shalowitz, Aaron L.: Shore and Sea Boundaries. Publ. 10-1, Coast & Geod. Surv., Dep. Com., 1964.
65. Sallenger, A. H.; Goldsmith, V.; and Sutton, C. H.: Erosion and Accretion From Chart Comparisons. SRAMSOE No. 66, Virginia Inst. Mar. Sci., 1974.  
Part I – Evaluation of Shoreline Comparisons.  
Part II – Evaluation of Bathymetric Comparisons.
66. Canavos, George C.: Criteria for the Optimal Design of Experimental Tests. NASA TM X-2663, 1972.
67. Resio, Donald T.; and Hayden, Bruce P.: An Integrated Model of Storm-Generated Waves. Tech. Rep. No. 8 (Contract Nonr-N00014-69-A-0060-0006), Dep. Environ. Sci., Univ. of Virginia, Dec. 1973. (Available from DDC as AD 774 915.)
68. Thompson, Edward F.; and Harris, D. Lee: A Wave Climatology for U.S. Coastal Waters. Fourth Annual Offshore Technology Conference – Preprints, Volume II, Paper No. OTC 1693, c.1972, pp. II-675 – II-688. (Also, available as Reprint 1-72, Coastal Eng. Res. Center, U.S. Army Corps Eng.)
69. Harris, D. Lee: Characteristics of Wave Records in the Coastal Zone. Waves on Beaches and Resulting Sediment Transport, R. E. Meyer, ed., Academic Press, Inc., 1972, pp. 1-51.
70. Walton, Todd L., Jr.: Littoral Drift Computations Along the Coast of Florida by Means of Ship Wave Observations. Tech. Rep. No. 15 (NOAA Grant No. NG-3-72), Coastal & Oceanogr. Eng. Lab., Univ. of Florida, Feb. 1973.
71. Bretschneider, C. L.: Engineering Aspects of Hurricane Surge. Estuary and Coast-line Hydrodynamics, Arthur T. Ippen, [ed.], McGraw-Hill Book Co., Inc., c.1966, pp. 231-256.
72. Saville, Thorndike, Jr.: North Atlantic Coast Wave Statistics Hindcast by Bretschneider-Revised Sverdrup-Munk Method. Tech. Mem. No. 55, Beach Erosion Board, U.S. Army Corps Eng., Nov. 1954.
73. Savage, Rudolph P.: Laboratory Determination of Littoral-Transport Rates. J. Waterways & Harbors Div., American Soc. Civil Eng., vol. 88, no. WW2, May 1962, pp. 69-92.
74. Caldwell, Joseph M.: Wave Action and Sand Movement Near Anaheim Bay, California. Tech. Mem. No. 68, Beach Erosion Board, U.S. Army Corps Eng., Feb. 1956.
75. Fairchild, J. C.: Correlation of Littoral Transport With Wave Climate Along Shores of New York and New Jersey. Tech. Mem. No. 18, Coastal Eng. Res. Center, U.S. Army Corps Eng., Nov. 1966. (Available from DDC as AD 647 213.)

76. Inman, Douglas L.; Komar, Paul D.; and Bowen, Anthony J.: Longshore Transport of Sand. Proceedings of Eleventh Conference on Coastal Engineering, Volume I, American Soc. Civil Eng., c.1969, pp. 298-306.
77. Longuet-Higgins, M. S.: Recent Progress in the Study of Longshore Currents. Waves on Beaches and Resulting Sediment Transport, R. E. Meyer, ed., Academic Press, Inc., 1972, pp. 203-248.
78. Galvin, Cyril J., Jr.: Longshore Energy Flux, Longshore Force, and Longshore Sediment Transport. Trans., American Geophys. Union, vol. 54, no. 4, Apr. 1973, p. 334.
79. Poole, Lamont R.: Random-Access Technique for Modular Bathymetry Data Storage in a Continental-Shelf Wave-Refraction Program. NASA TM X-3018, 1974.
80. Uchupi, Elazar: Atlantic Continental Shelf and Slope of the United States - Physiography. Geol. Surv. Prof. Paper 529-C, Dep. Interior, 1968.
81. Emery, K. O.; and Uchupi, Elazar: Western North Atlantic Ocean: Topography, Rocks, Structure, Water, Life, and Sediments. Memoir 17, American Assoc. Petrol. Geol., 1972.
82. Hack, John T.: Submerged River System of Chesapeake Bay. Bull. Geol. Soc. of America, vol. 68, no. 7, July 1957, pp. 817-830.
83. Moore, David G.; and Curray, Joseph R.: Sedimentary Framework of Continental Terrace Off Norfolk, Virginia, and Newport, Rhode Island. Bull. American Assoc. Petrol. Geol., vol. 47, no. 12, 1963, pp. 2051-2054.
84. White, William A.: Drainage Asymmetry and the Carolina Capes. Geol. Soc. of America Bull., vol. 77, no. 3, Mar. 1966, pp. 223-240.
85. Emery, K. O.; and Milliman, John D.: Quaternary Sediments of the Atlantic Continental Shelf of the United States. Quaternaria, vol. 12, 1970, pp. 3-34.
86. Payne, Lawrence Harold: Sediments and Morphology of the Continental Shelf Off Southeast Virginia. M.A. Thesis, Columbia Univ., 1970.
87. Spencer, Randall S.: Geology of the Outer Coastal Plain, Southeastern Virginia: Chesapeake - Norfolk - Virginia Beach. Eleventh Annual Field Conference of the Atlantic Coastal Plain Geological Association Guidebook, Part 1, Oct. 17-18, 1970.
88. Pierce, J. W.; and Colquhoun, D. J.: Configuration of the Holocene Primary Barrier Chain, Outer Banks, North Carolina. Southeastern Geol., vol. 11, no. 4, 1970, pp. 231-236.
89. Pierce, J. W.; and Colquhoun, D. J.: Holocene Evolution of a Portion of the North Carolina Coast. Geol. Soc. of American Bull., vol. 81, no. 12, Dec. 1970, pp. 3697-3714.

90. Pierce, J. W.; So, C. L.; Roth, H. D.; and Colquhoun, D. J.: Wave Refraction and Coastal Erosion, Southern Virginia and Northern North Carolina. Geol. Soc. of America Abstr. With Programs, vol. 2, no. 3, Mar. 1970, p. 237.
91. Hoyt, John H.; and Henry, Vernon J., Jr.: Origin of Capes and Shoals Along the Southeastern Coast of the United States. Geol. Soc. of America Bull., vol. 82, no. 1, Jan. 1971, pp. 59-66.
92. Stanley, Daniel J.; Sheng, Harrison; and Pedraza, Carlos P.: Lower Continental Rise East of the Middle Atlantic States: Predominant Sediment Dispersal Perpendicular to Isobaths. Geol. Soc. of America Bull., vol. 82, no. 7, July 1971, pp. 1831-1839.
93. Pilkey, Orrin H.; and Field, Michael E.: Lower Continental Rise East of the Middle Atlantic States: Predominant Sediment Dispersal Perpendicular to Isobaths: Discussion. Geol. Soc. of America Bull., vol. 83, no. 11, Nov. 1972, pp. 3537-3538.
94. Swift, Donald J. P.; Dill, Charles E., Jr.; and McHone, John: Hydraulic Fractionation of Heavy Mineral Suites on an Unconsolidated Retreating Coast. J. Sediment. Petrol., vol. 41, no. 3, Sept. 1971, pp. 683-690.
95. Swift, Donald J. P.; Sanford, Robert B.; Dill, Charles E., Jr.; and Avignone, Nicholas F.: Textural Differentiation on the Shore Face During Erosional Retreat of an Unconsolidated Coast, Cape Henry to Cape Hatteras, Western North Atlantic Shelf. Sedimentology, vol. 16, no. 3/4, June 1971, pp. 221-250.
96. Weinman, Zvi Henry: Analysis of Littoral Transport by Wave Energy: Cape Henry, Virginia to the Virginia, North Carolina Border. M.S. Thesis, Old Dominion Univ., 1971.
97. Kraft, John C.: Sedimentary Facies Patterns and Geologic History of a Holocene Marine Transgression. Geol. Soc. of America Bull., vol. 82, no. 8, Aug. 1971, pp. 2131-2158.
98. Kraft, John C.; Sheridan, Robert E.; and Maisano, Marilyn: Time-Stratigraphic Units and Petroleum Entrapment Models in Baltimore Canyon Basin of Atlantic Continental Margin Geosynclines. American Assoc. Petrol. Geol. Bull., vol. 55, no. 5, May 1971, pp. 658-679.
99. Swift, Donald J. P.; Kofoed, John W.; Saulsbury, Francis P.; and Sears, Phillip: Holocene Evolution of the Shelf Surface, Central and Southern Atlantic Shelf of North America. Shelf Sediment Transport: Process and Pattern, Donald J. P. Swift, David B. Duane, and Orrin H. Pilkey, eds., Dowden, Hutchinson & Ross, Inc., c.1972, pp. 499-574.

100. Swift, Donald J. P.; Holliday, Barry; Avignone, Nicholas; and Shideler, Gerald: Anatomy of a Shore Face Ridge System, False Cape, Virginia. *Mar. Geol.*, vol. 12, 1972, pp. 59-84.
101. Shideler, Gerald L.; and Swift, Donald J. P.: Seismic Reconnaissance of Post-Miocene Deposits, Middle Atlantic Continental Shelf – Cape Henry, Virginia to Cape Hatteras, North Carolina. *Mar. Geol.*, vol. 12, 1972, pp. 165-185.
102. Swift, Donald J. P.; and Boehmer, W. Richard: Brown and Gray Sands on the Virginia Shelf: Color as a Function of Grain Size. *Geol. Soc. of America Bull.*, vol. 83, no. 3, Mar. 1972, pp. 877-883.
103. Meisburger, Edward P.: Geomorphology and Sediments of the Chesapeake Bay Entrance. *Tech. Mem. No. 38, Coastal Eng. Res. Center, U.S. Army Corps Eng.*, June 1972.
104. Nichols, Maynard M.: Inner Shelf Sediments Off Chesapeake Bay. I, General Lithology and Composition. *Spec. Sci. Rep. No. 64, Virginia Inst. Mar. Sci.*, Apr. 1972.
105. Schubel, J. R.; and Zabawa, C. F.: Report on Investigations to Delineate the Ancestral River Valley Systems of the Chesapeake Bay. *Maritime Sediments*, vol. 8, no. 1, Apr. 1972, pp. 32-35.
106. Shideler, Gerald L.: Textural Trend Analysis of Coastal Barrier Sediments Along the Middle Atlantic Bight, North Carolina. *Sediment. Geol.*, vol. 9, no. 3, June 1973, pp. 195-220.
107. Shideler, Gerald L.: Evaluation of a Conceptual Model for the Transverse Sediment Transport System of a Coastal Barrier Chain, Middle Atlantic Bight. *J. Sediment. Petrol.*, vol. 43, no. 3, Sept. 1973, pp. 748-764.
108. Shideler, Gerald L.; Swift, Donald J. P.; Johnson, Gerald H.; and Holliday, Barry W.: Late Quaternary Stratigraphy of the Inner Virginia Continental Shelf: A Proposed Standard Section. *Geol. Soc. of America Bull.*, vol. 83, no. 6, June 1972, pp. 1787-1804.
109. Fisher, John J.: Late Quaternary Stratigraphy of the Inner Virginia Continental Shelf: A Proposed Standard Section: Discussion. *Geol. Soc. of America Bull.*, vol. 84, no. 6, June 1973, pp. 2159-2160.
110. Shideler, Gerald L.; Swift, Donald J. P.; Johnson, Gerald H.; and Holliday, Barry W.: Late Quaternary Stratigraphy of the Inner Virginia Continental Shelf: A Proposed Standard Section: Reply. *Geol. Soc. of America Bull.*, vol. 84, no. 6, June 1973, pp. 2161-2163.



111. Harbridge, William; Hamilton, Lance; and Pilkey, Orrin: Seasonal Ripple Mark Response, Cape Hatteras Continental Shelf. Geol. Soc. of America Abstr. With Programs, vol. 5, no. 5, Feb. 1973, p. 401.
112. Sabet, M. A.: Gravity and Magnetic Investigation, Eastern Shore Area, Virginia. Geol. Soc. of America Bull., vol. 84, no. 6, June 1973, pp. 2119-2126.
113. Thomas, John B.; and Goodwin, Bruce K.: Heavy Minerals of the Continental Shelf Off the Eastern Shore of Virginia. Geol. Soc. of America Abstr. With Programs, vol. 5, no. 5, Feb. 1973, p. 444.
114. Everts, Craig H.; and Seelig, William N.: Geometry of Profiles Across Some Inner Continental Shelves of the United States. Trans., American Geophys. Union, vol. 54, no. 4, Apr. 1973, p. 336.
115. Swift, D. J. P.: Delaware Shelf Valley: Estuary Retreat Path, Not Drowned River Valley. Geol. Soc. of America Bull., vol. 84, no. 8, Aug. 1973, pp. 2743-2748.
116. Higgins, Michael W.; Zietz, Isidore; and Fisher, George W.: Interpretation of Aeromagnetic Anomalies Bearing on the Origin of Upper Chesapeake Bay and River Course Changes in the Central Atlantic Seaboard Region: Speculations. Geology, vol. 2, no. 2, Feb. 1974, pp. 73-76.
117. Lovegreen, Jon R.: Paleodrainage History of the Hudson River-Estuary. Geol. Soc. of America Abstr. With Programs, vol. 5, no. 1, Jan. 1974, pp. 49-50.
118. Thornbury, William D.: Principles of Geomorphology. John Wiley & Sons, Inc., c.1954, pp. 451-452.
119. Veatch, A. C.; and Smith, P. A.: Atlantic Submarine Valleys of the United States and the Congo Submarine Valley. Geol. Soc. of America Spec. Papers No. 7, Sept. 30, 1939.
120. Garrison, Louis E.; and McMaster, Robert L.: Sediments and Geomorphology of the Continental Shelf Off Southern New England. Mar. Geol., vol. 4, no. 4, Aug. 1966, pp. 273-289.
121. Hayes, Miles O.: Lognormal Distribution of Inner Continental Shelf Widths and Slopes. Deep-Sea Res. & Oceanogr. Abstr., vol. 11, no. 1, Jan./Feb. 1964, pp. 53-78.
122. Curray, Joseph R.: Sediments and History of Holocene Transgression, Continental Shelf, Northwest Gulf of Mexico. Recent Sediments, Northwest Gulf of Mexico - 1951-1958, Francis P. Shepard, Fred B. Phleger, and Tjeerd H. van Andel, eds., American Assoc. Petrol. Geol., 1960, pp. 221-266.

123. Curray, Joseph R.: Late Quaternary History, Continental Shelves of the United States. The Quaternary of the United States, H. E. Wright, Jr., and David G. Frey, eds., Princeton Univ. Press, 1965, pp. 723-735.
124. Emery, K. O.: Atlantic Continental Shelf and Slope of the United States – Geologic Background. Geol. Surv. Prof. Paper 529-A, U.S. Govt. Printing Office, 1966.
125. Shepard, Francis P.; and Dill, Robert F.: Submarine Canyons and Other Sea Valleys. Rand McNally & Co., c.1966.
126. Richards, Horace G.: Stratigraphy of Atlantic Coastal Plain Between Long Island and Georgia: Review. American Assoc. Petrol. Geol. Bull., vol. 51, no. 12, Dec. 1967, pp. 2400-2429.
127. Richards, Horace G.: The Tertiary History of the Atlantic Coast Between Cape Cod and Cape Hatteras. Palaeogeogr., Palaeoclimatol., Palaeoecol., vol. 5, no. 1, 1968, pp. 95-104.
128. Milliman, John D.; and Emery, K. O.: Sea Levels During the Past 35,000 Years. Science, vol. 162, no. 3858, Dec. 6, 1968, pp. 1121-1123.
129. Garrison, Louis E.: Development of Continental Shelf South of New England. American Assoc. Petrol. Geol. Bull., vol. 54, no. 1, Jan. 1970, pp. 109-124.
130. Guilcher, A., ed.: Symposium on the Evaluation of Shorelines and Continental Shelves in Their Mutual Relations During the Quaternary. Quaternaria, vol. 12, 1970.
131. Kelling, Gilbert; and Stanley, Daniel J.: Morphology and Structure of Wilmington and Baltimore Submarine Canyons, Eastern United States. J. Geol., vol. 78, no. 6, Nov. 1970, pp. 637-660.
132. Gill, Edmund D.: The Paris Symposium on World Sealevels of the Past 11,000 Years. Quaternaria, vol. 14, 1971, pp. 1-6.
133. Rona, Peter A.: Exploration Methods for the Continental Shelf: Geology, Geophysics, Geochemistry. ERL-238-AOML-8, Nat. Oceanic & Atmos. Admin., June 1972.
134. Williams, S. Jeffress; and Duane, David B.: Regional Shelf Studies – A Guide to Engineering Design. Reprint 3-72, Coastal Eng. Res. Center, U.S. Army Corps Eng., Sept. 1972.
135. Hicks, Steacy D.: On the Classification and Trends of Long Period Sea Level Series, Shore & Beach, vol. 40, no. 1, Apr. 1972, pp. 20-23.

136. Field, Michael E.: Buried Strandline Deposits on the Central Florida Inner Continental Shelf. *Geol. Soc. of America Bull.*, vol. 85, no. 1, Jan. 1974, pp. 57-60.
137. McMaster, Robert L.; and Ashraf, Asaf: Extent and Formation of Deeply Buried Channels on the Continental Shelf Off Southern New England. *J. Geol.*, vol. 81, no. 3, May 1973, pp. 374-379.
138. Frank, William M.; and Friedman, Gerald M.: Continental-Shelf Sediments Off New Jersey. *J. Sediment. Petrol.*, vol. 43, no. 1, Mar. 1973, pp. 224-237.
139. Corell, Robert W.; Westneat, A. S.; and Yildiz, Asim: The Science and Technology of Utilizing the Bottom Resources of the Continental Shelf – 2nd Annual Report. UNH-SG-102 (Sea Grant No. NG-30-72 and DC 1-36114), Univ. of New Hampshire, Jan. 1973.
140. Jordaan, Jan M., Jr.: Effects of Hydrographic Changes Due to Nearshore Dredger Dumping on Wave Refraction and Littoral Sand Balance. *Proceedings of Ninth Conference on Coastal Engineering, American Soc. Civil Eng.*, 1964, pp. 310-322.
141. Harrison, W.; Malloy, R. J.; Rusnak, Gene A.; and Terasmae, J.: Possible Late Pleistocene Uplift, Chesapeake Bay Entrance. *J. Geol.*, vol. 73, no. 2, Mar. 1965, pp. 201-229.
142. Newman, W. S.; and Rusnak, G. A.: Holocene Submergence of the Eastern Shore of Virginia. *Science*, vol. 148, no. 3676, June 11, 1965, pp. 1464-1466.
143. DeAlteris, Joseph Thomas: The Recent History of Wachapreague Inlet, Virginia. M.A. Thesis, Virginia Inst. Mar. Sci., College of William and Mary in Virginia, 1973.
144. Daly, Reginald Aldworth: *The Floor of the Ocean – New Light on Old Mysteries.* Univ. of North Carolina Press, 1942.
145. Duane, David B.; Field, Michael E.; Meisburger, Edward P.; Swift, Donald J. P.; and Williams, S. Jeffress: Linear Shoals on the Atlantic Inner Continental Shelf, Florida to Long Island. *Shelf Sediment Transport: Process and Pattern*, Donald J. P. Swift, David B. Duane, and Orrin H. Pilkey, eds., Dowden, Hutchinson & Ross, Inc., c.1972, pp. 447-498.
146. Stahl, L.; Koczan, J.; and Swift, D.: Anatomy of a Shoreface-Connected Sand Ridge on the New Jersey Shelf: Implications for the Genesis of the Shelf Surficial Sand Sheet. *Geology*, vol. 2, no. 3, Mar. 1974, pp. 117-120.
147. Munk, Walter H.; and Traylor, Melvin A.: Refraction of Ocean Waves: A Process Linking Underwater Topography to Beach Erosion. *J. Geol.*, vol. LV, no. 1, Jan. 1947, pp. 1-26.

148. Harrison, W.; Brehmer, Morris L.; and Stone, Richard B.: Nearshore Tidal and Nontidal Currents, Virginia Beach, Virginia. Tech. Mem. No. 5, Coastal Eng. Res. Center, U.S. Army Corps Eng., Apr. 1964. (Available from DDC as AD 440 881.)
149. Moody, David Wright: Coastal Morphology and Processes in Relation to the Development of Submarine Sand Ridges Off Bethany Beach, Delaware. Ph. D. Diss., Johns Hopkins Univ., 1964.
150. Vincent, Linwood: Quantification of Shoreline Meandering. Tech. Rep. No. 7 (Contract Nonr-N00014-69-A-0060-0006), Dep. Environ. Sci., Univ. of Virginia, Nov. 1973. (Available from DDC as AD 773 050.)
151. Pore, N. A.; and Richardson, W. S.: Second Interim Report on Sea and Swell Forecasting. ESSA Tech. Mem. WBTM TDL 17, U.S. Dep. Com., Jan. 1969.
152. Covault, Craig: NASA Defining Oceanographic Satellite. *Aviat. Week & Space Technol.*, vol. 99, no. 15, Oct. 8, 1973, p. 19.
153. Apel, John R.: A Hard Look at Oceans From Space. AIAA Paper No. 73-11, Jan. 1973.
154. Moore, Richard K.; and Pierson, Willard J., Jr.: Worldwide Oceanic Wind and Wave Predictions Using a Satellite Radar-Radiometer. *J. Hydronaut.*, vol. 5, no. 2, Apr. 1971, pp. 52-60.
155. Apel, J. R.; and Proni, J. R.: Scientific Results From Remote Sensing of the Oceans. *Mar. Technol. Soc. J.*, vol. 8, no. 1, Jan. 1974, pp. 25-28.
156. Harrison, Edwin F.; and Green, Richard N.: Orbit Analysis for Coastal Zone Oceanography Observations. AIAA Paper No. 73-207, Jan. 1973.
157. Anon.: Three Crewmen Missing After Boat Overturms. *Daily Press (Newport News, Va.)*, 78th yr., no. 346, Dec. 12, 1973, p. 19.
158. Allen, Louis: Marine Weather Forecasting. *UnderSea Technol. & Oceanology Int. Offshore Technol.*, vol. 14, no. 5, May 1973, pp. 29-30.
159. Whitlock, Charles H.; and Talay, Theodore A.: The Influence of Surface Waves on Water Circulation in a Mid-Atlantic Continental-Shelf Region. NASA TN D-7771, 1974.
160. Hoult, David P.: Oil Spreading on the Sea. *Annual Review of Fluid Mechanics*, Volume 4, Milton van Dyke, Walter G. Vincenti, and J. V. Wehausen, eds., Annu. Rev., Inc., 1972, pp. 341-368.
161. Sonu, C. J.; Murray, S. P.; and Smith, W. G.: Environmental Factors Controlling the Spread of Oil. *Naval Res. Rev.*, vol. 24, no. 5, 1971, pp. 11-19.

162. Purpura, James A.: Establishment of a Coastal Setback Line in Florida. Proceedings of the Thirteenth Coastal Engineering Conference, Volume II, American Soc. Civil Eng., c.1973, pp. 1599-1615.

## BIBLIOGRAPHY

- Adamo, Louis C.; Baer, Ledolph; and Hosmer, Jean P.: Icosahedral-Gnomonic Projection and Grid of the World Ocean for Wave Studies. *J. Geophys. Res.*, vol. 73, no. 16, Aug. 15, 1968, pp. 5125-5132.
- Adams, Oscar S.: Latitude Developments Connected With Geodesy and Cartography – Lambert Equal Area Meridional Projection. Spec. Publ. No. 67, Coast & Geod. Surv., U.S. Dep. Com., 1949.
- Allen, Louis: Marine Weather Forecasting. *UnderSea Technol. & Oceanology Int. Offshore Technol.*, vol. 14, no. 5, May 1973, pp. 29-30.
- Anon.: Universal Transverse Mercator Grid. Army Map Serv., U.S. Army Corps Eng.
- Anon.: Cartographic Automatic Mapping Program (CAM) Documentation. CIA/BGI-CD-70-2, Cent. Intel. Agency, May 4, 1970.
- Anon.: Hurricane-Wave Protection – Beach-Erosion Control, Brunswick County, N.C., Beach Projects (Yaupon Beach and Long Beach Segments). General Design Memorandum – Phase I, Eng. District, Wilmington, U.S. Army Corps Eng., July 1973.
- Anon.: Three Crewmen Missing After Boat Overturns. *Daily Press (Newport News, Va.)*, 78th yr., no. 346, Dec. 12, 1973, p. 19.
- Apel, John R.: A Hard Look at Oceans From Space. AIAA Paper No. 73-11, Jan. 1973.
- Apel, J. R.; and Proni, J. R.: Scientific Results From Remote Sensing of the Oceans. *Mar. Technol. Soc. J.*, vol. 8, no. 1, Jan. 1974, pp. 25-28.
- Bascom, Willard: Waves and Beaches – The Dynamics of the Ocean Surface. Anchor Books, c.1964.
- Battjes, Jurjen A.: Refraction of Water Waves. *J. Waterways & Harbors Div., American Soc. Civil Eng.*, vol. 94, no. WW4, Nov. 1968, pp. 437-451.
- Bretschneider, C. L.: Field Investigation of Wave Energy Loss in Shallow Water Ocean Waves. Tech. Mem. No. 46, Beach Erosion Board, U.S. Army Corps Eng., Sept. 1954.
- Bretschneider, C. L.; and Reid, R. O.: Modification of Wave Height Due to Bottom Friction, Percolation, and Refraction. Tech. Mem. No. 45, Beach Erosion Board, U.S. Army Corps Eng., Oct. 1954. (Available from DDC as AD 48 974.)
- Byrne, Robert J.: Field Occurrences of Induced Multiple Gravity Waves. *J. Geophys. Res.*, vol. 74, no. 10, May 15, 1969, pp. 2590-2596.

- Caldwell, Joseph M.: Wave Action and Sand Movement Near Anaheim Bay, California. Tech. Mem. No. 68, Beach Erosion Board, U.S. Army Corps Eng., Feb. 1956.
- Canavos, George C.: Criteria for the Optimal Design of Experimental Tests. NASA TM X-2663, 1972.
- Chandler, Pierce L., Jr.; and Sorensen, Robert M: Transformation of Waves Passing a Submerged Bar. Proceedings of the Thirteenth Coastal Engineering Conference, Volume I, American Soc. Civil Eng., c.1973, pp. 385-404.
- Chao, Yung-Yao: The Theory of Wave Refraction in Shoaling Water, Including the Effects of Caustics and the Spherical Earth. Geophys. Sci. Lab. TR-70-7 (Contracts N62306-67-C-0124 and N62306-70-A-0075), Dep. Meteorol. & Oceanogr., New York Univ., June 1970. (Available from DDC as AD 711 304.)
- Chao, Yung-Yao; and Pierson, Willard J., Jr.: An Experimental Study of Gravity Wave Behavior Near a Straight Caustic. Geophys. Sci. Lab. TR-70-17 (Contract N00014-67-A-0467-001), Dep. Meteorol. & Oceanogr., New York Univ., Dec. 1970. (Available from DDC as AD 721 437.)
- Chao, Yung-Yao: An Asymptotic Evaluation of the Wave Field Near a Smooth Caustic. J. Geophys. Res., vol. 76, no. 30, Oct. 20, 1971, pp. 7401-7408.
- Chao, Yung-Yao: Refraction of Ocean Surface Waves on the Continental Shelf. Fourth Annual Offshore Technology Conference – Preprints, Volume I, Paper No. OTC 1616, c.1972, pp. I-965 – I-976.
- Chao, Yung-Yao; and Pierson, Willard J.: Experimental Studies of the Refraction of Uniform Wave Trains and Transient Wave Groups Near a Straight Caustic. J. Geophys. Res., vol. 77, no. 24, Aug. 20, 1972, pp. 4545-4554.
- Chao, Yung-Yao: Wave Refraction Phenomena Over the Continental Shelf Near the Chesapeake Bay Entrance. Geophys. Sci. Lab. Contrib. No. 134 (Contract Nos. N62306-70-0075 and DACW 72-71-C-0012), Dep. Meteorol. & Oceanogr., New York Univ., Sept. 1972.
- Coleman, James M.; and Wright, Lynn D.: Analysis of Major River Systems and Their Deltas: Procedures and Rationale, With Two Examples. Tech. Rep. No. 95 (Contract N00014-69-A-0211-0003), Coastal Stud. Inst., Louisiana State Univ., Apr. 15, 1971. (Available from DDC as AD 723 575.)
- Colonell, Joseph M.; and Goldsmith, Victor: Computational Methods for Analysis of Beach and Wave Dynamics. Quantitative Geomorphology: Some Aspects and Applications, Marie Morisawa, ed., Publ. in Geomorphology, State Univ. of New York, 1971, pp. 199-222.

- Colonell, Joseph M.; Farrell, Stewart C.; and Goldsmith, Victor: Wave Refraction Analysis: Aid to Interpretation of Coastal Hydraulics. Hydraulic Engineering and the Environment, Proceedings of the Hydraulic Division Specialty Conference, American Soc. Civil Eng., 1973, pp. 131-140.
- Corell, Robert W.; Westneat, A. S.; and Yildiz, Asim: The Science and Technology of Utilizing the Bottom Resources of the Continental Shelf - 2nd Annual Report. UNH-SG-102 (Sea Grant No. NG-30-72 and DC 1-36114), Univ. of New Hampshire, Jan. 1973.
- Covault, Craig: NASA Defining Oceanographic Satellite. Aviat. Week & Space Technol., vol. 99, no. 15, Oct. 8, 1973, p. 19.
- Curray, Joseph R.: Sediments and History of Holocene Transgression, Continental Shelf, Northwest Gulf of Mexico. Recent Sediments, Northwest Gulf of Mexico - 1951-1958, Francis P. Shepard, Fred B. Phleger, and Tjeerd H. van Andel, eds., American Assoc. Petrol. Geol., 1960, pp. 221-266.
- Curray, Joseph R.: Late Quaternary History, Continental Shelves of the United States. The Quaternary of the United States, H. E. Wright, Jr., and David G. Frey, eds., Princeton Univ. Press, 1965, pp. 723-735.
- Daly, Reginald Aldworth: The Floor of the Ocean - New Light on Old Mysteries. Univ. of North Carolina Press, 1942.
- DeAlteris, Joseph Thomas: The Recent History of Wachapreague Inlet, Virginia. M.A. Thesis, Virginia Inst. Mar. Sci., College of William and Mary in Virginia, 1973.
- Dean, Robert G.: Relative Validities of Water Wave Theories. J. Waterways & Harbors Div., American Soc. Civil Eng., vol. 96, no. WW1, Feb. 1970, pp. 105-119.
- Dean, R. G.: Evaluation and Development of Water Wave Theories for Engineering Application. Volume I - Presentation of Research Results. Tech. Rep. No. 14 (Contract No. DACW 72-67-0009), Coastal & Oceanogr. Eng. Lab., Univ. of Florida, Dec. 1972.
- Deetz, Charles H.; and Adams, Oscar S.: Elements of Map Projection With Applications to Map and Chart Construction. Spec. Publ. No. 68, Fifth Ed., Coast & Geod. Surv., U.S. Dep. Com., Rev. 1944.
- Dobson, R. S.: Some Applications of a Digital Computer to Hydraulic Engineering Problems. Tech. Rep. No. 80 (Contract Nonr 225(85)), Dep. Civil Eng., Stanford Univ., June 1967. (Available from DDC as AD 659 309.)
- Duane, David B.; Field, Michael E.; Meisburger, Edward P.; Swift, Donald J. P.; and Williams, S. Jeffress: Linear Shoals on the Atlantic Inner Continental Shelf, Florida to Long Island. Shelf Sediment Transport: Process and Pattern, Donald J. P. Swift, David B. Duane, and Orrin H. Pilkey, eds., Dowden, Hutchinson & Ross, Inc., c.1972, pp. 447-498.



- Emery, K. O.: Atlantic Continental Shelf and Slope of the United States – Geologic Background. Geol. Surv. Prof. Paper 529-A, U.S. Govt. Printing Office, 1966.
- Emery, K. O.; and Milliman, John D.: Quaternary Sediments of the Atlantic Continental Shelf of the United States. *Quaternaria*, vol. 12, 1970, pp. 3-34.
- Emery, K. O.; and Uchupi, Elazar: Western North Atlantic Ocean: Topography, Rocks, Structure, Water, Life, and Sediments. *Memoir 17, American Assoc. Petrol. Geol.*, 1972.
- Everts, Craig H.; and Seelig, William N.: Geometry of Profiles Across Some Inner Continental Shelves of the United States. *Trans., American Geophys. Union*, vol. 54, no. 4, Apr. 1973, p. 336.
- Fairchild, J. C.: Correlation of Littoral Transport With Wave Climate Along Shores of New York and New Jersey. *Tech. Mem. No. 18, Coastal Eng. Res. Center, U.S. Army Corps Eng.*, Nov. 1966. (Available from DDC as AD 647 213.)
- Farrell, Stewart C.; Rhodes, Eugene G.; and Colonell, Joseph M.: Saco Bay, Maine, A Test of Computer Models for Wave Forecasting and Refraction. *Geol. Soc. of America Abstr. With Programs*, vol. 3, no. 7, Oct. 1971, pp. 562-563.
- Farrell, Stewart C.: Present Coastal Processes, Recorded Changes, and the Post-Pleistocene Geologic Record of Saco Bay, Maine. *Ph. D. Thesis, Univ. of Massachusetts*, 1972.
- Field, Michael E.: Buried Strandline Deposits on the Central Florida Inner Continental Shelf. *Geol. Soc. of America Bull.*, vol. 85, no. 1, Jan. 1974, pp. 57-60.
- Fisher, John J.: Late Quaternary Stratigraphy of the Inner Virginia Continental Shelf: A Proposed Standard Section: Discussion. *Geol. Soc. of America Bull.*, vol. 84, no. 6, June 1973, pp. 2159-2160.
- Frank, William M.; and Friedman, Gerald M.: Continental-Shelf Sediments Off New Jersey. *J. Sediment. Petrol.*, vol. 43, no. 1, Mar. 1973, pp. 224-237.
- Galvin, Cyril J., Jr.: Wave Breaking in Shallow Water. *Waves on Beaches and Resulting Sediment Transport*, R. E. Meyer, ed., Academic Press, Inc., 1972, pp. 413-456.
- Galvin, Cyril J., Jr.: Longshore Energy Flux, Longshore Force, and Longshore Sediment Transport. *Trans., American Geophys. Union*, vol. 54, no. 4, Apr. 1973, p. 334.
- Garrison, Louis E.; and McMaster, Robert L.: Sediments and Geomorphology of the Continental Shelf Off Southern New England. *Mar. Geol.*, vol. 4, no. 4, Aug. 1966, pp. 273-289.

- Garrison, Louis E.: Development of Continental Shelf South of New England. *American Assoc. Petrol. Geol. Bull.*, vol. 54, no. 1, Jan. 1970, pp. 109-124.
- Gill, Edmund D.: The Paris Symposium on World Sealevels of the Past 11,000 Years. *Quaternaria*, vol. 14, 1971, pp. 1-6.
- Goldsmith, Victor; and Colonell, Joseph M.: Effects of Nonuniform Wave Energy in the Littoral Zone. *Proceedings of the Twelfth Coastal Engineering Conference, Volume II*, American Soc. Civil Eng., 1970, pp. 767-798.
- Goldsmith, Victor: Coastal Processes of a Barrier Island Complex and Adjacent Ocean Floor: Monomoy Island - Nauset Spit, Cape Cod, Massachusetts. Ph. D. Diss., Univ. of Massachusetts, 1972.
- Goldsmith, Victor; Sutton, Carolyn H.; and Davis, Jane S.: Bathymetry of the Virginian Sea. Part I - Chesapeake Bight (Cape Henlopen to Cape Hatteras, Continental Shelf and Upper Slope). SRAMSOE No. 39 (Sea Grant Project No. 5-72), Virginia Inst. Mar. Sci., [1973].
- Goldsmith, Victor; Morris, W. Douglas; Byrne, Robert J.; and Sutton, Carolyn H.: The Virginian Sea Wave Climate Model: A Basis for the Understanding of Shelf and Coastal Sedimentology. *Geol. Soc. of America Abstr. With Programs*, vol. 5, no. 2, Feb. 1973, p. 167.
- Goldsmith, Victor; Colonell, Joseph M.; and Byrne, Robert J.: The Causes of Nonuniform Wave Energy Distribution Over the Shelf and Along the Shoreline. VIMS Contrib. No. 559 to International Symposium on Interrelationships of Estuarine and Continental Shelf Sedimentation (Talence, France), July 1973.
- Goldsmith, Victor; Byrne, Robert J.; Sallenger, Asbury H.; and Drucker, David M.: The Influence of Waves on the Origin and Development of the Offset Coastal Inlets of the Southern Delmarva Peninsula, Virginia. VIMS Contrib. No. 579 to the Second International Estuarine Research Conference: Geology Section - Coarse-Grained Sediment Transport and Accumulation in Estuaries (Myrtle Beach, S.C.), Oct. 1973.
- Greenhood, David: *Mapping*. Univ. of Chicago Press, c.1964.
- Griswold, Gale M.: Numerical Calculation of Wave Refraction. *J. Geophys. Res.*, vol. 68, no. 6, Mar. 15, 1963, pp. 1715-1723.
- Gulcher, A., ed.: Symposium on the Evaluation of Shorelines and Continental Shelves in Their Mutual Relations During the Quaternary. *Quaternaria*, vol. 12, 1970.
- Hack, John T.: Submerged River System of Chesapeake Bay. *Bull. Geol. Soc. of America*, vol. 68, no. 7, July 1957, pp. 817-830.
- Hall, Blaine R.: Application of Terrestrial Drainage Basin Studies to Submarine Canyons. Term Paper for Geology 3210 - Geomorphology, Univ. of Texas at El Paso, May 1, 1973.

- Harbridge, William; Hamilton, Lance; and Pilkey, Orrin: Seasonal Ripple Mark Response, Cape Hatteras Continental Shelf. Geol. Soc. of America Abstr. With Programs, vol. 5, no. 5, Feb. 1973, p. 401.
- Hardy, J. R.: Some Grid and Projection Problems in the Numerical Calculation of Wave Refraction. J. Geophys. Res., vol. 73, no. 22, Nov. 15, 1968, pp. 7083-7087.
- Harris, D. Lee: Characteristics of Wave Records in the Coastal Zone. Waves on Beaches and Resulting Sediment Transport, R. E. Meyer, ed., Academic Press, Inc., 1972, pp. 1-51.
- Harrison, Edwin F.; and Green, Richard N.: Orbit Analysis for Coastal Zone Oceanography Observations. AIAA Paper No. 73-207, Jan. 1973.
- Harrison, W.; Brehmer, Morris L.; and Stone, Richard B.: Nearshore Tidal and Nontidal Currents, Virginia Beach, Virginia. Tech. Mem. No. 5, Coastal Eng. Res. Center, U.S. Army Corps Eng., Apr. 1964. (Available from DDC as AD 440 881.)
- Harrison, W.; and Wilson, W. S.: Development of a Method for Numerical Calculation of Wave Refraction. Tech. Mem. No. 6, Coastal Eng. Res. Center, U.S. Army Corps Eng., Oct. 1964. (Available from DDC as AD 453 226.)
- Harrison, W.; Malloy, R. J.; Rusnak, Gene A.; and Terasmae, J.: Possible Late Pleistocene Uplift, Chesapeake Bay Entrance. J. Geol., vol. 73, no. 2, Mar. 1965, pp. 201-229.
- Hayes, Miles O.: Lognormal Distribution of Inner Continental Shelf Widths and Slopes. Deep-Sea Res. & Oceanogr. Abstr., vol. 11, no. 1, Jan./Feb. 1964, pp. 53-78.
- Hicks, Steacy D.: On the Classification and Trends of Long Period Sea Level Series, Shore & Beach, vol. 40, no. 1, Apr. 1972, pp. 20-23.
- Higgins, Michael W.; Zietz, Isidore; and Fisher, George W.: Interpretation of Aeromagnetic Anomalies Bearing on the Origin of Upper Chesapeake Bay and River Course Changes in the Central Atlantic Seaboard Region: Speculations. Geology, vol. 2, no. 2, Feb. 1974, pp. 73-76.
- Hoult, David P.: Oil Spreading on the Sea. Annual Review of Fluid Mechanics, Volume 4, Milton van Dyke, Walter G. Vincenti, and J. V. Wehausen, eds., Annu. Rev., Inc., 1972, pp. 341-368.
- Hoyt, John H.; and Henry, Vernon J., Jr.: Origin of Capes and Shoals Along the Southeastern Coast of the United States. Geol. Soc. of America Bull., vol. 82, no. 1, Jan. 1971, pp. 59-66.

- Inman, Douglas L.; Komar, Paul D.; and Bowen, Anthony J.: Longshore Transport of Sand. Proceedings of Eleventh Conference on Coastal Engineering, Volume I, American Soc. Civil Eng., c.1969, pp. 298-306.
- Ippen, Arthur T., [ed.]: Estuary and Coastline Hydrodynamics. McGraw-Hill Book Co., Inc., c.1966.
- Jeffers, Karl B.: Hydrographic Manual. Third ed. Publ. 20-2, Coast & Geod. Surv., U.S. Dep. Com., 1960.
- Jen, Yuan: Wave Refraction Near San Pedro Bay, California. J. Waterways & Harbors Div., American Soc. Civil Eng., vol. 95, no. WW3, Aug. 1969, pp. 379-393.
- Jordaan, Jan M., Jr.: Effects of Hydrographic Changes Due to Nearshore Dredger Dumping on Wave Refraction and Littoral Sand Balance. Proceedings of Ninth Conference on Coastal Engineering, American Soc. Civil Eng., 1964, pp. 310-322.
- Karlsson, Thorbjorn: Refraction of Continuous Ocean Wave Spectra. J. Waterways & Harbors Div., American Soc. Civil Eng., vol. 95, no. WW4, Nov. 1969, pp. 437-448.
- Kelling, Gilbert; and Stanley, Daniel J.: Morphology and Structure of Wilmington and Baltimore Submarine Canyons, Eastern United States. J. Geol., vol. 78, no. 6, Nov. 1970, pp. 637-660.
- Keulegan, Garbis H.; and Harrison, John: Tsunami Refraction Diagrams by Digital Computer. J. Waterways & Harbors Div., American Soc. Civil Eng., vol. 96, no. WW2, May 1970, pp. 219-233.
- Koh, Robert C. Y.; and Le Méhauté, Bernard: Wave Shoaling. J. Geophys. Res., vol. 71, no. 8, Apr. 15, 1966, pp. 2005-2012.
- Kraft, John C.; Sheridan, Robert E.; and Maisano, Marilyn: Time-Stratigraphic Units and Petroleum Entrapment Models in Baltimore Canyon Basin of Atlantic Continental Margin Geosynclines. American Assoc. Petrol. Geol. Bull., vol. 55, no. 5, May 1971, pp. 658-679.
- Kraft, John C.: Sedimentary Facies Patterns and Geologic History of a Holocene Marine Transgression. Geol. Soc. of America Bull., vol. 82, no. 8, Aug. 1971, pp. 2131-2158.
- Langfelder, L. J.; Stafford, D. B.; and Amein, M.: Coastal Erosion in North Carolina. J. Waterways & Harbors Div., American Soc. Civil Eng., vol. 96, no. WW2, May 1970, pp. 531-545.
- Lepetit, J. P.: Étude de la Réfraction de la Houle Monochromatique par le Calcul Numérique. Bull. Centre Recher. & Essais de Chatou, no. 9, Oct. 1964, pp. 3-25.

- Longuet-Higgins, M. S.: Recent Progress in the Study of Longshore Currents. Waves on Beaches and Resulting Sediment Transport, R. E. Meyer, ed., Academic Press, Inc., 1972, pp. 203-248.
- Lovegreen, Jon R.: Paleodrainage History of the Hudson River-Estuary. Geol. Soc. of America Abstr. With Programs, vol. 5, no. 1, Jan. 1974, pp. 49-50.
- May, James P.; and Tanner, William F.: The Littoral Power Gradient and Shoreline Changes. Coastal Geomorphology, Donald R. Coates, ed., Publ. in Geomorphology, State Univ. of New York, 1972, pp. 43-60.
- McCann, S. Brian; and Bryant, Edward A.: Beach Changes and Wave Conditions, New Brunswick. Proceedings of the Thirteenth Coastal Engineering Conference, Volume II, American Soc. Civil Eng., c.1973, pp. 1293-1304.
- McMaster, Robert L.; and Ashraf, Asaf: Extent and Formation of Deeply Buried Channels on the Continental Shelf Off Southern New England. J. Geol., vol. 81, no. 3, May 1973, pp. 374-379.
- Mehr, Emanuel: Surf Refraction - Computer Refraction Program. NWRP 36-0962-068, U.S. Navy, Sept. 1962.
- Meisburger, Edward P.: Geomorphology and Sediments of the Chesapeake Bay Entrance. Tech. Mem. No. 38, Coastal Eng. Res. Center, U.S. Army Corps Eng., June 1972.
- Milliman, John D.; and Emery, K. O.: Sea Levels During the Past 35,000 Years. Science, vol. 162, no. 3858, Dec. 6, 1968, pp. 1121-1123.
- Mogel, Theodor R.; Street, Robert L.; and Perry, Byrne: Computation of Alongshore Energy and Littoral Transport. Proceedings of the Twelfth Coastal Engineering Conference, Volume II, American Soc. Civil Eng., 1970, pp. 899-917.
- Moody, David Wright: Coastal Morphology and Processes in Relation to the Development of Submarine Sand Ridges Off Bethany Beach, Delaware. Ph. D. Diss., Johns Hopkins Univ., 1964.
- Moore, David G.; and Curray, Joseph R.: Sedimentary Framework of Continental Terrace Off Norfolk, Virginia, and Newport, Rhode Island. Bull. American Assoc. Petrol. Geol., vol. 47, no. 12, 1963, pp. 2051-2054.
- Moore, Richard K.; and Pierson, Willard J., Jr.: Worldwide Oceanic Wind and Wave Predictions Using a Satellite Radar-Radiometer. J. Hydronaut., vol. 5, no. 2, Apr. 1971, pp. 52-60.
- Munk, Walter H.; and Traylor, Melvin A.: Refraction of Ocean Waves: A Process Linking Underwater Topography to Beach Erosion. J. Geol., vol. LV, no. 1, Jan. 1947, pp. 1-26.

- Newman, W. S.; and Rusnak, G. A.: Holocene Submergence of the Eastern Shore of Virginia. *Science*, vol. 148, no. 3676, June 11, 1965, pp. 1464-1466.
- Nichols, Maynard M.: Inner Shelf Sediments Off Chesapeake Bay. I, General Lithology and Composition. *Spec. Sci. Rep. No. 64, Virginia Inst. Mar. Sci.*, Apr. 1972.
- O'Brien, M. P.: Wave Refraction at Long Beach and Santa Barbara, California. *Bull. Beach Erosion Board*, vol. 4, no. 1, Jan. 1, 1950, pp. 1-14.
- O'Keefe, John A.: The Universal Transverse Mercator Grid and Projection. *Prof. Geogr.*, vol. 4, 1952, pp. 19-24.
- Orr, Terry E.; and Herbich, John B.: Numerical Calculation of Wave Refraction by Digital Computer. *C.O.E. Rep. No. 114 (Sea Grant Publ. No. 209), Texas A & M Univ.*, Dec. 1969.
- Payne, Lawrence Harold: Sediments and Morphology of the Continental Shelf Off Southeast Virginia. *M.A. Thesis, Columbia Univ.*, 1970.
- Pierce, J. W.; and Colquhoun, D. J.: Configuration of the Holocene Primary Barrier Chain, Outer Banks, North Carolina. *Southeastern Geol.*, vol. 11, no. 4, 1970, pp. 231-236.
- Pierce, J. W.; and Colquhoun, D. J.: Holocene Evolution of a Portion of the North Carolina Coast. *Geol. Soc. of America Bull.*, vol. 81, no. 12, Dec. 1970, pp. 3697-3714.
- Pierce, J. W.; So, C. L.; Roth, H. D.; and Colquhoun, D. J.: Wave Refraction and Coastal Erosion, Southern Virginia and Northern North Carolina. *Geol. Soc. of America Abstr. With Programs*, vol. 2, no. 3, Mar. 1970, p. 237.
- Pierson, Willard J., Jr.; Neumann, Gerhard; and James, Richard W.: Practical Methods for Observing and Forecasting Ocean Waves by Means of Wave Spectra and Statistics. *H. O. Publ. No. 603, U.S. Naval Oceanogr. Office*, 1971.
- Pierson, Willard J.: The Loss of Two British Trawlers - A Study in Wave Refraction. *J. Navigation*, vol. 25, no. 3, July 1972, pp. 291-304.
- Pilkey, Orrin H.; and Field, Michael E.: Lower Continental Rise East of the Middle Atlantic States: Predominant Sediment Dispersal Perpendicular to Isobaths: Discussion. *Geol. Soc. of America Bull.*, vol. 83, no. 11, Nov. 1972, pp. 3537-3538.
- Poole, Lamont R.: Random-Access Technique for Modular Bathymetry Data Storage in a Continental-Shelf Wave-Refraction Program. *NASA TM X-3018*, 1974.
- Pore, N. A.; and Richardson, W. S.: Second Interim Report on Sea and Swell Forecasting. *ESSA Tech. Mem. WBTM TDL 17, U.S. Dep. Com.*, Jan. 1969.

- Purpura, James A.: Establishment of a Coastal Setback Line in Florida. Proceedings of the Thirteenth Coastal Engineering Conference, Volume II, American Soc. Civil Eng., c.1973, pp. 1599-1615.
- Resio, Donald T.; and Hayden, Bruce P.: An Integrated Model of Storm-Generated Waves. Tech. Rep. No. 8 (Contract Nonr-N00014-69-A-0060-0006), Dep. Environ. Sci., Univ. of Virginia, Dec. 1973. (Available from DDC as AD 774 915.)
- Richards, Horace G.: Stratigraphy of Atlantic Coastal Plain Between Long Island and Georgia: Review. American Assoc. Petrol. Geol. Bull., vol. 51, no. 12, Dec. 1967, pp. 2400-2429.
- Richards, Horace G.: The Tertiary History of the Atlantic Coast Between Cape Cod and Cape Hatteras. Palaeogeogr., Palaeoclimatol., Palaeoecol., vol. 5, no. 1, 1968, pp. 95-104.
- Richardus, Peter; and Adler, Ron K.: Map Projections for Geodesists, Cartographers and Geographers. American Elsevier Pub. Co., Inc., 1972.
- Roberts, James A.: The Reshaping of South Beach, Crescent City, California, After the Tsunami of 27-28 March 1964. MRI64 Pa-202 presented to the Beach Erosion Control Conference (Santa Monica, Calif.), Dec. 2, 1964.
- Robinson, Arthur H.; and Sale, Randall D.: Elements of Cartography. Third ed. John Wiley & Sons, Inc., c.1969.
- Rona, Peter A.: Exploration Methods for the Continental Shelf: Geology, Geophysics, Geochemistry. ERL-238-AOML-8, Nat. Oceanic & Atmos. Admin., June 1972.
- Sabet, M. A.: Gravity and Magnetic Investigation, Eastern Shore Area, Virginia. Geol. Soc. of America Bull., vol. 84, no. 6, June 1973, pp. 2119-2126.
- Sallenger, A. H.; Goldsmith, V.; and Sutton, C. H.: Erosion and Accretion From Chart Comparisons. SRAMSOE No. 66, Virginia Inst. Mar. Sci., 1974.  
Part I - Evaluation of Shoreline Comparisons.  
Part II - Evaluation of Bathymetric Comparisons.
- Savage, Rudolph P.: Laboratory Determination of Littoral-Transport Rates. J. Waterways & Harbors Div., American Soc. Civil Eng., vol. 88, no. WW2, May 1962, pp. 69-92.
- Saville, Thorndike, Jr.: North Atlantic Coast Wave Statistics Hindcast by Bretschneider-Revised Sverdrup-Munk Method. Tech. Mem. No. 55, Beach Erosion Board, U.S. Army Corps Eng., Nov. 1954.
- Schubel, J. R.; and Zabawa, C. F.: Report on Investigations to Delineate the Ancestral River Valley Systems of the Chesapeake Bay. Maritime Sediments, vol. 8, no. 1, Apr. 1972, pp. 32-35.

- Shalowitz, Aaron L.: Shore and Sea Boundaries. Publ. 10-1, Coast & Geod. Surv., Dep. Com., 1964.
- Shepard, Francis P.; and Dill, Robert F.: Submarine Canyons and Other Sea Valleys. Rand McNally & Co., c.1966.
- Shideler, Gerald L.; and Swift, Donald J. P.: Seismic Reconnaissance of Post-Miocene Deposits, Middle Atlantic Continental Shelf – Cape Henry, Virginia to Cape Hatteras, North Carolina. Mar. Geol., vol. 12, 1972, pp. 165-185.
- Shideler, Gerald L.; Swift, Donald J. P.; Johnson, Gerald H.; and Holliday, Barry W.: Late Quaternary Stratigraphy of the Inner Virginia Continental Shelf: A Proposed Standard Section. Geol. Soc. of America Bull., vol. 83, no. 6, June 1972, pp. 1787-1804.
- Shideler, Gerald L.: Textural Trend Analysis of Coastal Barrier Sediments Along the Middle Atlantic Bight, North Carolina. Sediment. Geol., vol. 9, no. 3, June 1973, pp. 195-220.
- Shideler, Gerald L.; Swift, Donald J. P.; Johnson, Gerald H.; and Holliday, Barry W.: Late Quaternary Stratigraphy of the Inner Virginia Continental Shelf: A Proposed Standard Section: Reply. Geol. Soc. of America Bull., vol. 84, no. 6, June 1973, pp. 2161-2163.
- Shideler, Gerald L.: Evaluation of a Conceptual Model for the Transverse Sediment Transport System of a Coastal Barrier Chain, Middle Atlantic Bight. J. Sediment. Petrol., vol. 43, no. 3, Sept. 1973, pp. 748-764.
- Shideler, Gerald L.: Evaluation of Textural Parameters as Beach-Dune Environmental Discriminators Along the Outer Banks Barrier, North Carolina. Southeastern Geol., vol. 15, no. 4, Apr. 1974, pp. 201-222.
- Smith, Benjamin S. L.; and Camfield, Frederick E.: A Refraction Study and Program for Periodic Waves Approaching a Shoreline, and Extending Beyond the Breaking Point. Tech. Rep. No. 16 (Contract No. N00014-69-A0407), Coll. Mar. Stud., Univ. of Delaware, Nov. 1972.
- Sonu, C. J.; Murray, S. P.; and Smith, W. G.: Environmental Factors Controlling the Spread of Oil. Naval Res. Rev., vol. 24, no. 5, 1971, pp. 11-19.
- Spencer, Randall S.: Geology of the Outer Coastal Plain, Southeastern Virginia: Chesapeake – Norfolk – Virginia Beach. Eleventh Annual Field Conference of the Atlantic Coastal Plain Geological Association Guidebook, Part 1, Oct. 17-18, 1970.
- Stahl, L.; Koczan, J.; and Swift, D.: Anatomy of a Shoreface-Connected Sand Ridge on the New Jersey Shelf: Implications for the Genesis of the Shelf Surficial Sand Sheet. Geology, vol. 2, no. 3, Mar. 1974, pp. 117-120.



- Stanley, Daniel J.; Sheng, Harrison; and Pedraza, Carlos P.: Lower Continental Rise East of the Middle Atlantic States: Predominant Sediment Dispersal Perpendicular to Isobaths. *Geol. Soc. of America Bull.*, vol. 82, no. 7, July 1971, pp. 1831-1839.
- Stoker, J. J.: *Water Waves – The Mathematical Theory With Applications*. Interscience Publ., Inc., 1957.
- Stoupe, David Edward: *Ocean Wave Crest and Ray Refraction in Shoaling Water by Computer*. M.S. Thesis, U.S. Naval Postgraduate School, 1966.
- Swift, Donald J. P.; Sanford, Robert B.; Dill, Charles E., Jr.; and Avignone, Nicholas F.: Textural Differentiation on the Shore Face During Erosional Retreat of an Unconsolidated Coast, Cape Henry to Cape Hatteras, Western North Atlantic Shelf. *Sedimentology*, vol. 16, no. 3/4, June 1971, pp. 221-250.
- Swift, Donald J. P.; Dill, Charles E., Jr.; and McHone, John: Hydraulic Fractionation of Heavy Mineral Suites on an Unconsolidated Retreating Coast. *J. Sediment. Petrol.*, vol. 41, no. 3, Sept. 1971, pp. 683-690.
- Swift, Donald J. P.; Holliday, Barry; Avignone, Nicholas; and Shideler, Gerald: Anatomy of a Shore Face Ridge System, False Cape, Virginia. *Mar. Geol.*, vol. 12, 1972, pp. 59-84.
- Swift, Donald J. P.; and Boehmer, W. Richard: Brown and Gray Sands on the Virginia Shelf: Color as a Function of Grain Size. *Geol. Soc. of America Bull.*, vol. 83, no. 3, Mar. 1972, pp. 877-883.
- Swift, Donald J. P.; Kofoed, John W.; Saulsbury, Francis P.; and Sears, Phillip: Holocene Evolution of the Shelf Surface, Central and Southern Atlantic Shelf of North America. *Shelf Sediment Transport: Process and Pattern*, Donald J. P. Swift, David B. Duane, and Orrin H. Pilkey, eds., Dowden, Hutchinson & Ross, Inc., c.1972, pp. 499-574.
- Swift, D. J. P.: Delaware Shelf Valley: Estuary Retreat Path, Not Drowned River Valley. *Geol. Soc. of America Bull.*, vol. 84, no. 8, Aug. 1973, pp. 2743-2748.
- Thomas, John B.; and Goodwin, Bruce K.: Heavy Minerals of the Continental Shelf Off the Eastern Shore of Virginia. *Geol. Soc. of America Abstr. With Programs*, vol. 5, no. 5, Feb. 1973, p. 444.
- Thompson, Edward F.; and Harris, D. Lee: A Wave Climatology for U.S. Coastal Waters. *Fourth Annual Offshore Technology Conference – Preprints, Volume II, Paper No. OTC 1693*, c.1972, pp. II-675 – II-688. (Also, available as Reprint 1-72, Coastal Eng. Res. Center, U.S. Army Corps Eng.)
- Thornbury, William D.: *Principles of Geomorphology*. John Wiley & Sons, Inc., c.1954.

- Thrall, David E.: Development of a Computer Program To Simulate Wind Wave Generation, Refraction, and Shoaling in the Gulf of Maine. EDAL Rep. No. 113 (Rep. No. UNH-SG-106), Univ. of New Hampshire, Mar. 1973.
- Tissot, M. A.: Mémoire sur la Représentation des Surfaces et les Projections des Cartes Géographiques. Gauthier-Villars, Imprimeur (Paris), 1881.
- Uchupi, Elazar: Atlantic Continental Shelf and Slope of the United States – Physiography. Geol. Surv. Prof. Paper 529-C, Dep. Interior, 1968.
- Veatch, A. C.; and Smith, P. A.: Atlantic Submarine Valleys of the United States and the Congo Submarine Valley. Geol. Soc. of America Spec. Papers No. 7, Sept. 30, 1939.
- Vincent, Linwood: Quantification of Shoreline Meandering. Tech. Rep. No. 7 (Contract Nonr-N00014-69-A-0060-0006), Dep. Environ. Sci., Univ. of Virginia, Nov. 1973. (Available from DDC as AD 773 050.)
- Walker, James R.; Palmer, Robert Q.; and Kukea, Joseph K.: Recreational Surfing on Hawaiian Reefs. Proceedings of the Thirteenth Coastal Engineering Conference, Volume III, American Soc. Civil Eng., c.1973, pp. 2609-2628.
- Walton, Todd L., Jr.: Littoral Drift Computations Along the Coast of Florida by Means of Ship Wave Observations. Tech. Rep. No. 15 (NOAA Grant No. NG-3-72), Coastal & Oceanogr. Eng. Lab., Univ. of Florida, Feb. 1973.
- Weinman, Zvi Henry: Analysis of Littoral Transport by Wave Energy: Cape Henry, Virginia to the Virginia, North Carolina Border. M.S. Thesis, Old Dominion Univ., 1971.
- White, William A.: Drainage Asymmetry and the Carolina Capes. Geol. Soc. of America Bull., vol. 77, no. 3, Mar. 1966, pp. 223-240.
- Whitlock, Charles H.; and Talay, Theodore A.: The Influence of Surface Waves on Water Circulation in a Mid-Atlantic Continental-Shelf Region. NASA TN D-7771, 1974.
- Wiegel, Robert L.: Oceanographical Engineering. Prentice-Hall, Inc., c.1964.
- Williams, S. Jeffress; and Duane, David B.: Regional Shelf Studies – A Guide to Engineering Design. Reprint 3-72, Coastal Eng. Res. Center, U.S. Army Corps Eng., Sept. 1972.
- Wilson, W. Stanley: A Method for Calculating and Plotting Surface Wave Rays. Tech. Mem. No. 17, Coastal Eng. Res. Center, U.S. Army Corps Eng., Feb. 1966. (Available from DDC as AD 636 771.)
- Wilson, W. Stanley; Wilson, Donald G.; and Michael, Jeffrey A.: Analysis of Swell Near the Island of Aruba. J. Geophys. Res., vol. 78, no. 33, Nov. 20, 1973, pp. 7834-7844.

Wright, L. D.; and Coleman, J. M.: River Delta Morphology: Wave Climate and the Role of the Subaqueous Profile. *Science*, vol. 176, no. 4032, Apr. 21, 1972, pp. 282-284.

Wright, L. D.; and Coleman, J. M.: Variations in Morphology of Major River Deltas as Functions of Ocean Wave and River Discharge Regimes. *American Assoc. Petrol. Geol. Bull.*, vol. 57, no. 2, Feb. 1973, pp. 370-398.