

NONLINEAR SEISMIC ANALYSIS OF A REACTOR STRUCTURE

WITH IMPACT BETWEEN CORE COMPONENTS

Ronald G. Hill

Hanford Engineering Development Laboratory*

23

SUMMARY

The seismic analysis of the FFTF-PIOTA (Fast Flux Test Facility-Postirradiation Open Test Assembly), subjected to a horizontal DBE (Design Base Earthquake) is presented. The PIOTA is the first in a set of open test assemblies to be designed for the FFTF. Employing the direct method of transient analysis, the governing differential equations describing the motion of the system are set up directly and are implicitly integrated numerically in time. A simple lumped-mass beam model of the FFTF which includes small clearances between core components is used as a "driver" for a fine mesh model of the PIOTA. The nonlinear forces due to the impact of the core components and their effect on the PIOTA are computed.

INTRODUCTION

The reactor core of the FFTF** is designed to accommodate bowing of fuel assemblies which is caused by the core's neutronic and thermal environment. The individual fuel assemblies have a floating collar design at the above core load pad where adjacent assemblies contact to take into account the deformations of the core components. During certain periods of the reactor cycle small clearances may exist between core components; hence, it is important to determine the effect of design impact loads between these structural components to preclude unacceptable stress levels and failures.

The topic of impact is the subject of numerous studies. Special purpose computer program solutions have been developed for analysis of impact of reactor internal structures by Bohm and Nahavandi, reference 1, using explicit integration procedures. The analysis reported in this paper uses implicit integration procedures through the transfer function capabilities of the general purpose computer program NASTRAN to solve for the nonlinear loads due to impact between structural members.

*The Hanford Engineering Development Laboratory is a United States Energy Research and Development Administration Laboratory. HEDL is operated by the Westinghouse Hanford Company.

**See Nomenclature Table.

NOMENCLATURE*

FFTF-PIOTA	Fast Flux Test Facility-Postirradiation Open Test Assembly
DBE	Design Base Earthquake
NASTRAN	<u>NASA STRUCTURAL ANALYSIS</u>
OTA	Open Test Assembly
DOF	Degrees of Freedom
BANDIT	Computer Program -- to determine minimum bandwidth
PWR	Pressurized Water Reactor
IVHM	In-Vessel Fuel Handling Machine
HEDL	Hanford Engineering Development Laboratory
CYBER	HEDL Computer-Control Data Corporation Model 74-18
TRD	Transient Response Displacement
DMAP	Direct Matrix Abstraction Program
PNDL	A DMAP Module
MSC	McNeal Schwendler Corporation
INFONET	Computer Sciences Corporation Computer Network System
COSMIC	Agency for United States Government Release of Computer Programs
I/O	Input/Output Units
CPU	Central Processing Units
SDRC	Structural Dynamics Research Corporation
CYBERNET	Control Data Corporation Computer Network System

*In order of use.

SYMBOLS

B_{aa}	damping matrix
K_{aa}	stiffness matrix
M_{aa}	mass matrix
U_a	a set of coordinates expressed as a column matrix of two terms for each grid point; y, θ_z (see figure 3)
ω_3	pivotal frequency
$f(t)$	seismic forcing function
$f(n)$	nonlinear impact load
ρ	percent critical damping

MODELING PROCEDURES

Figures 1 and 2 portray the salient points of the FFTF reactor. The reactor is idealized with lumped-mass, spring, gap and beam elements for translation and rotational motion. The DBE, a translational input is applied directly to the reactor head. The core components, fuel assemblies, etc., are pinned at the core barrel and lateral support is provided at the pad locations by the gap elements. The core components, if permitted to rotate, may be considered as inverted pendulums. The core components (reflector, fuel assembly, PIOTA), figure 3, are expanded horizontally until a return is made to the core barrel, for an enclosed representation of the FFTF core.

Figures 3 and 4 show the grid point and finite element notation for the coarse FFTF reactor model and the fine mesh PIOTA model. A fine mesh was used to model the PIOTA, figure 4, because of the boundary conditions between the PIOTA's components, the close coupling of its natural frequencies, and the predicted critical stress area at the PIOTA's outlet ports. The coarse reactor model is numbered in the 1000 series of grid points and 2000 for the element numbers. The model parameters such as size, mass, stiffness, and damping values are described for the respective models in references 2 and 3. The coarse reactor model is like the FFTF systems model used for both SCRAM and nonlinear seismic analysis, reference 2, with the exception that certain reactor components are not included in the subject model; i.e., Instrument Tree, IVHM, etc. The SCRAM and nonlinear seismic analysis, reference 2, was performed using proprietary (Westinghouse Advanced Reactor Division) special purpose computer programs.

The set of equations used to determine the seismic response is

$$[M_{aa}] \{\ddot{U}_a\} + [B_{aa}] \{\dot{U}_a\} + [K_{aa}] \{U_a\} = \{f(t)\} + \{f(n)\}$$

The physical set of equations for the models shown in figures 3 and 4 has 927 DOF, of which 537 belong to the PIOTA. The DOF after reduction for coordinates y and θ_z , boundary conditions, constraints, etc., is 297. This problem size (297 DOF, time step increment of 0.0005 second and a 5 second earthquake) involves a sizeable computation investment, approximately 3×10^6 iterations. Hence, further reduction of the problem was desirable. Of the three reduction methods considered, substructuring, modal synthesis and Guyan, the Guyan method was found best for minimum loss of accuracy in conjunction with nonlinear dynamic analysis. Its basis is that fewer DOF are needed to describe the inertia of a structure than are needed to describe its elasticity with comparable accuracy. In using the Guyan method NASTRAN recovers directly, displacements, accelerations, etc., for the coordinates used in the reduction process. The Guyan reduction method was used to reduce the 297 DOF to an analysis set of 104 DOF. The Guyan reduction process increased the bandwidth from 3 to 45; however, the run time was reduced by 65% based on CPU, see table I. The preprocessor BANDIT was used to reduce the bandwidth for the PIOTA model, figure 4. BANDIT was not applied to the FFTF model, figure 3, because of the gap elements and the straightforwardness of the model.

NONLINEAR TRANSIENT ANALYSIS

In this transient solution, the coupled equations of motion are integrated directly without any uncoupling by modal methods, Rigid Format No. 9. The two basic methods used for direct numerical integration are explicit integration in time and implicit integration in time. Difference formulas that relate the accelerations, velocities and displacements are used in both the explicit and implicit integration methods. NASTRAN (reference 4) uses a form of the Newmark Beta Method, implicit integration in time, that yields an unconditionally stable solution for a wide range of transient dynamic problems. The stability limit is a function of the period of the highest vibration mode of the system. Though the implicit integration method is not as fast per time step as the explicit method, the unconditional stability permits the use of large time steps. A time step of 0.0005 second was selected for the runs described herein and no numerical stability problem was encountered. The introduction of nonlinearities in the implicit method of integration may cause numerical stability problems in addition to those mentioned above. These problems are due to the inconsistent definition of displacement and velocity between linear and nonlinear forces and may result in the presence of a parasitic mass on the coordinates to which nonlinear forces are applied. The remedy is to add sufficient mass to the coordinate directly or to reduce the time step of integration so that the parasitic mass effect is negligible in

comparison to the nodal mass. A time step of 0.005 second was used to obtain a linear solution for the model shown in figure 3. This is the same time interval as the input acceleration-time history. With the addition of gap elements to the model, figure 3, the time step was reduced to 0.0005 second through the above parasitic mass consideration.

In NASTRAN, the nonlinear effects (gap elements) are treated through the use of an additional applied load vector. The gap element and the respective applied load vector are user-created by means of transfer functions. Gap elements similar to the ones shown in figure 3 are described in reference 5 with transfer function and nonlinear load card images.

DAMPING AND THE GAP ELEMENT

Two forms of damping* are used in this seismic analysis, structural and impact. In both forms, assumptions concerning the effects of damping on the nodal coordinates are based on a viscous model in which the energy dissipated per cycle is proportional to frequency. A uniform structural damping of 2% of the critical for the DBE was input to the model (figure 2) in terms of stiffness, as follows:

$$[Baa] = \frac{2g}{\omega_3} [Kaa]$$

This method, reference 4, of inputting equivalent viscous damping is an approximation, since the viscous damping forces are larger at higher frequencies and smaller at lower frequencies. The structural damping, Baa, has small effect, or is of no effect, on the response of the model. This is due to the overruling effect and nature of impact damping (10% vs 2% of the critical).

The impact damping is related to the nonlinearities of the gap element. The impact damping and stiffness, c and k, figure 5, are based on a coefficient restitution method (rebound) and the Hertz theory of impact of two solids, i.e., an elastic statical consideration. The relationship between coefficient of restitution and critical damping is derived in reference 2 and is shown in this report as figure 6. An impact damping value of 10% of the critical was used in this analysis. This represents high viscous damping. Impact damping values for FFTF reflector and fuel assemblies have not been measured experimentally. However, there are data available from PWR fuel assemblies tests, reference 2, and from a FFTF IVHM test, reference 5, to corroborate the high impact damping value. Figure 6 shows a comparison of these impact damping values, 19% for PWR fuel assemblies and 15% for the vertical IVHM test. The

*Structural - hysteretic damping

Impact - Maxwell representation of viscous damping

IVHM 15% value was determined from the rate of decay of successive re-bounds. Therefore, the 10% of the critical damping is considered conservative for these analyses.

The vertical drop IVHM test, reference 5, affords a means to assess the validity of the NASTRAN gap element. In comparing the experimental results with those computed from the simple scalar lumped-mass NASTRAN model, there was close agreement. The free fall times and displacements for this test and model were readily calculated by hand methods.

The general form of the gap element used in this analysis is shown in figure 5(a). Gaps in positive and negative directions (for example, the boundary conditions of a rod moving within a tube), can be represented by this element. A gap element with closing capability only (i.e., that portion of the force deflection curve shown in the third quadrant, figure 5(b), and the analogous mechanical model shown in figure 5(c)), was used to represent the clearances between the core components, at twelve places (figure 3). The expanded representation of the core with the gap closure described above, yields a closed core configuration for impact analysis of individual core components. Figure 5(c) shows the mechanical model where the impact spring and gap are accompanied by energy dissipation, and viscous damping. Functionally, the viscous damper, c_1 should act only when the gap is closed, $x_1 > u_1$. At the time these seismic analyses were performed, a switchable, viscous damper had not been verified for use in NASTRAN. A pseudo Maxwell model, figure 5(c), was used in this analysis; the Maxwell model does not necessitate a switchable damper, since the damper c_1 is in series with the impact spring k_1 . The linear spring k_3 , which was small compared with k_1 , improved the stability of the numerical solution, i.e., a larger time step was used.

SEISMIC TIME HISTORY

The input to the FFTF seismic model, Grid Point 1001, figure 3, consisted of an acceleration time history with data points at 0.005 second intervals. This seismic transient is the singular output at the concrete ledge from a two-dimensional finite element soil interaction model of the containment building (reference 6). The dynamic coupling between the containment building and the reactor vessel is assumed to be negligible.

A DBE with 2% of the critical damping, and a duration of 20 seconds was specified (reference 6). Previous investigations (reference 2) revealed that only the accelerations from 1.5 seconds to 6.5 seconds were significant; this then is the seismic transient that was used for the PIOTA analysis (figure 7). The DBE earthquake was divided into ten increments, as shown in figure 7, for computer restart advantage and clarity of output. The printout time interval was ten times the integration time step, or 0.005 seconds. The analysis was started at 1.5 seconds; thus, there is a 1.5 second time shift in the output response, see figure 7.

SOFTWARE AND COMPUTER FACILITIES COMPARISON

This section compares the off-load* results with those obtained on the HEDL-CYBER for a 0.5 second DBE input to the FFTF-PIOTA model. The CYBER was not available to perform the 5 second DBE due to other commitments.

In performing the CYBER and off-load benchmark runs we found that the COSMIC version of NASTRAN, Level 15.5, computed incorrect nonlinear loads. The nonlinear load computations were evaluated by the IVHM model described in reference 5; the results for the IVHM model can readily be checked by hand methods. The IVHM evaluation revealed that the PNLD module in NASTRAN Level 15.5 was not functioning correctly. DMAP instruction number 139, NASTRAN Rigid Format No. 9 gives the relationship of the PNLD module to the computations of TRD. The source language for NASTRAN is essentially written in FORTRAN IV; the DMAP instructions are a compilation of this source language. The IVHM analysis was successfully performed in 1972 on the UNIVAC 1108 using Level 15.1, hence a CDC 6600 version of NASTRAN Level 15.1 was installed on the CYBER and used for the CYBER computations described in this report.

Benchmark runs were performed at the four computing facilities shown on table I. The CYBER run was used as a reference for evaluating the off-load results. The reference run column II, table I, is identical to the FFTF-PIOTA runs described herein with the exception of the OMIT 1 cards. The OMIT bulk data cards are used to achieve the Guyan reduction described previously in this report. It is difficult to compare results from dissimilar computing facilities because of timing algorithms, input-output variances, system dependent software, etc. These problems were alleviated in the FFTF-PIOTA evaluation by comparing the run time required for the TRD module, see table I; this module uses the majority of the central processing time needed for direct transient analyses.

Table I, columns III through VI, show that the MSC version of NASTRAN gives significant reductions in run time when compared to the HEDL or INFONET COSMIC version of NASTRAN. The benchmark run that the MSC performed in Los Angeles, column IV, had two alterations, the transfer functions used for the gap elements were replaced by multipoint constraint equations to utilize the more efficient symmetric matrix decomposition rather than unsymmetric decomposition, and certain data that was transferred to peripheral storage in Level 15.1 was held in main core in MSC-20, thus eliminating peripheral processing-calls. The above alterations account for the reduction in I/O time of 1237 to 26 seconds and CPU reduction of 864 to 569 seconds. The MSC-Los Angeles results shown in column IV were obtained subsequent to the analyses described in this report.

*Off-load -- Computer facilities other than available at HEDL-CYBER

The deck used by SDRC in their benchmark run was identical to the CYBER run, columns II and III, table I. The improvement in run time, I/O 3300 versus 1237 seconds and CPU 1134 versus 864 seconds, is due primarily to the version of NASTRAN utilized, COSMIC Level 15.1 versus MSC-20; the operating systems, CYBER and CYBERNET, are similar, both are basically CDC 6600 machines. The solution for the SDRC benchmark run was identical to the CYBER results, columns II and III. Therefore, as a result of these benchmark evaluations and the need for off-load capability, the SDRC facilities at Cincinnati, Ohio, NASTRAN MSC-20 and the CYBERNET operating system were used to perform the 5 second earthquake run described in this report, see column VI, table I.

RESULTS

NASTRAN, as a large, general-purpose, structural-analysis program, has features, through checkpoint and restart, to recover and compute element stresses, forces and moments for each of the elements shown in figures 3 and 4. Output for this analysis was restricted to bending moment and shears for the boundary-adjacent elements numbers 1, 24 and 52, and for element number 46, a reduced section on the output port of the holddown tube, figure 4. Tabulated peak values for each increment are shown in table II. Figures 8 through 11 show typical load versus time plots. The amplitude of these PIOTA loads are largely dependent on the nonlinear loads caused by impact between core components, see figure 9. The effect of the impact load on the wave form of the element loads can be seen by noting that core impacting at Grid Point 1022 does not occur until 0.18 seconds, figure 9; the corresponding loads in Element 52, figure 11, are very low until this time. The wave form of the PIOTA loads at the head, figure 10, is not directly influenced by the impacting of core components, the PIOTA acts as a mechanical filter.

CONCLUDING REMARKS

A seismic analysis of a reactor internal component with impact between core components has been performed. From this effort, it can be concluded that NASTRAN has good nonlinear transient analysis capabilities. At the present time, solutions are relatively expensive from a computational standpoint when compared with solutions from special purpose computer programs. However, with the efficiencies projected for Level 16 and the use of certain operating system and modeling procedures noted in this report, NASTRAN can effectively be used for nonlinear seismic analysis.

In using NASTRAN's nonlinear features, it is suggested that one begin with small sample problems with known solutions. The setup of nonlinear elements using NASTRAN's transfer function capabilities is a user-oriented function which presents opportunities for data errors; data checking by NASTRAN is minimal since the nonlinear features are mathematical abstractions.

The design of the PIOTA was found to be structurally adequate for the DBE.

ACKNOWLEDGEMENTS

The principal collaborators in these analyses were L. K. Severud, J. M. Anderson, R. A. Lujan, HEDL Engineering Department; W. A. McClelland, SDRC, and J. A. Joseph, MSC.

REFERENCES

1. Bohm, George J., and Nahavandi, Amir N.: Dynamic Analysis of Reactor Internal Structures with Impact Between Components, Nuclear Science and Engineering, Vol. 47, 1972.
2. Morrone, A.: FFTF Scram and Nonlinear Reactor System Seismic Analysis, FRA-1074, October 1973.
3. Anderson, J. M., and Lujan, R. A.: FFTF - Post Irradiation Open Test Assembly Design Support Document: Preliminary Stress Analysis, HEDL-SR2, September 21, 1973.
4. The NASTRAN Theoretical Manual, NASA SP-221, 1969.
5. Hill, R. G.: Transient Analysis of an IVHM Grapple Impact Test. NASTRAN: Users' Experiences, NASA TM X-2637, 1972, pp. 161-178.
6. Final Seismic Analysis Report for the FFTF: (Bechtel Report) BR-5853-C-2, January 18, 1974.

TABLE I

FFTF-PIOTA FINITE ELEMENT MODEL--SEISMIC BENCHMARK-COMPARISON⁽²⁾--NASTRAN RUN TIME-MODULE TRD⁽¹⁾

	BENCHMARK RUNS					V ⁽⁹⁾
	I	II	III	IV	V	
	CDC6600					
	IBM360-195		SDRC-OHIO			SDRC-OHIO
	DENVER	HEDL	CYBERNET	MSC-LOS ANGELES	CYBERNET	CYBERNET
	INFONET	CYBER	MSC-20(7)	CYBERNET	MSC-20	MSC-20
	LEVEL 15.5	LEVEL 15.1(6)		MSC-20		
DOF ⁽³⁾ - PHYSICAL SET Up	927	927	927	927	388 ⁽⁸⁾	925
DOF - ANALYSIS SET Ua ⁽¹⁾	297	297	297	282	95	104
BANDWIDTH - B ⁽⁴⁾	3	3	3	8 rms ⁽⁵⁾	95	45
ACTIVE COLUMNS - C ⁽⁴⁾	25	25	25	-	0	2
MODAL REDUCTION	-	-	-	-	YES ⁽⁸⁾	-
GUYAN REDUCTION	-	-	-	-	-	YES
TRD - IO, SEC	3263	3300	1237	26	996	997
TRD-CPU, SEC	388	1134	864	569	458	392
TRD - COST \$	294	312	453	136	240	205

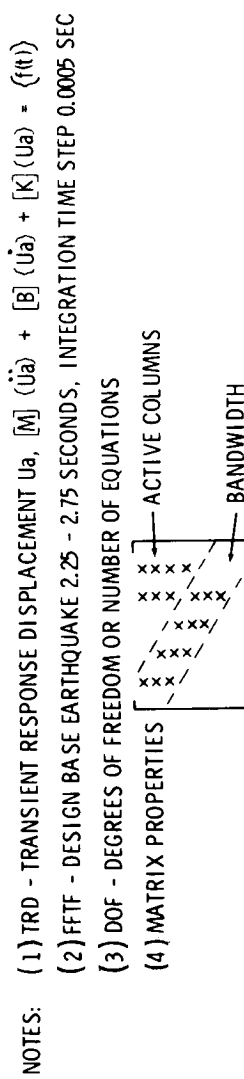

- NOTES: (1) TRD - TRANSIENT RESPONSE DISPLACEMENT Ua, [M] (Ua) + [B] (Ua) + [K] (Ua) = {f(t)}
- (2) FFTF - DESIGN BASE EARTHQUAKE 2.25 - 2.75 SECONDS, INTEGRATION TIME STEP 0.0005 SEC
- (3) DOF - DEGREES OF FREEDOM OR NUMBER OF EQUATIONS
- (4) MATRIX PROPERTIES [ACTIVE COLUMNS]
- (5) THE NASTRAN PREPROCESSOR WAVEFRONT WAS USED FOR MINIMUM BANDWIDTH, ON ALL OTHER RUNS THE NASTRAN PREPROCESSOR BANDIT WAS USED TO MINIMIZE THE BANDWIDTH
- (6) NASA PUBLIC RELEASE THROUGH COSMIC
- (7) PROPRIETARY SOFTWARE, McNEAL SCHWENDLER CORP (MSC)
- (8) STRUCTURAL DYNAMICS RESEARCH CORP (SDRC) PROPRIETARY NASTRAN PREPROCESSOR NIP WAS USED TO REPRESENT THE 537 Up SET OF THE PIOTA THROUGH MODAL SYNTHESIS METHODS

TABLE II
SUMMARY-PIOTA
DESIGN BASE EARTHQUAKE LOADS (1)

INCREMENT	ELEMENT NO. 1(4)				ELEMENT NO. 24				ELEMENT NO. 46				ELEMENT NO. 52			
	M _A ^(2,3)	M _B ^(2,3)	S ^(2,3)	t ⁽²⁾	M _A	M _B	S	t	M _A	M _B	S	t	M _A	M _B	S	t
1	-5,114.0	-6,336.0	132.0	0.485	84.8	-1,507.0	47.0	0.475	3,655.0	3,532.0	30.7	0.490	211.0	-254.1	62.0	0.485
2	-9,216.0	-11,631.0	262.0	1.0	-1,191.0	-2,117.0	66.2	0.990	5,207.0	4,811.0	98.9	1.0	331.0	-409.8	98.8	1.00
3	-9,216.0	-11,631.0	262.0	1.0	-3,322.0	-5,906.0	184.6	1.385	13,900.0	13,800.0	24.9	1.345	4,023.0	3,096.0	123.5	1.315
4	-2,966.0	-3,817.0	92.4	1.78	-1,034.0	-1,839.0	57.4	1.785	-10,859.0	-10,181.0	-169.0	1.93	-574.0	98.0	-209.6	1.93
5	4,566.0	5,703.0	-123.4	2.025	-1,084.0	-1,928.0	60.2	2.16	-11,980.0	-11,212.0	-191.8	2.035	-901.5	229.9	-151.0	2.485
6	341.0	419.0	-84.6	3.00	991.0	1,762.0	-55.1	2.525	11,312.0	-10,785.0	-132.0	2.985	1,445.0	2,622.0	-157.0	2.535
7	4,666.0	6,027.0	-148.0	3.06	719.0	1,277.0	-40.0	3.060	-11,888.0	-11,076.0	-203.0	3.015	-982.0	468.0	-193.0	3.030
8	-4,927.0	-6,121.0	130.0	3.87	-682.0	-1,213.0	38.0	3.870	9,286.0	8,635.0	163.0	3.825	694.0	-345.0	138.0	3.935
9	3,469.0	4,566.0	-119.0	4.46	-1,090.0	-1,831.0	57.0	4.305	2,138.0	-2,464.0	418.0	4.315	-1,208.0	-1,199.0	-1.2	4.255
10	2,542.0	3,031.0	-53.0	4.87	-454.0	-808.0	25.0	4.670	-5,676.0	-5,313.0	-91.0	4.510	-389.0	408.0	-106.0	4.505
MAXIMUM LOADS	9,216.0	11,631.0	262.0	--	3,322.0	-5,906.0	184.0	--	13,900.0	13,800.0	-373.0	--	4,023.0	3,096.0	328.0	--

(1) FFTF - DESIGN BASE EARTHQUAKE

(2) UNITS: M_A, M_B in-lb; S, lb; t, sec. 1 in-lb = 0.11298 N-m; 1 lb = 4.448 N

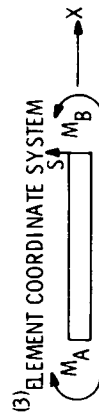

(4) MAXIMUM VALUES FOR EACH INCREMENT, BASED ON M_A

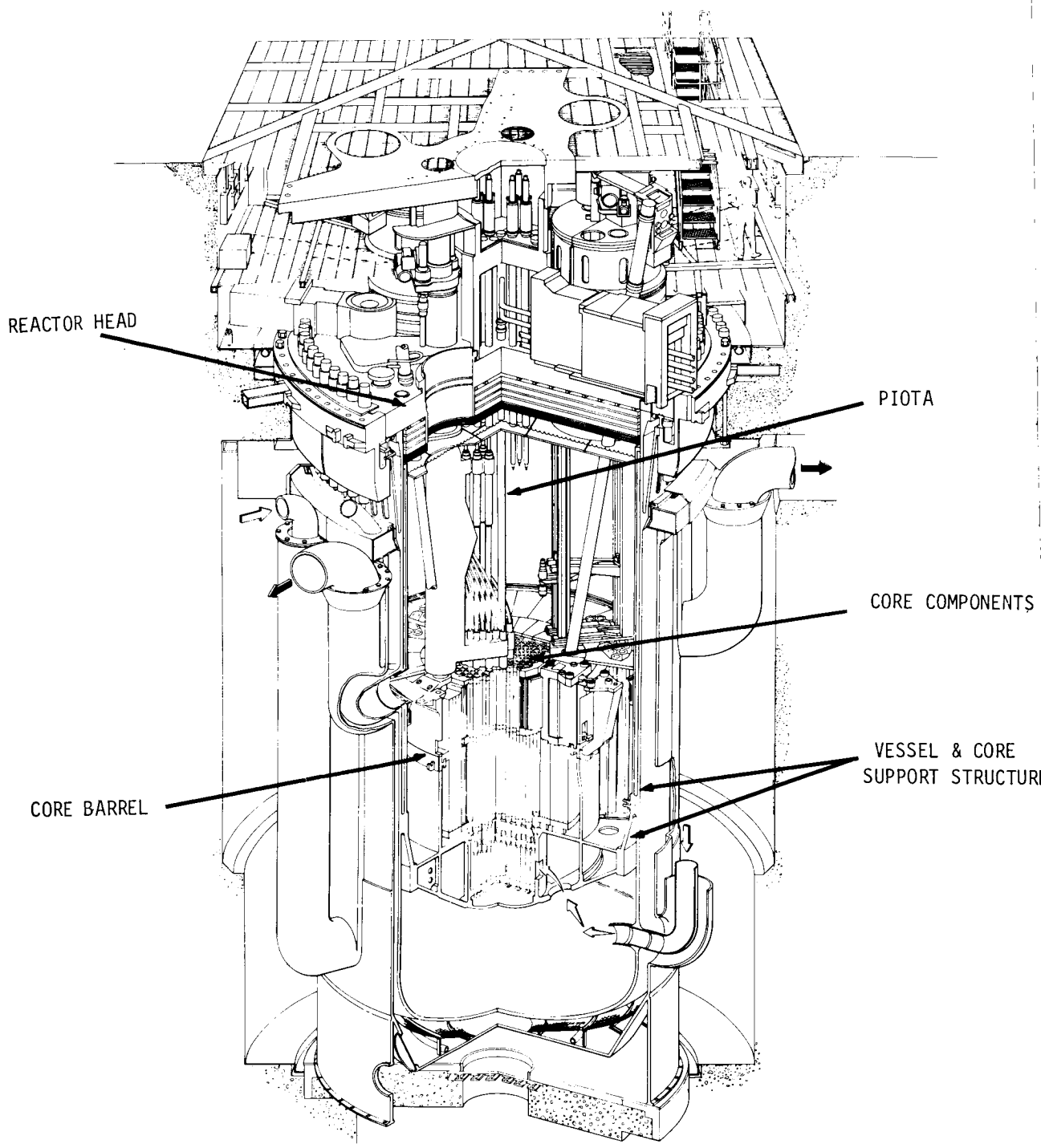

Figure 1.- FFTF reactor.

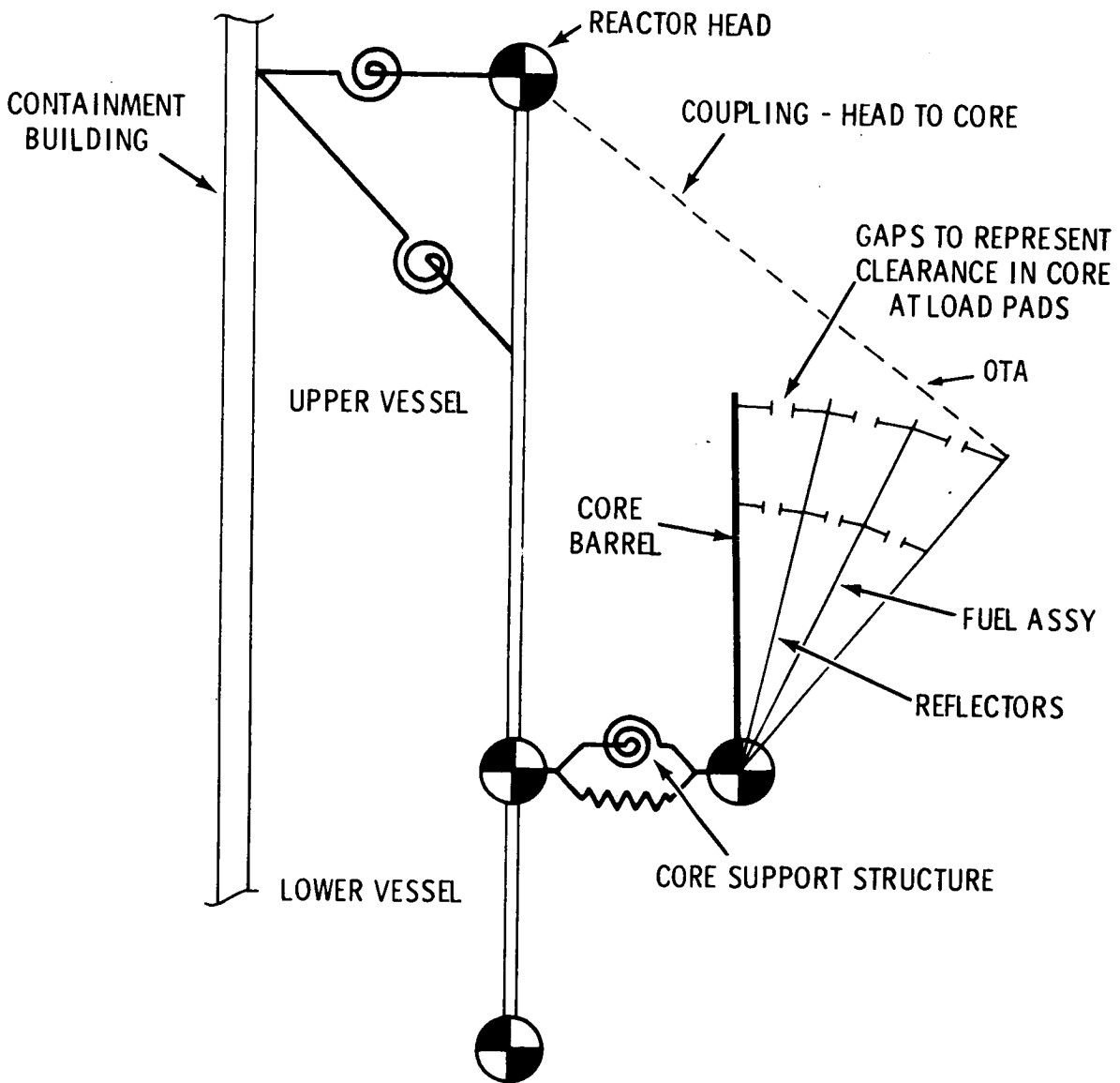
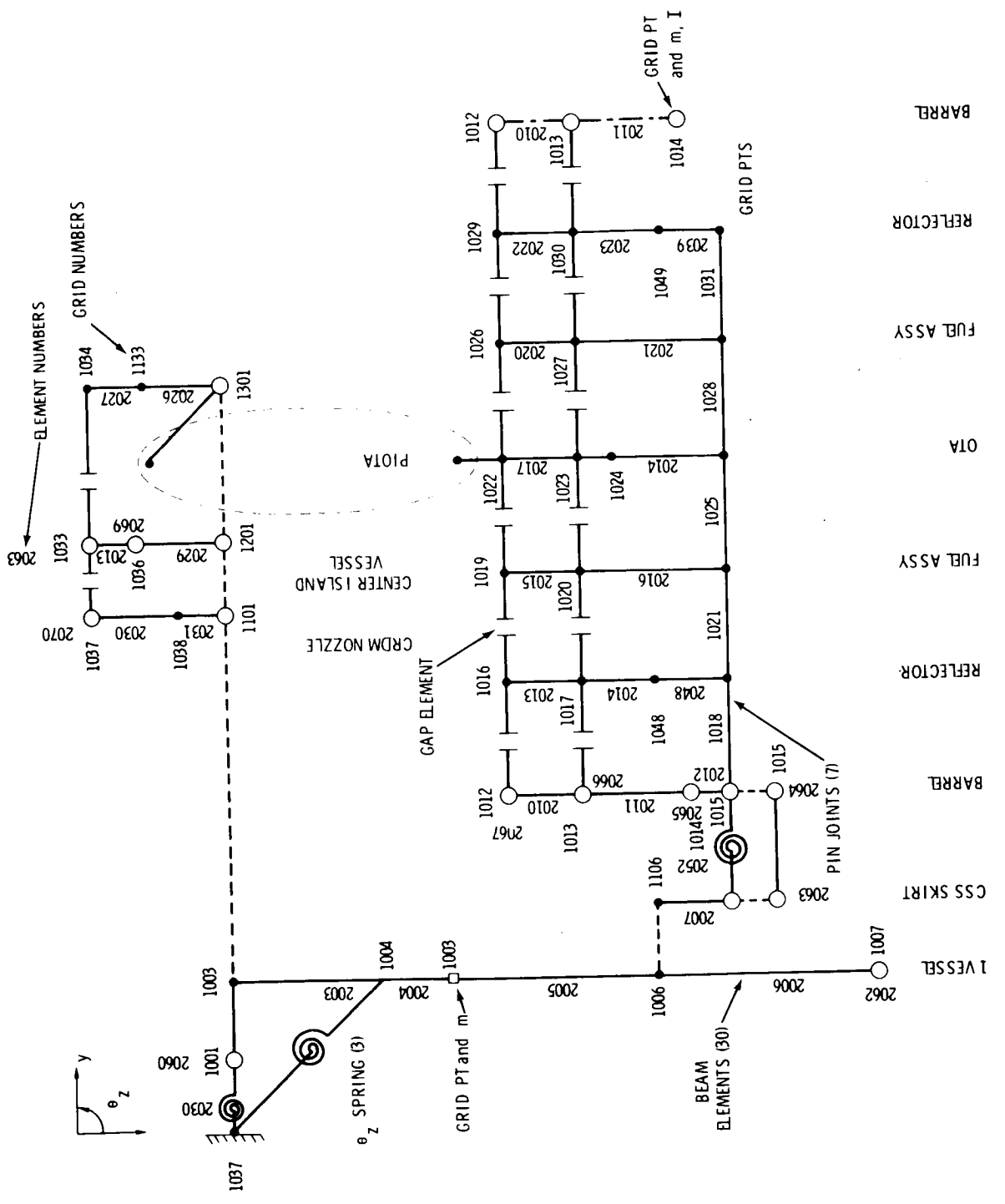

Figure 2.- Schematic of FFTF lumped-mass beam model.



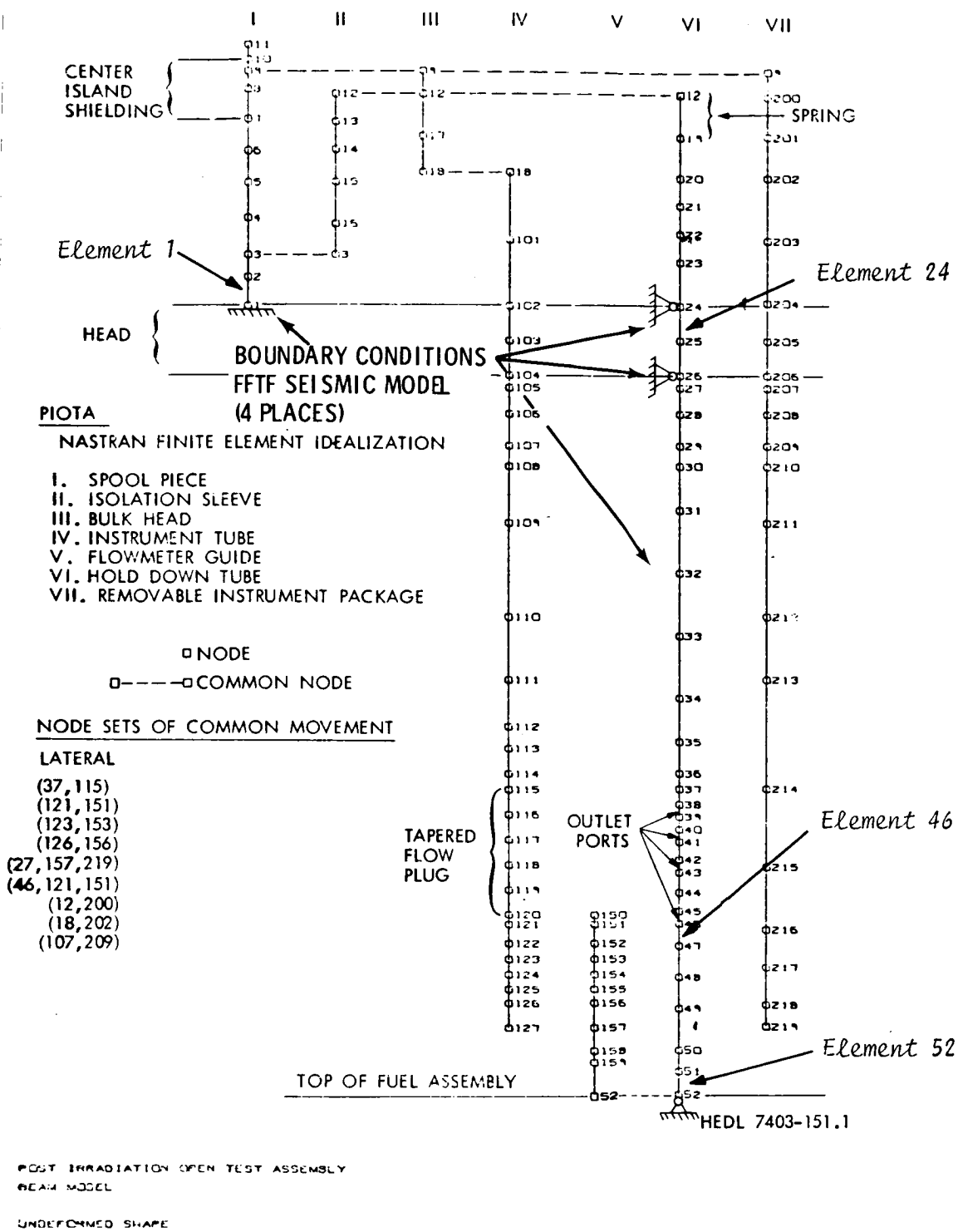
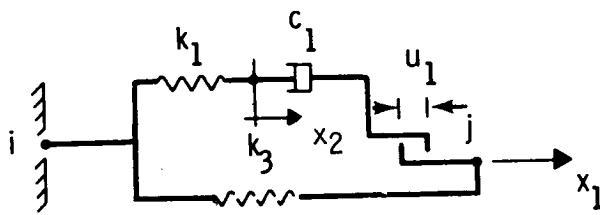
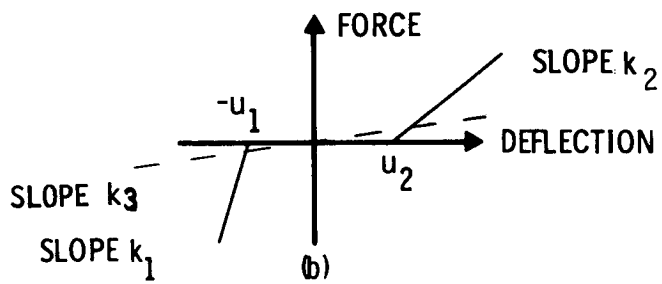
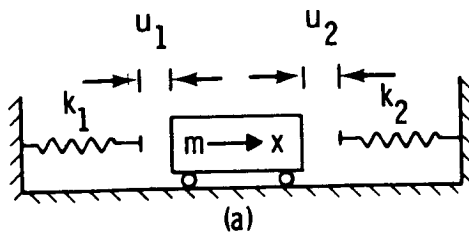

Figure 4.- PIOTA model.



$$x_1 > u_1 \text{ AND } k_3 \equiv 0$$

$$f_1 = k_1 x_1 + c_1 (\dot{x}_1 - \dot{x}_2) = \text{FORCE @ } j$$

MAXWELL MODEL
(c)

Figure 5.- Gap element.

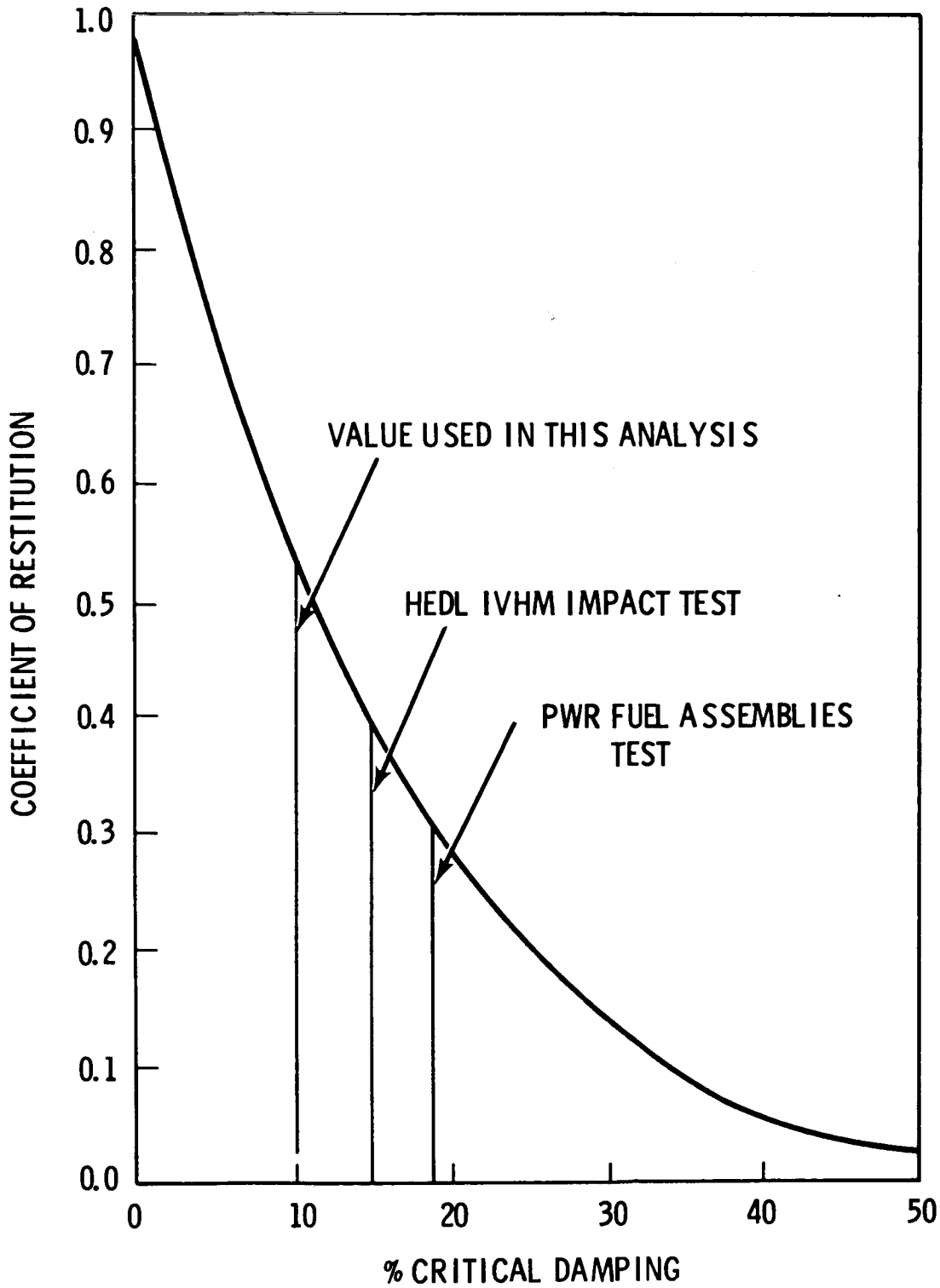
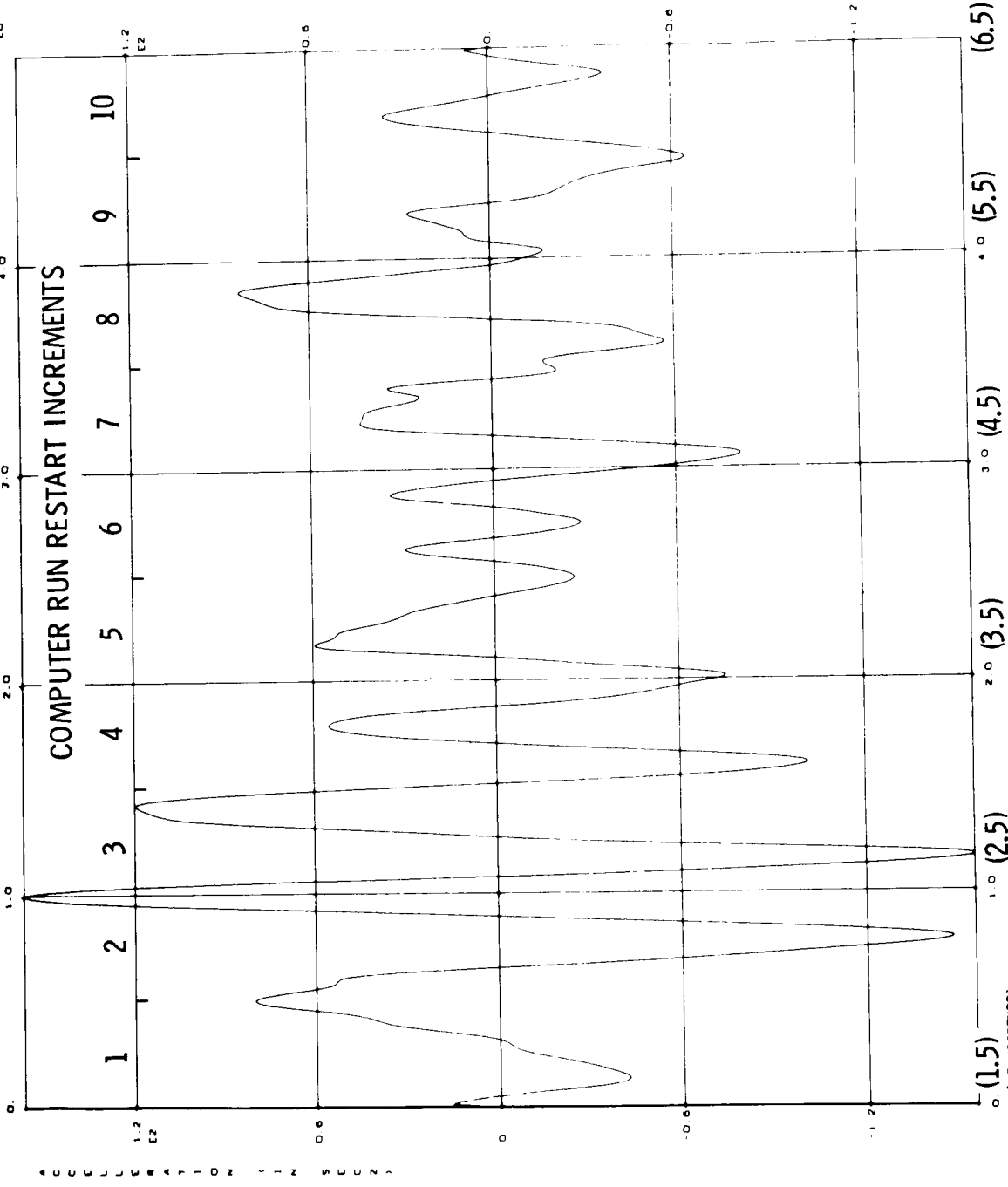

Figure 6.- Coefficient of restitution vs percent of critical damping at impact.



4 C C C C
 5 U L L L
 6 R E Z
 7 A T T I O N
 8 C I N
 9 E C C R
 0)

TIME (SECONDS)
 ACCELERATION OF ORIO POINT (G)
 FFT AND OVA DYNAMIC MODEL SEISMIC RESPONSE
 OBE EARTHQUAKE DESIGN BASE EARTHQUAKE

Diagram 7 Design base earthquake. $1 \text{ in/sec}^2 = 0.0254 \text{ m/sec}^2$

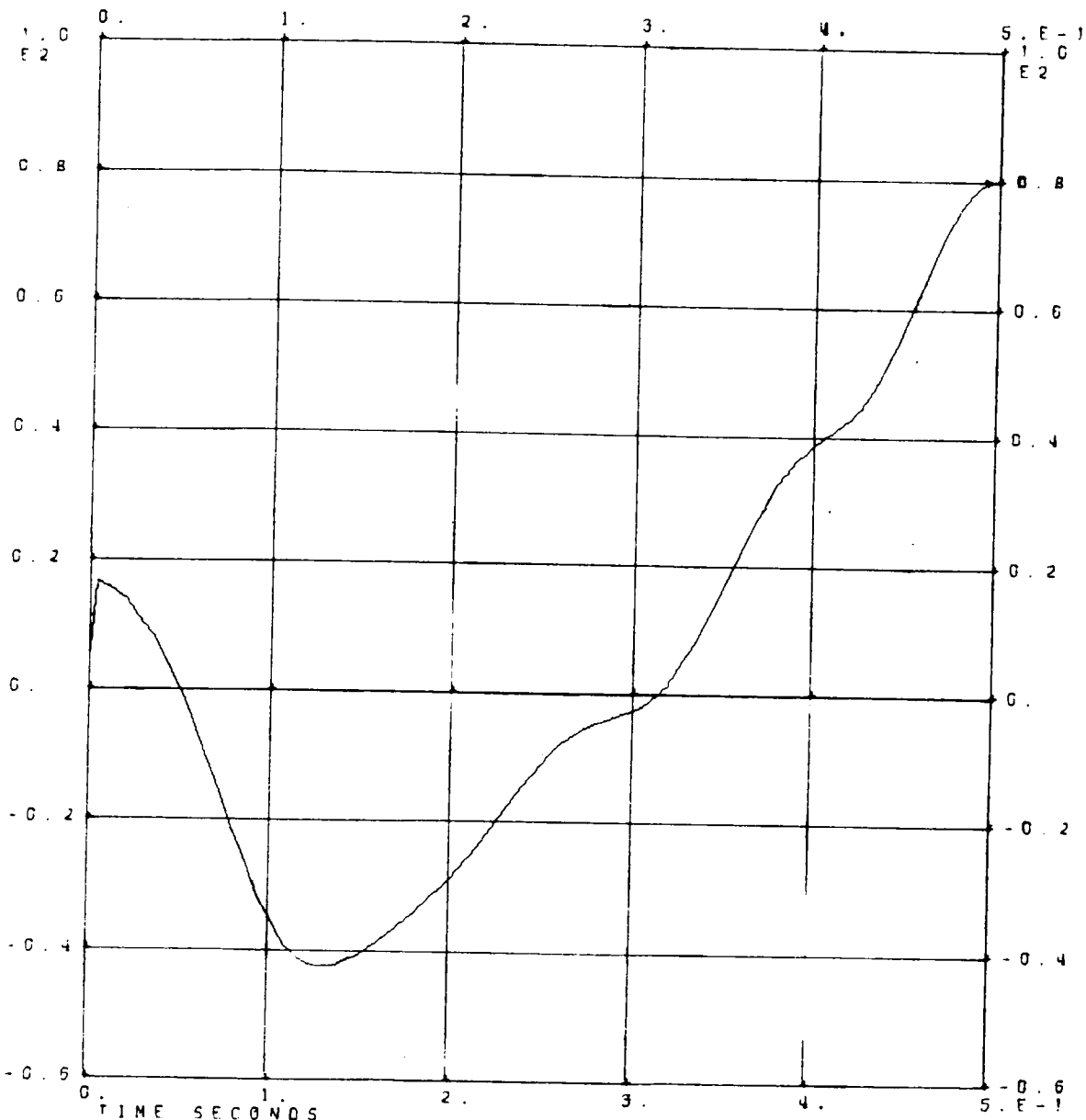

DESIGN BASE EARTHQUAKE INPUT
 VESSEL AND REACTOR INTERNALS PLUS PIGTA - SEISMIC MODEL
 DESIGN BASE EARTHQUAKE - DAMPERS IN SERIES WITH GAP ELEMENTS
 SUBCASE 1

Figure 8.- Increment 1 - acceleration input (see figure 7).
 1 in/sec² = 0.0254 m/sec².

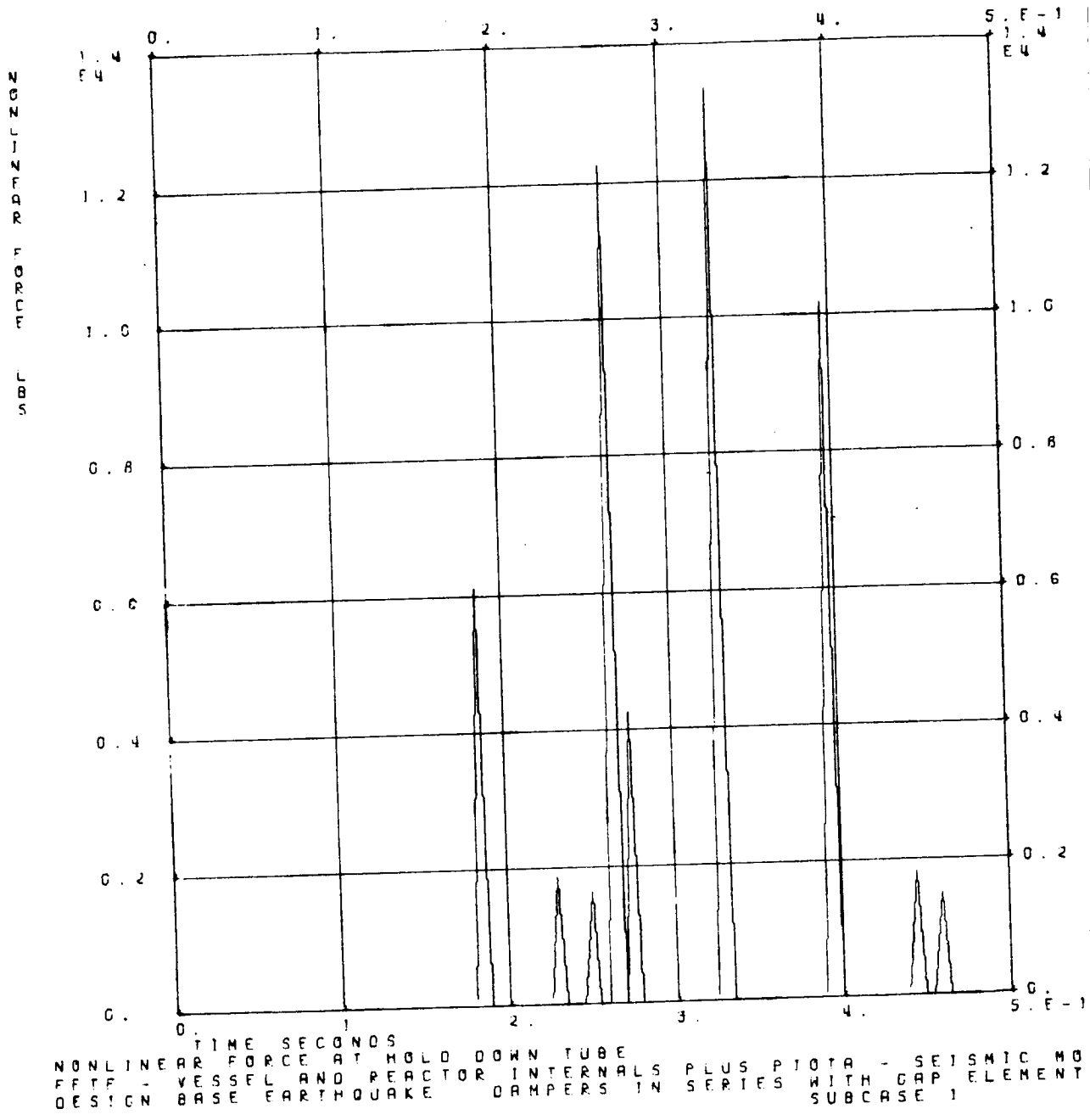
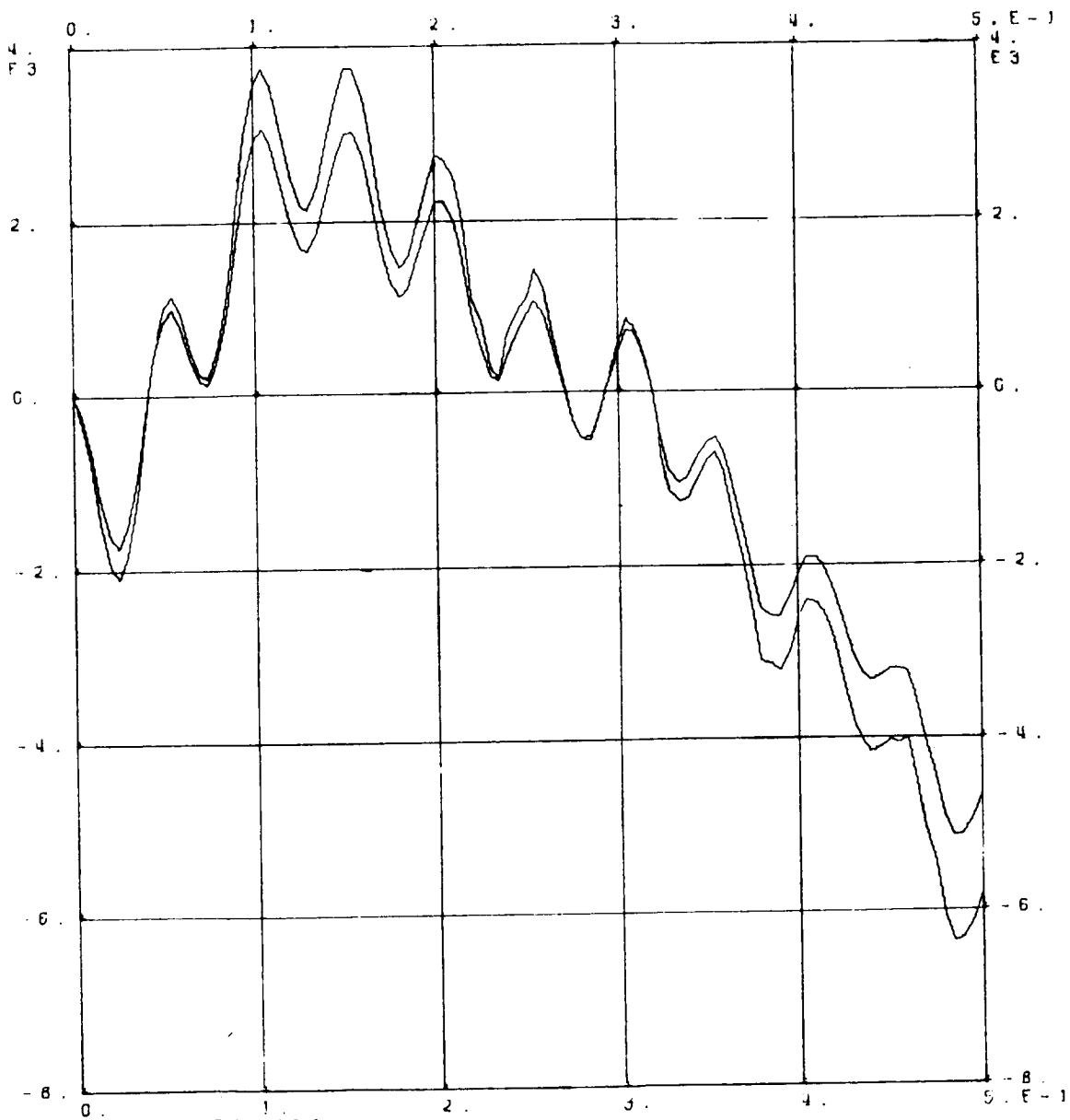

Figure 9.- Increment 1 - impact load grid pt 1022 (see figure 3).
 1 lb = 4.448 N.



PIOTA SPOOLPIECE TIE DOWN TO HEAD - ELEMENT 1
 FFTF - VESSEL AND REACTOR INTERNALS PLUS PIOTA - SEISMIC MODEL
 DESIGN BASE EARTHQUAKE - DAMPERS IN SERIES WITH GAP ELEMENTS
 SUBCASE 1

Figure 10.- Increment 1 - moments, element 1 - PIOTA
 (see figure 4). 1 in-lb = 0.11298 N-m.

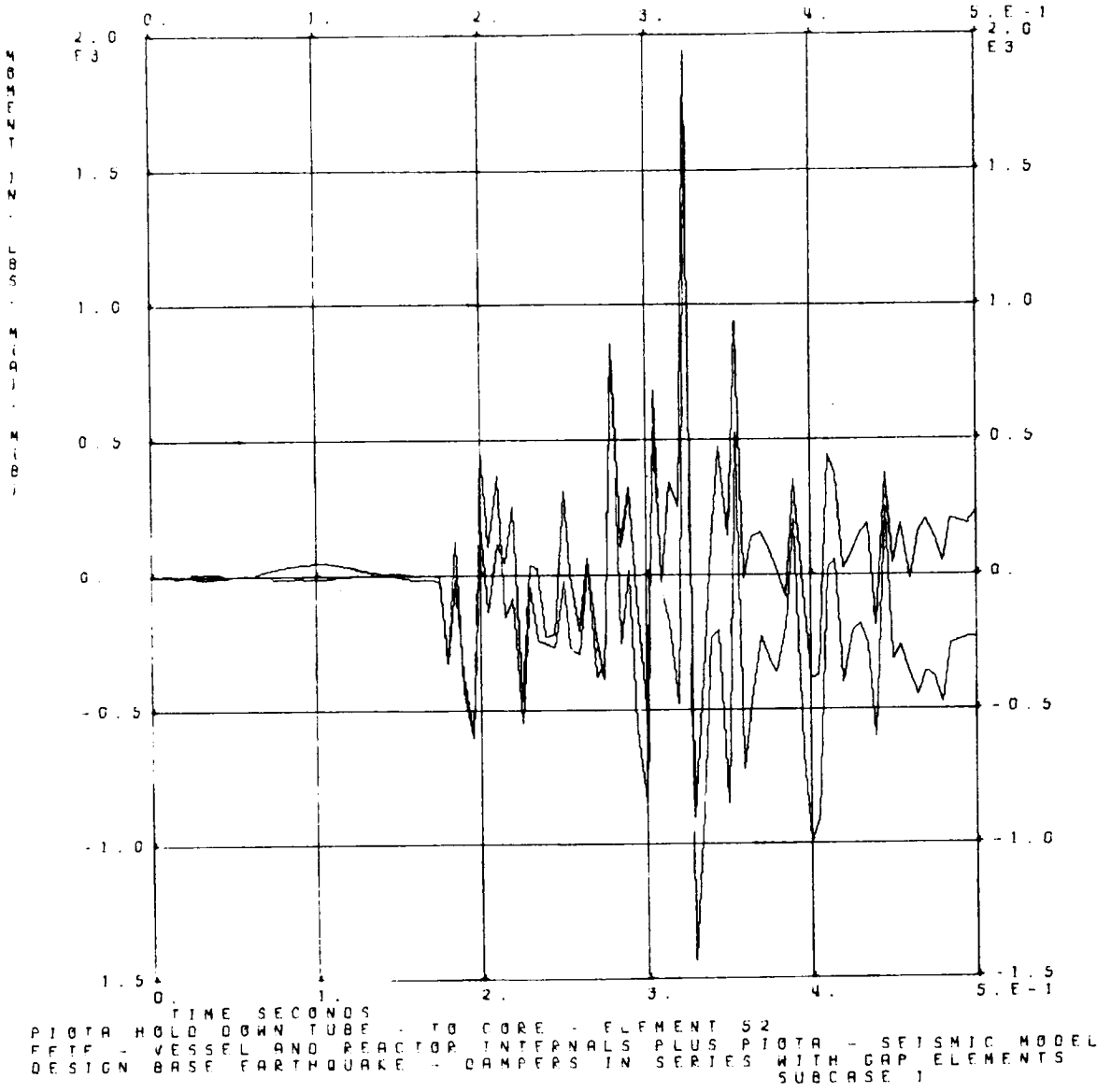

Figure 11.- Increment 1 - moments, element 52 - PIOTA
 (see figure 4). 1 in-lb = 0.11298 N-m.