

# NASTRAN MODELING AND ANALYSIS OF RIGID AND FLEXIBLE WALLED ACOUSTIC CAVITIES

Joseph A. Wolf, Jr., and Donald J. Nefske

Research Laboratories  
General Motors Corporation  
Warren, Michigan

## SUMMARY

The acoustic slot elements, CSLOTi, have been applied to analyze two-dimensional enclosures with fixed or moving boundaries. The capability has been utilized to compute (a) the acoustic natural modes and frequencies of a rigid walled enclosure and (b) the sound pressure at any point inside an enclosure when the surrounding walls are forced to vibrate. Applications to an automobile passenger compartment illustrate the technique.

The axisymmetric fluid elements, CFLUIDi, have been used in conjunction with a suitable choice of symmetry planes and a model of the surrounding structure to approximate a two-dimensional enclosure with flexible walls. The enclosure walls are modeled using finite elements or structural modes. Illustrative examples include a comparison of rectangular cavity modes with those calculated using the acoustic slot element and the free vibration modes of two enclosures coupled through a flexible rectangular panel.

## INTRODUCTION

Modification of the NASA Structural Analysis (NASTRAN) program for connected slot acoustic analysis was first discussed by Herting et al. (Ref. 1) at the 1971 NASTRAN Users' Colloquium. This capability was later included in NASTRAN, along with an axisymmetric hydroelastic model, as documented in the NASTRAN Theoretical and User's Manuals (Refs. 2 and 3). The capability provided for therein includes rigid or moving wall two-dimensional slot models and rigid, moving, or elastic wall axisymmetric models.

The present paper describes some adaptations of this acoustic analysis capability which have not been described in the NASTRAN documentation, and it illustrates these adaptations through applications to some problems of practical interest. Examples include calculation of acoustic modes and frequencies for irregularly shaped cavities, calculation of frequency response for piston-like wall excitation of an acoustic cavity slot-model, use of axisymmetric hydroelastic elements to approximate a two-dimensional cavity with flexible walls, and modeling of cavities coupled through flexible panels. The implementation is within the present NASTRAN framework and involves no new elements or rigid format alterations.

## ACOUSTIC FINITE ELEMENT MODELING WITH THE CSLOTi ELEMENT

The acoustic slot-element capability of NASTRAN was originally developed by Herting et al. (Ref. 1) and is described in Section 16.2 of the Theoretical Manual (Ref. 2) and Section 1.9 of the User's Manual (Ref. 3). While the slot elements -- CSLOT3 (a triangular element) and CSLOT4 (a quadrilateral element) -- were originally intended for analyzing slotted regions which extend radially outward from a central core (such as the lobes of a rocket motor cavity), it has been noted that "The slot elements can also be used . . . to solve both static and dynamic two-dimensional potential problems including, in addition to acoustic problems, fluid flow, heat conduction, gravity waves in shallow water, electrical wave transmission, etc." (Ref. 2, p. 16.2-2). However, the implementation of these elements to treat such two-dimensional problems has not been discussed in the NASTRAN documentation, and the purpose of this paper is to describe such an application to treat one of these problems -- namely, the acoustics of two-dimensional, irregularly shaped enclosures with rigid or moving walls. Specifically, the use of the slot elements is illustrated for computing (a) the acoustic natural modes and frequencies of a rigid walled enclosure (Normal Modes Analysis) and (b) the sound pressure at any point inside an enclosure when the surrounding walls are forced to vibrate (Direct Frequency Response). Examples include applications to the automobile passenger compartment.

### NORMAL MODES ANALYSIS

Rigid Format number 3 -- Normal Modes Analysis -- can be used to extract the acoustic natural modes and frequencies of a slot-element model of the cavity. The bulk data cards which are required to implement this capability include:

<u>Card</u>	<u>Purpose</u>
AXSLOT	parameter definition
GRIDS	scalar point specification
CSLOT3, CSLOT4	element definition
EIGR	eigenvalue extraction technique

Plots of the finite element model may be obtained by using the standard NASTRAN plot request case control cards, with the exception of the card "SET n INCLUDE PLOTEL" (n = set number) which must be included.

To investigate the convergence of the slot element solution, computed eigenfrequencies for a one-dimensional tube with closed ends have been compared with the exact solution, and the results of this investigation are shown in Figure 1. The percentage error in the computed frequency can be deduced to be proportional to  $(n/N)^2$  where n is the mode number and N is the number of elements used. These results can be applied to an irregularly shaped enclosure to estimate the number of elements required in a particular direction in order to attain a desired degree of accuracy of a particular mode.

For example, one can estimate that accuracy to within 10 percent can be obtained for the first four modes in a particular direction by using about ten elements in that direction.

Figure 2 illustrates the application of the slot elements to analyze an irregularly shaped enclosure, namely an automobile passenger compartment of the "hatchback" type. The computed resonant frequencies and the nodal lines for the lowest four modes are shown in Figure 3 for the compartment completely closed (for comparison, see similar computations reported in Refs. 4 & 5) and also for the compartment with the hatch open. (An open portion of the boundary can be modeled by applying single point constraints at the boundary GRIDS points.) The modes shown in the figure are analogous to the modes which occur in the tube except for the effects introduced by the irregular boundary shape. The open hatch configuration reduces the fundamental frequency, analogous to what occurs when one end of the closed-closed tube is opened, although in this case the fundamental frequency is not halved as it is for the tube. The figure shows some comparisons of the computed frequencies with experimentally obtained frequencies, and the agreement can be seen to be quite favorable.

#### DIRECT FREQUENCY RESPONSE

Rigid Format number 8 -- Direct Frequency and Random Response -- can be used to compute the sound pressure at the gridwork of points of the finite element model, for prescribed vibration input at the boundary. This capability, while not described in detail in the NASTRAN documentation, is alluded to on p. 1.9-2 of the User's Manual (Ref. 3) by the statement, "Dynamic load cards . . . may be introduced to account for special effects." Here the use of the RLOAD2 card with the slot-elements is described for the purpose of making direct frequency response computations of the acoustic sound pressure inside an enclosure.

The complete list of bulk data cards which are required includes:

<u>Card</u>	<u>Purpose</u>
AXSLOT	parameter definition
GRIDS	scalar point specification
CSLOT3, CSLOT4	element definition
RLOAD2	boundary condition specification
DAREA	vibration modeshape specification
DPHASE	vibration phase specification
FREQ1	vibration frequency specification
TABLED4	vibration type specification

To prescribe a vibration of the boundary, the RLOAD2 card is used to specify DAREA and DPHASE cards which are applied directly to the GRIDS points defining the boundary. The DAREA cards specify the modeshape of the vibration, and the DPHASE cards specify the phase of the vibration. The FREQ1 card determines the frequencies at which the computations are made, and the TABLED4 card specifies the type of modeshape (i.e., acceleration or displacement) being

input. Specifying only a constant on the TABLED4 card indicates an acceleration modeshape, and specifying only an  $f^2$  dependence ( $f$  = frequency) indicates a displacement modeshape.

Figure 4 illustrates the scheme which has been used for discretizing the modeshape for preparing the DAREA cards. The scheme lumps the area in region I on the DAREA card for GRIDS point 1, the area in region II on the DAREA card for GRIDS point 2, etc., where the areas are defined by the bisectors of the distances between the points. For this scheme, width = 1 is assumed to be specified on the AXSLOT card.

Figure 5 shows a typical application of this capability to compute the sound pressure inside an automobile passenger compartment when the back windshield is vibrating in a prescribed modeshape with a prescribed acceleration. The figure illustrates the application which involves computing the pressure  $P_A$  at point A when a half-sine acceleration modeshape is prescribed. The response at A as a function of panel frequency  $\omega$  can be obtained, and a plot of the solution is also shown in the figure. The frequencies  $f_1, f_2, f_3, \dots$  at which the response becomes infinite are the acoustic resonant frequencies of the compartment which can be computed as described above under "Normal Modes Analysis."

#### ACOUSTIC FINITE ELEMENT MODELING WITH THE CFLUIDi ELEMENT -- APPROXIMATION OF PLANE PROBLEM

In addition to possessing the rigid and moving boundary modeling capabilities of the slot element, the axisymmetric element may be connected to structural elements to provide flexible boundary models. By a judicious choice of overall geometry and of fluid symmetry planes, the CFLUIDi elements may be used to approximate a two-dimensional cavity and thus provide a flexible wall capability not otherwise available in NASTRAN. Referring to Figure 6, we see that if the radius  $R_0$  is sufficiently large, and the angle  $\Delta\phi$  is sufficiently small, the resulting thin slice can be made as close to a cavity of uniform depth as desired. The fractional difference in depth,  $\Delta d/d$ , is given by  $h/R_0$ . Thus for a cavity depth variation of  $\pm 1\%$  from nominal, one would select  $R_0 = 50 h$ . To complete the two-dimensional analogy, one assumes that the fluid motion normal to the cross section is negligible compared with the in-plane components. In the NASTRAN model, this is accomplished by selecting a NOSYM value of NO, and including only  $N1 = 0$  (zeroth harmonic) in the harmonic numbers for solution on the AXIF card. To correctly model the interaction terms, a FLSYM card is included, with an even integer,  $M = 360^\circ/\Delta\phi$ , and  $S1 = S2 = S$ .

The influence of the out-of-plane curvature on the acoustic resonances is illustrated using a 2.0 by 1.1 m rectangular cavity previously discussed by Shuku and Ishihara (Ref. 4). The model chosen contained an 8 by 4 mesh of rectangular acoustic elements. Results are presented in Table I for three values of  $R_0$ , along with results for the NASTRAN slot element and the exact analytical results. Even for a depth variation of  $\pm 22\%$  ( $R_0 = 2.31 h$ ), the

first four cavity frequencies are within one-half percent of the slot results and within five percent of the theoretical values, as predicted in Figure 1.

### FLEXIBLE WALL MODELING

A sample axisymmetric hydroelastic model including structural boundaries is discussed in section 1.7.5 of Ref. 3. For the applications included herein, the model is nominally two-dimensional as far as the fluid is concerned. With this assumption the model may be applied as well to irregular cavities of uniform cross section, with any type of boundary structure. As before, the fluid motion is represented by its zeroth harmonic, and the coupling between boundary and fluid is obtained on the basis of including more than one structural grid (GRIDB) per fluid ring boundary (RINGFL). If an alternate solution is desired, requiring higher fluid harmonics (to include the effect of transverse cavity modes, for example), the limit  $N < 100$  on the AXIF card must be modified somehow in the code, for with the thin slice concept used here, the first transverse (circumferential) symmetric harmonic would have a harmonic number exceeding this limit. For example, with  $R_0 = 50 h$  and  $d = h$  (see Figure 6 for geometry),  $\Delta\phi = 1.13^\circ$  and  $M = N = 318$ .

The boundary structure may be modeled by using the various NASTRAN plate, beam, etc. elements, or by means of structural modes, using MPC equations and modal mass and stiffness properties as described in section 14.1 of Ref. 2. When desired, forcing functions at the wall may be expressed in terms of time varying loads at one or more locations or in terms of a prescribed acceleration history at one or more locations. The latter is accomplished by the usual artifice of adding a large mass at each forced point and then applying a time varying force whose magnitude is determined from Newton's second law of motion to give the desired acceleration.

### MULTIPLE CAVITY MODELING

There are many interesting technical problems which involve acoustic cavities coupled through flexible panels. Previous work in this area (Refs. 5 and 6, for example) has usually entailed the development of special finite element computer codes. The extension of the present modeling technique to encompass the analysis of this problem area within NASTRAN is conceptually straightforward, albeit somewhat tedious.

What is required is the definition of a second fluid-structure boundary for each coupling panel, along with the necessary constraint equation tying the two boundaries together. Two ways of accomplishing this are shown schematically in Figure 7. Simple rigid link type MPC equations are sufficient to tie the boundaries together. At the user's convenience, depending upon the previous modeling effort, the intervening plates may be defined to attach to one set of GRIDB points, or alternatively, the plate elements may be defined relative to a set of GRID points, to which both sets of GRIDB points are

connected via MPC equations. The resulting mass and stiffness terms are identical. Note that the coupled RINGFL and GRID elements defining the boundary are coincident in a given R-Z plane and are located on the panel mid-plane. If desired, the coupling panel may be modeled using its vibration modes, as discussed earlier.

To illustrate the technique, the free vibration modes of two equally sized enclosures coupled through an intervening flexible panel are calculated and compared with the results of Reference 6. The finite element model is shown in Figure 8. For the air in the cavities, the speed of sound  $c = 344.4$  m/s and the density  $= 1.225$  kg/m<sup>3</sup>. For the aluminum plate, the thickness  $= 3.2$  mm, the density  $= 2865$  kg/m<sup>3</sup>, the modulus of elasticity  $= 493$  MPa and Poisson's ratio  $= 1/3$ . The plate model had four elements in the depth direction and was simply supported on all edges.

As a check, the uncoupled cavity and plate natural frequencies have been calculated and are presented in Table II, along with the results of two alternate solutions. The first five natural frequencies are within four percent of the theoretical values. The results for the coupled system are compared in Table III with the values published in Reference 6. The difference in frequencies is eight percent or less for the first seven modes. The first three mode shapes are shown in Figure 9 and illustrate the expected structural-acoustic interaction.

#### CONCLUDING REMARKS

As in other areas of use, the flexibility and redundancy inherent in the NASTRAN code permit the adaptation of the acoustic and hydroelastic modeling capability to several interesting applications not envisioned in the program documentation. The discussion and examples included herein are indicative of the practical structural-acoustic problems which may be analyzed using NASTRAN.

#### ACKNOWLEDGEMENT

The authors are indebted to Dr. D. L. Smith for providing the experimental data shown in Figure 3.

## REFERENCES

1. Herting, D. N., et al.: Acoustic Analysis of Solid Rocket Motor Cavities by a Finite Element Method. Published in NASTRAN: USERS' EXPERIENCES, NASA TM X-2378, pp. 285-324, Sept. 1971.
2. MacNeal, R. H., editor: The NASTRAN Theoretical Manual. NASA SP-221(01), NASA, Washington, D.C., December 1972.
3. McCormick, C. W., editor: The NASTRAN User's Manual. NASA SP-222(01), NASA, Washington, D.C., May 1973.
4. Shuku, T., and Ishihara, K.: The Analysis of the Acoustic Field in Irregularly Shaped Rooms by the Finite Element Method. Journal of Sound and Vibration, Vol. 29, No. 1, pp. 67-76, 1973.
5. Craggs, A.: An Acoustic Finite Element Approach for Studying Boundary Flexibility and Sound Transmission Between Irregular Enclosures. Journal of Sound and Vibration, Vol. 30, No. 3, pp. 343-357, 1973.
6. Stead, G.: A Finite Element Approach to Sound Transmission Between Rooms. M.S. Thesis, University of Alberta, Edmonton, Alberta, Canada, September 6, 1973. Also presented with A. Craggs: Sound Transmission Between Enclosures: A Study Using Plate and Acoustic Finite Elements. Eighth International Congress on Acoustics, London, 1974.

TABLE I

NATURAL FREQUENCIES IN HERTZ FOR A 2.0 BY 1.1 m RECTANGULAR CAVITY  
(Calculations Based on  $c = 340$  m/s)

Cavity Mode	NASTRAN Axisymmetric Model			NASTRAN Slot Model	Theory
	$R_0 = 2.31$ h	$R_0 = 23.1$ h	$R_0 = 138.5$ h		
1,0	85.55	85.55	85.55	85.55	85.00
0,1	159.30	158.55	158.55	158.54	154.55
2,0	174.40	174.40	174.40	174.40	170.00
1,1	184.68	184.00	184.00	183.99	176.38

TABLE II

NATURAL FREQUENCIES IN HERTZ FOR UNCOUPLED TWO CAVITY SYSTEM

Modal Description	NASTRAN Model	Model of Ref. 6	Theory
P(1,1)†: First Plate Mode	274	273	273
C(1,0)*: First Longitudinal Cavity Mode	293	289	289
C(0,1)*: First Transverse Cavity Mode	360	356	357
P(2,1)†: Second Plate Mode	366	373	371
C(1,1)*: First Mixed Cavity Mode	477	460	459

†Plate simply supported at all boundaries.

\*Pairs of modes with equal frequencies occur in the uncoupled system.



TABLE III

## NATURAL FREQUENCIES IN HERTZ FOR COUPLED TWO CAVITY SYSTEM

Mode Number	Description*	NASTRAN Model	Model of Ref. 6
1	C(1,0) plus P(1,1) in phase	262	243
2	C(1,0), no plate mode	293	289
3	C(1,0) plus P(1,1) out of phase	307	312
4	C(1,1) plus P(2,1) in phase	348	336
5	C(0,1), no plate mode	360	356
6	C(1,1) plus P(2,1) out of phase	373	377
7	C(1,1), no plate mode	477	460

\*The description "in phase" indicates that the pressure difference across the plate appears to produce the plate motion. "Out of phase" indicates that the plate motion appears to produce fluid over (under) pressure (see also Figure 9).

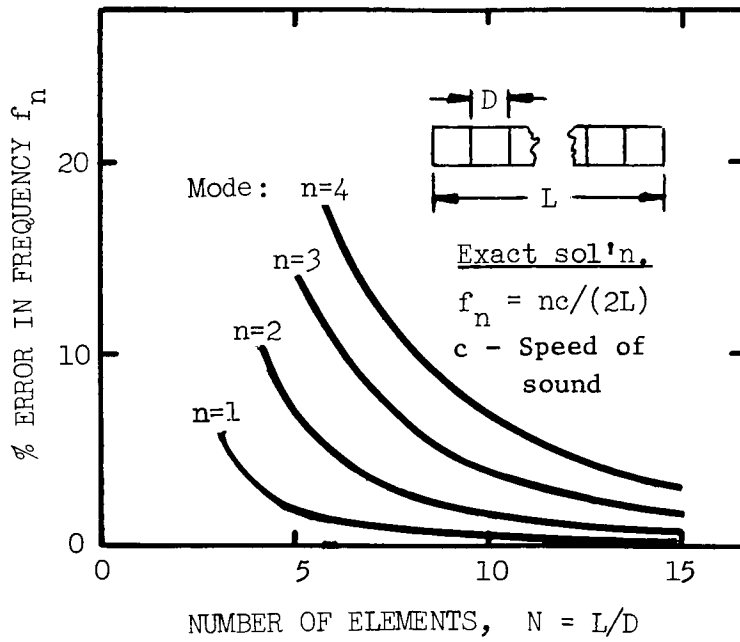

FIG. 1 RATE OF CONVERGENCE OF THE SLOT ELEMENTS

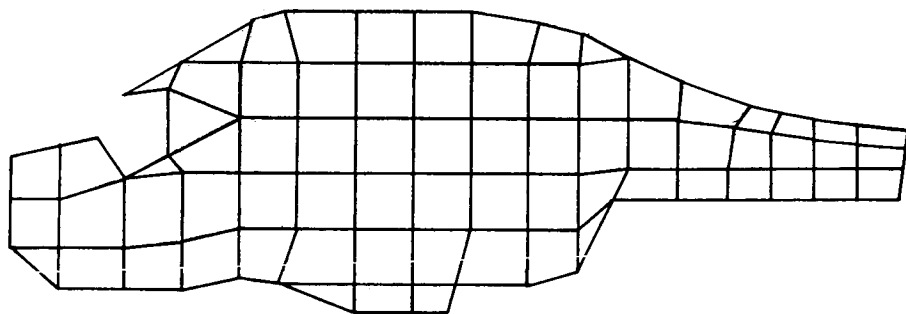
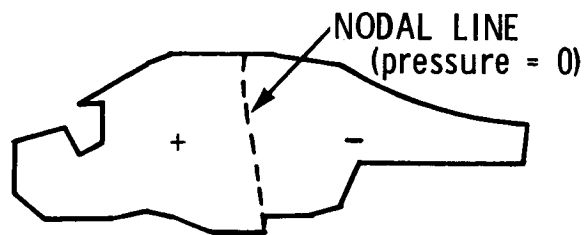

FIG. 2 FINITE ELEMENT MODEL OF AUTOMOBILE PASSENGER COMPARTMENT OF THE HATCHBACK TYPE

HATCH CLOSED

HATCH OPEN



(a) 68 Hz (60 Hz EXP.)

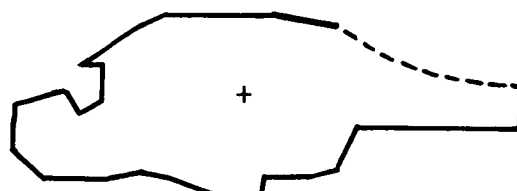

(a) 40 Hz

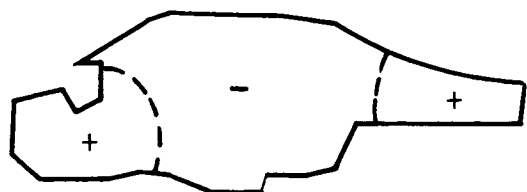

(b) 105 Hz (110 Hz EXP.)

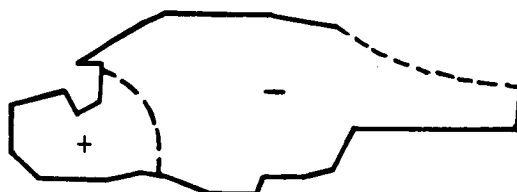

(b) 106 Hz

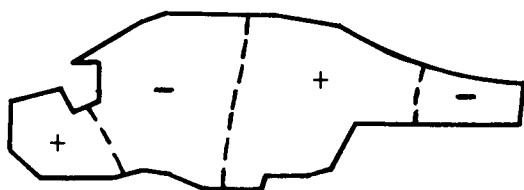

(c) 152 Hz (135 Hz EXP)

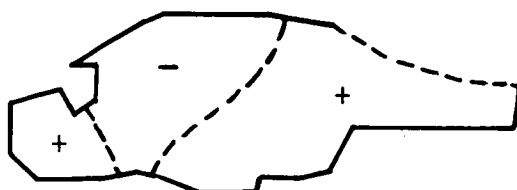

(c) 160 Hz

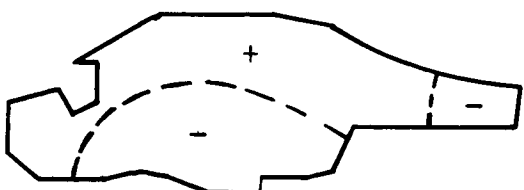

(d) 179 Hz



(d) 195 Hz

FIG. 3 ACOUSTIC RESONANT MODES AND FREQUENCIES OF PASSENGER COMPARTMENT ENCLOSURE (EXPERIMENTAL FREQUENCIES ARE SHOWN IN PARENTHESES. FOR COMPUTATIONS  $c = 341$  METERS/SEC.)

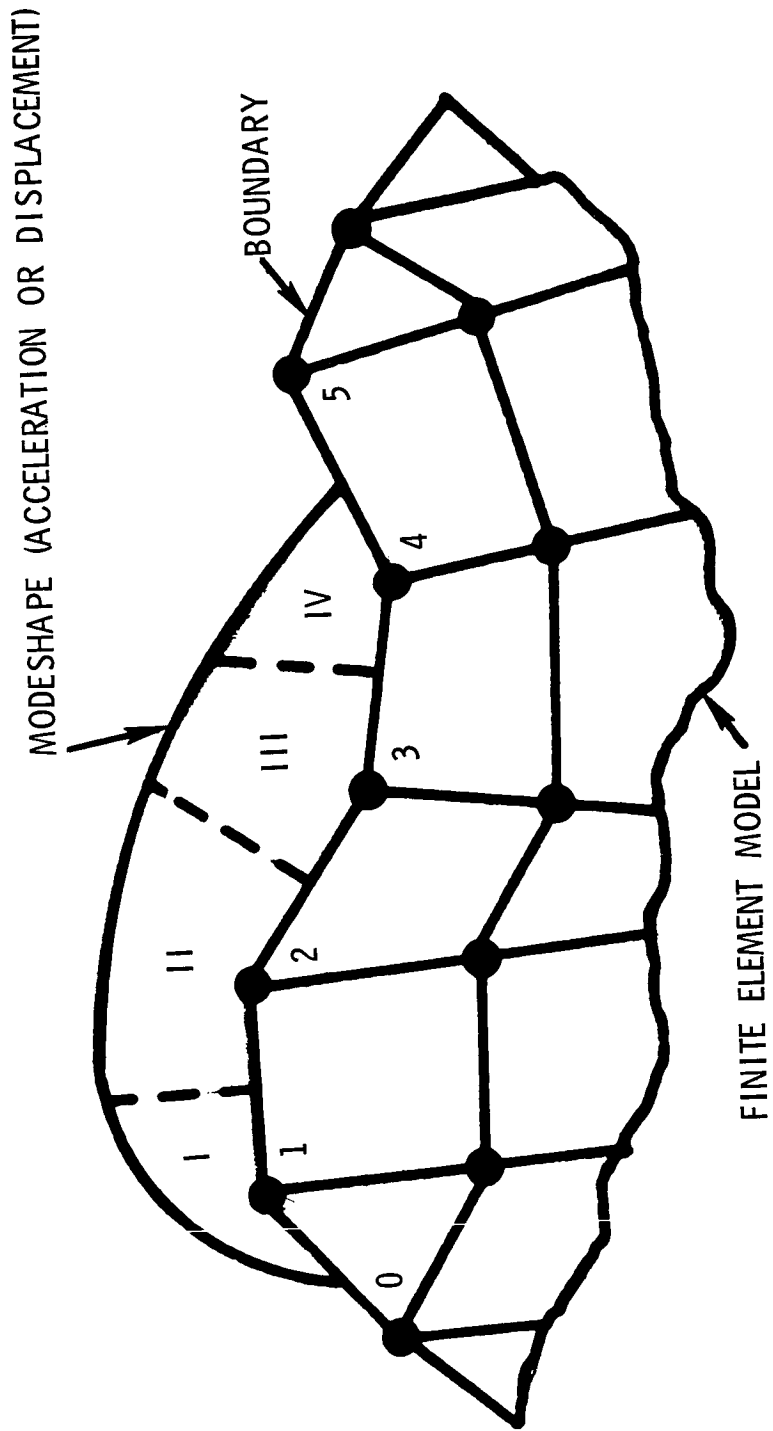

FIG. 4 SCHEME FOR DISCRETIZING PRESCRIBED BOUNDARY VIBRATION

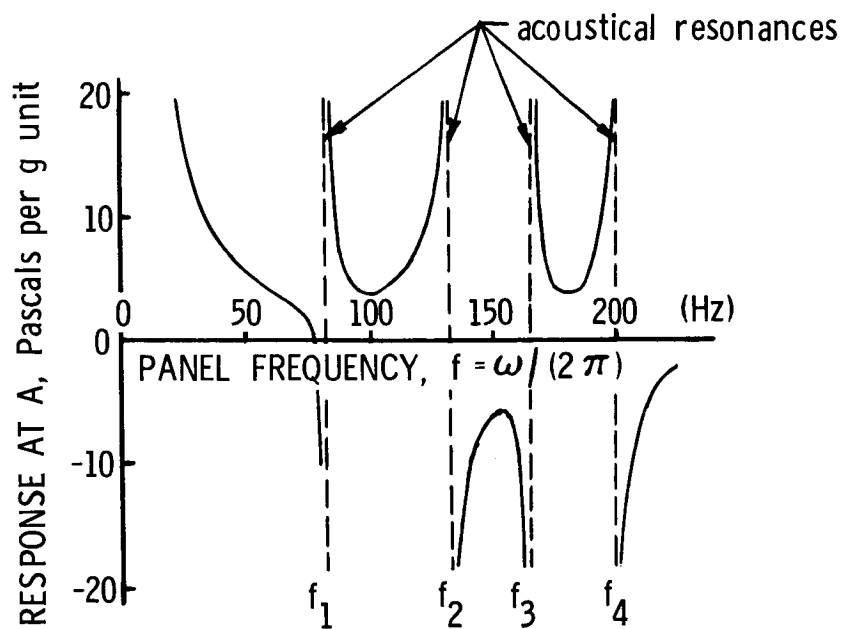
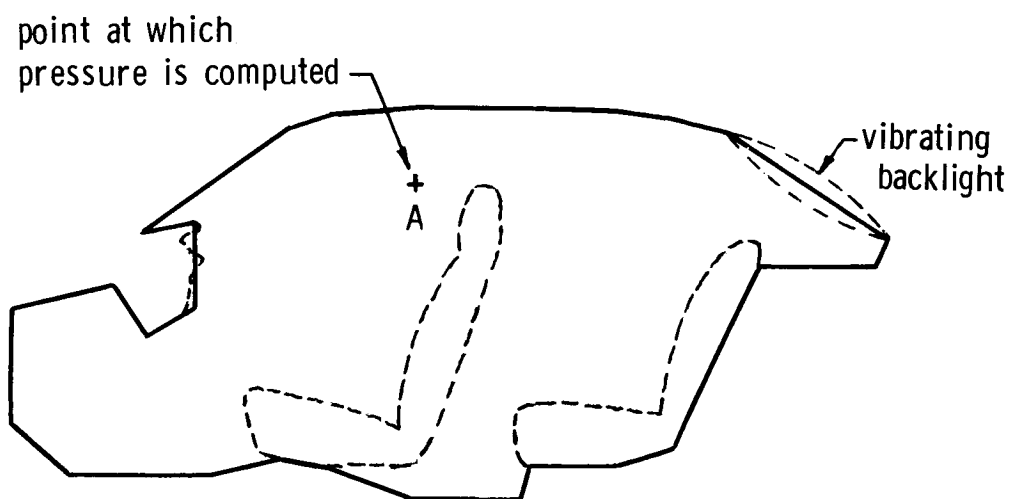

FIG. 5 FREQUENCY RESPONSE COMPUTATION OF THE SOUND PRESSURE AT THE FRONT PASSENGER EAR POSITION

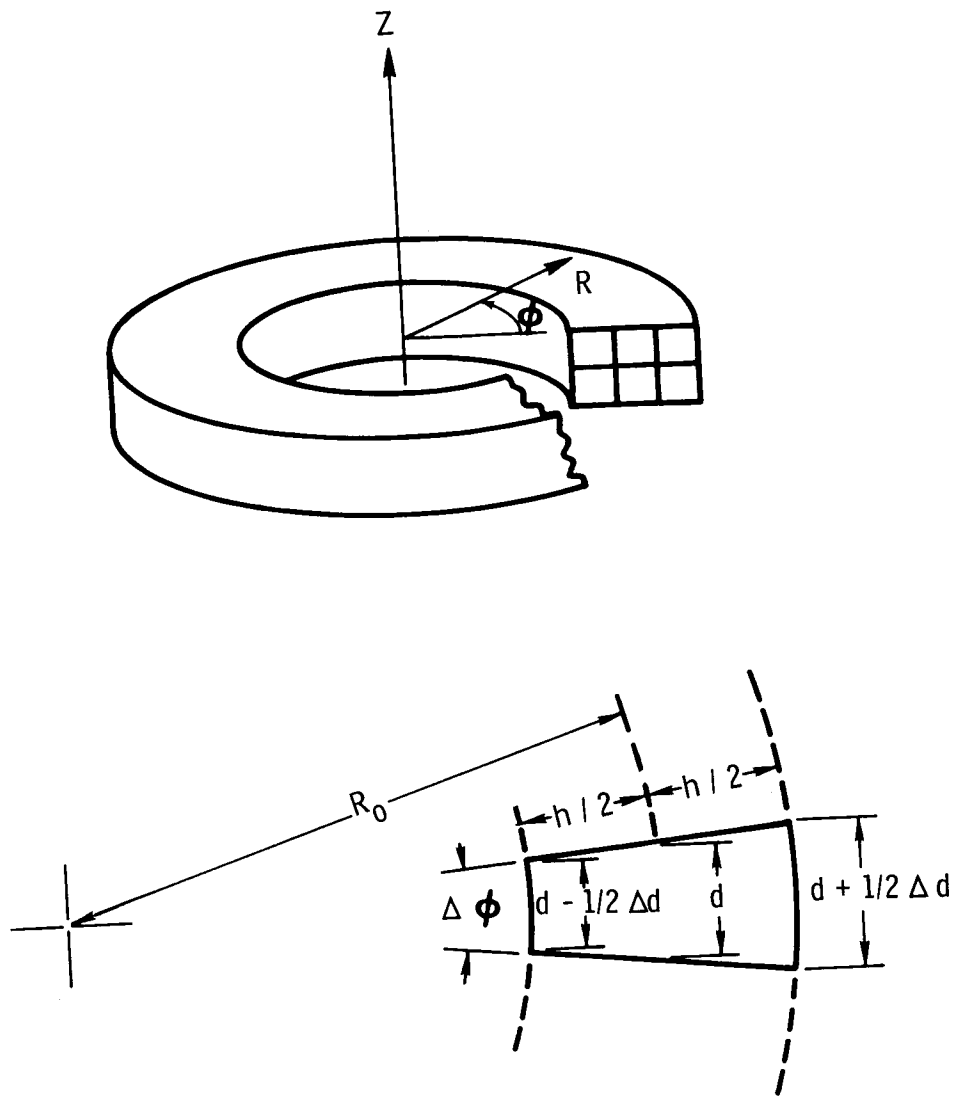
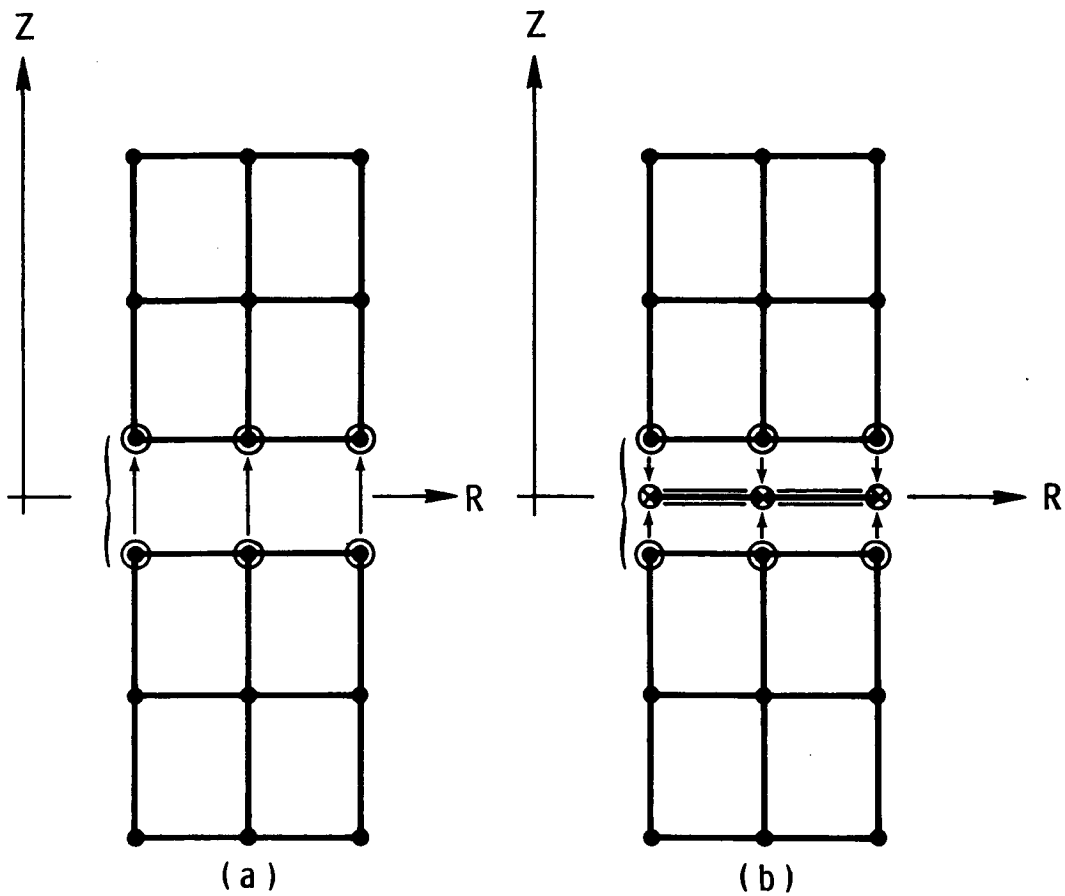

FIG. 6 USE OF AXISYMMETRIC ELEMENT TO APPROXIMATE A RECTANGULAR CAVITY



KEY:

- FLUID RING MESH POINT (RINGFL)
- ⊙ BOUNDARY GRID POINT (GRIDB)
- ⊗ STRUCTURAL GRID POINT (GRID)
- ≡ FLEXIBLE BOUNDARY ELEMENT
- FLUID ELEMENT
- CONSTRAINT (MPC)
- { DENOTES COINCIDENT POINTS

FIG. 7 NASTRAN MODELING OF CAVITIES COUPLED THROUGH A FLEXIBLE BOUNDARY

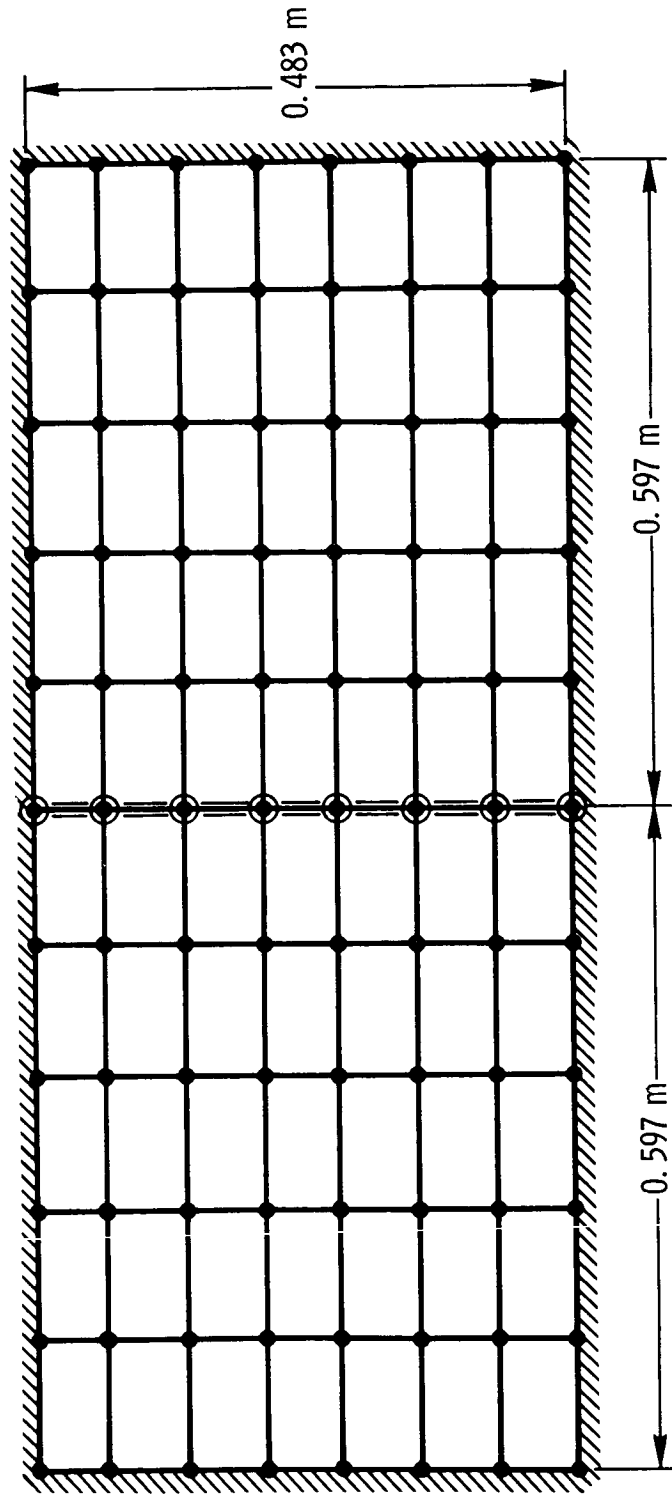

- KEY:
- FLUID RING MESH POINT (RINGFL)
  - ⊙ BOUNDARY GRID POINT (GRIDB)
  - ▨ FLEXIBLE BOUNDARY ELEMENT (CQUAD4)
  - FLUID ELEMENT (CFLUID4)

FIG. 8 NASTRAN MODEL OF TWO CAVITIES COUPLED THROUGH  
A 0.483 BY 0.178 m ALUMINUM PANEL



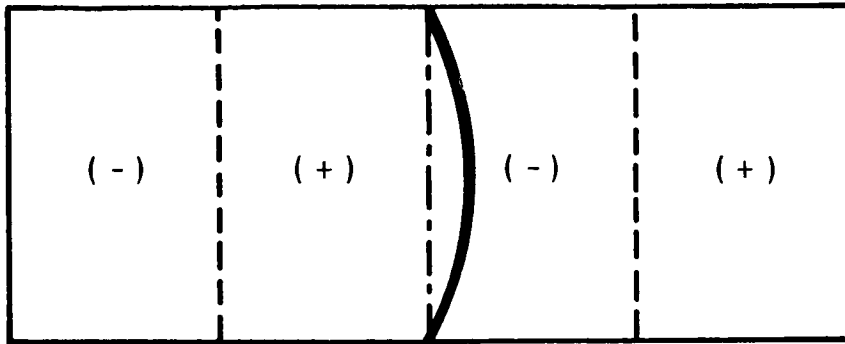

(a) FIRST MODE - 262 Hz

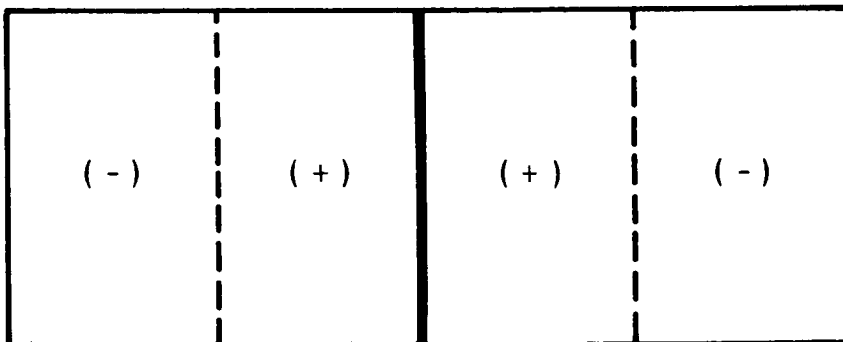

(b) SECOND MODE - 293 Hz

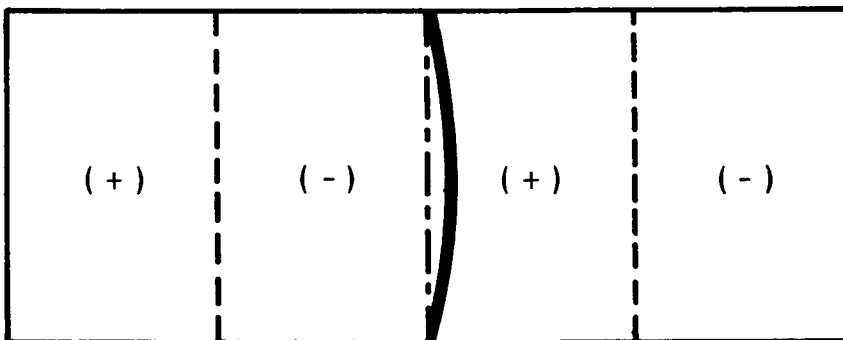

(c) THIRD MODE - 307 Hz

——— ALUMINUM PANEL  
 - - - - - NODAL LINE (ZERO CHANGE IN PRESSURE)  
 (+), (-) RELATIVE SIGN OF OVER (UNDER) PRESSURE

FIG. 9 THREE MODES OF COUPLED TWO CAVITY SYSTEM