

FLIGHT FLUTTER TESTING OF THE P6M

G. Kachadourian, R. L. Goldman, D. M. Roha — *The Martin Co.,
Baltimore, Md.*

Abstract

On the P6M the shake behavior, i.e., the response to random excitation at subcritical speeds of lowly damped airplane modes, is as important as the actual flutter speed. The approach is to first study the problem by means of analyses and wind-tunnel tests. With these predictions are compared flight test data obtained by spectral analysis of tape recordings of the airplane vibration responses to random aerodynamic turbulence.

A similar spectrum analysis approach has been used in high speed wind-tunnel tests. Furthermore, a resonance excitation technique has been developed for low speed wind-tunnel testing, and surprisingly well defined V-g curves have been obtained. The effect of various parameters on both shake and flutter of T-tails with and without dihedral have been studied.

Preliminary flight tests yielded good correlation; they also yielded interesting information concerning a low frequency transonic snaking mode and concerning excitation by shed vortices.

INTRODUCTION

The P6M is a large four jet seaplane whose development provides a new weapons concept for the naval aviator. For the flutter engineer, however, it introduces an aero-elastic problem that is fairly typical for most modern large scale aircraft. Looking at a picture of the P6M, Figure 1, we see, for instance, that the T-tail stabilizer sits on the tip of a tall, flexible, swept back fin which in turn is attached to a long, slender, flexible hull (a system with many



Figure 1. Martin P6M "SEAMASTER"

degrees of freedom). Also, the swept back wings, as might be expected, introduce flexibility and therefore additional degrees of freedom to the dynamics behavior problem.

The approach to the problem of predicting the dynamic behavior of the P6M has been to use the standard flutter tools, Analysis, Model Test, and Flight Test. Since it would be dangerous not to know an aircraft's basic dynamic behavior prior to flight test, we first studied the problem by analysis and in wind tunnel tests. The results predicted that the aircraft would be flutter free within the designed flight envelope. During the current flight flutter test program we are, therefore, only concerned with checking these predictions and determining whether the aircraft behaves in any unusual manner.

In carrying out this approach we have developed both a specific and a random excitation technique for obtaining experimental data. A specific resonance excitation technique was developed for use in low-speed wind tunnel tests, and a random excitation technique was developed for flight flutter testing after earlier investigations in a high-speed wind tunnel. This random excitation method, as will be shown later, is a technique involving spectral analysis of aircraft response to aerodynamic turbulence and has proven so far to be a reliable approach to our sub-critical investigations of the P6M.

Past experience on large flexible aircraft has shown that of equal importance as the prediction of the flutter speed itself is the determination of the aircraft's sub-critical behavior. A large aircraft usually has vibration modes that are lowly damped at sub-critical speeds; this lowly damped sub-critical response, although it is not immediately dangerous, can limit both the life of the aircraft and its acceptability.

On the P6M it became apparent, through early analysis and model tests and from early flight tests on a previous model, that the response of lowly damped modes to random excitation at sub-critical speeds would be as important as the actual flutter speed. Changes were incorporated in the present P6M configuration to control the sub-critical behavior and one purpose of the current flight flutter tests is to check whether these changes are as effective as predicted.

SUB-CRITICAL BEHAVIOR

Before proceeding, let me establish what we mean in the analytical sense by the phrase "lowly damped, sub-critical behavior." In typical V-g plots, the lowly damped mode is characterized by a curve which runs relatively close to the zero damping axis. Such modes are susceptible to atmospheric turbulence and if they are predominantly tail modes they are continuously excited by turbulent flow from the wing-engine area. When the excitation band is broad enough and strong enough, all such modes are continuously excited and aircraft response can become large.

ANALYSIS ON THE P6M

Turning now to the flutter analysis of the P6M, in Figure 2, we see a typical V-g plot based on an incompressible analysis of the ship's T-tail. (Reference 1) This analysis includes five degrees of freedom, three of which are shown here, and takes into account the effects of sweep and the well-known detrimental effect of stabilizer dihedral for T-tails, Mode II, (Reference 2) the flutter mode, rises suddenly from a highly damped condition to the flutter speed. This mode, as shown here in the illustration is characterized by a stabilizer rolling or rocking motion. Modes IV and V are all highly damped and

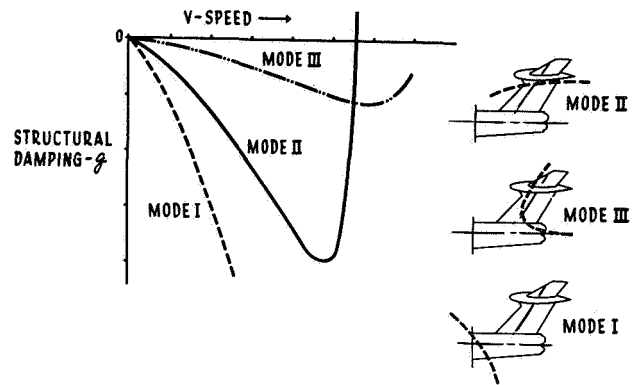

Figure 2. Incompressible P6M T-Tail Analysis

therefore not indicated on the plot. Mode III, however, is one of the previously mentioned lowly damped modes. Mode III, as shown in Figure 2, stays close to the zero damping axis throughout the usable flight range. The illustration also shows that Mode III is characterized by a stabilizer yawing motion. Mode I (Figure 2) bears further consideration, although this mode (hull lateral bending mode) is highly damped in this incompressible analysis it suffers from the common transonic "snaking" instability and becomes lowly damped in the compressible analysis. (Reference 1).

In order to provide quantitative correlation with the analysis, the usual series of flutter model tests, both low and high-speed, were undertaken. (Reference 1) The low-speed tests included tests of complete and empennage models while the high-speed tests were concerned only with empennage models.

For the low-speed wind tunnel tests, a specific resonance excitation technique was developed for obtaining in-flight or more accurately tunnel flight damping information. (Reference 3) This technique incorporates the system of strings, springs, and pulleys shown in Figure 3. By pulling on the control handle and varying the motor speed the model could be excited in any of its resonant modes at any one selected tunnel speed. The control handle was sharply

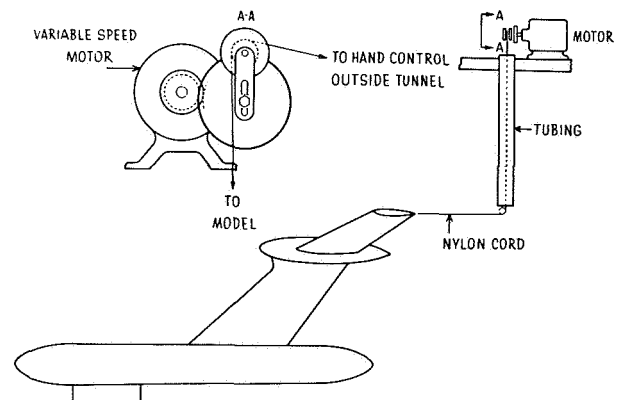

Figure 3. Specific Resonance Excitation System

released when the selected mode was at resonance. This removed the excitation force and permitted the motion to damp out. These damped motions were recorded and the logarithmic decrements of decay were then calculated for each mode.

By using this simple method, the damping in all the modes was measured at one tunnel speed and well defined experimental V-g curves of the type shown in Figure 4 were quickly obtained. Figure 4 also indicates the analytical plot for comparison. Again we see the flutter mode II which is highly damped but rises sharply to the critical speed. The analysis to test comparison indicates some conservatism in the analysis. Mode III as predicted in the analysis is lowly damped and in the peak area it was susceptible to tunnel turbulence.

During the high-speed wind tunnel tests, mode II was also found to be the flutter mode. In this case, however, it was not possible to obtain sub-critical damping information through use of any of the usual specific excitation techniques. Instead strain gage responses to tunnel turbulence were recorded on tape for a few runs and analyzed. In Figure 5 we see a composite of the spectral analysis for these runs at several Mach numbers less than the flutter Mach number. The amplitude and width of the peaks give some indication of the variation of damping in the flutter mode as the flutter speed is approached. This type of analysis has a distinct advantage in that it makes use of a type of random excitation (tunnel turbulence) that is always present in tunnel testing. This method is being further developed and it is planned to obtain quantitative evaluation of the technique in a forthcoming development program.

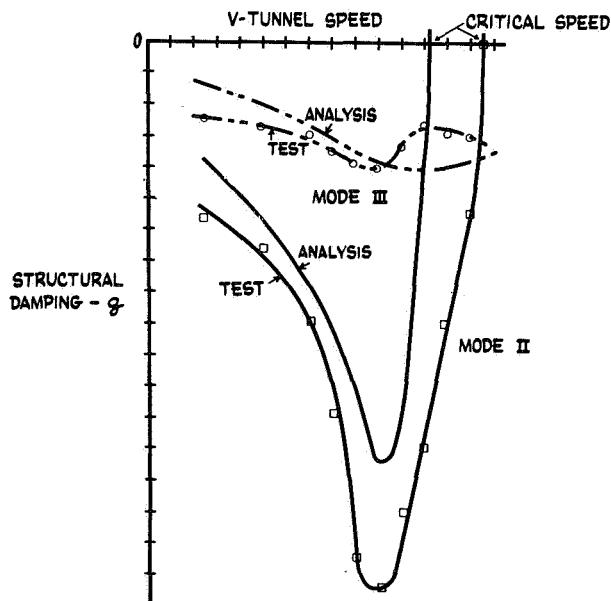

Figure 4. Experimental V-g Plot

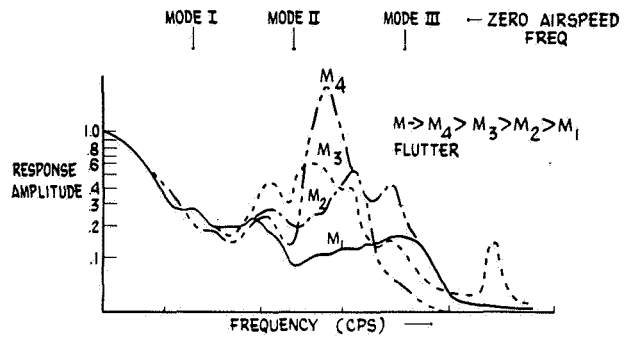

Figure 5. Spectrum Analysis of Flutter Model Response in High Speed Wind Tunnel

During the high-speed wind tunnel tests the existence of the lowly damped "snaking" mode I was also experimentally verified. This low-frequency hull lateral bending mode did not appear in the low-speed tests but showed up as expected in the transonic range of the high-speed tests.

RANDOM EXCITATION FLIGHT FLUTTER TESTING ON THE P6M

From the proceeding analysis and model tests, the basic behavior of the aircraft was rather well known. Now we are only interested in checking these predictions, especially, the "sub-critical behavior," by flight flutter testing. To do this a random excitation method was developed involving spectral analysis of aircraft response, and it is to this topic that I shall devote the remaining part of the paper.

Normally, flight flutter testing employs methods which require specific excitation techniques using such devices as control surfaces, explosive charges, shakers and so forth. (Reference 4) The limitations of these specific excitation methods center around rapid data evaluation and high costs for equipment, ever, is that flights have to be made specifically for the purpose of flight flutter testing.

The random excitation method as applied to the P6M appears to us to overcome many of these difficulties. Random excitation as a vibration source is not a new concept but in fact has been suggested as an approach to this problem for some time. (Reference 5) Today, with the use of efficient tape recording systems and corresponding spectrum analyzers, this technique becomes fairly attractive. In fact, from our most recent results it appears to be a relatively inexpensive technique that gives results that are as reliable as those obtained using other more expensive and complicated methods. Of particular importance is the fact that data can be collected from every flight test run without resorting to special flights.

The technique takes advantage of atmospheric turbulence as a source of random excitation. The "hash" usually associated with normal flight response records comes primarily from this turbulence. In

the past it was advantageous to get rid of this response by performing tests in turbulent free air. In the random excitation method this "hash" is recorded and analyzed.

THEORETICAL RESPONSE OF AN AIRCRAFT TO ATMOSPHERIC TURBULENCE

Theoretically the procedure involves correlation of power spectrums of turbulence and power spectrums of response at a given air speed and altitude. This process is illustrated in Figure 6. The input power spectrum of atmospheric turbulence, $\Phi(\omega)$, as derived by several authors (Reference 6 and 7) using a statistical approach, is a function of a turbulence level L , airspeed U and frequency ω . The output power spectrums of aircraft response, $\Psi(\omega)$, are easily obtained from analysis of accelerometer tape recordings. By taking the ratio of the output curve to the input curve, the square of the mechanical admittance or transfer function, $H^2(\omega)$, is obtained. The admittance term is an indication of the energy passing from the input to the output response and therefore is proportional to damping. The lower the damping the larger the admittance. At the response peaks, the admittance terms are therefore a measure of the modal in-flight damping. By plotting the modal admittance terms for several aircraft speeds it is theoretically possible to obtain an indication of the approach of flutter or a measure of the sub-critical behavior.

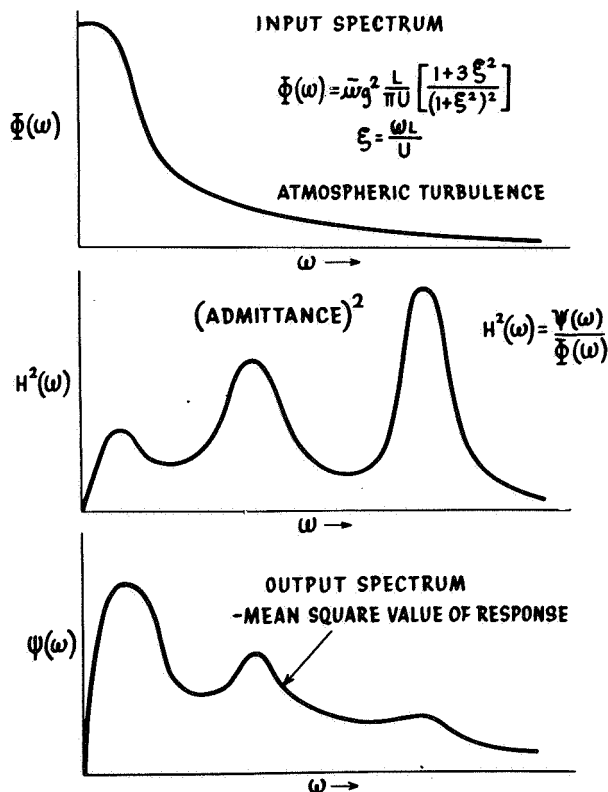

Figure 6. Theoretical Aircraft Response to Atmospheric Turbulence

In practice this procedure is not so simple. The actual turbulence spectrum on the aircraft is modified by buffeting and flow separation, the turbulence level can vary greatly in a normal flight and in addition local resonances can confuse the measurements.

P6M FLIGHT TESTS

Because of these difficulties the random excitation method used on the P6M lacks the exactness required by the theoretical approach and instead concentrates on the spectral analysis of the response information alone. By analyzing the data from many runs it is possible to minimize the effects of variations in turbulence and obtain a clear picture of the aircraft's behavior.

An early approach to this random excitation method of flight testing was used on a previous model P6M and involved a simplified harmonic analysis of oscillograph records of aircraft flight response. A particular investigation into transonic "snaking" on this ship yielded significant results as shown in Figure 7. Here the average response in a given frequency range 2.5 cps, is plotted against Mach number for different altitudes, and clearly shows a transonic "snaking" boundary. On the basis of such information it became possible to eliminate the "snaking" problem on the present model of the P6M.

An improved random excitation technique has been developed for the present P6M flight test program for the evaluation of all sub-critical behavior. The limited results obtained so far have yielded good correlation with Analysis and Model Tests.

The technique involves spectral analysis of aircraft acceleration responses and is illustrated in Figure 8. Accelerometer responses are telemetered to the ground where they are visually monitored and recorded on tape. The frequencies are first increased up to 16 times to provide longer sampling times and

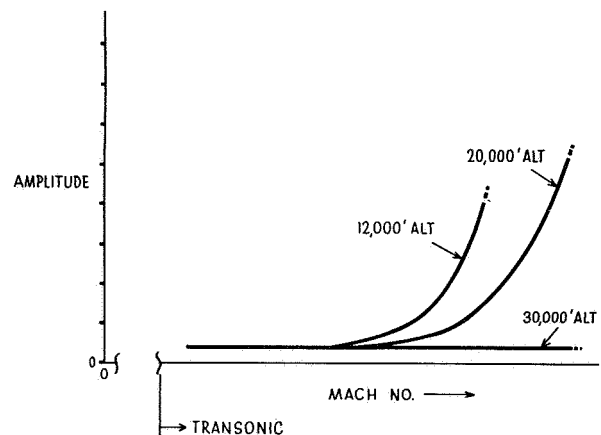
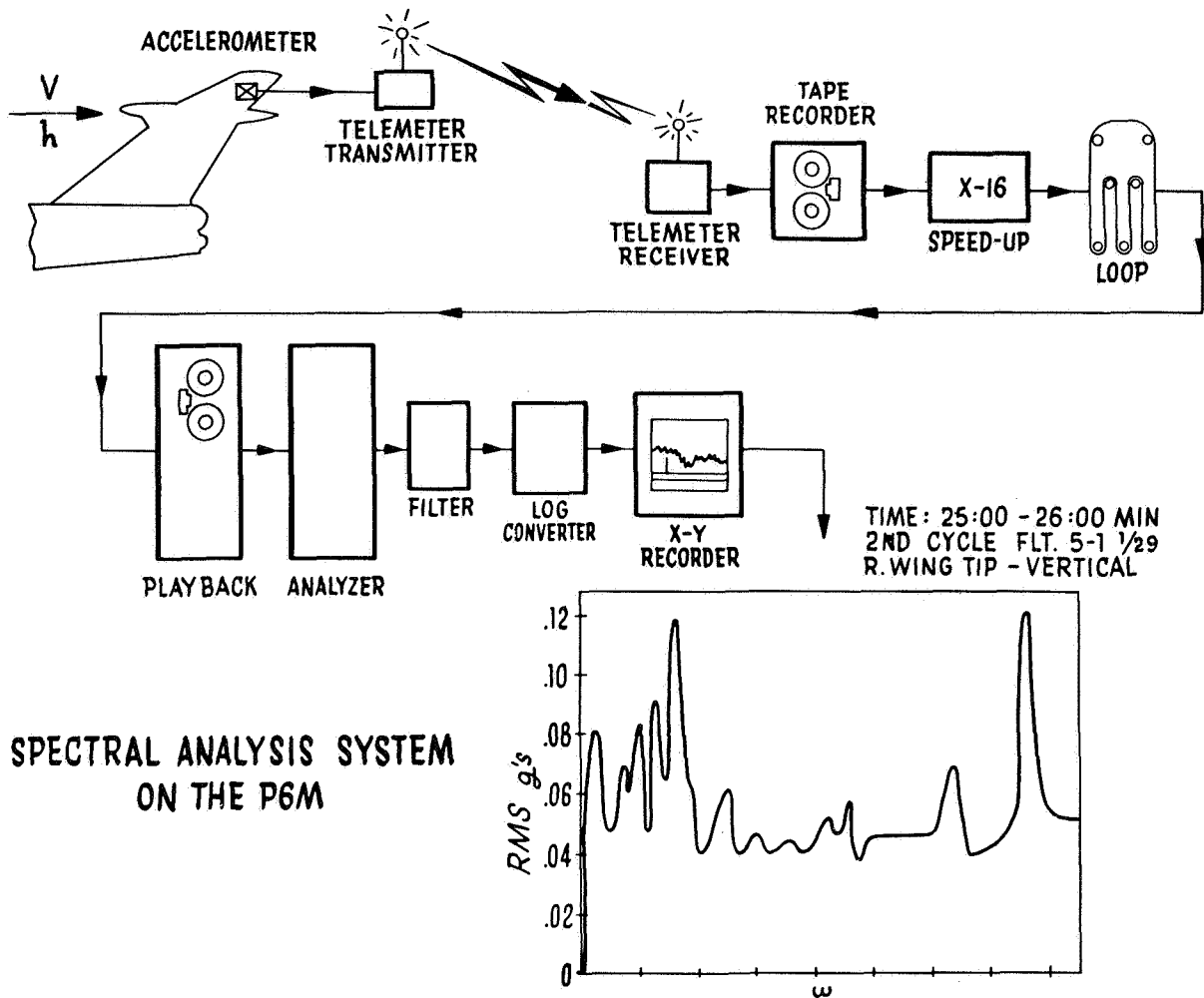

Figure 7. Transonic Snaking Response



SPECTRAL ANALYSIS SYSTEM ON THE P6M

Figure 8. Spectral Analysis System on the P6M

easier handling by the available playback systems. The output is then placed on a continuous loop and detected on an Ampex record playback unit.

This signal is then fed into a Technical Products Wave Analyzer. This analyzer determines the amplitude and frequency of the complex wave input within the desired frequency range. These data are then processed through a band pass filter and a log converter, and plotted on an X-Y recorder. Thus the tape loop is automatically scanned and a plot of the mean RMS acceleration amplitude versus frequency is obtained as shown. In Figure 8 we see a completed analysis for one-minute of flight time at a constant speed and altitude. The peaks coincide with the aircraft vibration modes.

As stated before only the response data are evaluated; no correlation of these plots with a specific turbulence input has been tried because of our inability to represent the actual turbulence. This does not lead to any difficulty, however, since information is obtained every minute while the aircraft is flying.

This gives us a large statistical source from which to obtain an average response.

To unify this store of information, a turbulence factor, based on the rigid body response, is determined for each run and the plots normalized to a unit rigid body response level. By statistically integrating these normalized results, we obtain cross plots of responses in each mode for various altitudes, speeds, and configurations. These plots yield the information necessary to establish the dynamic behavior and the effectiveness of changes designed to improve the in-flight damping.

CONCLUSION

To date the amount of data analyzed has not been large enough to either prove or disprove the adequacy of this technique for flight flutter testing. We are presently analyzing several flights in order to determine the repeatability and clarity of the spectral plots. The method, although it still has some developmental problems, appears to offer the flutter

engineer several attractive advantages, foremost of which is the fact that every minute of flight time yields dynamics information without the necessity for the conduct of special test flights for flutter.

The combination of analysis and model tests has proven to be a good approach to sub-critical investigations on the P6M. In particular, a specific resonance excitation method has been developed for low-speed wind tunnel tests that yields damping information in all the modes at one tunnel speed. When this information is coupled with the random excitation technique of flight flutter testing, a means of correlation is provided that is more simple and apparently as accurate as any of the many more expensive and complicated techniques in use at the present time.

References

1. Tomassoni, J. and O'Hearne, C. Vibration and Flutter Studies Models YP6M-1 and P6M-2 - Martin Engineering Report No. 9204 Volume I-III (Confidential) 1957.
2. Goldman, R. L. Flutter of T-tails with Dihedral-Martin Engineering Report No. 8205, 1957.
3. Goldman, R. L. XP6M-1 T-tail Flutter Model Low Speed Tests with Revised Fin Stiffness - Martin Engineering Report 9086 (Confidential), 1957.
4. Schwartz, M. D. Investigation of Flight Flutter Testing Techniques, -MIT, Aeroelastic and Structures Research Laboratory Report, 1951.
5. Bisplinghoff, R. L., Ashley, H., Halfman, R. L. - Aeroelasticity - Addison - Wesley Publishing Co., 1955.
6. Liepmann, H. W. - On the Application of Statistical Concepts to the Buffeting Problem - Journal of the Aeronautical Sciences, 1952.
7. Press, H. and Houbolt, J. C. - Some Applications of Generalized Harmonic Analysis to Gust Loads on Airplanes - Journal of the Aeronautical Sciences, 1954.