

FLIGHT FLUTTER TESTING OF MULTI-JET AIRCRAFT

J. Bartley — Boeing Airplane Co., Seattle, Washington

Abstract

Extensive flight flutter tests have been conducted by BAC on B-52 and KC-135 prototype airplanes. The paper will discuss the need for and importance of these flight flutter programs to Boeing airplane design. Basic concepts of flight flutter testing of multi-jet aircraft and analysis of the test data will be presented. Exciter equipment and instrumentation employed in these tests will be discussed.

INTRODUCTION

During the past 6 years the Boeing Airplane Company has accumulated an extensive experience with the flight flutter testing of multi-jet aircraft, including the B-52, 707-80 commercial prototype and the KC-135 tanker. This has been occasioned by the complex flutter characteristics associated with the general design of these airplanes involving a high aspect ratio wing carrying flexibly-mounted nacelle pods and a long slender fuselage. The resulting assembly presents a large number of possible flutter modes of the basic structure. Figure 1 shows the number of anti-symmetrical modes and frequencies of interest from a flutter standpoint for one distribution of fuel on the B-52. These data were obtained from a ground vibration test of a B-52 flutter model, and the frequencies shown are model values which are 4.5 times actual airplane frequencies.

Furthermore, added complication comes from the fact that fuel is carried internally throughout the wing and fuselage, and in the case of the B-52, the external tanks are mounted on the outboard wing, presenting a wide variation in fuel configurations to be cleared for flutter. Figure 2 illustrates the distribution of fuel tanks in the B-52 wing and fuselage.

Structural characteristics and internal wing fuel distribution of the jet transports are generally similar to the B-52, although the structural frequencies are somewhat higher.

Initial appraisal of the B-52 flutter problems indicated that a comprehensive theoretical analysis would require approximately 20 degrees of freedom, a prohibitive number for the computing machinery available at that time. The alternative which was decided upon was to build dynamically scaled flutter models for wind tunnel flutter testing. Results of the wind tunnel flutter investigations indicated a marked sensitivity of flutter speeds to moderate changes in wing and nacelle strut stiffness and weight distribution. Also, flutter occurred in approximately 5 different modes all of which involved strong coupling of the wing and fuselage.

FLIGHT TEST EQUIPMENT AND PROCEDURE

Although the wind tunnel flutter investigations indicated adequate flutter speed margins for the nominal B-52 configuration, it was decided to embark on a flight flutter program which would provide maximum safeguards against the occurrence of unanticipated flutter on this airplane. This decision was based on the feeling that the overall complexity of the B-52 structure made it necessary to provide an additional measure of safety over and above that provided by the wind tunnel test results. A systematic monitoring of the flutter behavior of the airplane as test speeds are increased in increments up to the design speed limit was established as the basic flight flutter test plan. Telemetering of response data to a ground station permitting a crew of flutter personnel to analyze the behavior of the airplane carefully during flight flutter tests was considered an essential part of the plan to provide maximum overall flight safety.

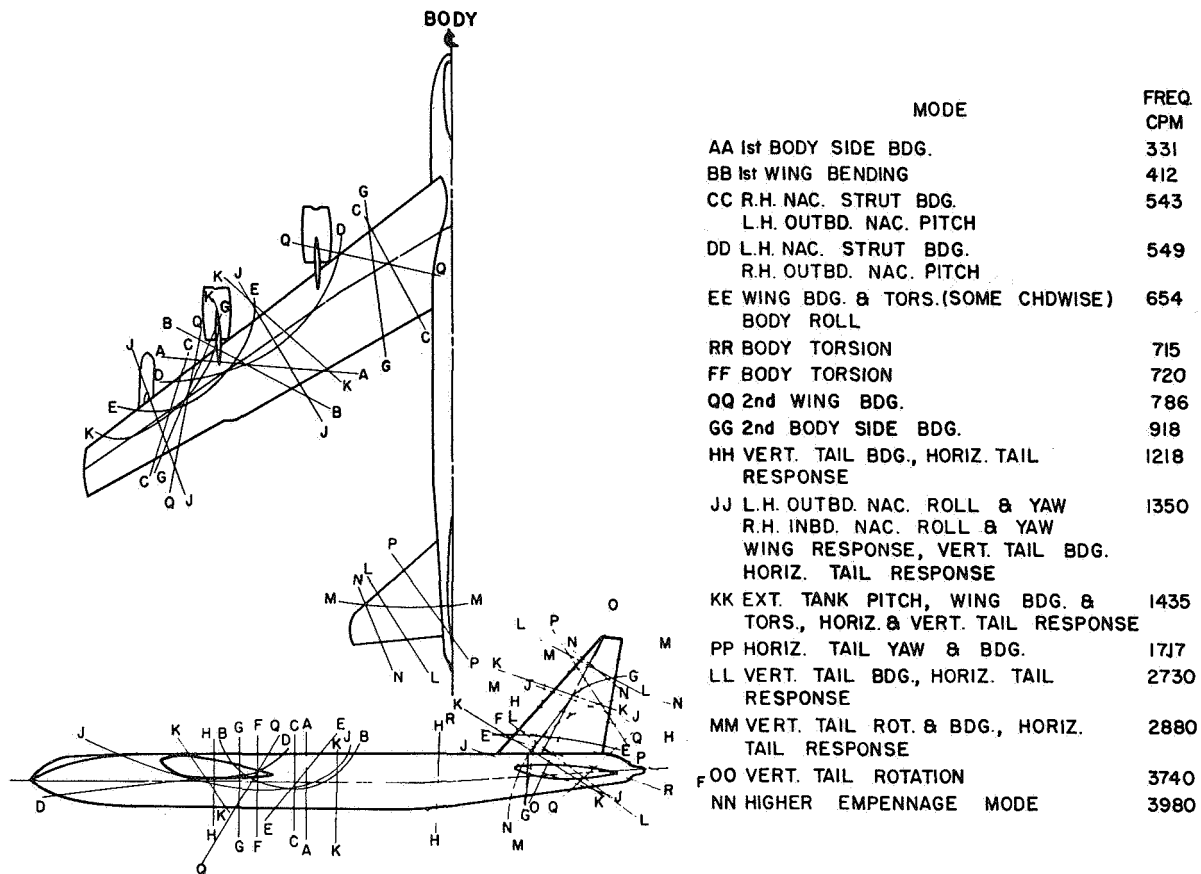

Figure 1. Antisymmetrical Modes and Frequencies - High Gross Weight

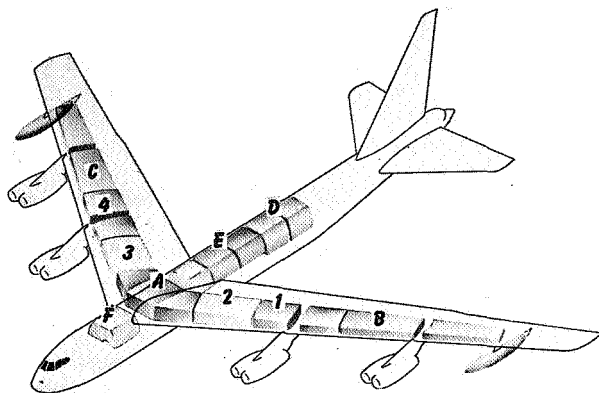

Figure 2. B-52 Fuel Distribution

The general philosophy of flight flutter testing at Boeing is to employ it as a check or confirmation of margins of safety predicted by wind tunnel testing or analysis, and not as an investigative technique. That is, flight test plans call for configurations to be flown only at speeds which have been cleared previously with adequate margins by wind tunnel tests or by analysis.

Excitation of the airplane structural modes is provided by two methods: through control impulse and by an oscillating airfoil shaker located at one wing tip. In the simpler of the two methods, the input pulse from abrupt displacement of the control surfaces is used to excite response in those modes of vibration most easily excited by each control surface, generally the lower frequency modes. Tests are conducted at successive speeds, in increments of 5 to 20 knots, up to limit test speed based on predicted placard or design speed limit as shown in Figure 3. Trend in the rate of decay of the response (damping) with increasing airspeed is used as an indication of approach to flutter in each mode which can be excited by the control pulse. A telemetered record of response to an elevator impulse is shown in Figure 4. Note that the pulse excites two superimposed modes at nearly the same frequency (this is most noticeable on the trace of wing chordwise response). The mode of lower frequency damps out rapidly leaving the higher frequency mode to decay by itself. Figure 5 shows the sampling curve vs airspeed obtained for one mode using control impulse testing techniques.

Generally, a great deal of judgment on the part of the ground crew is involved in analysis of the decay

TEST SPEEDS - FLIGHT FLUTTER YB - 52

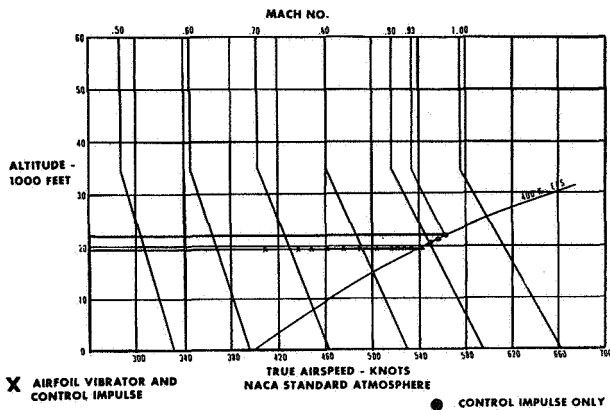

Figure 3. Test Speeds - Flight Flutter YB-52

OVERALL DAMPING (g) VERSUS AIRSPEED - CONTROL IMPULSE TESTING B-52 AIRPLANE

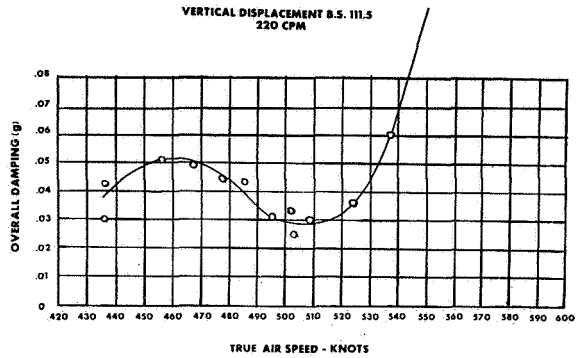

Figure 5. Overall Damping (g) Versus Airspeed - Control Impulse Testing B-52 Airplane

data. Repeatability is only fair, although it tends to improve as damping decreases.

Responses from 29 locations on the airplane, and force input from the wing tip vibrator, are recorded on a Miller Model J oscillograph installed in the airplane. Figure 6 shows the location of pickups on fixed structure and the airfoil force vector. The double headed vectors indicate the measurement of angular motion about the axis of the vector. In addition, there are 7 control surface and tab deflection indicators. The 5 starred locations in Figure 6, plus the vibrator force, are telemetered to the ground station using a Bendix FM TXV-13 transmitter and TGRS receiving station. Flight test time required for each test condition, using this technique, averages about 3 minutes including analysis. However, it has

the disadvantage of being limited in the number of modes which can be excited, generally 2 or 3, and mode separation is not altogether satisfactory.

An alternate method of flight testing employs an electric motor-driven airfoil installed at the right wing tip of the test airplane. The unit which was designed and constructed in the Structural Test Unit at Boeing, has a programmed frequency sweep which covers the range of critical frequencies of the airplane. The sweep from the lower to the upper limit of frequency is accomplished in about 7 minutes. The slow rate of sweep is required in order to allow each structural resonance sufficient time to build up and decay as the vibrator continues through its sweep. A section of Brush record showing typical response to the vibrator sweep is given in Figure 7.

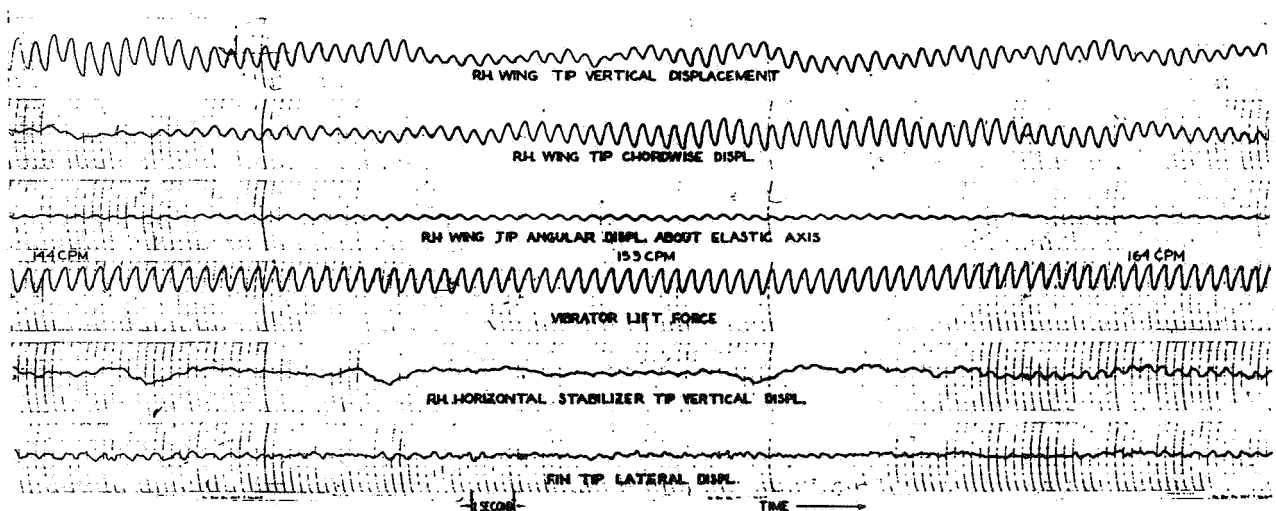

Figure 4. Telemetered Record of Typical Airplane Response to Wing Tip Vibrator Excitation

LOCATION OF PICKUPS AND DIRECTION OF MEASUREMENT

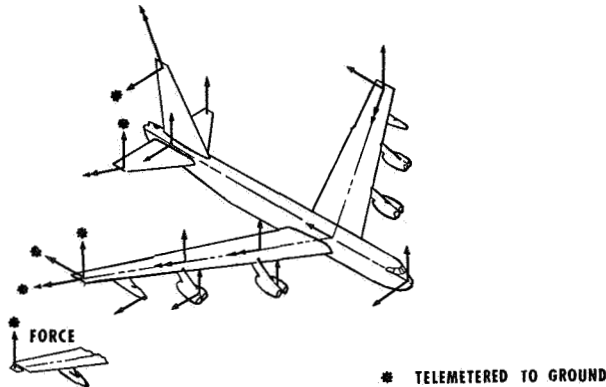

Figure 6. Location of Pickups and Direction of Measurement

Flight test time required for each test condition, which employs both control impulse and vibrator sweep, averages about 15 minutes including analysis.

Initial efforts at providing controlled mechanical vibratory excitation on a B-52 airplane in flight were aimed toward the use of a rotating unbalance vibrator. Such a unit, hydraulically driven, was designed, fabricated and installed in the tail of the YB-52 airplane. Required to provide a reasonably uniform rotating force vector over the frequency range, with good speed control and powerful braking in the event of control failure, the tail vibrator emerged a very complex system which taxed the limit of auxiliary power available on the airplane. Although it provided adequate excitation of wing and body modes, the tail vibrator, because of its overall complexity, failed to perform as reliably as is necessary for flight test work. It was replaced by the more reliable airfoil vibrator unit upon completion of the early phases of B-52 flight flutter testing.

The airfoil vibrator is comprised on an unswept tapered airfoil driven by a 1/2 horsepower DC electric motor. The airfoil has an area of 2 square feet, with a 2-foot span, 16-inch root chord, 8-inch tip chord, and a thickness ratio of 6 percent. The axis of rotation is along the quarter chord, and the airfoil is mass balanced uniformly along the span to maintain the center of gravity slightly forward of the rotational axis. This provides a safeguard against flutter involving the airfoil in the event of a free

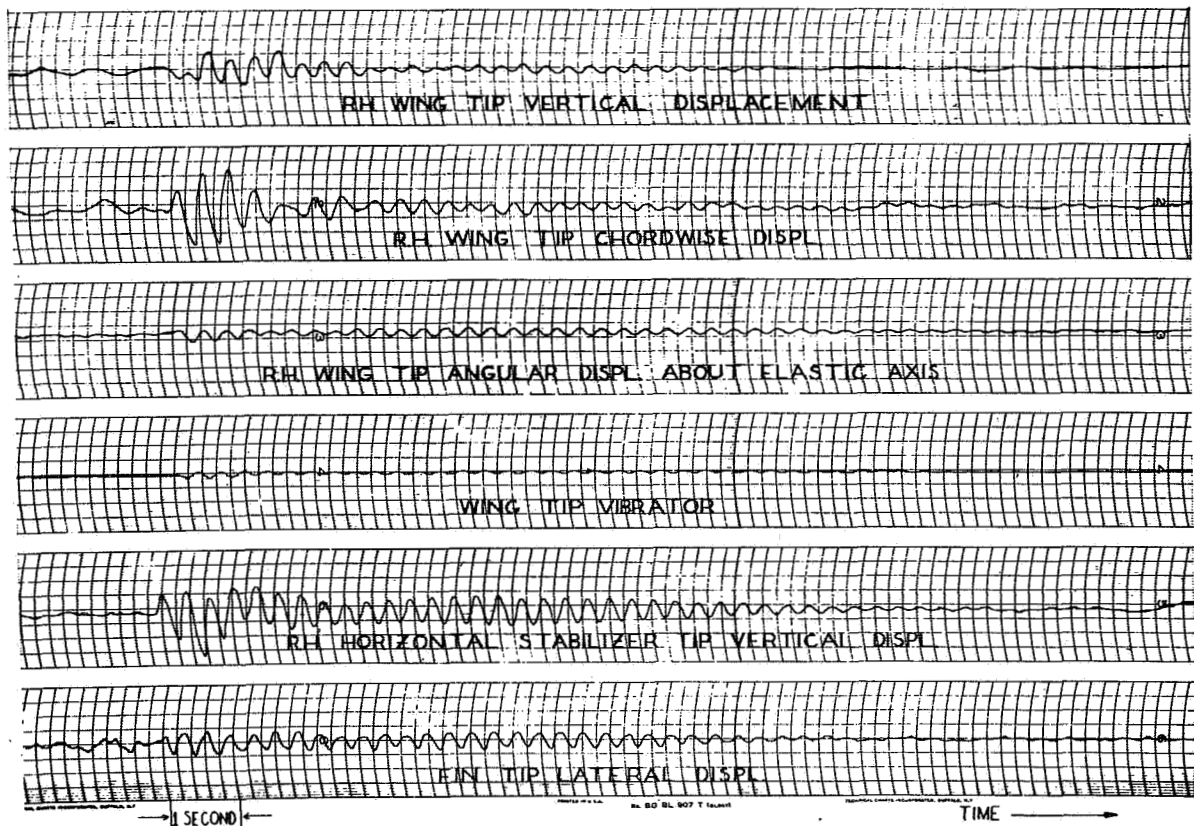

Figure 7. Telemetered Record of Airplane Response to Elevator Impulse

airfoil resulting from failure of the driving system. The oscillatory angle of the airfoil can be varied from 0 to a maximum of ± 4 degrees. The oscillatory frequency can be varied between 85 and 600 cycles per minute. Both the angle of attack and frequency of oscillation can be controlled by the pilot during flight. In addition, the programmed automatic sweep of the frequency range is provided by electronic control of the amplidyne power supply for the electric drive motor. Frequency control during the programmed sweep is within 1/2 percent of the prescribed frequency.

An emergency stop is provided which will halt oscillatory motion of the shaker in less than 1 cycle. This may be used to collect damping data from decay of the shaker-induced structural oscillation.

The weight of the entire unit at the wing tip is approximately 150 pounds. The vibrator weight is counterbalanced by an equivalent weight at the opposite wing tip to maintain symmetry of weight distribution of the outboard wing of the test airplane.

Figure 8 shows the airfoil installed at the wing tip of the B-52 airplane.

The entire drive unit (motor, gear box, support, etc.) is housed in the wing tip fairing.

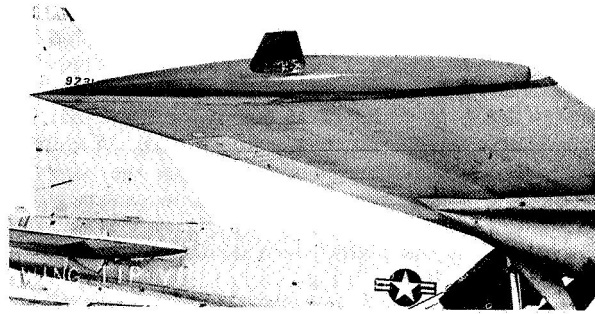

Figure 8. Wing Tip Vibrator - YB-52

When the vibrator is used, force to produce unit response is plotted against airspeed since this ratio tends toward zero as damping of a mode decreases. More modes of vibration are excited through use of the airfoil vibrator than with the pulse technique (roughly 8 or 9 compared with 2 or 3) and frequency separation is highly superior. Figure 9 shows plots of force/displacement amplitude versus speed for 6 of the modes which were excited by the vibrator during testing of one B-52 configuration.

RESPONSE DATA USING WING TIP VIBRATOR B-52 AIRPLANE

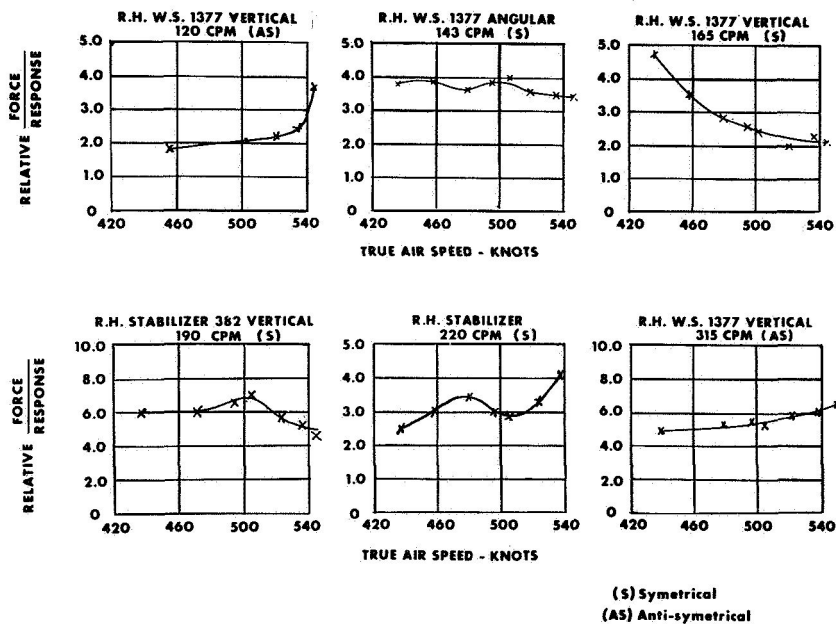

Figure 9. Response Data Using Wing Tip Vibrator B-52 Airplane

During level flight test conditions, both methods of excitation are employed at each test speed, and the plots of damping and response to vibrator input are made concurrently. Flight flutter tests in level flight are conducted up to level flight maximum speed (400 knots EAS, $M = .89$ at 19,500 ft for the B-52). Beyond this speed, up to 400 knots EAS, $M = .93$, the tests require diving the airplane and the interval of time available at test conditions is necessarily brief. Therefore, control impulse testing only is employed at these speeds. By the time the level flight high speed is reached, the modes of concern have been identified from the combined shaker and impulse testing, so it is relatively safe at that point to continue on up in speed employing control impulse only.

Because the amplitude of airplane response to pulse and airfoil excitation is quite small (one-half to three-fourths of an inch double amplitude at the wing tip) it is essential that the tests be flown in smooth air. Although flutter tests have been discontinued because of turbulence, it has been a rare occurrence and not a major problem. High speed buffet becomes significant only at the maximum test Mach number, $M = .93$, where strong buffet is encountered.

Results of wind tunnel flutter tests have indicated that variation of outboard internal and/or external wing fuel is more effective in altering flutter characteristics than variation of inboard wing and body fuel. Accordingly, the configurations tested in the flight flutter program involve a more detailed breakdown of fuel in these tanks than in the main wing and body fuel tanks. An illustration of the number of flight flutter test configurations involving combinations of outboard wing internal and external tank loadings is shown in Figure 10.

Twenty-eight configurations were tested on B-52's carrying 3000 gallon external tanks. A some-

FLIGHT FLUTTER TEST CONFIGURATIONS B-52 WITH 3000-GAL. EXTERNAL TANKS

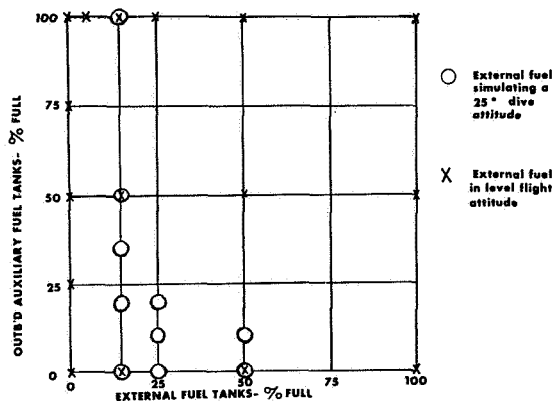

Figure 10. Flight Flutter Test Configurations B-52 with 3000-Gal. External Tanks

what smaller number of configurations were tested on the B-52 with 1000 gallon external tanks and on B-52 airplanes and jet transports without external tanks.

The external tanks carried on B-52 production airplanes contain baffles which prevent significant shift of fore-and-aft center of gravity during transient response conditions. Holes in the baffles allow fuel to flow through slowly thereby permitting a substantial shift in fore-and-aft center of gravity for sustained climb or dive attitudes. The flight speeds associated with sustained climb are limited by power considerations and do not present a critical flutter problem. However, sustained dive attitudes at high speeds are possible, and configurations with external tank fuel distributed forward in the tank are studied in the wind tunnel and checked in the flight test program. The external tanks of the test airplane are divided into 3 compartments, and each compartment is loaded with the proper amount of ballast mixture to represent (in a level flight condition of the flutter test airplane) the weight and cg of external tank fuel in the uncompartimented tank on an airplane in a 25° dive attitude. Figure 11 illustrates this simulation. The ballast is made up of a mixture of water and glycerin (anti-freeze).

3000 GALLON COMPARTMENTED TEST TANK

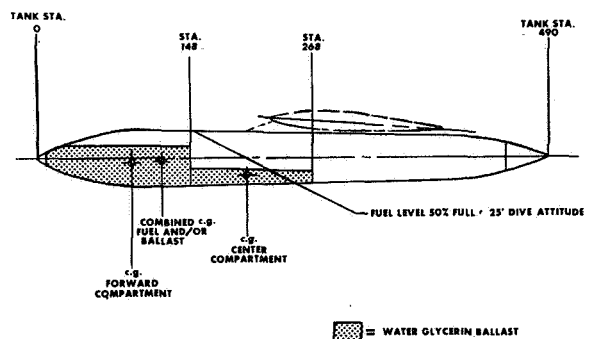

Figure 11. 3000 Gallon Compartmented Test Tank

RESULTS

Before discussing flight test results and comparing with wind tunnel data, some description of the nature of our wind tunnel testing should be presented. The wind tunnel program has been conducted using dynamically scaled models of the complete B-52, 707 and KC-135 basic structure. A flutter model of the B-52 airplane is shown in Figure 12.

Structural stiffnesses of the wing, fuselage, nacelle strut and empennage structure are repre-

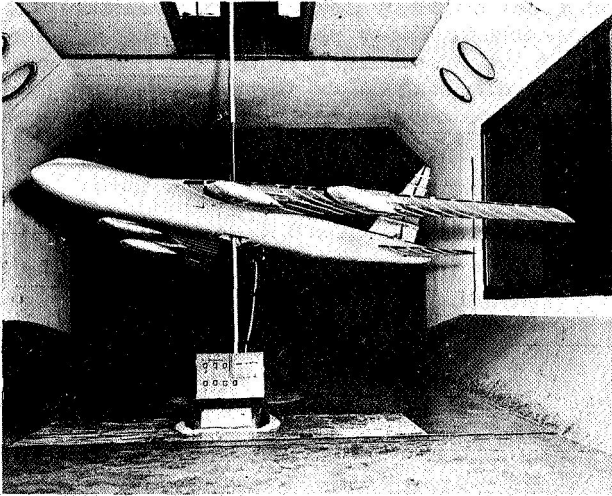

Figure 12. Flutter Model of the B-52 Airplane

sented by single dural spars which are covered by slotted balsa sections forming the geometric external contour of the model. The flutter model tests have been conducted in low-speed wind tunnels, with maximum test speeds being in the neighborhood of 200 miles per hour. The model is flown in the wind tunnel on the rod-trunnion arrangement shown in Figure 12, gradually increasing tunnel velocity until flutter occurs in the most critical mode. Measurements of damping of the various modes present in the model below the critical flutter speeds are not obtained. Wind tunnel turbulence provides generous excitation of the model, so that flutter occurs once the critical speed is reached.

Because the procedure used up to the present in conducting wind tunnel flutter tests at Boeing differs from that employed in flight flutter tests, it is not possible to obtain a direct comparison of wind tunnel model and airplane flutter characteristics in the stable area below the critical flight speed. As stated previously, the policy at Boeing has been to avoid flying into a region of known or suspected flutter. As a consequence, our experience has been primarily one of negative agreement; that is, the wind tunnel results predict freedom from flutter up to a specified limit, and the flight flutter tests provide confirmation.

Actually, during the early B-52 flight flutter testing, correlation with previous wind tunnel test results could be classified as no better than fair. Although no flutter incidents occurred, the mode of the airplane which exhibited lowest damping during the flight test program had not fluttered nor indicate low damping during the wind tunnel testing of comparable configurations. The mode involved was a symmetrical higher order mode of the wing coupled with body vertical bending. There was an appreciable chordwise component of wing motion. The frequency was approximately 160 cpm. Finally, indication of deterior-

ation of damping in this mode was experienced at maximum true airspeed during testing of configurations carrying empty external tanks with a capacity of 3000 gallons. Wind tunnel tests had indicated adequate flutter margins for these configurations.

A detailed reanalysis was made of structural representation of the airplane on the part of the elastic model. A carefully controlled stiffness test of the airplane nacelle strut and local wing attachment structure revealed that the flutter model was considerably out of scale in this parameter. Correction of this deficiency resulted in good correlation between model and airplane data where airplane configurations had been flown near enough to flutter to permit a reliable extrapolated prediction of the critical speed, Figure 13.

COMPARISON OF WIND TUNNEL AND FLIGHT FLUTTER RESULTS

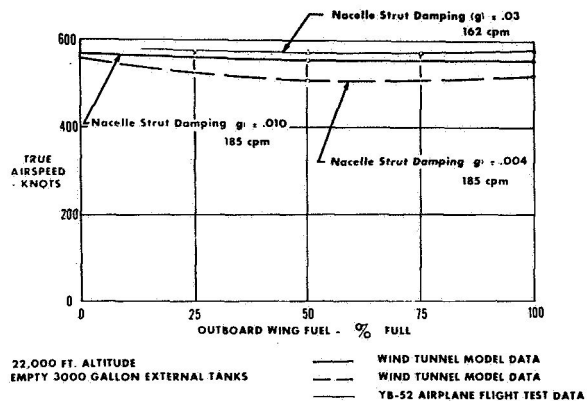

Figure 13. Comparison of Wing Tunnel and Flight Flutter Results

The figure shown is for configurations flown with various amounts of fuel in the outboard wing and with empty 3000 gallon external tanks. Similar correlation exists for B-52 configurations carrying empty 1000 gallon external tanks.

It is noteworthy, in considering the application of these flight test techniques to the B-52, 707 and KC-135 flight flutter programs, that wind tunnel tests had shown that potential flutter modes are of the "non-explosive" type. That is, evidence of a flutter condition (reduced damping trend) appears on the model at speeds appreciably below the critical speed. Furthermore, because of the low frequencies associated with the basic structure of these airplanes and the large masses involved, the rate of divergence of the flutter oscillations against time is low.

In summary, flight flutter tests have been conducted on B-52, 707 and KC-135, airplanes totalling approximately 250 hours of flight time. The airfoil

vibrator has been used successfully on about 25 flights of the KC-135 airplane and 85 flights of B-52 airplanes. Almost 450 sweeps have been conducted during the flutter testing of these airplanes using the airfoil vibrator.

The flight flutter techniques employed provide adequate safeguard against catastrophic flutter of the

airplanes on which they are used. Aircraft with characteristic flutter problems involving high-frequency, rapidly-divergent flutter will require more refined data analysis and flight test planning; however, the concept of employing an airfoil shaker is believed to be applicable.