

N76-19180

## 8. THE SKYLAB PARASOL

By Jack A. Kinzler\*

### SUMMARY

A need to provide an alternate thermal protection system for the Skylab space station cluster became apparent shortly after launch when severe damage occurred to the Orbital Workshop as it passed through the period of maximum dynamic pressure. Data indicated that the combination micrometeoroid and thermal shield on the sun-facing side of the vehicle had been destroyed. NASA management urgently requested all Centers and aerospace contractors to come forward with proposals for restoring Skylab to a habitable and operational mode as soon as possible. This paper discusses the simultaneous design, fabrication, and test of the Skylab Parasol System which was completed in 6 days of around-the-clock effort after which it was successfully deployed and served its purpose on the Skylab II Mission.

### INTRODUCTION

The urgency of the effort necessary to produce a substitute thermal shield in a few days was based on NASA's concern for both foodstuffs and scientific film stored aboard the spacecraft where cabin temperatures approaching 316 degrees Kelvin (120 degrees Fahrenheit) were rapidly exceeding mission limitations. Consequently, the Skylab II crew launch was deferred approximately 10 days to permit the agency to consider various repair options and select the best candidate.

Numerous thermal shield concepts were advanced, some requiring extravehicular activity deployment, while others were deployable from inside the Orbital Workshop. The Skylab Parasol design was selected as the primary sunshade device based on simplicity of design, ability to fabricate quickly, and early demonstration of a working prototype which featured semiautomatic deployment from within the workshop under shirt-sleeve environment conditions.

The outstanding contributions to the parasol design, fabrication, and test given by Johnson Space Center directors, engineers, and technicians are gratefully acknowledged. Their combined efforts made the Skylab Parasol possible.

### DESIGN REQUIREMENTS

The Skylab Parasol was designed to meet the following requirements: (1) provide a 6.7- by 7.3-meter (22- by 24-feet) canopy over the Orbital Workshop, (2) deploy from cabin in shirt-sleeve environment, (3) have 177.9-newton

---

\*NASA Lyndon B. Johnson Space Center, Houston, Texas

(40-pound) push limit for ease of crew operation, (4) have jettison capability, (5) have container size limit of 30 by 30 by 152 centimeters (12 by 12 by 60 inches), (6) have maximum weight limit of 45 kilograms (100 pounds), (7) use readily available, proven materials, (8) simplify fabrication, and (9) use existing flight qualified hardware wherever possible.

#### SYSTEM DESCRIPTION

The design philosophy is best demonstrated by examining the overall mechanism and some of its detail parts. Figure 1 shows the packed parasol. An existing T027 photometer experiment canister was used as a container. This choice was based on appropriate size and the fact that an interface with the solar scientific airlock existed in the proximity of the unprotected portion of the Orbital Workshop. A modified inboard backplate utilized an existing seal design which permitted use of extension rods of the same basic design as those qualified for T027. The existing photometer ejection rod was also included to provide the capability to jettison. A teflon liner and a set of retractable exit flaps were added to the canister interior to protect the canopy material during extension. Major components of the parasol, other than the modified canister, were a 6.7- by 7.3-meter (22- by 24-foot) aluminized mylar/nylon laminate canopy that was essentially opaque to solar thermal energy, a canopy mast; a mast hub with four sets of deployment springs; four telescoping deployment tubes; seven extension rods; and the T027 canister support tripod. The combined stowage weight of the parasol, extension rods, and the container was 35.2 kilograms (77.5 pounds).

#### DEPLOYMENT

The following deployment sequence was used. Each step is referenced to steps of Figure 2.

1. Upon transfer from the Command Module to the Orbital Workshop, the parasol canister was attached to the scientific airlock port on the sun-facing side of the Orbital Workshop. Step A.
2. After appropriate venting, the scientific airlock port door was opened. Extension rods and a push knob were threaded on the mast in sequence, one at a time, as the parasol was extended gradually in the folded condition to a distance of 4.9 meters (16 feet). Release knobs attached to the tip ends (stowed inboard) of the telescoping tubes retained the telescoping tube assembly until full extension and latching had occurred. Step B.
3. At this point the crew released the telescoping tube array to permit further deployment out of the canister. A distance-calibrated final extension rod was installed, after which the canopy and telescoping tube deployment array were pushed to a position 6.4 meters (21 feet) beyond the outer surface of the Orbital Workshop where automatic deployment began via the deployment springs. Step C.

4. After completion of the automatic deployment sequence, the crew verified the deployment condition via an observer in the Command Module. Step D.

5. Upon full deployment, the crew returned the parasol to a position 20.3 centimeters (8 inches) above the Orbital Workshop's outer skin by reversing the extension rod deployment procedure. Using the rod clamp and orientation knob, the deployed parasol was repositioned by the crew to obtain optimum thermal protection and locked in place for the balance of the mission. Step E.

The actual deployment was deliberately done very carefully and slowly and took about 2 hours. Consequently, the parasol was extended out but not deployed while on the dark side of the orbit. The resulting cold condition prevented the immediate and complete deployment or flattening of the parasol fabric. However, as the spacecraft returned to the sun side, the material warmed up sufficiently to permit proper flattening out. Oscillation of the extension rods by the crew aided the final positioning process.

The Orbital Workshop external skin temperature of 364 degrees Kelvin (195 degrees Fahrenheit) dropped to 308 degrees Kelvin (95 degrees Fahrenheit) within 12 hours after parasol deployment. The internal cabin temperature of 316 degrees Kelvin (120 degrees Fahrenheit) dropped below 311 degrees Kelvin (100 degrees Fahrenheit) within a day and stabilized after 6 days at 297 degrees Kelvin (75 degrees Fahrenheit).

## DESIGN DETAILS

### Telescoping Tubes

The initial parasol demonstration model utilized easily obtainable, tapered, telescoping, friction-lock, fiberglass, fishing rods as a medium to deploy and support the canopy. Although considered a possible candidate for the flight article, a more substantial equivalent was produced by using stock readily available, 6061-T6 aluminum tubing, modified to produce the tube joint design depicted in Figure 3.

In order to compensate for the excess clearance between outside diameter and inside diameter of the standard 0.89-millimeter (0.035-inch) wall aluminum tubing series, a pair of convolutions was rolled into each tube's inside diameter which reduced the nominal stock clearance from 1.27 millimeters to 0.25 millimeter (0.050 to 0.010 inch) for a close sliding fit. This modification also provided a positive stop surface which interfaced at deployment with a similar convolution on the outside diameter of the mating tube.

An integral stop tang on the tubing is another major feature of this design. A pair of precision machined U-shaped slots was cut 180 degrees apart near the outboard end of each telescoping tube section, after which the resulting tangs were bent inward to form leaf-spring-like detents. It was necessary to machine a perpendicular surface on the previously rolled tube convolution to complete the positive stop mechanism. Minimal material thickness and uniformity of fit required special jigs for fabricating and verifying the operation of

the latch mechanism. Using mandrels, a conventional tube beading machine and a modified hand-flaring tool with appropriately radiused rollers, Johnson Space Center shop technicians perfected this detail as actual manufacturing was underway. All exterior tube surfaces were anodized and all interior surfaces were alodined to minimize galling and improve corrosion resistance.

#### Masthead Deployment Mechanism

The masthead deployment mechanism consists of a two-piece masthead and four sets of matched torsion springs (Fig. 4) mounted in a manner to guide as well as rotate the telescoping tube arrays through a 90-degree arc during canopy deployment. Due to the necessary offset location of the deployed canopy, versus the fixed location of the scientific airlock port in the Orbital Workshop, the deployment hub design required an asymmetric layout of the torsion spring sockets in conjunction with offset rigging of the canopy to achieve the desired results.

The initial demonstration masthead deployment system utilized four conventional, closely wound, extension springs with one end nested in each of the base telescoping tubes and the other clamped in counter-bores in the original hub. Although this design worked satisfactorily as a combination pivot and rotating force, it was superseded by the twin torsion type springs which was a stronger spring with better directional control. A pair of torsion springs made of 3.175-millimeter (1/8-inch) diameter music wire provided sufficient torque, 33.9 newton-meters (300 inch-pounds), to rotate the extended telescoping tube and canopy assembly through 90 degrees of rotation under zero-g conditions. Because the parasol components would be weightless when deployed in space, very low torsional force was considered necessary, while excessive torsional force was considered dangerous in that too rapid a deployment sequence might endanger other elements of the parasol system installation.

The two-piece masthead design featured a compact arrangement for terminating all eight springs in a small diameter hub, yet provided sufficient spacing width for stability. A combination of radiused grooves in the masthead collar, terminating in the opposed 90-degree blind drilled holes, permitted the torsion springs to overlap one another without affecting their function. A similarly designed split plug bushing was machined to fit the inside diameter of the telescoping tube to form a positive anchor for the other end of the torsion springs.

#### Canopy

The expediency of the parasol development effort dictated the selection of a fabric available at Johnson Space Center. The material chosen was a laminate of orange, 0.063-millimeter (0.0025-inch), rip-stop nylon bonded to 0.013-millimeter (0.0005-inch), aluminized Mylar (Fig. 5). Fabrication consisted of sewing adjacent 91.44-centimeter (36-inch) wide panels together, after which a hem around the periphery was reinforced with 2.54-centimeter (1-inch) nylon tape. A polybenzimidazole (PBI) line was sewn into the hem and provided a means of attaching the canopy in an offset manner to the ends of the telescoping deployment tubes.

0

The canopy was installed on the sun-facing side of the tubular deployment mechanism with the nylon side toward the sun. The basic nylon/Mylar material has an absorptivity/emissivity ratio ( $\alpha/\epsilon$ ) of 0.47 and the vapor-deposited aluminized side an emissivity ( $\epsilon$ ) of 0.04.

#### DEVELOPMENT AND ACCEPTANCE TESTING

Determination of the type and scope of development and acceptance testing necessary to qualify the parasol for flight evolved quickly as the design details became known to members of the Johnson Space Center's test evaluation team. A command post was established on the floor of Johnson Space Center's central fabrication shop where all design, fabrication, and test requirements were coordinated around the clock over the 6-day period. This expedited arrangement resulted in completion of a data package containing a full drawing set, written assembly and test procedures, along with fully documented quality control coverage. The test program that evolved was aimed at providing sufficient tests to demonstrate the flight readiness of the parasol assembly. Test time was extremely limited and contingent upon hardware availability. Selected examples of a few of the materials, subsystems, and assembly verification tests that were performed are described as follows.

#### Telescoping Joint Tensile Tests

The objective of this test was to determine the tensile strength of the smallest diameter telescoping tube-joint of the telescoping tube assembly. An Instron tensile test device was used. The test specimen was a prototype joint fabricated from 9.53-millimeter and 12.7-millimeter (3/8-inch and 1/2-inch) diameter 6061-T6 aluminum tubing. Failure occurred at a load of 213.19 kilograms (470 pounds). At that point the inner tube pulled past the first boss of the telescoping joint. A load of 140.61 kilograms (310 pounds) was required to pull past the second boss and separate the tubing sections. The test indicated that the tube sections could not be pulled apart by a crew-generated force.

#### Deployment Development Tests

A series of successive deployment tests was performed in the high bay area of Johnson Space Center's central shops. The objective of this series was to evaluate the deployment characteristics of the spring-hub assembly, the telescoping tube array, the fabric packing configuration, teflon liner performance, and general packing density problems, if any. The setup consisted of an overhead crane, a suspended platform to which the parasol canister was attached, and a protected floor area to receive the deployed test article. To give the astronaut crew some firsthand experience, it was arranged for backup crewman, Bill Lenoir, to perform the deployment procedure while Jack Lousma and Owen Garriott acted as observers. Figure 6A shows deployment from the packed canister using extension rods under one-g conditions. The first test demonstrated the adequacy of the overall concept while causing some doubt about telescopic tube

latch-up. After deployment, the individual telescope tube lock tabs were inspected carefully and found to vary slightly in degree of built-in spring detent. The controlled adjustment of the lock tabs via appropriate tooling fixtures would alleviate the variance caused by the previously used hand-bending technique. The follow-on deployment demonstration tests provided additional confidence in the system's operation. Because of gravitational effects on the unequal mass distribution of weight within the canister package and resulting irregular deployment pattern, one test featured an alternate deployment where the parasol was not packed in the canister and was manually released from the platform with all telescoping tubes in the extended and locked position. Figure 6B depicts this deployment.

#### Canopy Material Test

The material selected for the parasol was subjected to a complete program of expedited materials testing ranging from verification of the "as received" mechanical properties to determination of the degradation of properties as a result of combined thermal/vacuum/ultraviolet radiation exposures which simulated on-orbit conditions. Accelerated exposure tests were conducted at Johnson Space Center, Marshall Space Flight Center, and TRW Systems in Redondo Beach, California. Properties measured included solar absorptance, total emittance, breaking strength, elongation, and tear strength. Before and after exposure, scanning electron microscope photomicrographs were taken at various magnifications to 5000x to determine the material surface conditions with respect to the formation of flaking or dust generation which could have generated contamination which would have interfered with Skylab experiments. Tests of out-gassed products were also performed under reduced pressure environments to ensure that the materials generated no potentially toxic products during launch and flight prior to deployment.

While ultraviolet-radiation-induced changes were observed in the materials' properties, in all cases testing verified that adequate integrity could be expected to be retained through the initial use period. Subsequent to deployment, additional ground testing verified acceptability to more than 2000 equivalent sun hours of orbital exposure.

As an additional precaution against possible long-term canopy degradation and to preclude higher internal temperature, an alternate thermal shield carried on the initial mission, a twin-boom sunshade, was deployed over the parasol on the second manned flight. At the conclusion of 9 months' exposure to a combined thermal vacuum/ultraviolet radiation environment, observations made by the crew of Skylab IV during final fly-around inspection indicated the protruding portion of the parasol that had been continuously exposed appeared to be in satisfactory condition.

#### Full Parasol Deployment at Vacuum ( $1 \times 10^{-2}$ )

The objective was to verify the operational readiness of the total parasol assembly under simulated space flight vacuum conditions. This test was conducted

in Chamber A of Johnson Space Center's Space Environment Simulation Facility. The parasol canister mounted to an I-beam structure within the chamber and a cable and pulley arrangement coupled with an appropriate drive motor and load cell system was used to activate the parasol and gather force data. A net was provided at the bottom of the chamber to catch the deployed parasol canopy and telescoping tubes. With a TV monitoring system in place, the cable drive system was actuated gradually and load cell readings were recorded. At 186.83 newtons (42 pounds) applied load, the drive switch was turned off and the load went to 44.48 newtons (10 pounds) indicating the push rod had moved. Each successive application of power again caused movement with extension force dropping to 22.24 newtons (5 pounds). Deployment continued to the point where the unevenly distributed weight of the deployed canopy material caused a significant bend in the telescoping tubes on the long side of the canopy. This condition resulted in the tubes that supported the short side of the canopy being released from the end of the canister last, thus causing a pitch-over toward the long side as the canopy came to rest in the net. This test condition, attributable to the one-g deployment, resulted in additional verification of the strength of the telescopic tubes since no damage was incurred.

#### CONCLUDING REMARKS

The Skylab Parasol is an outstanding example of the inherent advantages of a practical mechanical system design which features ease of fabrication and use of readily available materials. The choice of the parasol as the primary thermal protective device was based on readiness, demonstrated ease of deployment, and proven thermal effectiveness. The highly successful deployment on the Skylab II Mission, accompanied by crew reports on the ease of deployment, verified the operational aspects of the design. The drop in the Orbital Workshop interior temperature from 316 degrees Kelvin (120 degrees Fahrenheit) to 297 degrees Kelvin (75 degrees Fahrenheit) provided a habitable environment in which the flight crew was able to successfully complete its mission (Fig. 7).

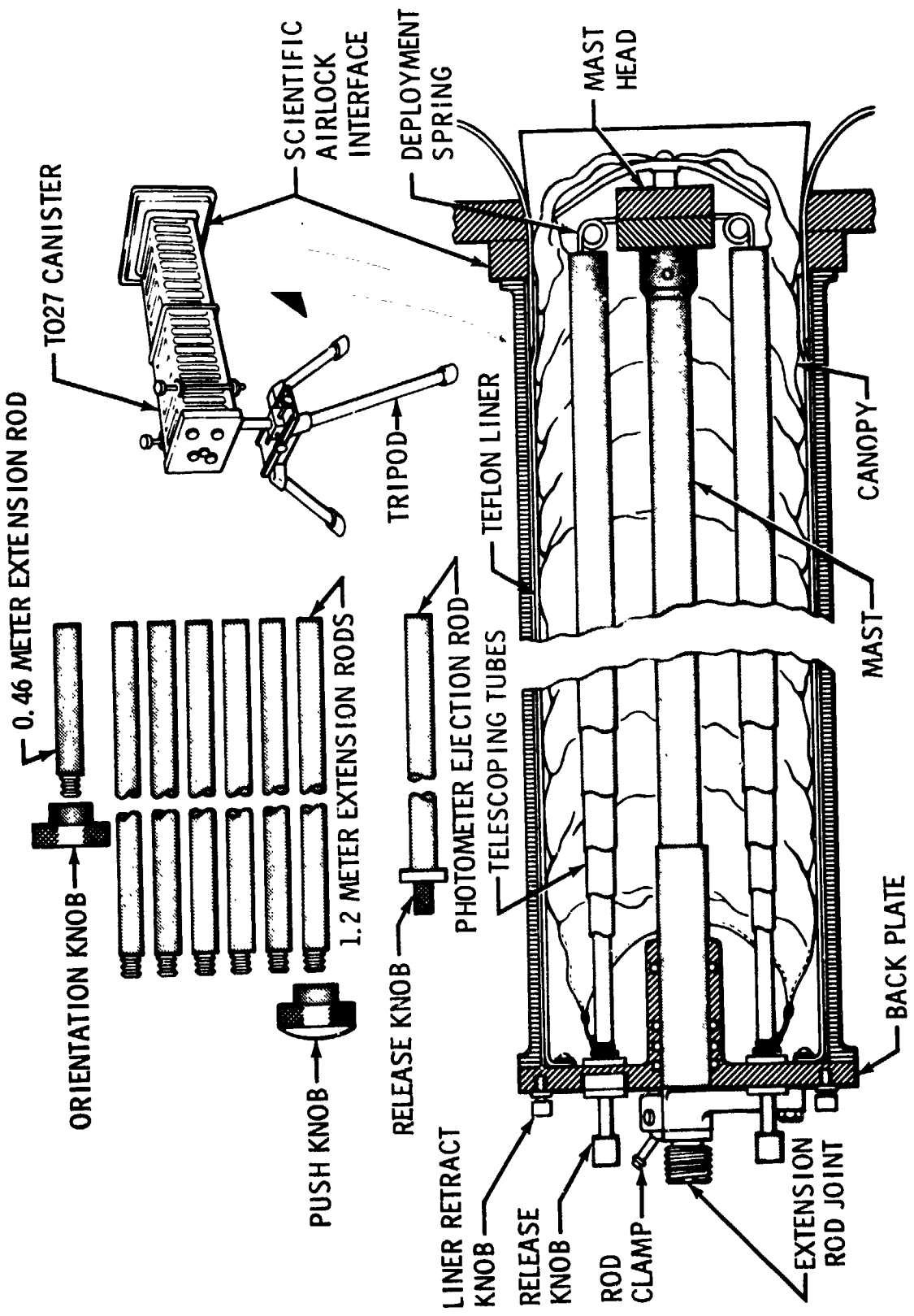

Figure 1. Parasol Packed Configuration



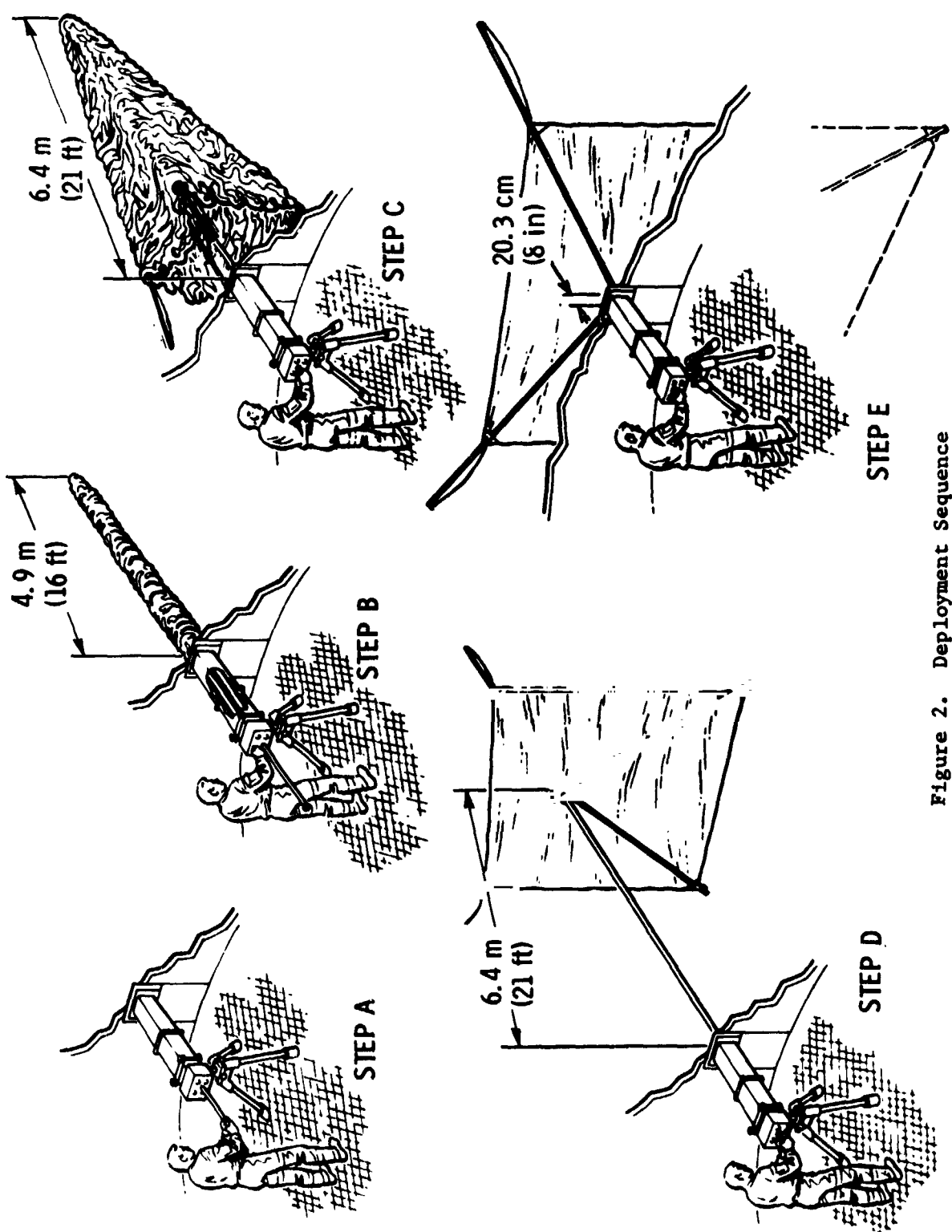

Figure 2. Deployment Sequence

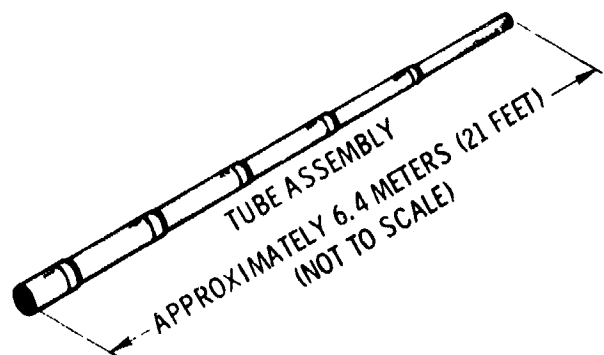
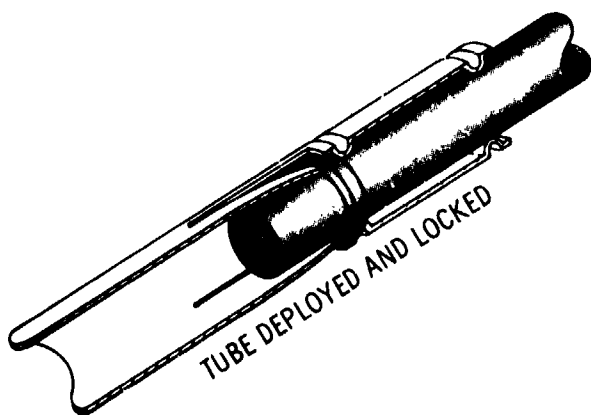
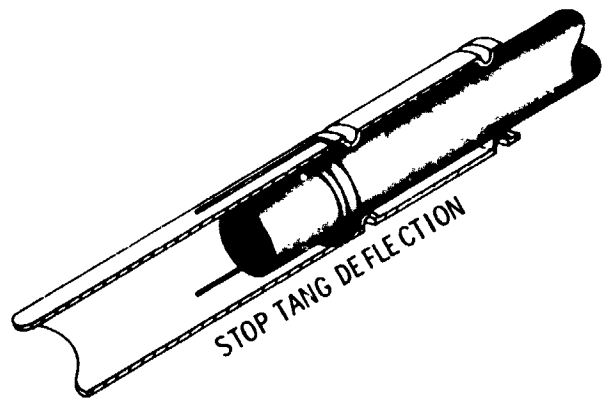
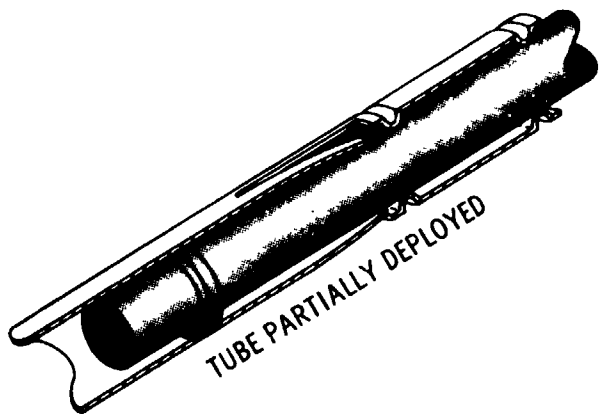

Figure 3. Telescoping Tube Details

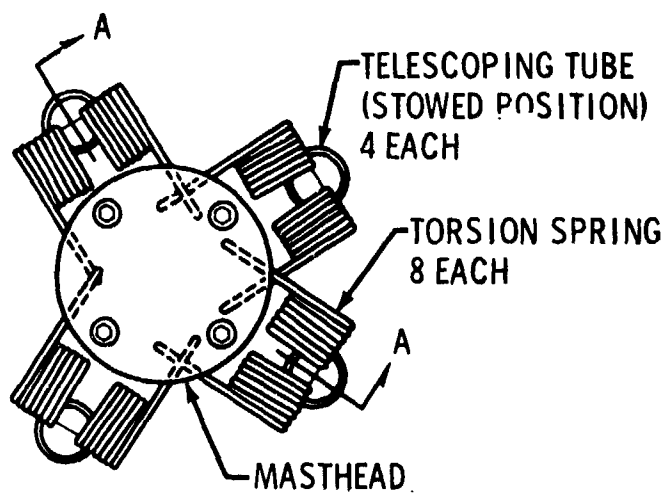
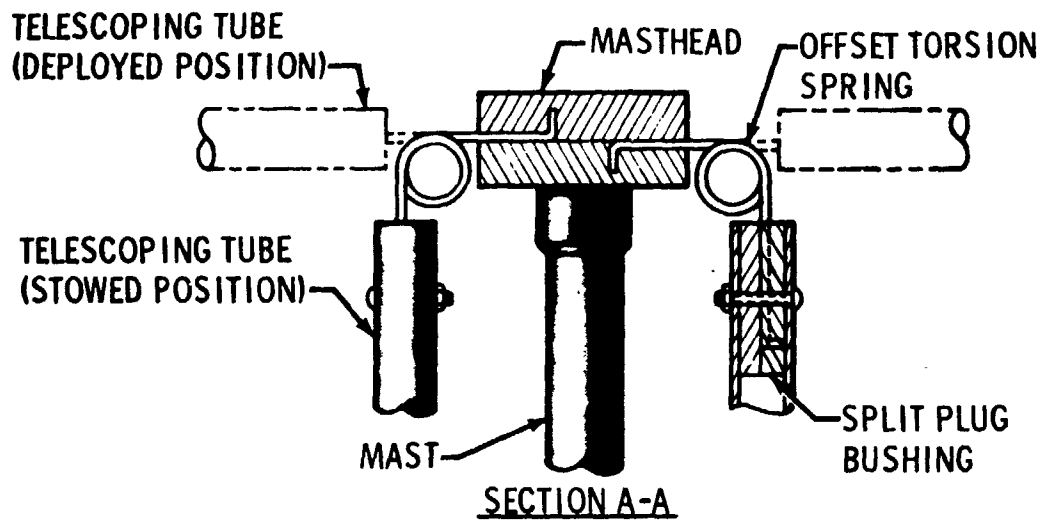

Figure 4. Deployment Mechanism

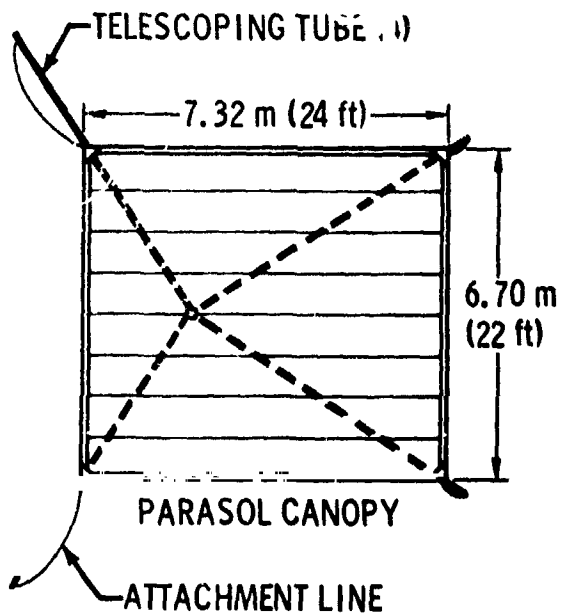
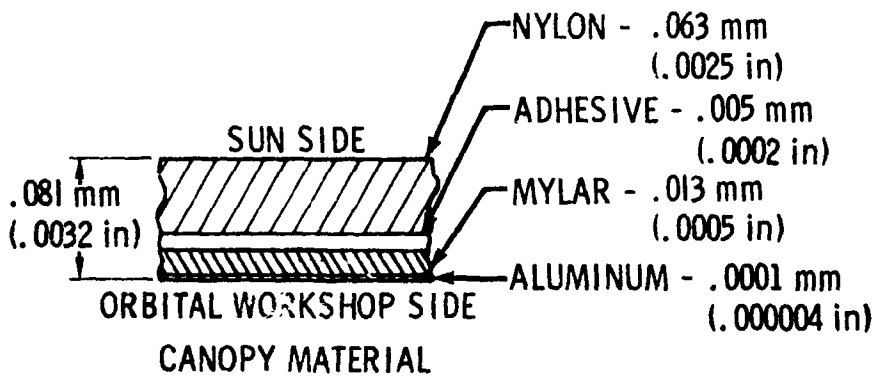

Figure 5. Parasol Canopy Details

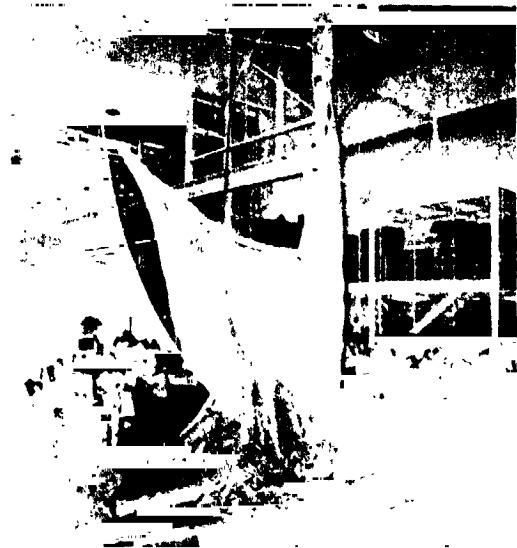
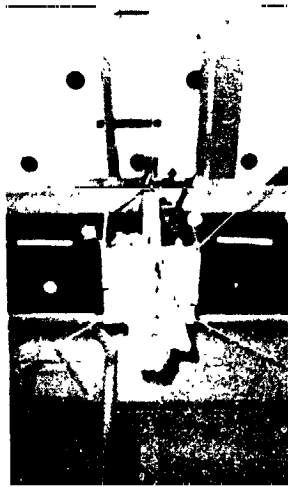

Figure 6A. Deployment of Canopy from Canister

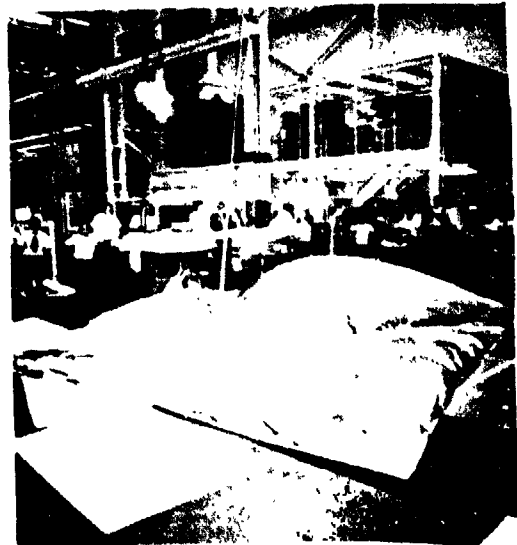

Figure 6B. Manual Release of Extended Canopy

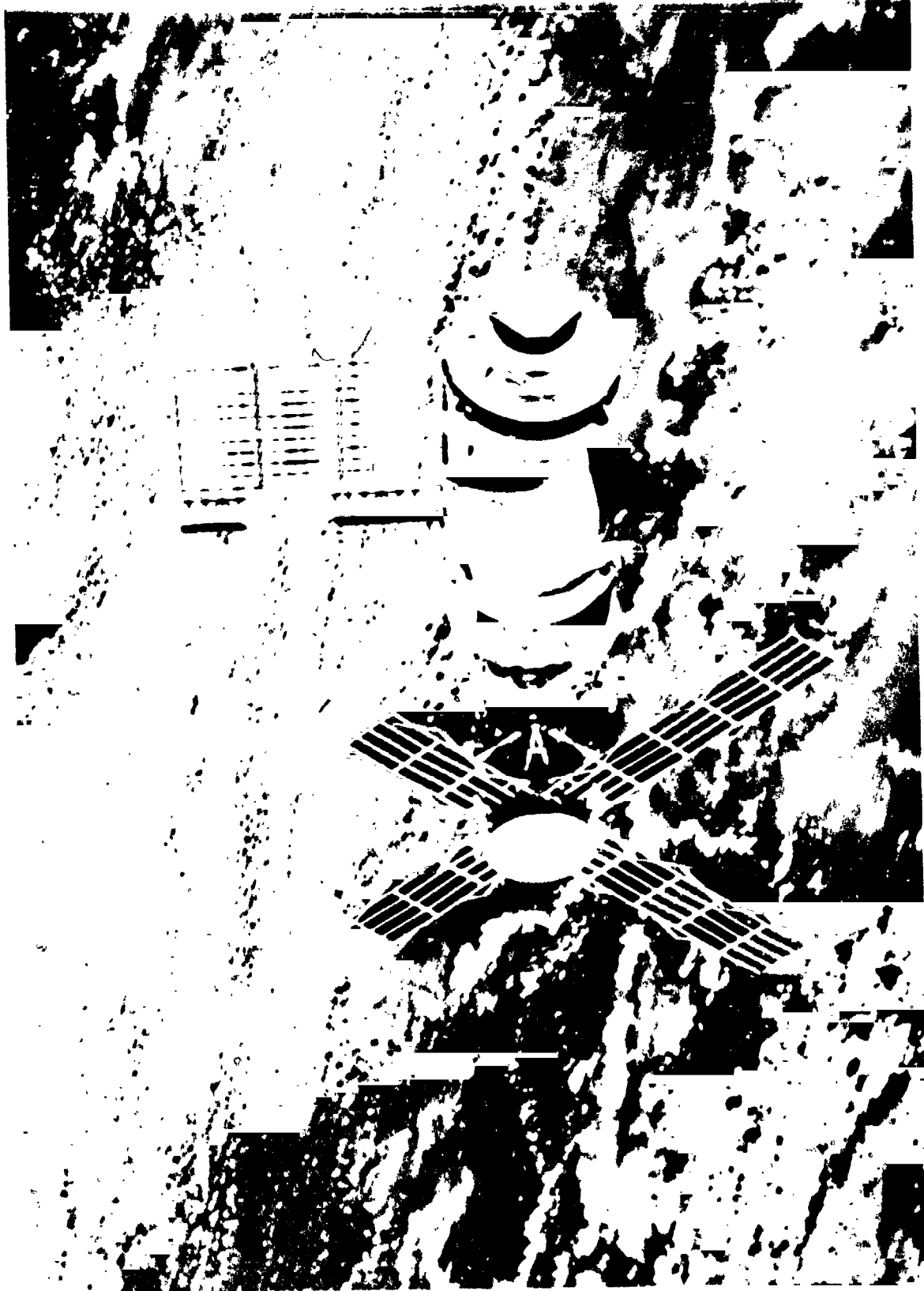

Figure 7. Skylab in Orbit with Parasol Deployed