



CR135170

A Method to Estimate Weight and Dimensions of Aircraft Gas Turbine Engines

Final Report

Volume I: Method of Analysis

(NASA-CR-135170) A METHOD TO ESTIMATE WEIGHT AND DIMENSIONS OF AIRCRAFT GAS TURBINE ENGINES. VOLUME I: METHOD OF ANALYSIS Final Report (Boeing Co., Seattle, Wash.) 50 p HC PC3/ME AC1 CSCL 21E G3/07 N77-25171 Unclass 30427

May 1977

Boeing Military Airplane Development
Seattle, Washington 98124

Prepared for

National Aeronautics and Space Administration

NASA-Lewis Research Center

Contract NAS3-19913

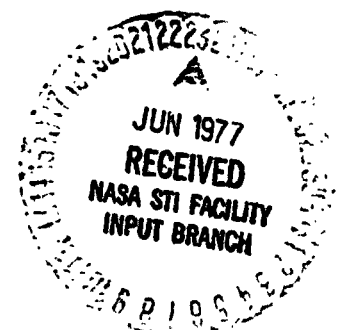

1. Report No. CR135170	2. Government Accession No.	3. Recipient's Catalog No.	
4. Title and Subtitle A Method to Estimate Weight and Dimensions of Aircraft Gas Turbine Engines--Final Report		5. Report Date May 1977	
		6. Performing Organization Code	
7. Author(s) R. J. Pera, E. Onat, G. W. Klees, E. Tjonneland		8. Performing Organization Report No. D6-44258	
9. Performing Organization Name and Address Boeing Military Airplane Development P. O. Box 3707 Seattle, Washington 98124		10. Work Unit No.	
		11. Contract or Grant No. NAS3-19913	
12. Sponsoring Agency Name and Address National Aeronautics & Space Administration Washington, D. C. 20546		13. Type of Report and Period Covered Contractor Report	
		14. Sponsoring Agency Code	
15. Supplementary Notes Final Report (see also NASA CR135171 and CR135172) Program Manager, Laurence Fishbach, Wind Tunnel and Flight Division, Mission Analysis Branch, NASA Lewis Research Center, Cleveland, Ohio			
16. Abstract A computerized method has been developed to estimate weight and envelope dimensions of aircraft gas turbine engine within +5% to 10%. The method is based on correlations of component weight and design features of 29 data base engines. Rotating components are estimated by a preliminary design procedure where blade geometry, operating conditions, material properties, shaft speed, hub-tip ratio, etc., are the primary independent variables used. The development and justification of the method selected, the various methods of analysis, the use of the program, and a description of the input-output data are discussed in this report.			
17. Key Words (Suggested by Author(s)) Engine Weight Weight Analysis Gas Turbines Turbine Engine Aircraft Propulsion Computerized Simulation Prediction Analysis Techniques		18. Distribution Statement Unclassified-Unlimited	
19. Security Classif. (of this report) Unclassified	20. Security Classif. (of this page) Unclassified	21. No. of Pages 50	22. Price*

* For sale by the National Technical Information Service, Springfield, Virginia 22161

NASA C 168 (Rev. 03-77)

A METHOD TO ESTIMATE WEIGHT AND DIMENSIONS OF AIRCRAFT GAS TURBINE ENGINES

By R. J. Pera, E. Onat, G. W. Klees, E. Tjonneland

SUMMARY

A method has been developed to estimate engine weight and major envelope dimensions of aircraft jet engines. The computerized method, called WATE-1 (Weight Analysis of Turbine Engines), determines the weight of each major component in the engine, such as compressors, burners, turbines and frames. A preliminary design approach is used where the stress level, maximum temperature, material, geometry, stage loading, hub-tip ratio, and shaft mechanical overspeed are used to determine the component weight.

A relatively high level of detail was found to be necessary in order to obtain a total engine weight within the required $\pm 10\%$ accuracy. Component weight data for 29 different engines were used as a data base to develop the method. The list of engines included military and commercial, turbofans and turbojets, augmented and dry, hardware engines and proposed engines, and supersonic and subsonic engines. WATE-1 is applicable to all of these engine types as well as to shaft-power engines.

The accuracy of the method is generally better than $\pm 10\%$, on the order of $\pm 5\%$. The accuracy was verified by applying the method to 8 different engines, some of which were in the original data base. Engines used in the validation were selected by NASA after completion of the program.

INTRODUCTION

Aircraft and propulsion system studies are frequently conducted by industry and Government. These studies may encompass a wide variety of engine concepts ranging from relatively simple turbofans and turbojets to complicated variable-cycle engines. The industry in general has acquired an adequate

computer capability to evaluate the thermodynamic performance of these diverse engine concepts, however, an accurate method of estimating engine weight and dimensions has not previously been available. The engine manufacturers have developed suitable methods, however they are not available to the public.

One method that has been available to the general industry predicted engine weight by statistical correlations of major cycle characteristics such as airflow, bypass ratio, overall pressure ratio, etc. This method is probably capable of rough estimates for conventional engines; however, it is not applicable to nonconventional engines and could not predict weight within ± 5 to $\pm 10\%$ as would be required in typical preliminary design studies.

This program development was initiated to provide a more flexible and more accurate method based on correlations of component weight and physical characteristics, such as compressor airflow size, pressure ratio, hub-tip ratio, etc. This type of approach then would be more capable of estimating nonconventional engines, since the weight of each individual component would be accounted for. As shown in the following section on Methods of Analysis, no adequate correlations could be found and a final method was chosen that is based on a mechanical preliminary design which is responsive to the major engine design variables.

LIST OF SYMBOLS

a	acceleration	TR	blade taper ratio
A	area	U	tip speed
AR	blade aspect ratio	V	volume
C	blade chord, or convergent nozzle	W	Weight, or weight flow rate
C-D	convergent-divergent nozzle	τ	shear stress
C/S	solidity	λ	turbine loading parameter
D	diameter	ρ	Density
F	force	ω	Rotational Velocity
g	gravitational constant	σ	Stress
h	height, or specific enthalpy	γ	ratio of specific heats
H/T	hub-tip radius ratio	ϵ	heat exchanger effectiveness
H	Total enthalpy	θ	ratio of local total temp ($^{\circ}$R) to 518.67
HP	high-pressure spool	δ	ratio of local total pressure (psf) to 2116.2
J	778 ft-lb/BTU		
K	factor for blade volume		
L	length	Subscripts:	
LP	low pressure spool	h	hub
M	mass flow, or Mach number	t	tip
N	number of elements	b	blade
P	pressure	c	case, or corrected conditions
PTO	power takeoff	S	stator
R	radius, or gas constant	hw	hardware
RPM	revolutions per minute	Stg	Stage
S	surface area, or blade spacing	O	stagnation conditions
T	temperature	bp	blade pull
t	thickness	2	Engine inlet station

METHOD OF ANALYSIS

A thermodynamic simulation of each engine in the data base, table 1, was made in order to obtain corrected airflows, temperatures, pressures, etc., data on each component. A component weight breakdown was also available for each engine. These computer models contain information that is proprietary to the engine manufacturer, and therefore they are not herein disclosed. These data have been reduced to a nonproprietary form, however, to illustrate the correlation procedure that was used.

Figure 1 shows fan and compressor weight of the data base engines plotted against number of stages. The component weight has been divided by the entry corrected airflow $\left(\frac{w\sqrt{\theta_2}}{\delta_2}\right)$ in order to normalize the size of each compressor. As can be seen, there is a considerable range of scatter in the data that prevents the definition of a characteristic trend. Some components weigh two to three times as much as other components having the same number of stages.

Table 1. Data Base Engines

Engine	Manufacturer	Manufacturing status ¹	Type of cycle ²	Augmentation ³	Primary use ⁴
GE4/J4C	GE	P	TJ	AB	C
GE4/J6	GE	X	TJ	AB	C
GE9/F2B	GE	X	TF	AB	M
JT11F	P&WA	P	TJ	AB	M
TJ70	W.E	S	TJ	AB	C
GE4/J6G	GE	S	TJ	AB	C
GE4/J6M2	GE	S	TJ	-	C
JT8D 15	P&WA	P	TF	-	C
JT9D	P&WA	P	TF	-	C
TF34	GE	P	TF	-	M
VSCÉ 502	P&WA	S	TF	DH	C
VCE 201A	P&WA	S	VCE	-	C
VCE 201B	P&WA	S	VCE	-	C
VCE 302A	P&WA	S	VCE	-	C
VSCÉ 502B	P&WA	S	TF	DH	C
VCE 112B	P&WA	S	VCE	-	C
VSCÉ 501	P&WA	S	TF	DH	C
VCE 110B	P&WA	S	VCE	-	C
A/B TF 2	P&WA	S	TF	AB	C
D/H TF 2	P&WA	S	TF	DH	C
D/H TF 12	P&WA	S	TF	DH	C
JT10D	P&WA	X	TF	-	C
CFM56	GE/SNECMA	P	TF	-	C
CF6 50	GE	P	TF	-	C
CFE	GE	P	TF	-	C
JT8C	P&WA	P	TF	-	C
CJ805 23	GE	P	TF	-	C
YJ93	GE	P	TJ	AB	M
JT3D	P&WA	P	TF	-	C

¹ Manufacturing status: P = production; S = study proposal; X = experimental

² TJ = turbojet; TF = turbofan; VCE = variable cycle engine

³ Augmentation type: AB = afterburner; DH = ductheater

⁴ C = commercial; M = military

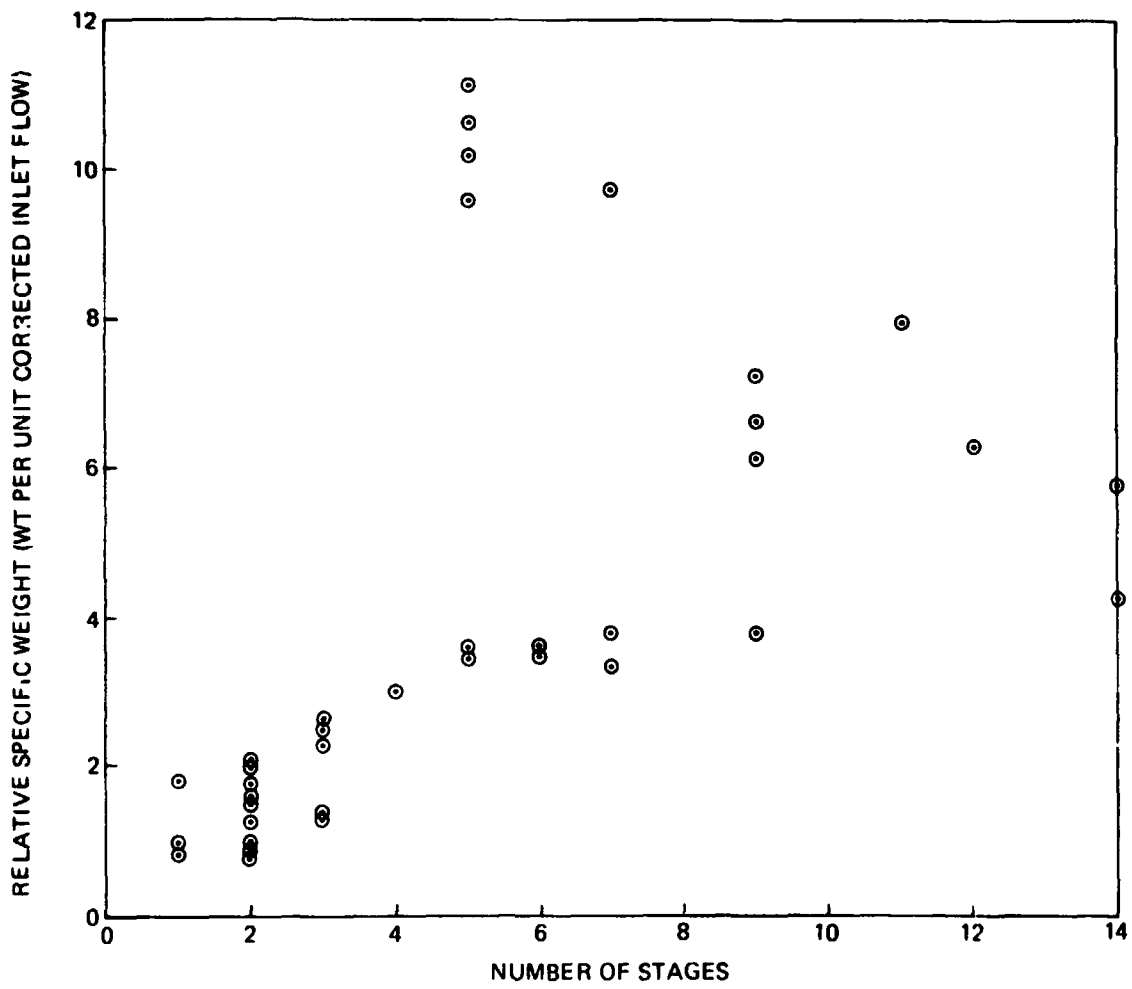

Figure 1. Data Base Engines: Fan and Compressor Specific Weight

Attempts were made to improve this correlation. The data base information was examined to find if there were any mechanical design features (such as H/T, stage loading, etc.) that might account for the large weight difference. It was concluded that there was no single major cause; the weight difference was caused by several different design characteristics such as material properties, blade geometry, stage loading, shaft speed, and design life.

A similar problem occurred for turbines (figure 2), burners and diffusers (figure 3), augmentors (figure 4), and duct heaters (figure 5). Some components, however, did correlate well by this method and these are discussed in the Methods of Analysis section. At this point it was found that the correlation method failed to predict many of the major component weights within the desired accuracy and another method was adopted.

The adopted method was based on a preliminary mechanical design approach where the design variables are taken into account. In the compressor, for example, rotor blade weight is calculated as a function of specified geometric parameters. Blade pull stress is then found, and the disc weight that will support the blade rotational force is determined. This type of preliminary design approach was also used for the other components (figures 2 through 5). These methods are discussed in greater detail in the following section.

The WATE-1 method is intended to estimate weight for a given engine design. It will not design an engine. This function must be performed external to the program. WATE-1 utilizes component state conditions, flow, work, etc., which are generated in the engine cycle portion of the program (NNEP). NNEP operation is described in reference 3.

In normal use of WATE-1, the desired engine cycle is simulated in NNEP at sea level static conditions for the engine design point. The user of WATE-1 must be cognizant of other conditions in the flight envelope of operation where maximum component temperature, work, speed, or flow occur. If these conditions are greater than the design values, they will size the component and will have a significant impact on weight. WATE-1 allows input of scalars to account for these off-design conditions.

The NNEP simulation of the engine may require the use of components that are required mathematically, but are not desired in the engine weight or dimensions. These can be selectively eliminated.

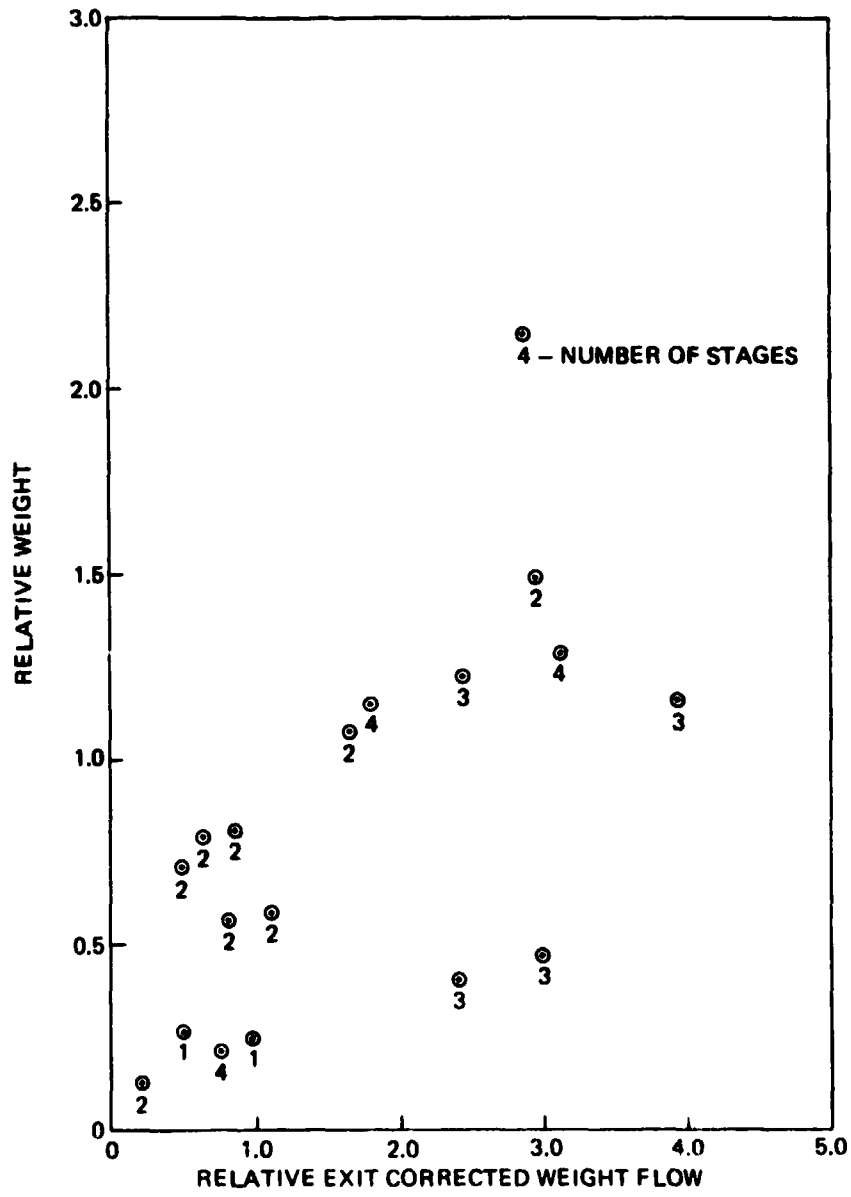

Figure 2. Data Base Engines: Turbine Weight

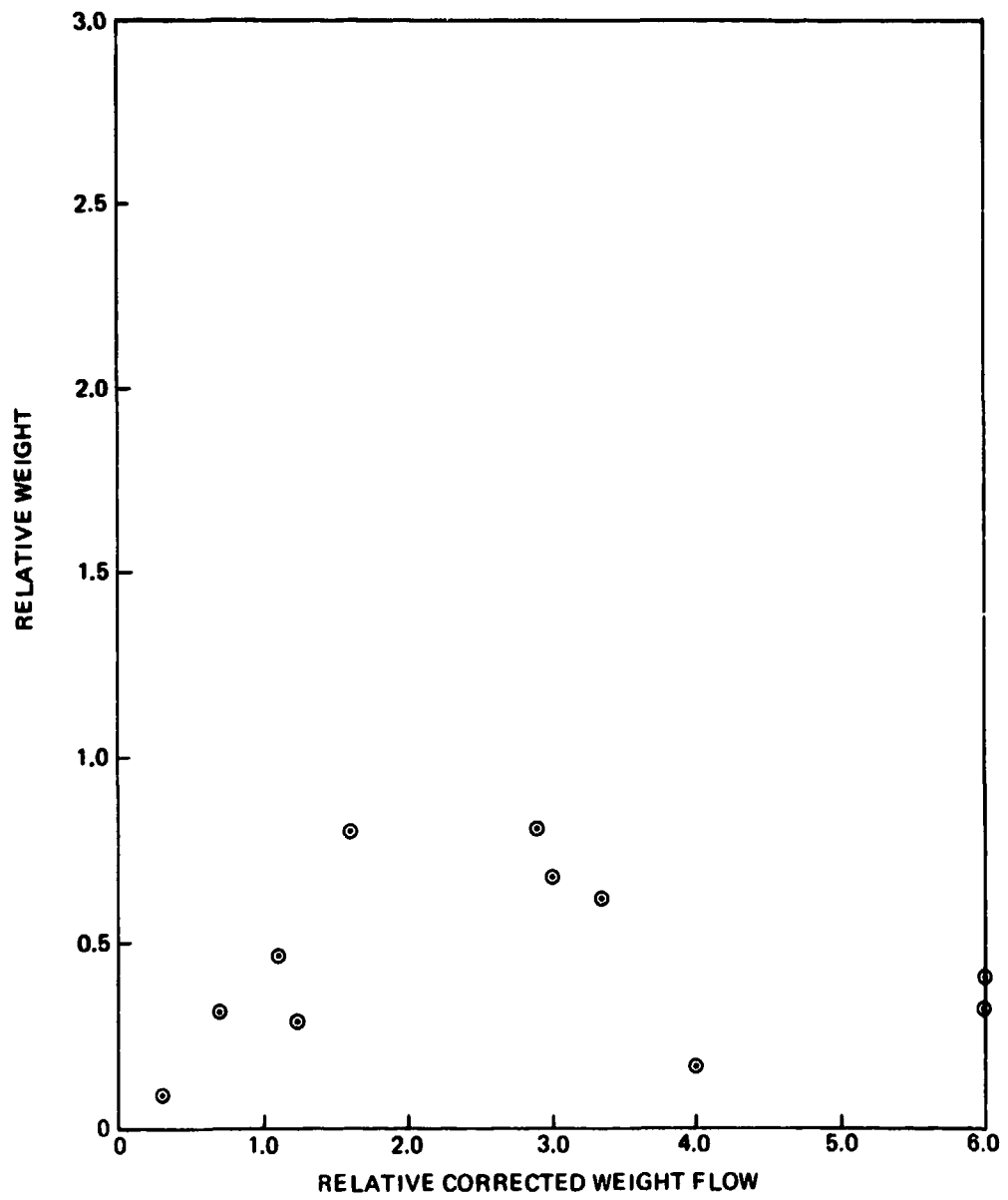

Figure 3. Data Base Engines: Burner and Diffuser Weight

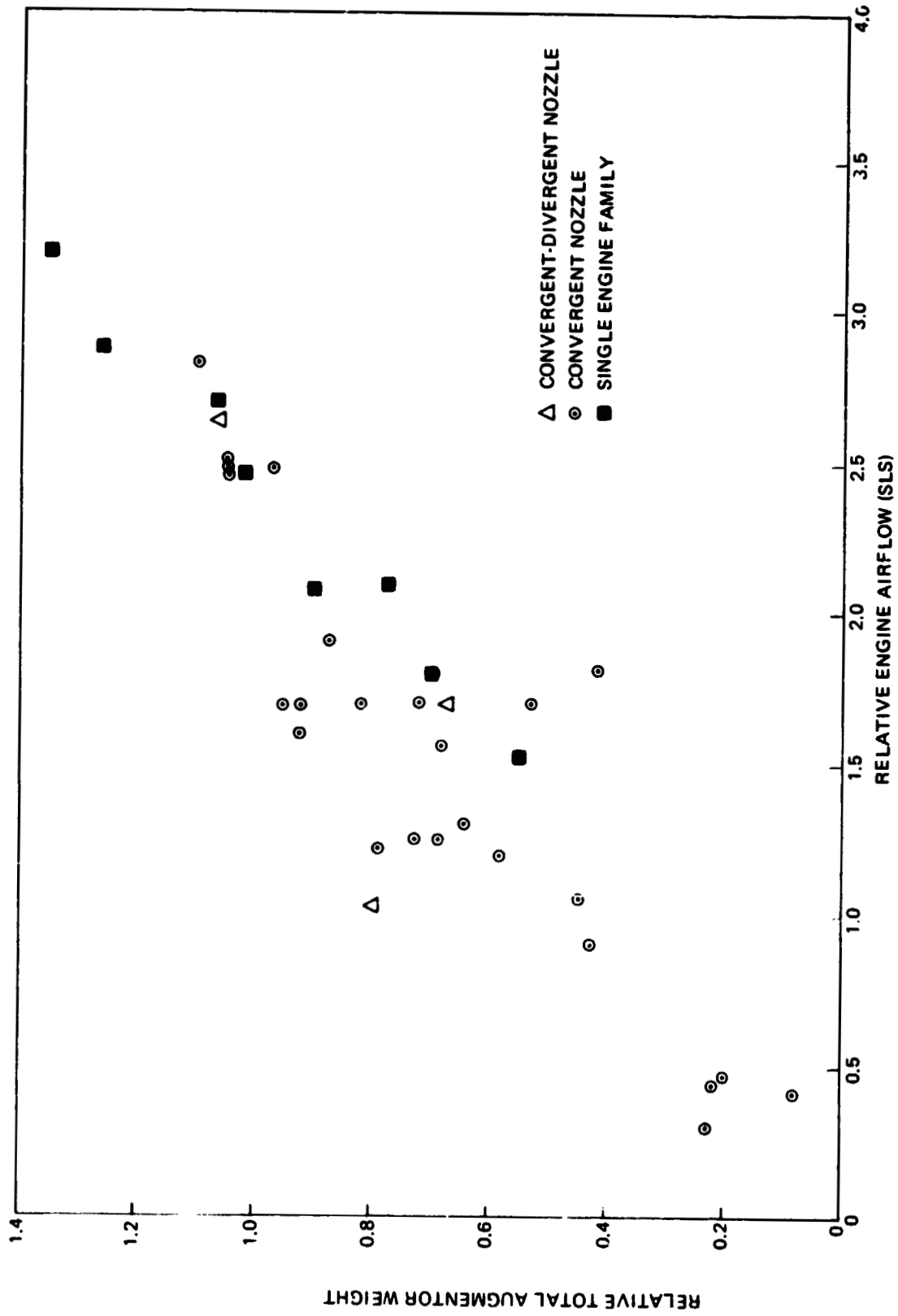

Figure 4. Data Base Engines: Augmentor Weight

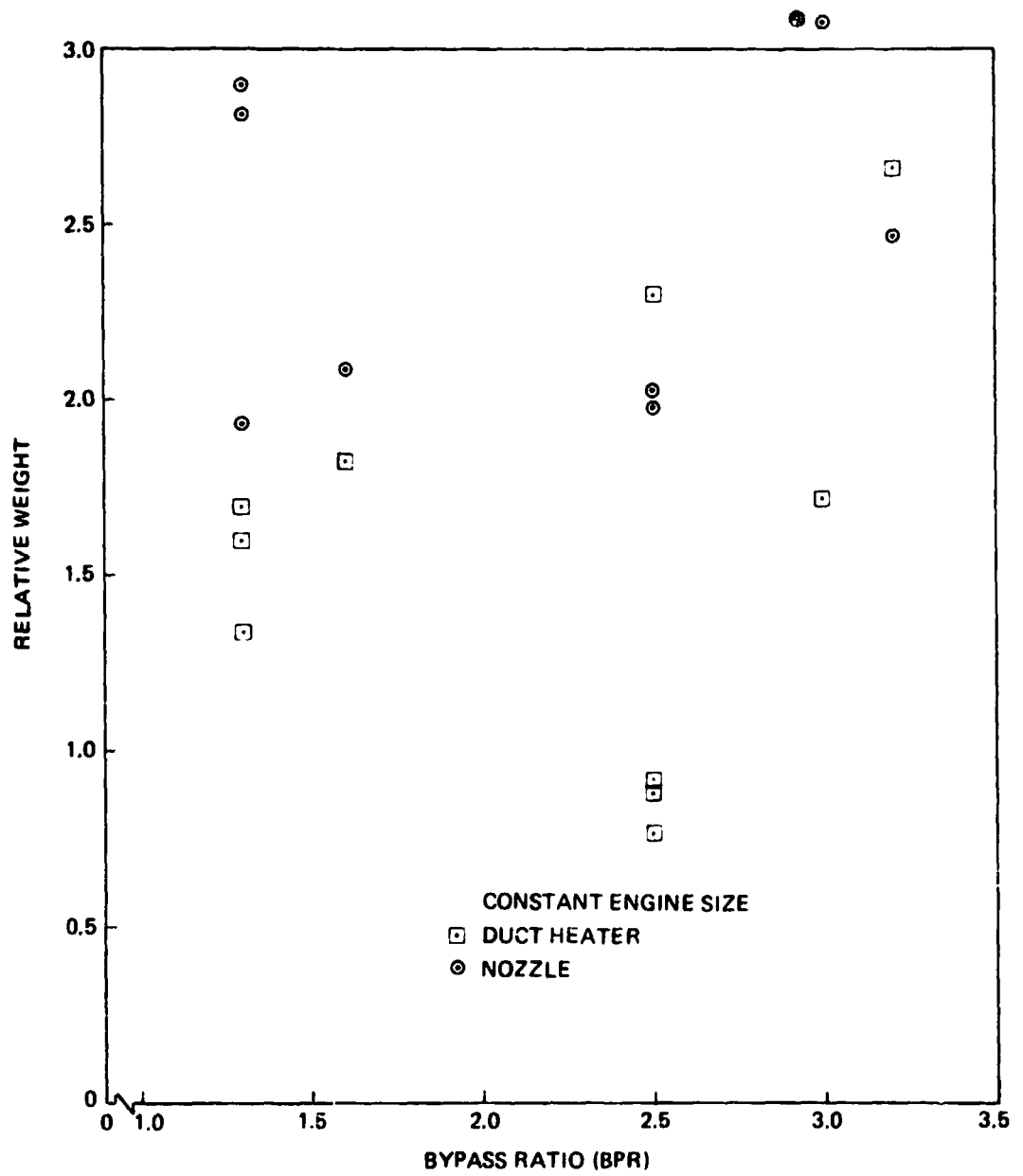

Figure 5. Data Base Engines: Duct Heater and Nozzle Weight

A more accurate weight estimate can be achieved by developing an array of engine cycle data over the intended flight envelope, and by selecting the maximum conditions for input. Such a procedure can be achieved by separating the weight code portion of WALE-1, and coupling it with a driver that permits manual or interactive computer input of these maximum conditions. This type of operation is preferred by the authors, however, the computer code must be specifically tailored to the user's computer and remote terminals.

The methods of analysis described for each component in the following section have been developed to achieve an overall accuracy of $\pm 10\%$. Since the rotating components comprise the major part of the total weight, considerable detail was necessary in order to achieve the accuracy goal. Normal program users may not have sufficient knowledge to adequately define all of the necessary inputs; however, typical values are given in the user's manual, vol. 2.

Fans and Compressors

The general procedure used for fan and compressor weight prediction is a stage-by-stage mechanical design as illustrated on figure 6. Rotor blade volume and weight is determined; then, blade pull stress, disc stress and disc volume are calculated. Connecting hardware, stator, blades, and case are then estimated and summed to give the total component weight. The following input data are necessary:

- An allowable pressure ratio for the first stage which reflects the design approach and technology level. Specific work for this stage will be held constant for additional stages. Number of stages can also be specified as an option.
- The entrance and exit Mach number of the component.
- The hub-tip ratio of the first stage.
- Compressor design mode: constant-mean, constant-hub, or constant-tip diameter.
- Effective density of blade material: defined as total blade weight divided by total volume.
- Maximum inlet and exit temperatures, if not at design.
- Aspect ratios for the first and the last stage blades.
- Blade solidity
- Density of disc material.

The total enthalpy change for the component is available in the stored data from the preceding NNLP cycle calculation. Equal work for each stage is assumed, and the number of stages required is found

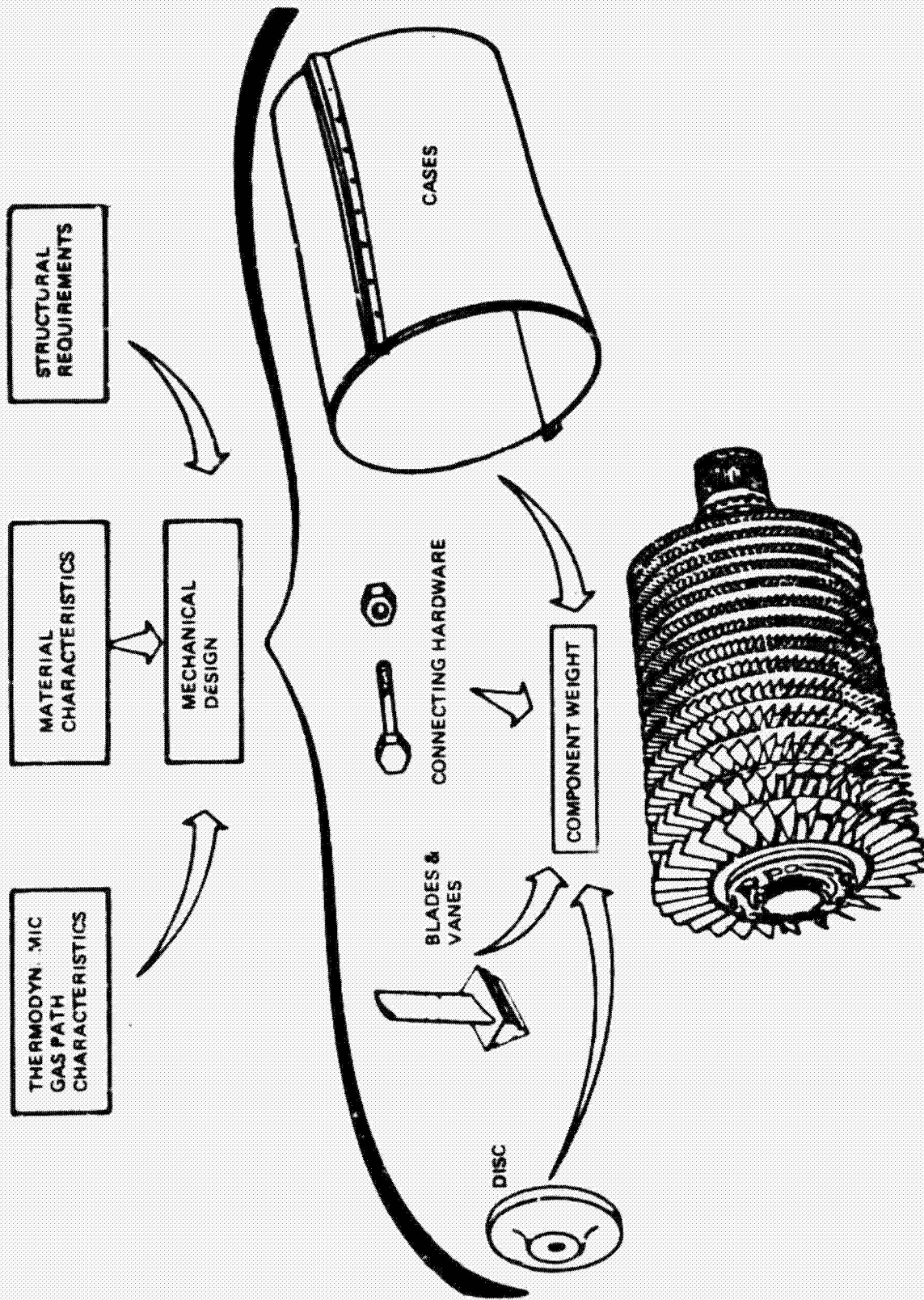

Figure 6. Compressor Weight Method

by iteration until the first stage pressure ratio is equal to or less than the specified maximum. This iteration is required to obtain equal work per stage with an integer number of stages. When the number of stages is specified, first stage pressure ratio is calculated based on the equal work per stage assumption and the allowable pressure ratio is ignored.

Shaft speed is then estimated by the curve given in figure 7. This is only an approximation in the event that shaft speed is not known, which is assumed to be the normal case in WATE-I usage. Turbin blade pull stress, radius ratio, and stage loading are typical fall-outs of this estimated shaft speed. When the WATE-I process is completed, these typical engine physical constraints may not be satisfied and must be inspected to determine whether the resultant engine design is reasonable. Shaft speed of additional compressor's driven on the same shaft will be set by the first (upstream) compressor.

In the event that an existing compressor is being weighed, or the shaft speed has previously been determined, a speed scalar can be applied to figure 7 data to permit adjustment of the calculated shaft speed to achieve a desired value. The speed scalar can also be used to obtain a more reasonable estimate of shaft speed for hp compressors where the entry temperature significantly effects the pressure ratio capability. The speed scalar can also be used for external iterations of the engine design

The first stage flow area is determined by the specified Mach number and by the corrected airflow from the cycle data. Inside and outside diameters of the flow path are then calculated from the specified radius ratio:

$$D_t = \sqrt{\frac{4A}{\pi (1 - H^2)}} \quad (1)$$

$$D_h = \frac{H}{T} \times D_t \quad (2)$$

Compressor RPM is determined by dividing the tip speed (found from figure 7) by the stage radius (R_t).

Dimensions of succeeding stages are based on the design mode selected (constant mean, tip, or hub design). Corrected airflow at the entry of each stage is determined from calculated state conditions. Stage entry Mach number is assumed to vary proportionally to the number of stages when a different entry and exit Mach number are specified. Tip speed for the downstream stages are then calculated from the stage dimensions and shaft speed.

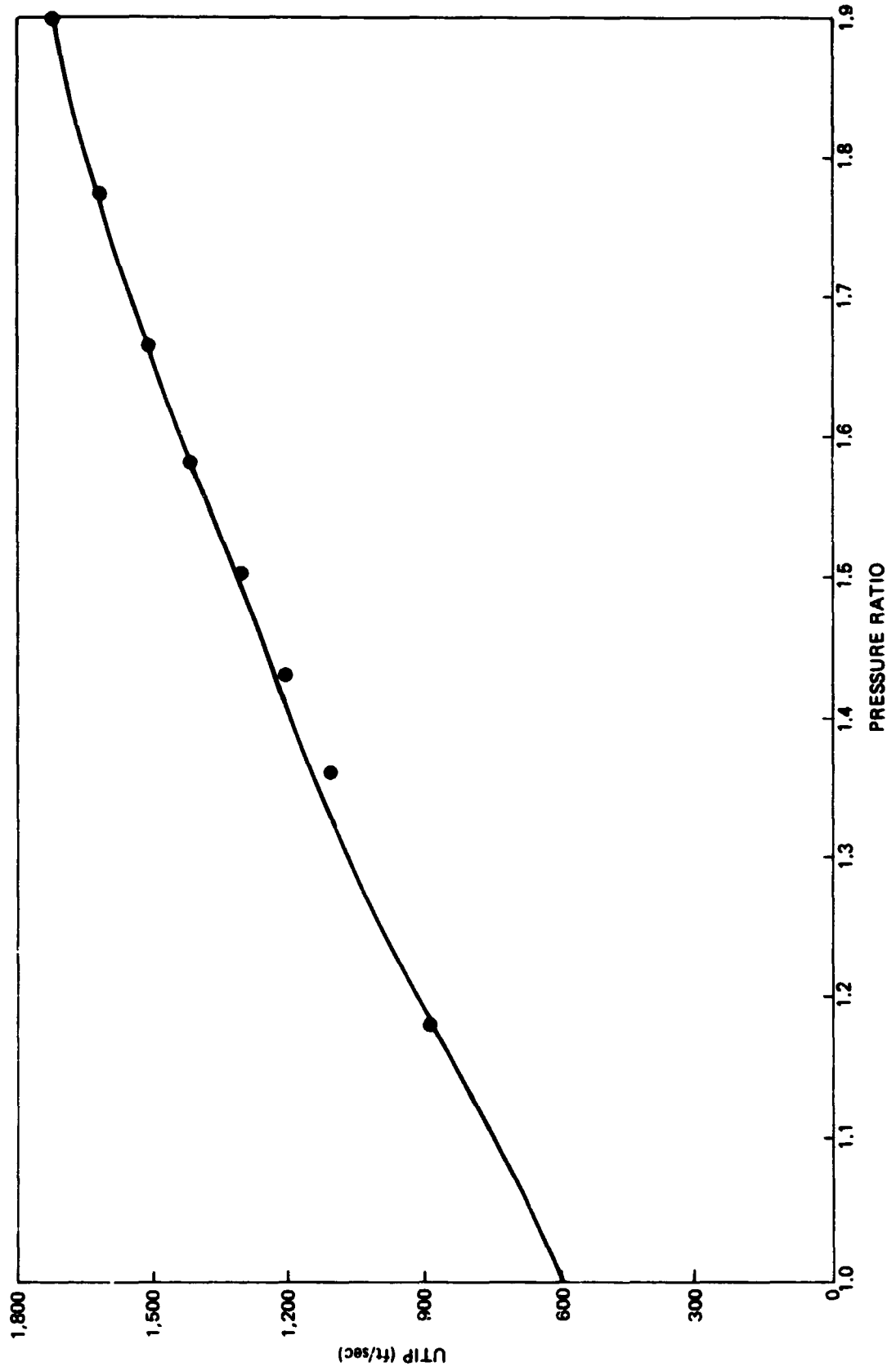

Figure 7. Compressor Tip Speed Estimate for Determination of Shaft Speed

Blade aspect ratio is determined by assuming a proportional change for each stage if entry and exit aspect ratio are different. Volume of metal in the blades is then calculated by:

$$V_b = K \times h_B^3 / AR^2 \quad (3)$$

Where K is a factor which accounts for fir-tree mount volume, taper ratio, and thickness-to-chord variations in typical blades. For the data base engine, K was found to be 0.055 for fan blades, .012 for compressor blades and for blades with H/T greater than .8:

$$K = .120 + .04 \left(\frac{H}{T} - .8 \right) \quad (4)$$

The rotating blade weight of each stage is determined from the blade volume and material density specified. Material density automatically changes from Ti to steel when the stage temperature exceeds a specified maximum, normally 700°F (371°C). Stage temperature is calculated from the NNEP output data and the specified over-temperature ratio. Stator weight and dimensions are assumed to be equal to the rotor blades and include the inner diameter stator shroud.

Stage length is found in the following manner. Blade chord (see figure 8) is the product of AR and blade height:

$$C_b = AR \times h_B \quad (5)$$

For the data base engines, the stator length was found to be equal to the rotor length (r blade chord), with 17% of the rotor length required for clearance between rotor and stator and the same clearance between the stator and next rotor. The sum of all stages gives the total compressor length. Inlet guide vanes are not included in the compressor weight, but can be included as a frame, see section 3.6.

Total number of blades is found from the specified solidity (C/S) and the chord length determined above.

$$N_b = \frac{\pi \times R_h \times (C/S)}{C_b} \quad (6)$$

This value is truncated to an integer number of blades, and the same value is used for the stator.

The maximum blade-pull stress occurs at the blade root and is a function of tip speed, blade height,

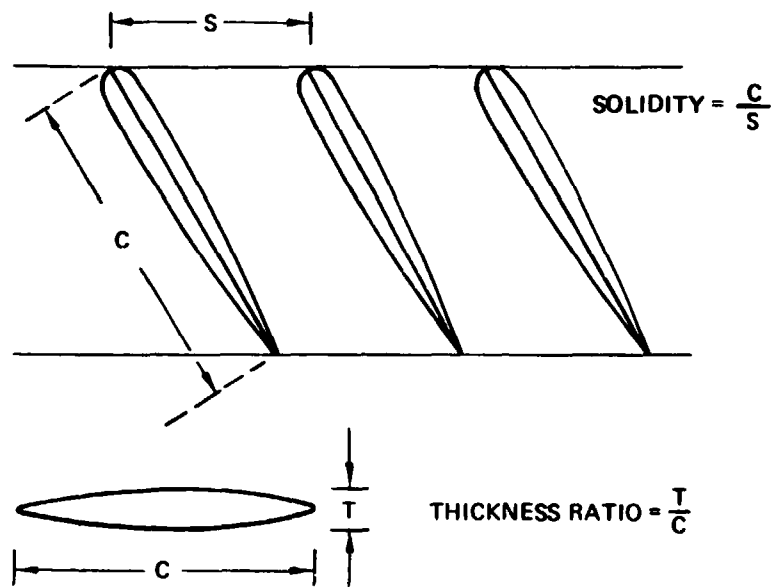
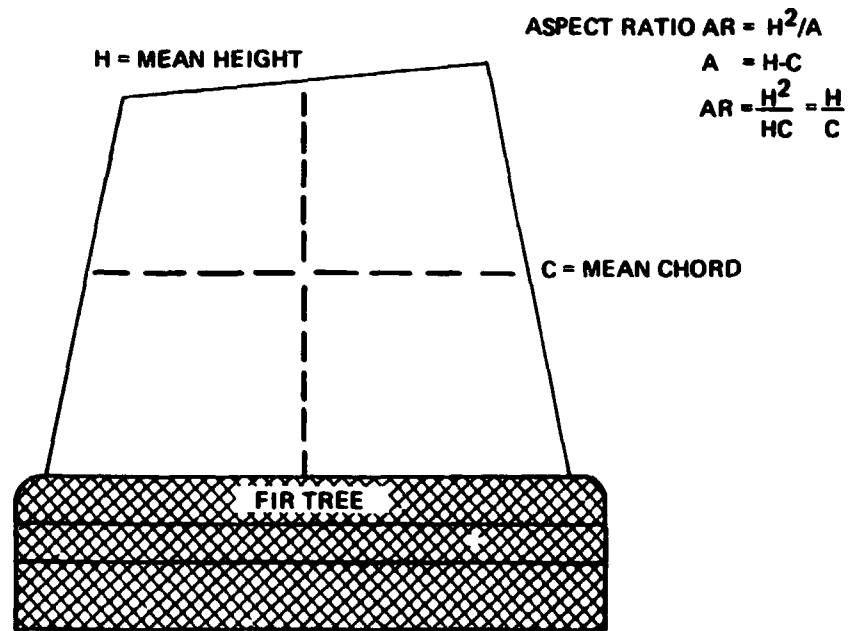

Figure 8. Blade Schematic

and material density. Expressed in terms of the nondimensional input blade geometry, the equation for blade-pull stress is:

$$\sigma_{bp} = \frac{\rho U^2}{gTR} \left[\frac{1 - (H/T)^2}{2} + \frac{TR-1}{12} (1-H/T) (1 + 3 H/T) \right] \quad (7)$$

The compressor discs are a large part of the total engine weight and it is therefore necessary to define this weight as accurately as possible. Disc weight is a function of: diameter, blade load carried on the rim of the disc, material type, speed, disc shape (or thickness distribution), and design stress level selected for life considerations. A theoretical functional correlation was developed which showed that disc thickness should vary inversely with the product of blade-pull stress and disc diameter, i.e., the blade load per unit thickness. For those engines in the data base where large-scale drawings were available, several typical discs were measured. Blade-pull stress and disc volume were calculated, and the results were plotted in the form of relative disc thickness versus load per unit thickness, figure 9.

There is an identifiable trend in these data that show a different characteristic for compressor discs and fan discs. Low hub-tip ratio of the fan probably accounts for the departure from the compressor trend. The allowable stress difference between steel and Ti causes the different trend for the two materials. Further improvements in the accuracy of the disc volume correlations could be made if the number of discs were increased in the data base and the rim loading term was modified by the design stress level or maximum allowable.

Figure 10 illustrates a stage coupling method that was used in most of the data base engines. The spacer and nuts and bolts are assumed to be steel, and the spacer was typically a .075-in thick cylinder located at 75% of disc radius. The connecting hardware (W_{hw}) is estimated by the following equation:

$$W_{hw} = .75 \times 2 \pi R_h \times .075 \times L_{Stg} \times \rho \quad (8)$$

where R_h is the disc radius (or blade hub radius), L_{Stg} is the stage length, and ρ is the material density.

The outer case is the last item of weight included in the compressor weight buildup. Average case thickness in the data base engines was 0.10 in equivalent thickness, including fasteners and flanges.

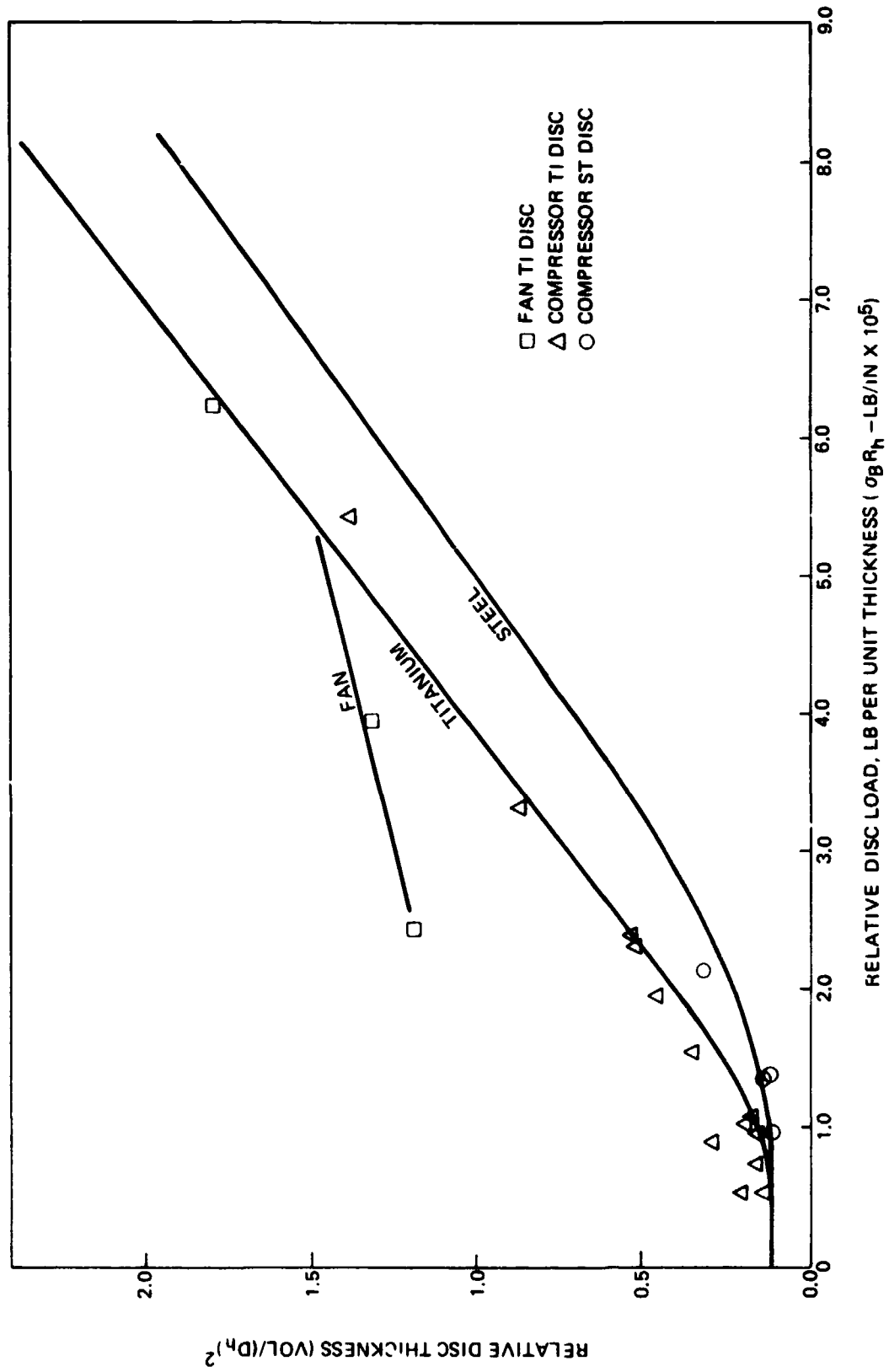

Figure 9. Data Base Engine: Compressor Disk Volume Correlation

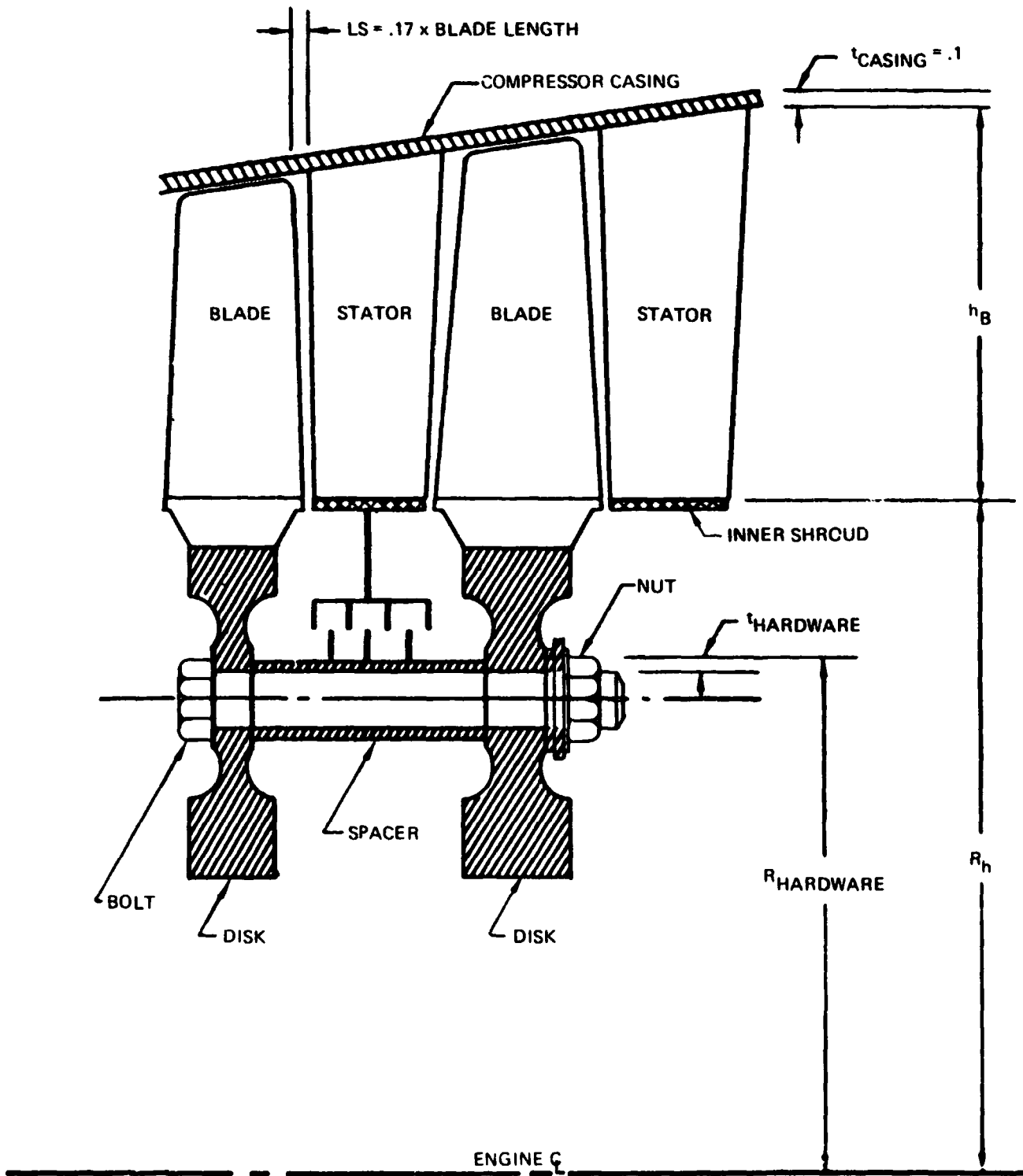

Figure 10. Stage Components

Case weight is calculated stage by stage, and the same material used in the disc is also assumed for the case. The equation is :

$$W_c = 2 \pi D_t L_{Stg} \rho \quad (9)$$

where D_t is the stage tip diameter.

Total stage weight is the sum of rotor blade, stators, disc, connecting hardware, and case. Stage weights are summed to give the total component weight.

Turbines

The method described for compressors is generally the same for turbines. Input data required are:

- Maximum tip diameter of the first stage, or number of stages
- Inlet Mach number (axial) of the first stage, and exit Mach number (axial) of the last stage
- Rotor blade aspect ratio of the first and last stages
- Solidity
- Reference disc stress, 0.2% yield point of the material selected
- Cooling indicator to modify the blade volume calculation for cooling holes.
- Design mode, constant hub, mean, or tip diameter
- Shaft overspeed factor
- Turbine loading parameters, $\lambda = U_t^2 / (\frac{\Delta H}{N_{Stg}} \times 2 \text{ gJ})$
- Blade material density

Two alternative procedures can be used to size the turbine: (1) specify maximum diameter of the first stage and find the number of stages from the work loading parameter, or (2) specify the number of stages and the diameter of the first stage is found from the work loading parameter. Shaft speed is transferred from the corresponding compressor; and in the case of (1), the number of stages is found by iteration until the resultant tip diameter is equal to or less than the specified diameter. Equal work per stage is assumed. Total component work and state conditions are taken from the NNEP-stored cycle data.

To determine blade height, the flow area necessary to pass the corrected airflow is calculated at the

inlet of each stage. When the first stage inlet Mach number is different from the last stage exit Mach number, a proportionate change is assumed for inlet Mach number of the other stages. Hub radius of the first stage is found by subtracting from the stage-projected area the exit-flow area required to satisfy the specified exit Mach number. Dimensions of the remaining stages are then determined from the design mode specification and the calculated exit area.

Aspect ratio and number of blades are determined by the same method used in determining the compressors. Blade volume is also determined by the same method, equation (3), except that $K = 0.195$. When the blade is a cooled blade (normally hp turbine blades with relatively low-aspect ratio), the calculated volume is reduced 20% to compensate for cooling-air passages. Blade weight is then found from the specified material density. Blade-pull stress is calculated by equation (7).

In a manner similar to the compressor discs, turbine discs were measured in the data base engines to produce the results shown in figure 11. The rim loading parameter ($\delta_{BP} \times R_h$) was modified by dividing by the 0.2% yield strength of the particular material used in each disc. There are many different steel alloys and superalloys that have different strength capabilities for which this correction compensates. Each disc has a different operating temperature, maximum allowable stress, and design life. These factors and other unknowns, such as the effect of hub tip ratio, are believed to be the primary cause of the data scatter. The best-fit curve shown in figure 11 is used in WATE-1 to estimate all turbine discs.

The relative disc thickness is found from figure 11 with the calculated independent variable ($\delta_{BP} \times R_h / \delta_{ref}$). Disc volume is found by multiplying the relative thickness parameter (V/D_h^2) by D_h^2 . Blade-material density is an input; however, disc material is assumed to be steel or superalloy with 0.286 density. Since all of the data base engines used steel or superalloy discs, correlations of other materials could not be made.

Each stage of the turbine is treated as a stator-rotor pair (as opposed to rotor-stator pair in the compressor). Stator blades are also assumed to have the same number, volume of material, and dimensions as the rotor blades. The stator weight is calculated by equation (3), with $K = 0.144$. Stator-rotor spacing is the same as compressors, 17% of the rotor length.

Connecting hardware and case weight are also determined by the same method as used in the compres-

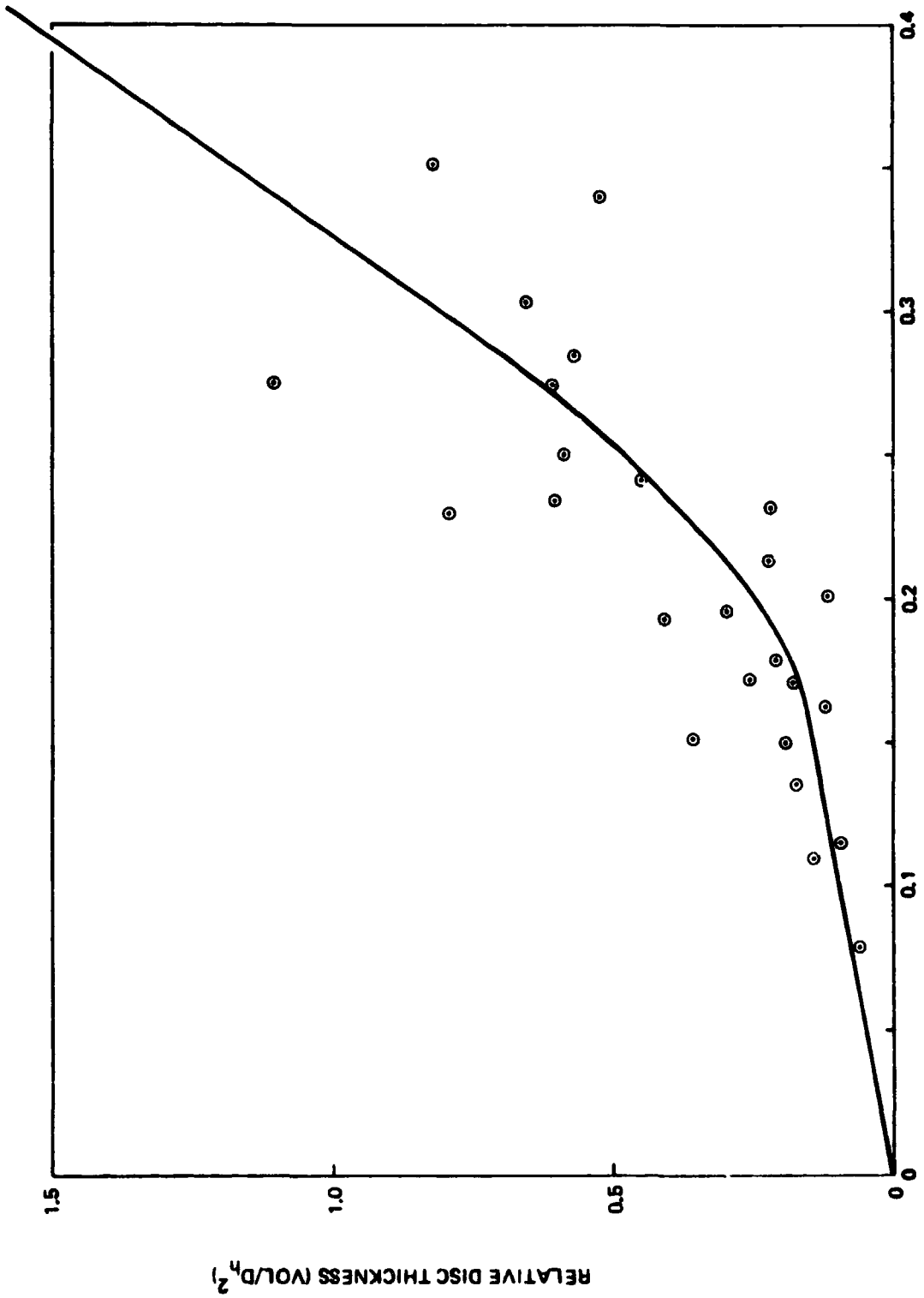

Figure 11. Data Base Engine: Turbine Disc Volume Correlation

sors. The total weight and length of the turbine component is the sum of disc, blade, stator, connecting hardware, and case.

No exit guide vanes (EGV) are assumed in the turbine component. EGV's, if required, can be considered a part of the exit frame weight (sec. 3.7).

Ducts

It is assumed that the major structural load in a duct is a result of the internal pressure. Also, it is assumed that the inner wall of the duct is the same gage as the outer wall. In the data base engines the outer surface of the OD walls were typically exposed to ambient pressure. The ID wall was subjected to fan pressure, hp compressor exit pressure, etc., and ΔP for the ID wall could not be generalized. Figure 12 illustrates the duct and nomenclature.

The equation for stress on a longitudinal section of a thin-walled cylinder subjected to an internal pressure is⁽³⁾

$$\sigma = \frac{P D}{2t} \quad (10)$$

and for solving for minimum thickness:

$$t_{\min} = \frac{P D_O}{2\sigma} \quad (11)$$

where σ is the allowable for the material, P is the internal total pressure, and D_O is the duct outside diameter.

Ti is assumed with 50,000 lb/in² allowable at temperatures below 700°F, and steel is assumed at 70,000 lbs/in² above this temperature. The appropriate material is selected based on the total temperature of the duct airflow. The weight is calculated as a function of duct length (L), the inner diameter (D_i), and the outer diameter (D_O):

$$W_{\text{duct}} = \pi t_{\min} \rho (D_O + D_i) L \quad (12)$$

Duct Mach number is specified as an input, and corrected airflow is determined from the NNEP cycle data. ID and OD are determined as a function of required flow area and the dimensions of the connecting upstream component. Care should be taken to ascertain whether these assumptions apply

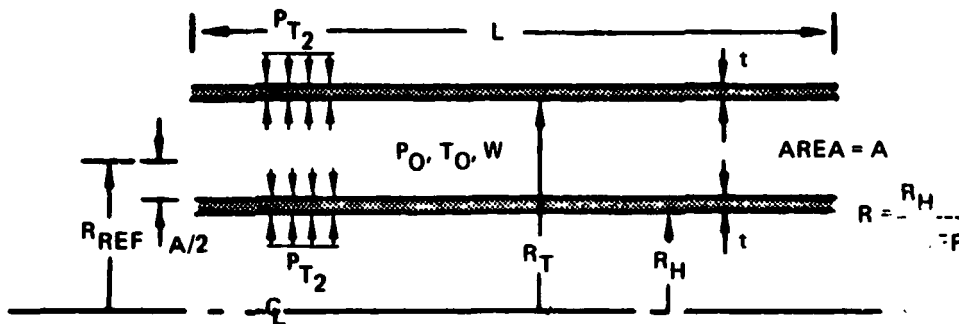

$$A = \frac{W_C}{(W_C/A)} = 2\pi R_{REF}^2 (1 - R^2)$$

SOLVE FOR R_H AND R_T

MATERIAL IS DETERMINED FROM T_0 $T_0 \leq 1,160^\circ R - T_i$
 $T_0 > 1,160^\circ R$ STEEL

$$\sigma = \frac{P_0 R_T}{t} \quad \text{SOLVE FOR } t \text{ WITH SPECIFIED } \sigma$$

$$W_{T \text{ DUCT}} = 2\pi (R_T + R_H) t \rho_{MAT} L$$

Figure 12. Duct Schematic

for specific engine configurations. For example, a thin-walled cylinder subjected to an external collapsing pressure will fail at a much lower pressure than it would if it were subjected to an internal bursting pressure, as assumed in the duct weight calculation. If both ID and OD walls of the duct are exposed to ambient pressure, the ID wall should be sized to avoid collapse, such as determined experimentally by Stewart³ for lap-welded steel tubes:

$$P_{\max} = 1000 \left[1 - \sqrt{1 - 1600 \left(\frac{t}{D} \right)^2} \right] \quad (13)$$

Expressed in terms of minimum wall thickness:

$$t_{\min} = \frac{D}{40} \sqrt{1 - \left(\frac{1 - P_{\max}}{1.000} \right)^2} \quad (14)$$

WATE-1 does not perform the above calculation to determine whether collapsing pressure sizes the ID wall. It also does not check to determine whether less than minimum material gages have been selected.

Rotating Splitter

A rotating splitter, Figure 13, is a circumferential separator of two flows within the same compressor. These flows normally have different pressures and temperatures, and the splitter must perform a sealing function. Stages that incorporate rotating splitters are treated the same as compressors: a rotor-stator pair comprises one stage, stator weight and size is assumed to be the same as the rotor blade, and rotor-stator spacing is 17% of rotor length.

The rotating splitter adds weight to the blade and increases the centrifugal blade force. Consequently, the disc must be heavier to carry the added load. Splitter weight, per blade is estimated by:

$$W_{SPL} = 2 \pi R_S C^2 \times 0.10$$

where C is the blade chord found by equation (5) and R_S is the radial location of the splitter.

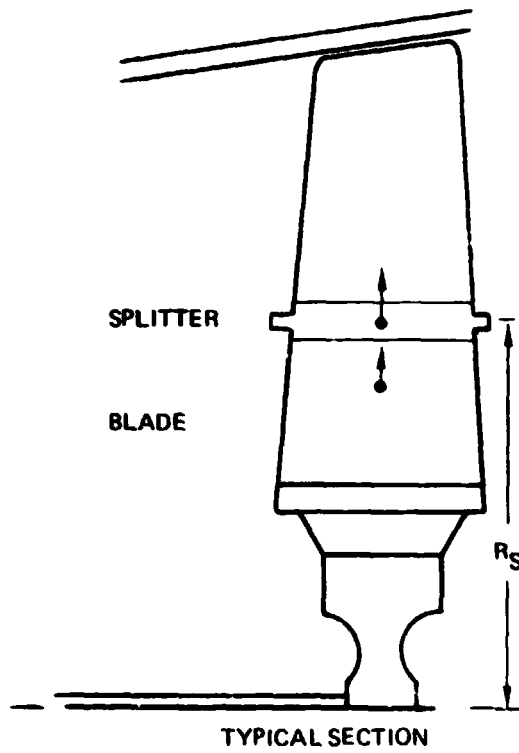
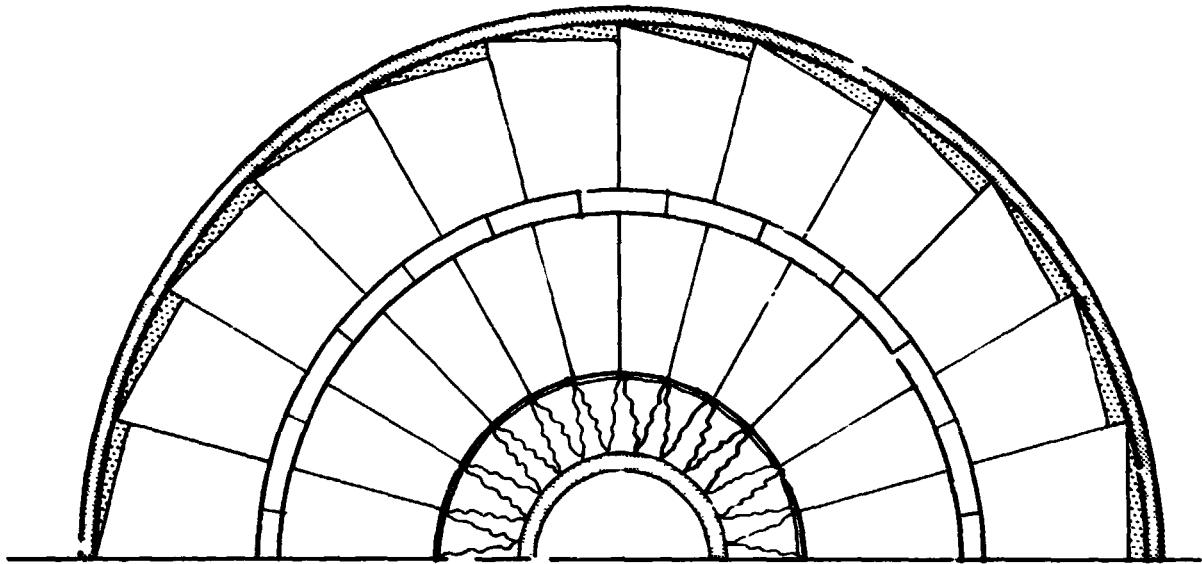

$$F = ma = \sigma A_{\text{ROOT}}$$

$$\Delta\sigma_{\text{RIM}} = \frac{2\pi}{\text{NB}} \rho_{\text{MATL}} U_S^2$$

$$\Delta W_T = 2\pi \left(\frac{T}{C}\right) \frac{b^2}{\text{AR}^2} \rho_{\text{MATL}} R_S$$

$$\frac{T}{C} = .1 \text{ FOR WEIGHT}$$

U_S = SPLITTER SPEED

NB = NUMBER OF BLADES

AR = ASPECT RATIO

b = BLADE HEIGHT

ρ_{MATL} = MATERIAL DENSITY

Figure 13. Rotating

Thickness of the splitter is assumed to be 10% of chord, however, this choice was based on only one engine, the General Electric CJ805-23. The CJ805-23 aft-fan blade has a rotating splitter which has a box section. The solid equivalent thickness of the hollow box was approximately 10% of chord. A more accurate estimate can be made by actual design of the cantilevered platform to the desired deflection and/or stress levels.

The centrifugal force contribution of the rotating splitter is:

$$F = ma = mR\omega^2 = \frac{W_{SPL}}{g} \times R_S \times \left(\frac{2\pi \times RPM}{60} \right)^2 \quad (15)$$

where RPM is the shaft speed determined in the same manner as compressors. Blade pull stress (equation 7) is increased by the amount

$$\Delta\sigma_{BP} = \frac{F_{SPL}}{A_B} = \frac{F_{SPL}}{C_B^2 \times t/c} \quad (16)$$

where C_B is determined by equation (5) and t/c is the thickness ratio of the blade (which is assumed to be 10%). Disc weight is determined with the increased stress level using the disc volume correlation, figure 9.

Shaft speed determination (as described in section 3.1) is only an estimate, and it assumes that blade-root stress is subcritical. Use of a rotating splitter will cause the blade-pull stress to increase significantly, and the WATE-1 output should be inspected to determine whether or not the stress level is acceptable. Reduction of shaft speed may be required to reduce the stress level.

If shaft speed is decreased, a larger number of stages will be required to accomplish the same work. Alternatively, the radius ratio of the compressor (or turbine) can be increased to restore work capacity (due to higher tip speed). Disc weight of each stage will increase for this compromise, however. The final choice must be iterated external to WATE-1 and may depend on whether or not the flow path is reasonably well matched to connecting components (such as the HP turbine and LP turbine flow path). These secondary effects may have a much larger impact on engine weight than will the weight of the splitter material - these effects should not be ignored.

Burners

This method is based on a calculated volume of materials, similar to the ducts method except for the addition of wall liners and fuel manifold and nozzles, as shown in figure 14. It is used for primary burners, duct heaters, and afterburners. Differences in configuration of these diverse types of burners are reflected in the specified residence time, through-flow velocity, and type of burner. When a primary burner is specified, a frame weight is added (see section 3.7). Primary burners and duct heaters require an input mean radius of the annular flow paths while the afterburner is assumed to have no inner wall.

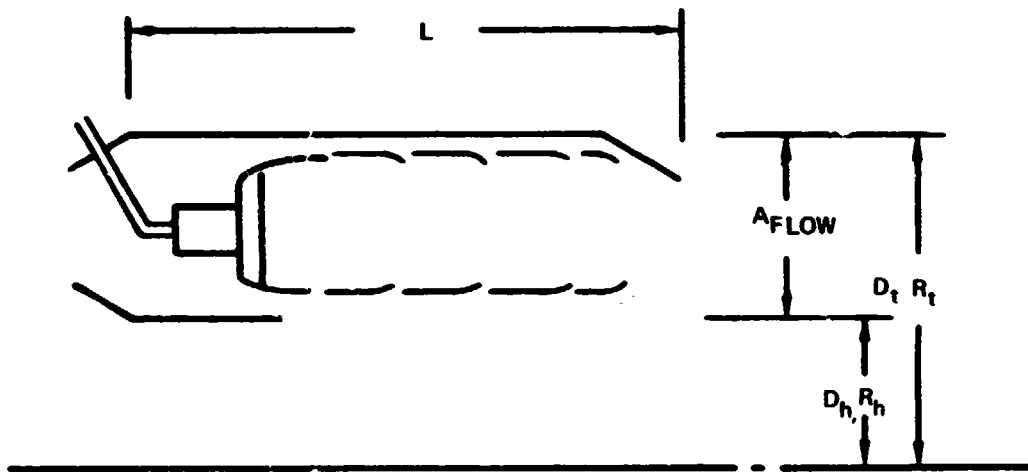

Figure 14. Burner Schematic

Burner flow area is determined from the input velocity, the mean radius, and the entry - corrected air-flow from the NNEP cycle data. Burner length is found to give the specified residence time based on the input velocity and entry conditions.

Flow area is used to obtain the inner and outer dimensions of the burner (R_t and R_h) with the specified mean radius located at mid-area. Outer-case thickness is determined by equation (11); the same thickness is used for the inner case. Material assumed is steel with $70,000 \text{ lb/in}^2$ allowable stress. Weight and volume of material for the inner and outer cases are found by equation (12), using burner length (L).

Liner weight is determined in a like manner, assuming 0.055-in thick steel walls, located at 20% of

passage height from the inner and outer case. The burner dome, fuel manifold, fuel nozzles, and other components are estimated by typical geometry taken from the data base engines as determined by the following equation:

$$W_{\text{dome}} = .0106L (R_t^2 - R_h^2) \quad (17)$$

Total burner weight is the sum of inner and outer cases and liners, burner dome and fuel nozzle system, and frame where applicable.

Shafts

A shaft is assumed to be the power connection between components, see figure 15. Multiple stages within a compressor or turbine are also connected by a shaft; however, this weight is included in that component's weight buildup.

The required inputs are:

- The component numbers connected (to determine length, power transmitted and shaft speed).
- The shaft material density and allowable stress.
- Radius ratio (of the inner shaft only).

Multiple concentric shafts can also be specified, and will be sized around the inner shaft with 0.20 in radial clearance assumed.

Dimensions of the inner shaft are determined to provide the necessary torque capability at the specified allowable stress. Total shaft power is the summation of work (ΔH) for all turbines on the shaft. Shaft speed (ω) is set equal to the smallest rotative speed of all components on the shaft (in the event that a transmission is used with a speed ratio different than unity). Torque is calculated by

$$T = \frac{\Sigma \Delta H}{\omega} \times J \quad (18)$$

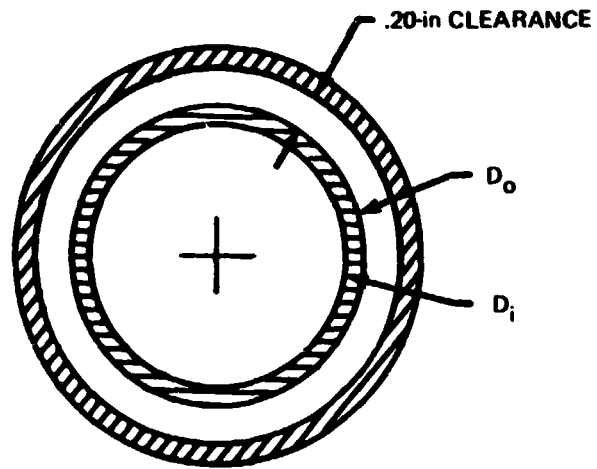
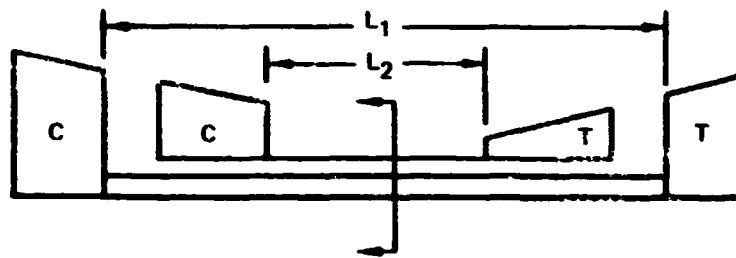

ENLARGED SECTION OF CONCENTRIC SHAFT

Figure 15. Shaft Schematic

Shear stress due to the torque load is defined by (3):

$$\tau = \frac{16T D_O}{\pi (D_O^4 - D_i^4)} \quad (19)$$

or in terms of the input diameter or radius ratio (D_O/D_i):

$$\tau = \frac{16T}{\pi D_O^3 \left[1 - \left(\frac{D_O}{D_i} \right)^4 \right]} \quad (20)$$

Solving for D_O in terms of allowable stress (τ_{all}):

$$D_O = \left\{ \frac{16T}{\pi \tau_{all} \left[1 - \left(\frac{D_O}{D_i} \right)^4 \right]} \right\}^{1/3} \quad (21)$$

Weight is then found by:

$$W = L \times \rho \times \pi \frac{D_O^2}{4} \left[1 - \left(\frac{D_O}{D_i} \right)^2 \right] \quad (22)$$

A similar procedure is used for concentric shafts. The second shaft's inside diameter is found by adding 0.40 in to D_O , and equation (21) is solved by iteration.

While it is assumed in the shaft-weight estimate that torque determines the shaft dimensions, it should be recognized that other design considerations may dictate shaft dimensions. Shaft critical speeds or longitudinal stiffness may actually design the shaft, but this is a function of bearing arrangement, mount stiffness, location of and stiffness of rotating masses. The calculated shaft weight should be considered to be an absolute minimum, and can possibly be much larger when these other criteria are considered.

Frames

A structural frame is normally required to span the engine flow path from the outer engine case to the shaft, usually to support a bearing (as shown in figure 16) for several typical engines. Mechanical

REPRODUCIBILITY OF THE ORIGINAL PAGE IS POOR

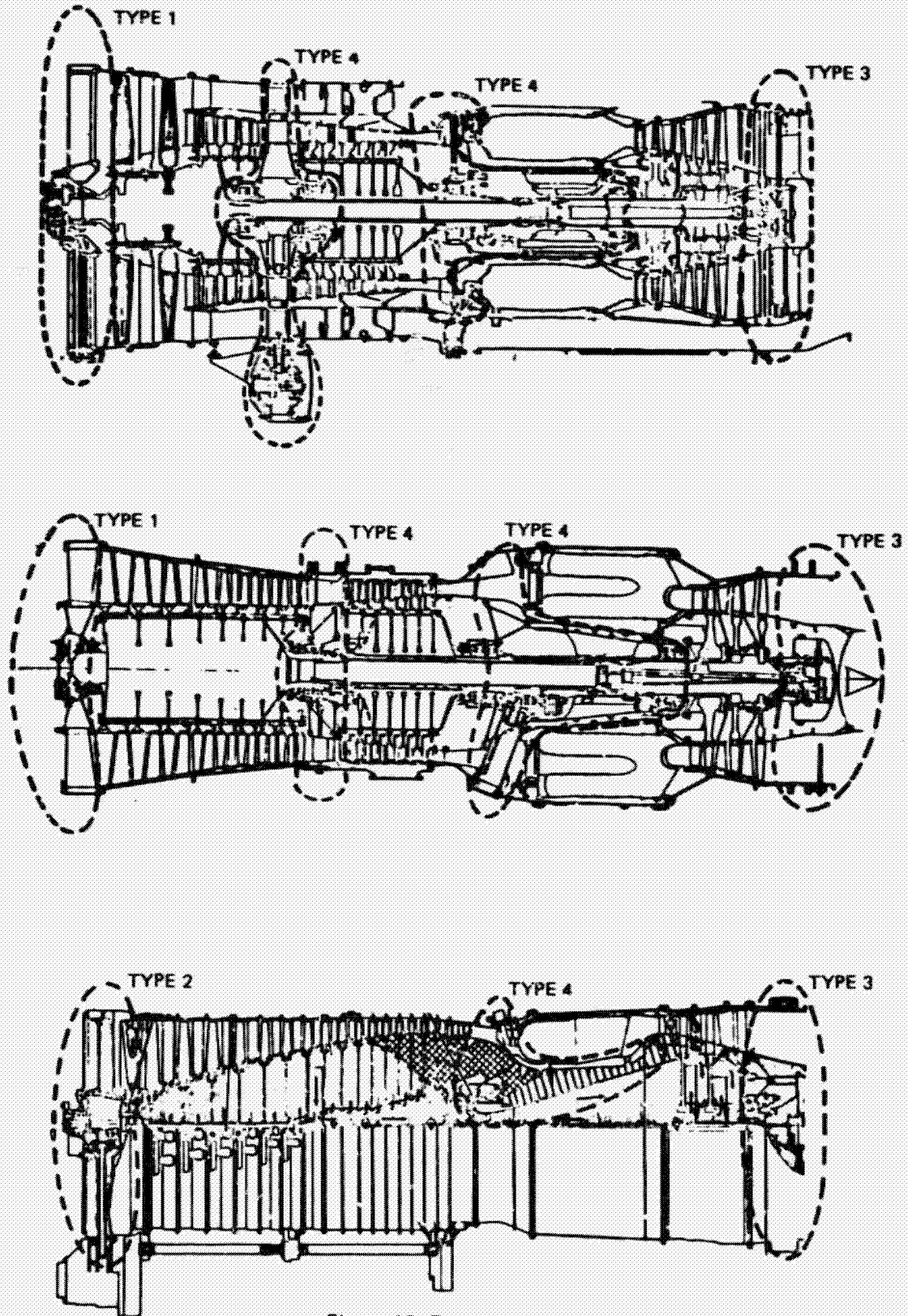

Figure 16. Frame Types

design of the frame would require a definition of all loads imposed on the frame under normal operating conditions, transients, and adverse operating conditions, such as a hard landing. This level of detail is normally not available at the preliminary design stage for which WATE-1 has been developed.

It has been found, however, that the frame weight of the data base engines correlates well with the total frame-projected area. These data are shown in figure 17 for four types of frames commonly used: single-bearing frames with and without PTO, turbine exit, and intermediate. Frame weight is determined from these data, based on the local diameter and the type of frame specified.

Nozzles

Unlike the rotating components, the loads and load paths of nozzles (particularly variable area C-D nozzles) are not readily defined on a general basis. A selected type of nozzle could be subjected to a detailed weight-estimating procedure, however, the trade-offs of internal and external performance with nozzle length and diameter would also be necessary to optimize the design. This type of data is not likely to be available at the level of development for which WATE-1 is intended.

A procedure has been developed that shows proper trends for multiple-stream nozzles and for variable geometry and fixed-geometry nozzles. Nozzle length is specified and should be selected to be representative for the type of nozzle, i.e., C or C-D. An effective surface area is calculated based on the diameter of the connecting component and the specified length.

Only circular, conical nozzles are assumed, however, coannular nozzles could be represented by specifying a circular nozzle for each flow path. Plug nozzles can be represented by specifying a larger effective length; e.g., from nozzle entry to end of plug. Wall thickness is assumed to be 0.10-in steel above 700°F and Ti below 700°F. Variable nozzles are calculated in the same manner except that the effective wall thickness is 2.75 times that of the fixed nozzle.

Mixers

A mixer is a device placed at the point of confluency of two coannular streams to increase the mixing

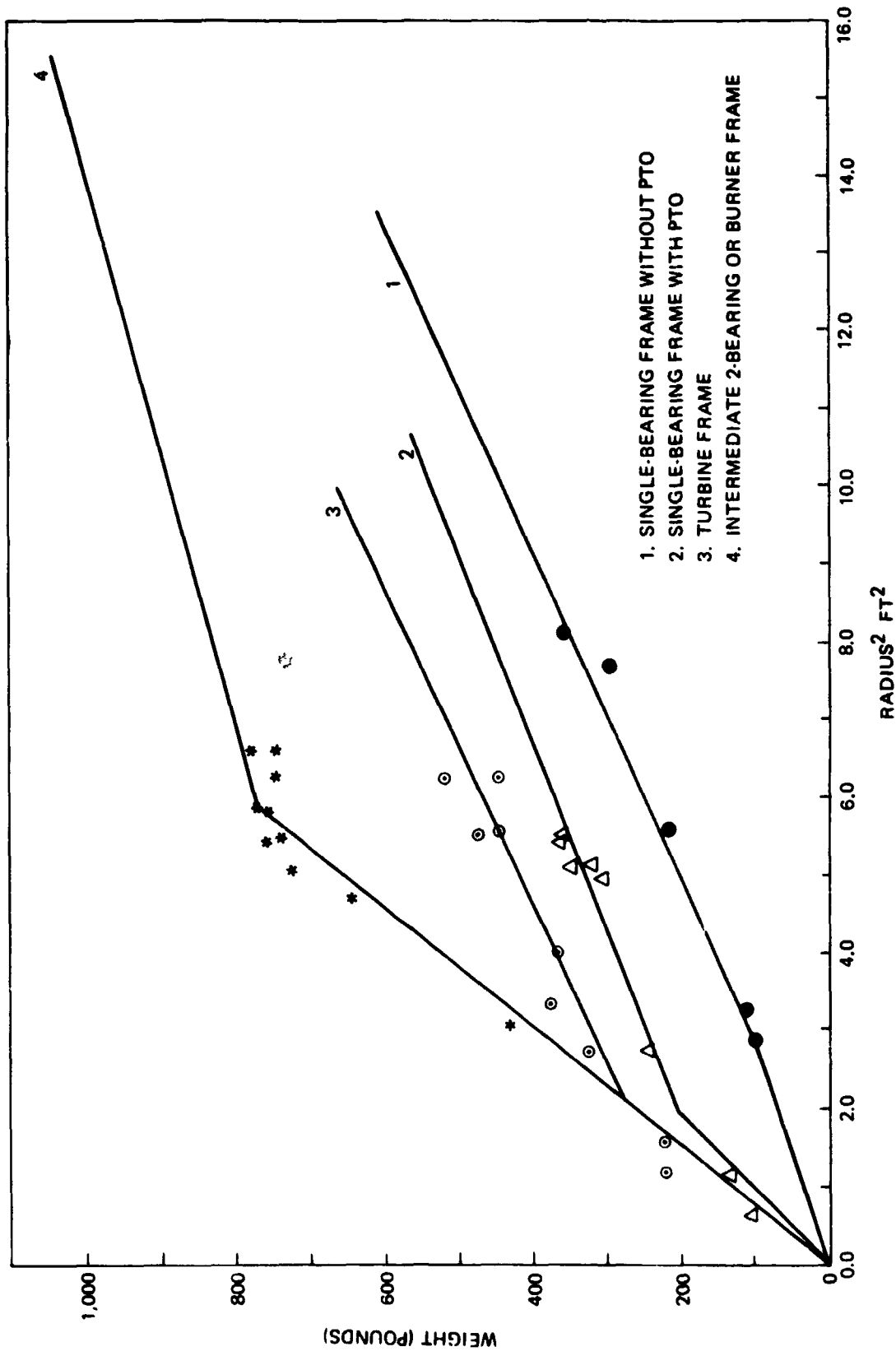

Figure 17. Frame Weight

boundary so that thermal mixing takes place in a minimum length. This type of mixer is sometimes called a daisy-mixer, chute-mixer, or forced-mixer.

Flow area of each annular path is taken from the NNEP cycle data, and the inlet radius (R_i) of the upstream component is used as a starting point for locating R_{mid} and R_o , as shown in Figure 18. Normally R_i will be the hub radius of the last turbine stage.

Mixer length (L) and number of passages (N) are required inputs. The following relationship has been developed that is representative of the surface area of typical mixers:

$$S = [3.93 R_m + 1.25N (R_o - R_i)] .028L \text{ (in}^2\text{)} \quad (23)$$

material assumed is 0.10-in thick steel.

Annulus Inverting Valve (AIV)

This device has been used in some variable-cycle engines to invert the annular position of two concentric flow paths. It accomplishes the flow inversion within a constant diameter envelope, and with constant-area duct passages. Figure 19 shows a typical example of an AIV. This AIV was designed to vary the bypass ratio in a JT8D engine.

The AIV weight method assumes a construction similar to that shown in Figure 19, except that instead of sheet-metal, the material is assumed to be Ti honeycomb at 1.1 lb/ft² below 700°F and steel honeycomb at 1.87 lb/ft² above 700°F. If desired, different materials can be specified.

An empirical relationship, similar to the mixer method, has been developed for estimation of the AIV weight

$$W_{AIV} = [2\pi R_i + 2\pi R_o + 3.93 R_m + 1.25N (R_o - R_i)] L \times \left(\frac{W}{A}\right) \quad (24)$$

where R_i is the hub radius of the upstream connecting component, and R_m and R_o are found to satisfy the input Mach number with the entry corrected airflow (see figure 20). The number of passages (N) is an input, and material weight per square foot (W/A) is selected depending on the

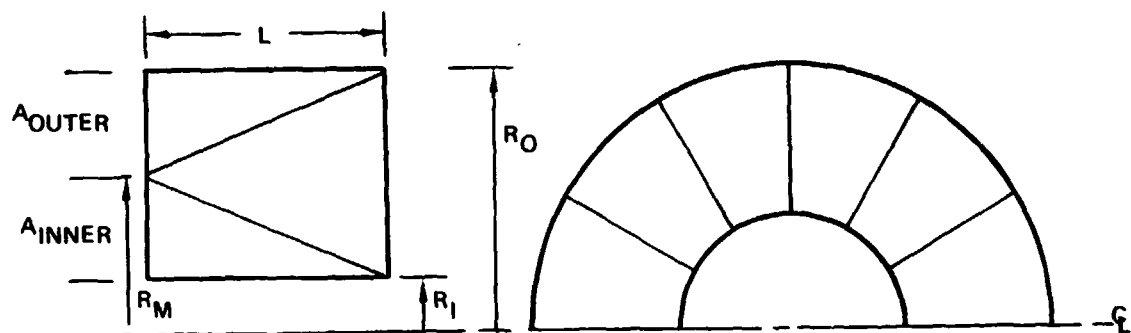

RM IS BASED ON INNER AREA AND R_I

$$L_{SP} \equiv L \frac{2A}{\pi} \sim \text{INPUT}$$

$$A = A_{OUTER} + A_{INNER}$$

L IS DETERMINED

$$WTM = (K_1 \times R_M + 1.25 \times N (R_O - R_I)) \times L \times K_2$$

$$K_1 = 3.927 \quad K_2 = .028$$

Figure 18. Mixer Schematic

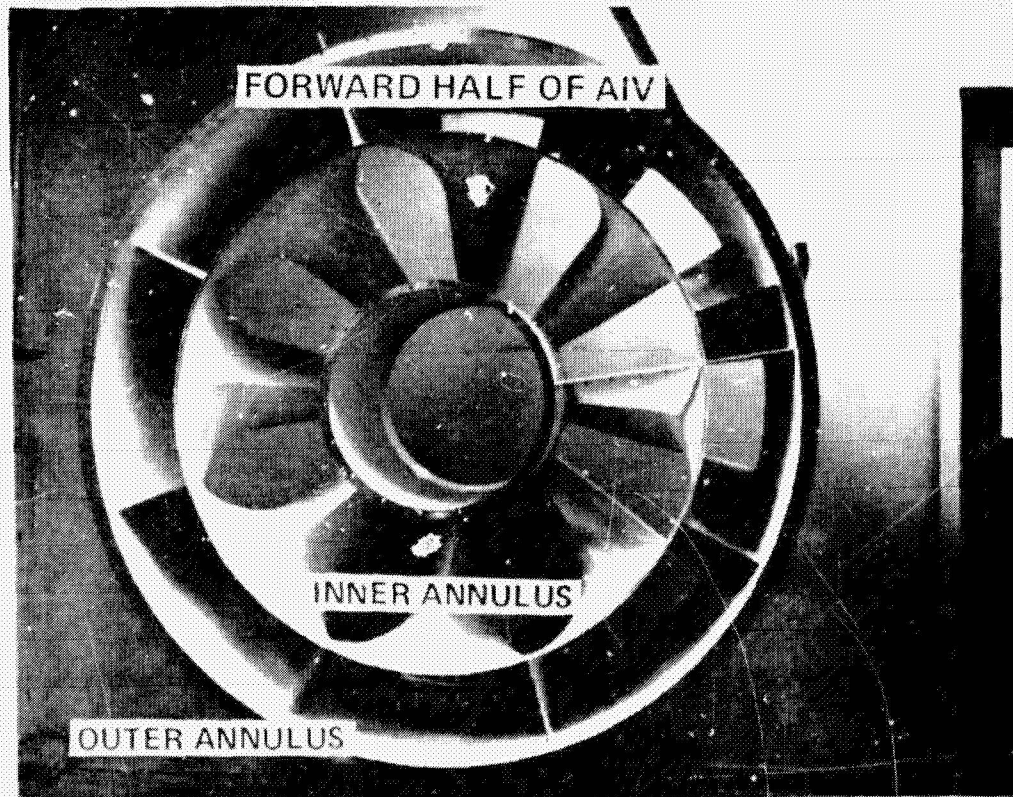
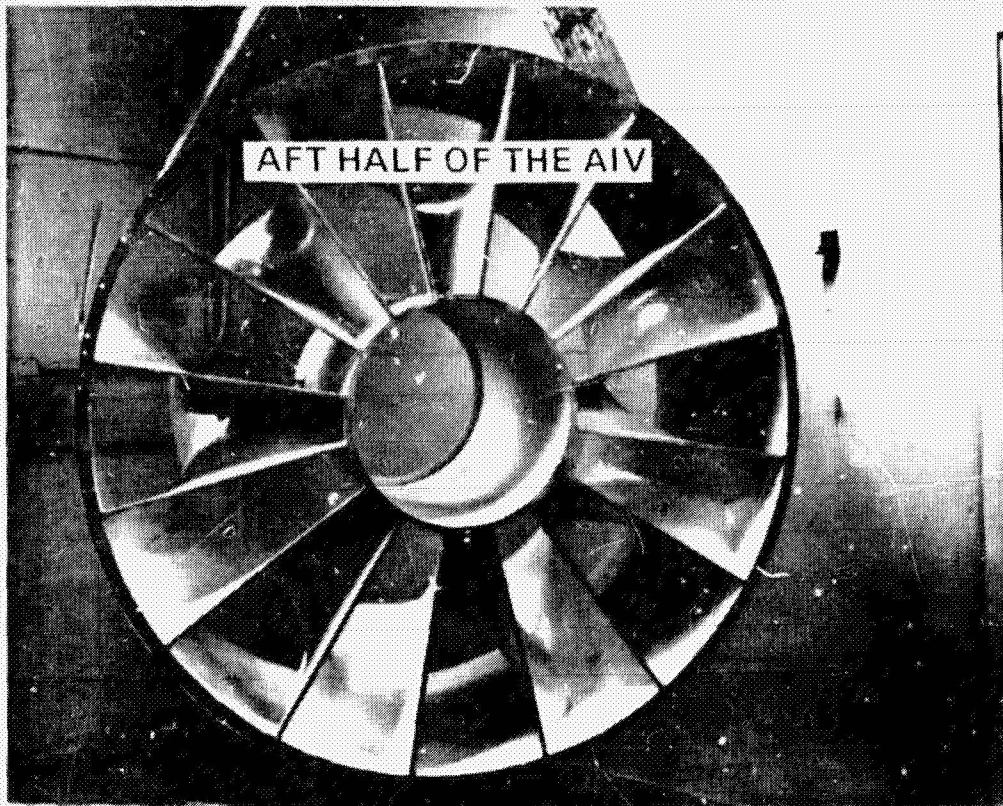
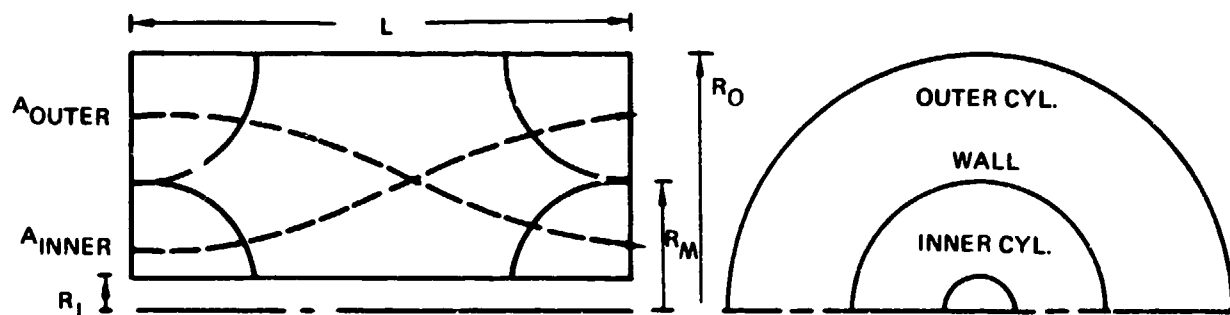

Figure 19. Typical Annulus Inverting Valve: JT8D Variable-Bypass Engine Test

REPRODUCED FROM THE
ORIGINAL PAGE IS POOR



$$L_{SP} = L/\sqrt{4A/\pi} \sim \text{INPUT } A = \frac{(A_{OUTER} + A_{INNER})}{2}$$

FROM MACH INPUT

A_{INNER} AND A_{OUTER} ARE FOUND

L IS DETERMINED

$$WTIC = 2 \cdot R_I \cdot L \cdot WTSI$$

$$WTOC = 2 \cdot R_O \cdot L \cdot WTSO$$

$$WTWALL = (K_1 \cdot R_M + K_2 \cdot N \cdot (R_O - R_I)) \cdot L \cdot WTSW$$

WTSI, WTSO AND WTSW ARE MATERIAL WEIGHT IN lb/ft²

$$R_M = \sqrt{A/\pi + R_I^2}$$

$$K_1 = 3.927 \quad K_2 = 1.25$$

Figure 20. Annulus-Inverting Valve Schematic

stream temperature. Length (L) of the AIV is calculated from the input specific length, L_{SP} :

$$L = \frac{L_{SP}}{\sqrt{4A/\pi}} \quad (25)$$

Specific length is preferred as an input because it is nondimensional, and it is a major variable that determines AIV pressure loss. A relatively good compromise between size and performance is achieved when $N = 8$ and $L_{SP} = 0.8$ to 1.0 , which results in a pressure loss between 2.5% and 1.5%.

If the AIV is of the switching type, where one half indexes in a rotational direction relative to the other half to change flow-path orientation, an actuator weight is estimated at 10% of total AIV weight. Additional structure to support the rotating half is not included and should be represented as an additional frame.

Transmission

A method of estimating the weight of various types of gear systems has been previously developed by Willis⁴. This method is used in WATE-1 for planetary gear sets and for simple reduction gear sets. The latter type is assumed for gear ratios equal to or less than 3.

The equation for planetary gears is:

$$W = .000833 T K_W \quad (26)$$

where T is input torque (ft-lb) and K_W is a weight factor determined as a function of gear ratio in figure 21. For simple offset gears the equation is:

$$W = .0005 T \times K_W \quad (27)$$

These equations assume 0.25 for the application factor, a surface durability factor of 600 for planetary, and a factor of 1.000 for simple gears, as recommended by the reference for aircraft propulsion applications.

Thrust Reversers

A weight estimating method previously developed for aircraft preliminary design studies is based on

the weight of 18 different reversers that are in current use. It has been found in correlations of these data that reverser weight (W) is a function of corrected mass flow ($W\sqrt{\frac{\theta}{\delta}}$) and nozzle pressure ratio (P_R), and is dependent on whether the stream is hot (primary) or cold (fan). The following relationship has been developed:

$$W = \left[K_1 \frac{W\sqrt{\theta}}{\delta} + K_2 \right] \left[K_3 P_R + K_4 \right] \quad (28)$$

where hot streams $K_1 = .52$, $K_2 = 423$, $K_3 = 1.004$ and $K_4 = -.5054$. For cold streams $K_1 = 2.22$, $K_2 = 11.0$, $K_3 = .23$, and $K_4 = .56$.

The WATE-1 method will apply the cold stream equation to a fan stream whether or not it is heated by a duct burner. The hot stream equation is used for turbine outlet streams or mixed-flow exhaust streams.

Heat Exchangers

Both rotary and fixed heat exchangers can be estimated; methods previously developed produce adequate results for preliminary design purposes, see figure 22.

For rotary heat exchangers, a ceramic core is assumed. Weights of this type of heat exchanger have been determined by the Corning Glass Company⁵ and are represented in table 2 for various levels of effectiveness and pressure loss. These data are developed for a total corrected airflow of 200 lbs/sec. For other sizes, these weights are scaled directly with corrected flow.

Fixed-tube heat exchangers are estimated by a heat transfer analysis⁶ whereby the required tube surface area is found to give the specified effectiveness. Flow area of the tubes is found from an input Mach number, number of tubes, and corrected flow.

Wall thickness of the tubes is determined by equation (11) to satisfy an assumed allowable stress of 50,000 lb/in² and a density of 0.168 below 700°F. A stress of 70,000 lb/in² and a density of 0.286 is assumed above 700°F. The length of tubes is determined to satisfy the surface area requirement.

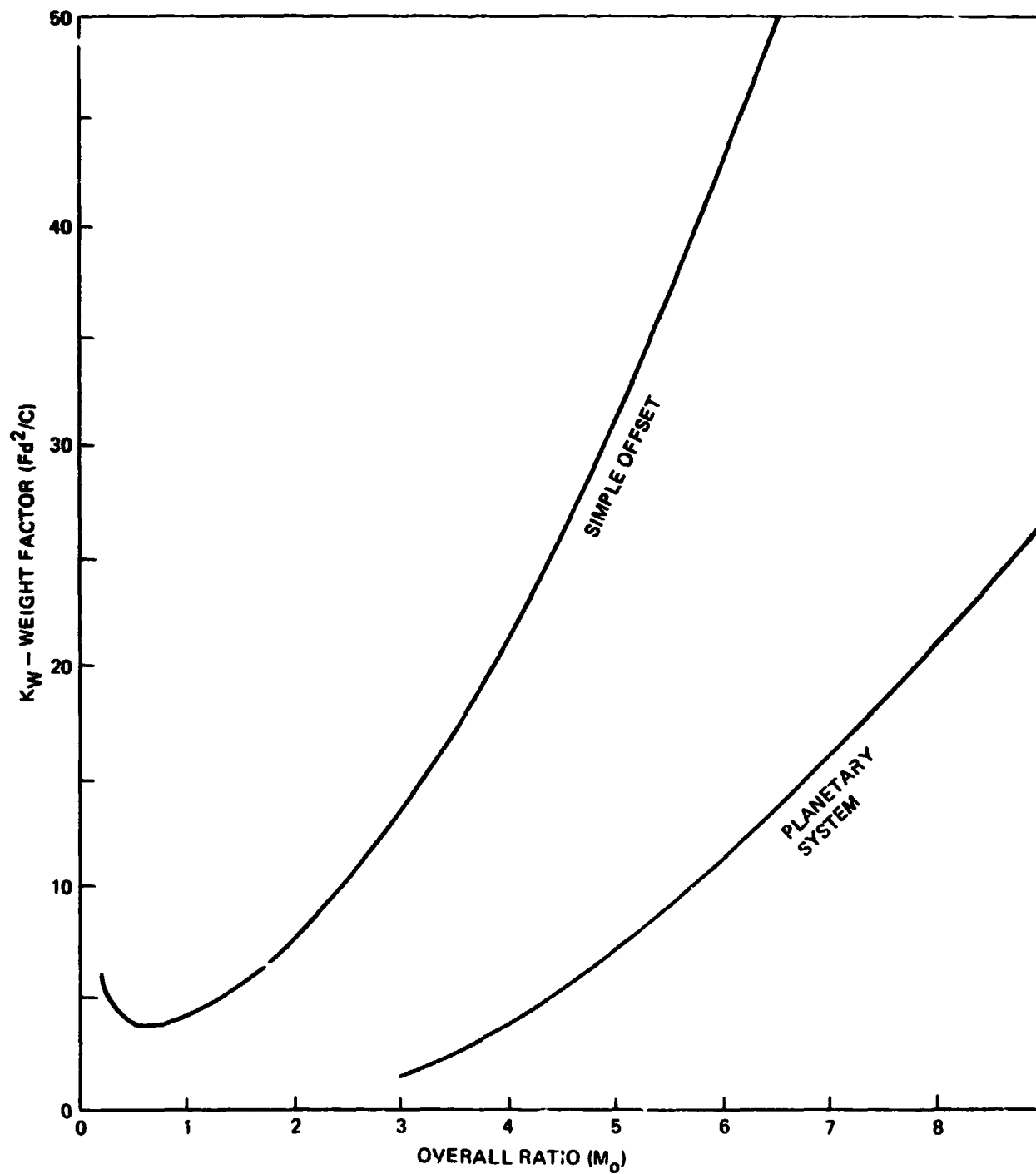
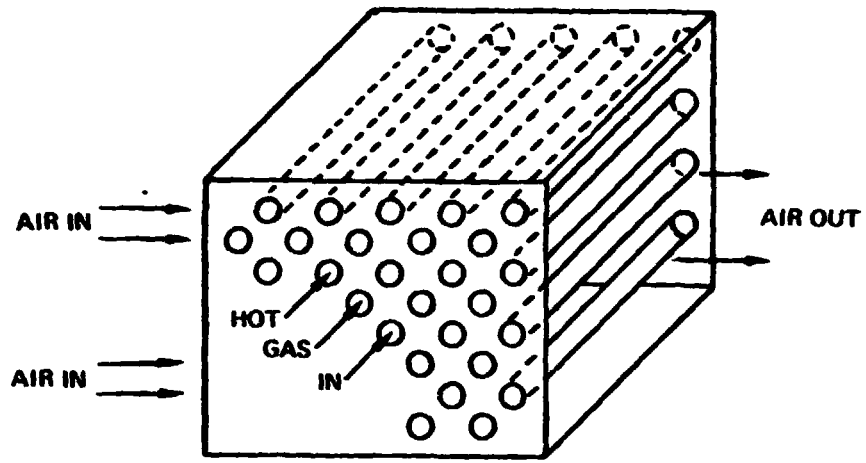
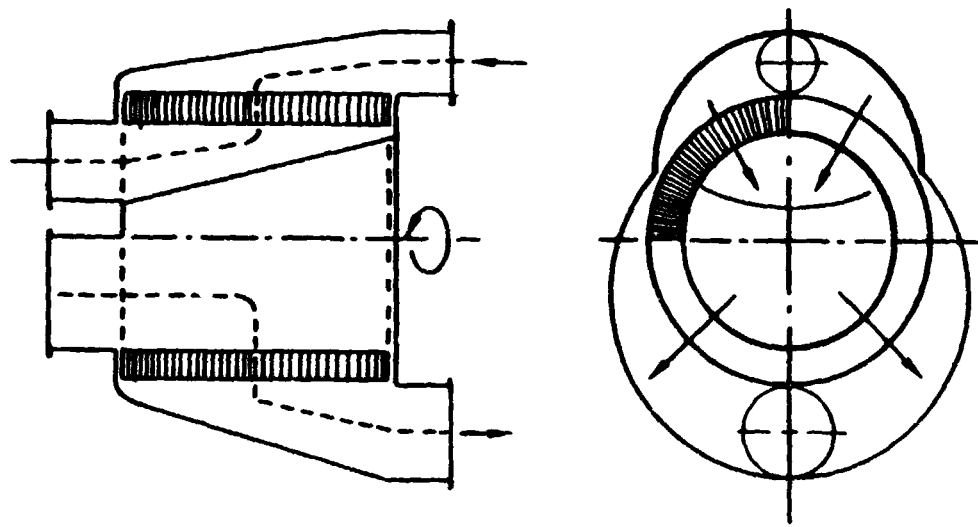

Figure 21. Transmission Weight



FIXED-TUBE HEAT EXCHANGER



ROTARY HEAT EXCHANGER

Figure 22. Heat Exchangers

Table 2. Ceramic Rotary Regenerator Weight

200 lb/sec corrected weight flow						
BPR	3		7		10	
$\Delta p/p$ (%)	5	10	5	10	5	10
Weight (lb)						
$\epsilon = 80\%$	374	542	628	445	600	423
85%	971	754	914	640	834	617
90%	1,622	1,188	1,428	1,085	1,313	994

Fixed-tube heat exchanger tube weight (W_t) is then found by

$$W_t = L_{\text{tube}} \times \pi (R_o^2 - R_i^2) \times \rho \quad (29)$$

where R_o and R_i are the tube radii and L is the total length required. Casings, mounting hardware, manifolds, and other equipment that may be necessary are assumed to be equal to W_t . Total heat exchanger weight is $2W_t$.

PROGRAM VALIDATION

A verification of the accuracy of the method can only be done by applying it to various types of engines and comparing the results with the actual measured engine weight and dimensions or with those estimated by the manufacturer for proposed engines. Since the manufacturer's estimate of proposed engines also includes some error, the real deviation or error of the WATE-1 method can only be found by comparing engines that have been built in production quantities.

In order to judge the accuracy of the method, the NASA program director selected 8 engines for comparison. These included both production and proposed engines. The selection was made after the method was completed and submitted for approval. Results of the WATE-1 estimates for these engines are shown in figure 23. As can be seen, dimensions and weight of the 8 selected engines are

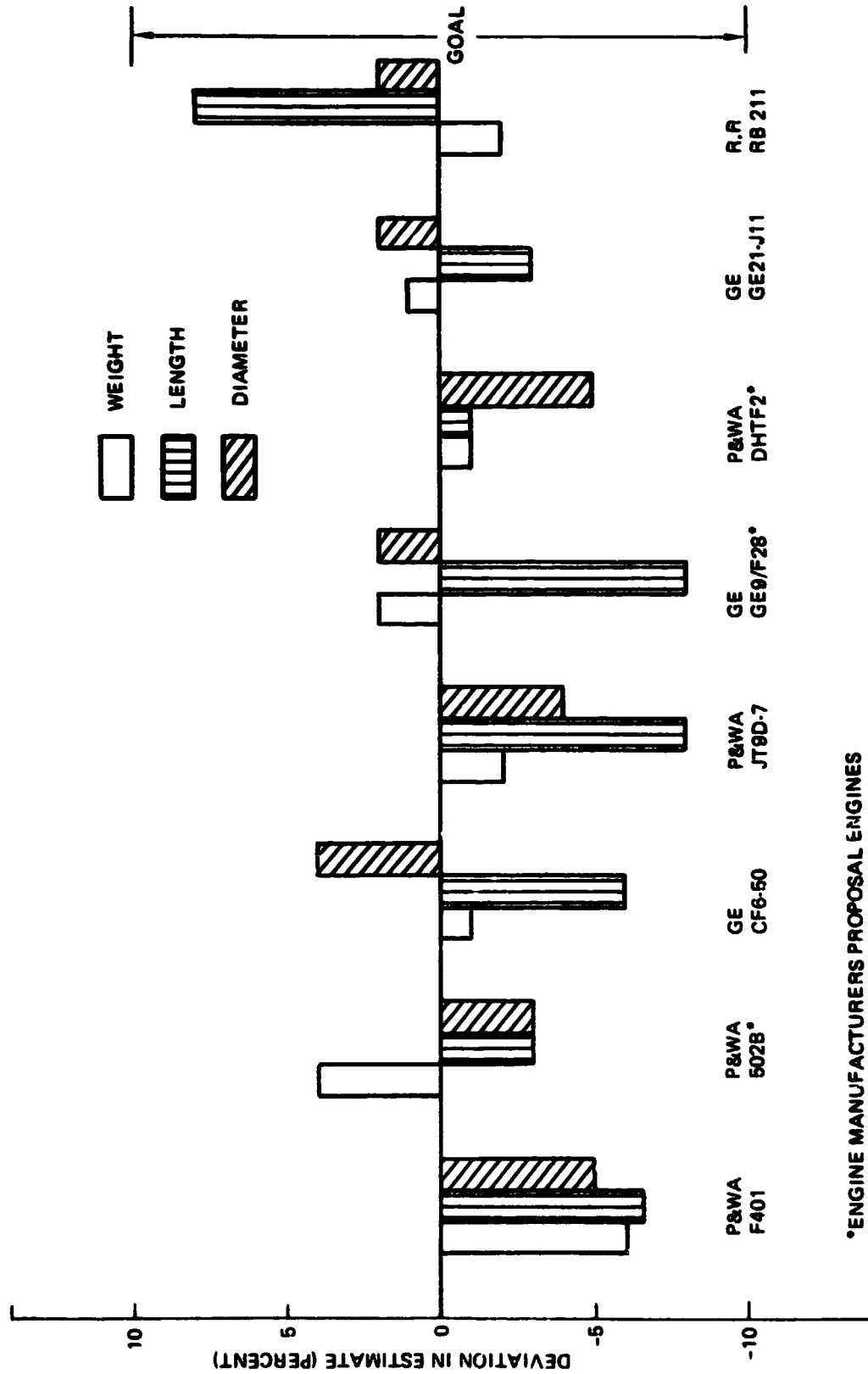

*ENGINE MANUFACTURERS PROPOSAL ENGINES

Figure 23. Program Results Compared to Manufacturers Quotations

within the $\pm 10\%$ accuracy goal. Major components are also within the same accuracy band, as shown in Figure 24, for two typical engines. This level of accuracy was also noted for the other engines selected for validation.

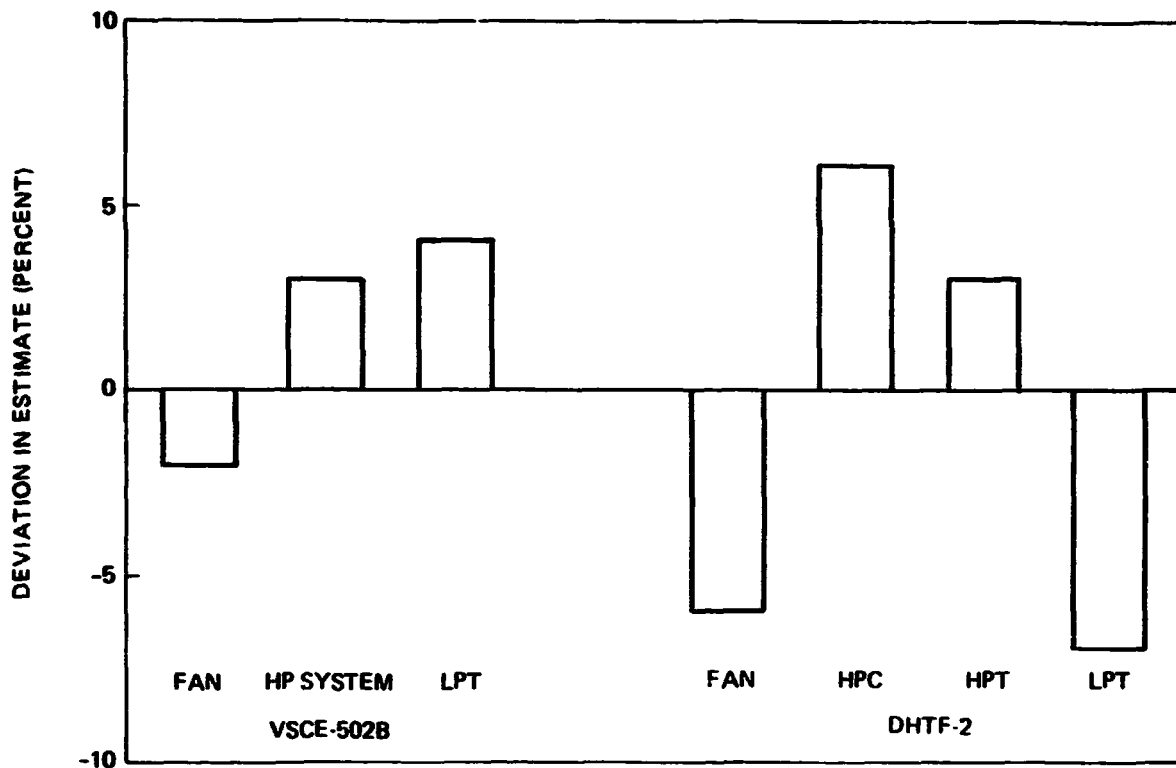

Figure 24. Compressor and Turbine Weight Validation

CONCLUSION

The WATE-1 method can provide a weight estimate within $\pm 10\%$ for a wide variety of aircraft gas turbine engines. The method, however, is limited to axial flow components.

This weight estimation method will not be made obsolete by future advancements in materials technology, component technology or by different physical arrangement of components. These features should provide a long period of usefulness with sufficient flexibility to apply to virtually any conceivable type of aircraft gas turbine engine.

REFERENCES

1. Gerend, R. P., and Roundhill, J. P., "Correlation of Gas Turbine Engine Weights and Dimensions." AIAA Paper 70-669, June 1970.
2. Fishbach, L. H. and Caddy, M. J., "NNEP - The Navy-NASA Engine Program." NASA TM X-71857, Dec. 1975.
3. Eshback, O. W., ed., Handbook of Engineering Fundamentals.
4. R. J. Willis, Jr., "Advance Gearing." Product Engineering, 21 January 1963.
5. "Ceramic Rotary Heat Exchanger Cores." Corning Glass Works, 1974.
6. Keith, F., Principles of Heat Transfer, International Textbook Co., 1967, pp. 483-508.