

# THE TRANSONIC REYNOLDS NUMBER PROBLEM

J. Lloyd Jones

NASA Ames Research Center

## INTRODUCTION

The purpose of this paper is to establish the theme for this meeting and to provide a base for departure in (a) the contemplation of the various needs for experimental research investigations utilizing the National Transonic Facility (NTF) and in (b) the consideration of the relative priorities that should be given within and across subdisciplines for guidance in planning for the most effective initial use of the facility. This purpose will be approached by reviewing some of the concerns that led to the advocacy for such a test capability and by giving a brief review of the activities that led to the current situation. There is nothing new in what is presented herein. Little, if anything, new in the understanding of the scaling of aerodynamic data has come about in the past eight years.

## SYMBOLS

A	area
a	speed of sound
b	wing span
$C_D$	drag coefficient
$C_L$	lift coefficient
$c_\ell$	section lift coefficient
$c_m$	section pitching-moment coefficient
$C_p$	pressure coefficient
c	chord
$\bar{c}$	mean geometric chord
E	bulk modulus of elasticity
$l$	characteristic length

M	Mach number
m	mass
p	pressure
$P_{t,max}$	maximum total pressure
q	dynamic pressure
R	Reynolds number
$\frac{R}{c}$	Reynolds number based on mean geometric chord
T	stagnation temperature
T.S.	test section
$T_{t,max}$	maximum stagnation temperature
u	local velocity in flow direction
V	velocity
y	direction normal to flow
$\Delta$	incremental value
$\eta$	percent semispan location on wing
$\mu$	kinematic viscosity
$\rho$	density
$\infty$	free-stream conditions

## FLOW MODELING SIMILARITY CRITERIA

It is fitting to begin with a brief review of Reynolds number and its significance as a scaling parameter in transonic-flow simulations. Osborne Reynolds initially noted the significance of the parameter  $\rho V \ell / \mu$  as a criteria for determining whether the flow of water in pipes would be laminar or "sinuous," that is, turbulent. He advanced the idea that the state of affairs in fluid flow in geometrically similar systems depends only on this parameter, but he did not comprehend its full significance. It remained for Lord Rayleigh and others to establish Reynolds' number ( $\rho V \ell / \mu$ ) as a basic dynamic characteristic that qualifies the state of viscous fluid motion in the sense that two steady flows are similar if the Reynolds numbers are the same; that is, that the ratio of inertia forces to viscous forces is the same in both instances, as

illustrated in figure 1. Of course, similitude also requires that the ratio of inertia forces to pressure forces be the same for both flows, but this is automatically satisfied in steady flows when the Reynolds numbers are the same. Hence, the condition of dynamic similarity is completely satisfied by making the Reynolds numbers equal at corresponding points in the flows.

Reynolds, of course, was working with the flow of water in pipes, or incompressible flows. At transonic speeds in air, for flow similarity, equal Reynolds numbers is not enough. The elastic forces due to compressibility also must be considered. To assure dynamic similarity for compressible fluids, it is therefore necessary to maintain the same ratio of inertia forces to elastic forces. The criteria for this requirement is to keep the Mach number equal for both flows, as is indicated in figure 2. Hence, for transonic wind-tunnel flows, one must assure the same Mach number and the same Reynolds number to truly simulate the flight conditions.

#### REYNOLDS NUMBER SENSITIVE FLOW PHENOMENA

Reynolds number is a very important parameter in the modeling of flows about flight vehicles because the viscous surface flow is extremely important in determining the resultant forces and moments. Many Reynolds number sensitive flow phenomena for various types of flight vehicles are listed in figure 3. Obviously, there is not time to discuss each of these phenomena, nor would such a discussion at this time really contribute to the purpose of this workshop. Generalizations can be made, however, in the definition of Reynolds number sensitive flows to obtain a clear view of their importance. Reynolds number sensitive flow simulation problems are encountered when the geometric scaling of viscous flow is important or when the coupling between the viscous surface flow and the external flow field is strong. In the first instance, the concern would be for the evaluation of skin friction or heat transfer. At transonic speeds, heat transfer is not an important problem; thus, it may be eliminated for the purpose of this discussion.

Skin friction, or friction drag, varies with Reynolds number. However, it varies in a manner that is predictable, and extrapolation can be made with reasonable confidence and precision if the flow is fully turbulent (or if the relative areas of laminar or turbulent flows are well defined) and if no appreciable areas of flow separation exist. The generally accepted practice in model testing is to fix transition near the leading edge, where it would occur in flight. This method is widely used, and drag results have been reasonably reliable, but some difficulties have been encountered in obtaining correct moment extrapolations because of the greater relative thickness of the turbulent boundary layer at low Reynolds numbers and its interaction with local shocks. This experience is illustrated in figure 4, where it may be seen that the correct prediction of flight pitching moment would be unlikely from the wind-tunnel results.

Viscous-inviscid flow coupling occurs when there are separated flows present. Vortex flows are included in this category. Flow separations and the attendant high drag and interference effects are very sensitive to Reynolds

number and presently cannot be extrapolated with confidence. Flow separation generally occurs when the kinetic energy in the boundary layer is diminished by encountering adverse pressure gradients, such as in regions of expansion on rearward sloping surfaces or through shock waves. Particular problems have been encountered at transonic speeds where local imbedded or recompression shocks occur on the surface of the vehicle.

### CONSEQUENCES OF LIMITATIONS IN SIMULATION

There are a number of examples where problems that have been encountered in flight test have been attributed to Reynolds number effects. Some of these are listed in figure 5. Perhaps the most publicized is the experience with the C-141 aircraft which is illustrated in figure 6. The interaction of the relatively thicker turbulent boundary layer, resulting from the lower wind-tunnel test Reynolds number, with the external inviscid and locally supersonic flow-field results in the recompression shock being located relatively farther forward on the wing. The corresponding wing pressure distributions are also shown in the figure. The consequence of the misprediction was additional cost for the reanalysis of the structure and a 9-month delay in the initial operational availability of the aircraft.

Another example, illustrated in figure 7, is the underprediction by 0.02 of the drag rise Mach number for the C-5A from wind-tunnel tests. If the true value had been predicted, a thicker and thus lighter wing could have been used, and the wing fatigue life problems encountered as a result of the reduction of structural margins to keep the gross weight within bounds might have been avoided. Replacement costs of the C-5A wings have been estimated to be about \$900 million.

A third example is the effect of Reynolds number on engine afterbody drag, as determined in an experimental program at the NASA Lewis Research Center and illustrated in figure 8. There have been unresolved questions raised about the proper accounting of tunnel-wall interference effects in these data because of the large size of the model in the wind tunnel; however, it appears that the extrapolation of the tunnel data in the absence of flight data could hardly be expected to predict the flight values correctly.

### AERODYNAMIC FACILITY STATUS

It will be noted that the examples cited for the manifestation of Reynolds number sensitive flow modeling problems have been mostly in the transonic-speed regime. In subsonic wind tunnels, problems of flow separation are encountered primarily at high-angle-of-attack attitudes with high-lift devices deployed as required for landing or take-off. The establishment of the maximum lift coefficient attainable is a task for the wind tunnel in the design process for a new aircraft. For many years, it was generally accepted that a Reynolds number of about  $7 \times 10^6$  was adequate for the prediction of  $C_{L,max}$ . However, as

high-lift systems have become more complex for swept-wing aircraft and leading-edge devices have been employed, this test Reynolds number no longer provides the confidence required for design purposes. The low local Reynolds numbers of the flow about leading-edge devices and the problem of maintaining geometric similarity for very thin model surfaces are thought to be responsible. This country has, however, gone to the expedient of providing very large subsonic tunnels capable of producing essentially "full-scale" test conditions for many aircraft partly because of the concern about properly predicting high-lift characteristics.

In the supersonic regime, the area of interest for aircraft is generally very slender configurations at small angles of attack or sideslip. As a result, there are no appreciable areas of separated flow, and extrapolation of small-scale data can be done with some confidence. An exception is for fighter aircraft in combat maneuvering flight attitudes, but in this case, the attendant drag in flight is so large that the speed quickly drops into the transonic regime. All things being considered, relatively small scale supersonic wind tunnels seem to be satisfactory for aircraft test purposes.

The major problems thus have been at transonic speeds, and it is here that the inadequacy of wind-tunnel test capabilities have been most critical in recent years. The complex, interacting flow fields in this speed regime are illustrated by the schlieren photograph of transonic flow over a wing section in figure 9. It is true that successful aircraft can and have been built to operate at transonic speeds. However, some serious and costly problems have been encountered, as illustrated herein. In the attempt to avoid such problems, the aircraft designers have been rather conservative in their design approach. Clearly, this has been the prudent approach, because the financial risk for a performance deficiency or major problem is very large. As a result, potential advances in performance and efficiency have not been realized. The limitations of transonic aerodynamic test facilities also have been a handicap to research personnel in identifying and establishing technology advances.

#### IDENTIFICATION OF DEFICIENCY IN TRANSONIC TEST CAPABILITY

The limitations in the existing transonic wind-tunnel facilities and the importance of those limitations have been recognized for some time. There has been general agreement in Industry and in Government since about 1967 that existing tunnels are inadequate for research and for the confident development of current and future aircraft, and that an urgent need exists to provide an improved transonic test capability. It has been recognized that a conventional continuous-flow tunnel with high Reynolds number capability would require an impractical amount of drive power. There has been general agreement that energy storage systems should be considered to reduce the power requirements. It generally has been agreed that anything less than "full scale" represented a compromise in the simulation. Until recently there has been no agreement on what compromise was acceptable. Figure 10 shows the maximum chord Reynolds number achievable in existing U. S. transonic wind tunnels and the flight Reynolds numbers for future aircraft as projected in 1969. (Here, the wing

mean geometric chord  $\bar{c}$  is used as the characteristic length " $l$ ".) In 1969, consideration was being given to superjumbo transport aircraft, very large cargo aircraft, large supersonic transports in acceleration and subsonic cruise, and low-altitude penetration for fighters and bombers.

#### OPTIONS FOR RESOLVING DEFICIENCY

If one acknowledges a need for higher Reynolds number test capability, the first question is how can it best be achieved? There are several options, as indicated in figure 11. The problem, of course, in modeling aircraft in flight with ground-test facilities arises because of the attempt, for reasons of cost (facility construction, operation and models) and workability, to use small-scale models. The scale, or " $l$ " in the simulation therefore tends to be of the order of 10 percent of the actual vehicle dimension. The first option, increasing the characteristic length " $l$ ", simply means giving up trying to use small models and accepting the high cost of full-scale ground test facilities. The primary costs for continuous wind tunnels lie in the rotating machinery of the drive system and in the tunnel shell. Drive-power requirements as a function of test-section size are shown in figure 12. Even for the modest size facilities shown on the chart and using increased pressure to achieve a Reynolds number of  $100 \times 10^6$ , the required drive horsepower is unrealistically large. Facility cost trends are shown in figure 13, and it may be seen that the cost to achieve a test Reynolds number capability of  $100 \times 10^6$  in continuous, or even blowdown tunnels, is also extremely high.

The option generally employed in the past has been to increase the stagnation pressure in the facility, and thereby compensate for the small " $l$ " by an increase in the fluid density  $\rho$ . Indeed, this is done to some degree in a number of the existing facilities shown in figure 13. Because of high model stresses and the limitations on workability, a practical limit of about 500 to 1000 kN/m<sup>2</sup> (approx. 5 to 10 atmospheres) has resulted for aerodynamic facilities; except for high supersonic facilities where the interest generally has been in bluff shapes. To illustrate this point, figure 14 shows the dynamic pressures of the test-section flow as a function of test-section size for several test Reynolds numbers from  $5 \times 10^6$  to  $100 \times 10^6$ . The limit from the consideration of model strength is shown to be 215 kN/m<sup>2</sup> (4500 psf). This limit was established in studies conducted by NATO countries and is consistent with the consensus of views expressed in this country. For a Reynolds number of  $100 \times 10^6$  in an ambient temperature tunnel, a very large tunnel would be required to stay within this limit.

Another problem introduced by high test dynamic pressures is that of model distortion. As illustrated in figure 15, there is considerable wing distortion. Clearly, any differences in wing geometry under load between model and aircraft must be reconciled. As a swept wing bends under load, the local angle of attack is reduced. The reduction is greatest near the wing tip. Tests have shown that this wing distortion effect can result in movement of the recompression shock in a direction counter to the anticipated aerodynamic effect of increased test Reynolds number. Excessive dynamic pressures can make this distortion effect very large, and the inaccuracies in the corrections may

therefore significantly affect the validity of the projected aircraft characteristics. Other important consequences of high test dynamic pressures are the large geometric distortions of the model aft-end region required to accommodate the large support sting, and the attendant increased sting interference effects on the flow over the model.

The third option (fig. 11) for increasing test Reynolds number capability in a ground facility is to reduce the temperature of the test gas. The resultant changes in gas properties for a given Mach number and stagnation pressure are illustrated in figure 16. As the gas temperature is decreased, the resulting increase in density and reduction in viscosity are much stronger effects on Reynolds number than the reduction in velocity through the decrease in the speed of sound; therefore, there is a net increase in Reynolds number.

The dynamic pressure, however, remains unchanged with a change in temperature. Since dynamic pressure is proportional to the square of the velocity ( $V \sim \sqrt{T}$ ) and directly to the density ( $\rho \sim 1/T$ ), this Reynolds number increase is achieved with no increase in dynamic pressure. Furthermore, since drive power is proportional to the product of dynamic pressure and velocity, the power required to operate a continuous-flow facility actually decreases with decreasing temperature of the test gas (power  $\sim \alpha \sqrt{T}$ ).

An additional and highly important benefit in test capability also results from this approach, as illustrated in figure 17. The ability to vary both temperature and pressure opens up a test envelope never before available in large transonic test facilities. This feature makes possible pure Reynolds number studies at a constant dynamic pressure (thus eliminating the undesirable variables of model distortion) as well as pure aeroelastic studies at a constant Reynolds number.

#### EVOLUTION OF NATIONAL TRANSONIC FACILITY

This third option, achieved through the use of cryogenic nitrogen, is the concept employed in the National Transonic Facility. This facility will provide the United States with a long-needed and significant advance in transonic aerodynamic test capability. It has come about as the result of a number of studies, proposals, and deliberations. A brief summary of the highlights in this process is shown on figure 18. The Ludwig tube concept for a transonic aerodynamic test facility was favored early because it was the least costly approach to attain very high test Reynolds numbers. It is essentially an energy storage concept and thereby does not require the high power drive system needed for a large continuous facility at high pressure. Studies of hydraulic drive and injector drive facilities were made in the 1969 to 1974 time period as alternative concepts using energy storage and avoiding very large and costly electrical drive systems. The Ludwig tube concept "HIRT" (High Reynolds Number Tunnel) was in fact approved by DOD and NASA in 1971 to be proposed as a National Facility. The short run time and the very high dynamic pressures characteristic of the facility, however, limited its test flexibility and prompted continued consideration of alternatives. The

cryogenic-facility concept emerged in 1971 with small, low-speed pilot tunnel experiments conducted over the following year to verify its potential. In 1973 the Langley pilot cryogenic tunnel became operational and validated the cryogenic concept at transonic Mach numbers and higher Reynolds numbers.

In 1973, it was determined in a special study effort that two separate facilities, a Ludwig tube and a cryogenic fan-driven facility, represented the least costly way to achieve the very high Reynolds numbers sought by the Air Force for development and evaluation, and the longer run times at more moderate Reynolds numbers ( $\approx 80 \times 10^6$ ) with much lower dynamic pressures sought by NASA for research. NASA and the DOD agreed to propose this dual facility concept and the Congress authorized HIRT in 1974. A reassessment of costs, which reflected the large increase in construction costs in 1974, resulted in a more than two-fold increase in the estimated cost for HIRT, and the Air Force decided not to proceed. A joint DOD/NASA review team then made some difficult compromises and, as a result, recommended a single cryogenic fan-driven facility having an intermediate Reynolds number capability between the Air Force and NASA stated needs. This facility was approved by DOD and NASA in 1975 and proposed to the Congress as an alternative approach, and Congress authorized its construction by NASA in 1976. This new facility, known as the National Transonic Facility, is to be located at the Langley Research Center and jointly operated by NASA and DOD for both research and development testing, as indicated in figure 19. The subjects listed under Research and Technology are, of course, the subjects to be addressed at this workshop. The first topic encompasses both fluid mechanics and applied theoretical aerodynamics.

#### UTILIZATION OF NTF

In addition to utilizing this new facility in an efficient and expeditious way to increase our understanding of the physical phenomena in the disciplinary areas shown, it is equally important to establish at an early time, through the capabilities of the NTF, the limits of capabilities of existing transonic facilities. In other words, it is important to determine where these facilities can and cannot be used with confidence. This knowledge will permit more effective and efficient use of the Nation's total test capabilities.



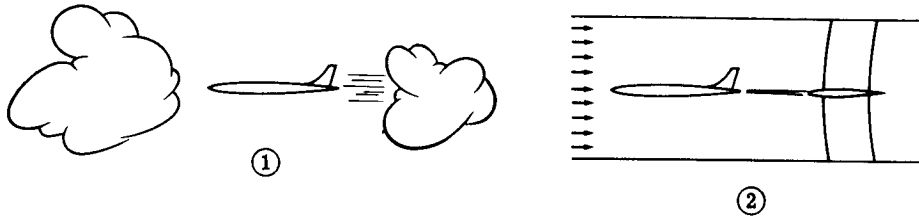

$$\left[ \frac{\text{Inertia forces}}{\text{Viscous forces}} \right]_{\textcircled{1}} = \left[ \frac{\text{Inertia forces}}{\text{Viscous forces}} \right]_{\textcircled{2}}$$

$$\frac{\text{Inertia forces}}{\text{Viscous forces}} \sim \frac{m\dot{V}}{\mu \left( \frac{du}{dy} \right)} \sim \frac{\rho V^2 l^2}{\mu V l} \sim \frac{\rho V l}{\mu} \quad \left( \begin{array}{l} \text{Reynolds} \\ \text{number,} \\ R \end{array} \right)$$

$$R_{\textcircled{1}} = R_{\textcircled{2}} \text{ for dynamic similarity}$$

Figure 1.- Dynamic similarity of viscous fluid motions.



$$\left[ \frac{\text{Inertia forces}}{\text{Elastic forces}} \right]_{\textcircled{1}} = \left[ \frac{\text{Inertia forces}}{\text{Elastic forces}} \right]_{\textcircled{2}}$$

$$\frac{\text{Inertia forces}}{\text{Elastic forces}} \sim \frac{m\dot{V}}{\text{Stress} \times \text{Area}} \sim \frac{\rho V^2 l^2}{E l^2} \sim \frac{\rho V^2}{E} \sim \frac{V^2}{a^2} \quad \left( \begin{array}{l} \text{Mach} \\ \text{number,} \\ M \end{array} \right)^2$$

$$M_{\textcircled{1}} = M_{\textcircled{2}} \text{ for dynamic similarity}$$

Figure 2.- Dynamic similarity of compressible fluid motions.

	VEHICLE TYPE				
	MANEUVER	SUBSONIC TRANSPORT AND CRUISE	SUPERSONIC CRUISE	HYPERSONIC	LAUNCH VEHICLES
BOUNDARY-LAYER GROWTH AND SEPARATION	X	X	X	X	X
BOUNDARY-LAYER TRANSITION		X	X	X	
TURBULENT BOUNDARY LAYERS	X	X	X	X	X
BOUNDARY LAYER/SHOCK INTERACTIONS	X	X	X	X	X
SEPARATED FLOWS	X			X	X
VISCOUS CROSS FLOW	X	X	X	X	X
VISCOUS CORNER FLOW	X				
VISCOUS MIXING EFFECTS	X	X	X	X	X
BASE FLOW AND WAKE DYNAMICS	X	X	X	X	X
BASE RECIRCULATION				X	X
BASE DRAG				X	X
SKIN FRICTION	X	X	X		
ROUGHNESS, PROTUBERANCE DRAG	X	X	X	X	X
PRESSURE FLUCTUATION	X				X
VORTEX FLOWS	X	X	X	X	X
INTERFERENCE FLOW FIELDS	X	X	X	X	X
JET PLUME INTERFERENCE	X	X	X	X	X
BLUFF BODY AERODYNAMICS				X	X
HEAT TRANSFER				X	X

Figure 3.- Reynolds number sensitive phenomena for various types of flight vehicles.

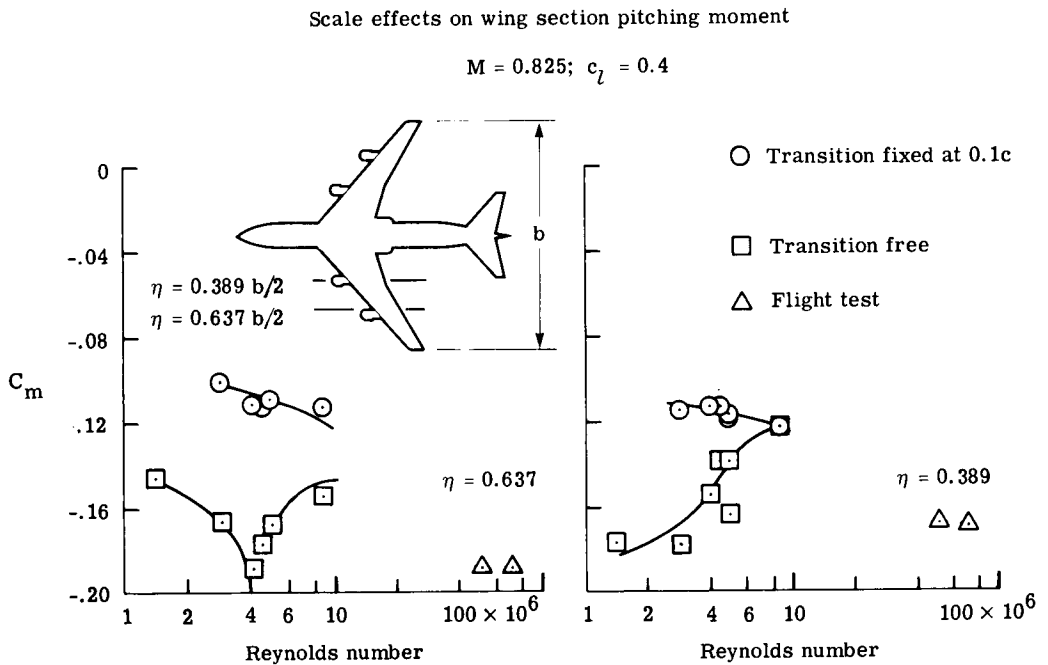

Figure 4.- Transition fixing in wind tunnels.

**Aircraft**

**Problems**

- C-141 -Wing flow incorrectly predicted. Stability, structural loads, and performance affected. Structural reevaluation testing and modifications cost 1 year and millions of dollars.
- F-111 -Transonic-flow interference effects incorrectly predicted. Airframe drag underestimated. Redesign and modifications costly.
- B-58 } Improper aerodynamic optimizations at transonic speeds. Low transonic
- B-70 } - acceleration margin resulted in range and maneuverability limitations
- YF-12 } reducing aircraft effectiveness.
- F-102 -Transonic drag rise improperly predicted caused major reconfiguration followed by replacement by F-106. Transonic base drag problems plagued both aircraft.
- CIVIL -Two jet transport aircraft required some redesign because of flow interactions between engines and wings. Uncertainties in prediction of pitching moments, drag, and maximum lift a concern in most cases.

Figure 5.- Problems discovered in flight test attributed to Reynolds number effects.

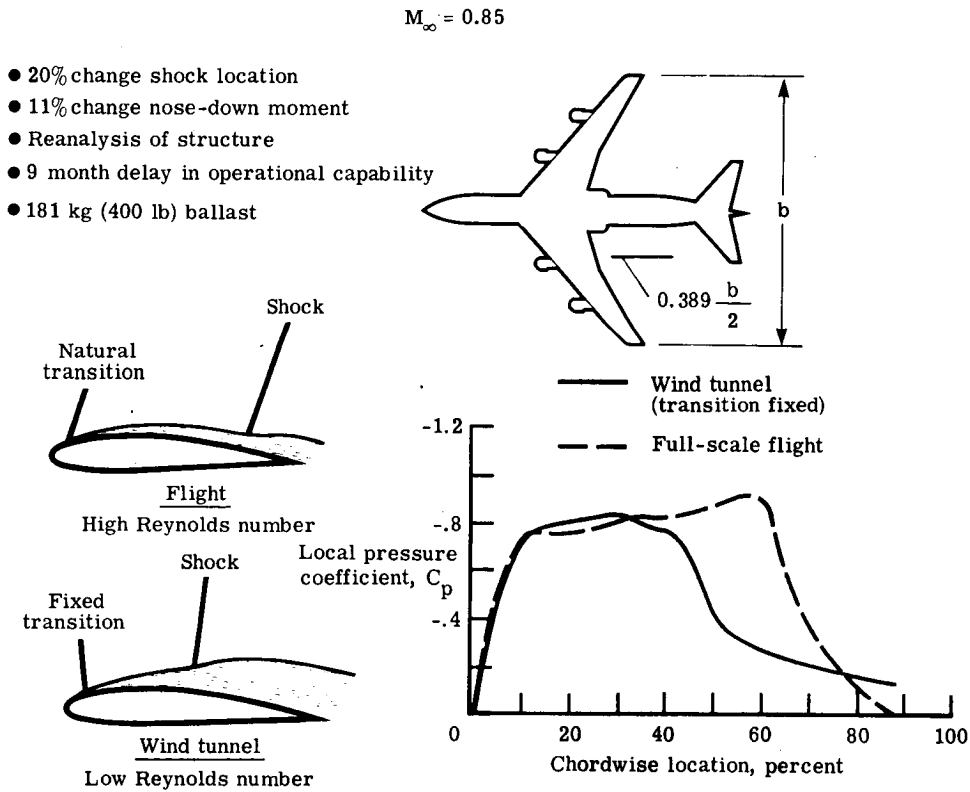
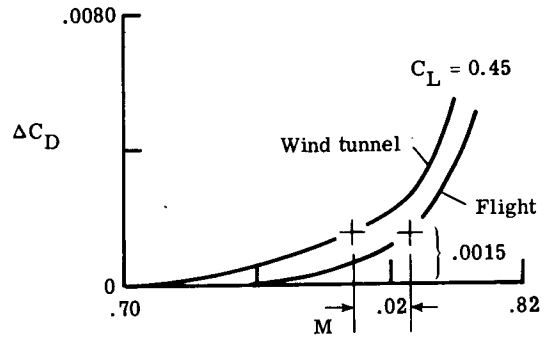
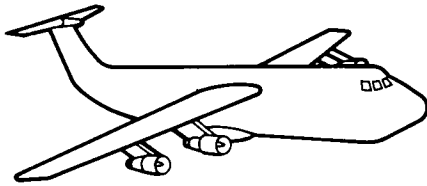

Figure 6.- Shock-induced flow separation.



- Wind tunnel prediction of drag rise Mach number .02 lower than flight results
- "Rule of thumb"..... 2% increase in wing thickness results in about .02 reduction in drag-rise Mach number
- Represents 3% wing weight reduction
- Weight reduction program resulted in reduced structural margins and caused fatigue life problem for wing
- Problem might have been avoided if drag-rise Mach number had been predicted accurately in wind tunnel and choice of thicker wing was permitted earlier in development cycle

Figure 7.- C-5A wing fatigue life problem.

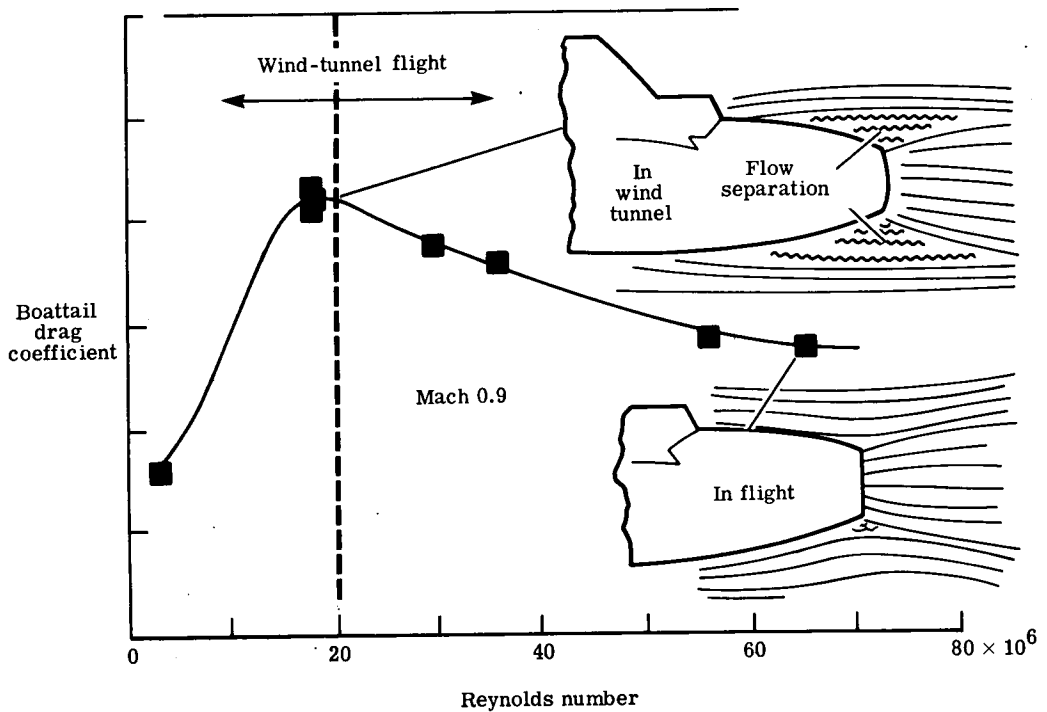

Figure 8.- Effect of Reynolds number on engine afterbody drag.

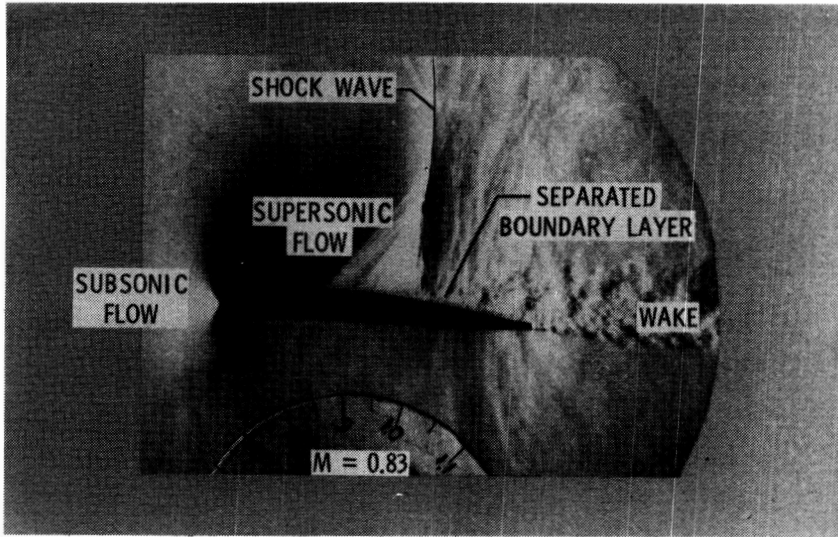

Figure 9.- Complex transonic flows vary with Reynolds number.

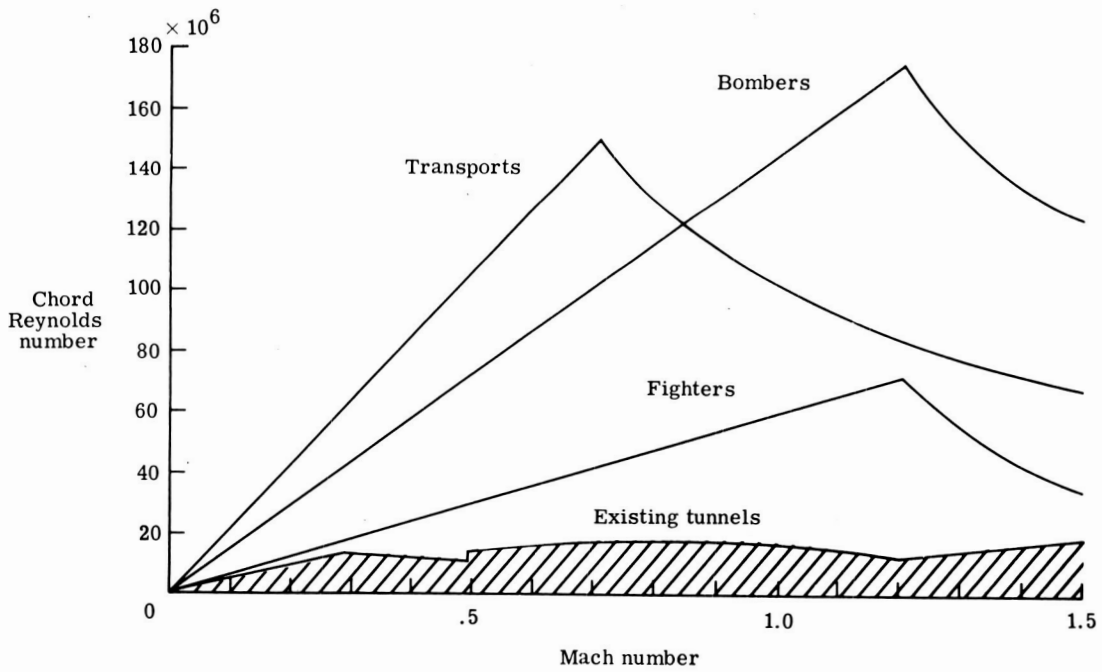

Figure 10.- 1969 projected flight Reynolds number.

$$R = \frac{\rho V \ell}{\mu}$$

- INCREASE SIZE (INCREASE  $\ell$ )
- INCREASE PRESSURE (INCREASE  $\rho$ )
- REDUCE TEMPERATURE (CHANGE  $\rho, V,$  AND  $\mu$ )

Figure 11.- Ways of increasing Reynolds number in a given gas.

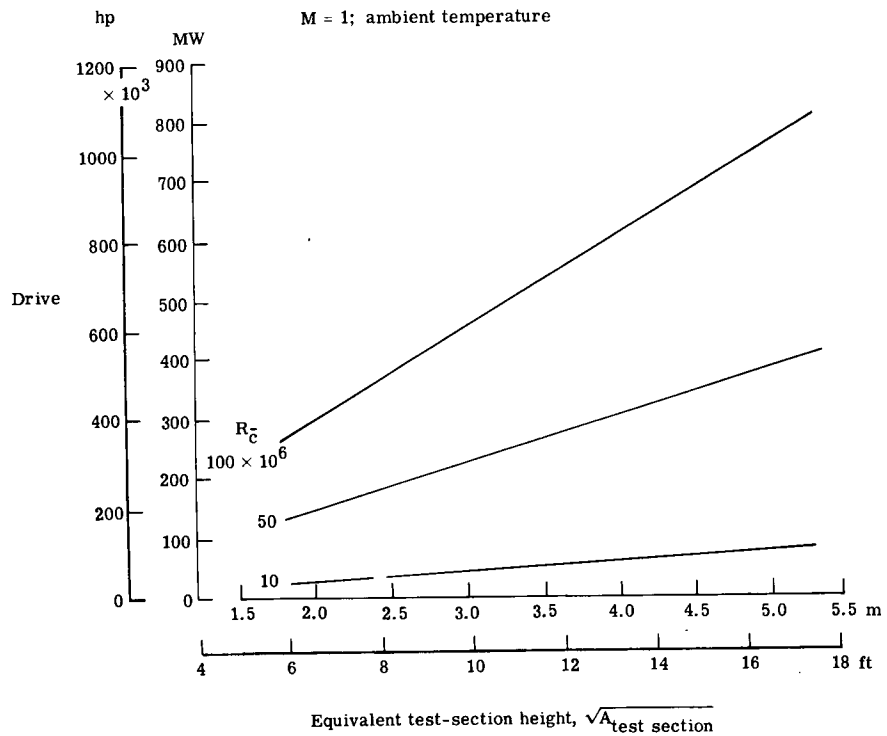

Figure 12.- Drive power requirements.

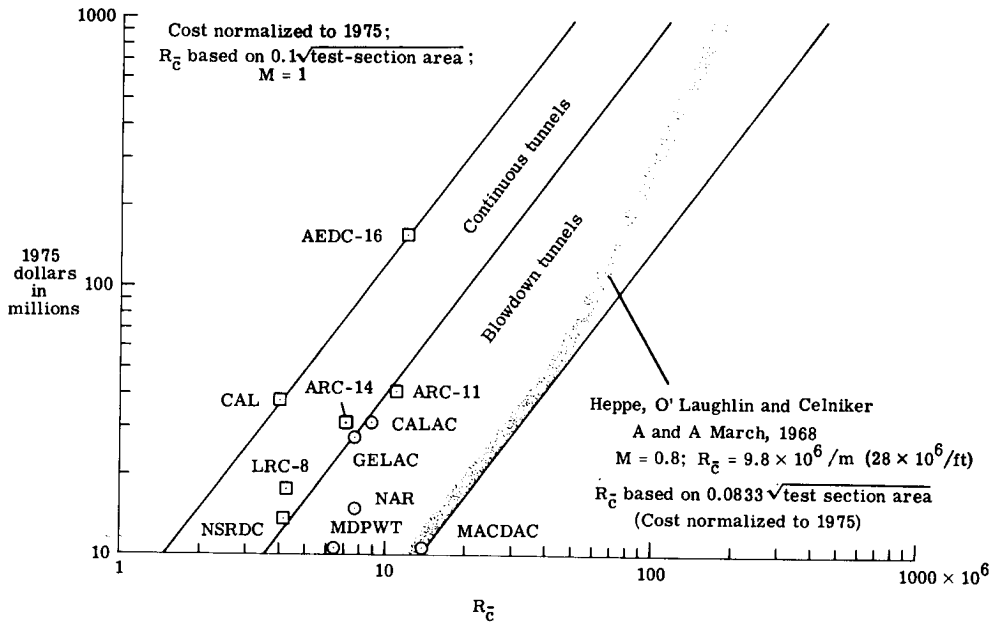

Figure 13.- Wind-tunnel cost trends.

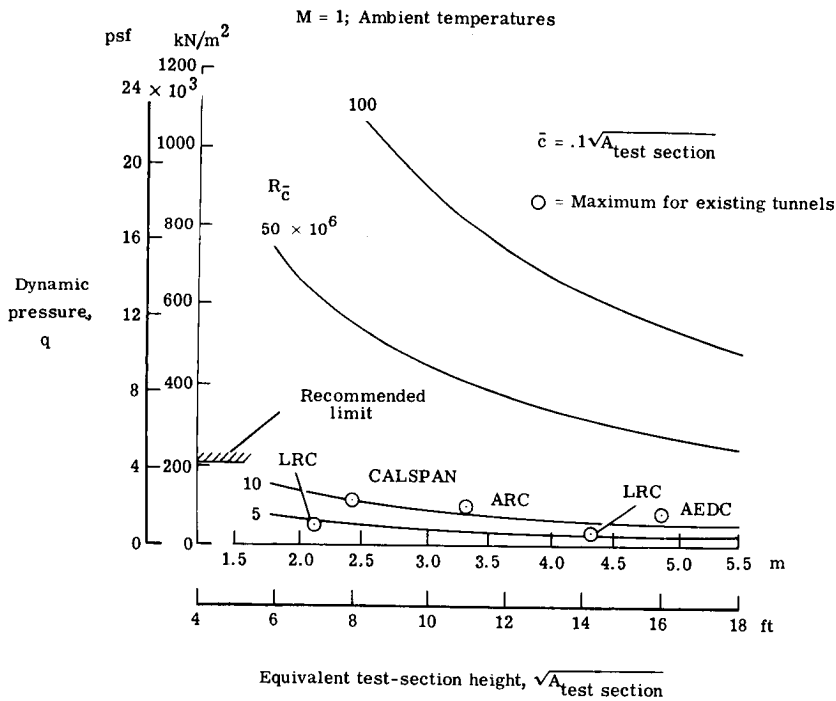

Figure 14.- Dynamic pressure at various test Reynolds numbers.

- WING AND BALANCE STRESS
- WING DISTORTION

- STING INTERFERENCE
- FUSELAGE DISTORTION

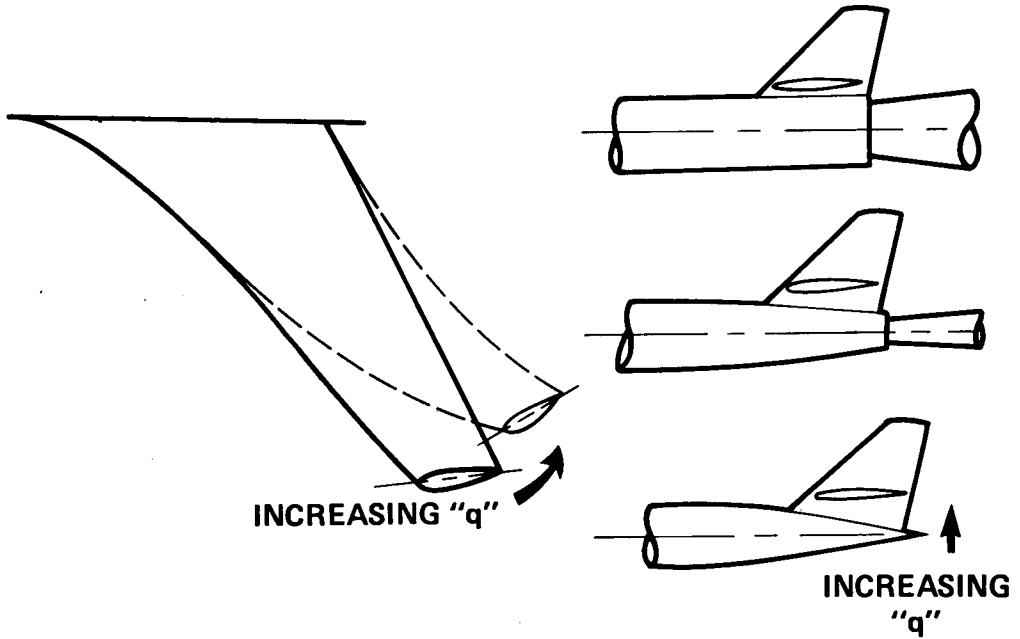

Figure 15.- Some dynamic pressure problems.

$M_\infty = 1.0$ ; Constant  $p_t$  and size

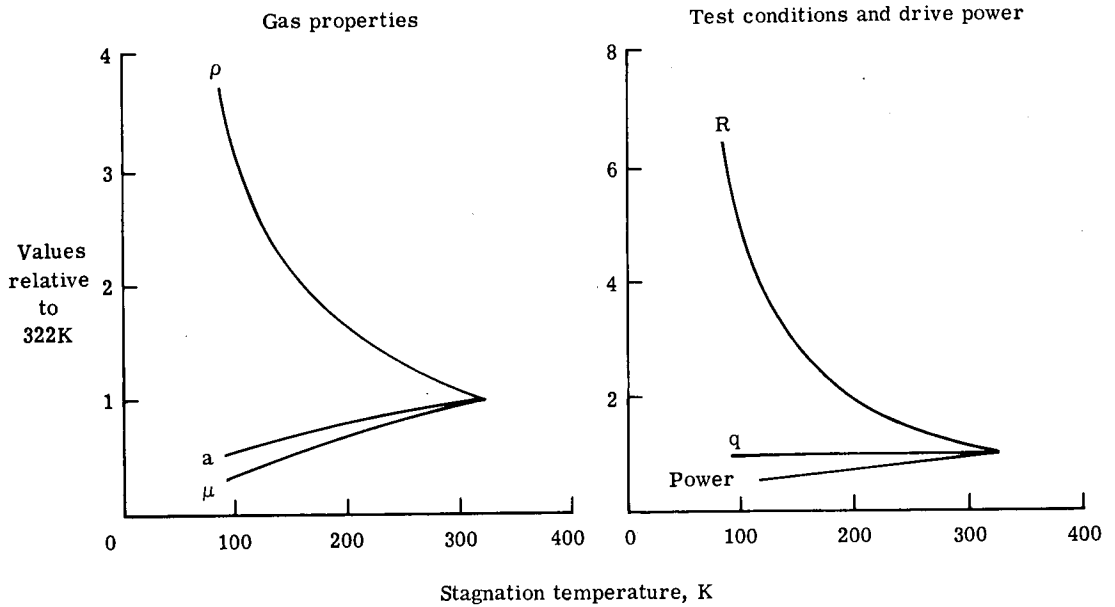

Figure 16.- Effect of temperature reduction.



$M_\infty = 1.0$ , 2.5 m × 2.5 m (8.2 ft × 8.2 ft) test section

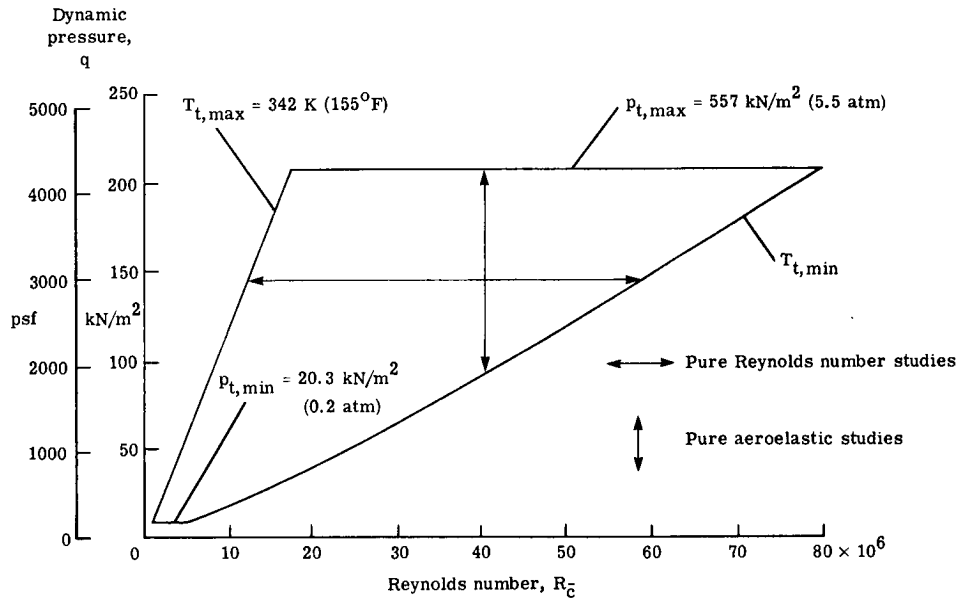

Figure 17.- Test envelope for a cryogenic wind tunnel.

- 1966-1975 -Air force design development of Ludweig tube facility (HIRT)
- 1969-1970 -NASA study of hydraulic drive conventional tunnel
- 1969-1972 -NASA design studies of injector driven tunnels
- 1971 -NASA/DOD (AACB) approves HIRT to propose as a national facility
- 1972-1973 -NASA experiments with cryogenic low-speed pilot tunnel
- 1973 -AACB study recommends HIRT (development) plus cryogenic TRT (research)
- 1974 -Congress authorizes Air Force to build HIRT
- 1974 -Construction cost escalations result in Air Force decision not to go forward with HIRT and AACB to make a reevaluation of transonic facilities
- 1975 -AACB approves cryogenic NTF as single facility to be jointly operated by NASA and DOD for research and development testing
- 1976 -Congress authorizes construction of NTF by NASA. Appropriates funds.

Figure 18.- National high Reynolds number wind tunnel planning.

**RESEARCH & TECHNOLOGY**

- A. THEORY DERIVATION/CONFIRMATION**
- B. CONFIGURATION AERODYNAMICS**
- C. PROPULSION AERODYNAMICS**
- D. DYNAMICS & AEROELASTICITY**

**SYSTEMS DEVELOPMENT & EVALUATION**

- A. COMPONENT STUDIES**
- B. PRELIMINARY DESIGN ASSESSMENT**
- C. CONFIGURATION DEVELOPMENT**
- D. FINAL AERODYNAMIC DESIGN EVALUATION**

Figure 19.- National transonic facility utilization.