

VORTEX ATTENUATION FLIGHT EXPERIMENTS

Marvin R. Barber, Earl C. Hastings, Jr.,*
Robert A. Champine,* and Joseph J. Tymczyszyn†

Dryden Flight Research Center

SUMMARY

Flight tests evaluating the effects of altered span loading, turbulence ingestion, combinations of mass and turbulence ingestion, and combinations of altered span loading and turbulence ingestion on trailed wake vortex attenuation were conducted in several NASA flight test programs. Span loadings were altered in flight by varying the deflections of the inboard and outboard flaps on a B-747 aircraft. Turbulence ingestion was achieved in flight by mounting splines on a C-54G aircraft. Mass and turbulence ingestion was achieved in flight by varying the thrust on the B-747 aircraft. Combinations of altered span loading and turbulence ingestion were achieved in flight by installing a spoiler on a CV-990 aircraft and by deflecting the existing spoilers on a B-747 aircraft.

The characteristics of the attenuated and unattenuated vortices were determined by probing them with smaller aircraft. Acceptable separation distances for encounters with the attenuated and unattenuated vortices are presented.

INTRODUCTION

Flight tests evaluating the effects of altered span loading, turbulence ingestion, combinations of mass and turbulence ingestion, and combinations of altered span loading and turbulence ingestion on trailed wake vortex attenuation were conducted

*Langley Research Center.

†Federal Aviation Administration, Western Region.

in several NASA flight test programs. The programs were initiated because ground facility (wind tunnel and water tank) measurements indicated that certain configuration changes offered potential for vortex attenuation, with a resultant increase in safety and airport capacity.

Table 1 summarizes the vortex attenuation flight experiments. The table also lists the aircraft involved in each experiment and gives some idea of the magnitude and timing of the programs.

Span loadings were altered in flight by varying the deflections of the inboard and outboard flaps on a Boeing B-747 aircraft. Figure 1(a) shows the B-747 airplane flying with a conventional or 30/30 landing flap configuration (i.e., inboard flap deflected 30° and outboard flap deflected 30°). Figure 1(b) shows the airplane flying with the 30/1 flap configuration (inboard flap deflected 30° , outboard flap deflected 1°). The following combinations of inboard/outboard flap deflections were tested: 30/30, 30/20, 30/10, 30/5, 30/1, and 5/30. The minimum outboard flap deflection was 1° so that the leading-edge flaps could be kept extended (the leading-edge flap deflections are programmed according to trailing-edge flap deflections). Various span loads were tested because of the attenuation potential forecast by the wind-tunnel tests reported in reference 1. The results of the flight tests of span loading alterations are reported in references 2 and 3.

Turbulence was created and ingested into the vortices in flight by mounting splines on a McDonnell Douglas C-54G aircraft and by varying the thrust of the engines on the B-747 aircraft. Figure 2 shows the splines on the aircraft in flight, and figure 3 shows details of the splines. These tests were preceded by wind-tunnel tests which are reported in conjunction with the flight tests in reference 4.

The inboard and outboard engines of the B-747 airplane are aligned directly in front of the outboard edges of the inboard and outboard flaps, respectively. Figure 1 illustrates the engine/flap alignment. This alignment naturally caused curiosity about the effects of changes in engine thrust on the wake vortices of the B-747 airplane in the normal landing configuration and in attenuated configurations. Therefore, the effects of engine thrust were evaluated on numerous occasions throughout the B-747 vortex attenuation flight tests.

The combined effects of altered span loading and turbulence ingestion were tested in flight by installing a fixed spoiler on the wingtip of a Convair CV-990 aircraft and by deflecting the existing spoilers on the B-747 airplane. Figures 4(a)

and 4(b) show the CV-990 wingtip spoiler from a distance and close up. Wind-tunnel tests of this configuration were conducted and reported in conjunction with flight tests in reference 5.

Figure 5 is a sketch of the B-747 spoiler/speed brakes, referred to herein as spoilers. The effects of various spoiler segment combinations on vortex attenuation were tested thoroughly in the Langley V/STOL wind tunnel (ref. 6). These results were sufficiently promising to warrant flight test verification. Therefore, the effects of deflecting these spoilers on vortex attenuation are being evaluated in flight tests.

All the B-747 flight tests were conducted with the NASA B-747 space shuttle carrier aircraft, and because the airplane was not always available, some of the tests could not be made before this writing. The scheduling problem also prevented many of the quantitative data from being processed in time for this paper. This paper therefore summarizes the qualitative assessment of the vortex attenuation provided by some of the B-747 configurations,

SYMBOLS

$ \dot{p} _{(measured)}$	roll axis angular acceleration measured during vortex encounter
$ \dot{p} _{\delta_{a_{max}}}$	maximum roll axis angular acceleration that can be generated by ailerons
C_{l_v}	vortex-induced rolling-moment coefficient
$C_{l_{\delta_a}}^{\delta_{a_{max}}}$	maximum rolling-moment coefficient that can be generated by ailerons
\bar{c}	mean aerodynamic chord

TEST TECHNIQUES

The technique of vortex attenuation flight testing has been described in detail in the paper by Jacobsen and Barber earlier in this conference. However, a review of the techniques from the pilot's standpoint is believed to be appropriate.

The most significant test in a qualitative evaluation of the vortex hazard to a trailing aircraft consists of probing the vortex as it would most likely be encountered in a real landing approach situation. To simulate this situation, the vortexes are probed with as small a penetration angle as possible. This type of probe is referred to as a parallel probe (i.e., the probing aircraft's flight path is approximately parallel to the vortex). The probe aircraft may enter the vortex wake from below, from above, or from either side. The probes result in pitch, roll, and yaw upsets that are representative of those that would be experienced by trailing aircraft in real situations. Qualitative assessments of these upsets enable the probe pilot to select separation distances (or times) behind a generating aircraft that result in acceptable levels of vortex-induced hazard.

The only limitation on a simulation of real vortex encounter situations is test altitude. Statistically it is known that most accidents attributed to trailed wake vortexes occur on landing approach at relatively low altitudes. Unfortunately, flight test experience to date has not resulted in sufficient confidence in either predictive techniques or the repeatability of flight test results to permit testing at altitudes less than those required for comfortable recovery from inverted flight. In practice, this means the tests must be conducted no lower than approximately **1500 meters (5000 feet)** above ground level.

Therefore, the probe pilot is evaluating an upset hazard at high altitudes above ground level and attempting to extrapolate his evaluation to low altitudes. This shortcoming has become more and more significant as the attenuated vortex configurations have enabled vortex encounters at closer separation distances, thereby increasing the need to verify the acceptability of the configuration.

In the past, probe pilots have estimated minimum separation distances by determining the separation distance at which the vortex-induced upsets would cause them to decide to execute a missed approach if they were performing an IFR approach. As noted, these determinations were made during parallel probes made approximately **1500 meters (5000 feet)** above ground level.

Figure 6 summarizes the data that were obtained from tests reported in references 7 to 10. The correlation of the data throughout the numerous test programs is relatively good and illustrates that the pilots' opinions obtained by using the previously discussed technique agree remarkably well with the minimum separation distances that were established by using the roll control criterion discussed by

Jacobsen and Barber. These data and the techniques for obtaining them were the baseline from which the vortex attenuation flight tests to be discussed herein were initiated. Experience gained in the vortex attenuation flight tests show some shortcomings in these data and indicate areas where present techniques are inadequate.

TEST RESULTS

Altered Span Loading

Span loadings were altered in flight by varying the deflections of the inboard and outboard flaps on a B-747 aircraft as shown in figures 1(a) and 1(b). Seventeen flights were flown by the B-747 airplane to complete these tests, and the Cessna T-37B and Learjet-23 (LR-23) aircraft were utilized as the probe aircraft. Both parallel and cross-track probes were performed during this test series. Most of the tests were preceded by the wind-tunnel tests reported in reference 1, and were partially reported in references 2 and 3.

The results of these tests are summarized in figure 7, which presents the pilots' qualitative assessments of the alleviation provided by retracting the outboard flap on the B-747 airplane. The landing-gear-up data show that a significant amount of attenuation was provided by retracting the outboard flap. These data agree with wind-tunnel data obtained from a model that did not have a landing gear. When the landing gear on the airplane was extended, a significant amount of the attenuation was lost.

An assessment of the correlation between the pilots' qualitative separation requirements and the requirements that would be dictated by the roll control criterion can be obtained by comparing figure 7 with figures 8(a) and 8(b). In general, these data show that the quantitative and qualitative requirements are in agreement.

During these tests it was also noted that engine thrust and aircraft sideslip had a significant effect on the attenuation provided by the altered span loadings. These effects are illustrated in figures 9 and 10.

The differences in the B-747 trailed vortex system with and without the outboard flap extended can be evaluated by reviewing the photographs in figures 11(a) to 11(j) and figures 12(a) to 12(g). A comparison of figure 11(a) and figure 12(a) indicates that with the outboard flap extended the dominant vortex is the vortex shed from

the outboard edge of the outboard flap. With the outboard flap retracted, the dominant vortex is that shed from the outboard edge of the inboard flap. In both cases, the wingtip vortex interacts with the dominant vortex. The effects of configuration on vortex life can also be compared. The unattenuated vortex persists for at least 45 seconds, when the cameraman ceased taking pictures. The attenuated vortex disappears completely in 30 seconds. After these tests, the vortex marking system was modified to include smokers at the inboard edge of the inboard flap to try to determine why the landing gear reduced the attenuation. The photographs in figures 13(a) and 13(b) show that the landing gear diffuses a powerful vortex at the inboard edge of the inboard flap, significantly reducing the attenuation provided by the 30/1 flap configuration. Though not available in the photographic record at this time, visual observations of the inboard vortex showed that it intermingled with the vortex off the outboard edge of the inboard flap when it was not diffused by the landing gear.

Although interesting from a research standpoint, the vortex attenuation afforded by the 30/1 flap configuration was disregarded for obvious operational reasons when the degrading effects of the landing gear were discovered. It should be noted that this configuration also imposed a center-of-gravity limitation on the B-747 airplane.

A flight evaluation of the vortices 4 nautical miles to 6 nautical miles behind the B-747 airplane in the 5/30 flap configuration was short and conclusive. Whereas the 30/1 flap configuration produced marked attenuation, the 5/30 vortex resulted in T-37B encounters that were even more violent than those caused by the conventional 30/30 landing configuration at 6 nautical miles. One encounter at 6 nautical miles produced a violent double snap roll which far exceeded the capability of the roll rate data acquisition system and also caused an engine flameout. These tests showed the correct approach to vortex attenuation to be increasing the inboard span loading,

Turbulence Ingestion

The ingestion of turbulence into the vortices in flight was accomplished by mounting splines on the wingtips of a C-546 aircraft (figs. 2 and 3). The Piper Cherokee (PA-28) airplane was used as the probe aircraft for these tests. The vortex attenuation results of these tests are shown in figure 14, which compares the probe aircraft's roll accelerations in the attenuated and unattenuated vortices. The data show that the PA-28 airplane has insufficient roll control power to overcome

the vortexes of the basic **C-54G** airplane at a separation distance of approximately 4 nautical miles, and that maximum roll control power is never required to oppose the vortex attenuated by splines. The data generally correlate with the pilots' opinions of the attenuation, which was that roll control became insufficient approximately 2.5 nautical miles behind the unattenuated **C-54G** airplane but that it was sufficient throughout the entire range of separations tested for the attenuated configuration. The unattenuated data represent the **C-54G** airplane in the clean configuration and therefore are not directly comparable to the data presented in figure 6, which are for the normal landing configuration.

The effects of the splines on the performance, handling qualities, and noise of the **C-54G** airplane were also measured. It was concluded that although the splines significantly reduced the rate of climb of the **C-54G** airplane, the airplane's four-engine performance was acceptable for this test program. (It should be noted that the splines were not retractable, as they would be for any configuration seriously proposed for operation.) The splines caused no noticeable changes in the handling qualities of the **C-54G** airplane. Finally, the maximum overall sound pressure level of the **C-54G** airplane during landing approach with splines on was approximately 4 decibels higher than with splines off.

The vortex attenuation potential of the splines should not be too easily discounted because of what may seem to be rather complex operational problems. An unpublished study concerning the feasibility of producing retractable splines concluded that the concept is practical.

Combinations of Mass and Turbulence Ingestion

Flight tests were conducted with the **B-747** airplane to evaluate the effects of engine thrust on vortex attenuation. In general, most of the **B-747** testing has been conducted with thrust for level flight at altitudes of approximately 3000 meters (10,000 feet), because a level flightpath makes it easier for the probe pilots to find and encounter the vortexes. However, considerable testing has been performed for all the attenuated and unattenuated configurations wherein the thrust was reduced from that required for level flight to that required for a -3° flightpath angle and further to flight idle (approximately -6° flightpath angle, depending on spoiler, flap, and gear configuration). To date, a detailed comparison of the pilots' qualitative assessments of the effects of engine thrust with quantitative data has not been

completed. In general, however, it appears that reducing the thrust from that required for level flight to flight idle adds approximately 2 nautical miles to the required separation distance. This generalization is true for both the 30/30 and 30/1 flap configurations (fig. 9).

Tests wherein the inboard and outboard engine thrust levels have been varied alternately have been conducted, but the data are not yet available. Tests to determine the effects of engine thrust on the attenuation provided by deflecting various spoiler segments are yet to be completed.

Combinations of Span Loading Alteration and Turbulence Ingestion

Wind-tunnel tests made as early as 1969 indicated that the character of the trailing vortex system could be changed significantly by adding a spoiler to the wing in the area of the vortex formation (ref. 5). Flight tests of a spoiler on the wingtip of a CV-990 aircraft (fig. 4) were conducted in 1970 as a result of these wind-tunnel tests. Unfortunately, at that time in-flight vortex marking systems were not available, and therefore the tests were rather inconclusive.

More recently, however, wind-tunnel tests have shown that extending various combinations of the B-747 spoilers is effective in attenuating its vortexes (ref. 6). Figure 5 shows that the four outboard spoiler panels on the B-747 airplane are in the vicinity of the outboard flap, where the dominant vortex is shed (fig. 11). Therefore, it is not surprising that extending these spoilers affects the resulting vortex system.

These tests were paced by wind-tunnel tests (ref. 6). In flight, the spoilers were deflected in the following combinations:

Spoiler panel											
1	2	3	4	5	6	7	8	9	10	11	12
Spoiler panel deflection, deg											
--	--	37	37	--	--	--	--	37	37	--	--
41	41	--	--	--	--	--	--	--	--	41	41
25	25	--	--	--	--	--	--	--	--	25	25
45	--	--	45	--	--	--	--	45	--	--	45
--	45	45	--	--	--	--	--	--	45	45	--

The deflection angles were chosen as a result of the flight crew's concern about the level of buffet induced by the spoilers and limitations of the control system on the production B-747 airplane. The 37° deflection for spoilers 3, 4, 9, and 10 and the 41° deflection for spoilers 1, 2, 11, and 12 were used because of the crew's concern about the safety of accepting a higher level of buffet. The 25° limit for the deflection of spoilers 1, 2, 11, and 12 was established because it caused the highest buffet level that the flight crew felt passengers would tolerate. The 45° deflections for the spoiler combinations (1, 4, 9, 12) and (2, 3, 10, 11) were limited primarily by the control system. It is interesting to note that the flight crew felt that the buffet level with a spoiler deflection of 45° was excessive for spoiler combination (2, 3, 10, 11), but acceptable for the spoiler combination (1, 4, 9, 12).

Figure 15 summarizes the pilots' qualitative separation requirements from the spoiler flight tests. The data illustrate that with spoilers 1, 2, 11, and 12 deflected 41°, significantly more attenuation is provided than with any other configuration. In fact, it would appear from these data that the 41° deflection of spoilers 1, 2, 11, and 12 could be proposed as an operational configuration that would allow light aircraft to be spaced as close as 3 nautical miles behind heavy aircraft. Therefore, a series of tests was developed to investigate the operational feasibility of using this configuration. This investigation was to include actual landings of the B-747 airplane with the spoilers extended and probes of its vortex at landing flare altitudes by the T-37B airplane.

Landing the B-747 airplane with the spoilers extended was accomplished in a relatively straightforward manner, and the pilots indicated that the spoilers did not significantly detract from the airplane's landing performance.

The proposed low altitude probes with the T-37B airplane required a reevaluation of the criteria on which probing was based at altitude. As discussed in TEST TECHNIQUES, the probe pilots used as a criterion the level of upsets which would force them to abandon an approach either on instruments or after breaking out at the bottom of an overcast. Among other factors, a bank angle limit of approximately 30° for the T-37B airplane at altitude was considered as a baseline (with lower limits for aircraft with larger wingspans). The adequacy of this partial criterion was questioned, however, when actual landings were proposed; lower control power, proximity to stalls or spins at low altitude, and the thrust required

to overcome the downwash of the generating airplane became additional items of concern.

Intentional probes of the downwash area between the B-747 vortices were made with the B-747 airplane with spoilers 1, 2, 11, and 12 deflected. The T-37B airplane probed this area to less than 2 nautical miles and found only light to moderate turbulence with an incremental downwash of approximately 150 meters per minute (500 feet per minute). The problem of adequate climb performance at low speeds in the landing configuration had to be considered, even when roll control power was adequate to overcome the vortex-induced roll. An additional unknown was the variation of vortex strength and life as a function of altitude and ground effect. Tests using ground-based sensors were conducted to evaluate the normal and attenuated vortex characteristics, but the results are not yet available.

Another question pertinent to the problem of separation distance is the effectiveness of attenuating devices for following aircraft that have considerably larger wingspans than the T-37B and LR-23 airplanes. Wind-tunnel and water tank tests on a McDonnell Douglas DC-9 scale model indicate a definite reduction in induced roll, but not as large a reduction as models of smaller wingspan experienced. This effect is due to the better fit of an airplane with a larger wingspan in the larger attenuated vortex.

All T-37B probe pilots agree that the attenuated vortex is much larger in diameter, is less well defined, and has lower tangential velocities than the usual, well-formed vortex tube. A DC-9 airplane is being instrumented and is to be test flown to determine the degree of effectiveness of vortex attenuation on an airplane with a significantly larger wingspan than the T-37B and LR-23 aircraft.

A comparison of the photographs presented in figures 16(a) and 16(b) with those shown in figures 17(a) and 17(b) will provide the reader with an illustration of the differences in the formation of the B-747 vortex systems with and without spoilers 1, 2, 11, and 12 extended.

CONCLUDING REMARKS

Flight tests made to evaluate the effects of altered span loading, turbulence ingestion, combinations of mass and turbulence ingestion, and combinations of altered span loading and turbulence ingestion on trailed wake vortex attenuation

showed aerodynamic attenuation to be possible and probably operationally practical. This conclusion is based on the fact that three of the methods tried provided significant levels of wake vortex attenuation.

REFERENCES

1. Corsiglia , Victor R . ; Rossow , Vernon J . ; and Ciffone, Donald L . : Experimental Study of the Effect of Span Loading on Aircraft Wakes. NASA TM X-62431, 1975.
2. Tymczyszyn, Joseph J . ; and Barber, Marvin R . : Recent Wake Turbulence Flight Test Programs. SETP 1974 Report to the Aerospace Profession - Eighteenth Symposium Proceedings. Soc . Exp . Test Pilots, Sept . 1974, pp . 52-68.
3. Smith, Harriet J . : A Flight Test Investigation of the Rolling Moments Induced on a T-37B Airplane in the Wake of a B-747 Airplane. NASA TM X-56031, 1975.
4. Hastings, Earl C . ; Patterson, J. C . , Jr . ; Shanks, Robert E . ; Champine, Robert A . ; Copeland, W . Latham; and Young, Douglas C . : Development and Flight Tests of Vortex-Attenuating Splines. NASA TM X-8083, 1975.
5. Corsiglia, Victor R . ; Jacobsen, Robert A . ; and Chigier , Norman: An Experimental Investigation of Trailing Vortices Behind a Wing With a Vortex Dissipator. Aircraft Wake Turbulence and Its Detection, John H . Olsen , Arnold Goldberg, and Milton Rogers, eds., Plenum Press, 1971, pp . 229-242.
6. Croom, Delwin R . : Low-Speed Wind-Tunnel Investigation of Various Segments of Flight Spoilers as Trailing-Vortex-Alleviation Devices on a Transport Aircraft Model. NASA TN D-8162, 1976.
7. Andrews , William H . ; Robinson, Glenn H . ; and Larson , Richard R . : Exploratory Flight Investigation of Aircraft Response to the Wing Vortex Wake Generated by Jet Transport Aircraft. NASA TN D-6655, 1972.
8. Robinson, Glenn H . ; and Larson, Richard R . : A Flight Evaluation of Methods for Predicting Vortex Wake Effects on Trailing Aircraft. NASA TN D-6904, 1972.

9. Andrews , William H .; Robinson, Glenn H .; and Larsdn , Richard R .: Aircraft Response to the Wing Trailing Vortices Generated by Large Jet Transports. NASA Aircraft Safety and Operating Problems—Volume 1. NASA SP-270, 1971, pp. 115-126 .
10. Barber, M. R.; Kurkowski, R. L.; Garodz, L. J.; Robinson, G. H.; Smith, H. J.; Jacobsen, R. A.; Stinnett, G. W.; McMurtry, T. C .; Tymczyszyn, J. J. ; Devereaux, R. L. ; and Bolster, A. J. : Flight Test Investigation of the Vortex Wake Characteristics Behind a Boeing 727 During Two-Segment and Normal ILS Approaches. NASA TM X-62398, 1975,

TABLE 1. - VORTEX ATTENUATION FLIGHT EXPERIMENTS

Method of attenuation	Means of attenuation	Host aircraft	Vortex-probing aircraft	Number of test flights	Time period for test flights
Altered span loading	Altered inboard/outboard flap deflections	B-747	Learjet-23 (LR-23) Cessna T-37B	≈17	1974
Turbulence ingestion	Splines	C-54G	Piper Cherokee (PA-28)	≈20	1973
Mass and turbulence ingestion	Altered inboard/outboard engine thrust levels	B-747	LR-23 T-37B	≈2	1974/1975
Altered span loading and turbulence ingestion	Wingtip-mounted spoiler Altered spoiler deflections	CV-990 B-747	LR-23 LR-23 T-37B McDonnell Douglas DC-9	≈2 ≈15	1969 1975/1976



(a) 30/30 flap configuration.



(b) 30/1 flap configuration.

Figure 1. B-747 span Zoad test configurations.

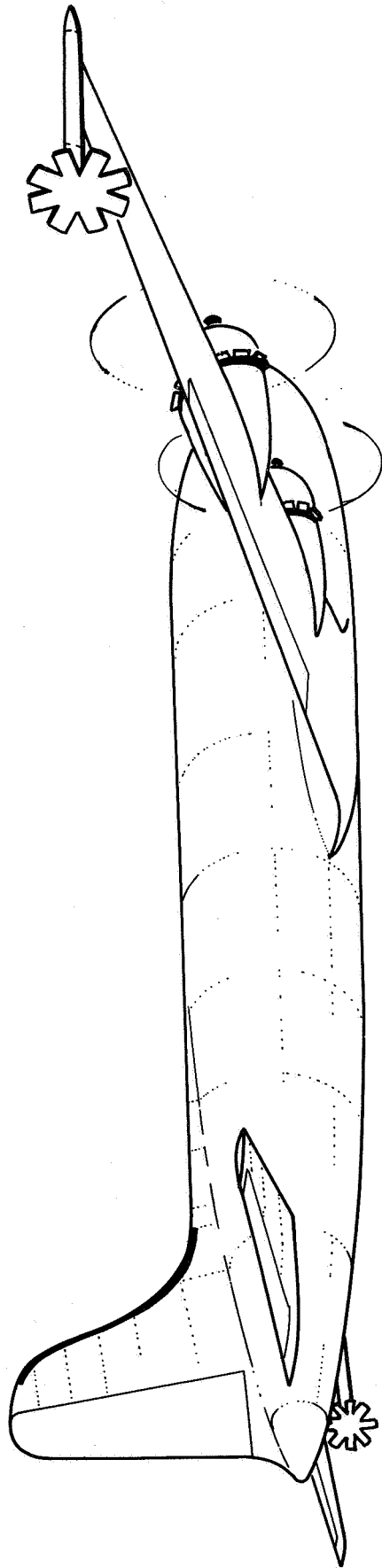

Figure 2. C-54G aircraft with splines installed.

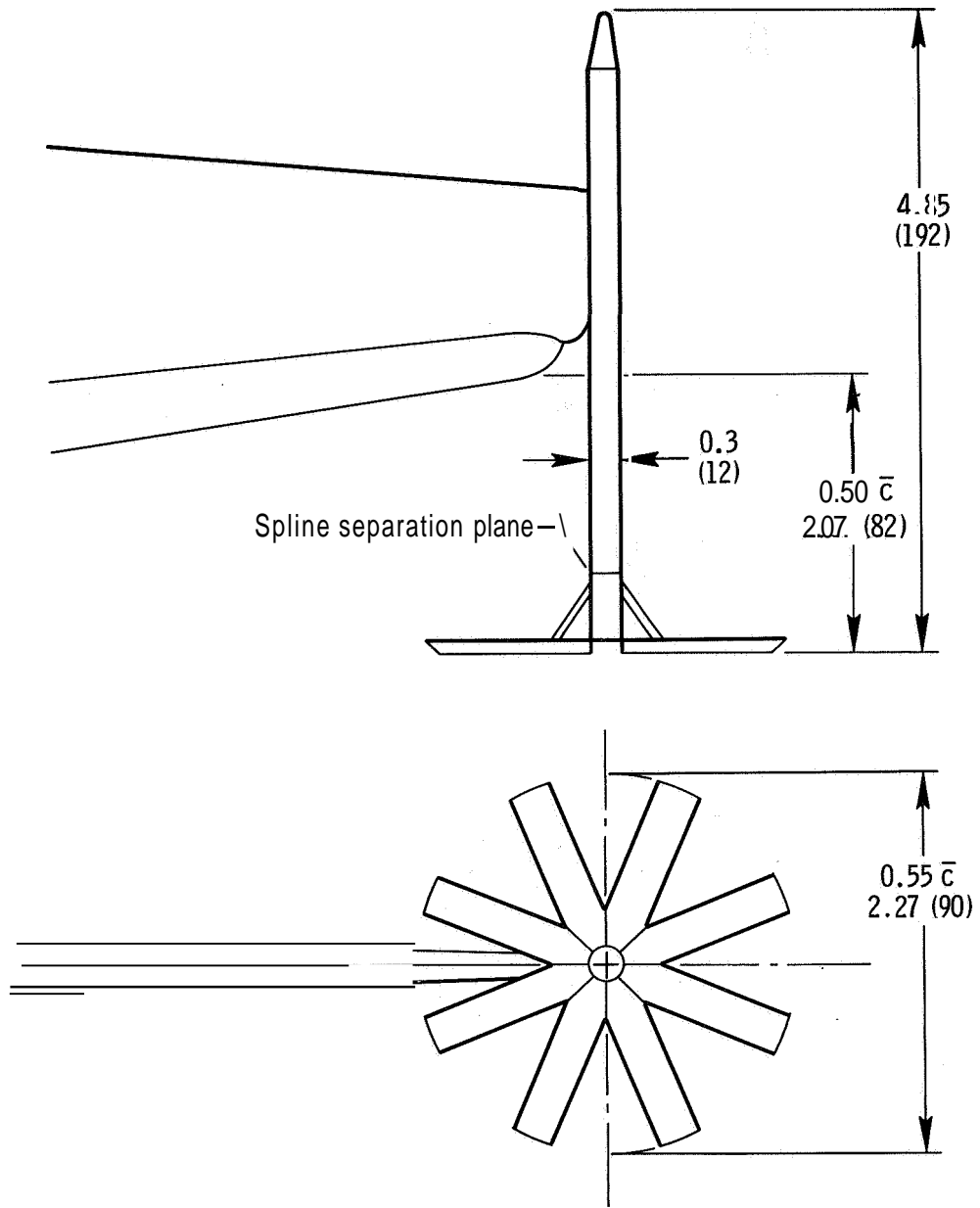
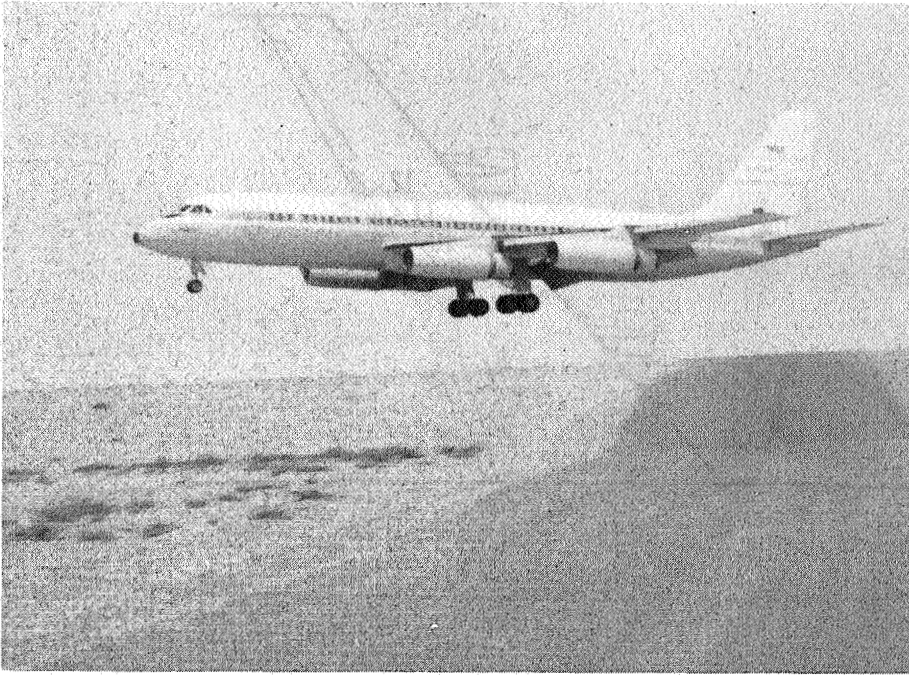
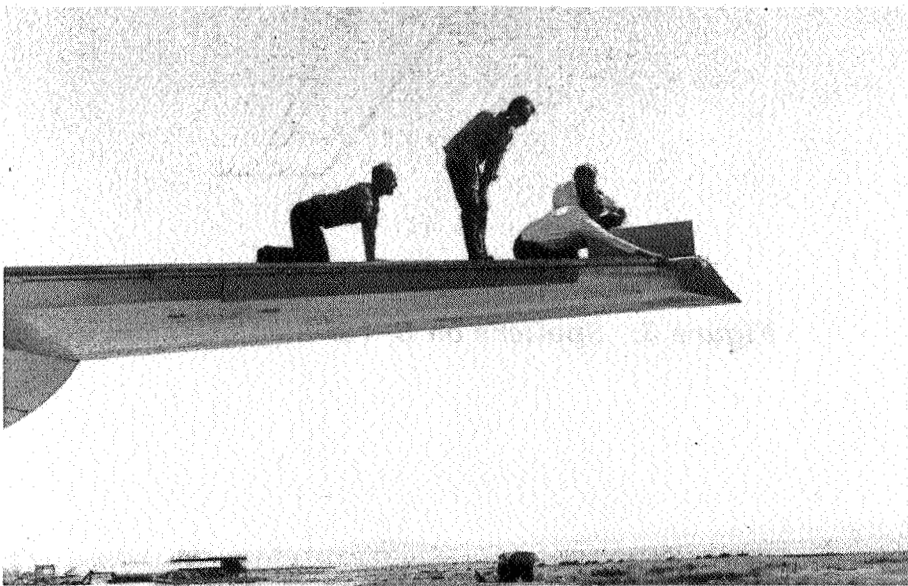

Figure 3. Diagram of spline arrangement. Dimensions in meters (inches).



(a) From a distance.



(b) Close up.

Figure 4. CV-990 wingtip spoiler.

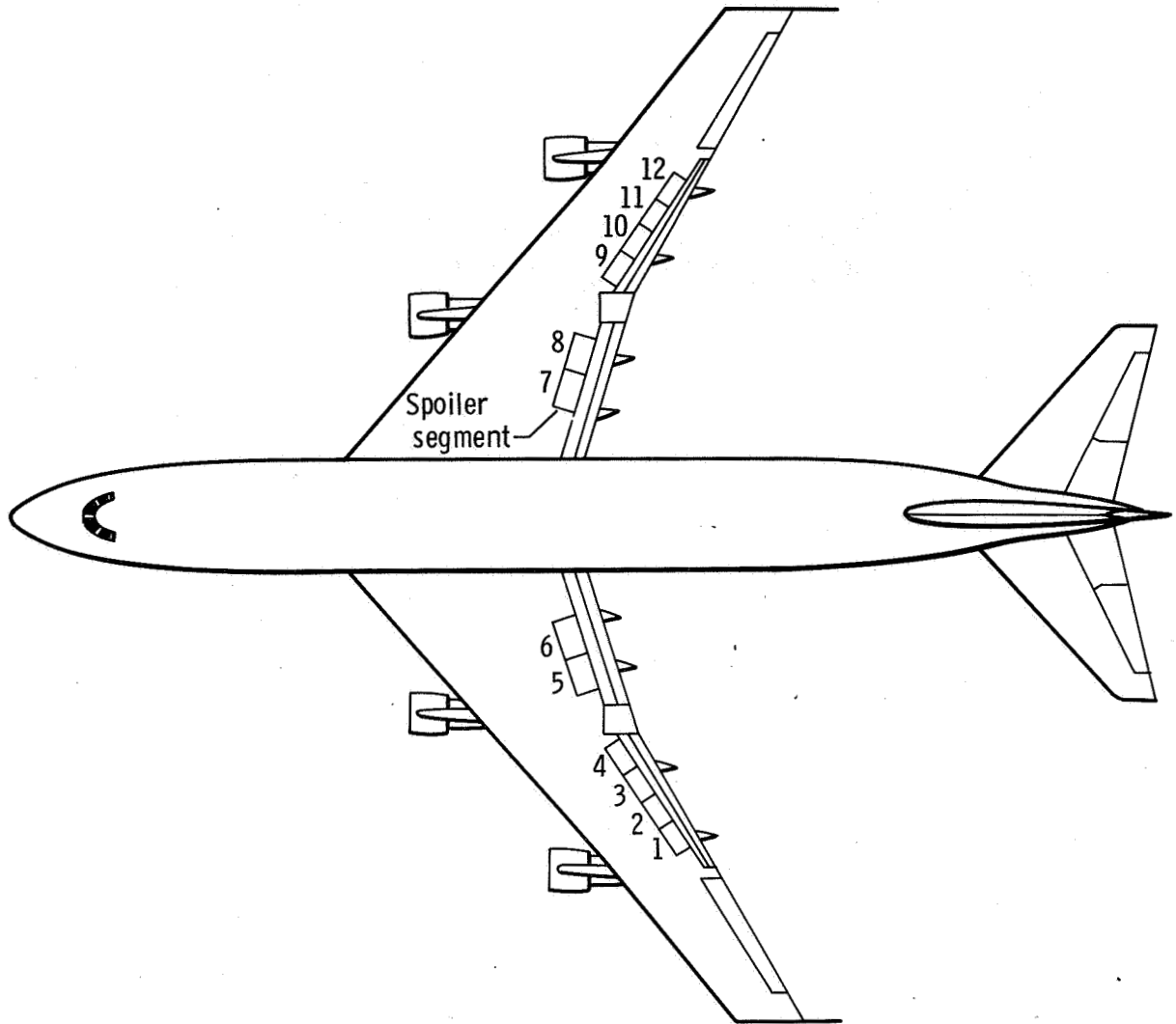

Figure 5. Spoilers on B-747 airplane.

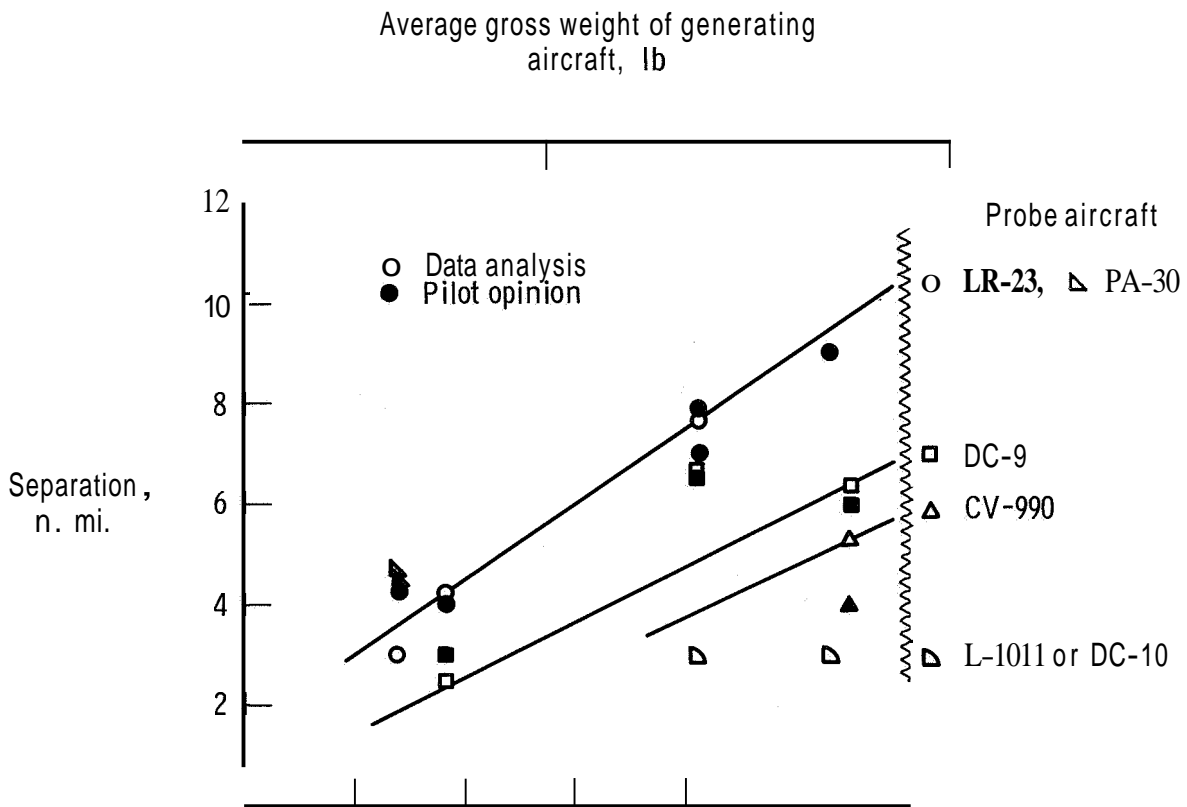

Figure 6. Minimum separation distance based on pilot opinion and roll control criterion. Generating aircraft in Zanding configuration; $\frac{|\dot{p}|_{measured}}{|\dot{p}|_{\delta a_{max}}} = 1$.

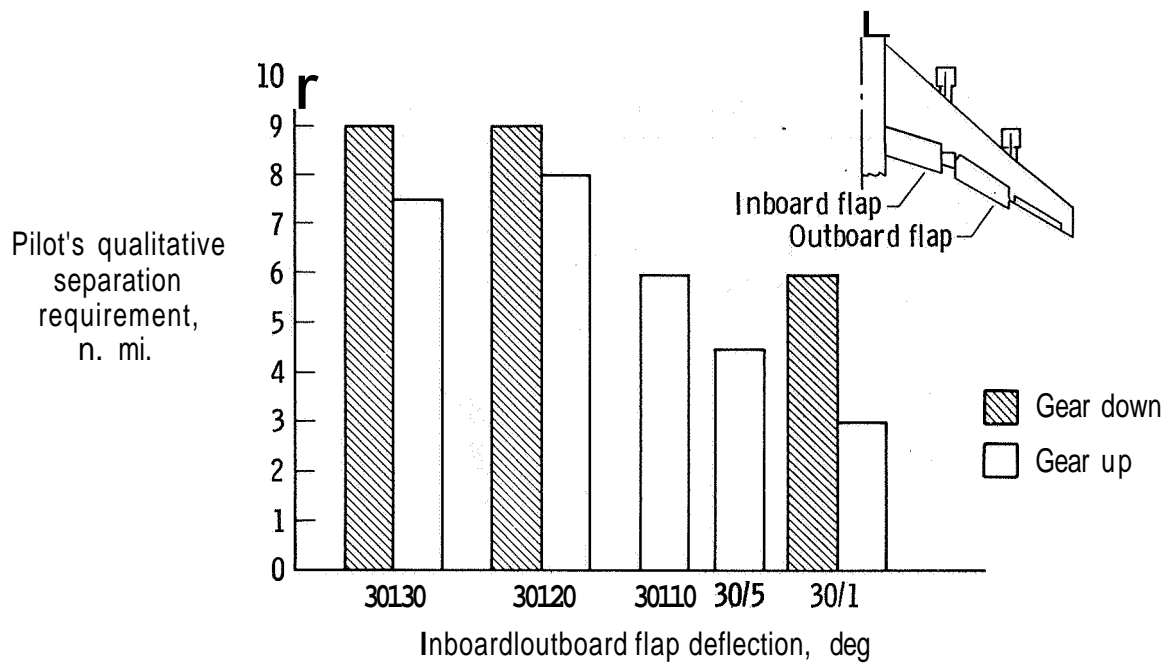
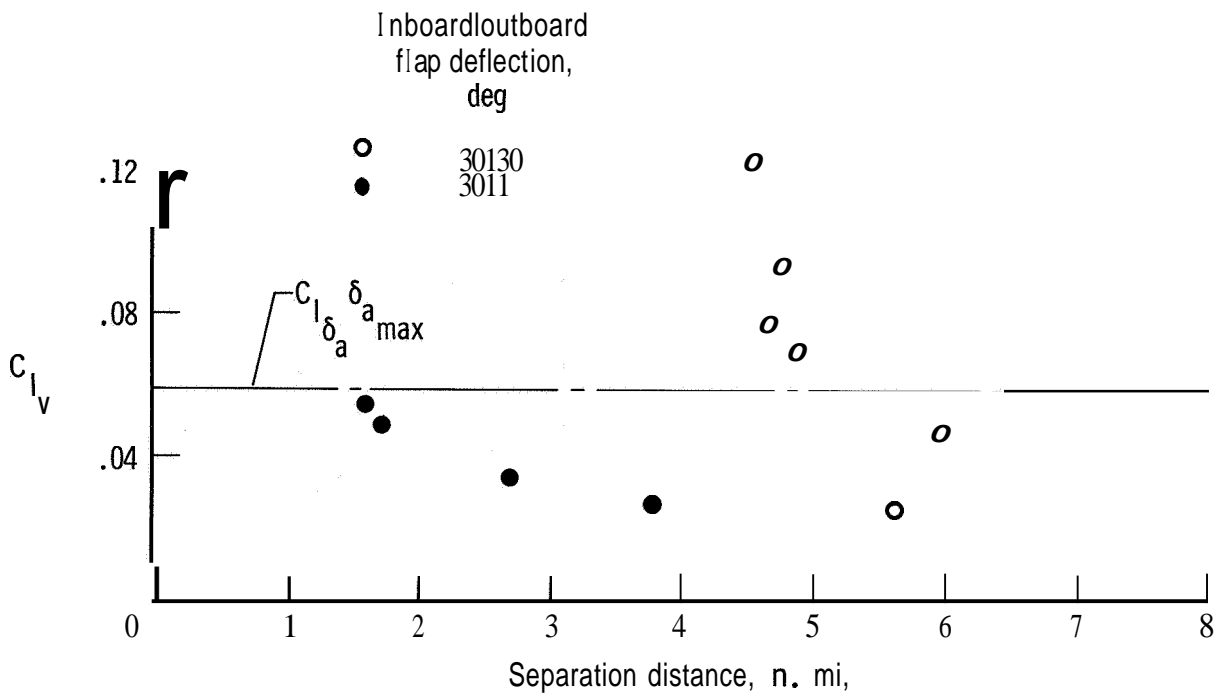
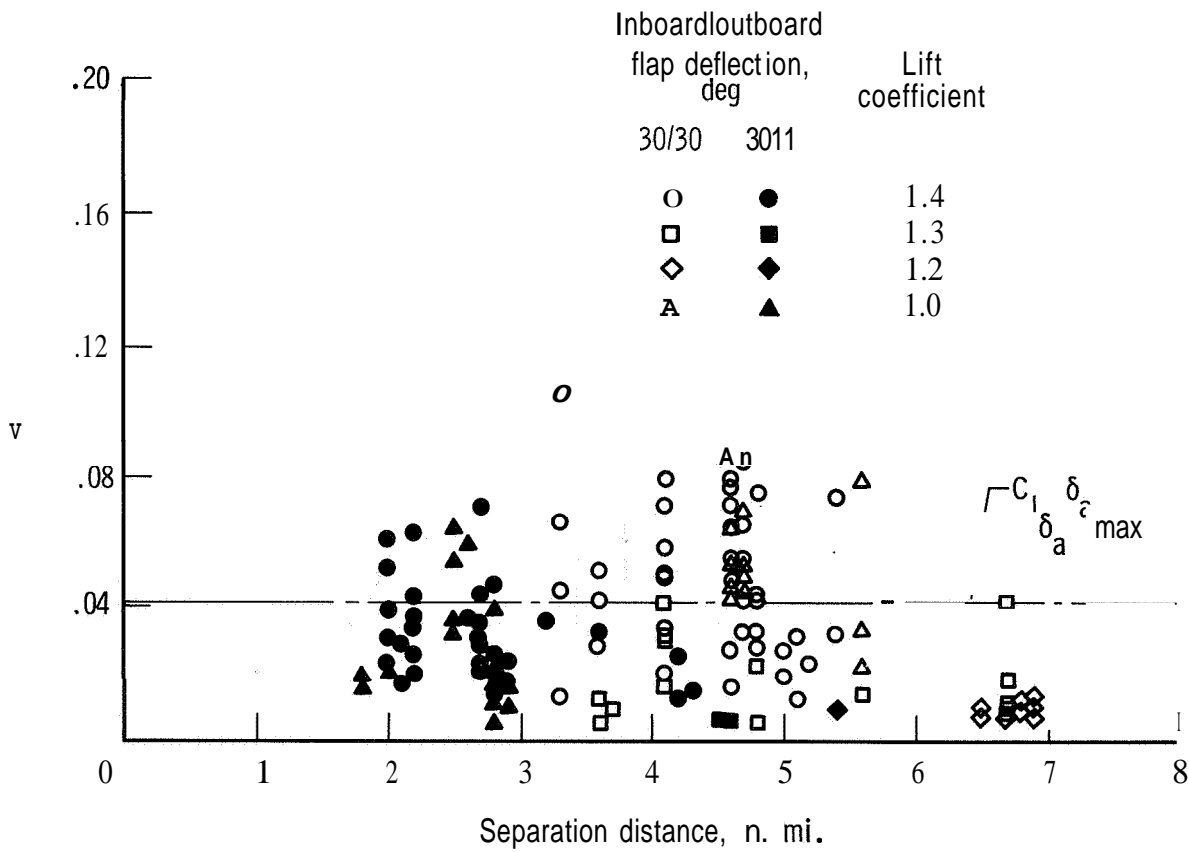

Figure 7. Effect of outboard flap and landing gear on wake vortex alleviation. B-747 airplane; thrust for level flight.



(a) Measured by T-37B airplane. B-747 lift coefficient = 1.2.



(b) Measured by LR-23 airplane.

Figure 8. Effect of B-747 flap configuration on vortex-induced rolling moments. B-747 gear up; thrust for level flight.

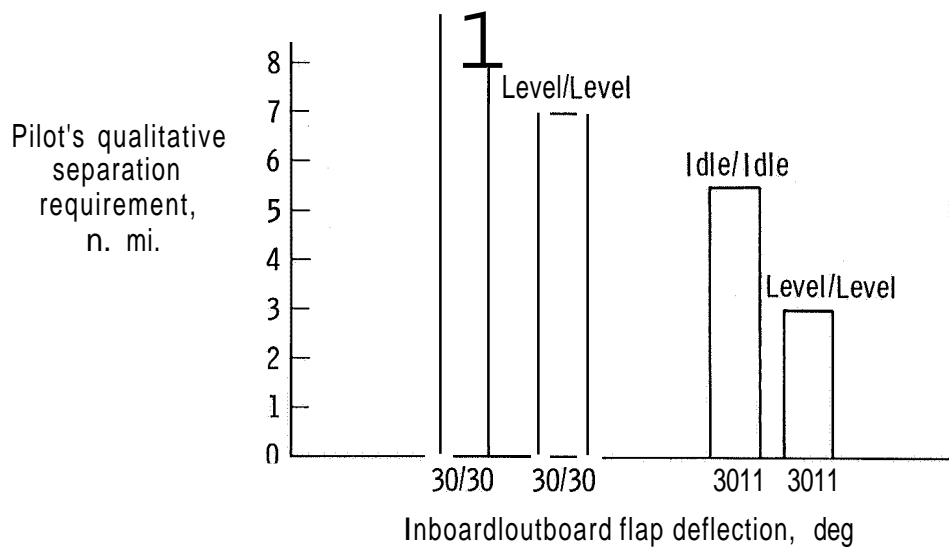

Figure 9. Effect of thrust on wake vortex alleviation. B-747 airplane; gear up.

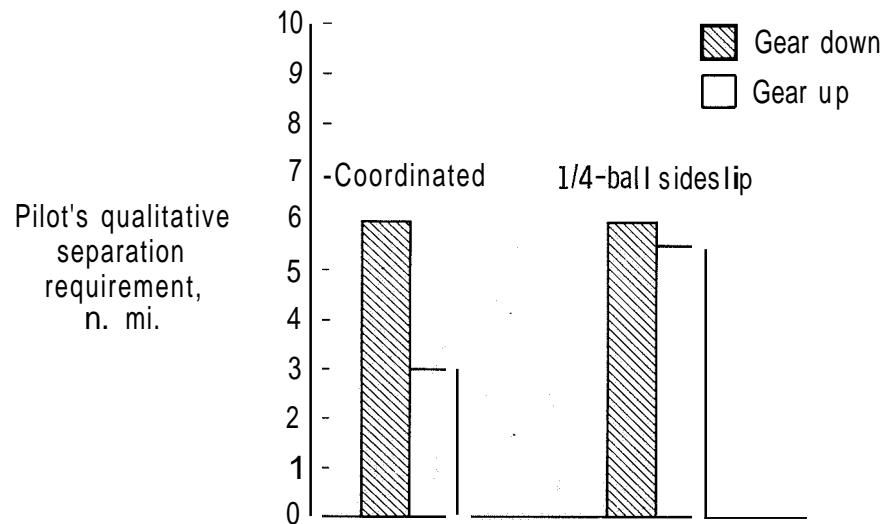
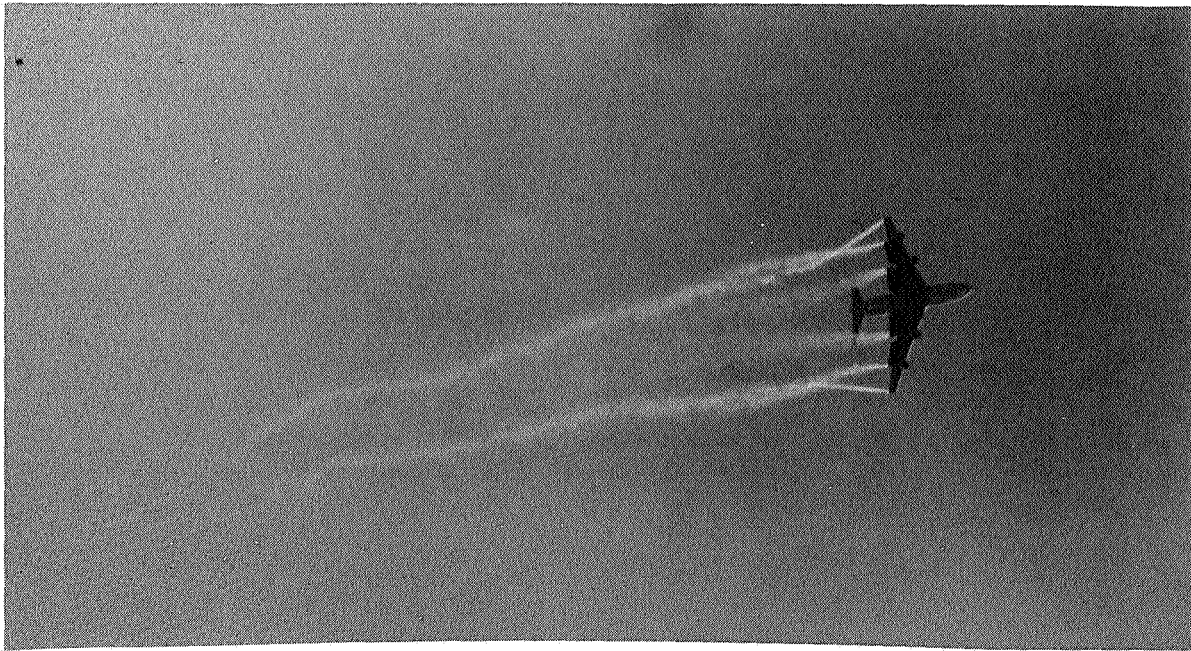
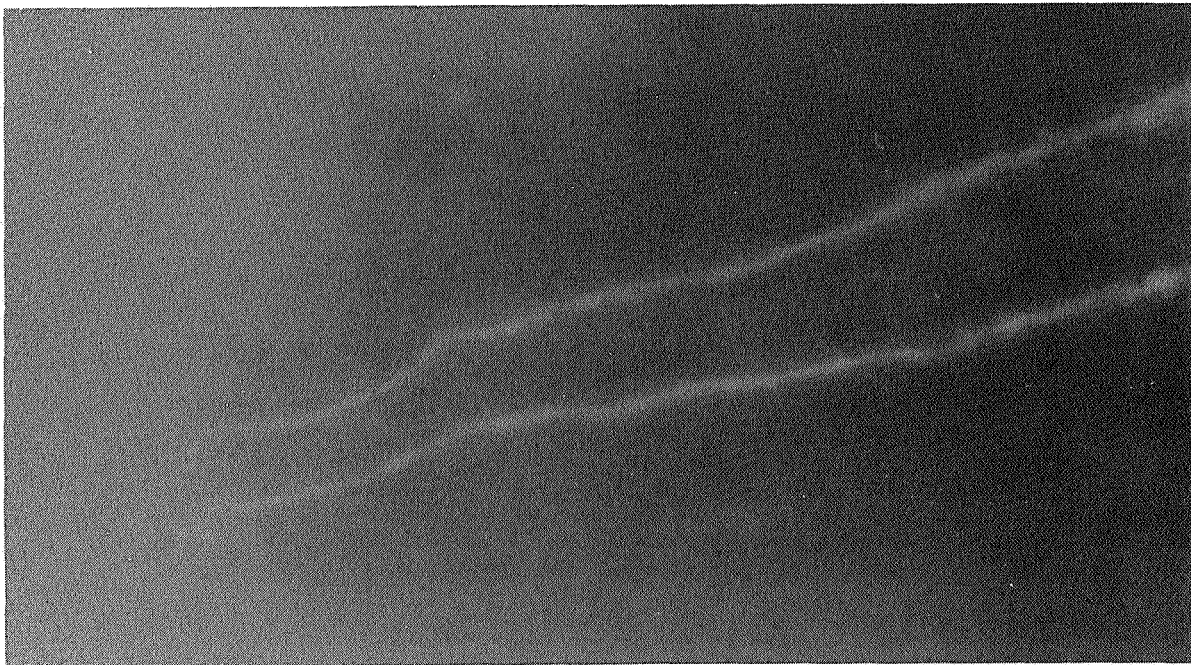

Figure 10. Effect of sideslip on wake vortex alleviation. B-747 airplane; 30/1 flap configuration; thrust for level flight.



(a) Time = 0 second.



(b) Time = 5 seconds.

Figure 11. B-747 wake vortex characteristics. 30/30 flap configuration; gear up; weight = 276,000kg (607,000Zb); airspeed = 150 knots.

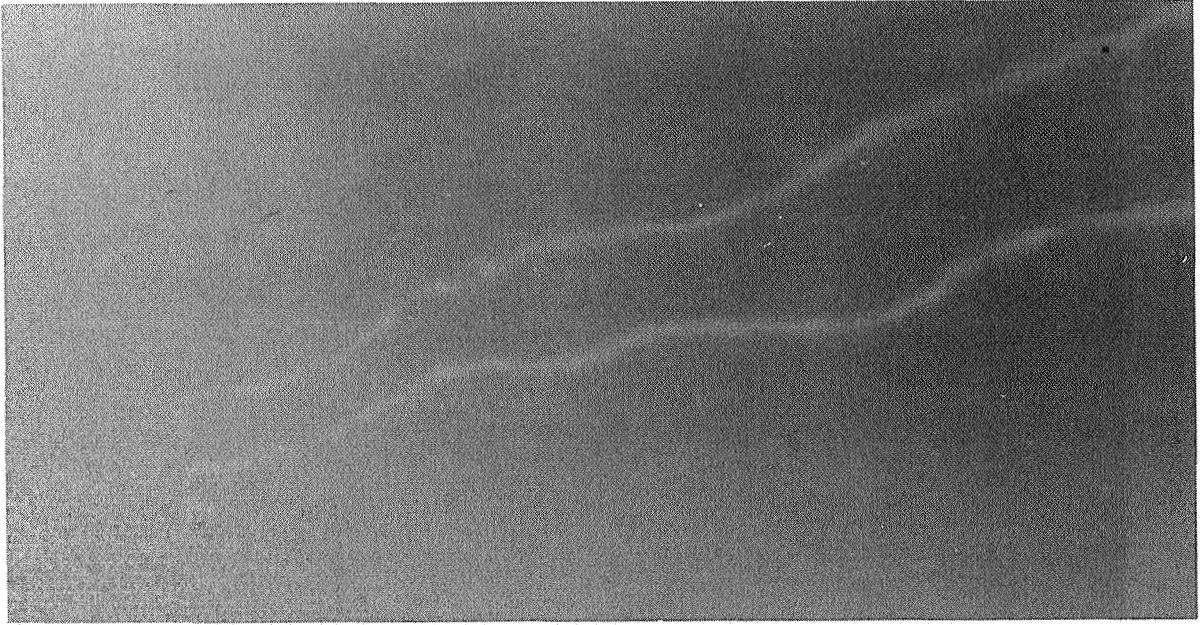

(c) Time = 10 seconds.



(d) Time = 15 seconds.

Figure 11. Continued.



(e) Time = 20 seconds.

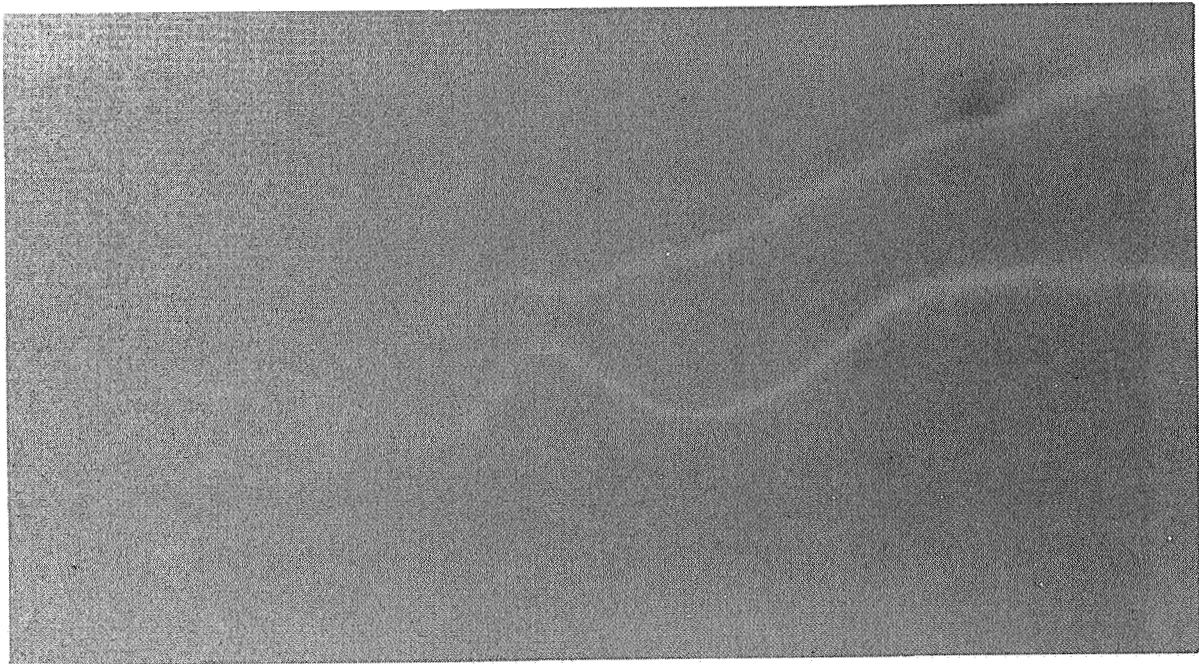

(f) Time = 25 seconds.

Figure 11. Continued.

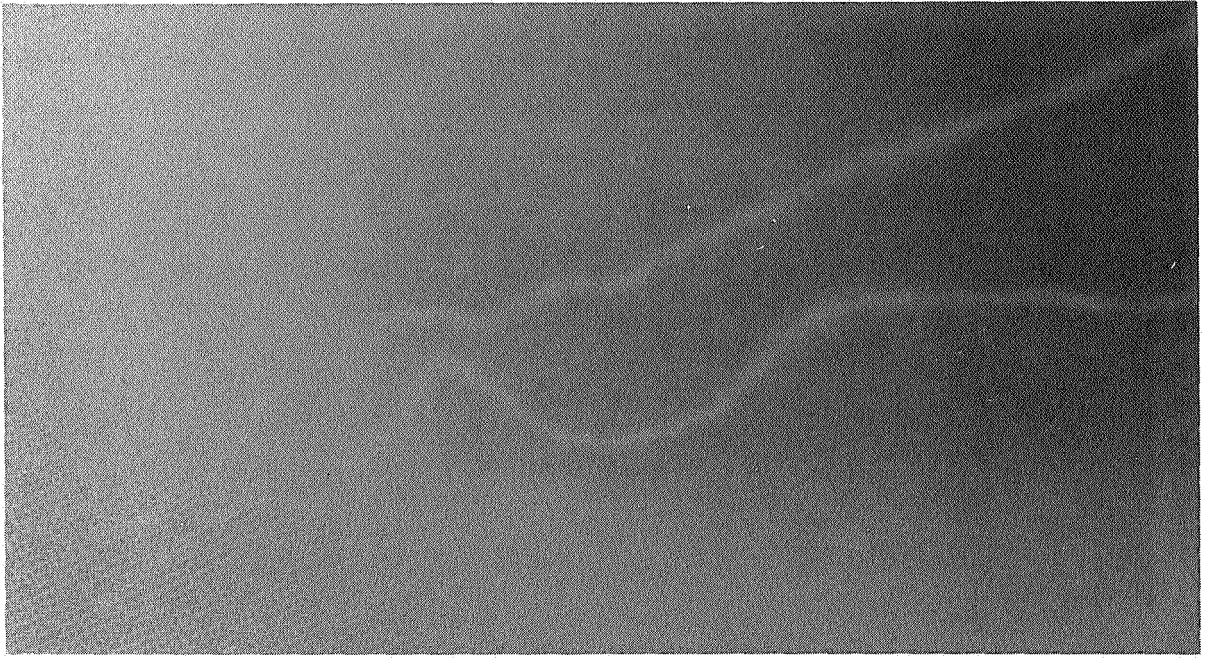

(g) Time = 30 seconds.

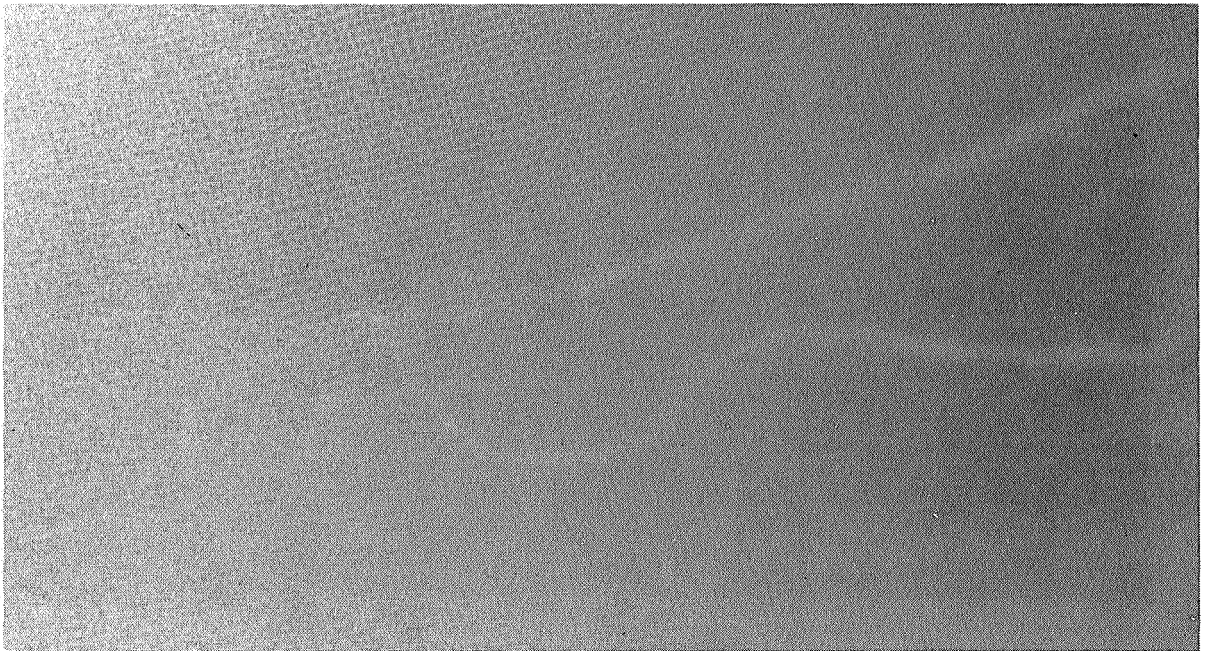

(h) Time = 35 seconds.

Figure 11. Continued.

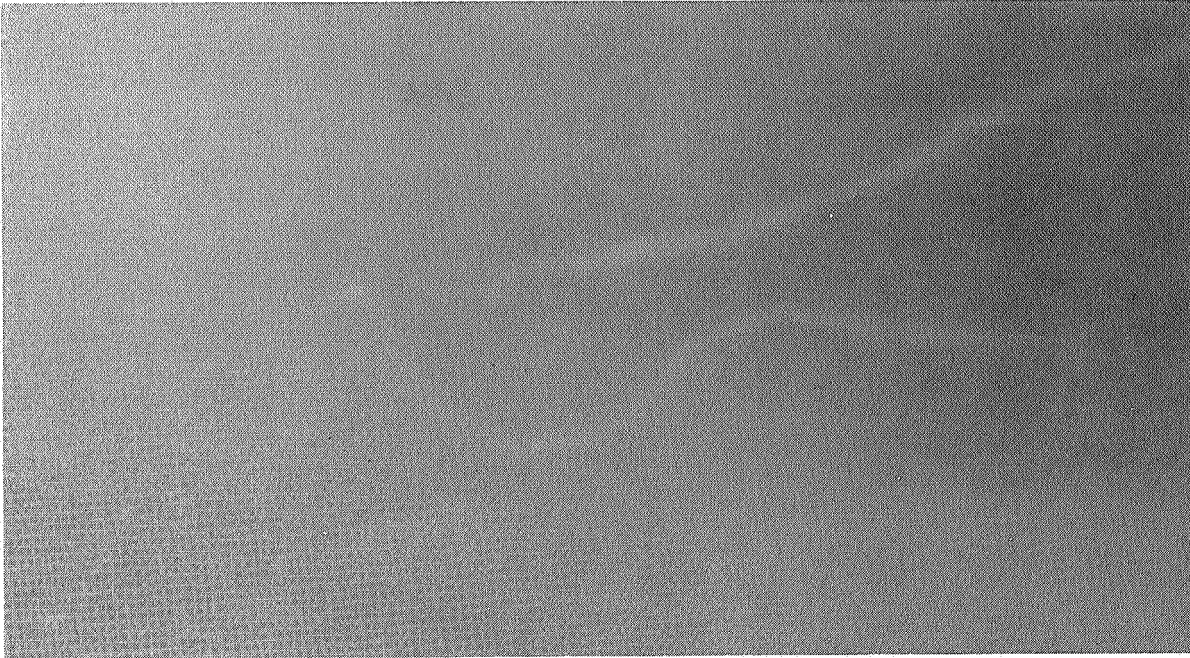

(i) Time = 40 seconds.

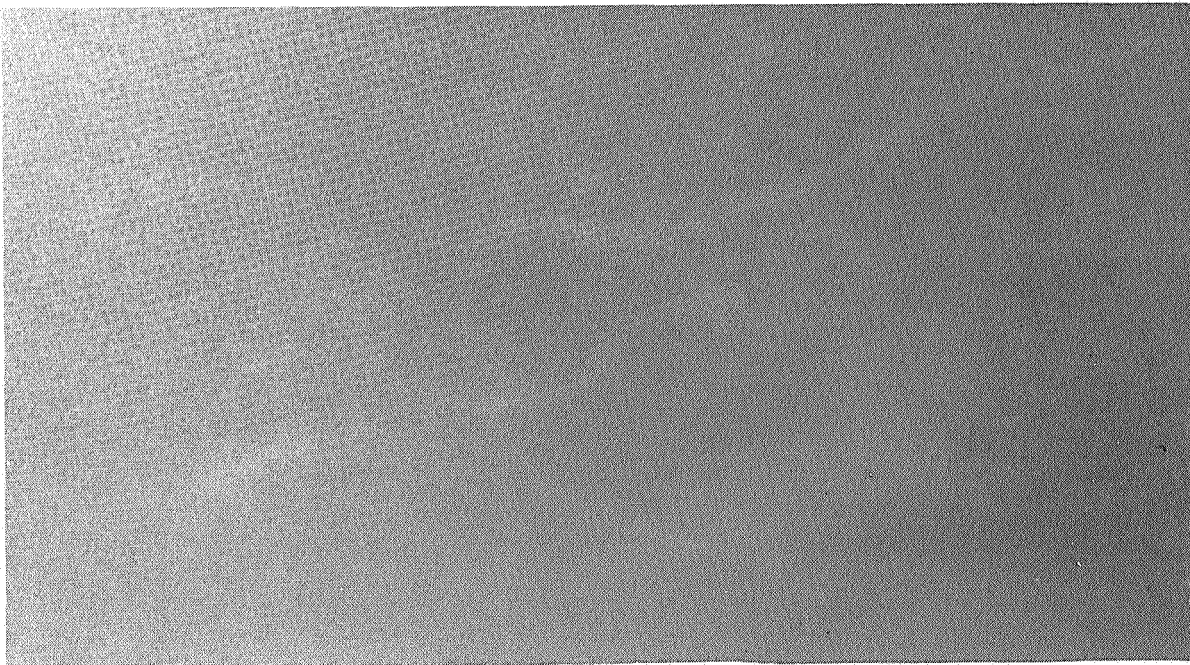

(j) Time = 45 seconds.

Figure 11. Concluded.

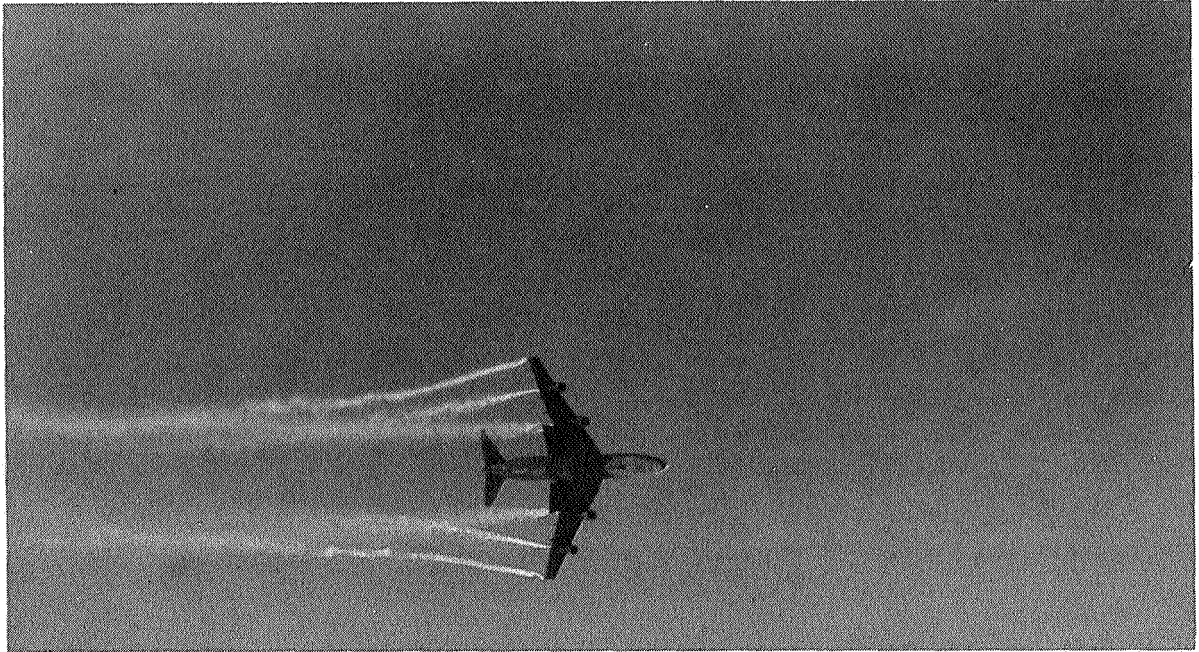

(a) Time = 0 second.

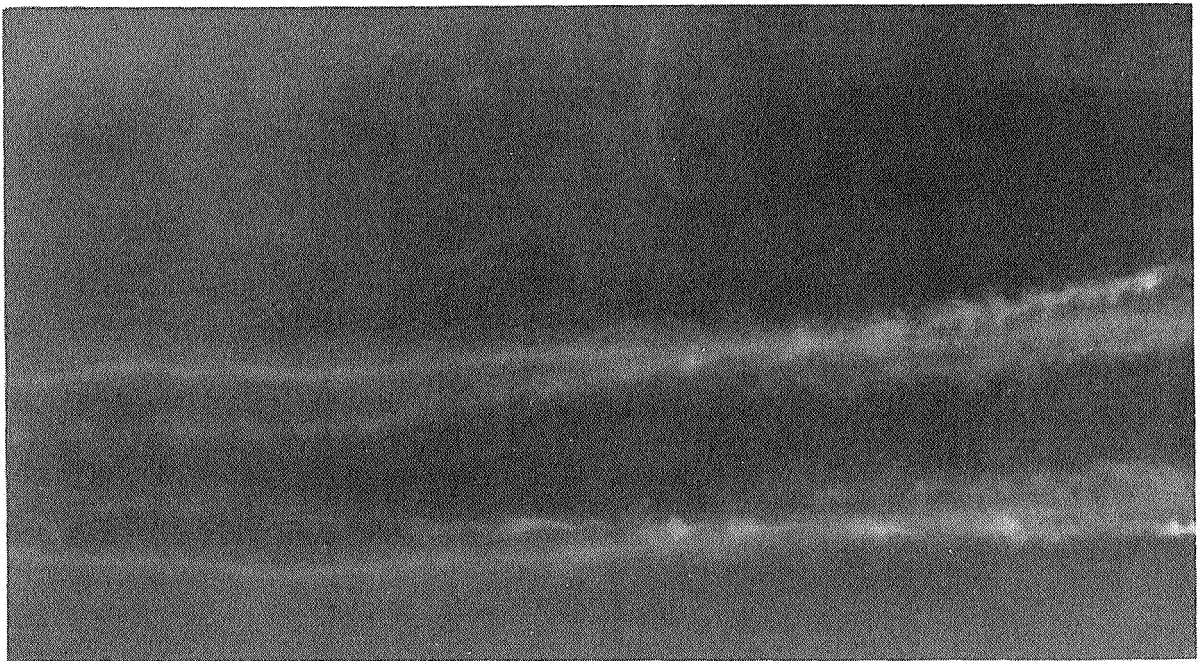

(b) Time = 5 seconds.

Figure 12. B-747 wake vortex characteristics. 30/1 flap configuration; gear up; weight = 263,000 kg (578,000 lb); airspeed = 150 knots.



(c) Time = 10 seconds.

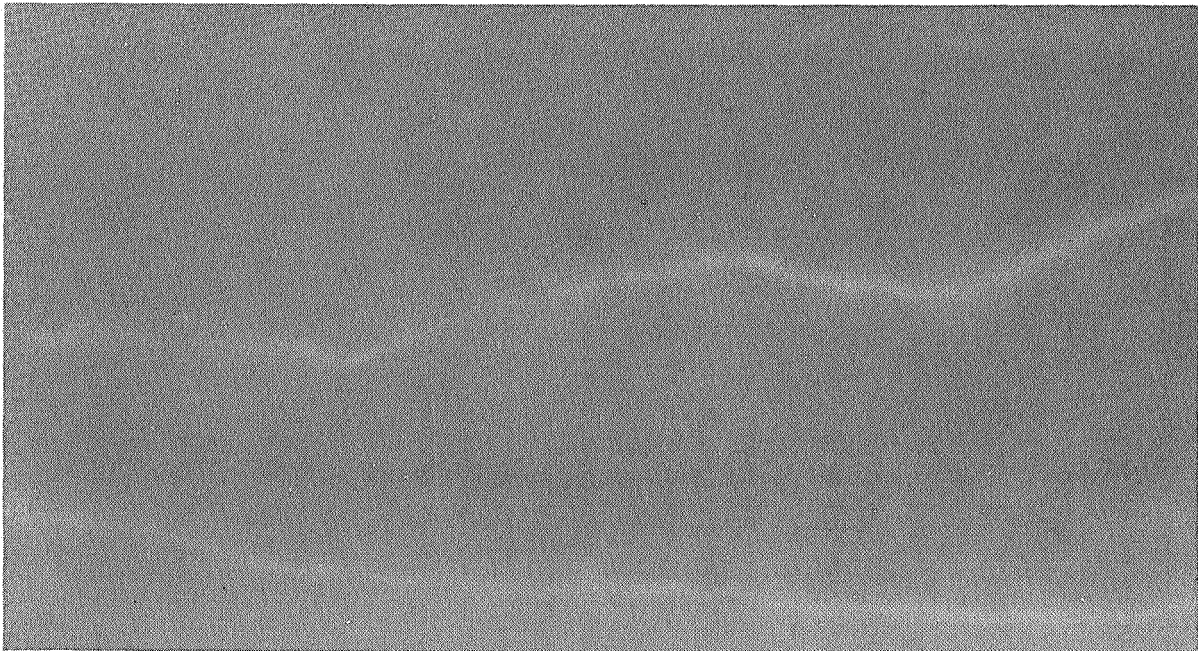

(d) Time = 15 seconds.

Figure 12. *Continued.*



(e) Time = 20 seconds.

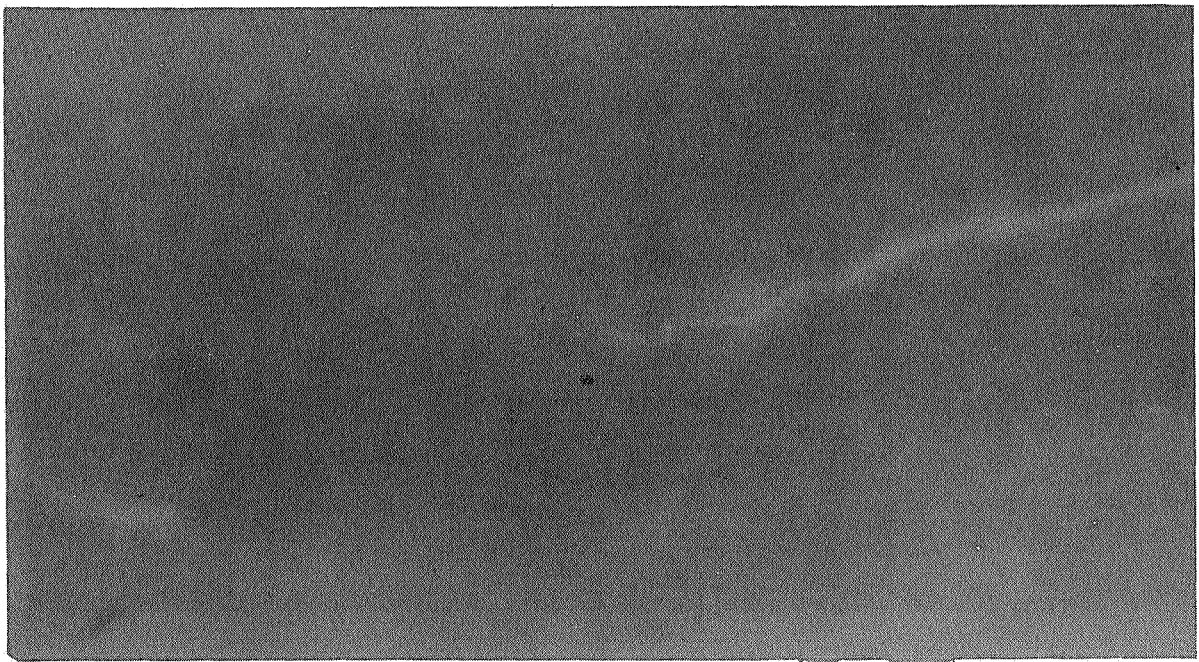

(f) Time = 25 seconds.

Figure 12. Continued.

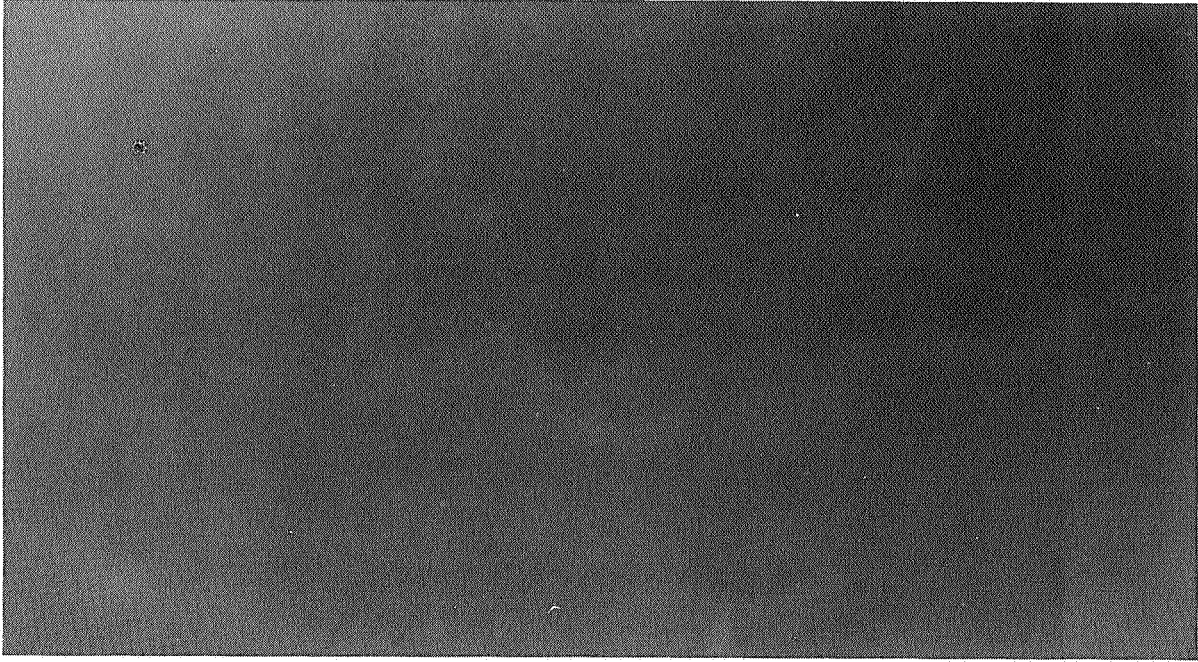

(g) Time = 30 seconds.

Figure 12. Concluded.



(a) Landing gear extended.



(b) Landing gear retracted.

Figure 13. Effect of landing gear extension on vortex for B-747 30/1 flap configuration.

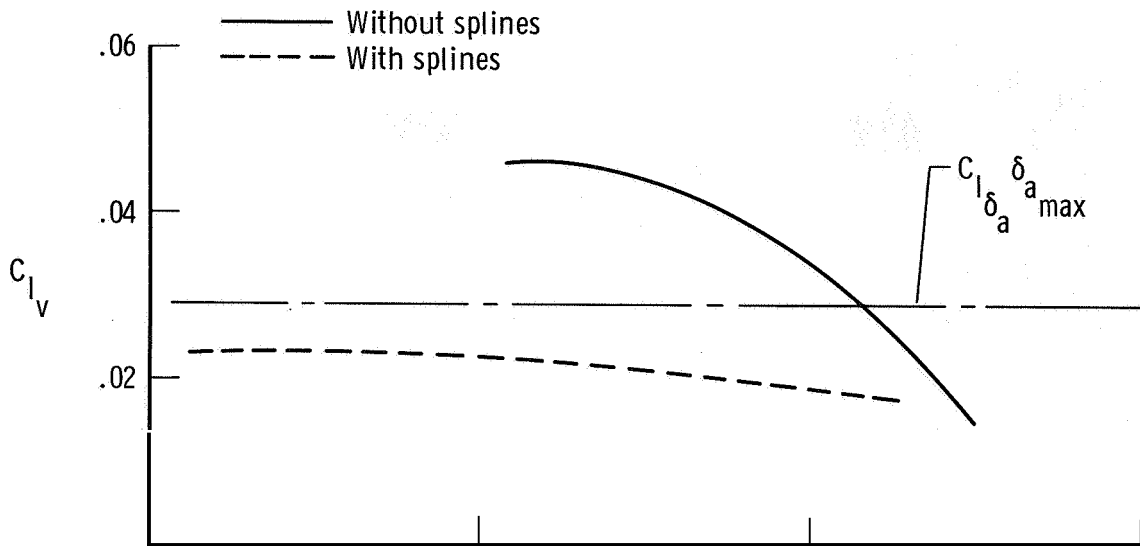

Figure 14. Effect of splines on vortex attenuation. C-54G generator aircraft, gear and flaps up, thrust for level flight; PA-28 probe aircraft.

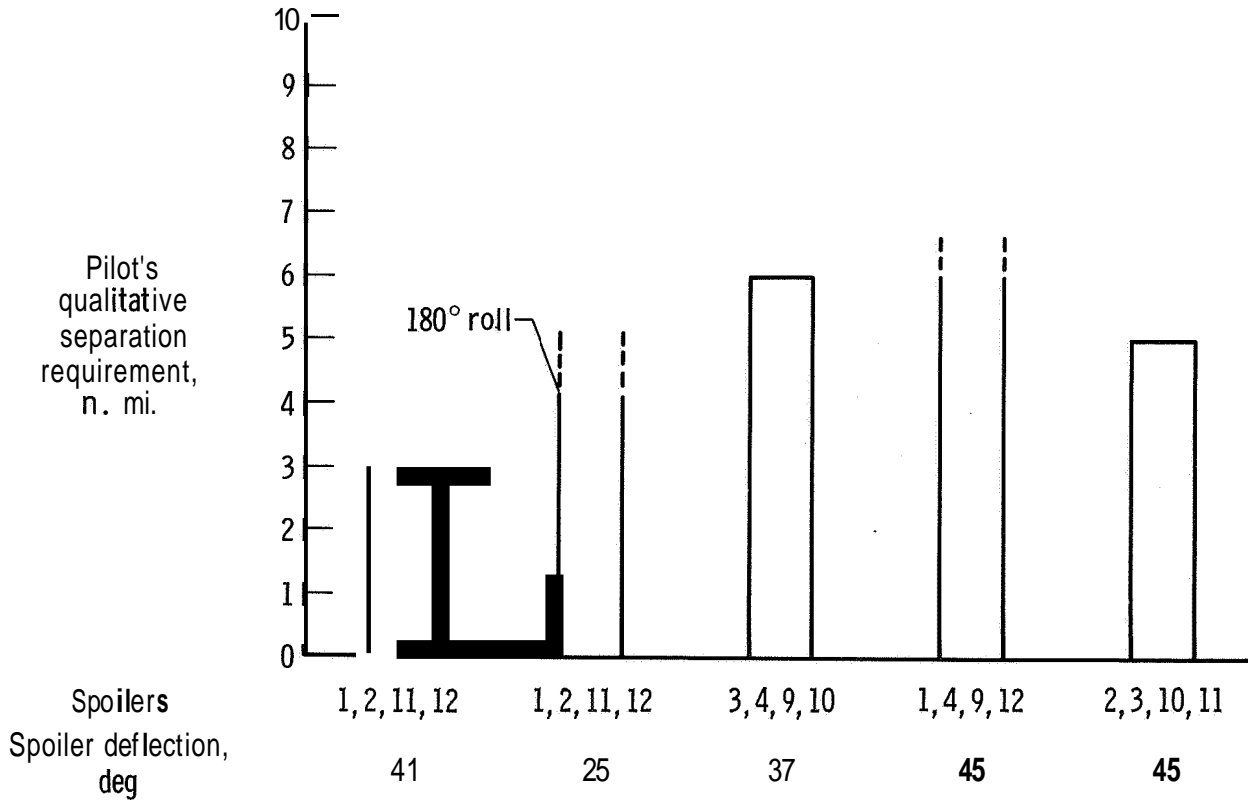

Figure 15. Effect of spoilers on wake vortex attenuation. B-747 airplane; thrust for 3° flightpath; 30/30 flap configuration; gear down; weight ≈ 250,000 kg (≈ 550,000 lb).



(a) Front view.



(b) Rear view.

Figure 16. Formation of B-747 wake vortexes. Conventional Zanding configuration.



(a) Front view.



(b) Rear view.

Figure 17. Formation of B-747 wake vortices. Conventional landing configuration with spoiler segments 1, 2, 11, and 12 deflected 41° .