

# TRANSITION FROM GLASS TO GRAPHITE IN MANUFACTURE OF COMPOSITE AIRCRAFT STRUCTURE

Harvey E. Buffum and Vere S. Thompson  
The Boeing Commercial Airplane Company

## SUMMARY

The Boeing Company has over 650,000 square meters (approx. 7,000,000 square feet) of structural fiberglass composites in commercial aircraft service. This provides a stepping stone for graphite composite structure. Similar design approaches, materials, tooling criteria, manufacturing methods and quality assurance techniques must be emphasized for both fiberglass and graphite composites. Further development is required to make graphite composites more cost-effective, to assure structural integrity and to establish design criteria, methods and data.

## INTRODUCTION

This paper describes the transition from fiberglass-reinforced plastic composites to graphite-reinforced plastic composites. The Boeing Company structural fiberglass design and manufacturing background are summarized initially. The paper describes how this experience provides a technology base for moving into graphite composite secondary structure and then to composite primary structure. The paper incorporates the early results of NASA composite contracts to illustrate the transition from glass to graphite composite. The technical requirements that must be fulfilled in the transition from glass to graphite composite structure are also included.

## STRUCTURAL FIBERGLASS TECHNOLOGY

Figure 1 illustrates the growth of composite parts on Boeing commercial aircraft and the major structural composite applications by model. (It should be noted that the term "structural fiberglass composite" is being used to distinguish those applications which are a structural part of the airframe from composites used for interior decorative linings, electronic boxes, ducts and other miscellaneous items.) There are over 650,000 square meters (approx. 7,000,000 square feet) of structural fiberglass composite parts currently flying on Boeing commercial jet aircraft.

The use of structural fiberglass parts started with only 18 square meters (approx. 200 square feet) on the Model 707 and has grown to over 930 square meters (approx. 10,000 square feet) on the 747. Applications have increased from the radome and small closure fairings on the Model 707 to wing leading and trailing edge panels, flaps, fairings and control surfaces on the Model 747 (Figure 2). The lower surface wing to body fairing, flap track fairing, wing flap and wing leading edge applications on the Model 747 are shown in Figure 3.

The use of structural fiberglass composites for applications other than radomes did not come easily. A weight saving could readily be shown for most proposed applications, but service experience was required to demonstrate the acceptability of structured fiberglass components. The manufacturing cost advantage was questioned and only after a side-by-side comparison to metal assemblies in the production environment (Figure 4) were decisions made to use composite construction in place of metal. Although initial fabrication costs are important, maintenance and repair costs are significant and should not be overlooked.

Using composites in place of metal required a different design approach. Substituting composite detail parts for the same configurations in metal was not cost effective. A close tie between design and manufacturing capability became essential to effective use of composites; and, as the designer found more applications, manufacturing methods were developed to provide the capability to produce them. Parallel and closely coordinated development programs between engineering and manufacturing organizations were essential to cost effective production. New applications for structural fiberglass components were usually preceded by cost trade studies, fabrication of feasibility hardware and establishment of production methods.

### Construction

Sandwich structures were used initially on the Model 727-100. Figure 5 shows the typical construction of composite sandwich parts made from fiberglass/epoxy materials. The sandwich construction shown in this figure reflects that which has been in use since 1962. It should be noted that no separate adhesive layer is used in joining the surface layers to the honeycomb core, and the moisture barrier film is laid up and cured as an integral part of the component.

A wide variety of configurations are being produced with varying contour, size and thickness, depending on application. Some parts are solid laminate construction rather than sandwich. Areas with high localized loading are met using titanium inserts. Other requirements such as antenna ground planes, lightning strike protection are satisfied by bonding of aluminum foil on inner surface, aluminum flame spray on outer surfaces and special finishing.

## Materials

Figure 6 illustrates the development of fiberglass material systems. Early parts were made by tailoring the glass fabric to the required configuration and pouring the liquid resin onto the fabric, spreading and sweeping the resin to impregnate the fabric, vacuum bagging the part and tool, and curing in an oven or autoclave. This wet layup method is very labor intensive.

The development of pre-impregnated fiberglass/epoxy materials ("prepregs") was a major step forward. Prepregs provide a relatively uniform amount of resin to the glass fabric and with proper processing yield consistent part properties. The prepreg materials used through the early 1960's required a 177°C (350°F) cure, some "bleeding" to remove excess resin and voids and a separate adhesive layer for joining to honeycomb core. Essentially, the processing requirements were the same as those required for today's graphite composite systems. Development efforts over the years have evolved a prepreg system which Boeing uses for most of its composite parts. This system cures at 120°C (250°F), does not require "bleeding" and does not require a separate adhesive layer for joining to honeycomb core. These advantages result in lower material costs, less labor, reduced flow time and reduced energy requirements.

Unidirectional material forms have been used very sparingly for airplane structural parts at Boeing. This is due in part to the much higher layup costs of unidirectional tapes as compared to woven fabrics.

Initial honeycomb core materials used by Boeing were polyester and nylon-phenolic for radomes. Later, heat resistant phenolic (HRP) core was used. The latest Boeing commercial applications use Nomex core due to a 16 kilograms per cubic meter (1 pound per cubic foot) weight savings compared to HRP core. The HRP core is still being used on earlier models. Polyimide core is used in special areas for temperature applications over approximately 190°C (375°F).

## Production Flow

The production flow (Figure 7) for fabricating structure fiberglass parts involves prepreg and core preparation, parts layup on laminating molds, autoclave cure, trim and exterior surface finishing. The prepreg is received in rolls, then "kits" are prepared of the skin, doubler, and filler plies. Kitting is the cutting and storing together of prepreg patterns for a specific part until the production schedule requires that part. Steps required for preparing honeycomb core details include slicing, forming, splicing, machining and potting.

Skin, doubler, filler ply details are oriented on a laminating mold according to the drawing, along with the honeycomb core detail. This is done by hand. With the appropriate design mechanization of the layup process is possible. However, high part quantities and an adequate production rate are needed to justify development and acquisition of suitable equipment.

Autoclaves are the principal curing method. The flexibility of the autoclave is most compatible with the production part mix and curing schedule. After cure, the parts are trimmed to size and painted.

Due to the use of an integrally-applied, bondable, moisture-barrier film applied to the part interior surface prior to cure, the finishing of composite parts is limited to the exterior (mold) surface. Part finishing is accomplished by application of the following: (1) pinhole filler, (2) surfacer, (3) conductive coating, (4) epoxy primer, and (5) enamel.

#### TRANSITION TO GRAPHITE COMPOSITE SECONDARY STRUCTURE

The transition to graphite composite secondary aircraft structure such as wing control surfaces, wing trailing and leading edge, vertical fin and stabilizer control surfaces and doors is based on our structural fiberglass composite technology base. Similar design approaches emphasizing sandwich construction, materials, tooling criteria, manufacturing methods and quality assurance techniques must be utilized.

The Model 727 Elevator design being developed as part of the NASA-ACEE program (Figure 8) consists of honeycomb sandwich skin panels (Figure 9), honeycomb sandwich ribs, and laminate spars. Woven fabrics, minimum thickness unidirectional tape, "no bleed" prepreg materials and Nomex core are employed to provide a minimum cost and weight structure. The manufacturing approach involves hand lamination, autoclave cure, mechanical assembly and in-process inspection. These design and manufacturing approaches are similar to those used for the Model 747 structural fiberglass components. Except for the single layer of unidirectional tape as the outer ply, the skin panel designs are essentially the same for the Model 727 graphite composite elevator and the Model 747 structural fiberglass rudder and elevator.

The Boeing structural fiberglass technology provides a stepping stone for producing graphite composite components. However, the design evolution work involving new application of different materials, forms and resin systems has necessitated a coordinated engineering/manufacturing development effort during the design of the NASA-ACEE components.

Areas of concern involved the substructure design and the comparative cost of different material forms including the finishing cost and weight impact. To resolve these concerns, feasibility hardware was fabricated to support the preliminary design of the graphite/epoxy elevator. An elevator rib design/manufacturing trade study (Figure 10) showed that a sine-wave laminate rib weighed the same as a sandwich rib, but the sine-wave rib was 2.5 times more costly than a sandwich rib. Based on this study, a sandwich construction was selected for the graphite composite elevator.

Other studies confirmed that woven fabric sandwich structure was most cost effective and provided fewer manufacturing problems than 2-ply preplied tape, 4-ply preplied tape, or 30.5-centimeter (approx. 12-inch) wide unidirectional tape. The relative cost was 1.00 for woven fabric, and 1.25, 1.10, and 1.39 for the tapes, respectively.

When these panels were finished, it was found that the woven fabric panel required 2.9 times longer to prepare the surface to meet aerodynamic requirements than the tape panels; and, the surface filler material caused a panel weight increase of approximately 21.6 grams per square meter (approx. 0.07 ounces per square foot). To minimize finishing time and reduce weight, the elevator skin panel design was changed to replace the outer ply of woven fabric with one ply of unidirectional tape (Figure 11). To prevent distortion, the fabric ply against the core was changed to tape. As noted in Figure 11, these changes did not affect the panel warpage or core collapse characteristics and resulted in only a 1 percent increase in the total fabrication cost. The use of fabric on the drill exit side has been found to minimize fiber breakout.

Additional work is required to make graphite composites secondary structure more cost effective. Important needs include improved material systems, kitting methods to reduce material wastage, hole preparation/fasteners techniques and nondestructive inspection methods.

A cost savings of over \$76.70 per square meter (approx. \$7.15 per square foot) (Figure 12) can be achieved by developing a controlled-flow, self-adhesive epoxy resin system for graphite composite sandwich construction (Figure 12). This savings would be realized by replacing the current "bleed" resin system. The controlled-flow, self-adhesive resin system would be similar to the present structural fiberglass resin system that has been used since 1965.

The Boeing NASA-ACEE contracts are using a "no-bleed" resin variation of the current "bleed" systems. This has resulted in cost savings of \$39 per square meter (approx. \$3.60 per square foot). A further cost savings of \$38 per square meter (\$3.50 per square foot) and a weight savings of 0.58 kilograms per square meter (approx. 0.12

pounds per square foot) can be realized by developing a controlled-flow, self-adhesive, epoxy resin system for sandwich panel fabrication.

The development of titanium rivets and blind fasteners is required for graphite composite secondary structure. These fasteners would replace nut plates and high torque bolts. They would be used for fastening the trailing edge of control surfaces, assembling front spar to rib, and attaching the last skin panel to the rib/spar substructure. A time savings of up to 1-1/2 minutes per fastener can be achieved by implementing titanium rivets and blind fasteners.

#### TRANSITION TO GRAPHITE COMPOSITE PRIMARY STRUCTURE

The transition to graphite composite primary aircraft structure such as vertical fin, stabilizer, or wing in-spar boxes will be built from our secondary graphite composite technology foundation. As shown by the Model 737 Graphite Composite Stabilizer design (Figure 13) and a wing box structural concept (Figure 14), the design will be skin-stringer rather than sandwich construction. Due to the higher load, more unidirectional or preplied tape will be required, especially on the outer skin plies.

Many of the design and manufacturing approaches that were developed for structural fiberglass or graphite composite secondary structure will be employed to build primary graphite composite structures. However, cost, loads and added structural integrity will require the establishment of new methods. Based on current fabrication cost data, the cost of producing large primary graphite structure such as a wing box is projected at over 6-1/2 hours per kilogram (approx. 3 hours per pound) at airplane 200. This cost must be reduced to less than 2.2 hours per kilogram (1 hour per pound) to be competitive with aluminum primary structure at airplane 200. The required 50 to 70 percent reduction in production cost will necessitate additional development work to improve materials and processing methods, mechanize detail fabrication and assembly operations and improve quality assurance methods.

Major materials and material processing related cost drivers that should be worked include development of structurally acceptable graphite pitch fibers, 160,000 end tow graphite and thicker graphite fiber. These developments would reduce the cost of graphite prepreg from its current level of about \$110 per kilogram (approx. \$50 per pound) to approximately \$22 per kilogram (approx. \$10 per pound). Also, improved lower flow, less brittle, no-bleed resin systems are required to produce primary graphite structure. Mechanized kitting equipment using water jet or mechanical cutting should be developed to reduce the cost of preparing the materials for detail fabrication.

Detail fabrication is the most productive area for reducing the cost of manufacturing graphite primary structure. Approximately 39 percent of the cost is incurred during detail fabrication. Mechanized fabrication methods such as pultrusion, compression/elastomeric/injection molding, machine layup and filament winding must be developed to achieve the 50 to 70 percent reduction in manufacturing cost.

The Boeing pultrusion process (Figure 15) involves the pulling of graphite prepreg through a shaped ceramic die while effecting a continuous cure of the composite material simultaneously with its compaction during the passage through the die. Microwave energy is used for the curing of the material. A feed system is used to handle and feed composite prepreg tapes into the microwave curing chamber containing the ceramic die. The pultrusion process is employed to fabricate substructural shape such as angles, "T's," "Z's," tapered and curved members, and hat sections and sandwich panel stock. A 50 to 80 percent reduction in fabrication labor and tooling cost can be achieved by using pultruded substructural shapes and panel stock.

Elastomeric, compression and injection molding techniques would be used to manufacture clip brackets, fittings and other similar components, while a mechanized layup machine would be used to produce broadgoods and to laminate outer skin plies of structures having large platform areas. For these applications, the machine would lay preplied tape or woven fabric directly onto a laminating mold. Molding of subcomponents and mechanized layup of outer skin plies or broadgoods would result in a projected labor savings of 50 to 60 percent compared to current hand lamination and processing methods.

Filament winding has proven to be an excellent method of fabricating shapes of rotation. Graphite primary structure such as spars, ribs, landing gear beams, wing panels and eventually fuselage sections can be produced by filament winding. A trade study showed that the relative cost of filament winding wing spars would be 0.7 compared to 1.0 for hand lamination and autoclave cure.

To further reduce production cost, mechanized methods should be developed for trimming, drilling, assembling and inspecting graphite primary structure. Automated assembly equipment, similar to the numerical control metal spar machine shown in Figure 16, should be implemented to eliminate the present labor intensive drilling and fastening methods. Also, adaptive and in-line process control techniques (Figure 17) should be used to reduce inspection costs and assure structural integrity.

Figure 18 illustrates how the detail fabrication assembly and inspection methods described previously would be used to produce graphite wing structure. A comparative cost analysis indicated that the use of these methods would result in a projected fabrication cost of less than 2.2 hours per kilogram (1 hour per pound) at airplane 200.

#### CONCLUDING REMARKS

Structural fiberglass composites provide an excellent stepping stone to graphite composites. The structural fiberglass approaches for design to cost, manufacturing/engineering interface, materials, tooling, production and inspection are a technology base for moving into graphite secondary and primary aircraft structure. The cost and service experience of producing and flying over 650,000 square meters (approx. 7,000,000 square feet) of structured fiberglass in commercial operations further expands this technology base for graphite composites.

Metal technology does not provide a stepping stone for moving into graphite composites. Cost data, design and manufacturing approaches, service experiences are not applicable.

Improved material systems, mechanized fabrication and assembly and adaptive and in-line inspection methods must be developed for graphite composites to become more cost effective. Cost effectiveness will be one of the primary considerations to the implementation of graphite composites on commercial aircraft.



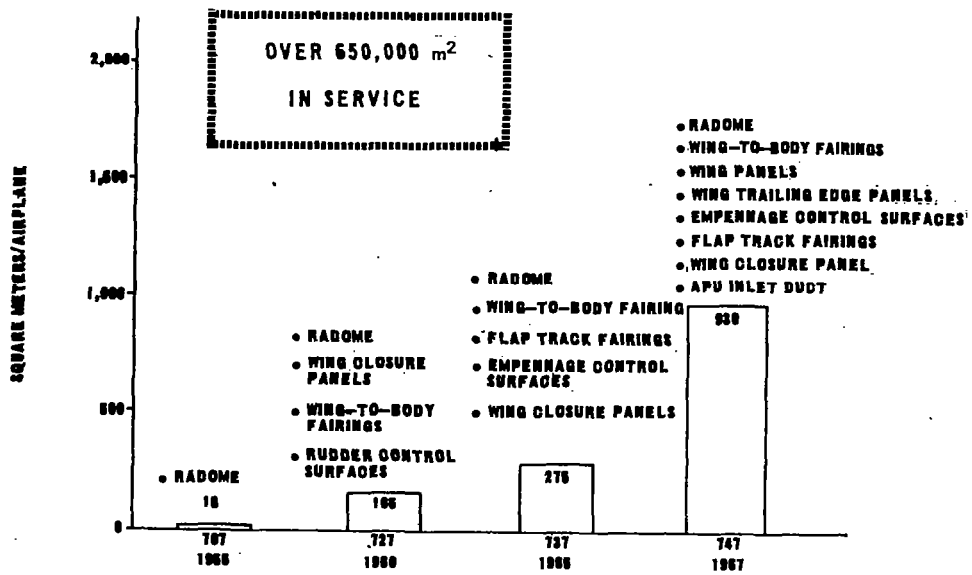

Figure 1.- Commercial structural fiberglass growth.

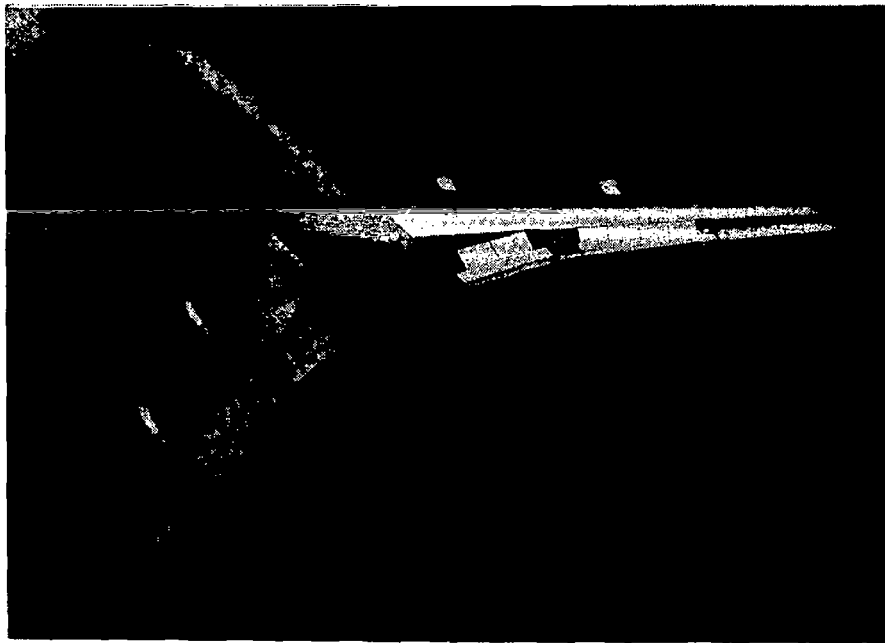

Figure 2.- Applications of model 747.

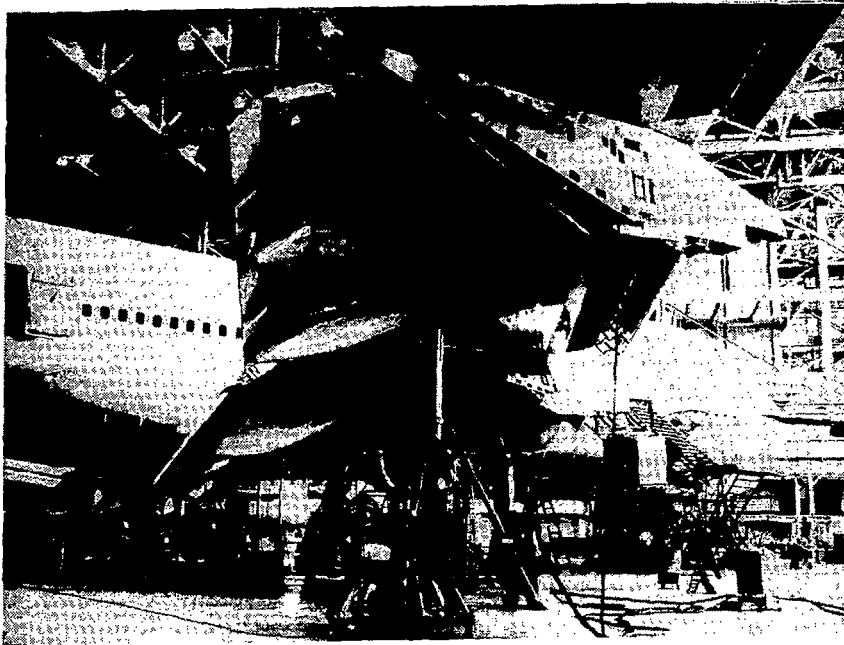

Figure 3.- Lower surface of model 747.

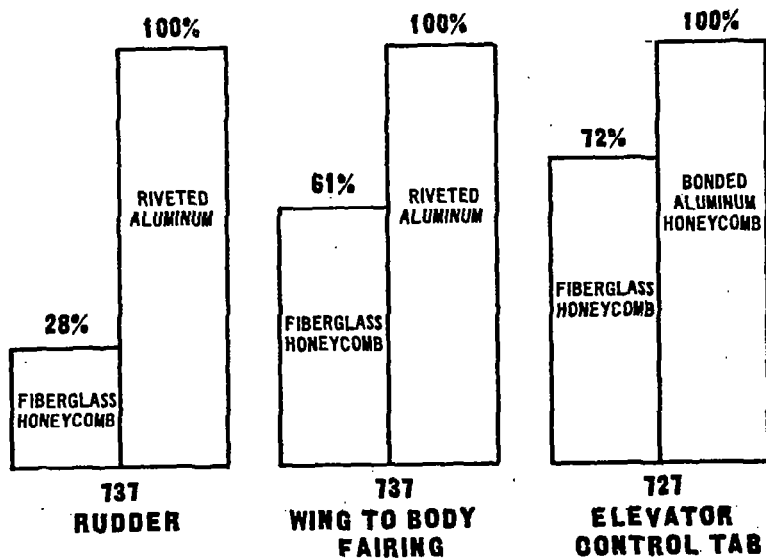

Figure 4.- Cost comparisons.

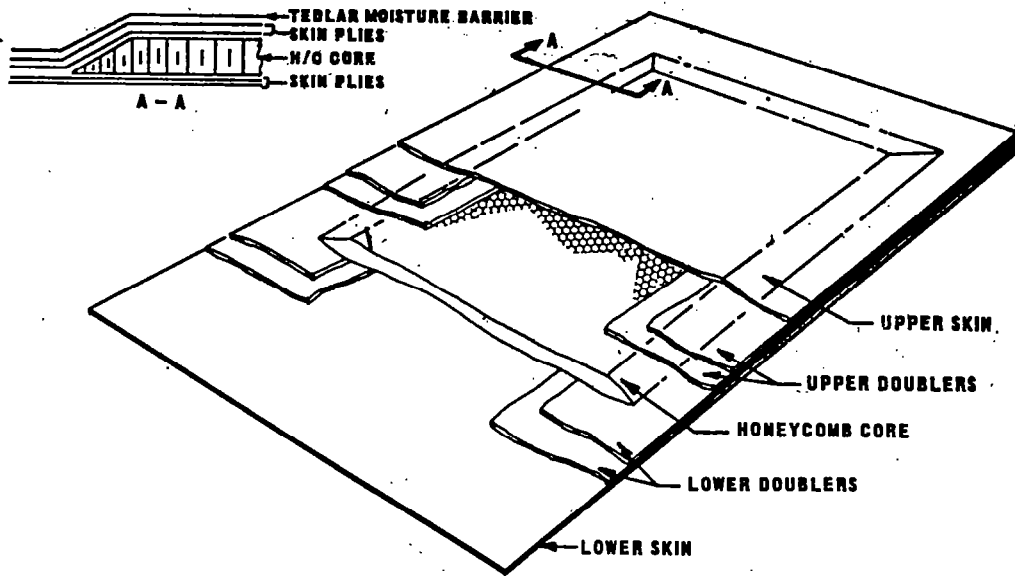
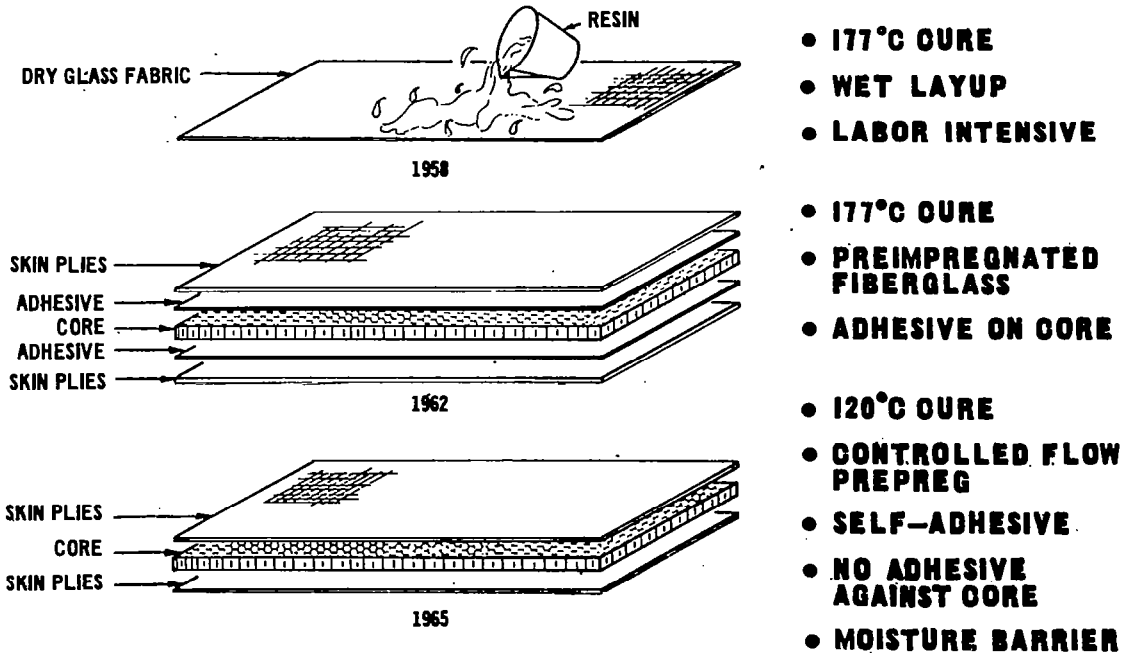

Figure 5.- Typical construction structural fiberglass.



- 177°C CURE
- WET LAYUP
- LABOR INTENSIVE
  
- 177°C CURE
- PREIMPREGNATED FIBERGLASS
- ADHESIVE ON CORE
  
- 120°C CURE
- CONTROLLED FLOW PREPREG
- SELF-ADHESIVE
- NO ADHESIVE AGAINST CORE
- MOISTURE BARRIER

Figure 6.- Fiberglass material development.

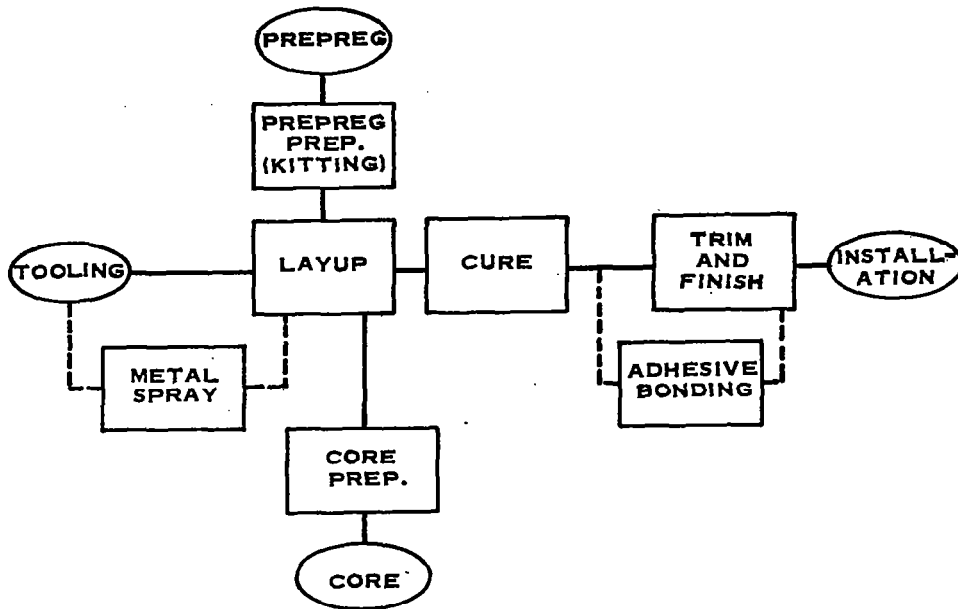

Figure 7.- Production flow.

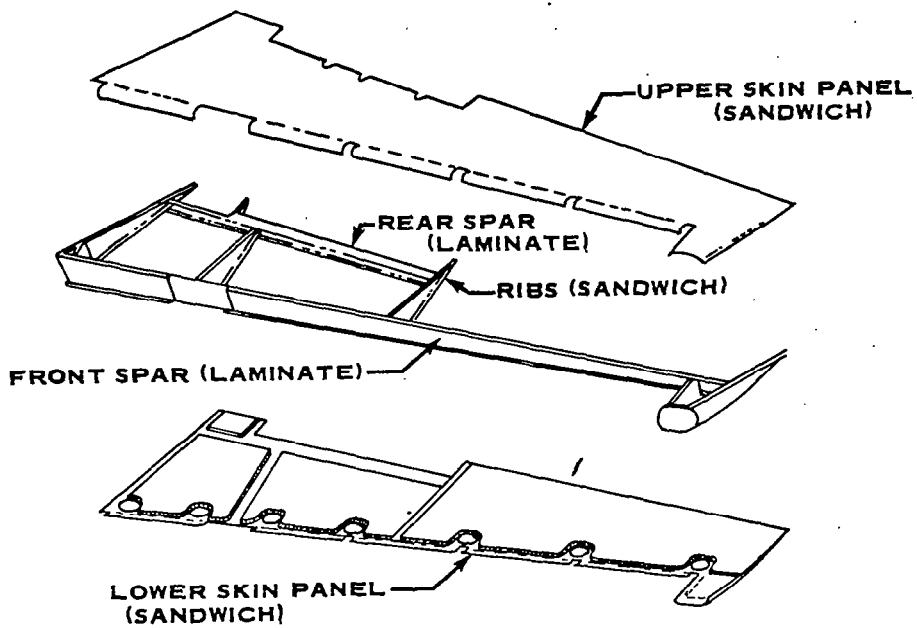

Figure 8.- Model 727 graphite composite elevator.



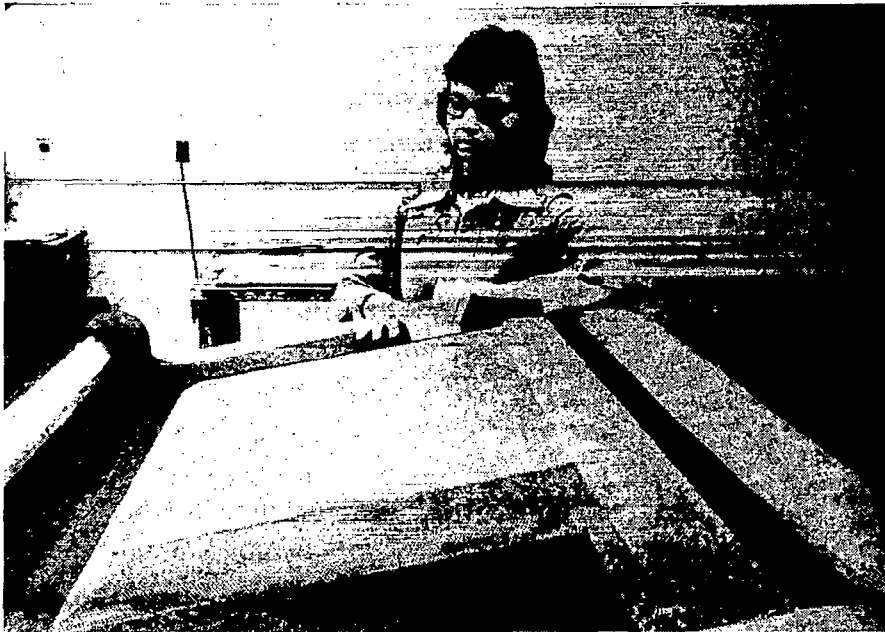

Figure 9.- Elevator skin panel section.



FIGURE 10

RIB DESIGN TRADE STUDY

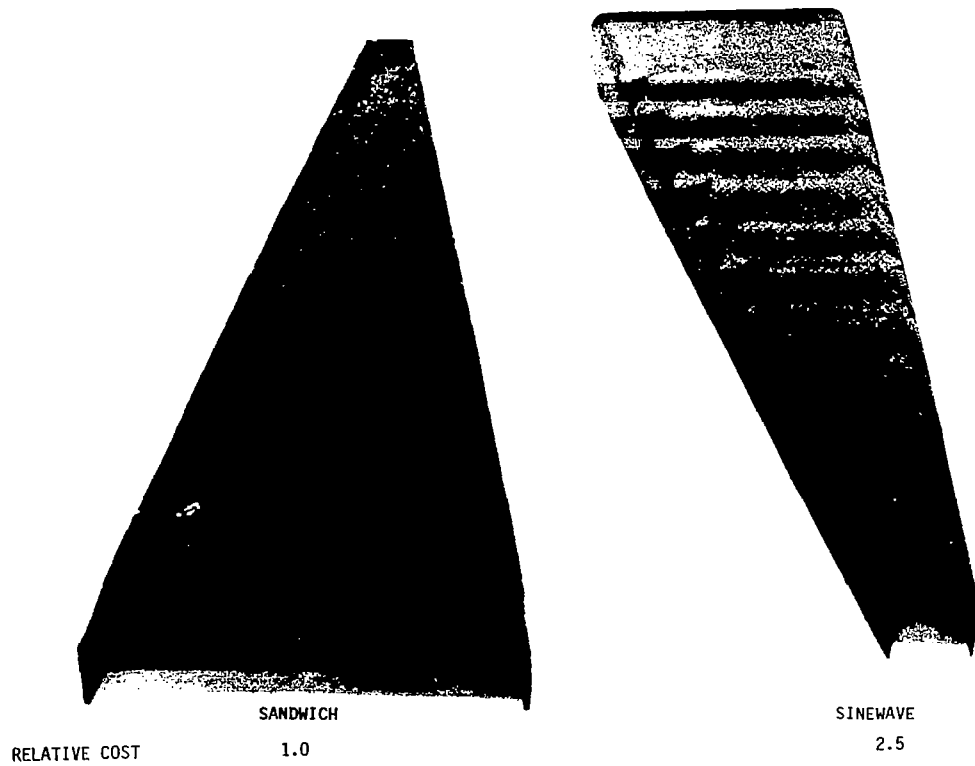
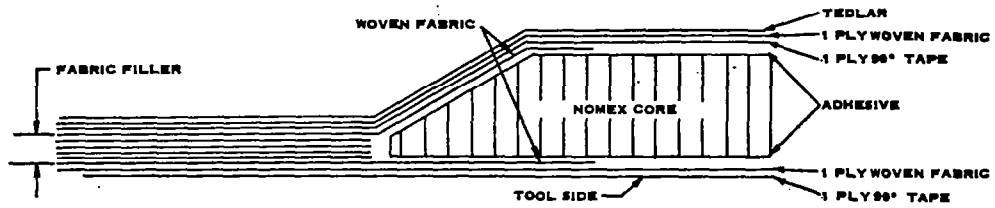

Figure 10.- Rib design trade study.



- NO CORE COLLAPSE OR WARPAGE
- RELATIVE COST INCLUDING FINISHING
  - ALL FABRIC 1.00
  - COMBINATION 1.01
  - ALL TAPE 1.35
- SLIGHT DRILLING BREAKOUT - ENTRANCE (TAPE) SIDE
- NO DRILLING BREAKOUT - EXIT (FABRIC) SIDE

Figure 11.- Graphite composite 727 elevator skin panel configuration.

|                       | COST SAVINGS<br>(DOLLARS) | WEIGHT SAVINGS<br>(KILOGRAMS) |
|-----------------------|---------------------------|-------------------------------|
| ● BLEEDER ELIMINATION | \$38.77/m <sup>2</sup>    |                               |
| ● NO ADHESIVE         | \$38.02/m <sup>2</sup>    | 0.58 kg/m <sup>2</sup>        |
| SUB TOTAL             | \$76.79/m <sup>2</sup>    | 0.58 kg/m <sup>2</sup>        |
| ● 120°C vs 177°C CURE |                           |                               |
| ● UTILITY SAVINGS     | \$0.43/m <sup>2</sup>     |                               |
| ● ADDITIONAL IMPACTS  |                           |                               |
| ● MAINTENANCE         | +                         |                               |
| ● TOOL LIFE           |                           |                               |
| ● SCHEDULE            |                           |                               |
| TOTAL                 | \$77.22/m <sup>2</sup> +  | 0.58 kg/m <sup>2</sup>        |

REFERENCES: INDUSTRIAL ENGINEERING COST STUDIES

Figure 12.- Improved prepregs.



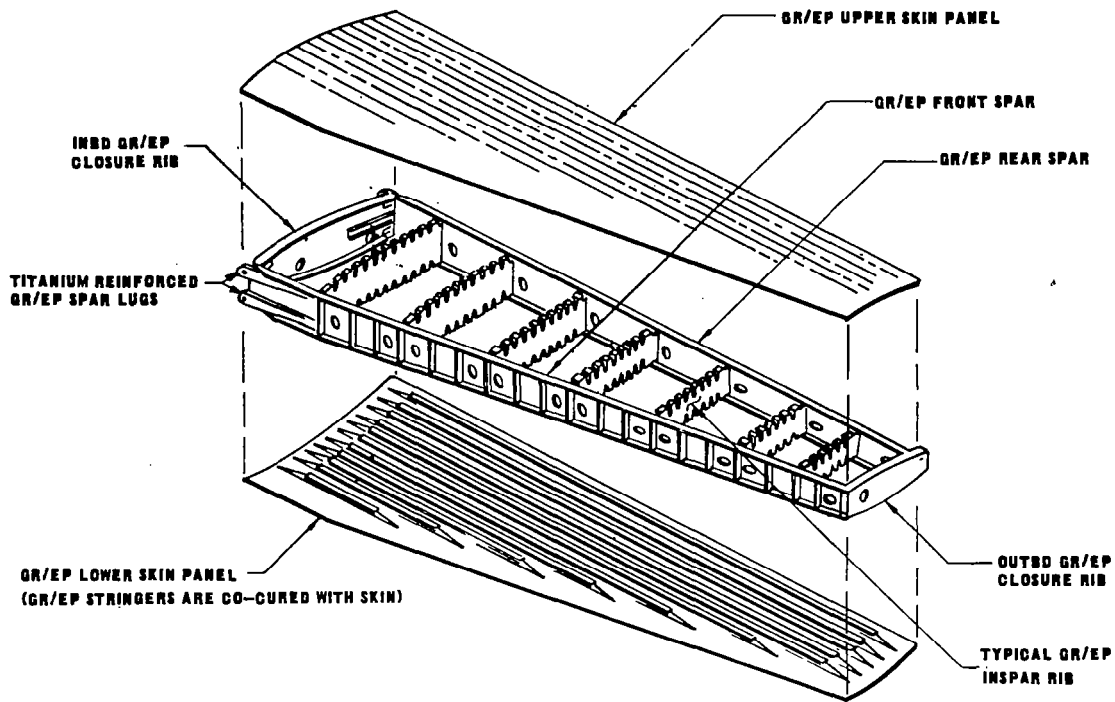

Figure 13.- Model 737 graphite composite stabilizer concept.

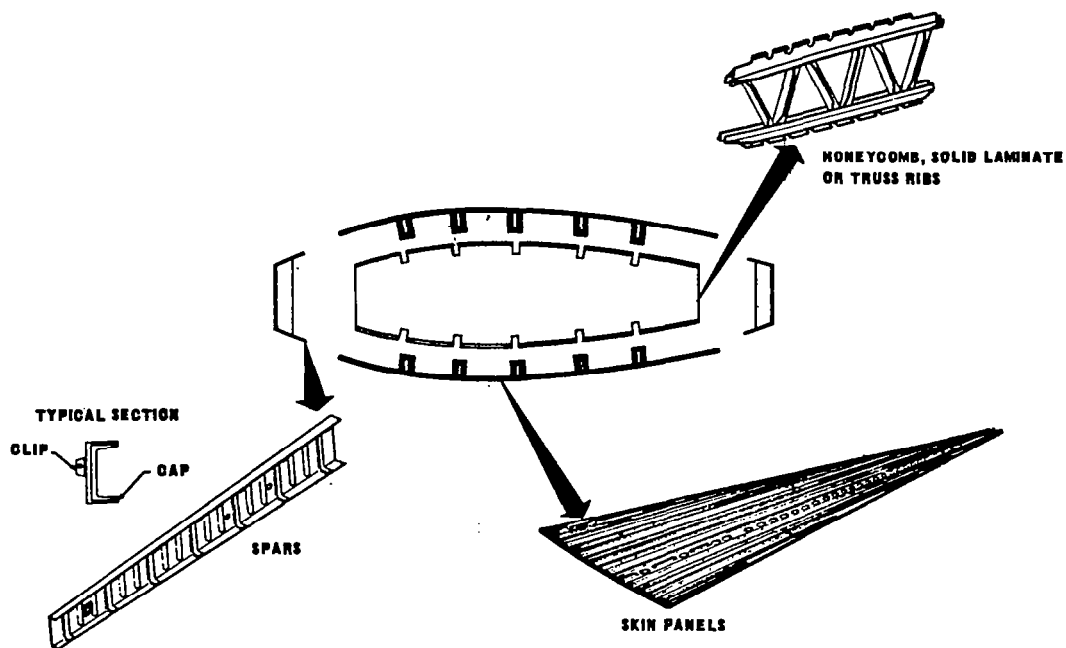

Figure 14.- Graphite composite wing concept.

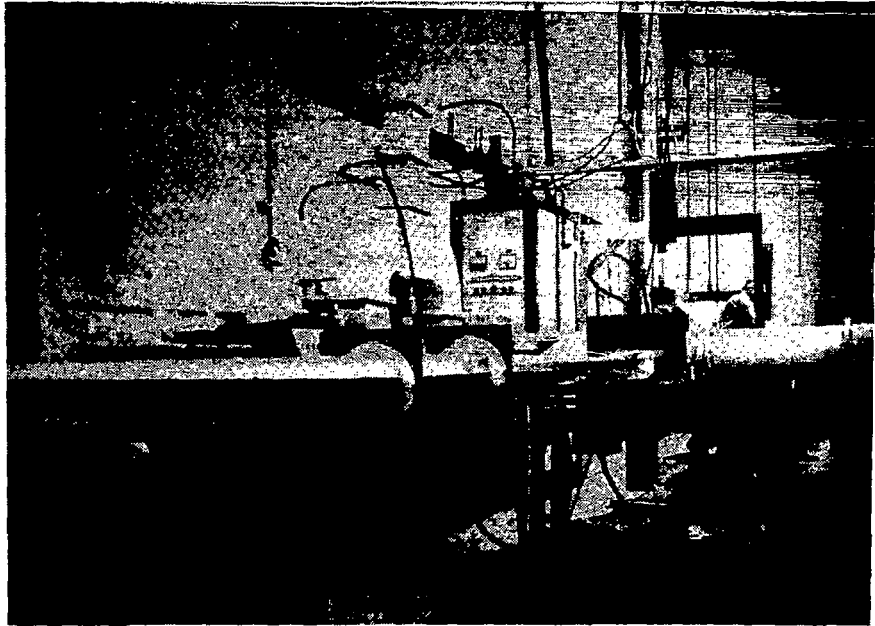

Figure 15.- Boeing pultrusion unit.

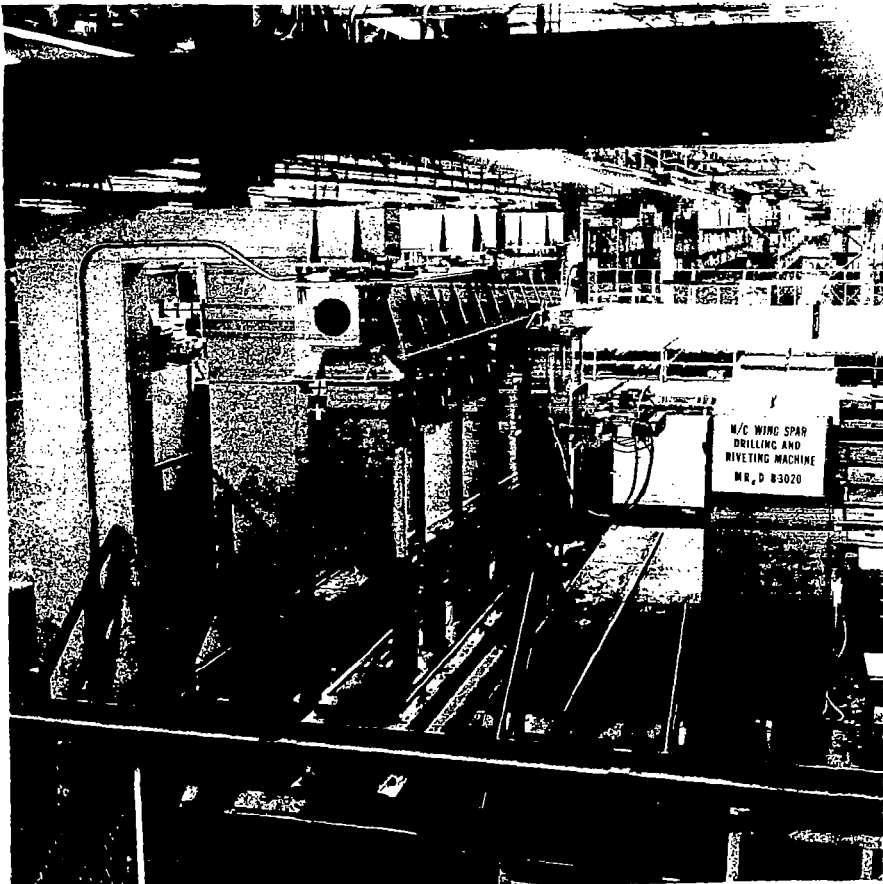

Figure 16.- Metal spar assembly machine.



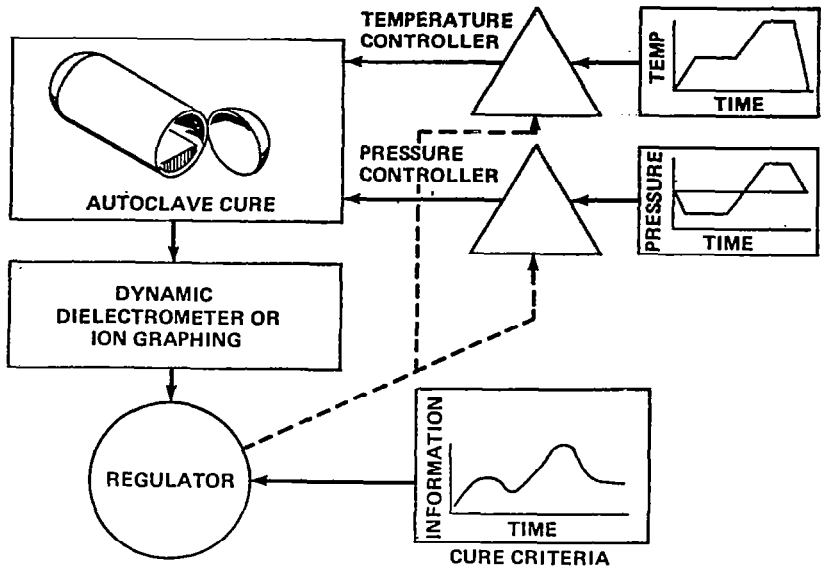

Figure 17.- Adaptive cure process control.

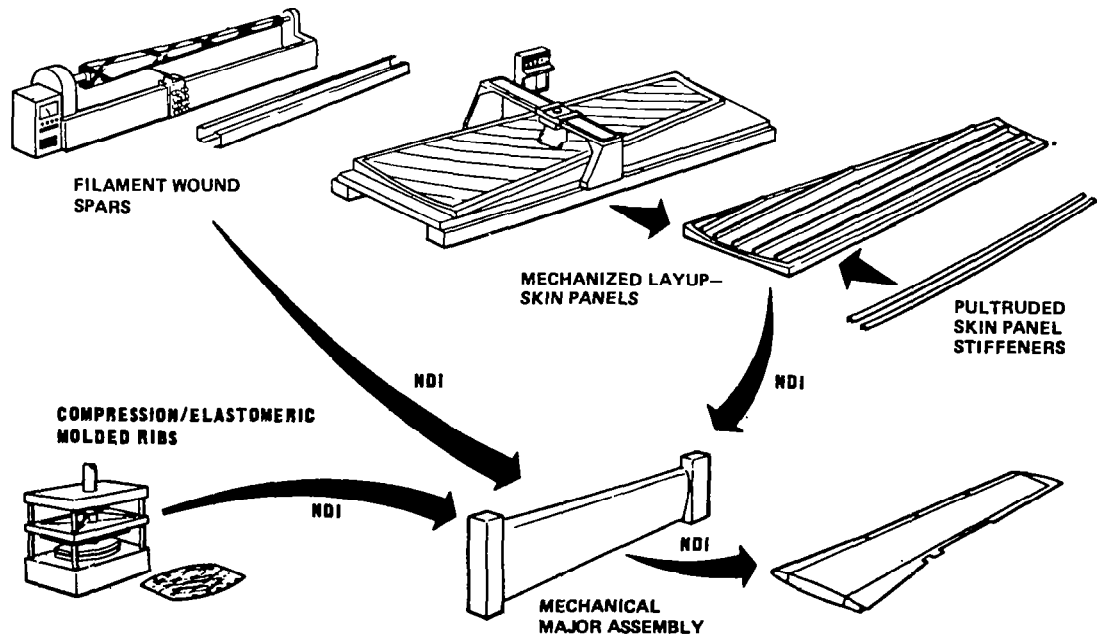

Figure 18.- Production manufacturing concepts.