

## RELEASE OF CARBON FIBERS FROM BURNING COMPOSITES

Vernon L. Bell  
NASA Langley Research Center

The first of the elements in our plan to work the carbon fiber risk analysis is the source of the fiber itself. At the first conference a little more than a year ago, our knowledge of just how much fiber might be released from the crash and ensuing fire of a composite-carrying airplane was rather shaky, at best. As noted in Figure 1, we did have some quantitative results, mostly using the Navy-developed test involving the burning of composite pieces followed by the explosive destruction of the burned composite residue, but the results of that test using portions of 737 spoilers and DC-10 rudders varied widely from specimen to specimen. However, we did come up with weighted averages for all tests of 12% and 10% single fiber release, respectively, for the spoiler and rudder. Nevertheless, no one was at all satisfied with the burn plus explosive test sequence as a valid scenario for the events to be expected in the crash of a commercial airliner. We were just beginning to acquire some results, courtesy of NASA-Ames' Redwood City contract test facility, which suggested that single fiber release might be much, much lower for more realistic means of disturbing the burned composite residue. We also knew that the forms of fibers which were released were varied, but we decided to concentrate on single fibers as the most likely form of fiber to constitute a long distance threat, if indeed a threat could exist. We had also just begun to find out that the fire-generated fibers were much shorter than had earlier been supposed, a finding which was a bright spot on the horizon of vulnerability. And then, too, we had begun to suspect that the oft-quoted "indestructibility" of graphite fibers was not necessarily true for the carbon fibers in most common use today. We believed that an undetermined amount of the fibers could be completely consumed in real life fires. Based on the earliest release data, O.R.I. (one of the contractors performing the risk analysis) was using 20% as the amount of single fiber from aircraft crash fires. A.D. Little was using two numbers: 5% for fires without explosions and 25% for fires with subsequent explosions.

Figure 2 lists the principal test facilities for the generation of the fiber release data which is given in this report. The lion's share of the laboratory work was done in the Navy's Dahlgren environmental chamber, with added support from the Scientific Services, Inc. facility at Redwood City, California, under the sponsorship of NASA's Ames Research Center. An excellent study of the fundamentals of composite fires was performed in AVCO's fire test facility. Of the three demonstration

test activities, I have only reported on that which TRW's Defense and Space Systems Group conducted for the Air Force at the Naval Surface Weapons Center, China Lake, California since NASA Langley sponsored the data reduction and analysis from those tests. Dick Pride will discuss the results from the Navy's shock tube fire facility at Dahlgren and the Army's Dugway Proving Ground.

Before showing the fiber release data, a word of explanation is in order regarding how we have measured and calculated most of the single fiber release (Figure 3). The data I shall present was acquired, for the most part, by passive instrumentation means, especially by the settling of fibers onto 15.2 x 22.9 cm (6 x 9 in.) sheets of transparent films coated with a very sticky adhesive. Sometimes fibers in a horizontal airflow mode are trapped by encountering cylinders made by rolling up sticky Mylar film. A third general technique traps fibers in a horizontal flow mode onto a bridal veil filter, usually with about 1 mm or less mesh size, coated with a sticky substance. After the deposited or trapped fibers are counted and a mean length determined, a total number of fibers given off is calculated based on the area sampled. From that total number, the mean length, and the density of carbon fibers, a total weight of single fibers released is computed. A percentage of the total carbon fiber initially present (not burned away) can then be calculated. So the number which I will generally present to you will be the weight percent of single fibers released, based on the initial weight originally present in the composite. The risk analyses to be presented later use that weight percent to determine the single fibers of a spectrum of lengths which can be predicted to be released from commercial aircraft crashes.

With that introduction behind us, I would now like to present the total results of our very comprehensive carbon fiber release test program which has been conducted over the past couple of years. I will then go into the detail of each separate piece of that program, which I hope will leave you convinced that we have a pretty good handle on how much potentially hazardous carbon fiber can be expected to be released from the total representation of an aircraft crash fire. I will first present the data in terms of the amount of fiber which could be released from fires, then give some characteristics of fire-released fibers, and finally tell you how we have utilized the data.

As I mentioned earlier, most of our early data came from a burn plus subsequent explosive destruction of the fibrous residue. The explosive destruction of the residual burned composite naturally leads to a large release of fiber. In some of our tests, the amount of explosive, 56.7 g (2 oz), was equal to the amount of carbon fiber present in the sample, simply because the explosive was held constant for each test, regardless of the specimen size or configuration. Although there may be crash/fire situations

involving military aircraft where a 226.8 kg (500 lb) bomb can act on 500 lb of carbon fiber in the plane, the whole idea of the explosive is admittedly unacceptable for the civilian aircraft test situation. Nevertheless, we acquired that sort of data and we are using it as the upper limit for fiber release possibilities.

So let me show you the results of the burn/explosion test on some prototype aircraft parts in Figure 4. As you can see, simple flat plates tested under the same conditions as the parts gave very low fiber release, as did an experimental turbine fan blade with polyimide resin from NASA's Lewis Research Center. A 5% release resulted from a honeycomb panel using Nomex honeycomb core between two-ply skins of carbon/epoxy tape, with an outer ply of glass fabric. (I'll have more to say about this piece of structure later). And then lastly, we have the DC-10 rudder and 737 spoiler test results which were mentioned previously. The results shown here reflect the refinements in Dugway's statistical counting procedure, leading to the present fiber release numbers of 4.1 and 5.5% for the rudder and spoiler tests.

Some data has been presented in Figure 5 which reflects the other extreme for fiber release: that given off when composites or fiber materials are burned quiescently without intentional disturbance of the fibrous residues. The specimens were burned for 20 minutes with the propane burner used in the Navy's Dahlgren Chamber. The amounts of single fibers released from three particular 737 spoiler pieces are at least three orders of magnitude less than the amounts which were released from the very same specimens which were burned and then exploded. The same vast difference between burn alone and burn plus explosion was found for the fiberglass/carbon/Nomex honeycomb paneling material which I mentioned earlier. Also shown in this figure are the low release amounts obtained by simply burning 0.45 kg. (1-pound) spools of virgin T-300 and HMS carbon fiber. Interesting, but not altogether unexpected, was the observation that after the flame was extinguished following the 20-minute burn period, the mass of T-300 fiber continued to glow for more than 90 minutes, resulting in over 90% mass loss of the fiber by oxidation. Such was not the case for the more "graphitized" HMS fiber which had virtually no mass loss. Since carbon fiber is generally manufactured, transported, and utilized on spools, this data should alleviate considerably any fears concerning warehouse, truck, and industrial fires involving virgin fiber.

The fiber release numbers for the NASA flat plates in the last figure came from a series of tests which were meant to determine the effects of composite configuration, both thickness and lay-up method, on fiber release. The results of that study shown in Figure 6 were somewhat confusing to us, since for both the burn only and the burn/explode tests, the 3.2 millimeter (1/8 inch) thick plates gave off much greater amounts of single fiber than

did the thinner and thicker specimens. However, these test specimens which were fabricated in-house at Langley, had been analyzed and QC'd very thoroughly by Robert Jewell. When we examined that back-up data, it was found that all of the test panels, except for the 3.2 mm (1/8 inch) cross-plyed panel, had respectable resin contents of 30-35%. But the 1/8 inch cross-plyed panel had a resin content of only 26 percent, and the C-scan analysis showed it to be porous. We believe that the lack of sufficient resin to thoroughly saturate the bundles of fibers could well have led to the abnormally high single fiber release values for the 1/8 inch specimens, since the usual fiber-holding char from the epoxy resin would be lacking in the porous portions of the composite plates. So for the first time, we suggest that the quality of composites could have a significant effect upon fiber release. Yet, it is probably safe to say that the stringent quality control procedures exercised in the manufacture of aircraft composite parts would prevent such poor quality parts from being used.

One particular test series conducted by the Navy's chamber test facility employed conditions which I feel could be the most extreme to be expected in a fire situation which might act upon composite parts in a crashed commercial airliner. These results, shown in Figure 7, were obtained by burning standard flat plates for 20 minutes with a propane burner, with airflow both during and after the completion of the burn, and also with the instantaneous release of pressurized air directed at the burned composite fibrous residue. Incidentally, the materials used in the entire Dahlgren study of the effects of various types of disturbances on fiber release were carried out using 0.15 x 0.15 m (6" x 6") specimens from 0.00336 meter (0.132 inch) thick plates of crossplyed AS/3501-6 composites, all cut from two 0.61 m x 1.22 m (2 ft. x 4 ft.) high quality panels. So we felt extremely confident of the constancy of the tests up through the completion of the act of burning the specimens. The first two bars in Figure 7 show that very small amounts of single fiber were released when a 5 m/sec (10 knot) flow of air was directed at the horizontal edge of the plate, either during the 20-minute burn (first bar) or for 10 minutes following the 20-minute burn. The third bar shows very little release of single fibers when a 15 m/sec (30-knot) flow of air was directed against the edge of the specimen during its 20-minute burn period. However, the reason for that result was that the 30 knot airflow simply overwhelmed the propane flame and cooled the specimen to such an extent that very little resin was consumed. So the only reliable high airflow test was the one shown by the fourth bar, where a 30 knot flow of air was directed at a 20-minute pre-burned specimen. As you can see, single fiber release was relatively high and 30 knots of inflowing air is not unreasonable for a large pool fire. The last three bars show the amounts of fiber released when pressurized quantities of air were released instantaneously at 20-minute

pre-burned composite residues. The resulting velocities of air, from 135 to 470 knots, could realistically simulate such events from raging firestorms to exploding fuel tanks.

The forms of disturbance involved in fiber release testing have been roughly broken into those considered to be external in nature, including the forces caused by explosives, air blasts and airflow, and impacts; and others considered to be internal in nature. One series of tests conducted at Dahlgren was an extremely thorough evaluation of the amounts of fiber released when the burned composite residue was impacted with various shapes and weights of pendulum heads at the end of a swinging pendulum, which has been depicted in Figure 8. Duplicate tests involving each of the five pendulum heads impacting the composite residue at four different angles of impact were run. The results shown here, which prove that the amounts of single fiber released in this manner were consistently low, seem to minimize such concerns as portions of aircraft structure collapsing onto burning or burned composite parts.

Another type of test which also addressed the possibility of fiber release by means of an external impact was the drop impact test developed and used by Scientific Services, Inc. (SSI) at Redwood City, California under a contract from the NASA Ames alternate materials program. This facility, which I described a year ago, utilized a projectile of various weights falling from different heights onto a burned composite plate in a chamber which enabled a complete collection of single fibers and other fibrous fragments. The results in Figure 9 show that all drop weights and heights gave extremely small amounts of single fibers when the projectile was dropped onto burned crossplied composite specimens, and perhaps slightly higher amounts from woven composite plates. However, the use of woven carbon fabrics in the fabrication of the specimens clearly led to a marked reduction in the total amounts of fiber fragments since the projectile punched a clean hole through the burned composite residue, compared to the massive shattering caused to the crossplied panels.

Figure 10 shows the results of what I have called disruption of the composites by forces internal to the burned fibrous residue. The burned residues from the standard 20-minute burn periods were flexed to destruction and twisted as means of simulating some other possible events that could happen in the midst of an aircraft crash fire. The specimens were also vibrated at 30 cycles per second, and simply dropped from a 2.44 meter (8 foot) height. It is apparent that these disruptive forces released amounts of single carbon fibers equally as small and smaller than did the mechanical and drop impact tests. So we feel that the entire series of impact tests conducted at the Navy's Dahlgren chamber test facility should go a long way toward defining and testing most of the likely forms of disruption to the burned carbon

fiber composites.

A carbon fiber release study, complementary to those which I have just described, was performed in the AVCO fire test facility. This facility utilized a chamber using natural gas as the fuel, but it was particularly attractive for simulating the burning of composites in jet fuel fires since it had a realistic combination of radiant and convective heat fluxes. This versatile test facility was used to study a number of different fire variables, some of which have been shown in Figure 11. Variation of the fuel to air ratios from lean to rich, holding other fire properties constant, did not seem to have a marked effect upon the amounts of single fibers released, although it did have a considerable impact on the amount of fibers oxidized by the fire. However, the effect of edge restraint in reducing the amounts of fiber released was clearly demonstrated, since according to the results shown here, nearly ten times as much fiber was released from a specimen with three edges exposed to the flame as evolved from a specimen which was mounted in a metal frame. That could be a significant factor in release of fiber from shattered composite parts in a crashed aircraft. Although the AVCO facility used an airflow of up to 8 meters/second (15 knots), pulses of argon directed at the burning composite plates were used to simulate turbulent forces in a raging fire, and the results in this chart show that such gas pulses did, indeed, increase the amount of released fibers. Movies of the AVCO tests give a strong impression that the argon pulses give the fire the turbulence which is typical of pretty healthy fuel fires.

At this point, I will summarize in Figure 12, in a very general way, what we have found about the effects of disturbance of burned fibrous residue from the standpoint of importance in causing single fibers to be given off. The explosive disruption is still generally conceded to be the extreme, but near subsonic blasts of air are almost as severe. And as I have already shown, the severity of disturbance diminishes rapidly with lesser air velocities, impacts, internal disturbances, and finally, simple burning.

I would now like to leave the broad subject of amount of fiber release and tell you what we have found out about the physical characteristics of the fibers which have been released. Last year at this time we had some results from the SSI Redwood City tests, and some TRW measurements from the Air Force outdoor tests, and as I mentioned previously, those results indicated that fire-released fibers were generally much shorter than had been expected, with average lengths of 1-3 millimeters. All of the single fiber release data I have presented thus far has been for fibers over 1 millimeter in length. A general spectrum of fiber lengths over 1 millimeter in length has been given in Figure 13, and that general spectrum has been confirmed by just about all

the composite fire testing that has been done, including that by TRW at China Lake and their Capistrano Test Site, SSI at Redwood City, AVCO, and the Navy in the Dahlgren chamber and shock tube, with the variations being encompassed in the shaded portions of the bars. I hasten to add that I said "just about all" and I will describe the exceptions to you soon. The predominance of fibers shorter than 3 mm in length has a marked effect upon the susceptibility of electrical equipment to the fibers, as will be pointed out in Mr. Taback's presentation on vulnerability of equipment.

A consideration of all the lengths of carbon fibers generated in fires is quite interesting. Such a study has been made by Dr. Ben Sussholz of TRW. The results have been shown in Figure 14. Dr. Sussholz counted and measured carbon fibers from several different tests down to 5 micrometers in length, so that should give you an appreciation for what a monumental task it was. Results of three of the tests have been shown in this figure. The first one, from a burn plus explosion test conducted by TRW, shows that more than 98 weight percent of the fibers detected and counted were less than 1 millimeter in length. At a meeting of carbon fiber representatives earlier this year, I presented that number and some skepticism concerning the validity of it was expressed. Consequently, I reviewed the data and realized that CTS-3 was an unusually severe explosion since twice the usual amount of C-4 explosive was used and it was placed both above and below the burned composite. Obviously, it really powdered up the fiber. However, CTS-1 was a test closely duplicating the normal burn plus explosive tests conducted at the Navy's Dahlgren chamber, and the results of that test, shown in the center, still indicate the great majority of fibers were less than one millimeter long, and probably electrically innocuous. Even the simple burning of a 737 spoiler specimen, with no subsequent disturbance of the fibrous residue, resulted in almost three-quarters of the fibers being under 1 millimeter. This substantiates a general feeling that the most widely used carbon fibers, such as T-300, AS, etc. have some sort of flaws in the fiber which promote the burn-through of the fiber at very short intervals.

I mentioned that just about all of the testing has resulted in carbon fibers which were less than 3 mm in length. However, recent tests in the Navy's chamber at Dahlgren have given us a striking exception. One of the materials subjected to a burn plus explode sequence, the results for which were shown earlier (Figures 4 and 5), was a 9.5 mm (3/8 in.) thick panel composed of a Nomex honeycomb core bonded on both sides to a skin consisting of a single ply of glass fabric and two plies of carbon fiber tape, with the glass being on the outside of the panel. When this panel was burn-tested in several ways, the results were as shown in Figure 15. A simple burning of the panel for 20 min with no intentional disturbance resulted in very few fibers,

calculated at no more than 0.01% of the amount of carbon fiber initially present in the panel. When a post-burn current of air at 15 meters/second (30 knots) was directed at the burned fiber residue for 10 minutes, one percent of the mass of carbon fibers was released but with a mean length of nearly 10 millimeters. The 20 minute burn plus explosive destruction reported before gave a significantly larger efflux of fibers, a little over 5 percent, and they were of a mean length a little longer than those from the burn alone. Then when a sample was burned for 20 minutes and the residue was impacted with a single blast of air at 244 meters/sec (470 knots), the result was not only a high amount of release in terms of mass (8 weight percent), but the mean fiber lengths were 5.7 millimeters, or more than twice the mean for the burn alone. In both the airflow and airblast tests, there were some very long single fibers, running up to 40 and 50 millimeters. There was something very unique from the standpoint of not only the amount of fiber release (in terms of mass) from this particular test specimen, but also from the standpoint of the physical dimensions of the fibers. On the other hand, due to the longer lengths in those two tests, less fibers were actually released from the airblast test than from the burn/explode test, but they were just a great deal longer. These anomalous results may or may not be significant from the standpoint of the effect on electrical equipment. I believe this will be brought up by Mr. Taback in his presentation on vulnerability.

Throughout the source release testing program, we have wanted to get an idea of just how readily carbon fibers can be oxidized completely, since that fiber which burns up cannot be electrically hazardous. However, the temperatures considered to be representative of fuel fires, from 1150-1365 K (1600-2000<sup>o</sup>F), are so high and the rate of carbon fiber oxidation in air at those temperatures is so fast that it has been extremely tough to try to study the process in the laboratory. Nevertheless, Mr. George Sykes of NASA Langley has made a good try at studying fiber oxidation at high temperatures with thermogravimetric analysis (TGA), and some of the results of that study are shown in Figure 16. Of course a large fuel fire involves not one temperature but a range of temperatures and a mixture of mostly radiative and convective heat fluxes. In this case, he settled on 1250 K as a good middle ground temperature, (which was also the highest temperature his equipment could reach), and heated the virgin fibers up to that temperature from room temperature at a rate of 375 K per minute, meaning it took almost 3 minutes to reach 1250 K. At that point, the analysis became isothermal and weight loss was computed from that point. In addition to temperature variations in a real fire, there are also wide variations in the oxygen content of the fire, and the extent of fiber oxidation will be highly dependent on the oxygen present. Therefore, he performed the isothermal TGAs for four possible oxygen levels, and the results shown in the figure give an idea of just



how rapidly AS carbon fibers could be completely oxidized away. With no oxygen present (nitrogen atmosphere), the fibers will last a long time at 1250 K. At the other extreme, in air the complete oxidation can occur in less than a minute. These data, while not answering directly our difficult question of "How much carbon fiber will be burned up in a fire?", were extremely useful for a theoretical fire modeling effort by Science Applications, Inc. (SAI), which I will describe shortly.

Whereas the Langley study was conducted by the thermogravimetric analysis of virgin fibers, another oxidation study was done by AVCO Corporation. In this case they used actual fibrous residue from single plies of burned out composites in their combined radiative-convective fire facility. The results of their study, given in Figure 17, led to two plots of fiber mass loss with time using two types of fires, fuel rich and fuel lean. As expected, mass loss is much faster with the fuel lean or air rich fire than for the fuel rich fire. For comparison, although the AVCO study was done at only 1145 K, the air curve from the Langley TGA study is overlaid for comparison and the rate of fiber weight loss closely approximates the rate of mass loss for the AVCO fuel lean fire, as it should.

One of the early studies in this program into the oxidation of carbon fibers was performed by the TRW Defense and Space Systems Group during their reduction and analysis of the results of the Air Force's China Lake outdoor fire tests. Some of their early studies which included thermogravimetric lab work as well as analysis of the outdoor composite burn tests resulted in the important conclusions shown in Figure 18. The reduction of the fiber diameters of such burned composites as the 737 spoilers represented a tremendous loss of fiber mass, and that oxidation as manifested by fiber diameter reduction was observed for other thin composites. As will be shown in the next figure, high quality, thick composites seem to show less fiber oxidation, perhaps because of the reduced specific surface area in thick composites. And lastly, TRW believed that the very process of combining virgin carbon fibers with resins into a composite and burning away the resin left certain unspecified residues on the fibers which catalyzed the oxidation of the fibers. Although we could not confirm that observation at Langley by TGA studies, the phenomenon may still be valid since an investigation at the Jet Propulsion Laboratory showed that certain metallic species could indeed cause a drastic conversion of virgin carbon fibers to combustible fibers.

A manifestation of fiber oxidation in fires involving composites is the release of carbon fibers with reduced diameters. When the fiber collection data from TRW's Capistrano test series and the China Lake outdoor burn tests were studied, they revealed another important change in the fire-generated fibers from the

unburned fibers originally in the composites. TRW found that the fibers resulting from relatively thick (6.4 mm or 1/4 inch) composite plates used in the Capistrano test (as well as in Navy burn plus explosion tests at Dahlgren) had roughly the same diameters as the initial fibers used to make up the composites. For example, Figure 19 shows that the post-test fibers from the CTS-3 test, depicted by the solid bars, have been reduced in diameter only a minor amount compared to the diameter spectrum of the pre-test fibers shown by the dotted line bars. Test CTS-3 involved burning a one square foot composite plate with a propane burner, followed by the destruction of the residue with 4 ounces of C-4 explosive. However, fibers which resulted from the burning of representative aircraft parts in jet fuel pool fires at China Lake were drastically reduced in diameter, as demonstrated by the results for the 737 spoiler fibers given in the figure. Generally, it seems that large pool fires acting on relatively thin composites lead to a substantial oxidation of the fibers to lower diameters, while use of propane burners for combustion of composites do not. However, poor quality, porous, resin-starved composites burned with relatively small, low-radiative gas fires can still produce fibers with markedly reduced diameters.

Other factors of the fire can also result in a significant reduction in fiber diameter, indicating oxidative conditions. Figure 20 shows the large amount of oxidation that occurred when two 3.2 mm (1/8 in.) thick composite specimens (AF-4 and AF-6) were burned in propane fires in the Dahlgren facility, immediately after the cessation of which a 15-meter per second (30 knot) airflow was applied to the still-smouldering residue fiber mats. The large extent of fiber oxidation is obvious from the fact that most of the fibers measured from both tests were less than 4 microns in diameter, compared to the usual 6-8 micron diameter for the virgin fibers. An important ramification of fiber diameter reduction will be addressed later in this presentation.

At the beginning of this fiber release test program, we were disappointed to find such a paucity of information about the nature of the kinds of fires which would be involved in commercial aircraft crashes. Some analytical fire modeling for methane fires had been done, but those fires were poor substitutes for the "smoky" fires created by jet fuels. Even so, experimental verification of existing codes was lacking. Mr. Joe Mansfield of NASA's Ames Research Center accepted the challenge to provide the sort of jet fuel fire and fire plume background which would enable the prediction of both the amount of fiber which could come out of a large jet fuel fire and how they would behave in the resulting fire plume, up to the region where the plume and fibers begin to form a downwind dissemination pattern. Also needed was a knowledge of those characteristics which could allow for the prediction of fiber consumption in the fire. The result was a comprehensive analytical program, with a mathematical

model developed by Science Applications, Inc., to determine the characteristics of large liquid fuel fires, including the spatial variations of such factors as the flame velocity, temperature, soot concentration, etc., as well as the manner and extent to which carbon fibers released in the lower regions of the fire are transported and consumed within the fire. Because of the shortage of actual data with which to test the mathematical model, an experimental test program involving fire temperature, velocity and chemistry measurements was conducted at the NASA White Sands facility by means of JP-4 pool fires (Figure 21), with pool diameters of 7.62 meters (25 feet) and 15.24 meters (50 feet). Typical of the results of this excellent analytical-experimental program are those shown in the next two figures.

The isothermal contours shown in Figure 22 indicate there was a small but extremely hot region in the center of the flame. However, there is a rather large region in the center with temperatures still hot enough (1400-1500 K) to burn up carbon fibers, if sufficient air was present. The plot at the right indicates that the fiber consumption model predicted up to 15-16% oxidation of single fibers released in the fire for both 7.6 and 10.7 meter (25 and 35 foot) fires, with consumption nearly complete at a height of 20-30 meters above the fire.

In Figure 23, the original SAI model predicted excessive fire temperatures. When the experimental fire chemistry sampling showed the coexistence of both fuel and oxidizer in the center of the flame, the fluctuating chemistry model shown was developed to account for the "unmixedness" of the fires, although that model gave temperatures still somewhat higher than the experimental test data from White Sands. The oxygen mass fraction sampling data at the right shows that the oxygen content of the 15 meter fire was considerably greater than predicted by the models. This was expected to lead to a higher than originally expected consumption of carbon fibers in jet fuel pool fires.

In addition to the electrical hazards, there has been an uncertainty about the possible health hazards of carbon fibers. Under the Intergovernment Action Plan, the National Institute of Occupational Safety and Health (NIOSH) was charged with the responsibility of studying the health issues of carbon fibers. However, since NASA has done the lion's share of the testing leading to fiber release, we have tried to be alert to the formation and dissemination of fibers which could in any way provide information of value to NIOSH. In addition to our interest in the fire-induced oxidation of carbon fibers as a means of getting rid of them, the partial oxidation of the fibers shown in two previous figures can lead to fibers with sufficiently small diameters to make them respirable to humans. For guidance in what dimensions for fibers and what exposure levels should be of concern, we can look at the standards for a known fiber health hazard. Those for

asbestos control have been shown in Figure 24. The concentration and exposure levels considered to be hazardous according to 1976 OSHA standards should be kept in mind throughout this conference when expected carbon fiber levels are mentioned.

Dr. Wolf Elber of NASA Langley performed a study with a scanning electron microscope of fibers which were collected on a square 0.6 mm stainless steel mesh from the sooty exhaust of burned composites in the Navy's shock tube fire facility at Dahlgren. He was able to separate nearly 600 fibers from the soot by a settling procedure in water containing detergent. The accounting of the fiber lengths versus diameters is given in Figure 25. According to the guidelines for asbestos fibers, those fibers in the shaded lower left hand region of the figure would be of such small size as to possibly be respirable, and in this case totals 37 out of 576, or about 6-1/2% of all the fibers. To put the quantity into the proper perspective, on a weight basis those fibers with the small diameters were less than one-quarter percent of all carbon fibers isolated and measured.

Similar results were obtained by Dr. Ben Sussholz of TRW who counted and measured the small diameter fibers from the two Dahlgren burn plus airflow experiments AF-4 and AF-6 (Figure 20). However, it still has to be shown whether or not there is anything at all hazardous about carbon fibers from a health standpoint.

Our present knowledge to that effect is summarized in Figure 26. As just indicated, we have found only a few carbon fibers in our test programs which were possibly of respirable size. Only one study involving the response of animals to carbon fibers is known. In that one, guinea pigs were exposed to  $2.9 \times 10^6$  fibers/cubic meter for 100 hours, or a total exposure of  $10^{12}$  fiber-sec/m<sup>3</sup>. Only 5 carbon fibers were found in the lungs of the autopsied animals and only one fiber was intracellular. There was no indication of macrophage formation, which would be suggestive of an antagonistic response of the animals to harmful foreign matter. As far as humans are concerned, it is known that many carbon materials have been implanted without indication of problems, so it seems fairly certain that carbon is innocuous to humans from a chemical standpoint. As Mr. Pride will tell you, NIOSH personnel have been involved in our large scale composite fire tests at Dugway Proving Ground and we feel certain they are the proper researchers to follow the carbon fiber health issue.

To return to the principal objective of our carbon fiber release testing program, the next figure (Figure 27) indicates, in a general way, the overall mass balance to be expected when a composite burns up in a fire. At the right-hand side of the ledger, the greatest share of the fiber originally in the composite will

end up as some form of fibrous residue at the site of the fire and/or as oxidation products, such as water vapor, carbon oxides, and soot. However, some of the thin, single ply strips of burned composites will be transported for relatively short distances, i.e., up to a mile or so. On the other hand, we expect that from 5 to 17-18% of the total mass of carbon fiber initially present in the composite will be released as single fibers, with no more than 1 to 3½% being of concern from an electrical standpoint. (The origin of those 1 and 3½% limits will be shown in Figure 28). And lastly, something under 0.05% at most will be given off as single fibers of such dimensions to be considered respirable.

A very general summary of a great many of the carbon fiber fire release tests has been given in Figure 28. The tests have run the gamut from simple, quiet burning of composites, an event which undoubtedly would occur to some extent in the fire involving a crashed commercial airliner, all the way to fires followed by ordinance-based explosions and pressurized gas explosions. Most of the participants in the actual risk analyses adjudged 1% to be an appropriate weight percent release of carbon fiber for all non-explosive fires, while 3½% was chosen as the release number to be applied in the case of all fires with subsequent explosions. (Those two numbers are represented by the two horizontal dashed lines in the figure). We feel those numbers are extremely conservative, meaning they still represent somewhat higher amounts of single fibers being released than are felt would actually occur.

The application of the large mass of data which has been herein presented is given in Figure 29.

First, a study of commercial air transport accident records led to an opinion that 85% of the accidents with fires resulted in fires only, while 15% of the accidents had fires with explosions sometime after the onset of fire. More precisely, only 5% of the crashes with fires had explosions after 3 minutes of fire, which was considered to be the minimum time to completely consume the epoxy resins in the composite parts which could have been present. Second, a release number of 1% single fibers was chosen for aircraft fires without accompanying explosions, while 3-1/2% of the total available carbon fiber in the burned composite parts was chosen as single fiber release for those fires with explosions. And lastly, for every kilogram of carbon fibers released from a burning composite, there will be 5 billion fibers, having an exponential distribution of lengths with a 2 millimeter mean length. In addition, although the diameter of carbon fibers has a relatively minor effect on the electrical properties, the five billion fibers per kilogram were considered to have their original diameters of about 8 microns. So, as the bottom line of this program, the data shown here represents the source of carbon

fibers to be used in the final carbon fiber risk analysis.

An acknowledgement of the excellent contributions to the source release program is in order. Dr. Kenneth R. Musselman and Mr. Ted Babinsky directed and conducted the entire test program in the Navy's Dahlgren environmental chamber, the magnitude of which is apparent from the data just presented. Dr. Ben Sussholz of TRW provided a wealth of data from the China Lake tests, and deserves special praise for his timeless efforts in counting, measuring, and analyzing fiber sizes. The overwhelming job of counting the fibers from hundreds of tests was accomplished for us by Mr. John Trethewey's group at the Army's Dugway Proving Ground as a pathfinding effort, and later by various individuals with the Bionetics Corporation. Mr. Joseph Mansfield provided invaluable assistance to this program not only by the contributions of Scientific Service, Inc., but also, and especially, by his planning and direction of the pioneering fire plume modeling and experimental work performed by Science Applications, Inc. and NASA White Sands personnel. Mr. J. Glenn Alexander of the AVCO Corporation provided an excellent study on the fire parameters in the burning of composites, while Mr. George Sykes of NASA Langley contributed a valuable, necessary and long overdue study of the fundamental thermal properties of carbon fibers.

- o AMOUNTS - DISTURBANCE APPARENTLY NEEDED FOR RELEASE
  - o BURN/EXPLODE TESTS: 737 SPOILER - SINGLE TESTS: 6-40%; AVE.: 12%  
DC-10 RUDDER - SINGLE TESTS: 7-15%; AVE.: 10%
  - o BURN/DROP IMPACT TESTS: < 0.1% SINGLE FIBERS (FLAT PLATES)
- o FIBER FORMS - SINGLE FIBERS, LINT OR CLUSTERS, THIN STRIPS
- o FIBER SIZES - FIBERS FROM FIRES ARE VERY SHORT ( $\bar{L} < 3$  MM)
- o OXIDIZABILITY - AS, T300, CELION TYPES BURN EASIER THAN HIGH MODULUS FIBERS
- o RISK ANALYSIS -
  - o O. R. I.: 20% SINGLE FIBER
  - o A. D. LITTLE: 5% SINGLE FIBER (FIRE WITH SUBSTANTIAL DAMAGE)  
25% SINGLE FIBER (FIRE PLUS EXPLOSION)

Figure 1.- Knowledge of fiber release: November, 1978.

## LABORATORY TESTS

- NAVY/DAHLGREN (VA) CHAMBER
- NASA/AMES - SSI/REDWOOD CITY, CA
- AVCO CORP./LOWELL, MA

## DEMONSTRATION TESTS

- NAVY/DAHLGREN SHOCK TUBE
- NASA/LANGLEY - ARMY/DUGWAY, UT
- AIR FORCE - TRW AT NWC/CHINA LAKE, CA

Figure 2.- Test facilities for fiber release.

- RELEASED FIBERS IN FALLING MODE:
  - SETTLE ONTO STICKY DEPOSITION PAPERS
- RELEASED FIBERS IN HORIZONTAL FLOW MODE:
  - ARE TRAPPED BY STICKY PAPER CYLINDERS
  - ARE TRAPPED BY STICKY MESH FILTERS
- RELEASED FIBERS COUNTED VIA OPTICAL MICROSCOPIC TECHNIQUES
  - DIRECT COUNT OF REPRESENTATIVE REGIONS
  - BUFFON NEEDLE DROP PROBABILITY METHOD
- ONLY FIBERS GREATER THAN 1 MM USED FOR FIBER RELEASE
- WEIGHT PERCENT OF FIBERS BASED ON AMOUNT OF FIBER PRESENT IN AFFECTED COMPOSITES

Figure 3.- Determination of fiber release data.

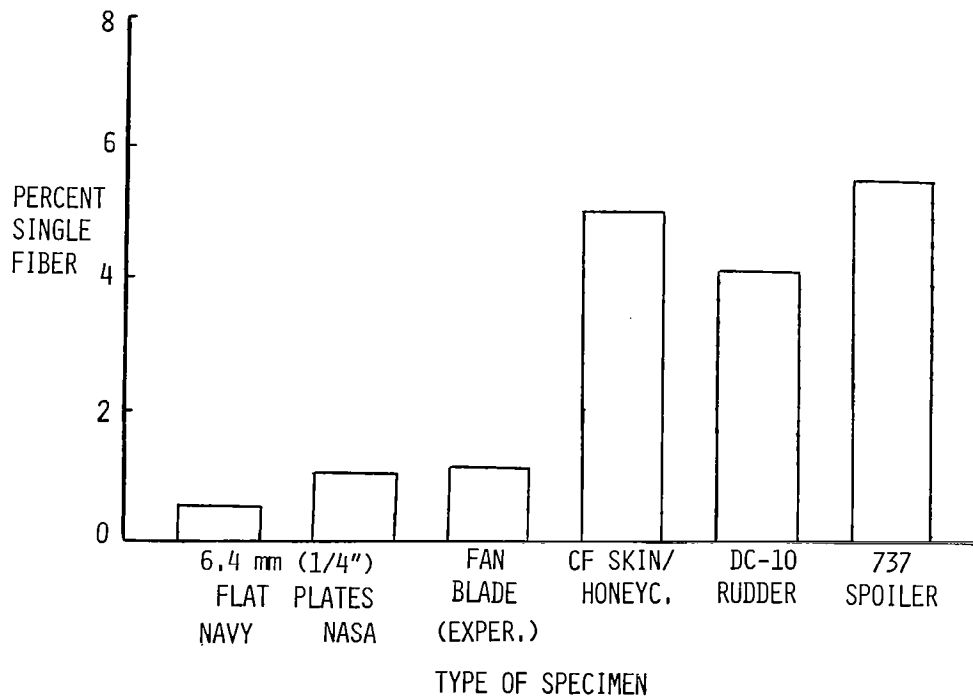

Figure 4.- Single fiber release from prototype composite aircraft parts exposed to fire plus explosives (Navy/Dahlgren chamber).



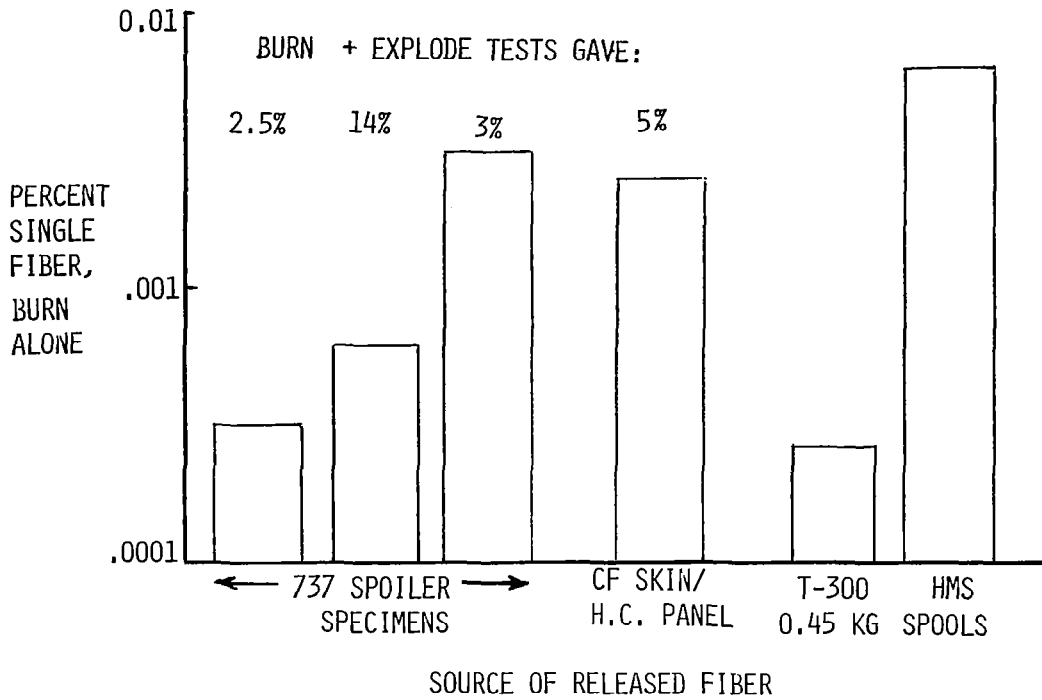

Figure 5.- Release of single fibers from propane fire vs. burn/explosive test (Navy/Dahlgren chamber).

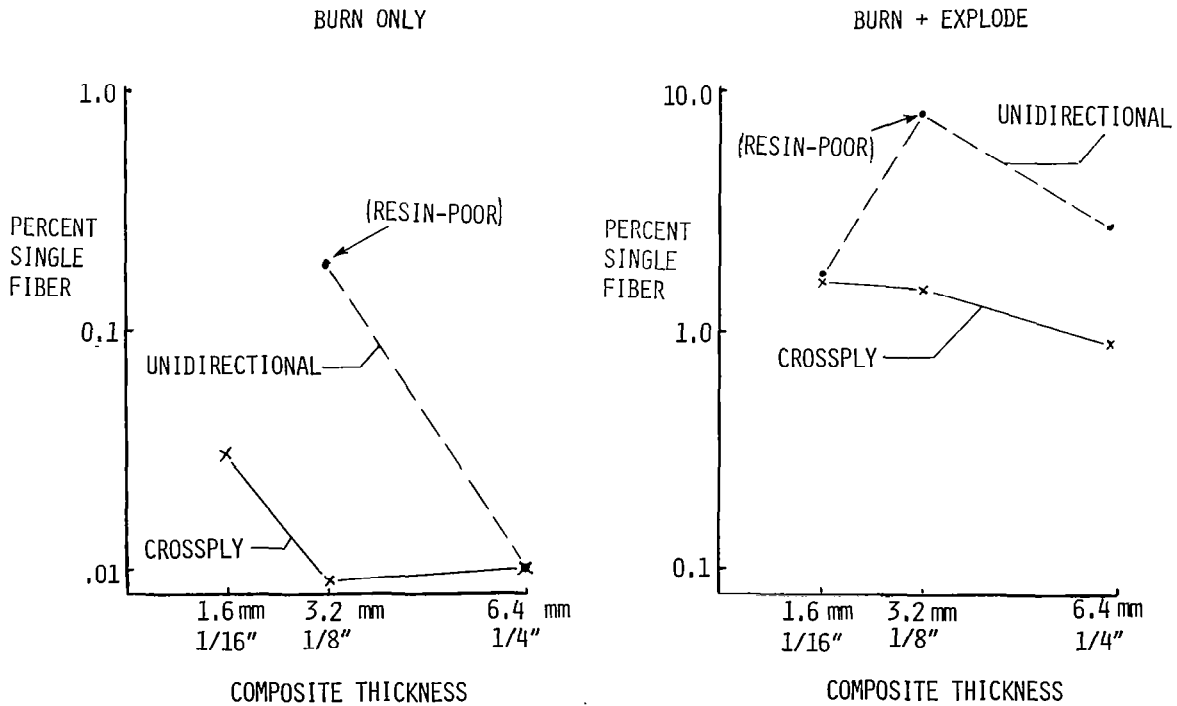

Figure 6.- Effects of composite configuration on single fiber release (Navy/Dahlgren chamber).

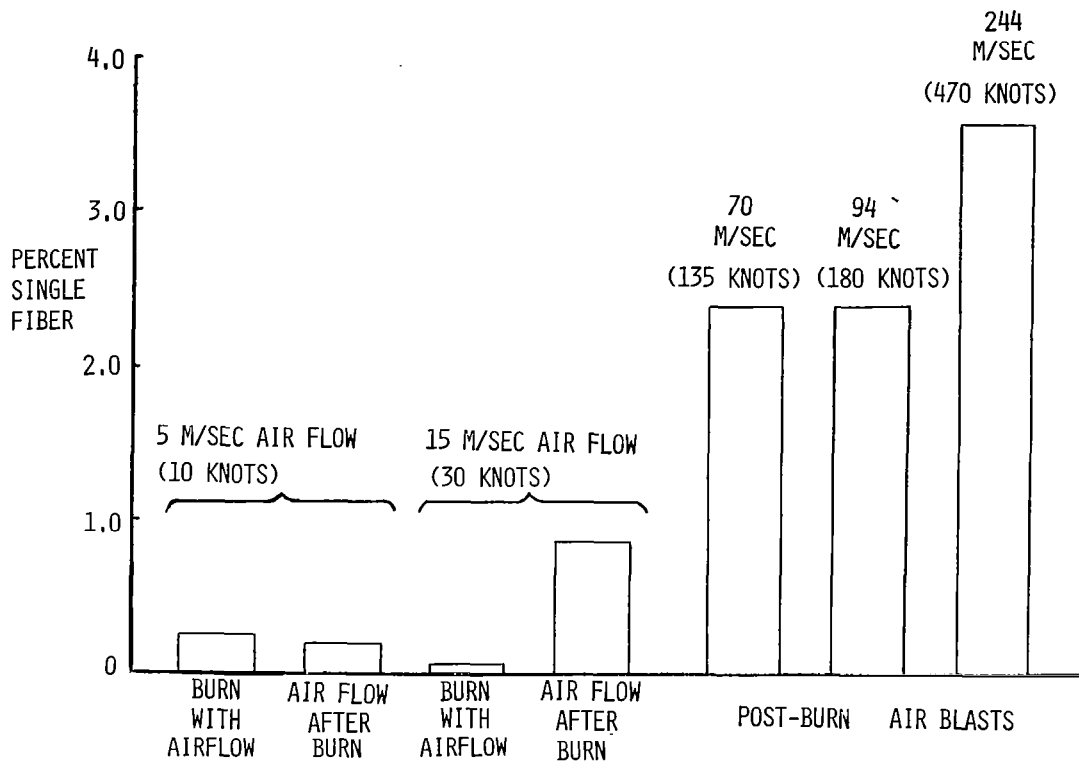
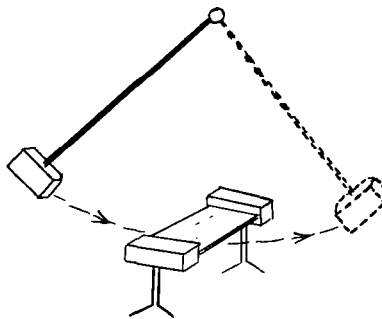

Figure 7.- Effects of low and high airflow on single fiber release (Navy/Dahlgren chamber).



<u>TYPE OF HEAD*</u>	<u>% CF</u>	<u>IMPACT ANGLE**</u>	<u>% CF</u>
ROUND, 11.4 KG	0.22	0°	0.13
WEDGE, 11.4 KG	.11	45°	.13
ROUND, 5.5 KG	.04	90°	.22
WEDGE, 5.5 KG	.17	135°	.19
FLAT, 5.5 KG	.10		

\* IMPACT ANGLE = 90°

\*\* 11.4 KG ROUND HEAD

Figure 8.- Effects of pendulum impact on single fiber release (Navy/Dahlgren chamber).

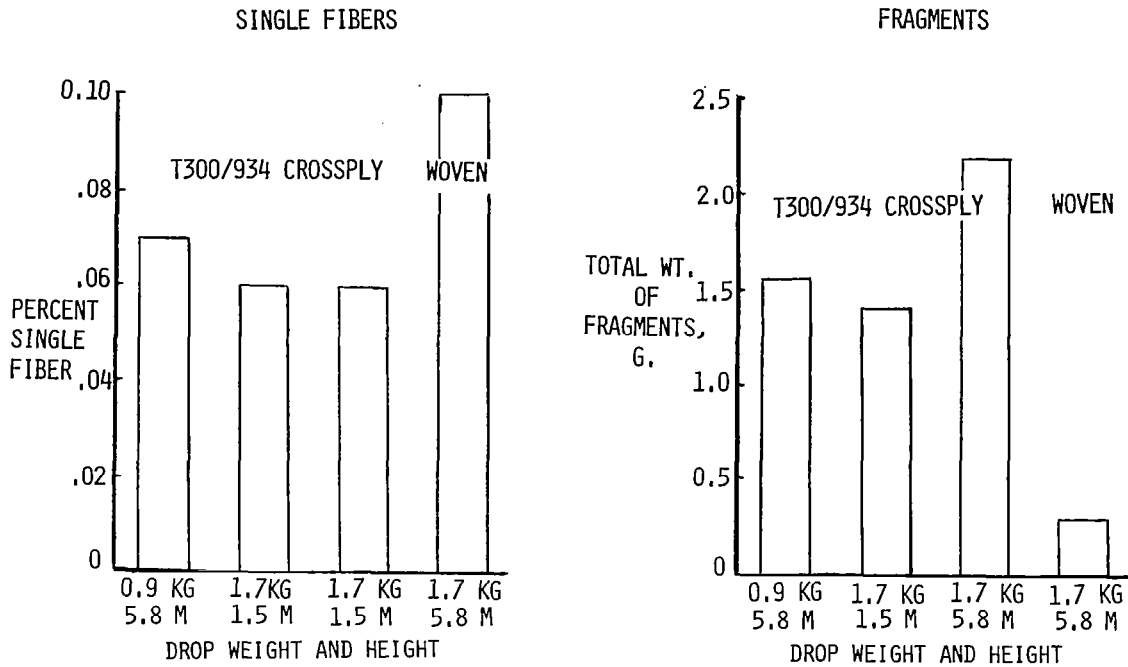

Figure 9.- Single carbon fibers and composite fragments from fire plus drop impact tests (NASA-Ames/Redwood City facility).

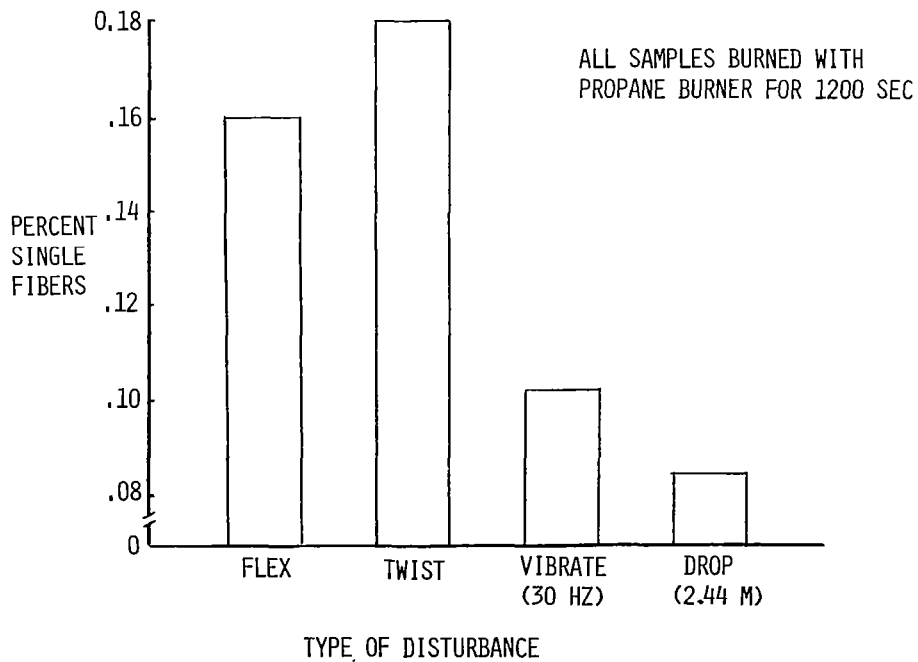

Figure 10.- Effects of internal disturbances on single fiber release (Navy/Dahlgren chamber).

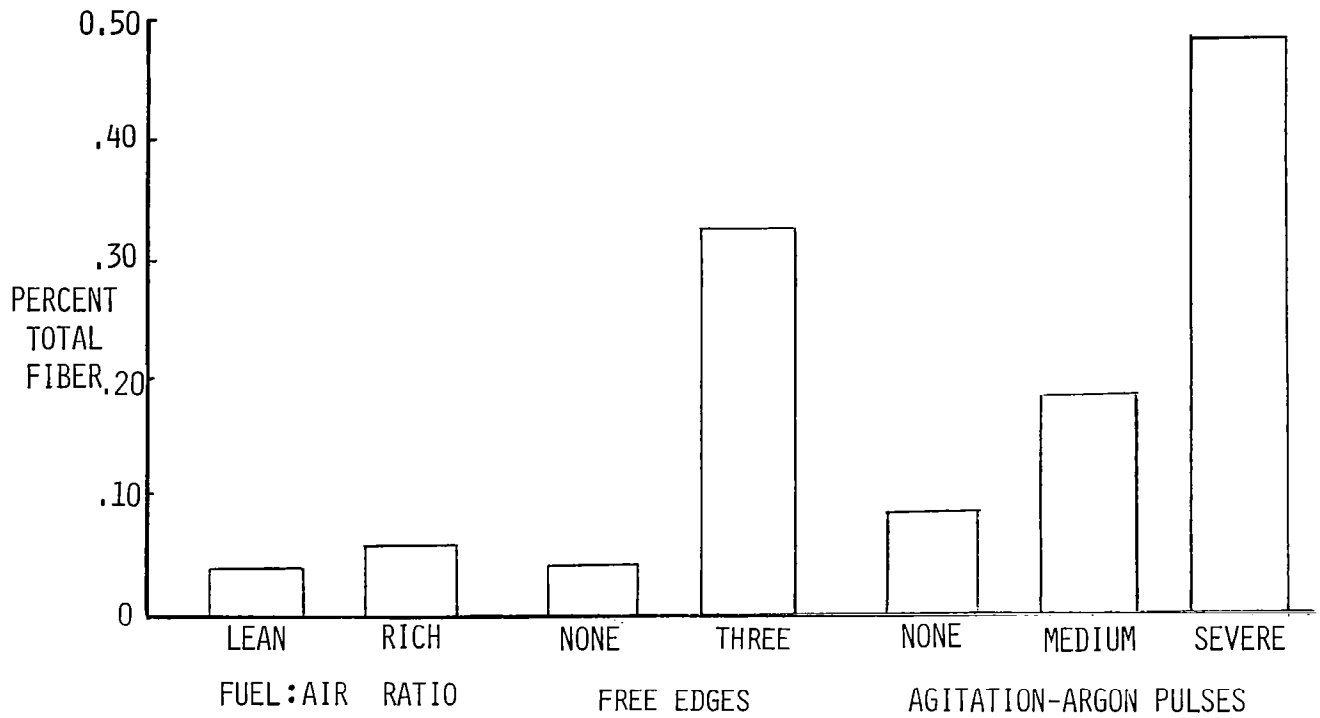

Figure 11.- Effects of fire variables on total fiber release (AVCO fire test facility).

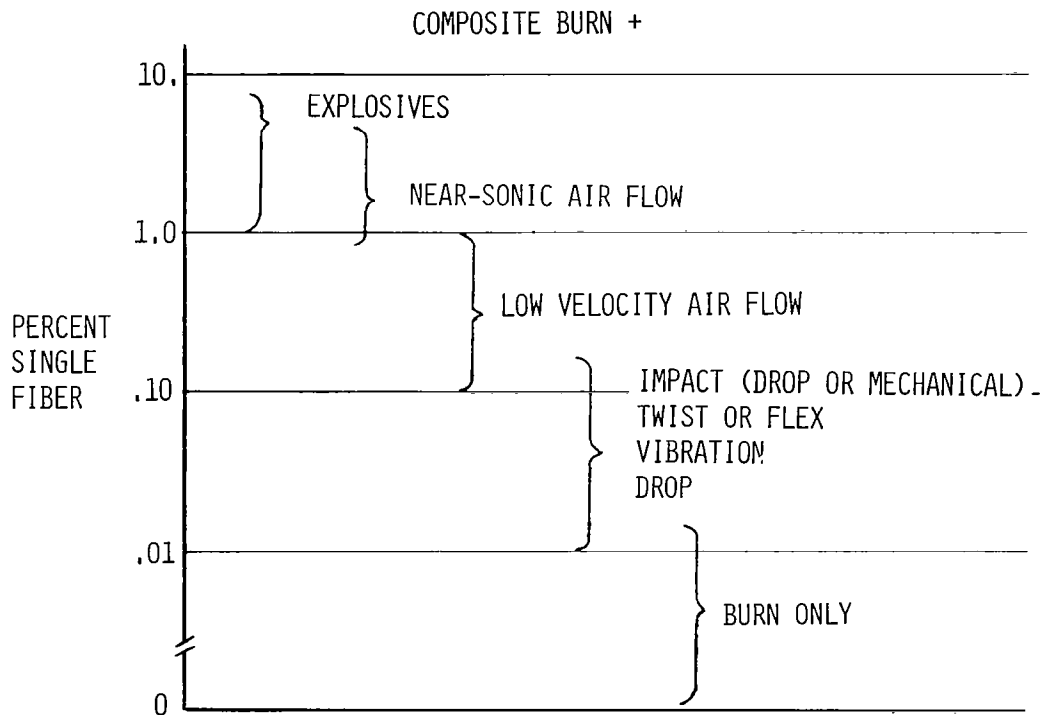

Figure 12.- Summary of effects of disturbance on fiber release from burned composites.

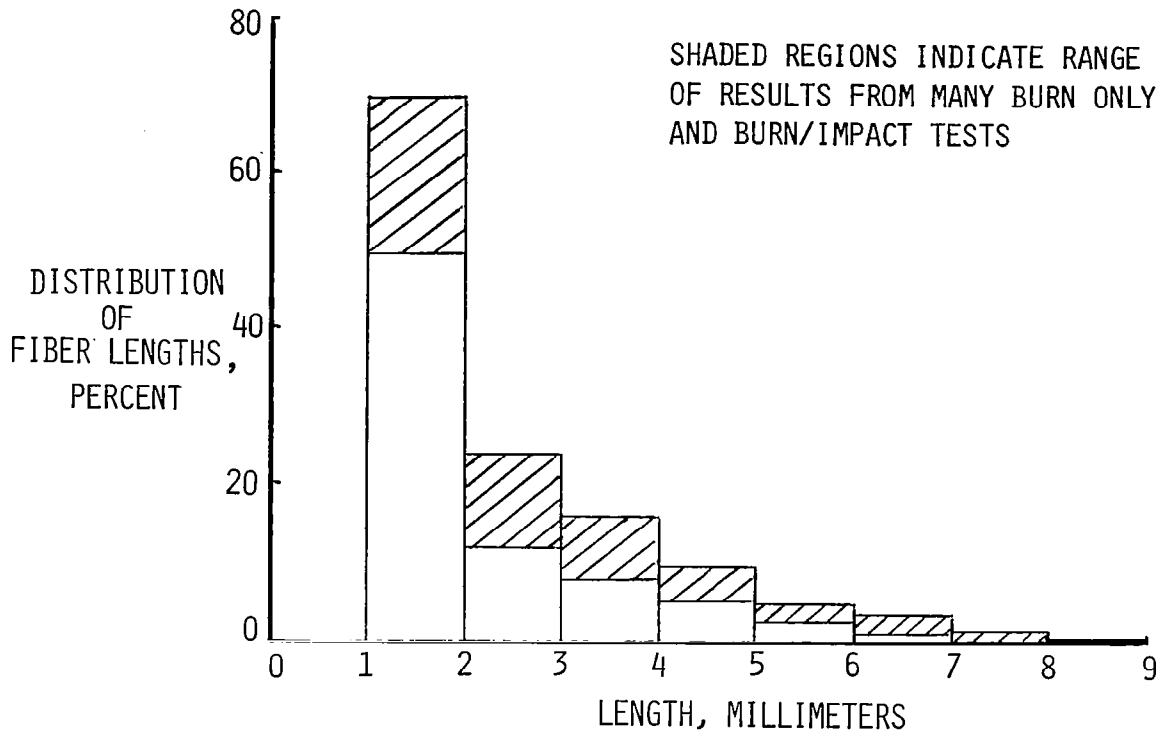

Figure 13.- Spectrum of single fibers over one millimeter long.

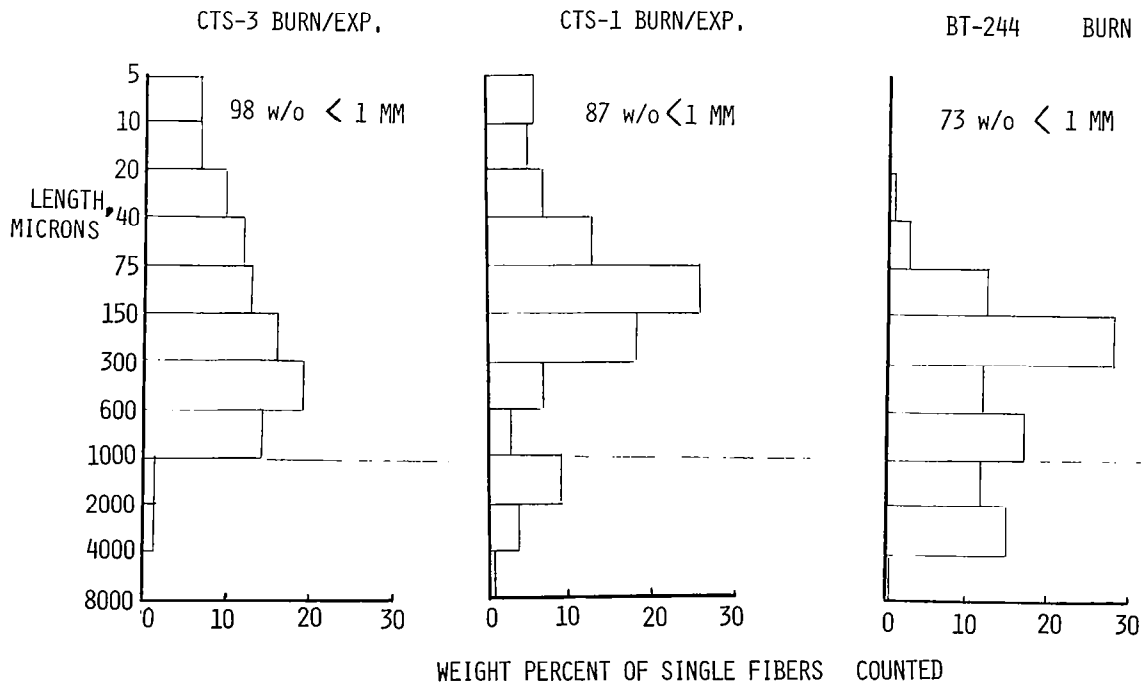

Figure 14.- Distribution of all lengths of single fibers.

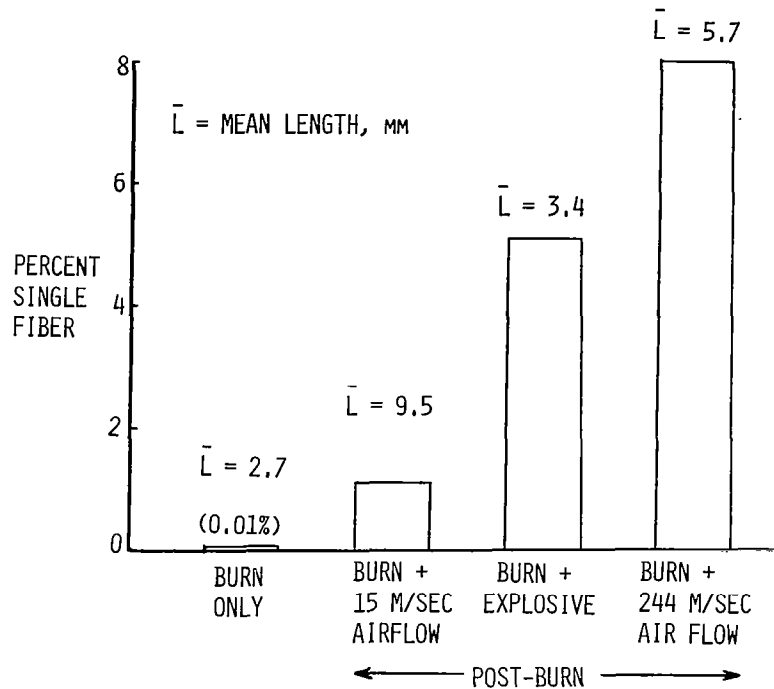

Figure 15.- Release of single fiber from hybrid glass/carbon/nomex honeycomb panel (Navy/Dahlgren chamber).

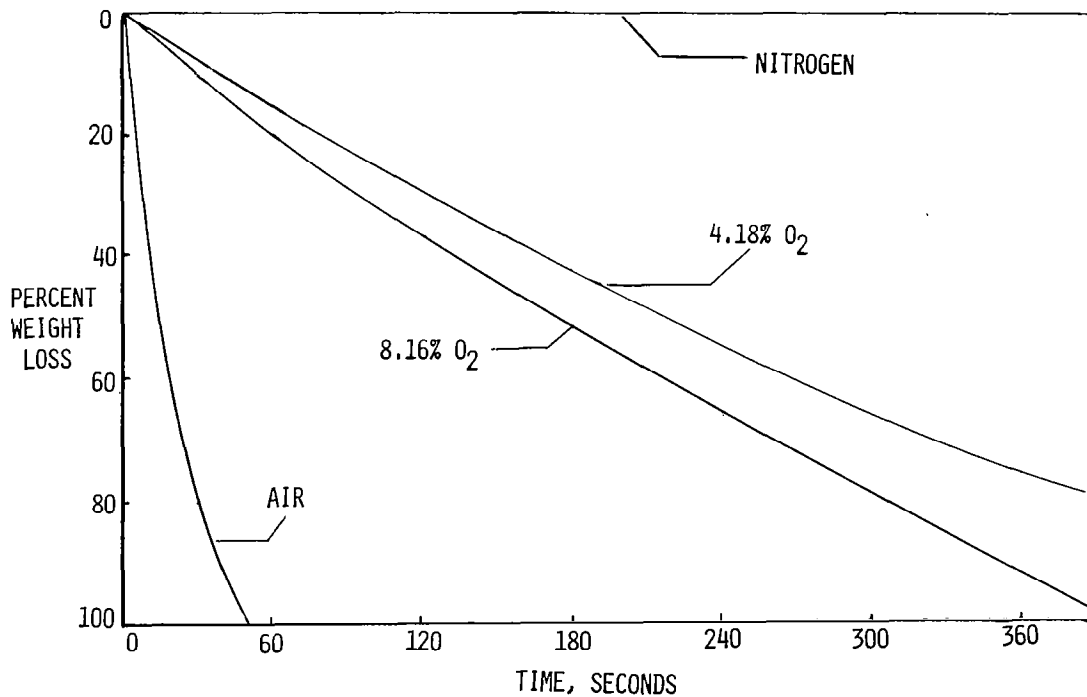

Figure 16.- Iso-thermogravimetric analyses of "AS" carbon fibers at 1250 K (1800 °F).

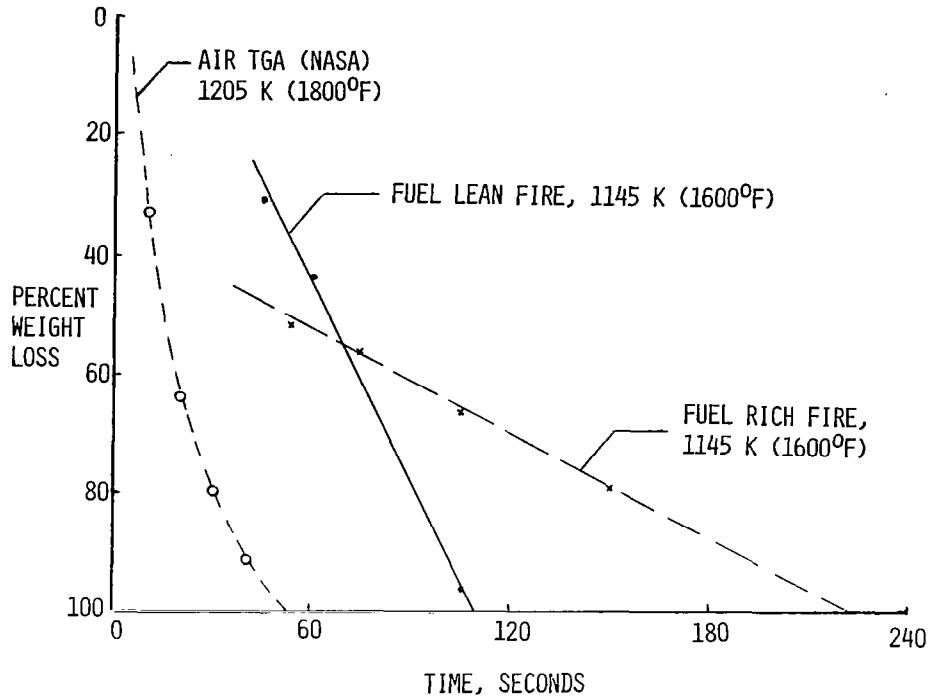

Figure 17.- Oxidative mass loss of single ply mats of carbon fibers (AVCO fire test facility).

- 50% OXIDATIVE MASS LOSS IN 240 SECOND JP-5 BURN OF SPOILER PROVED BY REDUCTION IN FIBER DIAMETER
- EQUALLY LARGE OXIDATIVE MASS LOSS SHOWN FOR OTHER THIN COMPOSITE PARTS (BARRELS, COCKPIT)
- MUCH LOWER OXIDATIVE MASS LOSSES NOTED FOR THICK COMPOSITE PANELS
- RESIDUES FROM COMBUSTION OF MATRIX RESINS MAY CATALYZE OXIDATION OF CARBON FIBERS (NOT CONFIRMED BY NASA STUDIES)

Figure 18.- Carbon fiber oxidation studies.

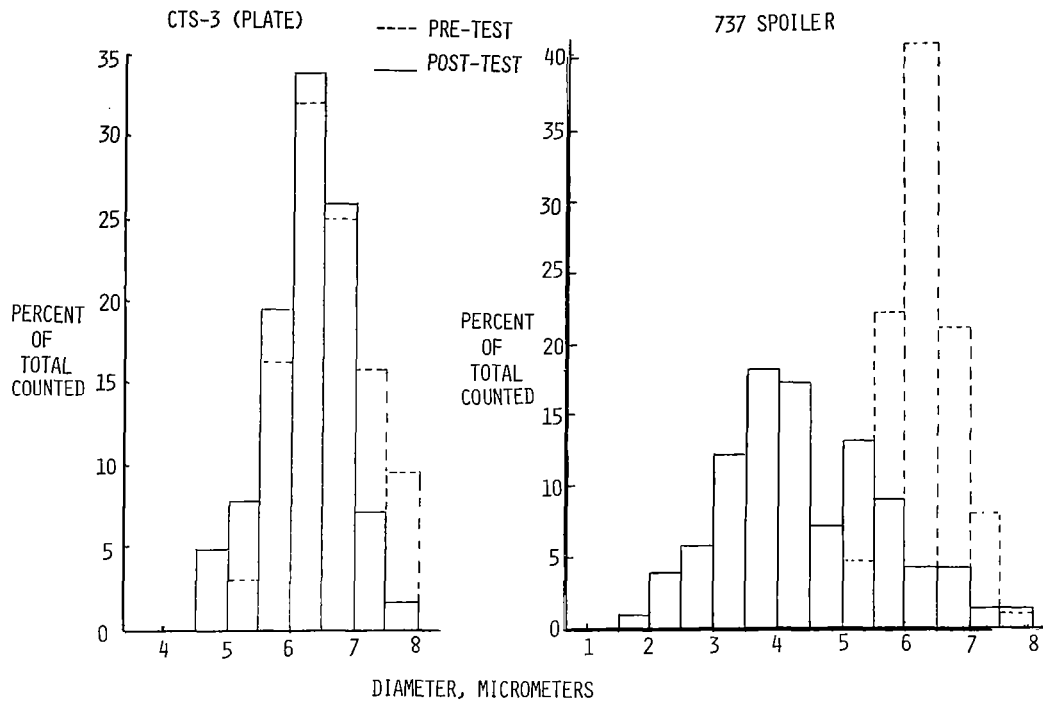

Figure 19.- Comparison of pre- and post-test diameters.

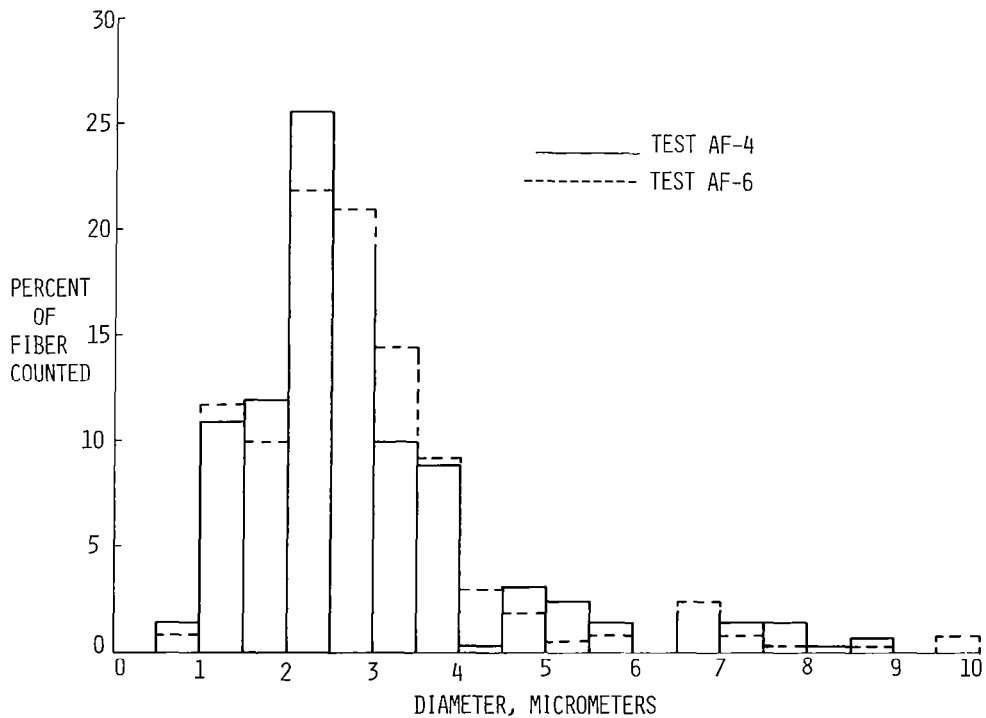

Figure 20.- Reduced fiber diameters from burn plus airflow tests.



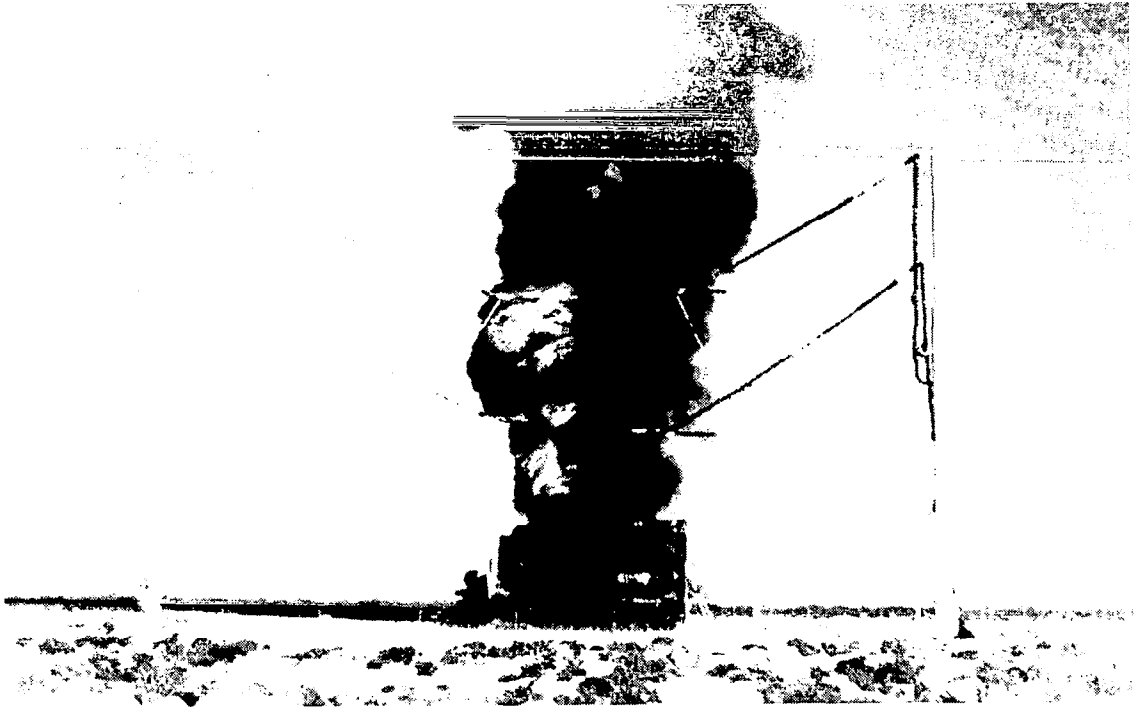

Figure 21.- Fire plume model verification tests (White Sands, New Mexico).

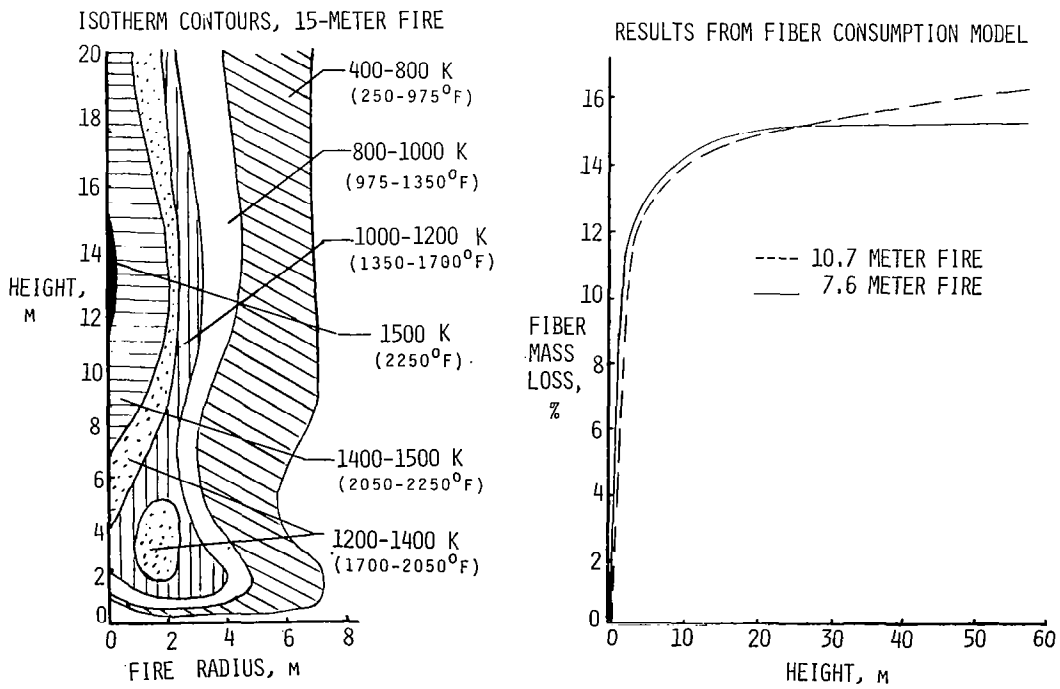

Figure 22.- Results from fire experiments and modeling.

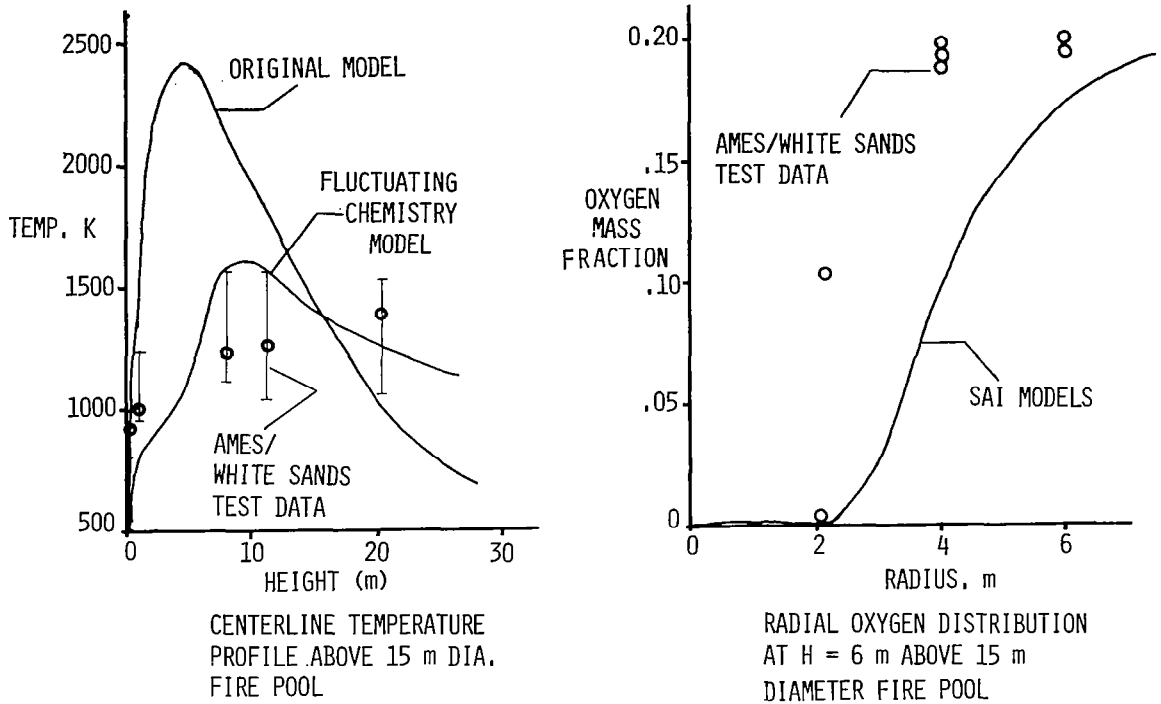

Figure 23.- Results from fire experiments and modeling.

ASBESTOS FIBERS ARE CONSIDERED HAZARDOUS IF:

(OSHA - 1976)

- DIAMETERS  $< 3.5 \mu\text{m}$ ; LENGTHS  $> 5.0 \mu\text{m}$
- ASPECT RATIO:  $3:1 < L/D < 10:1$
- 8-HR T. W. A. CONCENTRATIONS  $> 2 \times 10^6 \text{ FIBERS}/\text{M}^3$  ( $E = 5.6 \times 10^{10} \frac{\text{FIBER-SEC}}{\text{M}^3}$ )
- CONCENTRATION, ANYTIME IS  $> 10^7 \text{ FIBERS}/\text{M}^3$

Figure 24.- Health hazards of asbestos fibers.

>8			0	0	0	1	2	0	1					
8			1	2	3	0	8	1	4	1				
7			0	0	11	11	21	6	2	0				
6			0	11	9	17	11	3	12	2	1	1		
5			8	22	19	29	39	21	7	5	3	2	1	
4			8		22		19		29		39		21	
3			0	1	8	22	41	38	36	9	8	3	1	
2			3	0	14	8	12	28	8	2	3			
1			0	2	8	13	2	6	1	2				
<1			0	0	1	2	4	1	4	0				
TOTALS					37								576	
	<	10	18	32	56	100	178	316	562	1000	1780	3160	5620	>
	FIBER LENGTH, MICROMETERS													

Figure 25.- Distribution of fiber lengths and diameters from JP-1 fuel fire.

KNOWLEDGE OF CARBON FIBER HEALTH EFFECTS:

- SMALL AMOUNTS OF FIRE-GENERATED CF HAVE DIMENSIONS COMPARABLE TO HAZARDOUS ASBESTOS
- A SINGLE STUDY OF ANIMALS SHOWED NO SHORT-TERM RISK AFTER MASSIVE DOSES OF CARBON FIBER
  - $C = 3 \times 10^6$  FIBERS/M<sup>3</sup>;  $E = 1 \times 10^{12}$  FIBER-SEC/M<sup>3</sup>
  - FEW CARBON FIBERS IN LUNGS; ONLY ONE WAS INTRACELLULAR
- LONG TERM RESULTS UNKNOWN

Figure 26.- Present knowledge of carbon fiber health risk.

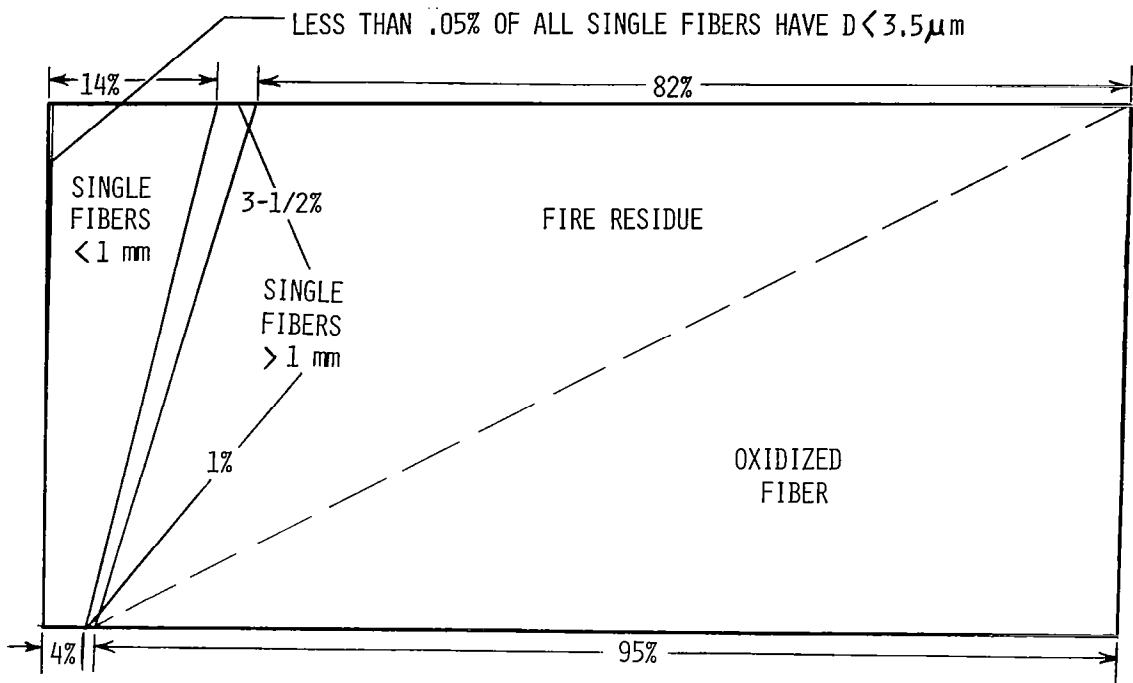

Figure 27.- Mass balance for carbon fibers from burned composites (percent of initial fiber mass).

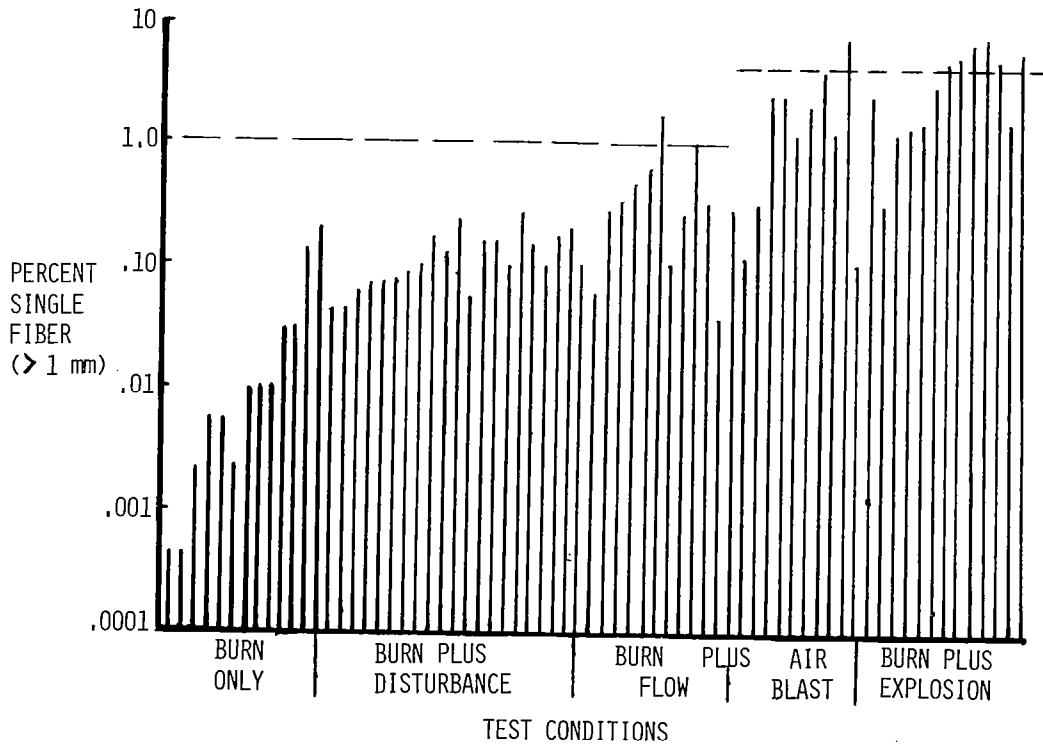

Figure 28.- Summary of all fiber release tests.

- COMMERCIAL AIRCRAFT ACCIDENT RECORDS INDICATE:
  - 85% OF ACCIDENTS WITH FIRES HAVE NO EXPLOSIONS
  - 15% OF ACCIDENTS WITH FIRES DO HAVE EXPLOSIONS
  
- OF TOTAL AMOUNT OF CF IN COMPOSITE PARTS EXPOSED TO FIRE:
  - 1% WILL BE RELEASED FROM FIRES ALONE
  - 3-1/2% WILL BE RELEASED FROM FIRES AND EXPLOSIONS
  
- FOR EVERY KILOGRAM OF CF RELEASED:
  - $5 \times 10^9$  SINGLE FIBERS WILL BE RELEASED
  - EXPONENTIAL DISTRIBUTION OF FIBER LENGTH WITH MEAN OF 2 MILLIMETERS
  - FIBER DIAMETERS SAME AS ORIGINAL (8  $\mu$ M)

Figure 29.- Recommended accidental carbon fiber release  
for risk analysis computations.