

N80-22397

NASA
CR
3265-
v.1
c.1

TECHNOLOGY REQUIREMENTS FOR FUTURE EARTH-TO-GEOSYNCHRONOUS
ORBIT TRANSPORTATION SYSTEMS. VOLUME I.

V. A. Caluori, et al

Boeing Aerospace Company
Seattle, Washington

April 1980

LOAN COPY: RETURN TO
AFWL TECHNICAL LIBRARY
KIRTLAND AFB, N. M.

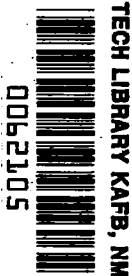

U.S. DEPARTMENT OF COMMERCE
National Technical Information Service

NTIS

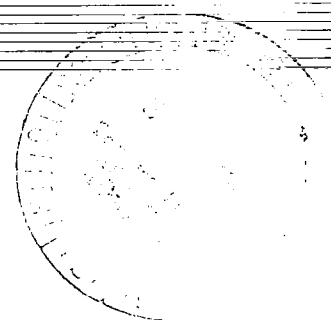



0062105

N80-22397

Unclas
19104

NASA Contractor Report 3265

Technology Requirements for Future
Earth-to-Geosynchronous Orbit
Transportation Systems
Volume I - Executive Summary

Vincent A. Caluori, Robert T. Conrad,
and James C. Jenkins
Boeing Aerospace Company
Seattle, Washington

Prepared for
Langley Research Center
under Contract NAS1-15301

NASA
National Aeronautics
and Space Administration

**Scientific and Technical
Information Office**

1980

REPRODUCED BY
NATIONAL TECHNICAL
INFORMATION SERVICE
U.S. DEPARTMENT OF COMMERCE
SPRINGFIELD, VA. 22161

1. Report No. NASA CR-3265		2. Government Accession No.		3. Recipient's Catalog No.	
4. Title and Subtitle Technology Requirements for Future Earth-to-Geosynchronous Orbit Transportation Systems. Volume I - Executive Summary				5. Report Date April 1980	
				6. Performing Organization Code	
7. Author(s) Vincent A. Caluori, Robert T. Conrad, and James C. Jenkins				8. Performing Organization Report No.	
9. Performing Organization Name and Address Boeing Aerospace Company P. O. Box 3999 Seattle, Washington 98124				10. Work Unit No.	
				11. Contract or Grant No. NAS1-15301	
12. Sponsoring Agency Name and Address National Aeronautics and Space Administration Washington, DC 20546				13. Type of Report and Period Covered Contractor Report	
				14. Sponsoring Agency Code	
15. Supplementary Notes Langley Technical Monitor: Donald G. Eide Volume I of Final Report					
16. Abstract This final report consists of two volumes: Volume I - Executive Summary; and NASA CR-3266, Volume II - Technical Results. The study identifies technologies including accelerated technology that are critical to performance and/or provide cost advantages for "Future Earth-to-Geosynchronous Orbit Transportation Systems." This Executive Summary defines the constraints, ground rules and objectives of the study. Mission models are scoped and include priority missions, and cargo missions. Summary data, providing primary design concepts and features, are given for the SSTO, HLLV, POTV, and LCOTV vehicles. Significant system costs and total system costs in terms of life cycle costs in both discounted and undiscounted dollars are summarized for each of the vehicles.					
17. Key Words (Suggested by Author(s)) Orbit transfer vehicle Future Space Transportation Systems Priority Cargo Launch Vehicle Single Stage to Orbit Solar Electric Propulsion Life Cycle cost Space Operations			18. Distribution Statement Unclassified - Unlimited Subject Category 16		
19. Security Classif. (of this report) Unclassified		20. Security Classif. (of this page) Unclassified		21. No. of Pages 37	22. Price*

* For sale by the National Technical Information Service, Springfield, Virginia 22161

NASA-Langley, 1980

CONTENTS

	Page
1.0 Introduction	1
2.0 Summary	7
2.1 Establishing the Yard-Stick - Phase I	7
2.2 Technology Evaluation - Phase II	13
3.0 Conclusions	25
4.0 References	31

LIST OF FIGURES

<u>No.</u>	<u>Title</u>	
1	Priority flight requirements (exclusive of payload delivery requirements)	3
2	Priority payload delivery requirement	3
3	HLLV payload delivery requirement	4
4	SSTO design concept	9
5	HLLV design concept	9
6	POTV design concept	10
7	LCOTV design concept.	10
8	System costs	12
9	Total system cost summary.	13
10	Accelerated technology slush propellants	17
11	Accelerated technology impact on SSTO	19
12	Accelerated technology impact on HLLV	20
13	Accelerated technology impact on POTV	20
14	Accelerated technology impact on LCOTV	21
15	Pictorial concept - SSTO.	27
16	Pictorial concept - HLLV	28
17	Pictorial concept - POTV	29
18	Pictorial concept - LCOTV.	30

LIST OF TABLES

<u>No.</u>	<u>Title</u>	
1	Accelerated technology life cycle costs benefits summary	14
2	Life cycle cost impact of accelerated technology	22
3	Total system cost summary.	22

LIST OF SYMBOLS AND ACRONYMS

ACEE	Aircraft energy efficiency
ALRC	Aerojet Liquid Rocket Company
APU	Auxiliary power unit
APS	Auxiliary power system
ASE	Advanced space engine
BLOW	Booster lift-off weight
CCV	Control configured vehicle
CV/FBW	Control configured vehicle/fly-by-wire
Cg, c.g.	Center of gravity
CH ₄	Hydrocarbon fuel
cm	Centimeter
D&D	Design and development
DDT&E	Design, development, test and evaluation
DF/DE	Dual fuel/dual expander
DOE	Department of Energy
ECS	Environmental control system
EIS	Estimating information system
ELI	Extra low interstitial
EPS	Electrical power system
ET	External tank
EVA	Extra vehicular activity
FAB	Fabrication
FBW	Fly-by-wire
FPR	Flight performance reserve
FLT	Flight
FSTSA	Future Space Transportation System Analysis
G	Acceleration of gravity
GaAs	Galium arsenide solar cell
GCH ₄	Gaseous methane

GEO	Geosynchronous earth orbit
GLOW	Gross lift off weight
GO ₂	Gaseous oxygen
GSE	Ground support equipment
HL	Horizontal landing
HLLV	Heavy lift launch vehicle
IOC	Initial operating capability
I _{SP}	Specific impulse
I _{SP} ^{S.L.}	Specific impulse at sea level
I _{SP} ^{VAC}	Specific impulse at vacuum
IUS	Inertial upper stage
JPL	Jet Propulsion Laboratories
kg	Kilogram
km	Kilometer
KSC	Kennedy Space Center
LCC	Life cycle costs
LCOTV	Large cargo orbit transfer vehicle
LCH ₄	Liquid methane
L/D	Length over diameter ratio
LE	Leading edge
LEO	Low earth orbit
LO	Lift-off
LO ₂	Liquid oxygen
LH ₂	Liquid hydrogen
LO ₂ /LH ₂	Liquid oxygen and liquid hydrogen
LO ₂ /LCH ₄	Liquid oxygen and liquid methane
LRC	Langley Research Center
LRSI	Low temperature reusable surface insulation
M	Mach number
m	meter

Max	Maximum
MER	Manhour estimating relationships
MICM	Mature Industry Costing Methodology
Min	Minimum
MLI	Multi layer insulation
MR	Mass ratio
M Ton, MT	Metric Ton, 1000 kg
MPS	Main propulsion system
MSFC	Marshall Space Flight Center
NASA	National Aeronautics and Space Administration
nm	nautical mile
NPSH	Net position suction head
O/F	Oxidizer to fuel ratio
OLOW	Orbiter lift off weight
OMS	Orbital maneuver system
OTV	Orbit transfer vehicle
P_c	Chamber pressure
P/L	Payload
PCM	Parametric cost model
POP	Perpendicular to orbit plane
POST	Program to Optimize Simulated Trajectories
POTV	Priority orbit transfer vehicle
psi	Pounds per square inch
RCS	Reaction control system
R&D	Research and development
RP-1	Hydrocarbon fuel type RD-1
RSI	Reuseable surface insulation
SEI	System engineering and integration
SHAG	Small hole accelerator grid
SLH ₂	Slush hydrogen
SPS	Solar power satellite

SSME	Space shuttle main engine
SSTO	Single-stage-to-orbit
STE	Special test equipment
STS	Space transportation system
S	Wing area
TBO	Time between overhaul
t/c	Thickness ratio, wing thickness (t)/wing chord (c)
TFU	Theoretical first unit
THI	Tank head idle
TPI	Terminal phase initiation
TPS	Thermal protection system
TVC	Thrust vector control
T/W	Thrust overweight ratio
VTO	Vertical take-off
WBS	Work breakdown structure
WER	Weight estimating relationship
WP	Ascent propellant weight
W/S	Wing loading, weight (w)/wing area (s)
λ	Mass fraction = $\frac{\text{Propellant Weight}}{\text{Gross Lift Off Weight less Payload}}$
ϵ	Nozzle expansion ratio, emissivity or strain
ΔV	Velocity change

1.0 INTRODUCTION

Volume I of this final report is the executive summary of the work performed under Contract No. NAS1-15301 for NASA Langley Research Center (LRC). The final report documents and summarizes the technology requirements for future earth-to-geosynchronous-orbit transportation systems as required in the Exhibit A, NASA Statement of Work 1-16-6450.0039A dated February 8, 1978.

The impact of technology advancement on future space transportation elements has been the subject of a series of studies as addressed in references 1 and 2 at the Langley Research Center and by contractors under its sponsorship. The focus of these studies has been single-stage-to-orbit (SSTO) vehicles in the years 1990-2000 time frame. These studies consistently produced evidence of the cost effectiveness of selected technology advances, assuming a reasonable traffic model existed. The purpose of the study, which is summarized in this report, was to bring a unique perspective to these evaluations. Technology advancement effectiveness was to be measured in a total transportation system context. The system was to include both priority and cargo vehicles for missions from Earth to geosynchronous orbit. Priority cargo vehicles are the orbit transfer vehicle (OTV) and SSTO manned winged vehicles for the delivery of total entity types of payloads such as crew transfers, resupply of geosynchronous space depots, automated free-flying satellites, and refurbishment of geosynchronous automated satellites as opposed to large cargo OTV (LCOTV) of unmanned cargo and the heavy lift launch vehicle (HLLV) of LCOTV payloads POTV delivery and refurbishment, POTV propellant and heavy lift to LEO. A space base or depot at 500 km altitude was an integral part of the system although not defined in this study.

To balance the broadness of the vehicle family under study, a set of constraining input data and groundrules was specified. These constraints were necessary to maintain a focus on the objective of the study. Although the vehicles were to be innovative and represent a fresh look, there was no requirement to optimize them. Their general concepts were specified as follows: 1) the priority Earth-to-LEO (low earth orbit) vehicle was to be a vertical takeoff single-stage-to-orbit vehicle operating in a dual fuel mode (a hydrocarbon and a high specific impulse fuel are both burned initially, and the high specific impulse fuel is used alone during the later period of the ascent trajectory); 2) the priority orbit transfer vehicle (POTV) was to be space based with all its implications as noted in reference 3; 3) the cargo launch vehicle, or heavy lift launch vehicle (HLLV) was to be a

vertical takeoff, two-stage parallel burn configuration with propellant transfer from booster to orbiter. The booster was to stage at a "heat sink" velocity and return to base using an air-breathing flyback system; and, 4) the cargo OTV was to use a solar electric propulsion system which will be space based. This vehicle in fact must be assembled in space.

A mission model was specified. This model represented a space industrialization scenario leading to the deployment of a solar power satellite. It spanned 15 years from 1990 to 2005. The mission model included two basic categories of missions: priority and cargo. The former included the missions of the SSTO and POTV, which consisted of the priority launch rate (flights per year) requirements shown in Figure 1 and the priority payload delivery (metric tons of payload per year) requirement shown in Figure 2. The cost optimum payload capability of the SSTO-POTV combination was to be determined during the study, considering both the launch and payload requirements. Large cargoes will be delivered to LEO by the HLLV and from LEO to GEO by the LCOTV. The payload size of 227 metric ton (m-ton) was a study groundrule. The HLLV payload delivery requirement is shown in Figure 3. In addition, the HLLV had to deliver POTV's and LCOTV's, spares and fuel. Design criteria established in previous studies, reference 4, were groundruled. These criteria included thrust over weight (T/W), fuel splits for the dual fuel vehicles, landing speeds, reentry trim corridors, etc. Key study groundrules follow:

- o initial operating capability (IOC) 1990
- o all elements reusable
- o space base - depot at 500 km
- o KSC launch site: LEO base at 28.5° ; GEO destination - equatorial
- o heavy lift payload = 227 metric tons
- o priority cargo payload size(s) to be cost optimized
- o payload density = 100 kg/m^3
- o return payloads: SSTO - 100%; HLLV - 10%; POTV - 75%; LCOTV - none
- o all winged vehicles vertical take-off - 165 knots landing speed
- o re-entry trim corridors: SSTO $30^\circ - 60^\circ$; HLLV $35^\circ - 60^\circ$
- o SSTO - 2000 km cross range
- o SSTO OMS sized for 93 x 186 km insertion
- o T/W at liftoff = 1.3, maximum acceleration = 3g
- o CH_4 = hydrocarbon fuel

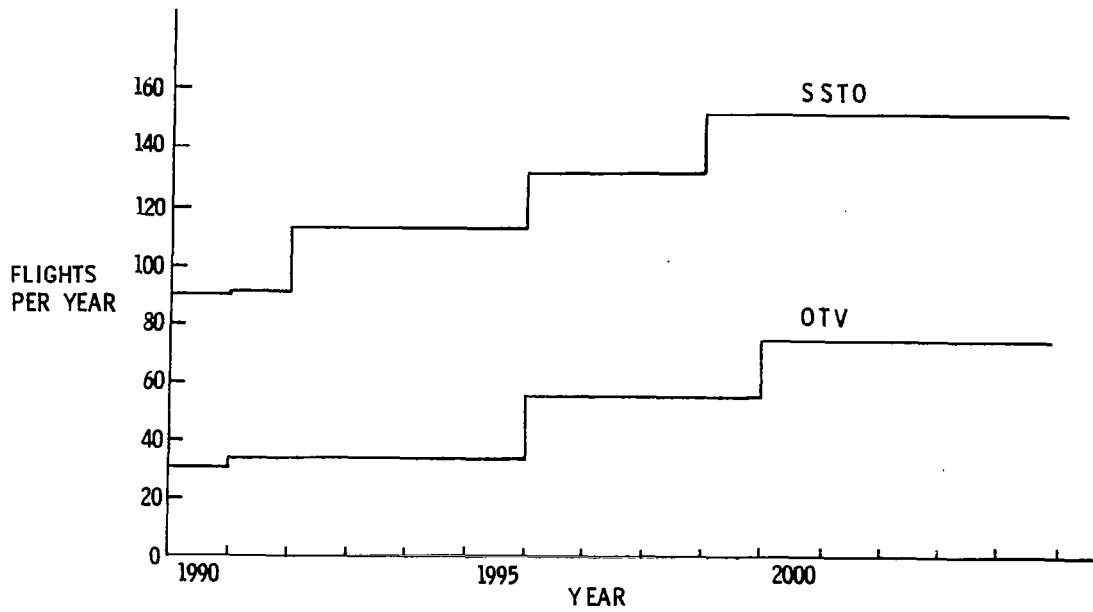

Figure 1.—Priority Flight Requirements (Exclusive of Payload Delivery Requirements)

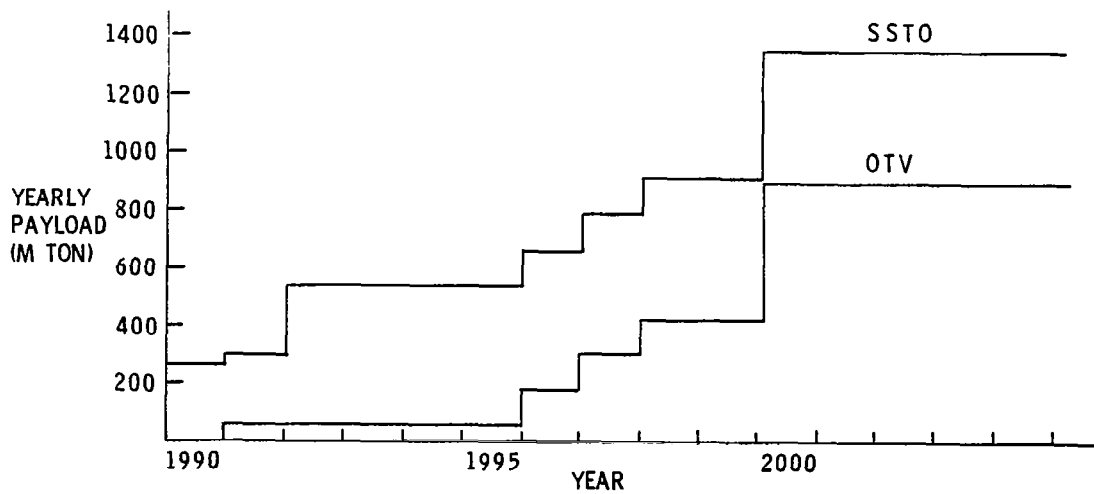

Figure 2.—Priority Payload Delivery Requirement

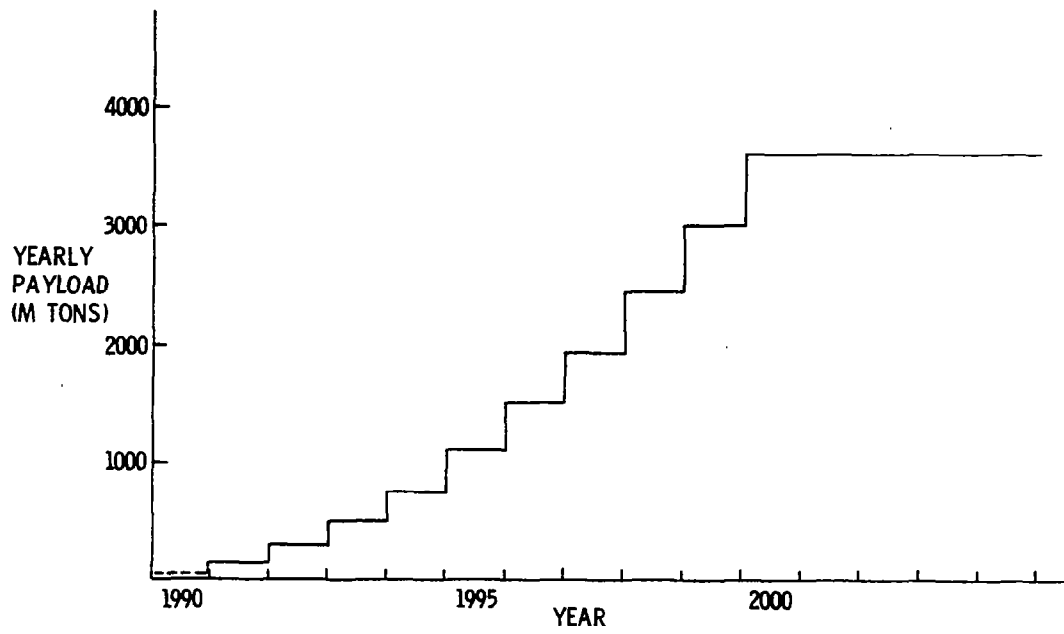
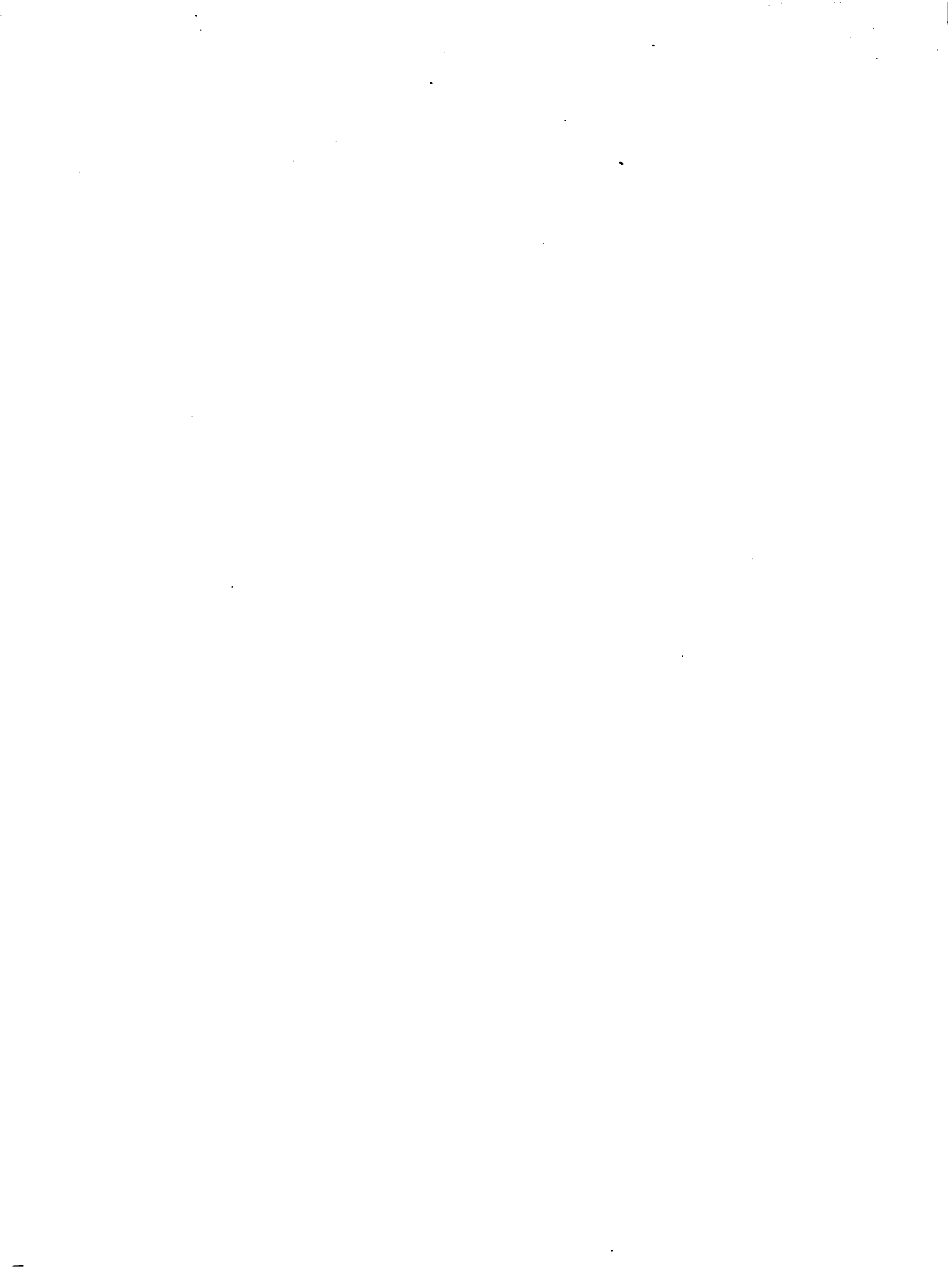

Figure 3.—HLLV Payload Delivery Requirement

A summary of the mission model and the vehicle roles within the system is tabulated as follows:

Scenario: 1990-2005 Time Frame -
Early Space Industrialization Leading to Solar Power
Satellite Deployment

<u>Vehicle</u>	<u>Mission Role</u>		<u>Requirements</u>	
			(Minimum)	(Maximum)
Priority Cargo OTV	o GEO Manned Sorties	Total Flights	1,319	
	o GEO Satellite	Annual Flt Rate	32	154
	o Crew Transfers	Annual Payload	0	853mt
Priority Cargo Launch Vehicle	o POTV Payloads	Total Flights	2,888	
	o LEO Satellites	Annual Flt Rate	108	252
	o Crew Transfers	Annual Payload	259mt	1,352mt
Large Cargo OTV	o Large Unmanned Cargo to GEO	Total Flights	56	
		Total Payload	29,860mt	
		Annual Flt Rate	1	13
		Annual Payload	33mt	3010mt
Heavy Lift Launch Vehicle	o LCOTV Payloads. OTV Delivery & Refurb	Total Flights	609	
		Total Payload	138,018mt	
	o OTV Propellant	Annual Flt Rate	15	74
	o Heavy Lift to LEO	Annual Payload	3,400mt	16,686mt



2.0 SUMMARY

2.1 ESTABLISHING THE YARDSTICK - PHASE I

The study was divided into two logical phases. The first phase was to produce an evaluation yardstick. This yardstick would be the life cycle costs (LCC) of the transportation system. The system would be based on normal growth technology or technology which through current or anticipated research and development (R&D) funding would have reached a degree of maturity necessary for a reasonable risk commitment to design, development, test and evaluation (DDT&E). The readiness date for a 1990 initial operating capability (IOC) is approximately 1985. A summary of the items which were considered normal growth and their application to the system vehicles follows:

	<u>SSTO</u>	<u>HHLV</u>	<u>POTV</u>	<u>LCOTV</u>
o Structures/Materials				
- Improved RSI	X	X		
- "Advanced Composites"	X	X	X	X
- Titanium Honeycomb	X	X		
o Propulsion				
- SSME Two-Position Nozzle	X	X		
- Hydrocarbon Booster Engine	X	X		
- "ASE" Type Engine	X	X	X	
- LOX/LH ₂ RCS	X	X	X	
- 50 cm ION Thruster				X
o Power, Power Conversion, Power Distribution				
- APU Driven Generators/Pumps	X	X		
- Hydraulics, 55,158 kPa (8000 psia)	X	X		
- High Voltage/solid State Elec. Power	X	X	X	X
- Silicon Solar Arrays/Annealable				X
o Subsystems				
- Improved Avionics	X	X	X	X
- Improved Landing Gear	X	X		
- 2nd Generation Shuttle				
Crew Accommodations	X			
Environmental Control	X	X		
- CCV/FBW Flight Control System	X	X		

An important input, in addition to current research conducted during the study, was the data base previously established in the single-stage-to-orbit studies. This normal growth technology baseline, although a considerable advancement over today's Space Shuttle technology, is clearly justifiable except in two areas. The hydrocarbon booster engine is not being pursued but was included in order to evaluate the dual fuel concept. The annealable solar array is a questionable normal growth item if solar power satellites are not pursued.

The vehicles which resulted from this normal growth technology are shown in Figures 4, 5, 6, and 7. Their primary features are also shown in these figures. As configured, these vehicles exhibited the following general characteristics. The SSTO vehicle is required to circularize at a 500 km altitude, is just under 5 million pounds* gross weight, and had a large complement of engines (5 pair, 5 SSME, 5 LO₂/LH₄). This vehicle was marginal in its effectiveness. The vehicle is at a performance threshold or on the knee of the curve, and therefore sensitive to slight perturbations. Its number of engines resulted in a tail heavy configuration with the resultant requirements for significant aerodynamic tailoring. The aerodynamic tailoring resulted in high wing sweep, shaped body, extendable body flap and a subsonic canard. The HLLV, on the other hand, exhibited a two stage vehicle's general performance insensitivity and the favorable effects of its large size. The requirements of the parallel burn mated configuration resulted in aft payload bay for the orbiter. Although this configuration is generally not sought after (as lox aft is) due to resultant body loads, the location did allow the payload bay to be designed to a "box" configuration. Studies of HLLV payloads had indicated a packing advantage with this shape. The priority OTV could be built very light because of reduced loads through space basing. The resulting high mass fraction (λ') produced a single stage vehicle (compared to 2 stages). The combination of an advanced space engine and excellent λ' placed this vehicle at a very high performance level. The heavy lift LCOTV with its high Isp and high payload to inert ratios is similar to the chemical OTV insofar as performance thresholds. It is opposed with respect to its operational characteristics. This vehicle uses engines like the chemical vehicle burns propellants. The long trip times result in total engine life being used in accomplishing a single mission. It is a hardware oriented vehicle and production costs dominate.

* 5 million pounds = 2 268 000 kg = 2268 metric tons.

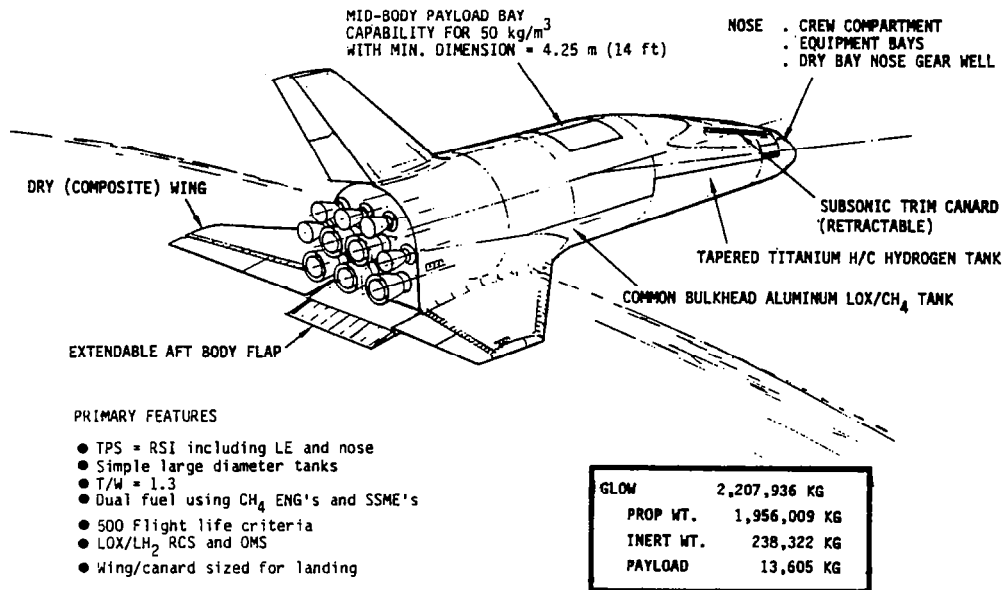

Figure 4.—SSTO Design Concept

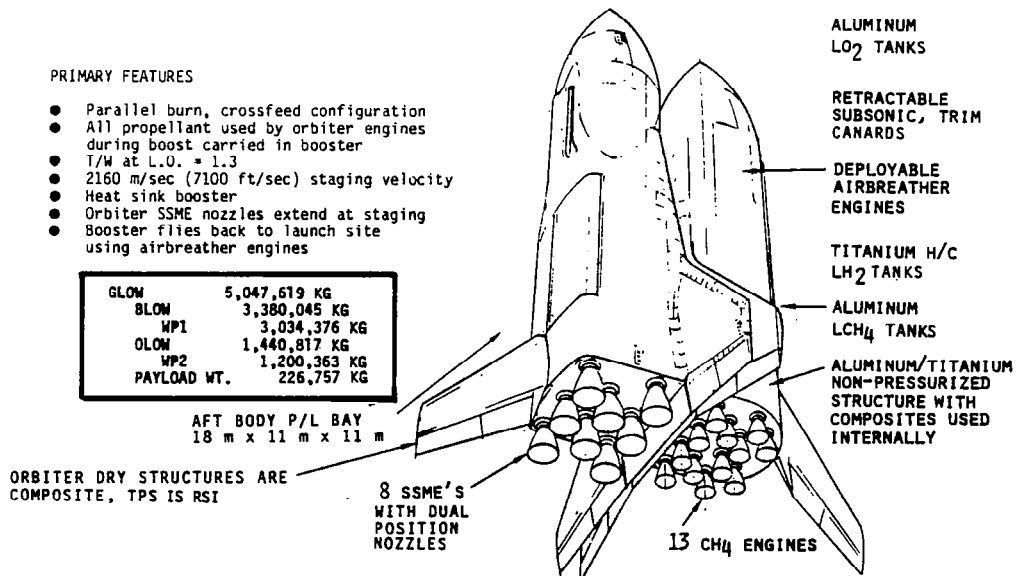
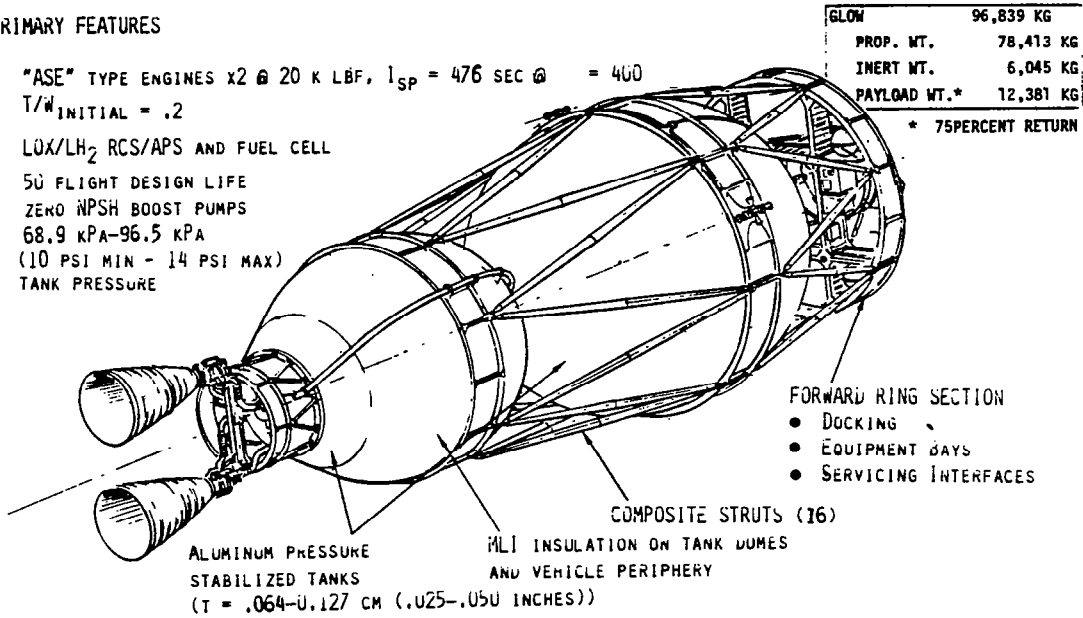

Figure 5.—HLLV Design Concept

PRIMARY FEATURES

- "ASE" TYPE ENGINES x2 @ 20 K LBF, $I_{SP} = 476 \text{ SEC @ } = 400$
- $T/W_{\text{INITIAL}} = .2$
- LOX/LH₂ RCS/APS AND FUEL CELL
- 50 FLIGHT DESIGN LIFE
- ZERO NPSH BOOST PUMPS
- 68.9 kPA-96.5 kPA
(10 PSI MIN - 14 PSI MAX)
TANK PRESSURE



GLOW	96,839 KG
PROP. WT.	78,413 KG
INERT WT.	6,045 KG
PAYLOAD WT.*	12,381 KG

* 75PERCENT RETURN

Figure 6.—POTV Design Concept

PRIMARY FEATURES

- ARGON FUELED ION THRUSTERS ($I_{SP} = 8,000$)
- $T/W \times 10^{-5}$ (180 DAY TRIP TIME)
- CONCENTRATION RATIO = 1, SIMPLE SOLAR ARRAY
- "SPACE FAB" TRI CHORD COMPOSITE BEAMS
- "HIGH" ASPECT RATIO, MAIN AXIS POP

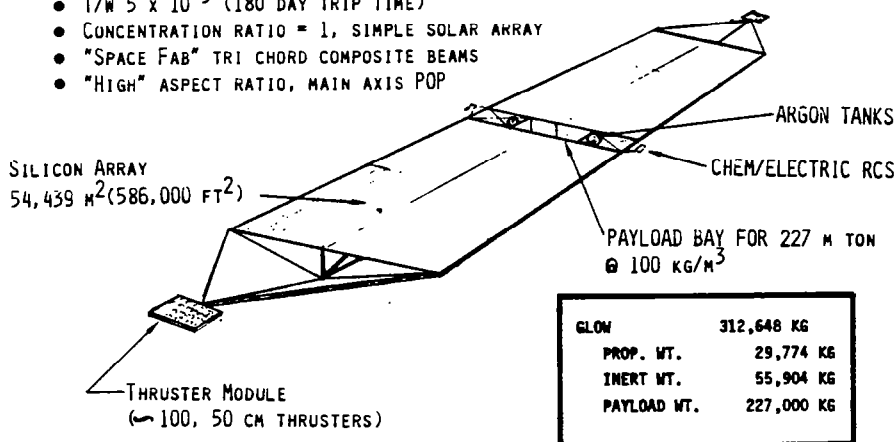

GLOW	312,648 KG
PROP. WT.	29,774 KG
INERT WT.	55,904 KG
PAYLOAD WT.	227,000 KG

Figure 7.—LCOTV Design Concept

ORIGINAL PAGE IS
OF POOR QUALITY

The mission model specified resulted in flight rates, fleet sizes and total number of flights for each vehicle. The ground rules used in arriving at the data and specific results are summarized below:

Groundrules:

- o baseline 2 shifts/day, 5 days/week, 50 weeks/yr = 4000 hr/yr
- o 3 shifts/day available on temporary basis
- o maximum vehicle flight rate/yr = 4000 ÷ vehicle turnaround time
- o fleet sized to meet maximum yearly flight rate with available vehicles (excludes vehicles being overhauled)
- o fleet also sized to meet maximum flight rate with one vehicle undergoing unscheduled maintenance for up to 3 months

Results:

	<u>HHLV</u>	<u>SSTO</u>	<u>LCOTV</u>	<u>POTV</u>
o Fleet Size:	3	8	13	5
o Maximum flight rate/yr:	74	252	13	154
o Total number flights:	609	2888	56	1319

Maximum vehicles rate per year is based on shifts/day, days/week and weeks/year to arrive at a total of 4000 hours per year including all ground and maintenance.

Hardware DDT&E and production costs were calculated using the Boeing Parametric Cost Model (PCM). Operations costs were based on the data base generated during studies of shuttle derivatives, heavy lift, and solar power satellite. Indirect labor costs in the shuttle user charges were reduced to an industry like percentage. This was done to avoid overshadowing the technology impacts. The distribution of system costs are shown in Figure 8. All costs are in 1977 dollars. Significant factors, for each vehicle, in these costs are summarized below:

The SSTO accounts for almost half of the total costs (42%) as shown in Figure 9. It must fly many missions and it has a large number of short lived engines (SSME @ 50 cycle life). Operations cost predominate.

The heavy lift launch vehicles' costs were 32% of the total. Half of this cost is found in this vehicle's DDT&E. This is caused by the requirement to buy the necessary flight test units in this program phase. A new booster engine was also charged to this vehicle.

The chemical OTV's DDT&E and production costs were overwhelmed by its operations costs. These costs were made up, almost entirely, by an orbit, propellant delivery cost. This vehicle's costs made up 17% of the total.

The large cargo OTV solar electric system costs were a small part of the system costs, 9%. Its costs were dominated by production. The primary factor in these costs were the costs of the solar array.

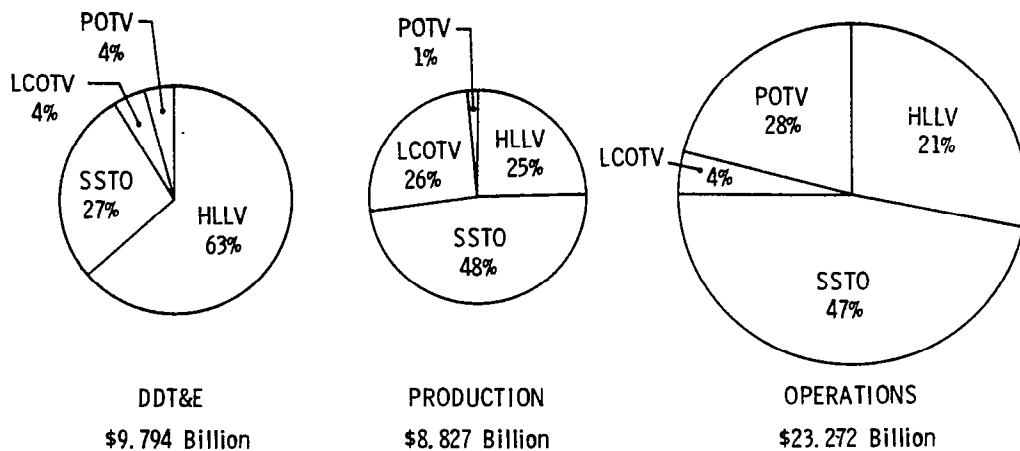
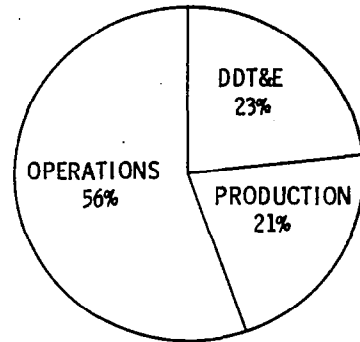

Figure 8. System Costs

<u>PROGRAM PHASE</u>	<u>MILLIONS OF DOLLARS</u>
TOTAL PROGRAM	41,636.73
DDT&E	9,783.53
PRGM. MANAGEMENT	277.62
ENGINEERING	3708.97
MANUFACTURING	4385.84
TEST	1407.47
PRODUCTION	8,542.05
PRGM. MANAGEMENT	696.69
SYST. ENGINEERING	193.35
MANUFACTURING	7701.72
OPERATIONS	23,311.15
OPERATIONS SUPPORT	10531.56
LAUNCH SUPPORT	12779.59



TOTAL: \$41,637 BILLION

Figure 9.—Total System Cost Summary

2.2 TECHNOLOGY EVALUATION-PHASE II

Having established the life cycle costs of the system, the first phase of the study was complete. The second phase objectives were to assess the value of accelerating technologies which were considered beyond normal growth. These items would be assessed individually against the same mission model. The second objective of this phase was to then apply the cost effective technology items to the fleet and evaluate their synergistic impact. Table I summarizes the accelerated technologies evaluated and gives the LCC benefits for each vehicle.

Composite structures was the most important item in cost benefit. The accelerated technology composite structures characteristics are summarized as follows.

- o characteristics
 - o all composite design vs metal substitution for normal growth improved weight fraction by 10% to a 40% total reduction
 - o expanded application to propellant lines
 - o reduced fab and DDT&E costs to "state of art" levels
 - o improved properties not considered
- o cost benefit
 - SSTO — \$3,112 million
 - HLLV — 986 million

TABLE 1 - Accelerated Technology Life Cycle Costs
Benefits Summary*

Life Cycle Cost Delta \$ x 10 ⁶					
TECHNOLOGY	SSTO	HLLV	POTV	LCOTV	TOTAL
Composite Structures	-3112	-986	-	-	-4098
Dual Expander Engine	-2118	-531	-	-	-2649
Eliminate Vertical Tail	-1652	-412	-	-	-2064
Extended Life SSME	-1261	-474	-	-	-1735
Integrated Subsystem	-434	-30	-102	-	-566
Slush LH ₂	-300	-	-	-	-300
Improved Avionics	-219	-9	-18	-	-246
Metallic TPS	-76	-36	-	-	-112
Plus Cluster Engine	-	-	(+2)	-	(+2)
Gallium Arsenide Array	-	-	-	(+58)	(+58)
100 cm Thruster	-	-	-	(+216)	(+216)
Long Life Thruster	-	-	-	(+72)	(+72)
Direct Power Processing	-	-	-	-386	-386

*These data reflect the benefit when each item is evaluated "by itself" on the reference vehicles.

It is significant that this area of composite structures still showed such cost benefits after the majority of its weight savings was taken as normal growth and improved properties such as higher temperature capability were not exploited. The significant parameter in the accelerated forecast was the improved production costs.

The dual fuel-dual expander engine is critical to SSTO. This engine is a tri-propellant engine burning LO₂ as the oxidizer with LCH₄ and LH₂ as fuels in two combustion chambers. A central chamber burns LO₂/LCH₄ and the annular outer chamber burns LO₂/LH₂. The engine burns in two modes; mode I uses both chambers to give good high thrust and Isp; mode II the central chamber is shutdown with engine operating as a high expansion ratio LO₂/LH₂ engine at high Isp. Characteristics of the accelerated technology dual fuel/dual expander engine follow:

- o dual fuel/dual expander - a complex, high pressure engine that can operate in two modes:
 - A) booster mode burning two fuels at moderate Isp and high thrust
 - B) upper stage mode burning hydrogen with high expansion ratio (high Isp) and reduced thrust

mode I:	<u>SEA LEVEL</u>	<u>VACUUM</u>
Thrust kg (lb)	$5.1 \times 10^6 \text{N}$ (1,150,000)	$5.7 \times 10^6 \text{N}$ (1,275,200)
Isp (sec)	352.2	390.5
ϵ	60.5	60.5

mode II:		
Thrust kg (lb)	_____	$1.8 \times 10^6 \text{N}$ (409,900)
Isp (sec)	_____	459.8
ϵ	_____	127

chamber pressures: hydrocarbon - 41,369 kPa (6000 psi) hydrogen - 20,684 kPa (3000 psi)

weight-kg (lbs)	4400 (9700)
length -m (inches)	4.0 (158)
exit diameter -m (inches)	2.7 (105)

Costs: \$1.22 billion DDT&E; \$18.5 million TFU

- o key advantage is thrust-to-weight ratio and costs for dual fuel propulsion

	<u>DF/DE</u>	<u>CH₄/SSME PAIR</u>
T/W { Mode 1 (S.L)*	118.6	92.6
Mode 2 (VAC)	42.3	34.8
costs (TFU)	\$ 18.5 Million	\$24.3 Million

* Sizing point 30% improvement in engine weight
(However, in a one-on-one comparison with CH₄ engine -10% disadvantage)

- o cost benefits

SSTO	\$2.067 Million (Net, includes DDT&E)
HLLV	\$ 531 Million*

* Net loser by \$687 million if DDT&E included.

This engine showed very significant cost benefits for the SSTO but would have been a loser if developed for the two-stage system alone. The key to this engine is that it must be compared in its intended role - as a dual fuel engine. Its advantages are superior T/W's and costs when compared to the engine system otherwise required to operate in the dual fuel mode. This engine always beats a pair of engines, but always loses in an engine-to-engine headon comparison. A reduction in numbers and type of engine is a cost advantage in spares; use on an HLLV also reduces procurement costs by greater benefit of learning.

The third most significant cost impact was the result of applying control configured vehicle (CCV) technology and removal of the launch vehicle vertical tails. LRC studies, reference 5, provided the necessary aerodynamic data base for this evaluation. The following summary of the accelerated technology CCV configuration, no vertical tail, lists the configuration revisions and cost benefits, it also includes additional benefits not assessed in the LCC's but are considered important.

- | o configuration revisions | <u>normal growth</u>
<u>SSTO wgt Δs</u> | |
|---|--|--------------|
| | <u>lb</u> | <u>kg</u> |
| o remove vertical tail, associated flight controls and body tie in. | - 15,115 | - 6,856 |
| o add wing tip aero trim surfaces | + 1,600 | + 726 |
| o add subsonic forward yaw surface (retractable) | + 450 | + 204 |
| o adjust RCS for additional duty cycle & altitude requirement | + 500 | + 227 |
| o add landing chute or alternate speed brake | + 1,600 | + 726 |
| o adjust wing sweep for favorable cg impact | - 1,374 | - 623 |
| o adjust growth | <u>- 1,234</u> | <u>- 560</u> |
| Total | - 13,570 | - 6,155 |
- o cost benefits
 SSTO - \$1,652 Million
 HLLV - 412 Million
- o other benefits
- o moves cg forward helping aero problem in pitch axis
 - o makes vehicle easier to inspect, handle and service
 - o reduces impact on ground equipmnt and facilities
 - o opens up configurations other than 2-stage belly-to-belly X-feed on cold side

The results shown for the extended life SSME could have been generalized. Any long life engine will pay off when the mission model gets large enough.

When a vehicle has all oxygen/hydrogen subsystems, there is a payoff for integrating them. Although producing a reasonable gain for the SSTO, this area did not meet expectations. It is an attractive area for the space based OTV operations since it would allow a single point for vehicle propellant servicing and may allow use of the auxiliary propulsion as a backup to the main engines.

A slush propellant evaluation was conducted. Previous studies have had mixed reviews for this technology but some recent evaluations (reference 2) were favorable. The evaluation was limited to slush hydrogen for the launch vehicles. Slush oxygen was not considered since: a major impact on ground facilities would be required; the oxidizer tanks would require insulation; these tanks are already volumetrically efficient; and they are sized by inertial loads rather than pressure. The evaluation did show a reasonable payoff for slush hydrogen on the SSTO, but not to the degree anticipated by previous studies. In fact it was a net cost loser on the HLLV. Figure 10 demonstrates the effectiveness of slush in terms of the tank volumetric efficiency. This data makes clear that slush will pay off only when tanks have poor volumetric efficiency. A typical example of this is aerodynamically shaped multi-lobe tanks on all hydrogen fueled vehicles.

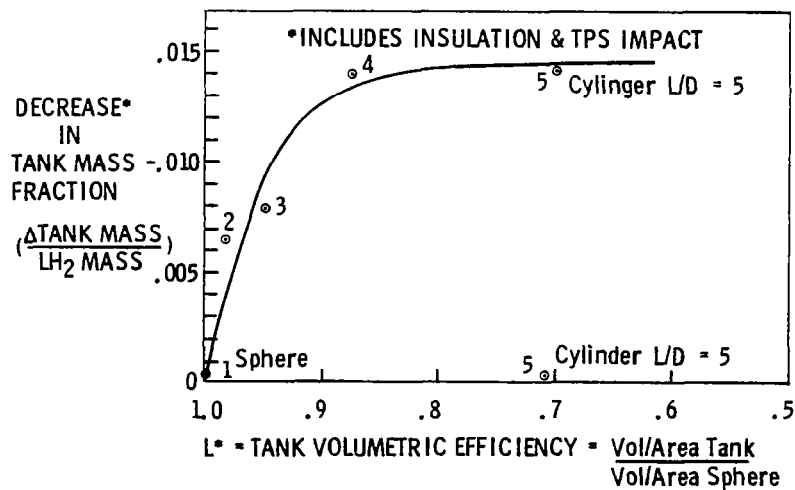

FINDINGS: PAYS ONLY FOR VEHICLES WITH TANKS OF LOW VOLUMETRIC EFFICIENCY (AERO-SHAPED) AND SIGNIFICANT HYDROGEN VOLUME.

Figure 10 – Accelerated Technology Slush Propellants

The accelerated technology solar-electric vehicle was exercised for a series of advances which are tabulated as follows:

	Cost Summary (\$ Millions)				
	GaAs Replaces		Baseline	Baseline	GaAsArray
	Baseline	Silicon	with 100 cm Thrusters	w/100 cm Thruster w/Long Life	100 cm Long Life Thruster Direct Power Processing
Total LCC	3,276	3,334	3,492	3,348	3,236
DDT&E	388	394	463	617	596
Production	1,930	2,009	1,964	1,963	1,911
Operations	958	930	1,063	767	728
Propellant	98	92	97	96	88

The results shown above are typical of a vehicle whose production costs are a significant percentage of the LCC and are not amortized by the mission model. Although life cycle costs were not favorably impacted except by direct power processing technology, operations costs were. These operations cost reductions are indicative of life cycle costs impacts in a more appropriate mission scenario. Although the GaAs advanced solar array has significantly improved conversion performance with respect to a silicon array its radiation resistant advantage was somewhat offset by annealing of either solar array. As a result although the area of array required was reduced, the reduction was not significant enough to offset the increase in cost for this advanced array.

The advanced thruster characteristics of long life and increased thrust per equivalent thruster diameter did result in improvements in operations costs. These cost improvements were offset by increases in DDT&E which were based on the increased weight, complexity and risk of such advancement and increases in production due to the increased weight and substantially reduced production rate.

The advantage of direct power processing however point thrust technology in its direction. This option requires a significant improvement in thruster operation in the sense of a self-regulating characteristic allowing an open loop direct solar array power supply.

The effect of the integrated application of the technology advances to the vehicle set is illustrated in Figures 11, 12, 13 and 14. The SSTO, which was the performance sensitive vehicle in the set, was enhanced by the technology advances to a considerable extent beyond the other vehicles. Accelerated technology makes this vehicle a reality. The forward CG movement allows a straightforward aerodynamic configuration. The heavy lift vehicles, although significantly improved, do not show dramatic size changes. The body fineness ratio was changed due to resizing the tank diameters to the reduced propellant load and due to the aerodynamically faired nose. The engine change also resulted in a shift in the optimum propellant split from 36% to 42% of the total in the orbiter. The priority OTV is essentially unchanged. At the high performance level of this particular concept a significant change is not possible. The LCOTV, is basically unchanged since its production costs were not significantly impacted. It is certainly a simpler machine in terms of its main propulsion system since there are only 26 large, long life thrusters (in place of 206) running open loop from their own dedicated array segments.

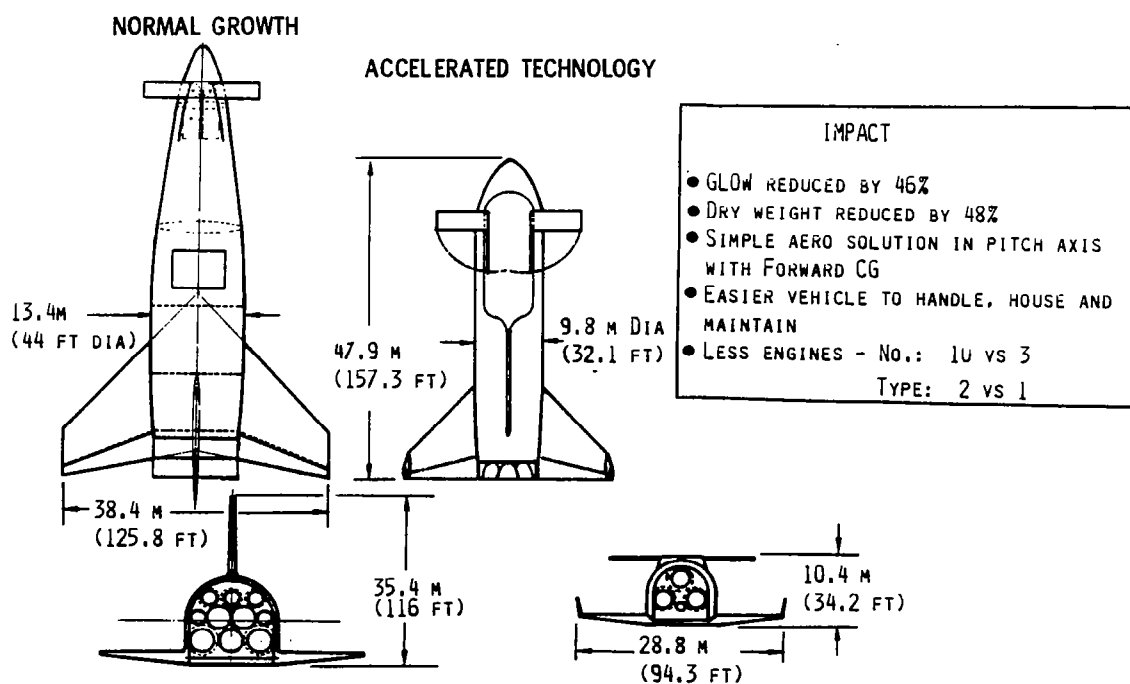

Figure 11.—Accelerated Technology Impact on SSTO

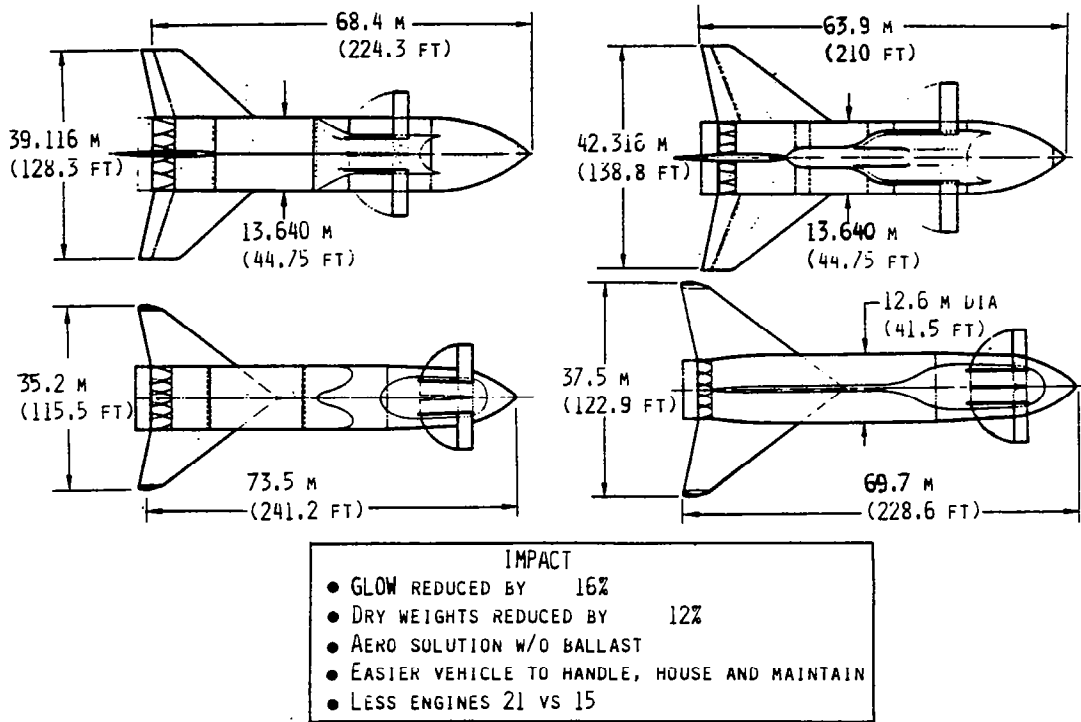

Figure 12.—Accelerated Technology Impact on HLLV

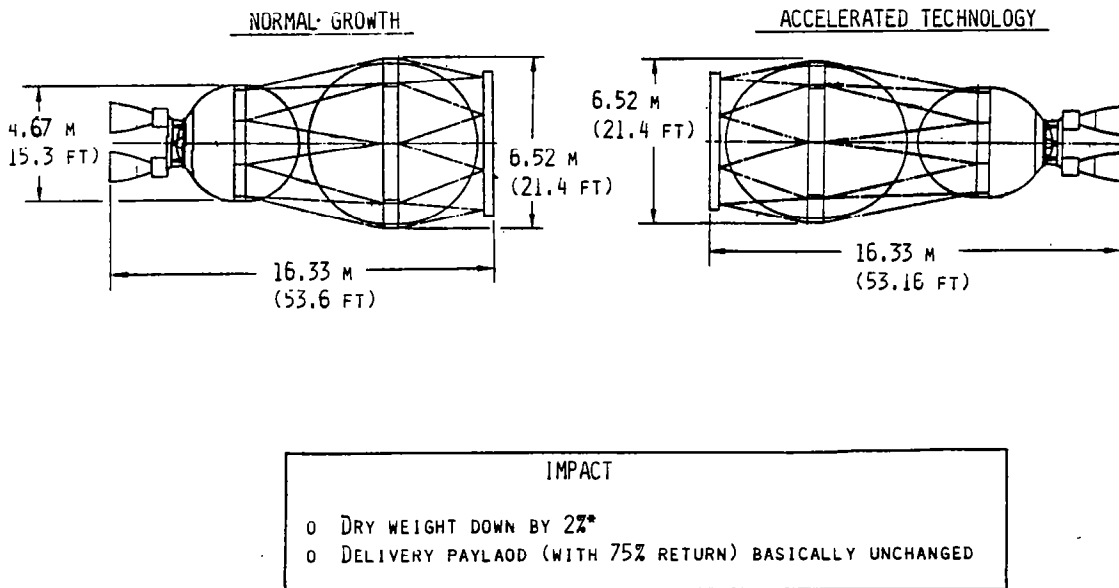

Figure 13.—Accelerated Technology Impact on POTV

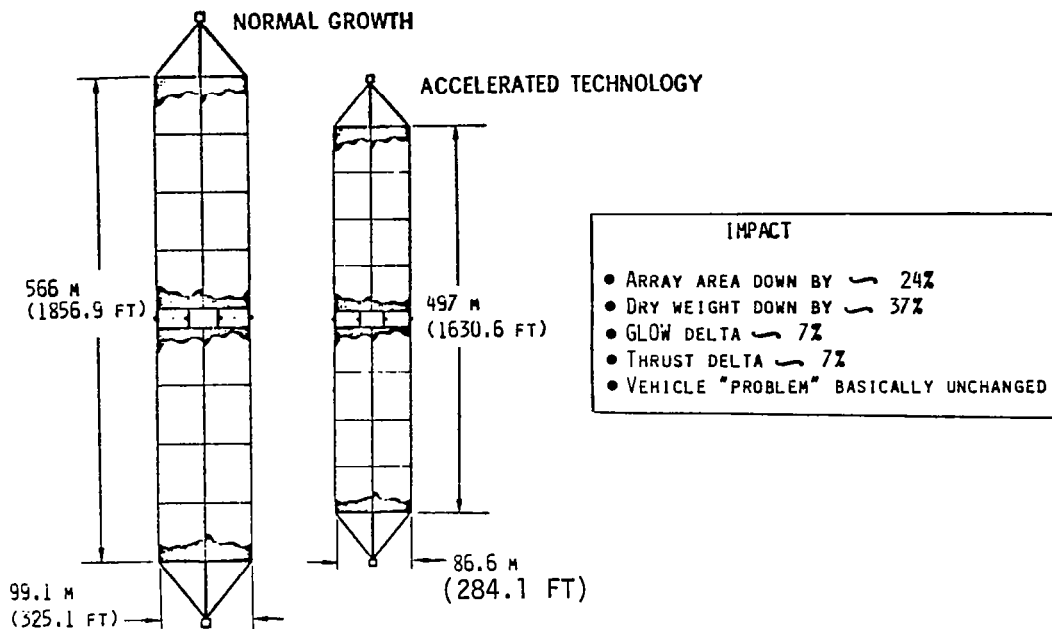

Figure 14.—Accelerated Technology Impact on LCOTV

The impact of the configuration revisions on life cycle costs is summarized in Tables 2 and 3. Table 2 shows the changes on a vehicle basis. The SSTO has the largest impact not only because of its dramatic improvement but also because it has the largest share of the mission model. Two-thirds of its savings were operations costs with the remainder accrued in the production phase. One of the largest factors in the operations cost reduction was the spares procurement. This is a result of engines with longer life and because the vehicle requires only three instead of ten engines.

The HLLV cost reductions are derived from the reduced size of the vehicles and the few number of engines required. An additional DDT&E savings was realized because the DF/DE engine was inherited from the SSTO. Operations cost changes were not significant, accounting for about 17% of the total cost reduction. The POTV remains basically unchanged, and shows a cost reduction based on the reduced cost of fuel delivered to LEO by the improved HLLV. The LOCTV, which shows very little change to LCC, reflects the impact of its high production costs not being amortized by the mission model. It should be noted that the mission model was not insignificant but a large fleet was required due to the fact that a vehicle requires one year to make the round trip and to be refurbished. This vehicle did not show significant reductions in its operations costs.

Table 2.—Life Cycle Cost Impact of Accelerated Technology

VEHICLE		NORMAL TECHNOLOGY	ACCELERATED TECHNOLOGY
SSTO	COST/FLIGHT	\$ 3.79 M	\$ 2.58 M
	COST/KG	\$278.00	\$189.00
	NET SAVINGS		\$5,262.25 M
HLLV	COST/FLIGHT	\$7.96 M	\$ 7.18 M
	COST/KG	\$35.00	\$32.00
	NET SAVINGS		\$2,353.66 M
POTV	COST/FLIGHT	\$4.97 M	\$ 4.29 M
	COST/KG	\$401.00	\$348.00
	NET SAVINGS		\$ 653.58 M
LCOTV	COST/FLIGHT	\$17.11 M	\$13.01 M
	COST/KG	\$75.00	\$57.00
	NET SAVINGS		\$ 39.03 M

Table 3.—Total System Cost Summary (\$ in millions)

	<u>NORMAL TECH.</u>	<u>ADV. TECH.</u>
TOTAL PROGRAM	41,636.73	33,327.27
DDT&E	9,783.53	8,638.80
PROGRAM MANAGEMENT	277.82	249.73
ENGINEERING	3,708.97	3,771.14
MANUFACTURING	4,385.84	3,355.19
TEST	1,407.47	1,262.74
PRODUCTION	8,542.05	6,183.23
PROGRAM MANAGEMENT	696.69	444.40
SUSTAINING ENGINEERING	193.35	159.10
MANUFACTURING	7,701.72	5,579.73
PRDD. TOOLING & S.T.E.	2,200.79	1,297.24
FLT. HARDWARE & SPARES	5,500.93	4,282.49
OPERATIONS	23,311.15	18,505.24
OPERATIONS SUPPORT	10,531.56	7,193.06
PROGRAM SUPPORT	2,185.65	2,156.53
SPARES PROCUREMENT	8,345.91	5,036.53
LAUNCH SUPPORT	12,779.59	11,312.18
OPERATIONS	5,054.71	4,778.65
PROPELLANT	7,724.88	6,533.53

• ADVANCED TECHNOLOGY SAVINGS: \$8,309.64 M

Table 3 shows the cost impact to the total transportation system. All three program phases show significant cost reductions. DDT&E costs were reduced due to the small vehicles and reduced manufacturing costs. Production was reduced for the same reasons as there were no changes to fleet size. The operations costs were reduced across the board with the dominant cost reduction occurring in spares procurement. This reduction again reflects the small vehicles and their reduced engine requirements. Advanced technology savings is \$8,309.64 million.

2.3 Contract Extension – Ground vs Space Based POTV Analysis

An extension to the basic contract was undertaken to compare ground based and space based POTVs.

Its objectives are summarized below.

- o Design a ground-based orbit transfer vehicle
- o Establish ground-based and space-based orbit transfer vehicle operations requirements
- o Compare operations requirements

The two subtasks undertaken to meet these objectives were: a) an operations analysis and, b) a design analysis. Due to the resource limitations of the extension and the wide scope of these objectives, this is a preliminary analysis. Its limitations include: a) only five major functions were reviewed to a level which allowed definition of requirements; b) the operations analysis was not iterated; c) many important trades were not made. Subjective judgement was substituted in order to follow through with the identified analysis technique.

This study was valuable, however, in a number of ways. The design analysis (section 5.2 of Vol. II) clearly establishes the dry mass advantage of the space based design over the ground based for the size range addressed. This advantage is sufficient to override liberal application of system redundancy which may be required to reduce "in space" servicing. This is clearly one of the major technology issues identified by this analysis. These issues are summarized in section 5.5 of Volume II. The analysis approach used in this task, and in a sense tested in its accomplishment, is a valuable tool for driving out the operational issues which must be addressed before the definitive case between ground and space basing can be made.

3.0 CONCLUSIONS

This study met its basic objectives and in addition provided valuable insights into several other areas. Its perspective from a total and integrated space transportation system was important in assessing the technology areas as noted below in a summary of the study findings:

- o Accelerating technology pays off. A twenty percent reduction in life cycle costs was realized. Technology advancement was more important to the launch vehicles particularly the SSTO.
- o Normal growth represented a substantial improvement from today's state of the art. This is important in two respects; it emphasizes the improvement seen from accelerating technology and; it represents a substantial challenge in itself. A new high pressure, hydrocarbon booster engine and wide spread application of composites are two key items in the baseline.
- o Composite structures with their promise of reduced weight and lower production costs is the most important technology area. Its high value was common across the entire transportation system.
- o A dual fuel/dual expander engine is critical technology for a single stage to orbit launch vehicle.
- o Control configured vehicle technology, particularly as applied to the removal of the vertical tail, shows excellent potential for launch vehicles. It not only can lead to vehicle improvements but will also ease the problems of operations and facilities.
- o Extended life engines have great value. The true benefits of a reusable STS via a substantial mission model will only be realized when engine technology provides improved life, low maintenance characteristics.
- o A single-stage to orbit vehicle not only becomes viable but can be considered attractive when technology is accelerated for its purposes.
- o The HLLV improvements with technology, although less dramatic than the SSTO, were substantial. Life cycle costs were reduced 18 percent and cost per flight dropped ten percent.
- o The impact on the OTV's was not as significant as for the launch vehicles. The electric LCOTV suffered because of its mismatch with the mission model. This vehicle requires a mission requirement which is not only large but carried over a significant time period allowing amortization of its high production costs.

- o The POTV, configured as an all propulsive space based concept, had little room for improvement from its normal growth baseline. The two areas where a substantial change in vehicle characteristics could be effected, inert weight and propulsion, were already at high performance levels.

In addition to these basic study findings, the following conclusions can also be drawn:

- o Comparison of ground and space based POTV's indicated significant design advantages for the space based POTV, a mass fraction of .936 as opposed to .910 for the ground based. In addition there was a reduction in operations. However, reliability was identified as a critical factor in retaining these advantages. The degree of reliability and the servicing capabilities of the space base are critical issues. This analysis is preliminary and additional study is required.
- o Significant improvements in the space based chemical OTV can only be made by changes in its operating modes such as use of aero-assist or geo refueling. The impact of these operational changes may result in identification of additional high yield technology areas.
- o Technology findings are sensitive to the vehicle concepts chosen. Some examples of the technology areas possibly affected are tabulated below.

- | | | |
|---|---|---|
| o Horizontal T.O. SSTO | - | TPS/Structures |
| o Less Than Two-stage HLLV or Reduced Size HLLV | - | Increased Sensitivity To Technology |
| o Ballistic HLLV | - | TPS/Structures |
| o Shuttle Tended-space Based OTV | - | Thermal Control/
Maintenance Free Design |
| o Aero-assisted OTV | - | TPS/Guidance |
| o Ground Based OTV | - | Structures/Thermal Control |
| o "Low G" Chemical LCOTV | - | Propulsion |

Figures 15, 16, 17 and 18 portray the vehicle designs as evolved under accelerated technology.

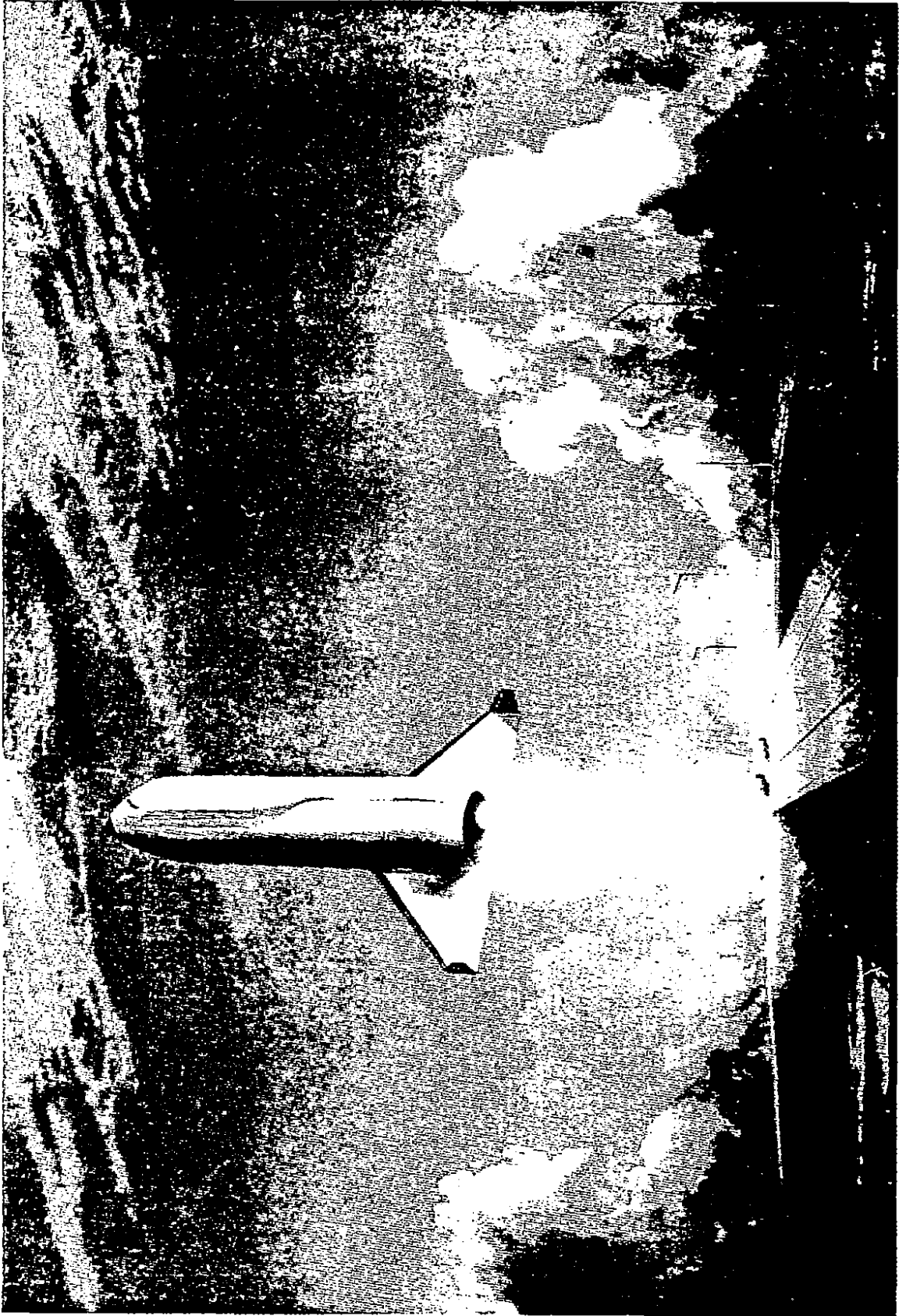

Figure 15 – SSTO Vehicle Concept—Accelerated Technology

ORIGINAL PAGE IS
OF POOR QUALITY



Figure 16 – HLLV Concept—Accelerated Technology

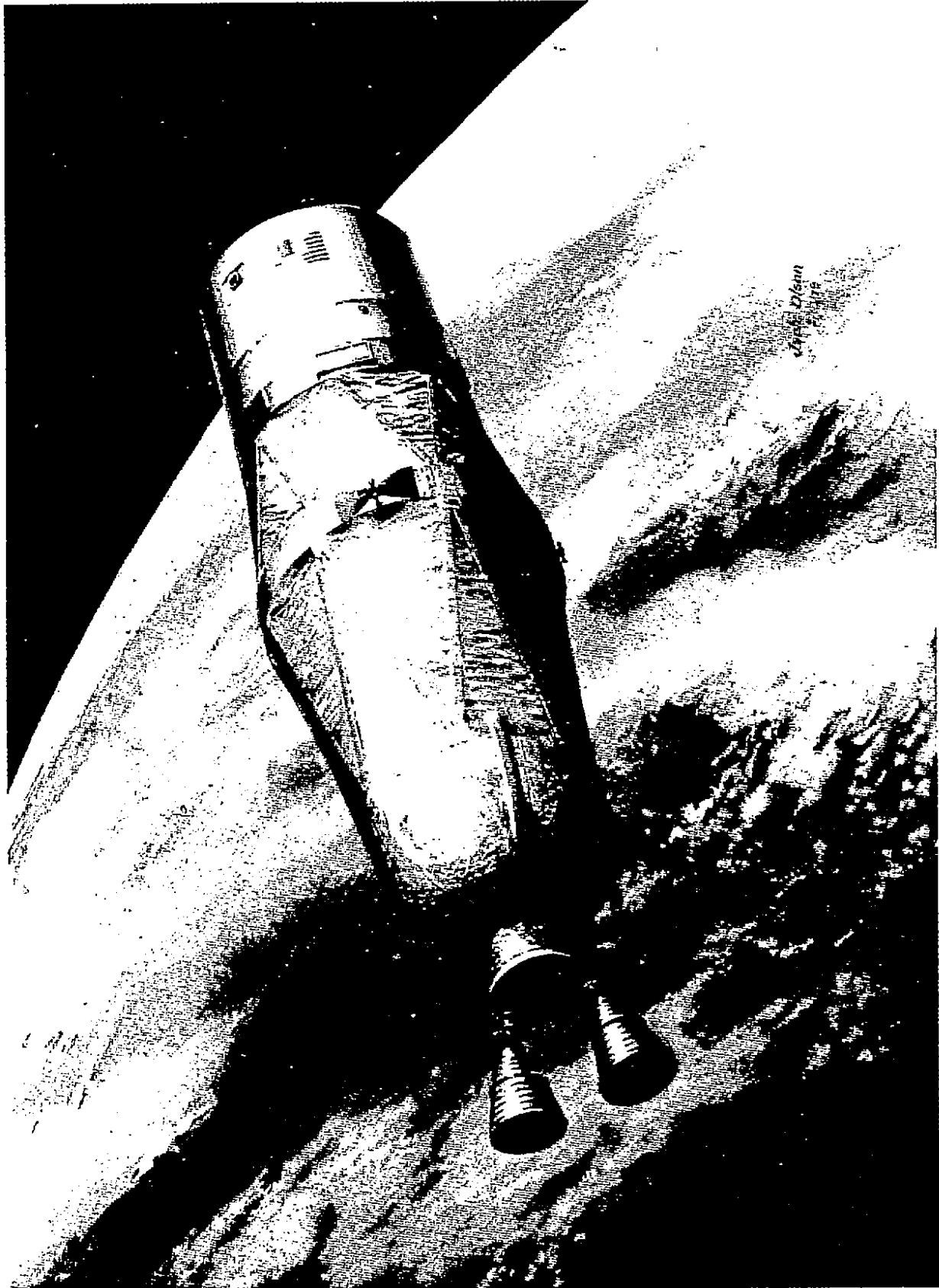

Figure 17 - POTV Concept - Accelerated Technology



Figure 18 – LCOTV Concept—Accelerated Technology

4.0 REFERENCES

1. Henry, B. Z.; and Eldred, C. H.: Advanced Technology and Future Earth-Orbit Transportation Systems. AIAA Conference on Space Manufacturing Facilities, May 1977.
2. Technology Requirements for Advanced Earth-Orbital Transportation Systems.
Final Report - NASA CR-2866, 1977
Volume 2: Summary Report - NASA CR-2879, 1978.
3. Rehder, J. J., and Eide, D. E.: A Space-Based Orbital Transport Vehicle-Bridge to the Future. AIAA Paper No. 79-0865, May 1979.
4. Martin, J. A.; and Wilhite, A. W.: Dual-Fuel Propulsion: Why It Works, Possible Engines, and Results of Vehicle Studies. AIAA Paper No. 79-878, May 1979.
5. Freeman, D. C.; and Powell, R. W.: The Results of Studies to Determine the Impact of Far-Aft Center-of-Gravity Locations on the Design of a Single-Stage-to-Orbit Vehicle System. AIAA Paper No. 79-0892, May 1979.