

NASA Conference Publication 2125  
DOE Publication CONF-791232

NASA  
CP  
2125  
c.1



# Thermal Energy Storage

Fourth Annual Review Meeting

LOAN COPY: RETURN TO  
AFWL TECHNICAL LIBRARY  
KIRTLAND AFB, N.M. 87117

A program review  
held at  
Tysons Corner, Virginia  
December 3-4, 1979

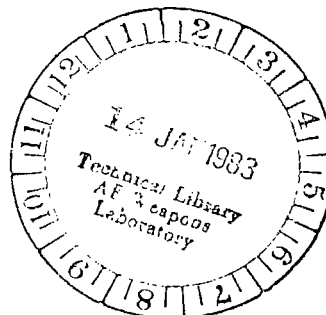



NASA Conference Publication 2125  
DOE Publication CONF-791232

# Thermal Energy Storage

## Fourth Annual Review Meeting

A program review sponsored by the  
U.S. Department of Energy, organized  
by the NASA Lewis Research Center,  
Cleveland, Ohio, and held at  
Tysons Corner, Virginia, December 3-4, 1979

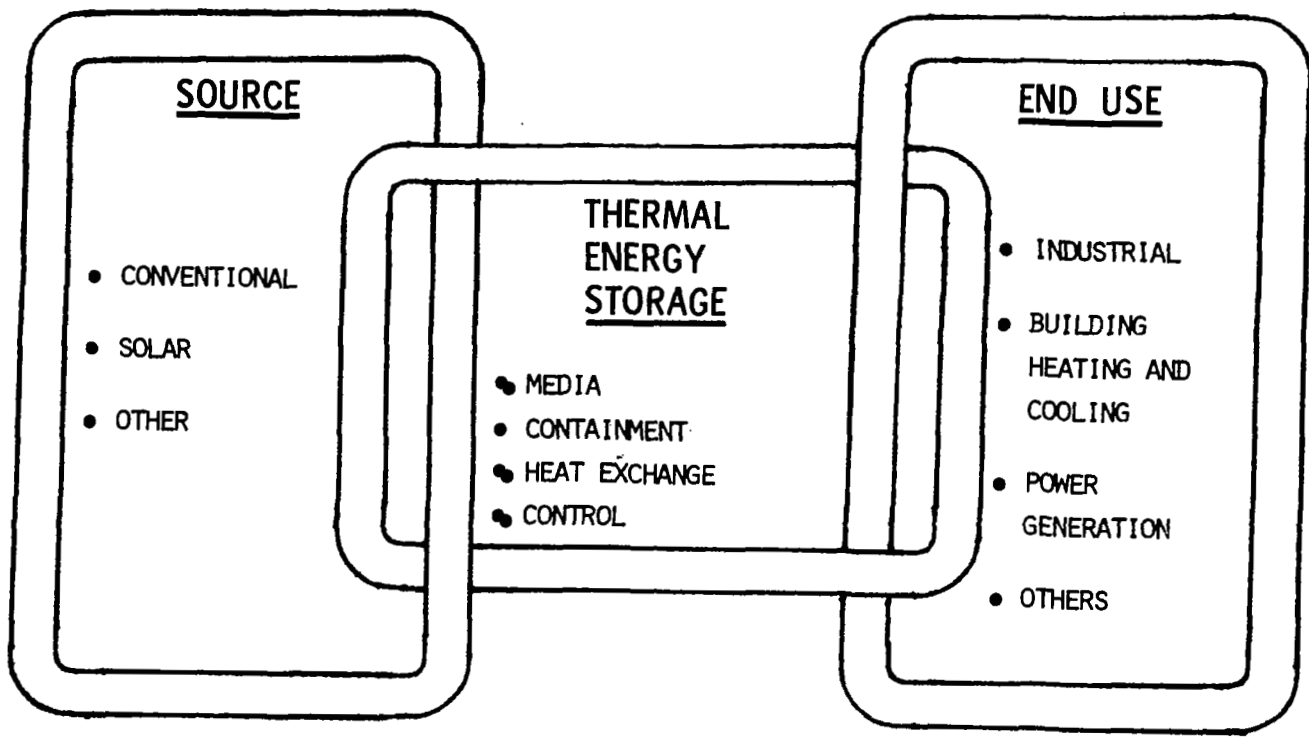

## PREFACE

Near term oil savings, solar (inexhaustible) energy applications and dispersed energy systems are the primary activities being emphasized by the Department of Energy in their energy-saving and energy substitution missions. Thermal storage is an important factor in the success of these missions by correcting the supply/use mismatch that occurs in most energy delivery systems. Attractive applications include solar and conventional space heating/cooling, industrial process/waste heat recovery, and load shifting for coal, nuclear, and solar thermal electrical power generation.

Within DOE, responsibility for the development of reliable, efficient, and low cost thermal storage technologies has been delegated to the Division of Energy Storage Systems. Implementation of the Thermal Energy Storage Program under the direction of John Gahimer has been assigned to lead laboratories consisting of national laboratories and other government agencies. In addition, with DOE's emphasis on decentralization of program management functions, a lead center role has been created. These management roles and the respective subprogram elements for FY 79/80 are as follows:

### Program Definition and Assessment (Lewis Research Center)

An essential function related to management of the overall thermal energy storage program is that of program definition and assessment. The major emphasis is the implementation of a program level assessment of thermal energy storage technology thrusts for the near and far term to assure an overall coherent energy storage program.

### Industrial Storage Applications (Lewis Research Center)

The major tasks in this program element are the implementation of a technology demonstration for the food processing industry, the development and technology demonstration for selected near-term, in-plant applications and the development and technology demonstration for advanced industrial applications.

### Solar Thermal Power Storage Applications (Sandia Laboratory Livermore)

This element is for a comprehensive advanced thermal energy storage technology and development program for FY 80-85 covering all solar thermal large and small power systems applications. Major emphasis will be given to advanced thermal storage for molten salt, central receiver systems and the organic sensible heat distributed receiver systems to support application areas such as Barstow and Shenandoah.



### Building Heating and Cooling Applications (Oak Ridge National Laboratory)

Primary emphasis is on the "customer side of the meter" storage applications to provide for utility load management. Development and demonstration of improved and advanced thermal storage subsystems for space conditioning in solar applications are included in the overall program goals.

### Research and Technology Development (Lewis Research Center and Solar Energy Research Institute)

This element provides for an advanced technology base which will lead to improved thermal energy storage concepts and designs for existing baseline storage systems. Generic, high risk technologies will be evaluated and appropriate technology development undertaken. A SERI interface will be maintained to coordinate and select those technologies which offer a significant advancement.

### Seasonal Thermal Storage Applications (Pacific Northwest Laboratory)

The objective of this project area is to stimulate interest in the feasibility of utilizing aquifers for seasonal thermal energy storage. Several diverse projects will be operated to demonstrate the technical, economic environmental, and institutional feasibility of aquifer storage systems.

Previous reviews of the Thermal Energy Storage Program have been reported as Contractors Information Exchange Meetings I, II, and III. The format for this fourth annual meeting was changed to reflect a year of transition and overall program planning for thermal storage; hence, the Thermal Energy Storage Program Review Meeting. Contained within this document are the respective project area overviews and selected presentations on specific technical and/or economic areas of concern. To provide a complete compendium of all of the on-going contracted activities, brief summary reports were solicited from each contractor and incorporated as part of this document.

The Lewis Research Center of the NASA organized the meeting and assembled this documentation. Project overviews and contractor reports contained herein were prepared by the responsible individuals/organizations. No technical editing or evaluation has been performed by NASA or DOE.

A. W. Nice, Chairman  
Thermal Energy Storage Program  
Review Meeting

## CONTENTS

	<i>Page</i>
<u>PREFACE</u> . . . . .	iii
<i>Program Overview</i>	
<u>BACKGROUND</u> . . . . .	1
<u>OBJECTIVE AND STRUCTURE</u> . . . . .	2
<u>THERMAL ENERGY STORAGE SYSTEM LEAD CENTER OVERVIEW</u> A. W. Nice, NASA Lewis Research Center. . . . .	3
<u>SEASONAL THERMAL ENERGY STORAGE PROGRAM</u> James E. Minor, Pacific Northwest Laboratory. . . . .	25
<i>Project Overview</i>	
<u>PROGRAM DEFINITION AND ASSESSMENT</u> . . . . .	33
PROGRAM DEFINITION AND ASSESSMENT OVERVIEW Larry H. Gordon, NASA Lewis Research Center . . . . .	35
SOLAR APPLICATIONS ANALYSIS FOR ENERGY STORAGE T. Blanchard, DOE/STOR Aerospace Corporation. . . . .	43
THERMAL ENERGY STORAGE SYSTEMS USING FLUIDIZED BED HEAT EXCHANGERS V. Ramanathan, T. E. Weast, and K. P. Ananth, Midwest Research Institute. . . . .	47
THERMAL ENERGY STORAGE AND TRANSPORT Walter Hausz, General Electric Company - TEMPO. . . . .	57
CONCEPTUAL DESIGN OF THERMAL ENERGY STORAGE SYSTEMS FOR NEAR-TERM ELECTRIC UTILITY APPLICATIONS Eldon W. Hall, General Electric Company . . . . .	79
<u>INDUSTRIAL STORAGE APPLICATIONS</u> . . . . .	85
INDUSTRIAL STORAGE APPLICATIONS OVERVIEW Rudolph A. Duscha, NASA Lewis Research Center . . . . .	87
APPLICATIONS OF THERMAL ENERGY STORAGE TO WASTE HEAT RECOVERY IN THE FOOD PROCESSING INDUSTRY F. Wojnar, H. J. Heinz Company and W. Lundberg, Westinghouse Electric Corporation . . . . .	95
COLLECTION AND DISSEMINATION OF TEST SYSTEM INFORMATION FOR THE PAPER AND PULP INDUSTRY M. W. Dietrich, NASA Lewis Research Center. . . . .	105

<u>SOLAR THERMAL POWER APPLICATIONS.</u> . . . . .	113
SOLAR THERMAL POWER APPLICATIONS LEAD LABORATORY OVERVIEW Lee G. Radosevich, Sandia Laboratories - Livermore. . . . .	115
THERMAL STORAGE EXPERIENCE AT THE MSSTF AND PLANS FOR THE FUTURE Thomas D. Harrison and Robert A. Randall, Sandia Labora- tories - Albuquerque. . . . .	125
THERMAL ENERGY STORAGE EFFORT AT JPL Donald L. Young, Jet Propulsion Laboratory. . . . .	131
INTERNALLY INSULATED THERMAL STORAGE SYSTEM DEVELOPMENT PROGRAM Owen L. Scott, Martin Marietta Corporation. . . . .	141
SANDIA LABORATORIES IN-HOUSE ACTIVITIES IN SUPPORT OF SOLAR THERMAL LARGE POWER APPLICATIONS Raymond W. Mar, Sandia Laboratories - Livermore . . . . .	157
HIGH TEMPERATURE UNDERGROUND THERMAL ENERGY STORAGE SYSTEM FOR SOLAR ENERGY R. Eugene Collins, University of Texas at Austin. . . . .	163
DEVELOPMENT OF A THERMAL STORAGE MODULE USING MODIFIED ANHYDROUS SODIUM HYDROXIDE Richard E. Rice and Peter E. Rowny, Comstock & Wescott, Inc . . . .	173
HIGH-TEMPERATURE MOLTEN SALT THERMAL ENERGY STORAGE SYSTEMS FOR SOLAR APPLICATIONS Randy J. Petri and T. D. Claar, Institute of Gas Technology . . . .	183
<u>BUILDING HEATING AND COOLING APPLICATIONS</u> . . . . .	191
BUILDING HEATING AND COOLING APPLICATIONS THERMAL ENERGY STORAGE PROGRAM OVERVIEW D. M. Eissenberg, Oak Ridge National Laboratory . . . . .	193
SUBCONTRACTED ACTIVITIES RELATED TO TES FOR BUILDING HEATING AND COOLING Jim Martin, Oak Ridge National Laboratory . . . . .	203
IN-HOUSE ACTIVITIES RELATED TO TES FOR BUILDING HEATING AND COOLING Bob Kedl, Oak Ridge National Laboratory . . . . .	213
THERMAL ENERGY STORAGE TESTING FACILITY R. J. Schoenhals, H. F. Kuehlert, and C. P. Lin, Purdue University. . . . .	223

APPLICATION OF THERMAL ENERGY STORAGE TO PROCESS HEAT RECOVERY IN THE ALUMINUM INDUSTRY John McCabe, Rocket Research Company . . . . .	233
HEAT STORAGE CAPABILITY OF A ROLLING CYLINDER USING GLAUBER'S SALT C. S. Herrick and K. P. Zarnoch, General Electric Company . . . . .	239
THERMAL ENERGY STORAGE TEST FACILITY Mark P. Ternes, Oak Ridge National Laboratory . . . . .	261
MATHEMATICAL MODELING OF MOVING BOUNDARY PROBLEMS IN THERMAL ENERGY STORAGE A. D. Solomon, Union Carbide Corporation. . . . .	265
CRAWL SPACE ASSISTED HEAT PUMP Mark P. Ternes, Oak Ridge National Laboratory . . . . .	271
LIFE AND STABILITY TESTING OF PACKAGED LOW-COST ENERGY STORAGE MATERIALS Galen R. Frysinger, University of Delaware. . . . .	277
EVALUATION OF THERMAL ENERGY STORAGE FOR THE PROPOSED TWIN CITIES DISTRICT HEATING SYSTEM Charles F. Meyer, General Electric Company - TEMPO. . . . .	283
SIMULATION AND EVALUATION OF LATENT HEAT THERMAL ENERGY STORAGE HEAT PUMP SYSTEMS Tony W. Sigmon, Research Triangle Institute . . . . .	297
EXPERIMENTAL EVALUATION OF THERMAL ENERGY STORAGE J. G. Asbury and H. N. Hersh, Argonne National Laboratory . . . . .	307
DEVELOPMENT OF OPTIMUM PROCESS FOR ELECTRON BEAM CROSS- LINKING OF HIGH DENSITY POLYETHYLENE THERMAL ENERGY STORAGE PELLETS, PROCESS SCALE-UP AND PRODUCTION OF APPLICATION QUANTITIES OF MATERIAL Ival O. Salyer, University of Dayton. . . . .	315
DISPERSED ENERGY STORAGE ANALYSIS R. A. Whisnant and J. W. Harrison, Research Triangle Institute . . . . .	329
<u>RESEARCH AND TECHNOLOGY</u> . . . . .	331
RESEARCH AND ADVANCED TECHNOLOGY OVERVIEW Richard W. Vernon, NASA Lewis Research Center . . . . .	333
ACTIVE HEAT EXCHANGE SYSTEM DEVELOPMENT FOR LATENT HEAT THERMAL ENERGY STORAGE Richard T. LeFrois, Honeywell, Inc. . . . .	337

ENERGY STORAGE-BOILER TANK, 1979 PROGRESS REPORT Talbot A. Chubb, J. J. Nemecek, and D. E. Simmons, Naval Research Laboratory . . . . .	353
THE SERI SOLAR ENERGY STORAGE PROGRAM Robert J. Copeland, John D. Wright, and Charles E. Wyman, Solar Energy Research Institute . . . . .	361
ACTIVE HEAT EXCHANGE SYSTEM DEVELOPMENT FOR LATENT HEAT THERMAL ENERGY STORAGE Joseph Alario and Robert Haslett, Grumman Aerospace Corporation . . . . .	375
HEAT STORAGE IN ALLOY TRANSFORMATIONS C. Ernest Birchenall, University of Delaware. . . . .	385
IMMISCIBLE FLUID - HEAT OF FUSION HEAT STORAGE SYSTEM D. D. Edie, S. S. Melsheimer, and J. C. Mullins, Clemson University. . . . .	391
<u>SEASONAL THERMAL ENERGY STORAGE . . . . .</u>	401
AQUIFER THERMAL ENERGY STORAGE PROGRAM Kenneth Fox, Pacific Northwest Laboratory . . . . .	403
COMPENDIA OF SEASONAL THERMAL ENERGY STORAGE AQUIFER THERMAL ENERGY TECHNICAL INFORMATION D. D. Hostetler, Pacific Northwest Laboratory . . . . .	413
Seasonal Thermal Energy Storage Aquifer Thermal Energy Reference Library Subject Listing. . . . .	415
Seasonal Thermal Energy Storage Aquifer Thermal Energy Reference Library. . . . .	497
TECHNICAL SUPPORT PROGRAM David A. Myers, Pacific Northwest Laboratory. . . . .	563
TECHNICAL SUPPORT PROGRAM Jay R. Eliason, Pacific Northwest Laboratory. . . . .	569
PRELIMINARY CONCLUSIONS OF A TECHNICAL FEASIBILITY STUDY OF LOW TEMPERATURE THERMAL ENERGY STORAGE IN THE TVA REGION A. R. Betbeze, Tennessee Valley Authority . . . . .	575
SEASONAL THERMAL ENERGY STORAGE IN AQUIFERS - MATHEMATICAL MODELING STUDIES IN 1979 Chin Fu Tsang, Lawrence Berkeley Laboratory . . . . .	581
COLD WATER AQUIFER STORAGE Donald L. Reddell, Richard R. Davison, and William B. Harris, Texas A & M University. . . . .	591

HOT-WATER AQUIFER STORAGE - A FIELD TEST A. D. Parr, F. J. Molz, and P. F. Andersen, Auburn University. . . . .	601
EQUILIBRIUM GEOCHEMICAL MODELING OF A SEASONAL THERMAL ENERGY STORAGE AQUIFER FIELD TEST J. A. Stottlemyre, Pacific Northwest Laboratory . . . . .	607
<i>International Activities</i>	
<u>DOE INTERNATIONAL ENERGY STORAGE ACTIVITIES</u> . . . . .	621
<u>ATES NEWSLETTERS.</u> . . . . .	623
<u>EXECUTIVE COMMITTEE SUMMARY REPORT FOR 1979 THERMAL ENERGY STORAGE PROGRAM REVIEW MEETING.</u> . . . . .	645

## BACKGROUND

There are major incentives for developing efficient and economical energy storage systems. Economic benefits by means of energy storage result through improved utilization of capital intensive energy conversion and delivery systems, and through the efficient utilization of intermittent energy sources where availability does not always coincide with the demand of energy. Energy storage can contribute to conservation of critical fuel reserves as well as providing environmental benefits. Thermal energy storage warrants particular attention in our economy since so much of the energy is produced, transferred, and utilized as heat.

The DOE Division of Energy Storage Systems (DOE/STOR) is responsible for formulating and managing research and development in energy storage technology. Major responsibility for project management in selected areas has been shifted to the DOE national laboratories and other government agencies.

### Headquarters and Field Management Structure for Thermal and Mechanical Energy Storage Program

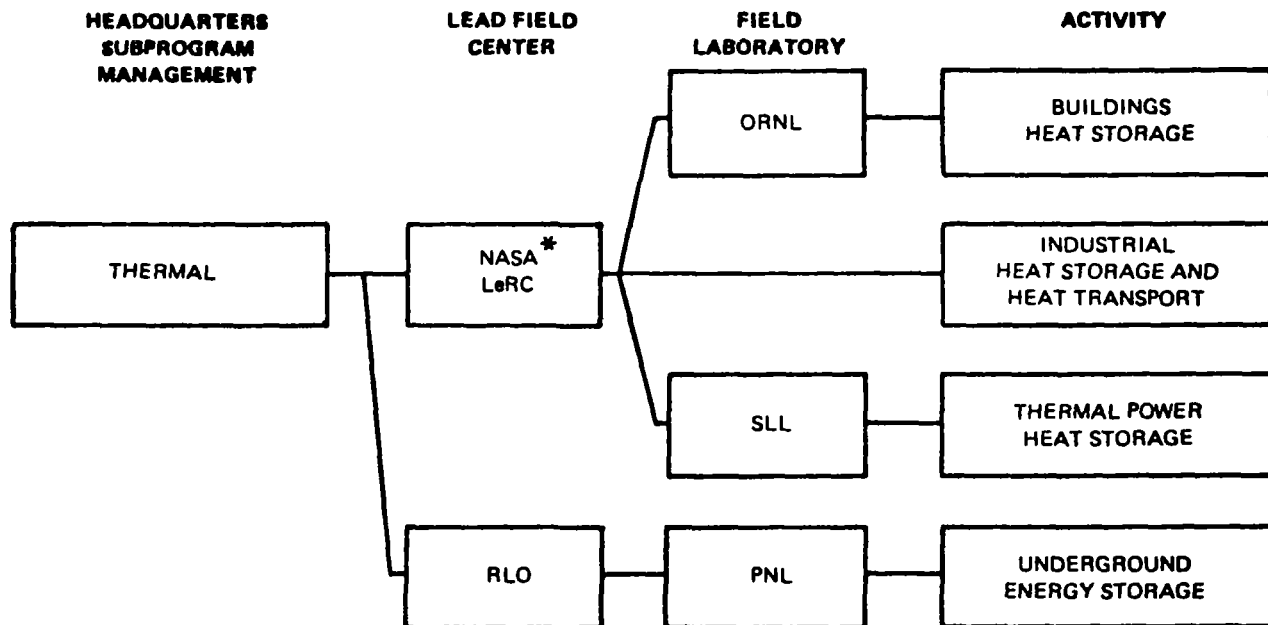

\*Acting

## OBJECTIVE AND STRUCTURE

The general objective of the Thermal Energy Storage Program is to develop the technology for cost and performance effective thermal energy storage systems for end-use application sectors. The technologies include all sensible and latent heat storage. Technologies for selected applications will be developed to the point of acceptance by the private sector or for systems integration and field testing by a DOE end-use Division. The Program's activities will be accomplished principally through contracts within the private sector to provide early and effective transfer of technology. Government funds in support of this Program will be provided by DOE.

Activities are coordinated with complementary projects and tasks being pursued by DOE end-use Divisions and national laboratories, the Solar Energy Research Institute (SERI), the Electric Power Research Institute (EPRI), the Tennessee Valley Authority (TVA), the Naval Research Laboratory (NRL), and the Battelle, Pacific Northwest Laboratory (PNL).

The lead center and lead laboratory structure of the Thermal Energy Storage Program is shown below.

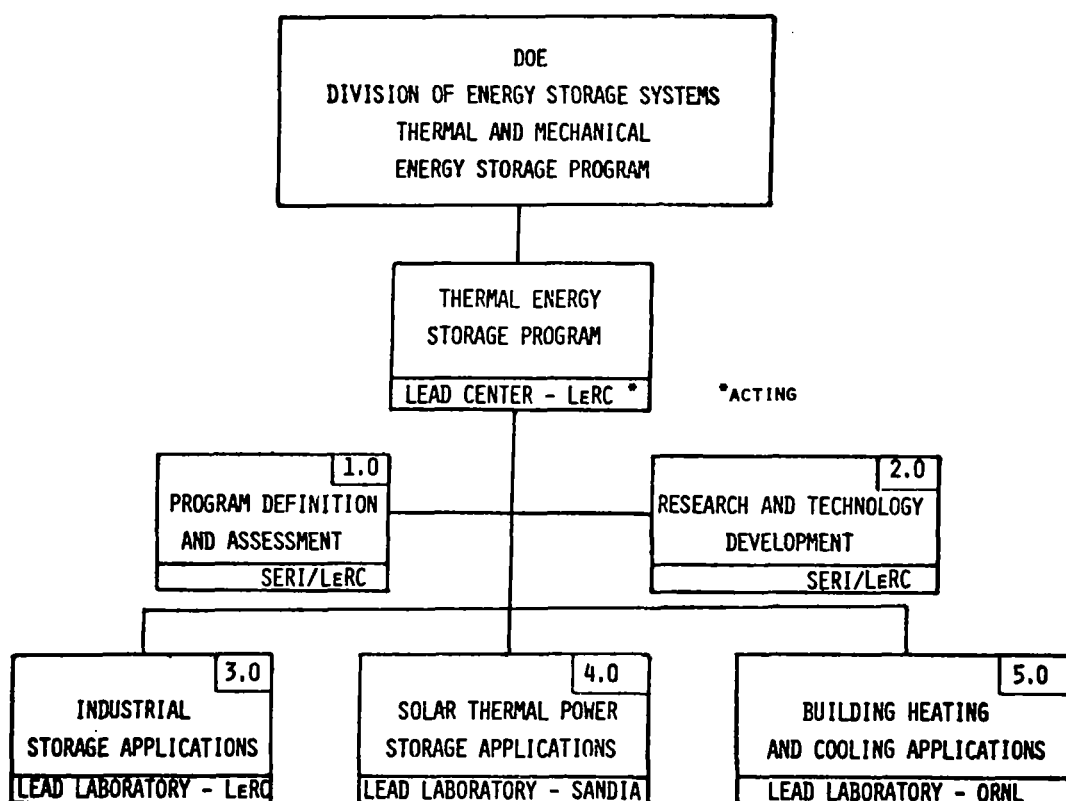

THERMAL ENERGY STORAGE PROGRAM STRUCTURE



THERMAL ENERGY STORAGE SYSTEM LEAD CENTER OVERVIEW

A. W. Nice  
NASA Lewis Research Center

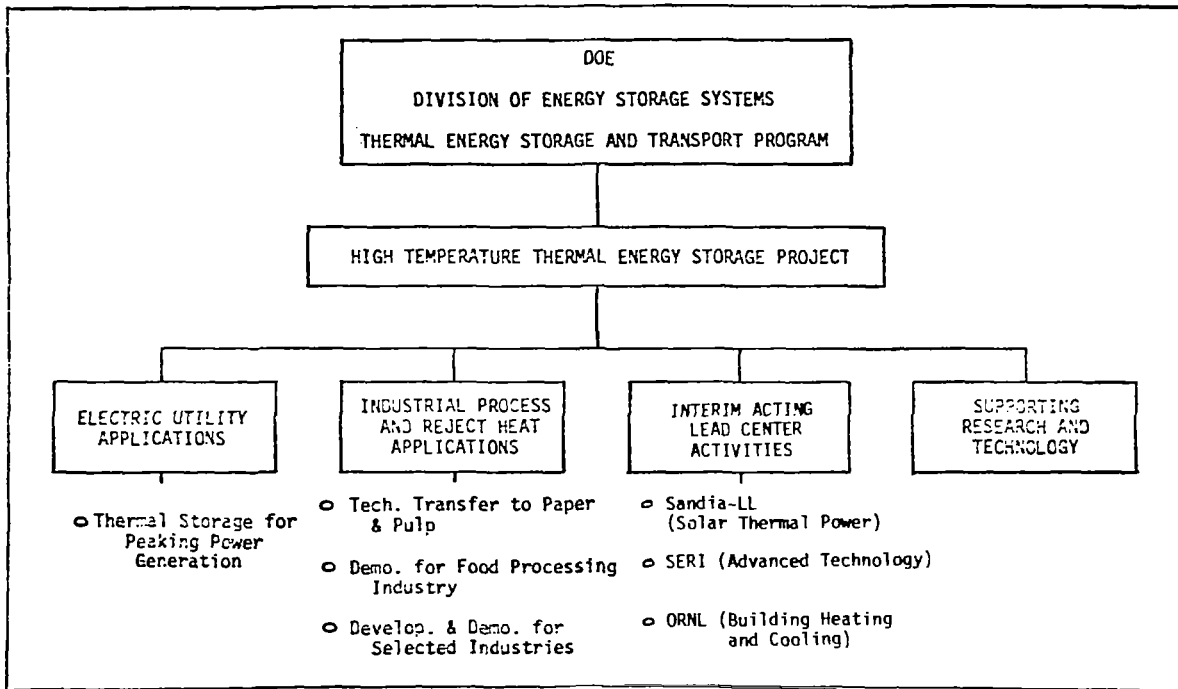

THERMAL ENERGY STORAGE PROJECT

RTOPS (DOE REIMBURSABLE)

- o 776-74-12 UTILITY THERMAL ENERGY STORAGE PROJECT
- o 776-71-43 THERMAL ENERGY STORAGE PROJECT

THERMAL ENERGY STORAGE PROJECT

AGENDA

PROGRAMMATIC OVERVIEW

- o FY 79 PLANS VS. FY 79 ACCOMPLISHMENTS
- o FY 80 PLANS
- o RESOURCE SUMMARY
- o ISSUES AND PROBLEMS

CURRENT TASK STATUS/RESULTS

- o UTILITY THERMAL STORAGE
- o HIGH TEMPERATURE THERMAL ENERGY STORAGE

THERMAL ENERGY STORAGE PROJECT

OVERVIEW

TITLE: UTILITY THERMAL ENERGY STORAGE SYSTEM TEST PROJECT

NASA CENTER: LEWIS RESEARCH CENTER (LERC)

OBJECTIVE: TO CONDUCT A LARGE SCALE FIELD TEST OF THE MOST ATTRACTIVE NEAR-TERM THERMAL ENERGY STORAGE (TES) SYSTEM INTEGRATED WITH AN OPERATIONAL UTILITY POWER PLANT

APPROACH:

- o SELECT, CONCEPTUALLY DESIGN, AND EVALUATE THE MOST PROMISING SYSTEMS FOR UTILITY APPLICATIONS
- o INITIATE DEVELOPMENT AND PRELIMINARY ENGINEERING OF A LARGE SCALE FIELD TEST IN AN OPERATING UTILITY

FUNDING: IN-HOUSE 5% CONTRACT 95%

COMMITMENT:

- o PREPARATION OF PDP TO INITIATE LARGE SCALE FIELD TEST IN AN OPERATING UTILITY

RTOP 776-74-12

THERMAL ENERGY STORAGE PROJECT  
OVERVIEW: UTILITY THERMAL STORAGE  
SCHEDULE/RESOURCES

ACTIVITY:	FY 78	FY 79	FY 80	FY 81	FY 82
<u>UTILITY TES FIELD TEST</u>		Activity Terminated			
INITIATE DEVELOPMENT AND FIELD TEST PLAN ACTIVITY	▼	▼			
DOE APPROVAL OF PLAN AND ESTABLISH SOURCE EVALUATION BOARD		▼	▼		
REDEFINITION TO THERMAL ENERGY STORAGE WITH COMPRESSED AIR ENERGY STORAGE SYSTEMS		—			
RESOURCES:					
REIMBURSABLE (\$ MILLIONS)	0.750	- 0 -			
IN-HOUSE MANYEARS (EQUIVALENT)	0.2	1.8			

Planned activity terminated July 79 based on results of utility TES study completed under RTOP 776-71-43

RTOP 776-74-12

THERMAL ENERGY STORAGE PROJECT  
OVERVIEW: UTILITY THERMAL STORAGE

STATUS

- o APPLICATION OF TES TO A UTILITY POWER PLANT WAS DETERMINED TO BE NOT ECONOMICALLY VIABLE AS A RESULT OF A GE STUDY "CONCEPTUAL DESIGN OF THERMAL ENERGY STORAGE SYSTEMS FOR NEAR-TERM UTILITY APPLICATIONS" PERFORMED UNDER RTOP 776-71-43
  
- o BY AGREEMENT WITH DOE/EES AND DOE/STOR THE ACTIVITY IS BEING REDEFINED TO SUPPORT THERMAL ENERGY STORAGE FOR COMPRESSED AIR ENERGY STORAGE SYSTEMS

RTOP 776-74-12

THERMAL ENERGY STORAGE PROJECT

UTILITY THERMAL STORAGE

FY 80 PLANS

OBJECTIVE: PROVIDE EXPERIMENTAL EVALUATIONS OF THERMAL ENERGY STORAGE SYSTEMS FOR APPLICATION TO COMPRESSED AIR ENERGY STORAGE AND OTHER END-USE SYSTEM APPLICATIONS

APPROACH:

- o PROVIDE A TES FLOW TEST FACILITY AND COMPLETE THE EVALUATION OF ONE PEBBLE BED TES CONCEPT APPLICABLE TO COMPRESSED AIR ENERGY STORAGE
- o FLOW TEST FACILITY DESIGN TO INCLUDE CAPABILITY FOR TESTING SOLAR AND INDUSTRIAL TES CONCEPTS

FUNDING: o IN-HOUSE 10% CONTRACT 90%

COMMITMENT: PREPARE FY 80 AOP FOR DOE/NASA APPROVAL

RTOP 776-74-12

THERMAL ENERGY STORAGE PROJECT

UTILITY THERMAL STORAGE

RESOURCE SUMMARY

	<u>FY 78</u>	<u>FY 79</u>	<u>FY 80</u>	<u>FY 81</u>	<u>FY 82</u>
REIMBURSABLE (\$ MILLIONS)	0.750	-	0.496 <sup>(1)</sup>	0.567	0.567
IN-HOUSE MY (EQUIVALENT)	0.2	1.8	1.4	1.5	1.5

(1) 0.750 FY 78 BA RECEIVED FROM DOE/EES  
-0.079 FY 78 & 79 LERC COSTS  
-0.500 FY 78 BA TRANSFERRED TO PNL AT DOE/EES REQUEST, OCT. 79  
-0.325 FY 80 BA TO BE PROVIDED BY DOE/STOR UNDER RTOP 776-71-43  
0.496 FY 80 BA

RTOP 776-74-12

THERMAL ENERGY STORAGE PROJECT  
UTILITY THERMAL STORAGE  
ISSUES AND PROBLEMS

- o RECEIPT OF FY 80 BA FROM DOE/STOR CONTINGENT ON LEAD CENTER  
ROLE DECISION

RTOP 776-74-12

THERMAL ENERGY STORAGE PROJECT  
OVERVIEW

- TITLE: HIGH TEMPERATURE THERMAL ENERGY STORAGE PROJECT
- NASA CENTER: LEWIS RESEARCH CENTER (LERC)
- OBJECTIVE: TO DEVELOP TECHNOLOGY FOR COST AND PERFORMANCE EFFECTIVE THERMAL ENERGY STORAGE SYSTEMS FOR ELECTRIC POWER GENERATION, BUILDINGS AND COMMUNITY SYSTEMS, TRANSPORTATION, SOLAR THERMAL POWER, AND INDUSTRIAL APPLICATIONS
- APPROACH:
- o CONTRACTS LET TO INDUSTRY TO DEVELOP TES SYSTEMS AND EVALUATIONS
  - o SUPPORTING R&T IMPLEMENTED TO ESTABLISH A TECHNOLOGY BASE, IDENTIFY NEW CONCEPTS AND RESOLVE GENERIC PROBLEMS
  - o EVALUATE CANDIDATE TES CONCEPTS
- FUNDING: IN-HOUSE 25% CONTRACT 74%
- COMMITMENT:
- o PREPARE PLANS FOR INDUSTRIAL TES APPLICATIONS
  - o CONDUCT SUPPORTING R&T INVESTIGATIONS
  - o PREPARE PLANS FOR SOLAR THERMAL POWER SYSTEMS TES APPLICATION

RTOP 776-71-43

THEMAL ENERGY STORAGE PROJECT

OVERVIEW: HIGH TEMPERATURE THERMAL ENERGY STORAGE PROJECT

SCHEDULE/RESOURCES

ACTIVITY	FY 78	FY 79	FY 80	FY 81	FY 82
INDUSTRIAL PROCESS AND REJECT HEAT APPLICATIONS	Complete Assessments ▼				
o TECHNOLOGY TRANSFER TO PAPER AND PULP INDUSTRY		Contract Award ▼	Contract Award ▼	Complete ▼	
o TES DEMONSTRATION IN SELECTED INDUSTRIES			Contract Award ▼	Contract Award ▼	Complete System Development ▼
o TES DEMONSTRATION FOR FOOD PROCESSING INDUSTRY			Contract Award ▼	Initiate Demo ▼	Complete Demo ▼
SOLAR THERMAL POWER SYSTEMS APPLICATIONS		R&D Plan Complete ▼			
o ACTIVE HEAT EXCHANGE DEVELOPMENT	Contract Award ▼		Complete ▼		
SUPPORTING R&T			Complete ▼		
			Fluidized Bed Study		
			Metal Alloy Media Study		
			Hi Temp Molten Salt Study		
REIMBURSABLE (\$ MILLIONS)	1,790	1,800	4,425	12,000	
IN-HOUSE MY (EQUIVALENT)	8.0	10.5	14.5	19.0	

THERMAL ENERGY STORAGE PROJECT  
OVERVIEW: HIGH TEMPERATURE THERMAL ENERGY STORAGE

STATUS

- o ACTING LEAD CENTER ACTIVITIES IMPLEMENTED
- o SOLAR MULTI-YEAR TES PLAN COMPLETED
- o MASTER BUY PLAN FOR INDUSTRIAL APPLICATIONS APPROVED BY NASA HEADQUARTERS, AUGUST 1979
- o INDUSTRIAL APPLICATIONS SOURCE EVALUATION BOARD ESTABLISHED AND PROCUREMENT ACTIVITIES IN PROGRESS
- o TES DEMONSTRATION FOR FOOD PROCESSING INDUSTRY RFP ISSUED
- o TECHNOLOGY TRANSFER TO PAPER AND PULP INDUSTRY CONTRACT PROPOSALS IN EVALUATION
- o EXPERIMENTAL STUDIES OF ACTIVE HEAT EXCHANGER CONCEPTS IN PROGRESS
- o SUPPORTING R&T STUDIES FOR FLUIDIZED BED CONCEPTS, METAL ALLOY MEDIA AND CARBONATE SALT MEDIA IN PROGRESS

RTOP 776-71-43

THERMAL ENERGY STORAGE PROJECT  
EY 80 PLANS

OBJECTIVES: TO DEVELOP THE TECHNOLOGY FOR COST AND PERFORMANCE EFFECTIVE TES FOR DOE IDENTIFIED END-USE APPLICATION SECTORS

APPROACH:

- o AWARD CONTRACTS TO INDUSTRIAL TES USERS FOR TECHNOLOGY DEMONSTRATIONS
- o IMPLEMENT SUPPORTING GENERIC R&T TO IDENTIFY NEW CONCEPTS
- o PROVIDE LEAD CENTER TECHNICAL AND RESOURCE MANAGEMENT TO THE LEAD LABORATORIES FOR SOLAR THERMAL POWER SYSTEMS APPLICATIONS, BUILDING HEATING AND COOLING APPLICATIONS AND ADVANCED TES TECHNOLOGY

FUNDING: IN-HOUSE 14% CONTRACT 86%  
NOTE: LEAD LABORATORIES FUNDED DIRECTLY BY DOE HDQTRS (6.200)

COMMITMENT:

- o COMPLETE INDUSTRIAL TES DEMONSTRATION CONTRACT ACTIVITY
- o DEFINE AND IMPLEMENT LEAD CENTER ASSIGNMENT PENDING DECISION ON LEAD CENTER ROLE

THERMAL ENERGY STORAGE PROJECT  
RESOURCE SUMMARY

	<u>FY 1980</u>	
REIMBURSABLE (\$ MILLIONS)	4.425	
IN-HOUSE MY (EQUIVALENT)	14.5	
LEAD LABORATORIES:		
o ORNL (BUILDING HEATING AND COOLING)	1.500	} FUNDED DIRECTLY BY DOE HDQTRS
o SANDIA-LL (SOLAR THERMAL)	3.500	
o SERI (ADVANCED TECHNOLOGY)	1.200	
	<hr/> 6.200	

RTOP 776-71-43

THERMAL ENERGY STORAGE PROJECT  
ISSUES AND PROBLEMS

ISSUE: LEAD CENTER ROLE DECISION

- PROBLEMS:
- o TIMELY IMPLEMENTATION OF ROLE IS IN JEOPARDY:
    - LEAD CENTER/LEAD LABORATORY ROLES AND RESPONSIBILITIES HAVE NOT BEEN DEFINED AND APPROVED BY COGNIZANT MANAGERMENTS
    - LEAD CENTER SHOULD BE ACTIVE IN FY 81 PROGRAM TECHNICAL AND RESOURCE GUIDELINE DEFINITIONS WITH HEADQUARTERS TO PERMIT TIMELY LEAD LABORATORY AOP PREPARATION
  - o IF DECISION IS TO TERMINATE, THE TRANSITION PROCESS MUST BEGIN SOON TO ASSURE ORDERLY TRANSFER OF CONTRACTUAL ACTIVITIES



THERMAL ENERGY STORAGE PROJECT

CURRENT TASK

STATUS/RESULTS

THERMAL ENERGY STORAGE PROJECT

UTILITY THERMAL ENERGY STORAGE PROJECT

TASK: PERFORM A DETAILED EVALUATION OF TES FOR MEETING PEAK POWER REQUIREMENTS OF ELECTRIC UTILITIES. TES IS MADE A PART OF THE STEAM ELECTRIC GENERATING PLANT, STORING THERMAL ENERGY FROM STEAM OR HOT FEEDWATER DURING LOW DEMAND PERIODS AND USING THE THERMAL ENERGY TO GENERATE ELECTRICITY DURING PEAK DEMAND PERIODS

APPROACH: THE STEAM TURBINE MUST BE SIZED TO DELIVER THE UTILITY PEAK POWER, BUT THE STEAM GENERATOR CAN BE DESIGNED AT LESS THAN PEAK POWER BY USING TES TO SUPPLY ENERGY TO MATCH THE TURBINE REQUIREMENTS. THEREFORE STEAM GENERATOR COSTS CAN BE LESS IN A STEAM PLANT WITH TES THAN IN ONE WITHOUT TES WHERE IT MUST DELIVER PEAK POWER.

TRADEOFF: REDUCED COSTS AND OFFSET BY THE COST OF THE TES SYSTEM

THERMAL ENERGY STORAGE PROJECT  
UTILITY THERMAL ENERGY STORAGE PROJECT

METHOD: OVER 40 TES CONCEPTS WERE EVALUATED AND EVENTUALLY REDUCED TO 12 CONCEPTS WHICH WERE THEN APPLIED TO TWO REFERENCE PLANTS, AN 800 MW PLANT BURNING HIGH SULFUR COAL AND AN 1140 MW PLANT UTILIZING A LIGHT WATER NUCLEAR REACTOR.

RESULTS OF ANALYSIS OF PERFORMANCE AND COSTS OF THE 12 TES PLANTS LED TO A SELECTION OF 4 OPTIONS FOR MORE DETAILED ANALYSIS.

TES MEDIA AND CONTAINMENT EVALUATIONS INCLUDED HOT OIL, MOLTEN SALT, ROCK, HIGH TEMPERATURE WATER, STEEL PRESSURE VESSELS, PRESTRESSED CAST IRON VESSELS AND CONTAINMENT IN LINED UNDERGROUND CAVITIES.

RTOP 776-74-12

THERMAL ENERGY STORAGE PROJECT  
UTILITY THERMAL ENERGY STORAGE PROJECT

SELECTED TWO OPTIONS USE HIGH SULFUR COAL PLANTS AND PEAKING TURBINES WITH  
OPTIONS: STEAM DRAWN FROM THE CYCLE AFTER THE HIGH PRESSURE TURBINE DURING THE OFF PEAK PERIOD. TES CONCEPTS WERE A BED OF ROCK WITH PORES FILLED WITH HOT OIL AT LOW PRESSURE AND AN UNDERGROUND CAVITY LINED WITH STEEL TO STORE HOT WATER UNDER HIGH PRESSURE

TWO OPTIONS USE NUCLEAR PLANTS AND THE THERMAL ENERGY OF HOT FEEDWATER IS STORED DURING OFF PEAK PERIODS. TES CONCEPTS WERE A PRESSURIZED CAST IRON VESSEL FOR STORAGE OF HOT FEEDWATER AND DUAL MEDIA. HOT OIL AND ROCK.

ANALYSIS: BASED ON THE CONCEPTUAL DESIGNS, THE COST AND PERFORMANCE OF THE FOUR TES SYSTEMS AS WELL AS THE REFERENCE NUCLEAR AND COAL PLANTS WERE DETERMINED.

THERMAL ENERGY STORAGE PROJECT  
UTILITY THERMAL ENERGY STORAGE PROJECT

- CONCLUSIONS:
- o THE LIMITED PEAKING CAPACITY THAT RESULTS WITH FEEDWATER ENERGY STORAGE (POWER SWINGS OF  $\pm 10-15\%$ ) REDUCES THE BENEFIT TO THE UTILITY
  - o COAL PLANTS WITH SEPARATE PEAKING TURBINES ARE SIGNIFICANTLY LOWER IN COST THAN THE TES NUCLEAR PLANTS BUT CANNOT COMPETE WITH GAS TURBINES FOR PEAKING DUTY AT 1500 HOURS OF OPERATION OR LESS PER YEAR UNLESS OIL BECOMES UNAVAILABLE OR INCREASES SIGNIFICANTLY IN COST (BASE YEAR - 1976)
  - o THE CAPITAL INVESTMENT REQUIRED FOR STORAGE IS GENERALLY EQUAL TO OR GREATER THAN THAT FOR AT LEAST SOME TYPES OF COMPLETE GENERATION EQUIPMENT
  - o NONE OF THE FOUR TES SYSTEMS, BASED ON THE NEAR-TERM DESIGNS OF THIS STUDY, ARE ECONOMICALLY ATTRACTIVE TO UTILITIES. COST REDUCTIONS IN THE RANGE OF 40% ARE REQUIRED FOR TES TO BECOME COMPETITIVE

RTOP 776-74-12

THERMAL ENERGY STORAGE PROJECT  
UTILITY THERMAL ENERGY STORAGE PROJECT

STATUS: THE ORIGINAL INTENTION OF THIS PROJECT WAS TO PERFORM A FULL SCALE FIELD TEST OF TES INTEGRATED WITH A CONVENTIONAL UTILITY IF STUDY SHOWED TES TO BE ECONOMICALLY VIABLE

SINCE THIS APPLICATION WAS FOUND TO BE ONLY marginally competitive, DOE/EES RECOMMENDED THAT THE PROJECT ACTIVITY BE REDEFINED TO SUPPORT THERMAL ENERGY STORAGE FOR COMPRESSED AIR ENERGY STORAGE SYSTEMS (CAES)

AN AOP IS PRESENTLY IN PREPARATION WHICH PROVIDES FOR THE DEVELOPMENT OF A TES FLOW TEST FACILITY TO SUPPORT CAES TECHNOLOGY. THIS ACTIVITY IS COORDINATED WITH PACIFIC NORTHWEST LABORATORIES WHO HAVE BEEN ASSIGNED RESPONSIBILITY FOR CAES DEVELOPMENT

THE PROPOSED ACTIVITY WILL INITIALLY PERMIT EVALUATION OF A PEBBLE BED CONFIGURATION THAT TRANSFERS HEAT BY DIRECT CONTACT WITH COMPRESSED AIR

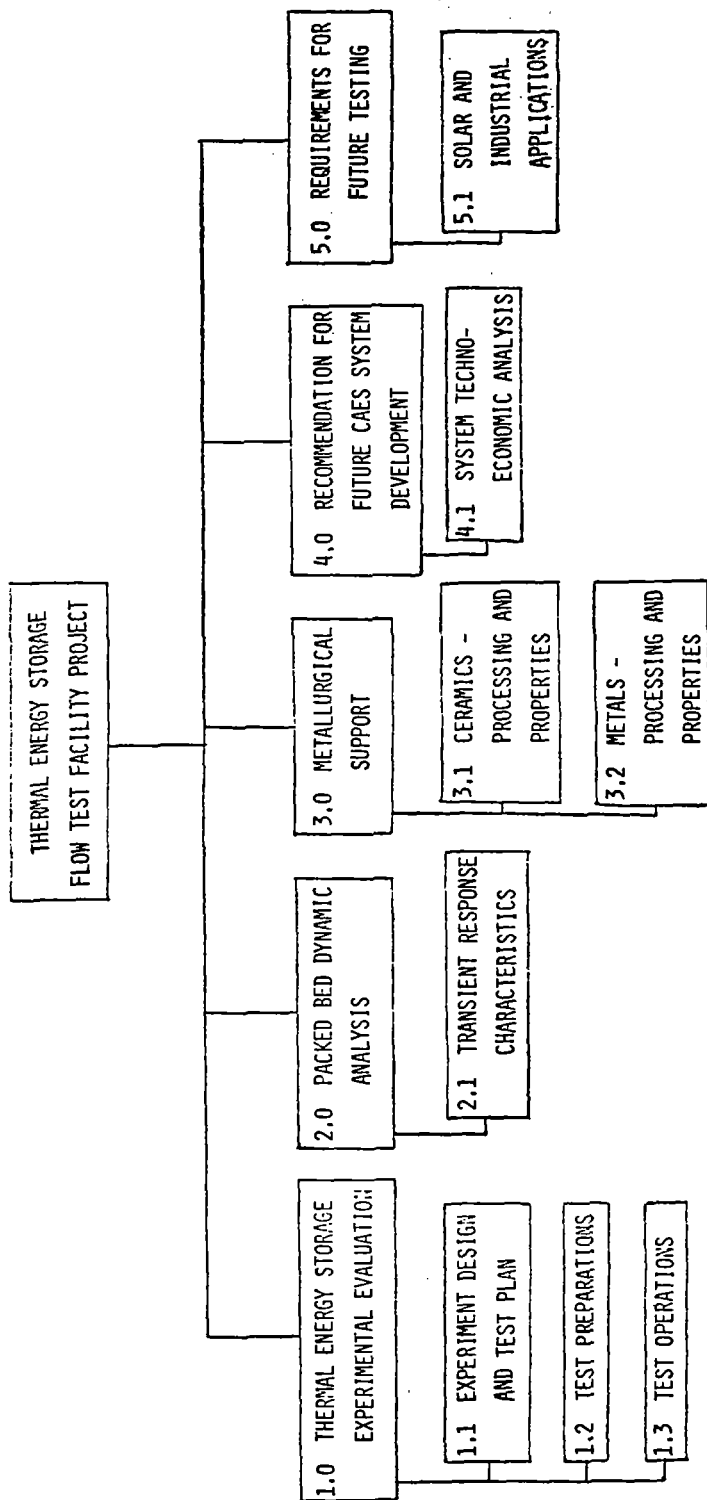

\*CAES = COMPRESSED AIR ENERGY STORAGE

FIGURE 1 - THERMAL ENERGY STORAGE FLOW TEST FACILITY PROJECT STRUCTURE

RTOP 776-74-12

FIGURE 2

MILESTONE SCHEDULE

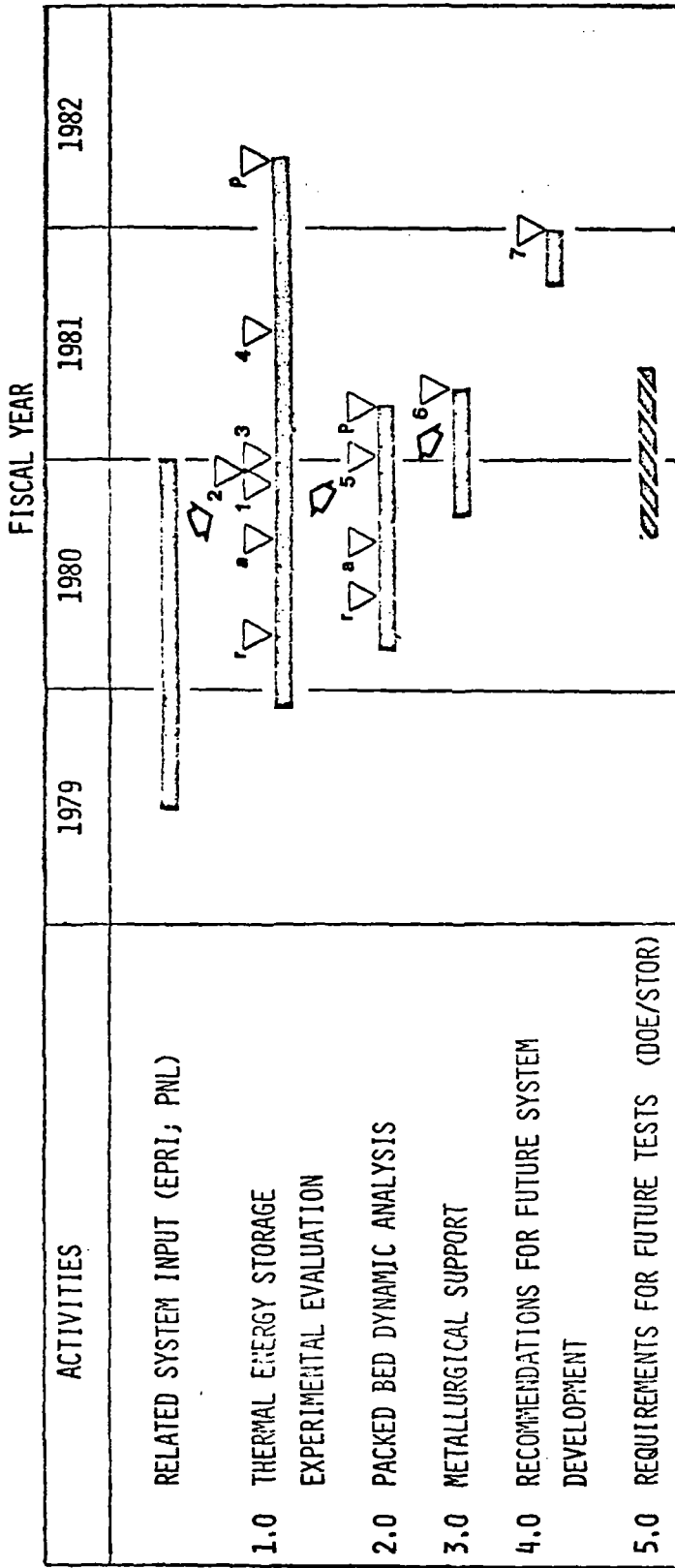

- 1. RELEASE LONG LEAD TIME TEST HARDWARE PROCUREMENT
  - 2. COMPLETE SYSTEM CONCEPTUAL DESIGN
  - 3. APPROVE PACKED BED TEST PLAN
  - 4. INITIATE TEST EVALUATION
  - 5. PROVIDE TRANSIENT RESPONSE CHARACTERISTICS
  - 6. COMPLETE ASSESSMENT OF STORAGE MEDIA PROCESSING AND PROPERTIES
  - 7. SUBMIT RECOMMENDATIONS FOR FUTURE DEVELOPMENT TO DOE
- 
- ▽ MILESTONES
  - r RELEASED RFP
  - AWARD CONTRACT
  - P PUBLISH REPORT
  - COMPETITIVE PROCUREMENT
  - ◁ ENGINEERING INPUT

INDUSTRIAL PROCESS AND REJECT HEAT APPLICATION  
TECHNOLOGY TRANSFER TO PAPER/PULP INDUSTRY

OBJECTIVE: DETERMINE EXISTING APPLICATIONS OF TES IN BOTH THE U.S. AND INTERNATIONAL PAPER AND PULP INDUSTRIES. OBTAIN AND ANALYZE THE OPERATING DATA FROM A REPRESENTATIVE NUMBER OF THESE MILLS, AND TRANSFER THE INFORMATION TO THE U.S. PAPER AND PULP INDUSTRY

SOW OUTLINE: TASK I INDUSTRY SURVEY  
TASK II BENEFIT ANALYSIS  
TASK III INFORMATION DISSEMINATION.

STATUS: RFP ISSUED JUNE 1979; EIGHT (8) RESPONSES RECEIVED AND EVALUATED; NEGOTIATIONS ARE IN PROCESS; AWARD EXPECTED BY EARLY DECEMBER

RTOP 776-71-43

PAPER AND PULP

BOEING E&C/MEYERHAEUSER/SRI INTERNATIONAL

HEAT SOURCES IN PAPER AND PULP MILL

O EXCESS STEAM FROM HOG FUEL (WOOD WASTE) BOILER DURING  
LOW STEAM DEMAND PERIOD

ENERGY END USE APPLICATIONS

O PROCESS STEAM  
O FEEDWATER HEATING

RECOVERY/STORAGE/REUSE SYSTEM SELECTED

O GENERATE EXCESS STEAM DURING LOW DEMAND PERIODS  
O STORE IN STEAM ACCUMULATOR  
O PROVIDE PROCESS STEAM DIRECTLY OR USE FOR FEEDWATER  
HEATING DURING HIGH DEMAND PERIODS

RTOP 776-71-43

**INDUSTRIAL PROCESS AND REJECT HEAT SYSTEMS**  
**ENERGY SUPPLY CHARACTERISTICS WITH THERMAL ENERGY STORAGE**

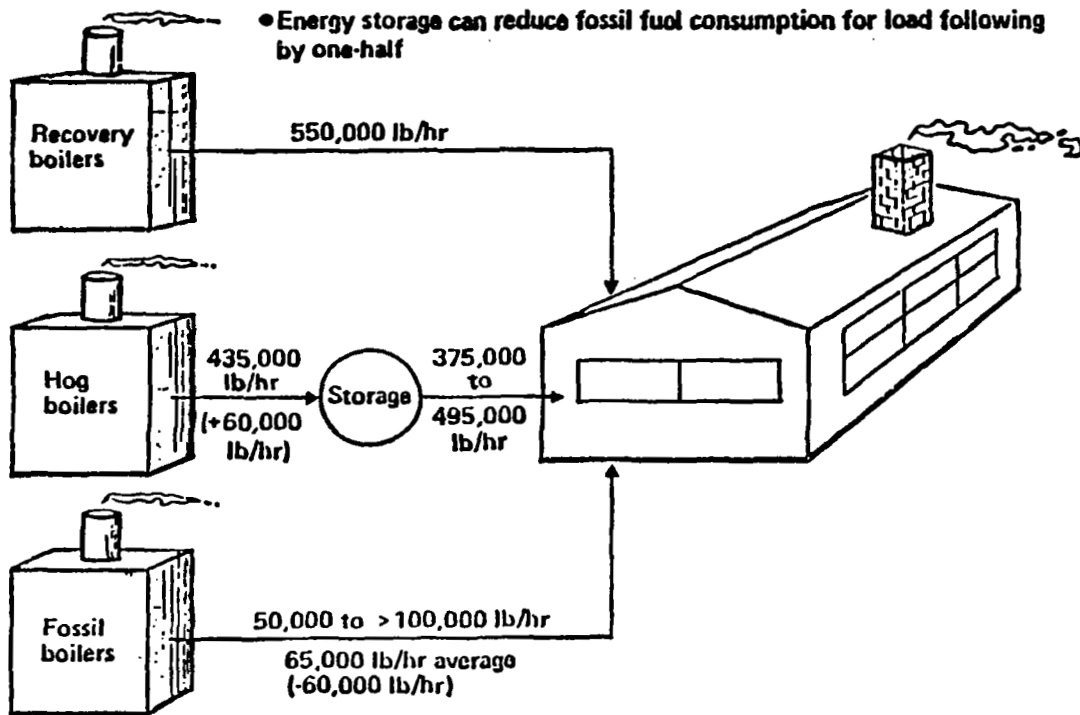

PAPER AND PULP

CONCLUSIONS:

SYSTEM IS ECONOMICALLY AND TECHNICALLY FEASIBLE ( 30% ROI)

INDUSTRY WIDE CONSERVATION POTENTIAL IS  $3 \times 10^6$  BBL OIL/YR (>1982)

DEVELOPMENT REQUIRED

o NONE

RTOP 776-71-43

INDUSTRIAL PROCESS AND REJECT HEAT APPLICATIONS  
DEVELOPMENT AND TECHNOLOGY DEMONSTRATION FOR SELECTED NEAR-TERM  
IN-PLANT APPLICATIONS

OBJECTIVE: DEVELOP AND DEMONSTRATE THERMAL ENERGY STORAGE SYSTEM TECHNOLOGIES CAPABLE OF CONTRIBUTING SIGNIFICANTLY TO ENERGY CONSERVATION THROUGH RECOVERY AND STORAGE OF INDUSTRIAL PROCESS AND REJECT HEAT FOR SUBSEQUENT USE

APPROACH:

- o PERFORM WORK UNDER COMPETITIVELY AWARDED PROCUREMENTS
- o COMPLETE REQUIRED SYSTEM AND COMPONENT DEVELOPMENT
- o CONDUCT TECHNOLOGY DEMONSTRATION TO ACCELERATE ACCEPTANCE BY INDUSTRY
- o RESTRICT SCOPE TO IN-PLANT APPLICATIONS
- o EMPHASIZE NEAR-TERM ENERGY CONSERVATION
- o MULTIPLE AWARDS: COST-SHARED CONTRACTS

STATUS:

- o WBS AND DRAFT OF SOW PREPARED
- o MASTER BUY PLAN APPROVED BY NASA HEADQUARTERS
- o SOURCE EVALUATION BOARD ESTABLISHED AND MEETING
- o RFP RELEASE EXPECTED IN MID-DECEMBER

RTOP 776-71-43

INDUSTRIAL PROCESS AND REJECT HEAT APPLICATIONS  
DEVELOPMENT AND TECHNOLOGY DEMONSTRATION FOR SELECTED NEAR-TERM  
IN-PLANT APPLICATIONS

OBJECTIVE: DEVELOP THERMAL ENERGY STORAGE SYSTEMS CAPABLE OF CONTRIBUTING SIGNIFICANTLY TO ENERGY CONSERVATION THROUGH RECOVERY AND STORAGE OF INDUSTRIAL PROCESS AND REJECT HEAT FOR SUBSEQUENT USE

SOW OUTLINE:

TASK 1	CONCEPTUAL SYSTEM DESIGNS
TASK 2	SYSTEM AND COMPONENT DEVELOPMENT
TASK 3	BENEFIT ANALYSIS
TASK 4	PRELIMINARY ENGINEERING DESIGN
TASK 5	TECHNOLOGY DEMONSTRATION PLAN
TASK 6	TECHNOLOGY DEMONSTRATION SYSTEM DESIGN
TASK 7	SYSTEM FABRICATION, INSTALLATION AND CHECKOUT
TASK 8	PERFORMANCE DEMONSTRATION AND EVALUATION
TASK 9	TECHNOLOGY TRANSFER
TASK 10	PROJECT MANAGEMENT

RTOP 776-71-43



INDUSTRIAL PROCESS AND REJECT HEAT APPLICATIONS  
TECHNOLOGY DEMONSTRATION FOR FOOD PROCESSING INDUSTRY  
(SOLE SOURCE: H. J. HEINZ COMPANY)

OBJECTIVE: PERFORM A TECHNOLOGY DEMONSTRATION OF A THERMAL ENERGY STORAGE/  
WASTE HEAT RECOVERY (TES/WHR) SYSTEM IN A FOOD PROCESSING PLANT

SOW OUTLINE: TASK 1 SYSTEM DEFINITION REVIEW AND DEMONSTRATION PLAN OUTLINE  
TASK 2 TECHNOLOGY DEMONSTRATION SYSTEM DESIGN  
TASK 3 SYSTEM FABRICATION, INSTALLATION AND CHECKOUT  
TASK 4 PERFORMANCE DEMONSTRATION AND EVALUATION  
TASK 5 TECHNOLOGY TRANSFER  
TASK 6 REPORTING

STATUS: SOLE SOURCE RFP ISSUED JUNE, 1979; PROPOSAL RECEIVED  
OCTOBER 1979; AWARD EXPECTED BY MID-DECEMBER

RTOP 776-71-43

FOOD PROCESSING

WESTINGHOUSE/HEINZ

HEAT SOURCES IN FOOD PROCESSING PLANTS

HOT WASTE WATER FROM FOOD PROCESSING

ENERGY END USE APPLICATIONS

EQUIPMENT CLEAN UP

PREHEAT INCOMING WATER FOR FOOD PROCESSING

RECOVERY/STORAGE/REUSE SYSTEM SELECTED

CAPTURE HEAT FROM WASTE WATER

STORE 25% IN HOT WATER TANK; USE REST FOR PREHEAT

USE TOPPED-OFF STORED WATER FOR EQUIPMENT CLEAN UP

RTOP 776-71-43

# FOOD PROCESSING PLANT ENERGY RECOVERY AND STORAGE SYSTEM

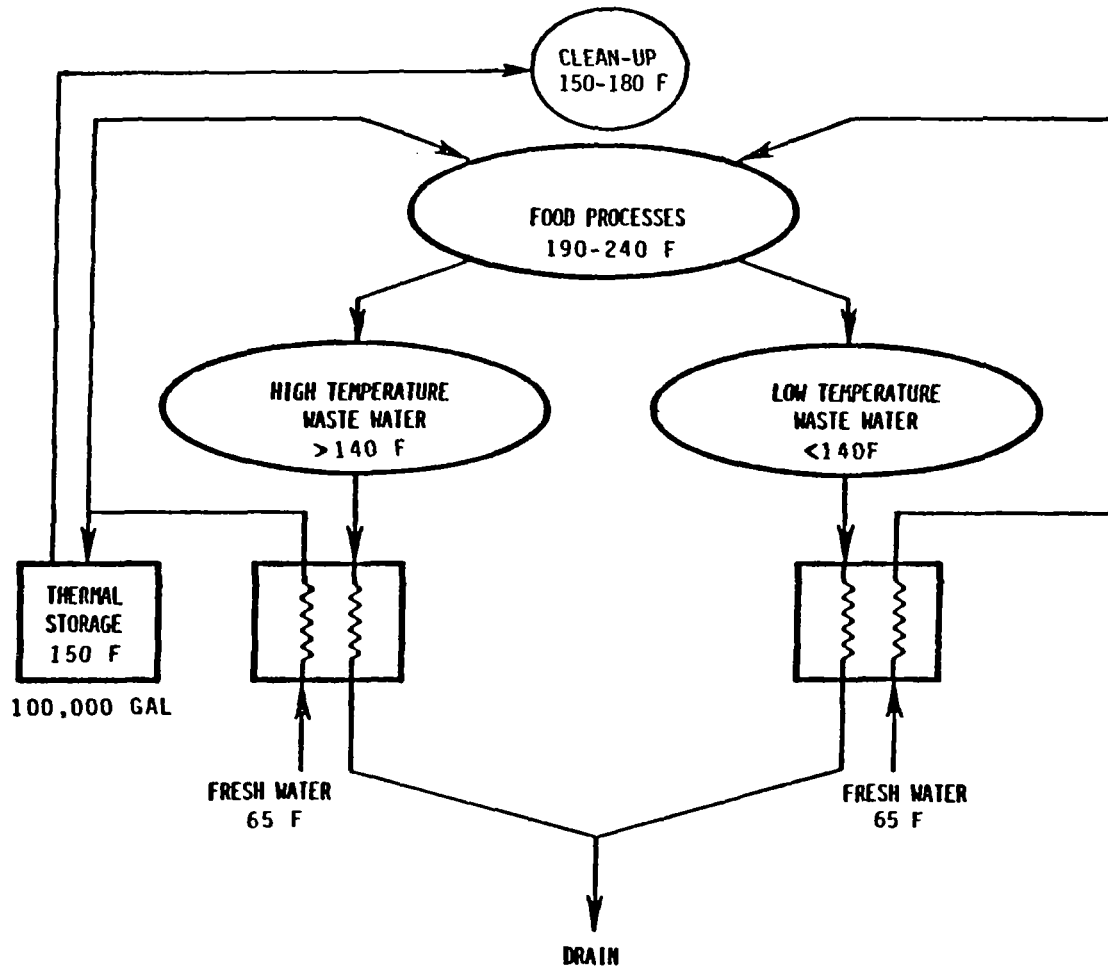

RTOP 776-71-43

## FOOD PROCESSING

### CONCLUSIONS:

SYSTEM IS ECONOMICALLY AND TECHNICALLY FEASIBLE (> 35% ROI)

INDUSTRY WIDE CONSERVATION POTENTIAL IS  $1 \times 10^6$  BBL OIL/YR (> 1982)

DEVELOPMENT REQUIRED

- o NONE

RTOP 776-71-43

### SR&T PROGRAM

- OBJECTIVES:
- o ESTABLISH ADVANCED TECHNOLOGY BASE
  - o RESOLVE GENERIC TES PROBLEMS
  - o PROVIDE EXPERIMENTAL AND ANALYTICAL SUPPORT FOR TES PROGRAM

- APPROACH:
- o IDENTIFY NEW CONCEPTS
  - o ASSESS SELECTED CONCEPTS/APPLICATIONS
  - o EXPERIMENTALLY DETERMINE MEDIA PROPERTIES/CHARACTERISTICS
  - o DEVELOP HEAT EXCHANGER HARDWARE
  - o EXPERIMENTALLY EVALUATE TES MODULES

RTOP 776-71-43

LERC PROJECT ACTIVITIES

SUPPORTING RESEARCH AND TECHNOLOGY

<u>Activity</u>	<u>Contractor</u>	<u>Status</u>
Laboratory studies to determine characteristics of carbonate phase change media as latent heat storage media for applications in advanced solar thermal power	IGT NAS3-20806 \$99K 8/80 9/77	Low temperature (< 1000°F) media study complete, final report in review, follow-on contract award 8/79 for high temperature (> 1300°F) study \$137K
Laboratory studies to determine feasibility of metal alloy media. Determine energy density, heat capacity, volume change.	Univ. of Delaware MSG 3184 \$91K 8/79 7/78	Alloys containing Mg, Si, Al, Cu and Zn identified, property and containment studies in progress, Grant extension 9/79, \$93K
Develop NaOH phase change Thermbank TES module. Extension of two previous contracts which included a computer model and laboratory scale module testing.	Comstock & Wescott DEN 3-138 \$93K 2/80 5/79	Hardware being fabricated for advanced design which includes an integral heat exchanger
Feasibility study of fluidized bed concepts for TES applications	Midwest Research Inst. DEN 3-96 \$99K 2/80 1/79	Candidate concepts and applications identified

SR&T ACTIVITIES - Cont.

<u>Activity</u>	<u>Contractor</u>	<u>Status</u>
Design, build, and evaluate active heat exchange concepts with phase change media.	Honeywell DEN 3-38 \$330K 5/78 12/79	Hardware being fabricated
Design, build, and evaluate active heat exchange concepts with phase change media.	Grumman Aerospace Corp. DEN 3-39 \$224K 6/78 12/79	Hardware being fabricated

INTERIM ACTING LEAD CENTER ACTIVITIES

- o PREPARED DRAFT PLAN "THERMAL ENERGY STORAGE TECHNOLOGY DEVELOPMENT FOR SOLAR THERMAL POWER SYSTEMS" MULTI-YEAR PROGRAM PLAN FOR DOE/STOR/CST IN MARCH 1979
- o PREPARED FINAL "MULTI-YEAR PLAN FOR THERMAL AND MECHANICAL ENERGY STORAGE PROGRAM" FOR DOE/STOR IN JUNE 1979
- o HELD PRELIMINARY MANAGEMENT MEETINGS WITH ORNL, SANDIA AND SERI TO DISCUSS IMPLEMENTATION REQUIREMENTS FOR LEAD CENTER AND LEAD LABORATORY ROLES
- o PARTICIPATED IN LEAD LABORATORY AOP PREPARATION BASED ON DOE HEADQUARTERS GUIDELINES
- o PREPARATIONS FOR ANNUAL PROGRAM REVIEW, TO BE HELD IN WASHINGTON, D.C. DECEMBER 3-4 IN PROGRESS

## SEASONAL THERMAL ENERGY STORAGE PROGRAM

James E. Minor  
Pacific Northwest Laboratory

### INTRODUCTION

The DOE Division of Energy Storage Systems is responsible for formulating and managing research and development in energy storage technology. As one element of STOR Division's Thermal Energy Storage Program, Pacific Northwest Laboratory (PNL) was assigned management of the Seasonal Thermal Energy Storage Program in April, 1979. During the latter part of FY 1979, PNL formed a Program Office for this purpose. STES Program plans were formulated, work breakdown structure developed, and existing contract work reviewed. The experimental and demonstration work of the Seasonal Thermal Energy Storage Program will be performed by industry, PNL and other DOE laboratories, and universities.

In this overview, the STES Program incentives, objectives, and long range implementation plan for achieving program goals are described. Procurements in progress in the Demonstration Program will be described in subsequent papers. Specific projects contributing to technical studies will be discussed by PNL Program staff and by contractor representatives.

### PROGRAM INCENTIVES

Storage of thermal energy is expected, in the near term, to provide a significant contribution toward achieving the goals of the National Energy Plan. This contribution will encourage a shift from use of insufficient or costly fuels such as oil and natural gas to more abundant or available energy sources such as coal, solar, and nuclear power. Thermal energy storage, when incorporated in energy supply and conservation systems, permits efficient and economical use of intermittent energy sources such as solar or off-peak electrical power. Thermal storage also may allow use of waste heat from industrial and utility sources.

The STES Program is designed to demonstrate the storage and retrieval of energy on a seasonal basis, using heat or cold available from waste or other sources during a surplus period to reduce peak period demand, reduce electric utility load problems, and contribute to the establishment of favorable economics for district heating and cooling systems for commercialization of the technology. Aquifers, ponds, earth, and lakes have potential for seasonal storage. The initial thrust of the STES Program is toward utilization of groundwater systems (aquifers) for thermal energy storage.

During the last decade, the storage of thermal energy in aquifers has received considerable attention. The motivations for storing large quantities

of thermal energy on a long-term basis have been numerous including: a) the need to store solar heat that is collected in the summer for use in the winter months; b) the cost effectiveness of utilizing heat now wasted in electrical generation plants; c) the need to profitably use industrial waste heat; and d) the need to more economically provide summer cooling for buildings. Seasonal aquifer storage should contribute significantly to satisfy the above needs. Most geologists and ground-water hydrologists agree that heated and chilled water can be injected, stored, and recovered from aquifers. Geologic materials are good thermal insulators, and there are potentially suitable aquifers distributed throughout the United States. Recent studies and small-scale field experiments have reported energy recovery rates above 70 percent for seasonal storage. The U.S. Department of Energy predicts that, by the year 2000, seasonal aquifer storage could replace or conserve up to 350 million barrels of oil per year. However, successful demonstration of large-scale aquifer thermal energy storage has not yet been attempted and the concept's economic feasibility and institutional acceptability have yet to be established.

Many potential energy sources exist for use in an aquifer thermal energy storage system. These include solar heat, power plant cogeneration, winter chill, and industrial waste heat sources such as aluminum plants, paper and pulp mills, food processing plants, garbage incineration units, cement plants, and iron and steel mills. For heating, energy sources ranging from 50 to over 250°C are available. Potential energy uses include space heating on an individual or district scale, heating for industrial or institutional plants and heat for processing/manufacturing.

#### PROGRAM OBJECTIVES

The objective of the Seasonal Thermal Energy Storage (STES) Program is to demonstrate the economic storage and retrieval of energy on a seasonal basis, using heat or cold available from waste sources or other sources during a surplus period to reduce peak period demand; reduce electric utilities peaking problems; and contribute to the establishment of favorable economics for district heating and cooling systems. Aquifers, ponds, earth, and lakes have potential for seasonal storage. The initial thrust of the STES Program is toward utilization of ground-water systems (aquifers) for thermal energy storage.

The program has the further objective of evaluating other methods of seasonal storage, both from existing literature and by following current work in other countries. New program thrusts may be recommended as a result of these studies.

#### PROGRAM IMPLEMENTATION

The STES Program is divided into an Aquifer Thermal Energy Storage (ATES) Demonstration Task and a parallel Technical Support Task. Seasonal storage in aquifers will be evaluated in the ATES Demonstration Task, beginning with the conceptual design of site-specific systems and operation of a smaller number



of demonstration projects. The basic function of such an energy storage system is to accept, store, and discharge energy in accordance with availability and demand. Thus, the aquifer storage system provides a buffer between the time-dependent energy inputs and thermal loads or outputs. An aquifer thermal energy storage system is an integrated system consisting of an energy source, thermal transport, a storage aquifer, and a user application. Energy may be supplied for storage from a solar collector, heat pump, industrial heat source, a cogeneration power plant, or other sources. Conversely, chilled water may be supplied and stored for future uses in air conditioning.

In response to a Request for Proposal (RFP), prospective contractors will submit proposals for ATEs Demonstration Project conceptual designs (Phase I). The contractors will develop conceptual designs for integrated systems containing energy source, thermal transport, aquifer storage, and user subsystems. Aquifers will be characterized by geologic exploration and analysis of existing data. Functional design criteria will be developed for each subsystem and for the integrated systems. From the functional design criteria and the aquifer characterization reports, proposals will be evaluated for continuing work in Phase II. Phase II is the detailed design, construction, startup, and operation of ATEs Demonstration Projects. Timing of this task is shown in Figure 1.

The parallel Technical Support Task is designed to provide support to the overall STES Program. The initial activities of this task are primarily directed toward support of the ATEs Demonstration Task. These activities will include social, economic, environmental assessment, and technical research and development studies to provide a sound technical base for the demonstration projects. The long-range task goals include investigation and evaluation of other seasonal thermal energy storage concepts which may be considered for future emphasis. It is the intent of the Technical Support Task to reduce technological barriers to the development of energy storage systems prior to the significant investment in demonstration or commercial facilities. Through research and testing on novel storage concepts, aquifer characteristics, system designs, and system operating criteria, this task can assist developers in obtaining a successful energy storage facility. This task is designed to not only provide technological information on energy storage systems, but also to assist in identifying systems which are economically sound, environmentally acceptable, and within existing legal and institutional constraints.

A major function under the Technical Support Task is development of one or more Leading Edge Test Facility(s) (LETf). The LETf is a site or sites established to test heating and/or chilling technologies for energy storage in aquifers. This facility is the forerunner of demonstration projects for aquifer thermal energy storage. As a forerunner, the facility will assist in the development of energy storage technology through research and development activities. This facility will have the capability of performing full-scale tests on both heating and chill energy storage technologies. More than one LETf may be required. The aquifer requirements (confined versus unconfined), heat sources and end uses of low-temperature versus high-temperature storage concepts may necessitate the use of more than one leading edge unit.

The Seasonal Thermal Energy Storage (STES) Program will involve industry, other Department of Energy (DOE) laboratories, and universities. Major tasks and subtasks of the program are shown in Figure 2. Figure 2 also shows the responsible organizations working on the subtasks. Figure 3, the Network Diagram, shows the coordination of effort planned to meet program objectives.

FIGURE 1. AQUIFER THERMAL ENERGY STORAGE PROGRAM

	1979				1980				1981				1982				1983				1984				1985									
	S	O	N	D	J	F	M	A	M	J	J	S	O	N	D	1	2	3	4	1	2	3	4	1	2	3	4	1	2	3	4	1	2	3
PUBLISH RFP	▲																																	
CONDUCT PROPOSERS CONFERENCE	▲																																	
RECEIVE CONTRACTOR PROPOSALS																																		
COMPLETE CONTRACTOR SELECTION																																		
PRESENT ATEES PROJECT SELECTION TO DOE																																		
PRESENT ATEES MISSION ANALYSIS TO DOE																																		
COMPLETE NEGOTIATIONS & CONTRACT AWARD OF CONCEPTUAL DESIGN CONTRACTS																																		
START PHASE I DESIGNS																																		
COMPLETE PHASE I DESIGNS																																		
START PHASE II																																		
COMPLETE PHASE II																																		

FIGURE 2. STES PROGRAM ORGANIZATION

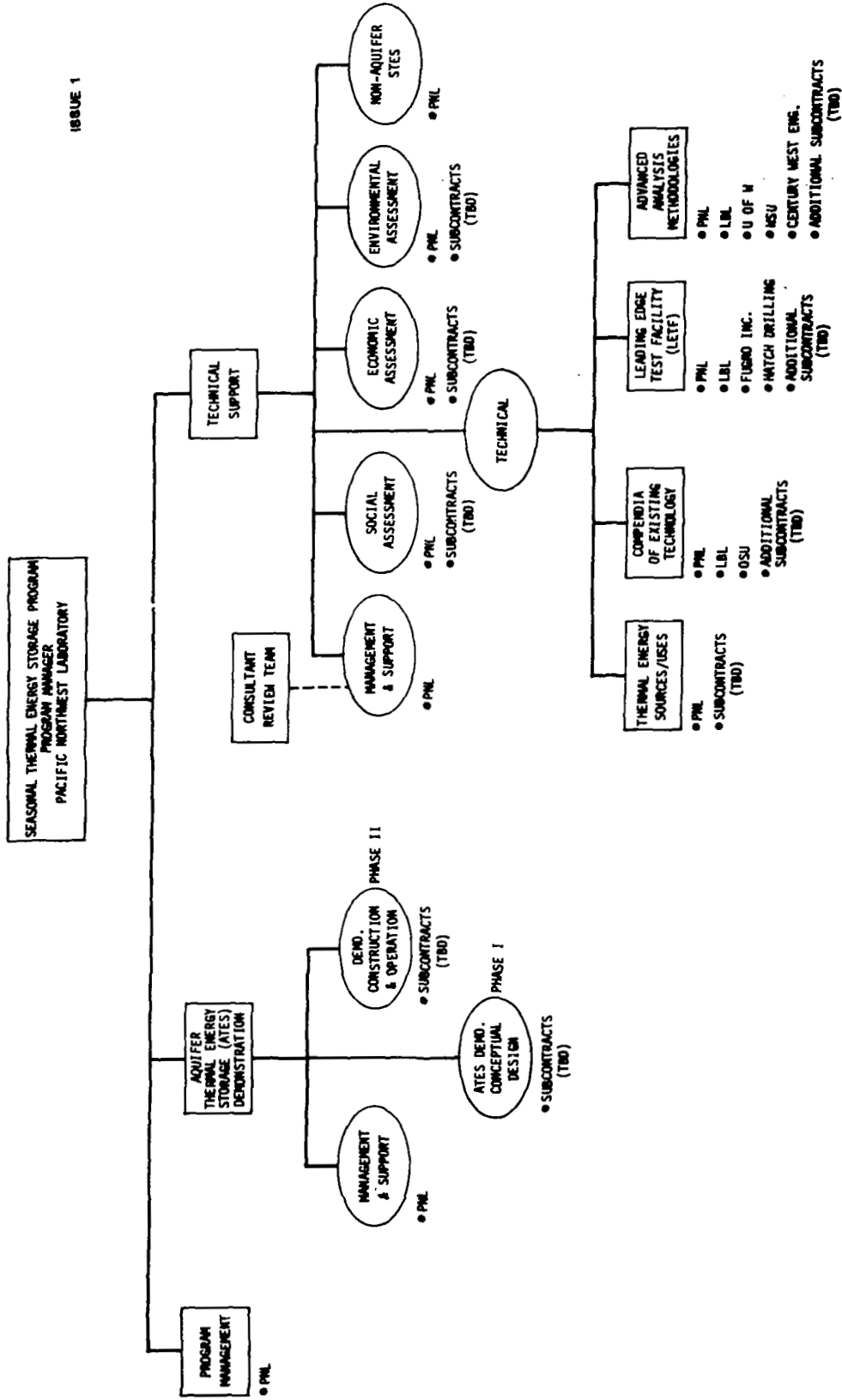

### FIGURE 3. SUMMARY NETWORK SEASONAL THERMAL ENERGY STORAGE

ISSUE 3  
10-1-78

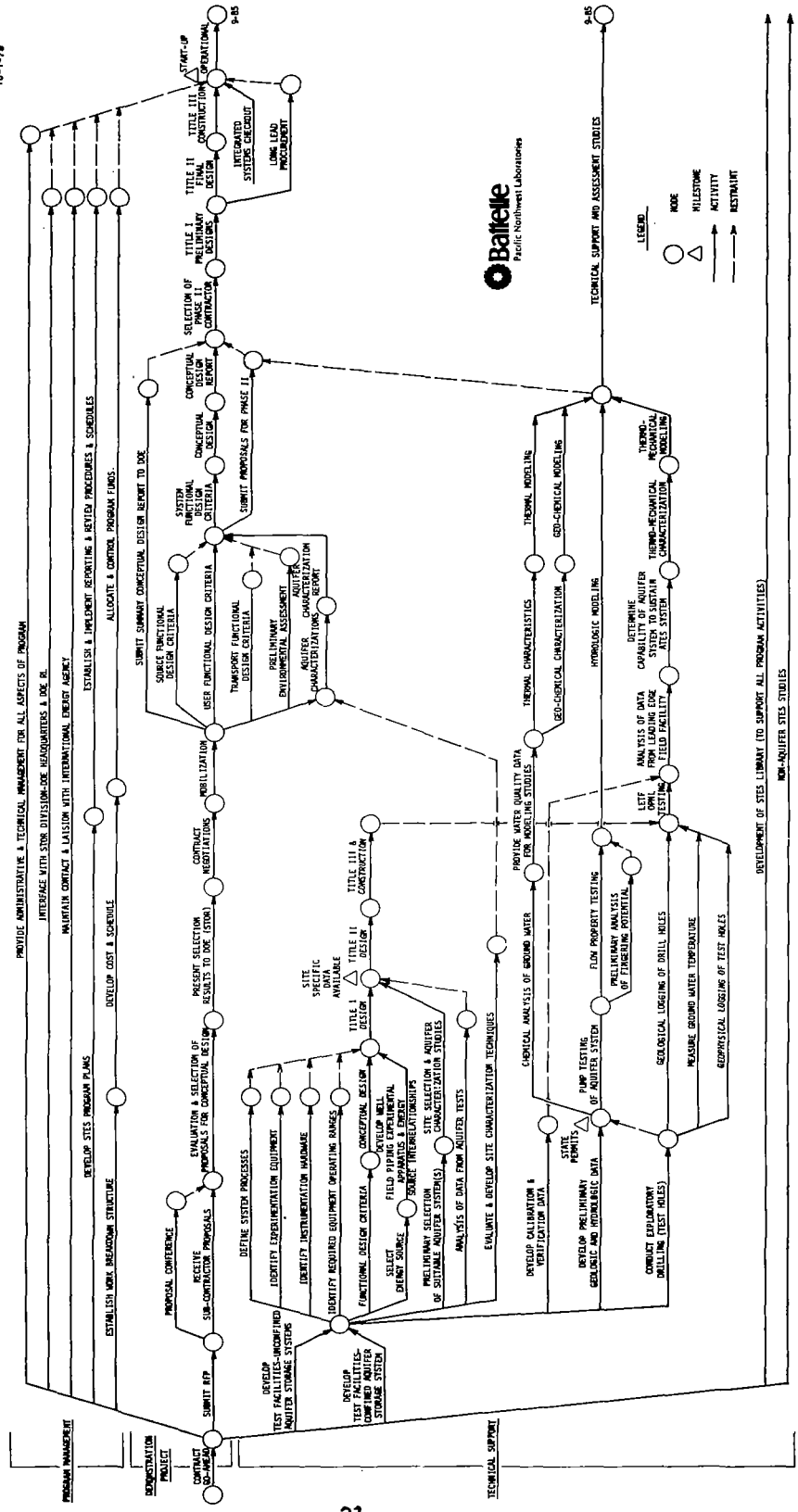



## PROGRAM DEFINITION AND ASSESSMENT

An essential function related to management of the overall thermal energy storage program is that of program definition and assessment. The major emphasis in this activity is the implementation of a program level assessment of thermal energy storage technology thrusts for the near and far term to assure an overall coherent energy storage program. Included is the identification and definition of potential new thermal energy storage applications, definition of technology requirements, appropriate market sectors. This activity also includes the necessary coordination, planning and preparation associated with program reviews, workshops, multi-year plans and annual operating plans for the major lead laboratory tasks. SERI assessment tasks will be coordinated and integrated into this activity.





PROGRAM DEFINITION AND ASSESSMENT  
OVERVIEW

Larry H. Gordon  
NASA Lewis Research Center

The activities described in this program area assume that LeRC is performing the lead center function for the DOE Thermal Energy Storage Project and therefore, include those functions related to management of the lead laboratories. A primary emphasis is placed on the implementation of overall program definition and associated thermal energy storage system evaluations. In this context the objectives are: 1) to provide overall TES program guidance and 2) to ensure timely developments/demonstrations. To achieve these objectives, a competitive contract would be awarded which would consist of the following:

- a. Conducting a supporting analysis of the current program areas with major emphasis on solar thermal applications. Storage alternatives will be identified along with technology requirements. Value comparisons will be performed and commercialization requirements will be identified.
- b. Identifying new applications and their technology requirements. New storage concepts defined and economic evaluation will be performed. Suitable demonstrations will be recommended in those application areas offering potential for substantial ROI.
- c. Assuring overall integration and coordination of thermal storage developments with the appropriate DOE end-use divisions. This task will include assessments of technical progress, coordination of development goals, and milestones. Particular attention will be given to the impact of environmental requirements.

As shown in Figure 1, the Thermal Storage Program develops reliable, efficient, inexpensive storage technologies to support other DOE or private sector end-users in their substitution and energy savings missions. Within DOE this is accomplished by technology transfer agreements between STOR and the respective end-use divisions. The lead center is responsible for ensuring that the milestones, resources, and technology transfers are accomplished. Initially, an energy storage program assessment is performed for a particular application area. If this assessment indicates that thermal energy storage is competitive with respect to other storage technologies (batteries, flywheels, etc.), then the objective/goals can be defined for a project area. The lead laboratory provides the necessary management to implement the project and provide the necessary technology for transfer to the end-user.

Lead laboratory project structure generally takes a form similar to that shown in Figure 2. System studies are application oriented and consist of concept identification, technoeconomic assessments, and conceptual design studies. Concept development activities include development of storage concepts to the point of establishing the technical feasibility and assessing the concepts based on general application requirements. Establishing technical feasibility involves both concept feasibility studies and small-scale laboratory experiments.

The subsystem development phases culminates with technology readiness or technology validation for the storage subsystem. Activities include subsystem definition, engineering development, and subscale research experiments (SRE's). Throughout these various project phases continuous efforts are directed toward generic advanced technology and exploratory research studies thus providing a supporting research and technology base.

To examine how program/project assessments relate to and influence the project structure, let us use the electric utility application area as an example. Approximately four (4) years ago, an assessment of "Energy Storage Systems Suitable for Use by Electric Utilities" was made by Public Service Electric and Gas Company of New Jersey (ref. 1). The specific objectives of this program assessment for DOE (ERDA) and the Electric Power Research Institute were:

- o Identify the potential effect of energy storage on the electric utility systems of the United States.
- o Determine the status of development and the feasibility of commercialization of candidate energy storage technologies, and establish their key technical and cost characteristics.
- o Evaluate the relative merits of energy storage options on the basis of economic, operational, and environmental factors.
- o Identify research and development needed to advance the various storage technologies.

Based on this assessment, one of the major findings was that with sufficient off-peak energy available from baseload coal and nuclear capacity, energy storage could provide generating capacity for up to 17 percent of peak load demand (kW). An energy storage technology which was considered to be competitive with conventional pumped hydro was thermal energy. Hence, a DOE (ERDA) project was created for thermal energy storage in peak following electric utility applications. (See example inserts in Figure 1).

The first project assessment conducted as part of the system studies phase was performed by Bechtel Corp (ref. 2). For near-term utility applications it was felt that thermal energy storage could be easily "retrofitted" to existing power plants. However, the project assessment concluded that high capital costs and long retrofit downtimes negated the use of thermal energy storage. On a positive side, it was recommended that thermal energy storage might be attractive for "new construction" coal and nuclear power plant application. A second assessment for New Plant Thermal Energy Systems was performed by General Electric (ref. 3).

This "new plant" assessment was quite extensive and examined some 50+ technologies applicable to thermal energy storage subsystems. From this matrix, twelve (12) concepts were selected for a detailed technoeconomic assessment as shown in Figure 3. Conceptual designs of four selected TES system concepts were integrated into conventional base loaded plant designs. These concepts, as indicated on Figure 3, were as follows:

- a. A dual media, sensible heat, thermal energy storage integrated with a high sulfur coal power plant and supplying steam to a separate peaking power conversion system.
- b. An underground, high temperature water, thermal energy storage integrated with a high sulfur coal power plant and supplying steam to a separate peaking power conversion system.
- c. An above ground, high temperature water, thermal energy storage integrated with a Pressurized Water Reactor power plant and supplying boiler feedwater preheat.
- d. A dual media, sensible heat, thermal energy storage integrated with a Pressurized Water Reactor power plant and supplying boiler feedwater preheat.

Nevertheless, the bottom line of this assessment concluded that load leveling thermal storage is only marginally competitive with baseload, coal fired, cycling plants.

How the results of the Bechtel and General Electric assessments affected the "Peak Following Thermal Storage for Steam Electric Power" project is graphically shown in Figure 4. Based on the "negative" and "marginally competitive" assessments, the planned concept development and technology validation phase of the project were redefined. Future development activities for utilities will be directed toward compressed air energy storage (CAES). CAES incidentally, was also a competitive storage technology identified by the PSE&G Program assessment.

To further emphasize the scope of these assessments, an on-going program assessment for Solar Applications Analysis for Energy Storage will be reviewed by the Aerospace Corporation. In addition, the various project assessments required for TES in Solar Thermal Electric Power Applications will be reviewed by Sandia Laboratory Livermore. The importance of all of these assessments cannot be over-emphasized as a primary means of meeting the objectives of this Program Definition and Assessment activity.

Another input used to achieve the activity's objectives is to periodically have an independent review of the Thermal Storage Program. Specifically, for this program review, a committee was established and was charged to provide DOE/STOR and its management centers with a broad, objective review of the goals, content, and accomplishments of the Thermal Energy Storage Program. In this review, the committee was directed to:

- o Include all thermal energy storage subsystem technologies (containment, heat exchange, media, controls, and institutional constraints) and technologies for heat transport.
- o Exclude thermochemical heat pump storage subsystems.

And for consistency, the following definitions were noted:

Buffering Storage	1/2 to 2 hours
Diurnal Storage	2 to 12 hours
Long (Seasonal) Duration Storage	Greater than 12 hours
Near-Term Time Frame	1980 to 1985
Mid-Term Time Frame	1985 to 1990
Far-Term Time Frame	1990 and beyond

The review committee consisted of eleven (11) members representing a cross-section of state energy departments, academia, DOD, EPRI, and the National Research Council. Members or their representatives are listed in Figure 5. Prior to this meeting, specific questions to be addressed by the committee were generated. These questions, noted in Figures 6-7, will serve as the basis not only for discussion by the committee but also for open discussions throughout the two day program meeting. Responses will be reported in the proceedings for this program review.

REFERENCES

1. (PSE&G) Public Service Electric and Gas Company, An Assessment of Energy Storage Systems Suitable for Use by Electric Utilities, Volumes 1, 2, and 3, EPRI EM-264 ERDA E (11-1)-2501; Prepared for Electric Power Research Institute and Energy Research and Development Administration; Newark, New Jersey, July 1976.
2. Bechtel Corporation, Retrofitted Feedwater Heat Storage for Steam Electric Power Stations Peaking Power Engineering Study, CONS/2863-1; Final Report prepared for ERDA; Bechtel Corporation, Research and Engineering, San Francisco, California, October 1976.
3. General Electric Company-TEMPO, "Conceptual Design of Thermal Energy Storage Systems for Near-Term Electric Utility Applications", Volume 1, 2, DOE/NASA/0012-78/1, Final report prepared for DOE under contract DEN 3-12, October 1978.

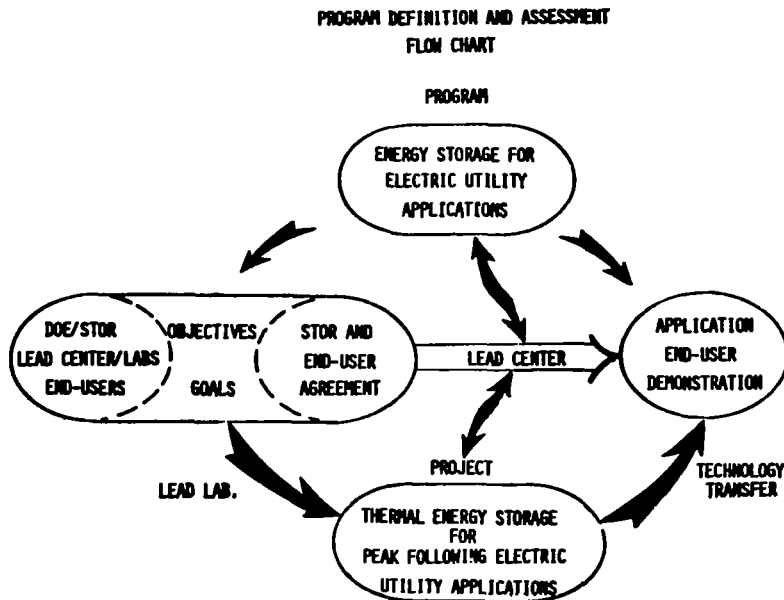
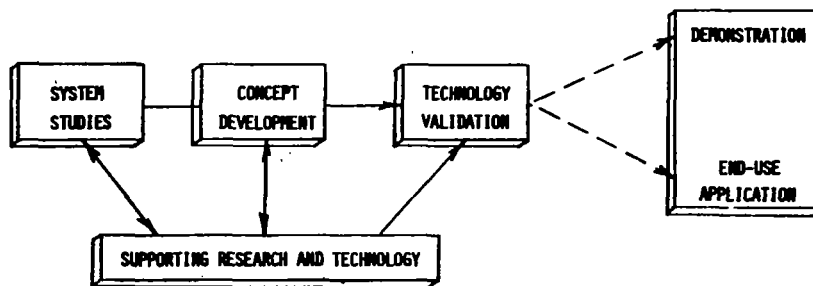

FIGURE 1



PROJECT STRUCTURE

FIGURE 2

**NEW PLANT TES ASSESSMENT**

(GENERAL ELECTRIC)

**CONCEPTS**

TYPE	MEDIUM	FEATURE	UTILIZATION
SENSIBLE HEAT	WATER	PRESTRESSED CAST-IRON VESSEL	FWH, SG
		PRESTRESSED CONCRETE AND WELDED STEEL PRESSURE VESSELS	FWH, SG
		CONCRETE-SUPPORTED CAVERN TANK	SG
		AIR-SUPPORTED CAVERN TANK	FWH
		AIR-SUPPORTED CAVERN TANK - STEEL LINED	SG
		AQUIFER	FWH
	WATER/STEEL	HEAVY WALLED STEEL CYLINDERS	FWH, SG
	OIL	DUAL TANKS	FWH
	OIL AND ROCK	THERMOCLINE TANK	FWH, SG
	OIL/MOLTEN SALT	TWO STAGE, DUAL OR THERMOCLINE TANK	SG
MOLTEN SALT	DUAL TANKS	SG	
	PHASE CHANGE	SALT EUTECTIC	DIRECT CONTACT SYSTEM

FWH - FEEDWATER HEAT  
SG - STEAM GENERATION

FIGURE 3

PEAK-FOLLOWING THERMAL STORAGE FOR STEAM ELECTRIC POWER

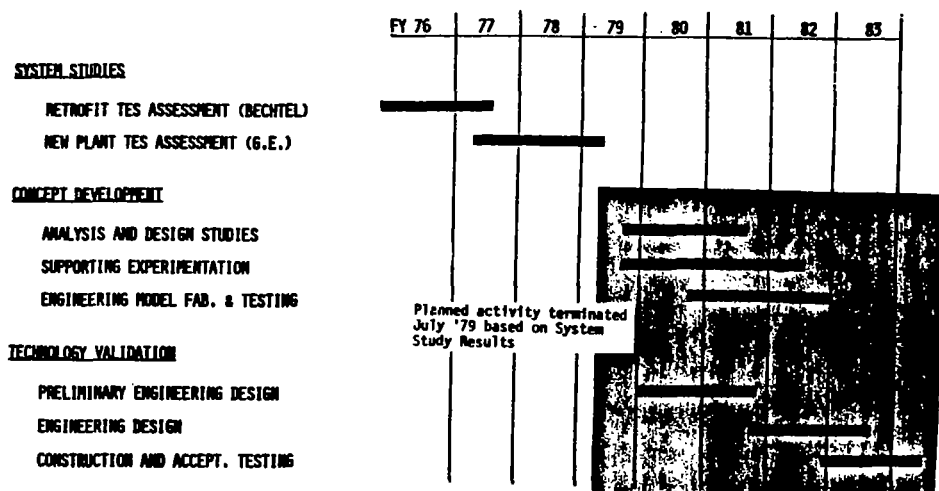

FIGURE 4

Philip Jarvinen	- Lincoln Laboratory
Andrew Kource	- U.S. Army
Michael O'Callaghan	- Massachusetts Institute of Technology
C. J. Swet	- Consultant, Thermal Storage
Milo Belgen	- Ohio Department of Energy
Henry Rice	- Nebraska Public Power
D. D. Wyatt	- National Research Council
Brian Swaiden	- U.S. Navy

FIGURE 5

TES REVIEW COMMITTEE

QUESTIONS:

1. IF STOR HAD TWICE THE FUNDING, WHAT PROGRAMS SHOULD BE INCREASED? WHAT NEW PROJECTS SHOULD BE INITIATED?
2. IF STOR PROGRAMS WERE REDUCED BY ONE HALF, WHAT PROGRAMS SHOULD BE REDUCED? WHAT PROGRAMS SHOULD BE DELETED?
3. ARE STOR PROGRAMS MISSION ORIENTED?
  - o DOES THE REVIEW COMMITTEE SEE REAL WORLD APPLICATIONS FOR ALL TECHNOLOGIES?
4. NEAR-TERM PROJECTS IN THE INDUSTRIAL, SOLAR THERMAL ELECTRIC, AND BUILDING HEATING/COOLING APPLICATION SECTORS REQUIRE HEAVY BUDGET OUTLAYS RESULTING IN DE-EMPHASIZING LONG-TERM, BASE TECHNOLOGY WORK.
  - a. DO WE HAVE A PROPER FUNDING BALANCE OF LONG-TERM VS. NEAR-TERM? IF NOT, WHAT SHOULD BE CHANGED?
  - b. IS THERE A PROPER FUNDING BALANCE AMONG THE NEAR-TERM PROJECTS?
  - c. DO YOU PERCEIVE AN ADEQUATE DEVELOPMENT TECHNOLOGY BASE THAT WILL LEAD TO DEVELOPMENT OF NEW TECHNOLOGY INITIATIVES IN THE FUTURE? IF NOT, WHAT SUGGESTIONS?
5. WHAT SHOULD STOR BE LOOKING FOR IN INTERNATIONAL COOPERATIVE PROGRAMS AND WHAT SHOULD STOR BE PROTECTING IN INTERNATIONAL NEGOTIATIONS?
6. WHAT ARE THE BEST MECHANISMS FOR TRANSFERING TECHNOLOGY TO THE COMMERCIAL BASE?
7. HOW DO WE DECIDE WHEN ACTIVITIES ARE READY FOR TRANSFER?
8. WHAT ARE YOUR OVERALL IMPRESSIONS OF THE PROGRAM:
  - o FOCUS, BALANCE, DIRECTION?
  - o TIMELINESS?
  - o USEFULNESS?
9. WHAT OTHER KEY QUESTIONS DO YOU THINK THIS REVIEW COMMITTEE SHOULD ADDRESS? DO YOU THINK THERE ARE BETTER WAYS TO RUN THIS REVIEW COMMITTEE?
10. DO YOU HAVE ANY SUGGESTIONS FOR IMPROVING THIS CONFERENCE AND OTHER INFORMATION EXCHANGE MEETINGS?

FIGURE 6-7





## SOLAR APPLICATIONS ANALYSIS FOR ENERGY STORAGE

T. Blanchard  
DOE/STOR Aerospace Corporation

The Department of Energy, Division of Energy Storage Systems (STOR) recently started an analysis of the role of energy storage as it relates to solar energy systems to 1) determine where storage technologies can best support solar energy applications, 2) assess the current status of storage technologies, 3) establish requirements and specifications for storage technologies and 4) evaluate the adequacy of the current storage R&D program to meet these requirements. The basic objective of the study is to determine where the greatest potential exists for energy storage in support of those solar energy systems which could have a significant impact on the U. S. energy mix. Such a determination could consequently provide program guidance as to how STOR can best expand their R&D resources to meet this potential.

The four parts of the study can be seen on the facing chart. The first will be the determination of the spectrum of roles for solar energy storage technologies. This will include an evaluation of the potential impact of solar/storage systems to displace fossil fuel systems. The second part will look at ongoing and completed solar/storage assessments to determine their adequacy and validity and will identify specific requirements and goals for storage technologies. Specific operational properties of storage technologies, as well as the system performance and cost goals required to meet the solar program needs, will be identified. The above information will then be utilized to determine the adequacy of the STOR R&D program, and recommendations will be made for supplementing or altering the STOR multiyear program plan, as needed.

## SOLAR APPLICATIONS ANALYSIS FOR ENERGY STORAGE

**WHAT DO WE HOPE TO ACHIEVE DURING THIS ANALYSIS OF SOLAR APPLICATIONS AND THEIR REQUIREMENTS FOR ENERGY STORAGE?**

- **AN ANALYSIS OF THE SPECTRUM OF SOLAR ACTIVITIES AND APPLICATIONS TO DETERMINE THEIR NEEDS FOR ENERGY STORAGE, SENSITIVITY TO THE AVAILABILITY AND PROPERTIES OF STORAGE, AND POTENTIAL IMPACT OF THE SOLAR/STORAGE SYSTEMS ON FOSSIL FUEL USE**
- **BRING TOGETHER BOTH SOLAR AND STORAGE PROGRAM RESEARCHERS TO ASSESS THE RESULTS OF ONGOING AND COMPLETED EFFORTS AND DEVELOP ADDITIONAL PARAMETRIC DATA TO IDENTIFY REQUIREMENTS AND GOALS FOR STORAGE TECHNOLOGIES IN SUPPORT OF SOLAR PROGRAMS**
- **IDENTIFICATION OF SPECIFIC ENERGY STORAGE PROPERTIES, DESIRED FEATURES AND PERFORMANCE/COST GOALS IN ORDER TO MEET THE NEEDS OF SOLAR PROGRAMS**
- **WITHIN THE CONTEXT OF TEA ACTIVITIES GENERATE DECISION CRITERIA WITH WHICH TO EVALUATE THE ADEQUACY OF STORAGE TECHNOLOGIES MULTI YEAR PROGRAMS PLANS WITH RESPECT TO THEIR SUPPORT OF PROPOSED SOLAR PROGRAMS**

The study is planned to be completed in about 24 months and consists of three specific tasks, applications analysis, storage technology and systems analysis, and solar and storage systems assessment. The relationship of energy storage to both the user and the energy source will be addressed and input/output requirements and energy source/user relationships will be used to establish characteristic storage data.

In order to determine the need for energy storage and desired system properties, i.e., size, storage, density, etc., interactions between the user and solar energy source must be examined and specific items of information determined. These required data inputs and analysis represent those that must be developed in order to generate rationale and tradeoffs necessary to determine goals and requirements of storage systems. Much of this information has been developed in prior solar program/project studies that have addressed the problem of storage from a limited perspective or economic viewpoint that possibly presupposed the need for storage. The multitude of separate solar projects that have addressed energy storage must be reviewed to determine the level to which storage had been considered and the availability of information to develop storage requirements. In those areas lacking sufficient information, special studies will be proposed to develop the needed data. Parametric analyses will also be required to examine the influence of energy storage characteristics on the economic and performance aspect of solar applications. The results of the parametric studies can be used to establish driving or highly leveraged storage/solar application categories in terms of performance or economy. The identification of this type of sensitivity information is essential in developing an overall set of goals and requirements for energy storage.

## STUDY APPROACH

### TASK I APPLICATIONS ANALYSIS

#### REVIEW & SCREEN ENERGY SOURCE/USER DATA FROM ONGOING AND COMPLETED SOLAR PROGRAM EFFORTS

- REVIEW TO ASSESS LEVEL OF STORAGE CONSIDERATION
- ANALYZE STORAGE SYSTEM SPECIFICATIONS/REQUIREMENTS
- CONSOLIDATE SPECIFICATIONS/REQUIREMENTS

### TASK II STORAGE TECHNOLOGY AND SYSTEMS ANALYSIS

#### ASSESS THE ABILITY OF CURRENT STORAGE TECHNOLOGY PROGRAMS TO MEET REQUIREMENTS/GOALS

- DEVELOP CANDIDATE STORAGE OPTIONS & CHARACTERISTICS
- EVALUATE AND ASSESS PREVIOUS ANALYSES OF OPTIONS
- SPECIAL STUDIES: ECONOMIC, TECHNICAL, INSTITUTIONAL, ENVIRONMENTAL
- SUMMARIZE ASSESSMENT OF EACH APPLICATION CATEGORY

### TASK III SOLAR AND STORAGE SYSTEMS ASSESSMENT

#### RECOMMEND STORAGE R&D EFFORTS

- ASSESS TASK I & II EFFORTS TO DETERMINE STATUS OF STORAGE TECHNOLOGIES TO MEET REQUIREMENTS OF SOLAR APPLICATIONS
- RECOMMEND R&D PROGRAMS

Overall guidance and management of the study is being provided by STOR's Technical and Economic Analysis Branch and by The Aerospace Corporation. Technical expertise and support required in reviewing solar program data and in performing required special studies will be provided through the use of an Application and Storage Advisory Panel which includes three subpanels for specific storage technology assessments. Due to the cross-section of solar programs and offices involved, membership in the Applications and Storage Advisory Panel is quite broad and includes representation from DOE, and the National and Solar Laboratories.

Technical support for the study is solicited mainly from these National and Solar Laboratories; however, representatives from the university and industrial sectors will be utilized as needed to provide specific expertise.

## Organizational Structure

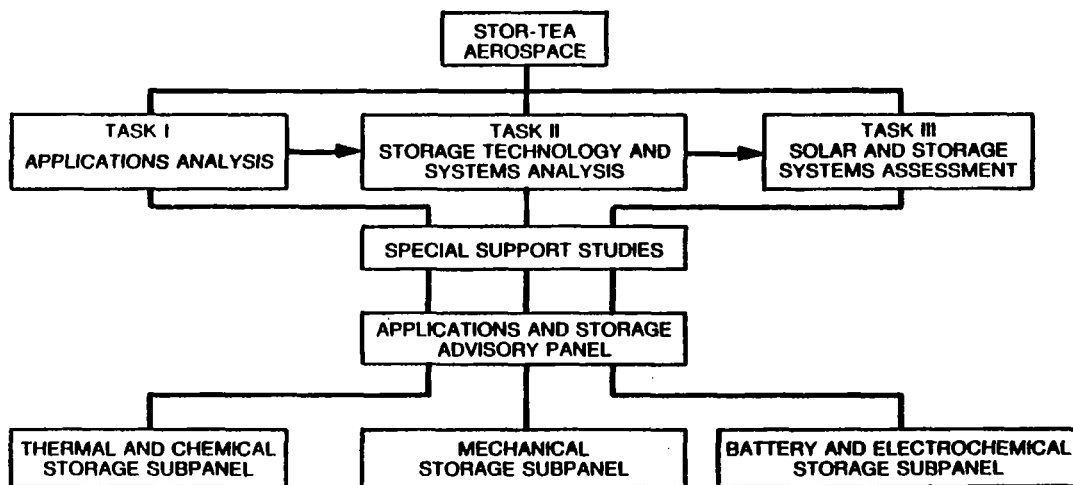

As mentioned earlier, the study is currently planned to conclude in about two years during which time recommendations would be made for inclusion in the STOR program planning cycle. However, as a means for providing some near term guidance to STOR, a workshop was held in November, 1979. This workshop was attended by representatives from DOE and the National and Solar Laboratories as well as academic and industrial sector.

The workshop was conducted to identify the areas where the use of energy storage systems could have some impact upon the applications of solar energy sources and to select several which could have a near term impact for either displacing a portion of the fossil fuel energy sector or for providing a noticeable effect on the conservation of existing energy resources. First, the three dimensional matrix seen on the facing figure was to be completed to identify which solar sources are most appropriate to provide energy for the identified applications areas, and those storage technologies which best support the solar energy/application combinations. One sample matrix, for Residential-Single Family applications, was completed during the workshop. The development of a methodology for completing the matrixes was a meaningful product of the workshop and the matrixes for the other applications areas will be completed in the near future by the workshop participants.

## Solar Applications/Energy Storage Matrix

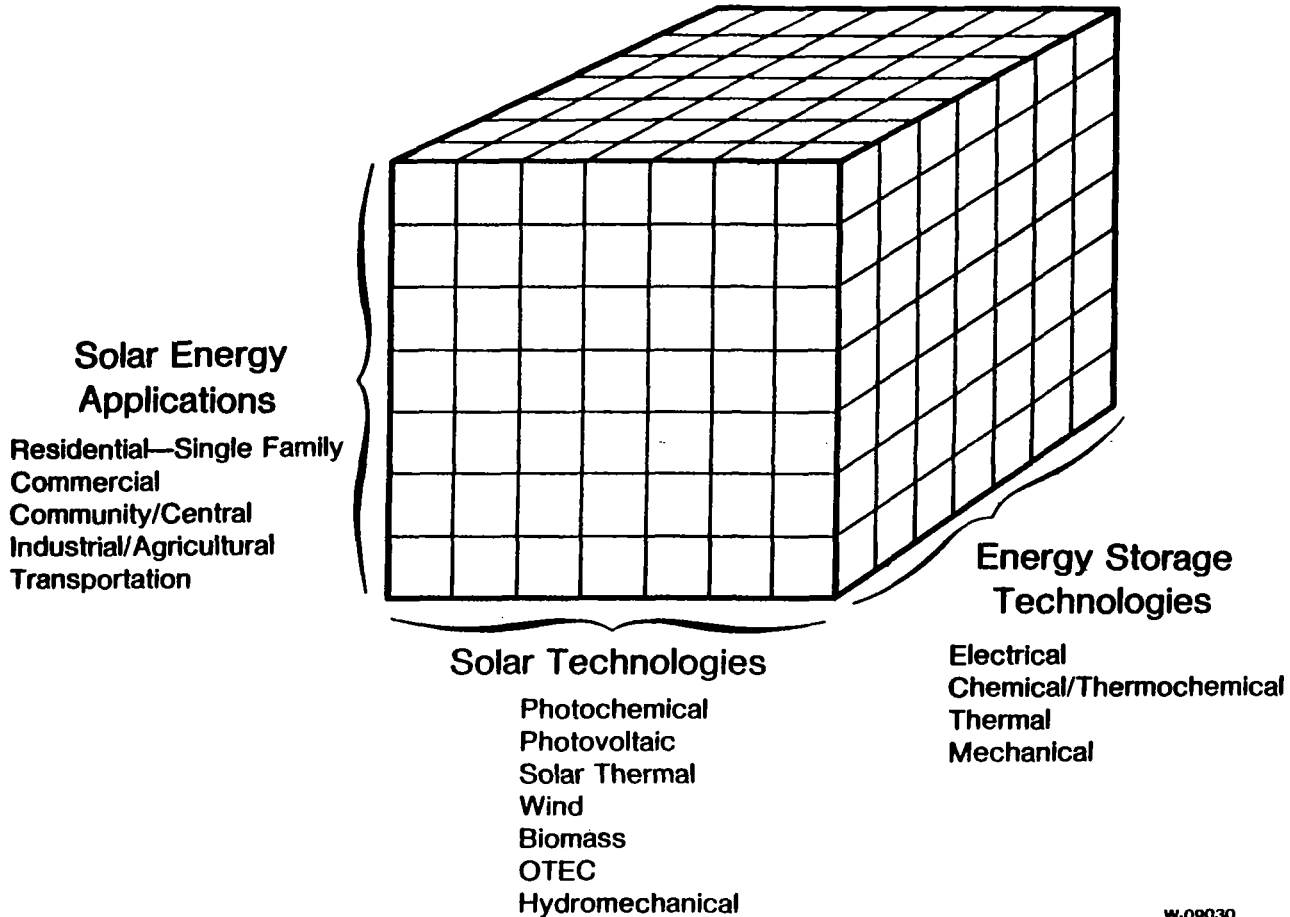

W-09030

## THERMAL ENERGY STORAGE SYSTEMS USING FLUIDIZED BED HEAT EXCHANGERS

V. Ramanathan, T. E. Weast, and K. P. Ananth  
Midwest Research Institute

### PROJECT OUTLINE

**Project Title:** TES Utilizing Fluidized Beds Assessment

**Principal Investigator:** Dr. K. P. Ananth

**Organization:** Midwest Research Institute  
425 Volker Boulevard  
Kansas City, MO 64110

**Project Goals:** The objective of this project is to identify and analyze the operation, characteristics and economics of potential thermal energy storage applications using fluidized bed heat exchangers.

**Project Status:** Identify potential fluidized bed concepts for thermal energy storage applications and perform a technoeconomic evaluation of selected heat exchanger/storage applications.

Potential fluidized bed/thermal storage applications have been identified.

A technoeconomic evaluation is being performed on two selected concepts

**Contract Number:** DEN3-96

**Contract Period:** January 1979 to September 1979

**Funding Level:** \$99,000

**Funding Source:** NASA Lewis Research Center

THERMAL ENERGY STORAGE SYSTEMS USING  
FLUIDIZED BED HEAT EXCHANGERS\*

V. Ramanathan, T. E. Weast, and K. P. Ananth  
Midwest Research Institute - Kansas City

SUMMARY

A systems study is being conducted to determine the viability of using Fluidized Bed Heat Exchangers (FBHX) for Thermal Energy Storage (TES) in applications with potential for waste heat recovery. Of the candidate applications screened, Cement Plant Rotary Kilns and Steel Plant Electric Arc Furnaces were identified, via the chosen selection criteria, as having the best potential for successful use of FBHX/TES system. A computer model of the FBHX/TES systems has been developed and the technical feasibility of the two selected applications has been verified. Economic and trade-off evaluations are in progress for final optimization of the systems and selection of the most promising system for further concept validation.

INTRODUCTION

The development of efficient (TES) systems is necessary for many energy conservation programs to be technically and economically attractive. By utilizing the mass of a fluidized material for thermal energy storage, the energy transfer and storage functions can be integrated into a common FBHX/TES system. Systems used for recovery of sensible heat generally use either conventional tubular type exchangers or direct contact of a working fluid with a fixed storage media which require large heat transfer surface areas and may be subject to plugging of the flow by loose particles. In addition to TES, FBHX's can eliminate these potential heat transfer problems.

The objective of this project is to identify and analyze operating characteristics and economics of potential FBHX/TES systems when used for waste heat recovery and utilization. The conceptual study formulated to address this objective is divided into two major tasks. Task I defines potential FBHX concepts and identifies potential applications into which TES can be efficiently integrated. Task II evaluates the technical and economic feasibility of the two

---

\* NASA - Lewis Research Center; Contract No. DEN 3-96.

most promising systems identified in Task I and recommends one application for additional study or demonstration.

This paper summarizes the results of Task I and the status of Task II which is still in progress. Interim conclusions and future efforts are also presented.

## TASK I - FBHX CONCEPT DEFINITION, TES APPLICATION IDENTIFICATION, AND SYSTEM INTEGRATION AND SELECTION

### FBHX Concept Definition

Since the TES media is the mass of the FBHX bed material, it is necessary to evaluate the numerous FBHX configurations for identification of the most effective types for TES systems. Numerous configurations of fluidized bed heat exchangers are possible. Representative FBHX configurations are depicted in Figure 1. A vertical multistage bed with countercurrent contacting is presented in Figure 1(a). In this system, solids are heated by the gas stream which is used to fluidize the bed. A fluidized bed with an internal heat exchanger is depicted in Figure 1(b). The high temperature inlet gas fluidizes the bed in this system. Crosscurrent contacting in a multistage bed is shown in Figure 1(c). Heat exchange is between the hot fluidizing gas and the bed solids. Figure 1(d) is a cross-flow system with an internal heat exchanger, in which air fluidizes the incoming hot alumina particles and heat is transferred to the cooling water circulating in the heat exchanger. Figures 1(e) and 1(f) illustrate liquid fluidized bed heat exchangers with internal heat exchangers.

The various potential fluidized bed heat exchanger/storage configurations were ranked according to such operating parameters as efficiency of heat recovery, heat transfer rate, system pressure drop, environmental problems, stability of bed operation, etc. The following conclusions were reached regarding the application of fluidized beds for energy storage:

- Fluidized beds generally require a high pressure drop and hence, their operating power requirements are high. This limits their use to rather high temperature applications where the amount of energy recovered is large relative to operating energy requirements. Therefore, liquid-fluidized beds were eliminated from further consideration for storage applications.

- When designing multistage beds, the bed stages should be kept as shallow as possible to minimize the pressure drop.

- Multistage fluidized beds, which have a larger temperature recovery effectiveness, are preferable to single stage beds; however, increasing the number of stages may also increase the total system pressure drop.

- Multistage counter flow systems have higher thermal efficiency than multistage cross flow systems with an equal number of stages. A stable flow of solids against gases can be obtained by down flow pipes or overflow weirs installed between stages. Such multistage shallow beds have successfully operated in such unit operations as continuous adsorption.

### TES Application Identification

A large number of industrial processes, solar power generation, and HVAC systems were considered for potential application of FBHX for TES. Due to the large number of potential applications, they were grouped by unit process with similar waste characteristics (Table I). Thus, a selected FBHX/TES system for a unit process in one industry may also be adaptable to other industries with similar unit processes. Flow charts were obtained for the unit processes and energy balances performed in order to evaluate the potential for energy recovery.

### Integration and Selection

In order to reduce the potential applications to the six most promising systems for a more detailed review, a number of criteria were selected for the processes. The criteria for this analysis were:

- Waste stream temperature  $\geq 260^{\circ}\text{C}$  ( $500^{\circ}\text{F}$ )
- Flow rate  $\geq 283 \text{ m}^3/\text{min}$  (10,000 cfm)
- Annual energy recoverable from total industry  $\geq 1.05 \times 10^{10}$  MJ/yr ( $10^{12}$  BTU/yr)
- Need for TES
- Proximity of energy source to use
- Unique benefits such as pollutant removal or reduced plugging

The six applications designated with an asterisk (\*) in Table I were chosen for a more detailed review. Five additional selection criteria were then established for final screening of the six candidates. The additional criteria were:

- Adaptability to candidate process
- Growth potential of candidate process
- Relative simplicity of system when integrated with FBHX/TES



- Timeliness
- Acceptability to industry

As a result of the final screening process the cement plant rotary kiln and the steel plant electric arc furnace were chosen for detailed techno-economic evaluation.

## TASK II - TECHNOECONOMIC EVALUATION

The technical aspects of the evaluation for the rotary kiln and electric arc furnace applications of FBHX/TES systems are nearly complete. Each technical evaluation included establishing a plant process flow configuration, an operational scenario, a preliminary FBHX/TES design, and parametric analysis.

The process flow configurations for each application (Figures 2 and 3) are similar in that the TES charge cycle for both designs uses hot exhaust gases to heat the bed material (sand) in a counter flow, multistage, shallow FBHX. The hot solids are then stored in an insulated structure until the energy is needed. During the TES discharge cycle the same counter flow, multistage shallow FBHX is used to heat low temperature gases for a waste heat boiler. The cooled solids are stored in another insulated structure to await the next charge cycle. The electric arc furnace application also includes a buffer FBHX/TES to smooth the short duration (2-3 hr) periodic variations in gas temperature before proceeding to the long-term FBHX/TES described above. Options to eliminate the separate buffer are presently being considered.

The initial operating scenario for the cement plant requires approximately 80% of the rotary kiln exhaust gas to be sent directly to a waste heat boiler for power generation while the remaining 20% is used to charge the TES system. During discharge, 100% of the rotary kiln gases are sent directly to the waste boiler while approximately 20% of the boiler exhaust is recycled through the FBHX/TES to recover energy and added to the kiln gases at the waste heat boiler inlet. This results in a theoretical power production swing from 80 to 120% of the nominal generating capacity without TES and allows significant if not total reduction in peak power demand.

The initial operating scenario for the steel plant requires 100% of the electric arc furnace exhaust gases to be sent to the FBHX/TES system during a charge cycle when all power is purchased at off-peak rates. When power is purchased at on-peak rates, both the TES system and the electric arc furnace gases would be available for power production and reducing peak demand.

A parametric analysis is being performed to determine the optimum FBHX/TES design. A computer model was developed to determine the effects of the number of stages, gas temperatures, gas flows, bed materials, charge discharge times, and parasitic power required for operation.

Work on the economic-analysis has been initiated. The estimated capital investment costs, annual operating costs, and unit energy costs to construct and operate each model system will be determined. Capital investment costs will represent the total investment required to construct a new system and will include direct costs, indirect costs, contractor's fees, and contingency. Annual operating costs will represent the variable, fixed, and overhead costs required to operate the systems. Unit energy costs for each model system are the annual operating cost of the system divided by the annual energy savings. All costs associated with the waste heat boiler system and the fluidized bed heat exchanger TES system will be determined separately. The total cost of the model system will equal the sum of the individual costs.

#### CONCLUDING REMARKS

The technical feasibility of FBHX for TES systems has been verified by analysis of two selected conceptual systems. Initial results for the cement plant rotary kiln indicate that the diversion of 20% of the kiln exhaust gases to a 5-stage FBHX/TES system during a 12-hr charge period allows power production to be increased 11% during a 12-hr discharge period. Similarly the diversion of 100% of the electric arc furnace gases during an 8-hr charge cycle of an 8-stage FBHX/TES system allows power production to be increased 34% during a 16-hr discharge period.

When the economic and trade-off analysis are concluded, we will be able to establish whether TES systems using FBHX are economically viable and if so, identify one of the systems for further study or demonstration.

TABLE 1

POTENTIAL APPLICATIONS OF FLUIDIZED BED HEAT EXCHANGERS AS A FUNCTION OF UNIT PROCESSES OR WASTE ENERGY STREAM

<u>Unit Process/Waste Energy Stream</u>	<u>Industry</u>
1. Kiln Exhaust Gases, Clinker Cooler Exhaust Gases	*Cement ** Lime Sodium Carbonate Pulp Mill Zinc Oxide Primary Aluminum Clay and Ceramic Products Phosphate Fertilizer
2. Periodic Kiln	Clay Ceramics
3. Sinter and Pellet Machine/Cooler Exhaust Gases	*Iron and Steel Primary Zinc Primary Lead
4. Electric Arc Furnace Exhaust Gases	*Iron and Steel ** Iron Foundry Steel Foundry Ferroalloy Nonferrous Foundry Secondary Nonferrous Smelting and Refining Refractories
5. Solar Brayton	*Utility
6. Reverberatory Furnace Exhaust Gases	*Primary Copper Primary Lead Nonferrous Foundry Secondary Nonferrous Smelting and Refining
7. Boilers (HVAC)	Industrial, Commercial, Residential
8. Blast Furnace Exhaust Gases	Iron Primary Lead Secondary Nonferrous Smelting and Refining
9. Dryer Exhaust Gases	Phosphate Fertilizer Clay and Ceramics Products Asphalt Paving Textile Industry Pulp and Paper Industry Food Industry (grain drying)
10a. Compressor Exhaust Air	Chemical and Allied Products Pneumatic Machinery Compressed Gas Chillers (food industry)
10b. IC Engine Exhaust Gases	Various Industries
11. Distillation Column Exhaust Streams	Chemical and Allied Products Petroleum Refining
12. Wash-down Water	Food Industry Textile Industry
13. Cupola Exhaust	Iron Foundry
14. Coke Oven	*Iron and Steel

\* Six applications selected for additional study

\*\* Two applications selected for detailed Technoeconomic Evaluation

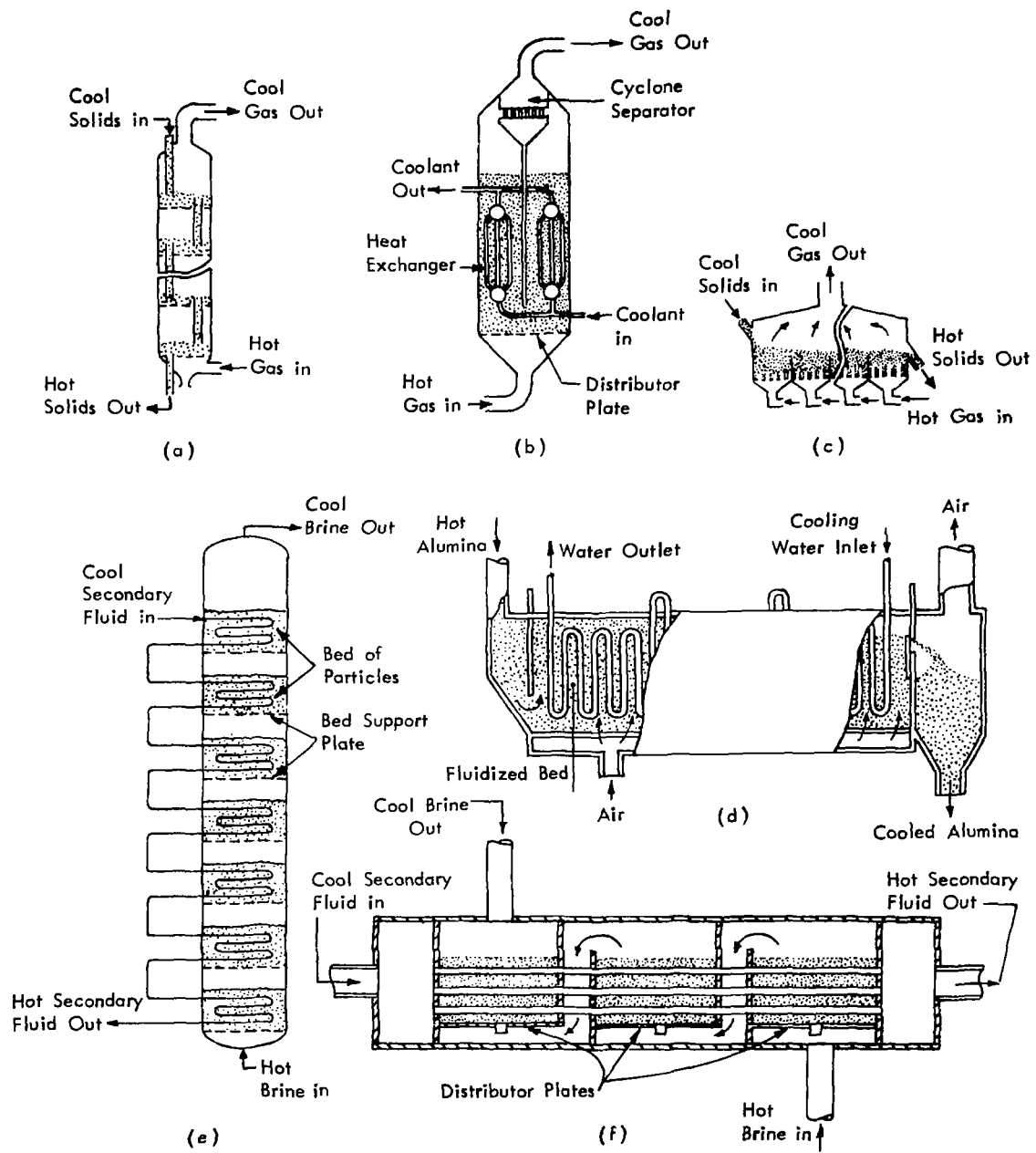

Figure 1 - Representative Configurations of Fluidized Bed Heat Exchangers

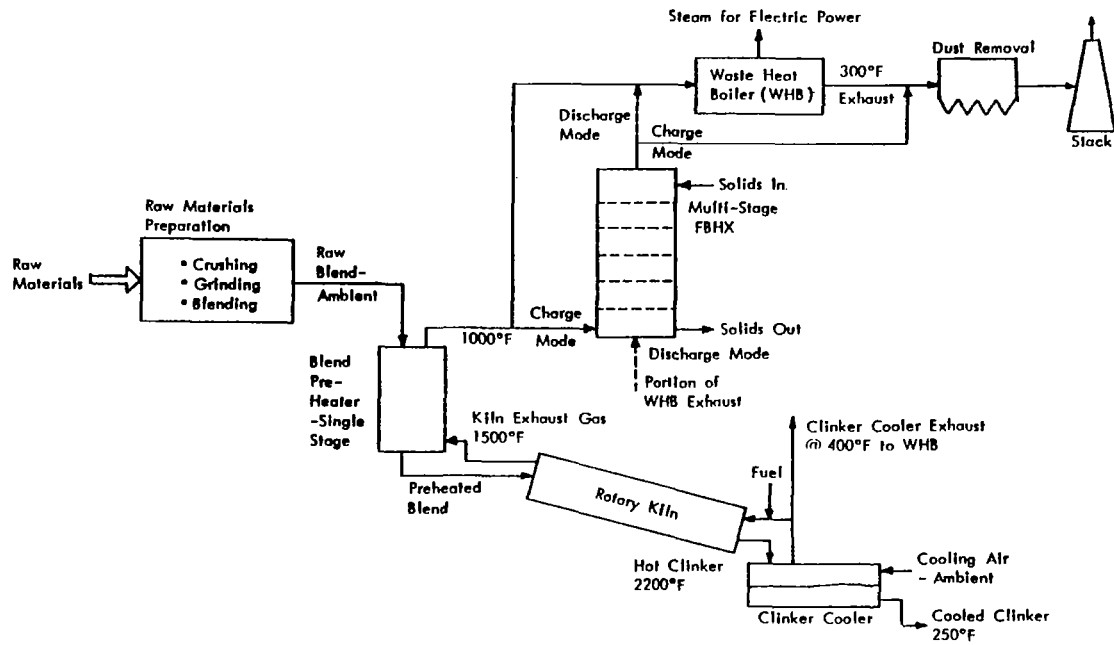

Figure 2 - Conceptual FBHX/TES System in Cement Plant Rotary Kiln

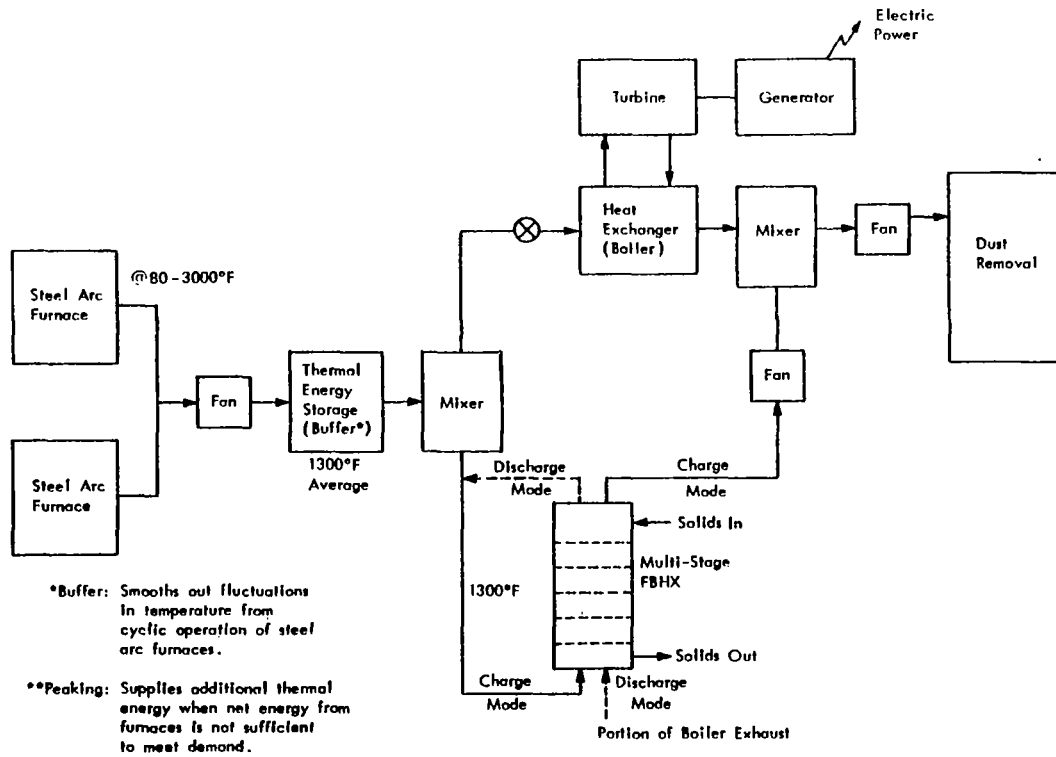

Figure 3 - Conceptual FBHX/TES System in Steel Plant Electric Arc Furnace



## THERMAL ENERGY STORAGE AND TRANSPORT

Walter Hausz  
General Electric Company - TEMPO

### PROJECT OUTLINE

Project Title: Combined Thermal Storage and Transport for Utility Applications

Principal Investigator: Walter Hausz

Organization: General Electric Company - TEMPO  
Center for Advanced Studies  
P. O. Drawer QQ  
Santa Barbara, CA 93102  
Telephone: (805) 965-0551

Project Goals: Investigate technical and economic factors in utilizing TES and transporting thermal energy from electric utilities to industrial and commercial/residential consumers, distant from the utility plant. Examine benefits and problem areas for utilities.

Project Status: Completed. Final report submitted April 1979 (EPRI EM-1175: GE79TMP-26).

The sendout cost of thermal energy (from nuclear and coal baseload plants) versus temperature was found; the transport cost for 50 km of dual pipeline was found for high temperature water (HTW), steam, Caloria HT43, and HITEC. The delivered cost of thermal energy was compared to locally generated process heat from oil and coal. HTW was the most economic means of transport; it was superior to hot oil, molten salt, and steam for temperatures below 250°C (500°F). Delivered heat costs were less than locally generated heat - without any storage - if desired supply and demand patterns and capacity factor (CF) match; with TES - if low CF demand and the utility supply are completely decoupled. An added benefit of complete decoupling is the capability to generate peaking power at baseload costs.

Contract Number: EPRI Research Project 1199-3 (related to prior contracts NASA/DOE DEN3-12 and EPRI Project 1082-1)

Contract Period: September 1978 - April 1979

Funding Level: \$37,847

Funding Source: Electric Power Research Institute (FFAS/Storage; William Stevens, Program Manager)

## THERMAL ENERGY STORAGE AND TRANSPORT

Walter Hausz — General Electric  
Center for Advanced Studies

### ABSTRACT

The extraction of thermal energy from large LWR and coal-fired plants for long distance transport to industrial and residential/commercial users is analyzed. Transport as high temperature water is considerably cheaper than transport as steam, hot oil, or molten salt over a wide temperature range. The delivered heat is shown to be competitive with user-generated heat from oil, coal, or electrode boilers at distances well over 50 km when the pipeline operates at high capacity factor. Thermal energy storage makes meeting of even very low capacity factor heat demands economic and feasible. Storage gives the utility flexibility to meet coincident electricity and heat demands effectively.



## SUMMARY

It has long been recognized that there are thermodynamic benefits to the joint production of electricity and heat, and its aliases: cogeneration, Dual Energy Use Systems (DEUS), and Combined Heat and Power. Electricity and heat can be supplied by this means with less fuel than by separate production, by a factor of as much as two. Greater use of this technique has been inhibited in the past by economic, technical, and institutional problems.

Some of these problems can be mitigated by economic storage and transport of thermal energy. The study here described examined the range of thermal transport media, thermal storage concepts, and system configurations, under current scenarios of future energy costs, and found areas that should be attractive to utilities and to those concerned with energy conservation.

The study was performed for The Electric Power Research Institute as RP1199-3, "Combined Thermal Storage and Transport for Electric Utility Applications," W. Hausz, EPRI, 1979 [1]\*. Thermal energy transport media compared include high temperature water (HTW), steam, hot oil (Caloria HT-43), and molten salt (HITEC). Thermal energy storage means examined included aboveground storage of HTW, dual-media hot oil and rock, and below-ground storage of HTW in excavated caverns. The economic and technical data in these storage concepts were derived from an earlier related study [2,3].

---

\* Numbers in brackets designate References shown at the end of the paper.

The basic methodology used was the comparison of the delivered cost of heat, at the end of a dual pipeline (sendout/return), with the cost of heat from alternative sources, in dollars per megawatt hour thermal ( $\$/MWh_t$  – equivalent to mills/kWh). Comparable specified economic scenario assumptions were used for all alternatives. The data and methodology is that of the EPRI *Technical Assessment Guide* (TAG) [4], except that mid-1976 dollars were used as in [2,3].\*

Both conventional light water reactor (LWR) and high sulfur coal-fired steam plants (HSC) were considered as sources for extracted heat. The value of the extracted heat was equated to the cost of the electricity lost because of the heat extraction. Incremental costs of capital equipment such as heat exchangers and the thermal transport system, and of the operating costs such as pumping power and thermal losses through insulation gave a cost value to the delivered cost of heat. This was compared to steam or sensible heat generated by the conversion from oil or coal fired boilers or electrode boilers.

Over a wide range of temperatures, from under 100°C to over 300°C, high temperature water (HTW) was a more economic transport medium than steam, hot oil or molten salt. For HTW at 227°C (440°F), a 50-km pipeline, and operation at high capacity factor (0.75) of the dual energy use system (DEUS) and the competing alternatives, there was a marked advantage of DEUS over alternatives. The margin of benefit was 13 percent over local coal-fired boilers, 46 percent over oil-fired boilers and over 70 percent over electrode boilers.

For lower capacity factors of the heat demand, the capital cost of the thermal transport and terminal equipment reduced the advantage of DEUS; at about 0.30 capacity factor (CF), it became zero versus both coal and oil but still had an advantage over electrode boilers.

---

\* Use 1.26 factor for rough mid-1979\$.

If thermal energy storage is added to both ends of the pipeline to maintain its capacity factor at 0.75 or higher, the advantage is regained for low CF heat demand patterns. Even with the added costs of storage, the margin of DEUS is 20 percent over oil fired boilers at 0.25CF and 19 percent over coal.

The thermal storage permits completely decoupling the supply and demand of heat; a utility can supply maximum electrical output during peak hours and reduce electric output in order to charge the TES during off peak hours, while the heat demand peak can be at any time of day including coincidence with the electric peak demand. This additional benefit adds to the economic attractiveness of the DEUS.

#### JOINT PRODUCTION OF HEAT AND POWER

Utilities must recover all fixed and variable costs through revenues received from electricity generated. When some part of the steam mass flow through the turbine system is extracted before the shaft-work of normal operation has all been delivered, the electric output is decreased. The thermal energy extracted must return revenues at least equal to those lost from electric output. A reduction of one megawatt of electricity may accompany the extraction of from 3 to 10 megawatts thermal ( $MW_t$ ). The ratio of electricity lost to thermal energy gained, an equivalence factor  $F_e$ , determines the minimum cost that must be charged for heat:  $C_t = F_e \times C_e$ .

Using the literature on district heating with HTW gives a scatter diagram of values of  $F_e$  versus temperature, for unspecified technical conditions. In addition to this data, conventional LWR and HSC plants, used as reference plants in [2,3] were computer analyzed with the assistance of General Electric's Large Steam Turbine Division, to find  $F_e$  as a function of both the amount of thermal energy extracted and the temperatures and state (HTW or steam) at

which it is extracted from and returned to the steam cycle. Figure 1 summarizes these results.

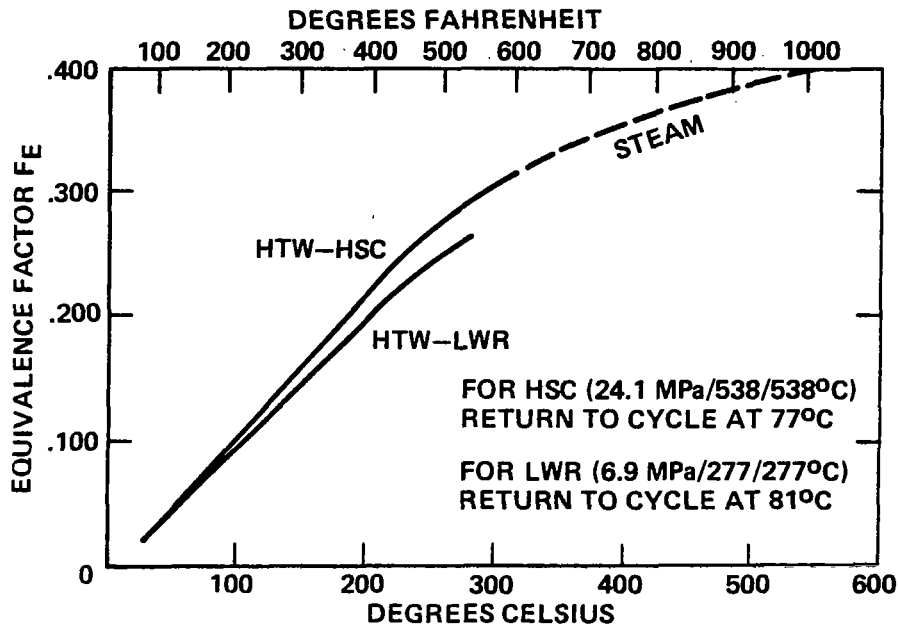

Figure 1. Equivalence factor relating heat cost to electricity cost.

The value of  $F_e$  is independent of the amount of thermal energy extracted, except that design constraints of the turbine system limit the maximum safe extraction. Extraction as HTW appears linear versus temperature for the small sample of extraction points analyzed; there is sound thermodynamic reasoning to confirm this over a reasonable range of temperatures. Since the coal-fired plant has a higher cycle efficiency than the LWR, the equivalence factor is higher, ie, it takes fewer  $MW_t$  to lose a  $MW_e$ . For both plants the water extracted is returned to a convenient point between feedwater heaters at a return temperature circa 80°C.

The economic methodology used [4] assumes 6 percent annual inflation indefinitely, and provides a scenario for each fuel; nuclear, coal, and oil with a higher escalation rate than the general inflation rate. This reflects in the investment costs as a fixed charge rate (FCR) of 0.18, to give uniform

levelized annual costs over the 30-year life of the plants. Fuel and O&M costs are also levelized to an equivalent value between the fuel cost in the year of initial operation and 30 years later. This roughly doubles the unit cost of fuels compared to current fuel prices, making the cost of electricity and heat look high to someone used to using current values. For the reference power plants operating at 0.75 CF, the unit cost of electricity in 1976 dollars for 1990 initial operation is 42.48  $\$/MWh_e$  (same as mills per kWh) from the LWR and 53.21  $\$/MWh_e$  from the HSC. As an example then, the equivalent cost of heat extracted at 227°C (440°F) is 9.56  $\$/MWh_t$  from the LWR and 13.40  $\$/MWh_t$  from the HSC.

Above about 300°C it is difficult to consider HTW. The dash line for the HSC extending to 538°C (1000°F) is an estimate of  $F_e$  for steam. Since steam in large quantities can only be extracted at a few points, between turbines, for any particular turbine design, interpolation is difficult. For steam temperatures below 300°C, the value of  $F_e$  does not differ greatly from the curves for HTW, depending on the details of extraction and return.

#### THERMAL TRANSPORT

For all transport fluids considered, dual pipelines (sendout and return) were assumed to be buried, with periodic U-shaped bends inserted for thermal expansion, and thermal insulation with a moisture protective outer layer around each pipe. Computer optimization of pipeline cost was performed for every case considered. For each pipe diameter considered, the thermal insulation thickness is varied in steps to minimize the sum of the annual costs for capital charges on the insulation and the cost of heat lost through the insulation. In an iterative calculation, pipe diameter is incremented in 2-inch steps (for conventionally available pipe sizes), and the annual costs for capital charges on the pipeline and its installation and on the pumps or compressors required are added to the cost of pumping power (electricity) and to the costs of the insulation-plus-

losses to find a minimum. Allowable stresses in the pipe are limited to 60 percent of the yield strength, as for moderately populated open country. The yield strength is derated per handbook data for the required pipe temperature.

With this program, transport media compared were HTW, steam (with condensate return), a hot oil such as Exxon Caloria HT-43, and a molten salt such as DuPont HITEC (eutectic of sodium and potassium nitrates and nitrites). Each was examined over its useful temperature range; each was examined over a range of transported thermal power levels from under 100 MW<sub>t</sub> to 1000 MW<sub>t</sub>. Figure 2 summarizes the results.

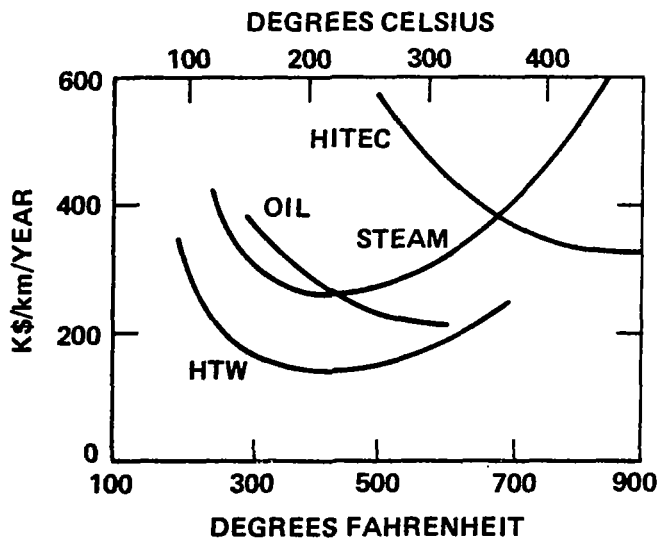

Figure 2. Cost of thermal energy transport dual pipeline.

The curves shown are for a sendout thermal power of 300 MW<sub>t</sub>. The mass flow required for this level varies with the temperature and enthalpy difference between the sendout and return flows. As the return temperature is 80°C in all cases, the required mass flow, hence the annual costs, rise sharply as the sendout temperature decreases toward this limit. At high temperatures, high pressure containment is required for HTW or steam, so for these fluids the cost rises rapidly with temperature in the upper range. Oil and molten salt

do not require high pressure at high temperature, but the cost of temperature derating (or use of more exotic pipe materials) does tend to counterbalance the effect of increasing enthalpy difference with temperature.

For steam, saturated steam was considered up to 300°C; above that 4.5 MPa (650 psi) steam at variable superheat was considered up to 538°C (1000°F). The specific volume increases with temperature, contributing to the rise in annual cost.

The ordinate for these curves is the annual cost in thousands of dollars per kilometer (K\$/km/yr). At roughly the temperature of minimum transport cost of HTW, i.e. 227°C (440°F) the boiler feedwater temperature for the LWR, annual costs at 0.75 capacity factor are 141 K\$/km including the cost of heat losses through insulation or 116 K\$/km without it. This latter totals 4.8 M\$ for 50 km and adds 2.94 \$/MWh<sub>t</sub> cost increment to the cost of heat extracted. Both the delivered heat and the pumping energy required are proportional to capacity factor; the other cost components are independent of it. At lower capacity factors the pipeline annual costs must be allocated over fewer MWh<sub>t</sub> delivered so the cost of delivered heat increases. The cost increment per MWh<sub>t</sub> delivered would decrease with the power level of the pipeline, roughly as 1/(power)<sup>1/2</sup> over the range 100-1000 MW<sub>t</sub>.

#### COST OF ALTERNATIVES

Commonly used local sources of industrial process heat are oil- or gas-fired boilers (for steam) or heat exchangers (for sensible heat), and coal-fired boilers where environmental constraints permit. For lower temperatures in residential and commercial use, oil and gas dominate.

Oil and natural gas as sources are high cost fuels, but permit relatively low capital costs for the boiler/heat exchanger. Using similar leveling assumptions, the fuel costs of oil and gas based on [4] give 6.64 \$/MBtu for

1 percent sulfur residual oil, and 7.55 \$/MBtu for gas, or 22.66 and 25.76 \$/MWh<sub>t</sub>. Fixed charges on the oil- or gas-fired capital equipment are only 1.13 \$/MWh<sub>t</sub> at 0.75 CF. At 85 percent boiler efficiency, and including variable O&M, the variable costs for oil are 26.86 \$/MWh<sub>t</sub> and total costs are 28 \$/MWh<sub>t</sub>. Costs are clearly dominated by the cost of fuel and the boiler efficiency. For small sizes, eg, residential use, the boiler efficiency will be much lower, hence the cost of heat higher.

Coal-fired boilers have a lower fuel cost but higher capital plant costs for the boilers, fuel handling and storage, and flue gas desulfurization and cleanup. With a levelized fuel cost of 2.08 \$/MBtu or 7.09 \$/MWh<sub>t</sub>, a boiler efficiency of 82 percent, and variable O&M including consumables of 2.82 \$/MWh<sub>t</sub>, the variable charges total 11.47 \$/MWh<sub>t</sub>. Exxon [5] provides a basis for capital costs of small coal-fired plants (100 to 400 thousand pounds of steam per hour) which, adjusted to 1976 dollars and an investment cost basis comparable to that used for the reference electric plants, gives fixed charges of 6 \$/MWh<sub>t</sub> at 0.75 CF. These total to 17.47 \$/MWh<sub>t</sub>.

For very small boilers, industry may use electrode boilers, using electricity as "fuel." For these the fixed charges are trivial, but the variable charges very high. The total must be over 45 \$/MWh<sub>t</sub>, and counting transmission and distribution fixed charges and losses may be over 65 \$/MWh<sub>t</sub> even at high capacity factor.

#### COMPARISON WITH ALTERNATIVES

A method of comparing the delivered cost of heat with the alternatives available to users is displayed by the example in Figure 3. The cost of heat delivered (COH<sub>d</sub>) is found by adding the cost increments incurred in each step. For this base case example, the utility supplies 300 MW<sub>t</sub> heat extraction at 227°C sendout, 80°C return. The capacity factor is 0.75, depicted as 18 hours



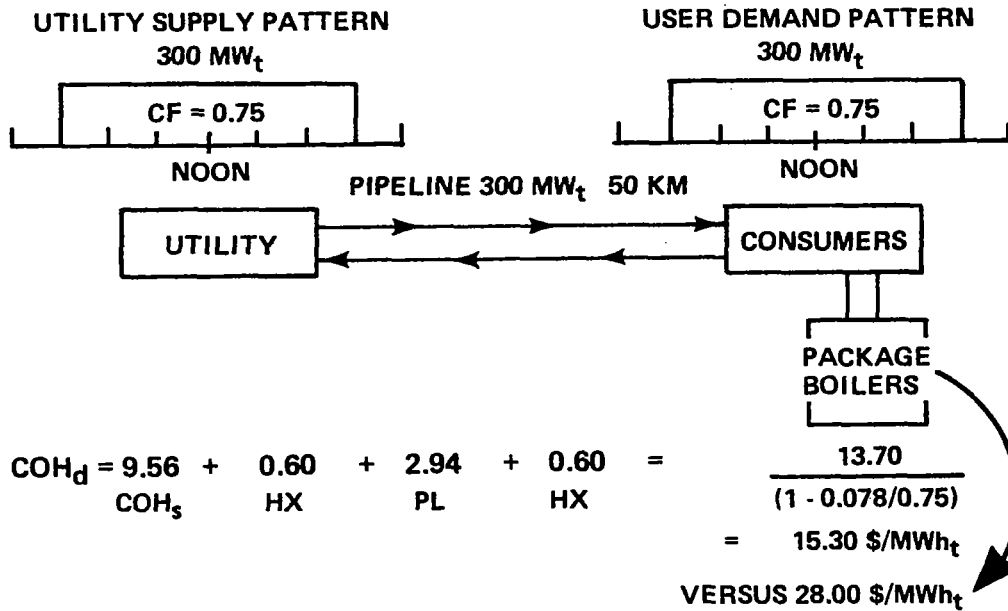

Figure 3. Approach to COH<sub>d</sub> base case.

a day, although the actual outages may be forced outage or maintenance distributed through the year. The consumer demand for heat is also at 0.75 CF, matching the utility output in time so no storage is needed.

For these conditions, it was indicated that the equivalence factor  $F_e$  for the LWR gives a cost of heat at the sendout point (COH<sub>s</sub>) of 9.56 \$/MWh<sub>t</sub>. Some terminal equipment is required at both ends for suitable interfaces. At the sendout end, additional feedwater heater capacity must be added to handle the mass and heat flows of heat extraction. The cost of these heat exchangers is the 0.60 \$/MWh<sub>t</sub> increment shown as HX. Assuming that the pipeline is a closed loop of high purity water, a similar heat exchanger capacity is needed at the user end for steam or sensible heat production for the user's processes.

The cost increment for 50 km of pipeline is 2.94 \$/MWh<sub>t</sub> as described. All these components total 13.70 \$/MWh<sub>t</sub>. However, thermal energy losses through the optimized insulation reduce the amount of heat delivered; the assigned COH<sub>d</sub> must be larger to produce the revenues required to recover all costs. For 50 km of pipeline, and 300 MW<sub>t</sub> the pipeline losses are 23 MW<sub>t</sub> or 7.8 percent.

Heat losses occur continuously; power output is assumed at 0.75 CF so a larger percentage as indicated in the denominator in Figure 3 is required to correct  $COH_d$ . The corrected  $COH_d$  is 15.30  $\$/MWh_t$ . This can be compared to the cost of heat from oil-fired boilers of 28  $\$/MWh_t$  as shown, or the 17.47  $\$/MWh_t$  found for coal-fired boilers at this CF. The benefit over oil, gas, or electrode boilers is great; that over coal-fired boilers is small.

To get a similar comparison for both the LWR and HSC plants over a range of temperatures of HTW transport, Figure 4 shows the  $COH_d$  from both plants over the temperature range to over 300°C, and the cost of the oil and coal alternatives, which are essentially independent of temperature over this range. The low temperature of the minimum cost points reflects not only pipeline costs (Figure 2) but the equivalence factor (Figure 1). There is a significant temperature range for which the  $COH_d$  from both LWR and HSC plants is lower than local coal-fired boilers.

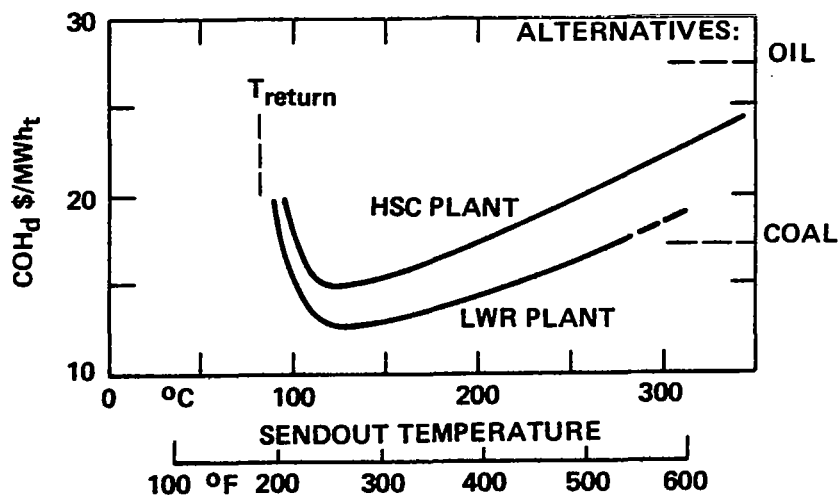

Figure 4. Delivered cost of heat vs sendout temperature for high capacity factor case (CF = 0.75).

## THE USES OF TES

For lower capacity factors of the user's heat demand, the cost of delivered heat from the pipeline will increase if the pipeline must operate at the user's capacity factor. Thermal energy storage should be considered.

Thermal energy storage (TES) has two functions: To keep the pipeline and terminal equipment capacity factor high, and to provide flexibility in supply management to the utility to meet heat and electricity demands. For the former use, only TES at the user end of the pipeline is needed to buffer the difference between supply and demand. For the latter use, TES at both ends is desirable to decouple the electricity demands on the utility from user demands for heat.

Earlier studies [2,3] found that underground storage of HTW in excavated caverns, and dual-media TES using insulated tanks filled with rocks or taconite, with the voids partly filled with hot oil used as a heat transfer fluid, were the two lowest cost forms of TES. Caverns are lowest cost but only feasible where the geology is suitable; dual-media storage has a low technical risk with taconite and complete filling of the voids with oil, but would be considerably lower cost with riverbed gravel and reduced use of oil by draining each tank except during the charging and discharging period.

The capital costs of TES have energy-dependent and power-dependent parts. For the cavern storage these components were found to be [1]: 4500 \$/MWh<sub>t</sub> stored and 13,000 \$/MW<sub>t</sub> maximum charge or discharge rate. For the dual-media storage, they are: 1740 \$/MWh<sub>t</sub>, 66,000 \$/MW<sub>t</sub>. Clearly, the cavern storage is superior for rapid charging and discharging; dual-media storage becomes superior when slow charge and discharge of 15 hours or more is needed.

An example portrayed in Figure 5 illustrates the method and benefits of storage for low capacity factor heat demands. The same 300 MW<sub>t</sub>, 50 km pipeline is assumed; the same sendout and return temperatures of HTW (227/80°C), and source, an LWR, are assumed. The heat demand pattern is made extreme;

900 MW<sub>t</sub> is required for six hours at mid-day, or the capacity factor is 0.25. Extraction of heat from the utility plant is assumed to be completely mismatched, ie, occurs solely during 12 nighttime hours when electric loads are light.

To meet the load and keep the pipeline capacity at 0.75, storage of a day's heat extraction is necessary, 5400 MWh<sub>t</sub>, with two-thirds at the user end and one-third at the utility end. The train of incremental costs in COH<sub>d</sub> are as shown. The sendout cost of heat and the pipeline cost are unchanged. Because of the reduced capacity factor at each end, terminal equipment (HX) costs rise, corresponding to 0.50 CF at the utility and 0.25 at the user end. The cost of 5400 MWh<sub>t</sub> storage, dischargeable over six hours is 6.20 \$/MWh<sub>t</sub> with dual-media storage, or 3.24 \$/MWh<sub>t</sub> with cavern storage. Figure 5 uses the former, more expensive but more available. As with Figure 3, a correction to the sum of these costs is made to account for the 10.5 percent energy losses during transmission. The resulting COH<sub>d</sub> of 23.90 \$/MWh<sub>t</sub> is to be compared to that for oil-fired boilers at 0.25 CF, 30 \$/MWh<sub>t</sub> or for coal-fired boilers at the same CF, 29.47 \$/MWh<sub>t</sub>.

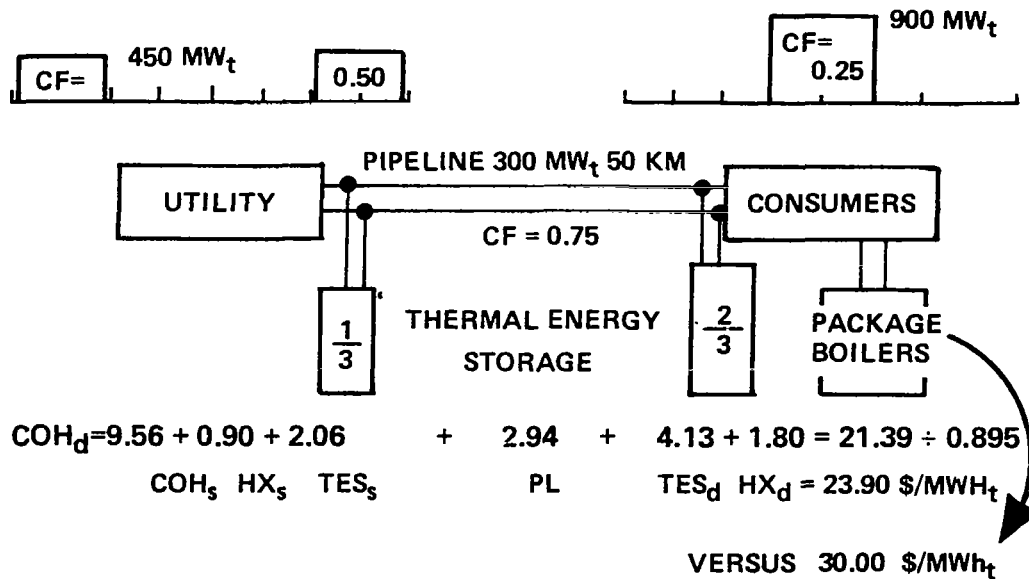

Figure 5. Effect of storage on COH<sub>d</sub>.

Figure 6 depicts the comparable results for other transport temperatures for both the LWR and the HSC sources. This case of extreme mismatch and low capacity factor also shows considerable margin for COH<sub>d</sub> over the alternatives for both sources over a wide range of temperatures. Designs for specific utilities and site areas will usually fall between the no storage and maximum storage cases with intermediate margins of benefit.

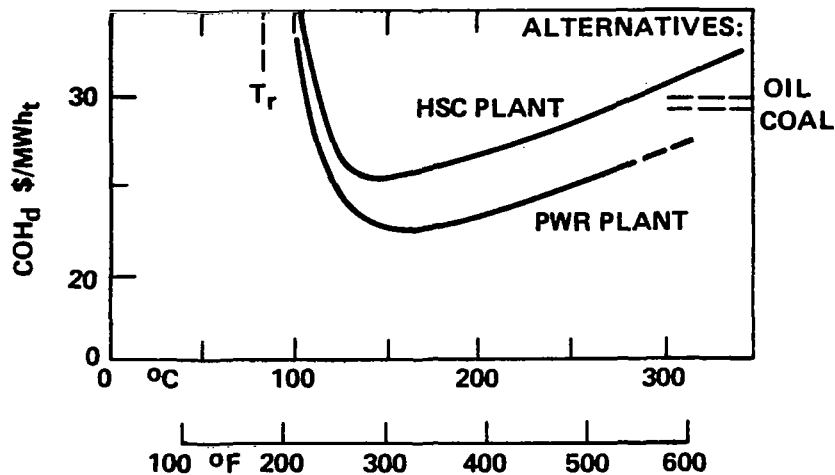

Figure 6. Delivered cost of heat vs sendout temperature with storage, and demand CF = 0.25.

#### BENEFITS AND PROBLEMS

- CONSERVATION. DEUS or joint production of heat and power conserves energy. A 1000 MW<sub>e</sub> LWR can, with near-term available technology, produce 775 MW<sub>e</sub> and 920 MW<sub>t</sub> delivered, at 215°C, with 14 percent less primary energy than separate production of this heat and electricity. The savings is still greater if lower temperature heat is wanted or if backpressure turbine technology is used to raise the ratio of heat to electricity output. A concomitant utility benefit is the reduction of the waste heat discharge requirements.

- MARKET. A significant portion of the industrial process heat market and the need in all sectors for space heating and hot water, which total to roughly

44 percent of the U.S. primary fuel usage, can be served. Temperature requirements data of the thermal energy use, both past and forecast, are sparse and disparate. A projection derived from several sources [6,7,8] was projected for the year 2000 as shown in Figure 7.

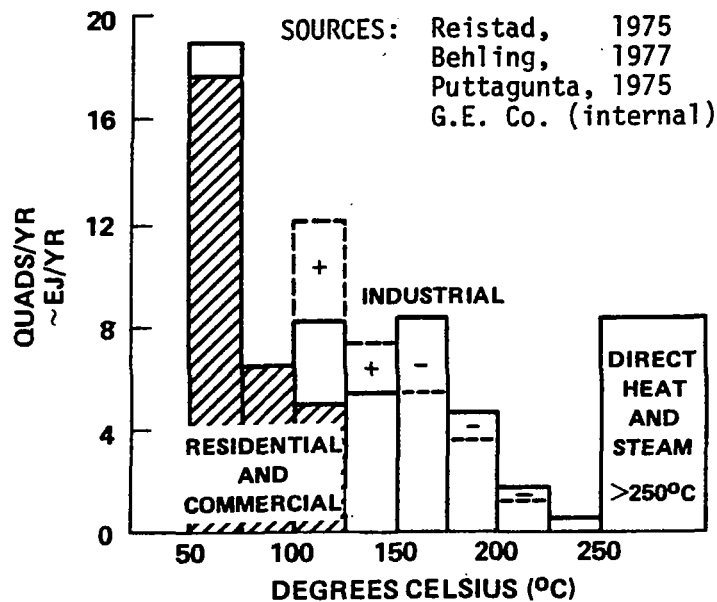

Figure 7. Estimated U.S. energy use by temperature range AD 2000.

In 25°C increments the expected annual use in exajoules (EJ) or quads is shown. Residential and commercial space heating and hot water needs are in the 50-100°C range; some commercial use, eg absorption air cooling, is in the 100-125°C range. About 40 percent of the industrial heat use is direct heat or steam above 250°C, which is not the most likely market for transported heat. While some industrial heat use below 250°C is sensible heat most of it is process steam. One disparity found is that between the temperature at which heat is generated and that at which it is used. The solid bars indicate the estimated temperature distribution of steam produced; the dotted bars indicate the temperature distribution at which it is used. It is convenient where multiple steam temperatures are needed to generate at the highest temperature and

throttle some part of the flow to the other temperatures and pressures needed. The - and + indicate the estimated transferral of part of the thermal energy to a lower temperature regime by throttling or cascaded processes.

Transport of HTW at 227°C can meet all sensible heat needs at 200°C and lower. For conversion of HTW to steam a fairly high temperature drop is required in the heat exchanger to convert most of the delivered energy to steam. HTW at 227°C can be 75 percent converted to 0.2 MPa (30 psia) steam with the remainder as sensible heat for water and space heating, or can be 15 percent converted to 1.55 MPa (225 psia) steam at 200°C, 30 percent converted to 0.50 MPa (70 psia) steam at 150°C, 30 percent at 0.2 MPa and the 25 percent remainder as sensible heat. A major portion of the steam needs below 200°C depicted in Figure 7 can be met from HTW at 227°C, but a problem of matching the multi-temperature needs of each consumer may exist. Transport at 277°C or higher will of course permit higher conversion rates to the higher temperatures of steam with only moderate penalties as in Figures 4 and 6.

#### PEAK POWER BENEFITS

The use of TES to decouple utility supply from user demand for heat permits the utility to load storage and supply heat needs during off-peak hours. It can produce full rated electric output during peak hours, say for 6 hours a day, 2200 hours per year. Generation of such electricity at 0.25 CF normally costs the utility about twice as much as base load electricity, counting the increase in the fixed charges per  $MWh_e$  required by the low CF, and the more expensive fuel and/or lower efficiency plant used for peaking generation. With the peaking flexibility of the DEUS system described by Figures 5 and 6, peaking electricity is made at the base load cost. Alternatively the benefit can be credited to the thermal output, decreasing the  $COH_d$  by 6 to 10  $\$/MWh_t$ .

The use of TES directly for electric peaking power was studied in depth in [2,3] and found not to be attractive to utilities unless major cost reductions were possible. Using the same cost data and storage methods, this study [1] finds TES attractive for peak power production. The reasons for this difference should be briefly explained.

The direct approach was to extract steam off-peak, store it as HTW or dual media, and discharge it by converting to boiler feedwater or to steam to run through a peaking turbine. The turnaround efficiency was low (40-80 percent), because of the degradation in steam conditions entering the peaking turbine compared to that extracted for storage. The cost per kW<sub>e</sub> of peaking turbines and related equipment was high because of low efficiency from the degraded steam. The cost of storage limited discharge to the number of hours likely to be used frequently. When discharged, there was no flexibility to maintain power if the peaking requirement continued, so utility reserve capacity could not be reduced.

In the DEUS approach, the turnaround efficiency for peaking power is 100 percent and the turbine efficiency is maximum, not degraded during peaking hours. The turbine cost for rated capacity is included in the foregoing analyses, and is not an extra. If the peaking requirement continues beyond six hours, rated electric output can be continued, so there is full capacity credit for it in determining reserves. It is only necessary to assure that the storage is replenished before the next day's peak heating demand.

## CONCLUSIONS

We conclude that not only are DEUS systems economically viable with available technology but also they can provide added benefits to utilities in peaking power flexibility and reduced thermal discharges. This route to energy conservation could provide the largest contribution to energy savings, scarce



fuel displacement, and urban pollution reduction available to us within the next two decades.

Implementation will not proceed rapidly without a large and convincing demonstration. Are there sites where the concentration of industrial process heat, and residential/commercial heat requirements can use DEUS effectively? A study by Dow Chemical Co. [9] found 119 locations in the U.S. which require at least 160 MW<sub>t</sub> as process heat within a two-mile radius. An additional 24 locations needed 650 MW<sub>t</sub> within a five-mile radius and another 19 locations required over 1300 MW<sub>t</sub> within a ten-mile radius. The study covered steam use at under 200°C (400°F) and omitted plants smaller than 70 MW<sub>t</sub>. The sites occur in 36 States; about half of them are in the Gulf Coast States.

A recent study of district heating in the Twin Cities area, Minneapolis and St. Paul, [10] showed a potential need for 3000 to 4500 MW<sub>t</sub> peak thermal energy production in two growth scenarios. The study shows benefits in cost and energy savings for up to 2000 to 3000 MW<sub>t</sub> of seasonal energy storage.

Opportunities abound. The next step however must be a site-specific study and design with the cooperation and participation of the responsible utility, local industry, local and State regulatory agencies, and the Department of Energy.

#### REFERENCES

1. Hausz, Walter, *Combined Thermal Storage and Transport for Utility Applications*, GE79TMP-26 (EPRI EM-1175); Prepared for the Electric Power Research Institute; General Electric Co.-TEMPO, Santa Barbara, California, April 1979.
2. Hausz, W., B.J. Berkowitz, and R.C. Hare, *Conceptual Design of Thermal Energy Storage Systems for Near Term Electric Utility Applications; Volume One: Screening of Concepts, Volume Two: Appendices - Screening of Concepts*,

- GE78TMP-60 (NASA CR-159411) (NTIS: DOE/NASA/0012-78/1 and DOE/NASA/0012-78/2); Prepared under Contract DEN3-12 for the U.S. Department of Energy, the National Aeronautics and Space Administration, and the Electric Power Research Institute; General Electric Co.-TEMPO, Santa Barbara, California, October 1978.
3. Hall, E.W., W. Hausz, R. Anand, N. LaMarche, J. Oplinger, and M. Katzer, *Conceptual Design of Thermal Energy Storage Systems for Near Term Utility Applications*, GE79ET0101 (NASA CR-159577); Prepared for the National Aeronautics and Space Administration-Lewis Research Center under Contract DEN3-12 for the U.S. Department of Energy-Office of Energy Technology and the Electric Power Research Institute under Contract RP1082-1; General Electric Co.-Energy Technology Operation, Schenectady, New York, July 1979.
  4. (EPRI) Electric Power Research Institute, *Technical Assessment Guide*, Special Report EPRI PS-866-SR, The Technical Assessment Group of The EPRI Planning Staff, Palo Alto, California, June 1978.
  5. Exxon Research and Engineering Company, *Application of Fluidized-Bed Technology to Industrial Boilers*, NTIS #PB-264 528; Final report prepared for the U.S. Energy Research and Development Administration; January 1977.
  6. Reistad, Gordon M., *Analysis of Potential Nonelectrical Applications of Geothermal Energy and Their Place in the National Economy*, UCRL-51747, Lawrence Livermore Laboratory, University of California, Livermore, February 14, 1975.
  7. Behling, David J., Jr., *Analysis of Past and Expected Future Trends in U.S. Energy Consumption, 1947-2000*, BNL-50725; Prepared for the Office of the Assistant Administrator for Planning and Analysis, U.S. Department of Energy; Economic Analysis Division, National Center for Analysis of Energy Systems, Brookhaven National Laboratory, Upton, New York, February 1977.

8. Puttagunta, V.R., *Temperature Distribution of the Energy Consumed as Heat in Canada*, AECL-5235, Atomic Energy of Canada Ltd., Whiteshell Nuclear Research Establishment, Pinawa, Manitoba, Canada, October 1975.
9. Barnes, R.W., *The Potential Industrial Market for Process Heat from Nuclear Reactors*, ORNL/TM-5516; Prepared for Oak Ridge National Laboratory/ Energy Research and Development Administration; Dow Chemical Company, Midland, Michigan, 196 pp, July 1976.
10. Meyer, Charles F., *Potential Benefits of Thermal Energy Storage in the Proposed Twin Cities District Heating-Cogeneration System*, GE79TMP-44 (ORNL/SUB-7604-2); Final report prepared for the Oak Ridge National Laboratory; General Electric Co.-TEMPO, Santa Barbara, California, July 1979.



CONCEPTUAL DESIGN OF THERMAL ENERGY STORAGE SYSTEMS  
FOR NEAR-TERM ELECTRIC UTILITY APPLICATIONS

Eldon W. Hall  
General Electric Company

PROJECT OUTLINE

Project Title: Conceptual Design of Thermal Energy Storage (TES) Systems  
for Near-Term Electric Utility Applications

Principal Investigator: Eldon W. Hall

Organization: General Electric Company  
Energy Technology Operation  
1 River Road  
Schenectady, NY 12345  
Telephone: (518) 385-9090

Project Goals: Identify, design, and evaluate promising thermal energy  
storage systems for mid-term applications in conventional  
electric utilities for peaking power generation.

Evaluate candidate thermal energy storage systems and  
select the most promising concepts.

Complete conceptual designs of selected thermal energy  
storage systems integrated with conventional utilities.

Define characteristics of alternate systems for peaking  
power generation, viz gas turbines and coal fired cycling  
plants.

Perform competitive benefit analysis of thermal energy  
storage systems with alternate systems for peaking power  
generation.

Make recommendations for development and field test of  
thermal energy storage with a conventional utility.

Coordination with Electric Power Research Institute  
(Co-funder); Tennessee Valley Authority; DOE/Division of  
Electric Energy Systems

Project Status: Contract results were as follows:

Thermal energy storage was only marginally competitive with  
coal fired cycling power plants and gas turbines for  
peaking power generation.

A development and field test program does not appear viable  
to utilities at the present time.

Contract Number: DEN3-12 and EPRI RP 1082-1

Contract Period: December, 1977 to August, 1979

Funding Level: NASA - \$360,000, EPRI - \$150,000

Funding Source: NASA Lewis Research Center and Electric Power Research  
Institute

CONCEPTUAL DESIGN OF THERMAL ENERGY STORAGE SYSTEMS FOR NEAR-  
TERM ELECTRIC UTILITY APPLICATIONS

Eldon W. Hall

General Electric Company

This project makes a detailed evaluation of thermal energy storage (TES) for meeting peak power requirements of electric utilities. TES is made a part of the steam electric generating plant, storing thermal energy from steam or hot feedwater during low demand periods and using the thermal energy to generate electricity during peak demand periods.

While the steam turbine must still be sized to deliver the utility peak power, the steam generator can be designed at less than peak power (near average power) by using TES to supply energy to match the turbine requirements. Steam generator costs can therefore be less in a steam plant with TES than in one without TES where it must deliver peak power. These reduced costs are offset by the cost of the TES system and somewhat higher fuel use because of reduced efficiency. Less expensive baseload fuels, however, can be used to produce peak power.

Over forty TES concepts gleaned from the literature and personal contacts were examined for possible application.

Initial criteria for selection emphasized near-term availability and potential for economic feasibility. Many storage media, forms of containment, and cycle configurations for conversion to electricity were included in the concepts examined. Media included hot oil, molten salt or sulfur, rock or other solid media, and high temperature water. As the latter requires pressure vessels for containment at high temperature, such containment concepts as steel pressure vessels, prestressed cast iron vessels (PCIV), prestressed concrete pressure vessels (PCPV), and several concepts of containment in lined underground cavities were examined.

The initial screening reduced the set to twelve selections, some of which combined the elements of several concepts. These selections were then applied to two reference plants, an 800 MW plant burning high-sulfur coal, and an 1140 MW plant utilizing a light water nuclear reactor. Results of analysis of performance and costs of the twelve TES plants led to approval of four options by DOE/NASA and EPRI for more detailed consideration and conceptual design.

Two of the options use high sulfur coal-fired plants (HSC) and peaking turbines to supply the peaking power from steam generated from the thermal energy stored during off-peak periods. Steam is withdrawn from the cycle after the high-pressure turbine during the off-peak period to obtain the required energy for storage. With peaking turbines, power swings of  $\pm 50$  percent of the normal power are possible. One of the coal concepts stores the thermal energy in a dual media of a bed of rock with pores filled with hot oil at low pressure as a heat transfer medium. The other option uses an underground cavity lined with steel to store hot water under high pressure. Concrete is used to transfer the stress from the liner to the supporting rock.

The other two options utilize conventional nuclear plants and obtain power variations by reducing the feedwater extraction during peak power periods and increasing the extraction during off-peak periods. The thermal energy of the hot feedwater during the off-peak periods is stored to heat feedwater during the peak periods. Because of limitations on feedwater extraction, power swings are limited to  $\pm 10$  to 15 percent of normal power. One of the concepts utilizes the PCIV for storage of hot feedwater and the other utilizes the dual media, hot oil and rock, to store the feedwater thermal energy.

To avoid difficult design problems in coal-fired boilers with reheaters when large quantities of steam are withdrawn at the HP turbine outlet, the coal plants for TES were designed without reheaters resulting in small increases in both cost and heat rate.

Based on the conceptual designs, the cost and performance of the four TES systems as well as reference nuclear and coal plants were determined. The EPRI Technical Assessment Guide (TAG) (8/77) was used as a basis for the reference plants and fuel and operating costs. Costs of the other systems were made as consistent as possible with the TAG basis. A total installed cost in mid-1976 dollars and a levelized busbar energy cost was found for each plant assuming a 30-year life beginning operation in 1990.

Cycling coal plants were considered as a possible alternative to TES systems for peak load following. Performance and cost estimates on the same basis as the other plants were therefore made for two 512 MW cycling plants, one at 1800 psig/950<sup>0</sup>F/950<sup>0</sup>F steam conditions and another at 2400/1000/1000.

The 1977 Consent Decree places a number of restrictions on the General Electric Company regarding the furnishing of performance and pricing information on large steam turbine-generators. Accordingly, performance data, performance differences data and pricing information on steam turbine-generators included in this report are estimated data, for the most part calculated in 1976, but which are accurate enough for the intended purpose of this study.

The limited peaking capacity that results with feedwater energy storage reduces the benefit that the nuclear systems which were studied can provide a utility. These systems also have a high cost increment for peaking in both capital and levelized busbar electricity costs.

The coal plants with separate peaking turbines provide peaking power about equal to cycling coal plants in both total investment cost and levelized electricity cost. Both the TES and cycling coal plants are significantly lower in cost than the TES nuclear plants but still cannot compete with gas turbines for peaking duty at 1500 hours of operation or less per year unless oil becomes unavailable or increases significantly in cost.



The significantly higher cost of the TES nuclear plants compared to the coal plants is attributed principally to the feedwater storage mode and the high cost of key TES components, not to the fact that these TES systems were integrated with a nuclear plant.

A major disadvantage of TES systems as compared to cycling coal plants or gas turbines is their limited capacity to operate at any time if required because of other system outages. Increasing TES system capacity, however, so that it can operate more hours per day increases the cost more than the benefits obtained.

The capital investment required for storage is generally equal to or greater than that for at least some types of complete generation equipment, especially peaking systems. Hence, if storage systems are to be viable, there must be an opportunity to displace some of the high fuel or production costs of peaking generation equipment with lower production costs of baseload or intermediate equipment. Any production cost savings which are possible will depend on the fuel costs and efficiencies of both the peaking and storage systems.

The values of the TES systems to utilities are sensitive to the cost difference between gas turbine fuel and coal. TES integrated with a coal plant could be competitive with gas turbines for peaking if the 1990 fuel cost differential between oil and coal becomes greater than 3.6 \$/MBtu in 1976 dollars. The current EPRI estimate is a difference of 2.15 \$/MBtu on the same basis.

While recent price increases in oil indicate that the differences could easily exceed the 3.6 \$/MBtu in 1976 dollars by 1990, the coal based TES systems still could not compete with the cycling coal plants. The nuclear based TES systems might compete only if they were designed to use peaking turbines and the cost of both oil and coal increased unreasonably relative to the cost of nuclear fuel.

The TES systems meet the design objectives of being load following and daily cycling plants that are not dependent on scarce fuels. a 12% penetration of TES system plants into a typical generation mix (EPRI Utility System D) would reduce the system oil consumption by 32% (3.3 million barrels per year). However, a 12% penetration by cycling coal plants in the same utility system would reduce oil consumption by 52%.

None of the four TES systems, based on the near-term designs for this study, are economically attractive to utilities. Cost reductions of 10 to 40% are required for TES to be competitive with cycling coal plants and 40 to 50% if they are to be competitive with gas turbines at 1500 hours of annual operation. About one-half of the TES costs are related to the storage related items, with the remaining costs for standard state-of-the-art equipment such as turbines, piping, valving, etc. Reductions in total costs, therefore, must come almost entirely from reductions in the TES storage related costs.

Additional testing and development work on large TES systems would be required prior to a major commitment to TES by utilities. This large scale demonstration would be required to substantiate the performance figures for final system designs. The study design performance parameters were all extrapolated from smaller storage applications.

While not investigated in this study, major redesigns of the base plants to incorporate alternate TES systems would be required to improve the performance of TES for peaking applications. These changes would increase their cost and eliminate their use in near-term applications.

Additional refinements of near-term TES plant designs to improve the economic competitiveness with alternate peaking systems, especially cycling coal plants, will probably yield only marginal improvements.

## INDUSTRIAL STORAGE APPLICATIONS

### Program Area Synopsis:

The major tasks in this program element are the implementation of a technology demonstration for the food processing industry, development and technology demonstrations for selected near-term, in-plant applications and advanced industrial applications. These tasks will be supported by an on-going system studies activity which will assess advanced applications, solar industrial applications, and heat transport requirements. An important adjunct to this activity is the continued implementation of technology transfer through information collection and dissemination.



## INDUSTRIAL STORAGE APPLICATIONS OVERVIEW

Rudolph A. Duscha  
NASA Lewis Research Center

Significant conservation benefits and the substitution of domestic non-critical fuels for critical fuels (oil and natural gas) are possible through the use of thermal energy storage (TES) of industrial process and reject heat for subsequent use. The use of TES can either provide conservation through reject energy recovery and reuse or permit a shift in fuel from oil or natural gas to other non-critical fuels. One of the goals of the Department of Energy's (DOE) Division of Energy Storage Systems is to provide the storage technology capability to provide at least 10% of the industrial process heat or energy requirements of the U.S. industry by the year 2000. The purpose of Industrial Storage Applications, one element of DOE's Thermal Energy Storage Program, is to develop TES systems capable of contributing to the achievement of DOE's goal for the year 2000.

In order to achieve this long range goal it is clear that in the mid-term time frame (CY 85-90) demonstration of conservation of significant amounts of critical fuels is required. The groundwork to do this was started with an Energy Research and Development Administration (ERDA) funded study to determine the economic and technical feasibility of TES in conjunction with waste heat recovery (Ref. 1). This study was directed toward identifying industrial processes characterized by fluctuating energy availability and/or demand, a key criterion for TES applicability.

At least twenty (20) industries were identified as areas where thermal energy storage had potential for application to some degree. After the conclusion of this general feasibility study program, ERDA issued a Program Research and Development Announcement (PRDA). This PRDA requested proposals for individual studies of specific industries which were to be selected by each proposer. The overall objective was to identify specific applications of TES in specific industries through these system studies, and in subsequent work develop and validate potential systems, demonstrate feasibility on a large scale, and then transfer the technology to the total industry to result in widespread implementation.

As a result of this PRDA (and after the then recent metamorphosis from ERDA to DOE) DOE's Division of Energy Storage Systems awarded five contracts to study five industries with potential significant energy savings through the use of TES systems. These industries were paper and pulp, food processing, steel and iron, cement, and primary aluminum. The aluminum study produced results that were applicable to district heating systems. Because of this distinct application the aluminum study results (Ref. 2) and subsequent follow-on work are being discussed under Building Heating and Cooling Applications and will not be discussed here.

The other four system studies were conducted with each one having a similar generalized task breakdown structure. An analytical survey was conducted for each industry to determine the potential total recoverable energy. Candidate storage systems and applications for using the recovered energy were evaluated. Preliminary conceptual designs were evolved for which performance analyses were conducted. Economic analyses were made for the most promising designs, and the potential technical feasibility and economic benefits were assessed and summarized. Any development required was identified, and each study was concluded with a commercialization plan being formulated.

The results of these studies indicated that within these industries thermal energy storage of process and reject heat for subsequent in-plant use appears to be economically and technically feasible with significant near-term conservation benefits. Potential annual fuel savings with large scale implementation of near-term TES systems for these industries is over  $9 \times 10^6$  bbl of oil. This savings is due to recuperation and storage in the food processing industry, direct fuel substitution in the paper and pulp industry, and reduction in electric utility peak fuel use through in-plant production of electricity from utilization of reject heat in the steel and cement industries.

The technology identified falls into three categories: (1) Existing operational TES system applications for which detailed information has not been made public; (2) Promising system applications that involve current technology, require no development, and are ready for immediate technology demonstration to stimulate commercial introduction; and (3) Promising system applications that require development prior to a large scale industrial technology demonstration.

The paper and pulp application (category 1) is summarized in Figure 1. For mills with hog fuel (wood waste) boilers with excess steam generation capacity, TES would allow the substitution of more hog fuel for oil or natural gas. Typically, the base loaded hog fuel boilers with slow response times are augmented by oil or gas boilers to meet rapid steam demands. TES through the use of a steam accumulator can provide a load smoothing capability that would directly reduce the use of oil or natural gas. The results of this study are presented in Ref.3.

Mills, both in the U.S. and the Scandanavian countries, have been identified with such TES systems in place. However, information on these systems has not been made publicly available. A contract will soon be awarded for a program to obtain, analyze and disseminate this information to the U.S. paper and pulp industry. A more detailed discussion of this program appears later in this same section.

The food processing application (category 2) is summarized in Figure 2. TES in conjunction with recuperation can reduce energy consumption in a typical food canning plant. Preheating fresh make-up water through conventional heat exchange with the waste hot water stream results in a direct conservation of energy. In addition, when the process demands diminish while waste hot water is still available, the heated incoming fresh water can be diverted to storage. Hot water that accumulates in storage during the production period would then be used during the equipment clean-up period. Results of this study are presented in Ref. 4.

It was concluded that waste heat recovery from selected food processes is technically feasible and can be performed economically using available, off-the-shelf hardware. Therefore, a contract is being negotiated to proceed with a technology demonstration in a food canning plant. This demonstration will be used to evaluate actual hardware performance, to optimize the system design, and to determine actual costs and benefits resulting from the waste heat recovery and storage system. The results will then be publicized to encourage the installation of similar waste heat recovery systems within the food processing industry.

The steel and iron application (category 3) is summarized in Figure 3. Hot gas in the primary fume evacuation system of electric arc steel remelting furnaces is the reject heat energy source. The fume stream would charge a solid sensible heat storage packed bed. Discharge of the TES system through a heat exchanger would generate steam to drive a turbogenerator. TES is used to permit electric power to be generated during peak demand times instead of continuously. The economic benefits to be derived from the use of TES for peak power generation is a direct function of either a demand charge, time of day pricing, or a combination of both. Results of this study are presented in Ref. 5.

Although the TES concept of this study yielded favorable predictions of critical fuel displacement and investment returns, the approach is not ready to be applied directly to a full scale demonstration without an interim concept development period. Therefore, any further work will have to be as a result of competition with other applications in a similar state of readiness. This will be discussed further after the next system study discussion.

The cement application (category 3) is summarized in Figure 4. Hot gas from a long, dry-process cement kiln would be used in a waste heat boiler to produce steam for driving a turbogenerator to produce electricity for in-process use. Approximately 80-90% of the kiln exit gas would go directly through the waste heat boiler with the rest being used to charge a solid sensible heat storage packed bed. When the kiln is down for maintenance the packed bed would be discharged through the waste heat boiler thereby eliminating a power demand charge which could be significant. Results of this study are presented in Ref. 6.

The results of the cement study are similar to those of the steel study. Favorable predictions of critical fuel savings and investment returns resulted, but an interim concept development period would be required.

A procurement activity is in progress for the development and technology demonstration of thermal energy storage systems for industrial process and reject heat applications. This will be a competitive procurement with multiple awards planned. Because of the pending contracts involving TES in the paper and pulp and food processing industries, these industries are being excluded from this procurement. The emphasis of this procurement is to more fully evaluate U.S. industry for other applications of in-plant use of stored thermal energy using cost-effective near-term technology. In-plant use is being specified to preclude proposals for district heating applications which are being adequately covered by the follow-on effort to the aluminum study.

The objective of this procurement is to develop, if needed, and demonstrate TES systems that offer the potential of saving significant quantities of energy or critical fuels in the near-term on a cost-effective basis. Specific goals are to: contribute to the DOE goal of providing 10% of the U.S. industry's process heat or energy requirements by the year 2000 through thermal energy storage; be cost-effective by providing a return-on-investment that will significantly attract broad scale implementation; be acceptable by the industry as being operationally safe and reliable; and be environmentally acceptable. Cost-sharing will be an important factor in contract awards for this procurement.

Figure 5 summarizes in a schedular form the major activities under the Industrial Storage Applications element. Line 1 shows the continuing System Studies and Supporting Technology activity. The PRDA system studies discussed in this paper produced significant results that were transferred to other activities. The Technology Transfer to Paper and Pulp Industry activity is anticipated as being an 18 month program from early 1980 to mid-1981. The Technology Demonstration for Food Processing Industry activity is a three-year program from early 1980 to 1983. The Development and Technology Demonstration for Selected Near-Term In-Plant Applications is anticipated as being a five-year program from mid-1980 to mid-1985. Continuing System Studies activities include Heat Transport Applications, Solar Industrial Applications and New or Advanced Applications. Significant results from this activity will be transferred in early 1982 to Development and Technology Demonstration for Advanced Applications. An important factor in all of these activities is the continued implementation of technology transfer through information collection and dissemination.



## REFERENCES

1. Glenn, D. R.: Technical and Economic Feasibility of Thermal Energy Storage. General Electric Co., (COO-2258-1), 1976.
2. Katter, L. B.; and Haskins, R. L.: Applications of Thermal Energy Storage to Process Heat and Waste Heat Recovery in the Primary Aluminum Industry. Rocket Research Co. (CONS/5080-1), 1978.
3. Carr, J. H.: Application of Thermal Energy Storage to Process Heat Storage and Recovery in the Paper and Pulp Industry. Boeing Engineering and Construction (CONS/5082-1), 1978.
4. Lundberg, W. L.; and Christenson, J. A.: Applications of Thermal Energy Storage to Waste Heat Recovery in the Food Processing Industry. Westinghouse Electric Corporation (CONS/5002-1), 1979.
5. Katter, L. B.; and Peterson, D. J.: Applications of Thermal Energy Storage to Process Heat and Waste Heat Recovery in the Iron and Steel Industry. Rocket Research Co. (CONS/5081-1), 1978.
6. Jaeger, F. M.; Beshore, D. G.; Miller, F. M.; and Gartner, E. M.: Applications of Thermal Energy Storage in the Cement Industry. Martin Marietta Aerospace (CONS/5084-1), 1978.

SYSTEM STUDY RESULTS

INDUSTRY: PAPER AND PULP

CONTRACTOR: BOEING E&C/WEYERHAEUSER/SRI INTERNATIONAL

HEAT SOURCES IN PAPER AND PULP MILL

- 0 EXCESS STEAM FROM HOG FUEL (WOOD WASTE) BOILER DURING LOW STEAM DEMAND PERIOD

ENERGY END USE APPLICATIONS

- 0 PROCESS STEAM
- 0 FEEDWATER HEATING

RECOVERY/STORAGE/REUSE SYSTEM SELECTED

- 0 GENERATE EXCESS STEAM DURING LOW DEMAND PERIODS
- 0 STORE IN STEAM ACCUMULATOR
- 0 PROVIDE PROCESS STEAM DIRECTLY OR USE FOR FEEDWATER HEATING DURING HIGH DEMAND PERIODS
- 0 SAVE 100,000 BBL OIL/MILL ANNUALLY; 30% RETURN ON INVESTMENT

Figure 1

SYSTEM STUDY RESULTS

INDUSTRY: FOOD PROCESSING

CONTRACTOR: WESTINGHOUSE/HEINZ

HEAT SOURCES IN FOOD PROCESSING PLANTS

- 0 HOT WASTE WATER FROM FOOD PROCESSING

ENERGY END USE APPLICATIONS

- 0 EQUIPMENT CLEAN UP
- 0 PREHEAT INCOMING WATER FOR FOOD PROCESSING

RECOVERY/STORAGE/REUSE SYSTEM SELECTED

- 0 CAPTURE HEAT FROM WASTE WATER
- 0 STORE 2% IN HOT WATER TANK; USE REST FOR PREHEAT
- 0 USE TOPPED-OFF STORED WATER FOR EQUIPMENT CLEAN UP
- 0 SAVE 3-5% OF FUEL USAGE; 3 YEAR PAYBACK PERIOD

Figure 2

SYSTEM STUDY RESULTS

INDUSTRY: STEEL AND IRON

CONTRACTOR: ROCKET RESEARCH/BETHLEHEM STEEL/SEATTLE CITY LIGHT

HEAT SOURCES IN ELECTRIC ARC STEEL PLANT

- o PRIMARY FUME STREAM FROM ELECTRIC ARC FURNACE
- SOAK PIT STACK GASES
- BAR MILL FURNACE STACK GASES

ENERGY END USE APPLICATIONS

- o ELECTRICAL ENERGY GENERATION
- INGOT PREHEATING
- COMBUSTION AIR PREHEATING
- SCRAP PREHEATING

RECOVERY/STORAGE/REUSE SYSTEM SELECTED

- o CAPTURE HEAT FROM ELECTRIC ARC FURNACE FUME STREAM
- o STORE IN PACKED BED
- o GENERATE STEAM TO PRODUCE ELECTRICITY DURING PEAK PERIODS
- o SAVE  $2 \times 10^6$  BBL OIL ANNUALLY; 5 YEAR PAYBACK PERIOD

Figure 3

SYSTEM STUDY RESULTS

INDUSTRY: CEMENT

CONTRACTOR: MARTIN MARIETTA AEROSPACE/H. M. CEMENT/PORTLAND CEMENT ASSOCIATION

HEAT SOURCES IN DRY KILN CEMENT PLANTS

- o KILN EXIT GAS
- o CLINKER COOLER WASTE GAS
- KILN SMELL HEAT LOSS

ENERGY END USE APPLICATIONS

- o ELECTRICAL ENERGY GENERATION
- RAW MATERIAL DRYING
- FUEL DRYING
- OIL VISCOSITY REDUCTION

RECOVERY/STORAGE/REUSE SYSTEM SELECTED

- o CAPTURE HEAT FROM KILN EXIT GAS AND CLINKER COOLER WASTE GAS
- o STORE IN PACKED BED
- o GENERATE STEAM TO PRODUCE ELECTRICITY EVEN WHEN KILN IS DOWN
- o SAVE  $4 \times 10^6$  BBL OIL ANNUALLY FOR INDUSTRY; 50% ROI FOR COMBINED SYSTEM

Figure 4

INDUSTRIAL THERMAL STORAGE APPLICATIONS

SUMMARY - SCHEDULE

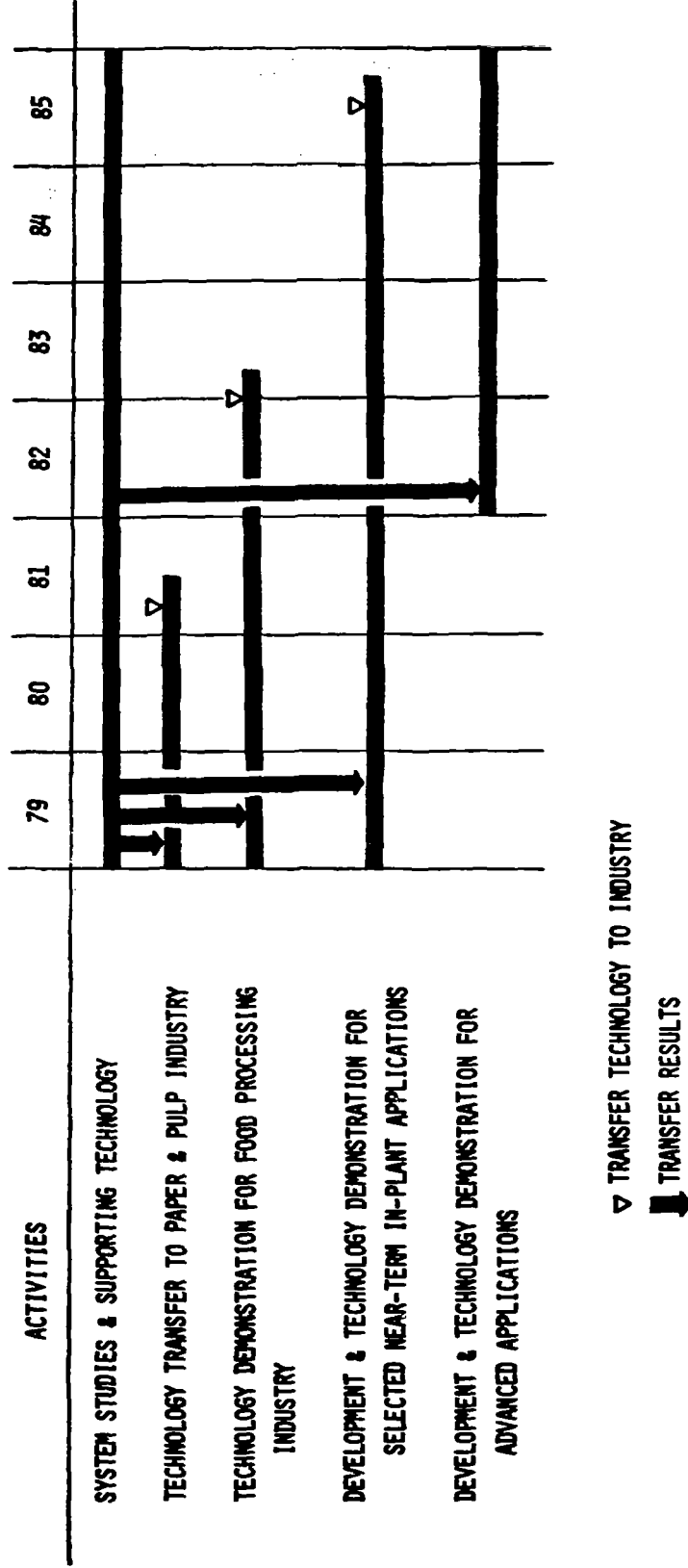

Figure 5

APPLICATIONS OF THERMAL ENERGY STORAGE TO WASTE HEAT RECOVERY  
IN THE FOOD PROCESSING INDUSTRY

F. Wojnar                      and                      W. L. Lundberg  
H. J. Heinz Company                      Westinghouse Electric Corporation

PROJECT OUTLINE

**Project Title:** TES for Food Processing Assessment

**Principal Investigator:** Wayne L. Lundberg

**Organization:** Westinghouse Electric Corporation  
Advanced Energy Systems Division  
P.O. Box 10864  
Pittsburgh, PA 15236  
Telephone: (412) 892-5600

**Project Goals:** To assess the potential for waste heat recovery in the food processing industry and to evaluate prospective waste heat recovery systems and the benefits of thermal energy storage.

Analyze factory and food system operations of two manufacturing plants of Heinz USA Division of H. J. Heinz Company to determine waste heat availability applications

Perform a waste heat recovery system design

Assess potential energy savings in the food industry

Recommend a demonstration plan

**Project Status:** Waste heat is available in significant quantities which can be used for existing, on-site energy demands

Thermal energy storage/waste heat recovery (TES/WHR) systems can be effectively applied in these applications

Economics for waste heat recovery can be attractive for facilities with high energy demand levels

Return-On-Investment for recommended TES/WHR is estimated at 35-40%

**Contract Number:** EC-77-C-01-5002

**Contract Period:** August 1977 to October 30, 1978

**Funding Level:** \$96,195

**Funding Source:** U.S. Department of Energy  
Division of Energy Storage Systems

APPLICATIONS OF THERMAL ENERGY STORAGE TO WASTE HEAT RECOVERY  
IN THE FOOD PROCESSING INDUSTRY

F. Wojnar  
H. J. Heinz Company

W. L. Lundberg  
Westinghouse Electric Corporation

SUMMARY

The canning segment of the food processing industry is a major energy user within that industry. Most of its energy demand is met by hot water and steam and those fluids, in addition to product cooling water, eventually flow from the processes as warm waste water. To minimize the possibility of product contamination, a large percentage of that waste water is sent directly to factory drains and sewer systems without being recycled and in many cases the thermal energy contained by the waste streams also goes unreclaimed and is lost from further use. A study discussed herein indicates that the recovery of waste heat in canning facilities can be performed in significant quantities using systems involving thermal energy storage (TES) that are both practical and economical. A demonstration project has been proposed to determine actual waste heat recovery costs and benefits and to encourage system implementation by the food industry.

BACKGROUND

A study project\* was conducted by Westinghouse and completed in October, 1978 to assess the potential for waste heat recovery in the food industry and to evaluate prospective waste heat recovery system concepts employing thermal energy storage. The project was performed with the cooperation of the H. J. Heinz Company (USA Division) and during the project, Heinz USA arranged access to two of their manufacturing plants and permitted Westinghouse personnel to analyze factory operations and food system performance at each site. The project's most productive work was accomplished at the company's Pittsburgh Factory. The Pittsburgh plant is engaged in the manufacture of baby foods and juices, canned soups and canned bean products. This product line places the factory in the Canned Specialties (SIC 2032) industry but the food processes and the associated hardware are also common to the Canned Fruits and Vegetables (SIC 2033) segment of the food industry. Therefore, the results of work at the factory would be applicable to SIC 2033 as well as to Canned Specialties and they did in fact prove to be particularly

---

\*Contract EC-77-C-01-5002, 8/31/77 - 9/30/78, \$96,195.00.

interesting and attractive. They showed that a variety of waste heat sources and applications are available at a food canning facility and that those sources and applications could be coupled economically by systems containing a storage element.

The Pittsburgh Factory operates several common food processing systems (can/bottle washers, continuous coolers, stationary retorts and continuous pasteurizers) that produce heated waste water having temperatures in the 100 to 200°F range. The waste water streams are sent directly to the factory drain system as they emerge from the processes and waste heat recovery currently is not attempted. Flow rate and temperature data were taken from each system during the study and it was concluded that the temperatures were sufficiently high to permit accessing a portion of the available waste heat by conventional heat exchange. Three separate energy demands occur at the Pittsburgh Factory that could use this energy. They involve the heating of boiler make-up water, fresh water for the food processes and factory clean-up water. The make-up and food processing demands peak during the one or two production shifts of each day in unison with waste heat availability. Therefore, supplying waste heat to those demands will generally not involve significant storage. The hot water clean-up effort, however, is performed after-hours when the production systems are down and meeting a portion of that energy demand with waste heat from the production period would of course require a buffering storage device.

To assess the role of TES in canning industry waste heat recovery, a recovery system concept for application to the factory's Meat Products Building was devised and analyzed. Meat Products is the largest manufacturing unit at the factory and it houses several food processing operations and two waste heat applications that cause it to be similar in a variety of ways to manufacturing plants operated by other food processing companies throughout the industry. The waste water streams to be collected by the system (see fig. 1) would come from the stationary retorts, the can and bottle washers installed on several product filling lines and from the continuous pasteurizing system. The high temperature waste streams from these processes will flow by gravity to a collection tank and then by forced flow to a plate heat exchanger where heat will be transferred to circulating fresh water. The hot fresh water will then return to the food processes via the thermal energy storage tank and the existing water heater system (serving with the recovery system in a topping capacity) while the cooled waste water will flow directly to the existing drain system. The circulation flow rate,  $W_F$ , in the heat exchanger/TES loop will be controlled to satisfy the daytime production demand for hot fresh water,  $W_p$ , and also to accumulate during the production period a surplus volume of hot water which will be stored for later use during clean-up operations. The analysis of the system concept demonstrated a fundamental fact about waste heat recovery using thermal storage. Storage is beneficial in that it permits the recovery of an additional increment of waste heat over that which can be used immediately at the time of waste heat production. However, storage is also expensive and generally, at current fuel values, it will not support itself economically. Therefore, in a total recovery system involving storage, the storage portion must be "carried" by

a relatively low cost element that recycles waste heat immediately. By this approach, it is possible to design and optimize the total system for maximum heat recovery while still meeting the investment return hurdle rate.

The study predicted reductions in fossil fuel usage at the factory of nearly 3% through installation of the Meat Products waste heat recovery system. Projecting this to the canning segments (SIC 2032 and 2033) of the food industry results in an annual industry energy saving of approximately  $0.002 \times 10^{15}$  Btu having a fuel oil equivalent of 340,000 barrels. It should also be recognized that the same recovery system concept may be applicable to other segments of the food industry besides canning. A possible example is the frozen food industry where high temperature waste heat is now available in refrigerant vapor (as opposed to hot waste water). This energy could be used to preheat the large quantities of hot fresh water that are required in many frozen food plants during the production periods and during the after-hours clean-up. Alternate system applications in industry segments other than canning would lead to even larger reductions in fuel usage and they should be fully explored.

The predicted payback period for the Meat Products system is approximately three years. The Meat Products Building houses seven production floors and the recovery system piping, which accounts for nearly one-third of the operational system's cost, must traverse all seven floors. Still, the predicted payback would be acceptable to most companies and it quite possibly could be less than three years if the system were installed in a more compact factory. In view of this, the system commercialization prospects are attractive.

The best procedure for convincing industry that waste heat recovery by this method can be carried out economically and without adversely affecting product quality or plant operations is to install a demonstration system and then to carefully monitor its performance and report the findings. A project to do precisely that at the Pittsburgh Factory has been proposed by Heinz USA and the following section addresses the purpose, task and schedular features of that proposal.

## DEMONSTRATION PROJECT

### Purpose and Participants

The purpose of the demonstration project proposed by Heinz USA is four-fold:

1. To design, install and place in operation a system employing thermal energy storage that will recover heat from food system waste water.
2. To monitor the operation of the waste heat recovery system in a production setting over a period of one year, to assess its performance and to evaluate the benefits that accrue environmentally and in the form of dollar and fossil fuel savings.



3. To effectively inform the food industry, particularly the canning segment, concerning the actual costs and benefits of system operation and to encourage industry acceptance and implementation of the system concept.
4. To recommend a plan for system implementation in the food processing industry.

In particular, the demonstration system will be based upon the concept described above and it will be installed in the factory's Meat Products Building where it will service food processes that are housed in that building. The system design will conform to standard Heinz engineering practice and it will abide by all applicable food industry regulations as imposed by the regulating agencies - USDA, FDA, OSHA, etc. Actual costs incurred to design and place the system in operation will be carefully recorded, recognizing that a study of the system's economic performance will be of prime importance.

The recovery system will be equipped with normal operational instrumentation. It will also be equipped with special demonstration instrumentation and an automatic data acquisition system (DAS). The demonstration instrumentation and the DAS would normally not be required in a production version of the waste heat recovery system. In this case, however, that equipment is essential to assess the system's thermal performance. All data collected by the DAS will be stored in a form compatible with a separate computer system which will be used to analyze the data during the performance evaluation phase.

Under the proposed management plan, Heinz USA will have overall project management responsibility and will execute the efforts of system definition review, system fabrication, installation, checkout, and operation. Other phases of the project will be subcontracted by Heinz USA. The demonstration system engineering and operational evaluation work is planned for subcontracting to the Advanced Energy Systems Division of the Westinghouse Electric Corporation. Westinghouse would then develop a detailed engineering design for the system which would include the preparation of engineering drawings, operation and maintenance procedures and manuals and predictions of system performance characteristics. In addition, Westinghouse would monitor and evaluate actual system performance, prepare performance analyses and carry out the program control and reporting functions.

It is planned that execution of the technology transfer task will be delegated to the National Food Processors Association (NFPA). As part of that effort, the NFPA would be responsible for an assessment of the system implementation potential within the food processing industry and for an analysis of benefits that would accrue if this implementation potential materialized. Further, the NFPA would plan and conduct on-site project reviews. The reviews would be attended by food industry personnel to report progress and to assess project results and findings. In addition, the NFPA would coordinate the development of a plan for implementing the demonstration system concept on an industry-wide basis.

## Proposed Project Tasks

The proposed project would consist of five technical tasks geared to accomplishing the objectives identified above. The tasks are described below.

### Task 1 - System Definition Review and Demonstration Plan Preparation

During this task, all previous work and the resulting system concept will be reviewed to verify the concept's acceptability. This effort is needed to provide the best system base for the demonstration project. The second Task 1 effort will address the preparation of a demonstration plan. This work will involve all project participants and will establish program details and a detailed schedule to meet the program goals.

### Task 2 - System Design

In Task 2, the demonstration system design will be completed and all system hardware will be specified based upon the concept stemming from the completed Task 1. In addition, an operation and maintenance manual will be prepared and a major design review will be conducted. The design resulting from Task 2 will consider and include all operational hardware, instruments and controls and all hardware for the measurement and recording of special demonstration performance data.

### Task 3 - System Fabrication, Installation and Checkout

Task 3 will include the procurement of all hardware for the demonstration system and its installation and checkout at the Heinz USA Pittsburgh Factory. The checkout phase will exercise all operational equipment, the special demonstration instruments and DAS and the data analysis computer program.

### Task 4 - Performance Demonstration and Evaluation

The objective of this task is to assess the system's thermal performance, its operational performance and its practicality in a production setting. This work will be based largely upon data from the proposed demonstration instruments (see fig. 2) which will be used to determine heat recovery rates and to evaluate important operational concerns such as heat exchanger fouling rates and heat exchanger maintenance/cleaning requirements.

### Task 5 - Technology Transfer

This task is of major importance and its purpose is three-fold.

- To communicate demonstration plans and results to the food processing industry and in particular to those industry segments involved in the preparation of canned food products.

- To assess the potential for implementing the demonstration system concept within the canning and food processing industries.
- To prepare a logical and efficient plan that will encourage system implementation within those industries.

The Task 5 work will be coordinated by the National Food Processors Association using established lines of communication between the association and its 850 member firms. The NFPA is a major canning industry trade association and its members are responsible for 90% of the canned goods packed in the United States for human consumption. This organization is therefore well suited and a logical choice to handle the technology transfer effort.

### Demonstration Project Schedule

The proposed project schedule is shown in fig 3.

### CONCLUSION

Heat recovery applying storage is relatively expensive and the completed study shows that to operate economically, a recovery system containing a storage feature will require an appropriate mix of immediate-need and storage-based waste heat applications. The survey work performed at the Heinz Pittsburgh Factory indicates that low grade waste heat (<200°F) is available in abundance in food canning facilities in the form of hot waste water streams and that a variety of suitable low temperature applications with the required mix will also exist. The study predicted attractive fuel savings and payback periods and therefore a demonstration effort to verify those predictions should be launched and has been proposed.

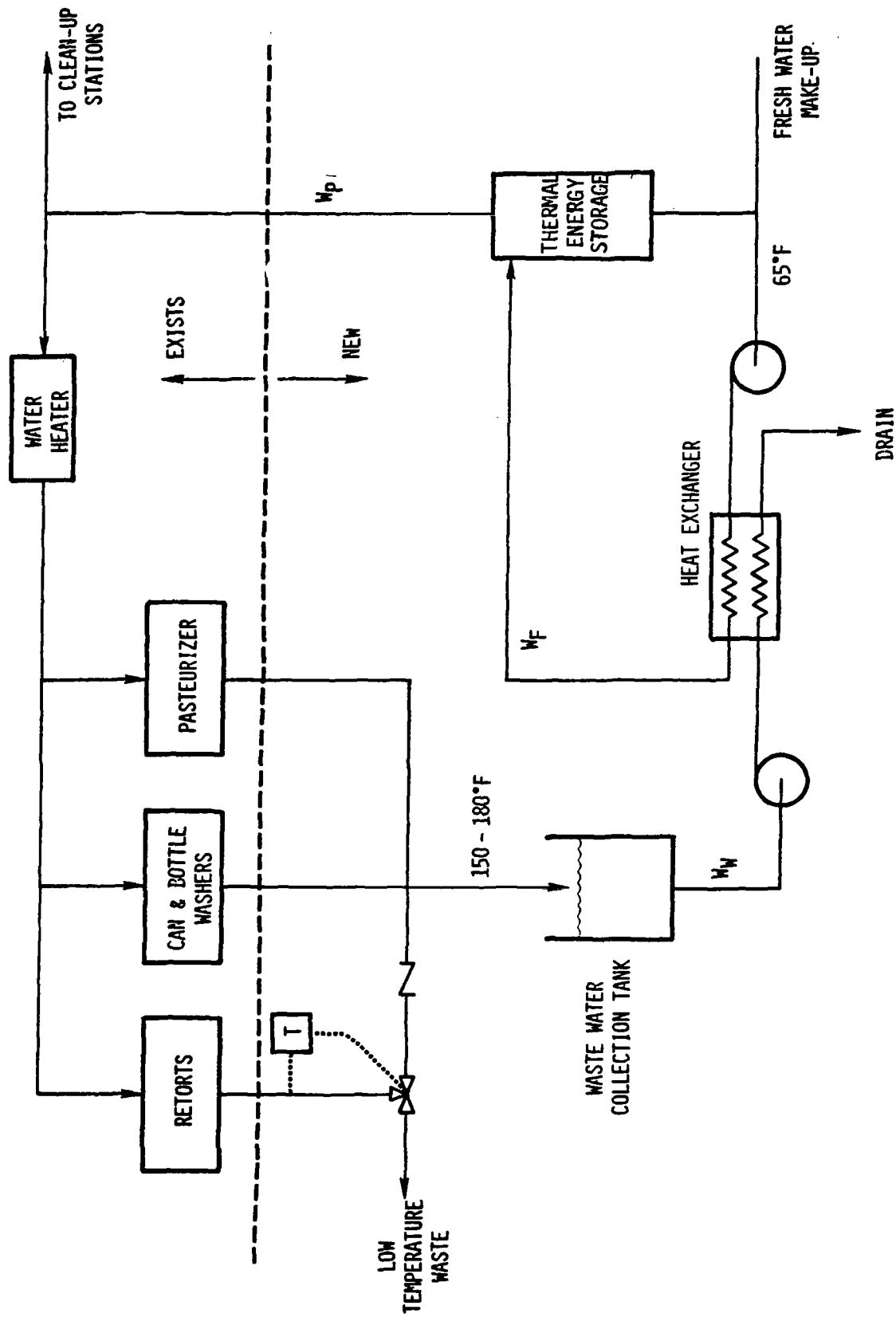

Fig. 1 - Waste Heat Recovery System Schematic

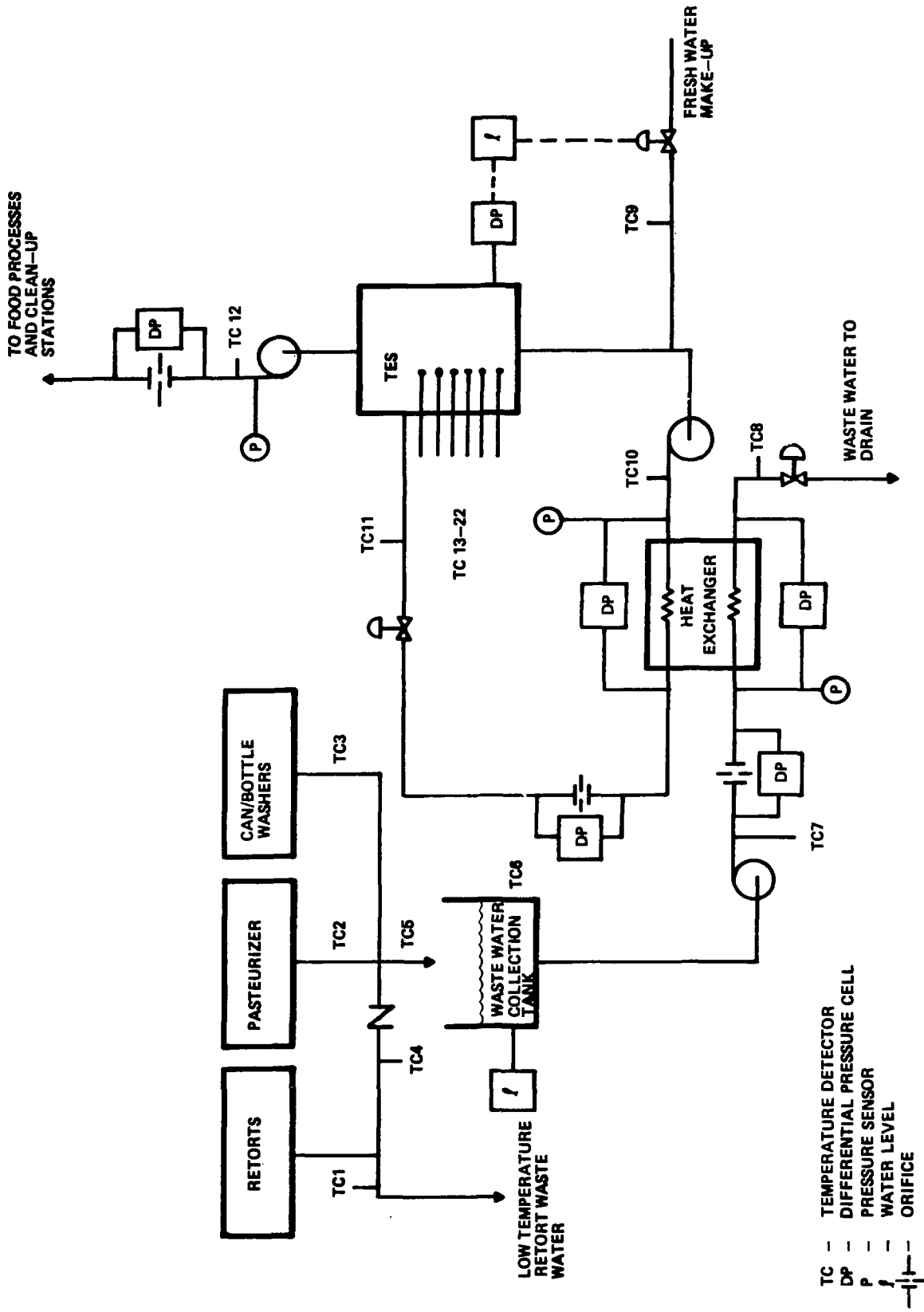

Fig. 2 - Demonstration System Instrumentation

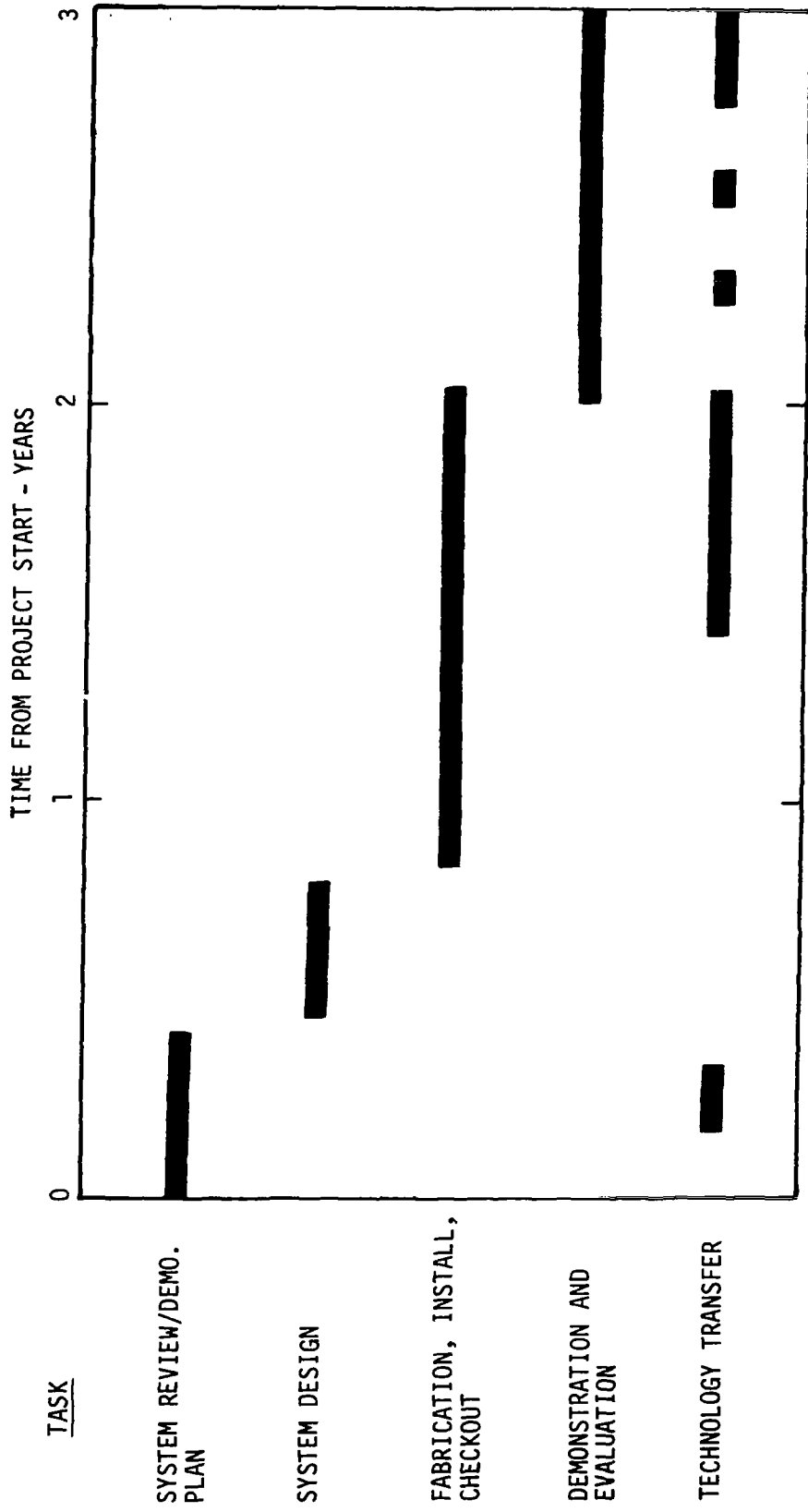

Fig. 3 - Demonstration Project Schedule

COLLECTION AND DISSEMINATION OF TES SYSTEM INFORMATION  
FOR THE PAPER AND PULP INDUSTRY

M. W. Dietrich  
NASA Lewis Research Center

PROJECT OUTLINE

Project Title: Collection and Dissemination of Thermal Energy Storage System Information for the Paper and Pulp Industry

Principal Investigator: Howard Edde

Organization: Howard Edde, Inc.  
1402 140th Place, N. E.  
Bellevue, WA 98007  
(207) 643-0900

Project Goals: The objectives of this procurement are to determine existing applications of TES in both the U.S. and international paper and pulp industries, to obtain and analyze the operating data from a representative number of these mills, and to transfer this information to the U.S. paper and pulp industry.

The Statement of Work (SOW) requires the contractor to conduct a knowledgeable survey of both U.S. and international paper and pulp mills using thermal energy storage (TES) systems as a part of their production processes; to obtain from these mills, sufficient operating data to conduct a benefits analysis encompassing; (a) energy conservation assessment, (b) economic benefits analysis, and (c) environmental impact assessment; and propose an information dissemination plan using brochures, displays and presentations at paper and pulp industry technical and management meetings that will effectively present the benefits of TES to the U.S. paper and pulp industry.

Project Status: Contract initiation meeting held in February, 1980.

Contract Number: DEN3-190

Contract Period: January, 1980 to March, 1981

Funding Level: \$113,816

Funding Source: NASA Lewis Research Center

COLLECTION AND DISSEMINATION OF TES SYSTEM INFORMATION  
FOR THE PAPER AND PULP INDUSTRY

M. W. Dietrich  
NASA Lewis Research Center

TASK OVERVIEW

- o CONTRACTED EFFORT
- o CONTRACTOR: TBD
- o PERIOD OF PERFORMANCE: 15 MONTHS
- o STATUS: COMPLETING NEGOTIATIONS WITH POTENTIAL CONTRACTORS.  
CONTRACT TO BE AWARDED IN JANUARY, 1980.

BACKGROUND

- o INITIAL PAPER AND PULP SYSTEMS STUDY (BOEING) 1978
- o IDENTIFIED AN OPERATIONAL TES INSTALLATION
- o DECISION TO PROCEED DIRECTLY TO TECHNOLOGY TRANSFER



## PAPER AND PULP ENERGY SUPPLY CHARACTERISTICS

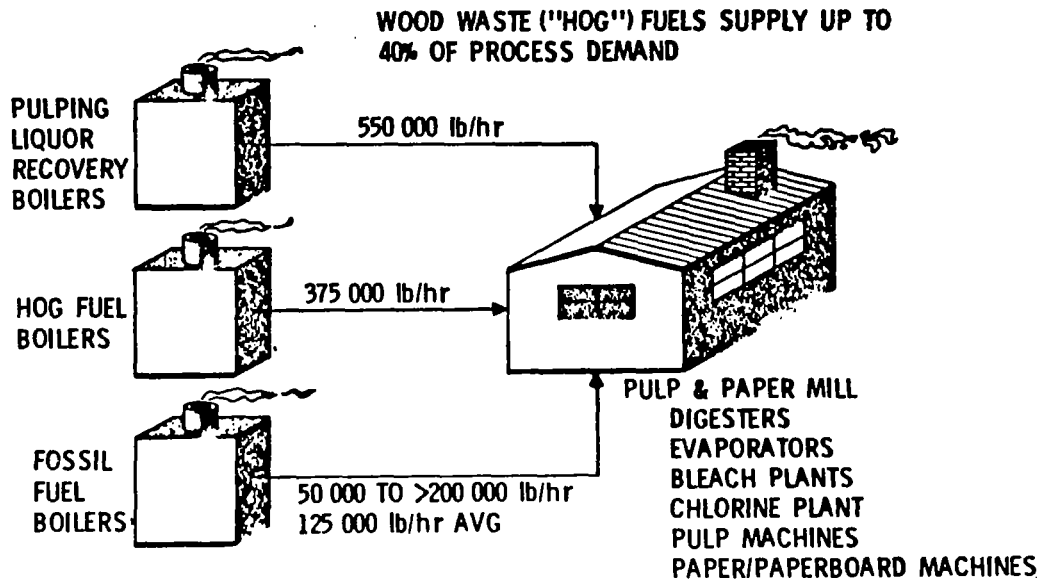

## ENERGY SUPPLY CHARACTERISTICS WITH THERMAL ENERGY STORAGE

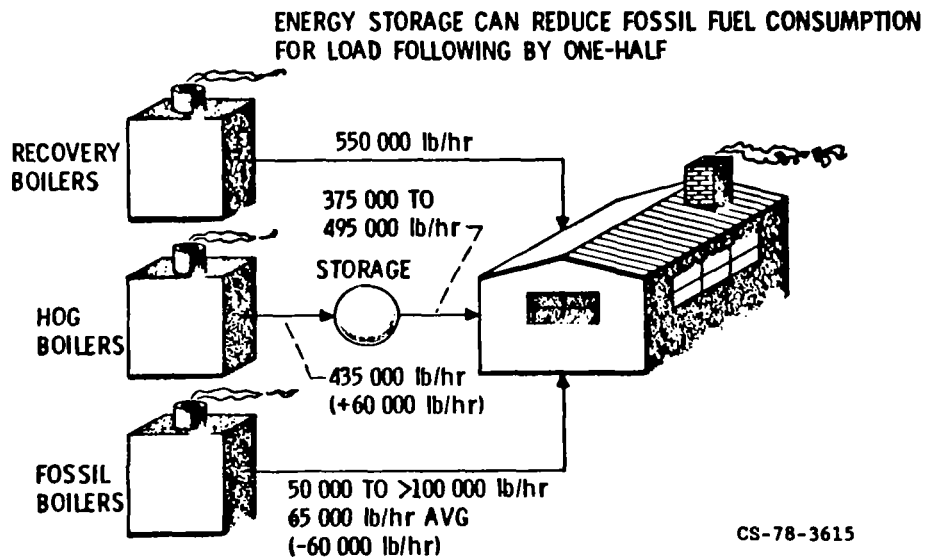

## PAPER AND PULP

### CONCLUSIONS:

SYSTEM IS ECONOMICALLY AND TECHNICALLY FEASIBLE (>30% ROI)

INDUSTRY WIDE CONSERVATION POTENTIAL IS  $3 \times 10^6$  BBL OIL/YR (>1982)

### DEVELOPMENT REQUIRED

- o NONE

### TECHNOLOGY DEMONSTRATION POSSIBLE

- o FULL SCALE IN AN OPERATING MILL BY FY 81

## PAPER AND PULP TECHNOLOGY TRANSFER

### APPROACH

- o DETERMINE EXISTING APPLICATIONS OF TES IN BOTH U.S. AND INTERNATIONAL PAPER AND PULP MILLS
- o OBTAIN AND ANALYZE OPERATING DATA FROM A REPRESENTATIVE NUMBER OF THE MILLS
- o DISSEMINATE BENEFITS FROM THE ANALYSIS TO THE U.S. PAPER AND PULP INDUSTRY

## METHODOLOGY

### SURVEY

- o CONDUCT THOROUGH SURVEY OF U.S. AND INTERNATIONAL PAPER AND PULP MILLS
- o TABULATE DATA SHOWING NAME AND LOCATION OF MILL, PRODUCT, ANNUAL PRODUCTION, TYPE AND SIZE OF TES SYSTEM, STORAGE MEDIUM, MAXIMUM CHARGING AND DISCHARGING RATES OF TES SYSTEM, MAXIMUM STEAM CAPACITY, MAXIMUM ELECTRICAL GENERATING CAPACITY, FUEL MIXTURE (I.E. % FOSSIL FUEL, % OTHER)
- o REDUCE TABLE TO "REPRESENTATIVE" LIST
- o DEFINE OPERATING CHARACTERISTICS OF "REPRESENTATIVE" MILLS TO OBTAIN HEAT SOURCES, END USES, TYPICAL PROCESS OPERATING CYCLES, ALL STREAM CONDITIONS, PROCESS THERMAL AND ELECTRICAL LOADS

## METHODOLOGY - CONT.

### BENEFIT ANALYSIS

- o CONDUCT ENERGY CONSERVATION ASSESSMENT  
COMPARING DATA FROM:
  - RETROFITTED MILLS BEFORE AND AFTER TES INSTALLATION
  - NEWLY BUILT MILLS WHICH INCLUDE TES AS A PART OF THEIR INITIAL DESIGN
- o DETERMINE ANNUAL FUEL SAVINGS IN BOE/TON OF OUTPUT PRODUCT FOR "REPRESENTATIVE" MILLS
- o EXPAND DATA TO BE DESCRIPTIVE OF FUEL CONSERVATION POTENTIAL FOR U.S. PAPER AND PULP INDUSTRY FOR EXTENSIVE IMPLEMENTATION
- o PROJECT FUEL CONSERVATION BENEFITS FOR NEAR-TERM (THRU 1985) AND LONG TERM (THRU 2000)

METHODOLOGY - CONT.

- o CONDUCT AN ECONOMIC ANALYSIS USING:
  - FUEL CONSERVATION PROJECTIONS
  - PRICE PROJECTIONS OF OIL GAS, "HOG" FUEL, ELECTRICITY, ETC.
  
- o COMPUTE ROI FOR REPRESENTATIVE TES INSTALLATION
  
- o CONSIDER ANY OTHER ECONOMIC ADVANTAGE OBTAINED THRU INSTALLATION OF TES
  
- o PROJECT ECONOMIC BENEFITS FOR NEAR-TERM (THRU 1985) AND LONG-TERM (THRU 2000) ASSUMING WIDE-SPREAD IMPLEMENTATION OF TES BY THE PAPER AND PULP INDUSTRY
  
- o CONDUCT AN ENVIRONMENTAL IMPACT ASSESSMENT

METHODOLOGY - CONT.

INFORMATION DISSEMINATION

- o PREPARE INFORMATION DISSEMINATION PLAN TO INCLUDE:
  - BROCHURES
  
  - DISPLAY
  
  - PRESENTATIONS AND MEETING ATTENDANCE

ACTIVITY	1979												1980												1981																							
	J	F	M	A	M	J	J	A	S	O	N	D	J	J	A	S	O	N	D	J	J	A	S	O	N	D	J	F	M	A	M	J	J	A	S	O	N	D										
3.4 TECHNOLOGY TRANSFER																																																
3.4.1 Information collection and dissemination - Paper/Pulp (CP: TBD)																																																

- ▽ Milestone
- ▽ Rescheduled Activity
- ▼ Completed Activity
- s Establish SEB
- r Release RFP
- a Award Contract
- P Publish Report
- SS Sole Source Procurement
- CP Competitive Procurement
- IAA Interagency Agreement
- DHP DOE Headquarters Procurement
- PA Planning Activity



## SOLAR THERMAL POWER APPLICATIONS

### Program Area Synopsis:

A comprehensive development of thermal storage technologies has been planned with DOE to match the solar thermal power system requirements and milestones in the FY 80-85 period. The program provides advanced storage subsystems for nearer term solar thermal applications, and establishes a storage technology base for future applications. Early efforts will stress storage for repowering/industrial retrofits, total energy, and small community systems. These applications reflect the current direction of the Thermal Power Systems Branch of the DOE Division of Central Solar Technology. The program will be implemented by DOE-designated lead laboratories with overall program management to be the responsibility of a DOE-designated lead center. SERI's tasks as they relate to supporting research and technology are an integral part of this activity.





## SOLAR THERMAL POWER STORAGE APPLICATIONS

### LEAD LABORATORY OVERVIEW

Lee G. Radosevich  
Sandia Laboratories, Livermore

### SUMMARY

This overview describes the implementation of the applications elements of the Thermal Energy Storage for Solar Thermal Applications (TESSTA) program. The TESSTA program evolved from a joint plan of the DOE Division of Energy Storage Systems (STOR) and Central Solar Technologies (CST). The program includes the accelerated development of thermal storage technologies matched to solar thermal power system requirements and scheduled milestones. The program concentrates on storage development in the FY80 to 85 time period with emphasis on the more near-term solar thermal power system applications. The basic strategy of the program is both aggressive and flexible. Reflecting the current direction of the Thermal Power Systems (TPS) Branch, CST, storage for repowering/industrial retrofit, total energy, and small community system applications is stressed in the early years.

### GENERAL PROGRAM DESCRIPTION

Recognizing thermal energy storage as potentially critical to the successful commercialization of solar thermal power systems, the DOE Divisions of Energy Storage Systems (STOR) and Central Solar Technologist (CST) have established a comprehensive and aggressive thermal energy storage technology development program in direct support of solar thermal power applications. The program concentrates on storage subsystem development in the FY80 to 85 time period with emphasis on the more near-term solar thermal power system applications.

The overall objective of this storage development program is to develop general solar thermal energy storage technologies that provide:

- Second-generation storage subsystems offering cost/performance improvements over the first-generation storage subsystems currently being developed for solar thermal power applications.
- First-generation storage subsystems for those solar thermal applications that presently have no storage subsystems under development.
- A technology base to support storage subsystem development for future solar thermal power applications.

Implementation of the first two program elements, which are application oriented, is the responsibility of the Field Lead Laboratory, Sandia Laboratories Livermore (SLL), who also directs and coordinates the storage activities of Jet Propulsion Laboratory (JPL) and Sandia Laboratories Albuquerque (SLA). The Field

Lead Laboratory for implementation of the technology base goal is the Solar Energy Research Institute (SERI). Private industry, competitively selected, and universities perform the implementation as operating contractors with SLL, SLA, JPL, and SERI performing only that R&D appropriate to a national laboratory and necessary for management of the program.

#### APPLICATIONS PROGRAM DESCRIPTION

The applications portion of the program has been divided into seven major elements according to the tasks outlined in Figure 1. The first element represents generic activities required to support program management functions; the remaining six elements are keyed to storage development for specific collector/receiver technologies. Several tasks have been further divided into subtasks which represent specific concepts being pursued. Project applications\* for the six major elements have been identified to provide a development focus for the storage technology development. The relation between the elements and the project applications is shown in Figure 2.\*\* A summary description of first and second generation thermal energy storage technologies for each application element is given in Table I.

The TESSTA program has developed cost and performance goals for these solar thermal system applications. Representative goals for both first generation and second generation systems are shown in Table II.

The cost goals, which assume fully developed storage technologies incorporated in large commercial systems, represent the lowest achievable total capital cost consistent with system performance requirements. They were based on the results of studies of commercial solar and conventional power systems that incorporate thermal energy storage.

A general performance goal for a storage subsystem is to maximize the round trip efficiency, that is, maximize system performance when operating from storage. The round trip efficiency combines the recoverable energy and power cycle conversion efficiencies of the storage subsystem. High recoverable energy efficiency, that is, the energy out of storage divided by the energy in, is important in that it minimizes the required collector area. Furthermore, it is the primary criterion when the recovered energy is utilized for industrial process heat. Power conversion cycle efficiency will vary depending on the conditions of the working fluid input to the power conversion subsystem from storage. Ideally, the

---

\*The repowering/industrial retrofit program may result in two system applications: repowering of an existing electric power generating plant and retrofitting of an existing industrial process heat plant. Storage requirements, which may differ significantly for the two applications, will be further defined pending completion of conceptual design studies in FY80.

\*\*The solar interface operating conditions and candidate applications are representative cases only. For example, several water/steam collector/receivers at various operating conditions are under consideration for the repowering/industrial retrofit system application.

conditions of the working fluid coming from storage would be identical to the conditions of the working fluid input directly from the solar collection subsystem. In this case, no modifications in operation of the power conversion subsystem are necessary, nor is there any loss in the ability to generate rated load.

#### APPLICATIONS PROGRAM STATUS

The basic TESSTA program development flow, consists of three phases:

1. Storage concept development - concept feasibility and lab experiments,
2. Storage subsystem development, and
3. System applications including new projects or retrofits.

The status of this development for each of the major program focused elements is described in Figures 3 to 8.

The strategy of the program is both aggressive and flexible. Reflecting the current direction of the Thermal Power Systems (TPS) Branch, CST, storage for repowering/industrial retrofit, total energy, and small community system applications is stressed in the early years. Particular attention is being directed toward identifying and implementing storage development required for industrial process heat applications. A summary of major FY80 activities in each of these application sectors is presented in Figure 9 and described below.

#### REPOWERING/INDUSTRIAL RETROFIT SYSTEM APPLICATIONS

The major area of emphasis in this application sector is molten salt sensible heat storage. Early studies conducted under the TPS Advanced Central Receiver Program identified molten nitrate salts as attractive storage media candidates. In particular, molten draw salt (60%  $\text{NaNO}_3$ , 40%  $\text{KNO}_3$  by wt.) was singled out because of its low cost, high energy density and potential high operating temperature. A recent study under the TPS program has examined low cost containment techniques in order to reduce the storage subsystem cost even further. This study identified a low cost liner concept which may be applicable to liquid metal as well as molten salt storage.

During FY80 the TESSTA program will initiate storage subsystem development for nitrate salt sensible heat storage. This includes the design, construction, testing, and evaluation of a molten salt subscale research experiment of sufficient scale to insure successful operation of the full-size subsystem. A major objective of this development is to advance state-of-the-art in high temperature containment. Salt material studies are also underway at SLL and contracted work is planned to establish the long-term stability and corrosion behavior of molten nitrate salts at elevated temperatures.

A second area of emphasis for this application is second generation storage development for saturated steam and superheated steam receivers. Studies will be initiated in FY80 for latent heat storage concept development for process heat applications and sensible and/or latent heat storage concept development for Barstow retrofit and repowering applications. Subsystem research experiment design, fabrication, testing, and evaluation will follow in later years.

## TOTAL ENERGY SYSTEM APPLICATIONS

Activities in this application sector provide support for and advanced alternatives to storage subsystems under development for midtemperature solar thermal applications, such as irrigation and Shenandoah. First generation storage subsystem support includes analyses and testing of organic fluid single and dual media storage systems at the Midtemperature Solar Thermal Test Facility. Studies to be performed in FY80 include control strategies for a multitank storage subsystem, thermocline performance of single media systems for buffer or diurnal operation, feasibility of a moving piston, and design and fabrication of a dual media system for installation and testing during FY81.

The development of a second generation latent heat storage subsystem for a Shenandoah midtemperature solar thermal application is also planned in FY80. Studies include storage media screening, engineering analyses, conceptual design, and cost estimates. Subsystem research experiment design, fabrication, and testing will follow in later years.

## SMALL COMMUNITY SYSTEM APPLICATIONS

The major emphasis of this application sector is the development of a dish mounted latent heat storage subsystem for three small community system applications. Power conversion cycles under consideration include Rankine, Brayton, and Stirling. Development activities include storage requirements definition, conceptual design, media stability and compatibility tests, thermal performance analyses, cost estimates, and a SRE. During FY80 storage requirements definition, concept development and SRE design studies will be initiated for each of the above power conversion cycles.

TABLE I  
DESCRIPTION OF FIRST AND SECOND GENERATION THERMAL ENERGY STORAGE TECHNOLOGIES

APPLICATION*	SOLAR INTERFACE	STORAGE TECHNOLOGY	
		FIRST GENERATION	SECOND GENERATION
BARSTOW	WATER/STEAM COLLECTOR/RECEIVER	OIL/ROCK THERMOCLINE	SALT, TRICKLE OIL
REPOWERING	MOLTEN SALT COLLECTOR/RECEIVER	MOLTEN SALT WITH EXTERNAL INSULATION	MOLTEN SALT WITH INTERNAL INSULATION
IEA	LIQUID METAL COLLECTOR/RECEIVER	LIQUID METAL WITH EXTERNAL INSULATION	MOLTEN SALT OR LIQUID METAL WITH INTERNAL INSULATION, AIR/ROCK
EPRI/DOE HYBRID	GAS COLLECTOR/RECEIVER	REFRACTORY BRICK WITH WELDED STEEL TANK	REFRACTORY BRICK WITH PCIV
SHENANDOAH	ORGANIC FLUID COLLECTOR/RECEIVER	SILICONE OIL/TACONITE THERMOCLINE	SALT, TRICKLE OIL
SMALL COMMUNITY	LIQUID METAL/SALT COLLECTOR/RECEIVER	REFRACTORY WITH WELDED STEEL TANK-GROUND BASED	LATENT HEAT SALT-DISH MOUNTED

\*Storage development for these representative applications is emphasizing second generation technology development. First generation technology development will be initiated during FY80 on additional applications, such as industrial retrofit process heat.

TABLE II  
THERMAL ENERGY STORAGE PERFORMANCE AND COST GOAL SUMMARY (FY79 DOLLARS)

APPLICATION*	SOLAR INTERFACE	ROUND TRIP EFFICIENCY		CAPITAL COST		IMPROVEMENT (%)
		FIRST GENERATION (%)	SECOND GENERATION (%)	FIRST GENERATION (\$/KWH)	SECOND GENERATION (\$/KWH)	
BARSTOW	WATER/STEAM COLLECTOR/RECEIVER	70	80	46	35	24
REPOWERING	MOLTEN SALT COLLECTOR/RECEIVER	98	98	28	14	50
IEA	LIQUID METAL COLLECTOR/RECEIVER	98	98	100	43	57
EPRI/DOE HYBRID	GAS COLLECTOR/RECEIVER	80	80	88	61	31
SHENANDOAH	ORGANIC FLUID COLLECTOR/RECEIVER	96	96	51**	25**	51
SMALL COMMUNITY	LIQUID METAL/SALT COLLECTOR/RECEIVER	TBD	TBD	TBD	TBD	TBD

\* Applications shown are all electrical power generating systems except for the total energy Shenandoah system. Performance and cost goals will be established for process heat applications pending completion of conceptual design studies in FY80.

\*\*based on  $KWH_t$ ; costs for other applications are based on  $KWH_e$

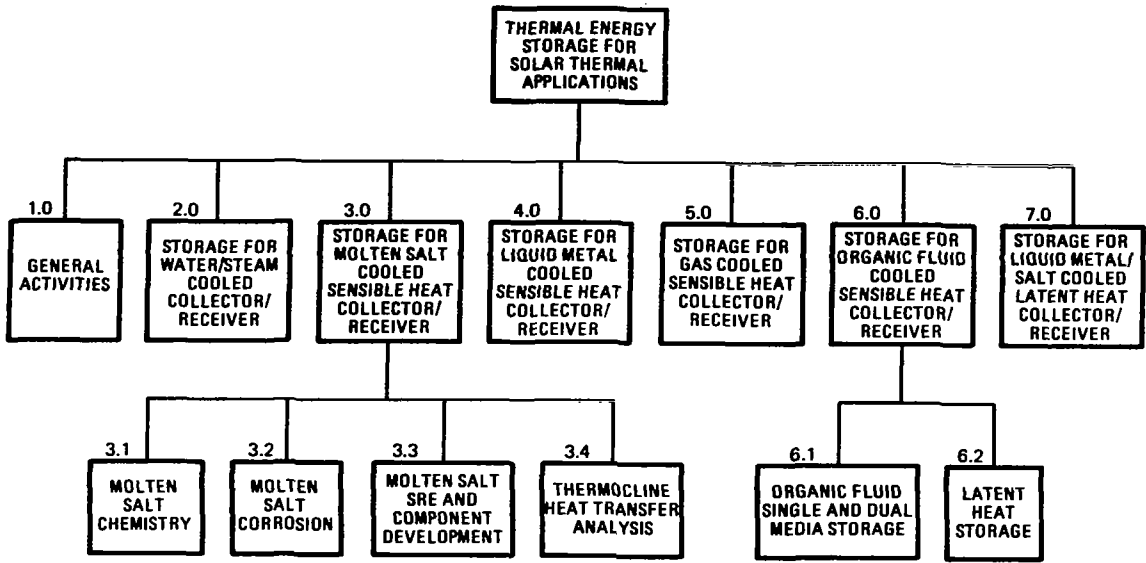

TASK OUTLINE  
FIGURE 1

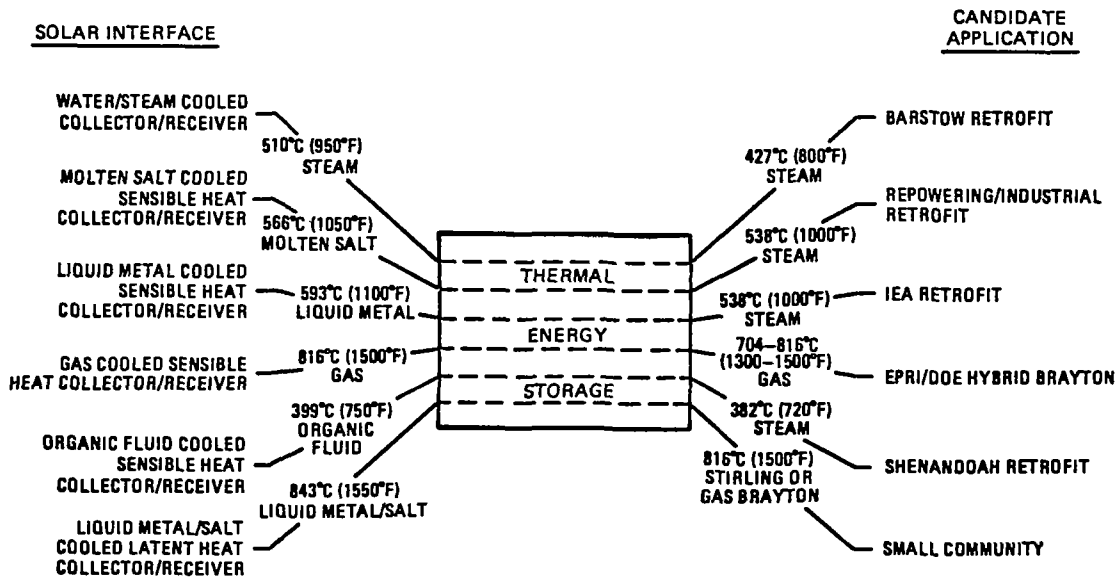

FOCUSSED ELEMENTS  
FIGURE 2

**STORAGE FOR WATER/STEAM COOLED  
COLLECTOR/RECEIVER**

<b>STORAGE TECHNOLOGY STATUS*</b>	<b>PLANNED DEVELOPMENT</b>
<ul style="list-style-type: none"> <li>● <b>BARSTOW SRE COMPLETE</b></li> <li>● <b>MCDONNELL DOUGLAS EXTENDED LIFE STORAGE FLUID TESTS COMPLETE</b></li> <li>● <b>MARTIN MARIETTA STORAGE FLUID MAINTENANCE TESTS COMPLETE</b></li> </ul>	<ul style="list-style-type: none"> <li>● <b>LONG TERM</b> <ul style="list-style-type: none"> <li>- Develop Storage Subsystem for Saturated Steam Receiver for Process Heat</li> <li>- Develop Second Generation Storage Subsystem for Repowering or Barstow Retrofit</li> </ul> </li> <li>● <b>FY80</b> <ul style="list-style-type: none"> <li>- Initiate Storage Concept Development for above applications</li> </ul> </li> </ul>

\*This work was funded under the TPS Program

FIGURE 3

**STORAGE FOR MOLTEN SALT COOLED SENSIBLE  
HEAT COLLECTOR/RECEIVER**

<b>STORAGE TECHNOLOGY STATUS*</b>	<b>PLANNED DEVELOPMENT</b>
<ul style="list-style-type: none"> <li>● <b>CONCEPTUAL DESIGNS OF MOLTEN DRAW SALT STORAGE COMPLETE</b></li> <li>● <b>LABORATORY EXPERIMENTS OF LOW COST CONTAINMENT TECHNIQUES COMPLETE</b></li> <li>● <b>COMPARISON OF THERMOCLINE VS. HOT/COLD TANK DESIGNS COMPLETE</b></li> <li>● <b>PRELIMINARY STORAGE AND CONTAINMENT MATERIAL SCREENING TESTS COMPLETE</b></li> </ul>	<ul style="list-style-type: none"> <li>● <b>LONG TERM</b> <ul style="list-style-type: none"> <li>- Develop Second Generation Storage Subsystem using Internal Insulation for Repowering</li> </ul> </li> <li>● <b>FY80</b> <ul style="list-style-type: none"> <li>- Complete Internal Insulation Storage Concept Development</li> <li>- Initiate SRE</li> <li>- Perform Salt Chemistry/Corrosion Studies</li> </ul> </li> </ul>

\* This work was funded under the TPS Program.

FIGURE 4

**STORAGE FOR LIQUID METAL COOLED SENSIBLE  
HEAT COLLECTOR/RECEIVER**

<b>STORAGE TECHNOLOGY STATUS*</b>	<b>PLANNED DEVELOPMENT</b>
<ul style="list-style-type: none"> <li>● CONCEPTUAL DESIGN OF LIQUID SODIUM STORAGE FOR CENTRAL RECEIVERS COMPLETE</li> <li>● NO ADDITIONAL DEVELOPMENT WORK REQUIRED FOR FIRST GENERATION SYSTEM</li> </ul>	<ul style="list-style-type: none"> <li>● LONG TERM               <ul style="list-style-type: none"> <li>- Develop Second Generation Storage Subsystem for Central Receiver Repowering or IEA Retrofit Applications</li> </ul> </li> <li>● FY80               <ul style="list-style-type: none"> <li>- Complete Low Level Planning Activities</li> <li>- Complete Laboratory Air/Rock Thermal Cycling Tests</li> </ul> </li> </ul>

\*This work was funded under the TPS Program.

FIGURE 5

**STORAGE FOR GAS COOLED SENSIBLE  
HEAT COLLECTOR/RECEIVER**

<b>STORAGE TECHNOLOGY STATUS*</b>	<b>PLANNED DEVELOPMENT</b>
<ul style="list-style-type: none"> <li>● CONCEPTUAL DESIGN OF REFRACTORY BRICK STORAGE FOR CENTRAL RECEIVERS COMPLETE</li> <li>● DESIGN AND FABRICATION OF A GROUND BASED REFRACTORY STORAGE TEST MODULE FOR A POINT FOCUSING DISH ONGOING</li> </ul>	<ul style="list-style-type: none"> <li>● LONG TERM               <ul style="list-style-type: none"> <li>- Develop Second Generation Storage Systems using PCIV containment or Latent Heat Media for EPRI/DOE Hybrid Brayton Retrofit</li> <li>- Develop Latent Heat Storage for Point Focusing Dishes</li> </ul> </li> <li>● FY80               <ul style="list-style-type: none"> <li>- Complete Tests of Refractory Storage Test Module</li> <li>- Initiate Latent Heat Storage Concept Development for Point Focusing Dishes</li> </ul> </li> </ul>

\* This work was funded under the TPS Program.

FIGURE 6



**STORAGE FOR ORGANIC FLUID COOLED SENSIBLE  
HEAT COLLECTOR/RECEIVER**

STORAGE TECHNOLOGY STATUS*	PLANNED DEVELOPMENT
<ul style="list-style-type: none"> <li>● CONCEPTUAL DESIGN &amp; LABORATORY TESTS OF TRICKLE OIL STORAGE FOR SHENANDOAH COMPLETE</li> <li>● SHENANDOAH WILL INCLUDE FLEXIBILITY FOR TRICKLE OR DUAL MODE MODE TESTING - THEREFORE NO TRICKLE OIL SRE IS CURRENTLY PLANNED</li> <li>● SINGLE MEDIA THERMOCLINE TANK DESIGN AND FABRICATION FOR MTF TESTS COMPLETE</li> <li>● SINGLE MEDIA THERMOCLINE SYSTEM FOR IRRIGATION APPLICATIONS OPERATIONAL</li> </ul>	<ul style="list-style-type: none"> <li>● LONG TERM                             <ul style="list-style-type: none"> <li>- Provide support for First Generation Storage Subsystems for Midtemperature Applications</li> <li>- Develop Second Generation Storage Subsystem for Midtemperature Applications</li> </ul> </li> <li>● FY80                             <ul style="list-style-type: none"> <li>- Complete Single Media Thermo-cline Tests</li> <li>- Complete Dual Media Thermo-cline Tank Design</li> <li>- Initiate Second Generation Storage Concept Development</li> </ul> </li> </ul>

\* This work was funded under the TPS Program.

**FIGURE 7**

**STORAGE FOR LIQUID METAL/SALT COOLED LATENT  
HEAT COLLECTOR/RECEIVER**

STORAGE TECHNOLOGY STATUS*	PLANNED DEVELOPMENT
<ul style="list-style-type: none"> <li>● HEAT PIPE/MOLTEN SALT TEST MODULE DESIGN AND FABRICATION COMPLETE</li> </ul>	<ul style="list-style-type: none"> <li>● LONG TERM                             <ul style="list-style-type: none"> <li>- Develop Storage Subsystems for Small Community System Applications using Rankine, Brayton and Stirling Power Conversion Cycles</li> </ul> </li> <li>● FY80                             <ul style="list-style-type: none"> <li>- Initiate dish Mounted Latent Heat Storage Requirements Definition and Concept Development</li> <li>- Initiate High Temperature Latent Heat Materials Studies</li> <li>- Initiate SRE Design</li> </ul> </li> </ul>

\*This work was funded under the TPS Program.

**FIGURE 8**

## **SUMMARY - FY80 FOCUSED DEVELOPMENT**

- **REPOWERING/INDUSTRIAL RETROFIT SYSTEM APPLICATIONS**
  - Molten Salt Sensible Heat Storage
  - Second Generation Storage Concept Development for Water/Steam Receivers
  
- **TOTAL ENERGY SYSTEM APPLICATIONS**
  - Organic Fluid Thermocline Testing
  - Second Generation Storage Concept Development for Organic Fluid Receivers
  
- **SMALL COMMUNITY SYSTEM APPLICATIONS**
  - Dish Mounted Latent Heat Storage Concept Development for Point Focusing Dish Collectors

**FIGURE 9**

## THERMAL STORAGE EXPERIENCE AT THE MSSTF AND PLANS FOR THE FUTURE\*

Thomas D. Harrison and Robert A. Randall  
Sandia Laboratories  
Albuquerque, New Mexico 87185

### SUMMARY

The purpose of this presentation is 1) to review the background of thermal storage development at the Midtemperature Solar Systems Test Facility (MSSTF) at Sandia Laboratories, 2) to define the problems which have been encountered, 3) to outline a course of action for resolving these problems, 4) to determine scaling effects of going from laboratory models to full-size applications, and 5) to apply the lessons learned to thermal storage needs in near-term solar projects.

### MULTIPLE TANK THERMAL STORAGE

The Multiple Tank Thermal Storage subsystem shown in Figure 1 was designed at Sandia to provide thermal storage for the testing operations and to evaluate the multiple tank concept in an operating environment. A three-tank design was chosen because the operating strategies and control problems are representative of those encountered in the field with a larger system.

The basic design requirement for the multiple tank subsystem is to store 860kWh ( $2.935 \times 10^6$  Btu) thermal energy between the temperature limits of 241° to 309°C (467° to 588°F). The heat transfer and storage medium is Therminol 66®. A volume of 22.62 m<sup>3</sup> (6 000 gallons) of Therminol 66® will satisfy this requirement. The subsystem was designed so that any two of the three identical tanks could hold a volume of 23.24 m<sup>3</sup> (6 140 gallons). Allowing for 10% ullage, the volume of each tank is 12.78 m<sup>3</sup> (3 377 gallons).

The subsystem was required to deliver thermal energy at a rate of 283 kW (0.966 Btu/h) and to receive thermal energy at a rate of 502 kW ( $1.713 \times 10^6$  Btu/h). To facilitate pumping of the storage fluid, a gas pressure of 110 kPa (16 psi) is maintained inside the tanks. Because of this pressure the tanks were designed to meet ASME pressure vessel standards.

---

\*Sandia Laboratories is a Department of Energy (DOE) facility. This work was supported by the Division of Solar Technology, USDOE, under Contract DE-AC04-76 DP00789.

The specific dimensions and shape of the tanks and the choice of type and thickness of tank insulation were determined with the aid of a computer program developed at Sandia. This program predicted heat loss through the tank surfaces for the daily operating cycle of typical winter or summer days, given tank shape and insulation types and thicknesses. After the tank shape was established, the criterion for selection of insulation thickness and type was minimum cost. The total estimated cost, using current prices, was computed for various thicknesses and types of insulation. Added to this was the cost of extra collector area to compensate for heat loss. The most economical choice for material is intermediate service fiberglass. The optimum thickness is 0.4 metre (15.6 inches). Since the cost increases only slowly as thickness increases, the thickness finally chosen for the tank insulation was 0.533 metre (21 inches).

Each tank contains instrumentation for sensing both temperature and liquid level. At the bottom of each tank, a 45-cm (18-inch) diameter "well" is provided so that nearly all the liquid in each tank can be drained. All lines for filling and draining the tank enter at the wells.

The significant problems encountered were 1) the need for a complex control system, 2) an energy loss of about 50% in excess of design calculations, and 3) accumulation of low temperature fluid in the bottom of the tank.

The control complexity arises from the 500 or more possible combinations of the many parameters involved in the operation of a three-tank system. The reasons for the high thermal losses are still under review, but apparently include 1) loss of hot inert gas from ullage, 2) improper installation and subsequent degradation of insulation, and 3) convection, or thermal siphoning, of heat transfer fluid along horizontal pipes leading to closed valves. After a period of storage, these losses result in the accumulation in the bottom of the tank of up to 1.9 m<sup>3</sup> (500 gallons) of fluid which has cooled below the usable temperature. This cool fluid is the first to be delivered from the tank and special operating strategies are required to deal with it.

#### THERMOCLINE THERMAL STORAGE

The first thermal storage subsystem installed in the MSSTF was the thermocline subsystem shown in Figure 2. This system was used to evaluate the storage of thermal energy in water at temperatures up to 232°C (450°F), or in Therminol 66<sup>®</sup> at temperatures up to 320°C (608°F). The volume of the tank between the diffusers is 5 m<sup>3</sup> (1 563 gallons). The theoretical energy storage capacity is 292 kWh (10<sup>6</sup> kJ) for Therminol 66<sup>®</sup> between the temperatures 243° to 311°C (470° to 592°F). The subsystem is composed of five elements:

1. A low-carbon-steel pressure vessel, fabricated to ASME Pressure Vessel Codes, with 2.5-cm (1-inch) thick walls,
2. Vacuum foil insulation around the vertical walls of the tank,
3. Diffusers at the top and bottom of the tank to minimize flow disturbances when fluid is pumped in or drawn out of the tank,
4. Two "T" valves to allow injection of fluid at 310°C (590°F) into the top of the tank while simultaneously withdrawing fluid at 243°C (470°F) from the bottom of the tank, and vice versa, and
5. A temperature probe to measure the vertical temperature profile of the fluid within the tank.

The major disadvantages in this thermocline storage subsystem are 1) the thermocline region initially occupies 20% of fluid volume, 2) the thermocline enlarges with time, 3) energy in the thermocline region is usually not usable because of low quality, 4) thermal energy losses are in excess of design calculations. The advantages are 1) control is simplified, 2) withdrawing hot fluid from the top of the vessel gives high assurance that it will be at the proper temperature, 3) the subsystem is adaptable to multi-medium storage, and 4) the subsystem is 20% less expensive than a multiple tank system of the same thermal storage capacity. Because of these advantages, Sandia is concentrating future evaluation effort on the thermocline concept.

Other thermocline subsystems are being evaluated by Sandia. The subsystems installed at the Willard, NM, and Coolidge, AZ, Irrigation Projects are part of large solar systems and are not instrumented for thorough evaluation of the thermal storage subsystem. Nevertheless, some useful information is being obtained.

#### FUTURE ACTIVITIES

The problems defined in the two existing thermal storage subsystems at the MSSTF cannot be solved using these facilities, either because instrumentation is lacking or because of the difficulty of modifying existing hardware. The thermal storage subsystems at Willard and Coolidge are instrumented for analysis of gross operational effects and not for the study of macroscopic events which occur in a thermocline storage facility. For these reasons a new thermocline tank was designed.

A new thermocline tank is presently being installed in place of the old one at the MSSTF (see Figure 3). The objective is to produce useful design information for the installation and efficient operation of thermocline storage subsystems for use with line-focusing solar collectors used in total energy and industrial process heat applications. It will be operated as a single-media, direct storage thermocline tank. The capacity will be 4.5 m<sup>3</sup> (1 179 gallons). The tank is made of 4.76-mm (3/16-inch) low carbon steel

with stainless steel legs to minimize conduction. Multiple ports at the top and bottom give access for plumbing and instrumentation. The entire top can be removed if required for internal modifications or changes in instrumentation. A 45-cm (18-inch) diameter hatch provides personnel access. The installation of stainless steel legs and of the thinnest walls possible is a result of past experience.

Various diffuser designs can be installed for evaluation. The tank is instrumented with 350 temperature sensors. Two vertical thermocouple probes will be installed inside the tank to measure the temperature at 5-cm (2-inch) intervals. Also, thermocouples will be attached to both the inside and outside walls of the tank, and there will be thermocouples between each layer of insulation. A displacement-type gage will measure fluid level. Four turbine flowmeters will measure rate of flow of hot and cold fluid into and out of the tank. The data from the sensors are acquired and stored by a minicomputer. Plumbing connections allow hot fluid to be received from either the solar collectors or from the Multiple Tank Thermal storage subsystem. The tank legs will rest on a 5-cm (2-inch) pad of load-bearing insulation. The tank will be insulated with 38 cm (15 inches) of fiberglass.

Subscale models of diffuser designs will be tested in the laboratory and then fabricated full scale for testing in the system. The first design has been completed and the diffuser fabricated.

Subscale tests are also being conducted to investigate the stability of thermoclines. Full-scale testing of the new tank will begin early in 1980. Testing will include 1) heat loss measurements under steady-state flow conditions at temperatures of 200°, 260°, and 315°C (400°, 500°, 600°F); 2) static heat loss tests with initial temperature at these same levels; and 3) tests of thermocline stability and duration under static conditions, at various charge and discharge rates, and at various temperatures. All these tests will be done both with the tank completely filled using an auxiliary tank to accommodate expansion, and then with ullage space in the tank.

The difference in performance between laboratory scale models and resulting components of the new thermocline tank will provide a measure of scaling effects.

One output of the evaluation will be a design handbook for the installation and efficient operation of storage concepts for industrial process heat and other solar applications.

#### REFERENCE

1. Harrison, T. D., et al.: Solar Energy Test Facility Results, High Temperature Thermocline Storage Subsystem. SAND77-1528. Sandia Laboratories, Albuquerque, NM, April 1978.

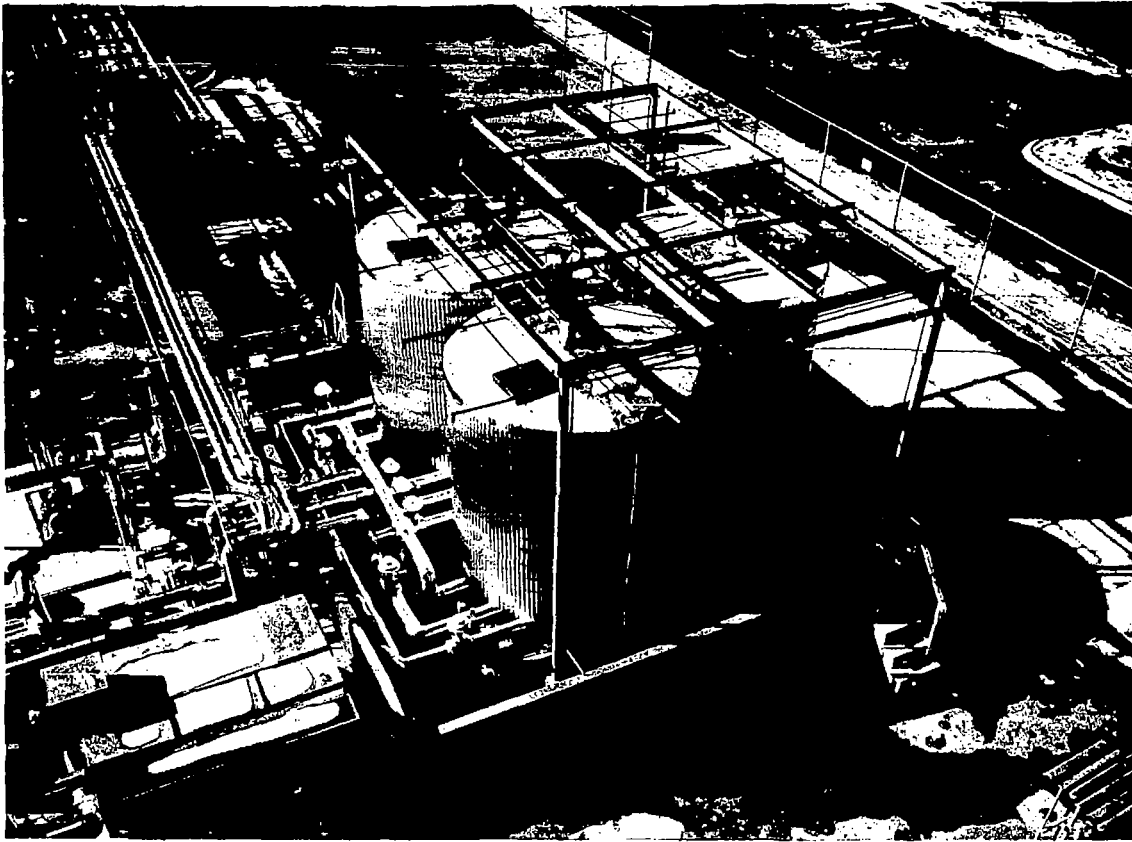

Figure 1. The Multitank Thermal Storage Subsystem

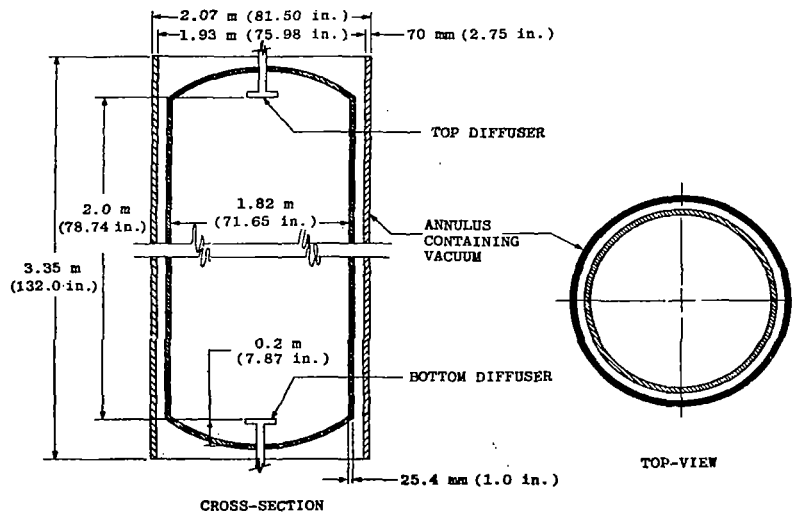

Figure 2. Cross Section and Top View of High-Temperature Storage Tank

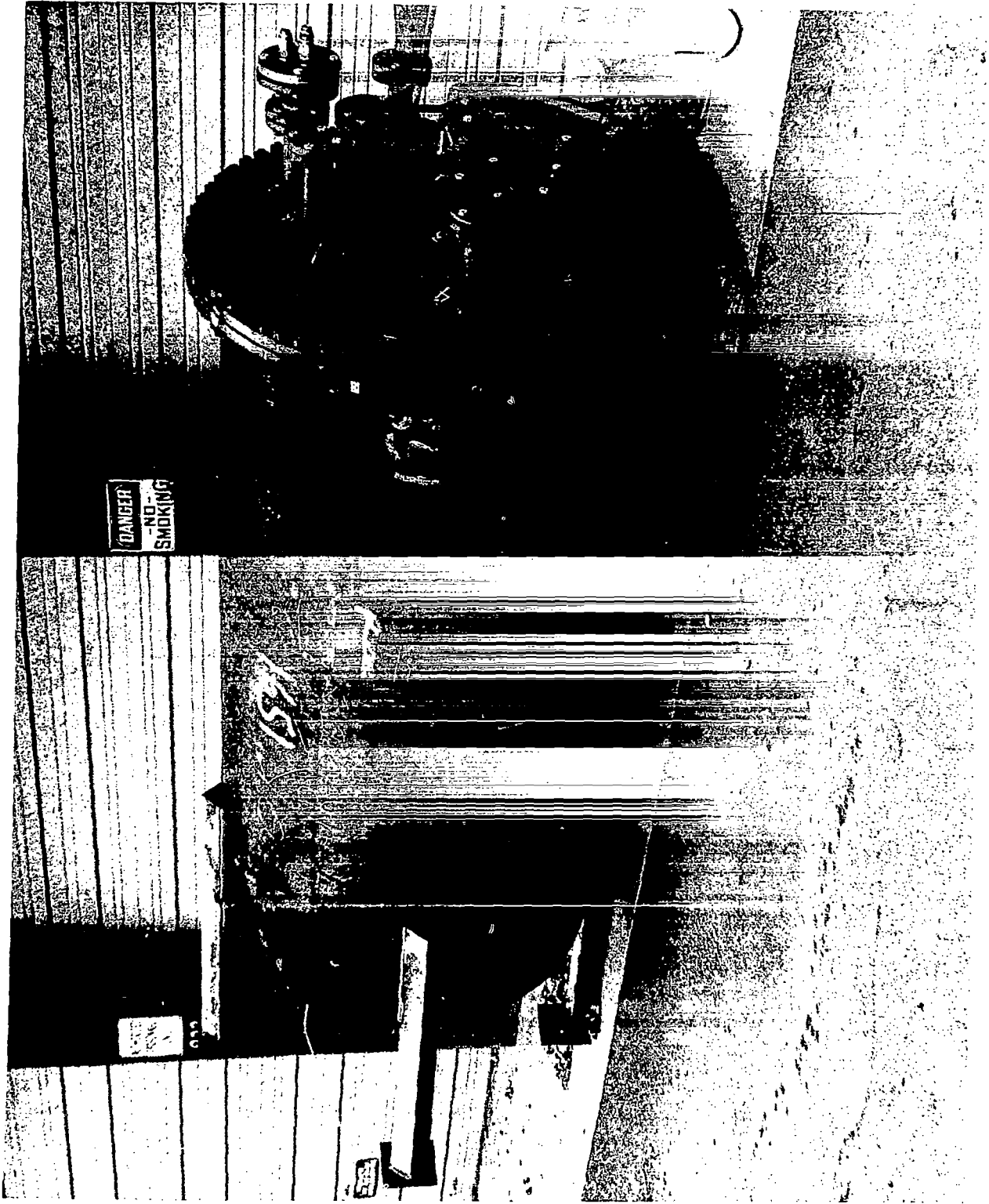

Figure 3. The New Thermocline Thermal Storage System



## **THERMAL ENERGY STORAGE EFFORT AT JPL**

Donald L. Young  
Jet Propulsion Laboratory

### **OUTLINE OF THE PRESENTATION**

- JPL INTEREST IN THERMAL ENERGY STORAGE
- IMMEDIATE APPLICATIONS
- METHODOLOGY FOR JPL EFFORT
- TASKS FOR JPL SUPPORT TO SLL
- JPL IN-HOUSE WORK
- PLANNED PROCUREMENTS
- SCHEDULE

### **JPL PARABOLIC DISH PROGRAM**

#### **OBJECTIVES**

- TO ESTABLISH TECHNICAL, OPERATIONAL & ECONOMIC READINESS OF PARABOLIC DISH SYSTEMS FOR ELECTRIC AND THERMAL APPLICATIONS
- TO DEVELOP PARABOLIC DISH SYSTEMS TO THE POINT AT WHICH SUBSEQUENT COMMERCIALIZATION ACTIVITIES CAN LEAD TO SUCCESSFUL MARKET PENETRATION

## JPL INTEREST IN THERMAL ENERGY STORAGE

- PROVIDE TECHNICAL SUPPORT TO THE THERMAL ENERGY STORAGE FOR SOLAR THERMAL APPLICATIONS (TESSTA) PROGRAM
- IDENTIFY CONCEPTS, ASSESS THEIR FEASIBILITY, AND DEVELOP ENGINEERING DESIGNS OF PARABOLIC DISH LATENT THERMAL ENERGY STORAGE ELEMENTS
- PLAN AND CONDUCT SUBSYSTEM RESEARCH EXPERIMENTS AT PARABOLIC DISH TEST SITE (PDTS, EDWARD) TO DEMONSTRATE THE READINESS OF THE LATENT HEAT ENERGY STORAGE
- IDENTIFY CONCEPTS AND ASSESS THEIR FEASIBILITY FOR ADVANCED, HIGH TEMPERATURE (1500-2800°F) THERMAL STORAGE

## CURRENT APPLICATIONS

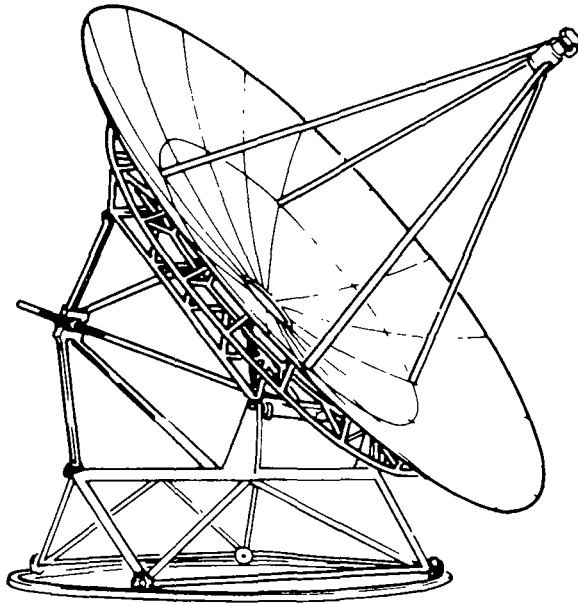

- SMALL COMMUNITY SOLAR THERMAL POWER EXPERIMENT (EE-1)
- ISOLATED LOAD EXPERIMENTS SERIES (EE-2 ETC)
- THERMAL APPLICATIONS EXPERIMENTS SERIES (EE-3)
- ADVANCED DISH STIRLING

ENERGY STORAGE REQUIRED TO BUFFER THE ENERGY CONVERSION SYSTEM FROM HARMFUL TRANSIENTS & PROVIDE BETTER SYSTEM CONTROL

## CURRENT APPLICATIONS

<u>SYSTEM</u>	<u>ECS/SIZE</u>	<u>STORAGE TEMP RANGE</u>	<u>APPLICATION/TIME PERIOD</u>
EE-1	RANKINE/15 KWe	800→1300 <sup>0</sup> F	GRID CONNECTED, SMALL COMMUNITY/1981
EE-2	BRAYTON/15 KWe	1200→1700 <sup>0</sup> F	ISOLATED/1981
EE-3	THERMAL LOADS	TBD	ISOLATED/1982
STIRLING	STIRLING/20 KWe	1500→1600 <sup>0</sup> F	ENGINEERING EXPERIMENTS 1981 SYSTEM TESTS 1984

## BRIEF DESCRIPTION OF PLANT

- 1 MW PLANT USING NEAR TERM TECHNOLOGY
- APPROXIMATELY 10 ACRE SITE WITH 65 PARABOLIC CONCENTRATORS, EACH 11 METERS IN DIAMETER AND EACH HAVING ITS OWN:

- RECEIVER
- ENGINE
- GENERATOR

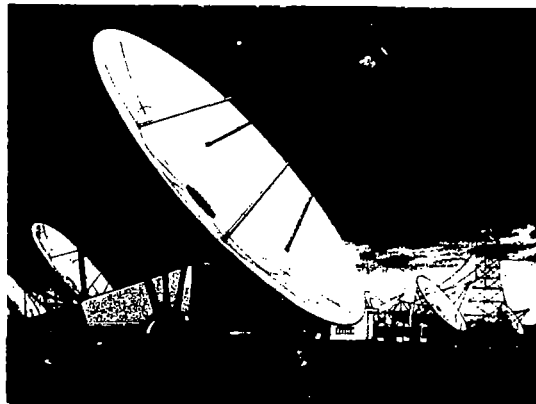

THE ELECTRICAL OUTPUT OF THE INDIVIDUAL GENERATORS IS COMBINED AND CONNECTED TO A SMALL COMMUNITY DISTRIBUTION SYSTEM

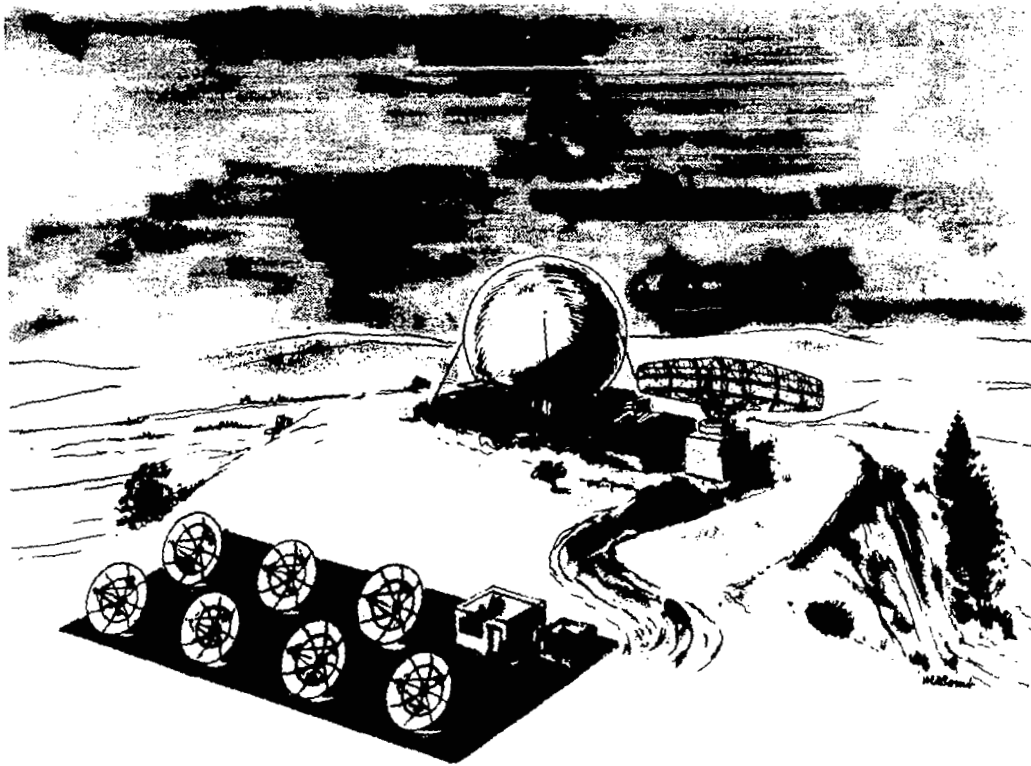

### STEAM-RANKINE SOLAR RECEIVER

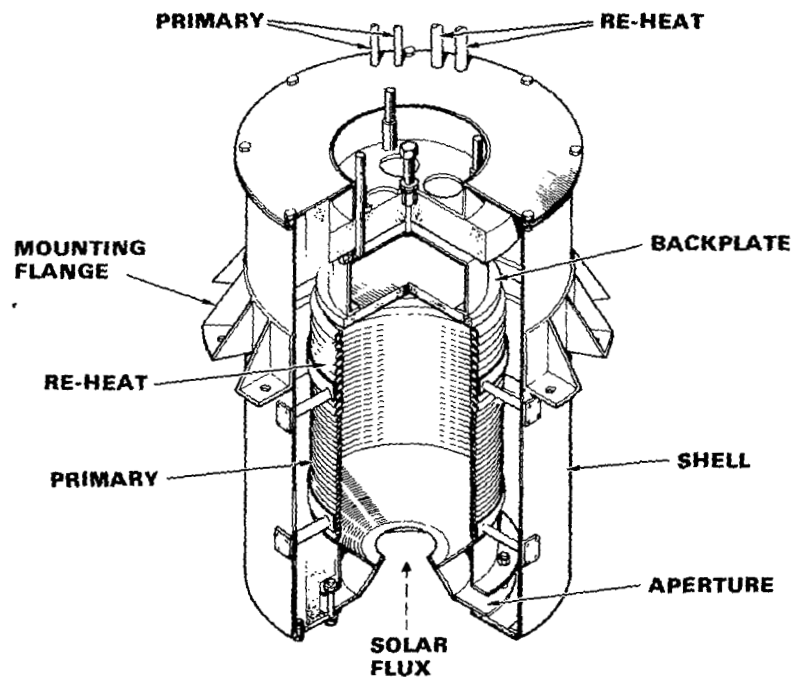

5-43005

## PLATE FIN BRAYTON SOLAR RECEIVER

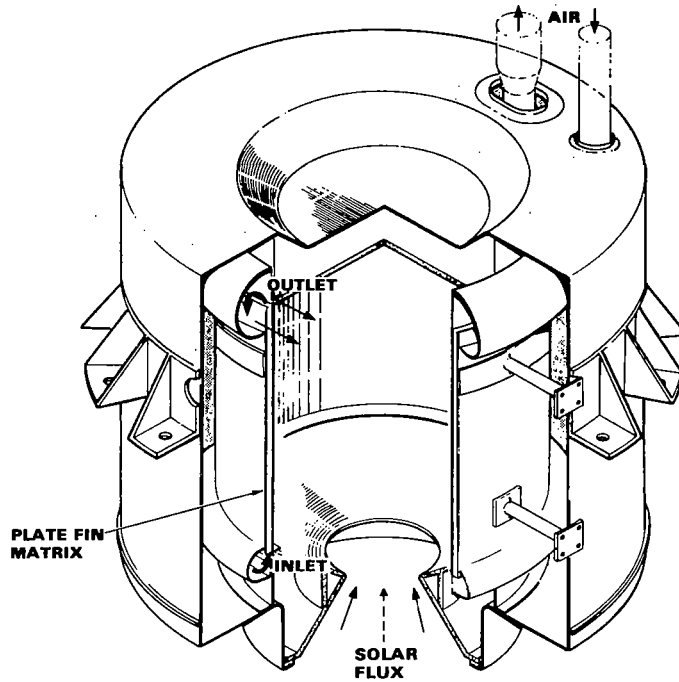

S-42342

## FUTURE APPLICATIONS

- ADVANCED BRAYTON ENGINE (2300-2700<sup>0</sup>F)
- FUELS AND CHEMICAL APPLICATIONS (1500-3500<sup>0</sup>F)
- INDUSTRIAL PROCESS HEAT APPLICATIONS (1000-2500<sup>0</sup>F)
- COMBINED CYCLE (BRAYTON/RANKINE) ENGINES (1000-2700<sup>0</sup>F)

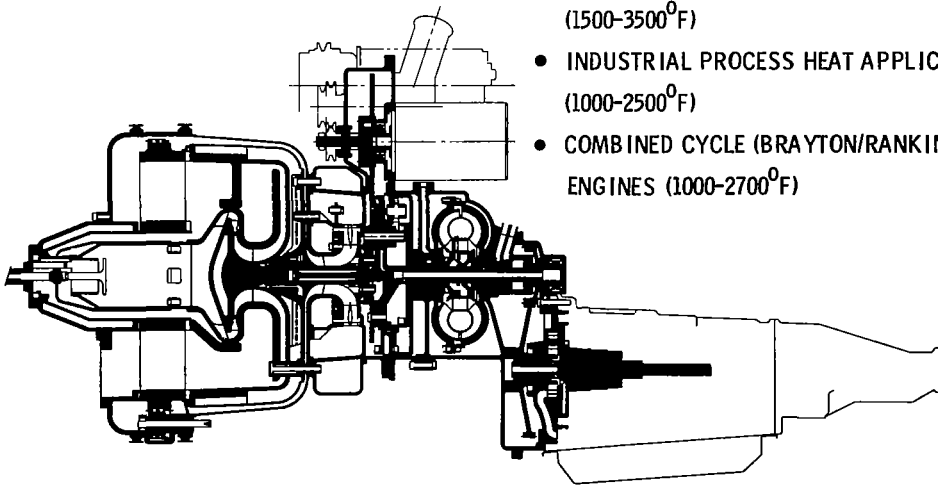

100% Solar Still System  
Host Receiver/TES/Engine-Generator  
with Sodium Heat Pipe Thermal Transport

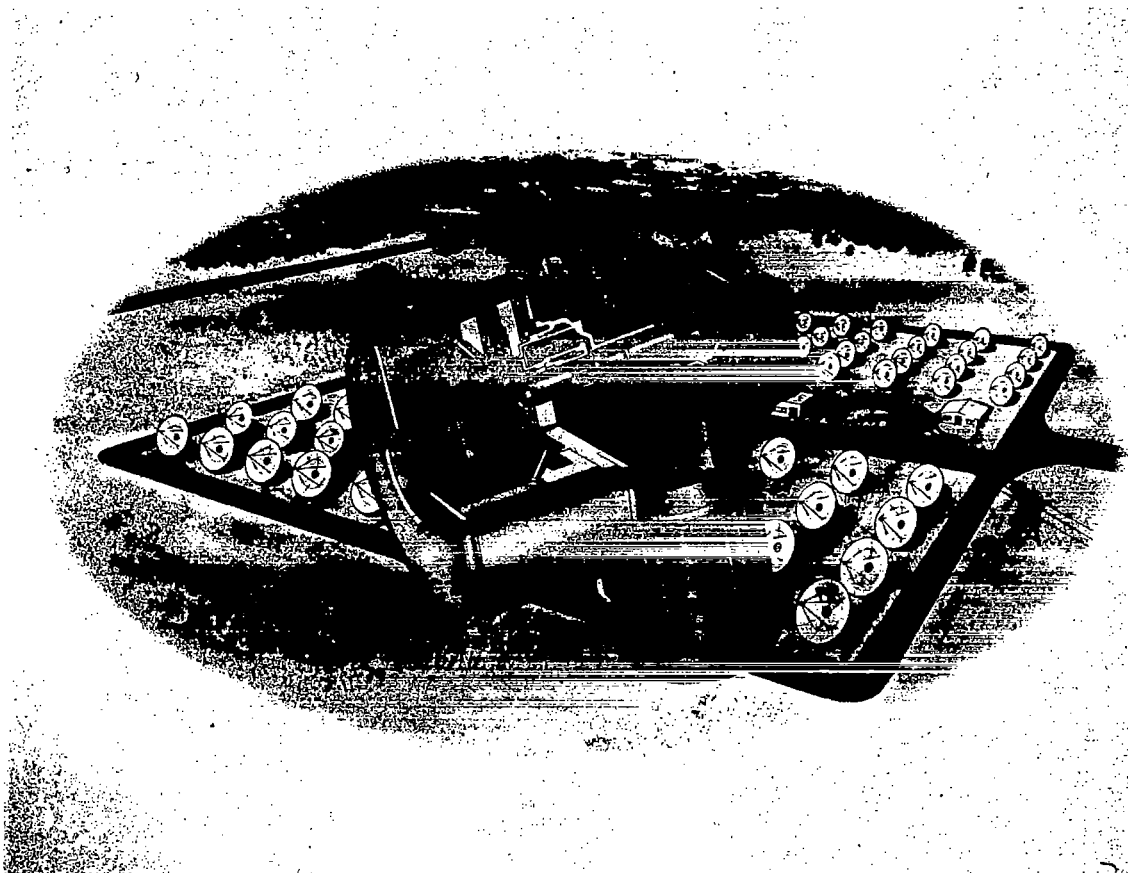
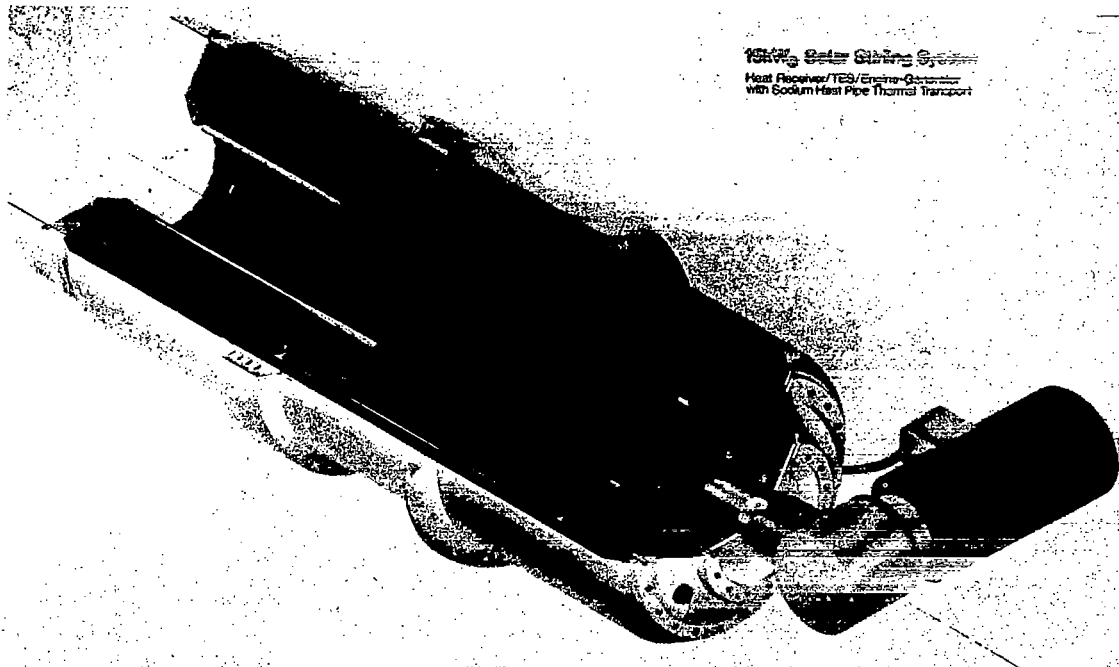

**PRESSURIZED MATRIX  
HIGH TEMPERATURE SOLAR THERMAL RECEIVER**

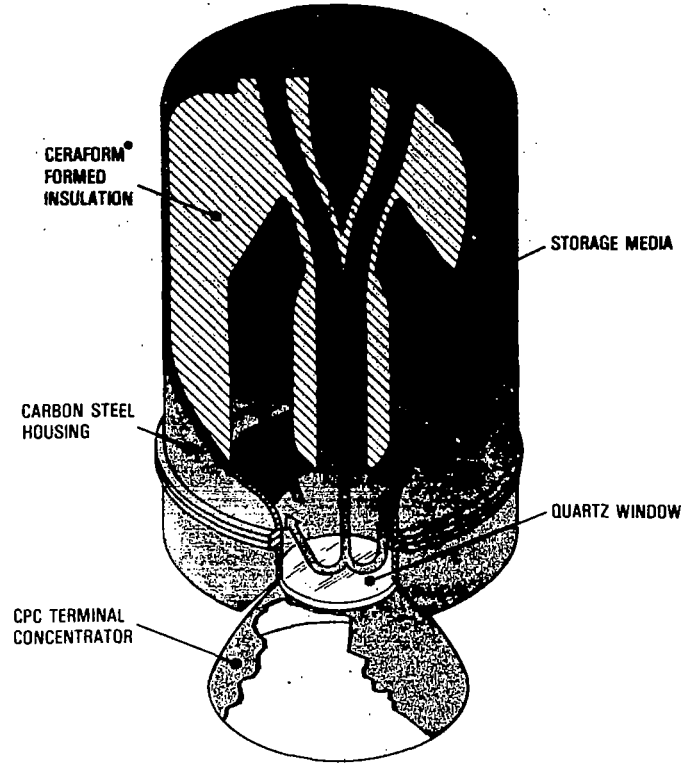

**ADVANCED GAS TURBINE POWERTRAIN**

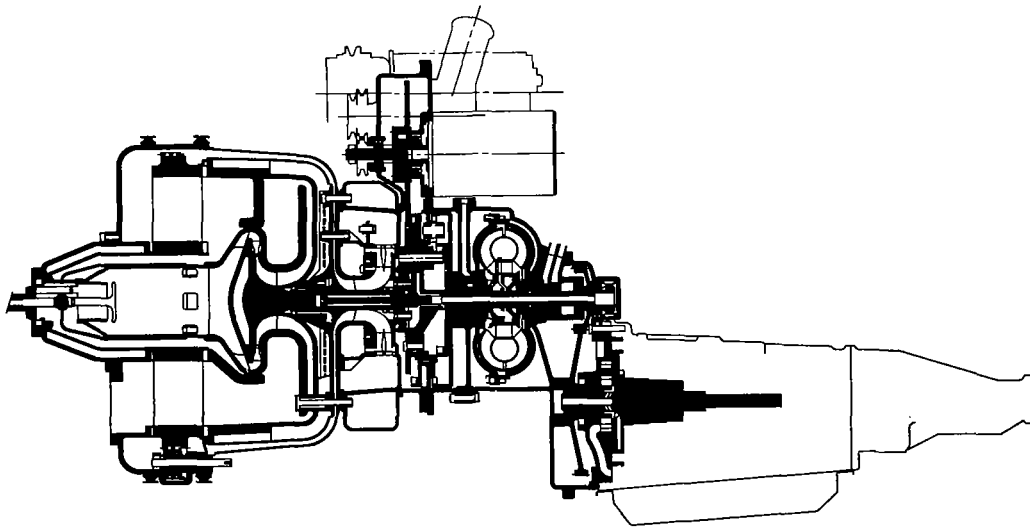

## METHODOLOGY FOR THE JPL EFFORT

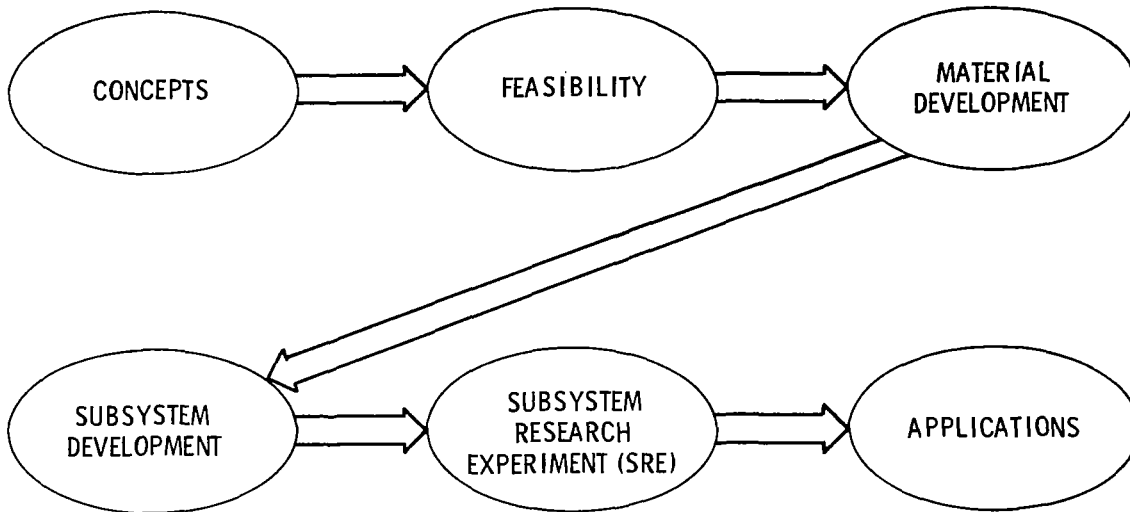

## TASKS FOR JPL SUPPORT TO SLL

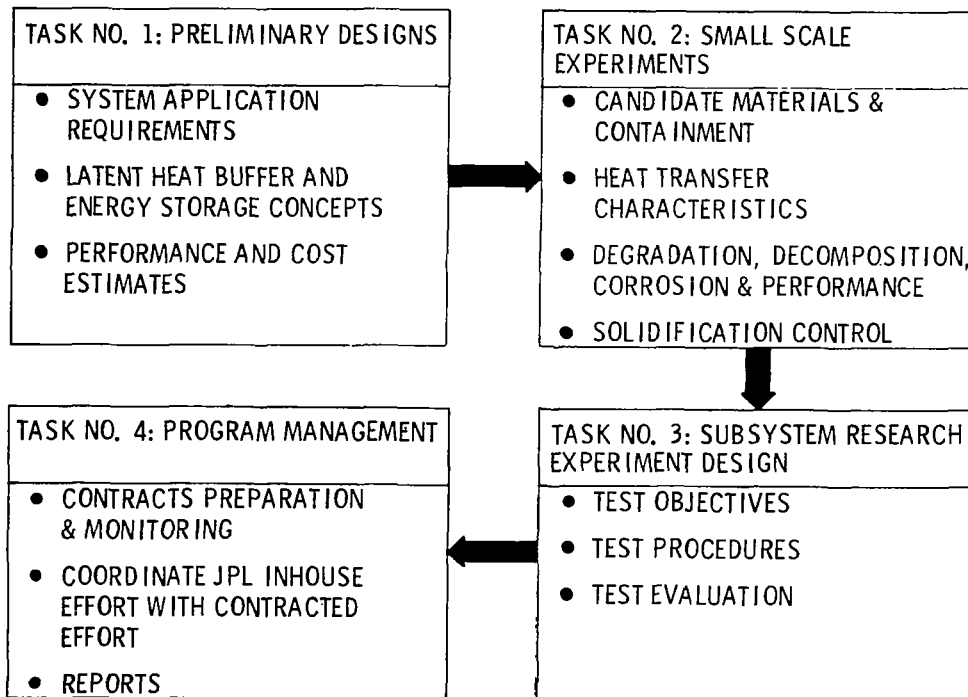



## **JPL IN-HOUSE EFFORT**

**PURPOSE:** TO DEVELOP THE NECESSARY BACKGROUND, DATA BASE, AND CAPABILITY TO WRITE AND MANAGE INDUSTRIAL CONTRACTS FOR THE DEVELOPMENT OF THERMAL ENERGY STORAGE FOR DISH-APPLICATIONS.

### **PLANNED EFFORT IN:**

- APPLICATION REQUIREMENTS
- CONCEPTS SELECTION OF ~50 KWHT TES USING PCM FOR 800-2400<sup>0</sup>F TEMPERATURE RANGE
- NOVEL IDEAS OF HEAT TRANSFER AT HIGH TEMPERATURES
- STORAGE MEDIA SCREENING & SELECTION
- CONTAINMENT MATERIALS, CORROSION, AND STABILITY OF PCM
- DEVELOPMENT OF COMPUTER CODES FOR THE TRANSIENT ANALYSES OF LATENT HEAT STORAGE SYSTEMS
- DEFINE AND PLAN SUBSYSTEM RESEARCH EXPERIMENTS

## **A LIST OF PRELIMINARY THERMAL ENERGY STORAGE COMPONENTS**

### **1. PHASE CHANGE MATERIALS**

- NaF (~1810<sup>0</sup>F)
- NaF + MgF<sub>2</sub> (~1526<sup>0</sup>F)
- NaF + KF + MgF<sub>2</sub> (~1265<sup>0</sup>F)
- K<sub>2</sub>CO<sub>3</sub> + Li<sub>2</sub>CO<sub>3</sub> + LiOH (~800<sup>0</sup>F)

### **2. HEAT EXCHANGER CONCEPTS**

- FLEXING SURFACES
- HEAT PIPES
- FLUIDIZED BEDS
- TUBE & SHELL WITH SCRAPING

### **3. CONTAINMENT**

- RECEIVER INTEGRATED
- ENGINE INTEGRATED
- SEPARATE TANK

## PLANNED PROCUREMENTS

1. DEFINITION OF REQUIREMENTS FOR DISH MOUNTED LATENT HEAT BUFFER ENERGY STORAGE FOR THE FOLLOWING ENERGY CONVERSION SYSTEMS:
  - RANKINE
  - BRAYTON
  - STIRLING
2. NOVEL CONCEPTS OF LATENT HEAT STORAGE OF SMALL SIZES
3. MEASUREMENT OF THERMAL PROPERTIES OF SELECTED PHASE CHANGE MATERIALS
4. DEGRADATION AND DECOMPOSITION OF THE SELECTED PHASE CHANGE MATERIALS FOR CYCLIC THERMAL LOADING
5. SOLIDIFICATION CONTROL OF THE SELECTED PHASE CHANGE MATERIALS
6. CORROSION CONTROL OF THE SELECTED HIGH TEMPERATURE PHASE CHANGE MATERIALS
7. SUBSYSTEM RESEARCH EXPERIMENT DESIGNS

## SCHEDULE

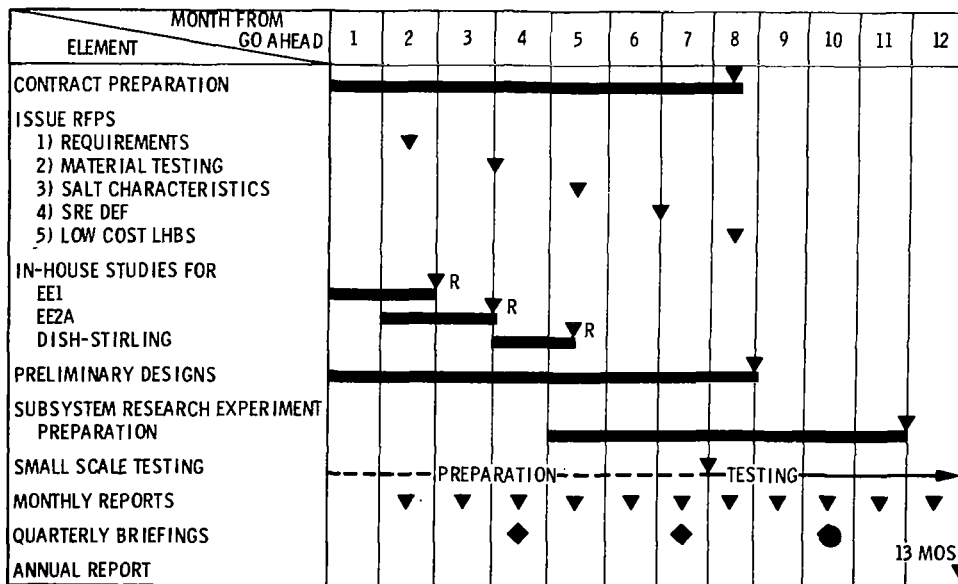

INTERNALLY INSULATED THERMAL  
STORAGE SYSTEM DEVELOPMENT PROGRAM\*

Owen L. Scott  
Martin Marietta Corporation

INTRODUCTION

The purpose of the program is to define a cost effective thermal storage system for a solar central receiver power system using molten salt stored in internally insulated carbon steel tanks. The program is divided into four tasks: testing of internal insulation materials in molten salt; preliminary design of storage tanks, including insulation and liner installation; optimization of the storage configuration; and definition of a subsystem research experiment to demonstrate the system.

The purpose of the materials tests was to determine which materials could be used in contact with the molten salt as an insulating material. The material long-life compatibility with the molten salt had to be determined, and the thermal properties of the salt-saturated material needed to be known. The approach of the materials tests was to place fifteen or more representative samples into test for 500 hours and select the five best candidate materials. These selected materials would then be tested for 5000 hours and evaluated at several points throughout the test. The effect of thermal cycling on the salt-saturated material also needed to be evaluated.

The analytical evaluation leads up to a cost optimization for various storage systems. The design and costing of tank insulation and foundation was necessary. The three types of thermal storage systems evaluated were thermocline, dual tank, and cascade (see Figures 1 to 3). A thermocline tank system stores both the hot and cold fluid in the same tank and depends on the fluid density difference to prevent fluid mixing. An analytical computer model was developed to analyze the thermocline tank. The dual tank system stores the hot fluid and cold fluid in separate tanks. As the hot fluid is used and cooled, it is stored in the cold tanks, so half of the tankage is always empty. The cascade system allows a tank to be used either as a cold tank or a hot tank. It is possible with this system to reduce the number of empty tanks as compared to the dual tank system.

The safety study is a separate document which addresses the safety considerations of using molten draw salt along with utility company evaluation.

The design of a small scale test program for demonstrating molten salt thermal storage is presented along with estimated program cost. The system is of sufficient size that representative insulation thicknesses can be used. The

---

\*Sandia Laboratories, Livermore Contract 83-3638 to Martin Marietta Corporation, T. R. Tracey, Program Manager.

object of the test is to satisfactorily answer questions about a molten salt storage and system operation such that confidence to build a full-scale system is achieved.

#### SUMMARY

The material compatibility tests showed that none of the materials tested would be acceptable as internal tank insulation when in contact with the molten salt. Since a wide range of materials were tested, it is unlikely that any insulation material will be compatible with molten salt. Since the use of internal insulation is extremely advantageous in reducing tank shell cost, a metal liner is recommended to protect the internal insulation from the molten salt. It is also cost effective to use a metal liner because the low thermal conductivity of dry insulation is much less than the conductivity of insulation wet with salt. A commercial stainless steel liner that is orthogonally folded to allow for expansion can be used for this application. Only minor liner development is considered necessary. These liners have seen many years of commercial service with exceptional reliability.

The most economical tanks are large, cylindrical, carbon steel ones with externally supported umbrella roofs. Tank wall thickness in this study was limited to 0.041 m (1.63 in.) to eliminate the need for post-weld heat treatment. Tanks storing hot salt (839 K (1050°F)) are internally and externally insulated to maintain a shell temperature of 588 K (600°F). The internal insulation separated from the salt by a metal liner is a lightweight refractory brick for the floor and walls and a fibrous insulation for the ceiling. The external insulation is a fibrous insulation for the walls and a load-bearing mineral block for the roof; both are covered with lagging for weather protection. The internal and external insulation is balanced to maintain the tank shell at a uniform temperature of 589 K (600°F). The cold tank (561 K (550°F)) requires external insulation only.

The tank foundation design is a water-cooled concrete slab that prevents the soil from reaching the boiling point of water, and also eliminates the necessity for a stainless steel tank bottom. Placing the tank directly on the ground (whether insulated or not) is not recommended, as very little is known of soil properties at elevated temperatures and boiling water trapped in the soil can produce unpredictable results.

A thermal analytical model and analysis of a thermocline tank was performed. Data from a present thermocline test tank was compared to gain confidence in the analytical approach. The thickness of the temperature-degraded fluid between the hot and cold temperatures (the thermocline) was determined for salt tanks. Small tanks, large heat losses, and large heat capacity of the wall insulation will all increase the thickness of the thermocline. Limiting the thermocline thickness is best achieved by outflowing some of the thermocline fluid at both the low and high temperature ends.

A computer analysis of the various storage system parameters (insulation thickness, number of tanks, tank geometry, etc.) showed that 1) the most cost-effective configuration was a small number of large cylindrical tanks, and

2) the optimum is set by the mechanical constraints of the system, such as soil bearing strength and tank hoop stress, not by the economics. Figure 4 shows a cost comparison of the three different storage concepts studied. Capital cost refers to the cost of the system components, effective cost is capital cost plus the cost of the extra heliostats, etc., necessary to compensate for the system's energy losses.

The cost of the tankage system with internal insulation is less than one half the cost of comparable salt storage system without internal insulation. Using a cascade system instead of a dual tank system introduces the technical problem of thermal cycling of the internal insulation, but reduces the cost very little. It is important to note that this cost-of-storage comparison is limited to storage system/central receiver combinations that have been proposed.

The design suggested for the tank development program is a dual tank system with tank sizes of 4.6 m (15 ft) by 4.6 m (15 ft) high. The system includes an air cooler and a fossil fuel heater necessary to vary the salt temperature. Included in the tank development program is liner verification.

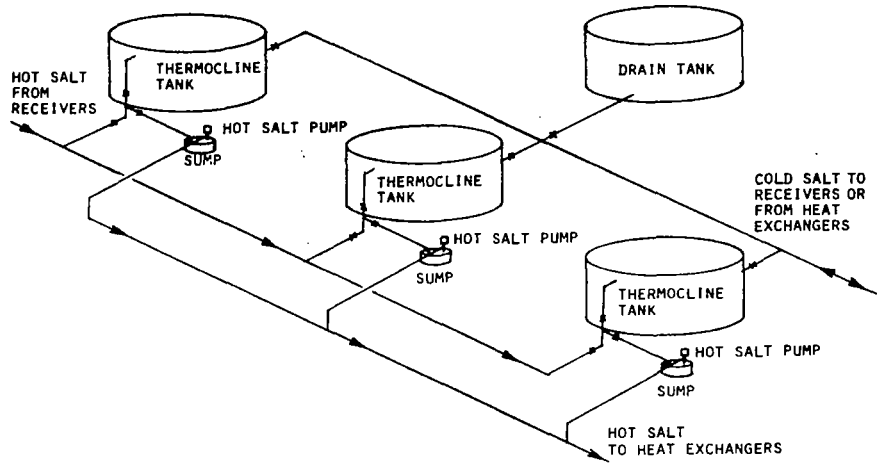

Figure 1 Thermocline Storage System Schematic

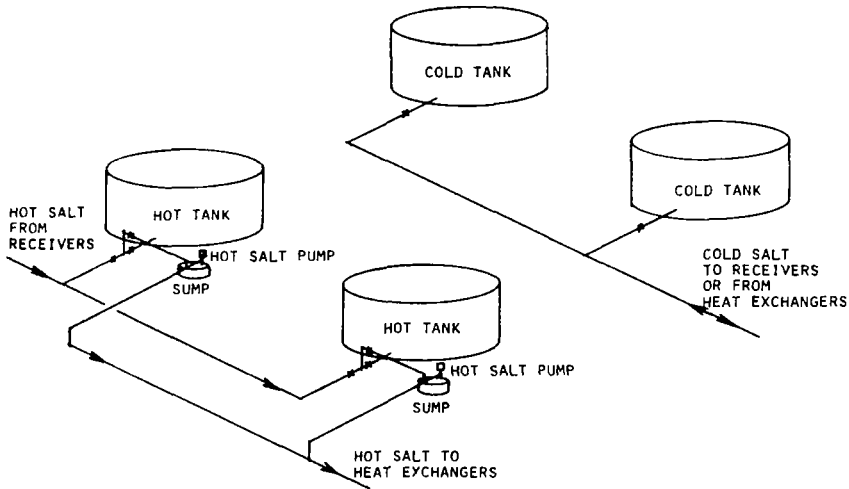

Figure 2 Dual Tank Storage System Schematic

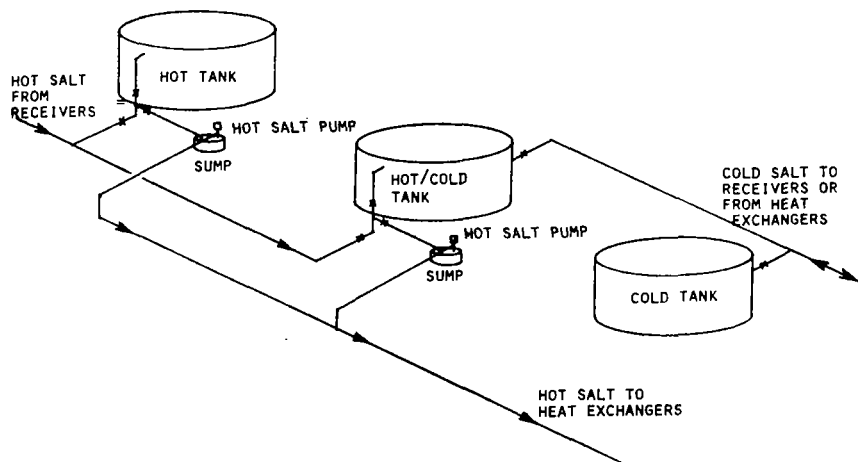

Figure 3 Cascade Storage System Schematic

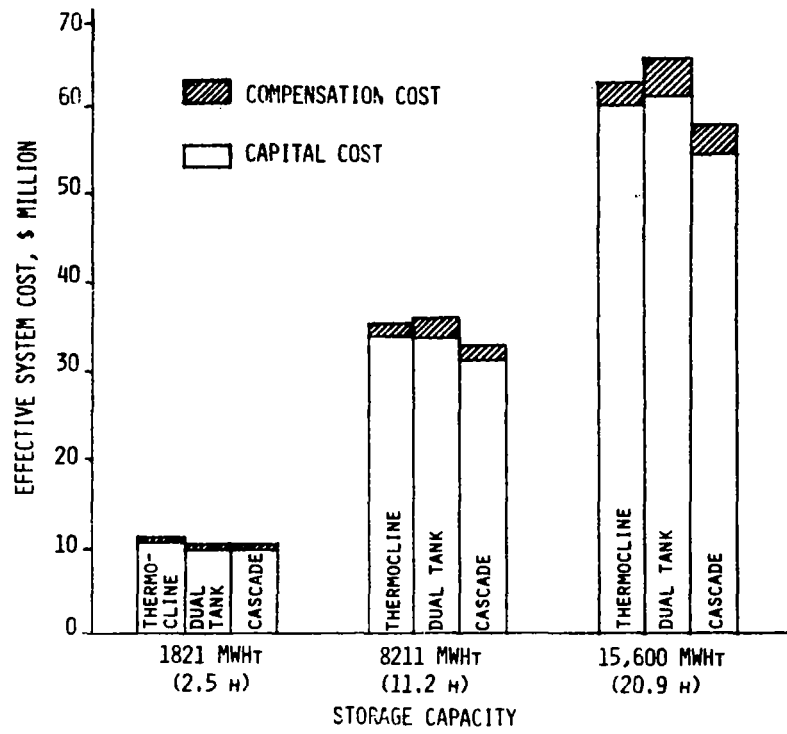

Figure 4 Effective Storage System Cost Vs Storage Size (300 MWe Plant)

---

CONTRACT FOR:	SANDIA LABORATORIES LIVERMORE, CALIFORNIA
CONTRACT NO.:	83-3638
PERIOD OF PERFORMANCE:	MARCH 1979 - DECEMBER 1979
FUNDING LEVEL:	\$216,500
LEVEL OF COMPLETION:	95%

---

PURPOSE OF CONTRACT

---

DETERMINE COST OPTIMUM OF STORAGE SYSTEM USING MOLTEN SALT FOR SOLAR SYSTEMS

- o TYPE, NUMBER, SIZE OF TANK
- o INSULATIONS
- o FOUNDATION
- o MATERIAL

DETERMINE COMPATIBILITY OF INSULATION MATERIAL WITH MOLTEN SALT

ANALYZE THERMOCLINE TANKS BY DEVELOPING A COMPUTER MODEL

EVALUATE SAFETY ASPECT OF SALT



TESTED MATERIALS

MANUFACTURER AND MATERIAL	DENSITY		COMPOSITION PRODUCTS IN PERCENT								
	lb/ft <sup>3</sup>	gm/cm <sup>3</sup>	Al <sub>2</sub> O <sub>3</sub>	SiO <sub>2</sub>	Fe <sub>2</sub> O <sub>3</sub>	TiO <sub>2</sub>	CaO	MgO	ALKALIES Na <sub>2</sub> O;B <sub>2</sub> O <sub>3</sub> K <sub>2</sub> O	OTHERS	IGNITION LOSS
<u>Brick</u>											
Maximul KR	142-146	2.27-2.34	42.76	53.15	1.07	1.11	0.47	0.57	0.87		
Lo Erode KR	135-143	2.16-2.29	57.94	32.06	0.91	1.29	6.67	0.22	0.59		
Hi Strength KR	126-133	2.02-2.13	43.64	38.31	3.68	1.06	11.11	0.41	1.39		
Krilite 30 KR	30	.48	55.5	38.2	1.6	1.4	2.2	0.2	1.2		
Krilite 60 KR	60	.96	55.5	38.2	1.6	1.4	2.2	0.2	1.2		
K-30 B&W	51	.82	46.0	52.0	0.9	1.4	0.5	0.1	0.4		
Firebrick 80-D B&W	151	2.42	45.0	52.0	1.4	1.7	0.1	+	0.3		
Visil HW	116-120	1.86-1.92	0.5	98.9	0.3	0.02	0.02	0.1	0.2		
Krimax CS-124 KR	150-154	2.40-2.47	46.2	49.7	1.6	1.9	0.06	0.17	0.23		
Semacid SE	137	2.2	36.30 <sup>3</sup>	57.88	2.74		0.82	0.54	1.38		.38
<u>Castable</u>											
IRC 24LI KR	56-58	.90-.93	40.55	36.15	1.65	1.30	16.39	0.37	1.93		1.63
Coreline KR	176	2.82	87.1	6.2	0.4	0.2	0.1	0.2	6.2 <sup>4</sup>		
Firelite 2100 KM	65	1.04	38.4	31.2	4.8	1.5	22.4	0.5	0.2		0.8
Firecrete 2800 JM	123	1.97	50.3	39.3	4.0	2.0	4.0			0.4	
KA0 TAB 95 B&W	166	2.66	95.0	0.1	0.1	+ <sup>2</sup>	4.6	+	0.1		

TESTED MATERIALS (CONCLUDED)

MANUFACTURER AND MATERIAL	DENSITY		COMPOSITION PRODUCTS IN PERCENT								
	lb/ft <sup>3</sup>	gm/cm <sup>3</sup>	Al <sub>2</sub> O <sub>3</sub>	SiO <sub>2</sub>	Fe <sub>2</sub> O <sub>3</sub>	TiO <sub>2</sub>	CaO	MgO	ALKALIES Na <sub>2</sub> O;B <sub>2</sub> O <sub>3</sub> K <sub>2</sub> O	OTHERS	IGNITION LOSS
<u>Foamglass</u>											
Foamsil-12 PC	25	.40	4.0	88.0					8.9 <sup>1</sup>	0.1	
<u>Fibreous Board</u>											
Duraboard CC	28-30	.45-.48	43.5	45.6	0.9		1.4		0.3		
<u>Other</u>											
T-Bond KT	194.5	3.12	0.2	0.6	0.2		1.9	97.1			

Manufacturer

KR - Kaiser Refractories  
 B&W - Babcock & Wilcox  
 HW - Harbison-Walker Refractories  
 SE - Stebbins Engineering  
 JM - Johns-Manville  
 PC - Pittsburgh Corning  
 CC - Carborundum Co.

<sup>1</sup> B<sub>2</sub>O<sub>3</sub> 7.0  
 K<sub>2</sub>O 1.0  
 Sb<sub>2</sub>O<sub>3</sub> 0.2  
 Na<sub>2</sub>O<sub>7</sub> 0.4-0.7

<sup>2</sup> + = Trace

<sup>3</sup> Includes a small amount of TiO<sub>2</sub>

<sup>4</sup> Na<sub>2</sub>O 0.2  
 K<sub>2</sub>O 0.1  
 P<sub>2</sub>O<sub>5</sub> 5.9

## TEST CONDITIONS

---

### PRESCREENING

TIME = 500 HOURS

TEMPERATURE = 593 C (1100°F)

### LONGEVITY

TIME = 500, 1000, 3000, 5000 HOURS

TEMPERATURE = 566 C (1050°F)

## SUMMARY MATERIAL COMPATIBILITY RESULTS

---

SEM SHOWS ALTERATION OF STRUCTURE AND NEW COMPOUNDS BEING FORMED.

K/R PETROGRAPHIC ANALYSIS AND X-RAY DEFRACTION SHOWS MATERIAL BEING ATTACKED AT VARIOUS RATES BUT ALL BEING ATTACKED.

SALT EVALUATION SHOWS ALUMINUM AND SILICON BEING LEACHED FROM ALL PRODUCTS.

K/R ACKNOWLEDGES NEW COMPOUND WILL FREEZE ABOVE 288 C (550°F).

CONCLUSION: IT IS UNLIKELY THAT PRODUCT WILL SURVIVE A MOLTEN SALT ENVIRONMENT FOR 30 YEARS.

## THERMOCLINE THICKNESS vs RATIO AND BITE

---

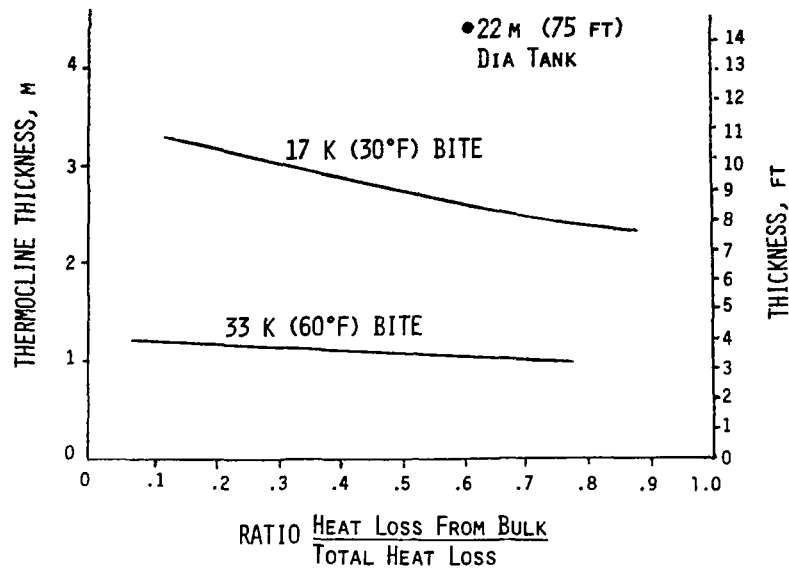

## THERMOCLINE SUMMARY

---

A THERMAL ANALYTICAL MODEL WAS DEVELOPED WHICH SIMULATES A THERMOCLINE TANK

COMPARISON MADE WITH A FRENCH OIL TANK TEST SHOWED GOOD AGREEMENT

THE THERMOCLINE THICKNESS IS SENSITIVE TO:

- THERMOCLINE TEMPERATURE BITE
- TANK SIZE
- HEAT CAPACITY OF WALL

THE EFFECT OF BULK FLUID CIRCULATION ON THERMOCLINE THICKNESS IS MUCH LESS THAN THE EFFECTS OF BITE AND WALL HEAT CAPACITY

THERMOCLINE THICKNESS FOR THE OPTIMUM SYSTEM STUDY WAS 2.62 M (8.6 FT) BASED ON A 16.6 K (30°F) TEMPERATURE BITE

## TANK BEARING ON HOT SOIL

- EXTENSIVE TELEPHONE SURVEY OF COMPANIES, FEDERAL BUREAUS AND COLLEGE PROFESSORS SHOW THIS IS A NEW TECHNICAL AREA
- SOIL PROPERTIES REQUIRED AT TEMPERATURE
  - BEARING
  - THERMAL EXPANSION
  - DEFORMATION
  - CREEP
  - COHESION
  - SHEAR
- GROUND WATER
  - SOURCE - DIRECT SOIL PERCOLATION
  - UPSTREAM STORMS THROUGH PVIOUS SOIL LAYER
  - RESULT - LIFTING OF SOIL OVERBURDEN AND TANK WHEN STEAM IN SOIL PORES EXCEED LITHOSTATIC SOIL LOAD
- PRESENT PRACTICES
  - PHTHALIC ANHYDRIDE TANKS, 422 K (300°F) ON GROUND - INSULATING CONCRETE
  - ASPHALT TANKS, 561 K (550°F) - COOLED FROM GROUND
  - FURNACES - PLACED ABOVE GROUND

## MOLTEN SALT STORAGE TANK - CYLINDRICAL

DESIGN: ATMOSPHERIC  
SHELL DESIGN TEMPERATURE: 600°F  
MATERIAL: SA-516, GR. 70  
CORROSION ALLOWANCE: .003m (.125 in.)  
CODE: API-650 CONSTRUCTION, NO STAMP.  
MAX. SPECIFIC GRAVITY (COLD) 1.907  
EARTHQUAKE: ZONE 3  
SPOT X-RAY  
STRESS RELIEVING: NOT REQUIRED

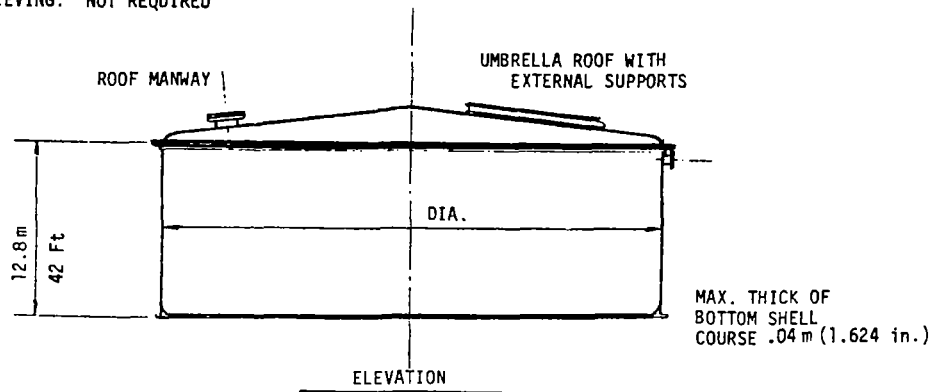

## CYLINDRICAL TANK COST vs SIZE

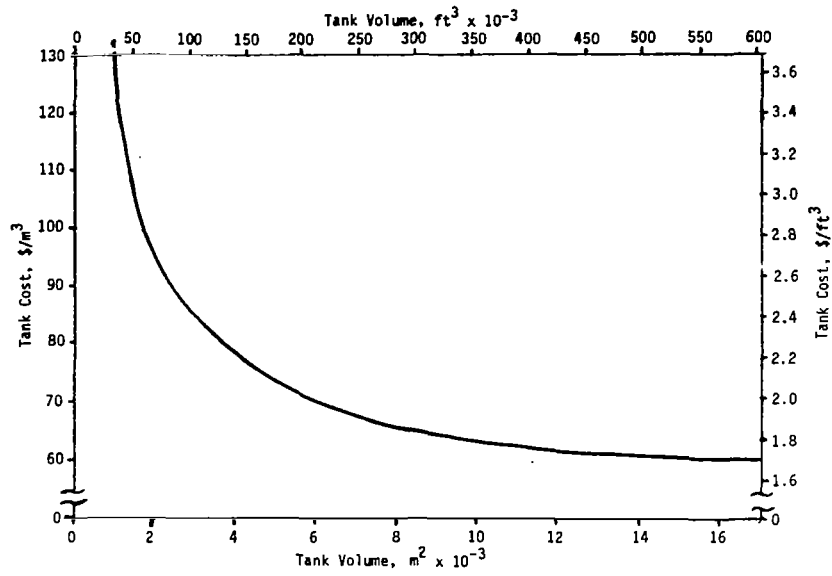

## THERMOCLINE STORAGE SYSTEM

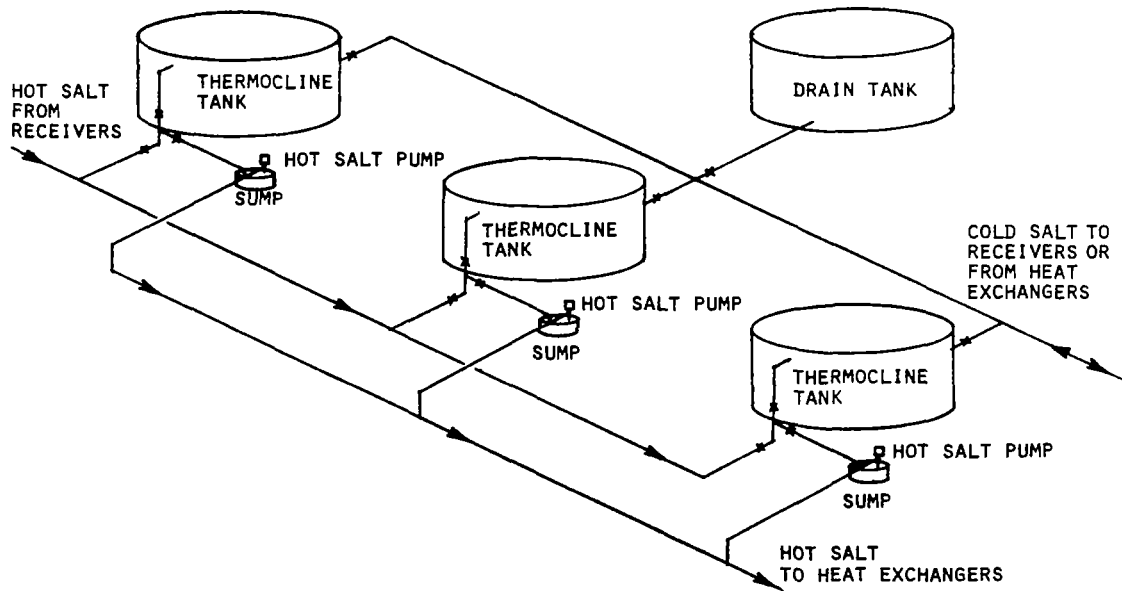

### DUAL TANK STORAGE SYSTEM

---

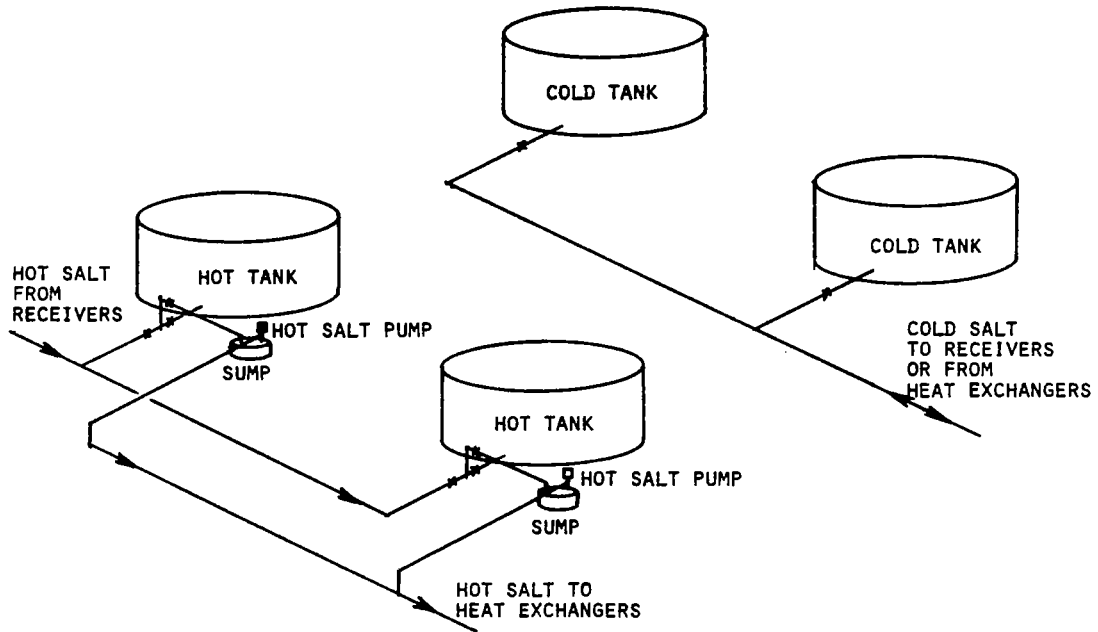

### CASCADE STORAGE SYSTEM

---

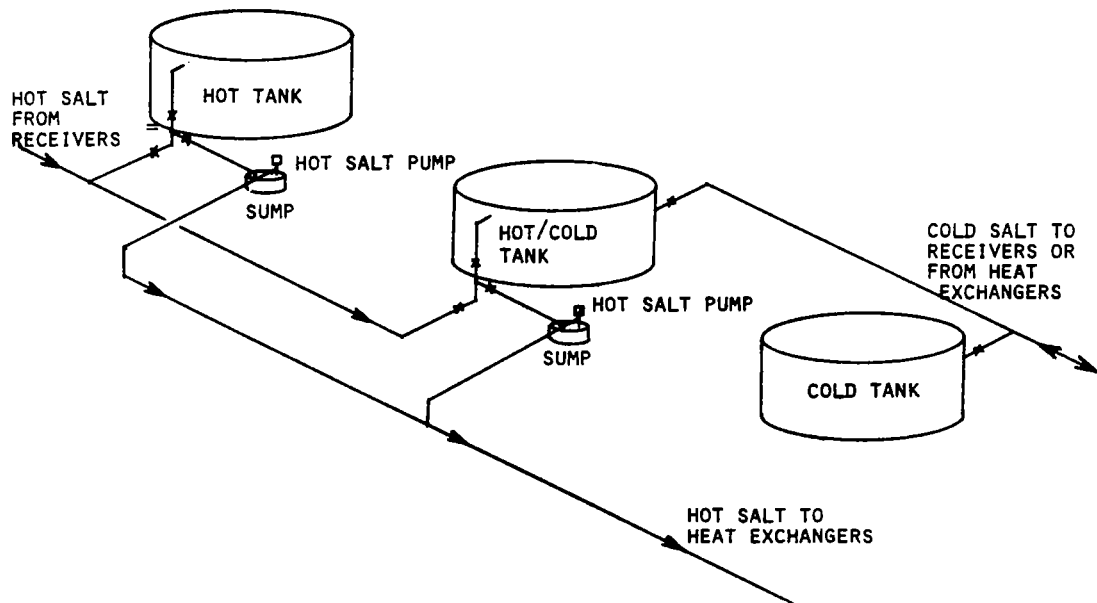

## SPAM - STORAGE PARAMETRIC ANALYSIS MODEL

### GOALS OF PROGRAM

- FIND THE CAPITAL AND EFFECTIVE\* COSTS OF MOLTEN SALT STORAGE SYSTEMS DEFINED BY THE USER
- FIND THE SENSITIVITIES OF THESE COSTS TO VARIOUS SYSTEM PARAMETERS
- DETERMINE THE OPTIMUM STORAGE SYSTEM CONFIGURATION

### APPROACH

CALCULATE THE SUBSYSTEM AND SYSTEM COSTS FOR EACH USER-DEFINED CONFIGURATION, VARYING SUCH THINGS AS INSULATION THICKNESS, H/D RATIO, AND NUMBER OF TANKS.

PRINT OUT ALL COMBINATIONS, ALLOWING USER TO SEE SENSITIVITY TO A GIVEN PARAMETER, AND TO CHOOSE THE OPTIMUM CONFIGURATION.

\*EFFECTIVE COST TAKES INTO ACCOUNT THE COST OF EXTRA HELIOSTATS, ETC., NEEDED TO COMPENSATE FOR THE STORAGE SYSTEM HEAT LOSS.

## HOT TANK OPTIMIZATION (8200 MWH<sub>T</sub> STORAGE)

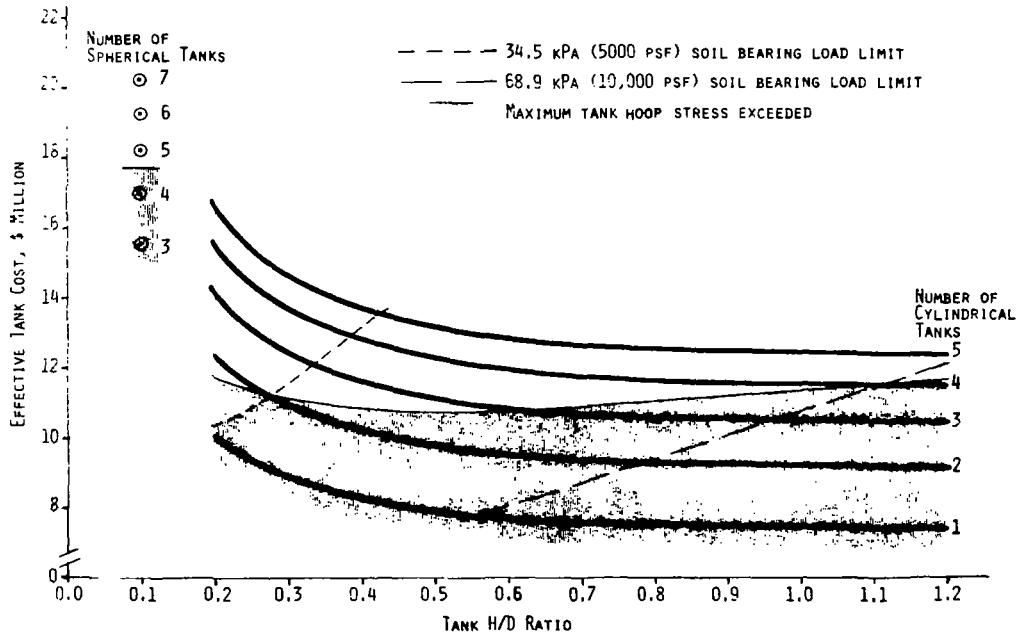

EFFECTIVE SOLAR STORAGE SYSTEM COST vs STORAGE SIZE (300 MWe PLANT)

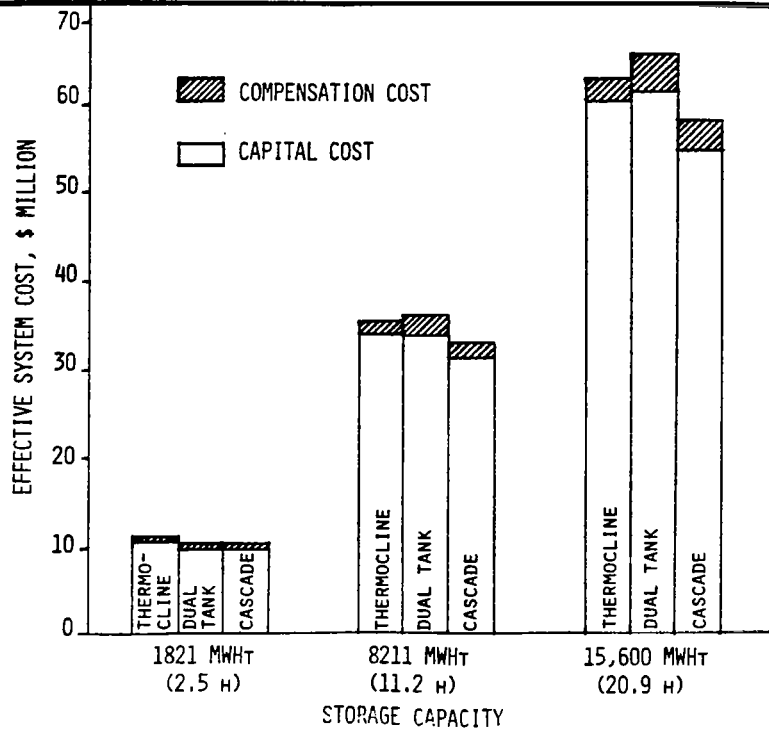

EFFECTIVE COST OF SOLAR STORAGE vs STORAGE SIZE

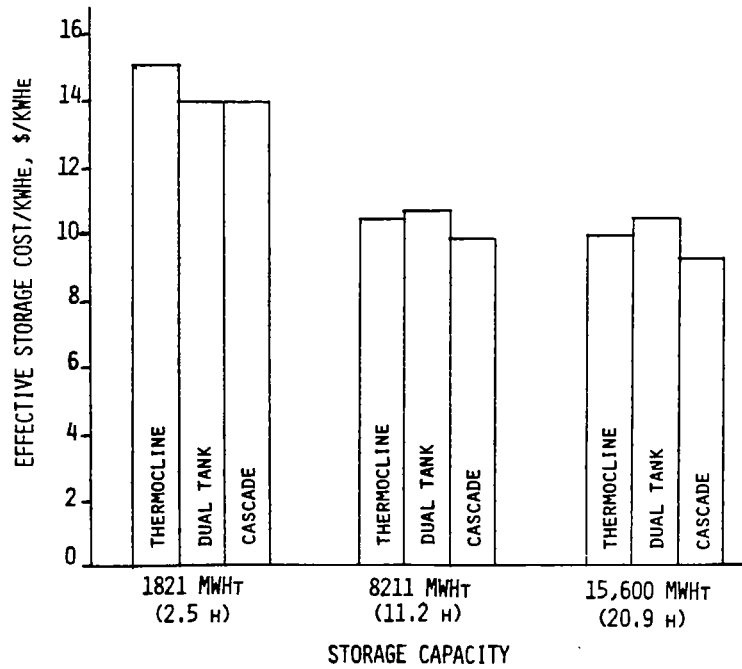



## CONCLUSIONS AND RECOMMENDATIONS

- THE OPTIMUM TANK CONFIGURATION FOR EACH SYSTEM IS THE SMALLEST NUMBER OF LARGE TANKS POSSIBLE WITHIN THE MECHANICAL CONSTRAINTS (SOIL BEARING LOAD, TANK HOOP STRESS).
- FOR SMALL STORAGE SYSTEMS WHERE ALL THE SALT CAN BE STORED IN ONE TANK (<3000 MWh<sub>T</sub>), THE DUAL TANK SYSTEM IS THE MOST ECONOMICAL SYSTEM.
- FOR INTERMEDIATE STORAGE SYSTEMS (≈10,000 MWh<sub>T</sub>), THE DUAL TANK SYSTEM IS RECOMMENDED AS THE COST ADVANTAGES OF THE THERMOCLINE AND CASCADE SYSTEMS DO NOT WARRANT THE ADDED TECHNICAL RISK.
- FOR LARGE STORAGE SYSTEMS (>15,000 MWh<sub>T</sub>), THE COST ADVANTAGE OF THE CASCADE SYSTEM IS ATTRACTIVE ENOUGH TO ENCOURAGE A SOLUTION TO THE THERMAL CYCLING PROBLEM. IN LIGHT OF THE CURRENT INFORMATION, THOUGH, A DUAL TANK SYSTEM IS STILL RECOMMENDED.

## SYSTEM SCHEMATIC

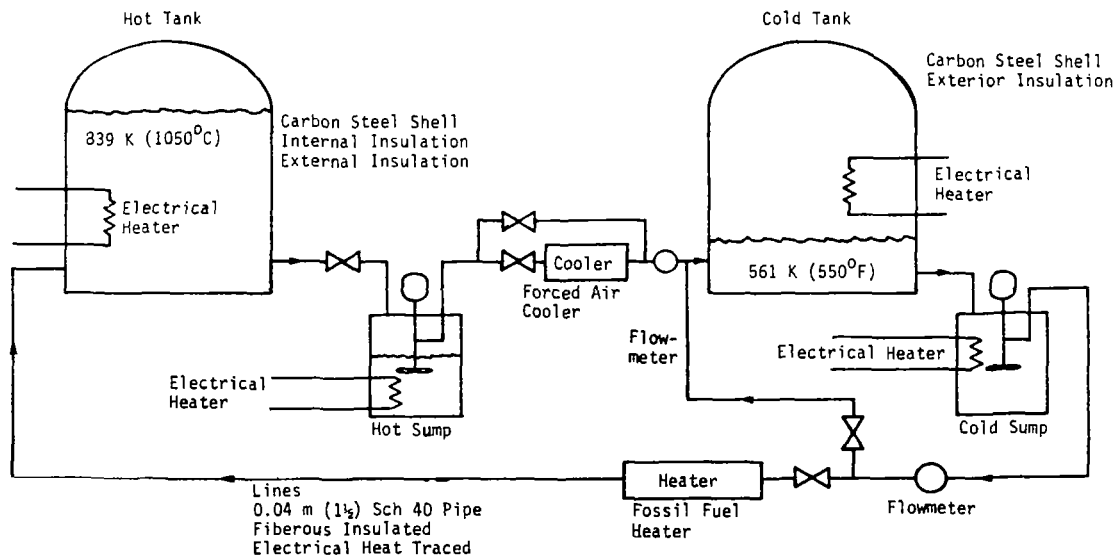



SANDIA LABORATORIES IN-HOUSE ACTIVITIES IN SUPPORT OF  
SOLAR THERMAL LARGE POWER APPLICATIONS\*

Raymond W. Mar  
Sandia Laboratories, Livermore

SUMMARY

Research activities have been planned and carried out in direct support of the development of thermal energy storage subsystems for solar thermal large power applications. The emphasis has been on characterizing the behavior of molten nitrate salts with regard to thermal decomposition, environmental interactions, and corrosion. The results to date and future activities are summarized in this paper.

INTRODUCTION

Sandia's in-house activities are defined with the overall objective of advancing solar thermal large power systems. As such, many of these activities are equally supportive of STOR and TPS interest, and generic in-house research programs have evolved. No attempt is made here to partition the in-house activities according to funding division, since a clear demarcation does not exist in many cases.

MOLTEN NITRATE SALT STUDIES

Molten nitrate sensible heat thermal energy storage systems have emerged as one of the leading choices of primary heat transfer and thermal storage media in advanced solar power systems (ref. 1). The salt composition of greatest interest is draw salt (nominally a 50-50 molar mixture of  $\text{NaNO}_3$  and  $\text{KNO}_3$ ), and most of the activities to date have concentrated on this composition. Numerous problems have been identified which require resolution in order to prove technical feasibility, carry out detailed designs, and predict long term performance. An in-house program (supplemented by subcontracted activities) has been developed to solve these problems. These activities can be conveniently divided into the following technical areas:

---

\*Work supported by U. S. Dept. of Energy, DOE, under Contract DE-AC04-76DP00789

- Thermal Stability
- General Corrosion
- Environmental Corrosion Cracking
- Electrochemical Studies
- Thermal Properties

Each of these areas are discussed below with regard to (1) the nature of the problem, (2) accomplishments to date, and (3) future activities.

### Thermal Stability

It is recognized that nitrate salts can degrade by numerous processes; some examples are given below (unbalanced):

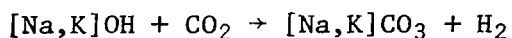
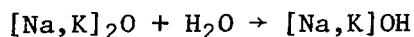
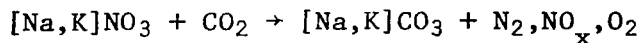
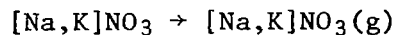
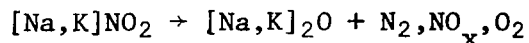
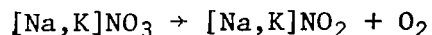

All of these reactions are thermodynamically favored to some extent. The problem is to define the extent and rate at which these reactions occur.

Many parameters conceivably influence the degradation process, a partial list being temperature, surface area, surface to volume ratio, ullage gas composition, salt purity and gas flow rate over the salt. A Plackett-Burman experimental design (ref. 2) has been run in order to determine the main effect variables. Preliminary analyses of the data indicate temperature is by far the most important variable; detailed data analyses are currently being carried out. In addition to these main effect screening studies, in-depth studies are underway using a TGA/EGA (thermogravimetric/evolved gas analysis) apparatus capable of simultaneously measuring sample weight changes and analyzing evolved gas species in vacuum and controlled pressures up to one atmosphere. Results to date show it is incorrect to assume the reduction reaction ( $[\text{Na,K}]\text{NO}_3 \rightarrow [\text{Na,K}]\text{NO}_2 + .5\text{O}_2$ ) is the only major decomposition process as suggested by others (ref. 3). Rather, numerous modes of decomposition appear to be active;  $\text{N}_2$  and  $\text{NO}_x$  are generated as products of decomposition along with  $\text{O}_2$ .

Future activities will be aimed at isolating the different decomposition processes, and determining their individual rates. The prime mode of study will be with the TGA/EGA apparatus. Several supplementary subcontracted activities have been defined: (1) phase diagram determinations and (2) H<sub>2</sub>O/CO<sub>2</sub> interaction rates and mechanisms. Requests for proposals have been prepared and are scheduled for release in early FY80.

### General Corrosion

Molten nitrates do not appear to create an overly severe general corrosion environment. Static immersion tests have indicated that general corrosion takes place by oxidation. Parabolic rates have been observed for high chromium alloys, suggestive of protective oxide formation. The oxide layers appear to be adherent, and are not susceptible to thermal cycling. However, in order to extrapolate this data to 30 year time periods with confidence, mechanistic understanding of the corrosion process is needed. Furthermore, a cause for concern has arisen; chromium has been observed in the salt, which implies a potential mass transport problem in an operating system with thermal gradients and flowing fluids. Static immersion tests have led to the selection of Incoloy 800 as the prime candidate for high temperature use (1050°F), although the less costly stainless steels cannot be discounted on the basis of general corrosion.

Three single-material thermal convection loops have been constructed out of 304, 316, and I800, and they are currently in operation. To date, the loops have experienced 4000, 1000 and 1000 hours of operation respectively. Sample coupons have been extracted at 500 hour intervals and analyzed for extent of corrosion. Thin oxide layers formed on the alloys; net weight changes are negative for 304, and positive for 316 and I800.

Future activities include the continued operation of these loops and complementary immersion tests will be carried out with the objective of determining the rates of the various processes involved (e.g. oxide formation, Cr<sub>2</sub>O<sub>3</sub> dissolution, Cr diffusion). The in-house studies will be supplemented by a subcontracted study at ORNL, where 304, 316, and I800 loops experiments will be carried out in sealed environments.

### Environmental Corrosion Cracking

A major concern to design engineers is the coupled interaction of an aggressive environment and applied stress on containment materials. A well known problem of this type is chloride stress corrosion cracking, where the chemical action of the environment acts on tips of propagating cracks to greatly accelerate crack growth. It is not known whether the nitrate salt environment induces corrosion cracking; no data are available to suggest that there is or isn't a problem.

A plan has been developed to determine the potential for environmental cracking; slow strain rate, stress corrosion, and corrosion fatigue

experiments are planned, and will be initiated in FY80.

### Electrochemical Studies

Currently, decomposition and corrosion processes are being studied independently as discussed above. It is also recognized that one can expect strong synergistic interactions between the salt chemistry (ionic species), decomposition processes, and corrosion processes; therefore, an ability to determine ionic species (quantitatively and qualitatively) in the salt melt is clearly desired. Electrochemical techniques can provide the capability; however, techniques must be developed and perfected. Electrochemical approaches can also be used for real time studies of corrosion, providing a potential for a sensitive corrosion tool complementing other corrosion activities discussed above.

In-house activities have concentrated on the development of an oxide ion sensitive electrode. Because the oxide ion ( $O^{2-}$ ) is purported to be a key component in thermal decomposition, corrosion, and  $CO_2/H_2O$  interaction processes, it is felt that a means to directly measure its presence is required to gain a fundamental understanding of salt behavior. An oxide ion sensitive electrode of the form  $Pb, PbO/ZrO_2Y_2O_3$  has been developed and Nernst behavior demonstrated over the range of  $10^{-10}$ - $10^{-4}$  molal  $O^{2-}$  with excellent stability, response, and reproducibility. A cyclic voltammetric set-up has been completed, and preliminary studies on nitrate melts have demonstrated the potential for using cyclic voltammetry to identify ionic melt species.

Techniques to determine the ionic species in the melt will continue to be developed, and eventually used to monitor the salt chemistry as thermal decomposition, atmospheric interaction, and corrosion processes occur. Subcontracted electrokinetic studies are also planned in which the kinetics of passive oxide film formation on candidate alloys will be investigated.

### Thermal Properties

The high temperature viscometer has been modified to study molten salts, and experiments will be carried out to measure viscosity, surface tension, and density as a function of temperature, salt composition and gaseous environment. If it is determined that accurate high temperature thermal conductivity and heat capacity data are required, studies will be initiated.

### OTHER STUDIES

The major emphasis of Sandia's in-house program has been on molten draw-salt behavior. For the sake of completeness, other in-house thermal energy storage related activities are mentioned here. It is known that the use of hydrocarbon fluids as a thermal storage medium is temperature limited due to the degradation of the oil. Rates of fluid loss have been determined for three different hydrocarbon oils: Caloria HT43, SUN 21, and Therminol 66. In

addition, fluid loss rates pertinent to oil/granite and oil/sand dual media systems were also determined; the filler material (granite and sand) caused enhanced fluid loss rates in all cases.

Dual media systems have also been proposed for nitrate salt systems. The compatibility of nitrate salts with granite rock and pelletized iron ore (taconite) have been cursorily examined; the results indicate the salts are not compatible with granite rock materials, but may possibly be used in direct contact with taconite at temperatures up to 550°C.

#### REFERENCES

1. Tallerico, L., "A Description and Assessment of Large Solar Power Systems Technology," SAND79-8015, Sandia Laboratories, August, 1979.
2. Plackett, R. L., and Burman, J. P., *Biometrika*, 33, 305 (1946).
3. Tracey, T. R., "Conceptual Design of Advanced Central Receiver Power System, Phase I," Martin Marietta Corporation, final report for contract EG77-C-03-1724, September, 1978.





HIGH TEMPERATURE UNDERGROUND THERMAL ENERGY STORAGE  
SYSTEM FOR SOLAR ENERGY

R. Eugene Collins  
University of Texas at Austin

PROJECT OUTLINE

Project Title: High Temperature Underground Thermal Storage of Solar Energy

Principal Investigator: R. E. Collins

Organization: Energy Foundation of Texas  
University of Houston  
Houston, TX 77004  
Telephone: (713) 749-3887

Project Goals: The objective of this project is to establish the feasibility of high temperature underground thermal storage of energy and arrive at a practical system design.

Project Status: Results to date indicate that salt cavern storage of hot oil is both technically and economically feasible as a method of storing huge quantities of heat at relatively low cost. One particular system identified in this study utilizes a gravel filled cavern leached within a salt dome. Thermal losses are shown to be less than one-percent of cyclicly-transferred heat. A system like this having a 40 MW<sub>t</sub> transfer rate capability and over eight hours of storage capacity is shown to cost about \$13.50 per KWh<sub>t</sub>.

Contract Number: XP-9-8319-1

Contract Period: August 1, 1979 - July 31, 1980

Funding Level: \$110,500

Funding Source: Solar Energy Research Institute

## High Temperature Underground Thermal Storage of Solar Energy

Principle Investigator: R. Eugene Collins, Professor of Petroleum Engineering  
University of Texas at Austin, Austin, Texas 78712

Sub-Sub Contract to the University of Texas at Austin, through the Energy  
Foundation of Texas from the Solar Energy Research Institute,  
Contract # XP-9-8319-1.

Objectives: This report documents the second year of a feasibility study of underground storage of solar energy as sensible heat. This effort addresses storage temperatures high enough to utilize conventional steam-electric power generation on the recovery cycle. The method of storage now under evaluation utilizes cavern storage of heat transfer oil at temperatures up to 650°F in leached caverns within salt domes. A study of aquifer storage of hot water at these temperatures was discontinued when it became apparent that such storage would encounter major problems from mineral (silica) solution and requirements for down-hole pumps for the recovery cycle. Research and development efforts have been focused on the following technical problems:

- a) Thermal losses
- b) Cavern stability
- c) Cavern construction
- d) Well designs
- e) heat exchanger interfacing
- f) economics for cavern storage systems:

Conclusions. Studies indicate that salt cavern storage of hot oil will be both technically and economically practical as a method of solar energy storage for electric power generation. The best system identified in this study is a gravel filled cavern using at least one input and one output well, operated in a thermocline mode with injection and retrieval on a diurnal cycle. Thermal losses should be less than one percent of cyclicly-transferred heat. The gravel filling would act as a heat storage medium and as a stabilizer against cavern deformation due to plastic flow of salt. (See Figure 1.).

During the second contract year it has been shown that such a system can be built using existing technology and available materials. In particular, the design and operation of such a system for interfacing to a 10 MW<sub>e</sub> central receiver like the one being built at Barstow, California has been evaluated. A cavern storage system could be built for about \$4 million having a 10 MW<sub>e</sub>

transfer rate capability and 8+ hours of storage capacity. Storage would be at about 650°F and cost about \$13.50 per kWh<sub>t</sub>. This compares favorably with DOE objectives, but larger cavern storage systems would be more cost effective with costs estimated at a low \$7.50 per kWh<sub>t</sub>. Thus, cavern storage would be preferred to above-ground storage where it is geologically feasible. A review and summary of the various studies carried out during the past year isolate and explain primary conclusions.

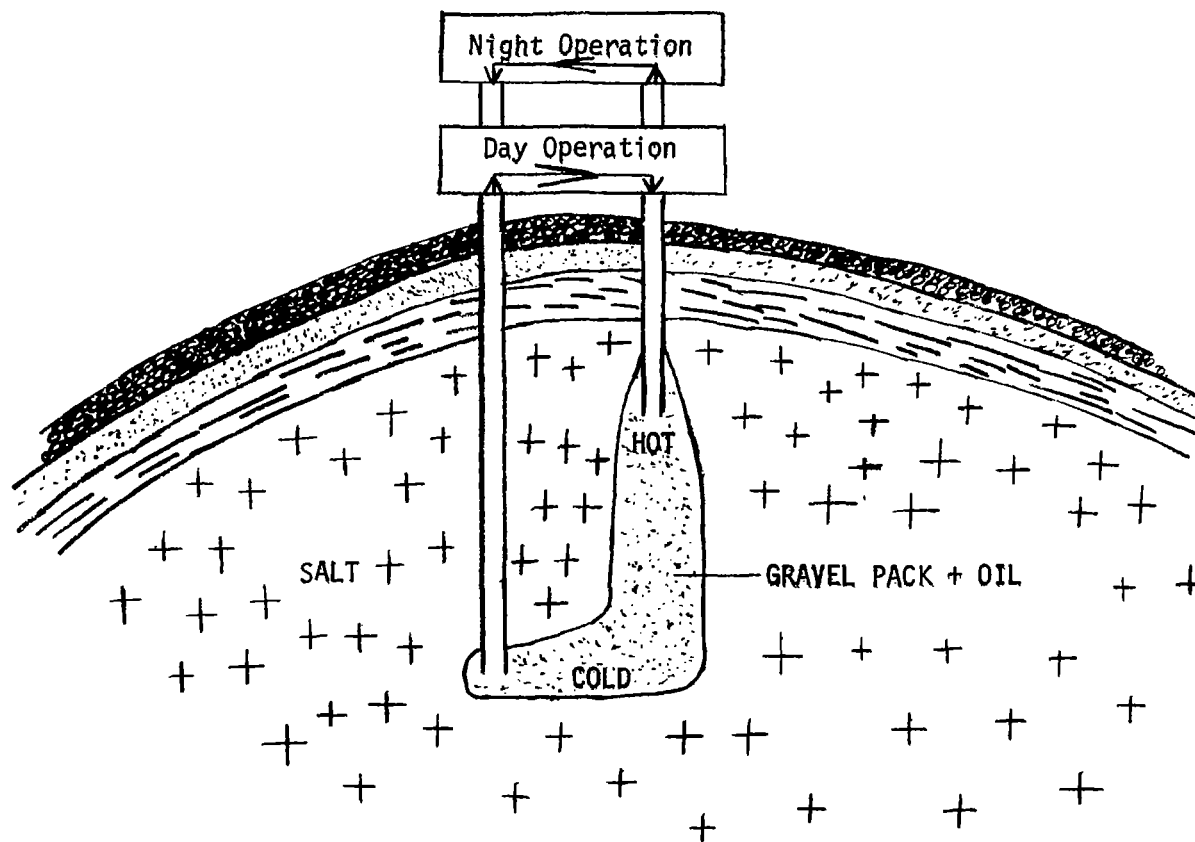

Figure 1. Schematic of gravel filled salt cavern for thermocline storage of heat using heat transfer oil.

Thermal Losses from Cavern Storage Systems. In the first year of the five-year study, we have reported results on thermal losses, calculated with a computer simulator assuming a cavern with perfect mixing (homogeneous temperature inside), for cyclic operating conditions. Those studies showed that for daily cycles of a hot oil storage cavern--8 hours injection and 16 hours retrieval--thermal losses would decline rapidly from a moderately high

value to less than one percent of the transferred energy by the end of one year of operation. This model has also been used to study effects of non-cyclic operation that would result with shut-down of the solar collector in cloudy weather. These studies indicated that losses would not be prohibitive for shut-down periods up to several days if the cavern were sufficiently large.

The simulator under study is an oversimplified model, for it assumes perfect mixing of oil within a spherical cavern. The model also describes a storage system consisting of two caverns, a hot cavern and a cold cavern with a nitrogen gas cap in each cavern. The nitrogen gas cap is compressed during fluid injection and the expansion of the gas produces back-flow in the retrieval cycle, thus negating the requirement of a downhole pump. However this system requires caverns at significant depth to sustain required internal pressures and poses problems of mechanical stability.

It now appears that the preferred cavern storage system will be a single gravel filled cavern with two wells operated in a thermocline mode using oil and rocks essentially like the above ground tanks; one well connects to the top of the cavern (the hot well) and one to the lower end of the cavern (the cold well). (See Figure 1.).

Gravel filling in a thermal storage cavern serves three purposes:

1) the gravel is a storage medium for sensible heat and reduces the required oil volume, 2) the gravel restricts thermal convection and stabilizes the thermocline, and 3) the gravel provides mechanical support and rigidity to the cavern to prevent cavern deformation due to creep of the salt, or plastic flow, provided that internal fluid pressure is less than external geostatic pressure.

The perfect mixing model has therefore been put aside and attention devoted to the formulation of computer simulators for the study of fluid movement, heat transfer, and thermal losses in a gravel filled cavern operated as a thermocline with oil. Preliminary results from these models show that the order of magnitude of the thermal loss in this system is not radically different from that in the homogeneous cavern.

Two new simulators are being evaluated; the first is designed to describe in detail the mass and heat flow within the cavern as well as the heat flow within the salt, while the second simulator is designed for accurate description of the heat flow across the cavern boundaries and within the salt

while the mass and heat flow within the cavern are treated by more approximate means. This program is operational and is being used to generate systematic data on cavern operations.

The model has already been used to show that a thermocline cavern storage system for a small scale system (10 MW<sub>e</sub>) with eight hours storage would lose about 2.6% of the useful stored heat during one daily cycle after about three months of continuous operation. The loss rate at the end of one year of continuous operation is approximately 1.5%. For systems of larger size (100 MW<sub>e</sub> or more) the long term loss rate would be 1%, or less, of the cyclicly transferred heat.

Cavern Stability Studies. The major problem anticipated for the cavern storage system was cavern deformation due to creep of the salt at high temperatures, or plastic flow. Published experimental data for a wide range of strains, rates of strain and temperatures have been curve-fitted to provide an adequate description of the viscoelastic/plastic properties of halite. This rheological model for halite is given as a general equation of strain rate as a function of strain, differential stress and temperature for uni-axial conditions. For particular constant stress and temperature values it can be integrated numerically to give the total strain as a function of time. For a temperature of 599°F and an expected differential pressure of 300 psi, the integration yields a total strain on an element of halite of 1.8% in 20 years or 2.2% in 50 years. The same element of halite, when subjected to a differential pressure of 600 psi at the same temperature would suffer a total deformation of 8.4% in 20 years or 14% in 50 years. Note that these results do not take into account the rigidity of the gravel pack which would function to reduce these deformations.

Gravel filling will be a greater deterrent to cavern deformation than initially anticipated. It is well known that a container filled with rigid granules in firm contact cannot undergo a shear deformation without expansion of the container volume. Thus, since the pressure of the overburden must be overcome, in order for the cavern to expand, the gravel should give great rigidity to the cavern. A simulator is currently being developed to determine the deformation and rates of deformation experienced by a spherical cavity filled with saturated gravel, the boundary of which is subjected to hydrostatic loading. This simulator is now in the debugging stage. A survey of the literature is also underway to find sufficient data to determine the elastic/creep constants of saturated sands to be used as input to the simulator.

The critical factor for the stabilizing role of the gravel on the cavern appears to be maintenance of fluid pressure within the pore space less than the confining geostatic pressure of the salt. An analytical solution for the pressure distribution within the cavern has been obtained, valid within some simplifying assumptions, which shows that fluid pressure increases required to maintain fluid flow will generally be on the order of a few hundred psi. Such pressures could be tolerated in caverns at reasonable depths. Further study of these flow effects is underway, using both analytical and numerical methods.

Thermal Storage Fluids. The optimum fluid to be used in the cavern storage system would minimize replacement costs for a given power from the system. Replacement costs are directly proportional to fluid loss rate due to thermal degradation. Published experimental data for fluid loss rates of some commercially available heat transfer fluids have been examined from this viewpoint. Caloria HT43, SUN 21 and Therminol 66 were considered. Of these it appears that Caloria HT 43 would be most suitable with a loss rate of about 6.25% per year at 600°F. However, more information is required on effects of contact with metals, air, water and salt on rate of degradation.

Well Designs and Cavern Construction. A comprehensive review of the literature indicated that existing equipment, materials, and procedures for oil wells can be adopted for construction of wells for the cavern storage system. The main body of the second-year report on this project provides a detailed description of the process of drilling, completing the wells, leaching the caverns, and placing gravel in the caverns.

The major consideration in the well designs is the requirement of adequate cement bond in the installation of the well casing pipe to constrain the pipe against thermal expansion. The thermal expansion of the injection tubing can be accommodated by thermal expansion joints. A rigid, porous silica foam coating on the exterior of this tubing can provide good thermal insulation.

Other major considerations in the design of cavern systems are brine disposal while leaching and the technique of gravel placement.

Detailed casing designs have been formulated for wells of three flow rates, 1500 gpm, 2000 gpm, and 2500 gpm, and two depths, 3000 ft and 5000 ft. Detailed cost estimates account for materials, installation, and supervision. Costs have also been estimated for cavern leaching and gravel filling.

Heat Exchangers and Power Generation. Since a specific solar collector has not yet been identified to interface with a cavern heat storage system, the 10 MW<sub>e</sub> system being built at Barstow, California, was used for evaluation purposes. Using data provided in the McDonnell Douglas report on this system, design studies were carried out to determine the type of modifications of the heat exchangers and power generation equipment that might be required in order to interface the solar collector with a cavern storage system. Though some modifications would be necessary, none are considered to be of major significance.

Larger systems--100 MW<sub>e</sub> to 1000 MW<sub>e</sub>-- would require a much more complex interfacing of the solar collector, cavern storage, and steam-electric turbines. One proposed design for such larger systems is a cross-compound system using steam-electric conversion at two different temperature levels, one direct from the collector and one direct from the cavern, with cross coupling. This would be desirable since output from the solar tower would be at 900-1000°F while cavern storage is limited to about 650°F by the oil storage fluid.

Detailed cost estimates were prepared for the 10 MW<sub>e</sub> system and some preliminary estimates of costs for larger systems were made; these are shown below.

Economics. The total cost, C, of a cavern storage system is given by

$$C = c_c \cdot V + C_w + C_D + C_a$$

where

- $c_c$  = unit volume cost of cavern and contents (gravel, oil)
- $V$  = cavern volume
- $C_w$  = costs of hot and cold wells
- $C_D$  = cost of brine disposal well
- $C_a$  = cost of above ground equipment.

For systems of the size envisioned in this study, one brine disposal well ( $C_D = \$620,000$ ) would be adequate for the cavern leaching operation. The unit volume cost of the cavern and its contents is approximately \$2.85/ft<sup>3</sup>. This includes costs of leaching, gravel placement, and oil. The cavern volume is dependent upon the desired storage capacity while  $C_w$  and  $C_a$  depend upon the desired transfer rate.

Cost estimates for the components of a cavern system with a transfer rate of 33 MW<sub>t</sub> and 8-hour storage period, given in various sections of the complete second year report, are summarized below:

Total storage system costs for 33 MW<sub>t</sub>  
transfer rate and 8-hour storage period.

	million \$
Cavern Contents (139,000 ft <sup>3</sup> @ c <sub>c</sub> = \$2.85)	0.396
C <sub>w</sub> (1 hot well, 1 cold well)	1.638
C <sub>D</sub> (1 brine disposal well)	.620
C <sub>a</sub> (heat exchangers, pumps)	<u>.733</u>
TOTAL	\$3.387

The total cost of this system is approximately \$3.4 million. This sum corresponds to total storage system costs of \$103/kW<sub>t</sub> and \$13/kWh<sub>t</sub>. These figures compare favorably with Department of Energy cost goals for near term sensible heat storage. Cost goals (C<sub>t</sub>) can be compared to power related costs (C<sub>p</sub>) and capacity related costs (C<sub>s</sub>). Power related cost (C<sub>p</sub>) depends upon the capability of the storage system to accept and deliver thermal energy at a given rate (heat exchangers, wells, pumps, etc.). Capacity related cost (C<sub>s</sub>) is related to the maximum amount of energy that can be contained within storage (oil, gravel, construction costs of cavern capacity). These relations are shown below:

Storage System Costs

	C <sub>t</sub>		h hours of storage	C <sub>p</sub>	C <sub>s</sub>
	\$/kW <sub>t</sub>	\$/kWh <sub>t</sub>		power cost \$/kW <sub>t</sub>	Capacity cost \$/kWh <sub>t</sub>
DOE Goals	90	15	6	45	7.50
DOE Goals*	105	13.3	8	45	7.50
This study (small system)	103	13	8	91	1.50

Here:  $C_t(\$/kW_t) = C_p + h \cdot C_s$

$C_t(\$/kWh_t) = (C_p + h \cdot C_s)/h$

\*DOE 6 hour costs converted to 8 hour costs for direct comparison with this study.



The underground storage value for the power cost is about twice the DOE goal, but the capacity cost is much less. This difference exists because the underground system has very low containment costs which reduce capacity related costs ( $C_s$ ), but the power related costs ( $C_p$ ) are increased primarily due to the well costs.

Cost figures quoted are for a minimum underground system, costs for larger commercial scale systems would be less. Minor modifications in well design would conceivably allow doubling the flow rates used in this study. With this change, the cost of a large storage system (100 MW<sub>e</sub> or larger) would be approximately \$60/kW<sub>t</sub> or \$7.50 kWh<sub>t</sub>. Therefore, cavern storage appears to be an attractive option for near term sensible heat storage for solar power systems of large size. Cavern storage may also be economically favorable for storage periods long enough (16 hours) to provide baseline electric power.



DEVELOPMENT OF A THERMAL STORAGE MODULE USING MODIFIED  
ANHYDROUS SODIUM HYDROXIDE

Richard E. Rice and Peter E. Rowny  
Comstock & Wescott, Inc.

PROJECT OUTLINE

Project Title: Latent Heat (NaOH) Storage for Total Energy Systems

Principal Investigator: Richard Rice

Organization: Comstock & Wescott Incorporated  
765 Concord Avenue  
Cambridge, MA 02238  
Telephone: (617) 547-2580

Project Goals: To conduct laboratory scale testing of a modified anhydrous NaOH latent heat storage concept for small solar thermal power systems such as total energy systems utilizing organic Rankine systems.

Project Status: Under a previous contract, NAS3-20615, a module was tested and a computer simulation code developed. This follow-on effort consists of diagnostic test on the module and investigation of alternative heat transfer fluids and heat exchange concepts.

Post test analysis of the previously tested module indicated no internal corrosion or leakage. The module has been refilled with Thermkeep (91.8% Anhydrous NaOH, 8% NaNO<sub>3</sub>, and 2% MnO<sub>2</sub>) and prepared for a second test series using an alternative heat transfer fluid, Caloria HT-43. Silicone B was initially to be used; however, this fluid was found to be mildly reactive with the NaOH. The computer simulation model has been modified to predict the performance of this module in a solar total energy system environment. In addition, the computer model has been expanded to investigate parametrically the incorporation of a second heat exchange inside the TES module which will vaporize and superheat the Rankine cycle power fluid.

Contract Number: DEN3-138

Contract Period: May 1979 to February

Funding Level: \$92,500

Funding Source: NASA Lewis Research Center

DEVELOPMENT OF A THERMAL STORAGE MODULE USING  
MODIFIED ANHYDROUS SODIUM HYDROXIDE\*

Richard E. Rice and Peter E. Rowny  
Comstock & Wescott, Inc.

Barry M. Cohen, Consultant

INTRODUCTION

The program reported herein is a continuation of a prior program (ref. 1) which included the design, construction, and testing of an experimental one-tenth scale-model of a phase change thermal energy storage (TES) system suitable for use in electricity generating systems such as the Sandia Solar Total Energy Test Facility (SSTETF) at Albuquerque, New Mexico. This was used to generate data with which to verify a previously developed computer model of the TES unit. The TES unit employs a single passive internal heat exchanger which is used both for charging and discharging heat by means of a non-phase change heat transfer fluid such as Therminol-66. The TES unit and test bed are described in ref. 1.

The nominal composition of the TES medium (Thermkeep) is:

Anhydrous NaOH, commercial grade	91.8% (wt)
NaNO <sub>3</sub>	8.0
MnO <sub>2</sub>	0.2

The commercial grade of NaOH typically contains 1-2% of NaCl and 1-2% of Na<sub>2</sub>CO<sub>3</sub>.

The program which is approximately 50% completed includes the following tasks:

1. The experimental model developed under the prior contract is to be examined to determine whether or not deterioration has occurred during the testing, such as mechanical damage to the heat exchanger, or chemical changes in the TES medium.
2. Restoration of the TES system to operating condition, installation of a different heat transfer fluid approved by the NASA Program Manager, and the running of a series of thermal charging and discharging cycles to obtain additional experimental data for correlation with the computer model for further validation.

---

\* The program is being performed under Contract No. DEN3-138 issued by NASA Lewis Research Center.

3. Extension of the computer model of the TES system to include a second heat exchanger in the TES unit, so that the unit can be charged by means of a non-phase change fluid (e.g. from solar collectors) flowing in one heat exchanger, and discharged by a phase change fluid flowing in the other (e.g. the power fluid of a Rankine cycle engine).
4. Upon completion of the computer model a reference design of a lowest cost TES system is to be developed suitable for use in solar electric power generation.

#### POST-TEST ANALYSIS OF TES UNIT

During the prior program the TES unit was used to obtain data from 23 cycling tests which ranged in duration from 4 hours to 48 hours, and in temperature from approximately 230 C to 315 C. These tests extended over a period of about 5 months during which the unit was maintained continuously within the operating temperature range. Thereafter the unit self-cooled very slowly to ambient temperature.

#### Chemical Analysis of Thermkeep

The first step of the post-test analysis was the removal of samples of Thermkeep for chemical analysis to determine whether or not segregation of components occurred (Thermkeep being a non-eutectic mixture), and whether reduction of  $\text{NaNO}_3$  resulted in an increase in  $\text{NaNO}_2$ . The latter is formed at a very slow rate by oxidation of the steel tank and heat exchanger and is reoxidized to  $\text{NaNO}_3$  by air "breathed" into the clearance space above the Thermkeep during cycling, thus maintaining chemical stability. Samples for analysis were obtained through holes cut in the wall of the tank. Because the heat exchanger substantially fills the tank, the samples were removed from locations within 5 cm of the tank wall. Tank height is 244 cm and diameter is 71.8 cm.

The samples were analyzed in pairs, one pair taken from the original lot of Thermkeep and seven pairs taken from seven locations in the tank. The results of the analysis are shown in table I. The six components were independently determined and the small deviation of the total from 100% indicates the precision of the analyses. The analyses show that the  $\text{NaNO}_2$  content of the Thermkeep did not increase in the TES unit, indicating chemical stability of the system.

The  $\text{NaNO}_3$  content of Thermkeep (8%) is lower than that of the  $\text{NaOH-NaNO}_3$  eutectic (33%  $\text{NaNO}_3$ ). Upon cooling, the solid phase which forms on heat exchanger surfaces, and on the tank walls due to insulation loss, has a higher ratio of  $\text{NaOH}$  to  $\text{NaNO}_3$  than the liquid phase. The samples of Thermkeep (which were close to the tank wall) all show an increased  $\text{NaOH/NaNO}_3$  ratio. Since it is believed unlikely that nitrogen was lost from the system, this is tentatively attributed to a small-scale segregation of components during solidification, which would be reversed upon remelting. To obtain more information on

this point, additional samples which are awaiting analysis were taken after the Thermkeep had been completely remelted by a method which prevented segregation of components during sampling.

The cycling mode of the TES unit during the testing program that preceded the sampling was such that the Thermkeep near the bottom (location 7) was permanently solid. The upper portion (locations 1-4) was substantially completely liquefied during each cycle. Table I shows that the NaOH/NaNO<sub>3</sub> ratio is higher at sampling locations 5 and 6 than at others. This is believed to indicate a small degree of vertical segregation of the components of Thermkeep in the tank. Further testing is required to determine whether or not this represents a stable state in the TES tank or whether further segregation would occur with continued cycling. In either case this condition could be reversed by periodically remelting the Thermkeep in this zone of the tank.

#### Examination of Heat Exchanger

Following removal of the Thermkeep samples, the Thermkeep was melted and partially drained to expose the upper third of the heat exchanger. The heat exchanger consists of 25 helical coils of .64 cm diameter steel tubing formed in a helix 10 cm in diameter, manifolded at top and bottom for parallel flow of the heat transfer fluid. Figure 1 shows the heat exchanger during fabrication and figure 2 shows it in the tank, exposed for examination. No significant changes were observed and it was concluded that no repair was required before proceeding with the test program.

#### EXPERIMENTAL VALIDATION OF COMPUTER MODEL

The selection of a heat transfer fluid for the computer model validation program was based on several factors. It must have thermo-physical properties significantly different from those of Therminol-66 which was used in the prior program in order to extend the range of correlation. It must not react violently nor produce toxic reaction products when in contact with Thermkeep at the operating temperature, and it must be a fluid which would be suitable for use in a demonstration system. From among the candidates, the NASA Program Manager approved Caloria HT43, a product of Exxon Corp. The heat transfer fluid system has been flushed and recharged with HT43.

Data for experimental validation of the computer model (details of which can be found in ref. 1) are to be obtained from several types of charging and discharging runs during which HT43 flow rates and temperatures, the Thermkeep temperature, and the TES tank surface temperature will be measured. The runs will include charging and discharging at constant rates, consecutive cycles at constant charge and discharge rates, and cycles simulating a solar daily cycle. This actual performance is to be compared with performance predicted by the computer model.

This phase of the program is just starting and only preliminary results are available. Figures 3 and 4 show partial results of a slow discharge test

with HT43 entering at 235 C and flowing upward through the heat exchanger at 0.0489 kg/s (1.1 gal/min). The temperature of the Thermkeep in the TES tank was measured by thermocouples located inside the tank, 11 cm (4.3 in) and 27 cm (10.8 in) from the wall, and others on the wall. Temperatures of the Thermkeep are plotted against distance from the top of the tank, as measured, and as predicted by the computer model. Figure 3 shows the initial condition of the TES tank resulting from an immediately preceding charging which left the temperature of the wall about 17 C lower than the interior. The computer response to the initial temperatures is also shown. Figure 4 shows the state after one hour of discharging and the computer prediction. The Thermkeep is liquid above 292 C and most of the latent heat is delivered between 292 C and 270 C. This is reflected in figure 4 by an increase in the vertical thermal gradient below the latent heat range, and a decrease within it. The location of the upper surface of the Thermkeep is also shown. This will move downward due to the decrease in specific volume of the Thermkeep as solidification continues in later stages of the run, which will be continued to a total of about 6 hours.

#### ADVANCED HEAT EXCHANGER MODEL

Figures 5 and 6 show schematically how the TES unit can be used in a solar powered electricity generating system such as the SSTETF. The experimental TES unit and computer model presently being tested correspond to figure 5. Heat transfer fluid heated by solar collectors to approximately 310 C flows to a heat exchanger where the Rankine cycle fluid (e.g. toluene) is vaporized and superheated. Excess heat is delivered to the TES unit. The return temperature to the collectors is 243 C. In the absence of solar heat, flow through the TES is reversed.

The advanced computer model will provide for two heat exchangers in the TES unit, one for the heat transfer fluid and one for the Rankine cycle fluid, as in figure 6. The algorithms provide for heat transfer within the TES unit from the heat transfer fluid to Thermkeep, from Thermkeep to the Rankine fluid, and directly from the heat transfer fluid to the Rankine fluid. This will allow analysis of two configurations: 1) two independent heat exchangers with the total output from the solar collectors flowing through the Thermkeep; 2) two thermally coupled exchangers with only stored heat flowing through the Thermkeep. Potential advantages of these configurations are the elimination of the external heat exchanger and, more importantly, potential improvement in performance of the TES unit resulting from the fact that during discharging the temperature of the Rankine fluid entering the bottom of the TES is much lower than that of the heat transfer fluid in the case of the single heat exchanger.

#### REFERENCE

1. Development of a Phase-Change Thermal Storage System Using Modified Anhydrous Sodium Hydroxide for Solar Electric Power Generation, DOE/NASA/O615-79/1, NASA CR-159465.

TABLE I. ANALYSIS OF THERMKEEP FROM TES VESSEL, AND ORIGINAL MATERIAL (% BY WEIGHT)

Sample No.	Location No.	cm*	NaOH	NaNO <sub>3</sub>	NaNO <sub>2</sub>	MnO <sub>2</sub>	Na <sub>2</sub> CO <sub>3</sub>	NaCl	Total
1	Orig. Mat'l	N/A	86.94	8.467	.0306	.172	2.62	2.03	100.26
2			88.74	7.477	.0307	.171	1.45	1.98	99.85
3	1	172	91.50	4.652	.0020	.101	2.85	1.73	100.84
4			91.55	5.278	.0021	.085	1.48	1.35	99.75
5	2	144	91.17	5.041	.0023	.113	1.55	1.47	99.35
6			91.74	5.326	.0022	.110	1.43	1.63	100.24
7	3	117	91.88	4.503	.0019	.083	1.38	1.68	99.53
8			92.23	4.377	.0023	.110	1.35	1.85	99.92
9	4	89	89.50	5.623	.0023	.102	2.89	1.65	99.77
10			91.66	4.878	.0026	.095	1.36	1.76	99.76
11	5	62	94.30	2.791	.0017	.042	1.44	1.53	100.10
12			---	---	---	---	---	---	---
13	6	34	93.93	2.707	.0021	.057	1.40	1.76	99.86
14			94.59	2.546	.0032	.053	1.32	1.25	99.76
15	7	6	89.17	5.772	.0098	.137	2.88	1.58	99.55
16			89.88	5.138	.0095	.172	2.90	1.43	99.53

\* Distance from bottom of tank





Fig. 1. Heat Exchanger During Fabrication



Fig. 2. Heat Exchanger Exposed for Examination

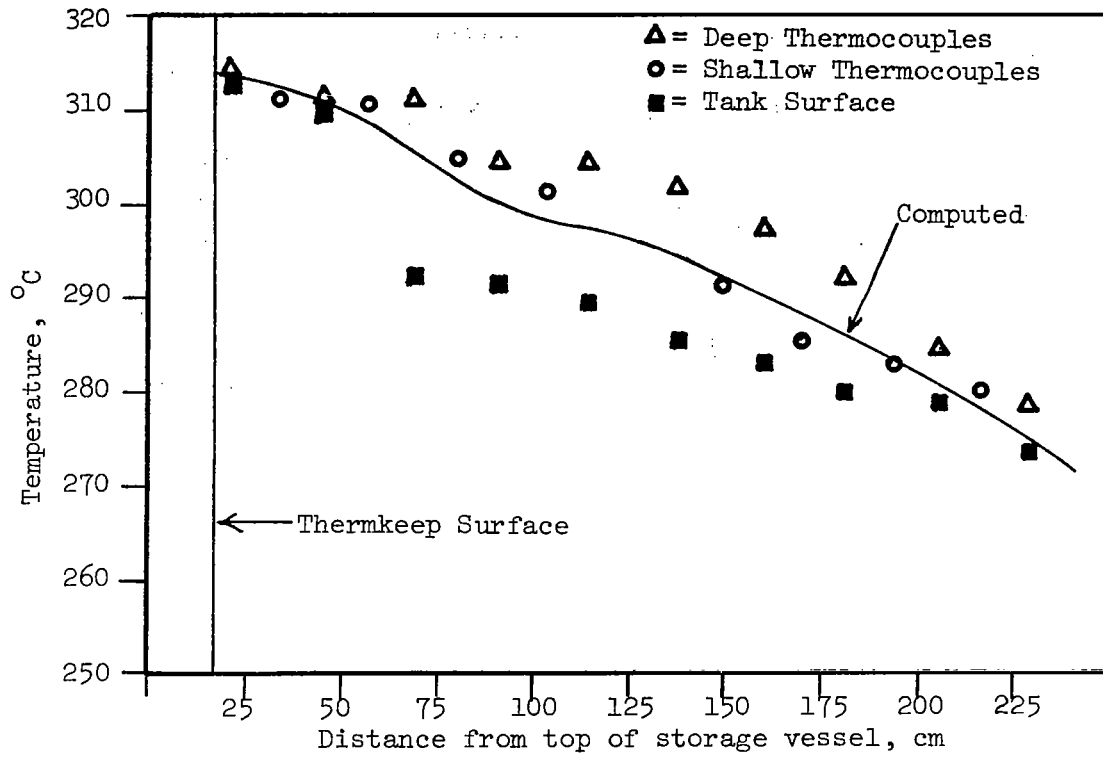

Fig. 3. Thermkeep Temperature vs. Axial Distance, Initial Condition

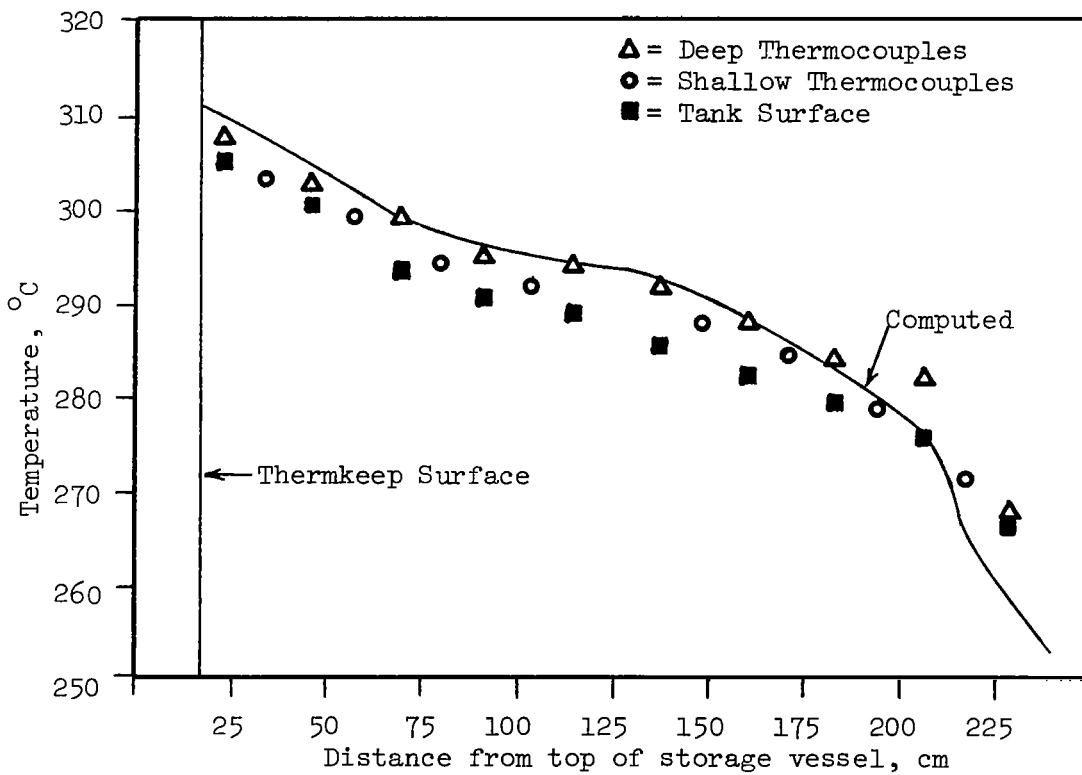

Fig. 4. Thermkeep Temperature vs. Axial Distance, after 1 Hour.

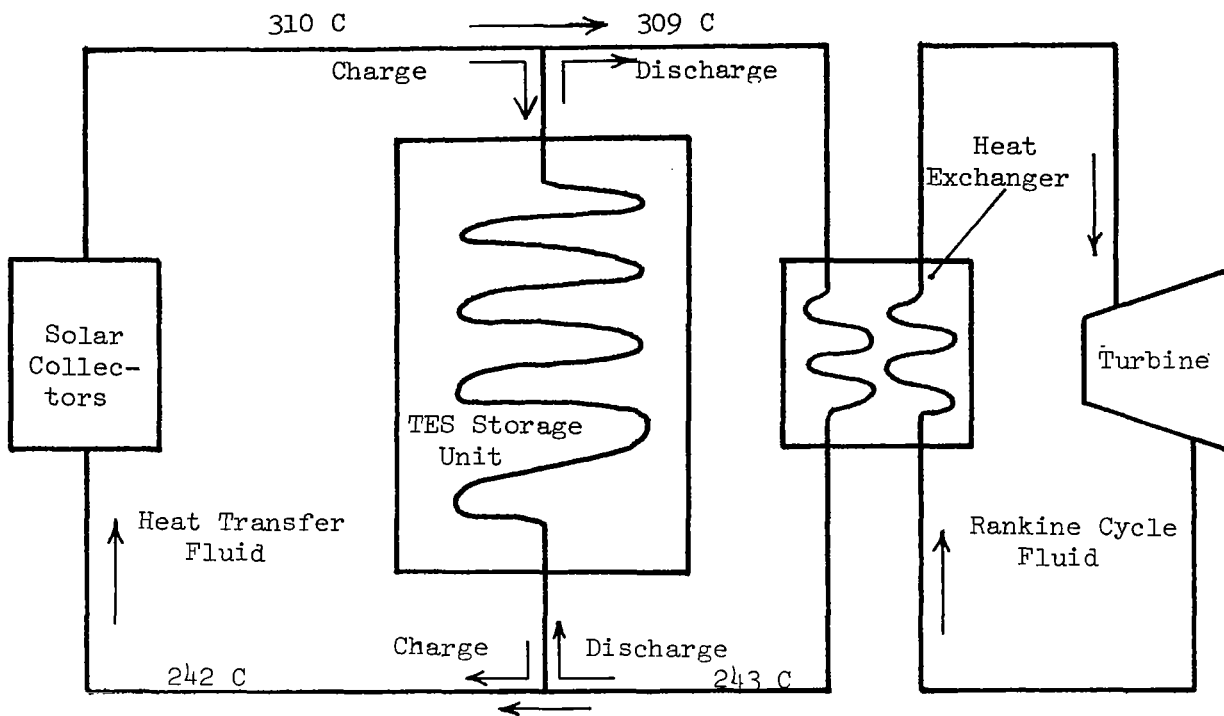

Fig. 5. Schematic of Solar Powered Electricity Generating System

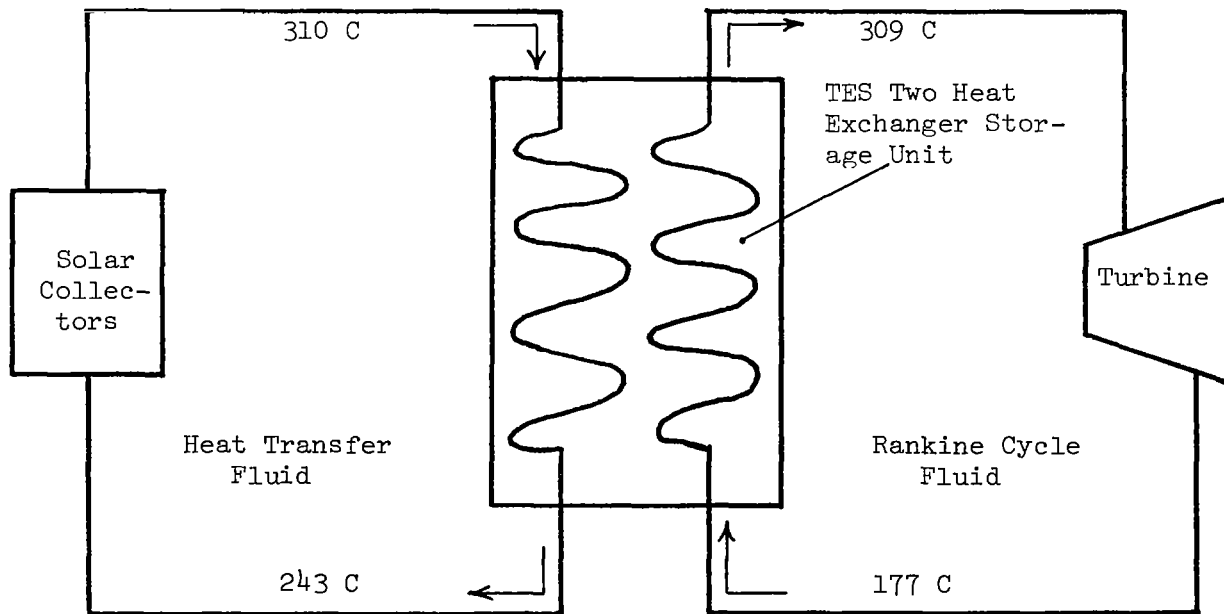

Fig. 6. Advanced Computer Model



HIGH-TEMPERATURE MOLTEN SALT THERMAL ENERGY STORAGE SYSTEMS  
FOR SOLAR APPLICATIONS

Randy J. Petri and T. D. Claar  
Institute of Gas Technology

PROJECT OUTLINE

Project Title: High Temperature, Molten Salt-Latent Heat, Thermal Energy Storage Development for Solar Applications

Principal Investigator: T. D. Claar

Organization: Institute of Gas Technology  
3424 South State Street  
Chicago, IL 60616  
Telephone: (312) 567-3672

Project Goals: Determine feasibility of using carbonate salts as storage media for high temperature applications (700°C - 870°C).

Review carbonate salt properties and select six salts as candidate media.

Investigate methods to enhance heat transfer through solid salt.

Conduct carbonate salt-containment material compatibility studies that include 3000 hour screening tests.

Measure thermophysical and transport properties of two most promising salts.

Project Status: Review of properties complete with the following six salts selected for compatibility studies: three (3) pure carbonates,  $K_2CO_3$ ,  $Li_2CO_3$  and  $Na_2CO_3$ ; two (2) eutectic mixtures,  $BaCO_3/Na_2CO_3$  and  $K_2CO_3/Na_2CO_3$ , and one (1) off-eutectic mixture of  $Na_2CO_3/K_2CO_3$ .

Compatibility studies scheduled to be completed by mid-1980.

Contract Number: DEN3-156

Contract Period: August 1979 to August 1980

Funding Level: \$136,840

Funding Source: NASA Lewis Research Center

# HIGH-TEMPERATURE MOLTEN SALT THERMAL ENERGY STORAGE SYSTEMS

## FOR SOLAR APPLICATIONS

Randy J. Petri and T. D. Claar  
Institute of Gas Technology

### PROGRAM SUMMARY

The objective of this program is to select, test and develop alkali and alkaline earth carbonate latent-heat storage salts, metallic containment materials, and thermal conductivity enhancement (TCE) materials to satisfy the high-temperature (704° to 871°C; 1300° to 1600°F) thermal energy storage (TES) requirements of advanced solar-thermal power generation concepts. This will be accomplished by experimental screening of candidate salt/containment/TCE materials combinations in capsule compatibility tests employing both reagent-grade and low-cost technical-grade salts. The results of these compatibility tests will lead to the selection of the materials combinations that best meet the anticipated solar power system requirements. Needs for more reliable salt thermophysical and thermodynamic property data will be identified, and selected measurements will then be performed to support the future development and scale-up of solar-thermal TES subsystems.

### MATERIALS COMPATIBILITY TESTING

#### Salt Selection

Alkali and alkaline earth carbonate salts are being developed as latent-heat thermal energy storage materials for high temperature (704° to 871°C) applications, on the basis of their desirable thermophysical properties, good thermal charge/discharge performances and endurance-stability exhibited by these materials in previous experimental programs at the Institute of Gas Technology.<sup>1,2</sup> Table 1 is a list of the carbonate salts originally identified and studied under Contract No. NAS3-20806<sup>2</sup> as candidate storage media for Brayton or Stirling solar power TES applications. Table 1 includes pertinent thermophysical salt property data and thermal discharge characteristics determined experimentally in 12.7 cm (5 in.) high X 7.6 cm (3 in.) diameter laboratory-scale TES modules having a 1.3 cm (0.5 in.) diameter heat exchanger tube. These modules were fabricated from AISI 304 and 316 stainless steels. The six salts identified by asterisks in this table have been selected as candidate salts for the compatibility screening tests to be conducted under the current program. Considerations in selecting these carbonate salt storage media included —

- Energy density
- Cost
- Melting/solidification temperatures

- Thermal cycling performance and endurance in laboratory-scale TES modules
- Vapor pressure and high-temperature stability
- Impurity levels in commercial-grade salts
- Toxicity, safety, hygroscopicity, and handling considerations
- Volumetric expansion on melting
- Heat capacity

The economic feasibility of latent-heat TES concepts requires the use of low-cost salt materials. Therefore, the potential corrosion problems, salt instabilities, and other limitations associated with using commercially available (technical-grade) carbonates will be investigated in the capsule screening tests. Table 2 is a list of technical-grade alkali and alkaline earth carbonates along with recent costs of each salt in bulk quantities. A number of companies have been identified and contacted as prospective suppliers of technical-grade carbonates. Chemical and physical property specifications and cost information on these carbonates are being obtained from chemical companies supplying these materials. Selection of the technical grade salts to be included in screening tests will be based on types of impurities present, impurity levels, and cost.

#### Containment Materials Selection

The work completed under Contract No. NAS3-20806 demonstrated the need to improve the long-term resistance to corrosion and thermal aging effects of containment materials in the elevated temperature regime of 704° to 871°C. The materials selected as candidate containment materials are generally required to possess superior resistance to —

- Hot corrosion, oxidation, and carburization on the salt side
- Intermetallic-phase precipitation, embrittlement, or other long-term aging effects caused by high-temperature (704° to 871°C) exposure
- Thermal cycling effects on corrosion and strength
- Interactions with working fluids (air, helium, and sodium) or their impurities.

In addition, mechanical property data are being compiled and evaluated to assure structural compatibility for the proposed high-temperature TES applications, including —

- Stress-to-rupture at elevated temperatures
- Thermal cycling fatigue behavior
- Strain and thermal aging effects
- Thermal expansion coefficients

Candidate containment materials are being selected primarily from among iron- and nickel-based stainless steels and high-temperature alloys. Most of these alloys contain a significant amount of chromium and thus form Cr<sub>2</sub>O<sub>3</sub>-rich

oxidation product scales. Chromia scales are protective under air oxidation conditions, but  $\text{Al}_2\text{O}_3$ -containing protective films are generally superior under molten carbonate conditions. Commercially available iron-nickel-chromium alloys, some containing approximately 2 to 5 wt % aluminum additions, are being considered. Application of a protective coating to iron-nickel-chromium alloy base materials by aluminizing techniques is also being evaluated. Various steel producers have been contacted as potential suppliers of these alloys, and available property data are being received.

#### Thermal Conductivity Enhancement Materials Selection

The incentive for TCE materials/configurations development arises from the fact that the thermal discharge performance of a TES subsystem is controlled largely by the rate at which the latent heat-of-fusion released at the solid/liquid interface is transported to the heat exchanger surface through the growing layer of solid salt. TCE selection criteria will thus include material thermal conductivity, expected chemical compatibility with the carbonate environment, cost, availability, and ease of fabrication into a desirable TCE configuration.

A preliminary list of candidate TCE materials is provided in Table 3. Aluminum is very attractive as a TCE material because of its high thermal conductivity of 220 W/m-K (127 Btu/hr-ft-°F) (~100X that of solid carbonates and 10X that of austenitic stainless steels). Under Contract No. NAS3-20806, a 95% porous reticulated aluminum structure increased the discharge heat flux through the ternary eutectic  $\text{Li}_2\text{CO}_3\text{-Na}_2\text{CO}_3\text{-K}_2\text{CO}_3$  salt (m.p. 397°C) by approximately 45%. However, aluminum cannot be used for the 704° to 871°C solar thermal TES applications because of its 660°C (1220°F) melting point. While iron and nickel-based materials are more compatible at these temperatures, they are more costly and have much lower thermal conductivities than aluminum and copper, greatly reducing their attractiveness as TCE materials. Copper also has a very high thermal conductivity of 308 W/m-K (178 Btu/hr-ft-°F) and a reasonably high melting point of 1083°C (1981°F). Pyrolytic graphite, while still a high-cost developmental material, is also reported to have a high thermal conductivity (208 W/m-K; 120 Btu/hr-ft-°F) and has a good thermal stability in non-oxidizing environments. Both copper and graphite would be severely oxidized in a high-temperature molten carbonate environment having access to the air environment. However, if gaseous oxidants are excluded by use of sealed containment or an inert cover gas, oxidation of copper and graphite TCE materials should be acceptably low. Candidate TCE materials will be corrosion tested in bulk form, or if available, as porous reticulated structures.

#### Screening Tests

Compatibility screening tests of the candidate salt/containment/TCE materials combinations will be conducted in welded containment capsules (2.54 cm diameter by 10.2 cm long) containing the salt and TCE material. The compatibility of 5 containment and 2 TCE materials will be evaluated with both reagent- and technical-grades of 6 candidate salt compositions. The first phase will be a 1000 hour test of the salt/containment/TCE matrix (minimum of 70 capsules).



Based on the post-test examination results of the 1000 hour test, the 30 most promising materials combinations will then be evaluated in a 3000 hour compatibility test. Compatibility evaluations will be based on —

- Depth and nature of salt-side corrosion of containment and TCE materials
- Air-side containment oxidation
- SEM/EDAX analysis of selected areas
- Containment alloy thermal aging effects
- Weld integrity in salt environment
- Gravimetric analyses of containment alloy and TCE coupons
- Chemical and physical analyses of salt

#### PROPERTY MEASUREMENTS

The design and scale-up of a latent-heat TES subsystem require accurate salt property data, such as melting/solidification temperatures, heat of fusion, volumetric expansion upon phase change, heat capacity and thermal stability. However, many of these salt property data for salts in the 704° to 871°C temperature range are either unavailable or subject to large error and inconsistency. Based on the results from previous experimental testing in laboratory scale TES modules and the 1000 and 3000 hour compatibility tests, at least two carbonate salt compositions most suitable for anticipated solar thermal energy storage applications will be identified. Available thermodynamic and thermo-physical property data for these salts will be critically reviewed and critical gaps will be identified. The required property measurements will then be performed on a maximum of six salt composition-purity level combinations. The results from this property measurement activity will subsequently be utilized in future carbonate TES development efforts.

#### REFERENCES

1. Maru, H. C., Dullea, J. F., and Huang, V. S., "Molten Salt Thermal Energy Storage Systems: Salt Selection", COO-2888-1, Institute of Gas Technology, Chicago, August 1976.
2. Maru, H. C. et al., "Molten Salt Thermal Energy Storage Systems: System Design," COO-2888-2, Institute of Gas Technology, Chicago, February 1977.
3. Petri, R. J., Claar, T. D., and Marianowski, L. G., "Evaluation of Molten Carbonates as Latent Heat Thermal Energy Storage Materials," 14th Inter-society Energy Conversion Engineering Conference, Boston, August 5-10, 1979.
4. Petri, R. J., Claar, T. D. and Tison, R. R., "High Temperature Molten Salt Thermal Energy Storage Systems", Contract No. NAS3-20806 Final Report, Institute of Gas Technology, Chicago, to be published.

**Table 1. CANDIDATE CARBONATE COMPOSITIONS TESTED UNDER  
CONTRACT NAS3-20806**

No.	Salt System	Composition		Literature Melting Point		$\Delta H_f$ J/kg	Thermal Conductivity W/m-K
		Wt %	Mol %	°C	°F		
1	Li <sub>2</sub> CO <sub>3</sub> -CaCO <sub>3</sub>	44.3-55.7	37-63	662	1224	274,468	-
*2	Na <sub>2</sub> CO <sub>3</sub> -BaCO <sub>3</sub>	52.2-41.8	37-63	686	1267	172,124	-
*3	K <sub>2</sub> CO <sub>3</sub> -Na <sub>2</sub> CO <sub>3</sub> - Li <sub>2</sub> CO <sub>3</sub>	48.8-50.0- 1.2	44-55-1	706	1303	162,820	1.73
*4	K <sub>2</sub> CO <sub>3</sub> -Na <sub>2</sub> CO <sub>3</sub>	50-50	44-56	710	1310	162,820	1.73
*5	Li <sub>2</sub> CO <sub>3</sub>	100	100	726	1333	607,086	1.96
*6	Na <sub>2</sub> CO <sub>3</sub> -K <sub>2</sub> CO <sub>3</sub>	81-3-18.7	85-15	790- 737	1454- 1360	253,534	-
*7	Na <sub>2</sub> CO <sub>3</sub>	100	100	858	1576	265,164	1.83
*8	K <sub>2</sub> CO <sub>3</sub>	100	100	891	1636	200,036	1.73

No.	Heat Capacity at Melting Point J/kg-K		Density at 25°C kg/m <sup>3</sup>	Discharge Solidification Range		$\bar{Q}$ mp + 50°C (90°F) mp - 50°C (90°F) W/m <sup>2</sup>	No. of Cycles	Hours at Operational Temperature
	Cp (s)	Cp (L)		°C	°C			
1	-	-	-	662	- 657	40,420	25	312
*2	-	-	-	717	- 712	41,680	36	984
*3	1674.7	1549.1	2399.6	706	- 695	44,420	22	528
*4	1674.7	1549.1	2399.6	708	- 700	36,950	13	336
*5	2637.7	2512.1	2108.0	734	- 730	76,660	22	672
*6	-	-	2513.3	790	- 738	46,120	38	1032
*7	1004.8	1004.8	2527.7	868	- 862	45,650	21	288
*8	1507.2	1507.2	2428.4	916	- 912	72,510	2	96

\* Selected as candidate salt for compatibility screening tests.

Table 2. ESTIMATED COSTS OF TECHNICAL GRADE ALKALI  
AND ALKALINE EARTH CARBONATES\*

Salt	Description	Cost,	
		\$/kg	\$/lb
1. $\text{Li}_2\text{CO}_3$	Powder, bags	2.06	1.03
2. $\text{Na}_2\text{CO}_3$	Powder	0.07	0.03
3. $\text{K}_2\text{CO}_3$	Granulated, purified	0.44	0.20
	Calcined 99 to 100% $\text{K}_2\text{CO}_3$	0.42	0.19
4. $\text{MgCO}_3$	Powder, bags	0.22	0.10
5. $\text{CaCO}_3$	Ultrafine, USP bags	0.20	0.09
	Natural dry-ground air-floated, -325 mesh, bags	0.02	0.01
6. $\text{SrCO}_3$	Glass ground, bags	0.62	0.28
7. $\text{BaCO}_3$	Precipitated, bags	0.46	0.21
	Photo grade, bags	0.37	0.17
	Electronics grade, bags	0.37	0.17

\* Chemical Marketing Reporter, September 19, 1979.

Table 3. POTENTIAL HEAT CONDUCTION ENHANCEMENT MATERIALS

Material	Melting Pt., °C (°F)	Thermal		Heat Capacity		Materials Cost			
		Conductivity at 500°C (932°F)		Room Temp.		\$/kg	\$/lb	\$/m <sup>3</sup>	\$/ft <sup>3</sup> *
		W/m-K	Btu/hr-ft-°F	J/kg-K	Btu/lb-°F				
Aluminum	660 (1220)	220	127	921	0.22	1.74	0.79	4,732	134
Copper	1083 (1981)	308	178	385	0.09	1.65	0.75	14,726	417
Iron	1536 (2797)	38	22	461	0.11	3.02	1.37	23,766	673
Molybdenum	2610 (4730)	116	67	255	0.06	9.70	4.40	99,128	2,807
Nickel	1453 (2647)	57	33	502	0.12	4.76	2.16	42,448	1,202
316 Stainless Steel	1370 (2478)	21	12	502	0.12	2.80	1.27	22,531	638
ATJ Graphite	sublimes	78	45	837	0.20	9.85	4.47	22,107	626
Pyrolytic Graphite	sublimes	208	120 <sup>†</sup>	837	0.20	---	---	---	---
Silicon Carbide	2700 (4892)	87	50	836	0.20	---	---	---	---
CS Graphite	sublimes	76	44	837	0.20	1.10	0.50	2,401	68

\* Costs based on 100% of theoretical density.

<sup>†</sup> a -b plane.

## BUILDING HEATING AND COOLING APPLICATIONS

### Program Area Synopsis:

Plans are being developed for a comprehensive thermal energy storage technology and development program covering building heating and cooling applications in the residential and commercial sectors.

Three elements have been identified to undergo an Applications Assessment, Technology Development, and Demonstration. The element receiving primary emphasis is the Utility Load Management TES Application where the stress is on the "customer side of the meter". A second element involves improved and advanced thermal storage subsystems for space conditioning. The third element is Conservation by means of increased thermal mass within the building envelope and by means of low-grade waste heat recovery.



BUILDING HEATING AND COOLING APPLICATIONS THERMAL  
ENERGY STORAGE PROGRAM OVERVIEW

D. M. Eissenberg  
Oak Ridge National Laboratory

**PROGRAM OBJECTIVE IS REDUCED CONSUMPTION OF  
OIL AND GAS FOR RESIDENTIAL/COMMERCIAL  
SPACE CONDITIONING BY USING THERMAL  
ENERGY STORAGE**

- SWITCHING TO COAL AND NUCLEAR  
(ELECTRICITY)
- INCREASED UTILIZATION OF SOLAR
- MORE EFFICIENT USE OF OIL AND GAS

**THE PROGRAM IS DIRECTED AT ACHIEVING  
SIGNIFICANT REDUCTION IN OIL/GAS  
CONSUMPTION**

- NEAR- TO MID-TERM TECHNOLOGIES
- NEW AND RETROFIT INSTALLATIONS
- BROAD GEOGRAPHIC/CLIMATIC  
APPLICATIONS

## THE PROGRAM IS DIVIDED INTO THREE ELEMENTS

- STORAGE OF OFF-PEAK ELECTRICITY AS THERMAL ENERGY
- STORAGE OF SOLAR ENERGY AS THERMAL ENERGY
- INCREASE IN HEATING AND COOLING SYSTEMS' EFFICIENCY BY MEANS OF THERMAL ENERGY STORAGE

EACH PROGRAM ELEMENT WILL EXPLORE IMPROVED AND ADVANCED STORAGE MATERIALS AND TECHNOLOGIES

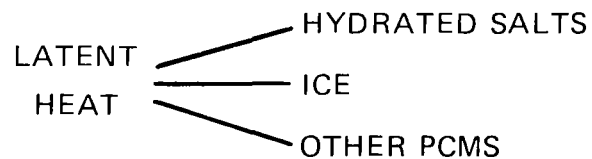
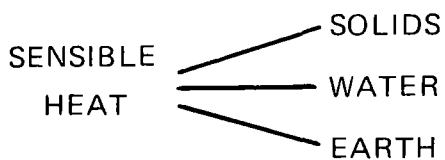



## **APPROPRIATE STORAGE MATERIALS AND TECHNOLOGIES WILL BE THOROUGHLY EXPLORED**

- TECHNO-ECONOMIC ANALYSES
- ADVANCED CONCEPT DEVELOPMENT
- APPLIED RESEARCH
- TECHNOLOGY DEVELOPMENT
- ENGINEERING DEMONSTRATIONS

## **OFF-PEAK ELECTRICITY UTILIZATION IS THE MAJOR PROGRAM ELEMENT**

- BASED ON INCENTIVES OFFERED ELECTRICITY CONSUMER TO OWN AND UTILIZE TES SYSTEMS
- INVOLVES HEAT AND/OR COOL STORAGE
- NEAR-TERM
- WIDESPREAD APPLICATION/LARGE FUEL SWITCHING POTENTIAL

## TES SYSTEMS FOR OFF-PEAK ELECTRICITY UTILIZATION MUST SATISFY THREE CONSTRAINTS

- COST EFFECTIVE (INCENTIVE > COST)
- FUNCTIONAL (COMFORTABLE, CONVENIENT, RELIABLE, SAFE)
- TECHNICALLY EFFECTIVE (ACHIEVE UTILITY LOAD LEVELING GOALS)

SEVERAL PATHS TO IMPROVED OR ADVANCED CUSTOMER-OWNED TES ARE BEING FOLLOWED

	RESIDENTIAL	COMMERCIAL
● HEATING	REFRACTORY BRICK WATER MOLTEN SALTS	WATER
● COOLING	ICE HYDRATED SALTS	ICE WATER

## **SOLAR THERMAL STORAGE IS A SECOND MAJOR THRUST AREA**

- **PASSIVE SOLAR**
- **ACTIVE SOLAR HEATING**
- **ACTIVE SOLAR COOLING**
- **SOLAR ASSIST HEAT PUMPS**

### **PROGRAM OBJECTIVE FOR PASSIVE SOLAR STORAGE TECHNOLOGY IS IMPROVEMENT OVER TROMBE WALL**

- **REDUCED WEIGHT, VOLUME**
- **FLATTENED DIURNAL TEMPERATURE SWING**
- **INCREASED ARCHITECTURAL OPTIONS**

**BY INCORPORATION OF PHASE-CHANGE MATERIALS INTO BUILDING MATERIALS**

**OBJECTIVE OF STORAGE TECHNOLOGY DEVELOPMENT  
FOR ACTIVE SOLAR HEATING APPLICATION IS  
OVERALL SYSTEM COST REDUCTION AND  
INCREASED ACCEPTABILITY**

- STORAGE AT MINIMUM TEMPERATURE FOR USE  
OPTIMIZES COLLECTOR PERFORMANCE
- WEIGHT, VOLUME REDUCTION
- REDUCED PEAK CAPACITY OF BACKUP

**SOLAR COOLING, A MORE DISTANT OPTION, REQUIRES  
DEVELOPMENT OF APPROPRIATE STORAGE  
TECHNOLOGIES TO REDUCE TOTAL  
SYSTEM COST**

- HOTSIDE (120°C)
- COLDSIDE (7°C)

**HOT-SIDE STORAGE MATERIALS ARE BEING DEVELOPED  
UNDER A SMALL PROGRAM**

**OBJECTIVE OF THERMAL STORAGE FOR SOLAR-  
ASSISTED HEAT PUMPS IS LOW-COST BOOSTING  
OF HEAT PUMP PERFORMANCE**

- STORAGE OF SOLAR HEAT AT NEAR- AMBIENT  
TEMPERATURE
- COMBINED WITH OFF-PEAK ELECTRICITY USE
- SINGLE STORAGE MEDIUM FOR BOTH HEAT  
AND COOL

**DEVELOPMENT OF STORAGE FOR USE WITH  
CONVENTIONAL OIL OR GAS HEATING  
SYSTEMS CAN REDUCE FUEL  
CONSUMPTION**

- REDUCED CYCLING FREQUENCY
- REDUCED HEATING, STACK LOSSES
- DISTRIBUTED OR CENTRAL STORAGE
- NEW OR RETROFIT

**TECHNO-ECONOMIC ANALYSIS IS REQUIRED TO  
DETERMINE MERITS**

# USE OF THERMAL STORAGE TO TEMPER THE HEAT SOURCE/SINK FOR RESIDENTIAL OR COMMERCIAL HEAT PUMPS CONSERVES ELECTRICITY

- CRAWLSPACE/EARTH STORAGE
- DAILY ACES

CURRENT DEVELOPMENT OF A CRAWLSPACE SOURCE HEAT PUMP LOOKS VERY PROMISING

THE PROGRAM FOR FY 1980-81 WILL INCLUDE MAJOR PROJECTS ADDRESSING TWO PROGRAM ELEMENTS

## MAJOR

- RESIDENTIAL COOL STORAGE FOR OFF-PEAK ELECTRICITY
- RESIDENTIAL HOT STORAGE FOR OFF-PEAK ELECTRICITY
- RESIDENTIAL STORAGE INCORPORATED IN BUILDING MATERIALS
- RESIDENTIAL HOT STORAGE FOR SOLAR HEATING
- COMMERCIAL HOT/COLD STORAGE FOR OFF-PEAK ELECTRICITY

**ADDITIONAL MINOR AND SUPPORT PROGRAMS  
ADDRESS ALL PROGRAM ELEMENTS**

**MINOR**

- RESIDENTIAL HOT STORAGE FOR INCREASING OIL/GAS BURNER EFFICIENCY
- RESIDENTIAL HOT SIDE STORAGE FOR SOLAR COOLING
- RESIDENTIAL HOT/COOL STORAGE FOR INCREASING HEAT PUMP EFFICIENCY

**SUPPORT**

- ASSESSMENT OF STORAGE/HEAT PUMP SYSTEMS
- ASSESSMENT OF STORAGE/OIL-GAS HEATER SYSTEMS
- ANALYSIS OF PHASE-CHANGE HEAT/MASS TRANSFER
- PERFORMANCE TESTING OF HOT AND COOL TES SYSTEMS
- FIELD TESTING OF COOL STORAGE SYSTEMS





SUBCONTRACTED ACTIVITIES RELATED TO TES FOR BUILDING

HEATING AND COOLING

Jim Martin  
Oak Ridge National Laboratory

**ORNL IS MANAGING THE DOE/STOR PROGRAM IN  
THERMAL ENERGY STORAGE FOR BUILDING  
HEATING AND COOLING**

**SUBCONTRACT PROGRAM ELEMENTS**

- UTILITY LOAD MANAGEMENT
- SOLAR APPLICATIONS
- CONSERVATION

**THE FY 79 (LTTEs) PROGRAM INCLUDED  
SUBCONTRACTS IN THE UTILITY LOAD  
MANAGEMENT APPLICATION AREA**

**FY 79 ACTIVITIES**

- LIFE AND STABILITY TESTING OF  
PACKAGED LOW COST ENERGY  
STORAGE MATERIALS

UNIVERSITY OF DELAWARE (IEC)

**LIFE AND STABILITY TESTING OF PACKAGED LOW COST  
ENERGY STORAGE MATERIALS (PROPRIETARY  
GLAUBERS SALT-CLAY MIXTURE IN "CHUBS")**

**CONTRACTOR**

**UNIVERSITY OF DELAWARE – IEC**

**OBJECTIVE**

- **VERIFY INTEGRITY OF CHUB PACKAGING SYSTEM**
- **VERIFY LIFE AND STABILITY OF PACKAGED PC MATERIAL**

**APPROACH**

- **DETERMINE WATER VAPOR RETENTION OF FILM**
- **EXPOSURE TO TEMPERATURE EXTREMES**
- **EXPOSURE TO VIBRATION AND DROP TESTS**
- **ACCELERATED AND DIURNAL THERMAL CYCLING**

**LIFE AND STABILITY TESTING OF PACKAGED LOW  
COST ENERGY STORAGE MATERIALS  
(PROPRIETARY GLAUBERS SALT-  
CLAY MIXTURE IN "CHUBS") (CONT'D)**

**STATUS**

- **FINAL REPORT COMPLETE EXCEPT FOR REVISIONS BY THE CONTRACTOR**
- **CHUBS DELIVERED FOR EVALUATION**
  - **ORNL**
  - **VARICUS UTILITIES**
- **ABOVE OBJECTIVES WERE MET**
- **EFFECT OF CYCLING ON CHUB HEAT OF FUSION DETERMINED**

**UTILITY LOAD MANAGEMENT WILL BE THE  
MAJOR APPLICATION AREA IN FY 80**

- DEVELOPMENT OF TES SYSTEM FOR  
RESIDENTIAL SPACE COOLING  
RFP
- RESISTANCE STORAGE HEATER COMPONENT  
DEVELOPMENT  
RFP
- DEVELOPMENT OF TES TEST FACILITY\*  
ANL (PURDUE UNIVERSITY)
- DEMONSTRATION OF STORAGE HEATER  
SYSTEMS FOR RESIDENTIAL APPLICATIONS  
ANL
- SIMULATION AND EVALUATION OF LATENT  
HEAT TES-HEAT PUMP SYSTEMS  
RTI

**DEVELOPMENT OF TES SYSTEMS FOR RESIDENTIAL  
SPACE COOLING**

- MAJOR PART OF SUBCONTRACT FUNDING IN FY 80  
WILL BE FOR THIS EFFORT

**OBJECTIVE**

- DEVELOP STORAGE SYSTEMS AND COMPONENTS  
UTILIZING PCM
- DESIGN PROTOTYPE OF UNITS WITH STRONG  
POTENTIAL FOR COMMERCIALIZATION
- DEFINE INTERACTION BETWEEN COOL STORAGE  
ECONOMICS AND PREDICTED ELECTRIC RATE  
STRUCTURES FOR SYSTEMS DEVELOPED

**APPROACH**

- SOLICIT PROPOSALS VIA RFP

## **DEVELOPMENT OF TES SYSTEMS FOR RESIDENTIAL SPACE COOLING (CONT'D)**

### **SCOPE**

- 1 1/2 – 2 1/2 YEAR PROGRAM
- PHASE I – R&D ON STORAGE CONCEPT
- PHASE II – PROTOTYPE DESIGN, SPECIFICATION AND COSTING
- PHASE II – BASED ON PHASE I RESULTS OR ALREADY DEVELOPED TES CONCEPTS
- MULTI-AWARD PROGRAM

### **SCHEDULE**

- CBD NOTICE OF INTENT HAS BEEN ISSUED
- RFP, DECEMBER '79
- CONTRACT AWARD, MAY '80

## **RESISTANCE STORAGE HEATER COMPONENT DEVELOPMENT**

### **OBJECTIVE**

- DEVELOP AND TEST COST EFFECTIVE CERAMIC BRICKS PRODUCED FROM OLIVINE OR OTHER SUITABLE DOMESTIC REFRACTORY FOR APPLICATION TO RESISTANCE STORAGE HEATERS
- DEVELOP AN IMPROVED BRICK DESIGN
- DEVELOP MANUFACTURING TECHNIQUES

### **APPROACH**

- SOLICIT PROPOSALS VIA RFP

## **RESISTANCE STORAGE HEATER COMPONENT DEVELOPMENT (CONT'D)**

### **SCOPE**

- DETERMINATION OF CRITERIA FOR PERFORMANCE OF CERAMIC BRICKS FOR STORAGE HEATERS
- DEVELOP AND TEST PROTOTYPE BRICKS OF OLIVINE OR OTHER SUITABLE DOMESTIC REFRACTORY
- DEVELOP MANUFACTURING TECHNOLOGY AND DETERMINATION OF MANUFACTURING COSTS
- MANUFACTURE OF QUANTITIES OF BRICKS FOR FIELD TESTS

### **SCHEDULE**

- RFP, FEBRUARY '80
- CONTRACT AWARD, JULY '80
- PERFORMANCE PERIOD 3 YEARS

## **DEMONSTRATION OF STORAGE HEATER SYSTEMS FOR RESIDENTIAL APPLICATIONS**

### **CONTRACTOR**

ANL

### **OBJECTIVE**

- VALIDATE IMPACT ON UTILITIES COST EFFECTIVENESS AND CUSTOMER ACCEPTANCE OF COMMERCIALY AVAILABLE TES UNDER US OPERATING CONDITIONS
- IDENTIFY AND DEFINE AFTER-THE-METER R&D NEEDS

### **APPROACH**

- TWO DEMONSTRATIONS
  - VERMONT – 23 DEMONSTRATIONS; 19 CONTROLS
  - MAINE – 10 DEMONSTRATIONS; 8 CONTROLS

### **STATUS**

- DATA FROM FIRST WINTER SEASON HAVE BEEN COLLECTED (SECOND SEASON 79-80 WILL BE CONTINUED)
- SURVEY OF CUSTOMER ATTITUDES HAS BEEN COMPLETED

## **SIMULATION AND EVALUATION OF LATENT HEAT TES – HEAT PUMP SYSTEMS**

### **CONTRACTOR**

RTI

### **OBJECTIVE**

- DERIVE THE RELATIVE VALUE OF TES FOR HEAT PUMPS AS A FUNCTION OF STORAGE TEMPERATURE, MODE OF STORAGE, GEOGRAPHIC LOCATION AND TIME-OF-USE UTILITY RATE STRUCTURE

### **APPROACH**

- CARRY OUT COMPUTER SIMULATION STUDY USING AVAILABLE MODELS AND DATA BASES

### **STATUS**

- THERMAL LOAD SIMULATION MODEL OPERATIONAL
- INPUT DATA BEING COMPILED
- SIMULATION SITES, MODEL BUILDING DESIGN AND WEATHER DATA HAVE BEEN DEFINED

## **APPLICATION OF TES FOR SOLAR APPLICATIONS PRESENTLY A SECONDARY EFFORT**

### FY 79 SUBCONTRACTS

- DEVELOPMENT OF AN OPTIMUM PROCESS FOR EB CROSSLINKING OF HDPE TES PELLETS  
UNIVERSITY OF DAYTON
- DEVELOPMENT OF HIGH TEMPERATURE PCM  
UNIVERSITY OF DELAWARE (M.E.)
- TES SUBSYSTEMS FOR SOLAR HEATING APPLICATIONS  
GENERAL ELECTRIC
- DIRECT CONTACT HEAT TRANSFER PCM  
CLEMSON UNIVERSITY

### FY 80 SUBCONTRACTS

- DEVELOPMENT OF TECHNOLOGY FOR INCORPORATION OF PCM INTO RESIDENTIAL BUILDING MATERIALS FOR BUILDING HEATING  
RFP

## DEVELOPMENT OF OPTIMUM PROCESS FOR EB CROSSLINKING OF HDPE TES PELLETS

### CONTRACTOR

UNIVERSITY OF DAYTON

### OBJECTIVE

- DEVELOP AN OPTIMUM EB PROCESS FOR CROSSLINKING COMMERCIALY AVAILABLE HDPE PELLETS TO OBTAIN THE HIGHEST HEAT OF FUSION

### APPROACH

- TEST VARIOUS HDPE PELLETS PREPARED UNDER DIFFERENT IRRADIATION CONDITIONS

### STATUS

- THE OPTIMUM PROCESS HAS BEEN IDENTIFIED DOSE OF 8 MEGARADS  
DUPONT 7040 HDPE
- A 250-LB BATCH OF PELLETS IS PREPARED FOR EVALUATION BY THE UNIVERSITY OF DAYTON
- PHASE CHANGE TEMPERATURE OF PELLETS 130-145°C
- COST OF CROSSLINKING OF PELLETS 1¢/LB

## TES SUBSYSTEMS FOR SOLAR HEATING APPLICATIONS

### CONTRACTOR

GENERAL ELECTRIC

### OBJECTIVE

- DEVELOP THE ROLLING CYLINDER HEAT STORAGE CONCEPT USING GLAUBERS SALT

### APPROACH

- INTERNAL AND EXTERNAL HEAT TRANSFER STUDIES
- PERFORMANCE TESTING WITH GLAUBERS SALT
- CORROSION TESTING
- DEVELOPMENT OF MATHEMATICAL MODEL
- SELECTION AND DESIGN OF CONCEPT

### STATUS

- SELECTED PROTOTYPE DESIGN OF THE ROLLING CYLINDER CONCEPT
- RECOMMENDED CONFIGURATION AS FOLLOWS

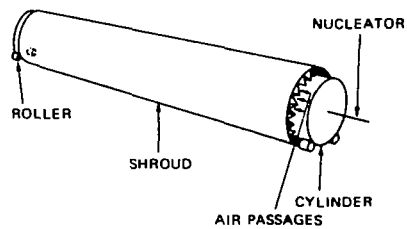

## **DEVELOPMENT OF TECHNOLOGY FOR INCORPORATION OF PCM INTO RESIDENTIAL BUILDING MATERIALS**

### **OBJECTIVE**

- **IMPROVEMENT OVER SENSIBLE HEAT SYSTEMS**  
REDUCED WEIGHT, VOLUME  
FLATTENED DIURNAL TEMPERATURE SWING  
INCREASED ARCHITECTURAL OPTIONS

### **APPROACH**

- **SOLICIT PROPOSALS VIA RFP**

### **SCOPE**

- **SURVEY TO DEVELOP THERMAL COMFORT CRITERIA**
- **R&D PROGRAM UTILIZING PROMISING CONCEPTS**
- **EVALUATION TESTING**

### **SCHEDULE**

- **ISSUE RFP BY OCTOBER '80**

## **TES APPLIED TO CONSERVATION IS THE THIRD PROGRAM ELEMENT**

### FY 79 SUBCONTRACTS

- **APPLICATION OF TES TO PROCESS HEAT AND  
WASTE HEAT RECOVERY IN THE ALUMINUM  
INDUSTRY\***  
ROCKET RESEARCH COMPANY
- **TWIN CITIES DISTRICT HEATING, TES STUDY**  
GENERAL ELECTRIC

### FY 80 SUBCONTRACTS

- **APPLICATION ANALYSIS AND TECHNOLOGY  
ASSESSMENT OF TES FOR CONSERVATION  
APPLICATIONS**  
TRW
- **APPLICATION OF TES TO PROCESS HEAT AND  
WASTE HEAT RECOVERY IN THE ALUMINUM  
INDUSTRY (PHASE II)\***  
ROCKET RESEARCH COMPANY



## **TWIN CITIES DISTRICT HEATING**

### **CONTRACTOR**

**GENERAL ELECTRIC**

### **OBJECTIVE**

- **EVALUATE THE TECHNICAL AND ECONOMIC FEASIBILITY OF INCORPORATING TES COMPONENTS INTO THE PROPOSED TWIN CITIES DISTRICT HEATING PROJECT**

### **STATUS**

- **THIS ACTIVITY HAS BEEN COMPLETED**
- **POTENTIAL BENEFITS ARE FOUND TO BE SUBSTANTIAL IN**
  - ENERGY CONSERVATION**
  - FAVORABLE ECONOMICS**
  - REDUCED AIR AND THERMAL POLLUTION**
- **FINAL REPORT IN PUBLICATION**

### **APPLICATION ANALYSIS AND TECHNOLOGY ASSESSMENT OF TES**

#### **CONTRACTOR**

**TRW**

#### **OBJECTIVE**

- **INVESTIGATE TES SYSTEMS PERFORMANCE, ENERGY CONSERVATION AND ECONOMICS FOR**
  - **INCREASED THERMAL CAPACITANCE WITHIN RESIDENTIAL STRUCTURES**
  - **STORAGE FOR WASTE HEAT RECOVERY AND USE FROM FLUE GASES OF RESIDENTIAL FOSSILE FUELED FURNACES**

#### **SCOPE**

- **DEVELOP TES SYSTEMS BASELINES**
- **ANALYZE FOR SEASONAL IMPACT IN VARIOUS REGIONS OF THE COUNTRY**
- **ESTIMATE MARKET PENETRATION**
- **ESTIMATE FUEL CONSERVATION**

#### **SCHEDULE**

- **EFFORT IS JUST STARTED**



IN-HOUSE ACTIVITIES RELATED TO TES FOR BUILDING HEATING AND COOLING

Bob Kedl  
Oak Ridge National Laboratory

## **IN-HOUSE EFFORTS CONCENTRATED IN 2 AREAS**

1. R&D RELATED TO TES
2. EVALUATION OF STORAGE SYSTEMS  
DEVELOPED BY OTHERS

## **IN-HOUSE EFFORTS CONSIST OF 4 PROJECTS**

1. THERMAL ENERGY STORAGE TEST FACILITY
2. TES LABORATORY
3. ANALYTICAL AND PHYSICAL MODELING (PCM's)
4. TES AND TRANSPORT IN THE EARTH FOR  
HEAT PUMP ASSIST

**THERMAL ENERGY STORAGE TEST FACILITY  
(TEST FACILITY)**

**OBJECTIVES:**

R&D RELATED TO TES  
EVALUATION OF TES UNITS BUILT BY OTHERS  
EVALUATION OF TESTING STANDARDS

**PROJECT DESCRIPTION:**

FABRICATE LIQUID TRANSPORT TEST FACILITY  
FOLLOWED BY AIR TRANSPORT TEST FACILITY  
SPECIFICATIONS

	<u>LIQUID</u>	<u>AIR</u>
CAPACITY	50,000-500,000 Btu	50,000-500,000 Btu
TEMPERATURE	0-150°C	0-(TBD)°C

CONSIDERABLE OPERATIONAL FLEXIBILITY

**TEST FACILITY (CONT'D)**

**STATUS:**

**LIQUID LOOP**

DETAILED DESIGN COMPLETE  
COMPONENTS ORDERED  
OPERATIONAL – MARCH 1980

**AIR LOOP**

DESIGN INITIATED

## THERMAL ENERGY STORAGE TEST FACILITY (LIQUID TRANSPORT)

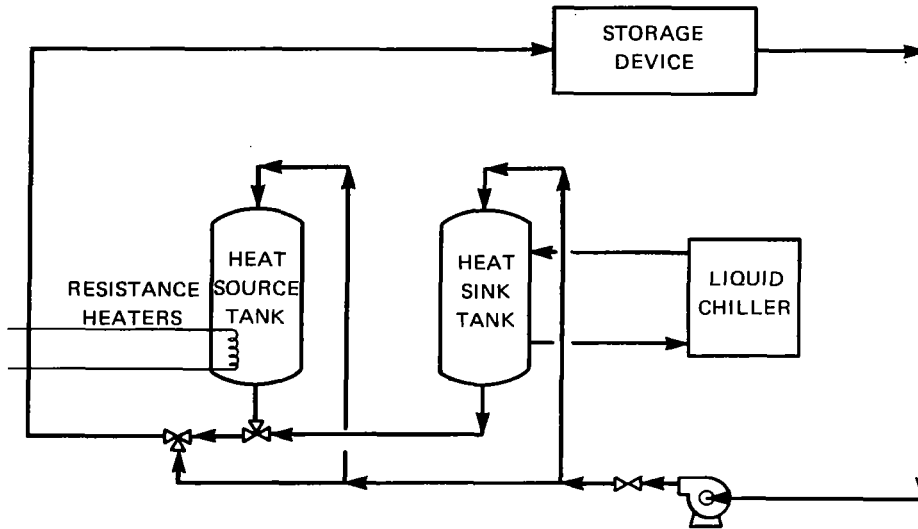

## TEST FACILITY (CONT'D)

FUTURE PLANS:

LIQUID LOOP

STRATIFIED WATER STORAGE

PCM STORAGE UNITS (RFP)

AIR LOOP

PCM STORAGE UNITS (RFP)

## TES LABORATORY

### OBJECTIVE:

- CONDUCTING SPECIAL TESTS AND EVALUATIONS IN SUPPORT OF, AND COMPLIMENTARY TO THE TEST FACILITY

### PROJECT DESCRIPTION:

- GENERAL PURPOSE LABORATORY FOR SPECIAL TESTS ON SMALL QUANTITIES OF TES MODULES
- ACCELERATED AGING TESTS (e.g. CYCLING)
- EXPOSURE TO OFF-DESIGN STRESSES (e.g. EXTREMES IN TEMPERATURE)
- OTHER TESTS SPECIFIC TO THE TES CONCEPT
- CALORIMETRY ON SINGLE MODULES
- R&D RELATED TO TES

## TES LABORATORY (CONT'D)

### STATUS:

GETTING UNDERWAY

SOME LABORATORY INSTRUMENTS  
INSTALLED

TESTING UNDERWAY ON

UNIVERSITY OF DELAWARE  
CHUBS

GLASS BLOCKS CONTAINING  
 $\text{CaCl}_2 \cdot 6\text{H}_2\text{O}$

## **ANALYTICAL AND PHYSICAL MODELING (PCM's)**

### **OBJECTIVE:**

**TO UNDERSTAND AND DEVELOP PREDICTIVE  
CAPABILITY FOR THERMAL TRANSPORT IN  
PCM STORAGE SYSTEMS**

### **APPROACH:**

**DEVELOP MATH MODELS FOR DYNAMIC THERMAL  
BEHAVIOR OF MELTING/FREEZING SYSTEMS**

**OPERATE PHYSICAL MODELS TO TEST AND  
IMPROVE MATH MODEL**

## **ANALYTICAL AND PHYSICAL MODELING (CONT'D)**

### **RESULTS TO DATE :**

**MATH MODEL BASED ON CONDUCTION IS  
OPERATIONAL, CONFIRMED, AND  
DOCUMENTED**

**PHYSICAL MODEL (SLAB GEOMETRY)  
OPERATED IN CONDUCTION AND  
NATURAL THERMAL CONVECTION  
MODES – EXTENSIVE DATA COLLECTED –  
DOCUMENTATION FORTHCOMING**

# PHYSICAL MODEL (SLAB GEOMETRY)

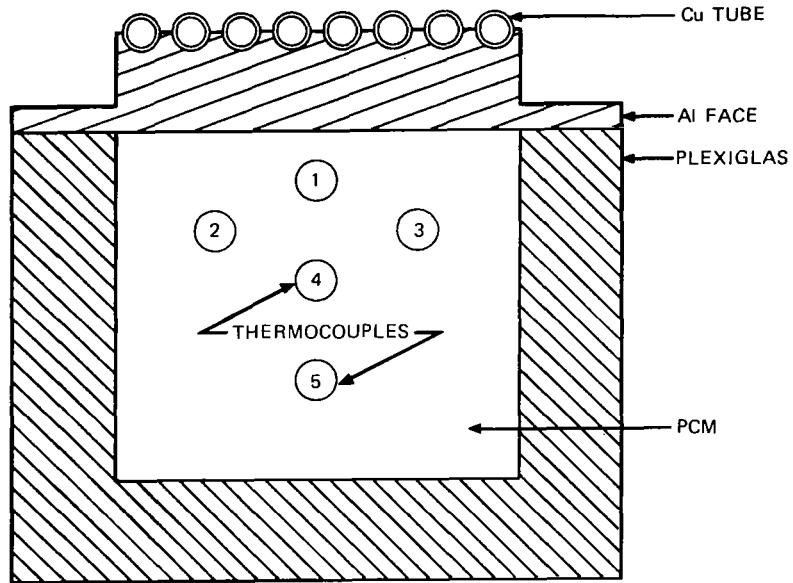

7MAY 14:41:56:18 FRZ. FILLED CELL 1&2&3

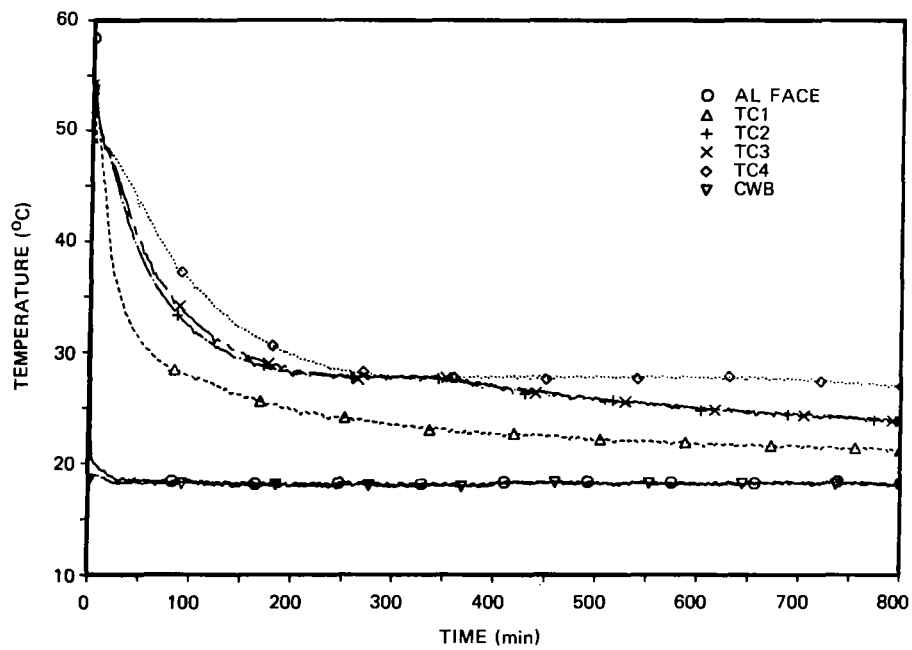



## ANALYTICAL AND PHYSICAL MODELING (PCM's)

### FUTURE PLANS:

PHYSICAL MODEL WILL BE USED TO QUANTIFY  
EFFECTS OF NATURAL THERMAL CONVECTION

MATH MODEL WILL BE MODIFIED TO INCLUDE  
EFFECTS OF NATURAL THERMAL CONVECTION

EXISTING MATH MODEL WILL BE USED TO STUDY  
THERMAL TRANSPORT IN PCM STORAGE SYSTEMS

UNIVERSITY OF DELAWARE CHUBS

PASSIVE SOLAR APPLICATIONS (TROMBE  
WALLS CONTAINING PCM's)

## SURFACE TEMPERATURE OF CHUBS

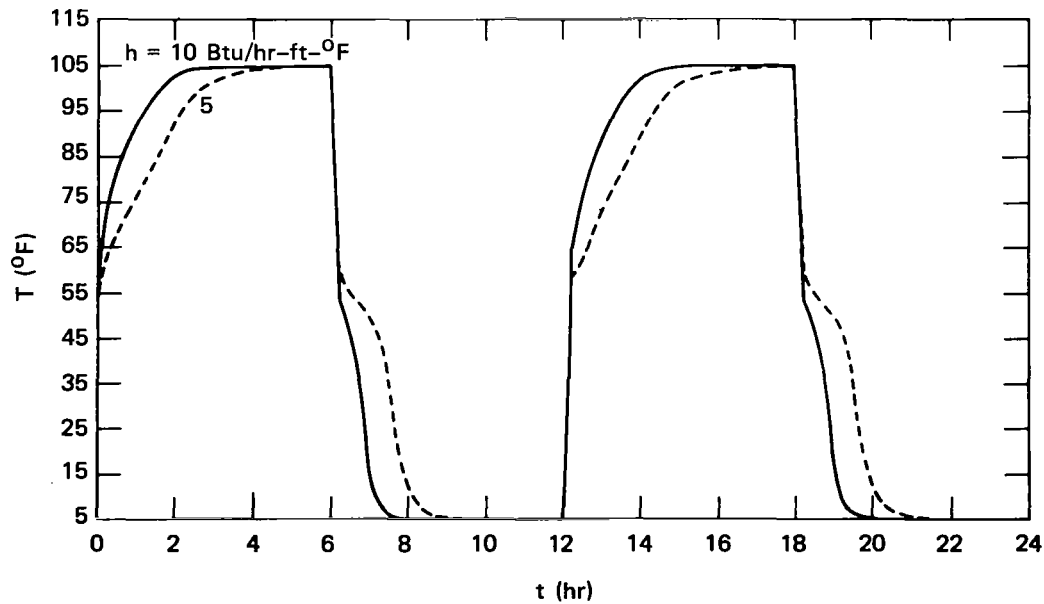

## TES AND TRANSPORT IN THE EARTH FOR HEAT PUMP ASSIST

### OBJECTIVE:

DEVELOP AND DEMONSTRATE A CONCEPT THAT UTILIZES HEAT STORED IN THE EARTH UNDER A HOME TO IMPROVE THE PERFORMANCE OF HEAT PUMPS

### BACKGROUND:

UNIVERSITY OF TENNESSEE FIELD EXPERIMENT INDICATES POSSIBLE ENERGY SAVINGS OF 25%

### PROJECT DESCRIPTION (3 EXPERIMENTS):

1. MEASURE EFFECTIVE THERMAL CONDUCTIVITY OF WET SOIL (LABORATORY)
2. MEASURE THERMAL TRANSPORT FROM GROUND TO AIR IN CRAWL SPACE
3. FIELD TEST INVOLVING EXISTING HOME

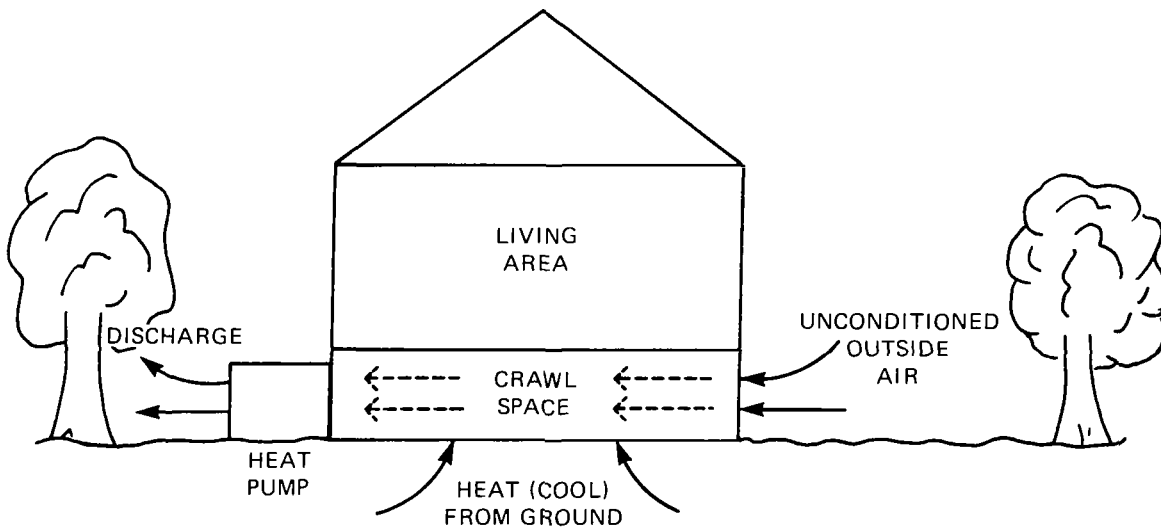

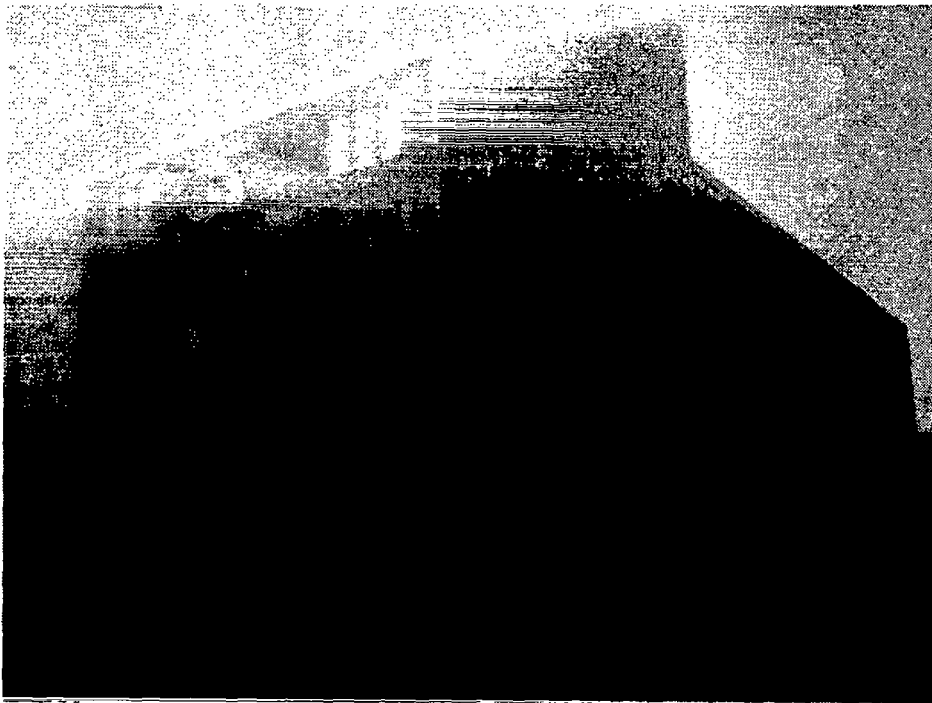
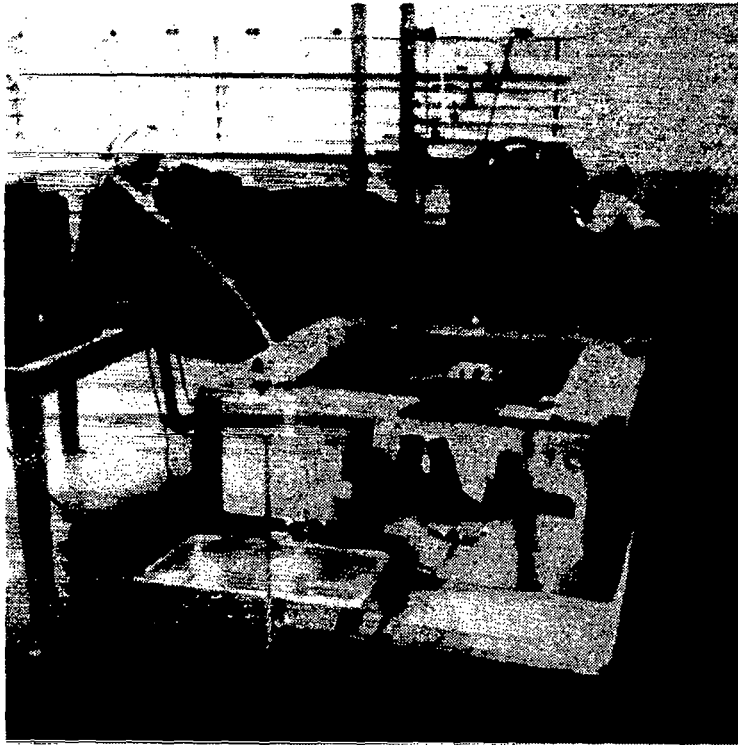

### FIELD TEST RESIDENCE

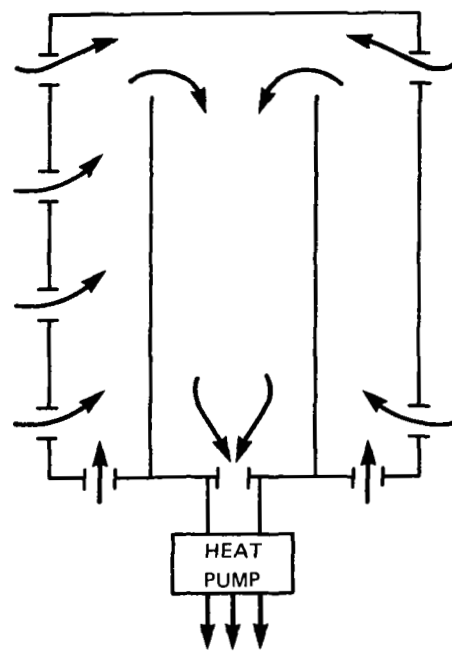

## THERMAL ENERGY STORAGE TESTING FACILITY

R. J. Schoenhals, H. F. Kuehlert, and C. P. Lin  
Purdue University

### PROJECT OUTLINE

Project Title: Operation of a Storage Heater Test Facility

Principal Investigator: J. Asbury

Organization: Argonne National Laboratory  
9700 South Cass Avenue  
Argonne, IL 60439  
Telephone: (312) 972-3779

Project Goals: Determine the thermal performance of resistance storage heaters in respect to current standards. Propose additional standards as appropriate.

Design and construct a storage heater test facility at Purdue University with capability for measuring the performance of electric resistance heated storage units. Compare performance of commercial units based on existing standards. Propose additional performance standards as appropriate.

Project Status: Calorimeter construction is completed, and testing procedures are being prepared. Tests of storage heaters are in progress.

Contract Number: 31-109-38-4666

Contract Period: October, 1978 to September, 1980

Funding Level: \$100K

Funding Source: Argonne National Laboratory

## THERMAL ENERGY STORAGE TESTING FACILITY\*

R.J. Schoenhals, H.F. Kuehlert, and C.P. Lin  
Purdue University

### SUMMARY

Development of a prototype testing facility for electrically heated thermal energy storage units is being pursued. Test procedures are being evaluated and verified by means of simultaneous redundant measurements and analysis. The quality of measurements obtained with the use of a calibrated calorimeter chamber has been improved. Testing of commercially available units is being performed, and experience gained in this activity will be used to further refine and substantiate the test procedures being formulated.

### INTRODUCTION

This project deals with the development of a facility for testing of residential electrically heated thermal energy storage (TES) units. Experiments are presently being conducted with devices which utilize high heat capacity ceramic bricks as the energy storage medium. Large central units are now available for replacing conventional residential furnaces. Also on the market are small self-contained room-size units which avoid the necessity for ductwork and a central air handling system.

Energy charging of these devices occurs at night using less expensive off-peak electrical energy. During this period the electrical heaters inside the unit are activated, heating the ceramic bricks to a high temperature. Air then is caused to flow over the bricks intermittently throughout the day and evening as required to maintain the residence air temperature. The air flowing over the bricks is heated during this process, and the bricks are correspondingly cooled so that their temperature level is eventually lowered thus preparing them for acceptance of another energy charge during the next night-time period.

Use of off-peak electrical energy with TES systems makes it possible for a utility to increase its total energy output with a given quantity of generating capacity. With fewer customers drawing appreciable amounts of energy during the day, the daily peak is reduced. Concurrently, the usual decrease in load at night is reduced as more customers draw energy during this period for charging of TES units. This concept has been in use in some areas in Europe for several years. More recently it has been introduced in the U.S. on a small scale, mostly on an experimental basis by certain utilities with a limited number of customers. As a result, field test data are being collected by a

---

\* This project is supported by Argonne National Laboratory, Energy and Environmental Systems Division, Special Projects Group, under Contract No. 31-109-38-4666.

number of organizations, including the utilities themselves, the Electric Power Research Institute and Argonne National Laboratory.

Although electrically heated TES units are now on the market in the U.S., standard performance testing procedures have not yet been established in this country. Available information which can assist in the development of such procedures includes a German Standard, DIN 44572, which has been established specifically for electrically heated TES units. Within the U.S. a standard has been established for testing of other types of TES units by the American Society of Heating, Refrigerating and Air Conditioning Engineers (ASHRAE), ASHRAE Standard 94-77. Both of these documents have been quite helpful in guiding the present work.

Currently ASHRAE Standards Project Committee 94A is in the process of writing descriptions of standard test procedures for electrically heated TES units. Simultaneously, experimental and analytical work is being pursued in this project in order to assist ASHRAE in its effort. Personnel of Argonne National Laboratory and Oak Ridge National Laboratory provide coordination by maintaining contact with ASHRAE Committee 94A and by monitoring the activities conducted in this project.

#### GENERAL DESCRIPTION OF THE PROJECT

The objective of this project is the development of a prototype TES testing facility that can be duplicated at established commercial or government laboratories, or at TES manufacturers' R & D laboratories. In addition to defining the characteristics of the test apparatus, appropriate test procedures are to be defined and verified. The goal is to achieve the type of facility and associated methods that can be easily and economically used elsewhere. Thus, simplicity is desired, as opposed to tests which would be elaborate, expensive and time consuming. Complexity is reluctantly added only when the simplest procedures fail to yield results of sufficient accuracy.

Quantities to be identified by tests conducted with a particular TES unit include total energy charge, heat loss during charging and standby, and rate of delivery of energy during discharge. For the larger central units the rate of energy delivery can be calculated after measuring the air flow rate through the device and the temperature difference between the inlet and outlet air. This type of test can be performed with the unit placed in a typical laboratory setting. Heat losses are not measured directly in this case, but uniformity can be obtained from test to test by requiring that the laboratory air temperature be maintained within a specified range.

Certain advantages are obtained by testing the smaller room-size units inside a calibrated calorimeter chamber. Once the chamber has been properly calibrated the heat loss from a TES unit during charging and standby and the rate of energy delivery during discharge can be determined by measuring the inlet to outlet air temperature difference across the chamber. Measurement of the air flow rate through the chamber is not required either during calibration or during the test of the TES unit, according to the German Standard DIN 44572.

In this project various test methods are being studied both experimentally

and analytically. Simultaneous redundant measurements are made where possible in order to establish the validity of the procedures. For example, although the calorimeter method does not require a direct measurement of the air flow rate, a standard nozzle has been installed for this purpose in order to provide an independent determination of the heat loss from the calorimeter chamber. Also, electrical input energy during charging of a TES unit is determined by 3 techniques: (1) by use of a calibrated watt-hour meter, (2) by means of a conventional wattmeter and (3) by electrically integrating the signal from a watt transducer. By making these additional measurements it is possible to learn more about the magnitudes of the quantities of interest and to verify the accuracy and precision with which they can be determined from the measurements. It is hoped that once this kind of verification has been accomplished in this project, eventual recommended test procedures will involve the smallest number of straightforward measurements possible for meaningful determinations of the quantities of interest.

Figure 1 contains a photograph showing one of the large central TES units (foreground) and the calorimeter chamber which has been fabricated for testing of the room-size units. The blower which draws air through the chamber is on the left. Air enters the chamber on the right. Figure 2 shows the opposite side of the chamber. Some of the instrumentation can be seen in this view as well as a small TES unit which is ready for installation in the chamber for testing.

#### RESULTS AND DISCUSSION

The calorimeter chamber was designed and fabricated to keep heat losses small. The chamber walls and door are lined on the inside with a layer of Styrofoam approximately 10 cm thick. The outlet consists of a flaired rectangular section which is followed by a duct of round cross-section. The round portion is well insulated on the outside with glass wool. A schematic diagram of the essential features of the system illustrating the various energy flow rates is given in Figure 3. Both analysis and measurements indicate that the heat loss from the chamber and from the outlet duct is typically about 15% of the heat delivered to the interior of the chamber by the heating unit.

For purposes of calibration an electrical heater is installed inside the chamber and operated under steady state conditions. The rate at which heat is delivered to the interior of the chamber is then equal to the measured rate at which electrical energy is supplied to the heater. The blower which draws air slowly through the chamber is operated at various speeds, and the inlet to outlet temperature rise is recorded. Plots of these measurements, as shown in Figure 4, constitute a calibration of the calorimeter system.

Figure 5 shows the inlet to outlet temperature difference during and after the charging process for an actual test of a 2kW TES unit which is now on the market. Since the internal blower within this unit was not operated during the test the results indicate heat losses during charging and standby. Initially the unit was at room temperature, but as electrical energy was supplied its internal temperatures rose, and heat transfer from the unit to the air inside the chamber increased as indicated by the inlet to outlet air temperature difference. After 8 hours of charging the electrical input was terminated, and the rate of heat loss from the unit to the air gradually decreased.





Figure 1. Central TES Unit (Foreground) and Calorimeter Chamber for Testing of Room-Size TES Units

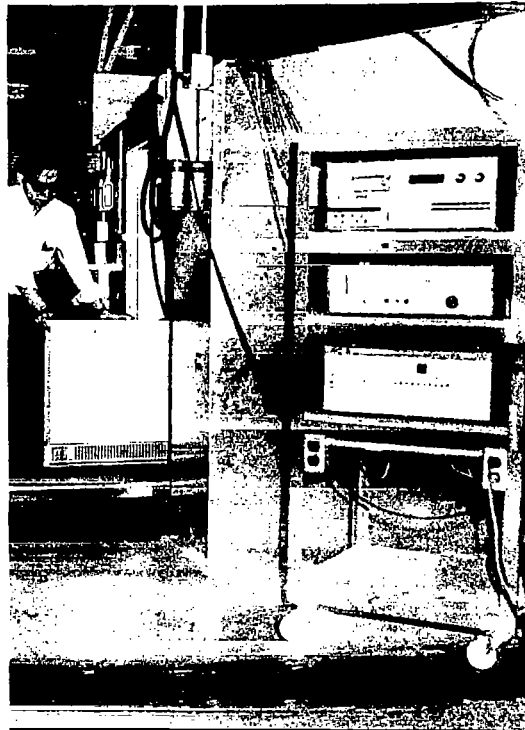

Figure 2. View of Calorimeter Chamber from Opposite Side

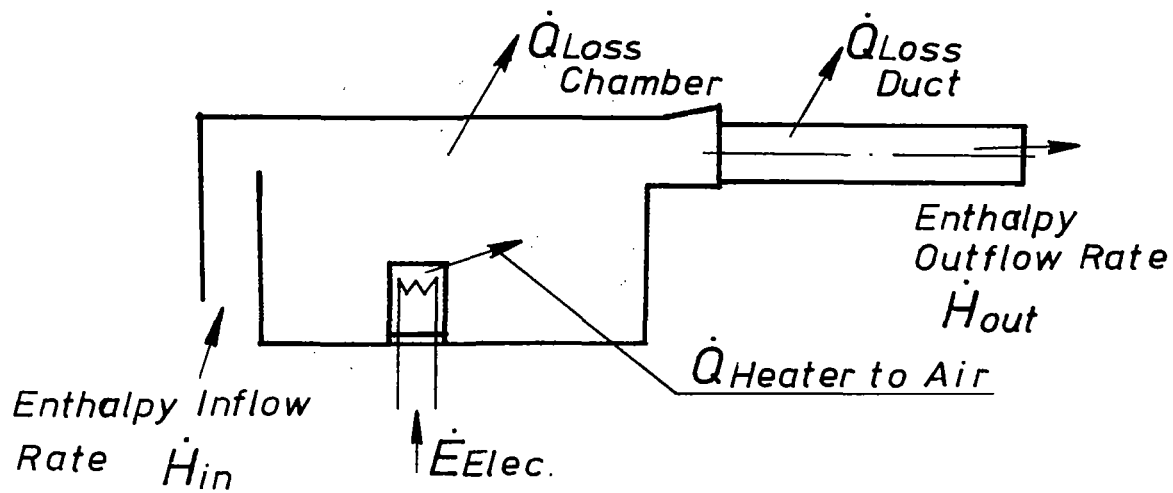

Figure 3. Schematic Diagram of the Essential Features of the Calorimeter Chamber Illustrating the Various Energy Flow Rates

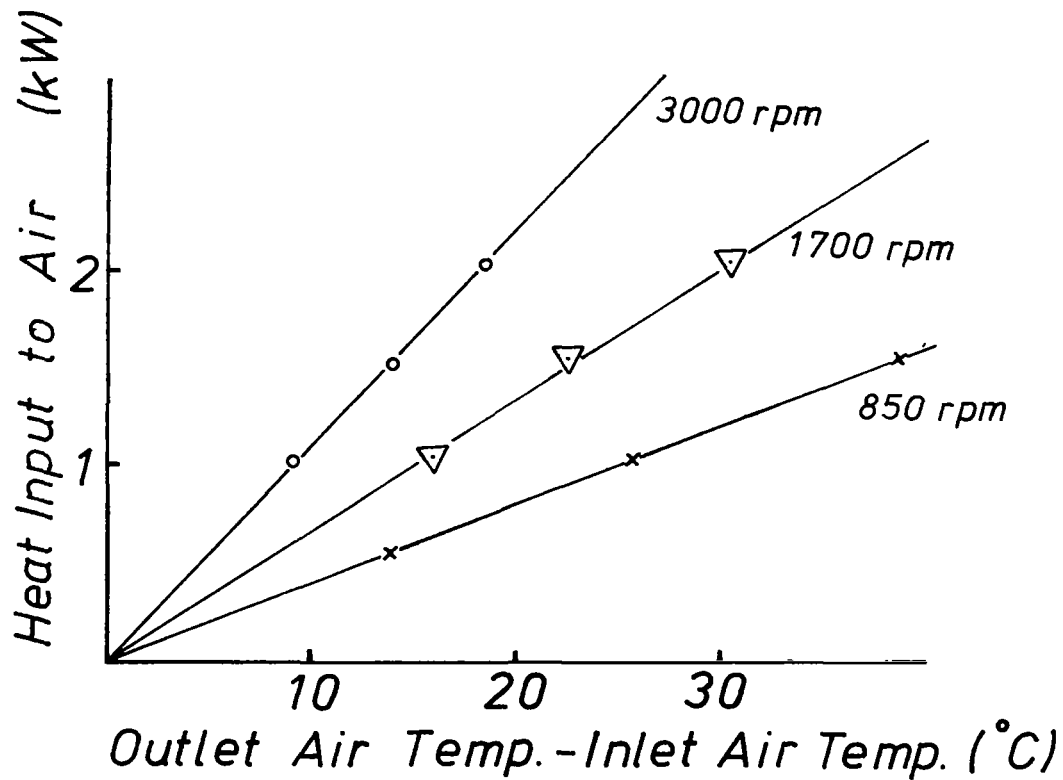

Figure 4. Calibration Chart Obtained Under Steady State Conditions with Calorimeter Blower Speed as Parameter

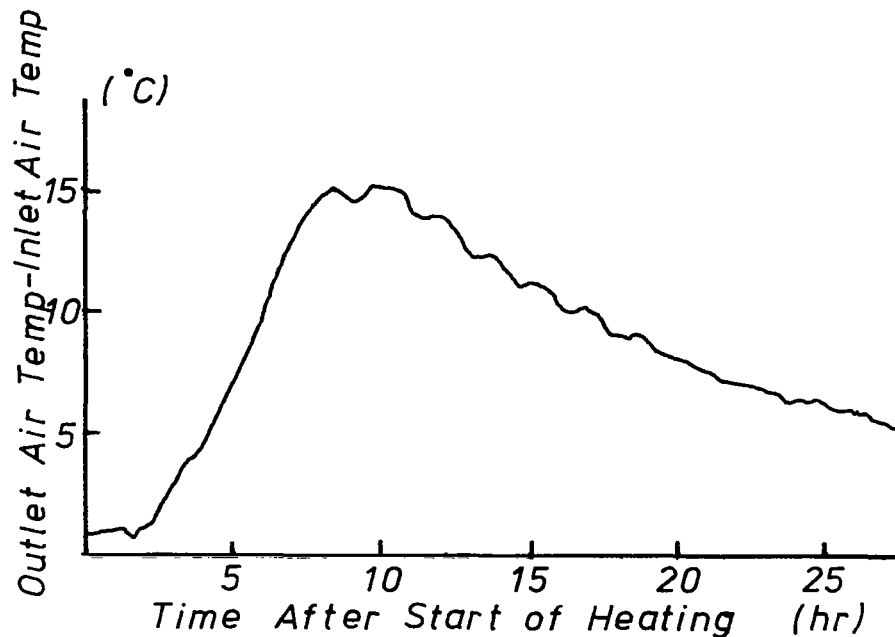

Figure 5. Measured Inlet to Outlet, Temperature Difference During and After an 8 Hour Charging Period for a 2KW TES Unit (Calorimeter Blower Speed = 850 rpm)

For any instant of time the temperature difference from Figure 5 can be used with the calibration chart in Figure 4 to determine the rate at which the heating unit under test delivered heat to the air inside the calorimeter. This procedure provides correct results under the following assumptions:

1. The net enthalpy outflow rate for the air, as indicated by the measured temperature difference during the test, is the same as that occurring during the calibration test at the same measured temperature difference.
2. The heat loss from the calorimeter system to the surroundings during the test is the same as that occurring during the calibration test at the same measured temperature difference.
3. The rate of change of internal energy of the chamber and the air contained inside is negligible during the test.

The procedure indicated above is very desirable because of its simplicity. However, the assumptions listed raise questions about the validity and accuracy of the results obtained. Therefore, these aspects are being evaluated during the course of this project.

In regard to assumption 1 it should be pointed out that typically there are air temperature variations over the outlet duct cross-section. Because of this a thermopile, consisting of 20 pairs of thermocouples connected in series, is employed with alternate junctions placed in the inlet duct and outlet duct, respectively. The inlet duct has a rectangular cross-section and the outlet duct has a round cross-section. Locations of the thermocouples in the ducts are indicated in Figure 6, (a) and (b). Figure 6 (c) illustrates the series arrange-

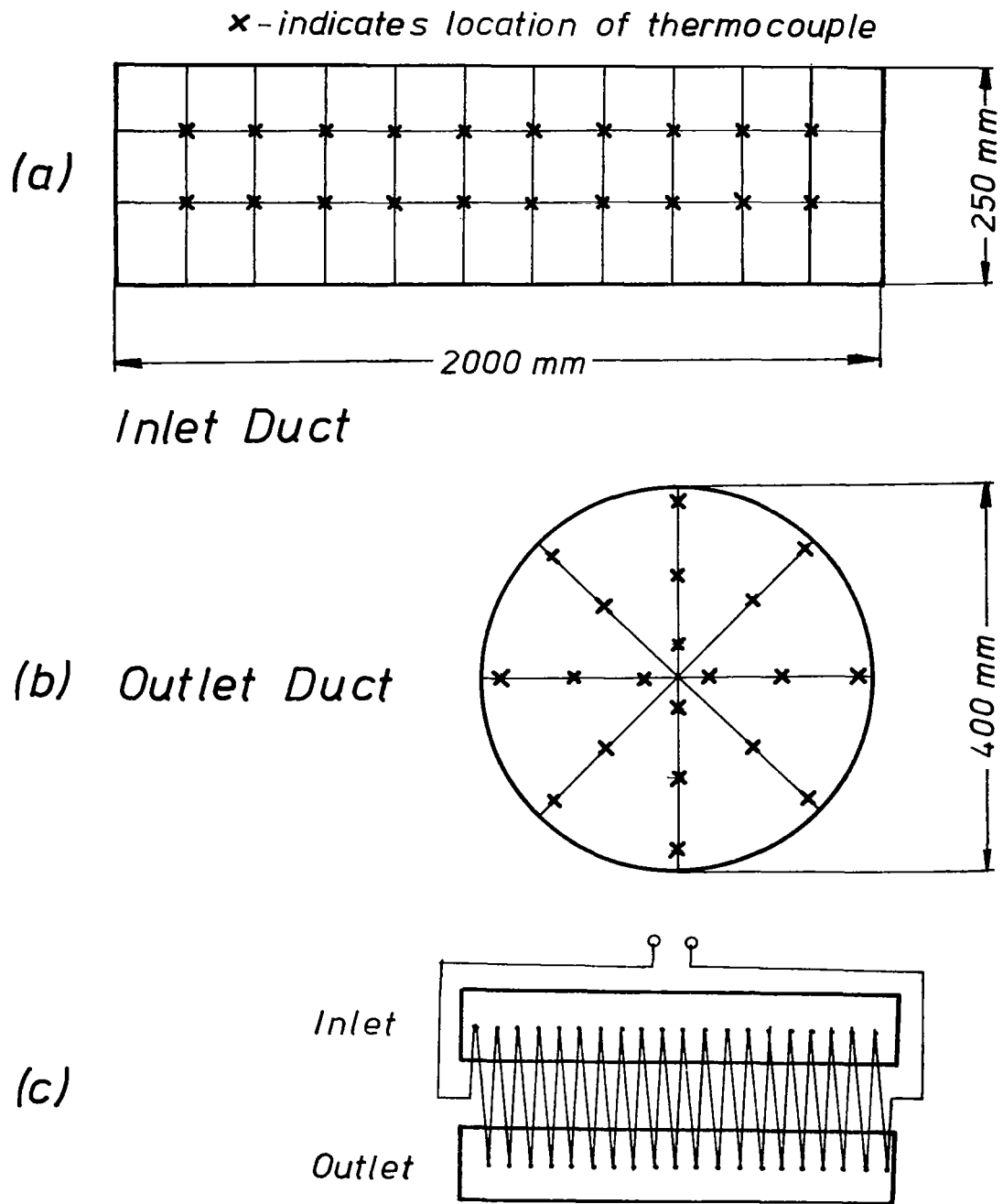

Figure 6. Thermocouple Arrangement: (a) Inlet Duct, (b) Outlet Duct, and (c) Thermopile Formed by Series Arrangement of Thermocouples

ment of the thermocouple pairs. With this procedure the voltage output indicates essentially the difference between the average inlet and average outlet air temperatures (averages taken over the duct cross-sections).

On a rigorous basis the enthalpy flow rate for the outlet air is indicated by the mixed mean temperature, which depends upon the temperature profile and the velocity profile in the outlet duct. The velocity profile is unknown, unless very detailed velocity measurements are made within the duct to determine it. In general the mixed mean temperature is not equal to the average temperature, but these two temperatures approach each other as the air temperature over the cross-section becomes more uniform, no matter what the velocity profile may be. The room air entering the calorimeter has a uniform temperature, so this condition is achieved in the inlet duct. However, initial operation of the chamber revealed sizable temperature variations within the air in the outlet duct. Temperature variations within the outlet duct cross-section as high as 53% of the average inlet to outlet temperature difference were detected by means of individual thermocouples placed at the locations of the thermopile thermocouples. The air in the chamber and in the duct apparently stratifies due to buoyancy, and the warmer and cooler portions of the air tend to remain separated as they move through the outlet duct. Under these conditions the measured average inlet to outlet temperature difference is not guaranteed to represent the net enthalpy flow rate accurately, because of the possible deviation between the average and mixed mean outlet temperatures. Hence, such measurements are not considered acceptable.

In order to obtain a more nearly uniform outlet air temperature baffles were installed in the chamber in an attempt to create a more uniform temperature for the air entering the outlet duct. This produced a small improvement. Mixing louvers placed at the entrance to the outlet duct unfortunately were found to produce no improvement. However, a more carefully designed set of mixing louvers was installed further downstream in the duct, and the duct was lengthened to allow a greater distance for mixing. The 53% difference referred to above was reduced to only 5% with this re-designed system, at the same heating rate and air flow rate. The deviation between the average and mixed mean outlet temperatures is estimated to be only about 1% of the average inlet to outlet temperature difference. This is considered quite satisfactory, but work is continuing on this problem to see if the present arrangement will be effective over the ranges of heating rate and flow rate to be encountered.

#### FUTURE WORK

Efforts will continue to be devoted to reducing inaccuracies and verifying the test procedures and apparatus being developed. Commercially available room-size units of different sizes are being tested, and the calorimeter chamber system and the associated test procedures will be refined as this experience is accumulated. Testing of central units will proceed simultaneously, first in a conventional laboratory environment and eventually in an environmentally controlled chamber in order to determine how significant the ambient air temperature is in affecting the test results. If test results are found to be not very sensitive to the ambient air temperature, a severe specification for the ambient air temperature can be avoided in the eventual recommended standard test procedure for these units.



APPLICATION OF THERMAL ENERGY STORAGE TO PROCESS HEAT  
RECOVERY IN THE ALUMINUM INDUSTRY

John McCabe  
Rocket Research Company

PROJECT OUTLINE

Project Title: Aluminum Waste Heat for Bellingham District Heating

Principal Investigator: John McCabe

Organization: Rocket Research Company  
York Center  
Redmond, WA 98052  
Telephone: (206) 885-5000

Project Goals: Assess the economic viability and public acceptance of a district heating system in Bellingham, Washington

Conduct a review of the technological impact on the Itarco aluminum plant.

Evaluate other thermal energy sources for back-up.

Evaluate institutional considerations.

Perform a detailed system cost analysis.

Project Status: All tasks are proceeding on schedule with no significant results to date.

Contract Number: 86Y-4253C

Contract Period: April, 1979 to September, 1980

Funding Level: \$1,000,000

Funding Source: ORNL

## PROJECT SUMMARY

ORGANIZATION: Rocket Research Company - Prime Contract  
Subcontractors to RRC:

Trans Energy Systems - District Heating  
System Installation  
Ekono Oy - District Heating System Design  
Martin-Simonds Associates - Community  
Relations Consultants  
Bechtel Corporation - A & E Consultant for  
Intalco Plant

ADDRESS: York Center  
Redmond, Washington 98052

PROJECT TITLE: Application of Thermal Energy Storage to Process  
Heat and Waste Heat Recovery in the Aluminum  
Industry

PROJECT MANAGER: J. E. McCabe TELEPHONE NO.: (206) 885-5000

CONTRACT NO.: 86Y4253C CONTRACT PERIOD: 4/1/79 - 9/30/80

CONTRACT AMOUNT: \$1,014,653

### PROJECT GOALS:

The goals of this project are to assess the economic viability and the institutional compatability of a district heating system in the city of Bellingham, Washington, and to determine the technical and economic advantages of using thermal energy storage methods.

### PROJECT STATUS:

The project is currently in the ninth month of an eighteen month program. The waste heat streams at the aluminum plant that will provide the energy for the district heating system have been characterized and the energy demand of the district heating system service area has been defined. A comparative evaluation of the technical and economic features of three thermal energy storage methods will be initiated this month. Energy storage, in the form of hot water, will allow greater use of the constant energy supply by the variable energy demand. The thermal storage methods to be evaluated include: 1) a confined aquifer, 2) an abandoned coal mine located beneath the city of Bellingham, and 3) an above ground, insulated metallic tank.



## I. PURPOSE

This project is directed toward determining the economic viability and institutional compatibility of a district heating system that uses waste heat from an aluminum plant as the source of thermal energy. The project has been designed to show how existing energy storage techniques can enhance the utility of low temperature waste streams. This project will provide technical and economic comparisons of energy storage in confined aquifers, in an abandoned coal mine, and in above-ground, insulated, metallic storage tanks.

## II. BACKGROUND

Under a Department of Energy (DOE) Contract, Rocket Research Company has investigated the use of aluminum process reject heat as a source of energy for large scale district heating. During Phase I of a multi-phased program, RRC conducted a preliminary evaluation of a district heating network for the City of Bellingham, Washington, with reject heat recovered from the Intalco Aluminum Corporation plant located in Ferndale, Washington. The baseline District Heating System is a network of closed-loop hot water pipes that recover energy at approximately 250°F from the fume hood ducts at Intalco and transmits the energy to a relatively high density commercial/residential population center for space and hot water heating. Results of the tradeoff studies conducted during Phase I show that the District Heating System concept is both technically and economically attractive because the system design concept is based on existing technology and implementation of the concept will be economically competitive with existing systems using conventional fossil fuels.

RRC estimates that approximately 40 percent of the low quality heat generated at Intalco which is presently unuseable, could be effectively applied to space and hot water heating in the city of Bellingham by means of a district heating system to serve as many as 20,000 residences and commercial buildings. If this energy recovery was realized from all of the nations' aluminum plants, a savings equivalent to six to eleven million barrels of oil could be realized annually. By the year 2000, the cost of this energy is projected to be about one quarter that of conventional energy sources.

Because the viability of a District Heating System in Bellingham is largely dependant on cost and institutional considerations, Phase II of the program is presently addressing these areas so that the necessary level of confidence can be established prior to a major commitment of funds. As part of this Phase II effort, RRC is also conducting the following technical and economic evaluations:

- 1) seasonal storage of hot water in an abandoned coal mine below the city of Bellingham and in confined aquifers,
- 2) integration of waste energy streams from nine local facilities (oil refineries, wood and paper mill, cement plant, etc.) with the District Heating System,
- 3) determining the impact on the Intalco facility when it is integrated with the District Heating System, and,
- 4) assessment of the state of development of district heating system equipment.

### III. PROJECT DESCRIPTION

The project has been organized into five major tasks. These tasks are described in the following paragraphs.

Task I is a marketing analysis effort which is directed toward characterizing the potential market in terms of energy demand, peak loads, scope of system conversions required, etc., and an assessment of the rate at which subscribers will join the utility.

Task II is a technology review that is concerned with three specific areas: 1) the impact on the Intalco facility when it is integrated with the district heating system, 2) the technical and economic comparison of hot water storage in confined aquifers, in an abandoned coal mine and in metallic, insulated tanks, and 3) an assessment of the technological status of district heating system equipment.

Task III will evaluate the feasibility of utilizing energy waste streams from 9 facilities in the area (2 oil refineries, a paper mill, cement plant, etc.) to increase and/or supplement the energy capability of the district heating system.

Task IV is concerned with the legal, political and social constraints that collectively are referred to as institutional considerations. Included will be evaluation of the various public and private entities that can own, market, store, sell, distribute, and manage a district heating utility. Items to be considered in the evaluation include: financing, taxation, regulations and permits, rate making, environmental considerations, right of way acquisition, contracts with energy supplier and user, impact on existing utilities, and DHS liability.

Task V, the system cost analysis effort, will definitize the design of the district heating system to the level which will permit a

detailed cost estimate to be made for building and operating the system. Evaluations will then be made of the different ownership structures and the financing options available to each ownership structure. System design and operating information, construction schedules, ownership and financing options will all be included in computer programs that will permit the sensitivity evaluation of all technical and economic factors so that the program can be optimized for various criteria, i.e., minimum rate to consumer.

#### IV. RESULTS

The project is currently in the ninth month of an 18-month program. The Marketing Analysis Task is nearing completion with the energy demand surveys and conversion cost studies more than 90% complete. The Community Advisory Group will continue to meet every month to discuss issues of concern. For the Technology Review task the effort concerned with determining the impact on the Intalco facility when it is integrated with the district heating system has been completed. The part of the Technology Review Task associated with evaluating aquifer storage and the use of an abandoned coal mine as an aquifer versus the use of metallic tanks is now being initiated. An evaluation study has been conducted for the heat exchanger to be installed in the ducts at Intalco and testing of a simulated heat exchanger element to assess fouling rates has been initiated. The task to evaluate the use of waste streams from alternate energy sources is in the initial phase with the only activity being the coordination meetings held with each of the 9 candidates. The Institutional Considerations task is an active phase of the program. Meetings have been held with the Washington State Utilities and Transportation Commission concerning regulations that are applicable to a district heating system and there has been a series of meetings with bond underwriters, bond counsel and management consultants to discuss financing options. Additional activities involve the analysis of legal authority, discussions of environmental impact permits with city and county planners and with the State Department of Ecology, right-of-way acquisition and construction impacts. The System Cost Analysis task is in the initial stage. A preliminary system design phase has been completed as a basis for providing a preliminary cost of energy.

#### V. FUTURE ACTIVITIES

Effort will continue on each of the five tasks during the coming months. The marketing analysis task will be reduced considerably -- the effort remaining involves support of the Community Advisory Group in Bellingham and preparation of the Market Analysis Report.



# HEAT STORAGE CAPABILITY OF A ROLLING CYLINDER USING GLAUBER'S SALT

C. S. Herrick and K. P. Zarnoch  
General Electric Company

## PROJECT OUTLINE

Project Title: Thermal Energy Storage Subsystems for Solar Heating Applications

Principal Investigator: W. E. Smith

Organization: General Electric Company  
Corporate Research and Development  
P. O. Box 8  
Schenectady, NY 12301  
Telephone: (518) 385-8147

Project Goals: Develop the rolling cylinder phase-change heat store concept to the point where a prototype design is completed and a cost analysis prepared.

A series of experimental and analytical tasks are defined to establish the thermal, mechanical, and materials behavior of rolling cylinder devices. These tasks include analyses of internal and external heat transfer, performance and lifetime testing of the phase-change materials, corrosion evaluation, development of a mathematical model, and design of a prototype and associated test equipment.

Project Status: Technical feasibility of the concept was demonstrated. Manufacturability studies were completed; baseline concept for prototype was selected.

Contract Number: EM-78-C-05-5759

Contract Period: August 1978 to October 1980

Funding Level: \$373,600

Funding Source: U.S. Department of Energy  
Conservation and Solar Applications

# **HEAT STORAGE CAPABILITY OF A ROLLING CYLINDER USING GLAUBER'S SALT**

**C. S. Herrick and K. P. Zarnoch  
Corporate Research and Development  
General Electric Company  
Schenectady, NY 12301**

## **INTRODUCTION**

Thermal energy storage by the melting and refreezing of a chemical compound (phase change storage) has the possibility of a high energy storage density and isothermal behavior. Both features are thought to be highly desirable for thermal storage in systems intended for the solar heating and cooling of buildings.

Unfortunately these attractive possibilities are difficult to realize in practice because they require that the refreezing step be carried out with a very high and constant Carnot efficiency and with fast kinetics to produce high heat release rates. High thermodynamic efficiency and fast kinetics are rarely operative in the same process.

Salt hydrates have relatively high latent heats of fusion (melting) as well as melting temperatures which are convenient for space heating and cooling systems. Most salt hydrates exhibit refreezing problems which are severe enough to prevent their widespread adoption for heat storage.

One potential solution to the salt hydrate refreezing problem is the Rolling Cylinder Heat Storage Device invented at the General Electric Research and

Development Center.[1-3] Prior experimental work in this laboratory has demonstrated that sodium sulfate decahydrate can be made to freeze rapidly, completely, and repeatedly when it is contained in a cylindrical vessel rotating slowly about its cylindrical axis with its axis horizontal. At rotational speeds near 3 rpm this mechanical arrangement produces just enough stirring action in the two phases to create effective chemical equilibrium even though the solid  $\text{Na}_2\text{SO}_4$  still hovers near the bottom of the vessel. Complete freezing is obtained with a calculated low expenditure of energy to generate the rolling motion. Satisfactory repeatable nucleation has been obtained over many cycles through the use of a tubular nucleator. Refreezing progresses without buildup of a crust of decahydrate crystals on the cylinder wall to interfere with rapid heat transfer.

To use a rolling cylinder in a heating/cooling system, the system designer must have accurate information describing the heat storage capacity, the temperature profile required to empty out a store and then refill it, and the rates at which heat can be withdrawn from the store or added to it.

Sensible heat storage in tanks of water is characterized by a generally low storage capacity, by wide temperature swings, and by permissible high rates of heat removal per unit of heat transfer area.

- 
- [1] C. S. Herrick, "A Rolling Cylinder Latent Heat Storage Device for Solar Heating/Cooling", ASHRAE Transactions, 85, 512 (1979).
  - [2] C. S. Herrick, U.S. Patent No. 4,154,292, May 15, 1979.
  - [3] C. S. Herrick and D. C. Golibersuch, "Qualitative Behavior of a New Latent Heat Storage Device for Solar Heating/Cooling Systems", General Electric Company Report No. 77CRD006, March 1977.

Phase change storage, on the other hand, is characterized by a generally high storage capacity, by narrow temperature swings, and by limiting low rates of heat removal per unit of heat transfer area. Configurations chosen by others for phase change storage usually try to provide a large heat transfer area and allow a crust of solid storage material to accumulate on the heat exchange surface. In the rolling cylinder solids do not accumulate on the heat exchange surface so the required heat transfer area is much smaller. In principle this smaller heat transfer area should be an advantage for the rolling cylinder store.

The broad goal of this work is to produce a quantitative assessment of the engineering properties needed to design a rolling cylinder heat store for use in space heating and cooling. This report describes calorimetry on a laboratory scale rolling cylinder to measure its thermal properties.

#### **Calorimeter Construction:**

Figure 1 shows the calorimeter which consisted mainly of a plywood box lined with foamed polystyrene insulation. A cylindrical chamber in the center holds the rolling cylinder. Figure 2 is a sketch of the assembled calorimeter. Air from the surrounding room is propelled into the calorimeter by a blower. After passing through the annular space between the cylinder and insulation thereby cooling the rolling cylinder, the air passes over a heater and out of the instrument. Resistance thermometers measure the air temperature rise due to heat from the cylinder and then a second rise due to the electric heater. A known electrical input to this heater provides the basic air flow rate measurement. Cylinder wall temperature was measured by a block of copper sliding against the rotating wall.





Figure 1 Calorimeter for Measuring Heat Flow Rates in a Rolling Cylinder

### LEGEND

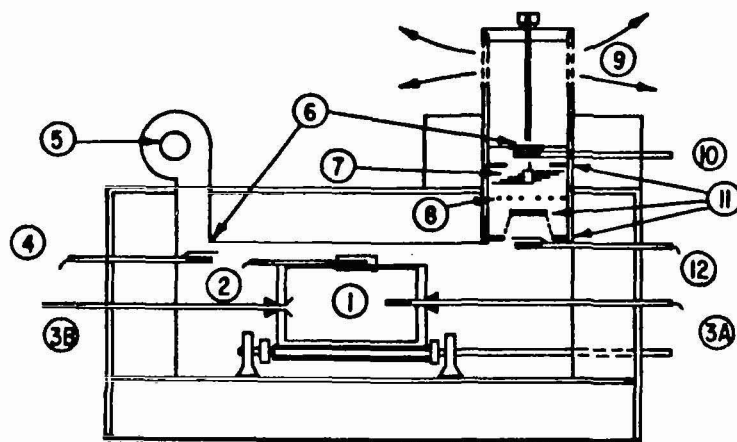

- ① ROLLING CYLINDER
- ② CYLINDER OUTSIDE TEMP.
- ③A CYLINDER INSIDE TEMP.
- ③B NUCLEATOR
- ④ INLET AIR TEMP.
- ⑤ AIR BLOWER
- ⑥ RADIATION SHIELDS
- ⑦ AIR MIXING SYSTEM
- ⑧ HEATER (CALROD)
- ⑨ EXHAUST AIR
- ⑩ OUTLET AIR TEMP.
- ⑪ AIR BAFFLE SYSTEM
- ⑫ AFTER CYLINDER TEMP.

Figure 2 Air Cooled Calorimeter for the Rolling Cylinder

Much care is required to assure that average air temperatures are measured rather than superheated-flow-streamline temperatures. All sensors provided a direct reading digital output, both visual and Binary Coded Decimal. Sensors were scanned at 3 minute intervals during the 15-18 hours required to complete one run. A programmable microprocessor directed the scanning and formatted the BCD output for recording on magnetic tape. Data reduction at a later time provided a heat balance around the calorimeter for each scan interval. After start-up the experiment ran to completion unattended, usually overnight. Computer data reduction and computer directed graph drawing were essential to convenient management of the large data output. Random error cancellation occurred to an important degree due to the large number of data points.

### Rolling Cylinder Construction

The rolling cylinders used in the calorimeter were 6 inches outside diameter, 12 inches long, and had transparent ends so the freezing process could be observed visually. Both ends were thermally insulated during calorimetry so that all heat was removed through the cylindrical surfaces where the heat transfer conditions were well defined. Two differing cylinder constructions were used, and both were satisfactory. The first consisted of a FERNICO metal cylinder (iron-nickel-cobalt alloy) 40-mil thick with FN glass plates applied to the cylinder ends by glass-blowing, see Figure 3. FERNICO metal alloy and FN glass make a satisfactory joint because they have matching coefficients of expansion. A tapered opening for a No. 7 rubber stopper was placed at the center of each end plate, one for a thermowell entry, and one for a tubular nucleator.

The second cylinder construction consisted of a length of commercial 304 stainless steel tubing. Some internal buffing of the tubing was required to control roughness. A plate of 1/2" thick polymethylmethacrylate with outward facing

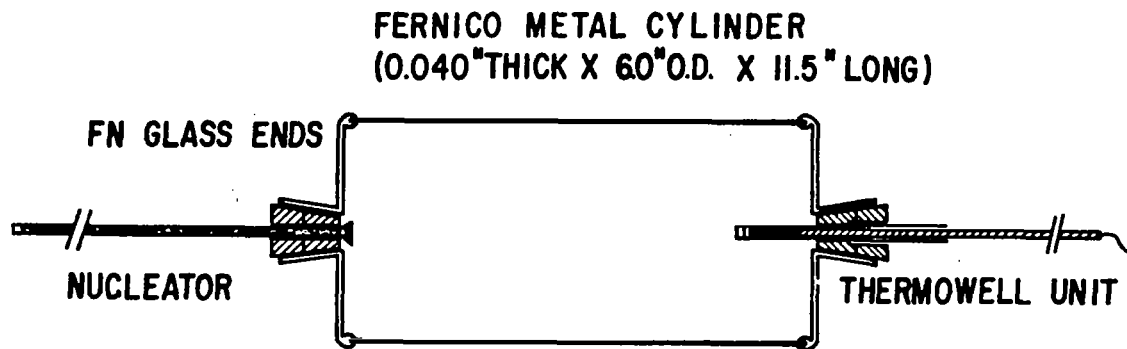

Figure 3 A Rolling Cylinder for Laboratory Scale Calorimetry

beveled edges was inserted on each end and sealed in place by filling the bevel spaces with RTV—room temperature vulcanizing silicone rubber. 1/4-inch IPS pipe threads at the center of each end provided for thermowell and nucleator connections.

Both the thermowell and nucleator were fabricated from 1/4-inch diameter copper tubing. The thermowell projected 6 inches inside the rolling cylinder along the central axis. The nucleator projected about 1/2 inch inside and 13 inches outside along the central axis but at the opposite end.

### Calorimeter Operation

Over 50 experiments have been completed in the calorimeter apparatus using Glauber's salt, sodium sulfate decahydrate, as the phase change thermal storage medium. Operating experience suggests an accuracy of about  $\pm 8\%$  in the quantity of heat measured.

### Thermal Profile

In Figure 4 one can see the entire thermal profile of a typical calorimetric run during the freezing of Glauber's salt as it progressed from start to finish. It is convenient and helpful to present all of the calorimetric data in terms of the percentage of the theoretical latent heat evolved. This permits meaningful comparison between cylinders of differing size, between cylinders operated at differing rates, or between differing kinds of storage. The latent heat of fusion of sodium sulfate decahydrate was taken to be 105.6 Btu/lb. [4].

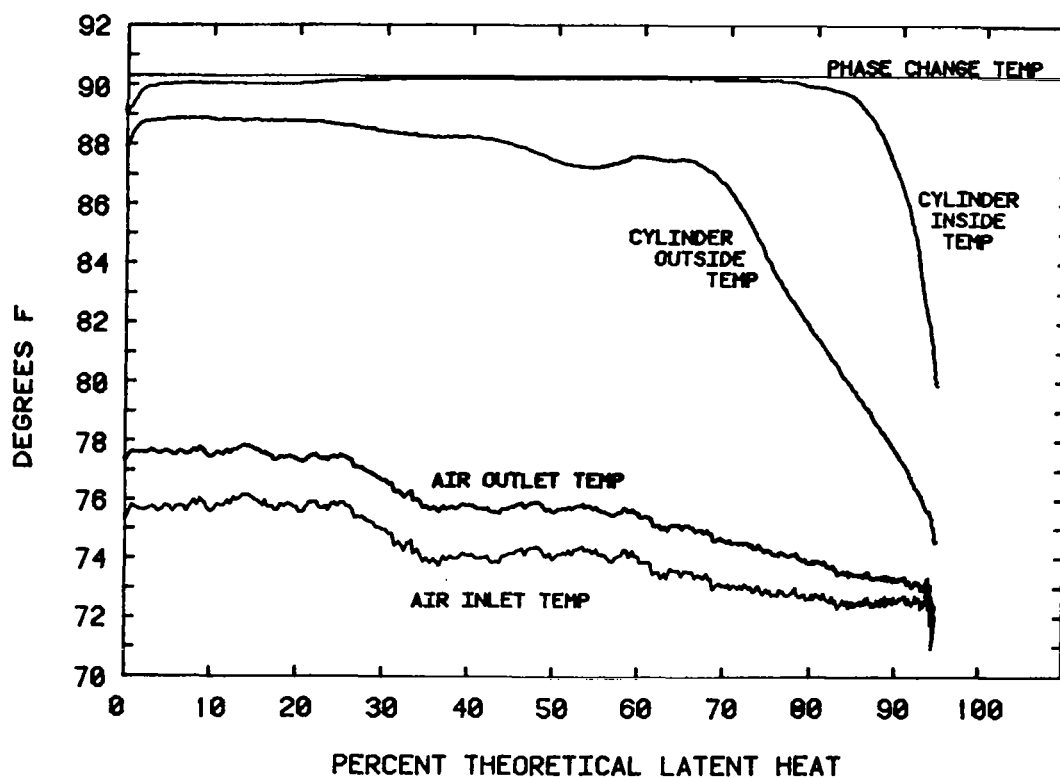

Figure 4 Run 52 at 3 RPM and 25% Excess  $\text{Na}_2\text{SO}_4$ . Cycle 31.

[4] G. Brodale and W. F. Giauque, J. Am. Chem. Soc., 80, 2042 (1958).

Zero percent latent heat occurs at the moment of nucleation. Normally nucleation occurs when the supercooling below phase change temperature is greatest. Thus the separation between cylinder inside temperature and phase change temperature at zero percent latent heat is a measure of the maximum supercooling and an indicator of nucleator performance. In Figure 4 nucleation occurred at about 89<sup>o</sup>F, a supercooling of 1.3<sup>o</sup>F for the cylinder contents. The total heat removal was 95% of the theoretical amount.

In addition to the air temperatures, the cylinder wall (outside) temperature and the cylinder axial (inside) temperature, one can find temperature drops ( $\Delta T$ ) from crystal face to cylinder contents (bulk liquid), from cylinder liquid to cylinder wall, and from cylinder wall to the cooling air.

The cylinder outside wall temperature remains within 3<sup>o</sup>F of the phase change temperature until 70% of the latent heat has been discharged from the cylinder. This is the most significant feature, the temperature of the heat exchanger surface. It can and will be used presently as the principal comparison between the results of different experiments.

Due to the 10% empty space at the top of the cylinder, the cylinder outside wall temperature will vary somewhat with angular position around the circumference. It was desirable and convenient to measure the lowest value; consequently, in design work these data will cause heat transfer rates to be slightly underestimated.

**Heat Removal Rates:**

The heat removal rate measured in run 52 (corresponding to Figure 4) appears in Figure 5. For comparison the ideal heat removal behavior is indicated by a dashed line forming a rectangle. The rolling cylinder performance does approximate the ideal behavior thus fulfilling the advance promise of good and sustained heat transfer capability. This desirable behavior results from avoiding the progressive accumulation of solids on the heat transfer surface where they become a thermal barrier.

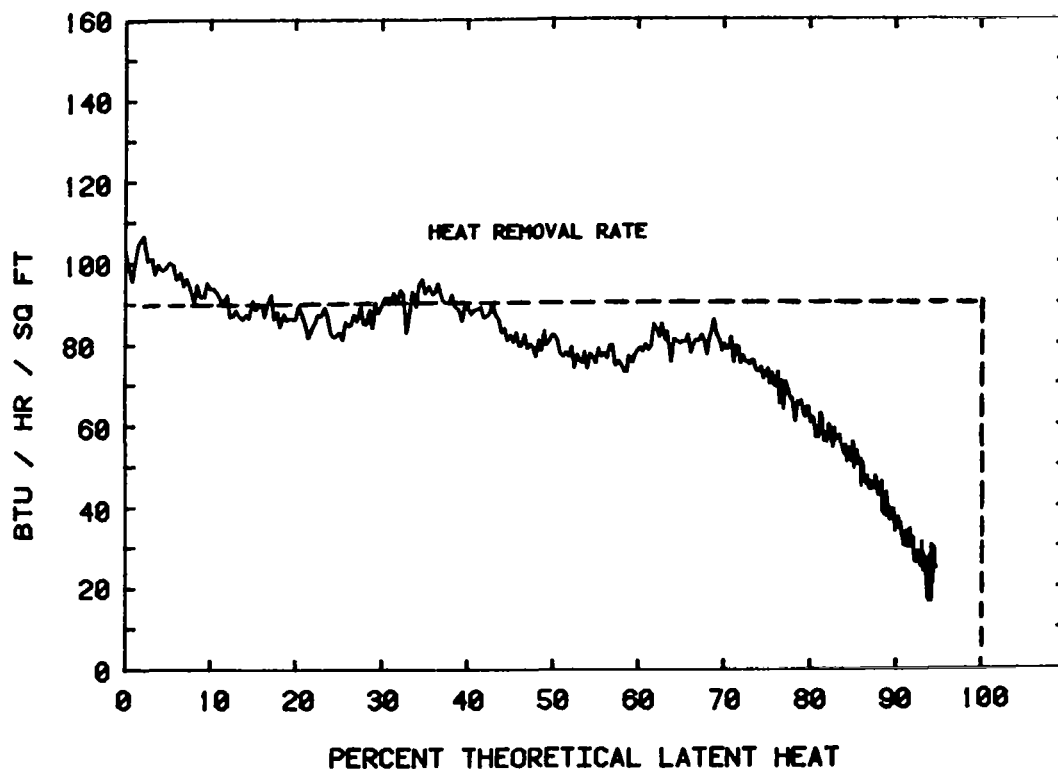

Figure 5 Run 52 Heat Removal Rate Illustrating the Close Approach to Ideal Behavior (dashed line)

Figure 6 illustrates a sustained heat removal rate of 200 Btu/hr/sq ft. This is the highest rate obtainable under experimental conditions convenient for the calorimeter, thus it is most probably not a limiting rate. Again, as in Figure 5 the shape of the heat removal rate compares well with the ideal behavior suggested by the dashed rectangle.

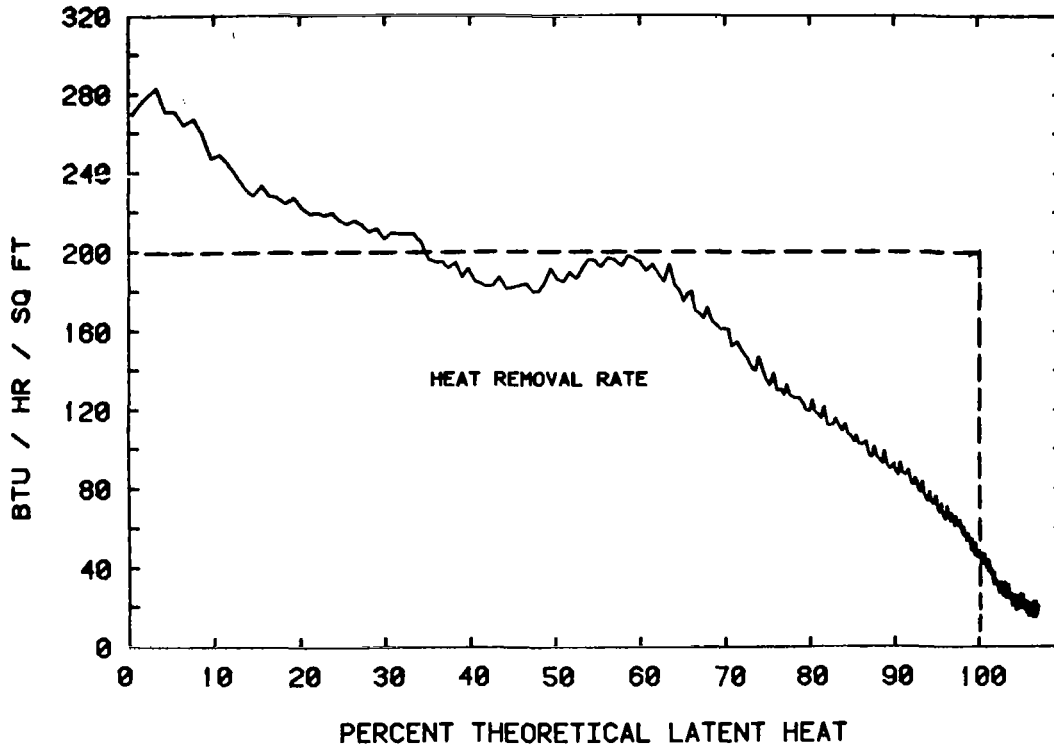

Figure 6 Heat Removal Rate in Run 80 at 3 RPM, 25% Excess  $\text{Na}_2\text{SO}_4$

It is strongly recommended that comparisons between latent heat storage subsystems be made using diagrams similar to Figures 5 and 6.

### Heat Transfer Coefficients:

Figure 7 shows the calculated values of heat transfer coefficients on each side of the cylinder wall. The outside coefficient is the expected value for air under the existing conditions. The inside value is based on the axial temperature and the metal wall temperature and thus is an overall value which includes the effects of mechanical motion or stirring, and diffusion in addition to boundary layer phenomena. The four distinct steps shown here suggest the possible existence of four different behavioral regimes inside the cylinder. Other runs provided less pronounced steps and many showed fewer than four, however all

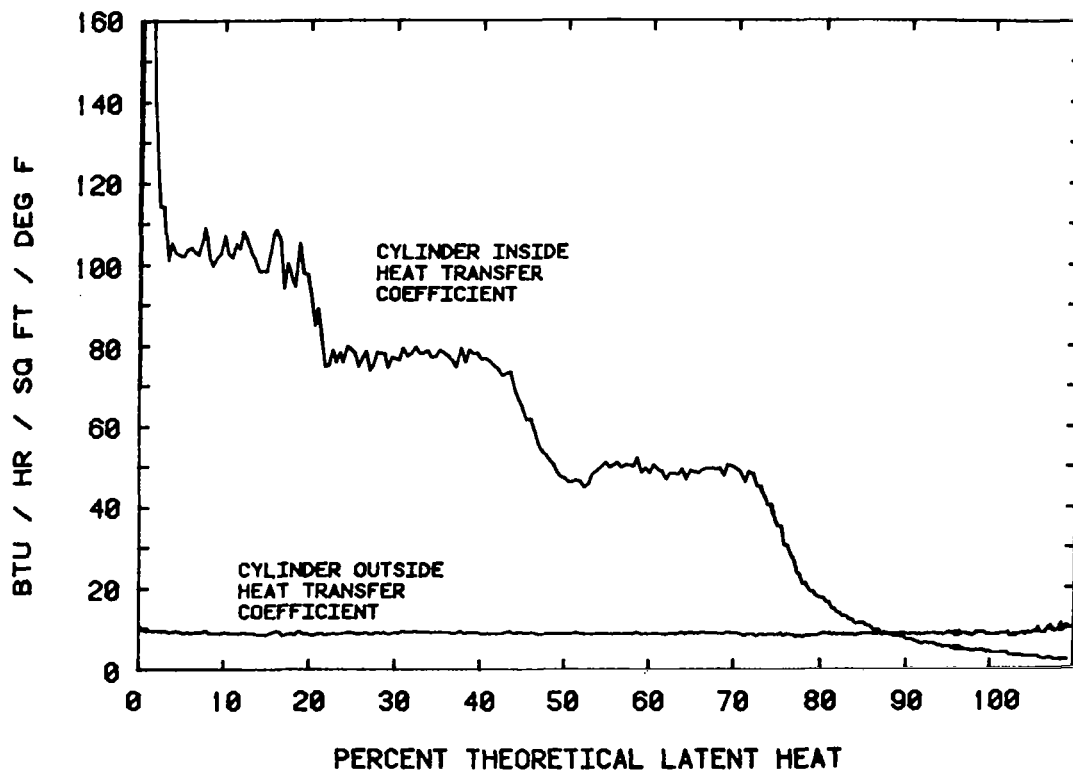

Figure 7 Heat Transfer Coefficients for Run 44, 3 RPM,  
25% Excess  $\text{Na}_2\text{SO}_4$ , Cycle 10



showed at least one step. The following identifications are tentatively assigned to the four separate behavioral patterns.

The first step (L to R in Fig. 7) is an artifact created by less-than-perfect liquid mixing in the cylinder at less than 25% of theoretical latent heat. The second step then becomes the initial state of the cylinder contents. The third step represents the introduction of a diffusional barrier probably associated with the encapsulation of  $\text{Na}_2\text{SO}_4$  by  $\text{Na}_2\text{SO}_4 \cdot 10\text{H}_2\text{O}$ . The fourth step covers the region in which the solids cease to move relative to the cylinder causing internal heat transport to decline to its lowest level.

#### **Excess Sodium Sulfate:**

A newly identified encapsulation effect operates in the rolling cylinder. Individual crystals of sodium sulfate decahydrate and anhydrous sodium sulfate adhere to one another tenaciously when they come into physical contact. Crystals of decahydrate formed early in the freezing process gather up a surface coating of anhydrous crystals due to this mutual adhesive effect. In turn the anhydrous crystals attract a coating of decahydrate. As the freezing process continues alternating layers of the two types accumulate on each growing crystal until all of the anhydrous sodium sulfate is buried beneath a layer of decahydrate. Since the continuing formation of decahydrate (at constant temperature) is dependent upon the availability of some solid anhydrous sodium sulfate it is likely that the encapsulating effect just described will create a visible resistance to the rate of crystallization at some point in the freezing process. In a cylinder containing stoichiometric decahydrate rotating at 3 rpm and cooling at 80 Btu/hr/sq ft this resistance becomes significant at about 45% frozen. At this point the cylinder outside wall temperature begins to fall rapidly because the combined effects of

solid out-diffusion, water in-diffusion, water in-migration along crystal defects, and crystal-crystal grinding is no longer able to provide access to sodium sulfate at the required rate.

The exact details of when this solution starvation point is reached and the size and population of growing crystals depend strongly on the degree of supercooling at the time nucleation occurs. Larger degrees of supercooling lead to larger and fewer growing crystals with deeper burial of anhydrous sodium sulfate in decahydrate.

It should be pointed out that in a stoichiometric mixture without encapsulation the quantity of anhydrous sodium sulfate, and thus its surface area available for reaction with solution to form new decahydrate approaches zero as the freezing reaction nears completion. Thus another form of anhydrous sodium sulfate starvation can be expected to slow down the completion of the reaction.

Both causes of reactant starvation can be effectively relieved by adding an excess of anhydrous sodium sulfate to the system. Figure 8 shows that at 3 rpm a 25% excess extends the high temperature nominally flat portion of the cylinder outside wall temperature to about 75% theoretical latent heat evolved and also allows the mixture to ultimately release 99.7% of theoretical latent heat. This excess causes about a 10% decrease in volumetric heat storage capacity.

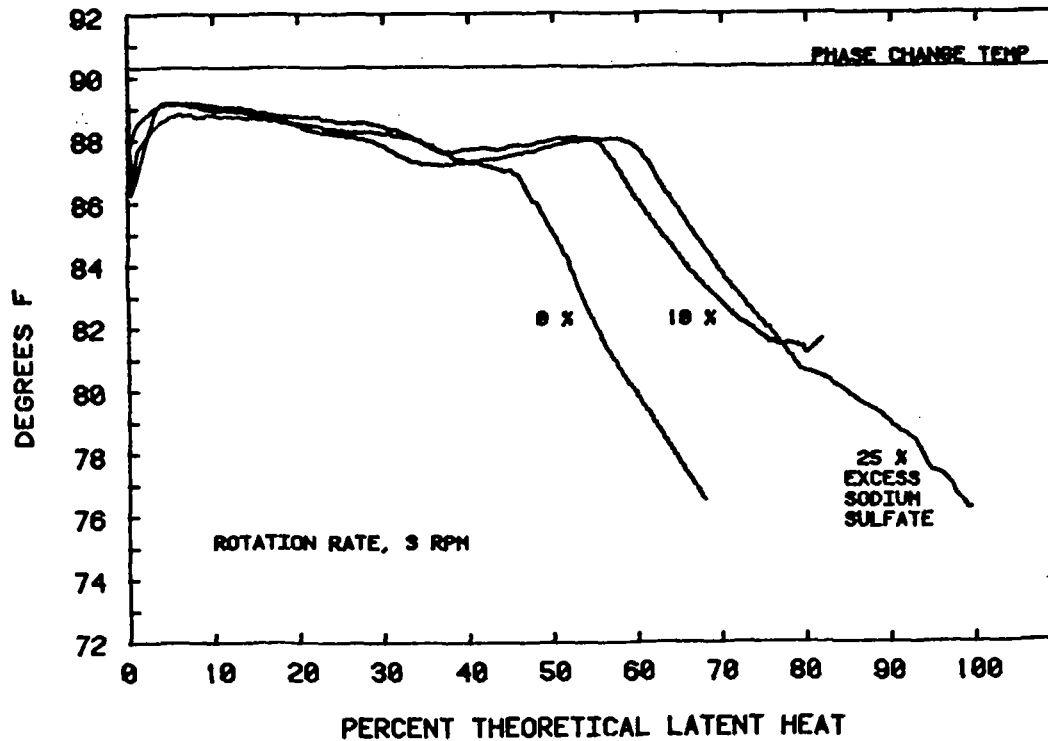

Figure 8 The Effect of Excess Sodium Sulfate on Decahydrate Formation. Cylinder Outside Wall Temperatures for Run 5, 8, 13

**Rotation Rate:**

Cylinder rotation rate determines the amount of stirring and the radial mixing of cylinder contents. The cylinder outside wall temperature is the best indicator of how well this internal mixing is being carried out. It is also probable

that a significant amount of crystal-crystal grinding results from the rotation. Figure 9 shows the effect of changing rotation rate on the outside wall temperature. There is little difference between speeds of 2 and 3 rpm as well as between 5 and 7 RPM. There is certainly an improvement in performance at the two higher speeds and the effect seems highly non-linear. No explanation for this behavior other than crystal-crystal grinding can be offered at the present time. Rotation rates of 2 or 3 RPM may be usable in working storage systems.

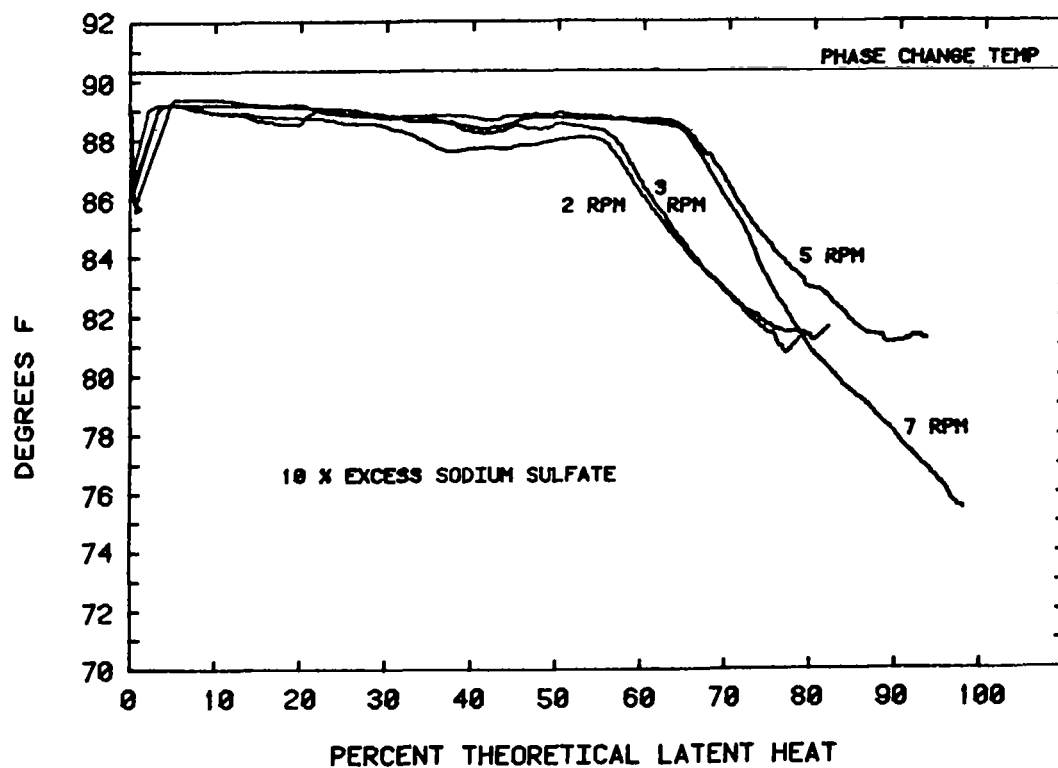

Figure 9 The Effect of Cylinder Rotation Rate on the Outside Wall Temperature

### **Commercial Sodium Sulfate:**

All of the early experiments were done using reagent grade sodium sulfate. Later experiments explored the use of sodium sulfate from four commercial sources, Prior Chemical Company, Ashland Chemical Company, Saskatchewan Chemical Company, and FMC. No differences in behavior were detected. The conclusion is that commercially pure sodium sulfate from most sources will be satisfactory for phase change heat storage in the rolling cylinder.

### **pH:**

Aqueous solutions of sodium sulfate from different sources vary widely in hydrogen ion concentration with reagent grade being acid and commercial grades being usually basic. The effect of pH, if any, on the sodium sulfate decahydrate - sodium sulfate - water system is not known at the present time. pH however is frequently an important variable in many crystallizing systems. To remove the possibility of an uncontrolled variable influencing the experimental results in an unknown way, all sodium sulfate was adjusted to pH 7.0 before use by adding sodium hydroxide or sulfuric acid as appropriate.

### **Melting**

Quantitative measurements of the heat required to melt Glauber's salt were not considered necessary as long as the system continues to yield 100% of the theoretical latent heat (within experimental error) with each refreezing cycle. The melting cycle is quite uneventful but differs somewhat from the refreezing cycle. In cases where refreezing proceeds to 100.0% initial melting produces one large

cylinder of solid which rolls with the rotary motion without causing problems. After a time it separates into the original constituent crystals and re-establishes the same internal flow patterns observed during refreezing.

The melting cycle was usually carried out at about 300 Btu/hr which is 3 times the usual refreezing rate. This high rate was achieved by raising the air temperature flowing over the cylinder. With the 40 mil wall thickness at 10% void space the maximum allowable air temperature was about 140°F. Higher air temperatures caused crystallization of  $\text{Na}_2\text{SO}_4$  adhered to the cylinder wall and should be avoided. Presumably these events occurred in the thin liquid film on the cylinder wall as it rotates past the void space. Reducing the void space should permit even higher air temperatures.

Melting  $\text{Na}_2\text{SO}_4 \cdot 10\text{H}_2\text{O}$  produces solid  $\text{Na}_2\text{SO}_4$  particles in colloidal sizes. Recrystallization of  $\text{Na}_2\text{SO}_4$  occurs rapidly so that the crystals are large enough to re-establish the initial solid-liquid flow pattern by the time the melting cycle is finished.

#### **Axial Solids Transport:**

The behavior of a long thin rolling cylinder when cooling is applied unevenly along its length has an important effect on heat storage system design. If complete freezing occurs at one end of the cylinder first, then moves progressively along the length of the cylinder to the other end, then the cylinder surface area available for heat transfer is reduced by the fraction of storage material frozen. To meet a selected heating load at a high fraction frozen would require a significant increase in storage size (and cost) over that necessary to meet the same load at a low fraction frozen. Uniform freezing would minimize storage size and cost.

In the calorimetry experiments just described where cylinder  $\text{Length/Diameter} = 2$ , the freezing process always occurred uniformly throughout the cylinder. It is possible that in some domestic heating systems  $L/D$  would have a value of 10 or 20. To evaluate the possibility of uniform freezing in such systems the apparatus of Figure 10 was constructed.  $L/D$  was 14. When a step upset was introduced by placing all of the solids at one end of the cylinder the time required to establish equilibrium (at 3 RPM) was always 0.5% of storage discharge time. This rapid equilibration of solids inside the cylinder strongly suggests that cylinders with  $L/D$  ratios as large as 20 or more will freeze uniformly due to the rapid internal heat transport by the axial flow of solids.

In a qualitative demonstration of internal heat transport it proved possible to maintain the Fig. 10 cylinder in a steady state by heating one end while cooling



Figure 10 The Axial Solids Transport Experiment Demonstrated Uniform Freezing in Long Cylinders

the other at approximately 100 Btu/hr/sq ft. The accompanying axial flow of solids was rapid enough that no end to end differences in solids levels could be detected visually.

### **Life Testing:**

Life tests are underway at a rate of one freeze/melt cycle per day, or 5 cycles per week. Freezing conditions (room air) are imposed from 4 pm to 8 am next day then melting conditions from 8 am until completely melted, usually about 2 pm. Normally the cylinders are frozen solid without visible amounts of liquid phase remaining.

Calorimetry is done every ten cycles to document possible changes in freezing performance. At the time this text was prepared more than 150 cycles had been completed. There has been no change in the quantity of latent heat evolved upon freezing which remains at 100%. The ability of the system to freeze completely has not been adversely affected by up to 150 freeze-melt cycles.

### **Summary**

The quantity of heat stored and the heat flow rates achieved have been measured in a laboratory sized rolling cylinder. In general the promises of good performance based on earlier qualitative results have been fulfilled. This report provides a brief summary of the quantitative evidence which has been accumulated to support the following statements concerning the rolling cylinder with Glauber's salt.



- Complete phase change
- Theoretical latent heat release
- Repeatable performance over 150 cycles
- High heat release rates
- High internal heat transfer rates
- High heat exchanger surface temperatures
- Commercial source salts are satisfactory
- Freezing occurs uniformly

### **Conclusion**

The quantitative laboratory scale results suggest that the rolling cylinder will be a high performance low temperature thermal storage device. No technical barriers were discovered to the further development of the rolling cylinder thermal storage device.

### **Acknowledgement**

We thank D. B. Sorenson and B. J. Lederman for advice and assistance with the instrument and computer aspects of this effort. The work described here was partially funded by the United States Department of Energy.



THERMAL ENERGY STORAGE TEST FACILITY

Mark P. Ternes  
Oak Ridge National Laboratory

PROJECT OUTLINE

Project Title: Operation of a TES Test Facility

Principal Investigator: Robert J. Kedl

Organization: Oak Ridge National Laboratory  
P. O. Box Y  
Oak Ridge, TN 37830  
Telephone: (615) 574-0748

Project Goals: Determine the thermal behavior of prototype thermal energy storage units in both heating and cooling modes; develop improved and advanced storage systems, propose performance standards.

Design and build a thermal cycling facility for determining the thermal behavior of full-scale TES units. The facility will have the capability for testing with both liquid and air heat transport, at variable heat input/extraction rates, over a temperature range of 0-280°F. Obtain and test commercial PCM TES systems, design and test improved or advanced systems.

Project Status: Liquid loop design completed and construction started. Design of the air loop has been initiated.

Contract Number: W-7405-eng-26

Contract Period: September 1978 continuing

Funding Level: \$20,000

Funding Source: U.S. Department of Energy  
Division of Energy Storage Systems

## THERMAL ENERGY STORAGE TEST FACILITY\*

Mark P. Ternes  
Oak Ridge National Laboratory  
Oak Ridge, Tennessee 37830

### SUMMARY

Two loops making up the Thermal Energy Storage Test (TEST) Facility, using either air or liquid as the thermal transport fluid, are being designed and developed. These loops will be capable of cycling residential-size thermal energy storage units through conditions simulating solar or off-peak electricity applications to evaluate the unit's performance. To date, the detailed design of the liquid cycling loop has been completed and is expected to be operational in March 1980; the design of the air cycling loop has been initiated.

### DISCUSSION

The Thermal Energy Storage Test (TEST) Facility will be a set of two loops, using either air or a liquid as the thermal transport fluid, capable of cycling both hot and "cool" residential-size thermal energy storage devices through a series of charge and discharge modes which simulate either solar or off-peak electricity TES applications. The TEST facility will be used to (1) independently evaluate the performance of storage systems using testing procedures which simulate working environments under which the system will operate as well as using procedures proposed by ASHRAE and NBS and (2) to provide support in further R&D work related to TES. Total storage capacity, charge and discharge rates, temperature profiles, and pressure drop across the storage device are, among others, the performance characteristics of interest.

Both cycling loops will be capable of fully charging or discharging a residential-size storage unit [52,800 to 528,000 KJ (50,000 to 500,000 BTU)]

---

\*Research sponsored by the Division of Energy Storage Systems, U.S. Department of Energy under contract W-7405-eng-26 with the Union Carbide Corporation.

By acceptance of this article, the publisher or recipient acknowledges the U.S. Government's right to retain a nonexclusive, royalty-free license in and to any copyright covering the article.

capacity] within four hours [required heat rate of 36.6 KW (125,000 BTU/h)]. The liquid loop will have a temperature range of 0°C to 140°C (32°F to 280°F) and will be able to use either water, ethylene glycol, or salt brine as the working fluid at flow rates between 7.6 l/min and 76 l/min (2 and 20 GPM). The temperature range of the air loop will be from 0°C (32°F) to some maximum temperature as yet undetermined. The loops will possess a high degree of versatility and controllability to produce a variety of input conditions called for by the testing procedures; specifically, they will be capable of providing varying temperature, flow rate, and, for the air loop, humidity input schedules in step function, sinusoidal, and stochastic patterns to fully simulate actual conditions and usage of solar and off-peak electricity storage units.

Three feedback loops, one for temperature control, one for flow rate control, and one for humidity control in the air loop, all capable of sensing loop parameters and making adjustments accordingly, will therefore be required. An integral part of these feedback systems will be an LSI-11 computer which will interface between the sensing and control devices; the computer will also serve as the main data acquisition system. Twenty-eight K of core and two floppy disks provide program and data storage, and, furthermore, the mini-computer will be interfaced with a remote computer to provide additional storage and computational capabilities.

The basic piping and instrumentation layout for the liquid loop is shown in Fig. 1. Mixing valve A, functioning with a feedback system initiating from temperature probe D, indirectly diverts the necessary amount of return liquid through either of the thermostated liquid holding tanks, as determined by valve B, and thereby reconditions the working fluid to its required inlet temperature. The loop flow rate will be monitored by a turbine flow meter C, which also feeds back information to the loop flow control valve E. Platinum resistance temperature probes, capable of measuring temperature to within a few tenths of a degree F, will be placed throughout the loop as well as in the storage device itself in sufficient quantity to effectively evaluate the storage system performance and to monitor the loop dynamics. Pressure differential cells complete the major instrumentation requirements of the loop. The air loop will be similar to the liquid loop in its basic layout, control systems, and instrumentation, with the additional requirement of measuring and controlling humidity.

The detailed design of the liquid cycling loop has been completed, and all the instrumentation has been ordered. Specifications for the major loop components (tanks and pump) are currently being prepared, and their procurement will then follow. The LSI-11 computer is on hand. It is expected that the loop will be operational in March 1980. The design of the air cycling loop has been initiated.

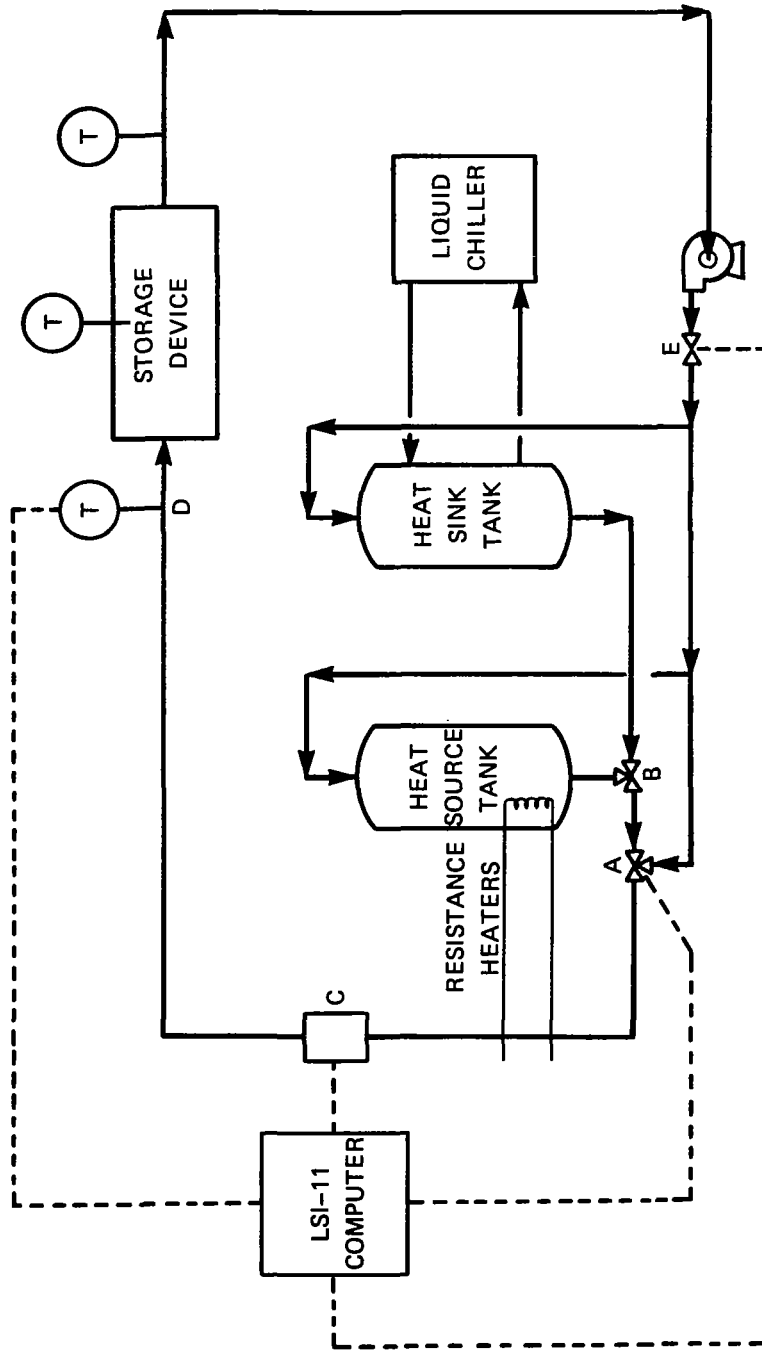

Fig. 1. Thermal Energy Storage Test Facility (Liquid Transport)

MATHEMATICAL MODELING OF MOVING BOUNDARY PROBLEMS IN  
THERMAL ENERGY STORAGE

A. D. Solomon  
Union Carbide Corporation

PROJECT OUTLINE

Project Title: Mathematical and Physical Modeling for TES Subsystems

Principal Investigator: A. Solomon

Organization: Oak Ridge National Laboratory  
Building 9704-1  
P. O. Box Y  
Oak Ridge, TN 37830  
Telephone: (615) 574-8696

Project Goals: Develop capability for predicting the performance of TES subsystems and components using PCM's based on mathematical and physical models.

Develop mathematical models of the dynamic thermal behavior of TES subsystems using PCM's based on solutions of the moving boundary thermal conduction problem and on heat and mass transfer engineering correlations.

Design, construct, and operate small-scale experiments to provide data for testing and improving the mathematical models.

Project Status: Mathematical model based on conduction in any module geometry has been completed. Physical model in slab geometry has been operated in conduction mode and natural thermal convection mode.

Contract Number: W-7405-eng-26

Contract Period: January, 1979 to October, 1980

Funding Level: \$85,000

Funding Source: U.S. Department of Energy  
Division of Energy Storage Systems

Project Title: Mathematical Modeling of Moving Boundary Problems in Thermal Energy Storage\*

Principal Investigator: A. D. Solomon

Organization: Union Carbide Corporation  
Nuclear Division  
P.O. Box Y, Bldg. 9704-1  
Oak Ridge, Tennessee 37830

Telephone: 615/574-8696

Project Objectives: To develop and apply computer and mathematical models in support of the thermal energy storage program, emphasizing their application to the moving boundary problem in phase change processes for Latent Heat storage.

Technical Progress: 1978-79

a) The Program TES

The computer program TES simulating the behavior of a phase change process in a single PCM body went through its final stages of development and validation. The program, applicable in slab, cylinder and spherical geometries, was applied to a broad family of problems, and its accuracy and validity tested wherever possible. A complete documentation is appearing in the form of a Union Carbide Report, No. CSD-51 [14].

b) Other Computer Codes

A number of additional codes have been prepared for situations not suited for TES, and as means for verifying the TES results. These include a multi-component version of TES, which is to be documented during the present year, and other codes for multidimensional phase change, radiation boundary conditions, and other cases. The methods upon which these codes are based, vary, so as to serve as additional validation tools for each other.

c) Comparison with Experiment

Comparisons of the results of various models with the experimental results of R. Deal have been undertaken [7]. This work has led to questions of the accuracy of inverse problem estimates (e.g. of the heat transfer coefficients and the conductivity) [11], and the development of additional support codes. An example of the use of a support

---

\*Research sponsored by the Division of Basic Energy Sciences and the Division of Energy Storage Systems, U.S. Department of Energy under contract W-7405-eng-26 with the Union Carbide Corporation.



code is given in figure 1, where a two dimensional code was used to judge the effect of the plexiglass wall in the experiment.

d) Scoping of Physical Processes

Numerical and analytical models were used for a number of scoping exercises including a PCM wall simulation [5] and a temperature cycling process for a Glaubers salt chub [13].

e) Development of Computable Analytical Models

A number of models extending earlier reported models for melt time of a simple body [3] and melting of a slab [9] were developed. These include a model of a convection surface heat transfer process [4].

f) Computing Considerations

In the course of validating TES and other programs, a number of questions related to their practical use arose. These were studied in [12], [15], and relate to the question of how to know if the results obtained from a phase change simulation scheme are actually correct.

g) Natural Convection Modeling

Experiments were made and rough comparisons carried out with analytical and numerical models for processes which include natural convection of the melt [1]. This work is to continue during the present year.

h) Other Support Activities

Other, more peripheral activities performed during the last year included the preparation of a survey paper on the mathematics of latent heat thermal energy storage processes [6], participation in the preparation of a bibliography of this area [16], and others ([2], [8], [10]).

HEATING PLATE-TEMPERATURE = 60 °C

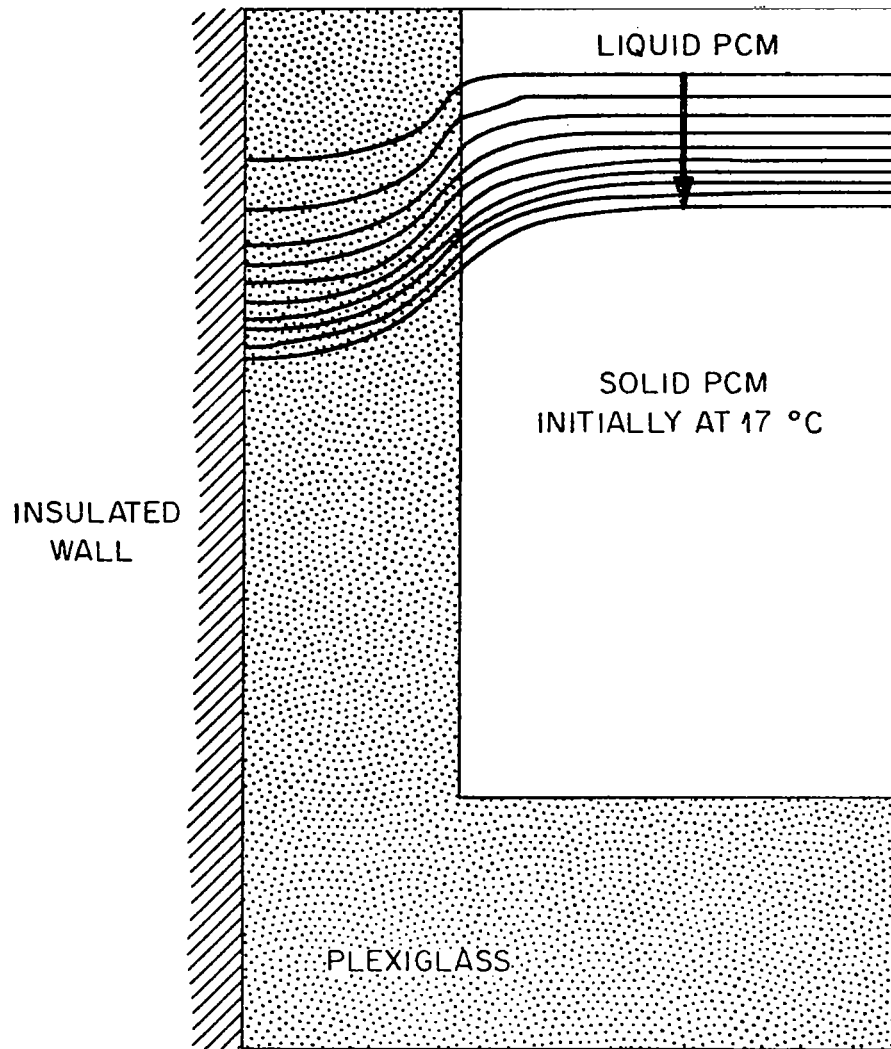

H  
0.4 cm

28° Isotherms in the N-Octadecane Paraffin Wax PCM and the Plexiglass Wall, at Time Intervals of 1200 sec.

## REFERENCES

1. M. Makarewicz, W. Cheng and J. Nwalor, Heat transfer characteristics of phase-changing materials, Oak Ridge National Laboratory, Report No. ORNL/MIT-286, February, 1979.
2. A. Solomon, The applicability and extendability of Megerlin's method for solving parabolic free boundary problems, pp. 187-202 in the Symposium and Workshop on Moving Boundary Problems, ed. D.G. Wilson, A. Solomon and P. Boggs, Academic Press, New York, 1978.
3. A. Solomon, Melt time and heat flux for a simple PCM body, Solar Energy 22 (1979), 251-257.
4. A. Solomon, A relation between surface temperature and time for a phase change process with a convective boundary condition, Letters in Heat and Mass Transfer 6 (1979), 192-200.
5. A. Solomon, Design criteria in PCM wall thermal storage, Energy (1979), to appear.
6. A. Solomon, Mathematical modeling of phase change processes for latent heat thermal energy storage, Union Carbide Corporation, Computer Science Division, Report No. CSD-39, 1979.
7. A. Solomon and R. Deal, Model/experiment comparisons for TES in phase change materials, Proceedings of the 72nd AIChE Annual Meeting, San Francisco, California, November, 1979.
8. A. Solomon, On modeling for moving boundary problems, Proceedings of the workshop on solar energy storage, Panjab University, Chandigarh, India, 1979 (to appear).
9. A. Solomon, An easily computable solution to a two-phase Stefan problem, Solar Energy 24 (1980), to appear.
10. A. Solomon, On moving boundary problems and latent heat thermal energy storage, Israel Journal of Chemical Engineering, to appear.
11. A. Solomon, On a phase-change process with a convective boundary condition, SIAM Journal of Applied Mathematics, submitted for publication.
12. A. Solomon, On surface effects in heat transfer calculations, Computers and Chemical Engineering, submitted for publication.
13. A. Solomon, A simulation study of a single Glaubers salt chub, Solar Energy, submitted for publication.

14. A. Solomon and C. Serbin, TES-A program for simulating phase change processes, Union Carbide Corporation, Report No. ORNL/CSD-51, December, 1979.
15. A. Solomon and D.G. Wilson, A note on the choice of the mesh size for heat transfer calculations, Letters on Heat and Mass Transfer, to be submitted for publication.
16. D.G. Wilson, A. Solomon and J. Trent, A bibliography on moving boundary problems with key word index, Union Carbide Corporation, Report No. CSD-44, 1979.

## CRAWL SPACE ASSISTED HEAT PUMP

Mark P. Ternes  
Oak Ridge National Laboratory

### PROJECT OUTLINE

Project Title: Technology Development of Earth Storage

Principal Investigator: M. P. Ternes

Organization: Oak Ridge National Laboratory  
P. O. Box Y  
Oak Ridge, TN 37830  
Telephone: (615) 574-0749

Project Goals: Develop technology and demonstrate systems for utilizing heat stored in undisturbed earth for improving the performance of heat pumps.

Carry out laboratory-scale experiments to measure the apparent thermal conductivity of undisturbed earth under unsteady state conditions and at high moisture contents. Construct and operate field experiments to determine heat transfer and recovery capacity of undisturbed earth under residential buildings (crawl space) and its effect on the performance of heat pumps for both heating and cooling.

Project Status: Laboratory-scale experiment in operation. Field study in a residential crawlspace was initiated.

Contract Number: W-7405-eng-26

Contract Period: January, 1979 to October, 1980

Funding Level: \$5,000

Funding Source: U.S. Department of Energy  
Division of Energy Storage Systems

## CRAWL SPACE ASSISTED HEAT PUMP\*

Mark P. Ternes  
Oak Ridge National Laboratory  
Oak Ridge, Tennessee 37830

### SUMMARY

A variety of experiments and simulations are currently being designed or are underway to determine the feasibility of conditioning the source air of an air-to-air heat pump using stored ground heat or "cool" to produce higher seasonal COP's and net energy savings. The ground would condition ambient air as it is drawn through the crawl space of a house. Tests have been designed to evaluate the feasibility of the concept, to determine the amount of heat or "cool" available from the ground, to study the effect of the system on the heating and cooling loads of the house, to study possible mechanisms which could enhance heat flow through the ground, and to determine if diurnal temperature swings are necessary to achieve successful system performance. All studies are currently operating or will be operational by the end of 1979.

### DESCRIPTION

Higher seasonal COP's and output capacity, accompanied by large energy savings, can potentially be realized by conditioning the outside air delivered to an air-to-air heat pump. The concept to be considered is a crawl space assisted heat pump where the air is conditioned by stored earth heat or "cool" as it is drawn through the crawl space of a house. A schematic representation of this concept is shown in Fig. 1.

In 1977, a graduate student at The University of Tennessee conducted a field experiment at a private residence in Oak Ridge, Tennessee, with the heat pump operating in the above mode during the winter season and observed

---

\*Research sponsored by the Division of Energy Storage Systems, U.S. Department of Energy under contract W-7405-eng-26 with the Union Carbide Corporation.

By acceptance of this article, the publisher or recipient acknowledges the U.S. Government's right to retain a nonexclusive, royalty-free license in and to any copyright covering the article.

that significant increases in air temperature were, in fact, achieved. A number of questions remained which need to be answered, however, before the feasibility and general applicability of the concept can be assured; it is unresolved whether the temperature increase of the air was due to heat addition from the ground or, rather, due to conduction and/or air exfiltration through the floor of the house, and thus the possible effects of the system on the heating and cooling loads of the house are unknown. It is also uncertain what tradeoffs were involved if the temperature change was partially due to house heat losses and partially due to ground heat addition. If the earth in an enclosed space can, indeed, supply a significant quantity of heat to air flowing above it, then further studies of the heat transfer and storage characteristics of the earth become of interest; namely, whether the required heat flux through the soil and to the air is explainable by simple conduction and convection of earth heat, whether the heat flow rate through soil can be enhanced by moisture diffusion induced by temperature gradients, and whether diurnal temperature swings effectively "charge" the upper-most layer of the earth during the daytime. Three separate areas of investigation are underway to address these questions.

The first investigation consists of a field test of a second house modified such that ambient air is drawn through the crawl space and delivered to the heat pump. It is similar to the initial field test except that additional instrumentation is being utilized. The objective of this second field test is to reaffirm the feasibility of the concept as well as to record and understand the transient characteristics and responses of the crawl space. A plastic moisture barrier will cover the earth surface to prevent moisture evaporation. Crawl space air temperatures, ground surface temperatures, and earth temperatures 0.15 m (6 in.) below the surface will be continuously recorded using a 12-point Honeywell recorder and type K thermocouples. An event recorder will also be used to monitor the defrost cycles of the heat pump. Figure 2 shows a schematic of the crawl space and the thermocouple locations.

The second investigation will consist of measuring the temperature rise of ambient air drawn by portable fans through two specially built insulated ducts located in the crawl space of an experimental control house being used in conjunction with energy conservation projects at ORNL. A plan view is shown in Fig. 3. Three sides of the duct will be formed of closed cell polystyrene sheeting 0.30 m (12 in.) thick, with the remaining side being open to the ground. The fan will be cycled through different "on/off" sequences with the use of a 24-hr timer to simulate actual heat pump operation. Two ducts will be used — one with a plastic moisture barrier on the earth surface and the other without — to gain a quantitative understanding of the different heat transfer mechanisms occurring in soil. With all joints in the ducts carefully sealed, the ducts will be thermally isolated from the house as well as the crawl space, and thus any temperature rise resulting from air flowing through the ducts will be due solely to heat addition from the ground. It will, therefore, be possible to determine directly the amount of useful heat available from the ground and, from comparisons with field experiments, it will be possible to determine the source(s) of the heat gains experienced in actual field operation. Moreover, questions concerning the necessity of diurnal

temperature swings and the impact of the system on the house environment will both be partially addressed. Duct temperatures, ground surface temperatures, and earth temperatures 0.15 m (6 in.) deep will be continuously recorded using a 12-point Honeywell recorder and type T thermocouples; additionally, air velocity, wet-bulb temperatures, and soil moisture content will be measured periodically.

The third investigation will address two issues partially addressed beforehand: specifically, the effect of diurnal temperature swings on the thermal conditions of the ground and the effect of moisture diffusion on the heat transfer characteristics of soil. Mathematical and computer modeling techniques are being employed to determine the storage and recovery capabilities of the earth when exposed to cyclic temperatures and to evaluate the effectiveness and importance of the temperature swings in charging the earth system during the daytime. The enhancement of soil heat transfer is being studied in a 0.61 m (2 ft) square box 0.30 m (1 ft) high, capable of maintaining a constant free surface water level in the soil test section and an imposed heat flux through the bottom. Temperatures are measured throughout the box using type K thermocouples and three Honeywell recorders; moisture content is monitored using fiber glass encased moisture probes. A schematic of the testing device is shown in Fig. 4.

#### STATUS

The heat pump modifications have been made for the second field test, and data acquisition has begun. Preliminary results show that for ambient air at 0°C (32°F) and ground surface temperatures of 10.6°C (51°F), air was delivered to the heat pump at 5.0°C (41°F). Acquisition of materials and instrumentation for the duct experiment is underway, and it is expected that the ducts will be constructed and operational by the end of 1979. To date, the effective thermal conductivity of wet clay as measured in the thermal conductivity experiment has been found to be 1.21 W/m °C (0.7 Btu/h ft °F) which conforms with literature values, and thus no significant heat transfer enhancement has been found.



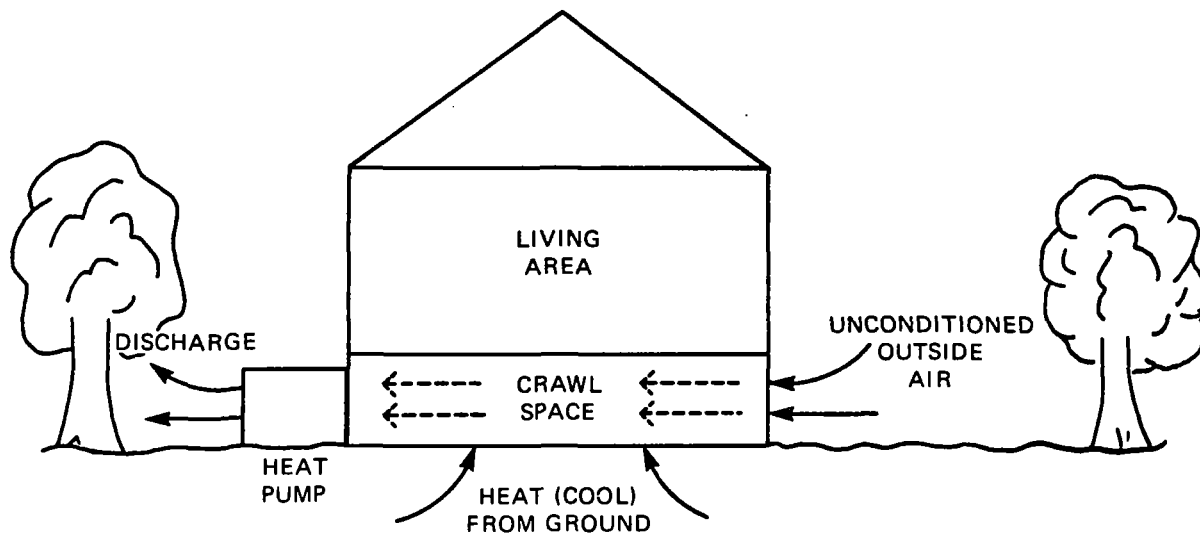

Fig. 1. Crawl Space Assisted Heat Pump

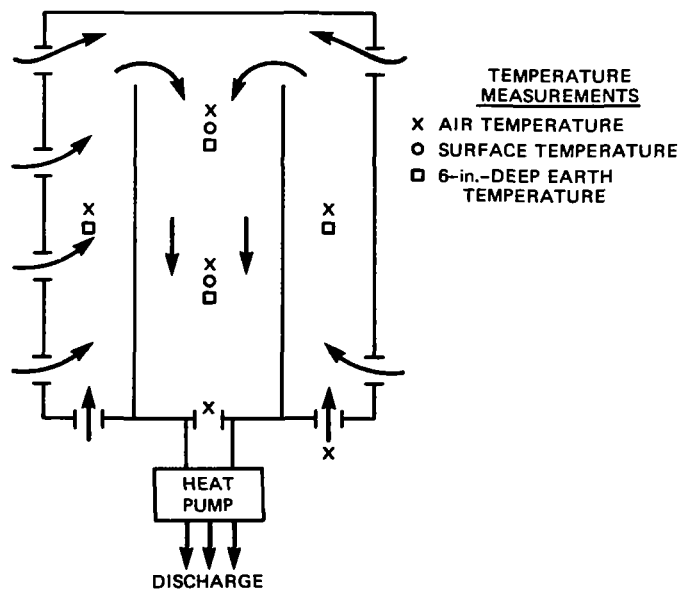

Fig. 2. Field Test Configuration

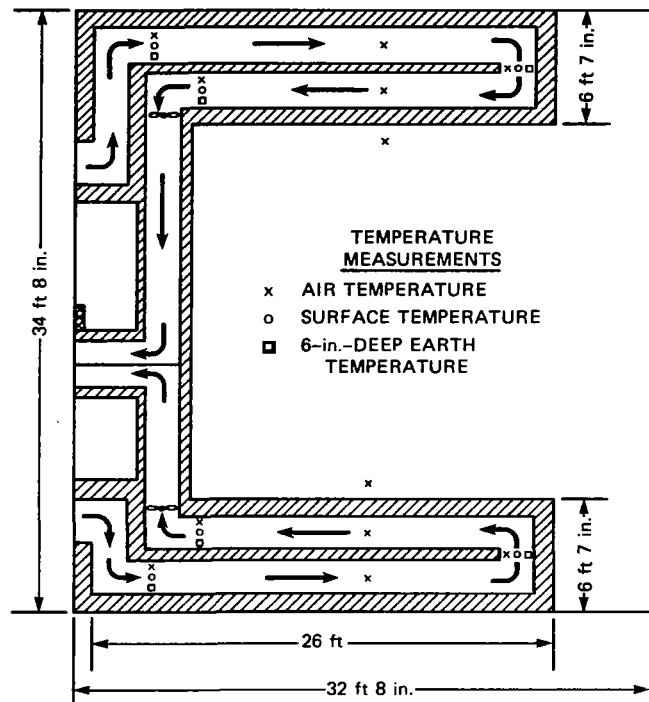

Fig. 3. Plan View of the Duct Experiment

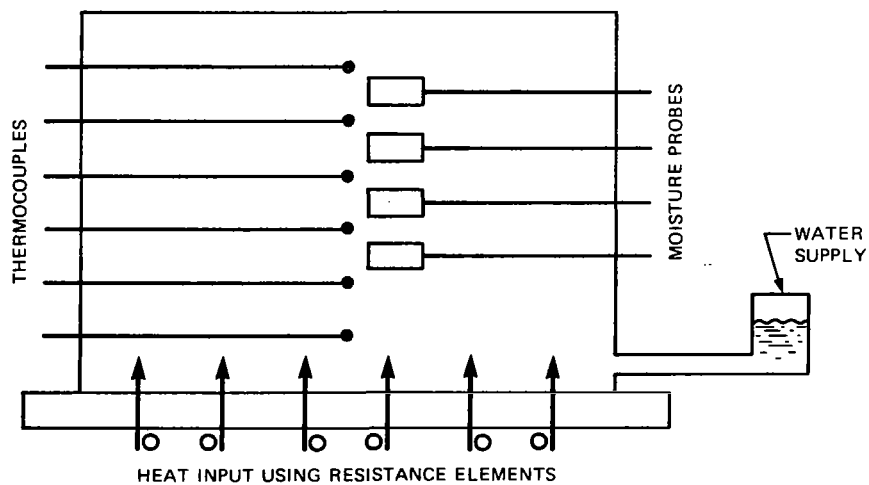

Fig. 4. Thermal Conductivity Testing Device

LIFE AND STABILITY TESTING OF PACKAGED LOW-COST  
ENERGY STORAGE MATERIALS

Galen R. Frysinger  
University of Delaware

PROJECT OUTLINE

Project Title: Life and Stability Testing of Packaged Low-Cost Energy Storage Materials

Principal Investigator: G. R. Frysinger

Organization: Institute of Energy Conversion  
University of Delaware  
One Pine Creek  
Wilmington, DE 19808  
Telephone: (302) 995-7155

Project Goals: Verify package integrity of the "chub" packaged materials system for storage of coolness with application to residential air conditioning; verify life and stability of packaged material by cycling and performance testing.

Determine that the moisture vapor retention characteristics of laminate film developed by DuPont is satisfactory for long-term chub performance. Determine stability, mechanical integrity, and thermal performance of chubs following mechanical shock, vibration, and temperature extremes. Carry out thermal performance tests of chubs following accelerated and diurnal thermal cycling.

Project Status: Activity has been completed. Based on acceptable moisture retention data, a thin film laminate was selected for the chubs. A 204-lb batch of chubs was cycled 405 times on an accelerated schedule. After cycling the heat of fusion was about 70 BTU/LB based on a 30°F temperature swing.

Contract Number: UCC 7585

Contract Period: September 1978 to November 1979

Funding Level: \$146,000

Funding Source: Oak Ridge National Laboratory

PROJECT SUMMARY

Project Title

"Life and Stability Testing of Packaged Low-Cost Energy Storage Materials"

Name of Contractor:

Institute of Energy Conversion  
University of Delaware  
Newark, Delaware 19711

Name of Principal Investigator:

Dr. Galen R. Frysinger, Manager, Energy Systems

Current Contract Period:

September 1, 1978 - September 30, 1979

Objective:

The package integrity of the "CHUB" packaged materials was tested to experimentally verify the ability of the package to retain the moisture within the salt mixture. The life and stability of the packaged material was verified by thermal cycling and performance measurement.

Project Status:

Final report was submitted to Department of Energy on September 25, 1979, in draft form for review. Expected to be available for public distribution in early 1980.

Funding Level:

\$146,000.00

Funding Source:

Department of Energy, Division of Energy Storage Systems.

### Concept of Thermal Energy Storage System

The "CHUB" (see first illustration) low-cost thermal energy storage component has a wide range of applications as an air stream integral heat exchange/storage unit. The second illustration indicates examples of storage assisted air conditioning and heat pump applications which make effective utilization of off-peak electrical power for heating/cooling thus saving the utility fuel and generation facility costs. The "CHUB" may also be used with active air solar collector systems for daytime storage of heat to provide extended house heating during periods of no solar insolation. Likewise, as a passive solar system, the "CHUBS" can be directly irradiated by solar energy, thus storing the thermal energy for later use within the dwelling. The "CHUBS" also can be used to store heat in the dwelling to increase the thermal mass by phase change transition.

The application which is closest to commercialization integrates the thermal energy storage with a conventional air conditioner providing the capability of using off-peak electrical power for residential cooling. The daily house heat gain is removed into thermal storage. The heat is rejected at night by the air conditioner using off-peak (lower cost electricity), the heat being more efficiently rejected against the lower outside ambient temperature. The thermal energy storage capacity is thus renewed to absorb the next day's heat gain. The net result from the utility's point of view is that the air conditioning compressor's electrical demand is shifted from the daytime hours to nighttime hours where the utility load demand is reduced.

### CHUB Qualification

The qualification of the "CHUB" thermal energy storage component by the University of Delaware, with the assistance of the Du Pont Company, was the objective of this contract from 1 September 1978 to 30 September 1979. Based on extensive laboratory verification of moisture vapor retention, a thin film laminate was specified having the characteristics required for successful containment of the Glauber's salt (sodium sulfate decahydrate) thermal energy storage materials over an operating life of 10-15 years. Significant test quantities of the qualified "CHUBS" were prepared at a

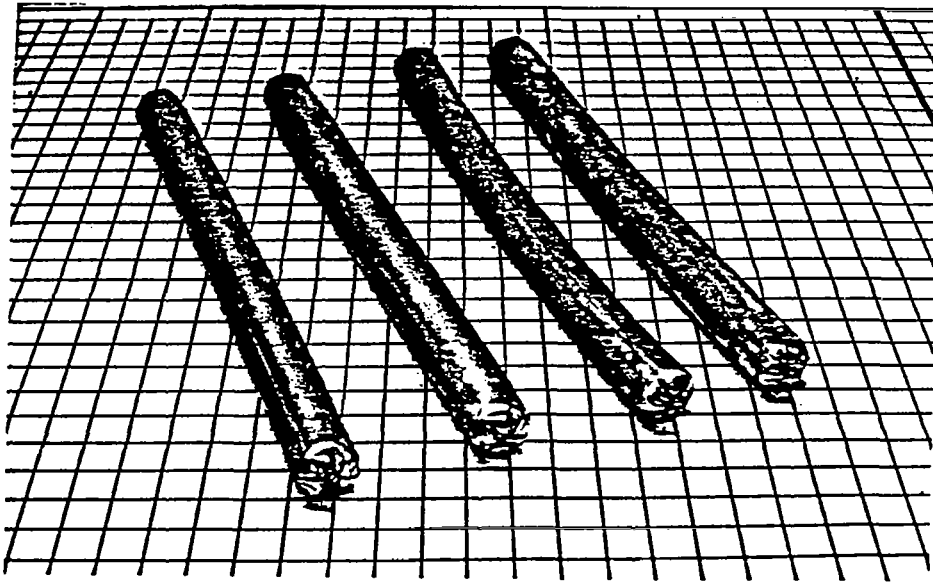

**Chub Applications**

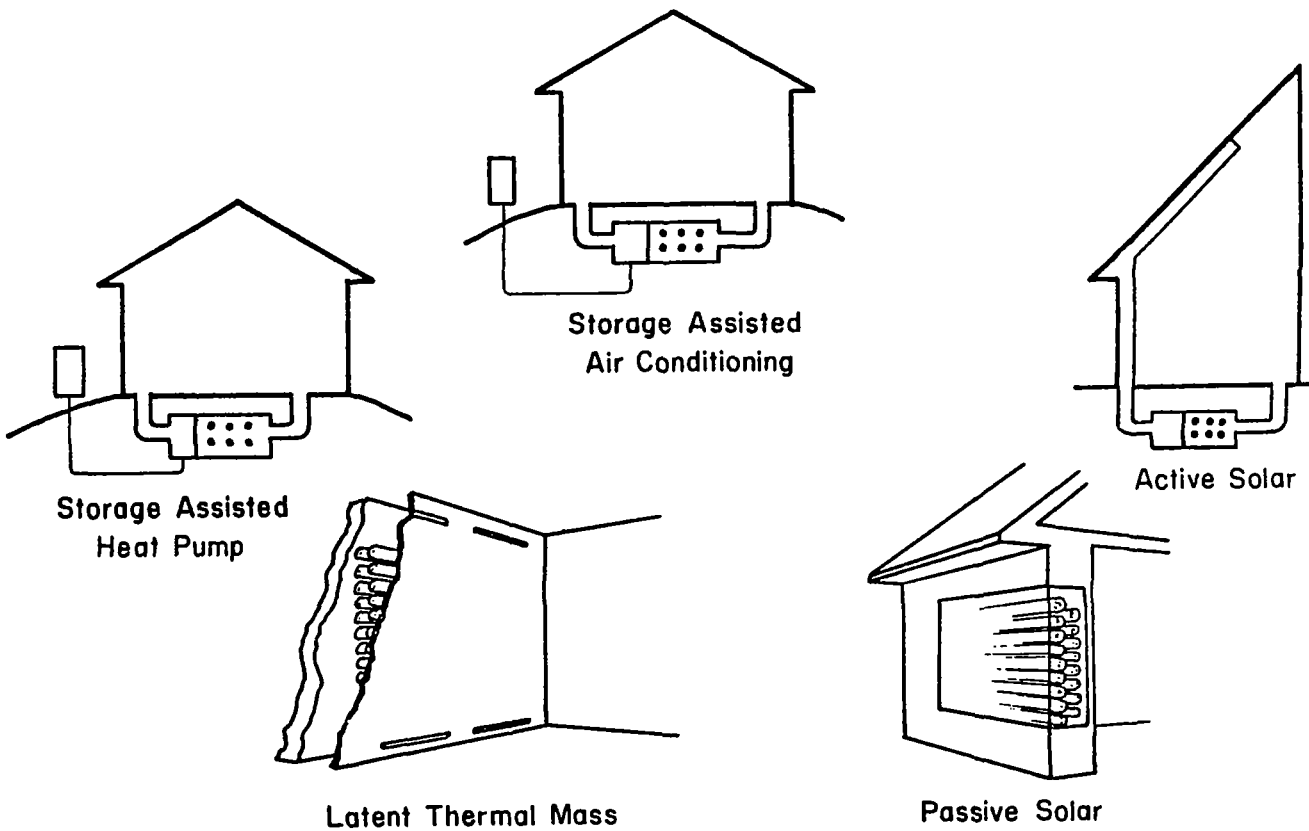

prototype fabrication facility set up and operated at the University of Delaware in June 1979. The "CHUBS" produced at this facility met and exceeded the moisture vapor retention characteristics determined in earlier laboratory testing. The thin film plastic laminate (4 mils) is capable of retaining the thermal energy storage mixture so that extrapolated room temperature weight loss is only about 0.92% in ten years, corresponding to a theoretical efficiency reduction due to water loss of only 2.0% over this operating period. The packaging was shown to be capable of meeting fabrication quality assurance standards, as well as the package integrity tests required to ensure viability during field handling and use. The laminate specified has been shown to be successful as a thermal energy storage packaging material capable of being used in high-speed machinery from the food processing industry for the commercial packaging of the "CHUBS". With the availability of the "CHUBS" from the University of Delaware's prototype fabrication facility in June 1979, long-term performance testing of the packaged thermal energy storage materials was possible. This was initiated and extended through the duration of the contract to verify packaging integrity and also to obtain significant long-term performance data for the Glauber's salt behavior. Heretofore, this performance data analysis had been obscured because of the deficiencies of previously used commercial-type packaging. Laboratory results had given indication of performance but without the realistic field containment methods and a stabilization of the long-term moisture balance changes, the data were erroneous because they were taken on a constantly changing composition. Since the "CHUB" packages eliminate this problem, the results from the present tests should have significantly increased validity.

The daily cycle tests and the accelerated tests (six cycles per day) initiated with the availability of the qualified material in June 1979 have led to preliminary results verifying long-term performance behavior. The performance after 400 cycles was verified before the completion of the contract work period at the end of September. Air calorimeter tests indicated a total thermal energy storage capacity at the end of 405 cycles of 70-75 Btu's per pound which includes contributions for specific heat over the normal operating range of 30°F and the latent heat at the transition point.





EVALUATION OF THERMAL ENERGY STORAGE FOR THE PROPOSED  
TWIN CITIES DISTRICT HEATING SYSTEM

Charles F. Meyer  
General Electric Company - TEMPO

PROJECT OUTLINE

Project Title: Twin Cities District Heating, Thermal Energy Storage Study

Principal Investigator: C. F. Meyer

Organization: General Electric Company - TEMPO  
816 State Street  
P. O. Drawer QQ  
Santa Barbara, CA 93102  
Telephone: (805) 965-0551

Project Goals: Evaluate the technical and economic feasibility of incorporating thermal energy storage components (primarily based on the annual cycle) into the proposed Twin Cities District Heating (DH) Project.

Review technical status of the Twin Cities Project, including work done by Studsvik AB. Prepare a conceptual design of one or more DH systems which are comparable but include TES as an integral part of the design. Compare the DH systems with and without TES in terms of estimated capital requirements, fuel consumption, delivered energy cost, and environmental aspects.

This activity has been completed. Potential benefits are found to be substantial, including energy conservation, favorable economics, and reduced air and thermal pollution.

Contract Number: Union Carbide Contract No. 7604

Contract Period: September 1978 - July 1979

Funding Level: \$135,000

Funding Source: U.S. Department of Energy  
Division of Energy Storage Systems

## PROJECT SUMMARY

Title: Evaluation of Thermal Energy Storage for the Proposed Twin Cities District Heating System

Principal Investigator: Charles F. Meyer

Organization: General Electric Company—TEMPO  
Center for Advanced Studies  
P.O. Drawer QQ  
Santa Barbara, California 93102  
Telephone: (805) 965-0551

Project Objectives: To evaluate the technical and economic feasibility of incorporating thermal energy storage components (primarily based on the annual cycle) into the district heating system proposed for the Minneapolis-St. Paul metropolitan area.

Project Status: Completed. Final report submitted July 1979 (ORNL/Sub-2604-2; GE79TMP-44).

The net energy savings of the proposed cogeneration/district heating system without TES are impressive. When TES is used, the net energy saved is found to be 2 to 14 percent greater, in spite of heat lost during storage, with fuel cost savings of \$14 to \$16 million per year. Reduction of air and thermal pollution are concomitant benefits. The capital investment requirements for boilers, cogeneration equipment, and transmission pipelines might be reduced by \$66 to \$122 million. The breakeven capital cost of aquifer TES is found to be from \$43 to \$59 per peak thermal kilowatt input to or withdrawal from storage.

Contract Number: UCC 7604

Contract Period: August 1978 - July 1979

Funding Level: \$133,744

Funding Source: U.S. Department of Energy, Division of Energy Storage Systems, via Oak Ridge National Laboratory.

## PURPOSE

TEMPO studies beginning in 1972 have shown that thermal energy storage (TES) in aquifers could greatly improve the opportunities for conserving substantial amounts of energy (with concomitant reduction in environmental pollution) through large-scale cogeneration (Meyer, Hausz, et al, 1976). If large-scale annual-cycle TES were available, it could solve the mismatch problem which limits the amount of cogenerated heat for which a market can be found. The mismatch problem arises because electricity must be generated in instantaneous response to demand (no feasible way to store electricity is available); and demands for heat seldom correspond to electric generation in time, location, or magnitude. The largest potential market for cogenerated heat is space heating — an annual-cycle load — served by district heat.

Comparing the capital requirements and fuel consumption of a specific cogeneration/district heating system which does not include TES to those of a system with TES, serving identical loads, provides a measure of the value of the TES.

## BACKGROUND INFORMATION

A major series of studies have been undertaken to evaluate the feasibility of installing a new, large district heating (DH) system in the Minneapolis-St. Paul metropolitan area. It would be based upon cogeneration of power and heat by Northern States Power. Among the leading sponsors and participants in the studies are the Minnesota Energy Agency, Northern States Power Company, and DOE/ORNL. Also participating are several other governmental agencies, utilities, universities, and a number of contractors and consultants.

The proposed new DH system would not send out steam, as is the universal practice in large DH systems in the United States, but hot water, as is the common practice in Europe. A Swedish firm, Studsvik Energiteknik AB, under a DOE/ORNL contract beginning in 1977, prepared a general description of the system and analyzed its economic feasibility, based upon their experience with European systems (Karnitz and Rubin, 1978; Jaehne, et al, 1979; Margen, et al, 1979a, 1979b).

Supplying space heating, tap water, air conditioning (absorption cycle), and low-temperature industrial process heat needs from a central source is a more efficient way to use fuel than to burn it in many small furnaces and boilers. A particularly efficient central source is a plant cogenerating power and heat.

The configurations proposed by Studsvik for a Twin Cities DH system did not include TES except that incidental to use of large hot-water pipelines: hot water has a high energy density, compared to steam, and the DH system has significant thermal inertia.

## PROJECT DESCRIPTION

### District Heating System Proposed by Studsvik

Figure 1 shows an annual load duration curve for space heat and hot tap water for the Twin Cities DH system after 20 years of buildup. The area houses about one million people. Two scenarios were developed by Studsvik. Only Scenario A

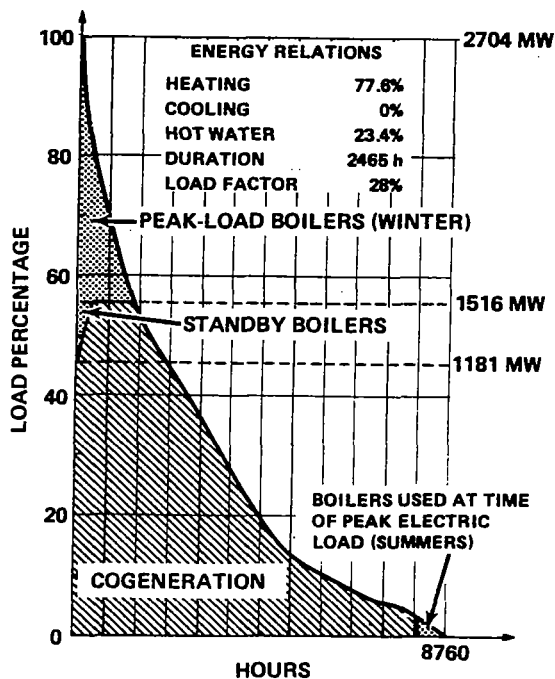

Figure 1. Annual load duration curve for space heat, hot tap water, and pipeline losses, showing load split between cogeneration and heat-only boilers. (After Studsvik)

will be discussed here. It restricts DH to the downtown and industrial/commercial areas and the dense residential areas. Heat load densities vary from 20 MW/km<sup>2</sup> (50 MW/mi<sup>2</sup>) to more than 70 MW/km<sup>2</sup> (180 MW/mi<sup>2</sup>). The peak coinciding consumer load is slightly more than 2600 thermal megawatts and heat loss from pipelines is about 83 thermal megawatts; 100-percent load on the vertical scale of Figure 1 thus corresponds to about 2700 thermal megawatts. The DH base load supply is from cogeneration plants, which would provide about 56 percent of the required thermal capacity but close to 90 percent of the thermal energy production.

During wintertime peak heat load conditions, 1188 MW of boiler capacity would be required in addition to 1516 MW of total heat production capacity of cogeneration plants. For reliability, the largest cogeneration plant, 335 thermal megawatts, is discounted and equivalent standby boiler capacity is added, bringing the total permanent boiler capacity to 1523 thermal megawatts. (Temporary, portable boilers would also be used, during the DH system buildup stage, until hot-water pipelines reach all heat-load areas.)

The cogeneration heat production capacity is obtained from a total of eight turbines, of which six are existing machines at two Northern States Power Company stations and two would be added. Initially, the newest three of the six existing turbines would be converted from single-purpose to extraction machines by connecting a steam pipe with appropriate regulating valves to the crossover steam line between the intermediate- and low-pressure turbines. These connections and appropriate heat exchangers would provide hot water at the DH sendout temperature of

about 146°C (295°F), with a total capacity of 727 thermal megawatts. Next, a new backpressure turbine of 110 MW thermal capacity would be added, using an existing boiler and building space. A few years later, the oldest three of the existing turbines would be converted, to supply 344 MW of heat extraction. The backpressure machine and the three older machines would supply 88°C (190°F) water, with a total capacity of 454 MW. This intermediate-temperature water would be heated to sendout temperature (146°C) by passing it through the heat exchangers of the three larger machines, achieving a two-stage heating process to improve thermodynamic efficiency. The eighth and final cogeneration unit, to be installed after the DH system has reached nearly full growth, would add 335 MW of thermal capacity, bringing the total cogeneration heat production capacity to 1516 MW.

For the main transmission pipeline, a design sendout temperature of 146°C (295°F) was chosen because it can be obtained from the natural point of steam extraction from converted turbines. A lower design temperature would not decrease the amount of electrical generation sacrificed. The nominal return temperature is 60°C (140°F) for the coldest day.

The two-way transmission system (sendout and return) for Scenario A is shown diagrammatically in Figure 2. The total length of dual pipeline is about 50 km (30 miles). For Scenario A, the transmission network terminates at 29 nodes, indicated by dots in Figure 2. At these points, the distribution subsystem is connected to the transmission system, via heat exchangers. The distribution subsystem operates at a temperature of 130°C (266°F), to permit the use of prefabricated pipes. Auxiliary peak-load and standby boilers are located at the nodes, to allow the transmission pipelines to be sized to transport only cogenerated heat — roughly half the peak load. This approach to siting permits the boilers to act as reserve units not only for cogeneration units but also for transmission pipeline outages. It is recognized that suitable sites may not be found for all boilers and adjustments will be necessary in a detailed network design. (The same reasoning is followed for siting TES; Heat Storage Wells would be located at the nodes.)

Figure 2. Hot-water transmission network for Scenario A.  
(Source: Studsvik)

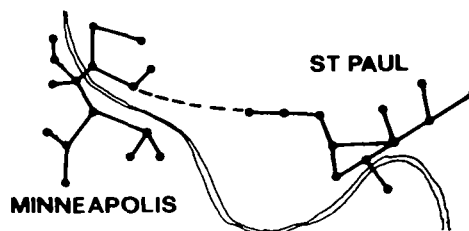

Table 1 shows the estimated capital investment costs for the three subsystems of the reference (Studsvik) cogeneration-DH system that may be affected by use of aquifer TES: the cogeneration capacity, the boilers, and the transmission pipelines. The total cost of cogeneration plant is divided into components which are of interest when TES is included in the system. Studsvik treats the cost of the new 110 MW backpressure turbine as zero for the following reasons: it will be installed in building space vacated some time ago, and matched to an existing boiler; a cost estimate of \$12 million (\$218/kW electric) was obtained from a turbine manufacturer, and the value of the turbogenerator for peak load electric generation is estimated to roughly match this cost; therefore, the unit involves zero net equivalent conversion cost.

TABLE 1. Estimated capital investments (millions of 1978 \$US).

Cogeneration plant (1516 thermal megawatts capacity):	
Conversion of three newest machines for extraction of 727 MW	14.0
Adding new backpressure machine, 110 MW	-0-
Conversion of three old machines for extraction of 344 MW	12.0
Adding new turbine to produce 335 MW	<u>29.0</u>
TOTAL	55.0
Boilers for peak and standby loads of 1523 MW at \$43 per thermal kilowatt	66.0
Transmission pipeline network, installed	105.0

The costs of the distribution subsystem and of converting buildings to use hot-water heat are substantial but are not shown because they are not affected by use of TES.

For the mature cogeneration-DH system proposed by Studsvik, the estimated annual fuel consumption and savings are shown in Table 2.

TABLE 2. Annual energy consumption and savings, reference system.

	<u>TWH</u>	<u>PJ</u>	<u>TBtu</u>	<u>MBOE*</u>
Gas saved	9.23	33.2	31.5	4.94
Oil burned	-1.20	- 4.3	- 4.1	-0.64
Coal burned	<u>-2.75</u>	<u>- 9.9</u>	<u>- 9.4</u>	<u>-1.47</u>
NET SAVINGS	5.28	47.4	18.0	2.83

\* Million barrels of oil, equivalent.

The saving in gas shows the fuel saving of consumers of gas, oil, or whatever alternative fuel might have been used instead of district heat service. This fuel saving is deduced by Studsvik on the assumption that the efficiency of the average consumer's boiler, burning gas or oil, is 70 percent: the total heat delivered to consumers by district heating service during the year, 6,461 TWH, is divided by 0.7 to find the energy saved.

The negative saving in oil consumption is the amount of oil needed to fire the peak load and standby boilers at 90 percent efficiency.

The negative saving in coal gives the equivalent increase in coal consumption if coal-fired plants are used to produce the electricity sacrificed due to cogeneration of hot DH water. It is computed as the loss of electricity due to cogeneration divided by an efficiency factor of 0.4 to convert to coal input for electricity production in a condensing power station.

The electricity sacrificed is found by multiplying the cogenerated heat production by a factor  $\beta_N$  which is approximately 0.2; i.e., 200 MWH of electricity is lost per 1000 MWH of cogenerated heat. At 40 percent efficiency, a coal plant (somewhere in the system) would burn 500 MWH of coal to replace the electricity sacrificed in cogenerating 1000 MWH of heat. A boiler at 90 percent efficiency would burn 1111 MWH of fuel to produce 1000 MWH of heat; the tradeoff is a good one.

### Analysis of DH System with TES

The capital investment requirements and fuel consumption of the Twin Cities system as proposed, with no TES, are compared to those of systems with TES and serving identical heat loads. The comparison provides a measure of the value of TES in a specific system. Some of the ground rules and assumptions are:

- The reference cogeneration-district heating system is that proposed by Studsvik. To facilitate comparison against the reference system, Studsvik's data on costs and performance, and their methodology for analysis of systems, are utilized wherever possible.

- Only the mature system is considered. The assumption is that TES devices would have been incorporated into the system during the 20 years from inception to maturity.

- Annual-cycle TES is of principal interest. The only annual-cycle TES technology to be considered is storage of hot water in aquifers.

- Availability of suitable aquifers for thermal storage is assumed.

- Because aquifer TES is still in the development stage and its cost and performance are speculative, a full cost-benefit analysis is not attempted at this time. Instead, the potential benefits are of principal interest. How much investment in boilers, cogeneration equipment, and transmission pipelines might be avoided if TES were used? How much less oil would be burned if TES displaced some or all of the boilers? How much more coal would have to be burned? What is the breakeven or allowable cost of aquifer TES?

- Utilizing the heat-cogeneration plant at as high a capacity factor\* as possible is desirable.

- The temperature drop between hot water into and hot water out of TES does not appear to be a substantial problem in the proposed Twin Cities system, because the system incorporates a drop from 146°C (295°F) to 130°C (266°F) at the nodes where most of the TES would be located; and the ratio of stored heat to transmitted heat usually is fairly small, so that blending will mitigate the temperature drop.

---

\*Capacity factor is defined as the ratio of average load on a machine or equipment for the period of time considered to the capacity of the machine or equipment (IEEE Std. 346-1974).

## Aquifer TES

Figure 3 illustrates schematically the Heat Storage Well concept of annual-cycle TES at low cost and low heat loss. Two water wells are drilled deep enough – say, 500 to 1000 feet – to provide sufficient hydrostatic head to maintain superheated water in liquid form, and to avoid aquifers used for water supply. The two wells of the doublet comprise a closed hydraulic system; water pumped from one well is injected into the companion well, several hundred feet away. The heat-storage medium is the porous rock comprising the aquifer and the water filling the pores, together with the relatively impervious aquifer cap and bottom. The energy storage capacity is very large – the aquifer may be 100 feet thick, and the hot water may extend 300 or more feet radially from the well – and costs essentially nothing. The TES capacity – the rate at which heat can be stored or withdrawn from storage – is determined by the size of the wells, the pumps employed, and the flow parameters of the aquifer. A reasonable estimate is that a Heat Storage Well doublet may have a 15-megawatt thermal capacity. Multiple wells are employed to obtain larger capacities. Thus, in contrast to most TES components, only the power capacity determines the cost of storage.

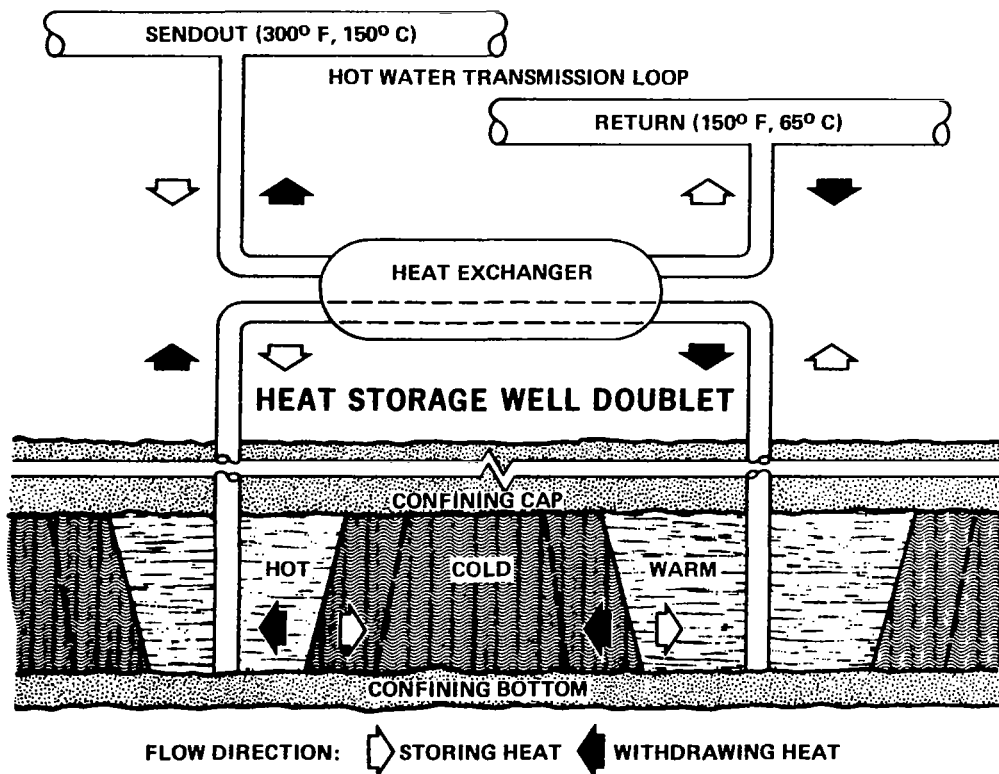

Figure 3. Schematic diagram of Heat Storage Well doublet operation.

Somewhat as with root cellars and ice caves, natural rocks and sand insulate the hot water stored in an aquifer. Three-fourths or more of the stored heat would appear to be recoverable after six months or longer (Meyer, Hausz, et al, 1976; *ATES Newsletter*, September 1979, reports by Molz and Tsang). This remains to be demonstrated on the necessary scale with water injected at temperatures above 100°C.



## Cases Studied

Four study cases were developed to describe potential DH system configurations which would incorporate TES and satisfy the same heat loads and pipeline losses as the reference system.

Each study case was analyzed month by month to find the heat production required to satisfy consumer heat loads, pipeline losses, and a nominal 25 percent heat loss from aquifer TES. (Losses of 35 and 15 percent were also considered but the results are not reported here.)

When heat demand exceeds available cogeneration heat-production capacity, TES is required to deliver heat. When available cogeneration heat-production capacity exceeds demand, excess capacity is used as appropriate to produce hot water to be stored. Maximum storage is scheduled during months just preceding the winter months of peak heat demand. This minimizes the storage time and the amount of hot water stored, hence the heat lost in storage.

## RESULTS

The four cases were developed sequentially. The rationale and system configuration for each case are discussed in what follows. The results are summarized in Table 3. The effects on capital investment requirements and fuel consumption, and the allowable (breakeven) cost of TES, will then be presented and discussed.

TABLE 3. Summary of effects of TES on system configuration and performance.

		Studsvik's Scenario A	CASE 1 Base case. No boilers. Same cogen. capacity as ref. case.	CASE 2 Reduce cogen. capacity by 344 MWth of old turbines.	CASE 3 Convert only new turbines. Add backpressure units. TES at nodes only.	CASE 4 Minimize pipe- line size. TES at both plant and nodes.
<b>COGENERATION</b>						
Extraction:	MW Capacity	1406	1406	1062	727	727
	Annual TWH	5.480	6.344	6.551	4.241	4.241
	10-month CF		0.60	0.76	0.80	0.80
Backpressure:	MW Capacity	110	110	110	440	475
	Annual TWH	0.465	0.775	0.775	3.084	3.333
	Annual CF	0.45	0.80	0.80	0.80	0.80
Total:	MW	1516	1516	1172	1167	1202
	Annual TWH	5.945	7.119	7.326	7.325	7.574
	Elec. sacrificed, TWH	1.10	1.24	1.43	1.16	1.17
<b>BOILERS</b>						
Peak:	MW Capacity	1188	-0-	-0-	-0-	-0-
Standby:	MW Capacity	335				
Total:	MW Capacity	1523				
	Annual TWH	1.049				
	Annual CF	0.08				
<b>HEAT STORAGE WELLS</b>						
At Nodes:	MW Capacity	-0-	1523	1867	1872	1839
	Annual TWH		0.533	1.344	1.350	2.450
At Plant:	MW Capacity	-0-	-0-	-0-	-0-	414
	Annual TWH					1.430
Total:	MW Capacity		1523	1867	1872	2253
	Total annual TWH stored		0.533	1.344	1.350	3.880
	Approx. annual TWH lost (at 0.75 recovery fraction)		0.133	0.336	0.338	0.613
<b>TRANS. PIPELINES (lumped)</b>						
	Peak capacity required, MW	1516	1516	1172	1167	865
	Annual capacity factor	0.45	0.54	0.71	0.72	1.0

Case 1 is a study of replacing boiler capacity with aquifer TES capacity. It shows that all boilers could be replaced with aquifer storage without exceeding capacity factor constraints on the reference-system cogeneration equipment.

Case 2 is a study of how much heat cogeneration capacity may be removed from the Case 1 configuration without exceeding capacity factor constraints on the cogeneration plant. It shows that the 344 MW of heat production capacity obtained by converting the three old machines could be dispensed with.

Case 3 examines the benefits of using as much backpressure capacity as is realistically possible. Some extraction capacity is retained: the three newest turbines are converted for crossover extraction to give 727 MW of heat capacity, needed during the first three years of implementation of the DH system.

Using more backpressure capacity than in the reference case becomes feasible with TES because the cogenerated heat can always be either used or stored. There is no need for cold condensing. The capital cost to be amortized from electricity and heat revenues is lower than when extraction machines are used because there are no low-pressure stages, cold condenser, and cooling water facilities to stand idle during maximum heat production. Full advantage can be taken of the inherently smaller size, lower cost, and slightly better cogeneration efficiency of the backpressure turbine as compared to the extraction turbine. (The extraction mode is slightly less efficient because even at full extraction a small amount of steam must be bled through the low pressure stages for temperature control, then condensed at a loss of roughly 2300 J/kg (1000 Btu/pound).)

A key point to be made is that use of TES expands the role of the backpressure turbogenerator used in a DH system. It is no longer to be regarded as basically a source of district heat with electricity as a byproduct, or vice versa. It can be operated to produce electricity at a lower heat rate than base-load power plants (e.g., 1.29 kWh thermal per kWh electric; 4400 Btu/kWh<sub>e</sub>), with heat as a byproduct; or to produce district heat in the most energy-efficient way with electricity as a byproduct; or as a high-efficiency low-cost producer of electricity and heat as joint products. There is a limitation: enough heat must be produced at appropriate times to charge TES, so that heat from TES will be available when needed. However, there is considerable latitude in choosing the appropriate times.

Figure 4 illustrates graphically the use in Case 3 of less cogeneration capacity, at a higher capacity factor, with TES, and with no boilers, to satisfy the same heat demand as the reference system shown earlier in Figure 1.

Case 4 explores the effects of using TES both at the plant and the nodes, rather than only at the nodes, in order to minimize the transmission pipeline size. This is a limiting case: the analysis is made on the basis of a single pipeline operating year-round at full capacity, which obviously would never be the actual situation. It shows that a substantial reduction in pipeline size is possible (up to 43 percent), saving capital cost, pumping power, and heat loss.

#### Capital Cost Benefits and Allowable TES Cost (in 1978 \$US)

Table 4 summarizes the capital investment costs of the reference system that may be avoided by use of TES (assuming a heat recovery fraction of 0.75). In

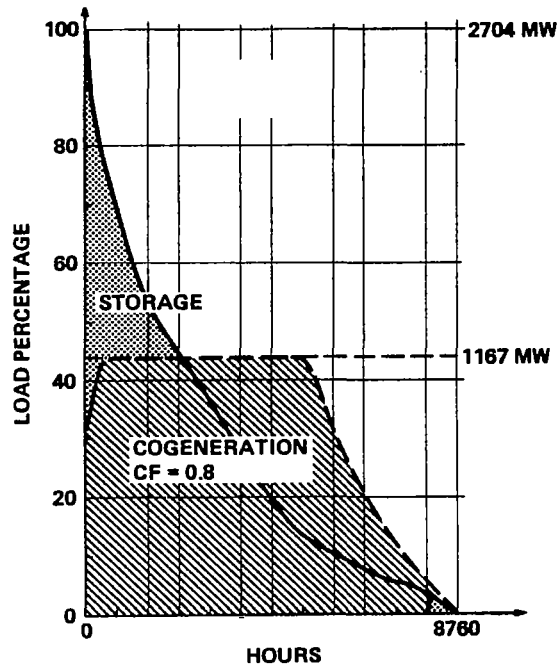

Figure 4. Load curve for Case 3, showing cogeneration and annual-cycle storage.

TABLE 4. Capital cost savings and breakeven cost of TES.

Case:	1	2	3	4
Capital costs avoided, \$M	66	92	110	122
TES capacity, MW <sub>t</sub>	1523	1867	1872	2253
Breakeven cost of TES, \$/kW <sub>t</sub>	43	49	59	54

Case 1, for example, the \$66 million represents the cost of boilers replaced by TES. Other cases include, in addition to the cost of the boilers, reduced cost of cogeneration equipment and of the transmission pipeline.

Even though the required amount of aquifer TES increases for each successive case, the breakeven or allowable capital cost per kilowatt of TES capacity also increases, because of capital costs avoided.

Unlike other TES devices, the cost of aquifer TES is almost entirely determined by the megawatt (power-related) capacity. The storage medium (water), the containment (aquifer), and the insulation (sand and rock) cost nothing once wells are drilled; the only energy-related cost, for pumping, is very low. A very rough estimate of the capital cost of the aquifer storage is \$23 to \$50 per peak thermal kilowatt into or out of storage. This rough estimate remains to be verified by field installations and tests.

#### Fuel Consumption and Energy Benefits

For the reference system and for the systems with TES, the gas (or oil, or other alternative fuel) not used by consumers of district heat amounts to 9.23

thermal TWH per year (31.5 trillion Btu) and would cost about 161 million 1978 dollars. This is the basic energy-conservation benefit of a Twin Cities cogeneration-district heating system.

Peak load and standby boilers required for the reference system would burn about 1.20 thermal TWH of oil per year (0.64 million barrels). These boilers are not needed in the systems with TES; the oil is replaced by coal used in cogeneration. This is an important fuel-substitution benefit of the TES system.

Cogeneration plants sacrifice some electrical generation in order to produce useful heat instead of waste heat. To replace electricity sacrificed in cogenerating heat, the reference system requires burning about 2.75 thermal TWH of coal per year (0.39 million tons), at a cost of \$11 million. The net annual savings in fuel cost and energy for the reference system are then about \$131 million and 5.28 thermal TWH, equivalent to 2.83 million barrels of oil.

Systems with TES burn no oil and save the same amount of gas as the reference system. Partially offsetting the saving in oil is the extra coal that must be burned to provide heat otherwise produced by boilers, and to make up the heat lost in storage. The net annual thermal energy and fuel cost savings for the cases studied are summarized in Table 5.

The fuel cost savings are a factor in evaluating the breakeven operating cost of TES.

TABLE 5. Net annual energy and fuel cost saved by TES.

Case:	1	2	3	4
Net thermal energy savings				
TWH/yr	6.03	5.43	5.46	5.37
TBtu/yr	20.6	18.5	18.6	18.3
* MBOE/yr	3.22	2.91	2.92	2.87
% over reference system	14	3	3	2
Fuel cost saving compared to reference system, \$M/yr	16	14	14	14
* Million barrels of oil, equivalent				

### Conclusions

The potential benefits of incorporating aquifer TES into the proposed Twin Cities cogeneration-district heating system include:

- Saving the cost of installing boilers
- Avoiding problems of siting boilers at each transmission node
- Avoiding air-pollution problems of dispersed boilers
- Replacing oil burned in boilers with coal burned at central cogeneration plants
- Reducing net energy consumption and cost
- Operating cogeneration equipment at higher capacity factor, to reduce cost of both electricity and heat

- Permitting more economic cogeneration, with backpressure turbines instead of extraction turbines
- Reducing the amount of cogeneration capacity required
- Reducing thermal pollution from power plants
- Reducing the need for cooling water or towers
- Reducing size, cost, and heat losses of transmission pipelines.

Annual-cycle aquifer storage appears capable of providing these benefits.

## REFERENCES

- ATES Newsletter* (A Quarterly Review of Aquifer Thermal Energy Storage), Earth Sciences Division, Lawrence Berkeley Laboratory, University of California, Berkeley, Vol. 1, No. 4, September 1979.
- Jaehne, Herbert, Michael Karnitz, Alan Rubin, and Peter Margen, *District Heating/Cogeneration Application Studies for the Minneapolis-St. Paul Area*, Presented at the 41st Annual Meeting of the American Power Conference, Chicago, Illinois, April 23-25, 1979.
- Karnitz, M.A., and A.M. Rubin, "Large-Scale Cogeneration/District Heating Studies for the Minneapolis-St. Paul Area," IECEC Paper 789614, *Proceedings of the 13th Intersociety Energy Conversion Engineering Conference*, San Diego, California, August 20-25, 1978; SAE P-75, IEEE 78-CH1372-2 ENERGY, Society of Automotive Engineers, Inc., Warrendale, Pennsylvania, Vol. 1, Chap. 8, pp 888-894, 1978.
- Margen, Peter, et al, *District Heating/Cogeneration Application Studies for the Minneapolis-St. Paul Area: Executive Summary - Overall Feasibility and Economic Viability for a District Heating/New Cogeneration System in Minneapolis-St. Paul*, ORNL/TM-6830/P2; Prepared for the Oak Ridge National Laboratory under Subcontract No. 11Y-13502-V; Studsvik Energiteknik AB, Nyköping, Sweden, August 1979.
- Margen, Peter, et al, *District Heating/Cogeneration Application Studies for the Minneapolis-St. Paul Area: Technical Report - Overall Feasibility and Economic Viability for a District Heating/New Cogeneration System in Minneapolis-St. Paul*, ORNL/TM-6830/P3; Prepared for the Oak Ridge National Laboratory under Subcontract No. 11Y-13502-V; Studsvik Energiteknik AB, Nyköping, Sweden, (in publication).
- Meyer, Charles F., Walter Hausz, Bonnie L. Ayres, and Helen M. Ingram, *Role of the Heat Storage Well in Future U.S. Energy Systems*, GE76TMP-27, (NTIS PB-263 480); Technical Completion Report prepared for the Office of Water Research and Technology, U.S. Department of the Interior; General Electric Co.-TEMPO, Santa Barbara, California, 186 pp, December 1976.
- Meyer, Charles F., *Potential Benefits of Thermal Energy Storage in the Proposed Twin Cities District Heating-Cogeneration System*, GE79TMP-44 (ORNL/SUB-7604-2); Final report prepared for the Oak Ridge National Laboratory; General Electric Co.-TEMPO, Santa Barbara, California, July 1979.
- (ORNL) Oak Ridge National Laboratory, *Proceedings, District Heating/Cogeneration Symposium*, held in Minneapolis, Minnesota, April 2-3, 1979, Report CONF-790401; Prepared under Contract No. W-7405-eng-26; Oak Ridge, Tennessee, October 1979.



# SIMULATION AND EVALUATION OF LATENT HEAT THERMAL ENERGY STORAGE

## HEAT PUMP SYSTEMS

Tony W. Sigmon  
Research Triangle Institute

### PROJECT OUTLINE

Project Title: Simulation and Evaluation of Latent Heat TES-Heat Pump Systems

Principal Investigator: A. Sigmon

Organization: Research Triangle Institute  
P. O. Box 12194  
Research Triangle Park, NC 27709  
Telephone: (919) 541-5936

Project Goals: Derive the relative value of TES for heat pump storage (heating and cooling) as a function of storage temperature, mode of storage (hotside or coldside), geographic locations, and utility time-of-use rate structures.

Computer models will be used to simulate the performance of a number of TES/heat pump configurations. Models will be based on existing performance data of heat pump components, available building thermal load computational procedures, and generalized TES subsystem design. Different electricity rate structures will be assumed for each site. Life-cycle costs for each site, configuration and rate structure will then be computed.

Project Status: The following six cities have been chosen as simulation sites: Boston, MA; Fort Worth, TX; Miami, FL; Nashville, TN; Phoenix, AZ; and Seattle, WA. These cities possess a wide range of climates and therefore offer the opportunity to evaluate the performance of various TES/Heat Pump configurations under a wide range of operating constraints.

Contract Number: DE-AC-01-79ET-26707

Contract Period: 6 months (FY 79 continuing into FY 80)

Funding Level: \$61,000

Funding Source: U.S. Department of Energy  
Division of Energy Storage Systems

# SIMULATION AND EVALUATION OF LATENT

## HEAT THERMAL ENERGY STORAGE

### HEAT PUMP SYSTEMS<sup>+</sup>

Tony W. Sigmon  
Research Triangle Institute

#### SUMMARY

A computer model is being developed for the purpose of evaluating the performance of a number of latent heat Thermal Energy Storage (TES)/Heat Pump systems for residential heating and cooling applications. The basis for this evaluation will be system annualized life cycle cost. Annual system performance will be determined at various simulation sites across the continental United States using manufacturers performance data for the basic heat pump components and the computed performance characteristics of a simplified TES subsystem design. The systems considered will be required to satisfy building heating and loads calculated using TRNSYS (Ref. 1) for different imposed electricity rate structures. Both the TES/Heat Pump system performance and the load simulation model will be driven by hourly weather data provided by Sandia National Laboratory (Ref. 2). By interfacing TES/Heat Pump performance with these thermal loads, optimum systems will be selected for each combination of site and rate structure considered.

#### INTRODUCTION

The combination of heat pump systems combined with thermal energy storage have the advantage of: 1) providing a means of substituting lower cost thermal energy during heating operation for that which is normally supplied by resistance heaters, 2) improving the efficiency of heat pump systems during both heating and cooling operation and 3) decreasing heat pump operating cost by allowing the heat pump to operate primarily during periods in which low cost electricity is provided under time-of-day (TOD) electricity rate structures. Although the focus of previous work has been aimed at heat pumps combined with sensible heat storage subsystems, the advantages associated with latent heat storage has precipitated research and development efforts considering latent heat TES/Heat Pump systems as well. Latent heat systems in general store more energy per unit volume than do sensible heat systems, allow for storage at constant temperature and do not require the internal heat exchanger needed by many sensible heat storage systems.

This analysis will consider six different TES/Heat Pump configurations. These proposed designs include: 1) direct TES/Heat Pump systems in which the

---

<sup>+</sup> Work performed under contract to U. S. Department of Energy Contract No. DE-AC-01-79ET-26707



storage subsystem is charged within the refrigeration cycle itself and discharged by direct heat exchange between indoor return air and storage material, 2) indirect systems that are both charged and discharged within the refrigeration cycle of the heat pump, 3) hybrid systems that act as direct systems during cooling operation and indirect systems during heating and 4) hybrid systems that act as indirect systems during both heating and cooling. The storage subsystem considered is of a rectangular design which provides for heat transfer between both storage material and refrigerant and storage material and air.

For each combination of simulation site and electricity rate structure, specific TES/Heat Pump configurations will be optimized to determine the combination of component sizes that minimizes life cycle costs. These individual optimized systems will then be ranked based on both life cycle cost and specific performance factor for the combination of simulation site and rate structure under consideration.

### THERMAL LOAD CHARACTERIZATION

In order to properly evaluate the performance of each TES/Heat Pump system, they must be required to satisfy realistic heating and cooling loads. These thermal loads will be computed using the TRNSYS computer simulation. The methodology used in this model follows ASHRAE recommended procedures which utilize transfer functions for calculating conduction heat gains and losses. These heat gains/losses are then combined with other specified or computed, sensible and latent heat loads to determine the total hourly latent and sensible heat load for the house. The assumption made in this analysis is that the heating/cooling system will exactly satisfy these load requirements. The computation of these thermal loads requires that hourly (or any other increment of time) weather data be provided for the entire simulation period along with a general building design and construction characteristics.

#### Site Selection

The following six cities have been chosen as simulation sites: Boston, MA; Fort Worth, TX; Miami, FL; Nashville, TN; Phoenix, AZ; and Seattle, WA. These cities possess a wide range of climates and therefore offer the opportunity to evaluate the performance of various TES/Heat Pump configurations under a wide range of operating constraints.

The choice of sites has been based primarily on weather data provided through the SOLMET Typical Meteorological Year (TMY) weather tapes and work completed by the General Electric Corporation. The TMY data consists of hourly weather information for 26 cities across the United States for a "typical" year. This typical weather year was developed using data that had been collected over a number of years for each of the 26 sites. Using these weather data, the number of annual heating and cooling degree-days for each of the 26 sites was then computed.

Each of these sites was then identified as being within one of 12 climatic regions of the continental United States. These regions were defined

by the General Electric Corporation (Ref. 3) in a study entitled "Regional Conceptual Design and Analysis Studies for Residential Photovoltaic Systems." Simulation sites were then chosen based on location and the extremes in climatic conditions as given by the heating and cooling degree-days.

### Building Design

The TRNSYS model requires only a general description of the design itself; however, detailed information dealing with the construction, orientation, and insulation levels of the building must be defined. The building design, orientation, and construction will be the same for each of the sites; however, insulation levels will be varied in order to characterize existing practices in various regions of the country.

The basic building design will consist of a rectangular, single story, 140 m<sup>2</sup> (1500 ft.<sup>2</sup>) wood panel residence with a full basement. Although this design is not necessarily representative of that to be found at all of the simulation sites, it does offer a reasonable and justifiable approximation to the design that might exist at each site.

### TES/HEAT PUMP SIMULATION

The approach to be utilized in modeling the TES/Heat Pump system is based on balancing mass and energy flows within the refrigeration cycle. The method to be used follows the same general procedures suggested by Oak Ridge National Laboratory (Ref. 4). This procedure is as follows:

1. assume values for the thermodynamic states at various points within the cycle;
2. find the flow balance conditions for these assumed thermodynamic states using compressor and capillary tube performance data;
3. for these flow balance conditions use evaporator and condenser performance data to arrive at new thermodynamic states; and
4. continue until agreement is reached.

Manufacturer's component performance data will be used for heat exchangers, compressor and expansion valves while a simple TES subsystem will be modeled in order to compute storage subsystem performance.

### TES/Heat Pump Configurations

The six TES/Heat Pump configurations to be considered are classified depending upon the method used to discharge the TES subsystem. Direct systems are discharged by the transfer of heat between the storage material and the indoor air stream, while indirect systems are discharged by using the TES subsystem as a low temperature sink (cooling) or high temperature source (heating) for the heat pump. All six configurations involve charging the TES subsystem within the refrigeration cycle of the heat pump by using the storage

subsystem as either an evaporator or condenser as appropriate.

Figures 1 and 2 show schematically two of the six configurations which are being considered. Figure 1 is a representation of an indirect system that stores thermal energy for use only in the heating mode. The system operates as a conventional heat pump during cooling. During the charging cycle the TES subsystem acts as a condenser, while at the same time storing energy by means of the change of phase of the storage material from solid to liquid. During discharge, the TES subsystem then behaves as an evaporator for the heat pump cycle and rejects heat to the refrigerant by means of the change of phase from liquid to solid. This system offers the advantage of providing a relatively high temperature source for the heat pump with the exact source temperature depending upon the melt temperature of the storage material. A direct system used for storage heating would be charged by maintaining the storage temperature at a level that could be used for direct heating (40-60°C).

Figure 2 is a schematic of an indirect TES/Heat Pump system used for cooling purposes. The system operates as a conventional heat pump during heating operation. During the cooling season the storage subsystem is charged by converting the storage material from a liquid to a solid by allowing the TES subsystem to act as an evaporator. The subsystem is then discharged by reversing this process. This system effectively increases the efficiency of the heat pump cycle by allowing the TES subsystem to act as a low temperature sink for the heat pump during discharge operation. A direct system used for storage cooling would be charged by maintaining the storage temperature at a level that could be used for direct cooling (-1-10°C). A complete list of the configurations to be considered is given in Table 1.

#### TES Subsystem

Three basic criteria for the selection of a TES subsystem are: 1) the subsystem must have the capability to transfer heat between the storage material and refrigerant (charging or indirect discharging), 2) the subsystem must possess the capability to transfer heat between the storage material and air (direct discharging) and 3) the subsystem must be able to treat the humidification problems associated with space cooling.

All of these criteria may be addressed using the designs shown in Figures 3 and 4. Rectangular volumes containing the storage material will be stacked in the storage subsystem. Sandwiched between these volumes will be refrigerant coils. Since these coils will not require the entire volume between the storage containments, air will be passed through these spaces to allow for direct discharge. A closed form solution for the resulting melting and solidification problem has been found by Edwards (Ref. 5) and will be used to develop performance curves for the storage subsystem. This procedure allows for a stepwise solution along the length of the subsystem for both the melt/freeze and the refrigerant (air) side heat transfer problems.

Although the parameters to be considered in developing performance curves have not as yet been determined, entering refrigerant (air) temperature, refrigerant (air) flow rate, thickness of the storage material, and length of

the subsystem appear to be of prime importance in determining both the rate of heat transfer and the total storage capacity.

#### TES/Heat Pump System Performance

TES/Heat Pump system performance will be determined for each site by interfacing together the thermal loads computed using TRNSYS and the refrigeration cycle performance for each configuration. For each electricity rate structure system control strategies will be developed that will define the operating strategy for each configuration. The intent of these control strategies will be to minimize system life cycle cost by charging and discharging the TES subsystem at the most opportune times. For each combination of simulation site and rate structure considered, various TES/Heat Pump systems will be optimized to determine that combination of component sizes that minimizes life cycle costs. These optimized systems will then be ranked based on life cycle cost and specific performance factor for each combination of simulation site and rate structure considered.

#### REFERENCES

1. Klein, S. A., et al. "TRNSYS: A Transient Simulation Program." Prepared by the Solar Energy Laboratory of the University of Wisconsin, Report 38-10, June 1979.
2. Hall, Irving, et al. "Generation of Typical Meteorological Years for 26 Solmet Stations." Sandia Laboratory Report No. SAND 78-1601, August 1978.
3. Buerger, E. J., et al. "Regional Conceptual Design and Analysis Studies for Residential Photovoltaic Systems." General Electric Space Division, Sandia Laboratory Report No. SAND 78-7039, January 1979.
4. Ellison, R. D., and F. A. Creswick. "A Computer Simulation of Steady-State Performance of Air-to-Air Heat Pumps." Oak Ridge National Laboratory Report No. ORNL/CON-16, March 1978.
5. Edwards, J. A., and Mody. "Transient Analysis and Optimization of an Extended Surface Thermal Storage Unit Which Utilizes a Phase Change Material." Alternate Energy Sources: International Compendium, Vol. I-II, pp. 597-617, Hemisphere Publishing Company, 1978.

Table 1. TES/Heat Pump Configurations

Option	Melt Temperature ( $^{\circ}\text{C}$ )	Heating Operation	Cooling Operation	Storage System Use
1	$40 \leq T_m \leq 60$	Heat Pump/ Direct Heating	Heat Pump	Direct space heating
2	$-1 \leq T_m \leq 40$	Heat Pump/ Indirect Heating	Heat Pump	High temperature source for heat pump during heating
3	$-1 \leq T_m \leq 10$	Heat Pump	Heat Pump/ Direct Cooling	Direct space cooling
4	$10 \leq T_m \leq 27$	Heat Pump	Heat Pump/ Indirect Cooling	Low temperature sink for heat pump during cooling
5	$-1 \leq T_m \leq 10$	Heat Pump/ Indirect Heating	Heat Pump/ Direct Cooling	High temperature source for heat pump during heating -- Direct Space cooling in cooling mode
6	$-1 \leq T_m \leq 27$	Heat Pump/ Indirect Heating	Heat Pump/ Indirect Cooling	High temperature source for heat pump during heating -- Low temperature sink for heat pump during cooling

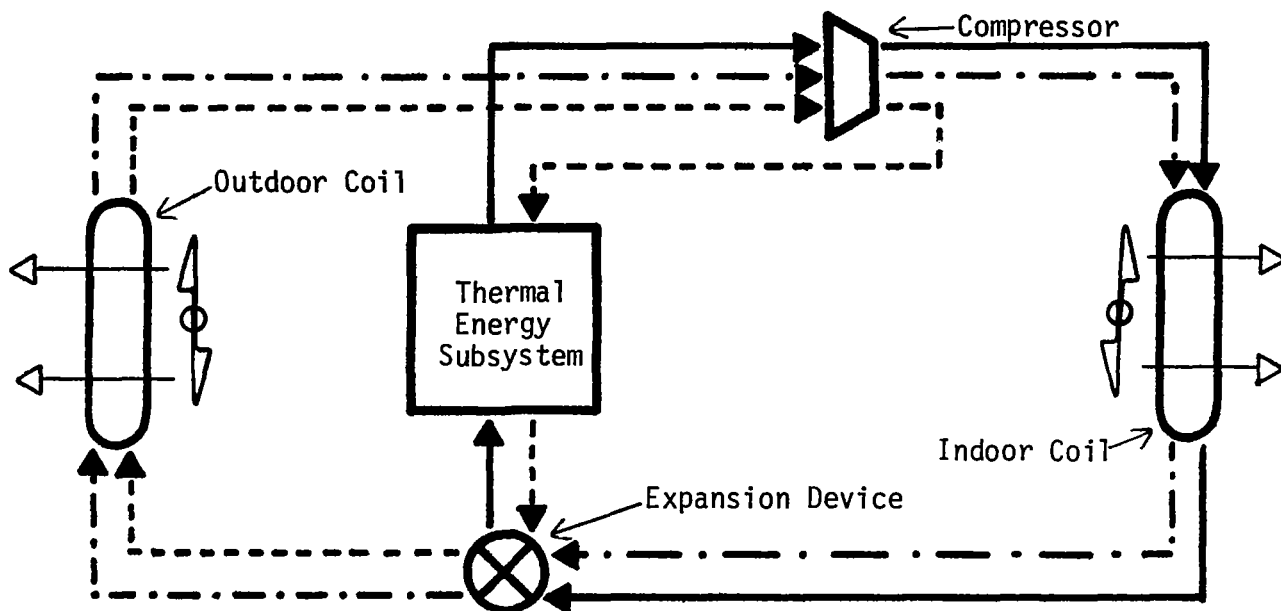

Figure 1. Indirect TES/Heat Pump Configuration  
(Storage Heating Only)

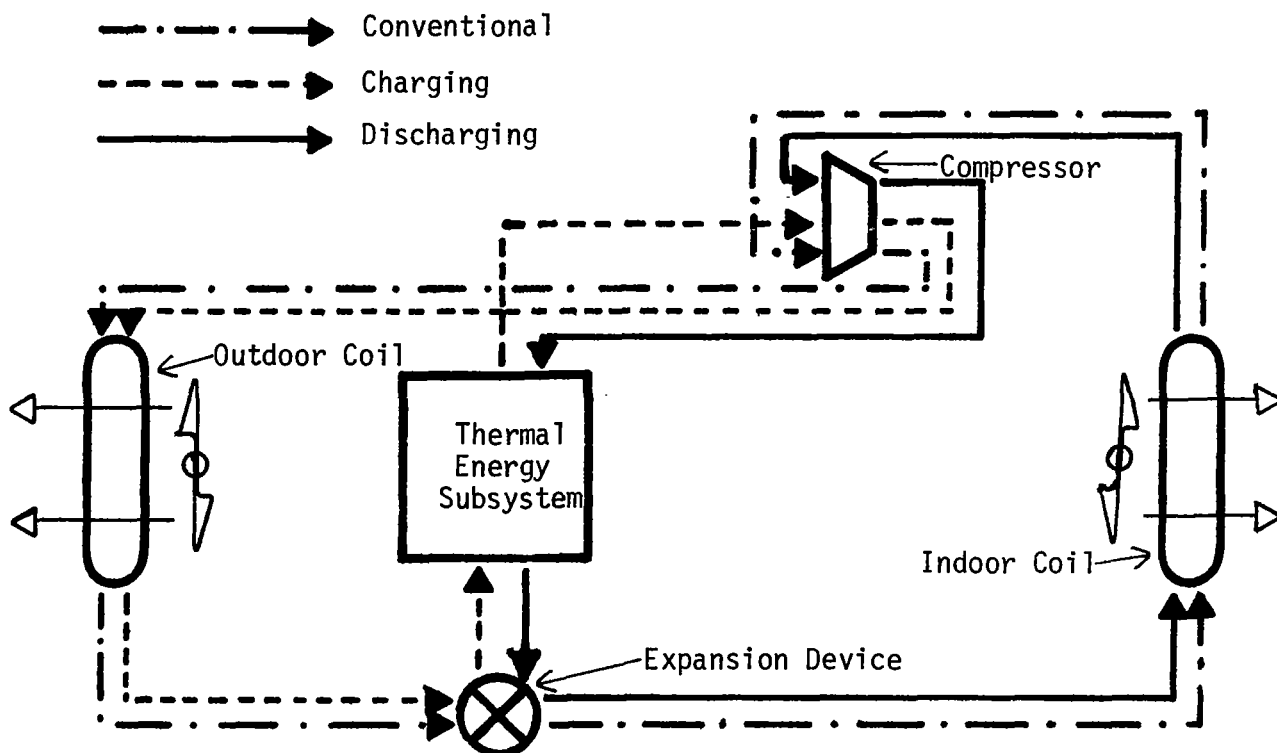

Figure 2. Indirect TES/Heat Pump Configuration  
(Storage Cooling Only)

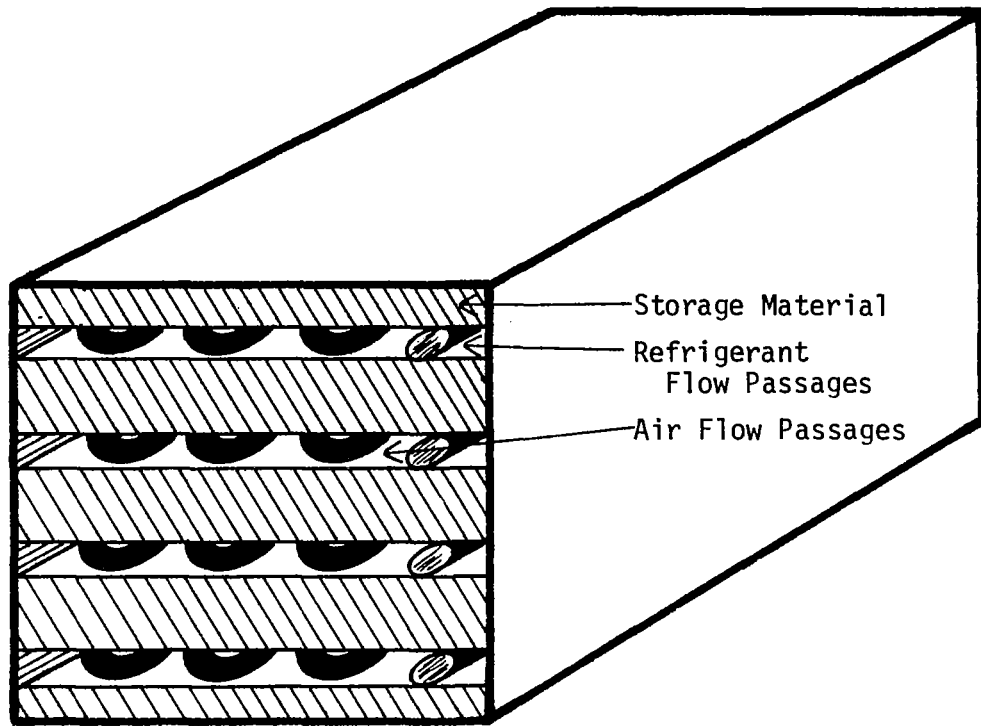

Figure 3. TES Subsystem Design

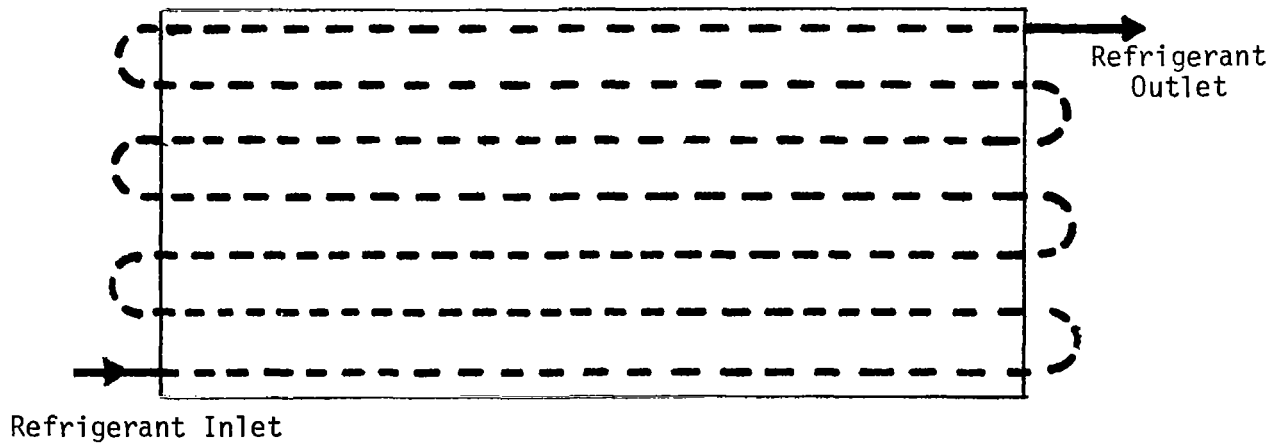

Figure 4. TES Subsystem Design (Top View)





## EXPERIMENTAL EVALUATION OF THERMAL ENERGY STORAGE

J. G. Asbury and H. N. Hersh  
Argonne National Laboratory

### PROJECT OUTLINE

Project Title: Demonstration of Storage Heater Systems for Residential Applications

Principal Investigator: J. Asbury

Organization: Argonne National Laboratory  
9700 South Cass Avenue  
Argonne, IL 60439  
Telephone: (312) 972-3779

Project Goals: Demonstrate the thermal performance, utility impact, and customer acceptance of residential TES systems using off-peak electricity. Identify and define after-the-meter TES R&D needs.

Two separate demonstrations are included. The University of Vermont and Central Vermont Public Service Company are collecting and analyzing data over two heating seasons for 17 ceramic TES systems, 6 hydronic TES systems, and 19 control systems. The University of Maine and Central Maine Power Company are collecting and analyzing data from 10 ceramic TES systems and 8 control systems.

Project Status: Data were collected from the first winter season. A survey of customer attitudes was completed.

Contract Number: ANL 189 #49897

Contract Period: FY 79 continuing

Funding Level: \$590,000

Funding Source: U.S. Department of Energy  
Division of Energy Storage Systems

## PROJECT SUMMARY

Project Title: - Experimental Evaluation of Thermal Energy Storage

Principal Investigators: J.G. Asbury and H.N. Hersh

Organization: Special Projects Group, Energy and Environmental Systems Division  
Argonne National Laboratory  
Argonne, IL 60439

### Project Goals:

- Experimentally validate the technical performance of commercially available TES residential heating units under severe U.S. weather conditions.
- Assess the benefits and costs of TES to the customer, the utility and society.
- Determine user acceptance of TES.
- Identify and define TES issues, R&D needs and barriers to commercialization.
- Establish uniform TES testing standards.

### Project Status:

- Installations have been completed in 45 test and 30 control sites and data collected; based on results for one heating season, and comparison with electric baseboard systems, the technical performance of TES ceramic and hydronic systems is good.
- A preliminary assessment of the benefits and costs of customer-owned TES for residential and commercial applications indicates that the net returns to society of such investments exceed their costs by a substantial margin.
- A user survey by an independent organization indicates a high degree of customer acceptance.
- Issues of proper rate design and correct sizing of TES capacity by vendors and contractors have emerged and are currently being examined.
- A calorimeter chamber has been built and standardized procedures for testing TES modular units are being developed as an aid to commercialization.

Contract Period - FY80  
Contract Funding - \$150K

# EXPERIMENTAL EVALUATION OF THERMAL ENERGY STORAGE: AN INTERIM REPORT

H.N. Hersh

Argonne, IL 60439

## 1. BACKGROUND

Early results from the ANL assessment of energy storage technologies indicated that customer-owned TES units of the type used in Europe could provide a cost-effective means for utility load management in the U.S. (1). It was necessary, therefore, that the technical and economic viability of this technology be examined under U.S. conditions. These conditions now include a changing regulatory atmosphere encouraging rate reform and, of course, climatic conditions more extreme than in Europe. The region selected for this field study was New England, with its strong dependence on oil and scarcity of natural gas. Electric baseboard heating is a major heating alternative in this area. In Vermont, utilities had already begun to investigate thermal energy storage and off-peak rates as one form of load management and had instituted programs to reduce loads by direct utility control of storage hot water heaters.

## 2. SCOPE AND OBJECTIVES

We report here some results of the first year's tests involving a collaborative effort among ANL, Purdue University, the Universities of Maine and of Vermont, and several local cooperating electric utility companies (Central Maine Power Co., Central Vermont Public Service Co., Green Mountain Power Co. and Vermont Electric Cooperative).

The principal objectives of the study are to:

- Validate the technical performance of commercially available TES units under severe U.S. weather conditions.
- Assess the benefits and costs of TES.
- Determine potential customer and utility acceptance of customer-owned TES.
- Identify and define TES issues, R&D needs and barriers to commercialization.
- Establish uniform TES testing standards.

The method adopted for achieving each objective is described below.

### 3. FINDINGS

Since work is still in progress the findings reported here must be regarded as tentative.

#### 3.1 Technical Performance

Field tests in Vermont and Maine are being carried out to evaluate the performance of TES systems. TES systems are operating in 45 test homes, and monitoring equipment records the electric heating demand and the inside and outside temperatures every 15 minutes in these test homes and in 30 control homes. All of the participating homes have been energy-audited by an electric utility. Most of the TES units in the test homes are room-type ceramic storage heaters, but six hydronic storage heaters and one central ceramic storage furnace are also being tested. The control sites are heated with conventional resistance baseboard units. All units were sized by the vendor to meet the full design-day heating load and were commercially installed.

During the first heating season, data were collected from 34 test and 26 control sites, with some loss of data and uncertainties due to malfunctions in monitoring equipment and problems in magnetic tape handling. Functional performance of the TES systems has generally been good, and it has been concluded that TES units, if properly sized for the home, perform well. This preliminary conclusion applies equally to dispersed and central ceramic units and to hydronic central units.

The major criterion for this assessment was the maintenance of essentially identical inside temperatures in thermally matched test and control homes throughout the heating season, e.g., on typical wintry January days, on October days (which have more volatile temperature fluctuations), and on the coldest day of the year. In Vermont the lowest temperature recorded at the sites was  $-28^{\circ}\text{F}$  on February 12, 1979; in Maine 70 degree-days were accumulated on February 14, providing opportunities to observe heating-system performance under "design" conditions and to evaluate shortcomings in sizing formulas. Graphical records of daily electrical demand and inside temperatures of test homes clearly distinguish adequately sized storage heating systems

that use only off-peak electricity from those that additionally require the use of electricity generated during high-use times.

### 3.2 Social Benefits and Costs

Studies of the economics of TES in Maine and Vermont using a social welfare approach indicate that there are net social benefits and that benefits can accrue to both user and utility (2,3). This conclusion is based upon a comparison of the estimated costs and consequent savings.

Factors taken into account include:

- (1) additional customer costs, compared to direct baseboard systems, of installed TES systems (room units and central furnaces) in homes having a wide range of heat loss;
- (2) utility costs of special controls, meters and transformers;
- (3) utility returns due to estimated future savings in foregone generation, transmission and distribution needs (discounted to present value).

In Vermont, benefit-cost ratios are estimated to be greater than 3.4 for room units and greater than 5.6 for central units (3). The higher ratio for central units is due to their lower capital cost per kilowatt of heat loss. In Maine, the total savings are estimated to be about \$344 per kilowatt of heat loss, and the additional capital cost with respect to electric baseboard heaters is about \$225 per kilowatt of heat loss. (The cost of electric baseboard heaters is about \$150/kW.)

### 3.3 Potential Customer and Utility Acceptance

A survey of users by an independent research organization revealed equal satisfaction with storage heaters and with instant heaters (baseboard). The survey was based on 156 households, of which 131 are heated via thermal storage and 25 by direct electric heating (4). Over 95% of the owners of homes with TES units would recommend TES to a friend (the same as for users of baseboard heaters). The improvements most frequently suggested were decreasing the physical size of the room units and improving their appearance.

Many utilities that have had exposure to, or interest in, TES as a load management tool feel it can have a positive impact. However, public concern about the environmental degradation due to the use of nuclear and coal baseload fuels negatively affects utility planning and initiative, creating uncertainties in the size and stability of the cost differential of baseload and non-baseload electricity.

### 3.4 Issues

Many issues must be identified and resolved before there can be any extensive adoption of TES. Among them are capital cost of TES equipment, correct sizing of the TES systems and proper rate structure.

- Electricity Pricing - The problem of increasing the use of TES is that of transferring some of the anticipated utility savings to the customer so that TES will be an attractive investment. The problem is complex. At this time, based on an on-going comparative analysis, a load management agreement between customer and utility seems better than either a time-of-use rate format or a time-of-use plus demand-charge rate. Load management agreements insure more control of utility capacity growth and less customer risk of rate instability.
- How Much Storage? - The adoption of TES will be very sensitive to calculating and installing the proper amount of storage heating capacity. Preliminary energy-use studies of TES in Maine indicate that the sizing method for an 8-hour charge period is marginal for extreme weather conditions. Simulation studies have underscored the potential problem of developing a shoulder peak of demand of supplemental heat which is required toward the end of the on-peak period. The problem of supplying a building with optimal thermal storage capacity is one of skirting the Charybdis of inadequate storage capacity (which may neither cut oil demand nor sufficiently decrease the need for investments in new generating capacity)

and the Scylla of too much installed storage capacity (which may be so expensive that the customer will not buy the TES system). This sizing problem has several interrelated elements:

- (1) the incentive of the vendor to make a sale by lowering the capital cost (i.e., recommending smaller capacity than may be required),
  - (2) the goal of the customer or real estate developer who wants TES but wants to minimize initial cost (thereby impacting the utility on its peak demand days),
  - (3) different sizing methods used by different vendors, and
  - (4) the intrinsic uncertainty in the heating capacity margin required by different users and types of use.
- Capital Costs of TES and Control Equipment - Sensible heat storage devices and control units are essentially simple products. Reducing the capital costs of TES systems by cheaper manufacturing methods and more vendor competition can ameliorate, to some extent, some of the above problems and provide customer incentive to buy TES equipment.

### 3.5 Testing

TES units of different manufacture can have different characteristics and storage capacities. Depending on details of design, units having the same nominal rating and total storage capacity may have different rates of spontaneous radiative emission, rates of forced discharge, hot air temperatures, storage medium temperatures, etc. Since the units are modular, it will be possible to measure and compare their thermal performance by appropriate calorimetric techniques. Simple electric-input thermal-output ratings can then be used by customers in making buying decisions and total performance characteristics can be used by architects and others for heating-system design; such available information should accelerate the rate of commercialization. For this reason, developing and promulgating standard calorimetric procedures that can be duplicated in other laboratories is a component of the ANL program. At Purdue University a calorimeter has been built following

the German standard as described in DIN 44572. Initial attempts to calibrate and use this calorimeter indicated the necessity for a redesign. Several design modifications were made and investigated experimentally. The present design has greatly improved uniformity in the cross-sectional temperature distribution of the outlet duct where the temperature of the exiting air is measured. A 2-kW room-size TES unit is soon to be installed in the calorimeter chamber for testing. At the same time a 30-kW central unit is being readied for installation and initial calorimetric measurements in a large, environmentally controlled room.

#### 4. COMMENTS

The findings so far support the expectation of earlier studies: TES is technically and economically viable in winter-peaking electric service areas of the U.S. that rely on electricity for space heating, where the underutilized baseload energy is supplied by coal or other cheaper baseload fuels. It is probably not too early for industry and the government to start those studies and activities necessary to accelerate the introduction of sensible-heat thermal energy storage where it is deemed possible and desirable. While further studies are necessary for solid documentation, there is presently a need for TES handbooks, seminary for potential suppliers, installers and contractors, and the dissemination of technical and financial information to public utilities, regulatory commissions, consumer groups, financial institutions, etc.

#### REFERENCES

1. Asbury, J.G., et al., "Assessment of Energy Storage Technologies and Systems", ANL/ES-54 (August 1976).
2. Mirchandani, G., et al., "Investments in Storage Heating", UVM/EE-3 (May 1979).
3. Nelson, S., "Assessment of Cost-Effectiveness of Thermal Energy Storage From Electricity in New England", Unpublished ANL Report (September 1979).
4. Elrick and Lavidge, Inc., "Storage Heating Study Report", for Argonne National Laboratories (July 1979).



DEVELOPMENT OF OPTIMUM PROCESS FOR ELECTRON BEAM CROSS-LINKING OF HIGH  
DENSITY POLYETHYLENE THERMAL ENERGY STORAGE PELLETS, PROCESS SCALE-UP  
AND PRODUCTION OF APPLICATION QUANTITIES OF MATERIAL

Ival O. Salyer  
University of Dayton

PROJECT OUTLINE

Project Title: Development of an Optimum Process for EB Crosslinking of  
HDPE TES Pellets

Principal Investigator: I. O. Salyer

Organization: Dayton Laboratory  
Monsanto Research Corporation  
1515 Nicholas Road  
Dayton, Ohio 45407  
Telephone: (513) 268-3411

Project Goals: Develop a thermal energy storage system based on thermally  
form-stable pellets of crosslinked high-density  
polyethylene (HDPE) prepared by electron beam (EB)  
irradiation.

The optimum EB irradiation conditions for HDPE having the  
highest possible heat of fusion will be identified. A  
250-lb batch of the optimum material will be prepared and  
evaluated in a 12,000-BTU pilot storage unit. If the  
evaluation proves promising, a 15,000-lb batch will be  
prepared, tested, and delivered to DOE (ORNL) for  
full-scale application tests.

Project Status: DuPont 7040 and 8 megarads have been selected as the  
optimum HDPE and dose, respectively. The 250-lb batch has  
been prepared.

Contract Number: Union Carbide Contract No. 7641

Contract Period: January 1979 - January 1980

Funding Level: \$55,000

Funding Source: Oak Ridge National Laboratory

## PROJECT SUMMARY

**Project Title:** Development of Optimum Process for Electron Beam Crosslinking of High Density Polyethylene Thermal Energy Storage Pellets, Process Scale-up and Production of Application Quantities of Material.

**Principal Investigator:** Ival O. Salyer

**Organization:** University of Dayton  
300 College Park  
Dayton, Ohio 45469  
Telephone: (513) 229-4235

**Project Goals:** The objective of this project is to define the electron beam irradiation conditions for preparing thermally form stable polyethylene pellets for a thermal energy storage application in the temperature interval of 120-140° Celsius.

**Project Status:** The objective of preparing thermally form stable crosslinked polyethylene has been achieved by electron beam irradiation. The irradiated polyethylene pellets have retained their initial physical form and heat of fusion after more than 100 melt-freeze cycles in ethylene glycol. Although the pellets adhere to one another at their points of contact, the pellet bed has remained porous to the free flow of the heat exchange fluid. Tests of the polyethylene pellet bed have been completed in the five pound thermal energy storage test unit. Sufficient polyethylene has been processed by electron beam irradiation to complete the planned tests in the 250 pound prototype thermal energy storage unit. We plan to complete these tests in the 250 pound unit and issue a final report in January 1980.

**Contract Number:** 9641

**Contract Period:** 5 January 1979 - 4 January 1980

**Funding Level:** \$54,585

**Funding Source:** Department of Energy, Division of Energy Storage Systems, Oak Ridge National Laboratory

## INTRODUCTION

The University of Dayton is conducting a program whose purpose is to investigate the crosslinking of high density polyethylene by electron beam irradiation. The objective of the program is to define the conditions required to prepare thermally form stable high density polyethylene by electron beam irradiation. High density polyethylene has a melting point in the temperature interval of 125-140° Celsius and values for the latent heat of fusion has been reported as high as 49 calories per gram. At its melting point, the high density polyethylene changes from a white opaque crystalline solid to a clear transparent visco-elastic liquid phase. This property was especially useful in visual observations of the pellet bed in the thermal energy storage test column. The melting temperature of polyethylene makes it especially suited for solar absorption air conditioning. Further, polyethylene melts congruently and can be cycled repeatedly through its melting point with no decrease in the value of the heat of fusion. Although solar air conditioning provides an important application and supplied the initial impetus for this investigation, the thermal storage capability of high density polyethylene should be considered for applications which will utilize the off-peak electric generating capacity and/or solar heating applications.

In a previous investigation crosslinking of polyethylene by chemical methods were investigated. The crosslinked polyethylene products were found to have excellent thermal form stability and retained their initial value of the heat of fusion after more than 400 cycles through the melting point. These chemical methods are at least as effective as the polyethylene products crosslinked by electron beam irradiation but only at much higher costs per pound of finished product. The cost for preparing polyethylene cross-linked by electron beam irradiation are estimated to add between 0.5 and 1.0 cents per pound to the cost of the polyethylene. In comparison to other materials being considered for thermal energy storage, polyethylene will require a significantly smaller volume and weight than systems which utilize only sensible heat as the storage mechanism. Importantly, polyethylene can deliver this heat energy which is stored in the change of phase at temperatures between 125° and 140° Celsius.

## EXPERIMENTAL

The principal objective of this project has been to define the irradiation conditions required to prepare thermally form stable high density polyethylene (HDPE). This objective has been achieved through the following experimental tasks.

1. Evaluate the heat of fusion and the melting temperature of several commercially available HDPE specimens as they are delivered by the manufacturer. It should be noted that HDPE products presently available have not been optimized on the basis of the value of their heat of fusion. Values as high as 58 calories per gram, or even higher, may be possible in HDPE which is more completely crystallizable.

2. Select HDPE specimens for electron beam irradiation exposures, and irradiate the selected materials to several different radiation dosage levels.

3. Evaluate the irradiated HDPE specimens for their thermal form stability, retained heat of fusion, and their melting temperature.

4. Select the irradiation conditions for which the HDPE specimens are thermally form stable, cycle irradiated HDPE samples through the melting point in a five pound thermal energy storage test column.

5. Evaluate the performance of the HDPE specimens in the five pound thermal energy storage test column.

6. Irradiate HDPE pellets for cyclic testing through the melting point in the 250 pound prototype thermal energy storage test unit.

7. Evaluate the performance of the irradiated HDPE specimens in the 250 pound test unit.

A total of 13 different commercially available high density polyethylene specimens were obtained from five different manufacturers. Listed in Table 1 are the names of the suppliers, the type of high density polyethylene, and the nominal physical property values supplied by the manufacturer. The polyethylene specimens were supplied in the form of pellets approximately 0.125 inches in diameter with the single exception of the Phillips Marlex TR-885 which was supplied in both pellet and powder forms.

We conducted experimental measurements of the melting temperature and the heat of fusion on each of these 13 specimens. These measurements were performed in our Perkin-Elmer Differential Scanning Calorimeter, Model DSC-2. The HDPE samples were contained in the standard Perkin-Elmer aluminum pans and a nitrogen atmosphere was maintained around the sample during the measurement. Measurements of the melting temperature and the heat of fusion were performed between 25 and 150 degrees Celsius at heating and cooling rates of 10 degrees Celsius per minute. The instrument was calibrated by measuring the area under the time-temperature scan during the melting of a measured quantity of high purity indium.

The melting and freezing of the polyethylene specimens were observed to occur over a range of temperatures. The results of these measurements are presented in Table 2. The values of the temperatures,  $T_1$ ,  $T_2$ , and  $T_3$ , are the values respectively, at which the transition was observed to begin, the temperature at which the maximum displacement was observed in the time-temperature plot, and the temperature at the end of the transition. An analysis of the time-temperature scans showed that more than 90 percent of heat of the transformation occurred within  $\pm 2$  degrees Celsius of the temperature,  $T_2$ , even though the heating and cooling rates were 10 degrees Celsius<sup>2</sup> per minute.

Four of the commercial polyethylene products were selected for the electron beam irradiation experiments. These products were, the DuPont 7040 pellets, the Phillips TR-885 pellets, the U. S. Industrial Chemicals LS-630 pellets, and the Gulf 9606 pellets. The three variables associated with the electron beam irradiation which were studied in our tests were:

1. the total radiation dose received by the pellets,
2. the accelerating potential of the electron beam,
3. the electron beam current,
4. the irradiation in inert atmospheres, and
5. the effects of stirring the pellets during the irradiation.

The HDPE pellets were irradiated at the electron beam facility of the Radiation Dynamics Incorporated located in Plainview, New York. Samples of the HDPE pellets supplied by the four different manufacturers were irradiated with an electron beam accelerating potential of three million volts and at an electron beam current of 20 milliamperes to radiation doses of 2, 4, 6, 8, 10, or 12 megarads for a total of 24 irradiated samples. Tests were performed at electron beam currents of 10.3 milliamperes and 5.65 milliamperes. In these two tests the HDPE pellets were irradiated to a total dose of eight megarads in the three million volt facility. Tests were performed with accelerating potentials of 1.5 and 4.5 million volts. In these tests HDPE pellets were irradiated to a total dose of eight megarads in the 1.5 and 4.5 million volt facilities and to 12 megarads in the 1.5 million volt facility. The effect of stirring the pellets during the irradiation processing was studied at three million volts, 20 milliamperes, and at an eight megarad dose. Irradiation exposures were performed with the pellets under three different atmospheres, helium, nitrogen, and carbon dioxide. Two samples were irradiated under the carbon dioxide atmosphere. In one case the HDPE pellets were given a pre-irradiation heat treatment at 100° Celsius for 12 hours in the carbon dioxide atmosphere and in the other case they were irradiated without the benefit of the heat treatment.

The irradiated polyethylene pellets were evaluated for their thermal form stability; and the values for their melting points and their retained heats of fusion were measured in the Differential Scanning Calorimeter. The thermal form stability of the irradiated pellets was evaluated by placing a small quantity of the pellets, approximately 30 gram samples, in refluxing ethylene glycol, Prestone II. The pellets were maintained in the ethylene glycol at temperatures between 145° Celsius and 165° Celsius for extended time intervals. These tests showed that DuPont 7040 pellets maintain satisfactory thermal form stability at radiation dose levels of eight megarads. Stirring of the pellets during the irradiation process appeared to be beneficial. The thermal form stability of the irradiated pellets was unaffected by changes in either the electron beam current or the electron beam accelerating potential. There was some improvement in the pellets which were irradiated under the inert atmospheres. The pre-irradiation heat treatment at 100° Celsius under the carbon dioxide atmosphere minimized the adhesion of the pellets at their points of contact. Typical results of these tests are shown in Figure 1.

The values for the heats of fusion and melting temperatures which were measured on the irradiated pellets are presented in Table 3. No significant change was observed in the values of the melting temperature of the polyethylene pellets as a function of the radiation dose. All of the irradiated pellets show a trend toward slightly lower values for the heat of fusion with increasing radiation dose levels.

Three irradiated polyethylene materials were evaluated in the five pound thermal energy storage test column. The materials which were tested are the DuPont 7040 pellets, the U. S. Industrial Chemicals LS-630 pellets, and the Gulf 9606 pellets. All of the pellets had received an eight megarad dose in the electron beam. The temperatures of the ethylene glycol were measured as a function of time at the inlet and outlet ports of the thermal energy storage column, and the temperature within the polyethylene pellet bed was measured at a point which was located approximately six inches from the inlet port. This distance is one third of the length of the storage column. The five pound thermal energy storage test unit is shown in Figure 2. The polyethylene pellet bed was cycled between 100° Celsius and 145° Celsius through more than 100 complete cycles. The melting and freezing of the pellet bed was observed by the thermal arrest of the thermocouples. The melting and freezing of the pellet bed was confirmed by a visual observation of the pellet bed through an observation port in the side of the storage column. A typical plot during the cooling cycle of the temperatures at the inlet and outlet ports and within the pellet bed itself is presented in Figure 3. As shown in this figure the temperature of the ethylene glycol at the inlet port drops rapidly to 100° Celsius. The temperature measured within the

pellet bed shows the thermal arrest as the pellet bed freezes at that point, and the temperature of the ethylene glycol at the outlet port remains at the freezing temperature of the pellet bed until the solidification of the polyethylene is completed. The completion of the freezing of the pellet bed is observed by the rapid drop in temperature of the ethylene glycol at the outlet port of the storage column. The time-temperature plots of the storage column after more than 100 cycles were compared to the time-temperature plots which were measured before the accumulation of the heating and cooling cycles. This comparison of the performance of the storage column before and after the cycling tests did not show any significant differences. The condition of the pellets after their removal from the storage column is shown in Figure 4. Although the pellets had adhered to one another at their points of contact, the pellet bed had maintained an open porous structure throughout the thermal cycling tests. The pellet bed did not exhibit any increased resistance to the flow of the ethylene glycol as the number of heating and cooling cycles increased.

The DuPont 7040 pellets with a radiation dose of eight megarads were selected for evaluation in the 250 pound prototype thermal energy storage unit. This unit is shown in Figure 5. The apparatus has been installed and is ready for the scaled-up tests of the performance of the polyethylene pellet bed. A sufficient quantity of the DuPont 7040 pellets have been irradiated to a dose of eight megarads to completely fill the 250 pound unit. The irradiation of the pellets was accomplished at the Radiation Dynamics Incorporated electron beam facility. We expect to begin this series of thermal cycling tests this week.

## RESULTS

During the course of this project we have established:

1. that the crosslinking of the polyethylene is dependent primarily on the total radiation dose of the material and is not dependent either on the accelerating potential of the electrons or the electron beam current,
2. that polyethylene pellets irradiated to a dose of eight megarads have sufficient thermal form stability and retained heat of fusion to be utilized as a thermal energy storage material,
3. that the polyethylene pellets can be satisfactorily irradiated in air. Pellets irradiated in carbon dioxide or nitrogen atmospheres show less propensity to adhere together after being thermally cycled above their melting point,

4. that the heat of fusion of the irradiated pellets shows a trend toward slightly lower values with increasing value of the radiation dose,

5. no change was observed in the melting point of the pellets with increased radiation doses,

6. that the irradiated pellets will adhere at their points of contact in an unstirred pellet bed when heated above their melting point; in a stirred bed the pellets do not adhere together even when heated above their melting points for extended time periods, and

7. that pellets irradiated to a dose of eight megarads will maintain an open porous structure even after repeated thermal cycling through their melting point. Free flow of the heat transfer fluid through the pellet bed was observed after more than 100 cycles through the melting point of polyethylene.

Future Work: Based on the encouraging results we have obtained on the electron beam irradiation of high density polyethylene we recommend that Task 3 be implemented. The objective of Task 3 is the preparation of 15,000 pounds of electron beam crosslinked polyethylene pellets, the evaluation of the cross-linked material on a laboratory and pilot plant side, and the implementation of a full-scale applications test.

Acknowledgement: This work was performed at the University of Dayton under ORNL Sub 9641 by the following personnel: I. O. Salyer, J. E. Davison, R. Chartoff, and J. E. Minardi. The electron beam irradiation of the polyethylene pellets was performed in the facilities of the Radiation Dynamics Incorporated at Plainview, New York.



TABLE 1  
HIGH DENSITY POLYETHYLENE SPECIMENS  
RECEIVED FOR EVALUATION

Supplier	High Density Polyethylene	Melt Index* dg./min.	Density* g/cc
1. DuPont	Alathon 7040, Pellets	6.0	0.96
	Alathon 7050, Pellets	17.5	0.96
2. Phillips Petroleum	Marlex TR-885, Powder	30	0.964
	Marlex TR-885, Pellets	30	0.964
	6006, Pellets	0.7	0.958
	6030, Pellets	3	0.960
3. U. S. Industrial Chemicals Co.	LS-556, Pellets	8	0.955
	LS-606, Pellets	10	0.962
	LS-630, Pellets	32	0.962
4. Dow	8064, Pellets		
	1-12065, Pellets		
	4-2060, Pellets		
5. Gulf	9606, Pellets		

\*nominal values supplied by vendor

TABLE 2  
MELTING TEMPERATURE AND ENTHALPY OF FUSION  
OF HIGH DENSITY POLYETHYLENE SPECIMENS

Sample	<u>Heating Cycle</u>			Enthalpy of fusion cal/g	<u>Cooling Cycle</u>			Enthalpy of fusion cal/g
	Temp. °K				Temp. °K			
	T <sub>1</sub>	T <sub>2</sub>	T <sub>3</sub>		T <sub>1</sub>	T <sub>2</sub>	T <sub>3</sub>	
7040	382	408	412	46.2	393	388	364	48.2
7050	385	406	410	47.3	393	387	370	44.2
TR-855, Powder	384	406	409	47.6	395	390	369	50.5
TR-855, Pellets	388	407	410	46.6	394	390	377	46.0
6006	384	411	420	47.1	398	392	365	49.1
6030	383	408	412	44.4	396	392	368	47.4
LS-556	385	406	410	38.2	393	390	377	41.2
LS-606	384	407	410	45.6	395	391	372	44.6
LS-630	381	407	411	47.3	394	390	367	45.6
8064	390	407	411	43.7	394	389	375	43.2
1-12065	387	407	411	40.5	395	390	370	42.2
4-2060	389	406	410	42.4	393	386	372	43.4
9606	370	405	410	45.6	394	389	360	43.3

TABLE 3  
THE ENTHALPY OF FUSION AND THE MELTING TEMPERATURE OF  
HDPE PELLETS AS A FUNCTION OF ELECTRON BEAM IRRADIATION

Sample	Radiation Level megarad	Heating Cycle			Enthalpy of Fusion cal/g	Cooling Cycle			Enthalpy of Fusion cal/g
		Temp. °K				T <sub>1</sub>	T <sub>2</sub>	T <sub>3</sub>	
		T <sub>1</sub>	T <sub>2</sub>	T <sub>3</sub>					
7040	as received	382	408	412	46.2	393	388	364	48.2
	2	373	408	412	42.8	393	388	362	40.5
	4	373	408	414	43.2	393	387	361	40.9
	6	371	406	411	39.9	393	387	362	38.8
	8	369	407	411	42.9	393	388	363	40.1
	10	373	405	410	40.4	393	387	361	40.0
	12	371	405	410	37.9	393	387	363	35.7
	8 <sup>1</sup>	373	406	412	38.0	393	387	368	36.6
	8 <sup>2</sup>	373	406	412	39.8	392	386	363	38.8
	8 <sup>3</sup>	373	404	409	37.9	393	387	364	36.4
TR-885	as received	388	407	410	46.6	394	390	377	46.0
	2	376	406	409	48.7	394	390	360	48.8
	4	377	406	409	48.7	394	390	362	46.7
	6	373	407	410	51.0	394	390	360	50.2
	8	373	406	411	40.7	392	388	360	40.5
	10	373	406	411	40.2	393	388	362	40.2
	12	373	405	411	39.7	393	389	364	41.5
LS-630	as received	381	407	411	47.3	394	390	367	45.6
	2	372	405	408	45.4	394	390	361	48.3
	4	373	406	409	47.8	393	389	361	45.3
	6	373	406	410	49.0	393	390	360	46.2
	8	373	406	411	43.6	392	390	360	40.4
	10	372	406	411	42.0	392	388	359	40.7
	12	373	405	409	42.9	393	390	360	38.9
Gulf 9606	as received	370	405	410	45.6	394	389	360	43.3
	2	369	405	409	41.1	393	389	361	39.4
	4	368	405	410	41.8	393	388	360	36.3
	6	371	404	409	35.2	392	387	360	35.0
	8	367	403	407	35.5	392	388	360	33.0
	10	366	401	406	35.7	393	387	360	31.7
	12	367	401	406	37.0	395	387	360	34.3

---

NOTES: 1. electron beam current - 10.30 milliamperes  
 2. electron beam current - 5.65 milliamperes  
 3. HDPE stirred during radiation exposure



(a)

Condition: as received  
Time: 2 hour exposure

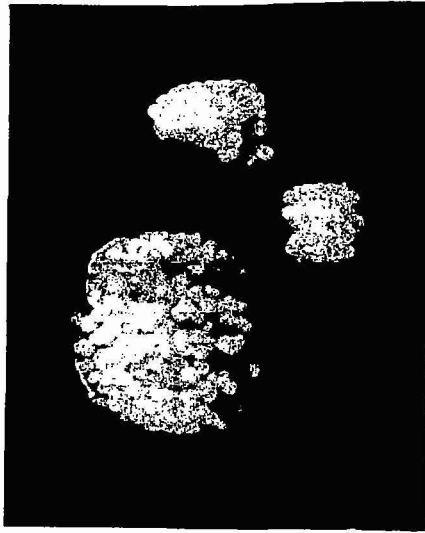

(b)

Condition: 4 megarad dose  
Time: 2 hour exposure

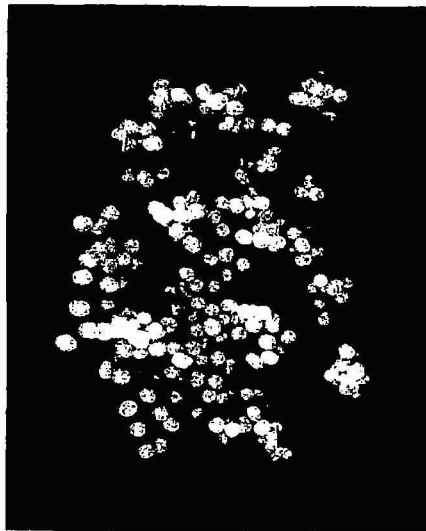

(c)

Condition: 8 megarad dose,  
unstirred  
Time: 72 hour exposure

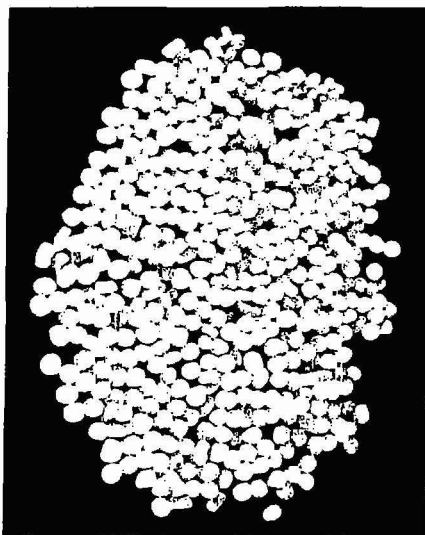

(d)

Condition: 8 megarad dose,  
This sample was thoroughly  
stirred after each 2 megarad  
exposure during the electron  
beam processing  
Time: 96 hour exposure

Figure 1. DuPont 7040 pellets after exposure in boiling ethylene glycol.

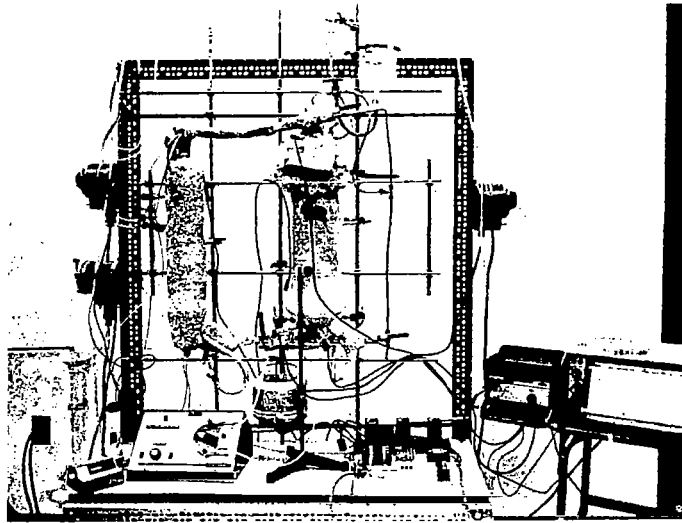

Figure 2. View of the five pound laboratory scale thermal energy storage test unit.

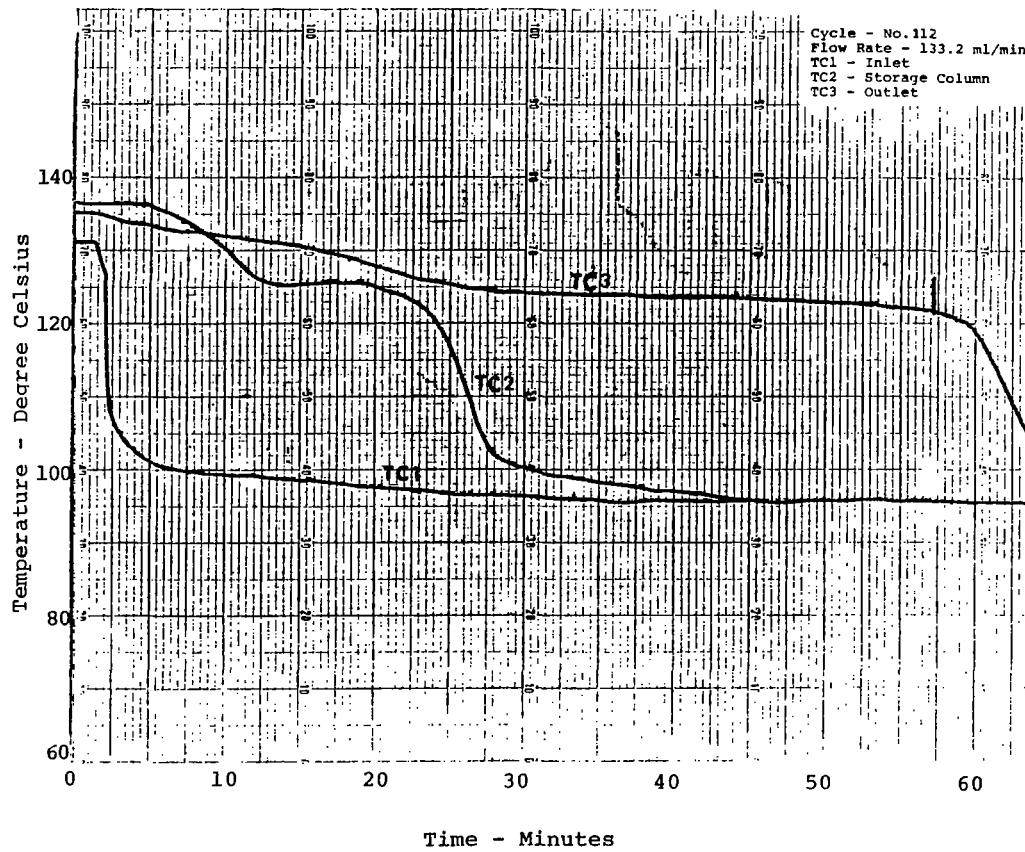

Figure 3. Temperature versus time plot for the 112th cooling cycle of the DuPont 7040 pellets in the five pound thermal energy storage test unit.



Figure 4. DuPont 7040 HDPE pellets after more than 100 complete melting and freezing cycles. The HDPE pellets had received an eight megarad dose of radiation.

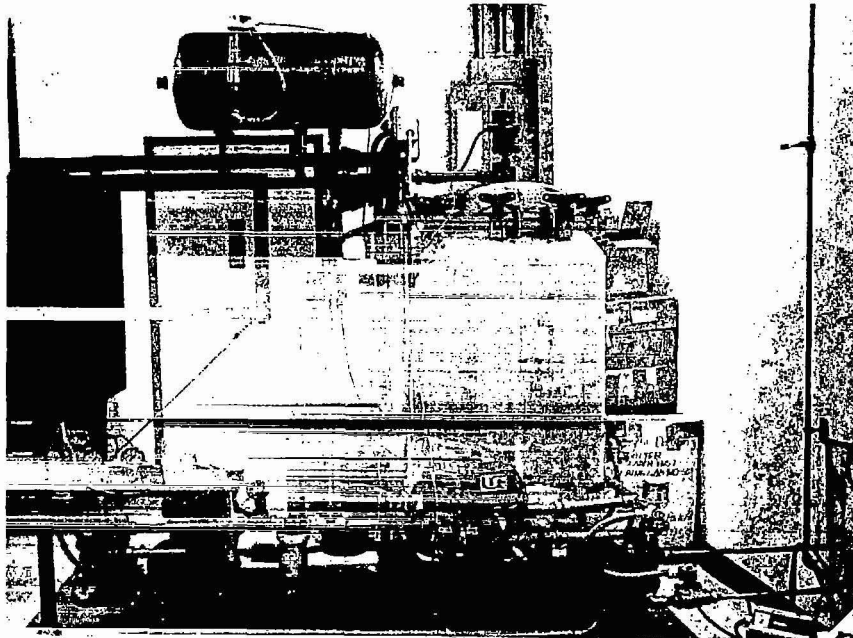

Figure 5. View of the 250 pound prototype thermal energy storage test unit.



## DISPERSED ENERGY STORAGE ANALYSIS\*

R. A. Whisnant and J. W. Harrison  
Research Triangle Institute

### SUMMARY

The objective of this project is twofold: (1) to develop and demonstrate a methodology that may ultimately be used by DOE/STOR in the planning and control of storage technologies, and (2) to perform technical and economic analyses for the evaluation of specific storage systems. The focus of the work is on dispersed (primarily customer side of the meter) thermal energy storage with particular attention being given to the comparison of dispersed storage with centralized storage. The contract for this study was initiated near the end of FY79 and there are no reportable results at this time (12/1/79.) An analysis of latent thermal energy storage for residential heat pump applications being carried out under the same contract is described in a separate paper.

---

\* Work being performed under Contract No. DE-AC-01-79ET-26707 for Division of Energy Storage, U. S. Department of Energy





## RESEARCH AND TECHNOLOGY

### Program Area Synopsis:

This development program will establish an advanced technology base which will lead to improved thermal energy storage concepts and designs for existing baseline storage subsystems. Generic, high risk technologies will be evaluated and appropriate development efforts for promising technologies will be initiated. A close liaison will be maintained with SERI to select and coordinate the development of those technologies that offer significant advancement based upon the results of current SERI studies. This activity includes the management of current contracts and grants, and the NASA-Lewis Research Center in-house storage tests.



## RESEARCH AND ADVANCED TECHNOLOGY OVERVIEW

Richard W. Vernon  
NASA-Lewis Research Center

During FY 79-80, NASA Lewis Research Center has served as the lead center for DOE/STOR's Thermal Energy Storage Program. The activities of the lead center include coordinating a research and technology development program and managing several of the efforts within that program. The program has three objectives. The first objective is to establish advanced technologies for TES systems to improve upon baseline system performance and/or lower storage system costs. The second objective is to resolve problems that are generic to several applications. Typical examples of these problems are requirements for improved heat transfer and identification of suitable storage media or appropriate containment materials. The third objective is to provide any support required for the development of baseline TES systems.

The research and technology development program consists of several types of activities. New storage concepts are identified and then assessed to determine performance and cost potentials and identify required technology developments. Materials that are candidates for TES media are investigated to determine heat transfer and corrosion characteristics. Proof-of-concept experiments are conducted for the concepts that have the most potential. Another activity is the engineering evaluation of prototype storage modules to evaluate present technology. There are two characteristics that are common to most of these activities. The activities are relatively short-term projects and usually include laboratory or bench scale experiments.

Many of the projects, especially those that are focused on a specific application, are originated at and implemented by the lead laboratories. The projects may be conducted by a private organization on contract to the lead laboratory or may be conducted in-house. The functions of the lead center are to coordinate the various projects between the organizations involved, to recommend projects that are focused on a specific application, and to conduct investigations that address issues generic to several applications. The individual lead laboratories have described the research and advanced technology projects they are managing. The projects being managed by NASA Lewis Research Center are shown in figure 1. Summaries of the projects being conducted by Honeywell, Inc. and the Naval Research Laboratory are presented immediately following this presentation. Objectives and the status of the remaining projects are presented in figures 2 through 6. For further information refer to the project summaries that are included in the compendium distributed at the meeting or to the reports for each project that will be included in the proceedings of this meeting.

RESEARCH AND ADVANCED TECHNOLOGY

NASA-LEWIS ACTIVITIES

- o IMPROVED HEAT TRANSFER FOR PCM  
GRUMMAN AEROSPACE CORPORATION  
HONEYWELL INCORPORATED
- o MEDIA FOR HIGH TEMPERATURE APPLICATIONS  
INSTITUTE OF GAS TECHNOLOGY  
UNIVERSITY OF DELAWARE
- o TES FLOW TEST FACILITY  
CONTRACTOR TBD
- o TES MODULE EVALUATION  
IN-HOUSE
- o ENERGY STORAGE-BOILER TANK  
NAVAL RESEARCH LAB

Figure 1

RESEARCH AND ADVANCED TECHNOLOGY

IMPROVED HEAT TRANSFER FOR PCM

OBJECTIVE: DEVELOP ACTIVE HEAT EXCHANGE CONCEPTS

CONTRACTOR: GRUMMAN AEROSPACE CORPORATION  
CONTRACT NO. DEN 3-38

STATUS: MEDIA SELECTED  
EUTECTIC MIXTURE KCL, NaCl, MgCl<sub>2</sub>

CONCEPTS SELECTED

- o DIRECT CONTACT HEAT EXCHANGER  
TESTS IMMINENT
- o ROTATING DRUM SCRAPER  
BEING FABRICATED

Figure 2

RESEARCH AND ADVANCED TECHNOLOGY

MEDIA FOR HIGH TEMPERATURE APPLICATIONS

OBJECTIVE: IDENTIFY CANDIDATE MEDIA AND DETERMINE PROPERTIES

CONTRACTOR: INSTITUTE OF GAS TECHNOLOGY  
CONTRACT NO. DEN 3-156

STATUS: CARBONATE MEDIA SELECTED  
PURE SALTS -  $K_2CO_3$ ,  $LiCO_3$ ,  $Na_2CO_3$   
EUTECTIC MIXTURES -  $BaCO_3/Na_2CO_3$ ,  $Na_2CO_3/K_2CO_3$   
OFF-EUTECTIC -  $Na_2CO_3/K_2CO_3$   
COMPATIBILITY TESTS SCHEDULED EARLY '80

Figure 3

RESEARCH AND ADVANCED TECHNOLOGY

MEDIA FOR HIGH TEMPERATURE APPLICATIONS

OBJECTIVE: IDENTIFY CANDIDATE MEDIA AND DETERMINE PROPERTIES

CONTRACTOR: UNIVERSITY OF DELAWARE  
GRANT NO. - NSG 3184

STATUS: METAL ALLOYS IDENTIFIED CONTAINING  
Mg, Si, Al, Cu, Zn  
METHOD DEVELOPED TO MEASURE VOLUME CHANGE  
X-RAY ABSORPTION TECHNIQUE  
CONTAINMENT MATERIAL STUDY INITIATED  
SILICON CARBIDE

Figure 4

RESEARCH AND ADVANCED TECHNOLOGY

TES MODULE EVALUATION

OBJECTIVE: EVALUATE TECHNOLOGY OF PROTOTYPE HARDWARE

MODULE DESCRIPTION:  
CALMAC MANUFACTURING CORPORATION  
 $Na_2SO_4$  (SOLID-SOLID PCM)  
ELECTRICALLY HEATED, THERMINOL 66  
400,000 BTU  
THREE PELLET CONFIGURATIONS

STATUS: TESTS RECENTLY INITIATED

Figure 5

RESEARCH AND ADVANCED TECHNOLOGY

TES MODULE EVALUATION

OBJECTIVE: EVALUATE TECHNOLOGY OF PROTOTYPE HARDWARE

MODULE DESCRIPTION:  
COMSTOCK & WESCOTT  
ELECTRICALLY HEATED, NaOH (PCM) HOT WATER  
600,000 BTU

STATUS: PERFORMANCE CHARACTERIZATION COMPLETE  
LIFE TESTING INITIATED  
DEVELOPMENT AREAS IDENTIFIED  
MODIFIED UNIT TO BE INSTALLED

Figure 6



ACTIVE HEAT EXCHANGE SYSTEM DEVELOPMENT FOR LATENT HEAT  
THERMAL ENERGY STORAGE

Richard T. LeFrois  
Honeywell, Inc.

PROJECT OUTLINE

**Project Title:** Active Heat Exchanger System Development for Latent Heat Thermal Energy Storage

**Principal Investigator:** Richard T. LeFrois

**Organization:** Honeywell, Inc.  
Energy Resources Center  
2600 Ridgeway Parkway  
Minneapolis, MN 55413  
Telephone: (612) 378-4940

**Project Goals:** Develop an active heat exchange system, utilizing a phase change thermal storage medium, where operating characteristics are compatible with a 250<sup>o</sup> to 350<sup>o</sup>C steam power cycle.

Identify and select concepts for test.

Design, fabricate, assemble and test laboratory scale modules.

Evaluate results.

Recommend further development requirements.

**Project Status:** Heat exchanger tubes coated with 1-2 mil electroless nickel were tested in a 600<sup>o</sup>F molten/hydroxide environment. Latent heat extraction could not be satisfactorily demonstrated in this experiment due to low heat transfer coefficients (90-250 BTU/hr-ft<sup>2</sup>-<sup>o</sup>F for salt-oil T's between 5-50<sup>o</sup>F).

**Contract Number:** DEN3-38

**Contract Period:** May, 1978 to September, 1979.

**Funding Level:** \$328,701

**Funding Source:** NASA Lewis Research Center

ACTIVE HEAT EXCHANGE SYSTEM  
DEVELOPMENT FOR LATENT HEAT  
THERMAL ENERGY STORAGE

R. T. LeFrois  
Honeywell Inc., Technology Strategy Center

SUMMARY

Alternative mechanizations of active heat exchange concepts were analyzed for use with heat of fusion Phase Change Materials (PCM's) in the temperature range of 250° to 350°C for solar and conventional power plant applications. Over 24 heat exchange concepts were reviewed, and eight were selected for detailed assessment. Two candidates were chosen for small-scale experimentation: a coated tube and shell heat exchanger and a direct contact reflux boiler.

A dilute eutectic mixture of sodium nitrate and sodium hydroxide was selected as the PCM from over fifty inorganic salt mixtures investigated. Based on a salt screening process, eight major component salts were selected for further evaluation. Using an economic assessment program coupling the candidate salt mixtures and heat exchange concepts,  $\text{NaNO}_3$ ,  $\text{NaNO}_2$ , and  $\text{NaOH}$  appeared to be the best major components in the temperature range of 250 to 350°C. The minor components, selected in similar fashion, are  $\text{NaOH}$ ,  $\text{NaOH}$ , and  $\text{NaNO}_3$ , respectively.

Preliminary experiments with various tube coatings indicated that a nickel or chrome plating or Teflon or Ryton coating had promise of being successful. An electroless nickel plating was selected for further testing. A series of tests with nickel-plated heat transfer tubes showed that the solidifying sodium nitrate adhered to the tubes and the experiment failed to meet the required discharge heat transfer rate of 10 kW(t).

Testing of the reflux boiler is under way. Direct injection of cool high-pressure water as a spray into the ullage was accomplished and steam was generated. The injected water was compatible with the salt mixture under the conditions imposed. An improved injector and a modified water preheater are being readied for "full up" testing.

INTRODUCTION

Thermal energy storage (TES) is important for efficient use of energy resources. Advanced storage technologies can improve the operation and economics of electric power systems by storing excess off-peak energy for later use in meeting peak demands.



In electric utilities, baseload is the round-the-clock load that is met with the most fuel-efficient equipment. As the daily load increases, the utility incrementally brings the next most efficient equipment on-line. For the near term, energy storage can effectively increase the use of existing baseload equipment. In the longer term, energy storage can increase the percentage of baseload capacity. Thus, there is an economic incentive for utilities to use baseload plants to meet the peaking loads now met by less fuel-efficient equipment.

Energy storage is a practical necessity for solar-thermal generation of electric power. It is necessary for plant stability and control issues related to high-frequency solar transients. Two techniques can be used to maintain the reliability of the grid with a large solar plant on the line. In the first technique, the solar plant is backed up with a conventional plant that is pressed into service as needed after available instantaneous solar power has been supplied to the grid. The second technique controls the delivery of power to the grid so that the collected energy can be stored when it is available and not needed to meet grid demand. This stored energy becomes available for electric generation when the demand is high and direct insolation is not available.

For these applications, the specific operating conditions and machinery typically used in power plants needs to be considered. The operational regime of conventional turbomachinery is shown in Figure 1. In Figure 2 operating conditions for current and advanced solar power plants and for utility systems are shown with corresponding entry flow temperatures. Notice that most of the steam power plants operate within a band of 4.1 MPa to 16.5 MPa (600 psia to 2400 psia); the saturation temperatures corresponding to these pressures are between 250° and 350°C.

Heat from storage is used to boil water and provide high-temperature steam to the plant. To provide steam at 250° to 350°C, heat should be stored at a temperature greater than the desired steam temperature. With an assumed temperature drop of 18°C, the useful temperature range for storage media is from 268° to 368°C. Salts with melting points up to 400°C were thus considered in PCM selection.

#### SELECTION OF HEAT EXCHANGE CONCEPTS

A candidate heat exchange concept applicable to latent heat thermal storage units must be capable of transferring heat from a source into the frozen medium causing it to melt. Likewise, the concept must be capable of transferring the thermal energy stored in the medium to a sink while the medium undergoes a solidification process. In both cases, the concept should permit relatively high heat transfer rates while undergoing the phase changes.

Because of Honeywell's experience using inorganic salts with active heat exchange devices, a dilute eutectic medium was used as a basis in formulating candidate concepts. Experience in working with dilute eutectic media indicates that the charging or melting process is not a critical issue; heat transfer during solidification from the melt is the major issue.

A survey of heat transfer and chemical processing literature was made to determine the equipment used industrially and the chemical and physical processes exploited in extracting the latent heat of fusion from a melt. An investigation of crystallization process was performed to determine if existing industrial methods might be directly applicable to or provide new ideas for latent heat storage design.

The processing literature is limited in coverage of heat exchanger crystallizers, as this approach has often been disregarded in favor of alternatives. The major design and operating problem of a cooling crystallizer is crystal deposits on the heat exchanger tubes. Once this takes place, the accumulation can increase rapidly, and not only does the heat transfer from the molten salt decrease dramatically, but the solids are not in a mobile form for pumping. Following is a list of different methods used in the past and innovative ideas put forth by Honeywell engineers to overcome the solid film problem.

- Mechanical Solids-removing Techniques:
  - Agitation
  - Vibration
  - Ultrasonics
  - Internal surface scrapers
  - External surface scrapers
  - Flexing surfaces
  - Tumbling solids
  - Fluidized beds
- Hydraulic Techniques:
  - Flow variations
  - Fluid pulsing
  - Jet impingement
  - Sprayed surface exchanger
  - Freeze-remelt
- Techniques Involving Physical Properties of the Salt:
  - Crystal volume change
  - Crystal weakening additive
  - Conductivity-enhancing additives
  - Magnetic susceptibility
  - Electrostatic separation
  - Finishing and coating of heat-exchanger surfaces
  - Delayed nucleation and supercooling
- Other Concepts:
  - Direct contact heat exchange
  - Shot tower latent heat of fusion concept
  - Prilling tower crystallization
  - Liquid metals salt system
  - Immiscible salts

- Encapsulation (passive system)
- Distributed tube exchanger (passive system)

From the survey, Honeywell selected the following concepts as candidates for further evaluation.

- Internal Surface Scraper
  - External Surface Scraper
  - Coated Tube and Shell
  - Jet Impringement
  - Reflux Boiler/Self-pressurizing
  - Reflux Boiler/Continuous Salt Flow
  - Reflux Boiler/Continuous Salt Flow with Hydraulic Head Recovery
  - Tumbling Abrasive
- } Direct Contact  
Heat Transfer

These concepts embody the most conventional and promising heat transfer processes. The passive tube-intensive system was chosen as a reference system against which cost comparisons could be made.

A comparative analysis of the active heat exchange systems listed indicates that the most economical systems are those that employ the most compact heat transfer surfaces. The compactness of the tube and shell heat exchanger and the high heat transfer rate associated with the direct contact reflux boiler concept are the two features that appear to be the most promising for large-scale implementation, i.e., 1000 MW(t) rate and 6-hour capacity.

The coated tube and shell concept capitalizes on commercial availability of tube and shell heat exchangers and assumes successful development of a non-stick finish for the exchanger tubes. Studies and discussions with consultants have indicated that there is a good possibility of achieving major reductions in the adhesion strength of solid salts to the cold metal surfaces of the tubes. One technique suggested is polishing the heat transfer surfaces to minimize the mechanical bonding of the salt to the surface. Another technique involves the application of a thin coating of an amorphous material or a material with a crystallizing structure different from, yet compatible with, the salt. This might reduce bonding strength of the microscopic scale.

The second system recommended for further study is the direct contact reflux boiler. Although two heat exchange processes are used (salt to water/steam and condensing steam on tubes), the individual thermal resistances are so low that their sum is less than the thermal resistance of most liquid-to-pipe-to-pipe-to-liquid exchange processes. Consequently, a high overall heat transfer coefficient can be continuously maintained. Furthermore, the system can be designed to operate without salt transfer pumps. This is accomplished by gravity filling the refluxing boiler and subsequently expelling the slurry with residual steam pressure.

Improved thermal efficiency through elimination of the heat exchangers can be achieved in a system where the heat transfer medium is the working fluid. The lifetime of this type of system is directly related to the content of salt remaining in the working fluid as it enters the turbine. The salt content can be minimized by good separator design.

#### COATED TUBE AND SHELL HEAT EXCHANGE CONCEPT MECHANIZATION

The coated tube and shell heat exchange system for use with molten salts is similar to any conventional tube and shell heat exchange system. The differences lie in the tube surface property and the heat storage medium. Available evidence indicates that the proper choice of tube surfaces, surface preparation, and medium selection will reduce the salt-to-tube bond strength to permit the solid salt to be removed by modest hydrodynamic forces.

Analysis showed that the tube and shell heat exchange system was the most cost-effective closed heat transfer system. Only the open-cycle reflux boiler, which can take advantage of a higher output temperature, shows possibilities of being more cost-effective. From the hardware development standpoint, the tube and shell heat exchanger technology is better developed and more widely used than any other industrial heat exchanger technology. The main questions to be resolved in its application to molten salt thermal storage are the suitable combinations of surfaces and medium, and the temperature, flow rate, and heat rate range within which the system can be operated.

Figure 3 is a diagram of a typical counterflow heat exchanger with an enlarged section of tube broken out to illustrate the different surface conditions to be explored. Figure 4 is a schematic diagram of a 1000 MW(t) system with 6 hours of storage capacity using tube and shell heat exchangers to effect the removal of the heat of fusion from the molten salt medium thermal storage. For this system, it is expected that the maximum slurry density that is readily transportable in the pipe lines will be on the order of 20 percent. To achieve high latent heat recovery from storage, the slurry is returned to storage where gravity separation is used, causing the solids to settle to the bottom of the tank. The less dense liquid rises to the top to be recirculated through the exchanger.

In a large heat exchanger, as was considered for the large-scale system, the fluids in the course of a single pass through the exchanger will flow past several hundred rows of tubes as dictated by the tube sheets (baffles). It becomes a monumental task to build a small heat exchanger model with hundreds of ranks of tubes, but the effect can be approximated by recirculating the flow repeatedly over the same tubes. This was the approach decided upon for this experimental model.

## COATED TUBE AND SHELL EXPERIMENT

This experiment, shown schematically in Figure 5, consists of an insulated mild steel tank that is heated externally with controllable guard heaters. A sump-type pump is mounted in the main storage tank such that the pump is always immersed in molten salt. A discharge line connects the salt pump to the flowby module. The module consists of a rectangular chamber with a tubular cross-flow heat exchanger which extends across the test chamber.

The solid tubes are inactive; i.e., they do not transfer heat but are flow patterns. Fifteen tubes, 19 millimeters in diameter, are arranged to transmit heat (plain tubes). These tubes are blanked off at the outboard ends and fed with cooling oil from a manifold through concentric internal tubes. Heated oil flows out through the outlet oil manifold.

The tube bundle is arranged with separator plates and, together with the oil manifolding, may be removed as a unit for servicing and changing of coated tube elements. When the unit is inserted into the test chamber, salt flow, as shown by the arrows in Figure 5, passes through the tube bundle three times. Turning vanes maintain a proper flow pattern to simulate a large tube bundle.

A discharge duct located above and at the outlet of the tube bundle and the salt stream channels the flow back to the tank. A butterfly valve regulates the back pressure and flow level in the channel. A force gauge attached to a contoured pintle measures changes in momentum of the salt slurry. By measuring the liquid height and by knowing the force, the salt slurry flow can be calculated. An electrical contact probe was planned to determine liquid levels in the flow meter. A small quantity of salt will be continually drained off the channel through a tube. This salt will flow into the main settling tank.

## REFLUX BOILER CONCEPT MECHANIZATION

The reflux boiler concept of heat exchange is depicted in Figure 6. The molten salt thermal storage medium is pumped at high pressure into the pressure vessel, where water is injected into the salt. The water flashes to steam, which raises the pressure. The steam flows to a shell and tube condenser. Here the steam condenses and transfers its latent heat to boil the water flowing inside boiler tubes. This steam can be delivered to a turbine. The condensate is collected and refluxed into the boiler to start the cycle over. Because the condenser and reflux boiler both operate at nearly the same pressure, the condensate pump need only supply enough head to overcome the salt hydrostatic head and the throttling necessary to achieve balanced flows through the injection nozzles.

The salt slurry leaving the reflux boiler has a larger potential energy due to the high pressure. A hydraulic expander can be used to recover the  $VdP$  energy by directly coupling the expander to the pump. For incompressible

fluids, a well designed pump can be run in reverse to recover head. Therefore, the expander can be a well designed motoring pump. Salt level control in the reflux boiler will be maintained by modulating the slurry discharge stream.

A commercial size thermal storage system is shown schematically in Figure 7. This system was sized to deliver 1000 MW(t) for 6 hours using eight refluxing boilers and eight condenser units. Molten salt is pumped from the top of the storage tank through the reflux boilers, and the salt slurry is directed back into the bottom of the storage tanks. Settling, with increased separation of the liquid and solid phases, will occur in the storage tanks to increase the percentage of latent heat recoverable.

#### REFLUX BOILER EXPERIMENT

The experimental apparatus used to model the reflux boiler system for a 10-kWh(t) capacity and 10-kW(t) rate must resolve the technical issues yet circumvent the development of expensive, specialized equipment. This can be done by operating the model in a batch mode and using compressed gas to transfer the molten salt into the system. This eliminates the need for a high-pressure salt pump. In addition, the low-head, high-temperature pump necessary for feedwater refluxing is replaced by a low-temperature, high-pressure pump and water preheater.

The experimental apparatus, shown in Figure 8, consists of a reflux boiler nearly filled with molten salt into which hot water is injected under high pressure. The molten salt gives up heat to boil the water. The steam bubbles to the surface of the salt and passes to the condenser, where it condenses on the cool condenser coils heating the secondary heat transfer fluid. For the experiment, the secondary fluid will be heat transfer oil Mobiltherm 603 to provide close temperature control and high heat transfer rates without using a high-pressure recirculating water loop.

The water-steam cycle will not be operated in a refluxing mode, but will be operated open-loop to provide an accurate means of measuring and controlling the water injection rate. This is achieved by measuring the rate of water uptake at the pump suction port. The condensate receiver provides a means of collecting and storing a nominal 15-minute flow of water, which can later be cooled and analyzed for salt content to estimate salt carryover. Further analysis of salt carryover can be made by disassembly of the shell and tube condenser at the end of a test run.

The advantages of this mechanization from a modeling standpoint are:

- No high-pressure pumping of salt is required.
- No throttling of a high-pressure salt or salt plus water is required.
- No valves in the salt lines must be opened or closed while high-pressure differentials exist across them.

## EXPERIMENTAL RESULTS

### Coated Tube and Shell Flowby

Testing of the coated tube and shell flowby concept has been completed. The module was exercised over a range of  $\Delta T$ 's and salt flow velocities for a given maximum oil flow rate. The tube bundle was plated with 1 to 2 mils of electroless nickel in accordance with MIL-C-26074B. The heat exchange module failed to meet the required 10 kW(t) heat extraction rate. Overall heat transfer coefficients ranged between 500 to 1500  $W/m^2-K$  for salt velocities of 0.5 to 1.5 m/s and temperature differences of 2<sup>o</sup> to 12C<sup>o</sup>. For a given salt velocity and  $\Delta T$ , the heat transfer coefficient decreased with time, indicating the buildup of a salt layer on the tubes. Increasing the salt velocity improved the heat extraction rate, but increasing the  $\Delta T$  for a given salt flow did not improve the heat extraction rate.

### Reflux Boiler

Testing of the reflux boiler is under way. Direct injection of cool, high-pressure water as a spray into the ullage was accomplished, and steam was generated. The injected water was compatible with the salt mixture under the conditions imposed. An improved water injector and modified water preheater are being readied for "full up" testing.

# TEMPERATURE AND PRESSURE REGION OF CONVENTIONAL TURBOMACHINERY

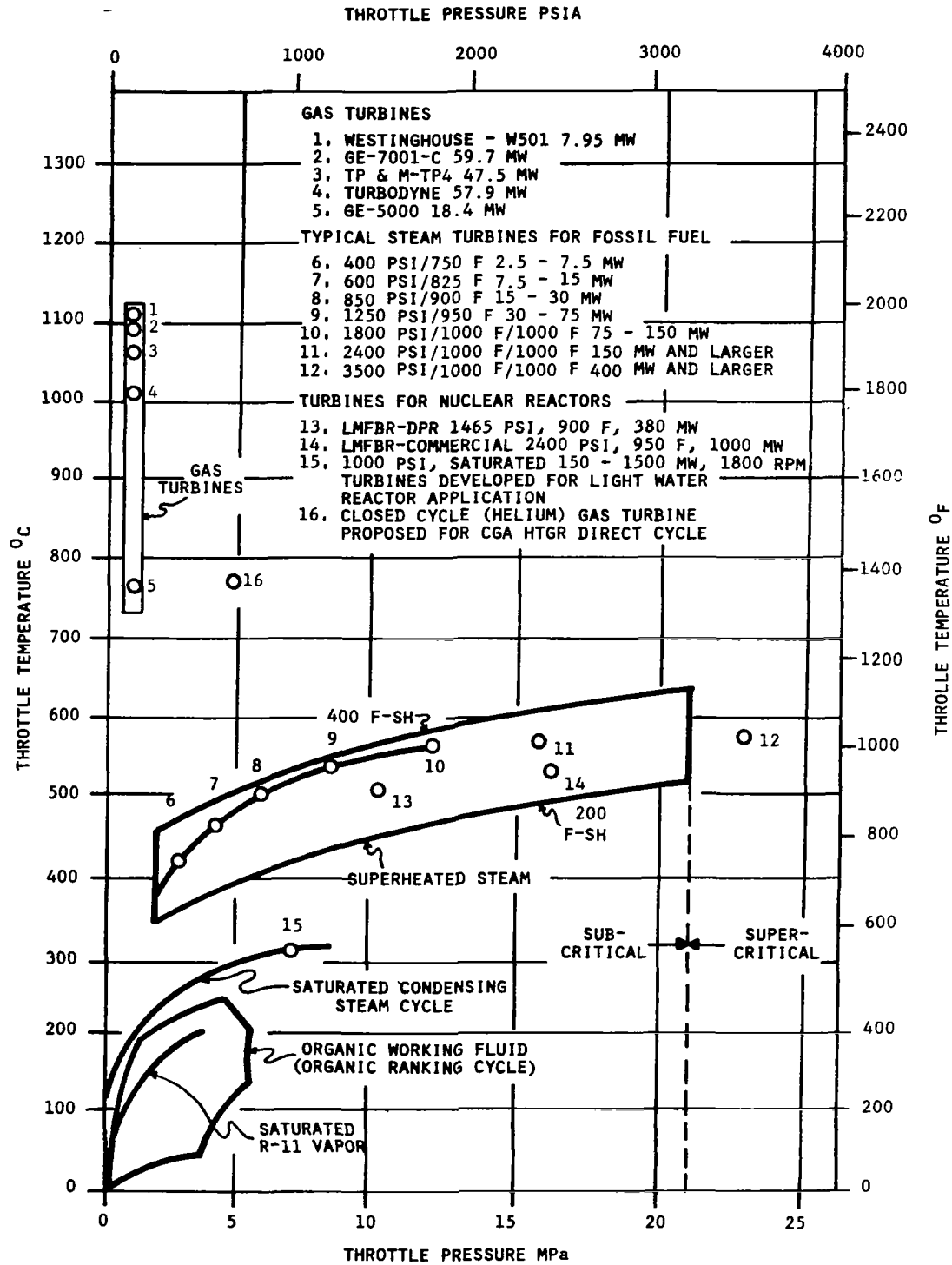

Figure 1



POWER SYSTEM CYCLE

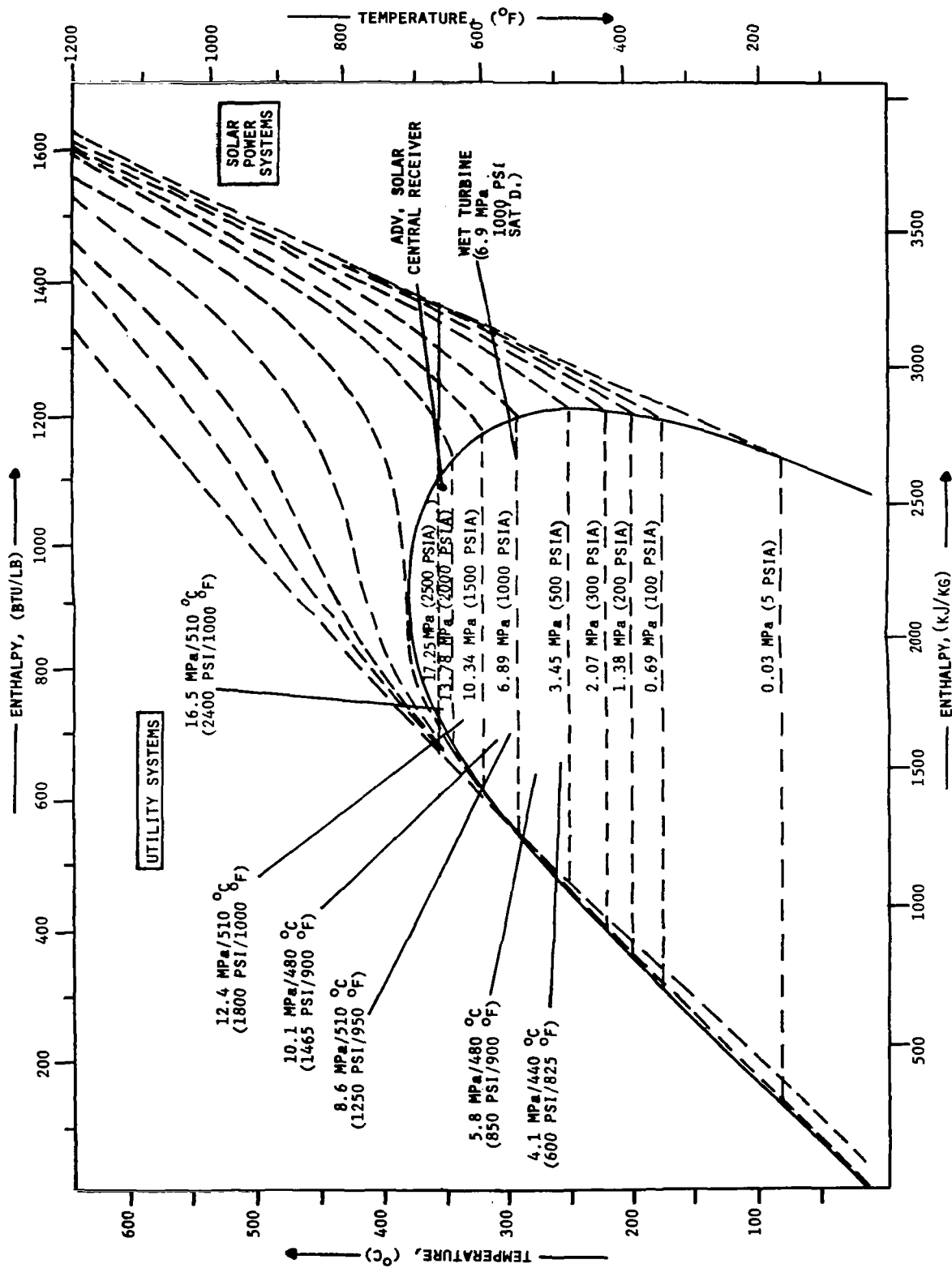

Figure 2

COATED TUBE AND SHELL HEAT EXCHANGER WITH FLOWBY

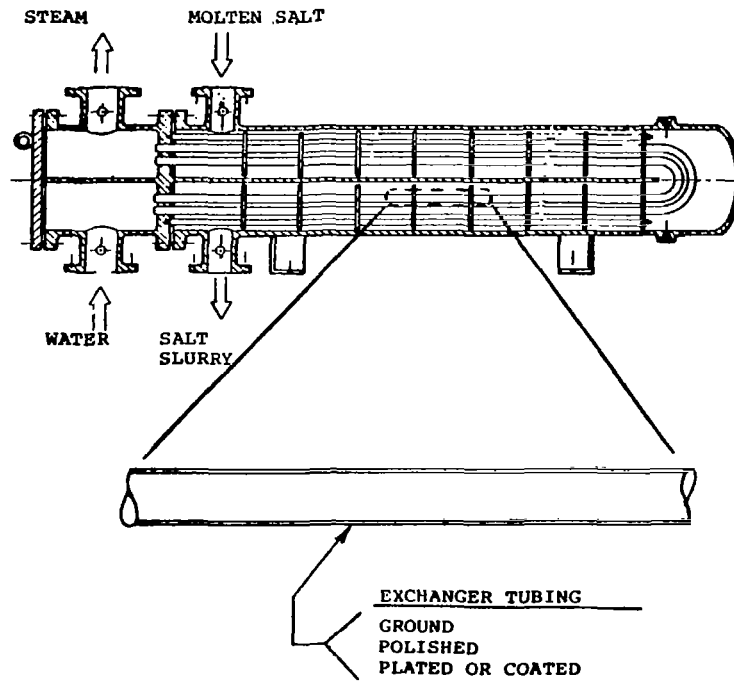

Figure 3

TUBE AND SHELL HEAT EXCHANGE SYSTEM

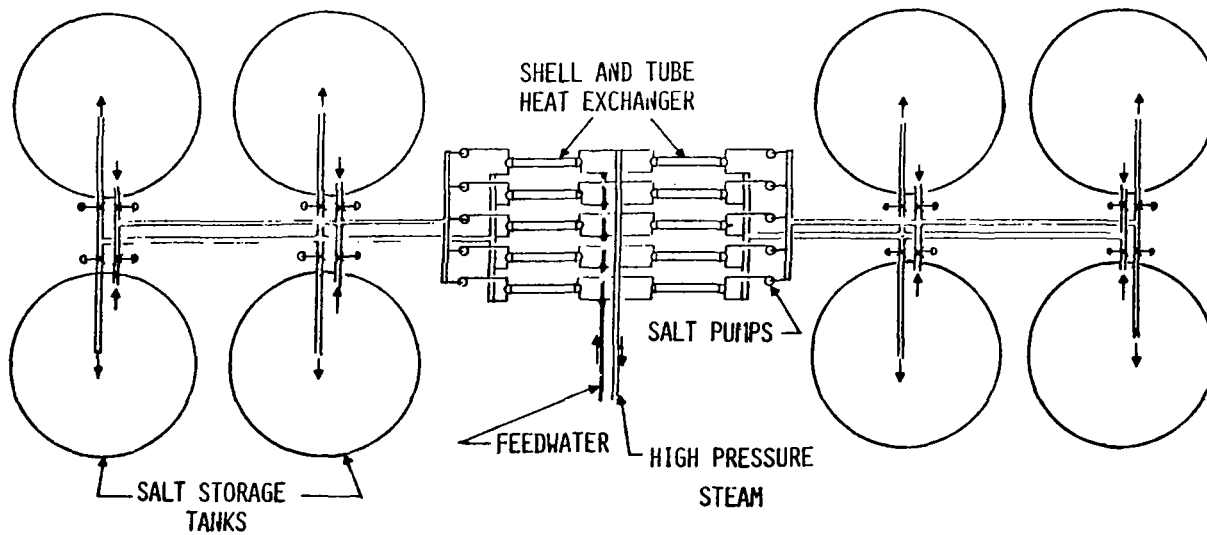

Figure 4

FLOWBY HEAT EXCHANGER - GENERAL SCHEMATIC

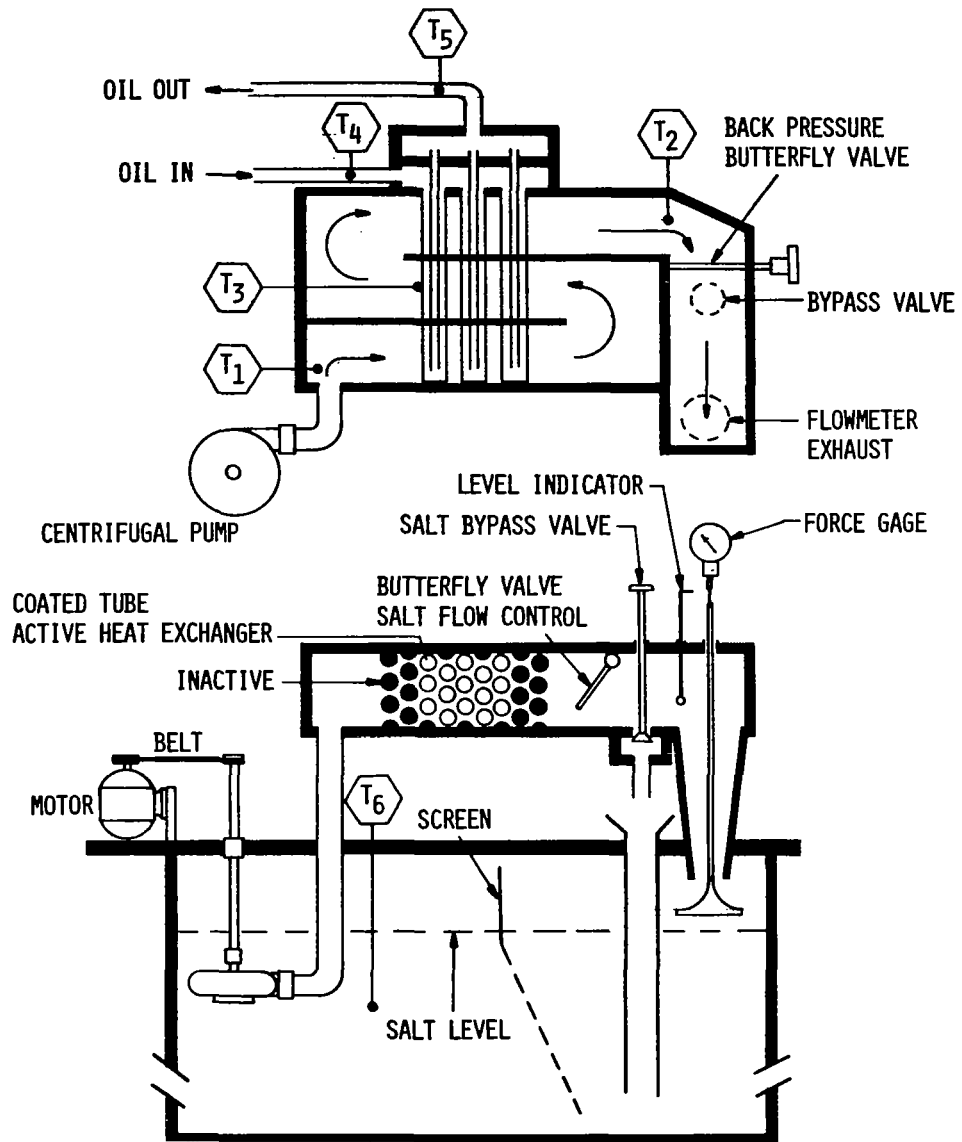

Figure 5

CONTINUOUS SALT FLOW REFLUX BOILER WITH HYDRAULIC HEAD RECOVERY

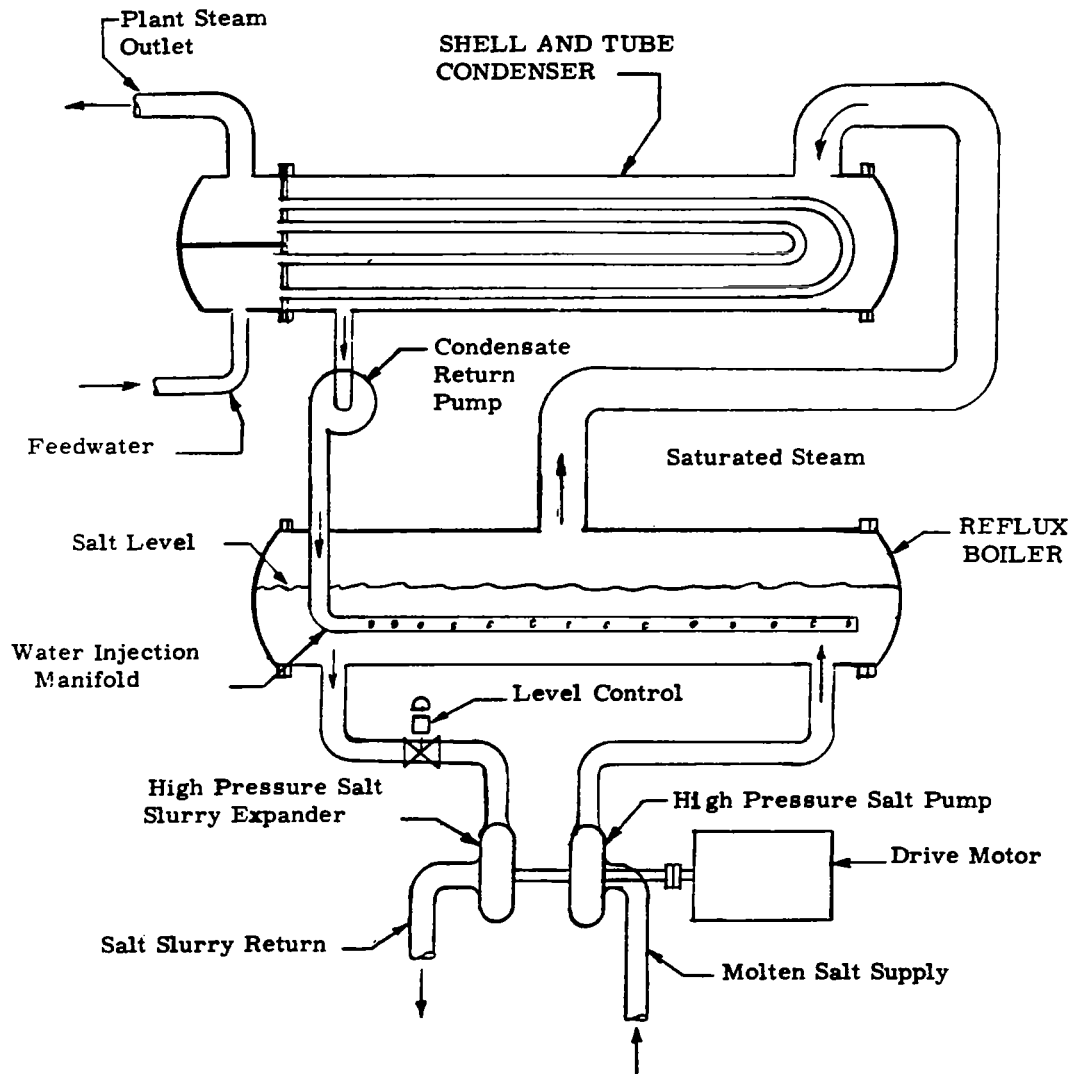

Figure 6

CONTINUOUS SALT FLOW REFLEX BOILER WITH HYDRAULIC HEAD RECOVERY

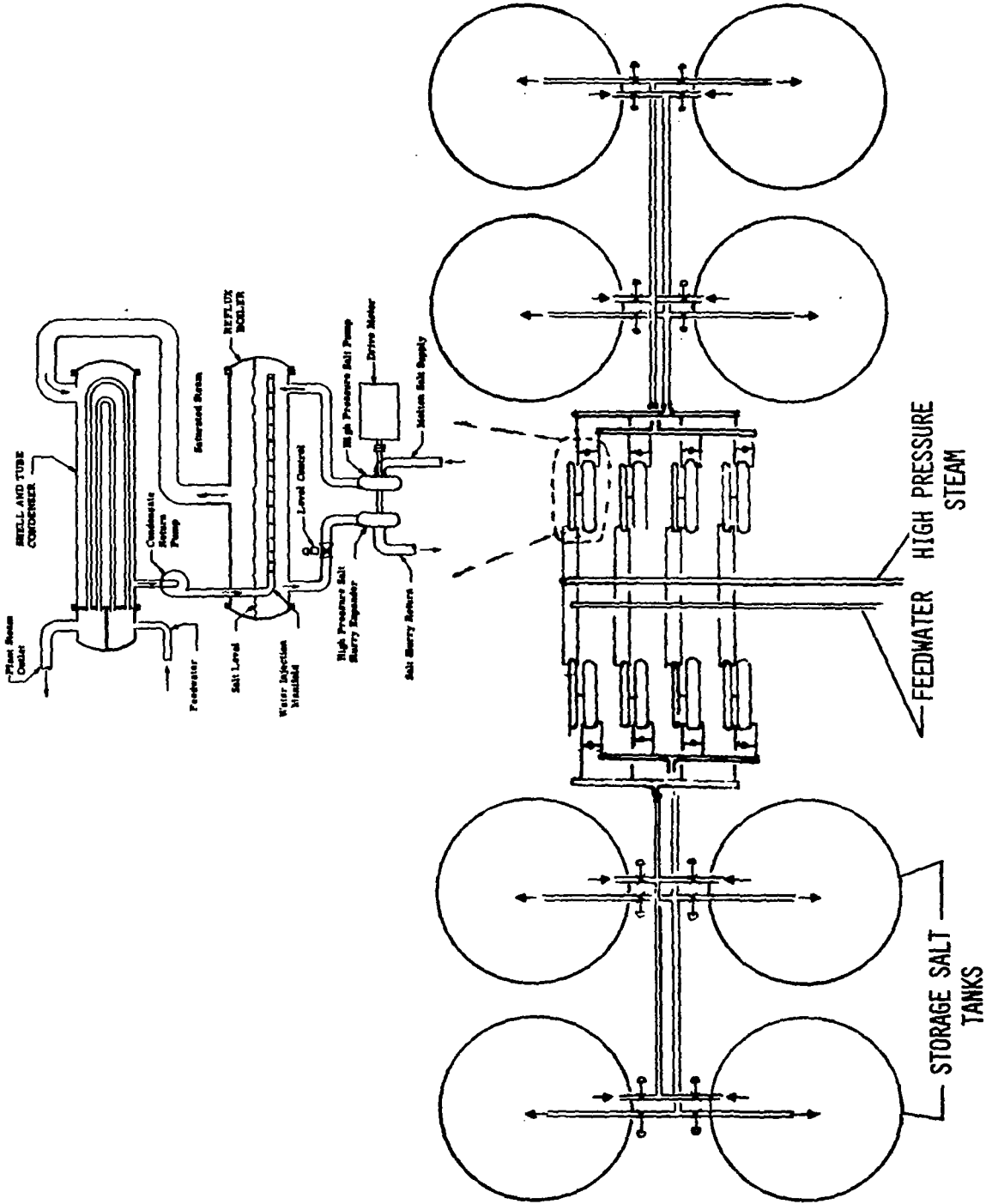

Figure 7

REFLUX BOILER MODULE  
(GUARD HEATER PANELS REMOVED)

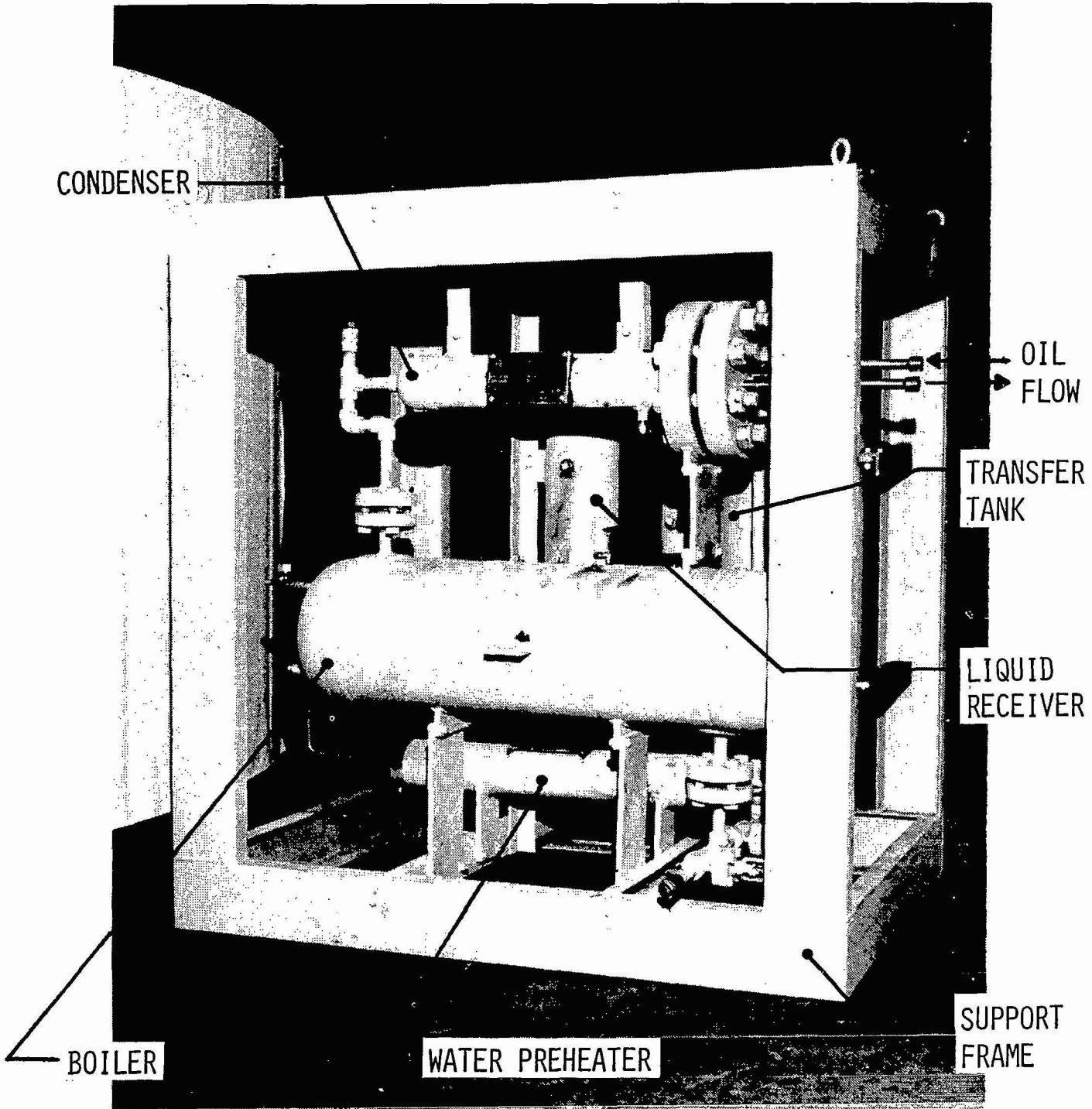

Figure 8

ENERGY STORAGE-BOILER TANK, 1979 PROGRESS REPORT

Talbot A. Chubb, J. J. Nemecek, and D. E. Simmons  
Naval Research Laboratory

PROJECT OUTLINE

**Project Title:** Heat of Fusion Energy Storage - Boiler Tank

**Principal Investigator:** Dr. Talbot A. Chubb

**Organization:** Naval Research Laboratory  
Code 7120  
Washington, D. C. 20375  
Telephone: (202) 767-3580

**Project Goals:** Demonstrate feasibility of heat-of-fusion energy storage-boiler tank.

Evaluate media and heat transfer fluid properties and cycle life characteristics.

Perform storage media-containment materials compatibility studies.

Design, build, and operate a 2 MWh storage-boiler tank.

**Project Status:** Completed property determinations and selected a eutectic salt (NaCl, KCl, Mg Cl<sub>2</sub>) having a melting point of about 385°C, and M-terphenyl as the heat transfer fluid.

Compatibility studies are complete and mild steel containers have been selected.

Fabrication of 2 MWh storage-boiler tank is proceeding and scheduled to be completed in December, 1979. Operation and tests are scheduled through 1980.

**Contract Number:** EC-77-A-31-1024 and NRL M003

**Contract Period:** July, 1976 to February, 1980

**Funding Level:** DOE - \$360,000, NRL - \$190,000

**Funding Source:** DOE-Division of Energy Storage Systems and NRL

## ENERGY STORAGE-BOILER TANK, 1979 PROGRESS REPORT\*

T. A. Chubb, J. J. Nemecek and D. E. Simmons  
Naval Research Laboratory

The objective of the Program EC-77-A-31-1024, Heat of Fusion Energy Storage-Boiler Tank, is the demonstration of heat-of-fusion energy storage in containerized salts. The smallest size storage unit that effectively demonstrates the heat transfer problems associated with such storage, is about 2 MWh. A proof-of-concept 2 MWh energy storage tank is currently under construction on the grounds of the Naval Research Laboratory in Washington, DC. This energy storage unit is the largest heat-of-fusion storage unit in the U. S. program.



Fig. 1. Energy Storage Boiler Tank at the Naval Research Laboratory

Figure 1 shows the energy storage site at the Naval Research Laboratory. The energy storage tank proper is being installed in the square building in the right center of the picture. The roof covering the tank site is a weather shield which can be removed by the light gantry crane. The Butler building is used for storage of Dacotherm insulation, a light-weight sodium silicate insulation, which surrounds the tank during operation. The small sheds near the tank are electrical junction boxes from which 150 kW of heater power is made available for energizing the tank and from which power connections are made to the feedwater pump, the terphenyl circulation pump, an air compressor used for



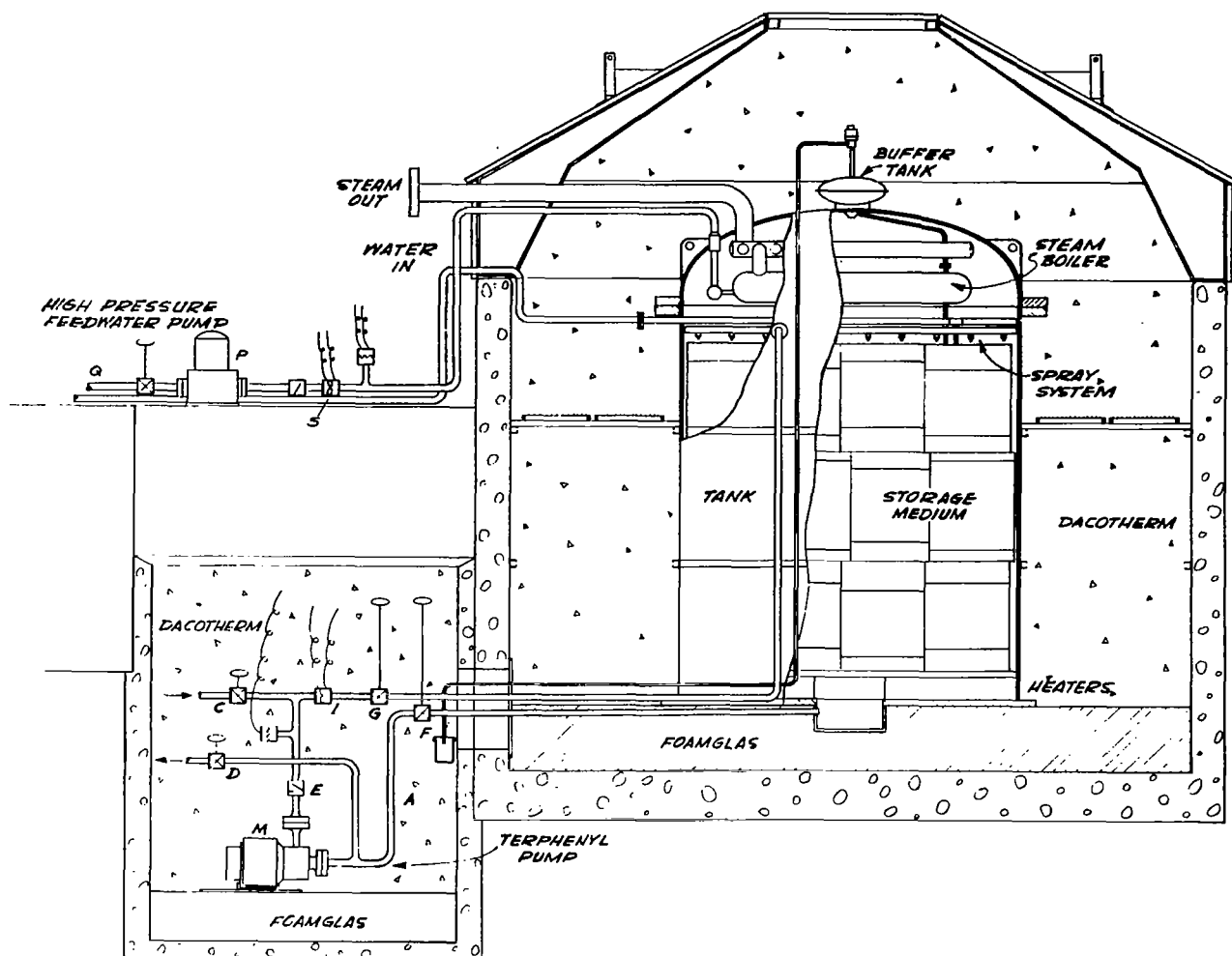

Fig. 2. Cutaway view of 2 MWh Energy Storage Boiler Tank

conveying the Dacotherm insulation, and other auxiliary power purposes. The larger shed houses the compressor, feedwater pump, and controller. The trailer is used to house instrumentation which will monitor temperatures, pressures, flow rates, etc., connected with operation of the facility.

Figure 2 shows the energy storage boiler tank design. The tank is 10.5 feet in diameter and 12 feet high to the level of the flanged ring. A mating domed lid interfaces with this flange, increasing the interior height to 15 feet. The tank is largely filled with containerized salt. The salt canisters are 4" in diameter, 19" high and are racked into hexagonal baskets for loading. The tank rests on a Foamglas base 2 feet thick, and is surrounded on its side by 40+ inches of Dacotherm insulation. Insulation is adequate to permit the tank to hold its heat for more than 3 weeks. Energization is provided by electrical heater elements embedded in aluminum castings. Twelve such castings rest on the bottom of the tank and provide a total input capacity of 180 kW. Power is brought into the tank through hermetic electrical feedthroughs (Varian #9545009). Internal heat transfer is provided by about

1600 kg of M-terphenyl heat transfer fluid which is operated in a boiling-condensing mode (M-terphenyl is the major constituent of Monsanto's Therminol 88 heat transfer fluid). The lid of the tank contains a boiler-superheater assembly. This assembly receives its energy by condensation of M-terphenyl vapor. The boiler-superheater is expected to provide a peak power output of more than 500 kW.

Also shown in Figure 2 is a pit located below tank level. This pit is the terphenyl pump pit. A hot chemical circulation pump is located in the bottom of the pit. It receives liquid terphenyl from the tank under gravity head. The chemical pump delivers the liquid terphenyl to shower heads located above the salt cans and sprays the terphenyl over the salt cans during energy withdrawal periods. Evaporation of the liquid film of terphenyl which coats the salt tanks provides the means by which heat is removed from the salt cans during energy withdrawal.

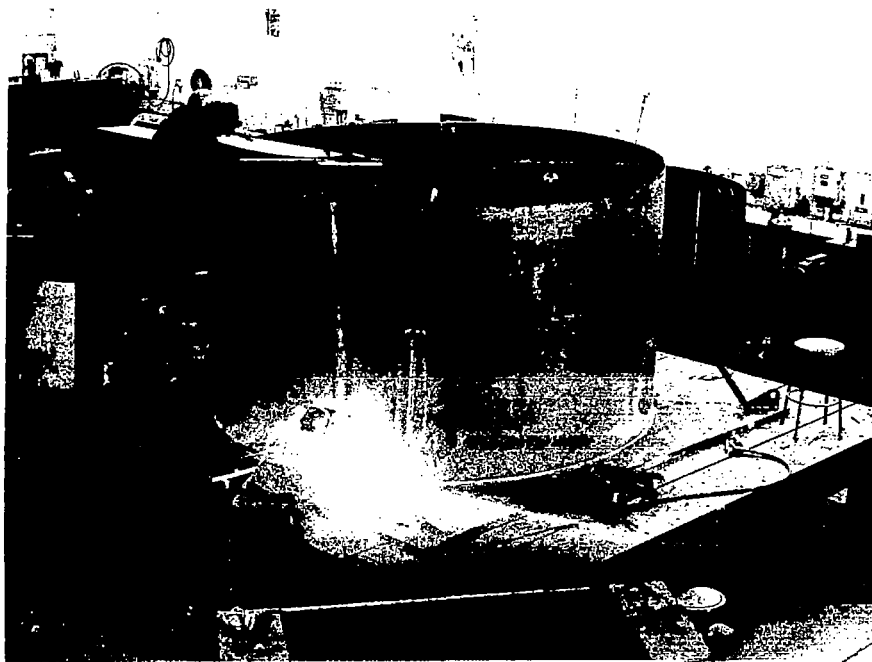

Fig. 3. Containment vessel of 2MWh tank under construction in NRL shop.

Figure 3 shows the energy storage boiler tank under construction in the NRL shop. The tank has a two inch thick steel base with reinforcing ribs. The tank walls are half inch mild steel. The tank is of normal welded construction.

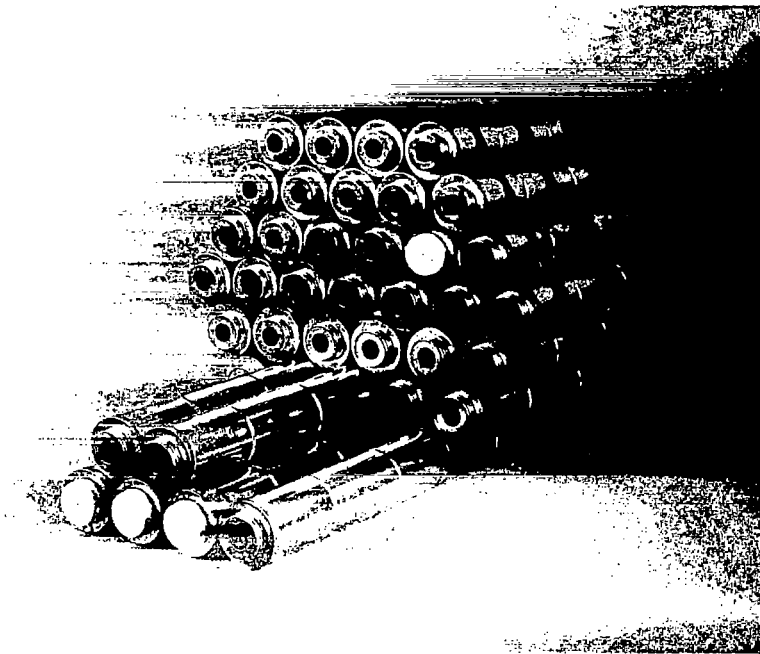

Fig. 4. Salt cans for 2 MWh tank.

Steel cans play an important role in the energy storage boiler tank. These cans, which must contain molten eutectic salt, make use of welded seams in the forming of the can bodies. The cans to be used in the 2 MWh tank were procured from Ellisco Corporation, Fig. 4. The screw-on caps provide protection during salt warehousing, but contain breathing holes that open at operating temperature.

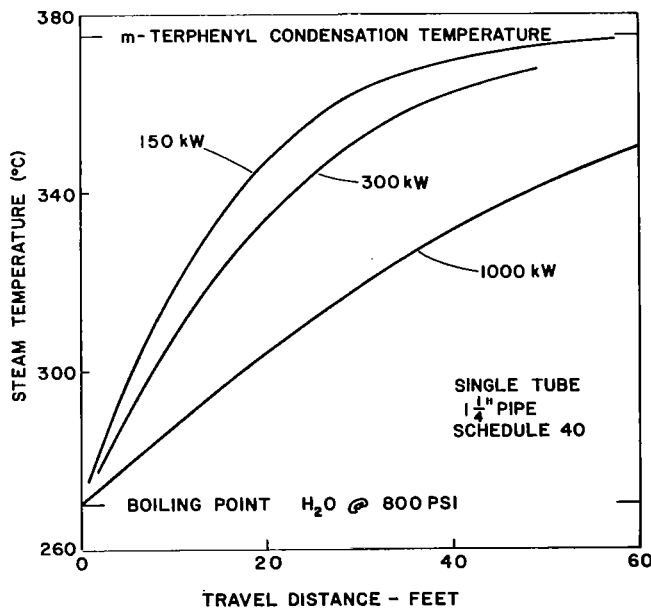

Fig. 5. Calculated temperature growth inside superheater.

Fig. 5 shows the calculated temperature growth in the steam as it flows through the superheater. The figure permits calculation of output steam temperature for various energy withdrawal rates. The superheater in the 2MWh tank is 60 feet long. At 1000 kW energy withdrawal an output temperature of 350°C is predicted. The boiler-superheater assembly consists of 12 4-inch boiler tubes in parallel feeding a single superheater line. Energy transfer to the boiler-superheater assembly is limited primarily by thermal conduction through the film of

TABLE 1 - Specifications: 2 MWh Tank

<u>ITEM</u>	<u>VALUE</u>
<u>Storage Characteristics</u>	
Storage Capacity (a)	1.82 MWh = 6.55 GJ = $6.2 \times 10^6$ BTU
Max Energy Input Rate	150 kW
Min Fill Time	12.1 h
Design Output Rate	150 kW
Design Energy Withdrawal Time	12.1 h
Heat Loss to Environment	3000 W estimated
Energy Half-Life	25 days
<u>Tank Configuration</u>	
Inside Diameter	3.18 m (10.4 ft)
Inside Height to Flange	3.66 m (12.0 ft)
Inside Height to Dome	~4.6 m (~15 ft)
<u>Containerized Salt</u>	
Salt Mass	27 T (metric)
No. Cans	4000
Can Diameter	4" = 10.2 cm
Can Height	18.2" = .46 m
Can Volume	3.75 liter
Salt Mass Per Can	6.82 kg (liquid density = $1.82 \text{ gcm}^{-3}$ ) (b)
<u>Heat Flux Into Salt</u>	
Can Sidewall Area	690 m <sup>2</sup>
Heat Flow Density @ 150 kW at Can Wall	254 W m <sup>-2</sup>
Temperature Drop Through 4 cm of Salt (c)	20°C
<u>Terphenyl Circulation</u>	
Terphenyl Content	1.6 T (metric)
Mass Flow Rate @ 150 kW	.54 kg s <sup>-1</sup>
Condensation Rate @ 150 kW	.68 liter s <sup>-1</sup> of liquid (10.7 gpm)
Vapor Pressure @ 365°C (d)	100 kPa (1.0 atm, 14.7 psia)
Perfect Gas Density	4.40 g liter <sup>-1</sup>
Gas Volumetric Flow	.123 m <sup>3</sup> s <sup>-1</sup>
Flow Velocity for 10% Open Area	.15 m s <sup>-1</sup> (.05 ft s <sup>-1</sup> )
<u>Steam System</u>	
Steam Pressure	5.4 MPa (800 psi)
Steam Temperature	371°C (700°F)
Steam Output (@ 150 kW Withdrawal)	.05 kg s <sup>-1</sup> (393 lb hr <sup>-1</sup> )
Water Feed Temperature	21°C (71°F)
Water Flow Rate	.05 liter s <sup>-1</sup> (.8 gpm)

(a) Salt heat-of-fusion only.

(b) Based on observed pour level in cans which are subsequently weighed.

(c) Based on  $k = .87 \text{ W m}^{-1}$ . Ref. radius = 3 cm.

(d) Handbook of Chemistry and Physics, 48th edition, p. C-560 (1967).

terphenyl condensate which continually forms on the boiler components; to a lesser extent heat transfer is limited by heat flow across the metal-steam interface in the steam superheater tube.

Specifications for the tank are shown in Table 1. Heat-of-fusion storage provides 90% of the 2 MWh rated storage capacity. The specified energy withdrawal rate is 150 kW, corresponding to an output of 800 psi superheated steam of 180 kg hr<sup>-1</sup> (393 lbs hr<sup>-1</sup>). A maximum steam output rate of more than 600 kg hr<sup>-1</sup>, i.e. 500 kW, should be achieved.

It is expected that the energy storage boiler tank will be installed on-site within the next couple of months. It is hoped to initiate heat transfer tests later in the winter. Installation of the salts will probably occur during the spring of 1980, with energy storage runs beginning shortly thereafter. A detailed report is in preparation.



## THE SERI SOLAR ENERGY STORAGE PROGRAM

Robert J. Copeland, John D. Wright, and Charles E. Wyman  
Solar Energy Research Institute

### PROJECT OUTLINE I

Project Title: Ranking Methodology for Comparing Thermal Storage

Principal Investigator: R. J. Copeland

Organization: Solar Energy Research Institute  
1617 Cole Boulevard  
Golden, CO 80401  
Telephone: (303) 231-1012

Project Goals: The objective of this subtask is to develop a methodology to identify thermal storage concepts for solar thermal applications and use that methodology to select thermal storage technologies for development.

A ranking methodology has been developed to compare thermal storage concepts when they are performing the same mission. A complete storage coupled solar thermal system which includes collector fields, receiver, conversion equipment, etc., is specified, and a reference thermal storage concept is assigned to the system. A single mission is defined by specifying collector area, application, etc. A comparison is then made of the delivered energy cost when the reference thermal storage concept is employed in the solar thermal system to that when an alternate storage option is utilized to perform the same mission. This comparison can be repeated for as many storage concepts and solar thermal missions as desired.

The ranking methodology employs both the cost and performance factors associated with each storage alternative to determine the storage concept or concepts most suited to the defined mission. The methodology is being developed in two forms: a simplified version to be used to quickly screen thermal storage concepts and a computer version to conduct in-depth evaluations. Cost and performance data to be generated by a competitively selected subcontractor will be used in the ranking methodology, and two or three thermal storage concepts will be recommended as candidates for development in FY 80 for each of the solar thermal system targets.

In later years, SERI will make recommendations based on the ranking methodology for selection of only one thermal storage concept for development.

Organization: Solar Energy Research Institute

Project Status: The simplified ranking methodology has been developed and documented in the report "Preliminary Requirements for Thermal Storage Subsystems in Solar Thermal Applications" to be released in the fall of 1979.

Solar thermal system cost and performance have been generated by SERI and a subcontractor for use in the ranking methodology.

Contract Number: EG-77-C-01-4042

Contract Period: October 1978 to September 1979

Funding Level: \$172,000 (Includes 50% Value Analysis)

Funding Source: DOE/Thermal Power Systems  
DOE/Energy Storage Systems



## PROJECT OUTLINE II

**Project Title:** Latent Heat Storage Research

**Principal Investigator:** John Wright

**Organization:** Solar Energy Research Institute  
1617 Cole Boulevard  
Golden, CO 80401  
Telephone (303) 231-1756

**Project Goals:** The Latent Heat Storage Research Subtask seeks to quantitatively understand the basic hydrodynamic and heat transfer processes governing the operation of direct contact latent heat storage units.

The problem is approached from both the analytical and experimental viewpoints. The proper model to correlate immiscible fluid residence time with heat transfer will be determined by an investigation of the heat transfer to single droplets of immiscible fluid. The model chosen will be used along with hydrodynamic observations to analyze the heat transfer data gathered in the pilot scale multi-drop unit. Other effects to be investigated will be the effect of immiscible fluid flow rate on salt carryover, and a determination of whether the kinetics of crystallization may be the rate limiting step in the phase change process. The initial research is done using low temperature salt hydrates for heating and cooling storage; however, the effort will be extended to higher temperature ranges.

**Project Status:** Mathematical models developed to predict heat transfer behavior of single and multi-drop systems.

Single-drop experiment constructed.

Multi-drop experiment designed and under construction.

Preliminary experiments to characterize suitability of salt hydrates for direct-contact experiments underway.

Economic analysis of the value of sensible and latent heat storage for home heating completed.

**Contract Number:** EG-77-C-01-4042

**Contract Period:** October 1978 to September 1979

**Funding Level:** \$127,500

**Funding Source:** DOE/Thermal Power Systems  
DOE/Energy Storage Systems

## THE SERI SOLAR ENERGY STORAGE PROGRAM

Robert J. Copeland, John D. Wright, and Charles E. Wyman  
Solar Energy Research Institute

### SUMMARY

The SERI Solar Energy Storage Program provides research on advanced technologies, systems analyses, and assessments of thermal energy storage for solar applications in support of the Thermal and Chemical Energy Storage Program of the DOE Division of Energy Storage Systems. Currently, research is in progress on direct contact latent heat storage and thermochemical energy storage and transport. Systems analyses are being performed of thermal energy storage for solar thermal applications, and surveys and assessments are being prepared of thermal energy storage in solar applications.

### INTRODUCTION

As part of the Thermal and Chemical Energy Storage Program of the DOE Division of Energy Storage Systems, thermal energy storage technologies are developed for identified application areas by the laboratories designated with the appropriate lead responsibility. The SERI Solar Energy Storage Program supports the Thermal Energy Storage Program by researching advanced technologies and performing systems analyses and assessments.

The general objective of the SERI Solar Energy Storage Program is to develop a better understanding of advanced thermal energy storage technologies for solar applications and to obtain information that allows storage developers to select promising thermal storage technologies for solar applications. To accomplish this objective, research and development are performed on advanced thermal storage options in an attempt to resolve technical and economic uncertainties that hinder development. New thermal storage concepts also are defined as part of this effort. Systems analyses are conducted for defined solar applications to determine thermal storage requirements and to aid in selecting thermal storage concepts. Surveys and assessments also are performed to examine the match between thermal energy storage technologies and solar application areas. For FY80, the emphasis of these activities is to support the joint plan between the DOE Division of Energy Storage Systems and the Division of Central Solar Technology for developing thermal energy storage for solar thermal applications (ref. 1). The SERI FY80 solar energy storage activities are discussed in the following narrative, with two areas discussed in some detail and the other two summarized briefly.

## ADVANCED TECHNOLOGY RESEARCH AND DEVELOPMENT

### Thermochemical Storage and Transport Research

A new area in the SERI Solar Energy Storage Program for FY80 is thermochemical storage and transport research. Previous studies have raised questions as to the efficiency and cost capabilities of reversible thermochemical reactions for energy storage and transport (ref. 2). However, reversible reactions show significant technical promise because of their ability to store large quantities of heat at ambient conditions, an attribute which makes them appear particularly promising for long duration storage and transport. Therefore, an effort is in progress to define the efficiency and cost constraints for thermochemical storage and transport and to assess quantitatively the performance of such systems. The information developed also will be used to determine whether there are research opportunities that could make thermochemical energy storage and transport cost effective. If the cost and efficiency constraints are not prohibitive, laboratory research will be performed to understand the actual behavior of reaction systems.

### Latent Heat Storage Research

The objective of latent heat storage research at SERI is to provide a quantitative understanding of advanced latent heat storage systems which can be used to assess their potential. This section of the paper presents the results of an economic analysis of latent and sensible heat storage for home heating, a heat transfer analysis of a direct contact heat storage system, and a brief description of experiments to be undertaken to validate models and determine key mechanisms.

A comparative analysis of sensible and latent heat storage for home heating was carried out to define any performance or economic advantages attributable to the use of latent heat storage. Air/rock, air/salt hydrate, water, and water/salt hydrate systems were compared for a range of storage and collector sizes for locations of Albuquerque, N. Mex., and Madison, Wis. For a given load and size of collector array, increases in storage mass increase the amount of solar energy delivered until all the energy collected is used, the load is fully supplied, or losses from storage exceed the gains. Curves describing the energy delivered to the load as a function of the storage mass for fixed collector areas, heating loads, and locations were obtained from previous studies (ref. 3). The cost of the solar system may be defined as a function of collector area and storage size. Dividing the cost of the system by the annual delivered energy yields a criterion for judging the relative economics of latent and sensible heat storage.

In this analysis no allowance was made for subcooling or degradation of the phase change material. Therefore, the conclusions drawn from the analysis

are optimistic projections for latent heat storage. The major conclusions for home heating use include:

- Air-based salt-hydrate latent heat storage offers a four to one reduction in storage volume over rock bed systems, while liquid-based salt hydrate systems offer a two to one reduction over hydronic storage.
- Constant temperature operation during phase change provides no operational advantage, and the volume reduction is the only advantage afforded by latent heat systems.
- The distinction between air- and liquid-based systems is far more important than that between sensible and latent heat systems.

These conclusions apply only for the home heating application analyzed, and more advantages are anticipated for latent heat storage in hot or cold side air conditioning storage or in solar thermal steam generation.

Latent heat storage must be economically competitive with sensible heat storage for home heating unless space is at a premium. One of the major impediments to successful use of latent heat storage is the expense of providing sufficient heat transfer surface to overcome solid phase resistance during heat extraction. This problem possibly may be avoided by the use of inexpensive containment materials or direct contact heat exchangers as suggested originally by Etherington and recently researched by workers at Clemson University and the Desert Research Institute (refs. 4,5). Research at SERI has been directed at the latter approach since the results may be useful for higher temperature operation as well. To date, heat transfer in macroscopic systems has been analyzed in terms of volumetric heat transfer coefficients. This method is convenient for reporting experimental results but, because the fundamental physical processes governing heat transfer do not appear explicitly, it is of limited value in scaling up or in designing a system with a different geometry, phase change material, or immiscible fluid.

Experiments are being conducted on salt hydrate/oil systems (Figure I) such as would be used for space heating. This temperature range was chosen to simplify the experimental portion of the work. As the models are developed further, it is expected that effort will shift to higher temperature applications where constant temperature operation and volume reduction are more critical and latent heat storage may be more beneficial.

Heat transfer in a direct contact system can be described by the familiar equation

$$q = U A \Delta T, \quad (1)$$

where  $q$  = heat transfer rate ( $J/s$ ),  $U$  = overall heat transfer coefficient ( $J/s \text{ } ^\circ C \text{ cm}^2$ ),  $A$  = surface area ( $\text{cm}^2$ ), and  $T$  = temperature ( $^\circ C$ ). However, the determination of  $U$  and  $A$  is not simple.

The heat transfer area  $A$  is equal to the surface area per drop of oil multiplied by the number of drops in the system. Surface area per drop is a

function of drop diameter, which is itself a function of flow rate, distributor geometry, and fluid properties. The number of drops in the system is a function of dispersed phase flow rate, drop size, and physical properties.

If fluid flows slowly through a nozzle, drops will form at the surface, grow, detach, and rise. When the flow rate increases to a critical velocity, a jet forms and the drop diameter suddenly decreases. As flow rate increases the jet lengthens. When the jet length is a maximum, the surface area per unit volume of fluid also goes through a maximum. This critical flow rate and the drop size at this velocity may be determined from theory. The drop size at other flow rates must be found by empirical correlations with limited ranges of applicability (refs. 6-8).

If single drops rise through an infinite, quiet, continuous phase, their terminal velocities may be predicted from a force balance. When many drops rise simultaneously, they decrease the effective free area through which the drop rises. This reduction in free area compresses the streamlines around the drop, producing additional drag and dramatically reducing the rise velocity. This interaction may be described quantitatively and used to predict the number of drops in a storage unit (ref. 9).

Defining a heat transfer coefficient is a difficult process. Drops with diameters greater than 0.7 cm or rising with  $N_{Re} > 200$  are often classified as large. They periodically shed their wakes, setting up oscillations within the drop which provide internal mixing. Such drops have resistance to heat transfer only at the surface, and heat transfer is relatively rapid. The fractional approach to thermal equilibrium is given by

$$E_m = 1 - e^{-\frac{Ah}{V \rho C_p} t} \quad (2)$$

where  $E_m$  = fractional approach to equilibrium  $[(T - T_i)/(T_c - T_i)]$ , with  $c$  referring to the continuous phase and  $i$  to the interior of the drop;  $h$  = heat transfer coefficient ( $J/s \text{ } ^\circ C \text{ cm}^2$ );  $V$  = volume ( $\text{cm}^3$ );  $\rho$  = density ( $\text{g/cm}^3$ );  $C_p$  = specific heat ( $J/g \text{ } ^\circ C$ ); and  $t$  = time (s).

In drops with diameters less than 0.3 cm and rising at low velocities, surface tension is strong enough to stop all movement within the drop. These small drops behave as rigid spheres in which internal conduction is the rate limiting mechanism. The fractional approach to equilibrium is much slower than that of mixed drops and is given by

$$E_m = 1 - \frac{6}{\pi} \sum_{n=1}^{\infty} \frac{1}{n^2} \exp\left(-\frac{\pi^2 n^2 \alpha_d}{a^2} t\right), \quad (3)$$

where  $\alpha$  = thermal diffusivity ( $\text{cm}^2/\text{s}$ ) and  $a$  = drop radius (cm).

For drops of intermediate size toroidal internal circulation patterns are set up. The dominant resistance is again internal but the characteristic distance for conduction is approximately half the radius. The fractional approach to equilibrium may be approximated as

$$E_m = 1 - \frac{6}{\pi} \sum_{n=1}^{\infty} \frac{1}{n^2} \exp\left(-\frac{\pi^2 n^2 2.5 \alpha_d}{a^2} t\right) \quad (4)$$

Effective heat transfer coefficients may be defined for circulating and rigid drops, but they are simply a mathematical convenience (ref. 10).

The predictions of the model have been compared with heat transfer data obtained on a system at Clemson University. The data compare reasonably well with results predicted from existing expressions for drop size, holdup, and heat transfer to a circulating drop, although a different heat transfer model is required at the end of the melting period. While this agreement is encouraging, it is not proof of model validity. As no experimental measurements were taken of the effect of drop size or holdup, the choice of heat transfer mechanism is simply an adjustable parameter in the model, since the drop size is such that any one of the three heat mechanisms could apply. Furthermore, several of the relations contain constants which were obtained experimentally at conditions considerably removed from those found in latent heat thermal storage units. Therefore, it is necessary to carry out experiments to independently validate or modify the equations for drop size, holdup, and heat transfer mechanism.

To test drop size predictions and to determine whether the rising drops behave as rigid spheres, circulating drops, or oscillating drops, a "single drop" experiment is being utilized. This experiment allows the measurement of drop size and heat transfer rate where flow rate, contact time, and continuous phase temperature can be closely controlled. To investigate holdup, a pilot-scale, "multi-drop" column is being constructed. This unit will also allow assessment of the total model and will be useful in studying continuous phase entrainment, phase segregation, and crystallization behavior.

## SYSTEMS ANALYSES AND ASSESSMENTS

### Thermal Storage Survey and Assessment

The thermal storage technologies under development must fit the intended solar applications. Therefore, continual communication is critical among researchers developing solar and storage technologies. In this area, SERI continually surveys the thermal storage technologies under development within the Division of Energy Storage Systems and elsewhere (ref. 11). Communications are then developed with the various solar application areas and their needs are identified through discussions and analyses. The goal of these activities is

to arrive at a coordinated plan that will provide timely development of thermal storage technologies for defined solar applications.

### Systems Analysis of Thermal Storage

The systems analysis of thermal storage is being conducted to support decision points in the Thermal Energy Storage for Solar Thermal Applications Program (ref. 1). In this program, second and third generation thermal storage technologies will be developed to provide lower cost and/or improved performance over the first generation technologies currently being deployed in Solar Thermal Large Scale Experiments (LSE). In each of the seven elements of the program, thermal storage technologies will be developed that are appropriate for different types of solar thermal systems:

- water/steam collector/receiver;
- molten salt collector/receiver;
- liquid metal collector/receiver;
- gas collector/receiver;
- organic fluid collector/receiver;
- liquid metal/salt collector/receiver; and
- advanced technologies (third generation).

For the first six elements, the second generation technologies developed will be verified through a retrofit of a solar thermal LSE (e.g., Barstow, repowering, Shenandoah, etc.). The last element develops advanced technologies for all types of solar thermal systems.

The objectives of the SERI systems analysis effort are to provide value data on thermal storage and rankings of thermal storage concepts. The value data are the basis for thermal storage cost goals which are then used to screen thermal storage concepts. Those concepts which pass this first screening are ranked on a delivered energy unit cost basis (busbar energy cost for electric power) within a specified program element. The process is then repeated as needed for other elements. In this manner, promising thermal storage concepts will be identified for development.

Value expresses quantitatively the price that a user is willing to pay for a system for a given application based on the cost of alternative systems, including capital, fuel, and operations and maintenance (O&M). The value of solar thermal systems thus depends on the energy supply alternatives (oil, gas, coal, nuclear, etc.), assumed future prices and escalation rates, and the performance of the solar thermal system. For electric power applications, Aerospace (ref. 12) and Westinghouse (ref. 13) have performed calculations of value for storage-coupled solar thermal systems.

For a given collector area, with all other parameters constant except storage capacity (H), the contribution to the total system value by thermal

storage is calculated from the storage-coupled solar thermal system value as follows:

$$\text{Total Thermal Storage Value} \Big|_H = \text{Solar Thermal System Value} \Big|_H - \text{Solar Thermal System Value} \Big|_{H=0}, \quad (5)$$

where the last term refers to the solar thermal system with no storage or only buffer storage. This calculation may be repeated to provide the thermal storage value as a function of both solar thermal collector area and location. To identify the appropriate combinations of storage and collector area, the ratio of system cost to system value must be minimized for that collector area.

The approach described by equation (5) has been followed to calculate the value of thermal storage for solar thermal electric power applications. Table I presents the results for stand-alone solar thermal plants based on the Westinghouse and Aerospace data. The values shown are for a plant startup in the late 1980s and a small solar thermal penetration in the utility grid (less than 10% of the peak generation capacity). The data were generated employing conservative to average fuel price assumptions and Barstow technology. For more efficient thermal storage concepts, a higher value and cost goal will result; for less efficient concepts the value and cost goal will be lower.

The cost goals in Table I are the total capitalized value of thermal storage, which include direct, nondirect, and O&M costs. Direct costs include equipment, materials, labor, installation, etc. Nondirect costs are generally calculated as a percentage of the direct costs. Based on similarities with conventional power plants, the following nondirect factors are employed unless better data are available:

- contingency and spares--15 %;
- indirects (licences, fees, studies, etc.)--10 %; and
- interest during construction--19 %.

The total is a 44 % increase in the direct costs.

Operations and maintenance (O&M) are annual costs. The capitalized equivalent is:

$$\text{Capitalized O\&M} = \frac{\left( \text{Annual O\&M Cost} \right) \left( \text{Levelizing Factor} \right)}{\left( \text{Fixed Charge Rate} \right)} \quad (6)$$

Typical data for electric utilities are:

- annual O&M cost--1-2 % direct cost;



- levelizing factor--1.88; and
- fixed charge rate--17 %.

When available, actual O&M data should be employed. The net effect is to increase the cost by an additional 11 % (O&M 1 %) to 22 % (O&M at 2 %) of the direct capital cost. Combining the nondirect and O&M factors, the total capitalized cost is 1.55 to 1.66 times the direct capital cost. This cost should be compared to the cost goals in Table I.

Once several thermal storage concepts are established to be within the cost goals for a program element, SERI will provide comparisons for DOE to identify promising candidates for development. For each program element a reference solar thermal system and thermal storage concept are defined. Then, the delivered energy costs are calculated when the reference thermal storage concept is replaced by an alternative, with all other parameters constant (i.e., storage capacity, collector area, location, dispatch strategy). Each of these parameters is then varied systematically over its expected range. This procedure is repeated for each alternative, and the delivered energy cost for all thermal storage concepts are then compared.

The calculation of the delivered energy cost depends strongly upon the cost and performance of the thermal storage concepts. This information will be supplied by a subcontractor with experience in this type of analysis. This subcontractor will rework the thermal storage developer's data to ensure that all data are consistently calculated for the cost and performance analysis.

In addition to the cost goals and the delivered energy cost of each concept, other factors will be considered in selecting storage concepts for development. These include:

- safety,
- development status and program schedules,
- applicability to several program elements,
- development cost,
- development risk, and
- program priorities.

The Department of Energy, NASA Lewis Research Center, Sandia Livermore Laboratories, and SERI will participate in the selection of the storage concepts for development.

#### CONCLUDING REMARKS

The SERI Solar Energy Storage Program summarized in this paper consists of activities in advanced technology research and development and in systems analyses and assessments. Some details were given of the effort in latent heat storage research and the systems analysis of thermal storage. The intent of

all these activities is to provide technical and economic information that will aid the rapid selection and development of thermal storage technologies for solar applications. At this time, particular emphasis is given to the definition of thermal energy storage for solar thermal applications because of the need to provide appropriate storage technologies for the solar thermal systems now under development. In the future, SERI's Solar Energy Storage Program will assist the rapid development of a variety of storage technologies which will augment the displacement of conventional fuels by renewable solar energy sources.

#### REFERENCES

1. Thermal Energy Storage for Solar Thermal Applications, Draft Multiyear Program Plan. U.S. Dept. of Energy, Div. of Energy Storage Systems, Div. of Central Storage Technology, July 10, 1979.
2. Iannucci, J. J.; Fish, J. D.; Bramlette, T. T.: Review and Assessment of Thermal Energy Storage Systems Based Upon Reversible Chemical Reactions. SAND 79-8239, Sandia Laboratories, August, 1979.
3. Morrison, J. D.: Performance of Solar Heating Systems Utilizing Phase Change Energy Storage. M. S. Thesis, U. of Wisconsin, 1976.
4. Costello, V. A.: Heat Transfer and Calorimetric Studies in a Direct Contact Latent Heat of Fusion Energy Storage System. M. S. Thesis, Clemson Univ., 1978.
5. Hallet, J. et al.: Studies of a Salt Hydrate Heat Storage System. Desert Research Institute, Aug. 1978.
6. Christiansen, R. M.; Hixon, A. N.: Breakup of a Liquid Jet in a Denser Liquid. Ind. Eng. Chem., no. 49, 1957, p. 1019.
7. Scheele, G. F.; Meister, B. J.: Drop Formation at Low Velocities in Liquid-Liquid Systems. AIChE J., vol. 14, no. 1, Jan. 1969, pp. 9-19.
8. Skelland A. H. P.; Huang, Y. F.: Continuous Phase Mass Transfer During Formation of Drops from Jets. AIChE J., vol. 25, no. 1, Jan. 1979, pp. 80-87.
9. Gal-or, B.; Waslo, S.: Hydrodynamics of an Ensemble of Drops (or Bubbles) in the Presence or Absence of Surfactants. Chem. Eng. Science, vol. 23, pp. 1431-1446.
10. Sideman, S.: Direct Contact Heat Transfer Between Immiscible Liquids. Vol. 6 of Advances in Chemical Engineering, Academic Press, NY, 1966, pp. 207-286.

11. Baylin, F.: Low Temperature Thermal Energy Storage: A State-of-the-Art Survey. SERI/PR-54-164, Solar Energy Research Inst., Golden, CO, July 1979.
12. Melton, W. C.: Performance, Value, and Cost of Solar Thermal Electric Central Receivers Outside the Southwest. ATR-78(7689-04)-1, The Aerospace Corporation, May 16, 1978.
13. Requirements Definition and Impact Analysis of Solar-Thermal Power Plants. Quarterly Review handouts, Westinghouse Electric Corp., Advanced Systems Group, prepared under EPRI RP-648, July and Sept. 1978.

Table 1. RECOMMENDED COST GOALS<sup>a</sup> FOR THERMAL STORAGE IN SOLAR THERMAL ELECTRIC PLANTS

(1976\$)

Storage Capacity (hours)	High Insolation (Barstow, CA)		Medium Insolation (Midland, TX)		Low Insolation (Seattle, WA)	
	(\$/kW <sub>e</sub> )	(\$/kWh <sub>e</sub> ) <sup>b</sup>	(\$/kW <sub>e</sub> )	(\$/kWh <sub>e</sub> ) <sup>b</sup>	(\$/kW <sub>e</sub> )	(\$/kWh <sub>e</sub> ) <sup>b</sup>
3	255	85	120	40	60	20
6	300	50	180	30	90	15
9	-- <sup>c</sup>	-- <sup>c</sup>	225	25	110	12

<sup>a</sup>Total cost of a thermal storage concept (including power-related, energy-related, nondirects, and O&M) must be lower than the value-derived cost goal.

<sup>b</sup>\$/kW<sub>e</sub> = Total thermal storage value.

\$/kWh<sub>e</sub> = Average thermal storage value; equal to total thermal storage value divided by h, the storage capacity.

<sup>c</sup>Data not available.

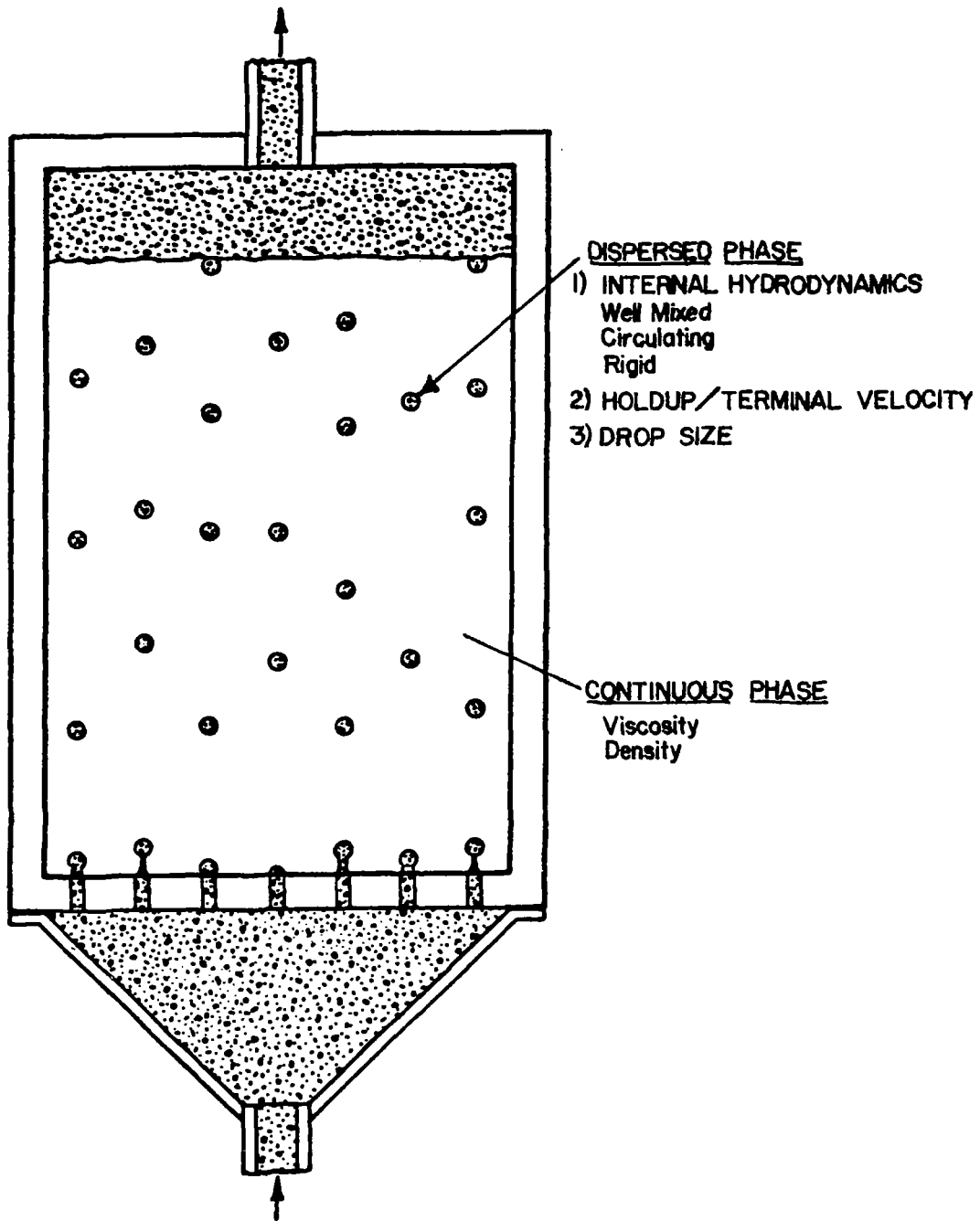

FIG.I MECHANISMS CONTROLLING HEAT TRANSFER

ACTIVE HEAT EXCHANGE SYSTEM DEVELOPMENT FOR LATENT  
HEAT THERMAL ENERGY STORAGE

Joseph Alario and Robert Haslett  
Grumman Aerospace Corporation

PROJECT OUTLINE

**Project Title:** Active Heat Exchanger System Development for Latent Heat Thermal Energy Storage

**Principal Investigator:** J. Alario

**Organization:** Grumman Aerospace Corporation  
Bethpage, NY 11714

**Project Goals:** Develop an active heat exchange system; utilizing a phase change thermal storage medium, where operating characteristics are compatible with a 250° to 350°C steam power cycle.

Identify and select concepts for test.

Design, fabricate, assemble and test laboratory-scale modules.

Evaluate results.

Recommend further development requirements.

**Project Status:** Coupon adhesion tests using a chloride salt phase change media and sample tube materials indicated salt adhesion to all surfaces. Consequently, concepts designed and fabricated for laboratory-scale tests included a direct-contact heat exchange concept and a rotating drum mechanical scraper concept.

**Contract Number:** DEN3-39

**Contract Period:** June 1978 to September 1979

**Funding Level:** \$225,000

**Funding Source:** NASA Lewis Research Center

ACTIVE HEAT EXCHANGE SYSTEM DEVELOPMENT  
FOR LATENT HEAT THERMAL ENERGY STORAGE\*

Joseph Alario and Robert Haslett  
Grumman Aerospace Corporation

SUMMARY

The overall objective of this program is the development of an active heat exchange process in a latent heat thermal energy storage (TES) system which is suitable for utility applications. Various active heat exchange concepts were identified from among three generic categories: scrapers, agitators/vibrators and slurries. The more practical ones were given a more detailed technical evaluation and an economic comparison with a passive tube-shell design for a reference application. Two concepts were selected for hardware development: 1) a direct contact heat exchanger in which molten salt droplets are injected into a cooler counterflowing stream of liquid metal carrier fluid, and 2) a rotating drum scraper in which molten salt is sprayed onto the circumference of a rotating drum, which contains the fluid heat sink in an internal annulus near the surface. A fixed scraper blade removes the solidified salt from the surface which has been nickel plated to decrease adhesion forces.

An evaluation of suitable Phase Change Material (PCM) storage media with melting points in the temperature range of interest (250 to 400°C) limited the candidates to molten salts from the chloride, hydroxide and nitrate families, based on high storage capacity, good corrosion characteristics and availability in large quantities at reasonable cost. The specific salt recommended for laboratory tests was a chloride eutectic (20.5KCL o 24.5NaCL o 55.0MgCL<sub>2</sub> by wt.), with a nominal melting point of 385°C.

At this point in time, the hardware has been built and is being assembled and instrumented prior to test evaluation.

INTRODUCTION

Thermal energy storage is a promising method for extending the steam generating capabilities of both conventional fossil fuel power plants and advanced solar thermal energy conversion systems. Excess thermal energy available from the steam boiler (or concentrating solar collector) can be stored during off-peak demand periods and then used to increase steam capac-

---

\*Work performed for NASA/Lewis Research Center under Contract DEN 3-39.

ity during peak load periods. In a solar application, this stored energy would be substituted for the primary energy source during nonsunlight periods.

Using the latent heat of fusion (phase change) for energy storage is particularly attractive because the heat absorbed per pound of material is relatively high, resulting in a more compact system. However, the performance of conventional passive tube and shell heat exchangers is impeded by the high thermal resistance of solid deposits on the discharge tube surfaces. Significant performance and cost benefits can be realized if active heat exchange concepts can be developed which prevent the buildup of a solid salt layer on the heat transfer surfaces. This program was initiated to design and test two active heat exchange concepts for latent heat thermal energy storage systems suitable to the utility industry.

## DESCRIPTION OF DEMONSTRATION CONCEPTS

### Summary of Element Test Results

In support of our concepts evaluation phase, two laboratory scale element tests were run to assess the capability of removing solidified PCM from the surface of a tube treated with a non-stick coating. Two types of tests were conducted: 1) a coupon adhesion test with sample materials (mild steel, chrome and nickel plated steel, titanium, glass) and the actual chloride salt eutectic, and 2) a visual demonstration using an impinging stream of nitrogen bubbles to break apart solidified PCM around a cooling tube.

Test results were negative and discouraged the further development of those concepts that relied on non-stick surfaces or turbulence within the PCM media. The chloride salt adhered to all tube surfaces tested, although the highly polished nickel and chrome plated samples gave best results. The surface turbulence caused by impinging gas bubbles did not impede the buildup of PCM around a Teflon tube - the most non-sticking of surfaces.

### System Description

The active TES heat exchanger system (Figure 1) consists of three basic components: the central heat exchanger module; a salt module; and a liquid metal module. In all cases the storage medium is a chloride salt eutectic (20.5 KCL o 24.5 NaCL o 55.0 MgCL<sub>2</sub>) and the heat transfer fluid is a liquid metal lead-bismuth eutectic (44.5 Pb o 55.5Bi). The nominal melting points are 385°C (725°F) for the salt and 125°C (257°F) for the metal. Test modules have been designed for a storage capacity of 10 KW<sub>t</sub> and a heat transfer rate of 10 KW<sub>t</sub>.

The central heat exchanger module can be readily configured to contain either of the heat exchange concepts. This is done by simply replacing the top half of the tank with the necessary hardware. The bottom half, which serves as the storage bin for the solidified salt, is used by both concepts.

It also contains electrical firerod heaters which are used to melt the salt during the thermal charging cycle. These heaters simulate the fluid heat source of an actual application. As the salt melts, it drains into the salt module, which acts as a holding tank for the molten salt. It also contains a submersible pump, driven by an air motor, which is used to pump the molten salt to the heat exchanger module during the discharge part of the demo cycle. Firerod heaters are provided to control the initial salt temperature and to prevent inadvertent solidification.

The liquid metal is used as a heat transfer fluid to remove the heat from the molten salt, which takes place within the heat exchange module. The metal is stored in the liquid metal module which also contains the pump used to pump it through the heat exchanger. Electrical heaters are provided to control the liquid metal temperature.

During the thermal discharge cycle operation, the heat picked up by the liquid metal from the molten salt is transferred to an open water cooling loop through an annular heat exchanger. The cooled metal is then returned to the heat exchange module where it can once again serve as an acceptable heat sink. This process continues until all of the molten salt has been solidified, then the charging cycle can be started again.

All tanks and piping are made from 1020 mild steel or equivalent, except for the two charge/drain canisters and the liquid metal/water heat exchanger which are made from stainless steel. A gaseous blanket of dry nitrogen at 34.5 kPA (5 psig) is used to protect the system from moisture and corrosion. All of the tanks and plumbing are insulated with high temperature JM Cera-blanket insulation, with thermal losses estimated at less than 5 percent. Thermocouples are provided both within the tanks and on the outside surfaces of the plumbing. Figure 2 shows the system at an initial assembly stage.

#### Direct Contact Heat Exchanger

This concept is illustrated in Figure 3. During the usage cycle, heat is removed from the salt by direct contact heat transfer with a liquid metal carrier fluid within the heat exchange reservoir. (See Figure 4). Both the heat storage and carrier fluids must be completely nonreactive and immiscible with each other. The molten salt is pumped from the holding tank into the bottom of the heat exchange reservoir where because of its lower density, it bubbles through the metal giving up its heat as it solidifies. At the same time, the heated liquid metal returns to its holding tank from where it is pumped to a conventional external heat exchanger. Here the liquid metal releases its energy to the ultimate heat sink fluid (water in the case of this demo unit). The cooled liquid metal is then returned to the top of the heat exchange reservoir where it can once again be heated. As the solid salt agglomeration rises to the top of the heat exchange reservoir, it is directed over the edges and falls to the bottom of the surrounding tank. It remains there until the next charging cycle, when the entire sequence is repeated.



## Rotating Drum Scraper

The rotating drum heat exchanger concept minimizes the required heat transfer surface area by eliminating most of the thermal resistance within the solidified storage medium (e.g., salt). This is accomplished by the action of a fixed scraper blade which continually removes the solid salt buildup and keeps the liquid solid interface close to the heat exchange surface. The concept as proposed for this demonstration test module is illustrated in Figure 5.

During the usage or discharge cycle (heat removal from storage), the molten salt flows through slit nozzles onto the circumference of the rotating drum. The liquid metal heat sink fluid flows through an annular passage within the drum, cooling the outer surface and freezing the molten salt. The solidified layer of salt is then scraped off after making a partial (270 degree) rotation, falling into a storage bin which is located beneath the drum. The storage bin also contains a source fluid heat exchanger which is used to melt the salt during the charging cycle.

### Test Evaluation Plan

The general test objective is to demonstrate a  $10 \text{ kWh}_t$  storage capacity and a  $10 \text{ kW}_t$  heat recovery rate at the nominal design conditions. However, there will be specific performance criteria that will be measured in order to permit a realistic assessment of each concept and determine the viability of larger scale demonstration units.

Multiple charge/discharge cycles will be run to evaluate the following:

- o Percentage energy recovery
- o Energy expended for heat recovery
- o Efficiency of energy recovery (energy recovered-energy expended) / energy recovered
- o Heat transfer rate as a function of time
- o Effect of varying critical parameters (flow rates, inlet temperatures, drum speed, etc.)
- o Heat losses from system

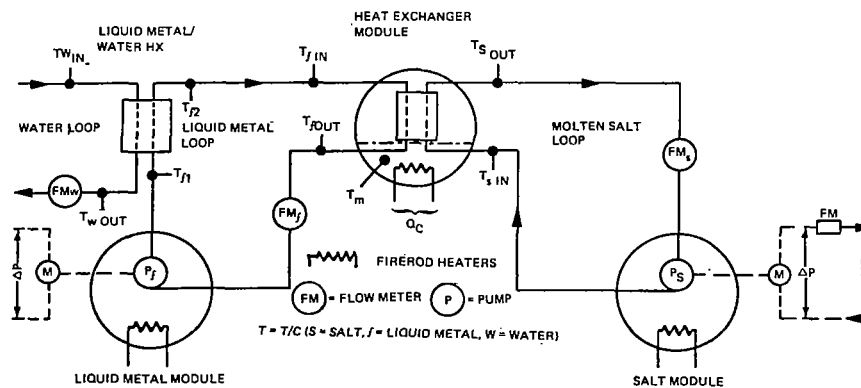

FIGURE 1 DEMONSTRATION ACTIVE TES SYSTEM SCHEMATIC

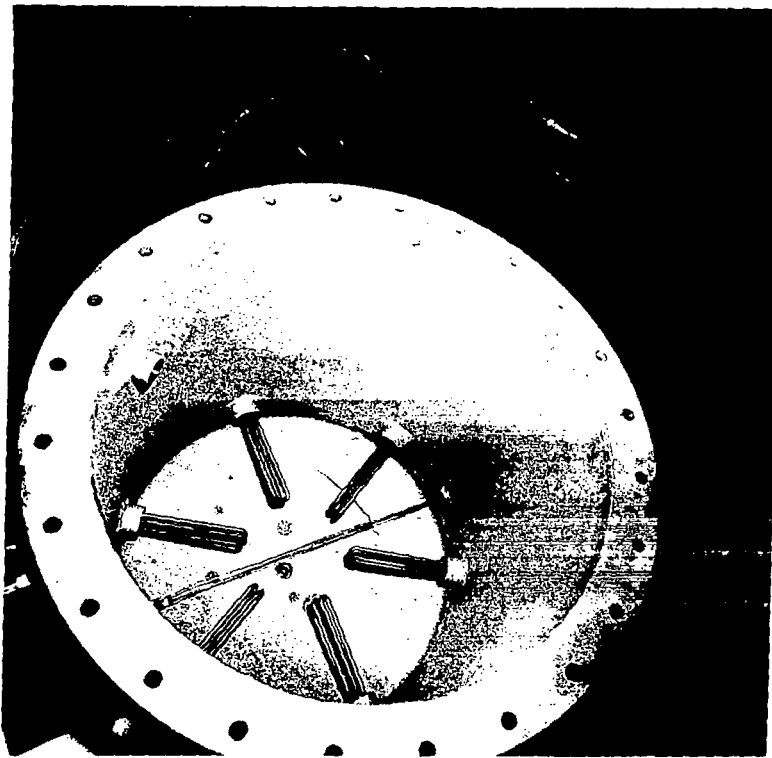

Fig. 2 Active Heat Exchange System, Preliminary Assy

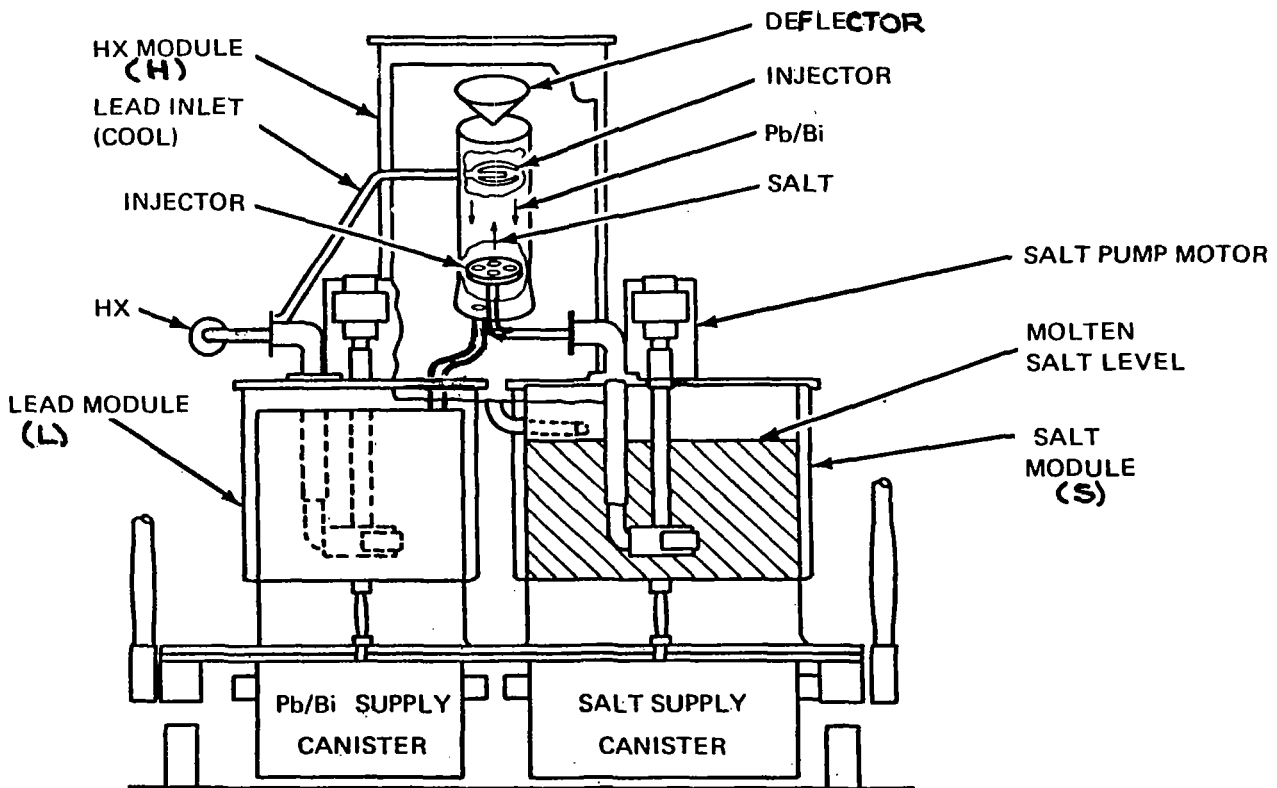
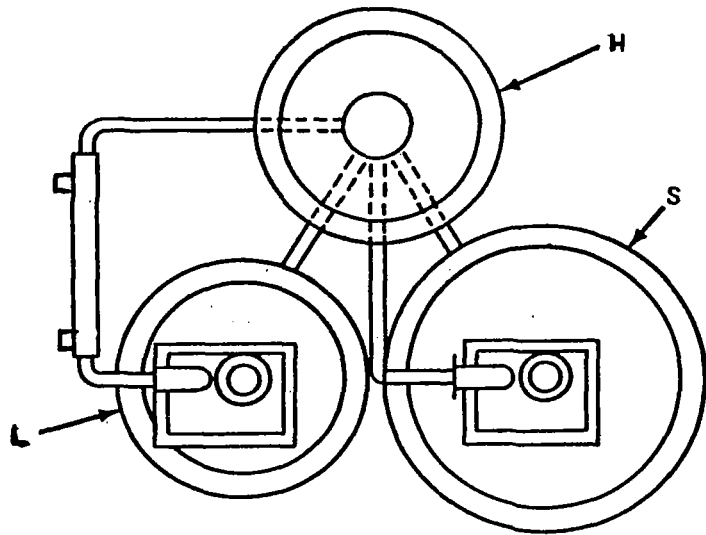

Figure 3 Direct Contact HX Concept

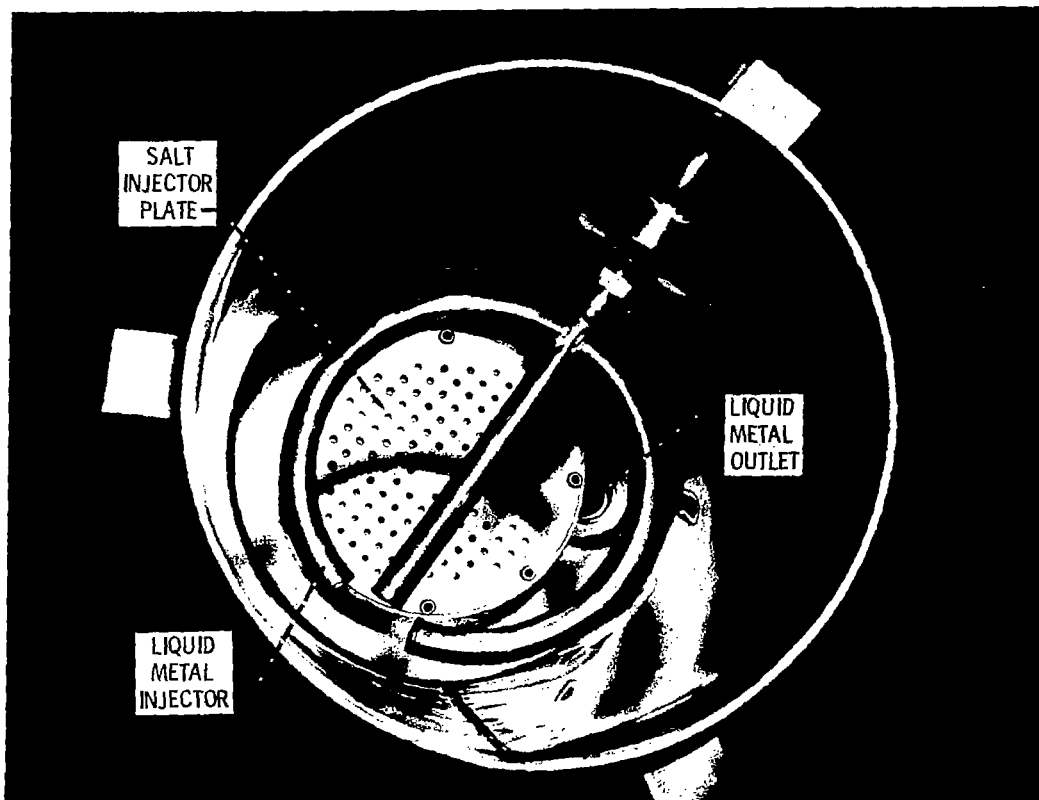
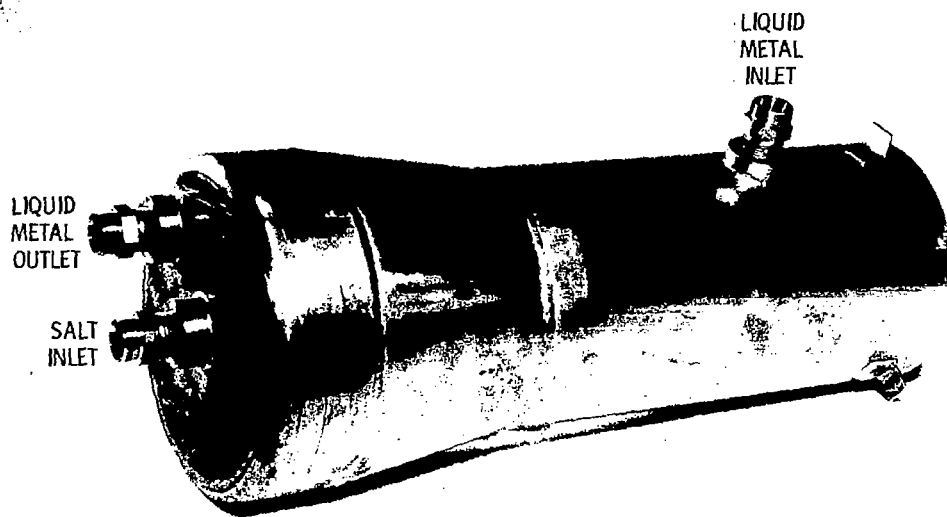

Fig. 4 Direct Contact Heat Exchange Reservoir

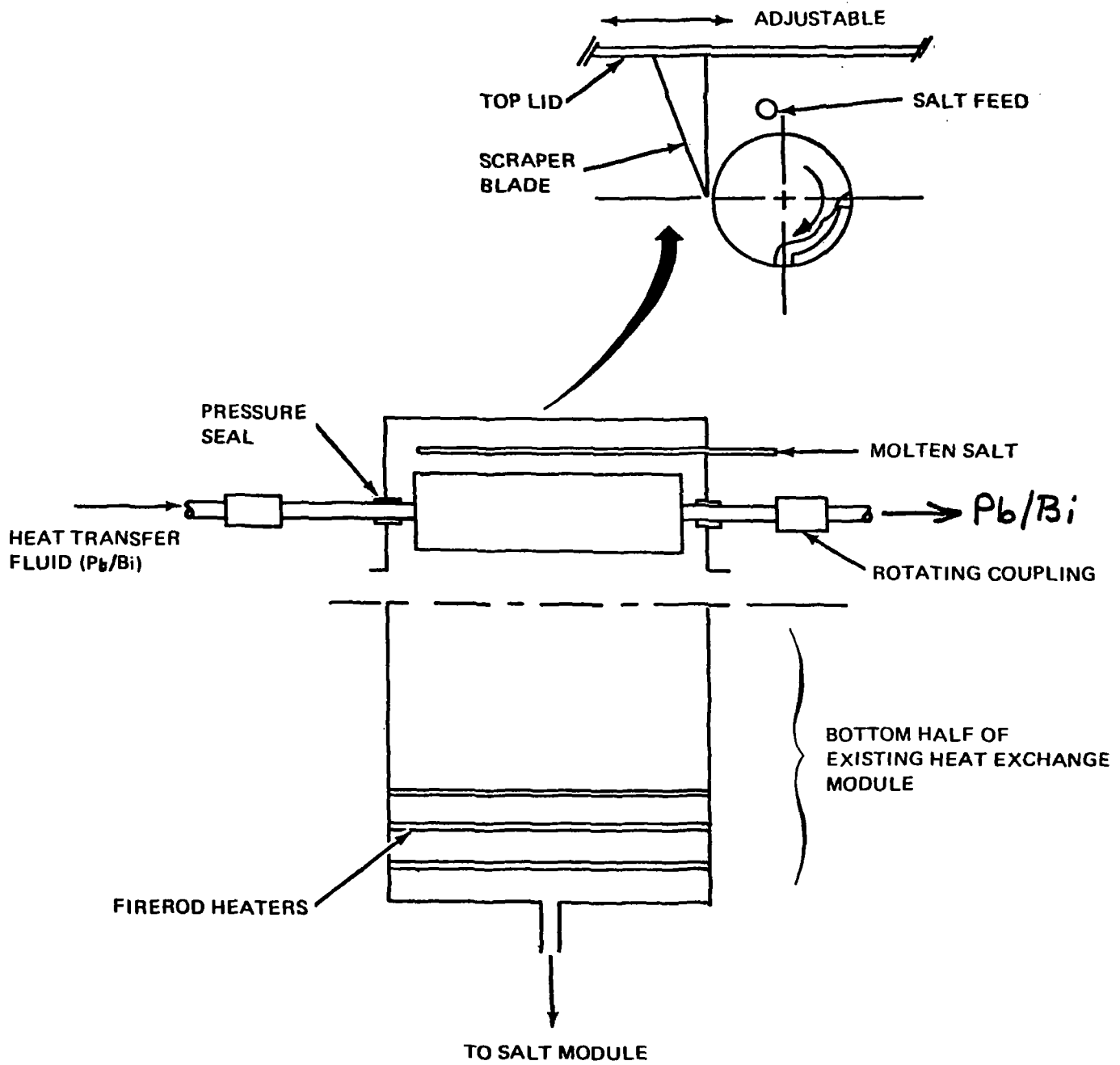

Figure 5 Rotating Drum Heat Exchanger Concept



## HEAT STORAGE IN ALLOY TRANSFORMATIONS

C. Ernest Birchenall  
University of Delaware

### PROJECT OUTLINE

**Project Title:** Heat Storage in Alloy Transformations

**Principal Investigator:** Professor C. Ernest Birchenall

**Organization:** University of Delaware  
Department of Chemical Engineering  
Newark, DE 19711  
Telephone: (302) 738-2543

**Project Goals:** Determine feasibility of using eutectic metal alloys as thermal energy storage media for high temperature applications (650°C to 950°C)

Survey alloy data to identify candidate alloys.

Measure properties of candidate alloys including specific heat, latent heat, coefficient of expansion near the transformation temperature, and the volume change during transformation.

Conduct media - containment material compatibility studies.

Perform storage system analysis to compare performance and cost of systems using alloy and alternate media for selected applications.

**Project Status:** Candidate alloys limited on the basis of cost to those that contain the following elements: Al, Cu, Mg, Si, Zn, CA and P.

Several new ternary alloys have been identified in Cu-Si-Zn, Mg-Cu-Ca, and P-Cu-Zn systems.

Specific heat and latent heat property measurements essentially complete.

A new method employing x-ray absorption technique has been developed to measure volume change during phase transformation. Pure aluminum and two aluminum alloys have been measured. Equipment is being refined.

Alloy media-containment material study was recently initiated to investigate three types of materials: graphite, silicon carbide, and surface-coated iron alloys.

System studies are presently being initiated.

**Contract Number:** NSG 3184

**Contract Period:** July, 1978 to September, 1980

**Funding Level:** \$183,738

**Funding Source:** NASA Lewis Research Center

## HEAT STORAGE IN ALLOY TRANSFORMATIONS\*

C. Ernest Birchenall  
University of Delaware

### SUMMARY

Heats of transformation of eutectic alloys have been measured for many binary and ternary systems by differential scanning calorimetry and thermal analysis. Only the relatively cheap and plentiful elements Mg, Al, Si, P, Ca, Cu, Zn were considered. A new method for measuring volume change during transformation has been developed using x-ray absorption in a confined sample. Thermal expansion coefficients of both solid and liquid states of aluminum and of its eutectics with copper and with silicon also were determined. Preliminary evaluation of containment materials lead to the selection of silicon carbide as the initial material for study. Possible applications of alloy PCMs for heat storage in conventional and solar central power stations, small solar receivers and industrial furnace operations will be examined.

### RESEARCH PROGRAM

The initial purpose of this work was to identify alloys that transform by the eutectic mechanism or by congruent melting and that have sufficiently large heats of transformation to be considered for heat storage applications. Where good precision of calorimetric measurement could be achieved, heat capacities of the solid and liquid states were also desired. Because the volume change during transformation was considered to be important for the design of a reliable and efficient storage system, a new method based on x-ray absorption was devised, to be tested and refined for the study of this property. It was recognized that the cost of containment is likely to determine the feasibility of using heat storage systems in various applications, so the emphasis in the program is shifting toward this problem. Although it would suffice to find container materials to hold specific alloys in their appropriate temperature ranges, silicon carbide is to be investigated as a material that might serve for all alloys studied over the whole temperature range.

As alloy characteristics are defined by measurement it becomes possible to develop realistic models for system applications. Modeling should permit cost comparisons of alloy storage with molten salt storage for the same overall system operating parameters. Also some estimates of the feasibility of using heat storage on an absolute basis should be possible for some applications that offer no technical difficulties. Work of this sort is being initiated and the emphasis on it will increase.

---

\*Under National Aeronautics and Space Agency Grant No. NSG 3184 funded by the Division of Energy Storage Systems, Department of Energy.



## RESULTS TO DATE

The quantitative measurements are summarized in Tables 1 (heat of transformation and heat capacity) and 2 (volume change during melting and coefficients of thermal expansion). For alloys that transform below 970K the thermal measurements have been made by differential scanning calorimetry (DSC) with an estimated precision of 3 pct. for heats of transformation and 10 pct. for heat capacities. Alloys that transform at higher temperature have been measured by differential thermal analysis (DTA) with an estimated precision of about 5 pct. for heats of transformation. Work is in progress to attempt to improve the heat capacity measurements in the high temperature range.

The alloys with underlined compositions are the best in their respective temperature ranges. Between 779 and 852K the alloys do not appear to have competition from other materials when comparisons are made on either a mass, or especially a volume, basis. The Si-Mg eutectic at 1219K is likely to be most advantageous for any applications in that temperature range. Below 608K metallic storage does not appear to be feasible without the use of more expensive metals such as Pb, Sn, Bi and Sb. Inorganic salt eutectics are much more likely to be used in this range.

The volume change measurements show that the aluminum eutectics expand about 5 pct. on melting, in contrast with some salts which expand more than 20 pct. The 7 pct. expansion of pure aluminum is likely to be close to the maximum among the alloys being considered for heat storage applications.

The volume change measurements reported were done by absorption of x-rays from a conventional generator for an x-ray diffraction apparatus. The characteristic  $K_{\alpha}$  radiation from a copper or molybdenum tube was selected using absorption filters and an energy dispersive counting system with discriminator or by using a graphite crystal monochromator at the source with the same detector system. A new system offering greater stability and simplicity with some sacrifice in intensity has been assembled in which  $AgK_{\alpha}$  radiation from radioactive Cd 109 is the x-ray source. With this simpler system it is anticipated that higher furnace temperatures can be achieved because the furnace does not have to fit on a diffractometer track.

## WORK IN PROGRESS

A few additional alloys are to be melted in search of new ternary or quaternary eutectics or congruently melted intermetallic phases. Newly discovered ternary eutectic alloys in the Mg-Cu-Ca and Mg-Si-Cu systems and a new ternary intermetallic phase in Cu-Si-P will have their heats of transformation determined by calorimetry. The only additional calorimetric measurements that are planned are checks on values that do not appear to be consistent with expectations or in which errors may have arisen owing to vapor losses of one of the components

The volume measurements will be extended to cover the most promising eutectic systems. It is anticipated that the casting of pore-free samples is the most difficult and critical step in the procedure. Several other metals and possibly some eutectic salts will be measured for comparison.

SiC test plates are being prepared for determining chemical compatibility with the eutectic alloys. Wetting angles, weight loss and the structures of phases that grow at the interface will be considered in assessing the suitability of this material. Some conventional high temperature alloys also will be tested for comparison. Later the preparation of alloys with coated surfaces will be attempted if the need remains.

#### APPLICATIONS APPRAISAL

Heat storage might offer economic advantages for applications at several size levels. Only those applications whose storage might be done between 670 and 1220K will be considered. The following types of systems applications will be surveyed: 1. Storage to level the heat generating rate of fossil- or nuclear-fueled central power stations. 2. Short term storage to regulate the temperature of solar receiver surfaces and long term storage to match solar input to output demand. 3. Storage with temperature regulation by the transformation in industrial furnaces. 4. High temperature storage of heat for home comfort control.

The purpose of 1 is to improve heat generating efficiency of central power stations. However, the need for load-following electrical generating capacity would not be eliminated. The system load might be leveled if enough distributed heat storage of type 3 could be installed. Solar receivers, large or small, must absorb heat at high flux density during periods of high insolation. They require short term storage to smooth the fluctuations in solar radiation intensity and long term storage to supply energy at night and during periods of dense cloud cover. Industrial furnaces often are operated isothermally, a condition supplied naturally by eutectic storage. The problem in this application is a simple, reliable detector to signal when the alloy is nearly completely melted or nearly completely frozen. Economy might be achieved in this application if energy is taken during off-peak periods for use during peak-load periods when labor is likely to be cheaper. The benefit from alloy storage for home comfort conditioning must come from the large reduction in storage volume when compared with storage in hot rocks or water.

One or more specific cases will be chosen for engineering evaluation of the potentialities of alloy storage. It appears that the industrial furnace storage and control and solar receiver storage may be the most favorable cases at this stage of development of the alloy storage technology. However, only a few preliminary calculations have been done.

#### CONCLUSIONS

Eutectic alloy systems with good volumetric heat storage density have been demonstrated for the temperature range 670 to 1220K. The volume changes during transformation appear to be near 5 pct. The alloys that do not contain Ca appear to be compatible with graphite as a container material. SiC should be less reactive, stronger and a better heat conductor. Containment in coated alloys also may be practical.

Heat storage in alloy transformations should be technically feasible for a wide range of applications. Studies are being started to determine which are

likely to be the most favorable applications economically for the present state of understanding.

Table 1. Thermal Properties of Selected Metal Eutectics

Alloy (Mole Fractions)	Eutectic Temperature (°K)	Maximum Heat Storage Capacity in kJ/kg		Heat Capacity kJ/kg-°K
		Calculated	Measured*	
Mg-0.24Zn-0.05Si	608	260		
<u>Mg-0.29Zn</u>	616	230	210	{ 1.04s 1.511
Mg-0.14Zn-0.14Ca	673	405		- -
<u>Al-0.35Mg-0.06Zn</u>	720	406	310	{ 1.73s
<u>Al-0.375Mg</u>	724	376	310	{ 1.621
Mg-0.13Cu-0.08Zn	725	408	253	- -
<u>Al-0.17Cu-0.16Mg</u>	779	406	360	{ 1.09s 1.181
Mg-0.105Ca	790	431	269	- -
Al-0.175Cu	821	359	353	{ 1.11s 1.111
<u>Al-0.126Si-0.051Mg</u>	833	549	545	{ 1.39s 1.211
Mg <sub>2</sub> Cu	841	398	243	- -
<u>Al-0.31Cu-0.07Si</u>	844	561	423	- -
<u>Al-0.12Si</u>	852	571	515	{ 1.49s 1.271
MgZn <sub>2</sub>	861	259	220	- -
Zn-0.4Cu-0.15Mg	978	313		
Cu-0.157P	987			
<u>*Cu-0.25P-0.14Zn</u>	993		368	
Cu-0.42Mg	995	235		
<u>*Si-0.35Cu-0.28Mg</u>	1023	892	422	
<u>*Cu-0.17Zn-0.15Si</u>	1038		125	
<u>Cu-0.29Si</u>	1076	308	196	
<u>*Cu-0.13Si-0.17P</u>	1093		92	
Cu-0.49Ca	1106		25	
<u>*Si-0.45Mg-0.07Zn</u>	1207		310	
<u>Si-0.471Mg</u>	1219	1212	805	

\*By Alan Riechman and Diana Farkas

Table 2. Density Changes During Melting for Al and Two Al-Eutectic Alloys.  
 Linear (Solid) and Volumetric (Liquid) Expansion Coefficients.\*

Material	Temp. °C	Density kg/m <sup>3</sup>	$\frac{\Delta V}{V_s}$	Linear Expansion Coeff. (Solid), K <sup>-1</sup>	Volume Expansion Coeff. (Liquid), K <sup>-1</sup>
Al	20(s)	2690	0.072	$2.77 \times 10^{-5}$ (20 to 660°C)	$9 \times 10^{-5}$ (660 to 760°C)
	660(s)	2558			
	660(l)	2377			
	760(l)	2343			
Al-17 at. pct. Cu	20(s)	3506	0.051	$1.5 \times 10^{-5}$ (20 to 548°C)	$1.1 \times 10^{-4}$ (548 to 748°C)
	548(s)	3424			
	548(l)	3258			
	748(l)	3186			
Al-12 at. pct. Cu	20(s)	2626	0.048	$1.7 \times 10^{-5}$ (20 to 579°C)	$1.3 \times 10^{-5}$ (579 to 679°C)
	579(s)	2553			
	579(l)	2445			
	779(l)	2382			

\*Measured by Andrew Harrison and Silvia Balart

## IMMISCIBLE FLUID - HEAT OF FUSION HEAT STORAGE SYSTEM

D. D. Edie, S. S. Melsheimer, and J. C. Mullins  
Clemson University

### PROJECT OUTLINE

**Project Title:** Immiscible Fluid - Heat of Fusion Heat Storage System

**Principal Investigators:** D. D. Edie, S. S. Melsheimer and J. C. Mullins

**Organization:** Clemson University  
Department of Chemical Engineering  
Earle Hall  
Clemson, SC 29631

**Project Goals:** The primary objective is to evaluate the feasibility of direct contact heat transfer in phase change energy storage using aqueous salt systems. A secondary objective is to improve knowledge and understanding of heat and mass transfer in direct contact aqueous crystallizing systems.

**Project Status:** In order to facilitate research into this energy storage device, the project was divided into four major research areas:

- (1) crystal growth velocity study on selected salts
- (2) selection of salt solutions
- (3) selection of immiscible fluids
- (4) studies of heat transfer and system geometry
- (5) system demonstration.

The project status is as follows:

- (1) This study is complete. Crystal growth data was previously obtained for  $\text{Na}_2\text{HPO}_4 \cdot 7\text{H}_2\text{O}$ ,  $\text{Na}_2\text{HPO}_4 \cdot 12\text{H}_2\text{O}$ ,  $\text{Na}_2\text{SO}_4 \cdot 10\text{H}_2\text{O}$  and  $\text{Na}_2\text{CO}_3 \cdot 10\text{H}_2\text{O}$  (1). During the past year data on  $\text{Na}_2\text{S}_2\text{O}_3 \cdot 5\text{H}_2\text{O}$  were also obtained.
- (2) This study is complete. Sodium carbonate and calcium nitrate were found unacceptable for this storage system but sodium thiosulfate, disodium hydrogen phosphate, sodium sulfate and calcium chloride were found to be acceptable (1).
- (3) The two most promising candidates of over 160 potential immiscible fluids were tested in a bench scale direct contact energy storage device.
- (4) This study is complete. It was found that while the number of immiscible fluid diffusers did not change the storage efficiency, increasing the storage container height did increase the storage efficiency (1).

**Contract Number:** EY-76-S-05-5190

**Contract Period:** 6/1/76 - 5/31/79

**Funding Level:** \$139,000

**Funding Source:** Department of Energy, Division of Energy Storage Systems

## Background:

Thermal energy storage is clearly an essential component of a solar energy system. Indeed, in optimizing the overall performance of virtually any conventional or nonconventional energy system, the storage of thermal energy is required. Heat of fusion systems clearly offer a great potential for high density storage of thermal energy, but this potential has been difficult to realize in practice due to phase segregation, slow rates of energy transport, long term degradation, nucleation problems and the corrosive nature of the systems. Direct contact heat transfer between the aqueous crystallizing solution and an immiscible heat transfer fluid has been proposed as a solution to these difficulties (2,3, 4,5). A feasibility study of this technique has been in progress at Clemson since 1975.

The essence of the technique is that a fluid, (lower in density and immiscible with the aqueous salt solution) is introduced at the bottom of the storage vessel as a dispersed phase. As bubbles of this fluid rise through the vessel, they transfer heat to or from the salt solution, and also agitate the vessel contents. The heat transfer fluid is pumped through the remainder of the primary heat transfer loop (e.g., solar collectors or heat pump exchanger and the air heating units of a residential heating system.) Figure 1 is a schematic of the immiscible fluid-heat of fusion storage system.

## Results and Discussion:

### 1. Crystal Growth Velocity Studies

This fundamental area of study was reported on at the third annual thermal energy storage contractor's information exchange meeting (1). The same apparatus previously detailed was used to collect crystal growth data for  $\text{Na}_2\text{S}_2\text{O}_3 \cdot 5\text{H}_2\text{O}$ . This growth data is shown in Figure 2. For a given undercooling only  $\text{Na}_2\text{CO}_3 \cdot 10 \text{H}_2\text{O}$  grew significantly faster.  $\text{Na}_2\text{SO}_4 \cdot \text{H}_2\text{O}$ ,  $\text{Na}_2\text{HPO}_4 \cdot 12\text{H}_2\text{O}$  and  $\text{Na}_2\text{HPO}_4 \cdot 7\text{H}_2\text{O}$  all had slower growth rates. Commercially available  $\text{CaCl}_2$  was so impure that reliable growth data could not be obtained for  $\text{CaCl}_2 \cdot 6\text{H}_2\text{O}$ .

### 2. Selection of Salt Solutions:

This study was completed in 1978 and was previously reported (1).

### 3. Selection of Immiscible Fluids:

A list of over 160 potential immiscible fluids was compiled at the beginning of this study. Excessively high cost, toxicity or high density ruled out many fluids. Bench scale tests showed that fluid viscosities greater than 4-5 cp resulted in excessive carry-over of salt solution during cycling of the storage system. Properly placed and sized screens within the immiscible fluid extended the viscosity range to about 10cp. Various separator designs were investigated including beads floating at the interface. Two of these fluids, Marcol 72 and Therminol 60, were selected for testing in the bench scale apparatus. The fluids were evaluated for solution carry-over, and for system energy storage efficiency, using disodium hydrogen phosphate as the storage medium.

Solution carry-over was determined by measuring the aqueous liquid volume collected in a separator downstream of the storage vessel exit, and by monitoring the salt concentration in the heat transfer fluid by means of atomic absorption spectroscopy. The system was cycled through a series of consecutive runs (15 with Marcol, 13 with Therminol), and periodic measurements made. The total aqueous volume collected was 20 ml in the case of Marcol 72, and 7 ml for Therminol 60. This represents under 2% of the system volume in the former case, and well under 1% in the latter. The salt concentration (as dodecahydrate) in the fluid reached a maximum of 120  $\mu\text{g/ml}$  in the case of Marcol, and 32  $\mu\text{g/ml}$  with Therminol, both well under 0.01% by mass.

The aqueous solution entrained in the heat transfer fluid was quite finely dispersed, and it seems quite likely that the separator did not collect all of it. Upon shutdown after the 15 cycle Marcol run, no observable salt deposition was found in the system, nor were deposits observed in the case of the Therminol run. While this did not represent conclusive proof of the absence of carry-over problems in operation of the direct contact system with these fluids, it certainly was promising.

The system thermal efficiency was also monitored during the consecutive cycles described above to ascertain any effect of heat transfer fluid on system thermal storage performance. The average storage efficiency for 12 cycles of Marcol 72 was 77.6% and for 12 cycles of Therminol 60 was 74.3%. Thus the choice of fluid did not appear to change the storage efficiency.

It was observed that the average storage efficiencies obtained compare well with the value obtained earlier for disodium hydrogen phosphate and Varsol (1). Significantly, there was no trend of efficiency with extent of cycling with Marcol 72. That is, no degradation of performance was evident. With Therminol, only two cycles were monitored for efficiency. One aspect of the system operation that did improve significantly with time was the degree of under-cooling, which decreased appreciably as operation of the storage system continued. With Therminol 60 the undercooling (subcooling below the phase transition temperature before the onset of crystallization) was 8° on the first cycle, and less than 1°C on the eighth and subsequent cycles.

Based on these results, and consideration of the physical properties of the fluids, Therminol 44 also appeared to be an especially attractive candidate for use in direct contact storage units. Its flash point is higher than that of Marcol 72, yet its viscosity is appreciably lower, implying lower carry-over. No operational data are available at present, however.

#### 4. Studies of Heat Transfer and System Geometry:

This study was completed in 1978 and was previously reported (1).

#### 5. System Demonstration:

Using the results of these four preliminary studies a pilot scale system was constructed and tested over a one month period. An overall

schematic diagram of the apparatus is shown in Figure 3. The storage vessel was constructed from mild steel plate coated with epoxy paint to prevent corrosion. The tank was 80 cm high by 60.6 cm in diameter, flanged on top to allow insertion of the immiscible fluid feed manifold. The tank was insulated with 8.9 cm of fiberglass to reduce heat loss to the environment.

The immiscible fluid diffusers used in this experiment were made from one inch (2.54 cm) plexiglass rod. The six diffusers were connected to a feed manifold which hung from the tank lid and was inserted into the tank as a unit.

A phase separator was placed into the system below the immiscible fluid exit. The basket for the phase separator was constructed from one-quarter inch mesh screen. The basket had a depth of five inches (12.72 cm) and a width of fourteen inches (35.56 cm). The packing material for the phase separator was approximately one inch thick fiberglass. In addition, a layer of polyethylene beads approximately 5 cm thick was floated at the solution-fluid interface.

A separator tank was placed on the exit of the storage tank to collect any remaining salt solution carry-over by the immiscible fluid.

In order to have approximately constant flow rates, a positive displacement gear pump was used. To prevent over-pressurization of the system during crystallization, a pressure switch was installed on the tank inlet. This switch, set at thirty-five psig, tripped an alarm input to the data-logging and control computer which switched the system to heating for a timed period to "defrost" the diffuser exit area.

The tank temperature was monitored with several thermocouples and a three junction thermopile was used to determine the temperature difference between the inlet and outlet immiscible fluid temperatures. Immiscible fluid flow rates were continuously monitored. Further details on the apparatus and experimental procedure are given by Mills (6).

#### Calorimetric Studies

Thermal storage efficiency was measured to detect any salt degradation with continuous cycling. Thermal storage efficiency is defined as the amount of energy added to or withdrawn from the salt solution divided by that which could be obtained if thermodynamic equilibrium was achieved. An efficiency of 100% would indicate that equilibrium has been reached.

Several calorimetric runs were made with water as the storage medium in order to calibrate the apparatus. In these runs the "efficiency" should always be 100% with deviations from this value indicative of experimental error. The overall average efficiency for both heating and cooling was 97.1%. Possible sources of error include inaccuracies in measuring the flow rate and the  $\Delta T$  across the thermopile and an error in the overall heat transfer coefficient for the tank. The 2.9% error in closure was judged to be adequate to proceed with the salt studies.

For the Marcol-disodium phosphate system cycled for 22 days the average cooling and heating efficiencies were 72.0% and 66.4%, respectively. The cooling efficiency was lower than the average cooling efficiencies (77.3%)



obtained in earlier bench scale work by Marra (7), Costello (8), and Kizer (9). The earlier researchers used an  $\sim 2^{\circ}\text{C}$  ( $3.6^{\circ}\text{F}$ ) approach (between inlet and outlet streams to indicate when the cycle was complete, while in this work it was felt that  $5^{\circ}\text{F}$  ( $2.77^{\circ}\text{C}$ ) approach was the closest approach the system would probably achieve in practical operation. Since at this point some crystallization was still occurring in the tank, extending the cycle should give increased efficiencies. A cooling run performed subsequently with a  $\Delta T$  approach of  $2.25^{\circ}\text{C}$  ( $4.05^{\circ}\text{F}$ ) gave an efficiency 76.0%, only 1.3% lower than the average cooling efficiencies obtained by the other researchers. No undercooling was observed.

#### Effects of Carry-Over on System Performance

The main thrust of this research was to test the performance of the proposed direct contact-latent energy storage system on a pilot scale. The single most important question was the effect that carry-over of the salt solution by the immiscible fluid would have on the performance of the system.

Polyethylene beads floating at the Marcol-salt solution interface served as a primary phase separator. A second phase separator was then placed in the tank in the immiscible fluid above the floating bead layer. This phase separator was made from fiberglass filter material attached to a quarter inch screen mesh basket below the Marcol exit.

To monitor the apparent salt concentration buildup, atomic absorption analysis (the analytical procedure is given by Marra (7)) was used.

Table I shows the results of the atomic absorption analysis for days 13 through 22 of the extended cycle tests. Note that the cooling runs had a much lower salt concentration than the heating runs, thus indicating that salt was depositing from the Marcol somewhere in the system. The overall level of salt concentration in the Marcol rose on successive runs, thus indicating greater potentials for salt deposition. The amount of carry-over collected in the separation tank also increased with time as can be seen in Table II. On the nineteenth day of the extended cycle tests, 2.85 gallons (10.8 liters) carried over into the separator tanks, over a hundred times the normal amount. Evidently the separator beads must have been agglomerated by crystallizing salt. The Marcol would then collect below the bead layer, lift the beads to the top of the tank and pass large quantities of the salt solution. Such behavior had been observed in the bench scale apparatus [Marra (7)]. Table II also shows the number of "defrost" cycles per cooling run for this set of salt runs. The number of "defrost" cycles decreased significantly after the 2.85 gallons of salt solution was carried over on the nineteenth day. Subsequently, the number of cycles started to increase again with each succeeding run.

In his studies of Marcol 72 and Therminol 60 Marra found that the concentration of salt hydrate increased in the immiscible fluid with time.

The same behavior was found in this study and suggests that the salt hydrate concentration will build up to a level resulting in salt deposition from the immiscible fluid irrespective of the immiscible fluid used.

On day twenty-four of the run the inlet pressure during a cooling cycle failed to drop below twenty-five psig after the "defrost" cycle. Since the system was evidently again getting plugged with salt deposits, the system was again cleaned out and Varsol used to replace the Marcol as the immiscible fluid to investigate the effect of fluid on the fouling problem. Unfortunately, after one day a mechanical failure of the pump forced shut-down. Upon opening the storage tank, it was found that the salt had backed up partially into the diffusers, and then crystallized.

As no suitable replacement pump was available, the study was terminated to allow evaluation and redesign of the system before resumption of the investigation.

A simple experiment verified that the salt in the Marcol was crystallizing onto cool heat exchange surfaces. Three gallons of hot Marcol that had been drained from the surge tank were placed in a bucket with a cooling coil immersed in it. Upon examination of the coil after two days salt crystallized from the Marcol was observable on the coil.

#### CONCLUSIONS

1. The thermal storage efficiencies obtained in this pilot scale study are consistent with efficiencies obtained in bench scale studies.
2. The disodium phosphate showed no signs of degradation during the run.
3. Salt solution carry-over presents a significant problem to system operability, with salt deposition from the immiscible fluid occurring in the heat exchanger during the cooling runs.
4. Modifications to the system design to counteract the detrimental effects of salt carry-over and of diffuser plugging must be devised to achieve a viable direct contact phase change unit.

#### RECOMMENDATIONS

It is quite clear from this and previous studies that significant salt solution carry-over in the immiscible fluid is inevitable, and a successful system design must allow for the inevitable salt deposition. In this regard, three key principles are evident. First, the surge tank external to the storage vessel must be eliminated by allowing expansion volume in the storage vessel itself. Second, the heat exchanger design must allow for salt deposition during cooling cycles. By using sufficiently large tubes an external forced convection heat exchanger system should be feasible. This clearly should be closely coupled to the storage tank, and located downstream of the pump. Finally, the immiscible fluid feed manifold should be designed to allow introduction of the fluid at various levels in the tank depending on pressure drop. Thus, as crystallization proceeds and blocks diffusers low in the tank, outlets higher in the tank would become active. On heating cycles the tank would then be melted from the top down.

One scheme for dealing with the heat exchange problem, proposed by Barlow (10) and by Helshoj (11), is to locate it within the heat transfer fluid layer at the top of the storage vessel. Both also proposed means for varying the point of fluid introduction with state of crystallization. However, the internal heat exchanger, while very attractive from the point of view of minimizing the effect of deposition, may present severe heat transfer rate limitations due to the limited heat transfer area and the natural convection mechanism.

#### REFERENCES

1. Edie, D. D., S. S. Melsheimer and J. C. Mullins, "Project Report," Proceedings of the Third Annual Thermal Energy Contractor's Information Exchange Meeting, D.O.E. CONF-781231, pp. 156-164, Springfield, Virginia, December 5-6, 1978.
2. Edie, D. D., S. S. Melsheimer and J. C. Mullins, "Project Report," Proceedings of the Second Annual Thermal Energy Contractor's Information Exchange Meeting, D.O.E. CONF-770995, pp. 29-35, Gatlinburg, Tennessee, September 29-30, 1977.
3. Edie, D. D., C. G. Sandell, L. E. Kizer and J. C. Mullins, "Fundamental Studies of Direct Contact Latent Heat Energy Storage," Proceedings of the 1977 Annual Meeting of the American Section of the International Solar Energy Society, Vol. 1, Section 17, pp. 16-30, Orlando, Florida, June 6-10, 1977.
4. Edie, D. D., and S. S. Melsheimer, "An Immiscible Fluid-Heat of Fusion Energy Storage System," Proceedings of the International Solar Energy Society Conference, Vol. 8, pp. 262-272, Winnipeg, Canada, August 18, 1976.
5. Costello, V. A., S. S. Melsheimer, and D. D. Edie, "Heat Transfer Calorimetric Studies of a Direct Contact-Latent Heat Energy Storage System," Thermal Storage and Heat Transfer in Solar Energy Systems, A.E.M.E., New York, 1978.
6. Mills, A. D., Extended Cycle Studies of a Direct Contact-Latent Heat of Fusion Energy Storage System, M.S. Thesis, Clemson University, 1979.
7. Marra, J. F., Heat Transfer Fluids for Direct Contact Energy Storage, M.S. Thesis, Clemson University, 1979.
8. Costello, V. A., Heat Transfer and Calorimetric Studies in a Direct Contact-Latent Heat of Fusion Energy Storage System, M.S. Thesis, Clemson University, 1978.
9. Kizer, L. E., Calorimetric Studies of Salt Hydrates for Direct Contact Thermal Energy Storage, M.S. Thesis, Clemson University, 1978.
10. Barlow, D.: Personal Communication, OEM Products, Tampa, FL, July 1978.
11. Helshoj, E.: Personal Communication, Effex Innovation A/S, Copenhagen, Denmark, June 1979.

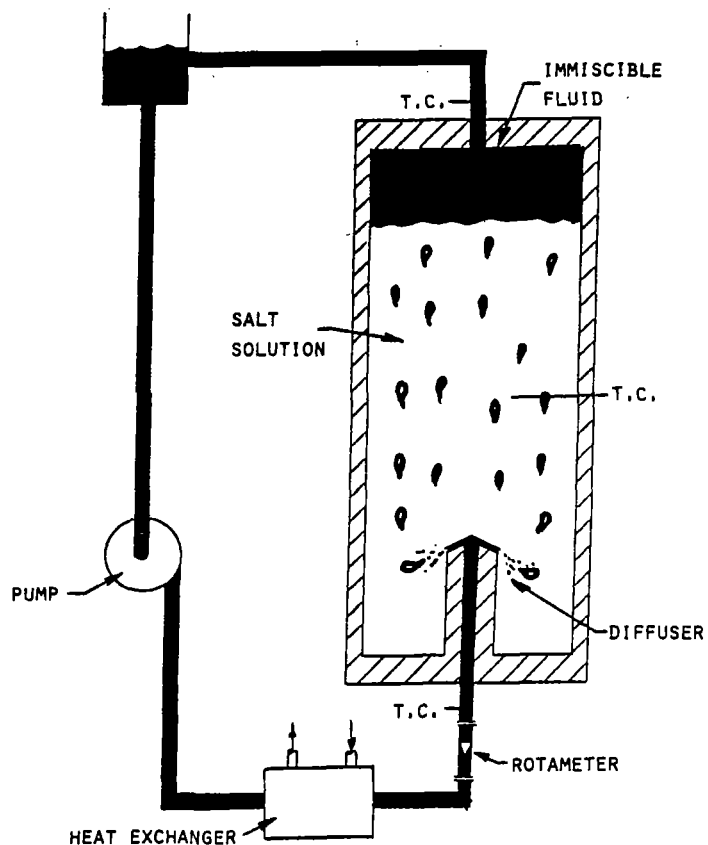

Figure 1. Immiscible Fluid - Heat of Fusion Storage System.

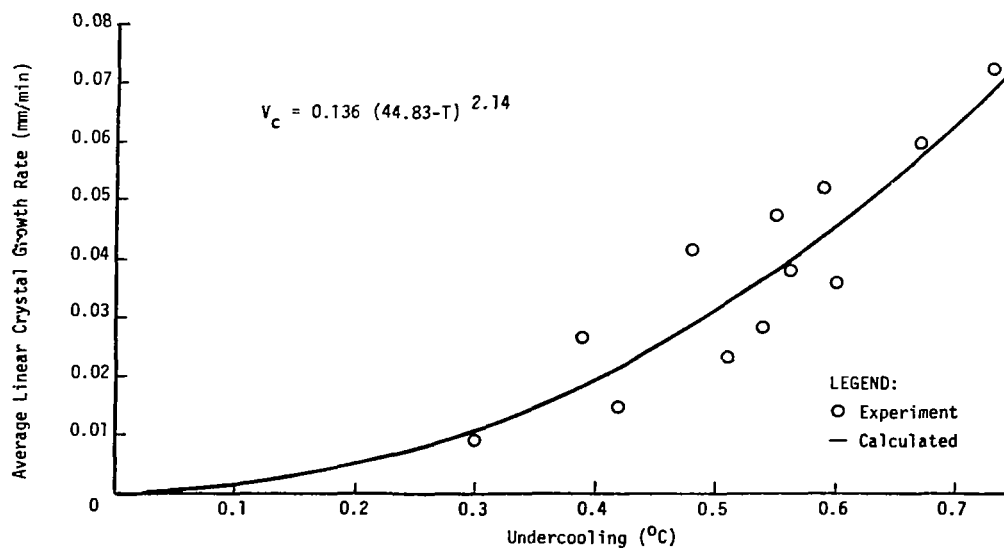

Figure 2. Average Linear Crystal Growth Rate of Sodium Thiosulfate Pentahydrate in a 55.00 Mass Percent Solution as a Function of Undercooling.

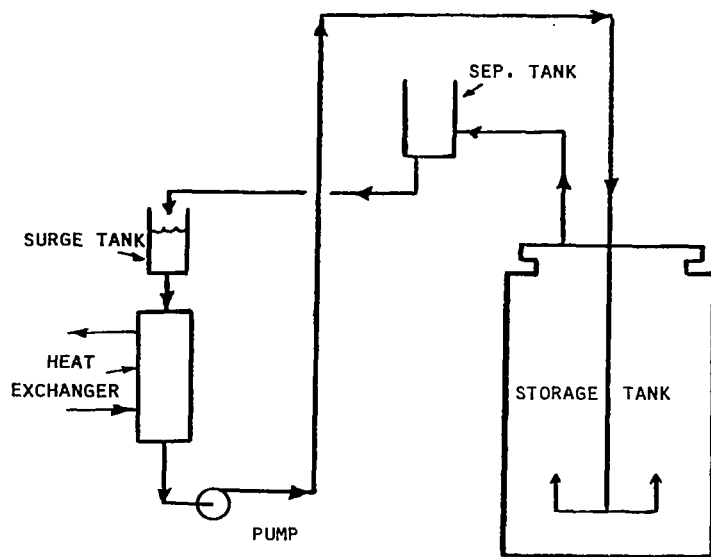

Figure 3. Schematic of Pilot Scale Energy Storage Apparatus

TABLE I. Atomic Absorption Analysis Results for the Extended Salt Run

Day	Concentration of $\text{Na}_2\text{HPO}_4 \cdot 12\text{H}_2\text{O}$ ( $\mu\text{g/ml}$ )	Type of Run
13	16.58	Cooling
14	46.10	Heating
15	23.82	Cooling
17	21.85	Cooling
18	106.45	Heating
19	37.01	Cooling
20	137.82	Heating
21	18.15	Cooling
21	134.29	Heating
22	13.94	Cooling

TABLE II. Carry-Over Data for the Extended Salt Run

Day	Period of Collection (hr)	Superficial Velocity (cm/sec)	Amount (ml)	Number of Defrost Cycles
14	24	0.047	11	2
15	22	0.047	13	2
16	24	0.047	15	
17	24	0.047	27	7
18	24	0.047	67	8
19	24	0.047	10790	
20	28	0.047	86	1
21	28	0.046	44	2
23	33	0.043	123	4



## SEASONAL THERMAL ENERGY STORAGE

### Program Area Synopsis:

The objective of the STES Program is to demonstrate the economic storage and retrieval of energy on a seasonal basis, using heat or cold available from solar, industrial or utility sources during an energy surplus season for use during peak demand periods. The initial thrust of the STES program is toward utilization of aquifers for thermal energy storage. Seasonal storage in aquifers will be evaluated in the Aquifer Thermal Energy Storage Demonstration Program, beginning with conceptual design of site specific systems which will store energy from solar, industrial, or utility sources and utilize energy for district space conditioning, process or agricultural purposes, and continuing through the construction and operation of a smaller number of Demonstration Projects. A parallel Technical Support Program will provide data on aquifer behavior, data from field tests, economic and mathematical modeling data. The program will also monitor work on pond, lake, and earth storage; primarily under IEA sponsorship and evaluate the need for additional field tests.





## AQUIFER THERMAL ENERGY STORAGE PROGRAM

Kenneth Fox  
Pacific Northwest Laboratory

### PROJECT OUTLINE

Project Title: Aquifer Thermal Energy Storage Program

Principal Investigator: Kenneth Fox

Organization: Pacific Northwest Laboratory  
P. O. Box 999  
Richland, WA 99352  
Telephone: (509) 942-0891 FTS: 444-0891

Project Goals: To stimulate the interest of industry by demonstrating the feasibility of utilizing an aquifer for seasonal thermal energy storage. Technical, economic, environmental and institutional feasibility are being considered.

This program is divided into two phases:

Phase I - This phase consists of the preparation of conceptual designs for fully integrated thermal energy storage systems which include an energy source, thermal transport, a storage aquifer and a user application. Up to ten conceptual designs will be prepared on a cost reimbursable basis. Each proposal will be specific to one of the following categories: a) High Temperature Heat Storage ( $100^{\circ}\text{C}$ ); b) Low Temperature Heat Storage ( $100^{\circ}\text{C}$ ); c) Chill Storage; d) Combined Heat and Chill Storage. Proposals are due on December 5. Contractor selection will be completed by March and design work should start July, 1980. The nominal time frame for conceptual design is two years.

Phase II - Upon completion of the conceptual designs, up to five will be selected for final design, construction, startup, and operation. This work will be accomplished on a cost sharing basis between DOE and the operating entity. The nominal time frame for this phase is three years.

Project Status: RFP Promulgated: September 7, 1979  
Proposer's Conference Held: October 11, 1979  
Proposals Received: December 5, 1979  
Contractor Selection Due: March, 1980  
Phase I Work Starts: July, 1980  
Phase I Work Completes: June, 1982  
Phase II Work Starts: December, 1982  
Phase II Work Completes: December, 1985

Contract Number: EY-76-C-06-1830

Contract Period: June 1979 to December 1985

Funding Level: \$1,800,000 (FY-1980)

Funding Source: Energy Storage Systems Division  
U.S. Department of Energy

## AQUIFER THERMAL ENERGY STORAGE PROGRAM

Kenneth Fox  
Pacific Northwest Laboratory

### INTRODUCTION

Management of the Aquifer Thermal Energy Storage Demonstration Program is a task assigned to Pacific Northwest Laboratory operated by Battelle Memorial Institute, under the Seasonal Thermal Energy Storage Program. This Program is funded by the Department of Energy, Division of Energy Storage.

### OBJECTIVE

The purpose of the Aquifer Thermal Energy Storage Demonstration Program is to stimulate the interest of industry by demonstrating the feasibility of utilizing an aquifer for seasonal thermal energy storage, thereby, reducing crude oil consumption, minimizing thermal pollution, and significantly reducing utility capital investments required to account for peak power requirements. This purpose will be served if several diverse projects can be operated which will demonstrate the technical, economic, environmental, and institutional feasibility of aquifer thermal energy storage systems.

### DESCRIPTION OF PROGRAM PHASING

In order to assure that only those programs which have a good probability of success are actually constructed and operated, this program has been divided into two phases. Phase I consists of conceptual design and Phase II consists of final design, construction, startup, and operation for a sufficient period to demonstrate the feasibility of the system.

#### Phase I

Phase I is actually more than merely preparation of the conceptual design. The key element in the storage system is of course, the aquifer itself. No artificial energy repository will be accepted. The storage media must be a naturally occurring geologic formation. This means that during Phase I, in addition to the preparation of a conceptual design for the entire system, "the naturally geologic formation" must be identified and characterized to the extent necessary to assure that it is compatible to the other elements in the system. This characterization of the aquifer will require much more time than the preparation of a conceptual design would normally involve.

The proposers are given freedom in the energy source and user application. For the energy source, possibilities include waste heat from an industrial source, cogeneration steam from a power plant, a solar collector, a heat pump, or chilled water from a winter chill application to be used for summer air conditioning. User application might be district heating, agricultural uses, such as drying, industrial uses which might require chill or heat for a particular process. The entire system is tied together by an energy transport system which carries the energy from the source to the aquifer and from the aquifer to the user application. In most instances, it is anticipated that the transport system will also carry water removed from an aquifer back to the same aquifer or a nearby formation for reinjection.

Phase I will require approximately two years and there will be up to ten contracts for conceptual design. It is anticipated that the aquifer characterization will take the best part of a year and the remainder of the time will be involved preparing a conceptual design which balances the energy source, the aquifer for storage and the user application with a suitable transport system. During this period, a preliminary environmental assessment will be required and an investigation of the institutional restraints will be made. Along with conceptual design reports, we will receive a proposal for Phase II work. It is intended that the timing will be such that all Phase II proposals will be received together and the choice of Phase II contractor will be made in as brief a time span as possible so as to minimize disruptions of the working teams which are to continue. Phase I work will have been carried out under cost reimbursable contracts with entities which will most likely consist of joint ventures between an architect/engineer, a user application such as a district heating association, an energy source which might be a utility or industrial plant, and a municipality in many cases which will manage the system.

## Phase II

Up to five of the conceptual designs prepared under Phase I will be chosen for continuation in Phase II. In Phase II, final design, construction, startup, and operation will take place. Phase II will be accomplished on a cost sharing basis in which the cost of design, construction, and operation will be shared between the government and the proposing organization. In the selection process for Phase II, it is hoped that in addition to identifying those projects that have the highest prospect for demonstrating the feasibility of the aquifer thermal energy storage concept, we will also obtain projects that do not duplicate work already underway by industry, climatic and geographic distribution, and those that have the greatest potential for widespread application throughout the country. It is hoped that we obtain a diversity of effort that allows the coverage of four basic technical areas. These are high-temperature heat storage, low-temperature heat storage, chill storage, and combined heat and chill storage.

## MILESTONES

Figure 1 shows the milestones and the schedules for their achievement during the entire program. Of particular importance will be the phasing of Phase I contracts such that they all complete in approximately the same time frame. We should thereby be able to make a choice of those that are to proceed to Phase II, such that there will be a minimum disruption in existing organizations. The proposals for Phase II work will be submitted along with the conceptual design work and therefore, the choice of Phase II contracts can be accomplished in a relatively short period of time. However, the cost sharing arrangements are a negotiable item, and therefore, the negotiation of Phase II contracts could require considerable effort and time.

## INTEREST

The interest in this program from industry has been most encouraging. The Department of Energy first advertised a Request for Expression of Interest in January, 1979, and from this an initial core of approximately 40 interested companies was received. It is quite clear that from this time on several of these companies have been investigating the possibilities for programs of this nature. The announcement of the Request for Proposals appeared in the Commerce Business Daily on September 7, 1979, and from this nearly 200 requests were received. The distribution of the origin of the requests is shown in Figure 2. It was interesting to note that many of them were from individual companies that recognized the need to form a joint venture in order to propose, and many of these individual entities were searching for partners toward such a joint venture. We, therefore, decided to provide each requesting organization with a copy of our proposer's mailing list. We thus performed a "mating" service which, in at least a few cases, has resulted in consultants, geologists, architect/engineers, potential user applications, and potential energy sources finding a match. Since the technical portion of the proposal is not due until December 17, it would be premature to describe the nature of the proposals that will be evaluated. However, in Figures 3 and 4, I have shown hypothetical but typical proposals of the type we expect to be receiving. I will describe these, as I think they will give a better understanding of the nature of the potential demonstration projects.

### Hypothetical Aquifer Thermal Energy Storage Demonstration Projects

#### Project #1 (Figure 3)

A mid-western city with a population base of approximately 200,000 is undergoing an urban renewal program. As part of this urban renewal program, a large section of the downtown area is being supplied with district heat from a central power plant. In the industrial area of the town, approximately five miles from the center of this urban renewal, there is a large food processing plant which currently disposes of waste heat through a heat exchanger which in

turn discharges into a large river running near the town. The Chamber of Commerce has approached the contractor in charge of the urban renewal program, the owner of the food processing plant, and a major engineer/architect firm headquartered in the mid-west. They have assembled these three organizations and propose participating in the Aquifer Thermal Energy Storage Program. These three have in turn formed a joint venture and added a geological consulting firm to assist them in the aquifer technology. The geologist has given a preliminary evaluation that indicates a high probability of suitable aquifers in the area between the food processing plant and the urban renewal area. Much of this land is municipally owned at this time, and therefore, there is a good prospect that the land and water rights will be available. This joint venture is now preparing a proposal which will involve diverting all or a portion of the waste heat from the processing plant into an injection system which will heat the aquifer through direct injection of waste heat. A withdrawal system will be located after the general direction of flow and rate of flow are determined and the heat withdrawn from the aquifer will be run through a heat exchanger at the site and then transported to the district application. The project manager will be the engineer/architect firm who will work with the urban renewal contractor on the interface with the heat supply, with the food processing company on the design and financial arrangements for the waste heat source, and will design the transport system, the heat exchangers and the pumping system to be used. The geological consultant will prepare a plan for the characterization of the aquifer and will pick the sites at which test borings will be made to determine the aquifer characteristics. Meanwhile, the geological consultant will have assembled sufficient data from Federal and State surveys and from well drilling in the immediate area of the municipal land to determine that the project is feasible and worth the investment that must be made in order to prepare a proposal. Some of the other problems which are currently being investigated are these:

- 1) Is there an alternate source of heat that can be used in the event of a failure of the energy supply system or some loss of the transport system during the critical cold winter months? Should redundancy be built into the system in the form of an auxiliary boiler?
- 2) Must the current design of the district heating system be revised to increase piping sizes to allow for the lower temperature to be expected from the aquifer fed heat exchanger as compared to direct generation?
- 3) Are there any environmental impediments toward implementation of this project? For example, are the aquifers in the area being examined likely to be those which feed the municipal drinking water system?
- 4) Does the economic future for the food processing plant and the management of the corporation look stable enough to warrant a five-year commitment to this energy source?

## Project #2 (Figure 4)

A large university located on the outskirts of a small mid-Atlantic city is currently heated by its own boiler plant, which is obsolescent and must be replaced in the near future. At the same time, the university is concerned about the increasing electric bill caused by individual air conditioning installed in each building of the campus. The university has hired an HVAC engineering corporation to make a study of their requirements and to recommend a cost efficient means of providing heating and air conditioning for the entire campus throughout the year. The engineer/architect is currently examining the possibility of a combination heat and chill aquifer system which could provide heating and cooling to the entire campus through separate aquifer systems. Inasmuch as the plan involves replacing the entire heating system for the buildings, the HVAC engineer proposes to replace the existing heating system with a forced air system in which the air is heated or chilled by water from the appropriate aquifer system. One aquifer system would be heated from waste heat received from the power plant, while the other would be chilled in the winter from a heat exchanger system to be established above ground using winter chill to cool the aquifer. The system looks particularly attractive because the air conditioning requirements are relatively small as the entire campus is seldom operated throughout the summer. Inasmuch as a new heating system must be installed in many of the buildings just by virtue of age, the enlargement of the heating system required by the larger volume of flow required from the aquifer system does not substantially add to the cost of the renewal. An economic analysis is being made of the cost benefits, including the capital cost of the aquifer system as compared to the installation of a new boiler and heating plant, and the significant reduction in operating costs which will result from using waste heat as opposed to burning fossil fuel or relying on an increasingly expensive off-campus source of electricity for heating. The same problems must be investigated as were investigated in Case 1, namely the environmental concerns, reliability of the heat source, alternate means of providing energy should there be a failure in the source, the possibility of legal prohibitions against injection or removal of large quantities of water, and other "what if" concerns.

## CONCLUSION

Aquifer thermal energy storage as a closed cycle energy efficient system is a new, and as yet, an unproven concept in the United States. However, the individual elements in the user application, the aquifer storage systems, the energy transport system, and the energy source are certainly not beyond current technology. While it is still too early to predict the nature of the projects that will be chosen, and therefore, the direction the program will take, we have cause for optimism in our ability to seed industry with the demonstrated effectiveness of this technique.

FIGURE 1. AQUIFER THERMAL ENERGY STORAGE PROGRAM

	1979				1980												1981				1982				1983				1984				1985			
	S	O	N	D	J	F	M	A	M	J	J	S	O	N	D	1	2	3	4	1	2	3	4	1	2	3	4	1	2	3	4	1	2	3	4	
PUBLISH RFP	▲																																			
CONDUCT PROPOSERS CONFERENCE	▲																																			
RECEIVE CONTRACTOR PROPOSALS				△																																
COMPLETE CONTRACTOR SELECTION							△																													
PRESENT ATES PROJECT SELECTION TO DOE							△																													
PRESENT ATES MISSION ANALYSIS TO DOE								△																												
COMPLETE NEGOTIATIONS & CONTRACT AWARD OF CONCEPTUAL DESIGN CONTRACTS									△																											
START PHASE I DESIGNS										△																										
COMPLETE PHASE I DESIGNS																						△														
START PHASE II																							△													
COMPLETE PHASE II																																			△	

FIGURE 2. DISTRIBUTION OF RFPs BY STATE

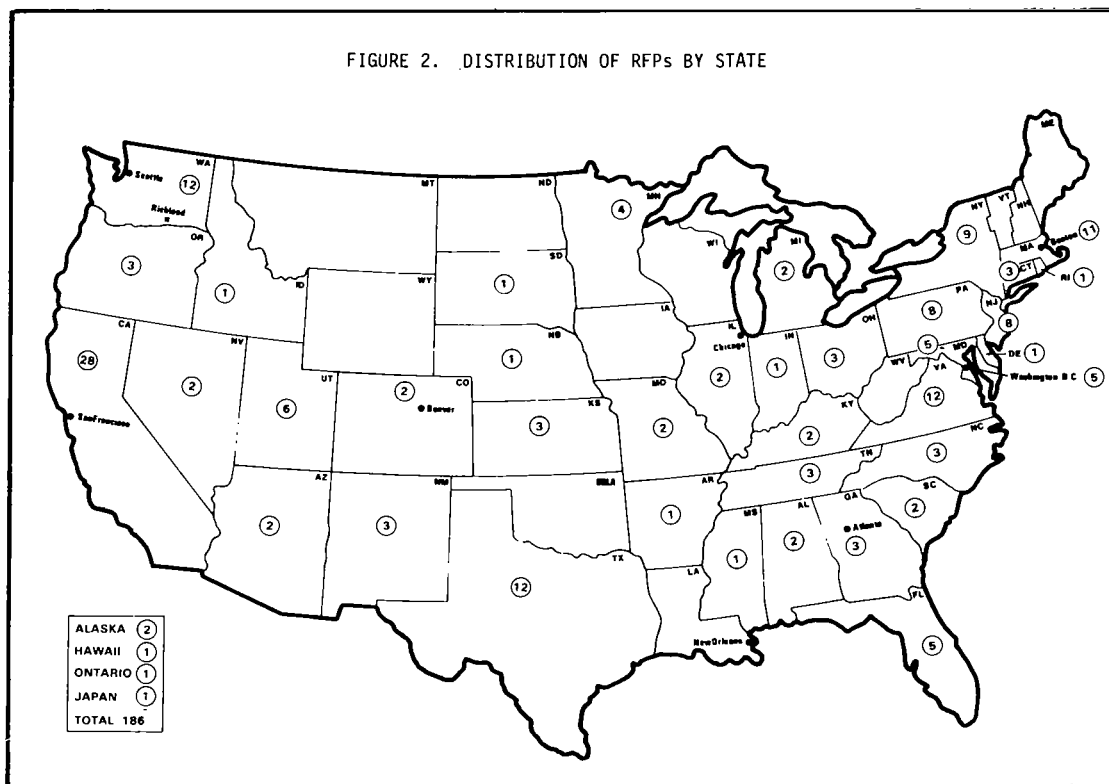



FIGURE 3. SEASONAL THERMAL ENERGY STORAGE

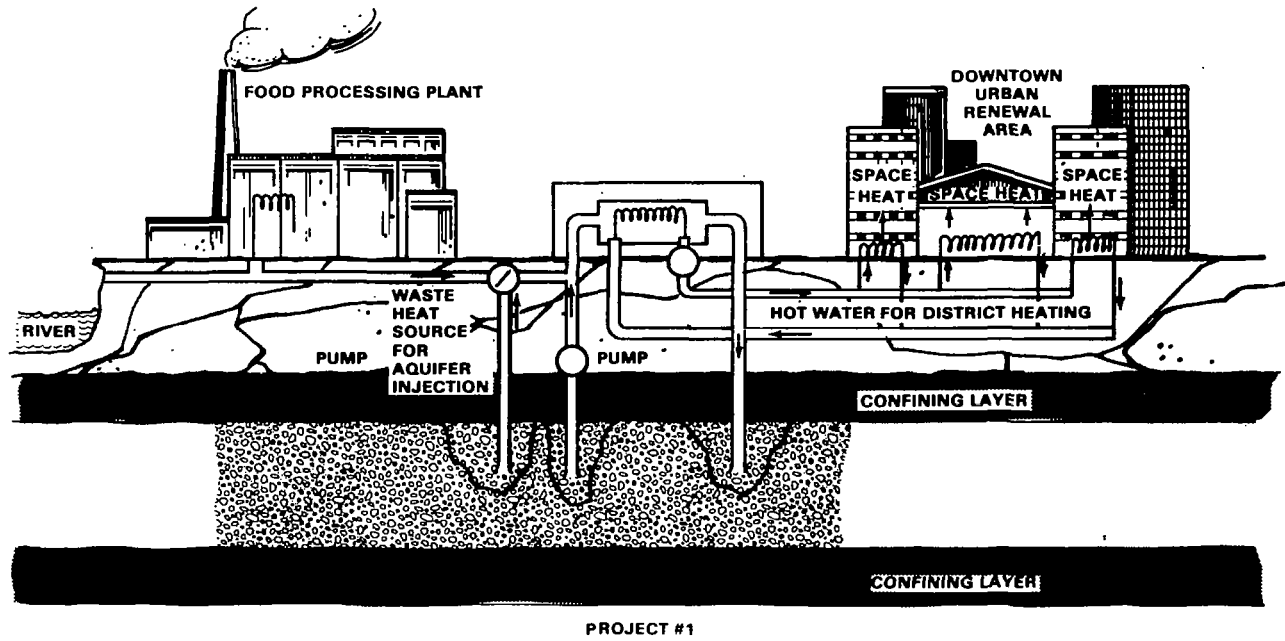
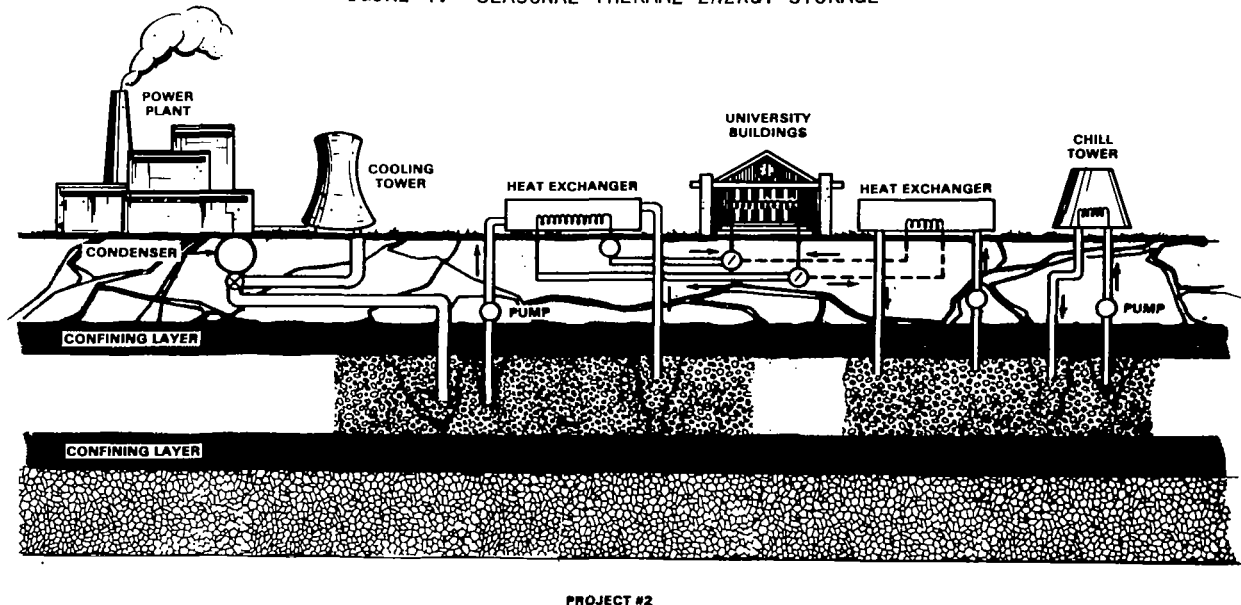

FIGURE 4. SEASONAL THERMAL ENERGY STORAGE





COMPENDIA OF SEASONAL THERMAL ENERGY STORAGE

AQUIFER THERMAL ENERGY

TECHNICAL INFORMATION

D. D. Hostetler  
Pacific Northwest Laboratory

PROJECT OUTLINE

Project Title: Compendia of STES Technical Information

Principal Investigator: D. D. Hostetler

Organization: Pacific Northwest Laboratory  
P. O. Box 999  
Richland, WA 99352  
Telephone: (509) 375-2781 FTS: 444-7511

Project Goals: The primary goal of the Compendia Subtask is to organize, summarize, and communicate information related to STES.

Compendia task objectives will be accomplished primarily by establishing the STES library, publication of a compendia of existing information, and publication of the ATES technical manual. The library will serve as a focal point of information transfer for both STES staff and outside contractors. The Compendia will be a concise but complete description pertaining to the development and application of STES concepts. The ATES technical manual will be the primary technology transfer medium for support of the ATES concepts.

Project Status: The following are current activities:

- o A cross-referenced STES library with over 750 publications.
- o A developing annotated bibliography of library contents

The following are planned FY-1980 activities:

- o The publication of several documents covering developing technologies related to STES concepts is planned. These documents will summarize the best available technology for selected topics.

- o Computerization of the STES annotated bibliography (plus key words) will be done. This will enable rapid, customized literature searches by any interested party; such as outside contractors for the demonstration facilities.
- o The ATES technical manual format will be established and the initial manual will be published.

Contract Number: EY-76-C-06-1830

Contract Period: October 1979 (Continuing)

Funding Level: \$250,000 (FY 1980)

Funding Source: Energy Storage Systems Division  
U.S. Department of Energy

Seasonal Thermal Energy Storage  
Aquifer Thermal Energy  
Reference Library  
Subject Listing

CONTENTS

CORROSION, SCALING, AND ENCRUSTATION . . . . .	417
ECONOMIC FEASIBILITY . . . . .	419
ENERGY SOURCES . . . . .	422
ENVIRONMENTAL CONSIDERATIONS . . . . .	427
FLUID FLOW AND ENERGY TRANSPORT IN RESERVOIRS. . . . .	433
HEAT TRANSFER EQUIPMENT. . . . .	439
HYDRAULIC GRADIENT CONTROL . . . . .	442
INSTITUTIONAL AND SOCIETAL CONSIDERATIONS. . . . .	443
NONAQUIFER STORAGE METHODS . . . . .	445
REINJECTION. . . . .	447
RESERVOIR AND SURFACE FACILITY INSTRUMENTATION . . . . .	451
RESERVOIR CHARACTERIZATION METHODS . . . . .	451
RESERVOIR CONSOLIDATION AND SUBSIDENCE . . . . .	457
RESERVOIR PLUGGING PROBLEMS. . . . .	459
RESERVOIR PRETREATMENT AND REHABILITATION. . . . .	461
SITE SELECTION AND REGIONAL ASSESSMENTS. . . . .	462
STES-RELATED DEMONSTRATIONS. . . . .	465
STES-RELATED EXPERIMENTS . . . . .	472
STES-RELATED MATHEMATICAL AND COMPUTER MODELING. . . . .	474
TECHNOLOGY TRANSFER TO PUBLIC. . . . .	482
THERMAL FATIGUE OF RESERVOIR AND WELL MATERIALS. . . . .	482
WATER QUALITY. . . . .	484

WATER TREATMENT AND FILTERING TECHNIQUES . . . . .	486
WELLBORE AND PIPING HEAT LOSSES. . . . .	487
WELL CASING AND SCREENING MATERIALS. . . . .	488
WELL CONSTRUCTION AND MAINTENANCE. . . . .	489
WELL FIELD DESIGN AND OPERATING CRITERIA . . . . .	492
MISCELLANEOUS. . . . .	494

Seasonal Thermal Energy Storage  
Aquifer Thermal Energy  
Subject Listing

CORROSION, SCALING, AND ENCRUSTATION

- Allegrini, G. and G. Benvenuti. 1970. "Corrosion Characteristics and Geothermal Power Plant Protection. (Collateral Processes of Abrasion, Erosion and Scaling)." U.N. Symposium on the Development and Utilization of Geothermal Resources, 2(1):865-881. [5]
- American Petroleum Institute. 1958. "Corrosion of Oil- and Gas-Well Equipment." Book 2 of the Vocational Training Series. [634]
- Cuellar, G. 1975. "Behavior of Silica in Geothermal Waste Waters." Proceedings Second U.N. Symposium on the Development and Use of Geothermal Resources, 1343-1347. [83]
- Dodd, F. J., A. E. Johnson, and W. C. Ham. 1975. "Material and Corrosion Testing at the Geysers Geothermal Power Plant." Proceedings Second U.N. Symposium on the Development and Use of Geothermal Resources. [96]
- Fulford, R. S. 1968. "Effects of Brine Concentration and Pressure Drop on Gypsum Sealing in Oil Wells." Journal of Petroleum Technology, p. 559-564. [119]
- Hanck, J. A. and G. Nekoksa. 1975. "Corrosion Rate Monitoring at the Geysers Geothermal Power Plant." Proceedings Second U.N. Symposium on the Development and Use of Geothermal Resources, p. 1980-1984. [156]
- Hermannsson, S. 1970. "Corrosion of Metals and the Forming of a Protective Coating on the Inside of Pipes Carrying Thermal Waters Used by the Reykjavik Municipal District Heating Service." Proceedings of the U.N. Symposium on the Development and Utilization of Geothermal Resources, 2(1):1602-1612. [182]
- Hoepfner, S. 1974. "Combating Air and Gas Problems." Water Well Journal, 28(5):29-30. [185]
- Johnson, H. E. and A. C. Nestle. \_\_\_\_\_. "A Survey of Corrosion Control in Drilling and Annular Fluids." National Association of Corrosion Engineers, Publication 1D168. [215]
- Kryukov, P. A. and E. G. Larionov. 1970. "Physico-Chemical Sampling of High Temperature Wells in Connection with their Encrustation by Calcium Carbonate." Proceedings of the U.S. Symposium on the Development and Utilization of Geothermal Resources, 2(1):1624-1628. [292]

- Lindemuth, T. E., E. H. Houle, S. H. Suemoto, and V. C. VanDerMast. 1976. "Experience in Scale Control with East Mesa Geothermal Brine." International Symposium on Oilfield and Geothermal Chemistry, SPE-6605. [318]
- "Maintaining the Yield of Water Wells." 1965. The Johnson Drillers Journal, January-February, pp. 1-4. [332]
- Oliker, I. 1977. "Heat Exchanger and Thermal Storage Problems in Power Stations Serving District Heating Networks." ASME Paper 77-HT-36. [393]
- Ozawa, T. and J. Fujii. 1970. "A Phenomenon of Sealing in Production Wells and the Geothermal Power Plant in the Matsukawa Area." U.S. Symposium on the Development and Utilization of Geothermal Resources, 2(2):1613-1618. [396]
- Phillips, S. L., A. K. Mathur, and R. E. Doebler. 1976. "A Survey of Treatment Methods for Geothermal Fluids." SPE, 6606. [411]
- Subcasky, W. J. \_\_\_\_\_. "Petroleum Industry Experience in Water Injection." [477]
- Technical Practices Committee. 1977. "Monitoring Techniques for the Control of Corrosion of Drill Pipe, Casing, and Other Components in Contact with Drilling Fluids." NACE ID177. [488]
- Technical Practices Committee. 1976. "The Role of Bacteria in the Corrosion of Oil Field Equipment." NACE Pub. 3. [487]
- Technical Unit Committee. 1954. "Sulfide Corrosion Cracking of Oil Production Equipment." NACE 1154. [489]
- Tolivia, E. 1970. "Corrosion Measurements in a Geothermal Environment." U.N. Symposium on the Development and Utilization of Geothermal Resources, 2(2):1596-1601. [496]
- Treseder, R. S. and R. Wieland. 1976. "Down-Hole Corrosion in a Salton Sea Geothermal Well." SPE 6613. [498]
- Vetter, O. J., D. A. Campbell, and M. J. Walker. 1978. Geothermal Fluid Investigations at RGI's East Mesa Test Site. PNL-2556. [508]
- Vetter, O. J. G. and R. C. Phillips. 1970. "Prediction of Deposition of Calcium Sulfate Scale Under Down-Hole Conditions." Journal of Petroleum Technology, October, 1299-1308. [509]
- Yanagase, T., Y. Suginochara, and K. Yanagase. 1970. "The Properties of Scales and Methods to Prevent Them." U.S. Symposium on the Development and Utilization of Geothermal Resources, 2(2):1619-1623. [540]



## ECONOMIC FEASIBILITY

- Anderson, J. H. 1972. "Economic Power from Geothermal Heat." [11]
- Asbury, J. G., R. F. Giese, and R. O. Mueller. 1979. "Residential Electric Heating and Cooling: Total Cost of Service." Workshop on New Modes of Residential HVAC: Economic Incentives and Barriers, Electric Power Research Institute. [241]
- Bernard, W. J. 1978. "Deep, Geopressed Aquifers: A New Energy Source?" Petroleum Engineer International, 50(3):84-90. [30]
- Besant, R. W. and C. B. Winn. 1976. "Cost Effective Solar Heating of Houses With Seasonal Storage of Energy." International Solar Energy Society, American Section, 4:409-424. [257]
- Bezdek, R. H., A. S. Hirschberg, and W. H. Babcock. 1979. "Economic Feasibility of Solar Water and Space Heating." Science, 23:1214-1220. [255]
- Bloomster, C. H., L. L. Fassbender, and C. L. McDonald. 1977. Geothermal Energy Potential for District and Process Heating Application in the U.S. - An Economic Analysis. BNWL-2311. [35]
- Bodvarsson, G. and J. Zoega. 1961. "Production and Distribution of Natural Heat for Domestic and Industrial Heating in Iceland." U.N. Conference on New Source of Energy, Jokull, 11:48-55. [245]
- Boersma, L., L. R. Davis, G. M. Reistad, J. C. Ringle, and W. E. Schmisser. 1974. A System Analysis of the Economic Utilization of Warm Water Discharge from Power Generating Stations. Bulletin No. 48. Engineering Experimental Station, Oregon State University. [602]
- Briggs, J. B. and C. J. Shaffer. 1977. "Seasonal Heat Pump Performance for a Typical Northern United States Environmental." Tree-1181. [55]
- Collins, R. E. and K. E. Davis. 1976. "Geothermal Storage of Solar Energy for Electric Power Generation." Proc. International Conference on Solar Heating and Cooling, pp. 411-424. [74]
- Collins, R. E., J. R. Fanchi, G. O. Morrell, K. E. Davis, T. K. Guha, and R. L. Henderson. \_\_\_\_\_. "High Temperature Underground Thermal Energy Storage." [75]
- Cortell, B. 1977. "Ground Water/Solar Heat." Water Well Journal, May, p. 73. [79]

- Coulbois, P. and J. P. Herault. 1975. "Conditions for the Competitive Use of Geothermal Energy in Home Heating." Proceedings Second U.N. Symposium on the Development and Use of Geothermal Resources, 3:2104-2108. [81]
- Culver, G. and G. M. Reistad. \_\_\_\_\_. "Evaluation and Design of Downhole Heat Exchangers for Direct Application." [84]
- Desert Reclamation Industries. 1978. "Aquifer Storage at J. F. Kennedy International Airport." [92]
- Despois, J. and F. Nougarede. 1977. "Underground Heat Storage." Revue Generale de Thermique, 184:357-366. [94]
- Dooley, J. L., G. P. Frost, L. A. Gore, R. P. Hammond, D. L. Rawson and S. L. Ridgeway. 1977. A Feasibility Study of Underground Energy Storage Using High-Pressure, High-Temperature Water. RDA-TR-7100-001 (CONS-1243-1). [630]
- Engen, I. A. 1978. Residential Space Heating Cost: Geothermal vs Conventional Systems. TREE-1182. [107]
- Fox, E. C. and J. F. Thomas. \_\_\_\_\_. A Preliminary Economic Analysis of Aquifer Winter-Chill Storage at the John F. Kennedy Airport. ORNL/TM-6876. [118]
- Guyer, E. C. and M. W. Golay. 1977. "Evaluation of Combined Thermal Storage Pond/Dry Cooling Tower Waste Disposal Systems." ASME, 77-HT-57. [277]
- Hausz, W. 1974. "Heat Storage Wells Conserve Fuels." Symposium Papers - Efficient Use of Fuels in the Metallurgical Industries, 185-201. [166]
- Hausz, W., B. J. Berkowitz and R. C. Hare. 1978. Conceptual Design of Thermal Energy Storage Systems for Near Term Electric Utility Applications. DOE/NASA/0012-78/1, Vol 1 and 2. (Vol 1: Screening Concepts; Vol. 2: Appendices - Screening of Concepts.) [170]
- "House on Ice." 1979. Ground Water Age, May, pp. 16-19. [192]
- Katter, L. B. and R. L. Hoskins. 1978. Application of Thermal Energy Storage to Process Heat and Waste Heat Recovery in the Primary Aluminum Industry. CONS/5080-1. [878]
- Kazmann, R. G. 1978. "Underground Hot Water Storage Could Cut National Fuel Needs 10%." Civil Engineering, 48(5):57-60. [227]
- Kimble, O. K., R. G. Kazmann and W. R. Whitehead. 1975. Cyclic Storage of Fresh Water in Saline Aquifers. Louisiana Water Resources Research Institute. Bull. 10. [237]

- Kroeker, J. D. and R. C. Chewing. 1953. "Costs of Operating the Heat Pump in the Equitable Building." Heating, Piping and Air Conditioning, November, p. 135-144. [290]
- Lienau, P. J. and J. W. Lund. \_\_\_\_\_. "Utilization and Economics of Geothermal, Space Heating in Klamath Falls, Oregon." Oregon Institute of Technology. [317]
- Lund, J. W., P. J. Lienau, G. G. Culver, and C. V. Higbee. \_\_\_\_\_. "Klamath Falls Geothermal Heating District." [327]
- Meyer C. F. 1976. "Status Report on Heat Storage Wells." Water Resources Bulletin, 12(2):237-252. [352]
- Meyer, C. F., W. Hausz, B. L. Ayres and H. M. Ingram. 1976. Role of the Heat Storage Well in Future U.S. Energy Systems. GE76TMP-27. [357]
- Ridgeway, S. L. and J. L. Dooley. 1976. "Underground Storage of Off-Peak Power." Eleventh Intersociety Energy Conversion Engineering Conference Proceedings, pp. 586-590. [429]
- Salieva, R. B. and R. P. Saliev. 1975. "Principles of Technological-Economic Calculations in Solar Technology." Geliotekhnika, 11(5):44-51. [445]
- Spencer, R. S., W. S. Butler, M. K. Enns, and B. W. Wilkinson. 1976. "The Potential for Fuel Economics Via Combined Steam Power Production." Eleventh Intersociety Energy Conversion Engineering Conference Proceedings, Volume 1. [466]
- Stracke, K. J., D. C. Mason, and R. G. Altman. 1969. "Cyclic Steam-Injection Operations - Guadalupe Field, California." Drilling Production and Practice - American Petroleum Institute, p. 35-39. [473]
- Willhite, G. P. and J. Wagner. 1974. Disposal of Heated Water Through Ground Water Systems. Vol. II. User's Manual. Numerical Simulation of Fluid Flow and Heat Transfer in Ground Water Systems. Kansas Water Resources Research Institute. Contribution No. 134. (PB-236-303). [526]
- Willhite, G. P., J. Wagner, F. Simonpictri and J. Stoker. 1974. Disposal of Heated Water Through Ground Water Systems. Vol. I. Technical and Economic Feasibility. Kansas Water Resources Research Institute. Contribution No. 134. (PB-236-302). [527]

## ENERGY SOURCES

- Anderson, J. H. 1972. "Economic Power from Geothermal Heat." [11]
- Anonymous. 1977. "Groundwater Aquifers for Solar Storage." Texas Energy and Mineral Resources, 3(7):4. [16]
- Bernard, W. J. 1978. "Deep, Geopressed Aquifers: A New Energy Source?" Petroleum Engineer International, 50(3):84-90. [30]
- Besant, R. W. and C. B. Winn. 1976. "Cost Effective Solar Heating of Houses With Seasonal Storage of Energy." International Solar Energy Society, American Section, 4:409-424. [257]
- Bezdek, R. H., A. S. Hirschberg, and W. H. Babcock. 1979. "Economic Feasibility of Solar Water and Space Heating." Science, 23:1214-1220. [255]
- Bloomster, C. H., L. L. Fassbender, and C. L. McDonald. 1977. Geothermal Energy Potential for District and Process Heating Application in the U.S. - An Economic Analysis. BNWL-2311. [35]
- Bodvarsson, G. 1961. "Utilization of Geothermal Energy for Heating Purposes and Combined Schemes Involving Power Generation and/or By-Products." U.N. Conference on New Sources of Energy, Jokull, 11:49-59. [248]
- Bodvarsson, G. 1961. "Physical Characteristics of Natural Heat Resources in Iceland." Jokull, 11:29-38. [ ]
- Bodvarsson, G. 1974. "Geothermal Resource Energetics." International Journal of Geothermal Research, 3(3):83-92. [41]
- Bodvarsson, G. 1976. "Thermoelastic Phenomena in Geothermal Systems." Second United Nations Symposium on the Development and Use of Geothermal Resources, 2:903-907. [42]
- Bodvarsson, G. 1977. "A Secondary Recovery Method for the Extraction of Geothermal Energy." RLO-2227-T21-1. [43]
- Bodvarsson, G. and G. M. Reistad. 1975. "Econometric Analysis of Forced Geoheat Recovery for Low-Temperature Uses in the Pacific Northwest." Second United Nations Symposium on the Development and Use of Geothermal Resources, 3:1559-1564. [45]
- Boersma, L., L. R. Davis, G. M. Reistad, J. C. Ringle, and W. E. Schmisser. 1974. A System Analysis of the Economic Utilization of Warm Water Discharge from Power Generating Stations. Bulletin No. 48. Engineering Experimental Station, Oregon State University. [602]

- Boldizar, T. 1970. "Geothermal Energy Production from Porous Sediments in Hungary." Proceedings United Nations Symposium, Development and Utilization of Geothermal Resources, 2(1):99-109. [46]
- Bouwer, H. 1979. "Geothermal Power Production with Irrigation Waste Water." Ground Water, 17(4):375-384.4. [51]
- Calm, J. M. 1978. "Recovery of Wasted Heat with Centralized and Distributed Heat Pump Systems." Argonne National Laboratory, ASME Winter Annual Meeting. [262]
- Carver, J. A. 1975. "Legal and Institutional Planning for Macro-Conservation Measures." Public Utilities Fortnightly, 95(9):29-33. [62]
- Cavallieri, G. and G. Foligno. 1977. "Proposal for the Production and Seasonal Storage of Hot Water to Heat a City." Solar Energy, 19(6):677-683. [260]
- Collins, R. E. and K. E. Davis. 1976. "Geothermal Storage of Solar Energy for Electric Power Generation." Proc. International Conference on Solar Heating and Cooling, pp. 411-424. [74]
- Committee on Natural Resources. 1974. An Act Relating to Conservation of Geothermal Resources. State of Washington, 43rd Legislature, 3rd Extraordinary Session. Substitute House Bill No. 135. [76]
- Cortell, B. 1977. "Ground Water/Solar Heat." Water Well Journal, May, p. 73. [79]
- Cummings, R. G., G. E. Morris, J. W. Tester, and R. L. Bivins. 1979. "Mining Earth's Heat: Hot Dry Rock Geothermal Energy." Technology Review, February, pp. 58-68. [618]
- Davidson, R. R., W. B. Harris and J. H. Martin. 1975. "Storing Sunlight Underground. The Solaterre System." Chemtech, December, pp. 736-741. [86]
- Day, J. A., A. F. Clark, W. C. Dickinson, and A. Iantuono. 1975. Industrial Process Heat From Solar Energy. UCRL-76390. [87]
- Denis, L.H.D., A.J.H. Bedue, and Malherbaud. 1979. "Method of and Arrangement for the Seasonal Storage and Use of Hot Water Produced in Particular by Electrical Power-Generating Thermal and Nuclear Stations." Patent No. 4,159,736. [89]
- Dickinson, W. C., A. F. Clark, J. A. Day, and L. F. Wouters. 1976. "The Shallow Solar Pond Energy Conversion System." Solar Energy, 18(1):3-10. [270]

- Dooley, J. L., G. P. Frost, L. A. Gore, R. P. Hammond, D. L. Rawson and S. L. Ridgeway. 1977. A Feasibility Study of Underground Energy Storage Using High-Pressure, High-Temperature Water. RDA-TR-7100-001 (CONS-1243-1). [630]
- Dvorov, I. M. and N. A. Ledentsova. 1975. "Utilization of Geothermal Water for Domestic Heating and Hot Water Supply." Proceedings Second U.N. Symposium on the Development and Use of Geothermal Resources, 3:2109-2116. [101]
- Engen, I. A. 1978. Residential Space Heating Cost: Geothermal vs Conventional Systems. TREE-1182. [107]
- ERDA and Electric Power Research Institute. 1975. Proceedings of the Workshop on Compressed Air Energy Storage System. ERDA-76-124. Energy Research Development Administration, Conservation Research and Technology Division. [783]
- "Getting Steamed Up Over Waste Heat." 1979. Nature, 380:349. [275]
- Givoni, B. 1977. "Underground Longterm Storage of Solar Energy - An Overview." Solar Energy, 19:617-623. [135]
- Guyer, E. C. and M. W. Golay. 1977. "Evaluation of Combined Thermal Storage Pond/Dry Cooling Tower Waste Disposal Systems." ASME, 77-HT-57. [277]
- Hammond, A. L. 1972. "Conservation of Energy: The Potential for More Efficient Use." Science, 178:1079-1081. [ ]
- Hausz, W., B. J. Berkowitz and R. C. Hare. 1978. Conceptual Design of Thermal Energy Storage Systems for Near Term Electric Utility Applications. DOE/NASA/0012-78/1, Vol 1 and 2. (Vol 1: Screening Concepts; Vol. 2: Appendices - Screening of Concepts.) [170]
- Jet Propulsion Laboratory Staff. 1974. Conference on Research for the Development of Geothermal Energy Resources. N75-20831-864. [214]
- Johnson, W. C. \_\_\_\_\_. "Oregon Institute of Technology Aquaculture Using Geothermal Energy." [216]
- Katter, L. B. and R. L. Hoskins. 1978. Application of Thermal Energy Storage to Process Heat and Waste Heat Recovery in the Primary Aluminum Industry. CONS/5080-1. [878]
- Kemper, W. D., W. R. Walker and J. Sabey. \_\_\_\_\_. "Trans-Seasonal Storage of Energy in Moist Soils." [231]

- Krishnaswamy, V. S. and R. Shankar. 1974. "Geothermal Fields in India Explored for Power Generation." Geothermics, 3:124-125. [287]
- Lang, W. 1977. "Air Stored for Peaking Power." Electrical World, 187(1):30-31. [300]
- Lawrence Berkeley Laboratory. 1975. Geothermal and Geosciences Program Annual Report 1975. PUB-206. [303]
- Lawrence Berkeley Laboratory. 1978. "Mexican-American Cooperative Program at the Cerro Prieto Geothermal Field." Abstracts First Symposium on the Cerro Prieto Geothermal Field, Baja California, Mexico. LBL-7098. [308]
- Lienau, P. J. 1978. Agribusiness Geothermal Energy Utilization Potential of Klamath and Snake River Basins, Oregon. IDO/1621-1. [786]
- Lienau, P. J. 1978. "Potential Utilization of Geothermal Energy for Space and Process Heating in Eleven States." Oregon Institute of Technology. [616]
- Lienau, P. J. 1977. "Utilization of Geothermal Energy in Iceland." [316]
- Lienau, P. J. and J. W. Lund. 1974. "Multipurpose Use of Geothermal Energy." Proceedings of the International Conference on Geothermal Energy for Industrial, Agricultural, and Commercial-Residential Uses. Oregon Institute of Technology. [624]
- Lund, J. W. 1978. "Geothermal Energy Utilization for the Homeowner." [325]
- Lund, J. W. 1978. "Geothermal Hydrology and Geochemistry of Klamath Falls, Oregon Urban Area." Oregon Institute of Technology, Geo-Heat Utilization Center. [326]
- Lund, J. W., P. J. Lienau, G. G. Culver, and C. V. Higbee. \_\_\_\_\_. "Klamath Falls Geothermal Heating District." [327]
- Margen, P. 1978. "The Use of Nuclear Energy for District Heating." Progress in Nuclear Energy, 2:1-28. [334]
- Meyer, C. F. 1977. "Heat Storage Wells: Key to Large-Scale Cogeneration?" Public Power, July-August, pp. 28-30. [353]
- Meyer, C. F. 1978. "Large Scale Thermal Energy Storage for Cogeneration and Solar Systems." 5th Energy Technology Conference and Exposition. [355]

- Meyer, C. F. 1979. Potential Benefits of Thermal energy Storage in the Proposed Twin Cities District Heating - Cogeneration System. ORNL/SUB-7604-1. [877]
- Meyer, C. F., W. Hausz, B. L. Ayres and H. M. Ingram. 1976. Role of the Heat Storage Well in Future U.S. Energy Systems. GE76TMP-27. [357]
- Meyer, C. F., D. K. Todd and R. C. Hare. 1972. Thermal Storage for Eco-Energy Utilities. GE72TMP-56. [361]
- Milora, S. L. and J. W. Jefferson. 1976. "Geothermal Energy as a Source of Electrical Power." MIT Press. [564]
- Molz, F. J., J. C. Warman, T. E. Jones and G. E. Cook. 1976. "Experimental Study of the Subsurface Transport of Water and Heat as Related to the Storage of Solar Energy." Storage, Water Heater, Data Communication Education, 8:238-244. [371]
- Office of Technology Assessment. 1979. Materials and Energy from Municipal Waste. Stock #052-003-00642-9. U.S. Government Printing Office. [769]
- Olszewski, M. 1975. "Agricultural Greenhouse Uses of Power Plant Reject Heat." Ph.D. Thesis, University Microfilms International. [843]
- Olszewski, M. and G. J. Trezek. 1976. "Performance Evaluation of an Evaporative Pad Greenhouse System for Utilization of Power Plant Reject Heat." Journal of Environmental Quality, 5(3):261-269. [394]
- Pacific Northwest Solar Energy Association. 1979. "Solar 79 Northwest." Proceedings Supplement. [593]
- Rabbimov, R. T., G. Y. Umarov and R. A. Zakhidov. 1974. "Experimental Study of Aquifer Heating in Solar-Energy Accumulation." Geliotekhnika, 10(2):20-27. [423]
- Rabbimov, R. T., G. Y. Umarov and R. A. Zakhidov. 1971. "Storage of Solar Energy in a Sandy-Gravel Ground." Geliotekhnika, 7(5):57-64. [422]
- Ridgeway, S. L. and J. L. Dooley. 1976. "Underground Storage of Off-Peak Power." Eleventh Intersociety Energy Conversion Engineering Conference Proceedings, pp. 586-590. [429]
- Salieva, R. B. and R. P. Saliev. 1975. "Principles of Technological-Economic Calculations in Solar Technology." Geliotekhnika, 11(5):44-51. [445]
- Schaetzle, W. J., C. E. Brett and J. M. Calm. 1978. Heat Pump Centered Integrated Community Energy Systems. Argonne National Laboratory. [ ]



- Schrock, V. E. and A. D. K. Laird. 1976. "Physical Modeling of Combined Forced and Natural Convection in Wet Geothermal Formations." Journal Heat Transfer, May, pp. 213-220. [879]
- Sepaskhah, A. R., L. Boersma, L. R. Davis and D. L. Slegel. 1973. "Experimental Analysis of a Subsurface Soil Warming and Irrigation System Utilizing Waste Heat." Winter Annual Meeting of American Society of Mechanical Engineers. Paper No. 73-WA/HT-11. [880]
- Smith, G. C., J. A. Stottlemire, L. E. Wiles, W. V. Loscutoff, and H. J. Pincus. 1978. FY-1977 Progress Report. Stability and Design Criteria Studies for Compressed Air Energy Storage Reservoirs. PNL-2443. [458]
- Spencer, R. S., W. S. Butler, M. K. Enns, and B. W. Wilkinson. 1976. "The Potential for Fuel Economics Via Combined Steam Power Production." Eleventh Intersociety Energy Conversion Engineering Conference Proceedings, Volume 1. [466]
- Studsvik. 1978. Minneapolis-St. Paul District Heating Study. ORNL/SUB-77/13502/4. [476]
- Thorsteinsson, T. 1975. "Redevelopment of the Reykir Hydrothermal System in Southeastern Iceland." Proceedings Second United Nations Symposium on the Development and Use of Geothermal Resources, 3:2173-2180. [495]
- Tsang, C. F., P. Fong, C. W. Miller and M. Lippmann. \_\_\_\_\_. Daily Sensible Heat Storage in Aquifers for Solar Energy Systems. Lawrence Berkeley Laboratories. [502]
- U.S. Department of Energy, Division of Energy Storage Systems. 1979. "Thermal Energy Storage Application Areas." [550]

#### ENVIRONMENTAL CONSIDERATIONS

- American Petroleum Institute. 1978. "Subsurface Salt Water Injection and Disposal." Vocational Training Series, Book 3. [790]
- American Petroleum Institute. 1975. "Environmental Protection Laws and Regulations Related to Exploration, Drilling, Production, and Gas Processing Plant Operations." [10]
- Anonymous. \_\_\_\_\_. "Groundwater Heat Pump Effluent Disposal Regulations by State." [244]
- Axtmann, R. C. 1975. "Chemical Aspects of the Environmental Impact of Geothermal Plant." Proceedings Second United Nations Symposium on the Development and Use of Geothermal Resources. [19]

- Bailey, R. G. 1978. "Descriptions of the Ecoregions of the United States." Forest Service, U.S. Department of Agriculture. [640]
- Bernard, W. J. 1978. "Deep, Geopressed Aquifers: A New Energy Source?" Petroleum Engineer International, 50(3):84-90. [30]
- Bolton, P. 1961. "Prevention of Water Source Contamination." American Water Works Association Journal, 53(10):1243-1250. [47]
- Braunlich, F. H. 1975. "Well Completion -- Techniques and Methods." Environmental Aspects of Chemical Use in Well Drilling Operations, EPA-560/1-75-004, pp. 73-100. [54]
- Brown, R. F. and C. D. Signor. 1974. "Artificial Recharge - State of the Art." Ground Water, 12(3):152-158. [56]
- Campbell, M. D. and G. F. Gray. 1975. "Mobility of Well-Drilling Additives in the Ground-Water System." Environmental Aspects of Chemical Use in Well Drilling Operations, EPA-560/1-75-004. [59]
- Carvell, K. L. and P. A. Johnston. 1978. Environmental Effects of Right-of-Way Management on Forrested Ecosystems. EA 491, Electric Power Research Institute. [771]
- Collins, A. G. 1971. "Oil and Gas Wells - Potential Polluters of the Environment?" Water Pollution Control Federation Journal, 43:2383-2393. [70]
- Collins, A. G. 1975. "Chemical Applications in Oil- and Gas-Well Drilling and Completion Operations." Environmental Aspects of Chemical Use in Well Drilling Operations, EPA-560/1-75-004, pp. 231-260. [71]
- Collins, A. G. 1975. "Possible Contamination of Ground Waters by Oil- And Gas-Well Drilling and Completion Fluids." CONF-7505133-1. [72]
- Committee on Natural Resources. 1974. An Act Relating to Conservation of Geothermal Resources. State of Washington, 43rd Legislature, 3rd Extraordinary Session. Substitute House Bill No. 135. [76]
- Davidson, E. and M. Fox. 1974. "Effects of Off-Road Motorcycle Activity on Mojave Desert Vegetation and Soil." Madrono, 22(8):381-412. [673]
- Despois, J. and F. Nougarede. 1976. "Underground Storage of Heat." CONF-7605137-1 (trans). [93]
- Drost, W. 1973. "Application of Groundwater Measurements by Means of Radioisotopes on Groundwater Exploration." World Congress on Water Resources, CONF-7309143-11, pp. 357-369. [99]

- Eckert, A. W. \_\_\_\_\_. "EPA Jurisdiction Over Well Injection Under the Federal Water Pollution Control Act." Natural Resources Lawyer, 9(3):455-465. [103]
- Federal Register. 1978. "National Environmental Policy Act - Regulations." 43(230):55978-56007. [607]
- Gass, T. E. 1977. "Energy Development and Its Effect on Ground Water." Water Well Journal, 31(4):34-35. [125]
- Grantham, C. K. and J. P. Sloan. 1975. "Toxicity Study Drilling Fluid Chemicals on Aquatic Life." Environmental Aspects of Chemical Use in Well-Drilling Operations, EPA-560/1-75-004, pp. 103-112. [142]
- Gregg, D. O. and K. G. Kennedy. 1975. "Movement of Chemical Contaminants in Ground Water." Environmental Aspects of Chemical Use in Well Drilling Operations, EPA-560/1-75-004, pp. 289-309. [145]
- A Guide to the Underground Injection Control Program. 1979. USEPA, Office of Drinking Water (WH550). [152]
- Hausz, W. 1976. "Annual Storage: A Catalyst For Conservation." General Electric TEMPO. [164]
- Helweg, O. J. 1978. "Regional Ground-Water Management." Ground Water, 16(5):318-321. [180]
- Henry, H. R., J. R. McDonald, and R. M. Alverson. 1971. Aquifer Performance Tests Under Two-Phase Flow Conditions. PB 209 535. [181]
- Hill, C. T. \_\_\_\_\_. "Thermal Pollution and Its Control." Environmental Affairs, 406-420. [184]
- Hoepfner, S. 1974. "Combating Air and Gas Problems." Water Well Journal, 28(5):29-30. [185]
- Holt, L., R. Jones and G. Hagey. 1978. Environmental Development Plan (EDP) Energy Storage Systems, FY1977. DOE/EDP-0015. [622]
- Kazmann, R. G. 1971. "Exotic Uses of Aquifers." Journal of the Irrigation Division ASCE, 97(IR3):515-522. [224]
- Kazmann, R. 1974. "Waste Surveillance in Subsurface Disposal Projects." Ground Water, 12:412-426. [225]
- Kazmann, R. G. 1975. "Groundwater and Environmental Geology." Environmental Geology, 1:137-142. [226]

- Kazmann, R. G., O. K. Kimbler and W. R. Whitehead. 1974. "Management of Waste Fluids in Salaquifers." Journal of the Irrigation and Drainage Division ASCE, 100(IR4):413-424. [228]
- Lehr, J. H. 1978. "Environmental Aspects of Low Temperature Thermal Energy Storage in Aquifers." Proceedings of the Thermal Energy Storage in Aquifers Workshop. LBL-8431. [ ]
- Lehr, J. H. 1975. "Objectives of Well-Drilling Regulations." Environmental Aspects of Chemical use in Well-Drilling Operations, EPA-560/1-75-004, pp. 555-570. [311]
- Lindorff, D. E. 1979. "Ground Water Pollution - A Status Report." Ground Water, 17(4):9-17. [319]
- Louden, L. R. and R. E. Mc Glothlin. 1975. "Waste Water Base Drilling Fluid Disposal." Environmental Aspects of Chemical Use in Well-Drilling Operations, EPA-560/1-75-004. [323]
- McCune, C. C. 1977. "On-Site Testing to Define Injection-Water Quality Requirements." Journal of Petroleum Technology, January, pp. 17-24. [340]
- McNabb, J. F. and W. J. Dunlap. 1975. "Subsurface Biological Activity in Relation to Groundwater Pollution." Ground Water, 13(1):33-44. [344]
- Meyer, C. F., W. Hausz, B. L. Ayres and H. M. Ingram. 1976. Role of the Heat Storage Well in Future U.S. Energy Systems. GE76TMP-27. [357]
- Meyer, C. F. and D. K. Todd. 1973. "Conserving Energy with Heat Storage Wells." Environmental Science and Technology, 7(6):512-516. [358]
- Moulder, E. A. 1970. "Freshwater Bubbles: A Possibility for Using Saline Aquifers to Store Water." Water Resources Research, 6(5):1528-1531. [374]
- Oil and Gas Conservation Act. 1951. State of Washington, Dept. Nat. Res. Chapter 146. (H.B. 143). [397]
- Oil and Gas Conservation Committee. 1954. General Rules and Regulations Governing the Conservation of Oil and Gas. State of Washington, Dept. Nat. Res. [392]
- Oil and Gas Conservation Committee. \_\_\_\_\_. Instructions for Oil and Gas Drillers. State of Washington. [391]
- Peters, R. R. 1975. "Techniques of Shallow-Well Drilling." Environmental Aspects of Chemical Use in Well-Drilling Operations, EPA-560/1-75-004, pp. 27-38. [403]

- Price, D., D. H. Hart, and B. L. Foxworthy. 1965. Artificial Recharge in Oregon and Washington - 1962. USGS, Water Supply Paper 1594-C. [441]
- Robichaux, J. 1975. "Bactericides Used in Drilling and Completion Operation." Environmental Aspects of Chemical use in Well-Drilling Operations, EPA-560/1-75-004. [432]
- Romero, J. C. 1970. "The Movement of Bacteria and Viruses Through Porous Media." Groundwater, 8(2):37-48. [434]
- Schrock, V. E. and A. D. K. Laird. 1976. "Physical Modeling of Combined Forced and Natural Convection in Wet Geothermal Formations." Journal Heat Transfer, May, pp. 213-220. [879]
- Shew, D. C. and J. W. Keeley. 1975. "Ground-Water Problems Associated with Well-Drilling Additives." Environmental Aspects of Chemical Use in Well-Drilling Operations, EPA-560/1-75-004. [454]
- Simpson, J. P. 1975. "Drilling Fluid Principles and Operations." Environmental Aspects of Chemical Use in Well-Drilling Operations, EPA-560/1-75-004, pp. 61-71. [455]
- Smith, J. E. 1975. "Regulation of Onshore and Offshore Oilfield Waste Disposal." Environmental Aspects of Chemical Use in Well-Drilling Operations, EPA-560/1-75-004. [460]
- Specken, G. A. 1975. "Treatment and Disposal of Waste Fluids From Onshore Drilling Sites." Environmental Aspects of Chemical Use in Well-Drilling Operations, EPA-560/1-75-004. [465]
- Spencer, R. S., W. S. Butler, M. K. Enns, and B. W. Wilkinson. 1976. "The Potential for Fuel Economics Via Combined Steam Power Production." Eleventh Intersociety Energy Conversion Engineering Conference Proceedings, Volume 1. [466]
- Stottlemire, J. A., R. A. Craig, W. V. Loscutoff, D. W. Boehm, and G. C. Chang. 1978. "Environmental Concerns Related to Compressed Air Energy Storage." Compressed Air Energy Storage Symposium Proceedings, PNL-SA-7112. [553]
- Talmage, S. S. and C. C. Coutant. 1978. "Thermal Effects." J. Water Pollution Control Federation, 50:1514-1529. [577]
- Technical Information Center, DOE. \_\_\_\_\_. "Highland Uranium Solution Mining Project." USNRC, Washington, DC. (Micro-Fiche) [575]
- U.S. Environmental Affairs Department. 1977. "Environmental Research Annual Status Report, February 1977." API. [109]

- U.S. Environmental Protection Agency. \_\_\_\_\_. "Manual of Water Well Construction Practices." EPA-570/9-75-001. [774]
- U.S. Environmental Protection Agency. 1979. Draft Consolidated Permit Application Forms and Proposed National Pollutant Discharge Elimination System Regulations. Federal Register; Thursday, June 14. [110]
- U.S. Environmental Protection Agency. 1979. Proposed Consolidated Permit Regulations. Federal Register; Thursday, June 14. [111]
- U.S. Environmental Protection Agency. 1979. Water Programs, State Underground Injection Control Programs, Minimum Requirements and Grant Regulations. Federal Register; Friday, April 20. [112]
- U.S. Environmental Protection Agency and the National Water Well Association. 1971. Proceedings of the National Ground Water Quality Symposium. [113]
- U.S. Nuclear Regulatory Commission, Office of Nuclear Reactor Regulations. 1979. "Environmental Standard Review Plans for the Environmental Review of Construction Permit Applications for Nuclear Power Plants." NUREG-0555. [778]
- U.S. Nuclear Regulatory Commission, Office of Nuclear Reactor Regulations. 1975. "Final Environmental Statement." NUREG-75/019. [775]
- Vasek, F. C., H. B. Johnson, and D. H. Eslinger. 1975. "Effects of Pipeline Construction on Cresote Bush Scrub Vegetation of the Mojave Desert." Madrono, 23(1):1-64. [755]
- Vollmar, A. T., B. G. Maza, P. A. Medica, F. B. Turner, and S. A. Bamberg. 1976. "The Impact of Off-Road Vehicles on a Desert Ecosystem." \_\_\_\_\_, 1(2):115-129. [756]
- Walker, W. R. and W. E. Cox. 1976. "Deep Well Injection of Industrial Wastes." Virginia Water Resources Research Center. [773]
- Warner, D. L. and J. H. Lehr. 1977. An Introduction to the Technology of Subsurface Wastewater Injection. EPA-600/2-77-240. (PB-279 207). [514]
- Webb, R. H., H. C. Ragland, W. H. Godwin, and D. Jenkins. 1978. "Environmental Effects of Soil Property Changes with Off-Road Vehicle Use." Environmental Management, 2(3):219-233. [759]

## FLUID FLOW AND ENERGY TRANSPORT IN RESERVOIRS

- Andrews, C. B. and M. P. Anderson. 1979. "Thermal Alteration of Groundwater Caused by Seepage from a Cooling Lake." Groundwater. [15]
- Bakhmeteff, B. A., and N. V. Feodoroff. 1937. "Flow Through Granular Media." Journal of Applied Mechanics, 4:A96-A103. [22]
- Benson, S. M., C. B. Goranson, J. P. Haney, and R. C. Schroeder. 1979. The Status of the Resource Evaluation at Susanville, California. LBL-9469. [29]
- Birtles, A. B. and M. J. Reeves. 1977. "Computer Modeling of Regional Groundwater Systems in the Confined-Unconfined Flow Regime." Journal of Hydrology, 34(1/2):97-127. [256]
- Blake, T. R. and S. K. Garg. 1976. "On the Species Transport Equation for Flow in Porous Media." Water Resource Research, 12(4):748-750. [32]
- Bodvarsson, G. 1969. "On the Temperature of Water Flowing through Fractures." Journal of Geophysical Research, 74(8):1987-1992. [38]
- Bodvarsson, G. 1973. "Temperature Inversions in Geothermal Systems." Ge exploration, 11:141-149. [649]
- Bodvarsson, G. 1977. "Unconfined Aquifer Flow with Linearized Free Surface Condition." Jokull, 27:84-87. [36]
- Bodvarsson, G. and A. Bjornsson. 1976. "Hydroelastic Cavity Resonators." Jokull, 26:20-24. [44]
- Brashears, M. L. 1941. "Ground Water Temperature on Long Island, New York, as Affected by Recharge of Warm Water." Economic Geology, 36:811-828. [53]
- Chappelear, J. E. and C. W. Volek. 1969. "The Injection of a Hot Liquid into a Porous Media." Society of Petroleum Engineers, 9(1):100-114. [64]
- Churchill, D. J. 1977. "Flow Measurement and Characterization in Shallow Geothermal Systems Used for Downhole Heat Exchanger Applications." Thesis, Oregon State University. [603]
- Combarous, M. A. and S. A. Bories. 1975. "Hydrothermal Convection in Saturated Porous Media." Advances in Hydroscience, 10:231-307. [628]
- Cooley, R. L. and A. B. Cunningham. 1977. "Consideration of Total Energy Loss in Theory of Flow to Wells." NTIS, PB-264 717. [597]

- Crichlow, H. B. 1972. "Heat Transfer in Hot Fluid Injection in Porous Media." [82]
- Denson, K. H., A. Shinkdala, and C. D. Fenn. 1968. "Permeability of Sand with Dispersed Clay Particles." Water Resources Research, 4(6):1275-1276. [271]
- Donaldson, E. C. and B. A. Baker. 1977. "Particle Transport in Sandstones." Society of Petroleum Engineers, Reprint No. 6905. [97]
- Donaldson, I. G. 1962. "Temperature Gradients in the Upper Layers of the Earth's Crust Due to Convective Water Flows." Journal of Geophysical Research, 67(9):3449-3459. [98]
- Edwards, A. L. 1972. TRUMP: A Computer Program for Transient and Steady-State Temperature Distributions in Multidimension Systems. UCRL-14754, Rev. 3. [104]
- Faust, C. R. and J. W. Mercer. 1977. "Finite-Difference Model of Two-Dimensional, Single, and Two-Phase Heat Transport in a Porous Medium - Version 1." Open File Report 77-234. [115]
- Gass, T. E. 1976. "Ground Water Flow in Unconsolidated Formations." Water Well Journal, 30(10):22-23. [123]
- Goyal, K. P. and D. R. Kassoy. 1979. Heat and Mass Transfer in a Saturated Porous Wedge with Impermeable Boundaries. LBL-9328. [141]
- Goyal, K. P. and D. R. Kassoy. 1978. Heat and Mass Transfer Studies of the East Mesa Anomaly. Presented at Fourth Workshop Geothermal Reservoir Eng. LBL-9330. [690]
- Gray, W. G. and K. O'Neill. 1976. "On the General Equations for Flow in Porous Media and Their Reduction to Darcy's Law." Water Resources Research, 12(2):148-154. [144]
- Green, D. W. 1963. "Heat Transfer with a Flowing Fluid Through Porous Media." [146]
- Guha, T. K., K. E. Davis, R. E. Collins, J. R. Fanchi and A. C. Meyers. 1977. "Manmade Geothermal Energy." Alternative Energy Sources and International Compendium, Vol. 6, Geothermal Energy and Hydropower. T. N. Verziroglu (ed.), pp. 2641-2654. [151]
- Hadley, W. A. and R. Eisenstadt. 1955. "Thermally Actuated Moisture Migration in Granular Media." Transactions, American Geophysical Union, 36(4):615-623. [154]



- Hanson, J. 1978. "Heat Transfer Effects in Forced Geohat Recovery Systems." Ph.D. Thesis, Oregon State University. [610]
- Hantush, J. S. 1967. "Growth and Decay of Groundwater-Mounds in Response to Uniform Percolation." Water Resources Research, 3(1):227-234. [159]
- Hantush, M. S. and C. E. Jacob. 1954. "Plane Potential Flow of Ground Water with Linear Leakage." Transactions, American Geophysical Union, 35(6):917-936. [160]
- Hantush, M. S. and C. E. Jacob. 1955. "Non-Steady Radial Flow in an Infinite Leaky Aquifer." Transactions, American Geophysical Union, 36(1):95-100. [161]
- Hantush, M. S. and C. E. Jacob. 1960. "Flow to an Eccentric Well in a Leaky Circular Aquifer." Journal of Geophysical Research, 65(10):3425-3431. [162]
- Henry, H. R., J. R. McDonald, and R. M. Alverson. 1971. Aquifer Performance Tests Under Two-Phase Flow Conditions. PB 209 535. [181]
- Horton, C. W. and F. T. Rogers. 1945. "Convection Currents in a Porous Medium." Journal of Applied Physics, 16:367-370. [190]
- "How to Calculate Heat Transmission in Hot Fluid Injection." 1964. Petroleum Engineer, November, pp. 110-120. [194]
- Jacob, C. E. 1940. "On the Flow of Water in an Elastic Artesian Aquifer." Transactions, American Geophysical Union, 21:574-586. [201]
- Jacob, C. E. 1943. "Correlation of Ground-Water Levels and Precipitation on Long Island, NY: Part 1 - Theory." Transactions, American Geophysical Union, 24:564-573. [203]
- Jacob, C. E. 1946. "Radial Flow in a Leaky Artesian Aquifer." Transactions, American Geophysical Union, 27(2):198-205. [205]
- Kassoy, D. R. 1975. "Heat and Mass Transfer in Models of Undeveloped Geothermal Fields." Proceedings Second U.N. Symposium on the Development and Use of Geothermal Resources, 3:1707-1711. [219]
- Kassoy, D. R. and A. Zebib. 1975. "Variable Viscosity Effects on the Onset of Convection in Porous Media." The Physics of Fluids, 18(12):1649-1651. [220]
- Kimble, O. K. 1970. "Fluid Model Studies of the Storage of Fresh Water in Saline Aquifers." Water Resources Research, 6(5):1522-1527. [236]

- Kley, W. and H. G. Nieskens. 1975. "Möglichkeiten der Warmespeicherung in Einem Porengrundwasserleiter und Technische Probleme bei einer Rückgewinnung der Energie." Z. dt. Geol. Ges., 126:397-409. [239]
- Kumar, A. and O. K. Kimbler. 1970. "Effect of Dispersion, Gravitational Segregation, and Formation Stratification on the Recovery of Freshwater Stored in Saline Aquifers." Water Resources Research, 6(6):1689-1700. [295]
- Kusuda, T. and P. R. Achenbach. 1964. "Earth Temperature and Thermal Diffusivity at Selected Stations in the United States." ASHRAE Transactions, 1914:61-75. [296]
- LaGarde, A. 1965. "Considerations Sur Le Transfert De Chaleur En Milieu Poreux." Revue De L'Institut Francais Du Petrole, XX(2):383-445. [297]
- Lapwood, E. R. 1948. "Convection of a Fluid in a Porous Medium." Proc. Cambridge Phil. Soc., 44:508-521. [301]
- Lauwerier, H. A. 1955. "The Transport of Heat in an Oil Layer Caused by the Injection of Hot Fluid." Applied Sci. Research, Section A, 5:145-150. [302]
- Lippman, M. J., C. F. Tsang, and P. A. Witherspoon. 1977. "Analysis of the Response of Geothermal Reservoirs Under Injection and Production Procedures." SPE-6537. [322]
- Lundstrom, L. and H. Stille. 1978. Large Scale Permeability Test of the Granite in the Stripa Mine and Thermal Conductivity Test. LBL-7052, SAC-02. [328]
- Malofeev, G. E. 1960. "Calculation of the Temperature Distribution in a Formation When Pumping Hot Fluid into a Well." Neft'1 Gaz, 3(7):59-64. [782]
- Mathey, B. 1977. "Development and Resorption of a Thermal Disturbance in a Phreatic Aquifer with Natural Convection." Journal of Hydrology, 34:315-333. [338]
- Mathey, B. and A. Menjöz. 1977. "Transferts De Chaleur En Mileu Heterogene Sature: Comparasion Des Resultats Analytiques Et Numeriques Avec Les Resultats Experimentaux In Situ." Symposium on Hydrodynamic Diffusion and Dispersion in Porous Media, p. 79-87. [339]
- Mercer, J. W., G. F. Pinder and I. G. Donaldson. 1975. "A Galerkin - Finite Element Analysis of the Hydrothermal System at Wairakei, NEW ZEALAND." Journal of Geophysical Research, 80(17):2608-2621. [348]

- Molz, F. J. and L. C. Bell. 1977. "Head Gradient Control in Aquifers Used for Fluid Storage." Water Resources Research, 13(4):795-798. [368]
- Molz, F. J., J. C. Warman, T. E. Jones and G. E. Cook. 1976. "Experimental Study of the Subsurface Transport of Water and Heat as Related to the Storage of Solar Energy." Storage, Water Heater, Data Communication Education, 8:238-244. [371]
- Narasimhan, T. N. 1978. The Significance of the Storage Parameter in Saturated-Unsaturated Groundwater Flow. LBL-7041. [380]
- Narasimhan, T. N. and P. A. Witherspoon. 1976. "An Integrated Finite Difference Method for Analyzing Fluid Flow in Porous Media." Water Resources Research, 12(1):57-64. [384]
- Narasimhan, T. N. and P. A. Witherspoon. 1978. "Numerical Model for Saturated-Unsaturated Flow in Deformable Porous Media: 2. The Algorithm." Water Resources Research, 14(2):255-261. [385]
- Narasimhan, T. N. and P. A. Witherspoon. 1978. "Numerical Model for Saturated-Unsaturated Flow in Deformable Porous Media: 3. Applications." Water Resources Research, 14(6):1017-1033. LBL-7037. [386]
- Neuman, S. P. and T. N. Narasimhan. 1975. Mixed Explicit-Implicit Iterative Finite Element Scheme for Diffusion-Type Problems: I. Theory. LBL-4405. [387]
- Rabbimov, R. T., R. A. Zhakhidov and G. Y. Umarov. 1974. "Temperature Distribution in Accumulation of Solar Energy in an Aquifer." Geliotekhnika, 10(2):15-19. [424]
- Roache, P. J. and T. S. Mueller. 1970. "Numerical Solutions of Laminar Separated Flows." AIAA J., 8(3):530-538. [430]
- Romero, J. C. 1970. "The Movement of Bacteria and Viruses Through Porous Media." Groundwater, 8(2):37-48. [434]
- Rubin, H. 1977. "Thermal Convection in a Cavernous Aquifer." Water Resources Research, 13(1):34-40. [436]
- Saffman, P. G. 1959. "A Theory of Dispersion in a Porous Medium." Journal of Fluid Mechanics, 6:321-349. [444]
- Sorey, M. L. 1978. Numerical Modeling of Liquid Geothermal Systems. USGS, Professional Paper 1044-D. [464]

- Spillette, A. G. 1965. "Heat Transfer During Hot Fluid Injection into an Oil Reservoir." Society of Petroleum Engineers of AIME, Thermal Recovery Techniques, SPE Reprint Series 10:21-16. [467]
- Straus, J. M. and G. Schubert. 1977. "Thermal Convection of Water in a Porous Medium: Effects of Temperature and Pressure-Dependent Thermodynamic and Transport Properties." Journal of Geophysical Research, 82(2):325-333. [474]
- Swartzenbruber, D. 1962. "Non-Darcy Flow Behavior in Liquid-Saturated Porous Media." Journal of Geophysical Research, 67(13):5205-5213. [485]
- VanDerHeld, E. F. M. and F. G. VanDrunen. 1949. "A Method of Measuring the Thermal Conductivity of Liquids." Physica, 15(10):865-881. [507]
- Ward, J. C. 1964. "Turbulent Flow in Porous Media." Journal of the Hydraulics Division, ASCE, 90(HY5):1-12. [511]
- Wooding, R. A. 1957. "Steady-State Free Thermal Convection of Liquid in a Saturated Permeable Medium." Journal of Fluid Mechanics, 2:273-285. [534]
- Wooding, R. A. 1958. "An Experiment on Free Thermal Convection of Water in Saturated Permeable Material." Journal of Fluid Mechanics, 3:582-600. [621]
- Wooding, R. A. 1960. "Rayleigh Instability of a Thermal Boundary Layer in Flow Through a Porous Medium." Journal of Fluid Mechanics, 9:183-192. [535]
- Wooding, R. A. 1962. "Free Convection of Fluid in a Vertical Tube Filled with Porous Material." Journal of Fluid Mechanics, 13:129-144. [536]
- Wooding, R. A. 1964. "Mixing-Layer Flows in a Saturated Porous Medium." Journal of Fluid Mechanics, 19:103-113. [537]
- Wooding, R. A. and H. J. Morel-Seytoux. 1976. "Multiphase Fluid Flow Through Porous Media." Annual Review of Fluid Mechanics, 8:233-274. [538]
- Wyllie, M. R. J. and M. B. Spangler. 1952. "Application of Electrical Resistivity Measurements to Problem of Fluid Flow in Porous Media." Bulletin of American Association of Petroleum Geologists, 36(2):359-403. [539]

## HEAT TRANSFER EQUIPMENT

- Ambrose, E. R. 1974. "The Heat Pump: Performance Factor, Possible Improvements." Heating, Piping and Air Conditioning, 46(5):77-82. [8]
- Ambrose, E. R. 1967. "Heat Pumps - Utilities Viewpoint." J. ASHRAE, 9(9):36-37. [9]
- Beers, T. S. 1967. "Heat Pumps - Consultants Viewpoint." J. ASHRAE, 9(9):42-44. [28]
- Briggs, J. B. and C. J. Shaffer. 1977. "Seasonal Heat Pump Performance for a Typical Northern United States Environmental." TREE-1181. [55]
- Calm, J. M. 1978. "Recovery of Wasted Heat with Centralized and Distributed Heat Pump Systems." Argonne National Laboratory, ASME Winter Annual Meeting. [262]
- Clark, W. W. 1958. "Know the Enemies, a Factual Study of the Electric Heat Pump." Gas, 34:57-62. [67]
- Cole, M. H. 1970. "Heat Pumps Today - Part 1." ASHRAE Symposium on Heat Pumps - Improved Design and Performance, pp. 41-48. [68]
- Culver, G. and G. M. Reistad. \_\_\_\_\_. "Evaluation and Design of Downhole Heat Exchangers for Direct Application." [84]
- Culver, G. and G. M. Reistad. \_\_\_\_\_. "Testing and Modeling of Downhole Heat Exchangers in Swallow Geothermal Systems." [85]
- Ellenberger, F. R., A. B. Hubbard, W. R. Foote, F. Burggraf, J. J. Martin and N. J. Bloomfield. 1950. "Evaluating Heat Pump Performance." ASHRAE Transactions, 56(1382):87-106. [106]
- Engen, I. A. 1978. Residential Space Heating Cost: Geothermal vs Conventional Systems. TREE-1182. [107]
- Gannon, R. 1978. "Ground-Water Heat Pumps - Home Heating and Cooling from Your Own Well." Popular Science. February, pp. 78-82. [122]
- Gass, T. E. and J. H. Lehr. 1977. "Ground Water Energy and the Ground Water Heat Pumps." Water Well Journal, 31(4):42-47. [128]
- Gass, T. E. and J. H. Lehr. 1977. "Ground Water Energy and the Ground Water Source Heat Pump." Water Well Journal, 15(3):244-249. [129]
- Harnish, J. R. 1967. "Heat Pumps - Manufacturer's Viewpoint." J. ASHRAE, 9(9):40-41. [163]

- "Heat Pumps." 1974. Heating and Ventilating News, 17(12):10-12. [701]
- "The Heat Pump. Heat Sources and Sinks." 1950. Heating, Piping, and Air Conditioning, 22(11):87-91. [173]
- "Heat Pump Power for U.S. Flats." 1974. Building Research and Practice, January/February, p. 51. [174]
- "Heat Pump Reliability Shows Big Gains." 1973. Electric World, August, pp. 78-80. [175]
- "Heat Pumps: Selection and Application." 1965. Air Conditioning, Heating and Ventilating, 62(10):55-86. [176]
- "Heat Pump Takes on All Comers." 1964. Domestic Heating News, 13(5):24-26. [679]
- Heiss, H. W. 1977. "Research Foundation Utilizes Ground Water Heat Pumps." Water Well Journal, 31(4):58-59. [178]
- Holman, J. P. 1976. "Heat Transfer." 4th Edition, McGraw Hill, Inc. [827]
- Holton, W. C. 1951. "Effect of Molecular Weight of Entrained Fluid on the Performance of Steam-Jet Ejectors." Transactions of the ASME, 905-910. [188]
- Japhet, R. E. 1967. "Heat Pumps - Manufacturer's Viewpoint." J. ASHRAE, 9(9):41-42. [212]
- Kihara, D. H. and P. S. Fukunaga. 1975. "Working Fluid Selection and Preliminary Heat Exchanger Design for a Rankine Cycle Geothermal Power Plant." Proceedings Second U.N. Symposium on the Development and Use of Geothermal Resources, pp. 2013-2019. [235]
- Kirschbaum, H. S. 1977. An Investigation of Methods to Improve Heat Pump Performance and Reliability in a Northern Climate. EPRI EM-319. [623]
- Komedera, M. 1956. "The Domestic Heat Pump. Standard Equipment of the Future." Engineering, 182(4720):236-40. [286]
- Komedera, M. 1957. "Heat Pumps for Water Heating." Heating and Ventilating Engineering; and J. Air Conditioning, 30(359):554-564. [599]
- Komedera, M. 1957. "Heat from Ground Utilized by Heat Pump, Part 1." Heating and Ventilating Engineering, and J. Air Conditioning, 31(362):65-72. [615]

- Komedera, M. 1957. "Heat From Ground Utilized by Heat Pump, Part 2." Heating and Ventilating Engineering, and J. Air Conditioning, 31(363):122-128. [600]
- Kreitlow, D. B. 1978. "Geothermal Well Downhole Heat Exchanger Design Analysis." Thesis, Oregon State University. [596]
- Lienau, P. J. and J. W. Lund. \_\_\_\_\_. "Utilization and Economics of Geothermal, Space Heating in Klamath Falls, Oregon." Oregon Institute of Technology. [317]
- Lund, J. W., P. J. Lienau, G. G. Culver, and C. V. Higbee. \_\_\_\_\_. "Klamath Falls Geothermal Heating District." [327]
- McLean, G. O. 1955. "The Dual Purpose Domestic Heat Pump." Journal of the Institute of Fuel, 28:224-228. [343]
- Megley, J. W. 1968. "Heat Pumps Provide Economical Services for Apartment Tenants." Heating, Piping and Air Conditioning, 40(1):124-131. [345]
- Milburn, H. L. 1964. "Computerizing Heat Pump Operating Costs." J. ASHRAE, 6(8):67-71. [365]
- Newman, M. E. 1977. "Heat Pump and Water on the Rocks." Building Systems Design, October/November, pp. 36-41. [388]
- "NWWA Ground Water Heat Pump Research Imperatives." 1977. Water Well Journal, pp. 60-61. [389]
- Oliker, I. 1977. "Heat Exchanger and Thermal Storage Problems in Power Stations Serving District Heating Networks." ASME Paper 77-HT-36. [393]
- Penrod, E. B. 1954. "Sizing Earth Heat Pumps." Refrigeration Engineering, 62(4):57-61, 108, 112. [401]
- Pope, W. L., H. S. Pines, R. L. Fulton, and P. A. Doyle. 1978. Heat Exchanger Design - Why Guess a Design Fouling Factor When It Can Be Optimized. LBL-7067. [419]
- Ross, P. N. 1975. "Process Heat - The Temperature Amplifier - A Kind of Industrial Heat Pump." Electric Apparatus, 28(3):29-31. [586]
- Rozenfeld, L. M. and G. S. Serdakov. 1968. "Increasing the Efficiency of a Heat Supply System Based on Geothermal Water by Using Heat Pumps." Thermal Engineering, 15(8):75-81. [435]

Schaetzle, W. J., C. E. Brett and J. M. Calm. 1978. Heat Pump Centered Integrated Community Energy Systems. Argonne National Laboratory. [ ]

Segerstrom, S. 1971. "Heat Pumps Today." J. ASHRAE, 13(7):63-65. [452]

Smith, G. S. 1951. "Climatology as an Aid in Heat Pump Design." Heating, Piping and Air Conditioning, 23(6):101-107. [459]

Spofford, W. A. 1959. "Heat Pump Performance for Package Air Sources Units." J. ASHRAE, 1(4):59-63. [468]

Sumner, J. 1955. "Central Heating by Heat Pump. Report of Three Years Operation in a Bungalow." Engineering, 179:439-441. [483]

Sumner, J. A. 1955. "Domestic Heating by the Heat Pump." Journal of the Institution of Heating and Ventilating Engineers, 23:129-151. [484]

Tull, R. H. 1966. "New Developments in Heat-Pump Systems." J. ASHRAE, 8(9):64-67. [505]

"Water Well Journal Funds Heat Pump Research." 1977. Water Well Journal, 31(8):45. [515]

Weber, E. L. 1963. "Heat Pump Employs Panel Heating as Refrigerant Condenser." Heating, Piping and Air Conditioning, 35(10):95-97. [516]

Wehlage, E. F. 1976. "Needed: Effective Heat Transfer Equipment." Mechanical Engineering, 98:27-33. [517]

#### HYDRAULIC GRADIENT CONTROL

Banks, H. O. 1952. "Utilization of Underground Storage Reservoirs." Transactions, American Society of Civil Engineers, 118:220-234. [25]

Campbell, M. D. and G. F. Gray. 1975. "Mobility of Well-Drilling Additives in the Ground-Water System." Environmental Aspects of Chemical Use in Well Drilling Operations, EPA-560/1-75-004, pp. 261-288. [59]

Cooper, H. H. and C. E. Jacob. 1946. "A Generalized Graphical Method for Evaluating Formation Constants and Summarizing Well-Field History." Transactions, American Geophysical Union, 27(IV):526-534. [77]

Helweg, O. J. 1978. "Regional Ground-Water Management." Ground Water, 16(5):318-321. [180]

Kimber, O. K. 1970. "Fluid Model Studies of the Storage of Fresh Water in Saline Aquifers." Water Resources Research, 6(5):1522-1527. [236]



- Lakshminarayana, V. and S. P. Rajagopalan. 1978. "Type-Curve Analysis of Time-Drawdown Data for Partially Penetrating Wells in Unconfined Anisotropic Aquifers." Ground Water, 16(5):328-333. [298]
- "Maintaining the Yield of Water Wells." 1965. The Johnson Drillers Journal, January-February, pp. 1-4. [332]
- Molz, F. J. and L. C. Bell. 1977. "Head Gradient Control in Aquifers Used for Fluid Storage." Water Resources Research, 13(4):795-798. [368]
- Schreiber, D. L., A. E. Reisenauer, K. L. Kipp, and R. T. Jaske. 1973. Anticipated Effects of an Unlined Brackish-Water Canal on a Confined Multiple-Aquifer System. BNWL-1800. [450]
- Theis, C. V. 1935. "The Relation Between the Lowering of the Piezometric Surface and the Rate and Duration of Discharge of a Well Using Groundwater Storage." Transactions, American Geophysical Union, 2:519-524. [490]
- Theis, C. V. 1938. "The Significance and Nature of the Cone of Depression in Ground-Water Bodies." Economic Geology, 33:889-902. [491]

#### INSTITUTIONAL AND SOCIETAL CONSIDERATIONS

- American Petroleum Institute. 1975. "Environmental Protection Laws and Regulations Related to Exploration, Drilling, Production, and Gas Processing Plant Operations." API Bulletin 18. [10]
- Anonymous. \_\_\_\_\_. "Groundwater Heat Pump Effluent Disposal Regulations by State." [244]
- Bloomster, C. H., L. L. Fassbender, and C. L. McDonald. 1977. Geothermal Energy Potential for District and Process Heating Application in the U.S. - An Economic Analysis. BNWL-2311. [35]
- Carver, J. A. \_\_\_\_\_. "Institutional Aspects of Utilizing Heat Storage in Aquifers - A Proposal for a Prototype Test." University of Denver. [61]
- Carver, J. A. 1975. "Legal and Institutional Planning for Macro-Conservation Measures." Public Utilities Fortnightly, 95(9):29-33. [62]
- Carver, J. A., Jr. 1978. Institutional Aspects of Utilizing Heat Storage in Aquifers - A Proposal for a Prototype Test. LBL-8431. Proceedings of the Thermal Energy Storage in Aquifer Workshop. Lawrence Berkeley Laboratories, Berkeley, CA. [ ]

- Committee on Natural Resources. 1974. An Act Relating to Conservation of Geothermal Resources. State of Washington, 43rd Legislature, 3rd Extraordinary Session. Substitute House Bill No. 135. [76]
- Eckert, A. W. \_\_\_\_\_. "EPA Jurisdiction Over Well Injection Under the Federal Water Pollution Control Act." Natural Resources Lawyer, 9(3):455-465. [103]
- Federal Register. 1978. "National Environmental Policy Act - Regulations." 43(230):55978-56007. [607]
- Geothermal Drilling Rules and Regulations. Chapter 332-17 WAC. [132]
- Gleason, V. E. 1978. "The Legalization of Ground-Water Storage." Water Resources Bulletin, 14(3):532-541. [136]
- A Guide to the Underground Injection Control Program. 1979. USEPA, Office of Drinking Water (WH550). [152]
- Holt, L., R. Jones and G. Hagey. 1978. Environmental Development Plan (EDP) Energy Storage Systems, FY1977. DOE/EDP-0015. [622]
- Margen, P. 1978. "The Use of Nuclear Energy for District Heating." Progress in Nuclear Energy, 2:1-28. [334]
- McFarland, C. R. 1979. Oil and Gas Exploration in Washington, 1900-1978. Department of Natural Resources, Division of Geology and Earth Resources. Info. Circ. 67. [342]
- Meyer C. F. 1976. "Status Report on Heat Storage Wells." Water Resources Bulletin, 12(2):237-252. [352]
- Meyer, C. F., W. Hausz, B. L. Ayres and H. M. Ingram. 1976. Role of the Heat Storage Well in Future U.S. Energy Systems. GE76TMP-27. [357]
- Oil and Gas Conservation Act. 1951. State of Washington, Dept. Nat. Res. Chapter 146. (H.B. 143). [397]
- Oil and Gas Conservation Committee. 1954. General Rules and Regulations Governing the Conservation of Oil and Gas. State of Washington, Dept. Nat. Res. [392]
- Oil and Gas Conservation Committee. \_\_\_\_\_. Instructions for Oil and Gas Drillers. State of Washington. [391]
- Smith, J. E. 1975. "Regulation of Onshore and Offshore Oilfield Waste Disposal." Environmental Aspects of Chemical Use in Well-Drilling Operations, EPA-560/1-75-004. [460]

- Thomas, H. E. 1955. Water Rights in Areas of Ground-Water Mining. USGS, Circular 347. [492]
- Thomas, H. E. 1961. Ground Water and The Law. USGS, Circular 446. [493]
- Walker, W. R. and W. E. Cox. 1974. "Subsurface Environment - Private Property or Public Domain?" Journal of the Hydraulics Division, ASCE, 100(HY 11):1699-1705. [614]
- U.S. Environmental Protection Agency. 1979. Draft Consolidated Permit Application Forms and Proposed National Pollutant Discharge Elimination System Regulations. Federal Register; Thursday, June 14. [110]
- U.S. Environmental Protection Agency. 1979. Proposed Consolidated Permit Regulations. Federal Register; Thursday, June 14. [111]
- U.S. Environmental Protection Agency. 1979. Water Programs, State Underground Injection Control Programs, Minimum Requirements and Grant Regulations. Federal Register; Friday, April 20. [112]

#### NONAQUIFER STORAGE METHODS

- Alavian, V. 1973. "Design and Construction of a Research Station for the Study of Induced Vertical Mixing in a Thermally Stratified Pond Using Warm Water Discharge." M.S. thesis, Wisconsin University. (PB-237 701). [4]
- Aziz, K., S. A. Bories, and M. A. Combarous. 1973. "The Influence of Natural Convection in Gas, Oil and Water Reservoirs." Journal of Canadian Petroleum Technology, 12:41-47. [20]
- Bathen, K. H. 1971. "Heat Storage and Advection in the North Pacific Ocean." J. Geophysical Research, 76(3):676-687. [259]
- Bloss, S. and V. Grigull. 1976. "Energy Storage and Temperature Distribution in Lakes." Int'l Seminar on Future Energy Production Heat and Mass Transfer Problems, 2:801-811. [254]
- Cavallieri, G. and G. Foligno. 1977. "Proposal for the Production and Seasonal Storage of Hot Water to Heat a City." Solar Energy, 19(6):677-683. [260]
- Denis, L.H.D., A.J.H. Bedue, and Malherbaud. 1979. "Method of and Arrangement for the Seasonal Storage and Use of Hot Water Produced in Particular by Electrical Power-Generating Thermal and Nuclear Stations." Patent No. 4,159,736. [89]

- Dickinson, W. C., A. F. Clark, J. A. Day, and L. F. Wouters. 1976. "The Shallow Solar Pond Energy Conversion System." Solar Energy, 18(1):3-10. [270]
- ERDA and Electric Power Research Institute. 1975. Proceedings of the Workshop on Compressed Air Energy Storage System. ERDA-76-124. Energy Research Development Administration, Conservation Research and Technology Division. [783]
- Givoni, B. 1977. "Underground Longterm Storage of Solar Energy - An Overview." Solar Energy, 19:617-623. [135]
- Guyer, E. C. and M. W. Golay. 1977. "Evaluation of Combined Thermal Storage Pond/Dry Cooling Tower Waste Disposal Systems." ASME, 77-HT-57. [277]
- Hausz, W. 1974. "Heat Storage Wells Conserve Fuels." Symposium Papers - Efficient Use of Fuels in the Metallurgical Industries, 185-201. [166]
- Hausz, W., B. J. Berkowitz and R. C. Hare. 1978. Conceptual Design of Thermal Energy Storage Systems for Near Term Electric Utility Applications. DOE/NASA/0012-78/1, Vol 1 and 2. (Vol 1: Screening Concepts; Vol. 2: Appendices - Screening of Concepts.) [170]
- "House on Ice." 1979. Ground Water Age, May, pp. 16-19. [192]
- Katter, L. B. and R. L. Hoskins. 1978. Application of Thermal Energy Storage to Process Heat and Waste Heat Recovery in the Primary Aluminum Industry. CONS/5080-1. [878]
- Kemper, W. D., W. R. Walker and J. Sabey. \_\_\_\_\_. "Trans-Seasonal Storage of Energy in Moist Soils." [231]
- Lang, W. 1977. "Air Stored for Peaking Power." Electrical World, 187(1):30-31. [300]
- Margen, P. 1978. "The Use of Nuclear Energy for District Heating." Progress in Nuclear Energy, 2:1-28. [334]
- Olszewski, M. 1975. "Agricultural Greenhouse Uses of Power Plant Reject Heat." Ph.D. Thesis, University Microfilms International. [843]
- Rabbimov, R. T., G. Y. Umarov and R. A. Zakhidov. 1971. "Storage of Solar Energy in a Sandy-Gravel Ground." Geliotekhnika, 7(5):57-64. [422]
- Sepaskhah, A. R., L. Boersma, L. R. Davis and D. L. Slegel. 1973. "Experimental Analysis of a Subsurface Soil Warming and Irrigation System Utilizing Waste Heat." Winter Annual Meeting of American Society of Mechanical Engineers. Paper No. 73-WA/HT-11. [880]

U.S. Department of Energy, Division of Energy Storage Systems. 1979.  
"Thermal Energy Storage Application Areas." [550]

### REINJECTION

- Allen, R. D. 1979. Thermal Energy Storage in Aquifers, An Overview. Battelle, Pacific Northwest Laboratories. [620]
- American Petroleum Institute. 1978. "Subsurface Salt Water Injection and Disposal." Vocational Training Series, Book 3. [790]
- Axtmann, R. C. 1975. "Chemical Aspects of the Environmental Impact of Geothermal Plant." Proceedings Second United Nations Symposium on the Development and Use of Geothermal Resources, pp. 1323-1327. [19]
- Baier, D. C. and G. M. Wesner. 1971. "Reclaimed Wastewater for Groundwater Recharge." Water Resources Bulletin, 7(5):991-1001. [240]
- Bodvarsson, G. 1972. "Thermal Problems in the Siting of Reinjection Wells." Geothermics, 1(2):63-66. [249]
- Bouwer, H. 1979. "Geothermal Power Production with Irrigation Waste Water." Ground Water, 17(4):375-384.4. [51]
- Brashears, M. L. 1941. "Ground Water Temperature on Long Island, New York, as Affected by Recharge of Warm Water." Economic Geology, 36:811-828. [53]
- Briggs, L. I., Jr. 1968. "Geology of Subsurface Waste Disposal in Michigan Basin." American Association of Petroleum Geology, Memoir 10, pp. 128-153. [266]
- Brown, R. F. and C. D. Signor. 1974. "Artificial Recharge - State of the Art." Ground Water, 12(3):152-158. [56]
- Brune, G. 1970. "How Much Underground Water Storage Capacity Does Texas Have?" Water Resources Bulletin, 6(4):588-601. [265]
- Chappelear, J. E. and C. W. Volek. 1969. "The Injection of a Hot Liquid into a Porous Media." Society of Petroleum Engineers, 9(1):100-114. [64]
- City of Shanghai Hydrogeological Team. 1977. "Artificial Recharge into Groundwater Systems." Written in Chinese; translation of the Summary by C. F. Tsang (on file). (Underground Artificial Recharge Writing Group.) [598]

- Collins, A. G. 1970. "Are Oil- and Gas-Well Drilling, Production and Associated Waste Disposal Practices Potential Pollutants of the Environment?" Presented before Division of Water, Air and Waste; American Chemical Society. CONF-700911-6. [69]
- Collins, A. G. 1971. "Oil and Gas Wells - Potential Polluters of the Environment?" Water Pollution Control Federation Journal, 43:2383-2393. [70]
- Collins, A. G. 1977. "Enhanced Oil Recovery Injection Waters." Society of Petroleum Engineers, SPE Reprint No. 6603. [73]
- Collins, R. E. and K. E. Davis. 1976. "Geothermal Storage of Solar Energy for Electric Power Generation." Proc. International Conference on Solar Heating and Cooling, pp. 411-424. [74]
- Cuellar, G. 1975. "Behavior of Silica in Geothermal Waste Waters." Proceedings Second U.N. Symposium on the Development and Use of Geothermal Resources, 1343-1347. [83]
- DeWalle, D. R. and J. L. Richenderfer. 1974. "Field Prototype: Description and Operation." Institute for Research on Land and Water Resources, Research Publication #86, pp. 83-92. [95]
- Eckert, A. W. \_\_\_\_\_. "EPA Jurisdiction Over Well Injection Under the Federal Water Pollution Control Act." Natural Resources Lawyer, 9(3):455-465. [103]
- Einarsson, S. S., A. Vides, and G. Cuellar. 1975. "Disposal of Geothermal Waste Water by Reinjection." Proceedings Second U.N. Symposium on the Development and Use of Geothermal Resources, 2:1349-1363. [105]
- Garza, S. 1977. Artificial Recharge for Subsidence Abatement at the NASA-Johnson Space Center. Open File Report 77-219. U.S. Geological Survey. [606]
- Gillespie, J. B., G. D. Hargadine, and M. J. Stough. 1977. "Artificial Recharge Experiments Near Lakin, Western Kansas." Kansas Water Resources Board, Topeka, KS, Bulletin 20. [608]
- Goyal, K. P. and D. R. Kassoy. 1979. Fault Zone Controlled Charging of a Liquid Dominated Geothermal Reservoir. LBL-9237. [140]
- A Guide to the Underground Injection Control Program. 1979. USEPA, Office of Drinking Water (WH550). [152]
- "How to Calculate Heat Transmission in Hot Fluid Injection." 1964. Petroleum Engineer, November, pp. 110-120. [194]

- Kazmann, R. 1974. "Waste Surveillance in Subsurface Disposal Projects." Ground Water, 12:412-426. [225]
- Kazmann, R. G., O. K. Kimbler and W. R. Whitehead. 1974. "Management of Waste Fluids in Salaquifers." Journal of the Irrigation and Drainage Division ASCE, 100(IR4):413-424. [228]
- Lauwerier, H. A. 1955. "The Transport of Heat in an Oil Layer Caused by the Injection of Hot Fluid." Applied Sci. Research, Section A, 5:145-150. [302]
- Lindorff, D. E. 1979. "Ground Water Pollution - A Status Report." Ground Water, 17(4):9-17. [319]
- Lippman, M. J., C. F. Tsang, and P. A. Witherspoon. 1977. "Analysis of the Response of Geothermal Reservoirs Under Injection and Production Procedures." SPE-6537. [322]
- Louden, L. R. and R. E. Mc Glothlin. 1975. "Waste Water Base Drilling Fluid Disposal." Environmental Aspects of Chemical Use in Well-Drilling Operations, EPA-560/1-75-004, pp. 515-522. [323]
- Marx, J. W. and R. H. Langenheim. 1959. "Reservoir Heating by Hot Fluid Injection." Petroleum Transactions, AIME, 216:312-315. [336]
- Mathey, B. 1977. "Development and Resorption of a Thermal Disturbance in a Phreatic Aquifer with Natural Convection." Journal of Hydrology, 34:315-333. [338]
- McCune, C. C. 1977. "On-Site Testing to Define Injection-Water Quality Requirements." Journal of Petroleum Technology, January, pp. 17-24. [340]
- Moss, J. T. and P. D. White. 1959. "How to Calculate Temperature Profiles in a Water Injection Well." Oil and Gas Journal, 57:174-178. [373]
- Murphy, H. D. 1977. Fluid Injection Profiles - A Modern Analysis of Wellbore Temperature Surveys. SPE-6783. [377]
- Piper, A. M. 1969. Disposal of Liquid Wastes by Injection Underground - Neither Myth nor Millenium. USGS, Circular 631. [413]
- Plummer, K. H. and T. M. Rachford. 1974. "Economic Feasibility." An Agro-Power Waste Water Complex for Land Disposal of Waste Heat and Waste Water. Institute for Research on Land and Water Resources, Pennsylvania State University, Research Publication Number 86, pp. 9-45. [415]

- Price, D., D. H. Hart, and B. L. Foxworthy. 1965. Artificial Recharge in Oregon and Washington - 1962. USGS, Water Supply Paper 1594-C. [441]
- Rahman, M. A., E. T. Smerdon, and E. A. Hiler. 1969. "Effect of Sediment Concentration on Well Recharge in a Fine Sand Aquifer." Water Resources Research, 5(3):641-646. [425]
- Schrock, V. E. and A. D. K. Laird. 1976. "Physical Modeling of Combined Forced and Natural Convection in Wet Geothermal Formations." Journal Heat Transfer, May, pp. 213-220. [879]
- Smith, C. R. and S. J. Pirson. 1963. "Water Coning Control in Oil Wells by Fluid Injection." Society of Petroleum Engineers Journal, 3:314-326. [457]
- Smith, J. E. 1975. "Regulation of Onshore and Offshore Oilfield Waste Disposal." Environmental Aspects of Chemical Use in Well-Drilling Operations, EPA-560/1-75-004, pp. 579-591. [460]
- Specken, G. A. 1975. "Treatment and Disposal of Waste Fluids From Onshore Drilling Sites." Environmental Aspects of Chemical Use in Well-Drilling Operations, EPA-560/1-75-004, pp. 451-462. [465]
- Spillette, A. G. 1965. "Heat Transfer During Hot Fluid Injection into an Oil Reservoir." Society of Petroleum Engineers of AIME, Thermal Recovery Techniques, SPE Reprint Series 10:21-16. [467]
- Subcasky, W. J. \_\_\_\_\_. "Petroleum Industry Experience in Water Injection." [477]
- Technical Practices Committee. 1975. "Selection of Metallic Materials to be Used in All Phase of Water Handling for Injection into Oil Bearing Formations." NACE Standard RP-04-75. [486]
- Tsang, C. F. 1977. "Artificial Recharge into Groundwater Systems." City of Shanghai Hydrogeological Team (writtin in Chinese, Summary translated into English by Tsang). [598]
- Walker, W. R. and W. E. Cox. 1974. "Subsurface Environment - Private Property or Public Domain?" Journal of the Hydraulics Division, ASCE, 100(HY 11):1699-1705. [614]
- Warner, D. L. and J. H. Lehr. 1977. An Introduction to the Technology of Subsurface Wastewater Injection. EPA-600/2-77-240. (PB-279 207). [514]
- Willhite, G. P. 1967. "Over-all Heat Transfer Coefficients in Steam and Hot Water Injection Wells." Journal of Petroleum Technology, May, pp. 607-615. [524]



Willman, B. T., V. V. Valleroy, G. W. Runberg, A. J. Cornelius, and L. W. Powers. 1961. "Laboratory Studies of Oil Recovery by Steam Injection." Journal of Petroleum Technology, 222:681-690. [528]

U.S. Environmental Protection Agency. 1979. Water Programs, State Underground Injection Control Programs, Minimum Requirements and Grant Regulations. Federal Register; Friday, April 20. [112]

#### RESERVOIR AND SURFACE FACILITY INSTRUMENTATION

Bodvarsson, G. and J. Zoega. 1961. "Production and Distribution of Natural Heat for Domestic and Industrial Heating in Iceland." U.N. Conference on New Source of Energy, Jokull, 11:48-55. [245]

Denis, L.H.D., A.J.H. Bedue, and Malherbaud. 1979. "Method of and Arrangement for the Seasonal Storage and Use of Hot Water Produced in Particular by Electrical Power-Generating Thermal and Nuclear Stations." Patent No. 4,159,736. [89]

Guest, R. J. and C. W. Zimmerman. 1973. "Compensated Gamma Ray Densimeter Measures Slurry Densities in Flow." Petroleum Engineer, 45(10):80-87. [150]

Katter, L. B. and R. L. Hoskins. 1978. Application of Thermal Energy Storage to Process Heat and Waste Heat Recovery in the Primary Aluminum Industry. CONS/5080-1. [878]

Pettitt, R. A. 1975. Testing, Drilling, and Logging of Geothermal Test Hole GT-2, Phase III. LA-5965-PR. [407]

Vetter, O. J., D. A. Campbell, and M. J. Walker. 1978. Geothermal Fluid Investigations at RGI's East Mesa Test Site. PNL-2556. [508]

#### RESERVOIR CHARACTERIZATION METHODS

Adachi, T., S. Serata, and S. Sakurai. 1969. "Determination of Underground Stress Field Based on Inelastic Properties of Rock." Proceedings 11th Symposium on Rock Mechanics, University of California, pp 293-328. [631]

Archie, G. E. 1942. "The Electrical Resistivity Log as an Aid in Determining Some Reservoir Characteristics." Transactions, AIME, 146:54-62. [242]

Barnes, B. A. and P. Livingston. 1947. "Value of the Electric Log for Estimating Ground-Water Supplies and the Quality of the Ground Water." Transactions, American Geophysical Union, 28(6):903-911. [26]

- Bodvarsson, G. 1961. "Physical Characteristics of Natural Heat Resources in Iceland." Jokull, 11:29-38. [ ]
- Bodvarsson, G. 1970. "Confined Fluids as Strain Meters." J. Geophysical Research, 75(14):2711-2718. [253]
- Bodvarsson, G. 1973. "Downward Continuation of Constrained Potential Fields." Journal of Geophysical Research, 78(8):1288-1292. [40]
- Bosazza, V. L. 1952. "On the Storage of Water in Rocks In-Situ." Transactions American Geophysical Union, 33(1):42-48. [48]
- Brace, W. F., A. S. Orange, and T. R. Madden. 1965. "The Effect of Pressure on the Electrical Resistivity of Water-Saturated Crystalline Rocks." Journal of Geophysical Research, 70(22):5669-5678. [52]
- Brown, R. F. and C. D. Signor. 1974. "Artificial Recharge - State of the Art." Ground Water, 12(3):152-158. [56]
- Brown, R. H. 1953. "Selected Procedures for Analyzing Aquifer Test Data." American Water Works Association Journal, 45:844-866. [57]
- Brune, G. 1970. "How Much Underground Water Storage Capacity Does Texas Have?" Water Resources Bulletin, 6(4):588-601. [265]
- Chow, V. 1951. "Drawdown in Artesian Wells Computed by Nomograph." Civil Engineering, 21(10):48-49. [65]
- Chow, V. 1952. "On the Determination of Transmissibility and Storage Coefficients from Pumping Test Data." Transactions American Geophysical Union, 33(3):397-404. [66]
- Cliff, W. C., W. J. Apley, and J. M. Creer. 1979. "Evaluation of Potential Geothermal Well-Head Flow Sampling and Calorimeter Methods." LBL-9248. GREMP-7. [267]
- Davis, E. G. and M. F. Hawkins. 1964. "Linear Fluid-Barrier Detection by Well Pressure Measurements." Journal of Technology, 16:259-260. [672]
- Denison, E. B. 1976. "Making Downhole Measurements Through Modified Drill Pipe." World Oil, 183(5):86-69. [90]
- Dobbs, R. K. 1969. "Effective Exploration Inspection." (Water Pressure Tests in Borings, 3(2)-Sept), (Prevention and Interpretation of Core Loss, 4[1]), (Supplemental Borehole Logging, 5(1)-Feb). Foundation Sciences, Inc., Newsletter. [678]

- Drost, W. 1973. "Application of Groundwater Measurements by Means of Radio-isotopes on Groundwater Exploration." World Congress on Water Resources, CONF-7309143-11, pp. 357-369. [99]
- Eggers, D. E. 1973. "Downward Continuation and Transformation of Potential Fields with Application to Marine Magnetic Anomalies." Thesis, \_\_\_\_\_. [605]
- Fenske, P. R. 1977. "Radial Flow with Discharging Well and Observation Well Storage." Journal of Hydrology, 32:87-96. [116]
- Fenske, P. R. 1977. "Type Curves for Recovery of a Discharging Well with Storage." Journal of Hydrology, 33:341-348. [117]
- Gambolati, G. 1977. "Deviations From the Thesis Solution in Aquifers Undergoing Three-Dimensional Consolidation." Water Resources Research, 13(1):62-68. [121]
- Gill, M. A. 1975. "Iterative Method of Determining Aquifer Constants." Journal of the Irrigation and Drainage Division, ASCE. 101(IR1):81-85. [134]
- Glover, R. E. and W. T. Moody. 1976. "Drawdown Due to Pumping in an Anisotropic Aquifer." Water Resource Bulletin, 12(5):941-950. [137]
- Goldstein, N. E., R. A. Morris, and M. J. Wilt. \_\_\_\_\_. Assessment of Surface Geophysical Methods in Geothermal Exploration and Recommendations for Future Research. LBL-6815. [609]
- Goranson, C. B. and R. C. Schroeder. 1979. Site Specific Geothermal Reservoir Engineering Activities at Lawrence Berkeley Laboratory. LBL-9463. [138]
- Goranson, C. B., R. C. Schroeder, and J. Haney. 1979. Evaluation of Coso Geothermal Exploratory Hole No. 1 (CGEH-1), Coso Hot Springs: KGRA, China Lake, California. LBL-8675. [139]
- Grist, D. M., G. O. Langley, and E. L. Neustater. 1975. "The Dependence of Water Permeability on Core Cleaning Methods in the Case of Some Sandstone Samples." J. Canadian Petroleum, 14(2):48-52. [278]
- Halevey, E. and A. Nir. 1962. "The Determination of Aquifer Parameters with the Aid of Radioactive Tracers." Journal of Geophysical Research, 67(6):2403-2409. [155]
- Hantush, M. S. 1961. "Drawdown Around a Partially Penetrating Well." Journal of the Hydraulics Division, ASCE, 87(HY4):83-98. [158]

- Hewitt, C. H. 1963. "Analytical Techniques for Recognizing Water-Sensitive Reservoir Rocks." Journal of Petroleum Technology, August, pp. 813-818. [183]
- Holzschuh, J. C. 1976. "A Simple Computer Program for the Determination of Aquifer Characteristics from Pump Test Data." Ground Water, 14(5):283-285. [189]
- Howard, J., et al. 1978. Geothermal Resource and Reservoir Investigations of U.S. Bureau of Reclamation Leaseholds at East Mesa, Imperial Valley, California. LBL-7094. [193]
- Huyakorn, P. and C. R. Dudgeon. 1976. "Investigation of Two-Regime Well Flow." Journal of the Hydraulics Division ASCE, 102(HY9):1149-1165. [196]
- Ineson, J. 1963. "Applications and Limitations of Pumping Tests: Hydrogeological Significance." Journal of the Institute of Water Engineers, 17:200-215. [198]
- Ineson, J. and D. A. Gray. 1964. "Electrical Investigations of Borehole Fluids." Journal of Hydrology, 1:204-218. [285]
- Jacob, C. E. 1947. "Drawdown Test to Determine Effective Radius of Artesian Well." Transactions, American Society of Civil Engineers, 112(2321):1047-1064. [207]
- Jacob, C. E. 1946. "Appendix A - Report of the Subcommittee on Permeability." Transactions, American Geophysical Union, 27(II):245-273. [206]
- Jacob, C. E. and S. W. Lohman. 1952. "Nonsteady Flow to a Well of Constant Drawdown in an Extensive Aquifer." Transactions, American Geophysical Union, 33(4):559-569. [209]
- Johnson, T. L. 1977. "Pumping Tests Provide Useful Data." Johnson Driller's Journal, pp. 4-7. [704]
- Katz, D. L. and M. R. Tek. 1970. "Storage of Natural Gas in Saline Aquifers." Water Resources Research, 6(5):1515-1521. [221]
- Kaveler, H. H. and Z. Z. Hunter. 1952. "Observations From Profile Logs of Water Injection Wells." Petroleum Transactions, AIME, 195:129-134. [222]
- Keys, W. S. 1967. "The Application of Radiation Logs to Groundwater Hydrology." Proceedings of the Symposium on Isotopes in Hydrology, p. 477-488. [232]

- Lang, S. M. 1960. "Interpretation of Boundary Effects From Pumping Test Data." American Water Works Association Journal, 52(3):356-364. [299]
- Lawrence Berkeley Laboratory. 1978. Invitational Well-Testing Symposium Proceedings. LBL-7027. [305]
- Lawrence Berkeley Laboratory. 1978. Second Invitational Well-Testing Symposium Proceedings. LBL-8883. [306]
- Lawrence Berkeley Laboratory. 1978. Geothermal Exploration Technology Annual Report 1978. LBL-8603. [307]
- Lundstrom, L. and H. Stille. 1978. Large Scale Permeability Test of the Granite in the Stripa Mine and Thermal Conductivity Test. LBL-7052, SAC-02. [328]
- Lynch, E. J. 1964. "Recent Development Formation Evaluation." World Oil, 158:110-118. [329]
- Marine, I. W. 1975. "Water Level Fluctuations Due to Earth Tides in a Well Pumping From Slightly Fractured Crystalline Rock." Water Resources Research, 2(1):165-171. [335]
- Meyer, W. R. 1962. "Use of a Neutron Moisture Probe to Determine the Storage Coefficient of an Unconfined Aquifer." Geological Survey Research, USGS Professional Paper 450, pp. E174-E176. [362]
- Miller, C. W. and J. M. Zerzan. 1979. Downhole Pressure Changes Measured with a Fluid Filled Capillary Tube. LBL-9303. [367]
- Moss, J. T. and P. D. White. 1959. "How to Calculate Temperature Profiles in a Water Injection Well." Oil and Gas Journal, 57:174-178. [373]
- Murphy, H. D. 1977. Fluid Injection Profiles - A Modern Analysis of Wellbore Temperature Surveys. SPE-6783. [377]
- Naney, J. W., D. C. Kent and E. H. Seely. 1976. "Evaluating Ground-Water Paths Using Hydraulic Conductivities." Groundwater, 14(4):205-213. [379]
- Obbink, J. G. 1969. "Construction of Piezometers, and Method of Installation for Ground Water Observations in Aquifers." Journal of Hydrology, 7:434-443. [390]
- Pettitt, R. A. 1975. Planning, Drilling, and Logging of Geothermal Test Hole GT-2, Phase I. LA-5819-PR. [405]
- Pettitt, R. A. 1975. Testing, Drilling, and Logging of Geothermal Test Hole GT-2, Phase II. LA-5897. [406]

- Pettitt, R. A. 1977. Planning, Drilling, Logging, and Testing of Energy Extraction Hole EE-1, Phases I and II. LA-6906-MS. [408]
- Pettitt, R. A. 1978. Testing, Planning, and Redrilling of Geothermal Test Hole GT-2, Phases IV and V. LA-7586-PR. [409]
- Price, M. 1977. "Specific Yield Determinations From a Consolidated Sandstone Aquifer." Journal of Hydrology, 33:147-156. [442]
- Pruess, K., G. Bodvarsson, R. C. Schroeder, P. A. Witherspoon, R. Marconcini, G. Neri, and C. Ruffilli. 1979. Simulation of the Depletion of Two-Phase Geothermal Reservoirs. LBL-9606. [443]
- Qvale, E. B. 1976. "Seasonal Storage of Thermal Energy in Water in the Underground." Eleventh Intersociety Energy Conversion Engineering Conference Proceedings, pp. 628-635. [421]
- Rushton, K. R. and Y. K. Chan. 1977. "Numerical Pumping Test Analysis in Unconfined Aquifers." Journal of the Irrigation and Drainage Division, ASCE 103(IR1):1-12. [438]
- Schmidt, K. D. 1977. "Water Quality Variations for Pumping Wells." Groundwater, 15(2):130-137. [449]
- Somerton, W. H. and S. El-Hadidi. 1971. "Well Logs Can Indicate Formation Drillability." World Oil, 173(7):55-56. [463]
- Stallman, R. W. 1956. "Numerical Analysis of Regional Water Levels to Define Aquifer Hydrology." Transactions, American Geophysical Union, 37(4):451-460. [469]
- Stark, M., N. Goldstein, H. Wollenberg, B. Strisower, H. Hege, and M. Wilt. 1979. Geothermal Exploration Assessment and Interpretation, Klamath Basin, Oregon - Swan Lake and Klamath Hills Area. LBL-8186. [470]
- Strausberg, S. I. 1957. "Estimating Distances to Hydrologic Boundaries from Discharging Well Data." Ground Water, 5(1):5-8. [748]
- Streltsova, T. D. and K. R. Rushton. 1973. "Water Table Drawdown Due to a Pumped Well in an Unconfined Aquifer." Water Resources Research, 9(1):236-242. [475]
- Sugisaki, R. 1961. "Measurement of Effective Flow Velocity of Ground Water by Means of Dissolved Gases." American Journal of Science, 259:144-153. [478]

- Truesdell, A. H. 1975. "Summary of Section III Geochemical Techniques in Exploration." Proceedings Second U.N. Symposium on the Development and Use of Geothermal Resources, 1:liii-lxxix. [499]
- Truesdell, A. H. and W. Singers. 1974. "The Calculation of Aquifer Chemistry in Hotwater Geothermal Systems." Journal Research, USGS, 2(3):271-278. [500]
- Turcan, Jr., A. N. 1962. Estimating Water Quality From Electrical Logs. USGS, Professional Paper 450, pp. C135-C136. [506]
- Warner, D. L. and J. H. Lehr. 1977. An Introduction to the Technology of Subsurface Wastewater Injection. EPA-600/2-77-240. (PB-279 207). [514]
- Waxman, M. H. and E. C. Thomas. 1974. "Electrical Conductivities in Shaly Sands-1. The Relation Between Hydrocarbon Saturation and Resistivity Index: II. The Temperature Coefficient of Electrical Conductivity." J. Petroleum Technology, pp. 213-225. [758]

#### RESERVOIR CONSOLIDATION AND SUBSIDENCE

- Davis, G. H. and J. R. Rollo. 1969. "Land Subsidence to Decline of Artesian Head at Baton Rouge, Lower Mississippi Valley, USA." USA Proceedings, Tokyo Symposium on Land Subsidence. IASH/AIHS Uneco., pp. 174-184. [273]
- Gabrysch, R. K. and C. W. Bonnet. 1976. "Land-Surface Subsidence at Seabrook, Texas." AD-A035 621. [120]
- Gambolati, G. 1977. "Deviations From the Thesis Solution in Aquifers Undergoing Three-Dimensional Consolidation." Water Resources Research, 13(1):62-68. [121]
- Gambolati, G., P. Gatto, and R. A. Freeze. 1974. "Mathematical Simulations of the Subsidence of Venice 2 - Results." Water Resource Research, 10(3):563-577. [276]
- Garza, S. 1977. Artificial Recharge for Subsidence Abatement at the NASA-Johnson Space Center. Open File Report 77-219. U.S. Geological Survey. [606]
- Gass, T. E. 1977. "Land Subsidence." Water Well Journal, 31(5):30-31. [126]
- Geertsma, J. 1973. "Land Subsidence Above Compacting Oil and Gas Reservoirs." J. Petroleum Technology, June, p. 734-744. [131]

- Green, J. H. 1964. The Effect of Artesian Pressure Decline on Confined Aquifer Systems and its Relation to Land Subsidence. Water-Supply Paper 1779-T. U.S. Geological Survey. [691]
- Helm, D. C. 1975. "One-Dimensional Simulation of Aquifer System Compaction Near Pixley, CA: 1. Constant Parameters." Water Resources Research, 2(3):465-478. [284]
- Isigaki, A., S. Komaki, T. Endo, and N. Miyabe. 1969. "Short Period Variation in Land Subsidence." Proceedings of Tokyo Symposium. IASH/AIHS, Unesco., Volume 2. [ ]
- Jones, L. L. and J. P. Warren. 1976. "Land Subsidence Costs in the Houston Baytown Area of Texas." American Waterworks Association Journal, 68(11):597-599. [217]
- Kazmann, R. G. 1975. "Groundwater and Environmental Geology." Environmental Geology, 1:137-142. [226]
- Keady, D. M., et al. 1975. Status of Land Subsidence Due to Ground-Water Withdrawal Along the Mississippi Gulf Coast. PB-243 558. [229]
- Lawrence Berkeley Laboratory. 1977. Geothermal Subsidence Research Program Plan. LBL-5983. [716]
- Lippman, M. J., T. N. Narasimhan, and P. A. Witherspoon. 1977. "Modeling Subsidence Due to Geothermal Fluid Production." ASCE 3107. [321]
- Lippman, M. J., C. F. Tsang, and P. A. Witherspoon. 1977. "Analysis of the Response of Geothermal Reservoirs Under Injection and Production Procedures." SPE-6537. [322]
- Lofgren, B. E. 1969. "Field Measurement of Aquifer-System Compaction, San Joaquin Valley, CA." USA Proceedings Tokyo Symposium on Land Subsidence, IASH/AIHS Unesco., pp. 272-284. [571]
- Lofgren, B. W. 1961. Measurement of Compaction of Aquifer System in Areas of Land Subsidence. Professional Paper 424-B, pp. B49-B52. U.S. Geological Survey. [570]
- Meinzer, O. E. 1928. "Compressibility and Elasticity of Artesian Aquifers." Economic Geology, 23:263-291. [347]
- Narasimhan, T. N. and P. A. Witherspoon. 1976. "Numerical Model for Land Subsidence in Shallow Groundwater Systems." International Association of Hydrological Sciences Proceedings of the Anaheim Symposium, p. 133-143. [383]



- Panel on Rock Mechanics Problems that Limit Energy Resource Recovery and Development. 1978. Limitations of Rock Mechanics in Energy-Resource Recovery and Development. The National Research Council. [398]
- Poland, J. F. and G. H. Davis. 1956. "Subsidence of the Land Surface in the Tulare-Wasco (Delano) and Los Banos-Kettleman City Area, San Joaquin Valley, California." Transactions, American Geophysical Union, 37(3):287-296. [416]
- Poland, J. F. 1960. "Land Subsidence in the San Joaquin Valley, CA., and its Effect on Estimates of Ground Water Resources." Int'l Assoc. Science Hydrogeology, Publication 52, pp. 324-335. [730]
- Poland, J. F. and J. H. Green. 1962. Subsidence in the Santa Clara Valley, California: A Progress Report. USGS, Water Supply Paper 1619-C. [417]
- Poland, J. F. and G. H. Davis. 1969. "Land Subsidence Due to Withdrawal of Fluids. Reviews in Engineering Geology II, p. 187-269. [418]
- Stilwell, W. B., W. K. Hall, and J. Tawhai. 1975. "Ground Movement in New Zealand Geothermal Fields." Proceedings Second U.N. Symposium on the Development and Use of Geothermal Resources, p. 1427-1433. [471]
- Tolman, C. F. and J. F. Poland. 1940. "Ground-Water, Salt-Water Infiltration and Ground-Surface Recession in Santa Clara Valley, Santa Clara County, Calif." Transactions, American Geophysical Union, 21:23-25. [497]
- Winslow, A. G. and W. W. Doyle. 1954. "Land-Surface Subsidence and It's Relation to the Withdrawal of Groundwater in the Houston-Galveston Region, Texas." Economic Geology, 49:413-422. [529]

#### RESERVOIR PLUGGING PROBLEMS

- Abrams, A. 1977. "Mud Design to Minimize Impairment Due to Particle Invasion." Journal of Petroleum Technology, 29(5):586-592. [1]
- Allison, L. E. 1947. "Effects of Microorganisms on Permeability of Soil Under Prolonged Submergence." Soil Science, 63:439-450. [6]
- Aruna, M., N. Arihara and H. J. Ramey, Jr. 1977. "The Effect of Temperature and Stress on the Absolute Permeability of Sandstones and Limestones." CONF-770440, pp. 541-550. [18]
- Behnke, J. J. 1969. "Clogging in Surface Spreading Operations for Artificial Groundwater Recharge." Water Resources Research, 5(4):870-876. [258]

- Campbell, M. D. and G. F. Gray. 1975. "Mobility of Well-Drilling Additives in the Ground-Water System." Environmental Aspects of Chemical Use in Well Drilling Operations, EPA-560/1-75-004, pp. 261-288. [59]
- Donaldson, E. C. and B. A. Baker. 1977. "Particle Transport in Sandstones." Society of Petroleum Engineers, SPE Reprint No. 6905. [97]
- Dudgeon, C. R. 1976. "Drilling Mud Invasion of Unconsolidated Aquifer Materials." Australian Water Resources Council, Technical Paper No. 17. [100]
- Hegelson, H. C. and D. H. Kirkham. 1974. "Theoretical Prediction of the Thermodynamic Behavior of Aqueous Electrolytes at Higher Pressures and Temperatures: I. Summary of the Thermodynamic/Electrostatic Properties of the Solvent." American Journal of Science, 274:1089-1198. [177]
- Hewitt, C. H. 1963. "Analytical Techniques for Recognizing Water-Sensitive Reservoir Rocks." Journal of Petroleum Technology, August, pp. 813-818. [183]
- Jacob, C. E. 1946. "Appendix A - Report of the Subcommittee on Permeability." Transactions, American Geophysical Union, 27(II):245-273. [206]
- Katz, D. L. and M. R. Tek. 1970. "Storage of Natural Gas in Saline Aquifers." Water Resources Research, 6(5):1515-1521. [221]
- "Maintaining the Yield of Water Wells." 1965. The Johnson Drillers Journal, January-February, pp. 1-4. [332]
- Molz, F. J., A. D. Parr, P. F. Anderson, V. D. Lucido, and J. C. Warman. 1979. Thermal Energy Storage in Confined Aquifers. Water Resources Research Institute, Auburn University. [626]
- Mungan, N. 1965. "Permeability Reduction Through Changes in pH and Salinity." Journal of Petroleum Technology, December, pp. 1449-1453. [376]
- Rahman, M. A., E. T. Smerdon, and E. A. Hiler. 1969. "Effect of Sediment Concentration on Well Recharge in a Fine Sand Aquifer." Water Resources Research, 5(3):641-646. [425]
- Ramey, H. J., Jr. 1975. "Pressure Transient Analysis for Geothermal Wells." Proceedings Second U.N. Symposium on the Development and Use of Geothermal Resources, 3:1749-1757. [426]
- Reed, M. G. 1977. "Formation Permeability Damage by Mica Alteration and Carbonate Dissolution." Journal of Petroleum Technology, September, pp. 1056-1060. [428]

Robeck, G. G. 1969. "Microbial Problems in Ground Water." Groundwater, 7(3):33-35. [431]

Robichaux, J. 1975. "Bactericides Used in Drilling and Completion Operation." Environmental Aspects of Chemical use in Well-Drilling Operations, EPA-560/1-75-004, pp. 183-198. [432]

Subcasky, W. J. \_\_\_\_\_. "Petroleum Industry Experience in Water Injection." [477]

Weinbrandt, R. M., H. J. Ramey and F. J. Casse. 1975. "The Effect of Temperature on Relative and Absolute Permeability of Sandstones." Society of Petroleum Engineers Journal, October, pp. 376-384. [518]

#### RESERVOIR PRETREATMENT AND REHABILITATION

Bullen, R. S. and T. F. Bratrud. 1976. "Fracturing With Foam." J. Canadian Petroleum Technology, 15(2):27-32. [263]

Clark, J. B. 1949. "A Hydraulic Process for Increasing the Productivity of Wells." Petroleum Transactions, AIME, 1:1-8. [ ]

Govier, G. W. 1976. "Enhanced Recovery in Alberta -- A Review and the Role of the Energy Resources Conservation Board." J. Canadian Petroleum Tech., 15(3):13-19. [280]

Hanson, M. E., B. K. Crowley, and J. S. Kahn. 1975. "Massive Hydraulic Fracturing: Identification of Critical Technical Issues for Application in Increasing Gas Production in the Western United States." USCRL, 51751. [696]

"Maintaining the Yield of Water Wells." 1965. The Johnson Drillers Journal, January-February, pp. 1-4. [332]

Pettitt, R. A. 1975. Testing, Drilling, and Logging of Geothermal Test Hole GT-2, Phase II. LA-5897. [406]

Pettitt, R. A. 1975. Testing, Drilling, and Logging of Geothermal Test Hole GT-2, Phase III. LA-5965-PR. [407]

Pettitt, R. A. 1977. Planning, Drilling, Logging, and Testing of Energy Extraction Hole EE-1, Phases I and II. LA-6906-MS. [408]

Schaffer, D. C. 1974. "The Right Chemicals Are Able to Restore or Increase Well Yield." The Johnson Drillers Journal, March-April, pp. 4-6. [447]

## SITE SELECTION AND REGIONAL ASSESSMENTS

- Anderson, K. and J. E. Kelly. 1976. "Exploration for Groundwater in the Madison Limestone, Niobrara County, Wyoming." 28th Annual Field Conference - Wyoming Geological Assoc. Guidebook. CONF-7609159:277-281. [12]
- Benson, S. M., C. B. Goranson, J. P. Haney, and R. C. Schroeder. 1979. The Status of the Resource Evaluation at Susanville, California. LBL-9469. [29]
- Blackwell, D. D., E. Granados, and J. B. Koenig. 1977. "Heat Flow and Geothermal Gradient Exploration of Geothermal Areas in the Cordillera de Guanacaste of Costa Rica." Geothermal Resources Council, Transactions, 1:17-18. [33]
- Bodvarsson, G. 1961. "Physical Characteristics of Natural Heat Resources in Iceland." Jokull, 11:29-38. [ ]
- Bowen, R. G., D. D. Blackwell, and D. A. Hull. 1977. Geothermal Exploration Studies in Oregon. Misc. Paper No. 19. Department of Geology and Mineral Industries, State of Oregon. [650]
- Brashears, M. L. 1941. "Ground Water Temperature on Long Island, New York, as Affected by Recharge of Warm Water." Economic Geology, 36:811-828. [53]
- Briggs, L. I., Jr. 1968. "Geology of Subsurface Waste Disposal in Michigan Basin." American Association of Petroleum Geology, Memoir 10, pp. 128-153. [266]
- Desert Reclamation Industries. 1978. "Aquifer Storage at J. F. Kennedy International Airport." [92]
- Dooley, J. L., G. P. Frost, L. A. Gore, R. P. Hammond, D. L. Rawson and S. L. Ridgeway. 1977. A Feasibility Study of Underground Energy Storage Using High-Pressure, High-Temperature Water. RDA-TR-7100-001 (CONS-1243-1). [630]
- Ebeling, L. L. and D. L. Reddell. 1976. Energy (Hot Water) Storage in Groundwater Aquifers. ASAE Paper No. 76-2540. [102]
- Fox, E. C. and J. F. Thomas. \_\_\_\_\_. A Preliminary Economic Analysis of Aquifer Winter-Chill Storage at the John F. Kennedy Airport. ORNL/TM-6876. [118]
- Gillespie, J. B., G. D. Hargadine, and M. J. Stough. 1977. "Artificial Recharge Experiments Near Lakin, Western Kansas." Kansas Water Resources Board, Topeka, KS, Bulletin 20. [608]

- Guha, T. K., K. E. Davis, R. E. Collins, J. R. Fanchi and A. C. Meyers. 1977. "Manmade Geothermal Energy." Alternative Energy Sources and International Compendium, Vol. 6, Geothermal Energy and Hydropower. T. N. Verziroglu (ed.), pp. 2641-2654. [151]
- Helweg, O. J. 1978. "Regional Ground-Water Management." Ground Water, 16(5):318-321. [180]
- Jacob, C. E. 1941. "Notes on the Elasticity of the Lloyd Sand on Long Island, NY." Transactions, American Geophysical Union, 22:783-787. [202]
- Jacob, C. E. 1943. "Correlation of Ground-Water Levels and Precipitation on Long Island, NY: Part I - Theory." Transactions, American Geophysical Union, 24:564-573. [203]
- Jacob, C. E. 1944. "Correlation of Ground-Water Levels and Precipitation on Long Island, NY: Part II - Correlation of Data." Transactions, American Geophysical Union, 25:928-939. [204]
- Krishnaswamy, V. S. and R. Shankar. 1974. "Geothermal Fields in India Explored for Power Generation." Geothermics, 3:124-125. [287]
- Kusuda, T. and P. R. Achenbach. 1964. "Earth Temperature and Thermal Diffusivity at Selected Stations in the United States." ASHRAE Transactions, 1914:61-75. [296]
- Lawrence Berkeley Laboratory. 1978. Geothermal Exploration Technology Annual Report 1978. LBL-8603. [307]
- Lefebre, V. 1977. Chemical Dynamics of a Confined Limestone Aquifer. WRRRI Report No. 084, PB-265666. [309]
- Lenzer, R. C., G. W. Crosby, and C. W. Berge. 1977. "Recent Developments at the Roosevelt Hot Springs KGRA." Energy and Mineral Resource Recovery, CONF-770440, pp 60-67. [313]
- Lienau, P. J. 1978. Agribusiness Geothermal Energy Utilization Potential of Klamath and Snake River Basins, Oregon. IDO/1621-1. [786]
- Lund, J. W. 1978. "Geothermal Hydrology and Geochemistry of Klamath Falls, Oregon Urban Area." Oregon Institute of Technology, Geo-Heat Utilization Center. [326]
- Meyer, A. F. 1960. "Effect of Temperature on Ground-Water Levels." Journal of Geophysical Research, 65(6):1747-1752. [350]

- Molz, F. J., A. D. Parr, P. F. Anderson, V. D. Lucido, and J. C. Warman. 1979. Thermal Energy Storage in Confined Aquifers. Water Resources Research Institute, Auburn University. [566]
- Müffler, L. J. P. 1978. Assessment of Geothermal Resources of the United States - 1978. Circular 790. U.S. Geological Survey. [560]
- Narasimhan, T. N., R. C. Schroeder, C. G. Goranson, D. G. McEdwards, D. A. Campbell, and J. H. Barkman. 1977. Recent Results From Tests on the Republic Geothermal Wells, East Mesa, California. LBL-7017. [382]
- National Waterwell Association. (Pre-publication release.) "Shallowest Aquifer Water Level Elevations for the United States." [558]
- Pettitt, R. A. 1975. Planning, Drilling, and Logging of Geothermal Test Hole GT-2, Phase I. LA-5819-PR. [405]
- Qvale, E. B. 1976. "Seasonal Storage of Thermal Energy in Water in the Underground." Eleventh Intersociety Energy Conversion Engineering Conference Proceedings, pp. 628-635. [421]
- Reistad, G. M., W. E. Schmisser, J. R. Shay, and J. B. Fitch. 1978. "An Evaluation of Uses for Low to Intermediate Temperature Geothermal Fluids in the Klamath Basin, OR." Oregon State University. [785]
- Smith, G. C., J. A. Stottlemyre, L. E. Wiles, W. V. Loscutoff, and H. J. Pincus. 1978. FY-1977 Progress Report. Stability and Design Criteria Studies for Compressed Air Energy Storage Reservoirs. PNL-2443. [458]
- Stark, M., N. Goldstein, H. Wollenberg, B. Strisower, H. Hege, and M. Wilt. 1979. Geothermal Exploration Assessment and Interpretation, Klamath Basin, Oregon - Swan Lake and Klamath Hills Area. LBL-8186. [470]
- Studsvik. 1978. Minneapolis-St. Paul District Heating Study. ORNL/SUB-77/13502/4. [476]
- Thompson, G. A. and D. B. Burke. 1974. "Regional Geophysics of the Basin and Range Province." Annual Review of Earth and Planetary Science, 2:213-238. [494]
- Thorsteinsson, T. 1975. "Redevelopment of the Reykir Hydrothermal System in Southeastern Iceland." Proceedings Second United Nations Symposium on the Development and Use of Geothermal Resources, 3:2173-2180. [495]
- VonderHaar, S. and I. P. Cruz. 1979. "Fault Interactions and Hybrid Transform Faults in the Southern Salton Trough Geothermal Area, Baja Calif., Mexico." Geothermal Resource Council Annual Meeting, Reno, Nev. Lawrence Berkeley Laboratory. [510]

- Warman, J. C., F. J. Molz and T. E. Jones. 1977. Subsurface Waste Heat Storage: Experimental Study. ORO/5003-1. [513]
- White, D. E. and D. L. Williams. 1975. "Assessment of Geothermal Resources of the United States, 1975." USGS, Circular 726. [545]
- Witherspoon, P. A. 1978. Mexican-American Cooperative Program at the Cerro Prieto Geothermal Field. LBL-7095. [530]
- Wollenberg, H. A., R. E. Bowen, H. R. Bowman, and B. Strisower. 1979. Geochemical Studies of Rocks, Water, and Gases at Mt. Hood, Oregon. LBL-7092. [532]

### STES-RELATED DEMONSTRATIONS

- Adams, R. H. and A. M. Khan. 1969. "Cyclic Steam Injection Project Performance Analysis and Some Results of a Continuous Steam Displacement Pilot." Thermal Recovery Techniques. SPE Reprint Series, (10):62-69. [3]
- Allen, R. D. 1979. Thermal Energy Storage in Aquifers. An Overview. Battelle, Pacific Northwest Laboratories. [620]
- American Gas Association. 1978. "The Underground Storage of Gas in the United States and Canada." 28th Annual Report on Statistics, Committee on Underground Storage. [789]
- Anonymous. 1977. "Groundwater Aquifers for Solar Storage." Texas Energy and Mineral Resources. 3(7):4. [16]
- Besant, R. W. and C. B. Winn. 1976. "Cost Effective Solar Heating of Houses With Seasonal Storage of Energy." International Solar Energy Society, American Section, 4:409-424. [257]
- Bodvarsson, G. and J. Zoega. 1961. "Production and Distribution of Natural Heat for Domestic and Industrial Heating in Iceland." U.N. Conference on New Source of Energy, Jokull, 11:48-55. [245]
- Bundy, F. P., C. S. Herrick, and P. G. Kosky. 1976. "The Status of Thermal Energy Storage." Report No. 76CRD041. [58]
- Burlingame, M. V. 1965. "Aquifer Storage Ideal for Natural Gas." Pipe Line Industry, pp. 32-65. [655]
- Campbell, M. D. and J. H. Lehr. 1973. "Rural Water Systems Planning and Engineering Guide." Commission on Rural Water, Washington, DC. [60]

- Cavallieri, G. and G. Foligno. 1977. "Proposal for the Production and Seasonal Storage of Hot Water to Heat a City." Solar Energy, 19(6):677-683. [260]
- Collins, R. E. and K. E. Davis. 1976. "Geothermal Storage of Solar Energy for Electric Power Generation." Proc. International Conference on Solar Heating and Cooling, pp. 411-424. [74]
- Collins, R. E., J. R. Fanchi, G. O Morrell, K. E. Davis, T. K. Guha, and R. L. Henderson. \_\_\_\_\_. "High Temperature Underground Thermal Energy Storage." [75]
- Cormary, Y., P. Iris, J. P. Marie, G. deMarsily, H. Michel, and M. F. Saquine. \_\_\_\_\_. "Heat Storage in a Phreatic Aquifer: Compuget Experiment (Gard, France)." [78]
- Cortell, B. 1977. "Ground Water/Solar Heat." Water Well Journal, May, p. 73. [79]
- Culver, G. S., J. W. Lund, and L. S. Svanevik. 1974. "Klamath Falls Hot Water Well Study." Oregon Institute of Technology. [604]
- Davidson, R. R., W. B. Harris and J. H. Martin. 1975. "Storing Sunlight Underground. The Solaterre System." Chemtech, December, pp. 736-741. [86]
- Denis, L.H.D., A.J.H. Bedue, and Malherbaud. 1979. "Method of and Arrangement for the Seasonal Storage and Use of Hot Water Produced in Particular by Electrical Power-Generating Thermal and Nuclear Stations." Patent No. 4,159,736. [89]
- Desert Reclamation Industries. 1978. "Aquifer Storage at J. F. Kennedy International Airport." [92]
- Despois, J. and F. Nougarede. 1976. "Underground Storage of Heat." CONF-7605137-1 (trans). [93]
- Despois, J. and F. Nougarede. 1976. "Underground Storage of Heat." Presented to Annual Meeting, French Society of Heat Engineers, Thermal Aspects of Today's Energy Problems, Grenoble, France. [676]
- Despois, J. and F. Nougarede. 1977. "Underground Heat Storage." Revue Generale de Thermique, 184:357-366. [94]
- Dooley, J. L., G. P. Frost, L. A. Gore, R. P. Hammond, D. L. Rawson and S. L. Ridgeway. 1977. A Feasibility Study of Underground Energy Storage Using High-Pressure, High-Temperature Water. RDA-TR-7100-001 (CONS-1243-1). [630]



- Ebeling, L. L. and D. L. Reddell. 1976. Energy (Hot Water) Storage in Groundwater Aquifers. ASAE Paper No. 76-2540. [102]
- Energy Technology. 1978. Third Annual Proc. of Thermal Energy Storage Contractors' Information Exchange Meeting. CONF-781231. [108]
- ERDA and Electric Power Research Institute. 1975. Proceedings of the Workshop on Compressed Air Energy Storage System. ERDA-76-124. Energy Research Development Administration, Conservation Research and Technology Division. [783]
- Esmail, O. J. and O. K. Kimbler. 1967. "Investigation of the Technical Feasibility of Storing Fresh Water in Saline Aquifers." Water Resources Research, 3(3):683-695. [114]
- Fox, E. C. and J. F. Thomas. \_\_\_\_\_. A Preliminary Economic Analysis of Aquifer Winter-Chill Storage at the John F. Kennedy Airport. ORNL/TM-6876. [118]
- Givoni, B. 1977. "Underground Longterm Storage of Solar Energy - An Overview." Solar Energy, 19:617-623. [135]
- Givoni, B. 1979. "Store Energy in the Ground." Chem.Tech., pp. 384-390. [685]
- Gringarten, A. C. and J. P. Sauty. 1975. "Simulation des Transferts de Chaleur dans Les Aquiferes." Bulletin B.R.G.M., Section III(1):25-34. [149]
- Guha, T. K., K. E. Davis, R. E. Collins, J. R. Fanchi and A. C. Meyers. 1977. "Manmade Geothermal Energy." Alternative Energy Sources and International Compendium, Vol. 6, Geothermal Energy and Hydropower. T. N. Verziroglu (ed.), pp. 2641-2654. [151]
- Hammond, A. L. 1972. "Conservation of Energy: The Potential for More Efficient Use." Science, 178:1079-1081. [ ]
- Hausz, W. 1974. "Heat Storage Wells Conserve Fuels." Symposium Papers - Efficient Use of Fuels in the Metallurgical Industries, pp. 185-201. [166]
- Hausz, W. 1976. "Annual Storage: A Catalyst For Conservation." General Electric TEMPO. [164]
- Hausz, W. 1977. "Seasonal Storage in District Heating." District Heating, July-August-September, pp. 5-11. [168]
- Hausz, W. 1979. Thermal Storage and Transport Briefing Charts. GE-TEMPO. [169]

- Hausz, W., B. J. Berkowitz and R. C. Hare. 1978. Conceptual Design of Thermal Energy Storage Systems for Near Term Electric Utility Applications. DOE/NASA/0012-78/1, Vol 1 and 2. (Vol 1: Screening Concepts; Vol. 2: Appendices - Screening of Concepts.) [170]
- Hausz, W. and C. F. Meyer. 1979. Technical Aspects of Thermal Storage in Aquifers. GE-TEMPO. [172]
- Hellstrom, G. \_\_\_\_\_. "Aquifer Storage Projects in Sweden." Dept. of Mathematical Physics, Lund Institute of Technology. [179]
- Hoffman, H. 1978. "Overview of Aquifer Thermal Energy Storage Program." Thermal Energy Storage in Aquifers Workshop. [186]
- Hoffman, H. W. \_\_\_\_\_. "Aquifers for Seasonal Thermal Energy Storage: An Overview of the DOE-STOR Program." CONF 7805131-1. [282]
- Hoffman, H. W.; S. K. Fraley and R. J. Kedl. 1977. Proceedings of the Second Annual Thermal Energy Storage Contractors' Information Exchange Meeting. CONF-770955. [187]
- Holt, L., R. Jones and G. Hagey. 1978. Environmental Development Plan (EDP) Energy Storage Systems, FY1977. DOE/EDP-0015. [622]
- "House on Ice." 1979. Ground Water Age, May, pp. 16-19. [192]
- Jank, R. \_\_\_\_\_. "Aquifer Storage Efforts in Germany." Projektleitung Energieforschung in der Kernforschungsanlage Julich. [211]
- Katter, L. B. and R. L. Hoskins. 1978. Application of Thermal Energy Storage to Process Heat and Waste Heat Recovery in the Primary Aluminum Industry. CONS/5080-1. [878]
- Katz, D. L. and M. R. Bek. 1970. "Storage of Natural Gas in Saline Aquifers." Water Resources Research, 6(5):1515-1521. [221]
- Kazmann, R. G. 1978. "Underground Hot Water Storage Could Cut National Fuel Needs 10%." Civil Engineering, 48(5):57-60. [227]
- Kazmann, R. G. 1971. "Exotic Uses of Aquifers." Journal of the Irrigation Division ASCE, 97(IR3):515-522. [224]
- Kemper, W. D., W. R. Walker and J. Sabey. \_\_\_\_\_. "Trans-Seasonal Storage of Energy in Moist Soils." [231]
- Kley, W. and H. G. Mielckens. 1975. "Möglichkeiten der Warmespeicherung in Einem Porengrundwasserleiter und Technische Probleme bei einer Rückgewinnung der Energie." Z. dt. Geol. Ges., 126:397-409. [239]

- Kovach, E. G. 1976. Thermal Energy Storage. Scientific Affairs Division, North Atlantic Treaty Organization: Brussels, BELGIUM. [625]
- Krishnaswamy, V. S. and R. Shankar. 1974. "Geothermal Fields in India Explored for Power Generation." Geothermics, 3:124-125. [287]
- Leggette, R. M. and M. L. Brashears, Jr. 1938. "Ground-Water for Air Conditioning on Long Island, New York." Transactions, American Geophysical Union, 19:412-418. [310]
- Lienau, P. J. and J. W. Lund. \_\_\_\_\_. "Utilization and Economics of Geothermal, Space Heating in Klamath Falls, Oregon." Oregon Institute of Technology. [317]
- Lund, J. W., P. J. Lienau, G. G. Culver, and C. V. Higbee. \_\_\_\_\_. "Klamath Falls Geothermal Heating District." [327]
- Margen, P. 1978. "The Use of Nuclear Energy for District Heating." Progress in Nuclear Energy, 2:1-28. [334]
- Meyer, C. F. 1973. "Are Heat-Storage Wells the Answer?" Electrical World, August 15, pp. 42-45. [351]
- Meyer C. F. 1976. "Status Report on Heat Storage Wells." Water Resources Bulletin, 12(2):237-252. [352]
- Meyer, C. F. 1977. "Heat Storage Wells: Key to Large-Scale Cogeneration?" Public Power, July-August, pp. 28-30. [353]
- Meyer, C. F. 1978. "Evaluation of Thermal Energy Storage for the Proposed Twin Cities District Heating System." Third Annual Thermal Energy Storage Contractor's Information Exchange Meeting. [354]
- Meyer, C. F. 1978. "Large Scale Thermal Energy Storage for Cogeneration and Solar Systems." 5th Energy Technology Conference and Exposition. [355]
- Meyer, C. F. 1979. Potential Benefits of Thermal energy Storage in the Proposed Twin Cities District Heating - Cogeneration System. ORNL/SUB-7604-I. [877]
- Meyer, C. F. and W. Hausz. \_\_\_\_\_. A New Concept in Electric Generation and Energy Storage. GE-TEMPO. [363]
- Meyer, C. F., W. Hausz, B. L. Ayres and H. M. Ingram. 1976. Role of the Heat Storage Well in Future U.S. Energy Systems. GE76TMP-27A. [357]
- Meyer, C. F. and D. K. Todd. 1973. "Conserving Energy with Heat Storage Wells." Environmental Science and Technology, 7(6):512-516. [358]

- Meyer, C. F. and D. K. Todd. 1973. "Heat-Storage Wells." Water Well Journal, 27:35-41. [359]
- Meyer, C. F. and D. K. Todd. 1973. "Heat-Storage Wells for Conserving Energy and Reducing Thermal Pollution." 8th Intersociety Energy Conversion Engineering Conference. [360]
- Meyer, C. F. and D. K. Todd. 1974. "Brunnen als Warmespeicher eine glichkeit, Energie zu Sparen und Thermische Umweltbelastung zu Verhuten?" Braunkohle, 26(9):275-280. [567]
- Meyer, C. F., D. K. Todd and R. C. Hare. 1972. Thermal Storage for Eco-Energy Utilities. GE72TMP-56. [361]
- Molz, F. J., A. D. Parr, P. F. Anderson, V. D. Lucido, and J. C. Warman. 1979. Thermal Energy Storage in Confined Aquifers. Water Resources Research Institute, Auburn University. [626]
- Molz, F. J. and J. Warman. 1978. "Aquifer Storage of Heat." Water Well Journal, February, pp. 46-47. [369]
- Molz, F. J., J. C. Warman and T. E. Jones. 1978. "Aquifer Storage of Heated Water: Part I - A Field Experiment." Ground Water, 16(4):234-241. [370]
- Molz, F. J., J. C. Warman, T. E. Jones and G. E. Cook. 1976. "Experimental Study of the Subsurface Transport of Water and Heat as Related to the Storage of Solar Energy." Storage, Water Heater, Data Communication Education, 8:238-244. [371]
- Moulder, E. A. 1970. "Freshwater Bubbles: A Possibility for Using Saline Aquifers to Store Water." Water Resources Research, 6(5):1528-1531. [374]
- Oliker, I. 1977. "Heat Exchanger and Thermal Storage Problems in Power Stations Serving District Heating Networks." ASME Paper 77-HT-36. [393]
- Papadopoulos, S. S. and S. P. Larson. 1978. "Aquifer Storage of Heated Water: Part II - Numerical Simulation of Field Results." Ground Water, 16(4):242-248. [399]
- Qvale, E. B. \_\_\_\_\_. "The Danish Seasonal Aquifer Warm Water - Storage Program." Laboratory for Energetics, Technical University of Denmark. [420]
- Qvale, E. B. 1976. "Seasonal Storage of Thermal Energy in Water in the Underground." Eleventh Intersociety Energy Conversion Engineering Conference Proceedings, pp. 628-635. [421]

- Rabbimov, R. T., G. Y. Umarov and R. A. Zakhidov. 1971. "Storage of Solar Energy in a Sandy-Gravel Ground." Geliotekhnika, 7(5):57-64. [422]
- Ridgeway, S. L. and J. L. Dooley. 1976. "Underground Storage of Off-Peak Power." Eleventh Intersociety Energy Conversion Engineering Conference Proceedings, pp. 586-590. [429]
- Rogers, F. C. and W. E. Larson. 1974. "Underground Energy Storage." American Power Conference 36th Annual Meeting, Chicago, IL, 36:369-378. [735]
- Sather, N. F., L. G. Lewis, G. T. Kartsounes, and H. H. Chiu. 1976. "Compressed Air Energy Storage Systems Studies." NTIS, TID-28797. [739]
- Schaetzle, W. J., C. E. Brett and J. M. Calm. 1978. Heat Pump Centered Integrated Community Energy Systems. Argonne National Laboratory. [ ]
- Smith, G. C., J. A. Stottlemire, L. E. Wiles, W. V. Loscutoff, and H. J. Pincus. 1978. FY-1977 Progress Report. Stability and Design Criteria Studies for Compressed Air Energy Storage Reservoirs. PNL-2443. [458]
- Smith, C. G. and J. S. Hanor. 1977. "Underground Storage of Treated Water: A Field Test." Groundwater, 13(5):410-417. [456]
- Stracke, K. J., D. C. Mason, and R. G. Altman. 1969. "Cyclic Steam-Injection Operations - Guadalupe Field, California." Drilling Production and Practice - American Petroleum Institute, p. 35-39. [473]
- Studsvik. 1978. Minneapolis-St. Paul District Heating Study. ORNL/SUB-77/13502/4. [476]
- Surface, M. O. 1977. "Exotic Power and Energy Storage." Power Engineering, 81(12):36-44. [578]
- Thorsteinsson, T. 1975. "Redevelopment of the Reykir Hydrothermal System in Southeastern Iceland." Proceedings Second United Nations Symposium on the Development and Use of Geothermal Resources, 3:2173-2180. [495]
- Tsang, C. F. 1979. Current Aquifer Thermal Energy Storage Projects. LBL-9211. [501]
- Tsang, C. F., P. Fong, C. W. Miller and M. Lippmann. \_\_\_\_\_. Daily Sensible Heat Storage in Aquifers for Solar Energy Systems. Lawrence Berkeley Laboratories. [502]

- Tsang, C. F. and M. J. Lippman. 1977. "Thermal Energy Storage in Aquifers." Earth Sciences Division, Annual Report. LBL-7028, pp. 9-13. [503]
- U.S. Department of Energy, Division of Energy Storage Systems. 1979. "Thermal Energy Storage Application Areas." [550]
- U.S. Department of Energy. 1979. "Project Summary Data Thermal and Mechanical Energy Storage Program FY-1979." DOE/ET-0091. [771]
- U.S. Department of Energy, Electrical Power Research Institute, and Pacific Northwest Laboratory. 1978. "Compressed Air Energy Storage Symposium Proceedings, Volume I." CONF-780 599. [766]
- U.S. Department of Energy, Electrical Power Research Institute, and Pacific Northwest Laboratory. 1978. "Compressed Air Energy Storage Symposium Proceedings, Volume II." CONF-780 599. [767]
- U.S. Department of Energy. 1977. Interagency Coordination Meeting on Energy Storage." CONF-7709116. [871]
- Warman, J. C., F. J. Molz and T. E. Jones. 1976. "Step Beyond Theory - Aquifer Storage of Energy." Proceedings of the Second Southeastern Conference on Application of Solar Energy. CONF-760423, pp. 476-487. [512]
- Werner, D. and W. Kley. 1977. "Problems of Heat Storage in Aquifers." Journal of Hydrology, 34:35-43. [521]
- Witherspoon, P. A. and J. A. Apps. 1977. Fundamental Geosciences Program Annual Report 1977. LBL-7058. [531]

#### STES-RELATED EXPERIMENTS

- Adams, R. H. and A. M. Khan. 1969. "Cyclic Steam Injection Project Performance Analysis and Some Results of a Continuous Steam Displacement Pilot." Thermal Recovery Techniques. SPE Reprint Series, (10):62-69. [3]
- Alavian, V. 1973. "Design and Construction of a Research Station for the Study of Induced Vertical Mixing in a Thermally Stratified Pond Using Warm Water Discharge." M.S. thesis, Wisconsin University. (PB-237 701). [4]
- American Gas Association. 1978. "The Underground Storage of Gas in the United States and Canada." 28th Annual Report on Statistics, Committee on Underground Storage. [789]

- Cormary, Y., P. Iris, J. P. Marie, G. deMarsily, H. Michel, and M. F. Saquine. \_\_\_\_\_. "Heat Storage in a Phreatic Aquifer: Compuget Experiment (Gard, France)." [78]
- Fox, E. C. and J. F. Thomas. \_\_\_\_\_. A Preliminary Economic Analysis of Aquifer Winter-Chill Storage at the John F. Kennedy Airport. ORNL/TM-6876. [118]
- "Getting Steamed Up Over Waste Heat." 1979. Nature, 380:349. [275]
- Huyakorn, P. and C. R. Dudgeon. 1976. "Investigation of Two-Regime Well Flow." Journal of the Hydraulics Division ASCE, 102(HY9):1149-1165. [196]
- Johnson, W. C. \_\_\_\_\_. "Oregon Institute of Technology Aquaculture Using Geothermal Energy." [216]
- Kley, W. and H. G. Nieskens. 1975. "Möglichkeiten der Wärmespeicherung in Einem Porengrundwasserleiter und Technische Probleme bei einer Rückgewinnung der Energie." Z. dt. Geol. Ges., 126:397-409. [239]
- Kukacka, L. E., J. Fontana, A. Zeldin, T. Sugama, W. Horn, N. Carciello, and J. Amaro. 1977. Alternative Materials of Construction for Geothermal Applications. BNL-50751. [293]
- Kumar, A. and O. K. Kimbler. 1970. "Effect of Dispersion, Gravitational Segregation, and Formation Stratification on the Recovery of Freshwater Stored in Saline Aquifers." Water Resources Research, 6(6):1689-1700. [295]
- Leggette, R. M. and M. L. Brashears, Jr. 1938. "Ground-Water for Air Conditioning on Long Island, New York." Transactions, American Geophysical Union, 19:412-418. [310]
- Molz, F. J., A. D. Parr, P. F. Anderson, V. D. Lucido, and J. C. Warman. 1979. Thermal Energy Storage in Confined Aquifers. Water Resources Research Institute, Auburn University. [626]
- Molz, F. J., J. C. Warman and T. E. Jones. 1978. "Aquifer Storage of Heated Water: Part I - A Field Experiment." Ground Water, 16(4):234-241. [370]
- Molz, F. J., J. C. Warman, T. E. Jones and G. E. Cook. 1976. "Experimental Study of the Subsurface Transport of Water and Heat as Related to the Storage of Solar Energy." Storage, Water Heater, Data Communication Education, 8:238-244. [371]

- Papadopoulos, S. S. and S. P. Larson. 1978. "Aquifer Storage of Heated Water: Part II - Numerical Simulation of Field Results." Ground Water, 16(4):242-248. [399]
- Rabbimov, R. T., G. Y. Umarov and R. A. Zakhidov. 1974. "Experimental Study of Aquifer Heating in Solar-Energy Accumulation." Geliotekhnika, 10(2):20-27. [423]
- Rahman, M. A., E. T. Smerdon, and E. A. Hiler. 1969. "Effect of Sediment Concentration on Well Recharge in a Fine Sand Aquifer." Water Resources Research, 5(3):641-646. [425]
- Schrock, V. E. and A. D. K. Laird. 1976. "Physical Modeling of Combined Forced and Natural Convection in Wet Geothermal Formations." Journal Heat Transfer, May, pp. 213-220. [879]
- Sepaskhah, A. R., L. Boersma, L. R. Davis and D. L. Slegel. 1973. "Experimental Analysis of a Subsurface Soil Warming and Irrigation System Utilizing Waste Heat." Winter Annual Meeting of American Society of Mechanical Engineers. Paper No. 73-WA/HT-11. [880]
- Vetter, O. J., D. A. Campbell, and M. J. Walker. 1978. Geothermal Fluid Investigations at RGI's East Mesa Test Site. PNL-2556. [508]
- Warman, J. C., F. J. Molz and T. E. Jones. 1977. Subsurface Waste Heat Storage: Experimental Study. ORO/5003-1. [513]
- Werner, D. and W. Kley. 1977. "Problems of Heat Storage in Aquifers." Journal of Hydrology, 34:35-43. [521]
- Wooding, R. A. 1958. "An Experiment on Free Thermal Convection of Water in Saturated Permeable Material." Journal of Fluid Mechanics, 3:582-600. [621]
- Wooding, R. A. 1962. "Free Convection of Fluid in a Vertical Tube Filled with Porous Material." Journal of Fluid Mechanics, 13:129-144. [536]

#### STES-RELATED MATHEMATICAL AND COMPUTER MODELING

- Aziz, K., S. A. Bories, and M. A. Combarous. 1973. "The Influence of Natural Convection in Gas, Oil and Water Reservoirs." Journal of Canadian Petroleum Technology, 12:41-47. [20]
- Bachmat, Y., B. Andrews, D. Holtz, and S. Sebastian. 1978. Utilization of Numerical Groundwater Models for Water Resource Management. EPA-600/8-78-012, PB-285 782. [21]



- Birtles, A. B. and M. J. Reeves. 1977. "A Simple Effective Method for the Computer Simulation of Groundwater Storage and its Application in the Design of Water Resource Systems." Journal of Hydrology, 34:77-96. [31]
- Birtles, A. B. and M. J. Reeves. 1977. "Computer Modeling of Regional Groundwater Systems in the Confined-Unconfined Flow Regime." Journal of Hydrology, 34(1/2):97-127. [256]
- Blake, T. R. and S. K. Garg. 1976. "On the Species Transport Equation for Flow in Porous Media." Water Resource Research, 12(4):748-750. [32]
- Bodvarsson, G. 1969. "On the Temperature of Water Flowing through Fractures." Journal of Geophysical Research, 74(8):1987-1992. [38]
- Bodvarsson, G. 1971. "Approximation Methods for Equivalent Strata." Journal of Geophysical Research, 76(17):3932-3989. [39]
- Bodvarsson, G. 1973. "Downward Continuation of Constrained Potential Fields." Journal of Geophysical Research, 78(8):1288-1292. [40]
- Bodvarsson, G. 1977. "Unconfined Aquifer Flow with Linearized Free Surface Condition." Jokull, 27:84-87. [36]
- Briggs, J. B. and C. J. Shaffer. 1977. "Seasonal Heat Pump Performance for a Typical Northern United States Environmental." Tree-1181. [55]
- Combarous, M. A. and S. A. Bories. 1975. "Hydrothermal Convection in Saturated Porous Media." Advances in Hydroscience, 10:231-307. [628]
- Cooley, R. L. and A. B. Cunningham. 1977. "Consideration of Total Energy Loss in Theory of Flow to Wells." NTIS, PB-264 717. [597]
- Cooper, H. H. and C. E. Jacob. 1946. "A Generalized Graphical Method for Evaluating Formation Constants and Summarizing Well-Field History." Transactions, American Geophysical Union, 27(IV):526-534. [77]
- Culver, G. and G. M. Reistad. \_\_\_\_\_. "Evaluation and Design of Downhole Heat Exchangers for Direct Application." [84]
- Culver, G. and G. M. Reistad. \_\_\_\_\_. "Testing and Modeling of Downhole Heat Exchangers in Swallow Geothermal Systems." [85]
- Donaldson, I. G. 1962. "Temperature Gradients in the Upper Layers of the Earth's Crust Due to Convective Water Flows." Journal of Geophysical Research, 67(9):3449-3459. [98]

- Edwards, A. L. 1972. TRUMP: A Computer Program for Transient and Steady-State Temperature Distributions in Multidimension Systems. UCRL-14754, Rev. 3. [104]
- Faust, C. R. and J. W. Mercer. 1977. "Finite-Difference Model of Two-Dimensional, Single, and Two-Phase Heat Transport in a Porous Medium - Version 1." Open File Report 77-234. [115]
- Fenske, P. R. 1977. "Radial Flow with Discharging Well and Observation Well Storage." Journal of Hydrology, 32:87-96. [116]
- Fenske, P. R. 1977. "Type Curves for Recovery of a Discharging Well with Storage." Journal of Hydrology, 33:341-348. [117]
- Gambolati, G. 1977. "Deviations From the Thesis Solution in Aquifers Undergoing Three-Dimensional Consolidation." Water Resources Research, 13(1):62-68. [121]
- Gambolati, G., P. Gatto, and R. A. Freeze. 1974. "Mathematical Simulations of the Subsidence of Venice 2 - Results." Water Resource Research, 10(3):563-577. [276]
- Glover, R. E. and W. T. Moody. 1976. "Drawdown Due to Pumping in an Anisotropic Aquifer." Water Resource Bulletin, 12(5):941-950. [137]
- Goranson, C. B. and R. C. Schroeder. 1979. Site Specific Geothermal Reservoir Engineering Activities at Lawrence Berkeley Laboratory. LBL-9463. [138]
- Goyal, K. P. and D. R. Kassoy. 1978. Heat and Mass Transfer Studies of the East Mesa Anomaly. Presented at Fourth Workshop Geothermal Reservoir Eng. LBL-9330. [690]
- Gray, W. G. and K. O'Neill. 1976. "On the General Equations for Flow in Porous Media and Their Reduction to Darcy's Law." Water Resources Research, 12(2):148-154. [144]
- Green, M. A., H. S. Pines, W. L. Pope, and J. D. Williams. 1977. Thermodynamic and Cost Optimization Using Program GEOTHM. LBL-6303. [147]
- Gregg, D. O. and K. G. Kennedy. 1975. "Movement of Chemical Contaminants in Ground Water." Environmental Aspects of Chemical Use in Well Drilling Operations, EPA-560/1-75-004, pp. 289-309. [145]
- Gringarten, A. C. and J. P. Sauty. 1975. "A Theoretical Study of Heat Extraction from Aquifers with Uniform Regional Flow." Journal of Geophysical Research. 80(35):4956-4962. [148]

- Gringarten, A. C. and J. P. Sauty. 1975. "Simulation des Transferts de Chaleur dans Les Aquiferes." Bulletin B.R.G.M., Section III(1):25-34. [149]
- Gupta, S. K., K. K. Tanji, and J. N. Luthin. 1975. "A Three-Dimensional Finite Element Ground Water Model." PB-248-925. [153]
- Hansen, V. E. 1952. "Complicated Well Problems Solved by the Membrane Analogy." Transactions, American Geophysical Union, 33(6):912-916. [157]
- Hantush, M. S. 1967. "Flow to Wells in Aquifers Separated by a Semi-impervious Layer." J. Geophysical Research, 72(6):1709-1720. [281]
- Hantush, J. S. 1967. "Growth and Decay of Groundwater-Mounds in Response to Uniform Percolation." Water Resources Research, 3(1):227-234. [159]
- Hantush, M. S. and C. E. Jacob. 1954. "Plane Potential Flow of Ground Water with Linear Leakage." Transactions, American Geophysical Union, 35(6):917-936. [160]
- Hantush, M. S. and C. E. Jacob. 1955. "Non-Steady Radial Flow in an Infinite Leaky Aquifer." Transactions, American Geophysical Union, 36(1):95-100. [161]
- Hantush, M. S. and C. E. Jacob. 1960. "Flow to an Eccentric Well in a Leaky Circular Aquifer." Journal of Geophysical Research, 65(10):3425-3431. [162]
- Hausz, W. 1978. The Need for a Heat Storage Well System Model. GE-TEMPO. [167]
- Helm, D. C. 1975. "One-Dimensional Simulation of Aquifer System Compaction Near Pixley, CA: 1. Constant Parameters." Water Resources Research, 2(3):465-478. [284]
- Holzschuh, J. C. 1976. "A Simple Computer Program for the Determination of Aquifer Characteristics from Pump Test Data." Ground Water, 14(5):283-285. [189]
- Horton, C. W. and F. T. Rogers. 1945. "Convection Currents in a Porous Medium." Journal of Applied Physics, 16:367-370. [190]
- "How to Calculate Heat Transmission in Hot Fluid Injection." 1964. Petroleum Engineer, November, pp. 110-120. [194]
- Huber, H. D., C. L. McDonald, C. H. Bloomster, and S. C. Schulte. 1978. User Manual for Geocity: A Computer Model for Geothermal District Heating Cost Analysis. PNL-2742. [195]

- Intercomp Resource Development and Engineering, Inc. 1976. A Model for Calculating Effects of Liquid Waste Disposal in Deep Saline Aquifer: Part I - Development; Part II - Documentation. PB-256 903. [199]
- Jacob, C. E. 1940. "On the Flow of Water in an Elastic Artesian Aquifer." Transactions, American Geophysical Union, 21:574-586. [201]
- Jacob, C. E. 1943. "Correlation of Ground-Water Levels and Precipitation on Long Island, NY: Part 1 - Theory." Transactions, American Geophysical Union, 24:564-573. [203]
- Jacob, C. E. 1946. "Radial Flow in a Leaky Artesian Aquifer." Transactions, American Geophysical Union, 27(2):198-205. [205]
- Jacob, C. E. and S. W. Lohman. 1952. "Nonsteady Flow to a Well of Constant Drawdown in an Extensive Aquifer." Transactions, American Geophysical Union, 33(4):559-569. [209]
- Kassoy, D. R. 1975. "Heat and Mass Transfer in Models of Undeveloped Geothermal Fields." Proceedings Second U.N. Symposium on the Development and Use of Geothermal Resources, 3:1707-1711. [219]
- Kumar, A. and O. K. Kimbler. 1970. "Effect of Dispersion, Gravitational Segregation, and Formation Stratification on the Recovery of Freshwater Stored in Saline Aquifers." Water Resources Research, 6(6):1689-1700. [295]
- Lakshminarayana, V. and S. P. Rajagopalan. 1978. "Type-Curve Analysis of Time-Drawdown Data for Partially Penetrating Wells in Unconfined Anisotropic Aquifers." Ground Water, 16(5):328-333. [298]
- Lapwood, E. R. 1948. "Convection of a Fluid in a Porous Medium." Proc. Cambridge Phil. Soc., 44:508-521. [301]
- Lauwerier, H. A. 1955. "The Transport of Heat in an Oil Layer Caused by the Injection of Hot Fluid." Applied Sci. Research, Section A, 5:145-150. [302]
- Lippman, M. J. \_\_\_\_\_. "Thermal Energy Storage in Aquifers Analytical Modeling at LBL." [320]
- Lippman, M. J., T. N. Narasimhan, and P. A. Witherspoon. 1977. "Modeling Subsidence Due to Geothermal Fluid Production." ASCE 3107. [321]
- Malofeev, G. E. 1960. "Calculation of the Temperature Distribution in a Formation When Pumping Hot Fluid into a Well." Neft' i Gaz, 3(7):59-64. [782]

- Mathey, B. 1977. "Development and Resorption of a Thermal Disturbance in a Phreatic Aquifer with Natural Convection." Journal of Hydrology, 34:315-333. [338]
- McCain, W. D. and T. D. Stacy. 1971. "A Method of Correlation of High Temperature, High Pressure Gas - Solid Adsorption Data." Society of Petroleum Engineers Journal, March, pp. 4-6. [ ]
- McDonald, C. L. and C. H. Bloomster. 1977. The Geocity Model: Description and Application. BNWL-SA-6343. [341]
- Mercer, J. W., G. F. Pinder and I. G. Donaldson. 1975. "A Galerkin - Finite Element Analysis of the Hydrothermal System at Wairakei, NEW ZEALAND." Journal of Geophysical Research, 80(17):2608-2621. [348]
- Miller, C. W. 1979. A Numerical Model of Transient Two Phase Flow in a Geothermal Well. LBL-9056. [366]
- Molz, F. J. and L. C. Bell. 1977. "Head Gradient Control in Aquifers Used for Fluid Storage." Water Resources Research, 13(4):795-798. [368]
- Moss, J. T. and P. D. White. 1959. "How to Calculate Temperature Profiles in a Water Injection Well." Oil and Gas Journal, 57:174-178. [373]
- Moulder, E. A. 1970. "Freshwater Bubbles: A Possibility for Using Saline Aquifers to Store Water." Water Resources Research, 6(5):1528-1531. [374]
- Narasimhan, T. N. and P. A. Witherspoon. 1976. "Numerical Model for Land Subsidence in Shallow Groundwater Systems." International Association of Hydrological Sciences Proceedings of the Anaheim Symposium, p. 133-143. [383]
- Narasimhan, T. N. and P. A. Witherspoon. 1976. "An Integrated Finite Difference Method for Analyzing Fluid Flow in Porous Media." Water Resources Research, 12(1):57-64. [384]
- Narasimhan, T. N. and P. A. Witherspoon. 1978. "Numerical Model for Saturated-Unsaturated Flow in Deformable Porous Media: 2. The Algorithm." Water Resources Research, 14(2):255-261. [385]
- Narasimhan, T. N. and P. A. Witherspoon. 1978. "Numerical Model for Saturated-Unsaturated Flow in Deformable Porous Media: 3. Applications." Water Resources Research, 14(6):1017-1033. LBL-7037. [386]
- Neuman, S. P. and T. N. Narasimhan. 1975. Mixed Explicit-Implicit Iterative Finite Element Scheme for Diffusion-Type Problems: I. Theory. LBL-4405. [387]

- Oster, C. A. 1976. Well-Hole Temperature Distribution in the Presence of Aquifers. BNWL-SA-5658. [395]
- Potter, R. W. 1979. "Reviews of Geophysics and Space Physics computer Modeling in Low Temperature Geochemistry." Paper #9R0355. U.S. Geological Survey, 17(4):850-860. [731]
- Pruess, K., G. Bodvarsson, R. C. Schroeder, P. A. Witherspoon, R. Marconcini, G. Neri, and C. Ruffilli. 1979. Simulation of the Depletion of Two-Phase Geothermal Reservoirs. LBL-9606. [443]
- Pruess, K., J. M. Zerzan, and R. C. Schroeder. 1979. "Description of the Three-Dimensional Two-Phase Simulator Shaft 78 for Use in Geothermal Reservoir Studies." SPE-7699. [440]
- Qvale, E. B. 1976. "Seasonal Storage of Thermal Energy in Water in the Underground." Eleventh Intersociety Energy Conversion Engineering Conference Proceedings, pp. 628-635. [421]
- Ramey, H. J. 1962. "Wellbore Heat Transmission." Journal of Petroleum Technology, April, pp. 427-435. [527]
- Roache, P. J. and T. S. Mueller. 1970. "Numerical Solutions of Laminar Separated Flows." AIAA J., 8(3):530-538. [430]
- Rushton, K. R. and L. M. Tomlinson. 1976. "Permissible Mesh Spacing in Aquifer Problems Solved by Finite Differences." Journal of Hydrology, 34:63-76. [439]
- Salieva, R. B. and R. P. Saliev. 1975. "Principles of Technological-Economic Calculations in Solar Technology." Geliotekhnika, 11(5):44-51. [445]
- Schreiber, D. L., A. E. Reisenauer, K. L. Kipp, and R. T. Jaske. 1973. Anticipated Effects of an Unlined Brackish-Water Canal on a Confined Multiple-Aquifer System. BNWL-1800. [450]
- Smith, C. R. and S. J. Pirson. 1963. "Water Coning Control in Oil Wells by Fluid Injection." Society of Petroleum Engineers Journal, 3:314-326. [457]
- Sneddon, I. N. 1946. "The Distribution of Stress in the Neighborhood of a Crack in an Elastic Solid." Proceedings, Royal Society, Series A 187:229-260. [461]
- Solomon, A. D. \_\_\_\_\_. "On Modeling for Moving Boundary Problems." CONF 79034-I, pp. 1-20. [747]
- Sorey, M. L. 1978. Numerical Modeling of Liquid Geothermal Systems. USGS, Professional Paper 1044-D. [464]

- Spillette, A. G. 1965. "Heat Transfer During Hot Fluid Injection into an Oil Reservoir." Society of Petroleum Engineers of AIME, Thermal Recovery Techniques, SPE Reprint Series 10:21-16. [467]
- Stallman, R. W. 1956. "Numerical Analysis of Regional Water Levels to Define Aquifer Hydrology." Transactions, American Geophysical Union, 37(4):451-460. [469]
- Streltsova, T. D. and K. R. Rushton. 1973. "Water Table Drawdown Due to a Pumped Well in an Unconfined Aquifer." Water Resources Research, 9(1):236-242. [475]
- Swartzenbruber, D. 1962. "Non-Darcy Flow Behavior in Liquid-Saturated Porous Media." Journal of Geophysical Research, 67(13):5205-5213. [485]
- Theis, C. V. 1938. "The Significance and Nature of the Cone of Depression in Ground-Water Bodies." Economic Geology, 33:889-902. [491]
- Truesdell, A. H. and W. Singers. 1974. "The Calculation of Aquifer Chemistry in Hotwater Geothermal Systems." Journal Research, USGS, 2(3)271-278. [500]
- Tsang, C. F., M. J. Lippmann, C. B. Goranson, and P. A. Witherspoon. 1977. Numerical Modeling of Cyclic Storage of Hot Water in Aquifers. LBL-5929. [504]
- U.S. Environmental Protection Agency. 1974. "Proceedings of the Second National Ground Water Quality Symposium." [770]
- Warman, J. C., F. J. Molz and T. E. Jones. 1976. "Step Beyond Theory - Aquifer Storage of Energy." Proceedings of the Second Southeastern Conference on Application of Solar Energy. CONF-760423, pp. 476-487. [512]
- Willhite, G. P. 1967. "Over-all Heat Transfer Coefficients in Steam and Hot Water Injection Wells." Journal of Petroleum Technology, May, pp. 607-615. [524]
- Willhite, G. P. and J. Wagner. 1974. Disposal of Heated Water Through Ground Water Systems. Vol. II. User's Manual. Numerical Simulation of Fluid Flow and Heat Transfer in Ground Water Systems. Kansas Water Resources Research Institute. Contribution No. 134. (PB-236-303). [526]
- Willhite, G. P., J. Wagner, F. Simonpictri and J. Stoker. 1974. Disposal of Heated Water Through Ground Water Systems. Vol. I. Technical and Economic Feasibility. Kansas Water Resources Research Institute. Contribution No. 134. (PB-236-302). [527]

- Wooding, R. A. 1957. "Steady-State Free Thermal Convection of Liquid in a Saturated Permeable Medium." Journal of Fluid Mechanics, 2:273-285. [534]
- Wooding, R. A. 1958. "An Experiment on Free Thermal Convection of Water in Saturated Permeable Material." Journal of Fluid Mechanics, 3:582-600. [621]
- Wooding, R. A. 1960. "Rayleigh Instability of a Thermal Boundary Layer in Flow Through a Porous Medium." Journal of Fluid Mechanics, 9:183-192. [535]
- Wooding, R. A. 1962. "Free Convection of Fluid in a Vertical Tube Filled with Porous Material." Journal of Fluid Mechanics, 13:129-144. [536]
- Wooding, R. A. 1964. "Mixing-Layer Flows in a Saturated Porous Medium." Journal of Fluid Mechanics, 19:103-113. [537]
- Wooding, R. A. and H. J. Morel-Seytoux. 1976. "Multiphase Fluid Flow Through Porous Media." Annual Review of Fluid Mechanics, 8:233-274. [538]
- Wyllie, M. R. J. and M. B. Spangler. 1952. "Application of Electrical Resistivity Measurements to Problem of Fluid Flow in Porous Media." Bulletin of American Association of Petroleum Geologists, 36(2):359-403. [539]

#### TECHNOLOGY TRANSFER TO PUBLIC

- Carver, J. A. \_\_\_\_\_. "Institutional Aspects of Utilizing Heat Storage in Aquifers - A Proposal for a Prototype Test." University of Denver. [61]
- Carver, J. A. 1975. "Legal and Institutional Planning for Macro-Conservation Measures." Public Utilities Fortnightly, 95(9):29-33. [62]
- Energy Technology. 1978. Third Annual Proc. of Thermal Energy Storage Contractors' Information Exchange Meeting. CONF-781231. [108]
- Manahan, S. E. 1976. Information Dissemination in the Water Resources Field. PB-260 486. [333]

#### THERMAL FATIGUE OF RESERVOIR AND WELL MATERIALS

- Aruna, M., N. Arihara and H. J. Ramey, Jr. 1977. "The Effect of Temperature and Stress on the Absolute Permeability of Sandstones and Limestones." CONF-770440, pp. 541-550. [18]



- Barbish, A. B. and G. H. F. Gardner. 1969. "The Effect of Heat on Some Mechanical Properties of Igneous Rocks." Society of Petroleum Engineers, AIME, SPE-2395. [641]
- Loy, S. E. 1975. "Techniques of Deep Well Drilling." Environmental Aspects of Chemical Use in Well-Drilling Operations, EPA-560/1-75-004, pp. 11-25. [324]
- Panel on Rock Mechanics Problems that Limit Energy Resource Recovery and Development. 1978. Limitations of Rock Mechanics in Energy-Resource Recovery and Development. The National Research Council. [398]
- Ratigan, J. L. 1976. "Analysis of the Potential for Thermally-Induced Rock Fracture Around Emplaced Heat Storage." Presented Int'l Joint Petroleum Mechanical Engineering and Pressure Vessel and Piping Conference. [735]
- Sanyal, S. K., S. S. Marsden, Jr., and H. J. Ramey, Jr. 1974. "Effect of Temperature on Petrophysical Properties of Reservoir Rocks." Society of Petroleum Eng., AIME, SPE-4898. [738]
- Sneddon, I. N. 1946. "The Distribution of Stress in the Neighborhood of a Crack in an Elastic Solid." Proceedings, Royal Society, Series A 187:229-260. [461]
- Stracke, K. J., D. C. Mason, and R. G. Altman. 1969. "Cyclic Steam-Injection Operations - Guadalupe Field, California." Drilling Production and Practice - American Petroleum Institute, p. 35-39. [473]
- Subcasky, W. J. \_\_\_\_\_. "Petroleum Industry Experience in Water Injection." [477]
- Weinbrandt, R. M., H. J. Ramey and F. J. Casse. 1975. "The Effect of Temperature on Relative and Absolute Permeability of Sandstones." Society of Petroleum Engineers Journal, October, pp. 376-384. [518]
- Willhite, G. P. and W. K. Dietrich. 1966. "Design Criteria for Completion of Steam Injection Wells." Society of Petroleum Engineers of AIME, (10):62-69. [525]
- Wingquist, C. F. 1976. "Elastic Moduli of Rock at Elevated Temperatures." U.S. Bureau of Mines, RI-7269. [769]
- Witherspoon, P. A. 1978. Swedish-American Cooperative Program on Radioactive Waste Storage in Mined Caverns Program Summary. LBL-7049. [533]
- Zoback, M. D. 1976. "Effect of High-Pressure Deformation on Permeability of Ottawa Sand." American Association of Petroleum Geologists Bulletin, 60(9):1531-1542. [542]

## WATER QUALITY

- Ackerman, T. V. and E. J. Lynde. 1944. "Effect of Storage Reservoir Detritus on Ground Water." American Water Works Association Journal, 36:315-322. [2]
- Alavian, V. 1973. "Design and Construction of a Research Station for the Study of Induced Vertical Mixing in a Thermally Stratified Pond Using Warm Water Discharge." M.S. thesis, Wisconsin University. (PB-237 701). [4]
- Andrews, C. B. and M. P. Anderson. 1979. "Thermal Alteration of Groundwater Caused by Seepage from a Cooling Lake." Groundwater, 15(3):595-602. [15]
- Anonymous. \_\_\_\_\_. "Groundwater Heat Pump Effluent Disposal Regulations by State." [244]
- Baier, D. C. and G. M. Wesner. 1971. "Reclaimed Wastewater for Groundwater Recharge." Water Resources Bulletin, 7(5):991-1001. [240]
- Balashov, L. S. 1975. "Rare Elements in Thermal Ground Water." Proceedings Second United Nations Symposium on the Development and Use of Geothermal Resources, p. 2187-2195. [23]
- Bodvarsson, G. 1972. "Thermal Problems in the Siting of Reinjection Wells." Geothermics, 1(2):63-66. [249]
- Bolton, P. 1961. "Prevention of Water Source Contamination." American Water Works Association Journal, 53(10):1243-1250. [47]
- Brashears, M. L. 1941. "Ground Water Temperature on Long Island, New York, as Affected by Recharge of Warm Water." Economic Geology, 36:811-828. [53]
- Campbell, M. D. and G. F. Gray. 1975. "Mobility of Well-Drilling Additives in the Ground-Water System." Environmental Aspects of Chemical Use in Well Drilling Operations, EPA-560/1-75-004, pp. 261-288. [59]
- Collins, A. G. 1971. "Oil and Gas Wells - Potential Polluters of the Environment?" Water Pollution Control Federation Journal, 43:2383-2393. [70]
- Collins, A. G. 1975. "Chemical Applications in Oil- and Gas-Well Drilling and Completion Operations." Environmental Aspects of Chemical Use in Well Drilling Operations, EPA-560/1-75-004, pp. 231-260. [71]
- Collins, A. G. 1975. "Possible Contamination of Ground Waters by Oil- And Gas-Well Drilling and Completion Fluids." CONF-7505133-1. [72]

- Collins, A. G. 1977. "Enhanced Oil Recovery Injection Waters." Society of Petroleum Engineers, SPE Reprint No. 6603. [73]
- Cosner, S. R. and J. A. Apps. 1978. A Compilation of Data on Fluids from Geothermal Resources in the United States. LBL-5936. [80]
- Gass, T. E. 1977. "Energy Development and Its Effect on Ground Water." Water Well Journal, 31(4):34-35. [125]
- Grantham, C. K. and J. P. Sloan. 1975. "Toxicity Study Drilling Fluid Chemicals on Aquatic Life." Environmental Aspects of Chemical Use in Well-Drilling Operations, EPA-560/1-75-004, pp. 103-112. [142]
- Gregg, D. O. and K. G. Kennedy. 1975. "Movement of Chemical Contaminants in Ground Water." Environmental Aspects of Chemical Use in Well Drilling Operations, EPA-560/1-75-004, pp. 289-309. [145]
- Henry, H. R., J. R. McDonald, and R. M. Alverson. 1971. Aquifer Performance Tests Under Two-Phase Flow Conditions. PB 209 535. [181]
- Kazmann, R. 1974. "Waste Surveillance in Subsurface Disposal Projects." Ground Water, 12:412-426. [225]
- Kazmann, R. G. 1975. "Groundwater and Environmental Geology." Environmental Geology, 1:137-142. [226]
- Lehr, J. H. 1975. "Objectives of Well-Drilling Regulations." Environmental Aspects of Chemical use in Well-Drilling Operations, EPA-560/1-75-004, pp. 555-570. [311]
- "Maintaining the Yield of Water Wells." 1965. The Johnson Drillers Journal, January-February, pp. 1-4. [332]
- McCune, C. C. 1977. "On-Site Testing to Define Injection-Water Quality Requirements." Journal of Petroleum Technology, January, pp. 17-24. [340]
- Morey, G. W., R. O. Fournier and J. J. Rowe. 1962. "The Solubility of Quartz in Water in the Temperature Interval from 25° to 300°C." Geochimica et Cosmochimica Acta, 26:1029-1043. [372]
- Mungan, N. 1965. "Permeability Reduction Through Changes in pH and Salinity." Journal of Petroleum Technology, December, pp. 1449-1453. [376]
- Peters, R. R. 1975. "Techniques of Shallow-Well Drilling." Environmental Aspects of Chemical Use in Well-Drilling Operations, EPA-560/1-75-004, pp. 27-38. [403]

- Robeck, G. G. 1969. "Microbial Problems in Ground Water." Groundwater, 7(3):33-35. [431]
- Romero, J. C. 1970. "The Movement of Bacteria and Viruses Through Porous Media." Groundwater, 8(2):37-48. [434]
- Schaffer, D. C. 1974. "The Right Chemicals Are Able to Restore or Increase Well Yield." The Johnson Drillers Journal, March-April, pp. 4-6. [447]
- Schmidt, K. D. 1977. "Water Quality Variations for Pumping Wells." Groundwater, 15(2):130-137. [449]
- Shew, D. C. and J. W. Keeley. 1975. "Ground-Water Problems Associated with Well-Drilling Additives." Environmental Aspects of Chemical Use in Well-Drilling Operations, EPA-560/1-75-004, pp. 223-230. [454]
- Smith, C. G. and J. S. Hanor. 1977. "Underground Storage of Treated Water: A Field Test." Groundwater, 13(5):410-417. [456]
- Subcasky, W. J. \_\_\_\_\_. "Petroleum Industry Experience in Water Injection." [477]
- Truesdell, A. H. and W. Singers. 1974. "The Calculation of Aquifer Chemistry in Hotwater Geothermal Systems." Journal Research, USGS, 2(3)271-278. [500]
- Turcan, Jr., A. N. 1962. Estimating Water Quality From Electrical Logs. USGS, Professional Paper 450, pp. C135-C136. [506]
- U.S. Environmental Protection Agency and the National Water Well Association. 1971. Proceedings of the National Ground Water Quality Symposium. [113]
- U.S. Environmental Protection Agency. 1974. "Proceedings of the Second National Ground Water Quality Symposium." [770]
- U.S. Environmental Protection Agency. 1977. "Proceedings of the 3rd National Ground Water Quality Symposium, Las Vegas, NV, 15-17 September 1976." PB-272 908. [784]

#### WATER TREATMENT AND FILTERING TECHNIQUES

- Bolton, P. 1961. "Prevention of Water Source Contamination." American Water Works Association Journal, 53(10):1243-1250. [47]

- Schaffer, D. C. 1974. "The Right Chemicals Are Able to Restore or Increase Well Yield." The Johnson Drillers Journal, March-April, pp. 4-6. [447]
- Shew, D. C. and J. W. Keeley. 1975. "Ground-Water Problems Associated with Well-Drilling Additives." Environmental Aspects of Chemical Use in Well-Drilling Operations, EPA-560/1-75-004, pp. 223-230. [454]
- Specken, G. A. 1975. "Treatment and Disposal of Waste Fluids From Onshore Drilling Sites." Environmental Aspects of Chemical Use in Well-Drilling Operations, EPA-560/1-75-004, pp. 451-462. [465]
- Warner, D. L. and J. H. Lehr. 1977. An Introduction to the Technology of Subsurface Wastewater Injection. EPA-600/2-77-240. (PB-279 207). [514]

#### WELLBORE AND PIPING HEAT LOSSES

- Alpert, J. E., S. C. VanDemark, D. D. Fritton, and D. R. DeWalle. 1976. "Soil Temperatures and Heat Loss for a Water Pipe Network Buried in Irrigated Soil." Journal Environmental Quality, 5(4):400-405. [7]
- James, R. 1970. "Collection and Transmission of Geothermal Fluids." U.S. Symposium on the Development and Utilization of Geothermal Resources, 1:99-105, Special Issue 2. [210]
- Lesem, L. B., F. Geytok, F. Marotta, and J. J. McKetta. 1957. "A Method of Calculating the Distribution of Temperature in Flowing Gas Wells." AIME Petroleum Transactions, 210:169-176. [314]
- Murphy, H. D. 1977. Fluid Injection Profiles - A Modern Analysis of Wellbore Temperature Surveys. SPE-6783. [377]
- Oster, C. A. 1976. Well-Hole Temperature Distribution in the Presence of Aquifers. BNWL-SA-5658. [395]
- Ramey, H. J. 1962. "Wellbore Heat Transmission." Journal of Petroleum Technology, April, pp. 427-435. [627]
- Rubinshtein, L. I. 1959. "The Total Heat Losses in Injection of a Hot Liquid into a Stratum." Neft'1 Gaz, 2(9):41-48. [437]
- Willhite, G. P. 1967. "Over-all Heat Transfer Coefficients in Steam and Hot Water Injection Wells." Journal of Petroleum Technology, May, pp. 607-615. [524]

## WELL CASING AND SCREENING MATERIALS

- Erickson, G. M. 1976. "Short, Large Diameter Screens Prove Effective." Johnson Driller Journal, 48(6):3. [274]
- Gates, C. F. and B. G. Holmes. 1967. "Thermal Well Completions and Operations." Proceedings of the Seventh World Petroleum Congress. 3:419-429. [130]
- Kalousek, G. L. and S. Y. Chaw. 1976. "Research on Cements for Geothermal and Deep Oil Wells." Society of Petroleum Engineers Journal, 16(6):307-309. [218]
- Kukacka, L. E., J. Fontana, A. Zeldin, T. Sugama, W. Horn, N. Carciello, and J. Amaro. 1977. Alternative Materials of Construction for Geothermal Applications. BNL-50751. [293]
- Kukacka, L. E., A. Zeldin, J. Fontana, N. Carciello, and T. Sugama. 1977. Cementing of Geothermal Wells. BNL-50738. [294]
- Loy, S. E. 1975. "Techniques of Deep Well Drilling." Environmental Aspects of Chemical Use in Well-Drilling Operations, EPA-560/1-75-004, pp. 11-25. [324]
- Obbink, J. G. 1969. "Construction of Piezometers, and Method of Installation for Ground Water Observations in Aquifers." Journal of Hydrology, 7:434-443. [390]
- Perkins, T. K., G. R. Wooley, and F. W. Ng. 1975. "Solutions for Some Problems Resulting From Refreezing of Permafrost Around a Wellbore." Environmental Aspects of Chemical Use in Well-Drilling Operations, EPA-560/1-75-004, pp. 39-59. [402]
- Peterson, J. S., C. Rohwer, and M. L. Albertson. 1953. "Effects of Well Screens on Flow Into Wells." Transactions, American Society of Civil Engineers, 120:563-607. [404]
- Scott, R. W. 1972. "Two New Drilling Systems Pass Initial Field Tests." World Oil, 174(1):35-43. [451]
- Snyder, R. E. 1978. Geothermal Well Completions. SAND 78-7010. [462]
- Suman, G. O. Jr. and R. C. Ellis. 1977. "Cementing Oil and Gas Wells. Part 3." World Oil, 184(6):48-57. [480]
- Technical Practices Committee. 1975. "Selection of Metallic Materials to be Used in All Phase of Water Handling for Injection into Oil Bearing Formations." NACE Standard RP-04-75. [486]

Technical Unit Committee. 1954. "Sulfide Corrosion Cracking of Oil Production Equipment." NACE 1154. [489]

Willhite, G. P. and W. K. Dietrich. 1966. "Design Criteria for Completion of Steam Injection Wells." Society of Petroleum Engineers of AIME, (10):62-69. [525]

#### WELL CONSTRUCTION AND MAINTENANCE

Abrams, A. 1977. "Mud Design to Minimize Impairment Due to Particle Invasion." Journal of Petroleum Technology, 29(5):586-592. [1]

Blakeley, L. E. 1945. "The Rehabilitation, Cleaning, and Sterilization of Water Wells." American Water Works Association Journal, 37:101-114. [34]

Braunlich, F. H. 1975. "Well Completion -- Techniques and Methods." Environmental Aspects of Chemical Use in Well Drilling Operations, EPA-560/1-75-004, pp. 73-100. [54]

Collins, A. G. 1970. "Are Oil- and Gas-Well Drilling, Production and Associated Waste Disposal Practices Potential Pollutants of the Environment?" Presented before Division of Water, Air and Waste; American Chemical Society. CONF-700911-6. [69]

Collins, A. G. 1975. "Chemical Applications in Oil- and Gas-Well Drilling and Completion Operations." Environmental Aspects of Chemical Use in Well Drilling Operations, EPA-560/1-75-004, pp. 231-260. [71]

Dellinger, T. B. and B. J. Livesay. 1973. "Diamond-Bit Research Provides Basic Drilling Parameters." Oil and Gas Journal, 70(3):86-95. [88]

Dudgeon, C. R. 1976. "Drilling Mud Invasion of Unconsolidated Aquifer Materials." Australian Water Resources Council, Technical Paper No. 17. [100]

Edwards, J. H. 1974. "Engineering Design of Drilling Operations." Presented Spring Meeting Southern District, API Div., pp. 39-55. [682]

Gass, T. E. 1977. "Part I: Well Development." Water Well Journal, 31(4):40-42. [127]

Gates, C. F. and B. G. Holmes. 1967. "Thermal Well Completions and Operations." Proceedings of the Seventh World Petroleum Congress. 3:419-429. [130]

Geothermal Drilling Rules and Regulations. Chapter 332-17 WAC. [132]

- Gibb, J. P. and E. W. Sanderson. 1969. "Cost of Municipal and Industrial Wells in Illinois." Illinois State Water Survey. Circular 98. [133]
- Gray, G. R. 1973. "New Muds Designed to Improve Drilling Rate, Hole Stability." World Oil, 176(6):84-86. [143]
- Guest, R. J. and C. W. Zimmerman. 1973. "Compensated Gamma Ray Densimeter Measures Slurry Densities in Flow." Petroleum Engineer, 45(10):80-87. [150]
- Hoepfner, S. 1974. "Combating Air and Gas Problems." Water Well Journal, 28(5):29-30. [185]
- Kukacka, L. E., A. Zeldin, J. Fontana, N. Carciello, and T. Sugama. 1977. Cementing of Geothermal Wells. BNL-50738. [294]
- Lehr, J. H. 1975. "Objectives of Well-Drilling Regulations." Environmental Aspects of Chemical use in Well-Drilling Operations, EPA-560/1-75-004, pp. 555-570. [311]
- Lehr, J. H. 1977. "Well Maintenance and Rehabilitation." Water Well Journal, 31(8):8-9. [312]
- Louden, L. R. and R. E. Mc Glothlin. 1975. "Waste Water Base Drilling Fluid Disposal." Environmental Aspects of Chemical Use in Well-Drilling Operations, EPA-560/1-75-004, pp. 515-522. [323]
- Loy, S. E. 1975. "Techniques of Deep Well Drilling." Environmental Aspects of Chemical Use in Well-Drilling Operations, EPA-560/1-75-004, pp. 11-25. [324]
- "Maintaining the Yield of Water Wells." 1965. The Johnson Drillers Journal, January-February, pp. 1-4. [332]
- McFarland, C. R. 1979. Oil and Gas Exploration in Washington, 1900-1978. Department of Natural Resources, Division of Geology and Earth Resources. Info. Circ. 67. [342]
- Mylander, H. A. 1953. "Oil Field Techniques for Water Well Drilling." American Water Works Association Journal, 45:764-772. [378]
- Obbink, J. G. 1969. "Construction of Piezometers, and Method of Installation for Ground Water Observations in Aquifers." Journal of Hydrology, 7:434-443. [390]
- Oil and Gas Conservation Committee. 1954. General Rules and Regulations Governing the Conservation of Oil and Gas. State of Washington, Dept. Nat. Res. [392]



- Oil and Gas Conservation Committee. \_\_\_\_\_. Instructions for Oil and Gas Drillers. State of Washington. [391]
- Perkins, T. K., G. R. Wooley, and F. W. Ng. 1975. "Solutions for Some Problems Resulting From Refreezing of Permafrost Around a Wellbore." Environmental Aspects of Chemical Use in Well-Drilling Operations, EPA-560/1-75-004, pp. 39-59. [402]
- Peters, R. R. 1975. "Techniques of Shallow-Well Drilling." Environmental Aspects of Chemical Use in Well-Drilling Operations, EPA-560/1-75-004, pp. 27-38. [403]
- Pettitt, R. A. 1975. Planning, Drilling, and Logging of Geothermal Test Hole GT-2, Phase I. LA-5819-PR. [405]
- Pettitt, R. A. 1975. Testing, Drilling, and Logging of Geothermal Test Hole GT-2, Phase II. LA-5897. [406]
- Pettitt, R. A. 1975. Testing, Drilling, and Logging of Geothermal Test Hole GT-2, Phase III. LA-5965-PR. [407]
- Pettitt, R. A. 1977. Planning, Drilling, Logging, and Testing of Energy Extraction Hole EE-1, Phases I and II. LA-6906-MS. [408]
- Pettitt, R. A. 1978. Testing, Planning, and Redrilling of Geothermal Test Hole GT-2, Phases IV and V. LA-7586-PR. [409]
- Pitt, W. A. J., Jr., F. W. Meyer, and J. E. Hull. 1977. "Disposal of Salt Water During Well Construction: Problems and Solutions." Groundwater, 15(4):276-283. [414]
- "Records and Drilling Reports." 1976. Water Well Journal, January, pp. 30-31. [427]
- Robichaux, J. 1975. "Bactericides Used in Drilling and Completion Operation." Environmental Aspects of Chemical use in Well-Drilling Operations, EPA-560/1-75-004, pp. 183-198. [432]
- Scott, R. W. 1972. "Two New Drilling Systems Pass Initial Field Tests." World Oil, 174(1):35-43. [451]
- Simpson, J. P. 1975. "Drilling Fluid Principles and Operations." Environmental Aspects of Chemical Use in Well-Drilling Operations, EPA-560/1-75-004, pp. 61-71. [455]
- Snyder, R. E. 1978. Geothermal Well Completions. SAND 78-7010. [462]
- Somerton, W. H. and S. El-Hadidi. 1971. "Well Logs Can Indicate Formation Drillability." World Oil, 173(7):55-56. [463]

- Specken, G. A. 1975. "Treatment and Disposal of Waste Fluids From Onshore Drilling Sites." Environmental Aspects of Chemical Use in Well-Drilling Operations, EPA-560/1-75-004, pp. 451-462. [465]
- Suman, G. O. Jr. and R. C. Ellis. 1977. "Cementing Oil and Gas Wells. Part 2." World Oil, 184(5):69-76. [479]
- Suman, G. O. Jr. and R. C. Ellis. 1977. "Cementing Oil and Gas Wells. Part 3." World Oil, 184(6):48-57. [480]
- Suman, G. O. Jr. and R. C. Ellis. 1977. "Cementing Oil and Gas Wells. Part 4." World Oil, 184(7):69-77. [481]
- Suman, G. O. Jr. and R. C. Ellis. 1977. "Cementing Oil and Gas Wells. Part 5." World Oil, 184(8):117-125. [482]
- U.S. Environmental Protection Agency. . "Manual of Water Well Construction Practices." EPA-570/9-75-001. [774]
- Warner, D. L. and J. H. Lehr. 1977. An Introduction to the Technology of Subsurface Wastewater Injection. EPA-600/2-77-240. (PB-279 207). [514]
- West, E. R. 1976. "Improved Drilling is a Result of Sound Engineering." World Oil, 183:57-59. [522]
- Willhite, G. P. and W. K. Dietrich. 1966. "Design Criteria for Completion of Steam Injection Wells." Society of Petroleum Engineers of AIME, (10):62-69. [525]

#### WELL FIELD DESIGN AND OPERATING CRITERIA

- Alexander, B. C. 1975. "Minimizing Costs in Well Field Design in Relations to Aquifer Models." Ph.D. Thesis, University of Arizona. [ ]
- Bostock, C. A., E. S. Simpson, and T. G. Roefs. 1977. "Minimizing Costs in Well Field Design in Relation to Aquifer Models." Water Resources Research, 13(2):420-426. [49]
- Hansen, V. E. 1952. "Complicated Well Problems Solved by the Membrane Analogy." Transactions, American Geophysical Union, 33(6):912-916. [157]
- Hantush, M. S. and C. E. Jacob. 1954. "Plane Potential Flow of Ground Water with Linear Leakage." Transactions, American Geophysical Union, 35(6):917-936. [160]

- Hantush, M. S. and C. E. Jacob. 1960. "Flow to an Eccentric Well in a Leaky Circular Aquifer." Journal of Geophysical Research, 65(10):3425-3431. [162]
- Hausz, W. and C. F. Meyer. 1979. Technical Aspects of Thermal Storage in Aquifers. GE-TEMPO. [172]
- Huyakorn, P. and C. R. Dudgeon. 1976. "Investigation of Two-Regime Well Flow." Journal of the Hydraulics Division ASCE, 102(HY9):1149-1165. [196]
- "Hydraulics and Economics of Well Field Layout." 1977. Public Works, 108(1):40-41. [197]
- Jacob, C. E. 1940. "On the Flow of Water in an Elastic Artesian Aquifer." Transactions, American Geophysical Union, 21:574-586. [201]
- Jacob, C. E. 1946. "Radial Flow in a Leaky Artesian Aquifer." Transactions, American Geophysical Union, 27(2):198-205. [205]
- Jacob, C. E. 1947. "Drawdown Test to Determine Effective Radius of Artesian Well." Transactions, American Society of Civil Engineers, 112(2321):1047-1064. [207]
- Kazmann, R. G. 1958. "Problems Encountered in the Utilization of Ground-Water Reservoirs." Transactions, American Geophysical Union, 39(1):94-99. [223]
- Kimbler, O. K., R. G. Kazmann and W. R. Whitehead. 1975. Cyclic Storage of Fresh Water in Saline Aquifers. Louisiana Water Resources Research Institute. Bull. 10. [237]
- Lakshminarayana, V. and S. P. Rajagopalan. 1978. "Type-Curve Analysis of Time-Drawdown Data for Partially Penetrating Wells in Unconfined Anisotropic Aquifers." Ground Water, 16(5):328-333. [298]
- Li, W. H. 1954. "Interaction Between Well and Aquifer." Proceedings American Society of Civil Engineers, 80(578):1-14. [315]
- Maddock, T. 1976. "A Drawdown Prediction Model Based on Regression Analysis." Water Resources Research, 12(4):818-822. [330]
- McFarland, C. R. 1979. Oil and Gas Exploration in Washington, 1900-1978. Department of Natural Resources, Division of Geology and Earth Resources. Info. Circ. 67. [342]
- Molz, F. J. and L. C. Bell. 1977. "Head Gradient Control in Aquifers Used for Fluid Storage." Water Resources Research, 13(4):795-798. [368]

- Mount, J. R. 1969. "A Simplified Technique for Well-Field Design." Groundwater, 7(3):5-8. [375]
- Schiff, L. and K. L. Dyer. 1965. "Some Physical and Chemical Considerations in Artificial Ground Water Recharge." Biennial Conference on Groundwater Recharge, Development and Management, H-60-71. [448]
- Schrock, V. E. and A. D. K. Laird. 1976. "Physical Modeling of Combined Forced and Natural Convection in Wet Geothermal Formations." Journal Heat Transfer, May, pp. 213-220. [879]
- Sheahan, N. T. 1977. "Injection/Extraction Well System - A Unique Seawater Intrusion Barrier." Groundwater, 15(1):32-50. [453]
- Theis, C. V. 1935. "The Relation Between the Lowering of the Piezometric Surface and the Rate and Duration of Discharge of a Well Using Groundwater Storage." Transactions, American Geophysical Union, 2:519-524. [490]
- Warner, D. L. and J. H. Lehr. 1977. An Introduction to the Technology of Subsurface Wastewater Injection. EPA-600/2-77-240. (PB-279 207). [514]

#### MISCELLANEOUS

- ASHRAE. "ASHRAE Handbook and Product Directory, 1977 - Fundamentals." [636]
- ASHRAE. "ASHRAE Handbook and Product Directory, 1978 - Applications." [637]
- ASHRAE. "ASHRAE Handbook and Product Directory, 1979 - Equipment." [638]
- Bodvarsson, G. 1972. "The Energy of Thermal Water." Geothermics, 1(3):93-95. [247]
- Hydraulic Maps. [629]
- International Activities of the Energy Research and Development Administration. 1977. "Hearing Before a Subcommittee of the Committee on Government Operations, House of Representatives." [200]
- Jenkins, N. 1976. "ITEC: A Congress that Stuck to Its Theme." Energy International, 13(12):15-25. [213]
- Lawrence Berkeley Laboratory. 1977. Earth Sciences Division Annual Report 1977. LBL-7028. [304]

- Koch, R. K., E. D. Calvert, C. R. Thomas, and R. A. Beall. 1976. Vapor Pressure of Liquid Titanium (2,008° to 2,379°K) and Liquid Platinum (2,045° to 2,379°K). Report Investigation 7271. U.S. Department of Interior. [712]
- National Waterwell Association. Catalog, Third Edition. [557]
- Newman, S. P. 1978. Comments on Papers at Aquifers Workshop. LBL-8431. Proceedings of the Thermal Energy Storage in Aquifers Workshop. [556]
- Saltzman, B. and J. A. Pollack. 1977. "Sensitivity of the Diurnal Surface Temperature Range to Changes in Physical Parameters. Journal of Applied Meteorology, 16:614-619. [446]
- U.S. Department of Energy. 1979. "Public Notice Inviting Proposals for the Preparation of a Conceptual Design for an Aquifer Thermal Energy Storage System for Seasonal Energy Storage for Use in District Heating/Cooling Applications." [91]



Seasonal Thermal Energy Storage  
Aquifer Thermal Energy  
Reference Library

- Abrams, A. 1977. "Mud Design to Minimize Impairment Due to Particle Invasion." Journal of Petroleum Technology, 29(5):586-592. [1]
- Ackerman, T. V. and E. J. Lynde. 1944. "Effect of Storage Reservoir Detritus on Ground Water." American Water Works Association Journal, 36:315-322. [2]
- Adachi, T., S. Serata, and S. Sakurai. 1969. "Determination of Underground Stress Field Based on Inelastic Properties of Rock." Proceedings 11th Symposium on Rock Mechanics, University of California, pp 293-328. [631]
- Adams, R. H. and A. M. Khan. 1969. "Cyclic Steam Injection Project Performance Analysis and Some Results of a Continuous Steam Displacement Pilot." Thermal Recovery Techniques. SPE Reprint Series, (10):62-69. [3]
- Adkison, J. A. 1976. "Programmable Controller Has its Place in Production of Oil." J. Oil and Gas, 74:131-135. [787]
- Advisory Council on Historic Preservation. \_\_\_\_\_. "Procedures for the Protection of Historic and Cultural Properties." Title 36 - Parks, Forest, and Public Property, Chapter VIII, pp. 422-430. [788]
- Advani, S. H., L. Z. Shuck, H. Y. Chang, and H. V. Gargaro. 1976. "Analytical and Experimental Investigations on Induced Fracturing of Reservoir Rock." American Society of Mechanical Engineers, 76-Pet-8. [632]
- Aktan, T. and S. M. Farouq Ali. 1975. "Effect of Cyclic and In-Situ Heating on the Absolute Permeabilities, Elastic Constants, and Electrical Resistivities of Rocks." Society of Petroleum Engineers, AIME, SPE-5633. [633]
- Alavian, V. 1973. "Design and Construction of a Research Station for the Study of Induced Vertical Mixing in a Thermally Stratified Pond Using Warm Water Discharge." M.S. thesis, Wisconsin University. (PB-237 701). [4]
- Alexander, B. C. 1975. "Minimizing Costs in Well Field Design in Relations to Aquifer Models." Ph.D. Thesis, University of Arizona. [ ]

- Allegrini, G. and G. Benvenuti. 1970. "Corrosion Characteristics and Geothermal Power Plant Protection. (Collateral Processes of Abrasion, Erosion and Scaling)." U.N. Symposium on the Development and Utilization of Geothermal Resources, 2(1):865-881. [5]
- Allen, R. D. 1979. Thermal Energy Storage in Aquifers, An Overview. Battelle, Pacific Northwest Laboratories. [620]
- Allison, L. E. 1947. "Effects of Microorganisms on Permeability of Soil Under Prolonged Submergence." Soil Science, 63:439-450. [6]
- Alpert, J. E., S. C. VanDemark, D. D. Fritton, and D. R. DeWalle. 1976. Soil Temperatures and Heat Loss for a Water Pipe Network Buried in Irrigated Soil." Journal Environmental Quality, 5(4):400-405. [7]
- Ambrose, E. R. 1974. "The Heat Pump: Performance Factor, Possible Improvements." Heating, Piping and Air Conditioning, 46(5):77-82. [8]
- Ambrose, E. R. 1967. "Heat Pumps - Utilities Viewpoint." J. ASHRAE, 9(9):36-37. [9]
- American Gas Association. 1978. "The Underground Storage of Gas in the United States and Canada." 28th Annual Report on Statistics, Committee on Underground Storage. [789]
- American Petroleum Institute. 1978. "Subsurface Salt Water Injection and Disposal." Vocational Training Series, Book 3. [790]
- American Petroleum Institute. 1975. "Environmental Protection Laws and Regulations Related to Exploration, Drilling, Production, and Gas Processing Plant Operations." API Bulletin 18. [10]
- American Petroleum Institute. 1958. "Corrosion of Oil- and Gas-Well Equipment." Book 2 of the Vocational Training Series. [634]
- Anderson, J. H. 1972. "Economic Power from Geothermal Heat." [11]
- Anderson, K. and J. E. Kelly. 1976. "Exploration for Groundwater in the Madison Limestone, Niobrara County, Wyoming." 28th Annual Field Conference - Wyoming Geological Assoc. Guidebook. CONF-7609159:277-281. [12]
- Andrews, C. B. 1979. "The Impact of the Use of Heat Pumps on Ground-Water Temperatures." Groundwater. [13]
- Andrews, C. B. 1976. "An Analysis of the Impact of a Coal-Fired Power Plant on the Groundwater Supply of a Wetland in Central Wisconsin." M.S. Thesis, University of Wisconsin. [601]



- Andrews, C. B. and M. P. Anderson. 1978. "Impact of a Power Plant on the Ground-Water System of a Wetland." Groundwater. [14]
- Andrews, C. B. and M. P. Anderson. 1979. "Thermal Alteration of Groundwater Caused by Seepage from a Cooling Lake." Groundwater, 15(3):595-602. [15]
- Anonymous. \_\_\_\_\_. "Groundwater Heat Pump Effluent Disposal Regulations by State." [244]
- Anonymous. 1977. "Groundwater Aquifers for Solar Storage." Texas Energy and Mineral Resources. 3(7):4. [16]
- Aparisi, R. R. and D. I. Teplyakov. 1977. "Utilization of Solar Radiation at Large Solar Plants with Hydraulic Storage." Geliotekhnika, 13(1):3-10. [243]
- Appel, C. A. and J. D. Bredehoeff. 1976. "Status of Ground-Water Modeling in the U.S." USGS Circular 737. [17]
- Archie, G. E. 1942. "The Electrical Resistivity Log as an Aid in Determining Some Reservoir Characteristics." Transactions, AIME, 146:54-62. [242]
- Aruna, M., N. Arihara and H. J. Ramey, Jr. 1977. "The Effect of Temperature and Stress on the Absolute Permeability of Sandstones and Limestones." CONF-770440, pp. 541-550. [18]
- Asbury, J. G., R. F. Giese, and R. O. Mueller. 1979. "Residential Electric Heating and Cooling: Total Cost of Service." Workshop on New Modes of Residential HVAC: Economic Incentives and Barriers, Electric Power Research Institute. [241]
- Asbury, J. G., R. F. Giese, R. O. Mueller, and S. H. Nelson. 1977. "Commercial Feasibility of Thermal Storage in Buildings for Utility Load Leveling." Proceedings, American Power Conference, 39:794-803. [791]
- Asbury, J. G., C. Maslowski, and R. O. Mueller. 1979. Solar Availability for Winter Space Heating: An Analysis of the Calendar Period 1953-1975. ANL/SPG-14. Argonne National Laboratory. [792]
- ASHRAE. "ASHRAE Handbook and Product Directory, 1977 - Fundamentals." [636]
- ASHRAE. "ASHRAE Handbook and Product Directory, 1978 - Applications." [637]
- ASHRAE. "ASHRAE Handbook and Product Directory, 1979 - Equipment." [638]
- Axtmann, R. C. 1975. "Chemical Aspects of the Environmental Impact of Geothermal Plant." Proceedings Second United Nations Symposium on the Development and Use of Geothermal Resources, pp. 1323-1327. [19]

- Aziz, K., S. A. Bories, and M. A. Combarous. 1973. "The Influence of Natural Convection in Gas, Oil and Water Reservoirs." Journal of Canadian Petroleum Technology, 12:41-47. [20]
- Aziz, K., T. Kaneko, and M. F. Mohtadi. \_\_\_\_\_. "17-b Natural Convection in Confined Porous Media." PACHEC 72, Session 17, Transport Phenomena, pp. 283-284. [635]
- Bachmat, Y., B. Andrews, D. Holtz, and S. Sebastian. 1978. Utilization of Numerical Groundwater Models for Water Resource Management. EPA-600/8-78-012, PB-285 782. [21]
- Baier, D. C. and G. M. Wesner. 1971. "Reclaimed Wastewater for Groundwater Recharge." Water Resources Bulletin, 7(5):991-1001. [240]
- Bailey, J. A., J. C. Mulligan, C. K. Liao, and S. I. Gucer. 1975. "Research on Solar Energy Subsystems Utilizing the Latent Heat of Phase Change of Paraffin Hydrocarbons for the Heating and Cooling of Buildings." NTIS, PB-244 872. [639]
- Bailey, R. G. 1978. "Descriptions of the Ecoregions of the United States." Forest Service, U.S. Department of Agriculture. [640]
- Bakmeteff, B. A., and N. V. Feodoroff. 1937. "Flow Through Granular Media." Journal of Applied Mechanics, 4:A96-A103. [22]
- Balashov, L. S. 1975. "Rare Elements in Thermal Ground Water." Proceedings Second United Nations Symposium on the Development and Use of Geothermal Resources, p. 2187-2195. [23]
- Balke, K. D. 1977. "Das Grundwasser als Energietrager." Brennst.-Wärme-Kraft, 29(5):191-194. [24]
- Banks, H. O. 1952. "Utilization of Underground Storage Reservoirs." Transactions, American Society of Civil Engineers, 118:220-234. [25]
- Barbish, A. B. and G. H. F. Gardner. 1969. "The Effect of Heat on Some Mechanical Properties of Igneous Rocks." Society of Petroleum Engineers, AIME, SPE-2395. [641]
- Barnes, B. A. and P. Livingston. 1947. "Value of the Electric Log for Estimating Ground-Water Supplies and the Quality of the Ground Water." Transactions, American Geophysical Union, 28(6):903-911. [26]
- Bass-Becking, L. G. M., I. R. Kaplan, and D. Moore. 1960. "Limits of the Natural Environment in Terms of pH and Oxidation-Reduction Potentials." Journal of Geology, 68(3):243-284. [642]

- Bathen, K. H. 1971. "Heat Storage and Advection in the North Pacific Ocean." J. Geophysical Research, 76(3):676-687. [259]
- Baylin, F. 1979. Low Temperature Thermal Energy Storage: A State-of-the-Art Survey. SERI/RR-54-164. Solar Energy Research Institute. [793]
- Beck, J. L. 1972. "Convection in a Box of Porous Material Saturated with Fluid." The Physics of Fluids, 15(8):1377-1383. [27]
- Beers, T. S. 1967. "Heat Pumps - Consultants Viewpoint." J. ASHRAE, 9(9):42-44. [28]
- Behnke, J. J. 1969. "Clogging in Surface Spreading Operations for Artificial Groundwater Recharge." Water Resources Research, 5(4):870-876. [258]
- Bell, J. S. and J. M. Shepherd. 1951. "Pressure Behavior in the Woodbine Sand." Petroleum Transactions, AIME, 192:19-28. [643]
- Bennion, D. W. and M. J. Goss. 1977. "A Sinusoidal Pressure Response Method for Determining the Properties of a Porous Medium and its In-Situ Fluid." Canadian Journal of Chemical Engineers, 55:113-117. [644]
- Benson, S. M., C. B. Goranson, J. P. Haney, and R. C. Schroeder. 1979. The Status of the Resource Evaluation at Susanville, California. LBL-9469. [29]
- Bernard, W. J. 1978. "Deep, Geopressured Aquifers: A New Energy Source?" Petroleum Engineer International, 50(3):84-90. [30]
- Besant, R. W. and C. B. Winn. 1976. "Cost Effective Solar Heating of Houses With Seasonal Storage of Energy." International Solar Energy Society, American Section, 4:409-424. [257]
- Bezdek, R. H., A. S. Hirschberg, and W. H. Babcock. 1979. "Economic Feasibility of Solar Water and Space Heating." Science, 23:1214-1220. [255]
- Birtles, A. B. and M. J. Reeves. 1977. "A Simple Effective Method for the Computer Simulation of Groundwater Storage and its Application in the Design of Water Resource Systems." Journal of Hydrology, 34:77-96. [31]
- Birtles, A. B. and M. J. Reeves. 1977. "Computer Modeling of Regional Groundwater Systems in the Confined-Unconfined Flow Regime." Journal of Hydrology, 34(1/2):97-127. [256]

- Blackwell, D. D., E. Granados, and J. B. Koenig. 1977. "Heat Flow and Geothermal Gradient Exploration of Geothermal Areas in the Cordillera de Guanacaste of Costa Rica." Geothermal Resources Council, Transactions, 1:17-18. [33]
- Blake, T. R. and S. K. Garg. 1976. "On the Species Transport Equation for Flow in Porous Media." Water Resource Research, 12(4):748-750. [32]
- Blakeley, L. E. 1945. "The Rehabilitation, Cleaning, and Sterilization of Water Wells." American Water Works Association Journal, 37:101-114. [34]
- Bloomster, C. H., L. L. Fassbender, and C. L. McDonald. 1977. Geothermal Energy Potential for District and Process Heating Application in the U.S. - An Economic Analysis. BNWL-2311. [35]
- Bloss, S. and V. Grigull. 1976. "Energy Storage and Temperature Distribution in Lakes." Int'l Seminar on Future Energy Production Heat and Mass Transfer Problems, 2:801-811. [254]
- Boberg, T. C. and R. B. Lantz. 1966. "Calculation of the Production Rate of a Thermally-Stimulated Well." Journal of Petroleum Tech., pp 1613-1623. [645]
- Bodvarsson, G. \_\_\_\_\_. "Remarks on Generalized Solutions of Improperly Posed Problems in the Exploration Sciences." Jokull, 23:37-44. [646]
- Bodvarsson, G. \_\_\_\_\_. "Some Considerations on the Optimum Production and Use of Geothermal Energy." Jokull, pp. 199-206. [647]
- Bodvarsson, G. 1961. "Physical Characteristics of Natural Heat Resources in Iceland." Jokull, 11:29-38. [ ]
- Bodvarsson, G. 1961. "Utilization of Geothermal Energy for Heating Purposes and Combined Schemes Involving Power Generation and/or By-Products." U.N. Conference on New Sources of Energy, Jokull, 11:49-59. [248]
- Bodvarsson, G. 1964. "Physical Characteristics of Natural Heat Resources in Iceland." Geothermal Energy, Proc. U.N. Conf. New Source of Energy, 2:82-90. [37]
- Bodvarsson, G. 1969. "On the Temperature of Water Flowing through Fractures." Journal of Geophysical Research, 74(8):1987-1992. [38]
- Bodvarsson, G. 1970. "A Surface Integral in Potential Theory." Geophysics, 35(3):501-503. [648]

- Bodvarsson, G. 1970. "Confined Fluids as Strain Meters." J. Geophysical Research, 75(14):2711-2718. [253]
- Bodvarsson, G. 1971. "Approximation Methods for Equivalent Strata." Journal of Geophysical Research, 76(17):3932-3989. [39]
- Bodvarsson, G. 1972. "The Energy of Thermal Water." Geothermics, 1(3):93-95. [247]
- Bodvarsson, G. 1972. "Thermal Problems in the Siting of Reinjection Wells." Geothermics, 1(2):63-66. [249]
- Bodvarsson, G. 1973. "Downward Continuation of Constrained Potential Fields." Journal of Geophysical Research, 78(8):1288-1292. [40]
- Bodvarsson, G. 1973. "Temperature Inversions in Geothermal Systems." Geoexploration, 11:141-149. [649]
- Bodvarsson, G. 1974. "Geothermal Resource Energetics." International Journal of Geothermal Research, 3(3):83-92. [41]
- Bodvarsson, G. 1976. "Thermoelastic Phenomena in Geothermal Systems." Second United Nations Symposium on the Development and Use of Geothermal Resources, 2:903-907. [42]
- Bodvarsson, G. 1977. "Unconfined Aquifer Flow with Linearized Free Surface Condition." Jokull, 27:84-87. [36]
- Bodvarsson, G. 1977. "A Secondary Recovery Method for the Extraction of Geothermal Energy." RLO-2227-T21-1. [43]
- Bodvarsson, G. 1978. "Energy Currents in Fractured Geothermal Systems." HDR Technical Workshop, Los Alamos, NM. (Abstract) [251]
- Bodvarsson, G. 1978. "Hydroelastic Oscillations in Fractured Systems." HDR Technical Workshop, Los Alamos, NM. [250]
- Bodvarsson, G. and A. Bjornsson. 1976. "Hydroelastic Cavity Resonators." Jokull, 26:20-24. [44]
- Bodvarsson, G. and R. P. Lowell. 1972. "Ocean-Floor Heat and the Circulation of Interstitial Waters." J. Geophysical Research, pp. 4472-4475. [246]
- Bodvarsson, G. and G. M. Reistad. 1975. "Econometric Analysis of Forced Geoheat Recovery for Low-Temperature Uses in the Pacific Northwest." Second United Nations Symposium on the Development and Use of Geothermal Resources, 3:1559-1564. [45]

- Bodvarsson, G. and J. Zoega. 1961. "Production and Distribution of Natural Heat for Domestic and Industrial Heating in Iceland." U.N. Conference on New Source of Energy, Jokull, 11:48-55. [245]
- Boersma, L., L. R. Davis, G. M. Reistad, J. C. Ringle, and W. E. Schmisser. 1974. A System Analysis of the Economic Utilization of Warm Water Discharge from Power Generating Stations. Bulletin No. 48. Engineering Experimental Station, Oregon State University. [602]
- Boldizar, T. 1970. "Geothermal Energy Production from Porous Sediments in Hungary." Proceedings United Nations Symposium, Development and Utilization of Geothermal Resources, 2(1):99-109. [46]
- Bolton, P. 1961. "Prevention of Water Source Contamination." American Water Works Association Journal, 53(10):1243-1250. [47]
- Bosazza, V. L. 1952. "On the Storage of Water in Rocks In-Situ." Transactions American Geophysical Union, 33(1):42-48. [48]
- Bostock, C. A., E. S. Simpson, and T. G. Roefs. 1977. "Minimizing Costs in Well Field Design in Relation to Aquifer Models." Water Resources Research, 13(2):420-426. [49]
- Bouwer, H. \_\_\_\_\_. "Land Subsidence and Cracking Due to Ground-Water Depletion." Ground Water. [50]
- Bouwer, H. 1979. "Geothermal Power Production with Irrigation Waste Water." Ground Water, 17(4):375-384.4. [51]
- Bouwer, H. 1968. "Returning Wastes to the Land, A New Role for Agriculture." J. Soil and Water Conservation, 23(5):164-168. [795]
- Bowen, R. G., D. D. Blackwell, and D. A. Hull. 1977. Geothermal Exploration Studies in Oregon. Misc. Paper No. 19. Department of Geology and Mineral Industries, State of Oregon. [650]
- Bowser, M. L. and W. E. Thomas. 1976. Bureau of Mines Portable Recording Methanometer. Report Investigation 7270. U.S. Department of Interior. [651]
- Brace, W. F., A. S. Orange, and T. R. Madden. 1965. "The Effect of Pressure on the Electrical Resistivity of Water-Saturated Crystalline Rocks." Journal of Geophysical Research, 70(22):5669-5678. [52]
- Brashear, J. P. and V. A. Kuuskraa. 1978. "The Potential and Economics of Enhanced Oil Recovery." J. Petroleum Technology, 30:1231-1239. [796]

- Brashears, M. L. 1941. "Ground Water Temperature on Long Island, New York, as Affected by Recharge of Warm Water." Economic Geology, 36:811-828. [53]
- Braunlich, F. H. 1975. "Well Completion -- Techniques and Methods." Environmental Aspects of Chemical Use in Well Drilling Operations, EPA-560/1-75-004, pp. 73-100. [54]
- Bredehoeft, J. D. 1967. "Response of Well-Aquifer Systems to Earth Tides." J. Geophysical Research, 72(12):3075-3087. [652]
- Briggs, J. B. and C. J. Shaffer. 1977. "Seasonal Heat Pump Performance for a Typical Northern United States Environmental." Tree-1181. [55]
- Briggs, J. E. and D. L. Katz. 1966. "Drainage of Water from Sand in Developing Aquifer Storage." Society of Petroleum Engineers, AIME, SPE-1501. [653]
- Briggs, L. I., Jr. 1968. "Geology of Subsurface Waste Disposal in Michigan Basin." American Association of Petroleum Geology, Memoir 10, pp. 128-153. [266]
- Brown, J. S. 1976. "Mammoth Waterflood Due Chawar Field." J. Oil and Gas, 74:194-206. [797]
- Brown, R. F. and C. D. Signor. 1974. "Artificial Recharge - State of the Art." Ground Water, 12(3):152-158. [56]
- Brown, R. H. 1953. "Selected Procedures for Analyzing Aquifer Test Data." American Water Works Association Journal, 45:844-866. [57]
- Brune, G. \_\_\_\_\_. "Le Stockage Thermique Dans Le Sol, En Vue De La Regularisation De L'Energie Solaire." [264]
- Brune, G. 1970. "How Much Underground Water Storage Capacity Does Texas Have?" Water Resources Bulletin, 6(4):588-601. [265]
- Brunton, G. D., D. M. Eissenberg, and R. J. Kedl. 1979. Low-Temperature Thermal Energy Storage Program, Annual Progress Report for October 1977-September 1978. ORNL/TM-6701. Oak Ridge National Laboratory. [798]
- Bullen, R. S. and T. F. Bratrud. 1976. "Fracturing With Foam." J. Canadian Petroleum Technology, 15(2):27-32. [263]
- Bundy, F. P., C. S. Herrick, and P. G. Kosky. 1976. "The Status of Thermal Energy Storage." Report No. 76CRD041. [58]

- Buretta, R. J. and A. S. Berman. 1976. "Convective Heat Transfer in a Liquid Saturated Porous Layer." Journal of Appl. Mech., pp. 249-253. [654]
- Burlingame, M. V. 1965. "Aquifer Storage Ideal for Natural Gas." Pipe Line Industry, pp. 32-65. [655]
- Calm, J. M. 1978. "Recovery of Wasted Heat with Centralized and Distributed Heat Pump Systems." Argonne National Laboratory, ASME Winter Annual Meeting. [262]
- Campbell, M. D. and G. F. Gray. 1975. "Mobility of Well-Drilling Additives in the Ground-Water System." Environmental Aspects of Chemical Use in Well Drilling Operations, EPA-560/1-75-004, pp. 261-288. [59]
- Campbell, M. D. and J. H. Lehr. 1973. "Rural Water Systems Planning and Engineering Guide." Commission on Rural Water, Washington, DC. [60]
- Capuano, L. E., Jr. 1979. "How Geysers Steam Wells are Drilled and Equipped." World Oil, pp. 69-72. [666]
- Carlson, F. M. and C. S. Land. 1976. "Effects of Compressibility and Solution Gas on the Gass Drive Mechanism for Linear and Radial Systems." J. Petroleum Technology, 28:1079-1086. [799]
- Carvell, K. L. and P. A. Johnston. 1978. Environmental Effects of Right-of-Way Management on Forrested Ecosystems. EA 491, Electric Power Research Institute. [771]
- Carver, J. A. \_\_\_\_\_. "Institutional Aspects of Utilizing Heat Storage in Aquifers - A Proposal for a Prototype Test." University of Denver. [61]
- Carver, J. A. 1975. "Legal and Institutional Planning for Macro-Conservation Measures." Public Utilities Fortnightly, 95(9):29-33. [62]
- Carver, J. A., Jr. 1978. Institutional Aspects of Utilizing Heat Storage in Aquifers - A Proposal for a Prototype Test. LBL-8431. Proceedings of the Thermal Energy Storage in Aquifer Workshop. Lawrence Berkeley Laboratories, Berkeley, CA. [ ]
- Casazza, J. A., T. R. Schneider, and V. T. Sulzberger. 1976. "Energy on Call." IEEE Spectrum, 3(6):44-47. [261]
- Castinel, G. and M. Combarnous. 1975. "Convection Naturelle dans une Couche Poreuse Anisotrope." Revue Generale de Thermique, 168:937-947. [781]
- Cavallieri, G. and G. Foligno. 1977. "Proposal for the Production and Seasonal Storage of Hot Water to Heat a City." Solar Energy, 19(6):677-683. [260]



- Cazal, A. \_\_\_\_\_. "Injection D'eau Chaude Dans Une Nappe A L'aide De Forage." [63]
- Centrilift, Inc. \_\_\_\_\_. "Electrical Submersible Pumps-Expanding Opportunities for Their Profitable Use." [780]
- Chakravorty, S. K., P. R. Brown, and N. Endsin. 1978. "A Review of Waterflood Performance in Garrington Cardium A and B Pools, Unit No. 2." J. Petroleum Technology, 30:869-876. [800]
- Chalmers, J. A. and E. J. Anderson. 1977. "Economic/Demographic Assessment Manual Current Practices, Procedural Recommendations and a Test Case." PG-274 546. [777]
- Chang, H. L. 1978. "Polymer Flooding Technology - Yesterday, Today, and Tomorrow." J. Petroleum Technology, 30:1113-1128. [801]
- Chang, H. L., H. M. Al-Rikabi, and W. H. Pusch. 1978. "Determination of Oil/Water Bank Mobility in Micellar-Polymer Flooding." J. Petroleum Technology, 30:1055-1060. [803]
- Chappelear, J. E. and C. W. Volek. 1969. "The Injection of a Hot Liquid into a Porous Media." Society of Petroleum Engineers, 9(1):100-114. [64]
- Chatas, A. T. 1976. "The Estimation of Aquifer Properties from Reservoir Performance in Water-Drive Fields." J. Pressure Vessel Tech., 76-Pet-49. [667]
- Chow, V. 1951. "Drawdown in Artesian Wells Computed by Nomograph." Civil Engineering, 21(10):48-49. [65]
- Chow, V. 1952. "On the Determination of Transmissibility and Storage Coefficients from Pumping Test Data." Transactions American Geophysical Union, 33(3):397-404. [66]
- Churchill, D. J. 1977. "Flow Measurement and Characterization in Shallow Geothermal Systems Used for Downhole Heat Exchanger Applications." Thesis, Oregon State University. [603]
- City of Shanghai Hydrogeological Tema. 1977. "Artificial Recharge into Groundwater Systems." Written in Chinese; translation of the Summary by C. F. Tsang (on file). (Underground Artificial Recharge Writing Group.) [598]
- Clark, J. B. 1949. "A Hydraulic Process for Increasing the Productivity of Wells." Petroleum Transactions, AIME, 1:1-8. [ ]
- Clark, W. W. 1958. "Know the Enemies, a Factual Study of the Electric Heat Pump." Gas, 34:57-62. [67]

- Cliff, W. C., W. J. Apley, and J. M. Creer. 1979. "Evaluation of Potential Geothermal Well-Head Flow Sampling and Calorimeter Methods." LBL-9248. GREMP-7. [267]
- Coats, K. H., L. A. Rapoport, and J. R. McCord. 1964. "Determination of Aquifer Influence Function from Field Data." J. Petroleum Tech., 6:1417-1424. [669]
- Cole, M. H. 1970. "Heat Pumps Today - Part 1." ASHRAE Symposium on Heat Pumps - Improved Design and Performance, pp. 41-48. [68]
- Collie, M. J. (ed). 1978. "Geothermal Energy Recent Development." Energy Technology Review No. 32. Noyes Data Corporation. [803]
- Collie, M. J., (ed). 1979. "Heat Pump Technology for Saving Energy." Energy Technology Review No. 39. Noyes Data Corporation. [804]
- Collins, A. G. 1970. "Are Oil- and Gas-Well Drilling, Production and Associated Waste Disposal Practices Potential Pollutants of the Environment?" Presented before Division of Water, Air and Waste; American Chemical Society. CONF-700911-6. [69]
- Collins, A. G. 1971. "Oil and Gas Wells - Potential Polluters of the Environment?" Water Pollution Control Federation Journal, 43:2383-2393. [70]
- Collins, A. G. 1975. "Chemical Applications in Oil- and Gas-Well Drilling and Completion Operations." Environmental Aspects of Chemical Use in Well Drilling Operations, EPA-560/1-75-004, pp. 231-260. [71]
- Collins, A. G. 1975. "Possible Contamination of Ground Waters by Oil- And Gas-Well Drilling and Completion Fluids." CONF-7505133-1. [72]
- Collins, A. G. 1977. "Enhanced Oil Recovery Injection Waters." Society of Petroleum Engineers, SPE Reprint No. 6603. [73]
- Collins, R. E. and K. E. Davis. 1976. "Geothermal Storage of Solar Energy for Electric Power Generation." Proc. International Conference on Solar Heating and Cooling, pp. 411-424. [74]
- Collins, R. E., J. R. Fanchi, G. O Morrell, K. E. Davis, T. K. Guha, and R. L. Henderson. \_\_\_\_\_. "High Temperature Underground Thermal Energy Storage." [75]
- Combarrous, M. A. and S. A. Bories. 1975. "Hydrothermal Convection in Saturated Porous Media." Advances in Hydroscience, 10:231-307. [628]

- Committee on Natural Resources. 1974. An Act Relating to Conservation of Geothermal Resources. State of Washington, 43rd Legislature, 3rd Extraordinary Session. Substitute House Bill No. 135. [76]
- Connor, D. W. and R. O. Mueller. \_\_\_\_\_. "The Elementary General Theory of Stratified Solar-Thermal Systems." Argonne National Laboratory. [805]
- Connor, D. W. and R. O. Mueller. 1979. "Analysis and Simulation of Stratified Heat Storage in Solar-Thermal." Argonne National Laboratory. [806]
- Cooley, R. L. and A. B. Cunningham. 1977. "Consideration of Total Energy Loss in Theory of Flow to Wells." NTIS, PB-264 717. [597]
- Cooley, R. L. and P. J. Sinclair. 1976. "Uniqueness of a Model of Steady-State Groundwater Flow." Journal of Hydrology, 31(3-4):245-269. [269]
- Cooper, H. H. and C. E. Jacob. 1946. "A Generalized Graphical Method for Evaluating Formation Constants and Summarizing Well-Field History." Transactions, American Geophysical Union, 27(IV):526-534. [77]
- Cooper, L. Y. 1977. "Heat Storage in the Ground Mass Surrounding Deep Dry Wells." ASME Winter Annual Meeting, Heat Transfer in Energy Conservation, pp. 99-105. [670]
- Cormary, Y., P. Iris, J. P. Marie, G. deMarsily, H. Michel, and M. F. Saquine. \_\_\_\_\_. "Heat Storage in a Phreatic Aquifer: Compuget Experiment (Gard, France)." [78]
- Cortell, B. 1977. "Ground Water/Solar Heat." Water Well Journal, May, p. 73. [79]
- Cosner, S. R. and J. A. Apps. 1978. A Compilation of Data on Fluids from Geothermal Resources in the United States. LBL-5936. [80]
- Coulbois, P. and J. P. Herault. 1975. "Conditions for the Competitive Use of Geothermal Energy in Home Heating." Proceedings Second U.N. Symposium on the Development and Use of Geothermal Resources, 3:2104-2108. [81]
- Crawford, M. 1977. "Transient Conduction in the Space Surrounding a Ring of Holes." ASME, 77-WA/HT-12. [268]
- Crichlow, H. B. 1972. "Heat Transfer in Hot Fluid Injection in Porous Media." [82]
- Cuellar, G. 1975. "Behavior of Silica in Geothermal Waste Waters." Proceedings Second U.N. Symposium on the Development and Use of Geothermal Resources, 1343-1347. [83]

- Culver, G. G. 1976. "Optimization of Teothermal Home Heating Systems." Oregon Institute of Technology, ERDA, INEL. [807]
- Culver, G. and G. M. Reistad. \_\_\_\_\_. "Evaluation and Design of Downhole Heat Exchangers for Direct Application." [84]
- Culver, G. and G. M. Reistad. \_\_\_\_\_. "Testing and Modeling of Downhole Heat Exchangers in Swallow Geothermal Systems." [85]
- Culver, G. S., J. W. Lund, and L. S. Svanevik. 1974. "Klamath Falls Hot Water Well Study." Oregon Institute of Technology. [604]
- Cummings, R. G., G. E. Morris, J. W. Tester, and R. L. Bivins. 1979. "Mining Earth's Heat: Hot Dry Rock Geothermal Energy." Technology Review, February, pp. 58-68. [618]
- Curry, D. M. and J. E. Cox. 1973. "The Effect of the Porous Material Characteristics on the Internal Heat and Mass Transfer." ASME, 73-HT-49. [671]
- Davidson, E. and M. Fox. 1974. "Effects of Off-Road Motorcycle Activity on Mojave Desert Vegetation and Soil." Madrono, 22(8):381-412. [673]
- Davidson, R. R., W. B. Harris and J. H. Martin. 1975. "Storing Sunlight Underground. The Solaterre System." Chemtech, December, pp. 736-741. [86]
- Davis, E. G. and M. F. Hawkins. 1964. "Linear Fluid-Barrier Detection by Well Pressure Measurements." Journal of Technology, 16:259-260. [672]
- Davis, G. H. and J. R. Rollo. 1969. "Land Subsidence to Decline of Artesian Head at Baton Rouge, Lower Mississippi Valley, USA." USA Proceedings, Tokyo Symposium on Land Subsidence. IASH/AIHS Uneco., pp. 174-184. [273]
- Day, J. A., A. F. Clark, W. C. Dickinson, and A. Iantuono. 1975. Industrial Process Heat From Solar Energy. UCRL-76390. [87]
- Delclaud, J. P. 1972. "New Results on the Displacement of a Fluid by Another in a Porous Medium." Society of Petroleum Eng., AIME, SPEE-4103. [674]
- Dellinger, T. B. and B. J. Livesay. 1973. "Diamond-Bit Research Provides Basic Drilling Parameters." Oil and Gas Journal, 70(3):86-95. [88]
- deMarsily, G. 1977. "Peut-on Stocker de l'Energie dans le Sol?" Submitted to Annales Des Mines. [277]

- Denis, L.H.D., A.J.H. Bedue, and Malherbaud. 1979. "Method of and Arrangement for the Seasonal Storage and Use of Hot Water Produced in Particular by Electrical Power-Generating Thermal and Nuclear Stations." Patent No. 4,159,736. [89]
- Denison, E. B. 1976. "Downhole Measurements through Modified Drill Pipe." Transactions of ASME, J. Pressure Vessel Tech., 76-Pet-53, pp. 1-6. [675]
- Denison, E. B. 1976. "Making Downhole Measurements Through Modified Drill Pipe." World Oil, 183(5):86-69. [90]
- Denson, K. H., A. Shinkdala, and C. D. Fenn. 1968. "Permeability of Sand with Dispersed Clay Particles." Water Resources Research, 4(6):1275-1276. [271]
- DeRenzo, D. J. (ed). 1978. "European Technology for Obtaining Energy from Solid Waste." Energy Technology Review No. 54. Noyes Data Corporation. [808]
- Desert Reclamation Industries. 1978. "Aquifer Storage at J. F. Kennedy International Airport." [92]
- Despois, J. and F. Nougarede. 1976. "Underground Storage of Heat." CONF-7605137-1 (trans). [93]
- Despois, J. and F. Nougarede. 1976. "Underground Storage of Heat." Presented to Annual Meeting, French Society of Heat Engineers, Thermal Aspects of Today's Energy Problems, Grenoble, France. [676]
- Despois, J. and F. Nougarede. 1977. "Underground Heat Storage." Revue Generale de Thermique, 184:357-366. [94]
- DeWalle, D. R. and J. L. Richenderfer. 1974. "Field Prototype: Description and Operation." Institute for Research on Land and Water Resources, Research Publication #86, pp. 83-92. [95]
- Dickinson, W. C., A. F. Clark, J. A. Day, and L. F. Wouters. 1976. "The Shallow Solar Pond Energy Conversion System." Solar Energy, 18(1):3-10. [270]
- Dobbs, R. K. 1969. "Effective Exploration Inspection." (Water Pressure Tests in Borings, 3(2)-Sept), (Prevention and Interpretation of Core Loss, 4[1]), (Supplemental Borehole Logging, 5(1)-Feb). Foundation Sciences, Inc., Newsletter. [678]
- Dobrynin, V. M. 1962. "Effect of Overburden Pressure on Some Properties of Sandstones." J. Society of Petroleum Eng., pp. 360-366. [677]

- Dodd, F. J., A. E. Johnson, and W. C. Ham. 1975. "Material and Corrosion Testing at the Geysers Geothermal Power Plant." Proceedings Second U.N. Symposium on the Development and Use of Geothermal Resources. [96]
- Donaldson, E. C. and B. A. Baker. 1977. "Particle Transport in Sandstones." Society of Petroleum Engineers, SPE Reprint No. 6905. [97]
- Donaldson, I. G. 1962. "Temperature Gradients in the Upper Layers of the Earth's Crust Due to Convective Water Flows." Journal of Geophysical Research, 67(9):3449-3459. [98]
- Dooley, J. L., G. P. Frost, L. A. Gore, R. P. Hammond, D. L. Rawson and S. L. Ridgeway. 1977. A Feasibility Study of Underground Energy Storage Using High-Pressure, High-Temperature Water. RDA-TR-7100-001 (CONS-1243-1). [630]
- Doscher, T. M. and F. A. Wise. 1976. "Enhanced Crude Oil Recovery Potential - An Estimate." J. Petroleum Technology, 28:575-585. [809]
- Downing, R. S. and F. A. Morrison, Jr. 1976. "Convective and Dispersive Transport in a Porous Medium." Computers and Fluids, 4:65-75. [680]
- Drost, W. 1973. "Application of Groundwater Measurements by Means of Radioisotopes on Groundwater Exploration." World Congress on Water Resources, CONF-7309143-11, pp. 357-369. [99]
- Dudgeon, C. R. 1976. "Drilling Mud Invasion of Unconsolidated Aquifer Materials." Australian Water Resources Council, Technical Paper No. 17. [100]
- Dvorov, I. M. and N. A. Ledentsova. 1975. "Utilization of Geothermal Water for Domestic Heating and Hot Water Supply." Proceedings Second U.N. Symposium on the Development and Use of Geothermal Resources, 3:2109-2116. [101]
- Dybbs, A. and S. Schweitzer. 1973. "Conservation Equations for Nonisothermal Flow in Porous Media." Journal of Hydrology, 20:171-180. [681]
- Earlougher, Jr., R. C. 1977. "Advances in Well Test Analysis." Henry L. Doherty Series, Monograph Volume 5. [810]
- Ebeling, L. L. and D. L. Reddell. 1976. Energy (Hot Water) Storage in Groundwater Aquifers. ASAE Paper No. 76-2540. [102]
- Eckert, A. W. \_\_\_\_\_. "EPA Jurisdiction Over Well Injection Under the Federal Water Pollution Control Act." Natural Resources Lawyer, 9(3):455-465. [103]

- Edwards, A. L. 1972. TRUMP: A Computer Program for Transient and Steady-State Temperature Distributions in Multidimension Systems. UCRL-14754, Rev. 3. [104]
- Edwards, J. H. 1974. "Engineering Design of Drilling Operations." Presented Spring Meeting Southern District, API Div., pp. 39-55. [682]
- Eggers, D. E. 1973. "Downward Continuation and Transformation of Potential Fields with Application to Marine Magnetic Anomalies." Thesis, \_\_\_\_\_ [605]
- Einarsson, S. S., A. Vides, and G. Cuellar. 1975. "Disposal of Geothermal Waste Water by Reinjection." Proceedings Second U.N. Symposium on the Development and Use of Geothermal Resources, 2:1349-1363. [105]
- Eisenberg, D. M. and H. W. Hoffman. \_\_\_\_\_. Low-Temperature Energy Storage Program, Progress Report for October 1978-March 1979. ORNL/TM-6936. Oak Ridge National Laboratory [811]
- Ellenberger, F. R., A. B. Hubbard, W. R. Foote, F. Burggraf, J. J. Martin and N. J. Bloomfield. 1950. "Evaluating Heat Pump Performance." ASHRAE Transactions, 56(1382):87-106. [106]
- Energy Technology. 1978. Third Annual Proc. of Thermal Energy Storage Contractors' Information Exchange Meeting. CONF-781231. [108]
- Engen, I. A. 1978. Residential Space Heating Cost: Geothermal vs Conventional Systems. TREE-1182. [107]
- ERDA and Electric Power Research Institute. 1975. Proceedings of the Workshop on Compressed Air Energy Storage System. ERDA-76-124. Energy Research Development Administration, Conservation Research and Technology Division. [783]
- Erickson, G. M. 1976. "Short, Large Diameter Screens Prove Effective." Johnson Driller Journal, 48(6):3. [274]
- Esmail, O. J. and O. K. Kimbler. 1967. "Investigation of the Technical Feasibility of Storing Fresh Water in Saline Aquifers." Water Resources Research, 3(3):683-695. [114]
- Faust, C. R. and J. W. Mercer. 1979. "Geothermal Reservoir Simulation Mathematical Models for Liquid- and Vapor-Dominated Hydrothermal Systems." Water Resources Research, 15(1):23-30. [812]
- Faust, C. R. and J. W. Mercer. 1979. "Geothermal Reservoir Simulation 2: Numerical Solution Techniques for Liquid- and Vapor-Dominated Hydrothermal Systems." Water Resources Research, 15(1):31-45. [813]

- Faust, C. R. and J. W. Mercer. 1977. "Finite-Difference Model of Two-Dimensional, Single, and Two-Phase Heat Transport in a Porous Medium - Version 1." Open File Report 77-234. [115]
- Federal Register. 1978. "National Environmental Policy Act - Regulations." 43(230):55978-56007. [607]
- Fenske, P. R. 1977. "Radial Flow with Discharging Well and Observation Well Storage." Journal of Hydrology, 32:87-96. [116]
- Fenske, P. R. 1977. "Type Curves for Recovery of a Discharging Well with Storage." Journal of Hydrology, 33:341-348. [117]
- Fox, E. C. and J. F. Thomas. \_\_\_\_\_. A Preliminary Economic Analysis of Aquifer Winter-Chill Storage at the John F. Kennedy Airport. ORNL/TM-6876. [118]
- Franco, A. 1978. "Miniplants Speed Projects, Slash Costs." J. Oil and Gas, 76:167-170. [814]
- Franco, A. 1976. "Thermal Work Humming in Venezuela." J. Oil and Gas, 74:132-138. [815]
- Freedman, S. I. and J. C. Dudley. 1972. "Off Peak Air Conditioning Using Thermal Energy Storage." NTIS, PB-238 105. [683]
- Fulford, R. S. 1968. "Effects of Brine Concentration and Pressure Drop on Gypsum Sealing in Oil Wells." Journal of Petroleum Technology, p. 559-564. [119]
- Gabrysch, R. K. and C. W. Bonnet. 1976. "Land-Surface Subsidence at Seabrook, Texas." AD-A035 621. [120]
- Gambolati, G. 1977. "Deviations From the Thesis Solution in Aquifers Undergoing Three-Dimensional Consolidation." Water Resources Research, 13(1):62-68. [121]
- Gambolati, G., P. Gatto, and R. A. Freeze. 1974. "Mathematical Simulations of the Subsidence of Venice 2 - Results." Water Resource Research, 10(3):563-577. [276]
- Gannon, R. 1978. "Ground-Water Heat Pumps - Home Heating and Cooling from Your Own Well." Popular Science. February, pp. 78-82. [122]
- Garza, S. 1977. Artificial Recharge for Subsidence Abatement at the NASA-Johnson Space Center. Open File Report 77-219. U.S. Geological Survey. [606]



- Gass, T. E. 1976. "Ground Water Flow in Unconsolidated Formations." Water Well Journal, 30(10):22-23. [123]
- Gass, T. E. 1977. "Don't Let the Bugs Get the Best of You." Water Well Journal, 32(1):26-27. [124]
- Gass, T. E. 1977. "Energy Development and Its Effect on Ground Water." Water Well Journal, 31(4):34-35. [125]
- Gass, T. E. 1977. "Land Subsidence." Water Well Journal, 31(5):30-31. [126]
- Gass, T. E. 1977. "Part I: Well Development." Water Well Journal, 31(4):40-42. [127]
- Gass, T. E. and J. H. Lehr. 1977. "Ground Water Energy and the Ground Water Heat Pumps." Water Well Journal, 31(4):42-47. [128]
- Gass, T. E. and J. H. Lehr. 1977. "Ground Water Energy and the Ground Water Source Heat Pump." Water Well Journal, 15(3):244-249. [129]
- Gates, C. F. and B. G. Holmes. 1967. "Thermal Well Completions and Operations." Proceedings of the Seventh World Petroleum Congress, 3:419-429. [130]
- Gates, G. L. and C. F. Parent. 1976. "Water-Quality Control Presents Challenge in Giant Wilmington Field." J. Oil and Gas, 74:115-125. [816]
- Geertsma, J. 1973. "Land Subsidence Above Compacting Oil and Gas Reservoirs." J. Petroleum Technology, June, p. 734-744. [131]
- Geological Society of America. 1976. "Abstracts with Programs, 1976." 1976 Annual Meetings, pp. 1148-1149. [817]
- George, C. J. and L. H. Stiles. 1978. "Improved Techniques for Evaluation Carbonate Waterfloods in West Texas." J. Petroleum Technology, 30:1547-1554. [818]
- Geothermal Drilling Rules and Regulations. Chapter 332-17 WAC. [132]
- "Getting Steamed Up Over Waste Heat." 1979. Nature, 380:349. [275]
- Getzen, R. T. 1977. "Analog-Model Analysis of Regional Three-Dimensional Flow in the Groundwater Reservoir of Long Island, NY." Professional Paper 982. U.S. Geological Survey. [684]
- Gibb, J. P. and E. W. Sanderson. 1969. "Cost of Municipal and Industrial Wells in Illinois." Illinois State Water Survey. Circular 98. [133]

- Gill, M. A. 1975. "Iterative Method of Determining Aquifer Constants." Journal of the Irrigation and Drainage Division, ASCE. 101(IR1):81-85. [134]
- Gillespie, J. B., G. D. Hargadine, and M. J. Stough. 1977. "Artificial Recharge Experiments Near Lakin, Western Kansas." Kansas Water Resources Board, Topeka, KS, Bulletin 20. [608]
- Givoni, B. 1979. "Store Energy in the Ground." Chem.Tech., pp. 384-390. [685]
- Givoni, B. 1977. "Underground Longterm Storage of Solar Energy - An Overview." Solar Energy, 19:617-623. [135]
- Glasby, G. P. 1969. "Minerals From the Sea." Endeavor, 3(2):82-85. [686]
- Gleason, V. E. 1978. "The Legalization of Ground-Water Storage." Water Resources Bulletin, 14(3):532-541. [136]
- Glenn, E. E. and M. L. Slusser. 1957. "Factors Affecting Well Productivity II. Drilling Fluid Particle Invasion into Porous Media." Petroleum Transactions, AIME, 210:132-139. [687]
- Glenn, D. R. 1979. "Industrial Applications of Thermal Energy Storage." Presented 3rd National Conference and Exhibition of Tech. for Energy Conservation. Institute of Gas Technology, CONF 790107-9. [688]
- Glover, R. E. and W. T. Moody. 1976. "Drawdown Due to Pumping in an Anisotropic Aquifer." Water Resource Bulletin, 12(5):941-950. [137]
- Goldstein, N. E., R. A. Morris, and M. J. Wilt. \_\_\_\_\_. Assessment of Surface Geophysical Methods in Geothermal Exploration and Recommendations for Future Research. LBL-6815. [609]
- Golibersuch, D. C. \_\_\_\_\_. "Peaking and Storage Activities in West Germany." Trip Report. [689]
- Goranson, C. B. and R. C. Schroeder. 1979. Site Specific Geothermal Reservoir Engineering Activities at Lawrence Berkeley Laboratory. LBL-9463. [138]
- Goranson, C. B., R. C. Schroeder, and J. Haney. 1979. Evaluation of Coso Geothermal Exploratory Hole No. 1 (CGEH-1), Coso Hot Springs: KGRA, China Lake, California. LBL-8675. [139]
- Govier, G. W. 1976. "Enhanced Recovery in Alberta -- A Review and the Role of the Energy Resources Conservation Board." J. Canadian Petroleum Tech., 15(3):13-19. [280]

- Goyal, K. P. and D. R. Kassoy. 1979. Fault Zone Controlled Charging of a Liquid Dominated Geothermal Reservoir. LBL-9237. [140]
- Goyal, K. P. and D. R. Kassoy. 1979. Heat and Mass Transfer in a Saturated Porous Wedge with Impermeable Boundaries. LBL-9328. [141]
- Goyal, K. P. and D. R. Kassoy. 1978. Heat and Mass Transfer Studies of the East Mesa Anomaly. Presented at Fourth Workshop Geothermal Reservoir Eng. LBL-9330. [690]
- Grantham, C. K. and J. P. Sloan. 1975. "Toxicity Study Drilling Fluid Chemicals on Aquatic Life." Environmental Aspects of Chemical Use in Well-Drilling Operations, EPA-560/1-75-004, pp. 103-112. [142]
- Gray, G. R. 1973. "New Muds Designed to Improve Drilling Rate, Hole Stability." World Oil, 176(6):84-86. [143]
- Gray, W. G. and K. O'Neill. 1976. "On the General Equations for Flow in Porous Media and Their Reduction to Darcy's Law." Water Resources Research, 12(2):148-154. [144]
- Green, D. W. 1963. "Heat Transfer with a Flowing Fluid Through Porous Media." [146]
- Green, J. H. 1964. The Effect of Artesian Pressure Decline on Confined Aquifer Systems and its Relation to Land Subsidence. Water-Supply Paper 1779-T. U.S. Geological Survey. [691]
- Green, M. A., H. S. Pines, W. L. Pope, and J. D. Williams. 1977. Thermodynamic and Cost Optimization Using Program GEOTHM. LBL-6303. [147]
- Gregg, D. O. and K. G. Kennedy. 1975. "Movement of Chemical Contaminants in Ground Water." Environmental Aspects of Chemical Use in Well Drilling Operations, EPA-560/1-75-004, pp. 289-309. [145]
- Gresko, T. M. and D. R. Glenn. \_\_\_\_\_. "Thermal Energy Storage Applied to Residential Heating Systems." IECEC, 11th, pp. 591-597. [692]
- Gring, L. M. and B. H. Caudle. 1972. "A Visual Study of Water Flooding a Microlayered Sandstones." Society of Petroleum Eng., AIME, SPE-4106. [693]
- Gringarten, A. C. and H. J. Ramey, Jr. 1974. "Unsteady-State Pressure Distributions Created by a Well with a Single Infinite-Conductivity Vertical Fracture." J. Society of Petroleum Eng., pp. 347-360. [279]

- Gringarten, A. C. and J. P. Sauty. 1975. "A Theoretical Study of Heat Extraction from Aquifers with Uniform Regional Flow." Journal of Geophysical Research. 80(35):4956-4962. [148]
- Gringarten, A. C. and J. P. Sauty. 1975. "Simulation des Transferts de Chaleur dans Les Aquiferes." Bulletin B.R.G.M., Section III(1):25-34. [149]
- Grist, D. M., G. O. Langley, and E. L. Neustater. 1975. "The Dependence of Water Permeability on Core Cleaning Methods in the Case of Some Sandstone Samples." J. Canadian Petroleum, 14(2):48-52. [278]
- Ground Water, July, 1963. 1(3). [694]
- Ground Water, January, 1964. 2(1). [694]
- Ground Water, October, 1964. 2(4). [694]
- Ground Water, Jan-Feb, 1969. 7(1). [694]
- Ground Water, Sep-Oct, 1970. 8(5). [694]
- Ground Water, July-Aug, 1971. 9(4). [694]
- Ground Water, March-April, 1972. 10(2). [694]
- Ground Water, March-April, 1973. 11(2). [694]
- Ground Water, March-April, 1975. 13(2):141-244. [694]
- Guest, R. J. and C. W. Zimmerman. 1973. "Compensated Gamma Ray Densimeter Measures Slurry Densities in Flow." Petroleum Engineer, 45(10):80-87. [150]
- Guha, T. K., K. E. Davis, R. E. Collins, J. R. Fanchi and A. C. Meyers. 1977. "Manmade Geothermal Energy." Alternative Energy Sources and International Compendium, Vol. 6, Geothermal Energy and Hydropower. T. N. Verziroglu (ed.), pp. 2641-2654. [151]
- A Guide to the Underground Injection Control Program. 1979. USEPA, Office of Drinking Water (WH550). [152]
- Gupta, S. K., K. K. Tanji, and J. N. Luthin. 1975. "A Three-Dimensional Finite Element Ground Water Model." PB-248-925. [153]
- Gustafson, G. 1977. "A Method for Calculating the Hydraulic Properties of Leaky Aquifer Systems." Noric Hydrology, 8(2):65-82. [695]

- Guyer, E. C. and M. W. Golay. 1977. "Evaluation of Combined Thermal Storage Pond/Dry Cooling Tower Waste Disposal Systems." ASME, 77-HT-57. [277]
- Hadley, W. A. and R. Eisenstadt. 1955. "Thermally Actuated Moisture Migration in Granular Media." Transactions, American Geophysical Union, 36(4):615-623. [154]
- Halevey, E. and A. Nir. 1962. "The Determination of Aquifer Parameters with the Aid of Radioactive Tracers." Journal of Geophysical Research, 67(6):2403-2409. [155]
- Hammond, A. L. 1972. "Conservation of Energy: The Potential for More Efficient Use." Science, 178:1079-1081. [ ]
- Hanck, J. A. and G. Nekoksa. 1975. "Corrosion Rate Monitoring at the Geysers Geothermal Power Plant." Proceedings Second U.N. Symposium on the Development and Use of Geothermal Resources, p. 1980-1984. [156]
- Hansen, V. E. 1952. "Complicated Well Problems Solved by the Membrane Analogy." Transactions, American Geophysical Union, 33(6):912-916. [157]
- Hanson, J. 1978. "Heat Transfer Effects in Forced Geoheat Recovery Systems." Ph.D. Thesis, Oregon State University. [610]
- Hanson, M. E., B. K. Crowley, and J. S. Kahn. 1975. "Massive Hydraulic Fracturing: Identification of Critical Technical Issues for Application in Increasing Gas Production in the Western United States." USCRL, 51751. [696]
- Hantush, M. S. 1961. "Drawdown Around a Partially Penetrating Well." Journal of the Hydraulics Division, ASCE, 87(HY4):83-98. [158]
- Hantush, M. S. 1961. "Economical Spacing of Interfering Wells." Int'l Assoc. Science Hydrogeology, Pub. 57, pp. 350-364. [697]
- Hantush, M. S. 1964. "Hydraulics of Wells." Advances in Hydroscience, Academic Press, Volume 1. [611]
- Hantush, M. S. 1967. "Flow to Wells in Aquifers Separated by a Semi-impervious Layer." J. Geophysical Research, 72(6):1709-1720. [281]
- Hantush, J. S. 1967. "Growth and Decay of Groundwater-Mounds in Response to Uniform Percolation." Water Resources Research, 3(1):227-234. [159]
- Hantush, M. S. and C. E. Jacob. 1954. "Plane Potential Flow of Ground Water with Linear Leakage." Transactions, American Geophysical Union, 35(6):917-936. [160]

- Hantush, M. S. and C. E. Jacob. 1955. "Non-Steady Radial Flow in an Infinite Leaky Aquifer." Transactions, American Geophysical Union, 36(1):95-100. [161]
- Hantush, M. S. and C. E. Jacob. 1960. "Flow to an Eccentric Well in a Leaky Circular Aquifer." Journal of Geophysical Research, 65(10):3425-3431. [162]
- Harboe, H. 1972. "Power in 2000 A.D." J. Fuel and Heat Technology, 19(3):1-5. [698]
- Harnish, J. R. 1967. "Heat Pumps - Manufacturer's Viewpoint." J. ASHRAE, 9(9):40-41. [163]
- Hausz, W. 1974. "Heat Storage Wells." General Electric TEMPO, P-655. [165]
- Hausz, W. 1974. "Heat Storage Wells Conserve Fuels." Symposium Papers - Efficient Use of Fuels in the Metallurgical Industries, pp. 185-201. [166]
- Hausz, W. 1976. "Annual Storage: A Catalyst For Conservation." General Electric TEMPO. [164]
- Hausz, W. 1977. "Seasonal Storage in District Heating." District Heating, July-August-September, pp. 5-11. [168]
- Hausz, W. 1978. The Need for a Heat Storage Well System Model. GE-TEMPO. [167]
- Hausz, W. 1979. Thermal Storage and Transport Briefing Charts. GE-TEMPO. [169]
- Hausz, W., B. J. Berkowitz and R. C. Hare. 1978. Conceptual Design of Thermal Energy Storage Systems for Near Term Electric Utility Applications. DOE/NASA/0012-78/1, Vol 1 and 2. (Vol 1: Screening Concepts; Vol. 2: Appendices - Screening of Concepts.) [170]
- Hausz, W. and C. F. Meyer. 1975. "Energy Conservation: Is the Heat Storage Well the Key?" Public Utilities Fortnightly, 95:34-38. [171]
- Hausz, W. and C. F. Meyer. 1979. Technical Aspects of Thermal Storage in Aquifers. GE-TEMPO. [172]
- Havrilak, R. J. 1976. "Energy Costs Dictate Efficient Well Design." Johnson Drillers Journal, 48(6):1-2, 13-15. [820]
- Haynes, C. D. and D. M. Grubbs. 1969. "Design and Cost of Liquid Waste Systems." Natural Resources Center, Report No. 692. [821]

- "Heat Pumps." 1974. Heating and Ventilating News, 17(12):10-12. [701]
- "The Heat Pump. Heat Sources and Sinks." 1950. Heating, Piping, and Air Conditioning, 22(11):87-91. [173]
- "Heat Pump Power for U.S. Flats." 1974. Building Research and Practice, January/February, p. 51. [174]
- "Heat Pump Reliability Shows Big Gains." 1973. Electric World, August, pp. 78-80. [175]
- "Heat Pump Takes on All Corners." 1964. Domestic Heating News, 13(5):24-26. [679]
- "Heat Pumps: Selection and Application." 1965. Air Conditioning, Heating and Ventilating, 62(10):55-86. [176]
- Hegelson, H. C, and D. H. Kirkham. 1974. "Theoretical Prediction of the Thermodynamic Behavior of Aqueous Electrolytes at Higher Pressures and Temperatures: I. Summary of the Thermodynamic/Electrostatic Properties of the Solvent." American Journal of Science, 274:1089-1198. [177]
- Heiss, H. W. 1977. "Research Foundation Utilizes Ground Water Heat Pumps." Water Well Journal, 31(4):58-59. [178]
- Hellstrom, G. \_\_\_\_\_. "Aquifer Storage Projects in Sweden." Dept. of Mathematical Physics, Lund Institute of Technology. [179]
- Helm, D. C. 1975. "One-Dimensional Simulation of Aquifer System Compaction Near Pixley, CA: 1. Constant Parameters." Water Resources Research, 2(3):465-478. [284]
- Helweg, O. J. 1978. "Regional Ground-Water Management." Ground Water, 16(5):318-321. [180]
- Henry, H. R., J. R. McDonald, and R. M. Alverson. 1971. Aquifer Performance Tests Under Two-Phase Flow Conditions. PB 209 535. [181]
- Herbeck, E. F., R. C. Heintz, and J. R. Hastings. 1976. "Fundamentals of Tertiary Oil Recovery: Part 2 - LPG Miscible Slug Process." Petroleum Engineer, 48:58-66. [822]
- Herbeck, E. F., R. C. Heintz, and J. R. Hastings. 1976. "Fundamentals of Tertiary Oil Recovery: Part 3 - Enriched Gas Miscible Process." Petroleum Engineer, 48:85-88. [823]

- Herbeck, E. F., R. C. Heintz, and J. R. Hastings. 1976. "Fundamentals of Tertiary Oil Recovery: Part 4 - High Pressure Lean Gas Miscible Process." Petroleum Engineer, 48:66-72. [824]
- Herbeck, E. F., R. C. Heintz, and J. R. Hastings. 1976. "Fundamentals of Tertiary Oil Recovery: Part 5 - Carbon Dioxide Miscible Process." Petroleum Engineer, 48:114-119. [825]
- Hermannsson, S. 1970. "Corrosion of Metals and the Forming of a Protective Coating on the Inside of Pipes Carrying Thermal Waters Used by the Reykjavik Municipal District Heating Service." Proceedings of the U.N. Symposium on the Development and Utilization of Geothermal Resources, 2(1):1602-1612. [182]
- Hernandez, J. W. 1977. "Underground Injection Program Set Under Safe Drinking Water Act." Water and Sewage Works, October, pp 67-69. [283]
- Hewitt, C. H. 1963. "Analytical Techniques for Recognizing Water-Sensitive Reservoir Rocks." Journal of Petroleum Technology, August, pp. 813-818. [183]
- Hill, C. T. \_\_\_\_\_. "Thermal Pollution and Its Control." Environmental Affairs, 406-420. [184]
- Hill, R. F. (ed). 1976. "Energy Technology III, Commercialization." Proceedings 3rd Energy Technology Conference, Government Institutes, Inc. [826]
- Hockman, E. L. 1972. "Requirements for Adequate Protection of our Nation's Drinking Water." Ground Water, 10(4):2-5. [702]
- Hoepfner, S. 1974. "Combating Air and Gas Problems." Water Well Journal, 28(5):29-30. [185]
- Hoffman, H. 1978. "Overview of Aquifer Thermal Energy Storage Program." Thermal Energy Storage in Aquifers Workshop. [186]
- Hoffman, H. W. \_\_\_\_\_. "Aquifers for Seasonal Thermal Energy Storage: An Overview of the DOE-STOR Program." CONF 7805131-1. [282]
- Hoffman, H. W., S. K. Fraley and R. J. Kedl. 1977. Proceedings of the Second Annual Thermal Energy Storage Contractors' Information Exchange Meeting, CONF-770955. [187]
- Holman, J. P. 1976. "Heat Transfer." 4th Edition, McGraw Hill, Inc. [827]
- Holt, L., R. Jones and G. Hagey. 1978. Environmental Development Plan (EDP) Energy Storage Systems, FY1977. DOE/EDP-0015. [622]



- Holton, W. C. 1951. "Effect of Molecular Weight of Entrained Fluid on the Performance of Steam-Jet Ejectors." Transactions of the ASME, 905-910. [188]
- Holzschuh, J. C. 1976. "A Simple Computer Program for the Determination of Aquifer Characteristics from Pump Test Data." Ground Water, 14(5):283-285. [189]
- Hooper, F. C. 1976. "Design of a Solar Heating System Using Seasonal Heat Storage." Solar Energy Conference, 8:260-261 (abstract only). [829]
- Hooper, F. C. and C. R. Attwater. 1977. "A Design Method for Heat Loss Calculation for In-Ground Heat Storage Tanks." ASME Winter Annual Meeting, Heat Transfer in Energy Conservation, pp. 39-43. [699]
- Hooper, F. C. and F. R. Lepper. 1950. "Transient Heat Flow Apparatus for the Determination of Thermal Conductivities." Transactions, American Society Heating Ventilating Engineer, 56:309-324. [838]
- Horner, D. R. 1951. "Pressure Build-Up in Wells." Proceedings Third World Petroleum Congress - Drilling and Production. The Hague. [700]
- Horton, C. W. and F. T. Rogers. 1945. "Convection Currents in a Porous Medium." Journal of Applied Physics, 16:367-370. [190]
- Horvath, E. and G. H. Elkan. \_\_\_\_\_. "A Model Aquifer System for Biological Compatibility Studies of Proposed Deep Well Disposal Systems." Ground Water Technology Division, NWWA, p. 174-185. [191]
- "House on Ice." 1979. Ground Water Age, May, pp. 16-19. [192]
- "How to Calculate Heat Transmission in Hot Fluid Injection." 1964. Petroleum Engineer, November, pp. 110-120. [194]
- Howard, J., et al. 1978. Geothermal Resource and Reservoir Investigations of U.S. Bureau of Reclamation Leaseholds at East Mesa, Imperial Valley, California. LBL-7094. [193]
- Huber, H. D., C. L. McDonald, C. H. Bloomster, and S. C. Schulte. 1978. User Manual for Geocity: A Computer Model for Geothermal District Heating Cost Analysis. PNL-2742. [195]
- Huyakorn, P. and C. R. Dudgeon. 1976. "Investigation of Two-Regime Well Flow." Journal of the Hydraulics Division ASCE, 102(HY9):1149-1165. [196]
- Huxtable, D. D. and D. R. Poole. 1976. "Thermal Energy Storage by the Sulfuric Acid-Water System." Int'l Solar Energy Society, American Section, 8:178-191. [830]

- Hydraulic Maps. [629]
- "Hydraulics and Economics of Well Field Layout." 1977. Public Works, 108(1):40-41. [197]
- Ineson, J. 1963. "Applications and Limitations of Pumping Tests: Hydrogeological Significance." Journal of the Institute of Water Engineers, 17:200-215. [198]
- Ineson, J. and D. A. Gray. 1964. "Electrical Investigations of Borehole Fluids." Journal of Hydrology, 1:204-218. [285]
- Intercomp Resource Development and Engineering, Inc. 1976. A Model for Calculating Effects of Liquid Waste Disposal in Deep Saline Aquifer: Part I - Development; Part II - Documentation. PB-256 903. [199]
- International Activities of the Energy Research and Development Administration. 1977. "Hearing Before a Subcommittee of the Committee on Government Operations, House of Representatives." [200]
- Isigaki, A., S. Komaki, T. Endo, and N. Miyabe. 1969. "Short Period Variation in Land Subsidence." Proceedings of Tokyo Symposium. IASH/AIHS, Unesco., Volume 2. [ ]
- Jacob, C. E. 1940. "On the Flow of Water in an Elastic Artesian Aquifer." Transactions, American Geophysical Union, 21:574-586. [201]
- Jacob, C. E. 1941. "Notes on the Elasticity of the Lloyd Sand on Long Island, NY." Transactions, American Geophysical Union, 22:783-787. [202]
- Jacob, C. E. 1943. "Correlation of Ground-Water Levels and Precipitation on Long Island, NY: Part I - Theory." Transactions, American Geophysical Union, 24:564-573. [203]
- Jacob, C. E. 1944. "Correlation of Ground-Water Levels and Precipitation on Long Island, NY: Part II - Correlation of Data." Transactions, American Geophysical Union, 25:928-939. [204]
- Jacob, C. E. 1946. "Radial Flow in a Leaky Artesian Aquifer." Transactions, American Geophysical Union, 27(2):198-205. [205]
- Jacob, C. E. 1946. "Appendix A - Report of the Subcommittee on Permeability." Transactions, American Geophysical Union, 27(II):245-273. [206]
- Jacob, C. E. 1947. "Drawdown Test to Determine Effective Radius of Artesian Well." Transactions, American Society of Civil Engineers, 112(2321):1047-1064. [207]

- Jacob, C. E. 1950. "Flow of Ground Water." Engineering Hydraulics, pp 321-386. [208]
- Jacob, C. E. and S. W. Lohman. 1952. "Nonsteady Flow to a Well of Constant Drawdown in an Extensive Aquifer." Transactions, American Geophysical Union, 33(4):559-569. [209]
- James, R. 1970. "Collection and Transmission of Geothermal Fluids." U.S. Symposium on the Development and Utilization of Geothermal Resources, 1:99-105, Special Issue 2. [210]
- Jameson, Jr., J. S. \_\_\_\_\_. "Panel Discussion." Independent Petroleum Association of America. [831]
- Jank, R. \_\_\_\_\_. "Aquifer Storage Efforts in Germany." Projektleitung Energieforschung in der Kernforschungsanlage Julich. [211]
- Japhet, R. E. 1967. "Heat Pumps - Manufacturer's Viewpoint." J. ASHRAE, 9(9):41-42. [212]
- Jardine, D. M. and D. W. Jones (principal investigators). 1978. "Phoenix House: Solar Assisted Heat Pump System Evaluation." Prepared by Kaman Science Corp by EPRI, ER-712. [832]
- Jenkins, N. 1976. "ITEC: A Congress that Stuck to Its Theme." Energy International, 13(12):15-25. [213]
- Jet Propulsion Laboratory Staff. 1974. Conference on Research for the Development of Geothermal Energy Resources. N75-20831-864. [214]
- Johnson, H. E. and A. C. Nestle. \_\_\_\_\_. "A Survey of Corrosion Control in Drilling and Annular Fluids." National Association of Corrosion Engineers, Publication 1D168. [215]
- Johnson, T. L. 1977. "Pumping Tests Provide Useful Data." Johnson Driller's Journal, pp. 4-7. [704]
- Johnson, W. C. \_\_\_\_\_. "Oregon Institute of Technology Aquaculture Using Geothermal Energy." [216]
- Jones, L. L. and J. P. Warren. 1976. "Land Subsidence Costs in the Houston Baytown Area of Texas." American Waterworks Association Journal, 68(11):597-599. [217]
- Jorgensen, D. G. 1968. "An Aquifer Test Used to Investigate a Quality of Water Anomaly." Ground Water, 6(6):18-20. [705]
- Kalhammer, F. R. and P. Z. Zugielbaum. \_\_\_\_\_. "Potential for Large-Scale Energy Storage in Electric Utility Systems." ASME. [706]

- Kalousek, G. L. and S. Y. Chaw. 1976. "Research on Cements for Geothermal and Deep Oil Wells." Society of Petroleum Engineers Journal, 16(6):307-309. [218]
- Karanjac, J. 1972. "Well Losses Due to Reduced Formation Permeability." Ground Water, 10(4):42-45. [833]
- Kassoy, D. R. 1975. "Heat and Mass Transfer in Models of Undeveloped Geothermal Fields." Proceedings Second U.N. Symposium on the Development and Use of Geothermal Resources, 3:1707-1711. [219]
- Kassoy, D. R. and A. Zebib. 1975. "Variable Viscosity Effects on the Onset of Convection in Porous Media." The Physics of Fluids, 18(12):1649-1651. [220]
- Katayama, K. and H. Nakagawa. 1970. "Research on Simultaneous Flow of Heat and Fluid Through Porous Media. (First report, Fundamental Theories)" Bulletin JSME, 13(62):1013-1021. [707]
- Katter, L. B. and R. L. Hoskins. 1978. Application of Thermal Energy Storage to Process Heat and Waste Heat Recovery in the Primary Aluminum Industry. CONS/5080-1. [878]
- Katz, D. L. and M. R. Tek. 1970. "Storage of Natural Gas in Saline Aquifers." Water Resources Research, 6(5):1515-1521. [221]
- Katz, D. L., M. R. Tek, and S. C. Jones. 1962. "A Generalized Model for Predicting the Performance of Gas Reservoirs Subject to Water Drive." Society of Petroleum Eng., AIME, SPE-428. [708]
- Kaveler, H. H. and Z. Z. Hunter. 1952. "Observations From Profile Logs of Water Injection Wells." Petroleum Transactions, AIME, 195:129-134. [222]
- Kazmann, R. G. 1958. "Problems Encountered in the Utilization of Ground-Water Reservoirs." Transactions, American Geophysical Union, 39(1):94-99. [223]
- Kazmann, R. G. 1971. "Exotic Uses of Aquifers." Journal of the Irrigation Division ASCE, 97(IR3):515-522. [224]
- Kazmann, R. 1974. "Waste Surveillance in Subsurface Disposal Projects." Ground Water, 12:412-426. [225]
- Kazmann, R. G. 1975. "Groundwater and Environmental Geology." Environmental Geology, 1:137-142. [226]

- Kazmann, R. G. 1978. "Underground Hot Water Storage Could Cut National Fuel Needs 10%." Civil Engineering, 48(5):57-60. [227]
- Kazmann, R. G., O. K. Kimbler and W. R. Whitehead. 1974. "Management of Waste Fluids in Salaquifers." Journal of the Irrigation and Drainage Division ASCE, 100(IR4):413-424. [228]
- Keady, D. M., et al. 1975. Status of Land Subsidence Due to Ground-Water Withdrawal Along the Mississippi Gulf Coast. PB-243 558. [229]
- Keenan, J. H. and F. G. Keyes. 1936. "Thermodynamic Properties of Steam (Including Data for the Liquid and Solid Phases)." Publication, John Wiley and Sons. [612]
- Keller, C. E., A. H. Davis, and J. N. Stewart, Jr. 1974. "The Calculation of Steam Flow and Hydraulic Fracturing in a Porous Medium with the KRAK Code." LA-5602-MS. [230]
- Kemper, W. D., W. R. Walker and J. Sabey. \_\_\_\_\_. "Trans-Seasonal Storage of Energy in Moist Soils." [231]
- Keys, W. S. \_\_\_\_\_. "Borehole Geophysics as Applied to Groundwater." Mining and Groundwater Geophysics/1967. Economic Geology Report No. 26, pp. 598-614. [834]
- Keys, W. S. 1967. "The Application of Radiation Logs to Groundwater Hydrology." Proceedings of the Symposium on Isotopes in Hydrology, p. 477-488. [232]
- Keys, W. S. and R. F. Brown. \_\_\_\_\_. "The Use of Temperature Logs to Trace the Movement of Injected Water." Hydrologist, Water Resources Division, U.S. Geological Survey. [233]
- Khaleel, R. and D. L. Raddell. 1977. Simulation of Pollutant Movement in Groundwater Aquifers. PB-268835. [234]
- Kihara, D. H. and P. S. Fukunaga. 1975. "Working Fluid Selection and Preliminary Heat Exchanger Design for a Rankine Cycle Geothermal Power Plant." Proceedings Second U.N. Symposium on the Development and Use of Geothermal Resources, pp. 2013-2019. [235]
- Kilgore, L. A. and D. C. Washburn, Jr. 1970. "Energy Storage of Site Permits Use of Large Excavators on Small Power Systems." Westinghouse Engineer. [709]
- Kikpatrick, F. A. 1976. Water Measurement and Monitoring in Energy Developing Areas. EPA 600/7-76-002, U.S. Environmental Protection Agency. [710]

- Kimblar, O. K. 1970. "Fluid Model Studies of the Storage of Fresh Water in Saline Aquifers." Water Resources Research, 6(5):1522-1527. [236]
- Kimblar, O. K., R. G. Kazmann and W. R. Whitehead. 1975. Cyclic Storage of Fresh Water in Saline Aquifers. Louisiana Water Resources Research Institute. Bull. 10. [237]
- Kirschbaum, H. S. 1977. An Investigation of Methods to Improve Heat Pump Performance and Reliability in a Northern Climate. EPRI EM-319. [623]
- Klarsfeld, S. M. 1970. "Champs de Temperature Associes aux Mouvements de Convection Naturelle dans un Millieu Poreux Limite." Revue Generale de Thermique, 108:1403-1423. [238]
- Kley, W. and H. G. Nieskens. 1975. "Moglichkeiten der Warmespeicherung in Einem Porengrundwasserleiter und Technische Probleme bei einer Ruckgewinnung der Energie." Z. dt. Geol. Ges., 126:397-409. [239]
- Klinkenberg, L. J. 1941. "The Permeability of Porous Media to Liquids and Gases." Drilling and Production Practice, American Petroleum Institute, pp. 200-213. [711]
- Koch, R. K., E. D. Calvert, C. R. Thomas, and R. A. Beall. 1976. Vapor Pressure of Liquid Titanium (2,008° to 2,379°K) and Liquid Platinum (2,045° to 2,379°K). Report Investigation 7271. U.S. Department of Interior. [712]
- Komedera, M. 1956. "The Domestic Heat Pump. Standard Equipment of the Future." Engineering, 182(4720):236-40. [286]
- Komedera, M. 1957. "Heat from Ground Utilized by Heat Pump, Part 1." Heating and Ventilating Engineering, and J. Air Conditioning, 31(362):65-72. [615]
- Komedera, M. 1957. "Heat From Ground Utilized by Heat Pump, Part 2." Heating and Ventilating Engineering, and J. Air Conditioning, 31(363):122-128. [600]
- Komedera, M. 1957. "Heat Pumps for Water Heating." Heating and Ventilating Engineering; and J. Air Conditioning, 30(359):554-564. [599]
- Konczak, Z. 1975. "The Influence of the Temperature on the Phenomena of Consolidation in Deformable Porous Media." Bulletin De L'Academie, 13(7):345-354. [715]
- Kovach, E. G. 1976. Thermal Energy Storage. Scientific Affairs Division, North Atlantic Treaty Organization: Brussels, BELGIUM. [625]
- Kreitlow, D. B. 1978. "Geothermal Well Downhole Heat Exchanger Design Analysis." Thesis, Oregon State University. [596]

- Krishnaswamy, V. S. and R. Shankar. 1974. "Geothermal Fields in India Explored for Power Generation." Geothermics, 3:124-125. [287]
- Krocker, J. D. and Associates. 1964. "Report on Loads, Capacities, and Operating Conditions of the Heat Pump Air Conditioning System in the Equitable Building, Portland, OR." [595]
- Kroeger, P. G. and S. Ostrach. 1974. "The Solution of a Two Dimensional Freezing Problem Including Convection Effects in the Liquid Region." International Journal of Heat Mass Transfer, 17:1191-1207. [288]
- Kroeker, J. D. and R. C. Chewning. 1948. "A Heat Pump in an Office Building." Heating, Piping, and Air Conditioning, February, p. 1-8. [289]
- Kroeker, J. D. and R. C. Chewning. 1953. "Costs of Operating the Heat Pump in the Equitable Building." Heating, Piping and Air Conditioning, November, p. 135-144. [290]
- Kroeker, J. D., R. C. Chewning, and C. E. Graham. 1948. "Heat Pump Results in Equitable Building." Heating, Piping, and Air Conditioning, June, p. 1-7. [291]
- Kryukov, P. A. and E. G. Larionov. 1970. "Physico-Chemical Sampling of High Temperature Wells in Connection with their Encrustation by Calcium Carbonate." Proceedings of the U.S. Symposium on the Development and Utilization of Geothermal Resources, 2(1):1624-1628. [292]
- Kukacka, L. E., J. Fontana, A. Zeldin, T. Sugama, W. Horn, N. Carciello, and J. Amaro. 1977. Alternative Materials of Construction for Geothermal Applications. BNL-50751. [293]
- Kukacka, L. E., A. Zeldin, J. Fontana, N. Carciello, and T. Sugama. 1977. Cementing of Geothermal Wells. BNL-50738. [294]
- Kumar, A. and O. K. Kimbler. 1970. "Effect of Dispersion, Gravitational Segregation, and Formation Stratification on the Recovery of Freshwater Stored in Saline Aquifers." Water Resources Research, 6(6):1689-1700. [295]
- Kusuda, T. and P. R. Achenbach. 1964. "Earth Temperature and Thermal Diffusivity at Selected Stations in the United States." ASHRAE Transactions, 1914:61-75. [296]
- LaGarde, A. 1965. "Considerations Sur Le Transfert De Chaleur En Milieu Poreux." Revue De L'Institut Francais Du Petrole, XX(2):383-445. [297]

- Lakshminarayana, V. and S. P. Rajagopalan. 1978. "Type-Curve Analysis of Time-Drawdown Data for Partially Penetrating Wells in Unconfined Anisotropic Aquifers." Ground Water, 16(5):328-333. [298]
- Lang, S. M. 1960. "Interpretation of Boundary Effects From Pumping Test Data." American Water Works Association Journal, 52(3):356-364. [299]
- Lang, W. 1977. "Air Stored for Peaking Power." Electrical World, 187(1):30-31. [300]
- Lapwood, E. R. 1948. "Convection of a Fluid in a Porous Medium." Proc. Cambridge Phil. Soc., 44:508-521. [301]
- Lauwerier, H. A. 1955. "The Transport of Heat in an Oil Layer Caused by the Injection of Hot Fluid." Applied Sci. Research, Section A, 5:145-150. [302]
- Lawrence Berkeley Laboratory. 1975. Geothermal and Geosciences Program Annual Report 1975. PUB-206. [303]
- Lawrence Berkeley Laboratory. 1977. Geothermal Subsidence Research Program Plan. LBL-5983. [716]
- Lawrence Berkeley Laboratory. 1977. Earth Sciences Division Annual Report 1977. LBL-7028. [304]
- Lawrence Berkeley Laboratory. 1978. Invitational Well-Testing Symposium Proceedings. LBL-7027. [305]
- Lawrence Berkeley Laboratory. 1978. Second Invitational Well-Testing Symposium Proceedings. LBL-8883. [306]
- Lawrence Berkeley Laboratory. 1978. Geothermal Exploration Technology Annual Report 1978. LBL-8603. [307]
- Lawrence Berkeley Laboratory. 1978. "Mexican-American Cooperative Program at the Cerro Prieto Geothermal Field." Abstracts First Symposium on the Cerro Prieto Geothermal Field, Baja California, Mexico. LBL-7098. [308]
- Lefebvre, V. 1977. Chemical Dynamics of a Confined Limestone Aquifer. WRRRI Report No. 084, PB-265666. [309]
- Leggette, R. M. and M. L. Brashears, Jr. 1938. "Ground-Water for Air Conditioning on Long Island, New York." Transactions, American Geophysical Union, 19:412-418. [310]



- Lehr, J. H. 1978. "Environmental Aspects of Low Temperature Thermal Energy Storage in Aquifers." Proceedings of the Thermal Energy Storage in Aquifers Workshop. LBL-8431. [ ]
- Lehr, J. H. 1975. "Objectives of Well-Drilling Regulations." Environmental Aspects of Chemical use in Well-Drilling Operations, EPA-560/1-75-004, pp. 555-570. [311]
- Lehr, J. H. 1977. "Well Maintenance and Rehabilitation." Water Well Journal, 31(8):8-9. [312]
- Lenzer, R. C., G. W. Crosby, and C. W. Berge. 1977. "Recent Developments at the Roosevelt Hot Springs KGRA." Energy and Mineral Resource Recovery, CONF-770440, pp 60-67. [313]
- Lesem, L. B., F. Geytok, F. Marotta, and J. J. McKetta. 1957. "A Method of Calculating the Distribution of Temperature in Flowing Gas Wells." AIME Petroleum Transactions, 210:169-176. [314]
- Leshuk, J. P., R. J. Zaworski, D. L. Styris, and O. K. Harling. 1978. "Solar Pond Stability Experiments." Solar Energy, 21(3):237-244. [572 C.2]
- Leshuk, J. P., R. J. Zaworski, D. L. Styris, and O. K. Harling. 1976. "Solar Pond Stability Experiments." American Section, Int'l Solar Energy Society, and Solar Energy Society of Canada, (Solar Thermal and Ocean Thermal), 5:188-202. [572 C.1]
- Li, W. H. 1954. "Interaction Between Well and Aquifer." Proceedings American Society of Civil Engineers, 80(578):1-14. [315]
- Lidorenko, N. S., G. F. Muchnik, S. D. Solomonov, and A. R. Gordon. 1974. "New Method for Investigation the Permeability of Porous Materials." Translated from Teplofizika Vysokikh Temperatur, 12(5):1085-1090. [713]
- Lienau, P. J. 1978. Agribusiness Geothermal Energy Utilization Potential of Klamath and Snake River Basins, Oregon. IDO/1621-1. [786]
- Lienau, P. J. 1978. "Potential Utilization of Geothermal Energy for Space and Process Heating in Eleven States." Oregon Institute of Technology. [616]
- Lienau, P. J. 1977. "Utilization of Geothermal Energy in Iceland." [316]
- Lienau, P. J. and J. W. Lund. 1974. "Multipurpose Use of Geothermal Energy." Proceedings of the International Conference on Geothermal Energy for Industrial, Agricultural, and Commercial-Residential Uses. Oregon Institute of Technology. [624]
- Lienau, P. J. and J. W. Lund. \_\_\_\_\_. "Utilization and Economics of Geothermal, Space Heating in Klamath Falls, Oregon." Oregon Institute of Technology. [317]

- Lindemuth, T. E., E. H. Houle, S. H. Suemoto, and V. C. VanDerMast. 1976. "Experience in Scale Control with East Mesa Geothermal Brine." International Symposium on Oilfield and Geothermal Chemistry, SPE-6605. [318]
- Lindorff, D. E. 1979. "Ground Water Pollution - A Status Report." Ground Water, 17(4):9-17. [319]
- Lindroth, D. P. 1974. Thermal Diffusivity of Six Igneous Rocks at Elevated Temperatures and Reduced Pressures. RI-7954. U.S. Bureau of Mines. [714]
- Lippman, M. J. \_\_\_\_\_. "Thermal Energy Storage in Aquifers Analytical Modeling at LBL." [320]
- Lippman, M. J., T. N. Narasimhan, and P. A. Witherspoon. 1977. "Modeling Subsidence Due to Geothermal Fluid Production." ASCE 3107. [321]
- Lippman, M. J., C. F. Tsang, and P. A. Witherspoon. 1977. "Analysis of the Response of Geothermal Reservoirs Under Injection and Production Procedures." SPE-6537. [322]
- Lo, H. Y. and N. Mungan. 1973. "Effect of Temperature on Water-Oil Relative Permeabilities in Oil-Wet and Water-Wet Systems." Society of Petroleum Eng., AIME, SPE-4505. [717]
- Lofgren, B. E. 1969. "Field Measurement of Aquifer-System Compaction, San Joaquin Valley, CA." USA Proceedings Tokyo Symposium on Land Subsidence, IASH/AIHS Unesco., pp. 272-284. [571]
- Lofgren, B. W. 1961. Measurement of Compaction of Aquifer System in Areas of Land Subsidence. Professional Paper 424-B, pp. 849-852. U.S. Geological Survey. [570]
- Lohman, S. W. 1972. Ground Water Hydraulics. Professional Paper 708. U.S. Geological Survey. [779]
- Louden, L. R. and R. E. Mc Glothlin. 1975. "Waste Water Base Drilling Fluid Disposal." Environmental Aspects of Chemical Use in Well-Drilling Operations, EPA-560/1-75-004, pp. 515-522. [323]
- Loy, S. E. 1975. "Techniques of Deep Well Drilling." Environmental Aspects of Chemical Use in Well-Drilling Operations, EPA-560/1-75-004, pp. 11-25. [324]
- Luikov, A. V. 1976. "Capillary Porous Materials and the Transfer of Heat or Energy." Int'l. Chemical Eng., 16(1):54-60. [718]

- Lund, J. W. 1978. "Geothermal Energy Utilization for the Homeowner." [325]
- Lund, J. W. 1978. "Geothermal Hydrology and Geochemistry of Klamath Falls, Oregon Urban Area." Oregon Institute of Technology, Geo-Heat Utilization Center. [326]
- Lund, J. W., P. J. Lienau, G. G. Culver, and C. V. Higbee. \_\_\_\_\_. "Klamath Falls Geothermal Heating District." [327]
- Lundstrom, L. and H. Stille. 1978. Large Scale Permeability Test of the Granite in the Stripa Mine and Thermal Conductivity Test. LBL-7052, SAC-02. [328]
- Lynch, E. J. 1964. "Recent Development Formation Evaluation." World Oil, 158:110-118. [329]
- Maddock, T. 1976. "A Drawdown Prediction Model Based on Regression Analysis." Water Resources Research, 12(4):818-822. [330]
- Madhav, M. R. and P. Basak. 1977. "Ground Subsidence Due to Nonlinear Flow Through Deformable Porous Media." Journal of Hydrology, 34:21-33. [331]
- "Maintaining the Yield of Water Wells." 1965. The Johnson Drillers Journal, January-February, pp. 1-4. [332]
- Malofeev, G. E. 1960. "Calculation of the Temperature Distribution in a Formation When Pumping Hot Fluid into a Well." Neft'1 Gaz, 3(7):59-64. [782]
- Manahan, S. E. 1976. Information Dissemination in the Water Resources Field. PB-260 486. [333]
- Margen, P. 1978. "The Use of Nuclear Energy for District Heating." Progress in Nuclear Energy, 2:1-28. [334]
- Marine, I. W. 1975. "Water Level Fluctuations Due to Earth Tides in a Well Pumping From Slightly Fractured Crystalline Rock." Water Resources Research, 2(1):165-171. [335]
- Marovelli, R. L. and K. F. Veith. 1965. Thermal Conductivity of Rock: Measurement by the Transient Line Source Method. RI-6604. U.S. Bureau of Mines. [719]
- Marx, J. W. and R. H. Langenheim. 1959. "Reservoir Heating by Hot Fluid Injection." Petroleum Transactions, AIME, 216:312-315. [336]
- Mather, J. D., D. A. Greenwood, and P. B. Greenwood. 1979. "Burying Britain's Radioactive Waste." Nature, 281:332-333. [720]

- Mathey, B. \_\_\_\_\_. "LeStockage Thermique Dans Les Nappes Souterraines." Symposium de la Societe suisse Pour l'energie Solaire, Lousanne, Suisse. 9 Juin, p. 62-72. [337]
- Mathey, B. 1977. "Development and Resorption of a Thermal Disturbance in a Phreatic Aquifer with Natural Convection." Journal of Hydrology, 34:315-333. [338]
- Mathey, B. and A. Menjot. 1977. "Transferts De Chaleur En Milieu Heterogene Sature: Comparasion Des Resultats Analytiques Et Numeriques Avec Les Resultats Experimentaux In Situ." Symposium on Hydrodynamic Diffusion and Dispersion in Porous Media, p. 79-87. [339]
- Mathey, B., E. Recordon, and B. Saugy. 1977. "Etude des Transferts de Masse et de Chaleur dans les Nappes Souterraines." Wasser, Energie Luft., 69(11-12):289-296. [569]
- McCaffey, F. G. 1976. "Interfacial Tensions and Aging Behavior of Some Crude Oils Against Caustic Solutions." J. Canadian Petroleum Tech., 15(3):71-74. [568]
- McCain, W. D. and T. D. Stacy. 1971. "A Method of Correlation of High Temperature, High Pressure Gas - Solid Adsorption Data." Society of Petroleum Engineers Journal, March, pp. 4-6. [ ]
- McCuen, R. H. and L. E. Asmussen. 1973. "Estimating the Effect of Heat Storage on Evaporation Rates." Hydrological Sciences, Bulletin XVIII, 26, pp. 191-196. [721]
- McCune, C. C. 1977. "On-Site Testing to Define Injection-Water Quality Requirements." Journal of Petroleum Technology, January, pp. 17-24. [340]
- McDonald, C. L. and C. H. Bloomster. 1977. The Geocity Model: Description and Application. BNWL-SA-6343. [341]
- McFarland, C. R. 1979. Oil and Gas Exploration in Washington, 1900-1978. Department of Natural Resources, Division of Geology and Earth Resources. Info. Circ. 67. [342]
- McGraw, R. \_\_\_\_\_. "Heat Conduction in Saturated Granular Materials." U.S. Army Terrestrial Sciences, Hanover, NH, pp. 114-131. [722]
- McLean, G. O. 1955. "The Dual Purpose Domestic Heat Pump." Journal of the Institute of Fuel, 28:224-228. [343]
- McNabb, J. F. and W. J. Dunlap. 1975. "Subsurface Biological Activity in Relation to Groundwater Pollution." Ground Water, 13(1):33-44. [344]

- Megley, J. W. 1968. "Heat Pumps Provide Economical Services for Apartment Tenants." Heating, Piping and Air Conditioning, 40(1):124-131. [345]
- Megley, J. W. and G. W. McElhaney. 1970. "Energy Requirements: Summary and Analysis of Results." ASHRAE Symposium on Heat Pumps - Improved Design and Performance, pp 20-29. [346]
- Meinzer, O. E. 1928. "Compressibility and Elasticity of Artesian Aquifers." Economic Geology, 23:263-291. [347]
- Mercer, J. W. and C. R. Faust. 1979. "Geothermal Reservoir Simulation: 3. Application of Liquid- and Vapor-Dominated Hydrothermal Modeling Techniques to Wairakei, New Zealand." Water Resources Research, 15(3):653-671. [835]
- Mercer, J. W., G. F. Pinder and I. G. Donaldson. 1975. "A Galerkin - Finite Element Analysis of the Hydrothermal System at Wairakei, NEW ZEALAND." Journal of Geophysical Research, 80(17):2608-2621. [348]
- "A Method of Correlation of High-Temperature, High-Pressure Gas-Solid Adsorption Data." \_\_\_\_\_. Society of Petroleum Engineers Journal. [349]
- Meyer, A. F. 1960. "Effect of Temperature on Ground-Water Levels." Journal of Geophysical Research, 65(6):1747-1752. [350]
- Meyer, C. F. 1973. "Are Heat-Storage Wells the Answer?" Electrical World, August 15, pp. 42-45. [351]
- Meyer C. F. 1976. "Status Report on Heat Storage Wells." Water Resources Bulletin, 12(2):237-252. [352]
- Meyer, C. F. 1977. "Heat Storage Wells: Key to Large-Scale Cogeneration?" Public Power, July-August, pp. 28-30. [353]
- Meyer, C. F. 1978. "Evaluation of Thermal Energy Storage for the Proposed Twin Cities District Heating System." Third Annual Thermal Energy Storage Contractor's Information Exchange Meeting. [354]
- Meyer, C. F. 1978. "Large Scale Thermal Energy Storage for Cogeneration and Solar Systems." 5th Energy Technology Conference and Exposition. [355]
- Meyer, C. F. 1979. Potential Benefits of Thermal energy Storage in the Proposed Twin Cities District Heating - Cogeneration System. ORNL/SUB-7604-1. [877]
- Meyer, C. F. and W. Hausz. \_\_\_\_\_. A New Concept in Electric Generation and Energy Storage. GE-TEMPO. [363]

- Meyer, C. F. and W. Hausz. 1978. "Energy Management Objectives and Economics of Heat Storage Wells." Thermal Energy Storage in Aquifers Workshop. [356]
- Meyer, C. F., W. Hausz, B. L. Ayres and H. M. Ingram. 1976. Role of the Heat Storage Well in Future U.S. Energy Systems. GE76TMP-27A. [357]
- Meyer, C. F. and D. K. Todd. 1973. "Conserving Energy with Heat Storage Wells." Environmental Science and Technology, 7(6):512-516. [358]
- Meyer, C. F. and D. K. Todd. 1973. "Heat-Storage Wells." Water Well Journal, 27:35-41. [359]
- Meyer, C. F. and D. K. Todd. 1973. "Heat-Storage Wells for Conserving Energy and Reducing Thermal Pollution." 8th Intersociety Energy Conversion Engineering Conference. [360]
- Meyer, C. F. and D. K. Todd. 1974. "Brunnen als Warmespeicher eine glicheit, Energie zu Sparen und Thermische Umweltbelastung zu Verhuten?" Braunkohle, 26(9):275-280. [567]
- Meyer, C. F., D. K. Todd and R. C. Hare. 1972. Thermal Storage for Eco-Energy Utilities. GE72TMP-56. [361]
- Meyer, W. R. 1962. "Use of a Neutron Moisture Probe to Determine the Storage Coefficient of an Unconfined Aquifer." Geological Survey Research, USGS Professional Paper 450, pp. E174-E176. [362]
- Michaels, A. I. 1979. "Revised Draft of IEA/CRD/Solar Heating and Cooling Systems, Annex VI - Central Solar Heating Plant with Seasonal Water Storage: Feasibility Study and Design." [364]
- Milburn, H. L. 1964. "Computerizing Heat Pump Operating Costs." J. ASHRAE, 6(8):67-71. [365]
- Miles, C. R. 1978. "Modeling and Flow Measurement of Shallow Geothermal Systems with Downhole Heat Exchangers." Thesis, Oregon State University. [594]
- Millard, V., N. G. Berndtsson, and J. A. Bray. 1976. "Current and Required Economics in Relation to Further Alberta Enhanced Recovery of Conventional Crude." J. Canadian Petroleum Tech., 15(3):20-31. [566]
- Miller, C. W. 1979. A Numerical Model of Transient Two Phase Flow in a Geothermal Well. LBL-9056. [366]
- Miller, C. W. and J. M. Zerzan. 1979. Downhole Pressure Changes Measured with a Fluid Filled Capillary Tube. LBL-9303. [367]

- Miller, R. E. 1961. Compaction of an Aquifer System Computed from Consolidated Tests and Decline in Artesian Head. Professional Paper 424B, pp B54-B58. U.S. Geological Survey. [565]
- Milora, S. L. and J. W. Jefferson. 1976. "Geothermal Energy as a Source of Electrical Power." MIT Press. [564]
- Minkowycz, W. J. and P. Cheng. 1976. "Free Convection About a Vertical Cylinder Embedded in a Porous Medium." Int'l J. Heat Mass Transfer, 19:805-813. [724]
- Molz, F. J. and L. C. Bell. 1977. "Head Gradient Control in Aquifers Used for Fluid Storage." Water Resources Research, 13(4):795-798. [368]
- Molz, F. J., A. D. Parr, P. F. Anderson, V. D. Lucido, and J. C. Warman. 1979. Thermal Energy Storage in Confined Aquifers. Water Resources Research Institute, Auburn University. [626]
- Molz, F. J. and J. Warman. 1978. "Aquifer Storage of Heat." Water Well Journal, February, pp. 46-47. [369]
- Molz, F. J., J. C. Warman and T. E. Jones. 1978. "Aquifer Storage of Heated Water: Part I - A Field Experiment." Ground Water, 16(4):234-241. [370]
- Molz, F. J., J. C. Warman, T. E. Jones and G. E. Cook. 1976. "Experimental Study of the Subsurface Transport of Water and Heat as Related to the Storage of Solar Energy." Storage, Water Heater, Data Communication Education, 8:238-244. [371]
- Morey, G. W., R. O. Fournier and J. J. Rowe. 1962. "The Solubility of Quartz in Water in the Temperature Interval from 25° to 300°C." Geochimica et Cosmochimica Acta, 26:1029-1043. [372]
- Moses, Jr., T. H. and J. H. Sass. 1979. Drilling Techniques Presently in Use by the Geothermal Studies Project, U.S. Geological Survey. Open File Report 79-763. U.S. Geological Survey. [563]
- Mosley, J. C. and J. F. Malina, Jr. 1968. Relationships Between Selected Physical Parameters and Cost Response for the Deep-Well Disposal of Aqueous Industrial Wastes. CRWR 28, Reprint of Technical Report. University of Texas, Austin. [768]
- Moss, J. T. and P. D. White. 1959. "How to Calculate Temperature Profiles in a Water Injection Well." Oil and Gas Journal, 57:174-178. [373]
- Moulder, E. A. 1970. "Freshwater Bubbles: A Possibility for Using Saline Aquifers to Store Water." Water Resources Research, 6(5):1528-1531. [374]

- Moulder, E. A. and D. R. Frazor. 1957. "Artificial Recharge Experiments at McDonald Well Field, Amarillo, TX." Texas Board of Water Engineers, Bulletin 5701. [562]
- Mount, J. R. 1969. "A Simplified Technique for Well-Field Design." Ground-Water, 7(3):5-8. [375]
- Mueller, R. O., J. G. Asbury, J. V. Caruso, D. W. Connor, and R. F. Giese. 1978. "Optimal Design of Seasonal Storage for 100% Solar Space Heating in Buildings." Publication in Proceedings of AAAS Symposium. (Efficient Comfort Conditioning: Heating and Cooling of Buildings.) Energy Storage Systems Division, U.S. Department of Energy. [561]
- Mueller, T. D. 1962. "Transient Response of Nonhomogeneous Aquifers." J. Society of Petroleum Eng., pp. 33-43. [725]
- Muffler, L. J. P. 1978. Assessment of Geothermal Resources of the United States - 1978. Circular 790. U.S. Geological Survey. [560]
- Mulac, A. J., W. L. Flower, R. A. Hill, and D. P. Aeschliman. 1977. "Enhanced Spontaneous Roman Scattering Technique for Highly Luminous Environments." 1977 Fall Meeting Western States Section, The Combustion Institute. SAND-77-1115c. [836]
- Mungan, N. 1965. "Permeability Reduction Through Changes in pH and Salinity." Journal of Petroleum Technology, December, pp. 1449-1453. [376]
- Murphy, H. D. 1977. Fluid Injection Profiles - A Modern Analysis of Wellbore Temperature Surveys. SPE-6783. [377]
- Mutti, D. H., J. E. Atwood, C. R. LaFayette, and A. O. Landrum. \_\_\_\_\_. "Corrosion Control of Gas-Lift Well Tubulars by Continuous Inhibitor Injection into the Gas-Lift Gas Stream." J. Petroleum Technology, 28:624-628. [837]
- Mylander, H. A. 1953. "Oil Field Techniques for Water Well Drilling." American Water Works Association Journal, 45:764-772. [378]
- Naney, J. W., D. C. Kent and E. H. Seely. 1976. "Evaluating Ground-Water Paths Using Hydraulic Conductivities." Groundwater, 14(4):205-213. [379]
- Narasimhan, T. N. 1978. The Significance of the Storage Parameter in Saturated-Unsaturated Groundwater Flow. LBL-7041. [380]
- Narasimhan, T. N. 1979. A Note on Volume Averaging. LBL-8792. [381]



- Narasimhan, T. N. 1969. "Methods of Analysis Pumping Test Data." Ground Water, 7(2):2-6. [559]
- Narasimhan, T. N., R. C. Schroeder, C. G. Goranson, D. G. McEdwards, D. A. Campbell, and J. H. Barkman. 1977. Recent Results From Tests on the Republic Geothermal Wells, East Mesa, California. LBL-7017. [382]
- Narasimhan, T. N. and P. A. Witherspoon. 1976. "Numerical Model for Land Subsidence in Shallow Groundwater Systems." International Association of Hydrological Sciences Proceedings of the Anaheim Symposium, p. 133-143. [383]
- Narasimhan, T. N. and P. A. Witherspoon. 1976. "An Integrated Finite Difference Method for Analyzing Fluid Flow in Porous Media." Water Resources Research, 12(1):57-64. [384]
- Narasimhan, T. N. and P. A. Witherspoon. 1978. "Numerical Model for Saturated-Unsaturated Flow in Deformable Porous Media: 2. The Algorithm." Water Resources Research, 14(2):255-261. [385]
- Narasimhan, T. N. and P. A. Witherspoon. 1978. "Numerical Model for Saturated-Unsaturated Flow in Deformable Porous Media: 3. Applications." Water Resources Research, 14(6):1017-1033. LBL-7037. [386]
- National Waterwell Association. (Pre-publication release.) "Shallowest Aquifer Water Level Elevations for the United States." [558]
- National Waterwell Association. Catalog, Third Edition. [557]
- Neuman, S. P. and T. N. Narasimhan. 1975. Mixed Explicit-Implicit Iterative Finite Element Scheme for Diffusion-Type Problems: I. Theory. LBL-4405. [387]
- Newman, M. E. 1977. "Heat Pump and Water on the Rocks." Building Systems Design, October/November, pp. 36-41. [388]
- Newman, S. P. 1978. Comments on Papers at Aquifers Workshop. LBL-8431. Proceedings of the Thermal Energy Storage in Aquifers Workshop. [556]
- Nicholls, R. L. 1977. "Optimal Proportioning of an Insulated Earth Cylinder for Storage of Solar Heat." Solar Energy, 19(9):711-714. [555]
- Nicholls, R. L. 1978. "Comparisons of Deep Well and Insulated Shallow Earth Storage of Solar Heat." Solar Energy, 20(2):127-137. [726]
- Nolen, J. S. and D. W. Berry. 1972. "Tests of Stability and Time-Step Sensitivity of Semi-implicit Reservoir Simulation Techniques." J. Society of Petroleum Eng., pp.253-266. [727]

- Noran, D. 1976. "Enhanced Recovery Requires Special Equipment." J. Oil and Gas, 75:75-80. [838]
- Noran, D. 1977. "Diversified Equipment Assists Enhanced Recovery." J. Oil and Gas, 75:75-80. [839]
- Noran, D. 1978. "Growth Marks Enhanced Oil Recovery." J. Oil and Gas, 76:113-140. [840]
- Noyes, R. (ed). 1978. "Cogeneration of Steam and Electric Power." Energy Technology Review No. 29. Noyes Data Corporation. [841]
- "NWWA Ground Water Heat Pump Research Imperatives." 1977. Water Well Journal, pp. 60-61. [389]
- Obbink, J. G. 1969. "Construction of Piezometers, and Method of Installation for Ground Water Observations in Aquifers." Journal of Hydrology, 7:434-443. [390]
- O'Brien, L. J., R. S. Cooke, and H. R. Willis. 1978. "Oil Saturation Measurements at Brown and East Voss Tannehill Fields." J. Petroleum Technology, 30:17-25. [842]
- Office of Technology Assessment. 1979. Materials and Energy from Municipal Waste. Stock #052-003-00642-9. U.S. Government Printing Office. [769]
- Oil and Gas Conservation Act. 1951. State of Washington, Dept. Nat. Res. Chapter 146. (H.B. 143). [397]
- Oil and Gas Conservation Committee. 1954. General Rules and Regulations Governing the Conservation of Oil and Gas. State of Washington, Dept. Nat. Res. [392]
- Oil and Gas Conservation Committee. \_\_\_\_\_. Instructions for Oil and Gas Drillers. State of Washington. [391]
- Oliker, I. 1977. "Heat Exchanger and Thermal Storage Problems in Power Stations Serving District Heating Networks." ASME Paper 77-HT-36. [393]
- Olszewski, M. 1975. "Agricultural Greenhouse Uses of Power Plant Reject Heat." Ph.D. Thesis, University Microfilms International. [843]
- Olszewski, M. and G. J. Trezek. 1976. "Performance Evaluation of an Evaporative Pad Greenhouse System for Utilization of Power Plant Reject Heat." Journal of Environmental Quality, 5(3):261-269. [394]
- Oster, C. A. 1976. Well-Hole Temperature Distribution in the Presence of Aquifers. BNWL-SA-5658. [395]

- Oster, C. A. and W. A. Scheffler. 1976. "Well Hole Temperature Distribution in the Presence of Aquifers." ASME, 76-Pet-59. [728]
- Ozawa, T. and J. Fujii. 1970. "A Phenomenon of Sealing in Production Wells and the Geothermal Power Plant in the Matsukawa Area." U.S. Symposium on the Development and Utilization of Geothermal Resources, 2(2):1613-1618. [396]
- Pacific Northwest Solar Energy Association. 1979. "Solar 79 Northwest." Proceedings Supplement. [593]
- Pandey, G. N., M. R. Tek, and D. L. Katz. \_\_\_\_\_. "Studies of Front-End Threshold Pressure Measurements." 73-T-17, pp. T112-T116. [729]
- Panel on Rock Mechanics Problems that Limit Energy Resource Recovery and Development. 1978. Limitations of Rock Mechanics in Energy-Resource Recovery and Development. The National Research Council. [398]
- Papadopoulos, S. S. and S. P. Larson. 1978. "Aquifer Storage of Heated Water: Part II - Numerical Simulation of Field Results." Ground Water, 16(4):242-248. [399]
- Parker, S. A. 1978. "Power Generation Using Thermal Vapor Pumping and Hydro-pumped Storage." Proceedings of Energy Technology Conference, pp. 786-795. [592]
- Pasquier, F. 1977. "Les Conditions Hydrogeologiques Du Stockage Southerrain D'Eau Chaude En Suisse." Bulletin Du Centre D'Hydrogeologie, (2):63-79. [400]
- Paul, J. K. 1977. "Solar Heating and Cooling Recent Advances." Energy Technology Review No. 16. Noyes Data Corporation. [844]
- Penrod, E. B. 1954. "Sizing Earth Heat Pumps." Refrigeration Engineering, 62(4):57-61, 108, 112. [401]
- Perkins, T. K., G. R. Wooley, and F. W. Ng. 1975. "Solutions for Some Problems Resulting From Refreezing of Permafrost Around a Wellbore." Environmental Aspects of Chemical Use in Well-Drilling Operations, EPA-560/1-75-004, pp. 39-59. [402]
- Peters, R. R. 1975. "Techniques of Shallow-Well Drilling." Environmental Aspects of Chemical Use in Well-Drilling Operations, EPA-560/1-75-004. [403]
- Peterson, J. S., C. Rohwer, and M. L. Albertson. 1953. "Effects of Well Screens on Flow Into Wells." Transactions, American Society of Civil Engineers, 120:563-607. [404]

- Pettitt, R. A. 1975. Planning, Drilling, and Logging of Geothermal Test Hole GT-2, Phase I. LA-5819-PR. [405]
- Pettitt, R. A. 1975. Testing, Drilling, and Logging of Geothermal Test Hole GT-2, Phase II. LA-5897. [406]
- Pettitt, R. A. 1975. Testing, Drilling, and Logging of Geothermal Test Hole GT-2, Phase III. LA-5965-PR. [407]
- Pettitt, R. A. 1977. Planning, Drilling, Logging, and Testing of Energy Extraction Hole EE-I, Phases I and II. LA-6906-MS. [408]
- Pettitt, R. A. 1978. Testing, Planning, and Redrilling of Geothermal Test Hole GT-2, Phases IV and V. LA-7586-PR. [409]
- Pettyjohn, W. A. 1979. "Ground-Water Pollution - An Imminent Disaster." Groundwater, 17(4):18-23. [410]
- Phillips, S. L., A. K. Mathur, and R. E. Doebler. 1976. "A Survey of Treatment Methods for Geothermal Fluids." SPE, 6606. [411]
- Pinder, G. F. 1973. "A Galerkin-Finite Element Simulation of Groundwater Contamination on Long Island, NY." Water Resources Research, 9(6):1657-1669. [412]
- Piper, A. M. 1969. Disposal of Liquid Wastes by Injection Underground - Neither Myth nor Milenium. USGS, Circular 631. [413]
- Pitt, W. A. J., Jr., F. W. Meyer, and J. E. Hull. 1977. "Disposal of Salt Water During Well Construction: Problems and Solutions." Groundwater, 15(4):276-283. [414]
- Plummer, K. H. and T. M. Rachford. 1974. "Economic Feasibility." An Agro-Power Waste Water Complex for Land Disposal of Waste Heat and Waste Water. Institute for Research on Land and Water Resources, Pennsylvania State University, Research Publication Number 86, pp. 9-45. [415]
- Poland, J. F. 1969. "Status of Present Knowledge and Needs for Additional Research on Compaction of Aquifer Systems." Proceedings Tokyo Symposium on Land Subsidence, IASH/AIHS Unesco, pp. 11-21. [591]
- Poland, J. F. 1960. "Land Subsidence in the San Joaquin Valley, CA., and its Effect on Estimates of Ground Water Resources." Int'l Assoc. Science Hydrogeology, Publication 52, pp. 324-335. [730]
- Poland, J. F. and G. H. Davis. 1956. "Subsidence of the Land Surface in the Tulare-Wasco (Delano) and Los Banos-Kettleman City Area, San Joaquin Valley, California." Transactions, American Geophysical Union, 37(3):287-296. [416]

- Poland, J. F. and G. H. Davis. 1969. "Land Subsidence Due to Withdrawal of Fluids. Reviews in Engineering Geology II, p. 187-269. [418]
- Poland, J. F. and J. H. Green. 1962. Subsidence in the Santa Clara Valley, California: A Progress Report. USGS, Water Supply Paper 1619-C. [417]
- Pope, W. L., H. S. Pines, R. L. Fulton, and P. A. Doyle. 1978. Heat Exchanger Design - Why Guess a Design Fouling Factor When It Can Be Optimized. LBL-7067. [419]
- Potter, R. W. 1979. "Reviews of Geophysics and Space Physics computer Modeling in Low Temperature Geochemistry." Paper #9R0355. U.S. Geological Survey, 17(4):850-860. [731]
- Powell, W. R. \_\_\_\_\_. "Community Annual Storage Energy System, Cases Simulation Model and Results." NP-23511. [583]
- Prats, M. 1978. "A Current Appraisal of Thermal Recovery." J. Petroleum Technology, 30:1129-1136. [845]
- Price, D., D. H. Hart, and B. L. Foxworthy. 1965. Artificial Recharge in Oregon and Washington - 1962. USGS, Water Supply Paper 1594-C. [441]
- Price, M. 1977. "Specific Yield Determinations From a Consolidated Sandstone Aquifer." Journal of Hydrology, 33:147-156. [442]
- Pruess, K., G. Bodvarsson, R. C. Schroeder, P. A. Witherspoon, R. Marconcini, G. Neri, and C. Ruffilli. 1979. Simulation of the Depletion of Two-Phase Geothermal Reservoirs. LBL-9606. [443]
- Pruess, K., J. M. Zerzan, and R. C. Schroeder. 1979. "Description of the Three-Dimensional Two-Phase Simulator Shaft 78 for Use in Geothermal Reservoir Studies." SPE-7699. [440]
- "P-100 Property Meter Stress - Property Measuring System." [732]
- Qvale, E. B. \_\_\_\_\_. "The Danish Seasonal Aquifer Warm Water - Storage Program." Laboratory for Energetics, Technical University of Denmark. [420]
- Qvale, E. B. 1976. "Seasonal Storage of Thermal Energy in Water in the Underground." Eleventh Intersociety Energy Conversion Engineering Conference Proceedings, pp. 628-635. [421]
- Raats, P. A. C. 1975. "Transformations of Fluxes and Forces Describing the Simultaneous Transport of Water and Heat in Unsaturated Porous Media." Water Resources Research, 2(6):938-942. [733]

- Rabbimov, R. T., G. Y. Umarov and R. A. Zakhidov. 1971. "Storage of Solar Energy in a Sandy-Gravel Ground." Geliotekhnika, 7(5):57-64. [422]
- Rabbimov, R. T., G. Y. Umarov and R. A. Zakhidov. 1974. "Experimental Study of Aquifer Heating in Solar-Energy Accumulation." Geliotekhnika, 10(2):20-27. [423]
- Rabbimov, R. T., R. A. Zhakhidov and G. Y. Umarov. 1974. "Temperature Distribution in Accumulation of Solar Energy in an Aquifer." Geliotekhnika, 10(2):15-19. [424]
- Rahman, M. A., E. T. Smerdon, and E. A. Hiler. 1969. "Effect of Sediment Concentration on Well Recharge in a Fine Sand Aquifer." Water Resources Research, 5(3):641-646. [425]
- Raimondi, P., B. J. Gallagher, R. Ehrlich, J. H. Messmer, and G. S. Bennett. 1977. "Alkaline Waterflooding: Design and Implementation of a Field Pilot." J. Petroleum Technology, 29:1359-1368. [846]
- Ramey, H. J. 1962. "Wellbore Heat Transmission." Journal of Petroleum Technology, April, pp. 427-435. [627]
- Ramey, Jr., H. J., A. Kumar, and M. S. Gulati. 1973. "Gas Well Test Analysis Under Water-Drive Conditions." American Gas Association. [847]
- Ramey, H. J., Jr. 1975. "Pressure Transient Analysis for Geothermal Wells." Proceedings Second U.N. Symposium on the Development and Use of Geothermal Resources, 3:1749-1757. [426]
- Ranney, M. W. 1979. "Crude Oil Drilling Fluids." Chemical Technology Review No. 121; Energy Technology Review No. 35. Noyes Data Corporation. [848]
- Ratigan, J. L. 1976. "Analysis of the Potential for Thermally-Induced Rock Fracture Around Emplaced Heat Storage." Presented Int'l Joint Petroleum Mechanical Engineering and Pressure Vessel and Piping Conference. [735]
- "Records and Drilling Reports." 1976. Water Well Journal, January, pp. 30-31. [427]
- Reed, M. G. 1977. "Formation Permeability Damage by Mica Alteration and Carbonate Dissolution." Journal of Petroleum Technology, September, pp. 1056-1060. [428]
- Reistad, G. M., W. E. Schmisser, J. R. Shay, and J. B. Fitch. 1978. "An Evaluation of Uses for Low to Intermediate Temperature Geothermal Fluids in the Klamath Basin, OR." Oregon State University. [785]

- Riaz, M., P. L. Blackshear Jr., and H. O. Pfannkuch. 1976. "High-Temperature Energy Storage in Native Rocks." Int'l Solar Energy Society, American Section, 8:127-137. [849]
- Ridgeway, S. L. and J. L. Dooley. 1976. "Underground Storage of Off-Peak Power." Eleventh Intersociety Energy Conversion Engineering Conference Proceedings, pp. 586-590. [429]
- Roache, P. J. and T. S. Mueller. 1970. "Numerical Solutions of Laminar Separated Flows." AIAA J., 8(3):530-538. [430]
- Robeck, G. G. 1969. "Microbial Problems in Ground Water." Groundwater, 7(3):33-35. [431]
- Robichaux, J. 1975. "Bactericides Used in Drilling and Completion Operation." Environmental Aspects of Chemical use in Well-Drilling Operations, EPA-560/1-75-004, pp. 183-198. [432]
- Rodrigues-Amaya, G. 1976. "A Decomposed Aquifer Model Suitable for Management." NTIS, PB-265 091. [590]
- Rogers, F. C. and W. E. Larson. 1974. "Underground Energy Storage." American Power Conference 36th Annual Meeting, Chicago, IL, 36:369-378. [735]
- Romagnoli, P., G. Cuellar, M. Jimenez, and G. Ghezzi. 1975. "Aspectos Hidrogeologicos del Campo Geotermico de Ahuachapan, El Salvador." Proceedings Second United Nations Symposium on the Development and Use of Geothermal Resources, 1:563-570. [433]
- Romero, J. C. 1970. "The Movement of Bacteria and Viruses Through Porous Media." Groundwater, 8(2):37-48. [434]
- Rose, K. S. 1978. "Gelled Acid Coaxes Oil from Tight Permian Carbonates." World Oil, 187:115-116. [850]
- Rosen, R. 1978. "Central Solar Heat Station in Studsvik." Studsvik Report, STUDSVIK/ET-78/77. [589]
- Ross, P. N. 1975. "Process Heat - The Temperature Amplifier - A Kind of Industrial Heat Pump." Electric Apparatus, 28(3):29-31. [586]
- Rozenfeld, L. M. and G. S. Serdakov. 1968. "Increasing the Efficiency of a Heat Supply System Based on Geothermal Water by Using Heat Pumps." Thermal Engineering, 15(8):75-81. [435]
- Rubin, H. 1977. "Thermal Convection in a Cavernous Aquifer." Water Resources Research, 13(1):34-40. [436]

- Rubinshtein, L. I. 1959. "The Total Heat Losses in Injection of a Hot Liquid into a Stratum." Neft'1 Gaz, 2(9):41-48. [437]
- Rushton, K. R. and Y. K. Chan. 1977. "Numerical Pumping Test Analysis in Unconfined Aquifers." Journal of the Irrigation and Drainage Division, ASCE 103(IR1):1-12. [438]
- Rushton, K. R. and L. M. Tomlinson. 1976. "Permissible Mesh Spacing in Aquifer Problems Solved by Finite Differences." Journal of Hydrology, 34:63-76. [439]
- Saffman, P. G. 1959. "A Theory of Dispersion in a Porous Medium." Journal of Fluid Mechanics, 6:321-349. [444]
- Saleem, Z. A. and C. E. Jacobs. 1973. "Drawdown Distribution Due to Well Fields in Coupled Leaky Aquifers. 1. Infinite Aquifer Systems." Water Resources Research, 9(6):1671-1678. [587]
- Salieva, R. B. and R. P. Saliev. 1975. "Principles of Technological-Economic Calculations in Solar Technology." Geliotekhnika, 11(5):44-51. [445]
- Salk, M. S. and S. G. DeCicco (ed.). 1978. Environmental Monitoring Handbook for Coal Conversion Facilities. ORNL-5319. [776]
- Saltzman, B. and J. A. Pollack. 1977. "Sensitivity of the Diurnal Surface Temperature Range to Changes in Physical Parameters." Journal of Applied Meteorology, 16:614-619. [446]
- Santing, G. 1951. "A Horizontal Scale Model Based on the Viscous Flow Analogy for Studying Ground Water Flow in an Aquifer Having Storage." Toronto, Int'l Assoc. Science Hydrogeology, pp. 105-115. [736]
- Sanyal, S. K., S. S. Marsden, Jr., and H. J. Ramey, Jr. 1974. "Effect of Temperature on Petrophysical Properties of Reservoir Rocks." Society of Petroleum Eng., AIME, SPE-4898. [738]
- Sanyal, S. K. and H. T. Meidav. 1977. "Important Considerations in Geothermal Well Log Analysis." Society of Petroleum Eng., AIME, SPE-6535. [737]
- Sarot, J. 1979. "Heat Storage Thermal Study of Large Diameter Drilled and Especially Turbodrilled-Storage Tanks." Polytechnique DeMons, Report E/X/2.1/79/1. [588]
- Sather, N. F., L. G. Lewis, G. T. Kartsounes, and H. H. Chiu. 1976. "Compressed Air Energy Storage Systems Studies." NTIS, TID-28797. [739]



- Schaetzle, W. J., C. E. Brett, and J. M. Ansari. \_\_\_\_\_. "Thermal Energy Storage in Aquifers for a Solar Power Plant." [851]
- Schaetzle, W. J., C. E. Brett and J. M. Calm. 1978. Heat Pump Centered Integrated Community Energy Systems. Argonne National Laboratory. [ ]
- Schaetzle, W. J., C. E. Brett, and D. M. Grubbs. \_\_\_\_\_. "A Heat Pump Community-Integrated Energy System Using Annual Aquifer Energy Storage." To be presented at ASHRAE Winter Annual Meeting, February 1980. [852]
- Schaetzle, W. J., C. E. Brett, and D. M. Grubbs. \_\_\_\_\_. "Annual Thermal Energy Storage in Groundwater Aquifers." Solar Energy Storage Options, Trinity University. [853]
- Schaetzle, W. J., C. E. Brett, and D. M. Grubbs. \_\_\_\_\_. "Community Integrated Cooling and Heating System." Int'l Conference on Energy. [854]
- Schaetzle, W. J., C. E. Brett, and D. M. Grubbs. \_\_\_\_\_. "Direct Cooling Utilizing Aquifer Thermal Energy Storage." Argonne National Laboratory. [855]
- Schaetzle, W. J., C. E. Brett, and D. M. Grubbs. 1979. "Annual Energy Storage in Aquifers for Community Energy Systems." Int'l Energy Symposia, Montreux, Switzerland. [856]
- Schaetzle, W. J., C. E. Brett, and D. M. Grubbs. 1979. "Energy Storage in Ground-Water Aquifers." ISES Silver Jubilee Congress 1979. [857]
- Schaetzle, W. J., L. R. Fang, C. E. Brett, and D. M. Grubbs. 1979. "A Solar Energy System with Annual Aquifer Storage." ASME Solar Energy Division, ASME Winter Annual Meeting. [858]
- Schaetzle, W. J., J. E. LeCroy, M. S. Seppanen, and C. E. Brett. \_\_\_\_\_. "Waste Heat Utilization with Annual Aquifer Storage." Argonne National Laboratory. [859]
- Schaffer, D. C. 1974. "The Right Chemicals Are Able to Restore or Increase Well Yield." The Johnson Drillers Journal, March-April, pp. 4-6. [447]
- Schiff, L. and K. L. Dyer. 1965. "Some Physical and Chemical Considerations in Artificial Ground Water Recharge." Biennial Conference on Groundwater Recharge, Development and Management, H-60-71. [448]
- Schmidt, K. D. 1977. "Water Quality Variations for Pumping Wells." Groundwater, 15(2):130-137. [449]

- Schneider, F. N. and W. W. Owens. 1976. "Relative Permeability Studies of Gas-Water Flow Following Solvent Injection in Carbonate Rocks." J. Society Petroleum Eng., pp. 23-30. [740]
- Schreiber, D. L., A. E. Reisenauer, K. L. Kipp, and R. T. Jaske. 1973. Anticipated Effects of an Unlined Brackish-Water Canal on a Confined Multiple-Aquifer System. BNWL-1800. [450]
- Schrock, V. E. and A. D. K. Laird. 1976. "Physical Modeling of Combined Forced and Natural Convection in Wet Geothermal Formations." Journal Heat Transfer, May, pp. 213-220. [879]
- Schroder, J. 1975. "Thermal Energy Storage and Control." ASME, 74-WA, pp. 893-896. [585]
- Schumacher, M. M. (ed). 1978. "Enhanced Oil Recovery Secondary and Tertiary Methods." Chemical Technology Review No. 103; Energy Technology Review No. 22. Noyes Data Corporation. [860]
- Scott, R. W. 1972. "Two New Drilling Systems Pass Initial Field Tests." World Oil, 174(1):35-43. [451]
- Seegerstrom, S. 1971. "Heat Pumps Today." J. ASHRAE, 13(7):63-65. [452]
- Sepaskhah, A. R., L. Boersma, L. R. Davis and D. L. Slegel. 1973. "Experimental Analysis of a Subsurface Soil Warming and Irrigation System Utilizing Waste Heat." Winter Annual Meeting of American Society of Mechanical Engineers. Paper No. 73-WA/HT-11. [880]
- Serata, S. 1974. "Borehole Stress Property Measuring System." U.S. Patent No. 3,796,091. U.S. Patent Office, Washington, DC. [741]
- Shaffer, L. H. 1977. "Solar Ponds: Low Cost Solar Energy Management Systems." Energy, pp. 18-20. [742]
- Sheahan, N. T. 1977. "Injection/Extraction Well System - A Unique Seawater Intrusion Barrier." Groundwater, 15(1):32-50. [453]
- Sheely, C. O. 1978. "Description of Field Tests to Determine Residual Oil Saturation by Single-Well Tracer Method." J. Petroleum Technology, 30:194-202. [861]
- Shew, D. C. and J. W. Keeley. 1975. "Ground-Water Problems Associated with Well-Drilling Additives." Environmental Aspects of Chemical Use in Well-Drilling Operations, EPA-560/1-75-004, pp. 223-230. [454]
- Siegel, R. 1974. "Conformal Mapping Technique for Two-Dimensional Porous Media and Jet Impingement Heat Transfer." Proceedings of Fifth Int'l Heat Transfer Conference, 1:205-209. [743]

- Signal, A. K., D. P. Mikherjec, and W. H. Somerton. 1976. "Effect of Heterogeneous Wettability on Flow of Fluids Through Porous Media." J. Canadian Petroleum Tech., 15(3):20-31. [584]
- Simpson, J. P. 1975. "Drilling Fluid Principles and Operations." Environmental Aspects of Chemical Use in Well-Drilling Operations, EPA-560/1-75-004, pp. 61-71. [455]
- Singh, B. S. and A. Dybbs. 1974. "Heat Transfer Characteristics of Porous Media." Proceedings of Fifth Int'l Heat Transfer Conference, 5:98-102. [744]
- Singh, M. M. and P. J. Huck. 1971. "Effect of Specimen Size on Rock Properties." Society of Petroleum Eng., AIME, SPE-3528. [745]
- Sloat, B. \_\_\_\_\_. "Injection Water Treatment Starts in the Producing Wells." Society of Petroleum Engineers, AIME, SPE-875. [746]
- Smith, C. G. and J. S. Hanor. 1977. "Underground Storage of Treated Water: A Field Test." Groundwater, 13(5):410-417. [456]
- Smith, C. R. and S. J. Pirson. 1963. "Water Coning Control in Oil Wells by Fluid Injection." Society of Petroleum Engineers Journal, 3:314-326. [457]
- Smith, G. C., J. A. Stottlemyre, L. E. Wiles, W. V. Loscutoff, and H. J. Pincus. 1978. FY-1977 Progress Report. Stability and Design Criteria Studies for Compressed Air Energy Storage Reservoirs. PNL-2443. [458]
- Smith, G. S. 1951. "Climatology as an Aid in Heat Pump Design." Heating, Piping and Air Conditioning, 23(6):101-107. [459]
- Smith, J. E. 1975. "Regulation of Onshore and Offshore Oilfield Waste Disposal." Environmental Aspects of Chemical Use in Well-Drilling Operations, EPA-560/1-75-004, pp. 579-591. [460]
- Sneddon, I. N. 1946. "The Distribution of Stress in the Neighborhood of a Crack in an Elastic Solid." Proceedings, Royal Society, Series A 187:229-260. [461]
- Snyder, R. E. 1978. Geothermal Well Completions. SAND 78-7010. [462]
- Solomon, A. D. \_\_\_\_\_. "On Modeling for Moving Boundary Problems." CONF 79034-1, pp. 1-20. [747]
- Solomon, A. D. 1979. Mathematical Modeling of Phase Change Process for Latent Heat Thermal Energy Storage. ORNL/CSD-39. Oak Ridge National Laboratories. [554]

- Somerton, W. H. and S. El-Hadidi. 1971. "Well Logs Can Indicate Formation Drillability." World Oil, 173(7):55-56. [463]
- Sorey, M. L. 1978. Numerical Modeling of Liquid Geothermal Systems. USGS, Professional Paper 1044-D. [464]
- Specken, G. A. 1975. "Treatment and Disposal of Waste Fluids From Onshore Drilling Sites." Environmental Aspects of Chemical Use in Well-Drilling Operations, EPA-560/1-75-004, pp. 451-462. [465]
- Spencer, R. S., W. S. Butler, M. K. Enns, and B. W. Wilkinson. 1976. "The Potential for Fuel Economics Via Combined Steam Power Production." Eleventh Intersociety Energy Conversion Engineering Conference Proceedings, Volume 1. [466]
- Spillette, A. G. 1965. "Heat Transfer During Hot Fluid Injection into an Oil Reservoir." Society of Petroleum Engineers of AIME, Thermal Recovery Techniques, SPE Reprint Series 10:21-16. [467]
- Spofford, W. A. 1959. "Heat Pump Performance for Package Air Sources Units." J. ASHRAE, 1(4):59-63. [468]
- Spotila, J. R. 1978. "Thermoregulation of Fish and Turtles in Thermally-Stressed Habitats." NTIS, C00-2502-15.. [862]
- Stalkup, F. I. 1978. "Carbon Dioxide Miscible Flooding: Past, Present, and Outlook for the Future." J. Petroleum Technology, 30:1102-1112. [863]
- Stallman, R. W. 1956. "Numerical Analysis of Regional Water Levels to Define Aquifer Hydrology." Transactions, American Geophysical Union, 37(4):451-460. [469]
- Stark, M., N. Goldstein, H. Wollenberg, B. Strisower, H. Hege, and M. Wilt. 1979. Geothermal Exploration Assessment and Interpretation, Klamath Basin, Oregon - Swan Lake and Klamath Hills Area. LBL-8186. [470]
- Stecher, P. G. (ed). 1979. "Industrial and Institutional Waste Heat Recovery." Energy Technology Review No. 37. Noyes Data Corporation. [864]
- Stickford, Jr., G. H., C. F. Holt, and G. R. Whitacre. 1976. "Analysis of Buried Heat Storage Tank Losses." Int'l Solar Energy Society, American Section, 10:173-175. [582]
- Stilwell, W. B., W. K. Hall, and J. Tawhai. 1975. "Ground Movement in New Zealand Geothermal Fields." Proceedings Second U.N. Symposium on the Development and Use of Geothermal Resources, p. 1427-1433. [471]

- Stottlemire, J. A., R. P. Smith, and R. L. Erikson. 1979. Potential Physical and Chemical Property Alterations in a Compressed Air Energy Storage Porous Rock Reservoir. PNL-2974. [472]
- Stottlemire, J. A., R. A. Craig, W. V. Loscutoff, D. W. Boehm, and G. C. Chang. 1978. "Environmental Concerns Related to Compressed Air Energy Storage." Compressed Air Energy Storage Symposium Proceedings, PNL-SA-7112. [553]
- Stracke, K. J., D. C. Mason, and R. G. Altman. 1969. "Cyclic Steam-Injection Operations - Guadalupe Field, California." Drilling Production and Practice - American Petroleum Institute, p. 35-39. [473]
- Strange, L. K. and A. W. Talash. 1977. "Analysis of Salem Low-Tension Waterflood Test." J. Petroleum Technology, 29:1380-1384. [865]
- Straus, J. M. and G. Schubert. 1977. "Thermal Convection of Water in a Porous Medium: Effects of Temperature and Pressure-Dependent Thermodynamic and Transport Properties." Journal of Geophysical Research, 82(2):325-333. [474]
- Strausberg, S. I. 1957. "Estimating Distances to Hydrologic Boundaries from Discharging Well Data." Ground Water, 5(1):5-8. [748]
- Streltsova, T. D. 1976. "Unsaturated Zone and Vertical Flow Components in Draining Unconfined Formations." Journal of Hydrology, 31:119-124. [581]
- Streltsova, T. D. and K. R. Rushton. 1973. "Water Table Drawdown Due to a Pumped Well in an Unconfined Aquifer." Water Resources Research, 9(1):236-242. [475]
- Stuart, M. W. and C. P. Serfass (ed). \_\_\_\_\_. "Energy Storage News Briefs and Research Abstracts." Office of Energy Programs, George Washington University. [866]
- Studsvik. 1978. Minneapolis-St. Paul District Heating Study. ORNL/SUB-77/13502/4. [476]
- Subcasky, W. J. \_\_\_\_\_. "Petroleum Industry Experience in Water Injection." [477]
- Sudol, G. A., R. F. Harrison, and H. J. Ramey, Jr. 1979. "Annotated Research Bibliography for Geothermal Reservoir Engineering." GREMP-1, TR-78-70. LBL-8664. [867]
- Sugisaki, R. 1961. "Measurement of Effective Flow Velocity of Ground Water by Means of Dissolved Gases." American Journal of Science, 259:144-153. [478]

- Sulzberger, V. T. and J. Zemkoski. 1977. "The Potential for Application of Energy Storage Capacity on Electrical Utility Systems in the United States, Part 2." IEEE Transactions Power Apparatus and System, Pas-96(1):213-221. [580]
- Sulzberger, V. T. and J. Zemkoski. 1976. "Potential for Application of Energy Storage Capacity on Electrical Utility Systems in the United States." IEEE Transactions on Power Apparatus and System, Pas-95(6):1872-1881. [579]
- Suman, G. O. Jr. and R. C. Ellis. 1977. "Cementing Oil and Gas Wells. Part 2." World Oil, 184(5):69-76. [479]
- Suman, G. O. Jr. and R. C. Ellis. 1977. "Cementing Oil and Gas Wells. Part 3." World Oil, 184(6):48-57. [480]
- Suman, G. O. Jr. and R. C. Ellis. 1977. "Cementing Oil and Gas Wells. Part 4." World Oil, 184(7):69-77. [481]
- Suman, G. O. Jr. and R. C. Ellis. 1977. "Cementing Oil and Gas Wells. Part 5." World Oil, 184(8):117-125. [482]
- Sumner, J. 1955. "Central Heating by Heat Pump. Report of Three Years Operation in a Bungalow." Engineering, 179:439-441. [483]
- Sumner, J. A. 1955. "Domestic Heating by the Heat Pump." Journal of the Institution of Heating and Ventilating Engineers, 23:129-151. [484]
- Surface, M. O. 1977. "Exotic Power and Energy Storage." Power Engineering, 81(12):36-44. [578]
- Swartzendbruber, D. 1962. "Non-Darcy Flow Behavior in Liquid-Saturated Porous Media." Journal of Geophysical Research, 67(13):5205-5213. [485]
- Swet, C. J. and W. J. Masica. 1977. "Thermal Storage for Electric Utilities." Conference New Options Energy Technology. AIAA/EET/IEEE, pp. 26-32. [868]
- Talmage, S. S. and C. C. Coutant. 1978. "Thermal Effects." J. Water Pollution Control Federation, 50:1514-1529. [577]
- Tanayeva, S. A. 1974. "Investigation of the Effective Thermal Conductivity of Porous Materials." Heat Transfer Soviet Research, 6(2). [749]
- Taunton, J. W. and E. N. Lightfoot. 1970. "Free Convection Heat or Mass Transfer in Porous Media." Chemical Engineering Science, 25:1939-1945. [750]

- Taylor, K. 1976. "The Influence of Subsurface Energy Storage on Seasonal Temperature Variations." J. Applied Meteorology, 15(11):1129-1138. [576]
- Technical Information Center, DOE. \_\_\_\_\_. "Highland Uranium Solution Mining Project." USNRC, Washington, DC. (Micro-Fiche) [575]
- Technical Practices Committee. 1977. "Monitoring Techniques for the Control of Corrosion of Drill Pipe, Casing, and Other Components in Contact with Drilling Fluids." NACE ID177. [488]
- Technical Practices Committee. 1976. "The Role of Bacteria in the Corrosion of Oil Field Equipment." NACE Pub. 3. [487]
- Technical Practices Committee. 1975. "Selection of Metallic Materials to be Used in All Phase of Water Handling for Injection into Oil Bearing Formations." NACE Standard RP-04-75. [486]
- Technical Unit Committee. 1954. "Sulfide Corrosion Cracking of Oil Production Equipment." NACE 1154. [489]
- Theis, C. V. 1935. "The Relation Between the Lowering of the Piezometric Surface and the Rate and Duration of Discharge of a Well Using Groundwater Storage." Transactions, American Geophysical Union, 2:519-524. [490]
- Theis, C. V. 1938. "The Significance and Nature of the Cone of Depression in Ground-Water Bodies." Economic Geology, 33:889-902. [491]
- Thomas, H. E. 1955. Water Rights in Areas of Ground-Water Mining. USGS, Circular 347. [492]
- Thomas, H. E. 1961. Ground Water and The Law. USGS, Circular 446. [493]
- Thompson, G. A. and D. B. Burke. 1974. "Regional Geophysics of the Basin and Range Province." Annual Review of Earth and Planetary Science, 2:213-238. [494]
- Thorsteinsson, T. 1975. "Redevelopment of the Reykir Hydrothermal System in Southeastern Iceland." Proceedings Second United Nations Symposium on the Development and Use of Geothermal Resources, 3:2173-2180. [495]
- Tinker, G. E., R. W. Bowman, and G. A. Pope. 1976. "Determination of In-Situ Mobility and Wellbore Impairment from Polymer Injectivity Data." J. Petroleum Technology, 28:586-596. [869]
- Todd, D. K. 1964. "Economics of Groundwater Recharge by Nuclear and Conventional Means." NTIS, UCRL-7850. [574]

- Tolivia, E. 1970. "Corrosion Measurements in a Geothermal Environment." U.N. Symposium on the Development and Utilization of Geothermal Resources, 2(2):1596-1601. [496]
- Tolman, C. F. and J. F. Poland. 1940. "Ground-Water, Salt-Water Infiltration and Ground-Surface Recession in Santa Clara Valley, Santa Clara County, Calif." Transactions, American Geophysical Union, 21:23-25. [497]
- Townsend, S. J. 1976. "Economic Implications of the CANHO H<sub>2</sub>/O<sub>2</sub> MHD Energy Storage System Employing Hydrogen as the Recycled Energy Carrier for Dedicated Use Within an Electric Power Plant." Proceedings 1st World Hydrogen Conference, Volume 3, Session 8C (abstract only). [751]
- Trantham, J. C., H. L. Patterson, Jr., and D. F. Boneau. 1978. "The North Burbank Unit, Tract 97 Surfactant/Polymer Pilot-Operation and Control." J. Petroleum Technology, 30:1068-1074. [870]
- Treseder, R. S. and R. Wieland. 1976. "Down-Hole Corrosion in a Salton Sea Geothermal Well." SPE 6613. [498]
- Truesdell, A. H. 1975. "Summary of Section III Geochemical Techniques in Exploration." Proceedings Second U.N. Symposium on the Development and Use of Geothermal Resources, 1:liii-1xxix. [499]
- Truesdell, A. H. and W. Singers. 1974. "The Calculation of Aquifer Chemistry in Hotwater Geothermal Systems." Journal Research, USGS, 2(3)271-278. [500]
- Tsang, C. F. 1979. Current Aquifer Thermal Energy Storage Projects. LBL-9211. [501]
- Tsang, C. F. 1978. "A Summary of Current Studies in Aquifer Thermal Energy Storage." NTIS, CONF 780443-2, pp. 14. LBL-7066. [551]
- Tsang, C. F. 1978. "Aquifer Thermal Energy Storage." LBL-CONF 780714-2, pp. 30. [552]
- Tsang, C. F. 1977. "Artificial Recharge into Groundwater Systems." City of Shanghai Hydrogeological Team (writtin in Chinese, Summary translated into English by Tsang). [598]
- Tsang, C. F., P. Fong, C. W. Miller and M. Lippmann. \_\_\_\_\_. Daily Sensible Heat Storage in Aquifers for Solar Energy Systems. Lawrence Berkeley Laboratories. [502]
- Tsang, C. F. and M. J. Lippman. 1977. "Thermal Energy Storage in Aquifers." Earth Sciences Division, Annual Report. LBL-7028, pp. 9-13. [503]



- Tsang, C. F., M. J. Lippmann, C. B. Goranson, and P. A. Witherspoon. 1977. Numerical Modeling of Cyclic Storage of Hot Water in Aquifers. LBL-5929. [504]
- Tull, R. H. 1966. "New Developments in Heat-Pump Systems." J. ASHRAE, 8(9):64-67. [505]
- Turcan, Jr., A. N. 1962. Estimating Water Quality From Electrical Logs. USGS, Professional Paper 450, pp. C135-C136. [506]
- U.S. Department of Energy. 1979. "Public Notice Inviting Proposals for the Preparation of a Conceptual Design for an Aquifer Thermal Energy Storage System for Seasonal Energy Storage for Use in District Heating/Cooling Applications." [91]
- U.S. Department of Energy. 1979. "Project Summary Data Thermal and Mechanical Energy Storage Program FY-1979." DOE/ET-0091. [771]
- U.S. Department of Energy. 1977. Interagency Coordination Meeting on Energy Storage." CONF-7709116. [871]
- U.S. Department of Energy, Division of Energy Storage Systems. 1979. "Thermal Energy Storage Application Areas." [550]
- U.S. Department of Energy, Electrical Power Research Institute, and Pacific Northwest Laboratory. 1978. "Compressed Air Energy Storage Symposium Proceedings, Volume I." CONF-780 599. [766]
- U.S. Department of Energy, Electrical Power Research Institute, and Pacific Northwest Laboratory. 1978. "Compressed Air Energy Storage Symposium Proceedings, Volume II." CONF-780 599. [767]
- U.S. Environmental Affairs Department. 1977. "Environmental Research Annual Status Report, February 1977." API. [109]
- U.S. Environmental Protection Agency. . "Manual of Water Well Construction Practices." EPA-570/9-75-001. [774]
- U.S. Environmental Protection Agency. 1979. Draft Consolidated Permit Application Forms and Proposed National Pollutant Discharge Elimination System Regulations. Federal Register; Thursday, June 14. [110]
- U.S. Environmental Protection Agency. 1979. Proposed Consolidated Permit Regulations. Federal Register; Thursday, June 14. [111]
- U.S. Environmental Protection Agency. 1979. Water Programs, State Underground Injection Control Programs, Minimum Requirements and Grant Regulations. Federal Register; Friday, April 20. [112]

- U.S. Environmental Protection Agency. 1978. "EPA Proposed Hazardous Waste Regulations Under the Resource Conservation and Recovery Act." Environmental Reporter, 9(34):1580-1581. [619]
- U.S. Environmental Protection Agency. 1977. "Proceedings of the 3rd National Ground Water Quality Symposium, Las Vegas, NV, 15-17 September 1976." PB-272 908. [784]
- U.S. Environmental Protection Agency. 1976. "National Interim Primary Drinking Water Regulations." Title 40, CFR 141; 40 FR 59565. [613]
- U.S. Environmental Protection Agency. 1974. "Proceedings of the Second National Ground Water Quality Symposium." [770]
- U.S. Environmental Protection Agency and the National Water Well Association. 1971. Proceedings of the National Ground Water Quality Symposium. [113]
- U.S. Nuclear Regulatory Commission, Office of Nuclear Reactor Regulations. 1979. "Environmental Standard Review Plans for the Environmental Review of Construction Permit Applications for Nuclear Power Plants." NUREG-0555. [778]
- U.S. Nuclear Regulatory Commission, Office of Nuclear Reactor Regulations. 1975. "Final Environmental Statement." NUREG-75/019. [775]
- VanDerHeld, E. F. M. and F. G. VanDrunen. 1949. "A Method of Measuring the Thermal Conductivity of Liquids." Physica, 15(10):865-881. [507]
- Van Everdingen, A. F. 1953. "The Skin Effect and its Influence on the Productive Capacity of a Well." Petroleum Transactions, AIME, 198:171-176. [753]
- Van Everdingen, A. F. and W. Hurst. 1949. "The Application of the Laplace Transformation to Flow Problems in Reservoirs." Petroleum Transactions, AIME, 1:305-326. [752]
- Van Poolen, H. K. 1964. "Radius of Drainage and Stabilization Time Equations." J. Oil and Gas, pp. 138-144. [754]
- Vasek, F. C., H. B. Johnson, and D. H. Eslinger. 1975. "Effects of Pipeline Construction on Cresote Bush Scrub Vegetation of the Mojave Desert." Madrono, 23(1):1-64. [755]
- Vetter, O. J. and D. A. Campbell. 1979. "Scale Inhibition in Geothermal Operations -- Experiments with Dequest 2060 Phosphonate in Republic's East Mesa Field." GREMP-5. LBL-9089. [549]

- Vetter, O. J., D. A. Campbell, and M. J. Walker. 1978. Geothermal Fluid Investigations at RGI's East Mesa Test Site. PNL-2556. [508]
- Vetter, O. J. G. and R. C. Phillips. 1970. "Prediction of Deposition of Calcium Sulfate Scale Under Down-Hole Conditions." Journal of Petroleum Technology, October, 1299-1308. [509]
- Vollmar, A. T., B. G. Maza, P. A. Medica, F. B. Turner, and S. A. Bamberg. 1976. "The Impact of Off-Road Vehicles on a Desert Ecosystem." \_\_\_\_\_, 1(2):115-129. [756]
- VonderHaar, S. and I. P. Cruz. 1979. "Fault Interactions and Hybrid Transform Faults in the Southern Salton Trough Geothermal Area, Baja Calif., Mexico." Geothermal Resource Council Annual Meeting, Reno, Nev. Lawrence Berkeley Laboratory. [510]
- Wagner, O. E. 1977. "The Use of Tracers in Diagnosing Interwell Reservoir Heterogeneities-Field Results." J. Petroleum Technology, 29:1410-1415. [872]
- Waldschmidt, W. A. 1941. "Cementing Materials in Sandstones and Their Probable Influence on Migration and Accumulation of Oil and Gas." Bulletin, American Assoc. Petroleum Geologists, 25(10):1839-1879. [548]
- Walker, W. R. and W. E. Cox. 1976. "Deep Well Injection of Industrial Wastes." Virginia Water Resources Research Center. [773]
- Walker, W. R. and W. E. Cox. 1974. "Subsurface Environment - Private Property or Public Domain?" Journal of the Hydraulics Division, ASCE, 100(HY 11):1699-1705. [614]
- Wallick, G. C. and J. S. Aronofsky. 1954. "Effect of Gas Slip on Unsteady Flow of Gas Through Porous Media - Experimental Verifications." J. Petroleum Technology, Publication 239, pp. 27-29. [757]
- Walton, W. C. 1962. "Selected Analytical Methods for Well and Aquifer Evaluation." Illinois State Water Survey, Bulletin No. 49. [873]
- Ward, J. C. 1964. "Turbulent Flow in Porous Media." Journal of the Hydraulics Division, ASCE, 90(HY5):1-12. [511]
- Warman, J. C., F. J. Molz and T. E. Jones. 1976. "Step Beyond Theory - Aquifer Storage of Energy." Proceedings of the Second Southeastern Conference on Application of Solar Energy. CONF-760423, pp. 476-487. [512]
- Warman, J. C., F. J. Molz and T. E. Jones. 1977. Subsurface Waste Heat Storage: Experimental Study. ORO/5003-1. [513]

- Warner, D. L. and J. H. Lehr. 1977. An Introduction to the Technology of Subsurface Wastewater Injection. EPA-600/2-77-240. (PB-279 207). [514]
- "Water-Borne Rotation Solar Collecting and Storage Systems." \_\_\_\_\_. U.S. Patent 4,148,301, Sheet 1-3. [874]
- "Water Well Journal Funds Heat Pump Research." 1977. Water Well Journal, 31(8):45. [515]
- Waxman, M. H. and E. C. Thomas. 1974. "Electrical Conductivities in Shaly Sands-1. The Relation Between Hydrocarbon Saturation and Resistivity Index: II. The Temperature Coefficient of Electrical Conductivity." J. Petroleum Technology, pp. 213-225. [758]
- Webb, R. H., H. C. Ragland, W. H. Godwin, and D. Jenkins. 1978. "Environmental Effects of Soil Property Changes with Off-Road Vehicle Use." Environmental Management, 2(3):219-233. [759]
- Weber, E. L. 1963. "Heat Pump Employs Panel Heating as Refrigerant Condenser." Heating, Piping and Air Conditioning, 35(10):95-97. [516]
- Weber, K. J., P. H. Klootwijk, J. Konieczek, and W. R. VanderVlugt. 1978. "Simulation of Water Injection in a Barrier-Bar-Type, Oil-Rim Reservoir in Nigeria." J. Petroleum Technology, 30:1555-1565. [875]
- Wehlage, E. F. 1976. "Needed: Effective Heat Transfer Equipment." Mechanical Engineering, 98:27-33. [517]
- Weinbrandt, R. M., H. J. Ramey and F. J. Casse. 1975. "The Effect of Temperature on Relative and Absolute Permeability of Sandstones." Society of Petroleum Engineers Journal, October, pp. 376-384. [518]
- Weissenbach, P. B. 1974. "Langzeitspeicherung fur Niedrigtemperaturwarme." VDI-Berichte, NR 223:39-44. [519]
- Wentwork, W. E. and E. Chen. 1976. "Simple Thermal Decomposition Reactions for Storage of Solar Thermal Energy." Solar Energy, 18(3):205-214. [547]
- Werner, D. and K. D. Balke. 1977. "Die Warmeausbreitung in der Umgebung eines Kuhlwasser-Sickerbrunnens." GWF-Wasser/Abwasser, 118:528-531. [520]
- Werner, D. and W. Kley. 1977. "Problems of Heat Storage in Aquifers." Journal of Hydrology, 34:35-43. [521]
- West, E. R. 1976. "Improved Drilling is a Result of Sound Engineering." World Oil, 183:57-59. [522]

- Westinghouse Study. \_\_\_\_\_. "Solar Energy for Heating and Cooling of Buildings." pp. 171-173. [546]
- White, D. E. and D. L. Williams. 1975. "Assessment of Geothermal Resources of the United States, 1975." USGS, Circular 726. [545]
- Wickersham, G. 1978. "Review of C. E. Jacob's Doublet Well." [523]
- Willhite, G. P. 1967. "Over-all Heat Transfer Coefficients in Steam and Hot Water Injection Wells." Journal of Petroleum Technology, May, pp. 607-615. [524]
- Willhite, G. P. and W. K. Dietrich. 1966. "Design Criteria for Completion of Steam Injection Wells." Society of Petroleum Engineers of AIME, (10):62-69. [525]
- Willhite, G. P. and J. Wagner. 1974. Disposal of Heated Water Through Ground Water Systems. Vol. II. User's Manual. Numerical Simulation of Fluid Flow and Heat Transfer in Ground Water Systems. Kansas Water Resources Research Institute. Contribution No. 134. (PB-236-303). [526]
- Willhite, G. P., J. Wagner, F. Simonpictri and J. Stoker. 1974. Disposal of Heated Water Through Ground Water Systems. Vol. I. Technical and Economic Feasibility. Kansas Water Resources Research Institute. Contribution No. 134. (PB-236-302). [527]
- Williams, D. A. and J. B. Tiedmann. 1974. "Heat Pump Powered by Natural Gradients." Proceedings, 9th Conference Intersociety Energy Conservation of Engineers, ASME Paper 749041, pp. 538-549. [544]
- Willman, B. T., V. V. Valleroy, G. W. Runberg, A. J. Cornelius, and L. W. Powers. 1961. "Laboratory Studies of Oil Recovery by Steam Injection." Journal of Petroleum Technology, 222:681-690. [528]
- Wingquist, C. F. 1976. "Elastic Moduli of Rock at Elevated Temperatures." U.S. Bureau of Mines, RI-7269. [769]
- Winslow, A. G. and W. W. Doyle. 1954. "Land-Surface Subsidence and It's Relation to the Withdrawal of Groundwater in the Houston-Galveston Region, Texas." Economic Geology, 49:413-422. [529]
- Witherspoon, P. A. 1978. Mexican-American Cooperative Program at the Cerro Prieto Geothermal Field. LBL-7095. [530]
- Witherspoon, P. A. 1978. Swedish-American Cooperative Program on Radioactive Waste Storage in Mined Caverns Program Summary. LBL-7049. [533]

- Witherspoon, P. A. and J. A. Apps. 1977. Fundamental Geosciences Program Annual Report 1977. LBL-7058. [531]
- Witherspoon, P. A., I. Javandel, S. P. Neuman, and R. A. Freeze. 1967. "Interpretation of Aquifer Gas Storage Conditions from Water Pumping Tests." American Gas Association. [876]
- Wollenberg, H. A., R. E. Bowen, H. R. Bowman, and B. Strisower. 1979. Geochemical Studies of Rocks, Water, and Gases at Mt. Hood, Oregon. LBL-7092. [532]
- Wooding, R. A. 1957. "Steady-State Free Thermal Convection of Liquid in a Saturated Permeable Medium." Journal of Fluid Mechanics, 2:273-285. [534]
- Wooding, R. A. 1958. "An Experiment on Free Thermal Convection of Water in Saturated Permeable Material." Journal of Fluid Mechanics, 3:582-600. [621]
- Wooding, R. A. 1960. "Rayleigh Instability of a Thermal Boundary Layer in Flow Through a Porous Medium." Journal of Fluid Mechanics, 9:183-192. [535]
- Wooding, R. A. 1962. "Free Convection of Fluid in a Vertical Tube Filled with Porous Material." Journal of Fluid Mechanics, 13:129-144. [536]
- Wooding, R. A. 1964. "Mixing-Layer Flows in a Saturated Porous Medium." Journal of Fluid Mechanics, 19:103-113. [537]
- Wooding, R. A. and H. J. Morel-Seytoux. 1976. "Multiphase Fluid Flow Through Porous Media." Annual Review of Fluid Mechanics, 8:233-274. [538]
- Wyllie, M. R. J. and M. B. Spangler. 1952. "Application of Electrical Resistivity Measurements to Problem of Fluid Flow in Porous Media." Bulletin of American Association of Petroleum Geologists, 36(2):359-403. [539]
- Yanagase, T., Y. Suginojara, and K. Yanagase. 1970. "The Properties of Scales and Methods to Prevent Them." U.S. Symposium on the Development and Utilization of Geothermal Resources, 2(2):1619-1623. [540]
- Young, K. L. 1967. "Effect of Assumptions Used to Calculate Bottom-Hole Pressures in Gas Wells." J. Petroleum Technology, pp. 547-550. [764]
- Yuan, S. W., A. M. Blook, and M. Mazli. 1977. "Heat Transfer in Solar Energy Storage." ASME, 77-HT-38. [543]
- Yuan, S. W., A. M. Bloom, and M. Nazli. 1976. "Long Duration Earth Storage of Solar Energy." CONF-761220, p. 33-39. [541]

Yuan, S. W. and L. S. Galwin. 1976. "A Central Solar Energy Utilization System." Int'l Seminar Future Engineers Prod. Heat and Mass Transfer Probl., 1:139-148. [765]

Zoback, M. D. 1976. "Effect of High-Pressure Deformation on Permeability of Ottawa Sand." American Association of Petroleum Geologists Bulletin, 60(9):1531-1542. [542]





TECHNICAL SUPPORT PROGRAM

David A. Myers  
Pacific Northwest Laboratory

PROJECT OUTLINE

Project Title: Leading Edge Test Facilities

Principal Investigator: D. A. Myers

Organization: Pacific Northwest Laboratory  
P. O. Box 999  
Richland, WA 99352  
Telephone: (509) 375-2462 FTS: 444-7511

Project Goals: To obtain that data which can be derived only from a field test facility.

Aquifer Characterization - A drilling and testing program has been instituted at two sites in the State of Washington.

Heat Exchanger - A conceptual design for the surface heat exchange facility has been developed.

Test Plan - A preliminary test plan has been developed and is being detailed.

Hydrologic Modeling - Mathematical models of the hydrology of the proposed sites will be done; these models will be updated based on information derived from the aquifer characterization task.

Identification of Aquifers - A search for additional sites applicable for STES/LETF activities is being continued.

Project Status: Work started on geohydrologic characterization at two possible field research pilot plant sites (Leading Edge Test Facilities).

Contract Number: EY76-C-06-1830

Contract Period: June, 1979 to December, 1985

Funding Level: \$813,000 (FY 1980)

Funding Source: Energy Storage Systems Division  
U.S. Department of Energy

## TECHNICAL SUPPORT PROGRAM

David A. Myers  
Pacific Northwest Laboratory

### INTRODUCTION

The Battelle Technical Subtasks include three major areas: 1) Compendia of Existing Technology; 2) Leading Edge Test Facility(s); and 3) Advanced Analysis Methodologies. These tasks include, but are not limited to those efforts to be discussed by Lawrence Berkeley Laboratory, Auburn University, Texas A&M University, and the Tennessee Valley Authority. The efforts described here are parallel to and in support of the ATES Demonstration Program described by Mr. Kenneth Fox of PNL.

### COMPENDIA OF EXISTING TECHNOLOGY

The Seasonal Thermal Energy Storage Program Compendia is designed to provide a single resource point for all aspects of this new technology. The STES Compendium will be comprised of several smaller compendia which encompass a wide range of topics related to the various aspects of STES, Table 1. Current efforts are directed primarily at aquifer thermal energy storage, however, non-aquifer concepts are being considered and included.

To adequately service the needs of the program, a library of related literature is being formed. This library currently consists of more than 750 documents. The library is in the process of being cross referenced to the subject titles currently identified for individual compendia. Because most of the compendia subjects have had little or no concern with thermal energy storage in the past, the literature is being reviewed and STES-related abstracts written for inclusion in an annotated bibliography.

The compendium will consist of a series of "research papers" and technical manuals. Research papers will be written to cover developing technologies. Typical subjects to be covered include: Thermal conductivities in soils; aquifer plugging mechanisms; computer models; energy sources; and numerous other topics. Technical manuals will be written covering developed technologies, although some manuals should be available in the open literature, many will need to be rewritten specifically for STES. Possible technical manual subjects include well construction, well treatment, and heat exchanger sizing.

## LEADING EDGE TEST FACILITY(S)

A Leading Edge Test Facility(s) (LETf) is envisioned to lead the way for full scale demonstration of Aquifer Thermal Energy Storage. To adequately accomplish this task, it is necessary that the majority of the problems to be faced by a full scale demonstration, be answered by the LETf. Thus, each technical step must be taken. These steps include: aquifer characterization; facility design; environmental and related concerns; and actual field testing and experimentation.

### Aquifer Characterization

Current LETf activities center around this effort. Literature searches were conducted for the Bellingham and Richland sites. Field reconnaissance was carried out, locating existing wells and obtaining all pertinent data not readily available from the literature. State Water Resource offices were contacted to obtain necessary permits prior to initiation of test drilling. Test drilling indicated the existence of a potentially useable saline aquifer in the Bellingham area, while test drilling at the proposed Richland Site has shown a high variability in the aquifer limiting its potential as a low temperature site. Pump testing of the aquifers at both sites remains to be done. In addition to these sites currently under investigation, sites at Mobile, Alabama, College Station, Texas, and within the TVA service area are also under consideration and will be discussed by contractors in subsequent presentations.

### Surface Facility Design

Preliminary design of both low and high temperature facilities has been done. These facilities feature closed loop boiler/heat sources and high efficiency heat exchangers to bring the ground water up to the design temperature. The system includes test sections for the examination of the effects of thermal cycling on materials and automatic data systems to accurately monitor the energy being injected.

### Subsurface Designs

Conceptual designs of wells and site layouts have been made. It is conceivable that a simple doublet design may not be the best for all conditions, therefore alternative configurations have been designed. With adequate test drilling the most appropriate design can be selected for each LETf site. Monitoring wells have been designed to provide in situ data on depth dependent temperature and hydrostatic head. Provision for sampling of the thermally altered ground water has been made.

## Environmental and Related Concerns

The impact of Seasonal Thermal Energy Storage on the environment is one of the major factors which will effect the potential application of the technology. One of the primary purposes of the LETF is to ascertain the reality of these potential impacts. Numerous federal, state and local regulations cover the use of aquifers. The impact of Aquifer Thermal Energy Storage on the native ground water may be controlled at the federal level by the proposed Underground Injection Control Regulations (UIC), the Safe Drinking Water Act (SDWA), and the National Environmental Protection Act, all administered by the Environmental Protection Agency.

At the state level, environmental, legal and institutional constraints include: State Environmental Protection Acts; Water Rights legislation; Mineral Rights; Drilling Requirements and numerous other potential rules and regulations.

At the local level, impacts and concerns as the local environment, land use plans, economic impact and public reaction, have been voiced. These topics must be covered at LETF sites to lay a proper ground work for future Seasonal Thermal Energy Storage applications.

## ADVANCED ANALYSIS METHODOLOGIES

The development of predictive and interpretive tools is essential to the development of Aquifer Thermal Energy Storage. Three major thrusts are being pursued; an energy/hydrologic modeling effort, bench scale laboratory analysis, and development of field analytical tools.

### Mathematical Analysis

Existing codes are being modified to include energy conservation. In this effort a three-dimensional hydrologic model is being adapted to include energy conservation and transport in order to track thermal responses in an aquifer system. The modeling work to be described by Dr. Chin Fu Tsang of Lawrence Berkeley Laboratories is a major contribution to this subtask. A second effort is directed at development of an analytical check to ascertain if the available codes are "error free". This analytical check will also be used in code verification for the "ideal" problem.

### Laboratory Analysis

At PNL, Terra Tek, Incorporated and the University of Washington, efforts are being made to describe the responses of the geohydrologic regime to induce stress caused by Seasonal Thermal Energy Storage activities. Three major areas have been identified: Fluid reinjection at elevated temperatures and pressures; the determination of thermal diffusivity; and the delineation of thermo-mechanical properties. A flow facility capable of duplicating in situ stresses, pressures and flow rates is under design and scheduled for use during FY 1981.

### Field Analysis

Work is currently underway at Washington State University and at PNL to develop appropriate field analytical tools that will aid in predicting system responses Seasonal Thermal Energy Storage activities. These tools include modification of existing interpretive techniques as well as the development of new tools specifically for Seasonal Thermal Energy Storage application.

TABLE 1. EXAMPLE COMPENDIA SUBJECTS

1. Site selection and regional assessments
2. Energy sources
3. Fluid flow and energy transport in reservoirs
4. Environmental considerations
5. Institutional and societal considerations
6. Economic feasibility
7. STES related experiments
8. STES related mathematical and computer modeling
9. STES related demonstrations
10. Nonaquifer storage methods
11. Well drilling and maintenance
12. Well casing and screening materials
13. Reservoir characterization methods
14. Reservoir pretreatment and rehabilitation
15. Well field design and operating criteria
16. Reservoir consolidation and subsidence
17. Corrosion, scaling, and encrustation
18. Thermal fatigue of reservoir and well material
19. Well bore and piping heat losses
20. Heat transfer equipment
21. Water treatment and filtering techniques
22. Water quality
23. Reservoir plugging mechanisms
24. Reinjection

## TECHNICAL SUPPORT PROGRAM

Jay R. Eliason  
Pacific Northwest Laboratory

### INTRODUCTION

The Technical Support Program is designed to provide support to the Seasonal Thermal Energy Storage Program which has the overall objective of commercially demonstrating the applicability of seasonal thermal energy storage. The initial activities of this task are a parallel effort primarily directed toward support of the Aquifer Thermal Energy Storage Demonstration Program. These activities will include social, economic, environmental assessment, and technical research and development studies to provide a sound technical base for the Demonstration Projects. The long-range task goals include investigation and evaluation of other seasonal thermal energy storage concepts which may be considered for future emphasis. Studies will be conducted independent of the ATES Program, but will be designed and timed to provide key input to the program.

During FY-1979, the program was established at PNL and several ongoing projects initiated by ORNL were being conducted in the aquifer technology area. Responsibilities for continuation or termination of these studies were transferred to PNL as the contracts expired or at the FY-1979-1980 transition. Studies to be continued are now being integrated into the overall Technical Support Program.

### APPROACH

The Technical Support Program has been organized to provide near-term support to the ATES Demonstration Program and long-range investigation and evaluation of other seasonal thermal energy storage concepts. These goals will be accomplished by acquiring needed data from continuation of ongoing ORNL projects transferred to PNL, establishing research teams within PNL to coordinate and provide data and by subcontracting with other DOE National laboratories, private industry, universities, and other government agencies for required data collection and analysis. The program has been organized into the following subtasks:

## SUBTASK I

### Management

Program management will include planning, technical review, and reporting. Also, a Technical Consultant Review Team consisting of recognized peers in the related technology areas will report directly to the manager and/or his technical assistant. This Review Team will meet on an annual basis to overview the program. They will also be available for consulting on specific task activities.

## SUBTASK II

### Social Assessment

The social impact of this technology development results primarily from the inherent commitment of the local environment for energy storage, i.e., the commitment of a local ground-water aquifer for storage of the heated or cool water. These commitments may also cause changes in water quality other than thermal which could limit the future uses of the resource. Task activities will be addressed by this program to minimize the impact and to assure social acceptability of this emerging energy technology.

## SUBTASK III

### Economic Assessment

Economic analyses are one of the primary objectives of the overall Seasonal Thermal Energy Storage Program. These studies will be conducted in all phases of the Technical Support Program and the ATES Demonstration Program to assess the economic feasibility of the concepts being evaluated. The primary task objectives are to develop a methodology to evaluate the economics of various energy storage concepts under the expected range of environmental, technical and economic conditions, and to conduct supporting assessments.

## SUBTASK IV

### Environmental Assessment

The primary task activity is the development of environmental documentation support for the STES Program. This activity will include determination and meeting environmental documentation requirements for both programmatic and site-specific studies. Also, activities will include environmental research prioritization/acquisition of required input, and environmental advisory assistance.



## SUBTASK V

### Technical

These Technical Support studies are designed to provide a sound base for development and evaluation of seasonal thermal energy storage concepts. The following subtask descriptions have been identified as key elements of the initial STES Program.

#### Thermal Energy Sources/Uses

This subtask is designed to determine the primary sources of heat (or chill) that would be suitable for STES systems and determine typical temperature and thermal storage capacity requirements for such systems.

#### Compendia of Existing Technology

This task involves the collection of known information pertinent to STES summarizing it by topic and incorporating it into a working library at PNL. Topics which do not have recent or relevant technical overviews available will be identified and these reviews will be conducted to develop working documentation which can be utilized as technical support to the Demonstration Program. Also, as part of the ongoing Technical Support Program subtasks, basic technical design data will be developed which are the end products to be provided to the Demonstration Tasks. These data will be summarized and published as individual inserts into an ATE technical manual as they are identified to expedite technology transfer.

#### Leading Edge Test Facility(s)

In order to obtain needed engineering design data and to conduct supporting research for the STES Program, sites are being selected and developed for this purpose. Research will include development of test facilities to lead the Demonstration Programs (Leading Edge Test Facility(s)), in development of both unconfined aquifer storage systems and confined aquifer storage systems. These Leading Edge Test Facilities will provide research teams with opportunities to evaluate and develop site-characterization techniques and operational experience necessary for siting of aquifer storage systems. Data collected at these test sites will provide required calibration and verification of advanced analysis methodologies being developed for site characterization and assessment.

#### Advanced Analysis Methodologies

Accurate assessment of STES concepts will require development of advanced hydrologic assessment methodologies which have not been required in routine hydrologic assessments. Methodology development will include: development of

models to provide capabilities for analyzing the complex hydrologic systems, interactions associated with the storage of energy, development of laboratory analysis for characterization of the mineralogy, ground-water chemistry, thermal diffusivity, fluid-flow properties and thermomechanical properties, and development of field hydrologic analysis techniques for assessing the capacity and efficiency of aquifers for energy storage.

## SUBTASK VI

### Non-Aquifer Seasonal Thermal Energy Storage

The major thrust of the STES Program at the present time is in aquifer storage, studies will be conducted to evaluate other proposed STES systems, such as large pond storage, earth storage, and other more advanced concepts. These concepts will be evaluated with respect to consideration for future program emphasis.

## STATUS

The STES Program was assigned to PNL late in FY-1979. PNL activities in FY-1979 included review and assessment of aquifer-related programs to be transferred from ORNL, development of the STES Program plan including obtaining commitments of management and support staff, and initiation of subcontract activities to support the program.

Aquifer Technology Projects funded during FY-1979 by ORNL have been reviewed and selected contracts will be incorporated into the PNL STES Program. The following studies were ongoing at ORNL during FY-1979:

#### Auburn University Mobile Field Test

- Continuing program (PNL)
- Report on second thermal cycle due December 31, 1979

#### Texas A&M College Station Field Test

- Chill storage and recovery cycle completed
- Data analysis and report due March 31, 1980

#### NYSERDA JFK Site

- Project complete
- Final report received

#### USGS Bellingham Site Review

- Project complete
- Report received

ORNL Techno-Economic Analysis

- Project complete
- Report being published

ORNL Generic Environmental Impact Analysis

- Continuing program
- Draft document prepared
- Task transferred to PNL

TVA Application Assessment

- Continuing program (PNL)
- Subcontractor Acres American report completed
- Scheduled completion date March 31, 1980

LBL Thermal Hydraulic Analysis

- Continuing program (PNL)
- Interim reports received for FY-1979

PNL Geochemical Analysis

- Project complete
- Final report approved for publication

The STES Program has been developed within PNL and management and support staff assigned. The WPAS for the FY-1980 program was prepared and submitted to DOE-HQ.

The Technology Support Program subtask coordinating staff has been assigned and the FY-1980 budgets established. Subcontract support for the program is being negotiated with ongoing contractors and is being solicited for other subtask requirements.



PRELIMINARY CONCLUSIONS OF A TECHNICAL FEASIBILITY STUDY OF LOW  
TEMPERATURE THERMAL ENERGY STORAGE IN THE TVA REGION

A. R. Betbeze  
Tennessee Valley Authority

PROJECT OUTLINE

Project Title: Application of Low-Temperature Thermal Energy Storage in the  
TVA Region

Principal Investigator: Jerry J. Phillips

Organization: Tennessee Valley Authority  
350 Commerce Union Bank Building  
Chattanooga, TN 37401  
Telephone: (615) 755-3251

Project Goals: The objectives of the study include: 1) the identification  
of potential sources and users of low-temperature thermal  
energy, such as institutional heating and cooling and  
industrial processes, in addition to TVA facilities; and 2)  
the identification of appropriate aquifer sites for  
storage. Particular emphasis will be given to defining the  
criteria for storage in aquifers.

Survey the TVA region for thermal energy producers

Development of criteria for storing thermal energy in  
aquifers

Survey the TVA region for aquifer storage system sites

Survey potential thermal energy users in the TVA region

Assess the opportunities for thermal energy storage systems  
in the TVA region

Project Status: Surveys for thermal energy producers, aquifer storage  
system sites, and thermal energy users have been completed  
and are in a report prepared by Acres American, Inc.  
Preliminary criteria for storing thermal energy in aquifers  
have been developed. Opportunities for thermal energy  
storage systems in the TVA region are being assessed and  
plans for aquifer testing and development of a test  
facility are being prepared.

Contract Number: EW-78-I-05-6112

Contract Period: December 1978 to September 1979

Funding Level: \$90,000

Funding Source: U.S. Department of Energy  
Division of Energy Storage Systems

PRELIMINARY CONCLUSIONS OF A TECHNICAL FEASIBILITY STUDY  
OF LOW TEMPERATURE THERMAL ENERGY STORAGE  
IN THE TVA REGION\*

A. R. Betbeze  
Tennessee Valley Authority

SUMMARY

The technology required to implement Low Temperature Thermal Energy Storage (LTTES) is fully developed and commercially available, and no foreseeable technical barriers to implementation in the TVA region are apparent. The major constraint on system feasibility is attributed to possible environmental effects and economic practicality and not to technical limitations.

The major development work now required is the determination of the long-term effects on the aquifer and adjacent groundwaters from the implementation of an LTTES plant.

DISCUSSION

The integration of LTTES into a utility energy supply scheme can assist that utility in meeting the energy demands of its customers. Because of the relative simplicity of the LTTES utilization system and the use of current state-of-the-art components, utility economic advantages are perceived. The primary advantages are:

- (1) A reduction in the requirement to build new, additional electrical generation and transmission facilities.
- (2) A reduction in the growth of electric power rates.

Tennessee Valley Authority, through the initiation of this LTTES development program, has prepared a logical approach to the development of the entire LTTES technology using aquifer storage. The work, reported herein, has as its objective the determination of the technical feasibility of the LTTES concept. Technical feasibility of the concept is established when:

- (1) Significant technical parameters have been identified.

---

\*This report is based primarily on work performed by ACRES American, Inc., M. J. Hobson, Project Manager, under contract to TVA.

- (2) Technical parameters have been evaluated.
- (3) System components have been identified and evaluated.
- (4) Parameters or components requiring further development work have been identified.

In order to locate the significant energy sources and potential users, it was necessary to quickly establish the areas where aquifers were readily available for energy storage. An extensive review of the published literature in geology and geohydrology of the TVA service area indicated that only the aquifers within the coastal plain area (western Tennessee and northern Mississippi) were consistently suitable for use for LTTEs thermal storage.

On the basis of their geologic and geohydrologic characteristics, the following four confined aquifers in unconsolidated sediments were considered potentially suitable to store the heated and/or chilled water:

- Memphis Aquifer (500-Foot Sand)
- Wilcox Group (Lower Wilcox Aquifer)
- Ripley Formation (McNairy Sand)
- Coffee Sand

Although these aquifers seem to possess necessary characteristics for an efficient and effective storage, several questions associated with water chemistry, increase in temperature and pressure, and groundwater flow need to be answered.

The TVA service area, in particular the coastal plain region, was surveyed to determine the presence of potential producers and users of low temperature thermal energy. To this end, the source of heat for input to LTTEs is defined as the waste heat from industrial facilities and the collection of thermal energy from solar arrays. Solar arrays can provide a viable heat input in locations where waste heat is not available.

The work performed during this survey indicated that there exists within the desired geographical area a large quantity of waste heat of suitable quality. These waste heat sources are located in clusters, near metropolitan areas, in relatively close proximity to potential users.

Aquifer LTTEs systems can also be used for the storage of chilled water for space cooling and/or light process cooling. The ultimate source for the cooling of this chilled water has been determined to be the atmosphere during the winter months through the use of cooling towers. Prior to cooling in the tower, precooling of the aquifer water, using cold surface waters as the source, is technically feasible.

The uses of low temperature thermal energy are concluded to exist primarily in the space heating/cooling of high population density residential areas and industrial, institutional, and commercial facilities. The work performed during the survey identified various users of low temperature thermal energy and specified their geographical location. User energy consumption for space heating/cooling was also estimated.

Because the survey of producers and users resulted in the determination that they are located in clusters, in relatively close proximity to one another, there exists an excellent opportunity to continue with the LTTES development program.

Potential generic systems for the utilization of low temperature thermal energy were identified. Because of the wide range of design possibilities that depend largely on site-specific considerations, the work emphasized major design guidelines for the development of utilization schemes. For simplicity and convenience, the treatment of utilization systems was divided into four subsystems that maintain relatively independent functions, namely recovery, storage, transmission, and distribution.

The principal methods of reclaiming thermal energy from industrial and power plant waste heat, solar energy, and environmental energy sources make use of heat exchangers. Heat exchangers are available in a variety of design configurations to meet a wide range of system applications. For anticipated operating conditions of low temperature thermal energy utilization systems, off-the-shelf exchangers capable of meeting design requirements should be readily available. In situations where the quality of available thermal energy is insufficient for user needs, heat pumps can be used onsite to provide the needed temperature increase up to about 121° C (250° F). The use of heat pumps extends considerably the potential for waste heat utilization.

The transmission distance between the points of supply and use is one of the most important parameters in the thermal energy utilization system. Transmission distance governs the acceptable supply temperature and the economics of waste heat utilization. The limits of heat transmission line design are set by constraints of economic feasibility, rather than by available technology. Practical transmission distance now ranges between 8 and 41 kilometers (5 to 25 miles) for low temperature systems.

Several storage well configurations are possible, but the doublet storage well concept provides the most system flexibility for aquifer thermal energy storage. This doublet concept offers easy changeover between the charging and discharging modes. The use of indigenous groundwater as the fluid medium also minimizes geotechnical problems.



## CONCLUSIONS

These conclusions are preliminary as the feasibility study is not complete at this time.

- (1) The technology required to implement all phases of the energy utilization system is fully developed and commercially available and no foreseeable technical barriers to implementation are apparent. The major constraint on system feasibility is attributed to economic practicality and not to technical limitations.
- (2) The preferred transport medium for low temperature thermal energy is water, especially for long distance transmission.
- (3) The storage well doublet is the most flexible and practical storage system concept among several alternatives.

The necessary work for the determination of the technical feasibility of LTTES has been performed. Surface LTTES components require no development for implementation into LTTES; state-of-the-art equipment technology is adequate. Present knowledge of well drilling and the present technology of well pumps are sufficient for the requirements of LTTES.

The major development work required is the determination of the long-term effects on the aquifer and adjacent groundwaters from the implementation of an LTTES plant.



SEASONAL THERMAL ENERGY STORAGE IN AQUIFERS - MATHEMATICAL  
MODELING STUDIES IN 1979

Chin Fu Tsang  
Lawrence Berkeley Laboratory

PROJECT OUTLINE

Project Title: Mathematical Modeling of Thermal Energy Storage in  
Aquifers and Support for Seasonal Thermal Energy Storage  
Projects

Principal Investigator: Chin Fu Tsang

Organization: Lawrence Berkeley Laboratory  
1 Cyclotron Road  
Berkeley, CA 94720  
Telephone: (415) 843-2740 FTS: 451-5782

Project Goals: Develop methods for evaluating hydrodynamic and thermal  
factors for aquifer thermal energy storage (ATES).  
Disseminate information on aquifer thermal energy storage  
and provide technical support for the Seasonal Thermal  
Energy Storage (STES) Program.

Develop numerical models to simulate water and heat flow  
in geologic media, and use these models to predict and  
evaluate performance of aquifer thermal energy storage  
tests. Compile, publish, and distribute a bimonthly ATES  
Newsletter.

Project Status: A numerical model was developed, verified, and tested to  
simulate and predict ATES performance.

Issuance of the ATES Newsletter, initiated in FY-1978,  
continued in FY-1979.

Modeling of the Auburn field test was completed with  
evaluation of the first and second heat  
injection/recovery cycles.

Work planned for FY-1980 includes continuation of the  
ATES Newsletter, modeling of the Texas A&M University  
1978-1979 field experiment, completion of ATES generic  
sensitivity and parametric studies, and STES technical  
support as required.

Contract Number: W7405-ENG26

Contract Period:

Funding Level: \$96,700 (FY 1979)

Funding Source: Energy Storage Systems Division  
U.S. Department of Energy

Seasonal Thermal Energy Storage in Aquifers -  
Mathematical Modeling Studies in 1979

Chin Fu Tsang  
Earth Sciences Division  
Lawrence Berkeley Laboratory

Introduction

Lawrence Berkeley Laboratory (LBL) first began working on seasonal thermal energy storage in aquifers in 1976. Initial studies have included comprehensive generic calculations based on a numerical model to calculate the coupled heat and fluid flows in a three-dimensional, complex-geometry aquifer system. Various situations have been considered, including hot or cold water storage, storage for different periods of time, inhomogeneity of the storage aquifer, the presence of barriers, regional flow, and the situation of a storage well partially or fully penetrating the aquifer. Many of the results have been published in a series of papers (for example, References 1-3).

In 1978, LBL organized and hosted the First International Workshop on Aquifer Thermal Energy Storage. Active workers from nine countries participated in this workshop and their contributions were published in The Workshop Proceedings (Reference 4). Since the Workshop, a periodic Newsletter (Reference 5) has kept researchers abreast of the current status of various projects worldwide. Many of these projects are reviewed in invited conference review papers published in 1979 (References 6 and 7).

During fiscal year 1979 (October 1978 - September 1979) major LBL work involved the numerical modeling of the recently-completed hot water storage field experiments at Auburn University. This work was funded by the U.S. Department of Energy, Energy Storage Division, through Battelle Pacific Northwest Laboratory and Oak Ridge National Laboratory. Work was also done, under separate funding, on the basic understanding of thermal stratification, dispersion, and buoyancy flow in an aquifer used for hot or cold water storage. These questions are crucial in determining the efficiency of aquifer energy storage and will be discussed elsewhere (References 8 and 9).

The remainder of this paper will summarize the results of the simulation of Auburn field experiments. Details of the simulation will be published in a paper under preparation.

#### Simulation of Auburn Field Experiments

The recent experiments by Auburn University involved two injection-storage-recovery cycles. Details may be found in a companion paper (Reference 10). The first six month injection-storage-production cycle involved the storage of 55000 m<sup>3</sup> of water at about 55°C. The injection took 79.2 days, at the end of which the hot water was stored for 52.5 days. Production was then started at an average rate of 245.6 gpm until the recovered water temperature fell to 32.8°C. At that point 66% of the injected energy was recovered. The second injection-storage-production cycle was carried out in essentially the same manner, using 58,000 m<sup>3</sup> of water at an average temperature of 55.4°C. When the production temperature had dropped to 33°C, a recovery of 76% of the injected energy was realized.

The first stage of the simulation involved the determination of the hydraulic parameters of the aquifer (the transmissivity and storativity), and the location of a linear hydrologic barrier through well test analysis. Conventional well test type curve analysis techniques require a constant or carefully controlled flow rate. To get around this limitation, LBL has developed a computer-assisted analysis method, program ANALYZE (References 11 and 12) that can handle a system of several production and injection wells, each flowing at an arbitrarily varying flow rate. This program was applied to the Auburn case, treating the injection period also as a part of the well test data (Reference 13).

With parameters thus obtained, the LBL three-dimensional, complex geometry, single-phase model, CCC, was used to make detailed modeling studies. A radially symmetric mesh was assumed. There is one major hydrologic parameter that was not determined by well test analysis. This parameter, the ratio of vertical to horizontal permeability, has to be inferred from field experience and parameter studies. After making a preliminary parameter study, we decided to use a value of 0.10 for this ratio. The same ratio was suggested by the USGS (Reference 14).

Because neither the injection flow rate nor temperature was held constant, it was necessary in our simulations to break up both the injection (and production) periods into segments having average flow rate and temperature values, conserving injected mass and energy (Figure 1). Results of the simulation include the recovery factor, plots of production temperatures versus time, as well as temperature contour plots and temperature profiles at various times during the injection, storage, and production periods. Both the first and second cycles have been successfully simulated.

For the first cycle, the simulated recovery factor of 0.68 agrees well with the observed value of 0.66. For the second cycle the simulated value is 0.78, and the observed value is 0.76. The details of the comparison between simulated and observed energy recovery can be studied in production temperature versus time plots (Figures 2 and 3). For both cycles, the initial simulated and observed temperatures agree (55°C). During the early part of the production period, the observed temperatures decrease slightly faster than the simulated temperature. During the latter part, the simulated temperatures decrease faster than the observed temperature so that by the end of the production period the simulated and observed temperatures again agree (33°C). The discrepancy over the whole range is, at most, 1-2 degrees.

Temperature contour maps of vertical cross-sections of the aquifer at given times (e.g., Figure 4) show the details of buoyancy flow, heat loss through the upper and lower confining layers, and the radial extent of the hot water in the aquifer. Buoyancy flow is important in this rather permeable system. Comparison with temperatures recorded in observation wells throughout the aquifer show that the simulated temperature distribution agrees generally with observed temperatures. However, these discrepancies are much larger than the differences between calculated and observed production temperatures. Apparently there are local variations in the aquifer which tend to average out. Temperatures versus radial distance at given depths and times are also plotted (e.g. Figures 5 and 6) and, from these profiles, the effects of thermal conductivity and dispersion on the shape of the thermal front can be studied.

In order to prove the mesh-independence of these results, the first cycle has been modeled again, using first a coarser mesh (doubling the radial step) and then a finer mesh (half the radial step). The coarse mesh recovery factor is 0.65, to be compared with a value of 0.66 using our first mesh. Interestingly, the coarse mesh simulation yields a recovery factor slightly closer to the observed value than does the original simulation, so the increased numerical dispersion may be more closely simulating thermal dispersion due to local heterogeneities in the aquifer. Temperature as a function of radial distance (Figure 7) and the production temperature as a function of time (Figure 8) show the insensitivity of the results to the mesh chosen.

#### Plans for Next Year

In the coming year we have been asked by the Department of Energy through Battelle Pacific Northwest Laboratory to model the Texas A and M University chilled water storage experiment that was recently completed. Further generic and parameter studies will be made, including calculations of effects of varying the ratio of vertical and horizontal permeabilities, the storativity parameter, the storage temperatures and effects of the well partially or fully penetrating the aquifer. The Aquifer Thermal Energy Storage Newsletter edited and published by Lawrence Berkeley Laboratory will also be continued.

#### References

1. Chin Fu Tsang, Marcelo J. Lippmann and Paul A. Witherspoon, "Numerical Modeling of Cyclic Storage of Hot Water in Aquifers," talk presented at the Symposium on "Use of Aquifer Systems for Cyclic Storage of Water," of the Fall Annual Meeting of the American Geophysical Union, San Francisco, December 9, 1976.
2. Chin Fu Tsang, Marcelo J. Lippmann and Paul A. Witherspoon, "Underground Aquifer Storage of Hot Water from Solar Energy Collectors," proceedings of International Solar Energy Congress, New Delhi, India, January 16-21, 1978.
3. Chin Fu Tsang, Tom Buscheck, Donald Mangold, Marcelo J. Lippmann, "Mathematical Modeling of Thermal Energy Storage in Aquifers," proceedings of Aquifer Thermal Energy Storage Workshop, Lawrence Berkeley Laboratory, Berkeley, California, May 10-12, 1978.

4. Proceedings of Aquifer Thermal Energy Storage Workshop, Lawrence Berkeley Laboratory, Berkeley, California, May 10-12, 1978. Lawrence Berkeley Laboratory Report LBL 8431.
5. ATEs Newsletter, a quarterly review of aquifer thermal energy storage; Chin Fu Tsang, editor, published by Lawrence Berkeley Laboratory, Berkeley, California 94720.
6. Chin Fu Tsang, "A Review of Current Aquifer Thermal Energy Storage Projects." Invited paper at the International Assembly on Energy Storage, Dubrovnik, Yugoslavia, May 28 - June 1, 1979.
7. Chin Fu Tsang and Deborah Hopkins, "Aquifer Thermal Energy Storage - a Survey." Invited paper at Symposium on "Recent Trends in Hydrogeology," Berkeley, California, February 8-9, 1979 to be published as Special Paper of the Geological Society of America.
8. Goran Hellstrom, Chin Fu Tsang, and Johan Claesson, "Heat Storage in Aquifers: Buoyancy flow and Thermal Stratification Problems," paper in preparation.
9. Tom Buscheck, Johan Claesson, Christine Doughty, Goran Hellstrom and Chin Fu Tsang, "Thermohydrological Aspects of Aquifer Thermal Energy Storage," paper in preparation.
10. F.J. Molz, A.D. Parr, and F.P. Andersen, "Thermal Energy Storage in a Confined Aquifer - Second Cycle," paper to be submitted to the Journal of Water Resources Research.
11. Chin Fu Tsang, Donald McEdwards, T.N. Narasimhan, and Paul A. Witherspoon, "Variable Flow Well Test Analysis by a Computer Assisted Matching Procedure," Paper No. SPE-6547, 47th Annual California Regional Meeting of SPE of AIME, Bakersfield, California, April 13-15, 1977.
12. Donald McEdwards and Chin Fu Tsang, "Variable Rate Multiple Well Testing Analysis," proceedings of Invitational Well-testing Symposium, Berkeley, California, October 19-21, 1977.
13. Christine Doughty, Donald McEdwards, Chin Fu Tsang, "Multiple Well Variable Rate Well Test Analysis of Data from the Auburn University Thermal Energy Storage Experiment," LBL Report No. 10194.
14. S.S. Papadapulos and S.P. Larson, 1978, Aquifer Storage of Heated Water: Part II: Numerical simulation of field results; Groundwater, v. 16, no. 4.



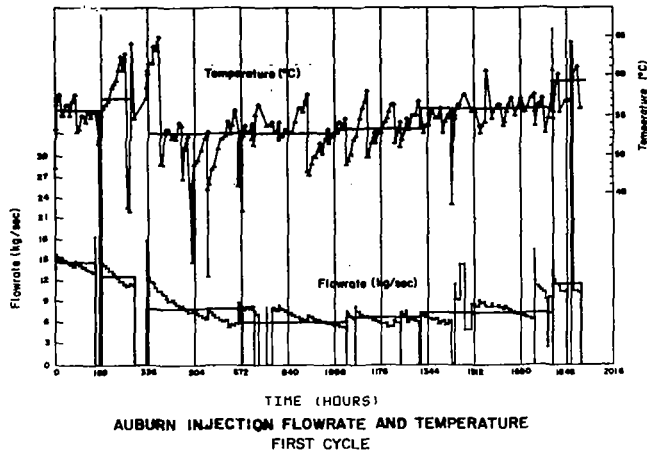

Figure 1. Injection flowrate and temperature versus time, and the average segments used in the simulation.

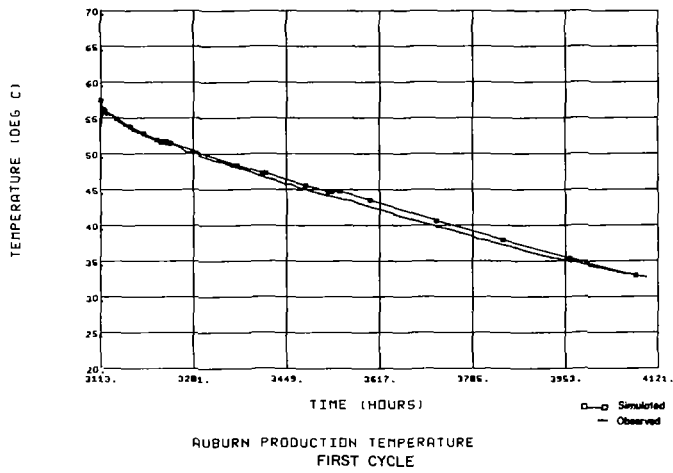

Figure 2. Observed and simulated production temperature as a function of time for the first cycle.

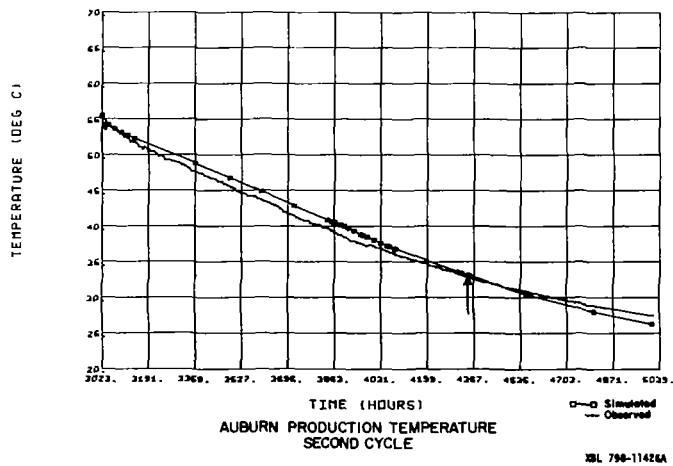

Figure 3. Observed and simulated production temperature as a function of time for the second cycle.

AUBRNO2  
 Calculated temperature  
 t = 1900 hrs.

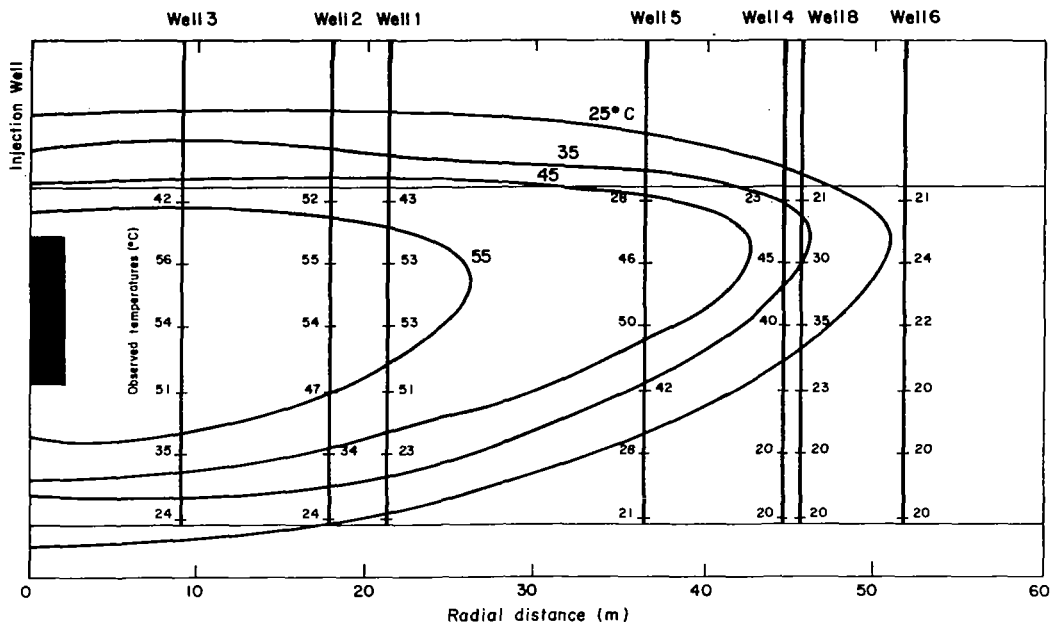

Figure 4. Simulated temperature contours in a vertical cross section of the aquifer at the end of the injection period of the first cycle, observed temperatures are also indicated.

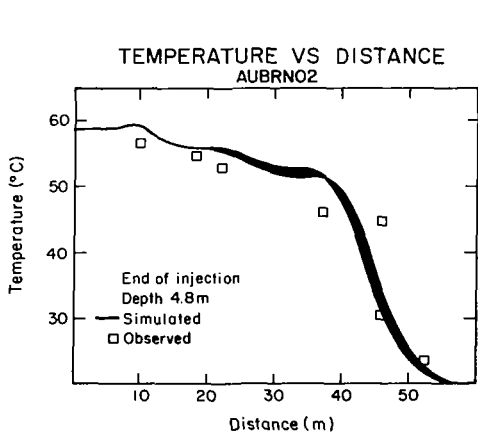

Figure 5. Temperature versus radial distance at the end of injection period for the first cycle. Shaded curve indicates simulated values, boxes show observed values.

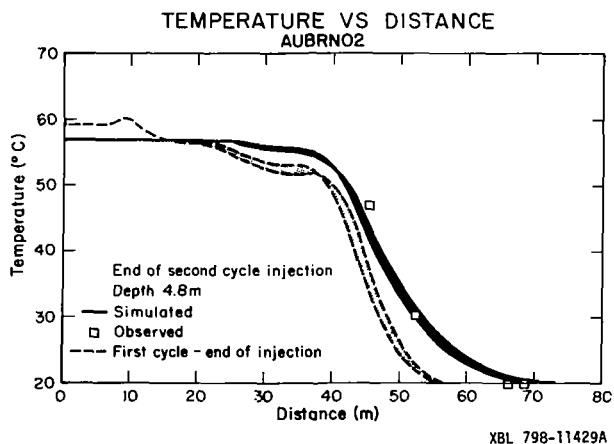
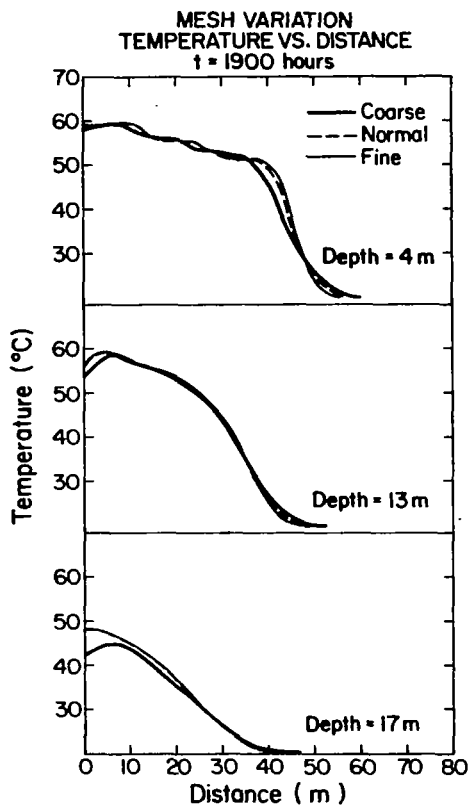

Figure 6. Temperature versus radial distance at the end of injection period for the second cycle. The broken curves shows the simulated values for the first cycle, for comparison.



XBL 791-13295

Figure 7. Simulated temperature versus radial distance at the end of the injection period for the coarse, normal, and fine meshes.

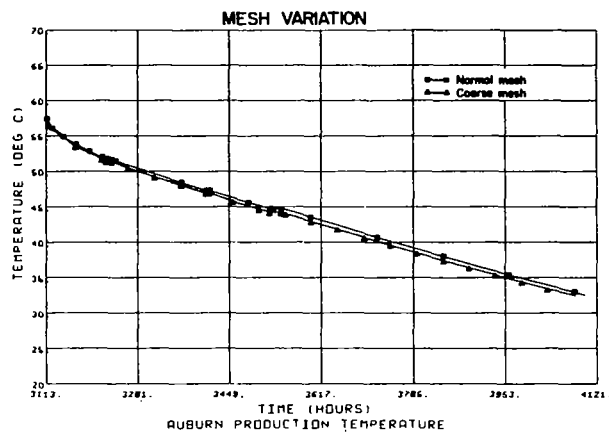

Figure 8. Production temperature versus time for the coarse and normal meshes.



## COLD WATER AQUIFER STORAGE

Donald L. Reddell, Richard R. Davison, and William B. Harris  
Texas A & M University

### PROJECT OUTLINE

Project Title: Storage of Cold Water in Ground-Water Aquifers for Cooling

Principal Investigators: Donald L. Reddell and Richard R. Davison

Organization: Texas A&M Research Foundation  
FE Box H  
College Station, TX 77843  
Telephone: (713) 845-3931 FTS: 522-3931

Project Goals: Design, develop and demonstrate a working prototype system in which water is pumped from an aquifer at 70°F in the winter time, chilled to a temperature of less than 50°F, injected into a ground-water aquifer, stored for a period of several months, pumped back to the surface in the summer time.

Phase I - This phase consisted of construction of the facilities for the study.

- o Drilling of withdrawal and injection wells.
- o Drilling and instrumentation of observation wells.
- o Construction of a cooling pond.
- o Installation of surface piping, pumping, and associated facilities.

Phase II - This phase consisted of project operation and data collection and analysis.

- o Injection cycle.
- o Storage period.
- o Recovery cycle.
- o Data analysis and reporting.

Project Status: Operation of the facility was initiated in October 1978. A total of 8.1 million gallons of chilled water at an average temperature of 48°F were injected. This was followed by a storage period of 100 days. The recovery cycle was completed September 8, 1979, with a total of 8.1 million gallons recovered. Approximately 20 percent of the chill energy was recovered.

Data analysis is now in progress and a final report will be issued by March 31, 1980.

Contract Number: 7386

Contract Period: October, 1978 to April, 1980

Funding Level: \$219,000

Funding Source: Energy Storage Systems Division  
U.S. Department of Energy

## COLD WATER AQUIFER STORAGE

Donald L. Reddell, Richard R. Davison and  
William B. Harris  
Texas A&M University

### SUMMARY

A cold water aquifer storage experiment was conducted at Texas A&M University during the winter of 1979. Parameters for designing cooling ponds to chill water from 295 K to 277 K were developed. In addition, data on the movement of chilled water through a highly permeable, shallow, unconfined aquifer were obtained. This study provided a least-cost method for obtaining data on chilled water movement in aquifers to verify numerical models and to evaluate problems with chilled water storage. Regional flow in the aquifer and natural recharge to the aquifer during the second wettest year in history reduced the thermal energy recovery from an expected 40 percent to 20 percent. No aquifer plugging problems were experienced during injection and recovery operations. The cooling pond operation was an exceptional success.

### INTRODUCTION

Ground water aquifers are available in most sections of the world. Approximately 80 percent of the populated areas of the earth have aquifers capable of delivering over  $6.3 \times 10^{-4} \text{ m}^3/\text{s}$ . These aquifers are capable of yielding or receiving water. Recharge wells have been widely used for years as a water conservation measure.

Space cooling, or air conditioning, is a major energy user in this country. Attempts at solar cooling using the summer sun have not been particularly successful. An available source of low cost cooling is abundantly available in most regions of the country during the winter. If a low-cost storage system could be developed, this natural winter cold could be stored and recovered for space cooling during the summer. Aquifers may be the necessary low-cost storage system to make this system work.

A project to investigate the use of aquifers for storing cold water was conducted by Texas A&M during the winter of 1979. This project had the following objectives:

- (1) Develop and experimentally verify design criteria for operating a cooling pond in the 295 to 277 K temperature range,

- (2) Collect field data from a cold water aquifer injection experiment for use in verifying numerical models of aquifer thermal energy storage systems, and
- (3) Evaluate any well plugging problems caused by injecting a highly aerated water into an aquifer.

This project is not a demonstration project; it is a low budgeted field experiment to evaluate problems associated with cold water aquifer storage. To reduce project costs, the aquifer selected is a very permeable, shallow unconfined aquifer with significant regional movement and natural recharge. A confined slowly-permeable aquifer is available at a deeper depth with characteristics more conducive for aquifer thermal energy storage. However, the shallow aquifer with less favorable characteristics was chosen to allow us to stay within a total construction cost budget of \$50,000.

#### UNITS

Values reported in this report are in SI units. However, the actual measurements and calculations were made in U.S. Customary Units.

#### COOLING POND EVALUATION

A spray pond 15 m wide, 30 m long and 1.8 m deep was dug and then lined with a 32 mil Hypalon rubber liner to prevent seepage. Spray nozzles are mounted on three parallel 0.1 m distribution pipes supported by a wooden frame. The distribution pipes are 2.1 m above the pond bottom. Each distribution pipe supports 25 spray nozzles on 0.6 m by 0.01 m risers. Pond water is circulated by a 0.038 m<sup>3</sup>/s centrifugal pump which supplies about 0.010 m<sup>3</sup>/s to the filter and 0.028 m<sup>3</sup>/s to the spray nozzles. A drift fence 2.4 m high was installed along each long side of the pond to prevent drift of water.

The spray pond performance exceeded expectations especially at low wind velocities. Data indicated that the cooling capacity of this pond increased linearly with the water circulation rate. This indicated that the pond area was not limiting and that more cooling capacity could be achieved by increasing the size of the recirculation pump.

With a water spray rate of  $6.62 \times 10^{-4}$  m<sup>3</sup>/s per linear meter of spray header and no wind, the spray pond produced cooling at the rate of

$$Q = 1.298 (T - T_{wb}) \quad , \quad (1)$$

where  $Q$  = cooling rate (kW/m of spray header),  
 $T$  = temperature of spray water (K), and  
 $T_{wb}$  = wet bulb temperature (K).

At the present circulation rate (no wind) about 310 kW of cooling was achieved with a 3.9 K approach temperature. This high performance at virtually zero wind speed is especially significant in view of the many cold, clear, still nights in the Bryan, Texas area. Weather records in Bryan indicate that during an average winter, 1300 hours are available when water averaging 280 K could be produced with a 3.9 K approach temperature. Thus, a cooling pond of the size used in this experiment could produce about  $1.44 \times 10^{12}$  J of cooling during a typical Bryan, Texas winter.

The cooling capacity of this cooling pond could be significantly increased by enlarging the recirculation capacity of the pond. We have modified the cooling pond, enlarged its cooling capacity, and plan to operate the pond on a limited basis during the winter of 1980 to evaluate its cooling capacity under the modified conditions.

#### AQUIFER INJECTION EVALUATION

The field experiment is located about 16 km west of Bryan, Texas. The wells are drilled into the Brazos River alluvium aquifer to a total depth of 17 m. The principal production zone is a coarse sand and gravel from 12 to 17 m. A fine sand 1.5 m thick overlies the sand and gravel zone. A slowly permeable silty clay overlies the sand and causes a semi-confined aquifer effect. However this silty clay zone has sufficient vertical permeability to allow significant quantities of natural recharge to enter the aquifer. The normal static water level is 7.5 m. During 1979, 1.15 m of rainfall occurred (the second wettest year on record) and the static water level increased from 7.5 m to 5.8 m.

A production well was drilled about 700 m west of the Brazos River, and an injection well was drilled another 408 m west of the production well. The production well was test pumped at the rate of  $0.028 \text{ m}^3/\text{s}$ , and the injection well at the rate of  $0.013 \text{ m}^3/\text{s}$ . The production well had a hydraulic conductivity of 180 m/d and the injection well had a hydraulic conductivity of 140 m/d. The hydraulic gradient at the injection site has varied from 0.001 to 0.005. Thus, regional movement of 0.14 to 0.70 m/d has probably occurred in this aquifer during the past year. These conditions are not conducive for demonstrating an aquifer thermal energy storage system in which the recovery of injected energy is the primary objective. However, the objective of this experiment was to inexpensively evaluate field temperature profiles for use in verifying numerical models. From that point of view, the experiment has been a success.



A system of 10 observation wells are located around the injection well and another 10 observation wells are located around the production well. These wells were used to measure the water levels and temperature profiles at various radii from the wells.

The first cold water was injected on January 4, 1979. Water was injected on 24 days during January, 24 days during February, and 11 days during March. The volume of water injected during January, February, and March was 13,625, 12,490, and 4540 m<sup>3</sup>, respectively. A total of 30,655 m<sup>3</sup> was injected during the entire 3-month period. The average injection rate during the period was 520 m<sup>3</sup>/d; exactly equal to the design injection rate.

The injection temperature fluctuated some during the experiment but was kept approximately equal to 282 K. Colder water could have been easily produced. In an actual demonstration of the cold water system, it would be desirable to inject colder water, but the objective of this project was to establish a measurable temperature difference in the aquifer, and collect data for verifying numerical models. This was accomplished. The average injection temperature throughout the injection period was 282 K.

The resulting temperature profiles around the injection well are shown in figures 1 and 2. Figure 1 shows the temperature profile on January 31, 1979. On this date, the temperature profiles appear to be uniform. An upward bulge in the temperature profile near the injection well is the result of being an unconfined aquifer. Some upward movement into the overlying clays occurred.

Figure 2 shows the profiles on February 28, 1979. The profiles are not mirror images of each other. Regional flow occurs from right to left in figure 2. It can be seen how the regional flow has moved the cold water farther in the down gradient direction. By July 8, 1979, when recovery of water was initiated, regional flow had moved the cold water zone 30 to 40 meters down gradient from the injection well (Fig. 3). A zone of cold water in the slowly permeable clays still existed near the well. But this had little chance of being recovered during the pump out period.

On July 9, 1979, the injection well was pumped at the rate of  $6.31 \times 10^{-3}$  m<sup>3</sup>/s. This was continued for 30 days and the pumping rate was then increased to  $9.46 \times 10^{-3}$  m<sup>3</sup>/s. Pumping was stopped on September 6, 1979, after withdrawing 30,655 m<sup>3</sup> of water. This water was returned to the original pumping well and reinjected into the aquifer. The temperature of the recovered water was initially 290 K and increased to a final temperature of 292 K.

A total of  $1.56 \times 10^{12}$  J was injected during the winter period and  $0.36 \times 10^{12}$  J was recovered during the pump out. This provided a 23 percent thermal recovery efficiency during the first year of operation. We had expected to obtain at least a 40 percent thermal recovery efficiency; but the large regional flow rate in the coarse gravel zone of the aquifer prevented this from occurring.

## NUMERICAL SIMULATION

At the present time, Texas A&M is using two numerical models to analyze the data from this injection experiment. One of these is a finite difference aquifer model and the other is a finite element aquifer model. Work on developing the models was initiated in October of 1979 and only preliminary results are available. Figure 4 shows results of an initial computer model run 54 days after injection was initiated. Qualitatively, the present numerical model shows agreement with the field data. However, some refinement of input data, such as natural recharge rates and vertical permeabilities, is needed before a final match is obtained. We hope to have the two numerical models working by March 1, 1980.

## GEOCHEMICAL STUDIES

The aquifer used for this experiment had a very high iron content of 9.1 ppm. When aerated in the cooling pond, an iron precipitate was formed. Much of the iron was precipitated in the cooling pond. However, prior to injection, the water was passed through a sand filter to remove any remaining iron. The iron content of the injected water was not detectable. It was necessary to backwash the filter after injecting every 950 m<sup>3</sup> of water.

During the pump out, we expected the iron content of the recovered water to have increased because of the obvious regional flow problem. However, the iron content started out at non-detectable levels and had only increased to about 0.3 to 0.4 ppm at the end of the pump out. The exact reason for this is not known at this time and is still under investigation.

The important factor is that the injection well did not indicate any signs of plugging during its 3 months of injection. The specific capacity was  $2.69 \times 10^{-3}$  m<sup>3</sup>/m at the beginning of the injection period, and it was still  $2.69 \times 10^{-3}$  m<sup>3</sup>/m at the end of the injection period. What would happen over a several year period is unknown, but we were encouraged about the first year's results.

To prevent biological contamination, the water was chlorinated prior to injection.

During the injection phase, a total of 29,100 kg of solids were injected into the well. During the pump out a total of 28,800 kg of solids were removed. Although this shows that some solids may be left in the aquifer, the results are well within experimental error, and no significant statistical difference exists between the two.

## CONCLUSION

As a demonstration of ATEs technology, the first cooling cycle at Texas A&M might be considered marginal because no useful cold water was recovered. However, as an experiment the project was very encouraging. Every aspect of the system operation equaled or exceeded expectations. There were no signs of well plugging during the injection cycle. The cooling pond proved to be an exceptionally efficient and low-cost method of producing cold water; and with the knowledge gained, a further increase in the cooling pond capacity is anticipated.

The simple sand filter worked perfectly, and in conjunction with the oxidation in the spray pond, completely removed the iron from the water. No plugging of the well was indicated during this initial injection cycle. The observation wells gave a complete hydraulic and thermal history of the aquifer during the experiment.

The poor thermal recovery was due to regional flow. This had been expected to a degree, but it was made worse by the second wettest winter and spring on record which raised the water table 1.7 m. During the next few months, this injection cycle will be simulated using computer models of the aquifer system.

WELL: SOUTH (NE,NW) DATE: JAN. 31, 1979

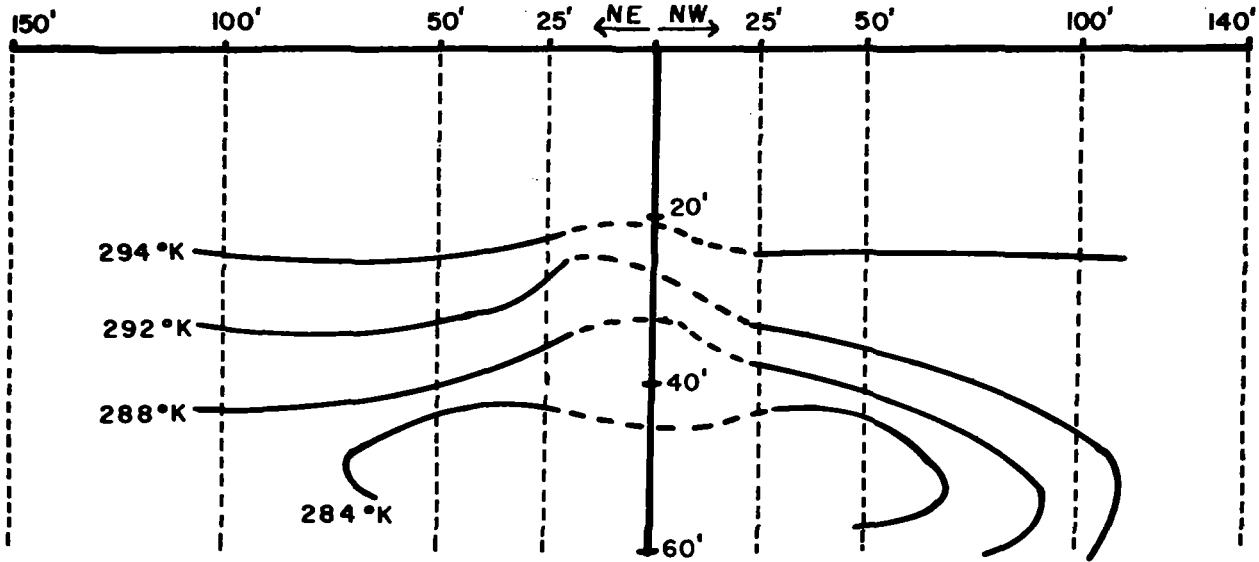

Figure 1. Temperature profiles after injection at 13,625 m<sup>3</sup> of cold water.

WELL: SOUTH (NE,NW) DATE: FEB. 28, 1979

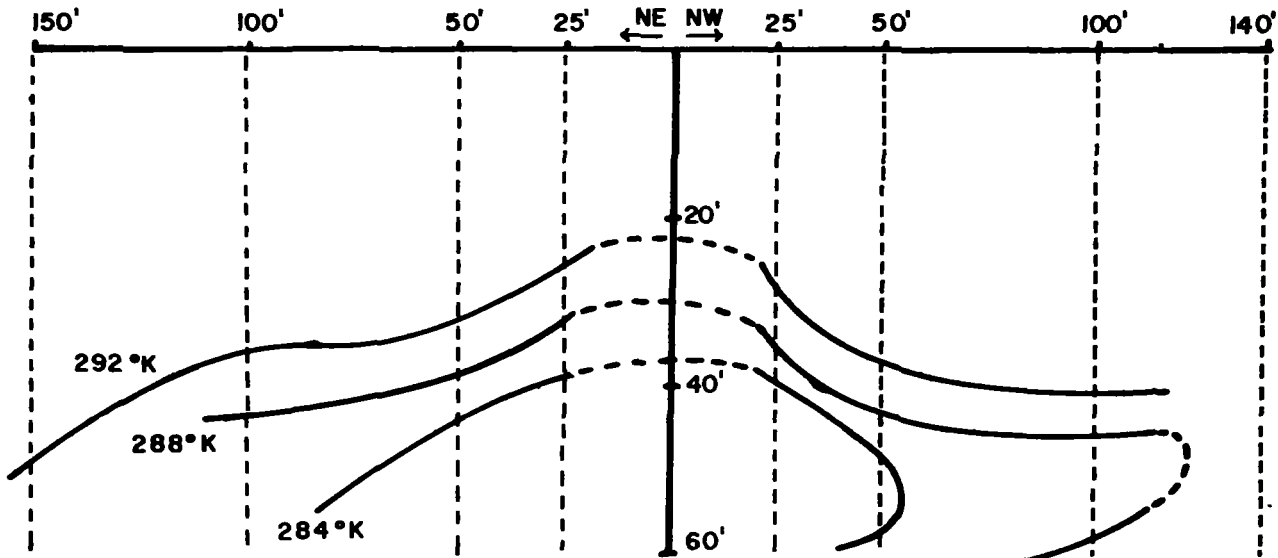

Figure 2. Temperature profiles after injection at 26,115 m<sup>3</sup> of cold water.

WELL : SOUTH (NE,NW) DATE : JULY 8, 1979

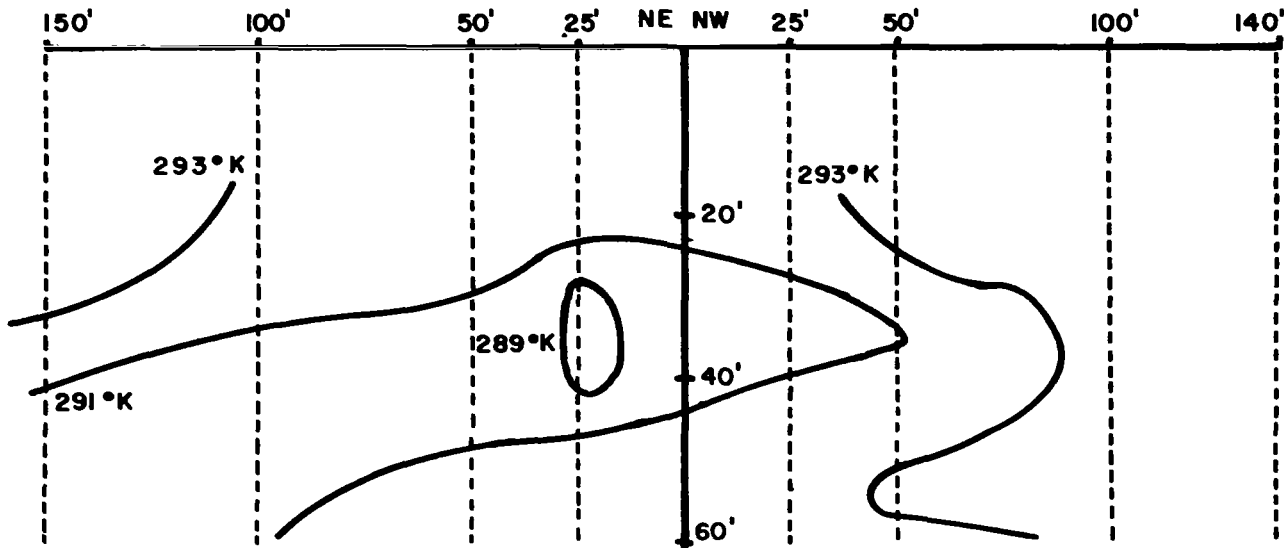

Figure 3. Temperature profiles after a 90-day injection period and a 90-day storage period.

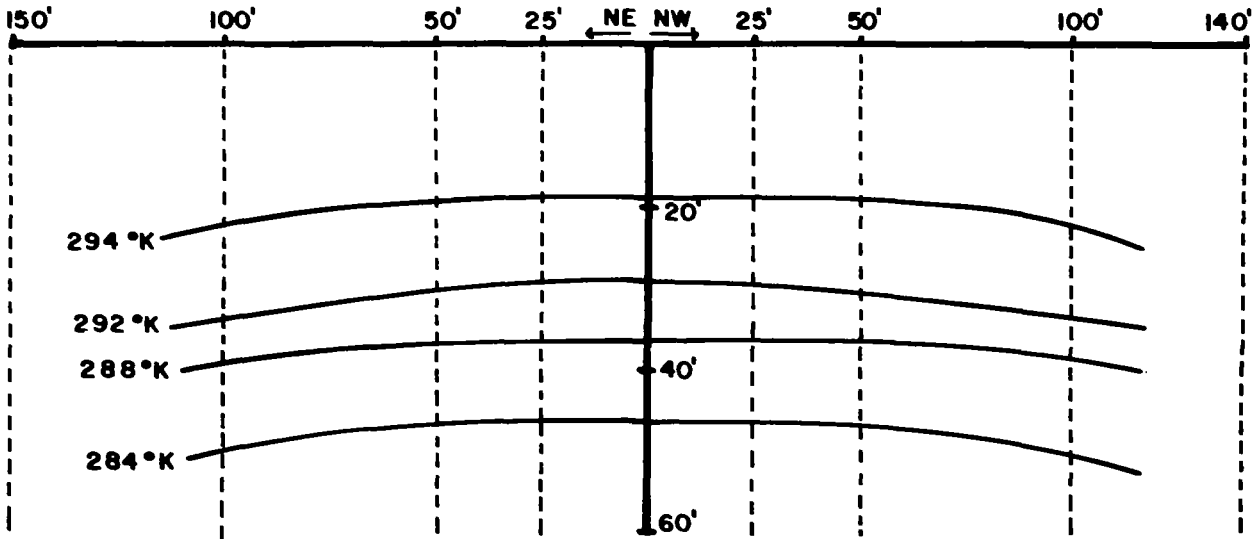

Figure 4. Results from initial simulation of temperature profiles following 54 days of injection.



## HOT-WATER AQUIFER STORAGE - A FIELD TEST

A. D. Parr, F. J. Molz, and P. F. Andersen  
Auburn University

### PROJECT OUTLINE

Project Title: Thermal Energy Storage in Confined Aquifers

Principal Investigator: F. J. Molz and A. D. Parr

Organization: Water Resources Research Institute  
Auburn University  
Auburn, AL 36830  
Telephone: (205) 826-5075

Project Goals: To inject heated water into a confined aquifer, store it for a period of time, and pump it out.

To record water temperatures and hydraulic heads during the injection-storage-recovery cycle.

To determine to the extent possible the feasibility of storing thermal energy in confined aquifers.

Construction of facilities:

- o Drilling of withdrawal and injection wells.
- o Drilling and instrumentation of observation wells.
- o Installation of surface support facilities.

Operation, data collection, and analysis:

- o First cycle
  - Injection
  - Storage
  - Recovery
- o Second cycle
  - Injection
  - Storage
  - Recovery
- o Data analysis and reporting

Project Status: The second cycle has been completed and data are now being analyzed. Final reports and publications are also being prepared. Data have been provided to LBL for simulation modeling analysis.

Contract Number: 7338

Contract Period: July 1977 to December 1979

Funding Level: \$387,283

Funding Source: Energy Storage Systems Division  
U.S. Department of Energy

## HOT-WATER AQUIFER STORAGE - A FIELD TEST

A.D. Parr, F.J. Molz, and P.F. Andersen  
Auburn University

### INTRODUCTION

The storage of hot water in aquifers is considered one of the most promising near-term alternatives for seasonal storage of thermal energy. Excess heat produced during the summer could be stored in groundwater regions and pumped out during the winter months when demand for heat is greatest. The insulating properties of the earth and the vast volumetric capacity of its aquifers make this concept particularly attractive. Auburn University has been involved in a large-scale field study of heat storage in a confined aquifer near Mobile, Alabama. Currently, two injection-storage-recovery cycles have been completed.

The first cycle involved the injection of 54,800 cubic meters of 55°C water into the confined aquifer. The ambient temperature of the water in the confined aquifer and in the upper semi-confined aquifer from which the supply water is pumped was 20°C. After a storage period of 51 days, the injection well was pumped until the temperature of the recovered water dropped to 33°C. At that point 55,300 cubic meters of water had been withdrawn and 66 percent of the injected energy had been recovered.

A volume of 58,000 cubic meters of 55°C water was injected during the second cycle. The water was stored for 63 days and then recovered. When the recovery temperature equalled the temperature at the end of the recovery period for the first cycle, 33°C, 66,400 cubic meters had been pumped from the aquifer and 76 percent of the injected energy had been recovered. The recovery period for the second cycle continued until the water temperature was 27.5°C and 100,100 cubic meters of water was recovered. At the end of the cycle about 90 percent of the energy injected during the cycle had been recovered.

### EXPERIMENTAL SET-UP

The experimental site is located near Mobile, Alabama, at a soil borrow area at the Barry Steam Plant of the Alabama Power Company. The basic injection system is shown in Figure 1. Water was pumped from an upper semi-confined aquifer, passed through a boiler where it was heated to a temperature of about 55°C, and injected into a medium sand confined aquifer. The injection well has a 6-inch (15-cm) partially-penetrating steel screen. The top of the storage formation is about 40 meters below the surface and the formation thickness is about 21 meters.



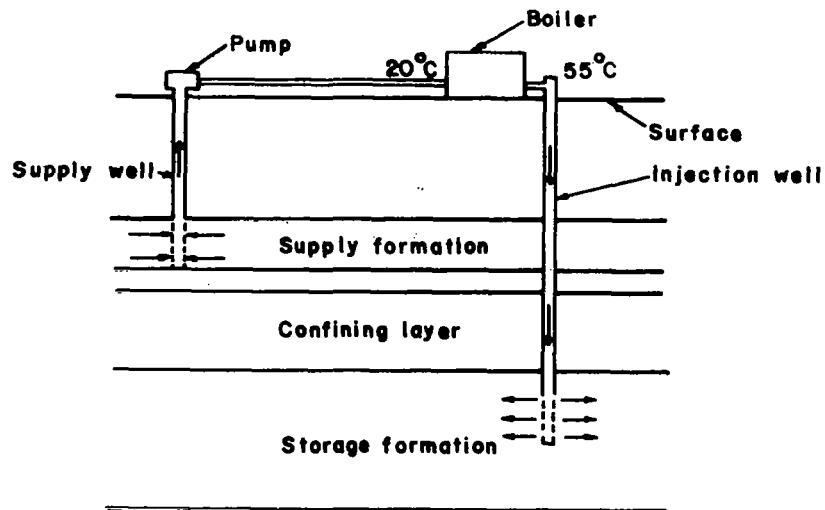

Figure 1. Schematic of Hot-Water Injection System

The relative location of the supply and injection wells and of 14 observations wells is shown in Figure 2. The observation wells were used to monitor temperature and phreatic surface elevations during the experiments. The readings were used primarily to calibrate numerical models describing heat and mass transport in aquifers.

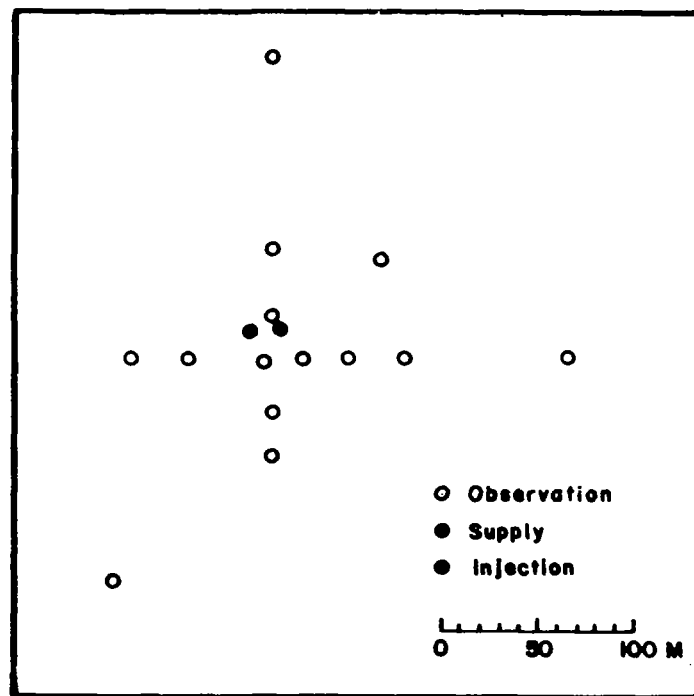

Figure 2. Top View of Well Field at Experimental Site

Figure 3 shows a schematic of a typical observation well in which temperature was measured. The six thermistors were equally spaced over the aquifer thickness. The wells were backfilled with sand in order to preclude extraneous vertical mixing due to convection in the wells.

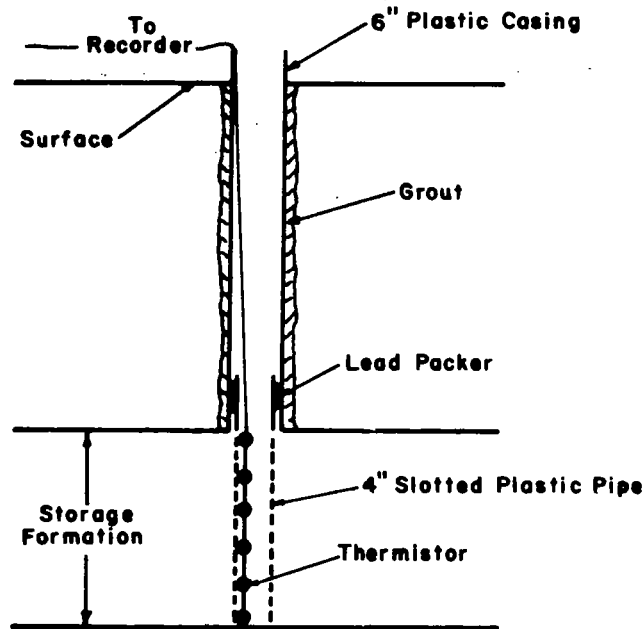

Figure 3. Side View of Typical Observation Well

#### EXPERIMENTAL PROCEDURE

Water was injected into the aquifer at rates from 6.3 to 12.6 liters per second during the first cycle. The injection period was 79 days. The variability of the injection rate was due to clogging of the formation around the injection well. Near the end of the first cycle injection period it was realized that backwashing the injection well for a few minutes immediately increased the specific capacity of the well and helped control the clogging problem. After a storage period of 51 days water was recovered from the injection well with a submersible pump at a nearly constant rate of 15.8 liters per second. The recovered water was discharged into a nearby canal.

The injection period for the second cycle lasted 63 days and the discharge rate varied from 9.8 to 13.6 liters per second. The improved discharge rate was attributed to periodic injection well backwashing performed throughout the injection period. After a 63-day storage period, the water was recovered at an average rate of about 14 liters per second.

Hydraulic heads and temperatures were recorded in the observation wells throughout both cycles. The measurements provided a method of observing and analyzing the hydrodynamic and thermodynamic behavior of the injected hot water in the confined aquifer region. Specific presentation and discussion

of this data are beyond the scope of this paper.

### EXPERIMENTAL RESULTS

A plot of recovery temperature versus recovery volume is shown in Figure 4 for both cycles. The improvement of the second cycle was due to the residual heat remaining in the aquifer and the surrounding aquitards after completion of the first cycle.

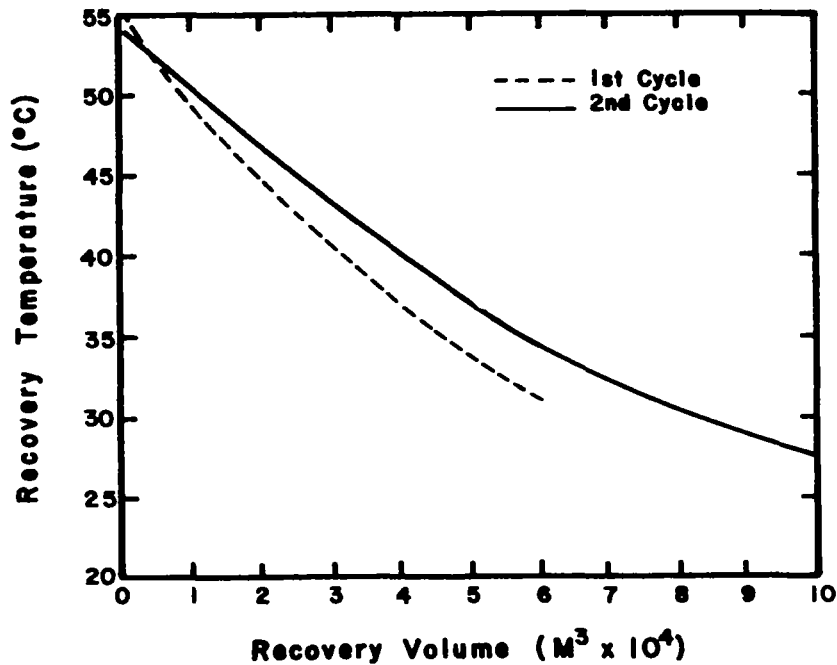

Figure 4. Recovery Temperature versus Recovery Volume

A measure of the effectiveness of a heat storage containment system is the fraction of the energy input of the system that can be recovered at the end of the storage period. This fraction, called the recovery factor, is determined by dividing the energy output,  $E_{out}$ , by the energy input,  $E_{in}$ . Figure 5 shows the recovery factor versus recovery temperature for both cycles. The recovery factors for the first and second cycles were 0.66 and 0.76, respectively, for the same recovery temperature of  $33^{\circ}C$ . The second cycle recovery period was continued until the recovery temperature reached  $27.5^{\circ}C$ , and the recovery factor was about 0.90. Figure 6 shows recovery factor versus recovery volume.

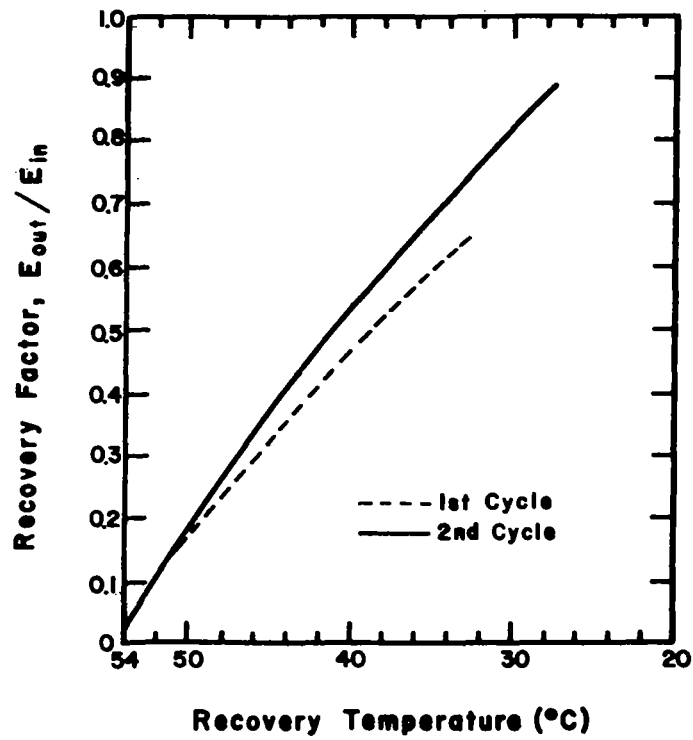

Figure 5. Recovery Factor versus Recovery Temperature

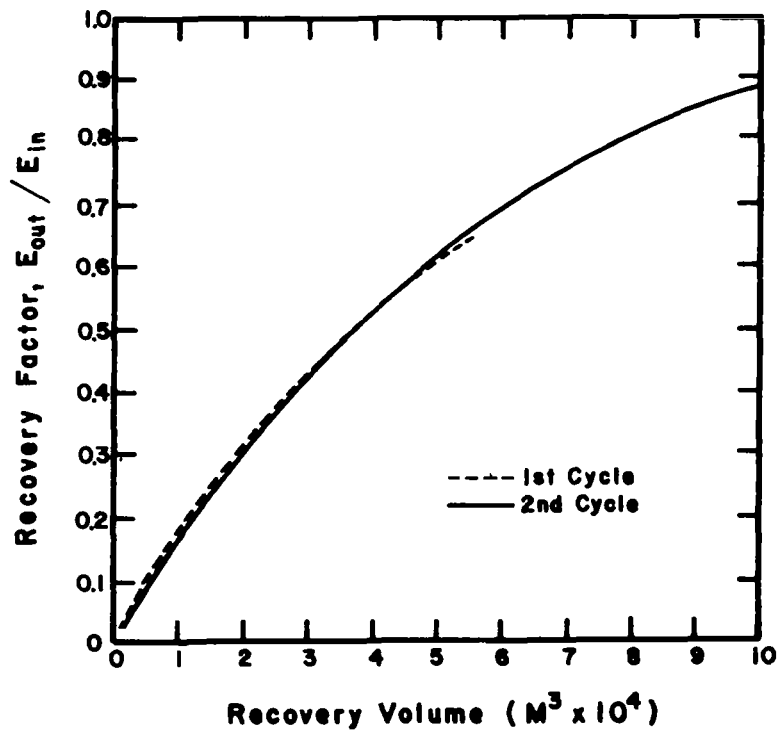

Figure 6. Recovery Factor versus Recovery Volume

EQUILIBRIUM GEOCHEMICAL MODELING OF A SEASONAL THERMAL ENERGY

STORAGE AQUIFER FIELD TEST

J. S. Stottlemyre  
Pacific Northwest Laboratory

PROJECT OUTLINE I

Project Title: Advanced Analysis Methodologies (Mathematical Modeling)

Principal Investigator: C. T. Kincaid

Organization: Pacific Northwest Laboratory  
P. O. Box 999  
Richland, WA 99352  
Telephone: (509) 375-2867 FTS: 444-7511

Project Goals: To develop numerical simulation technology capable of predicting the transport of a stored thermal resource within the ground-water environment.

Expand currently available ground-water models to include energy transport.

Verify the expanded models through use of available data sets (which include energy parameters).

Apply the verified models to proposed LETF sites.

Develop an energy transport model for unconfined aquifers.

Apply the unconfined model to a representative aquifer/energy storage system.

Document the models developed.

Apply data from the laboratory and field experiments to account for observed changes.

Project Status: Project was initiated in October, 1979.

Contract Number: EY-76-C-06-1830

Contract Period: October 1979 (Continuing)

Funding Level: \$170,400 (FY 1980)

Funding Source: Energy Storage Systems Division  
U.S. Department of Energy

## PROJECT OUTLINE II

Project Title: Advanced Analysis Methodologies (Laboratory)

Principal Investigator: J. A. Stottlemyre

Organization: Pacific Northwest Laboratory  
P. O. Box 999  
Richland, WA 99352  
Telephone: (509) 375-2733 FTS: 444-7511

Project Goals: To conduct laboratory investigations of well injection and water quality problems anticipated under ATES reservoir operating conditions.

Develop laboratory scale equipment capable of closely "simulating" in situ ATES mechanical and thermal loading conditions. Priorities are on effective stress, temperature, and fluid-flow conditions. Such equipment should be available to support LETF and demonstration sites.

Investigate the phenomena of time and/or temperature-dependent changes in hydraulic conductivity and bulk compressibility.

Develop a standard suite of tests applicable to each potential LETF or demonstration facility. Emphasis shall be on identifying operational and/or environmental problems and recommending mitigating techniques

Project Status: Project was initiated in October 1979.

Contract Number: EY-76-C-06-1830

Contract Period: October 1979, Continuing

Funding Level: \$105,000 (FY 1980)

Funding Source: Energy Storage Systems Division  
U.S. Department of Energy

## EQUILIBRIUM GEOCHEMICAL MODELING OF A SEASONAL THERMAL ENERGY STORAGE AQUIFER FIELD TEST

J. A. Stottlemyre  
Pacific Northwest Laboratory

### ABSTRACT

The report summarizes a geochemical mathematical modeling study designed to investigate the well plugging problems encountered at the Auburn University experimental field tests. The results, primarily of qualitative interest, include: 1) loss of injectivity was probably due to a combination of native particulate plugging and clay swelling and dispersion, 2) fluid-fluid incompatibilities, hydrothermal reactions, and oxidation reactions were of insignificant magnitude or too slow to have contributed markedly to the plugging, and 3) the potential for and contributions from temperature-induced dissolved gas solubility reductions, capillary boundary layer viscosity increases, and microstructural deformation cannot be deconvolved from the available data.

### INTRODUCTION

Since 1976, two field experiments have been conducted by Auburn University involving storage of heated waters in a shallow, confined aquifer near Mobile, Alabama (ref. 1 and 2). The first experiment involved injection of 7,570 m<sup>3</sup> of 37°C, filtered water from an electric power plant cooling water canal. The storage aquifer is located between 40 and 62 m below the land surface. The heated canal water was stored for 37 days and then recovered with an overall thermal efficiency of 67%. The process was inhibited by significant plugging of the injection well. This has been attributed to clay and silt particles suspended in the canal water; filtering above the 5-micron range improved but did not eliminate the problem.

A second experiment, utilizing the same storage aquifer, involved a 79-day injection of 55,345 m<sup>3</sup> of 55°C boiler heated water. The water source was an unconfined aquifer located between 25 m and 34 m below the land surface. The water was stored for 50 days and then retrieved over a 41-day period. The recovery efficiency was 65% over a temperature range of 55°C and 3°C. Ambient groundwater temperature was 20°C. Figure 1 is a schematic of this second experiment. It is important to note that the supply water was extracted from an overlying aquifer and, therefore, the system did not represent a true doublet configuration.

Clogging of the injection well again proved to be a major operational difficulty. Loss of permeability resulted in a decrease in the maximum

injection rate from  $12.6 \text{ l}\cdot\text{sec}^{-1}$  (200 gpm) to  $6.3 \text{ l}\cdot\text{sec}^{-1}$  (100 gpm). Plugging of the well may have been due to the water sensitive nature of the storage aquifer sediments. Montmorillonite clay in combination with low cation concentration of the supply water relative to the storage aquifer water may have resulted in swelling and dispersion of clay particles as shown conceptually in figure 2. Such water sensitivity is a documented phenomenon which lends itself to laboratory identification and field pretreatment (ref. 3, 4, 5). It is also possible that the supply aquifer water contained suspended solids and/or dissolved gases which may have contributed to the plugging.

In general, there are other potential reservoir permeability damage mechanisms including precipitation of minerals due to the mixing of incompatible groundwaters, water-rock incompatibility, increased temperatures, boundary layer viscosity anomalies (ref. 6), and microstructural deformation (ref. 7).

The primary objective of this study is to investigate fluid-fluid incompatibility, fluid-rock incompatibility, hydrothermal mineral alterations, and redox reactions with respect to potential contribution to the loss of well injectivity observed at the Auburn field experiments. This investigation was based on equilibrium chemical thermodynamic computer modeling. No laboratory and/or post-experimental field data are available for comparison, and therefore the results of this computer study are only of qualitative value.

#### Sediment and Groundwater Characterization

Approximate groundwater chemistry is shown in table 1. Sediment mineralogy and grain size distribution are given in tables 2 and 3.

#### Description of Test Cases

The objective of this study is to analyze some potential alternate causes of formation plugging at the Auburn field test. The following observations are noted:

- The shallow partially confined supply aquifer is low in ionic concentration relative to the storage aquifer, and has unknown suspended solid and dissolved gas concentrations.
- The deeper, confined, storage aquifer water is assumed to be in chemical equilibrium with the formation mineralogy at a temperature of  $19.5^{\circ}\text{C}$ .
- The supply and storage waters were increased in temperature from  $19.5^{\circ}\text{C}$  to approximately  $55^{\circ}\text{C}$ .



- Plugging occurred when the supply aquifer water was used as the working fluid.
- Plugging apparently did not occur when the storage formation water was injected back into the storage aquifer. This water was not heated however (Molz, Auburn University, personal communication).

Based on these observations and a water sensitivity test conducted at Auburn University, (Molz, personal communication), it is probable that the loss in well injectivity resulted primarily from particle plugging and clay swelling and dispersion. The montmorillonite content is less than a percent by weight; however, this is often sufficient to inhibit the flow of low salinity waters (ref. 3). Furthermore, dispersed particles in the micron and submicron range can often significantly reduce permeability (ref. 5).

Other potential reservoir damage mechanisms amenable to chemical thermodynamic modeling include:

- mineral precipitation as the working fluid temperature is increased
- mineral precipitation as oxygen is introduced to the system
- mineral precipitation due to the mixing of the potentially incompatible supply and storage formation waters
- mineral precipitation due to a chemical incompatibility between the supply water and the storage aquifer sediment and/or hydrothermal alteration products.

To study these four potential categories, several computer simulations were conducted as listed in table 4.

#### Data Analysis and Conclusions

For each computer simulation, the following equilibrium data were tabulated: 1) equilibrium mineralogy, 2) type and quantity of new mineral precipitates, 3) fluid temperature and pH, and 4) aqueous species concentrations. It is assumed that if minerals precipitate to any significant degree, decreased formation permeability might result.

Increasing the working fluid temperature and/or oxygen content (Eh) apparently has a negligible effect on mineral precipitation. Hematite, a ferric (iron) oxide, is the only mineral susceptible to precipitation. However, as shown in table 5, the quantity in moles per kilogram of water is rather insignificant. In addition, mixing the supply aquifer water and the storage aquifer water does not result in deleterious mineral precipitation; therefore, fluid-fluid incompatibility should be discounted as a contributing factor in the observed formation plugging at the Auburn field tests.

Alteration of the storage aquifer mineralogy was also investigated. This scenario involves interacting the heated supply water with ambient temperature groundwater and sediments in the storage aquifer. Table 6 shows the ionic concentrations in the groundwater and equilibrium mineralogy predicted by EQUILIB for four different injection water temperatures. With respect to the mineralogy at 55°C, it can be observed that EQUILIB predicts that calcite, muscovite, and kaolinite all react to some extent and that the minerals adularia and calcium montmorillonite would be formed as products. Similarly, the feldspars microcline and low-albite apparently react and zoisite is a predicted reaction product. As the injection water temperature is increased, there is a net decrease in the amount of solid material within any volume of rock equilibrated at these temperatures. To maintain a mass balance, there is an increase in the aqueous species concentration of the fluid. This might indicate that as the temperature decreases with increasing distance from the well, precipitation may occur. If the fluid is saturated with respect to certain mineral species at elevated temperature near the well, transport of the fluid to a lower temperature environment could result in precipitate formation. The consequences of such precipitation would depend, in part, on the quantity and density of the precipitate and the interstitial makeup of the sedimentary matrix. However, kinetics is an additional factor that must be considered.

Based on equilibrium predictions, it might be argued that hydrothermal mineral alteration contributed to the plugging observed at the Auburn test site. However, the computer results should be viewed with caution and considered to be qualitative only. Because of thermodynamic inconsistencies in the data base and the equilibrium assumption, results predicted by complex geochemical computer codes may not always be accurate. The assumption that the heated supply water, the storage aquifer water, and the storage aquifer mineralogy have achieved a stable equilibrium becomes quite restrictive if the temperature under consideration is as low as 55°C. Reaction rates of rock-forming minerals with aqueous solutions may be extremely slow. Hydrothermal reactions probably do not occur rapidly enough to account for the plugging observed in the first 48 hours of the Auburn experiment.

It is concluded that with the possible exception of clay swelling and dispersion, fluid-rock incompatibility was not a contributing factor in the formation damage in the Auburn tests. Furthermore, heating the supply water, introducing oxygen, and mixing the supply and storage formation waters apparently had no effect on precipitation of minerals or the creation of alteration products that could reasonably explain the formation damage. Based on the limited evidence, it is assumed that water sensitivity (clay swelling and dispersion), particulate plugging, and outgassing of dissolved gasses represent the most reasonable explanations for the loss of injectivity in this specific case. More detailed study might reveal that temperature-induced capillary boundary layer viscosity anomalies or microstructural deformation may have been contributing factors. Table 7 is a summary of the potential formation damage mechanisms and a qualitative estimate of the relative likelihood of each having occurred at the Auburn facilities.

## REFERENCES

1. Molz, F. J., J. C. Warman, and T. E. Jones. 1978. "Aquifer Storage of Heated Water: Part I - A Field Experiment." Groundwater. 16(4), July-August.
2. Molz, F. J., A. D. Parr, P. F. Andersen, V. D. Lucido, and J. C. Warman. 1979. Thermal Energy Storage in Confined Aquifers. Annual Report to the U.S. Department of Energy under Union Carbide Subcontract 7338.
3. Hewitt, C. H. 1963. "Analytical Techniques for Recognizing Water Sensitive Reservoir Rocks." Journal of Petroleum Technology. 15.
4. Day, J. J., B. B. McGlothlin, and J. L. Huitt. 1967. Laboratory Study of Rock Softening and Means of Prevention During Steam or Hot Water Injection. Society of Petroleum Engineers.
5. Reed, M. G. 1972. "Stabilization of Formation Clays with Hydroxy-Aluminum Solutions." Journal of Petroleum Technology.
6. Danesh, A., H. J. Hamey. 1978. "The Effect of Temperature Level on Absolute Permeability of Unconsolidated Silica and Stainless Steel." TRANSACTIONS. Geothermal Resources Council, Vol. 2.
7. Casse, F. J. 1974. The Effect of Temperature and Confining Pressure on Fluid Flow Properties of Consolidated Rocks. Ph.D. Dissertation, Stanford University.

TABLE 1. GROUNDWATER CHEMISTRIES AS SUPPLIED BY AUBURN UNIVERSITY

Water Type	Supply Aquifer (Unconfined Aquifer) mg/l		Storage Aquifer (Confined Aquifer) (mg/l)	
	Sample 1	Sample 2	Sample 1	Sample 2
	Na	3.40	0.60	7.60
Ca	0.33	0.21	0.05	0.38
Fe	0.07	0.07	0.06	0.05
Si	6.30	9.10	10.40	9.70
CaCO <sub>3</sub>	3.80	3.80	176.00	176.00
pH	7.19	7.19	7.38	7.38
Temperature	19.5°C	19.5°C	19.5°C	19.5°C

TABLE 2. INITIAL SAMPLE MINERALOGY BASED ON OPTICAL PETROGRAPHY AND X-RAY DIFFRACTION

Mineral	Composition	Concentration (Vol%)
Calcite	CaCO <sub>3</sub>	3.7
Quartz	SiO <sub>2</sub>	76.5
Hematite	Fe <sub>2</sub> O <sub>3</sub>	2.5
Muscovite	KAl <sub>2</sub> (AlSi <sub>3</sub> )O <sub>10</sub> (OH) <sub>2</sub>	1.3
Kaolinite	Al <sub>4</sub> Si <sub>4</sub> O <sub>10</sub> (OH) <sub>8</sub>	2.8
Alkali Feldspar	(K,Na)AlSi <sub>3</sub> O <sub>8</sub>	8.3
Plagioclase Feldspar	NaAlSi <sub>3</sub> O <sub>8</sub> - CaAl <sub>2</sub> Si <sub>2</sub> O <sub>8</sub>	4.5
Montmorillonite	(1/2Ca,Na,K) <sub>0.7</sub> (Al,Mg,Fe) <sub>4</sub> (Al,Si) <sub>8</sub> O <sub>20</sub> (OH) <sub>4</sub> • nH <sub>2</sub> O	0.4

TABLE 3. GRAIN SIZE DISTRIBUTION FROM SIEVE ANALYSIS

<u>Size Fraction</u>	<u>Weight Percent</u>	<u>Description</u>	<u>Phi Size</u>
18 x 35	0.22	Coarse Sand	0.0-1.0
35 x 120	86.39	Medium Sand Fine Sand	1.0-3.0
120 x 200	4.82	Very Fine Sand	3.0-3.7
200 x 325	4.18	Very Fine Sand Coarse Silt	3.7-4.5
-325	4.39	Coarse Silt and Finer	

TABLE 4. COMPUTER TEST CASES

<u>Input</u>	<u>Oxygen</u>	<u>20°C</u>	<u>55°C</u>	<u>100°C</u>	<u>150°C</u>
1) Supply Water Alone	-	-	X	X	X
2) Supply Water Alone	X	X	X	X	X
3) Storage Water Alone	-	X	X	X	X
4) Supply Water Plus Storage Water	X	X	X	X	X
5) Supply Water Plus Storage Water Plus Minerals	X	-	X	X	X

TABLE 5. MINERALS PRECIPITATED DUE TO HEAT, OXYGEN AND/OR FLUID-FLUID INCOMPATIBILITY

<u>Fluid</u>	<u>Oxygen</u>	<u>Temperature (°C)</u>	<u>pH</u>	<u>Eh</u>	<u>Insoluble Minerals</u>	<u>Quantity (moles/kg water)</u>			
Supply Water Alone	Yes	20	7.19	+0.807	quartz SiO <sub>2</sub>	0.192E-03			
					hematite Fe <sub>2</sub> O <sub>3</sub>	0.627E-06			
					hematite Fe <sub>2</sub> O <sub>3</sub>	0.627E-06			
Supply Water Alone	No	55	8.36	+0.541	hematite Fe <sub>2</sub> O <sub>3</sub>	0.627E-06			
					100	7.77	+0.354	hematite Fe <sub>2</sub> O <sub>3</sub>	0.627E-06
								150	7.34
Supply Water Alone	No	55	8.36	-0.215	minnesotaite Fe <sub>3</sub> Si <sub>4</sub> O <sub>10</sub> (OH) <sub>2</sub>	0.418E-06			
					100	7.77	-0.159	hematite Fe <sub>2</sub> O <sub>3</sub>	0.627E-06
								150	7.34
Storage Water Alone	No	20	7.38	-0.091	quartz SiO <sub>2</sub>	0.274E-03			
					55	8.95	-0.268	minnesotaite Fe <sub>3</sub> Si <sub>4</sub> O <sub>10</sub> (OH) <sub>2</sub>	0.328E-06
								100	8.36
Supply Water Plus Storage Water	Yes	20	7.27	+0.367	quartz SiO <sub>2</sub>	0.234E-03			
					55	8.76	-0.079	hematite Fe <sub>2</sub> O <sub>3</sub>	0.560E-06
								100	8.17
Supply Water Plus Storage Water	Yes	150	7.71	-0.151	hematite Fe <sub>2</sub> O <sub>3</sub>	0.560E-06			
					150	7.71	-0.151	hematite Fe <sub>2</sub> O <sub>3</sub>	0.560E-06

TABLE 6. WATER AND MINERAL EQUILIBRIUM CONCENTRATIONS AT VARIOUS TEMPERATURES

Aqueous Species	Moles/kg H <sub>2</sub> O			
	20°C	55°C	100°C	150°C
N <sup>+</sup>	0.247-03	0.125-02	0.125-02	0.125-02
Ca <sup>++</sup>	0.611-05	0.614-04	0.284-03	0.601-03
Fe <sup>++</sup>	0.492-06	0.318-13	0.193-22	0.288-16
Fe <sup>+++</sup>	0.627-06	0.405-13	0.270-12	0.547-11
Si	0.316-03	0.291-03	0.845-03	0.215-02
CO <sub>3</sub> <sup>-</sup>	0.132-03	0.476-02	0.407-02	0.828-02
OH <sup>-</sup>	0.100-06	-	-	-
H <sup>+</sup>	0.100-05	-	-	-
O <sub>2</sub>	0.390-03	-	-	-
Al <sup>+++</sup>	-	0.124-05	0.203-05	0.720-05
K <sup>+</sup>	-	0.690-03	0.234-02	0.233-02
pH	7.27	8.260	7.270	6.760
Eh	-	+0.018	+0.769	+0.361
PCO	-	-	0.047	0.417
<u>Mineralogy</u>				
Calcite (CaCO <sub>3</sub> )	0.100-01	0.537-02	0.606-02	0.186-02
Quartz (SiO <sub>2</sub> )	0.400-02	0.609-02	0.505-02	0.751-02
Hematite (Fe <sub>2</sub> O <sub>3</sub> )	0.100-02	0.100-02	0.100-02	0.100-02
Muscovite (KAl <sub>3</sub> Si <sub>3</sub> O <sub>10</sub> (OH) <sub>2</sub> )	0.100-02	0.280-05	-	-
Kaolinite (Al <sub>4</sub> Si <sub>4</sub> O <sub>10</sub> (OH) <sub>8</sub> )	0.100-02	0.707-03	-	-
Microcline (KAlSi <sub>3</sub> O <sub>8</sub> )	0.100-02	-	-	-
Low Albite (NaAlSi <sub>3</sub> O <sub>8</sub> )	0.100-02	-	-	-
k-Montmorillonite K <sub>0.7</sub> (Al,Mg,Fe) <sub>4</sub> (Al,Si) <sub>8</sub> O <sub>20</sub> (OH) <sub>4</sub> · nH <sub>2</sub> O	0.100-02	-	-	-
Adularia (KAlSi <sub>3</sub> O <sub>8</sub> )	-	0.164-02	-	-
Zoisite (Ca <sub>2</sub> Al <sub>3</sub> Si <sub>3</sub> O <sub>12</sub> (OH))	-	0.228-02	0.160-02	0.377-02
Ca-Montmorillonite (1/2Ca) <sub>0.7</sub> (Al,Mg,Fe) <sub>4</sub> (Al,Si) <sub>8</sub> O <sub>20</sub> (OH) <sub>4</sub> · nH <sub>2</sub> O	-	-	0.280-02	-
Total	2.00-02	1.710-02	1.65-02	1.41-02

TABLE 7. POTENTIAL DAMAGE MECHANISMS FOR THE AUBURN FIELD TESTS

<u>Mechanism</u>	<u>Qualitative Potential</u>	<u>Comments</u>
<u>Temperature-Induced Phenomena</u>		
• Mineral precipitation	Low	Mathematical modeling potential for dissolved oxygen in the supply aquifer
• Outgassing	Moderate	
• Increased quartz-water boundary layer viscosity	Unknown	Limited available data
• Microstructural deformation	Unknown	Limited available data
<u>Fluid-Fluid and Fluid-Rock</u>		
<u>Chemical Incompatibility</u>		
• Clay swelling and dispersion	High	Significant montmorillonite, low salinity water injection
• Mineral precipitation (fluid mixing)	Low	Mathematical modeling
• Mineral precipitation (oxidation)	Low	Mathematical modeling
<u>Fluid-Rock Physical Incompatibility</u>		
• Suspended solids	Moderate	Potential for micron and sub-micron particles in the supply aquifer water
• Existing formation	High	Loose clay and silt particles



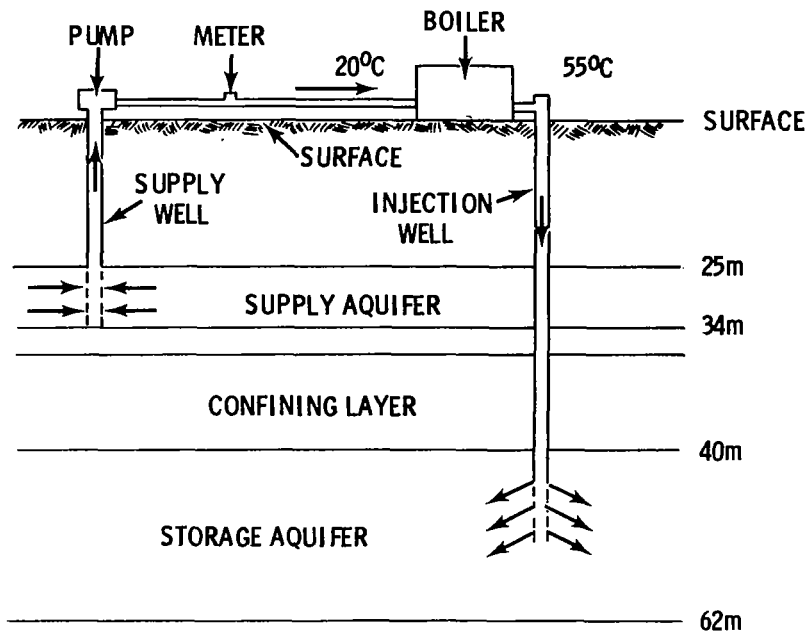
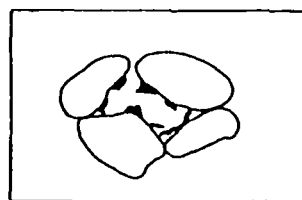

FIGURE 1. SCHEMATIC DIAGRAM OF THE SECOND MOBILE, ALABAMA, FIELD TEST SYSTEM (ref. 2)

SWELLING CLAY

PARTICLE PLUGGING



brine

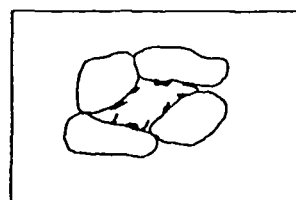

brine

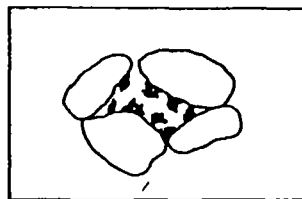

fresh water

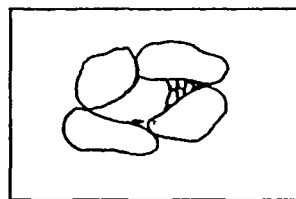

fresh water

FIGURE 2. CONCEPTUALIZATION OF CLAY SWELLING AND DISPERSION



DOE INTERNATIONAL ENERGY

STORAGE ACTIVITIES

Through an Implementing Agreement coordinated by the International Energy Agency, a program of Research and Development on Energy Conservation through Energy Storage was activated September 22, 1978. The Department of Energy participates in the program for the Government of the United States.

Annex I to the Implementing Agreement has the objective of undertaking preliminary design studies of a variety of large-scale, low temperature thermal storage systems. A second objective is to carry out comparative evaluations of the design studies, and to select at least one to be the basis of a proposed, jointly funded demonstration project.

Annex II to the Implementing Agreement has the objective of obtaining operational experience in the construction and operation of a large-scale insulated artificial body of water in which waste heat is stored for seasonal use.

Participants in Annex I and Annex II are as follows:

<u>Country</u>	<u>Annex No.</u>	<u>Name</u>	<u>Organization</u>
Belgium	I	Joseph Brych	Faculté Polytechnique de Mons
Denmark	I&II	E. Björn Quale	Laboratory of Energetics The Technical University of Denmark
EEC	I	Pieter Zegers	European Community DG XII C <sub>2</sub>
Germany	I&II	Reinhard Jank	Kernforschungsanlage/PLE
Netherlands	II	Ir. W.J. Heijnen	Delft Soil Mechanics Laboratory
Sweden	I&II	Ingvar ö Andersson	Board for Energy (NE)
Switzerland	I	André Burger	Centre d'Hydrogéologie
United States	I&II	Dr. George F. Pezdirtz	Division of Storage Systems Department of Energy



# ATES NEWSLETTER

A Bimonthly Review of Aquifer  
Thermal Energy Storage

EARTH SCIENCES DIVISION/LAWRENCE BERKELEY LABORATORY/UNIVERSITY OF CALIFORNIA  
Sponsored by U.S. Department of Energy through Oak Ridge National Laboratory

Volume 1, Number 1

October 1978

## INTRODUCTION

This is the first issue of ATEs newsletter, which is intended to review the current developments in research on thermal energy storage in aquifers. We hope to publish bimonthly summaries of the work being done at various research centers throughout the world, including a description of the goals which researchers are pursuing and the present status of various projects in the areas related to underground storage of thermal energy. Our purpose is not to catalog technical information in detail, but rather to provide concise summaries of the progress of current projects.

## ABOUT THIS PUBLICATION

This newsletter grew out of the Workshop on Thermal Energy Storage in Aquifers held at Lawrence Berkeley Laboratory (LBL) in May of this year, in which all projects in the U. S. and six European countries and Japan were reviewed. At the Workshop a need was expressed for the continuing exchange of information on various developments in the field of energy storage research. After discussions between officials of the U. S. Department of Energy, Oak Ridge National Laboratory, and foreign participants, it was suggested that LBL bear responsibility for the publication of a newsletter, under the editorship of Dr. Chin-Fu Tsang. Of course it is vital to the publication that all participating institutions and individuals contribute summaries of their current plans and progress and advise us of any significant results and/or accomplishments. In this way, all will benefit from a thorough and timely review of the latest work in the field of thermal energy storage.

All Newsletter contributions, ideas, and suggestions should be sent to:

Dr. Chin-Fu Tsang, Editor  
ATES Newsletter  
Building 90, Room 1012H  
Lawrence Berkeley Laboratory  
Berkeley, California 94720, U. S. A.

Telephone: (415) 843-2740, extension 5782

## ABOUT THIS ISSUE

This first edition contains summaries of all projects reported at the Workshop on Thermal Energy Storage in Aquifers held on May 10-12, 1978 at Lawrence Berkeley Laboratory. Since summaries were written by LBL staff, any errors are not the responsibility of the authors. Please let us know of any inaccuracies.

For each project summarized, a contact author is noted, together with his affiliation, so that you may write him directly for further information.

## CONFINED AQUIFER EXPERIMENT—HEAT STORAGE

Contact: Fred J. Molz or James C. Warman, Civil Engineering Department, Auburn University, Auburn, Alabama.

The objectives of an experimental program at Auburn University included the actual testing of hot water storage in aquifers and the provision of data for calibration of mathematical models describing the transport of heat in groundwater. The program consisted of four phases: (1) the drilling of an exploratory well at the field site; (2) construction of the central injection well and three observational wells, and preliminary pumping tests; (3) completion of the observation well field, performance of final pumping tests, and the measurement of aquifer thermal properties; and (4) a cycle of warm water injection, storage, and recovery.

Considering the relatively small injection volume and a partially penetrating injection well, the authors were encouraged with an observed thermal recovery factor of 0.68. The researchers concluded that clogging would be one of the most serious problems in the intermediate to long-term operation of heat storage wells, making it necessary to use heated water with extremely low suspended solids. To minimize the possibility of chemical or mechanical clogging of an injection well, they suggest the use of formation water as an influent to the heating system.

The authors caution that, if a storage aquifer contains even small amounts of clay, fluids must not be injected that would cause the clay fraction to swell. The pH and ion contents of the water must be compatible with the particular clay mineral. Exposure to distilled water can cause some clays to swell. It is also important that the injected water not precipitate any chemical compounds in the storage aquifer or onto the aquifer matrix.

## MATHEMATICAL MODELING OF AQUIFER THERMAL ENERGY STORAGE

Contact: Chin Fu Tsang, Lawrence Berkeley Laboratory, Berkeley, California.

The goal of the LBL project is to apply numerical models and other techniques: (1) to study and understand the hydrodynamic, thermal, and chemical behavior of an aquifer when used for hot or chilled water storage; (2) to estimate the percentage of stored energy that can later be recovered; and (3) to suggest optimal arrangements for implementation.

We use a numerical model developed at LBL, called "CCC," which stands for "Conduction, Convection, and Compaction." It is based on the so-called integrated-finite-difference method. The model computes heat and mass flow in three-dimensional water-saturated porous systems. Concurrent with the mass and energy flow, the vertical deformation of the aquifer system is simulated using the one-dimensional consolidation theory of Terzaghi. Thus, in the same calculations we can simultaneously include the effects of temperature on rock and fluid properties (e.g., heat capacity, viscosity, and density); heat convection and conduction in the aquifer, caprock, and bedrock; effects of gravity; as well as aquifer inhomogeneity, and possible compaction and the associated land subsidence due to pressure changes during the injection-withdrawal history.

Different hypothetical cases have been carefully studied, including: (1) storage for annual seasonal cycles, semiannual seasonal cycles, and daily cycles; (2) storage at different temperatures; (3) effects of full or partial penetration into the aquifer; (4) effects of a clay lens in the aquifer; (5) effects of aquifer inhomogeneity; (6) chilled water storage; (7) the possibility of land subsidence or uplift; (8) effects of regional flow; and (9) a two-well production-injection system.

Based on our numerical modeling studies, the concept of aquifer thermal energy storage appears to be very promising, with a high estimated recovery/storage ratio (> 80%). Further calculations are being performed, and the modeling of a field experiment has also been planned.

#### *THERMAL STORAGE OF COLD WATER IN GROUNDWATER AQUIFERS FOR COOLING PURPOSES*

Contact: Donald L. Reddell, Department of Agricultural Engineering, Texas A & M University, College Station, Texas.

The objectives of a study undertaken at Texas A & M University are to design, develop, and demonstrate a working prototype system in which chilled water will be stored in groundwater aquifers, to be withdrawn during summer months for use in air conditioning. Also addressing the question of how much thermal energy can be recovered from an aquifer, the researchers hope to demonstrate the economic as well as technical feasibility of cold water storage in aquifers.

Specific research objectives are (a) to design, construct, and operate a cooling pond to chill water from 70° F to less than 50° F, and to evaluate the operation of the cooling pond when coupled with an injection well; (b) to evaluate in detail the transmissivity, storativity, heat transfer coefficients, and heat storage properties of a groundwater aquifer located near the University; (c) to perform a field test in which cold water produced by the cooling pond is injected into the aquifer, stored for several

months, and then pumped out of the aquifer for air conditioning purposes; and (d) to monitor the resulting water movement and temperature profiles in a system of observation wells, use the results to verify available numerical models, and evaluate the concept of cold water storage.

Based on preliminary heat transfer models of the system, it is expected that native groundwater and rocks will be cooled to the injection water temperature within three to five injection cycles, after which approximately 85 percent of the injected water can be recovered at temperatures of 50° F or less. Because this initial cooling is needed to achieve optimum efficiency, it is proposed that the study be conducted for three years. This time period will also allow for some statistical variation of weather data to evaluate the overall long-term efficiency of the system.

#### *AIR CONDITIONING KENNEDY AIRPORT WITH WINTER COLD*

Contact: Henry I. Hibshman, Desert Reclamation Industries, Inc., Plainfield, New Jersey.

A feasibility study is currently under way for a possible conversion of the air conditioning system of the J. F. Kennedy International Airport (JFK), New York City, from a conventional refrigeration machine system to one using cold water stored in an aquifer under the airport. It is the first phase of a four-phase conversion plan that includes natural resources, engineering, and economic studies.

Based on interpolated data, it appears that the aquifer under the airport may be sufficient for storing all the chilled water needed for the system. There is, however, a large degree of uncertainty regarding the aquifer parameters that would determine the number of wells necessary and the pumping rates per well. A test well drilling program is planned in the near future to reduce the uncertainty.

The stored water would be chilled by either winter air or near-freezing Jamaica Bay water. Three ways of capturing the cold from winter air that have been considered are cooling towers, dry coolers, and cooling ponds. Use of cooling ponds has been rejected because of space limitations and the hazard to aircraft by attracted birds and the creation of fog.

JFK is surrounded on three sides by Jamaica Bay which is, in effect, a giant cooling pond with the complications of tidal flows and a variety of warm inflows, but with the advantage of a freezing point depressed to 28° F by salty seawater. Use of either bay water or water from cooling towers would necessitate a heat exchanger to avoid clogging. Preliminary results indicate that, for total conversion of a site such as JFK, capture of cold from a large body of water is preferable to the use of cooling towers. However, for one-quarter conversion of this site, use of the existing cooling towers is preferable. For new installations, preliminary analysis indicates that dry coolers may be preferable to cooling towers.

#### HIGH TEMPERATURE UNDERGROUND THERMAL ENERGY STORAGE

Contact: R. E. Collins, The University of Houston, Houston, Texas.

The University of Houston and Subsurface, Inc. are studying deep aquifer storage of very high pressure hot water and deep cavern storage of hot oil, using solution caverns in massive salt deposits. On the basis of preliminary studies, cavern storage appears to be the more feasible of the two methods. Computer simulators are currently being developed to study thermal losses and pumping requirements associated with deep storage in caverns and aquifers. The solution and transport of minerals and thermo-mechanical stresses on earth and well components will also be studied.

Using a working fluid of high temperature and pressure, it has been shown that deep underground storage of thermal energy can be achieved with relatively small conduction losses for cyclic injection and withdrawals, provided the system is sufficiently large. A mathematical model of steam injection into a permeable earth stratum containing brine has been developed to evaluate thermal losses, thermal degradation of retrieved heat, and injection and retrieval pumping requirements in various operational modes. The model has been programmed for computer use and is now in the final debugging stage.

A simple mathematical model has also been used to study the operation of a cavity heat storage system and to compute the temperature, the rate of heat loss, and the pressure as functions of time. For cyclic injection and withdrawal of hot oil, the loss ratio was found to fall to a reasonably small value after just a few weeks.

#### AQUIFER STORAGE PROJECTS IN SWEDEN

Contact: J. Claesson or G. Hellstrom, Lund Institute of Technology, Department of Mathematical Physics, Lund, Sweden.

There are two thermal energy projects presently ongoing in Sweden. One investigates the possibility of storing hot water in eskers (long and narrow glacial deposits of high permeability) and the other examines the theoretical aspects of underground heat storage, including the development of computer programs.

For storage in eskers, a computer program has been developed to obtain an estimation of the energy balance utilizing the explicit finite difference method to solve the energy equation. A comparison was made between two pumping strategies: waterflow always in the positive x-direction, and waterflow in the positive x-direction during six months of charging and in the opposite direction during the following six months of extraction. The second method was found best, with the injected water heating the aquifer matrix which then acts as a shield.

A more complex case was then studied in which thermal velocity was proportional to the actual need for or supply of energy. Energy efficiency was calculated for the first six years and reached 0.79 in the sixth year. The authors express reservations about the validity of the model but feel it definitely gives an upper limit to the energy efficiency.

The main objective of the underground storage project is to develop computer programs for heat and flow processes in energy storage systems. Under investigation is heat storage in groundwater regions; storage in waterpipes placed underground; storage by freezing in soils; and coupling with heat pumps and solar collectors.

#### AQUIFER STORAGE EFFORTS IN GERMANY

Contact: Reinhard Jank, Projektleitung Energieforschung in der Kernforschungsanlage, Jülich, Germany.

Since 1974, the German government has supported three major studies in the field of large-scale thermal energy storage. In October 1977 a meeting was held in Stuttgart to review ongoing German activities in the fields of warm water storage, aquifer heat storage, and latent heat storage, resulting in the publication of a 180-page report.

From these studies it was concluded that large scale energy storage is feasible but, at present, uneconomical. For seasonal heat storage, aquifer storage systems were found slightly preferable to storage by hot water lakes, and both were found superior to latent heat storage. It is expected that these conclusions may have to be changed due to results of current experiments.

The next phase in the German program now has two focuses: lake storage projects and an aquifer project. One lake storage project has already begun in Mannheim, and two more are scheduled to begin later in the year at Wolfsburg and Berlin.

An aquifer project was slated to begin in summer, 1978, investigating chemical transport, corrosion, and biology. It requires construction of a small-scale pilot plant for testing purposes only. If successful the project, due to be completed at the end of 1979, will define the location of a full-scale aquifer storage project to be operated within an actual district heating system.

Research plans in the near future include investigations of the following: chemical transport of matter using typical limestones and primitive rocks; the physical properties of representative soil material; precise chemical analyses of soil water; the necessity of chemical water treatment; theoretical descriptions of solubility as a function of temperature and other parameters; the corrosivity of the water to the components used; and the biological processes in the aquifer and its surroundings.

**UNDERGROUND HEAT STORAGE: DIMENSIONS, CHOICE OF A GEOMETRY, AND EFFICIENCY**

Contact: Bernard Mathey, Centre d'Hydrogéologie de l'Université, Neuchâtel 7, Switzerland.

Different methods for the calculation of the thermal efficiency of underground heat accumulators are examined using the overall dimensions and geometrical configurations as variables.

Parameters which must be considered when looking for a storage site are the permeability of geological formations and natural groundwater flow. These criteria are probably the most constraining factors when determining the advantages or disadvantages of underground heat accumulators.

Three choices of geometry are studied. First considered is a box-shaped accumulator for a family house or small apartment house heated by solar energy. The thermal balance was calculated by an approximate solution to a set of equations for energy production and use, taking into account the volume of heat stored and its surface area. The second choice of geometry was a sphere whose parameters were calculated from analytical laws in a stationary regimen for increasing dimensions. As a third choice, the accumulator consists of a large-diameter well provided with two horizontal radial drainage systems, 50 meters one above the other. The choice of this geometry is intended to limit loss of heat through natural convection, a phenomenon which causes the efficiency of the storage to decrease. Efficiency was calculated by a numerical method.

Further study is needed so that natural convection can be introduced into already existing models.

**HEAT STORAGE IN A PHREATIC AQUIFER: Campuget Experiment**

Contact: G. de Marsily or P. Iris, Ecole Nationale Supérieure des Mines de Paris, Fontainebleau, France

The first experiment in France with heat storage in aquifers was performed in 1976-1977. The objectives of the research were to make on-site measurements of the thermal parameters and to experiment with heat storage. Hot water was injected for twenty days and withdrawn after four months. Though only thirty percent of the heat was recovered, this was not considered surprising because of the size of the experiment.

The Campuget experiment, which ran from 1977-1978, had two focuses: realization of a full-scale interseasonal storage project in a phreatic aquifer, including study of its evolution, measurement of the efficiency of recovery, and numerical simulation; and utilization of the stored energy in existing greenhouses and in space heating.

The main observation was a decrease in efficiency between the first and second withdrawal periods. The decrease was attributed to an accumulation of rainfall between October and March, resulting in a reduction in the thickness of the unsaturated zone. The authors concluded that observed heat losses were due to a preferential circulation in the upper part of the aquifer combined with a thermal exchange across the unsaturated zone.

Quantitative interpretation of the experiment by mathematical modeling of the combined flow of heat and water in the aquifer is currently in progress using a 3-D finite element model of the diffusion-convection equation. Once the model is calibrated on the observed set of data, it is expected to provide estimates of: heat losses through the unsaturated zone; heat losses in the substratum; heat losses by convective transport toward the pumping well; and heat losses by unrecovered heat left inside the rock mass. Once fully developed, the model will be able to predict the efficiency of storage for a series of years of operation, for differing amounts of heat stored, and for different configurations.

The two major problems with the project are (1) the heat and water transfer in the unsaturated zone, both of which are moisture-content dependent and will require on-site measurements of hydraulic and thermal conductivity as a function of saturation, and (2) the influence of the formation heterogeneities.

**THE DANISH SEASONAL AQUIFER WARM-WATER-STORAGE PROGRAM**

Contact: E. B. Qvale, Laboratory for Energetics, Technical University of Denmark, 2800 Lyngby, Denmark.

The RISØ National Laboratory is managing a four and a half year program conducted primarily by the Laboratory for Energetics at the Technical University of Denmark. The program calls for the development of mathematical models; the design, construction, and operation of a demonstration plant; and a general nationwide geological and hydrological survey.

Work to develop mathematical models has been under way for about two years and has resulted in one- and two-dimensional models. The one-dimensional model was used only to get first-order estimates of storage requirements and losses. The two-dimensional model gives a rotationally symmetrical approximation to the reservoir. The condition of rotational symmetry will later be relaxed to expand the model into the desired three-dimensional form. Both the two- and three-dimensional descriptions are finite-element models. This work is expected to last another year and a half.



Geological and hydrological investigations will be made to locate a site for the demonstration plant. The preliminary objective is to find and convert a closed-down water supply well located near a district heating main into the demonstration plant. The design and construction of the plant is expected to run over 18 months.

Toward the end of the program, a general geological and hydrological survey will be carried out to identify sites that are both suitable for aquifer storage and located sufficiently close to existing or planned district heating systems.

*SURVEY OF THERMAL ENERGY STORAGE IN AQUIFERS  
COUPLED WITH AGRICULTURAL USE OF HEAT  
UNDER SEMIARID CONDITIONS*

Contact: A. Nir, Weizmann Institute of Science, Rehovot, Israel.

Semiarid zones pose difficulty in inland location of power stations because of limited water resources for direct or wet tower cooling. A total energy system which utilizes the heat of the cooling cycle needs a year-round user of low heat, which is generally unavailable in semiarid zones. The only potential use is for winter agriculture, such as greenhouses and soil heating in open areas to increase yields of present crops and allow introduction of new ones. The short period of heat utilization makes seasonal storage mandatory, and aquifer storage provides a possible solution if located within a reasonable distance to a power station and agricultural areas. A preliminary survey of this concept has been undertaken in Southern Israel. The outcome of the survey is expected to lead to a decision whether to undertake a detailed feasibility study for a specific area.

The proposed project calls for the power station to withdraw cold water from the aquifer and return warm water, in a closed cycle, to a warm region of the aquifer. During the cold season there would be an additional cycle in which warm water would be withdrawn and delivered to users.

Topics that need to be addressed include plant response to heat input in surrounding soil, water, and air; modeling of aquifers; heat dissipation

from soils; and materials and configurations for efficient heat transfer from water to soil. Pilot operations under consideration include recharge in specified geological formations; aquifer operation with controlled storage and recovery of heat; control of greenhouse and uncovered soil temperature; and a power plant condenser operation with high temperature rise and variable water quality.

*SEASONAL REGENERATION THROUGH UNDERGROUND STRATA*

Contact: T. Yokoyama, University of Yamagata, Yonezawa, Japan.

In Japan field experiments and numerical analyses have been conducted with respect to thermal energy storage in aquifers. Particular attention has been paid to the spacing of wells in order to avoid thermal and chemical pollution.

The test site consists of two dual-purpose wells and one observation well. In summer, cooling water is withdrawn; after direct cooling, waste water is sprinkled on the roof for heat collection by convection and radiation. After passing through a filtration tower, the water is further heated by a heat exchanger and then recharged through a second well. The process is reversed in winter.

Experiments with warm water recharging were carried out from July 16 to September 18, 1977. Even with daily discharging, researchers were able to maintain a constant water level. There was no evidence of clogging, and permeability appeared to remain constant. Between September 19 and December 25, there was no recharging. Warm water was then withdrawn and used to melt snow, while waste cool water was recharged.

The heat recovery coefficient was nearly 40 percent, but declined when recharged cool water reached the discharge well. There was good agreement between experimental and numerical results; and for all seasons, the quality of the recharge water remained at a near-natural level.

The authors concluded that when natural flow is slow compared with well flow rates, horizontal and vertical thermal diffusion are not significant, making seasonal regeneration feasible. Despite rough assumptions for underground strata, numerical analyses based on a complex potential function was judged sufficiently accurate.

# ATES NEWSLETTER

A Bimonthly Review of Aquifer  
Thermal Energy Storage

EARTH SCIENCES DIVISION/LAWRENCE BERKELEY LABORATORY/UNIVERSITY OF CALIFORNIA  
Sponsored by U.S. Department of Energy through Oak Ridge National Laboratory

Volume 1. Number 2 PUB-294

January 1979

## INTRODUCTION

The purpose of the ATES Newsletter is to review current events in the development of thermal energy storage in aquifers. We hope to publish bi-monthly summaries of work being done throughout the world. Our purpose is not to catalog technical information in detail, but rather to provide concise reports of the goals, present status and major results of projects related to underground storage of thermal energy.

The first issue was sent to 130 individuals and agencies in 13 different countries. The publication generated considerable response which we hope will lead to a vibrant exchange of information and ideas.

The continued success of the Newsletter depends on written contributions from researchers working in this field. Please keep us advised of research plans, significant results, and accomplishments. Contributions for the next issue should reach us by March 26, 1979. All contributions, ideas, and suggestions should be sent to:

Dr. Chin Fu Tsang, Editor  
ATES Newsletter  
Earth Sciences Division  
Lawrence Berkeley Laboratory  
Berkeley, California 94720 U.S.A.

Telephone: (415) 486-5782.

## PROCEEDINGS FROM THE AQUIFER WORKSHOP

Proceedings from the Workshop on Thermal Energy Storage in Aquifers held May 10-12, 1978, at the Lawrence Berkeley Laboratory, will be available in late February. A copy of the proceedings will be sent to all workshop participants. Anyone else who would like to obtain a copy should write to Dr. Chin Fu Tsang at the above address.

## Aquifer Storage Projects in the United States

### A SUMMARY

Contact: David M. Eissenberg, Oak Ridge National Laboratory, Oak Ridge, Tennessee 37830.

The U.S. aquifer storage program is managed by the Oak Ridge National Laboratory (ORNL) for the U.S. Department of Energy (DOE) Division of Thermal Energy Storage Systems (STOR). This research

and development program currently involves two field experiments, two planned large scale demonstrations, and various support studies including mathematical modeling, economic analysis, geochemistry, aquifer parameter assessment and environmental impact analysis.

### *Field Experiments*

Auburn University successfully completed one storage cycle of  $5.49 \times 10^4$  cubic meters ( $14.5 \times 10^6$  gal.) of water heated to  $55^\circ\text{C}$ . The temperature of the discharged water dropped from  $55^\circ\text{C}$  to  $33^\circ\text{C}$ , equivalent to a heat recovery of 65%. A second injection of  $5.68 \times 10^4$  cubic meters ( $15 \times 10^6$  gal.) of  $55^\circ\text{C}$  water has been completed and will be stored for two months.

Texas A&M completed construction and testing of a chilled water aquifer storage system. Chilled water will be stored as soon as winter weather begins in southern Texas.

### *Demonstration Projects*

New York State ERDA (Energy Research and Development Administration) has completed a four-borehole geological exploration program to delineate the lateral limits and thickness of the shallow confined aquifer under JFK Airport in New York City. The results of this program are currently being reviewed.

A subcontract for the development of an aquifer storage prototype doublet at Bellingham, Washington, is being negotiated. This prototype doublet will be integrated into the planned Bellingham district heating system.

### *Support Research and Development*

Lawrence Berkeley Laboratory (LBL) will continue to mathematically model the storage of thermal energy in aquifers. They have completed the modeling of thermal energy storage by means of daily cycle injection of hot water in a single well aquifer system. LBL is also analyzing the results of the first thermal storage cycle at Auburn University.

The Energy Division of ORNL will complete a generic environmental impact analysis of aquifer thermal energy storage by mid-1979.

In 1979, the Engineering Technology Division, ORNL, will do an economic analysis of aquifer storage with emphasis on chilled water storage at JFK Airport, New York.

Battelle Pacific Northwest Laboratories will mathematically model the effects of changes of

geochemical equilibrium in an aquifer due to thermal energy storage.

The Tennessee Valley Authority (TVA) will complete a survey of the thermal energy storage potential of the TVA service area this year. TVA geohydrologists are doing a generic parametric study of aquifers. The objective of this study is to determine what criteria, if any, may limit the suitability of an aquifer for thermal energy storage.

#### HIGH TEMPERATURE UNDERGROUND THERMAL ENERGY STORAGE

Contact: R. Eugene Collins, The University of Houston, Houston, Texas 77004.

The University of Houston, with Subsurface Disposal Corp. and Bovay Engineers, Inc., as subcontractors, is in the second year of a feasibility study of storage of high temperature ( $\sim 600^{\circ}\text{F}$ ) water in deep aquifers and high temperature oil ( $\sim 600^{\circ}\text{F}$ ) in solution-mined caverns in massive salt deposits.

A geological feasibility study has been completed showing that these storage methods would be possible in about 80% of the continental U.S.; only areas of mountain intrusions and the west coast of the continent are deemed totally unsuitable.

Studies, using computer simulators, have shown that diurnal storage of heat from a large scale central focus solar collector can be carried out with conduction losses declining on each cycle to a level on the order of one percent of cyclicly transferred heat in one year of operation. Energy transfer rates of 50 to 500 megawatts (thermal) are readily attainable and systems of several days capacity at these rates are possible. The major problem foreseen with salt cavern storage is possible deformation of the cavern due to "creep" or plastic flow. Computer simulator studies of this problem are underway and creep measurements on salt samples at high temperatures and pressures are planned because no measurements at proposed temperatures have been reported in the literature.

A solution to the creep problem may be to fill the cavern with gravel or coarse sand. This would also reduce oil requirements by 75%. We are now debugging computer simulators of such systems operating in a thermocline mode with two wells into the cavern, one hot and one cold.

Studies to date indicate that aquifer storage of hot water at temperatures above about  $300^{\circ}\text{F}$  will not be feasible because of downhole pumping requirements and problems with silica dissolution and reprecipitation. Therefore, we have reduced our effort in this study.

Preliminary studies of drilling procedures, well design and cavern leaching operations are nearing completion and some cost estimates have been made. We estimate that a 30 megawatt (thermal) cavern system would cost about \$4.6 million.

#### CONFINED AQUIFER EXPERIMENT - HEAT STORAGE

Contact: Fred J. Molz or A. David Parr, Civil Engineering Department, Auburn University, Auburn, Alabama 36830.

The concept of using confined groundwater aquifers for the temporary storage of large quantities of hot water has been proposed as a feasible choice for total-energy systems. The Water Resources Research Institute of Auburn University is performing a series of field experiments wherein this concept is being tested. To date, one preliminary experiment and one six-month injection-storage-recovery cycle have been completed.

The preliminary experiment involved the injection and recovery of about  $7570\text{ m}^3$  (2 million gallons) of water. The injection water was obtained from the effluent discharge canal of a power plant and had an average temperature of  $37^{\circ}\text{C}$  ( $98.6^{\circ}\text{F}$ ). The ambient temperature of the formation water in the confined storage aquifer was about  $20^{\circ}\text{C}$  ( $68.0^{\circ}\text{F}$ ). The injection, storage, and recovery periods were 420, 1416, and 2042 hours, respectively. The recovery period was terminated when the water temperature reached  $21^{\circ}\text{C}$  ( $69.8^{\circ}\text{F}$ ). About 67 percent of the injected energy was recovered. Clogging of the soil around the injection well posed a major problem during the injection period. The high level of suspended solids in the injection water was judged to be the primary cause of the clogging, although this was aggravated by swelling of clays in the storage formation.

The second experiment involved the injection and recovery of about  $54,900\text{ m}^3$  (14.5 million gallons) of water. During this experiment, the injection water was obtained from the formation water of an unconfined aquifer at the experimental site. The water was pumped from the unconfined aquifer, heated to a temperature of about  $55^{\circ}\text{C}$  ( $131^{\circ}\text{F}$ ) and injected into the confined storage aquifer. The injection, storage, and recovery periods were 1900, 1213, and 987 hours, respectively. The recovery period was terminated when the water being withdrawn from the storage aquifer fell to  $33^{\circ}\text{C}$  ( $91.4^{\circ}\text{F}$ ) which was  $13^{\circ}\text{C}$  ( $23.4^{\circ}\text{F}$ ) above the ambient water temperature in the confined aquifer. At this point, about 65 percent of the injected energy was recovered. The clogging problems that plagued the preliminary experiment were significantly reduced during the second experiment and were apparently due entirely to swelling of formation clays. Periodic backwashing of the injection well also contributed to the improvement.

A second six-month injection-storage-recovery cycle is presently underway. It is being performed in essentially the same manner as the first cycle. The injection period has just been completed, and the average specific capacity of the injection well was significantly better than in the previous experiment. This is encouraging since it appears that the degree of clogging may stabilize at an acceptable level when water low in suspended solids is used for injection.

*THERMAL ENERGY STORAGE FOR A LARGE DISTRICT HEATING SYSTEM*

Contact: Charles F. Meyer, General Electric-TEMPO Center for Advanced Studies, P.O. Drawer QQ, Santa Barbara, California 93102

The objective of the TEMPO project is to estimate the value of annual-cycle TES if it were incorporated into a proposed hot-water district heating (DH) system for the Twin Cities urban area in Minnesota.

A major series of studies is underway to evaluate the feasibility of installing a new, large, DH system in the Minneapolis-St. Paul metropolitan area. It would be based upon cogeneration of power and heat by the Northern States Power Company. Among the leading sponsors and participants in the studies are the Minnesota Energy Agency, Northern States Power Company, and DOE/ORNL. Also participating are several other governmental agencies, utilities, universities, and a number of contractors and consultants.

The proposed new DH system would not send out steam, as is the universal practice in large DH systems in the United States, but hot water, as is the common practice in Europe. A Swedish firm, Studsvik Energiteknik AB, under DOE/ORNL contract, is preparing the general description of the proposed system based upon their experience with European systems.

Supplying space heating, tap water, air conditioning (absorption cycle), and low-temperature industrial process heat needs from a central source is a more efficient way to use fuel than to burn it in many small furnaces and boilers. A particularly efficient central source is a plant cogenerating power and heat. The system proposed by Studsvik would employ coal-fired cogeneration for base load and oil-fired boilers for peaking and standby. DH configurations so far proposed have not included TES except that which is incidental to use of large hot-water pipelines; hot water has a high energy density and thermal inertia.

TEMPO's study assumes that annual-cycle (aquifer) TES is feasible. The economic and environmental benefits are being evaluated by comparing

the capital requirements and fuel consumption of a specific cogeneration/DH system which does not include TES to those of a system with TES, serving identical heat loads. This will provide a measure of the value of TES. Annual-cycle TES is of particular interest because the largest potential market for district heating is space heating.

Very preliminary results suggest that peaking and standby boilers may be replaced with heat storage wells, and cogeneration capacity reduced by about 20 percent. The reduced capital requirements are a measure of how much one could afford to pay for TES.

*DAILY HEAT STORAGE IN AQUIFERS FOR SOLAR ENERGY SYSTEMS*

Contact: Chin Fu Tsang, Earth Sciences Division, Lawrence Berkeley Laboratory, Berkeley, California 94720.

Recently, much interest has been generated by the concept of long-term seasonal storage of hot water in aquifers. However, the possibility of daily storage-retrieval cycles has not been explored in much detail. Calculations have been made to evaluate the storage-recovery ratio for daily hot water storage in an aquifer.

For this study we used the numerical model "CCC" (for Conduction, Convection and Compaction) which was developed at LBL for three-dimensional, liquid saturated, porous systems. Both the temperature dependence of fluid properties and gravitational effects are taken into account. Furthermore, the model "CCC" is coupled with another computer program which was developed to calculate the heat conduction effects at the wellbore as water is injected or produced from the aquifer. The coupled model is applied to a "typical" aquifer assuming two different hot water storage-retrieval schemes:

- (1) Twelve hours of injection into the aquifer followed by twelve hours of production;
- (2) Eight hours of injection in the daytime; followed by four hours of production in the evening; then shut-in for eight hours at night; and finally, a second four-hour production period in the early morning.

In both cases the aquifer hydrodynamic and thermal behaviors are analyzed. Preliminary results indicate recovery-storage ratios in excess of 75 percent.

### Aquifer Storage Projects in Europe and Japan

#### *THEORETICAL ANALYSIS AND COMPUTER SIMULATIONS OF SOLID-FLUID HEAT STORAGE SYSTEMS IN THE GROUND*

Contact: Johan Claesson, University of Lund, Dept. of Mathematical Physics, Box 725, S-220 07 Lund, Sweden.

Some results of our theoretical studies are presented in an interim report which contains 15 papers (240 pages). This report may be obtained from the author.

Three papers concern stationary heat losses from storage regions of the ground. Another paper studies analytically the buoyancy tilting of a vertical thermal front. An entropy analysis of the so-called numerical diffusion is presented. A mathematical analysis and a numerical model of a plane, two-hole, extraction-injection system are set out.

Another paper deals with heat storage in a cylindrical aquifer region with essentially vertical water flow. The dynamic three-dimensional diffusion-convection problem in and outside the aquifer is solved numerically under the simplifying assumption that the water flow is perfectly linear. The thermal recovery factor for the first five annual cycles has been computed for some sixty cases, when different parameters are varied. These parameters include the height and diameter of the aquifer region, the loading utilization strategy, protective insulations at the surfaces of the aquifer, and thermal properties in the aquifer and in the surrounding ground.

#### *THE EFFECT OF THERMAL DISPERSION ON INJECTION OF HOT WATER IN AQUIFERS*

Contact: Jean P. Sauty, Bureau de Recherches Géologiques et Minières, B.P. 6009, 45 Orléans, France.

Two series of experiments on hot water injection, storage and recovery have been performed in France in 1976 and 1977. Analysis of temperature profiles in the aquifer and temperature spot measurement in the caprock provided detailed knowledge of the thermal behavior of the reservoir. The 1976 data were used to calibrate a numerical model that was then able to accurately predict the results of the second series of experiments performed in 1977.

The results give strong evidence of the existence of heat dispersion during injection and recovery operations with a resulting apparent thermal conductivity in the aquifer much higher than the one measured usually by conventional methods.

This phenomenon is important for predicting the efficiency of heat storage or low temperature geothermal projects and cannot be neglected.

#### *SEASONAL THERMAL STORAGE IN AQUIFERS FOR AIR CONDITIONING*

Contact: Takao Yokoyama, Mechanical Engineering, University of Yamagata, Yonezawa 992, Japan.

In our experimental field, located in Yamagata Basin, relatively warm water (averaging 18.3°C) was repumped up from a heat source well and used for melting snow between January and March, 1978. Simultaneously, about 10,000 m<sup>3</sup> of the melted snow water (averaging 5.3°C) was injected into another heat sink well.

Four months later, in summer, 1978, we got chilled water with an average temperature of 14°C from the heat sink well. However, the reason we failed to get cooler water, about 10°C, is considered to be due to a shortage of the amount of injected water in winter and the short distance between the two wells.

Now we are engaged in injecting cool water sufficient for cooling our building in summer.

In addition to general three dimensional analysis, we consider the thermal-convection phenomena within wells which especially occurs in high temperature storage. Furthermore, we have estimated the difference for thermal energy storage and thermal pollution between a practical running, involving daily shut-in periods, and equivalent continuous running.

#### *AQUIFER STORAGE EFFORTS IN BELGIUM*

Contact: Professor Josef Brych, Faculté Polytechnique de Mons, rue de Houdain 9, 7000 Mons, Belgium.

In order to enhance the research on solutions to energy problems, the Belgian government started a national research and development program on energy in 1975. The first phase ended in August, 1978.

In the second phase, started in September, 1978, one of the projects is an interesting research on thermal energy storage, being a collaboration of several Belgian universities and institutions.

The aim of the research is threefold: first the evaluation, from a technical and economical viewpoint, of the different methods of storage and recuperation of thermal energy in the underground. Secondly, the preparation of the tests with the most promising methods. In the third place, the research of favorable places for tests and full scale implementation of such systems in combination with a thermal map of Belgium.

Up to now, general bibliographical research has been done on warm water storage systems using natural and artificial places above and under ground level, as there are: old stone-pits filled with water, lakes, old mines, aqueous porous stones, cavities and specially dug wells.

Concerning the last category, a Belgian project was accepted by the Executive Committee of the International Energy Agency, at the meeting in Lausanne the 9th and 10th of November, 1978. This project will treat the study and construction of vertical underground reservoirs using turbo-boring at large diameters. A semi-industrial model, of which the technical and economical study has already started, will be installed and will permit us to study the different parameters that influence the efficiency of the thermal recuperation in such reservoirs.

*RECENT DEVELOPMENTS IN EVALUATION OF THE ATES CONCEPT*

Contact: Aharon Nir, The Weizmann Institute of Science, P.O. Box 26, Rehovot, Israel.

The developments discussed below are a re-evaluation of previous knowledge through informal discussion and outside contacts created as a result of the 1978 LBL Workshop. (See A. Nir, "Survey of Thermal Energy Storage in Aquifers Coupled with Agricultural Use of Heat Under Semi-Arid Conditions," ATES Newsletter, October, 1978.)

(1) There is a need for more site specific models designed for actual experimental aquifers. The model should then serve, in the first place, as a guide to experimental design by simulating operations for a range of uncertain hydrogeological data, parameter values and experimental conditions. The experimental results should be used critically for model validation.

(2) Since several reports issued last year confirmed the constraints on sites for power plants due to cooling water shortages, there is a stronger case for aquifers as elements of cooling cycles. When combined with heat storage and economic heat use, it is the only alternative with a positive energy balance and benign environmental effects.

(3) The major gap of knowledge seems to be in the domain of optimal heat distribution under given experimental conditions. It requires simultaneous consideration of several novel subjects: the demand of heat of different species of plants and its distribution in time and space (soil and air); the capacity of the atmosphere to dissipate soil heat under different vegetative and artificial covers; and the techniques of optimal design for supply and control of this heat.

(4) Due to the nature of the many uncertainties which were already identified, their solution extending far into the future, no decision can be

expected at this stage which is based on cost-benefit analysis of the whole project. Decision analysis can, however, be undertaken which would indicate the scope and sequence of partial decisions, conditional on the increasing knowledge of critical components and of external conditions, such as demands for plant sites, agricultural markets and fuel prices.

*THE "SOIL THERM" SYSTEM FOR INTERSEASONAL EARTH STORAGE OF SOLAR HEAT FOR INDIVIDUAL HOUSING*

Contact: Georges Vachaud or J.Y. Ausseur, Institut de Mécanique de Grenoble, Laboratoire Associé au C.N.R.S., Université Scientifique et Médicale de Grenoble, B.P. 53 X - 38041, Grenoble, Cedex, France.

A design for application to residential interseasonal solar energy storage has been developed. Solar thermal energy is stored during the summer by shallow earth storage. Heat exchangers are realized with flat panel radiators connected to solar collectors and installed vertically, to a depth of four meters, in concentric trenches near the house. During the winter, the heat exchangers are interfaced with hot water household heat transfer. The solar collectors are furthermore used to preheat the fluid when it reaches a temperature lower than 28°C. Below a temperature of 20°C, an external source of energy (gas) is needed.

A numerical study has been made of the efficiency of the system. This model is based on the simultaneous solution of two equations: one equation giving the quantity of heat produced by the collectors as a function of the fluid temperature, the incoming radiation and air temperature; and the other equation predicting the fluid temperature as a function of heat transfer in the exchangers in the soil, using a diffusion-convection heat equation (transient and axisymmetric).

Different geometries have been considered with the following parameters: surface of exchange, depth of exchangers, number of concentric trenches, and influence of surface and lateral thermal isolation. It is shown that for an individual house, the external source of energy to provide and maintain an internal temperature of 20°C is no more than 8 to 20% of the annual need, depending upon the geometry of the system, with 50 m<sup>2</sup> of solar collectors.

A practical experimentation of this "SOIL THERM" design is actually being pursued for a real case.

# ATES NEWSLETTER

A Quarterly Review of Aquifer  
Thermal Energy Storage

EARTH SCIENCES DIVISION/LAWRENCE BERKELEY LABORATORY/UNIVERSITY OF CALIFORNIA  
Sponsored by U.S. Department of Energy through Pacific Northwest Laboratories

Volume 1. Number 3

May 1979

## INTRODUCTION

The purpose of the ATES Newsletter is to review current events in the development of thermal energy storage in aquifers. Our purpose is not to catalog technical information in detail, but rather to provide concise reports of the goals, present status and major results of ATES projects around the world. Each article is preceded by one or more contact persons (with their addresses) from whom more details may be obtained directly.

The previous issues were sent to more than 140 individuals and agencies in 14 different countries. The publication generated considerable response which we hope will lead to a vibrant exchange of information and ideas.

Because of the length of time required for international correspondence, and the time frame of storage projects now in progress, we have decided, after consultation with the U. S. Department of Energy, to publish the newsletter on a quarterly schedule beginning with this issue.

In the present issue, we included an article concerning aquifer thermal energy storage efforts in the Peoples Republic of China. It came as a surprise to us that significant industrial-scale storage projects have been going on there for over ten years, mainly in chilled water storage. We hope to have more information about their work in future issues.

Please send all contributions, ideas and suggestions to:

Dr. Chin Fu Tsang, Editor  
ATES Newsletter  
Earth Sciences Division  
Lawrence Berkeley Laboratory  
Berkeley, California 94720, U.S.A.

Telephone: (415) 486-5782.

## CONFINED AQUIFER EXPERIMENT - HEAT STORAGE

Contact: Fred J. Molz or A. David Parr, Civil Engineering Department, Auburn University, Auburn, Alabama 36830.

Groundwater aquifers provide one of the most promising alternatives for seasonal storage of large quantities of waste heat. The Water Resources Research Institute of Auburn University is performing a series of field experiments where-in this concept is being tested. One preliminary experiment and two six-month injection-storage-recovery cycles have been completed. The six-month experiments will be discussed herein.

The first six-month experiment involved the injection and recovery of about 55,000 m<sup>3</sup> of water. The injection water was pumped from an unconfined aquifer, heated to an average temperature of 55.2°C, and injected into the confined storage aquifer through a partially penetrating well. The ambient water temperature of the supply and storage aquifers was 20°C. The water was stored for about 52.5 days and then pumped out until the temperature of the recovered water fell to 32.8°C. At that point, 64.6% of the injected energy was recovered. The injection, storage, and recovery periods were 1900, 1213, and 987 hours, respectively.

The second six-month experiment was performed in essentially the same manner as the first. Approximately 58,000 m<sup>3</sup> of water, heated to an average temperature of 55.4°C, was injected into the confined aquifer and stored for about 62.5 days. When the water temperature reached 32.8°C during the recovery period of the second experiment, 73.8% of the injected energy had been recovered at a total recovery volume of about 67,000 m<sup>3</sup>. The recovery period for this experiment continued until the outflow temperature reached 27.5°C and the total recovery volume was about 100,096 m<sup>3</sup>. The total injection, recovery, and storage periods were 1521, 1502, and 1993 hours, respectively. A detailed analysis of this experiment is still under way.

The clogging problem encountered during the injection periods of both of the experiments was controlled by backwashing the injection well. The frequency of the backwashing operation was increased for the second six-month experiment and improved injection performance was realized. Although this is encouraging, it is likely that geochemical clogging problems will not be so easily controlled at other aquifer sites. Comprehensive investigations of the clogging phenomenon and possible methods for controlling it are in order.

#### MODELING AUBURN FIELD EXPERIMENTS

Contact: Chin Fu Tsang, Earth Sciences Division, Lawrence Berkeley Laboratory, Berkeley, California 94720

Lawrence Berkeley Laboratory is currently performing detailed calculations to model the first phase of the new series of Auburn University experiments by means of the numerical model "CCC" that was developed at LBL.

The work began with well test analysis on the Auburn data to obtain the aquifer characteristics. For this purpose we have used the program "ANALYZE" which we recently developed to carry out multiple-well, variable-flow well test analysis. Conventional type curve methods usually require constant flow or a prescribed, carefully-controlled variable flow rate from a single well. The present method allows arbitrarily varying flow rates from a number of wells and thus greatly enhances our capability to analyze well data. We have made a long-term well test analysis including not only constant flow pumping test data, but also variable-flow data from the injection period of the first cycle. We were able to determine the aquifer transmissivity, storativity, and the distance and direction of the nearest barrier.

With the aquifer characteristics thus obtained, preliminary modeling calculations have been done. Parameter studies are made by calculating three cases: (1) vertical permeability same as horizontal permeability, (2) vertical permeability 1/10 of the horizontal permeability, and (3) vertical permeability 1/10 the horizontal, thermal conductivity twice the normal value.

The vertical permeability value is unknown experimentally and so it is varied to explore its effects. A vertical permeability of 1/10 the horizontal permeability is not an unreasonable assumption in many field cases. The arbitrary increase in thermal conductivity is used to simulate effects of thermal dispersion. This approach was suggested by the recent work of Sauty at BRGM, France.

In each of the three cases, simulation was done up to 1900 hours, covering the complete injection period of the first cycle. It is found that results of case (2) are similar to those of case (3), indicating the insensitivity of results to a change in thermal conductivity of a factor of two. A larger change is necessary to study its effects. Results of case (1) and (2) are quite different due to the ease of buoyancy flow when the vertical permeability is larger. After some studies we decided to choose case (2) as the most reasonable when compared with experimental information.

In general, comparison shows a good correspondence between observed and calculated results. The effects of the barrier are clearly demonstrated. Currently, the storage and production periods are being simulated. When this is finished the calculated recovery factor will be checked against that observed.

#### TEXAS A & M COLD WATER STORAGE PROJECT

Contact: Donald L. Reddell, Texas A & M University, Department of Agricultural Engineering, College Station, Texas 77843.

The first cold water injection at the Texas A&M project was initiated on January 4, 1979. A total of 3.57 million gallons of 48°F water was injected in January, 3.28 million gallons of 48°F water was injected in February, and 1.40 million gallons of 49°F water was injected in March. For the season a total of 8.25 million gallons was injected at an average temperature of 48°F.

A major concern with this project had been the possibility of aquifer plugging because the water was exposed to the atmosphere and aeration during the chilling process. However, prior to injection, the water went through a sand filter and all traces of chemical precipitates and foreign material were removed. No evidence of aquifer plugging has occurred up to the present time. The aquifer is still taking water at the rate of 10 to 12 gpm/ft, which was the original capacity.

The cold water is confined in a region from 40 to 55 feet below land surface out to a radius of 100 feet from the injection well. A slight change in temperature has occurred at a radius of 150 feet. The change in temperature with respect to time is extremely slow at this time.

The cold water will be stored two months (April and May) and then a recovery cycle will be initiated in June. No major problems have occurred and the results are encouraging.



*THERMAL ENERGY STORAGE FOR A LARGE URBAN  
COGENERATION-DISTRICT HEATING SYSTEM*

Contact: Charles F. Meyer, General Electric-  
TEMPO Center for Advanced Studies, 816 State St.,  
P.O. Drawer QQ, Santa Barbara, California 93102

A general description of the cogeneration-district heating system proposed for the Minneapolis - St. Paul area in Minnesota was given in the ATEs Newsletter for January 1979. TEMPO is now writing its final report on a study of the potential capital cost and fuel consumption benefits if TES were incorporated into the system.

The results indicate that all boilers could be replaced with heat storage wells, saving fuel oil, concomitant air pollution, and the \$66 million cost of the boilers. The capacity factor of the cogeneration equipment which produces all heat for the system when there are no boilers is increased. In fact, the total cogeneration capacity could even be reduced by as much as 25%, if back-pressure turbines are installed instead of extraction turbines; this is feasible when large-scale annual-cycle storage is available to accept heat when production exceeds demand, and to deliver heat when the converse is true. Net energy savings for various cases studied are as high as 30%.

*HEAT STORAGE IN A PHREATIC UNCONFINED AQUIFER*

Campuget experiment: interpretation by models - development of the research.

Contact: P. Iris and G. de Marsily, Ecole des Mines de Paris, Fontainebleau, France.

In the Campuget experiment (1977-1978) we realized the storage of 20,000m<sup>3</sup> of water at 33.5°C, in summer, in an unconfined phreatic aquifer at 14°C (water table 2 m under the soil surface) and the seasonal recovery of the heat in winter for the heating of greenhouses. 18.5% of the energy stored was recovered between November 1977 and March 1978, at a temperature decreasing from 30°C to 14°C.

For the interpretation we used a two-dimensional finite element model (axisymmetric multi-layer) which was well fitted to the observed sets of data (thermal logging in the aquifer, temperature of recovery).

The heat losses to the atmosphere, due to a preferential circulation in the upper part of the aquifer combined with thermal exchange through the unsaturated zone (low thickness, high moisture content), represent 30% of the total heat stored and are the main causes for the low efficiency.

In summary, it appears that (1) the efficiency measured in the Campuget experiment is positive, considering the very bad experimental conditions (in the future, it will be necessary to store in a deeper unconfined aquifer); and (2) that the models (heat transfer into porous media with, in particular, the effect of kinematic dispersion) are able to represent reality with good precision. Some parameters need to be measured in situ in order to predict the efficiency of storage (thermal conductivity of the confining layers; global vertical distribution of permeability in order to solve the scale effect of the equivalent conductivity of the aquifer, etc.).

Three directions have been assigned to our research:

- (1) Define a measurement method (in situ) for the parameters of the model in order to predict the efficiency of storage before its realization.
- (2) Test the sensibility of the storage to the parameters (depth, thickness, local gradients, thermal parameters, etc.) in order to define the optimal conditions for a storage site.
- (3) Study technically and economically the surface installations for a global system of space heating with storage, solar collectors, and heat pumps (helio-geothermal heating).

The final aim is the realization of another seasonal storage project under good conditions and its implementation into a coherent system of space heating.

*SEASONAL THERMAL STORAGE IN AQUIFERS  
FOR AIR CONDITIONING*

Contact: T. Yokoyama, Department of Precision Engineering, University of Yamagata, Yonezawa 992, Japan.

Another test well has been drilled on the campus of Faculty of Engineering at the University of Yamagata with the cooperation of Japan Undergroundwater Co., Ltd. We shall install piping and collectors before winter. These collectors are not used for heat collection at high temperature but at low temperature. After six months or so, the stored warm water will be used for snow melting.

Storage amount, as well as well distance and natural underground water flow, will affect the recovery efficiency. In our last experiment we achieved only a 30-40% recovery efficiency. However, we have estimated that recovery efficiency can be increased to 50-60% if well distance is chosen three times that of the present value, i.e., the storage amount is nine times that of the present.

City of Shanghai Hydrogeological Team, Peoples Republic of China.

[This is a quick translation of major portions of the summary chapter of a technical publication (July 1977) of the Chinese National Geology Department at Beijing. Its purpose is to provide general information and it is not to be taken as an exact translation -- C.F. Tsang, Editor.]

In the late fifties, in the city of Shanghai, widespread use of groundwater by a number of factories led to subsidence and a significant drop in the groundwater level. In an attempt to remedy these problems, several factories began experimenting with reinjection of cold water from air conditioning systems. Experiments over the next few years were generally successful in restoring groundwater levels and increasing output from production wells. In addition, reinjection and well construction methods were continually improved through experiments with different techniques, volumes, and injection periods.

During the spring and summer of 1965, the Shanghai Cotton Mill Factory initiated a large-scale artificial recharge experiment using four different water sources: deep well water, industrial waste water, filtered industrial waste water, and tap water. Researchers also experimented with continuous versus intermittent withdrawal and with different reinjection-shut-in cycles. Temperature changes and water quality were monitored both before and after injection. These experiments indicated that there was little regional water flow in the aquifer and that there were only small changes in the temperature of water stored. These results became the basis for later projects which used winter

injection of cold water for summer use and summer injection of hot water for winter use.

During the same period, the Shanghai Water Company conducted extensive experiments using a variety of reinjection methods and three specially designed reinjection wells, 95 m deep, to study changes in groundwater level, water quality and temperature. Their experiments yielded relatively complete quantitative records which confirmed the effectiveness of using gravity recharge and underground production methods to raise groundwater levels.

Based on these large-scale experiments and their own studies, the City of Shanghai Hydrogeological Group concluded that reinjection was able to effectively control subsidence and groundwater levels and that it was possible to store cold water in winter for summer use in air conditioning. These conclusions led to a city-wide reinjection program in which 70 factories used 134 deep wells for simultaneous recharge. As a result, the water level increased by more than 10 m.

Groundwater produced during summer had a very low temperature and thus became a new source of chilled water for industrial use. At the conclusion of summer pumping there was a net average increase in the land level of six centimeters; the first time in several decades of continuous subsidence that any surface uplift had been observed.

The program grew in subsequent years so that there are now several hundreds of wells in use. Production and injection methods have been greatly improved and the program has been expanded to include summer injection of hot water for use in winter. Because of the success at Shanghai, several industrial cities and large villages have adopted similar reinjection and thermal energy storage programs.

# ATES NEWSLETTER

A Quarterly Review of Aquifer  
Thermal Energy Storage

EARTH SCIENCES DIVISION/LAWRENCE BERKELEY LABORATORY/UNIVERSITY OF CALIFORNIA  
Sponsored by U.S. Department of Energy through Pacific Northwest Laboratories

Volume 1, Number 4

September 1979

## INTRODUCTION

The purpose of the quarterly ATES Newsletter is to review current events in the development of thermal energy storage in aquifers. Our intent is to present concise reports of the goals, present status, and major results of ATES projects around the world. Each article is preceded by one or two contact persons and their addresses, from whom more details may be directly obtained.

Previous issues of the Newsletter have been sent to more than 178 individuals and agencies in 16 different countries. We hope that the considerable response generated by this publication will lead to a vibrant exchange of information and ideas.

The continued success of this Newsletter depends upon written contributions from researchers working in this field. Please keep us informed of research plans, significant results, and accomplishments. Contributions for the next issue should reach us by December 3, 1979. All contributions, ideas, and suggestions should be sent to:

Dr. Chin Fu Tsang, Editor  
ATES Newsletter  
Earth Sciences Division  
Lawrence Berkeley Laboratory  
Berkeley, California 94720, U.S.A.  
Telephone: (415) 486-5782.

## ATES REFERENCES LIST UPDATE

The reference list of articles concerning hot and cold water storage in aquifers first prepared in May, 1978 by Lawrence Berkeley Laboratory has recently been updated. Over 50 new titles have been added. Those interested in obtaining a copy should write to Dr. Chin Fu Tsang at the above address. We will also gratefully receive any information concerning errors and omissions, as well as suggestions for improving the listing.

## SEASONAL THERMAL ENERGY STORAGE: STES

Contact: J. E. Minor, Pacific Northwest Laboratory, Richland, Washington, 99352.

The U.S. Seasonal Thermal Energy Storage Program is managed by the Pacific Northwest Laboratory (PNL) for the U.S. Department of Energy (DOE), Division of Thermal Energy Storage Systems (STOR). This program is to demonstrate the economic storage and retrieval of energy on a seasonal basis, using heat or cold available during a surplus period. Aquifers, ponds, earth and lakes are typical media to be evaluated for seasonal storage. The program is now organized to conduct a demonstration of Aquifer Thermal Energy Storage (ATES) and to provide technical support for the ATES demonstrations and assessments of the non-aquifer STES concepts.

## Aquifer Thermal Energy Storage Demonstration Program

A Request for Proposals for the first phase of the Aquifer Thermal Energy Storage Demonstration Program is being mailed to interested organizations. This phase involves the conceptual design of an integrated aquifer storage system involving an energy source, a user application, an energy transport system, and an aquifer for off-season storage. The conceptual designs will take 18 to 24 months, since an important part of the work will be aquifer characterization. Four technological areas are being considered:

- (1) high-temperature heat storage (above 100°C),
- (2) low-temperature heat storage (below 100°C),
- (3) chill storage,
- (4) combined heat and chill storage.

Up to ten conceptual designs will be funded and from these, those showing the most promise for commercially attractive demonstrations will be selected for final design, construction, and operation. While the conceptual designs are being funded on a cost-reimbursement basis, the final design, construction and operation will be a cost-sharing operation between the user organization and the government.

This program should provide, in late 1985, several demonstrations throughout the country wherein energy, either as a by-product of an existing operation or a product of some innovative process, is being produced and stored in off-season and used when it is needed. The most obvious application appears to be for use in district heating and/or cooling, but other possible uses may well present themselves.

#### *Technical Support Program*

This program is designed to provide technical support to the Seasonal Thermal Energy Storage Program. The initial activities of this task are primarily directed toward support of the Aquifer Thermal Energy Storage Demonstration Program. These activities will include social, economic, and environmental assessment, technical research, and development studies to provide a sound technical base for the demonstration projects. The long-range task goals include investigation and evaluation of other seasonal thermal energy storage concepts which may be considered for future emphasis. These systems in combination with aquifer storage as a hybrid system may ultimately prove to be the most economical system.

#### *CONFINED AQUIFER EXPERIMENT HEAT STORAGE*

Contact: Fred J. Molz or A. David Parr, Civil Engineering Department, Auburn University, Auburn, Alabama 36830.

In September of 1978, the second six month injection-storage-recovery cycle of the Auburn University Aquifer Thermal Energy Storage Project began. Just as in the first cycle, water from an upper supply aquifer was heated to an average temperature of 55°C with an oil fired boiler and then injected into a lower storage aquifer. Injection and recovery temperatures, flow rates, temperatures at six depths in ten observation wells, and hydraulic heads in seven wells were recorded twice daily. The second cycle experiment was unique because the aquifer was still "warm" when injection of hot water began. Two weeks earlier, hot water recovery from the first cycle had been concluded at a production temperature of 33°C (13°C above ambient), with 65% of the injected thermal energy recovered.

Second cycle injection of hot water began on September 23 and continued until November 25. At that time 58,010 m<sup>3</sup> of water had been pumped into the storage aquifer. The major problem experienced during the first cycle was a

clogging injection well, which was remedied considerably by weekly "backwashing". This practice consisted of pumping approximately 2 m<sup>3</sup> of water from the storage formation and then injecting an equal amount of hot water. An immediate increase in the specific capacity and consequently the injection rate resulted when this procedure was repeated two or three times. After backwashing, the flow rate would then diminish at a fairly uniform rate. When it had dropped 20% (usually one week) the backwashing process would be repeated. This was done eight times during the injection phase and resulted in an increase of the average injection rate by 24% compared to the previous cycle.

A 63-day storage period ended on January 27, 1979 and production of hot water began with an initial water temperature of 54°C. By March 23 this temperature had dropped to 33°C, with 66,400 m<sup>3</sup> of water and 74% of the injected thermal energy recovered. This illustrates well the gain in thermal energy recovery with repeated injection-storage-recovery cycles. Production of hot water continued until April 20, at which time 100,100 m<sup>3</sup> of water and 89% of the injected thermal energy were recovered. The final production temperature was 27.5°C.

Another unique aspect of the second cycle was the measurement of land subsidence and rebound. From a station located 30 meters from the injection well, relative surface elevations of a point near the injection well and two points beyond the thermal front were measured to an accuracy approaching 0.1 mm. It was found that the surface elevation near the injection well rose 4 mm during injection, fell slowly during storage, and dropped more rapidly toward its original elevation during production. This movement appeared to be due to thermal expansion and contraction rather than to pressure effects.

Water samples were taken on a weekly basis throughout the production phase. One interesting finding was that approximately 3500 kg of clay were pumped from the formation. This lends more weight to the theory that clay dispersion was causing the clogging problem in the injection well.

#### *MODELING AUBURN ATEs FIELD EXPERIMENTS*

Contact: Chin Fu Tsang, Lawrence Berkeley Laboratory, Berkeley, California 94720.

Lawrence Berkeley Laboratory is continuing simulation of the Auburn University field experiments done in 1978 and 1979. Two injection-storage-recovery cycles have been modeled. Preliminary results, which are very encouraging, are reported here, while further analysis continues.

The parameters used in the numerical simulation were determined from well test analysis, laboratory measurements, and a preliminary parameter variation study (described in ATEs Newsletter, Vol 1, no. 3). With the aquifer characteristics thus obtained, a series of simulations were made, given the varying injection flow rates and temperatures, and the subsequent rest and production flow rates. Results of the simulation include the recovery factor and plots of production temperature versus time, as well as temperature contour plots and temperature profiles taken at various times during the simulations.

For the first cycle, the simulated recovery factor of 0.66 agrees well with the observed value of 0.65. For the second cycle the simulated value is 0.76, and the observed value is 0.74. Details of the comparison between simulated and observed energy recovery can be studied in production temperature versus time plots. For both cycles, the initial simulated and observed temperatures agree (55°C). During the early part of the production period, the observed temperature decreases slightly faster than the simulated temperature. During the latter part, the simulated temperature decreases faster than the observed temperature so that by the end of the production period the simulated and observed temperatures again agree (33°C). The discrepancy over the whole range is at most 1 to 2 degrees.

Temperature contour maps of vertical cross-sections of the aquifer at given times show the details of buoyancy flow, heat loss through the upper and lower confining layers, and the radial extent of the hot water in the aquifer. Buoyancy flow is important in this rather permeable system. Comparisons with temperatures recorded in observation wells throughout the aquifer show that the simulated temperature distribution generally agrees with observed temperatures. The discrepancies are much larger than the differences between calculated and observed production temperatures during the recovery period. Apparently there are local variations in the aquifer which tend to average out. Temperatures versus radial distance at given depths and times are also plotted, and from these profiles, the effects of thermal conductivity and dispersion on the shape of the thermal front can be studied.

In order to prove the mesh-independence of these results, the first cycle is being modeled again, using first a coarser mesh and a then a finer mesh. The coarse mesh recovery factor is 0.65, to be compared with a value of 0.66 using our first mesh. The fine mesh simulation is now in progress. Comparison of the temperature contours show thermal front spreading decreases slightly with increasing mesh fineness. Interestingly, the coarse mesh simulation yields a

recovery factor closer to the observed value than does the original simulation, so the increased numerical dispersion may be more closely simulating modeling thermal dispersion due to local heterogeneities in the aquifer.

Continuing work includes further parameter and generic studies. In particular, calculations are being made to determine the sensitivity of our results on each of the major parameters.

*POTENTIAL BENEFITS OF THERMAL ENERGY STORAGE IN THE PROPOSED TWIN CITIES DISTRICT HEATING COGENERATION SYSTEM*

Contact: Charles F. Meyer, GE-TEMPO, 816 State Street, P.O. Drawer QQ, Santa Barbara, California 93102.

Under contract to the U.S. Department of Energy via Oak Ridge National Laboratory, General Electric-TEMPO has completed a study of Thermal Energy Storage (TES) for a large urban cogeneration-district heating system in Minnesota. A final report has been written, whose title is given in the above heading. Currently identified as ORNL/SUB-7604-2, GE79TMP-44, it will appear later as a Department of Energy report. The abstract is given below. (Contact Dr. David M. Eissenberg, Building 9204-1, Oak Ridge National Laboratory, P.O. Box Y, Oak Ridge, Tennessee, 37830, regarding availability of copies.)

A new, large, cogeneration-district heating system has been proposed for the Twin Cities area, using hot water in a closed-loop system. The proposed system, as described by Studsvik Energiteknik AB of Sweden, does not employ thermal energy storage (TES). Four cases have been developed, describing system configurations which would employ TES, to evaluate the potential benefits of incorporating annual-cycle TES into the Twin Cities system. The potential benefits are found to be substantial, confirming results of earlier, generic studies of aquifer TES.

The reference (Studsvik) system employs oil-fired boilers to supplement cogenerated heat for handling peak loads and providing standby reserve. TES can serve the same function, with net energy savings in spite of heat loss during storage, by making it possible to operate the cogeneration equipment at higher capacity factors. Coal replaces oil as the fuel consumed. Energy savings of the reference system are impressive; energy savings with TES are 2% to 22% greater. Capital cost requirements for boilers,

cogeneration equipment, and pipelines are reduced by \$66 to \$258 million. The breakeven capital cost of TES is estimated to range from \$43 to \$76 per kilowatt peak thermal input to or withdrawal from aquifer TES. A factor in evaluating the breakeven operating cost of TES is the \$14 to \$31 million per year saving in cost of fuel. Abatement of air pollution and thermal pollution are additional benefits.

#### *ELECTRICAL UTILITY APPLICATIONS OF THERMAL ENERGY STORAGE AND TRANSPORT*

Contact: Walter Hausz, GE-TEMPO, 816 State Street, P.O. Drawer QQ, Santa Barbara, California 93102

A contract was recently completed for the Electric Power Research Institute (William Stevens, Project Manager - EPRI RP1199-3) by W. Hausz of General Electric-TEMPO. It was an intensive study of thermal energy storage and transport for electric utility applications. Several forms of thermal energy storage were examined, and a number of media for thermal energy transport were compared, including high temperature water (HTW), Caloria HT43 (oil), HITEC (molten salt), and steam. Over all, except for extremely high temperatures (>325°C), HTW was most economic by margins of over two to one at the lower temperatures.

Thermal storage methods considered include dual media of hot oil and rock, molten salt and rock, and pressurized containment of HTW, including aquifer storage. Emphasis in the study was not on the conventional low-temperature district heating application (<150°C) but on demonstrating the economic benefits of HTW at higher temperatures (220-280°C) for industrial heating and process steam applications.

Of most interest to ATES is a novel role suggested for aquifer storage. In industrial areas at the load end of pipeline transport of 50 km or more, the consumers have different requirements in the input temperature desired, the heat rejection temperature, and the daily and seasonal pattern of thermal energy use. Considerable flexibility in meeting these needs at the lowest cost can be gained by using not only the long-distance transport sendout pipe at 280°C and cold return pipe at 80°C, for example, but also a local pipeline at an intermediate temperature of perhaps 150°C, with aquifer storage between the intermediate and return pipeline. Daily storage in oil/rock dual media or underground steel lined caverns can buffer the demand pattern between the sendout and return pipe, and the various consumers can extract energy from the send-out pipe and return it to the intermediate or cold pipe, depending upon their needs. Other users, particularly district heating with its strong seasonal variability, can use the temperature range between intermediate and cold pipes.

#### *HIGH TEMPERATURE UNDERGROUND THERMAL ENERGY STORAGE*

Contact: R. Eugene Collins, Department of Petroleum Engineering, The University of Texas, Austin, Texas 78705.

The feasibility study of storage of high temperature (~600°F) water in deep aquifers and high temperature oil (~600°F) in solution-mined caverns in massive salt deposits (see ATES Newsletter, vol. 1, no. 2) is continuing into the third year at a new location. As of September, 1979, the new site is the University of Texas at Austin. New developments are summarized below.

It now appears that the preferred cavern storage system will be a single, gravel-filled cavern with two connecting wells operated in a thermocline mode essentially the same as above ground tanks using oil and rocks. A hot well connects to the top of the cavern, and a cold well connects to the lower end. The gravel filling serves three purposes:

- (1) as a storage medium for sensible heat and to reduce the required oil volume,
- (2) to restrict thermal convection and stabilize the thermocline,
- (3) to provide mechanical support and rigidity to the cavern to prevent cavern deformation due to creep, or plastic flow, of the salt.

Computer simulations are being used to investigate the thermal losses and pumping requirements of a cavern storage system. A small-scale, 10 MWe, system with 8 hours storage would lose about 3.8% of the useful stored heat during one daily cycle after about 3 months of continuous operation. The rate of loss at the end of one year of continuous operation is approximately 2.6%. For larger systems (100 MWe or more) the long term rate of loss would be 1% or less of the cyclicly transferred heat. The pumping power requirement for a small system is about 5% of the stored thermal heat. This includes the pressure differences inside the cavern, the potential energy difference, and friction losses in the pipes. For larger systems the percentage loss would be less.

A major problem anticipated for the cavern storage system was cavern deformation due to creep, or plastic flow, of the salt at high temperatures. A general equation of stress as a function of strain, rate of strain and temperatures for uniaxial conditions has been developed from published data. Techniques for extending this to arbitrary triaxial conditions are available and are being used to develop a model to make detailed studies of the effect of the gravel filling and cavern shape on deformation at high temperatures.

Design studies have been carried out to determine what heat exchangers and power generation equipment might be required to interface the solar collector with a cavern storage system. For a small 10 MWe system, simple designs seem feasible, but larger systems (100 MWe)

would require a much more complex interfacing of solar collector, cavern storage and steam-electric turbines. One possible design is a cross-compound system using steam-electric conversion at two different temperature levels, one direct from the collector and one direct from the cavern, with cross coupling.

A cost estimate of \$3.4 million for the components of a cavern system with a transfer rate of 33 MWt and 8-hour storage period has been developed. This corresponds to total system costs of \$103/kWt and \$13/kWh. These figures compare very favorably with the DOE cost goals for near-term sensible heat storage (\$105/kWt and \$13.13/kWh converted to thermal from electric at 25% efficiency and converted to 8-hour storage from 6-hour storage).

Cost figures quoted are for a minimum sized underground system. Costs for larger commercial-scale power systems would be less. Therefore, cavern storage appears to be an attractive option for near-term sensible heat storage for large-scale solar power systems. Cavern storage may also be economically favorable for storage periods long enough (16 hours) to provide baseline electrical power.

#### A THEORETICAL STUDY OF SENSIBLE ENERGY STORAGE IN AQUIFERS

Contact: Jean-Pierre Sauty or André Menjot, BRGM, Orléans, France.

When considering underground storage of hot water, the recovery factor is of major concern in determining the economic feasibility of a project. It is especially convenient to have at hand general type-curves by which an engineer can quickly decide whether or not a particular project should be carried out. In this light, a general study using mathematical models has been made to determine the effect of various physical parameters and operating conditions on the temperature of water produced after a storage period in a one-well system (alternative injection and production through the same borehole). For each case the overall heat return has been evaluated.

A dimensional analysis has determined the dimensionless parameters governing the behavior of the system in terms of physical factors (reservoir thickness, thermal conductivities, heat capacities ...) and operating conditions (flow rate, duration of injection, storage, and production periods). Type curves have been drawn and heat recovery factors evaluated for various combinations of these factors.

This study concerns single-phase, thermal energy storage in relatively deep aquifers (regional velocity neglected and the confining layers regarded as practically infinite in thickness).

For our study, we define the dimensionless parameters  $P_e$  and  $\Lambda$  as follows:

$$P_e = \frac{\rho_F C_F}{\lambda_A} \cdot \frac{Q}{2\pi h}$$

$$\Lambda = \frac{(\rho_A C_A)^2 h^2}{\lambda_R \rho_R C_R} \cdot \frac{1}{t_i}$$

where  $h$  is the aquifer thickness,  $\rho_F C_F$ ,  $\rho_R C_R$ , and  $\rho_A C_A$  the heat capacities of the fluid, the confining rocks and the aquifer, respectively, and  $\lambda_R$  and  $\lambda_A$  the respective thermal conductivities of the rock and aquifer. The Peclet number  $P_e$  represents heat loss at the thermal front, and the  $\Lambda$  coefficient the heat loss through the confining rocks.

It has been shown that for these numbers higher than 10, the recovery of a stabilized cycle is greater than 75% (still higher, if the reference temperature at the surface is lower than the natural aquifer temperature, meaning less heat loss). However, it should be considered that overall energy efficiency must take into account various losses in the well and at the surface as well as energy consumption (pumping water in and out of the wells).

A complementary study has established the practical storage conditions under which such dimensionless parameters can be reached, i.e., how to choose the volume stored during a cycle and the duration of a cycle as a function of the reservoir characteristics (primarily its thickness). Particular emphasis has been placed upon the possibility of preheating the system by an initial injection period prior to those performed during the subsequent cycles. In a very small number of cycles, the conditions of stabilization can be reached.

The particular case of asymmetric cycles has been studied with the following results:

- (1) production of a volume smaller than that injected increases the temperature level but lowers the heat recovery;
- (2) the production of a higher volume causes opposite effects.

Finally, these theoretical results have been confirmed from data obtained at the Bonnaud Site (Jura, France), where a storage experiment has been performed with 4 symmetric cycles (6 days injection and 6 days production). The experiment yielded a recovery coefficient of greater than 60% at the end of the fourth cycle for a Peclet number of 5 and a  $\Lambda$  coefficient of 13.

#### AQUIFER STORAGE IN BELGIUM

Contact: Professeur Josef Brych, Faculté Polytechnique de Mons, 9 Rue de Houdain, B 7000 Mons, Belgium

In 1975, the Belgian government began a national research and development program on energy, with the first phase ending in August, 1978. With the onset of the second phase in September, 1978, a project studying thermal energy storage and involving the collaboration of several universities and institutions was undertaken. The current stages of development are summarized below.

At the Faculté Polytechnique de Mons (Professor Brych, Neerdael, and Sarot), a study involving the use of large diameter drilling in "vertical underground reservoirs" of several thousand  $m^3$  is being made. Preliminary theoretical modeling is already complete. A semi-industrial model of about  $1 m^3$  is also completed, with testing to begin in late October, 1979.

The geological aspects of the project are being studied at the Université de Liège (Professor Calembert, Professor Monjoie and M. Marchand). A final report on suitable Belgian test sites and full scale implementation of warm water storage will soon be published.

At the Rijksuniversiteit te Gent (Professor Anselin, Nijs, and Debevere), urban heating is being studied.

#### UNDERGROUND COOLING BY GROUNDWATER HEAT PUMPS

Contact: Dr. K.-D. Balke, Universität Tübingen Institut und Museum für Geologie und Paläontologie, Sigwartstrasse 10, 7400 Tübingen 1, West Germany.

When a groundwater heat pump is used, groundwater is removed from an aquifer through a pumping well, cooled down within the heat pump, and reintroduced into the aquifer through an injection well. This process creates a cooler region around the injection well. The size and form of this negative thermal anomaly become important parameters for well positions and groundwater quality, and determine:

- (1) the minimum distance to be maintained between the production well and the injection well to avoid a thermal short circuit,
- (2) the distance between the production and injection wells required to extract thermally undisturbed groundwater,
- (3) possible physical, chemical or biological damage that could occur in the aquifer.

Since July, 1978, two hydrothermal test fields have been in operation in the Münsterlander Bucht (W. Germany) to investigate the growth and size of the negative thermal anomalies caused by injection wells of heat pumps. The test fields each have a meteorological station; one with a 5 m deep injection well and 28 groundwater gauges, the other with a 16 m well and 19 gauges. The aquifers are composed of fine and medium-grained sands. The injected cold water comes from heat pumps that heat single-family houses.

At present, the connections between the injected "negative" quantity of heat, the local hydrogeological and hydrothermal relations, the conditions of the wells, and the growth of the thermal anomaly are being quantitatively investigated. The thermal influences of air temperature and precipitation are also under analysis.

In addition to the thermal investigations, chemical and microbiological research will begin in the test fields in January, 1980.

#### THE UTILIZATION OF SEASONAL HEAT STORAGE IN SYSTEMS WITH COMBINED PRODUCTION OF HEAT AND POWER

Contact: Björn Qvale, Laboratory for Energetics Technical University of Denmark, DK-2800 Lyngby, Denmark.

The storage of heat in an energy supply system can be of value in conserving energy, insuring the dependability of the heat supply, and increasing the dependability of the production of electric power. Summarized below are the results of an evaluation of the significance of including heat storage in two heat and power supply systems.

The two locations studied are Randers, site of a backpressure turbine, and Aalborg, where an extraction turbine is to be installed. The methods of analysis applied are quite different in the two cases.

In Randers, the interaction between the local energy supply system and the surrounding superior system is managed indirectly, but effectively, by simple contractual agreements governing the prices of the sale and purchase of electricity. The impact of introducing heat storage into this system is studied quite simply through the economics of the local county energy supply organization.

In Aalborg, the case is more complex. The local electric power generation is integrated with the superior system. The price of electricity bought and sold is the same. However, the rate of production of electricity is managed by



the surrounding superior system. This in turn is governed partly by local demand and partly by the demands of the surrounding system.

A garbage incineration plant supplements the heat produced by the extraction turbine. The introduction of seasonal heat storage into this system will have a number of direct and indirect consequences:

- (1) it may affect the future schedule for establishing and operating power plants in the superior system;
- (2) the existence of seasonal heat storage may influence the choice of power plants in the system;
- (3) once the future plans have been decided, the existence of seasonal heat storage will materially affect the performance of the existing system with respect to economics, energy utilization and system reliability (in relation both to heat and power generation).

The impact of introducing energy storage into this system is studied by establishing detailed energy balances (hour by hour) and overall economic balances.

#### DANISH AQUIFER STORAGE PROJECT

Contact: J. A. Leth, Risø National Laboratory, (Danish Aquifer Storage Project) DK-4000 Roskilde, Denmark.

The Danish aquifer storage project is carried out jointly by Technical University of Denmark (Laboratory of Energetics), Geological Survey of Denmark and Risø National Laboratory. The goals of the project are:

- (1) to develop mathematical models for simulation of heat transport by storing hot water in porous geological layers,
- (2) to demonstrate the practical and economic aspects of underground heat storage by means of a test plant,
- (3) to make a survey based on available hydrological and geological data in order to find possible sites for underground heat storage near areas with district heating supplied from combined electricity and heat generating stations.

The demonstration plant for the project will probably be placed near either a combined power and heat generating station or a garbage burning plant. The well plan is expected to consist of one center well and four surrounding wells, with additional wells to compensate for groundwater

flow. The expected fluid temperature range is 80-120°C with a power output of about 1 MW.

Modeling efforts (J. Refstrup, Technical University of Denmark) include the development of a two-dimensional (three dimensional axisymmetric) finite element model. Based on a numerical solution of the governing partial differential equations, the model simulates coupled heat and fluid flow through porous media.

#### NEWS FROM YAMAGATA UNIVERSITY

Contact: Takao Yokoyama, Precision Engineering Faculty of Technology, Yamagata University, Yonezawa 992, Japan.

At Yamagata University in Yonezawa, Japan, three projects are currently under way.

#### Field experiments

At the new experimental field station of the Yamagata Campus, three rooftop solar collectors are being installed. One is constructed of vinyl acetate resin, another of aluminum, and the third of copper. They are to be used both for summer heat collection and winter snow melting. Since the project is still in the construction phase, experimentation with thermal aquifer storage has not yet begun.

#### Theoretical Analysis

It has been found that the seasonal recovery coefficient depends primarily upon natural regional groundwater flow. By studying fluid flow streamlines and the related stagnant points, we are able to determine the areas of storage and recovery. Theoretical analysis is now being compared to experimental data.

#### Measurement of Thermal Properties

At this time, we have little data on thermal properties of unconsolidated sand layers resembling actual aquifers. In our specimen, we have measured thermal properties of various kinds of sand layers and compared them with standard material of a glass at a constant rate of flow. In the future, varying flow rates will be used.

#### Other Projects

In the Yamagata Basin, Nihon Chikasu Kaihatsu Co., Ltd. has done experimental work with thermal aquifer storage (see ATEES Newsletter, vol. 1, no. 1). The experimental data are now being analysed.

**BUOYANCY FLOW AND THERMAL STRATIFICATION  
IN AQUIFER HOT WATER STORAGE**

Contact: Johan Claesson, University of Lund,  
Department of Mathematical Physics, Box 725,  
S-220 07 Lund 7, Sweden.

Injection of hot water into an aquifer, where the interface between hot and cold water is primarily vertical, creates an unstable system due to the density difference between the hot and cold water. The rate at which the system tends to equilibrium, i.e., with the hot water on top of the cold water, is a decisive factor in determining the feasibility of a system with vertical injection and production wells. A strong disturbance of the temperature field will lead to higher heat loss (larger surface area of the hot region, increased heat dispersion). It will also require a more complicated extraction system in order to avoid excessive mixing of hot and cold water in the well.

The aim of our study is to find an explicit order-of-magnitude expression for the influence of the buoyancy flow. It is then possible to estimate the rate at which the thermal front "tilts" without resorting to numerical models. The analysis is based on a number of analytical solutions for a vertical thermal front in cylindrical and two-dimensional Cartesian coordinates. The diffuseness of the thermal front is also taken into account. Several assumptions about the behavior of the thermal front must be made in order to modify the analytical solutions for nonvertical situations. Finally, the tilting rate for a given system is quantified by a characteristic tilting time-constant which equals the time it takes for an initially vertical front to tilt 45°. The most important parameter is the product of the vertical and horizontal permeability. The tilting time-constant is inversely proportional to the square root of this product. In order to verify the assumptions made when deriving the analytical solution, a number of simulations have been made using the numerical model "CCC" (Conduction, Convection and Compaction). These simulations confirm that the assumptions are reasonable.

As an illustration of the results we give the following example. Consider a 20 m thick alluvial aquifer with a vertical permeability that is 1/10th of the horizontal one. The heat capacity of the aquifer is 2.7 MJ/m<sup>3</sup>K. The temperature of the injected water is 85°C, and the ambient water is 15°C. The figure shows the tilting angle (assuming a straight front) as a function of permeability (m<sup>2</sup>) and storage time (days). Let us require that the thermal front should not tilt more than 60° during a storage period of 90 days. The corresponding maximum allowable permeability is then about 3 x 10<sup>-11</sup> m<sup>2</sup>. This example does not include the effects of a superposed forced convection, which will cause a further increase in the tilting angle.

In the field tests conducted so far, water at rather low temperatures (<55°C) have been injected into aquifers of relatively high permeability. The length of the storage cycle is about three months. To avoid excessive influence of buoyancy flow during an annual storage cycle with higher temperatures (~85°C), it is necessary to use less permeable aquifers.

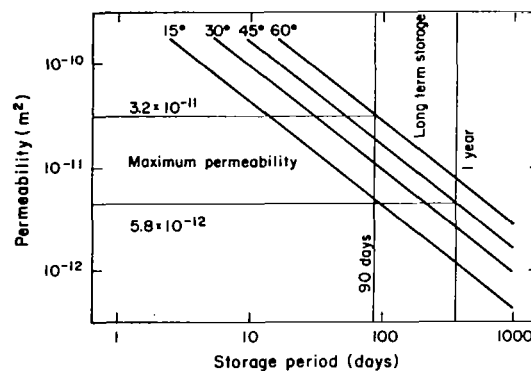

EXECUTIVE COMMITTEE  
SUMMARY REPORT  
FOR  
1979 THERMAL ENERGY STORAGE  
PROGRAM REVIEW MEETING

Background/Objective:

Annually the Thermal Energy Storage Program is reviewed by DOE/STOR to assess current efforts and define future activities. To provide a broad critique of the TES program, an executive review committee was established with members being solicited from academia, State energy departments and other non-DOE government organizations.

Committee members were provided with copies of the FY-79 Multi-Year Program Plan, Project Summary FACT Sheets, and the Proceedings from the 1978 TES meeting. The questions contained in this report served as the basis for an executive review meeting following the two days of project overviews and technical summation reports. Prior to the executive review meeting, the committee summarized their responses in writing. This report presents a summary of the Committee's responses as well as a synopsis of the discussion of the issues at the executive review meeting. A tape recording of the meeting has been retained for DOE/STOR use as desired.

Executive Review Committee Meeting Attendees:

Philip Jarvinen	- Lincoln Laboratory
Andrew Kource	- U.S. Army
Michael O'Callaghan	- Massachusetts Institute of Technology
C. J. Swet	- Consultant, Thermal Storage
Milo Belgen	- Ohio Department of Energy
Henry Rice	- Nebraska Public Power
D. D. Wyatt	- National Research Council
Brian Swaiden	- U.S. Navy

Others Attending:

Mr. Marshall Dietrich	- Lewis Research Center, NASA
Dr. David Eissenberg	- Oak Ridge National Laboratory
Mr. William Frier	- Division of Energy Storage Systems, DOE
Mr. John Gahimer	- Division of Energy Storage Systems, DOE
Mr. Larry Gordon	- Lewis Research Center, NASA
Dr. James Minor	- Pacific Northwest Laboratory
Mr. Arno Nice	- Lewis Research Center, NASA
Dr. James Swisher	- Division of Energy Storage Systems, DOE
Dr. Charles Wyman	- Solar Energy Research Institute

## Review Committee's Responses

The following narrative is a summary response for each of ten questions posed to the Committee. These responses are based primarily on written answers generated by the Committee prior to the executive review meeting. To a lesser extent, comments have also been included which were taken from the taped executive review session.

Each summary answer is presented in bulletized format and noted as either a majority or minority opinion. In addition, a brief narrative follows to document the respective individual discussions as recorded. The reviewers name have been intentionally omitted and it should be noted that not all of the reviewers participated in the Executive Review Session.

QUESTION (1)

IF STOR HAD TWICE THE FUNDING, WHAT PROGRAMS SHOULD BE INCREASED? WHAT NEW PROJECTS SHOULD BE INITIATED?

Majority (not prioritized)

- o Increase the number of aquifer demonstrations.
- o Accelerate phase change material development for building material applications.
- o Increase development effort for "customer side of the meter" heat pump applications.
- o Increase efforts pertaining to storage and transport of heat in thermochemical form.
- o Initiate TES demonstrations on federally owned property.
- o Increase fundamental research for direct contact heat exchanger aquifers.
- o Initiate demonstrations within the respective industrial sectors (food processing, cement).

Remarks

- o Although the use of federally owned property might eliminate or alleviate certain institutional problem areas, the credibility and the accessibility were seriously questioned.
- o Industrial demonstration (single application), if viable, should be sufficient for the respective industry to evaluate and incorporate without further government participation.

QUESTION (2)

IF STOR PROGRAMS WERE REDUCED BY ONE-HALF, WHAT PROGRAMS SHOULD BE REDUCED? WHAT PROGRAMS SHOULD BE DELETED?

Majority (not prioritized)

- o Reduce the efforts in the Building Heating and Cooling application area.
- o Reduce the number of aquifer storage projects.

## QUESTION (2) Cont.

### Majority - Cont.

- o Delete the following activities:
  - Crawl space air tempering
  - Electrically heat bricks
  - Heinz food processing demonstration
  - Storage for conventional oil and gas heat

### Minority

- o Delete projects with long range payoffs (i.e., concentrate only on near term activities).
- o Delete low temperature solar space heating applications.
- o Delete thromb wall efforts.
- o Delete high temperature solar electric

### Remarks

- o Deletions or reductions should be done at the individual activity level, rather than at the program element (e.g. BHAC, or Solar Thermal, Industrial, etc.) level.
- o Should establish a rationale for deletion or reduction of efforts; for example, lowest cost effectiveness and/or near, mid, far term payoffs.

## QUESTION (3)

ARE STOR PROGRAMS MISSION ORIENTED? DOES THE REVIEW COMMITTEE SEE REAL WORLD APPLICATIONS FOR ALL TECHNOLOGIES?

### Majority

- o Generally speaking, the economics are questionable. Little or no attention was given to market analysis with respect to this meeting.

### Minority

- o Real world applications for solar (high and low temperature) are not evident.

QUESTION (3) Cont.

Remarks

- o A negative report card was issued with regard to the marketing of thermal energy storage. It was not evident to either the Committee or other attendees (not intimate with the program) what the National thermal storage needs are. STOR should use these meetings to market their product while simultaneously reviewing the goals, etc. In addition, there should be information presented by DOE relating the STOR effort to the end-users needs. What interactions are occurring? In other words, why is STOR pursuing some of the activities as reported in the past two days.
- o In summary, the marketing (lack of) for TES is the primary area for STOR to address immediately.

QUESTION (4)

NEAR-TERM PROJECTS IN THE INDUSTRIAL, SOLAR THERMAL ELECTRIC, AND BUILDING HEATING/COOLING APPLICATION SECTORS REQUIRE HEAVY BUDGET OUTLAYS RESULTING IN DE-EMPHASIZING LONG-TERM, BASE TECHNOLOGY WORK.

- A. DO WE HAVE A PROPER FUNDING BALANCE OF LONG-TERM VS. NEAR-TERM? IF NOT, WHAT SHOULD BE CHANGED?
- B. IS THERE A PROPER FUNDING BALANCE AMONG THE NEAR-TERM PROJECTS?
- C. DO YOU PERCEIVE AN ADEQUATE DEVELOPMENT TECHNOLOGY BASE THAT WILL LEAD TO DEVELOPMENT OF NEW TECHNOLOGY INITIATIVES IN THE FUTURE? IF NOT, WHAT SUGGESTIONS?

Remarks

During the presentation there was little, if any, information presented on the financial resources for the STOR-TES program. Consequently, the committee could only comment in a very general nature as follows:

- o The TES program is weighted heavily toward near-term activities; hence, poor balance.
- o A broader technology base should exist.
- o STOR and the Energy Research Office should establish better communications.

#### QUESTION (5)

WHAT SHOULD STOR BE LOOKING FOR IN INTERNATIONAL COOPERATIVE PROGRAMS?  
WHAT SHOULD STOR BE PROTECTING IN INTERNATIONAL NEGOTIATIONS?

#### Majority (not prioritized)

- o STOR should investigate those opportunities to use foreign facilities which have unique features not available within the U.S. (e.g. very high temperature solar systems).
- o Funding should emphasize those projects that have a large foreign market potential for U.S. industry.
- o STOR should insulate domestic TES program funding from international cost overruns.
- o STOR should explore opportunities to participate in storage efforts of DOE end-user foreign project initiatives (e.g. solar thermal).

#### QUESTION (6)

WHAT ARE THE BEST MECHANISMS FOR TRANSFERRING TECHNOLOGY TO THE COMMERCIAL BASE?

#### Majority (not prioritized)

- o Primary emphasis should be directed to private sector rather than "end-use DOE Divisions.
- o Level of technology transfer must be of sufficient scale to prove both technical and economic feasibility.
- o Improvements should be made in all state energy liaison activities.
- o Private sector can be reached best by use of trade organizations, technical journals, and public displays of concepts (models, etc.).

#### Remarks

- o DOE/STOR must improve the "selling" of TES. When a DOE "end-use" Division does not have a planned commercialization effort STOR should provide the "marketing" activities. To promote government and state cooperation, consideration should be given to the annual governors conference as well as charging this liaison activity to a specific field laboratory. Interface between DOE/STOR state energy offices have been minimal if not non-existent.



QUESTION (7)

HOW DO WE (STOR) DECIDE WHEN ACTIVITIES ARE READY FOR TRANSFER?

Remarks

- o By keeping "end-users" informed throughout the developments, the transfer should occur naturally. The lack of "end-users" at the meeting (both government and the private sectors) should be corrected.
- o The private sector "end-users" should be the best indicators for directing technical interest (i.e., is or is not a market available).
- o Decisions to discontinue a technology thrust must be on a "case by case" basis. Generally speaking, if the private sector interest is not there, forget it.

QUESTION (8)

WHAT ARE YOUR OVERALL IMPRESSIONS OF THE PROGRAM?

- o FOCUS, BALANCE, DIRECTION
- o TIMELINESS
- o USEFULNESS

Remarks:

- o As presented, the TES program appears to be insufficient (should move faster). With the dollars presently available, more (hardware-wise) should have been accomplished.
- o There are few tangible items (TES modules, subsystems, etc.) for this program. More demonstrations ("show and tell") are strongly advocated.

QUESTION (9)

WHAT OTHER KEY QUESTIONS DO YOU THINK THIS REVIEW COMMITTEE SHOULD ADDRESS? DO YOU THINK THERE ARE BETTER WAYS TO RUN THIS REVIEW COMMITTEE?

Remarks

- o A permanent TES review committee (10-15 members) was advocated. Membership should consist of academia, industrial, and non-DOE government personnel evenly distributed.
- o The committee should be involved in both the annual and semi-annual DOE review meetings. And, if possible, additional time (1-2 days) should be allotted to the Committee for discussion/preparation of their review.

## QUESTION (10)

DO YOU (COMMITTEE) HAVE ANY SUGGESTIONS FOR IMPROVING THIS CONFERENCE AND OTHER INFORMATION EXCHANGE MEETINGS?

### Remarks

- o Slides (visual aids) should be standardized to a format which would best serve DOE interests.
- o More technical concepts (poster session) should be presented which would also provide more interchange of technical information.
- o The review cannot serve two objectives simultaneously. In other words, it must be resolved whether the intent is a management review or a technical review.
- o Management review meeting must be held in Washington, D. C. area. Technical meetings are optional as to location. Focusing on a specific laboratory or subsystems research experiment could provide attractive incentives for non-Washington area meetings.
- o To promote marketing of TES and to improve STOR's marketing image, the annual technical review meeting should be widely publicized (e.g. CBD).
- o The STOR/TEA role and interfacing with TES should be an important part of the review meeting.
- o The overall meeting arrangements were too regimented. A three day meeting may alleviate this.

### CONCLUDING REMARKS PERTAINING TO:

#### PROGRAM EVALUATION

It is disappointing to realize that nothing has been commercialized. In fact, no real test hardware (TES modules) has been developed.

#### PROJECT EVALUATION

Value derived cost goals are generally lacking except in solar thermal power applications. These value derived cost goals should be based on baseline alternatives of the best technology currently available.

PROJECT EVALUATION - Cont.

Project area must emphasize solving specific problem area prior to a multitude of demonstrations. As an example, STOR should establish competence in aquifer technology (Leading Edge Test Facility activities) before initiating many demonstrations.

For industrial retrofit, it would be unwise for the government to consider other methods (regulatory) rather than technical and economics benefits to make TES a reality. However, State support in this application area could be a viable approach in marketing, etc.

1. Report No. <b>NASA CP-2125</b>	2. Government Accession No.	3. Recipient's Catalog No.	
4. Title and Subtitle <b>THERMAL ENERGY STORAGE Fourth Annual Review Meeting</b>		5. Report Date <b>March 1980</b>	6. Performing Organization Code
		8. Performing Organization Report No. <b>E-428</b>	
7. Author(s)		10. Work Unit No.	11. Contract or Grant No.
9. Performing Organization Name and Address <b>National Aeronautics and Space Administration Lewis Research Center Cleveland, Ohio 44135</b>		13. Type of Report and Period Covered <b>Conference Publication</b>	
		14. Sponsoring Agency Code Report No. <b>CONF-791232</b>	
12. Sponsoring Agency Name and Address <b>U. S. Department of Energy Division of Energy Storage Systems Washington, D. C. 20546</b>		15. Supplementary Notes	
16. Abstract <b>Thermal Energy Storage (TES) programs implemented by the Department of Energy, Division of Energy Storage Systems were reviewed at the Fourth Annual Meeting held at Tysons Corners, Virginia on December 3-4, 1979. TES aims at applications where its use can correct a mismatch between energy supply and energy use. Effective utilization of TES can result in near term oil savings plus making solar and dispersed energy systems more feasible. The report reflects a year of transition in the overall program planning for thermal storage. Overviews, selected presentations, and summary reports are presented on Program Definition and Assessment; applications in Industrial Storage, Solar Thermal Power, Building Heating and Cooling, Seasonal Storage; Supporting Research and Technology; and International Activities.</b>			
17. Key Words (Suggested by Author(s)) <b>Thermal energy storage programs; Industrial; Solar; Heating; Cooling; Seasonal</b>		18. Distribution Statement <b>Unclassified - unlimited STAR Category 44 DOE Category UC-94a</b>	
19. Security Classif. (of this report) <b>Unclassified</b>	20. Security Classif. (of this page) <b>Unclassified</b>	21. No. of Pages <b>663</b>	22. Price* <b>A99</b>

\* For sale by the National Technical Information Service, Springfield, Virginia 22161