

## EFFECT OF REFINING VARIABLES ON THE PROPERTIES AND COMPOSITION OF JP-5

Martin Lieberman and William F. Taylor  
Exxon Research and Engineering Company

Changes are taking place in the petroleum refining industry. New crude sources are being used, refineries are being modified and there are changes taking place in the demand for the various refined products such as jet fuel, diesel fuel, heating oil and gasoline. As a result of these and other events, subtle but significant changes may take place in the properties and composition of JP-5 as well as with its potential availability.

Recognizing these events, the U.S. Navy, Naval Air Propulsion Center in Trenton, New Jersey awarded a contract to Exxon Research and Engineering Company to study this area. The study entitled, "Effect of Refining Variables on the Properties and Composition of JP-5" was conducted under U.S. Navy Contract N00140-78-C-1491. The primary objective of the program was to identify potential future problem areas that could arise from changes in the composition, properties and potential availability of JP-5 produced in the near future.

The study employed a systems type approach, looking at the various processing trains used to make JP-5 in the U.S. and abroad, the types of crudes used with the different processing trains and the crude-processing interactions that might impact on the quality and potential availability of JP-5 produced in the near future. Analyses were made separately for the two major geographical regions (PADs) currently producing JP-5 for the U.S. Navy. Potential fuel problems concerning thermal stability, lubricity, low temperature flow, combustion, and the effect of the use of specific additives on fuel properties and performance were identified and discussed.

Estimates were made of the maximum theoretical yield of JP-5 that could be derived by distillation of typical foreign and domestic crudes that are used widely by PAD 5 and PAD 3 refineries, as well as from the blends of crudes that are currently in the U.S. Strategic Petroleum Reserve (SPR). These estimates were made using the Exxon Assay Stream Program, a computerized technique that can predict yields and a wide range of fuel properties for specified crudes and blends of crudes for given boundary conditions. Yields and properties were estimated for current specification JP-5 as well as for a range of conditions for relaxed freeze and/or flash points.

Several important findings and trends in crude quality and/or processing were identified in the program that could have important implications for the in-service performance of JP-5 produced in the near future. These include the following:

### Crudes

- The average sulfur level of crudes being processed in the U.S. will continue

to increase significantly in the next decade. This is particularly true of PAD 5, the West Coast area.

- The use of Alaskan North Slope Crude is increasing greatly in PAD 5. This crude is relatively high in sulfur and aromatics compounds.
- Though used to a relatively small amount now, Mexican Isthmus Crude, a relatively high sulfur, high aromatics crude, should make a more significant contribution to the crudes used in PADs 3 and 5 in the next decade. The Strategic Petroleum Reserve contains a relatively large fraction of Mexican Isthmus Crude, thus making this crude potentially even more important in the future.
- As a result of the above, more severe processing may be required to make acceptable grade JP-5 in the future. Increased sulfur and/or aromatics content is a particular problem for PAD 5 refineries involved in making JP-5 for the Navy. Many of these refineries do not have hydroprocessing capability.

#### Refineries

- The refineries presently used to make JP-5 in the U.S. are located in PADs 3 and 5 only. About half of the PAD 5 refineries involved in JP-5 production are relatively small and have no middle distillate hydroprocessing capability. All four refineries making JP-5 in PAD 3 are large and have extensive hydroprocessing capability.
- Only about 20-25% of the available distillation capacity in PADs 3 and 5 is presently being utilized (contracted) to make JP-5 for the Navy, though most of the other refineries (not currently making JP-5) are utilized to manufacture middle distillates for other uses. The potential for expanding production is thus great if other refineries would participate.
- Foreign refineries making JP-5 are located in the Caribbean, Europe and the Far East. The fraction of foreign refinery capacity (refineries) that are involved in JP-5 production is about 5%. Thus, the potential for expansion of this refinery base for JP-5 production is even greater than the U.S.
- In FY-78, approximately  $10^9$  gals of JP-5 were made with U.S. refineries supplying about 77%, foreign refineries 23%. Exxon, Shell, and Mobil supply over 50%.
- Very little growth is projected in U.S. refinery capacity during the next 5 years, perhaps 5-8% over the (1980-85) five-year period. However, much more rapid growth is expected in the addition of hydroprocessing facilities. This is primarily a result of the need to adapt to higher sulfur, heavier crudes as indicated above.
- European refineries are installing several large fluid catalytic cracking and thermal cracking facilities in an attempt to provide more gasoline.

## JP-5 Processing

- A wide range of processing routes are used to make JP-5 with many of the unit processes involved having the potential to affect the quality of the JP-5 produced. Unit processes employed include:

<u>Unit Process</u>	<u>Possible Side Effect Problems Resulting From Use</u>
Hydrocracking	Removal of natural antioxidants. Removal of compounds that could affect lubricity.
Hydrogenation	Removal of natural antioxidants. Removal of compounds that could affect lubricity.
Mild Hydrotreating	Same as above but to a much lower extent. Should not generally impair lubricity.
Caustic Washing	Disulfide formation, soap formation, aldehyde polymerization.
Merox Sweetening	Production of disulfides and polysulfides which can adversely affect thermal stability.
Doctor Sweetening	Same as above plus introduction to lead compounds.

- Small refineries employ more chemical processing in making JP-5 than large refineries and generally do not have hydroprocessing capability.
- Processing of JP-5 is not aimed at thermal stability per se but is targeted toward critical specifications, such as smoke point improvement and color improvement.
- Use of sweetening processes which convert mercaptans to disulfides are more deleterious to thermal stability than those which actually remove mercaptans from the fuel.
- Hydrocracking has the potential to greatly increase the yield of middle distillates.
- Major processing problems of small refiners include:
  - + Smoke Point - Particularly troublesome to small refiners that have limited aromatics removal capacity. (North Slope and many California crudes with high aromatics levels require aromatics removal capacity.)
  - + Freeze Point - A problem with some high paraffinic crudes. Usually handled by reducing upper end of distillate cut, cutting JP-5 yield.
  - + WSIM - Addition of corrosion inhibitors and anti-icing agents have caused problems with WSIM.

- Use of additives can greatly affect fuel properties/performance.
  - + Use of some anti-icing agents and/or corrosion inhibitors can downgrade the WSIM specification.
  - + Use of the anti-icing additive ethylene glycol monomethyl ether (EGME) degrades distillate Flash Point. However, di-ethylene glycol monomethyl ether (di-EGME) does not.

#### Crude Property/Availability Tradeoff

- Different crudes exhibit a wide variation in the maximum theoretical yield of JP-5 they can provide for current specification. Typical variations range from 7 to 19 volume % of crude.
- Use of current JP-5 anti-icing additive reduces the maximum theoretical yield from 5 to 15 volume % depending on the type of crude.
- Relaxation of JP-5 freeze and/or flash point specifications can yield significant increases in potential fuel availability. Freeze point relaxation gives a somewhat greater effect on increasing the maximum theoretical yield.

#### Trends in Middle Distillate Demand

- Increased demand for middle distillate fuels in the next decade, primarily due to increased use of diesel fuel (if automobiles are converted to diesels) will make distillate supplies for jet fuel, including JP-5, tighter.
- Increased demand for commercial jet fuel should also have a potentially adverse effect on supplies of distillate available for JP-5.
- Conversion technology such as hydrocracking, catalytic or thermal cracking plus hydrogenation of heavier stocks, may provide an attractive way of increasing middle distillate supplies. This approach could be even more useful if the projected decrease in gasoline demand can free heavier crude fractions for processing to middle distillates.

#### Other General Observations

- The use of additives such as anti-icing agents, antioxidants, corrosion inhibitors can have a dramatic effect on fuel properties and performance. Extreme care must be exercised when a new additive is put in the fuel or a change in additive concentration is made to solve a particular problem. Though it might act to mitigate one problem, it may intensify or promote another. A good example is the addition of a corrosion inhibitor to improve fuel lubricity problems. Such a change could have severe degradation effects on the WSIM specification, which in turn could cause other operational problems. The future trend will probably be toward more hydroprocessing because of rising aromatics and S levels so that there may be a need for additives to re-establish desirable properties that have been "processed" out of the fuel (e.g. lubricity).

- As a result of the above, other alternative solutions to an operational problem which might involve modification of an inexpensive engine component or part may be preferable to changing additives or putting new additives in the fuel. This would be particularly the case if modification to the engine or other hardware component involved is restricted to a small fraction of the aircraft in service.
- JP-5, as well as other jet fuels, (except for specialty fuels such as JP-7, RP-1) are not processed with thermal stability as a specific objective but rather to meet the military specifications involved, which do not provide a good means of assessing thermal stability. The work conducted in this program provides much greater insight into the subtleties involved in the processing of JP-5 and how important each one of the unit processes involved in making the fuel is in producing fuel meeting current specifications.

TYPICAL PROCESSING SCHEMES EMPLOYED TO MAKE JP-5

SMALL REFINERIES PAD 5

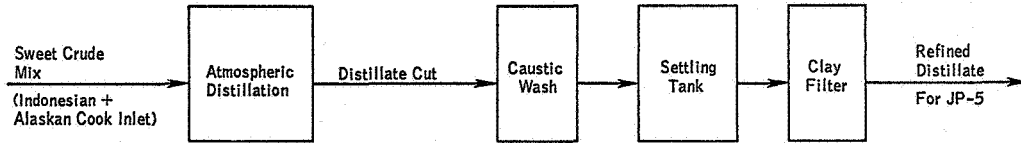

SMALL REFINERY V-B

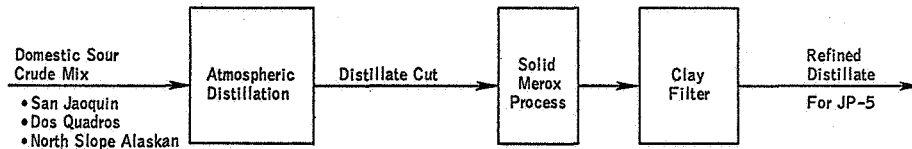

SMALL REFINERY V-C

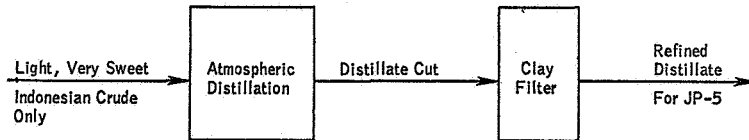

LARGE REFINERIES PAD 5

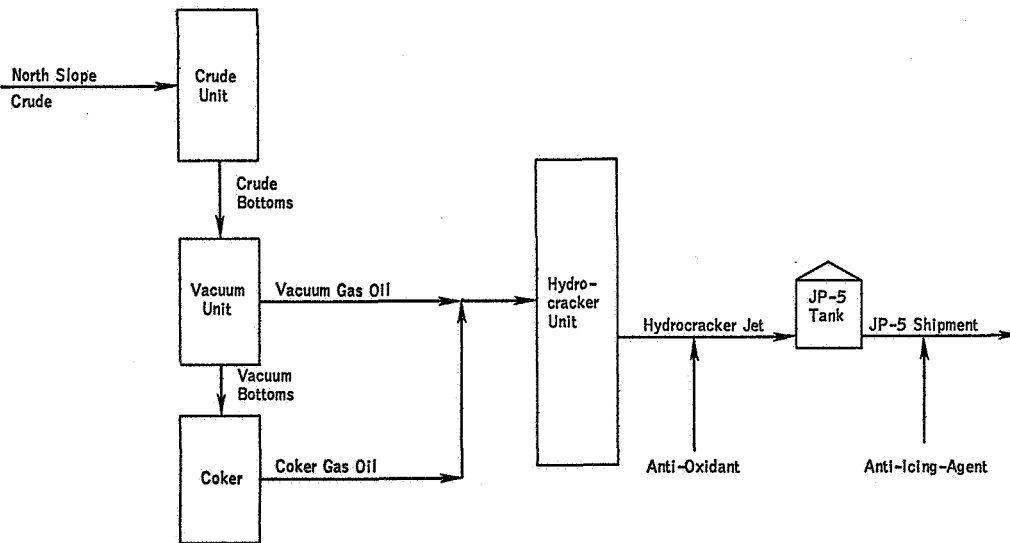

LARGE REFINERIES PAD 5

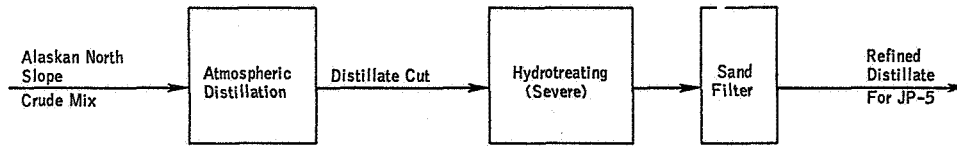

LARGE REFINERY V-E

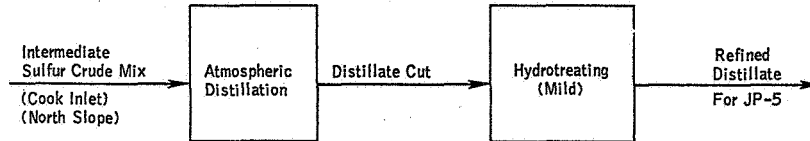

LARGE REFINERY V-F

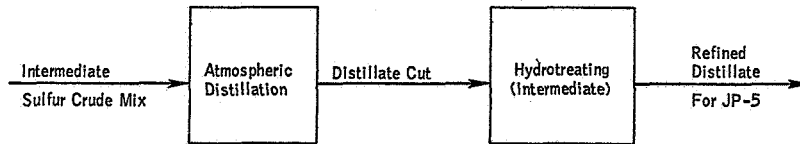

LARGE REFINERIES PAD 3

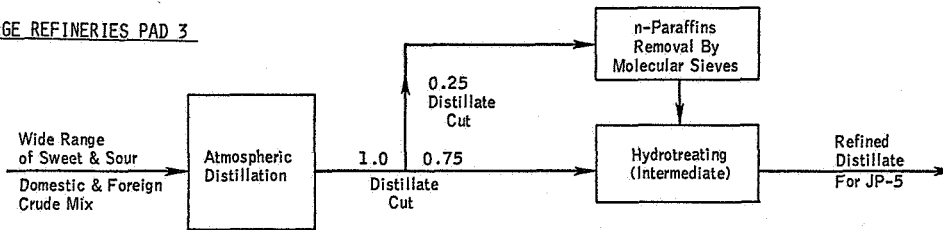

LARGE REFINERY III-B

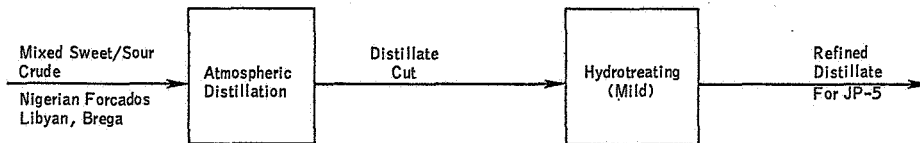

LARGE REFINERY III-C

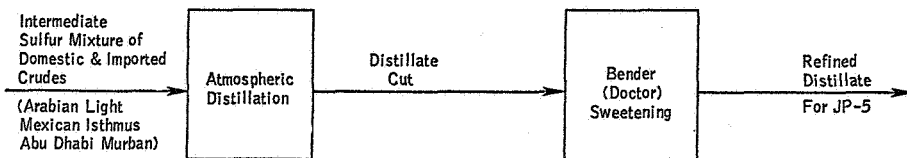

EFFECT OF RELAXATION OF FREEZE/FLASH POINT  
ON MAXIMUM THEORETICAL YIELD - PARAMETRIC REPRESENTATION

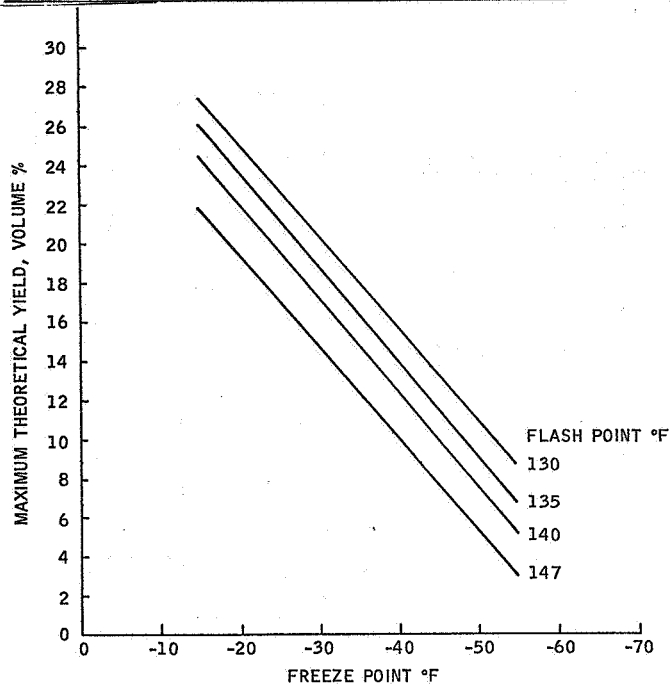

JP-5 POTENTIAL AVAILABILITY

EFFECT OF RELAXATION OF FREEZE POINT

FREEZE POINT OF	MAXIMUM THEORETICAL YIELD(1)					
	CRUDE	A	B	C	D	E
-51 (CURRENT SPECIFICATION)		7.0	19.3	14.2	11.5	12.3
-45		9.9	23.9	17.4	14.4	15.5
% INCREASE OVER CURRENT SPECIFICATION		41%	24%	23%	25%	26%
-40		12.3	27.7	20.0	16.7	18.4
% INCREASE OVER CURRENT SPECIFICATION		76%	44%	41%	45%	50%
-30		17.1	35.3	25.3	21.4	23.9
% INCREASE OVER CURRENT SPECIFICATION		144%	83%	78%	86%	94%
YIELD/FREEZE POINT COEFFICIENT, VOL%/°F		0.48	0.73	0.52	0.47	0.52

(1) CRUDE DESCRIPTION:

- A MEDIUM GRAVITY, HIGH SULFUR MEXICAN CRUDE
- B LIGHT GRAVITY, LOW SULFUR, HIGH AROMATIC INDONESIA CRUDE
- C LIGHT GRAVITY, LOW SULFUR, LOW AROMATIC NIGERIAN CRUDE
- D HEAVY GRAVITY, HIGH SULFUR, HIGH AROMATIC ALASKAN CRUDE
- E LIGHT GRAVITY, LOW SULFUR, CALIFORNIA CRUDE



JP-5 POTENTIAL AVAILABILITY

EFFECT OF RELAXATION OF FLASH POINT

<u>FLASH POINT OF</u>	<u>CRUDE</u>	<u>MAXIMUM THEORETICAL YIELD(1)</u>				
		<u>A</u>	<u>B</u>	<u>C</u>	<u>D</u>	<u>E</u>
147		4.8	15.6	12.2	9.5	9.6
% DECREASE UNDER CURRENT SPECIFICATION		31%	19%	14%	17%	22%
140 (CURRENT SPECIFICATION)		7.0	19.3	14.2	11.5	12.3
135		8.5	21.8	16.0	13.0	14.4
% INCREASE OVER CURRENT SPECIFICATION		21%	13%	13%	13%	17%
130		10.4	24.5	17.7	14.4	16.3
% INCREASE OVER CURRENT SPECIFICATION		49%	27%	25%	25%	33%
YIELD/FLASH POINT COEFFICIENT, VOL%/°F		0.33	0.52	0.32	0.29	0.39

(1) CRUDE DESCRIPTION:

- A MEDIUM GRAVITY, HIGH SULFUR MEXICAN CRUDE
- B LIGHT GRAVITY, LOW SULFUR, HIGH AROMATIC INDONESIAN CRUDE
- C LIGHT GRAVITY, LOW SULFUR, LOW AROMATIC NIGERIAN CRUDE
- D HEAVY GRAVITY, HIGH SULFUR, HIGH AROMATIC ALASKAN CRUDE
- E LIGHT GRAVITY, LOW SULFUR, CALIFORNIA CRUDE