

## LOW TEMPERATURE FUEL BEHAVIOR STUDIES

Francis J. Stockemer  
Lockheed-California Company

An experimental investigation was performed by the Lockheed-California Company\* to study aircraft fuels at low temperatures near the freezing point. The principal objective was an improved understanding of the flowability and pumpability of the fuels in a facility that simulated the heat transfer and temperature profiles encountered during flight in the long range commercial wing tanks.

A test tank simulating a section of an outer wing integral fuel tank, approximately full scale in height, was designed and fabricated. Internal tank construction included stringers, scavenging ejectors, pump inlet surge box, and other details corresponding to an airplane wing tank construction. The test tank was chilled through heat exchange plates on the upper and lower horizontal surfaces. Other surfaces were insulated. A viewing port was installed in each vertical panel. Figure 1 shows a cross-section of the apparatus. Figure 2 is a photograph of the test tank during final assembly. Figure 3 is a view of the lower portion of the completed tank; thermocouple rack 2 is at the center. Table 1 designates thermocouple locations.

Fuels used during the program included commercially obtained Jet A and Diesel D-2, a special JP-5 type derived from oil shale, paraffinic and naphthenic Jet A, Diesel D-2, and intermediate freeze point fuels, and the paraffinic intermediate treated with a pour point depressant; these fuels are itemized in Table 2. The pour point depressant and most of the fuels were furnished through the Coordinating Research Council (CRC) Group on Low Temperature Flow Performance of Aviation Turbine Fuels.

Tests were generally conducted by chilling the tank skins to a nearly constant temperature. During cooldown, cross lighting provided visual evidence of convective currents in the fuel. Fuel was withdrawn from the tank by gravity flow after the fuel reached a desired temperature with time. Suspensions of solid fuel particles were readily withdrawn and presented no obstacle to flow. The accumulation of solid particles remaining at the bottom of the tank, after the liquid was withdrawn, was defined as gravity holdup. For cases where 10% or less of the fuel was held up, the holdup was essentially a solid deposition. At greater holdups, entrapment of liquid fuel within the matrix of solids was discernible. Solid buildup commenced on the bottom of the tank, spread over the lower stringers, then began to form on the upper surfaces and vertical panels. At large holdups, accretions on the walls and upper surfaces sometimes fell and could obstruct gravity flow.

Temperatures measured at the approximate location of a commercial aircraft fuel temperature probe (10 centimeters or above) provided a good measurement of bulk temperature, but ignored lower temperatures near the chilled walls;

---

\*NASA Contract NAS3-20814

this effect is illustrated in Figure 4. Tests were also conducted at a varying wall temperature schedule, with fuel withdrawal occurring over the final 3-hour period to represent an extreme cold condition, long range flight; this schedule is shown in Figure 5, from data in Reference 1. With specification Jet A fuels, all fuel could be withdrawn, but there was evidence (from temperature gradients) of some solid formation at the time of minimum temperatures, and subsequent melting of the solid material. This is illustrated by the sequence of temperature profiles shown in Figure 6.

Sloshing, recirculation, and use of ejectors tended to decrease the temperature difference between the chilled walls and the bulk fuel and indirectly affected the holdup by altering the temperature profiles; this effect is seen in Figure 7. Tests with an internal baffle or with dehydrated fuel showed no change from comparable baseline tests.

Tests with an intermediate distillate fuel, treated with the addition of a suitable pour point depressant, provided a significant reduction in gravity holdup, compared to that of the undoped fuel. For the same temperature schedule, the treated fuel (No. 7) produced 10.2% holdup, compared with 25.5% for the untreated LFP-5 fuel. Tank results agreed with laboratory data reported by the manufacturer of the additive.

Figures 8, 9, 10, and 11 illustrate varying quantities of holdup.

Table 3 itemizes temperatures pertinent to freezing and subsequent gravity holdup.

Figure 12 shows the change in temperature at a specific height for various holdup quantities. Extrapolation of the curves to zero holdup always resulted in a temperature greater than freeze point. However, the effect was useful in controlling tests so as to produce variations in gravity holdup.

This experimental investigation provided considerable insight into the behavior of fuel at low temperatures representative of flight conditions. A rather large quantity of test data was obtained which could furnish material for further analysis.

Results of this investigation are reported in NASA CR-159615 "Experimental Study of Low Temperature Behavior of Aviation Turbine Fuels in a Wing Tank Model". References 1, 2, and 3 provide additional information relative to the use of aviation fuels at low temperatures.

#### REFERENCES

1. Pasion, A. J., and Thomas, I. "Preliminary Analysis of Aircraft Fuel Systems for use with Broadened Specification Jet Fuels" NASA CR-135198, May 1976.
2. Pasion, A. J. "In-flight Fuel Tank Temperature Survey Data" NASA CR-159569, May 1979.
3. Pasion, A. J. "Design and Evaluation of Aircraft Heat Source Systems for Use with High-Freezing Point Fuels" NASA CR-159568, May 1979.

TABLE 1  
DESIGNATION OF THERMOCOUPLE LOCATIONS

HEIGHT ABOVE BOTTOM		INITIAL LOCATION					T58 thru 100	
Cm.	In.	Rack 1	Rack 2	Rack 3	Rack 4	Rack 5	Rack 2	Rack 3
0	0	1	13	25	37	44	13	25
0.6	0.25	-	-	-	-	-	14	26
1.3	0.50	2	14	26	-	-	15	27
2.5	1.00	3	15	27	38	45	-	-
5.1	2.00	4	16	28	-	-	16	28
10.2	4.00	5	17	29	39	46	17	29
20.3	8.00	6	18	30	-	-	18	30
25.4	10.00	-	-	-	40	47	-	-
30.5	12.00	7	19	31	-	-	19	31
40.6	16.00	8	20	32	41	48	20	32
45.7	18.00	9	21	33	-	-	21	33
48.3	19.00	10	22	34	42	49	22	34
49.5	19.50	11	23	35	-	-	-	-
50.2	19.75	-	-	-	-	-	23	35
50.9	20.00	12	24	36	43	50	24	36

Thermocouples 51, 52, and 53 at centers of tank walls (fixed panels).  
Thermocouples 54 and 55 on upper skin each side of longitudinal center.

TABLE 2 - FUELS EMPLOYED IN TEST PROGRAM

FUEL IDENTIF'N.	FUEL TYPE	CRUDE SOURCE	APPROX. FREEZE POINT, °C	APPROX. FINAL BOIL. PT., °C	SPECIFIC GRAVITY, 15°C
No. 1	Jet A	Unknown	-44	257	0.8132
No. 3	Distillate (Diesel D-2)	Unknown	+ 2	326	0.8612
No. 7	Intermediate with Additive	Paraffinic, Same as LFP-5	-31	294	0.8294
No. 8	JP-5	Shale Oil	-34	261	0.8029
LFP-1	Jet A	Paraffinic	-41	267	0.8017
LFP-3	Distillate	Paraffinic	-17	314	0.8285
LFP-4	Distillate	Naphthenic	-14	346	0.8545
LFP-5	Intermediate	Paraffinic	-28	295	0.8299
LFP-6	Intermediate	Naphthenic	-28	282	0.8478
LFP-7	Distillate	Paraffinic, Same as LFP-1	-10	316	0.8251
LFP-8	Jet A	Naphthenic, Same as LFP-6	-52	263	0.8273
LFP-9	Jet A	Paraffinic, Same as LFP-3	-46	255	0.8001

TABLE - 3 COMPARISON OF SOLID-LIQUID TEMPERATURES

CHARACTERISTIC	FUEL No. 1	FUEL No. 3	FUEL No. 7	FUEL No. 8	FUEL LFP-1	FUEL LFP-3	FUEL LFP-4	FUEL LFP-5	FUEL LFP-6	FUEL LFP-7	FUEL LFP-8	FUEL LFP-9
Average Freeze Point (from Appendix A)					-41	-17	-14	-28	-28	-10		-46
NASA Freeze Point	-38	-14	-31	-34	-42	-19	-16	-30	-29	-7	-52	-45
Shell Cold Flow Test, Zero Holdup					-43	-15	-24	-30	-30	-15		-45
Shell Pour Point					-47	-30	-37	-32	-36	-18		-48
Lockheed Pour Point	-52	-21	-46	-37	-51	-27	-26	-38	-38	-18	-53	-48
Solid/Liquid Interface	-47	-24	-45	-33	-44	-20	-22	-31	-32	-12	-54	-46

(All temperatures in °C)

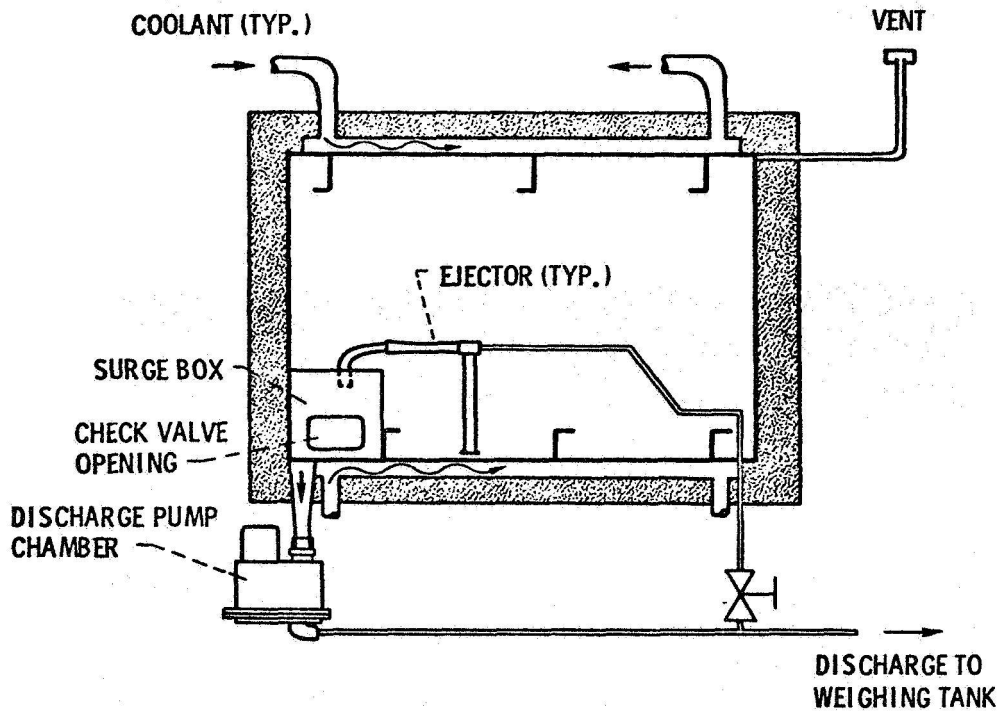

Figure 1. - Cross-section of apparatus.

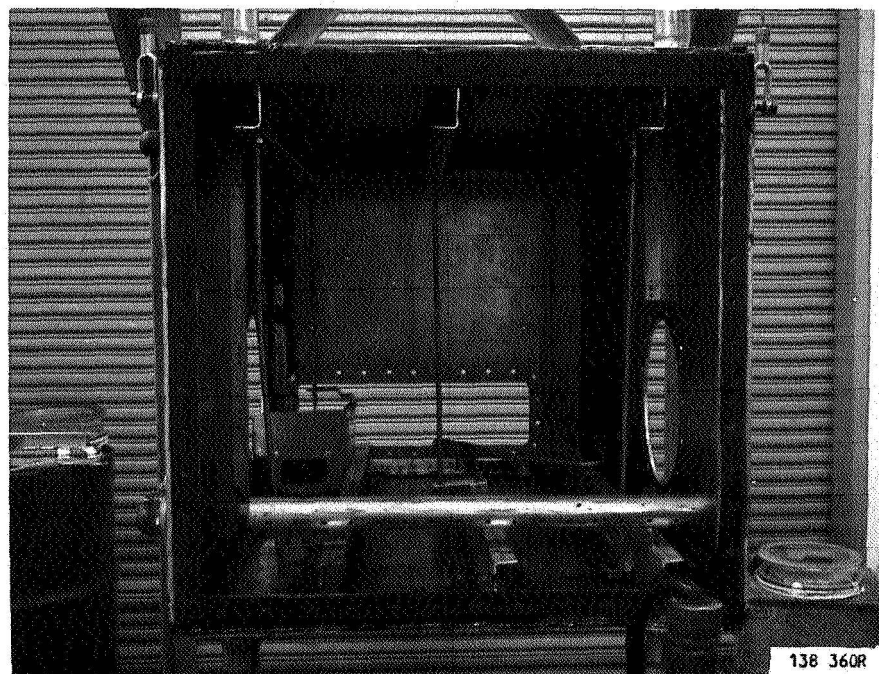

Figure 2 - Test Tank During Final Assembly, End Panel Removed

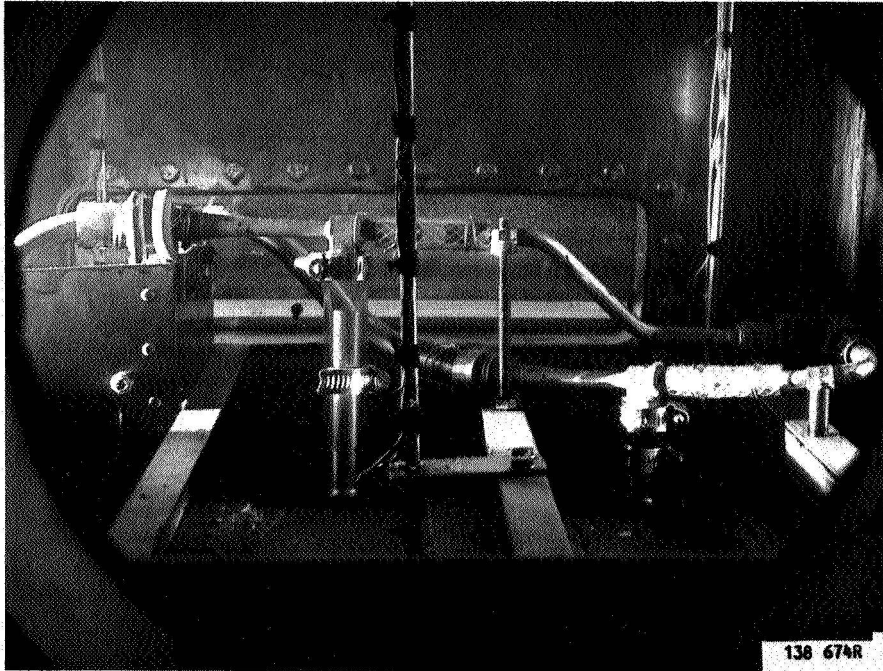

Figure 3 - Looking Through Fuel in Tank At Start of Test

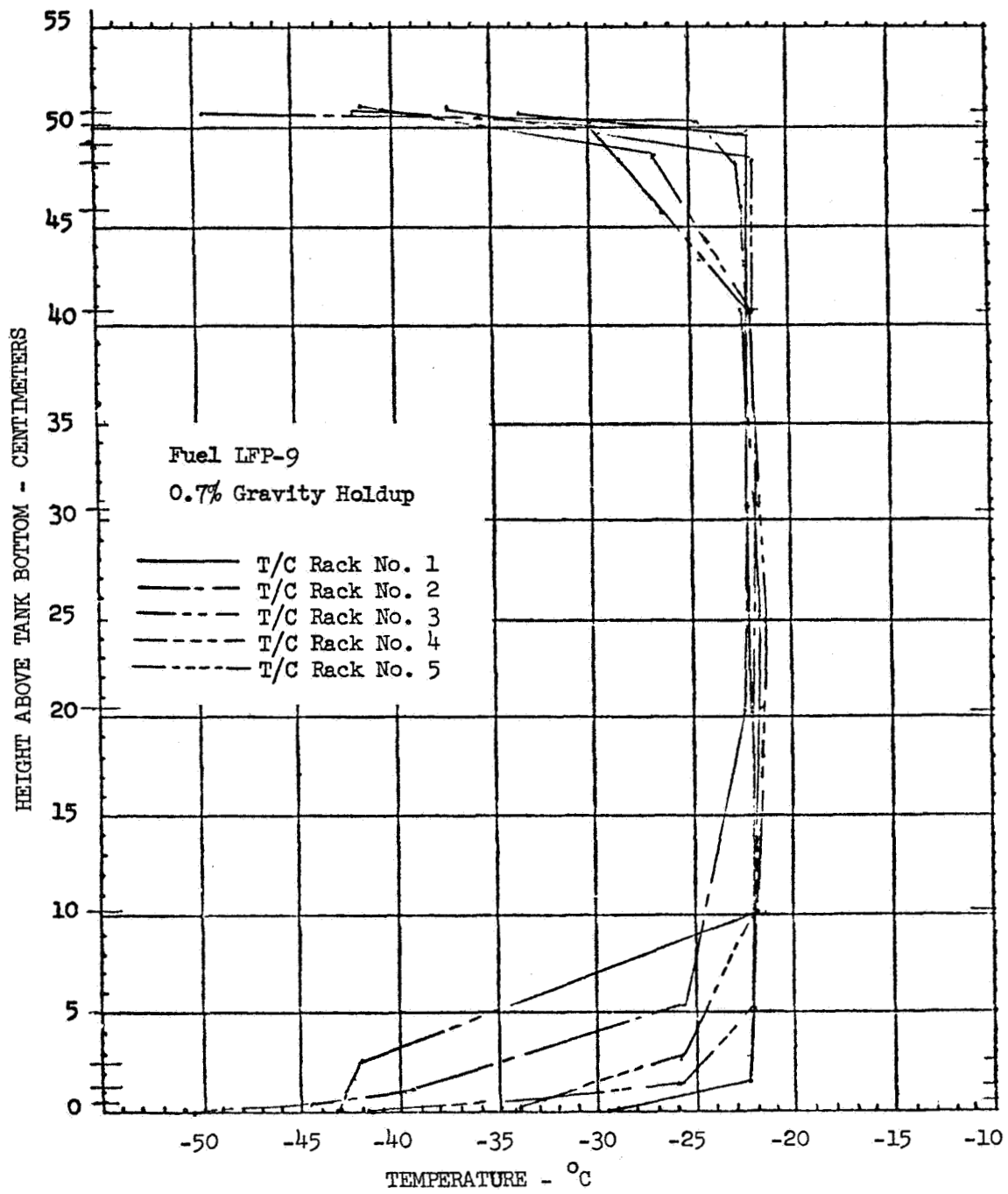

Figure - 4 Temperature Distribution at End of Test 75

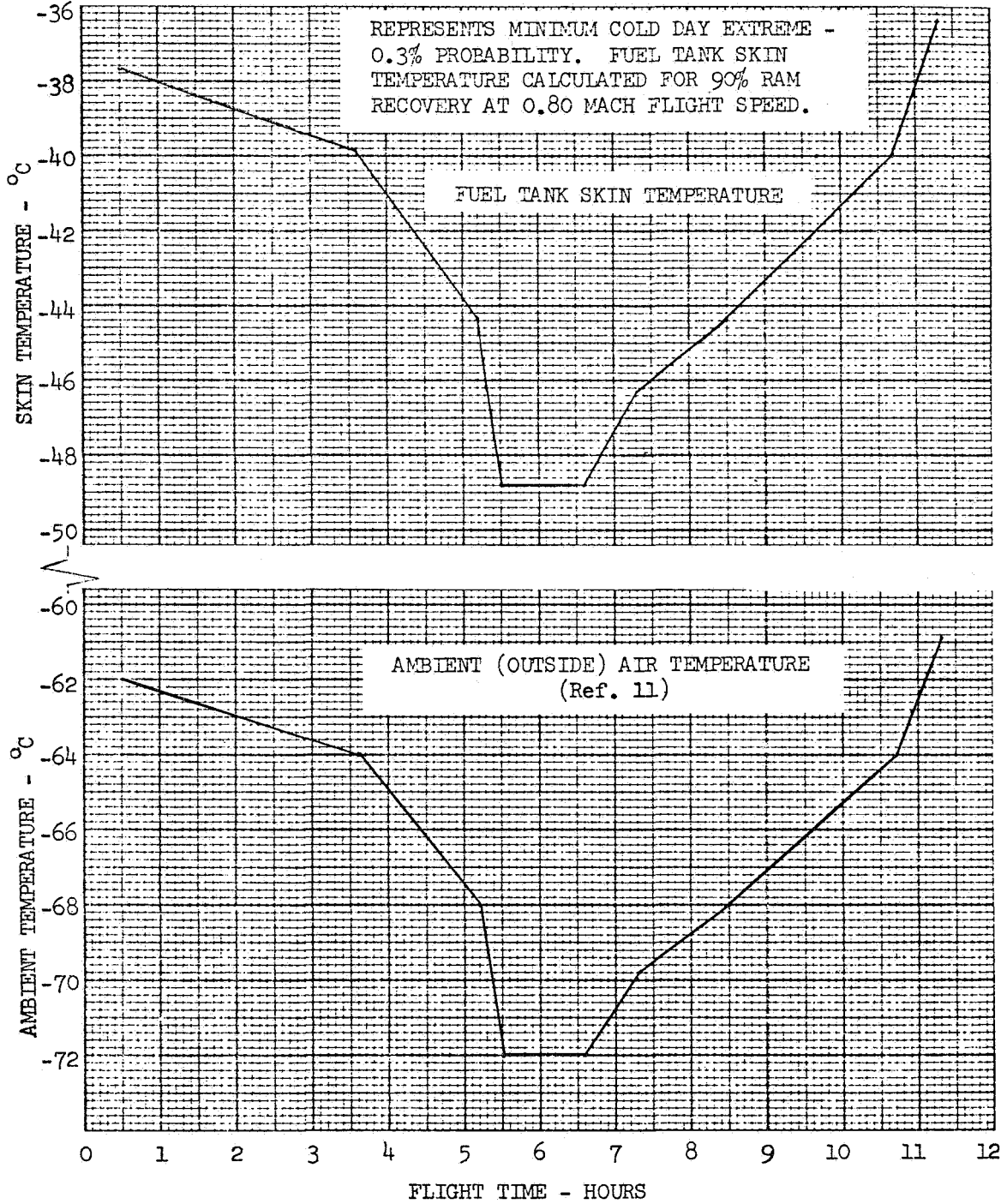

Figure - 5 Temperature Schedule for Scheduled Withdrawal Tests



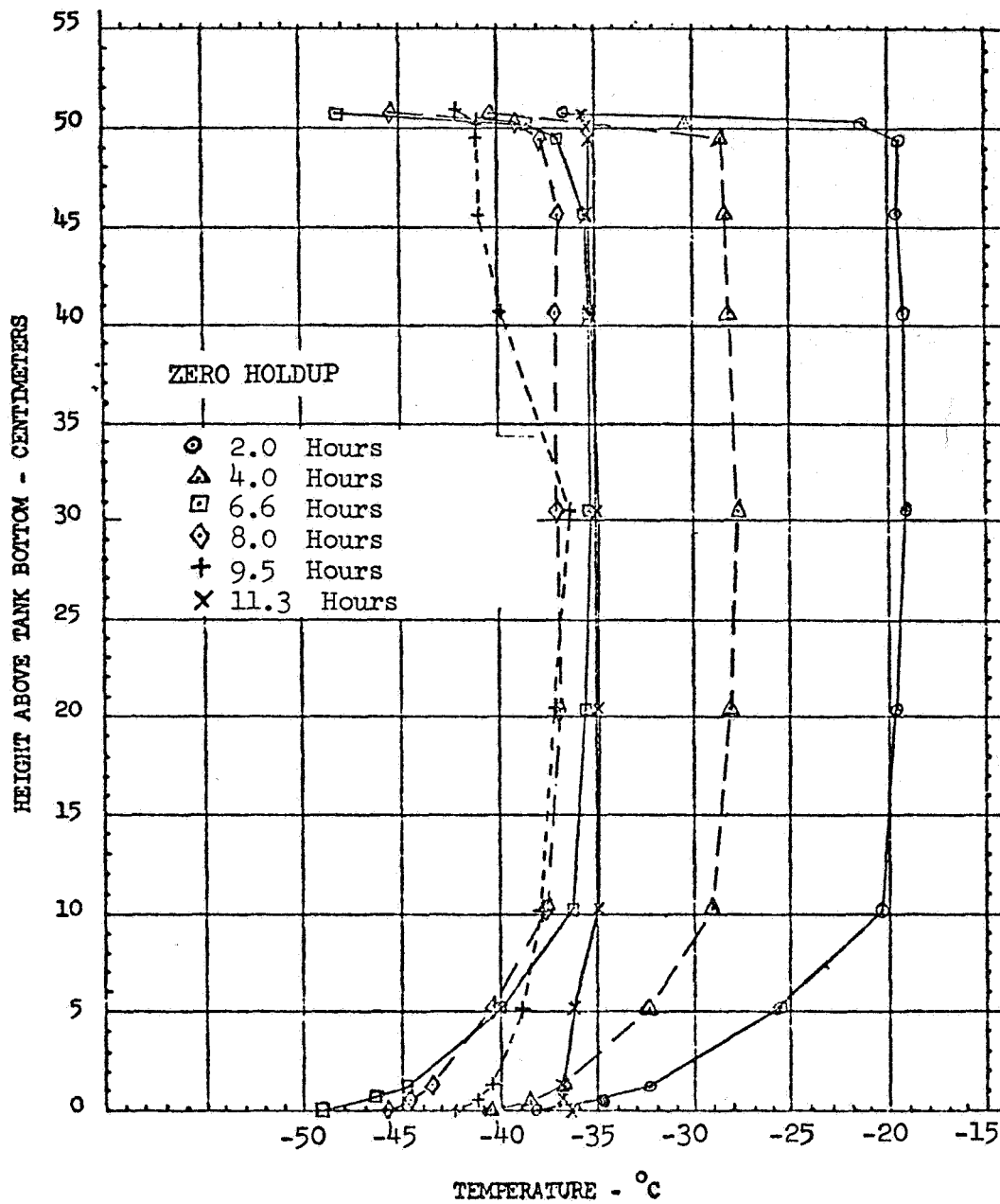

Figure - 6 Temperature Profiles at Center of Tank, Test 94 Scheduled Withdrawal, LFP-9 Fuel

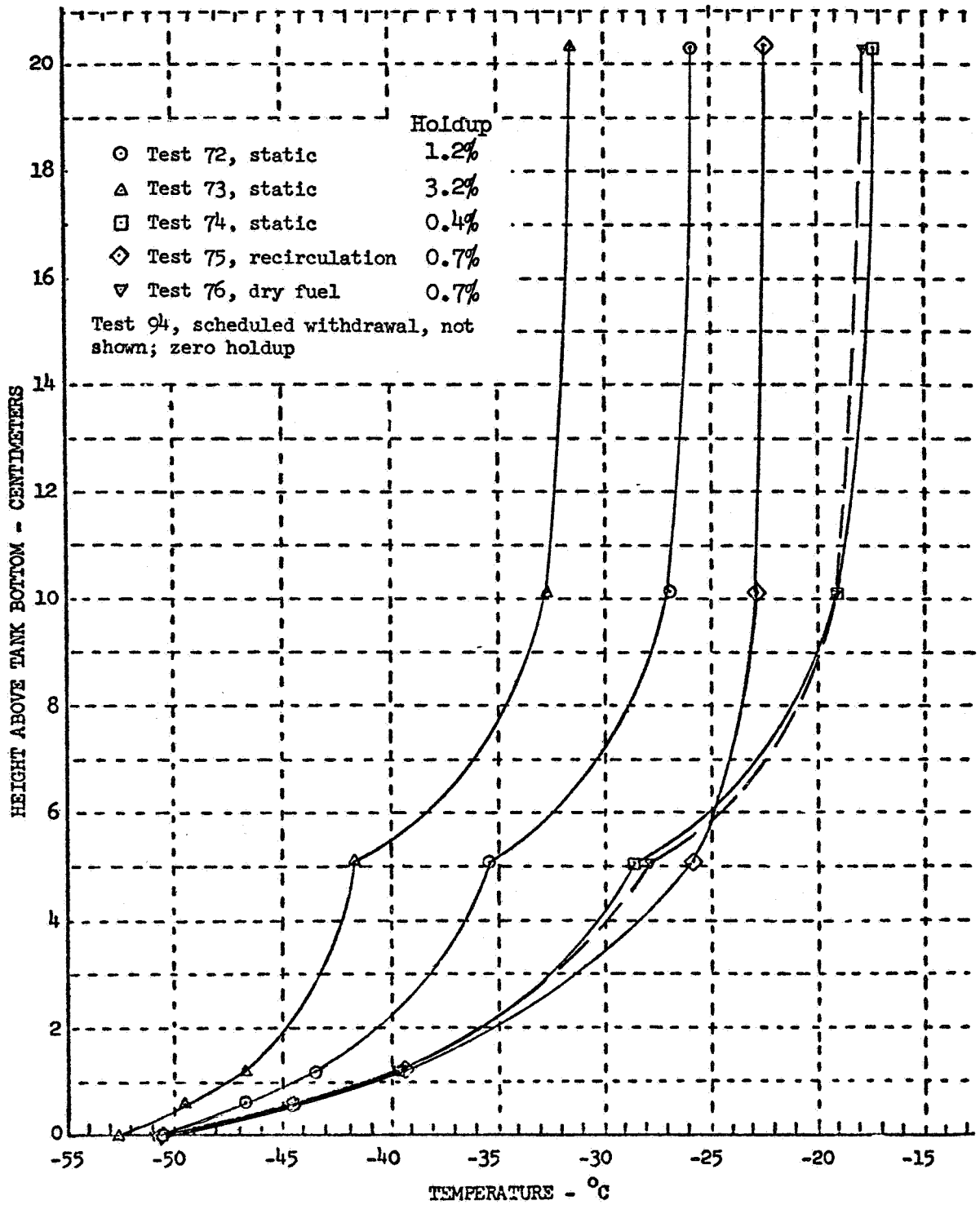

Figure - 7 Temperature Profiles from Center of Tank at End of Tests - Fuel LFP-9

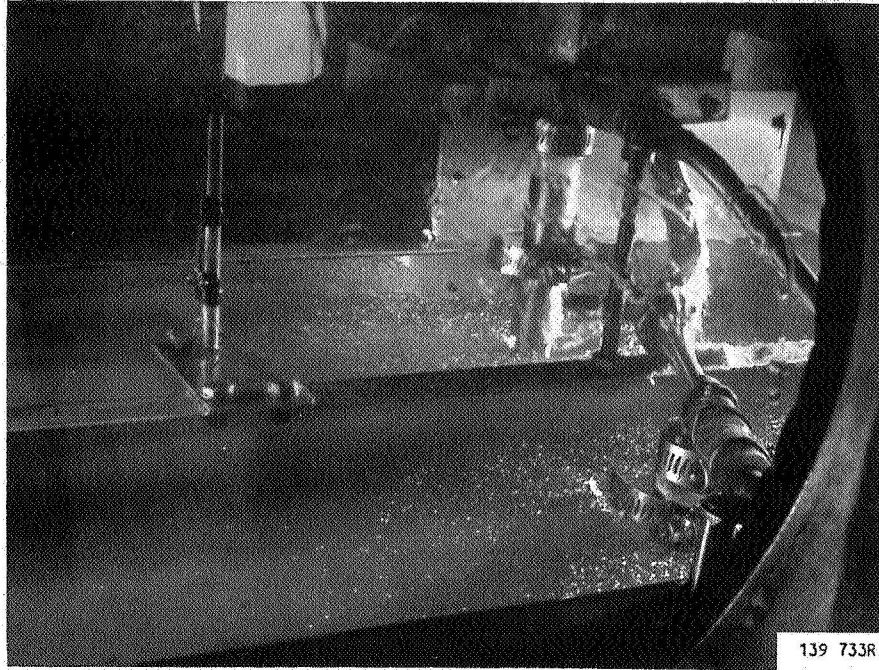

Figure 8 - Gravity Holdup of 3.2% at End of Test 73, LFP-9 Fuel

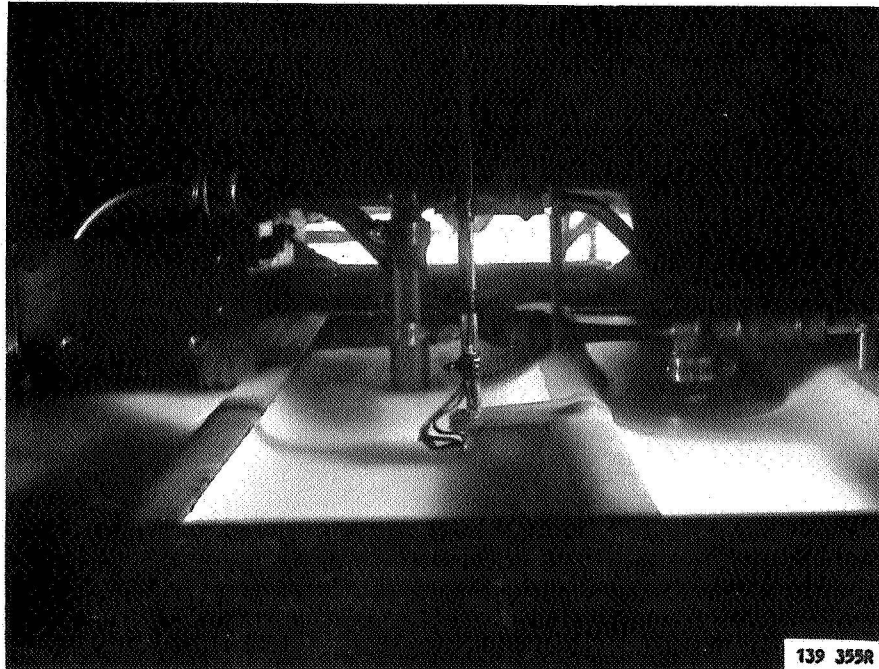

Figure 9 - Gravity Holdup of 4.5% at End of Test 46, LFP-7 Fuel

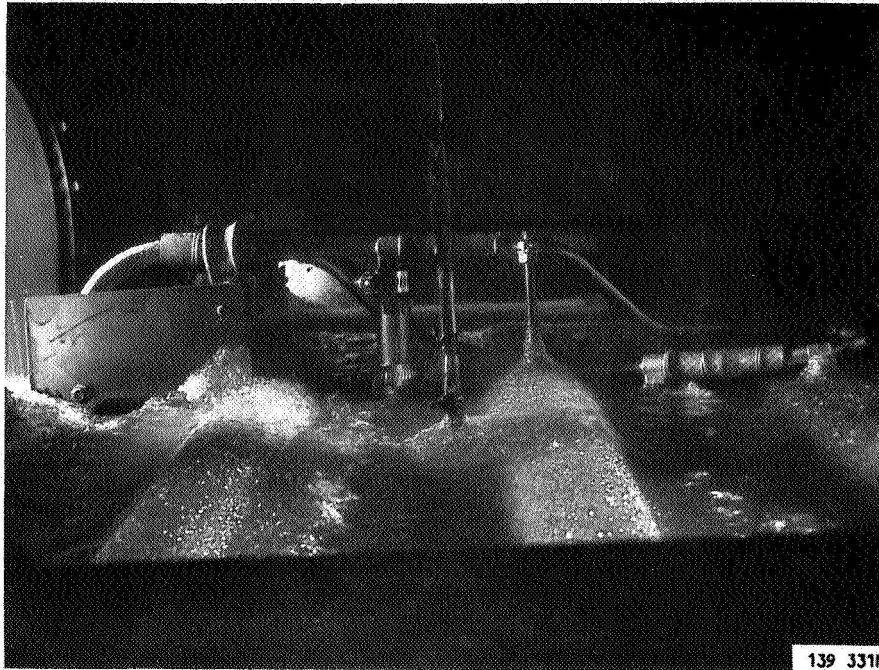

Figure 10 - Gravity Holdup of 8.8% at End of Test 41, LFP-6 Fuel

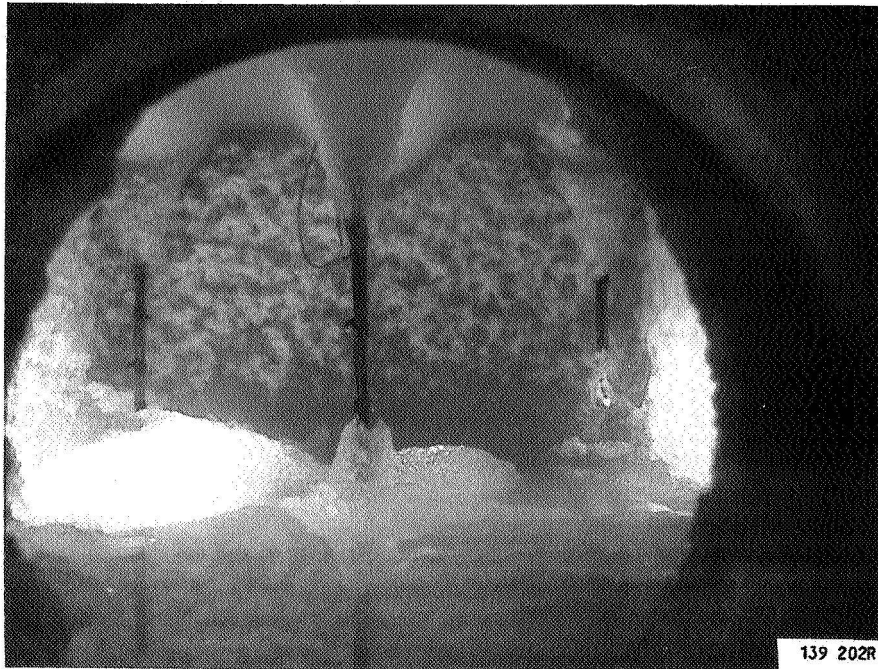

Figure 11 - Gravity Holdup of 57.2% at end of Test 36, LFP-1 Fuel

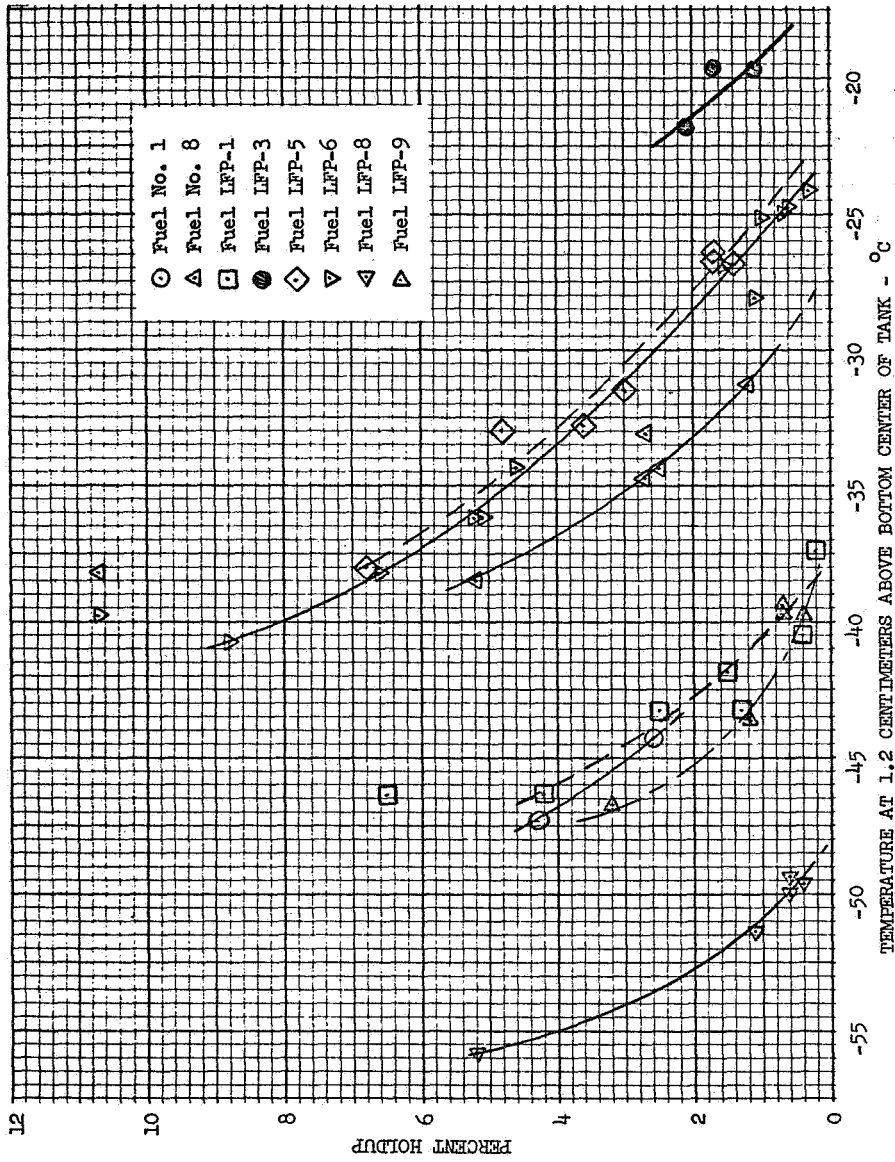

Figure - 12 Temperature at 1.2 Centimeters Above Bottom vs Percent Holdup