

## DOUBLY-PERIODIC ORBITS IN THE SUN-EARTH-MOON SYSTEM

R. Farquhar and D. Muhonen  
Goddard Space Flight Center  
and  
D. Dunham  
Computer Sciences Corporation

### ABSTRACT

A series of periodic orbits in the Earth-Moon circular restricted problem of three bodies has been found which is ideally suited for exploring the Earth's geomagnetic tail. The mean apsidal motion of the basic highly elliptical Earth orbit is maintained at about one degree per day by a sequence of lunar swingbys, keeping the apogees in the anti-Sun direction. Hence, the orbits are periodic in reference frames rotating at both lunar and solar rates. Apogee distances are alternately raised and lowered by the lunar swingby maneuvers. Several categories of these "Sun-synchronous" double lunar swingby orbits are identified. The strength and flexibility of this new trajectory concept is demonstrated with real-world simulations. A large variety of trajectory shapes can be used to explore the Earth's geomagnetic tail between 60 and 250  $R_E$ . Some of these orbits will be shown in a movie. NASA plans to use this technique during its proposed four-spacecraft program called Origins of Plasmas in the Earth's Neighborhood (OPEN). More details can be found in AIAA Paper 80-0112, "A New Trajectory Concept for Exploring the Earth's Geomagnetic Tail."

The following plots are a representative sample of the many existing types of these doubly-periodic orbits. The gravity model employed consisted of the Earth and Moon point masses, and the Moon's orbit was assumed to be circular. A patched-conic method was used for orbit computations. All trajectories are in the moon's orbital plane, and a projection of the Sun-Earth line is shown as a fixed reference. A classification scheme is used whereby each periodic orbit is specified by four numbers, [A, B, C, D], where:

"A" is the approximate number of months between lunar swingbys in the inner segment.

"B" is the number of complete circuits (apogees) in the inner segment.

"C" is the approximate number of months between lunar swingbys in the outer segment.

"D" is the number of complete circuits (perigees) in the outer segment.

"D" equals zero with most orbits applicable to magnetospheric studies, so these are specified by only three numbers, [A, B, C]. For "D" larger than zero, the orbits become butterfly shaped, with the spacecraft spending most of its time far from the anti-Sun line outside the geomagnetic tail. For "C" greater than 3 and "D" equals zero, the outer loop extends well beyond the Sun-Earth  $L_2$  libration point, where strong solar perturbations make the restricted Earth-Moon model unrealistic.

DOUBLE LUNAR SWINGBY ORBIT - (1.1.1) CLASS

PERIGEE 5.9 RE  
 APOGEE-1 86 RE  
 APOGEE-2 141 RE

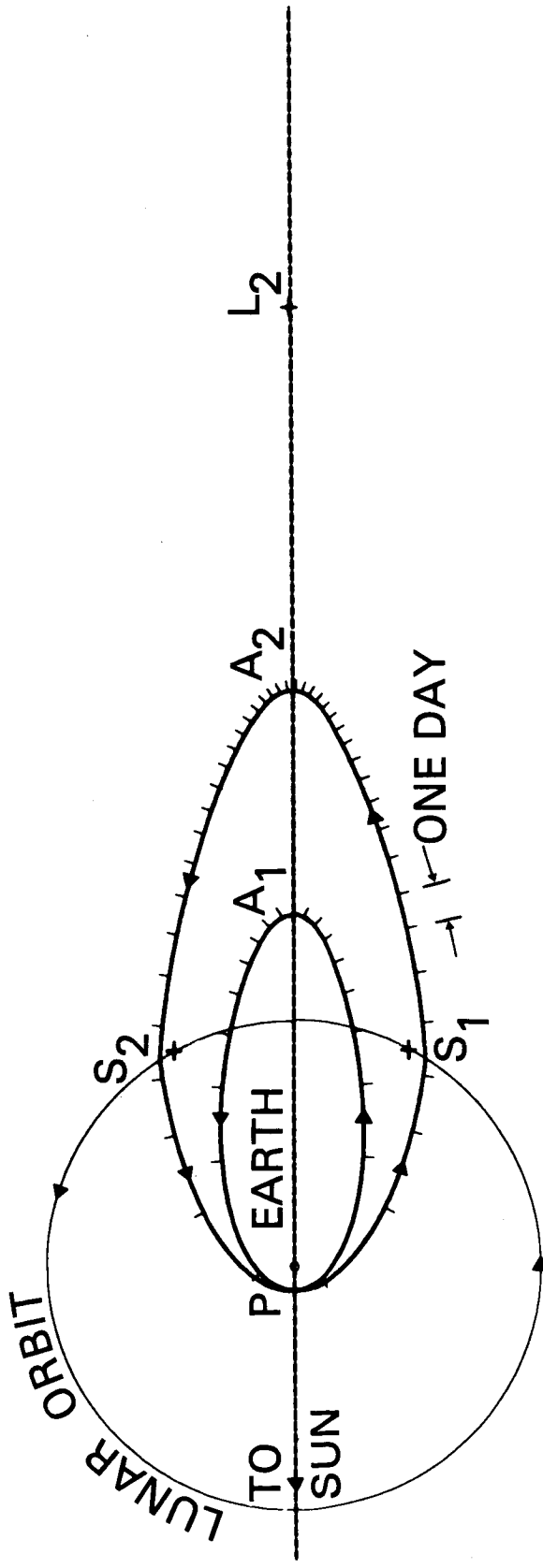

PERILUNE RADIUS AT LUNAR SWINGBYS 27.664 KM

DOUBLE LUNAR SWINGBY ORBIT - (1.1.2) CLASS

PERIGEE 5.4 RE  
 APOGEE-1 87 RE  
 APOGEE-2 205 RE

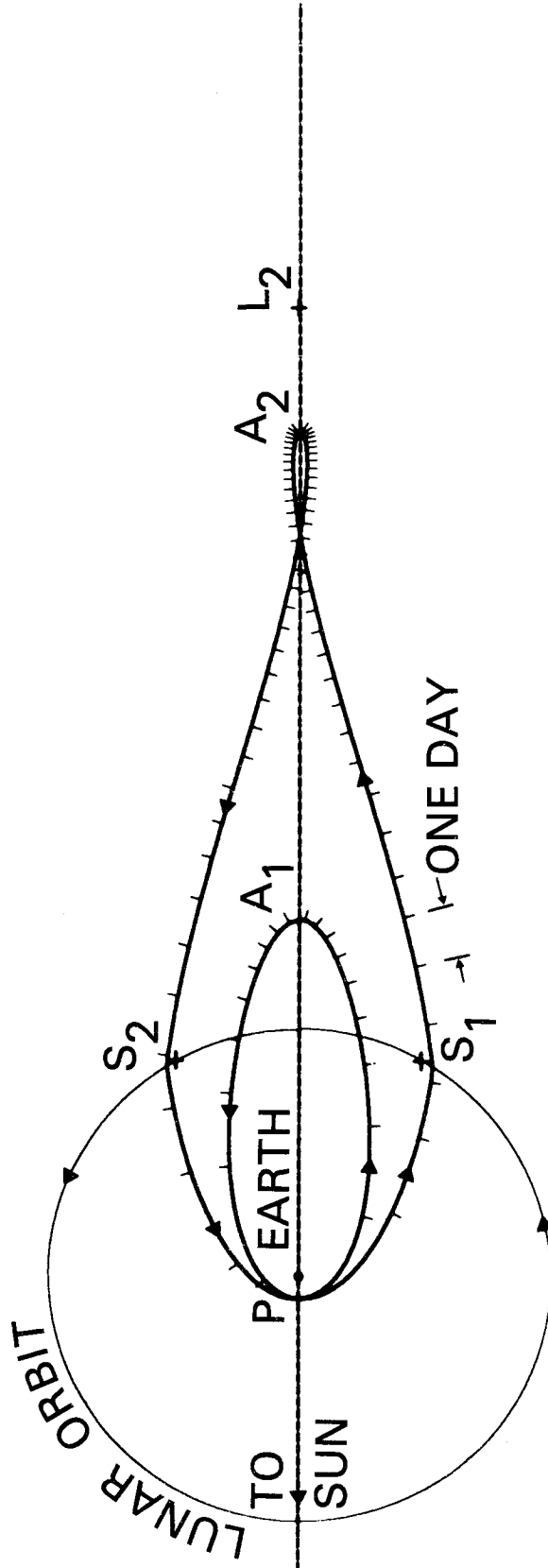

PERILUNE RADIUS AT LUNAR SWINGBYS 18.104 KM

DOUBLE LUNAR SWINGBY ORBIT - (1.1.3) CLASS

PERIGEE 7.1 RE  
 APOGEE-1 82 RE  
 APOGEE-2 257 RE

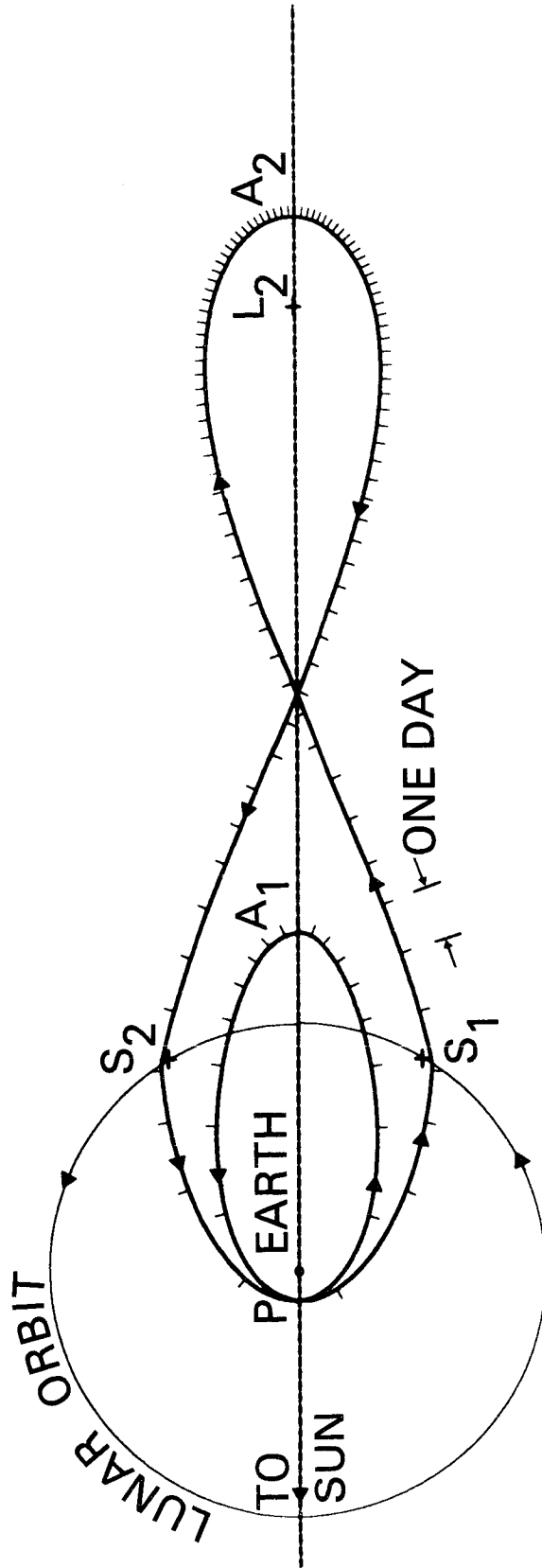

PERILUNE RADIUS AT LUNAR SWINGBYS 15.766 KM

DOUBLE LUNAR SWINGBY ORBIT - (2.3.1) CLASS

PERIGEE 6.0 RE  
 APOGEE-1 75 RE  
 APOGEE-2 141 RE

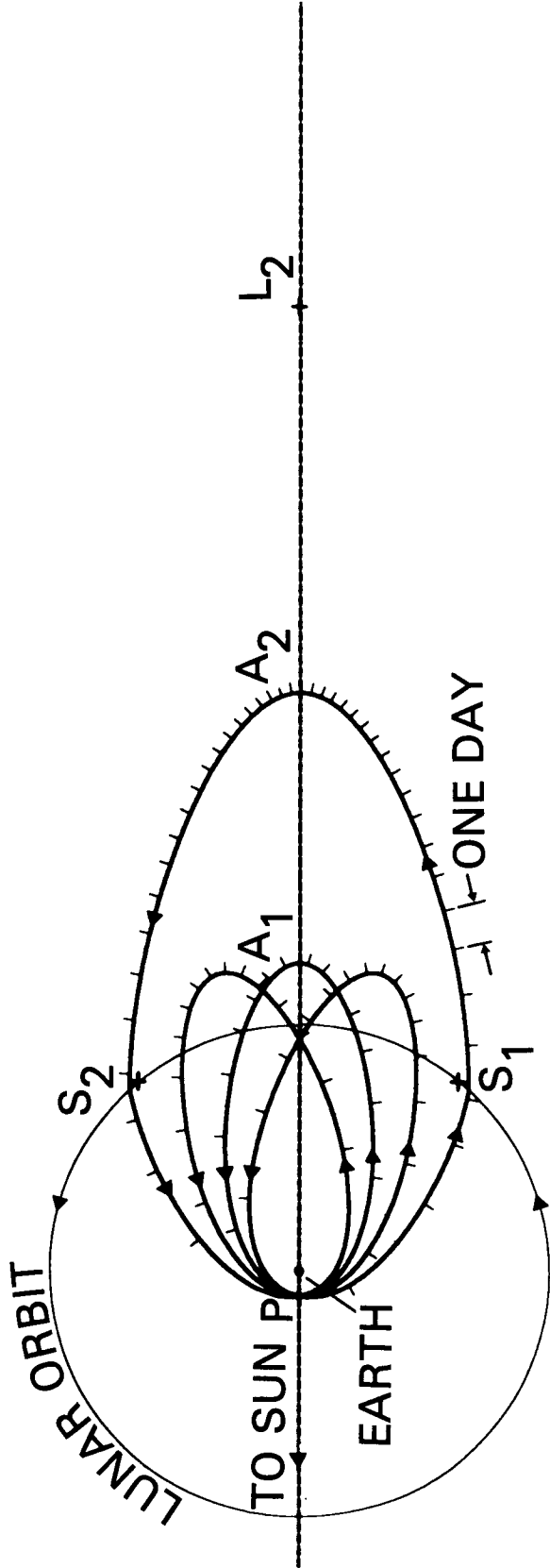

PERILUNE RADIUS AT LUNAR SWINGBYS 19.936 KM

DOUBLE LUNAR SWINGBY ORBIT - (2.4.2) CLASS

PERIGEE 1.0 RE  
 APOGEE-1 67 RE  
 APOGEE-2 205 RE

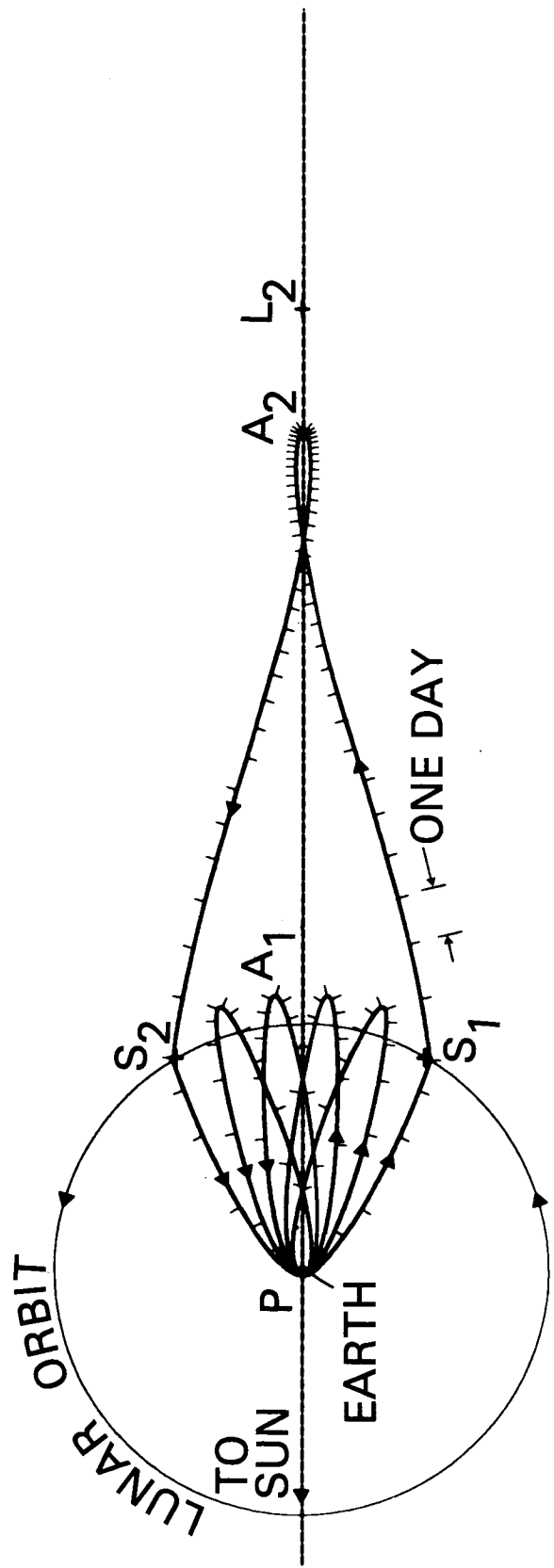

PERILUNE RADIUS AT LUNAR SWINGBYS 7.831 KM

DOUBLE LUNAR SWINGBY ORBIT - (3.4.3) CLASS

PERIGEE 16.2 RE  
 APOGEE-1 72 RE  
 APOGEE-2 249 RE

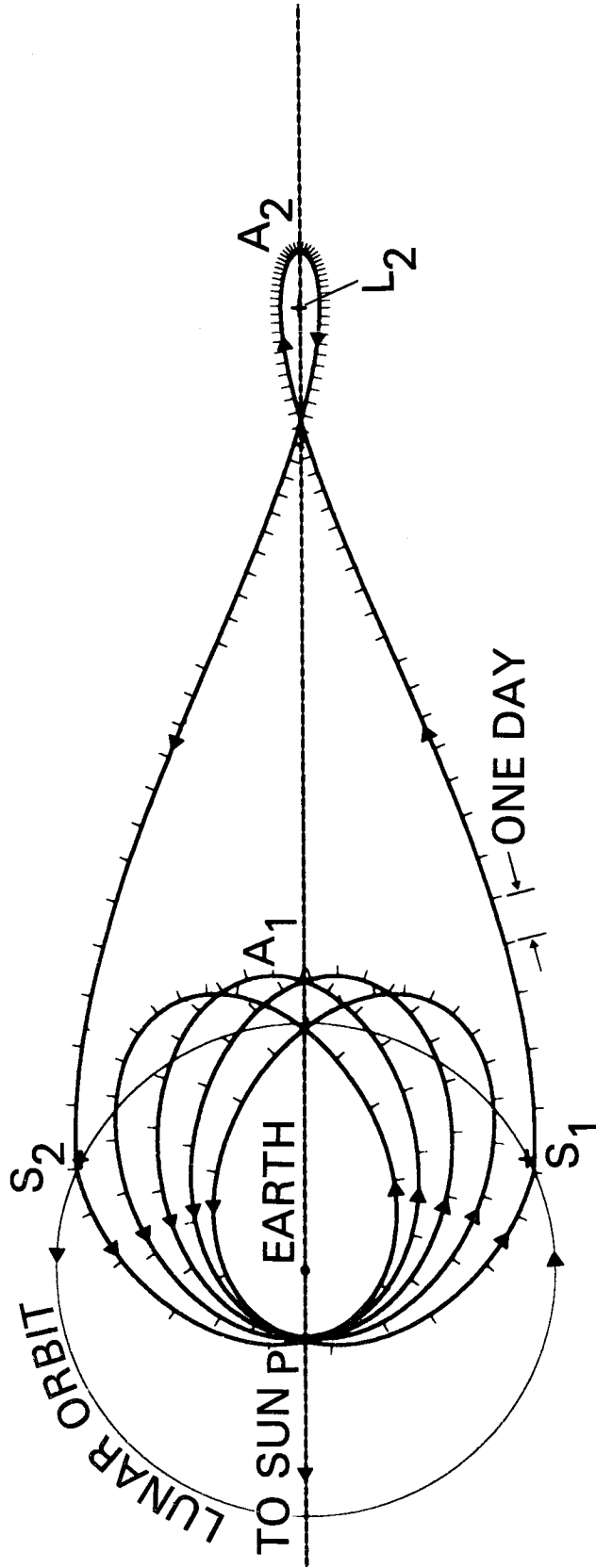

PERILUNE RADIUS AT LUNAR SWINGBYS 19.712 KM



DOUBLE LUNAR SWINGBY ORBIT - (3.5.1) CLASS

PERIGEE 8.5 RE  
 APOGEE-1 70 RE  
 APOGEE-2 139 RE

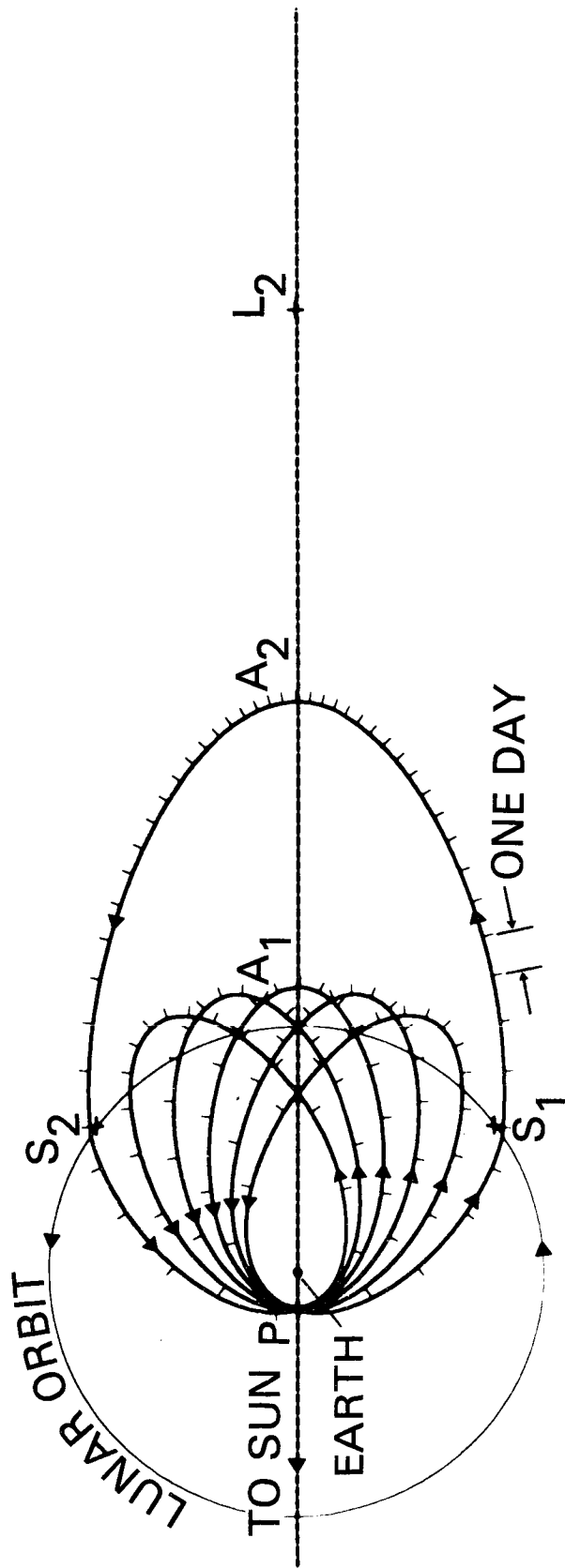

PERILUNE RADIUS AT LUNAR SWINGBYS 19.489 KM

DOUBLE LUNAR SWINGBY ORBIT - (3.6.2) CLASS

PERIGEE 3.9 RE  
 APOGEE-1 66 RE  
 APOGEE-2 202 RE

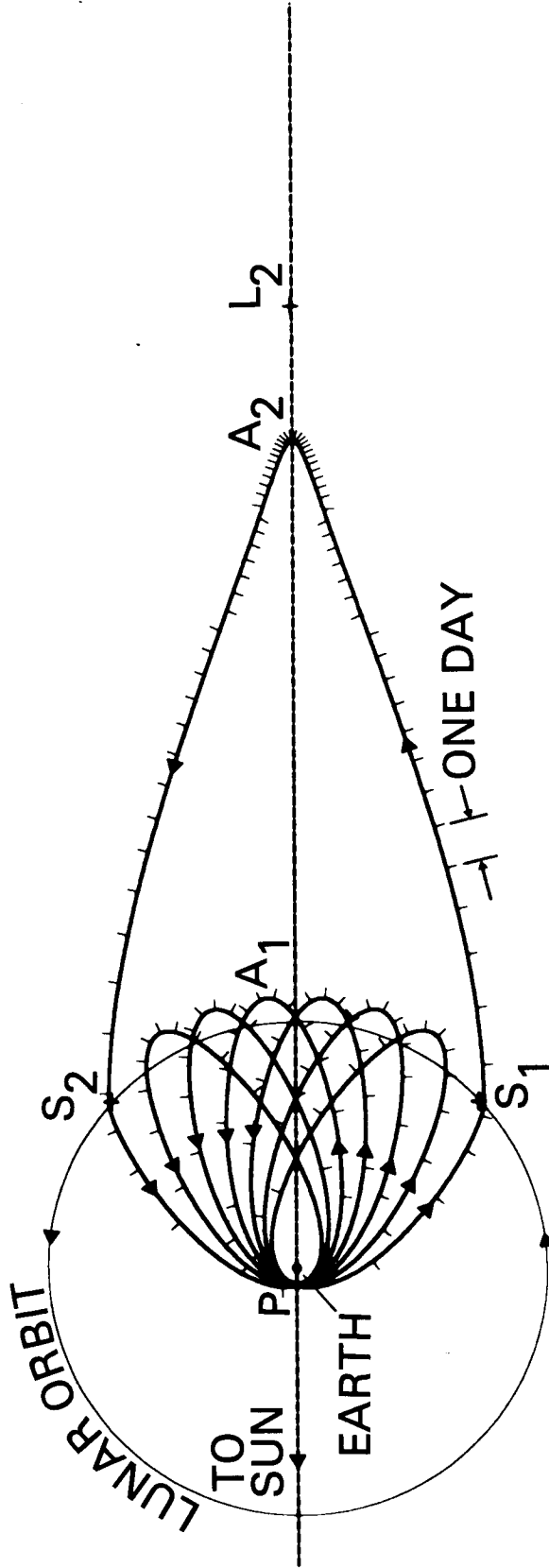

PERILUNE RADIUS AT LUNAR SWINGBYS 9.536 KM

DOUBLE LUNAR SWINGBY ORBIT - (3.7.3) CLASS

PERIGEE 2.0 RE  
 APOGEE-1 61 RE  
 APOGEE-2 256 RE

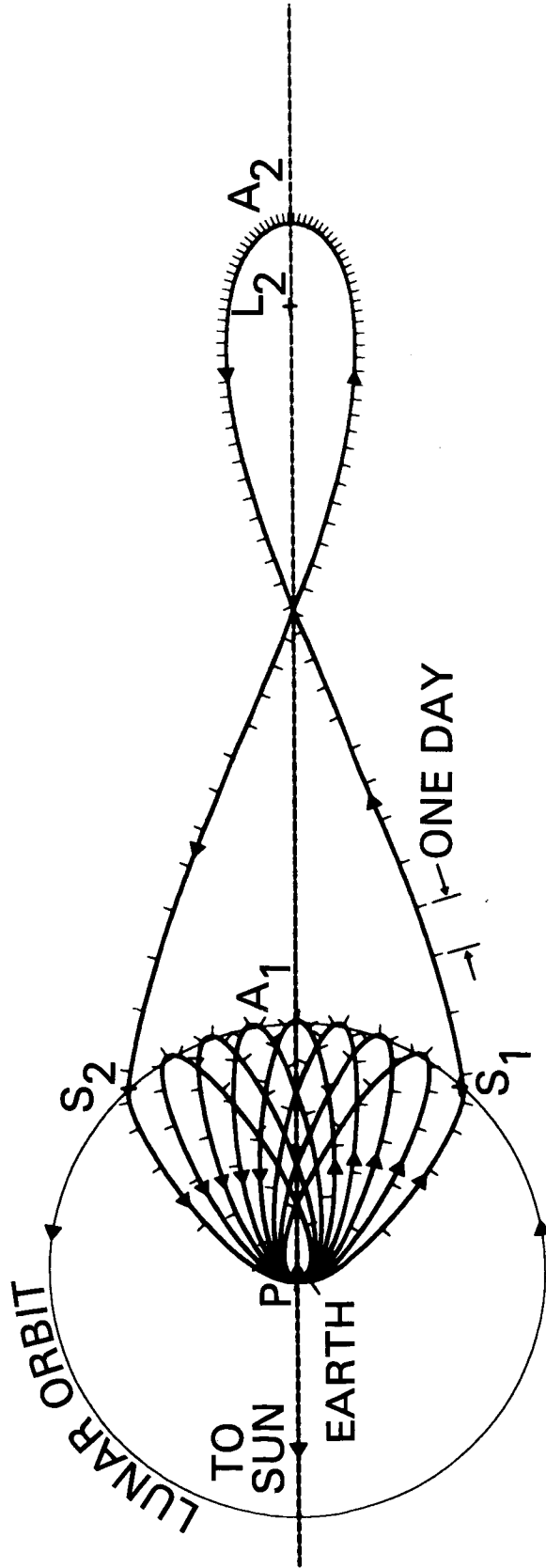

PERILUNE RADIUS AT LUNAR SWINGBYS 4.795 KM

DOUBLE LUNAR SWINGBY ORBIT - (4.8.1) CLASS

PERIGEE 7.1 RE  
 APOGEE-1 64 RE  
 APOGEE-2 139 RE

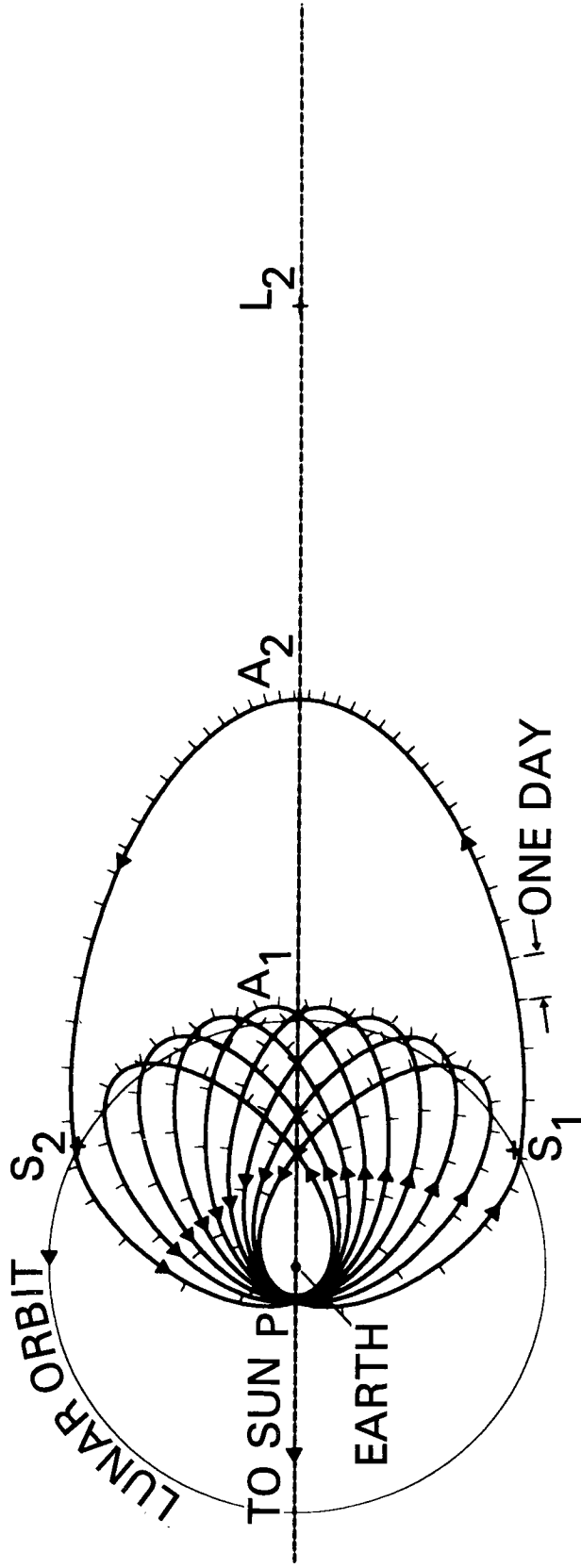

PERILUNE RADIUS AT LUNAR SWINGBYS 13.404 KM

DOUBLE LUNAR SWINGBY ORBIT - (4.9.2) CLASS

PERIGEE 4.1 RE  
 APOGEE-1 62 RE  
 APOGEE-2 200 RE

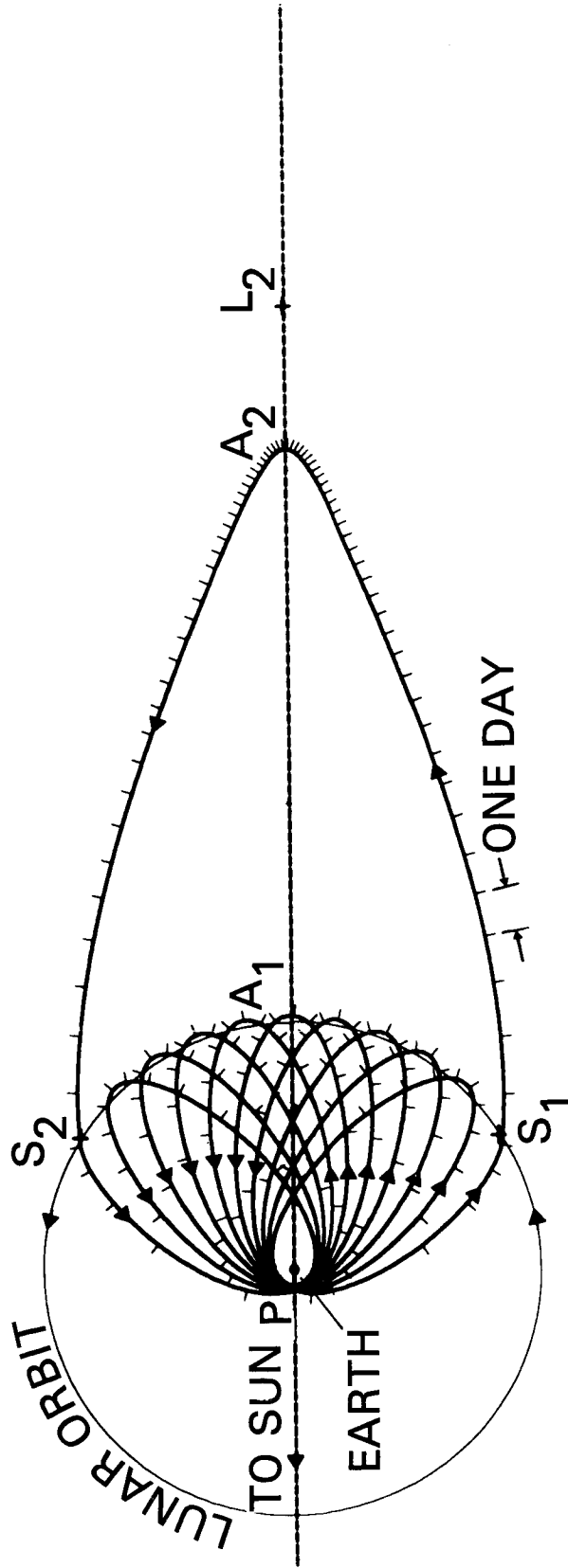

PERILUNE RADIUS AT LUNAR SWINGBYS 6.944 KM

DOUBLE LUNAR SWINGBY ORBIT - (5.10.3) CLASS

PERIGEE 9.9 RE  
 APOGEE-1 62 RE  
 APOGEE-2 248 RE

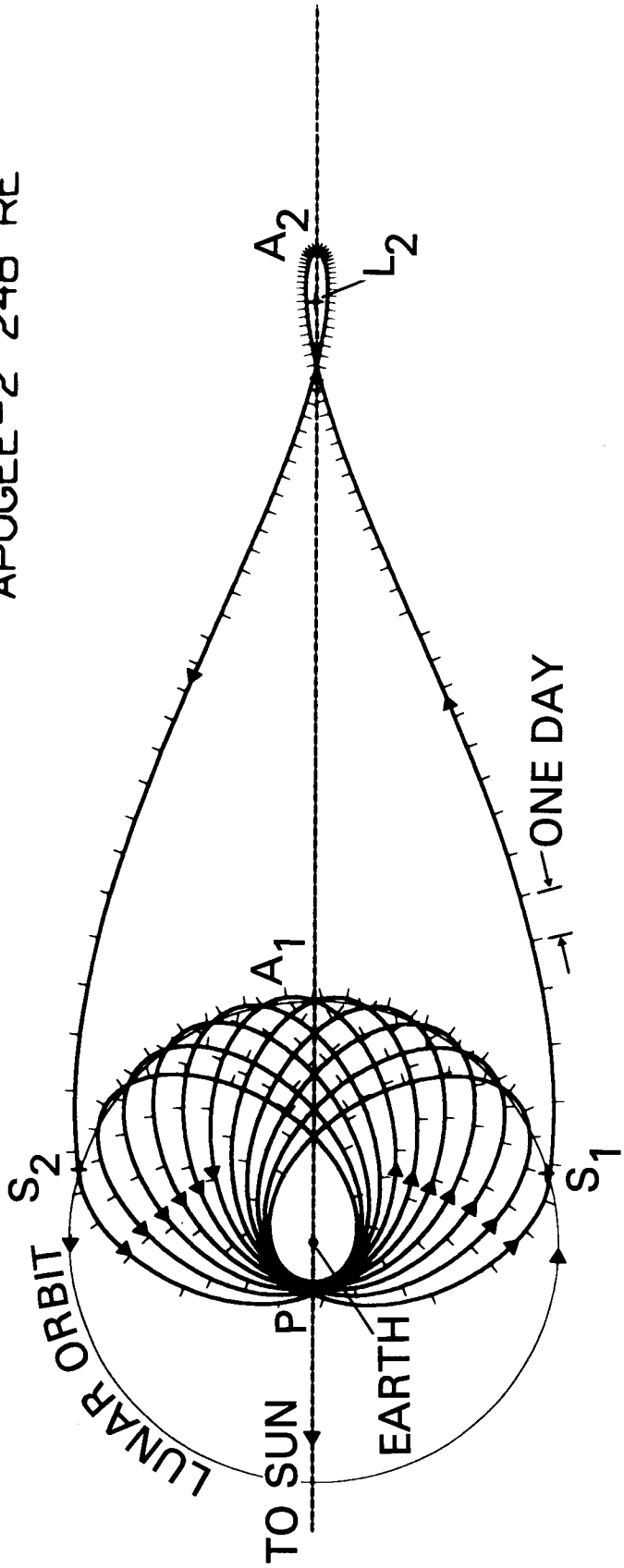

PERILUNE RADIUS AT LUNAR SWINGBYS 7.924 KM

DOUBLE LUNAR SWINGBY ORBIT - (5.11.1) CLASS

PERIGEE 6.7 RE  
 APOGEE-1 61 RE  
 APOGEE-2 138 RE

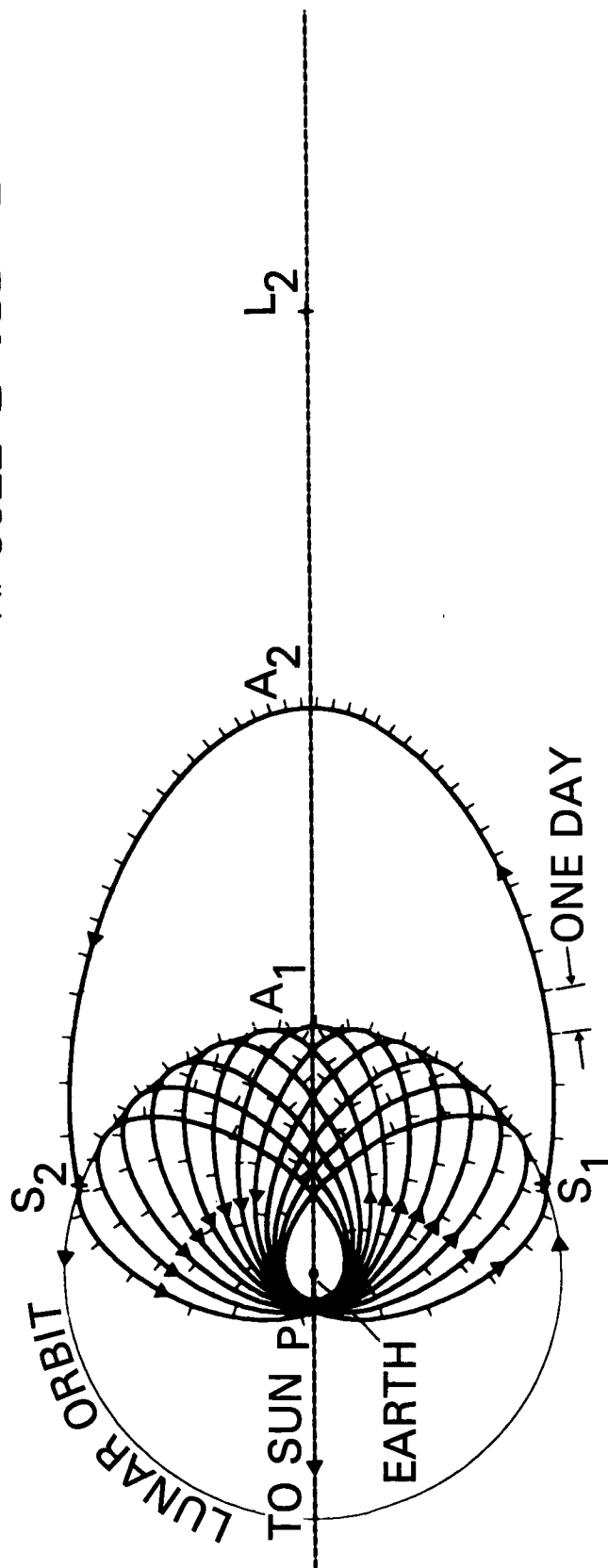

PERILUNE RADIUS AT LUNAR SWINGBYS 8.070 KM

DOUBLE LUNAR SWINGBY ORBIT - (1.1.3.1) CLASS

PERIGEE-1	11.4 RE
PERIGEE-2	33 RE
APOGEE-1	73 RE
APOGEE-2	148 RE

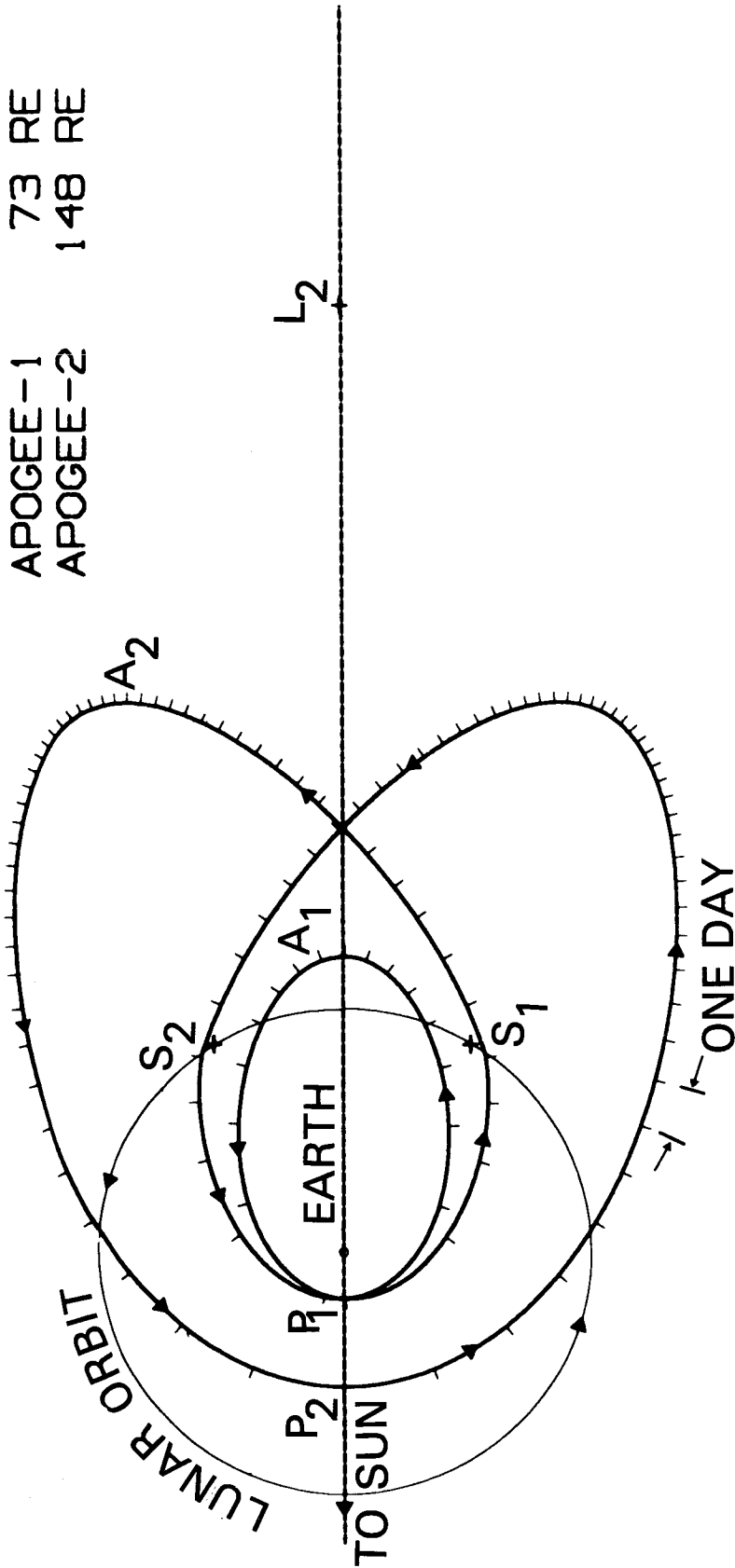

PERILUNE RADIUS AT LUNAR SWINGBYS 24.116 KM



DOUBLE LUNAR SWINGBY ORBIT - (1.1.4.2) CLASS

PERIGEE-1	14.9 RE
PERIGEE-2	41 RE
APOGEE-1	66 RE
APOGEE-2	123 RE

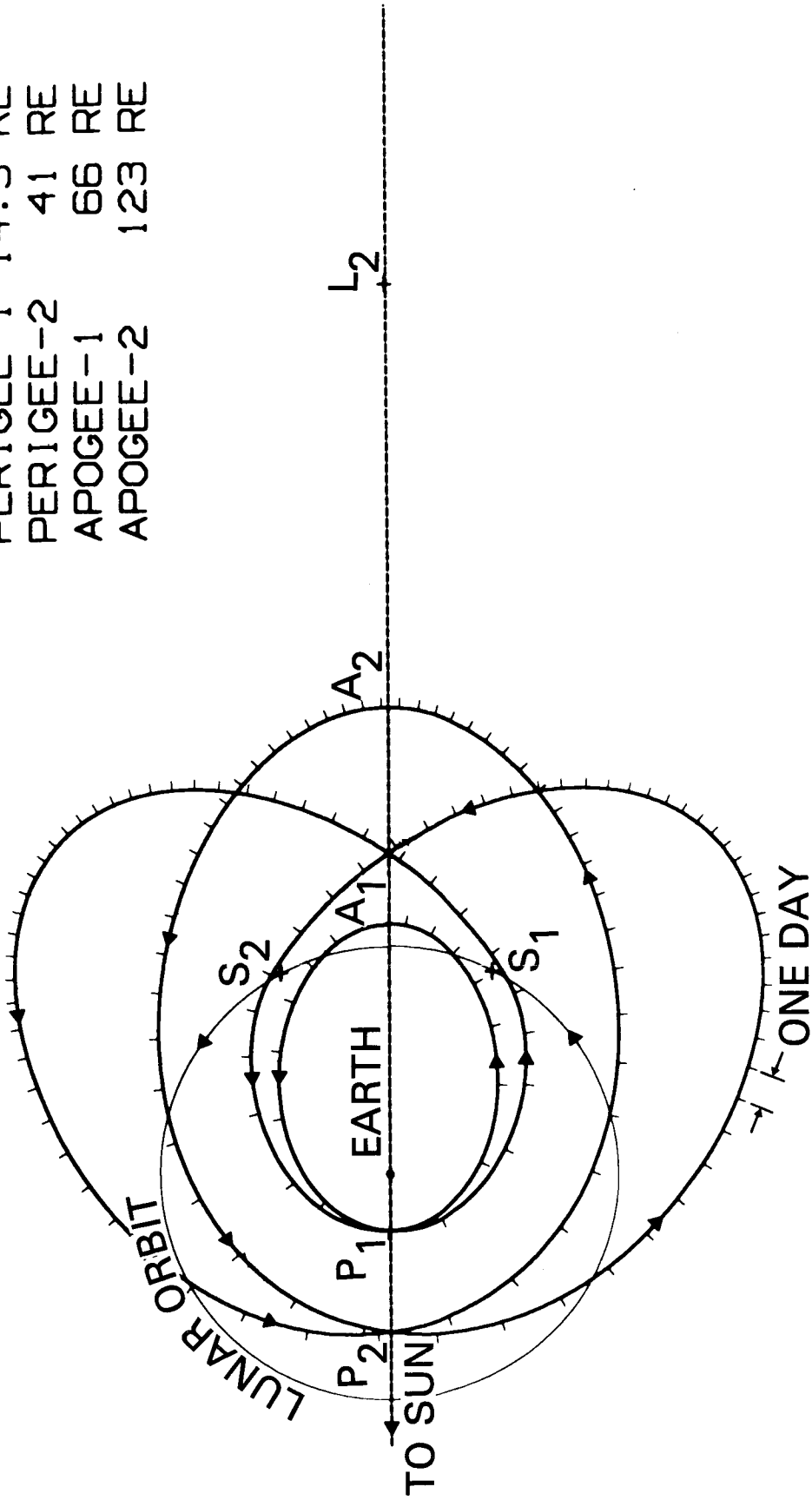

PERILUNE RADIUS AT LUNAR SWINGBYS 27.354 KM

DOUBLE LUNAR SWINGBY ORBIT - (2.4.2.1) CLASS

PERIGEE-1	4.4 RE
PERIGEE-2	27 RE
APOGEE-1	62 RE
APOGEE-2	118 RE

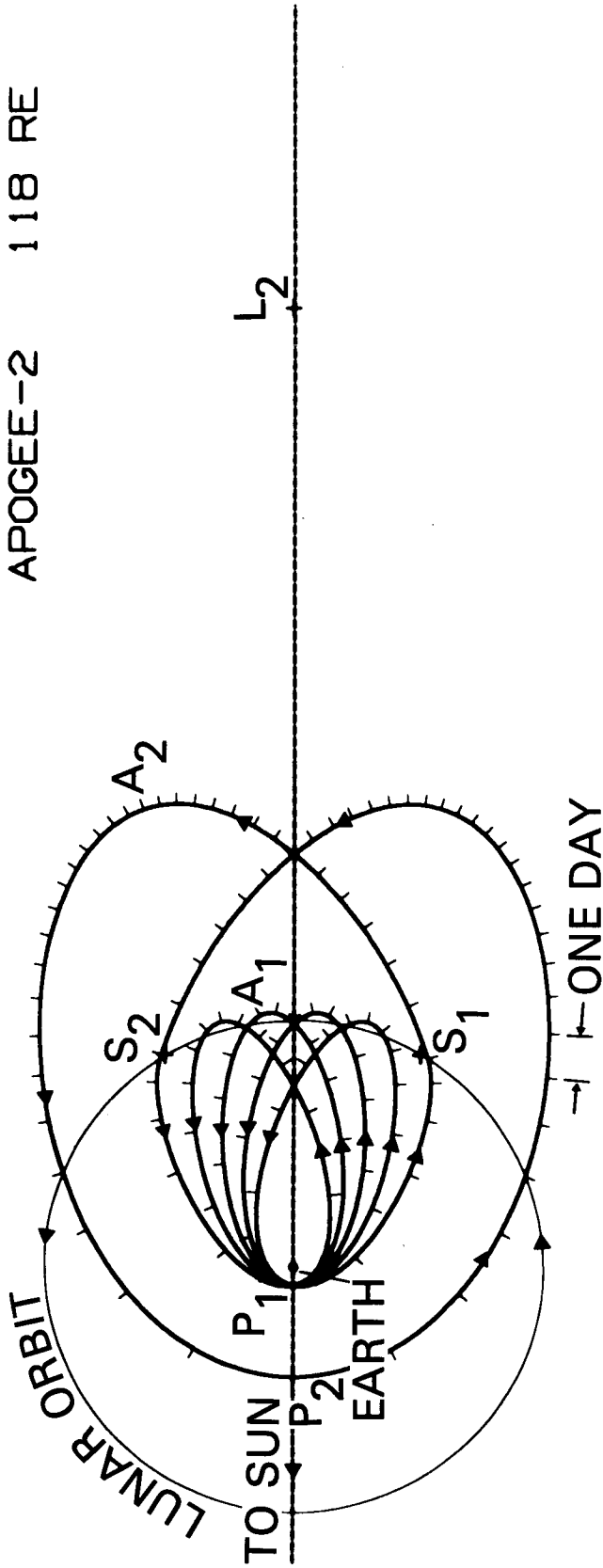

PERILUNE RADIUS AT LUNAR SWINGBYS 11.448 KM

DOUBLE LUNAR SWINGBY ORBIT - (3.6.2.1) CLASS

PERIGEE-1	7.8 RE
PERIGEE-2	35 RE
APOGEE-1	61 RE
APOGEE-2	113 RE

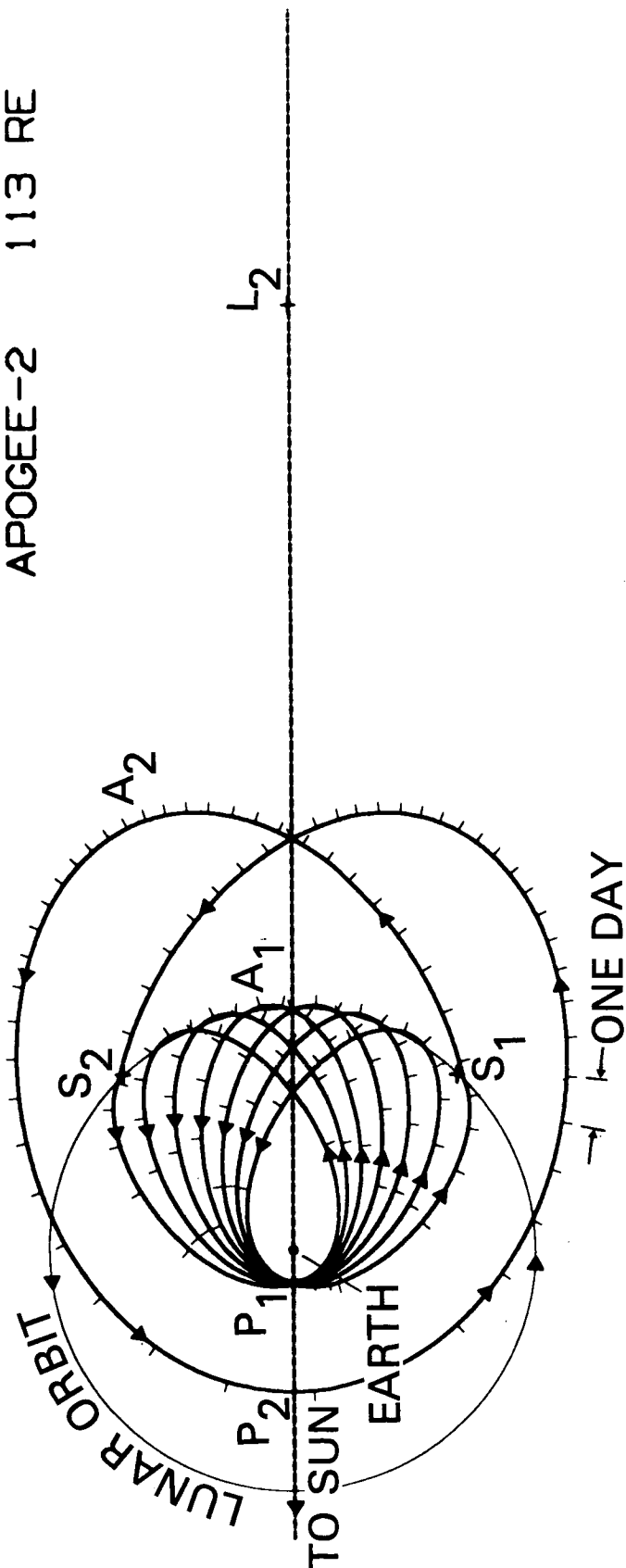

PERILUNE RADIUS AT LUNAR SWINGBYS 12.578 KM