

NASA Conference Publication 2108

NASA
CP
2108-
pt.2
c.1

LOAN COPY: RETURN
AFWL TECHNICAL LIB
KIRTLAND AFB, N.M.



Supersonic Cruise Research '79

Part 2

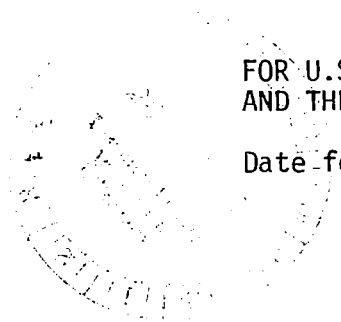
Proceedings of a conference
held at Langley Research Center
Hampton, Virginia
November 13-16, 1979



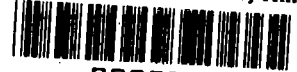
NASA

FOR U.S. GOVERNMENT AGENCIES
AND THEIR CONTRACTORS ONLY

Date for general release March 1981.



TECH LIBRARY KAFB, NM



0099731

NASA Conference Publication 2108

Supersonic Cruise Research '79

Part 2

**Proceedings of a conference
held at Langley Research Center
Hampton, Virginia
November 13-16, 1979**

NASA

National Aeronautics
and Space Administration

**Scientific and Technical
Information Office**

1980

PREFACE

Since 1972 the Supersonic Cruise Research (SCR) Program has provided an accelerated and focused technology effort which has resulted in development of improved analytical techniques, design procedures, and an expanded experimental data base. Progress made in the first 4 years was highlighted in a conference at Langley Research Center in 1976 (see NASA CP-001, Parts 1 and 2).

Subsequent to the 1976 conference, NASA had conducted and monitored additional supersonic cruise vehicle studies and enhanced the advanced supersonic technology data base through further tests. Significant achievements in the interim since the previous conference were reported to the technical community at the SCR '79 Conference held at Langley Research Center, November 13-16, 1979. This document is a compilation of papers, authored by representatives of airframe and engine manufacturers, the Federal Aviation Administration, three NASA research centers, and the Office of Technology Assessment (Congress of the United States), which were presented at the latter Conference.

The Conference was organized in six sessions as follows:

- I. Aerodynamics
- II. Stability and Control
- III. Propulsion
- IV. Environmental Factors
- V. Airframe Structures and Materials
- VI. Systems Integration and Economics

Papers and the authors thereof are grouped by session and identified in the CONTENTS. The order of papers is the actual order of speaker appearance at the Conference.

The size of the compilation necessitated publication in two parts (Parts 1 and 2). A list of attendees, by organizational affiliation, is included at the back of Part 2.

We would like to express appreciation to session chairmen and speakers whose efforts contributed to the technical excellence of the Conference.

Use of trade names or names of manufacturers in this report does not constitute an official endorsement of such products or manufacturers, either expressed or implied, by the National Aeronautics and Space Administration.

C. Driver
Hal T. Baber, Jr.

Conference Cochairmen



CONTENTS

Part 1*

PREFACE iii

SCR PROGRAM OVERVIEW 1
Vincent R. Mascitti

SESSION I - AERODYNAMICS
Chairman: Robert E. Bower

INTRODUCTORY REMARKS 9
Robert E. Bower

1. OVERVIEW OF THE LANGLEY SUBSONIC RESEARCH EFFORT ON
SCR CONFIGURATIONS 13
Paul L. Coe, Jr., James L. Thomas, Jarret K. Huffman,
Robert P. Weston, Ward E. Schoonover, Jr., and Garl L. Gentry, Jr.

2. RESULTS OF A LOW-SPEED WIND TUNNEL TEST OF THE MDC 2.2M SUPERSONIC
CRUISE AIRCRAFT CONFIGURATION 35
R. L. Roensch, J. E. Felix, H. R. Welge, L. P. Yip, and
L. P. Parlett

3. THE PREDICTION OF PRESSURE DISTRIBUTIONS ON AN ARROW-WING
CONFIGURATION INCLUDING THE EFFECT OF CAMBER, TWIST,
AND A WING FIN 59
Marjorie E. Manro, Percy J. Bobbitt, and Robert M. Kulfan

4. EXPLORATORY SUBSONIC INVESTIGATION OF VORTEX-FLAP CONCEPT ON
ARROW WING CONFIGURATION 117
Dhanvada M. Rao

5. WIND TUNNEL TEST RESULTS OF A NEW LEADING EDGE FLAP DESIGN FOR
HIGHLY SWEEPED WINGS - A VORTEX FLAP 131
L. James Runyan, Wilbur D. Middleton, and John A. Paulson

6. A STUDY OF WING BODY BLENDING FOR AN ADVANCED SUPERSONIC TRANSPORT . . 149
T. P. Goebel, E. Bonner, and D. A. Robinson

7. PREDICTION OF NACELLE AERODYNAMIC INTERFERENCE EFFECTS AT LOW
SUPERSONIC MACH NUMBERS 171
Robert M. Kulfan

8. ANALYTIC DEVELOPMENT OF AN IMPROVED SUPERSONIC CRUISE AIRCRAFT
BASED ON WIND TUNNEL DATA 205
R. L. Roensch and G. S. Page

*Papers 1 to 24 are presented under separate cover.

9. SUPERSONIC WINGS WITH SIGNIFICANT LEADING-EDGE THRUST AT CRUISE 229
 A. Warner Robins, Harry W. Carlson, and Robert J. Mack

SESSION II - STABILITY AND CONTROL

Chairman: Seth B. Anderson

- INTRODUCTORY REMARKS 249
 Seth B. Anderson
10. FLYING QUALITIES DESIGN CRITERIA APPLICABLE TO SUPERSONIC
 CRUISE AIRCRAFT 251
 Charles R. Chalk
11. ADVANCED SUPERSONIC TRANSPORT FIXED-BASE SIMULATOR EVALUATIONS
 AT LANDING APPROACH 269
 John B. Feather
12. SIMULATOR INVESTIGATION OF ARROW-WING LOW-SPEED HANDLING QUALITIES . . 285
 Ben T. Averett
13. DEVELOPMENT OF SCR AIRCRAFT TAKEOFF AND LANDING PROCEDURES FOR
 COMMUNITY NOISE ABATEMENT AND THEIR IMPACT ON FLIGHT SAFETY 299
 William D. Grantham and Paul M. Smith

SESSION III - PROPULSION

Chairman: Warner L. Stewart

- INTRODUCTORY REMARKS 337
 Warner L. Stewart
14. SUPERSONIC CRUISE RESEARCH PROPULSION SYSTEM STUDIES - SLIDE
 PRESENTATION (Text not available for publication) 339
 R. D. Allan and J. E. Johnson
15. VCE TEST BED ENGINE FOR SUPERSONIC CRUISE RESEARCH 347
 J. W. Vdoviak and J. A. Ebacher
16. VARIABLE STREAM CONTROL ENGINE FOR ADVANCED SUPERSONIC AIRCRAFT
 DESIGN UPDATE 357
 Richard B. Hunt and Robert A. Howlett
17. PROGRESS WITH VARIABLE CYCLE ENGINES 371
 John S. Westmoreland
18. EFFECTS OF INLET TECHNOLOGY ON CRUISE SPEED SELECTION 391
 L. H. Bangert, D. M. Santman, G. Horie, and L. D. Miller

SESSION IV - ENVIRONMENTAL FACTORS

Chairman: R. W. Schroeder

INTRODUCTORY REMARKS	415
R. W. Schroeder	
19. VCE EARLY ACOUSTIC TEST RESULTS OF GENERAL ELECTRIC'S HIGH-RADIUS RATIO COANNULAR PLUG NOZZLE	417
Paul R. Knott, J. F. Brausch, P. K. Bhutiani, R. K. Majjigi, and V. L. Doyle	
20. FLIGHT AND TUNNEL TEST RESULTS OF THE MDC MECHANICAL JET NOISE SUPPRESSOR NOZZLE	453
R. D. FitzSimmons, R. A. McKinnon, and E. S. Johnson	
21. EFFECTS OF NOZZLE DESIGN ON THE NOISE FROM SUPERSONIC JETS	479
John M. Seiner, Thomas D. Norum, and Lucio Maestrello	
22. STATUS OF NOISE TECHNOLOGY FOR ADVANCED SUPERSONIC CRUISE AIRCRAFT	493
James R. Stone and Orlando A. Gutierrez	
23. ENVIRONMENTAL EFFECTS OF AIRCRAFT AT CRUISE: AN UPDATE	519
N. Sundararaman	
24. ADVANCED TECHNOLOGY FOR CONTROLLING POLLUTANT EMISSIONS FROM SUPERSONIC CRUISE AIRCRAFT	535
Robert A. Duerr and Larry A. Diehl	

Part 2

SESSION V - AIRFRAME STRUCTURES AND MATERIALS

Chairman: R. R. Heldenfels

INTRODUCTORY REMARKS	553
R. R. Heldenfels	
25. STRUCTURAL CONCEPT TRENDS FOR COMMERCIAL SUPERSONIC CRUISE AIRCRAFT DESIGN	563
I. F. Sakata, G. W. Davis, and B. Saelman	
26. OPPORTUNITIES FOR STRUCTURAL IMPROVEMENTS FOR AN ADVANCED SUPERSONIC TRANSPORT VEHICLE	589
J. E. Fischler	
27. SUPERSONIC CRUISE RESEARCH AIRCRAFT STRUCTURAL STUDIES: METHODS AND RESULTS	617
J. Sobieszczanski-Sobieski, David Gross, William Kurtze, Jerry Newsom, Gregory Wrenn, and William Greene	

28. COMPRESSION PANEL STUDIES FOR SUPERSONIC CRUISE VEHICLES (To be published as NASA TP-1617) Robert R. McWithey, Dick M. Royster, and William L. Ko	
29. FABRICATION DEVELOPMENT AND EVALUATION OF ADVANCED TITANIUM AND COMPOSITE STRUCTURAL PANELS (To be published as NASA TP-1616) Thomas T. Bales, Edward L. Hoffman, Lee Payne, and Lawrence F. Reardon	
30. AN ASSESSMENT OF BUFFER STRIPS FOR IMPROVING DAMAGE TOLERANCE OF COMPOSITE LAMINATES	657
C. C. Poe, Jr., and John M. Kennedy	
31. EVALUATION OF HIGH-TEMPERATURE STRUCTURAL ADHESIVES FOR EXTENDED SERVICE	675
Carl L. Hendricks and Sylvester G. Hill	
32. ADVANCED MATERIALS AND FABRICATION PROCESSES FOR SUPERSONIC CRUISE AIRCRAFT	687
Marlon K. Guess, Russell S. Kaneko, and George G. Wald	
33. EFFECTS OF AN AST PROGRAM ON U.S. TITANIUM STORY	713
Richard D. Fitzsimmons	

SESSION VI - SYSTEMS INTEGRATION AND ECONOMICS
Chairman: G. G. Kayten

INTRODUCTORY REMARKS	739
G. G. Kayten	
34. CONCORDE WITH THE AIRLINES	741
Clive S. Leyman	
35. LONG-RANGE AIRPLANE STUDY - THE CONSUMER LOOKS AT SST TRAVEL	759
Karyl H. Landes and J. A. Matter	
36. ASSESSMENT OF THE IMPACT OF ADVANCED AIR-TRANSPORT TECHNOLOGY	805
R. L. Maxwell and L. V. Dickinson, Jr.	
37. OVERVIEW OF BOEING SUPERSONIC TRANSPORT EFFORTS - 1971-1979	821
A. Sigalla	
38. A FAMILY OF SUPERSONIC AIRPLANES - TECHNICAL AND ECONOMIC FEASIBILITY	833
Frank D. Neumann and Jerry W. Whitten	
39. IMPACT OF CHANGING FUEL CHARACTERISTICS ON SUPERSONIC CRUISE AIRPLANE	855
O. J. Hadaller, J. E. Schmidt, A. M. Momeny, and P. E. Johnson	
40. TECHNOLOGY DEVELOPMENT STATUS AT McDONNELL DOUGLAS	873
William T. Rowe	

41. SUPERSONIC MARKET AND ECONOMIC ANALYSES	889
Lucian S. Rochte	
42. THE IMPACT OF MATERIALS TECHNOLOGY AND OPERATIONAL CONSTRAINTS ON THE ECONOMICS OF CRUISE SPEED SELECTION	909
J. S. Clauss, Jr., F. A. Bruckman, D. L. Horning, R. H. Johnston, and J. V. Werner	
43. SUPERSONIC CRUISE VEHICLE RESEARCH/BUSINESS JET	935
Robert Kelly	
ATTENDEES	951

SESSION V - AIRFRAME STRUCTURES AND MATERIALS

INTRODUCTORY REMARKS

R. R. Heldenfels
NASA Langley Research Center

This session consists of nine papers which report some of the recent advances in airframe structures and materials technology for supersonic cruise aircraft. I will not review the contents of those papers but make a few general comments and describe some additional technical accomplishments that could not be included in the presentations that follow.

Since the 1976 SCAR conference (reference 1) progress has been made in all areas of structures and materials technology for supersonic cruise aircraft in both the technology programs conducted by the system study contractors and by NASA in-house and contracted research in the structures and materials program element.

Advances continue to be made in the structural analysis and design area with the result that computational procedures are available now to design quickly a vehicle structure that meets the requirements for strength, divergence and flutter with active controls included. This can be done accurately and early enough in the design process to avoid costly changes during detail design. New capabilities in optimization, computer program systems and application to SCR configurations are reported in references 2 to 14. References 15 to 20 provide technology for sizing thermally stressed structures including those containing composite laminates.

Increased emphasis has been given to titanium structures technology, particularly the SPF/DB process, and this work is covered in several of the papers which follow. Activity has continued on composite structures technology; the principal results will be reviewed in this paper and some of the papers that follow.

Significant progress and accomplishments in six areas of our research and technology program that will not be covered by the talks in this session are summarized in this paper.

Unsteady aerodynamics.- Flutter is an important design consideration for supersonic cruise vehicles that requires accurate unsteady aerodynamic inputs to the analysis. A modular, user-oriented, surface-panel, computer program (SOUSSA) has been developed for the subsonic and supersonic speed ranges. It can model the complete vehicle and has been used for a space-shuttle flutter analysis. A user training course has been held at Langley and the program will be available for general distribution from COSMIC soon. Other activity is developing programs for unsteady aerodynamics in the transonic speed range. These accomplishments are reported in references 21 to 32.

Measurement of atmospheric turbulence.- A program to measure the long-wave-length turbulence, that may be important in the determination of gust loads on large supersonic aircraft, is continuing. Data acquired below 15,240 meters (50,000 feet) has been published in references 33 to 42. Measurements are being made above 15,240 meters (50,000 feet) when the required aircraft are available. One turbulence spectra obtained indicates that further data are needed to define accurately the characteristics of turbulence at high supersonic-cruise altitudes.

Aircraft landing loads.- Research on landing loads has been concerned with methods for their accurate prediction and concepts for their alleviation. The ACOLAG program can predict landing dynamics (for three degrees of freedom) of a rigid airplane with a passive or an active control landing gear. It has been verified by comparison with landing loads data on the YF-12 airplane with a passive gear and laboratory drop-tests of an active-control gear (references 43 to 45). The FATOLA program predicts the takeoff and landing dynamics (for six degrees of freedom) of a flexible airplane with active or passive gear, reference 46. Future work is planned to evaluate an active-control landing gear on a fighter aircraft in a joint NASA/USAF project.

Time-temperature stress capabilities of composites.- This continuing study is evaluating five classes of composites for up to 50,000 hours of exposure to simulated supersonic cruise environments, references 47 to 52. Since the 1976 SCAR conference, data have been obtained for up to 25,000 hours of static thermal exposure and 10,000 hours of simulated flight.

The results of the long-term exposure program at the 10,000-hour point for all of the composite materials systems being evaluated are summarized in figure 1. The maximum test temperature shown was the maximum temperature considered for long-time application when the program began.

For all of the materials systems there has been a reduction in the estimated maximum temperature for a 10,000-hour design life. Matrix oxidation has been identified as a primary degradation mechanism in the resin systems. In contrast, reductions in the maximum use temperature for the metal matrix material (B/Al) for long-time applications are attributed to both fiber degradation and matrix oxidation.

This summary of results clearly points out that the maximum use temperature of composite materials for long-time application (10,000 hours) is significantly lower than for short-time use. The maximum use temperature appears lower for those applications which require cyclic exposures to load and temperature.

The results of room temperature residual strength tests of GR/PI specimens after 10,000 hours of flight simulation are summarized in figure 2. All properties were reduced from their baseline values as a result of the 10,000-hour exposure. Unnotched specimens were more severely affected than were notched specimens. Although matrix degradation is suggested by the severe reduction in interlaminar shear strength, no completely satisfactory explanation has been developed to explain why properties of unnotched specimens are more severely degraded than properties of notched specimens. Similar differences in proper-

ties of notched and unnotched specimens of GR/Ep composite material were also observed after 10,000 hours of flight simulation.

Plans for this study include continuation of the static and flight simulation exposures for the remaining materials in the program to 50,000 hours and the addition of a new graphite/polyimide material. That material will be selected using data from the NASA space technology program on Composites for Advanced Space Transportation Systems (CASTS), reference 53.

Graphite/polyimide composite applications.- The polyimide resin in the time-temperature-stress program was the best available when it was selected about five years ago. Many others have been developed since then, and some have been studied in the SCR program. Moreover, NASA has had a major effort to provide high-temperature graphite-polyimide structures technology for future space transportation systems (CASTS). The progress of that work, most of which is equally applicable to structures for supersonic cruise aircraft, was reported at a technical symposium held here earlier this year, reference 53. Great progress has been made in development of polyimide matrix materials that are easy to fabricate and have good thermal stability. Consequently, they can make a major contribution to structural weight reduction in a future supersonic transport as well as in future space transportation systems. Some aspects of this opportunity will be described in this and in the System Integration and Economics session of this conference. The fibers and resins of most interest will be thoroughly characterized in a few years. This contribution plus the composites technology for GR/Epoxy provided by the ACEE-Composite Primary Aircraft Structures (CPAS) Program should make the GR/PI system ready for an application development program for high temperature aircraft structures in the late 1980's.

Fuel tank sealants.- Ames Research Center is developing elastomers, based on a polymeric heterocyclic fluoroether, that could be a satisfactory fuel tank sealant for supersonic airplanes. This material has shown excellent thermal stability and low temperature flexibility. It is stable in the presence of jet fuels and has high resistance to oxidation at elevated temperatures. Past accomplishments are reported in references 54 to 60. Work is continuing to develop a process that will yield pilot plant quantities of useful sealants for evaluation in the flight environment.

The work I have described and that which will be reported in the papers that follow show that much progress has been made since the 1976 conference to provide new technology on a variety of structural concepts and materials. This technology can be used to design safe and durable structures of reduced weight and cost to improve the performance and economics of future supersonic cruise aircraft.

REFERENCES

1. Proceedings of the SCAR Conference. NASA CP-001. Conference held at the Langley Research Center, Hampton, Virginia, November 9-12, 1976.
2. Ricketts, Rodney H.; and Sobieszczanski, J.: Simplified and Refined Structural Modeling for Economical Flutter Analysis and Design. Presented at AIAA/ASME/SAE 18th Structures, Structural Dynamics and Materials Conference, San Diego, CA, March 21-23, 1977. AIAA Paper 77-421.
3. Green, W.; Sobieszczanski-Sobieski, J.: Minimum Mass Sizing of a Large Low-Aspect-Ratio Airframe for Flutter Free Performance, submitted for AIAA/ASME/ASCE/AHS 21st Structures, Structural Dynamics and Materials Conference, Seattle, Wash., May 12-19, 1980.
4. Sobieszczanski-Sobieski, Jaroslaw: An Integrated Computer Procedure for Sizing Composite Airframe Structures. NASA TP-1300, 1979.
5. Newsom, J. R.: A Method for Obtaining Practical Flutter Suppression Control Laws Using Results of Optimal Control Theory. NASA TP-1471, 1979.
6. Gross, D. W.: A Multi-Disciplinary Approach to Structural Design for Stochastic Loads. Presented at the AIAA 17th Aerospace Sciences Meeting, New Orleans, LA, Jan. 15-17, 1979, AIAA Paper No. 79-0238.
7. Gross, D.; Sobieszczanski-Sobieski, J.: Aircraft Design Application of Nonlinear Optimization Methods which Include Probabilistic Constraints. AIAA 18th Aerospace Sciences Meeting, Pasadena, California, Jan. 15-18, 1980, AIAA Paper No. 80-0153.
8. Sobieszczanski-Sobieski, Jaroslaw; and Goetz, Robert C.: Synthesis of Aircraft Structures Using Integrated Design and Analysis Methods - Status Report. Presented at a Symposium on Future Trends in Computerized Structural Analysis and Synthesis, Washington, DC, October 30-November 1, 1978. NASA CP-2059, pp. 63-71.
9. Stroud, W. J.; and Sobieszczanski, J.: Advanced Structural Design Methodology, Presented at the NASA CTOL Transport Technology Conference, Hampton, VA, February 28-March 3, 1978. NASA CP-2036, Part 1, pp. 311-330.
10. Sobieszczanski-Sobieski, J.; Gross, David; Kurtze, William; Newsom, Jerry; Wrenn, Gregory; and Greene, William: Supersonic Cruise Research Aircraft Structural Studies: Methods and Results. Supersonic Cruise Research '79, NASA CP-2108, 1980. (Paper no. 27 of this compilation.)
11. Wrenn, G. A.; McCullers, L. A.; and Newsom, J. R.: Structural and Aeroelastic Studies of a Supersonic Arrow-Wing Configuration. NASA CR-145325, July 1978 (Vought Corporation, NAS1-13500).

12. Sakata, I. F.; and Davis, C. W.: Evaluation of Structural Design Concepts for an Arrow Wing Supersonic Cruise Aircraft. NASA CR-2667, April 1977.
13. Turner, M. J.; and Grande, D. L.: Study of Metallic Structural Design Concepts for an Arrow Wing Supersonic Cruise Configuration. NASA CR-2743, December 1977.
14. Turner, J. J.; and Grande, D. L.: Study of Advanced Composite Structural Design Concepts for an Arrow Wing Supersonic Cruise Configuration. NASA CR-2825, April 1978.
15. Adelman, Howard M.; Sawyer, Patricia L.; and Shore, Charles P.: Development of Methodology for Optimum Design of Structures at Elevated Temperatures. Presented at 19th AIAA/ASME Structures, Structural Dynamics and Materials Conference, Bethesda, MD., April 3-5, 1978.
16. Adelman, Howard M.; Sawyer, Patricia L.; and Shore, Charles P.: Optimum Design of Structures at Elevated Temperatures. AIAA J., Vol. 17, No. 6, June 1979, pp. 622-629.
17. Haftka, R. T.; Prasad B.; and Tsach U.: PARS - Programs for Analysis and Resizing of Structures, User's Manual. NASA CR-159007, 1979.
18. Narayanaswami, R.; and Adelman, Howard M.: Evaluation of the Tensor Polynomial and Hoffman Strength Theories for Composite Materials, J. Composite Materials, Vol. II, October 1977, pp. 366-377.
19. Adelman, Howard M.; and Robinson, James C.: Recent Advances in Thermal-Structural Analysis and Design, presented at Langley Research Center Symposium on Recent Advances in Structures for Hypersonic Flight. NASA CP-2065, September 6-8, 1978.
20. Haftka, R. T.; and Shore, C. P.: Approximate Methods for Combined Thermal/Structural Design. NASA TP-1428, 1979.
21. Morino, L.: A General Theory of Unsteady Compressible Potential Aerodynamics. NASA CR-2464, 1974.
22. Morino, L.; Chen, L. T.; and Suciu, E. O.: Steady and Oscillatory, Subsonic and Supersonic Aerodynamics Around Complex Configurations. AIAA Journal, Vol. 13, No. 3, March 1975, pp. 368-374.
23. Morino, L.; and Chen, L. T.: Indicial Compressible Potential Aerodynamics Around Complex Aircraft Configurations. NASA SP-347, Part II, pp. 1067-1110, 1975.
24. Suciu, E. O.; and Morino, L.: Nonlinear Finite-Element Analysis of Lifting Surfaces in Incompressible Flow with Wake Roll-up. AIAA Paper 76-64, 1976.

25. Tseng, K.; and Morino, L.: Fully Unsteady Subsonic and Supersonic Potential Aerodynamics of Complex Aircraft Configurations for Flutter Applications. Proceedings of the AIAA 17th Structures, Structural Dynamics and Materials Conference, Valley Forge, PA, May 1976.
26. Tseng, K.; and Morino, L.: A New Unified Approach for Analyzing Wing-Body-Tail Configurations with Control Surfaces. AIAA Paper No. 76-418, 1976.
27. Tseng, K.; Puglise, J. A.; and Morino, L.: Recent Developments with the Green's Function Method. AIAA Paper No. 77-456, 1977.
28. Morino, L.; and Tseng, K.: Unsteady Subsonic and Supersonic Potential Aerodynamics for Complex Configurations. Proceedings of International Symposium on Innovative Numerical Analysis in Applied Engineering Sciences, Versailles, France, May 1977.
29. Morino, L.; and Tseng, K.: Steady, Oscillatory and Unsteady, Subsonic and Supersonic Aerodynamics (SOUSSA) for Complex Aircraft Configurations. AGARD CP-227, pp. 3-1 to 3-14, 1977.
30. Morino, L.: Steady, Oscillatory and Unsteady, Subsonic and Supersonic Aerodynamics - Production Version (SOUSSA Pl.1). Vol. I - Theoretical Manual. NASA CR-159130, 1979.
31. Smolka, S. A.; Preuss, R. D.; Tseng, K.; and Morino, L.: Steady, Oscillatory and Unsteady, Subsonic and Supersonic Aerodynamics - Production Version. Vol. II - User/Programmer Manual. NASA CR 159131, 1979.
32. Tseng, K.; and Morino, L.: Time-Domain Green's Function Method for Three-Dimensional Nonlinear Subsonic Flows. AIAA Paper No. 78-1204, 1978.
33. Sidwell, Kenneth: Mathematical Study of a Random Process Proposed as an Atmospheric Turbulence Mode. NASA CR-145200, May 1977.
34. Mark, William D.: Characterization of Nongaussian Atmospheric Turbulence for Prediction of Aircraft Response Statistics. NASA CR-2913, December 1977.
35. Sidwell, Kenneth: A Qualitative Assessment of a Random Process Proposed as an Atmospheric Turbulence Model. NASA CR-145247, September 1977.
36. Sidwell, Kenneth: Analysis of the Response of Linear Dynamic Systems to Product Random Processes. J. of Sound and Vibration, Vol. 55, No. 1, Nov. 1977, pp. 55-64.
37. Waco, David E.: Mesoscale Wind and Temperature Fields Related to an Occurrence of Moderate Turbulence Measured in the Stratosphere above Death Valley. Monthly Weather Review, Vol. 106, No. 6, June 1978, pp. 850-858.

38. Sidwell, Kenneth: Analysis of Dynamic System Response to Product Random Processes, NASA TM 78667, September 1978.
39. Mark, W. D.: Estimation Algorithms and Input-Response Relations for Non-gaussian Atmospheric Turbulence. Bolt, Beranek & Newman Report No. 3822, May 1978. (Submitted under Contract NAS1-14837).
40. Mark, W. D.; and Fischer, R. W.: Statistics of Atmospheric Turbulence Records Relevant to Aircraft Response Calculations. Bolt, Beranek & Newman Technical Memorandum No. 456, June 1978. (Submitted under Contract NAS1-14837).
41. David, Richard E.; Champine, Robert A.; and Ehernberger, L. J.: Meteorological and Operational Aspects of 46 Clear Air Sampling Missions with an Instrumented B-57B Aircraft. Vol. I - Program Summary, NASA TM 80044; Vol. II - Turbulence Missions by David E. Waco (Appendix C). NASA TM 80045, May 1979.
42. Trevino, George: On the Spectrum of Inhomogeneous Turbulence. Final Report on NASA Grant 1615, Del Mar College, August 1979.
43. Fasanella, Edwin L.; McGehee, John R.; and Pappas, M. Susan: Experimental and Analytical Determination of Characteristics Affecting Light Aircraft Landing-Gear Dynamics. NASA TMX-3561, 1977.
44. Ross, Irving; and Edson, Ralph: An Electronic Control for an Electrohydraulic Active Control Aircraft Landing Gear. NASA CR-3113, 1979.
45. McGehee, John R.; Carden, Huey D.; and Edson, Ralph: Improved Aircraft Dynamic Response and Fatigue Life During Ground Operations Using an Active Control Landing Gear System. Paper 78-1499, AIAA Aircraft Systems and Technology Conference, Los Angeles, CA, 1978.
46. Carden, Huey D.; and McGehee, John R.: Improvements to the FATOLA Computer Program Including Nosewheel Steering. NASA TM-78768, 1978.
47. Haskins, J.; and Kerr, J.: Time-Temperature-Stress Capabilities of Composite Materials for Advanced Supersonic Technology Applications. Third Conference on Fibrous Composites in Flight Vehicle Design, Part I, NASA TMX-3377, 1976, pp. 383-403.
48. Kerr, J.; Haskins, J.; and Stein, B.: Program Definition and Preliminary Results of a Long-Term Evaluation Program of Advanced Composites for Supersonic Cruise Aircraft Applications. ASTM STP 602, August 1976.
49. Haskins, J.; Wilkins, D.; and Stein, B.: Flight Simulation Testing Equipment for Composite Material System. ASTM STP 602, August 1976.
50. Haskins, J. F.; Kerr, J. R.; and Stein, B. A.: Time-Temperature-Stress Capabilities of Composites for Supersonic Cruise Aircraft Applications. Proceedings of the SCAR Conference, NASA CP-001, November 1976.

51. Haskins, J. F.; Kerr, J. R.; and Stein, B. A.: Flight Simulation Testing of Advanced Composites for Supersonic Cruise Aircraft Applications. AIAA Paper No. 77-401, March 1977.
52. Rummeler, D. R.; and Clark, R. K.: Mechanical and Thermophysical Properties of Graphite/Polyimide Composite Materials. Graphite/Polyimide Composites, NASA CP-2079, March 1979.
53. Graphite/Polyimide Composites. NASA CP-2079. Proceedings of a Technical Symposium held at Langley Research Center, Hampton, Virginia, February 28-March 1, 1979.
54. Paciorek, K.; Nakahara, J.; Kratzer, R.; and Rosser, R.: Mass Spectra of Some Perfluoroalkyl and Perfluoroalkylether Substituted 1, 2, 4-Oxadiazoles. Organic Mass Spectrometry 12 No. 2, p. 71 (1977).
55. Paciorek, K.; Kratzer, R.; Kaufman, J.; Nakahara, J.; Rosser, R.; and Parker, J.: Syntheses and Degradations of Fluorinated Heterocyclics II. Perfluoroalkyl and Perfluoroalkylether - 1, 2, 4-Oxadiazoles. J. of Fluorine Chemistry 10 (1977) 119-129.
56. Paciorek, K.; Kaufman, J.; Nakahara, J.; Ito, T.; Kratzer, R.; and Rosser, R.: Syntheses and Degradations of Fluorinated Heterocyclics III. Perfluoroalkyl and Perfluoroalkylether - 1, 3, 4-Oxadiazoles. J. of Fluorine Chemistry 10 (1977) 277-288.
57. Kray, W.; and Rosser, R.: Synthesis of Multifunctional Triarylfluoroethanes. Condensation of Fluoro Ketones. J. of Organic Chemistry, 42, 1186 (1977).
58. Korus, R.; and Rosser, R.: Gel Permeation Chromatography of Fluoroether Polymers. Analytical Chemistry 50, 249 (1978).
59. Rosser, R.; and Korus, R.: Synthesis of Perfluoroalkylether Oxadiazole Elastomers. Accepted in J. of Polymer Science 1979.
60. Rosser, R.; and Ross, L.: Preparation of Heterocyclic-Perfluoroether Block Copolymers. U. S. Patent 4, 145, 524. March 20, 1979.

MATERIAL	MAXIMUM TEMPERATURE TESTED	MAXIMUM TEMPERATURE FOR 10000 hr DESIGN LIFE	REMARKS
Gr/Ep (A-S/3501)	450 K (350°F)	394 K (250°F)	MATRIX DEGRADATION
B/Ep (B/5505)	450 K (350°F)	394 K (250°F)	MATRIX DEGRADATION
B/Al (B/6061)	728 K (850°F)	450 K (350°F)	FIBER DEGRADATION MATRIX OXIDATION
Gr/Pi (HT-S/710)	561 K (550°F)	505 K (450°F)	MATRIX DEGRADATION
B/Pi (B/P105A)	561 K (550°F)	DROPPED FROM PROGRAM	SEVERE MATRIX DEGRADATION

Figure 1.- Time-temperature-stress capabilities of composites; 10 000 hr results.

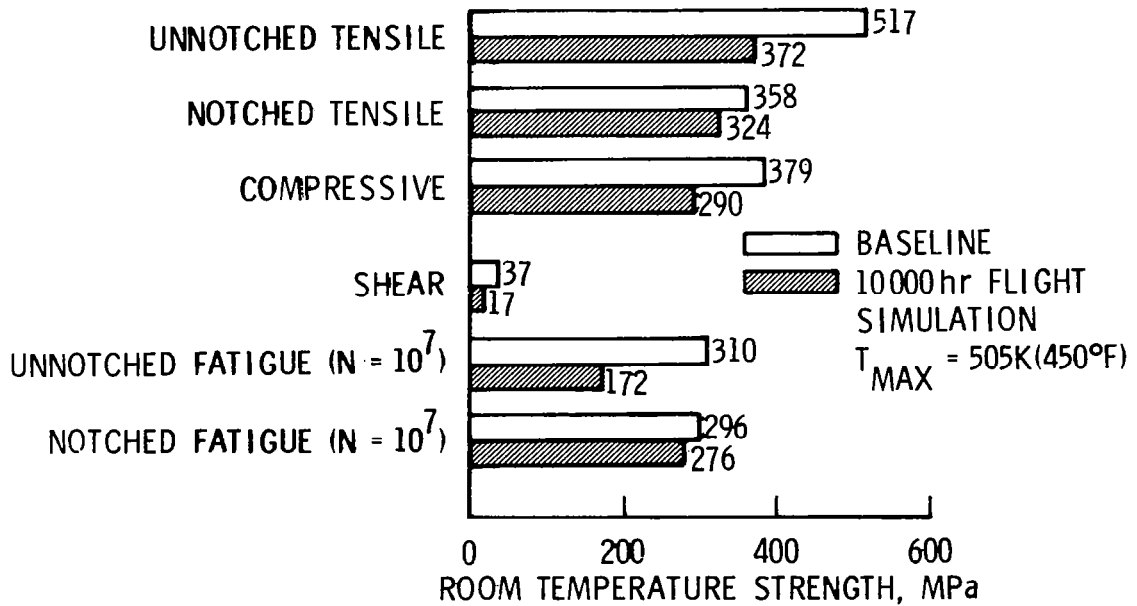


Figure 2.- Residual properties after 10 000 hours flight simulation testing; HTS/Skybond 710 [0 ± 45]₂.

STRUCTURAL CONCEPT TRENDS FOR COMMERCIAL

SUPERSONIC CRUISE AIRCRAFT DESIGN

I. F. Sakata, G. W. Davis and B. Saelman
Lockheed-California Company

ABSTRACT

An analytical study was performed to establish structural concept trends for future commercial supersonic transport aircraft. Highlights, including the more important design conditions and requirements, of an earlier contractual study and of a recent Lockheed independent development study are discussed. Knowledge of these design parameters, as determined through studies involving the application of flexible mathematical models, enabled inclusion of aeroelastic considerations in the structural-material concepts evaluation. The design trends and weight data of the previous contractual study of a Mach 2.7 cruise aircraft were used as the basis for incorporating advanced materials and manufacturing approaches to the airframe for reduced weight and cost. Structural studies of design concepts employing advanced aluminum alloys, advanced composites, and advanced titanium alloy and manufacturing techniques are compared for a Mach 2.0 arrow-wing configuration concept. Appraisals of the impact of these new materials and manufacturing concepts to the airframe design are shown and compared. The research and development to validate the potential sources of weight and cost reduction identified as necessary to attain a viable advanced commercial supersonic transport are discussed.

INTRODUCTION

The National Aeronautics and Space Administration (NASA) Langley Research Center has been pursuing a supersonic cruise research (SCR) program to provide a sound technical basis for future supersonic aircraft development.

The design of an advanced commercial supersonic cruise aircraft (figure 1) requires the achievement of the minimum possible structural weight fraction since the economic effectiveness of the aircraft is critically sensitive to weight as well as aerodynamic and propulsive efficiencies. The reduced weight fractions and operational costs are attainable through application of appropriate advanced technology encompassing new, improved materials; innovative design concepts; advanced controls concepts; and improved analytical methods. The impact of this advanced technology application is illustrated schematically on figure 2. The synergistic effect of weight savings on aircraft size, weight and range displayed is for an aircraft having a fuel fraction of approximately 50 percent of the takeoff gross weight.

Analytical investigations (ref. 1,2) have shown trends wherein advanced technology can reduce the structural weight fraction appreciably. Studies of manufacturing techniques for titanium alloys employing superplastic

forming-diffusion bonding (SPF/DB) have shown weight and cost reduction potential (ref. 3,4). Currently, experimental programs are being conducted to determine feasibility and provide technical data for application of SPF/DB and low cost titanium (LCT) manufacturing processes of beta titanium to supersonic airframe structures (ref. 5,6,7). Powder metallurgy development to enhance the characteristics and structural performance of the new aluminum alloys so as to be weight competitive with titanium at reduced cost also is being pursued (ref. 8).

A multidisciplinary study was performed to identify the advances in structural-material-manufacturing technology necessary to attain an economically viable commercial supersonic transport that could be operational in the early 1990's. The potential payoff in terms of weight and performance was identified by applying various structural-material concepts to a representative baseline configuration with appropriate weight reduction factors. Vehicle resizing was accomplished for a constant 290 passenger payload-7400 km (4000 n.mi) range mission using an advanced aircraft design synthesis and evaluation computer program. The results of this study were used as input data for an economic evaluation of advanced structural-material concepts and subsequent cruise speed selection (ref. 9).

The results of this study have provided insight into future research requirements in the areas of new, improved material systems and related structural concepts, manufacturing techniques, and design analysis methods. The trends indicate that material system selection for supersonic cruise aircraft applications will have to play a greater role than it did in the past for subsonic aircraft to achieve the maximum improvement in aircraft performance and economy.

REFERENCE STRUCTURAL AIRPLANE

The baseline concept is a transatlantic commercial transport with a passenger complement representative of current subsonic wide bodies. The technology level is that associated with a late 1980's start of design. This time frame implies the use of advanced structures and materials technology, advanced manufacturing technology, active controls and variable cycle power plants.

The reference airplane shown in Figure 3 is designed for long-range supersonic cruise at Mach 2.0 on a hot day. For design purposes, the aircraft has a maximum gross takeoff weight of 269 500 kg (592 000 lbm). The airplane seats 290 passengers in an all one-class, single-aisle cabin with six-abreast seating. Mission range is approximately 7400 km (4000 n.mi). The airplane features an arrow-wing planform with over/under nacelles that contain variable cycle power plants, wing leading edge and trailing edge high-lift devices combined with an aft-mounted horizontal tail, and advanced technology structural concepts. The overall length is 89.5 m (293.67 ft) and the wing span is 34.87 m (114.39 ft) as shown in table I.

The wing area is optimized for mission performance while meeting airport constraints of takeoff field length, second segment climb gradient, sideline noise, flyover noise, and approach speed. A wing loading of 458 kg/m^2 (95 psf) at takeoff results in a wing area of 587.93 m^2 (6232 ft^2). The wing leading edge is swept behind the Mach line in cruise so that rounded wing leading edges can be employed without cruise drag penalty. The leading edge sweep angles range from 1.187 rad (68 deg) at the root to 0.90 rad (51.7 deg) in the tip region. Both inboard and outboard trailing edge flaps are installed, and leading edge lift augmentation devices are utilized in the wing tip areas. Inboard wing flaps are end-plated by the engines and fuselage, providing high efficiency.

The primary flight controls are also indicated on figure 3. Longitudinal control is provided by an all-moving horizontal stabilizer with a geared elevator. Directional control is provided by an all-moving vertical stabilizer with a geared rudder. Lateral control is supplied by outboard ailerons, flaperons and spoiler-slot deflectors in a sequence scheduled by Mach number.

The airplane has four GE 21/J11B13 double-bypass, variable-cycle engines with an installed thrust of 180 000 N (40 500 lbf) per engine at sea level. These engines are mounted aft of the wing rear beam in an over/under arrangement. This arrangement uses shielding as a potential means for reducing jet and fan community noise.

In addition to reducing jet and fan noise, the over/under concept has other benefits. The spanwise location of the engines moves the thrust vector line for critical engine-out condition inboard by 10 percent, thus reducing the size of the vertical tail. Engine spanwise location impacts the main landing gear length when considerations for a combination of crosswind landing and scrape angle for rotation and touchdown are exercised; inboard movement of the engine results in reduced main gear length. The over/under arrangement also minimizes the required wing trailing edge cutout; which provides additional area for trailing edge flaps, thereby enhancing the low-speed lift capabilities.

Fuel is carried in both the wing and fuselage. Approximately 56 percent of the fuel is located below the floor within the fuselage in a combination of wing center section and aft fuselage fuel tanks. The remaining 44 percent is located in the wing. This distribution permits effective insulation from aerodynamic heating during the extended periods of high cruise speed and maximizes the heat sink capability of the bulk fuel for thermal control of aircraft systems and environment.

The wing-mounted landing gear retracts into a well just outboard of the body. The main landing gear is stowed in the wing root area, swinging down and aft into position. The tires are $0.81 \times 0.29 \times 0.38 \text{ m}$ ($32 \times 11.50 \times 15 \text{ in.}$). There is an 0.83 m (32.5 in.) stroke in the shock strut between the static ground position and the fully extended position.

DESIGN ANALYSIS

Current and past studies on commercial supersonic transports provide the foundation for rationally exploring the structural trends of new materials and manufacturing approaches. The creditability of the results of any trend study is directly related to the comprehensiveness of the design data upon which it is based. Two prior studies were of prime importance in establishing this baseline data. A description of the design methodology used and a summary of their results are presented.

Design Methodology

To realistically assess a new structural material approach for primary wing and fuselage structure, a multidisciplinary analytical investigation is required which includes part or all of the components of a structural design cycle. The complete design cycle encompasses each phase of the design process from the initial definition of the airplane configuration to the final determination of its strength and stiffness characteristics. Because of the complex nature of this design cycle, extensive use of computer programs and their associated math models is required. A typical large-order model used as the basis for the structural analysis of an advanced Mach 2.0 airplane is shown in figure 4. This model was used to determine the internal loads, stresses, and displacements on the overall airframe for the structural analysis; to calculate structural influence coefficients (SIC's) for aeroelastic load analysis; to determine the stiffness and mass matrices; and to compute vibration modes for flutter analysis. The basic grid system, number of elements, and the number of active degrees of freedom are indicated on the enclosed table of this figure.

Lockheed's structural design analysis system has the combined program capability of the NASA-developed NASTRAN finite element system and the Company's FAMAS system for aeroelastic analysis. The current Lockheed version of the NASTRAN system contains the COSMIC release Level 16.5 of NASTRAN, with all of its finite-element analysis capabilities in statics, dynamics and structural stability, and numerous Company-developed improvements. The Lockheed FAMAS system contains a very extensive matrix algebra system, and a large family of functional modules for aerodynamic loads, structural response and flutter analysis. This design analysis system was employed in varying degrees for the structural investigations of both the Mach 2.0 and Mach 2.7 airplanes (ref. 1,2).

Reference Studies

An analytical study (ref. 1) was performed under contract to NASA to determine the best structural approach for design of primary wing and fuselage structure of a Mach 2.7 arrow-wing supersonic cruise aircraft. Concepts were evaluated considering near-term start of design. Emphasis was placed on the complex interactions between thermal stress, static aeroelasticity, flutter, fatigue and fail-safe design, static and dynamic loads, and the effects of variations in structural arrangements, concepts, and materials on these interactions. Critical

design conditions and requirements were defined for the primary wing and fuselage structure. Results indicated that a hybrid wing structure incorporating low-profile convex-beaded and honeycomb sandwich surface panels of titanium alloy 6Al-4V was the most efficient. The substructure included titanium alloy spar caps reinforced with boron-polyimide composites. The fuselage shell consists of hat-stiffened skin and frame construction of titanium alloy 6Al-4V.

An independent development study is currently being conducted by Lockheed to quantify the structural-material trends of primary wing and fuselage structure of a Mach 2.0 supersonic cruise aircraft. Advanced aluminum and titanium materials and manufacturing processes are being evaluated for the airframe of this airplane. Strength designed airframes are being evaluated by means of the computerized design analysis system to assess the interaction of thermal stress, static aeroelasticity, fatigue and fail-safe design requirements, and static loads. In addition, a preliminary flutter analysis has been completed on an advanced titanium airframe to assess the stiffness requirements. These results, preliminary definition of the strength and stiffness requirements, have provided some insight into the design conditions and requirements for this airframe. Figure 5 presents the critical design requirements for the Mach 2.0 cruise aircraft. This study, when completed, will provide a comprehensive data base of structural approaches for this airplane that is comparable to that already established on the Mach 2.7 aircraft.

ADVANCED MATERIAL TRENDS

The material requirements for future supersonic cruise application will place demands for more efficient materials which can be cost-effectively fabricated into viable structures. Fortunately, promising advanced material systems with marked property improvements to help cope with the demands of supersonic cruise application are in the offing. In particular, improved aluminum alloys, titanium alloys and composite materials, and processes are emerging as highlighted in figure 6.

Advanced Aluminum Alloys

Although current aluminum alloys are compatible with the Mach 2.0 supersonic cruise environment, they are not structurally competitive with titanium alloys. Thus, cost advantages of aluminum are more than offset by significant weight penalties. Advances in aluminum processing and alloying technologies, particularly in powder metallurgy, offer new approaches for development of improved alloys with high strength, high toughness, improved corrosion resistance and fatigue life, and greater heat resistance than conventional alloys.

Analytical studies have identified the material characteristics essential to obtain the potential weight and cost benefits for given parts of supersonic airframe structures. Thus, the approach taken in the aluminum alloy development was to develop a family of aluminum alloys with specific property goals which represented structural equivalence to the titanium alloys. Figure 7 indicates

the increase in specific strength that is potentially available from powder metallurgy technology. Both improved strength and heat resistance are postulated over current alloys of aluminum (i.e., 2024-T81 and 7075-T6). Three sets of property goals were established to meet the supersonic cruise material needs (1) high toughness-fatigue resistant alloy for damage tolerant-fatigue sensitive design, (2) high strength alloy for compression strength-corrosion resistant design, and (3) high modulus-low density alloy for both stiffness critical and minimum gage design. The latter design goals of high stiffness and low density could possibly be realized from development of a single aluminum-lithium alloy. Future fabrication considerations include large scale powder metallurgy aluminum alloy structure encompassing extrusions, forgings and plate material forms in conjunction with advanced joining methods using adhesive bonding and weld bonding.

Advanced Titanium Alloys

New titanium alloys and manufacturing technologies are becoming available which will permit the designer-analyst to exploit more fully the inherent attributes of titanium for economic viability through reduced fabrication costs as shown in figure 8.

The cold formable beta alloys represent a breakthrough in cost reduction of airframe components. The beta alloys are strip producible, thus less costly than alloys such as Ti-6Al-4V produced by hand mill. With simple aging treatments, the metastable beta alloys attain higher specific strength than conventional alpha beta alloys. Further weight saving potential exists by exploiting the close tolerance and long lengths from continuous strip processing and selective roll taper forming of these alloys. A low cost isothermal brazing method is currently being developed by Lockheed for fabrication of beta alloy components. Heated dies are used to achieve rapid, out-of-furnace heating in an argon atmosphere. A 30 percent reduction in fabrication costs relative to the conventional hot forming method is postulated. The ability to produce precision titanium forgings at substantial cost savings has also been demonstrated. Net section forging by the Lockheed-California Company proprietary forging process has been produced in the 920-1030 K (1200-1400°F) forging range. This temperature range is tolerant of relatively inexpensive die materials and conducive to long die life.

SPF/DB is an emerging technology in the field of titanium fabrication which has high promise of reducing airframe fabrication cost by minimizing costly assembly and machining and minimizing weight by making efficient use of the metal. Fabrication cost reduction up to 50 percent over conventional hot forming has been shown. There is an extensive ongoing effort in the aerospace industry to move this technology into full production.

Advanced Composites

The stiffness-to-weight and strength-to-weight characteristics of fiber/matrix materials have long established their top position as candidates for extensive use in future aircraft structures. The weight savings benefits have

been demonstrated in numerous research and development and limited production programs. For supersonic cruise applications where surface temperatures range from 380 K (220°F) for Mach 2.0 cruise to 475 K (395°F) for Mach 2.7 cruise, the composite material systems projected for extensive use on current subsonic commercial transport aircraft are not suitable. Government-sponsored programs have been implemented to extend the current epoxy matrix composite technology in joint and attachment designs to include polyimide matrix composites (ref. 10). The program is designed to provide the data necessary to build graphite/polyimide (Gr/PI) lightly loaded flight components for advanced space transportation systems and high speed aircraft. For Mach 2.0 cruise application, the possibility of building secondary structural components employing an advanced epoxy matrix system (450 K cure) exists. Gains attributable to use of advanced composite materials are encouraging. However, many technologies must be developed further before confidence is at a level where composite materials represent a viable alternative to advanced aluminum and titanium alloys for primary structure of a commercial supersonic cruise aircraft. As in the case of subsonic application, there is a need for a planned development of an intermediate temperature matrix resin system, that is durable and processable, for long-time use in the 380 K to 450 K (220°F to 350°F) temperature range.

STRUCTURAL-MATERIAL CONCEPTS

Three structural-material concepts were considered for the Mach 2.0 airplane configuration shown in figure 3. The selected approaches are identified by the primary material system employed and include (1) an advanced aluminum alloy configuration, (2) an advanced titanium alloy configuration, and (3) an advanced composite configuration. Other material applications were also included for various components (i.e., wing, tail, body, inlet, nacelle, landing gear) of these configurations based on specific design requirements. For reference purposes, a conventional aluminum alloy configuration was also included. This reference configuration was assumed to be manufactured using the current high temperature aluminum alloys employed on the Anglo-French Concorde aircraft.

Although the details are not included as part of this paper, two structural-material concepts were considered for a Mach 2.55 cruise aircraft. These configurations employ the same combinations of material as the advanced titanium alloy and advanced composite configurations presented in this paper.

Advanced Aluminum Alloy Configuration

For this study, target properties were postulated for the advanced aluminum alloy materials that were equivalent to the specific properties of titanium alloy 6Al-4V, table II. These materials were employed in appropriate design regions as dictated by strength, stiffness, fatigue, and minimum gage design requirements (figure 9). The material usage for this configuration is shown in table III. As indicated on this table, 66 percent of the structural weight consists of advanced aluminum alloy usage. The balance of the airframe weight is made up of 12 percent advanced titanium, 10 percent steel, 1 percent composite, and 11 percent other materials. For an aircraft that performs a

290 passenger payload, 7400 km (4000 n.mi.) range mission, the takeoff gross weight and structural weight are 311 500 kg (686 600 lbm) and 79 600 kg (175 600 lbm), respectively. The usage of advanced aluminum alloys in this aircraft is 52 900 kg (116 600 lbm). The aluminum application consists of 35 percent for the high strength, corrosion-resistant alloy; 33 percent for the damage-tolerant, fatigue-resistant alloy; and 32 percent for the high stiffness, low density alloy.

As displayed on figure 9, the aft and tip box regions employ a spanwise-stiffened sheet/plate and extruded zee-stringer design. Advanced damage tolerant aluminum alloy is proposed for the design of the wing lower surface which is subjected to repeated high tensile forces. The high strength, corrosion-resistant alloy is proposed for compression-critical upper surface panels. A multiweb substructure of ribs and spars, fabricated from the advanced damage-tolerant alloy, is employed to provide support for the surface panels; to introduce loads from the leading edge and trailing edge surface controls; and to provide for fuel containment and fail-safety. The forward box structure uses both chordwise-stiffened and spanwise-stiffened surface panels with corresponding multispar and multirib substructure as shown. The surface panels are minimum gage design employing a low density-high stiffness alloy with an equivalent thickness of 0.20 cm (0.080 in.).

The fuselage shell structure consists of advanced damage tolerant skins, high strength extruded zee-stringers with frame supports at approximately 0.51 m (20.0 in.) spacing. Weld bonding and adhesive bonding are proposed for joining the skin, stringer, and frame elements.

Advanced Titanium Alloy Configuration

New technologies emerging in the field of titanium alloy development that will expand the application to commercial supersonic airframe structure were postulated. The more important aspects currently being pursued by Government and industry which include (1) SPF/DB, (2) low cost cold formable beta alloy sheet development, and (3) LCT fabrication process development were applied to appropriate regions of the airplane, as shown on figure 10.

The material usage for this configuration is shown in table IV. As indicated on this table, 75 percent of the structural weight consists of titanium usage. This increase in the primary material application from 66 percent advanced aluminum alloy to 75 percent titanium alloy results because of the application of the latter material to the space limited and temperature sensitive regions of both configurations.

For an aircraft that performs a 290 passenger payload, 7400 km (4000 n.mi.) range mission, the takeoff gross weight and structural weight are 311 500 kg (686 600 lbm) and 79 600 kg (175 600 lbm), respectively. The titanium alloy usage is 59 500 kg (131 100 lbm). The application of advanced titanium technology includes (1) 41 percent SPF/DB process with Ti-6Al-4V, (2) 20 percent LCT fabrication of beta alloy Ti-15V-3Cr-3Al-3Sn combined with Ti-6Al-4V, and (3) other titanium alloys associated with net forgings and large diffusion bonded structural components.

The structural concepts and arrangement for the wing and fuselage are shown on figure 10. The wing forward and aft box structure employs a smooth skin-circular arc stiffened beaded panel design, with the wing bending material concentrated in the spar caps. The surface panels transmit the chordwise axial and in-plane shear loads and out-of-plane pressure loads. SPF/DB is the method of fabrication proposed for the surface panels. The manufacturing limit for the surface panels was held to approximately 3.7 x 7.4 m (12 x 24 ft). In locating wing spars in the chordwise-stiffened wing area, a minimum spacing of 0.53 m (21 in.) was maintained between constraints such as fuel tank boundaries. Wing rib spacing was a nominal 1.52 m (60 in.) but was modified as required to suit geometrical design constraints. In the chordwise-stiffened and transition areas, SPF/DB truss spars were used except where a spar serves as a fuel tank wall. At such locations, spars have SPF circular-arc webs with stiffened "I" caps electron beam welded to the web structure. To facilitate fuel sealing, surface beads do not extend across tank boundaries. Wing spars in the aft wing box were fabricated as continuous subassemblies extending from tip to tip.

In the stiffness critical wing tip region, SPF/DB expanded sandwich panels are employed. The circular-arc spars and ribs are fabricated postulating SPF/DB. In the joint area, where a transition in structural arrangement was made, the outboard expanded sandwich surfaces were extended inboard so that spanwise components of the outboard surface loads due to wing bending loads are transferred directly into the chordwise-stiffened structure at the rib interface.

The fuselage structural arrangement includes roll-taper-formed stringers fabricated from beta alloy Ti-15V-3Cr-3Al-3Sn, crack stoppers between frames, floating zee frames and shear clips. Open-hat-section roll-taper-formed stringers, which provide structural efficiency, are proposed for the more highly loaded centerbody and aftbody regions. Isothermal brazing is proposed to join the stringers to the Ti-6Al-4V skins. Longitudinal skin-panel splices are located only at the top centerline of the fuselage and at the floor/shell intersections fore and aft of the wing carry-through area.

Advanced Composite Configuration

It was postulated that future developments in advanced composites materials will result in material systems compatible with long-lifetime operation in the supersonic environment with greater ductility and toughness, impact resistance, and resistance to crack and flaw propagation than the current epoxy resin matrix systems. The more ductile system will also be easier to machine and drill without damage. Two resin matrix systems are envisioned for supersonic cruise vehicle application: (1) an advanced graphite/epoxy system for secondary structure applications for temperatures up to 384 K (230°F), and (2) an intermediate temperature matrix (ITM) composite resin system for primary structure application for temperatures greater than 384 K (230°F) and up to 450 K (350°F).

The structural concepts and arrangement for the wing and fuselage are shown on figure 11. Several composite design concepts were examined for primary wing structure application. All the wing surface panel concepts were smooth-skin

designs which exploited the low coefficient of thermal expansion characteristics of the graphite composites. The fuselage is a more conventional skin-stringer and frame design.

The material usage for the primarily composite material design is shown in table V. The advanced composite usage represents 55 percent of the total structural weight. The aircraft also employs 17 percent advanced aluminum alloys, 8 percent advanced titanium alloys and manufacturing approaches, and 20 percent other materials including steel.

Because of the weight efficiency of the composite materials, the takeoff gross weight and structural weight are 264 900 kg (584 100 lbm) and 58 600 kg (129 300 lbm), respectively. The composite usage amounts to 32 400 kg (71 400 lbm) of the structural weight. Approximately 38 percent is for secondary structure using an advanced graphite/epoxy material system with the balance, or 62 percent, directed towards primary structure application using an advanced fiber/intermediate-temperature resin matrix.

Advanced composites application trends are shown on figure 12 for both fuselage and wing structure. For the fuselage the application of advanced Gr/Ep to the secondary structure results in a 6 percent weight reduction of total body weight. Use of an advanced fiber/intermediate-temperature resin matrix to the fuselage shell (57 percent composite usage) results in an additional 7.5 percent weight reduction. For the wing structure two design approaches are indicated. The application of composite materials to the secondary structure is common to both approaches. The figure indicates the approximately 28 percent composite usage results in about an 11 percent weight reduction. Aggressive application to the aft and tip box, and separately to the forward box, using advanced fiber/intermediate temperature resin matrix for the primary wing structure is indicated by the solid line. The application of advanced composites to the forward box region of the wing results in downward slope to the weight reduction trends. This change in slope is indicative of the composites not being weight efficient in this region based on minimum gage design constraints postulated for foreign object damage requirements. The most weight effective application for the wing is depicted by the weight reduction trends resulting from employing unidirectional composite reinforcement to the spar caps in the wing aft box region. The weight reduction shown for the wing tip is obtained by using advanced composites in this stiffness critical region.

The stiffness critical wing tip box and strength critical aft box structure shown in figure 11 are proposed as sandwich-type surface panels with laminated Gr/ITM face skins. A multiweb substructure of Gr/ITM ribs and spars are indicated to support the surface panels and to introduce the concentrated control surface loadings. The wing forward box is an advanced metallic design because of its weight efficiency based on foreign object damage requirements. Both chordwise- and spanwise-stiffened integrally stiffened extruded planks made from high stiffness, low density advanced aluminum alloy are employed in this region. The majority of the surface panels are minimum gage design with an equivalent thickness of 0.20 cm (0.080 in.)

The fuselage is bending critical over most of its length except in the forebody, where cabin pressure dictates minimum gage for the structure. The

use of Gr/ITM composites is proposed for the skin, stringers, and frames. A tee-stiffened design is employed for the lightly loaded pressure critical region. A hat stringer design is postulated for the bending critical centerbody and aftbody structure. A frame spacing of approximately 0.51 m (20.0 in.) and a frame depth of 7.6 cm (3.0 in.) is also indicated.

Secondary structure represents approximately 38 percent of the total composite application. The advanced Gr/Ep material system is proposed for these components. Major items for wing application include the leading edge and trailing edge surfaces, and the main landing gear doors. The fuselage applications encompass the floor and floor supports, doors, underwing fairings, and cargo compartment provisions. Limited application of Kevlar fibers and fiberglass is envisioned to improve impact resistance, to provide softening strips, and for electrical isolation.

WEIGHT TRENDS OF CONCEPTS

The advanced material application to the individual structural components of representative supersonic cruise aircraft optimized for Mach 2.0 and Mach 2.55 cruise was investigated. The aircraft weight trends in terms of takeoff gross weight and structural weight are shown on figure 13 for a vehicle sized to perform a constant 290 passenger payload - 7400 km (4000 n.mi) range mission. These data are further amplified in table VI and include (1) structural weight, (2) takeoff gross weight, (3) structural weight fraction, and (4) the fraction of the structural weight for the primary materials employed in the design.

For the Mach 2.0 aircraft, the gross weights for the advanced composite and advanced metallic configurations are 264 900 kg (584 100 lbm) and 311 500 kg (686 600 lbm), respectively. The structural efficiency of advanced composites application to the airframe results in a 15 percent decrease in takeoff gross weight over the advanced metallic designs. The structural weight decrease between the two is 21 100 kg (46 300 lbm) or approximately 27 percent. For reference purposes a Mach 2.0 supersonic cruise aircraft employing aluminum alloys comparable to that used on the current Concorde supersonic transport is shown as Conventional Aluminum. The takeoff gross weight and structural weight for this aircraft are 359 800 kg (793 200 lbm) and 102 900 kg (226 700 lbm), respectively. For the same payload range, the takeoff gross weight is 36 percent and structural weight 75 percent greater than the advanced composite aircraft.

For the two aircraft optimized for Mach 2.55 cruise the takeoff gross weight and structural weight are greater than their comparable Mach 2.0 designs due to increased demands of the supersonic environment. The structural weight is approximately 9 percent greater for the higher cruise Mach number aircraft resulting in an aircraft with takeoff gross weight which is about 5 percent greater than for the Mach 2.0 designs.

The structural material concepts for the Mach 2.0 aircraft were further applied to constant payload-range aircraft by interaction evaluation of

structural weight and performance to obtain the trends displayed on figure 14. These trends for the advanced metallic and the advanced composite applications to a Mach 2.0 cruise aircraft indicate that the most significant weight reduction results from resizing the airplane to reflect the lower structural weight achieved through advanced materials application. This resized smaller aircraft also has inherent cost benefits in terms of its manufacture and operation.

CONCLUDING REMARKS

A multidisciplinary study was performed to identify advances in structural-material-manufacturing technology necessary to attain an economically viable commercial supersonic cruise aircraft that could be operational in the early 1990's. Structural-material concepts applicable to both Mach 2.0 and Mach 2.55 cruise aircraft were considered. The design methodology to cope with the various interactive parameters established in previous studies provided guidance to structural-material concepts application. Potential payoffs in weight and performance were identified by applying design concepts to representative supersonic cruise vehicles with appropriate weight reduction factors. Flyaway cost reductions commensurate with the aircraft weight empty were also identified. Significant improvement in fuel fraction of a constant weight airplane employing composite materials displayed performance improvement of approximately 15 percent. Resizing the aircraft to the design payload-range goal resulted in a 20 percent reduction in the operating empty weight and a commensurate reduction in flyaway cost.

- Advanced composites - The greatest potential for improved structural efficiency is indicated by extensive application of advanced composites. Gains attributable to the use of composites materials are encouraging. However, many technologies and data that are being pursued in existing programs must be developed further before confidence is at a level where composite materials represent a viable alternative to the emerging advanced aluminum alloy and advanced titanium alloy technologies.
- Advanced aluminum alloys - Advances in aluminum processing and alloying technologies, particularly in powder metallurgy, offer new approaches for development of an improved family of heat resistant alloys with specific properties providing structural equivalence to titanium. These alloys represent a low cost alternative to titanium.
- Advanced titanium alloy and manufacturing - In space-limited and temperature-sensitive regions of the aircraft, the use of titanium alloys will be required. Superplastic forming-diffusion bonding is an emerging technology in the field of titanium fabrication which shows high promise for reducing airframe fabrication and assembly costs. The efficient use of metals by this process also results in weight saving benefits. The cold formable beta alloys represent a further breakthrough in cost reduction of airframe components. With simple aging treatment, the metastable beta alloys attain higher specific strength than the conventional alpha-beta alloys.

Isothermal brazing is a potentially low cost joining method for fabrication of beta alloy components by rapid out-of-furnace heating in an argon atmosphere.

The application of advanced metallic and advanced composite materials to the airframe is essential to attain lightweight structures. New technology offers opportunities to explore the benefits of combining these developments in the form of hybrid structures that are weight efficient, durable, damage tolerant, and cost-effective designs. These hybrids include: (1) structural assemblies of advanced metallic and composite components and (2) structural elements employing advanced metallic and composites in intimate contact. The latter ranges from fiber resin and/or metal matrix reinforced metal structures to advanced metallic systems where the fiber reinforcement is an integral ingredient of the material system.

RECOMMENDATIONS

The future development of commercial supersonic transport aircraft will require new, improved material systems, innovative design concepts, low cost manufacturing techniques and improved design analysis methods.

The application of these new developments on the next generation advanced technology long-range transport aircraft can occur in the early 1990's. The design of an airplane to meet this need will start in the late 1980's. With a concentrated effort, the technologies for applying the advanced material systems to the aircraft can be available by then.

The recommended road map for developing the essential supersonic airframe technology, in parallel with the other disciplinary technologies, is shown in figure 15. Initial efforts will focus on design data and design concepts development, followed by design, fabrication, and structural test of advanced large-scale airframe components. These activities must be complemented by materials and processes and design allowables development. Although improvements in design analysis of large flexible airframe structures has been demonstrated, continued efforts are essential to develop methods for rapid and accurate sizing of airframe structures employing computer-aided design procedures.

In recognition of current uncertainties concerning the timing and funding of the NASA SCR Program, early initiation of several long lead-time technology development efforts is recommended:

- Development of an intermediate temperature resin matrix composite material system to provide a firm material base for application of advanced composite to primary structure of supersonic aircraft.
- Development of a family of advanced aluminum alloys for supersonic airframe development that are low cost alternatives to the titanium alloys.
- Continued design concepts development to verify current trends resulting from this and other analytical investigations.

REFERENCES

1. Sakata, I.F.; Davis, G.W.: Evaluation of Structural Design Concepts for an Arrow-Wing Supersonic Cruise Aircraft. NASA CR-2667, May 1977.
2. Wright, B. R.; et al.: Supersonic Cruise Vehicle Technology Assessment Study of an Over/Under Engine Concept, NASA CR-159003, December 1978.
3. Evaluation of Low Cost Titanium Structure for Advanced Aircraft, NASA CR-145111, November 1976.
4. Wright, B. R.; et al.: Supersonic Cruise Vehicle Technology Assessment Study of an Over/Under Engine Concept, NASA CR-145285, October 1977.
5. Evaluation of Superplastic Forming and Co-Diffusion Bonding of Ti-6Al-4V Titanium Alloy for Supersonic Cruise Aircraft Research, Contract NAS1-15527, McDonnell Douglas Corporation, 1979.
6. Supersonic Cruise Research Structural Panel Program, Thirteenth Semi-Annual Report, SP-4989, June 1979.
7. Investigation of Low Temperature Forming of Beta Titanium Alloys for Supersonic Cruise Aircraft Research Applications, Contract NAS1-15568, Lockheed-California Company, 1979.
8. M. K. Guess, Jr., et al.: Advanced Materials and Fabrication Processes for Supersonic Cruise Aircraft, Supersonic Cruise Research '79, NASA CP-2108, 1980. (Paper 32 of this compilation.)
9. J. S. Clauss, Jr.; et al.: The Impact of Materials Technology and Operational Constraints on the Economics of Cruise Speed Selection, Supersonic Cruise Research '79, NASA CP-2108, 1980. (Paper 42 of this compilation.)
10. D. E. Skoumal; et al.: Design, Fabrication and Test of Graphite/Polyimide Composite Joints and Attachments for Advanced Aerospace Vehicles, Quarterly Technical Progress Report No. 2, NASA CR-159109, July 1979.

TABLE I. - AIRPLANE DIMENSIONAL DATA

Wing		
Total area (SW)	587.93 m ²	6232.0 ft ²
Aspect ratio (AR)	2.1	
Taper ratio (λ)	0.1278	
Span (b)	34.87 m	114.39 ft
Root chord (C _r)	35.80 m	117.45 ft
Tip chord (C _t)	4.58 m	15.01 ft
L.E. sweep (Λ_{LE})		
• Inboard	1.187 rad	68.0 deg
• Mid	1.127 rad	64.56 deg
• Tip	0.90 rad	51.7 deg
Fuselage		
Length	89.51 m	293.67 ft
Width	4.01 m	158.04 in.
Depth	4.01 m	158.04 in.

TABLE II. - FORECASTED MECHANICAL PROPERTIES FOR ADVANCED ALUMINUM ALLOYS

Alloy Class	Wing and Fuselage Primary Structure Application	E GPa (msi)	F _{tu} MPa (ksi)	F _{cy} MPa (ksi)	ρ kg/m ³ (pci)
Damage Tolerant ⁽¹⁾ Alloy	Wing lower surface; fuselage skins; fuselage forebody shell structure	73.8 (10.7)	469 (68)	427 (62)	2768 (0.10)
High Strength- ⁽¹⁾ Corrosion Resistant Alloy	Wing Upper surface; fuselage stringers; fuselage frames	72.4 (10.5) 86.2 (12.5)	579 (84) 517 (75)	565 (82) 503 (73)	2768 (0.10) 2768 (0.10)
High Stiffness ⁽¹⁾ Alloy	Wing tip region: upper and lower surface; fuselage afterbody	86.2 (12.5)	427 (62)	379 (55)	2491 (0.09)
Low Density ⁽¹⁾ Alloy	Wing minimum gage regions	86.2 (12.5)	427 (62)	379 (55)	2491 (0.09)

(1) Required fatigue life for general airframe structure of supersonic cruise aircraft is achieved by limiting the ultimate design allowable gross-area stresses of advanced aluminum alloy as forecasted below:

- Damage tolerant alloy - 379 MPa (55 ksi)
- High strength alloy - 338 MPa (49 ksi)
- High stiffness alloy - 310 MPa (45 ksi)
- Low density alloy - 310 MPa (45 ksi)

TABLE III. - WEIGHT MATRIX FOR ADVANCED ALUMINUM CONFIGURATION

Component	Fraction of structural weight					Weight	
	Aluminum	Titanium	Composite	Steel	Other	kg	lbm
Wing	0.92	0.05	0	0.02	0.01	35 800	79 000
Tail	0.93	0.04	0	0.01	0.02	2 700	5 900
Body	0.79	0.05	0.02	0.02	0.12	21 800	48 000
Landing Gear	0.01	0.25	0	0.38	0.36	14 100	31 200
Nacelle	0.04	0.30	0	0.66	0	2 300	5 100
Inlet	0.05	0.89	0	0.01	0.05	2 900	6 400
Total	0.66	0.12	0.01	0.10	0.11	1.00	1.00
Total (kg)	52 900	9 600	500	8 100	8 500	79 600	-
Weight (lbm)	116 600	21 100	1 200	18 000	18 700	-	175 600

TABLE IV. - WEIGHT MATRIX FOR ADVANCED TITANIUM CONFIGURATION

Component	Fraction of structural weight					Weight	
	Aluminum	Titanium	Composite	Steel	Other	kg	lbm
Wing	0.05	0.92	0	0.02	0.01	35 800	79 000
Tail	0.04	0.93	0	0.01	0.02	2 700	5 900
Body	0.05	0.79	0.02	0.02	0.12	21 800	48 000
Landing Gear	0.01	0.25	0	0.38	0.36	14 100	31 200
Nacelle	0.04	0.30	0	0.66	0	2 300	5 100
Inlet	0.04	0.89	0	0.01	0.06	2 900	6 400
Total	0.04	0.75	0.01	0.10	0.10	1.00	1.00
Total (kg)	3 000	59 500	500	8 100	8 500	79 600	-
Weight (lbm)	6 600	131 100	1 200	18 000	18 700	-	175 600

TABLE V. - WEIGHT MATRIX FOR ADVANCED COMPOSITE CONFIGURATION

Component	Fraction of structural weight					Weight	
	Aluminum	Titanium	Composite	Steel	Other	kg	lbm
Wing	0.33	0.05	0.58	0.02	0.02	24 100	53 042
Tail	0.40	0	0.60	0	0	1 500	3 412
Body	0.07	0	0.77	0	0.16	18 400	40 500
Landing Gear	0	0.20	0.12	0.31	0.37	10 800	23 900
Nacelle	0.04	0.50	0.40	0	0.06	1 700	3 800
Inlet	0.05	0.27	0.60	0.05	0.03	2 100	4 700
Total	0.17	0.08	0.55	0.07	0.13	1.00	1.00
Total (kg)	10 100	4 700	32 400	4 000	7 400	58 600	-
Weight (lbm)	22 300	10 400	71 400	8 800	16 400	-	129 300

TABLE VI. - AIRCRAFT MATERIAL MIX AND WEIGHT TRENDS

Configuration		Fraction of structural weight					Structural weight kg (lbm)	Gross weight kg (lbm)	Structural weight fraction
		Aluminum	Titanium	Composites	Steel	Others			
Optimized for Mach 2.0 cruise	Advanced aluminum	0.66	0.12	0.01	0.10	0.11	79 600 (175 600)	311 500 (686 600)	25.58
	Advanced titanium	0.04	0.75	0.01	0.10	0.10	79 600 (175 600)	311 500 (686 600)	25.58
	Advanced composite	0.17	0.08	0.55	0.07	0.13	58 600 (129 300)	264 900 (584 085)	22.12
	Conventional aluminum	0.70	0.11	0.01	0.10	0.10	102 900 (226 700)	359 800 (793 200)	28.59
Optimized for Mach 2.55 cruise	Advanced titanium	0.04	0.75	0.01	0.10	0.10	86 200 (190 000)	327 900 (722 900)	26.28
	Advanced composites	0.02	0.23	0.55	0.07	0.12	64 000 (141 100)	279 700 (616 600)	22.89

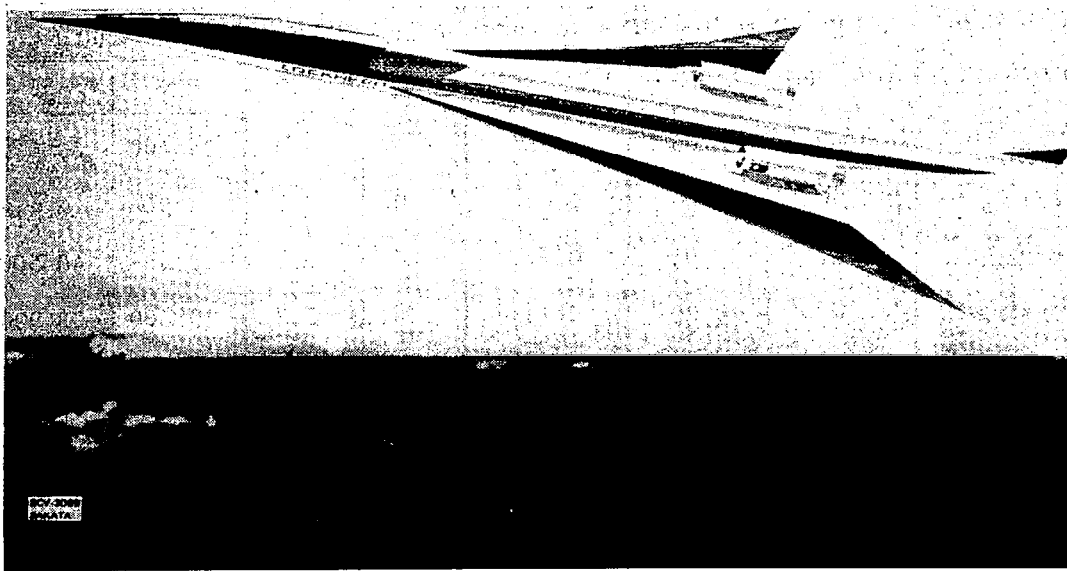


Figure 1.- Future commercial supersonic cruise aircraft.

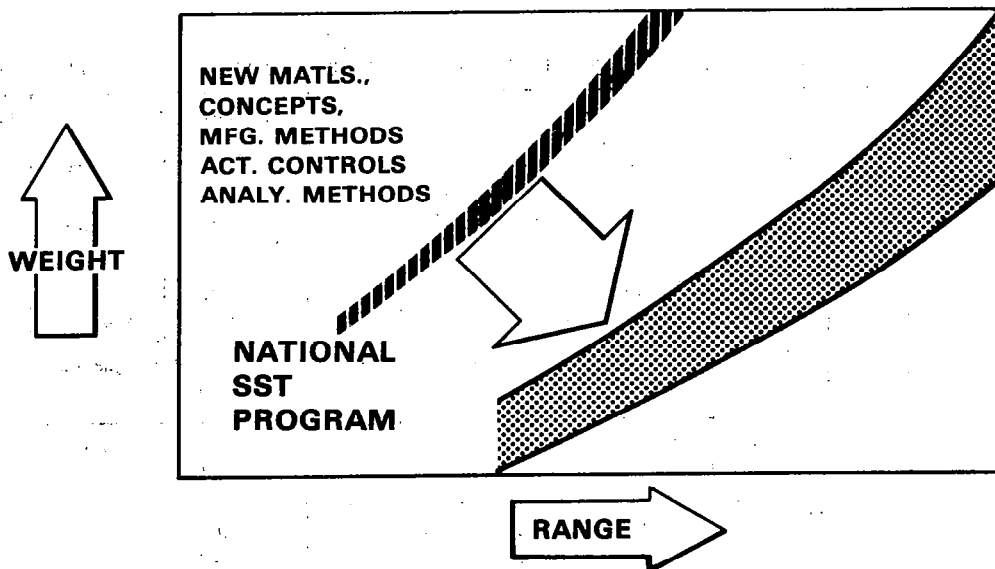


Figure 2.- Advanced technology trends.

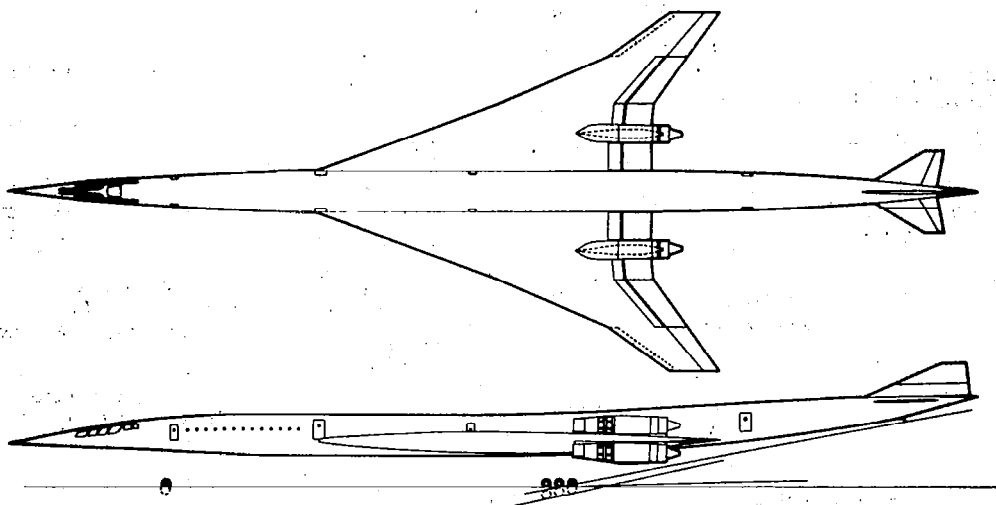
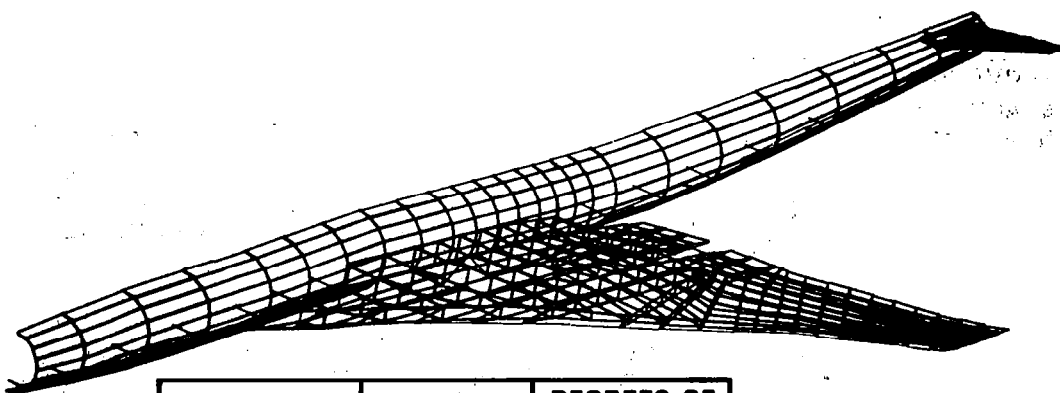


Figure 3.- Baseline configuration.



GRID POINTS	ELEMENTS	DEGREES OF FREEDOM
780	1750	2300

Figure 4.- Finite element structural analysis model.

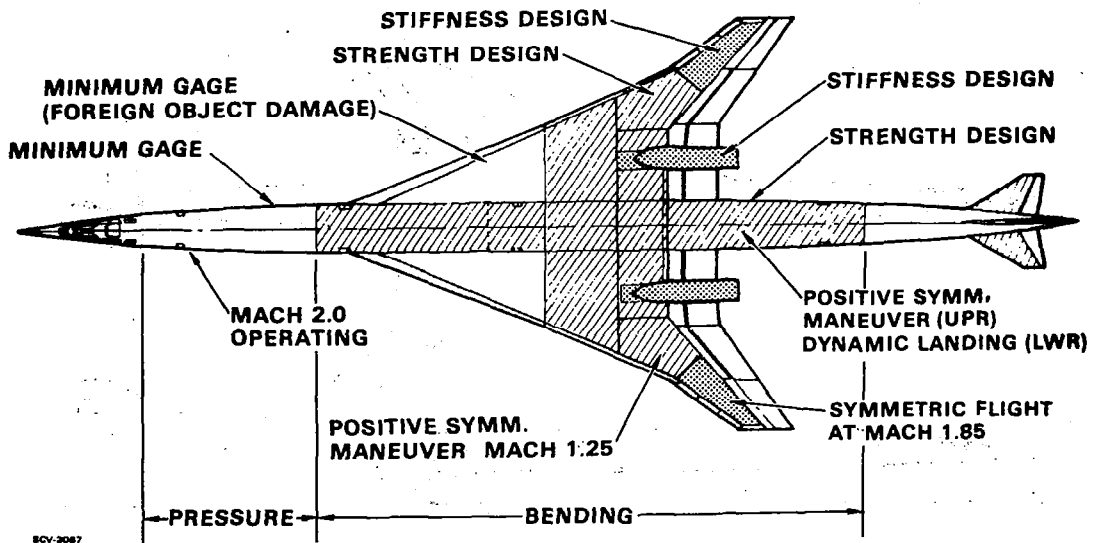


Figure 5.- Design requirements for supersonic cruise aircraft.

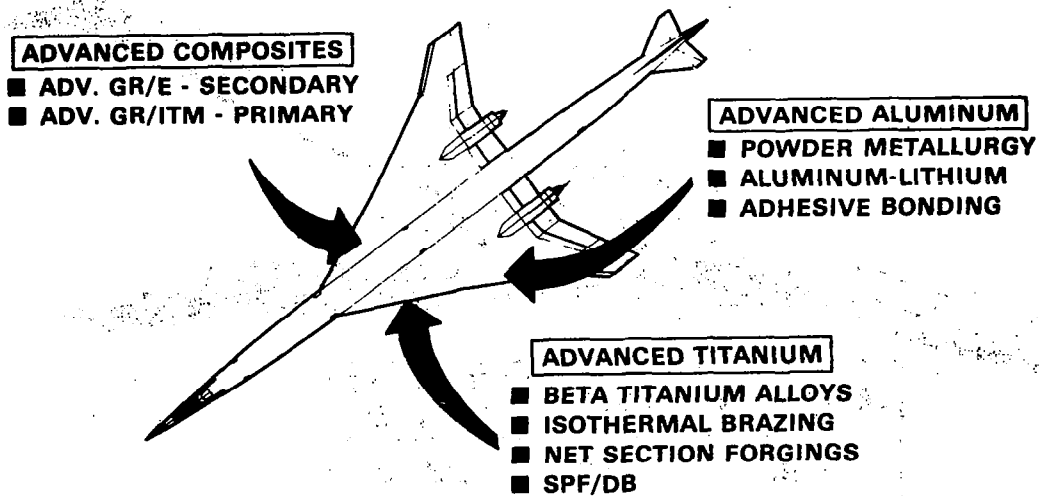


Figure 6.- Advanced material trends for supersonic cruise aircraft application.

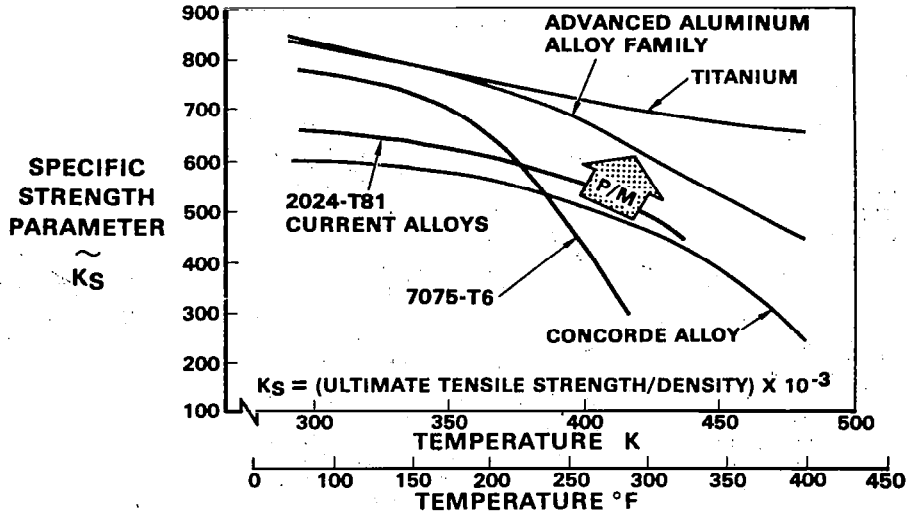


Figure 7.- Advanced aluminum material trends.

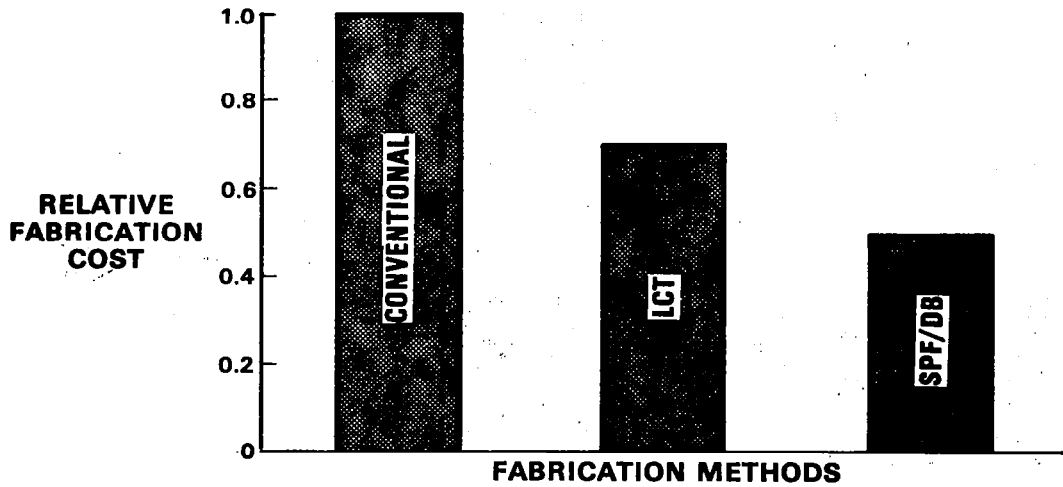


Figure 8.- Advanced titanium alloy fabrication cost trends.

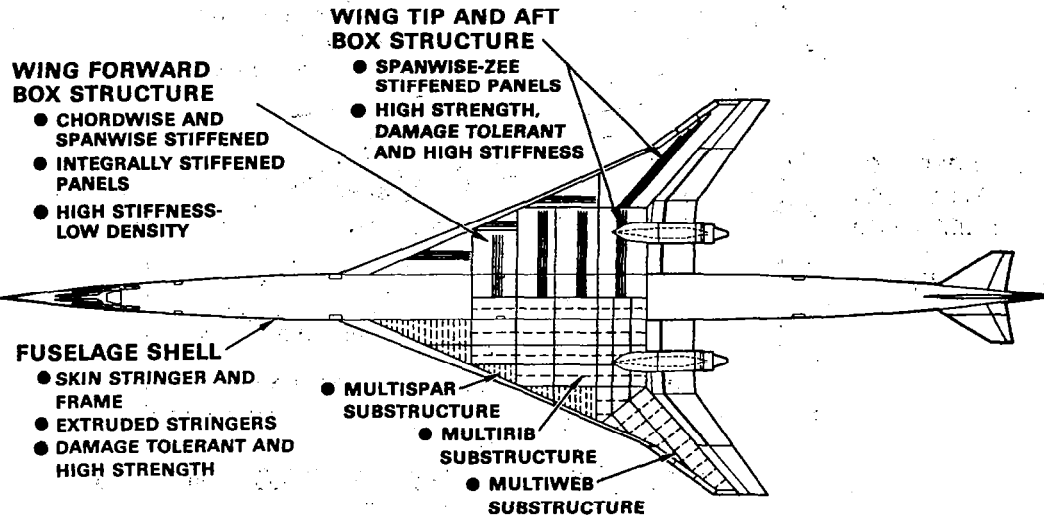


Figure 9.- Advanced aluminum alloy configuration.

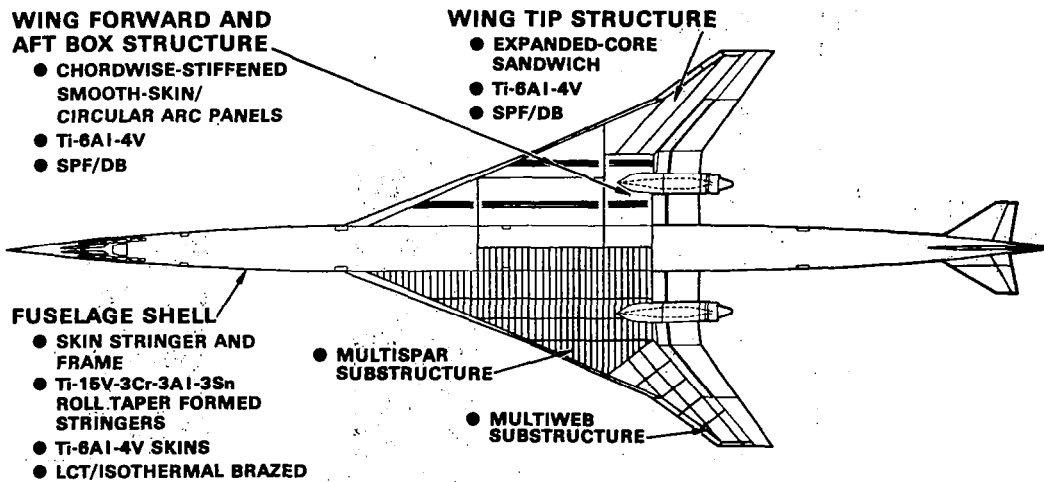


Figure 10.- Advanced titanium alloy configuration.

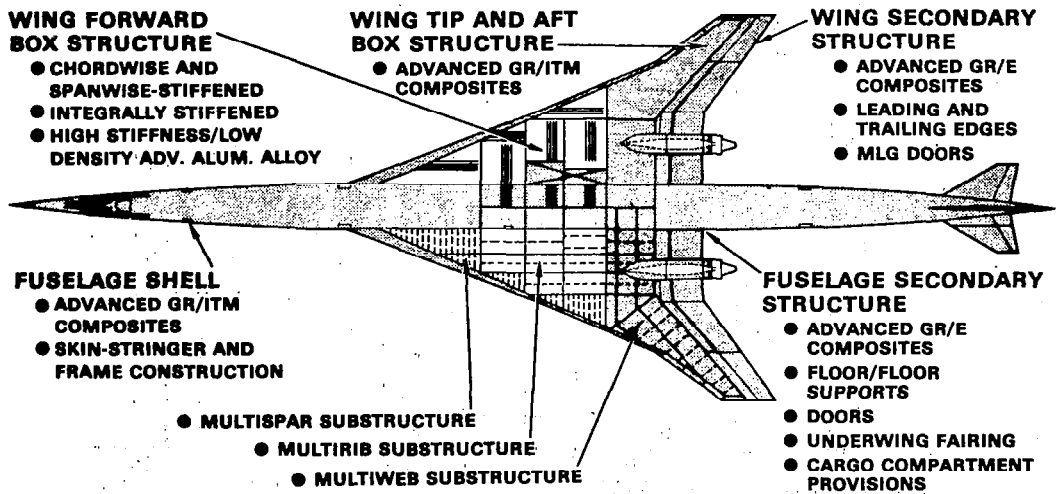


Figure 11.- Advanced composites configuration.

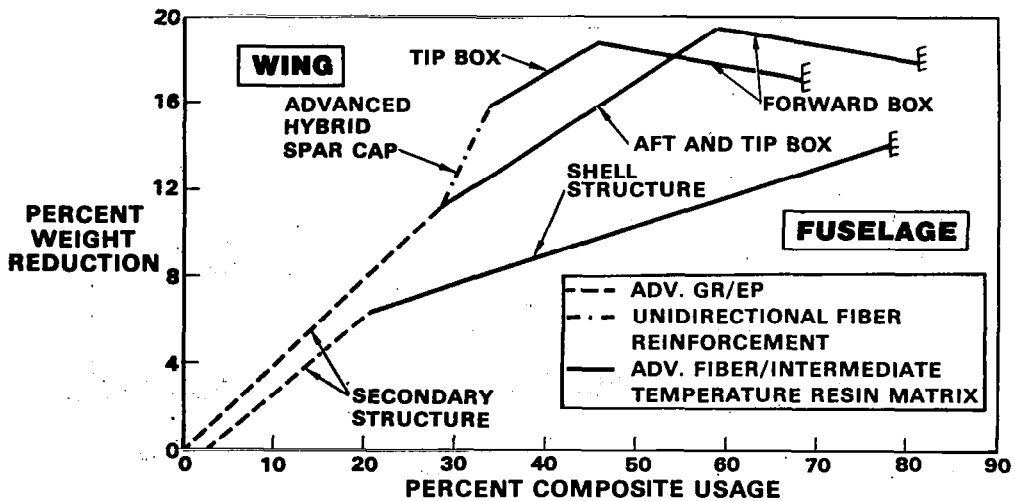


Figure 12.- Advanced composites application trends.

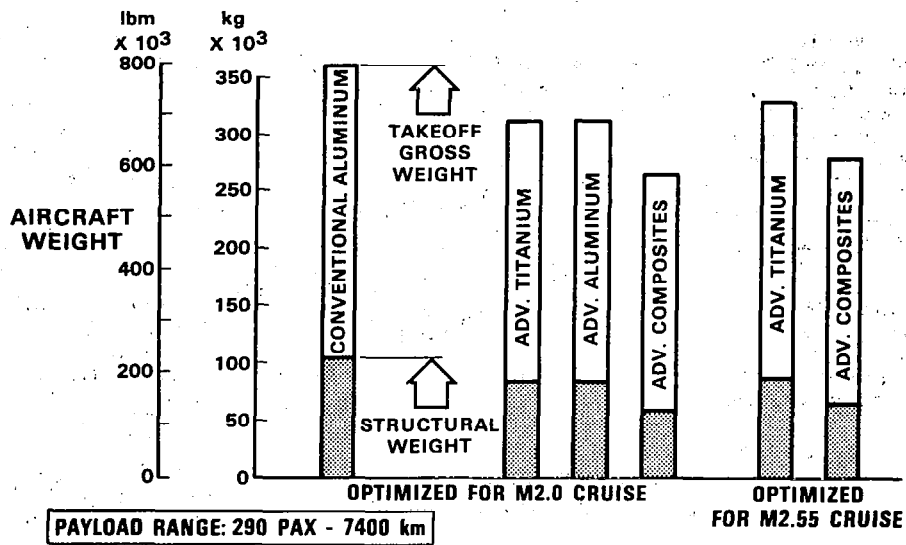


Figure 13.- Aircraft weight trends.

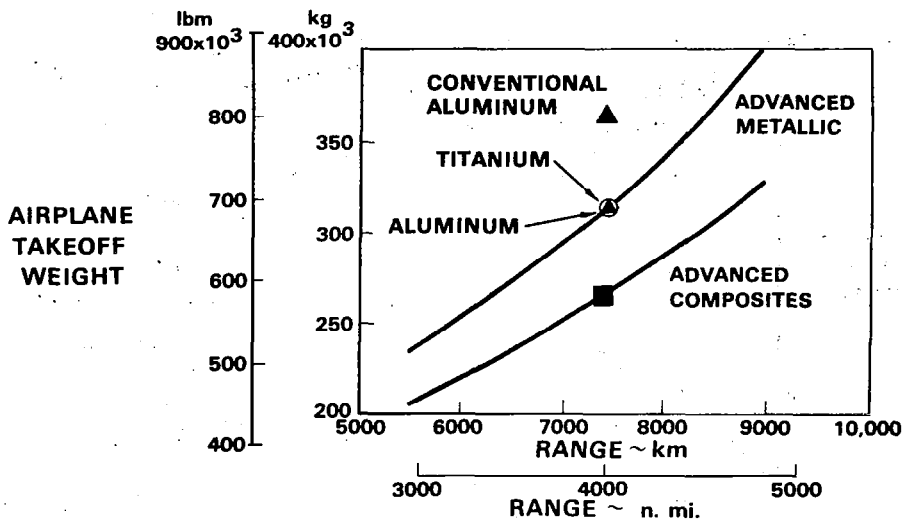


Figure 14.- Aircraft weight and performance trends - Mach 2.0 cruise.

**AIRFRAME DESIGN DEVELOPMENT
FOR COMMERCIAL SUPERSONIC
CRUISE AIRCRAFT**

OBJECTIVE:

**TO DEVELOP THE ESSENTIAL SUPERSONIC AIRFRAME
TECHNOLOGY BASE, IN PARALLEL WITH OTHER DISCIPLINARY
TECHNOLOGIES, WHICH WILL PERMIT SIGNIFICANT WEIGHT
AND COST REDUCTION OF LONG-LIFETIME COMMERCIAL
SUPERSONIC CRUISE AIRCRAFT.**

PRIMARY AND SECONDARY STRUCTURE

**MATERIAL APPLICATION, DESIGN DATA
AND CONCEPTS DEVELOPMENT**

- ADVANCED ALUMINUMS
- ADVANCED TITANIUMS
- ADVANCED COMPOSITES
- ADVANCED HYBRIDS

DESIGN VERIFICATION

DEMONSTRATION ARTICLES

SCV-3088
SAKATA

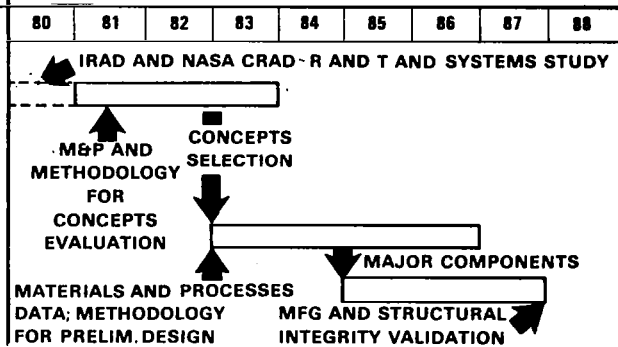


Figure 15.- Supersonic airframe design road map.

1. The first part of the document discusses the importance of maintaining accurate records of all transactions and activities. It emphasizes that proper record-keeping is essential for transparency and accountability, particularly in financial reporting and compliance with regulatory requirements.

2. The second part of the document outlines the various methods and tools used to collect, store, and analyze data. It highlights the need for robust data management systems that can handle large volumes of information and provide timely insights into organizational performance and trends.

3. The third part of the document focuses on the role of technology in enhancing data collection and analysis. It discusses the use of advanced software solutions and automation to streamline data processing and improve the accuracy and efficiency of reporting.

4. The final part of the document concludes by summarizing the key findings and recommendations. It stresses the importance of ongoing monitoring and evaluation to ensure that data collection and analysis processes remain effective and aligned with the organization's strategic goals.

OPPORTUNITIES FOR STRUCTURAL IMPROVEMENTS FOR
AN ADVANCED SUPERSONIC TRANSPORT VEHICLE

J. E. Fischler
Douglas Aircraft Company

SUMMARY

The superplastically formed diffusion-bonded (SPF/DB) program has developed successfully and far enough to recommend that a major structural program to validate the weight and cost of SPF/DB sandwich titanium structure should be initiated. The NASA Langley study of wing and fuselage SPF/DB sandwich panels is helping to show that this process is potentially structurally efficient. The Douglas SPF/DB expanded sandwich process that utilizes a welded core sheet that expands to face sheets has proven to be very efficient. Douglas has successfully fabricated many rectangular, triangular, and isogrid core sandwich structures by this process. The theoretical weight optimization design charts for the wing and fuselage concepts have been validated by small-scale tests. Many design applications have been fabricated. Projecting the results of an SPF/DB sandwich airframe structure to a MDC AST design shows significant weight and cost savings. A 6-percent lower direct operating cost (DOC) has been calculated. A growth AST utilizing composites, metal matrices, and SPF/DB sandwich shows future promise for a post-1990 technology readiness. Titanium SPF/DB sandwich has been compared to presently available aluminum structure and found to be superior for application to a Mach 2.2 supersonic transport.

INTRODUCTION

In a significant demonstration of technology leadership, the United States was as recently as 1974 producing 93 percent by value of the free world's civil transport aircraft (ref. 1). Since then, the Europeans have dramatically altered this ratio, and the question now must be asked, "Can advanced technology help the U.S. regain its former position of leadership?" Reviewing only the structures technology that has contributed to this U.S. leadership, structural and material process engineers are proud of the following contributions:

- o Starting from duraluminum and then using aluminum alloys, the 1-g stress has been increased from approximately $34\,474\text{ kN/cm}^2$ (5000 psi) for the DC-3 wing of 1934 to approximately $93\,079\text{ kN/cm}^2$ (13 500 psi) for the DC-10 wing of today (ref. 2), up 270 percent.
- o The DC-10 structure has been successfully fatigue-tested exceeding the Douglas-imposed design requirement of two lifetimes - 120,000 hours of aircraft operations. The DC-3 did not have a structural test requirement for fatigue life. The design life considered at that time was in the neighborhood of 7 to 10 years. Today, the DC-10 economic lifetime is con-

sidered to be more than 20 years. Therefore, the real economic lifetime has increased by a factor of at least two, and because today's aircraft is designed for almost twice the daily utilization, this factor may actually be near 4 times the DC-3 factor.

- o Demonstration of the structural integrity of Air Force aircraft became a comprehensive requirement early in the 1960s. Prior to this, static and fatigue ground tests were relied upon, with only a small amount of flight testing required for structural validation. Using strain gage calibration and pressure transducer data recorded during critical flight maneuvers, analyses were made of the actual quasi-static and dynamic loads to help the structures engineers correlate the margins of safety for static and fatigue loads. These structural integrity test programs provided the insight for designers to use to reduce the structural weight of subsequent commercial designs (ref. 3).
- o Today, prediction of fatigue (visible crack) as well as of crack growth, damage tolerance, fail-safe, and safe-life has been helped greatly by the advanced methods of finite element and fracture mechanics analysis. The analytical and test tools are now available to predict the critical fatigue points on a structure, estimate the crack growth rate, and set an inspection interval that will assure the detection of a crack before its residual strength deteriorates to the limit-load condition. These analytical tools are used to optimize the design concepts. Before a new aircraft is flown today, a thorough ground test program is used to verify the fatigue, damage tolerance, fail-safe, and safe-life requirements. These ground tests also are used to prove the detail design. The analysis methods and ground structural testing now available can be depended on to save additional structural weight (ref. 3).

The structures technology experts in the U.S. want to continue to contribute to making the U.S. the leader in world aviation and are anxious to make new contributions such as new types of construction and the development of new materials and material processes. These have been shown over the years to account for the largest share of the advanced technology weight savings (ref. 3). This report points out that for a potential total structural system weight reduction of 30 to 55 percent, approximately 15 to 25 percent can be gained by new structural concepts and materials and 5 to 10 percent from analysis. Therefore, to obtain the best structural design for a new aircraft, the largest advanced technology payoffs can be expected by using analysis to investigate new structural concepts, materials, and material processes. These weight and cost payoff analyses must then be verified as soon as possible by recording manufacturing costs and final weights for a major piece of structure. Of course, ground static and fatigue testing must be done to validate the design capability. Such major advanced airframe validation tests must be undertaken to assure U.S. leadership in the structures technology area.

This paper will only address the preliminary design opportunities for structural improvements from the investigation of candidate structural concepts, materials, and material processes that show promise for application to an advanced supersonic transport design. However, even in the preliminary design stages a great

deal of analysis, and of materials—allowable, coupon, and small component testing, is required in order to screen and reduce the candidate concepts, materials, and manufacturing process.

Only a vigorous research and development program, followed by the required structural testing to verify that the optimum structural concepts, materials, and manufacturing processes have been developed, will assure continued technology leadership for U.S. aircraft.

SYMBOLS

Values are in both SI and U.S. Customary units. The measurements and calculations are in U.S. Customary units.

a = half crack length, cm (in.)

ΔK = crack tip stress intensity range factor, $N/cm^2 \sqrt{cm}$ (psi $\sqrt{in.}$)

R = stress ratio, $\sigma_{MIN}/\sigma_{MAX}$

σ_{MIN} = minimum stress, N/cm^2 (psi)

σ_{MAX} = maximum stress, N/cm^2 (psi)

K_{IC} = critical stress intensity factor, $N/cm^2 \sqrt{cm}$ (psi $\sqrt{in.}$)

K = stress intensity factor, $N/cm^2 \sqrt{cm}$ (psi $\sqrt{in.}$)

σ = gross stress, N/cm^2 (psi)

N = newton, $kg \cdot m/S^2$

m/S^2 = meters per second squared

SPF/DB = superplastically formed and diffusion bonded

SCV = Supersonic Cruise Vehicle

M = Mach number

Subscripts:

MAX = maximum

MIN = minimum

e = equivalent

TITANIUM ALLOYS VERSUS ALUMINUM ALLOYS

It is necessary to address this subject in order to determine the proper direction for future development efforts. Aluminum alloys have been the workhorse for subsonic aircraft. Does the 1-g stress improvement of 270 percent from the DC-3 to the DC-10 hit a heat barrier, fatigue barrier, or fracture toughness barrier? Do the recent SPF/DB fabrication possibilities of making titanium sandwich yield advantages that are not possible using aluminum?

The relative efficiencies in ultimate tensile strength/density at room temperature, 150°C (302°F), and 500°C (932°F) are shown in figure 1 (from ref. 4) for titanium-6AL-4V, aluminum 7075, and aluminum HID 58. The short column compression panel buckling stress/density versus the structural loading index for the materials mentioned above is shown in figure 2 (also from ref. 4). The titanium alloys show superiority except at low compression load intensities. The values shown are only for axial loading, N_x , a short column, no normal pressure, and room temperature.

The AST has more than axial loading; it also has combined loads, higher temperatures, thermal gradients, and pressure normal to the surface. For typical wing structure (ref. 5) using SPF/DB hat-stiffened sheet, the optimum weight for 101.6-cm (40-in.) wide panels between spars is significantly higher than it is for sandwich structures, which will be shown later.

As in the case of DC-10 structures, the fatigue and damage tolerance requirements must be considered in preliminary design in order to obtain the overall structural efficiency for a particular structural concept.

The British data for the aluminum materials considered are shown since the British had experience with the more advanced creep-resistant HID 58 aluminum alloys of the Concorde and the resulting data would show the most appropriate aluminum comparison information for fatigue and damage tolerance. Figure 3 shows that at about 1 million cycles (approximately one lifetime which we wish to be fatigue free), titanium alloys show a significant increase in the peak stress/density over that of the aluminum alloys. Also of particular interest is the Ti 6AL-4V alloy which Douglas has been using in developing SPF/DB expanded sandwich structures.

After a crack forms, the rate of crack growth becomes very important because it determines how much longer the structure will last. The slower the crack growth rate, the longer the structure life. This continues until the "critical crack" size occurs which thereafter results in rapid crack growth until the crack is stopped (for damage-tolerant structures) at a crack stopper.

Comparing the fracture toughness divided by density of titanium versus aluminum shows the superiority of titanium in rate of crack growth equation (ref. 5).

Figure 4 shows that for a wide range of thicknesses, Ti 6AL-4V alloy is superior in fracture toughness to current aluminums (ref. 4). Douglas analysis has shown that titanium SPF/DB sandwich has a lower stress intensity factor by 65% than a corresponding sheet and this is more significant than the fracture toughness comparison with regard to rate of crack growth. These results will be addressed in a later section.

A problem with titanium 6AL-4V annealed material has recently surfaced regarding large-width sheets. A discussion with TIMET indicates that the desired wider sheets (203 to 254 cm (80 to 100 in.)) of titanium 6AL-4V annealed cannot be rolled to the required sheet thicknesses without small surface cracks occurring. However, TIMET expects that 15-3 titanium alloy can be mill-rolled to these wider sheets without surface cracks occurring. Douglas is concerned that the 15-3 poorer material characteristics (e.g., grain size, fatigue, crack propagation), higher superplastic forming pressures, and poorer diffusion bonding characteristics will outweigh its advantages over 6AL-4V annealed for expanded sandwich. One possibility to consider is to manufacture large face sheets out of 15-3 and weld together narrower core sheets of 6AL-4V annealed to match the width of the face sheets before forming. Until this possibility is explored more thoroughly, titanium suppliers must be encouraged to perfect an existing or new alloy that can be rolled into wider sheets without surface cracks.

The results of the titanium alloys versus aluminum alloys study indicate that present data comparisons show weight, strength, fatigue, fracture toughness, stress corrosion, and damage tolerance advantages for titanium. The continual review of these parameters (refs. 6 to 9) indicate that Douglas funding resources should continue to emphasize titanium. Recent fabrication and test data successes with titanium SPF/DB sandwich encourage Douglas to pursue titanium as the primary structure for an advanced supersonic transport.

STRUCTURAL CONCEPT COMPARISONS

The Douglas Aircraft Company has been studying various titanium structural design candidates for the wing and fuselage of an advanced supersonic transport (AST). During the past several years, four early candidate concepts were fabricated and are shown in figure 5. They are, left to right, a 206 by 73 cm (81 by 29 in.) aluminum brazed titanium honeycomb sandwich; a 244 by 93 cm (96 by 36.6 in.) panel using aluminum brazing and spotwelding of titanium hot-rolled z-stiffeners to titanium fuselage skins, frames, and cracks stoppers; a 152 by 91 cm (60 by 36 in.) diffusion-bonded titanium 6AL-4V sandwich that has been vacuum creep-formed to a double contour; and a 279 by 78 cm (110 by 31 in.) hat-stiffened, two-sheet superplastically formed 6AL-4V titanium panel. The first two concepts in figure 5, similar to what was proposed for the 1971 U.S. SST design, were used as the base cases for the MDC AST wing and fuselage, respectively.

Current structural activities have shifted to concentrate on the development, optimization, and design applications for SPF/DB structure. An important Douglas development for expanded sandwich is shown in figure 6. The top sketch shows two core sheets that are roll spot-welded together in the desired (optimum) pattern for the loads encountered. The edges of the core envelope are then welded closed and inserted between two face sheets in the limiting fixtures or die, as shown in the bottom sketch. Gas pressure between the core sheets is introduced and increased until the core sheets diffusion-bond to the face sheets. Before this occurs, the core forms partially (middle sketch). The superplastic ability of titanium 6AL-4V annealed material allows the core sheets to expand to the core cell extremities with little cleavage. The nuggets around the spot welds at 927°C (1700°F) are annealed and show material properties close to those of the basic material. The processing aspects of the new Douglas method of forming SPF/DB expanded sandwich is shown in figure 7 and the desirable structural aspects in figure 8. A contract with NASA Langley (ref. 5) is helping to further evaluate, develop, and test wing and fuselage concepts.

Candidate wing concepts that have been fabricated for this contract are shown in figure 9. Typical candidate fuselage and wing panels that will be statically and fatigue-tested for this contract are shown in figure 10. A prototype (89 by 94 cm (35 by 27 in.)) SPF/DB wing sandwich panel with 2.54 by 5.1 cm (1 by 2 in.) rectangular core cells is shown in figure 11. The optimization of these concepts is being done with sandwich and stiffened-sheet sizing programs. An example of the failure modes considered in the sizing program used for the SPF/DB expanded sandwich is shown in figure 12. An example of the test correlation with the optimization charts is shown for an isogrid core sandwich in figure 13. The test validation is excellent. X-rays of core geometries that have been successfully fabricated as expanded sandwiches are shown in figures 14 and 15. The designer inputs the edge loads, pressure, and thermal loads into the Douglas-developed optimization program designating the type of core patterns he wishes to consider.

Figure 16 shows a typical combination of loads for an inner wing location of an AST design. The lightest structural concept is the SPF/DB rectangular core sandwich. The high general stability of the sandwich, obtained with transverse webs that also help sustain the transverse loads directly, are the major contributors. Tailoring the core to the loads yields high structural efficiency.

In the case of the aluminum-brazed titanium honeycomb sandwich, the aluminum braze is wasted weight and the honeycomb core cannot be tailored in two directions. The isogrid core is not as efficiently tailored for low transverse loads. The hat-stiffened sheet concept is inefficient for even low transverse loads and moderate shear loads (the hat does not sustain the shear loads efficiently).

The expanded sandwich also has additional advantages for fatigue and damage tolerance. The stress intensity factor at the tip of a large 51-cm (20-in.) crack in a sheet can be reduced by 65 percent if a SPF/DB sandwich is used (figure 17). Finite-element analysis indicates that a crack on one side of a

sandwich will redistribute its loading through the core to the other uncracked face sheet, thus reducing the crack tip stress. The rate of crack growth depends on this crack tip stress factor, and when it is significantly reduced, a more damage-tolerant structure results. Three fuselage concepts have been analyzed as shown in figure 18.

Two stiffened sheet concepts -- a Z-stiffened panel and a SPL/DB hat-stiffened panel -- have fast cracks at approximately one-third the number of life cycles desired until they reach the frames which are on 51-cm (20-in.) spacings. These two concepts must therefore use crack stoppers to obtain the life cycles desired. The SPF/DB sandwich concept can almost sustain the lifetime cycles desired without crack stoppers. Actually, to meet the structures test requirements of two lifetimes outlined in figure 19, crack stopper straps are planned for the wing and fuselage SPF/DB sandwich structure to assure damage tolerance for a two-bay crack.

Douglas has developed the ability to add steel inserts in the outer face sheet as part of the SPF/DB titanium sandwich forming process. After forming, these inserts are removed and provide a cavity where weld-brazed titanium straps can be added as crack stoppers. This design application is shown in the intermediate spar drawing (figure 20). The tee section and expanded sandwich has been successfully fabricated in one step using the MDC SPF/DB process (figure 21).

The SPF/DB expanded sandwich developed by Douglas which uses two core sheets that expand to the face sheets can easily be used to include edge attachment doublers and doublers for an access door (figure 22). The doublers are laid up in the fixtures as additional sheets with the face sheets. When the core expands, it diffusion-bonds all the doublers together to form an integral heavier-edge sheet. This is all done in one step. The total cost is significantly lower than that for honeycomb sandwich where the densified core at the edges must be carefully machined to the correct depth to prevent a gap that is too great to be bridged by the aluminum braze. The formed isogrid hexagonals along the edge can also be used to space the bolted attachments.

WEIGHT, COST, AND DOC COMPARISONS

The results of the current MDC SPF/DB sandwich studies for the wing and fuselage yield the following structural weights and costs:

Wing -- The early base case aluminum-brazed titanium honeycomb assembly wing weight can be reduced 16.3 percent principally because the aluminum braze material has been eliminated and the rear spar lightened by using an SPF/DB sandwich rather than heavy skins, heavy stiffeners, and attachments (figure 23). The wing cost can be reduced 63.7 percent by SPF/DB sandwich. As compared to the base case it eliminates the costly honeycomb core, high labor costs for adding edge doublers, densified core machining, welding, and the treatment in a brazing oven. The SPF/DB sandwich panel is assembled in a fixture or die and all the parts are formed together in one step with little finish machining required. This one-step process eliminates the costly labor, assembly, and brazing compared to the aluminum brazed honeycomb core.

Fuselage — The fuselage aluminum weld-brazed titanium Z-stiffeners are poor for column stability, especially when subjected to high cabin pressures and temperatures during the cruise condition. Since a sandwich design has better general stability, it can sustain the compression and pressure for less weight. In addition, it has better fatigue and damage tolerance and thus creates substantial weight savings. However, the aluminum weld-brazed construction uses hot rolled Z-stiffeners which are relatively cheap. The one-step SPF/DB sandwich reduces the number of parts and therefore results in a small cost savings (figure 24).

Comparison of the weights of the conventional-structure DC-10-30 aircraft and the AST vehicle with major portions of the structure SPF/DB sandwich results in the comparisons shown in figure 25.

The results of a 1975 study of the relative DOC for increasing percentages of conventional 1971 U.S. SST titanium technology using aluminum and aluminum-brazed titanium are shown in the upper curve of figure 26. Using the more advanced airframe from our current studies of SPF/DB sandwich titanium can result in 6-percent gain, a most important improvement. This needs to be validated by a significant structural test program to gain confidence in manufacturing costs and weights.

An additional design application of using the SPF/DB expanded sandwich is shown in figure 27. This is a prototype cylinder made in one step using inner and outer mandrels and was used to prove the feasibility of making an 2.4 m (8 ft) diameter shell. A study was conducted of the six structural concepts shown in figure 28. The panel weights are shown versus the axial loading. In addition, an external compression pressure causes a transverse loading on the panels. The combined loading results in heavier weights for the monocoque stiffened sheet and the truss core sandwich. The transverse stiffening of the Astech diffusion-bonded honeycomb sandwich and the 3- and 4-sheet expanded sandwiches (which have transverse tailored webs) results in weight reductions as shown. It should be noted that for this particular application, the SPF/DB expanded sandwich (3-sheet) resulted in a lighter weight than the graphite/epoxy composites. The three-sheet expanded sandwich element is obtained by spot-welding a rectangular grid to the two top skins and blowing the inner skin superplastically to the third inner face sheet. The spot welds are spaced to allow the gas to flow through the holes formed by the spot weld spacing (figure 29).

FUTURE GROWTH AST

Using the concepts that have been described in this paper and an aggressive program of structural analyses and testing could result in technology readiness in the mid-1980s. Composites, metal matrices, and combined composites/metal matrices with SPF/DB structures should be explored for the future growth AST. However, real-time testing (for effects of elevated temperatures for 70,000 hours which matches two operating lifetimes of 100,000 hours) cannot be completed on time without a high risk for primary structure. Work done using estimated costs and allowables for 1984 is shown with the aluminum-brazed

titanium honeycomb sandwich as a base (figure 30). The rating reflects the structural efficiency of sandwich facings with the composites or metal matrices or metals shown. These concepts are based on the short time allowables known today projected to 1984. The weight savings at \$600 per pound and manufacturing costs anticipate a volume of material to build a significant number of development components. A rating of 2.5 (for SPF/DB expanded sandwich) is worth a 6-percent reduction in DOCs (see figure 26). The Mach 2.2 cruise environment would allow epoxy matrices to be efficient. If the cruise Mach number increases, the epoxy matrices will deteriorate to a lower rating and the metal matrices will improve their relative standings.

In May of 1979, presentations were made (ref. 10) that showed that more potential exists for metal matrix structures. In the case of applications for space structures, where resistance to thermal deformation is very important, it is also indicated that metal matrix materials are best. However, space structure environments are far different than those of an advanced supersonic transport.

For an AST environment, the boron and graphite/epoxy would be suitable for strength up to about Mach 2.2. At higher Mach numbers, the epoxy matrix deteriorates. However, the use of aluminum as a matrix allows the strength to deteriorate more slowly with temperature (ref. 10). Douglas has some experience with boron/aluminum (ref. 11). The poor fatigue properties, low transverse strength, and high cost of materials have not yet yielded a favorable comparison. Recent improvements, however, show promise for other metal matrices.

The fiber-reinforced lightweight matrix of aluminum shows significant weight savings compared to an all-titanium structure. However, for an AST, the long life required with cyclic ground-air-ground thermal differences will cause thermal stresses at the fiber-to-aluminum and aluminum matrix braze-to-titanium interfaces. In addition, the thermal coefficient of expansion and thermal conductance of these different materials will add additional thermal stresses. Analyses similar to those of ref. 9 must be performed to determine if the fatigue life will be sufficient. Test verification will also be required.

CONCLUDING REMARKS

1. The Number 1 NASA SCR priority in Douglas Aircraft Company's view is to launch a major structural program — new start — to validate the weight and manufacturing cost of SPF/DB sandwich titanium structure (figure 31).
2. The weight of the AST structure is influenced by many requirements (figure 19). Most important is the determination of the l-g wing and fuselage stress levels to obtain a crack-free operating lifetime. Real-time tests of coupons, joints, and candidate components need to be started as soon as possible to assure the confirmation of accelerated tests that compress the spectra. These accelerated tests should also be initiated as soon as possible.

3. Developing damage-tolerant structure by using relatively new structural concepts (e.g., SPF/DB expanded sandwich) and titanium 6AL-4V annealed for the primary structure (or possibly 15-3 improved) requires a dedicated program and a dedicated budget for analysis and testing over a long period of time.
4. To obtain the maximum benefit from the SPF/DB sandwich process, large panels must be formed. The standard width today is only 91.4 cm (36 in.). TIMET believes that wider panels (203 to 254 cm (80 to 100 in.)) are beyond the state of the art for titanium 6AL-4V annealed because small surface cracks are formed at these desired widths. The titanium suppliers must be encouraged to perfect an existing or new alloy that is good for SPF/DB sandwich. Otherwise, smaller panels will cause increases in weight due to attachments or decreased allowables of welding smaller panels together before forming SPF/DB sandwich.
5. The MDC NASA Langley study contract for wing and fuselage SPF/DB sandwich panels (ref. 5) is helping to show that the SPF/DB sandwich technology is potentially structurally efficient. The analysis and testing of larger panels with support structures having edge attachments is the next valuable step to validate allowables when subjected to the combined loadings of the AST environment. A 2- to 3-year well-planned large-scale program should enable the industry to gain the necessary confidence to build larger structural components.
6. SPF/DB titanium sandwich combined with composites or metal matrices can possibly be very efficient for a growth AST. However, long-time test results cannot be available for inclusion in a mid-80s technology readiness of an AST.
7. Titanium structure, specifically SPF/DB sandwich, shows greater structural efficiency than presently available aluminum structure for strength, fatigue, fracture toughness, crack growth rate, and damage tolerance. Better structural efficiency results in less weight and improved life.
8. The SPF/DB titanium sandwich studies show a 6-percent DOC saving compared with aluminum-brazed titanium structure as was proposed for the 1971 U.S. SST.

REFERENCES

1. Brizendine, J. C.: Current and Future Opportunities in Aeronautical Engineering. Presented to NASA/University of Kansas Conference on Aeronautics, University of Kansas, Lawrence, Kansas, by the President of Douglas Aircraft Company, McDonnell Douglas Corporation, October 23-24, 1974. Douglas Paper 6321.
2. Stone, M.: Airworthiness Philosophy Developed from Full-Scale Testing. Presented to Biannual Meeting of the International Committee on Aeronautical Fatigue, London, England, July 23-25, 1973. Douglas Paper 6099, Douglas Aircraft Company, McDonnell Douglas Corporation.
3. Stone, M.: An Examination of Unique Structural Requirements for a Heavy Advanced Transport System. Presented to Fifth Annual AIAA Meeting and Technical Display, Philadelphia, Pennsylvania, October 21-24, 1968. Douglas Paper 5278, Douglas Aircraft Company, McDonnell Douglas Corporation.
4. Harpur, N. F.: Applications of Titanium. Delivered to the Royal Society of Arts by the Design Director (Structures), British Aerospace. Paper available in Aircraft Engineering, January 1979.
5. Evaluation of Superplastic Forming and Codiffusion Bonding of Ti-6AL-4V Titanium Alloy for Supersonic Cruise Aircraft Research. Prepared by Douglas Aircraft Company for NASA Langley Research Center, Hampton, Virginia. Six-month report, Contract NAS-1-15527, Report MDC J4637, June 1979.
6. Technology Application Study of a Supersonic Cruise Aircraft. Prepared under Contract NAS-1-13612 by Douglas Aircraft Company for NASA Langley Research Center, Hampton, Virginia. Contract NASA CR-145130, Report MDC J4550, November 1976.
7. Technology Application Study of a Supersonic Cruise Vehicle. Prepared under Contract NAS-1-14624 by Douglas Aircraft Company for NASA Langley Research Center, Hampton, Virginia. NASA CR-145287, November 1977.
8. Technology Application Study of a Supersonic Cruise Vehicle. Prepared under Contract NAS-1-14624 by Douglas Aircraft Company for NASA Langley Research Center, Hampton, Virginia. NASA CR-145287, February 1979.
9. Technology Application Studies for Supersonic Cruise Aircraft. Prepared under Contract NAS-1-13612 by Douglas Aircraft Company for NASA Langley Research Center, Hampton, Virginia. NASA CR-144925, Douglas Paper MDC J4532, November 1975.

10. Society for the Advancement of Material and Process Engineering. Proceedings of 1979 Meeting, The Enigma of the Eighties, Volume 24, Books 1 and 2.
11. Elliot, S. Y.: Boron/Aluminum Skins for the DC-10 Aft Pylon. Prepared under Contract NAS1-13029 by Douglas Aircraft Company for NASA Langley Research Center, Hampton, Virginia. NASA CR-132645, May 1975.

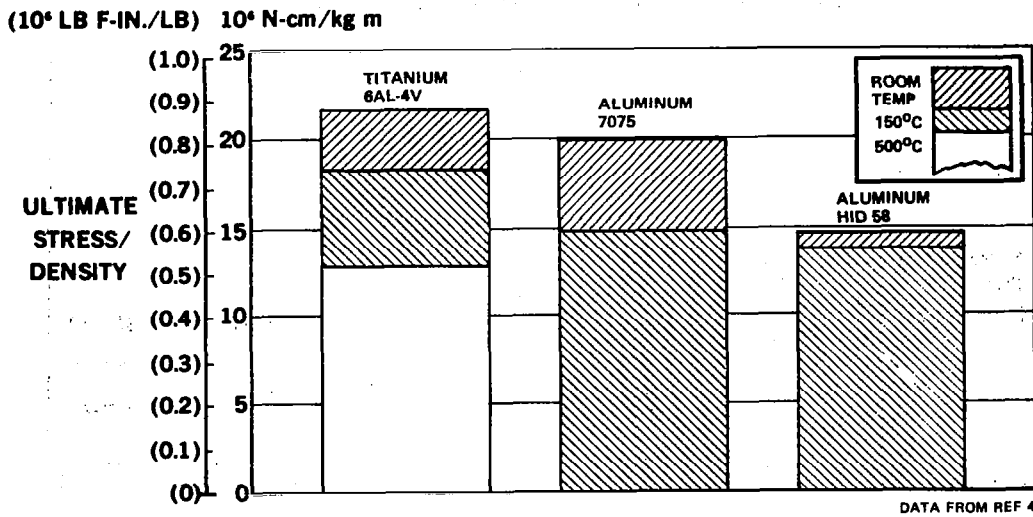


Figure 1.- Tensile stress/density at room temperature, 150°C, and 500°C.

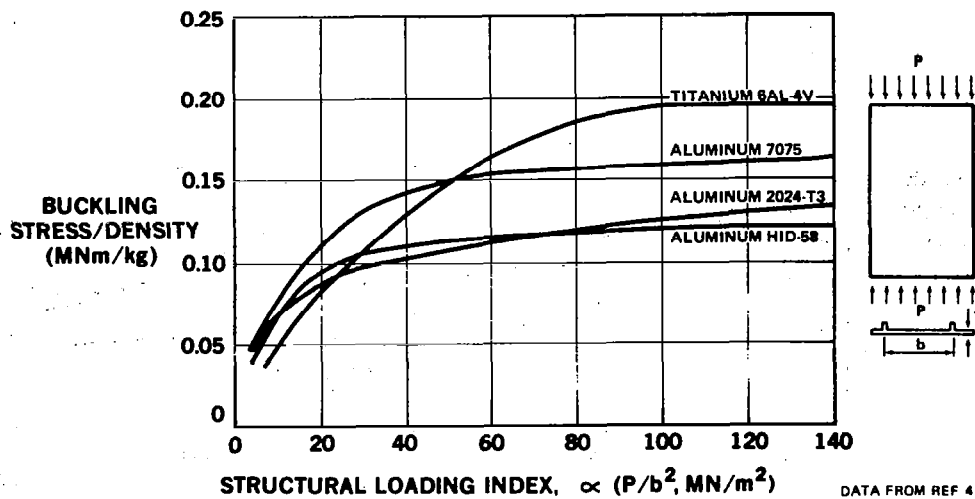


Figure 2.- Structural efficiency-panel buckling.

THEORETICAL STRESS CONCENTRATION, $K_t = 2.68$
 LOAD CYCLE = ZERO TO PEAK STRESS

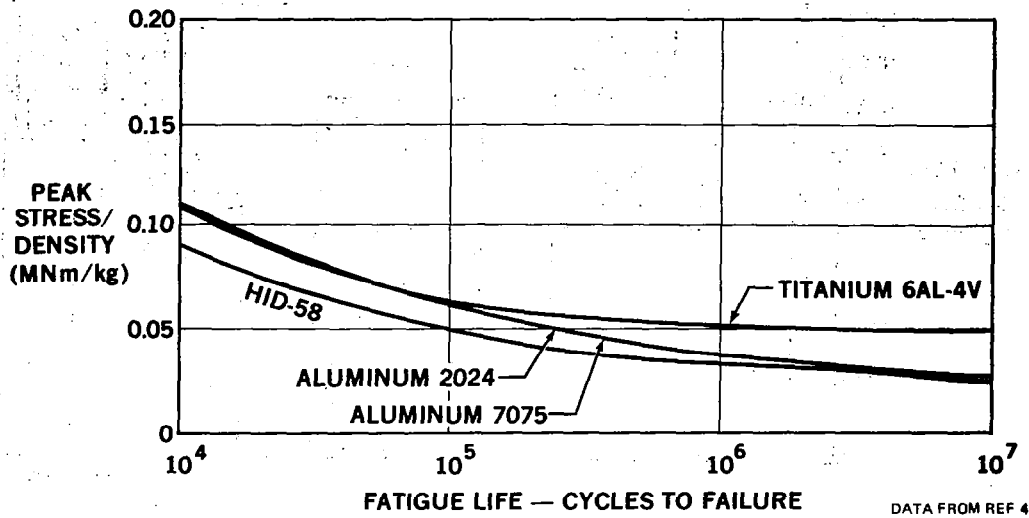


Figure 3.- Fatigue properties.

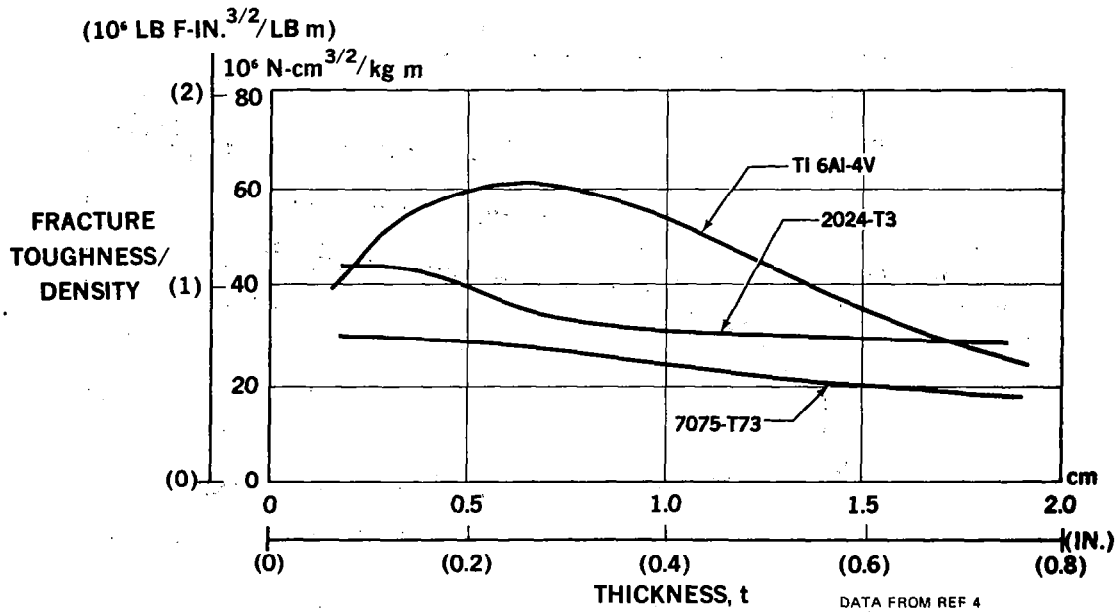


Figure 4.- Fracture toughness.

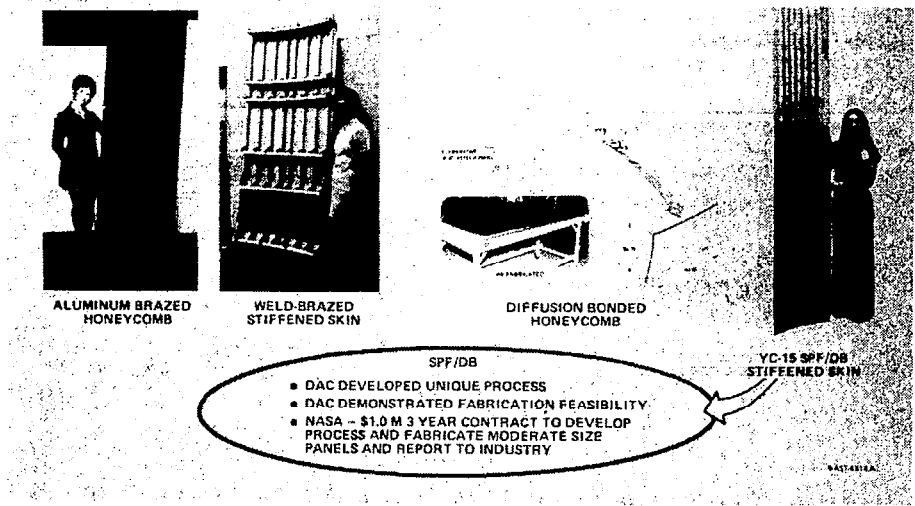


Figure 5.- Douglas titanium structural research and development program for AST.

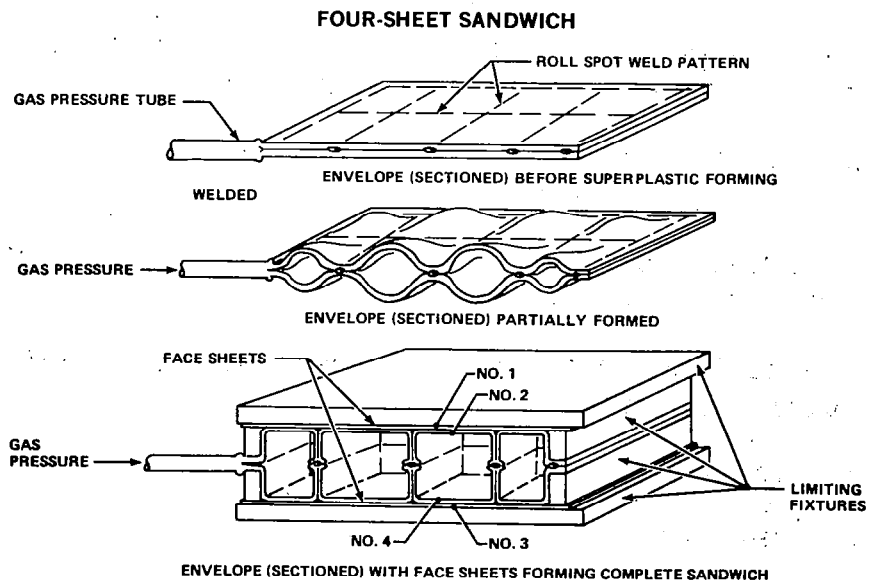


Figure 6.- SPF/DB sandwich phases of fabrication.

- NO EMBRITTLING PARTING AGENT IN THE INTERIOR CORE
- PERMITS SKIN THICKNESS VARIATIONS WITHOUT EXPENSIVE TOOLING
- PROCESS HAS BEEN PROVEN FOR 2, 3, AND 4 SHEET CONSTRUCTIONS
- CAN FACILITATE EDGE ATTACHMENTS, ACCESS DOORS, AND VERY RAPID CHANGES IN THICKNESS
- BLOWING FROM THE CENTER LOCKS ALL THE PARTS TOGETHER

Figure 7.- Processing aspects of MDC proprietary SPF/DB sandwich.

- ABILITY TO FORM SMALL CELLS AND TRANSVERSE WEBS, THEREFORE MORE EFFICIENTLY CARRY BIAXIAL AND SHEAR LOADS
- CAN MAKE THE FACE AND CORE TO ANY DESIRED CONFIGURATION AND THICKNESSES — TAILOR (OPTIMIZE)
- TRUSS CORE SANDWICH IS LESS EFFICIENT IN TRANSVERSE SHEAR THAN WEBS IN TRANSVERSE SHEAR
- ACHIEVED 10^6 CYCLES AT 20,684, 23,442, 26,200, AND 28,958 N/cm^2 (30,000, 34,000, 38,000 AND 42,000 PSI)
- JIG SLIPPED AT 31,716 N/cm^2
- ACHIEVED 98,595 N/cm^2 IN COMPRESSION — DID NOT BUCKLE

Figure 8.- Structural aspects of MDC proprietary SPF/DB sandwich.

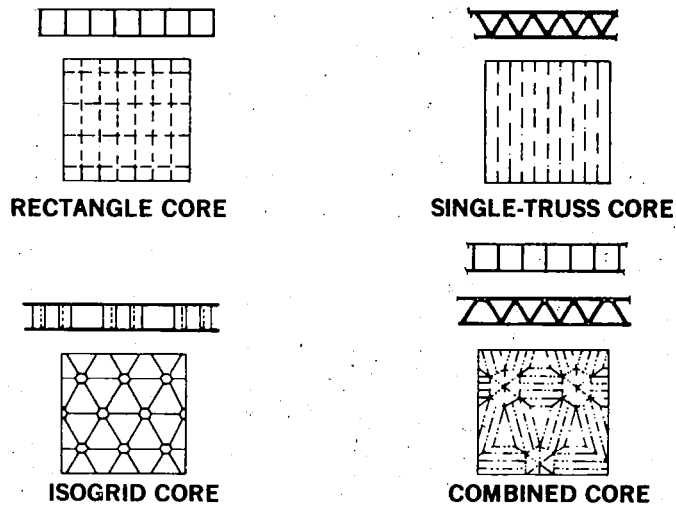


Figure 9.- NASA SPF/DB contract candidate wing concepts-study.

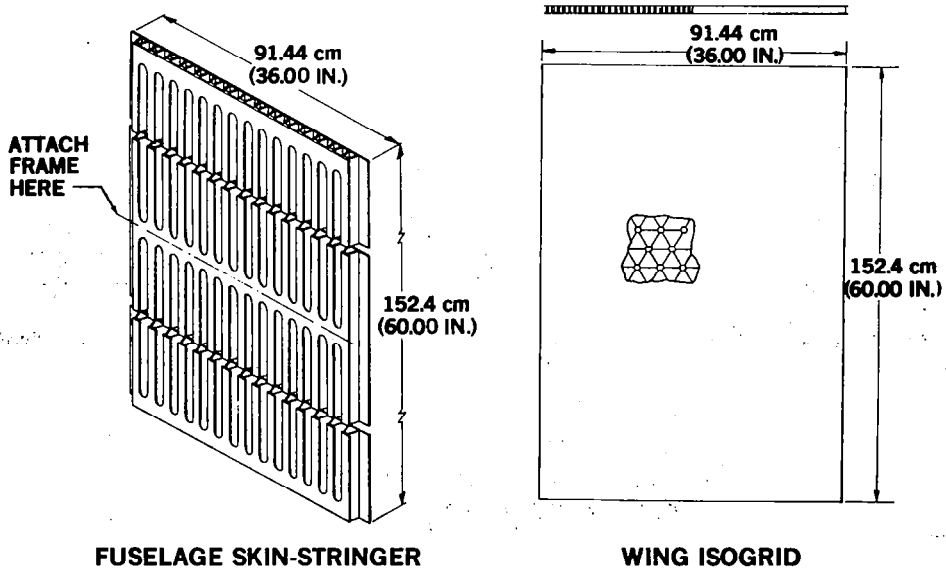


Figure 10.- SPF/DB typical panels-fabricate.

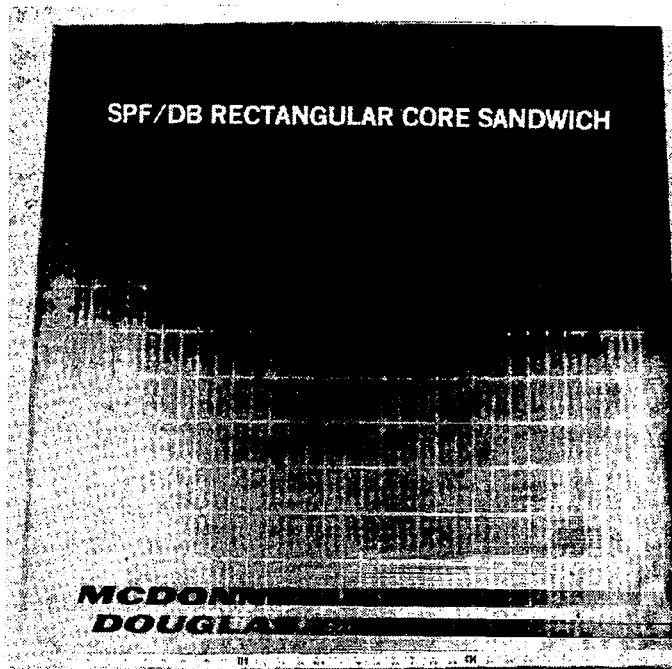


Figure 11.- SPF/DB rectangular core sandwich.

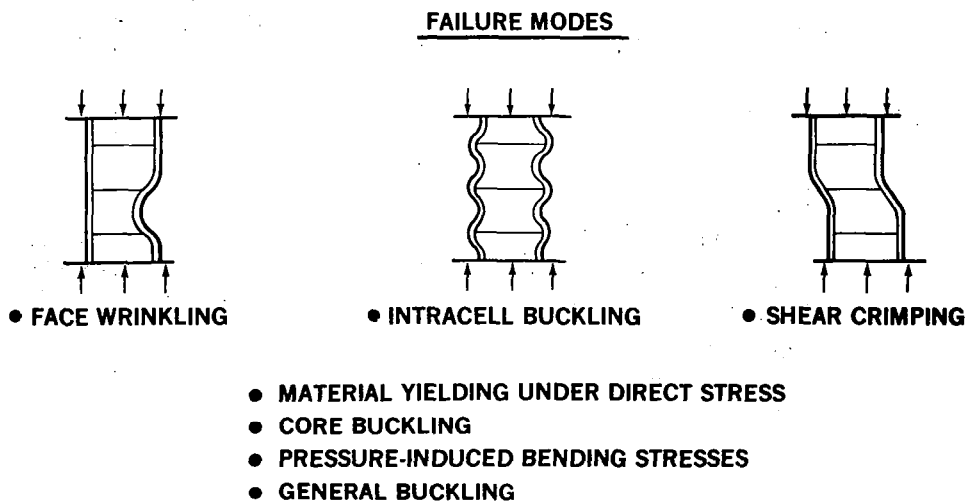


Figure 12.- Compression sandwich panel sizing program.

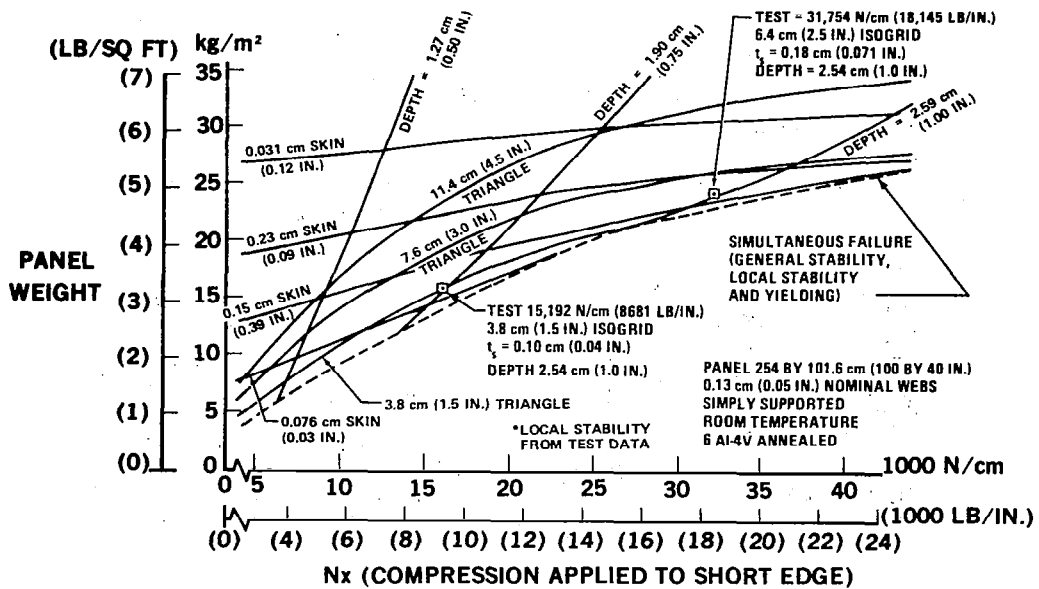


Figure 13.- SPF/DB structure isogrid optimization.

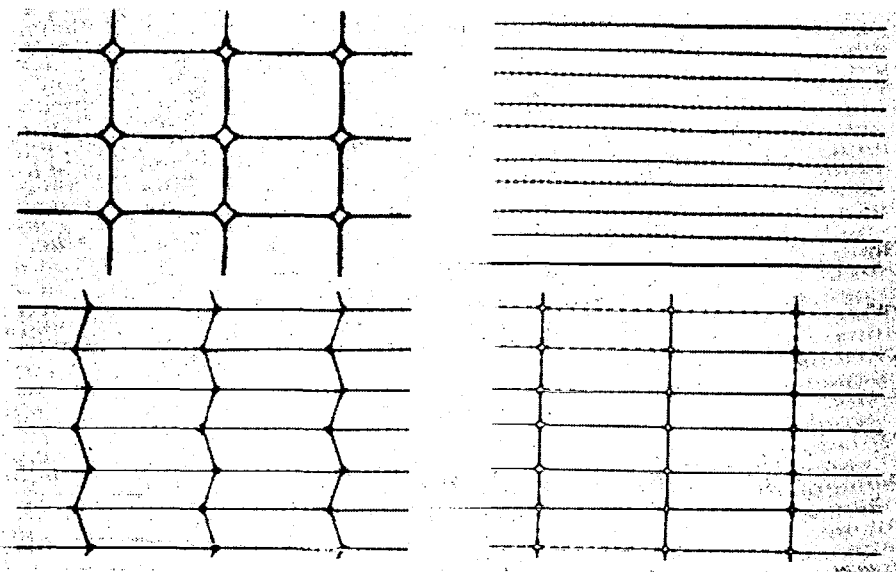


Figure 14.- X-rays of rectangular core concepts.

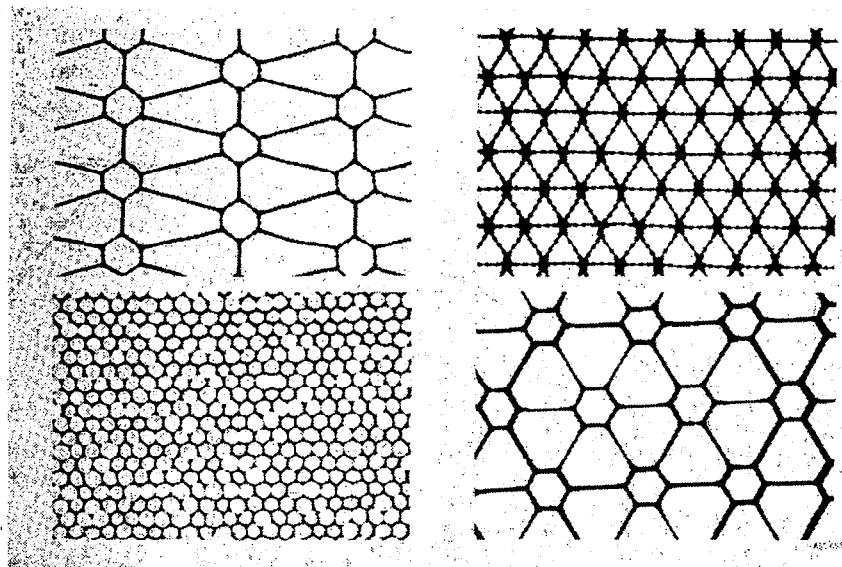


Figure 15.- X-rays of combined triangular and hexagonal core concepts.

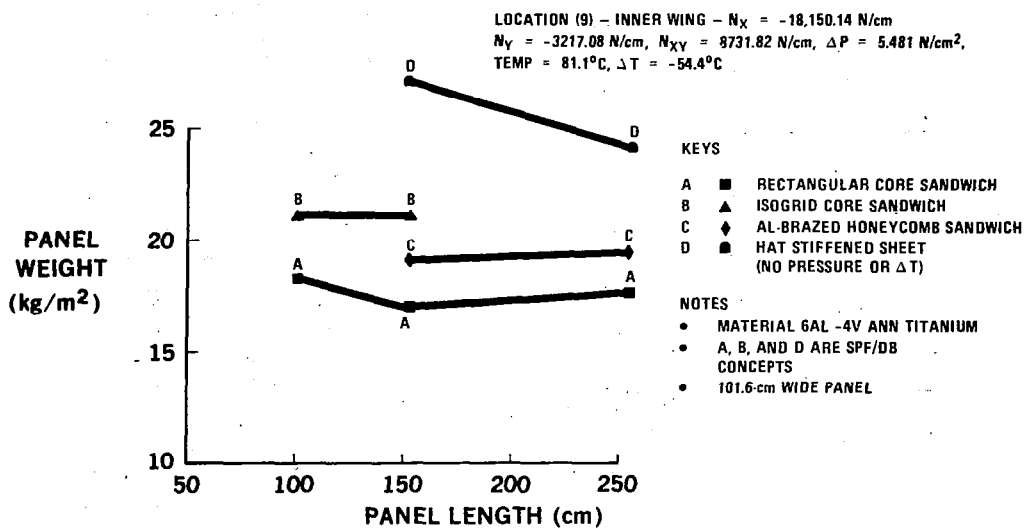


Figure 16.- Inner wing-location (9), optimum weight versus concepts.

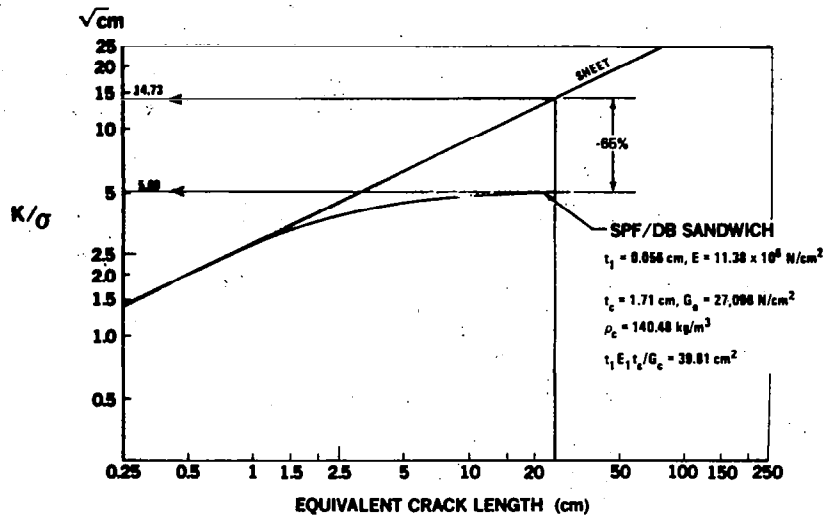


Figure 17.- Stress intensity at tip of crack versus half crack length-sheet versus titanium sandwich.

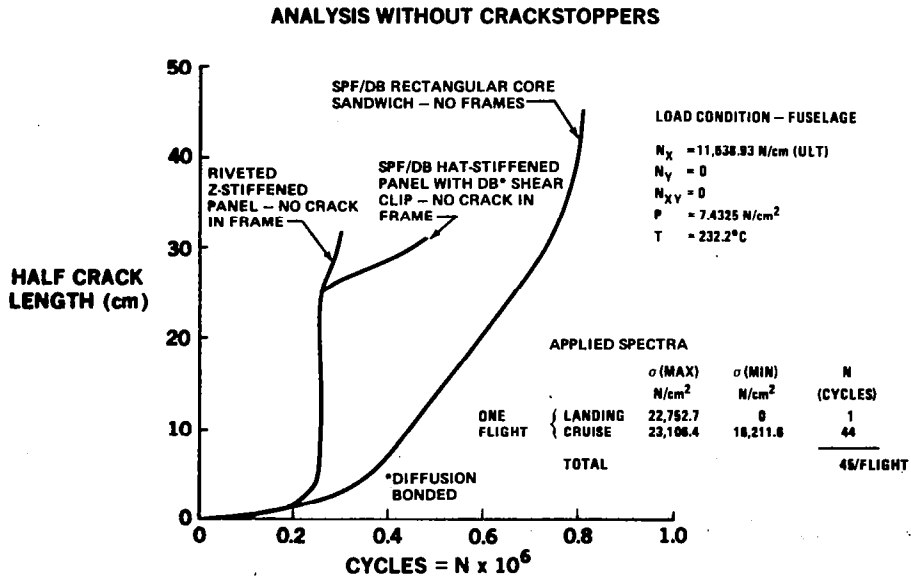


Figure 18.- Longitudinal fuselage crack growth time history.

PROSPECTIVE MATERIALS (COUPONS, SMALL AND LARGE COMPONENTS) FOR SUPERSONIC TRANSPORT VEHICLE WILL BE ANALYZED AND TESTED FOR:

- | | |
|--------------------------|--------------------------------------------------------------------------------------------------------------------------------------------------------------------------------------------------------------------------------------------------------------------------|
| 1. FATIGUE LIFE | DESIRE ONE OPERATING LIFETIME TO BE CRACK FREE. |
| 2. ULTIMATE LOAD | DESIRE TO SUSTAIN ULTIMATE LOAD THROUGHOUT OPERATING LIFETIME. IF A CRACK DEVELOPS BETWEEN INSPECTIONS THE RESIDUAL STRENGTH WILL NOT FALL BELOW LIMIT LOADS. ULTIMATE STRENGTH RESTORED AT NEXT INSPECTION. |
| 3. FAIL-SAFETY | SUSTAIN LIMIT LOAD AFTER A SINGLE-ELEMENT FAILURE. (DOUGLAS USES MORE THAN ONE ELEMENT) |
| 4. DAMAGE TOLERANCE | STARTING FROM AN INITIAL CRACK, AND AFTER TWO SELECTED INSPECTION INTERVALS, STRUCTURE MUST STILL SUSTAIN LIMIT LOAD. (DOUGLAS USES TWO-BAY CRACKS PLUS A SINGLE-ELEMENT FAILURE) |
| 5. CREEP | DESIRE NO MORE THAN 0.1 PERCENT CREEP FOR ONE OPERATING LIFETIME. |
| 6. FOREIGN OBJECT DAMAGE | THE STRUCTURE WILL SUSTAIN LIMIT LOADS AFTER: <ul style="list-style-type: none"> A. FAN BLADE FAILURE B. DOOR OR WINDOW FAILURE (SIZE: TBD) C. LIGHTNING STRIKE D. HAILSTONE IMPACT E. INTERIOR EXPLOSION (SIZE: TBD) |
| 7. ALSO CONSIDER: | <ul style="list-style-type: none"> A. CRASH LOADS B. EMERGENCY DESCENT C. DITCHING D. LANDING GEAR, PYLON, OR FLAP TO BREAK AWAY WITHOUT TANK, HYDRAULIC, OR ELECTRICAL RUPTURE. |

Figure 19.- Structures test requirements.

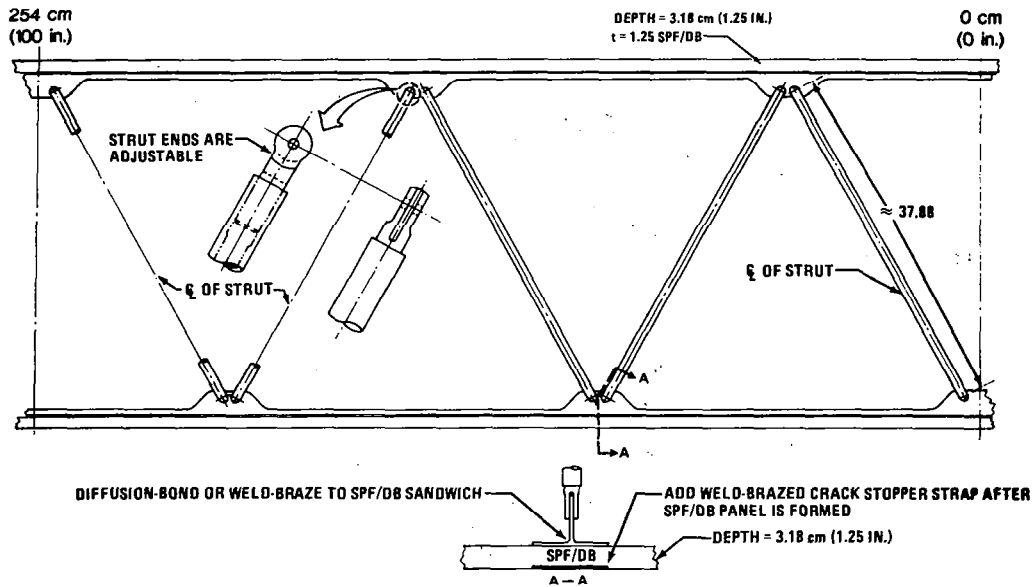


Figure 20.- SPF/DB sandwich panels with 101.6-cm (40-in.) spar depth with struts.

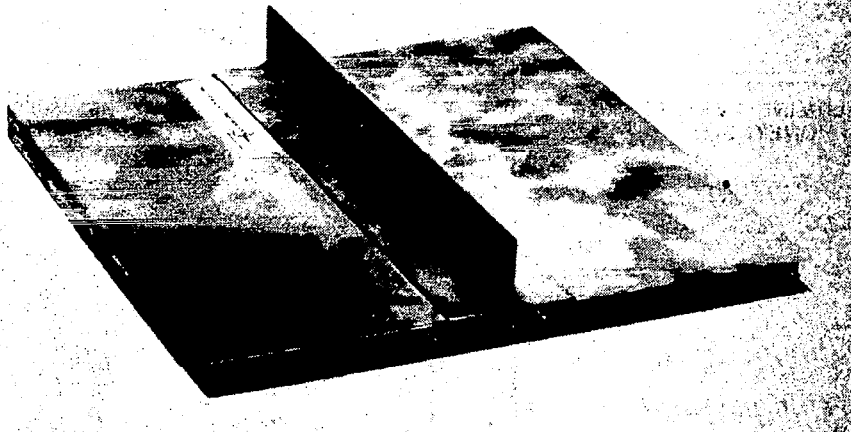


Figure 21.- SPF/DB sandwich panel with integral doublers and attached tee.

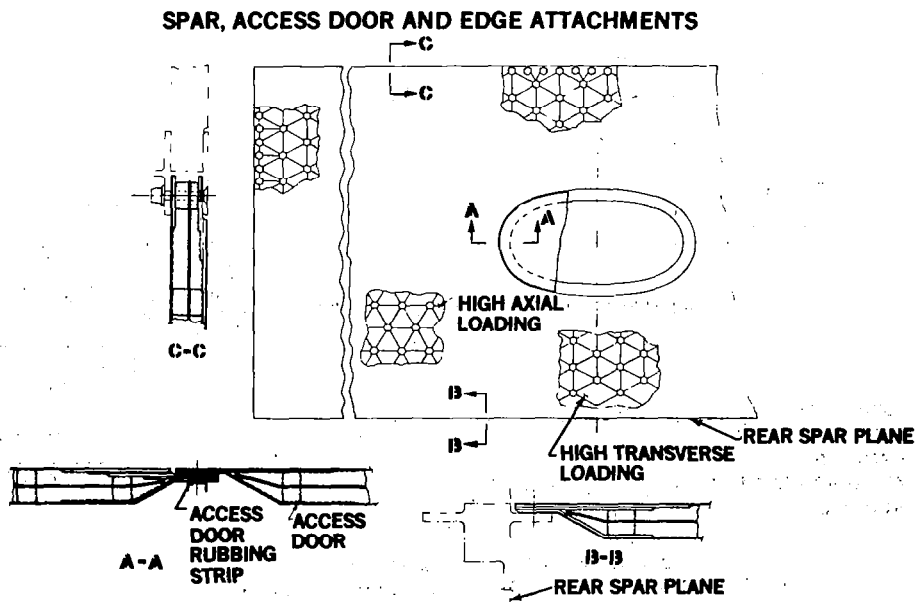


Figure 22.- SPF/DB isogrid panel design concept.

WING — 102-cm (40-IN.) BY 254-cm (100-IN.) BASE

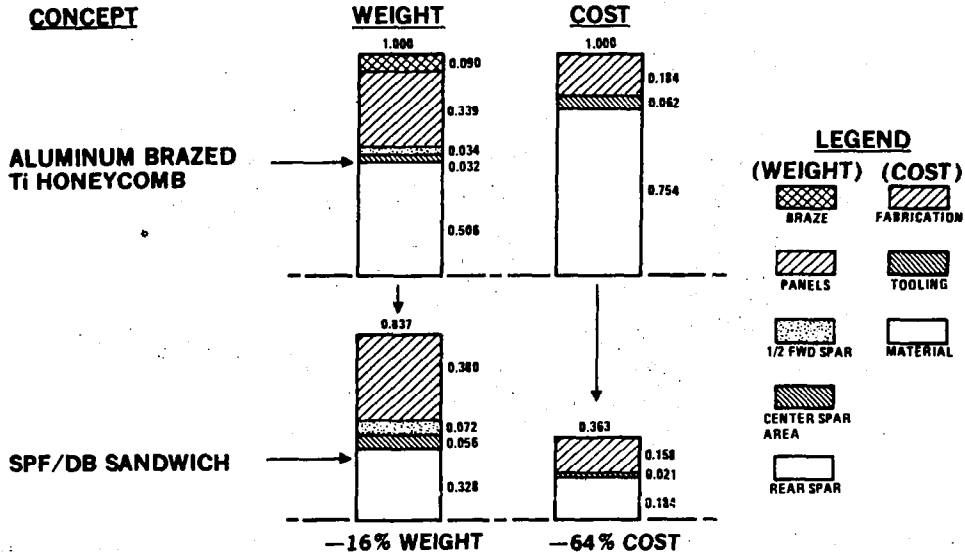


Figure 23.- Weight and cost comparisons.

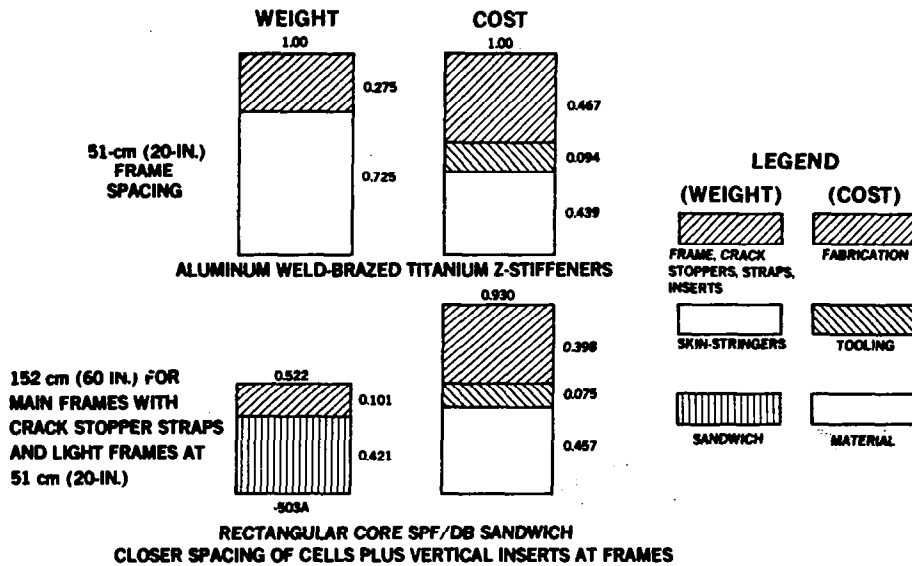


Figure 24.- Weight and cost comparison of fuselage.

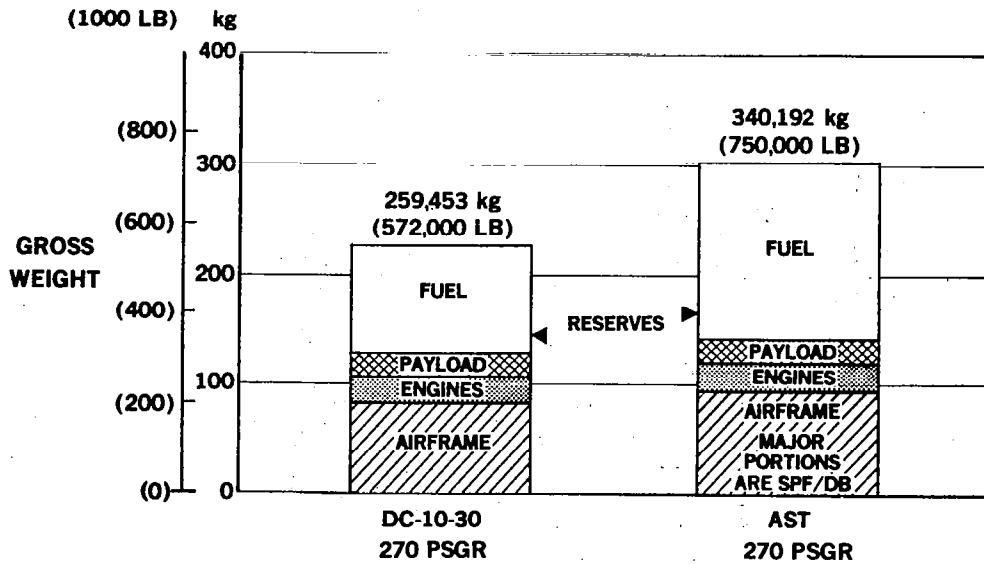


Figure 25.- Weights comparison.

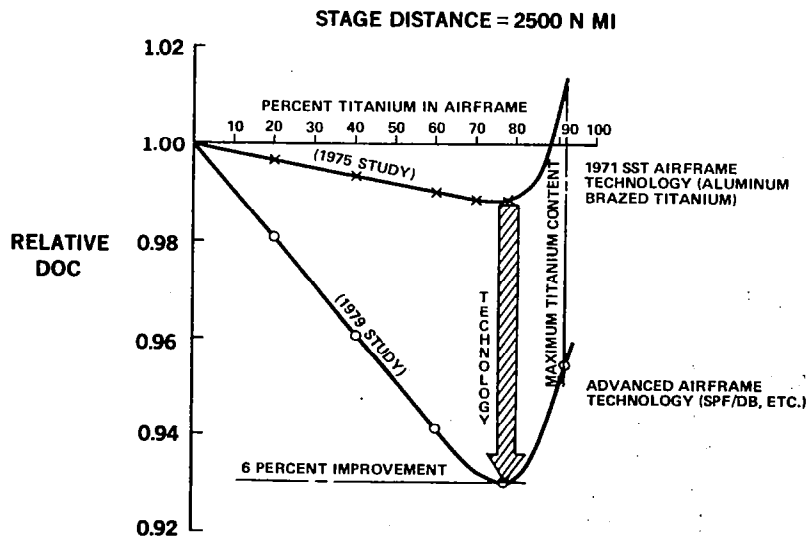


Figure 26.- Titanium advancements reduce operating costs.

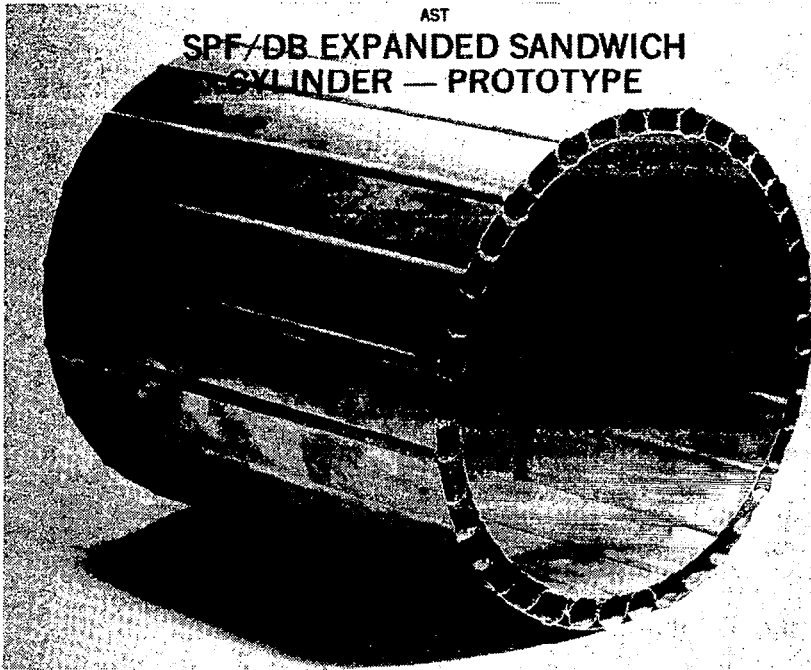


Figure 27.- SPF/DB expanded sandwich cylinder-prototype.

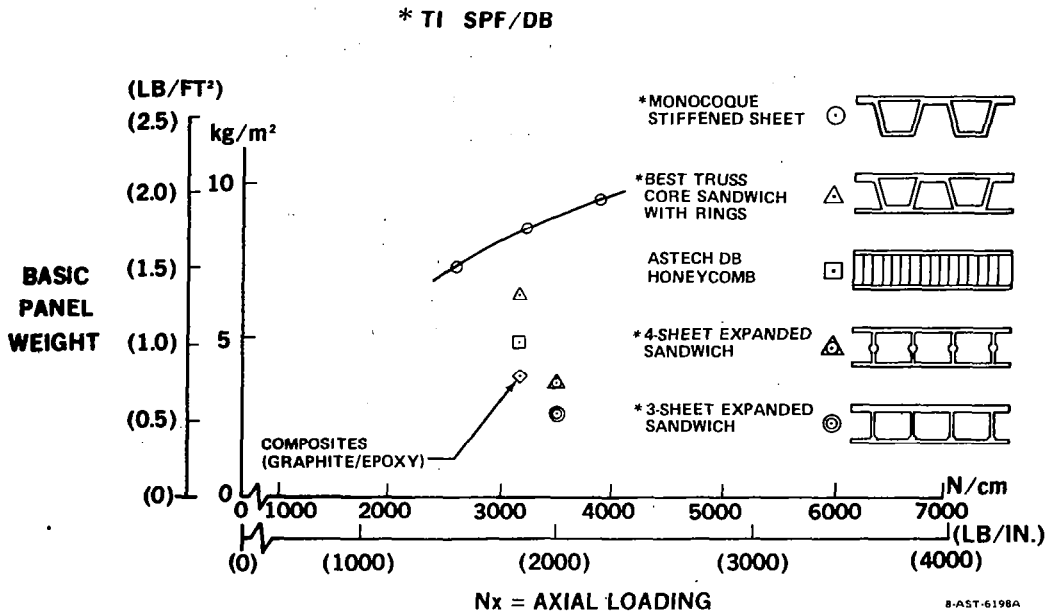


Figure 28.- Structural concepts.

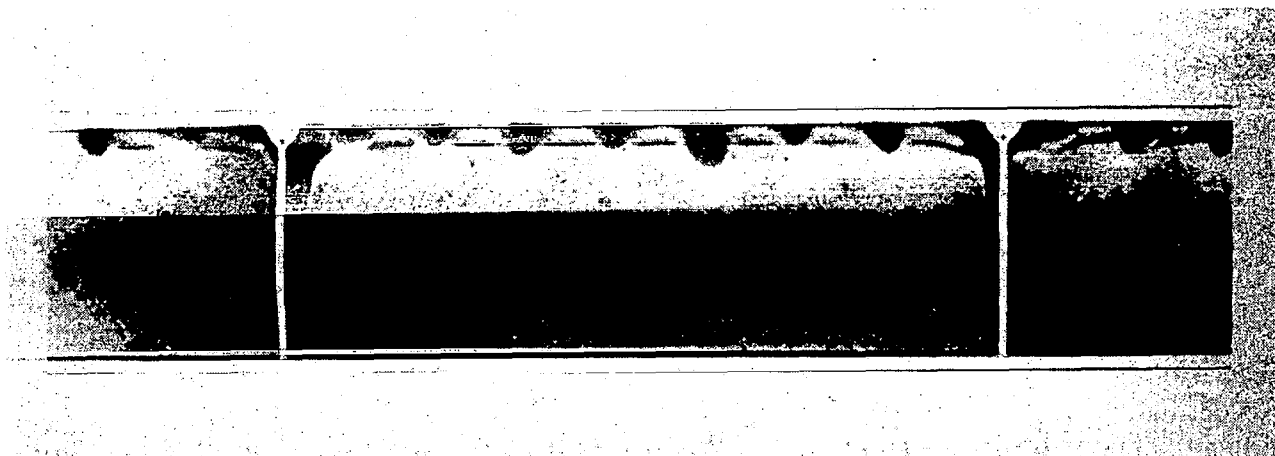


Figure 29.- Section through a three-element panel.

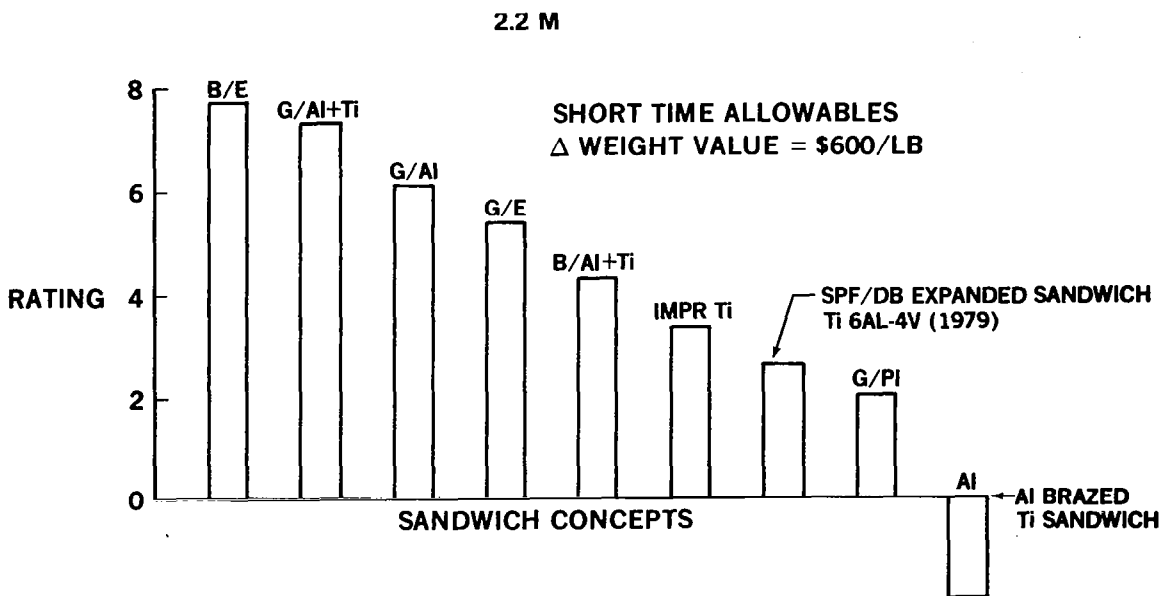


Figure 30.- For growth AST.

**FABRICATE AND TEST TITANIUM WING AND FUSELAGE
SECTIONS TO VALIDATE**

- **OPTIMUM DESIGN PARAMETERS**
- **WEIGHT FRACTIONS**
- **MANUFACTURING AND ASSEMBLY COSTS**

**CONFIGURATION INTEGRATION — DETERMINES SCALE OF
TECHNOLOGY READINESS**

Figure 31.- Critical structural technology items.

SUPERSONIC CRUISE RESEARCH AIRCRAFT STRUCTURAL STUDIES:

METHODS AND RESULTS

J. Sobieszczanski-Sobieski,¹ David Gross,² William Kurtze,²
Jerry Newsom,¹ Gregory Wrenn,² and William Greene²

SUMMARY

This paper reviews NASA Langley Research Center SCAR in-house structural studies that have been accomplished since the last SCR conference in November 1976. Both methods development and results generated are covered. In methods development, advances include a new system of integrated computer programs called ISSYS, progress in determining aerodynamic loads and aerodynamically induced structural loads (including those due to gusts), flutter optimization for composite and metal airframe configurations using refined and simplified mathematical models, and synthesis of active controls. Results given address several aspects of various SCR configurations. These results include flutter penalties on a composite wing, flutter suppression using active controls, roll control effectiveness, wing tip ground clearance, tail size effect on flutter, engine weight and mass distribution influence on flutter, and strength and flutter optimization of new configurations. The ISSYS system of integrated programs performed well in all the applications illustrated by the results, the diversity of which attests to ISSYS' versatility.

INTRODUCTION

The purpose of the paper is to present a status report of the Langley program on the structural synthesis of supersonic cruise aircraft. The program is a continuation of the effort described in reference 1 and presented at the first NASA Supersonic Cruise Aircraft Research (SCAR) Conference in November 1976. The primary goal of the program continues to be the development of an integrated analysis and synthesis methodology for the structural design of advanced configurations of the SCR arrow wing planform airframe, and the application of the methodology to specific variants of the arrow wing configurations in direct support of SCR aircraft design studies.

Accordingly, the paper is divided into two sections devoted to the development of methodology and to the application of methodology, respectively. The methods development section emphasizes improvements and extensions in analysis and design procedures accomplished since the publication

¹NASA Langley Research Center

²Kentron International, Hampton Technical Center

of reference 1 and the incorporation of these analysis and synthesis methods in a system of computer codes. The methods application section illustrates capabilities of the methodology while presenting the results of studies of previously unexplored characteristics of the SCR configuration.

LIST OF SYMBOLS

A_i, B_i	surface fit coefficients
\bar{A}	rms value of output divided by rms value of input
$F(r)_{ji}$	direction parameter from the given aerodynamic panel to any structural grid point
H_{ij}	elements of spline coefficient matrix
$H(s)$	practical feedback filter transfer function
$H(\omega)$	frequency response function
J	cost function
m	number of aerodynamic panels
M	Mach number
N	number of structural grid points
R	control weighting term
s	Laplace variable
S_i	coefficients of slope vector of aerodynamic panels
t	time
u	control input
\bar{u}	optimal control input
\hat{u}	practical control input
V_D	dive velocity
Z_j	coefficients of structural displacement vector
$\phi(\omega)$	atmospheric-turbulence power-spectral-density function
ω	circular frequency

Matrices:

[AIC]	aerodynamic influence coefficient matrix
[A]	system dynamics matrix
{B}	control distribution vector
$\{\Delta C_p\}$	differential pressure coefficient vector
[C]	system state-coefficient output matrix
[F]	direction parameter matrix
[H]	spline coefficient matrix
[K]	row matrix of optimal gain
[L]	generalized load matrix
{q}	generalized coordinate vector
[Q]	output weighting matrix
{s}	slope vector
[S]	area matrix
{X}	state vector
{Y}	output vector
{Z}	structural displacement vector
{ σ }	element stress vector
$[\phi_\sigma]$	stress coefficient matrix

Subscripts: defined throughout

ANALYSIS AND SIZING METHODOLOGY

The methodology presented in this section consists of the analysis and the structural sizing methods used in structural design studies of supersonic cruise research airframes. The analysis includes procedures for computational aerodynamics, structural statics and dynamics, turbulent atmospheric response and flutter. The structural sizing methods incorporate these analyses and mathematical optimization procedures to resize cross-sectional structural dimensions. The use of active control flutter suppression as an alternative to structural stiffening is discussed. The section also contains basic

information on the incorporation of these methods into a system of integrated computer programs called ISSYS for Integrated Synergistic Synthesis System.

Analysis Methods

Aerodynamics

The aerodynamics analysis capability in ISSYS has been developed as an integral part of an interdisciplinary approach to structural synthesis. Accordingly, the aerodynamic codes which have been implemented are those which are utilized for generation of loads in the form of pressures, aerodynamic influence coefficients, or generalized aerodynamic forces. These codes are panel method codes, and thus require a degree of sophistication in the aerodynamic models which imposes cost and time constraints on the overall problem of aircraft design and optimization.

Previous studies presented in reference 1 were conducted using the steady flow, vortex-lattice method detailed in reference 2, and the unsteady flow, kernel function procedure of references 3 and 4. The results shown in reference 1 were primarily strength and stiffness (flutter) sizing studies for a series of AST configurations of metal and composite construction.

Since the first NASA SCAR conference in November 1976, the aerodynamics analysis development has been concentrated in two areas. First, the need to evaluate load conditions due to atmospheric turbulence has necessitated the incorporation of additional subsonic, unsteady aerodynamics analysis capability into ISSYS. Second, the degree of complexity of the structural finite-element model required for proper structural definition has led to independent structural and aerodynamic model paneling. The differences in the structural and aerodynamic models have required the implementation of more advanced interpolation capabilities in ISSYS and the development of a matrix manipulation method referred to, in the ensuing discussion, as the "super-matrix" technique used for converting the pressure distribution obtained for an aerodynamic model to concentrated nodal forces on a finite element model.

Unsteady aerodynamics.- The unsteady aerodynamics theory, known as the Doublet Lattice Method (reference 5), has been incorporated in the ISSYS system. This method, generally accepted as the industry standard, is used to provide the unsteady aerodynamic loads required to compute turbulence response of the aircraft, to calculate its flutter boundaries, and to perform active controls synthesis studies. In this method, downwash at chosen reference points over the surface of a wing is equated to the surface integral of the differential pressure and an appropriate kernel function is used to obtain pressure influence coefficients.

Super-matrix technique.- Of first priority in the development of independent structural and aerodynamic models was the introduction of the surface spline capability (ref. 6) to allow interpolation between the structural and aerodynamic nodes. This is shown by the relationship

$$\{s\} = [F] [H] \{Z\}$$

which is derived in the Appendix of this paper. This relationship represents the operation of fitting the structural displacements on the structural grid with a surface spline and then transforming these displacements to slopes located at the centroids of the aerodynamic panels.

Next, there was the need to eliminate the repetitive aerodynamic calculations in the resizing process. As shown in the Appendix, a generalized load matrix $[L]$ given by the relationship

$$[L] = [F]_C [H]_C [AIC] [F] [H] [S]$$

can be defined for the aircraft at each Mach number under consideration. The loads in the structural system are thus produced by a single matrix multiplication, and the aerodynamic calculations need be performed only once for each Mach number.

Static Strength

Aerodynamic pressure is converted to concentrated forces applied at the nodal points of the structural finite element model. These forces are influenced by structural displacements computed by the finite element structural analysis program SPAR, whose details are described in the context of this application in reference 7. The displacements influence the wing camber surface shape. Therefore, the aerodynamic pressure distribution and, consequently, the loads are recomputed to reflect the wing shape changed according to the structural displacement analysis results. The sequence of aerodynamic and structural analyses is repeated until convergence of loads (aeroelastic loads) and displacements is achieved; then stresses corresponding to the converged displacements are calculated. This iterative procedure was described in detail in reference 1.

Turbulence Response

Turbulence response analyses are performed with the aid of the ISAC computer program system described in reference 8. In these analyses, the equations of motion incorporate the natural vibration modes of the free airplane as generalized coordinates. Vibration modal data (mode shapes, generalized masses, frequencies, and modal stress coefficients) are calculated for the aircraft finite-element model. Unsteady aerodynamic loads required for turbulence response analysis are computed using the Doublet Lattice program.

Power-spectral-density techniques are used to calculate both the aircraft rigid body and elastic dynamic responses due to continuous atmospheric turbulence. Active control systems can be included in the turbulence response computation to calculate their effect on the dynamic response. Frequency response functions of the generalized coordinates (for a unit sinusoidal gust velocity) are computed by the modal displacement method and

are used to obtain the frequency response functions of the structural stresses

$$\{\sigma(i\omega)\} = [\phi_\sigma] \{q(i\omega)\}$$

where $\{\sigma(i\omega)\}$ is a vector of frequency response functions of the stresses, $[\phi_\sigma]$ is a matrix of stress coefficients, and $\{q(i\omega)\}$ is the vector of generalized coordinates. These frequency response functions are used to calculate root-mean-square values according to the following expression:

$$\{\bar{A}\} = \left[\frac{\int_0^\infty \{|\sigma(i\omega)|\} \phi(\omega) d\omega}{\int_0^\infty \phi(\omega) d\omega} \right]^{\frac{1}{2}}$$

where $\phi(\omega)$ is the atmospheric turbulence power spectral density function. Structural stresses computed in this manner are incremental stresses and are superimposed on the stresses corresponding to steady state flight with a 1g load factor for structural sizing purposes.

Flutter Analysis

The flutter analysis used in ISSYS is a standard V-g procedure. It begins with the calculation of natural modes and frequencies of the strength sized airframe. These modes and frequencies are used to calculate generalized matrices of unsteady aerodynamic forces, mass and stiffness. The generalized matrices are substituted in the flutter matrix equation which is solved by a V-g method yielding the flutter matched points in the velocity and altitude intervals of interest. The fully computerized flutter solution takes the form of a sequence of computer programs documented in reference 9. The principal cost of the flutter analysis is incurred in the calculation of natural modes and frequencies. Therefore, two approximate but fast methods have been implemented in the structural optimization. One of these methods uses a simplified finite element model for repetitive calculation of natural modes and frequencies; the other uses a set of constant natural modes as Rayleigh-Ritz functions to reduce the dimensionality of the repetitive mode and frequency calculations.

Two-level modeling flutter analysis.- A procedure using a simplified finite element model (SM) in place of a refined finite element model (RM) during the flutter optimization reduces both computational costs and time usually required when repetitive dynamic and flutter analyses are performed on a complicated finite-element model. The simplified model is a close approximation in mass and stiffness to the refined model, but contains far fewer finite-elements.

Reference 10 describes in detail the method which is used for generating an SM from a given RM. The SM of the airframe is a beam and plate representation of structure built up of frames, spars, ribs and covers which are represented by individual finite elements in the RM. Conversion from the

RM to SM requires calculation of distributed and lumped masses and plate and beam stiffnesses equivalent to those of the built up structure.

The method follows the flow chart of figure 1, where the conversion of RM properties to SM properties is done primarily by three computer programs. One program converts the RM lumped mass data to the SM after completion of the SM node and element definition. The second program converts RM wing rib and spar data to the SM to maintain the proper moments of inertia. The third program converts the RM skin thicknesses to the SM and can also be used in the reverse process of converting the designed SM elements back to the RM. The transfer of engine and other aerodynamic surface data (fin, tails) is not automated and must be done manually.

Flutter analysis using constant natural modes.- In this method, the computer cost is reduced in the repetitive flutter analysis, not by use of a simplified model, but by use of invariant natural modes for generation of the generalized matrices of aerodynamic forces, mass, and stiffness. The details of this approach are described later in this paper in the flutter optimization section.

Structural Sizing Methods

The cross-sectional dimensions of the structure are determined in three consecutively executed optimizations: one for strength, one for flutter, and one for gust loads, in that order. In all cases the optimizations are performed for minimum of structural mass of the wing. Other components of the airframe, such as fuselage and tail, remain unchanged. The optimization constraints correspond to various flight and taxi conditions that characterize the typical missions of the aircraft. The constrained optimum is sought by means of program CONMIN (ref. 11). This program is a general purpose optimizer based on the nonlinear programming method of feasible-usable directions and is used throughout the reported studies for strength and also for flutter structural resizing.

Static Strength Optimization

Nonlinear mathematical programming is used as the optimization method. It is applied on an element-by-element basis to the wing cover membrane panels, as explained in reference 12. The procedure calls for displacement and stress analysis first. Next, each wing cover panel and the forces exerted on it by the neighboring elements are extracted from the finite-element model. Cross-sectional dimensions of such isolated panels are optimized to obtain a minimum mass while simultaneously satisfying panel constraints. The constraints include strength, strain, local buckling, and minimum gage limits. To hold down the computational cost, closed form, approximate formulas are used in the local buckling analysis. The design variables are the panel cross-sectional dimensions and, in the case of filamentary composite materials, the fiber orientation angles. Reference 13 gives a detailed discussion of the wing cover panel optimization procedures.

Since the individual panel optimizations alter the wing cover stiffness distribution, thereby changing the distribution of the internal forces acting between elements of the statically indeterminate wing structure; a series of panel optimizations is followed by reanalysis of the modified wing. This reanalysis yields new values of the internal forces; therefore, the individual panel optimizations have to be repeated. This iterative sequence of the finite-element model analysis and the individual panel optimizations continues until the internal forces converge. The ISSYS system, with its flexibility obtained by use of the Control Data Corporation NOS Command Language, allows for several different iterative procedures. In one such procedure, the previously described aeroelastic loads computation has been combined with an element-by-element wing cover optimization in one iterative process as proposed in reference 14. The procedure also includes computation of a jig shape for the aerodynamically efficient cruise shape of the aircraft. The computational flow is summarized in figure 2.

Flutter Optimization

The object of wing flutter optimization is to move the flutter boundaries outside a given flight envelope with a minimum of new material added to the wing that has previously been sized for strength. The new material is added only to the wing covers and its amount and distribution are determined by minimum mass optimization using program CONMIN (ref. 11). Two different optimization procedures have been developed; both of them use CONMIN as the optimizer, while they differ in the type of analysis carried out in the optimization loop.

Nonlinear programming using two-level modeling.- Organization of this procedure is shown in figure 3. It uses two finite-element models of different levels of detail as described previously in the section on flutter analysis. Generation of the SM from the RM data is computerized, but still requires a considerable amount of judgmental adjustments. The reverse resizing data transfer from the optimized, flutter-free SM back to RM is also computerized. Optimization of the wing for flutter constraint includes CONMIN and flutter analysis of the SM performed in a loop shown in inset in figure 3. Computer time is saved in this approach by using the SM flutter analysis inside the optimization loop. The additional material for flutter stiffening is treated as a new minimum gage imposed on the strength-sized wing cover material as documented in reference 1.

Nonlinear programming using constant natural vibration modes.- As mentioned previously, under this approach the analysis is applied to a single refined finite-element model, the same one which is used in strength optimization. Cost of the repetitive analysis is reduced by use of natural vibration modes as Rayleigh-Ritz displacement functions which decrease substantially the dimensionality of the analysis.

The procedure is summarized in a flow chart given in figure 4. It begins with computation of a set of natural vibration modes for the strength-sized wing structure. Next, these modes are used to condense the stiffness and mass matrices and their gradient matrices. Also, a mode independent

matrix of aerodynamic force influence coefficients is calculated. As explained previously, these operations are performed outside the optimization loop; hence their computational cost, which is large, is incurred only once.

Repeated in each passage through the optimization loop are: updating of the generalized condensed stiffness and mass matrices by a linear extrapolation, computation of natural modes and frequencies of the reduced problem, recalculation of the matrix of generalized aerodynamic forces, updating of the total structural mass, and computation of natural modes and frequencies of the reduced problem. A subset of the modes corresponding to the first several natural frequencies is substituted in the flutter equations. A similar analysis scheme was proposed in references 15, 16, and 17. Several computer codes from the system described in reference 15 are being evaluated for implementation in ISSYS.

Design variables used in the studies reported herein are thicknesses of wing cover areas, each area being composed of several adjacent finite-element panels. These thicknesses were added on top of the strength-size thicknesses in the form of patches, instead of being added as new minimum gages as in the two-level modeling method. The reason for this difference between the two methods is that in the constant natural modes method, the total value of the structural mass is approximated by linear interpolation. This interpolation requires continuity of the derivatives of mass with respect to the variable thicknesses. Continuity does not exist if the flutter stiffening material is added to the strength material in the form of a new minimum gage. In the two-level modeling method, however, such lack of continuity is acceptable since all the derivatives are recomputed in each iteration.

A final check of the flutter velocity is carried out using new natural vibration modes recomputed for the optimized structure. If the flutter velocity differs significantly from the one predicted by the approximate analysis based on the old modes, the entire optimization process is repeated using the new modes.

Resizing for Atmospheric Turbulence

Figure 5 illustrates the analytical path currently used within the ISSYS system to calculate the critical turbulence induced load conditions and to perform a strength resizing. Natural modes, frequencies, generalized masses, and modal stress coefficients are calculated using the a refined finite-element model of the airframe. The modes are then splined to the aerodynamic model nodal locations and the doublet lattice unsteady aerodynamic influence coefficients are calculated. These air loads and dynamic properties are then used as input in a dynamic response computer program which calculates the statistical characteristics of the stresses due to an assumed von Karman gust spectrum. At present, only vertical gusts are used in the resizing cycle.

Design envelope gust criteria are formulated in what is commonly known as 3σ conditions. The assumption of a normal distribution of the gust velocities implies a probability of occurrence greater than .9995. To facilitate use of standard criteria, input design conditions are treated as maximum design conditions. Stresses on each structural element are then calculated using the constant probability criteria as shown in reference 18 and added to stresses corresponding to steady state flight with a 1g load factor to create a set of stress conditions for gusts. These gust stresses are used together with stresses due to the taxi, cruise, and maneuver load conditions for structural resizing. Full discussion of the gust resizing procedure is given in reference 18.

Control Law Synthesis for Active Flutter Suppression

The method used to synthesize the flutter suppression control law is described in reference 19. For the purposes of control law synthesis, the complex coefficient equations of motion are written as a set of constant-coefficient differential equations. This is accomplished by using aerodynamic approximating functions. The constant coefficient differential equations can be reduced to state-variable form:

$$\begin{aligned}\{\dot{X}\} &= [A] \{X\} + \{B\} u \\ \{Y\} &= [C] \{X\}\end{aligned}$$

where \dot{X} is the rate of change with respect to time. Linear optimal control theory is then used to develop a full-state feedback control law that minimizes a quadratic performance function of the outputs of the system and control input,

$$J = \int_0^{\infty} [\{Y\}^T [Q] \{Y\} + (u R U)] dt$$

The optimal control law is then reduced to practical application by using a transfer function matching technique. This matching is accomplished by employing a nonlinear programming algorithm to search for the coefficients of a feedback compensator $H(s)$ that minimizes the error between the optimal frequency response and the compensated frequency response (fig. 6). If the deviation away from the optimal control law is small, the performance of the practical control law is similar to that of the optimal control law.

Computer Implementation

The preceding methodology has been incorporated into the Integrated Synergistic Synthesis System of computer codes (ISSYS). This system represents a logical evolutionary improvement in the computer-aided design of aircraft structures.

The ISSYS concept provides a library of control-card procedures for performing functional tasks. In the main job control deck, the calls to these control-card procedures can be intermixed with user specified operations in higher level procedures to perform whatever calculation sequences are desired. Thus, the ISSYS Library is analogous to system libraries used by FORTRAN programmers (see ref. 20). Another analogy is between the ISSYS main job control deck with the calls to task-performing procedures embedded in it and a FORTRAN main program containing calls to FORTRAN subroutines.

Maximum use is made of existing stand-alone computer programs (developed outside of ISSYS) and the capabilities of Control Data Corporation's Network Operating System (NOS). Relying on proven external sources in this manner decreases ISSYS development time and facilitates the incorporation of new analysis capabilities into the ISSYS system.

Use of NOS as an integral building block of ISSYS permits easy, straightforward modification and allows the execution of user generated procedures and programs intermixed with ISSYS tasks. By using ISSYS utility procedures, any part of the system can be modified at execution time for a special purpose application, or can be used to check a proposed permanent modification. These capabilities have produced a flexible, open-ended design system which is being continuously improved and expanded.

The ISSYS System Library is a single permanent file divided into four LIBEDIT* type sub-libraries as shown in figure 7. The first two consist of TEXT* type records containing the ISSYS Command Procedures (LIB1) and the Data Processors (LIB2). The third sub-library (LIB3) consists of OPL* type records containing instruction decks for programs such as AUTOLAY (used to assemble binary files for programs) and SORTMRG* (used in alphabetizing records in a library). The fourth sub-library (ISSLIB) is a ULIB* type user library. The latter is further divided into two sub-libraries containing REL* type relocatable binary records for each program and sub-routine and TEXT* type source decks.

The ISSYS Command Procedures in LIB1 can be classified into three categories: Task, Utility, and Auxiliary Procedures. Task Procedures, in general, perform engineering calculations as part of an analysis or design exercise. Utility Procedures are used in the maintenance of permanent data bases or of ISSYS itself--modifying or adding to any part of the system. Auxiliary Procedures are used by ISSYS to perform file manipulation or special output functions.

The major elements of an ISSYS job are the Job Control Deck, Task Procedures, Data Processors, Programs, the Local Data base, and Local Files. All other elements of the system are either generated during a run or contained within the ISSYS System Library.

Some typical ISSYS relationships are shown schematically in figure 8. A user provided Job Control Deck specifies the execution sequence with a

*The CDC-NOS utilities and record-types are described in reference 21.

series of ISSYS Commands. The Local Data base (LBASE) can either be provided directly or generated from a MODIFY or UPDATE permanent library, using ISSYS Utility Procedures. With LBASE established, the Job Control Deck can call analysis and design Task Procedures. These typically execute Data Processors, Programs, and other Task Procedures. A Data Processor uses Data Blocks from LBASE to form an input file for a program. The program generates output files which are normally used by the next Data Processor, etc. Thus, ISSYS acts as the execution-control and data-flow interface between the separate, stand-alone programs and the user supplied data.

As discussed in reference 20, an integrated modular system of computer programs can be developed simply, easily, and inexpensively on the basis of standard features of a commercial operating system supporting permanent files. Modularity of the system organization and control permits every engineering specialist to retain full responsibility for his discipline. In comparison with performing engineering calculations by means of separate, stand-alone programs, the program integration into a system with a common data base is highly effective in reducing the calendar time and manpower needed to carry out a given computational task.

APPLICATION OF THE METHODOLOGY

This section describes a sample of results selected to illustrate applications of the methodology to specific configurations of SCR aircraft. Two configurations, designated AST-102 and AST-105, are referred to in the discussion. Overall characteristics and construction details of a configuration AST-102 are given in reference 1. Configuration AST-105, depicted in figure 9, and documented in reference 22, differs from AST-102 in some overall dimensions, engine, and mass data, but is similar to AST-102 in the construction type and structural detail.

The results represent eight studies chosen to illustrate the capabilities of the methods. Strength and flutter sizing study results using the two-level modeling method are presented. Results using the constant mode method are then shown to illustrate the improvements obtained by this method. Turbulence response, control surface effectiveness, wing deflection studies, flutter sensitivity to engine mass or location changes and horizontal tail size, and active control flutter suppression are all presented.

Strength and Flutter Sizing of Arrow Wing Configuration AST-105-1 Using Two-Level Modeling

The SCR configuration designated AST-105-1 was sized for strength and flutter. As previously explained, the refined model (RM) shown in figure 10 was used in strength-sizing, while both the RM and a simplified model (SM) whose wing model is shown in figure 11 were used in the two-level modeling flutter resizing. The airframe was of titanium construction with a finite-element model (RM) containing 746 nodes and 2396 elements. In the strength

resizing, wing cover panels and shear webs were the resizable elements. Only the wing cover panels were resized in the flutter optimization.

The strength sizing was performed for five load cases which are critical for the failure modes of cruise fatigue, maximum wing root static over-stress, and lower surface panel compression. Based on prior studies, the starting gross weight of the aircraft for this sizing was 318,000 kg (701,200 lb). Three iterations with the aeroelastic analysis and resizing programs yielded a strength-sized aircraft gross weight of 308,700 kg (680,500 lb).

Thickness contours of the upper wing cover for the strength-sized wing box are depicted in figure 12. Design variables for the flutter optimization are shown in figure 13. Each numbered area represents a constant thickness "patch" whose thickness was a design variable. The "patch's" thickness was added to the strength-sized thicknesses as a new minimum gage producing a new final distribution of the wing cover thicknesses shown in figure 14.

A simplified model with 82 nodes and 159 elements was used in the flutter optimization. After optimization, the covers weighed an additional 1808 kg (3986 lb), yielding an aircraft gross weight of 310,500 kg (684,500 lb). Figure 15 shows the flutter boundaries for the strength-sized and the flutter-sized aircraft.

Flutter Sizing Using the Constant Natural Modes

Design variables used in the constant natural vibration mode method applied to the AST-105-1 configuration are the same as shown in figure 13; however, in the constant mode procedure, the flutter stiffening material thickness is added as a patch on top of the strength-sized thickness.

The results of flutter sizing are shown in figure 16 as additional "patch" thicknesses which are added to the strength-sized thicknesses to form a final thickness distribution depicted for the upper wing cover in figure 17. The method reduced the flutter weight penalty by 42 percent from that obtained by the two-level modeling method. This significant reduction is attributed to the better analysis accuracy of the constant natural mode method. Detailed structural mass and flutter velocity data are given in table I showing a good correlation of the flutter velocities obtained by means of approximate and "exact" modal analyses for the final structure.

Turbulence Response Analysis

The turbulence analysis has been based on the inputs of the SCR mission profile and gust velocity distribution over the altitude. Figure 18 shows the typical mission profile for the AST-102 configuration. Figure 19 represents the variation of maximum gust velocity with altitude as specified in MIL-A-008861A (USAF). The choice of a design point criterion of $M = 0.6$ yields a 19 m/sec maximum gust velocity. This velocity was applied to the

AST-102 using methods previously described, and stress distributions due to gust were calculated. Table II shows typical gust stress values superimposed on the stresses corresponding to 1g load factor (cruise) compared to other load conditions. It was found that for the configuration studied, gust stresses considered as combined stresses according to von Mises yield criteria do not appear to be critical; therefore, the configurations studied have not been subjected to the gust resizing.

Roll Control Effectiveness

Since this arrow wing is highly flexible, loss of control surface effectiveness due to wing deflection is to be expected. An evaluation was made to determine the amount of roll control surface effectiveness lost when the flexibility effects were included. This study included evaluation of maximum wing root bending moments for several combinations of control surface deflections at Mach 0.20 and 0.35 using Woodward-Carmichael linear aerodynamics (ref. 2). The ratio of the wing root bending moments for flexible and rigid wings is equivalent to the corresponding ratio of the roll angular accelerations and is referred to as "flexible-to-rigid" ratio.

The baseline model for this study is the stiffness-sized model of the AST-102 with the main flaps deflected 30° down. Figure 20 shows the planform of one wing with the locations of the main flaps and each of the control surfaces. This model has a landing mass of 196,460 kg (435,310 lbm) and a center of gravity located at 5320 cm (2094 in.).

The results of this study are listed in table III as the "flexible-to-rigid" ratios for each control surface and each Mach number for various control configurations. From table III it is seen that at Mach 0.2, the "flexible-to-rigid" ratios are higher indicating that less effectiveness is lost due to flexibility effects at Mach 0.2 than at Mach 0.35. Also, as expected, the control surfaces located closest to the wing root lose less control effectiveness due to flexibility effects.

Wing Deflections at Landing

The arrow wing is more sensitive to deflection constraints than a delta wing due to its highly swept trailing edge and large, flexible tip. Since the trailing edge tip is 2099 cm (827 in.) aft of the main landing gear, a potential ground clearance problem exists when the aircraft is at a significant angle of attack near the ground. This problem is more serious during landing than at take-off since during landing there is less fuel on board so that the wing is more lightly loaded and deflects upwards less. Ground clearance requirements can affect several areas of aircraft design including landing gear length, wing location, and wing stiffness and thickness. To determine the amount of wing deflection that would occur during landing, analyses were made with the finite-element model of the AST-102 in the landing configuration at the design approach speed of Mach 0.23 using Woodward-Carmichael linear aerodynamics. The baseline aircraft wing deflections at landing are shown in figures 21 and 22. The corresponding

deflections for other major cases are indicated for comparison and the ground level at both taxi and landing is shown in figure 22 to illustrate the wing tip clearance problem. Effects of increased wing depth, increased approach speed, and varying wing fuel distribution were studied for the baseline to determine the most effective means of controlling the wing deflections. The baseline model for this study is the flutter-sized AST-102 with the main flaps deflected 30° down (see figure 20).

The flutter-sized model is marginally acceptable from the standpoint of ground clearance. One reason for the problem is that there is a significant difference between cruise and landing deflections and landing deflections have not been considered during the sizing procedure. Thus, the landing gear may have to be lengthened to increase clearance. Since the source of the deflection problem is the aerodynamic load distributions, structural modifications, depth increase, or changes in fuel location have little effect on the wing tip position. However, an alternative would be to increase the approach speed which improves the net ground clearance.

Flutter Speed Sensitivity to Changes of Engine Mass and Location

A study was performed on the strength and flutter-sized AST-102 configuration to determine the effects of engine weight and location on flutter speed. The cases studied include three engine weights, the addition of a noise suppressor to the aft of each engine, and relocation of first the inboard and then the outboard engines forward 88.9 cm (35 in.). Table IV indicates the resulting flutter velocity at Mach 0.6 and 0.9 for each case, and figure 23 indicates the effects of engine mass on flutter speed.

For the cases studied, increases in the engine mass or the addition of noise suppressors have a mixed but relatively small influence on the flutter performance. The increase in flutter speed as engine mass changes is not sufficient to warrant the use of engine mass variations to solve flutter problems, considering the small mass penalty involved in stiffening the wing for flutter. Moving the inboard engine forward was detrimental to flutter behavior, while moving the outboard engine forward increased the flutter speed. Unfortunately, moving the engines forward is not practical due to present nacelle designs and thrust reverser requirements.

Flutter Speed Sensitivity to Horizontal Tail Size

A study was performed to determine the influence of horizontal tail size on wing flutter. The tail sizes considered are shown in table V, along with their mass and mass per unit area. The first two tails have the same mass, while the last three have the same mass per unit area. Results from the flutter analyses are shown in table V and in figure 24. Figure 24 shows that increased tail area has very little effect on the 3 Hz flutter mode at Mach 0.6, but it is definitely beneficial for the 2 Hz mode that is critical at Mach 0.9.

An analysis was made excluding the tail aerodynamics effect on wing flutter. At Mach 0.6, a 1 Hz mode was critical at a low flutter speed (389 keas). The inclusion of tail aerodynamics effectively suppresses this mode. This was verified using doublet-lattice unsteady aerodynamics in the flutter analysis. In general, increased horizontal tail size has a beneficial effect on wing flutter characteristics.

Active Control Flutter Suppression

An active flutter suppression system (FSS) control law was synthesized to provide a flutter-free airplane within the $1.2 V_D$ flight boundary. The control system uses the inboard section of a split-outboard aileron, depicted in figure 25, which is normally locked during transonic flight. By using an existing control surface, the weight penalty associated with the control system can be reduced compared to a system that would use a dedicated control surface.

The FSS synthesis was conducted at Mach .9 and 4572 m (15,000 ft) (approximately $1.2 V_D$). Using a trial-and-error approach, the wing sensor (accelerometer) was located in a position shown in figure 25 which provides a high sensitivity of the sensor to the flutter modes while minimizing that sensitivity to the other modes. (This is achieved by a locus method involving a parametric study of zeros of the transfer function between control surface input and acceleration output.) An additional accelerometer was located in the fuselage (at the aircraft center of gravity) and the difference between indications of the two accelerometers was used as a feedback to minimize coupling between rigid body and flexible modes.

Further synthesis to define feedback gains employed optimal control theory techniques. All designs included the actuator transfer function $40/(s+40)$ (ref. 23). Optimal full-state feedback gains were calculated that minimized the square of the control input. This control law was made practical by the technique described previously in the paper. Figure 26 shows a block diagram of the resulting system. This control law was then analyzed in terms of increase in flutter speed and control surface response in turbulence.

Figure 27 shows the open and closed loop flutter boundaries. The flutter boundary is based on a constant control law, that is, no gain scheduling. All points are moved to the right of the $1.2 V_D$ line, except at Mach .6, where it is just slightly to the left. This point can be moved to the right by a slight gain schedule between Mach .7 and Mach .6.

Control surface activity was evaluated at the Mach .9, $1.2 V_D$ condition. Using a gust design velocity of 4.572 m/sec (15 ft/sec), the root-mean-square control surface displacement is 7.25° and the rate is $105.45^\circ/\text{sec}$. Using the estimation methods of reference 24, this results in a power requirement of 20.69 kW (27.75 hp) and a hydraulic flow rate of 1.06 l/sec. These demands on the hydraulic system are well below the capacity available at the FSS flight conditions.

CONCLUSIONS

A methodology has been developed for the structural analysis and cross-sectional dimension optimization for complex flexible airframes such as the SCR arrow wing configuration. The methodology entails analysis of steady and unsteady aerodynamic forces acting on a flexible wing, analysis of displacements and stresses, computation of flutter speeds, gust response, and procedures for cross-sectional size optimization of the wing structural box. Included in the methodology are computations of jig shape and overall aircraft deformations.

The methodology is implemented in an integrated system of computer programs called ISSYS consisting of files that contain programs, procedure commands and the aircraft input data. The standard CDC-NOS Command Language and utilities are used for the ISSYS system's executive functions.

The effectiveness of ISSYS is demonstrated by a series of studies applied to two SCR airframe configurations. By use of the system design approach and a common data base, it was possible to obtain such diverse results as strength sizing and flutter stiffening of the wing, wing deformations during landing, flutter speed sensitivity to engine mass and tail size, gust response and resulting stresses and synthesis of an active control flutter suppression system. The methodology presently included in ISSYS represents the current state-of-the-art and is sufficiently general to apply to advanced airframes other than SCR airframe configuration.

The structure and architecture of ISSYS provides for a continuous expansion of analysis and synthesis capabilities.

APPENDIX: SUPER-MATRIX EQUATIONS

The relationship between the displacements of the structural grid points and the slopes of the aerodynamic panels can be determined by fitting the structural displacements with a surface spline and interpolating to the centroids of the aerodynamic panels. From the routine developed in reference 6, the spline influence coefficients are dependent only on geometry and can be represented by the matrix

$$[H] = \begin{bmatrix} H_{11} & \dots & H_{1N} \\ \vdots & & \vdots \\ H_{N+3,1} & \dots & H_{N+3,N} \end{bmatrix}$$

This matrix multiplied by the structural displacement vector yields the surface fit coefficients. Thus,

$$\begin{bmatrix} H_{11} & \dots & H_{1N} \\ \vdots & & \vdots \\ H_{N+3,1} & \dots & H_{N+3,N} \end{bmatrix} \begin{Bmatrix} Z_1 \\ \vdots \\ Z_N \end{Bmatrix} = [H] \{Z\} = \begin{Bmatrix} A_0 \\ A_1 \\ A_2 \\ B_1 \\ \vdots \\ B_N \end{Bmatrix}$$

The slope can now be determined by any point on the surface through the relationship (ref. 6)

$$S_i = \frac{\partial [H]}{\partial X_i} \cdot \{Z\} = A_1 + \sum_{j=1}^N B_j (X_j - X_i) (1 + \ln r_{ji}^2)$$

for $i = 1$ to the number of aerodynamic panels and $r_{ji}^2 = (X_j - X_i)^2 + (Y_j - Y_i)^2$. By letting $F(r)_{ji} = (X_j - X_i) (1 + \ln r_{ji}^2)$, the slopes of the aerodynamics panels can be determined by

$$\begin{Bmatrix} S_1 \\ \cdot \\ \cdot \\ \cdot \\ \cdot \\ \cdot \\ S_m \end{Bmatrix} = \begin{bmatrix} 0 & 1 & 0 & F(r)_{11} & \dots & F(r)_{i,N} \\ \cdot & \cdot & \cdot & \cdot & & \cdot \\ \cdot & \cdot & \cdot & \cdot & & \cdot \\ \cdot & \cdot & \cdot & \cdot & & \cdot \\ \cdot & \cdot & \cdot & \cdot & & \cdot \\ \cdot & \cdot & \cdot & \cdot & & \cdot \\ 0 & 1 & 0 & F(r)_{m,1} & & F(r)_{m,N} \end{bmatrix} \begin{Bmatrix} A_0 \\ A_1 \\ A_2 \\ B_1 \\ \vdots \\ B_N \end{Bmatrix}$$

which in a more simplified form may be written as

$$\{s\} = [F] [H] \{Z\}$$

Note that both [F] and [H] are dependent only on geometry and need be calculated only once.

The panel differential pressure coefficients (ΔC_p) can be determined in aerodynamic grid as a function of the displacements in the structural grid by the relationship

$$\begin{aligned} \{ \Delta C_p \}_A &= [AIC] \{s\} \\ &= [AIC] [F] [H] \{Z\} \end{aligned}$$

To find the elements of the differential pressure coefficients at the structural grid points, an analysis similar to the foregoing can be made. The only difference is that the value of the coefficients are interpolated rather than the slopes. The resulting relationship is

$$\{ \Delta C_p \}_S = [F]_C [H]_C \{ C_p \}_A$$

Expanded, the relationship becomes

$$\{ \Delta C_p \}_S = [F]_C [H]_C [AIC] [F] [H] \{Z\}$$

An area matrix [S] is generated which represents the area affected by the pressure at the given structural node. The product of $\{ \Delta C_p \}_S$ and the area matrix (which is diagonal) is the generalized loads matrix [L] which, when multiplied by the displacement vector, yields the loads at individual structural nodes $\{L_N\}$. Thus,

$$\begin{aligned} \{L_N\} &= [L] \{Z\} = \{\Delta C_p\}_S [S] \{Z\} \\ &= [F]_C [H]_C [AIC] [F] [H] [S] \{Z\} \end{aligned}$$

The generalized loads matrix is then

$$[L] = [F]_C [H]_C [AIC] [F] [H] [S]$$

REFERENCES

1. Sobieszczanski, J.; McCullers, L. A.; Ricketts, R. H.; Santoro, N. J.; Beskenis, S. D.; and Kurtze, W. L.: Structural Design Studies of a Supersonic Cruise Arrow Wing Configuration. Proceedings of the SCAR Conference, NASA CP-001, part 2, Nov. 1976, pp. 659-684.
2. Carmichael, Ralph L.; and Woodward, Frank A.: An Integrated Approach to the Analysis and Design of Wings and Wing-Body Combinations in Supersonic Flow. NASA TN D-3685, 1966.
3. Watkins, Charles E.; Woolston, Donald S.; and Cunningham, Herbert J.: A Systematic Kernel Function Procedure for Determining Aerodynamic Forces on Oscillating or Steady Finite Wings at Supersonic Speeds. NASA TR R-48, 1959.
4. Donato, Vincent W.; and Huhn, Charles R., Jr.: Supersonic Unsteady Aerodynamics for Wings with Trailing Edge Control Surfaces and Folded Tips. AFFDL-TR-68-30, U.S. Air Force, Aug. 1968. (Available from DDC as AD 840598.)
5. Giesing, J. P.; Kalman, T. P.; and Rodden, W. P.: Subsonic Unsteady Aerodynamics for General Configurations, Part I. Direct Application of the Nonplanar Doublet-Lattice Method, AFFDL-TR-71-5, Vol. 1, November 1971.
6. Harder, Robert L.; and Desmarais, Robert N.: Interpolation Using Surface Splines. J. of Aircraft, vol. 9, no. 2, February 1972, pp. 189-191.
7. Giles, Gary L.: Computer-Aided Methods for Analysis and Synthesis of Supersonic Cruise Aircraft Structures. Proceedings of the SCAR Conference, NASA CP-001, Part 2, Nov. 1976, pp. 637-658.
8. Peele, L. P.; Adams, W. J., Jr.: A Digital Program for Calculating the Interaction Between Flexible Structures, Unsteady Aerodynamics, and Active Controls (ISAC). NASA TM-80040, January 1979.
9. Desmarais, Robert N.; and Bennett, Robert M.: An Automated Procedure for Computing Flutter Eigenvalues. J. of Aircraft, vol. 11, no. 2, February 1974, pp. 75-80.
10. Ricketts, Rodney H.; and Sobieszczanski, J.: Simplified and Refined Structural Modeling for Economical Flutter Analysis and Design. Presented at the AIAA/ASME/SAE 18th Structures, Structural Dynamics, and Materials Conference, March 21-23, 1977.
11. Vanderplaats, Garret N.: The Computer for Design and Optimization. Computing in Applied Mechanics, R. F. Hartung, ed., AMD - vol. 18, American Soc. Mech. Eng., c. 1976, pp. 25-48.

12. Sobieszczanski, Jaroslaw: Sizing of Complex Structures by the Integration of Several Different Optimal Design Algorithms. AGARD Lecture Series No. 70 on Structural Optimization, AGARD-LS-70, September 1974.
13. Sobieszczanski-Sobieski, J.: An Integrated Computer Procedure for Sizing Composite Airframe Structures. NASA TP-1300, 1979.
14. Giles, Gary L.; and McCullers, L. A.: Simultaneous Calculation of Aircraft Design Loads and Structural Member Sizes. Presented at the AIAA 1975 Aircraft Systems and Technology Meeting, Los Angeles, CA, August 4-7, 1975 (AIAA Paper No. 75-965).
15. Haftka, R. T.; and Prasad, B.: Programs for Analysis and Resizing of Complex Structures. Presented at Symposium on Future Trends in Computerized Structural Analysis and Synthesis, Washington, D. C., October 30-November 1, 1978. Proceedings entitled "Trends in Computerized Structural Analysis and Synthesis," Pergamon Press, NY, 1978, pp. 323-330.
16. Bhatia, K. G.: Rapid Iterative Reanalysis for Automated Design. NASA TN D-7357, 1973.
17. Sobieszczanski-Sobieski, J.; and Hajela, Prabhat: Accuracy of an Approximate Static Structural Analysis Technique Based on Stiffness Matrix Eigenmodes. Presented at AIAA/ASME/ASCE/AHS 20th Structures, Structural Dynamics and Materials Conference, St. Louis, MO, April 4-6, 1979 (AIAA Paper No. 79-0748).
18. Gross, D. W.: A Multi-Disciplinary Approach to Structural Design for Stochastic Loads. Presented at the AIAA 17th Aerospace Sciences Meeting, New Orleans, LA, Jan. 15-17, 1979 (AIAA Paper No. 79-0238).
19. Newsom, J. R.: A Method for Obtaining Practical Flutter Suppression Control Laws Using Results of Optimal Control Theory. NASA TP-1471, 1979.
20. Sobieszczanski, J.: Building a Computer-Aided Design Capability Using a Standard Time Share Operating System. Integrated Design and Analysis of Structures, Proceedings of ASME Winter Annual Meeting, Houston, TX, December 1975.
21. Control Data, Cyber 70 Series, Models 72/73/74 6000 Series Computer Systems KRONOS 2.1 MANUAL, Publication No. 604070000, 1974, by Control Data Corporation, Tech. Publ. Dept., Arden Hills, MN. Also publications: 60407600, 60407100.
22. Baber, H. T., Jr.: Characteristics of the Advanced Supersonic Technology AST-105-1 Configured for Transpacific Range with Pratt and Whitney Aircraft Variable Stream Control Engines. NASA TM-78818, March 1979.
23. Gordon, C. K.; and Visor, O. E.: SCAR Arrow-Wing Active Flutter Suppression System. NASA CR-145147, 1977.

24. Anderson, R. D.; Flora, C. C.; Nelson, R. M.; Raymond, E. T.; and Vincent, J. H.: Development of Weight and Cost Estimates for Lifting Surfaces with Active Controls. NASA CR-144937, 1976.

TABLE I.- SUMMARY OF AST-105-1 FLUTTER SIZING RESULTS

Strength Sizing and Flutter Fix Structural Mass Both Wings

Wing cover mass subject to strength sizing 7289.8 kg

Additional wing cover mass required to stiffen for flutter

- Two-level modeling method 1808.0 kg

- Constant natural vibration modes method 941.7 kg

Correlation of Flutter Velocity Computed by Approximate Analysis Within the Optimization Loop and Full Analysis with Natural Vibration Modes Recomputed for Optimized Wing

Mach .6 3.8%

Mach .9 3.1%

TABLE II.- COMPARISON OF SELECTED COVER PANEL STRESSES (N/cm²) FOR CRITICAL LOAD CONDITIONS - AST-102 AIRCRAFT

Load Case		Cruise	Gust	2.5 g Maneuver
Location ^a				
1	σ_x	-3060	-20169	-11457
	σ_y	-15626	-7957	-53508
	τ_{xy}	660	12620	1431
2	σ_x	-6176	-4159	-17382
	σ_y	-11290	-40259	-40083
	τ_{xy}	6191	5524	20252
3	σ_x	-7153	-7395	-19878
	σ_y	-6961	-39831	-26804
	τ_{xy}	4371	11314	14390
4	σ_x	-5470	-10171	-14053
	σ_y	-5269	-28826	-21869
	τ_{xy}	4995	14872	18868
5	σ_x	407	-2183	1997
	σ_y	-9568	-21806	-35430
	τ_{xy}	95	-1804	-7562
6	σ_x	2784	-2173	1924
	σ_y	-12644	-35932	-50209
	τ_{xy}	-2170	-2841	-10224

^aLocations are shown in figure 28.

TABLE III.- FLEXIBLE-TO-RIGID RATIOS OF THE AST-102

Mach No.	Flaperon A	Aileron B	Flaperon C	$\frac{\text{Flexible}}{\text{Rigid}}$ Ratio
0.20	$\pm 25^{\circ}$	0°	0°	.8634
0.20	0°	$\pm 30^{\circ}$	0°	.7394
0.20	0°	0°	$\pm 10^{\circ}$.9178
0.20	$\pm 25^{\circ}$	$\pm 30^{\circ}$	0°	.7905
0.35	$\pm 25^{\circ}$	0	0°	.6328
0.35	0°	$\pm 30^{\circ}$	0°	.3552
0.35	0°	0°	$\pm 10^{\circ}$.7716
0.35	$\pm 25^{\circ}$	$\pm 30^{\circ}$	0°	.4726

TABLE IV.- FLUTTER VELOCITIES FOR VARYING ENGINE MASS AND LOCATION FOR THE AST-102

Case Investigated	Flutter Velocity keas		Delta Mass Per Aircraft kg (lbm)
	Mach 0.6	Mach 0.9	
Baseline Case	466	454	0
Medium-Weight Engine Case	460	466	5443.20 (12000.0)
Heavy-Weight Engine Case	473	481	10886.40 (24000.0)
Noise Suppressor Case	465	455	1088.64 (2400.0)
Inboard Engine Moved	456	452	- -
Outboard Engine Moved	494	466	- -

NOTE: Required velocity is 456 keas ($1.2 V_D$) for both Mach numbers.

TABLE V.- FLUTTER VELOCITIES FOR VARIOUS HORIZONTAL TAIL SIZES FOR THE AST-102

Tail Area m ² (ft ²)	Tail Mass kg (lbm)	Tail Mass/Area kg/m ² (lbm/ft ²)	Flutter Velocity Mach 0.6-keas	Flutter Velocity Mach 0.9-keas
56.1 (604)	2136 (4710)	37.4 (8.8)	466	454
35.7 (384)	2136 (4710)	59.8 (12.3)	462	444
71.3 (768)	4273 (9420)	59.8 (12.3)	461	465
107.0 (1152)	6409 (14130)	59.8 (12.3)	460	484

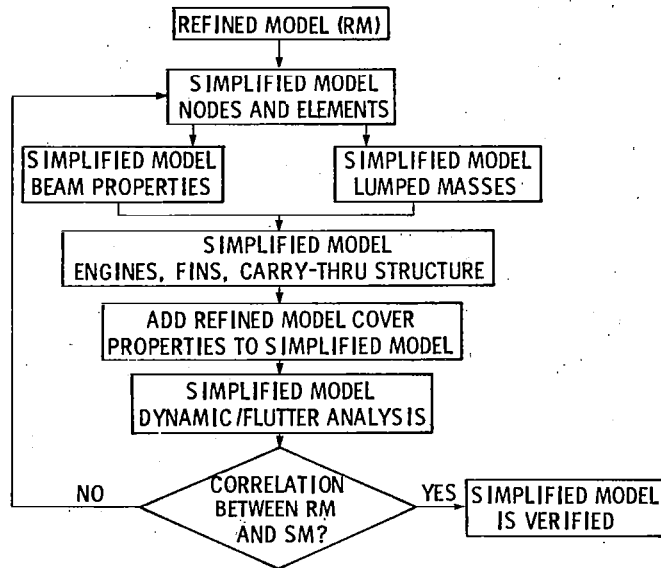


Figure 1.- Two-level modeling verification procedure.

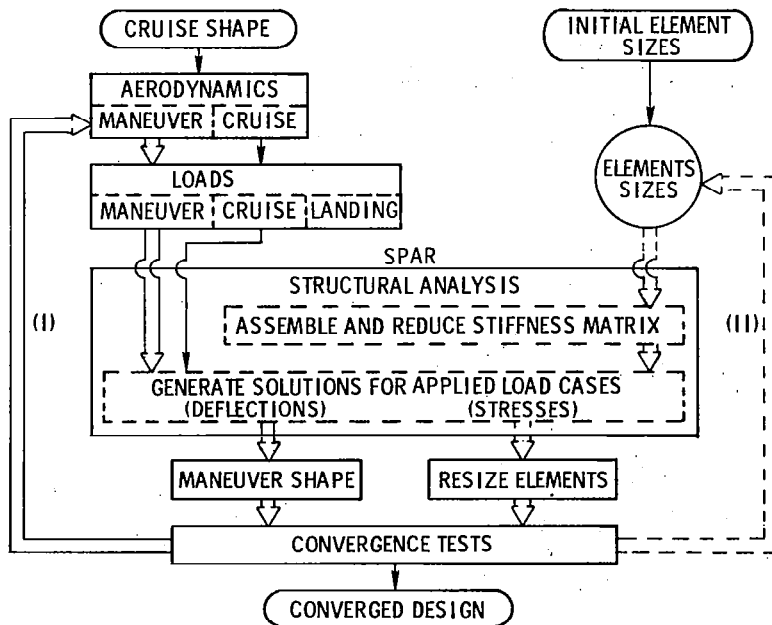


Figure 2.- Iterative procedures for aeroelastic loads computation (loop I) and wing cover resizing (loop II).

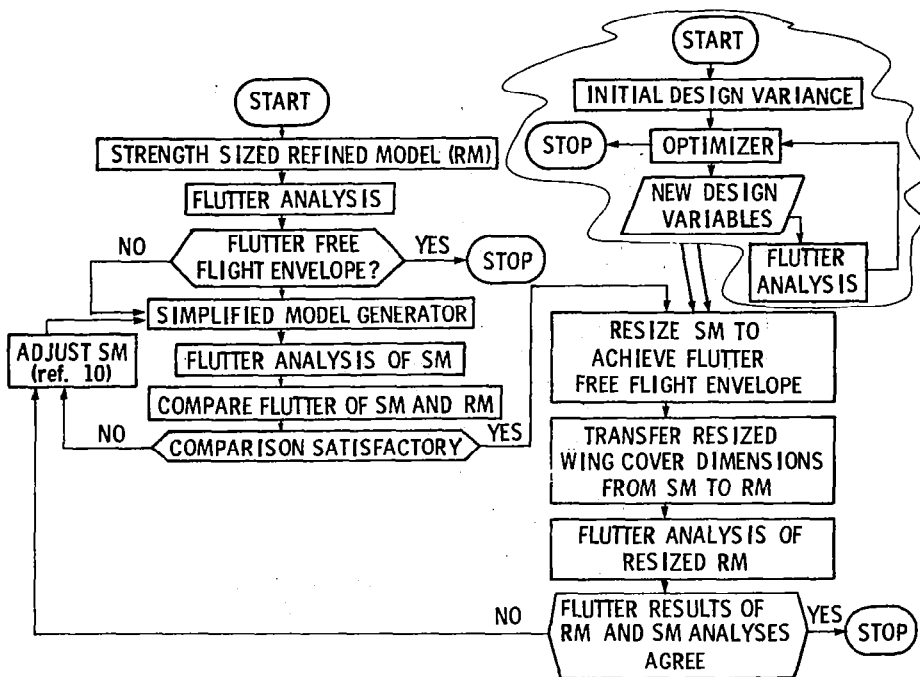


Figure 3.- Optimization procedure for flutter resizing using two-level modeling.

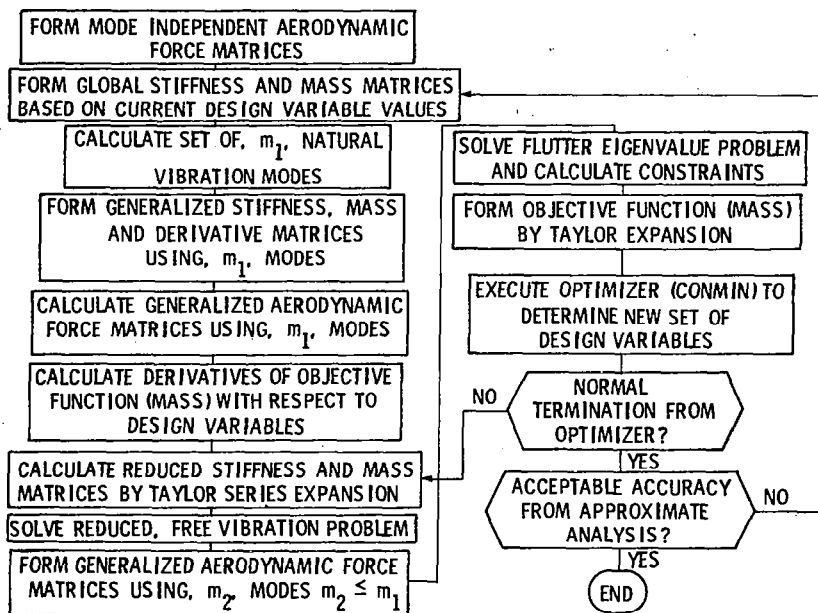


Figure 4.- Flow chart for Rayleigh-Ritz based (constant natural vibration modes) flutter optimization procedure.

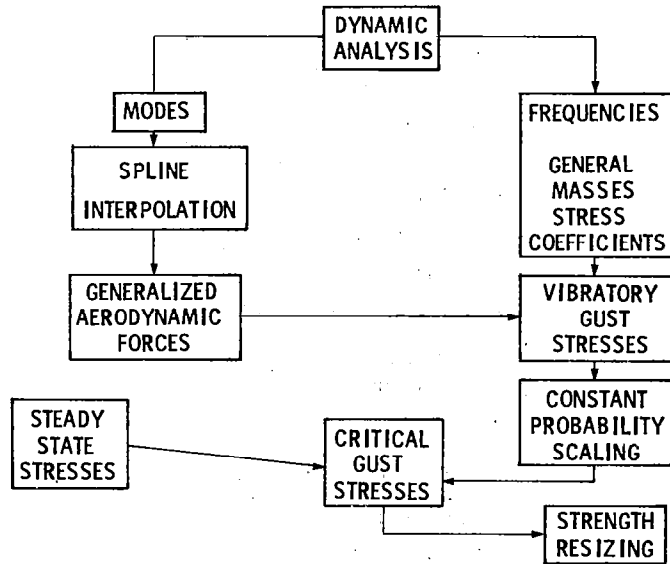


Figure 5.- Computational flow for gust resizing capability.

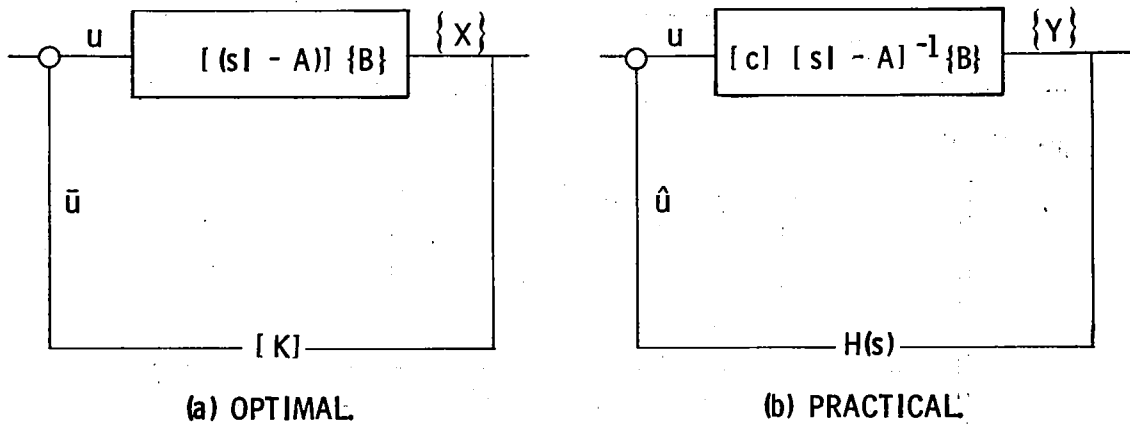


Figure 6.- Block diagrams of optimal and practical control laws.

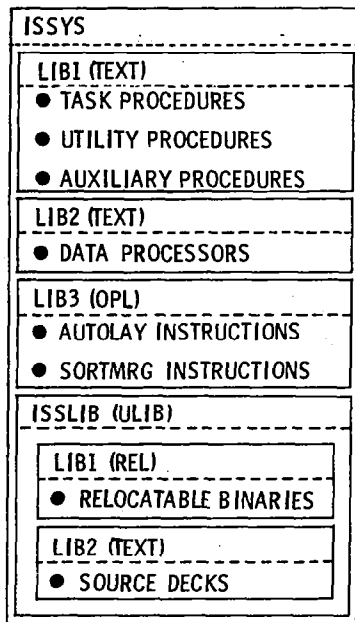


Figure 7.- ISSYS Library organization using CDC NOS utilities.

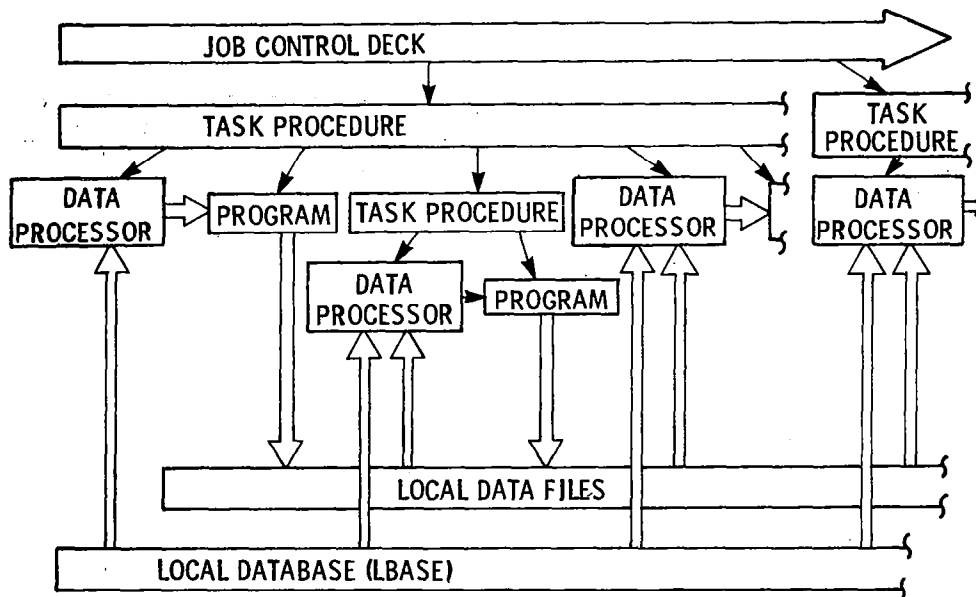


Figure 8.- Typical ISSYS execution control and data flow organization.

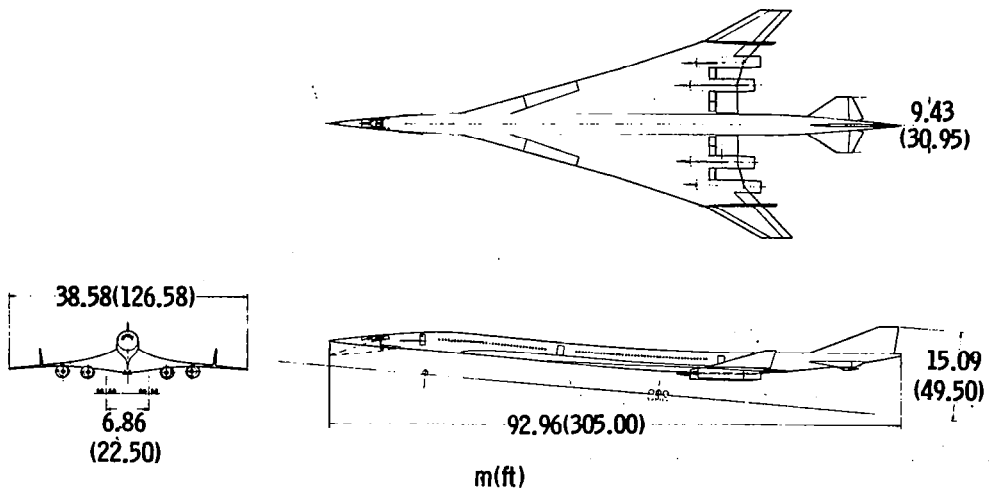


Figure 9.- AST-105-1 geometry.

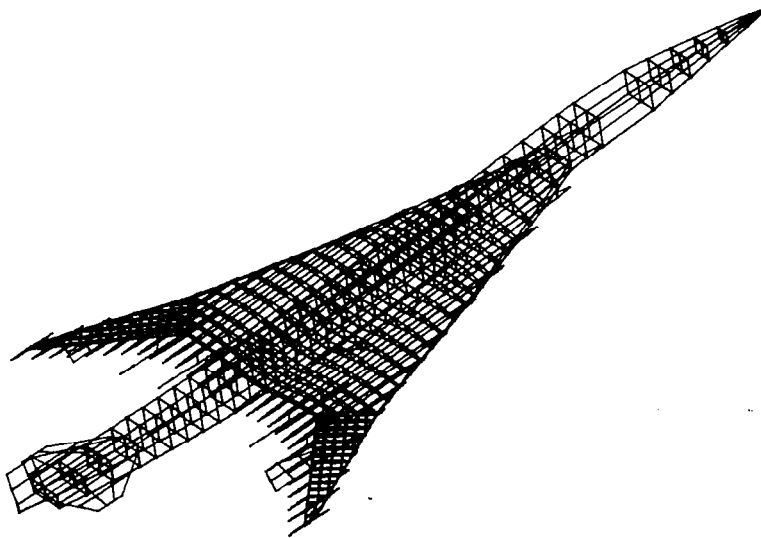


Figure 10.- AST-105-1 aircraft refined finite element model.

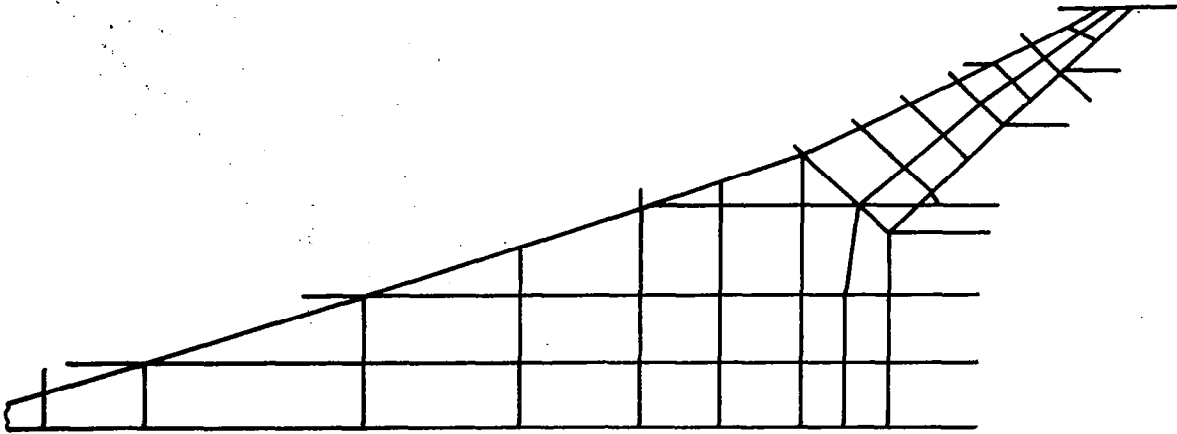


Figure 11.- AST-105-1 wing simplified finite element model.

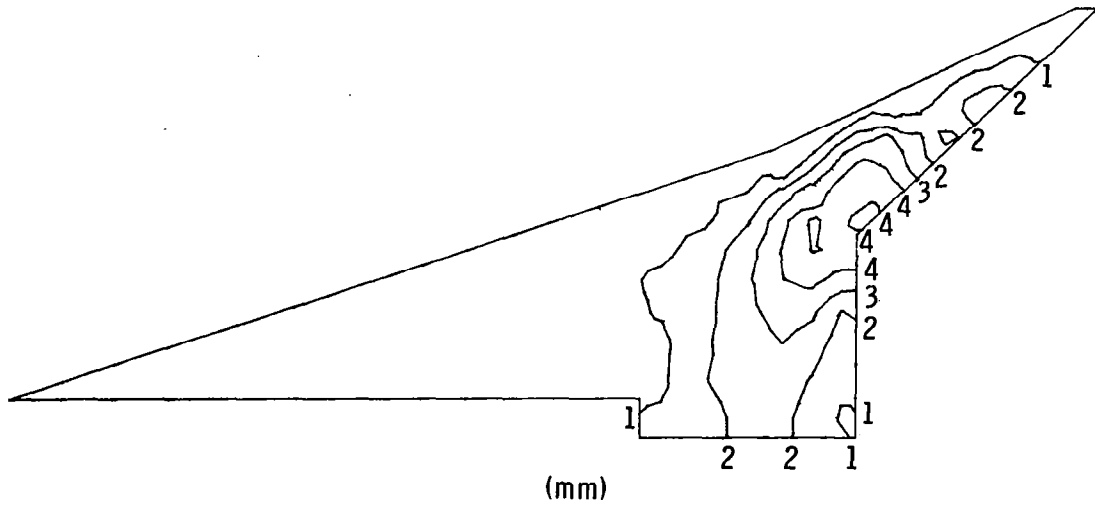


Figure 12.- Thickness contours for the AST-105-1 aircraft strength-sized upper wing cover panels.

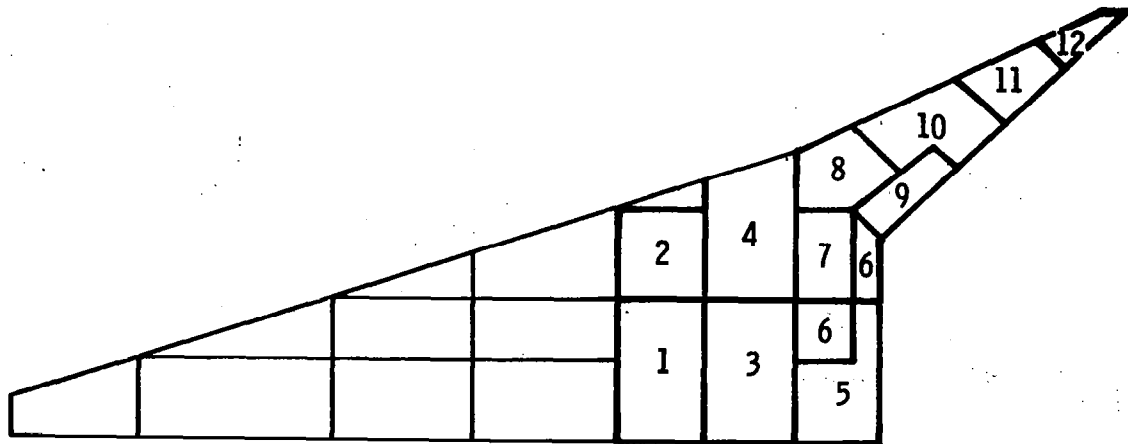


Figure 13.- Flutter optimization design variable "patches" for the AST-105-1 aircraft.

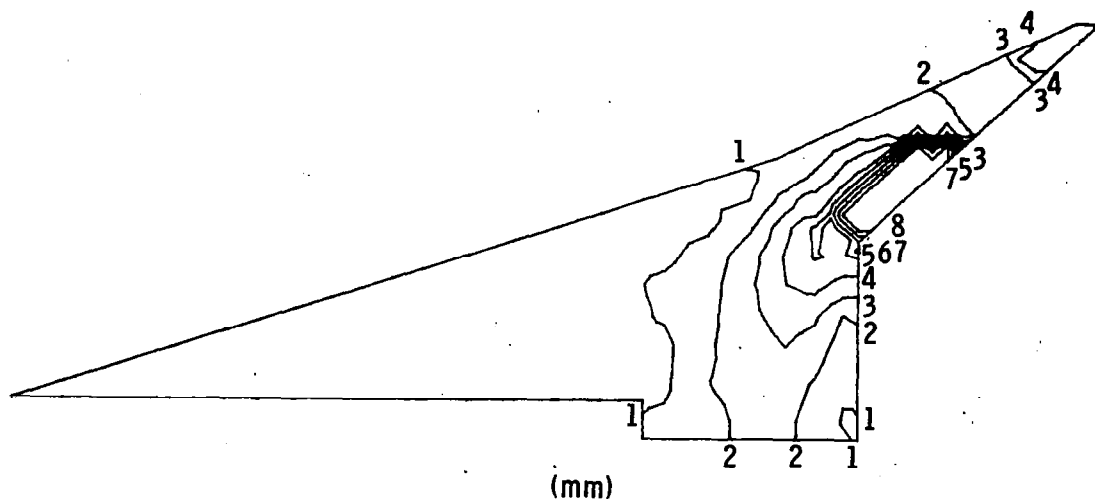


Figure 14.- Thickness contours for the flutter-sized AST-105-1 aircraft (upper cover) obtained by two-level modeling method.

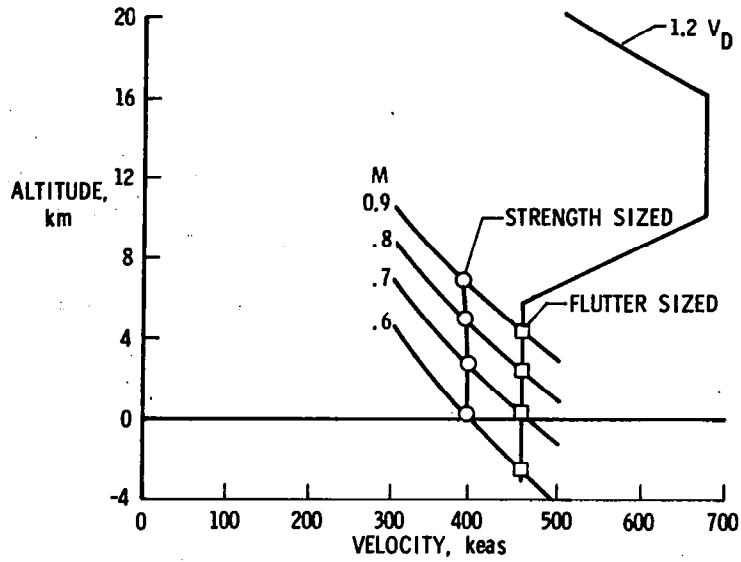


Figure 15.- Flutter boundary before and after flutter resizing of the strength-sized AST-105-1 aircraft.

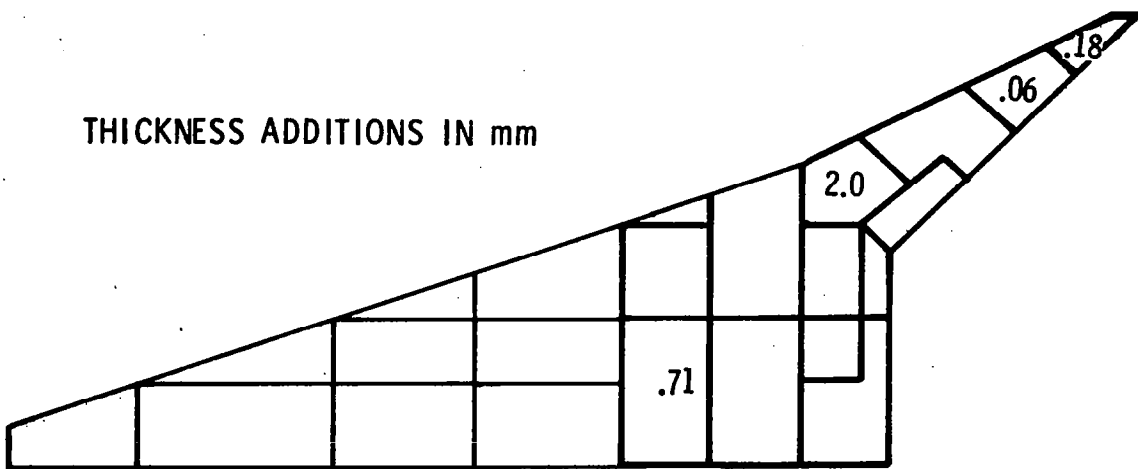


Figure 16.- Nonzero values of flutter resizing variables obtained by constant vibration modes method.

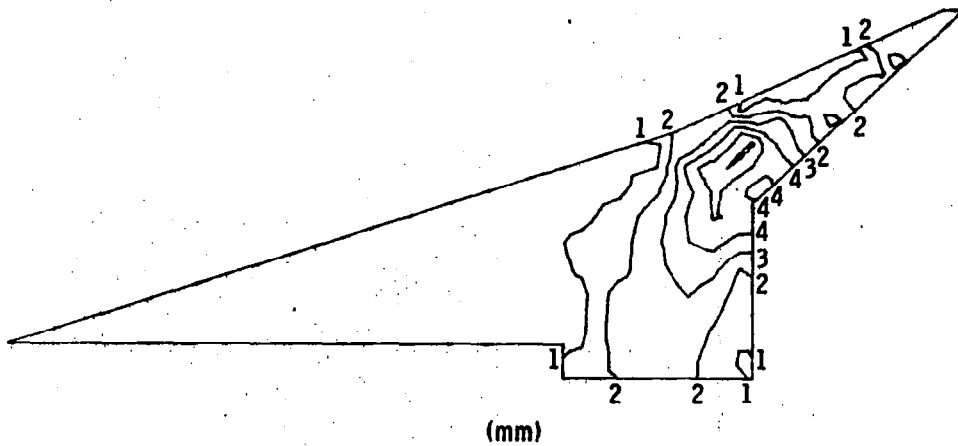


Figure 17.- Thickness contours for the flutter-sized AST-105-1 aircraft (upper cover) obtained by constant vibration mode method.

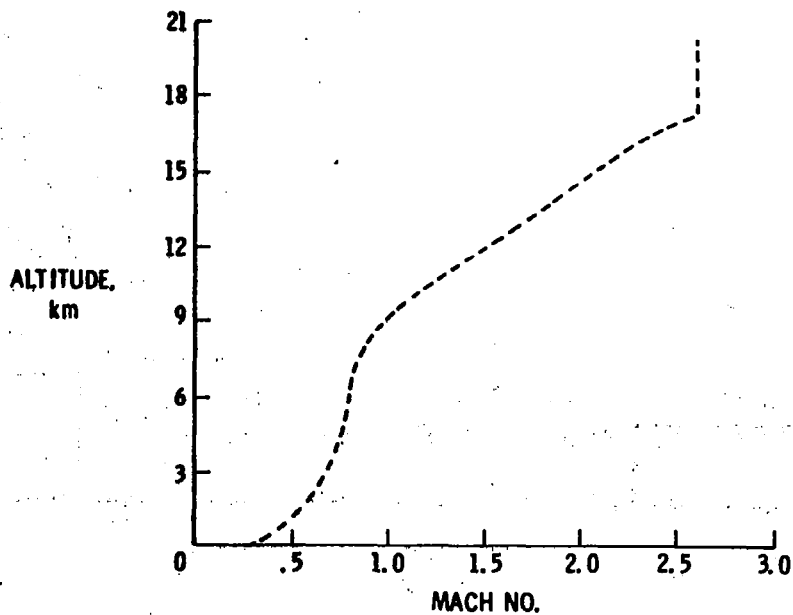


Figure 18.- AST-102 aircraft mission profile.

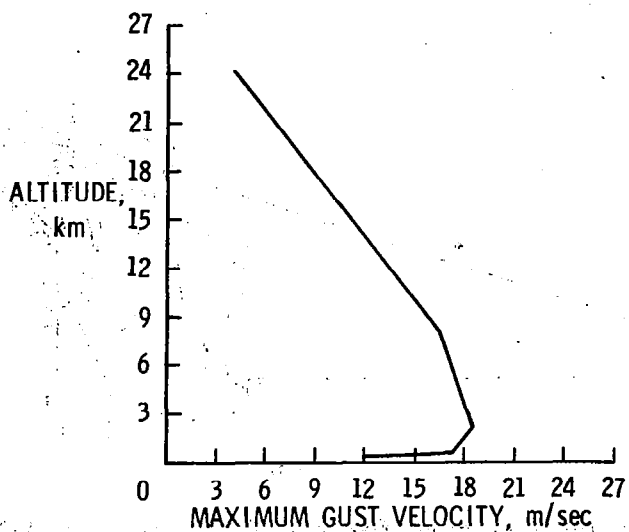
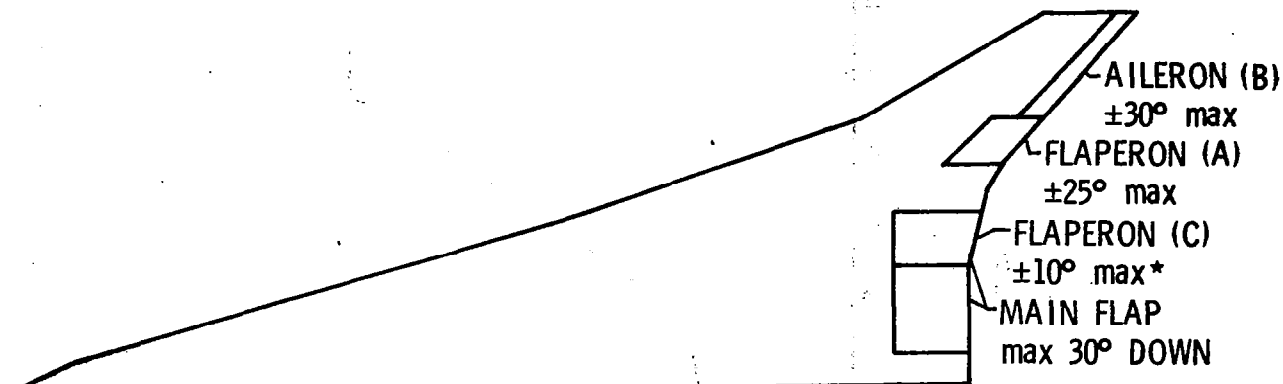


Figure 19.- 0.9995 (3σ) standard gust distribution.



* ±10° MEASURED FROM MAIN FLAP DEFLECTION

Figure 20.- AST-102 planform with control surfaces.

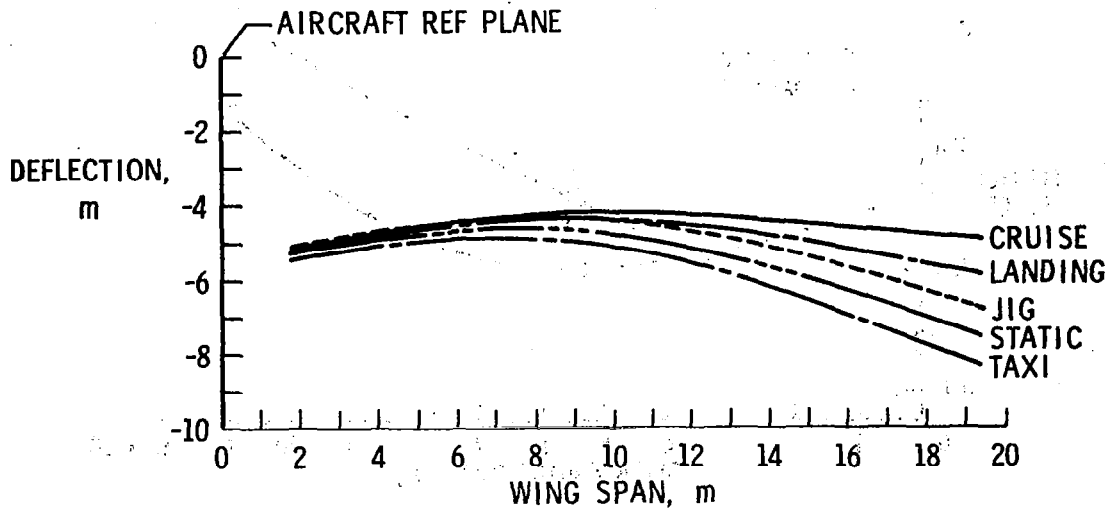


Figure 21.- AST-102 wing trailing edge deflections.

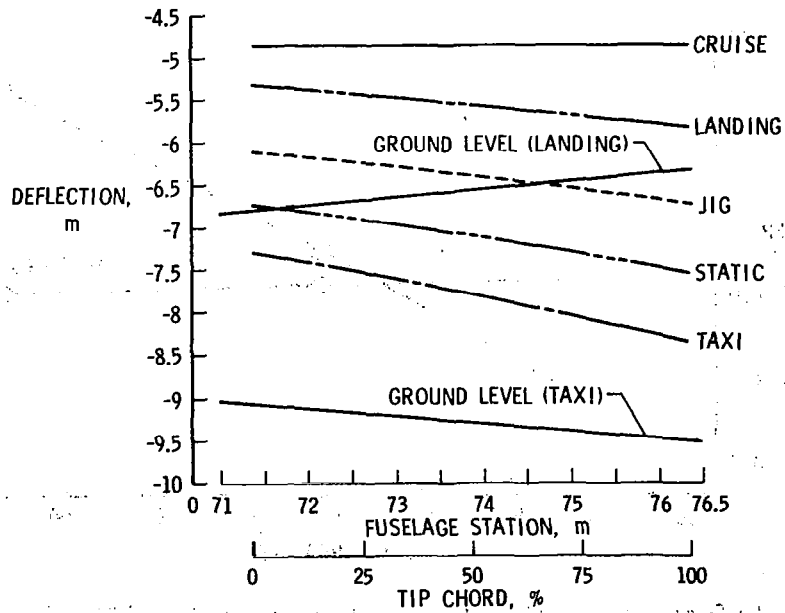


Figure 22.- AST-102 wing tip twist and deflection.

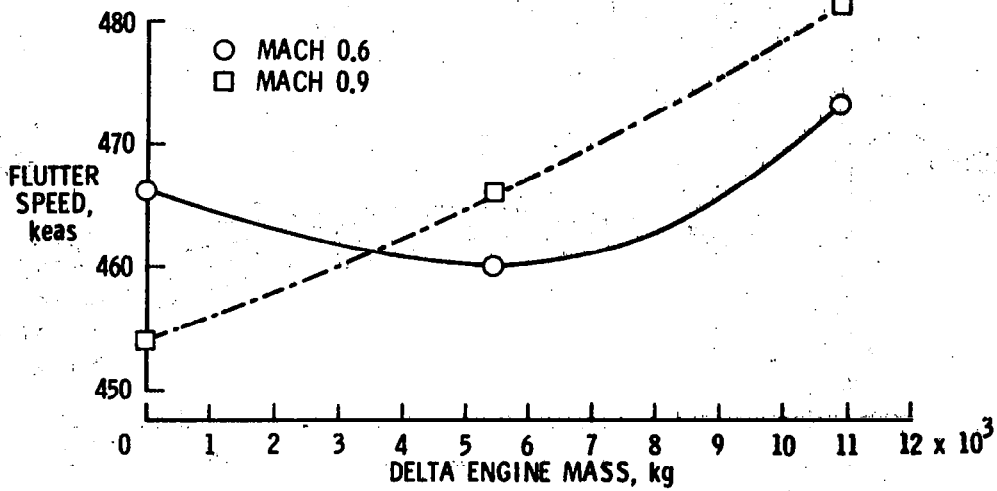


Figure 23.- Effects of engine mass on AST-102 flutter speed.

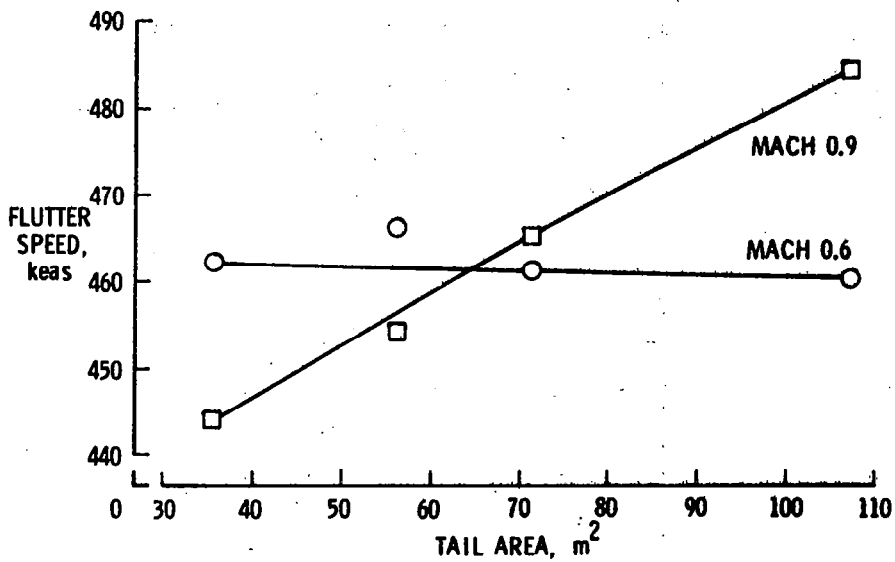


Figure 24.- Effects of horizontal tail area on AST-102 flutter speed.

• ACCELEROMETER

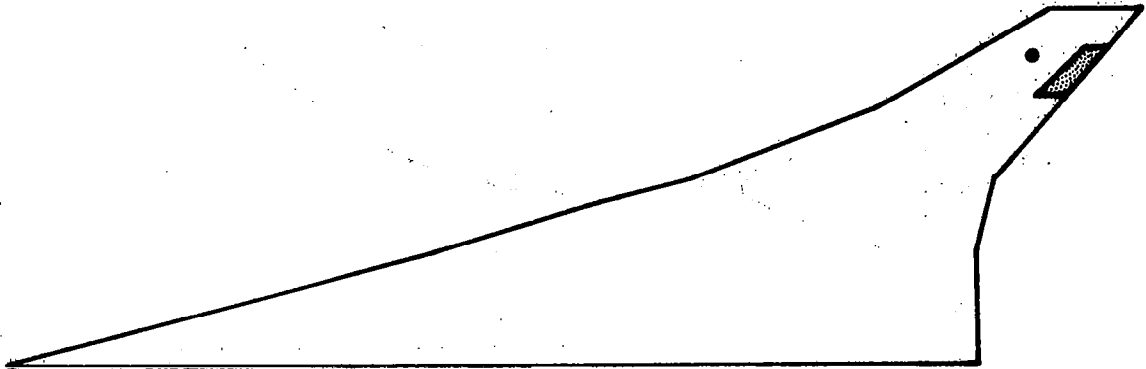


Figure 25.- Control surface and accelerometer used for active control flutter suppression system (FSS).

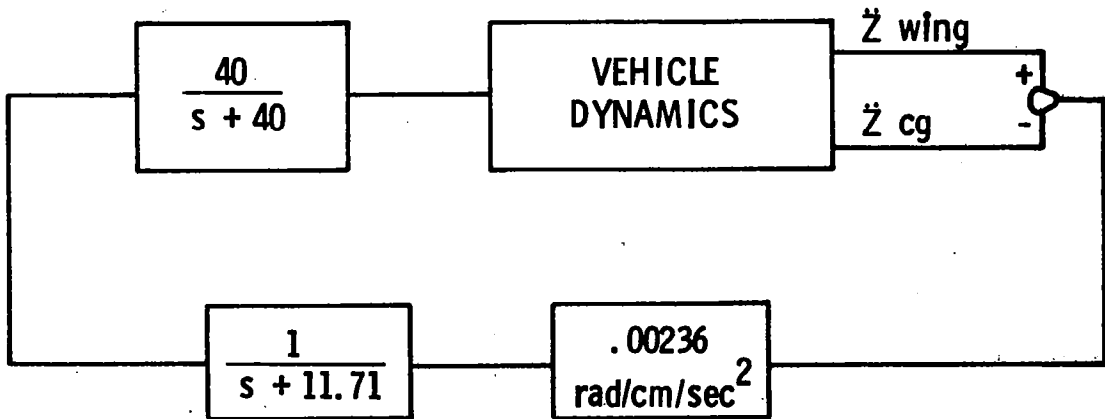


Figure 26.- FSS block diagram.

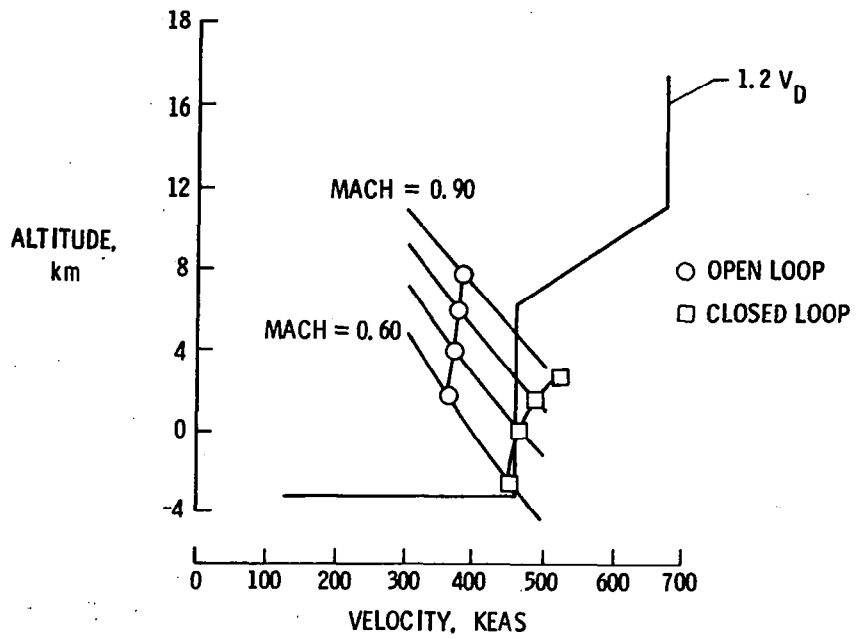


Figure 27.- Open- and closed-loop flutter boundaries for AST-102.

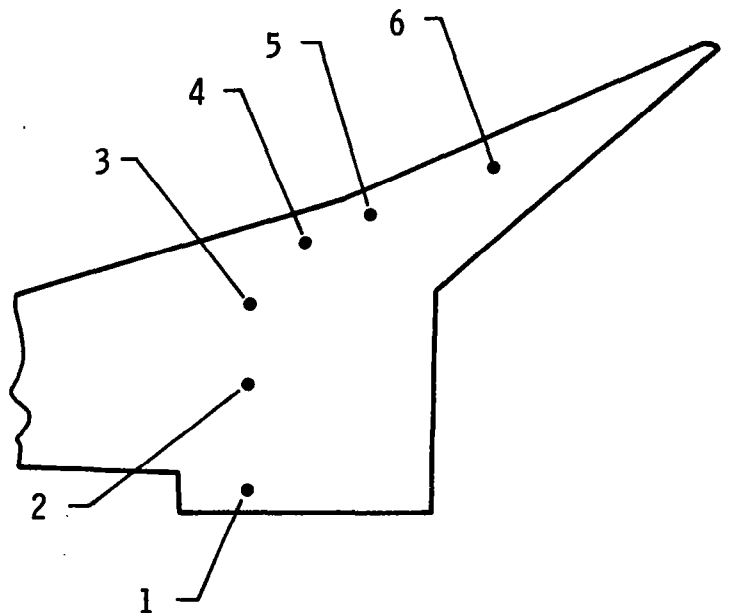


Figure 28.- Locations referred to in table II.

AN ASSESSMENT OF BUFFER STRIPS FOR IMPROVING DAMAGE TOLERANCE

OF COMPOSITE LAMINATES

C. C. Poe, Jr., and John M. Kennedy
NASA Langley Research Center
Hampton, Virginia 23665

SUMMARY

Graphite/epoxy panels with buffer strips were tested in tension to measure their residual strength with crack-like damage. Panels were made with [45/0/-45/90]_{2S} and [45/0/-45/0]_{2S} layups. The buffer strips were parallel to the loading directions. They were made by replacing narrow strips of the 0° graphite plies with strips of either 0° S-Glass/epoxy or Kevlar-49/epoxy on either a one-for-one or a two-for-one basis. In a third case, 0° graphite/epoxy was used as the buffer material and thin, perforated Mylar strips were placed between the 0° plies and the cross-ply to weaken the interfaces and thus to isolate the 0° plies. Some panels were made with buffer strips of different widths and spacings.

The buffer strips arrested the cracks and increased the residual strengths significantly over those of plain laminates without buffer strips. A shear-lag type stress analysis correctly predicted the effects of layup, buffer material, buffer strip width and spacing, and the number of plies of buffer material.

INTRODUCTION

The potential of graphite/epoxy (Gr/Ep) composite materials to reduce the weight and cost of aircraft structures has been clearly demonstrated. The technology to design and build damage tolerant structures still needs much additional development, however, before composite materials can be used extensively in primary aircraft structures.

Effective December 1978, paragraph 25.571 of the FAA Airworthiness Regulations requires that commercial transport aircraft (regardless of whether they are made of metallic or of composite materials) be evaluated for damage tolerance and fatigue. Section (a) of paragraph 25.571 states, "An evaluation of the strength, detail design, and fabrication must show that catastrophic failure due to fatigue, corrosion, or accidental damage will be avoided throughout the operational life of the airplane." Prior to December 1978, the structures of most commercial aircraft were designed (at the option of the manufacturer) to satisfy fail-safe requirements of the earlier version of FAR 25.571. Redundant structures with multiple load paths contained potential failures, and structures were shown to carry 80 percent or more of limit load with partial failures. Fail-safe design practices will likely be continued to satisfy the present mandatory damage tolerant requirement.

Experience to date has been largely with metal structures where fatigue crack propagation has been a major cause of large cracks and partial failures. In fibrous composite materials like Gr/Ep, fatigue crack propagation has not been shown to be a problem. However, accidental damage remains a serious threat to composite structures as well as metals. Sometimes commercial transport aircraft are struck by ground equipment or smaller foreign objects. Moreover, some of the Gr/Ep materials have been shown (see, for example, ref. 1) to be more severely damaged than metals by low-velocity impacts such as tool drops or runway debris. Unlike homogeneous metals, the damage may reduce compression strength as much as tension strength. (Only tension loading is considered in this paper.)

Buffer strips are a very attractive concept for improving the damage tolerance of Gr/Ep laminates loaded in tension. These narrow, parallel strips are made into the laminate itself by interrupting and replacing certain plies of the Gr/Ep laminate with another material or layup. The buffer strips can arrest a fracture and then give extra load capacity to the damaged laminate (refs. 2-5). Because the strips are narrow and relatively far apart, the stiffness, weight, and strength of the undamaged laminate is not significantly affected by the replacement.

In the earliest buffer strip work (ref. 2), $\pm 45^\circ$ layups were thought to be the best buffer strip materials. But later experiments (refs. 3-5) showed that 0° E-Glass or S-Glass give much better results. No analysis has been developed to relate the strength of damaged panels to the configuration and materials of the buffer strips and the layup of the basic laminate. Without such an analysis to guide design and development, a large number of buffer strip configurations and materials would have to be tested to develop optimum designs.

The purpose of the present investigation was to obtain experimental data that would guide the development of such an analysis. Accordingly, Gr/Ep buffer strip panels were made and tested in tension to determine their residual strengths. Each panel was cut at the center between buffer strips to represent damage. Panels were radiographed and crack-opening displacements were measured to indicate fracture, fracture arrest, and the extent of damage in the buffer strips after arrest. The panels had two layups, $[45/0/-45/90]_{2S}$ and $[45/0/-45/0]_{2S}$. Buffer strip width and spacing were varied. Three different buffer materials were used: 0° S-Glass/epoxy, 0° Kevlar-49¹/epoxy, and graphite-Mylar¹ (0° Gr/Ep with thin interleaves of perforated Mylar). The buffer strips were made by replacing narrow strips of the 0° graphite plies with strips of the 0° buffer material on either a one-for-one or a two-for-one basis. The latter panels had twice as many plies of buffer material as the former.

A shear-lag analysis similar to that in reference 6 was developed for the buffer strip panels. The analysis correctly predicted the same effects that the tests showed for the kind of buffer material, the number of plies of buffer

¹Kevlar-49, Mylar: Registered trademarks of E. I. du Pont de Nemours & Co., Inc.

material, layup, and the width and spacing of the buffer strips. Only the salient results of the analysis are presented here.

Certain commercial materials are identified in this paper in order to specify adequately which materials were used. In no case does such identification imply recommendation or endorsement of the product by NASA, nor does it imply that the materials are necessarily the only ones or the best ones available for the purpose.

LIST OF SYMBOLS

C_1	constant, \sqrt{m}
h_o, h_b	total thickness of 0° plies in basic laminate and in buffer strip, respectively, m
E_o, E_b	Young's modulus of 0° Gr/Ep and 0° buffer material, respectively, Pa
K_t	effective strain concentration factor at failure
W	total width of panel, m
W_a	length of arrested crack or spacing of buffer strips, m
W_b	width of buffer strips, m
ϵ_c	remote panel strain at failure
ϵ_o	remote panel strain
ϵ_{tu}	ultimate tensile strain
ϵ_{tub}	ultimate tensile strain of buffer material

The notation for laminate orientation in reference 7 is used in the present report. The cross-ply angles are listed in the order of layup, separated by a slash, with the entire listing enclosed within brackets. Where there is more than one consecutive lamina at a given angle or more than one consecutive group of laminae, the number of lamina or groups of laminae is denoted by a numerical subscript. The subscript S outside the brackets denotes symmetric. For example, $[45/0/-45/90]_{2S}$ means $[45/0/-45/90/45/0/-45/90/90/-45/0/45/90/-45/0/45]$.

EXPERIMENTAL PROCEDURES

Materials and Specimens

The specimens were made with T300²/5208³ Gr/Ep unidirectional tape. They

were cured at 450 K (350° F) with the material manufacturer's recommended cure cycle. Two basic layups were used: a 16-ply quasi-isotropic layup, [45/0/-45/90]_{2S}, and a 16-ply layup with half 0° plies and half ±45° plies, [45/0/-45/0]_{2S}. Each panel had four evenly spaced buffer strips parallel to the loading direction. One side of each panel was made flat (see fig. 1). The fiber volume fraction of the Gr/Ep laminate away from the buffer strips was about 0.60. The buffer strips were made with three different materials: S-Glass/5208 tape, Kevlar-49/5208 tape, and T300/5208 tape with interleaves of perforated Mylar, 13- μ m thick. (About 44 percent of the Mylar sheet area was punched out to permit a partial bond.)

The S-Glass and Kevlar-49 buffer strips were made by replacing narrow strips of the 0° graphite plies with strips of either 0° S-Glass or 0° Kevlar-49 tape on a one-for-one ($h_b/h_o = 1$) or a two-for-one ($h_b/h_o = 2$) basis. (The cross-sections in figure 1 illustrate a two-for-one replacement.) The strips had a width, W_b . Only the 0° graphite plies were interrupted by the buffer material. The ±45° and 90° graphite plies were continuous throughout the panels. The S-Glass, Kevlar-49, and graphite plies had about the same thickness after curing, 140 μ m. Thus, the one-for-one buffer strips had the same thickness as the basic laminate. The S-Glass and Kevlar-49 materials were chosen primarily because their tensile strains to failure, ϵ_{tub} , were much higher than that of the graphite. The ϵ_{tub} was 0.0281, 0.0158, and 0.0098 for the 0° S-Glass, Kevlar-49, and graphite materials, respectively.

The panels with one-for-one graphite-Mylar buffer strips were made exactly like an all-Gr/Ep laminate except for narrow Mylar interleaves at each buffer strip location. The Mylar strips had a width, W_b , and a spacing, W_a . The 0° plies were not interrupted or replaced. Instead, the perforated Mylar strips were placed between 0° and adjacent cross-ply (45°, -45°, and 90° plies) to weaken the interfaces within the buffer strips. Mylar strips were not placed between adjacent 0° plies or adjacent cross-ply. On the basis of work in reference 8, the weak Mylar interfaces were expected to arrest a fracture, even in a virtually all-Gr/Ep laminate, by limiting the stresses in the 0° graphite plies of the buffer strips. The panels with two-for-one and one-for-one graphite-Mylar buffer strips were made exactly alike except that in the two-for-one case an extra ply of 0° Gr/Ep was added for each 0° ply. The extra 0° graphite plies had a width, W_b , and a spacing, W_a , and were located just like the extra S-Glass and Kevlar-49 0° plies. (See the cross-sections in fig. 1.) The Mylar strips coincided with the extra 0° graphite plies and, as in the one-for-one case, were placed between 0° and adjacent cross-ply only.

Most of the panels were made with 13-mm-wide buffer strips spaced 51-mm apart (see fig. 1). A few panels with graphite-Mylar and S-Glass buffer strips were made with different dimensions to investigate the effect of buffer

²T300: Registered trademark of Union Carbide.

³5208: Registered trademark of Narmco Materials, Inc.

strip width and spacing. Table I gives buffer material and configuration and panel dimensions for each type of panel. Three panels of each type were made and tested. The length of the test section of all panels was greater than twice the panel width, W .

Slits about 250- μm wide were cut through each panel to represent damage (see fig. 1). The slits were located at the center of the panel, and the slit length was always less than the buffer strip spacing, W_a . Buffer strips were not cut.

Small coupon type specimens were also made to measure ultimate tensile strengths, moduli, and fracture toughness of the laminates.

Test Procedures and Equipment

The panels were loaded to failure in uniaxial tension at about 440 N/s. They were tested in servo-controlled, closed-loop testing machines with load as the feedback signal. Load, strains, and the opening displacement of the slit (commonly referred to as crack-opening displacement or COD) were recorded on magnetic tape using a digital data acquisition system. At numerous times during a test (always after audible and visual evidence of crack extension) the loading was stopped, and radiographs were made of the region that included the crack and middle two buffer strips. Load was held constant while the radiographs were made. The dye penetrant tetrabromoethane (TBE), which is opaque to X-rays, was used to enhance the image of the damaged areas. The lengths of the slits were generally chosen to ensure arrest of the fracture. The slit length for the first panel of a given type was therefore the longest, usually about 75 percent of the buffer strip spacing. The slit lengths for the other two panels were shorter, but not so short that the load to initiate the fracture was greater than the strength of the first panel. The fracture toughness of the basic laminate was used to predict the loads to initiate fracture.

No special effort was made to control the amount of moisture absorbed by the laminates. Several months normally elapsed between the time the panels were made and the time they were tested. Moisture content in a few of the panels was measured 9 months or more after they were tested. The moisture content ranged from 0.35 percent of the total weight for the newest panels to 0.58 percent for the oldest panels. This amount of moisture, and hence this variation in moisture content, was not expected to have much effect on the room-temperature test results.

RESULTS AND DISCUSSION

Typical Fracture Arrest Results

The test results for the three $[45/0/-45/90]_{2S}$ panels with two-for-one S-Glass buffer strips are shown in figure 2. The buffer strips were 13-mm wide and were spaced 51-mm apart. The remote strain is plotted against slit length

for each panel. The estimated failing strain of a sheet without buffer strips is shown for comparison. Coupon data from plain laminates were used to make all estimates of failing strains for panels without buffer strips. The fractures in the buffer strip panels initiated (solid symbols) at about the failing strain of a plain sheet, ran into the buffer strips, and stopped. Load was increased, and all three panels eventually failed (open symbols) at nearly the same strain. The strains at failure were higher than those at which the fractures initiated and at which plain sheets would have failed. For the longest slit, which was nearly as long as the buffer strip spacing, the failing strains were more than twice the strain at which a plain sheet would have failed.

All of the panels in which fractures were arrested behaved like those in figure 2. Fractures were arrested in most of the panels except when the initial cuts were too small and the corresponding failing loads were too high. For panels in which fractures were arrested, no consistent or strong correlation was found between slit length and the differences in remote failing strain. Therefore, remote failing strains were averaged for panels in a group in which fractures were arrested. The averages and the number of tests included in the averages are reported in table I. The scatter among panels of a given type was much less for S-Glass and Kevlar-49 buffer strips than for graphite-Mylar buffer strips.

The arrested fractures were not generally well-defined, through-the-thickness cracks. The 45° plies on the surfaces usually did not fracture but delaminated. The delaminated surface plies often obscured any visual evidence of the arrested fracture. The radiographs and the jumps in COD, however, gave clear evidence when the fracture initiated and arrested. (The jumps in COD even indicated minute damage at the slit ends long before the fracture initiated.) Figure 3 shows two radiographs of the panel in figure 2 with the 13-mm-long slit. One radiograph was taken at a load of 155 kN, about 19 kN lower than the load at which the fracture initiated. The other was taken just after the fracture initiated and the loading had been stopped. The two dark strips in the pictures are the S-Glass buffer strips which are more opaque to the X-rays than the Gr/Ep. In the first radiograph, only a small amount of damage is indicated at the slit ends. Whereas, in the second radiograph, the arrested fracture is clearly indicated by the heavy dark line extending from the slit ends to the buffer strips. The dark bands that extend from the fracture up to the left and down to the right at 45° indicate delaminations of the 45° surface plies. The second radiograph also reveals significant damage in the buffer strips as a result of the arrested fracture. The dark semi-circular regions at the ends of the fracture indicate delaminations. They extend about halfway across the buffer strips. The transverse lines in the regions of the buffer strips are splits in the 90° Gr/Ep plies caused by the high strains.

Effect of Buffer Material, Number of Buffer Plies, and Layup

Figure 4 shows the effect of buffer material, number of buffer plies, and basic layup on the remote failing strain of panels with arrested fractures. All data are for panels with buffer strips 13-mm wide and 51-mm apart. The estimated remote failing strains for panels without buffer strips are shown

for comparison. The plain panels were assumed to have a 51-mm crack, the same length as the arrested cracks in the buffer strip panels.

The remote failing strains of all panels with buffer strips in figure 4 were considerably larger than those estimated for panels without buffer strips. With one exception, remote failing strains were highest with S-Glass buffer material, were higher with more plies of a given buffer material, and were not affected by layup of the basic laminate for a given type of buffer strip. Failing strains were about the same for Kevlar-49 and graphite-Mylar buffer strips with a given number of plies. The one exception was $[45/0/-45/0]_{2S}$ panels with two-for-one graphite-Mylar buffer strips. The failing strain for those panels was consistently too small in comparison with the other results. This anomaly might be attributable to scatter, inasmuch as the average strain plotted in figure 4 represents only one test. (The fractures were not arrested in two of the three panels of that type.)

The residual strengths were quite different for the two different layups, even though the remote failing strains were about equal. The effective Young's modulus of the $[45/0/-45/0]_{2S}$ panels was about 50-percent larger than that of the $[45/0/-45/90]_{2S}$ panels. Therefore, the corresponding strengths were also about 50-percent larger. (The buffer strips affected the stiffness of the panels less than 15 percent.)

The fractures were self-similar in most of the panels, i.e., they followed a path colinear with the slit. After the panels failed, the S-Glass was delaminated from the Gr/Ep for most of the panel length (see fig.5), whereas the Kevlar-49 and the graphite-Mylar buffer strips were broken off at the fracture. However, radiographs taken before failure, like that in figure 3, showed that delaminations of the S-Glass were relatively small up to failure. Only small delaminations were observed up to failure for Kevlar-49 and graphite-Mylar buffer strips also. On the other hand, the failures were not self-similar in a number of the $[45/0/-45/0]_{2S}$ panels with S-Glass buffer strips. Between the time the fracture was arrested and the panel failed, the S-Glass in the middle two buffer strips began to delaminate and pull out of the Gr/Ep (see fig. 6). The delamination began at the ends of the fracture and proceeded in opposite directions along the middle two buffer strips as the load was increased. It eventually reached the ends of the panels where the grips were attached. Then, the panels failed partly across each end and up the delamination paths. The path of the failure looked something like a "Z." The $[45/0/-45/0]_{2S}$ panels delaminated along the middle two buffer strips because they had relatively few cross-plyies to transfer the large load from the fractured middle bay to the intact outer bays. (The $[45/0/-45/0]_{2S}$ layup has only one 45° ply per 0° ply, whereas the $[45/0/-45/90]_{2S}$ layup has two 45° plies per 0° ply.)

Effect of Buffer Strip Spacing

The effect of buffer strip spacing on failing strain is shown in figure 7. The remote failing strain is plotted against arrested crack length (buffer strip spacing) for $[45/0/-45/90]_{2S}$ panels with one-for-one S-Glass, one-for-one

graphite-Mylar, and two-for-one graphite-Mylar buffer strips. The in-plane dimensions for the large and small panels are in the same proportion for a given type of buffer strip. The ratio of buffer strip spacing to buffer strip width is eight for the graphite-Mylar panels and four for the S-Glass panels. (Panel widths are given in the table in figure 1.) The estimated curve for a very wide $[45/0/-45/90]_{2S}$ panel without buffer strips is shown for comparison.

For long through-the-thickness cracks in homogeneous materials and in composite laminates, the strength usually varies inversely with the square root of crack length times a constant. This expression was fitted to the failing strains of the buffer strip panels in figure 7 by adjusting the constant, C_1 , to best fit the data. The curves of $C_1/\sqrt{W_a}$ show that the failing strains of the buffer strip panels did follow the usual inverse square root of crack length relationship. The remote failing strain for the S-Glass panels with the smallest W_a was limited to 0.00805 because the net-section strain had reached the ultimate tensile strain of the Gr/Ep. The $C_1/\sqrt{W_a}$ curve was therefore not fitted to that data point.

Effect of Buffer Strip Width

The effect of buffer strip width on remote failing strain is shown in figure 8. The remote failing strain is plotted against buffer strip width for $[45/0/-45/90]_{2S}$ panels with arrested cracks and one-for-one and two-for-one graphite-Mylar buffer strips. The buffer strips were 7- and 13-mm wide and were 51-mm apart in both cases. For the two-for-one replacement, the failing strains were about equal for the two different buffer strip widths. But, for the one-for-one replacement, the failing strain was somewhat lower for the larger buffer strip spacing--opposite to what was expected. Each symbol in figure 8 represents only two tests because one panel of each type did not arrest the fracture. In the case of the one-for-one replacement, the lowest strain for the 7-mm width was slightly lower than the highest strain for the 13-mm width. Thus, the data for the two different widths with one-for-one replacement overlapped slightly, and the effect of buffer strip width was probably small for the one-for-one replacement as well as the two-for-one replacement.

Analysis

A shear-lag analysis similar to that in reference 5 was developed for the buffer strip panels. The model accounted for the differences in buffer material, the number of plies of buffer material, the matrix damage at the crack tips, the constraint of the cross-ply (i.e., the difference in layup), and the width and spacing of the buffer strips. Only the salient results of the analysis are presented here.

Values of $1/K_t$ from the shear-lag analysis are plotted in figure 9 against the arrested crack length or buffer strip spacing, W_a , multiplied by a stiffness ratio, $h_o E_o / (h_b E_b)$. The h_o and h_b are the thickness of 0° plies of graphite and buffer material, respectively. The E_o and E_b are the

Young's moduli of the 0° graphite and buffer material, respectively. Log scales were used for convenience. Average test values of $\epsilon_c/\epsilon_{tub}$ for all panels with arrested fractures were plotted in figure 9 for comparison. Each symbol represents one type of panel. (Values of $W_a h_o E_o / (h_b E_b)$ are given in table I for each type of panel.) Figure 9 shows that analytical values of $1/K_t$ correlated well with test values of $\epsilon_c/\epsilon_{tub}$. The analysis predicted correctly the effects of kind of buffer material, number of plies of buffer material, and buffer strip spacing or arrested crack length. (The failing strains for some of the S-Glass panels below the curve were limited by large net-section strains, as discussed previously. Failing strains of wider panels would have been higher and thus nearer the curve.) Although not shown here, the analysis also correctly predicted that buffer strip width had only a small effect on failing strain.

For large values of $W_a h_o E_o / (h_b E_b)$, the analysis curve in figure 9 is approximately linear with a negative slope of one-half. Thus, for most of the panels tested,

$$\frac{\epsilon_c}{\epsilon_{tub}} \approx \frac{C_1}{\sqrt{\frac{W_a h_o E_o}{h_b E_b}}}$$

or

$$\epsilon_c \approx C_1 \sqrt{\left(\frac{h_b}{h_o}\right) \left(\frac{\epsilon_{tub}^2 E_b}{E_o}\right) \left(\frac{1}{W_a}\right)} \quad (1)$$

Equation (1) shows that the remote failing strain varied as (1) the square root of number of buffer plies, relative to the number of 0° graphite plies, (2) the square root of $\epsilon_{tub}^2 E_b$, which is twice the modulus of resilience or toughness for a buffer material that is linear to failure, and (3) the inverse of the square root of arrested crack length, which was equal to the buffer strip spacing. The values of $\epsilon_{tub}^2 E_b$ for 0° graphite, 0° Kevlar-49, and 0° S-Glass are 14, 16, and 41 MPa, respectively. Correspondingly, the remote failing strains were about the same for Kevlar-49 and graphite-Mylar buffer strips of the same type and highest for the S-Glass buffer strips.

CONCLUDING REMARKS

Gr/Ep panels with buffer strips parallel to the loading direction were tested to measure their residual tension strength with crack-like damage. Panels were made with [45/0/-45/90]_{2S} and [45/0/-45/0]_{2S} layups. The buffer strips were made by replacing narrow strips of the 0° graphite plies with strips of either 0° S-Glass/epoxy or 0° Kevlar-49/epoxy on either a one-for-one or a two-for-one basis. In a third case, 0° Gr/Ep was used as the buffer material, and thin, perforated Mylar strips were placed between the 0° plies and

the cross-ply to weaken the interfaces and thus to limit strains in the 0° plies. Some panels were made with buffer strips of different widths and spacings. Three panels of each configuration were made and tested. The panels were cut at the center between buffer strips to represent damage. The cuts had various lengths.

The buffer strips arrested fractures except sometimes when the initial cuts were small and the corresponding failing loads were relatively high. The remote failing strains of all the buffer strip panels with arrested fractures were significantly higher than those estimated for panels with a crack equal to the buffer strip spacing (the arrested crack length) but without buffer strips.

A shear-lag type stress analysis correctly predicted the effects of kind of buffer material, number of buffer plies, layup, and the spacing and width of the buffer strips on the remote failing strain. The remote failing strains were shown to vary approximately with (1) the square root of the number of buffer strip plies, (2) the square root of the modulus of resilience or toughness of the buffer material (one-half the ultimate tensile strain squared times Young's modulus), and (3) the inverse of the square root of the arrested crack length, which was equal to the buffer strip spacing. The failing strains were not significantly affected by the changes in buffer strip width and layup. The S-Glass buffer material had the highest value of the modulus of resilience or toughness. The graphite-Mylar and the Kevlar-49 buffer materials had significantly smaller values that were about equal. Correspondingly, the panels with S-Glass buffer material had the highest remote failing strains, and the panels with graphite-Mylar and Kevlar-49 buffer material had lower failing strains, which were about equal.

REFERENCES

1. Rhodes, Marvin D.: Impact Tests on Fibrous Composite Sandwich Structures. NASA TM-78719, 1978.
2. Eisenmann, J. R.; and Kaminski, B. E.: Fracture Control for Composite Structures. Engr. Fracture Mechs., vol. 4, 1972, pp. 907-913.
3. Verette, R. M.; and Labor, J. D.: Structural Criteria for Advanced Composites. AFFDL-TR-76-142, Air Force Flight Dynamics Laboratory, 1977.
4. Hess, T. E.; Huang, S. L.; and Rubin, H.: Fracture Control in Composite Materials Using Integral Crack Arresters. Proceedings of AIAA/ASME/SAE 17th Structures, Structural Dynamics, and Materials Conference, May 5-7, 1976, pp. 52-60.
5. Avery, J. G.; and Porter, T. R.: Damage Tolerant Structural Concepts for Fiber Composites. Proceedings of the Army Symposium on Solid Mechanics, 1976. Composite Materials: The Influence of Mechanics of Fracture on Design, AMMRC-MS-76-2, Army Materials and Mechanics Research Center, 1976.
6. Zweben, Carl: Fracture Mechanics and Composite Materials: A Critical Analysis. Analysis of the Test Methods for High Modulus Fibers and Composites, ASTM STP-521, American Society for Testing and Materials, 1973, pp. 65-97.
7. Advanced Composites Design Guide. Volume I - Design. Third ed. (second revision). Contract No. F33615-74-C-5075, Air Force Flight Dynamics Laboratory, 1976.
8. Elber, Wolf: Toughening of Graphite-Epoxy Composites by Interlaminar Perforated Mylar Films. NASA TM-78643, 1978.

89: TABLE I.- CONFIGURATIONS AND AVERAGE REMOTE FAILING STRAINS OF BUFFER STRIP PANELS WITH ARRESTED FRACTURES

Buffer material	$\frac{h_b}{h_o}$	W_a , mm	W_b , mm	$\frac{E_o}{E_b}$ (a)	$\frac{W h E_o}{a o o}$, $\frac{h_b E_b}{b b}$, mm	ϵ_c	$\frac{\epsilon_{tub}}{\epsilon_c}$
[45/0/-45/90] _{2S}							
Mylar	1	51	13	1	50.8	0.00374 (2) ^b	2.62
	2		13		25.4	.00495 (2)	1.98
	1		7		50.8	.00423 (2)	2.32
	2	51	7		25.4	.00488 (3)	2.01
	1	102	13		101.6	.00278 (2)	3.53
Mylar	2	102		1	50.8	.00375 (2)	2.61
S-Glass	1	51		2.73	139.	.00586 (3)	4.80
S-Glass	2	51	13	2.73	69.4	.00651 (3)	4.32
S-Glass	1	20	5	2.73	55.5	.00805 (3)	3.49
Kevlar-49	1	51	13	2.23	113.	.00405 (2)	3.90
Kevlar-49	2	51	13	2.23	56.6	.00532 (3)	2.97
[45/0/-45/0] _{2S}							
Mylar	1	51	13	1	50.8	.00355 (2)	2.76
Mylar	2			1	25.4	.00354 (1)	2.76
S-Glass	1			2.73	139.	.00576 (3)	4.88
S-Glass	2			2.73	69.4	.00659 (3)	4.26
Kevlar-49	1			2.23	113.	.00373 (3)	4.24
Kevlar-49	2	51	13	2.23	56.6	.00547 (3)	2.89

^a $E_o = 140$ GPa.

^bNumber of tests for which ϵ_c was averaged (those in which fractures were arrested).

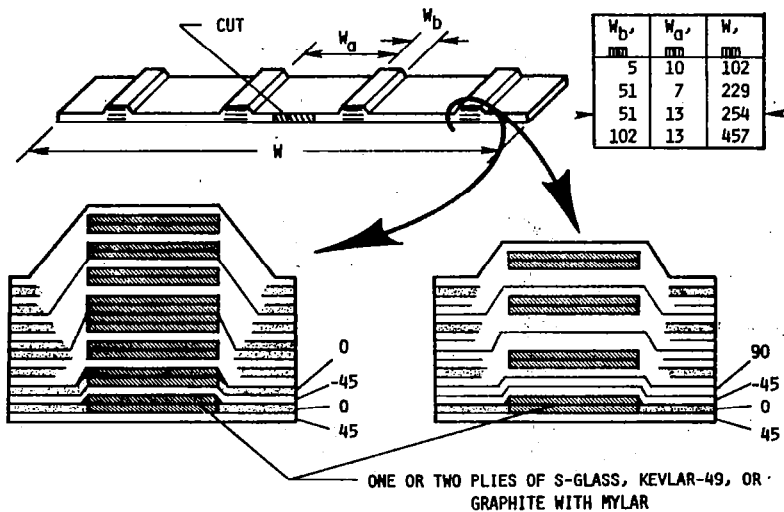


Figure 1.- Buffer strip panel configurations

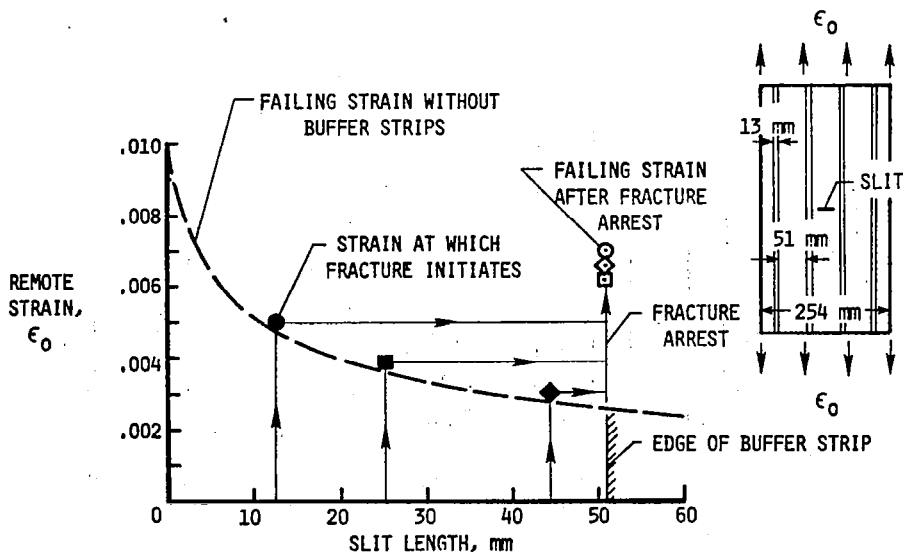


Figure 2.- Buffer strip test results. $[45/0/-45/90]_{2S}$ panels with 2 plies of S-Glass.

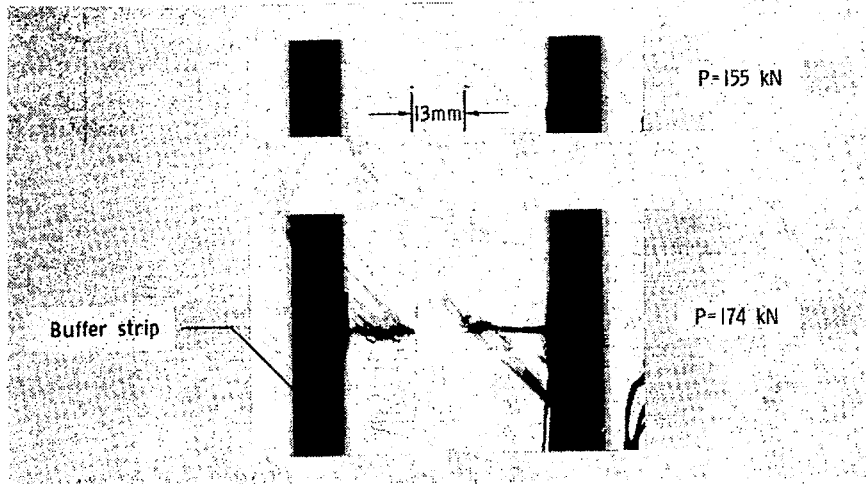


Figure 3.- Radiographs of graphite epoxy panel with 8-ply S-Glass buffer strips.

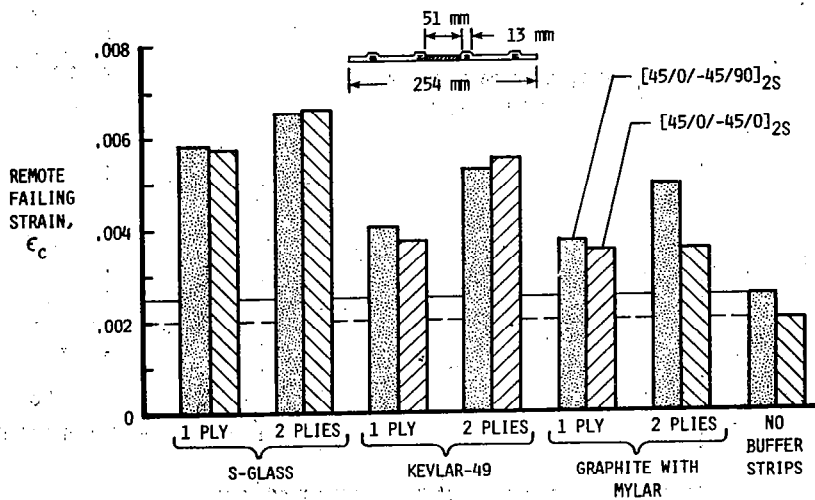


Figure 4.- Failing strains of panels with arrested cracks. Effect of buffer strip materials and layout.

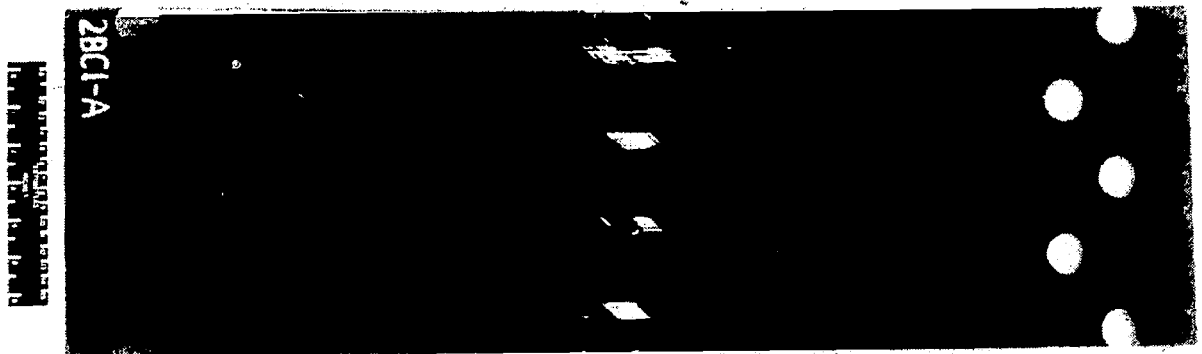


Figure 5.- $[45/0/-45/90]_{2S}$ panel with two plies of S-Glass after failure.

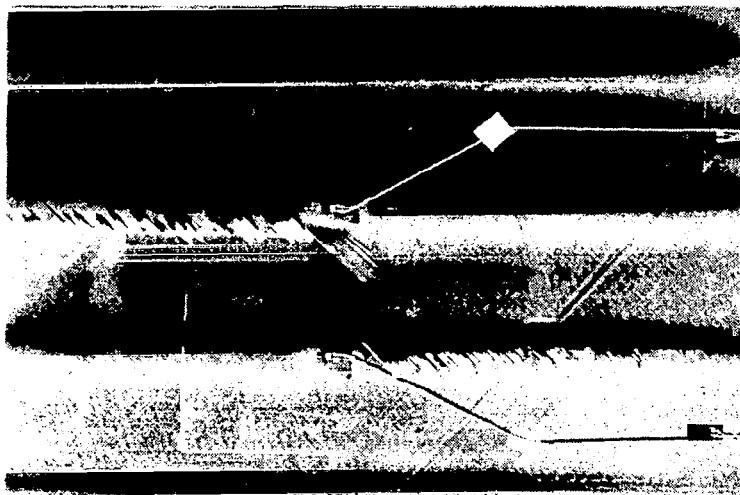


Figure 6.- $[45/0-45/0]_{2S}$ panel with two plies of S-Glass loaded to 95% of ultimate tensile load.

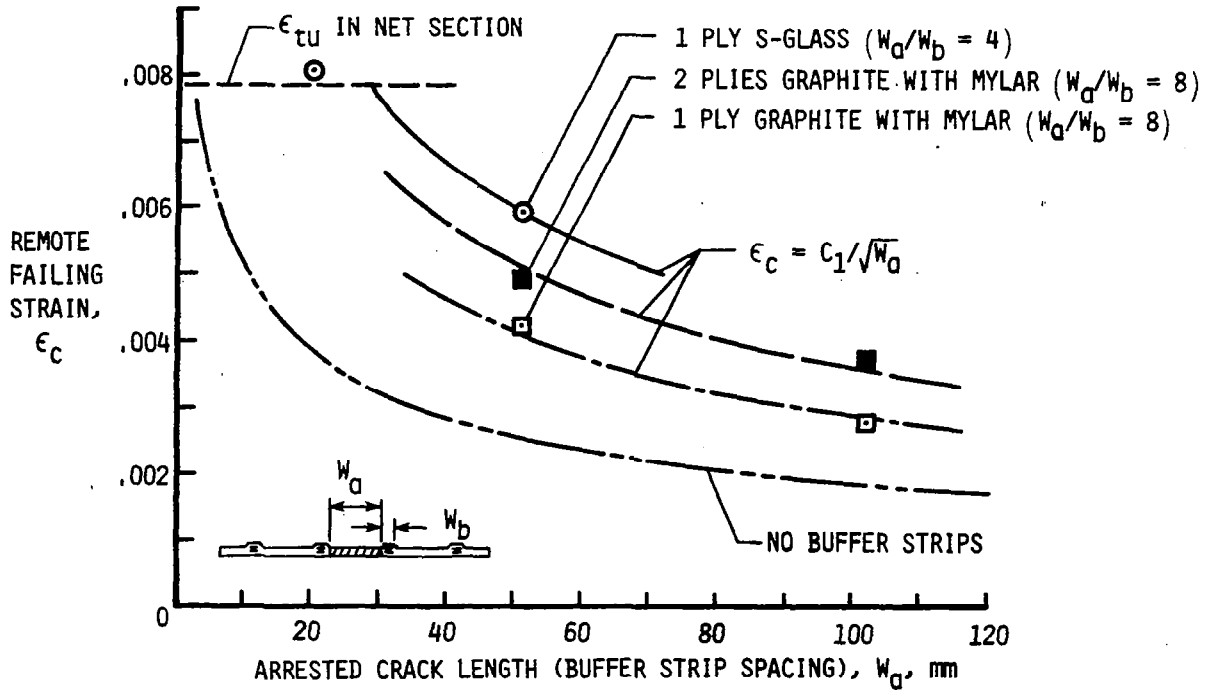


Figure 7.- Failing strains of panels with arrested cracks. Effect of buffer strip spacing $[45/0/-45/90]_{2S}$.

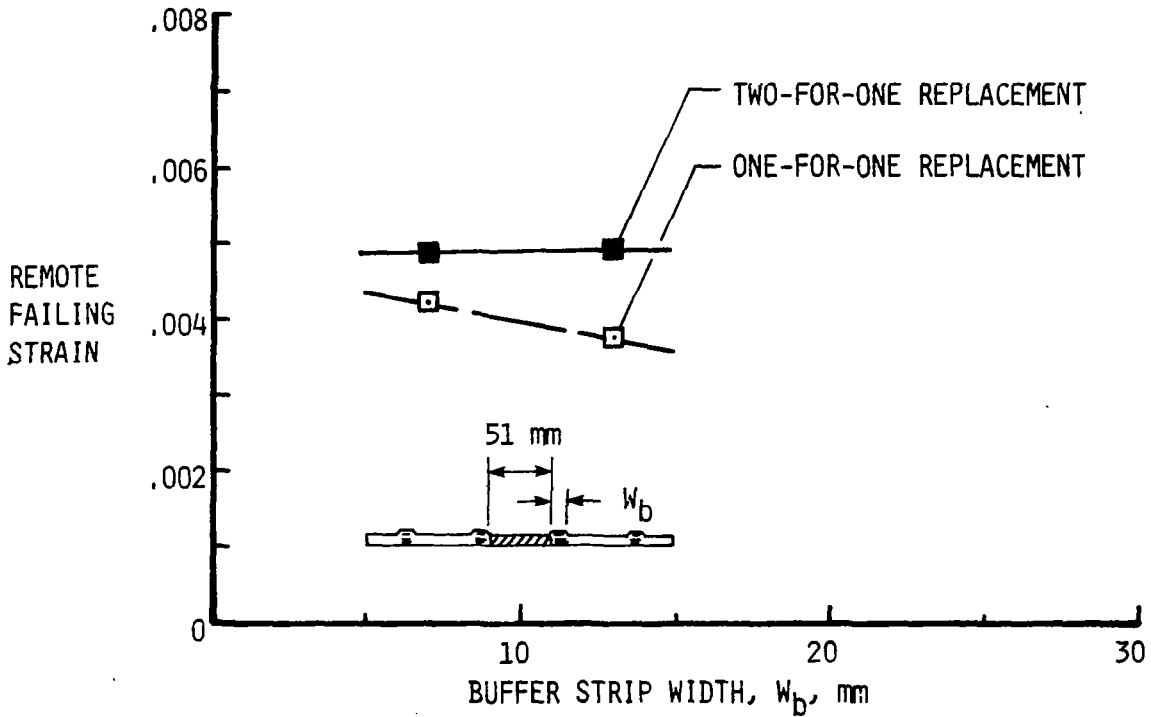


Figure 8.- Failing strains of panels with arrested cracks. Effect of buffer strip width $[45/0/-45/90]_{2S}$, graphite with mylar.

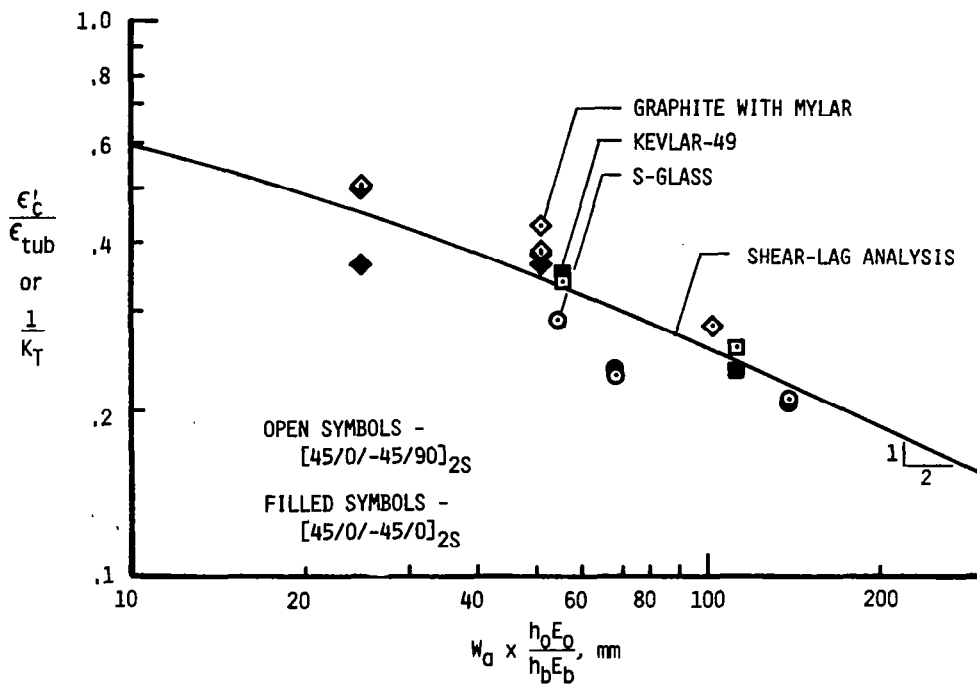


Figure 9.- Analysis of remote failing strains.
Panels with arrested cracks.

EVALUATION OF HIGH-TEMPERATURE STRUCTURAL ADHESIVES

FOR EXTENDED SERVICE*

Carl L. Hendricks and Sylvester G. Hill
Boeing Aerospace Company

SUMMARY

Candidate high-temperature stable resin formulations were evaluated for adhesive properties when bonded to titanium treated with various surface preparations. The adhesive formulations included LARC-13, NR150 A2, NR150 B2, NR056X, FM-34, HR-602, and polyphenylquinoxaline. Eight titanium surface preparations were compared for resulting bond strength with the candidate adhesives. After initial evaluation, three adhesive systems (comprised of adhesive, primer, and titanium surface preparation) were selected for further screening. The screening (still in progress) includes cure-cycle optimization and bond properties from 219K (-65°F) to 505K (450°F), after isothermal aging at 505 K (450°F) up to 15 000 hours, and after humidity aging at 322 K (120°F)/ 95 percent R. H. for up to 2000 hours. Large-area bond capability of the three adhesive systems will be demonstrated by fabrication of 30.5-cm (12-in) square titanium honeycomb sandwich and metal-to-metal bonded panels.

INTRODUCTION

Significant advancements in bonding technology have created renewed interest in high-temperature stable adhesive systems to support hardware design for supersonic cruise vehicles. These advances include: (1) the development of improved design concepts and analysis techniques for bonded aluminum structure, (2) development of new and/or improved high-temperature bonding systems, and (3) development of new, more durable surface treatments for titanium. Bonded titanium structure offers the potential for more efficient, less expensive structure possessing lower thermal conductivity than other concepts for many applications. Previously developed polyimide adhesives are

*This work was performed under NASA Contract NAS1-15605.

severely limited in processing due to condensation reaction volatile release during a critical portion of cure. Highly porous and weak bond lines result from attempts to fabricate large overlap bonds or honeycomb sandwich structures. Until improved high-temperature stable adhesive systems are developed and proven, supersonic cruise vehicle design will be restricted to alternate titanium structural concepts, such as diffusion bonding and brazing.

The objectives of this program are to:

1. Evaluate/select adhesive systems for SCR extended 505 K (450°F) service
2. Optimize and characterize selected adhesives and titanium surface preparations
3. Conduct long-term environmental exposure and tests on selected adhesives
4. Prepare material and process specifications
5. Demonstrate large-area bond feasibility

This paper presents the test results to date in the evaluation of several combinations of adhesives and titanium surface treatments. Candidate adhesive resins are primarily improved polyimide formulations and polyphenylquinoxaline. Titanium surface treatments include all processes available from well established to experimental.

The program overview is shown in the flow diagram of figure 1. Initial adhesive evaluation is followed by selection of the three most promising systems. Cure cycles are further optimized just prior to mechanical properties test and environmental exposure. Large-area bond process feasibility is demonstrated by fabrication of 30.5-cm (12-in) square honeycomb sandwich and metal-to-metal panels.

CANDIDATE ADHESIVE RESINS

The adhesive resins considered for initial evaluation represent polymer formulations which offer the best potential for applications involving long-term 505 K (450°F) aging and high humidity, and which potentially could be used in large-area bond structures. Ten such candidate resins were evaluated for this portion of the program. They were:

LARC-13	Supplied by NASA LaRC
LARC-13 Modification 1	Formulated by Boeing
LARC-13 Modification 2	Formulated by Boeing
Polyphenylquinoxaline	Supplied by NASA LaRC
Polyphenylquinoxaline Modification 1	Formulated by Boeing
NR150 B2	E. I. du Pont
NR150 A2	E. I. du Pont
NR056X	E. I. du Pont
HR 602	Hughes
FM-34 (Baseline)	American Cyanamid

LARC-13 is synthesized from a combination of nadic anhydride (NA), methylene dianiline (MDA), and benzophenone tetracarboxylic dianhydride (BTDA). This mixture undergoes transition to the polyamic-acid and, with additional heat, converts to a crosslinked polyimide structure. The polyamic-acid phase is formulated with 30 weight percent aluminum powder (Alcoa 101) and subsequently impregnated on Style 112A-1100 finished E glass fabric and B-staged to a low flow state.

LARC-13 Modification 1 is a formulation comprised of LARC-13 resin mixed with 50 phr Alcoa 101 aluminum powder. The film adhesive is prepared as described previously.

LARC-13 Modification 2 involves using methyl nadic capped polymer and addition of 20 mole percent of meta-phenylenediamine as codiamines. This results in a nominal polymer molecular weight of 1,300.

Polyphenylquinoxaline is the only adhesive resin candidate which is not polyimide based. The prepolymer solution was supplied by NASA Langley as a monoether in a solvent mixture of 1:1 practical grade m-cresol and mixed xylenes at about 16 percent resin solids.

NR150 B2, supplied by du Pont, is synthesized from 4',4'-hexafluoropropylidene bis (phthalic acid) and para- and meta-phenylenediamine in a solvent mixture of N-methylpyrrolidone (NMP) and ethanol.

NR150 A2, supplied by du Pont, is synthesized from 4',4'-hexafluoropropylidene bis (phthalic acid) plus diaminophenylether (DAPE) in NMP and ethanol.

NR056X is a modification of the NR150 series synthesized from a monomeric solution of 4',4'-hexafluoropropylidene bis (phthalic acid), phenylenediamine and DAPE [mole ratio (1.0/0.75/0.25)] in diglyme solvent. This resin is also supplied by du Pont.

HR-602 represents a different polyimide resin chemistry through use of an acetylene-terminated structure. Ideally, this system should process during final cure with essentially no release of volatiles. Hughes Aircraft supplied the HR-602 adhesive film for evaluation on this program.

FM-34 was included strictly as a baseline adhesive for the program and as a control to verify that bonding processes were performed correctly.

CANDIDATE ADHEREND SURFACE TREATMENTS

The eight candidate titanium surface treatments listed below were selected for study. They include treatments for which reliable processes already exist, potential new processes with limited but promising data, and new experimental processes.

- Chromic acid anodize (with fluoride)
- Phosphoric acid anodize (with fluoride)
- Pasa Jell 107
- Phosphate fluoride
- Phosphate fluoride (Picatinny modified)
- Phosphate fluoride (with grit blast)
- Turco 5578 etch
- British RAE Process ($H_2O_2 + NaOH$)

PRIMER EVALUATION

Prior to conducting the adhesive evaluation studies, a primer evaluation was conducted for each of the six basic adhesive resins. In this separate study, a series of crack extension specimens were prepared from all candidate surface treatments and two primers. The primers selected were those considered most compatible with each specific adhesive. Each polymer system was evaluated at room temperature, after exposure to 322 K (120°F)/100 percent relative humidity for 7 days, and after exposure to 505K (450°F) for 5 days.

The following titanium primers were evaluated for the basic resin systems:

LARC-13 - Primer 1 - LARC-13 resin with 30 percent aluminum filler diluted with dimethyl formamide (DMF). Primed panels were baked 1 hour at 408 K (275°F) prior to bonding. Primer 2 - BR-34 resin thinned with BR-34 thinner. Primed panels were baked 1 hour at 366 K (200°F) followed by 1 hour at 477 K (400°F).

NR150 B2 - Primer 1 - NR150 B2 resin diluted with DMF. Primer 2 - NR150 B2 with 30 percent aluminum filler and diluted with DMF. Panels with both primers were baked for 1 hour at 477 K (400°F) prior to bonding.

NR150 A2 - Primer 1 - NR150 A2 resin diluted with DMF. Primer 2 - NR150 A2 resin with 50 percent aluminum filler and diluted with DMF. Panels with both primers were baked for 1 hour at 477 K (400°F) prior to bonding.

Polyphenylquinoxaline (PPQ) - Primer 1 - PPQ resin thinned with a 50 percent mixture of cresol and xylene. Primed panels were baked 1 hour at 477 K (400°F). Primer 2 - NR150 B2 resin diluted with DMF. Primed panels were baked for 1 hour at 477 K (400°F).

HR-602 - Primer 1 - Hughes supplied HR-602-7 resin dissolved in NMP. Primed panels were baked at 450 K (350°F) for 4 minutes. This was the only primer evaluated for HR-602.

FM-34 - Primer 1 - BR-34 resin diluted with BR-34 thinner. Primed panels were baked 1 hour at 366 K (300°F) followed by 1 hour at 477 K (400°F). Primer 2 - NR150 B2 resin diluted with DMF. Primed panels were baked for 1 hour at 477 K (400°F).

Figure 2 illustrates the crack extension specimen configuration used for evaluation, as well as lap shear test and peel test specimens. Crack lengths were measured initially, then separate specimens were exposed for 5 days at 505 K (450°F) and 7 days at 322 K (120°F)/100 percent relative humidity. The specimen crack lengths were remeasured after exposure. Primer 1 for all adhesives was selected because of superior crack resistance and/or greater compatibility with the base adhesive resin.

INITIAL ADHESIVE EVALUATION

Subsequent to primer selection, the adhesive candidates were evaluated for bond characteristics using the 8 titanium surface

preparations. Cure cycles for each adhesive were those established on previous work or were provided by the supplier. Crack extension (from primer evaluation), lap shear, and T-peel tested at room temperature and 505 K (450°F) were used to determine adhesive properties. Figures 3 through 6 illustrate the measured crack length of the test specimens from selected adhesive systems. Figures 7 through 10 illustrate the lap shear values for some of the adhesives tested.

Examination of the data reveals the superior performance of both chromic acid anodize and phosphoric acid anodize surface treatments. Values for both the initial and environmentally exposed conditions are lower for crack length and higher for lap shear strengths. T-peel specimens for all systems produced unexpectedly low values, probably because polyimide resins are relatively brittle. The T-peel data did not contribute significantly to the selection process.

Data from previous Boeing programs have shown that joints treated with phosphoric acid anodize are not as thermally stable as those treated with chromic and acid anodize. Based on all available information, chromic acid anodize was selected as the most promising surface treatment for most of the adhesives.

Analysis of all the adhesive systems (adhesive resin, primer, and surface treatment) resulted in selection of the following three systems for continued screening:

<u>Resin</u>	<u>Primer</u>	<u>Surface Treatment</u>
LARC-13 with 30 percent Al powder	LARC-13 with 30 percent Al powder diluted with DMF	Chromic acid anodize
NR056X	NR056 diluted with NMP	Chromic acid anodize
PPQ	PPQ diluted with 50 percent cresol/ xylene	Chromic acid anodize

These three systems were selected based upon critical factors of relative process difficulty, thermal stability, material availability, cost, and mechanical properties. Modifications to the various resins did not exhibit any significant improvements over the base formulations and were eliminated from further consideration in this program. HR-602 was not selected because of its low shear properties with all metal surface treatments.

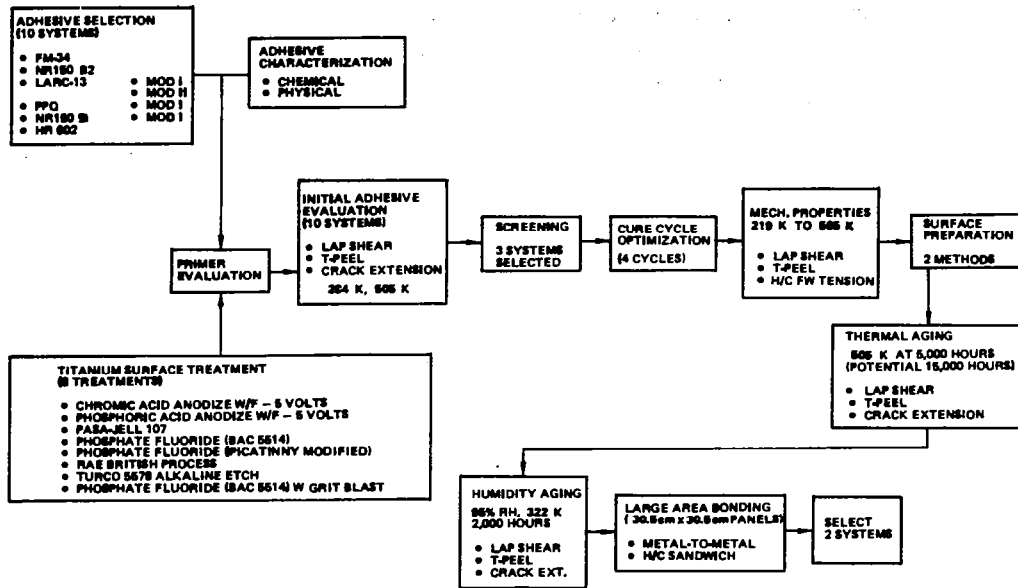


Figure 1.- Program flow diagram.

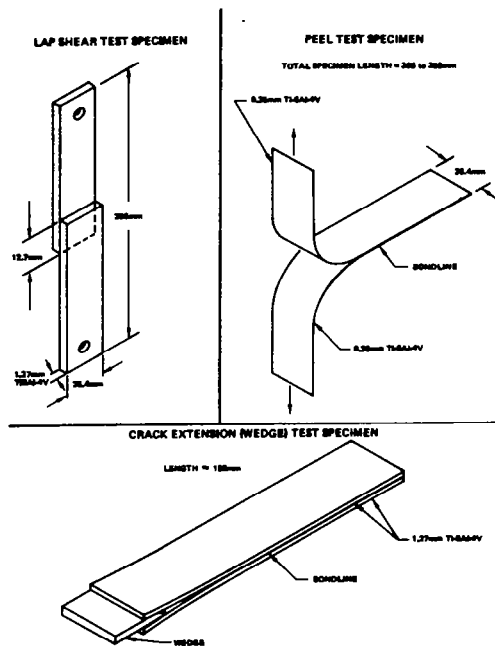


Figure 2.- Mechanical test specimens.

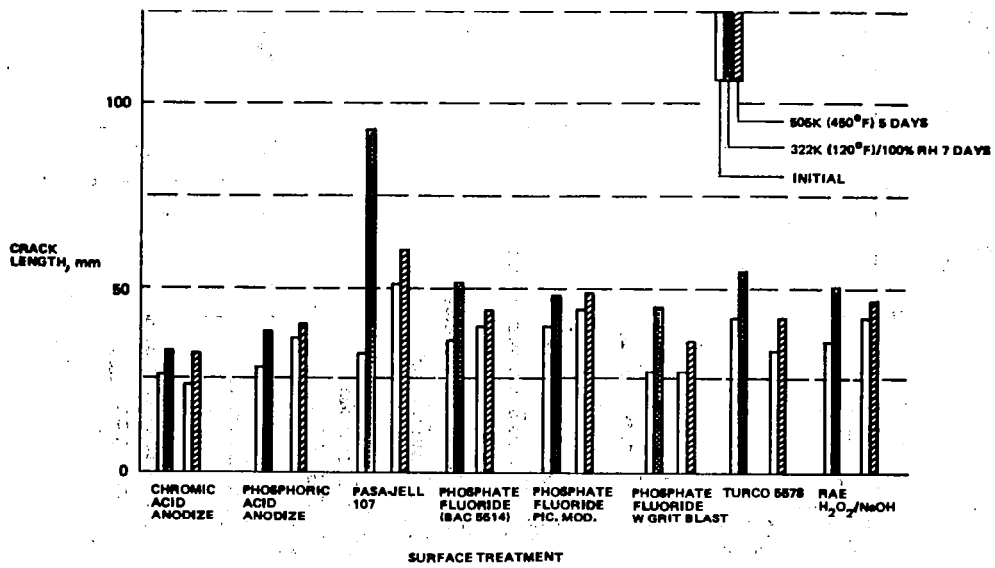


Figure 3.- Crack extension environmental exposure results - LARC-13.

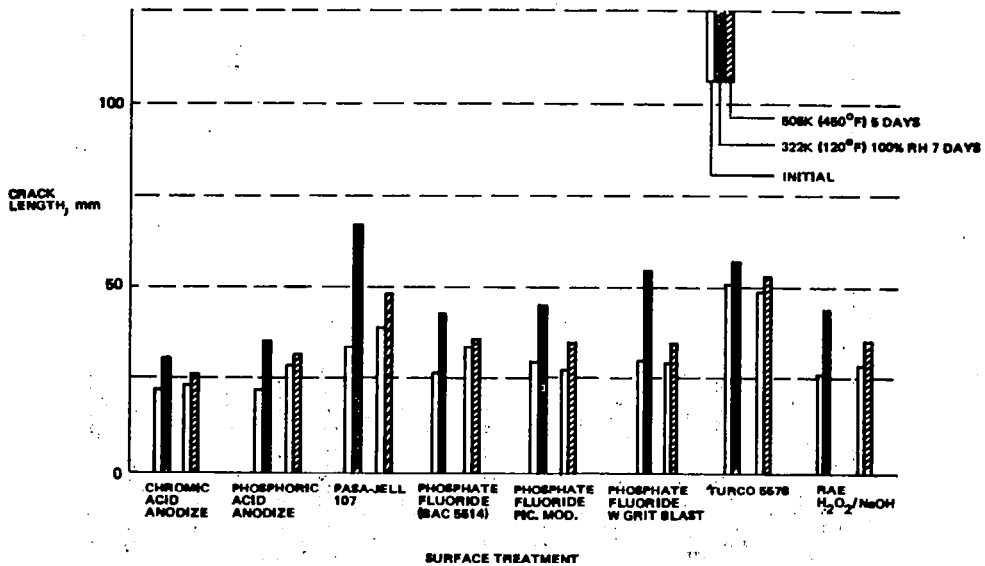


Figure 4.- Crack extension environmental exposure results - NR150 B2.

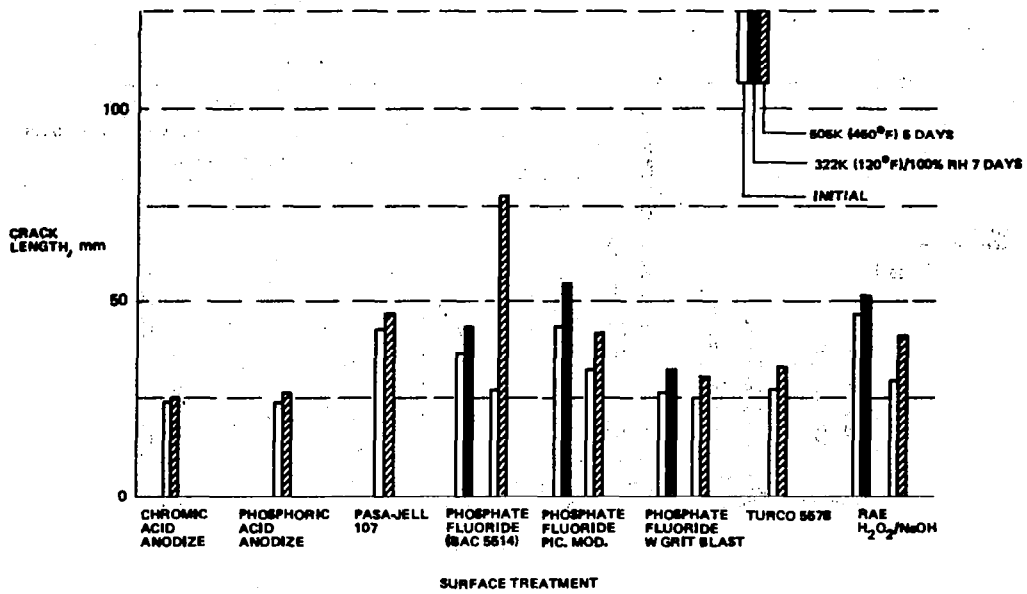


Figure 5.- Crack extension environmental exposure results - PPQ.

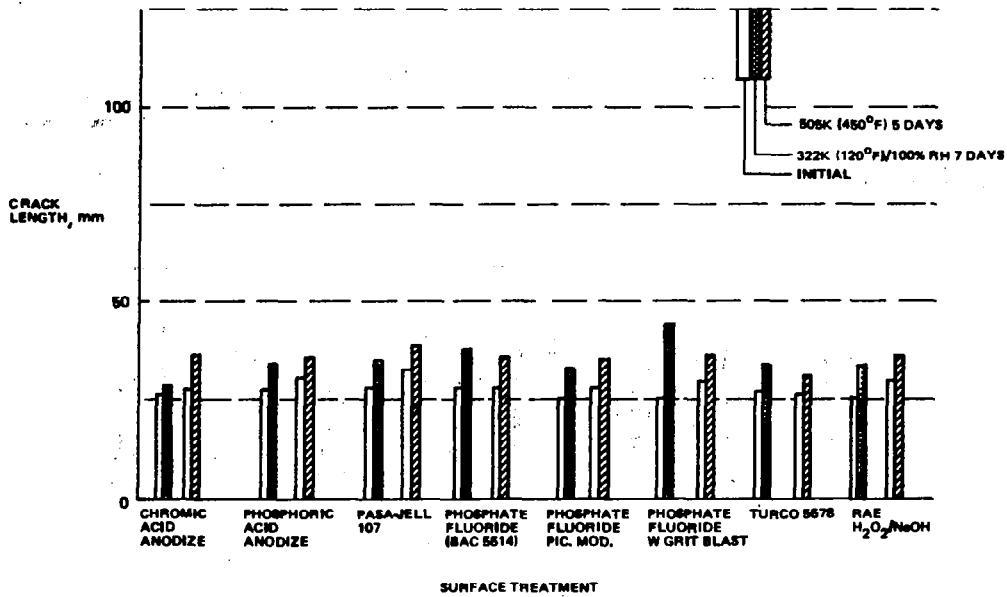


Figure 6.- Crack extension environmental exposure results - FM-34.

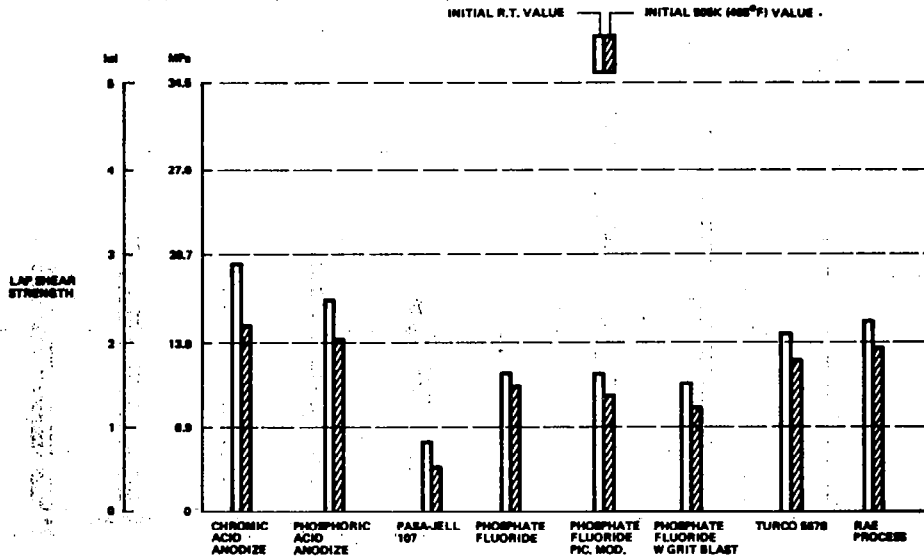


Figure 7.- Adhesive evaluation lap shear strength test results - LARC-13.

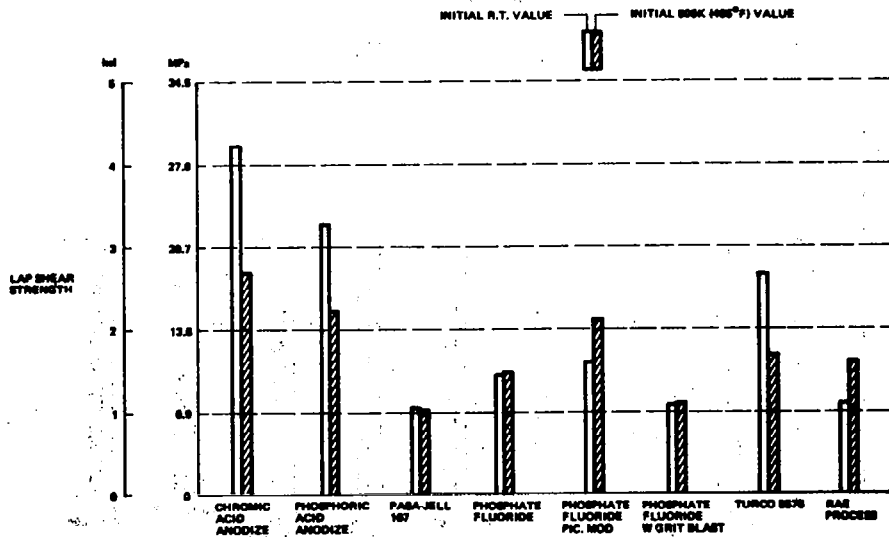


Figure 8.- Adhesive evaluation lap shear strength test results - NR056X.

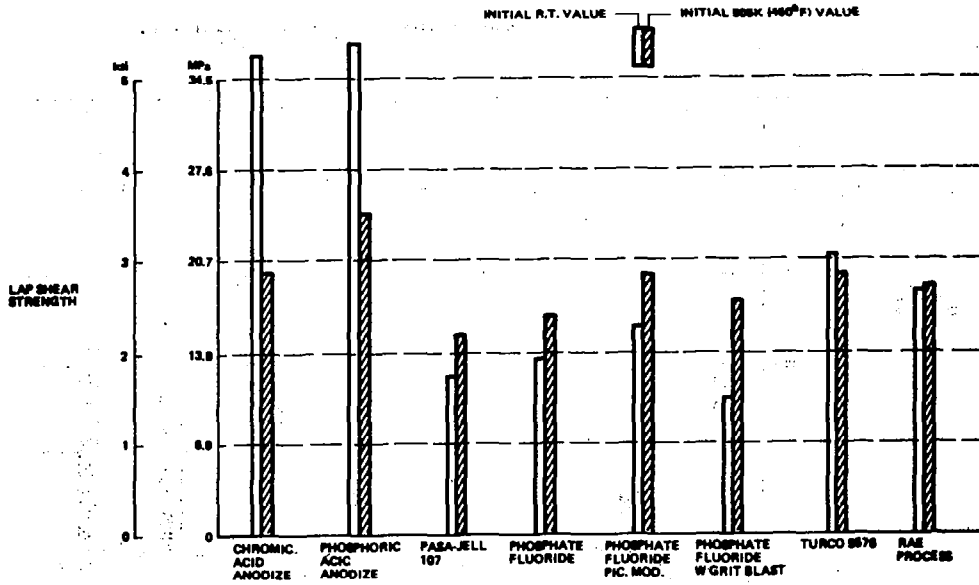


Figure 9.- Adhesive evaluation lap shear strength test results - PPQ.

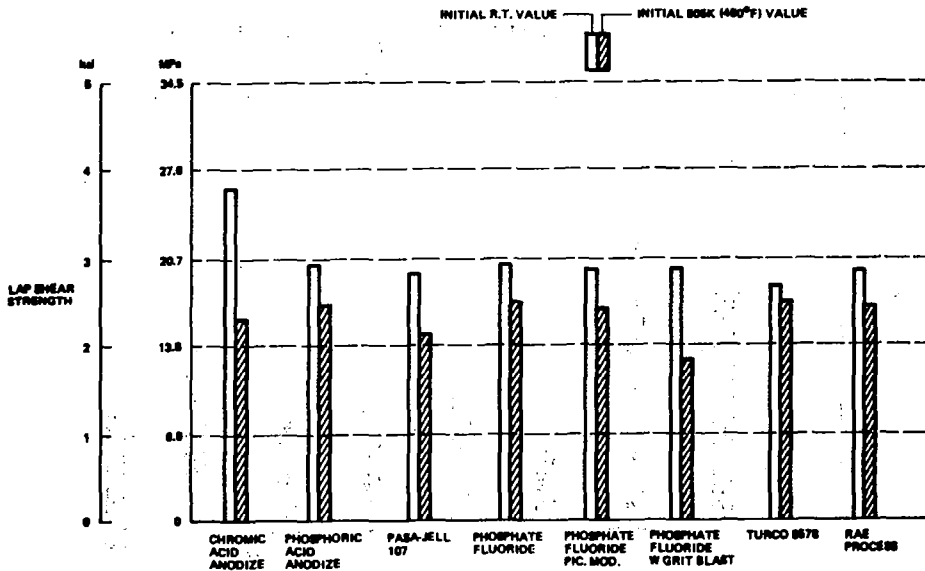


Figure 10.- Adhesive evaluation lap shear strength test results - FM-34.

ADVANCED MATERIALS AND FABRICATION

PROCESSES FOR SUPERSONIC CRUISE AIRCRAFT

Marlon K. Guess, Russell S. Kaneko and George G. Wald
Lockheed-California Company

SUMMARY

Research and development programs to develop high-strength aluminum alloys and low-cost materials and fabrication techniques for titanium alloys are being conducted by the Lockheed-California Company under contract to NASA Langley Research Center and through independent research. Thirteen aluminum alloy compositions are being evaluated by Aluminum Company of America (Alcoa) and the International Nickel Company (INCO) under subcontract to Lockheed. A section of a production component has been fabricated using superplastic forming and diffusion bonding (SPF/DB) and fabrication studies are being conducted on three low-temperature-forming beta titanium alloys. Cost studies indicate substantial structural cost-reduction potentials resulting from the use of both aluminum alloys and low-cost titanium fabrication techniques. Lowest overall costs are indicated for a composite/aluminum or composite titanium structure.

INTRODUCTION

Materials and Producibility studies at the Lockheed-California Company for the supersonic cruise vehicle (SCV) cover a wide range of alloys and advanced fabrication methods. Materials being studied include advanced aluminum alloys and graphite epoxies for Mach 2.0 applications. Titanium and polyimide composites are under evaluation for a Mach 2.0 and a Mach 2.55 aircraft. Producibility studies cover superplastic forming of both titanium and aluminum alloys; diffusion bonding of 6Al-4V titanium; room-temperature forming of beta titanium alloys; and isothermal brazing of titanium.

This paper covers development of high-temperature-resistant aluminum alloys which are structurally competitive with titanium alloys for Mach 2.0 applications. The review of superplastic forming and diffusion bonding covers development work being conducted on an L-1011 production component with plans for eventual production incorporation. Room-temperature-forming studies of beta titanium alloys under a NASA-Langley contract and isothermal brazing of titanium are also reviewed.

The paper concludes with an assessment of the producibility, cost, and weight advantages offered by the development of high-strength aluminum alloys, low-cost titanium, advanced fabrication methods, and graphite material systems.

SYMBOLS AND ABBREVIATIONS

F_{tu}	allowable tensile strength
F_{cy}	allowable compressive yield (0.2% offset)
F_{max}	maximum stress for constant amplitude fatigue using $K_t = 3$ and $R = 0.1$ for life of 10^5 cycles
F	allowable for titanium
F_n	allowable for titanium normalized by density for comparison with aluminum
K_t	stress concentration factor
n	fatigue cycles to failure
K_{max}	maximum stress intensity
ΔK	$K_{max} (1-R)$ for a crack growth rate of 2.54×10^{-8} meters/cycle (10^{-6} in/cycle)
R	stress ratio, ratio of minimum stress to maximum stress
a	one-half crack length
K_{IC}	plane strain fracture toughness
K_{app}	apparent plane stress fracture toughness or residual strength
E	modulus of elasticity
ρ	density
ksi	kips (1000 pounds) per square inch
msi	million pounds per square inch
MPa	megapascals
mg	milligrams
GPa	gigapascals
m	meter
L	longitudinal
T	transverse

ALUMINUM ALLOYS FOR SUPERSONIC APPLICATIONS

Background

Precipitation-hardening aluminum alloys have been widely used in the aerospace industry over the past 35 years because of their relatively low raw material and fabrication costs and the ability to develop satisfactory specific strengths for subsonic applications. For sustained use in the Mach 2.0 to 2.7 supersonic range, however, conventional aluminum alloys have presented some unacceptable drawbacks. First, conventional aluminum alloys are not as structurally efficient as titanium for many structural applications in a Mach 2.0 to 2.2 transport; and second, development of a high-strength aluminum alloy having good thermal stability at temperatures associated with sustained speeds above Mach 2.2 has been lacking (ref. 1). As a result of these limitations, airframe designers have been forced to accept reductions in performance or look for alternate materials to be used in structures for supersonic transport use.

Studies conducted by private airframe and engine manufacturers like Lockheed, Boeing, McDonnell Douglas, General Electric, and Pratt & Whitney under funding by NASA have indicated that a supersonic transport aircraft operating above Mach 2.2 would probably be fabricated from approximately 70 percent titanium. The reason for this is titanium's good stability in the temperature range of 149 to 260°C (300 to 500°F) associated with a Mach 2.2+ transport (figure 1). When operating below Mach 2.2, supersonic transport structures are only exposed to maximum temperatures in the range of 107 to 135°C (225 to 275°F). At these temperatures, aluminum could be incorporated in the airframe structure. The French and British incorporated a considerable amount of aluminum in the Concorde, which cruises at a speed of Mach 2.02; however, the alloy used has a strength-to-density ratio which is not competitive with titanium alloys (figure 2). Conventional aluminum alloys fail to be as cost effective as titanium for sustained supersonic applications because of their lower strength and temperature resistance.

Current advances in aluminum processing and alloying technologies have shown a potential for eliminating these strength and temperature barriers. The Air Force is funding research and development for structural aluminum alloys, which will retain their yield strength after exposure to 232°C (450°F) for 10,000 hours. In the commercial field, the Lockheed-California Company under NASA sponsorship is initiating studies for advanced aluminum alloys capable of retaining their strengths in the temperature range of 121 to 177°C (250 to 350°F). (See fig. 2.) These temperatures will be encountered at the Mach 2.0 to 2.4 speed range for periods up to 100,000 hours in commercial supersonic transports under current study. Such studies, underway at the Lockheed-California Company, indicate that commercial supersonic flight in the Mach 2.0 to 2.2 range may be almost as productive as flight at Mach 2.7.

New Material Developments

According to Alcoa, a considerable effort has been expended in attempts to improve the elevated temperature performance of aluminum alloys. One of

the most promising approaches studied by Alcoa relies on creating a fine dispersion of a second phase through rapid solidification and maintaining it through subsequent consolidation and processing into final product forms (ref. 2). Products of this type have typically exhibited stable, but unacceptably low, mechanical properties and thus have not gained widespread use. Recent work at Alcoa Laboratories has employed high-velocity gas atomization to form particulates. This process has demonstrated that through proper control of alloying, particulate cooling rate, consolidation temperature, and total deformation during consolidation, aluminum alloy products that develop very high room- and elevated-temperature tensile properties can be fabricated. This work has been limited in scope, however, and a wide variety of alloying additions and fabricating conditions remain unexplored.

The International Nickel Company (INCO), employing the newly developed process of mechanical alloying, has demonstrated a capability for coping with the problems of developing a high-strength, temperature-resistant aluminum alloy. Mechanical alloying is a technique for producing composite metal powders with controlled fine microstructures. It occurs by the fracturing and rewelding of a mixture of powder particles during milling via a highly energetic ball charge (refs. 3,4). The process takes place entirely in the solid state.

This process was developed by INCO for the manufacture of dispersion-strengthened alloys and it shows promise for developing the required properties in aluminum. Through the mechanical alloying process, homogeneous alloys strengthened by oxide dispersions, as well as additions of soluble and insoluble metallic ingredients, can be produced. The materials produced by the process display the exceptionally fine and stable types of microstructures which are needed to provide the desired improvement in elevated temperature properties of aluminum alloys. Commercialization of the process is now well under way.

These noted developments in new materials technology indicated the potential for more economical supersonic transports in the Mach 2.0 to 2.2 range. Therefore the Lockheed-California Company under NASA contract has initiated feasibility studies to investigate advanced high-temperature aluminum alloys in conjunction with Alcoa and INCO.

Requirements and Potential Applications for New Materials

Discussions between Lockheed, Alcoa, and INCO indicated that development of a single aluminum alloy competitive with titanium and all of its desirable properties was not a practical prospect. Since only a limited number of properties are critical for any given part of an aircraft structure, it was agreed that a family of aluminum alloys could readily compete with titanium. With this in mind, four sets of property goals have been established for improved aluminum alloys. These goals represent structural equivalence with titanium alloys in the properties that are critical for a given application. The four goals being considered are: high strength, damage tolerant, high stiffness, minimum gage or low density.

The high-stiffness and low-density goals are the same except for specific stiffness requirements, and will probably be met by development of a single aluminum-lithium alloy. The environmental requirements for the alloys cover an airframe life expectancy of 36,000 flights with 100,000 hours at 107°C (225°F). Room-temperature properties must be unaffected by elevated-temperature exposure and elevated-temperature properties must be equal to or greater than 80 percent of room-temperature properties. The four alloys must also be able to withstand a sustained load of 124 MPa (18 000 psi) at 107°C (225°F) for 100,000 hours with less than 0.1 percent creep. Corrosion resistance equal to or greater than the superior corrosion resistance presently being demonstrated by Lockheed's L-1011 subsonic commercial transport is also a requisite.

Mechanical property goals for the family of alloys were established by making the primary property equivalent to that for 6Al-4V titanium. Figures 3 through 5 show these property goals along with existing Concordé and commercial subsonic jet properties and the increase in properties required to make the alloys equivalent to titanium. In some cases secondary properties have also been increased. The increases were made after discussions with material developers indicated that the higher goals could probably be met without sacrificing primary goals, thus providing added material capabilities where secondary properties play a major role in design requirements.

Potential applications for the family of alloys are shown in figures 6 through 9. The damage-tolerant, fatigue-resistant alloys would be used for fuselage skins, wing and empennage lower surface panels, spars, and ribs. High-strength alloys would be used for fuselage stringers and frames and upper surface wing and empennage panels, spars, and ribs. High-stiffness applications shown in figure 8 cover the empennage surface panels and substructure, the wing tip surface panels, and the engine supports. Low-density alloy applications cover minimum gage structures such as leading edges, trailing edges and forward wing surface panels.

Current Status

Lockheed is presently in the first year of a program under NASA contract to develop aluminum alloys for SCV applications. Both Alcoa and INCO are under subcontract to Lockheed to assist in this development effort. Figure 10 illustrates the task breakdown.

Alcoa Development Status

Alcoa will fabricate five alloys for evaluation. Three damage-tolerant alloys will be extruded and two high-strength alloys will be forged. The evaluation will consist of three phases. During the first phase, five different fabrication and heat treating processes will be evaluated for each alloy representing 25 conditions. A second screening will then be used to select the best three alloy/process combinations for final evaluation. The first two phases will examine room- and elevated-temperature tensile properties, notch tensile properties, evaluate stability by determining effect of elevated-temperature exposure on room-temperature properties, and make a limited evaluation of fatigue. The final phase will include fracture toughness, notched fatigue, fatigue crack growth and corrosion.

The program schedule and detail status of Alcoa's development program is shown in figure 11. Powder has been atomized, billets hot-pressed, high-strength alloys forged and high-toughness alloys extruded according to plan. Chemical analysis has been completed and initial screening tests are underway.

INCO Development Status

INCO will fabricate eight alloys for testing and evaluation. Extrusions will be produced for six alloys that address the high-strength, corrosion-resistance goal, and for two alloys that are targeted to meet the high-modulus, low-density goal. The evaluation will consist of three phases. A set of 13 alloy composition/processing conditions will be investigated in the first and second phases. The first screen will use room- and elevated-temperature strength and fracture toughness as a basis for selecting the six most promising candidate materials. Stability, as measured by stress-rupture properties, will be used for second-level screening. The final testing phase includes notched fatigue, fatigue crack growth, and corrosion behavior as a means of evaluation.

INCO's program schedule and status are shown in figure 12. Fabrication of powder, billets and extrusions as well as heat-treat studies have been completed for the first two phases, and testing has been initiated.

ADVANCED TITANIUM ALLOYS

Background and New Developments

Conventional titanium structure has a history of being difficult and expensive to fabricate primarily because of the extensive hot forming, machining, drilling, and fastening involved. The usual design philosophy has been to adapt the manufacturing methods typically used in aluminum or steel airframe structures. New titanium alloys and manufacturing technologies are becoming available which allow exploiting fully the inherent attributes of titanium, thereby offering greater design freedom and reducing costs.

Superplasticity, which is a metal's capacity for extensive neck-free elongation, has been demonstrated in several titanium alloys including Ti-6Al-4V. Optimum temperatures for SPF are generally in the transformation range. Thermal cycles for superplastic forming and diffusion bonding (SPF/DB) of titanium are compatible, which permits combining these processes to fabricate complex structure not producible by conventional methods. The basic technology for SPF/DB of titanium sheet has been established over recent years, and there is a rather extensive on-going effort in the aerospace industry to move this technology into full production. The SPF process, either singly or combined with DB has high promise of economic payoff by minimizing costly assembly and machining and making efficient use of metal. Weight savings accrue because more efficient structures with fewer parts can be made.

Beta alloys, being strip producible, are less costly than alpha-beta alloys such as Ti-6Al-4V produced by hand mill. Beta alloys can be formed at room temperature leading to large reductions in fabricating costs. With simple aging treatments, the metastable betas attain higher specific strength than conventional alpha-beta alloys. Further weight savings potential exists in exploiting the close tolerances and long lengths from continuous strip processing and the selective roll taper forming of these alloys. Brazing and welding are potentially efficient means of joining the beta alloys. Lockheed is developing a low-cost isothermal brazing method using heated dies to achieve rapid, out-of-furnace heating in an argon atmosphere.

Lockheed currently has two advanced producibility technology programs for titanium that are applicable to SCV structures: 1) superplastic forming and diffusion bonding of Ti-6Al-4V alloy under IRAD, and 2) low-temperature forming and joining of beta titanium alloys under a NASA Langley contract and IRAD. Work on the new Ti-15V-3Cr-3Al-3Sn beta alloy was started last year. These programs are aimed at demonstrating the effective application of advanced titanium materials and fabrication methods to provide improved structural efficiency with significant cost savings as compared with conventional production hardware.

Potential Applications

Initial in-house manufacturing capability studies for SPF/DB at Lockheed-California Company involve a Ti-6Al-4V auxiliary power unit (APU) access door on our L-1011 wide-body transport. The present door, illustrated in figure 13, is made up of numerous details mechanically fastened together. The redesigned configuration for SPF/DB (figure 14) combines two-sheet integrally stiffened concepts with selective reinforcements. The ultimate objective of this activity is production application of the SPF/DB access door.

Convex beaded wing-panel concepts for SCV structure appear to be a natural for SPF/DB. A typical section including end closure is shown in figure 15. This panel section is one of the design concepts being evaluated for the SCV.

Cold-formable beta alloys are attractive for skin-stringer applications, especially in long lengths as used in fuselage structure. The skin-to-stringer joints would be brazed or weld-brazed. Lockheed's NASA program culminates in the design, fabrication, and test of panels representative of an SCV upper arrow wing panel. The design will consist of beta alloy hat-section stringers brazed to Ti-6Al-4V skins, a concept which is also applicable to the fuselage.

Current Status

Superplastic Forming and Diffusion Bonding

A 38- by 46-cm (15- by 18-in.) section of the APU access door will serve to evaluate design limits, processing requirements, and structural aspects of the SPF/DB design. Figure 14 gives the location of this section. Processing trials will include variants such as sheet thickness, cutouts, and doublers. A trial part made from two 0.81-mm (0.032-in.) sheets of Ti-6Al-4V is shown

in figure 16. Edge compression and bend tests are planned for this part, in addition to nondestructive and metallurgical examinations.

Cold-Formable Beta Alloys

Lockheed is presently in the first year of a three-year program to assess potential payoffs for the beta alloys over conventional titanium alloys for SCV applications. Candidate alloys are being subjected to a variety of forming studies including brake bending, stretch forming, hydroforming, and development of forming limit diagrams. Aging studies are being performed to develop optimum heat treatments. Low-cost brazing and welding methods are being investigated. Material characterization tests are being conducted to determine effects of forming strains, joining, and SCV environments on the basic material properties. Finally, structural panels will be designed, fabricated, and tested. What follows is a summary of the progress to date.

Alloy Identification and Screening. - Based on a literature survey which considered room temperature formability, mechanical properties, stability in a Mach 2.7 environment, and availability, three beta alloys were selected for screening tests: Ti-15V-3Cr-3Al-3Sn (Ti-15-3), Ti-3Al-8V-6Cr-4Mo-4Zr (Beta-C), and Ti-13V-11Cr-3Al (B-120). The latter alloy is serving only as a baseline alloy during the screening phase of the program. The Beta-C material has not been tested yet because material delivery has been delayed.

A preliminary assessment of room-temperature forming capability was made from tension and compression stress-strain curves developed on solution-treated (annealed) material. Table 1 summarizes the test results for Ti-15-3 and B-120. The lower yield (flow) stress of Ti-15-3 in both tension and compression is desirable from a forming standpoint. B-120 did exhibit slightly more uniform elongation in this test, and it has higher moduli. The strain-hardening exponents were similar. Plastic strain ratios (\bar{R}) greater than unity were obtained for both alloys indicating a resistance to thinning and, therefore, suitability for forming operations such as stretch forming, hydroforming, and drawing.

Mechanical properties screening tests in aged conditions selected for the projected maximum strength and an intermediate strength level will include room-temperature tension, residual strength of material stretch-strained to simulate forming strains, notched fatigue, fracture toughness, and 316°C (600°F) creep.

Table 2 summarizes the tension and residual strength test results for Ti-15-3 and B-120. Ti-15-3 displayed less directionality and slightly better ductility than B-120, while B-120 had the greater stiffness. Uniaxial pre-strain induced slight overaging with the peak strength age in B-120 and with both aged conditions in Ti-15-3, indicating that the alloys were fully aged by these treatments. Prestrain accelerated the aging reaction to increase strength only with the intermediate strength aging treatment for B-120.

Fatigue results for Ti-15-3 and B-120 in two aged conditions are presented in figure 17. The lower strength Ti-15-3 displayed the best fatigue behavior with an endurance strength about 15 percent higher than B-120 or the peak strength Ti-15-3.

Room Temperature Forming Studies. - Only bending data are available at this time. Press-brake bending of 2.0-mm (0.080-in.) gage Ti-15-3 using 15.2-cm and 91.5-cm (6 and 36-in.) wide specimens shows uniform bending behavior with respect to grain direction, and a minimum acceptable bend radius of 2.4t; the bends had light to moderate orange peel. In preliminary bend tests, 2.54-cm (1-in.) wide specimens achieved a 2.0t radius with acceptable surfaces in both 2.0- and 1.6-mm (0.080- and 0.063-in.) gages. For perspective, Ti-6Al-4V can be formed to only 4.5 to 5.0t radius. Springback data for various bend radii are given in figure 18.

Joining Studies. - The primary approach to the brazing development is to achieve sufficiently low brazing temperatures and short brazing cycles to permit the beta alloys to be brazed in the solution treated and aged (STA) condition with minimal overaging effect. Promising results have been obtained using aluminum brazing alloys and a brazing envelope of high-purity argon gas.

Room temperature lap shear strengths for various braze alloy foils are given in figure 19. Figure 20 shows some effects of the brazing thermal cycles on the tensile strength of aged Ti-15-3. With the present brazing cycles, a maximum brazing temperature of 621°C (1150°F) was found to be desirable to minimize overaging the Ti-15-3 STA material. Note in figure 19 that only filler metal 718 Al gave acceptable shear strength at these lower brazing temperatures.

Filler metals 3003 and 1100 produced superior wetting and shear strengths compared with the others. However, these two alloys have a minimum brazing temperature of approximately 663°C (1225°F) which may make it necessary to age-harden after brazing. An investigation on effects of aging after the brazing operation shows this process sequence to be feasible (Table 3). Braze shear strengths, aging response, and microstructures were not adversely affected.

Mechanized tungsten inert-gas (Tig) arc welding was selected to demonstrate butt joining of beta alloy sheets. Square butt welds were made without filler metal addition in 2.0 mm (0.080 in.) Ti-15-3. Weld quality was excellent with only minor porosity. The weld beads were almost flat with no machining necessary. Results of preliminary tension and bend tests are given in Table 4. Tig welds exhibited full joint efficiency both as-welded and after aging, with good ductility. As-welded joints withstood bending to a 4t bend radius.

PRODUCIBILITY/COST BENEFITS

Detailed production cost comparisons of aluminum, titanium, and composite structural concepts have been prepared considering advanced and conventional materials and fabrication techniques. Table 5 illustrates the results of this

study. Seven basic configurations were evaluated for a Mach 2.0 aircraft and three configurations were evaluated for a Mach 2.55 aircraft. The study shows that a structural concept using 17 percent advanced aluminum and 55 percent composites results in the lowest cost and weight for a Mach 2.0 aircraft. This is closely followed by an aircraft having 44 percent advanced aluminum and 21 percent composites secondary structure. For a Mach 2.55 aircraft, a structural concept using 55 percent composites and 23 percent titanium resulted in the lowest projected production cost and weight. Details of the material mix and weights for each aircraft type are presented in reference 5.

Figure 21 shows the relative material cost for a typical SCV structural component. As shown, material costs for both composites and titanium will be considerably higher than material costs for conventional and advanced aluminum alloys. Projected material costs for an advanced aluminum alloy component are about 85 percent higher than a conventional aluminum alloy component. The advanced titanium material costs were below conventional titanium material costs because structural concepts for advanced titanium employed a greater amount of sheet materials. Sheet stock has a higher fly-to-buy ratio and therefore, costs less on a dollars-per-pound-of-structure basis than other material forms. The use of graphite/polyimide matrix materials for Mach 2.55 applications results in a 66 percent material cost increase over graphite/epoxy matrix systems.

Relative fabrication and assembly costs for aluminum, titanium and composite structures are shown in figure 22. Conventional aluminum was used as a base and the 7 percent reduction for advanced aluminum fabrication techniques represents extensive use of adhesive bonding for primary structure. The 17 percent reduction for advanced titanium fabrication techniques over conventional methods results from the use of SPF/DB and low-cost beta alloys. It was estimated that these techniques would result in a 50 percent cost reduction on 62 percent of the titanium structure and that 55 percent of total fabrication costs consisted of detail fabrication and sub-assembly. A 10 percent increase in cost for graphite/polyimide over graphite/epoxy results from slightly higher layup costs and the need for a secondary cure.

CONCLUDING REMARKS

This paper has reviewed several research projects aimed at the development of advanced materials and producibility technology applicable to supersonic cruise vehicles.

- Advanced Aluminum Alloys. - A family of advanced aluminum alloys is being developed to be competitive with titanium for Mach 2.0 applications. The development effort by Lockheed and its subcontractors Alcoa and INCO is being performed under contract to NASA Langley Research Center. Powder metallurgy and mechanical alloying

techniques have been used to prepare 13 alloy systems, which are presently under evaluation. Results should be available in early 1980.

- Superplastic Forming/Diffusion Bonding (SPF/DB). - SPF/DB studies are being conducted under Lockheed independent research programs. A 38- by 46-cm (15- by 18-in.) section of the L-1011 APU access door has been fabricated and plans presently call for fabrication of a complete door assembly and eventual production incorporation. Cost/weight studies indicate a substantial reduction in number of parts and assembly hours and a 10 percent reduction in weight.
- Low-Cost Beta Titanium Alloys. - Development of low-cost fabrication techniques for beta titanium alloys is being conducted under a NASA Langley contract. Three alloys, Ti-15-3, Beta-C, and B-120 are being evaluated for room temperature forming and low-cost joining techniques. Studies to date indicate excellent cold formability for the Ti-15-3 alloy. Promising results for low-cost isothermal brazing have also been obtained using aluminum brazing alloys and a brazing envelope of high purity argon gas. Cost studies indicate a 30 percent cost reduction resulting from room-temperature forming of beta alloys and a 20 percent cost reduction using isothermal brazing techniques for assembly.
- Producibility Cost Studies. - Cost studies indicate that structures consisting of metals and composites will result in the lowest cost and weight.

REFERENCES

1. Douglas MDC 54394 "Studies of the Impact of Advanced Technologies Applied to Supersonic Transport Aircraft," Volume II First Year Summary Report, Sept. 1973, prepared under Contract No. NAS1-11939 for NASA Langley Res. Center, Hampton, Va.
2. R.R. Sawtell et al., "Elevated Temperature Al. Alloy Development," March 28, 1978 Alcoa Laboratories.
3. J.S. Benjamin, "Mechanical Alloying," Scientific American, Vol. 234, No. 5, May 1976, p. 40.
4. J.S. Benjamin and M.J. Bomford, "Dispersion-Strengthened Aluminum Made by Mechanical Alloying," Met. Trans. A, Vol. 8A, August 1977, p. 1301.
5. I.F. Sakata et al., "Structural Concept Trends for Commercial Supersonic Cruise Aircraft Design," Supersonic Cruise Research '79, NASA CP-2108, 1980. (Paper 25 of this compilation.)

TABLE 1. TENSILE AND COMPRESSIVE PROPERTIES OF ANNEALED BETA TITANIUM ALLOYS
1.6mm (0.063 in.) GAGE

Average Properties*			Ti-13V-11Cr-3Al			Ti-15V-3Cr-3Al-3Sn		
			L	45°	T	L	45°	T
Tension	Yield Strength (F_{ty})	MPa	889	924	945	758	779	745
		ksi	129	134	137	110	113	108
	Apparent Modulus (E_t)	GPa	106	90	112	77	88	80
		10^3 ksi	15.4	13.0	16.2	11.2	12.8	11.6
	**Uniform Elong. (n)	%	24	26	14	17	17	14
	Strain Hardening Coefficient (n), $S = K\epsilon^n$.034	.043	.034	.043	.034	.038
Plastic Strain Ratio, $R_i = \frac{\sigma_w}{\sigma_t}$, and $\bar{R} = \frac{R_1 + 2R_2 + R_3}{4}$		$R_1 = 0.81$	$R_2 = 2.10$	$R_3 = 0.90$	$R_1 = 1.38$	$R_2 = 1.20$	$R_3 = 1.63$	
		avg. = .037			avg. = .038			
		$\bar{R} = 1.48$			$\bar{R} = 1.35$			
Compression	Yield Strength (F_{cy})	MPa	906	927	956	785	787	803
		ksi	131	134	139	114	118	117
	Apparent Modulus (E_c)	GPa	103	98	108	88	92	89
		10^3 ksi	14.9	14.3	15.7	12.7	13.3	12.9

*Duplicate specimens
**0.005 mm/mm/s to yield and 0.05 mm/mm/s thereafter.

TABLE 2. AGED TENSILE PROPERTIES OF UNSTRAINED AND STRAINED BETA TITANIUM ALLOYS

Beta Alloy	Aging Treatment	Grain Direction	Condition	Ultimate Tensile Strength MPa (ksi)	0.2% Yield Strength MPa (ksi)	Elongation In 5.1 cm (2 in), %	Apparent Elastic Modulus GPa (10 ³ ksi)
Ti-13V-11Cr-3Al	482°C (900°F), 36h Peak Strength	L	STA STCWA	1455 (211) 1482 (215)	1331 (193) 1310 (190)	5.3 5.7	118 (16.8) 115 (16.6)
		T	STA STCWA	1510 (219) 1489 (216)	1407 (204) 1358 (197)	4.3 4.0	115 (16.7) 117 (17.0)
	482°C (900°F), 12h Intermediate Strength	L	STA STCWA	1310 (190) 1400 (203)	1186 (172) 1234 (179)	8.3 5.0	113 (16.4) 112 (16.3)
		T	STA STCWA	1351 (196) 1434 (208)	1261 (183) 1282 (186)	5.0 6.0	115 (16.6) 115 (16.7)
Ti-15V-3Cr-3Al-3Sn	454°C (850°F), 16h Peak Strength	L	STA STCWA	1400 (203) 1407 (204)	1303 (189) 1282 (186)	6.0 5.8	106 (15.4) 106 (15.3)
		T	STA STCWA	1434 (208) 1420 (206)	1351 (196) 1310 (190)	6.3 5.2	108 (15.6) 107 (15.5)
	483°C (900°F), 12h Intermediate Strength	L	STA STCWA	1351 (196) 1365 (198)	1255 (182) 1241 (180)	7.3 6.7	107 (15.5) 106 (15.3)
		T	STA STCWA	1379 (200) 1372 (199)	1303 (189) 1255 (182)	5.5 6.8	108 (15.6) 107 (15.5)

STA = Solution treated and aged. (Average of two specimens).
 STCWA = Solution treated, cold worked and aged. Represents "residual strength" of material stretched nominally 8% to simulate cold forming prior to aging. (Average of three specimens).

TABLE 3. EFFECT OF POST-BRAZE AGING ON Ti-15V-3Cr-3Al-3Sn SHEET

Test	Braze Alloy	Condition*	Properties		
Lap Shear	3003 3003 1100 1100	STA + Braze ST + Braze + 496°C (925°F), 12h STA + Braze ST + Braze + 496°C (925°F), 12h	Lap Shear - MPa (Ksi)		
			81-95 (11.8-13.8) 76-84 (11.0-12.2) 69-74 (10.0-10.8) 68-70 (9.8-10.1)		
Tension	- - - -	ST + 496°C (925°F), 12h ST + Braze** + 496°C (925°F), 12h ST + 496°C (925°F), 16h ST + Braze** + 496°C (925°F), 16h	F _{tu} - MPa (ksi)	F _{ty} - MPa (ksi)	e-%
			1282-1289 (186-187) 1262-1289 (183-187) 1282-1303 (186-189) 1282-1303 (186-189)	1200-1207 (174-175) 1200-1234 (174-179) 1186-1234 (172-179) 1207 (175)	7 5.7 7 6
Metallographic	3003 3003 1100 1100	ST + Braze ST + Braze + 496°C (925°F), 12h ST + Braze ST + Braze + 496°C (925°F), 12h	Ti-Aluminide Thickness - mm (in.)		
			.0025 (.0001) .0025 (.0001) .0013 (.00005) <.0013 (.00005)		

*ST = Solution treated;
 STA = Solution treated and aged;
 All braze cycles run at 671°C(1240°F).
 **Simulated braze cycle

TABLE 4. MECHANICAL PROPERTIES OF MECHANIZED TIG WELDS ON Ti-15V-3Cr-3Al-3Sn SHEET
2.0 mm (0.080 in.) GAGE

Condition	Test Dir*	Weld Dir	Tension Tests					Where Failed	Min Bend Radius
			F _{tu}		F _{ty}		e %		
			MPa	(ksi)	MPa	(ksi)			
ST	T	—	758	(110)	752	(109)	18	—	2t
ST + Weld	T	L	758	(110)	738	(107)	9	Weld	—
ST + Weld	T	L	765	(111)	752	(109)	10	Weld	—
ST + Weld	T	L	779	(113)	785	(111)	8.5	Weld	—
ST + Weld	T	L	—	—	—	—	—	—	4t
ST + Weld + 496°C (925°F), 12h	T	L	1282	(186)	1214	(176)	6.5	Base Metal	—
ST + Weld + 496°C (925°F), 12h	T	L	1276	(185)	1207	(175)	6.5	Base Metal	—
ST + Weld + 496°C (925°F), 12h	T	L	1282	(186)	1200	(174)	6	Base Metal	—

*Bend axis or loading direction as applicable.

TABLE 5. PRODUCTION COST COMPARISON FOR SCV AIRCRAFT (2) (4)

CONFIGURATION CODE	A2	D2A	B2	C2	C2A	E2A	I2A	D2.55A	E2.55A	I2.55A
Basic Configuration Description	Baseline Conventional Titanium Structure (75%)	Advanced Titanium Technology (75%)	Conventional Aluminum Technology Structure (70%)	Advanced Aluminum Mat'l Conventional Fab Techniques (66%)	Advanced Aluminum Mat'l and Fab Techniques (66%)	Advanced Composites (55%) Advanced Aluminum Mat'l and Fab Techniques (17%) (3)	Advanced Aluminum Mat'l and Fab Techniques (44%) Advanced Composites (21%) (3)	Advanced Titanium Technology (75%)	Advanced Composites (55%) Advanced Titanium Technology (23%) (3)	Advanced Titanium Technology (54%) Advanced Composites (20%) (3)
	MACH 2.0						MACH 2.55			
Recurring Structure Cost (1)	33 097	28 918	22 806	19 013	18 423	16 301	17 409	31 469	23 154	26 653
Total Recurring Cost (1)	82 996	79 443	72 827	65 368	64 635	58 924	61 051	83 907	68 548	74 490
Cost Savings Per Aircraft	—	3 553	10 169	17 628	18 361	24 072	21 945	911	14 448	8 506
Percent Savings	—	4.3%	12.3%	21.2%	22.1%	28.0%	28.4%	-1.1%	17.4%	10.3%
Least Cost Ranking	7	6	5	4	3	1	2	3	1	2

(1) Cumulative average at 300 Aircraft in 1978 dollars (\$1 000)
(2) Costs are for engineering planning purposes and are not to be construed as official company quotes or price estimates.
(3) Assumed development of lower cost mechanized manufacturing techniques for composites.
(4) Constant payload of 290 passengers and a range of 7401 Km (4,000 n.mi.)

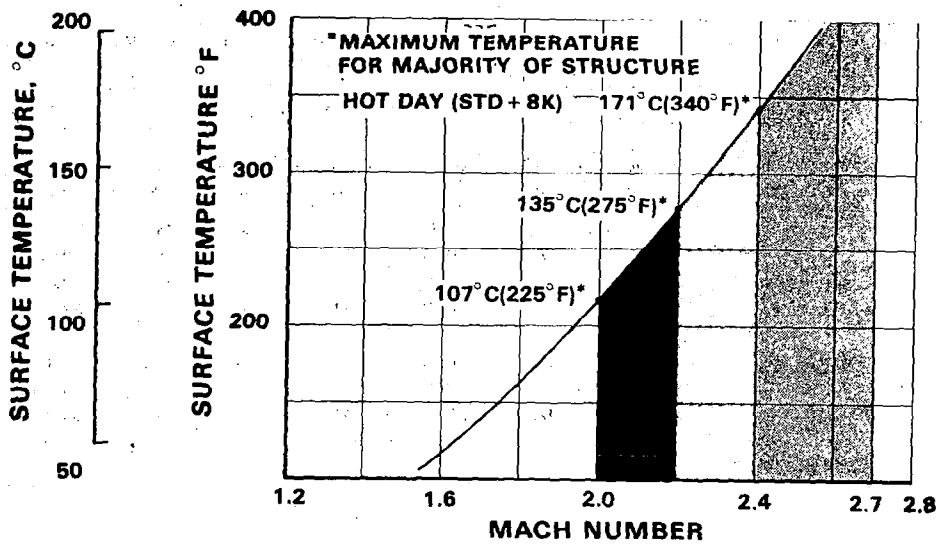


Figure 1.- Structural temperature at indicated Mach number.

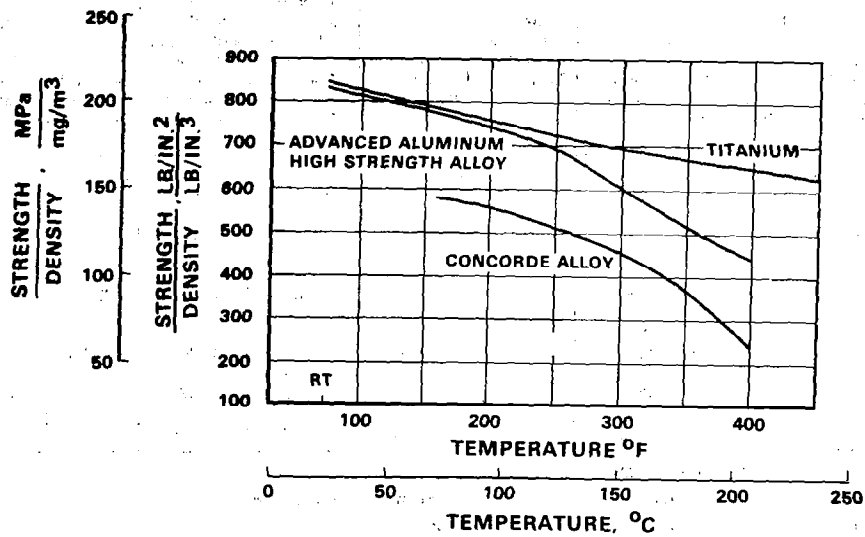


Figure 2.- Strength-density ratios for candidate materials.

PROPERTIES	ALUM. REF.		Ti 6-4 BASE $F_n = F \frac{\rho_{al}}{\rho_{ti}}$	ADVANCED ALUMINUM	
	CONCORDE 2618-T6	COM'L JET 2024-T3		GOALS	IMPROVEMENT
STRENGTH					
F_{tu} , MPa(ksi)	427(62)	427(62)	579(84)	489(68)	10% > 2618-T6
F_{cy} , MPa(ksi)	386(56)	269(39)	565(82)	427(62)	10% > 2618-T6
FATIGUE					
F_{max} , MPa(ksi) for $K_t=3$, $R=0.1$, $n=10^5$	131(19)	138(20)	207(30)	207(30)	50% > 2024-T3
ΔK , MPa \sqrt{m} (ksi $\sqrt{in.}$) $R=0.1$, $da/dn=2.54 \times 10^{-8}$ m/cycle (10^{-6} in./cycle)	6.2(5.6)	6.6(6.0)	6.2(5.6)	7.9(7.2)	20% > 2024-T3
OTHER					
K_{app} , MPa \sqrt{m} (ksi $\sqrt{in.}$)	76.9(70)	98.9(90)	89(81)	89(81)	16% > 2618-T6
K_{IC} , MPa \sqrt{m} (ksi $\sqrt{in.}$)	28.6(26)	33(30)	48.3(44)	33(30)	16% > 2618-T6
E, GPa(msi)	75.2(10.9)	73.8(10.7)	68.9(10.0)	73.8(10.7)	~ 2024-T3

Figure 3.- Damage tolerance and fatigue resistance goals for advanced aluminum alloys.

PROPERTIES	ALUM. REF		Ti 6-4 BASE $F_n = F \frac{\rho_{al}}{\rho_{ti}}$	ADVANCED ALUMINUM		IMPROVEMENT
	CONCORDE 2618-T6	COM'L JETS 7075-T6		GOALS $P \approx 0.1$	$P \approx 0.09$	
STRENGTH						
F_{tu} , MPa(ksi)	427(62)	531(77)	579(84)	<u>579(84)</u>	<u>517(75)</u>	10% > 7075-T6
F_{cy} , MPa(ksi)	386(56)	469(68)	565(82)	<u>565(82)</u>	<u>503(73)</u>	20% > 7075-T6
FATIGUE						
F_{max} , MPa(ksi) for $K_t=3$, $R=0.1$, $n=10^5$	131(19)	138(20)	207(30)	158(23)	145(21)	20% > 2618-T6
ΔK , MPa \sqrt{m} (ksi $\sqrt{in.}$) for $R=0.1$, $da/dn=2.54 \times 10^{-8}$ m/cycle (10^{-6} in./cycle)	6.2(5.6)	6.2(5.6)	6.2(5.6)	6.8(6.2)	6.2(5.6)	10% > 7075-T6
OTHER						
K_{app} , MPa \sqrt{m} (ksi $\sqrt{in.}$)	76.9(70)	65.9(60)	89(81)	65.9(60)	65.9(60)	~ 7075-T6
K_{IC} , MPa \sqrt{m} (ksi $\sqrt{in.}$)	28.6(26)	28.6(26)	48.3(44)	28.6(26)	28.6(26)	~ 7075-T6
E, MPa(msi)	75.2(10.9)	72.4(10.5)	68.9(10.0)	72.4(10.5)	85.5(12.4)	~ 7075-T6

Figure 4.- Strength and corrosion resistance goals for advanced aluminum alloys.

PROPERTIES	ALUM. REF. 2618-T6	Ti 6-4 BASE $F_n = F_{pa}/\rho_{ti}$	ADVANCED ALUMINUM	
			GOALS	IMPROVEMENT
STRENGTH				
F_{tu} , MPa(ksi)	427(62)	579(84)	427(62)	~ 2618-T6
F_{cy} , MPa(ksi)	386(56)	565(82)	379(55)	~ 2618-T6
FATIGUE				
F_{max} , MPa(ksi) for $K_t = 3$, $R = 0.1$, $n = 10^5$	131(19)	207(30)	138(19)	~ 2618-T6
ΔK , MPa \sqrt{m} (ksi $\sqrt{in.}$) $R = 0.1$, $da/dn = 2.54 \times 10^{-8}$ m/cycle (10^{-6} in./cycle)	6.2(5.6)	6.2(5.6)	6.2(5.6)	~ 2618-T6
OTHER				
K_{app} , MPa \sqrt{m} (ksi $\sqrt{in.}$)	76.9(70)	89(81)	65.9(60)	~ 7075-T6
K_{IC} , MPa \sqrt{m} (ksi $\sqrt{in.}$)	28.6(26)	48.3(44)	28.6(26)	~ 7075-T6
E/ρ , (msi/lb.in. $^{-3}$)	75.2(10.9)	68.9(10.0)	90.3(13.1)	25% > 7075-T6
ρ , Mg/m 3 (lb/cu. in)	2.77(0.1)		2.49(0.09)	10% > 7075-T6

Figure 5.- Stiffness and density goals for advanced aluminum alloys.

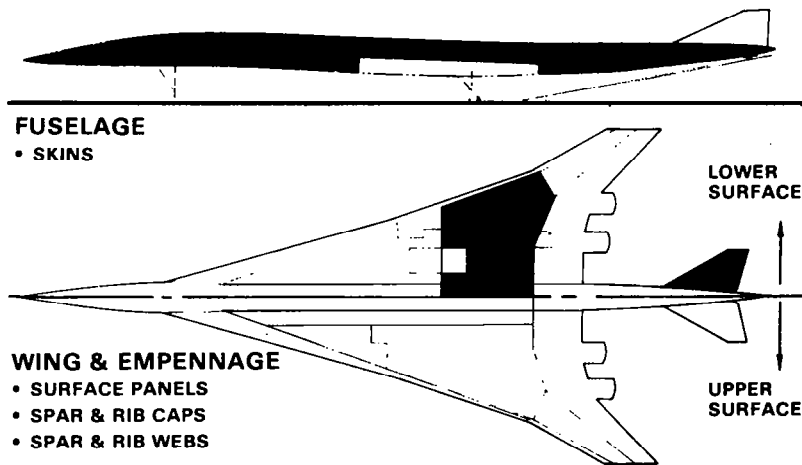


Figure 6.- Applications for advanced aluminum with damage-tolerant, fatigue-resistant properties.

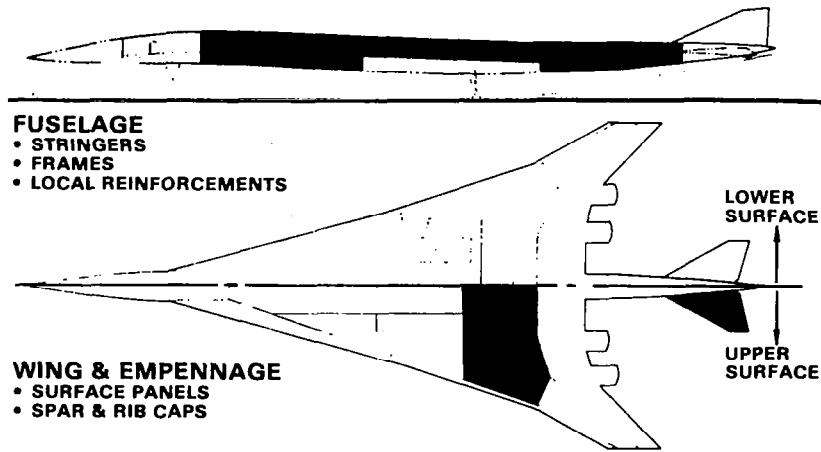


Figure 7.- Applications for advanced aluminum with high-strength, corrosion-resistant properties.

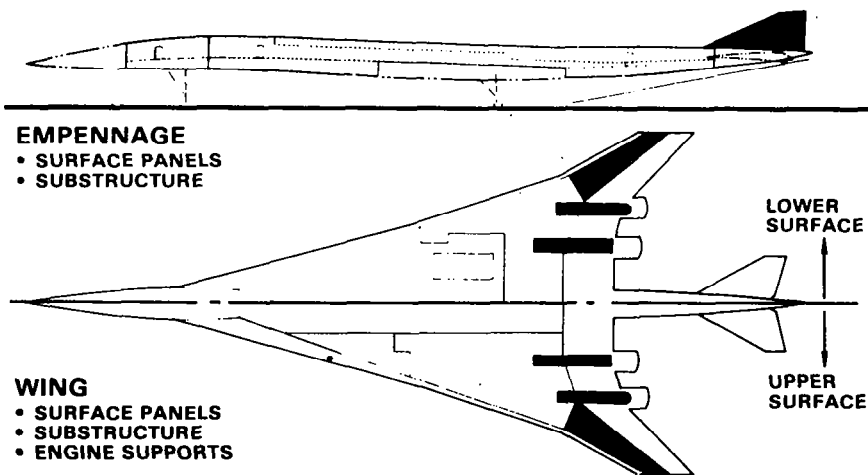


Figure 8.- Applications for advanced aluminum with high-stiffness properties.

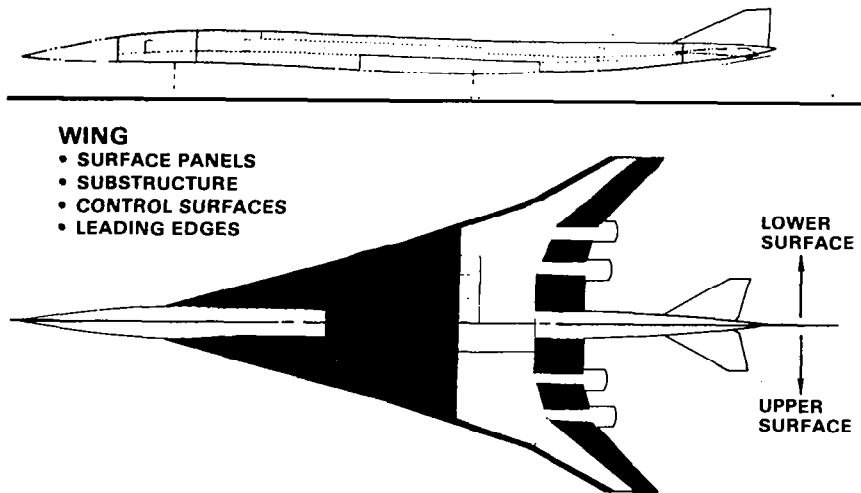


Figure 9.- Applications for advanced aluminum with low-density properties.

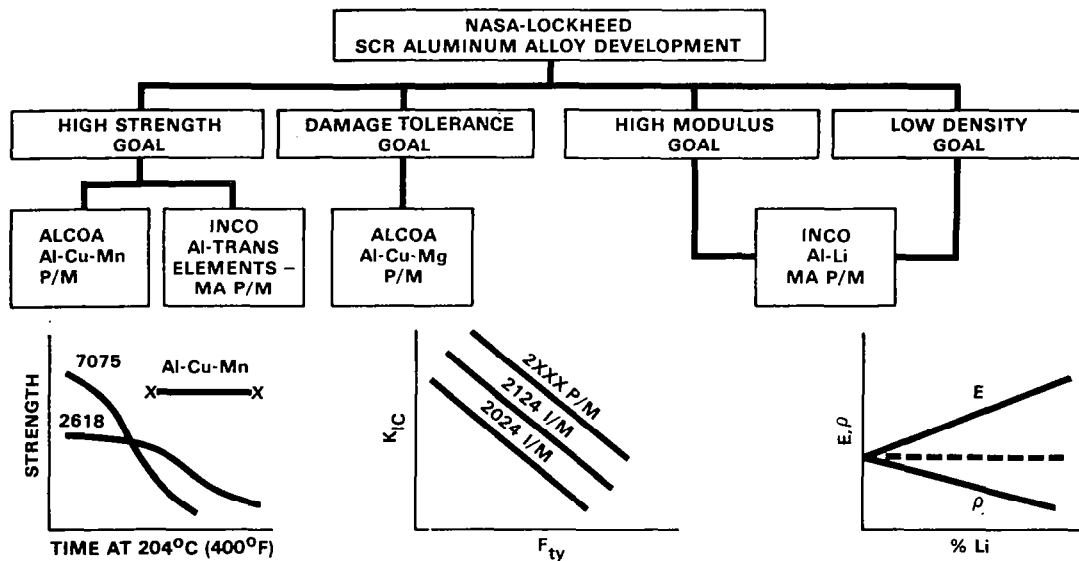


Figure 10.- Advanced aluminum alloy development task breakdown.

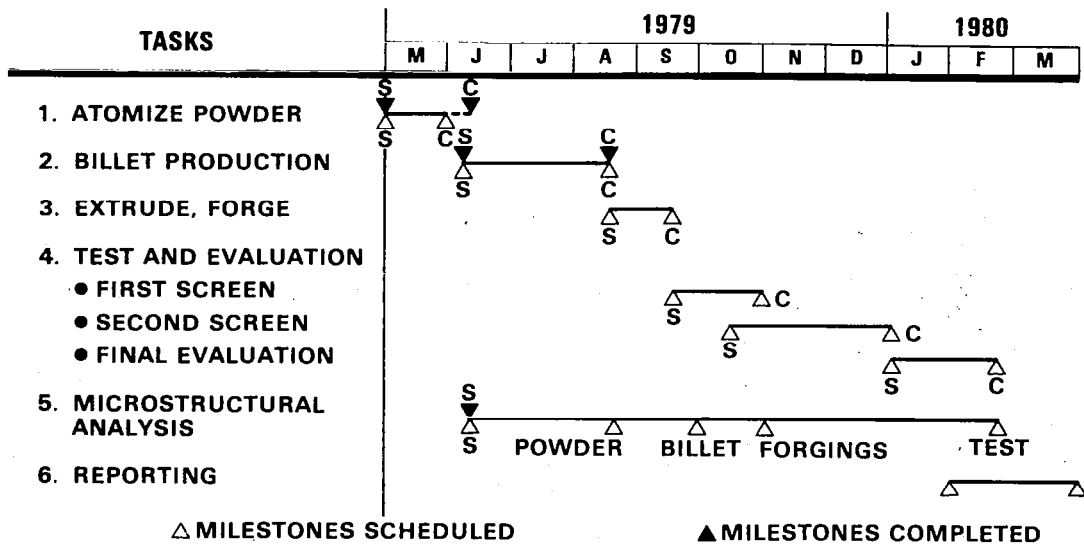


Figure 11.- Advanced aluminum program schedule - ALCOA.

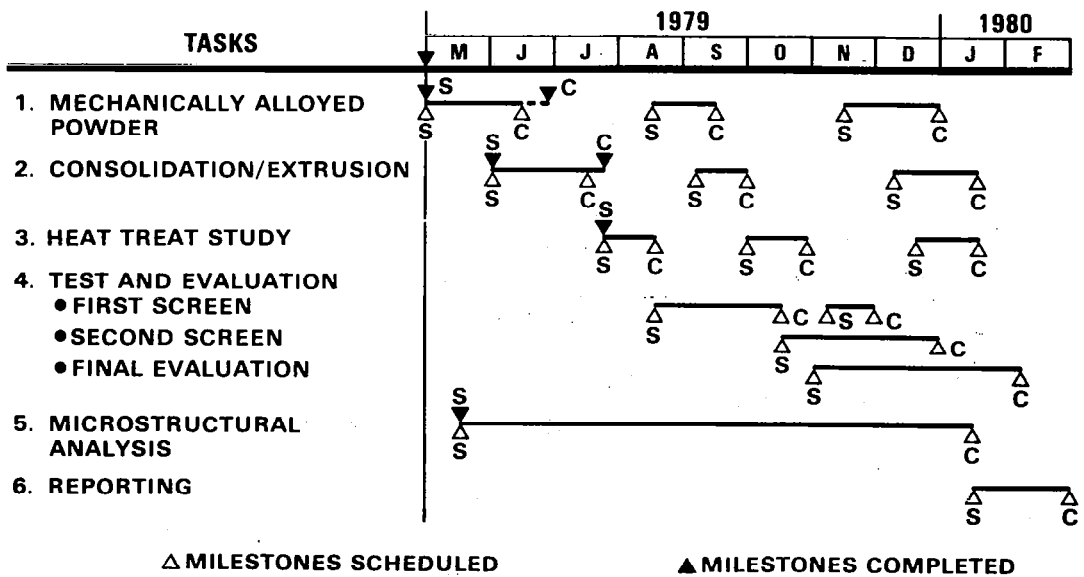


Figure 12.- Advanced aluminum program schedule - INCO.

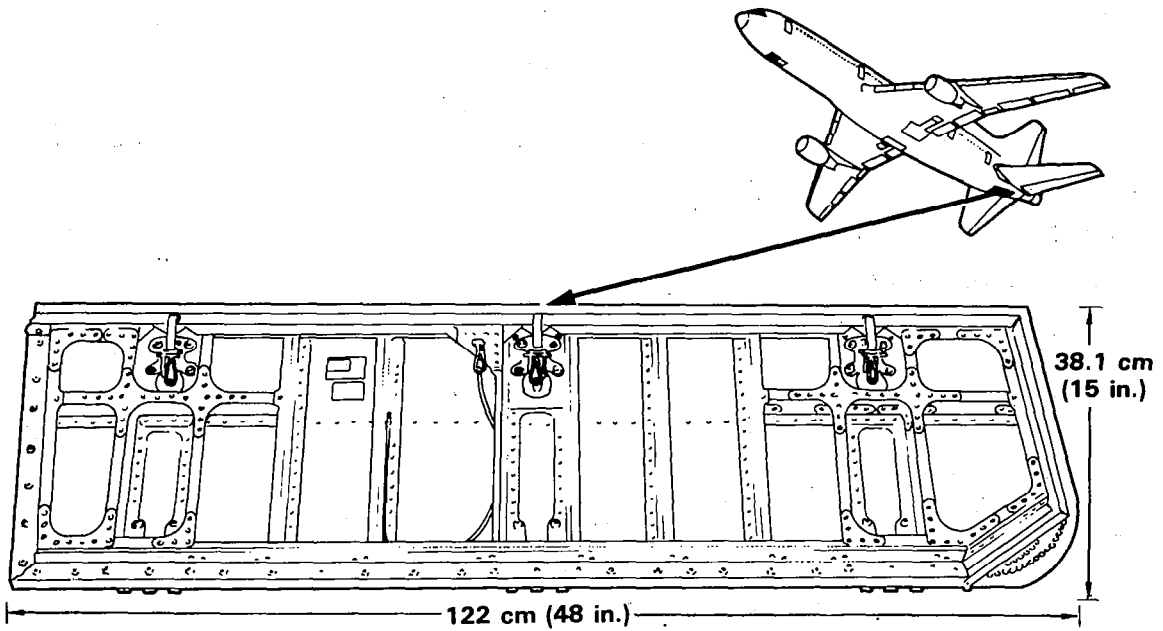
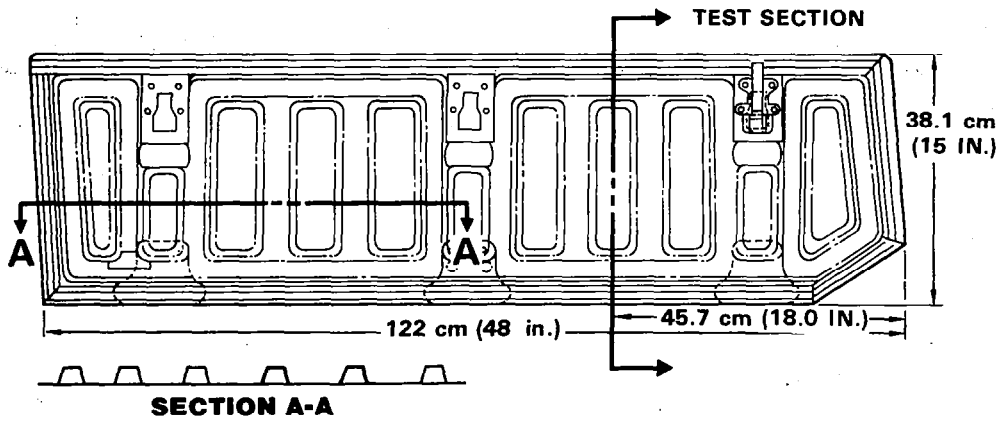


Figure 13.- Current auxiliary power unit access door for L-1011 transport.



ELIMINATES - 772 FASTENER COMPONENTS
 - 61 PARTS

SAVES - 70 ASSEMBLY HOURS
 - 10% WEIGHT REDUCTION

Figure 14.- Auxiliary power unit access door fabricated by SPF/DB.

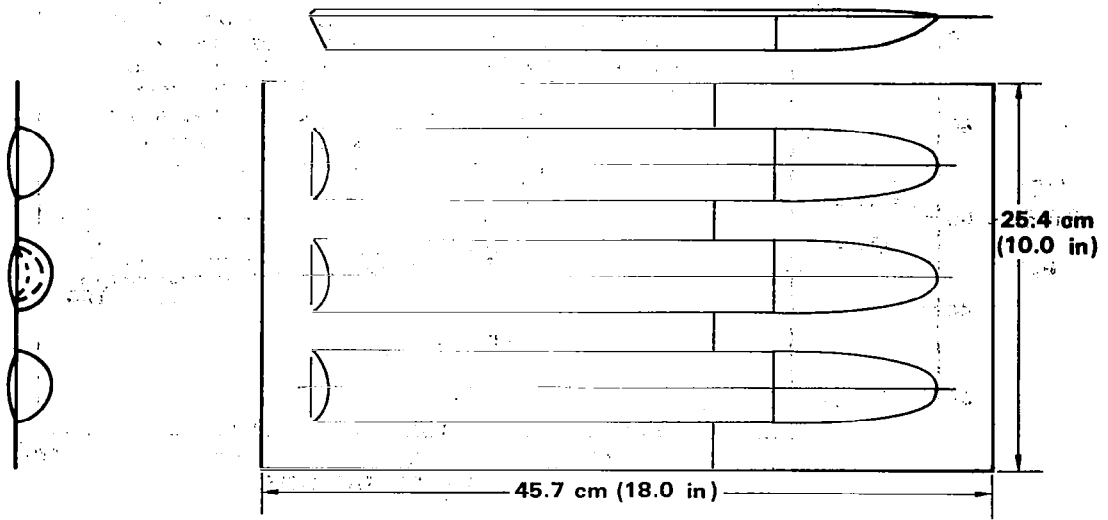


Figure 15.- SPF/DB wing panel section.

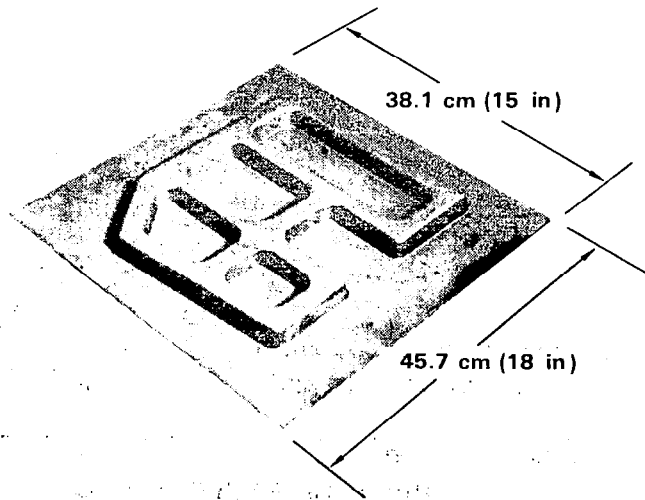


Figure 16.- SPF/DB trial section for L-1011 access door.

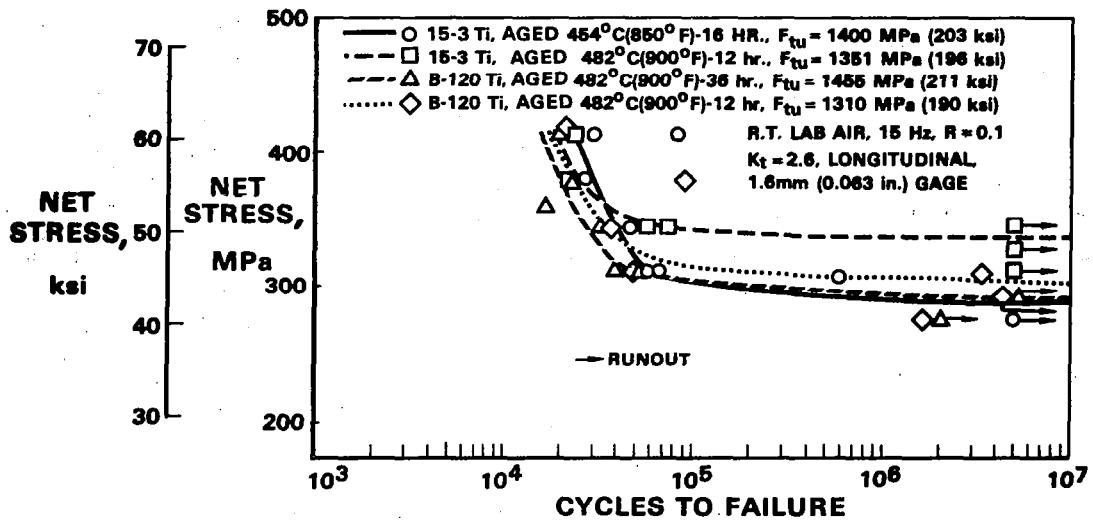


Figure 17.- Constant amplitude fatigue test results on beta titanium alloys.

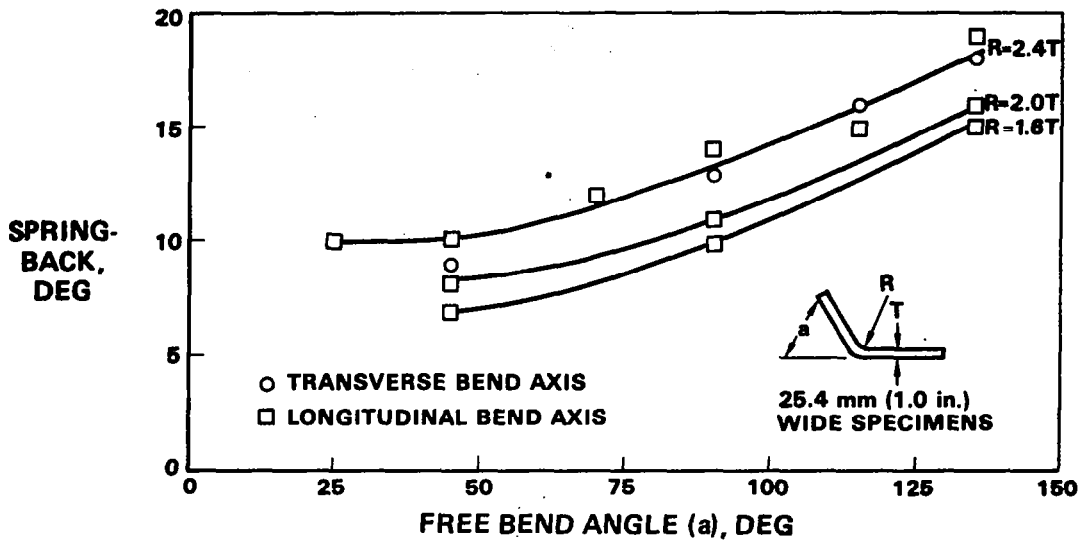


Figure 18.- Springback of annealed 2.0 mm (0.080 in.) Ti-15V-3Cr-3Al-3Sn beta alloy.

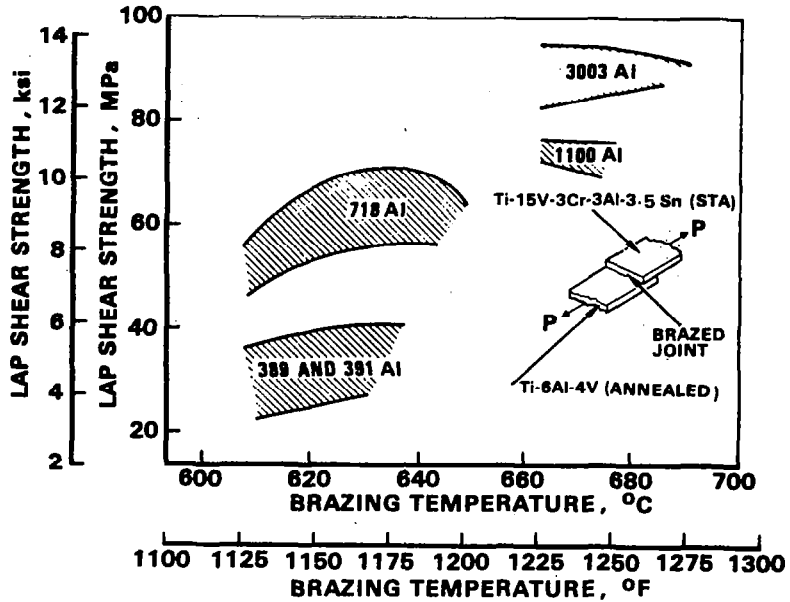


Figure 19.- Room-temperature shear strength of brazed joints.

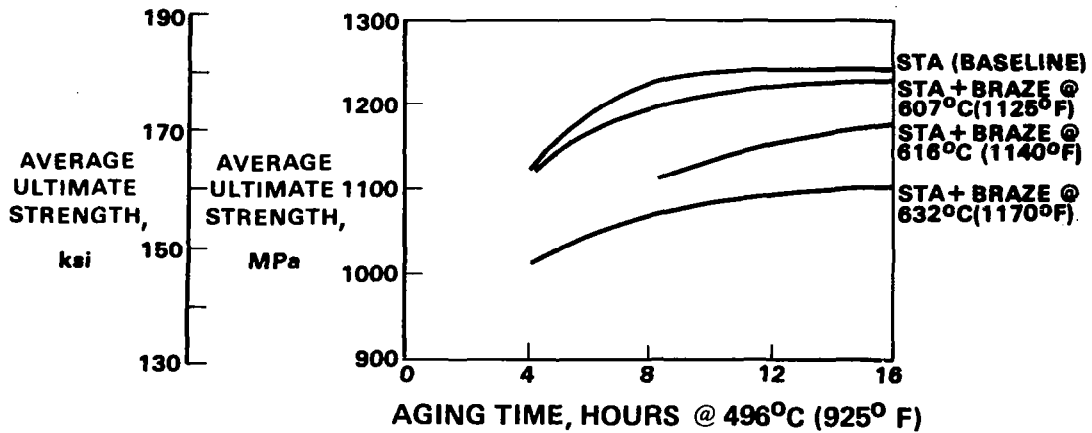


Figure 20.- Effect of braze cycle on tensile strength of aged Ti-15V-3Cr-3Al-3Sn.

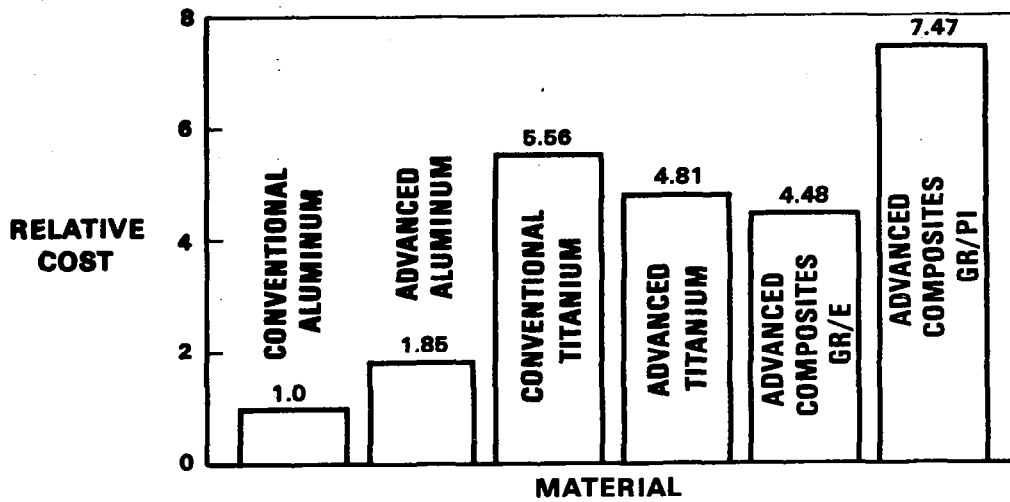


Figure 21.- Relative material cost for typical SCV structural component.

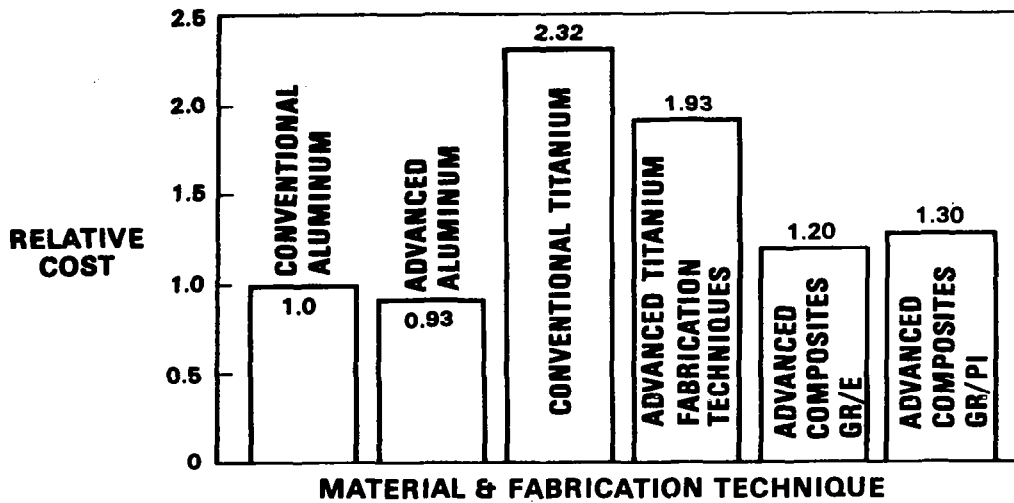


Figure 22.- Relative fabrication and assembly cost of proposed SCV material.

EFFECTS OF AN AST PROGRAM

ON U.S. TITANIUM STORY

Richard D. FitzSimmons
Douglas Aircraft Company
McDonnell Douglas Corporation

SUMMARY

The singular importance of titanium as the primary structural material for an efficient Advanced Supersonic Transport (AST) is outlined. The advantages of titanium over other metals are shown to apply to future subsonic aircraft as well as for supersonic designs. The cost problem of titanium is addressed and shown to be markedly reduced by the emerging technologies of superplastic forming/diffusion bonding sandwich, hot isostatic pressing of titanium powders, and isothermal forgings. IF demonstration programs should validate preliminary findings. The impact of a U.S. AST program on the United States titanium supply and demand picture is postulated.

INTRODUCTION

The history of titanium is relatively short. While titanium oxides have been known since 1791, a 95 percent pure sample of the element was not obtained until 1895, and a 99 percent pure sample a few years later. In 1940, the Kroll method using titanium tetrachloride and magnesium was first published which enabled researchers to identify the properties of this new titanium metal. Accordingly, in 1948, the first engineering usages were seen in the U.S., in the U.K. and in Germany. In perspective, 1948 is after the development of the world's first production jet engines or large multiengine, swept-wing airplanes. Therefore, in comparison with these other aviation advances, titanium technology is relatively new.

In 1937, the world production of titanium was 0.45 kg (1 lb). In 1944, it was 59 kg (130 lb). By 1950, it had reached 45,350 kg (100,000 lb) and ten years later 6,350,000 kg (14,000,000 lb). In 1978, world production had reached 73,000,000 kg (161,000,000 lb), and the next decade may see even more spectacular growth (Figure 1).

The production of titanium metal is capital intensive which, in an energy critical future world, may be an advantage as compared to aluminum production which is more energy intensive. The Kroll method of production using magnesium (or sodium) is a chlorination process from which titanium sponge is recovered (Figure 2a). It is a batch process and therefore expensive. The titanium ingot can be made from this sponge, and the ingot used for making mill products. Every 907.18 kg (1 ton) of mill products requires about 1814.37 kg (2 tons) of ingot which, in turn, requires 3628.74 kg (4 tons) of

rutile, 1814.37 kg (2 tons) of carbon, 1814.37 kg (2 tons) of chlorine, and 302.39 kg (1/3 ton) of magnesium. Steps in this process are shown in Figures 2b through 2g.

Titanium alloys offer physical properties that are superior to the traditional aluminum alloys with the potential for additional gains from development of new and improved alloys. There seems little doubt that titanium will play an important role as a corrosion-free structural material with broad applications in our future society, especially as the overall costs are reduced.

TITANIUM PROPERTIES

Mr. N. F. Harpur, in his Beatty Lecture in January 1979 on titanium, provided an excellent set of basic properties for titanium and his paper is the source of many of the facts included in this section. Titanium can be considered an abundant resource. There are well over 300 years of known supplies of rutile (titanium sponge is produced from rutile) on the beaches of Australia. And there are other sources as well (Figure 3). Titanium is the fourth most abundant structural metal and the ninth most abundant element (Figure 4). It is a silver grey, non-magnetic metal with the basic alloy possessing the strength of steel at about half the density. Today, about 90 percent of titanium usage is in the oxide form for paint. Only 10 percent is reduced to the metal form and in that form about 75 percent is used in aerospace applications, usually for elevated temperature critical components.

The status of titanium alloy as a structural material can best be summarized as follows:

- PRO's
- o higher specific strength than aluminum
 - o better high temperature properties than aluminum
 - o very good corrosion resistance
 - o better crack resistance than aluminum
 - o lower buy-to-fly ratio than aluminum or steel
 - o lower energy consumed to produce the raw material required for a finished part than is required for an aluminum part
 - o abundant ore
- CON's
- o more expensive raw material than aluminum or steel
 - o cutting or metal removal rates much lower than aluminum
 - o recycling not well developed (although 75 percent of usage is controlled within aerospace industry)
 - o more energy required to make 907.18 kg (1 ton) of ingot than required for aluminum
 - o has bad reputation in airlines due to corrosiveness with Skydrol (an extremely corrosive fluid)
 - o sponge availability in U.S. (domestic plus imports) is marginal, inadequate for the future
 - o mill capacity in the U.S. is now very limited

From an engineering or designers point-of-view the following have been substantiated.

- o Specific strength, usually depicted as ultimate stress to density ratio, is an important parameter by which to help select an airplane structural material, as weight required for strength is a major part of the structural weight. In this regard, titanium does look best at medium and high stress levels, even for low temperature (or subsonic) applications (Figure 5). However, a second parameter, high cost, both for the raw material and for manufacturing it, has made titanium an unpopular material as compared to low cost aluminum, except as elevated temperature becomes critical. As the price objections are overcome, titanium may well become a more desirable material for all new aircraft, both subsonic and supersonic. As this paper will show, the SPF/DB process, if used in the efficient sandwich form, offers competitive weights and costs for both low temperature (subsonic) and high temperature (supersonic) applications.
- o Because titanium has a higher strength than aluminum, for a given compression load, thinner material is required and therefore panel buckling must be addressed. Fortunately, titanium does offer improved buckling stress to density properties compared to aluminum for most typical loading conditions (Figure 6).
- o For fatigue designed structures, titanium again shows a superior value compared to aluminum. Increased fatigue life in terms of cycles to failure can be shown (Figure 7). With more and more attention being paid to eliminate the possibility of any cracks at all in one lifetime of the structure, titanium must be given more attention as a prime civil transport material. Also, the superior fracture toughness of titanium makes unavoidable microscopic cracks less likely to grow for medium to high thickness plates at the same crack tip stress intensity factor (Figure 8).
- o Almost without exception titanium is basically free of corrosion problems and can be used in the untreated condition. Skydrol hydraulic fluid, the inflammability development that was put into the first civil jet transports to prevent fires, unfortunately is the one known corrosive agent that ruins titanium (Skydrol will have to be replaced on a titanium airplane). This problem has caused titanium to have a bad name in airline maintenance circles today as being a corrosive metal. This is unfortunate as titanium is otherwise free of corrosion problems.

In comparison, aluminum is an active metal in the presence of many substances and care must be taken to prevent corrosion from becoming destructive. There may be a greater problem in the future as we try to assess the remaining life of one of today's aluminum airplanes. This is because designers have learned to work with each design application more efficiently than before. The trouble-free long-life structure of a DC-3 using 17ST aluminum was due to the conservatism used by the designers due to unknowns. The DC-3 may well prove to have a longer life than the more modern jet airplanes using 24ST or 75ST aluminums. This would be in spite of the fact that great pains have been taken in recent designs to obtain a long-life

structure by including fatigue testing for two complete lifetimes on all the structure.

Titanium should be better than aluminum as it is basically corrosion free and, unlike aluminum, does not require exterior treatment or cladding as does aluminum. A titanium airplane could well possess inherent longevity beyond that of an aluminum airplane if designed to the same strength criteria. The freedom from corrosion for titanium decreases somewhat at elevated temperatures, but it is still superior to other possible airplane structural materials.

It is an interesting idea that a titanium DC-8, if designed to the same strength conditions as the original aluminum structure, could have an operating life expectancy much greater than today's DC-8. For the ongoing CFM56 re-engine program this could have been most attractive. Such economic value from longer life expectancy could well become an important consideration in future subsonic aircraft sales.

- o In the 1971 U.S. SST, a titanium alloy Ti 6-4, 6 parts vanadium and 4 parts aluminum, was selected after Ti 8-1-1 was found to have a salt stress corrosion susceptibility at elevated temperature. MDC has now been advised by a supplier, TIMET, that if sheet widths greater than the standard 91.44 cm (36 in.) are desired (121.92 cm (48 in.) at premium rates) and in continuous rolls, a new alloy must be used, as unacceptable microscopic cracks develop in Ti 6-4. The other excellent properties of Ti 6-4 can be retained if a new alloy is used. The alloy Ti 15-3-3-3 is presently under development on an Air Force contract. For this alloy these microscopic cracks do not form and continuous rolls and wider sheet stock could be possible in the future. The weight and cost advantages to an airplane designer for this extra width and length of stock are substantial and this effort on new alloys needs to be aggressively pursued. Unfortunately, 15-3-3-3 has rapid grain growth at the beta transit temperatures of 773.89°C (1425°F). Its superplastic forming temperature is about 837.78°C (1540°F) and it should be diffusion bonded at about 893.33°C (1640°F). Therefore at these temperatures bad grain growth occurs. Another alloy combining the good properties of both 6-4 and 15-3 is probably required for an AST. At least such an alloy would be more desirable. Because titanium alloys development is so relatively new, the potential of finding a new alloy may be excellent (Figure 9).

MATERIAL COST CONSIDERATIONS

Raw Material Costs

For many years, the sponge price of titanium has been five times as expensive as aluminum, \$2.76/kg (\$1.25/lb) compared to 55¢/kg (25¢/lb) (Figure 10). In 1973, when the price of oil quadrupled, both aluminum ingot and titanium sponge prices were increased rapidly. The latest prices, for early 1979, show that titanium has escalated 250 percent from 1973, slightly faster than aluminum at 210 percent. This averages out to be 18 percent per

year and 16 percent per year, respectively. Needless to say, if such cost increases continue, the ability to sell new airplanes as compared to modifying older designs will be made more difficult. It is possible, as airplanes get more expensive, that pressure could develop to design for a 30 year lifetime rather than the 20 years used today. This would make titanium look more attractive.

To turn the titanium sponge into mill products is costly and this too has escalated in recent years. Plate is cheaper than sheet and both are cheaper than forgings (Figure 11). Sheet prices are seriously affected by the thicknesses required and this poses a problem to the designer. The typical cost variations for sheet materials are large and varied in 1976 prices from \$26.46/kg (\$12/lb) for 0.23 cm (0.090 in.) thickness to \$41.89/kg (\$19/lb) for 0.08 cm (0.030 in.) thickness. With aluminum sheet then at \$2.87/kg (\$1.30/lb), the challenge for titanium to be cost competitive is great. Some typical prices for 1979 are about 50 percent higher than these 1976 levels (Figure 12). Fortunately, raw material cost is only part, and a small part at that, of the total cost of an airplane structure.

Manufacturing Costs

Titanium is difficult to machine. Aluminum is easy to machine. Where metal removal rates of 420 cm³/min (30 in³/min) are common for aluminum, 42 cm³/min (3 in³/min) are more typical for titanium, like steels. Cutting rates for titanium sheet have been limited to 0.76 m/min or 1.02 m/min (30 in./min or 40 in./min) as compared to 15.24 m/min (600 in./min) or more for aluminum. However, recently, using lasers which work well in non-temperature-conductive titanium but poorly in conductive aluminum, cutting rates for titanium have been increased to as high as 15.24 m/min (600 in./min) with excellent results.

Because aluminum is easier to work than titanium, the buy-to-fly ratio that has resulted in industry is far different for the two. In aluminum, 10 to 20 times as much material is bought as is used in the finished part. With the expense of titanium stock, this ratio is held to 3 to 5 and, in the case of large forgings, can approach 2.0. Thus, much of the raw material cost differential is overcome for titanium today as compared to aluminum (Figure 13).

Using 1971 U.S. SST state-of-art for titanium as compared to aluminum, the manufacturing costs tend to break out as follows:

- o LABOR - titanium 1.68 times aluminum
- o TOOLING - titanium 1.63 times aluminum
- o MATERIAL - titanium 2.17 times aluminum

This is changing. Advanced technology developments are making great strides in reducing the manufacturing cost of titanium as compared to today's standards. Hot isostatic pressing (HIP) results look very promising with

cost savings of 39 percent. Isothermal forging, as validated in the Air Force BLATS (Built-Up Low Cost Advanced Titanium Structures) program carried out at McDonnell Aircraft, shows a 29 percent total cost savings compared to existing methods (Figure 14). And the superplastic forming co-diffusion bonding (SPF/DB) shows total cost savings of from 48 percent to as high as 64 percent for the MDC AST sandwich shown later. These are outstanding developments and are deserving to be labeled "significant breakthroughs." But these research results don't mean immediate application.

Titanium usage has now been perfected in the laboratory or on small specimens, showing that titanium usage can be economically competitive. The high cost material can be offset by the significant reduction in the fly-to-buy ratio. The expensive manufacturing costs of material removal, drilling, and machining to titanium can now be shown to be offset by the SPF/DB honeycomb designs. What was both labor and capital intensive has become low cost. The high assembly costs of many structures can now be shown to be greatly reduced by the use of SPF/DB honeycomb structures.

The industry is in serious need of major large structural validation test programs, maybe even a flight test article, to validate the weight and total cost estimates shown for these advanced titanium technologies, especially for SPF/DB sandwich titanium. The challenges would be exciting and the rewards commensurate with our vision. Here is an opportunity where Government support of technology validation could pay off manyfold to the U.S. And the spinoffs to society in innumerable other areas such as boats, salt water installations, or plumbing could be huge.

ENERGY CONSIDERATIONS

Comparison of the total energy required to make the raw materials required for an aluminum airplane structure and a titanium one is a timely matter. It may seriously affect future prices. Titanium does require twice as much energy per unit weight to produce than does aluminum (Figure 15). Even so, this is more than offset by the advantageous buy-to-fly ratio for titanium as compared to the very large buy-to-fly ratio used today for aluminum parts. Consequently, it does take less energy to make the raw material required to end up with a 0.45 kg (1 lb) titanium part than it does to end up with a 0.45 kg (1 lb) aluminum part.

A big difference exists between aluminum and titanium basic materials costs, with titanium roughly five times as expensive per unit weight. Nonetheless, inherent in this cost is the cost of the energy required to process each metal. For aluminum, somewhere around 20% of the cost is to cover the energy required during production of the basic material. In titanium, this is only about 4 to 5%. Titanium should, therefore, be less sensitive to future increases in energy costs than would be aluminum, other factors being equal. This may be very important in the future regarding designers' attempts to predict costs.

Comparisons of an AST and a wide body subsonic design show interesting results regarding the energy required to produce the material. When the buy-to-fly ratio is included (Figure 16), then the energy required to make the large amount of aluminum metal purchased for the wide body aircraft more than offsets the higher energy required per unit weight for the titanium for an AST, as long as titanium retains a low average buy-to-fly ratio. All the advanced technologies being studied today for titanium seem to be directed towards making this buy-to-fly ratio even lower than the values assumed here. It is interesting that an advanced technology titanium supersonic transport can actually require less total energy (7.7 million kilowatt hours) to produce the material than is required today for a typical wide-bodied subsonic design (9.4 million kilowatt hours).

TITANIUM SUPPLY AND DEMAND

Recent testimony to a Congressional Committee by the President of TIMET contained some interesting data regarding titanium, including some forecasts for the future (Figure 17). Titanium has been frequently in the limelight in recent months. It is newsworthy. Unfortunately, it is very difficult to separate out the relevant facts on supply and demand, especially since it is a competitive industry, and internationally competitive as well (Figure 18). What seems to be known is the following. Four companies in the U.S. left the sponge production business in the early 1960's. In England, the I.C.I. plant is to be closed in 1982; however, recent announcements indicate a desire to establish a new sponge production facility to support Rolls-Royce and the U.K. is reportedly looking for a U.S. partner. The French are exploring starting up a sponge plant in cooperation with the Germans. In the U.S., R.M.I. and Oremet have announced plans for expansion of sponge production and TIMET testified that it has the potential for some expansion. The Oremet plant has just recently come back on line following a major fire. Dow Chemical and Howmet have announced the formation of a new company to produce sponge and possibly mill products with production possible by 1984 or 1985.

There is no question that the titanium sponge and mill product industry was badly impacted by the cancellation of the U.S. titanium SST in 1971 after building new facilities to handle the anticipated titanium demand. This left an unused capacity for titanium producers and only recently has demand grown to match, or even exceed, supply. Unfortunately, no margin exists today and the future looks bleak if new facilities are not developed immediately.

The reduction in U.S. imports occasioned by the Russians reducing the supply available from 6.26 Gg (6897 tons) in 1974 to a modest 0.91 Gg (1000 tons) estimated for 1979 has been significant. The U.K. is no longer a supplier to the U.S., and from Japan, U.S. imports for 1979 are projected at 3.63 Gg (4000 tons). The criticality of the U.S. sponge supply in 1979 has occasioned some 2.72 Gg (6,000,000 lb) of scrap to be imported to the U.S. and reports are that the suppliers are recycling 19 percent more scrap than ever before. Still, demand exceeds supply.

How close to reality will be the TIMET forecasts for mill products requirements for 1980, 1981 and 1982 remains to be seen. This will have much to do with what kind of price changes occur during these years. As far as Douglas is concerned, these demand forecasts do not take into consideration the present production rates of civil aircraft, with their forecast for DC-9 titanium demand being less than Douglas is presently delivering. Douglas presently has a short-fall of 0.11 Gg (250,000 lb) for calendar year 1980 and purchase orders go begging. Substitutions for titanium parts is the only solution available and this does not help the titanium experience needed to enable building an all titanium AST. There can be little question but that titanium supply and demand will be out of balance for the present and near future with price escalation out of step with basic costs. Titanium should have low price escalation if the supply is increased adequately to meet the predicted growth in demand. There is little question but that supply and demand are critically close for the present and near future.

RESULTS AND DISCUSSIONS

Titanium Applied to An AST

In order to evaluate the impact of a titanium AST on the U.S. titanium industry, assumptions need to be made regarding AST markets, delivery dates, and delivery rates. Studies at MDC done recently for NASA and for internal planning of future airline needs have been described. A typical subsonic commercial transport schedule is superimposed on these market demand estimates (Figure 19). The subsonic transport rate selected might be considered typical for an AST as it represented initially an airplane for which there was no competition, an expensive commitment for the airlines, and one which was to be used on their prime competitive intercontinental routes. The first two years show that a very large number of airplanes, 150, are required to satisfy the airline competitive pressures. That would be 75 airplanes per year.

The new technologies for titanium described earlier are assumed to be validated for this example. The reductions in labor and materials, buy-to-fly ratios, and total manufacturing costs are all assumed to be validated as well. A titanium structure is assumed to remain optimum for this 2.2 Mach number MDC AST, and the results show why titanium SPF/DB honeycomb structures look so promising and need validation testing. With titanium SPF/DB honeycomb, the airplane price is reduced \$10 million, or 9 percent (Figure 20), as compared to the 1971 U.S. titanium state-of-the-art proposed for the last U.S. SST. This would cause the direct operating cost per seat mile to be reduced 6.5 percent, a most significant item, one that repeats itself every day over the twenty year (or thirty?) life of each AST (Figure 21). This operating cost reduction for titanium SPF/DB honeycomb looks especially attractive.

If the advanced technologies, such as SPF/DB sandwich, are validated, then this AST requirement for 75 aircraft in one year equates to about 10.43 Gg (23,000,000 lb) of titanium per year, a 50 percent increase over today's U.S. industrial capacity. Fortunately, this is much better, by

4.54 Gg (10,000,000 lb) than would have been the case using the technology of the 1971 U.S. titanium SST (Figure 22).

The impact of an AST program on the titanium industry would be substantial. Accordingly, the aerospace industry and Government working together need to keep communication open to see that the supply and demand requirements of titanium are balanced better than they are today.

MDC believes that both the advanced technology developments in titanium and a large increase in the U.S. titanium capacity in sponge and mill products are needed. This will be especially true as other demands of society develop for this "new" material, titanium. The historical ratio of 75 percent of the demand being for aerospace products is already changing as the largest supplier is now reporting 50 percent of its sales being for non-aerospace products.

CONCLUDING REMARKS

Recent cost escalations for titanium should not be used to forecast applicability of titanium to a future AST or supercruise fighter.

Supplies could be adequate for an AST program if sufficient time is given the titanium industry in order to set up the capital intensive sponge and mill product plants required. The fear remains that the time to develop a new airplane may not be all that much longer than to get a new titanium production plant on line, principally because these companies have been misled before and will be more cautious a second time.

The titanium industry needs to pursue advanced alloy developments to provide wider and longer sheet mill products. They need to keep materials available for unique R&D structural validation programs like a major titanium structural test program or a large structural flight test article for a supersonic cruise vehicle.

The non-aerospace uses seem to be expanding greatly due to the unique abilities of titanium to withstand corrosion, e.g. - water desalination equipment, reactors for chemical processing, electrodes for production of copper and chloride, and tubing for power plant surface - condensers (where 40-year warranties have been offered). Also titanium blades for stream turbines are being looked at to increase output and efficiency through use of larger turbines with longer turbine blades. Such developments must be watched carefully as the demand can grow very rapidly compared to aircraft lead times, with a result that the aerospace industry programs will suffer.

In a recent paper on Periodic Materials Scarcity, Mr. William Swager of Battelle reported that "The history of titanium supplies has shown that shortages have been caused by surges in demand. Prior to the surges, conditions discouraged investment in new domestic sponge capacity, and downstream ingot (and sheet) capacity was built dependent on foreign supplies. When the

surge in demand was recognized, it was too late to add domestic capacity. That's the pattern."

The message therefore is that industry must do several things in order for a titanium AST or a titanium fighter to become realistic potentials.

First, we must decide the real timing for an AST or when titanium would be the best material for a new fighter.

Second, we must recognize that titanium ingot and sheet production will not take care of itself without some guidance.

Third, we must recognize that other societal usages for titanium may grow beyond our estimates and overburden the suppliers.

Lastly, we must communicate, convincingly, our projected requirements to the suppliers.

A titanium AST or supercruiser will not come easily, but making it out of titanium utilizing the latest advanced technologies, especially of SPF/DB sandwich, will be worth all the difficulties. The spinoffs to society from this new technology can be enormous.

REFERENCES

1. Harpur, N. F., British Aerospace: Applications of Titanium. The Chester Beatty Lecture, Aircraft Engr., January 1979.
2. Lynd, L. E., U.S. Bureau of Mines: Titanium in 1978. Journal of Metals, May 1979.
3. Minkler, W. W., TIMET Division of Titanium Metals Corp.: Status of Titanium Sponge Expansion. Journal of Metals, May 1979.
4. Kernan, E. W., Federal Preparedness Agency: A Projection of U.S. Supply and Demand for Titanium Sponge to 1985. G.S.A. U.S. Government, February 1978.
5. Byrne, J. W., TIMET: Titanium Metals Corporation of America Position on H.R. 3591. House Trade Subcommittee Hearings, July 27, 1979.
6. Swager, W. L., Battelle Columbus Lab.: Periodic Materials Scarcity: Our National De Facto Materials Policy. Aerospace Technical Council of the Aerospace Industries Association, April 18, 1979.

ACKNOWLEDGEMENTS

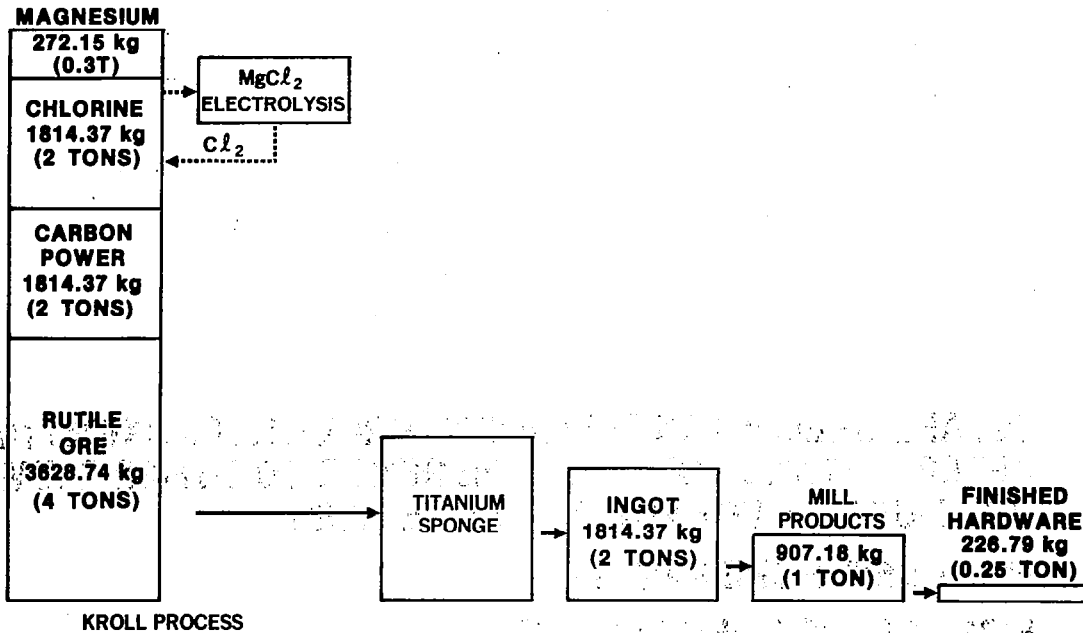
A great deal of credit must be given to Mr. Ken Carline who did much of the early research for this paper and to Mr. Wayne Reinsch of TIMET who assisted in critiquing the final draft.

- 1791 ESTABLISHED AS AN ELEMENT (THROUGH ITS OXIDE) NAMED AFTER "TITANS" DUE TO ADHERENCE TO OTHER ELEMENTS, NOT DUE TO MECHANICAL PROPERTIES**
- 1895 FIRST 95% PURE SAMPLE**
- 1898 FIRST 99+ % PURE SAMPLE**
- 1940 KROLL METHOD PUBLISHED USING $TiCl_4$ PLUS MAGNESIUM**
- 1948 FIRST ENGINEERING USES (USA, UK, GERMANY)**

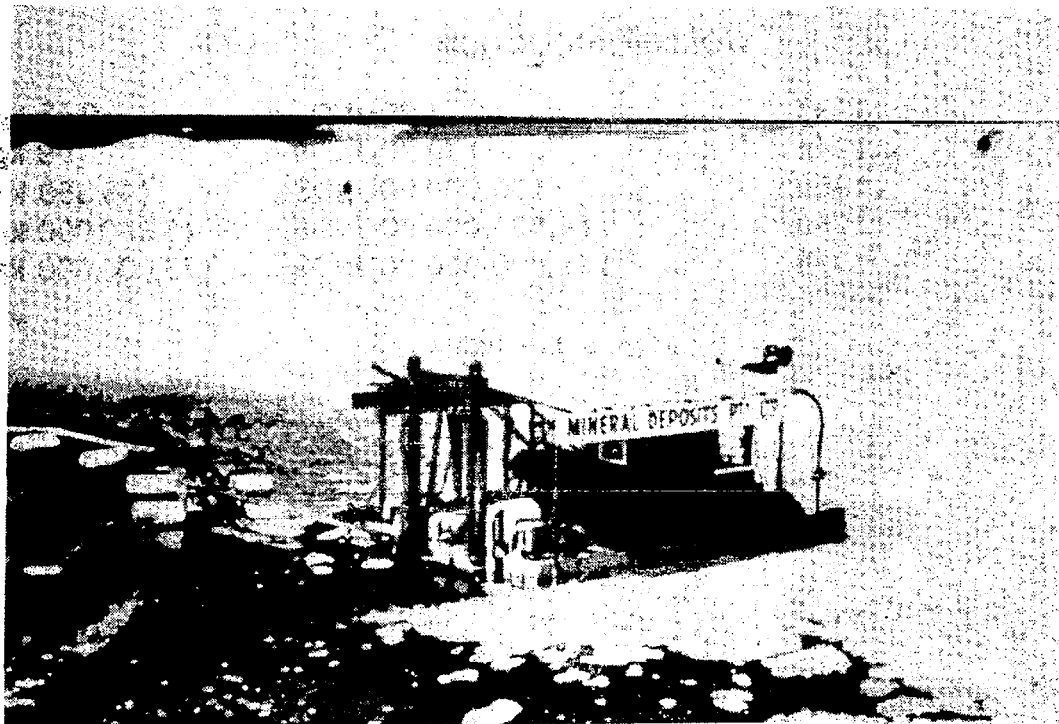
WORLD PRODUCTION

1937	1 POUND	(0.45 kg)
1944	130 POUNDS	(59 kg)
1950	100,000 POUNDS	(45,350 kg)
1960	14,000,000 POUNDS	(6,350,000 kg)
1978	161,000,000 POUNDS	(73,000,000 kg)

Figure 1.- History.



(a) Manufacture and processing of titanium.

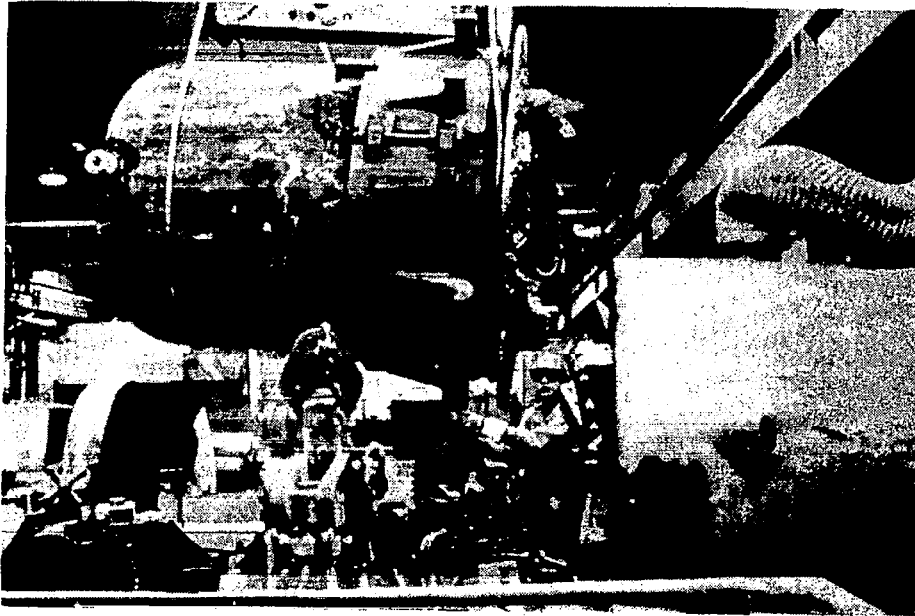


(b) Major source of rutile - Australian sands.

Figure 2.- Production of titanium metal.

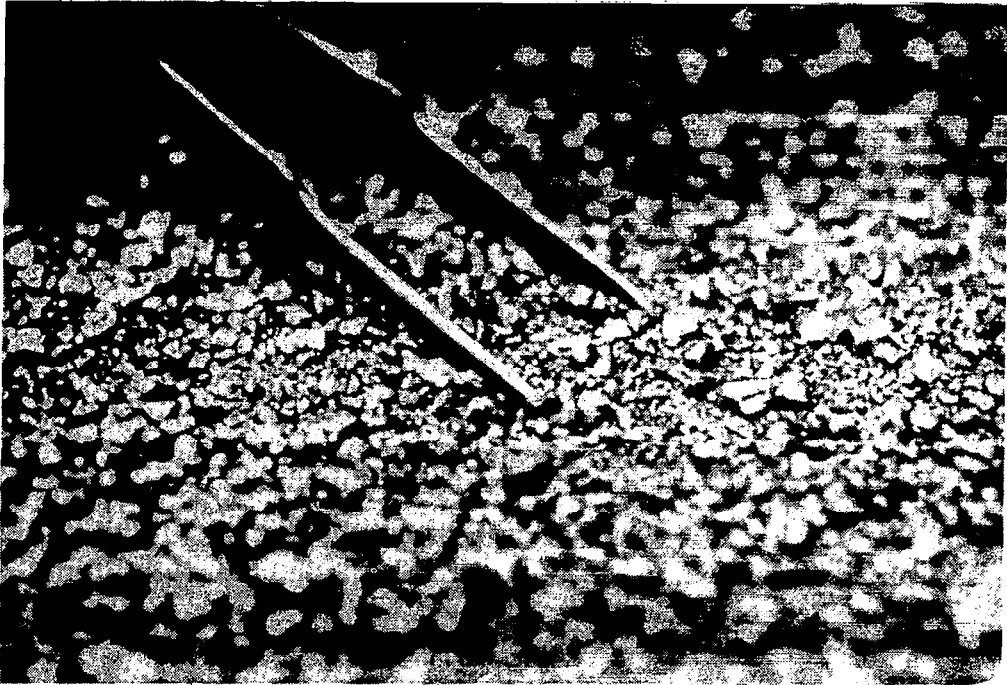


(c) Rutile prior to chlorination.

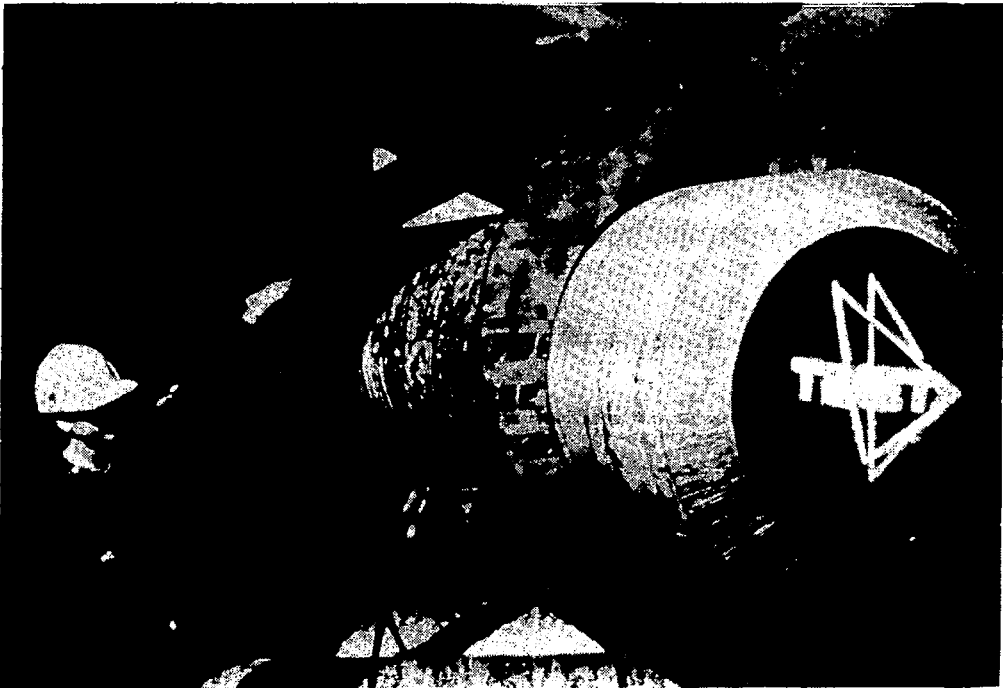


(d) Titanium sponge in reactor (after reduction of $TiCl_4$ with magnesium).

Figure 2.- Continued.



(e) Sponge after crushing to gravel size.



(f) 6803.89 kg (15,000 lb) titanium ingot.

Figure 2.- Concluded.

RUTILE — OCCURS IN BEACH SANDS (~6% TiO_2)

ILMENITE SLAG — OCCURS IN

SELECTED BEACH SANDS (25% TiO_2)

ROCK DEPOSITS (~20% TiO_2)

FERRUGINOUS ROCKS (~35% TiO_2)

HIGH-ALUMINA CLAY (~5% TiO_2)

COMMON SOIL (0.8% TiO_2)

HIGH-QUALITY RUTILE RESOURCES ARE FOUND MAINLY IN AUSTRALIA, INDIA, AND RUSSIA. U.S. IMPORTS MAINLY FROM AUSTRALIA

ILMENITES ARE USED MOSTLY FOR PAINT

U.S. IMPORTS 93% OF ITS RUTILE AND 23% OF ITS ILMENITE

Figure 3.- Main sources of titanium ore.

TITANIUM IS THE FOURTH MOST ABUNDANT STRUCTURAL METAL

TITANIUM IS THE NINTH MOST ABUNDANT ELEMENT

SILVERY-GRAY, NONMAGNETIC METAL WITH STRENGTH EQUAL TO STEEL AND ABOUT HALF THE DENSITY OF STEEL

ABOUT 90 PERCENT OF THE ORE IS FOR PAINT: 10 PERCENT FOR SPONGE (METAL)

ABOUT 75 PERCENT OF THE SPONGE PRODUCED IS FOR AEROSPACE

KNOWN WORLD RESOURCES OF RUTILE FROM WHICH SPONGE IS PRODUCED TOTAL OVER 199.6 Tg(220 million tons)

Figure 4.- Some facts about titanium.

Ti MELTING POINT — 3033°F (1670°C)

(LBf IN./LB x 10⁻⁶) Nm/kg x 10⁻⁶

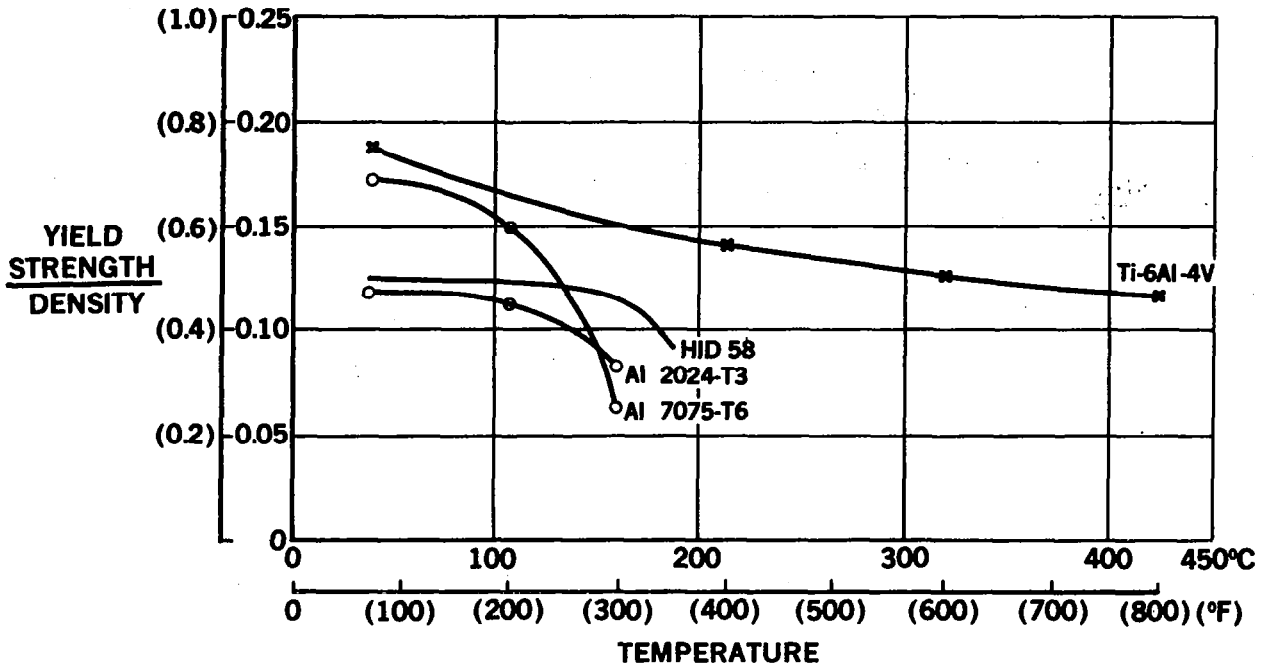
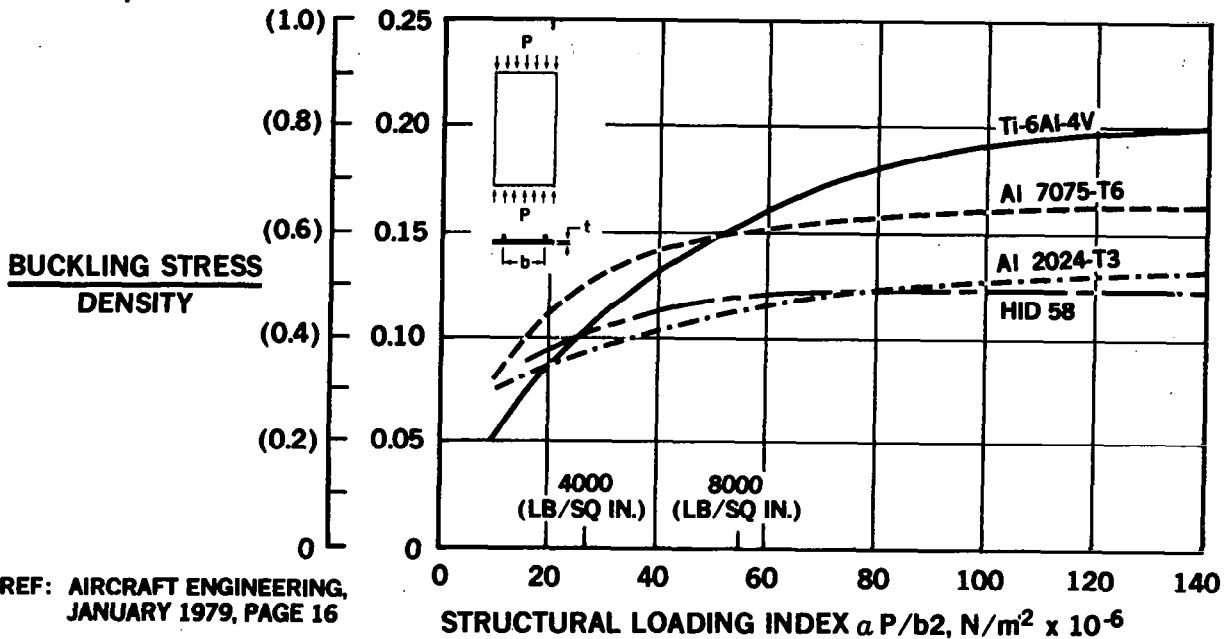


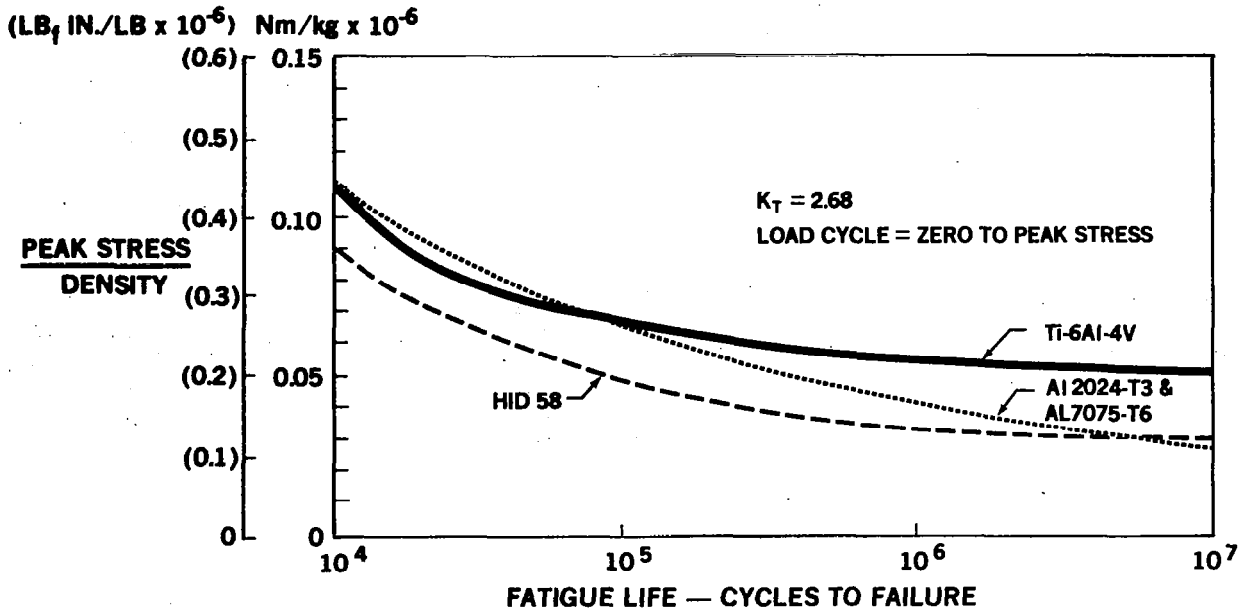
Figure 5.- Specific strength - titanium.

(LB_f IN./LB x 10⁻⁶) Nm/kg x 10⁻⁶



REF: AIRCRAFT ENGINEERING, JANUARY 1979, PAGE 16

Figure 6.- Titanium is better for panel buckling.



REF: AIRCRAFT ENGINEERING, JANUARY 1979, PAGE 17

Figure 7.- Titanium better for fatigue.

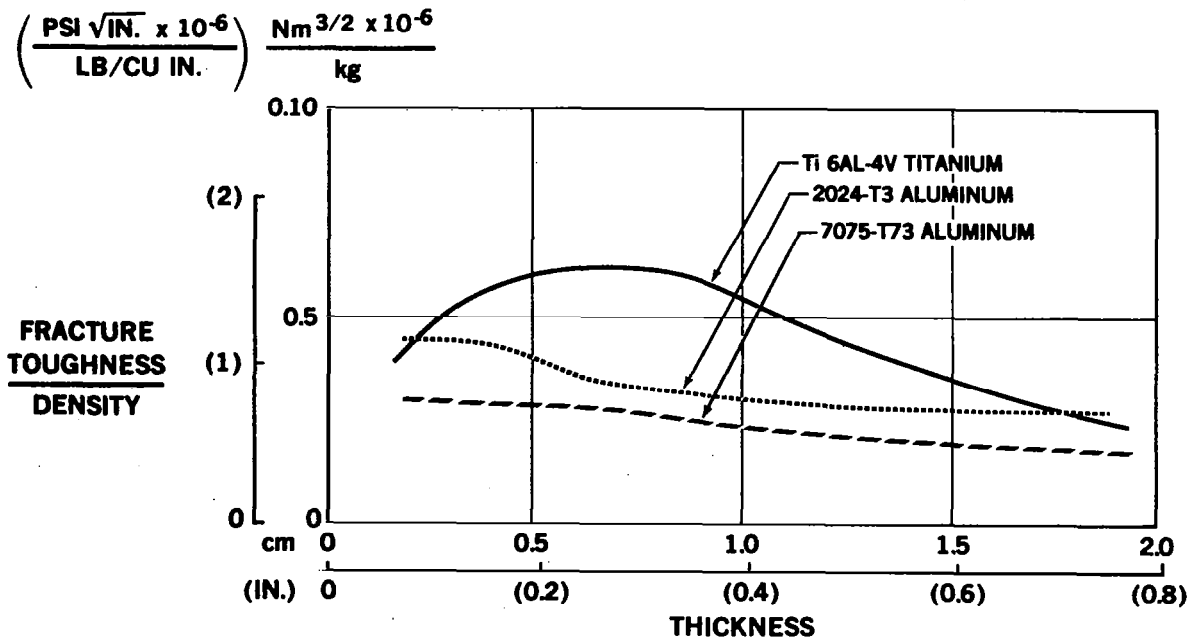
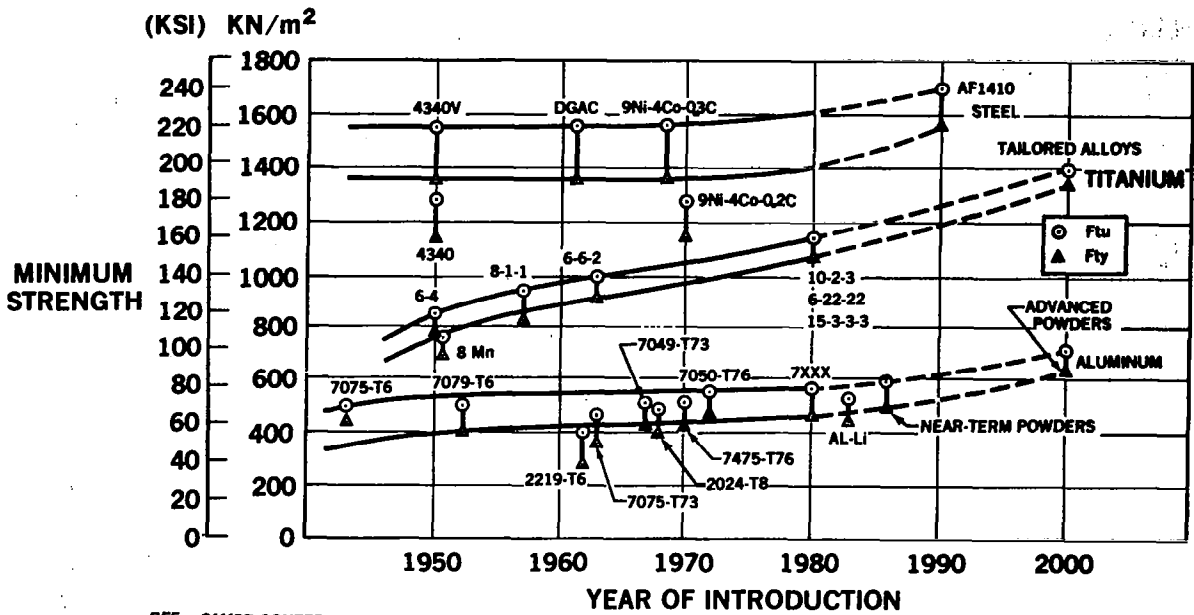


Figure 8.- Fracture toughness.



REF: SAMPE CONFERENCE PAPER, OCTOBER 1978, PRESENT AND FUTURE DEVELOPMENTS IN AEROSPACE MATERIALS AND STRUCTURES, CA PAEZ

Figure 9.- Titanium - Future development potential.

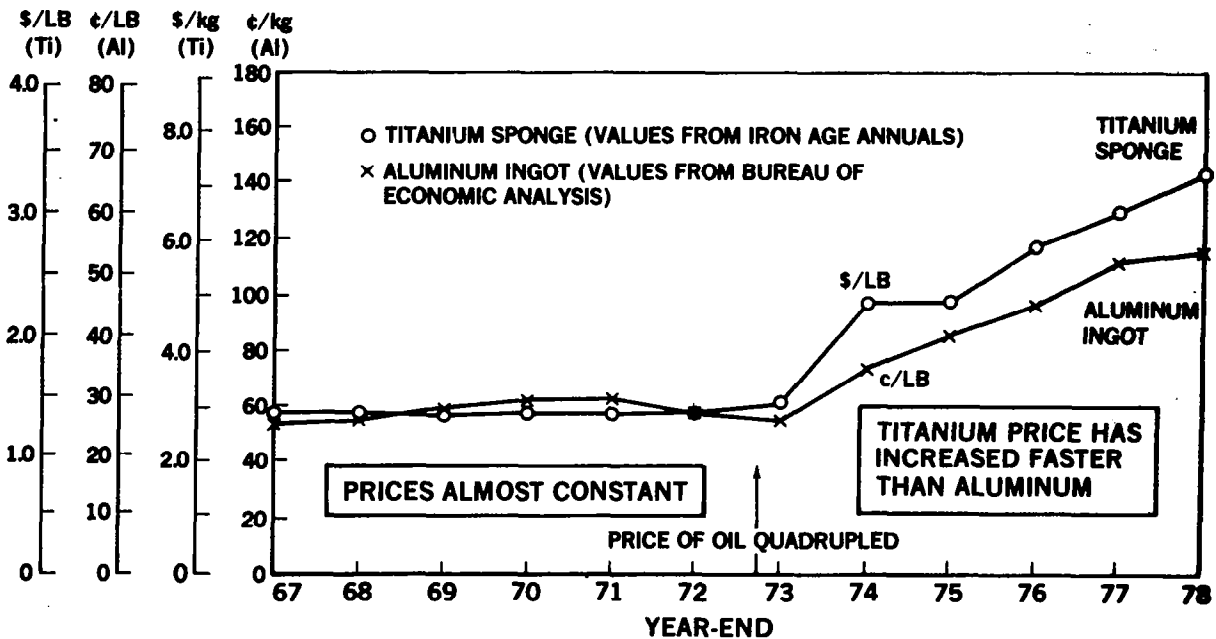


Figure 10.- Prices of titanium and aluminum.

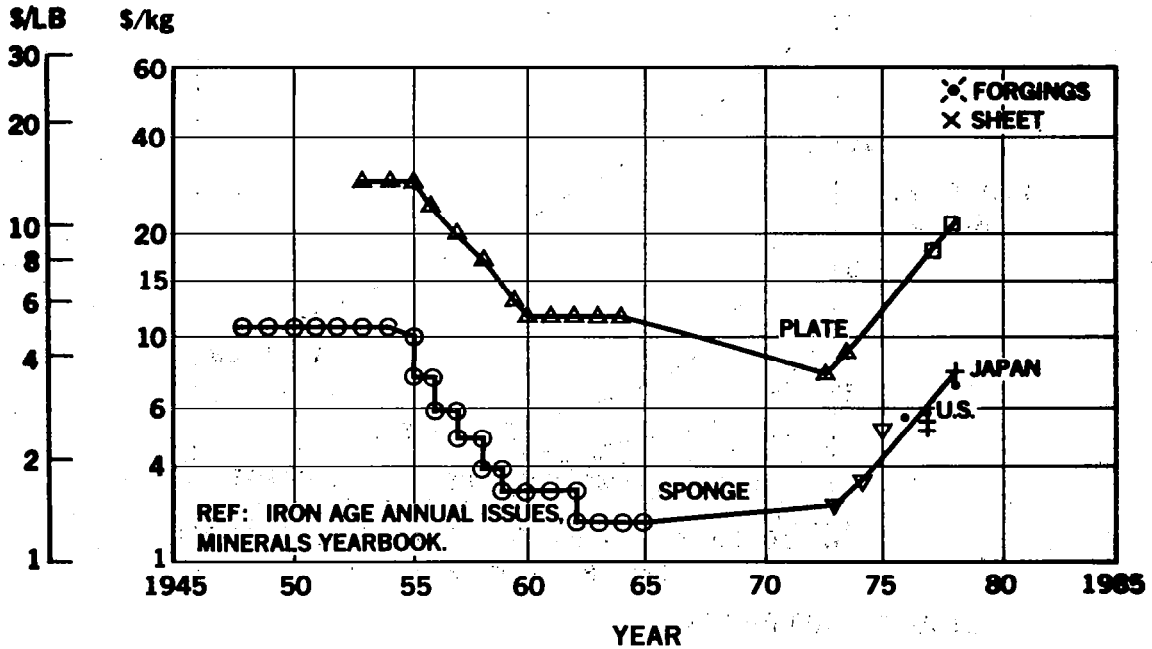


Figure 11.- Relative prices of titanium sponge and plate.

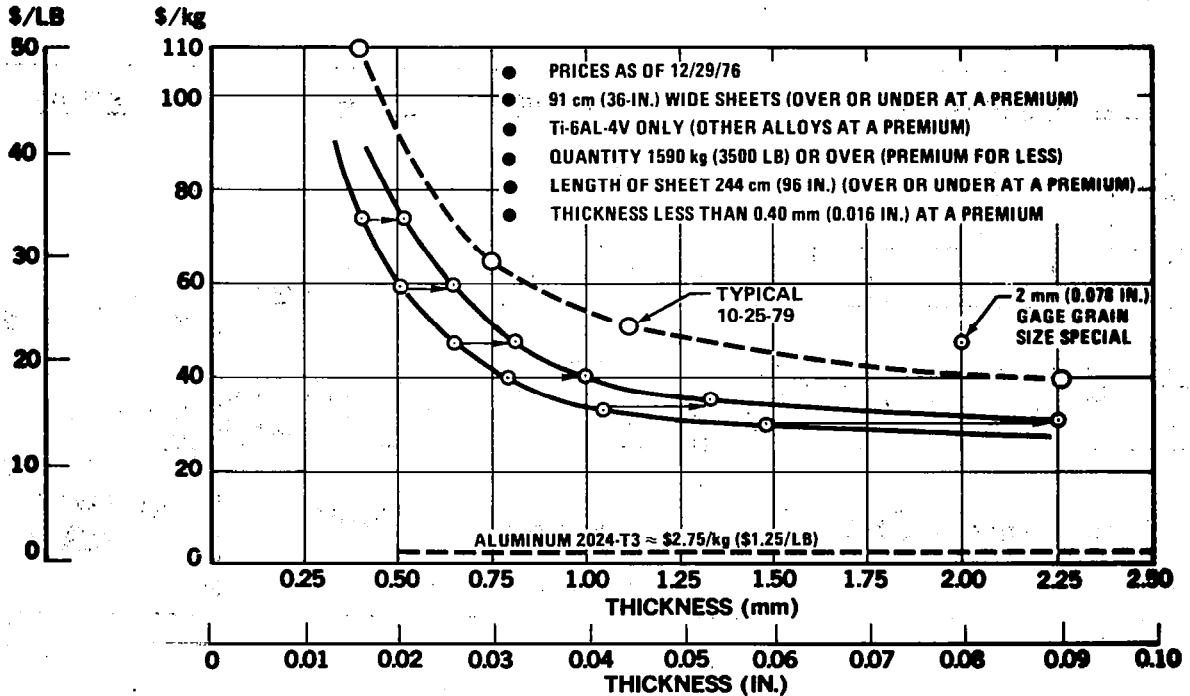
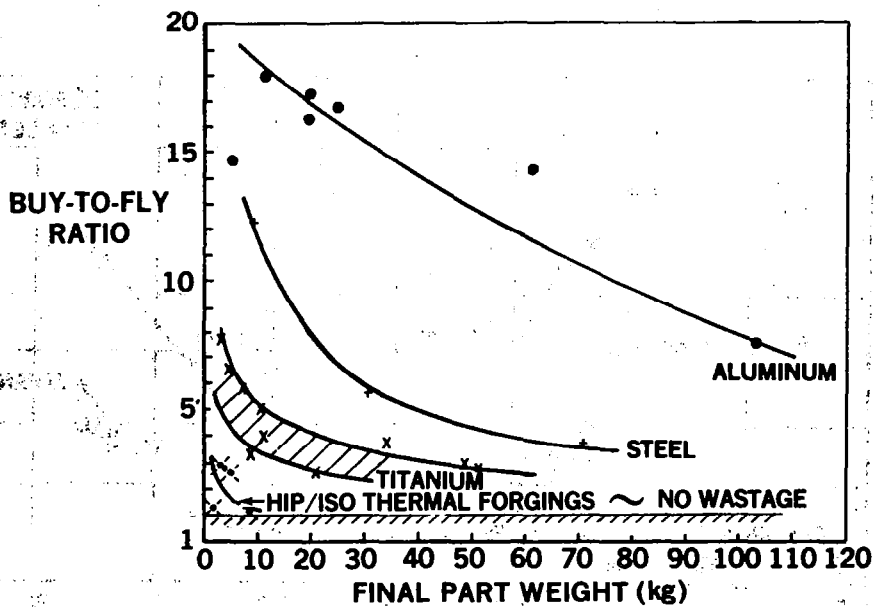


Figure 12.- Cost of titanium sheet-strip material.



INDUSTRY AVERAGES

Figure 13.- Buy-to-fly ratio for machined billets and forgings.

<u>HOT ISOSTATIC PRESSING</u>	<u>ISOTHERMAL FORGING</u>	<u>SPF/DB</u>						
<ul style="list-style-type: none"> ● ITEM: F-14A FUSELAGE BRACE ● COSTS BASED ON 176 AIRCRAFT 	<ul style="list-style-type: none"> ● ITEM: F-15 FUSELAGE LINK ● COSTS BASED ON 500 AIRCRAFT 	<ul style="list-style-type: none"> ● B-1 UPPER NACELLE DECK ● COSTS BASED ON 241 AIRCRAFT 						
1. EXISTING	1. EXISTING	1. EXISTING						
<table border="1"> <tr> <td>RAW FORGING = 2.8 kg (6.2 lb) COST = \$130</td> <td>MACHINING COSTS = \$270</td> <td>FINAL PART = 0.7 kg (1.5 lb) COST = \$400</td> </tr> </table>	RAW FORGING = 2.8 kg (6.2 lb) COST = \$130	MACHINING COSTS = \$270	FINAL PART = 0.7 kg (1.5 lb) COST = \$400	<table border="1"> <tr> <td>FORGINGS COST = \$1.2 MILLION</td> <td>MACHINING COST = \$1.1 MILLION</td> <td>TOTAL COST = \$2.3M</td> </tr> </table>	FORGINGS COST = \$1.2 MILLION	MACHINING COST = \$1.1 MILLION	TOTAL COST = \$2.3M	<ul style="list-style-type: none"> ● 680 PARTS ● 9940 FASTENERS ● 400 TOOLS ● 299 kg (660 lb) WEIGHT ● ASSEMBLY COST = \$295K
RAW FORGING = 2.8 kg (6.2 lb) COST = \$130	MACHINING COSTS = \$270	FINAL PART = 0.7 kg (1.5 lb) COST = \$400						
FORGINGS COST = \$1.2 MILLION	MACHINING COST = \$1.1 MILLION	TOTAL COST = \$2.3M						
2. HOT ISOSTATIC PRESSING	2. ISOTHERMAL FORGING	2. SPF DB						
<table border="1"> <tr> <td>NEAR NET SHAPE = 0.9 kg (1.9 lb) COST = \$200</td> <td>MACHINING COSTS = \$45</td> <td>FINAL PART = 0.7 kg (1.5 lb) COST = \$245</td> </tr> </table>	NEAR NET SHAPE = 0.9 kg (1.9 lb) COST = \$200	MACHINING COSTS = \$45	FINAL PART = 0.7 kg (1.5 lb) COST = \$245	<table border="1"> <tr> <td>FORGING = 7.3 kg (16 lb) COST = \$1.3 MILLION</td> <td>TOOLING AND MACHINING COST = \$0.32 MILLION</td> <td>TOTAL COST = \$1.6M</td> </tr> </table>	FORGING = 7.3 kg (16 lb) COST = \$1.3 MILLION	TOOLING AND MACHINING COST = \$0.32 MILLION	TOTAL COST = \$1.6M	<ul style="list-style-type: none"> ● 84 PARTS ● 1112 FASTENERS ● 100 TOOLS ● 163 kg (360 lb) WEIGHT ● ASSEMBLY COST = \$155K
NEAR NET SHAPE = 0.9 kg (1.9 lb) COST = \$200	MACHINING COSTS = \$45	FINAL PART = 0.7 kg (1.5 lb) COST = \$245						
FORGING = 7.3 kg (16 lb) COST = \$1.3 MILLION	TOOLING AND MACHINING COST = \$0.32 MILLION	TOTAL COST = \$1.6M						
COST SAVINGS = 39%	COST SAVINGS = 29%	COST SAVINGS = 48%						
REF GRUMMAN	REF MCDONNELL DOUGLAS, ST. LOUIS	REF ROCKWELL						

Figure 14.- Cost savings using new technology.

<u>MATERIAL</u>	<u>BASIC PRICE \$/Mg (\$/TON)</u>	<u>ENERGY KWH/Mg (KWH/TON)</u>	<u>ENERGY COST \$/Mg (\$/TON)</u>	<u>ENERGY SHARE OF BASIC PRICE (PERCENT)</u>
ALUMINUM	3,307 (3,000)	26,456 (24,000)	639 (580)	20
TITANIUM	26,456 (24,000)	52,911 (48,000)	1058 (960)	4

Figure 15.- Sensitivity of material cost to energy costs - estimates.

AIRCRAFT TYPE	MATERIAL	PERCENT	WEIGHT IN STRUCTURE* LB (kg)	BUY/FLY***	WEIGHT OF MATERIAL BOUGHT LB (kg)	ENERGY REQUIRED TO PRODUCE MATERIAL (KWH)
TYPICAL WIDE-BODY SUBSONIC DESIGN	ALUMINUM	87.5	120,770 (54,780)	5.8	700,466 (317,661)	8.41 x 10 ⁶
	STEEL	4.0	5,500 (2,495)	7.0	38,500 (17,460)	0.13 x 10 ⁶
	TITANIUM	5.5	7,590 (3,442)	4.0	30,360 (13,768)	0.73 x 10 ⁶
	OTHER	3.0	4,140 (1,887)	2.0	8,280 (3,755)	0.10 x 10 ⁶
	TOTAL	100.0	138,000 (62,604)			9.37 x 10 ⁶
AST	ALUMINUM	14.0	20,104 (9,117)	5.8	116,603 (52,879)	1.40 x 10 ⁶
	STEEL	5.0	7,180 (3,256)	7.0	50,260 (22,793)	0.18 x 10 ⁶
	TITANIUM	78.0	112,003 (50,793)	2.26	253,138 (114,798)	6.08 x 10 ⁶ (9.11)**
	OTHER	3.0	4,308 (1,950)	2.0	8,616 (3,907)	0.11 x 10 ⁶
	TOTAL	100.0	143,600 (65,216)			7.71 x 10 ⁶ (10.8)**

*EXCLUDES LANDING GEAR

** ALUMINUM BRAZED TITANIUM TECHNOLOGY (1971).

*** ASSUMED INDUSTRY AVERAGES

Figure 16.- Titanium technology advancements save energy.

1979-1981
(LB (kg) — MILLIONS)

	1979		1980		1981	
USA						
TIMET	26.0	(11.8)	27.0	(12.2)	28.0	(12.7)
RMI	15.0	(6.8)	18.0	(8.2)	18.0	(8.2)
OREMET	5.0	(2.3)	5.0	(2.3)	6.5	(2.9)
DOMESTIC TOTAL	46.0	(20.9)	50.0	(22.7)	52.5	(23.8)
UK	4.0	(1.8)	8.0	(3.6)	8.0	(3.6)
JAPAN	25.2	(11.4)	30.5	(13.8)	30.5	(13.8)
FREE WORLD TOTAL	75.2	(34.1)	88.5	(40.1)	91.0	(41.2)
USSR*	77.2	(35.0)	92.6	(42.0)	92.6	(42.0)
WORLD TOTAL	152.4	(69.1)	181.1	(82.1)	183.6	(83.2)

*NOT NOW EXPORTING TO WEST

Figure 17.- USA and world titanium sponge supply (TIMET estimates).

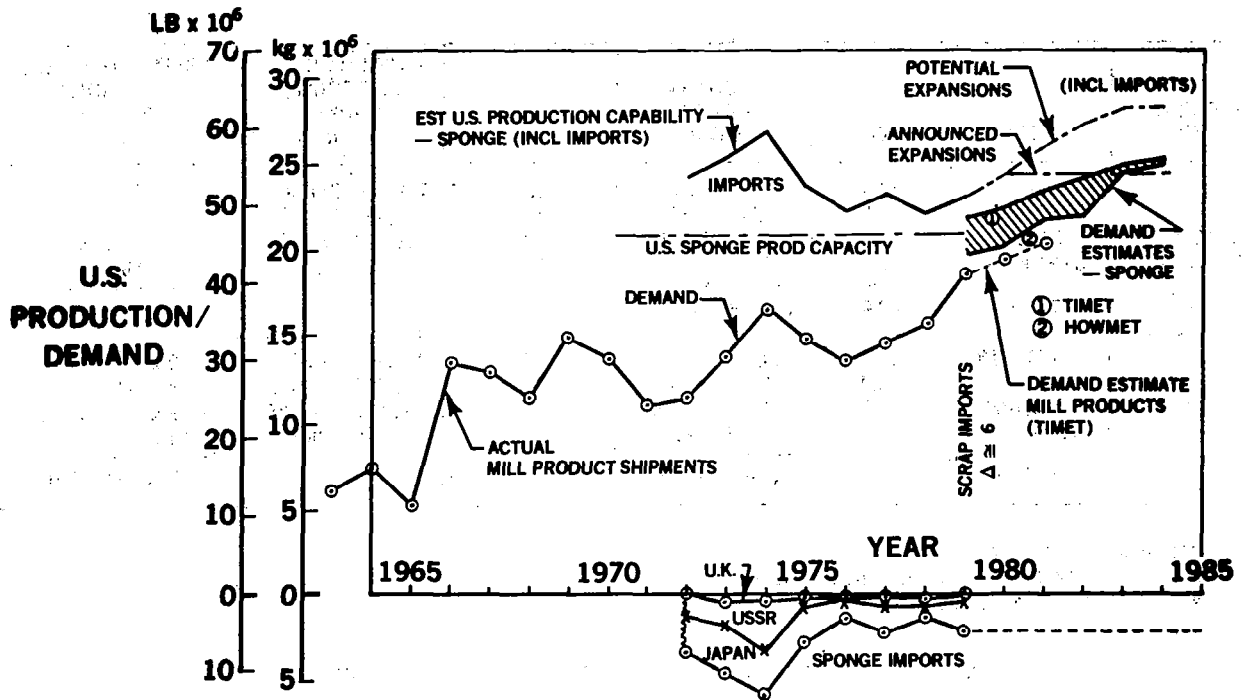


Figure 18.- U.S. titanium capabilities.

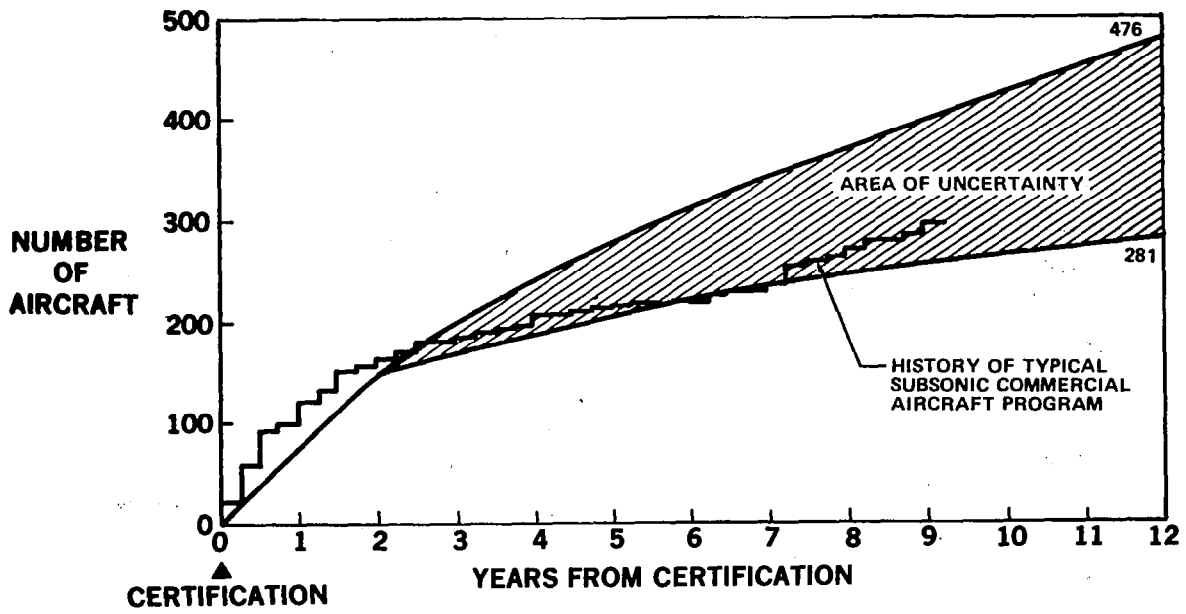


Figure 19.- AST market buildup.

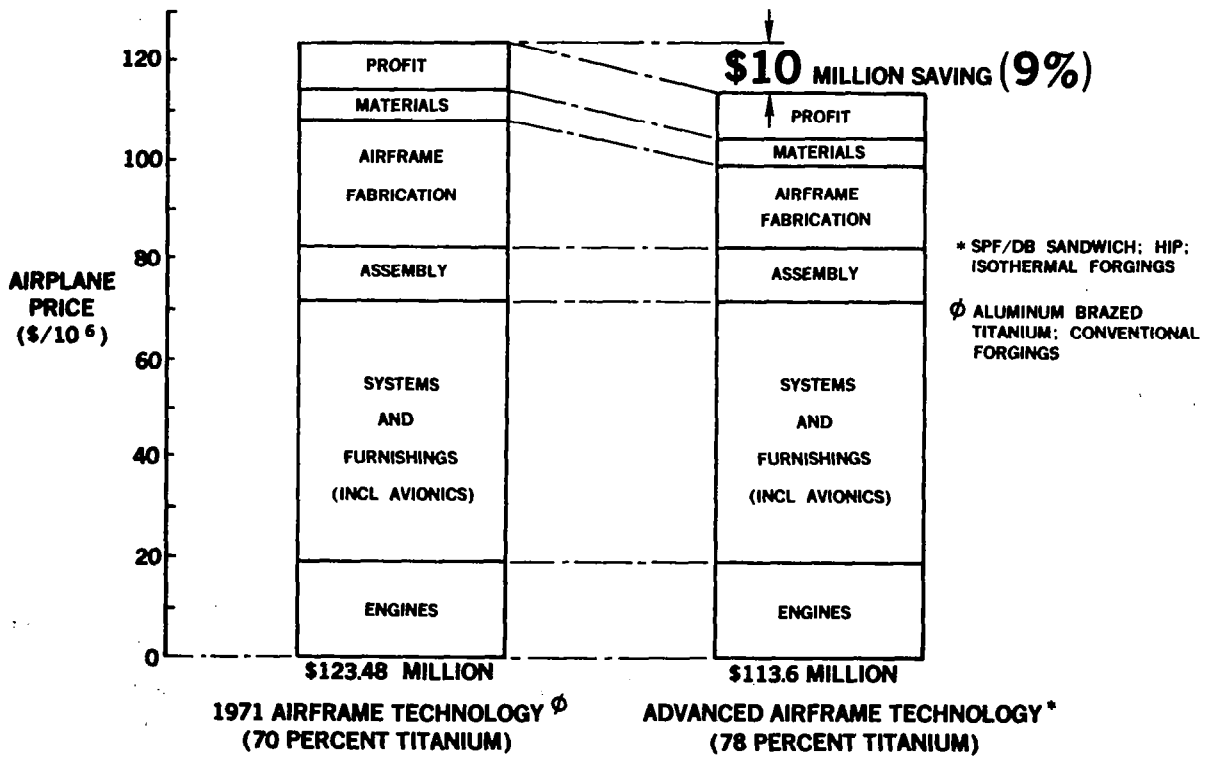


Figure 20.- Reduction of AST price with technology.

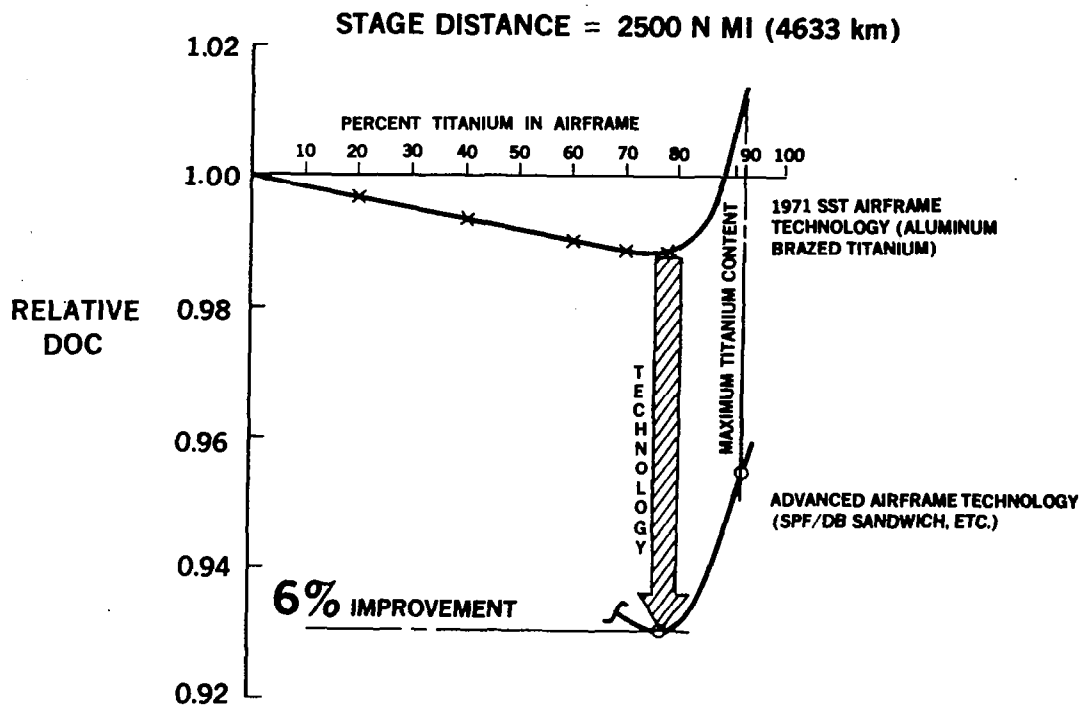


Figure 21.- Titanium advancements reduce operating costs.

(75 AIRCRAFT IN ONE YEAR)

		LB/YR	(kg/YR)
<u>AIRFRAME (EXISTING TECHNOLOGY)</u>			
TITANIUM SHEET AND PLATE	= 75,045 x 2.6 x 75	= 14,633,775	(6,637,769)
TITANIUM FORGINGS	= 36,963 x 5.0 x 75	= 13,861,125	(6,287,301)
TOTAL		= 28,494,900	(12,925,070)
<u>AIRFRAME (USING SPF/DB, HIP, ETC.)</u>			
TITANIUM SHEET AND PLATE	= 75,045 x 1.9 x 75	= 10,693,912	(4,850,677)
TITANIUM FORGINGS	= 36,963 x 3.0 x 75	= 8,316,675	(3,772,380)
TOTAL		= 19,010,587	(8,623,057)
<u>ENGINES (EXISTING TECHNOLOGY)</u>			
40 PERCENT TITANIUM CONTENT	= 0.4 x 12,000 x 4 x 4 x 75	= 5,160,000	(2,340,537)
<u>ENGINES (NEW TECHNOLOGY)</u>			
40 PERCENT TITANIUM CONTENT	= 0.4 x 12,000 x 4 x 3 x 75	= 4,320,000	(1,959,519)
TOTAL REQUIREMENT (OLD TECH)		= 33,654,900	(15,265,605)
TOTAL REQUIREMENT (NEW TECH)		= 23,330,587	(10,582,554)
SAVINGS WITH TECHNOLOGY		= 10,324,313	(4,683,051)

Figure 22.- AST titanium requirements.

SESSION VI - SYSTEMS INTEGRATION AND ECONOMICS

INTRODUCTORY REMARKS

G. G. Kayten
NASA Headquarters

We now begin the final session of the SCR '79 Conference, covering "Systems Integration and Economics." We have spent almost three days reviewing progress in the technical disciplines critical to supersonic cruise. It is apparent that important advances have been made - and are still being made - in low-speed and high-speed aerodynamics, in structural design and technology, in variable-cycle engine technology and its application to supersonic cruise aircraft design, and in improved environmental effects. It is somewhat less apparent where all of this progress is leading.

Some of the technical advances will eventually be utilized in military applications. Some will possibly appear in supersonic business jet aircraft. But the primary objective of the SCR program has been, and still is, to make possible the development of economically successful and environmentally acceptable advanced supersonic transports. To this end, a key element of the program since its inception has been a series of systems integration studies and economic analyses conducted by the major industrial participants.

These studies have provided mechanisms for investigating the application of the technologies to practical designs, testing and evaluating them against real-world criteria, and assessing their contributions and costs individually and in combination. The studies also serve a second and perhaps more important purpose. When a U.S. advanced supersonic transport materializes, it will not be as the result of technologists' enthusiasm, or national determination, or congressional action - although all of those are necessary ingredients. It will come about because corporate decisionmakers and the financial community are finally convinced that production and operation of the advanced supersonic transport can be sufficiently profitable ventures. So the integration studies, the economic analyses, and the market analyses constitute "howgozit" reports for us and for the industry, and serve as indicators of how close we are to the point at which favorable development decisions would be justified.

I think these final ten papers will demonstrate that, at the very least, we are certainly progressing toward this point, and that the recent progress provides even the conservative observer with a reasonable basis for optimism.

The session starts with three very significant introductory papers. One is a summary of Concorde operations to date. The only supersonic aircraft in airline service, Concorde offers the first actual test of supersonic cruise feasibility and the only real experience relative to passenger, airline, and community acceptance. It therefore provides a valuable baseline for our

projections into the future. The second paper presents the results of a recent market survey polling U.S. passenger attitudes and preferences with respect to supersonic air transportation.

The third introductory paper is a summary of the findings presented several weeks ago to the House Science and Technology Committee by the Office of Technology Assessment (OTA). OTA has been conducting for the Congress an assessment of the impact of advanced air transport technology, with particular emphasis on high-speed long-range passenger transportation. Their report will have an important bearing on the congressional action that will be required for any major expansion of NASA SCR activity.

The last seven papers cover the SCR systems studies conducted by the aircraft manufacturers, six addressing the advanced supersonic transport and one reporting on studies of a smaller research/business-jet vehicle.

CONCORDE WITH THE AIRLINES

Clive S. Leyman
Deputy Chief Development Engineer
(Supersonic Projects & Concorde)

British Aerospace
Aircraft Group
Weybridge - Bristol Division
Filton House
Bristol
ENGLAND

Concorde entered service with Air France and British Airways at 11.15 GMT on 21st January 1976, the two aircraft taking off in a blaze of publicity. Since then the aircraft has carried 400,000 passengers over 25 million miles and accumulated 30,000 flying hours - enough to take a sober look at the realities of supersonic aircraft operations.

The immediate reaction is that 400,000 paying customers can't be wrong, and that the aircraft clearly has enough passenger appeal to overcome the handicap of a 20% fare surcharge on the normal first class fare. However, it is airline managers not passengers that buy aircraft, and if designers and manufacturers wish to assess the potential for future supersonic operations, they must try to see Concorde through the eyes of the airlines.

Perhaps the dominant characteristic of the operations up to now has been the disappointingly low aircraft utilisation achieved. There are several reasons for this, one of which is the restricted route network. Figure 1 shows the routes in current operation, and the average load factor on each route from start of service. Until November 1977 British Airways operated only from London to Bahrain and Washington, whilst Air France operated Paris to Washington, with restricted frequencies to Rio de Janeiro and Caracas. Operations into New York were from the start essential if reasonable utilisation was to be achieved. As we all know this was eventually cleared in 1977, and routes from New York to Paris and London are possibly the best indication of the potential of supersonic travel available today. Even with these New York services, plus the Braniff extensions to Dallas/Fort Worth, the British Airways/Singapore Airlines extension from Bahrain to Singapore and the Air France

extension to Mexico City, the average aircraft utilisation throughout the nine aircraft fleet is only 1900 hours per year, which is a far cry from the utilisation on which economic forecasts were based.

The operating costs of supersonic aircraft are obviously an issue of great general interest. They are also very difficult to assess, partly because airlines are reluctant to publish detailed breakdown figures and partly because the marketing philosophy adopted for Concorde leads to high but somewhat indeterminate values of indirect costs.

For the purpose of this paper, Concorde's operating costs have been estimated using the formula proposed by NASA for ICAO Working Group E Studies. As can be seen from Figure 2, the effect of low utilisation is to increase the TOC's by 15%. When viewed against an average Concorde fare of 19 cents/km - say a yield of 11 cents/km at average load factors, it would appear that even at 1900 hours/year and TOC's of 5.4 cents/km, the airlines on paper should be making substantial profits out of Concorde operations. This is not borne out in their public statements, and it is certainly true that the 'formula' operating costs presented in Figure 2 are substantial under-estimates of the true operating costs. There are various reasons for this, only a few of which are susceptible to reduction by suitable design.

For example, the VIP passenger service - from seat reservation through streamlined check in, exclusive waiting lounge, a very high standard of cabin service, with 'Cordon Bleu' food and drink - is very costly to operate, and formula costs significantly under-estimate such operations. Selling costs also reflect this marketing philosophy, which although it may be optimum for Concorde, is surely not applicable to any future aircraft which aspires a bigger, less affluent market.

In other areas the formula does not, and really cannot, include book keeping allowances for fleet contributions to fixed overheads, upkeep of facilities etc., which will vary enormously from airline to airline, and which are more dependent on airline efficiency than on aircraft operating costs.

The nett profitability of the aircraft will of course depend on how the achieved load factor compares with the break even load factor. As a rough indication, it seems that with present fare levels, the latter, with all airline costs included, is about 50%. What then is the load factor that has been achieved in practice, and how much of the market has been captured by Concorde's premium service?

It is in fact quite difficult to get an answer to the second of these questions, as there are as many market predictions as there are estimators. For this paper, estimates of 1978 traffic have been taken from a UK Government/Airline/Manufacturer committee set up to examine potential Concorde routes.

It was assumed that the traffic captured by Concorde would be dependent upon the time saving offered, in three categories

<u>% TIME SAVED</u>	<u>CONCORDE CAPTURE OF 1976 TRAFFIC</u>	
	<u>FIRST</u>	<u>FULL FARE ECONOMY</u>
40%	75%	10%
40 - 30%	55%	7%
30 - 25%	40%	4.5%

These values were suitably escalated for growth according to the route, and corrected where necessary for the traffic lost if a less than daily frequency were offered - some passengers will not change their plans merely to travel by Concorde. Note however, that this is not a pro-rata scaling; for example a thrice weekly service is estimated to take 61% of the weekly traffic. Finally there was, and is, evidence of considerable 'off line' capture of traffic from other routes, and this also has to be allowed for.

A comparison of these estimates with actual traffic carried in 1978 is shown on Figure 3. Perhaps the most striking feature of this information is the traffic attracted by the Air France routes to Washington and Rio de Janeiro (and although not given, the Caracas route also shows better than expected results). According to the traffic predictions neither route should be an economic proposition, and although the Washington route must be regarded as a prestige service - helped now by the Dallas traffic - the Rio de Janeiro service seems to be a success story. Similarly for British Airways, the Bahrain route was never regarded as potentially profitable until the Singapore extension came on line. For various reasons, some political and some technical, this extension did not open fully until January 1979.

The important indications of traffic potential however are the New York/Paris/London routes. On these routes Concorde is in direct competition with regular, frequent subsonic services, and the Concorde frequency is at least once per day. On the Paris/New York run, the capacity offered matches the predicted traffic fairly well, and the market capture is a very reasonable 74% of that expected. If off line capture is ignored, the market capture is an apparent 89%. These figures surely indicate a healthy demand for supersonic travel, even at premium fares.

It is interesting to note that the London/New York route is the only route where the capacity offered is less than the predicted traffic requirement, and that this route has the highest load factor of all Concorde routes. There is therefore every reason to suppose that an increase in frequency of service between London and New York would be in order right now, and that further increases will be required as traffic builds up.

The load factors achieved on each route show seasonal and service frequency variations as would be expected. Figures 4 and 5 which give the load factors on British Airways routes, demonstrate several interesting features.

On the London/Bahrain route the load factor prior to the opening of the Singapore service was strongly affected by service frequency. With one service a week a load factor of 50% or more was achieved, with two services about 35%, and with three services less than 30%. Today, with the Singapore service in operation, the London/Bahrain load factor with three weekly services is around 60%. This is entirely in line with traffic predictions.

From London to the USA, the load factor shows the usual seasonal peaks in January, May/June and September. The New York load factors have been particularly encouraging, seldom falling below 55%, although as noted earlier, there is a case for increased service frequency on this route. One oddity, which is consistent with the subsonic pattern of traffic, is that the load factor throughout the year is some 15% higher westbound than eastbound. So far, the Washington-Dallas service has had little effect on the London-Washington load factors.

One interesting feature which has materialised is that British Airways subsonic first class traffic has increased since Concorde went into service. This so-called 'Halo' effect has had a valuable influence on the airlines subsonic operations.

A nett exodus of Concorde passengers from Europe is also apparent on the Air France Rio de Janeiro, Washington and New York routes (Figures 6 and 7). This is not so on the Caracas route, in fact the reverse tends to be the case. It is interesting to note that these South American routes show less seasonal variation than the Europe/North America routes, which perhaps indicates that the traffic is predominantly business orientated. In any event, the South American load factors are far above anything that might have been predicted.

Turning now to a less encouraging feature, it is apparent that the maintenance/reliability record of the aircraft could be improved. Although the service started well enough - in fact it compared fairly well with other subsonic operations in their initial months - the dispatch reliability has not improved as was hoped and it is currently about 92%, which is not entirely satisfactory at this stage of the aircraft's life (Figure 8). This feature, when combined with a relatively small fleet in each airline, is a powerful constraint on the extension of services which is needed to achieve adequate utilisation. Action has been taken to improve these statistics, but because of several reasons peculiar to Concorde operations, the necessary changes cannot be embodied quickly.

In addition to the publicly visible dispatch reliability record, there can be a hidden high trouble rate which requires an undue amount of labour and spares to keep the aircraft in service. This is most clearly seen as the rate of entries into the technical log of the aircraft, and is reflected also in the maintenance costs. Figure 9 shows the record of snags per 1000 hours of flying for Concorde and two other British Airways aircraft. Even after account is taken of Concorde's shorter flight time, its troubles rate is the highest, and in conjunction with the scheduled maintenance, which is additional to the snag clearance, the manpower required to keep the aircraft serviceable is higher than for comparable subsonic aircraft. Perhaps one reason for this high level of maintenance man hours is that the aircraft is treated as other long range aircraft. Supersonic aircraft need to notch up flights at an annual rate comparable to medium range aircraft if they are to be profitable, and it is arguable that the maintenance philosophy should be in keeping with this.

The most common causes of Concorde's dispatch delays are given in Figure 10 - a "dirty dozen" of hurt items, many of which will be familiar to engineers involved in maintenance problems.

It can be surprisingly difficult to identify and correct these faults. One reason is that with a low aircraft utilisation a significant period of calendar time can elapse before enough failures of a particular type have occurred to identify a common cause, and it is generally uneconomic to embody modifications for 'one off' failures. In addition, with only a small fleet of aircraft, equipment vendors are not exactly falling over backwards to embody changes, and the aircraft manufacturers are still subject to stringent Governmental financial control.

The powerplant effectively clocks up operational hours at four times the aircraft rate, and in this area it has been possible to identify more 'common cause' failures. A special four company committee was set up to deal with these, and suitable modifications are now finding their way into service, which should lead to a significant improvement in reliability, which, with delivery of additional aircraft (to British Airways at least), will permit increased utilisation and better economic performance.

Turning now to the purely operational side, it has been found that supersonic aircraft really do fly "above the weather" in cruise, and since the winds at 15 - 18 km (50 - 60,000 feet) are very low in relation to the aircraft cruise speed, the repeatability of fuel requirements and flight times has been excellent, and leads to block times which vary by only a few minutes and would justify a lower value for 'en route' reserves than is common on subsonic aircraft.

Operational requirements have led to some routing changes and in some cases extra performance requirements due to environmental or air traffic considerations. An example of this is shown on Figure 11 which shows the dog-leg route which has to be used to get out of Washington to avoid military danger areas.

The major constraint on supersonic operations is of course the sonic boom. Concorde operations are either overwater or overland through strictly defined 'supersonic corridors'. The only current example of the latter is over Lebanon and Saudi Arabia. So far there have been remarkably few problems. One particular point of importance is that the navigation system has to be exceedingly accurate to maintain the necessary standards, and this is achieved in Concorde by the use of three independent navigation systems with mixing and DME update to obtain the best answer.

In overwater operations two problems have emerged. Firstly the track must be held very carefully to keep the boom away from coasts and islands. Figure 12 shows the changes which had to be made in the return track to Paris to avoid booming the northernmost of the Channel Islands, and to avoid booming Nova Scotia the tracks to New York and Washington were moved 12 n miles further out to sea.

Secondly, a new phenomenon has emerged which is known as secondary boom, the mechanics of which are illustrated on Figure 13. "Secondary boom" occurs when the primary boom is reflected from the ground and then refracted downwards from wind and temperature shear layers in the stratosphere at 50 - 100 km. These reflected waves have negligible overpressure, but they can be heard and have been reported in several areas of the West of England and Nova Scotia. They are more likely to be 'heard' indoors, where the building structure (e.g. windows) may respond to the weak pressure wave. So far these secondary waves have not produced a high level of complaint.

Concorde was designed to be as quiet as subsonic aircraft of its generation, i.e. aircraft like the Boeing 707 and Douglas DC 8, and by and large it meets this criterion. In practice, at the time the design was frozen there was no more that could be done, and the result has been an uphill battle to get Concorde operations accepted.

All that can be done is to tailor the operations to minimise the nuisance. For example Figure 14 shows Concorde tracks in the New York terminal area. On the main runway 31L, Concorde's excellent handling allows a sharp turn away from the communities which maintains noise levels below limits and often well below the noise made by subsonic aircraft. On 13R, Concorde is operated as infrequently as possible to minimise noise over the communities and on 22R Concorde turns right after take-off to minimise noise over the Rockaway Park area.

At all airfields Concorde uses a decelerated approach procedure wherever possible to minimise noise. This allows a fast approach with an automatically controlled power reduction over the close in communities and a substantial (3 - 4 dB) reduction in noise level. This is largely only possible because of Concorde's excellent handling and the high degree of automation in the flight control system.

One feature that is worth noting is that complaints against Concorde have diminished with time. Figure 15 shows the number of complaints registered per movement at London, Washington and New York up to the time at which FAA ceased complaint totalling at the latter airports. There is evidence of an increase in complaints during the hot months, but the general trend is downwards.

It was stated earlier that extension of the Bahrain route to Singapore was delayed by political and technical factors. Politically the Malaysians decided, as is their right, that they wanted something in exchange for granting Concorde overflying rights, and the Indian Government decided not to allow supersonic overflight. This latter decision meant that the route had to be a dog-leg around Sri Lanka, which led to performance difficulties - after all the aircraft was basically designed for 3200 n miles Paris-New York, whereas Bahrain-Singapore on the 'new' route is 3660 n miles.

Although the payload/range characteristics have been quietly extended since entry into service (Figure 16), the Singapore run required the installation of a new low drag intake lip to become a viable year round operation. This modification was particularly pleasing technically because cowl drag was lowered without sacrificing any powerplant compatibility - in fact it is rather better now than in the original version.

This is not the end of the line, because we already have proposals for retrofittable performance and weight improvement modifications, although it is becoming steadily more difficult to devise cost effective schemes.

What of the future? The production line is closed at sixteen aircraft, four of which are white tails at present, two are development aircraft, with a further aircraft allocated to British Airways. Fuel, which is a major operating cost on Concorde is, as we all know, getting more expensive. Despite this we believe that Concorde operations will expand and will continue. There are several routes (Figure 17) which could support a Concorde service, and as traffic grows on existing routes, these will require extra frequencies. When dispatch reliability has been brought up to the target 96/98% and the current crop of maintenance problems got under control, the aircraft will generate impressive operating surpluses, and with the level of utilisation expected we see no reason why Concorde should not be flying profitably into the mid nineties - perhaps even until a replacement comes along.

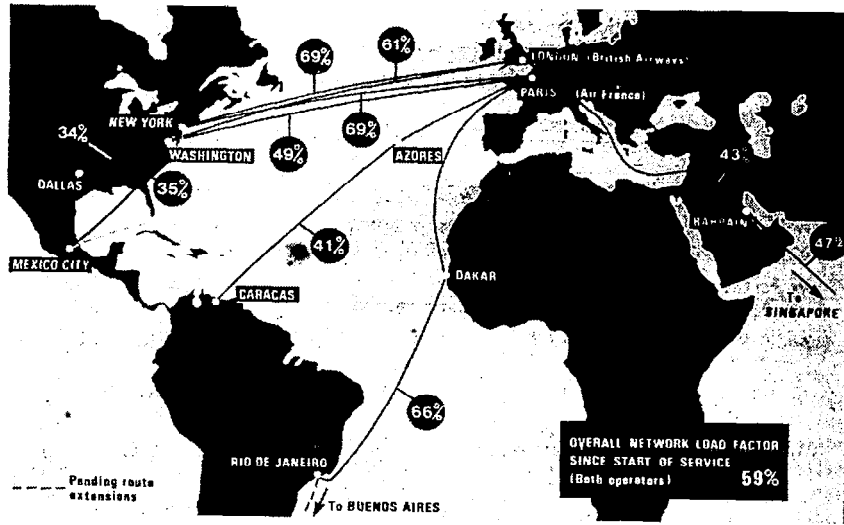


Figure 1.- Load factor summary - August 31, 1979.

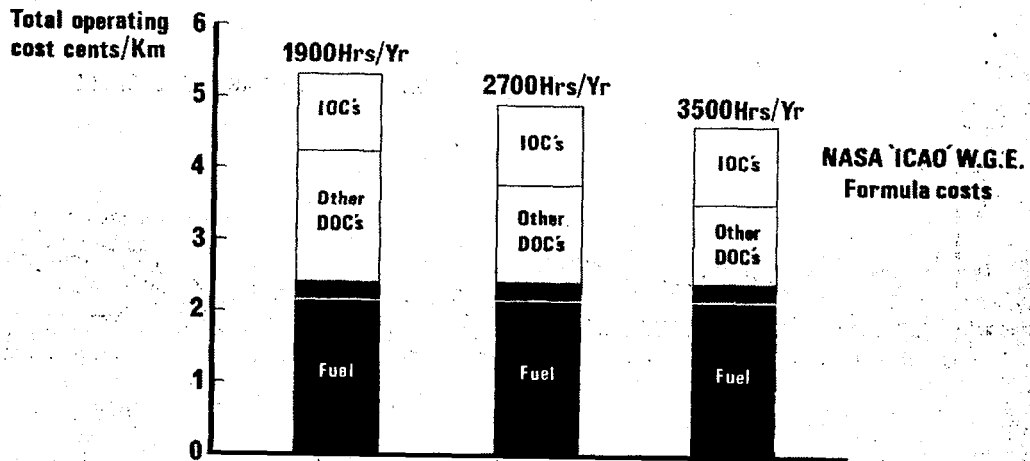


Figure 2.- Concorde estimated operating costs.

	Predicted traffic		Capacity offered	Passgrs carried	Market capture		Average L.F.
	(A)	(B)			(A)	(B)	
	27500	21840	29000	12336	46%	58%	43%
	111000	138750	89900	64858	58%	47%	72%
	11500	8800	22800	6040	53%	68%	27%
	7300	5785	30800	10492*	144%	181%	34%
	53500	64200	71800	47700	89%	74%	66%
	10500	9380	20800	14005	133%	149%	67%

- (A) With daily frequency offered, no offline capture
- (B) With actual frequency offered, including estimated offline capture

* Includes 1900 Washington-Mexico

Figure 3.- 1978 Concorde traffic.

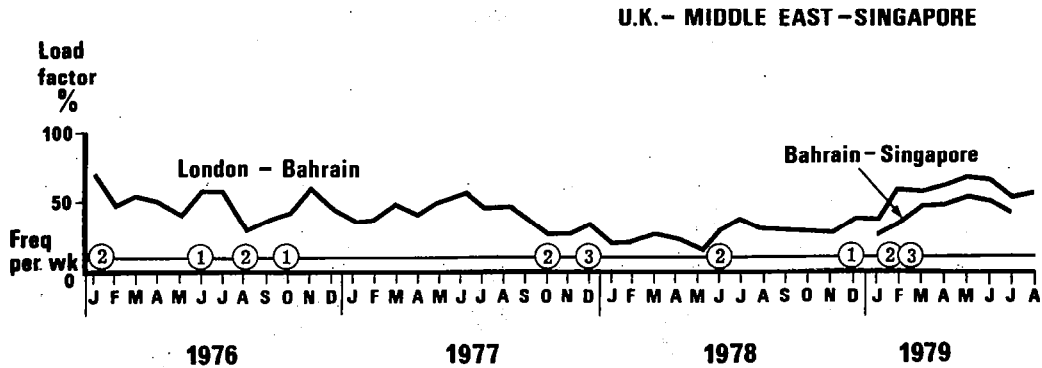


Figure 4.- Monthly average load factors for U.K.-Middle East-Singapore routes.

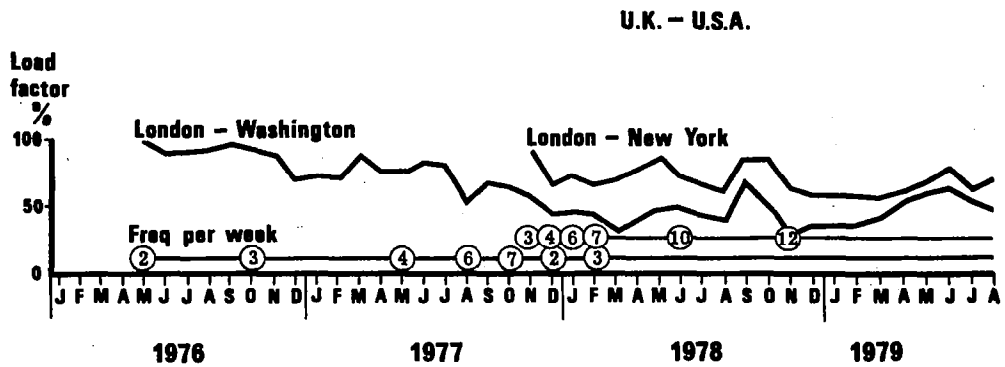


Figure 5.- Monthly average load factors for U.K.-U.S.A. routes.

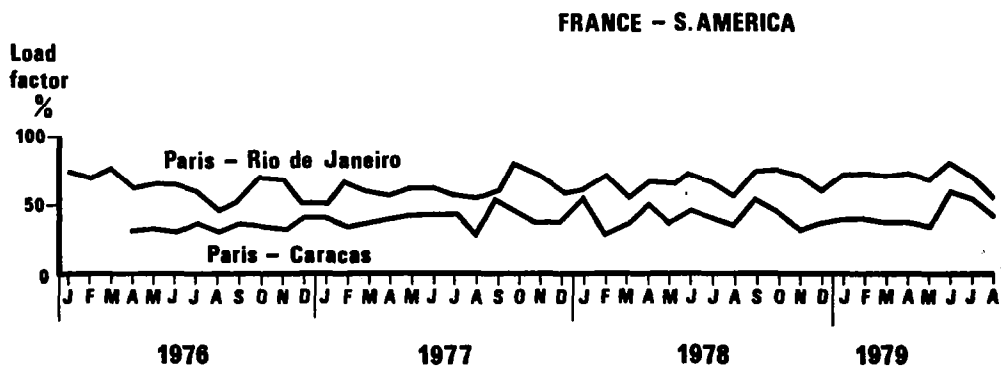


Figure 6.- Monthly average load factors for France-South America routes.

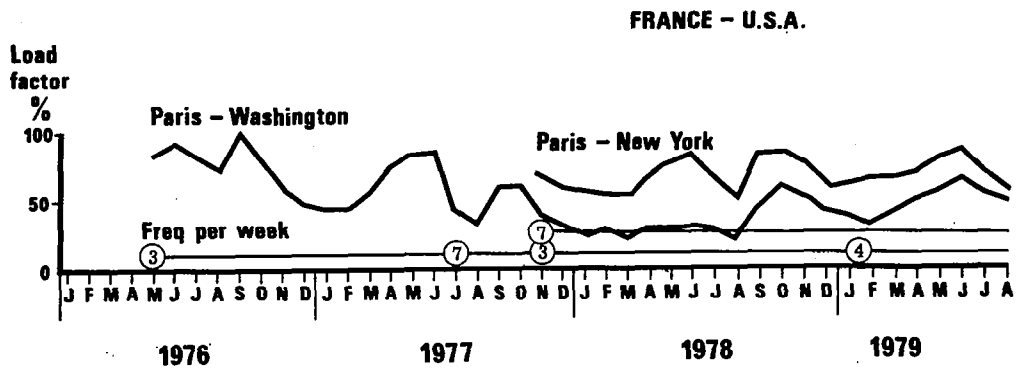


Figure 7.- Monthly average load factors for France-U.S.A. routes.

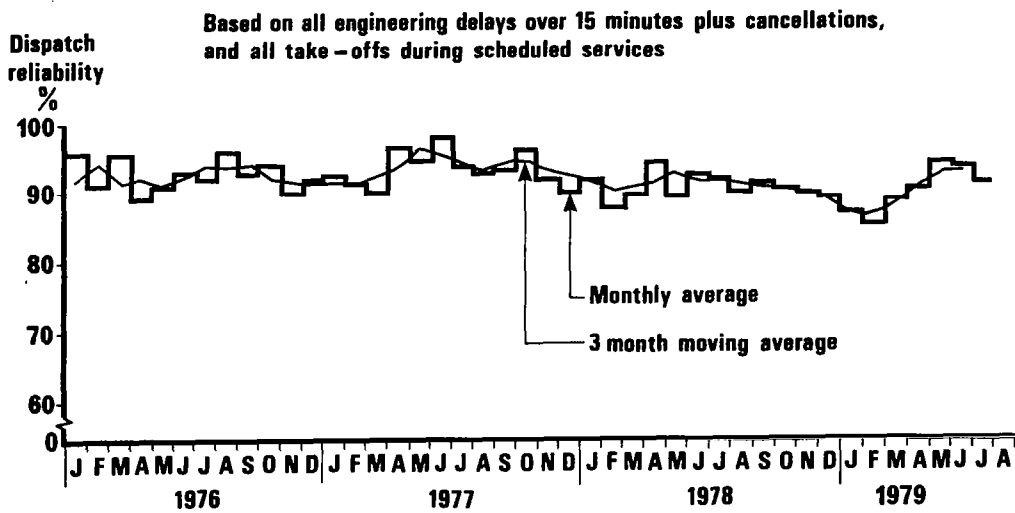


Figure 8.- Scheduled service dispatch reliability.

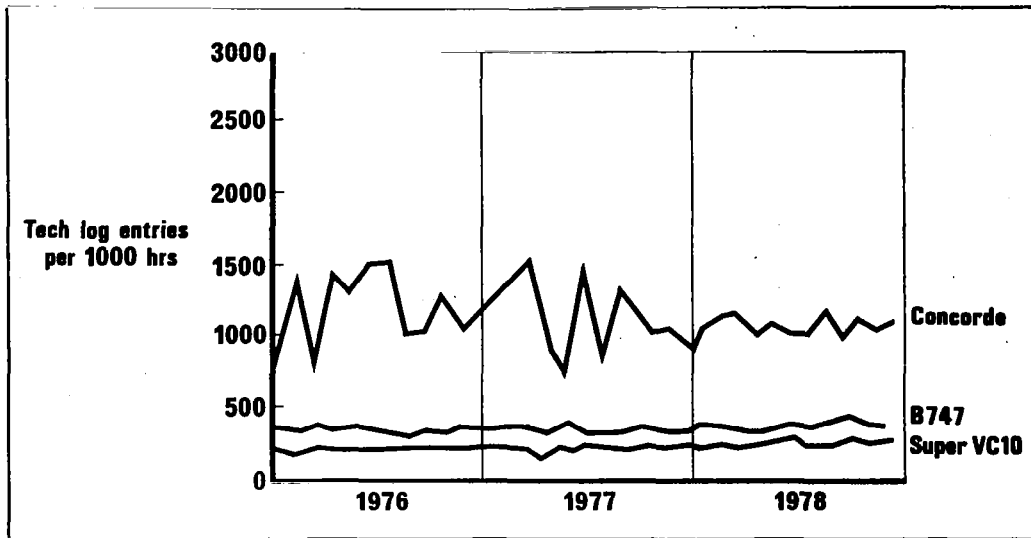


Figure 9.- Aircraft technical performance.

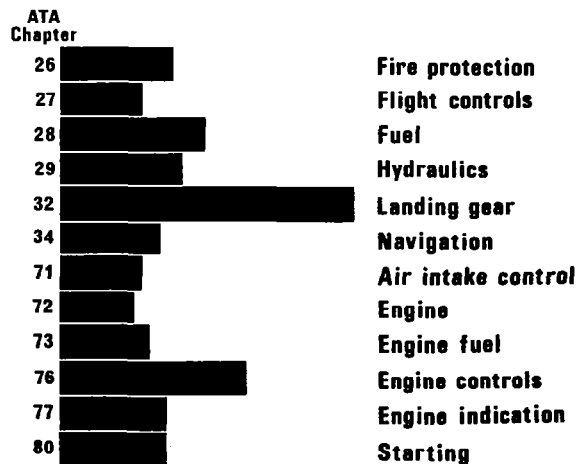


Figure 10.- Major causes of technical delays.

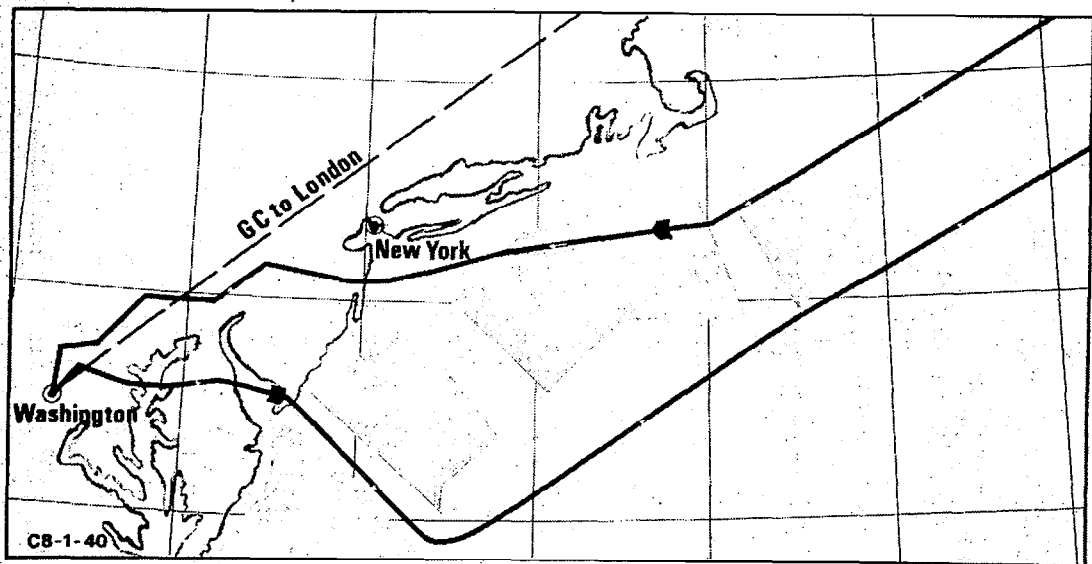


Figure 11.- Concorde tracks for Washington.

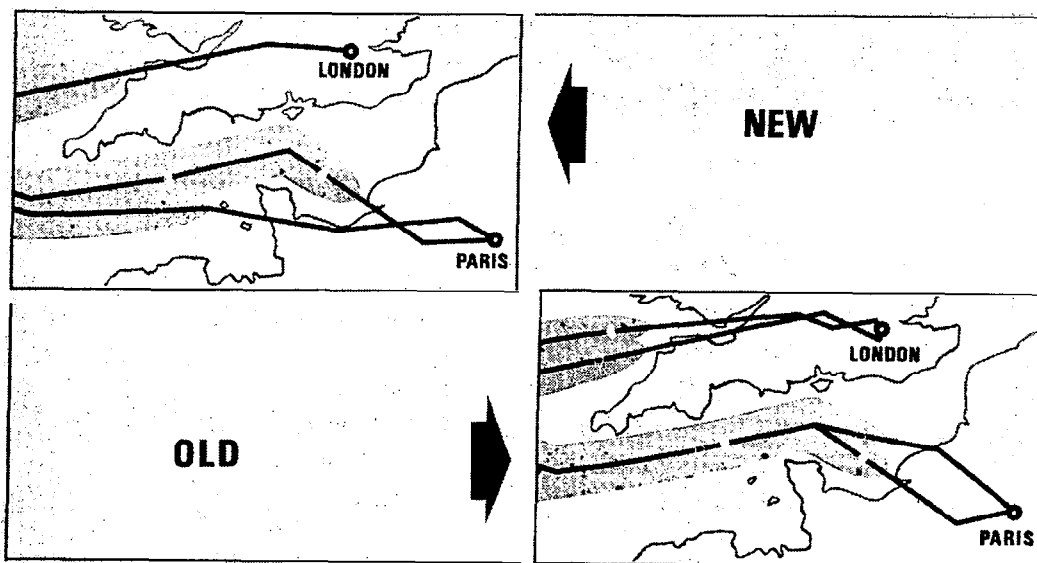


Figure 12.- Concorde track change - approaching Europe.

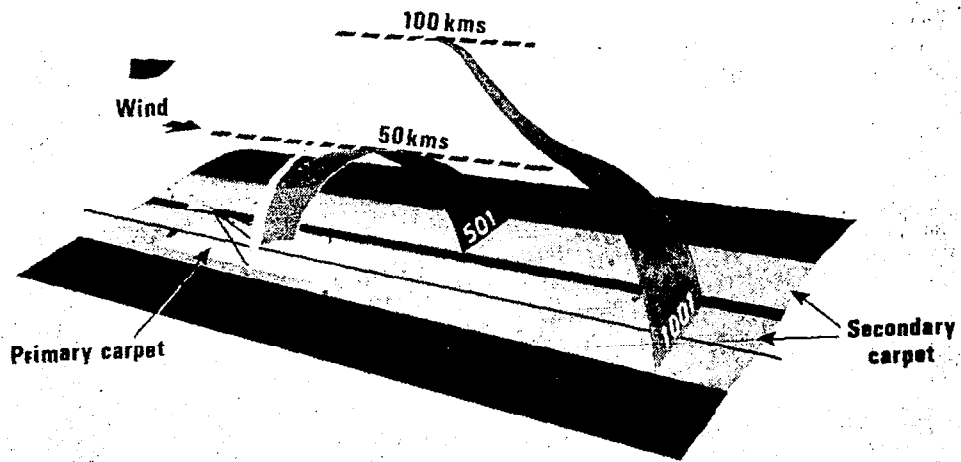


Figure 13.- Location of sonic boom carpet.

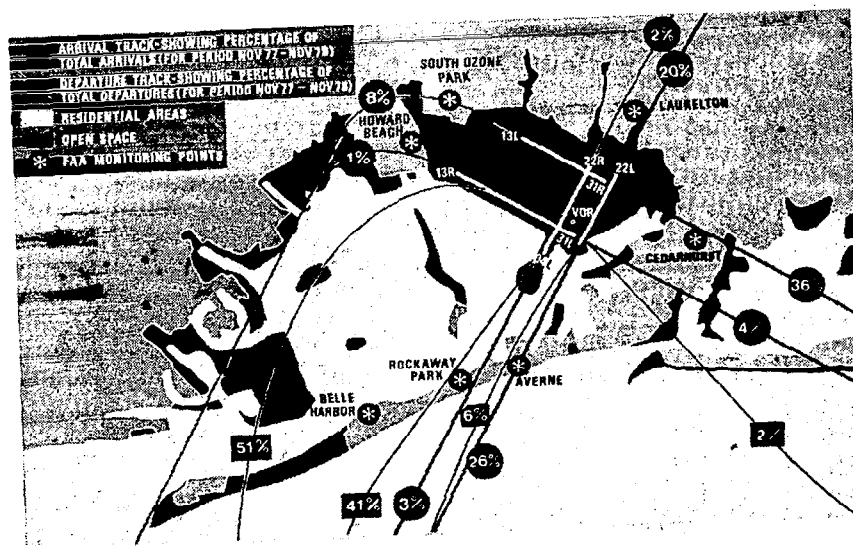


Figure 14.- Noise monitoring site locations and Concorde tracks at John F. Kennedy International Airport.

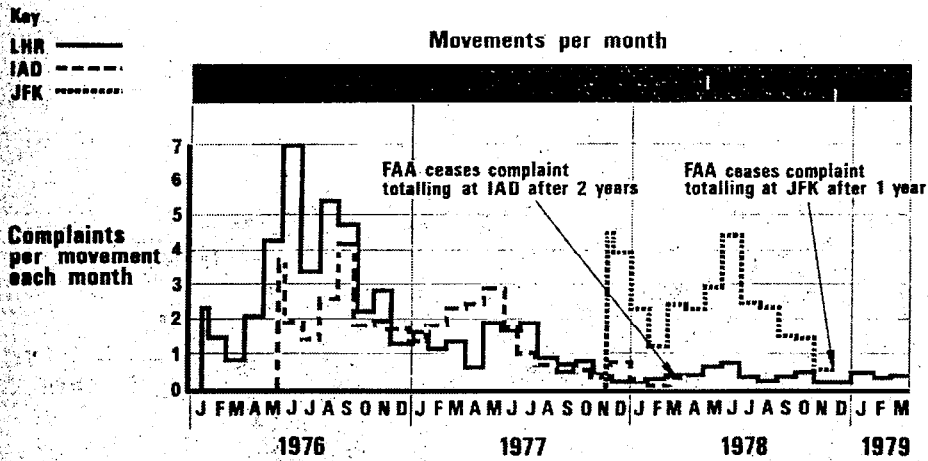


Figure 15.- Complaints per movement at Heathrow, Dulles, and John F. Kennedy Airports.

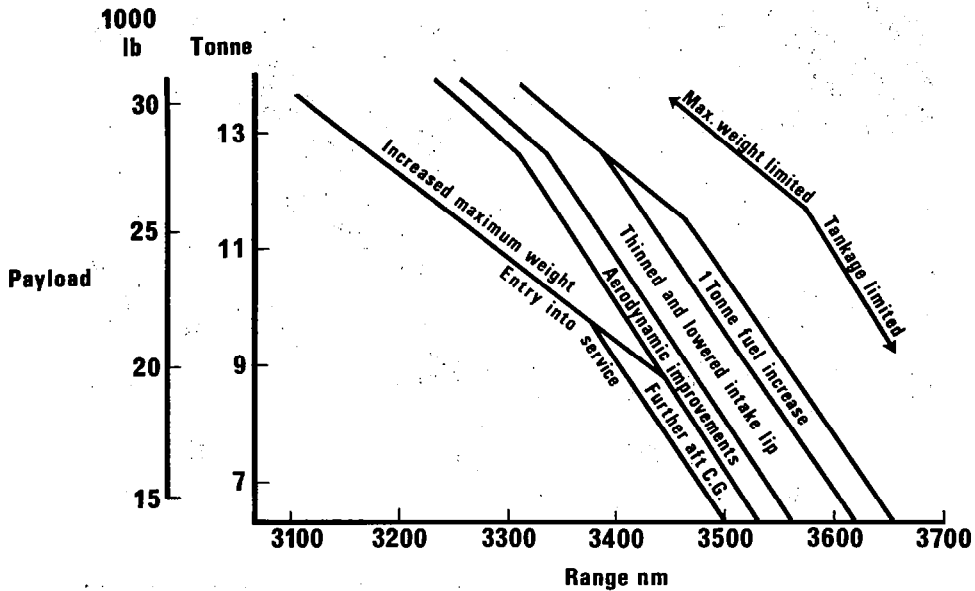


Figure 16.- Concorde payload/range characteristics.

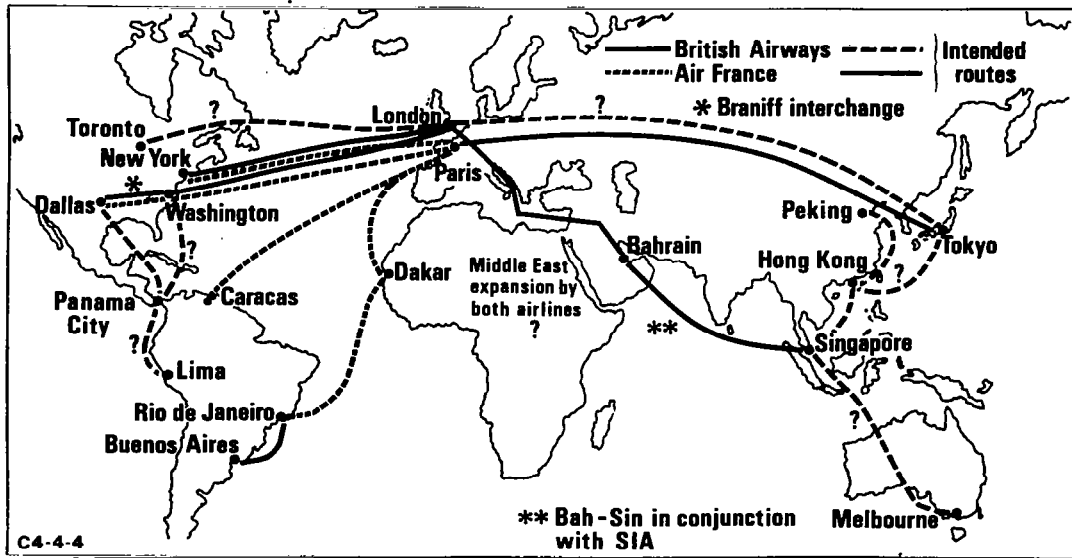


Figure 17.- World routes.



LONG-RANGE AIRPLANE STUDY
The Consumer Looks at SST Travel

Karyl H. Landes
Boeing Commercial Airplane Company

J. A. Matter
Boeing Computer Services, Consulting Division

INTRODUCTION

The Boeing Company and its subsidiary, Boeing Computer Services, retained Gilmore Research Group to conduct a study among long-range air travelers to ascertain attitudes toward several basic air travel decisions.

Of interest were tradeoffs involving time versus comfort and time versus cost as they pertain to supersonic versus conventional wide-body aircraft on overseas routes.

The market focused upon was the segment of air travelers most likely to make that type of tradeoff decision: those having flown overseas routes for business or personal reasons in the recent past.

The information generated by the study is intended to provide quantifiable insight into consumer demand for supersonic as compared to wide-body aircraft alternatives for long-range overseas air travel.

THE PRELIMINARY STUDY (SEATTLE-TACOMA AIRPORT): METHOD

Sample Frame

The sample frame was comprised of persons having the following characteristics:

- o They had taken at least two flights of five hours or more over water within the past two years.
- o They were U.S. citizens.
- o They did not work for an aircraft, air transportation, market research or advertising related industry.
- o They traveled through the Seattle-Tacoma airport during the period in which the study was conducted.

Sample Design and Reliability

The sample derived can be characterized as a convenience sample of travelers qualifying under the above criteria.

The sample exhibits considerable diversity in terms of characteristics of individual respondents and their points of origin, and may be viewed as reasonably representative of long-range over water air travelers with destinations in the North and South Pacific. (See Table 1.)

Interviewing Execution

The survey was conducted using personal interviews with qualified travelers.

Interviews were conducted by the professional interviewing staff of Northwest Certified Surveys, the data collection division of Gilmore Research Group. Interviewers were fully trained prior to conducting the study and supervised by senior field supervisors. In addition, all interviewers had prior air travel interviewing experience. The interviewing took place during the period of June 25 through June 29, 1979.

Incidence of Qualified Respondents

The incidence of qualified respondents was found to be 21%, with 1447 travelers screened to complete 304 interviews. Only 4% of those contacted refused to be screened (Table 1).

OBJECTIVES

Study objectives were the following:

- o Define the comparative incidence of business motivated flights versus personal or pleasure motivated flights.
- o Determine the fare class usually taken on these types of flights.
- o Quantify the relative preference between the following:
 - a conventional wide-body jet with normal seating that takes 10 hours on an overseas flight versus a supersonic aircraft with slightly less leg room which takes $3\frac{1}{2}$ hours on the same route.
 - a conventional wide-body jet which takes 10 hours on an overseas flight and costs \$500 versus a supersonic aircraft on the same route taking $3\frac{1}{2}$ hours and costing \$600.

- o Ascertain tradeoff preferences for business flights and for personal flights.
- o Determine the underlying reasons for the preferences expressed.
- o Define the incidence and experience in flying the supersonic Concorde and intentions to fly that aircraft in the future.

CHARACTERIZATION OF LONG-RANGE TRAVEL

Interpretive note to the reader: There are three categories of travelers referred to in this report: total travelers, business travelers and pleasure travelers. Persons classified as business travelers may also have taken qualifying pleasure trips. Those classified as pleasure travelers, however, have only made qualifying trips for personal or pleasure reasons.

Motivation for Flights: Business versus Personal

Among the long-range overseas travelers sampled, a total of 61% described all such flights they had taken within the past two years as "personal or pleasure" motivated, 22% indicated their flights were primarily business motivated, and 16% had taken qualifying flights of both types (Table 2).

Frequency of Long-range Overseas Travel

Table 3 documents the frequency of travel among all travelers and among both business and pleasure travelers.

Just over half (53%) of those sampled had taken two qualifying flights during the past two years (which translates to one round trip by air for nearly all of this group). An additional quarter had taken 3-4 flights, a total of 17% had taken 5-10 flights, and 6% had taken more than 10 qualifying flights during the period. The mean number of flights taken was 4.4.

Among business travelers, only about one-third had taken two flights. Nearly half (42%) had taken more than 5 flights. The overall mean was 6.3 flights.

Among pleasure travelers, 66% had taken two flights and 12% had taken more than five flights. The average number of flights was 3.3 among this group.

Class Usually Traveled on Business Flights

A total of 22% of long-range business travelers indicated their flights were usually first class. A total of 66% normally flew regular coach, and 11% attempted to utilize discount fare options (Table 4).

Differences exist between those normally paying their own business fare, e.g., self-employed/company owners or others paying their own business expenses, as compared to those for whom business expenses are paid. A total of 26% of those for whom expenses are paid usually fly first class, while 15% of those paying their own fare usually fly in this class on overseas routes. About two-thirds of both fare-paying categories normally fly regular coach fare status.

Class Usually Traveled on Personal or Pleasure Flights

Seventy-two percent of personal travelers normally fly regular coach class status (Table 5), while 22% fly with special discount rates. Only 6% usually fly first class.

Advance Knowledge of Type of Aircraft Flown

Table 6 documents that 56% of all long-range overseas travelers sampled were aware of the type of aircraft they would be flying prior to their flights. This can reasonably be interpreted to include knowledge of the aircraft manufacturer and model.

No significant differences exist between pleasure and business travelers with respect to advance knowledge of aircraft type.

INCIDENCE OF USE OF CONCORDE

Table 7 illustrates the limited use of the Concorde among those sampled—2% of all travelers in the sample had flown the Concorde at any time previously.

Quantitative analyses as to why that aircraft was chosen and expectations as to future repeat usage are not possible to interpret from the limited cell of past users.

TIME/COMFORT/PRICE TRADEOFFS IN BUSINESS TRAVEL

Time versus Comfort

Business travelers were asked to trade off time versus comfort for an imaginary Seattle to Tokyo business trip:

- o A 10-hour coach/economy class flight on a wide-body jet with normal seating (34 inches from the back of one seat to the back of the next seat) versus
- o A 3½-hour coach/economy class flight on a supersonic airplane with 2 inches less leg room than normal (32 inches from the back of one seat to the back of the next seat).

Table 8 illustrates that fully 90% of business travelers prefer a supersonic aircraft with 2 inches less leg room than normal, which would take 3½ hours on a Seattle to Tokyo flight as compared to a wide-body aircraft with normal seating taking 10 hours on the same route. Ten percent prefer the wide-body jet with larger seating area.

As shown in Table 9, 88 percent of business travelers preferring the supersonic airplane mentioned time savings as the reason for their choice. Few other reasons were mentioned.

Only 11 business travelers chose the wide-body jet on the comfort tradeoff question. Five mentioned roominess as the reason for their preference for the wide-body; five said they were opposed to supersonic transport.

Time versus Price

This tradeoff presented business travelers with the following two choices:

- o A 10-hour coach/economy class flight on a wide-body jet for \$500 (U.S. Dollars) versus
- o A 3½-hour coach/economy class flight on a supersonic airplane for \$600 (U.S. Dollars).

A total of 80% of business travelers preferred the supersonic and 20% the wide-body jet under this scenario (Table 10).

As shown in Table 11, 50 percent of those choosing the supersonic airplane said the time saved was worth \$100. An additional 35% mentioned time saved without mentioning cost.

Twenty-two business travelers chose the wide-body alternative in response to this tradeoff. Most expressed unwillingness to pay the extra \$100 (14 respondents, or 64% of those preferring the wide-body). Five business travelers said they were opposed to supersonic transport.

Readers caution: These preferences must be interpreted with respect to the actual price alternatives offered respondents; extrapolations or inferences with regard to other price levels should be avoided.

TIME/COMFORT/PRICE TRADEOFFS IN PERSONAL TRAVEL

Time versus Comfort

The entire sample was asked to trade off time versus comfort and time versus cost for personal travel. The results are reported in Table 12.

A total of 74% of all travelers, 81% of business travelers and 70% of pleasure travelers prefer the supersonic as contrasted to the wide-body jet when given the same time/comfort option for a pleasure/personal trip:

- o A 10-hour coach/economy class flight on a wide-body jet with normal seating (34 inches from the back of one seat to the back of the next seat) versus
- o A 3½-hour coach/economy class flight on a supersonic airplane with 2 inches less leg room than normal (32 inches from the back of one seat to the back of the next seat).

The reasons cited for preference of the supersonic airplane alternative again were time focused—fully 96% (217 respondents) thought it would significantly save time and allow more of that commodity at their destination (Table 13). Seven percent (16 respondents) felt the two inches were inconsequential, and seven percent indicated they simply "wanted to try the supersonic."

Forty-four of the 78 respondents who chose the wide-body cited its roominess as their reason. Twenty-five respondents said they were opposed to a supersonic airplane. Another 17 respondents said that they were in no hurry and did not mind a long flight.

Time versus Price

All respondents were given the option of time versus cost for pleasure travel:

- o 10-hour coach/economy class flight on a wide-body jet costing \$500 on the Seattle/Tokyo route versus
- o 3½-hour coach/economy class flight on a supersonic airplane costing \$600 on the same route

A majority (57%) of the total sample chose the supersonic airplane while 42% indicated they would prefer the wide-body jet. Business travelers were more willing to pay extra to save time on a pleasure trip than were pleasure travelers. Sixty-four percent of business travelers chose the supersonic airplane, compared to 52% of pleasure travelers (Table 14).

Thirty-nine percent of those choosing the supersonic airplane on this question said that the time saved was worth the \$100. An additional 49% mentioned time savings without mentioning cost. (See Table 15.)

Sixty-three percent of 128 respondents who chose the wide-body jet indicated that the additional cost of the supersonic airplane was too great. Fifteen respondents liked the wide-body roominess, and 28 were opposed to a supersonic aircraft. (Based on this last number, about 9% of the total sample were opposed to supersonic transport.)

Table 16 summarizes the tradeoff preferences among business travelers and pleasure travelers.

PRELIMINARY STUDY SUMMARY AND CONCLUSIONS

Experienced air travelers (304) were asked to imagine that they had two alternative flights available for a Seattle to Tokyo trip. In one case, the two flights cost the same, but one was on a wide-body jet with normal leg room and the other was on a supersonic airplane with two inches less leg room than normal. In a second case, the two planes available had identical seats and leg room, but one was a wide-body jet offering a coach fare of \$500 and the other was a supersonic airplane offering a coach fare of \$600. In both cases the wide-body jet flight would take 10 hours, while the supersonic flight would take only 3½ hours.

Business travelers (those with prior overseas business flights) made these two types of choices for both imaginary business and imaginary pleasure trips. Personal/pleasure travelers (without previous overseas business flights) responded only for the imaginary pleasure trip.

When asked whether they would sacrifice two inches of leg room to save 6½ hours on an overseas flight, the overwhelming majority of both business and pleasure travelers said they would. Ninety percent of business travelers chose the less roomy supersonic airplane for a business trip, 81% for a pleasure trip. Seventy percent of personal/pleasure travelers were also willing to sacrifice some comfort for speed.

There was slightly less willingness to sacrifice money in order to save time. Among business travelers, 80% chose a more expensive supersonic flight for a business trip, 64% chose the more expensive flight for a pleasure trip. Among personal/pleasure travelers, 52% were willing to spend an extra \$100 to fly supersonic.

"Saves time" was the reason given for choosing the supersonic airplane by the majority of those who preferred it. Many respondents added explicitly that time was worth money to them.

Of those who chose the wide-body jet in response to the comfort tradeoff, more than half mentioned the wide-body's roominess as the reason. On the cost tradeoff, over 60% of those preferring the wide-body jet said that the additional \$100 to fly supersonic was too much for them. A few respondents (28, or about 9% of the sample) were opposed to supersonic transport.

The comfort tradeoff results strongly suggested that passengers would not be deterred from flying on a supersonic airplane if seat pitch were reduced by two inches to permit greater cabin seating capacity. From the cost tradeoff results, it would appear that if increased cabin capacity and technological advances to reduce operating costs permit a supersonic ticket that is priced only moderately higher than regular coach, the supersonic airplane could be expected to capture a major portion of the overseas air-travel market.

However, because we do not know the extent to which the opinions of Seattle-Tacoma travelers reflect opinions in other parts of the United States, these conclusions had to be regarded as preliminary. In order to discover whether the high level of interest in supersonic travel observed at SeaTac was present elsewhere in the country, a more extensive survey effort was needed.

THE FIVE-AIRPORT STUDY: METHOD

Sample Frame

As in the preliminary study, the sample frame consisted of persons having the following characteristics:

- o They had taken at least two flights of five hours or more over water within the past two years.
- o They were U.S. citizens.
- o They did not work for an aircraft, air/transportation, market research, or advertising related industry.
- o During the period in which the study was conducted, they traveled through one of the following airports:

John F. Kennedy (New York)
Dulles (Washington, D. C.)
Dallas-Fort Worth
Los Angeles International
San Francisco International

Sample Design and Reliability

Again, the sample obtained in the five airport study was a convenience sample of travelers meeting the above criteria. Although demographic information (described below) was collected, no attempt was made to fill any quotas on the basis of demographic characteristics. It is not known whether observed differences in the demographic make-up of the samples collected at different airports were due to real differences in the populations of travelers that pass through these airports, or whether the differences were simply a result of sampling variability. However, as Table 17 shows, the sample collected did represent a broad cross section of experienced overseas travelers of different ages, sexes, and socioeconomic characteristics.

Interviewing Execution

Data collection took place between October 5 and October 19, 1979. As in the preliminary study, all data was collected through personal interviews with

qualified respondents who consented to participate when approached by an interviewer in the airport terminal building.¹ All interviewers were experienced employees of Gilmore Research or its affiliates. They were trained prior to conducting the study and supervised during the data collection by senior field supervisors. In addition, the validity of the interviews was verified by subsequent telephone calls to a subset of those respondents who had been willing to give their numbers for this purpose.

Incidence of Qualified Respondents

Across all five airports, the incidence of qualified and willing respondents was found to be 16%, with 10,863 travelers contacted to complete 1750 interviews. Twenty-two percent of those contacted refused to be screened. Table 17 shows incidence and refusal rates for the five airports for the tradeoff and price perception samples combined. (See explanation of the two samples below.)

OBJECTIVES

The five airport study had three major objectives:

- o Replicate and extend the Seattle-Tacoma findings with regard to time versus price and time versus comfort tradeoffs on overseas flights.
- o Collect age, sex, and socio-economic information and examine differences as a function of these variables in choice of SST versus wide-body subsonic alternatives for overseas flights.
- o Examine additional time versus price and time versus comfort tradeoffs. Specifically, quantify relative preferences for the following tradeoff alternatives:
 - a conventional wide-body jet with standard coach leg room (34 inches from seat back to seat back) that takes 11 hours on a San Francisco to Tokyo flight versus a supersonic airplane with 2 inches less leg room than normal that takes 4 hours on the same route
 - a conventional wide-body jet with standard leg room that takes 7 hours on a New York to London flight versus a supersonic airplane with two inches less leg room than normal that takes 3 hours on the same route.
 - a conventional wide-body jet that takes 11 hours on a San Francisco to Tokyo flight and costs \$525 versus a supersonic airplane with identical seats and leg room that takes 4 hours on the same route and costs either \$575, \$625, or \$675.

¹We would like to acknowledge the kind cooperation of operations personnel at Seattle-Tacoma, San Francisco, Dallas-Fort Worth, and Dulles International airports and also the cooperation of Braniff, United, and Western Airlines in allowing us to interview in the various airport terminals.

- a conventional wide-body jet that takes 7 hours on a New York to London flight and costs \$400 versus a supersonic airplane with identical seats and leg room that takes 3 hours on the same route and costs either \$450, \$500, or \$550.

In addition to these major objectives, there were two additional concerns:

- o Enlarge the sample of persons having Concorde experience and examine their reactions both to the Concorde and to the tradeoff alternatives presented in this study.
- o Check on travelers' awareness of present transoceanic air fares by running a separate control group of 50 travelers in each airport who guess what price they would expect a ticket on a supersonic airplane to cost relative to a regular coach ticket on both a transatlantic and a transpacific flight.

QUESTIONNAIRE CONSTRUCTION

Order of Presentation Counterbalancing

Copies of the tradeoff questionnaire and of the "price perception" questionnaire administered to the control group are included with this paper (Figure 1). The order in which the questions are shown in the sample questionnaires is one of four orders used with the tradeoff questionnaire and one of two orders used with the price perception questionnaire. The use of these different versions of the questionnaire was necessary to counterbalance any effects that order of question presentation might have on respondents' answers.

Specifically, on both the tradeoff and the price perception questionnaires, half of the respondents at each airport were first presented with a question about the New York to London trip followed by the same question about the San Francisco to Tokyo trip. For the other half of the respondents, this order was reversed.

On the tradeoff questionnaire only, the three different price levels for a supersonic ticket (\$50, \$100, or \$150 above coach fare) were also presented in different orders. For half the sample, the first time versus price tradeoff question asked whether subjects would be willing to pay \$50 extra to fly supersonic. If they said "yes" to this, they were asked if they would pay \$100. If they said "yes" again, the \$150 tradeoff was asked.

On their second time versus price tradeoff question, these subjects were first asked if they would pay \$150 for the supersonic flight. This time, if they said "no" to the highest price level, the interviewer asked if they would pay \$100. If they said "no" again, the \$50 tradeoff was asked.

For the remaining half of the respondents, the descending (\$150, 100, 50) order of prices was used with the first question and the ascending (\$50, 100, 150) order was used with the second question.

The four orders of the tradeoff questionnaires created by counterbalancing were shuffled together with the two orders of the price perception questionnaire before the sets of questionnaires (350 per airport) were sent out to the interviewing staff. There should thus be no confounds between the order of presentation, the airport, the interviewer, or the time during the study at which the interview was conducted.

Business versus Pleasure Travelers

As in the preliminary study, respondents were classified as "business" travelers if at least one of their overseas trips in the last two years was for business reasons. Travelers having no recent overseas business trips were classified as pleasure travelers. Business travelers answered four sets of tradeoff questions, one set for an imaginary transatlantic pleasure trip, one for an imaginary transpacific pleasure trip, one for an imaginary transatlantic business trip, and the last for a transpacific business trip. Pleasure travelers answered only for the two imaginary pleasure trips.

CHARACTERIZATION OF LONG-RANGE TRAVEL AND TRAVELERS

Motivation for Flights: Business versus Personal

The mix of business versus pleasure travelers varied from airport to airport, ranging from 30% business and 70% pleasure travelers at Dulles in Washington, D.C. to 46% business and 54% pleasure at Dallas-Fort Worth. Across all five airports, the business/pleasure split was 37% business and 63% pleasure travelers. (See Table 17.)

Characteristics of Business versus Pleasure Travelers

Demographic and socioeconomic data on the sample are presented in Table 17. This table indicates that, as would be expected, most business travelers were males (86%). The pleasure traveler sample was about half male (46%) and half female (54%). Fifty-eight percent of the business travelers were between the ages of 30 and 50; 15% were under 30; 27% were over 50. Among pleasure travelers, 34% were between 30 and 50; 23% were under 30; and 42% were over 50. Thus, younger and older adults were more prevalent in the pleasure traveler group.

Professional and managerial level occupations were most frequently given by both business and pleasure travelers. Seventy-one percent of the business travelers and 42% of the pleasure travelers had occupations in these categories. The pleasure sample also contained a large number of homemakers (20%) and retired persons (12%). Both the latter occupations are listed as "other" in Table 17.

Income levels for the business and pleasure traveler groups were fairly similar. Among business travelers, 9% had total family incomes under 20 thousand dollars per year; 30% had incomes between 20 and 40 thousand dollars; 26% had incomes between 40 and 60 thousand dollars; and 25% had incomes in excess of

60 thousand dollars annually. Twenty-two percent of the pleasure travelers had incomes under 20 thousand dollars; 31% had incomes between 20 and 40 thousand dollars; 18% fell between 40 and 60 thousand; and 13% were in excess of 60 thousand. Ten percent of the business and 15% of the pleasure travelers refused to give their income levels.

The somewhat lower income levels among the pleasure travelers is most likely related to the greater numbers of younger and older persons in this group. Younger persons have not been employed long enough to achieve the higher income levels and older persons are frequently living on some form of relatively low retirement income. In addition, both younger and older persons may be less likely to be part of multi-earner households.

Other background information collected on the sample indicated that business and pleasure travelers from all regions of the country were well represented, though more travelers from the Western part of the United States were included due to the fact that three of the five airports where surveying was conducted were in Western states. Seventy-five percent of the travelers interviewed were waiting in the airport prior to departure either on the first leg of a journey or on a connecting flight. About 7% of the sample was just completing a trip, and the remaining 18% of the respondents were at the airport to pick up or to drop off another party.

Overseas Flight Experience of the Sample

As expected, business travelers tended to have more recent overseas flight experience than did pleasure travelers. Twenty-two percent of the business travelers had taken two trips of five hours or more over water in the past two years while 60% of the pleasure travelers had two qualifying trips. Fifty-seven percent of the business travelers had taken between 3 and 10 overseas trips in the last two years, and 21% had taken 11 trips or more. Among pleasure travelers the comparable percentages were 39% with 3 to 10 trips and only 1% with 11 or more trips. Fifty-seven percent of the business and 56% of the pleasure travelers said they usually knew in advance what plane they would be taking on their trips of five hours or more. Thus, while the business travelers tended to be more experienced, both types of traveler were equally likely to be airplane conscious when making travel plans.

Class Usually Flown on Business and Pleasure Trips

The majority of both business and pleasure travelers said they usually flew regular coach on their flights of five hours or more, regardless of the purpose of the trip. Of those business travelers who said they paid for their own business travel, 62% usually flew on a regular coach ticket, while 72% of those business travelers whose travel expenses were paid said they usually flew coach on business flights. Twenty-three percent of those who paid their own way and 21% of those whose way was paid usually flew first class. Among those who paid their own way, 15% usually employed discount fares, while 7% of those whose way was paid used such fares.

About 23% of the business travelers interviewed had never taken a personal or pleasure flight of five hours or more. Among those business travelers who had taken long-range pleasure flights, 69% said they usually went coach, 15% flew first class, and 16% employed discount fares. Among pleasure travelers, 65% usually flew coach on their long flights, 8% flew first class, and 27% went discount.

These results indicate that even when they are not traveling on business, travelers who have taken recent overseas business flights are more likely than travelers with only pleasure flights to fly first class and less likely to seek discount fares. Examination of the results for business and pleasure travelers suggests that this is not due to the age, sex, occupation, income, or number of overseas flights of business travelers relative to pleasure travelers. It may be that a greater proportion of business travelers have been able to experience first class comfort and service on their long-range business flights and hence are willing to pay the additional amount to fly first class when they are traveling for personal reasons. Among pleasure travelers who have only flown overseas at their own nondeductible expense, there may be fewer flyers who have been able to discover that first class fare can be worth it.

EXPECTED DIFFERENCES BETWEEN WIDE-BODY AND SUPERSONIC TICKET PRICES

In order to better understand the sample's responses to the time/price tradeoffs presented to them in this study, we wished to discover whether respondents were aware of the large price differential between present coach fares and present supersonic fares. However, we did not want to sensitize our tradeoff questionnaire sample to the fact that we were using relatively small price differentials (\$50 to \$150) in the tradeoff questions. To avoid such sensitization, a separate control group of about 50 respondents at each airport was asked to guess what they thought present coach fare was on a New York to London trip and on a San Francisco to Tokyo trip. They were then asked what they thought the present supersonic fare was on the transatlantic trip and what they thought supersonic fare would be on a transpacific trip if a commercial supersonic airplane were to fly such a route. Background information on this control sample indicated that it was very similar in composition to the main sample that responded to the tradeoff questions.

The fare estimates we obtained showed considerable variability, but on the average, the price perception control group guessed that regular transatlantic coach fare was about \$381 (standard deviation = \$178). This is fairly close to the actual New York to London fare of \$369 (peak season fare according to the November, 1979 Official Airline Guide). The average estimate for transatlantic fare on a supersonic airplane was \$680 (s.d. = \$374), about double the estimated coach fare, but still substantially lower than the actual supersonic fare of \$1113 (again according to the November, 1979 OAG).

The control group guessed that regular coach fare for a San Francisco to Tokyo trip was about \$628 (s.d. = \$286), somewhat higher than the actual transpacific fare of \$502 (November, 1979 OAG). Their guess as to the probable supersonic fare across the Pacific was about \$1064 (s.d. = \$857).

In general then, knowledge of transatlantic coach fare seemed fairly good, though the control group thought transpacific travel at regular fare would be somewhat more expensive than it actually is. The control group was aware that present supersonic fares are considerably higher than regular coach fares, though they underestimated just how much higher. Nonetheless, we can conclude that our sample of experienced overseas travelers was generally knowledgeable about the present costliness of supersonic travel.

TIME VERSUS COMFORT TRADEOFFS

Figure 2 and tables 18, 19, and 20 show patterns of response obtained when subjects were presented with the two pairs of time/comfort tradeoff choices:

- o A conventional wide-body jet with standard leg room (34 inches from seat back to seat back) that takes 11 hours on a San Francisco to Tokyo flight versus a supersonic airplane with 2 inches less leg room that takes 4 hours on the same route. (Both cost \$525.)
- o A conventional wide-body jet with standard leg room that takes 7 hours on a New York to London trip versus a supersonic airplane with 2 inches less leg room that takes 3 hours on the same route. (Both cost \$400.)

Figure 2, which summarizes the five airport sample responses to these comfort tradeoffs, shows that 83% of business travelers said they were willing to sacrifice 2 inches of leg room to save 7 hours on a transpacific business flight, while 81% were willing to sacrifice this leg room to save 4 hours on a transatlantic flight. When the entire sample of both business and pleasure travelers responded to the comfort tradeoffs while thinking of imaginary pleasure trips, 78% said they would sacrifice leg room on a transpacific flight and 75% said they would sacrifice it on a transatlantic flight.

Table 18 shows that willingness to sacrifice leg room to save time on pleasure flights was slightly higher among business than among pleasure travelers. This table also shows that at Los Angeles and San Francisco fewer travelers, both business and pleasure, were willing to give up leg room to save time. Even in these airports, however, two thirds or more of the travelers surveyed thought the time savings on an SST flight were worth the sacrifice of leg room.

Additional information on responses to the comfort tradeoffs is presented in Table 19, which shows how persons of different ages, sexes, occupations, etc. responded to the tradeoffs for imaginary pleasure trips. From this table, it is apparent that the majority of persons in all demographic categories would prefer to fly an SST even with lesser leg room. However, there are fluctuations in the size of this majority as a function of some demographic variables. For instance,

Table 19 shows that preference for the SST was less prevalent among older persons, women, and persons with occupations categorized as "other." However, the women in this sample tend to be somewhat older on the average than the men, and persons classified "other" were predominantly homemakers and retired persons. Thus, the reduced preferences for the SST in these age, sex, and occupation categories are related and must be interpreted with caution. Differences as a function of other demographic variables were not so striking.

Table 20 presents the tradeoff data broken down as a function of the class that the respondents said they usually traveled when taking a long-range flight. Again, the most apparent result here is that 70% or more of the persons in all fare class categories felt they would give up leg room to get a significantly faster flight. Among business travelers, fluctuations as a function of fare class were not strikingly consistent, but among pleasure travelers, those who usually paid a discount fare were most willing to give up leg room, while those who usually paid first class fare were least likely to say they would make the two-inch sacrifice.

WILLINGNESS TO FLY SST IF THERE WAS MORE LEG ROOM AND
WILLINGNESS TO PAY EXTRA FOR MORE ROOM

For each trip scenario (transatlantic and transpacific), half of those subjects who said they would prefer a wide-body jet with normal leg room to an SST with less leg room were asked if they would fly the SST if it had normal leg room. (Recall that cost was held constant on the comfort tradeoffs.) Among business travelers imagining pleasure trips, 73% of 49 respondents who rejected the SST for the Atlantic trip and 58% of 50 respondents who rejected it for the Pacific trip said that they would take the SST if it had normal leg room. Among pleasure travelers, 54% of 107 respondents rejecting the less roomy SST on the Atlantic trip and 46% of 95 respondents rejecting it on the Pacific trip said they would fly the SST if it had normal leg room.

When the business travelers were imagining business trips, 71% of 45 respondents rejecting the SST for the Atlantic trip and 50% of 40 respondents rejecting it for the Pacific trip said they would fly the SST if it had normal leg room.

Also for each trip scenario, half of those subjects who chose the less roomy SST or who said they would take the SST if it had regular leg room were asked if they would be willing to pay extra to sit in a more roomy (normal leg room) area of the SST. Of 253 business travelers asked this question with regard to a 3-hour transatlantic pleasure trip, 30% said they would pay an average of \$59 extra for more room. Of 257 business travelers asked the question with regard to a 4-hour transpacific pleasure trip, 37% said they would pay an average of \$67 extra for more room. Thirty-one percent of 423 pleasure travelers said they would pay an average of \$58 for more room on a transatlantic flight; 32% of 400 pleasure travelers said they would pay about \$60 extra on a transpacific flight.

On a transatlantic business trip, 32% of 247 travelers said they would pay about \$62 extra for more room. Thirty-seven percent of 258 respondents said they would pay about \$72 extra on a transpacific business flight.

Thus, approximately a third of those travelers asked said they would pay a surcharge of 12 to 15% over coach fare to sit in a roomier area on the SST.

TIME VERSUS PRICE TRADEOFFS

Figure 3 and tables 19, 20, and 21 show patterns of response obtained when subjects were presented with two pairs of time/price tradeoff choices:

- o A conventional wide-body jet taking 11 hours on a San Francisco to Tokyo flight and costing \$525 versus a supersonic flight taking 4 hours and costing \$575/\$625/\$675. (Both have standard seats and leg room.)
- o A conventional wide-body jet taking 7 hours on a New York to London flight and costing \$400 versus a supersonic flight taking 3 hours and costing \$450/\$500/\$550.

Figure 3 summarizes responses to the time/price tradeoffs across all five airports surveyed. Among business travelers imagining a transpacific business trip, 82% said they would pay \$50 extra for an SST flight, 72% would pay \$100, and 67% would pay \$150. On the transatlantic flight, 79% of the business travelers would pay an extra \$50, 64% would pay \$100, and 54% would pay \$150.

When the entire sample was asked about an imaginary pleasure trip, 83% said they would pay \$50 extra to fly an SST across the Pacific, 63% would pay \$100, and 51% would pay \$150. On the transatlantic flight, 77% would pay \$50, 47% would pay \$100, and 33% would pay \$150.

In summary then, the pattern of results was a very reasonable one. At the \$50 level about 80% of the respondents imagining either a business or a pleasure trip said they were willing to pay extra to fly an SST. The percentage willing to pay the higher price levels fell off more rapidly when a pleasure trip was considered than when a business trip was considered, and it fell off more rapidly when the Atlantic trip was considered than when the longer Pacific trip was considered.

This basic pattern of results was observed at all five airports, as shown in table 19. This table also shows that, as with the comfort tradeoffs, business travelers were typically more willing than pleasure travelers to make a trade in favor of the SST even when considering a pleasure, rather than a business, flight.

The responses of pleasure travelers to the time/price tradeoffs were very similar from airport to airport. However, there was some variability observed among the different samples of business travelers. Generally speaking, the percentage of business travelers at San Francisco and at Dulles (Washington, D.C.) that was willing to make the time/price tradeoffs in favor of the SST was

somewhat lower than the percentage at Kennedy (New York), Dallas-Fort Worth, and Los Angeles. The lowered percentage in the San Francisco sample may have been due to the fact that this sample was somewhat younger and less affluent than the samples of business travelers at other airports. Table 19 indicates that less affluent travelers were less willing to make time/price tradeoffs in favor of the more expensive SST flight. The same table indicates that older persons were slightly less willing to make trades favoring the SST. This may explain the lower percentage of business travelers choosing the SST at Dulles, since the Dulles sample tended to be older than the samples from other airports.

The finding that older persons were less willing to trade in favor of the SST on the time/price questions was the same result seen with the time/comfort alternatives. Also like the time/comfort alternatives, a slightly lower percentage women and those with "other" occupations chose the SST at the three cost levels. The previously described confounding of sex, age, and "other" occupation complicates interpretation of this result.

As would be expected, table 19 shows a relationship between income level and willingness to pay higher amounts to fly an SST. The higher the total family income of a respondent, the more likely he or she was to choose the SST at the \$150 additional cost level. However, there did not appear to be a relationship between occupation and willingness to pay extra (excepting the lowered willingness to pay among "other" occupations as noted above). The indication is that persons with widely differing family income levels were included in the "manager/professional," the "white collar," and the "blue collar" classifications. Finally, there appeared to be no differences in willingness to make time/price trades in favor of the SST as a function of the area of the country in which respondents lived.

Table 20, showing responses to the tradeoffs as a function of fare class usually chosen on long-range flights, displays a similarly straightforward pattern of response to the time/price tradeoffs. At the \$50 level at least 70% of respondents in all fare categories expressed willingness to trade in favor of the SST. As the additional price went higher, discount flyers dropped out most rapidly, regular coach passengers dropped out somewhat less rapidly, and first class passengers dropped out least rapidly. The pattern of change as a function of usual fare class is quite similar for both business and pleasure travelers (though as mentioned above, pleasure passengers show less willingness to pay overall). Also among business travelers, those who said they customarily paid for their own travel did not appear strikingly less willing to pay extra to fly SST than those for whom business travel was paid.

RESPONSES OF EXPERIENCED CONCORDE TRAVELERS

One class of responses shown in table 19 has not yet been discussed. These are the responses of the 46 travelers who had already experienced supersonic flight at present high fare levels. Their responses to the comfort tradeoff questions were generally similar to the responses of the 1438 travelers who had not flown Concorde. On the time/price tradeoffs, however, the experienced SST

travelers were markedly more willing than other travelers to pay \$100 or \$150 extra to fly supersonic. It can be safely assumed that such price levels did not sound high to those who had already flown Concorde. Also, Concorde travelers are very affluent.

Of the 46 experienced Concorde travelers, most (35, or 76%) were business travelers and most were male (42, or 91%). Seven percent were under 30 years old; 48% were between 30 and 50; 46% were over 50. Seventy-six percent were managers or professionals; 9% were white collar workers; 9% were retired; and 2% were homemakers. Fifty percent of the experienced Concorde flyers had family incomes exceeding \$60,000 per year; 31% had incomes between \$40 and \$60,000; 11% had incomes below \$40,000; and 9% refused to give their income levels.

The Concorde travelers were typically quite experienced. Twenty percent had taken only two overseas flights in the past two years; 35% had taken from 3 to 10 flights; and 55% had taken 11 flights or more. Forty-three percent of these respondents had taken one flight on the Concorde (no time limit was specified here); 28% had taken two flights; the rest had taken three or more flights. When asked whether they usually knew what airplane they would be flying on their long-range flights, 70% of the Concorde flyers (versus about 57% of the general sample) said they did know what plane they would be taking.

As would be expected with such an affluent sample, there was a high incidence of persons who usually flew first class. Fifty percent of the Concorde experienced business travelers said they usually flew first class for business; 24% usually flew coach. No one mentioned a discount fare. Seventy-one percent of these business travelers had their travel paid for, while 26% paid themselves.

On pleasure trips, 55% of the Concorde experienced travelers who had taken long pleasure flights said they usually flew first class; 30% said they flew coach; and 15% said they flew discount.

Thirty-four respondents said they had taken business related trips on Concorde; 12 had taken pleasure trips. When speaking of their business trips, 44% said they had flown Concorde to save time; 32% said they had tried it out of curiosity; 18% gave miscellaneous responses; 6% did not answer. When speaking of their pleasure trips, five of the twelve respondents mentioned curiosity as the reason; two mentioned speed; other answers were miscellaneous.

Fifty-four percent of those with Concorde experience said they would fly Concorde again; 20% said they would not; and 26% were undecided or did not answer the question. Most of those who said they would fly Concorde again (22 of the 25 respondents who said this) mentioned speed as the reason. Of those who said they would not fly again (9 respondents), 3 said they thought Concorde uncomfortable. Other categories of negative response contained too few occurrences to be meaningful.

RESPONDENTS' REASONS FOR PREFERRING SUPERSONIC
VERSUS WIDE-BODY JET ALTERNATIVES FOR LONG-RANGE
TRAVEL

Reasons for Selecting the SST

As in the preliminary study at Seattle-Tacoma, speed was the overwhelming reason given for preferring the supersonic flight on both the comfort and the time/price tradeoffs. Well over 80% of those choosing the supersonic alternative on the price tradeoffs mentioned speed in some form when asked the reason for their choice; 70% more mentioned speed when giving reasons for their time/comfort choice of the SST. The other major reason mentioned for choosing the SST on the time/comfort tradeoffs was that space was not that important. About 40% of both business and pleasure travelers gave the latter reason when answering about pleasure trips; about 32% of the business travelers said space was not important when speaking of a business trip. (Total percentages here can exceed 100 due to multiple responses.)

Reasons for Selecting the Wide-Body Jet

Among those who chose the wide-body alternative at the \$50 level for an Atlantic pleasure trip, about 49% said the price for the SST was too high. About 32% of those rejecting the SST on the Pacific pleasure trip said the price was too high. Among business travelers, 19% mentioned high price when responding to an Atlantic business trip; 28% said they thought their company would not pay extra for them to fly the SST. On the Pacific business trip, 13% mentioned high cost; 29% doubted their company would pay.

Despite the explicit statement that the hypothetical SST to be considered in answering the time/price questions had the same seats and leg room as the wide-body jet, 10 to 14% of the pleasure travelers and 29 to 38% of the business travelers still mentioned wide-body comfort as their reason for rejecting the SST at the \$50 price tradeoff level. On the comfort tradeoff itself, about 70% of the wide-body preferring pleasure travelers mentioned comfort as their primary reason for rejecting the SST. Among business travelers preferring the subsonic wide-body, about 79% mentioned comfort as their reason.

There was some expression of anti-SST sentiment in response to both types of tradeoff questions. On the time/price trades, 57 to 58 pleasure travelers gave anti-SST sentiment as their reason for rejecting the SST alternative. (This is about 6% of all pleasure travelers.) However, on the comfort tradeoff, where cost was held constant, 40 to 44 pleasure travelers (about 5% of all pleasure travelers) said they opposed the SST. Thus, 14 to 17 of those who mentioned anti-SST sentiment were not so adamantly against the supersonic transport that they would reject it if the price were right.

Among business travelers, there were 12 to 17 persons (about 3% of all business travelers) who expressed anti-SST sentiment on the time/price tradeoffs and 9 to 11 who said they opposed the SST when explaining their comfort choice. Again, equal price seemed to mute a few travelers' objections to the SST. It appears, then, that about 49 persons (3% of the entire sample) felt

strongly enough against the SST to express opposition even when the price of an SST ticket was the same as a regular coach ticket. An additional 2% of the sample felt some qualms about the SST, but these qualms were not so strong that they would reject a much shorter flight at an equal price.

SUMMARY AND CONCLUSIONS

Interviews were conducted with approximately 1500 experienced overseas air travelers, 300 at each of five airports (John F. Kennedy, Dulles, Dallas-Fort Worth, Los Angeles International, and San Francisco International). These travelers were asked to imagine they had a choice between a supersonic airplane and a subsonic wide-body jet for a flight from New York to London and for a flight from San Francisco to Tokyo. On the "time/comfort" tradeoff choices, both planes offered the same fares, but the supersonic flight (4 hours over the Pacific, 3 hours over the Atlantic) would have two inches less leg room than the wide-body jet (11 hours Pacific, 7 hours Atlantic). On the "time/price" tradeoff choices, both planes would offer the same seats and leg room, but the shorter supersonic flight would cost \$50, \$100, or \$150 more than the wide-body jet flight (wide-body cost = \$525 Pacific, \$400 Atlantic).

As in the preliminary study, business travelers (those with prior overseas business flights) made these two types of choices for both imaginary business and imaginary pleasure flights. Pleasure travelers (without recent overseas business flights) responded only for imaginary pleasure flights.

The results of the preliminary study were closely replicated in the five airport follow-up, though results indicate that business travelers interviewed at Seattle-Tacoma were among the most enthusiastic with regard to SST flight alternatives. In the five airport sample, 81 to 83% of business travelers imagining a business trip said they would prefer the less roomy SST over the slower wide-body. Ninety percent chose the SST at SeaTac. Seventy-seven to 79% of the five airport business sample preferred the less roomy SST for a pleasure flight. Eighty-one percent of the SeaTac business travelers chose the less roomy SST for a pleasure trip. Seventy-three to 77% of the five airport pleasure travelers preferred the less roomy SST. The SeaTac percentage was 70%.

In order to check on the knowledgeableness of the sample with regard to present overseas fares for subsonic and supersonic airplanes, a separate control group of approximately 250 persons (50 per airport) with the same qualifications as the main sample was asked to guess what regular coach fare was on the New York to London and San Francisco to Tokyo routes and what supersonic fare was (or would be) on these routes. Generally, respondents seemed fairly knowledgeable. They were quite aware that supersonic travel was significantly more expensive than subsonic fare, though they underestimated somewhat on just how much more expensive. However, based on the responses of the control group, we can conclude that most overseas travelers realize that the \$50, \$100, and \$150 additional charges for an SST used in this study were low compared to the actual additional charge for a supersonic flight.

On the time/price tradeoffs, approximately 80% of both business and pleasure travelers on both Pacific and Atlantic business or pleasure trips said they would pay \$50 to fly SST. Fifty dollars was apparently an all but negli-

ble additional charge to most people. At the \$100 and \$150 additional price levels, business travelers were more willing to pay extra for a faster flight than were pleasure travelers. This is again similar to the results seen in the preliminary study at SeaTac. There, 80% of business travelers were willing to pay an extra \$100 on a transpacific business flight and 64% were willing to pay this amount for a pleasure flight. Fifty-two percent of the SeaTac pleasure travelers were willing to pay the \$100.

In the five airport sample, 72% of business travelers said they would pay \$100 for a transpacific business flight, and 68% said they would pay this amount on a pleasure flight. Sixty percent of the five airport pleasure travelers would pay \$100 on the transpacific trip. Sixty-seven percent of the business travelers were willing to pay \$150 for a transpacific SST on business, 54% would pay \$150 for a pleasure flight. Forty-nine percent of the pleasure travelers would pay \$150.

Comparable results were seen on the transatlantic trip, though on this shorter run a smaller number of both business and pleasure travelers were willing to pay the \$100 and \$150 additional to save 4 hours. Still, 54% of the business travelers considering a business trip, 37% of the business travelers considering a pleasure trip, and 31% of the pleasure travelers said they were willing to pay the \$150 extra (a 37.5% surcharge) to fly supersonic across the Atlantic.

Examination of responses to SST versus wide-body alternatives as a function of age, sex, occupation, income and region of country where respondents lived indicated that high levels of interest in moderately priced supersonic transportation were prevalent among experienced overseas air travelers in all the demographic and socioeconomic categories surveyed. It did appear, however, that older persons might be less enthused about SST travel than younger ones. Also, as would be expected, less affluent travelers were less willing to pay the higher surcharge levels.

Reasons given for preferring the SST generally related to the speed with which it could take travelers to their destination. Most of those rejecting the SST alternative on the price or comfort questions unsurprisingly mentioned price or comfort as the reasons for their preference for the wide-body subsonic jet. However, there appeared to be about 3 to 5% of the sample that was generally opposed to the introduction of commercial supersonic transports.

It is apparent, then, that the conclusions drawn on the basis of the preliminary study at SeaTac are generalizable to the experienced overseas air travelers interviewed for this study at other major airports in the United States. If an environmentally and economically viable supersonic transport can be developed, a high percentage of overseas air travelers appear willing to pay moderately elevated ticket prices in order to save significant amounts of time on long-range flights.

1 Gilmore Research Group Interviewer _____ San Francisco ()1
 2 2100 N. 45th Street Los Angeles ()2
 3 Seattle, WA 98103 Date _____ O'Hare ()3
 4 Job. No. 887 Dallas/Ft. Worth ()4
 5 Dulles ()5
 6 J.F. Kennedy ()6

Long Range Airplane Study - National

Hello, I'm _____ of Gilmore Research Group, an independent market research firm. We're conducting a brief survey among U.S. citizens; are you a U.S. citizen? 3-5

IF "NO" TERMINATE Yes ()

This survey is about 5 to 7 minutes in length and deals with air traveler preferences for airplanes for long range travel. Could you assist us with this research now?

1. First, are you or is any member of your family employed in any of these capacities...HAND YELLOW CARD

IF "YES" TO ANY, TERMINATE No ()

2. Using this card, please tell me why you are at the airport today...SHOW FLIP SIDE OF YELLOW CARD

- To take a flight ()1
- Arriving from a flight ()2
- To make a connection between flights ()3
- To take someone else to a flight ()4
- To pick someone else up from a flight ()5
- Other: _____ ()6
- Refuse ()7

3. Where do you live? 6

State _____

Other country (If Not U.S.) _____ 7-9

4. Within the last two years, how many flights of 5 hours or more over water have you taken?

NOTE: ROUND TRIP BY AIR = 2 "FLIGHTS"

IF "NONE" OR "1", TERMINATE, RECORD; RE-USE FORM

IF "2" OR MORE, ASK Qs 4a & 4b.

4a Of these flights, how many were primarily business motivated: 10-12

BUSINESS

None ()

4b How many were primarily motivated by personal or pleasure reasons? 13-15

None () 16-8

NOTE: NUMBERS IN 4a & 4b SHOULD ADD TO NUMBER IN Q4

IF "BUSINESS" BOX EMPTY, SKIP TO Q5c

IF "BUSINESS" BOX HAS NUMBER, ASK Qs 5a & 5b

BUSINESS FLIGHT RESPONDENTS

5a. Thinking now of all the business flights of 5 hours or more you have ever taken over land or water, have you usually traveled... READ 1-3:

- First class ()1
- Regular coach ()2
- Special discount fare ()3
- Don't know ()4

19

5b Do you usually pay for your own business travel or do you have a major financial interest in the firm that pays for your business travel?

- Yes ()1
- No ()2
- Don't know ()3
- Refused ()4

20

Figure 1.- Five-airport questionnaire.

ASK EVERYONE:

5c Thinking of all the personal or pleasure flights of 5 hours or more you have ever taken over land or water, have you usually traveled ... READ 1-3:

First class	()	1
Regular coach	()	2
Special discount fare	()	3

No such flights taken	()	4
Don't know	()	5

6. Do you usually know in advance on what type of airplane you will be flying for your flights of 5 hours or more?

Yes	()	1
No	()	2
Don't know	()	3

7. Have you ever flown on the Concorde?

ASK Qs 8-13 ←	Yes	()	1
	No	()	2
SKIP TO NEXT PAGE ←	DK/Refuse	()	3

CONCORDE FLYERS, ONLY

8. How many one way flights have you taken on the Concorde:

NOTE: ROUND TRIP = 2 "FLIGHTS" () 24-6

9. How many of your flights on the Concorde were primarily business motivated:

SKIP TO Q11 ← None () () 27-9

10. What were your reasons for flying the Concorde for these business flights?

_____ 30
 _____ 31
 _____ 32

11. How many of your flights on the Concorde were primarily motivated by personal or pleasure reasons?

SKIP TO Q13 ← None () () 33-5

12. What were your reasons for flying the Concorde for these pleasure flights?

_____ 36
 _____ 37
 _____ 38

13a Do you plan to fly the Concorde Again?

Yes	()	1
No	()	2
Don't know	()	3
Refuse	()	4

13b Why do you say that? _____

_____ 40
 _____ 41
 _____ 42

Figure 1.- Continued.

24. And now just a few short questions for the purposes of classification. Using this card, please tell me into which of the following age categories do you fall

BACK GREEN CARD

- 18-25 ()1
- 26-30 ()2
- 31-35 ()3
- 36-40 ()4
- 41-45 ()5
- 46-50 ()6
- 51-55 ()7
- 56-60 ()8
- 61-65 ()9
- Over 65 ()0
-
- Refused ()A

57

25. What is your occupation? (Be specific)

58

26. Into which of these groups did your total family income fall last year

FLIP SIDE OF GREEN CARD

- Under \$10,000 ()1
- \$10,000 - \$19,999 ()2
- \$20,000 - \$29,999 ()3
- \$30,000 - \$39,999 ()4
- \$40,000 - \$49,999 ()5
- \$50,000 - \$59,999 ()6
- \$60,000 - \$69,999 ()7
- Over \$70,000 ()8
-
- Refused ()9

59

This concludes my questions; thank you so much for your time and interest.

CHECK ONE

- Male ()1
- Female ()2

60

END CARD 2 60

NAME _____

PHONE _____

Figure 1.- Continued.

ASK EVERYONE

Now I am going to give you a series of 5" x 7" cards, each of which has printed on it a description of two flights, both coach/economy class flights with identical seats and leg room. They differ only in length of flight, type of aircraft and cost.

What I would like you to do is to imagine that you are planning a personal or pleasure trip from New York to London and you had to choose between the two flights described on each card. For each card tell me which flight you would choose and why.

CARD 1 WHITE	7 hr./wide-body/\$400	()1	59
	3 hr./supersonic/\$450	()2	
	-----	-----	
	Don't know	()3	
	Refused	()4	

Why? _____

60-1

IF "7 hr./wide-body/\$400" SKIP TO NEXT PAGE

CARD 2 WHITE	7 hr./wide-body/\$400	()1	62
	3 hrs./supersonic/\$500	()2	
	-----	-----	
	Don't know	()3	
	Refused	()4	

Why? _____

63-4

IF "7 hr./wide-body/\$400", SKIP TO NEXT PAGE

CARD 3 WHITE	7 hr./wide-body/\$400	()1	65
	3 hr./supersonic/\$550	()2	
	-----	-----	
	Don't know	()3	
	Refused	()4	

Why? _____

66-7

Figure 1.- Continued.

ASK EVERYONE

16. Now a different kind of question. If you had the following two choices, both coach/economy flights which cost \$400, which would you fly for a personal or pleasure trip from New York to London ...

SHOW PINK Card .1

wide-body/normal seating	()1
supersonic/2 in. less leg room	()2

Don't know	()3
Refused	()4
	68

17. Why? _____
- _____

69-70

BLANK 71-5

END CARD 1 80

SAME AS 1 1-5

Figure 1.- Continued.

ASK EVERYONE

Now I am going to give you a series of 5" x 7" cards, each of which has printed on it a description of two flights, both coach/economy class flights with identical seats and leg room. They differ only in length of flight, type of aircraft and cost.

What I would like you to do is to imagine that you are planning a personal or pleasure trip from San Francisco to Tokyo and you had to choose between the two flights described on each card. For each card tell me which flight you would choose and why.

CARD 3 BLUE

11 hr./wide-body/\$525	()1
4 hr./supersonic/\$675	()2

Don't know	()3
Refused	()4

Why? _____

IF "4 hr./supersonic/\$675", SKIP TO NEXT PAGE

CARD 2 BLUE

11 hr./wide-body/\$525	()1
4 hr./supersonic/\$625	()2

Don't know	()3
Refused	()4

Why? _____

IF "4 hr./supersonic/\$625", SKIP TO NEXT PAGE

CARD 1 BLUE

11 hr./wide-body/\$525	()1
4 hr./supersonic/\$575	()2

Don't know	()3
Refused	()4

Why? _____

6
7-8
9
10-11
12
13-14

Figure 1.- Continued.

ASK EVERYONE

16. Now a different kind of question. If you had the following two choices, both coach/economy flights which cost \$525 which would you fly for a personal or pleasure trip from San Francisco to Tokyo....

SHOW PINK Card 2

wide-body/normal seating	()1
supersonic/2 in. less leg room	()2
Don't know	()3
Refused	()4
	15

17. Why? _____

16-17

18. IF "wide-body/normal seating" in Q17 ASK: Would you fly the supersonic if it had normal leg room?

Yes	()1
No	()2
Don't know	()3
Refused	()4
	18

19. IF "supersonic/2 in. less leg room" in Q16, or "YES" to Q18 ASK: If an area with normal leg room were available on the supersonic airplane, how much extra would you be willing to pay to sit in this more roomy area?

(RECORD \$ VALUE) _____	
"would not pay extra"	()A
Other _____	()B
Don't know	()C
Refused	()D

19-22

Figure 1.- Continued.

ASK THESE QUESTIONS OF EVERYONE. ROTATE ORDER
START AT RED MARK



14. Imagine that you are planning a trip from New York to London. Suppose that you had the option of flying either on a conventional wide-body jet or on a supersonic airplane.

How much do you think a one-way regular coach ticket would cost if you chose to fly ... (READ a-b):

	RECORD \$ VALUE	DON'T KNOW	REFUSED	
a. the wide-body jet? _____		a. ()	b. ()	43-6
b. the supersonic airplane? _____		a. ()	b. ()	47-50



15. Imagine you are planning a trip from San Francisco to Tokyo. Again, you have the choice of a wide-body jet or a supersonic airplane. How much do you think a one-way regular coach ticket would cost if you chose to fly ... (READ a-b):

	RECORD \$ VALUE	DON'T KNOW	REFUSED	
a. the wide-body jet? _____		a. ()	b. ()	51-4
b. the supersonic airplane? _____		a. ()	b. ()	55-8

BLANK 59-75

END CARD 1 80

SAME AS 1 1-5

BLANK 6-56

Figure 1.- Concluded.

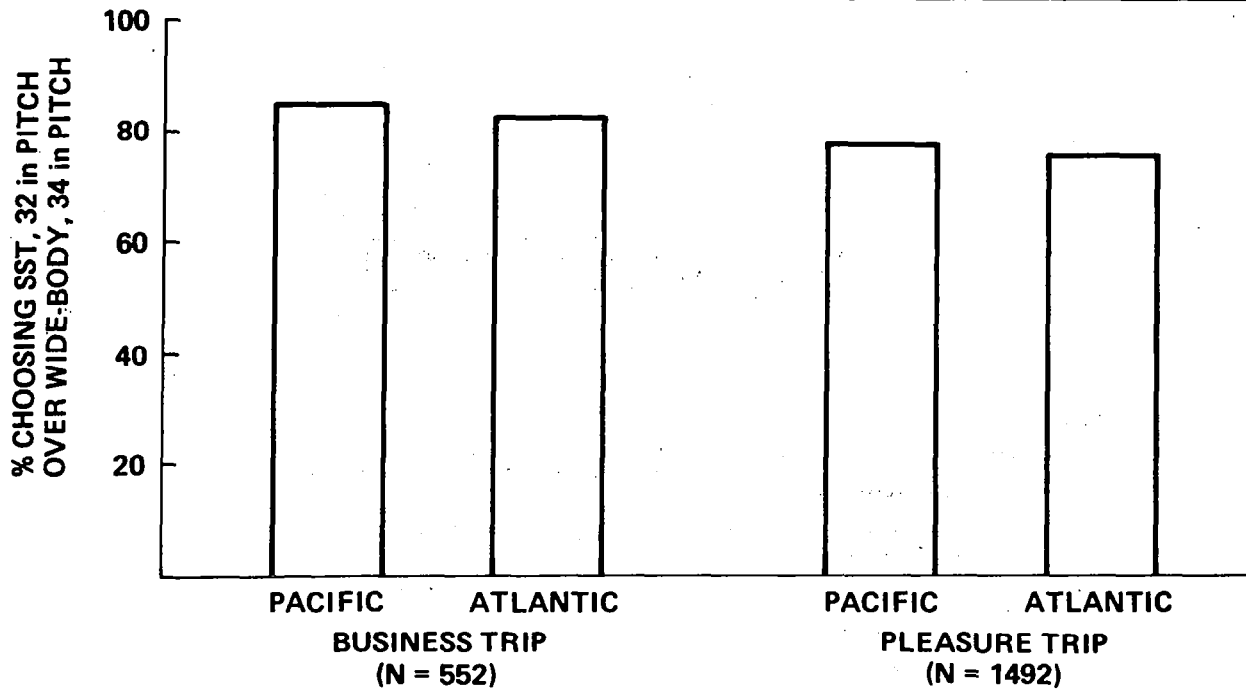


Figure 2. Summary of time/comfort tradeoffs.

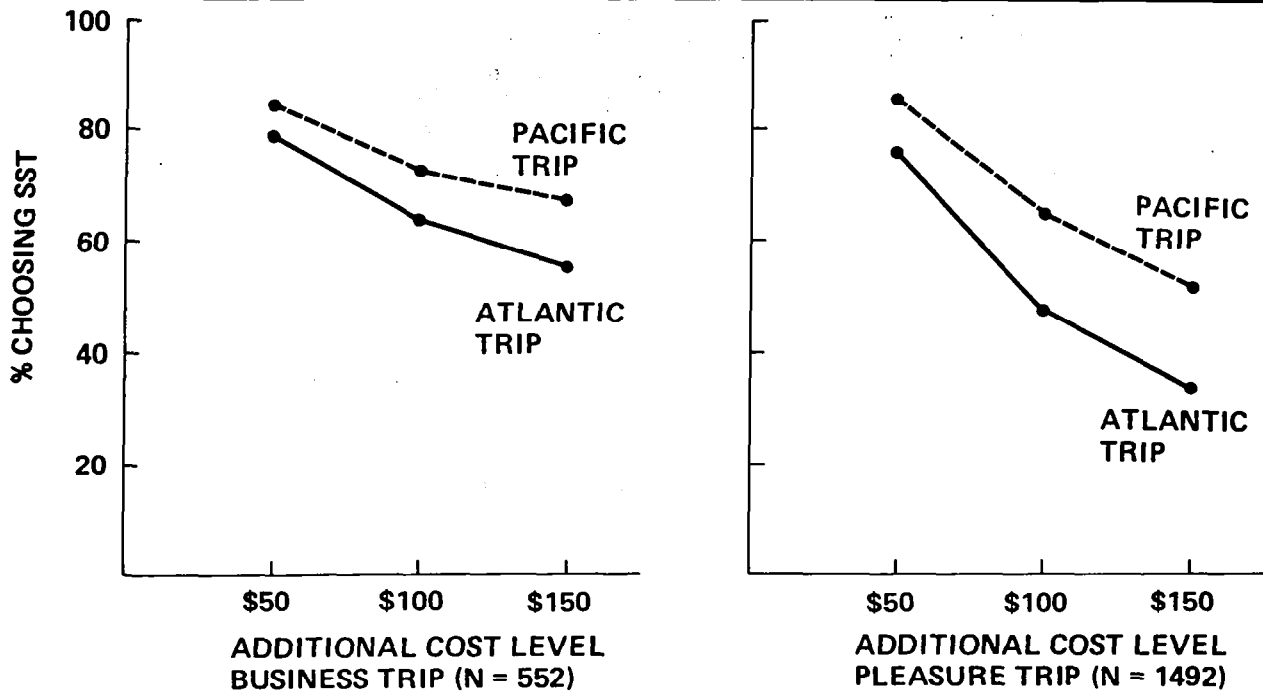


Figure 3. Summary of time/price tradeoffs.

Gilmore Research Group
2100 N. 45th St.
Seattle, WA 98103
Job. No. 5120 (2000)

1-3

LONG RANGE AIRPLANE STUDY

Hello, I'm _____ of Northwest Certified Surveys, an independent market research firm. We're conducting a brief survey among U.S. citizens; are you a U.S. Citizen?

IF "NO" TERMINATE Yes ()

This survey is very brief and deals with air traveler preferences for airplanes for long range travel. Could you assist us with this research now?

1. First, are you or is any member of your family employed in any of these capacities... HAND YELLOW CARD

IF "YES" TO ANY, TERMINATE No ()

2. Using this card, please tell me why you are at the airport today ... SHOW FLIP SIDE OF YELLOW CARD.

- To take a flight ()1
Arriving from a flight ()2
To make a connection between flights ()3
To take someone else to a flight ()4
To pick someone else up from a flight ()5
Other: _____ ()6
Refuse ()7

3. Where do you live?

City _____ State _____

Other country _____ 5-6

4. Within the last two years, how many flights of 5 hours or more over water have you taken?

NOTE: ROUND TRIP BY AIR = 2 "FLIGHTS" 7-9

IF "NONE" OR "1", TERMINATE, RECORD; RE-USE FORM

IF "2" OR MORE, ASK Qs 4a & 4b

- 4a Of these flights, how many were primarily business motivated?

BUSINESS None () 10-12

- 4b How many were primarily motivated by personal or pleasure reasons?

None () 13-15

NOTE: NUMBERS IN 4a & 4b SHOULD ADD TO NUMBER IN Q.4

IF "BUSINESS" BOX EMPTY, SKIP TO Q.5c

IF "BUSINESS" BOX HAS NUMBER, ASK Qs 5a & 5b

BUSINESS FLIGHT RESPONDENTS

- 5a Thinking now of all the business flights of 5 hours or more you have ever taken over land or water, have you usually traveled ... READ 1-3:

- First class ()1
Regular coach ()2
Special discount fare ()3
Don't know ()4 16

- 5b Do you usually pay for your own business travel?

- Yes ()1
No ()2
Don't know ()3
Refuse ()4 17

Figure 4. Preliminary survey questionnaire and show cards.

ASK EVERYONE:

- 5c Thinking of all the personal or pleasure flights of 5 hours or more you have ever taken over land or water, have you usually traveled ... READ 1-3:
- | | | |
|-----------------------|-----|---|
| First class | () | 1 |
| Regular coach | () | 2 |
| Special discount fare | () | 3 |
| No such flights taken | () | 4 |
| Don't know | () | 5 |
6. Do you usually know in advance on what type of airplane you will be flying for your flights of 5 hours or more?
- | | | |
|------------|-----|---|
| Yes | () | 1 |
| No | () | 2 |
| Don't know | () | 3 |
7. Have you ever flown on the Concorde?
- | | | |
|--------------------------|-----|---|
| ASK Qs 8-13 ← Yes | () | 1 |
| No | () | 2 |
| SKIP TO Q.14 ← DK/Refuse | () | 3 |

CONCORDE FLYERS, ONLY

8. How many one way flights have you taken on the Concorde? 21-23

NOTE: ROUND TRIP = 2 "FLIGHTS" ()

9. How many of your flights on the Concorde were primarily business motivated: 24-26

SKIP TO Q.11 ← None ()

10. What were your reasons for flying the Concorde for these business flights? 27

_____ 28

_____ 29

11. How many of your flights on the Concorde were primarily motivated by personal or pleasure reasons? 30-32

SKIP TO Q.13 ← None () ()

12. What were your reasons for flying the Concorde for these pleasure flights? 33

_____ 34

_____ 35

13a. Do you plan to fly the Concorde again?

Yes	()	1
No	()	2
Don't know	()	3
Refuse	()	4

13b. Why do you say that? 37

_____ 38

_____ 39

Figure 4.- Continued.

ASK EVERYONE

14a Imagine you are planning a personal or pleasure trip from Seattle to Tokyo. If you had the following two choices, both of which cost \$500, which would you fly for a personal or pleasure trip ... SHOW WHITE CARD:

- 10 hr/wide body/34" seating () 1
- 3½ hr/supersonic/32" seating () 2
- Don't know () 3
- Refuse () 4

14b Why? _____ 41

_____ 42

_____ 43

15a If you had to choose between these two flights, both of which had identical seats and leg room, which would you fly for a personal or pleasure trip ... SHOW FLIP SIDE OF CARD:

- 10 hr/wide body/\$500 () 1
- 3½ hr/supersonic/\$600 () 2
- Don't know () 3
- Refuse () 4

15b Why? _____ 45

_____ 46

_____ 47

CHECK BACK TO Q. 4a, FRONT PAGE. IF BOX HAS NUMBER -- HAS TAKEN 5-HOUR BUSINESS FLIGHT OVER WATER -- ASK Qs 16a-17b.

IF BOX BLANK -- NO BUSINESS FLIGHTS -- CONCLUDE INTERVIEW.

16a Imagine you are planning a business trip from Seattle to Tokyo. If you had the following two choices, both of which cost \$500, which would you fly for a business trip ... SHOW WHITE CARD:

- 10 hr/wide body/34" seating () 1
- 3½ hr/supersonic/32" seating () 2
- Don't know () 3
- Refuse () 4

16b Why? _____ 49

_____ 50

_____ 51

17a If you had to choose between these two flights, both of which had identical seats and leg room, which would you fly for a business trip... SHOW FLIP SIDE OF CARD

- 10 hr/wide body/\$500 () 1
- 3½ hr/supersonic/\$600 () 2
- Don't know () 3
- Refuse () 4

17b Why? _____ 53

_____ 54

_____ 55

This concludes my questions; thank you for your time and cooperation.

INTERVIEWER _____ DATE _____

Figure 4.- Continued.

Show Card—Questions 14a and 16a

A 10-hour coach/economy class flight on a wide-body jet with normal seating (34 inches from the back of one seat to the back of the next seat).

A 3-1/2-hour coach/economy class flight on a supersonic airplane with 2 inches less leg room than normal (32 inches from the back of one seat to the back of the next seat).

Show Card—Questions 15a and 17a

A 10-hour coach/economy class flight on a wide-body jet for \$500 (U.S. dollars).

A 3-1/2-hour coach/economy class flight on a supersonic airplane for \$600 (U.S. dollars).

Figure 4.- Concluded.

TABLE 1. CHARACTERIZATION OF SAMPLE

Description of all contacts	Total, %
Interviewed (qualified respondents) ^a	21
Not enough flights taken	54
Employment security	5
Not a U.S. citizen	14
Refusal	4
Other	<u>2</u>
Total % (contacts)	100 (1,447)
Reason for being at airport	Travelers, %
To depart on a flight	48
Arriving from a flight	12
To make a connection between flights	22
To take someone else to a flight	7
To pick up someone else from a flight	9
Other	<u>2</u>
Total % (travelers)	100 (304)
Living area	Travelers, %
Washington	35
California	11
Alaska/Hawaii	10
Other western states	7
Midwest	14
Eastern seaboard	8
South	11
Other continental U.S.	2
Outside continental U.S.	<u>2</u>
Total % (travelers)	100 (304)

^aTwo or more flights of five hours or more over water in the past two years.

TABLE 2. BUSINESS FLIGHTS VERSUS PERSONAL OR PLEASURE FLIGHTS

Q: Of these flights, how many were primarily business motivated?
How many were primarily motivated by personal or pleasure reasons?

Reason	Travelers, %
Personal or pleasure	61
Business	22
Both types	<u>16</u>
Total % (travelers)	99 ^a (304)

^aTotal percentages in all tables that are more or less than 100 are a result of rounding error or multiple responses.

TABLE 3. FREQUENCY OF LONG-RANGE FLIGHTS

Q. Within the last two years, how many flights of 5 hours or more over water have you taken?

Flights, No.	Total travelers, %	Business travelers, %			Pleasure travelers, %
		Total trips	Business trips	Pleasure trips	
0	0 ^a	0 ^a	0 ^a	58	0 ^a
1	0 ^a	0 ^a	4 ^a	5	0 ^a
2	53	32	48	24	66
3-4	24	26	20	9	22
5-6	10	19	9	3	5
7-10	7	10	9	2	5
10 plus	6	13	10	0	2
Total % (travelers)	100 (304)	100 (117)	100	101	100 (187)
Mean number of flights based on raw responses	4.4	6.3	5.4	1.2	3.3

^aIn order to qualify, respondents must have made 2 or more flights for business or pleasure. Business travelers may have made trips of both types.

TABLE 4. CLASS USUALLY TRAVELED ON LONG-RANGE BUSINESS FLIGHTS AMONG BUSINESS TRAVELERS

Q: Thinking now of all the business flights of 5 hours or more you have ever taken over land or water, have you usually traveled ... (asked of business flight respondents only)

Class traveled	Among all business travelers, %	Pay own business travel, %	Business travel paid, %
First class	22	15	26
Regular coach	66	64	67
Special discount rate	11	21	7
Don't know/no response	2	0	0
Total % (travelers)	101 (117)	100 (33) ^a	100 (82)

^aInterpret with caution (small sample base).

TABLE 5. CLASS USUALLY TRAVELED ON LONG-RANGE PERSONAL OR PLEASURE FLIGHTS

Q: Thinking of all the personal or pleasure flights of 5 hours or more you have ever taken over land or water, have you usually traveled . . . (asked of all respondents)

Class traveled	Total travelers, %	Personal pleasure travelers, %	Business travelers, %
First class	10	6	16
Regular coach	69	72	64
Special discount rate	<u>21</u>	<u>22</u>	<u>18</u>
Total % (travelers)	100 (304)	100 (187)	98 (117)

TABLE 6. ADVANCE KNOWLEDGE OF THE TYPE OF AIRCRAFT BEING FLOWN

Q: Do you usually know in advance on what type of airplane you will be flying for your flight of 5 hours or more? (asked of all respondents)

Answer	Total travelers, %	Business travelers, %	Pleasure travelers, %
Yes	56	57	55
No	<u>44</u>	<u>43</u>	<u>45</u>
Total % (travelers)	100 (304)	100 (117)	100 (187)

TABLE 7. INCIDENCE OF FLYING CONCORDE

Q. Have you ever flown on the Concorde? (asked of all respondents)

Response	Total travelers, %	Business travelers, %	Pleasure travelers, %
Yes	2	3	1
No	<u>98</u>	<u>97</u>	<u>99</u>
Total % (travelers)	100 (304)	100 (117)	100 (187)

Q. What were your reasons for flying the Concorde for these flights?

Response
Speed/time: "Speed" "Time. It's a beautiful way to fly and I really like the Concorde. Always pick it over others." "Politics, the office scheduled it because it was faster. I'm in politics."
Other: "We visited London, and we wanted to take the Concorde." "That was what they booked me on."

TABLE 8. TIME AND COMFORT TRADEOFF IN BUSINESS TRAVEL

Q: Imagine you are planning a business trip from Seattle to Tokyo. If you had the following two choices, both of which cost \$500, which would you fly for, a business trip . . . (asked of business flight respondents only)

Flight chosen	Among all business travelers, %	Class usually travel, %	
		First class	Coach/discount
10-hr/wide-body jet/ normal seating ^a	10	20	7
3½-hr/supersonic airplane/ 2 in. less leg room than normal ^a	90	80	93
Total % (travelers)	100 (109) ^b	100 (25) ^c	100 (84)

^aSee Figure 4 for exact wording of show cards.

^bEight missing responses

^cInterpret with caution (small sample base).

TABLE 9. REASONS UNDERLYING TIME/COMFORT TRADEOFF FOR BUSINESS TRAVEL

Preference for supersonic	Those favoring supersonic, %
Saves time, more time at destination: "Much faster; because of shorter hours in the air; for the convenience of saving on flying time; I just want to get there."	88
Dislike long airplane flights: "Boredom; you are too uncomfortable for 10 hours; less tired, more relaxed; I don't particularly care to be up there; there is nothing to see."	7
All others: "Since I'm not paying I'd rather fly 3½ hours."	8
Total % (travelers)	103 (97)
Preference for wide-body	Those favoring wide-body, %
Prefer wide-body (non-specific): "More room; more comfort...rest, etc.; I like comfort."	45
Against supersonic: "I don't want supersonic in U.S.; don't like supersonic. . . also I have a fear of the Concorde because it's new and a foreign plane."	45
Time not a factor	9
All others (wide-body): "Company is satisfied with (wide-body) so I am too; because of the environment."	27
Total % (travelers)	126 (11) ^a

^aInterpret with caution (very small sample base).

TABLE 10. TIME AND PRICE TRADEOFF IN BUSINESS TRAVEL

Flight chosen	Among all business travelers, %	Class usually travel, %		Pay own business travel, %	Business travel paid, %
		first class	coach/ discount		
10-hr/wide-body/\$500 ^a	20	16	20	23	18
3½-hr/supersonic/\$600 ^a	80	84	80	77	82
Total (travelers)	100 (109) ^b	100 (25) ^c	100 (84)	100 (30) ^c	100 (79)

^aSee Figure 4 for exact wording of show cards.

^bEight missing responses.

^cInterpret with caution (small sample base).

TABLE 11. REASONS UNDERLYING TIME/PRICE TRADEOFF FOR BUSINESS TRAVEL

Preference for supersonic	Those favoring supersonic, %
Time savings worth \$100: "Time is money; if the cost is not more than that for difference, I would take the faster flight, of course; again, to save the time in the air."	50
Time without reference to cost: "Definitely the fast one; I want to get there fast."	35
Easier to cope with time changes: "You don't have as much jet lag; easier to get back on your feet for business; speed, jet lag."	6
Dislike long airplane flights	3
All others: "Since I'm not paying I'd rather fly 3½ hours! business is paying for it."	14
Total % (travelers)	108 (86)
Preference for wide-body	Those favoring wide-body, %
Savings/cost (cost too high): "The price; less expensive; my company would probably not pay that extra \$100."	64
Against supersonic	23
All others (wide-body)	14
Total % (travelers)	101 (22) ^a

^aInterpret with caution (very small sample base).

TABLE 12. TIME AND COMFORT TRADEOFF FOR PERSONAL OR PLEASURE TRIP

Q. Imagine you are planning a personal trip from Seattle to Tokyo. If you had the following two choices, both of which cost \$500, which would you fly for a personal or pleasure trip. . . (asked of all respondents)

Flight chosen	Total travelers, %	Business travelers, %	Pleasure travelers, %
10-hr/wide-body jet/ normal seating ^a	26	19	30
3½-hr/supersonic airplane/ 2 in. less leg room than normal ^a	74	81	70
	100 (304)	100 (117)	100 (187)

^aSee Figure 4 for exact wording of show cards.

TABLE 13. REASONS UNDERLYING TIME/COMFORT TRADEOFF FOR PERSONAL OR PLEASURE TRAVEL

Preference for supersonic	Those favoring supersonic, %
Saves time, more time at destination: "To get there quicker; I just want to get there; the one that gets there the fastest; I don't like long flights; it just takes so long... long flights; because you don't get so tired sitting."	96
Don't need more space: "Two inches does not make that much difference; leg room OK."	7
Would like to try supersonic: "Would be interesting to try; because of new experience; I think it would be interesting to fly the supersonic."	7
All other: "Easier to cope with time change; easier to travel with children; I don't like riding in airplanes; because of societal ramifications."	9
Total % (travelers)	119 (226)
Preference for wide-body	Those favoring wide-body, %
Prefer wide-body (nonspecific): "More comfort, wider, etc.; It looks more comfortable; The wider seating is nicer to me."	56
Against supersonic: "I'm opposed to supersonic; No, opposed to faster types like Concorde; Don't want to fly in the supersonic until it is tested more."	32
Time not a factor: "I'm satisfied with the 10 hours; we are never in a hurry; I like to fly and am not in a hurry."	22
Prefer wider body proven record: "I would feel safer on the wide-body jet, they look more secure; I love 747s. We don't need all the unproven airplanes; stick with proven ones like we have now."	5
All others (wide-body): "If for pleasure; Company is satisfied with this one, so I am too."	8
Total % (travelers)	123 (78)

TABLE 14. TIME AND COMFORT TRADEOFF FOR PERSONAL OR PLEASURE TRAVEL

Q: Imagine you had to choose between these two flights, both of which had identical seats and leg room, which would you fly for a personal or pleasure trip . . . (asked of all respondents)

Flight chosen	All travelers, %	Business travelers, %	Pleasure travelers,%
10-hr/wide-body/\$500 ^a	42	35	47
3½-hr/supersonic/\$600 ^a	57	64	52
Don't know/no response	1	1	1
Total % (travelers)	100 (304)	100 (117)	100 (187)

^aSee Figure 4 for exact wording of show cards.

TABLE 15. REASONS UNDERLYING TIME/PRICE TRADEOFF FOR PERSONAL OR PLEASURE TRAVEL

Preference for supersonic	Those favoring supersonic, %
Prefer supersonic: "The time factor; it is three times the time; naturally take it; because of the shorter flying time."	49
Time savings worth \$100: "I would pay the extra \$100 for the shorter ride—6½ hours. That's a lot. You have time to spend when you get there; Speed; Speed again—rather pay extra."	39
Dislike long airplane flights	10
Would like to try supersonic	6
All others	5
Total % (travelers)	109 (173)
Preference for wide-body	Those favoring wide-body, %
Savings/cost (cost too high): "Less money; Because of the difference in price. I would have more money to spend later; Cheaper; I would save the money and take the longer flying time."	63
Against supersonic	16
Prefer wide-body: "The wider seating is nicer to me; More comfort, wider, etc.; . . . the planes are too crowded for sitting now."	12
Time not a factor	8
All others	8
Total % (travelers)	107 (128)

TABLE 16. SUMMARY OF TRADEOFF PREFERENCES

For business travel	Total travelers (304), %	Business travelers (109) ^a , %	Pleasure travelers (187), %
10-hr/wide-body jet/ normal seating	—	10	—
3½-hr/supersonic aircraft 2 inches less leg room than normal	—	90	—
10-hr/wide-body/\$500	—	20	—
3½-hr/supersonic/\$600	—	80	—
For pleasure travel	Total travelers (304), %	Business travelers (117), %	Pleasure travelers (187), %
10-hr/wide-body jet/ normal seating	26	19	30
3½-hr/supersonic airplane 2 inches less leg room than normal	74	81	70
10-hr/wide-body/\$500	42	35	47
3½-hr/supersonic/\$600	57	64	52

^aEight missing responses.

TABLE 17. CHARACTERIZATION OF SAMPLE, FIVE-CITY STUDY

Airport	JFK		Dulles		DFW		LAX		SFO		Total	
Type traveler	Business	Pleasure	Business	Pleasure	Business	Pleasure	Business	Pleasure	Business	Pleasure	Business	Pleasure
Number in category	97	203	92	210	138	163	110	185	115	179	552	940
Age (%)												
Under 30	12	27	7	17	10	23	12	21	33	30	15	23
30-50	63	32	53	41	65	36	64	29	44	30	58	34
Over 50	24	40	39	41	25	39	25	51	23	40	27	42
Sex (%)												
Male	84	45	87	44	92	55	86	41	78	47	86	46
Female	16	55	13	56	8	45	14	58	21	53	14	54
Occupation (%)												
Manager/professional	71	44	86	46	72	46	65	37	62	35	71	42
White collar	6	7	2	8	9	11	14	12	10	13	9	10
Blue collar	8	7	3	3	10	6	4	11	5	7	6	7
Other	14	41	9	43	9	37	18	39	23	44	15	41
Income (%)												
Under \$20,000	11	27	4	18	7	19	9	23	14	24	9	22
\$20-40,000	39	29	24	30	26	25	23	33	38	38	30	31
\$40-60,000	16	10	36	20	26	27	29	17	21	16	26	18
Over \$60,000	9	7	28	17	34	17	30	14	18	12	25	13
Refused	24	27	8	15	7	13	9	12	9	10	10	15
Residence (%)												
Northeast	38	38	11	16	17	4	18	14	17	16	20	18
Southeast	5	9	37	45	13	6	6	7	4	4	12	15
Midwest	16	18	4	1	9	17	9	12	17	12	11	12
West	32	27	41	34	57	69	64	67	56	65	51	51
Other/missing	10	7	7	4	4	4	3	1	7	3	6	4
Incidence rates*												
Unqualified	918	(56%)	1,333	(61%)	1,756	(75%)	1,839	(72%)	867	(40%)	6,713	(62%)
Refused	357	(22%)	520	(24%)	225	(10%)	387	(15%)	911	(43%)	2,400	(22%)
Acceptable interview	350	(22%)	350	(16%)	350	(15%)	350	(14%)	350	(16%)	1,750	(16%)

*For both trade-off and price perception samples.

TABLE 18. TIME/COMFORT TRADEOFF RESULTS

Airport	JFK		Dulles		DFW		LAX		SFO		Total		Sea
	PS	AS	PS	AS	PS	AS	PS	AS	PS	AS	PS	AS	
Business travelers, %	N = 97		N = 92		N = 138		N = 110		N = 115		N = 552		N = 117
• Business trip													
SST, 32 in pitch	88	80	86	82	88	88	76	76	78	77	83	81	90
Conventional jet, 34 in pitch	11	19	13	15	11	12	22	24	18	20	15	18	10
• Pleasure trip													
SST, 32 in pitch	88	81	86	83	87	83	67	69	70	70	79	77	81
Conventional jet, 34 in pitch	10	18	13	16	13	15	30	30	28	30	19	22	19
Personal/pleasure travelers, %	N = 203		N = 210		N = 163		N = 185		N = 179		N = 940		N = 187
• Pleasure trip													
SST, 32 in pitch	81	77	88	82	80	77	68	64	69	64	77	73	70
Conventional jet, 34 in pitch	18	23	11	15	20	23	31	35	29	34	21	26	30

TABLE 19. RESPONSE TO SST DEMOGRAPHICS

Tradeoff type	% choosing SST on comfort trade		% choosing SST at different levels of cost trade						
	Trip scenario	PS	AS	Pacific scenario			Atlantic scenario		
				\$50	\$100	\$150	\$50	\$100	\$150
AGE									
Under 30 (N = 303)	82	79	85	61	50	79	46	33	
30-50 (N = 636)	84	81	88	68	55	82	51	37	
Over 50 (N = 545)	69	66	77	60	48	71	43	29	
SEX									
Male (N = 907)	81	78	86	65	51	80	49	35	
Female (N = 582)	73	69	80	62	52	73	44	30	
OCCUPATION									
Manager/ professional (N = 783)	82	80	87	66	52	83	50	36	
White collar (N = 143)	79	76	87	66	54	81	52	39	
Blue collar (N = 102)	84	81	84	61	53	77	46	36	
Other (N = 466)	70	65	75	58	49	66	41	26	

Tradeoff type	% choosing SST on comfort trade		% choosing SST at different levels of cost trade						
	Trip scenario	PS	AS	Pacific scenario			Atlantic scenario		
				\$50	\$100	\$150	\$50	\$100	\$150
INCOME									
Under \$20,000 (N= 258)	77	74	79	52	42	72	40	30	
\$20-40,000 (N= 457)	80	75	84	60	47	80	45	30	
\$40-60,000 (N= 310)	82	78	88	70	53	79	49	34	
Over \$60,000 (N= 260)	75	74	85	73	65	80	61	45	
RESIDENCE									
Northeast (N = 282)	77	72	84	66	51	75	45	32	
Southeast (N = 210)	85	82	87	64	50	78	42	28	
Midwest (N = 172)	78	79	83	63	52	81	50	38	
West (N = 762)	76	72	81	62	51	79	49	35	
CONCORDE									
Previous experience (N = 46)	76	76	89	74	65	85	61	50	
No previous experience (N = 1438)	78	75	83	63	50	78	47	33	

TABLE 20. RESPONSE TO SST BY CLASS USUALLY FLOWN

Tradeoff type	% choosing SST or comfort trade		% choosing SST at different levels of cost trade					
	Trip scenario		Pacific scenario			Atlantic scenario		
	PS	AS	\$50	\$100	\$150	\$50	\$100	\$150
On business trips								
• Pay own travel								
• 1st class (N = 36)	83	72	80	86	83	81	75	69
• Coach (N = 96)	83	80	85	71	65	84	67	55
• Discount (N = 24)	75	79	71	58	58	72	55	38
• Travel paid								
• 1st class (N = 85)	82	78	88	84	82	86	78	73
• Coach (N = 291)	81	80	79	68	62	75	58	47
• Discount (N = 27)	85	78	85	63	56	70	55	48
On pleasure trips								
• Business travelers								
• 1st class (N = 63)	84	78	87	79	76	82	71	68
• Coach (N = 291)	78	75	88	67	51	81	52	33
• Discount (N = 67)	79	81	85	64	45	82	46	25
• Pleasure travelers								
• 1st class (N = 74)	72	70	77	66	61	77	62	54
• Coach (N = 607)	77	72	72	63	53	76	48	33
• Discount (N = 252)	82	77	82	55	39	73	31	19

TABLE 21. TIME/PRICE TRADEOFF RESULTS

Airport	JFK		Dulles		DFW		LAX		SFO		Total		Sea
	PS ^a	AS ^b	PS	AS	PS	AS	PS	AS	PS	AS	PS	AS	
Business travelers, %	N = 97		N = 92		N = 138		N = 110		N = 115		N = 552		N = 117
• Business trip													
\$50 for SST	85	77	77	75	87	83	86	83	79	77	82	79	—
\$100 for SST	75	65	66	51	76	68	79	75	67	60	72	64	80
\$150 for SST	70	49	57	42	70	59	77	68	61	50	67	54	—
• Pleasure trip													
\$50 for SST	96	86	92	83	87	85	85	83	77	71	87	81	—
\$100 for SST	74	55	71	42	72	61	69	59	56	43	68	52	64
\$150 for SST	57	38	46	25	63	46	56	43	45	31	54	37	—
Personal/pleasure travelers, %	N = 203		N = 210		N = 163		N = 185		N = 179		N = 940		N = 187
• Pleasure trip													
\$50 for SST	85	75	89	79	79	77	74	75	76	69	81	75	—
\$100 for SST	65	40	60	40	56	48	59	49	60	44	60	44	52
\$150 for SST	49	29	48	26	46	39	52	30	50	32	49	31	—

^aPacific scenario—SFO to Tokyo (except Seattle)

^bAtlantic scenario—JFK to London

ASSESSMENT OF THE IMPACT OF ADVANCED AIR - TRANSPORT TECHNOLOGY

R.L. Maxwell and L.V. Dickinson, Jr.

Office of Technology Assessment

U.S. Congress

In April of 1978, the former Chairman of the House Science & Technology Committee, Olin E. Teague, requested that the Office of Technology Assessment consider performing a technology assessment "to provide a fresh look at the impact of eventual widescale introduction of advanced high speed aircraft." The specific issue raised in this request was whether the potential benefits of advanced supersonic transport aircraft warrant the Federal Government increasing the level of its support during the next steps, which would be to validate concepts and develop the technology.

In responding to this request and in keeping with the role of OTA, the former Director suggested, and I agree, that this should be a broad and long-range study. He further suggested that we include all types of advanced aircraft technology, passenger and cargo. With this broader perspective, we could then more adequately evaluate the potential of specific technologies. As a result the total assessment examines the potential future for large long range aircraft, which includes advanced subsonic, advanced supersonic, and even hypersonic vehicles. It further includes commuter aircraft and air cargo. This paper will be confined primarily to the findings of our study of advanced long range aircraft which is nearing completion. We expect our work on commuter aircraft and air cargo to be completed early next year.

Barring some major disruption to continued growth in the world economy, we see no reason that there will not continue to be an expansion of the commercial air system and the need for more efficient aircraft to support its growth. During the next 20 years the market for long range aircraft will continue to be dominated by subsonic aircraft, for which there is still substantial opportunity for advancing technology to improve energy efficiency, general economic performance, and environmental compatibility. At the other end of the performance spectrum -- hypersonic aircraft -- we doubt that there will be any commercial applications within the next 30 years. In between is the issue of the role and importance of commercial supersonic flight capability. It is to this issue that most of this paper is directed.

It is important to make clear our perspective on the issue of supersonic aircraft, the now-designated Advanced Supersonic Transport, or AST. The situation is not one in which aircraft manufacturers have designed a supersonic airplane that they consider a justifiable risk. In fact, the potential manufacturers generally agree that the technology is not yet far enough along to make a decision to build such an aircraft. While they think it is conceivable to build an airplane that would meet today's environmental standards and be economically viable in unsubsidized competition, the overall

risk is still too great. Until further technology advances and validation are accomplished, and until a variety of economic questions are clearer, an AST is not likely to be a prudent investment.

The real issue now is whether the long range promise of an advanced supersonic transport -- one that may be designed perhaps 5 to 10 years from now -- is sufficient to justify the investment in getting the technology ready. If we keep with past practice, the burden of financing such research would fall in large measure on the American taxpayer, which is why the question was originally put to OTA by this committee.

In this perspective, our assessment is not a market study of the prospects for a specific supersonic aircraft design. This kind of study will have to be undertaken sometime in the future if anyone is to proceed with actual construction of a prototype aircraft. Ours is rather an evaluation of whether a trend in technological research toward a class of possible future supersonic aircraft seems sensible in the long run -- whether having a mastery of supersonic technology in this country will be an important factor in our international competitiveness in the future. Therefore, we have tried to look at supersonic technology as one of several possible directions for the continuing evolution of aircraft, and have tried to evaluate whether the game is worth the candle and whether the public investment is attractive.

MARKET FOR FUTURE LONG RANGE AIRCRAFT

Figure 1 reiterates a point I made earlier, that with reasonable luck in maintaining long-range economic growth in the world and reasonable success in coping with the growing need for increasingly costly energy, the total market for air travel and commercial aircraft should continue to expand substantially in the future. A reasonable expectation over the next thirty years is a quadrupling of passenger miles, a doubling of route miles and a total world market for new long range (greater than 2700 NM) aircraft resulting in expected potential sales of some \$150 billion of 1979 dollars. The new aircraft referred to here include both additions to the fleet and replacement aircraft. To put the \$150 billion into perspective this number represents about 3 years worth of new automobile sales in the U.S.

ADVANCED SUBSONIC AIRCRAFT

While the potential exists for supersonic transport aircraft to satisfy a portion of this long range market, it is expected that it will be dominated by subsonic aircraft -- at least in this century. This brings me to a point I made earlier that there is potential for substantial improvement in subsonic aircraft that could have favorable impacts on lowering the cost, energy usage, and emissions. As shown in Figure 2 such improvements provide the incentive for investment in new designs. For example, work on lighter weight materials and improved design and manufacturing techniques, improved aerodynamic efficiency, and more efficient and quieter engines are areas which

appear fruitful for an improved subsonic aircraft. There are other factors which will be important in new subsonic aircraft designs. The availability of fuel and rising fuel costs are two examples. Another is the possibility of more stringent noise standards in the future which would pose a challenge for both subsonic and supersonic aircraft.

TYPE OF FUEL

One of the most significant factors affecting aircraft design and the growth of air travel is the future type and price of fuel. In considering new aircraft, whether subsonic or supersonic, it must be remembered that they will most likely be in service 20 to 30 years after introduction. Therefore, given this long term service, we may well be on a different energy track in the future than that which exists today. As illustrated in figure 3, if the energy track is synthetic jet fuel, then aircraft can be expected to be adapted to use this type of alternative without major design changes. However, if the energy track is to use fuels significantly different from petroleum such as methane or hydrogen, these fuels will require new aircraft designs. Thus, one uncertainty is deciding what fuel a future aircraft should be designed to use. While that decision does not have to be made now, it would have to be made before starting a new aircraft program and is important in technology validation.

POTENTIAL FOR COMMERCIAL SUPERSONIC AIRCRAFT

I would now like to leave these general observations and discuss specifically the potential for and impacts of an advanced supersonic transport. Our analysis shows that supersonic travel has the potential of significantly altering the long term structure of the aircraft market and could have a major impact on the competitive picture. (Figure 4) Future development of an advanced supersonic transport appears justified if expected technological progress can be verified. The basic incentive for an AST is lower flight time and higher productivity - - productivity being defined as the number of seat-miles (km) generated by an aircraft per unit of time. Productivity is of course very important, but only one of many factors that must be taken into account in considering future air transport aircraft. The issue has not been whether a supersonic would potentially have higher productivity than a subsonic airplane. The question has been "At what cost?" We will address this question presently.

The most compelling argument for an AST is improved aircraft productivity. (Figure 5) For example, a Mach 2+ supersonic aircraft can transport roughly twice as many passengers per day as an equivalent sized subsonic aircraft. Since the beginning of commercial flight, the real cost of air travel has been dropping even though the cost of labor and other cost elements in aviation have been rising. This progressive reduction in the cost of commercial air travel in the past has been partly because technological improvements in successive new aircraft have made them more efficient and partly because they are more productive due to size and speed increases.

For the past twenty years, since the advent of jets, speed has not increased, but major productivity improvements have resulted almost entirely from increases in size. For example, a 300 seat airplane can carry twice as many passengers per day as a 150 passenger airplane, but it does not cost twice as much to build and operate. The potential for further productivity gains from size increases is not as impressive. They have not disappeared, however, because as the number of people using a route grows, larger aircraft have been substituted for smaller aircraft. Thus, while the larger aircraft may be further stretched in the future, as exemplified by the shading of the subsonic aircraft in the figure, the size increases will be constrained by the market demand and route densities. For example Boeing's new aircraft, the 757 and 767, planned for introduction in the mid '80's, will seat 150 -200 passengers and therefore will not continue the trend in improved productivity. On the other hand improvements in the aircraft technology may continue to lower the costs per seat-mile (km).

The rationale behind a supersonic aircraft is to take advantage of increased speed. The drawback in the past from pursuing speed-derived productivity has been cost. In other words the productivity could have been achieved, but at a much greater than proportionate increase in costs. Figure 6 shows that over time, however, this cost penalty has been decreasing -- that is the difference in the potential cost of supersonic aircraft compared to subsonic aircraft has been shrinking. While rising energy costs could slow the trend, it is reasonable to expect that through technological improvements this convergence will continue.

The figure indicates a relative convergence of costs of supersonic and subsonic aircraft as compared to present wide-body jets. I feel it is appropriate to clarify a few points. The advanced subsonic aircraft, designated ASUBT, assumed a 20 to 25 percent improvement in fuel efficiency over the Boeing 747. With respect to the AST, assumptions were made by the various aircraft manufacturers regarding fuel price. These included a range of fuel price increases of 50 percent to 100 percent in constant dollars between now and the year 2010. If the assumptions are valid, the shape of the curve would resemble that shown. The effect of fuel price on the aircraft's total operating cost is shown on the next figure.

EFFECT OF FUEL PRICE

Figure 7 shows the result of increasing fuel price, relative to all other costs. As can be seen, the supersonic aircraft is more sensitive to fuel price increases than a subsonic aircraft. The primary reason is that an AST will use about twice as much fuel on a seat-mile (km) basis as a same generation subsonic aircraft. Ranges of total operating costs are shown considering the following:

Supersonic: This includes a composite of several proposed AST's and not just one specific aircraft.

Subsonic: This band contains subsonic aircraft with improvements in fuel efficiency to 30 percent.

While a vast amount of disagreement exists over the future price and availability of fuel, this figure uses, for illustrative purposes, a fuel price that increases at a real rate of 3 percent annually (1978 dollars). Thus, in 1990, at a cost of \$0.71 per gallon, in 1978 dollars, the total operating cost (T.O.C.) of supersonic aircraft would be approximately 25 percent higher than a subsonic aircraft.* At \$1.29 (in 1978 dollars) per gallon in 2010 the T.O.C. for supersonics would be approximately 35 percent higher than that for subsonics. There are two important parameters which will impact this figure: first is the seating capacity of the aircraft and the second is labor cost. Rising labor costs would probably be more detrimental to subsonic aircraft economics than to supersonics due to the higher productivity of flight crews in supersonic aircraft operations.

UNCERTAINTIES

As we have just seen, energy price and availability are major uncertainties surrounding the long range prospects for a successful AST. There are others, as shown in Figure 8.

Noise

One of the most significant problems appears to be the ability to meet increasing sensitivity to community noise, especially in the vicinity of airports. This may lead to more stringent environmental standards in the future for both aircraft and airports. In dealing with this problem, one of the objectives of NASA's Supersonic Cruise Research (SCR) Program is directed toward achieving noise levels of supersonic aircraft comparable to competing long-range subsonic aircraft. Present NASA work indicates the possibility of meeting (FAR Part 36, Stage 2) noise regulations. More research and development and technology validation will be needed to meet Stage 3 requirements. Most likely there will be cost penalties associated with satisfying these more stringent regulations.

Public Interest and Acceptability

Another important point, that was quite significant in the former U.S. SST program, is public acceptance of supersonic transport development. The public may not be in favor of possible government support of a program leading to an aircraft perceived to be desired and affordable only by privileged classes.

* These calculations were made in the summer of 1979. Fuel prices have increased significantly since this time. This illustrates the major uncertainty that exists in this area.

Further, there could be a strong negative public reaction to an aircraft which has a high energy use as compared to other means of transportation.

There are also probably other issues, which will bring with them new uncertainties, yet to be identified. These uncertainties cannot be resolved by analysis. Only through the passage of time and the progress of research and development can they be reduced.

ENVIRONMENTAL CONCERNS

As indicated in Figure 9 the primary environmental concern now appears to be the impact of noise on the community. Public opinion is toward less tolerance of noise and this view will undoubtedly have a significant impact on future aircraft -- both supersonic and subsonic. Controversy over allowing the British-French Concorde to operate into Washington's Dulles Airport and into New York's John F. Kennedy Airport focused around its anticipated noise impact on the neighboring communities. The concept of the Concorde was evolved before noise rules were established for any class of aircraft. The engine configuration selected was not a design favoring minimum noise generation. Although supersonic transports will comprise only a small number of future aircraft operations, noise will continue to be a critical factor in any future U.S. aircraft program.

It is the general belief that the uncertainty about noise from supersonic aircraft will have to be reduced significantly before any manufacturer is likely to commit to a new supersonic aircraft program. The investment is too large to risk failure of not meeting a more stringent noise standard. Therefore, substantial research and engine hardware testing will be needed to develop the data to reduce this margin of uncertainty.

Sonic Boom

The sonic boom is another environmental concern carried over from the first SST program and the Concorde. Present federal regulations prohibit civil aircraft from generating sonic booms that reach the ground. This effectively bars any future SSTs from operating supersonically over land, forcing them to fly at subsonic speeds and at less efficient fuel consumption rates. Research indicates there may be ways to lower sonic boom pressures. But practical aerodynamic solutions appear to be many years off.

More recently, "secondary sonic booms" have been reported in connection with some Concorde operations. It has been suggested that secondary sonic booms are augmented by meteorological phenomena. The source of the noise could be waves from an airplane that propagate upwards and are then returned to the surface of the earth. Although measurements have indicated that the pressures of secondary booms are much lower than those resulting from conventional sonic booms, the Federal Aviation Administration and others are presently studying this potential environmental problem.

Atmospheric Pollution

In 1971, there was considerable concern that engine emissions of a fleet of supersonic airliners would deplete the ozone in the upper atmosphere. A reduction in this protective shield against the sun's rays, it was feared, would increase the incidence of skin cancer. However, studies since then, including a Federal Aviation Administration program now in progress to monitor the upper atmosphere, indicate that previous predictions of ozone loss through subsonic and supersonic aircraft pollution appear to have been substantially overstated. The science of atmospheric chemistry and physics is still growing and, as new data and models become available, it will be determined whether the current optimistic outlook is justified.

Considering air pollution problems on the ground, aircraft emissions around airports appear minimal when compared to emissions resulting from ground transportation vehicles. Furthermore, the problem appears to differ little between subsonic and supersonic aircraft.

NASA SUPERSONIC CRUISE AIRCRAFT RESEARCH PROGRAM

I would now like to briefly review some of the major technical advances in supersonic technology resulting from NASA's Supersonic Cruise Aircraft Research (SCAR) program (Figure 10). This program was established after the former U.S. SST program was cancelled in 1971.

Aerodynamics

- o In R&D in the aerodynamics area, supersonic cruise lift-to-drag ratios between 9 and 10 have been demonstrated in wind tunnel tests. These values represent a 20 percent improvement over both the Concorde and the 1971 Boeing SST configuration.

Structures

- o The most significant advancement in the structural area is probably the application of finite-element modeling and advanced computational methods. With an airplane structural model typically consisting of over 4,000 elements with 2,000 degrees of freedom, computer technology advancements have reduced the structural design turnaround time for a major aircraft component from 3 months to less than 1 week.
- o Another promising structural development is the concept of super-plastic forming and concurrent diffusion bonding of titanium. Studies indicate that significant weight reductions (10 to 30 percent) and cost reductions (50 percent) are potential results of application of these techniques. Effort has also gone into studying various forms of high-temperature polyimide composite structures and the potential weight savings resulting from their application.

Propulsion

- o A major part of the proposed NASA SCAR technology validation program would involve the development and testing of a new concept for a variable cycle aircraft engine. Research indicates this experimental engine would be able to operate at near optimum fuel efficiencies while cruising either at supersonic (turbojet) or subsonic (turbofan) speeds. The research also indicates the internal configuration of the engine could achieve significant reductions in noise levels at takeoff and landing.

Systems Studies

- o In the systems area, various advanced operational procedures are being studied which have the potential for lowering the noise over a community during takeoff and landing. An important result of these studies is that important gains in noise reduction are indicated to be possible.
- o The benefits of a family concept of aircraft designs are also encouraging. By using common fuselage and wing module designs on various size aircraft, it enables the manufacturer to meet changing needs of the airline customers for different payloads and ranges in a very cost effective manner.

As indicated, supersonic aircraft technology has advanced significantly since 1971. This work has been undertaken for a modest federal investment of approximately \$10 million per year over the last 7 years. Further advances, which could be achieved under a continuing NASA research program, could significantly improve the prospects for supersonic travel, both environmentally and economically.

POTENTIAL FOR COMMERCIAL SUPERSONIC CRUISE AIRCRAFT

Given this technical background and identification of both prospects and uncertainties, we conclude (Figure 11) that there is a good possibility that an environmentally acceptable and economically viable Advanced Supersonic Transport (AST) could be developed and could play a significant role in the long range, overwater travel market by the end of the century. As shown on the figure, although the Concorde is much more expensive to operate -- mainly due to its small payload -- than subsonic aircraft, it has demonstrated with 20 year old technology (1) safe supersonic commercial operations and (2) passenger acceptance at fares several times the subsonic coach fares.

An AST has the potential for alleviating many of the problems which characterized earlier supersonic aircraft even though it also would fly supersonically only over water. It is estimated that an AST could capture about \$50 billion (1979 dollars) of the potential \$150 billion

in sales up to the year 2010.

CONCLUDING REMARKS

In sum, as shown in Figure 12, the long term prospects for commercial supersonic transportation appear attractive -- attractive enough to keep our supersonic research effort active and reasonably healthy. On the other hand, the uncertainties surrounding an Advanced Supersonic Transport, specifically fuel price, fuel availability and noise, are too significant to warrant an accelerated research and development program until they are better resolved. These same uncertainties are also faced by our foreign competitors.

Thus, at this point in the study it appears appropriate to continue the research and development program at a moderate level to further develop factual information and reduce some of the technical uncertainties.

This posture would then lead to a point sometime in the future where a decision could be made as to how, or if, the research program should be accelerated to a level appropriate to achieve technology readiness. We believe this posture is appropriate due to the current uncertainties concerning fuel availability, fuel price and noise. This would still maintain the option for future development of an Advanced Supersonic Transport.

Given long-range economic growth in the world, the total market for air travel and commercial aircraft will continue to expand substantially

World Requirements — New Aircraft

	1980 Thru 2010	Potential Sales 1979 Dollars
Short - Medium Range (up to 2,700 nautical miles)	6,500 — 8,500 *	\$235 Billion
Long Range (over 2,700 nautical miles)	2,200 — 3,300 *	\$150 Billion

* Estimates exclude U.S.S.R. and People's Republic of China

Figure 1.- Growth in air travel and aircraft from 1980 to 2010.

There is still potential for technical advances in subsonic aircraft that could have favorable impacts on lowering the cost, energy usage, and emissions per seat mile

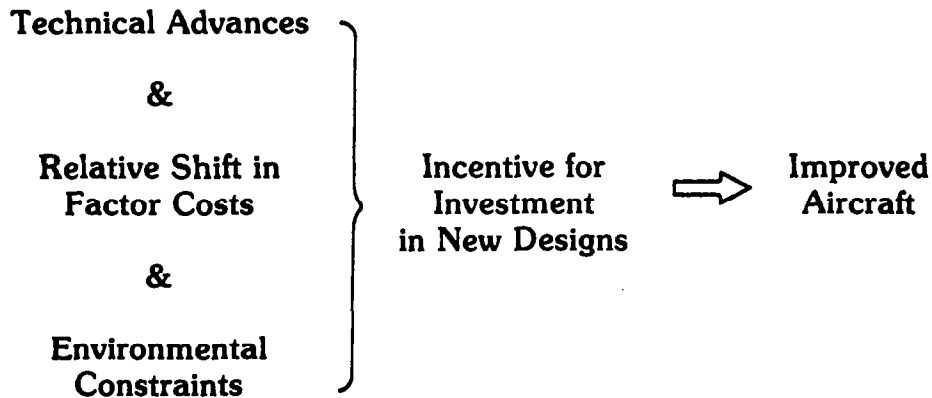


Figure 2.- Advanced subsonic aircraft. 1 mile = 1.6 kilometers.

Aircraft can be adapted to use synthetic petroleum fuels without major design changes

New advanced aircraft could be designed to use liquid methane or hydrogen

Figure 3.- Fuel adaptability.

Future development of an advanced supersonic transport (AST) appears justified if expected technological developments are realized

The Incentive: Lower flight time and higher productivity

The Uncertainties: The cost of achieving these goals with an environmentally compatible machine

Fuel availability and price

Figure 4.- Future development of advanced supersonic transport.

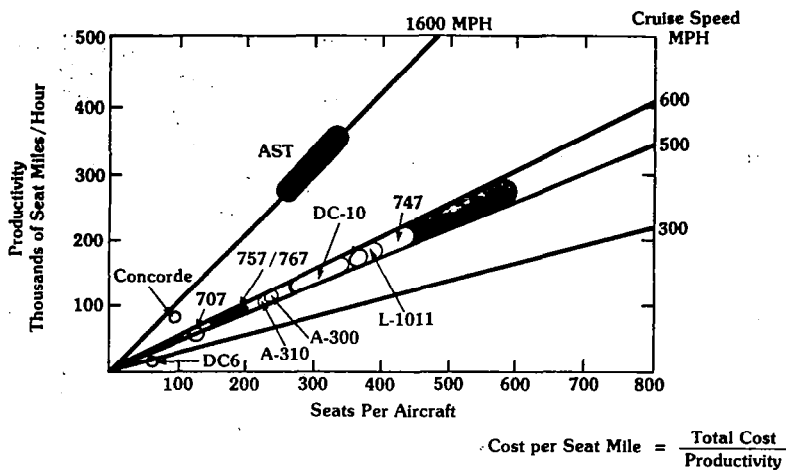


Figure 5.- Productivity of advanced supersonic transport (AST).
 1 mile = 1.6 kilometers.

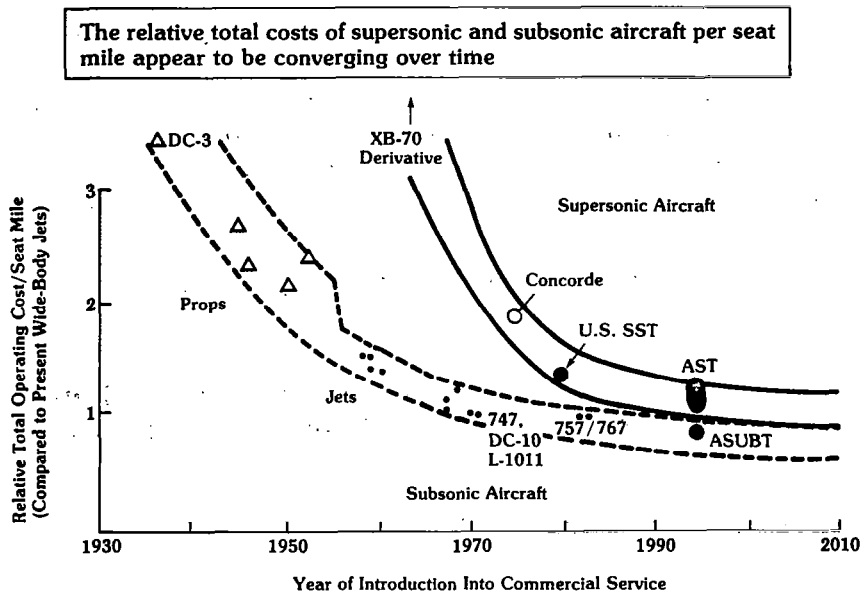
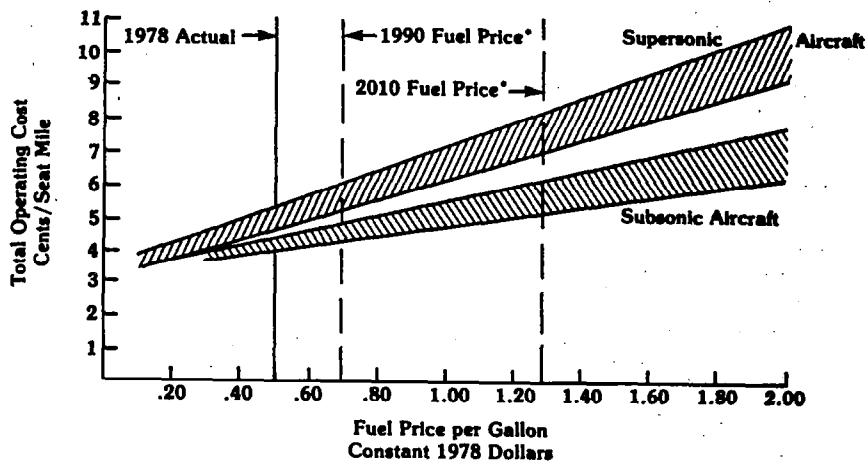


Figure 6.- Relative total cost of advanced supersonic transport (AST).
 1 mile = 1.6 kilometers.



* Assumes a 3% annual increase in fuel price over 1978 in constant dollars

Figure 7.- Effect of fuel price on aircraft operating cost.
 1 gallon = 0.0038 meter³; 1 mile = 1.6 kilometers.

A number of uncertainties exist which surround the long-range prospects for a successful AST

Noise — Ability to meet increasing sensitivity to community noise

Cost of technological uncertainty — Achieving an economically and environmentally acceptable aircraft

Energy price and availability

Public interest and acceptability

Figure 8.- Uncertainties in future prospects of advanced supersonic transport (AST).

The primary environmental concern now appears to be the impact of noise on the community

Other Environmental Areas:

- Sonic boom
- Air pollution — emissions

**Ozone
Airports**

Figure 9.- Environmental concerns with advanced supersonic transport.

Aerodynamics

Improved aerodynamic efficiency with lift/drag ratios between 9 and 10

Structures

Finite element modeling and advanced computational methods
New materials — superplastic forming and concurrent diffusion bonding of titanium

Propulsion

Variable cycle engine concept and improved control systems

System Studies

Operational procedures
Family aircraft concept

Figure 10.- Advances in supersonic technology since 1971.

ASTs have the potential for capturing a significant \$ share of the long-range aircraft market after 2000

Progression of supersonic aircraft (potential)

- **Concorde** — up to 2-3 times average subsonic fares
 - Payload too small
 - Customer appeal
- **AST** — Up to 1.3 times subsonic fares
 - Supersonic flight only over water
 - Efficient subsonic operation over land

Figure 11.- Potential for advanced supersonic transport (AST).

Long term prospects for supersonics are significant and real

The uncertainties are also significant and real

- Fuel price and availability
- Noise

Potential threat from foreign competitors appears muted by the same uncertainties

Continued support of a moderate R&D program appears appropriate

- Maintain option for future development of an AST
- Clarify and reduce uncertainties

Figure 12.- Summary of prospects of advanced supersonic transport (AST).

OVERVIEW OF BOEING SUPERSONIC TRANSPORT EFFORTS—1971-1979

A. Sigalla
Boeing Commercial Airplane Company

INTRODUCTION

The state of the art in supersonic cruise technology has been advanced continuously at the Boeing Company since the United States Supersonic Transport program was cancelled. Following that cancellation, the status of the technology was assessed carefully and emphasis was put on finding solutions for what had been considered the major technical difficulties. In particular, work on the breakthroughs needed to advance the technology was emphasized. This was done to ensure that eventual practical application of the technology would establish the design feasibility of economically-successful and environmentally-satisfactory highly-productive, supersonic, cruise airplanes. Currently, solutions to all major technical problems have been identified. Depending on the subject, either the problem is no longer a concern or the steps needed to bring about a solution have been mapped out clearly. This paper outlines the accomplishments of the Boeing Company's Supersonic Transport studies and complements other papers presented at this conference.

TECHNOLOGY ASSESSMENT

The major technical concerns identified after the 1971 SST program cancellations are summarized in Table 1. These concerns addressed not only the problem of completing the airplane design for that program, but also heavily emphasized the need to improve the airplane capability in light of increasing fuel prices and tighter noise regulations. Also listed on Table 1 are comments on how these concerns are viewed after several years of identifying and verifying relevant technology. As can be seen from this table, considerable progress has been made since 1971.

THE DOT SST FOLLOW-ON PROGRAM

The Department of Transportation/Supersonic Transport (DOT/SST) technology follow-on program was developed by the Department of Transportation Federal Aviation Agency, The Boeing Company, and a Government Interagency Review Panel. These development efforts were in response to recommendations from the Government Accounting Office to attain maximum return on the investment made in the 1971 prototype SST development effort. In recognition of the potential

benefits of the program, Congress authorized additional funds to pursue those objectives.

Both the government and industry were concerned with the detrimental impact of total termination of supersonic transport development activities. Stopping all work in progress could have created serious losses in critical technologies necessary for the continued superiority of the U.S. aerospace industry and for the desired advancement of related transportation fields. On the other hand, continuing development work to complete selected critical technology areas and ensure an effective technology transfer to other applications was determined to be of benefit to ongoing government and industry programs. The technologies selected for further studies are indicated in Figure 1 and amplified on Table 2.

Throughout the program, provisions were made to assure that complete and timely information on technology advancements was made available for transfer to a broad cross-section of U.S. industries and government agencies. Principal methods of technology transfer included:

- . design, development, and test guidelines data
- . engineering specifications
- . technical documentation and reports
- . periodic interagency/industry reviews of program developments
- . technology implementation in other products and programs

These methods were applied successfully in all the technology areas listed in Table 2. Not only has that program helped resolve many of the questions raised in connection with the 1971 SST program, but it also has resulted in significant applications to many other products. Table 3 highlights where advanced technology implementation in other products and programs is being achieved in the ten technology areas listed in Table 2.

THE NASA SCR PROGRAM

This program also has greatly helped identify and validate appropriate technologies. Key technical subjects that have been examined are variable-cycle engine, aerodynamics, multi-element structures and aeroelastic studies, blended fuselage, airplane family, takeoff noise, research airplane, and economics and market. The significant research results on some of these subjects are summarized in the following subsections.

Variable-Cycle Engine

The need for variable-cycle engines in relation to the problem of designing a successful SST had been recognized for a long time. But it was only as a result of the SCR program that coordinated research by airplane manufacturers, engine manufacturers, and NASA technologists led to the mechanical and thermodynamic definition of such engines by Pratt & Whitney Aircraft and General Electric. It should be noted that a variable-cycle engine is not defined by any specific mechanical scheme. Rather, it is defined by its ability to meet a set of requirements aimed at eliminating the poor subsonic and transonic performance of supersonic engines designed for higher Mach numbers without affecting adversely the supersonic cruise performance of those engines. Such requirements are high supersonic cruise performance with low specific fuel consumption and high specific thrust (comparable to a dry turbojet cycle), and subsonic cruise range factor almost equal to a supersonic cruise range factor with the goal that subsonic specific fuel consumption be at least halfway between those of a turbojet and a bypass ratio 5 turbofan. Currently defined study variable-cycle engines meet these requirements. A comparison of performance parameters of the General Electric engine for the 1971 SST with General Electric's current concept of a variable-cycle engine follows:

- . installed supersonic specific fuel consumption improvement—9.5 percent
- . propulsion pod weight improvement—9 percent (mission-matched engines)
- . installed subsonic specific fuel consumption improvement—22 percent (cruise-matched thrust)

These comparisons include engine cycle, engine/airplane match, and technology changes. The substantial superiority of the variable-cycle engine is clearly evident. Furthermore, variable-cycle engines possess features which inherently make them quieter for take-off and landing operations.

Noise

All the features and potential capabilities inherent in a supersonic airplane have been examined during the SCR program to make maximum use of these features for noise reduction without reducing the airplane's effective productivity potential. These features are listed and illustrated in Figure 2. They include the digital control systems inherent in supersonic configuration management and control of the center of gravity. With these systems, the airplane flight path can be modulated safely so that noise is minimized for any particular community when the system is used in combination with the inherent thrust capabilities and airflow variability of variable-cycle engines, and with the ability to adjust the supersonic airplane's simple trailing-edge flaps. Coupled with the inverted flow

discharge feature of variable-cycle engines and additional suppression of the jet stream, these capabilities could lead to a substantially-decreased takeoff noise relative to an airplane that did not take advantage of such features; the potentially-large takeoff noise reduction is shown in Figure 2. If validated by comprehensive testing and analysis, this technology would make it possible to reduce the SST noise levels to the noise levels of high bypass-ratio turbofan-powered, advanced, subsonic airplanes. The results of static acoustic testing at Boeing for takeoff noise reduction technology are shown in Figure 3. They indicate how the inverted flow discharge is capable of reducing noise and show the potential of adding suppression devices to complement the effect of inverted flow and further reduce the noise at takeoff. Similar potential noise benefits have been identified for noise during landing taking advantage of the supersonic intake to minimize forward radiated noise.

Structures

All aspects of structures technology are being investigated continuously during the SCR program including:

- . basic titanium structure technology
- . composite materials for high-speed flight
- . airplane structure design technology
- . mathematical modeling of structure
- . aeroelasticity and flutter
- . loads technology

Results of this work have been very encouraging and, in particular, have made it possible to define configurations of high aerodynamic potential. These configurations have been considered practical only because of the design refinements possible by the successful development of structural technologies; other papers at this conference cover aspects of these technologies, such as "Opportunities for Structural Improvements for an Advanced Supersonic Transport Vehicle" by J. E. Fischler (paper no. 26). The most obvious configuration payoffs are the fuel-efficient arrow wing planform and the blended-fuselage concept. The latter, in particular, would lend itself to a new way of developing a family of commercial transports, thus further enhancing the commercial viability of this type of airplane as discussed in the paper by Neumann and Whitten at this conference entitled "A Family of Supersonic Airplanes—Technical and Economic Feasibility" (paper no. 38).

Aerodynamics

As mentioned previously, structural developments have allowed aerodynamic configuration development that has led to improved supersonic lift-drag ratios (and hence fuel efficiency) since 1971. Configuration changes to the 1971 supersonic airplane that have led to such improvements and the gain validated in supersonic wind tunnel tests are shown in Figure 4.

Further benefits in fuel efficiency would occur with an arrow wing planform. To make such a planform more efficient at take-off and landing speeds the aerodynamics of highly-swept leading-edges are being studied in the SCR program. The result of using computer-aided design to develop leading-edge flaps for a highly-swept arrow wing are shown in Figure 5. The wind tunnel data plotted in this figure indicate good progress.

Research Airplane

In addition to the above, many other technological innovations have been identified also. However, eventually, technological advances in aviation are brought to maturity through flight testing. Accordingly, the question of flight experiments and of a research airplane to validate and demonstrate supersonic cruise technologies was examined. As a result of investigations, under the NASA SCR program, it was found that a research airplane of small to moderate size could demonstrate the needed technologies quite satisfactorily. The demonstrations would be relevant to a whole new class of supersonic cruise airplanes ranging from large supersonic transports down to small military airplanes. The research airplane could have dimensions similar to those of the supersonic business jet airplane shown in Figure 6, but with a much simpler fuselage. Alternatively, it may be more cost and research effective to flight test technologies on available, suitably modified, airplanes. A successful example of this approach applied to short takeoff and landing technology is the NASA Quiet Short Haul Research Aircraft (QSRA) shown in Figure 7. It was designed and built starting from an existing airplane.

SUMMARY AND CONCLUSIONS

Throughout the NASA SCR program, important strides have been made in the identification of design advances which would greatly improve supersonic airplane fuel efficiency, noise, and other performance and cost affecting parameters. Furthermore, these efforts have created an atmosphere in which it has been possible for new ideas to flourish and positive inventions to take place such as the variable-cycle engine and the blended fuselage. These technical gains have shown that, given availability of such technology, advanced supersonic transports could be developed that would be economically successful and environmentally acceptable. What is needed next is to transition these technologies to maturity through increased testing and additional research.

TABLE 1.- THE TECHNICAL DIFFICULTIES OF 1971

1971 Major Unresolved Questions	1979 Status
Feasibility of titanium sandwich for heavily loaded structure	Problem resolved. Current efforts address further improvements
Fuel tank sealants	Resolved. Current efforts address higher mach numbers
Airport noise	Solutions identified. Current efforts consist of defining required validation and its cost
Supersonic cruise range factor	20% improvement in range factor
Subsonic cruise range factor	20% improvement with variable-cycle cycle engine
Aeroelastic problems	Advanced finite element mathematical models provide means of solution. Current efforts focus on inclusion of wind tunnel aerodynamics in mathematical models
Ozone and similar concerns	More accurate forecasts show 1971 predictions to have been wrong. Current efforts concentrate on better understanding of atmospheric test data

TABLE 2.- MAJOR TECHNOLOGY ADVANCEMENTS OF SST DOT FOLLOW-ON PROGRAM

- | | |
|----------------------------------------------------------------------------------------------------------------------------------------------------------------------------------------------------------------------------------------------------------------------------------------------------------------------------------------------------------------------|-------------------------------------------------------------------------------------------------------------------------------------------------------------------------------------------------------------------------------------------------------------------------------------------------------------------------------------------------------------------------------------------------------------------------------------|
| <p>① Flight control System:</p> <ul style="list-style-type: none"> ● Digital computer technology for flight-critical control functions, including active controls ● Fly-by-wire (electrical circuits replacing mechanical systems) reliable system for commercial supersonic transports ● Computer system flight test demonstration | <p>⑥ Navigation, Guidance, and Display System:</p> <ul style="list-style-type: none"> ● Capabilities for all-weather operation, high-density terminal operations, noise abatement maneuvers, and economical flight performance ● Fully-automated flight throughout complex flight profiles ● Total system flight test demonstration ● Performance and functional characteristics analysis |
| <p>② Engine Noise Reduction:</p> <ul style="list-style-type: none"> ● Noise reduction demonstration, on turbojet SST-type engine, required for federal noise regulations as applied to the original U.S. SST ● Noise reduction/engine performance prediction technology ● Model-scale/full-scale test correlation | <p>⑦ Titanium Structure:</p> <ul style="list-style-type: none"> ● High toughness, high-strength alloy ● Lightweight high-performance brazed structure ● Acoustic treatment panels for engine noise reduction ● Welding methods and quality control ● Structural analyses and systems integrity |
| <p>③ Fuel Tank Sealant:</p> <ul style="list-style-type: none"> ● Long-life high-temperature sealant system ● Sealant system producibility and maintainability | <p>⑧ Titanium Hydraulic Tubing:</p> <ul style="list-style-type: none"> ● Reliable seamless tubing alloy ● Lightweight in-place tube welding and inspection ● Tubing system reliability and maintainability |
| <p>④ Engine Intake System:</p> <ul style="list-style-type: none"> ● Analytical procedures for intake design ● Model testing and analysis/design correlation | <p>⑨ Airloads and Pressure Distribution:</p> <ul style="list-style-type: none"> ● Definition of critical supersonic and transonic criteria ● Analysis prediction and test techniques |
| <p>⑤ Electrical Power System:</p> <ul style="list-style-type: none"> ● Variable-speed constant-frequency generator system reliability and economics ● Capabilities for supporting a fly-by-wire aircraft control system | <p>⑩ Flutter:</p> <ul style="list-style-type: none"> ● Active controls flutter suppression feasibility ● Flutter control analyses and predictions for structural efficiency |

TABLE 3.- MAJOR TECHNOLOGY TRANSFER--SST DOT FOLLOW-ON PROGRAM

- | | |
|-------------------------------------------------------------------------------------------------------------------------------------------------------------------------------------------------------------------------------------------------------------------------------------------------------------------------------------|-----------------------------------------------------------------------------------------------------------------------------------------------------------------------------------------------------------------------------------------------------------------------------------------------------------------------------------------|
| <p>① Flight Control System</p> <ul style="list-style-type: none"> ● NASA Terminal Configured Vehicle (TCV) aircraft ● NASA Airborne Advanced Reconfigurable Computer System (ARCS) ● YC-14 cargo aircraft ● AFFDL R&D test facility installation ● Boeing 757 and Boeing 767 | <p>⑥ Navigation, Guidance, and Display System</p> <ul style="list-style-type: none"> ● NASA Terminal Configured Vehicle (TCV) aircraft ● YC-14 cargo aircraft ● Boeing 757 and Boeing 767 |
| <p>② Engine Noise Reduction</p> <ul style="list-style-type: none"> ● NASA JT8D engine quiet nacelle ● 727, 737 commercial aircraft ● NASA R&D wind tunnel tests ● Future supersonic aircraft design | <p>⑦ Titanium Structure</p> <ul style="list-style-type: none"> ● B-1 bomber aircraft ● F-14, F-15, F-16, and F-18 fighter aircraft ● YC-14 cargo aircraft ● CH-53 helicopter aircraft ● NASA refan JT8D engine ● 737 commercial aircraft ● New commercial aircraft |
| <p>③ Fuel Tank Sealant</p> <ul style="list-style-type: none"> ● YF-12A and F-100 fighter/bomber aircraft ● SR-71 reconnaissance aircraft ● 747 commercial aircraft ● Concorde commercial aircraft ● NASA R&D flight cycle tests | <p>⑧ Titanium Hydraulic Tubing</p> <ul style="list-style-type: none"> ● Space shuttle ● B-1 bomber aircraft ● F-14, F-15 fighter aircraft ● E3A surveillance aircraft (welding techniques) ● 747 commercial aircraft ● New commercial aircraft |
| <p>④ Engine Intake System</p> <ul style="list-style-type: none"> ● NASA R&D on mach 3.5 intake system | <p>⑨ Airloads and Pressure Distribution</p> <ul style="list-style-type: none"> ● NASA R&D tests and analyses |
| <p>⑤ Electrical Power System</p> <ul style="list-style-type: none"> ● F-18, A-4N, and A-4M fighter aircraft ● NADC aircraft commercial and control system laboratory ● AFFDL analysis techniques | <p>⑩ Flutter</p> <ul style="list-style-type: none"> ● NASA R&D wind tunnel tests on active controls technology ● Future subsonic, transonic, and supersonic aircraft design |

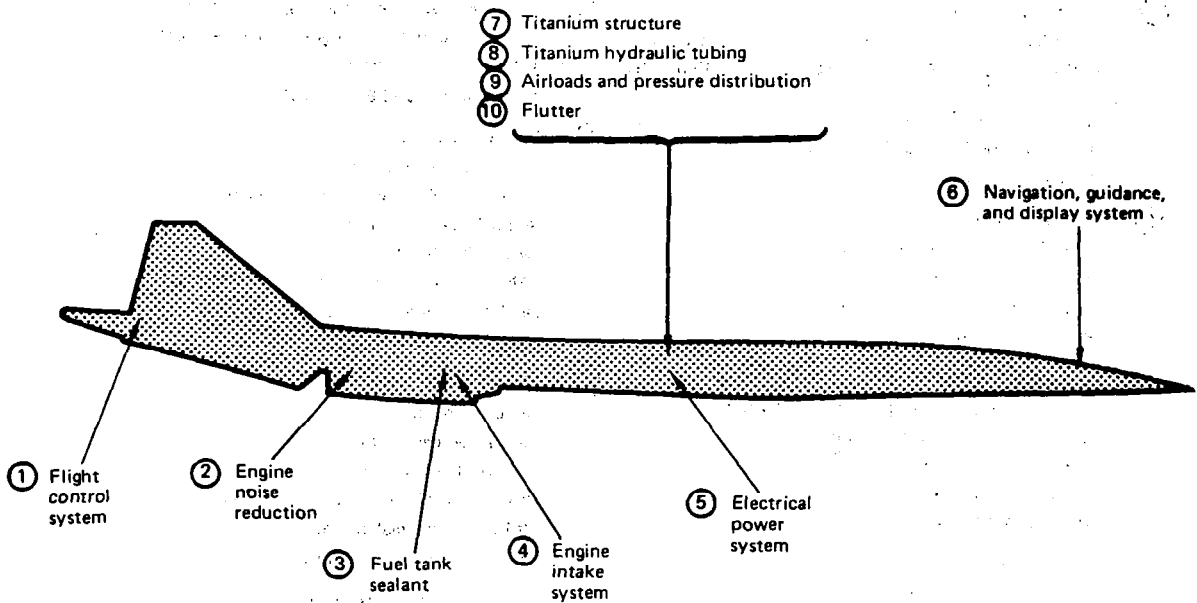


Figure 1.- 1972-1975 SST DOT follow-on program - selected SST follow-on technologies.

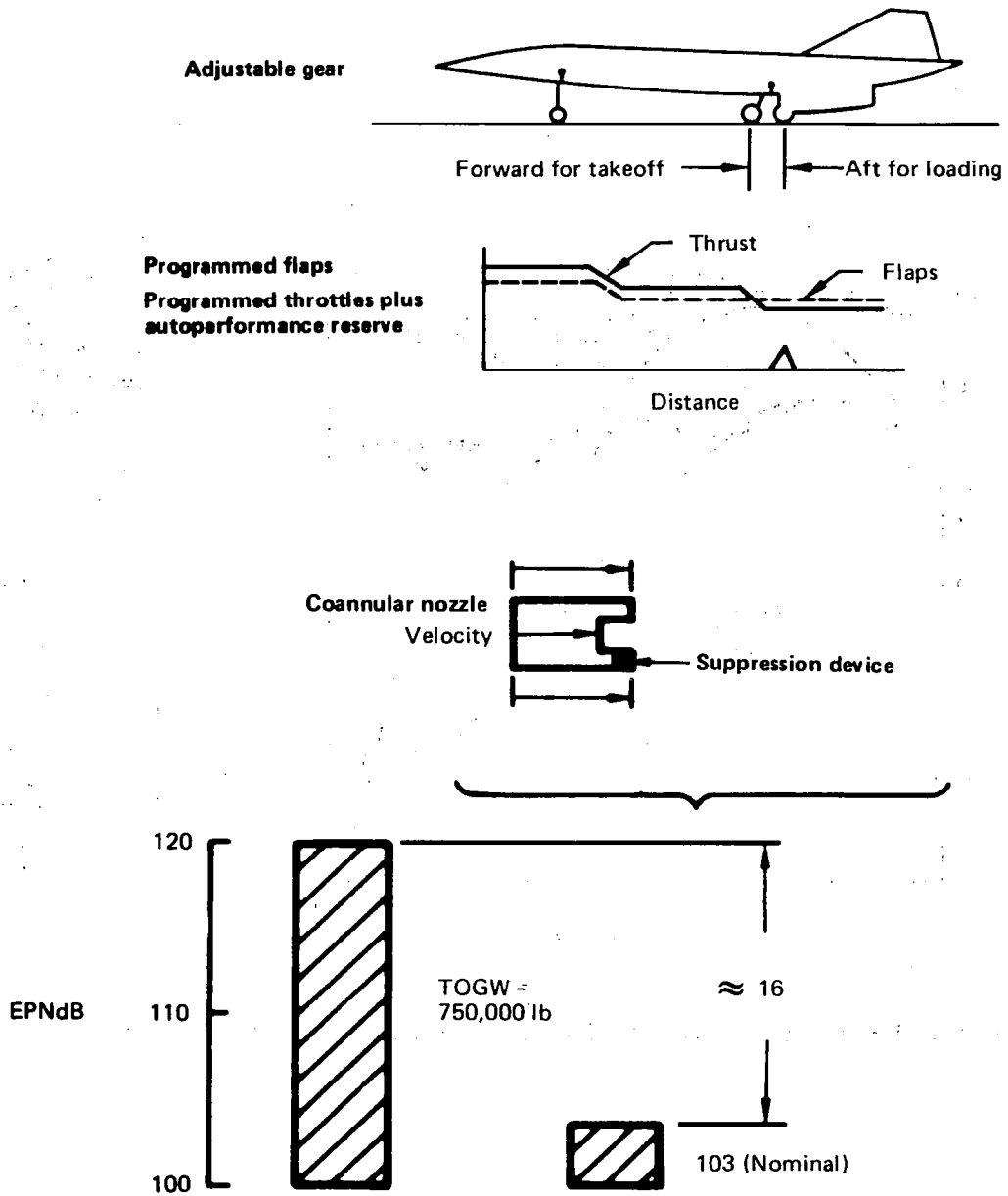
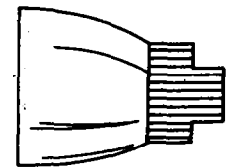
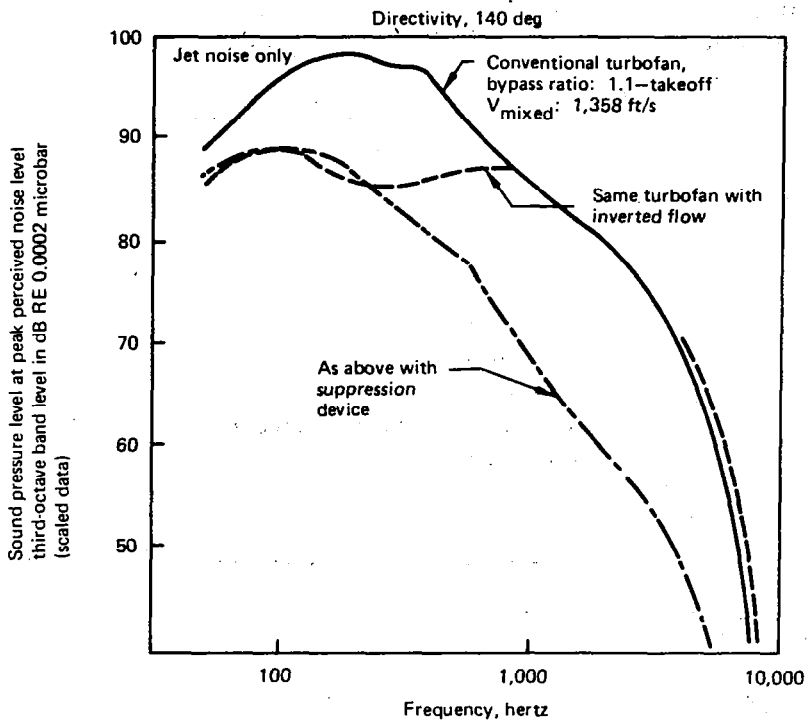
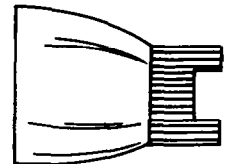


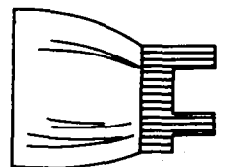
Figure 2.- Effect of technology advances on future SST potential community noise at takeoff.



Conventional
flow



Inverted flow



Inverted flow and
suppression device

Boeing anechoic test facility
static condition tests
1,500-ft distance

Figure 3.- Progress in jet noise reduction technology elements.

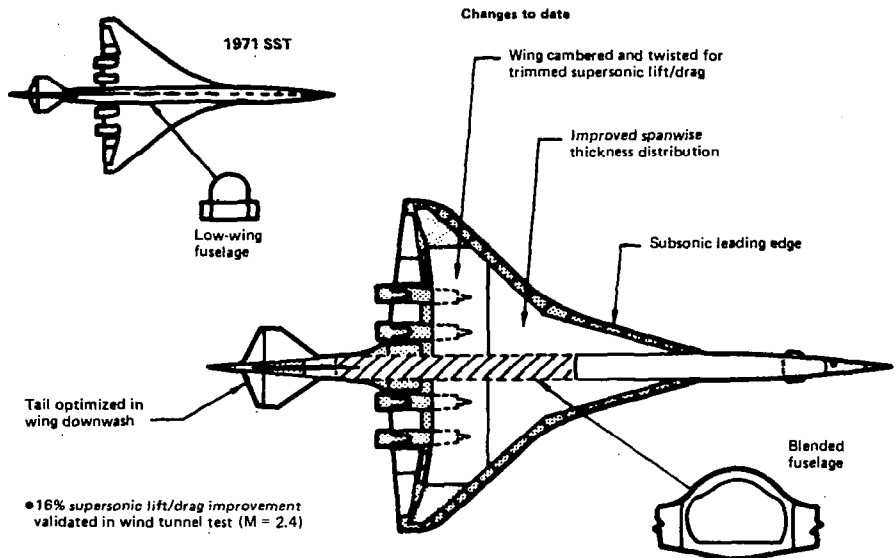


Figure 4.- High-speed aerodynamics.

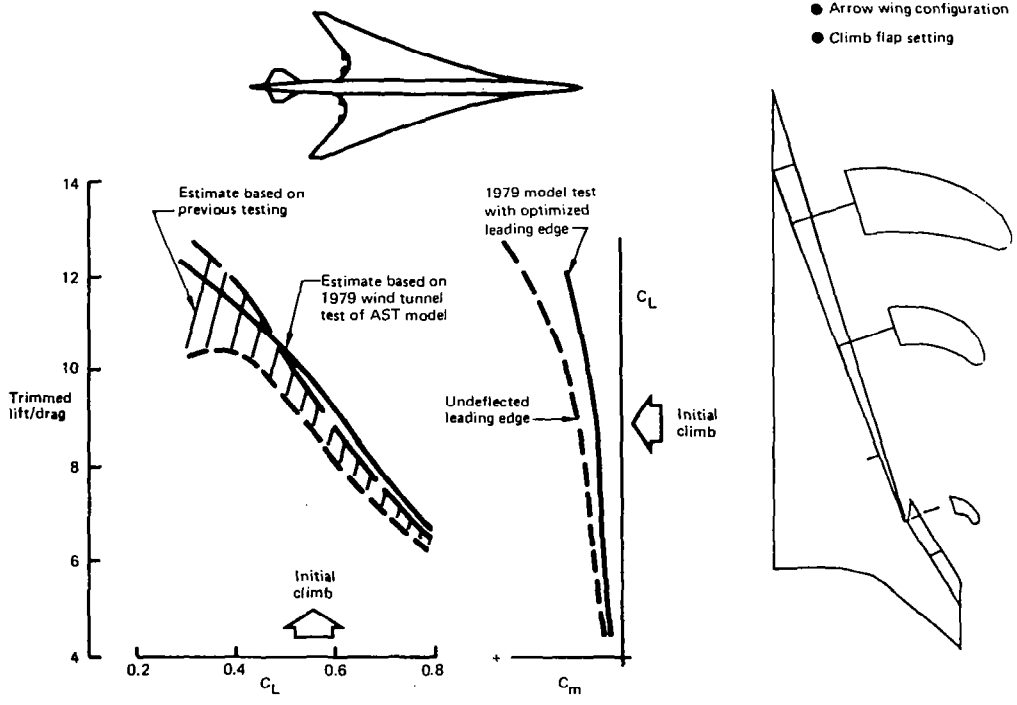


Figure 5.- Arrow wing low-speed aerodynamic technology.

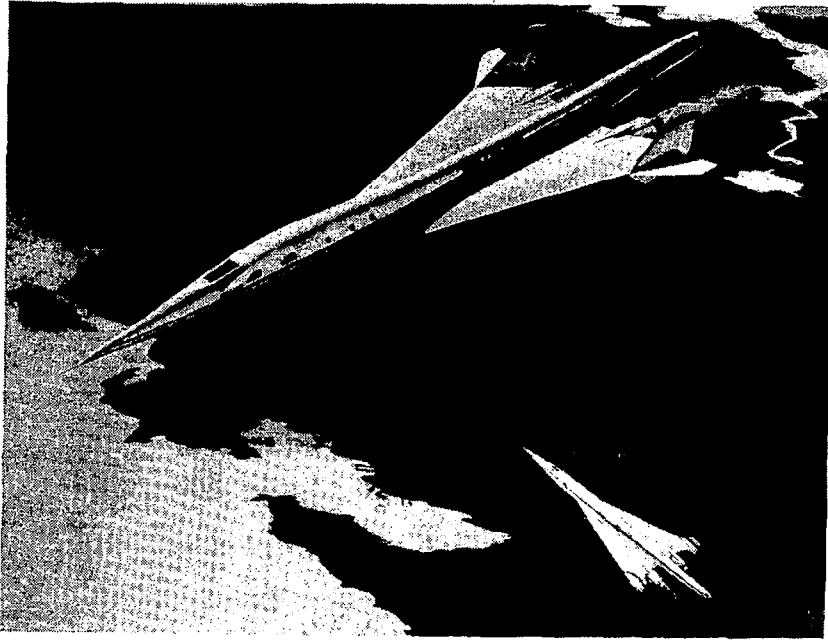


Figure 6.- Modified supersonic research airplane with executive jet fuselage.

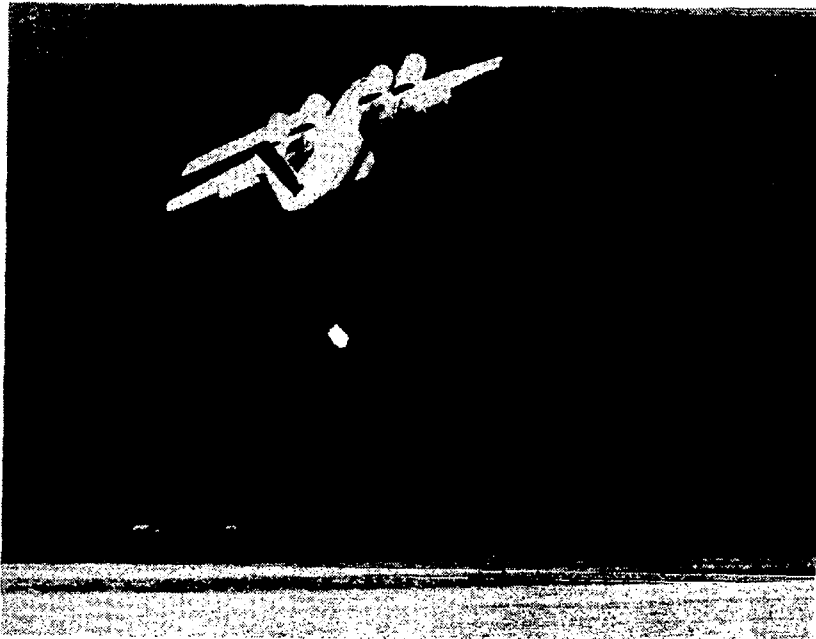


Figure 7.- Quiet Short-Haul Research Aircraft (QSRA) in flight.

A FAMILY OF SUPERSONIC AIRPLANES—TECHNICAL AND ECONOMIC FEASIBILITY

Frank D. Neumann and Jerry W. Whitten
Boeing Commercial Airplane Company

SUMMARY

The success of the subsonic jet transport airplane has been due, in part, to the manufacturer's ability to expand basic models into airplane families to satisfy emerging market requirements, giving the airlines the right airplane for the right market. As a benefit to the manufacturer, huge initial expenditures involved in any modern airplane program are spread over a bigger production run than is possible with a single-model program. As a further benefit, unit cost decreases as manufacturing experience increases, thereby reducing the financial risk to the manufacturer. The technical feasibility of this cost-effective family approach to the design of supersonic airplanes has now been established.

With the important improvements in key technologies proven in the laboratories during the 1970's, exciting possibilities can be projected on the performance and economic characteristics of a family of supersonic airplanes. Despite the severe constraints imposed by uncertain fuel costs and environmental considerations, it appears that overwater global, truly-rapid transit is within reach of being economically attractive to the majority of air travellers without becoming a financial or environmental burden to the general public.

INTRODUCTION: AIRPLANES COME IN FAMILIES

Airplanes have come historically in families rather than in single models. The manufacturer's ability to modify and improve basic models to adapt to the changing and expanding market requirements of the world's airlines has most likely been the reason for the success of the subsonic jet airplane (refs. 1 and 2). Examples of such families are the Douglas DC-8 and the Boeing 707. Both have stretched versions, where payload is traded for range, and advanced versions that incorporate new technologies, such as the step from turbojet engines to the more economical turbofan engines, or combinations of the above. Other examples are the Douglas DC-9 and the Boeing 727 airplane programs that today--15 years after the airplanes first flew--produce new, improved derivative introductions. These stretched, growth, and improvement versions have led to the legendary success of the DC-8, DC-9, 707, and 727 families of airplanes.

We are currently witnessing the emergence of a new family of subsonic widebody airplanes derived from the 747. The potential spectrum of passenger and range options is shown in Figure 1. The major in-service

derivatives of the initial 747-100 and -200 models are the 500-passenger short-range (SR) version, designed to meet the needs of Japan Airlines, and the special performance (SP) version, where passenger payload was reduced for increased range to meet Pan American's need for nonstop New York-to-Tokyo service. Freighter and combination freight and passenger versions have been selling for years, and a stretched version that will carry about 600 passengers is planned for the near future (ref. 3). Because of this building-block approach, where all models use many common elements, the 747 family has the potential of guaranteeing a long production run for the manufacturer and low production costs.

In a broader sense, perhaps all present subsonic commercial jet airplanes could be classified as a family of airplanes that fit the multiplicity of market demands. Though they may not share common components, e.g., fuselages, wings, and landing gears, they do share very similar technologies for the major systems, engines, manufacturing processes, aluminum alloys, construction methods, flight operating envelopes, and airline operations (fig. 2).

A FAMILY OF SUPERSONIC AIRPLANES

To improve the prospects for success in the market place, the family approach is essential to the design of future supersonic airplanes (fig. 3). The evolution from a basic supersonic airplane to a family could follow historic patterns, with one exception: substantial changes in passenger-carrying capacity will be difficult by the conventional fuselage "doughnut" approach so successfully used on the cylindrical fuselage of subsonic airplanes. The primary reasons for this difference are illustrated in Figure 4. They include the requirement for highly integrated "area-ruled" configurations, to give the desired high supersonic aerodynamic efficiency, and other physical limitations such as takeoff and landing rotation.

A new concept for a supersonic airplane family has evolved that could effectively solve the variable range and passenger capacity problem. It provides for modification of the fuselage cross section that makes it possible to build a family of three airplanes with four-, five-, and six-abreast passenger seating. This is done by replacing or modifying portions of the fuselage as illustrated in Figure 5. This family is depicted in Figure 6, which shows the extent of common geometry and components among the airplanes. All airplanes share the same wing, engines, and major subsystems. Only small sections of the fuselage would be different, and aerodynamic efficiency need not be compromised.

In terms of passenger capacity and airplane range, this airplane family is tailored to three potential markets, where the time savings of supersonic flight would be particularly important (fig. 7). The members of this supersonic airplane family are

- basic model A, which carries 270 passengers (all tourist) over transatlantic inland city pair distances, as well as transpacific one-stop city pair distances,
- derivative B, which carries 330 passengers (all tourist) over transatlantic distances, and
- derivative C, which carries 220 passengers (all tourist) over transpacific nonstop distances.

VALIDATION OF THE SUPERSONIC FAMILY CONCEPT

The validity of the family concept was investigated on the Boeing supersonic baseline configuration, known as model 733-633 and shown in Figure 8. This configuration is well defined and well understood. It evolved from the 1971 U.S. SST and is designed for mach 2.4 cruise, 340,000 kg maximum taxi weight, 270 passengers, and Pacific range capability. Major improvements include a new wing, a blended wing-fuselage, variable-cycle engines, selected use of composite structure, and other advanced technologies. Studies in recent years (refs. 4 through 8) have shown that this blended configuration is technically practical, cheaper to manufacture, and safe for a passenger airplane. Tests in the Boeing supersonic wind tunnel have confirmed an 18-percent improvement in supersonic lift-to-drag ratio over the 1971 U.S. SST. The design concept for the family of supersonic airplanes was one direct technology spin-off of that developmental work (fig. 9). In fact, the family's basic model A is essentially identical to model 733-633. Extensive studies have been conducted to validate the feasible characteristics of the family concept from the standpoint of aerodynamics, structures, systems, manufacturing, airplane cost, and airline operating economics (ref. 9). The results are briefly summarized in the following paragraphs.

Aerodynamics

Area distributions for the three airplanes of the family (fig. 10) demonstrate that the constraints of strict area-ruling for high supersonic efficiency have been satisfied. This provides evidence that the aerodynamic characteristics of the derivative airplanes need not be compromised, which makes it possible to capitalize fully on the benefits of the family approach.

The supersonic lift-to-drag ratio is almost identical for the three airplanes. On the largest airplane (B), the higher skin-friction drag is offset by lower induced drag, due to increased wing span, and vice versa on the smallest airplane (C). Constant lift-to-drag ratio allows the use of identical engines on all three airplanes.

Structures

The concept of lateral fuselage modification is well suited to the blended and conventional fuselage sections alike. This is illustrated in Figure 11. The production splices were located so that only the fuselage top section is unique to each airplane in the family. At the fuselage keel splice, different trimming of the similar parts will accommodate the differences among the three airplanes. Depending for which configuration the fuselage is modified, the two wings are moved in or out laterally by a distance equivalent to the width of one passenger seat. The wing-fuselage intersection remains unchanged, since fuselage width is changed by a constant distance over the entire inboard chord of the wing. New fuselage sections forward and aft of the wing provide the transition into a common nose and a common aft fuselage. No increase in the number of fuselage production breaks or panel splices is required by the proposed fuselage modification.

The fuselage structure was defined with a weight and cost-effective titanium sandwich structure. Sandwich structure was also found to be effective for handling the pressurization loads associated with the out-of-round derivative fuselages.

Systems

The commonality study showed that essentially the same subsystems can be used for all airplanes of the family. Required changes are primarily on length of tubes, wires, and cables, which are normally accomplished during the airplane manufacturing process. It is advantageous to oversize the air conditioning systems on the basic model to provide for growth to the larger derivative, which is estimated to add an insignificant 140 kg to the empty weight of the airplane.

Manufacturing

In a derivative airplane program, compared to a new airplane program, large savings are possible in development, tooling, and manufacturing labor costs because of commonality. For instance, because of these benefits, the cost of developing the 747SP was a fractional amount of that for the initial 747 (refs. 1 and 2). Therefore, in planning the manufacture of a family of supersonic airplanes, the objective is to use as much as possible common manufacturing facilities, parts, and tooling. This has been accomplished.

A supersonic airplane is estimated to contain about 150,000 different engineering design elements, referred to as parts. The total number of parts is estimated to be at least three times that number because of their multiple uses. These parts are classified into three categories:

- Common--These are common to all airplanes of the family and provide the biggest cost savings, because the same tools are used and because of the favorable effect of the learning curve.
- Similar--These are manufactured on common or multi-use tools and give significant cost savings. Similar elements, for instance, include the fuselage side panels and frames of the three airplanes. They are manufactured using common tools, but differ in material gauge and trim.
- Unique--These are unique to each airplane and give no cost savings. Only 3 percent of the parts are unique on the basic airplane (A), 6 percent on the larger airplane (B), and only 1 percent on the smaller airplane (C).

The high degree of commonality among the three airplanes is illustrated in Figure 12 both by part numbers and by weight.

Airplane Cost and Price

Since the airplane market had not been defined for this initial study, reasonable assumptions were made on development and production schedules, production rates, and production quantities. As shown in Figure 13, airplane deliveries are spread evenly over a 10-year production program, with a total of 500 airplanes being built at a rate of 50 per year. The assumed total family program consists of 300 type A, 150 type B, and 50 type C airplanes. First deliveries of types B and C would occur, respectively, 4 and 7 years after type A.

Cost estimates were made based on the available detailed technical descriptions of the three airplanes and their subsystems. The cost estimating parameter used was the weight of each major section and subsystem of the airplanes. To estimate the costs of the derivative airplanes B and C, the cost of the family's basic model A was separated into common and unique costs by section for nonrecurring and recurring costs. Dollars-per-unit-weight values determined by this method were applied to the unique airplane section weights of the derivative airplanes to estimate non-recurring and recurring costs.

Eighty-one percent of the manufacturing empty weight of the family basic model is common to the derivative airplanes. The effect of the derivative's high commonality on costs is indicated in Figure 14 by the small peaks that occur in the cumulative average airplane cost as the derivatives are introduced. This curve also shows that airplane cost can be reduced (compared to a single-airplane program) if, by offering derivatives, the total market can be increased. For this to happen requires high commonality and additional sales sufficient to outweigh the peak in the cost curve.

The basic premise of the advantage of a planned airplane family is that the addition of derivatives would increase the size of the market and

reduce airplane unit cost (or price, if based on cost). To show this potential, airplane prices were estimated for two assumed production program scenarios:

- a single-airplane program consisting of 300 type A airplanes, and
- an airplane-family program consisting of 300 type A, 150 type B, and 50 type C airplanes.

The average airplane cost-based price for the airplane family program was estimated to be 10 percent less than with the single-airplane program, assuming that two derivatives would increase the number of airplanes built from 300 to 500 (fig. 15). Considering that more derivatives have been built of subsonic airplanes than of their basic models, this is probably a conservative assumption. Later in this paper, it will be shown how inclusion of the derivative in the program planning and pricing can indeed significantly increase the market.

Cost-based prices for both the single-airplane and the airplane-family programs were calculated so that the total sales dollars gave a reasonable return on investment (ROI) to the airplane manufacturer. Prices for the individual airplane models within the family were based on airplane productivity. Supersonic airplane prices were estimated to be about three times those of subsonic airplanes of comparable passenger capacity and range.

Airline Operating Economics

The proposed airplane family would give the airlines superior demand flexibility, leading to significant improvements in operating economics and fuel efficiency. This is because trading payload and range is more favorable for a family of airplanes than it is for a single airplane. This improvement is illustrated in Figure 16. For instance, on the New York-to-London route, derivative B would average 24 percent lower direct operating cost (DOC) and 23 percent better fuel efficiency than derivative C, which is tailored for very long ranges. An airline with a long-range mission requirement can achieve better economics and fuel efficiency with derivative C than with either A or B. The latter two must offload passengers to fly the longer mission, a very inefficient trade on a supersonic airplane because of its small payload fraction. These data show that the best operating economics and fuel efficiency will be obtained with specialized members of a supersonic airplane family operating at average ranges very close to their design point.

MARKET PROSPECTS FOR THE YEAR 2005

Inspired by the promising results of the airplane family, a separate economic study was performed on a parametrically-derived set of supersonic

airplane families. This study provided answers to the question of supersonic ticket surcharge sensitivity to variations in key economic and airplane performance parameters. The A, B, and C family discussed previously was used in this study as a point of departure to define, parametrically, a new family of SSTs with a broader payload and range spectrum, consisting of models A', B', and C'. This new family incorporates the following performance improvements thought to be realistically achievable:

- five-percent better supersonic lift-to-drag ratio, achievable with a modest wing planform change, and
- five-percent reduced airplane operating empty weight (OEW), achievable with projected improvements in structures and sub-systems.

The economics for two of these airplanes look very promising, as indicated by the required ticket surcharges shown in Figure 17 (ref. 10): 26 percent for the 273-passenger Pacific-range airplane and 6 percent for the 360-passenger North Atlantic inland city-pair airplane. It should be emphasized what these surcharges are and what they are not. They are a surcharge relative to the average of all subsonic economy and discount fares. They are not surcharges relative to subsonic first-class fares. One limitation of this economic sensitivity study, however, is the fact that airplane prices were based on assumed production quantities of 500 units. Therefore, a separate market-size study was performed in order to take into account the interaction of cost-based price, market size, and required ticket surcharge. Airplanes A' and B' were analyzed both singly and as members of a family, using various market scenarios for the year 2005. The method and results of this market-size study will be discussed next.

Traffic Growth and Value-of-Time Model

When making predictions about the market prospects for supersonic airplanes 25 years into the future, it is difficult to defend the reasonableness of any assumption. Nevertheless, other than uncertain fuel costs, the two key driving forces upon economics are expected to be

- the traffic growth to the year 2005, by which time we might expect to have put a substantial fleet of second-generation supersonic airplanes into service, and
- the air traveller's value of time (i.e., the price an air traveller would be willing to pay for the time saved by flying the supersonic airplane).

Traffic growth, based on extrapolation beyond available 10-year industry forecasts, would roughly quadruple 1979 traffic by the year 2005, if based

on a low 5-percent annual growth rate, or quintuple, if based on a high 6-percent growth rate.

The surcharge that people would be willing to pay for flying faster is based on the premise that "Time is money!" and that the value of time can be related to an individual's income. A study done by United Technologies (ref. 11) shows data for Concorde and Icelandic Airlines where people have made the cost-time trade (fig. 18). Working with statistical data such as these indicates that air travellers, on a weighted average, value their time at about 1.8 times their hourly income.

To develop an SST market share model, a composite worldwide air traveller income distribution was developed first. Income in 1978 dollars per hour is shown in Figure 19 versus the percentage of air travellers whose income exceeds that value. For example, 22 percent of air travellers are shown to have incomes of 20 dollars per hour or more. The value-of-time multiplier of 1.8 was used to factor this income distribution. By entering the adjusted distribution at the dollar-per-hour cost of supersonic flight time savings, it was possible to determine the market penetration for an SST with various levels of surcharge. For example, at a surcharge with a corresponding cost of 36 dollars for every hour saved, those travellers with incomes of 20 dollars per hour or more would be diverted to the SST, giving the SST a market share of only 22 percent. This approach implies that without a surcharge, everyone would fly the faster airplane.

Market Size for Single-Airplane Programs

Having determined the future traffic and the market share model for the supersonic airplane, the airplane market, in terms of supply and demand, can be balanced. The supply curve represents the manufacturer's cost of producing various quantities of airplanes. The demand curve represents the effect of price on demand in the market place for these airplanes. The results of this closed-loop airplane market supply and demand analysis showed that a significant market would exist for airplane B' in a single-airplane program. The market for airplane B' varies from 240 airplanes, at the low traffic-growth rate and 65-percent load factor, to 580 airplanes, at the high-growth rate and 70-percent load factor (fig. 20). In every case, a reasonable return on investment is provided to both the airlines and the manufacturer. This significant airplane market is generated by the air traveller's willingness to make a cost-time trade, i.e. to pay a modest surcharge to get there faster.

It should be emphasized again that this surcharge is relative to the average of all subsonic economy and discount fares. It is not a surcharge relative to subsonic first-class fares. The required surcharges that correspond to the market quantities vary from 9 to 32 percent, depending on traffic growth and load factor, as shown in Figure 20. Fuel price increases will alter these surcharges, but not significantly (less than 10 percent to absorb a doubling from the 1978 U.S. international fuel price);

the fuel price effect on supersonic surcharge is shown in Figure 21. The conclusion that must be drawn is that the supersonic airplane is sensitive to, but not critically vulnerable to, fuel price increases.

Market Size for Two-Airplane Family Program

A second study determined the effect on market size if airplanes A' and B' were produced as members of a family. Airplane B' is capable of serving, nonstop, 90 percent of all potential trips, according to the distribution of trips by range shown in Figure 22. Theoretically, 8% more (or 98% of all trips) could be served nonstop by the longer range airplane A'. Available trips were segmented between the two family members by assigning the best airplane (lowest surcharge) to every city pair. Airplane A' is only assigned to serve city pairs exceeding the range capability of airplane B'. An aggregate demand curve was then established for both family members, using the procedure previously described for the single-airplane program. A market for 70 airplanes was found to exist for airplane A'. At the same time, the market for airplane B' grew by 30, increasing the total market from 460 for the single-airplane program to 560 for the two airplane family program (fig. 23). This is due primarily to the cost reductions associated with an airplane family of high commonality and the more efficient operation of both airplanes closer to their respective design points.

CONCLUDING REMARKS

No attempt was made to optimize airplane combinations in terms of size and range for this market-size study. Nonetheless, it is shown that, by the turn of the century, a significant market will exist for an advanced technology, environmentally acceptable supersonic airplane, in spite of a required minor surcharge and uncertain fuel costs.

This market-size study also confirms the premise of enhanced market prospects for a planned family of supersonic airplanes through the favorable circular economic relationship among increased market demand, increased production quantity, and reduced cost.

Technically and economically the concept of a supersonic airplane family with fuselages of different cross sections is practical and efficient, offering the essential payload and range flexibility that has led to the success of the subsonic jet transport. Therefore, future supersonic airplanes can and should be designed as members of a family (fig. 24).

REFERENCES

1. Lollar, T. E.; and Hufford, D. D.: The Design and Evolution of Commercial Transport Airplanes. The Boeing Company, Nov. 26-29, 1974.
2. The Importance of Derivative Airplane Programs. Aerospace Industries Association of America, Inc., October, 1977.
3. Steiner J. E.: Commercial Airplanes for the 1980's. The Boeing Company, 1979.
4. Proceedings of the Supersonic Cruise Aircraft Research (SCAR) Conference, Part 2. NASA CP-001, Langley Research Center, Hampton, Virginia, Nov. 1976.
5. Goodmanson, L. T.; and Sigalla, A.: The Next SST - What Will It Be? AIAA/SAE 13th Propulsion Conference, AIAA Preprint 77-797, July 1977.
6. Advanced Supersonic Configurations Studies Using Multicycle Engines for Civil Aircraft. Boeing Commercial Airplane Company, NASA CR-132723, Sept. 1975.
7. Advanced Supersonic Configurations Studies Using Multicycle Engines for Civil Aircraft. Boeing Commercial Airplane Company, NASA CR-145089, Nov. 1976.
8. Advanced Concept Studies for Supersonic Vehicles. Boeing Commercial Airplane Company, NASA CR-145286, Feb. 1978.
9. Advanced Concept Studies for Supersonic Vehicles. Boeing Commercial Airplane Company, NASA CR-159028, April 1979.
10. Economic Study of Multipurpose Advanced High-Speed Transport Configurations. Boeing Commercial Airplane Company, NASA CR-159126, Sept. 1979.
11. Dubin, A.: Supersonic Transport Market Penetration Model. AIAA Paper 78-1557, Aug. 1978.

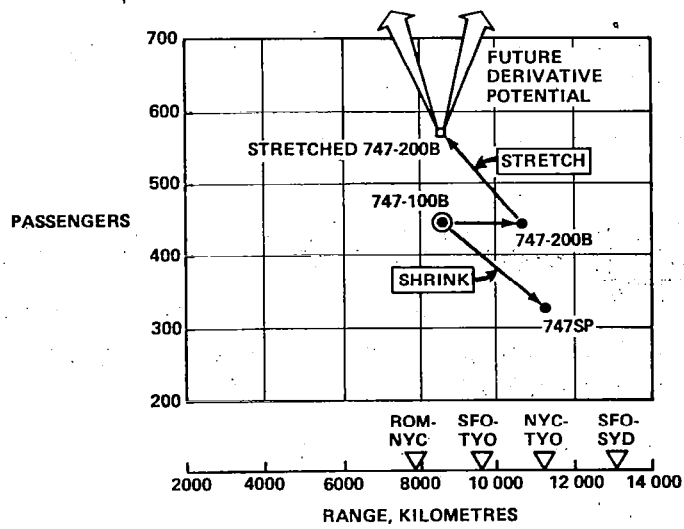


Figure 1.- Subsonic airplane family-Boeing 747 evolution.



Figure 2.- The Boeing family.

- DEFINE STRETCH/SHRINK CONCEPT
- VALIDATE TECHNICAL FEASIBILITY
- QUANTIFY FAVORABLE EFFECTS ON MANUFACTURING COST AND AIRLINE OPERATING ECONOMICS
- ANALYZE FUTURE MARKET SIZE

Figure 3.- Objectives of supersonic airplane family concept development.


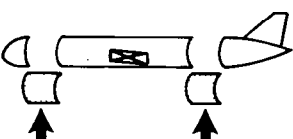
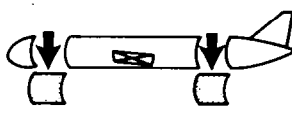

	STRETCH	SHRINK
SUBSONIC AIRPLANE 	ADD PLUGS  MANY PRECEDENTS	DELETE PLUGS  747SP PRECEDENT
SUPERSONIC AIRPLANE 	DIFFICULT BECAUSE: <ul style="list-style-type: none"> ● AREA RULING CONSTRAINTS ● FUSELAGE SECTION NOT CONSTANT ● FUSELAGE LENGTH CONSTRAINTS (ROTATION, ACCESS, EMPENNAGE SIZE) ● ALLOWS SMALL PAYLOAD VARIATIONS ONLY 	

Figure 4.- Conventional fuselage stretch.

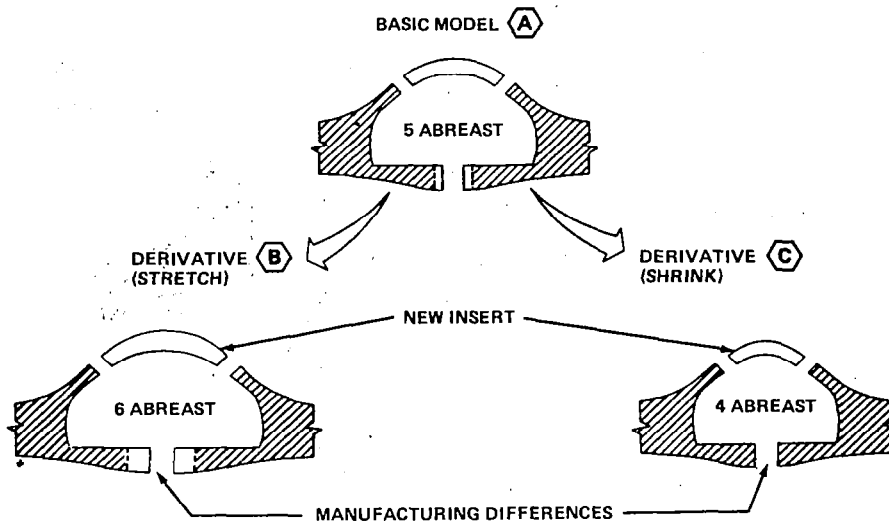


Figure 5.- Lateral fuselage modification.

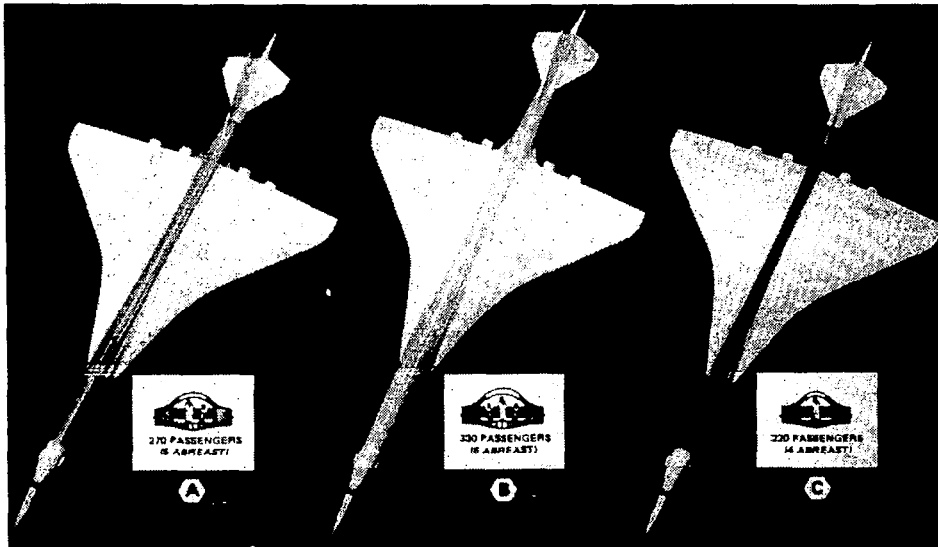


Figure 6.- Supersonic airplane family.

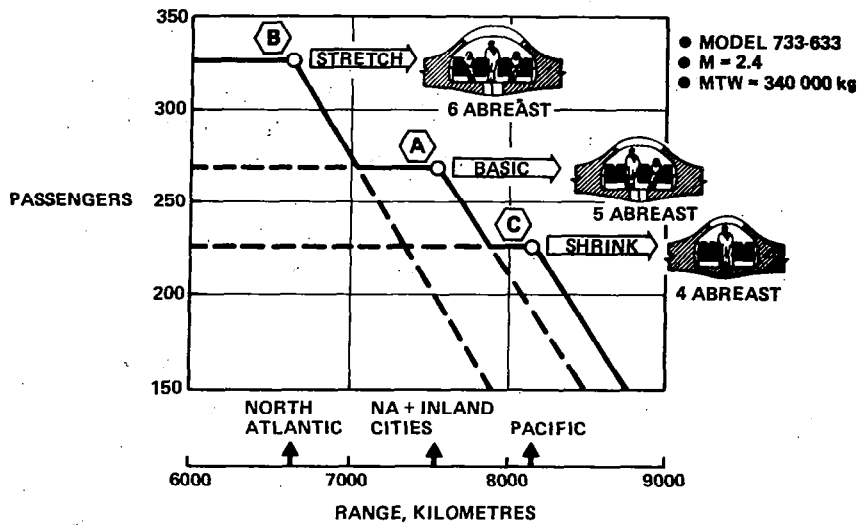


Figure 7.- Passenger/range capability.

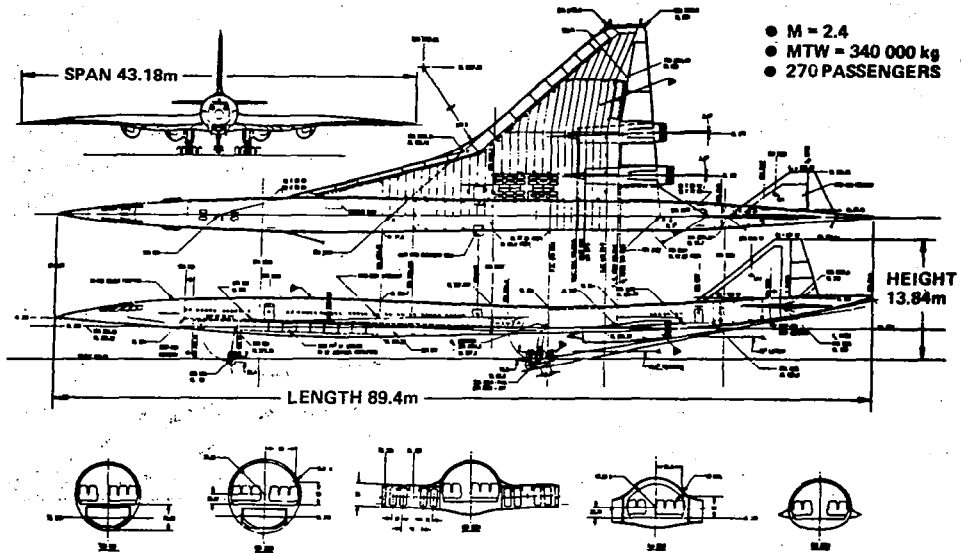


Figure 8.- Boeing model 733-633.

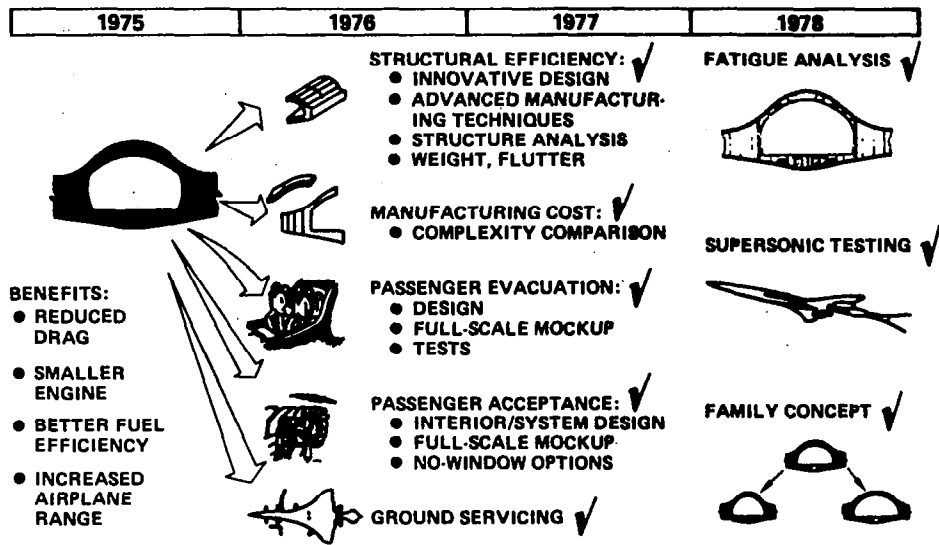


Figure 9.- Blended configuration development.

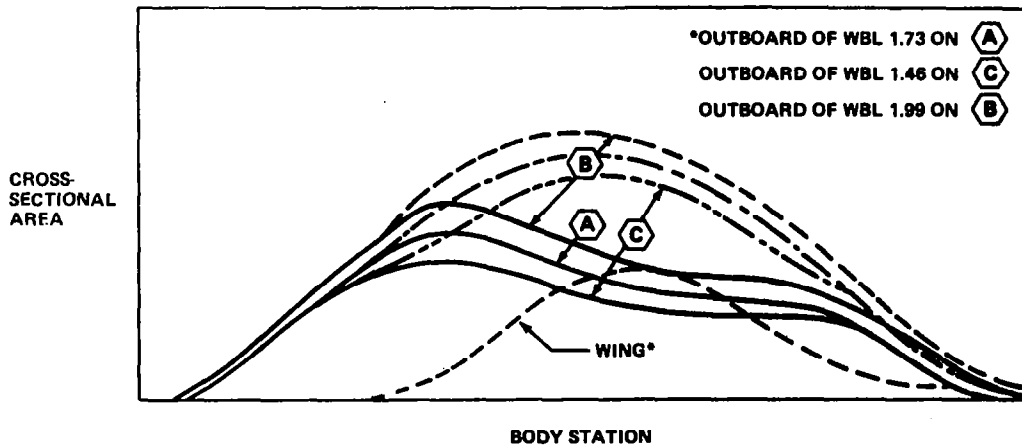


Figure 10.- Area distributions for supersonic efficiency.

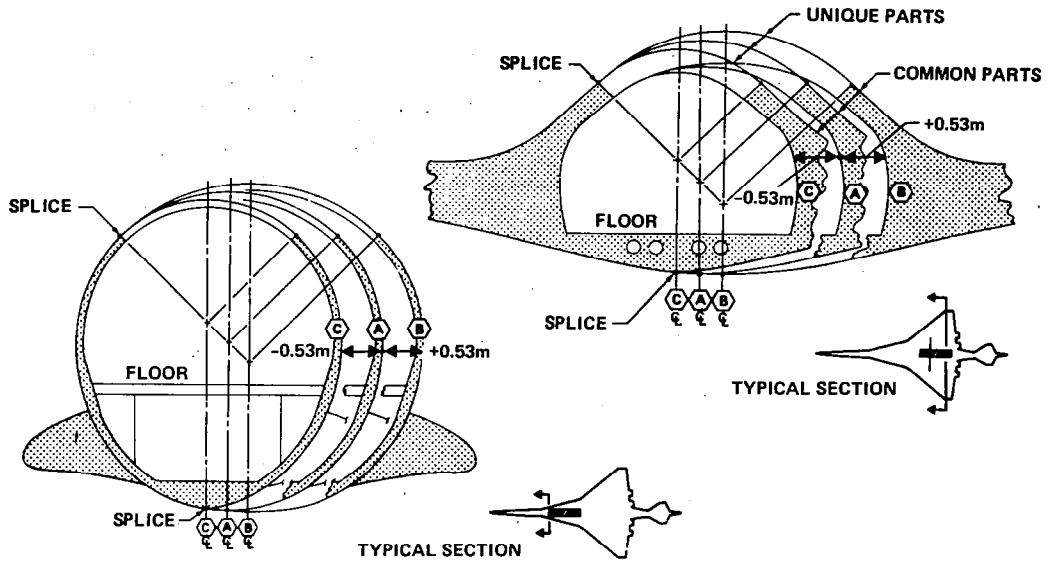


Figure 11.- Common wing and fuselage parts.

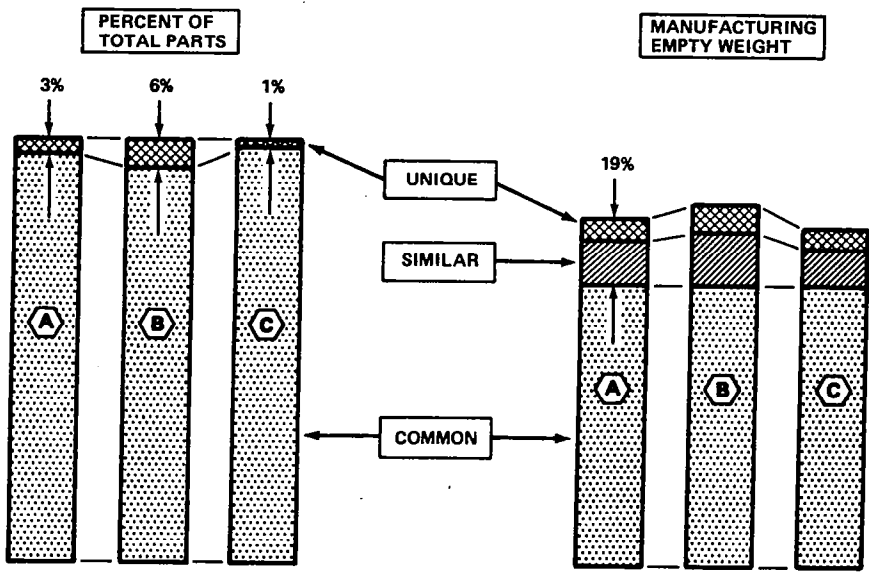


Figure 12.- Commonality among family members.

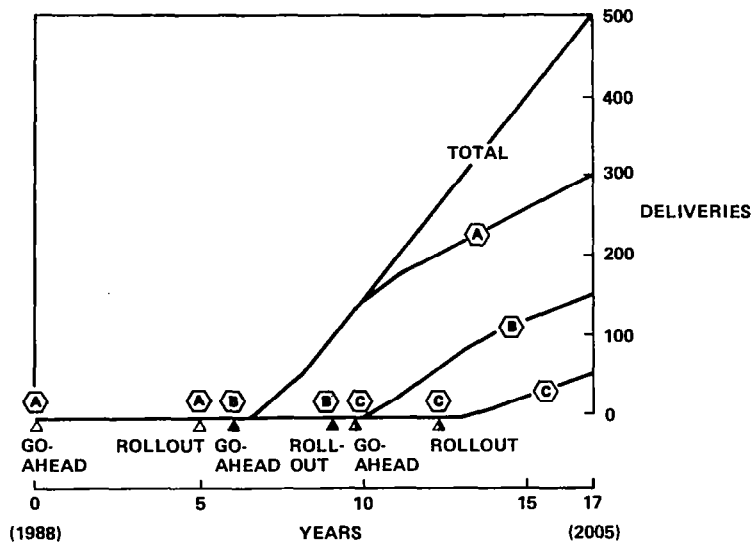


Figure 13.- Development and production schedules.

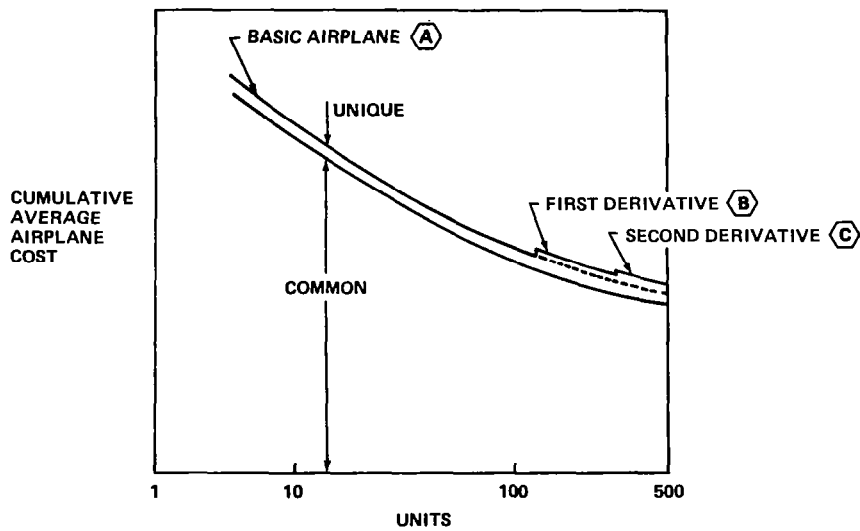


Figure 14.- Favorable effect of commonality on cost.

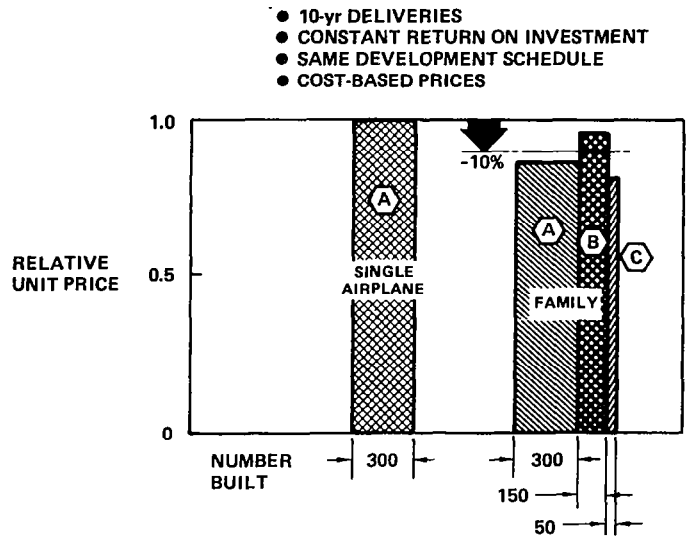


Figure 15.- Airplane price.

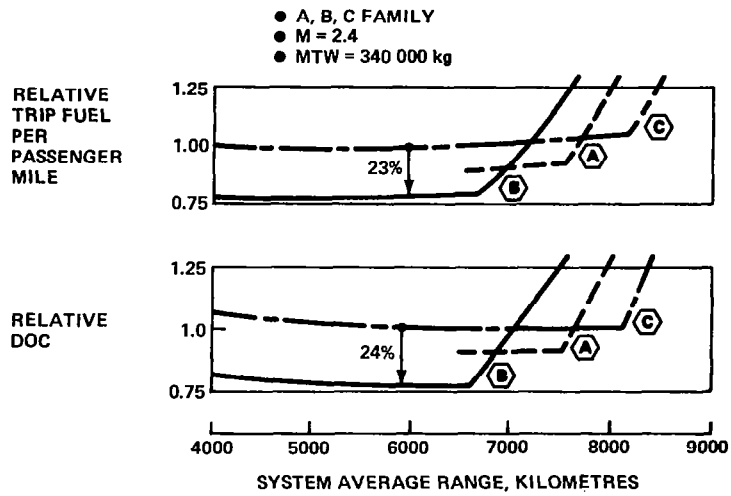


Figure 16.- Trip fuel and operating cost benefit.

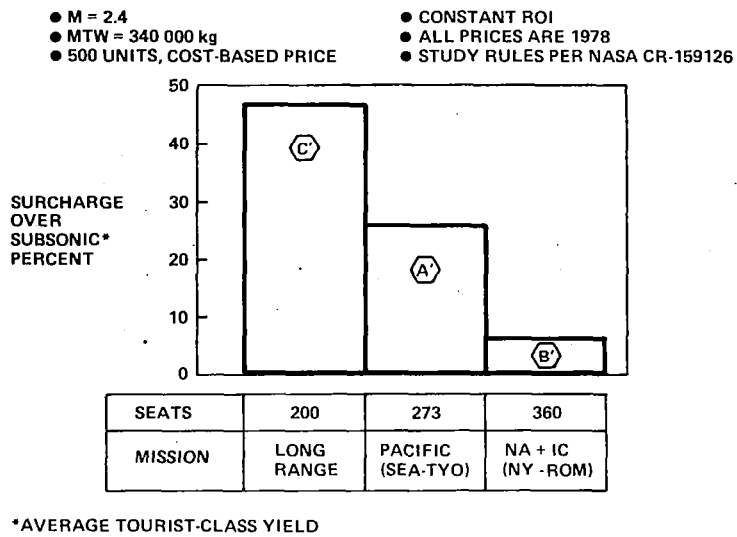


Figure 17.- Supersonic surcharge.

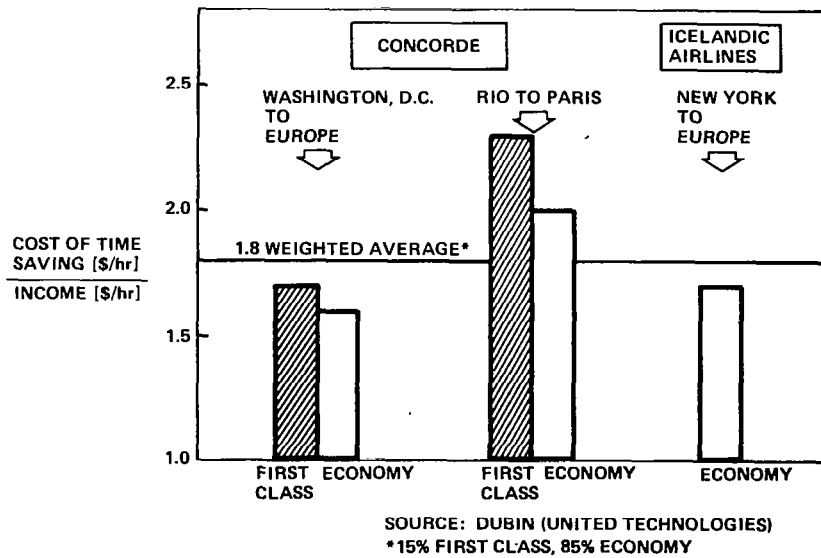


Figure 18.- Value-of-time history.

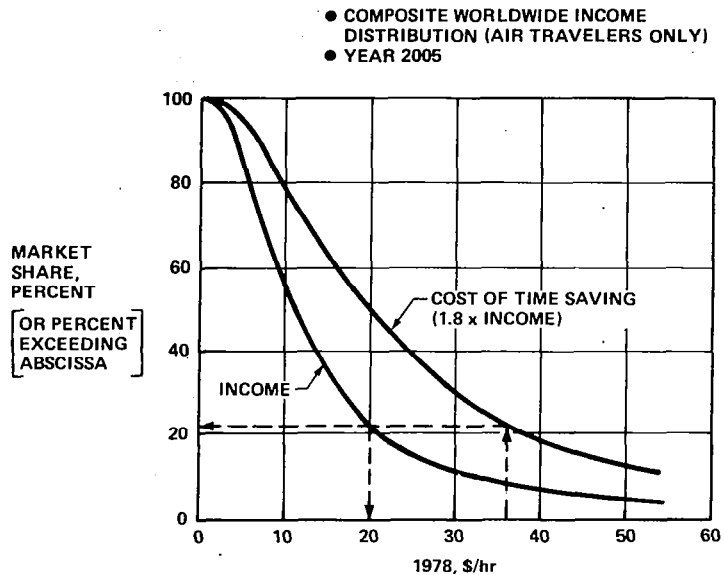
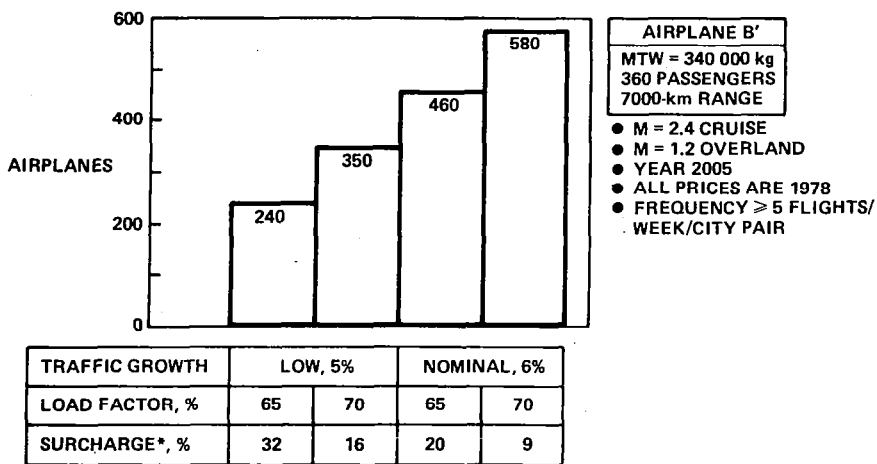


Figure 19.- Market share-effect of cost-of-time savings.



*RELATIVE TO SUBSONIC AVERAGE TOURIST CLASS YIELD

Figure 20.- Market size of single-airplane program.

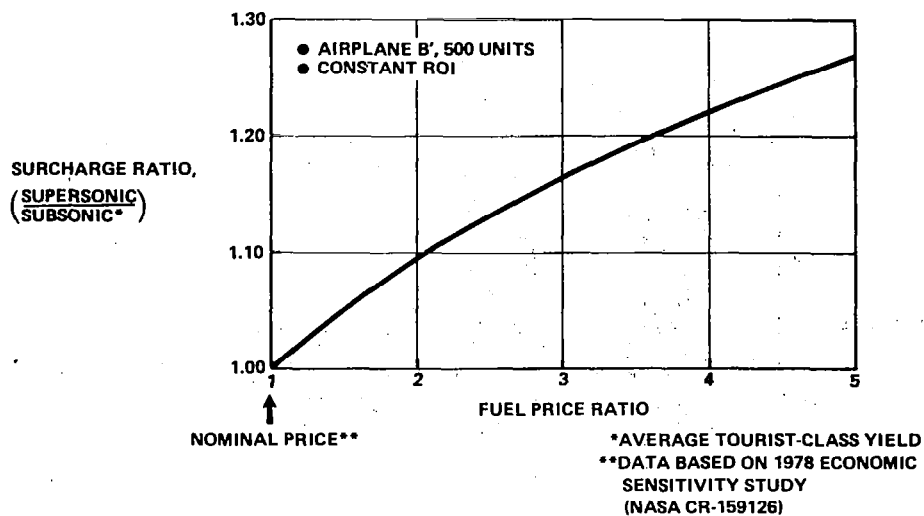


Figure 21.- Surcharge sensitivity to fuel price increase.

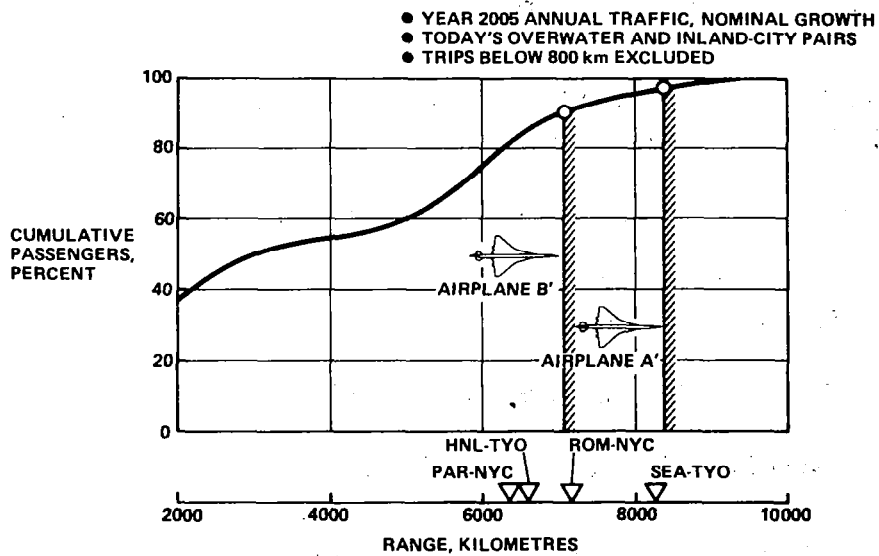


Figure 22.- Passenger distribution by range.

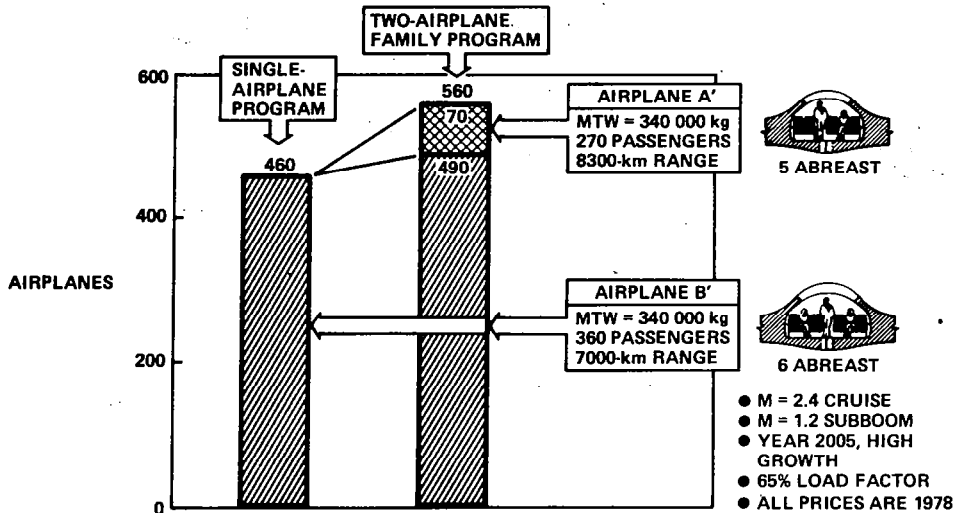


Figure 23.- Market size increase with two-airplane family program.

- SIGNIFICANT PAYLOAD/RANGE FLEXIBILITY ATTAINABLE FOR SUPERSONIC AIRPLANE
- TECHNICALLY FEASIBLE AND EFFICIENT
- REDUCED AIRPLANE AVERAGE UNIT COST POSSIBLE IF COMMONALITY IS HIGH
- IMPROVED AIRLINE OPERATING ECONOMICS
- INCREASED FUTURE MARKET SIZE FOR AIRPLANE FAMILY

Figure 24.- Conclusions on the supersonic airplane family concept.

IMPACT OF CHANGING FUEL CHARACTERISTICS ON SUPERSONIC CRUISE AIRPLANE

O. J. Hadaller, J. E. Schmidt, A. M. Momeny, and P. E. Johnson
Boeing Commercial Airplane Company

SUMMARY

The question of an advanced supersonic cruise research (SCR) airplane is related to future oil supplies and prices. The object of the study reported here was to develop technical data on the impact of changing fuel characteristics on the SCR airplane. Projections of crude oil characteristics typical of the 1985-to-2000 time period were made with the help of consultants to the oil industry. Refineries for the future were modeled to establish jet fuel yield and property data. Candidate jet fuels were then related to requirements of engine and aircraft systems for future airplanes, with emphasis on supersonic cruise airplanes. The study results do not show a need for broadening the fuel specification. Hypothetical study fuels with broader specifications were defined, however, as was the impact of their properties on the SCR airplane and systems.

INTRODUCTION

Jet fuel properties are greatly influenced by the sources of crude feedstock and the refining process used in the production of jet fuels. In the future, these properties may change. If that were to happen, then the fuel properties may not be compatible with SCR airplanes and engine systems. Knowledge of jet fuel characteristics and their impact on supersonic cruise vehicle systems, therefore, is needed to determine technology requirements. A study under the NASA SCR program was conducted to identify candidate jet fuels for the 1980's and beyond and to evaluate the favorable or unfavorable impact of these fuels on SCR airplane and engine systems.

This report describes the process of selecting a slate of crude oil feedstocks from likely foreign and domestic sources and the analytical process of developing corresponding fuel properties. Oil industry consultants provided guidance in selecting the feedstock and refinery configurations. Validation of the crude oil and product properties data was achieved by comparing those modeled for 1980 to today's known feedstock input and refinery product output data.

Variation of fuel properties, such as vapor pressure and viscosity, with fuel temperature were developed using reported estimating and extrapolation methods.

Validation of these methods is in progress. Candidate jet fuels obtained from refinery analyses were developed and some of these selected to evaluate the impact of these fuels using a Boeing SCR airplane (Model 733-633) and the Pratt & Whitney VSCE 515 variable-cycle engine installation as the study model. The effect of heating these fuels on airplane operation, performance, emissions, and maintenance was estimated with assumed heat-load inputs from aerodynamic heating and by fuel, mechanical, and engine systems.

TECHNICAL APPROACH

The development of domestic jet fuel property trends into the mid-1990's was accomplished by computer modeling of petroleum refinery operations. This consisted of

- developing crude oil supply scenarios by geographic region (i.e., West, Midwest, Gulf Coast, and East Coast),
- assembling crude oil data by type and properties representative of the supply scenarios,
- evaluating the development of synthetic petroleum sources and their integration into the energy supply system,
- assessing refining practices and modeling refinery equipment representative of jet-fuel-producing refineries in each region,
- exercising a refinery computer program called Gordian¹ at various initial and final boiling points for the jet fuel fraction,
- assembling and evaluating this Gordian computer program output with respect to jet fuel properties, and
- synthesizing the jet fuel property data to obtain candidate fuels and limits for SCR systems and engine analyses.

The technical approach is summarized in Figure 1.

REVIEW OF CRUDE OIL FEEDSTOCKS

The Oil and Gas Journal identifies approximately 30 domestic² and 95 foreign³ crude oil supplies. To model these crude oil supplies effectively, they were classified according to density and sulfur content. The classification system is outlined in Table 1. As an example, Alaskan North Slope crude would be a heavy density, high-sulfur type. A few crudes were selected to represent the crude oil supplies for a given region. These crudes are identified by year and geographic region in Table 2. In general, the trend is to heavier-density and higher-sulfur crudes supplemented by synthetics.

Synthetic Crudes

Only two resources, coal and oil shale, were identified with large enough reserves to make a significant contribution to United States crude oil supplies. Oil shale processed by surface retorting and hydroliquefaction of coal appear to have the best possibilities for syncrude development. Surface retorting processes by Paraho, Tosco, and Union are ready for subscale commercial operation and could contribute significantly to petroleum supplies by 1995. Coal liquefaction technology is not as well developed and may not make a significant contribution by 1995. An exception to this is the utilization of indirect coal liquefaction such as Sasol synthesis, a commercial process. This process results in finished products compatible with today's jet fuels, not a synthetic crude. Shale oil property data were derived from Department of Energy (DOE) sponsored research by Sohio and Chevron.^{4,5} Coal liquids data were from Exxon's research for DOE.⁶ Missing data for both petroleum and synthetic crudes were determined by interpolations, extrapolations, and correlations.

REFINERY PROCESSING OF JET FUEL

The refinery size, configuration, and operating extremes were developed by The Pace Company to represent typical refineries producing jet fuel in the Gulf, Midwest, East Coast, and West Coast fuel production districts.⁷ Some adjustment in equipment was necessary in the computer program representation to obtain the gasoline-distillate flexibility and product slates typical of the refining industry. Projected 1995 refinery equipment modifications would improve gasoline octane yields and add desulfurization capacity for distillate and residual fuel oils. Figures 2-7 show the jet fuel property data as a function of time. Two bands are identified. One band represents the properties of Jet A currently being delivered (U.S. average).⁸ These fuels are defined by a flash point of 55°C (130°F) and a freezing point of -45°C (-49°F). The other band is associated with the potential properties of Jet A at current specification values. The limits of each band are defined by the refinery operating at maximum distillate production and maximum gasoline production.

Also shown in Figures 2-7 are the American Society for Testing and Materials (ASTM) normal specification limits for the Jet A fuel properties and the specification limits for aromatic content and smoke point, if the user is notified by the fuel supplier. A specification limit for nitrogen content is not established. The arrow in each figure is directed toward values within the specification limits.

SELECTION OF STUDY FUELS

The credibility of the projected refineries was based on how well the model predicted existing jet fuel properties using 1978 crude supplies and refinery configurations. The data in Figures 2-7 (aromatics, specific gravity, heat of combustion, and smoke point) were compared to and found to be consistent with the 1978 inspection data.⁸ None of the studied petroleum-based jet fuels showed aromatics concentrations above 25 volume percent or smoke points below 18 mm. The highest sulfur and nitrogen for traditional petroleum sources (figs. 6 and 7) are in the West, which is the result of processing almost exclusively heavy-density, high-sulfur crudes. The dramatic increase in nitrogen and sulfur for the Midwest is the result of adding 20-percent shale oil to the crude slate. Work by Chevron⁹ and others indicate that fuels containing more than 500 ppm nitrogen will typically have high gum levels and stability problems. If suitable solutions to these problems are not forthcoming, additional hydrotreating will be required to remove the nitrogen. The result is an overall high-quality jet fuel similar to existing jet fuels obtained from processing light-density, low-sulfur crudes.

A significant result of the jet fuel study shows that properties derived from projected crude oil supplies and equipment modifications will not significantly change and are expected to fall within existing Jet A specification limits. However, for the purposes of investigating and quantifying impacts of fuel property changes on the SCR airplane, a set of candidate fuels with a much broader range of specifications was selected. A -29°C (-20°F) freezing point and a 29°C (85°F) flash point were chosen as practical limits. Specific gravity tends to increase with increasing freezing point. For an airplane with a volume-limited fuel tank, such as most long-range airplanes, increased range could be achieved with tanks filled to maximum capacity with high-density fuel. The 29°C (85°F) flash-point limit was chosen to evaluate the effects of increased volatility and the trend toward higher heat content fuels.

Data from over 200 projected jet fuels were scanned for -29°C (-20°F) freezing-point and 29°C (85°F) flash-point requirements. The resulting jet fuel study property limits in Table 3 were identified. In order to evaluate SCR systems and engines, six specific candidate fuels reflecting these property limits were selected for the impact studies. Three of the fuels were selected to represent petroleum-based fuels, and the other three represent fuels with a significant shale oil component. In each case, the fuel with the least desirable properties was from those meeting the freezing-point and flash-point limits. Table 4 lists those fuels. Note that these fuels are not projections for the 1995 to 2000 time period, but represent fuels for the purposes of this study.

Properties of Selected Study Fuels

The impact on SCR engine and airplane systems and operation required the definition of fuel properties over a range of the lowest temperature in the tanks to the temperature in the engine fuel injectors.

In general, the fuel properties are based on the crude oil assay data and on the NASA-Gordian refinery model data base, which describes the changes in properties that occur during the various processing operations. However, certain of the important properties are not included in the crude oil assay data and must be defined by correlations and extrapolations from available industry sources, including National Bureau of Standards, American Petroleum Institute, and Pratt & Whitney Aircraft. Validation of these properties is necessary. The heats of combustion were generally available as assay data, but, where not available for a given boiling range, were extrapolated from other ranges or obtained from a correlation with hydrogen content based on a variety of crude oils. Some viscosity data were generally available for the crude oils considered. However, these data had to be extrapolated and interpolated to the desired temperatures and boiling ranges. The viscosity correlation of the 1995 heavy-cut synthetic fuel (20-percent shale oil) is shown in Figure 8. Flash points and vapor pressures were obtained by correlations based on the ASTM distillation curve. The correlation of vapor pressure for the 1995 light-cut petroleum fuel is shown in Figure 9.

SUPERSONIC CRUISE RESEARCH SYSTEM COMPATABILITY WITH STUDY JET FUELS

The impact of the study fuels on SCR operation, performance, engine emissions, and maintenance were evaluated using the Boeing 733-633 technology study airplane and the Pratt & Whitney VSCE-515 variable-cycle engine installation. Exposure of the fuel to airplane operations and the heat loads on fuel by aero-dynamic heating, mechanical systems, and engine systems were identified as the significant impact factors.

Heat-load Study

Fuel system and thermal management studies were previously conducted in the NASA SCR program.¹⁰ The same heat-load study model was used in the present analysis to determine the impact of study fuels on engine and airplane systems. The heat-load distribution system shown in Figure 8 has a fuel recirculation system that is mandatory to reduce the engine interface temperature during descent and landing operations where fuel flow rates are low and system heat loads are high.

Figure 9 shows the fuel temperature history for a consecutive 5956-km (3216-nmi) flight with 32°C (90°F) on loaded fuel and hot reserve fuel on board from the previous flight. This is the most critical design condition for the system. The heat loads on fuel are shown for aerodynamic heating of

the fuel tanks, airplane mechanical systems, engine pump and oil cooler. Previous studies indicate that fuel management with the recirculation system may further reduce the temperature rise at the engine interface. However, based on the complexity, reliability, and fail-safe considerations of this system, the fuel temperature rise in the tanks appears to be at a practical minimum; fuel recirculation would be limited to descent and landing operations.

The heat loads on fuel from the airplane mechanical systems include heat added by environmental control systems, accessory drive system (ADS) and generator gearbox, and hydraulic system. Increased margin in interface temperatures appears possible with an update of the environmental control system (ECS) by using a system which recirculates cabin air and reduces engine air bleed extractions.

The heat load to fuel by the engine system is from fuel and hydraulic pumps and heat exchangers. The critical engine operating limit of 150°C (300°F) is set by the maximum temperature and time of exposure at the fuel nozzles to prevent fuel coking and high combustion system maintenance. The difference between the predicted fuel temperature and this limit appears marginal, based on using specification Jet A fuel. Study fuels with high levels of nitrogen may exhibit poor thermal stability and require greater margin, which would lead to a reduction in the limiting engine interface temperature. To avoid these problems, the components contributing to instability in the fuel must be removed in the refining process, or the fuel must be protected from high-temperature exposure.

IMPACT OF CHANGING FUEL CHARACTERISTICS ON ENGINE SYSTEMS

Emissions, cold temperature operations, maintenance and performance effects on the Pratt & Whitney VSCE-515 variable-cycle engine were investigated. The heavy petroleum and synthetic fuels appear to have the greatest impact on engine systems.

The heavy kerosene study fuels have high percentages of components such as nitrogen, sulfur, and naphthalene. These components can contribute to fuel instability at elevated temperatures. When the heavy fuels are subjected to high temperatures, as those shown in Figure 10, the fuel tends to decompose and cause deposits to form on heated engine surfaces. These deposits can inhibit heat transfer in heat exchangers and adversely affect atomization in the combustors. Further study is required to evaluate the tradeoffs between fuel refinery operations for removing components contributing to thermal instability and the tolerance of engine systems when the fuel is exposed to high-temperature operation.

The emissions characteristics have been estimated on the VSCE-515. The unburned hydrocarbon emissions, which are sensitive to fuel atomization, are significantly higher for the broad-cut and heavy kerosene fuels because of the higher viscosity of these fuels. The synthetic study fuels can produce greater increases in unburned hydrocarbon emissions than the petroleum-based fuels.

Moderate increases in nitrogen-oxide (NO_x) emissions are expected for the broad cut and heavy kerosene fuels derived from petroleum sources. These increases are attributed to increased thermal NO_x production. Greater increases in NO_x emissions are associated with the synthetic fuels because of the conversion of fuel-bound nitrogen to NO_x .

Assessment of ignition and combustion stability characteristics was based on the atomization of the fuel (i.e., viscosity) and its volatility. Because of the wide viscosity range of the study fuels, atomization effects appear to dominate, and difficulty in cold ignition can be anticipated with the heavy fuels. Current in-service engines are capable of cold ignition on fuels with viscosities less than 12 cs; but, as shown in Figure 10, the viscosity of the synthetic fuels is above this level over significant parts of the sea-level, ambient-temperature range the aircraft is likely to encounter. While cold-injection capability might be extended to include viscosities of up to 20 cs by advances in fuel-injector technology, this will not be sufficient to cover the entire viscosity range of the study fuels. It also appears that fuel heaters would become a necessity to cold-start with the high-viscosity synthetic fuels. Increases in the flash point of the fuel, which occur with the heavy kerosene fuels, will also aggravate the cold-ignition situation. These problems must be countered by further enhancement of atomization, which would require additional fuel heating.

Specific fuel consumption is proportional to the heat content of the fuel. The heavy fuels tend to have low heat content, compared to typical Jet A fuel, and will adversely affect engine performance and reduce airplane range on weight-limited flights.

IMPACT OF CHANGING FUEL CHARACTERISTICS ON AIRPLANE SYSTEMS

Fuel Systems

High-volatility fuels, such as the light petroleum study fuel, can start to evaporate when the fuel is subjected to high temperature and low pressure during SCR airplane operations. Near the end of supersonic cruise when the fuel temperature in the main tanks is above 65°C (153°F) and the ambient pressure in the vapor space is low, corresponding to a 19 000-m (62 000-ft) altitude, six percent or 500 kg (1100 lb) of the remaining fuel will boil off overboard unless the fuel vents are closed and the tanks are pressurized (fig. 11). The 733-633 airplane has unpressurized tanks. A method of avoiding boiloff and fuel loss would be to consider air-pressurized system design for high-altitude operation with light kerosene fuel. This would require about 20 N/m^2 (0.3 lb/in^2) additional pressure in the unpressurized tanks of the 733-633 airplane.

The vapor-handling capability of the fuel system boost pumps becomes a problem in pumping high-volatility fuels near their boiling points. Pumps that operate with high suction pressure can increase the vapor content, resulting

in pump cavitation. This can lead to difficulty in pumping the fuel and to durability problems, due to surface erosion within the pump stages.

The light kerosene fuel had a 4-percent reduction in heat capacity, compared to current typical Jet A. This reduces the heat sink available for cooling airplane mechanical and engine systems, since the fuel tank temperature will also increase by 4 percent.

The reduced flash point of the light kerosene from 38°C (100°F) to 30°C (85°F) lowers the flammability limits set by the 733-633 design criteria for the fuel system. Fire safety design and ground-handling requirements must be carefully reviewed to assure that the fire safety standards will be maintained.

A beneficial effect on SCR airplane operations can be achieved by using high-density fuels. The 733-633 airplane has high-aerodynamic efficiency, which has been achieved by low frontal area and low wave drag. As a result, volume available for fuel storage has been reduced to the minimum required for the design range. Higher-density fuels can extend the design range by providing greater on-board-loaded fuel weight and greater energy content per unit volume.

Mechanical Systems

Operation, maintenance, component life, and system safety were considered in the impact study of the fuel properties on airplane mechanical systems. The elements of the mechanical systems included the ECS hydraulic power and electrical power systems. The major interface between the fuel and mechanical systems occurs at the heat-transport-fluid loop to fuel and hydraulics to fuel heat exchangers. Other mechanical subsystems, such as ECS, drive system, and generator, are cooled by the heat-transport loop.

Higher viscosities, lower specific heat, and higher-nitrogen content all will affect mechanical systems. As indicated in Figure 10, higher viscosities can increase the weight and volume of the transport loop to fuel heat exchangers and the hydraulic/fuel heat exchangers. The effect of the lower specific heat of the light kerosenes is to reduce the available heat sink. This could necessitate modifying the system to use other heat-sink sources, such as water boilers. Higher-nitrogen content causes a potential for increased deposits in the heat exchangers, resulting in reduced heat transfer and higher maintenance. The 1995 heavy syncrude fuel has a 13-percent lower film coefficient compared to Jet A fuel, due to a large increase in viscosity. The overall conductance in the fuel/air heat exchanger is not significantly affected; but, in the fuel/transport fluid heat exchanger, the overall conductance was 15-percent higher with Jet A than with the 1995 fuel. A 15-percent increase in heat exchanger weight and volume is estimated for a system designed with 1995 heavy synthetic fuel. The higher viscosity of the 1995 heavy fuel will also require more power to pump at the same fluid velocity when compared with Jet A fuel.

System operation is not affected by the 1995 fuels, nor is system safety. The possibility of increased deposits could be a problem, since heat exchangers are installed and are not normally serviced during the life of an aircraft. If the fuel/transport fluid heat exchangers are installed in the fuel tanks, access and replacement would be difficult.

SUMMARY OF RESULTS

The preliminary results of the study reveal that, in general, projected crude feedstock sources and refinery operations will not produce changes in fuel properties outside the current Jet A fuel specification limits with the same freezing-point and flash-point temperatures. Also, SCR airplane operations do not show a need for broadening the fuel specifications. The potential for increased concentrations of nitrogen and sulfur, due to the introduction of shale oil in the 1990 time period, is recognized and the influence of these components on SCR systems requires continued study.

The study to investigate hypothetical broadening of the specification by increasing the boiling range over today's Jet A specification in the directions of reduced flash-point and increased freezing-point temperatures for the SCR airplane revealed the following:

- Light kerosene (i.e., reduced flash point) produces reasonably good quality fuels approaching current Jet A fuel.
- Heavy kerosene and synthetic fuels (i.e., increased freezing point) represent poorer quality fuels compared with current Jet A, due to high viscosity and high nitrogen and sulfur content.

Preliminary results of the effect of hypothetical study fuels with broadened fuel property limits on SCR operations revealed unfavorable impacts on the airplane fuel, mechanical, and engine systems. Broadening the fuel property limits for the SCR airplane will require advanced technology and system modifications to assure satisfactory operations.

REFERENCES

1. "Computer Model for Petroleum Refinery Operations," Gordian Associates Incorporated, New York, October 1977, Contract NASA-20620.
2. "Evaluations of World's Important Crudes," Oil and Gas Journal, 1973.
3. "A Guide to World Export Crudes," Oil and Gas Journal, 1976.
4. "Identification of Probable Automotive Fuels Composition: 1985-2000," U. S. Dept. of Energy, HCP/W3684-01/1.
5. R. F. Sullivan and B. E. Stangeland, "Catalytic Hydroprocessing of Shale Oil to Produce Distillate Fuels," Chevron Research Company, August 1977, DOE Contract EF-76-C-01-2315.
6. "EDS Coal Liquefaction Process Development," Exxon Research and Engineering Company, 1978, DOE Report FE-2363.
7. "Advanced Concept Studies for Supersonic Vehicles Fuel Industry Analysis," The Pace Company, April 1979, Subcontract of NAS1-14623.
8. E. M. Shelton, "Aviation Turbine Fuels," Department of Energy, Bartlesville, Oklahoma, 1978, BETC/PPS-79/2.
9. R. F. Sullivan and B. E. Stangeland, "Converting Green River Shale Oil to Transportation Fuels," Chevron Research Company, April 1978, DOE Contract EF-76-C-01-2315.
10. "Advanced Concept Studies for Supersonic Vehicles," NASA CR-145286, February 1978.

TABLE 1.- CRUDE OIL CLASSIFICATIONS

Density classification	Density range, degrees ^a	Specific gravity range
Light	> 38	< 0.835
Medium	38 ≤ Den ≤ 32	0.835 ≤ SPGR ≤ 0.865
Heavy	< 32	> 0.865
Sulfur classification	Sulfur content range, weight, %	
Low	< 0.5	
Medium	0.5 ≤ Weight (%) ≥ 1.0	
High	> 1.0	

^aAmerican Petroleum Institute

TABLE 2.- REFINERY FEEDSTOCKS SELECTED

Crude oils	Volume, %								
	West Coast			Midwest			Gulf and East Coasts		
	1978	1985	1995	1979	1985	1995	1978	1985	1995
Light density, low sulfur 1	—	—	—	50	30	10	50	50	40
Light density, low sulfur 2	3	3	2	—	10	10	—	—	—
Medium density, low sulfur 1 ^a	16	4	2	—	—	—	—	—	—
Medium density, low sulfur 2 ^a	—	—	—	—	—	—	—	10	20
Medium density, high sulfur ^a	4	3	—	50	—	—	40	10	—
Heavy density, low sulfur	—	—	—	—	10	10	—	—	—
Heavy density, high sulfur 1	33	43	45	—	20	20	10	10	10
Heavy density, high sulfur 2	44	47	48	—	—	—	—	—	—
Heavy density, high sulfur 3 ^a	—	—	—	—	30	30	—	20	28
Shale oil	—	—	3	—	—	20	—	—	—
Coal liquids	—	—	—	—	—	—	—	—	2

^aImported crudes

TABLE 3.- JET FUEL STUDY PROPERTY LIMITS

Physical characteristics	Limits
Specific gravity	0.85 maximum
Freezing point °C (°F)	-29 (-20) maximum
Flash point °C (°F)	29 (85) minimum
Initial boiling point °C (°F)	135 (275) minimum
Final boiling point °C (°F)	330 (625) maximum
Kinematic viscosity cs at 50°C (122°F)	5.2 maximum
Combustion characteristics	Limits
Heat of combustion MJ/kg (Btu/lb)	42.55 (18 300) minimum
Volume of aromatics (%)	25 maximum
Smoke point (mm)	18 minimum
Nitrogen (%)	0.2 maximum
Weight of sulfur (%)	0.4 maximum
Weight of hydrogen (%)	12.5 minimum
Volume of naphthalenes (%)	6 maximum

TABLE 4.- STUDY JET FUEL PROPERTY LIMITS^a

Fuel properties	Petroleum fuels			Petroleum/ synthetic fuels		
	Broad cut	Light kerosene	Heavy kerosene	Broad cut	Light kerosene	Heavy kerosene
Specific gravity	0.838	0.810	0.853	0.836	0.818	0.850
Kinematic viscosity, cs at 50°C (122°F)	2.13	1.46	3.0	2.25	1.54	3.2
Freezing point, °C (°F)	-29.0 (-20.0)	-46.6 (-51.9)	-29.0 (-20.0)	-29.0 (-20.0)	-45.6 (-50.0)	-29.0 (-20.0)
Flash point, °C (°F)	30.5 (87.0)	29.0 (84.2)	70.8 (159.5)	30.3 (86.5)	29.5 (85.1)	70.6 (159.1)
Initial boiling point, °C (°F)	135 (275)	135 (275)	205 (400)	135 (275)	135 (275)	205 (400)
Final boiling point, °C (°F)	330 (625)	275 (525)	315 (600)	330 (625)	275 (525)	315 (600)
Heat of combustion, MJ/kg (Btu/lb)	42.90 (18 446)	43.12 (18 544)	42.79 (18 402)	42.73 (18 373)	43.00 (18 489)	42.63 (18 330)
Smoke point, mm.	19.4	23.2	18.8	21.1	23.8	20.9
Weight hydrogen, %	13.0	13.7	12.7	13.1	13.5	12.9
Weight nitrogen, %	0.0370	0.0019	0.0325	0.1716	0.0827	0.1485
Weight sulfur, %	0.26	0.04	0.23	0.29	0.12	0.25
Volume aromatics, %	22.1	16.4	23.5	20.9	17.2	22.1
Volume paraffins, %	34.4	46.2	34.2	41.3	44.7	40.1
Volume naphthenes, %	43.4	37.3	42.2	37.7	38.1	37.8
Volume naphthenes, %	3.9	2.9	4.1	3.7	3.0	3.9
Volume olefins, %	0.7	0.5	0.7	0.6	0.5	0.7

^aThese are not projections of fuel properties. They represent consistent sets of extreme properties.

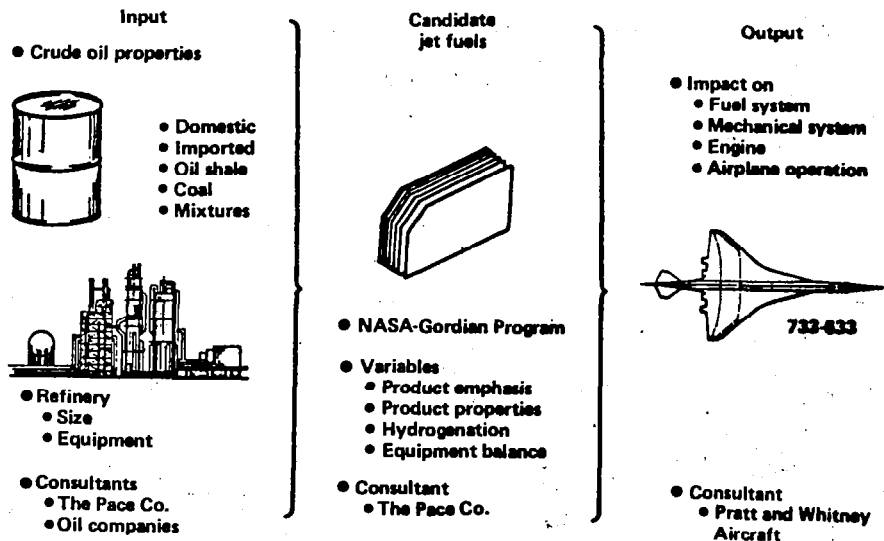


Figure 1.- Technical approach for fuel characteristics study.

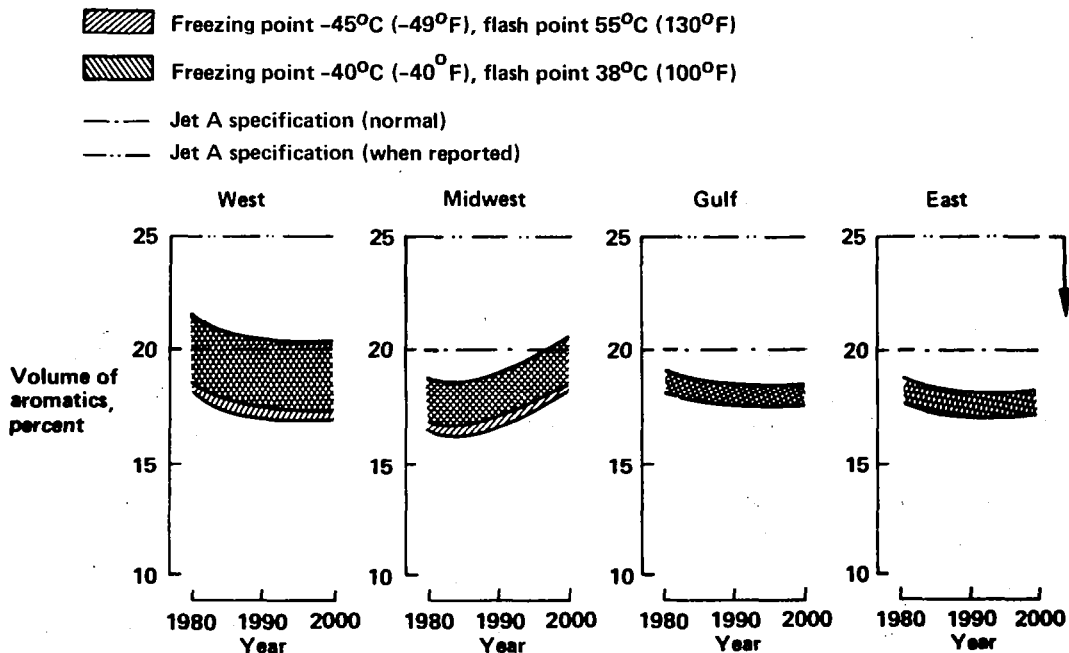


Figure 2.- Refinery jet fuel fraction - aromatics.

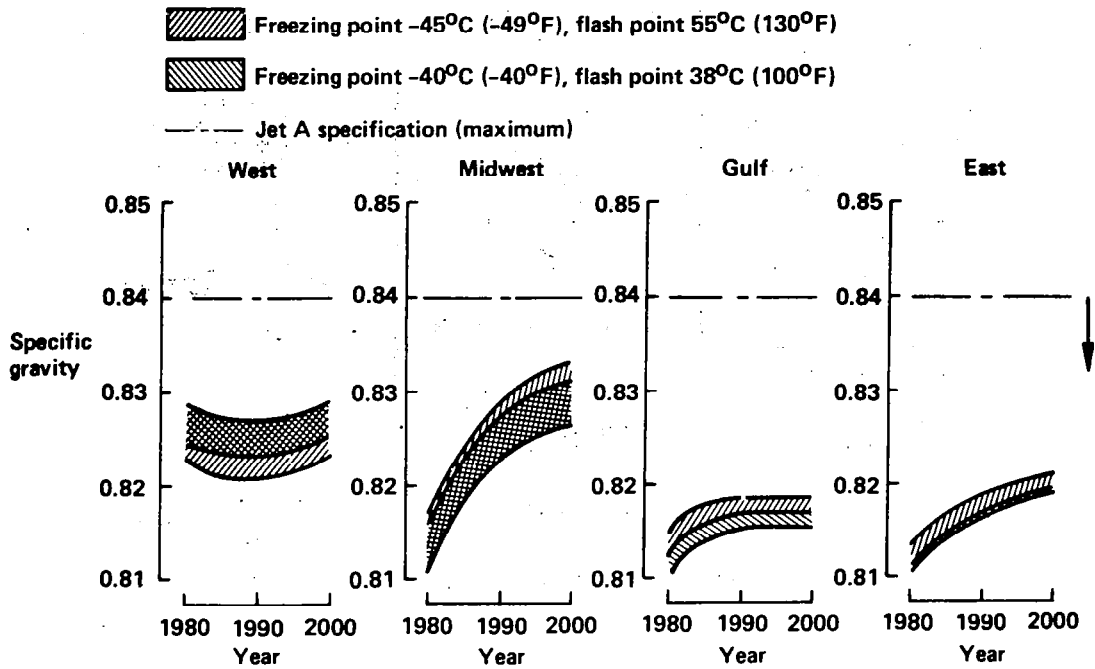


Figure 3.- Refinery jet fuel fraction - specific gravity.

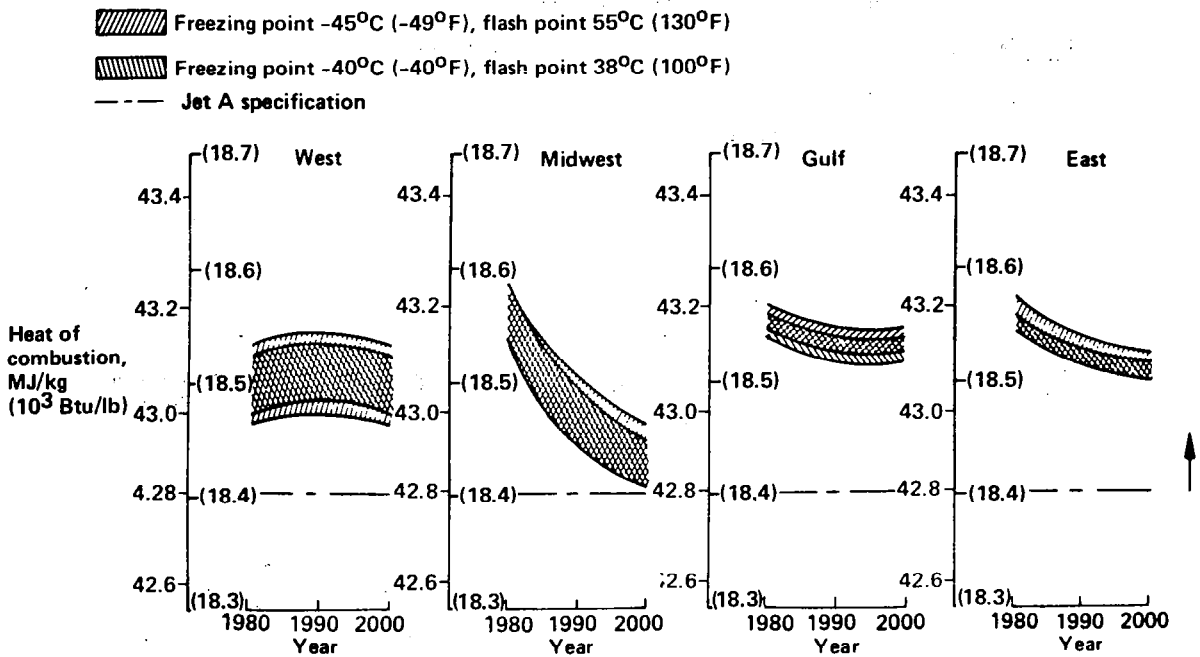


Figure 4.- Refinery jet fuel fraction - heat of combustion.

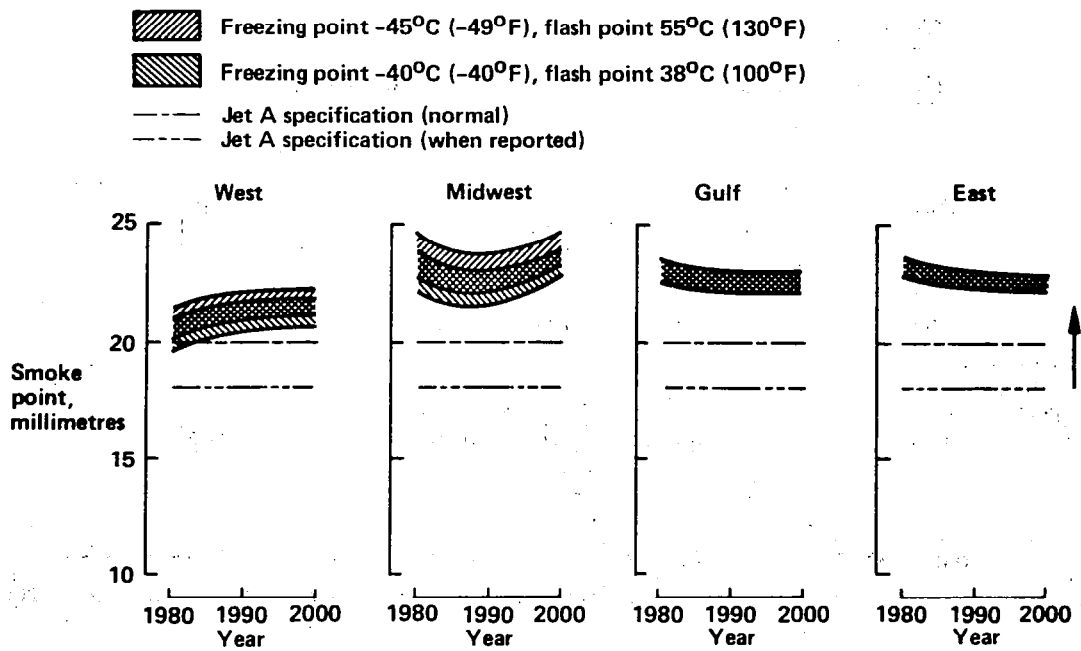


Figure 5.- Refinery jet fuel fraction - smoke point.

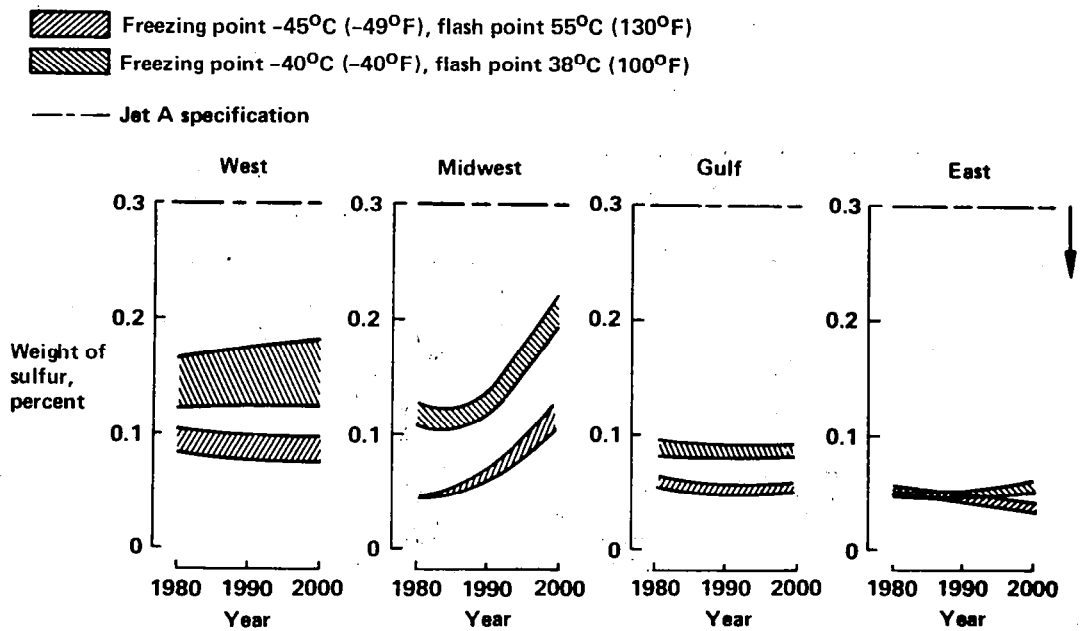




Figure 6.- Refinery jet fuel fraction - sulfur.

-  Freezing point -45°C (-49°F), flash point 55°C (130°F)
-  Freezing point -40°C (-40°F), flash point 38°C (100°F)

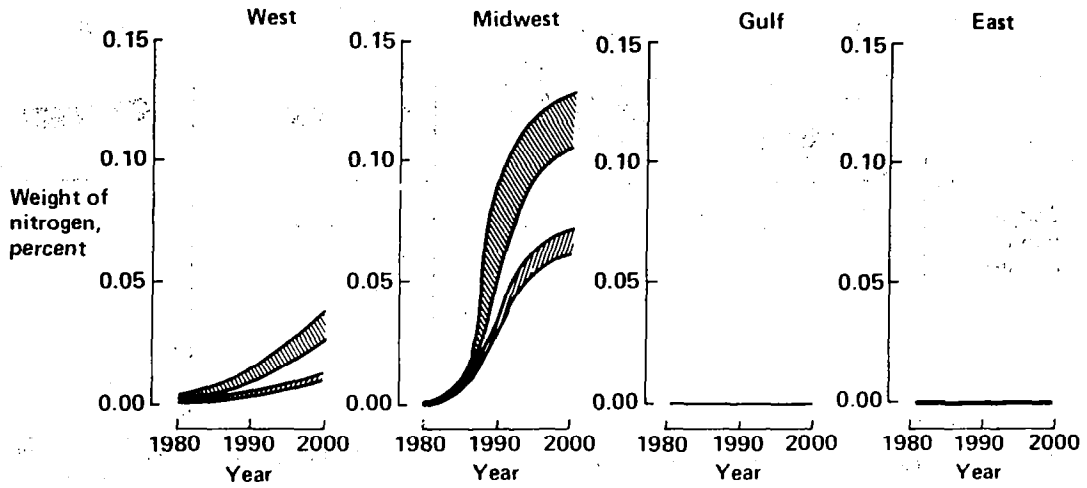


Figure 7.- Jet fuel processing - nitrogen.

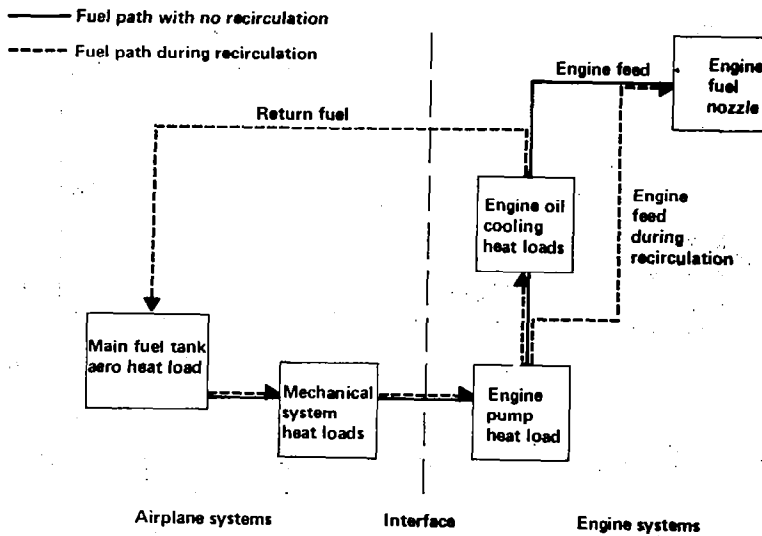


Figure 8.- Heat-load study model.

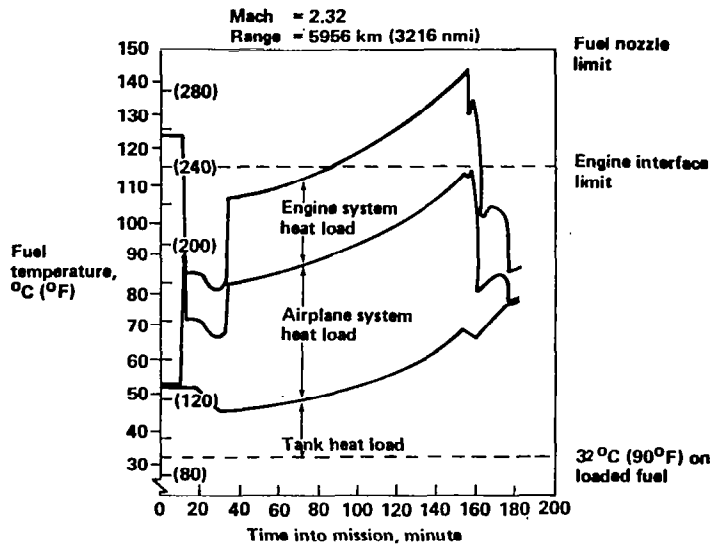


Figure 9.- Fuel temperature history.

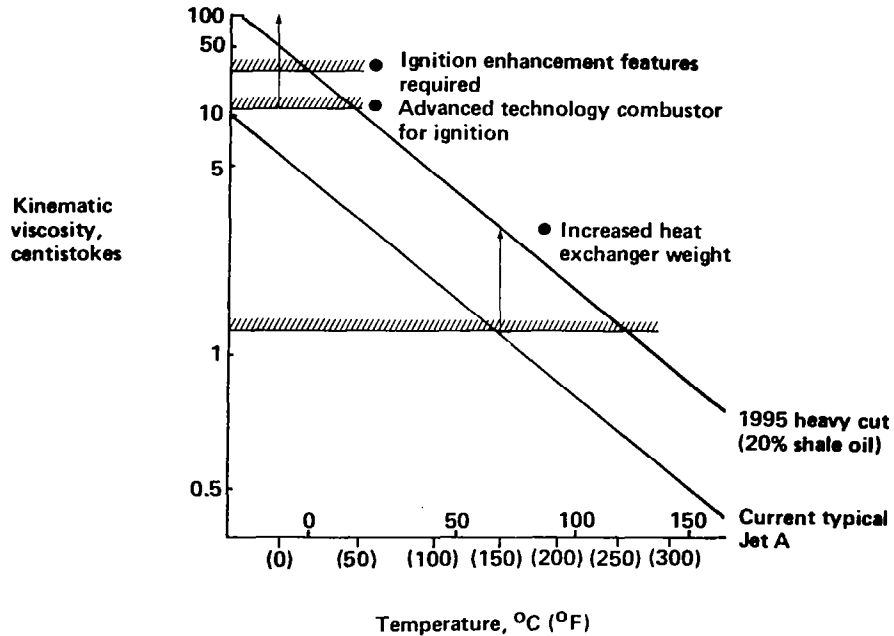


Figure 10.- Impact of high viscosity on systems.

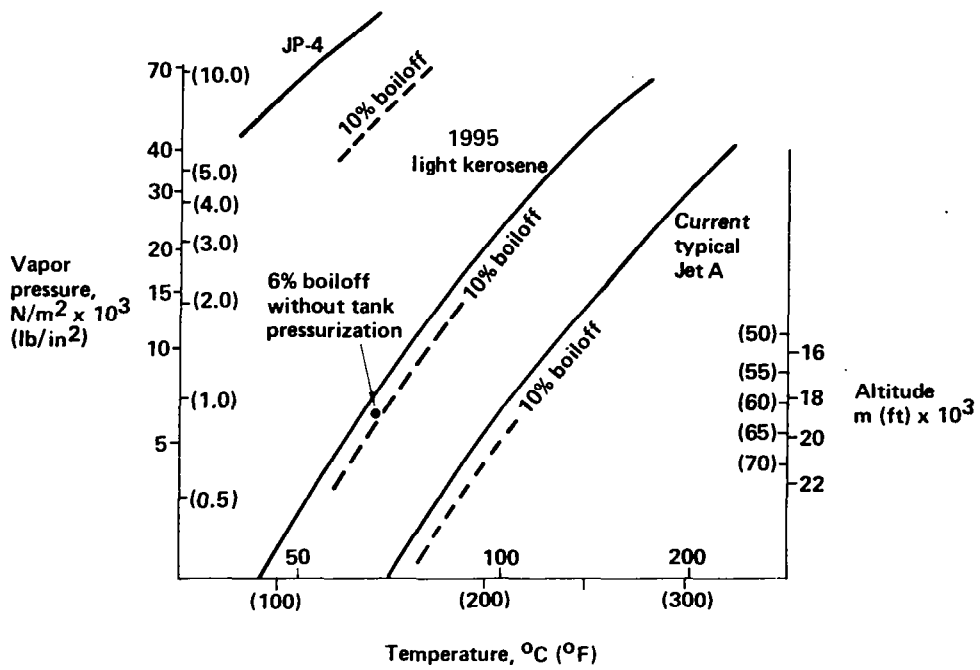


Figure 11.- Impact of high vapor pressure on fuel system.

TECHNOLOGY DEVELOPMENT STATUS AT MCDONNELL DOUGLAS

William T. Rowe
McDonnell Douglas Corporation

INTRODUCTION

During the 1979 SCR Conference, a presentation was included to provide the highlights of technology development activities at McDonnell Douglas. The presentation charts are included in the following section, along with a brief written explanation for each.

McDONNELL DOUGLAS ADVANCED SUPERSONIC TRANSPORT

Artist's rendition of the MDC advanced supersonic transport for long-haul, international, over-water operation.



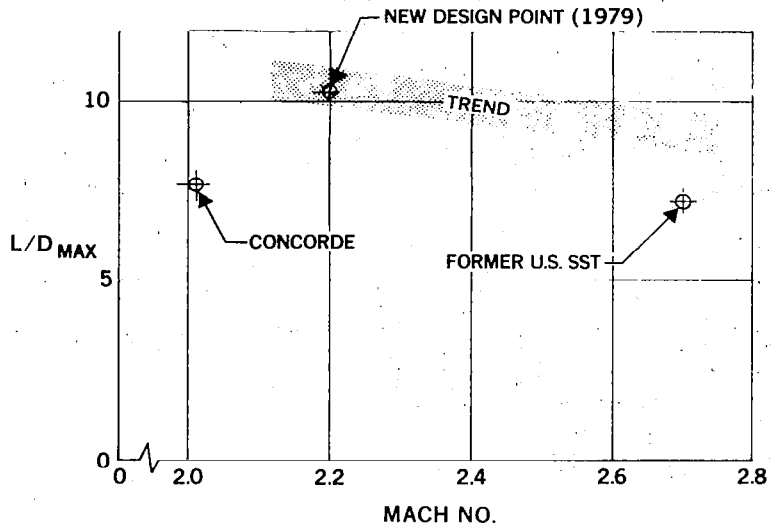
SUPERSONIC TRANSPORT TECHNOLOGY COMPARISON

Comparison of the significant technology items of the Concorde and the conceptual MDC baseline advanced supersonic transport. The four major improvements are in the areas of range performance, structures (improved materials), aerodynamics, and in community noise.

	CONCORDE	MDC BASELINE (1979) ^c	IMPROVEMENT
SPEED	MACH 2.02	MACH 2.2	9% FASTER
RANGE	3400 N MI	5500 N MI	62% FARTHER
PASSENGERS	100	225 TO 300	3 TIMES
STRUCTURES	ALUMINUM (WT FRACT = 0.279)	70% TITANIUM, 30% ALUMINUM/COMPOSITES (WT FRACT = 0.228)	
ENGINE	TURBOJET WITH AFTERBURNER	MINI-BYPASS TURBOJET OR VARIABLE CYCLE	
PROPULSION EFFICIENCY (M/SFC)	1.70	1.74	2% INCREASE
AERO EFFICIENCY (L/D)	7.6	10.0	32% INCREASE
TAKEOFF AND LANDING NOISE	116 EPNdB AVERAGE	108 EPNdB OR BETTER	FAR PART 36 OR BETTER
MARKET	PREMIUM CLASS	FIRST-CLASS AND FULL-FARE ECONOMY	300-500 ACFT

AERODYNAMIC EFFICIENCY

Current status of aerodynamics in configuration design. Test data have been used to establish realistic performance levels, and the new goal is based on wind-tunnel test data.



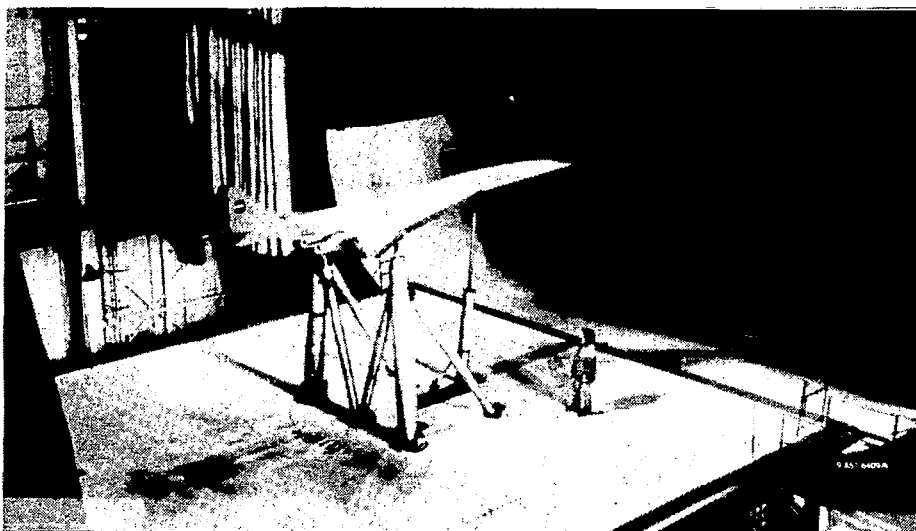
McDONNELL DOUGLAS/NASA AST IMPROVED WING ON NC MILLING MACHINE

The reoptimized wing for wind-tunnel validation of the new aerodynamic efficiency goal of $L/D = 10$. Improvements include more sweep in the other panel, refinements in the thickness and thickness distribution, and recambering to account for the presence of the nacelles.



NASA LOW-SPEED MODEL IN LANGLEY 30- BY 60-FT TUNNEL —
 McDonnell Douglas AST Baseline Design (1979 Tests)

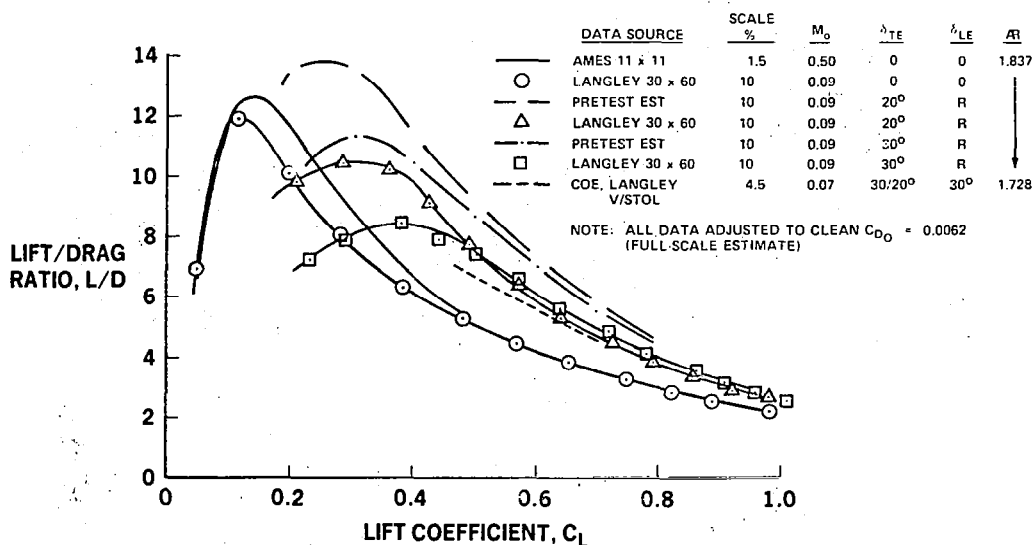
Photograph of the 10% scale model (9.45 m (31 ft) long) of the MDC conceptual baseline configuration during pressure distribution and drag testing.



LOW-SPEED L/D SUMMARY

Test results of the 10% scale low-speed model which shows the aerodynamic performance with leading and trailing edge devices undeflected, leading edge devices deflected, and trailing edge devices deflected 20° and 30°. Also comparisons are shown of the clean configuration from the 1.5% scale model tests in the Ames 11 x 11 foot tunnel and a NASA SCAT-15 configuration with leading and trailing edge devices deflected which was tested in the Langley V/STOL tunnel.

UNTRIMMED



CONTROL SYSTEMS

Controls systems studies have progressed to the point of simulation on the Douglas fixed base simulator. Equations have been programmed and evaluations with and without augmentation have been completed with several pilots in the loop. Gust and wind shear conditions can also be simulated on approach.

FLYING QUALITIES WITH RELAXED STATIC STABILITY CONFIGURATION ARE ACCEPTABLE WITH AUGMENTATION USING LINEAR SYSTEM CRITERIA

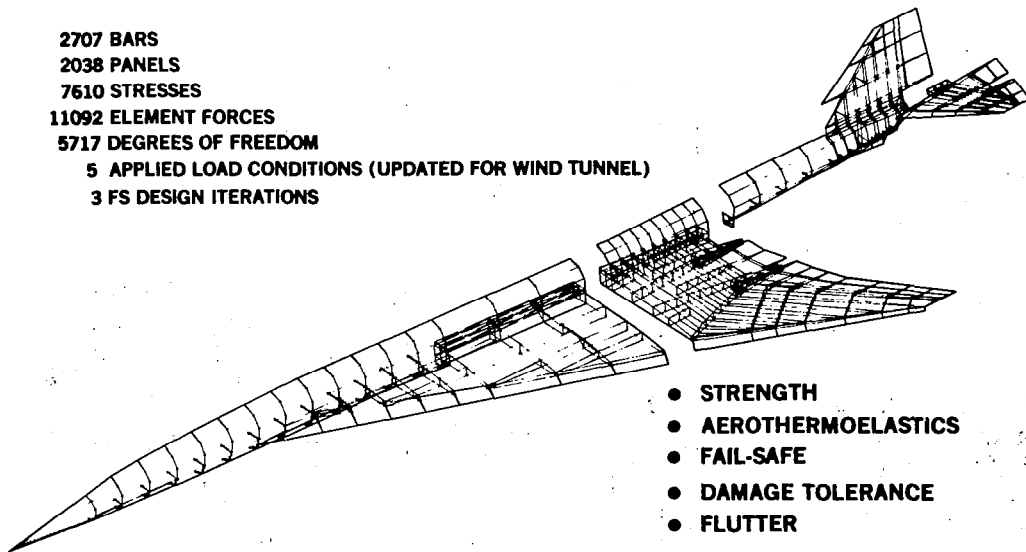
FIXED-BASE SIMULATOR WITH PILOT VERIFIES LONGITUDINAL AXIS ANALYSIS AND CHANGES TO IMPROVE LATERAL AXIS RESPONSES ARE UNDERWAY

NEED MOVING BASE SIMULATION AND FURTHER FLEXIBILITY DEFINITION

AST STRUCTURAL MODEL

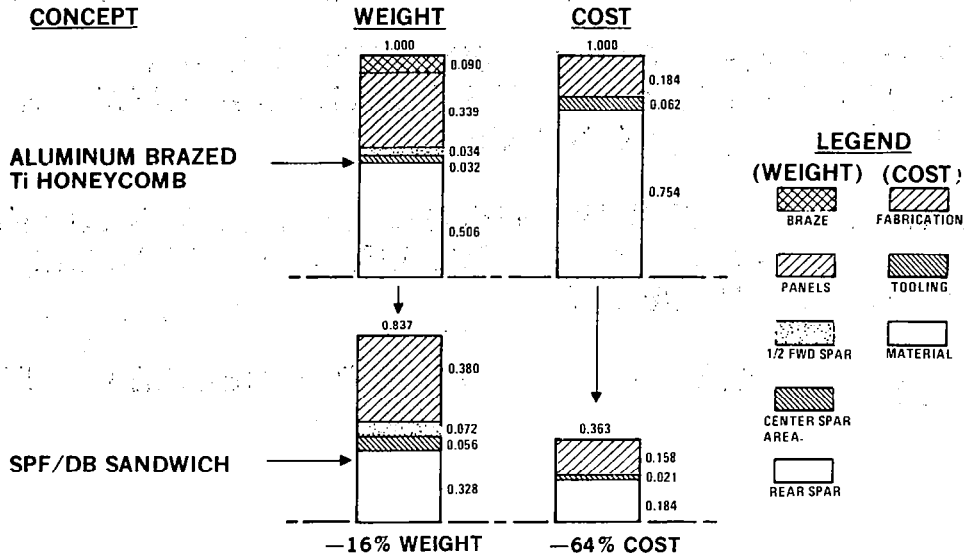
The structural modeling and analysis possible in the advanced design phase of the AST program has increased the capability and accuracy considerably. The complete solutions are now limited only by computing facilities and priorities.

2707 BARS
2038 PANELS
7610 STRESSES
11092 ELEMENT FORCES
5717 DEGREES OF FREEDOM
5 APPLIED LOAD CONDITIONS (UPDATED FOR WIND TUNNEL)
3 FS DESIGN ITERATIONS



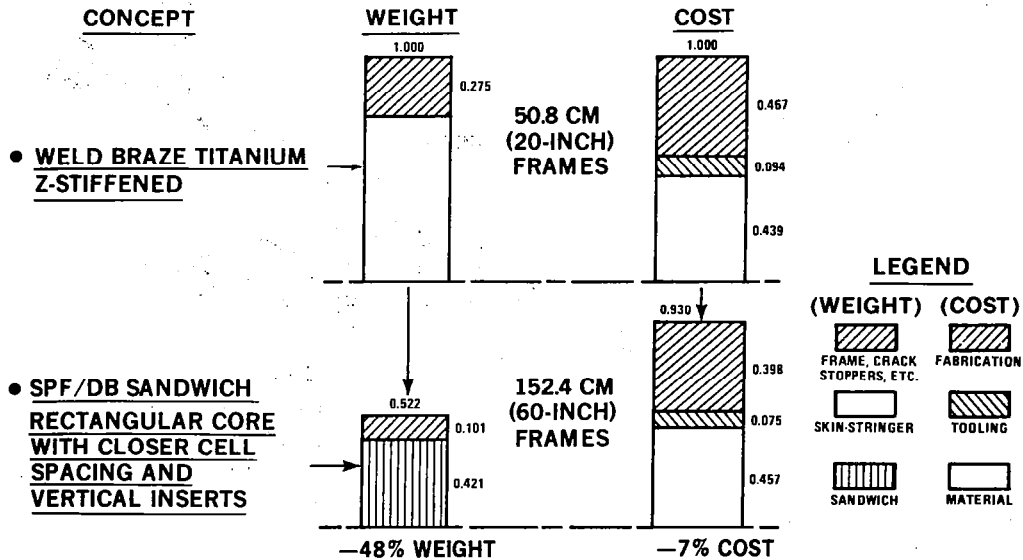
WEIGHT AND COST COMPARISONS
Wing - 102-cm (40-in.) by 254-cm (100-in.) Base

The MDC proprietary process for superplastic forming/diffusion bonding (SPF/DB) of titanium sandwich structure has been successfully demonstrated in the laboratory. Typical wing panel weights are reduced and costs are significantly reduced by this process over the aluminum brazed honeycomb process.



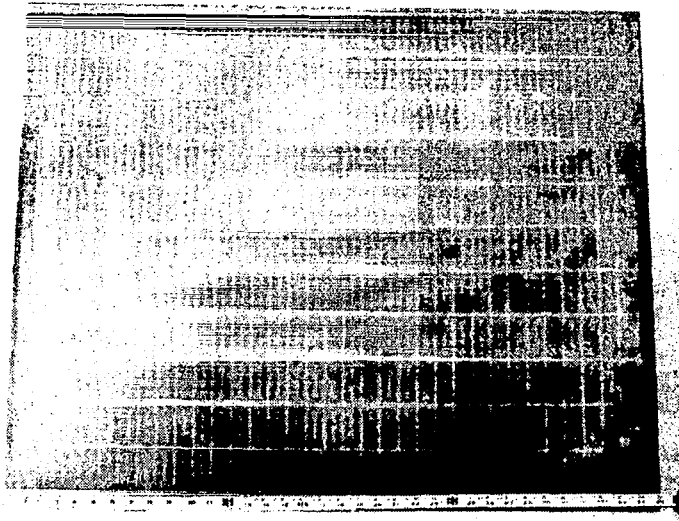
WEIGHT AND COST COMPARISONS
Fuselage - 120-cm (40-in.) by 305-cm (120-in.) Base

Typical fuselage panel weights are greatly reduced and there is some cost savings when the MDC SPF/DB process is used in fabrication instead of the conventional Z stiffened weld braze process.



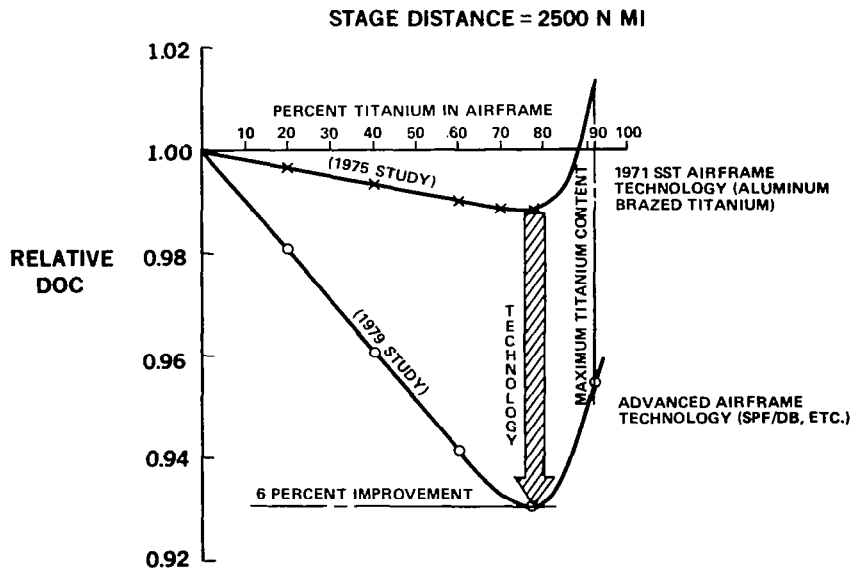
SPF/DB TITANIUM ACCOMPLISHMENTS

The 89-cm (35-in.) by 89-cm (35-in.) prototype of the wing sandwich panels to be fabricated under the NASA SPF/DB contract (NAS1-15527). The core is a rectangular pattern and the panel is approximately 2.54 cm (1 in.) in thickness.



TITANIUM ADVANCEMENTS REDUCE OPERATING COSTS

Distinct advantages in operating costs (DOC) are evident from incorporation of titanium instead of conventional aluminum construction. For aluminum brazed titanium structure, the reduction in DOC of 1% is achieved with a 78% titanium structure. Beyond 78%, the titanium structure suffers a weight penalty due to minimum gage considerations. The advanced technology titanium structure (including SPF/DB) results in both weight and cost savings over aluminum and a DOC improvement of 7%. Both designs are based on equivalent analysis techniques.



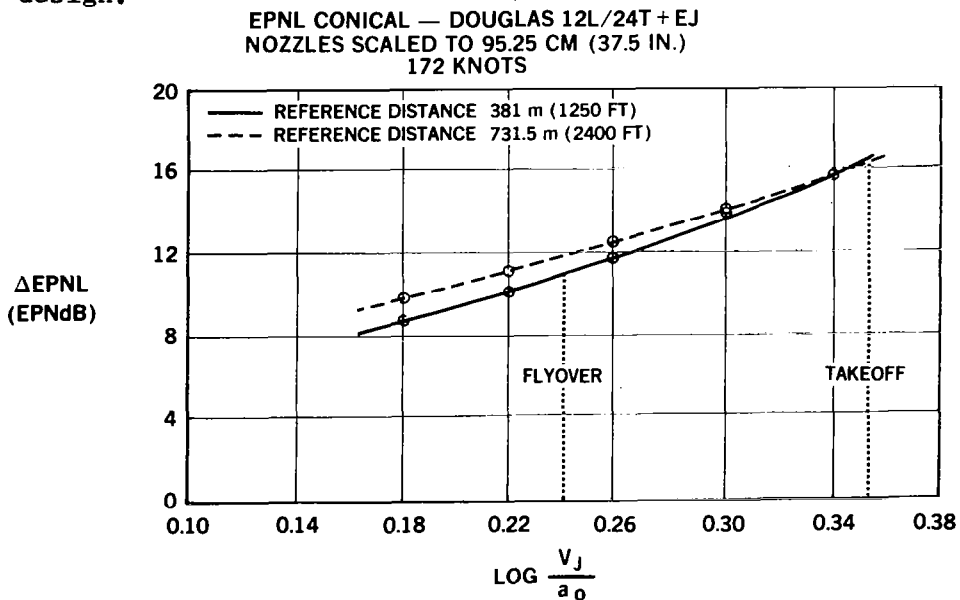
MDC SUPPRESSOR/EJECTOR NOZZLE FOR HS-125 FLIGHT TESTS

Photograph of the HS-125 flight test aircraft with the MDC suppressor/ejector nozzle mounted on the Rolls-Royce uprated Viper 601 engine. Testing was accomplished over the 137-m (450-ft) tower of the Severn River Bridge at Bristol, England.



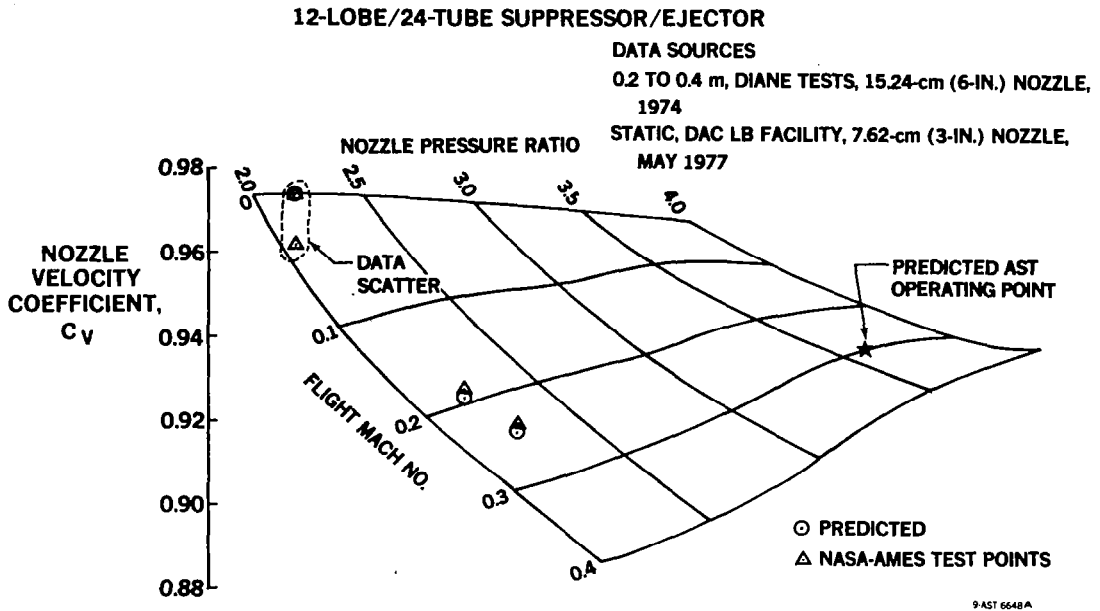
HS-125 FLIGHT TEST SUPPRESSION RESULTS

Flight test suppression values scaled to an equivalent full scale engine size for the MDC conceptual 2.2 m baseline configuration. The suppression levels demonstrated represent the best to date in actual flight for a mechanical suppressor design.



MDC AST NOZZLE PERFORMANCE

Nozzle performance for the MDC suppressor/ejector exhaust system shown are based on tests of a 15.2-cm (6-in.) diameter nozzle in the Douglas test facility. Ames 40 x 80 foot tunnel test data show excellent agreement.



The results of the HS-125 flight tests of the MDC suppressor/ejector nozzle have been applied to the applicable low-bypass turbojet engines at sideline and takeoff/cutback conditions. These engines provide noise levels considerably less than FAR part 36 (stage 2) noise levels and also lower values than estimated for the variable cycle engines. Noise levels/FAR part 36 (stage 2) noise requirements, EPNdB.

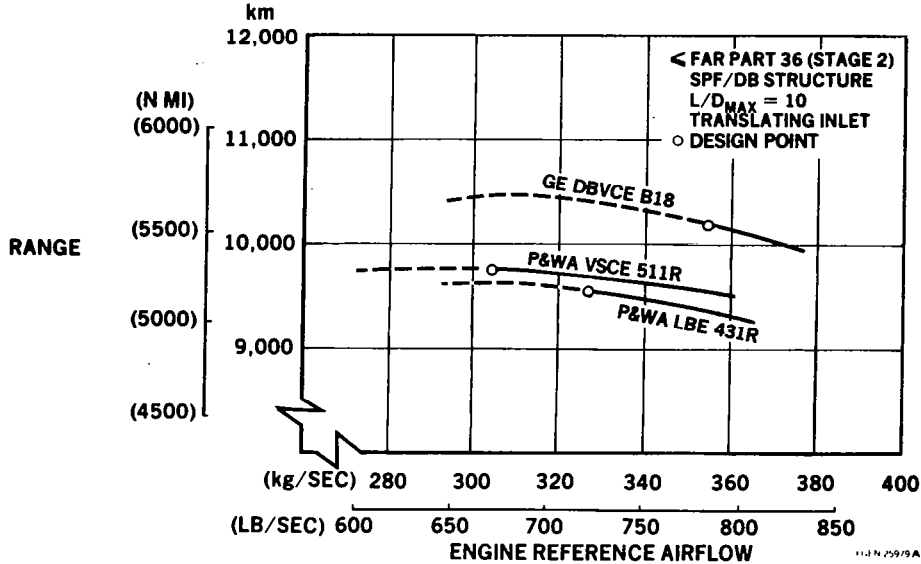
ENGINE	SIDELINE	CUTBACK
GE21/J10B7	106/-2	109/+1
P&WA LBE 431R	101/-7	104/-4
RR GN 20770	100/-8	105/-3
GE21/J11B18	107/-1	109/+1
P&WA VSCE 511R	106/-2	106/-2

↑ INCLUDES
MDC
MECHANICAL
SUPPRESSOR
TEST
RESULTS

AIRFRAME/ENGINE INTEGRATION SUMMARY

Significant range performance improvements are available when the increased lift to drag ratio (L/D) due to tailoring the wing for the presence of the nacelles and the reduced weight for incorporation of SPF/DB titanium sandwich structure. Range values which exceed 5500 n. miles are available with one of the advanced technology study engines.

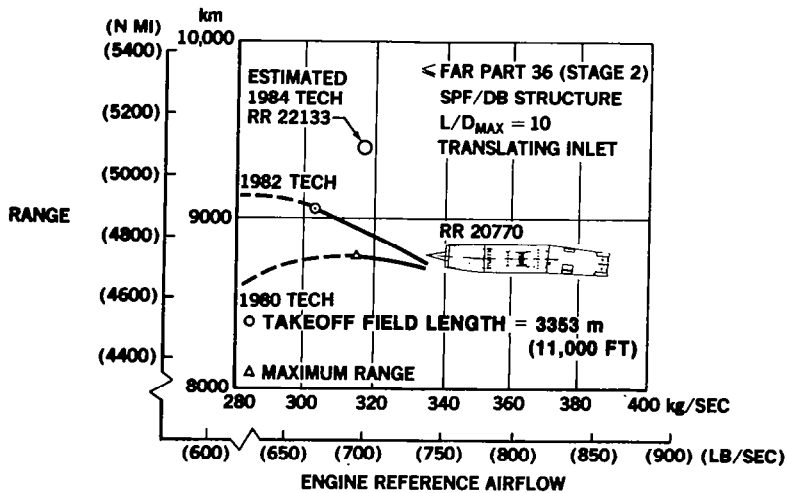
GROSS WEIGHT = 319,788 kg (705,000 LB)
 PAYLOAD (225 PASSENGERS) = 20,922 kg (46,125 LB)



SCALED OLYMPUS RANGE SUMMARY

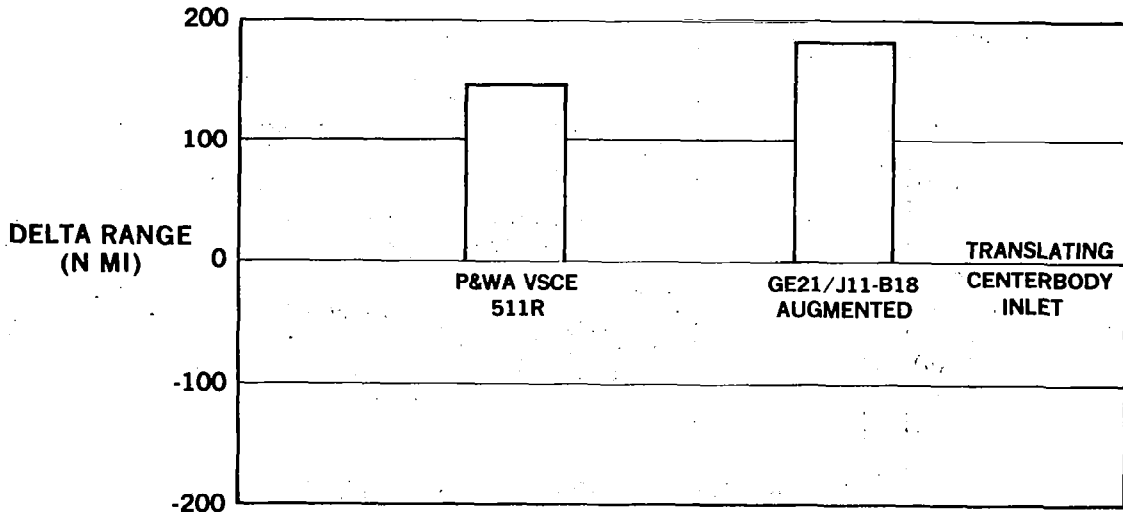
Rolls-Royce continues to participate in the AST technology development program by providing engine data for scaled up Olympus engines. The 1984 technology engine has a higher bypass ratio (0.2 vs 0.07) than the 1982 technology engine and although final calculations are not complete, it is estimated to provide a 5% improvement in range performance.

GROSS WEIGHT 319,788 kg (705,000 LB)
 PAYLOAD 20,922 kg (46,125 LB)



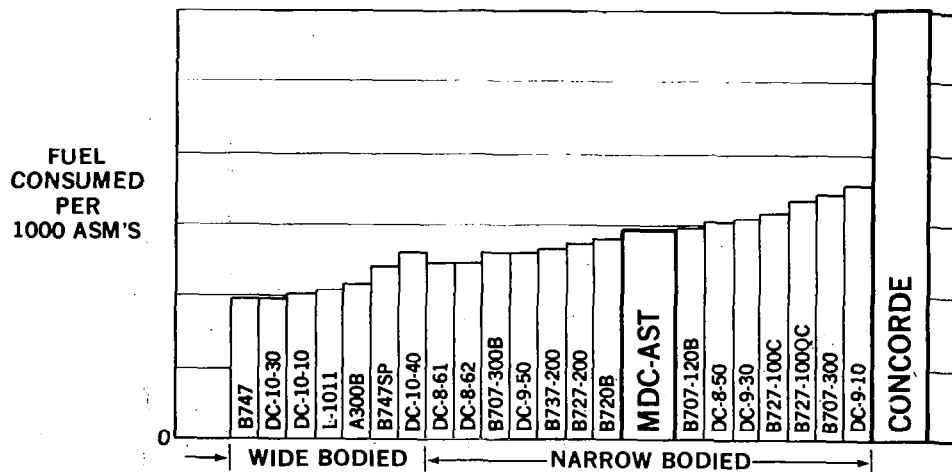
AST PERFORMANCE WITH BICONE INLET

Range performance shown is for the baseline with a translating centerbody inlet design incorporated. An alternate concept, collapsing bicone, is being studied which shows promise of range improvements of 150 to 180 n. miles.



FUEL EFFICIENCY COMPARISON

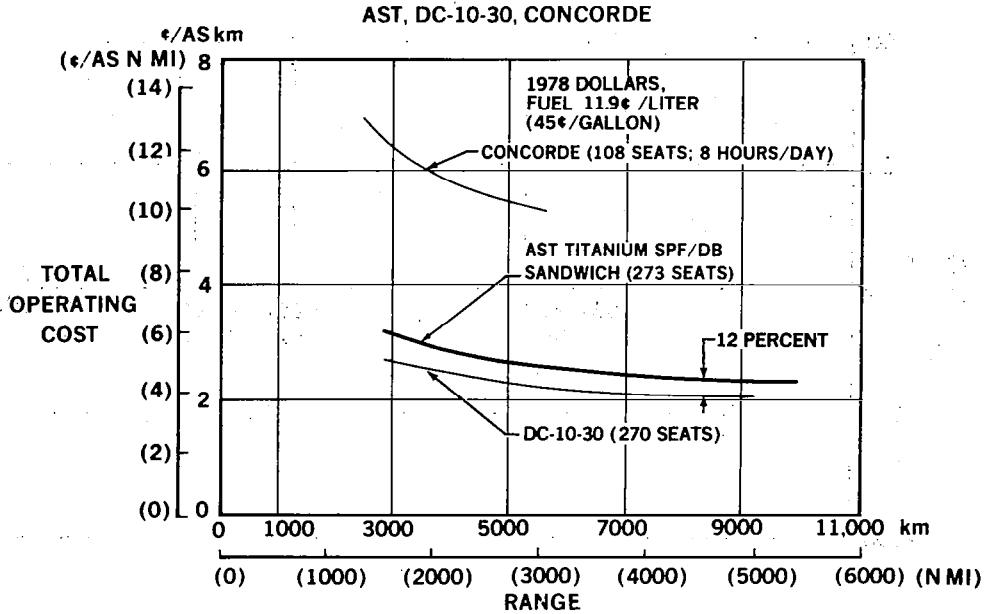
The fuel efficiency of the AST is shown compared to the wide bodied and narrow bodied subsonic jets and the Concorde.



SOURCES:
 CAB FOURTH QUARTER 1978 (SUBSONIC AIRCRAFT)
 DOUGLAS (AST, CONCORDE)

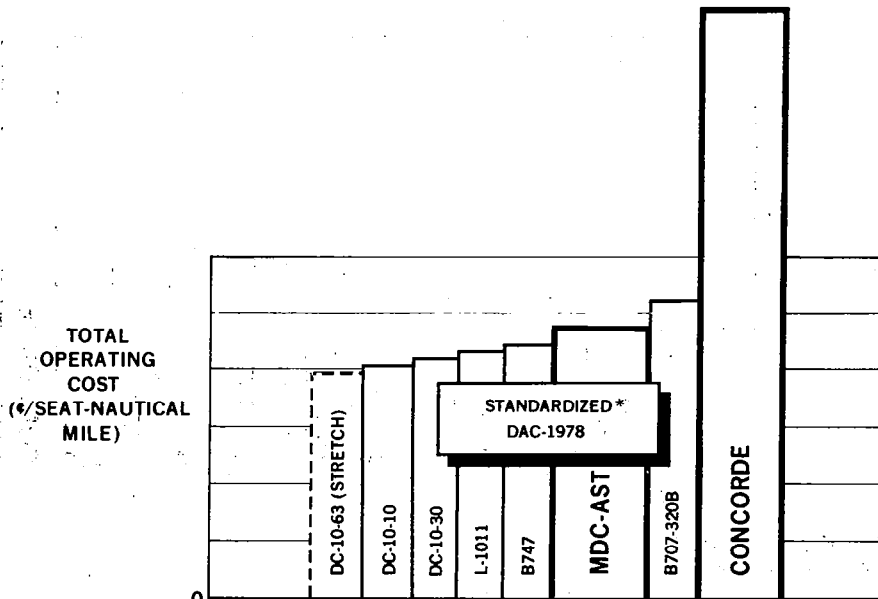
COMPARATIVE TOTAL OPERATING COSTS

The total operating costs (TOC) of the AST are shown to approach the level of the wide-bodied DC-10-30 at international ranges. Also, the Concorde values are approximately double the AST at its normal transatlantic range. MDC studies show that the AST can be operated in commercial service and make a profit with today's first class and economy class fares.



TOTAL OPERATING COSTS COMPARISON — INTERNATIONAL

The relative ranking of the AST compared to the subsonic international jets and the Concorde show it to be competitive. Again, the Concorde costs are double the values of the AST.



*STANDARDIZED TO SAME RANGE, SAME SEAT SPACING

MARKET SUMMARY (1985-2004)

The results of the MDC market survey over 175 city pairs in international operation produce a significant demand for advanced supersonic transports. The routes chosen are existing routes and modeling techniques were utilized in developing the passenger demand.

AIRCRAFT DEMAND

300 TO 500 AIRCRAFT

VALUE (1978 DOLLARS)

\$35 BILLION TO \$60 BILLION

ENVIRONMENTAL ISSUES

McDonnell Douglas continues to address the other issues which affect community and public reaction to an advanced supersonic transport. The four summarized here are currently being investigated.

EXHAUST EMISSIONS EFFECT ON HIGH ALTITUDE OZONE	—	NEGLECTIBLE EFFECT
SECONDARY SONIC BOOMS	—	NO APPRECIABLE ENVIRONMENTAL IMPACT
COSMIC RADIATION	—	NO PROBLEM
AIRPORT VICINITY EMISSION	—	FURTHER TESTING REQUIRED

CONCORDE PROGRAM

The news release left doubts about future activity in England and France on the advanced supersonic transport. Since the program may require international collaboration, the notes of the minister's meeting were reviewed and are summarized.

Re: September 22, 1979 British Press Release

Based upon the notes of the British/French Ministers Meeting

The communique said the ministers reviewed the French and British work on supersonic transport research and agreed that no joint program between the governments would be undertaken at this time.

BAC says this decision does not preclude research being performed by individual companies and BAC will continue a low-level effort. It also does not preclude the companies from making collaborative agreements with each other or with other companies, such as MDC.

BAC expects that France will continue the 50-50 Government/Aerospatiale/Snecma AST research.

British Government policy has been that all civil aircraft research is solely a British Aerospace responsibility and the September 22 decision is a continuation of this policy.

Ref: Telephone call from Clive Leyman,
Assistant Program Manager, Concorde, British Aerospace

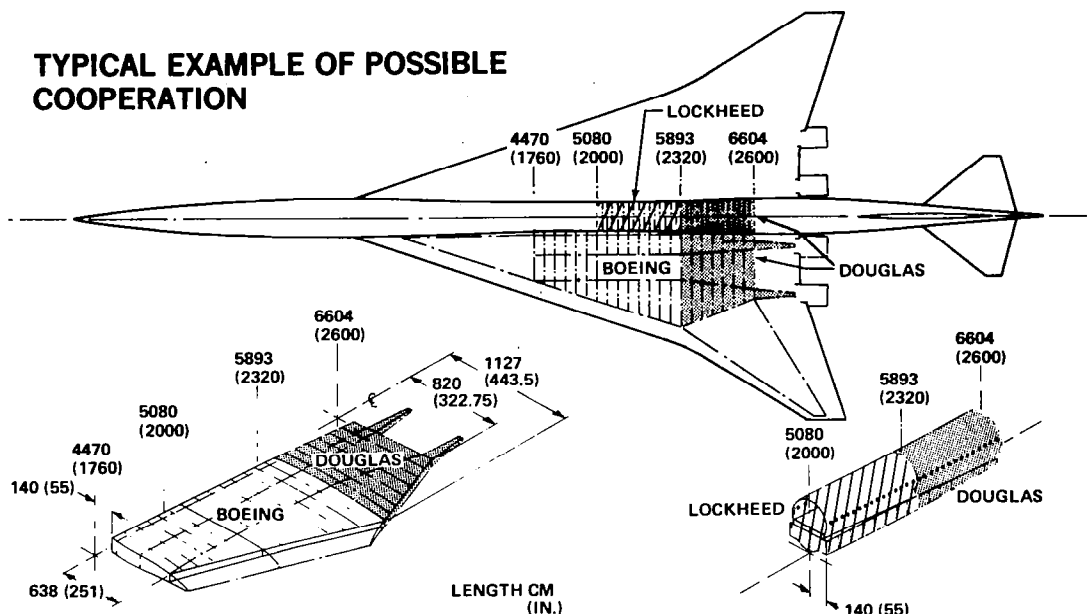
HIGH-PRIORITY TECHNOLOGY ITEMS

The top priority technology items are presented. Accelerated development testing and analyses are required in these areas in order that a state of technology readiness can be attained within a reasonable time.

- **FABRICATION AND TEST TITANIUM WING AND FUSELAGE SECTIONS TO VALIDATE**
 - OPTIMUM DESIGN PARAMETERS
 - WEIGHT FRACTIONS
 - MANUFACTURING AND ASSEMBLY COSTS
- **CONFIGURATION INTEGRATION — DETERMINES SCALE OF TECHNOLOGY READINESS**
- **NOISE SUPPRESSION— FOR ENGINE CYCLE SELECTION**
- **HIGH-SPEED LIFT AND DRAG — FOR CRUISE EFFICIENCY**
- **LOW-SPEED LIFT AND DRAG — FOR CLIMBOUT NOISE CONSIDERATIONS**
- **INLET COMPATIBILITY — FOR PERFORMANCE AND ACOUSTICS**
- **NOZZLE COMPATIBILITY — FOR PERFORMANCE AND ACOUSTICS**

TITANIUM WING AND FUSELAGE TEST COMPONENTS

A possible augmented technology development program can be formulated based on the concept of a cooperative industry effort. An example of possible cooperation in the structural program is illustrated. In this concept, one company serves as lead investigator in a particular area. The work can be cooperative or individual, but the lead investigator is responsible that all participants share in the final result.



TECHNOLOGY VALIDATION* (1978 \$)**

Two concepts for completing technology validation are shown. The funding values represent a consensus of industry estimates.

	IF JOINT PROGRAM	IF INDIV PROGRAMS
LOCKHEED AND BOEING AND MCDONNELL DOUGLAS	— — — <hr/> \$600M	\$350M \$325M \$420M <hr/>
GENERAL ELECTRIC OR PRATT & WHITNEY AIRCRAFT	— <hr/> \$300M	\$140M <hr/> \$400M
TOTAL	\$900M	\$1.6B

*TO ARRIVE AT AIRLINE ORDERS (AUTHORIZE TO PROCEED WITH PRODUCTION)

**USING AIA SUBMITTAL TO CONGRESS 1977

LETTER TO NASA ADMINISTRATOR — JUNE 1979

McDonnell Douglas continues to encourage NASA management, congressional, and senate subcommittees to support an accelerated SCR program for technology validation. Excerpts from the most recent letter from the president of Douglas Aircraft to the NASA administrator are presented.

RE: ADVANCED SUPERSONIC TRANSPORT TECHNOLOGY R&D

. . . the critical stage today remains the funding of the high risk technology validation research efforts that lead to a state of technology readiness for U.S. industry. This is a proper obligation of NASA for unique programs that are in the national interest. . . .



John C. Brizendine

PRESIDENT — DOUGLAS AIRCRAFT COMPANY

SUMMARY

THE DEMAND EXISTS FOR SUPERSONIC TRAVEL

TECHNOLOGY IS DEFINED FOR A MACH 2.2 ADVANCED SUPERSONIC TRANSPORT

AN EXPANDED TECHNOLOGY DEVELOPMENT PROGRAM IS NECESSARY TO ATTAIN A TECHNOLOGY READINESS POSITION

SUPERSONIC MARKET AND ECONOMIC ANALYSES

Lucian S. Rochte
McDonnell Douglas Corporation

SUMMARY

Projections are made of advanced supersonic transport (AST) markets of the free world for the period 1985-2004. Estimates are made of passenger traffic volume and airplane range and seat-capacity requirements for Mach 2.2 service by international regional market areas and by city-pairs within and between these areas. The volume of candidate traffic consists of first class and full-fare economy class passengers of the international long-haul, overwater routes and such tag-end markets as are needed to fill out airline network patterns. Market and traffic factors examined include variable load factors, growth rates, supersonic transport market shares, and schedule frequencies considering the different make-up of passenger traffic for the individual city-pairs.

Economic analyses are made of supersonic transport projected operations throughout the international regional market areas of the world. Economic factors analyzed include direct, indirect, and total operating costs and yield levels for first class and full-fare economy class traffic. A brief comparison is made between advanced supersonic transports and typical wide-bodied subsonic jet transports of the economic impact of increased fuel prices.

These economic analyses illustrate the benefits of advanced technology applied to next-generation supersonic transports in several pivotal technologies, including structures of superplastic formed/diffusion bonded sandwich titanium, improvements in aerodynamic cruise efficiency, and refined engine cycle performance.

INTRODUCTION

McDonnell Douglas (MDC) has conducted studies of the free world long-haul overwater passenger needs for supersonic travel for the period 1985-2004. Market studies were performed initially in 1973 under a NASA-Langley contract. Since then, market studies have continued using company funds. The results of these studies have been highly useful in defining the current baseline supersonic transport configuration and performance considering market, environmental, technological and economic factors. The current baseline advanced supersonic transport which resulted from this work is used extensively in sensitivity studies to determine the effect of specific technology gains on performance and operating costs.

The world long-haul overwater city-pair markets are examined to assess current passenger traffic activities including analyses of traffic density and fare class, city-pair distance, type of aircraft used and frequency of service. City-pairs are selected for supersonic service based on a comprehensive computer-aided evaluation process. A passenger traffic annual forecast of these markets is made covering the forecast period 1985-2004. The penetration of these markets for supersonic service is then estimated for each city-pair. The number of advanced supersonic transports required to meet the world passenger traffic needs is determined annually throughout the forecast period. The study does not include market elasticity considering fare levels and supersonic speed because analyses to date have indicated these are difficult to quantify.

ANALYSIS AND DISCUSSION

Baseline Advanced Supersonic Transport

The baseline advanced supersonic transport used in these market analyses has the performance shown in Figure 1.

The results of current market studies indicate that a 273 seat, mixed-class airplane with a range of 10,186 km (5500 n. mi.) provides a good match with the world-wide passenger traffic demand for supersonic service during the forecast period.

International Regional Market Areas

World requirements for supersonic service are determined by studying the long-haul traffic needs for each of the international regional market areas of the world. The traffic flow of these areas is then tied together with major trunkline city-pairs to provide for inter-area traffic flows, thereby linking all major areas of the world together in a complete supersonic system. The international regional traffic flows studied are shown in Figure 2.

Selection of City-Pair Markets

The selection and refinement of city-pair markets for supersonic service is a dynamic process. Initially, more than 500 origin-destination city-pairs were investigated as potential candidates for service. The city-pair markets that sustained initial evaluations of passenger traffic requirements for detailed study are based on the criteria shown in Figure 3. To be a candidate, a city-pair must have a sufficient volume of passenger traffic by the year 2004 to support a minimum of two round trips weekly. This is considered the minimum frequency to warrant scheduled supersonic service. City-pairs having relatively long subsonic distances at the origin or destination terminals, as a large percentage of the total distance, were screened out as being non-competitive with subsonic jets. A distance of 1610 km (870 n. mi) was assumed as the minimum for supersonic service for tag-end city-pair markets. All city-pairs selected should be geographically capable of integration into an operating network (not isolated).

The world city-pair market candidates have been investigated based on these criteria resulting in 175 city-pairs being selected for detailed investigation. These are distributed throughout virtually all the international regions of the world. A cross-section of city-pair candidates in the North Atlantic, Europe - Far East/Australasia, and Pacific regions is shown in Figures 4, 5 and 6, including the flight distance and the AST market share. In the market share studies, the AST capture rate for each city-pair varies considerably. City-pairs having primarily business travelers are expected to attract a large percentage to supersonic service where time-savings are important. Other city-pairs having a majority of tourist travelers are not expected to attract as many since time-savings are probably not as important and the traveler is more fare-sensitive.

Passenger Traffic Model

Passenger traffic between each city-pair has been analyzed with the aid of a computer program developed by MDC for this study (Advanced Supersonic Aircraft Fleet Evaluation Model). A base market has been used and the market projected annually to the year 2004. The computer program determines the weekly market in terms of the information shown in Figure 7. The input data shown below, in addition to aircraft performance and operational data, are used in the analysis.

- o Minimum and maximum load factors of 40-65 percent.
- o Minimum weekly frequency of two round-trips to initiate supersonic service.
- o Airplane daily utilization of 10 hours.
- o Induced passenger traffic of 10 percent.

A value of 10 percent for induced travel has been used to reflect the large drawdown area in the general vicinity of each city from which supersonic passengers would come, as demonstrated by the North Atlantic operations of the British/French Concorde where 50 percent of the traffic is transfer traffic.

Advanced Supersonic Transport Market Demand

The AST demand for the forecast period showing its relationship to the total long-haul, international market is illustrated in Figure 8. It has been determined that a lower bound of 297 baseline supersonic airplanes will be needed by the year 2004 to provide supersonic service over this world network of 175 city-pairs. This assumes an approximate penetration of 90 percent of the first class market, 50 percent of the full-fare economy class market, and none of the discounted-fare market. It also assumes an overall 10 percent induced passenger market each year for the supersonic airplane.

The upper bound result is that 509 baseline supersonic airplanes will be needed by the year 2004 if 100 percent of the first class market, 100 percent of the full-fare economy class market, and none of the discounted-fare market could be captured for supersonic travel, again using an overall 10 percent induced passenger market per year for the supersonic airplane.

The narrow band shown for 1980-1988 represents Concorde operations. An average annual passenger traffic growth rate of 6.8 percent is used for the forecast period.

The cumulative aircraft demand by year for both the nominal and high market estimates for the total system is summarized.

<u>Year</u>	<u>Aircraft Demand</u>				
	<u>1985</u>	<u>1990</u>	<u>1995</u>	<u>2000</u>	<u>2004</u>
Nominal	86	124	171	232	297
High	154	211	286	392	509

Discussion of the Advanced Supersonic Transport Market Demand

This estimated market demand represents requirements for commercial supersonic airplanes having the configuration and performance characteristics described earlier. Any changes in these parameters will undoubtedly result in changes in the aircraft demand.

No attempt has been made in the current study to determine the effect on market demand of changes in aircraft range. The range of the study airplane is 10,186 km (5500 n. mi.) with a full payload of 273 passengers.

From the east coast of the U.S., this range covers the distance from New York City to the eastern Mediterranean countries for a flight time of about five hours. From the west coast of the U.S., this range covers the distance from San Francisco to Shanghai, China with comparable flight time.

The Payoff of Technology

The results of more than three years of comprehensive analysis and test of titanium superplastic forming/diffusion bonding sandwich for primary structure by McDonnell Douglas at Long Beach have resulted in a 6.2 percent reduction in direct operating cost for this advance in technology alone for a 273 passenger supersonic airplane at an operating stage length of 5556 km (3000 n. mi.), in comparison with an airplane having 1971 technology structure (aluminum-brazed titanium honeycomb wing and a weld-brazed stiffened-skin fuselage), while achieving a range increase of 1072 km (579 n. mi.) to a maximum range of 10,186 km (5500 n. mi.) with a full payload (Figure 9).

With an annual utilization of 3600 hours, this operating cost saving amounts to more than \$2 million per year (1978 dollars) for each airplane using SPF/DB sandwich structure in comparison with an airplane using aluminum-brazed titanium structure. From an energy standpoint, each SPF/DB sandwich airplane saves an estimated four million gallons of fuel annually compared to the aluminum-brazed titanium airplane.

Indirect Operating Costs

To better understand indirect operating costs (IOC) of the AST, a detailed computer-aided analysis was performed of international commercial transport operations for several major U.S. scheduled carriers covering the period 1976-1978. Data sources included CAB Forms 41 which itemize expenses according to the applicable account numbers. The results of this work are applied in the AST total operating cost analyses. As shown in Figure 10, the IOC for the AST is 10 percent less than the DC-10-30 for a 5556 km (3000 n. mi.) stage length.

Total Operating Costs

The total operating cost comparison of the supersonic airplane and the DC-10-30 shown in Figure 11 is another illustration of the narrowing of the operating cost gap between possible future commercial supersonic service and typical subsonic wide-bodied service. Considering that both airplanes are of virtually the same seating capacity, the total operating cost of the AST on a seat-km (- mi.) basis is only 13 percent more than the DC-10-30 at a stage length of 5556 km (3000 n. mi.). The total operating cost of the Concorde is shown for reference. The economic benefit of advanced technology shown in Figures 9 and 11 demonstrates the high payoff potential of research fund

investments. Continued advances in technology can be applied to increases in aircraft range, as needed by the airlines, or these gains may be used to increase the payload, reduce the empty weight and operating cost or applied to some selected combination of these to increase profitability.

Economic Effect of Fuel Cost Changes on Supersonic Aircraft Operations

Over the years, there has been a great deal of conjecture concerning the energy efficiency of possible future advanced supersonic transport aircraft. Much of it stems from the Concorde experience which, unfortunately, compounds the economic disadvantages of a relatively small payload with the inefficiencies of a nonoptimum propulsion system. The combined effect of this is an aircraft having a high fuel consumption per seat-km (- mi.) in comparison with current subsonic wide-bodied jets. But here again, an investment in research can have substantial payoffs resulting from focused technological advances. As shown in Figure 12, an AST constructed of aluminum-brazed titanium (1971 technology) uses about one-half the fuel per seat-km (- mi.) of the Concorde for a typical North Atlantic range of 5556 km (3000 n. mi.) and about 58 percent more fuel per seat-km (- mi.) than the DC-10-30. Benefiting from the substantial weight saved by using advanced technology titanium SPF/DB sandwich structure, a fuel reduction of five percent per seat-km (-n mi.) can be realized for the AST compared to the 1971 technology structure.

There is no question that the baseline supersonic transport is not as energy efficient as large capacity, subsonic wide-bodied jets based solely on seat-km (- mi.) criteria and ignoring travel time. In comparison with the DC-10-30, the supersonic transport uses 53 percent more fuel per seat-km (- n. mi.) for a stage length of 5556 km (3000 n. mi.). The block time of the supersonic airplane for this stage length, however, is only 44 percent that of the subsonic jet. This is not an inconsiderable time saving and may well represent a cost-effective tradeoff of passenger travel time versus fuel use in favor of the lower travel time, particularly for the very long city-pair distances of the Pacific Basin.

The fuel efficiency of the AST is compared in Figure 13 with subsonic aircraft in the current fleet. It fits into the general pattern of fuel efficiency of the subsonic fleet - it is not as fuel efficient as the wide-bodied jets and is more fuel efficient than the others shown. The Concorde is shown for reference.

The effect of increases in fuel cost on total operating cost of the AST is shown in Figure 14. To better visualize this effect, the percent increase in total operating cost for the AST is compared with the DC-10-30. In this comparison, all other items are held constant - only the fuel cost is increased. As illustrated in the figure, as a reference, the total operating cost of the AST is 13 percent higher than that of the DC-10-30 at a fuel cost of 11.9 cents/liter (45 cents/gallon). At fuel costs which are double and triple the reference cost, the total operating costs of the AST are 21 percent and 27 percent higher than the DC-10-30, respectively.

As the energy efficiency of supersonic transport aircraft improves, the fare increase to offset future increases in fuel cost, compared to that of the DC-10-30, is relatively modest. This comparison is based on the supersonic airplane carrying first-class and full-fare economy passengers, while the DC-10-30 carries the discount economy class in addition to the other fare classes. As shown in Figure 15, a doubling of fuel cost [reference 11.9 cents/liter (45 cents/gallon)] requires an offsetting fare increase of 14.1 percent for the DC-10-30 and only 1.5 percent more (15.6 percent) for the supersonic airplane.

From this type of comparison, it could be concluded that, since the higher fuel consumption costs of the supersonic airplanes are passed through to the passenger, as are all other costs and the passenger makes a decision in the competitive market place as to the benefits of trip time and travel class, the matter of fuel consumed per seat-trip is treated routinely in the same relative way as the use of other resources in any other transportation decision.

Revenue Distribution and Market Shares - North Atlantic 1978

The North Atlantic market will continue to dominate the world international air passenger markets for the remainder of this century. An analysis of North Atlantic 1978 traffic revenue distribution in comparison with operating costs of subsonic and supersonic aircraft illustrates their profit potential in relation to the various fare classes. It is evident from Figure 16 that the first class yield of 12.4 cents/passenger-km (22.9 cents/passenger-n. mi.) is almost double the economy class yield of 6.9 cents/passenger-km (12.7 cents/passenger-n. mi.). Similarly, the full-fare economy class yield is substantially higher (62 percent) than the weighted-average yield of 4.2 cents/passenger-km (7.8 cents/passenger-n. mi.) for the discount economy groups.

When the total operating costs of the DC-10, AST, and Concorde are projected against the yields of the various revenue classes, as shown at the bottom of Figure 16, the cost-yield relationships can be better visualized. It is seen that the Concorde total operating cost is well under the first class yield and slightly below economy class yield. The MDC-AST and DC-10 total operating costs are considerably below the economy class yield. Of these three aircraft, the DC-10 alone looks attractive for the discounted fare low yield passenger market.

As shown in Figure 17, the North Atlantic first class and Concorde markets, although representing only about 6 percent of the passenger traffic, account for 16 percent of the revenue and demonstrate why the airlines consider these markets highly attractive sources of revenue. Similarly, the economy class yield is substantially higher than that of the discount groups. The economy class also represents an attractive market since it accounts for 30 percent of the North Atlantic revenue and 22 percent of the passenger traffic. The figure depicts the AST relative revenue and passenger volume percentages for both the nominal and high market capture assumptions.

A broader perspective of the AST total operating cost is shown in Figure 18 in which it is compared with several airplanes in the current fleet along with a future derivative of an existing wide-bodied jet. The AST fits into the general pattern of these airplanes - it has a lower total operating cost than a typical narrow-bodied jet and a higher cost than the wide-bodied jets shown. The Concorde is shown for reference.

CONCLUDING REMARKS

The MDC studies forecast an AST overwater market of between 297 and 509 aircraft by the year 2004 for international supersonic passenger service throughout virtually all regions of the world (Figure 19). This AST market is estimated at \$35 - \$60 billion. Advances in supersonic cruise technology continue to show reductions in operating costs with a narrowing of the gap between supersonic and subsonic transport operations. These advances are also reflected in considerable improvement in the fuel efficiency of AST designs. Projections show that AST fare increases to offset fuel price increases are comparable to subsonic transport operations considering the fare classes of the passengers being carried.

A next-generation AST designed to cruise at Mach 2.2 carrying 273 passengers for a range of at least 10,186 km (5500 n. mi.) provides a good combination of performance and economic attractiveness in meeting the needs of the major international long-haul, city-pair passenger markets of the world.

An adequately funded technology validation program aggressively implemented now, and continuously supported, could lead to the U.S. development and manufacture of an AST fleet operating in world service starting in 1990. Current investigations indicate that such an effort would be relatively low risk in meeting program goals.

CRUISE SPEED	2.2 MACH
PASSENGER CAPACITY (MIXED CLASS)	273 SEAT
RANGE	>10,186 k
TAKEOFF GROSS WEIGHT	340,200 k
NOISE	FAR PART
TAKEOFF FIELD LENGTH	≤3353 m

Figure 1.- Baseline advanced supersonic trans

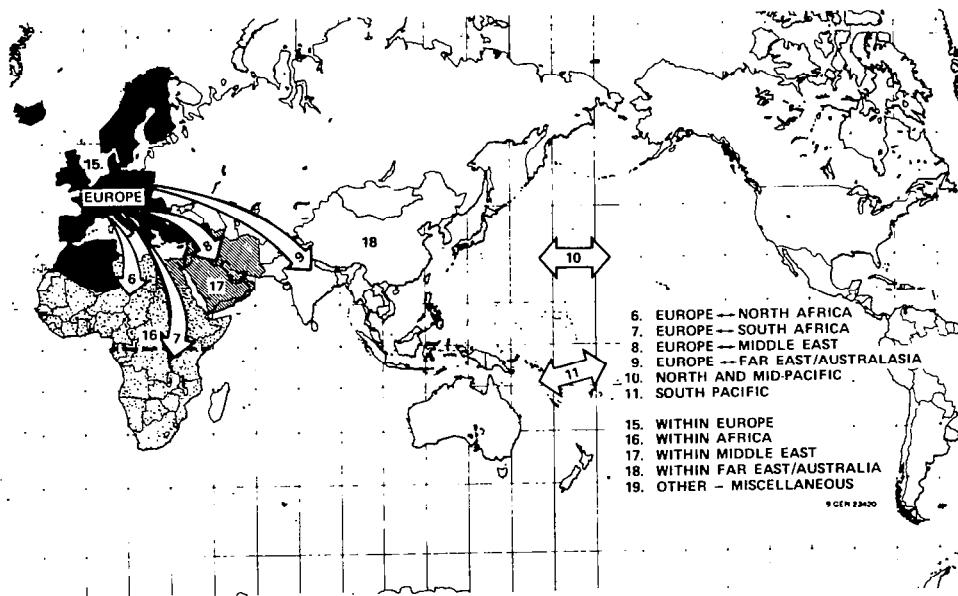
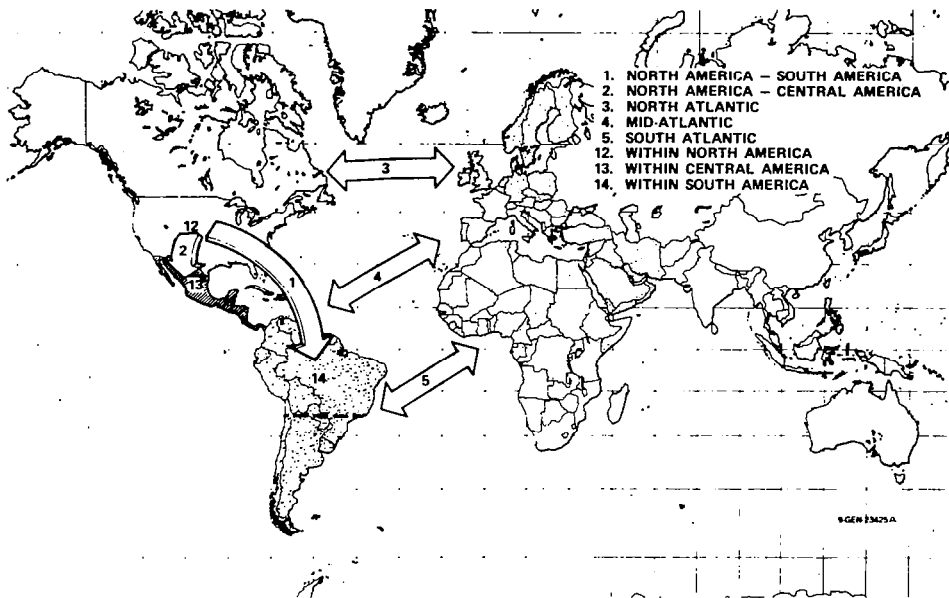


Figure 2.- International regional traffic flows.

TRAFFIC VOLUME TO SUPPORT MINIMUM OF TWO ROUND TRIPS WEEKLY BY YEAR 2004

CITY-PAIR DISTANCE WITHIN NONSTOP RANGE CAPABILITY OF AST

MINIMUM CITY-PAIR DISTANCE OF 1610 km (870 N MI)

CITY-PAIR NOT ISOLATED — LINK INTO OPERATING NETWORK

Figure 3.- City-pair passenger traffic criteria.

<u>CITY-PAIR</u>	<u>DISTANCE</u>		<u>MARKET SHARE PERCENT</u>
	<u>km</u>	<u>(N MI)</u>	
AMSTERDAM — CHICAGO	7256	(3918)	30
BOSTON — FRANKFURT	6136	(3313)	16
CHICAGO — LONDON	6673	(3603)	17
COPENHAGEN — NEW YORK CITY	6354	(3431)	18
LONDON — MIAMI	7117	(3843)	10
LONDON — TORONTO	5713	(3085)	14
LONDON — WASHINGTON, D.C.	5908	(3190)	18
MADRID — NEW YORK CITY	5769	(3115)	12
NEW YORK CITY — PARIS	5838	(3152)	13
NEW YORK CITY — ROME	6895	(3723)	17
PARIS — MONTREAL	5528	(2985)	14

Figure 4.- Typical regions and city-pair markets for North Atlantic.

<u>CITY-PAIR</u>	<u>DISTANCE</u>		<u>MARKET SHARE PERCENT</u>
	<u>km</u>	<u>(N MI)</u>	
ABU DHABI — BOMBAY	1990	(1075)	17
ATHENS — KARACHI	4327	(2337)	25
BAHRAIN — SINGAPORE	6734	(3636)	17
BAHRAIN — LONDON	5095	(2751)	33
BANGKOK — TOKYO	5636	(3043)	36
BOMBAY — DUBAI	1927	(1041)	17
BOMBAY — PERTH	7488	(4043)	17
COLOMBO — KARACHI	2576	(1391)	17
COLOMBO — SINGAPORE	2819	(1522)	17
LONDON — TEL AVIV	3593	(1940)	29

Figure 5.- Typical regions and city-pair markets for Europe-Far East/Australasia.

<u>CITY-PAIR</u>	<u>DISTANCE</u>		<u>MARKET SHARE PERCENT</u>
	<u>km</u>	<u>(N MI)</u>	
ANCHORAGE — TOKYO	5573	(3009)	16
AUKLAND — HONOLULU	7108	(3838)	24
GUAM — HONOLULU	6117	(3303)	14
HONOLULU — SYDNEY	8171	(4412)	30
HONOLULU — PAGO PAGO	4267	(2304)	27
HONOLULU — TOKYO	6199	(3347)	14
LOS ANGELES — PAPEETE	6610	(3569)	23
LOS ANGELES — TOKYO	8821	(4763)	32
SEATTLE — TOKYO	7721	(4169)	19
SAN FRANCISCO — TOKYO	8293	(4478)	32
TOKYO — VANCOUVER	7573	(4089)	18

Figure 6.- Typical regions and city-pair markets for Pacific.

NUMBER OF POTENTIAL PASSENGERS

NUMBER OF PASSENGERS CARRIED

YEAR OF INITIAL SERVICE

AVERAGE LOAD FACTOR

NUMBER OF ROUND TRIPS

AIRCRAFT DEMAND

Figure 7.- Weekly city-pair market potential.

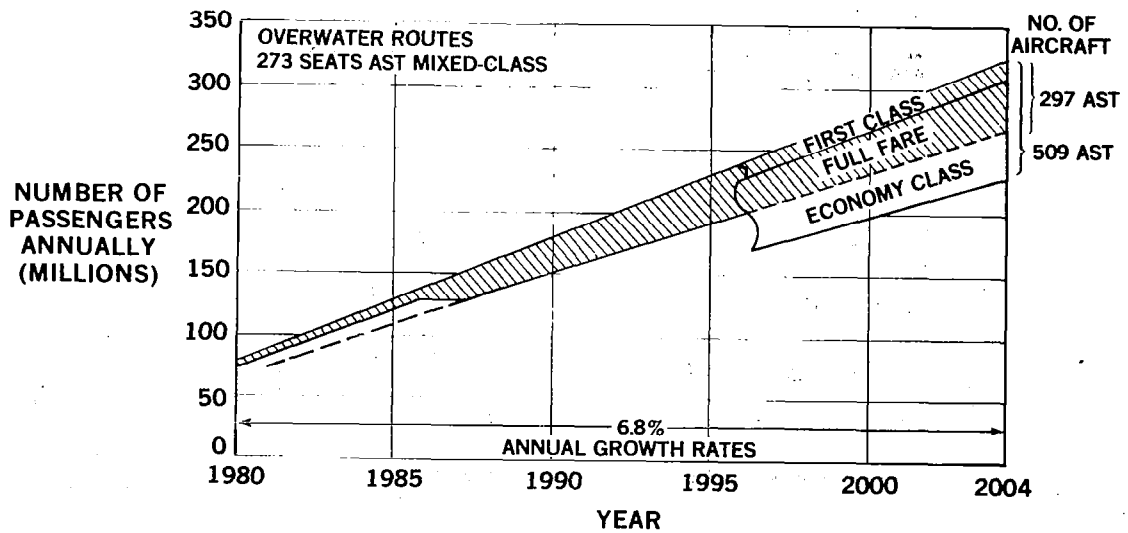


Figure 8.- Passenger demand for 1980-2004.

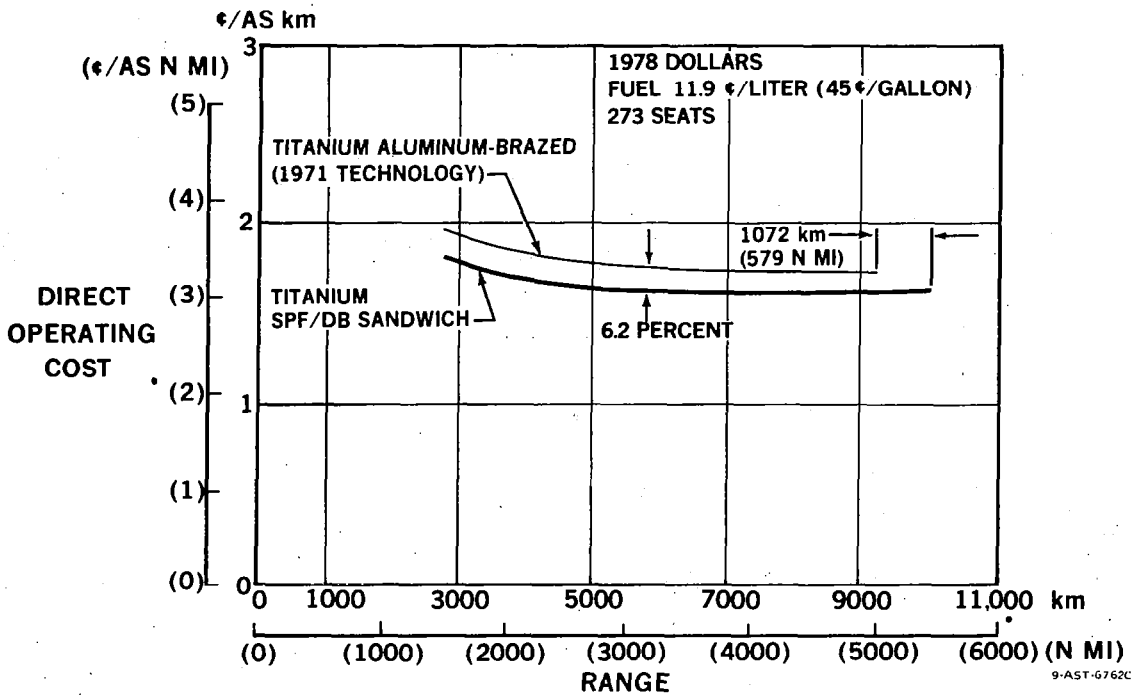


Figure 9.- Effect of advanced structures technology on direct operating cost.

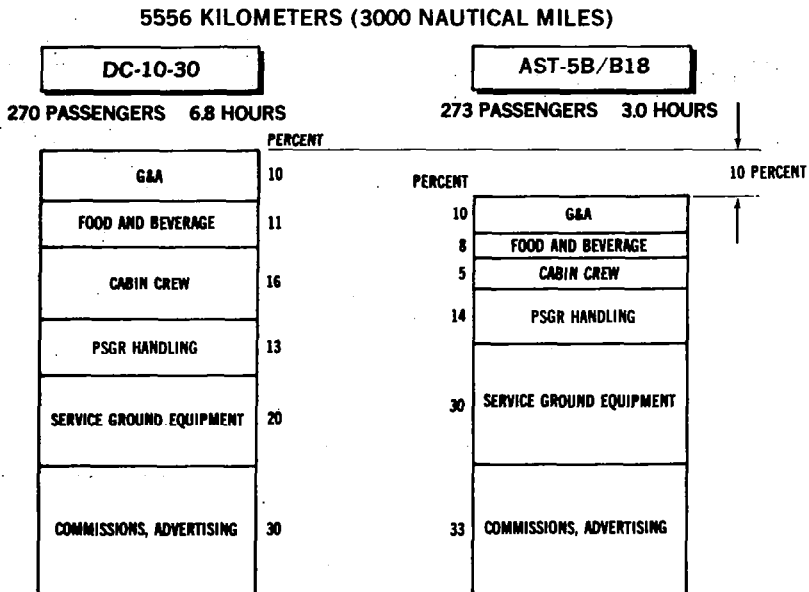


Figure 10.- Indirect operating cost comparison.

AST, DC-10-30, CONCORDE

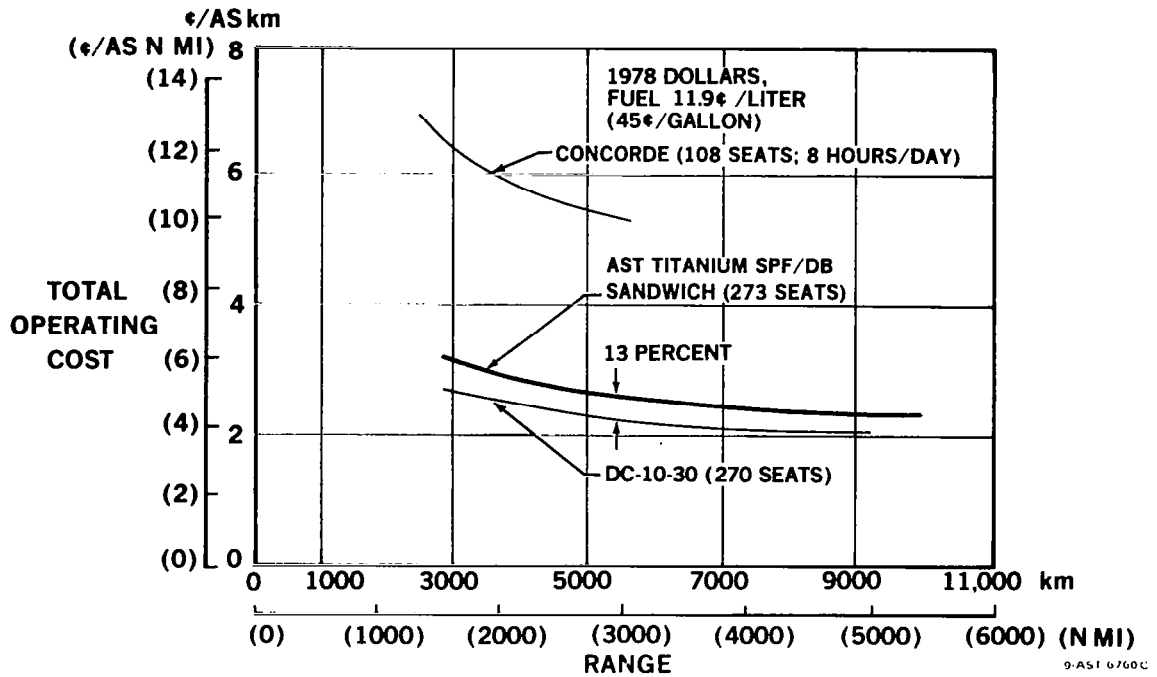


Figure 11.- Comparative total operating costs.

5556 km (3000 N MI) RANGE

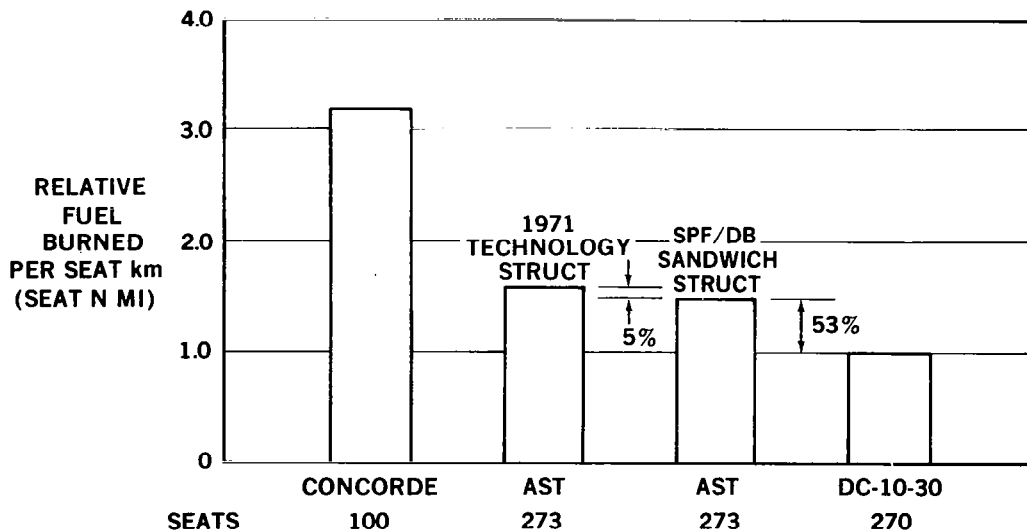
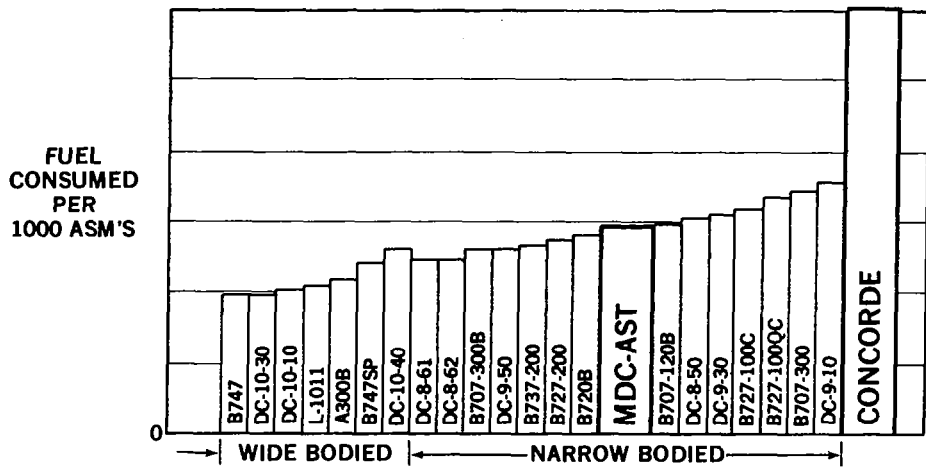


Figure 12.- Fuel use comparison.



SOURCES:
 CAB FOURTH QUARTER 1978 (SUBSONIC AIRCRAFT)
 DOUGLAS (AST, CONCORDE)

Figure 13.- Fuel efficiency comparison.

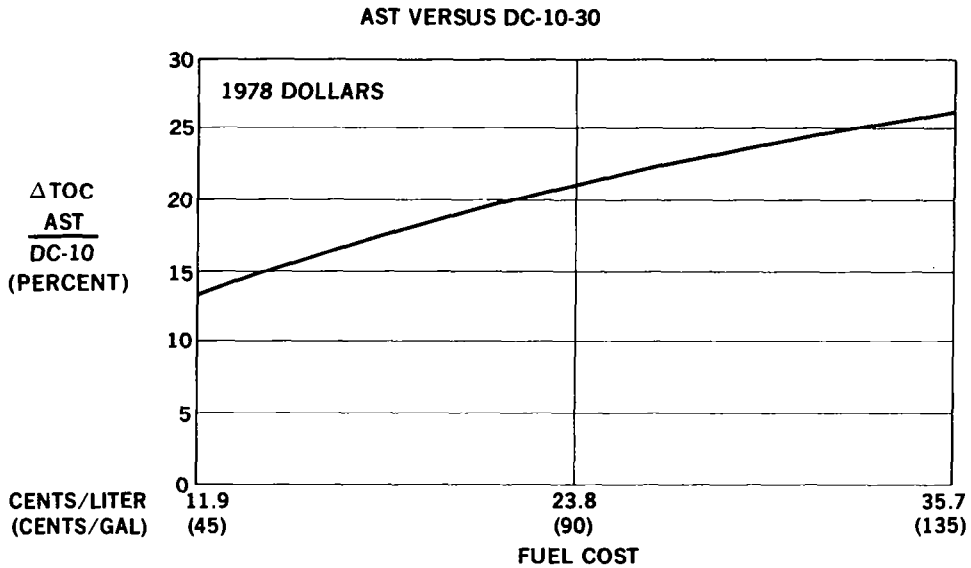


Figure 14.- Effect of fuel cost increase on total operating cost.

STAGE LENGTH: 5556 km (3000 N MI); LOAD FACTOR: 60 PERCENT
 AST YIELD: 8.4¢/PSGR-km (15.6¢/PSGR-N MI) FULL-FARE ECONOMY AND FIRST CLASS
 DC-10 YIELD: 6.0¢/PSGR-km (11.2¢/PSGR-N MI) DISCOUNT, FULL-FARE ECONOMY AND FIRST CLASS

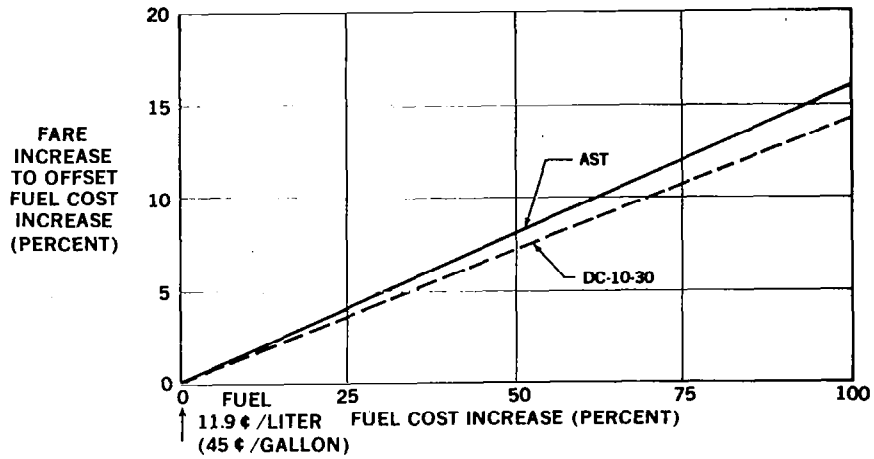


Figure 15.- Effect of fuel cost increase on fares in North Atlantic.

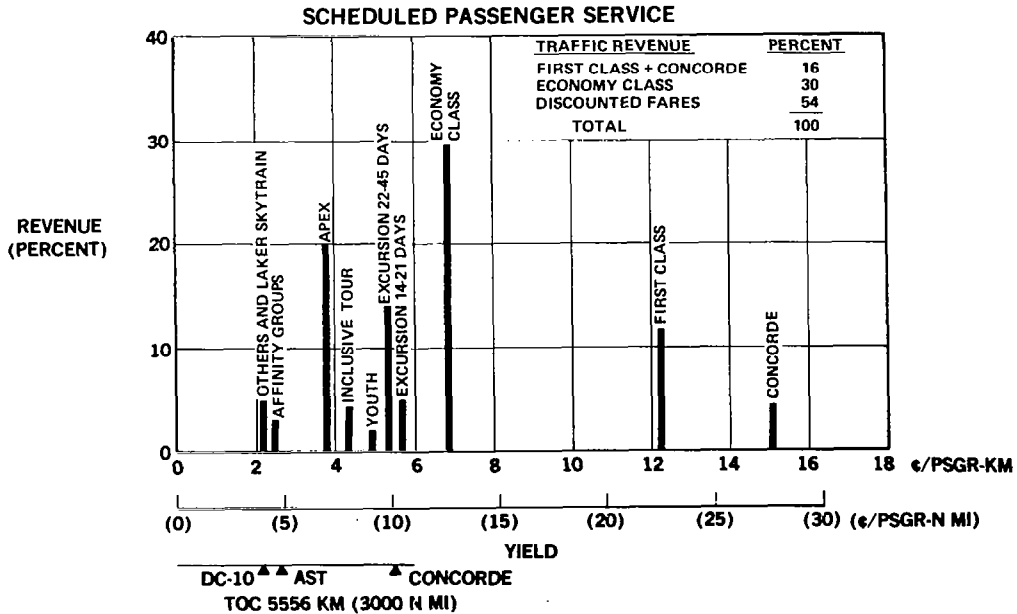


Figure 16.- Revenue distribution - 1978 North Atlantic.

NORTH ATLANTIC — 1978

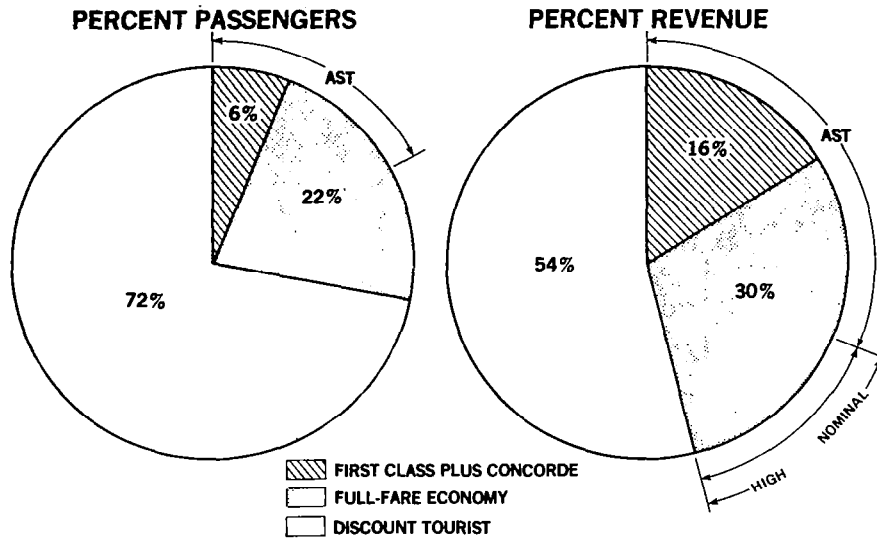
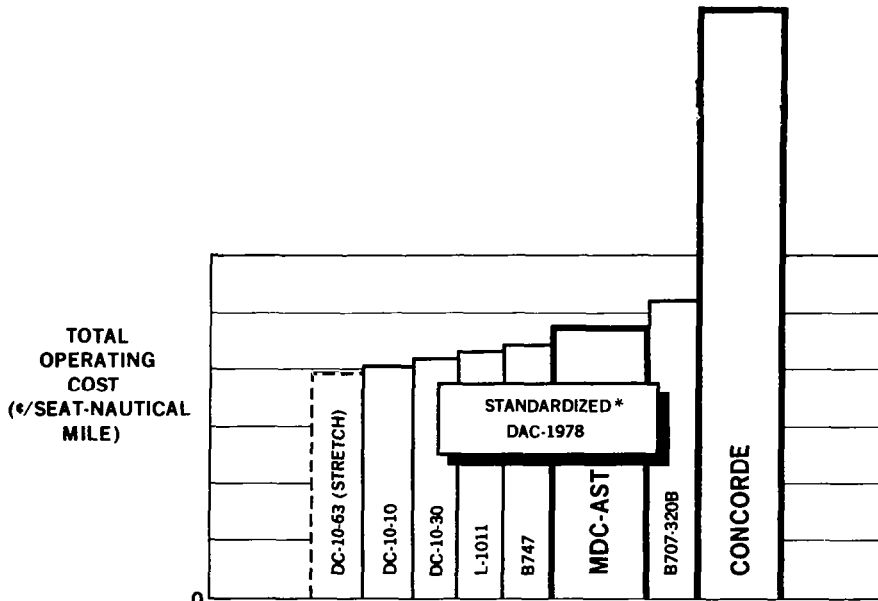


Figure 17.- Market shares.



*STANDARDIZED TO SAME RANGE, SAME SEAT SPACING

Figure 18.- Total operating cost comparison (international).

- MDC STUDIES FORECAST AN AST OVERWATER MARKET BETWEEN 297 AND 509 AIRCRAFT BY YEAR 2004.
- THIS AST MARKET IS ESTIMATED AT \$35-\$60 BILLION.
- TECHNOLOGY ADVANCES HAVE NARROWED THE GAP BETWEEN SUPERSONIC AND SUBSONIC TRANSPORT OPERATING COSTS.
- AST FARE INCREASES TO OFFSET FUEL PRICE INCREASES ARE COMPARABLE TO SUBSONIC TRANSPORTS CONSIDERING FARE CLASSES OF PASSENGERS BEING CARRIED.
- AST DESIGNED FOR MACH 2.2 CRUISE CARRYING PAYLOAD OF 273 PASSENGERS FOR 10,200 KILOMETERS (5500 NAUTICAL MILES) OR LONGER RANGE IS A GOOD MATCH WITH FORECAST MARKET DEMAND AND IS ECONOMICALLY ATTRACTIVE.
- U.S. AST COMMERCIAL OPERATIONS COULD START IN 1990
IF
AN AGGRESSIVE TECHNOLOGY VALIDATION PROGRAM WAS STARTED NOW AND CONTINUOUSLY SUPPORTED.

Figure 19.- Concluding remarks.



THE IMPACT OF MATERIALS TECHNOLOGY AND
OPERATIONAL CONSTRAINTS ON THE ECONOMICS OF
CRUISE SPEED SELECTION

J.S. Clauss, Jr., F.A. Bruckman, D.L. Horning,
R.H. Johnston and J.V. Werner
Lockheed-California Company

SUMMARY

A study was conducted to evaluate the impact of materials technology on the economic viability of supersonic transports, and to determine the effect of cruise Mach number on these evaluations. Six material concepts at Mach 2.0 and three material concepts at Mach 2.55 were proposed. The economic figure of merit was supersonic fare premium over subsonic economy for an acceptable airline return on investment. The fare premium goal was 10 percent. Realistic operational constraints based on airline scheduling analyses were used. The resulting evaluations, based on projected development, production, and operating costs, indicate that aircraft designs with advanced composites as the primary material ingredient have the lowest fare premiums at both Mach 2.0 and 2.55. The values are 11 percent and 16 percent, respectively. The designs having advanced metallics as the primary material ingredient are not as economical. Advanced titanium, employing advanced manufacturing methods such as SPF/DB, requires a fare premium of about 30 percent at both Mach 2.0 and 2.55. Advanced aluminum, usable only at the lower Mach number, requires a fare premium of 20 percent. Cruise speeds in the Mach 2.0-2.3 regime are preferred because of the better economics and because of the availability of two material concepts to reduce program risk — advanced composites and advanced aluminums. This cruise speed regime also avoids the increase in risk associated with the more complex inlets and airframe systems and higher temperature composite matrices required at the higher Mach numbers typified by Mach 2.55.

INTRODUCTION

A topic of first importance in the preliminary design of a supersonic cruise aircraft is the selection of the cruise Mach number because the direction that technologies must follow hinges a great deal on that selection. The term "selected cruise speed" is used here because no clear-cut technical rationale exists for determining an optimum supersonic cruise speed. This is in direct contrast to subsonic jet transports, for which nature has provided a convenient cruise-speed boundary in terms of the transonic drag rise. This boundary causes a distinct peak in the efficiency of the aircraft (represented by the range parameter $M \cdot (L/D)/SFC$) which is exploited by current subsonic jets.

Approaches to Cruise Speed Selection

The late fifties marked the emergence of an interest in the supersonic transport (SST) aircraft. This was also a time of intensive aircraft research, especially in the military field, and a time of optimism for what the future had to offer in terms of advanced air travel. The first proposed Mach 3 air transport emerged on the scene during that era.

As a justification for a Mach 3 transport, the variation of range parameter $M \cdot (L/D)/SFC$ with cruise Mach number was singled out as shown in figure 1. This parameter is a reflection of the aircraft's range efficiency. It increases continuously with Mach number beyond Mach 1 and can be greater at Mach 3 than at the subsonic peak around Mach 0.85. Also, it was thought at that time that productivity, being proportional to block speed for constant utilization, increased at supersonic speeds in the same manner as the range parameter.

The basic theme was the faster, the better — due to the aforementioned continuous increases in range efficiency and productivity. Little attention was paid to whether or not such speeds could be fully utilized in a real world market.

Technology constraints provided the only limits to supersonic cruise speed. During the National SST program of the sixties, Mach 3 flight was considered an upper bound on cruise speed because of limits in turbojet engine technology. Other constraints, such as fuel coking, resulted from aerodynamic heating at high speeds. Because of these technology limits, the cruise speed finally was set at Mach 2.7.

Technology has, of course, made progress since the aforementioned technical limits were in effect. We now have the benefit of considerable accumulated flight experience at sustained supersonic speeds with the SR-71, B-70, B-1, and F-111 military programs. Also, there is extensive commercial experience with the Concorde at Mach 2.

It is doubtful that Mach 2.7 can still be considered a technical upper bound on cruise speed. Today's technology could easily achieve sustained cruise speeds well beyond Mach 2.7. In other words, if it were decided to develop a Mach 3+ SST, the technology exists today to support this venture. There is a constraint on cruise speed from the cost of technology, however. The cost of high-speed technology must be weighed against its payoff in terms of operational utilization and market penetration.

The approach to cruise-speed selection being employed in this paper is summarized as:

- Realistic productivity must play a role in cruise speed selection
- The cost of technology and its effects on fares and market penetration must guide cruise speed selection

The cost of increasing cruise speed to gain the aforementioned efficiency and productivity improvements is assessed to see the effect on airplane cost, airline fares, and the resulting market penetration. An integral part of this approach is the employment of realistic productivity improvements with increasing cruise Mach number.

Market Economics

The success of any future commercial SST depends on many factors — some technical, some economical, and some operational. There are, however, two fundamental concerns which must be considered:

- At what fare level does the SST become attractive to the traveling public?
- What are the manufacturer's technology options to make the SST economically attractive?

The SST concept, first of all, must represent a cost-attractive mode of transportation to the traveling public, one that conforms to the demands of the transportation market. Without adequate public acceptance, the eventual economic success of the SST concept may be compromised. The other concern confronting the SST manufacturer involves his technology options in making the SST economically viable in terms of a cost that allows the airline to make a profit at a fare that is attractive to the traveling public.

Let us first examine the concern dealing with the fare levels. The fare which the public has to pay to fly the SST determines to what extent the SST will penetrate the existing transportation market. The importance of market penetration cannot be overemphasized for it has far-reaching economic consequences to both the airline and the manufacturer. A sizeable penetration of the SST into the long-haul overwater market assures the airlines that their investments will yield a sufficient return. To the manufacturer, it means a sufficiently large production run to allow an acceptable unit price and to recoup his development costs and provide the profits to sustain himself in business.

A striking example of how fare relates to market can be seen in the makeup of the current airline market. Table 1 shows the current fares and fare class distribution of the North Atlantic market, which can also be taken as representative of the world market. The significance of the table is the obvious relationship of fare size to fare class distribution. The lower the ticket price, the greater the market share of that fare class, with discount fares capturing almost three-fourths of the North Atlantic market. It is also easy to see why the Concorde has not been successful in penetrating a significant portion of the market.

The message is that any future SST must have an attractive fare structure which not only allows it to capture all the first class and economy fare class, but also to attract a percentage of the discount market. Unless

there is an unprecedented breakthrough in technology, a fare premium will most likely be charged for flying the SST, but this should not restrict the SST to only the upper fare classes. The key to capturing an adequate share of the market lies in providing an SST concept with a fare premium that adequately relates to the time savings and the value of time of the traveler.

The value of time is important because of the market split between the business- and the pleasure-oriented traveler and the difference in how these two factions value their time. The market split between the two also is shown in table 1. The data of table 1 do not give us any quantitative idea to what extent the SST will penetrate the market. However, a reasonable estimate can be determined through use of the market penetration model shown in figure 2. In such an analysis, the traveler's supersonic fare premium per hour-of-time-saved is compared with his own hourly income as modified by his value of time. Hourly income distribution, value of time factors, and airline market properties like those in table 1 are used in the analysis.

The penetration estimates are shown in figure 3. This figure shows the estimated market penetration of the SST into the long-haul overwater market versus an SST' fare premium over and above the subsonic economy fare. The fare premium at which there is zero penetration is academic and need not concern us. What is important is how much of the market is captured with the lower premiums. The figure indicates that with zero premium, about 40 percent of the market is penetrated -- all of first class and economy and part of the discount class.

In Lockheed's opinion, a 10-percent fare premium represents a reasonable surcharge and one that would meet only modest initial resistance by the public. One-third of the overseas travel market would be captured -- an acceptable start. We say start because, after the service introduction of the SST, a certain amount of self-generated market penetration will take place. This occurs because the SST will draw away all of the first class passengers and most of the economy passengers from subsonic jets. As a result, the subsonic jet operator must compensate for this loss of revenue. This is done by raising the fares to the discount and economy traveler. In turn, this will reduce the fare difference between subsonic and supersonic jets, making the latter more attractive. Therefore, a 10-percent fare premium is proposed as a goal for the SST.

Key Technology Options

The aircraft manufacturers and NASA are continually seeking out technology advancements in the critical technologies, notably:

Aerodynamics

- Planform refinement
- High lift systems
- Lateral control systems

Structures

- Advanced composite materials
- Advanced aluminum alloys
- Titanium SPF/DB
- Low cost titanium
- Active controls

Propulsion

- Variable geometry engines
- Coannular flow nozzles
- Mechanical suppressors
- Jet noise shielding

- Integrated controls

Operational procedures

- Programmed throttle takeoff
- Alternate approach techniques
- Flight management systems

Numerous technology advancements have been identified and assessed. A realistic appraisal is needed, however, as to what technologies have the greatest return in terms of reducing costs of aircraft ownership and operation.

Figure 4 gives an indication of the impact of a 10-percent improvement in the three major technologies on the takeoff gross weight of the SST. The gross weight is selected as a figure of merit because a reduction in gross weight has the greatest impact in reducing SST costs. Figure 4 shows that 10-percent improvements in airframe weight, propulsion efficiency and aerodynamic efficiency each result in equal TOGW reductions of about 13 to 14 percent.

The probability of obtaining significant SFC improvements over what is presently quoted by engine manufacturers is low. This is also the case with the aerodynamically efficient arrow wing. Also, propulsion and aerodynamic variations with Mach number will be small. Only minor adjustments in engine cycle parameters and in wing planform parameters will be made to account for supersonic cruise speed variations.

The most promising area for realizing significant weight/cost reductions rests with structure/material technology. A variety of material candidates exist, or are on the horizon, that have attractive cost and structural weight payoffs. Some of those materials are applicable over the entire Mach regime of interest — Mach 2.0 to 2.55; others are limited to the low end — Mach 2.0 to 2.3.

This paper addresses the impact of structures/material technology on the economics of cruise speed selection in the presence of realistic operational constraints.

A STUDY OF CRUISE SPEED SELECTION

The cruise speed selection study has the objective of evaluating the influence on cruise speed of:

- Structure/material technology
- Economic factors
- Operational constraints

This allows the selection of optimum material concepts for each Mach number studied. In addition, the best material concepts at each Mach number can be compared with one another to determine preferred supersonic cruise speeds.

The major guidelines for the study are:

- Optimized aircraft for Mach 2/2.55 cruise
- Fixed payload (290 pax)
- Fixed range—7408 km (4000 n.mi.) design/5949 km (3212 n.mi.) average stage length for economic evaluation
- Variety of structure/material concepts
- 300 Aircraft production run
- Scheduling study constraints and results
- 10% fare premium goal
- Projected technology
- No quantitative risk assessment

It is to be noted that in the Mach number range from 2.0 to 2.7, two discrete Mach numbers, 2.0 and 2.55, were singled out to give a representative indication of cruise speed cost trends. The Mach 2.0 design is representative of an airplane in the Mach 2.0 to 2.3 region, since the technologies used are applicable over this region. Similarly, the Mach 2.55 airplane is representative of an airplane in the Mach 2.5 to 2.7 region.

For each airplane, several structural/material concepts will be applied to yield a series of candidate aircraft for evaluation. Each airplane is designed to carry a payload of 290 passengers over a range of 7408 km (4000 n.mi.). Economic evaluations are assessed at an average stage length of 5949 km (3212 n.mi.).

Other guidelines include a 300-aircraft production run, operational constraints from the 1977 airline scheduling study, and the 10-percent supersonic fare premium goal developed in the introductory remarks.

It is emphasized that projected technology is used for the advanced titanium, advanced aluminum, and advanced composite airplane candidates to be evaluated. Each involves a different degree of risk; however, a quantitative risk assessment is beyond the scope of this paper.

CANDIDATE AIRCRAFT

Planform sketches of the Mach 2.0 and 2.55 study airplanes are shown in figure 5. The Mach 2.0 design is shown in the upper half of the figure while the Mach 2.55 design is shown in the lower half, thereby indicating graphically the minor variations in wing planform. Wing sweep and aspect ratio vary from 68 degrees and 2.1, respectively, for the Mach 2.0 design, to 73 degrees and 1.72 for the Mach 2.55 design.

Pertinent configuration data also are indicated in the planform sketches. The Mach 2.0 aircraft optimizes at a higher wing loading and lower thrust-weight ratio than the Mach 2.55 aircraft to meet the airport performance and community noise constraints. Wing loading and thrust weight are 444 kg/m^2 (91 psf) and 0.265, respectively, for the Mach 2.0 aircraft and 415 kg/m^2 (85 psf) and 0.275 for the Mach 2.55 aircraft.

In the propulsion area, both aircraft use variants of the GE 21-J11 double bypass variable cycle engine. The Mach 2.0 aircraft employs an external compression inlet while the Mach 2.55 aircraft uses a mixed compression inlet.

The material concepts considered for the Mach 2.0 and Mach 2.55 airplanes are summarized in table 2. These concepts result in nine candidate aircraft for economic evaluation, six at Mach 2.0 and three at Mach 2.55.

For each material concept, table 2 indicates the composition of the major ingredients as a percent of structural weight. It should be noted at the outset that all airplanes are hybrid, in that a mixture of materials is employed. The advanced titanium airplane is 75 percent titanium, not 100 percent. For each material concept, the primary and secondary ingredients are highlighted. These material concepts are based on the extensive structural concept studies reported in reference 1 as well as the related reference 2 paper dealing with advanced materials and fabrication processes.

Of the six Mach 2.0 concepts, the state-of-the-art aluminum design serves as a reference point. The particular aluminum is similar to that employed in the Concorde. The advanced titanium and advanced aluminum airplanes are assumed to have the same structural weight as conventional titanium because of comparable

strength-weight ratios. In actuality, studies by Rockwell and McDonnell Douglas of advanced titanium manufacturing techniques and by Lockheed of advanced aluminum structures indicate that these airplanes could be lighter. The advanced-aluminum-plus-composites airplane introduces composites of the GR/E type in the secondary structure. The composites-plus-advanced-aluminum aircraft employs an aggressive use of composites in primary structure where that material can be used to advantage for the particular structural design requirement. Because of the elevated temperatures involved, the existence of a hypothetical intermediate temperature matrix (ITM) composite is assumed. GR/E has been shown to be marginal for these applications.

A similar selection of material concepts is employed in the three Mach 2.55 candidates. Advanced titanium is the first, followed by advanced titanium plus composites, which employs composites in secondary structure. Finally the composites-plus-advanced-titanium design uses advanced composites of the GR/PI type in primary structure, where appropriate.

WEIGHT AND COST DATA

Determination of airframe structure cost, flyaway cost, acquisition cost and development cost was accomplished with a Lockheed cost model. A key element in this determination is derivation of the airframe structure cost from the weight statement and associated labor and material costs. Weight data for the current analysis is taken from reference 1 while the labor and material cost data is based on reference 2.

The airframe structural cost calculation procedure is indicated in the simplified flow chart of figure 6. The material usage factors from table 2 are combined with the product forms (sheet, forgings, plates, extrusions, etc.) for each airplane segment as well as net-to-buy ratios for each application. This yields the amount of raw stock for finished parts and hence the raw material costs. These are combined with the labor cost base for each material and each structural element (wing, body, etc.) to determine the total cost of structure. The labor and material dollars-per-pound values are applied to each element of the airplane weight statement to yield the total airframe structural cost for the particular airplane candidate under investigation.

The aircraft weights, structural production costs (on a per-pound basis), and the resulting all-up aircraft structural costs for the candidate designs are presented in figures 7, 8, and 9. The configuration with composites only in secondary structure have been eliminated in the cost charts for simplification. The aircraft structural weight and takeoff gross weight for each of the aircraft considered are presented in figure 7. For the Mach 2.0 aircraft, the conventional aluminum candidate weighs almost 363 000 kg (800 000 lb) at takeoff. It can be seen that a major weight reduction of about 45 000 kg (100 000 lb) is realized if the airframe material is changed from conventional aluminum to titanium. For this study, no weight changes are projected when changing

from titanium to advanced titanium or to advanced aluminum. This is because the projected strength to weight and stiffness to weight ratios for both of these materials are comparable to conventional titanium.

Additional weight reductions are projected when composites are substituted for metallics in secondary and primary structures. All in all, a primarily composite aircraft (55 percent composites) shows about a 90 700 kg (200 000 lb) gross weight advantage relative to the conventional aluminum aircraft, and about a 45 000 kg (100 000 lb) advantage relative to the titanium or advanced aluminum aircraft.

The weight trends of the Mach 2.55 aircraft parallel those of the Mach 2.0 concepts. The weight differences between Mach 2.0 and 2.55 concepts (same material) are primarily due to the need for a slightly larger aircraft for Mach 2.55 cruise.

The projected, average structural/material costs per unit weight (specific cost) of structure are shown in figure 8 for the total airplane. The reader is cautioned against any wide application of the data shown for it should be kept in mind that an aircraft contains many product forms, and the specific costs are as varied as the product forms themselves. Figure 8 shows that labor comprises the majority of production cost, anywhere from 55-70 percent. The data indicate that relative to conventional aluminum at 223 \$/kg (101 \$/lbm), advanced titanium costs 63 percent more. Advanced aluminum costs 4 percent more, while advanced composites cost 25 percent more. At Mach 2.55, advanced titanium and advanced composites cost 64 percent and 62 percent more, respectively, than aluminum at Mach 2.0.

While the specific structure cost is of immense interest in itself, the combination of these costs and airframe weight, as shown in figure 9, gives the total impact of material choices on aircraft costs. The projected structural cost data of figure 9 show that the use of titanium results in the most costly aircraft at Mach 2.0, i.e., \$33.1 million. A major cost breakthrough is indicated with the use of advanced aluminum at \$18.4 million. Further cost reductions are possible with the introduction of composites at \$16.3 million. The cost trends are similar at Mach 2.55 with the advanced composites being less costly than advanced titanium.

Trends with Mach number also can be detected in figure 9. The advanced titanium airplane at Mach 2.55 costs 9 percent more than it does at Mach 2.0. The advanced composite airplane costs 42 percent more at Mach 2.55 than at Mach 2.0. This is due to the more costly GR/PI composite system and the substitution of advanced titanium for advanced aluminum required at Mach 2.55.

In the data of figure 9, a surprising fact is the small cost difference of about 13 percent between a conventional titanium aircraft at \$33.1 million and an advanced titanium aircraft at \$28.9 million — the latter making extensive use of superplastic forming and diffusion bonding. Current projections indicate that a 50-percent labor cost reduction can be realized in employing this advanced manufacturing method. The discrepancy between this 50 percent and the 13 percent actually realized does need explanation.

Figure 10 represents a first-order analysis showing how projected cost reductions in a specific area are diluted in the over-all cost of the aircraft. This figure shows that for a nominal all-titanium aircraft, 63 percent of manufacturers' empty weight is structure, of which 75 percent is titanium. Therefore, any cost reductions attributed to titanium can only affect 75 percent of the airframe structure. Reference 1 indicates that for a titanium airframe, only 41 percent is amenable to superplastic forming processes with 20 percent to low-cost titanium processes. Thirty-nine percent remains for conventional processes such as forgings and extrusions. Therefore, on a cost basis, advanced manufacturing techniques affect only 46 percent of the structure.

Further, the projected 50-percent cost reduction applies only to the labor portion which is 70 percent of the total structural unit cost. When all these fractional cost applications are carried through to the airframe structural cost, only a 16-percent savings in recurring production costs is realized from a 50-percent labor cost reduction in advanced titanium manufacturing processes. This first-order reduction compares favorably with the 13 percent obtained from the detailed analysis made with the cost model.

Further dilutions of these and other differences between candidate airplane costs occur when complete fly-away costs are considered. As shown in table 3, airframe structure represents about one-third of the total fly-away cost (including amortized development).

Figure 11 presents a comparison of fly-away and total acquisition costs for the candidate airplanes under study. Acquisition costs include an allowance for logistics support and spares over and above the fly-away cost. The relative cost rankings of all the candidates remain the same as for airframe structural cost in figure 9. Advanced aluminums are attractive at Mach 2.0 (\$87 million acquisition), and advanced composites are superior at both Mach 2.0 and 2.55 with \$80 million and \$93 million acquisition costs, respectively. As indicated above, the differences between the airplane costs due to advanced technology have been reduced. For example, advanced titanium now has a cost only 3 percent lower than conventional titanium.

SCHEDULING/PRODUCTIVITY FACTORS

An important ingredient in the economic evaluation of the candidate material concepts at differing Mach numbers is the airplane productivity in terms of daily-revenue-distance flown per aircraft. The productivity assumptions used in this analysis are derived from a joint airline-Lockheed study reported in reference 3.

The study of reference 3 evaluated the airlines' use of increasing cruise speed within the framework of real-world scheduling factors as shown in figure 12. Schedules were developed for the same requirement for six subsonic and supersonic aircraft having speeds ranging from Mach 0.7 to 2.7.

Lockheed provided the flight profiles for the various airplanes while Trans World Airlines and Braniff International developed schedules in observance of airport curfews, passenger preferences, time zones, adequate flight frequency, city pairs and a 1990 passenger demand. Maintenance time allowances were generated, and airports within the system network were identified that have maintenance facilities.

Three individual route systems were studied as indicated in figure 13. Trans World Airlines was responsible for the trans-Pacific and North Atlantic regions. Braniff International was responsible for the North America-South America system where they have extensive operating experience.

The scheduling study results are summarized in terms of productivity and utilization versus cruise Mach number, in figures 14 and 15, respectively. In figure 14, productivity increases on the North America system are seen to level off beyond Mach 2.0. This is because no additional flights can be scheduled across the North Atlantic for speed increases in the Mach 2.0 to 2.7 regime. A similar behavior occurs in the North and South America system where productivity increases beyond Mach 2.2 are nonexistent. However, in the trans-Pacific area, the longer flight segments allow continuing productivity increases as Mach number increases to Mach 2.7. The aggregated productivity for all three regions is shown by the dark line in figure 14. It is seen that while productivity increases 100 percent as Mach number is increased from 0.8 to 2.0, further Mach number increases to 2.7 yield only an additional 10 percent productivity improvement.

Figure 15 summarizes the related data on utilization in terms of daily block time per aircraft. In looking at the overall result, it is seen that utilization is not constant as was assumed in earlier cruise speed selection studies. Rather, it falls off with Mach number beyond Mach 2.0 and is responsible for the reduced rate of productivity increase in this region.

ECONOMIC RESULTS AND DISCUSSION

We have already seen how different choices of airframe materials can have a pronounced impact on aircraft weight and cost. The economics analysis of the candidate concepts is designed to assess how the acquisition costs and operating costs at the Mach 2.0 and 2.55 cruise speeds affect the "bottom line" of the study, namely, the fare premium charged to the traveling public.

Total operating costs for the various SST concepts were determined through the use of the Lockheed economics model. In addition to the information on airframe costs and weights, the economics model must be supplied with information concerning aircraft performance, productivity, and other factors.

The major assumptions which relate to the economics model are:

- 1978 dollars
- 300 A/C production run
- Fuel cost = \$0.43/gal
- 16-year aircraft life
- 4% salvage value
- Load factor = 65%

- Productivity - km/day-acft
 - 19,636 at Mach 2.0
 - 20,956 at Mach 2.55
- Utilization - block hr/day-acft
 - 11.6 at Mach 2.0
 - 11.2 at Mach 2.55
- ROI = 12.7% for fare evaluation

Dollars used are for 1978, and fuel cost is 43 cents per gallon. The aircraft are depreciated over a sixteen-year life with a residual value of 4 percent. Passenger load factor is 65 percent, and airline return on investment (ROI) is set at 12.7 percent for evaluation of supersonic fare premiums.

To clarify cost terms used in the economic analysis, table 4 lists the cost definitions for fly-away cost, acquisition cost, operating expenses, revenue, and ROI. ROI is inversely proportional to book value, which is a strong function of acquisition cost.

The final results for the all-metallic SSTs studied are shown in figure 16. This figure shows the total operating costs (TOC) and the fares to be charged as fractions of the subsonic economy fare, assuming a 12.7 percent ROI for the airlines. Fares above 1.0 represent the required fare premiums. The goal of a 10-percent fare premium, outlined previously, is shown for comparison purposes.

It can be seen from figure 16 that the all-metallic candidate aircraft do not satisfy the 10-percent goal. With the exception of the advanced aluminum aircraft, all require a fare premium near 30 percent. By comparison, the advanced aluminum aircraft shows considerable promise with a fare premium of only 20 percent. It can also be noted that there is a negligible Mach number effect on the fare premium required; e.g., 30 percent at Mach 2.55 versus 28 percent at Mach 2.0 for the advanced titanium concepts.

Figure 17 shows the influence of composite materials application on the fare levels. The best choice of the all-metallic aircraft and the 10-percent fare goal are again shown for comparison purposes. It can be seen that at Mach 2.0 the composite aircraft in conjunction with advanced aluminum comes closest to our goal — a supersonic fare premium of only 11 percent. This is in relation to a premium of 20 percent for an advanced aluminum design. The application of composites also has a marked effect on reducing fare premium at Mach 2.55. The premium of 30 percent for the advanced titanium structure is reduced to 16 percent with advanced composite structure.

Mach number effects on supersonic fare premiums also can be discerned in figure 17. For metallic airplane concepts, it is seen that the fare premium increases from 20 percent to 30 percent as the change is made from advanced aluminum at Mach 2.0 to the advanced titanium required at Mach 2.55. For composite concepts, the fare premium increases from 11 percent at Mach 2.0 to 16 percent at Mach 2.55. This is due to the greater costs of the higher temperature composites and substitution of advanced titanium for advanced aluminum needed at Mach 2.55.

Finally, attention is drawn to the fact that the 43¢ per gallon fuel price reflects the price at the time of analysis initiation. Because fuel prices have increased dramatically since then, the study results are to be viewed as a snapshot in time. The sensitivity of the presented results to an increase in fuel price from 43¢ to 75¢ per gallon, a more representative price in today's economic environment, was examined. It was estimated that the base subsonic fare level would increase by about 14 percent. The projected fare premiums given in Figure 17 would change from 20 to 25 percent for the advanced aluminum aircraft and from 11 to 15 percent for the Mach 2.0 composite aircraft. The fare premium for the Mach 2.55 aircraft would change from 30 to 35 percent for the titanium aircraft and from 16 to 20 percent for the composite aircraft. Obviously, the SST fare premiums are sensitive to fuel prices. However, they are not overly sensitive to fuel price changes as is evidenced by only a 4 to 5 percent premium increase brought on by a near doubling of the fuel price. Also, the sensitivity analysis shows that the relative standing of the candidate SST configurations is preserved.

The results indicate no economic advantage for the higher cruise Mach numbers. Supersonic fares are increasing 8 percent for metallic concepts and 5 percent for composite concepts to achieve productivity improvements of 7 percent. This small leverage indicates that further increases in supersonic cruise speed would not be cost-effective.

In addition, there is the subject of risk in relation to cruise speed which was not to be treated quantitatively in this analysis because of a lack of hard data. However, qualitatively, there is no doubt that risk is adversely affected as speed is increased. A greater risk would have to be assigned to the Mach 2.55 aircraft because of more complex inlets and systems and the high-temperature composite needed to make the Mach 2.55 concept economically attractive. If setbacks are encountered in the development of the high-temperature composite, the fall-back position would be an all-titanium aircraft which appears to be economically unacceptable. In contrast, there is likely to be a lesser risk for the Mach 2.0 aircraft with the development of the intermediate temperature composite. Furthermore, should the composite development for the Mach 2.0 airplane be compromised in some way, the advanced aluminum concept could be an economically acceptable replacement.

CONCLUDING REMARKS

We have seen that the dominant factors in determining the economic viability of a supersonic cruise aircraft employing various material concepts are

the specific structural production costs (dollars per pound), the aircraft size and weight to meet a prescribed performance level, and the interplay between the two.

For metallic aircraft concepts, it has been determined that projected development, production, and operating costs result in fare levels that will be unattractive to the air traveler. Compared to a desired supersonic fare premium of 10 percent over the subsonic economy fare rate, advanced titanium aircraft require a premium of about 30 percent, regardless of cruise speed. Surprisingly, the advanced titanium manufacturing processes, such as superplastic forming/diffusion bonding, had a very small impact on reducing fare premium for the titanium designs. An advanced aluminum design requires a reduced fare premium of 20 percent, still short of the 10 percent goal. The advanced aluminum approach of course implies cruise Mach numbers in the Mach 2.0-2.3 regime.

It was further determined that aircraft with advanced composites as the primary material ingredient show the greatest potential for reducing weight and total operating costs. The estimated fare premium is 11 percent for the Mach 2.0 composite/advanced aluminum concept and 16 percent for the Mach 2.55 composite/advanced titanium concept. These are significant reductions from the best metallic concepts which had fare premiums of 20 percent at Mach 2.0 and 30 percent at Mach 2.55.

In addition, it was found that fuel price increases to more representative values do not alter the relative economic standing of the candidate SSTs. Also, the fare premiums are not overly sensitive to fuel price increases. A near doubling of price (43¢ to 75¢ per gallon) increased the premium by only 4 to 5 percent.

The lower cruise speeds of Mach 2.0 to 2.3, represented by the Mach 2.0 design, are attractive because of their lower total operating costs and supersonic fare premiums for both metallic and composite designs. Also, the availability of two material options at the lower speed — one meeting the fare premium goal and one approaching it — reduces the material selection risk. Higher cruise speeds such as Mach 2.55 do not appear economically attractive. Further, qualitative risk assessments indicate that risk must increase with increasing cruise speed due to more complex inlets and systems as well as the more hostile elevated temperature environment.

Thus, Mach 2.0 to 2.3 is selected as the preferred cruise speed regime at this time. It is recommended that the advanced SST cruise speed be reduced to this regime in the interest of maximizing its economic attractiveness. In the area of material technology, it is recommended that increased emphasis be placed on both advanced aluminum and intermediate temperature matrix (ITM) composite systems. In the case of the ITM composite, development must be initiated to fill the void left by the marginal performance of GR/E and the poor fabricability of GR/PI.

Increased advanced aluminum development effort and work on related advanced manufacturing techniques are essential for two reasons. First, the so-called advanced composite aircraft employs 17 percent advanced aluminum by weight so that advanced aluminum technology is an integral part of the advanced

composite aircraft. Second, the advanced aluminum aircraft, employing 66 percent aluminum by weight, is attractive as a backup option should the ITM composite not be developed.

Current efforts in advanced titanium manufacturing methods should be sufficient to perfect this approach for those applications in all aircraft candidates where titanium is optimum; i.e., space limited situations and engine compartments, nozzles, and certain elevated temperature regions on wing and fuselage.

REFERENCES

1. Sakata, I. F.; Davis, G. W.; and Saelman, B.: Structural Concept Trends for Commercial Supersonic Cruise Aircraft Design. Supersonic Cruise Research '79, NASA CP-2108, 1980. (Paper no. 25 of this compilation.)
2. Guess, M. K.; Kaneko, R. S.; and Wald, G. G.: Advanced Materials and Fabrication Processes for Supersonic Cruise Aircraft. Supersonic Cruise Research '79, NASA CP-2108, 1980. (Paper no. 32 of this compilation.)
3. Bond, E. Q.; Carroll, E. A.; and Flume, R. A.: Study of the Impact of Cruise Speed on Scheduling and Productivity of Commercial Transport Aircraft. NASA CR-145189, 1977.

TABLE 1. - ANATOMY OF CURRENT AIRLINE MARKET
(NORTH ATLANTIC ROUTES)

Fare Class	Fare in 1979 Dollars		Fare Class Distribution %	Business/Personal Split %
	Subsonic	Concorde		
First Class	689	827	5.5	60/40
Economy	348	-	22.0	40/60
Discount	172	-	72.5	10/90
			100.0	

TABLE 2. - AIRFRAME MATERIAL CONCEPTS

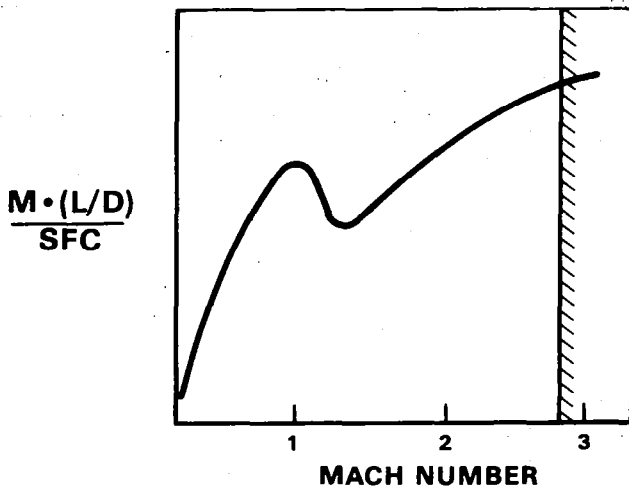
	Percent Structural Weight				
	Titanium	Aluminum	Composite	Steel	Others
<u>Mach 2.0 Concepts</u>					
State-of-the-art aluminum	10	(69)	1	10	10
State-of-the-art titanium	(75)	4	1	10	10
Advanced titanium	(75)	4	1	10	10
Advanced aluminum	12	(66)	1	10	11
Advanced aluminum + composites	13	(44)	(21)	11	11
Composites + advanced aluminum	8	(17)	(55)	7	13
<u>Mach 2.55 Concepts</u>					
Advanced titanium	(75)	4	1	10	10
Advanced titanium + composites	(54)	4	(20)	11	11
Composites + advanced titanium	(24)	2	(55)	7	12
<p>○ Primary material ingredient</p> <p>◌ Secondary material ingredient</p>					

TABLE 3. - ANATOMY OF TYPICAL FLY-AWAY COSTS

	Cost Fraction In Percent
Total Airframe Structure	32.7
Propulsion	16.7
Systems	17.8
QA & Warranty	14.8
Development	
• RDT&E	13.8
• Product Development	<u>4.2</u>
	100.0%

TABLE 4. - COST DEFINITIONS

Flyaway Cost	=	Amortized Development* + Production
Acquisition Cost	=	Flyaway + ILS + Spares
Expenses, TOC	=	DOC + IOC
Revenue	=	Subsonic Economy Fare Rate + SST Premium
ROI	=	$\frac{\text{Revenue} - \text{Expenses} - \text{Taxes}}{\text{Book Value}}$
*Post Technology Readiness		



BASIC AIM WAS FOR HIGHEST CRUISE SPEED BECAUSE:

- AIRCRAFT EFFICIENCY INCREASES WITH CRUISE SPEED
- PRODUCTIVITY WAS THOUGHT TO CONTINUOUSLY INCREASE WITH CRUISE SPEED

MACH 2.7 SELECTED BECAUSE OF TECHNOLOGY LIMITS AND OPTIMUM ECONOMICS

Figure 1.- Previous approach to cruise speed selection.

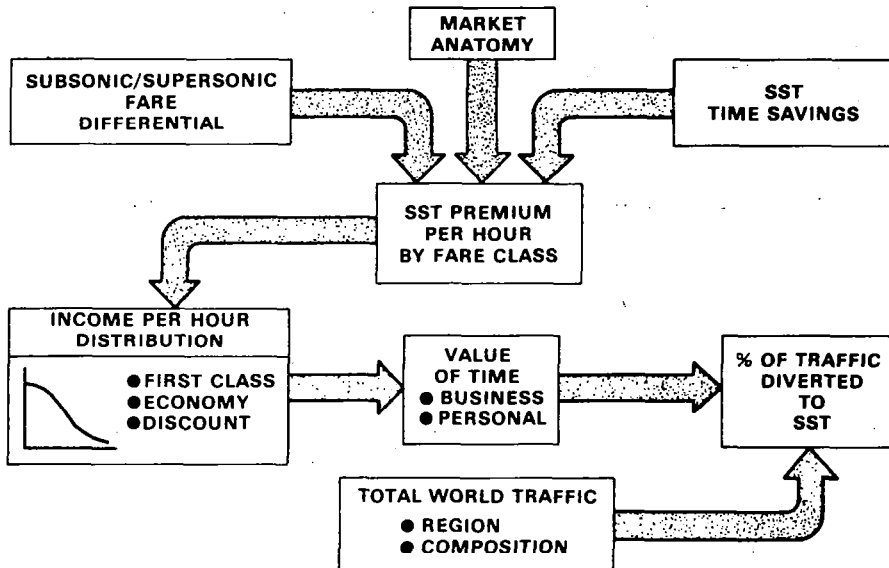


Figure 2.- SST market penetration analysis.

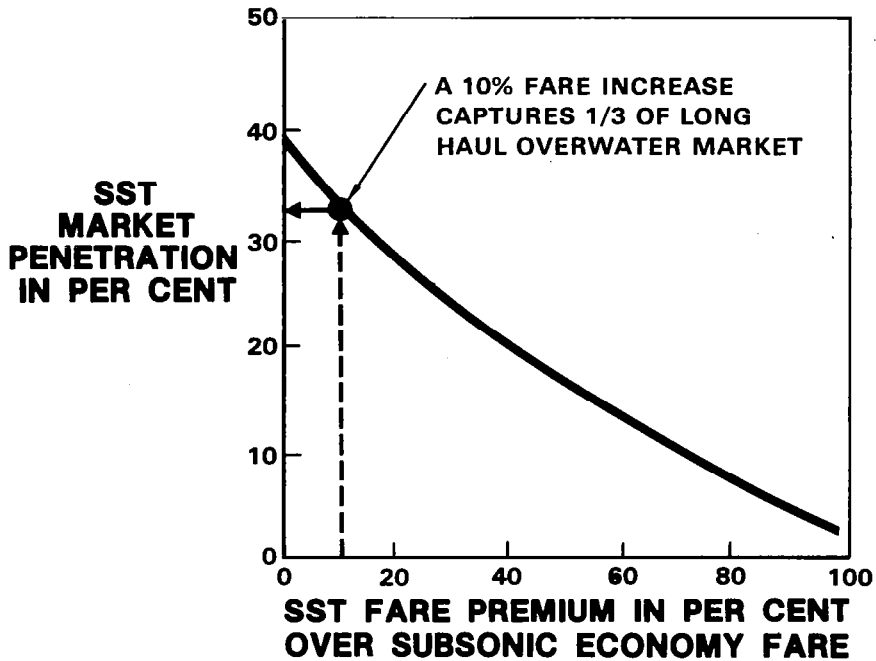


Figure 3.- Effect of SST fare premium on market penetration.

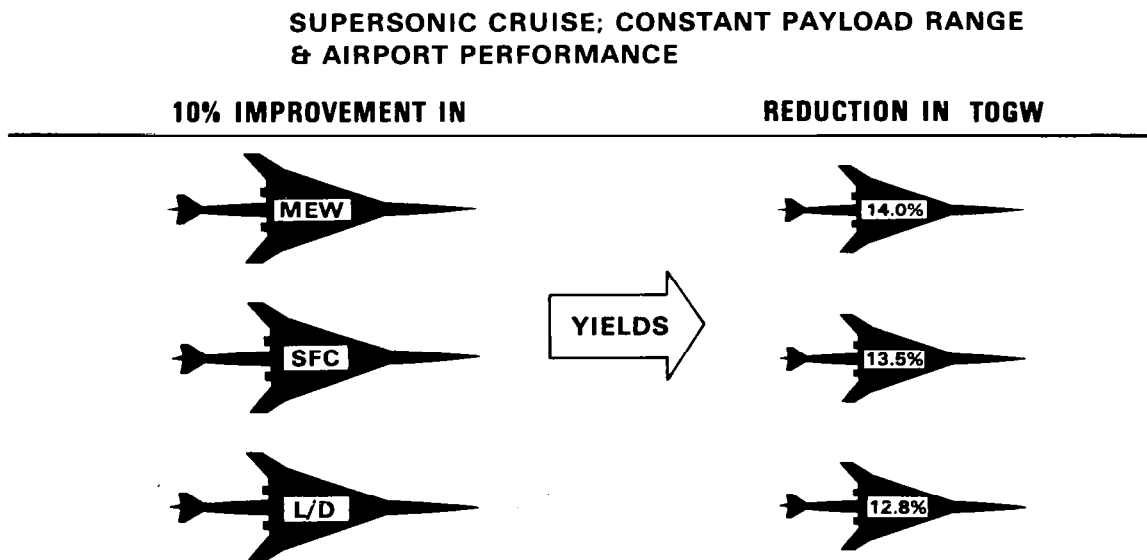
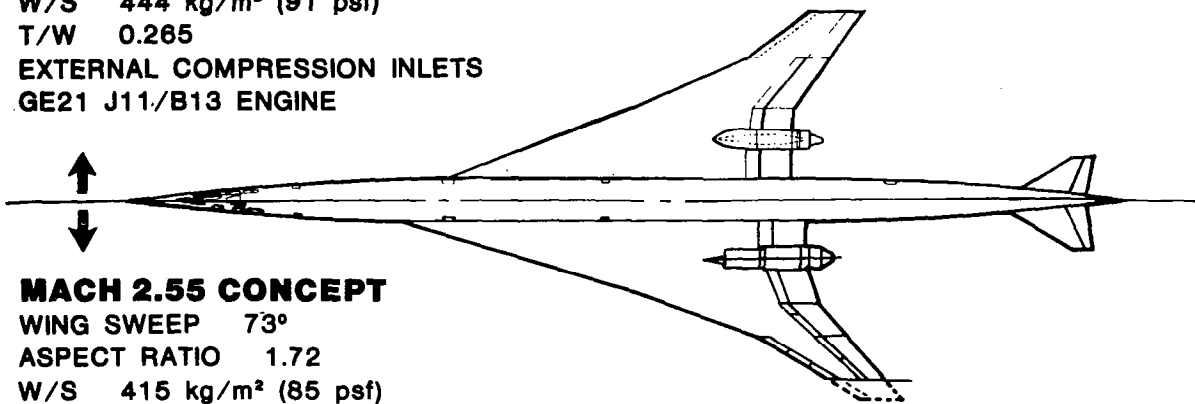


Figure 4.- Impact of technology improvements.

MACH 2.0 CONCEPT

WING SWEEP 68°
 ASPECT RATIO 2.1
 W/S 444 kg/m² (91 psf)
 T/W 0.265
 EXTERNAL COMPRESSION INLETS
 GE21 J11/B13 ENGINE



MACH 2.55 CONCEPT

WING SWEEP 73°
 ASPECT RATIO 1.72
 W/S 415 kg/m² (85 psf)
 T/W 0.275
 MIXED COMPRESSION INLETS
 GE21 J11/B11 ENGINE

Figure 5.- Study airplanes.

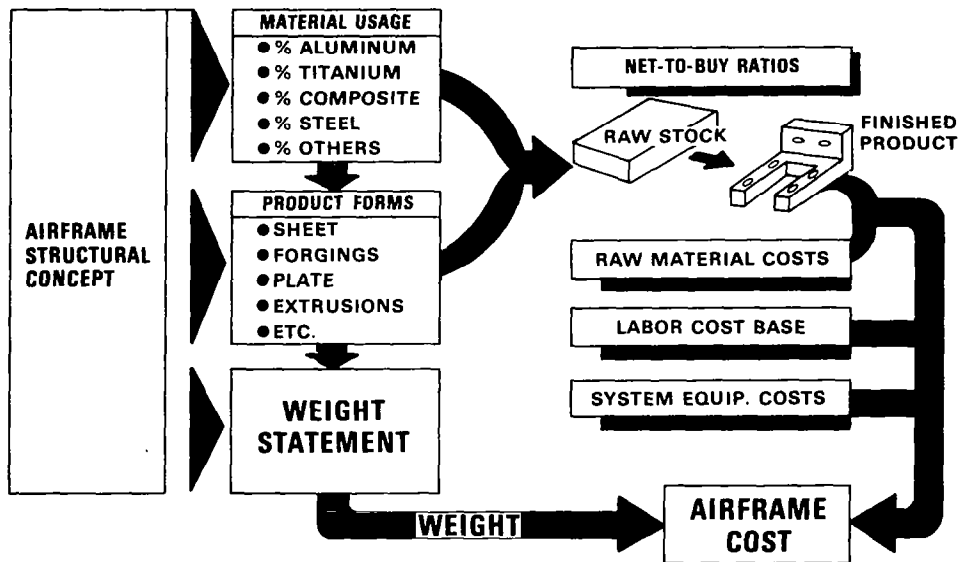


Figure 6.- Airframe cost derivation.

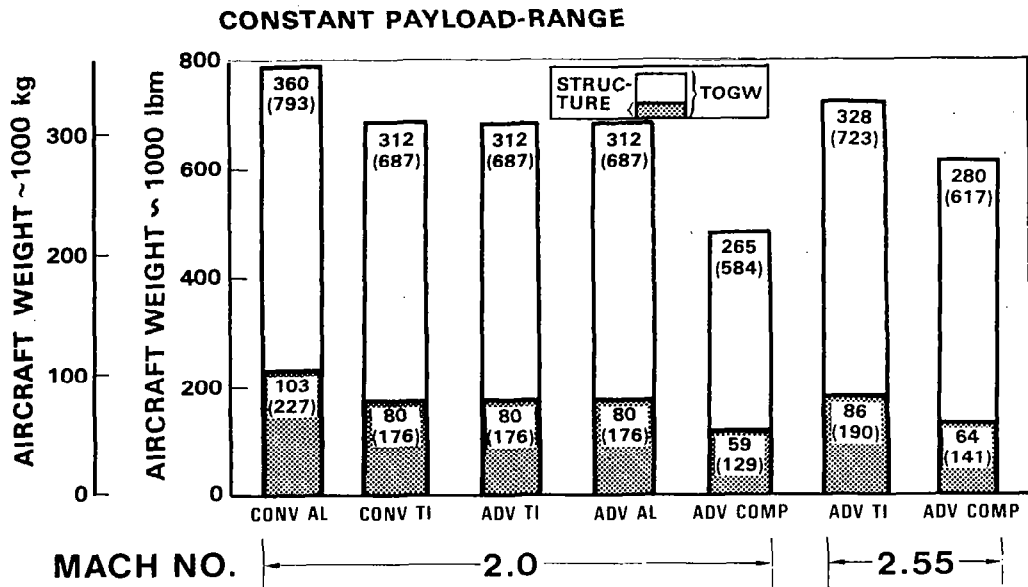


Figure 7.- Candidate aircraft weights.

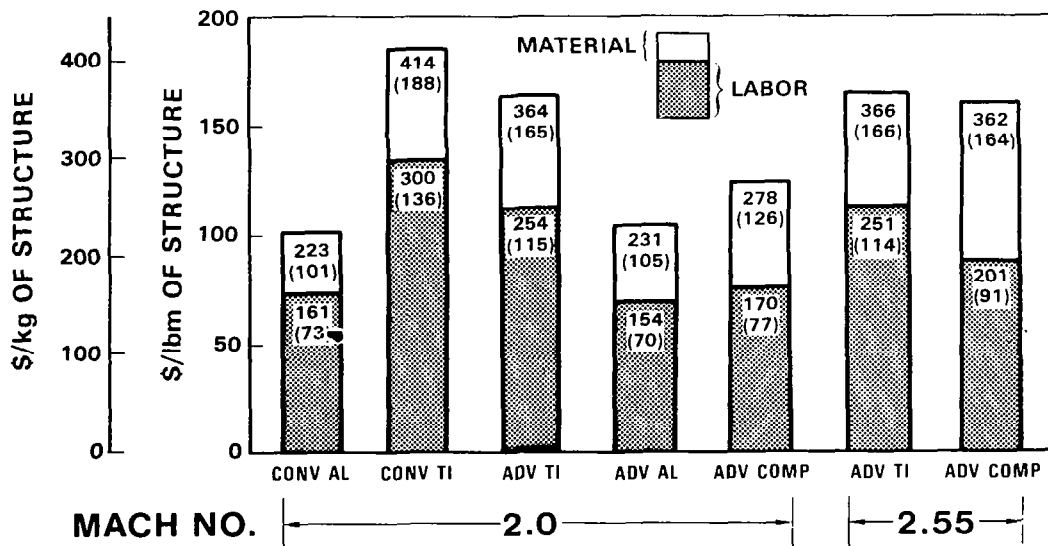


Figure 8.- Projected candidate aircraft unit structural cost.

COMBINATION OF WEIGHT AND \$/kg (\$/lbm)

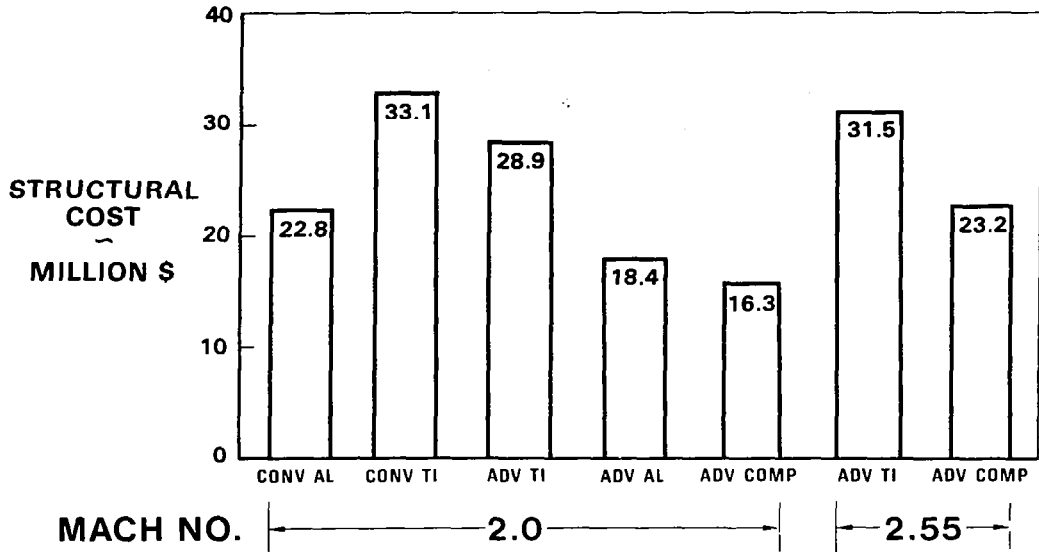


Figure 9.- Projected candidate aircraft structural cost.

MANUFACTURERS EMPTY WEIGHT

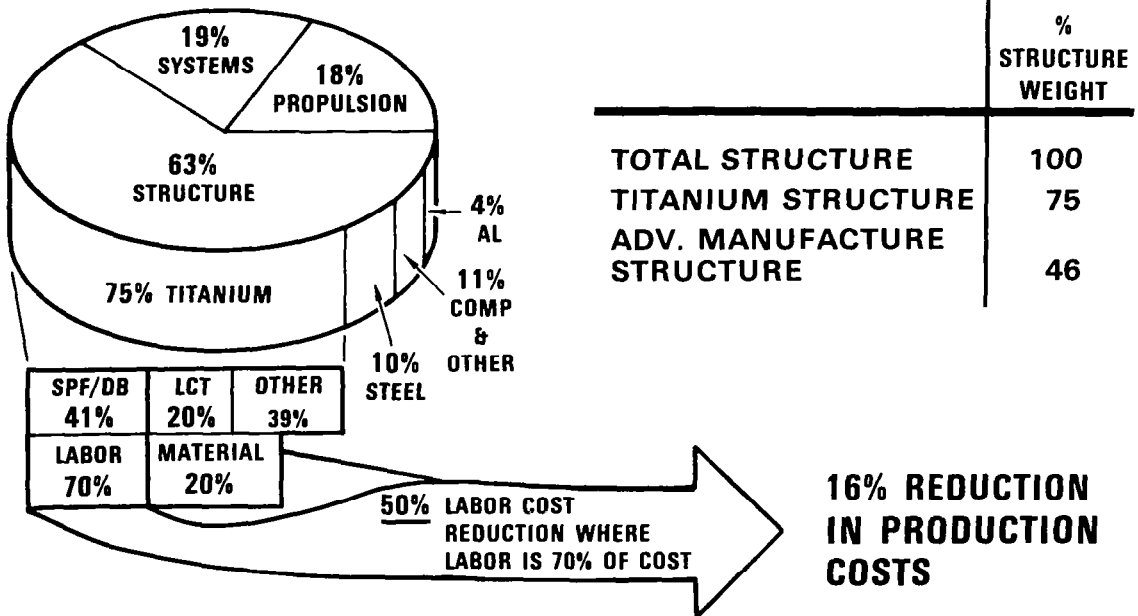


Figure 10.- Dilutions of cost reductions in titanium manufacturing.

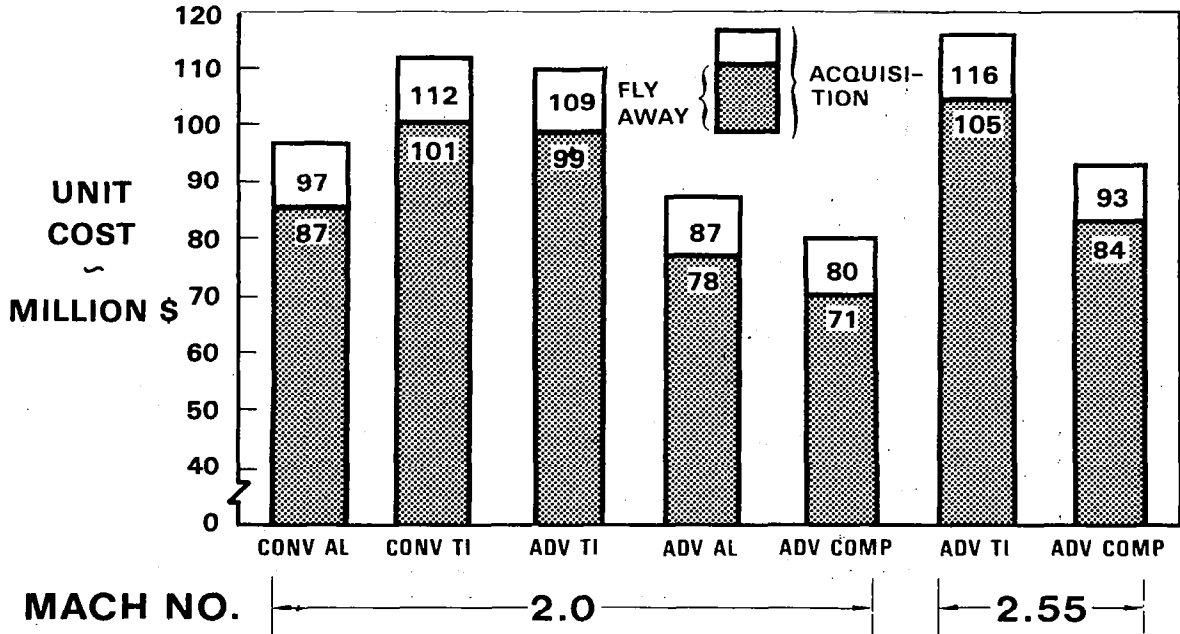


Figure 11.- Projected candidate aircraft flyaway and acquisition costs.

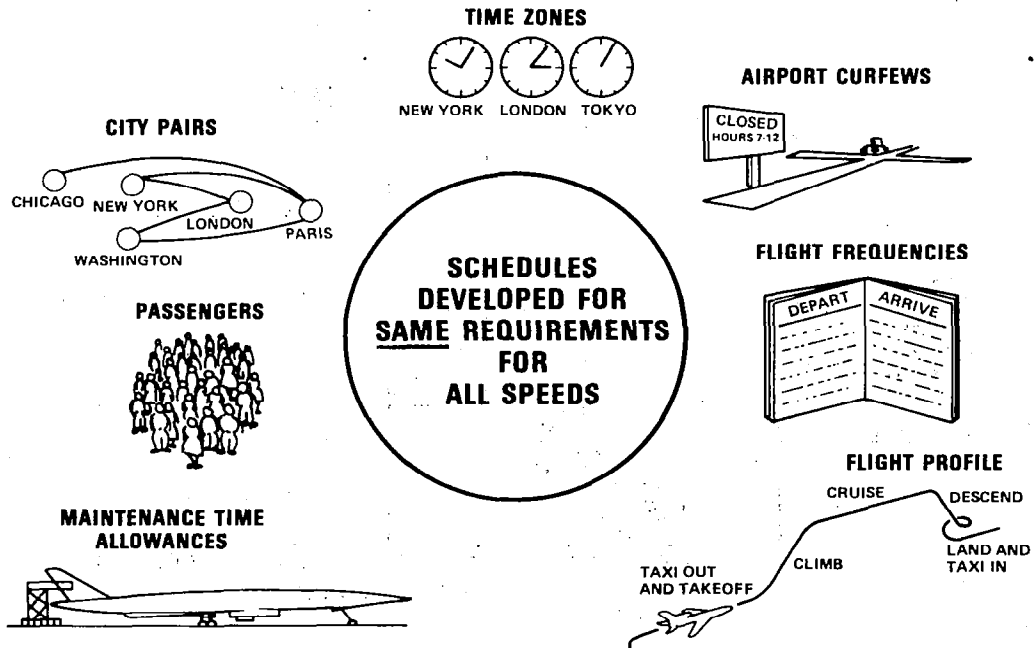


Figure 12.- Airline scheduling study.

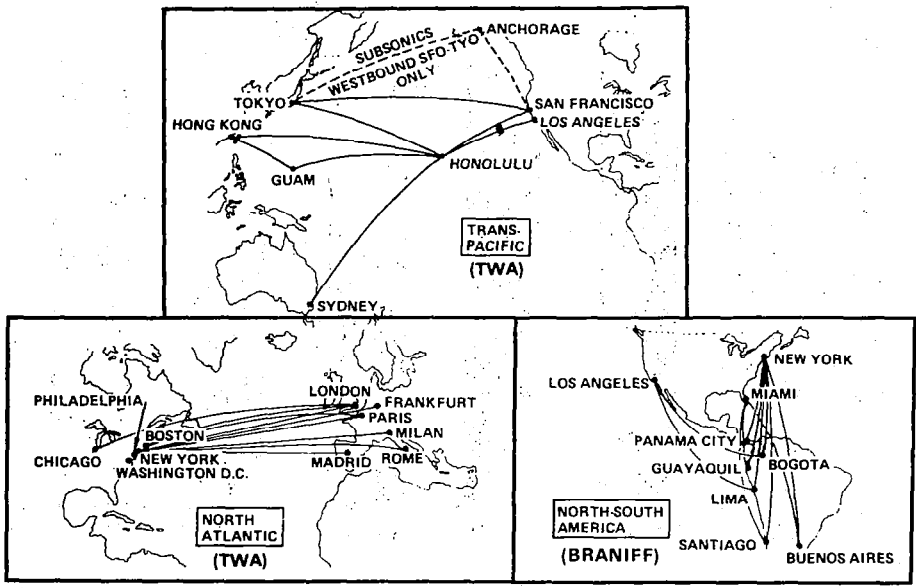


Figure 13.- Three individual route systems.

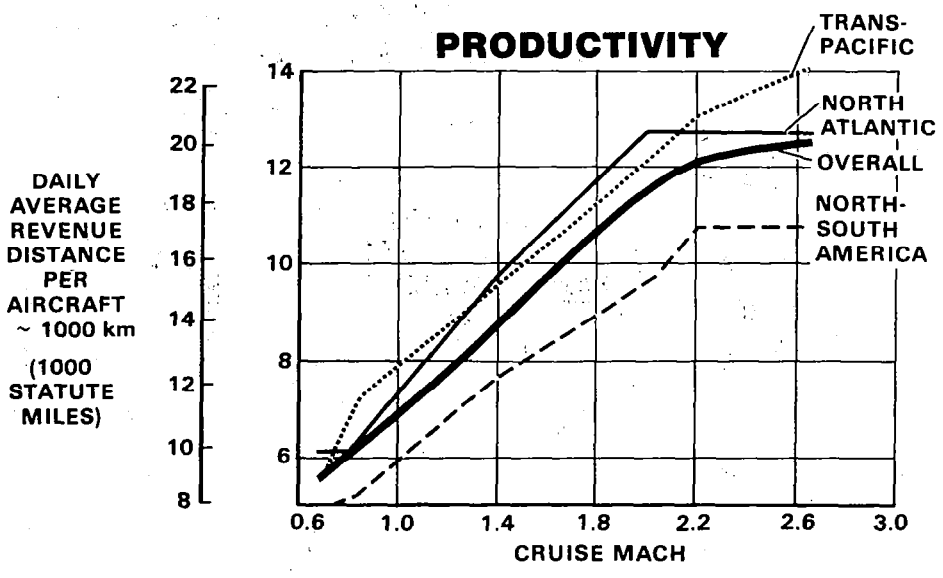


Figure 14.- Scheduling study results - productivity.

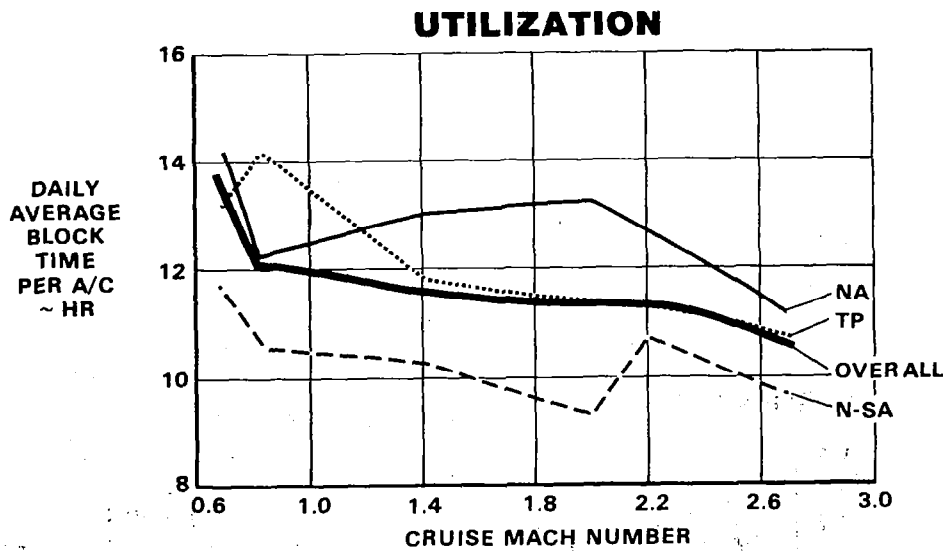


Figure 15.- Scheduling study results - utilization.

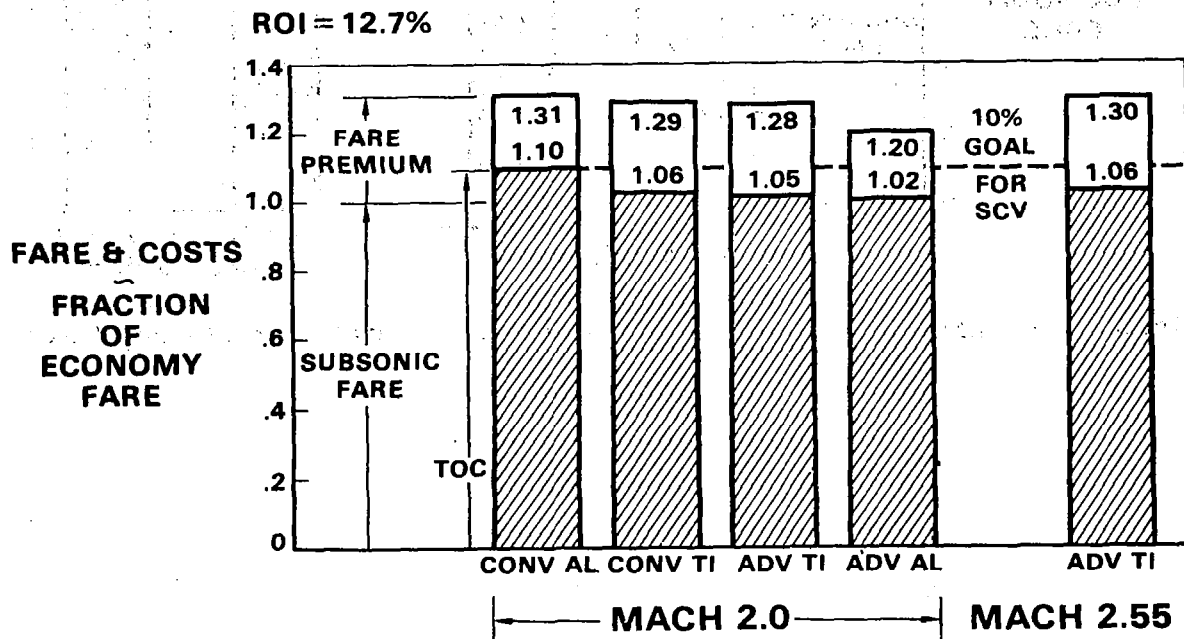


Figure 16.- Relative operating cost and fare comparisons for metallic candidate aircraft.

ROI = 12.7%

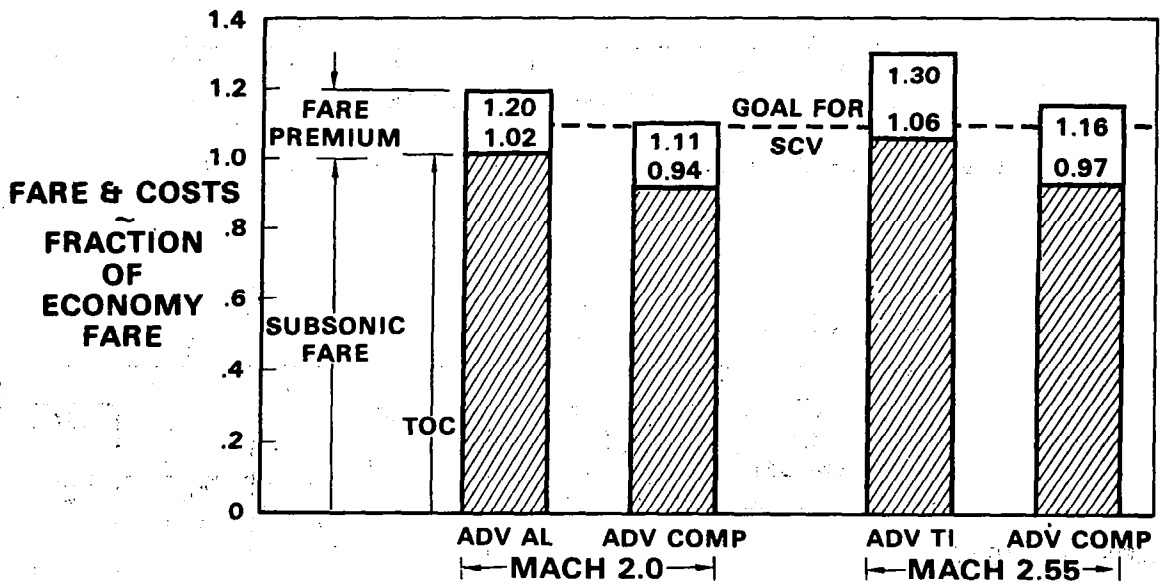


Figure 17.- Influence of composites on relative operating costs and fares.

SUPERSONIC CRUISE VEHICLE

RESEARCH/BUSINESS JET

Robert Kelly
North American Aircraft Division
Rockwell International

SUMMARY

A comparison study of a GE-21 variable-cycle propulsion system with a Multimode Integrated Propulsion System (MMIPS) was conducted while installed in small $M = 2.7$ supersonic cruise vehicles with military and business jet possibilities. The 1984 state-of-the-art vehicles were sized to the same transatlantic range, takeoff distance, and sideline noise. The results indicate the MMIPS would result in a heavier vehicle with better subsonic cruise performance. The MMIPS arrangement with one fan engine and two satellite turbojet engines would not be appropriate for a small supersonic business jet because of design integration penalties and lack of redundancy.

INTRODUCTION

Recent major commercial aircraft developments have been designed for the high subsonic flight regime. Will there only be subsonic commercial flight in the future? With the progress in supersonic technology and increasing need to reduce travel time, large commercial supersonic vehicles will become an eventuality in the future. But, what are the steps to get there? One possible course is to build the vehicle in one step. An alternate course is to validate the critical supersonic technologies in a small research vehicle prior to the building of a full-size supersonic vehicle. The latter course was assumed for this study. But would the research vehicle necessarily have only one use? Why not have the additional capability for military use or as a supersonic business jet. This study is based on these ideas (figure 1).

SYMBOLS

Values are given in both International System of Units (SI) and U.S. customary units. The measurements and calculations were made in U.S. customary units.

A/B	afterburner
AR	aspect ratio = $(\text{wingspan})^2 / \text{wing area}$
BFL	balanced field length
BPR	engine bypass ratio
EPNdB	effective perceived noise in decibels
FOD	foreign object damage
FPR	fan pressure ratio
FRATS	fiber-reinforced advanced titanium structures
$(L/D)_{\text{CRUISE}}$	lift-to-drag ratio at cruise
M	Mach no.
MMIPS	multimode integrated propulsion system
NBAA	National Business Aircraft Association
SPF/DB	superplastic forming and diffusion bonding
TOGW	takeoff gross weight
T/W	thrust-to-weight ratio
V_{APP}	approach velocity
W/S	wing loading (gross weight to wing area ratio)

DISCUSSION

The objectives of the study (figure 2) were to define a small supersonic cruise vehicle which could validate the critical supersonic cruise technologies (figure 3) required for a future large-scale supersonic transport based on a 1984 state of the art. In the area of structures, we are referring to the use of SPF/DB and FRATS. Aerodynamics would exploit the use of blended wing/body designs, advanced high-lift designs, and minimization of sonic boom. But the prime technology area of this study was propulsion and the resulting comparison of a GE-21 VCE propulsion system and MMIPS.

Variable cycle engines are a requirement for future supersonic vehicles in order to provide efficient supersonic as well as subsonic cruise and also to meet noise restrictions. The GE-21 gains additional variability over mixed-flow engines by incorporating a split fan, two variable area bypass injectors, and a variable area low-pressure turbine.

There are many possible arrangements of MMIPS as shown in figure 4. All concepts involve a prime turbofan engine with its bypass air fed to a turbojet (satellite) for supersonic cruise or bypassed around for takeoff or subsonic cruise. The one fan plus one satellite (1 x 1) version MMIPS shown in the figure is an in-line concept where the fan core gases are ducted around the satellite and the pressurized bypass air is ducted to or around the satellite. Similarly, the 1 x 2 MMIPS uses one fan plus two satellites and the 2 x 2 MMIPS concept uses two fans and two satellites. Any combination could be used as long as the required airflow availabilities and requirements are matched. For this study, the 1 x 2 MMIPS arrangement was used because of the intended use of an F-101 fan engine with two F-101 cores as the satellites in a near-term MMIPS vehicle. The bypass ratio 2.0 of the F-101 necessitated two core satellites.

The second objective was to make the vehicle environmentally acceptable, which assumes meeting FAR 36 stage III noise levels. These are the rules for all new subsonic aircraft whose applicability was assumed for the supersonic cruise vehicles.

The third objective was to maintain the potential for commercial and military applications. This means the vehicle design would not preclude use as a military aircraft such as a stealthy supercruise fighter and/or bomber with internal stores.

The approach to the study involved configuring a 1984 state-of-the-art vehicle around a GE-21 propulsion system and also around MMIPS. The two vehicles were then compared based on performance, cost, and risk.

Figure 5 indicates the constraints and goals for these vehicles. The cabin size was representative of a FALCON 20 with a 1.7-m (65.in.) cabin height. The flight NBAA profile involved a $M = 2.7$ cruise for a 3,200 nmi range with sufficient fuel to fly to an alternate airport 200 nmi away and land with 1/2 hour of loiter fuel.

Noise goals involved meeting FAR 36 stage III levels and limiting sonic boom overpressure to 24 Pa (0.5 psf), a level possibly permitting overland supersonic flights. Additional constraints limited approach speeds to a maximum of 160 KTS and imposed a balanced field length of 2591 m (8,500 ft).

The initial configuration (figure 6) for the MMIPS vehicle necessitated a single inlet to feed the fan because of the problems of twin duct instability with bifurcated inlets. This centerline bottom inlet configuration with the nose wheel directly in front of it presented a possible large FOD problem. A study (figure 7) was conducted to identify the pros and cons of a top-mounted inlet arrangement. The top-mounted inlet would permit a straight wing carry-through as opposed to rings around the inlet for the bottom inlet. The top-mounted inlet also would permit internal stores (in a bomber version) and a simpler main landing-gear arrangement and retraction. The top-mounted inlet would result in a larger inlet size because of the expansion field over the fuselage, possibly poor inlet flow field, and an additional 3 percent in wave drag. However, based on the FOD problem, the simpler wing structural arrangement, and maintaining military applications, the top-mounted inlet arrangement was used.

The top-mounted inlet MMIPS basepoint vehicle (figure 8) incorporated a droopable nose to minimize wave drag, a variable camber arrow wing, and a folding vertical tail for pitch stability. The fan engine had a bypass ratio of 3.2 and its core exhaust through a 2-D nozzle while the satellites used axisymmetric nozzles.

Because the philosophy of the study was to compare the GE-21 and MMIPS with results applicable to a large supersonic cruise vehicle where multiple MMIPS units would be used, the single top-mounted engine arrangement was used for the GE-21 vehicle as well as for the MMIPS vehicle.

With the basepoint vehicle as the reference, basic data and scaling information were generated by aerodynamics, propulsion, and mass properties, permitting sizing the vehicles to the 3,200 nmi range (figures 9 and 10). All the vehicles on the thrust/weight versus wing-loading plot have been sized to 3,200 nmi, and the contour lines of constant TOGW appear as a thumbprint.

The next step was to constrain the vehicles for takeoff and landing requirements, using maximum dry power for takeoff with the objective of obtaining the minimum weight vehicle. This gave the minimum-weight vehicle, unconstrained for noise and sized for 3,200 nmi and 2591-m (8,500 ft) BFL:

Reducing the power setting for takeoff to obtain less noise requires a larger propulsion system and/or wing area and thus heavier aircraft if the balanced field length of 2591 m (8,500 ft) is maintained. A matrix of vehicles was run with power setting at 100, 85, and 65 percent of dry power. Shown in figure 10 are the effects of the reduced power setting on TOGW while maintaining the same 2591-m (8,500 ft) BFL. The minimum vehicle weight line is also shown for these power settings.

Takeoff trajectories were calculated for a series of vehicles defined by this minimum-weight line. The trajectories and exhaust conditions were sent to General Electric to calculate effective perceived noise levels for various takeoff trajectories.

The results of the noise calculations are shown in figure 11 with TOGW as a function of sideline noise for both MMIPS and GE-21. The bottom right of the plots are for maximum dry power which gives the minimum weight. Moving up and to the left indicates a lower power setting for takeoff. The vertical dashed line indicates the FAR 36 stage III requirement for the 1978 rules.

Figure 12 is a comparison of the vehicles for sideline noise level of 101 EPNdB. Based on the same range, balanced field length, and sideline noise, the MMIPS vehicle was 8 percent heavier than the GE-21 vehicle but had an 8 percent greater subsonic range. The reserve fuel was less for the MMIPS because of the low fuel consumption achievable with this MMIPS cycle and because of the capability of shutting down the satellite engines for loiter and descent.

Figure 13 shows a comparison of the two vehicles, based on the 1978 FAR 36 rules as shown before but also based on the 1969 rules. The impact of the new rules are clearly shown, an increase of 13 percent for the MMIPS vehicle and 10 percent for the GE-21. Figure 14 shows a comparison of the two vehicles at the 1969 requirement and at the 1978 requirement. This comparison is shown strictly for trends. The comparison is somewhat invalid for the GE-21 at 1969 rules, while the MMIPS has oversized satellite engines for the 1978 rules. The MMIPS versus GE-21 comparison at the 101 EPNdB sideline noise level is the more realistic situation.

CONCLUDING REMARKS

Based on the study guide rules and approach used for the comparison of the GE-21 VCE vehicle and a 1 x 2 MMIPS vehicle, the following conclusions (figure 15) are considered applicable to a full-size commercial supersonic cruise vehicle.

1. The MMIPS vehicle was consistently heavier than the GE-21 vehicle.
2. The fan engine of MMIPS represents a difficult removal problem for maintenance.
3. The GE-21 vehicle had a slight performance advantage over the MMIPS vehicle for supersonic cruise, but the MMIPS vehicle had better subsonic performance and shorter landing distances. The better MMIPS performance resulted from shutting down the turbojets during warmup, loiters, subsonic cruise, and descents.
4. The costs for both vehicles were similar. The flyaway costs for the two vehicles were in the \$14 to \$15 million bracket per vehicle based on 1977 dollars and a production run of 200 aircraft.

Additional conclusions, applicable only to a supersonic business jet, were as follows:

1. The failed fan blades of the MMIPS engine could be ingested by the satellites resulting in a complete loss of power. Based on this possibility and the present lack of knowledge to alleviate it, the single 1 x 2 MMIPS would not be redundant. This would not be a problem for the large transport.
2. The single inlet requirement for the MMIPS forced a top-mounted inlet arrangement. This results in additional structural weight for the inlet and an additional 3 percent in wave drag, which also means more weight.

Although it was felt that the approach to the propulsion cycle work was the appropriate one, additional MMIPS and GE-21 cycle work is recommended (figure 16). This is especially recommended for the MMIPS since there are a number of approaches which have not been considered. Although the 1 x 2 MMIPS concept would not be appropriate for supersonic business jet due to lack of engine redundancy, two (1 x 1) MMIPS would eliminate this problem and also provide more design flexibility. This would make possible the elimination of the top-mounted inlet with its increased structural weight and higher wave drag.

The final recommendation is for a market study for the supersonic business jet. Specifically, the study would address the question of whether a sufficient market exists for this type of aircraft to warrant substantial investment by U.S. industry.

- ONLY SUBSONIC CRUISE IN FUTURE?
- FULL SIZE OR RESEARCH VEHICLE?
- RESEARCH VEHICLE ONLY OR ADDITIONAL CAPABILITY?

Figure 1.- Study background.

DEFINE A SUPERSONIC CRUISE RESEARCH/BUSINESS VEHICLE WHICH:

- CAN VALIDATE THE CRITICAL SUPERSONIC CRUISE TECHNOLOGIES
- IS ECONOMICALLY ATTRACTIVE AND ENVIRONMENTALLY ACCEPTABLE
- HAS POTENTIAL FOR COMMERCIAL PRODUCTION OR MILITARY APPLICATIONS

Figure 2.- Study objectives.

1984 STATE OF ART

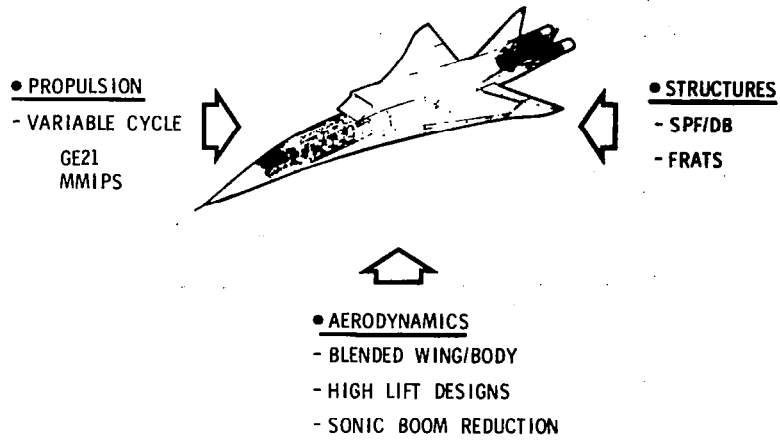


Figure 3.- Validate critical supersonic cruise technologies.

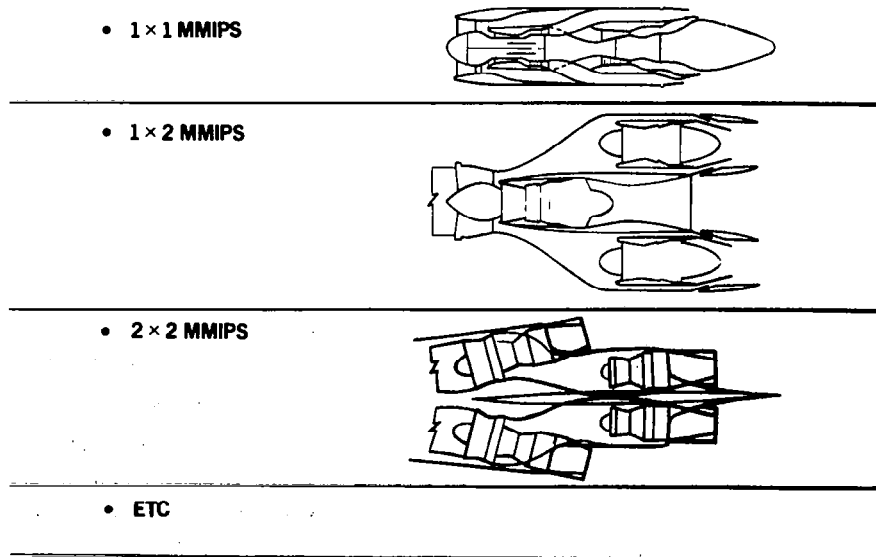
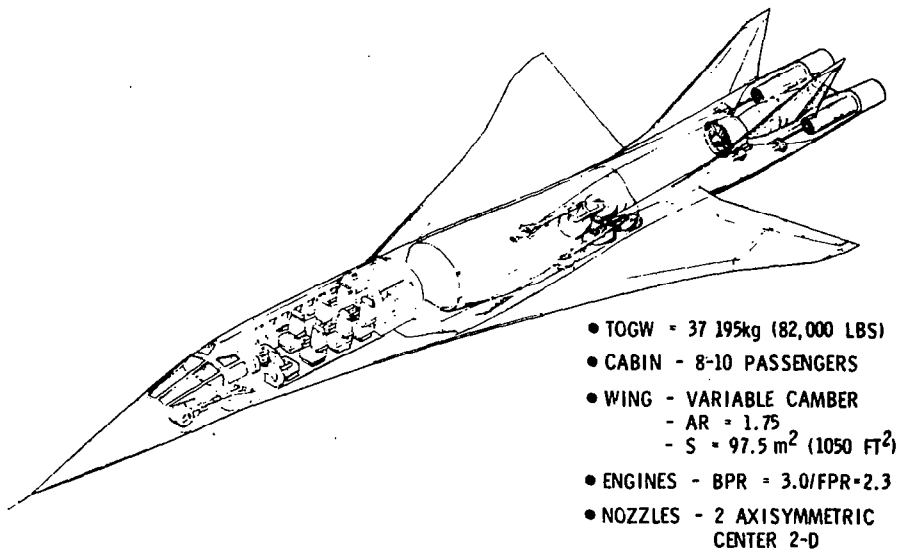


Figure 4.- MMIPS concepts.

- 1984 STATE OF ART
- 8 - 10 PASSENGER BUSINESS JET
- NBAA IFR FLIGHT PROFILE
- TRANSATLANTIC SUPERSONIC RANGE
- TRANSCONTINENTAL SUBSONIC RANGE
- M = 2.7 CRUISE
- NOISE LEVELS WITHIN FAR 36 STAGE III LEVELS
- SONIC BOOM OVER PRESSURE ≤ 24 Pa (0,5 PSF)
- APPROACH ≤ 82 m/s (160 KT)
- BALANCED FIELD LENGTH ≤ 2591 m (8500 FT)
- $(L/D)_{\text{CRUISE}} = 7.5$

Figure 5.- Constraints and goals.



- TOGW = 37 195kg (82,000 LBS)
- CABIN - 8-10 PASSENGERS
- WING - VARIABLE CAMBER
 - AR = 1.75
 - S = 97.5 m² (1050 FT²)
- ENGINES - BPR = 3.0/FPR=2.3
- NOZZLES - 2 AXISYMMETRIC CENTER 2-D

Figure 6.- Supersonic business jet MMIPS basepoint.

• BIFURCATED INLETS ELIMINATED BECAUSE OF POSSIBLE DISTORTION AND TURBULENCE OF FLOW AT COMPRESSION FACE LEADING TO COMPRESSOR STALL OR EVEN FLAMEOUT.

ITEM	LOCATION		COMMENTS
	TOP	BOTTOM	
INLET NOISE	LESS	HIGHER	LITTLE IMPORTANCE
FOD	LESS	MORE	CAN BE ELIMINATED WITH SCREENS
SHOCK LOSSES	—	LESS	—
INT LOSSES	LESS	—	NOT KNOWN
STRUCT INTEGRATION	EASIER	MORE DIFFICULT	WING CARRY-THROUGH
DROPPABLE STORES	YES	NO	—
WEIGHT	—	—	—
LANDING GEAR	DUAL & ST RETRACTION	TANDEM PROBABLE	DUAL - SIMPLE RETRACTION PREFERRED
STEALTHY	YES	NO	IMPORTANT ONLY FOR MILITARY APPL
INLET SIZE	20% LARGER	MINIMUM	—
INLET FLOW FIELD	UNFAVORABLE - POSSIBLY SEPARATED AND/OR VORTICAL FLOW	FAVORABLE	THE BIGGEST QUESTION - HOW SERIOUS
WEATHER EXPOSURE	MAXIMUM	MINIMUM	—
WAVE DRAG	+3%	—	—

Figure 7.- Inlet location comparison.

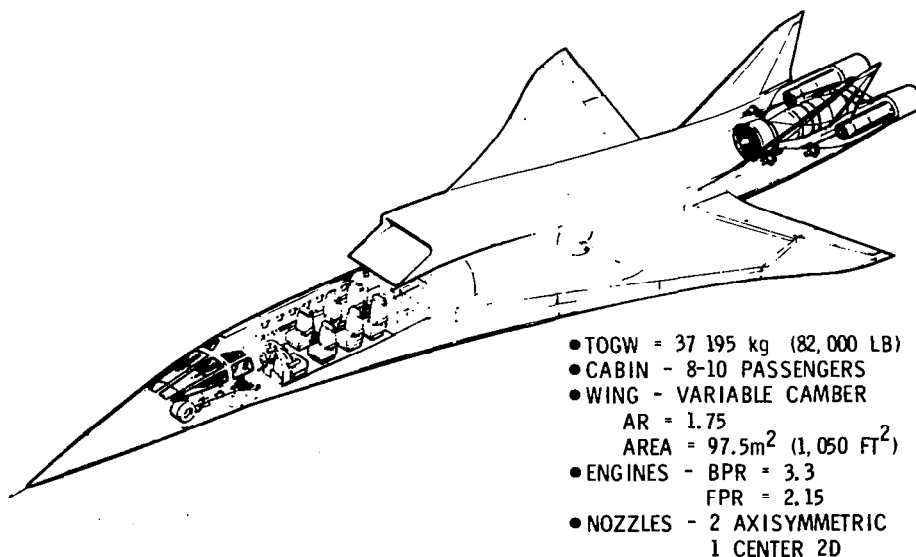


Figure 8.- Supersonic business jet concept.

- SIZE VEHICLES TO 5926 km (3200 NMI) RANGE
- CONSTRAIN VEHICLES BY TAKE-OFF AND LANDING REQUIREMENTS, BUT NOT NOISE
- RESIZE VEHICLES FOR REDUCED POWER TAKEOFFS WHILE MAINTAINING 2591 m (8500 FT) BALANCED FIELD LENGTH
- COMPARE VEHICLES ON LIKE NOISE BASIS FOR
 - PERFORMANCE
 - WEIGHT
 - COST
 - RISK

Figure 9.- Approach.

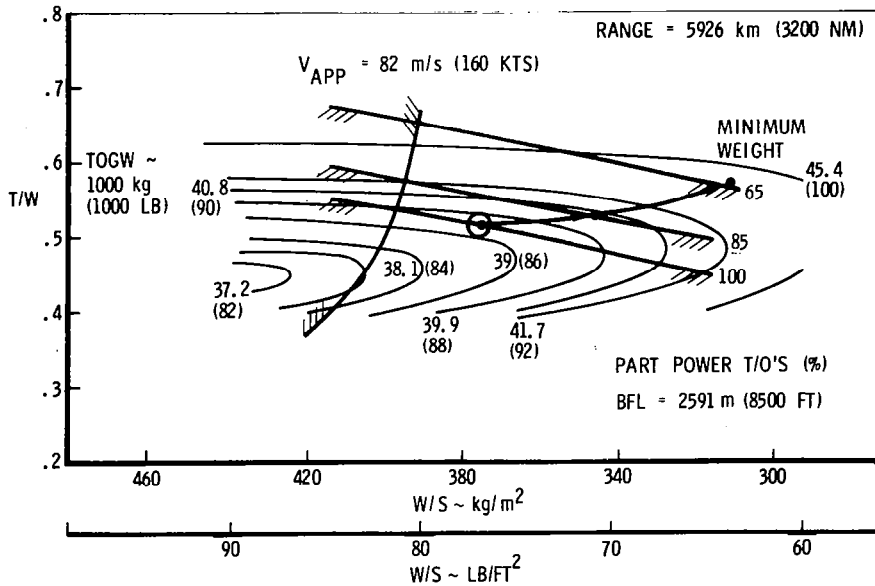


Figure 10.- GE21 vehicle.

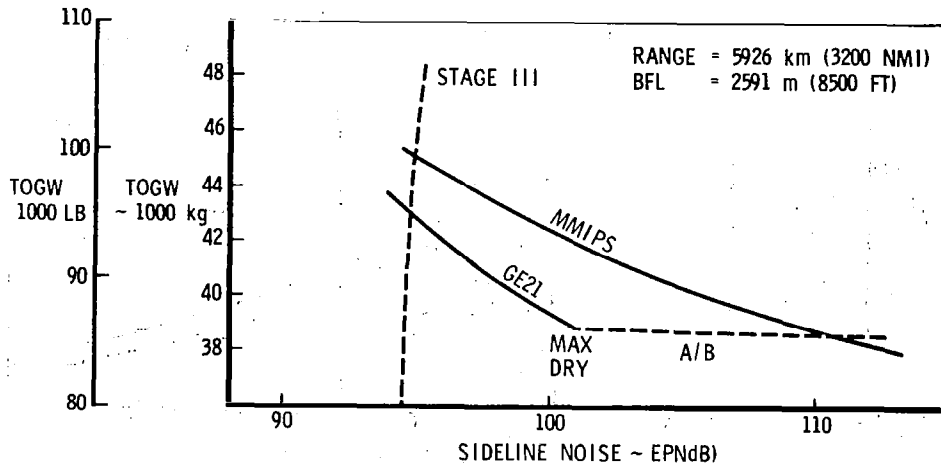


Figure 11.- Sideline noise (1978 rules).

1978 RULES

(Δ = MMIPS - GE21)

ITEM	MMIPS	GE21	Δ
• RANGE-SUPERSONIC-km (NMI)	5926 (3200)	5926 (3200)	0
• BALANCED FIELD LENGTH-m (FT)	2591 (8500)	2591 (8500)	0
• SIDELINE NOISE-EPNdB	101	101	0
• RANGE-SUBSONIC- km (NMI)	4824 (2605)	4482 (2420)	+343 (+185)
• TOGW-1000kg (1000 LB)	42.5 (93.6)	39.2 (86.4)	+3.3 (+7.2)
• TRIP FUEL- kg (LB)	15604 (34400)	15403 (33958)	+200 (+442)
• TAKEOFF DISTANCE -m (FT)	2484 (8150)	2316 (7600)	+168 (+550)
• FAA LANDING DISTANCE -m (FT)	2134 (7000)	2184 (7166)	-51 (-166)
• RESERVE FUEL- kg (LB)	2223 (4900)	2855 (6294)	-632 (-1394)

Figure 12.- Noise-constrained comparison.

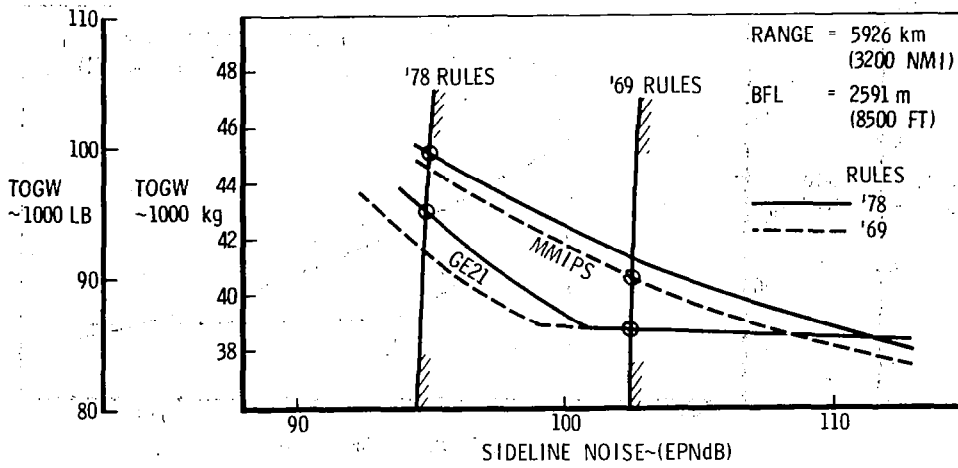


Figure 13.- Sideline noise (1969 and 1978 rules).

(Δ = MMIPS, - GE21)

ITEM	1969 RULES	1978 RULES
• RANGE-SUPERSONIC	0	0
• BALANCED FIELD LENGTH	0	0
• SIDELINE NOISE	0	0
• RANGE-SUBSONIC-km (NMI)	+717 (+387)	+328 (+177)
• TOGW-kg (LB)	+1497 (+3300)	+2767 (+6100)
• TRIP FUEL-kg (LB)	-66 (-145)	+358 (+789)
• TAKEOFF DISTANCE-m (FT)	-60 (-196)	-135 (-442)
• FAA LANDING DISTANCE-m (FT)	-280 (-917)	-121 (-396)

Figure 14.- Noise-constrained comparison meeting requirements.

BASED ON PRESENT STUDY GROUND RULES FOR A COMPARISON OF
THE GE-21 VCE COMPARISON WITH 1 X 2 MMIPS

- APPLICABLE TO FULL SIZE SST:
 1. MMIPS IS HEAVIER
 2. BURIED ENGINE MAINTENANCE PROBLEM FOR MMIPS
 3. GE-21 HAS SLIGHT PERFORMANCE ADVANTAGE EXCEPT FOR SUBSONIC CRUISE
 4. COSTS ARE SIMILIAR

- ALSO APPLICABLE TO BUSINESS JET
 1. 1 X 2 MMIPS HAS NO REDUNDANCY
 2. 1 X 2 MMIPS HAS REQUIREMENT FOR SINGLE INLET (TOP MOUNTED?)

Figure 15.- Recap.

- ADDITIONAL MMIPS AND GE21 CYCLE WORK

- TWO (1 X 1) MMIPS CONFIGURATIONS TO ELIMINATE ENGINE-OUT PROBLEM

- DIFFERENT CONFIGURATION TO MINIMIZE STRUCTURAL AND AERODYNAMIC PENALTIES

- MARKET STUDY FOR SUPERSONIC BUSINESS JET

Figure 16.- Recommendations.

1

THE UNIVERSITY OF CHICAGO

PHYSICS DEPARTMENT

5712 S. UNIVERSITY AVENUE

CHICAGO, ILLINOIS 60637

TEL: 773-936-3700

FAX: 773-936-3701

WWW.PHYSICS.UCHICAGO.EDU

ADMISSIONS OFFICE

5712 S. UNIVERSITY AVENUE

CHICAGO, ILLINOIS 60637

TEL: 773-936-3700

FAX: 773-936-3701

WWW.PHYSICS.UCHICAGO.EDU

PHYSICS DEPARTMENT

5712 S. UNIVERSITY AVENUE

CHICAGO, ILLINOIS 60637

TEL: 773-936-3700

FAX: 773-936-3701

WWW.PHYSICS.UCHICAGO.EDU

ADMISSIONS OFFICE

5712 S. UNIVERSITY AVENUE

CHICAGO, ILLINOIS 60637

TEL: 773-936-3700

FAX: 773-936-3701

WWW.PHYSICS.UCHICAGO.EDU

PHYSICS DEPARTMENT

5712 S. UNIVERSITY AVENUE

CHICAGO, ILLINOIS 60637

TEL: 773-936-3700

FAX: 773-936-3701

WWW.PHYSICS.UCHICAGO.EDU

ADMISSIONS OFFICE

5712 S. UNIVERSITY AVENUE

CHICAGO, ILLINOIS 60637

TEL: 773-936-3700

FAX: 773-936-3701

WWW.PHYSICS.UCHICAGO.EDU

PHYSICS DEPARTMENT

5712 S. UNIVERSITY AVENUE

CHICAGO, ILLINOIS 60637

TEL: 773-936-3700

SCR '79 CONFERENCE ATTENDEES

National Aeronautics & Space Administration Washington, DC

G. G. Kayten
J. Levine
P. E. Renas
J. A. Suddreth

National Aeronautics & Space Administration Ames Research Center Moffett Field, CA

S. B. Anderson

National Aeronautics & Space Administration Dryden Flight Research Center Edwards, CA

B. M. Kock
R. H. Smith

National Aeronautics & Space Administration Langley Research Center Hampton, VA

W. J. Alford, Jr.	D. E. Fetterman, Jr.	R. W. Leonard
R. R. Anderson	M. C. Fischer	J. S. Levine
Z. T. Applin	T. Folsche (Retired)	L. K. Loftin, Jr. (Ret.)
H. T. Baber, Jr.	W. E. Foss, Jr.	R. J. Mack
T. T. Bales	G. L. Gentry, Jr.	D. V. Maddalon
R. L. Barger	W. D. Grantham	D. J. Maglieri
P. J. Bobbitt	H. F. Hardrath	R. J. Margason
R. E. Bower	R. V. Harris, Jr.	V. R. Mascitti
E. Boxer	L. E. Hasel	R. R. McWithey
A. L. Braslow	D. P. Hearth	D. S. Miller
W. A. Brooks, Jr.	A. R. Heath, Jr.	J. K. Molloy
L. W. Brown	R. R. Heldenfels	H. G. Morgan
C. J. Camarda	W. G. Henry	C. E. K. Morris, Jr.
H. W. Carlson	H. H. Heyson	O. A. Morris
D. L. Clemmons, Jr.	E. L. Hoffman	S. J. Morris, Jr.
P. L. Coe, Jr.	S. Hoffman	M. T. Moul
D. W. Conner	J. C. Houbolt	R. J. Muraca
P. F. Covell	H. H. Hubbard	H. N. Murrow
R. G. Culpepper	C. M. Jackson, Jr.	M. J. Neubauer, Jr.
J. R. Davidson	L. S. Jernell	T. D. Norum
J. G. Davis, Jr.	J. L. Johnson, Jr.	W. I. Oehman
S. M. Dollyhigh	W. B. Kemp, Jr.	S. L. Padula
C. Driver	A. C. Kyser	S. P. Pao
W. D. Erickson	D. L. Lansing	
J. W. Fenbert		

Langley Research Center (Continued)

P. J. Perkins	W. C. Sawyer	L. P. Tosti
C. C. Poe, Jr.	J. M. Seiner	R. L. Trimpi
E. C. Polhamus	B. L. ShROUT	A. H. Whitehead, Jr.
J. P. Raney	M. J. Stuart	R. D. Witcofski
R. H. Rhyne	J. Sobieski	E. J. Wolff (Retired)
A. W. Robins	M. L. Spearman	W. W. Wong
J. C. Robinson	B. A. Stein	L. P. Yip
D. M. Royster	R. T. Taylor	J. C. Yu
D. R. Rummier	J. L. Thomas	

National Aeronautics & Space Administration
Lewis Research Center
Cleveland, OH

R. A. Duerr	W. L. Stewart
A. G. Powers	J. R. Stone
R. W. Schroeder	R. J. Weber

GOVERNMENT

Office of Technology Assessment
U. S. Congress
Washington, DC

L. V. Dickinson, Jr.
R. L. Maxwell

Federal Aviation Administration
Washington, DC

J. O. Powers
N. Sundararaman

City of Los Angeles
Department of Airports
Los Angeles, CA

W. V. Collins

AEROSPACE COMPANIES

The Boeing Company
Seattle, WA

D. B. Arnold
H. Bjornestad
H. A. Dethman
R. J. Gornstein
C. L. Hendricks
P. E. Johnson
R. June

R. M. Kulfan
G. W. N. Lampard
M. E. Manro
J. A. Matter
W. D. Middleton
F. D. Neumann
J. N. Nylander

W. E. Ohlson
J. V. O'Keefe
P. L. Sandoz
A. Sigalla
E. D. Tuseth
J. Vachal
D. West
J. W. Whitten

The Boeing Company
Washington, DC

R. B. Light

The Boeing Company
Hampton, VA

W. E. Parker

British Aerospace
Bristol, England

C. S. Leyman

Calspan Corporation
Buffalo, NY

K. D. Bird
C. R. Chalk
A. E. Schelhorn

Douglas Aircraft Company
Long Beach, CA

J. B. Feather
J. E. Fischler
R. D. FitzSimmons

E. S. Johnson
R. A. McKinnon
G. S. Page

R. L. Roensch
W. T. Rowe
F. R. Wilson

McDonnell Douglas Corporation
Hampton, VA

J. R. Temple

McDonnell Douglas Corporation
St. Louis, MO

R. N. Herring
D. H. Miller

Fairchild Republic
Farmingdale, NY

H. Kuo
A. D. Matarazzo

Gates Learjet
Wichita, KS

W. M. Gertsen

General Dynamics
Fort Worth, TX

R. G. Bradley
P. C. Leamer

General Electric Company
Lynn, MA

J. A. Ebacher
D. A. Grudier
B. Strachan
J. W. Vdoviak

General Electric Company
Evendale, OH

R. D. Allan
P. R. Knott
J. R. Osani

General Electric Aircraft Engine
Company
Cincinnati, OH

W. H. Heiser

General Electric Aircraft Engine
Company
Hillsboro, OH

J. I. Hope

General Electric Company
Newport News, VA

J. F. Falta

Grumman Aerospace Corporation
Bethpage, NY

G. Daferno
W. Kohlhoff
R. C. Meyer
A. Sciafani

Kentron International Incorporated
Hampton Technical Center, an LTV Company

D. S. Bevan	D. W. Gross	J. E. Price
G. R. Bogucki	W. F. James	J. W. Russell
R. A. DaCosta	P. Kidder	P. M. Smith
J. DeYoung	W. L. Kurtze	E. E. Swanson
B. F. Downie	W. A. Lovell	K. B. Walkley
G. J. Espil	G. L. Martin	G. F. Washburn
D. L. Everest, Jr.	J. G. McClure	S. D. Wilhoit
W. T. Freeman	L. A. McCullers	G. A. Wrenn
W. H. Greene	A. S. Potosky	

Lockheed-California Company
Burbank, CA

B. T. Averett	G. Carichner	I. F. Sakata
L. H. Bangert	J. S. Clauss, Jr.	R. E. Smith
F. A. Bruckman	M. K. Guess	

Lockheed Aircraft Corporation
Hampton, VA

W. E. Farrar

Pratt & Whitney Aircraft
East Hartford, CT

J. Godston	R. B. Hunt	W. H. Sens
G. Grafton	C. A. Nix, Jr.	W. Usab
R. W. Hines	R. E. Owens	J. S. Westmoreland
V. R. Holcombe		

Pratt & Whitney Aircraft
West Palm Beach, FL

J. Sabatella
H. Snyder

Pratt & Whitney Aircraft
Hampton, VA

J. O. Wagner

Pratt & Whitney Aircraft
Rocky River, OH
G. L. Kosboth

Rohr Industries
Chula Vista, CA
J. S. Burton

Rockwell International Corporation
Los Angeles, CA
L. A. Ascani
E. Bonner
R. J. Kelly
J. K. Pulley

Rockwell International Corporation
Thousand Oaks, CA
H. Hamilton
N. E. Paton

Titanium Metals Corporation of America
Pittsburg, PA
H. Rosenberg

Vought Corporation
Dallas, TX
R. G. Musgrove
W. A. Poindexter
D. B. Schoelerman

Wyle Laboratories
Hampton, VA
A. L. Abrahamson

USAF

TAC Headquarters
Langley Air Force Base, VA
M. R. Copp

AFSC Liaison Office
Langley Air Force Base, VA
Lt. Col. H. V. Neher
N. G. Vretakis

Rockwell International Corporation
Columbus, OH
V. R. Stewart

Rockwell International Corporation
Hampton, VA
J. G. Allen

Vought Corporation
Hampton, VA
E. M. Russell

SAC Headquarters
Offutt Air Force Base, NE
Captain D. K. Mang

Peterson Air Force Base, CO
Major R. T. Wilbanks

Wright-Patterson Air Force Base, OH

J. Barry, Jr.
W. F. Imfeld
F. Janik
E. Miller

W. M. O'Conner
G. E. Poth
J. Richens
R. L. Scarsella

C. J. Schmid
D. Smith
R. R. Smith
H. Stump
J. L. Terry

UNIVERSITIES

George Washington University
Washington, DC

D. D. Baals
M. R. Nichols
J. L. Whitesides

Old Dominion University
Norfolk, VA

D. M. Rao

Virginia Polytechnic Institute &
State University
Blacksburg, VA

G. R. Inger
J. A. Schetz

Massachusetts Institute of
Technology
Cambridge, MA

R. Ausrotas

Rensselaer Polytechnic Institute
Troy, NY

H. T. Nagamatsu

1. Report No. NASA CP-2108, Part 2		2. Government Accession No.		3. Recipient's Catalog No.	
4. Title and Subtitle SUPERSONIC CRUISE RESEARCH '79				5. Report Date March 1980	
				6. Performing Organization Code	
7. Author(s)				8. Performing Organization Report No. L-13385	
9. Performing Organization Name and Address NASA Langley Research Center Hampton, VA 23665				10. Work Unit No. 533-01-43-01	
				11. Contract or Grant No.	
12. Sponsoring Agency Name and Address National Aeronautics and Space Administration Washington, DC 20546				13. Type of Report and Period Covered Conference Publication	
				14. Sponsoring Agency Code	
15. Supplementary Notes					
16. Abstract					
<p>Since 1972 the Supersonic Cruise Research (SCR) Program has provided an accelerated and focused technology effort which has resulted in development of improved analytical techniques, design procedures, and an expanded experimental data base. Progress made in the first 4 years was highlighted in a conference at Langley Research Center in 1976 (see NASA CP-001, Parts 1 and 2).</p> <p>Subsequent to the 1976 conference, NASA had conducted and monitored additional supersonic cruise vehicle studies and enhanced the advanced supersonic technology data base through further tests. Significant achievements in the interim since the previous conference were reported to the technical community at the SCR '79 Conference held at Langley Research Center, November 13-16, 1979. This document is a compilation of papers, authored by representatives of airframe and engine manufacturers, the Federal Aviation Administration, three NASA research centers, and the Office of Technology Assessment (Congress of the United States), which were presented at the latter Conference.</p>					
17. Key Words (Suggested by Author(s)) Aerodynamics Aircraft design, testing, and performance Aircraft propulsion and power Aircraft stability and control			18. Distribution Statement For U.S. Government agencies and their contractors only. Date for general release March 1981. Refer questions regarding release of this report to NASA Headquarters, Code RJH-2, Jack Suddreth Subject Category 01		
19. Security Classif. (of this report) Unclassified		20. Security Classif. (of this page) Unclassified		21. No. of Pages 414	22. Price