

STUDIES OF SOME UNCONVENTIONAL SYSTEMS FOR SOLVING
VARIOUS LANDING PROBLEMS

T. J. W. Leland, J. R. McGehee, and R. C. Dreher
NASA Langley Research Center

SUMMARY

A review of three research programs which seek solutions to various landing problems through unconventional systems is presented in this paper. The programs, discussed individually, include first, the air cushion landing system (ACLS) where current efforts are concentrated on development of adequate ACLS braking and steering systems and on improved understanding of scaling laws and behavior. The second program is concentrated on use of a wire brush skid as a drag-producing device, which has been shown to have good friction coefficients and reasonable wear rates at ground bearing pressures up to 689 kPa (100 psi) and forward speeds up to 80 km/hr (50 mph). The third program shows great promise in an active control landing gear where significant airframe load reductions are possible during landing impact and subsequent rollout. Work in this area is continuing with studies concentrated on adaptation of the landing gear to a tactical fighter aircraft.

INTRODUCTION

In any discussion of the landing and ground handling problems of aircraft, particularly those with unusual mission requirements, the need often becomes apparent to look beyond the current, conventional systems to more unorthodox unconventional systems which may have some benefit in certain applications. This paper will discuss those current landing gear system research programs which might fall into the unconventional category, each in its own way exploring new or improved landing system concepts which address current or potential aircraft landing/ground handling problems. The most unconventional of these programs, the air cushion landing system, will be discussed first, followed by a presentation of studies of a wire brush skid as a landing gear or a drag-producing device. The last program to be discussed is an active control landing gear and will include some preliminary test results. Included in each discussion will be a status summary of current efforts and an indication of future directions.

AIR CUSHION LANDING SYSTEMS

General.- The air cushion landing system (ACLS) is designed to replace the conventional aircraft landing gear with a flexible toroidal trunk resembling, in the simplest version, a rubber life raft turned upside down and attached directly to the bottom fuselage of the aircraft. As shown in the sketch of

figure 1, low-pressure, high-volume air is introduced into the trunk through ducts in the fuselage, and the air is exhausted through peripheral jet holes located in the bottom of the trunk. A portion of this air is trapped in the cavity to provide the necessary lifting force, while the rest of the air is dumped outboard and provides an effective air bearing between trunk and ground. The result is a vehicle having nearly zero ground friction and an extremely low ground bearing pressure of perhaps 7-14 kPa (1-2 psi), which makes possible a wide choice of potential landing and take-off sites including water.

An ACLS may take a variety of forms, as shown in figure 2, depending upon the aircraft size, configuration and mission requirements. Larger aircraft, particularly, may require two or more trunk systems, but no very severe structural penalties ensue since the ACLS distributes the airframe load and no "hard points" are required for attachment as with the conventional landing gear. The trunk or trunks are of course retracted or otherwise stowed during flight, and several workable schemes have been proposed to accomplish this, as in references 1 and 2 for examples. One major ground operational problem for which no completely satisfactory solution exists is development of adequate steering and braking controls for an ACLS, and to study this and other problems the specialized test vehicle shown in the center of figure 2 was developed at Langley.

ACLS Test Vehicle.- The vehicle, shown in figure 2 with a small ACLS installed and in figure 3 supported by a larger ACLS, is a much-modified airboat 5.5 m (18 ft) in length and weighing approximately 2360 kg (5200 lb). A retractable tricycle landing gear taken from a light aircraft was installed as shown to provide a safety back-up in case of an ACLS failure or for steering and braking in case of emergency. Forward propulsion is provided by a 250 hp aircraft engine and propeller at the rear, as shown, and a small jet engine is installed amidships to provide a bleed air source for the ACLS fan. The vehicle was developed primarily to study various braking and steering schemes suitable for ACLS, and is large enough, and portable enough, so that such schemes can be tested in potential real-world conditions of paved or unpaved runways, sod fields, sand, and water.

The air cushion landing system shown installed on the vehicle in figure 3 is a generalized concept involving four separate trunks of circular cross-section arranged in a rectangular planform, each trunk supplied with air from a plenum through the flexible ducts visible in the figure. A hub-turbine fan located on the plenum is used to convert high-pressure, low-volume jet engine bleed air to the low-pressure, high-volume air required for ACLS operation. The four-trunk system was chosen to provide a stable ACLS for steering and braking studies, and also for the inherent control possibilities offered by the separate air supply to each trunk.

An additional advantage of the ACLS test vehicle is the relative ease with which major configuration changes may be made, or any sort of desirable structure or apparatus added on. This feature is illustrated by the photograph of figure 4 which shows the installation of a fixed retractable wheel and tire installed as a steering aid in the ACLS cavity. The wheel is down-loaded to a maximum of about 90 kg (200 lb) with a double-acting hydraulic cylinder, which also serves to retract the assembly. Taxi tests had shown

that the air rudders located in the propeller slipstream could, under the influence of a crosswind or runway crown, change with ease the heading of the vehicle but not its direction of travel. It was thought that a single, centrally located, lightly loaded tire might provide sufficient lateral resistance so that the rudders could change both heading and direction of travel. Qualitatively this proved to be the case, but detailed quantitative studies have been interrupted by a failure of the hub-turbine fan and no results can be shown in this paper.

Scale Model Studies.- As an aid to better understanding of air cushion landing system behavior and to provide initial design guidelines, a research contract was awarded to Foster-Miller Associates to develop a rational mathematical model and computer simulation of a generalized ACLS. The results of this study, summarized in reference 3, were quite promising, and to provide experimental corroboration, as well as a first approximation to scaling studies, a 1/3-scale model of the ACLS test vehicle was constructed as shown in figure 5. The model is roughly 1.5 m (5 ft) long and .9 m (3 ft) wide, and comparison with figure 3 will show the physical resemblance between 1/3-scale and full-scale trunks and air supply system. The computer simulation was adjusted to represent the 1/3-scale model, and replicate computer runs and experimental model tests were conducted. A sample comparison of results is shown in figure 6 for a 15 cm (6 in.) drop at 0° pitch attitude and indicates reasonably good agreement between analysis and experiment. The differences observed may be due to an incorrect scaling of trunk material stiffness or of the trunk air supply characteristics, both of which are extremely difficult to model adequately. This study will be continued for a wide variety of test conditions and, as soon as the full-scale ACLS test vehicle becomes available, replicate tests will be conducted in an attempt to define basic scaling relationships through comparison of math model, 1/3-scale model and full-scale results.

WIRE BRUSH SKIDS

General.- Skids have been used as landing gear from the first days of aviation, with the most recent adaptation probably being for research aircraft such as the X-15. In most cases use of the skid was dictated, not by any inherent benefit, but as a compromise solution forced by other operating problems (weight, simplicity, thermal protection, stowage volume, etc.). Skid research conducted by NASA in the early sixties (ref. 4) involving studies of many different types of skid materials showed that a skid constructed of wire brushes had a surprisingly good friction-speed relationship compared with flat-plate skids. Revived interest in skids as a drag-producing device led to further studies of the characteristics of wire brush skids at bearing pressures much higher than the 152 kPa (22 psi) of reference 4 since in modern applications the weight and volume of a skid should be as small as possible.

Skid Research Program.- This paper will summarize the results of the skid program described in detail in reference 5, wherein wire brush skids were constructed of 17-7 PH stainless steel spring wire as shown in figure 7. Two

different diameter wires and two bundle sizes were employed to explore the effects of wire density, and the instrumented tire test vehicle was adapted as shown in figure 8 to test the skids on several runway surfaces at Wallops Flight Center, at forward speeds up to 80 km/hr (50 mph). Loading on each skid was arranged to give actual ground bearing pressures of 345, 517, and 689 kPa (50, 75, and 100 psi), and measurements were made of developed skid friction and skid wear over sliding distances up to 1585 m (5200 ft). During the test program an attempt was also made to determine the extent of runway surface damage due to skid operations.

A sample of the test results of this program is presented in figure 9 where friction coefficient and wear index as a function of forward speed for one of the skids operating at two bearing pressures on two surfaces is shown. The figure shows that the drag friction coefficient is relatively insensitive to forward speed, but is affected by bearing pressure and by runway surface character. The wear index is seen to increase moderately with bearing pressure, as might be expected, and again a dependency on runway surface character is noted.

In evaluating the utility of a wire brush skid as a drag producer, it should be borne in mind that the drag friction coefficients are constant; that is, they are not constantly cycling as is the case with a braked wheel and tire under anti-skid control. Further, tests showed that the friction coefficient was unaffected by water on the runway. These facts indicate that, for certain applications (and braking for an ACLS comes immediately to mind), a wire brush skid is an extremely attractive alternative braking device and could conceivably replace wheel brakes on a conventional landing gear as used on returning spacecraft.

ACTIVE CONTROL LANDING GEAR

General.- Ground loads imposed on an airplane are important factors in the dynamic loading and hence fatigue damage of the airframe structure, and ground-induced structural vibrations may also be a source of crew and passenger discomfort. Analytical studies (ref. 6) have determined the feasibility of applying active loads control to the main landing gear to limit the ground loads transmitted to the airframe. As shown in figure 10, the analysis was capable of handling many of the non-linear parameters encountered during ground operations and featured a hydraulic control in series with the main gear oleo-pneumatic strut. The results indicated that significant load reductions were possible using this scheme, and so the analysis was used as a design tool in constructing the hardware necessary to provide an experimental validation of the analytical results.

Basic System Description.- The active control landing gear concept is shown schematically in figure 11 to consist essentially of a modified oleo-pneumatic landing gear strut, an electronic controller, and a hydraulic servo valve. The landing gear strut is modified as shown by an annular, fluid-

carrying tube running from the top of the strut to well down into the fluid portion of the strut. This annular tube is connected through the servo-valve to the hydraulic system, with the position of the servo valve spool determining whether high-pressure fluid is added to or removed from the strut. The spool is positioned by the electronic controller (see ref. 7), the heart of the system, which compares the kinetic energy at landing impact (a function of airplane mass and sink rate) with the work capability remaining in the strut (a function of strut stroke and strut hydraulic pressure). When these two energies are equal, a limit force command is generated and the controller acts to position the servo valve spool to maintain this value during the remainder of the impact. During the roll-out phase of the landing, a control bias returns the gear to the design stroke and will tend to maintain this level during ground operation.

Experimental Test Program.- For the experimental program a hand valve was added as shown in figure 11 to permit both conventional (passive) and active landing gear studies to be conducted by isolating the active portion of the system. The landing gear strut was taken from a light twin-engine aircraft, modified as shown in figure 11, and installed on the landing loads track test carriage as shown in figure 12. The fixture included a rigid airframe representation restricted to vertical and pitching motions, and a series of tests was conducted at various forward and sink speeds, and initial pitch attitudes. A sample of preliminary results is shown in figure 13 comparing active and passive landing gear impacts for the conditions shown, where a 19% c.g. force reduction was achieved by the active control system. This reduction was accomplished at the expense of added strut stroke, as shown, but the increased stroke required was much less than half the available stroke.

Similar striking load reductions are possible during the roll-out phase of the landing as shown in figure 14, where c.g. force reduction of 62% is obtained when the landing gear encounters the relatively uneven runway surface shown at the bottom of the figure. Results such as these are extremely encouraging, and the program is going forward with design of modifications necessary to install an active control landing gear on a tactical fighter aircraft.

CONCLUDING REMARKS

This paper has presented a review of three research programs which seek solutions to various landing problems through unconventional systems. The first, and most unconventional, of these is the air cushion landing system (ACLS), where current efforts are concentrated on development of adequate braking and steering systems and an improved understanding of scaling laws and behavior. The second program is concentrated on use of a wire brush skid as a drag producing device, which has been shown to have good friction coefficients and reasonable wear rates at ground bearing pressures up to 689 kPa (100 psi) and forward speeds up to 80 km/hr (50 mph). The third program shows great promise in an active control landing gear where significant load reductions are possible during landing impact and subsequent rollout. Work in this area

is continuing with studies concentrated on adaptation of the active control landing gear to a tactical fighter aircraft.

REFERENCES

1. Buzzard, Wallace C.; Perez, David J.; Wyen, Gerald; and Randall, (CAF) John, Maj.: Tests of the Air Cushion Landing System on the XC-8A. AFFDL-TR-78-61, April 1978.
2. Saha, Hrishikesh, Compiler: Air Cushion Landing Systems. Univ. of Tennessee Space Inst., c. 1973.
3. Boghani, A. B.; Captain, K. M.; and Wormley, D. N.: Heave-Pitch-Roll Analysis and Testing of Air Cushion Landing Systems. NASA CR-2917, February 1978.
4. Dreher, Robert C.; and Batterson, Sidney A.: Coefficients of Friction and Wear Characteristics for Skids Made of Various Metals on Concrete, Asphalt, and Lakebed Surfaces. NASA TN D-999, 1962.
5. Dreher, Robert C.: Friction and Wear Characteristics of Wire-Brush Skids. NASA TN D-1495, 1979.
6. McGehee, John R.; and Carden, Huey D.: Analytical Investigation of the Landing Dynamics of a Large Airplane With a Load-Control System in the Main Landing Gear. NASA TP-1555, 1979.
7. Ross, Irving; and Edson, Ralph: An Electronic Control for an Electro-hydraulic Active Control Aircraft Landing Gear. NASA CR-3113, 1979.

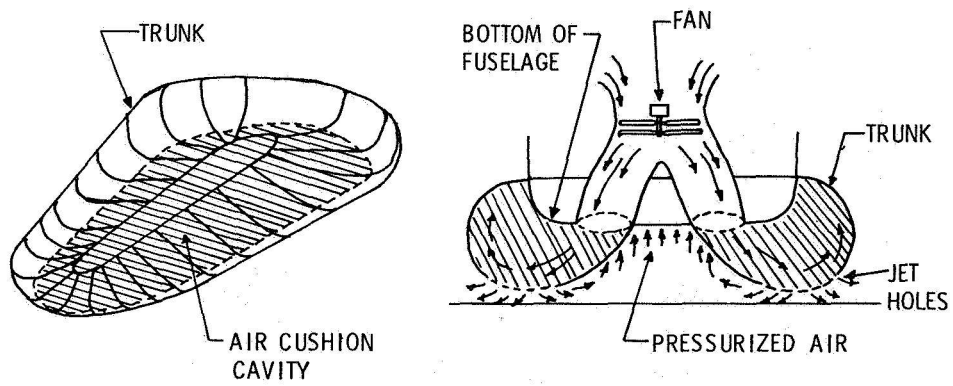

Figure 1.- Schematic representation of an air cushion landing system.

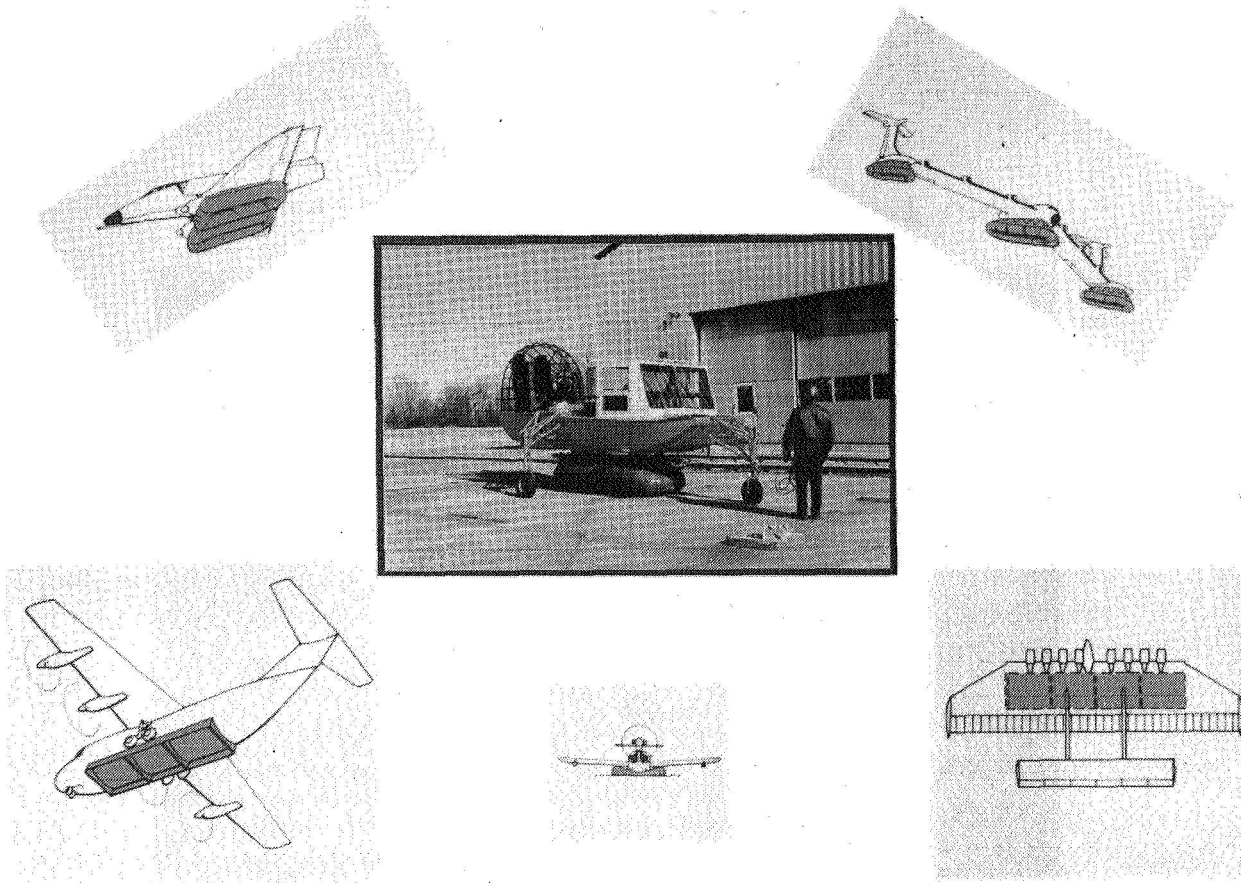

Figure 2.- Some advanced air cushion landing system configurations.

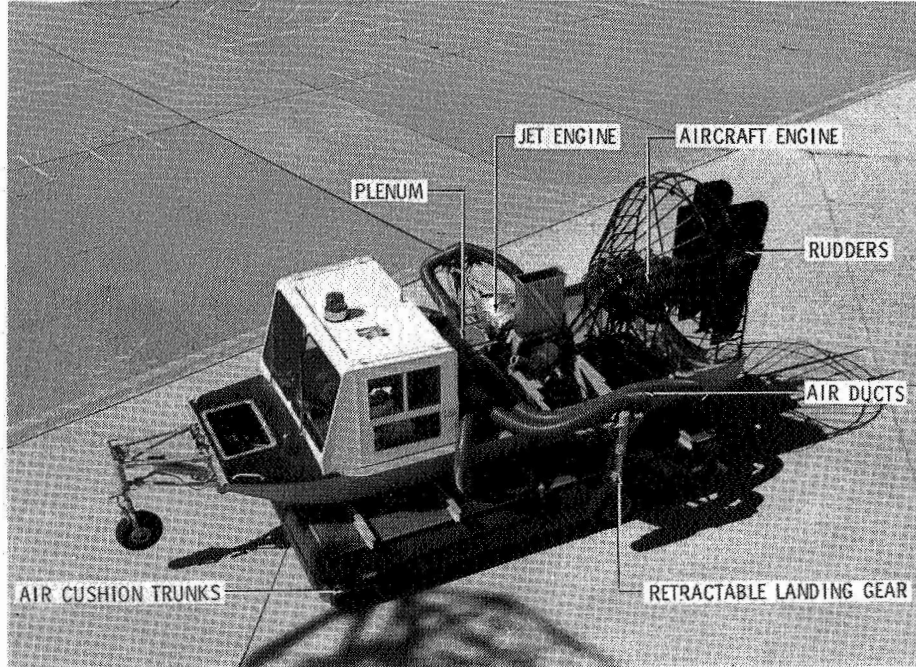

Figure 3.- Air cushion landing system test vehicle.

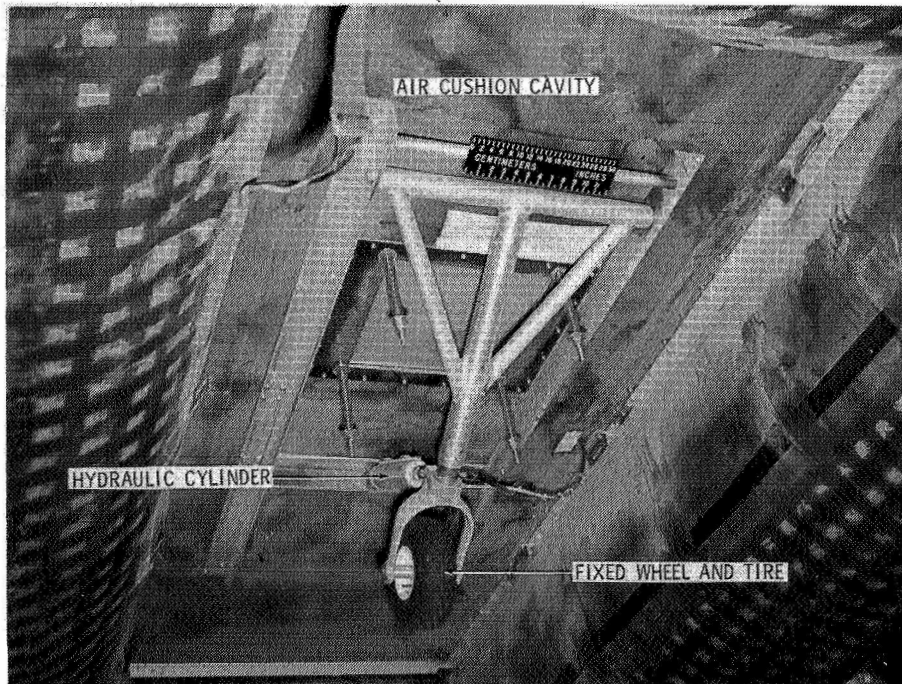

Figure 4.- Auxiliary wheel for ACLS steering.

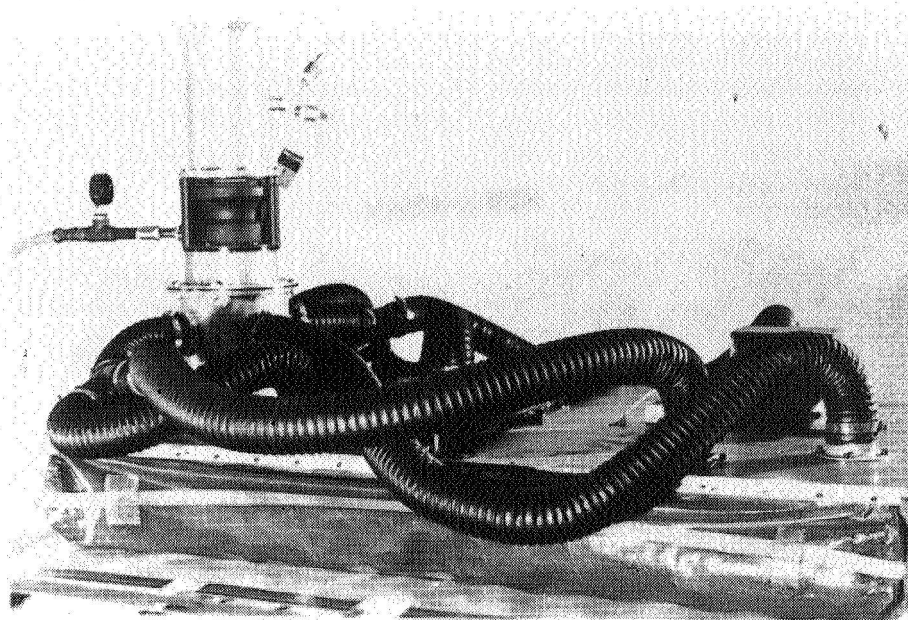

Figure 5.- Photograph of 1/3-scale model ACLS test vehicle.

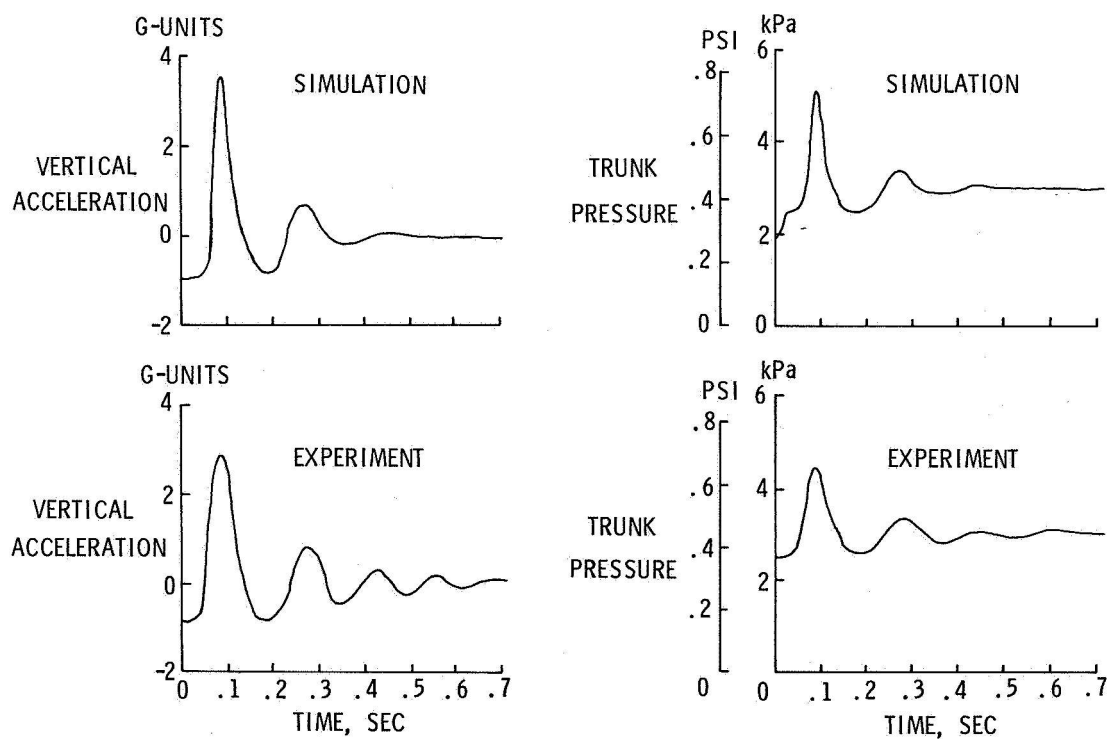

Figure 6.- Comparison of analytical and experimental test results of 1/3-scale model ACLS test vehicle. Static drop height = 15 cm (6 in); pitch attitude = 0°.

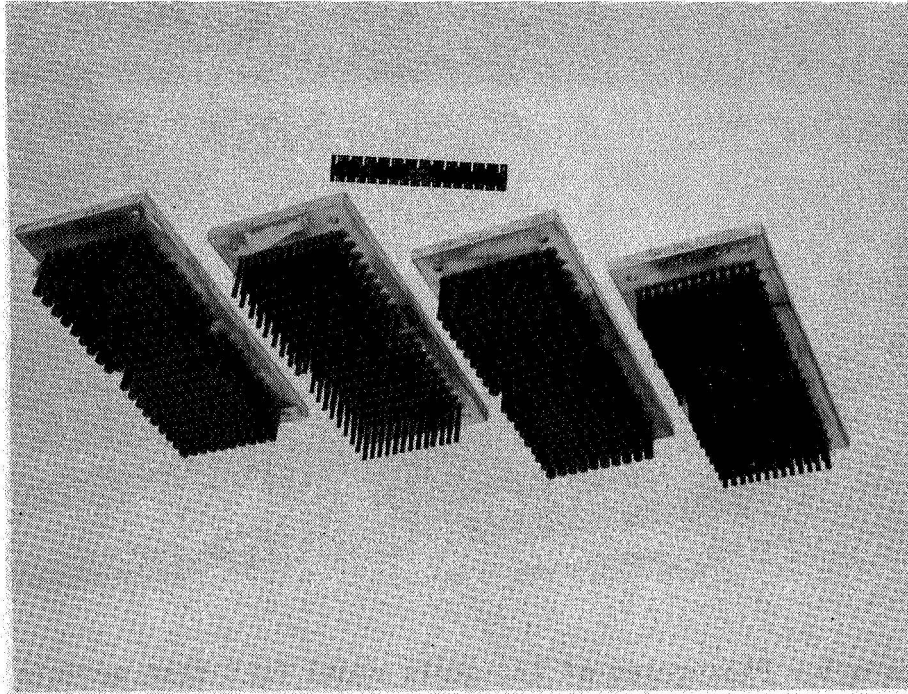

Figure 7.- Wire brush skids used in the research program.



Figure 8.- Instrumented ground vehicle as used for wire brush skid tests.

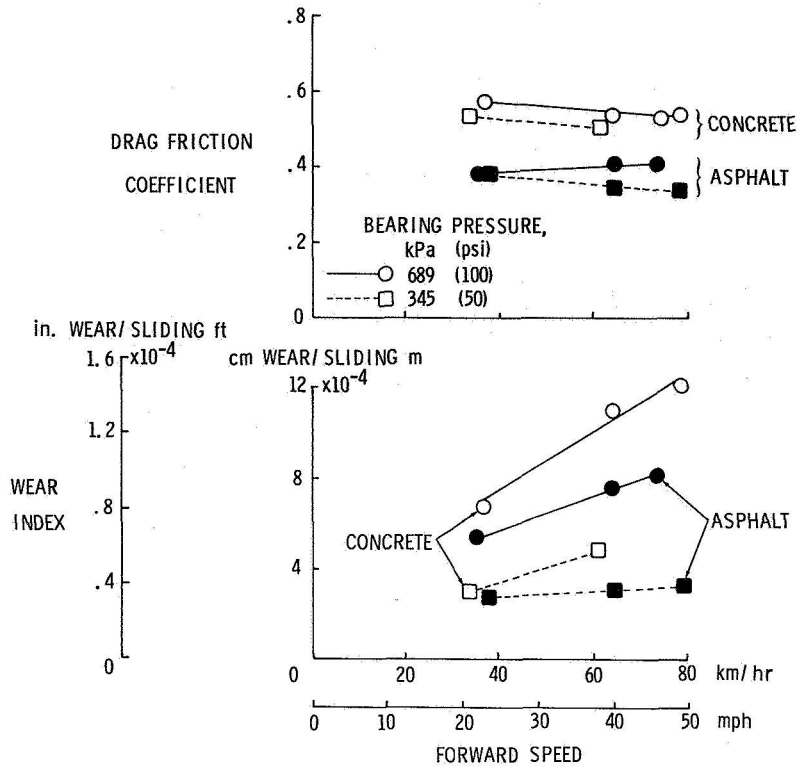

Figure 9.- Drag friction coefficient and wear index for a wire brush skid.

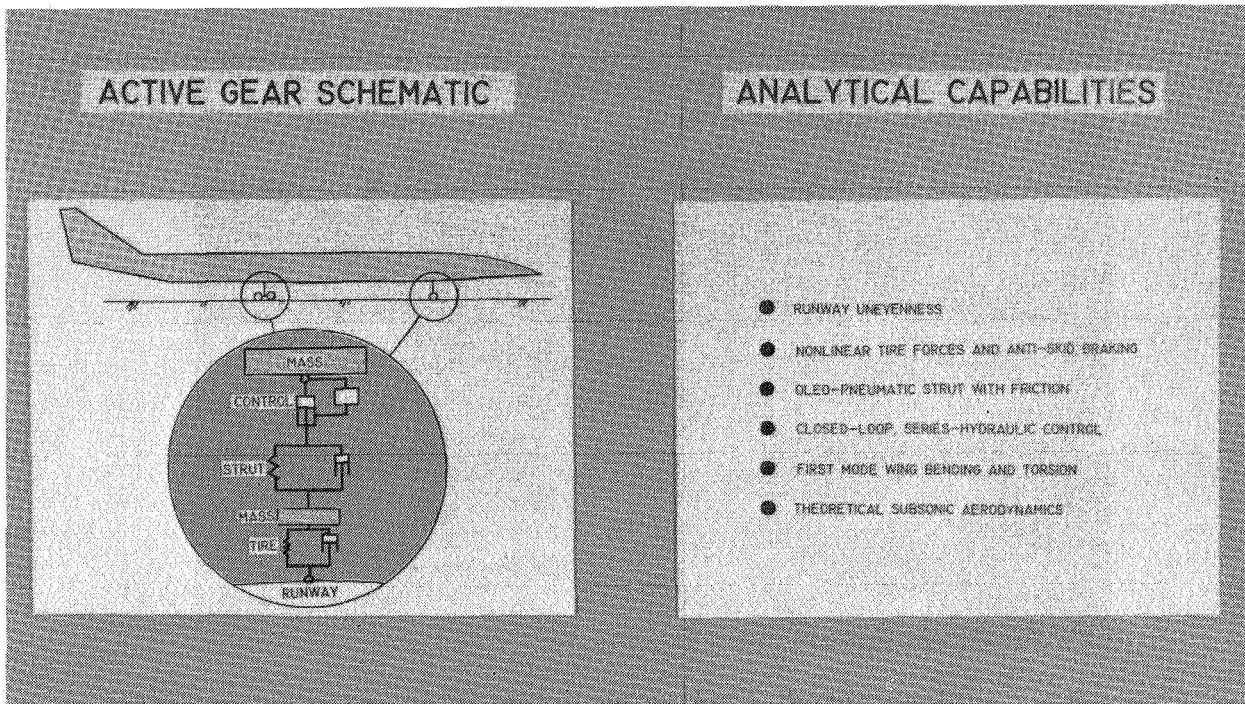

Figure 10.- Active control landing gear analysis.

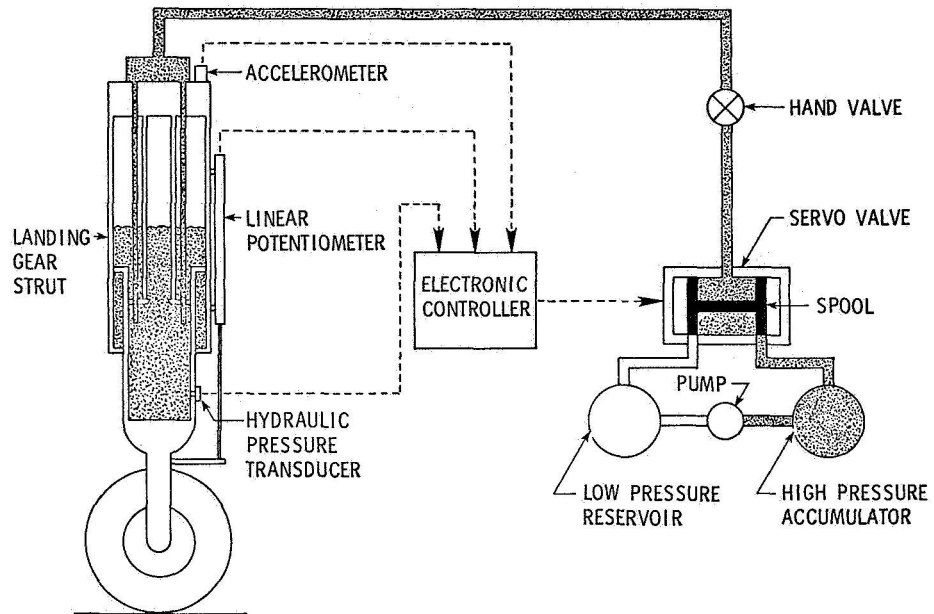

Figure 11.- Active control landing gear experimental test schematic.

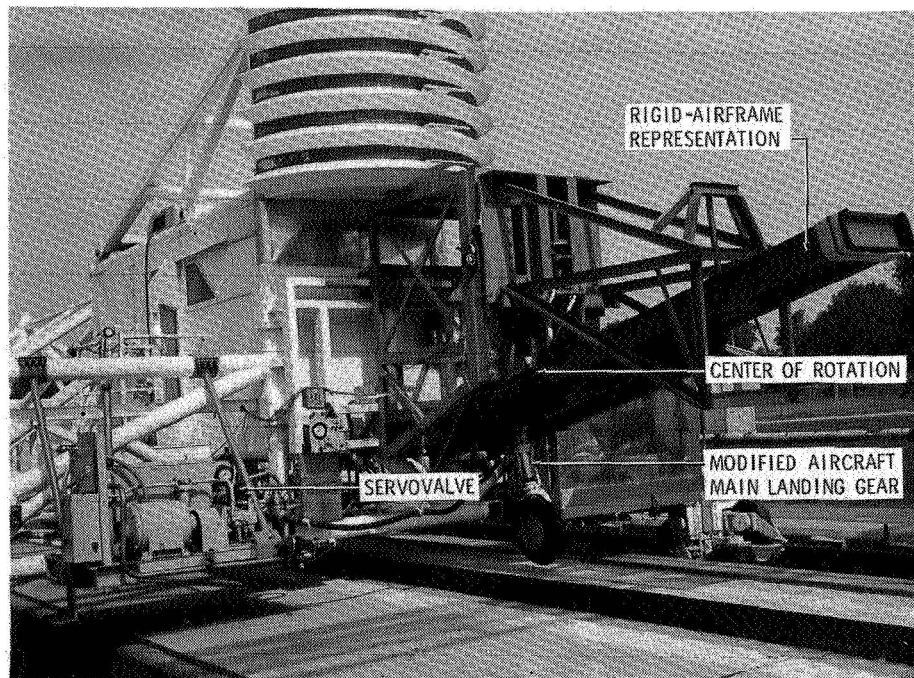

Figure 12.- Active control landing gear installed on test carriage.

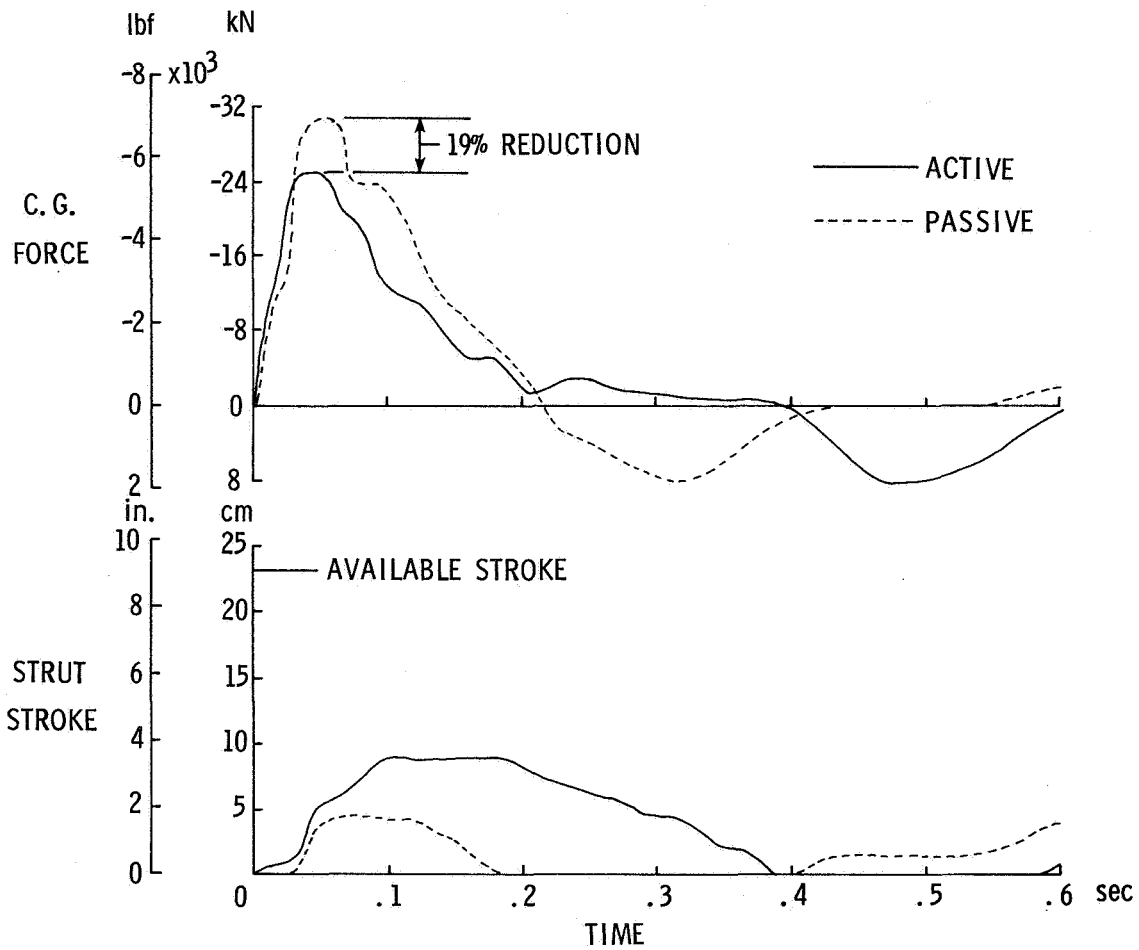

Figure 13.- Comparison of active and passive landing gear impact. Forward velocity = 80 knots; vertical velocity = 1.5 m/sec (5 ft/sec); pitch angle = 13°.

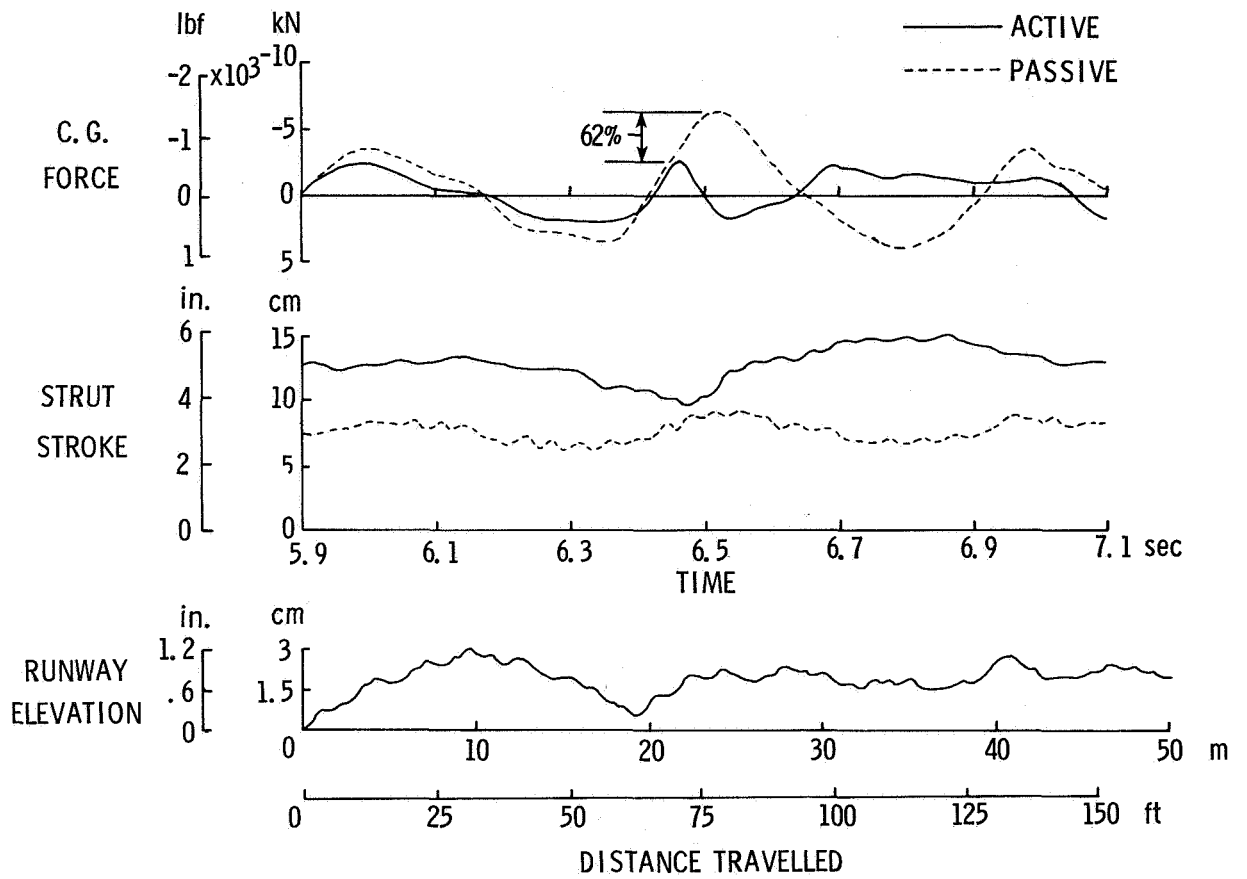

Figure 14.- Comparison of active and passive landing gear rollout. Forward velocity = 75 knots.