

JPL NO. 9950-502

DOE/JPL 954343-81/21
Distribution Category UC-63

FINAL REPORT
Covering the Period October 1, 1975 - February 6, 1981
on
**PROCESS FEASIBILITY STUDY IN SUPPORT OF
SILICON MATERIAL TASK I**
JPL Contract No. 954343

Silicon Material Task
Low-Cost Solar Array Project
to
JET PROPULSION LABORATORY
CALIFORNIA INSTITUTE OF TECHNOLOGY
by

**Carl L. Yaws
Ku-Yen Li
Jack R. Hopper
C. S. Fang
Keith G. Hansen**

February 6, 1981



This work was performed for the Jet Propulsion Laboratory, California Institute of Technology, under NASA Contract NAS7100 for the U.S. Department of Energy, Division of Solar Energy.

The JPL Low-Cost Solar Array Project is funded by DOE and forms part of the DOE Photovoltaic Conversion Program to initiate a major effort toward the development of low-cost solar arrays.

**LAMAR UNIVERSITY
Chemical Engineering Department
Chemistry Department
P. O. Box 10053
Beaumont, Texas 77710**

(NASA-CR-164009) PROCESS FEASIBILITY STUDY
IN SUPPORT OF SILICON MATERIAL TASK I Final
Report, 1 Oct. 1975 - 6 Feb. 1981 (Lamar
Univ., Beaumont, Tex.) 461 p HC A20/MF A01

N81-19570

CSSL 10A G3/44

Unclas
41679

Distribution Category UC-63

FINAL REPORT
Covering the Period October 1, 1975 - February 6, 1981
on
**PROCESS FEASIBILITY STUDY IN SUPPORT OF
SILICON MATERIAL TASK I**
JPL Contract No. 954343

Silicon Material Task
Low-Cost Solar Array Project
to
JET PROPULSION LABORATORY
CALIFORNIA INSTITUTE OF TECHNOLOGY
by
**Carl L. Yaws
Ku-Yen Li
Jack R. Hopper
C. S. Fang
Keith C. Hansen**

February 6, 1981

This work was performed for the Jet Propulsion Laboratory, California Institute of Technology under NASA Contract NAS7100 for the U.S. Department of Energy, Division of Solar Energy.

The JPL Low-Cost Solar Array Project is funded by DOE and forms part of the DOE Photovoltaic Conversion Program to initiate a major effort toward the development of low-cost solar arrays.

**LAMAR UNIVERSITY
Chemical Engineering Department
Chemistry Department
P. O. Box 10053
Beaumont, Texas 77710**

This report contains information prepared by Lamar University under JPL subcontract. Its content is not necessarily endorsed by the Jet Propulsion Laboratory, California Institute of Technology, or the National Aeronautics and Space Administration.

DISCLAIMER

"This report was prepared as an account of work sponsored by the United States Government. Neither the United States Department of Energy, nor any of their employees, nor any of their contractors, subcontractors, or their employees, makes any warranty, express or implied, or assumes any legal liability or responsibility for the accuracy, completeness or usefulness of any information, apparatus, product or process disclosed, or represents that its use would not infringe privately owned rights."

ACKNOWLEDGEMENT

The authors wish to acknowledge the valuable help and contributions of the following in the performance of this work:

Faculty-Staff

Dr. Larry L. Dickens
Dr. Fred C. Jelen
Dr. Fred H. Pitts
Dr. L. Wayne Sanders
Dr. Joseph W. Miller, Jr.
Mrs. India A. Roberts
Mrs. Katy Rankin
Mrs. Caroline E. Simmons

Graduate-Student Assistants

Thomas Chu
Prabodh M. Patel
Pratul N. Shah
Steve Hao Chang
Harry Yu
Lee-Hsin Tsao
Robin W. Borreson
L. David Hood
Cecil E. Gorin
Michael P. Patrizi
Maurice M. Sticker, Jr.
John R. Sitzman
Leslie A. Landry
Karen S. Hyatt
John Hera, Jr.
Cholticha Rungaroonthaikul
Steven Fortenberry
Milton L. Hooper

ABSTRACT

The Low-Cost Solar Array (LSA) Project at Jet Propulsion Laboratory (JPL) in Pasadena, California is being funded by the Department of Energy (DOE) for effective cost reduction in the production of silicon for solar cells. This study reports work performed at Lamar University in support of the LSA Project and presents results for process system properties, chemical engineering and economic analyses of the new technologies and processes being developed for the production of lower cost silicon for solar cells.

Analyses of process system properties are important for chemical materials involved in the several processes under consideration for semiconductor and solar cell grade silicon production. Major physical, thermodynamic and transport property data are reported for the following silicon source and processing chemical materials

- Silane
- Silicon Tetrachloride
- Trichlorosilane
- Dichlorosilane
- Silicon Tetrafluoride
- Silicon

The property data are reported for critical temperature, critical pressure, critical volume, vapor pressure, heat of vaporization, heat capacity, density, surface tension, viscosity, thermal conductivity, heat of formation and Gibb's free energy of formation. The reported property data are presented as a function of temperature to permit rapid usage in research, development and production engineering.

Chemical engineering analyses involving the preliminary process design of a plant (1000MT/yr capacity) to produce silicon via the technology under consideration were accomplished for the following processes:

- UCC Silane Process for Silicon
- BCL Process for Silicon - Case A
- BCL Process for Silicon - Case B
- Conventional Polysilicon Process (Siemens Technology)
- SiI_4 Decomposition Process
- DCS Process (Dichlorosilane)

Major activities in the chemical engineering analyses included base case conditions, reaction chemistry, process flowsheet, material balance, energy balance, property data, equipment design, major equipment list, production labor and forward for economic analysis. The process design package provided detailed

data for raw materials, utilities, major process equipment and production labor requirements necessary for polysilicon production in each process.

Using detailed data from the process design package, economic analyses for a 1000MT/yr silicon plant were accomplished for the processes under consideration for production of lower cost silicon. Primary results issuing from the economic analyses included plant capital investment and product cost which are useful in identification of those processes showing promise for meeting project cost goals.

Cost and profitability results issuing from the chemical engineering and economic analyses are summarized below:

<u>Process</u>	<u>Product Cost, \$/kg (1980 dollars)</u>	<u>Sales Price, \$/kg (1980 dollars)</u>
•UCC Silane Process for Silicon	9.66	13.00 @ 15% DCF
•BCL Process for Silicon - Case A	12.08	13.28 @ 5% DCF
•BCL Process for Silicon - Case B	11.07	13.14 @ 10% DCF
•Conventional Polysilicon Process (Siemens Technology)	53.77	-----
•SiH ₄ Decomposition Process	62.50	71.48 @ 5% DCF

For the summary tabulation, the product cost represents all cost associated with producing silicon including direct manufacturing cost, indirect manufacturing cost, plant overhead and general expenses. The sales price includes a profit for the company measured in terms of DCF (discounted cash flow) rate of return on the capital investment that the company spent in going into the business.

The cost and profitability analysis results of \$9.66 and \$13 per kg (1980 dollars) at 15% DCF for producing silicon by the UCC silane process (Union Carbide Corporation) indicate that this new technology for producing polysilicon shows good promise for meeting the cost goal of \$14 per kg of silicon material (1980 dollars) for solar cells.

For the BCL process - Cases A and B (Battelle Columbus Laboratories), cost and profitability results are \$11.07 - 12.08 and \$13.14 - 13.28 per kg (1980 dollars) at 5 - 10% DCF rate of return. These results indicate that this new technology for producing polysilicon shows promise for meeting the cost goal of \$14 per kg of silicon material (1980 dollars) for solar cells.

For the conventional polysilicon process, the cost analysis is based on a poly plant constructed in the 1960's (1965 or earlier) since several existing plants producing semiconductor grade polysilicon in the United States were constructed in the 1960's. The operating costs for the plant are applicable to the time period of interest such as 1980. The average product cost, \$53.77 per kg (1980 dollars), for the conventional polysilicon process corresponds to intermediate electrical costs (3.15 ¢/kw hr for 1980). These cost results for the conventional polysilicon process indicate that this Siemens technology using trichlorosilane for producing polysilicon does not show promise for meeting the cost goal of \$14 per kg of silicon material (1980 dollars) for solar cells.

The cost and profitability results of \$62.5 and \$71.48 per kg (1980 dollars) at 5% DCF rate of return for the SiI_4 decomposition process indicate that this new technology for producing polysilicon does not show promise for meeting the cost goal of \$14 per kg of silicon material (1980 dollars) for solar cells.

Using a hot wire method, gas phase thermal conductivity values of argon, hydrogen, silane, dichlorosilane, trichlorosilane, tetrachlorosilane and tetrafluorosilane were experimentally determined between 25°C and 350°C. Comparison of the values obtained in the study for argon and hydrogen with previously reported values indicated that the values should be accurate to ±2% throughout the temperature range.

Using a transpiration technique, gaseous viscosity values for nitrogen, dichlorosilane, trichlorosilane, and tetrafluorosilane were experimentally determined between 40°C and 200°C. Comparison of the values obtained in the study for nitrogen with previously reported viscosity values indicate that the values obtained are accurate to ±2% throughout the temperature range.

Studies were conducted to develop a method of generating silicon tetrafluoride from hexafluoroarsinic acid, a readily available by-product of the phosphate fertilizer industry. Conditions for the efficient precipitation of two SiF_4 precursors (Na_2SiF_6 and BaSiF_6) were determined. These precursors were then thermally decomposed to generate SiF_4 . Parameters such as temperature, heating time, and flow rate necessary for efficient production of SiF_4 were determined.

TABLE OF CONTENTS

	<u>Page</u>
1. INTRODUCTION - BACKGROUND.	1
2. PROCESS SYSTEM PROPERTIES ANALYSES	4
2.1 Silane Properties	4
2.2 Silicon Tetrachloride Properties.	24
2.3 Trichlorosilane Properties.	47
2.4 Dichlorosilane Properties	68
2.5 Silicon Tetrafluoride Properties.	87
2.6 Silicon Properties.	108
2.7 Thermal Conductivity Investigation.	131
2.8 Viscosity Investigation	151
2.9 Silicon Tetrafluoride Generation.	163
3. CHEMICAL ENGINEERING ANALYSES	182
3.1 SiH_4 Decomposition Process.	182
3.2 Conventional Polysilicon Process (Siemens Technology)	204
3.3 UCC Silane Process for Silicon (Union Carbide Corporation).	220
3.4 BCL Process for Silicon - Case A (Battelle Columbus Laboratories).	242
3.5 BCL Process for Silicon - Case B (Battelle Columbus Laboratories).	266
3.6 DCS Process (Dichlorosilane).	283
4. ECONOMIC ANALYSES.	298
4.1 SiH_4 Decomposition Process.	298
4.2 Conventional Polysilicon Process (Siemen's Technology)	312
4.3 UCC Silane Process for Silicon (Union Carbide Corporation).	325
4.4 BCL Process for Silicon - Case A (Battelle Columbus Laboratories).	341
4.5 BCL Process for Silicon - Case B (Battelle Columbus Laboratories).	356
4.6 DCS Process (Dichlorosilane).	371
5. SUMMARY - CONCLUSIONS.	386
Appendix	
A1. Additional Chemical Engineering Analyses.	390
A1.1 Silane Process - Case A	390
A1.2 Silane Process - Case B	406
A1.3 Silane Process - Case C	421
A2. Additional Economic Analyses.	422
A2.1 Silane Process - Case A	422
A2.2 Silane Process - Case B	435
A2.3 Silane Process - Case C	448

LIST OF FIGURES

<u>Figure No.</u>		<u>Page No.</u>
1-1	Typical Sequence for Process Selection.....	3
2.1-1	Vapor Pressure vs. Temperature for Silane.....	8
2.1-2	Heat of Vaporization vs. Temperature for Silane.....	9
2.1-3	Gas Heat Capacity vs. Temperature for Silane.....	10
2.1-4	Liquid Heat Capacity vs. Temperature for Silane.....	11
2.1-5	Liquid Density vs. Temperature for Silane.....	12
2.1-6	Surface Tension vs. Temperature for Silane.....	13
2.1-7	Gas Viscosity vs. Temperature for Silane.....	14
2.1-8	Liquid Viscosity vs. Temperature for Silane.....	15
2.1-9	Gas Thermal Conductivity vs. Temperature for Silane.....	16
2.1-10	Liquid Thermal Conductivity vs. Temperature for Silane.....	17
2.1-11	Heat of Formation vs. Temperature for Silane.....	18
2.1-12	Free Energy of Formation vs. Temperature for Silane.....	19
2.2-1	Vapor Pressure vs. Temperature for Silicon Tetrachloride....	29
2.2-2	Heat of Vaporization vs. Temperature for Silicon Tetra- chloride.....	30
2.2-3	Gas Heat Capacity vs. Temperature for Silicon Tetrachloride...	31
2.2-4	Liquid Heat Capacity vs. Temperature for Silicon Tetra- chloride.....	32
2.2-5	Liquid Density vs. Temperature for Silicon Tetrachloride....	33
2.2-6	Surface Tension vs. Temperature for Silicon Tetrachloride...	34
2.2-7	Gas Viscosity vs. Temperature for Silicon Tetrachloride....	35
2.2-8	Liquid Viscosity vs. Temperature for Silicon Tetrachloride...	36
2.2-9	Gas Thermal Conductivity vs. Temperature for Silicon Tetra- chloride.....	37
2.2-10	Liquid Thermal Conductivity vs. Temperature for Silicon Tetrachloride.....	38
2.2-11	Heat of Formation vs. Temperature for Silicon Tetrachloride...	39
2.2-12	Free Energy of Formation vs. Temperature for Silicon Tetra- chloride.....	40
2.3-1	Vapor Pressure vs. Temperature for Trichlorosilane.....	52
2.3-2	Heat of Vaporization vs. Temperature for Trichlorosilane....	53
2.3-3	Gas Heat Capacity vs. Temperature for Trichlorosilane.....	54
2.3-4	Liquid Heat Capacity vs. Temperature for Trichlorosilane....	55
2.3-5	Liquid Density vs. Temperature for Trichlorosilane.....	56
2.3-6	Surface Tension vs. Temperature for Trichlorosilane.....	57
2.3-7	Gas Viscosity vs. Temperature for Trichlorosilane.....	58
2.3-8	Liquid Viscosity vs. Temperature for Trichlorosilane.....	59
2.3-9	Gas Thermal Conductivity vs. Temperature for Trichlorosilane	60
2.3-10	Liquid Thermal Conductivity vs. Temperature for Trichloro- silane.....	61
2.3-11	Heat of Formation vs. Temperature for Trichlorosilane.....	62
2.3-12	Free Energy of Formation vs. Temperature for Trichlorosilane	63
2.4-1	Vapor Pressure vs. Temperature for Dichlorosilane.....	73
2.4-2	Heat of Vaporization vs. Temperature for Dichlorosilane....	74

Figure No.

Page No.

2.4-3	Gas Heat Capacity vs. Temperature for Dichlorosilane.....	75
2.4-4	Liquid Heat Capacity vs. Temperature for Dichlorosilane.....	76
2.4-5	Liquid Density vs. Temperature for Dichlorosilane.....	77
2.4-6	Surface Tension vs. Temperature for Dichlorosilane.....	78
2.4-7	Gas Viscosity vs. Temperature for Dichlorosilane.....	79
2.4-8	Liquid Viscosity vs. Temperature for Dichlorosilane.....	80
2.4-9	Gas Thermal Conductivity vs. Temperature for Dichlorosilane.	81
2.4-10	Liquid Thermal Conductivity vs. Temperature for Dichloro- silane.....	82
2.4-11	Heat of Formation vs. Temperature for Dichlorosilane.....	83
2.4-12	Free Energy of Formation vs. Temperature for Dichlorosilane.	84
2.5-1	Vapor Pressure vs. Temperature for Silicon Tetrafluoride....	92
2.5-2	Heat of Vaporization vs. Temperature for Silicon Tetra- fluoride.....	93
2.5-3	Gas Heat Capacity vs. Temperature for Silicon Tetrafluoride.	94
2.5-4	Liquid Heat Capacity vs. Temperature for Silicon Tetra- fluoride.....	95
2.5-5	Liquid Density vs. Temperature for Silicon Tetrafluoride....	96
2.5-6	Surface Tension vs. Temperature for Silicon Tetrafluoride...	97
2.5-7	Gas Viscosity vs. Temperature for Silicon Tetrafluoride....	98
2.5-8	Liquid Viscosity vs. Temperature for Silicon Tetrafluoride..	99
2.5-9	Gas Thermal Conductivity vs. Temperature for Silicon Tetra- fluoride.....	100
2.5-10	Liquid Thermal Conductivity vs. Temperature for Silicon Tetrafluoride.....	101
2.5-11	Heat of Formation vs. Temperature for Silicon Tetrafluoride.	102
2.5-12	Free Energy of Formation vs. Temperature for Silicon Tetra fluoride.....	103
2.6-1	Vapor Pressure vs. Temperature for Silicon.....	113
2.6-2	Heat of Vaporization vs. Temperature for Silicon.....	114
2.6-3	Heat of Sublimation vs. Temperature for Silicon.....	115
2.6-4	Liquid Heat Capacity vs. Temperature for Silicon.....	116
2.6-5	Solid Heat Capacity vs. Temperature for Silicon.....	117
2.6-6	Liquid Density vs. Temperature for Silicon.....	118
2.6-7	Solid Density vs. Temperature for Silicon.....	119
2.6-8	Surface Tension vs. Temperature for Silicon.....	120
2.6-9	Liquid Viscosity vs. Temperature for Silicon.....	121
2.6-10	Solid Thermal Conductivity vs. Temperature for Silicon.....	122
2.7-1	Wheatstone Bridge Circuit for Thermal Conductivity Cell.....	134
2.7-2	Filament Resistance as a Function of Temperature.....	135
2.7-3	Comparison of Thermal Conductivity Values for Argon.....	136
2.7-4	Comparison of Thermal Conductivity Values for Hydrogen.....	137
2.7-5	Gaseous Thermal Conductivity of Silane.....	139
2.7-6	Gaseous Thermal Conductivity of Dichlorosilane.....	141
2.7-7	Gaseous Thermal Conductivity of Trichlorosilane.....	143
2.7-8	Gaseous Thermal Conductivity of Tetrachlorosilane.....	145
2.7-9	Gaseous Thermal Conductivity of Tetrafluorosilane.....	147
2.7-10	Comparison of Thermal Conductivity Values for Tetrafluoro- silane.....	148
2.7-11	Gaseous Thermal Conductivity Values for Silane and Halo- genated Silanes.....	149
2.8-1	Constant Volume Gas Viscometer.....	154
2.8-2	Viscosity of Nitrogen.....	155
2.8-3	Viscosity of Gaseous Trichlorosilane.....	157

<u>Figure No.</u>	<u>Page No.</u>
2.8-4	The Viscosity of Gaseous Dichlorosilane as a Function of Temperature.....159
2.8-5	Viscosity of Gaseous Tetrafluorosilane.....160
2.9-1	Variation of SiF_4 Precursor Recovery with Reaction Ratio (NaCl Reaction).....167
2.9-2	Variation of SiF_4 Precursor Recovery with Reaction Ratio (NaF Reaction).....168
2.9-3	Variation of SiF_4 Precursor Recovery with Reaction Ratio (NaOH Reaction).....169
2.9-4	Variation of SiF_4 Precursor Recovery with Reaction Ratio (Na_2CO_3 Reaction).....170
2.9-5	Variation of BaSiF_6 Recovery with Reactant Ratio (BaCl_2 Reaction).....171
2.9-6	Variation of BaSiF_6 Recovery with Reaction Ratio (BaF_2 Reaction).....172
2.9-7	Variation of % SiF_4 Generated with Temperature.....173
2.9-8	Variation of % SiF_4 Generated with Reaction Time.....174
2.9-9	Variation of % SiF_4 Generated with Reaction Time.....175
2.9-10	Variation of % SiF_4 Generated with Reaction Time.....176
2.9-11	Variation of % SiF_4 Generated with Temperature.....177
2.9-12	Variation of % SiF_4 Generated with Reaction Time.....178
2.9-13	Variation of % SiF_4 Generated with Reaction Time.....179
2.9-14	Variation of % SiF_4 Generated with Reaction Time.....180
2.9-15	Variation of % SiF_4 Generated with Reaction Time.....181
3.1-1	Process Flow Diagram for SiF_4 Decomposition Process (Battelle).....183
3.2-1	Preliminary Process Flowsheet for Conventional Polysilicon Process.....206
3.3-1	Process Flowsheet for UCC Silane Process.....222
3.3-2	Process Flowsheet for UCC Silane Process.....224
3.3-3	Redistribution Equilibrium for UCC Silane Process (Provided by Union Carbide).....230
3.4-1	Process Flowsheet for BCL Process - Case A.....245
3.4-2	Process Flowsheet for BCL Process - Case A.....246
3.5-1	Process Flowsheet for BCL Process - Case B.....269
3.6-1	Process Flowsheet for DCS Process.....285

LIST OF TABLES

<u>Table No.</u>	<u>Page No.</u>
2.1-1	Critical Constants and Physical Properties of Silane.....7
2.2-1	Critical Constants and Physical Properties of Silicon Tetrachloride.....28
2.3-1	Critical Constants and Physical Properties of Trichlorosilane..51
2.4-1	Critical Constants and Physical Properties of Dichlorosilane...72
2.5-1	Physical Properties and Critical Constants of Silicon Tetrafluoride.....91
2.6-1	Physical Properties and Critical Constants of Silicon.....112
2.7-1	Gaseous Thermal Conductivity Values of Silane.....138
2.7-2	Gaseous Thermal Conductivity Values of Dichlorosilane.....140
2.7-3	Gaseous Thermal Conductivity Values of Trichlorosilane.....142
2.7-4	Gaseous Thermal Conductivity Values of Tetrachlorosilane.....146
2.7-5	Gaseous Thermal Conductivity Values of Tetrafluorosilane.....148
2.8-1	Viscosity of Gaseous Trichlorosilane.....156
2.8-2	Viscosity of Gaseous Dichlorosilane.....158
2.8-3	Gaseous Viscosity of Tetrafluorosilane.....160
3.1-1	Chemical Engineering Analyses: Preliminary Process Design Activities for SiH_4 Decomposition Process.....184
3.1-2	Base Case Conditions for SiH_4 Decomposition Process.....185
3.1-3	Reaction Chemistry for SiH_4 Decomposition Process.....186
3.1-4	Raw Material Requirements for SiH_4 Decomposition Process.....187
3.1-5	Utility Requirements for SiH_4 Decomposition Process.....188
3.1-6	List of Major Process Equipment for SiH_4 Decomposition Process.....189
3.1-7	Production Labor Requirements of SiH_4 Decomposition Process....203
3.2-1	Chemical Engineering Analyses: Preliminary Process Design Activities for Conventional Polysilicon Process.....207
3.2-2	Base Case Conditions for Conventional Polysilicon Process.....208
3.2-3	Reaction Chemistry for Conventional Polysilicon Process210
3.2-4	Raw Material Requirements for Conventional Polysilicon Process.....211
3.2-5	Utility Requirements for Conventional Polysilicon Process.....212
3.2-6	List of Major Process Equipment for Conventional Polysilicon Process.....213
3.2-7	Production Labor Requirements for Conventional Polysilicon Process.....219
3.3-1	Chemical Engineering Analyses: Preliminary Process Design Activities for UCC Silane Process.....223
3.3-2	Base Case Conditions for UCC Silane Process.....228
3.3-3	Reaction Chemistry for UCC Silane Process.....229
3.3-4	Raw Material Requirements for UCC Silane Process... ..231
3.3-5	Utility Requirements for UCC Silane Process.....232
3.3-6	List of Major Process Equipment for UCC Silane Process.....233
3.3-7	Production Labor Requirements for UCC Silane Process.....241
3.4-1	Chemical Engineering Analyses: Preliminary Process Design Activities for BCL Process - Case A.....244
3.4-2	Base Case Conditions for BCL Process - Case A.....253
3.4-3	Reaction Chemistry for BCL Process - Case A.....255
3.4-4	Raw Material Requirements for BCL Process - Case A.....256
3.4-5	Utility Requirements for BCL Process - Case A.....257
3.4-6	List of Major Process Equipment for BCL - Case A.....258
3.4-7	Production Labor Requirements for BCL Process - Case A.....265

3.5-1	Chemical Engineering Analyses: Preliminary Process Design Activities for BCL Process - Case B.....	268
3.5-2	Base Case Conditions for BCL Process - Case B.....	270
3.5-3	Reaction Chemistry for BCL Process - Case B.....	272
3.5-4	Raw Material Requirements for BCL Process - Case B.....	273
3.5-5	Utility Requirements for BCL Process - Case B.....	274
3.5-6	List of Major Process Equipment for BCL Process - Case B.....	275
3.5-7	Production Labor Requirements for BCL Process - Case B.....	282
3.6-1	Chemical Engineering Analyses: Preliminary Process Design Activities for DCS Process.....	286
3.6-2	Base Case Conditions for DCS Process.....	287
3.6-3	Reaction Chemistry for DCS Process.....	288
3.6-4	Raw Material Requirements for DCS Process.....	289
3.6-5	Utility Requirements for DCS Process.....	290
3.6-6	List of Major Process Equipment for DCS Process.....	291
3.6-7	Production Labor Requirements for DCS Process.....	297
4.1-1	Estimation of Product Cost for SiI ₄ Decomposition Process.....	300
4.1-2	Cost and Profitability Analysis Summary for SiI ₄ Decomposition Process.....	301
4.1-3	Economic Analyses: Preliminary Economic Analysis Activities for SiI ₄ Decomposition Process.....	302
4.1-4	Process Design Inputs for SiI ₄ Decomposition Process.....	303
4.1-5	Base Case Conditions for SiI ₄ Decomposition Process.....	304
4.1-6	Raw Material Costs for SiI ₄ Decomposition Process.....	305
4.1-7	Utility Cost for SiI ₄ Decomposition Process.....	306
4.1-8	Estimated Cost of Major Process Equipment for SiI ₄ Decomposition Process.....	307
4.1-9	Production Labor Costs for SiI ₄ Decomposition Process.....	309
4.1-10	Estimation of Plant Investment for SiI ₄ Decomposition Process.....	310
4.1-11	Estimation of Total Product Cost for SiI ₄ Decomposition Process.....	311
4.2-1	Estimation of Product Cost for Conventional Polysilicon Process.....	314
4.2-2	Economic Analyses: Preliminary Economic Analysis Activities for Conventional Polysilicon Process.....	315
4.2-3	Process Design Inputs for Conventional Polysilicon Process.....	317
4.2-5	Raw Material Cost for Conventional Polysilicon Process.....	318
4.2-6	Utility Cost for Conventional Polysilicon Process.....	319
4.2-7	Purchased Cost of Major Process Equipment for Conventional Polysilicon Process.....	320
4.2-8	Production Labor Cost for Conventional Polysilicon Process.....	322
4.2-9	Estimation of Plant Investment Cost for Conventional Polysilicon Process.....	323
4.2-10	Estimation of Total Product Cost for Conventional Polysilicon Process.....	324
4.3-1	Estimation of Product Cost for UCC Silane Process.....	327
4.3-2	Cost and Profitability Analysis Summary for UCC Silane Process.....	328
4.3-3	Economic Analyses: Preliminary Economic Analysis Activities for UCC Silane Process.....	329
4.3-4	Process Design Inputs for UCC Silane Process.....	330
4.3-5	Base Case Conditions for UCC Silane Process.....	331
4.3-6	Raw Material Cost for UCC Silane Process.....	332

<u>Table No.</u>	<u>Page No.</u>
4.3-7	Utility Cost for UCC Silane Process.....333
4.3-8	Purchased Cost of Major Process Equipment for UCC Silane Process.....334
4.3-9	Production Labor Cost for UCC Silane Process.....338
4.3-10	Estimation of Plant Investment for UCC Silane Process.....339
4.3-11	Estimation of Total Product Cost for UCC Silane Process.....340
4.4-1	Estimation of Product Cost for BCL Process - Case A.....343
4.4-2	Cost and Profitability Analysis Summary for BCL Process - Case A.....344
4.4-3	Economic Analyses: Preliminary Economic Analysis Activities for BCL Process - Case A.....345
4.4-5	Base Case Conditions for BCL Process - Case A.....346
4.4-6	Raw Material Cost for BCL Process - Case A.....347
4.4-7	Utility Cost for BCL Process - Case A.....348
4.4-8	Estimated Cost of Major Process Equipment for BCL Process - Case A.....349
4.4-9	Production Labor Cost for BCL Process - Case A.....353
4.4-10	Estimation of Plant Investment for BCL Process - Case A.....354
4.4-11	Estimation of Total Product Cost for BCL Process - Case A.....355
4.5-1	Estimation of Product Cost for BCL Process - Case B.....353
4.5-2	Cost and Profitability Analysis Summary for BCL Process - Case B.....359
4.5-3	Economic Analyses: Preliminary Economic Analysis Activities for BCL Process - Case B.....360
4.5-4	Process Design Inputs for BCL Process - Case B.....361
4.5-5	Base Case Conditions for BCL Process - Case B.....362
4.5-6	Raw Material Cost for BCL Process - Case B.....363
4.5-7	Utility Cost for BCL Process - Case B.....364
4.5-8	Estimated Cost of Major Process Equipment for BCL Process - Case B.....365
4.5-9	Production Labor Cost for BCL Process - Case B.....368
4.5-10	Estimation of Plant Investment for BCL Process - Case B.....369
4.5-11	Estimation of Total Product Cost for BCL Process - Case B.....370
4.6-1	Estimation of Product Cost for DCS Process.....373
4.6-2	Cost and Profitability Analysis Summary for DCS Process.....374
4.6-3	Economic Analyses: Preliminary Economic Analysis Activities for DCS Process.....375
4.6-4	Process Design Inputs for DCS Process.....376
4.6-5	Base Case Conditions for DCS Process.....377
4.6-6	Raw Material Cost for DCS Process.....378
4.6-7	Utility Cost for DCS Process.....379
4.6-8	Purchased Cost of Major Process Equipment for DCS Process.....380
4.6-9	Production Labor Cost for DCS Process.....383
4.6-10	Estimation of Plant Investment for DCS Process.....384
4.6-11	Estimation of Total Product Cost for DCS Process.....385

1. INTRODUCTION - BACKGROUND

The Low-Cost Solar Array Project (LSA) of Jet Propulsion Laboratory (JPL) had its beginning in 1975, and was concerned with achieving our national solar energy goal (1) to "develop at the earliest feasible time those applications of solar energy that can be made economically attractive and environmentally acceptable as alternate energy sources." Solar cell grade silicon for photovoltaic systems will need to be produced in great volume at considerable reduced prices to accomplish this significant energy goal.

The Low-Cost Solar Array (LSA) Project at Jet Propulsion Laboratory (JPL) in Pasadena, California is being funded by the Department of Energy (DOE) for effective cost reduction in the production of silicon for solar cells. An important overall objective of the project is to reduce the cost of electricity produced with solar cells from today's \$10-25 per W (Peak) to \$0.70 per W (1980 dollars) by 1986. Cost reductions for solar cells are allocated to major tasks encompassing everything from initial silicon production to final array assembly. The cost goal for the silicon material that goes into solar cells is about \$14 per kg of material (1980 dollars).

Semiconductor grade silicon which is currently produced via the conventional Siemens process by several major manufacturers (Dow-Corning, Monsanto, Motorola, Texas Instruments and Great Western) in the United States is too expensive to meet the silicon material cost goal. Lower cost silicon is needed for solar cells. Alternate processes that depart from the conventional process need to be developed by several concerns to produce a less costly silicon material.

Process evaluation - which is a very useful tool in research and development - is useful in investigation of such alternate processes for solar cell grade silicon. The planning and implementation of a research and development program involves decision making on what work can be left out with least jeopardy to short and long term consequences and what work should be pursued with the best chance for success in achieving short and long term goals. Early process evaluation investigation including preliminary economic evaluation aids the decision making involved in whether to commit extra funds to carry-out a project from research to large scale plant.

-
1. ERDA, National Solar Energy Program, Industrial Briefing, NASA/JPL Low-Cost Silicon Solar Array Project, NASA Headquarters, Washington, D.C. (February 5, 1975).

The early study particularly minimizes the risks involved in the process development from early research to large scale plant. The process evaluation investigation should be initiated with the very inception of the research project and continued throughout its life until the project is proved successful or abandoned because it cannot effectively meet the financial and product purity goals.

In research and development, a screening out is required for those projects and processes which are believed to be unsound or least attractive. Economics dictate that the money should not be wasted on projects which may turn out to be useless. The many alternate projects and processes which are available necessitate the effective use of a screening procedure, not to locate a fool-proof venture, but to try to select the best possible project.

Process evaluation investigation may effectively deal with a complete process or part of a process. Major cost areas of a process and profitability potential of a proposed process may be pinpointed. It is also equally valuable in comparing alternate processes and in the selection of processes with the best technical and economic features.

A typical sequence for process selection is presented in Figure 1-1. The process evaluation activities are shown in relation to their usefulness in the selection of a process for scale-up to pilot plant and large scale plant. These process evaluation activities (system properties, chemical engineering and economic analysis tasks) may be effectively utilized in the investigation of alternate processes for low cost, high volume production of silicon suitable for solar cells.

In this process feasibility study in support of Silicon Material Task I of the LSA, the proposed scope of work is to perform investigations and analyses of processes for the low cost, high volume production of silicon suitable for solar cells. The objective of this program is to validate the commercial practicality of these alternate processes based on the following process evaluation criteria:

1. Analyses of Process-System Properties
2. Chemical Engineering Analyses
3. Economic Analyses

Each of these evaluation criteria is focused on the production of solar cell grade silicon at greatly reduced cost.

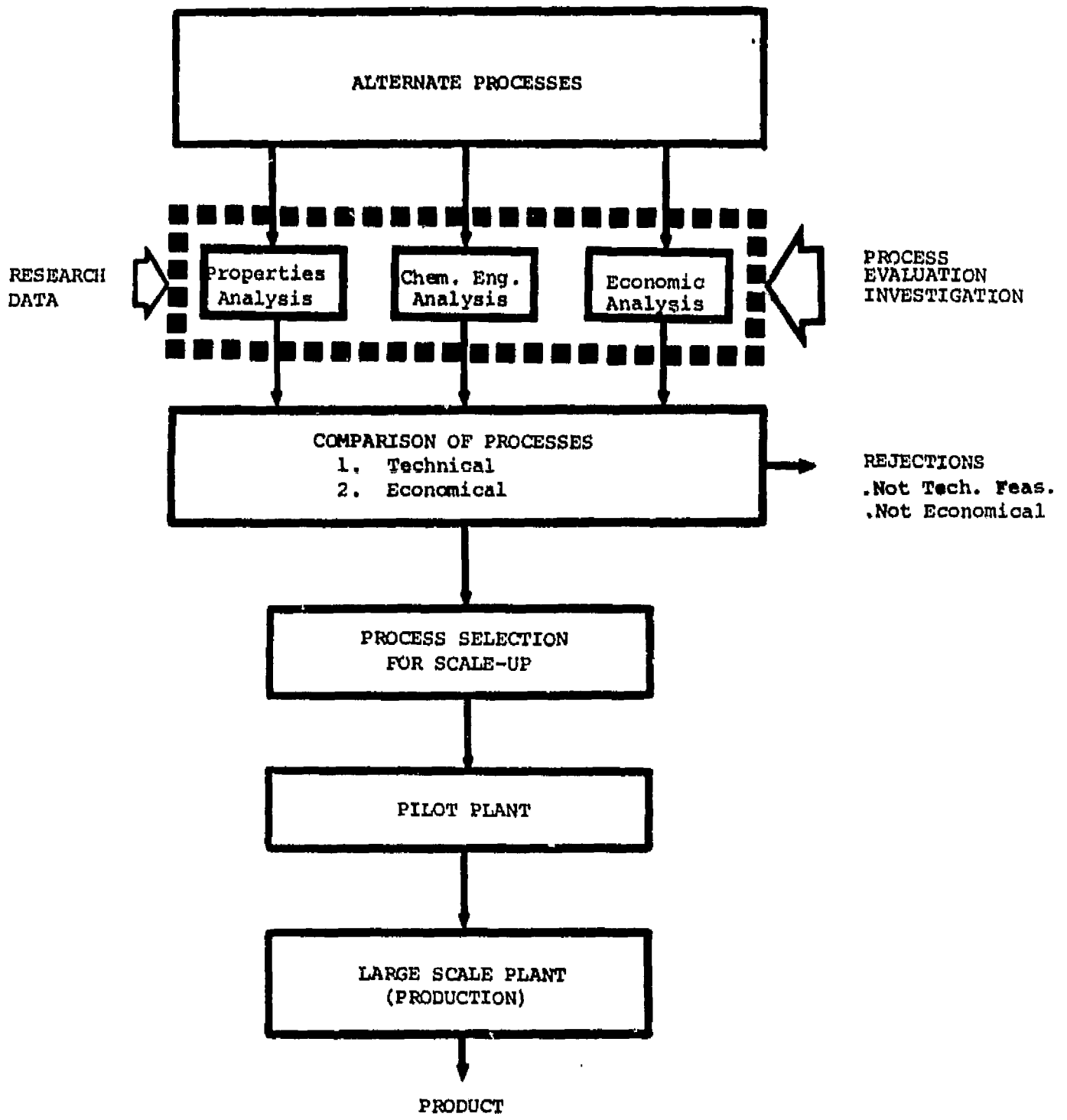

Figure 1-1 TYPICAL SEQUENCE FOR PROCESS SELECTION

2. PROCESS SYSTEM PROPERTIES ANALYSES

2.1 Silane Properties

Critical Properties (Table 2.1-1)

Experimental data for the critical temperature and pressure of silane are available (2, 15, 20, 22, 25, 27, 29, 45, 47, 49, 50, 51). However, all sources cite Adwentowski (51), who prepared his sample from Mg_2Si and used the fraction boiling at $-116^\circ C$. Since the boiling point of silane is generally accepted as $-112^\circ C$, these data may not be completely reliable.

The critical compressibility factor, Z_c , was estimated by the Garcia-Barcena method:

$$Z_c = f(T_b) - g(T_b/M) \quad (2.1-1)$$

where T_b = boiling point, $^\circ K$; and M = molecular weight $g/g - mol$. The terms $f(T_b)$ and $g(T_b/M)$ are shown as a nomograph (29). Reid and Sherwood tested this equation using sixteen inorganic compounds and found an average deviation of 1.8%. The accuracy of the correlation was tested by applying it to similar inorganic and organic compounds (NH_3 , N_2H_4 , B_2H_6 , CH_4). Average deviation was 3.6% for the compounds tested.

The critical volume was found by the real gas relation:

$$V_c = Z_c RT_c / P_c \quad (2.1-2)$$

using the Adwentowski data and the estimated value of Z_c .

Vapor Pressure (Figure 2.1-1)

Observed vapor pressure data for silane are available (2, 13, 15, 18, 20, 25, 27, 36, 45, 51, 60) over nearly the entire liquid phase from melting point (mp) to boiling point (bp) to critical point (cp). The available data were correlated with the least squares technique for vapor pressure as a function of temperature using the following correlation relation (64):

$$\log P_v = A + \frac{B}{T} + C \log T + DT + ET^2 \quad (2.1-3)$$

Average deviations were less than 3.5%. Greater deviations were encountered with other vapor pressure equations. For example, average absolute deviations exceeded 38% for the Cox-Antoine type equation.

Heat of Vaporization (Figure 2.1-2)

Heat of vaporization data for silane are available only at the boiling point (2, 21, 22, 23, 27, 41).

These data vary less than 1%. Watson's correlation (27, 29) was used to extend the heat of vaporization over the entire liquid phase:

$$\Delta H_v = \Delta H_{v1} \left(\frac{T_c - T}{T_c - T_1} \right)^n \quad (2.1-4)$$

where ΔH_{v1} is the heat of vaporization at the boiling point (T_1) and $n = 0.38$.

Heat Capacity (Figures 2.1-3 and 2.1-4)

Heat capacity of the ideal gas at atmospheric pressure is primarily based on structural and spectral data. Values from the various sources (5, 16, 20, 22, 25, 39, 44, 52) are in excellent agreement with differences less than 1%.

Liquid heat capacity data (6) are available in the mp-bp temperature interval. The data were extended to cover the full liquid phase with the density relation: liquid heat capacity \times density = constant. The constant value was .2895. Testing of the relationship with the available data produced average deviation of 7%.

Density (Figure 2.1-5)

Liquid density data for silane are available (2, 15, 18, 23, 25, 35, 48, 52) from the melting point to the boiling point. The Yaws-Shah equation (62) for density of the saturated liquid was used to extend the data to the critical point:

$$\rho = AB \cdot (1 - T_r)^{2/7} \quad (2.1-5)$$

where ρ = density, g/cm³, T_r = reduced temperature, T/T_c , A, B = correlation parameters. The correlation parameter values for silane are $A = 0.2447$ and $B = 0.3137$. Average deviation of calculated and experimental data was 1.48%.

Surface Tension (Figure 2.1-6)

Data for surface tension (7) are available from the melting point to the boiling point. These data were extended using the Othmer relation (29):

$$\sigma = \sigma_1 \left(\frac{T_c - T}{T_c - T_1} \right)^n \quad (2.1-6)$$

where σ_1 = surface tension at T_1 , dynes/cm; T_c = critical temperature, °K; T = temperature, °K; n = the correlation parameter, 1.2. Deviations between data and correlated values were less than 1%.

Viscosity (Figures 2.1-7 and 2.1-8)

The Stiel and Thodos correlation (29) was used to

augment limited data on gas viscosity (2, 15, 20, 23, 25, 52, 53, 57) at atmospheric pressure. All data sources cite Rankine (57) who made his measurement in 1922 at 15° and 100°C. Deviations between data and correlation were less than 1% for the two data values.

Liquid viscosity data are available (30) in the temperature range between the melting point and boiling point. The data were extended to cover the entire liquid range with the following correlation (63) for viscosity of the saturated liquid as a function of temperature:

$$\log \mu_L = A + B/T + CT + DT^2 \quad (2.1-7)$$

Correlation values and data were in good agreement with average absolute deviation of 1.4%.

Thermal Conductivity (Figures 2.1-9 and 2.1-10)

Gas thermal conductivity for silane was estimated by the modified Eucken correlation for polyatomic gases. The Eucken correlation agrees well with Svehla (40); deviations were less than 1%. There are no experimental data available for gas thermal conductivity.

Liquid thermal conductivity for silane was estimated with the modified Stiel and Thodos relation (29). The correlation was tested with experimental data for methane. The average deviations were less than 17%. The deviations for silane are probably in the same range. The presented results are intended to represent correct order-of-magnitude values.

Heat of Formation and Free Energy of Formation (Figures 2.1-11 and 2.1-12)

Values for the heat of formation, ΔH_f , and free energy of formation, ΔG_f , are available from American (39) and Russian (12) sources. Average values were selected. The deviation between data and selected results was 0.2 K cal/mol.

TABLE 2.1-1--CRITICAL CONSTANTS AND PHYSICAL
PROPERTIES OF SILANE

<u>Identification</u>	<u>Silane</u>
Formula	SiH ₄
State (std. cond.)	gas (colorless)
Molecular Weight, M	32.12
Boiling Point, T _b , °C	-111.9
Melting Point, T _m , °C	-184.7
Critical Temp, T _c , °C	-3.5 (Questionable Value)
Critical Pressure, P _c , atm	47.8 (Questionable Value)
Critical Volume, V _c , cm ³ /gr mol	130.06 (Estimated)
Critical Compressibility Factor, Z _c	0.281 (Estimated)
Critical Density, ρ _c , gr/cm ³	0.247 (Estimated)
Acentric Factor (Ω)	0.0774

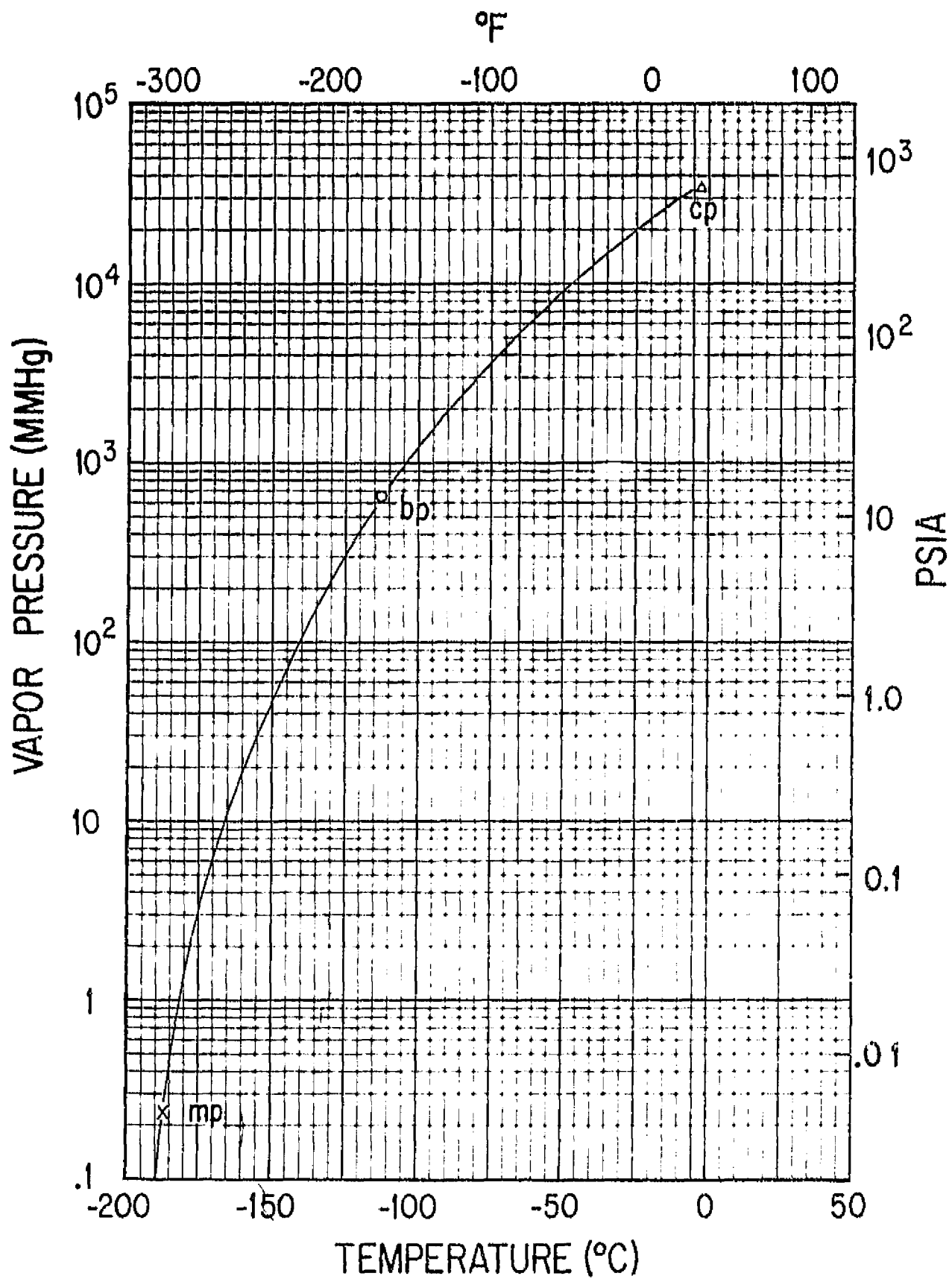

Figure 2.1-1 Vapor Pressure vs. Temperature for Silane

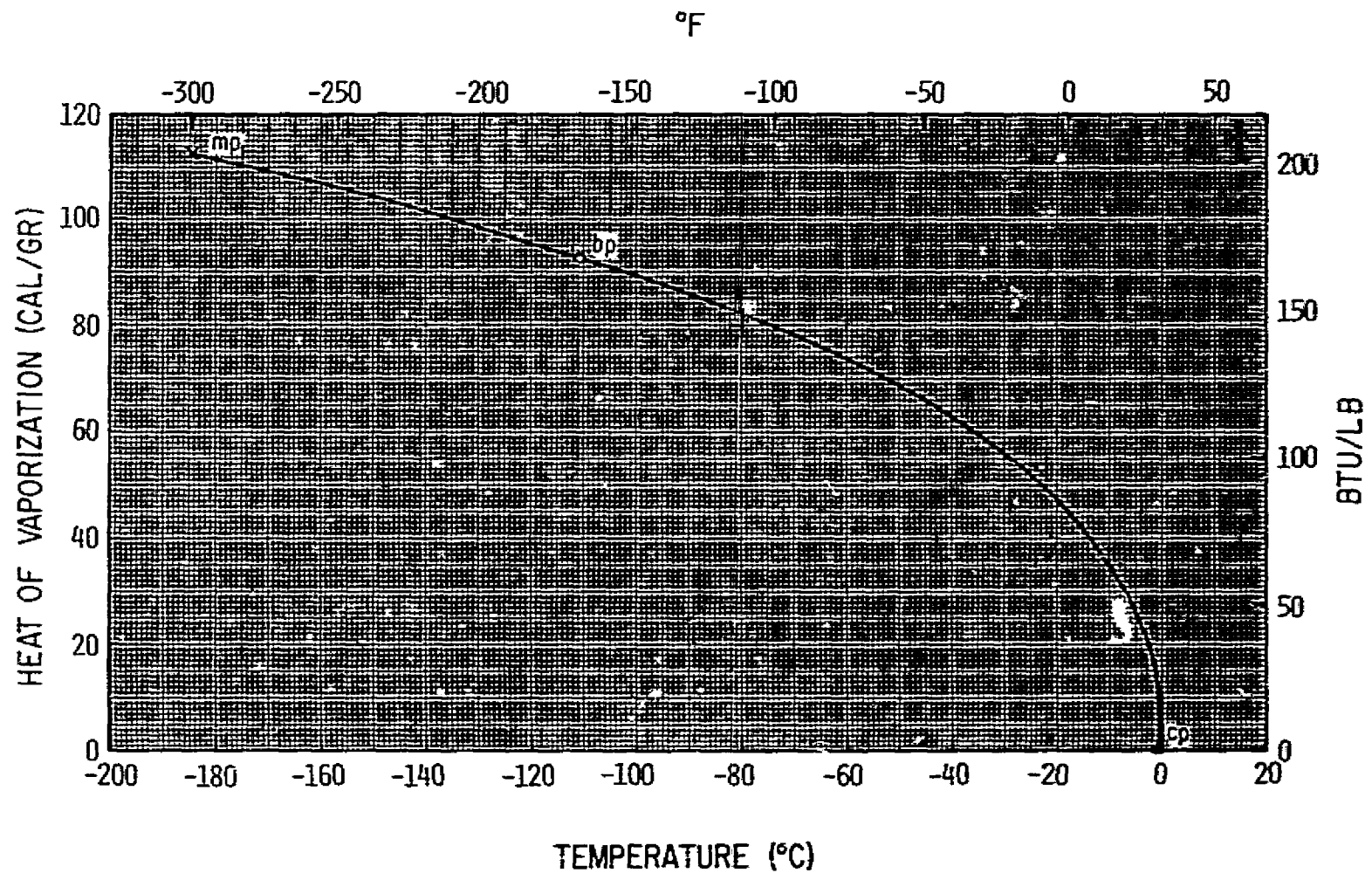

Figure 2.1-2 Heat of Vaporization vs. Temperature for Silane

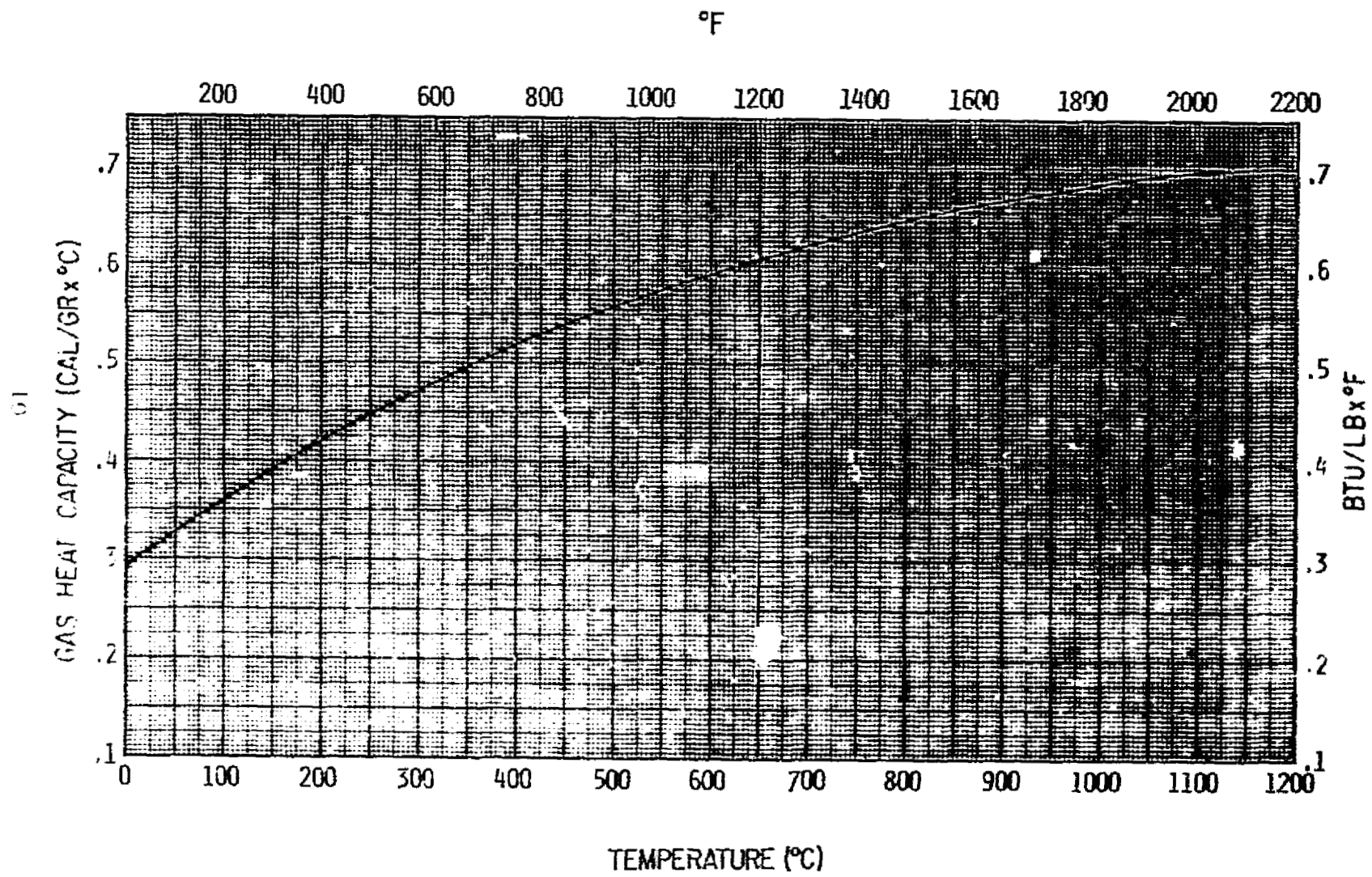

Figure 2.1-3 Gas Heat Capacity vs. Temperature for Silane

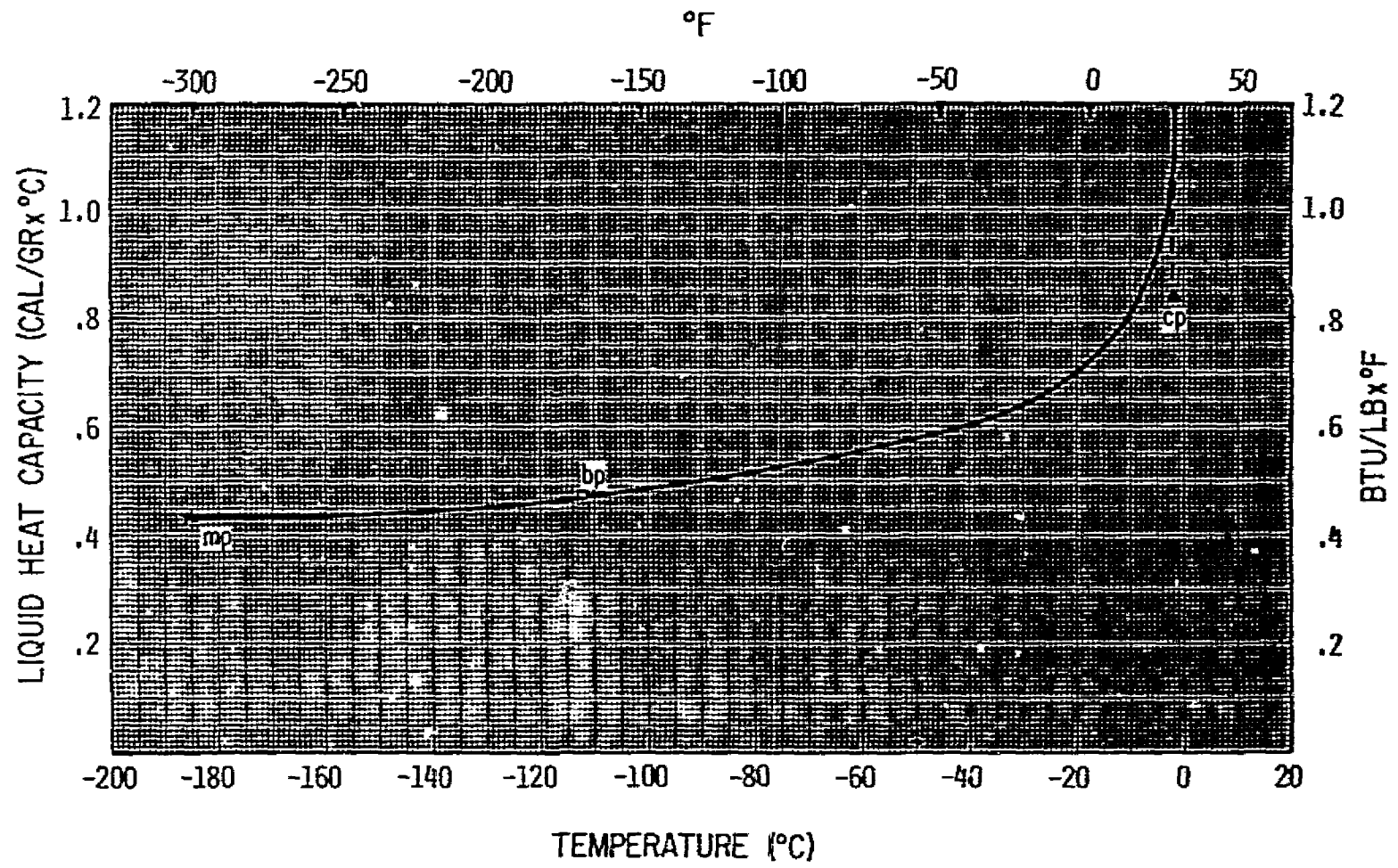

Figure 2.1-4 Liquid Heat Capacity vs. Temperature for Silane

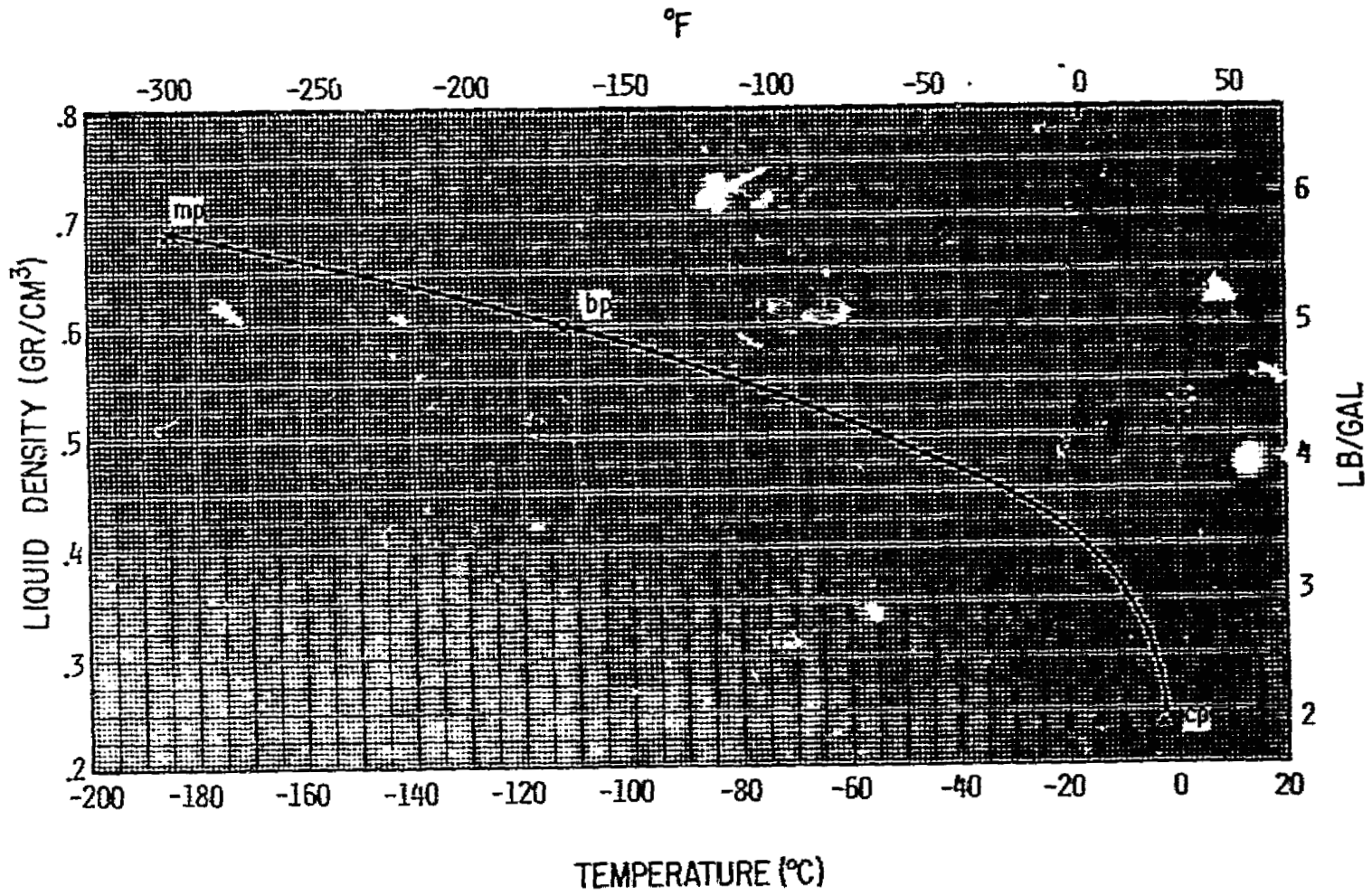

Figure 2.1-5 Liquid Density vs. Temperature for Silane

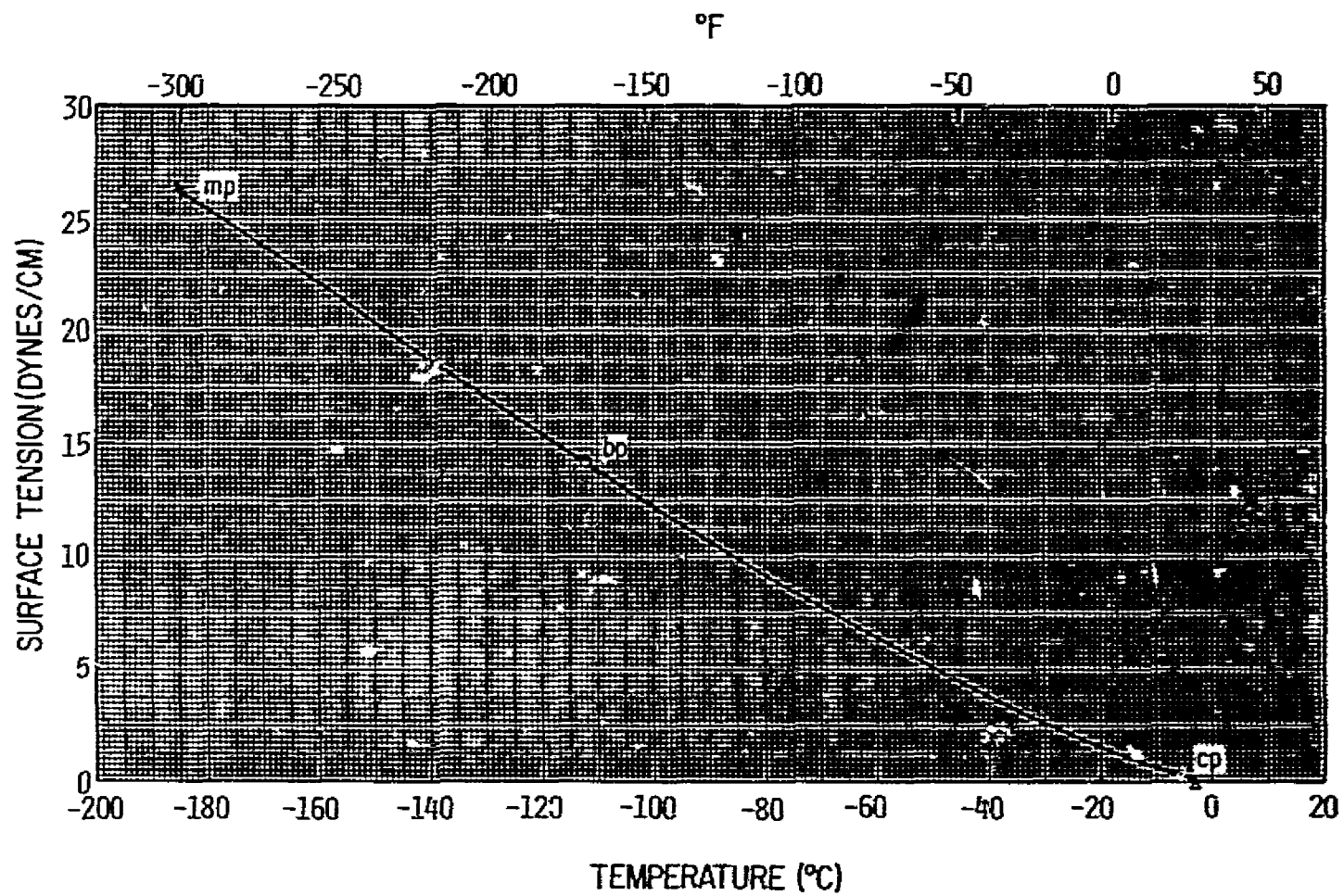

Figure 2.1-6 Surface Tension vs. Temperature for Silane

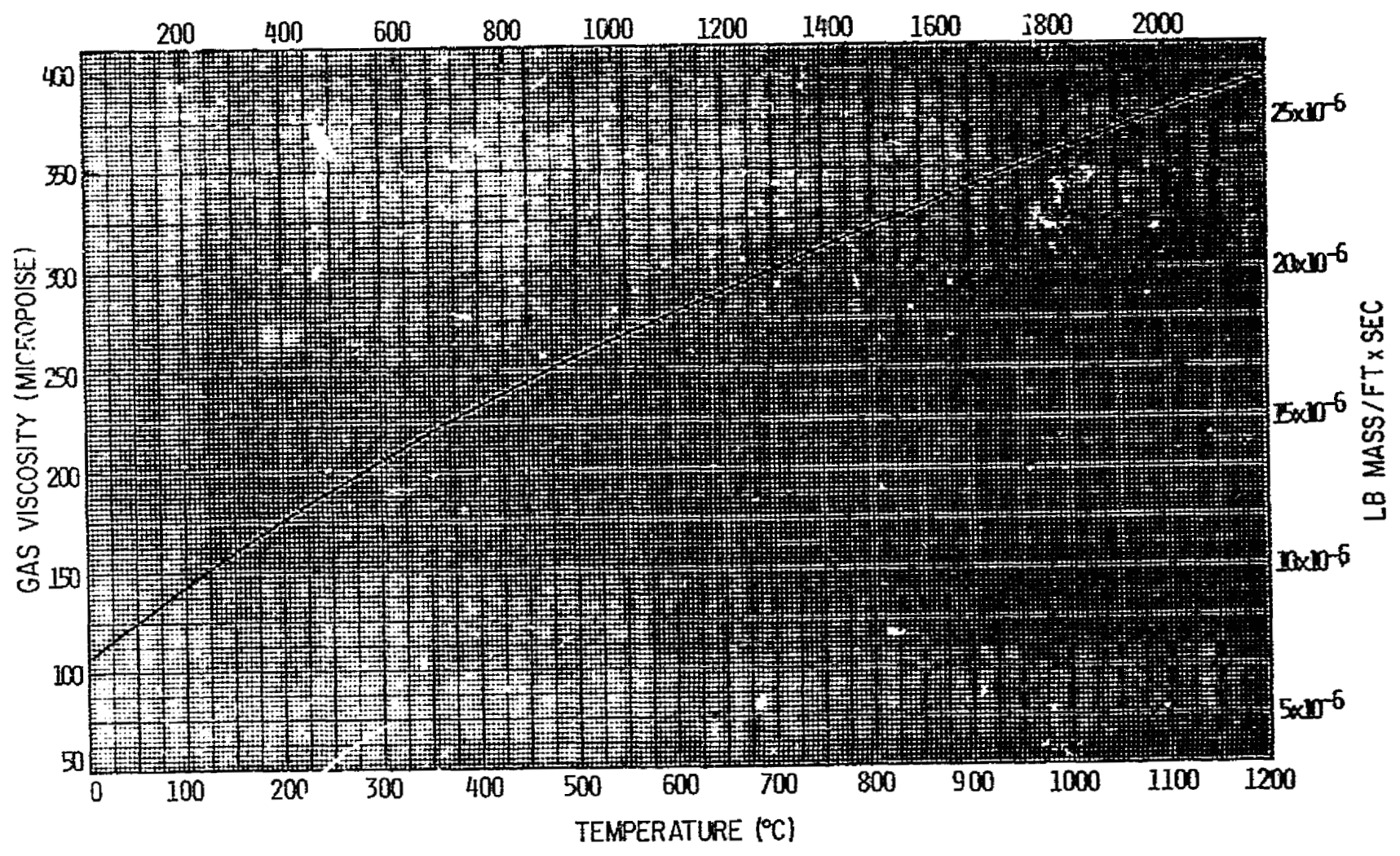

Figure 2.1-7 Gas Viscosity vs. Temperature for Silane

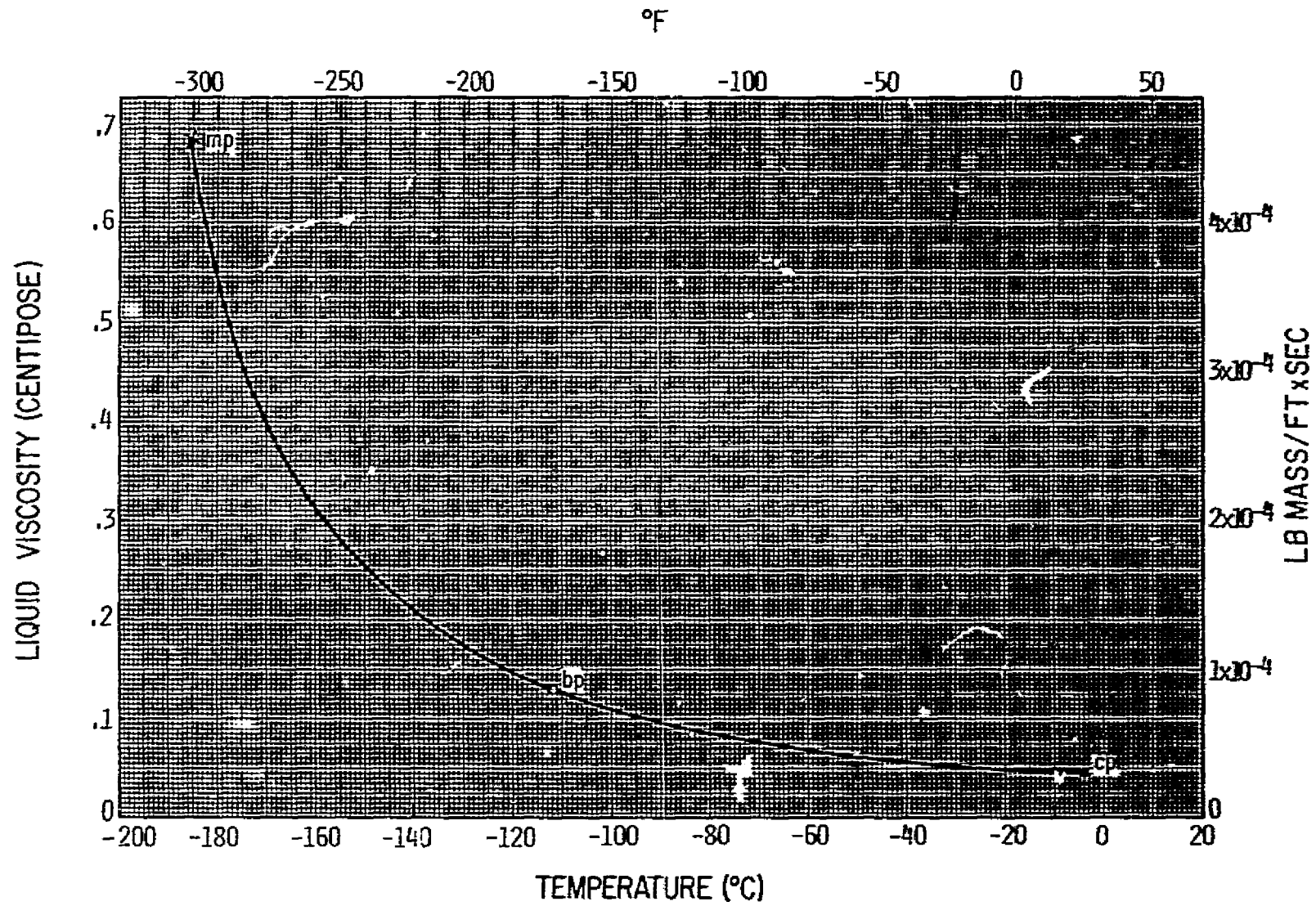

Figure 2.1-8 Liquid Viscosity vs. Temperature for Silane

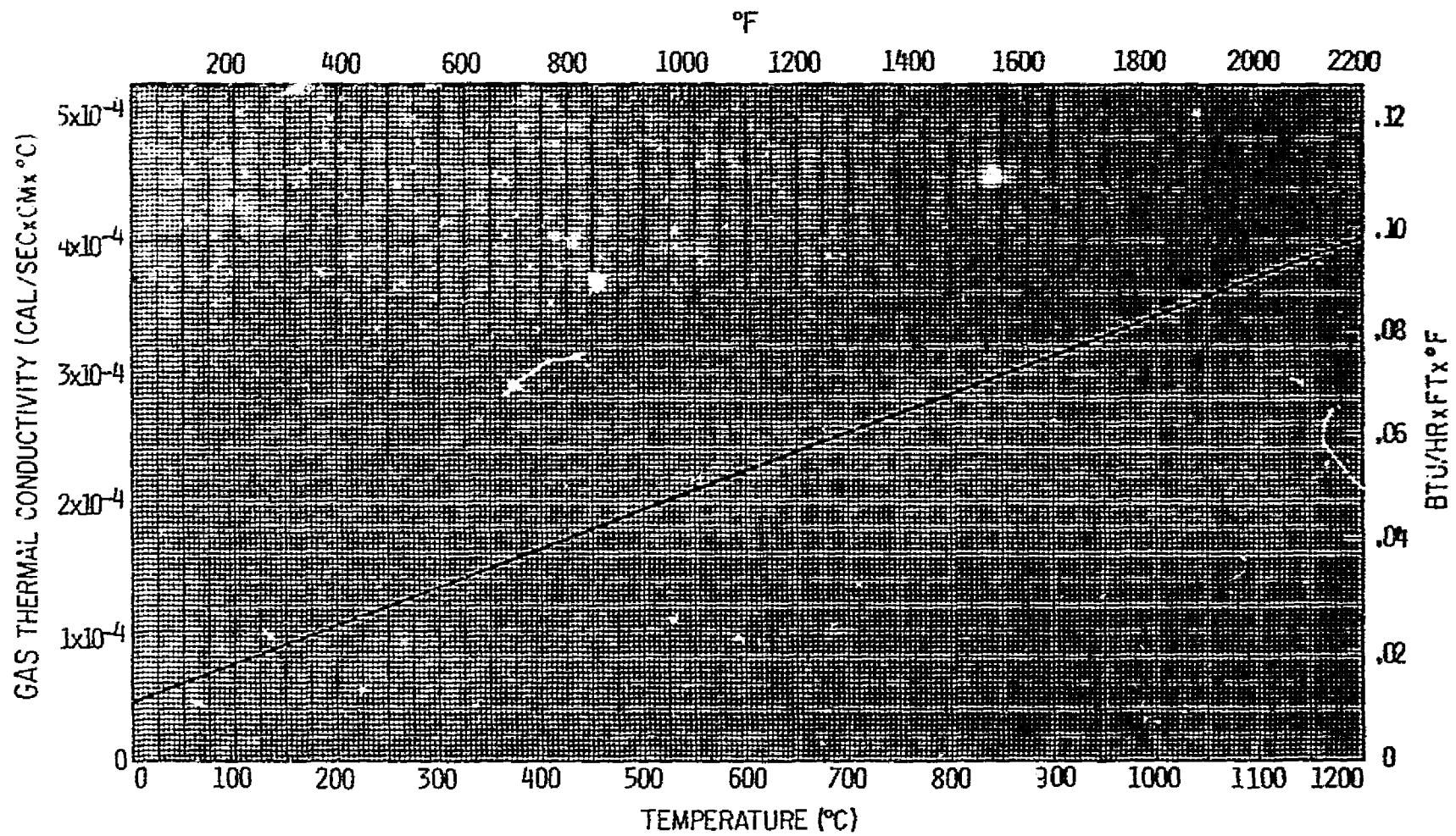

Figure 2.1-9 Gas Thermal Conductivity vs. Temperature for Silane

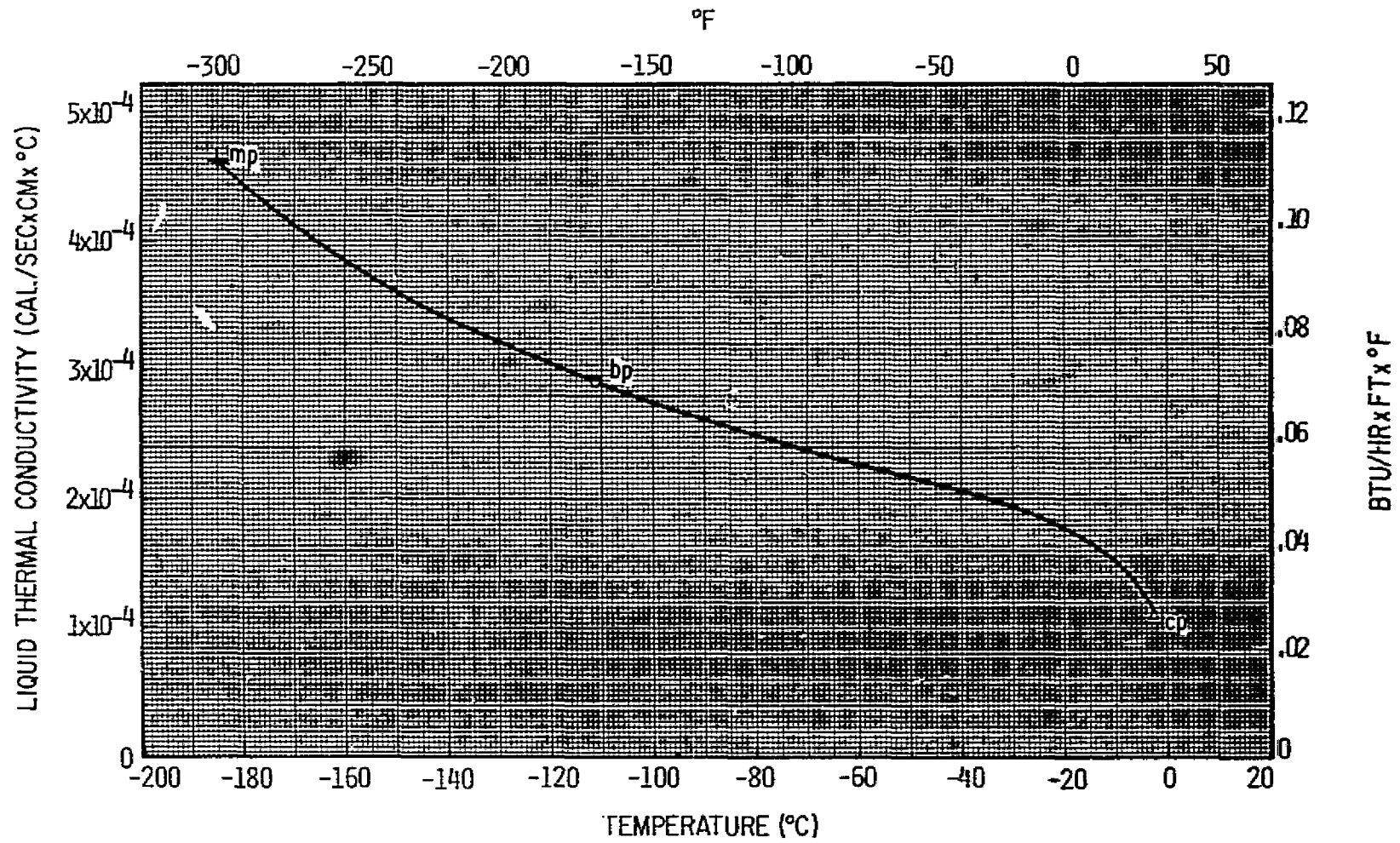

Figure 2.1-10 Liquid Thermal Conductivity vs. Temperature for Silane

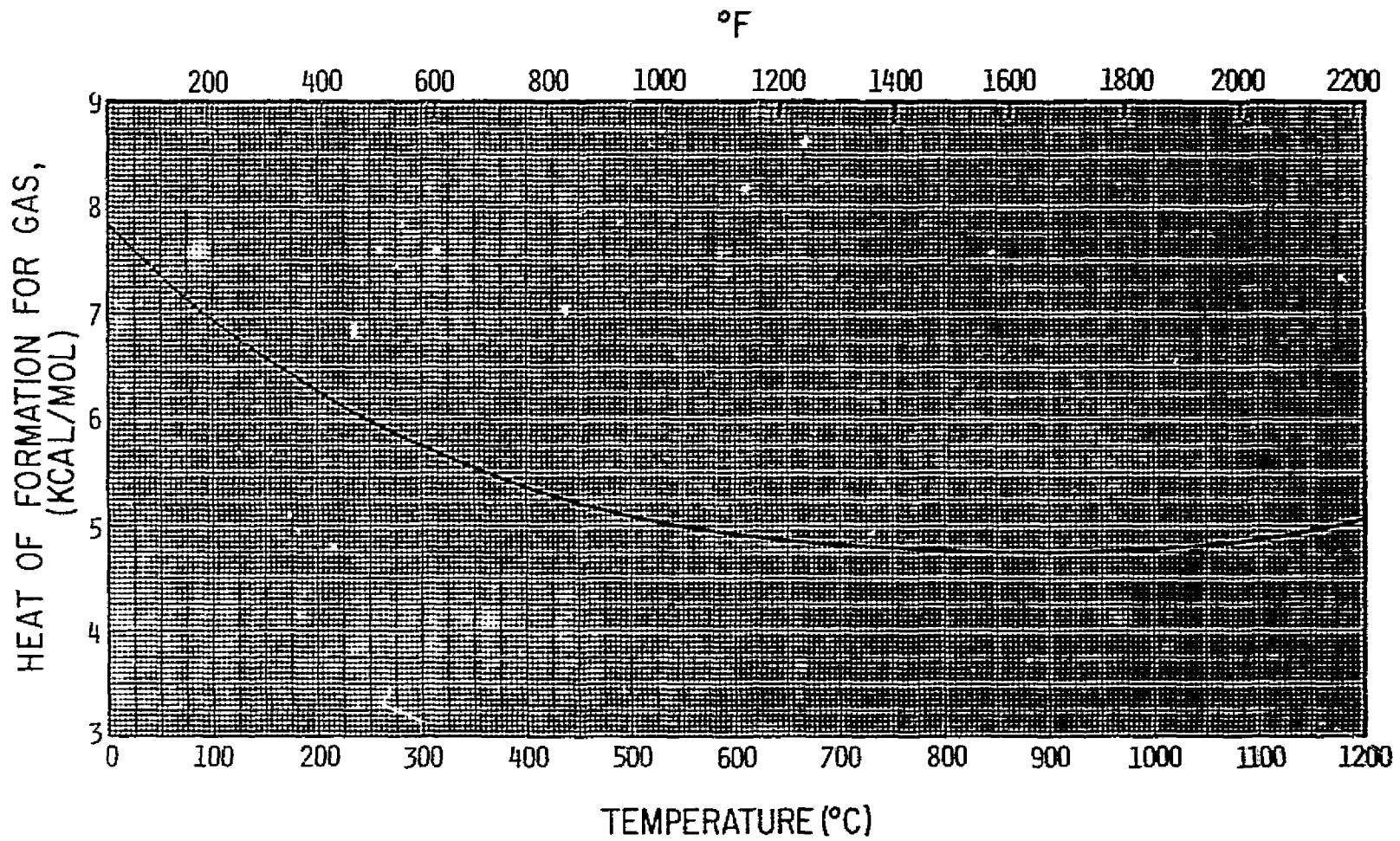

Figure 2.1-11 Heat of Formation vs. Temperature for Silane

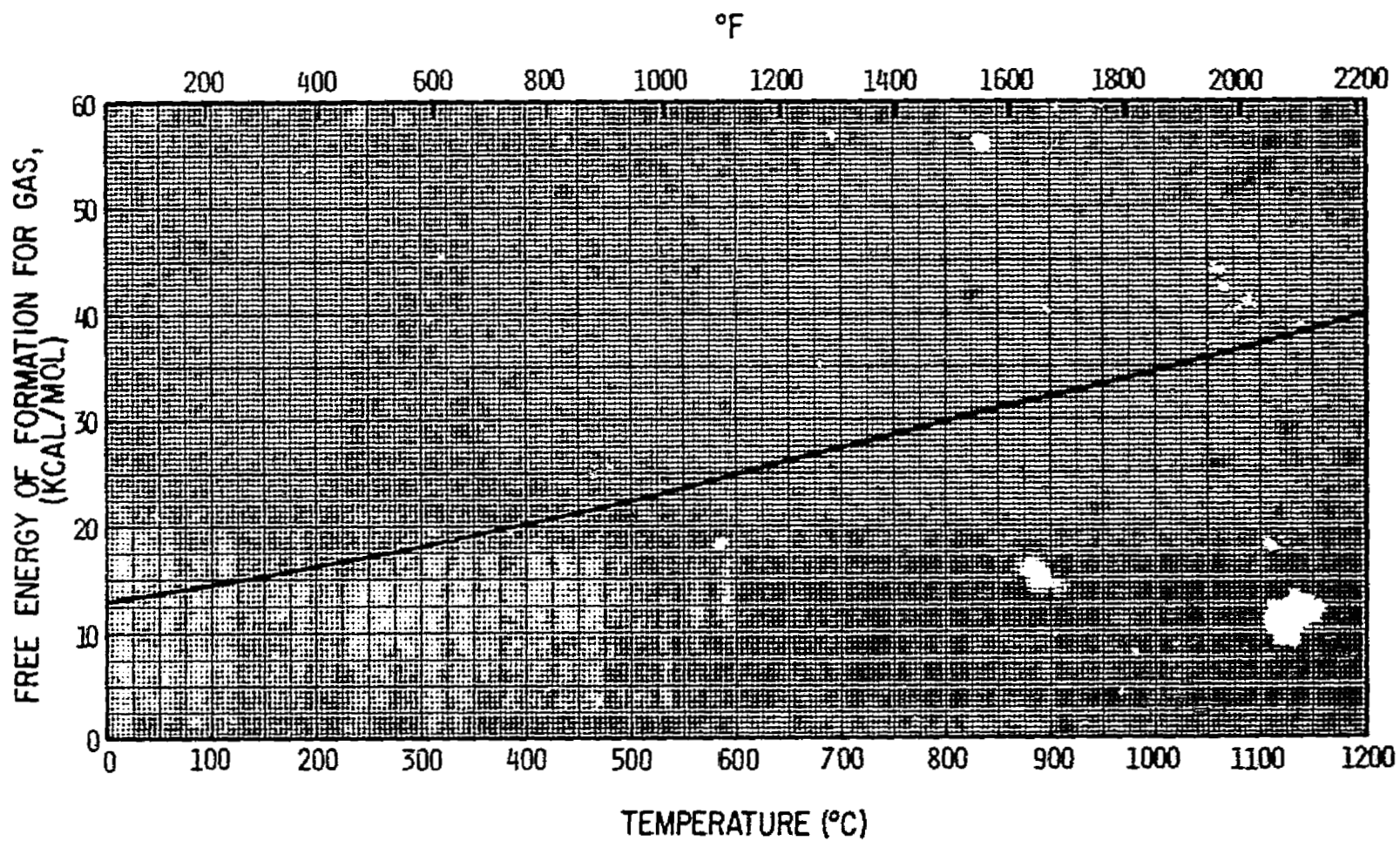

Figure 2.1-12 Free Energy of Formation vs. Temperature for Silane

REFERENCES FOR SILANE

1. Altshuller, A. P., J. Chem. Phys., 23, 761 (1955).
2. Bailar, J.C., Jr., ed., "Comprehensive Inorganic Chemistry" Vol. 1, Pergamon Press, Oxford, (1973).
3. Brimm, E. O. and Humphreys, H. M., J. Phys. Chem., 61, 829 (1957).
4. Casado, F. L., Anales Real Soc. Espan. Fis. Quim, Ser. B 60 (2-3), 131 (1964).
5. Cerny, C. and Erdos, E., Chem. Listy, 47, 1742 (1953).
6. Clusius, K., Z. Physik. Chem., B23, 213 (1933).
7. Devyatykh, G. G., et al, Dokl. Akad. Nauk SSSR 1969, 188 (5), 1082 (1970).
8. English, W. D., J. Am. Chem. Soc., 74, 2927 (1952).
9. Everett, D. H., J. Chem. Soc., 2566 (1960).
10. Feher, F., et al. Angew. Chem. (Intl. Ed. in Eng.), 2, 617 (1963).
11. Feher, F., et al. Z. Anorg. Allgen. Chem., 329(1-2), 31(1964).
12. Golosova, R. M. et al. Zh. Fiz. Khim., 45, (5), 1066 (1971).
13. Grosh, J., et al, Proc. Nat. Acad. Sci. U. S., 58(6), 2196 (1967).
14. Gunn, S. R. and Green, L. G., J. Phys. Chem., 65, 779 (1961).
15. "International Critical Tables," McGraw-Hill, New York (1926).
16. Karapet'yants, M.Kh. and Karapet'yants, M. L., "Thermodynamic Constants of Inorganic and Organic Compounds", trans. J. Schmorak, Israel Program for Scientific Translations, Ann Arbor-Humphrey Science Publishers, Ann Arbor (1970).
17. Kirk, R. E. and Othmer, D. F., eds., "Encyclopedia of Chemical Technology," 1st & 2nd ed., Interscience Encyclopedia, Inc. New York (1948-1970).
18. Klein, M. L. et al, Discuss. Faraday Soc. 1969, 48, 93 (1969).
19. Kovalchuk, D. S. and Morozov V.P., Tr. Dnepropetr. Khim.-Tekhnol Inst. No. 16, Pt. 1, 1 (1962).
20. "Landolt-Bornstein Tables," orig. volumes to present, Vol. 2 (pt. 2a, 3, 4, 5a, 5b), Springer-Verlag Berlin, Germany (1956-present).

21. Lange, N. A., ed., "Lange's Handbook of Chemistry," revised 10th ed., McGraw-Hill, New York (1961).
22. Lange, N. A., "Lange's Handbook of Chemistry," revised 11th ed., McGraw-Hill, New York (1973).
23. "Thermophysical Properties of Gases and Liquids," No. 1, V. A. Rabinovich, ed., p. 102, Israel Program for Scientific Translations, Jerusalem (1970), avail. from U. S. Dept. Comm., Springfield, Va. 22151.
24. Maslov, Y. P., Khimi Prakt Primenenie Kremneorgan. Soedin. Tr. Konf., 1958 (6), 265 (1961).
25. "Matheson Gas Data Book," 5th ed., Matheson Co., East Rutherford, N.J. (1971).
26. Mik va, Y., Nippon Kagaku Zasshi, 81, 1512 (1960).
27. Perry, R. H. and Chilton, C. H., ed., "Chemical Engineer's Handbook" 5th ed., McGraw-Hill, N.Y., (1973).
28. Ramaswamy, K. L., Proc. Indian Acad. Scie., 2A, 213 (1935).
29. Reid, R. C., and Sherwood, T. K., "The Properties of Gases and Liquids," 2nd ed., McGraw-Hill Book Company, N.Y. (1966).
30. Runovskaya, I. V., Zh. Neorg. Khim., 15 (9), 2581 (1970).
31. Sergeeva, T. N., etal. Izv. Vyssh. Ucheb. Zaved., Khim. Tekhnol., 14 (6), 881 (1971).
32. Shaulov, Y. K. etal., Zh. Fiz. Khim, 40 (8), 1893 (1966).
33. Sneed, M. C. and Brasted, R. C., "Comprehensive Inorganic Chemistry", Vol. 7, p 99, D. Van Nostrand Co., Inc., New York, (1958).
34. Steele, W. C., etal. J. Am. Che. Soc., 84, 4441 (1962).
35. Stock, A., Z. Elektrochem., 32, 341 (1926).
36. Stokland, I. K., Kgl. Norske Videnskab. Selskabs, Forh. 12, 122 (1940).
37. Stokland, I. K., Kgl. Norske Videnskab. Selskabs Forh, 19, No. 10. 33 (1946).
38. Stone, F. G. A., "Hydrogen Compounds of the Group IV Elements", Prentice Hall, Inc., Englewood Cliffs (1962).
39. Stull, D. R. and Prophet, H., Janaf Thermochemical Tables, Cat. No. C13:48:37, Stock No. 0303-0872, NSRDS-NBS37, Avail. Supt. Documents, Washington, D.C. (1971).
40. Svehla, R. A., "Estimated Viscosities and Thermal Conductivities of Gases at High Temperature," NASA Tr R-132, Lewis Research Center, Cleveland (1962).

41. Taft, R. W. Jr. and Sisler, H. H., *J. Chem. Education*, 24, 175 (1947).
42. Thomas, W. and Zander, M., *PTB-Mitt.*, 80, (3), 189 (1970).
43. Vlasov, S. M. and Devyatykh, G. G., *Zh. Neorg. Khim*, 11, (12), 2681 (1966).
44. Wagman, D. D., et al., NBS Technical Note 270-3, Avail. from Supt. Documents, Washington, D.C., 171 (1968).
45. Weast, R. C., ed., "CRC Handbook of Chemistry and Physics," 55th ed., Chemical Rubber Co., Cleveland (1974).
46. Wintgen, R., *Ber.* 52B, 724 (1919).
47. Woolsey, G., *J. Chem. Soc.*, 59, 1577 (1937).
48. Zorin, A. D., et al, *Zh. Neorg. Khim*, 12 (10), 2529 (1967).
49. Kaye, G. W. C. and Laby, T. H., "Tables of Physical and Chemical Constants and Some Mathematical Functions," John Wiley and Sons, Inc., New York, (1959).
50. Lewis, G. N. and Randall, M., "Thermodynamics," 2nd ed., McGraw-Hill, New York, (1961).
51. Adwentowski, K. and Drozdowski, E., *Bull. intern. acad. sci. Cracovie*, (A), 330, (1911).
52. Matheson Gas Products Catalog E-2, 2nd ed., East Rutherford, New Jersey, (1970).
53. Armirotto, A. L., Reprint from *Solid State Tech.*, Oct. 1968.
54. Heukelom, W., *Rec. Trav. Chim.*, 68 (9/10), 661 (1949).
55. Kobe, K. A. and Lynn, R. E., Jr., *Chem. Reviews*, 52, 121 (1953).
56. Mellor, J. W., "Inorganic and Theoretical Chemistry," (original volumes and supplements), Longmans, Green and Co., London, (1956).
57. Rankine, A. O., and Smith, C. J., *Proc. Phys. Lond.*, 34, (1922).
58. Spencer, C. F. and Danner, R. P., *J. Chem. Eng. Data*, 17, (2), 236 (1972).
59. Paneth, F., "Radio-Elements as Indicators and Other Selected Topics in Inorganic Chemistry," McGraw-Hill Book Co. Inc., New York (1928).
60. Stock, A. and Somieski, C., *Berichte der Deutschen Chemischen Gesellschaft*, III (1916).
61. Ogier, *Comptes Rendus L'academie des Sciences, de L'institute de Frances*, 88, 236 (1879).

62. Yaws, C. L. and Shah, P. N., Chem. Eng., 84, No. 22, (October 25, 1976).
63. Yaws, C. L. and Schorr, G. R. and Miller, J. W., Jr., Che. Eng., 157 (Nov. 22, 1976).
64. Yaws, C. L., Patel, P. M., Schorr, G. R. and Shah, P. N., Che. Eng., 159 (Nov. 22, 1976).

2.2 Silicon Tetrachloride Properties

Critical Properties (Table 2.2-1)

Experimental results for the critical temperature, pressure and volume of silicon tetrachloride are available (B5, B8, B9, B11, B32, B33, B35, B36, B44, B50, B56, B59, B82, B83). The results among the several investigators are in general agreement. Deviations from the selected values are 1.71%, 0.5%, and 10.8% respectively for critical temperature, pressure and volume.

The critical compressibility factor, Z_c , was calculated using the following equation:

$$Z_c = P_c V_c / RT_c \quad (2.2-1)$$

Also given in the table are values for the acentric factor, ω which is defined by:

$$\omega = -\log P_r - 1.000 \quad (\text{at } T_r = 0.70) \quad (2.2-2)$$

The acentric factor is an important parameter in generalized thermodynamic correlations involving virial coefficients, compressibility factor, enthalpy and fugacity.

Vapor Pressure (Figure 2.2-1)

Experimental vapor pressure data for silicon tetrachloride are available (B7, B22, B24, B27, B30, B32, B43, B53, B78, B103) from slightly above the melting point (mp) to boiling point (bp) and at the critical point (cp). Available data were extrapolated using the YSSP vapor pressure correlation (B102):

$$\log P_v = A + \frac{B}{T} + C \log T + DT + ET^2 \quad (2.2-3)$$

where

P_v = vapor pressure of saturated liquid, mm of Hg

A, B, C, D, E = correlation constants for chemical compound

T = temperature, °K

The correlation constants (A, B, C, D and E) were determined using a generalized least squares computer program for minimizing deviation of

calculated and experimental data values screened from the literature. Average absolute deviation was about 0.7% for the fifty-eight data points.

Heat of Vaporization (Figure 2.2-2)

Heat of vaporization data for silicon tetrachloride are available only at the boiling point (B5, B11, B22, B30, B36, B65, B82, B86). Watson's correlation was used to extend the heat of vaporization over the entire liquid phase:

$$\Delta H_V = \Delta H_{V_1} \left[\frac{T_C - T}{T_C - T_1} \right]^n \quad (2.2-4)$$

where ΔH_{V_1} is the heat of vaporization at the boiling point (T_1) and $n = 0.38$.

Heat Capacity (Figures 2.2-3 and 2.2-4)

Heat capacity data for silicon tetrachloride as ideal gas at low pressure are available (B3, B10, B17, B20, B28, B32, B34, B43, B45, B52, B67, B73, B76, B82, B84, B86, B91). The values, which are primarily based on structural and spectral measurements, are in close agreement.

The heat capacity data for the gas phase were correlated by a series expansion in temperature

$$C_p = A + BT + CT^2 + DT^3 \quad (2.2-5)$$

where C_p - heat capacity of ideal gas at low pressure, cal/(g-mol)(°K); A, B, C and D = characteristic constants for the chemical compounds; and T = temperature, °K. Average absolute deviation is about 0.6%.

Liquid heat capacity data are available (B5, B22, B28, B30, B26, B43, B52, B60, B65, B76, B77, B82, B104) in the mp-bp temperature interval. The data were extended to cover the entire liquid phase with the relation:

$$\text{liquid heat capacity} \times \text{density} = \text{constant} \quad (2.2-6)$$

The constant value was 0.3054. Testing of the relationship with the available data produced average deviation of 4%.

Density (Figure 2.2-5)

Liquid density data are available (B1, B49, B50, B59, B65, B77, B79, B81, B82) from near the melting point to the critical point. The Yaws-Shah equation (B100, B107) for density of the saturated liquid was used to extend the data to the critical point:

$$\rho = AB^{-1} (1 - T_r)^{2/7} \quad (2.2-7)$$

The agreement of calculated and experimental values was very good with average absolute deviation of only 0.44%.

Surface Tension: (Figure 2.2-6)

Data for surface tension (B5, B22, B27, B49, B82) are available in the melting point to boiling point temperature range. The data were extended using the Öthmer relation:

$$\sigma = \sigma_1 \left[\frac{T_c - T}{T_c - T_1} \right]^n \quad (2.2-8)$$

where σ_1 = surface tension at T_1 , dynes/cm

T_c = critical temperature, °K

T = temperature, °K

and n = the correlation parameter, 1.14. Testing of the relationship with the available data produced average deviation of less than 1%.

Viscosity (Figure 2.2-7 and 2.2-8)

The modified Yoon and Thodos correlation (B105, B106) was used to augment limited data (B36, B51) on gas viscosity at low pressure:

$$\eta\xi = 4.610 T_r^{0.618} - 2.04 e^{-0.449 T_r} + 1.94 e^{-4.058 T_r} + 0.1 \quad (2.2-9)$$

where $\xi = T_c^{1/6} M^{-1/2} P_c^{-2/3}$

The deviation between data and correlation was 2%.

Liquid viscosity data are available (B5, B8, B32, B36, B49, B51, B107) in both mp-bp and bp-cp temperature ranges. The data were extended to cover the entire liquid range with the following correlation (B107) for viscosity of the saturated liquid as a function of temperature.

$$\log \mu_L = A + B/T + CT + DT^2 \quad (2.2-10)$$

Average deviation between correlation and data was less than 3%.

Thermal Conductivity (Figure 2.2-9 and 2.2-10)

Gas-phase thermal conductivity data are available (B75, B109) in the temperature range of 70 to 300°C. The data were correlated by a series expansion in temperature (B107):

$$\lambda_G = A + BT + CT^2 + DT^3 \quad (2.2-11)$$

where λ_G = gas thermal conductivity, cal/cm²sec°C; A, B, C and D = characteristic constants for the chemical compounds and T = temperature, °K. The estimates of Svehla (B73) agree with the above correlation. The deviation between data and correlation values was 1.10%.

Thermal conductivity for liquid phase is available (B25) at only one temperature (32°C). The modified Stiel and Thodos equation (B107) was used to cover the entire saturated-liquid phase.

Heat and Free Energy of Formation (Figures 2.2-11 and 2.2-12)

Values for the heat of formation (ΔH_f) and Gibbs' free energy of formation (ΔG_f) for the ideal gas are available from American (B72) and Russian (B17, B64) sources. American values were selected.

TABLE 2.2-1

CRITICAL CONSTANTS AND PHYSICAL PROPERTIES OF SILICON TETRACHLORIDE

Identification	Silicon Tetrachloride
Formula	SiCl ₄
State (Std. Cond.)	Liquid
Molecular Weight, M	169.90
Boiling Point, T _b , °C	57.3
Melting Point, T _m , °C	-69.4
Critical Temp., T _c , °C	234.0
Critical Pressure, P _c , atm	37.0
Critical Volume, V _c , cm ³ /grmol	326.3
Critical Compressibility Factor, Z _c	0.290
Critical Density, ρ _c , gr/cm ³	0.5207
Acentric Factor, ω	0.2556

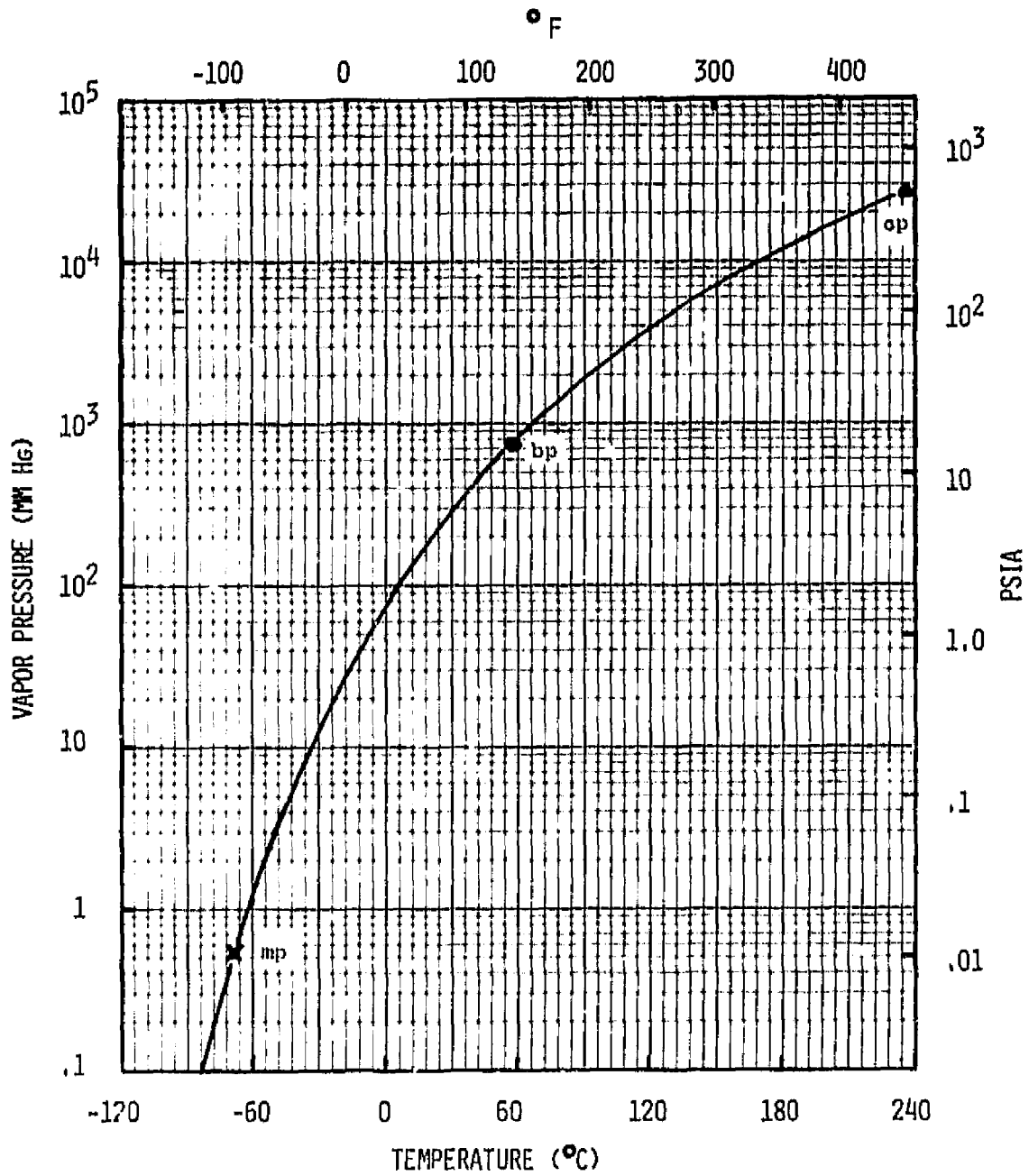

Figure 2.2-1 Vapor Pressure vs Temperature for Silicon Tetrachloride

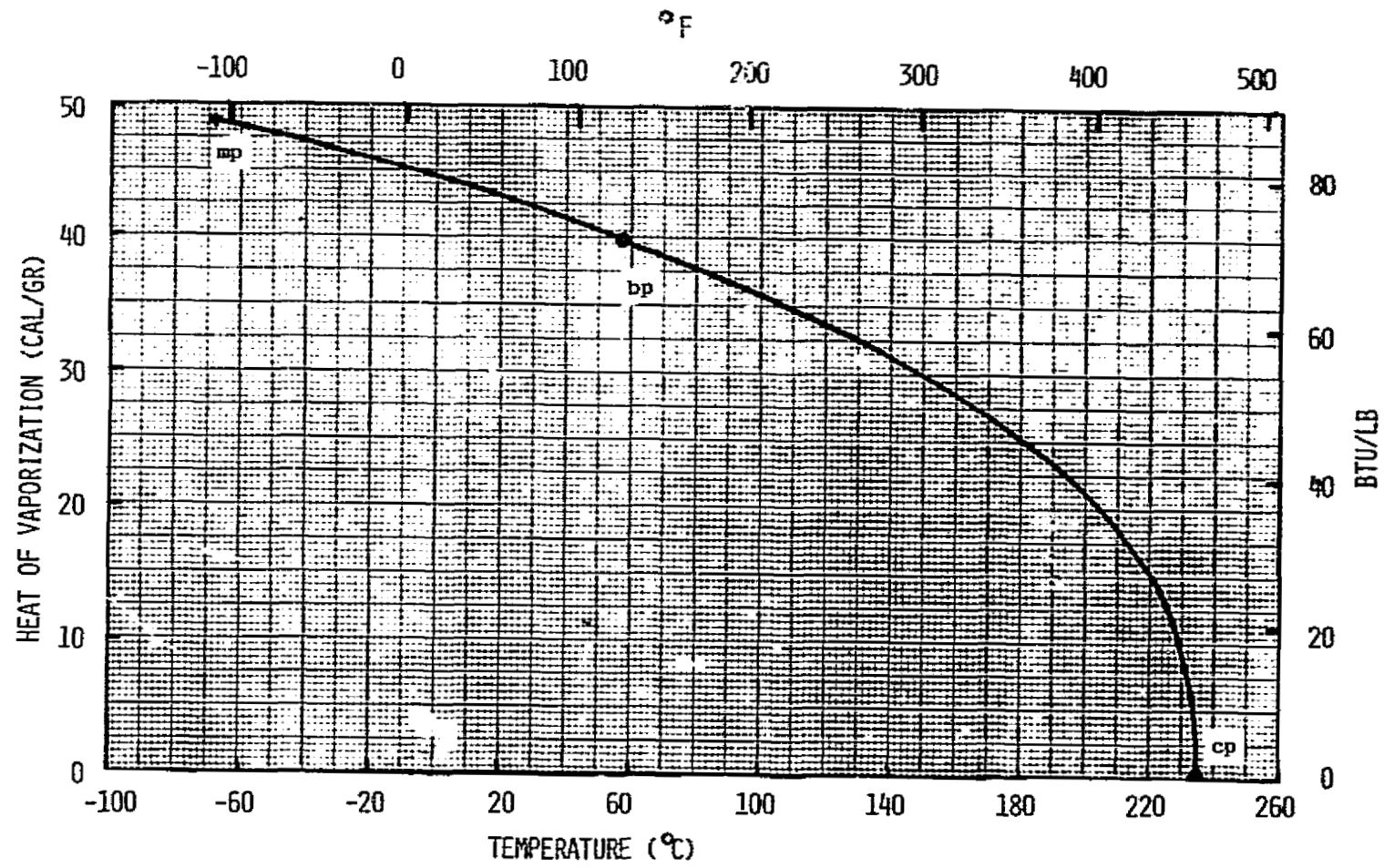

Figure 2.2-2 Heat of Vaporization vs Temperature for Silicon Tetrachloride

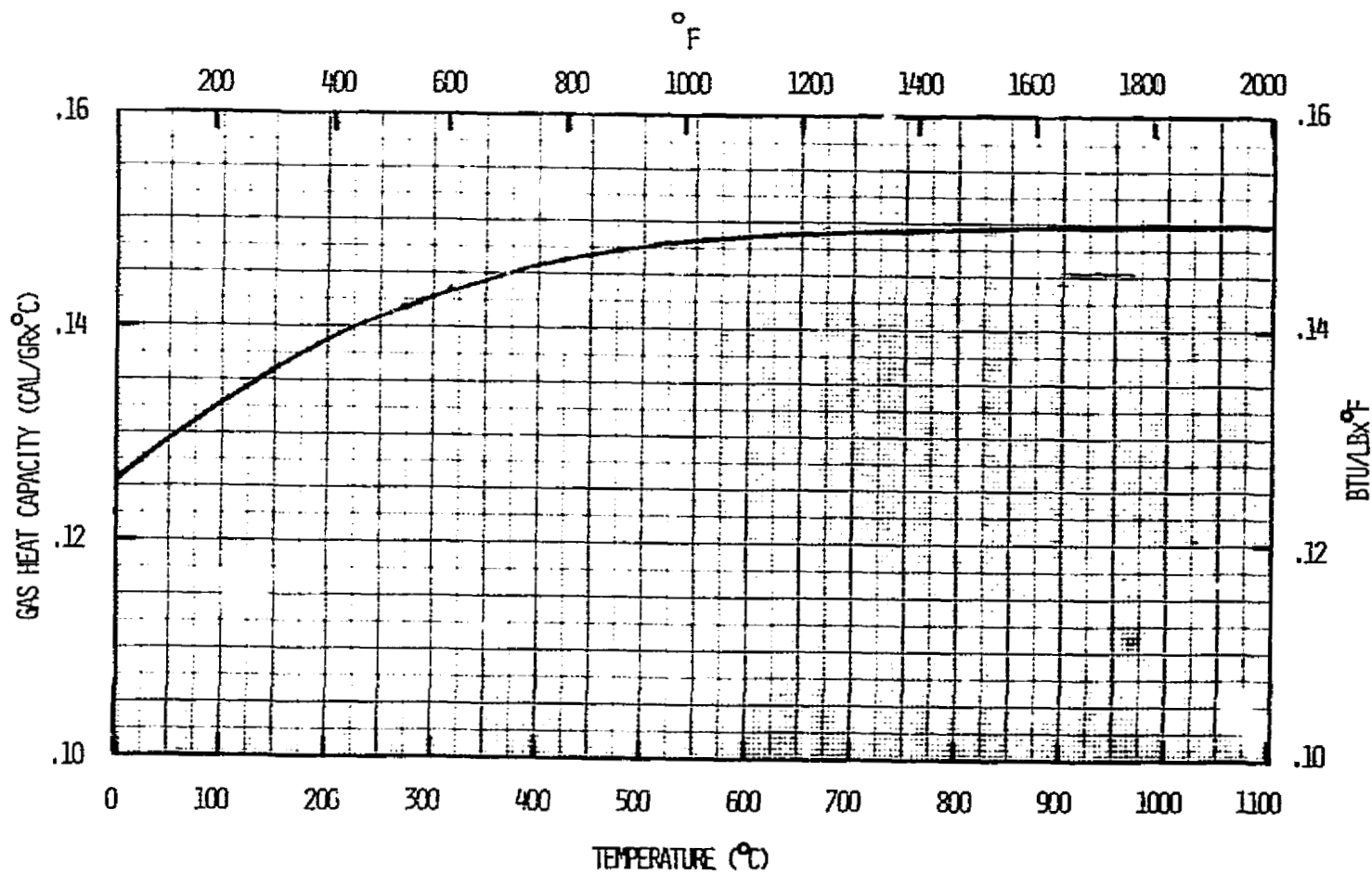

Figure 2.2-3 Gas Heat Capacity vs Temperature for Silicon Tetrachloride

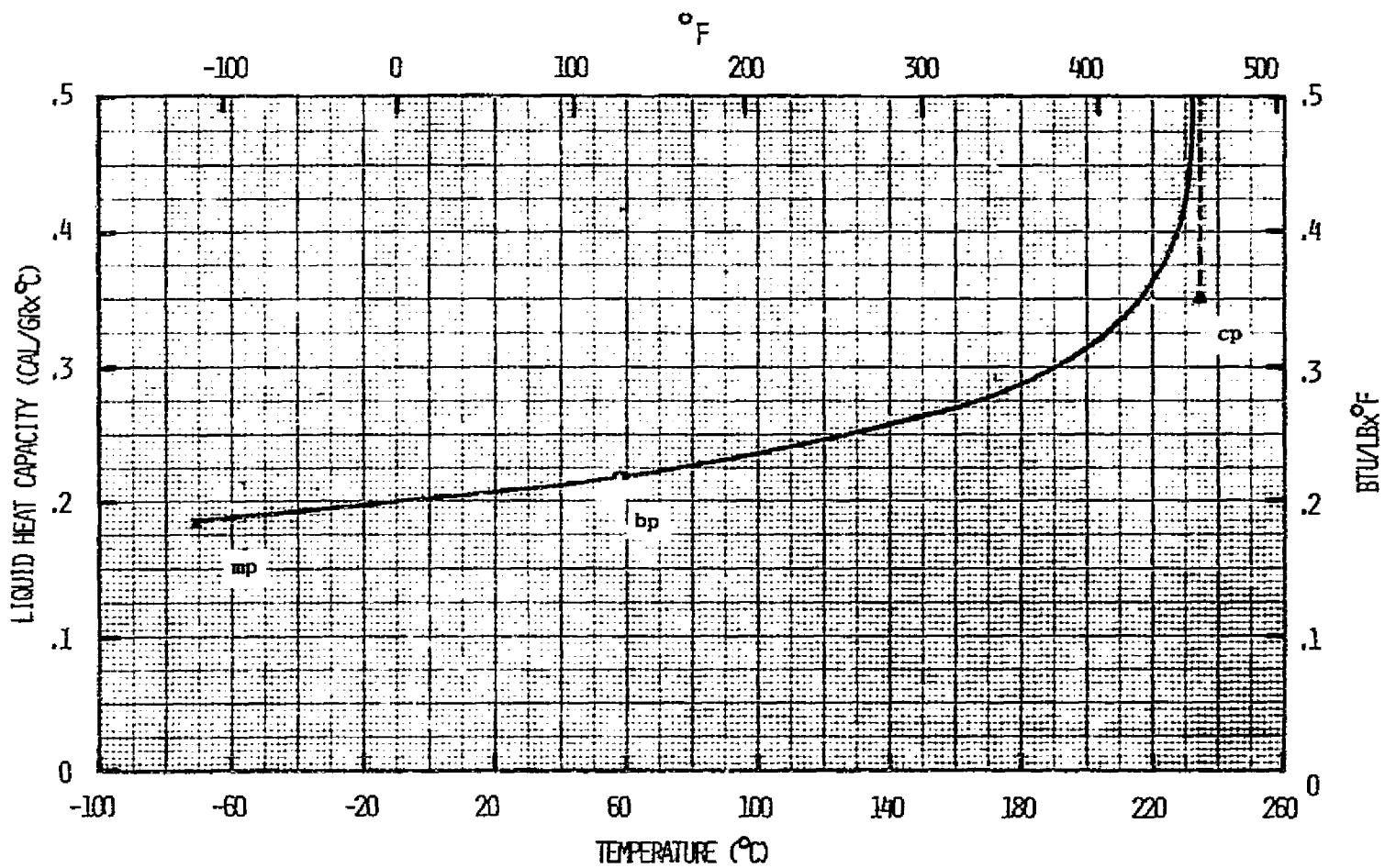

Figure 2.2-4 Liquid Heat Capacity vs Temperature for Silicon Tetrachloride

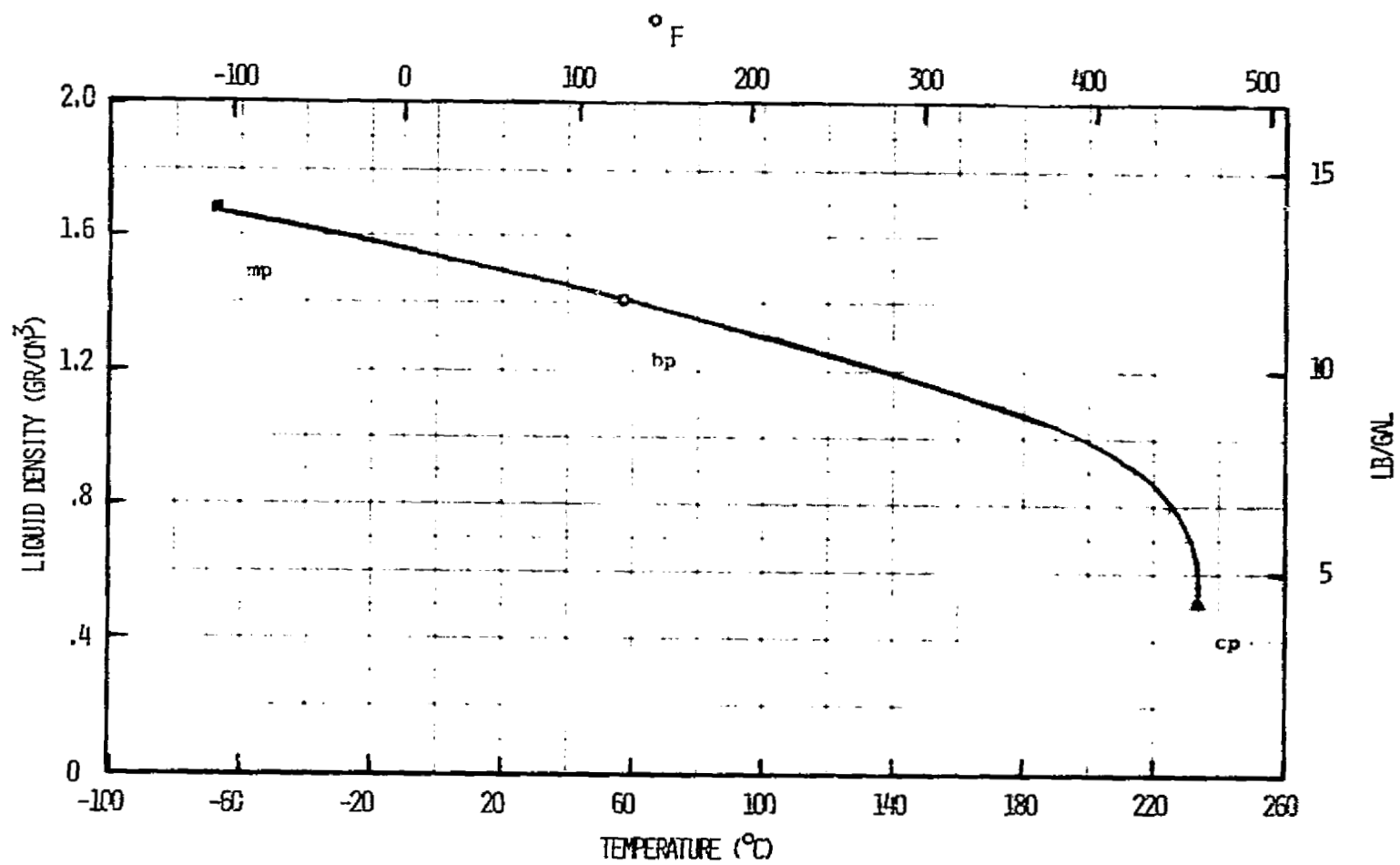

Figure 2.2-5 Liquid Density vs Temperature for Silicon Tetrachloride

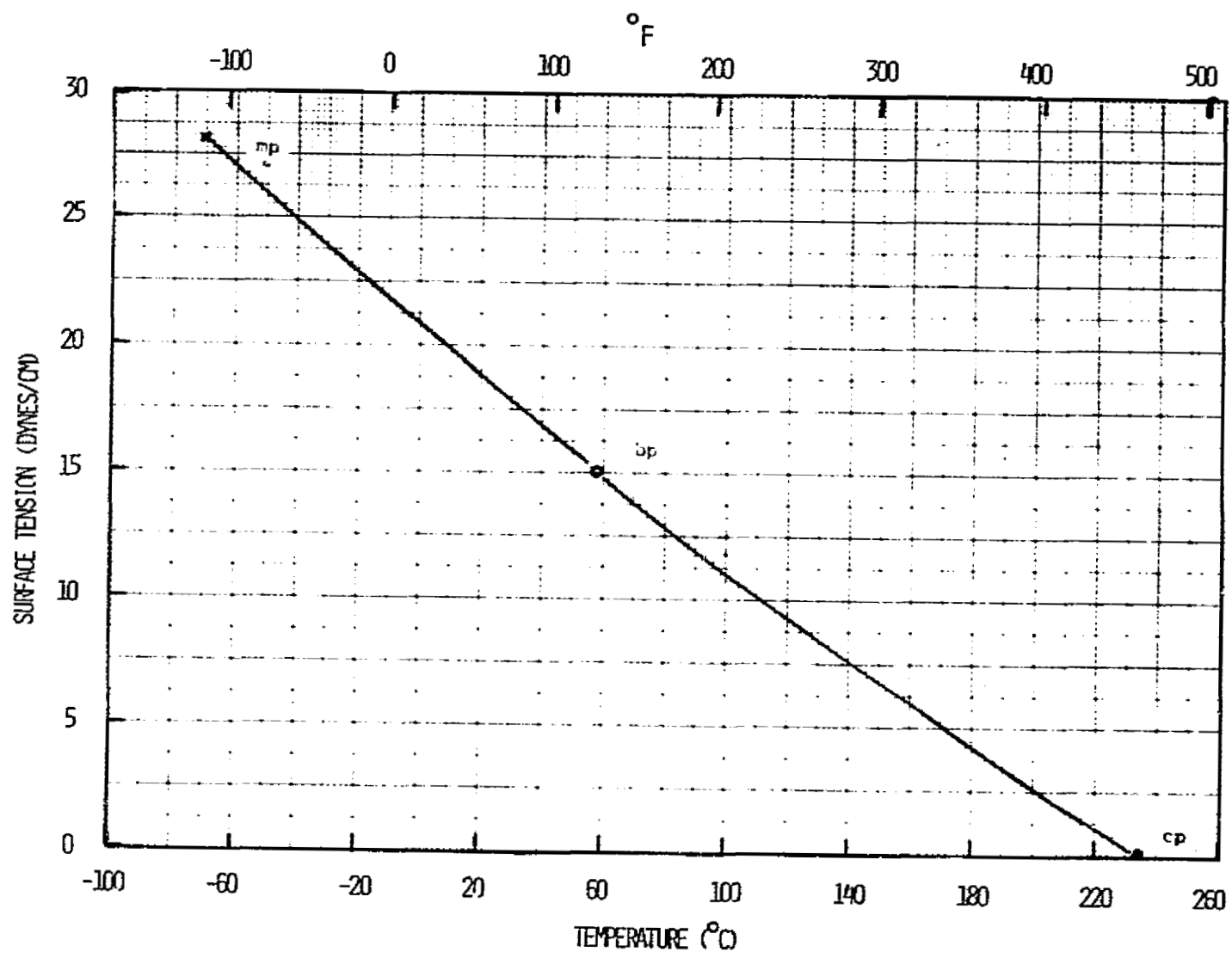

Figure 2.2-6 Surface Tension vs Temperature for Silicon Tetrachloride

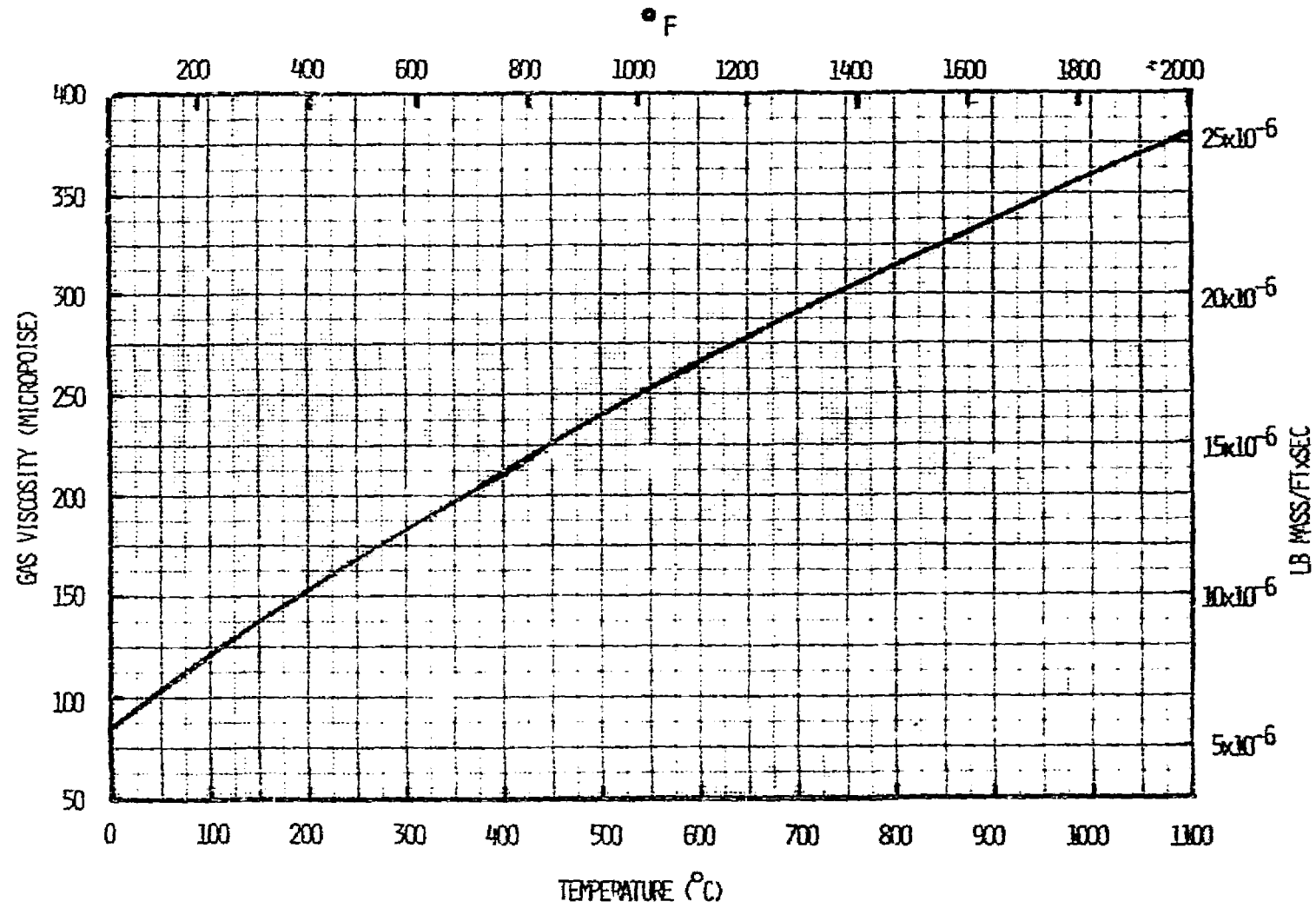

Figure 2.2-7 Gas Viscosity vs Temperature for Silicon Tetrachloride

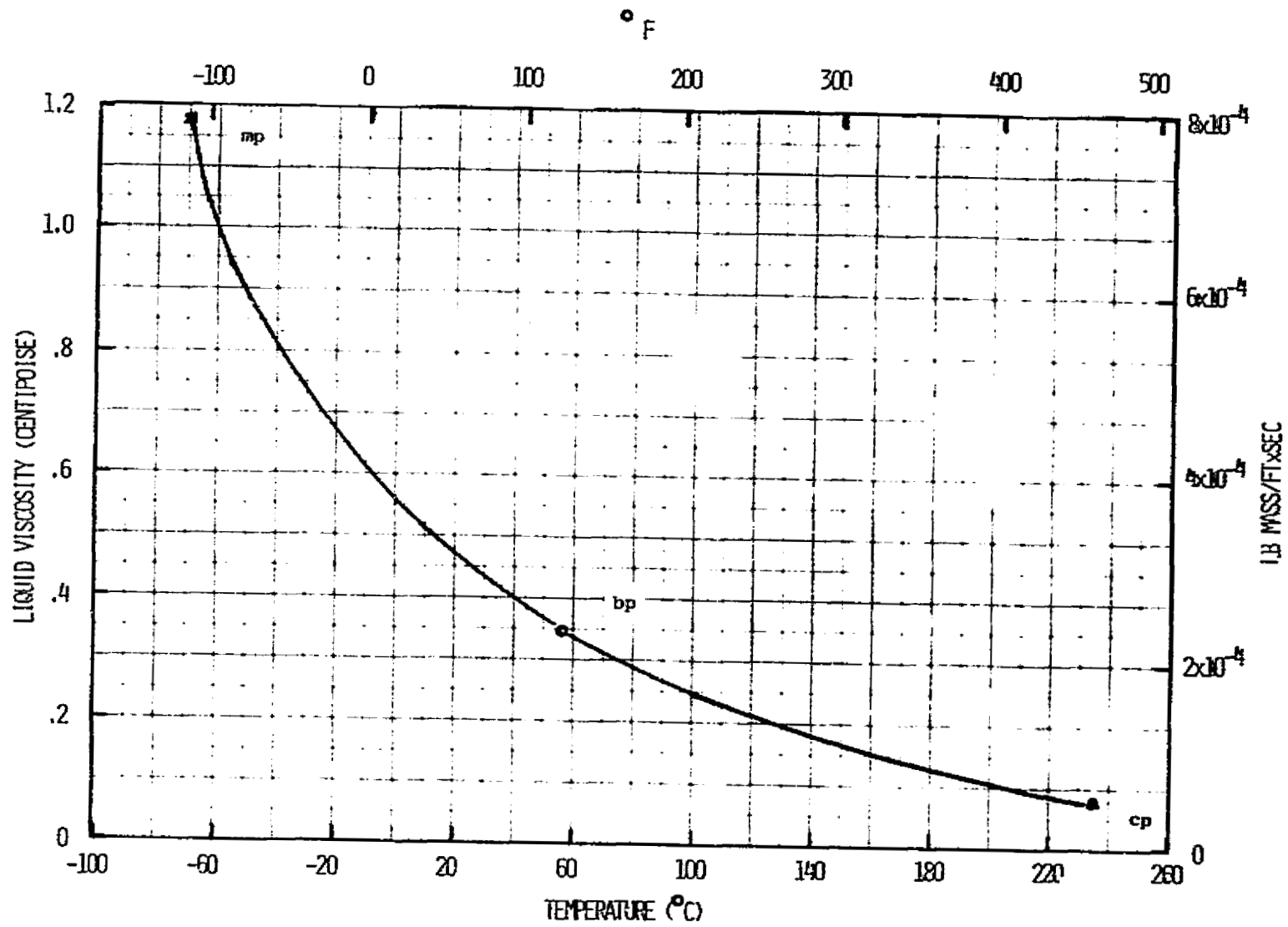

Figure 2.2-8 Liquid Viscosity vs Temperature for Silicon Tetrachloride

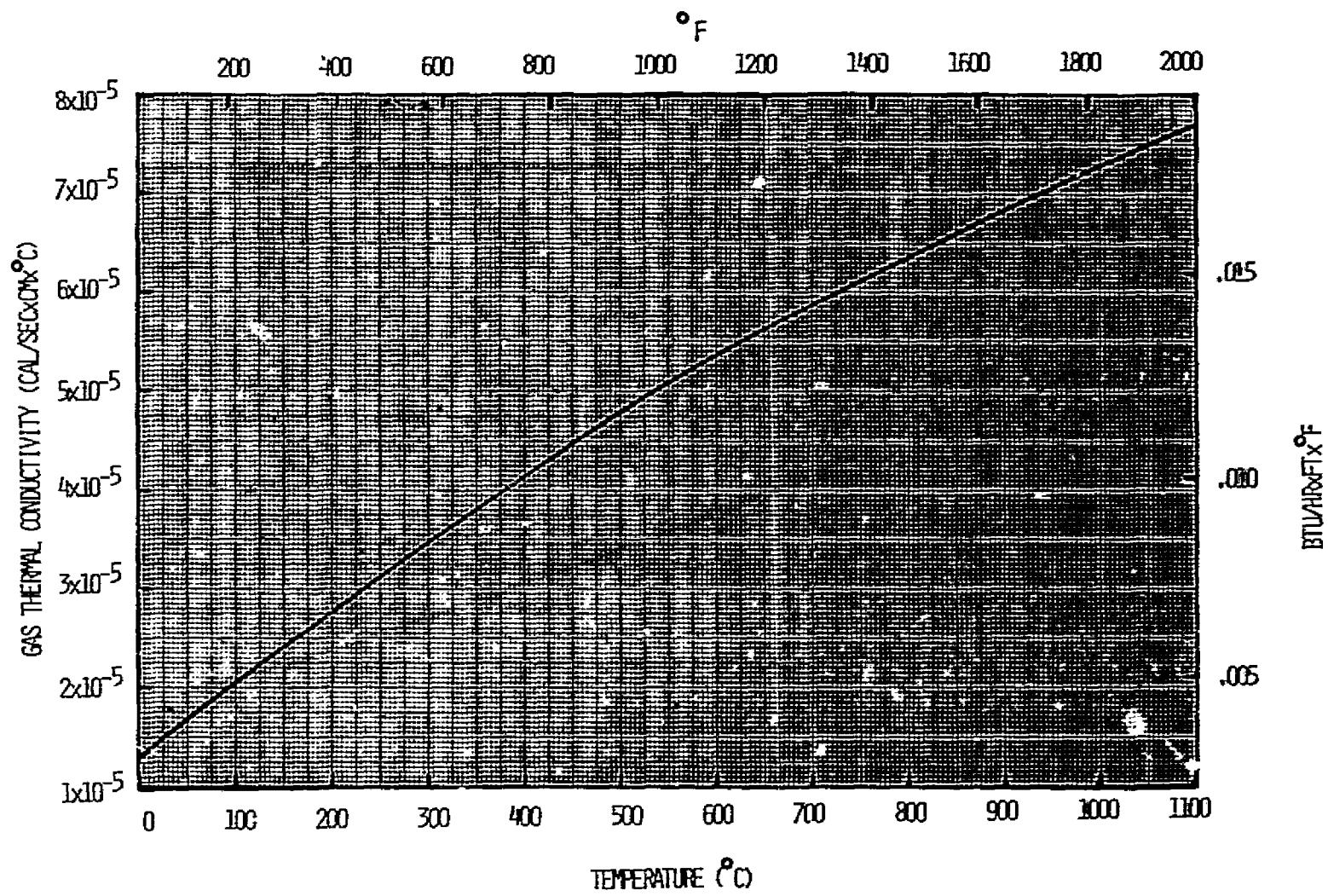

Figure 2.2-9 Gas Thermal Conductivity vs Temperature for Silicon Tetrachloride

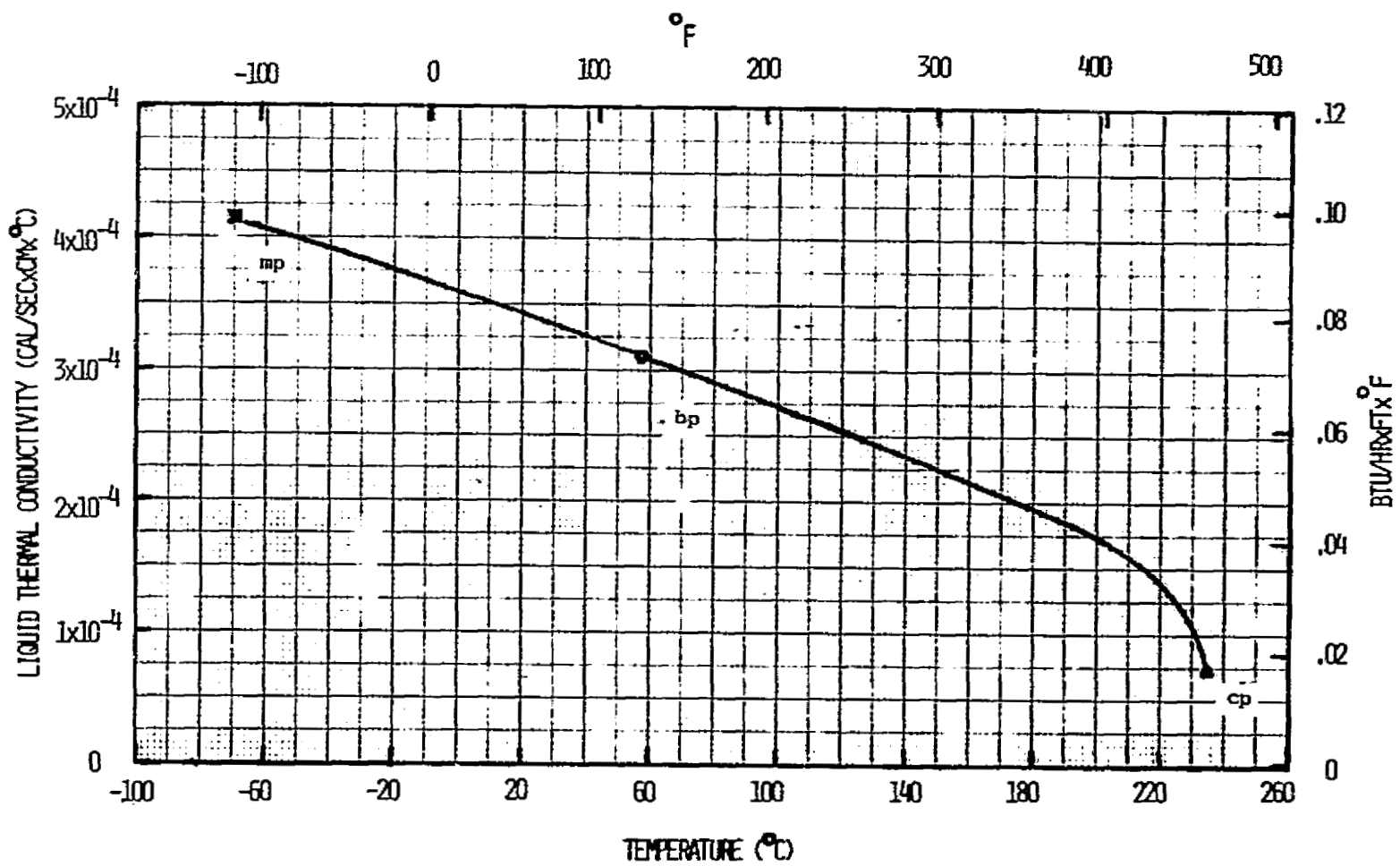

Figure 2.2-10 Liquid Thermal Conductivity vs Temperature for Silicon Tetrachloride

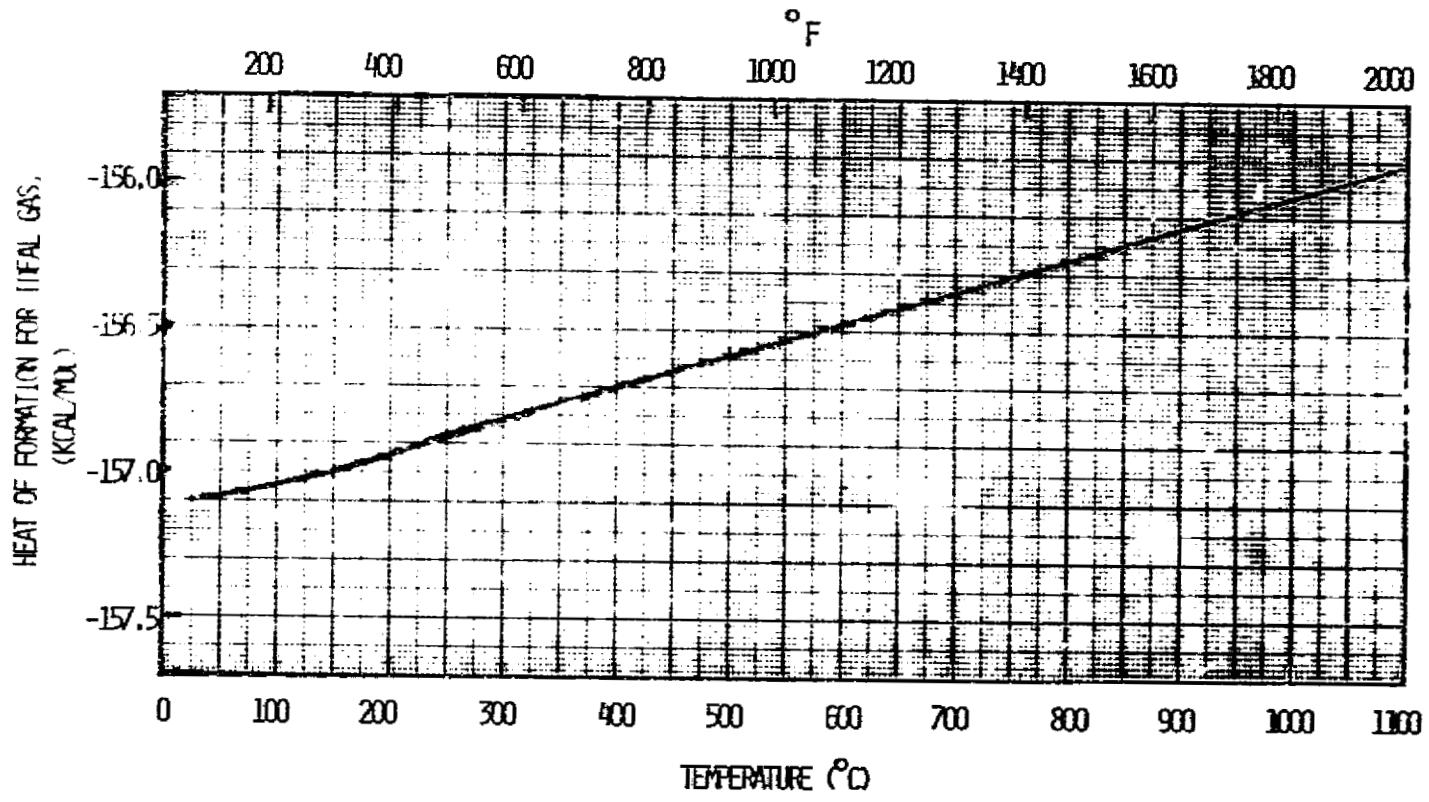

Figure 2.2-11 Heat of Formation vs Temperature for Silicon Tetrachloride

Downloaded from ASHRAE
Transactions
by guest on 06/15/2015

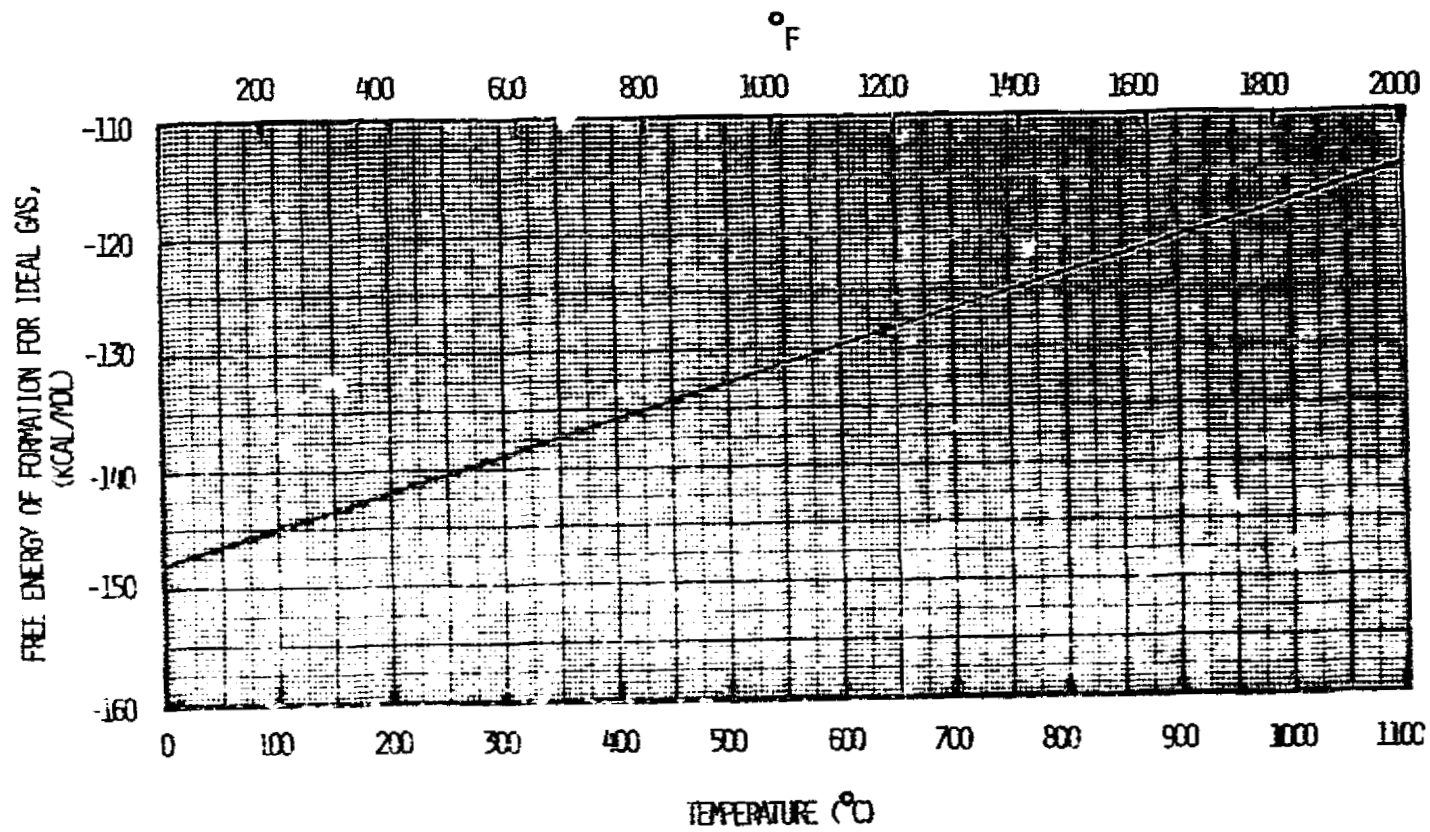

Figure 2.2-12 Free Energy of Formation vs Temperature for Silicon Tetrachloride

REFERENCES FOR SILICON TETRACHLORIDE

- B 1. Anderson, H. H., J. Am. Chem. Soc., 67, 859 (1945)
- B 2. Andrade, E. N. da C., Proc. Phys. Soc. (London), 52, 748 (1940)
- B 3. Antonov, A. A., and Maslov, P. G., Zhur. Prik. Khim., 40 (12), 2787 (1967)
- B 4. Balk, P. and Dang, D., J. Phys. Chem., 68, 960 (1964)
- B 5. Bailar, J. C., Jr., Ed., "Comprehensive Inorganic Chemistry," 1, Pergamon Press, Oxford (1973)
- B 6. Bartsch, V. K. and Wolf, E., Zeitschrift fur anorganische und allgemeine Chemie, 383, 66 (1971)
- B 7. Boublik, T., others, "The Vapor Pressure of Pure Substances," Elsevier, N. Y. (1973)
- B 8. Bowden, S. T. and Morgan, A. R., Philosophical Magazine, 29, 367 (1940)
- B 9. Bratsznajder, S., "Prediction of Transport and Other Physical Properties of Fluids," Pergamon Press, Warsaw (1971)
- B10. Cerny, C. and Erdos, E., Chem. Listy, 47, 1742 (1953)
- B11. Dean, J. A., Ed., "Lange's Handbook of Chemistry," 11th ed., McGraw-Hill, N. Y. (1973)
- B12. Emblem, H. G. and Stockwell, G. E., Ind. Chemist, 29, 3 (1953)
- B13. Everett, D. H., J. Chem. Soc., 2566 (1960)
- B14. Gibling, T. W., J. Chem. Soc., I & II, 299 (1941)
- B15. Gibling, T. W., J. Chem. Soc., III & IV, 611 (1942)
- B16. Gibling, T. W., J. Chem. Soc., V & VI, 146 (1943)
- B17. Golosova, R. M., Korobov, V. V. and Karapet'yants, M. Kh., Russ. J. Phys. Chem., 45(5), 598 (1971)
- B18. Grady, R. I., Chittum, J. W., Lyon, C. K., Analyt. Chem., 23(5), 805 (1951)
- B19. Gross, P., others, Trans. Faraday Soc., 65(11), 2856 (1969)
- B20. Herman, R. C., J. Chem. Phys., 6, 406 (1938)
- B21. Herzog, R., Ind. & Eng. Chem., 36(11), 997 (1944)
- B22. "International Critical Tables," Vol I-VI, McGraw-Hill, N. Y. (1926-1929)

- B23. Jasper, J. J., *J. Phys. Chem. Ref. Data*, 1(4), 877 (1972)
- B24. Jenkins, A. C. and Chambers, G. F., *Ind. and Eng. Chem.*, 46(11), 2367 (1954)
- B25. Jenkins, A. C. and Reid, A. J., *Ind. and Eng. Chem.*, 46 (12), 2566 (1954)
- B26. Karapet'yants M. L., "Tables of Some Thermodynamic Properties of Different Substances," *Trudy MKh TI in Mendeleeva*, No. 34, Moscow (1961) (Russ)
- B27. Kearby, K., *J. Am. Chem. Soc.*, 58, 374 (1936)
- B28. Kelley, K. K., *Bull. Bur. Mines*, No. 383 (1935)
- B29. King, W. R. and Cajar, L. N., *J. Chem and Eng. Data*, 7 351 (1962)
- B30. Kirk, R. E. and Othmer, D. F., "Encyclopedia of Chemical Technology," 1st and 2nd ed., Interscience Encyclopedia Inc., N. Y., (1948-1970)
- B31. Korchemskaya, K. M., others, *Zhur. Priklad, Khim.*, 33, 2703 (1960) (Russ)
- B32. "Landolt-Bornstein Tables," orig. volumes to present, Vol. 2 (pt. 2a, 3, 4, 5a, 5b), Springer-Verlag Berlin, Germany (1956-present)
- B33. Lange, N. A., Ed., "Handbook of Chemistry," 10th ed., McGraw-Hill, N. Y. (1961)
- B34. Lapidus, I. I., others, *Tepolfiz. Vys. Temp.*, (High Temp.), 6 (1), 60 (1968) (Eng)
- B35. Lapidus, I. I., others, *Izv. Vysshikh Uchebn, Zavedenii, Tsvetn. Met.*, 9 (2), 92 (1966) (Russ)
- B36. Lapidus, I. I., others, "Thermophysical Properties of Gases and Liquids," No. 1, V. A. Rabinovich, ed., 102, Israel Program for Scientific Translation, Jerusalem (1970), avail. from U. S. Dept. Comm., Springfield, Va. 22151
- B37. Luchinski, G. P., *J. Gen. Chem.*, 7, 2116 (1937) (U.S.S.P.)
- B38. Maslov, Yu. P., *Khim. i Prakt. Primenenie Kremneorgan. Soedin. Tr. Konf.*, Leningrad 1959(6), 265 (pub. 1961)
- B39. MacKenzie, C. A., others, *J. Am. Chem. Soc.*, 72, 2032 (1950)
- B40. Mark, A., *J. Electrochem. Soc.*, 108 (9), 880 (1961)
- B41. Matsen, J. M. and Johnson, E. F., *J. Chem. Eng. Data*, 5 (4), 531 (1970)
- B42. Meissner, H. P., *Chem. Eng. Prog.*, 45(2), 149 (1949)
- B43. Mellow, J. W., "Inorganic and Theoretical Chemistry," (original volumes and supplements), Longmans, Green and Co., London, 1956

- B44. Menzer, W., *Naturwissenschaften*, 45, 126 (1958)
- B45. Mikawa, Y., *Nippon Kagaku Zasshi*, 81, 1512 (1960)
- B46. Mumford, S. A., and Phillips, J. W., *J. Chem. Soc.*, 155 (1928)
- B47. Nagarajan, G., *Bull. Soc. Chim. Belges*, 73 (1/10), 7681 (1964)
(Eng)
- B48. Nisel'son, L. A. and Seryakov, G. V., *Russ. J. Inorg. Chem.*, 5 (5), 348 (1960)
- B49. Nisel'son, L. A., others, *Russ. J. Inorg. Chem.* 10(6), 705 (1965)
- B50. Nisel'son, L. A., others, *Russ. J. Inorg. Chem.*, 12 (6), 752 (1967)
- B51. Pena, M. D. and Esteban, F., *An. Real Soc. Espan. Fis. Quim., Ser. A* 62
(11-12), 347 (1966) (Eng)
- B52. Perry, R. H., others, "Chemical Engineers' Handbook," 4th ed.,
McGraw-Hill, N. Y. (1963)
- B53. Perry, R. H. and Chilton, C. H., "Chemical Engineers' Handbook,"
5th ed., McGraw-Hill, N. Y. (1973)
- B54. Pironne, M. H., *Physikalische Zeitschrift*, 40 (5), 145 (1939)
- B55. Popov, V. V., *Plasticheskie Massy*, 1960 (8), 25 (1960)
- B56. Reid, R. C. and Sherwood, T. K., "The Properties of Gases and
Liquids," 2nd ed., McGraw-Hill, N. Y. (1966)
- B57. Reid, R. C. and Sobel, J. E., *I & EC Fundamental*, 4(3), 328 (1965)
- B58. Ring, M. A., others, *J. Organometal. Chem.*, 5 (2), 124 (1966)
- B59. Sackmann, H., and Arnold, H., *Z. Elektrochem.*, 63, 565 (1959)
- B60. Savogina, M. S., *Izv. Vysshikh Uchebn. Zavedenii, Khim. Khim.
Tekhnol*, 9(3), 379 (1966) (Russ)
- B61. Schafer, H. and Heine, H., *Zeitschrift fur anorganische und
allgemeine Chemie.* 332, 25 (1964)
- B62. Schafer, V. H., others, *Zeitschrift fur anorganische und allgemeine
Chemie.* 352, 122 (1967)
- B63. Schafer, H., "Silicium, Schwefel, Phosphate, & Silic. Sek. Anorg. Chem.
Intern. Union Leine u. angew. Chem.," Munich, 1954 (pubd. 1955)
- B64. Shaulov, Y. K., others, *Zh. Fiz. Khim.*, 40 (1), 100 (1966)
- B65. "Silanes," Technical Brochure, Union Carbide Corp.,
Division, N. Y. (1966)

- B66. Simons, J. H. and Hickman, J. B., *J. Phys. Chem.*, 56, 420 (1952)
- B67. Spencer, H. M., *J. Am. Chem. Soc.*, 674, 4441 (1962)
- B68. Steels, W. C., others, *J. Am. Chem. Soc.*, 84, 4441 (1962)
- B69. Stock, A., "Hydrides of Boron and Silicon," Cornell Univ. Press, N. Y. (1933), (reissued 1957)
- B70. Stock, A. and Somieski, C., "Siliciumwasserstoffe: VI Chlorierung and Metylierung des Manosilans," 52, 695 (1959)
- B71. Stone, F. G. A., "Hydrogen Compounds of the Group IV Elements," Prentice-Hall, Inc., Englewood Cliffs, N. J. (1962)
- B72. Stull, D. R. and Prophet, H., Project Directors, "JANAF Thermochemical Tables," 2nd ed., NSRDS-NBS37, Natl. Bur. Stds., Washington, D. C., (1971)
- B73. Svehla, R. A., "Estimated Viscosities and Thermal Conductivities of Gases of High Temperature," NASA TR 4-132, Lewis Research Center, Cleveland (1962)
- B74. Thomas, L. H., *J. Chem.*, Part II, 2132 (1959)
- B75. Timrot, D. L., others, *Teplofiz. Vys. Temp.*, (High Temp.) 5(5), 824 (1967)
- B76. Wagman, D. D., others, "Selected Values of Chemical Thermodynamic Properties NBS Tech. Note 270-3, Natl. Bur. Stds., Washington, D. C. (1968)
- B77. Weissler, A., *J. Am. Chem. Soc.*, 71, 1272 (1949)
- B78. Weiwad, V. F., others, *Z. Phys. Chemie*, 253, 114 (1973)
- B79. Weast, R. C., Ed., "CRC Handbook of Chemistry and Physics," 55th ed., CRC Press, Cleveland (1974)
- B80. Wolf, E., *Z. Anorg. Allgem. Chem.*, 313, 228 (1961)
- B81. Yakshim, M. M., *Russ. J. Inorg. Chem.*, 6(11), 1229 (1961)
- B82. Yaws, C. L., others, *Sol. State Tech.*, 16 (1), 39 (1973)
- B83. Heukelom, W., *Rec. Trav. Chim.*, 68 (9/10), 661 (1949)
- B84. "Janaf Thermochemical Tables," McGraw-Hill, land, Mich. (1965)
- B85. Seifer, A. L., others, *IZV. Vysshikh Uchebn. Zavedonij. Tsvetn. Met.*, 9 (3), 85 (1966) (Russ).
- B86. Wicks, C. E. and Block, F. E., "Thermodynamic Properties of 65 Elements," Bull 605 Bur. of Mines, U. S. Govt. Printing off., Washington (1963)

- B87. Spencer, H. M., J. Am. Chem. Soc., 67, 1859 (1945)
- B88. Udovenko, V. V., others, Russ. J. Inorg. Chem., 2(4), 246 (1957)
- B89. Latimer, W. M., J. Am. Chem. Soc., 44, 90 (1922)
- B90. Vold, R. D., J. Am. Chem. Soc., 59, 1515 (1937)
- B91. Maslov, P. G., others, High Temperature (English Trans. of *Templofiz. Vysokikh Temperature*), 5(2), 245 (1967)
- B92. Lutschinsky, G. P., Z. Physik. Chem., 171, A, 348 (1934)
- B93. Glassner, A., "Technical Report ANL 5750," (1957)
- B94. Ulbrich, R., Z. fur Naturforsch., 21a (6), 763 (1966)
- B95. O'Neal, H. E. and Ring, M. A., "Inorganic Chemistry," 5(3), 435 (1966)
- B96. Mathews, J.F., Chemical Reviews, 72 (1), (1972).
- B97. Barin, I. and Knacke, O., Thermochemical Properties of Morg. Substances, 686 (1973)
- B98. VanLaar, J. J., Die Zustandsgleichung von Gasen and Flussigkeiten, 183 (1924)
- B99. Prostov, V. N. and Popova, O. G., Russ. J. Phys. Chem. 49(3), 366 (1975)
- B100. Yaws, C. L. and Shah, P. N., Chem. Eng., 84, No. 22, (Oct. 25, 1976)
- B101. Yaws, C. L., Schorr, G. R. and Miller, J. W., Jr., Chem. Eng., 157 (Nov. 22, 1976)
- B102. Yaws, C. L., Patel, P. M., Schorr, G. R., and Shah, P. M., Chem. Eng., 159 (Nov. 22, 1976)
- B103. Ohe, S., "Computer Aided Data Book of Vapor Pressure", 1878, Data Book Publishing Company, Tokyo, Japan (1976)
- B104. Touloukian, Y. S. and Makita, T., "Thermophysical Prop. of Matter", Supplement to Vol. 6, 83, IPI/Plenum, New York (1976)
- B105. Reid, R. C., others, "The Properties of Gases and Liquids", 3rd ed., McGraw-Hill, New York (1977)
- B106. Yoon, R. and Thodos, G., AIChE Journal, 16(2), 300 (1970)
- B107. Yaws, C. L., "Physical Properties", McGraw-Hill, New York (1977)
- B108. "Silicum (B)", 15, 664 (1959)
- B109. Yaws, C. L. Yang, C. S., Hansen, K. C. and J. W. Miller, Quarterly Technical Progress Report (XI), ERDA/JPL 954343-78/11, Distribution Category UC-63 (June, 1978)

- B110. Yaws, C. L., Miller, J. W., Jr., Lutwack, R. and Hsu, G., "Electricity from Sunlight: Low Cost Silicon For Solar Cells", Energy and the Environment-Proceedings of the Fifth National Conference, A.I.Ch.E.-A.P.C.A., p. 329, Cincinnati, Ohio (Oct. 31 - Nov. 3, 1977).

2.3 Trichlorosilane Properties

Critical Properties (Table 2.3-1)

Experimental data for the critical temperature and critical volume are available (G33, G28) from a Russian investigation of orthobaric densities and critical parameters. The critical pressure for trichlorosilane was estimated by Lydersen method (G62, G67):

$$P_c = \frac{M}{(\sum \Delta p + 0.34)^2} \quad (2.3-1)$$

where P_c is critical pressure (atm), M is molecular weight (gr/gr-mol), and Δp is critical property increments for atoms making up the molecule. This method produced only 1.6% error when compared with the experimentally determined critical pressure of silicon tetrachloride.

The critical compressibility factor, Z_c , was calculated from its definition:

$$Z_c = \frac{P_c V_c}{R T_c} \quad (2.3-2)$$

Vapor Pressure (Figure 2.3-1)

Observed vapor pressure data from several sources (G15, G29, G44, G61) for trichlorosilane are in general agreement from -85°C to just above the boiling point. The experimental data were extended to cover the entire liquid phase using the YSSP correlation relation (G63):

$$\log P_v = A + \frac{B}{T} + C \log T + DT \quad (2.3-3)$$

where

P_v = vapor pressure of saturated liquid, mm of Hg

A, B, C, D = correlation constants for chemical compound

T = temperature, $^\circ\text{K}$

The deviation of experimental and correlation results was small at 0.8% error for the 36 available data points.

Heat of Vaporization (Figure 2.3-2)

Heat of vaporization data for trichlorosilane are available only at the boiling point (G25, G18, G38, G46, G27). Using the known value at the boiling point, Watson's correlation (G62) was used to extend the heat of vaporization over the entire liquid phase:

$$\Delta H_V = \Delta H_{V1} \left[\frac{T_C - T}{T_C - T_1} \right]^n \quad (2.3-4)$$

where $n = .38$ and ΔH_{V1} applies at the boiling point (T_1).

Heat Capacity (Figures 2.3-3 and 2.3-4)

Heat capacity of the ideal gas at low pressure has been calculated by various Russian (G23, G25, G45, G11), American (G53, G56) and other (G6, G30) workers. The values, taken from various structural and spectral data, are in close agreement. The JANAF values (G53) were selected.

The liquid heat capacity of trichlorosilane is reported to be .23 between 25 and 60°C (G19, G46). The values are extended over all liquid temperatures by the relationship:

$$\text{Heat Capacity} \times \text{Density} = \text{Constant} \quad (2.3-5)$$

The constant, C., was estimated to be 0.298.

Testing of this relationship with available data for silicon tetrachloride produced an average deviation of 4%.

Liquid Density (Figure 2.3-5)

Liquid density data for trichlorosilane are available from -10°C to the critical point (G33, G32, G61, G12, G26). The experimental data was extrapolated to the melting point by use of the Yaws-Shah relationship (G63) for saturated liquid:

$$\rho_L = AB^{-(1-T_r)^{2/7}} \quad (2.3-6)$$

where $A = .4856$ and $B = .2618$. Correlation values and experimental results were in close agreement. The deviation was less than 1% for the 31 published data points from several independent sources.

Surface Tension (Figure 2.3-6)

Data for the surface tension of trichlorosilane are available from 0°C to 40°C (G32, G26). These data were extended using the Othmer relations (G62):

$$\sigma = \sigma_1 \left[\frac{T_c - T}{T_c - T_1} \right]^n \quad (2.3-7)$$

where σ_1 = surface tension at T_1 , dynes/cm, and n = the correlation parameter, 1.2. The other parameters have their usual meaning. Deviations between data and correlation values were 3% or less, largely due to the deviations between reported experimental values.

Viscosity (Figures 2.3-7 and 2.3-8)

Data for the gas viscosity of trichlorosilane were available only at 0°C and at boiling point (G25). The values at higher temperatures were estimated using the modified and revised corresponding-state method of Thodos and Yoon (G67, G68):

$$\eta_G \xi = 4.610 \tau_1^{0.618-2.04} e^{-0.449T_r} + 1.94 e^{-4.058T_r} + 0.1 \quad (2.3-8)$$

where η_G = viscosity, $\xi = T_c^{1/6} M^{-1/2} P_c^{-2/3}$, and T_r is the reduced temperature. The percentage error was less than .4%. Testing with silicon tetrachloride gave good agreement of correlation and experimental results (16 data points produced a 2% deviation).

Liquid viscosity data for trichlorosilane are available from -7°C to 60°C (G32, G26, G19, G25, G46). At low temperatures (from the boiling to the melting point), values were estimated using the log η_L vs $1/T$ linear relationship. At high temperatures (up to the critical point), the Stiel and Thodos correlation was used with $\mu_L \xi = f(Z_c, T_r)$ where $f(Z_c, T_r)$ is given as a generalized liquid viscosity correlation (G62). The percentage error with the available experimental data was about 2%.

Thermal Conductivity (Figures 2.3-9 and 2.3-10)

The gaseous thermal conductivity of trichlorosilane has recently been reported from 46°C to 350°C (G66). The experimental values were extended using a modified form of the Mistic and Thodos correlation (G63, G67):

$$\lambda_G = C_p/\gamma (10^{-6}) (14.52 T_r - 5.14)^n \quad (2.3-9)$$

where $n = .71$. The average absolute percentage error was 1.5%.

Liquid thermal conductivity data for trichlorosilane are not available. Using the estimation method of Sheffy and Jonnson (G62):

$$\lambda_L = \{(4.66) (10^{-3}) [1 - .00126 (T - T_m) / T_m]^{.216} M^{.300}\} \quad (2.3-10)$$

$\lambda_L = 2.783 \times 10^{-4}$ cal/cm x sec x °K was derived for the value at 60°C.

Using the Pachaiyappan-Vaidyanathan method of estimation (G64):

$$\lambda_L = 8.84 \times 10^{-4} \rho_L \quad (2.3-11)$$

the value of 2.64×10^{-4} ca./cm x sec x °K was derived for 60°C.

These estimation methods produced errors of 16% and 17.5%, respectively, on the one published value for SiCl_4 ; and hence, should be taken to represent only an order of magnitude estimate. The estimate was extended over the entire liquid range using a modification of the Stiel and Thodos method (G62, G63):

$$\lambda_L = \frac{f(\rho_r)}{\gamma Z_c} + \lambda_G \quad (2.3-12)$$

Heat and Free Energy of Formation (Figures 2.3-11 and 2.3-12)

Values of the heat (ΔH_f) and Gibb's free energy of formation (ΔG_f) for the ideal gas are available from various Russian (G11, G45), American (G53) and other (G6, G30) sources and are in close agreement. The American values were selected.

TABLE 2.3-1

Critical Constants and Physical Properties of Trichlorosilane

<u>Identification</u>	<u>Trichlorosilane</u>
Formula	SiHCl_3
State (std. cond.)	liquid
Molecular Weight, M	135.453
Boiling Point, T_b , °C	31.8
Melting Point, T_m , °C	-126.6
Critical Temp., T_c , °C	206
Critical Pressure, P_c , atm	40.01*
Critical Volume, V_c , $\text{cm}^3/\text{gr mol}$	268
Critical Compressibility Factor, Z_c	.273*
Critical Density, ρ_c , gr/cm^3	.505
Acentric Factor (Ω)	.188*

*Estimated

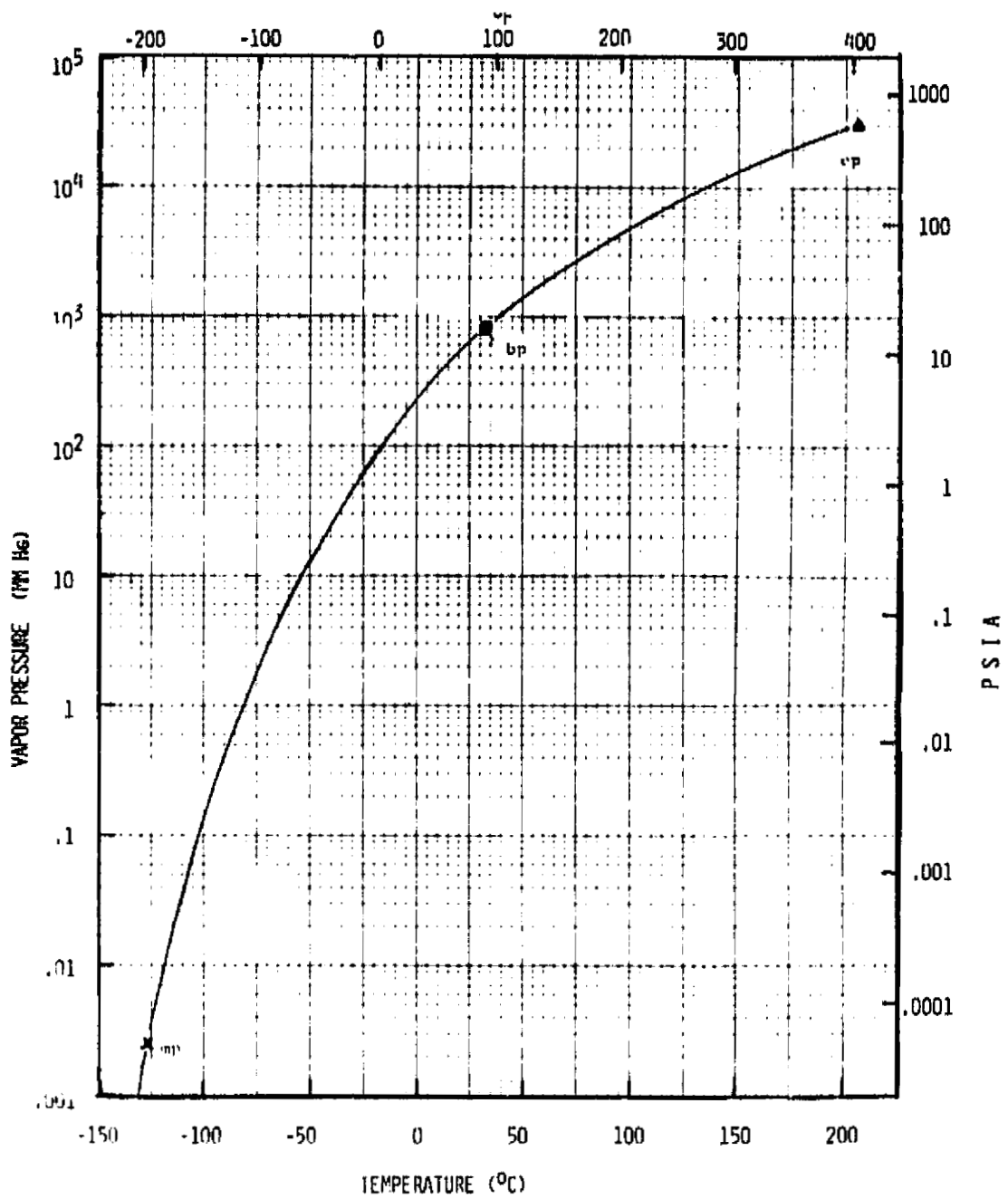

Figure 2.3-1 Vapor Pressure vs Temperature for Trichlorosilane

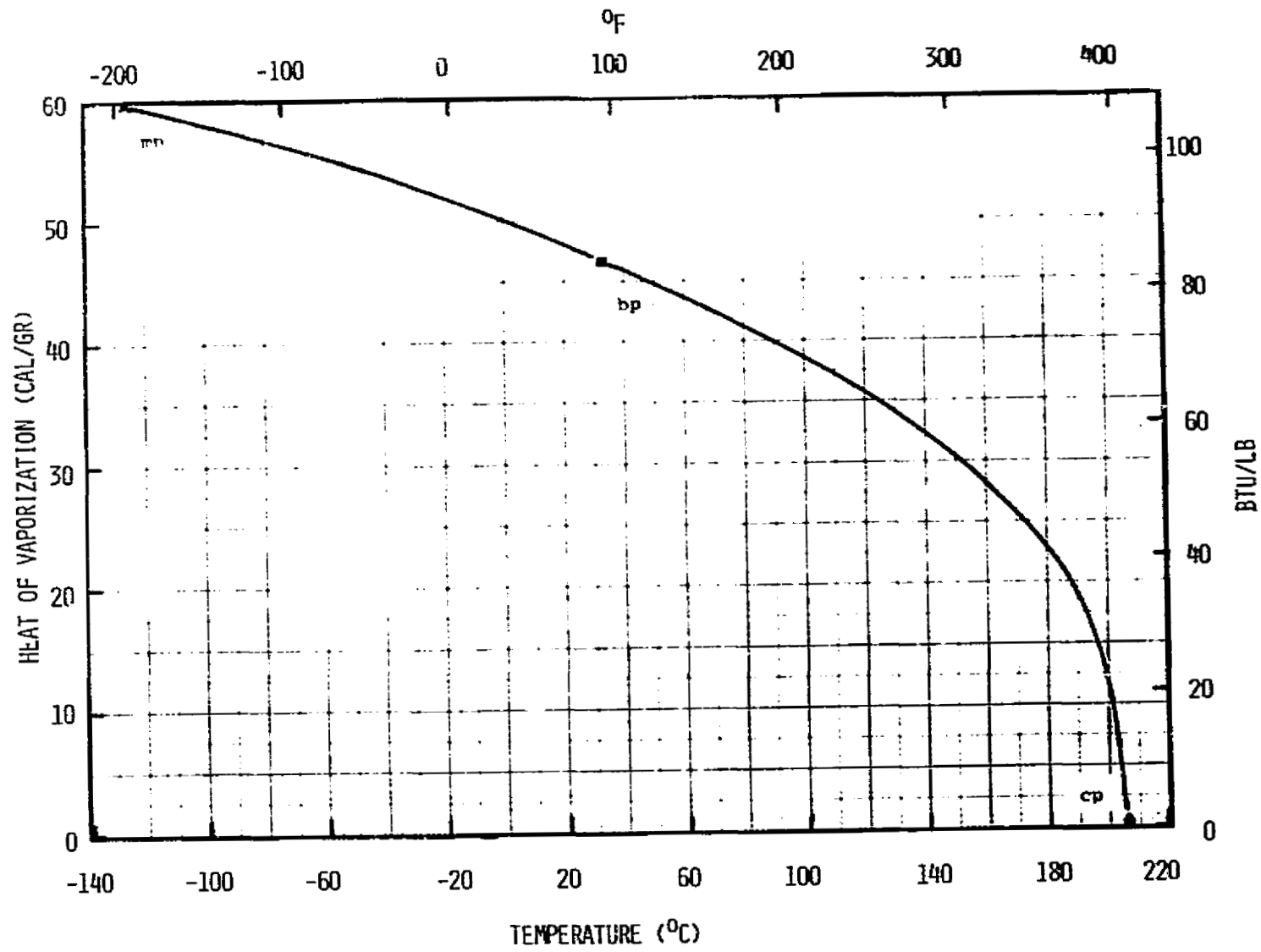

Figure 2.3-2 Heat of Vaporization vs Temperature for Trichlorosilane

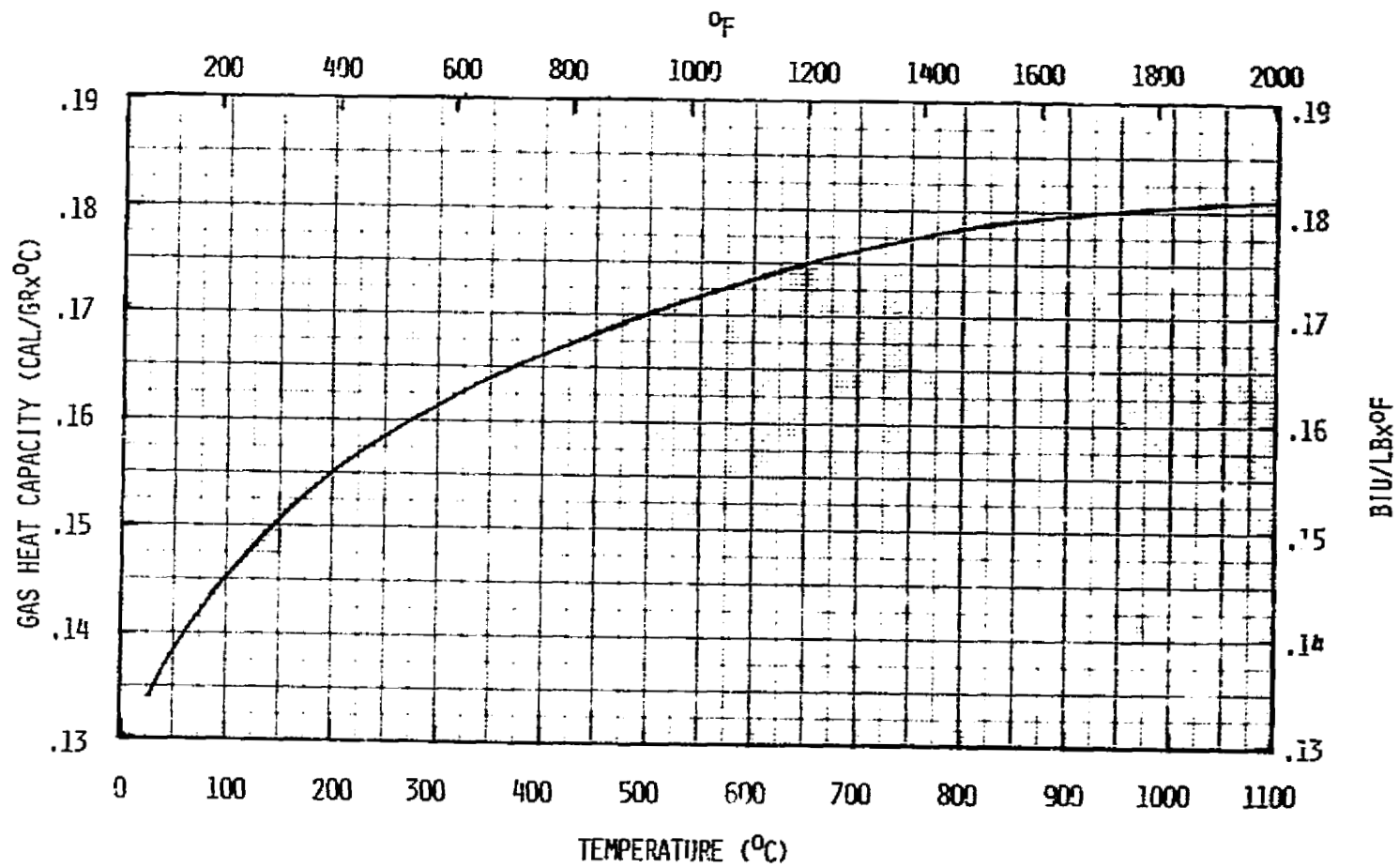

Figure 2.3-3 Gas Heat Capacity vs Temperature for Trichlorosilane

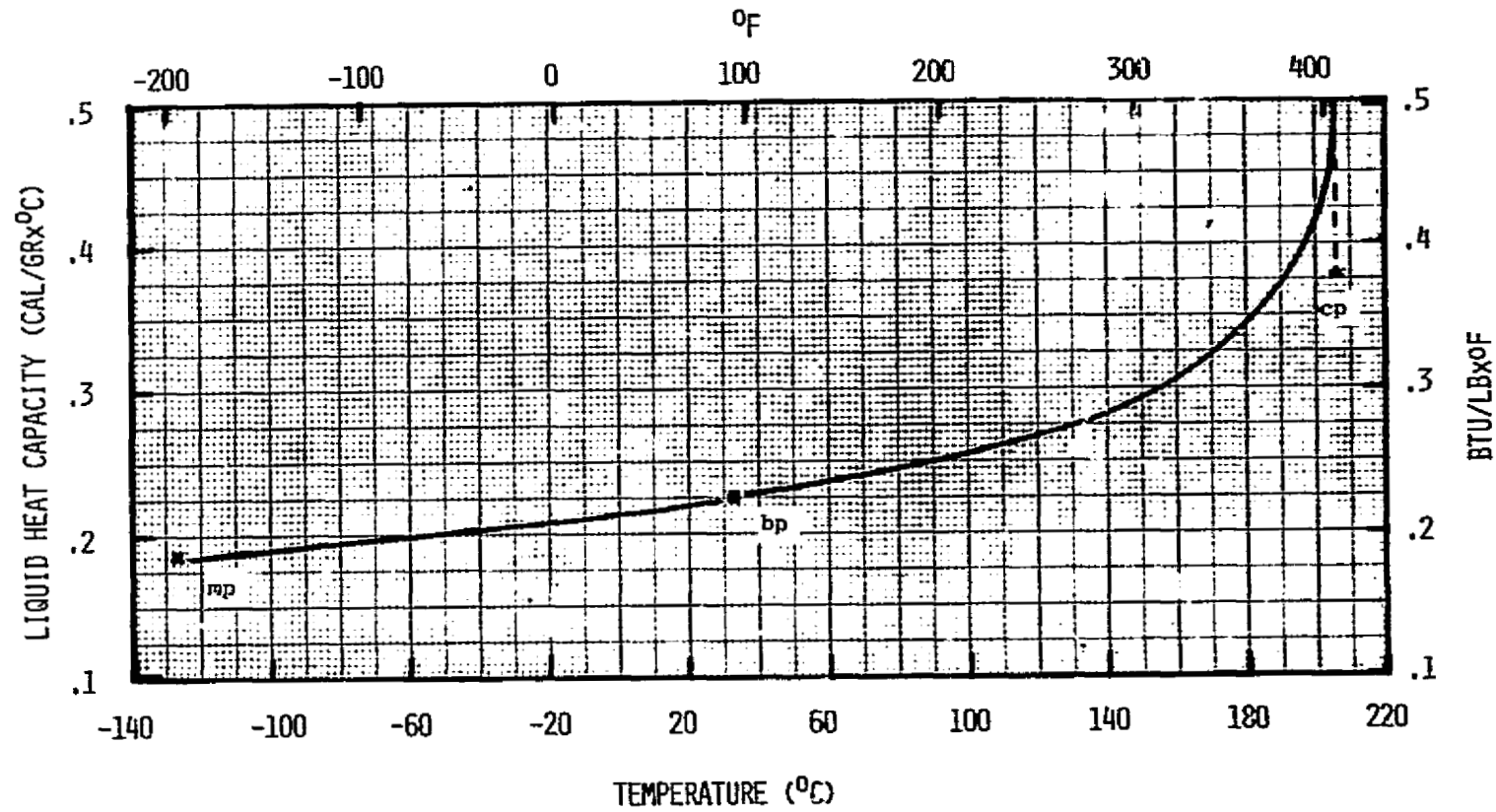

Figure 2.3-4 Liquid Heat Capacity vs Temperature for Trichlorosilane

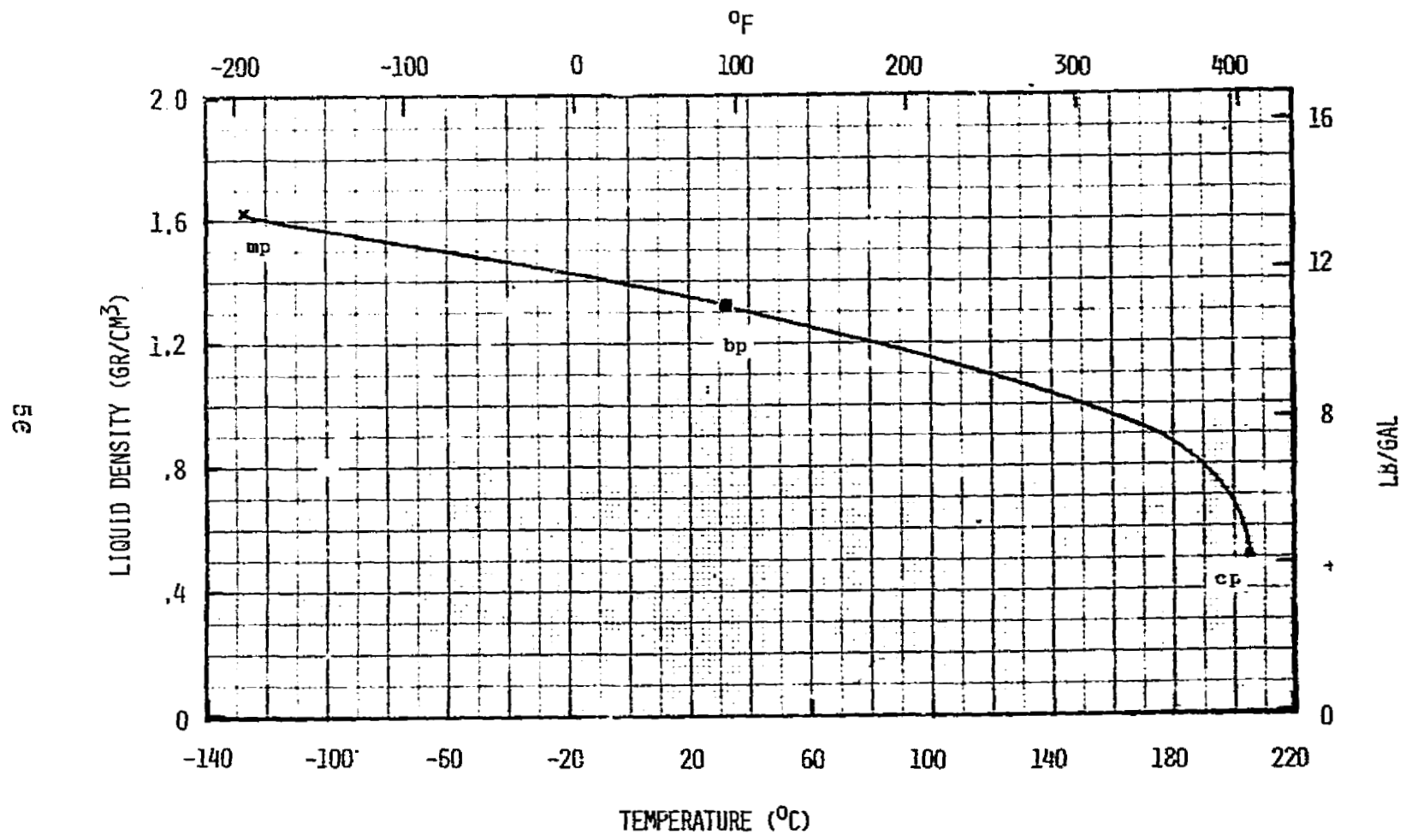

Figure 2.3-5 Liquid Density vs Temperature for Trichlorosilane

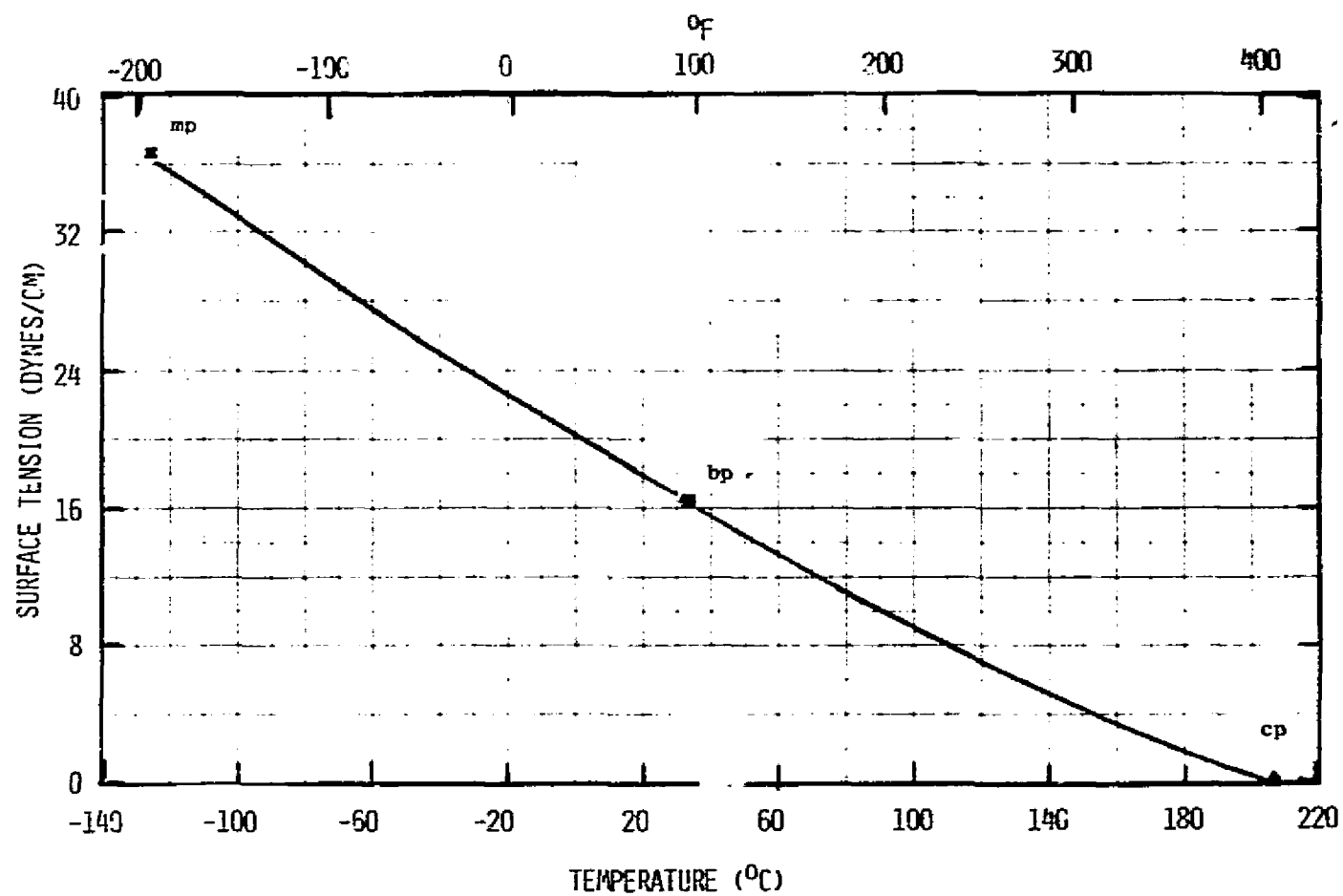

Figure 2.3-6 Surface Tension vs Temperature for Trichlorosilane

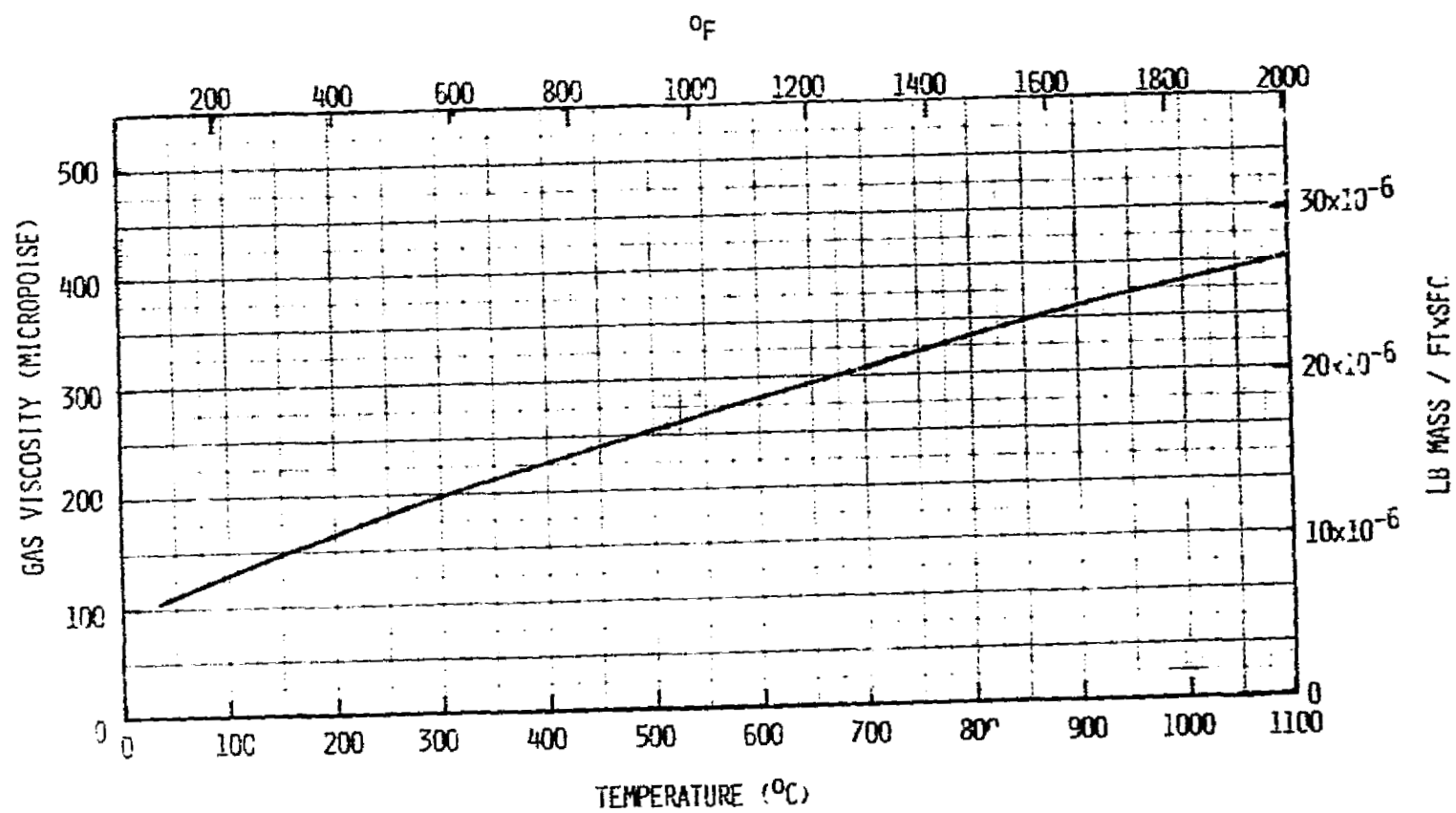

Figure 2.3-7 Gas Viscosity vs Temperature for Trichlorosilane

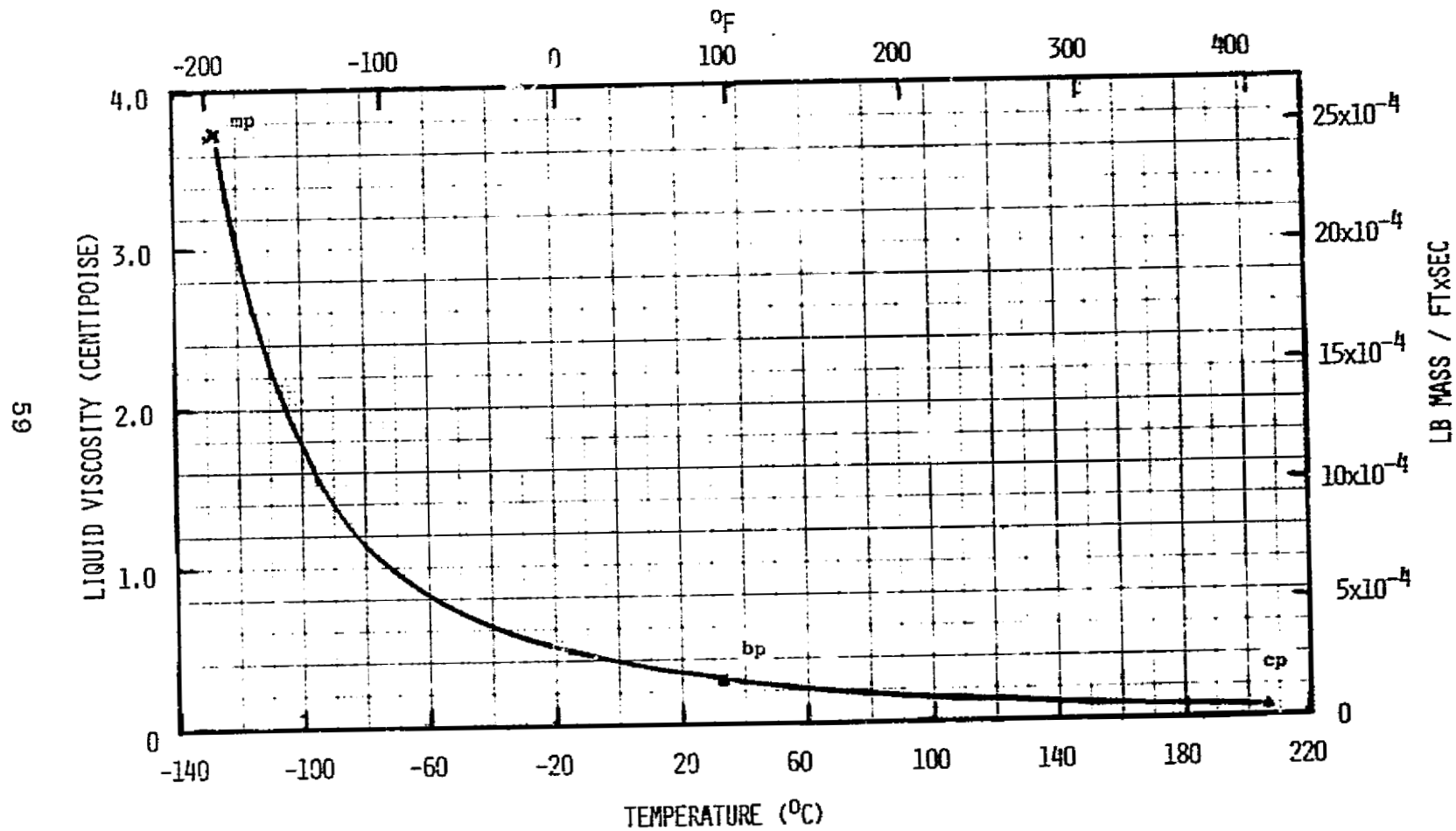

Figure 2.3-8 Liquid Viscosity vs Temperature for Trichlorosilane

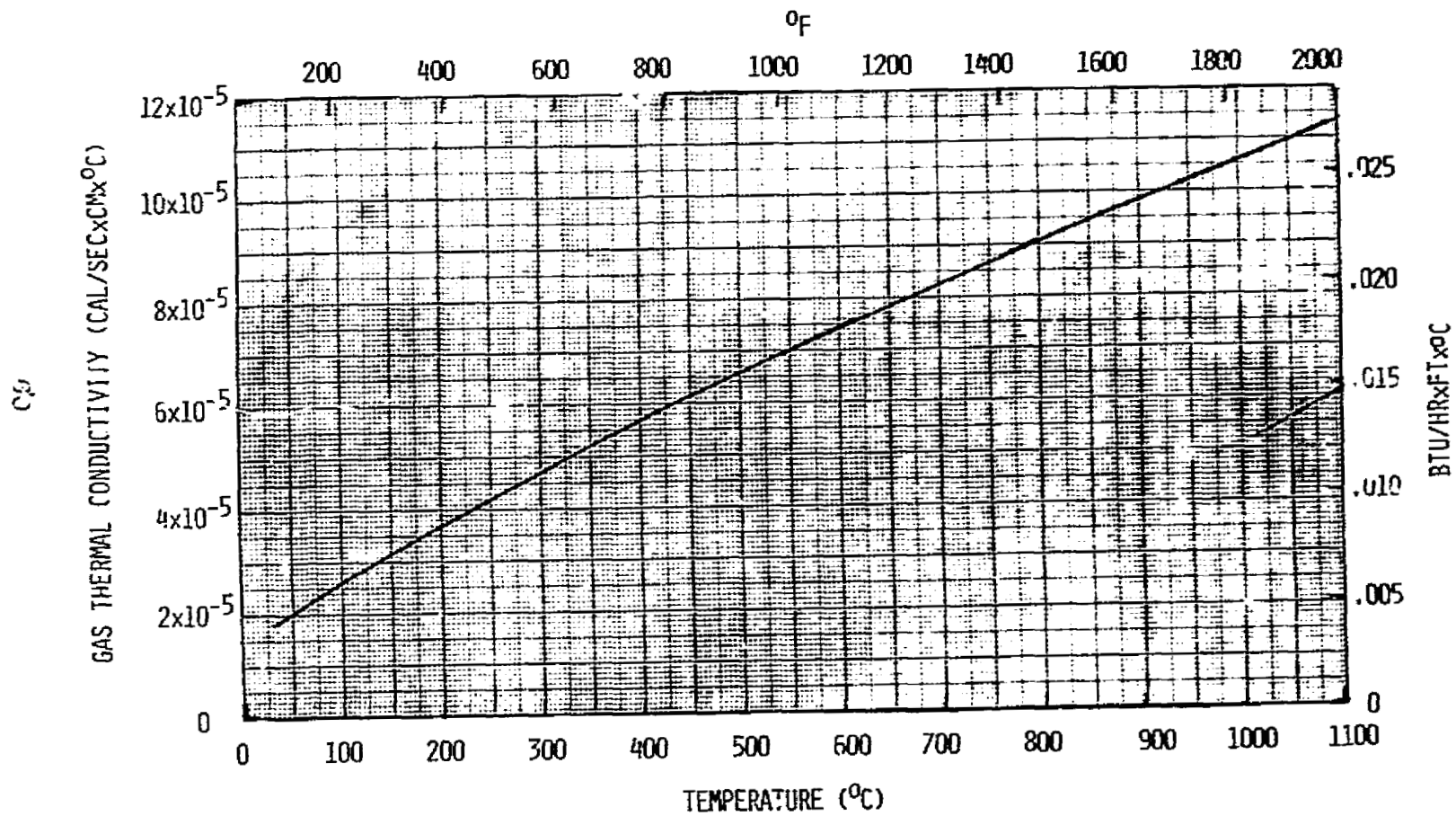

Figure 2.3-9 Gas Thermal Conductivity vs Temperature for Trichlorosilane

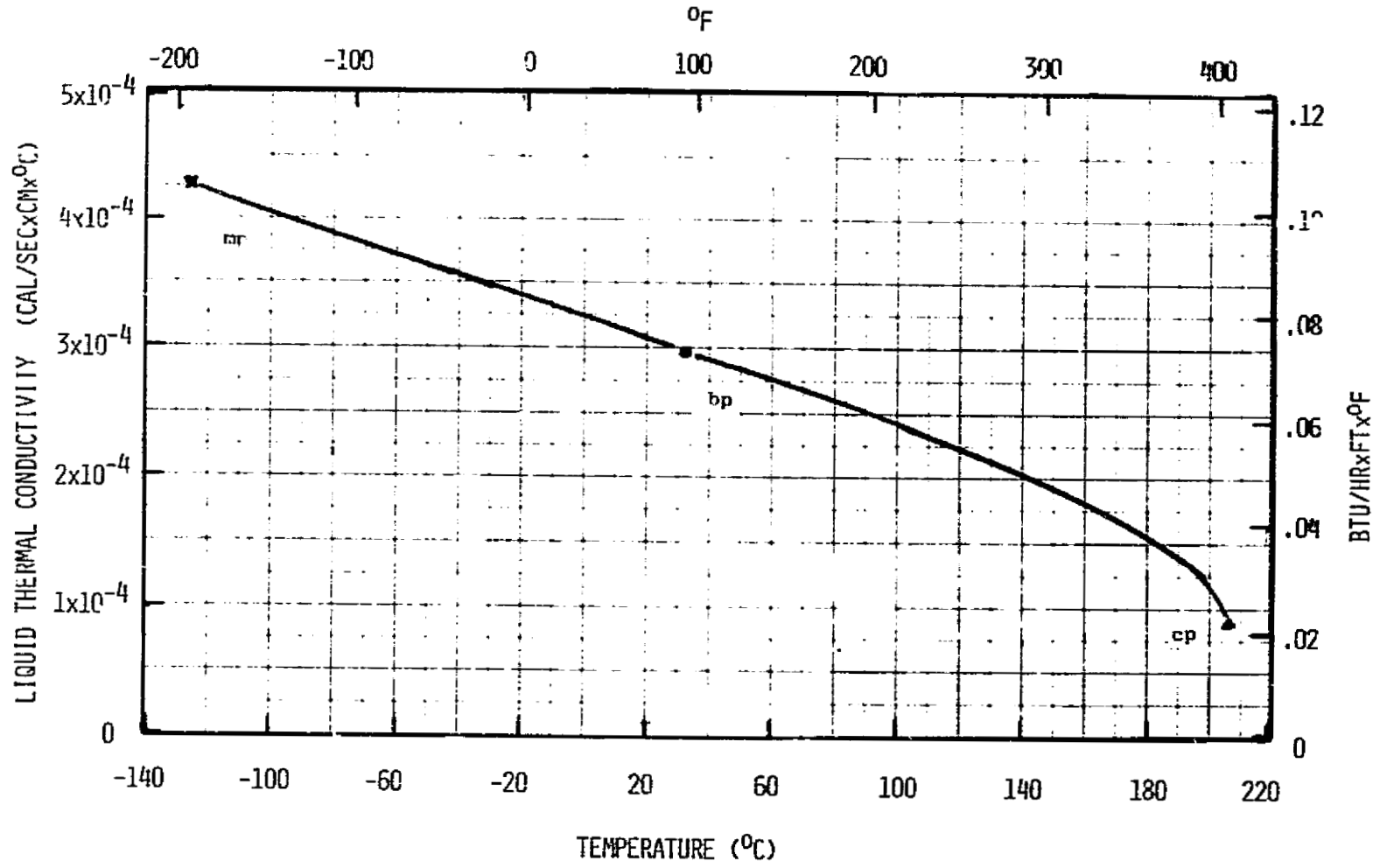

Figure 2.3-10 Liquid Thermal Conductivity vs Temperature for Trichlorosilane

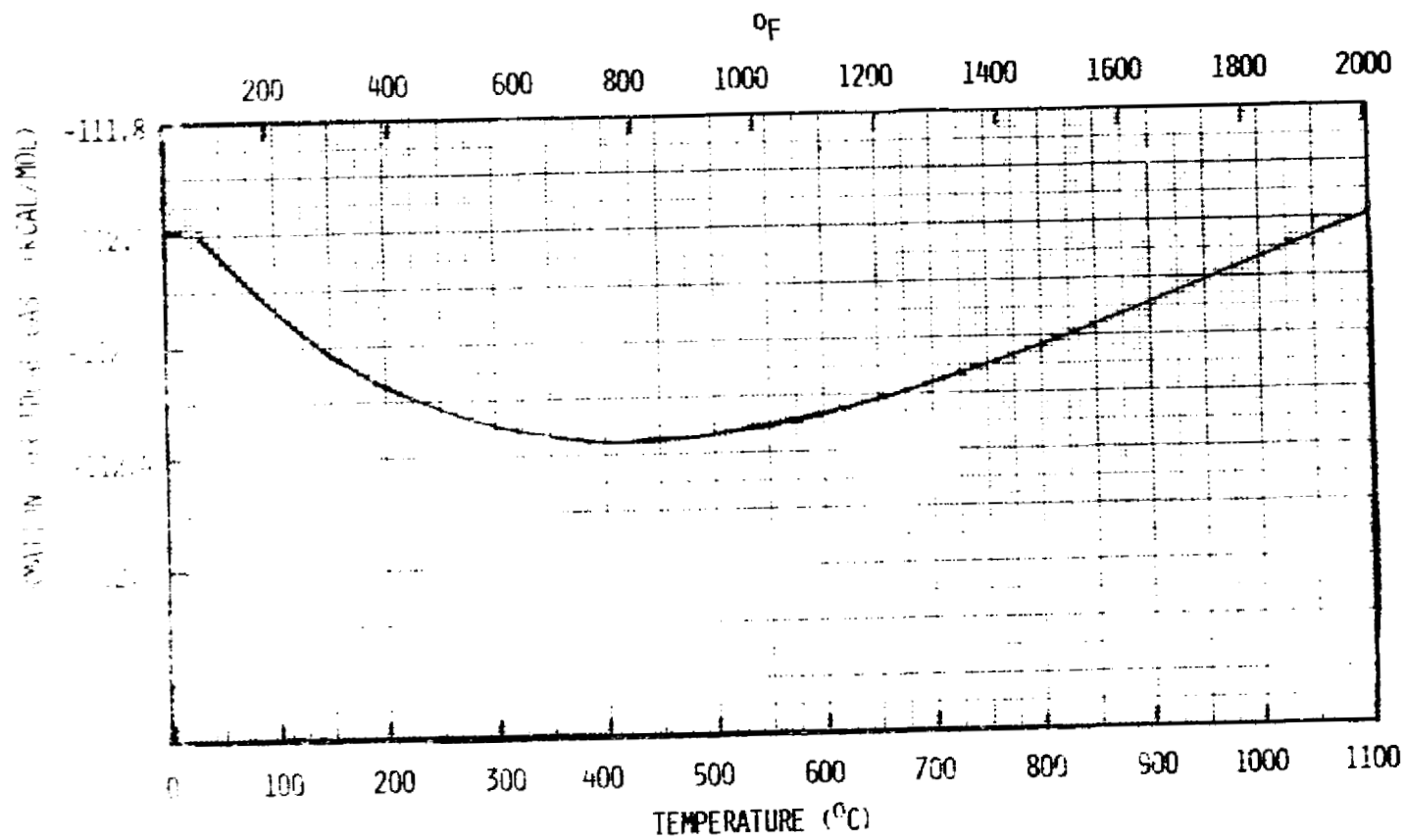

Figure 2.3-11 Heat of Formation vs Temperature for Trichlorosilane

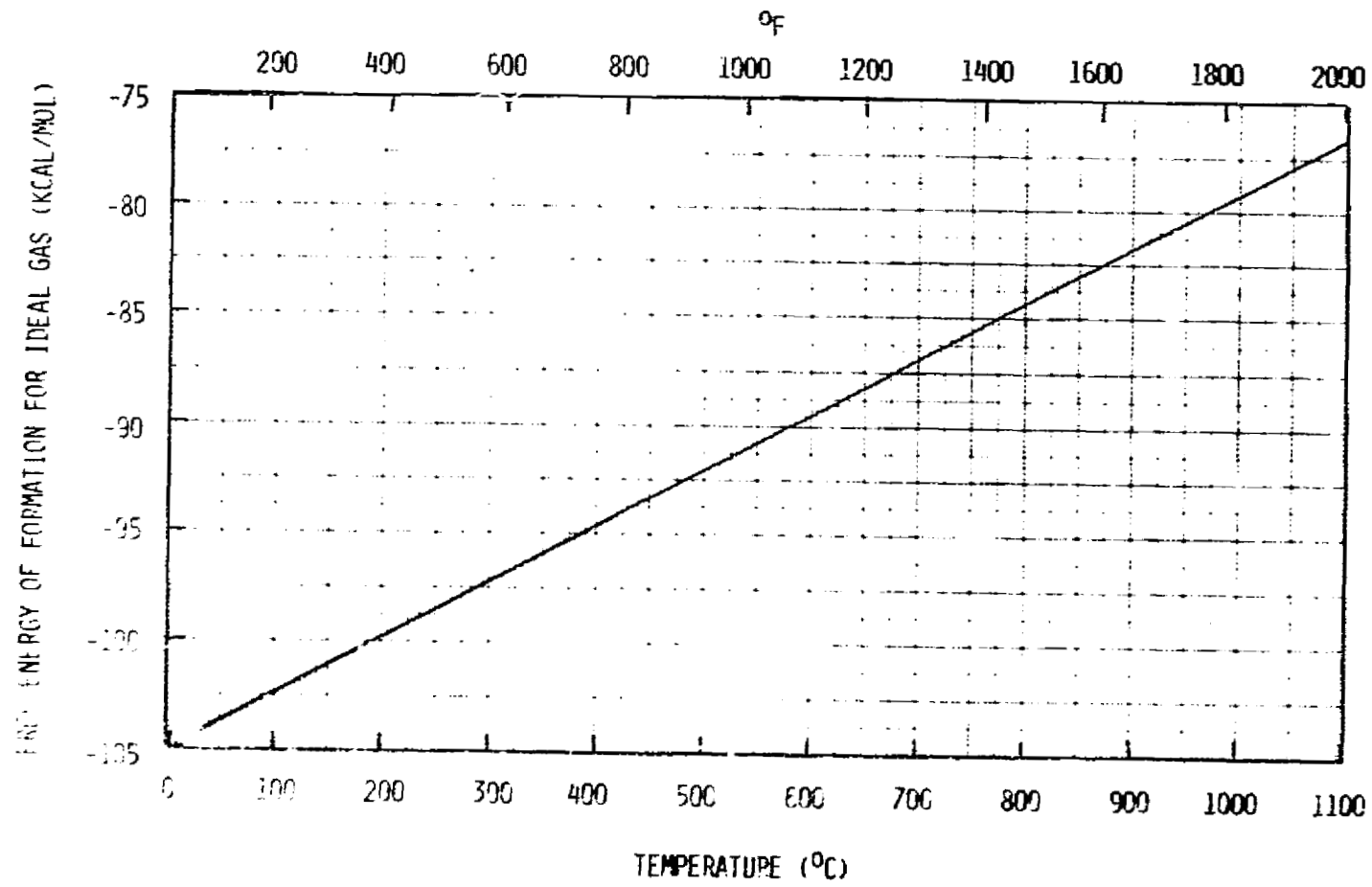

Figure 2.3-12 Free Energy of Formation vs Temperature for Trichlorosilane

REFERENCES FOR TRICHLOROSILANE

- G1. Andrade, E. N. da C., Proc. Phys. Soc. (London), 52, 748 (1940).
- G2. Bailar, Jr., J. C., others, Comprehensive Inorganic Chemistry, Vol. 1, Pergamon Press, Elmsford, New Jersey (1973).
- G3. Boiko, V. V., others, Thermodin. Thermokhin. Konstanty, 1970, 224-9 (1970) Russ.
- G4. Booth, H. E. and Stilwell, W. D., J. Am. Chem. Soc., 56, 1529 (1934).
- G5. Boublik, T., others, The Vapor Pressures of Pure Substances, Elsevier Scientific Pub. Co., New York (1973).
- G6. Carny, C. and Erdon, E. Chem Listy, 47, 1742, (1953).
- G7. Dean, J. A., ed., Lange's Handbook of Chemistry, 11th ed., McGraw-Hill, New York, (1973).
- G8. Yaws, C. L., others, Solid State Technology, 16, 1, 39 (1973).
- G9. Ebsworth, E. A., Volatile Silicon Compounds, MacMillan Co., New York, (1963).
- G10. Everett, D. H., J. Chem. Soc., 2566 (1960).
- G11. Golosova, R. M., others, Russ. J. Phys. Chem., 45(5), 598 (1971).
- G12. Grady, R. I., others, Analyt. Chem., 23 (5), 805 (1951).
- G13. Hunt, L. P., others, J. Electrochem Soc., 119 (12), 1741-5, (1972).
- G14. "International Critical Tables", Vol I-VI, McGraw-Hill New York (1926-1929).
- G15. Jenkins, A. C., and Chambers, G. P., Ind. and Eng. Chem., 46 (11), 2367 (1964).
- G16. Karapet'yants, M. L., "Tables of Some Thermodynamic Properties of Different Substances", Trudy MKh TI in Mendeleeva, No. 34, Moscow (1961) Russ.
- G17. Karapet'yants, M. Kh. and M. L., Thermodynamic Constants of Inorganic and Organic Compounds, Ann-Harbor-Humphrey Science Pub., Ann-Arbor, (1970).
- G18. Kelley, K. K., Bull. Bur. Mines, No. 383 (1935).
- G19. Kirk, R. E., Kirk-Othmer Encyclopedia of Chemical Technology, Vol. 18, Interscience Publishers, New York, (1969).
- G20. Korchemskaya, K. M., others, Zhur. Priklad. Khim., 23, 1503-6 (1960).
- G21. "Landolt-Bornstein Tables", Original volumes to present. Springer-Verlag, Berlin, Germany, (1956-present).
- G22. Lange, N. A., ed, Handbook of Chemistry, 10th ed., McGraw-Hill Book Co., New York (1972).

- G23. Lapidus, I. I., others, *Tepolfiz Vys Temp. (High Temp.)*, 6 (1), 60 (1968).
- G24. Lapidus, I. I., others *Izv. Vysshikh. Uchebn., Zavedeni, Tsvetn. Met.*, 9 (2), 92-96 (1966) Russ.
- G25. Lapidus, I. I., others, "Thermophysical Properties of Gases and Liquids", No. 1, Rabinovich, V. A., ed., 102, Israel Program for Scientific Translation (1970).
- G26. MacKenzie, C. A., others, *J. Am. Chem. Soc.*, 72, 2032 (1950).
- G27. Maslov, Yu. P., *Khim. i Prakt. Primenenie Krennorgan. Soedin. Tr. Konf., Leningrad 1958* (6), 265 (pub. 1961).
- G28. Matthews, J. R., *Chemical Reviews*, 72 (1), (1972).
- G29. Mellor, J. W., *Inorganic and Theoretical Chemistry*, Vol. 6, Longmans, Green and Co., New York (1947).
- G30. Mikawa, Y., *Nippon Kagaku Zasshi*, 81, 1512 (1960).
- G31. Movsumzade, E. N., others, *Izv. Vyssh. Ucheb. Zaved., Neft Gas 1973*, 16 (6), 73-75 (1973) Russ.
- G32. Niselson, L. A., others, *Russ. J. Inorg. Chem.*, 10 (6), 705 (1965).
- G33. Niselson, L. A., others, *Russ. J. Inorg. Chem.*, 12 (6), 752 (1967).
- G34. Ohe, Shuzo, *Computer Aided Data Book of Vapor Pressure*, Data Book Pub. Co., Tokyo, Japan (1976).
- G35. O'Neal, H. E. and Ring, M. A., *Inorg. Chem.*, 5 (3), 435 (1966).
- G36. Pedley, J. B., others, U. S. Nat. Tech. Inform. Serv. AD Rep. 1972 No. 773468/4GA 21pp (1972).
- G37. Pedley, J. B., others, *Comput. Anal. Thermochem. Data* (1972).
- G38. Perry, R. H., others, *Chemical Engineers' Handbook*, 4th ed., McGraw-Hill, New York, (1973).
- G39. Popov, V. V., *Plastichcheskie Massy*, 1960 (8), 26 (1960).
- G40. Prostov, V. N. and Popova, O. G., *Zh. Fiz. Khim.* 49 (3) 631-3 (1975) Russ.
- G41. Rochow, E. G., *An Introduction to the Chemistry of the Silicones*, John Wiley and Sons, New York (1946).
- G42. Rozhdestvenskii, I. B., others, *Sb.Tr.-Glavniiproekt Energ. Inst.*, 7, 88-121, (1973) Russ.
- G43. Seifer, A. L., others, *Izv. Vysshikh. Uchebn., Zavedeni, Tsvetn. Met.*, 9 (3), 85 (1966) Russ.

- G44. Shakhparonov, M. I., others, Zhur. Priklad. Khim., 33, 2699-2703 (1960).
- G45. Shaulov, Y. K., others, Zh. Fiz. Khim., 40 (8), 1893 (1966).
- G46. "Silanes", Technical Brochure, Union Carbide Corp., Silicones Division, New York (1966).
- G47. Sirtl, E., others, J. Electrochem. Soc., 121, (7), 919-924 (1974).
- G48. Sneed, M. C. and Brasted, R. C., Comprehensive Inorganic Chemistry, Vol. 7, D. Van Nostrand Co., New York (1958).
- G49. Steele, W. C., others, J. Am. Chem. Soc., 84, 4441 (1962).
- G50. Stock, A., Hydrides of Boron and Silicon, Cornell Univ. Press, New York, (1933), (reissued 1957).
- G51. Stock, A. and Somieski, C., "Siliciumwasserstoffe:VI, Chlorierung and Metylierung der Monosilans", 52, 695 (1919).
- G52. Stone, F. G. A., Hydrogen Compounds of Group IV Elements, Prentice-Hall, Inc. Englewood Cliffs, N. J. (1962).
- G53. Stull, D. R., and Prophet, H., JANAF Thermochemical Tables, NBS-RS-37, Nat. Bur. Stds., (1971).
- G54. Thomas, L. H., J. Chem. Soc., Part II, 2132-2154 (1959).
- G55. Timmermans, Jean, The Physico-Chemical Constants of Binary Systems in Concentrated Solutions, Vol. 4, Interscience Pub., Inc., New York (1960).
- G56. Touloukian, Y. S. and Makita, T., Thermochemical Properties of Matter, Supplement to Vol. 6, "Specific Heat", Plenum, New York (1976).
- G57. Wagman, D. D., others, "Selected Values of Chemical Thermodynamic Properties", NBS Tech., Note 270-3, Natl. Bur. Stds., Washington, D. C. (1968).
- G58. Walsh, R. and Welis, J. M., Faraday Trans. 1, 72 (5), 1212-20 (1976).
- G59. Weast, R. C., ed., CRC Handbook of Chemistry and Physics, 49th ed., CRC Co., Cleveland, Ohio (1968-1969).
- G60. Wolf, E., A. Anorg. Allgem. Chem., 313, 228 (1961).
- G61. Gmelin, Gmelins Handbuch der Anorganischen Chemie, No. 15, Silicium, Part B, Verlag Chemie, GMBH, Weinheim, Bergstrasse (1959).
- G62. Reed, R. C. and Sherwood, T. K., The Properties of Gases and Liquids, 2nd ed., McGraw-Hill Book Co., New York (1966).

- G63. Yaws, Carl L., Physical Properties, Chemical Engineering, McGraw-Hill Publishing Co., New York (1977).
- G64. Pachaiyappan, V. and Vaidyanathan, K. R., "Symposium on Thermophysical Properties", 6th Symposium ASME, 15 (1973).
- G65. Flynn, L. W. & Thodos, G., J. Chem. Eng. Data, 31, 457 (1961).
- G66. Yaws, C. L., Fang, C. S., Hansen, K. C. and Miller, J. W., Jr., Quarterly Technical Progress Report (XI), ERDA/JPL 954343-7H/11, Distribution Category UC-63 (June, 1978).
- G67. Reed, R. C. others, The Properties of Gases and Liquids, 3rd Ed., McGraw-Hill Publishing Co., New York (1977).
- G68. Yoon R. and Thodos, G., AIChE Journal, 16 (2) 300 (1970).
- G69. Yaws, C. L., Miller, J. W., Jr., Lutwack, R., and Hsu, G., "Electricity from Sunlight: Low Cost Silicon For Solar Cells", Fifth National Conference on Energy and the Environment, A.I.Ch.E.-A.P.A.C., Cincinnati (Oct. 31-Nov. 3, 1977).

2.4 Dichlorosilane Properties

Physical Properties and Critical Constants (Table 2.4-1)

Physical properties and critical constants are listed in Table IA-1 for dichlorosilane. Values of critical temperature, T_c , critical pressure, P_c , and critical volume, V_c , for dichlorosilane were estimated by using Lydersen's structural contribution method with derived critical property increments for silicon (H16). This method produced only 2.3% error for T_c and 3.4% error for V_c when compared with the experimental values of trichlorosilane and it produced 0% error for T_c , V_c , and P_c when compared with the known values of silicon tetrachloride. The estimated values for the known values for the critical properties are also within reasonable agreement (4% for T_c , 0.2% for P_c , and 14% for V_c) of calculated Russian values (H10).

The critical compressibility factor, Z_c , was determined from its definition:

$$Z_c = \frac{V_c RT_c}{P_c} \quad (2.4-1)$$

The result from Eq. (IA-1) was the same as that derived by the Garcia-Barcena' boiling point method (H16):

$$Z_c = f(T_b) - g(T_b/M) \quad (2.4-2)$$

Vapor Pressure (Figure 2.4-1)

The vapor pressure of dichlorosilane has been determined from -80°C to 30°C (H23, H35). The experimental data was extended over the entire liquid range using the YSSP vapor pressure correlation (H30):

$$\log P_v = A + \frac{B}{T} + C \log T + DT + ET^2 \quad (2.4-3)$$

where P_v is the vapor pressure of saturated liquid, mm Hg; T is temperature, $^\circ\text{K}$; and A , B , C , D , E are correlation constants derived using a generalized least squares computer program. Average absolute deviation was about 1% for the 13 experimental data points.

Heat of Vaporization (Figure 2.4-2)

Heat of vaporization data for dichlorosilane are available only at the boiling point (H1, H0, H10, H19, H31). Using the known value at the boiling point, Watson's correlation was used to extend the heat of vaporization over the entire liquid phase:

$$\Delta H_V = \Delta H_{V_1} \left[\frac{T_C - T}{T_C - T_1} \right]^n \quad (2.4-4)$$

where $n = .38$ and ΔH_{V_1} applies at the boiling point (T_1).

Heat Capacity (Figures 2.4-3 and 2.4-4)

Ideal gas heat capacity data for dichlorosilane are available from various American (H5, H13, H25, H26), Russian (H6, H7, H10, H12, H32) and other (H9, H33) workers. The values, which are in close agreement, are based on bond additivities and spectral measurement. The JANAF values were selected.

Measured saturated-liquid heat capacity data for dichlorosilane are unavailable in the literature. Values were estimated from -60°C to 60°C using the Yuan and Stiel corresponding state method (H16). For polar liquids, the correlation takes the form:

$$C_{O_1} - C_P^O = \Delta C^{(0p)} + \omega(\Delta C_O^{(1p)}) + X(\Delta C_O^{(2p)}) + X^2(\Delta C_O^{(3p)}) + \omega^2(\Delta C_O^{(4p)}) + X\omega(\Delta C_O^{(5p)}) \quad (2.4-5)$$

where C_P^O is the ideal gas heat capacity, ω is the acentric factor, X is the Stiel polar factor and the functions: $(\Delta C_O^{(0p)})$, etc. are tabulated as functions of the reduced temperature. The relationship that heat capacity times density is constant was used to extend the values over the entire liquid range. Application of the Yuan and Stiel correlations to silicon tetrachloride, trichlorosilane, and silicon tetrafluoride gave average absolute percentage errors of 3.1, 6.7, and 4.3 respectively. Due to the limited experimental data points, the calculated liquid heat capacities should be considered as order-of-magnitude estimates.

Density (Figure 2.4-5)

Liquid density data are available at the melting point (H8, H9, H10, H18, H27) and at 7°C (H35). The limited data were extended over the entire liquid range using a modification of the Rackett equation:

$$\rho = \rho_C Z^{(1-T_r)^{2/7}} \quad (2.4-6)$$

where ρ_C is critical density, T_r is reduced temperature and Z is a parameter defined by the experimental data.

Surface Tension (Figure 2.4-6)

The Brock and Bird corresponding states method (H16) was used to estimate the surface tension of dichlorosilane since no experimental data is available. The equation is:

$$\sigma = P_C^{2/3} T_C^{1/3} (0.133 \alpha_C - 0.281) (1 - T_r)^{11/9} \quad (2.4-7)$$

where σ is surface tension, dynes/cm, α_C is the Riedel parameter, P_C is critical pressure, atm.; T_C is critical temperature, °K; and T_r is the reduced temperature. Application of this method to silicon tetrachloride and trichlorosilane gave results within 4% and 0.8% absolute deviation with experimental data, respectively.

Viscosity (Figures 2.4-7 and 2.4-8)

Gas viscosity calculations at low pressure were made using the methods of (1) Yoon and Thodos for non-hydrogen-bonding polar gases, (2) Golubev, and (3) Reichenberg (H16). Since the calculated values were in close agreement, they were fitted to the series expansion:

$$\eta_G = A + BT + CT^2 \quad (2.4-8)$$

where η_G is in micropoise; T is temperature, °K; and A , B and C are computer derived parameters using a generalized least squares program. The average absolute percentage deviation was less than 1.8%.

Liquid viscosities at temperatures below the boiling point were calculated using the methods of Thomas, and of Morris (up to 60°C) (H16). Values from the boiling point to the critical point were calculated using the correlation methods of Letson and Stiel, and Stiel and Thodos (H16). Calculated values were extended over entire liquid range and fitted to the equation:

$$\log \eta_L = A + \frac{B}{T} + CT + DT^2 \quad (2.4-9)$$

where η_L is in centipoise; T is temperature, °K; and A , B , C and D are derived parameters using a generalized least squares computer program. This was done in order to fit together the calculated values which apply in the different temperature ranges. The average percentage deviation was 3.3% with the greater deviation being near the melting point; therefore, this should be considered to be an order-of-magnitude correlation.

Thermal Conductivity (Figures 2.4-9 and 2.4-10)

Gas-phase thermal conductivity data are available from 28°C to 350°C (H28). The data were correlated and extended to higher temperatures by a series expansion in temperature:

$$\lambda_G = A + BT + CT^2 + DT^3 \quad (2.4-10)$$

where λ_G is gas thermal conductivity, cal/cm x sec x °C; T is temperature, °K; and A, B, C and D are computer derived constants characteristic of the chemical compound. The absolute deviation between data and correlation values was less than 0.5%.

Thermal conductivity data of the liquid phase is unavailable. Modifications of the estimation methods of Sato and Reidel (H16):

$$\lambda_L = \frac{2.64 \times 10^{-3}}{M^{1/2}} \frac{3 + 20 (1 - T_r)^{2/3}}{3 + 20 (1 - T_{r_b})^{2/3}} \quad (2.4-11)$$

and of Robbins and Kingree (H15):

$$\lambda_L = \frac{(88 - 4.94 H) \times 10^{-3}}{\Delta S^*} \frac{.55}{T_r} C_{p_L} \rho^{4/3} \quad (2.4-12)$$

where used to derive values at 32°C. These modified estimation methods produced error of less than 1% absolute deviation on the one published value of SiCl₄. The average of the estimate at 32°C was extended over the entire liquid range using a modification of the Stiel and Thodos method (H16):

$$\lambda_L = \frac{f(\rho_r)}{\Gamma Z_c} + \lambda_G \quad (2.4-13)$$

The modified Sato-Reidel equation produced a similar range of values. Since assumptions in these calculations include the accuracy of the one data point for silicon tetrachloride and the chemical similarities in a homologous series, these values should be considered only order-of-magnitude estimates.

Heat and Free Energy of Formation (Figures 2.4-11 and 2.4-12)

Heat of formation and Gibb's free energy of formation for the ideal gas have been estimated by Russian (H32, H36) and American (H25) workers up to at least 1500°K. Some estimated values differ significantly having about 35% deviation for ΔH_f and about 45% deviation for ΔG_f (H32, H36). The JANAF values (H25) were selected.

TABLE 2.4-1

CRITICAL CONSTANTS AND PHYSICAL PROPERTIES OF DICHLOROSILANE

<u>Identification</u>	<u>Dichlorosilane</u>
Formula	SiH ₂ Cl ₂
State (std. cond.)	gas
Molecular Weight, M	101.008
Boiling Point, T _b , °C	8.3
Melting Point, T _m , °C	-122.0
Critical Temperature, T _c , °C	178.9*
Critical Pressure, P _c , atm	44.0*
Critical Volume, V _c , cm ³ /gr mol	228.3*
Critical Compressibility Factor, Z _c	.276*
Critical Density, ρ _c , gr/cm ³	.4424*
Acentric Factor (ω)	.1107

*Estimated

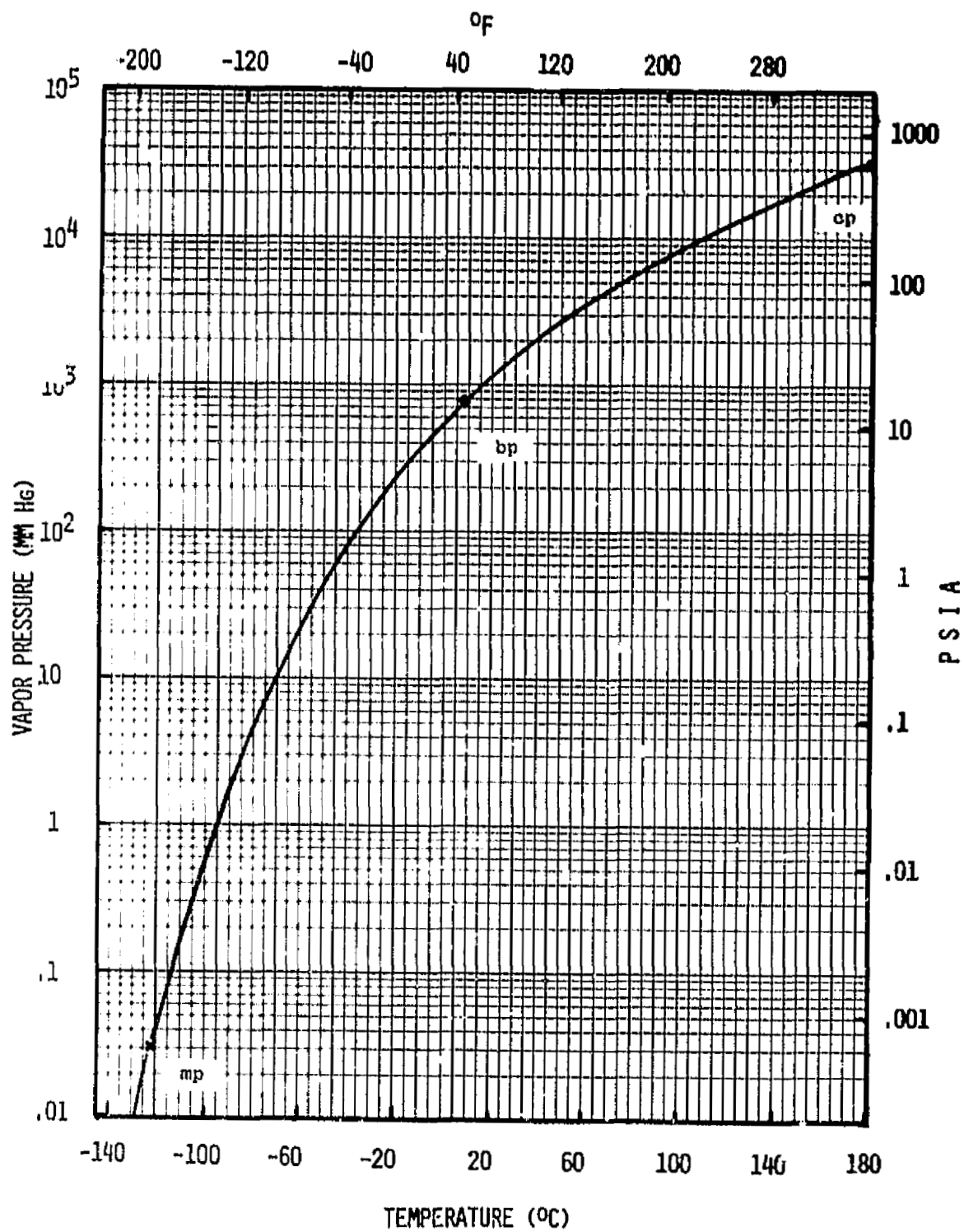

Figure 2.4-1 Vapor Pressure vs Temperature for Dichlorosilane

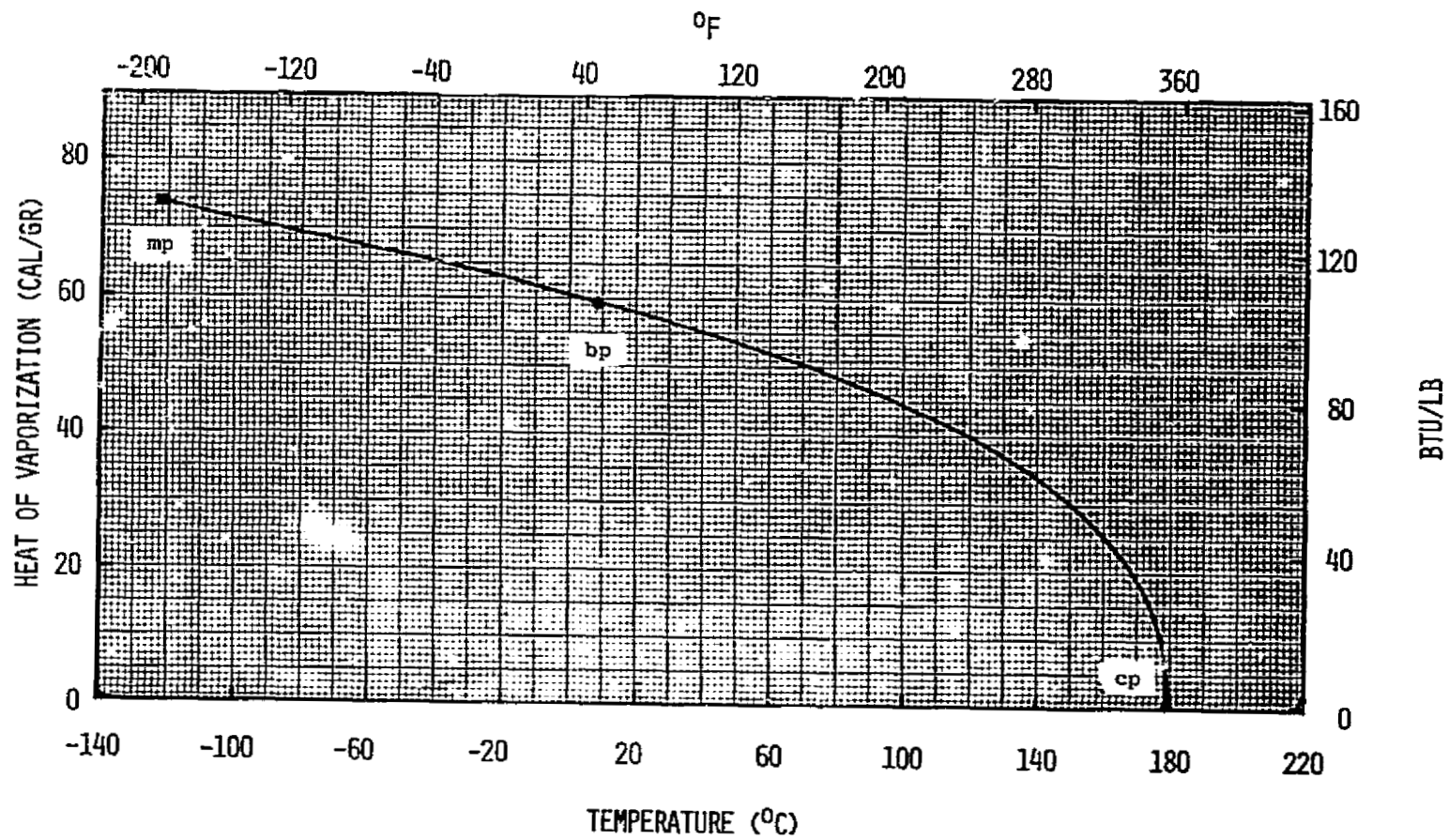

Figure 2.4-2 Heat of Vaporization vs Temperature for Dichlorosilane

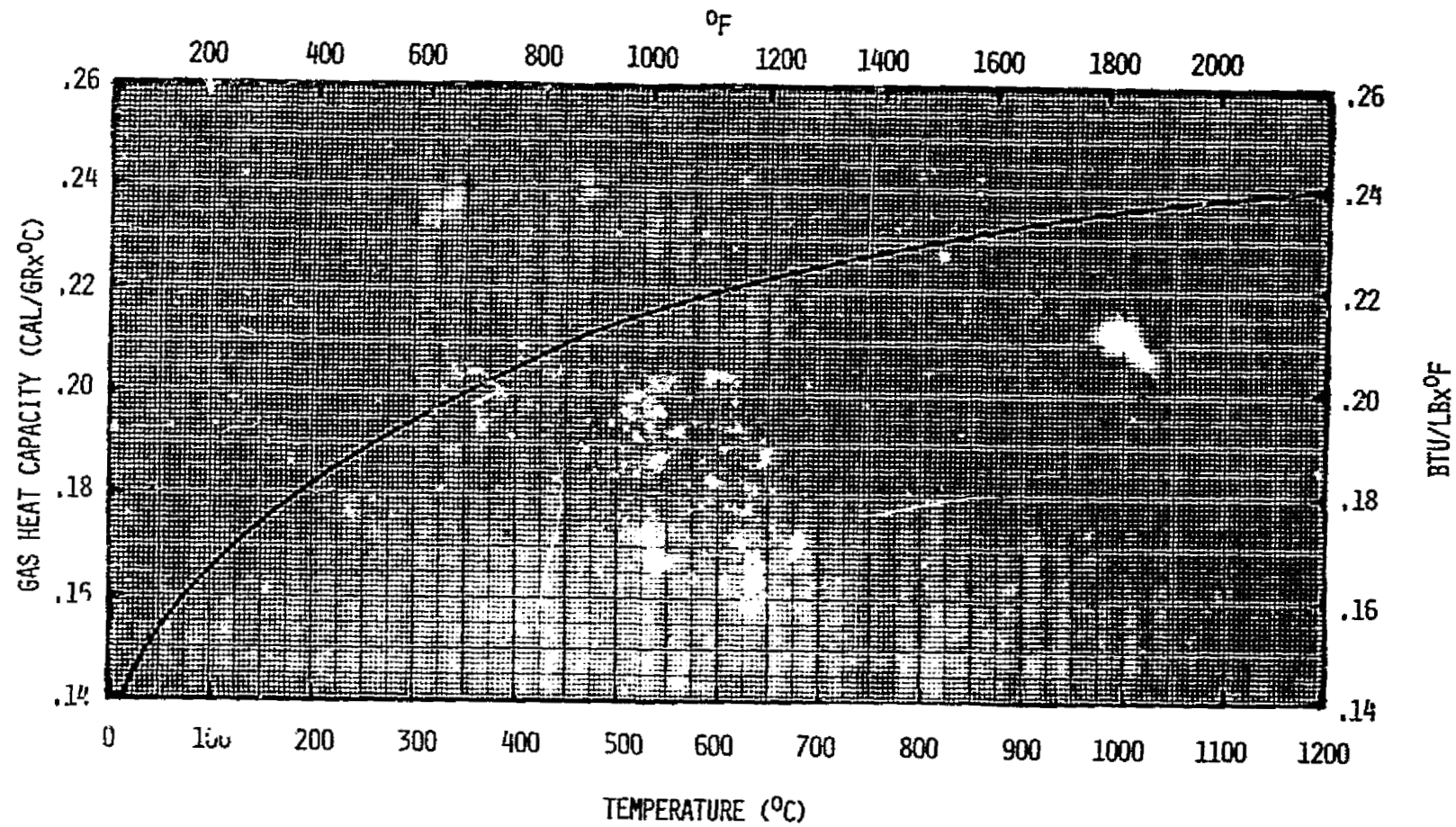

Figure 2.4-3 Gas Heat Capacity vs Temperature for Dichlorosilane

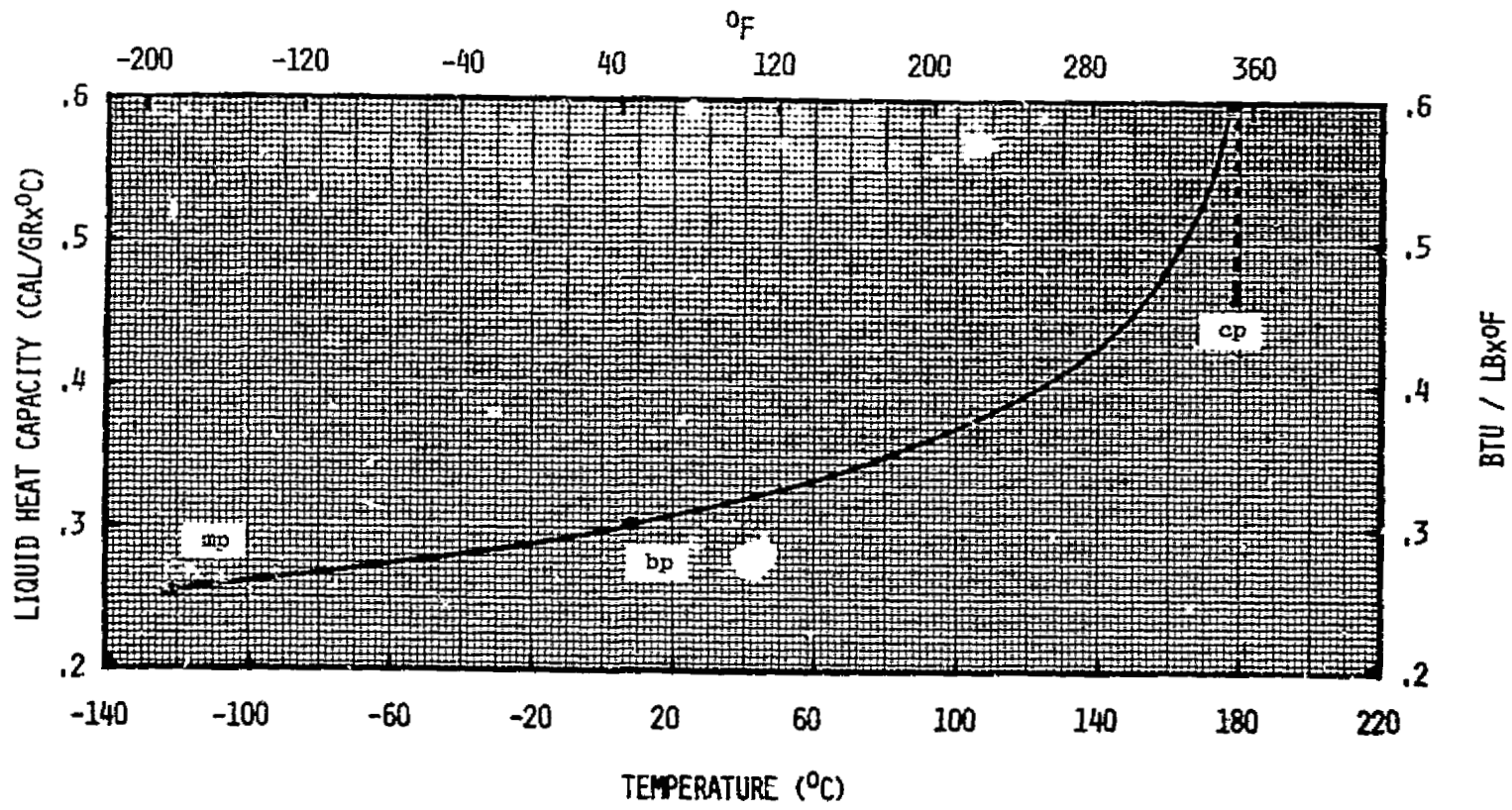

Figure 2.4-4 Liquid Heat Capacity vs Temperature for Dichlorosilane

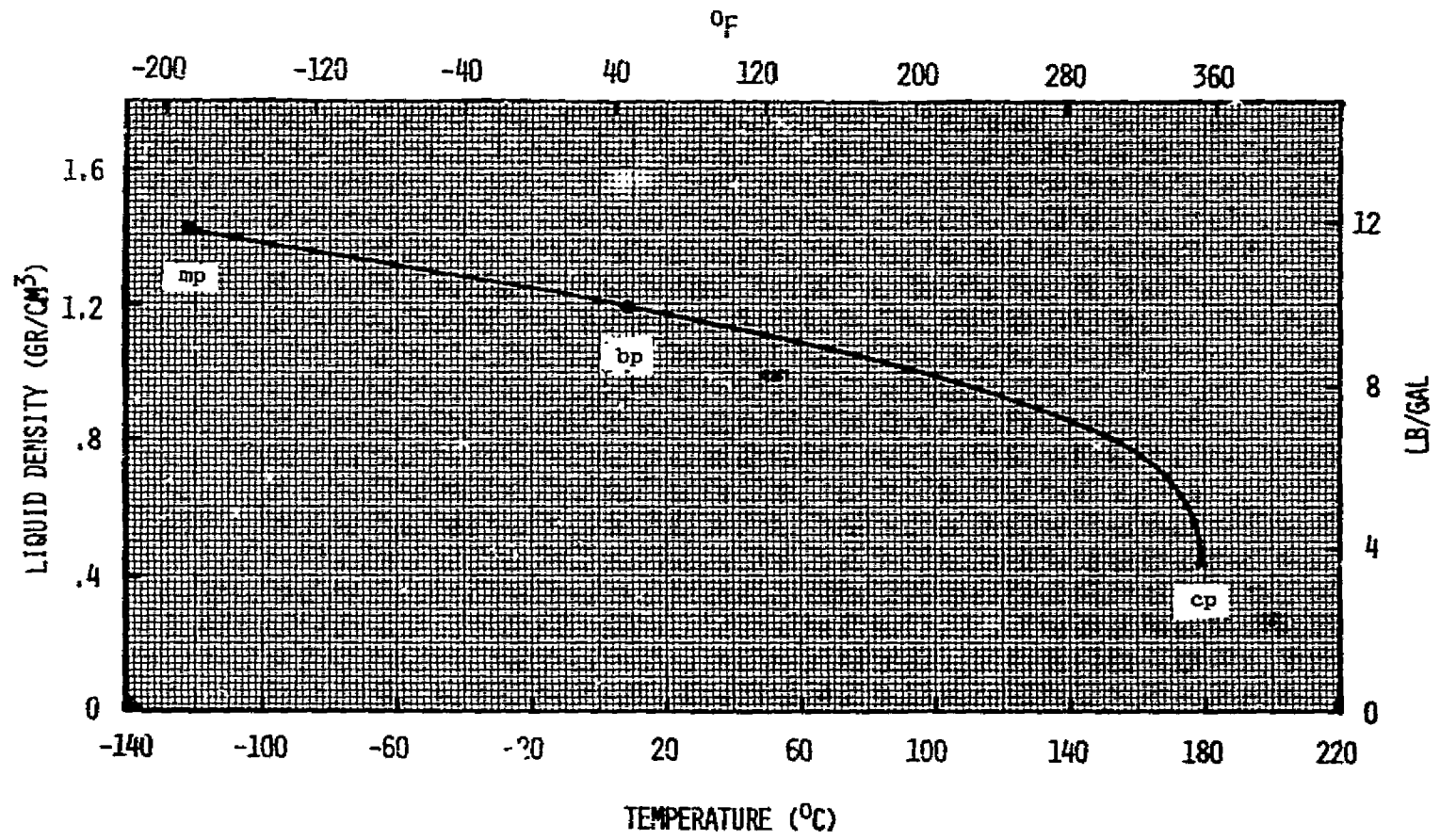

Figure 2.4-5 Liquid Density vs Temperature for Dichlorosilane

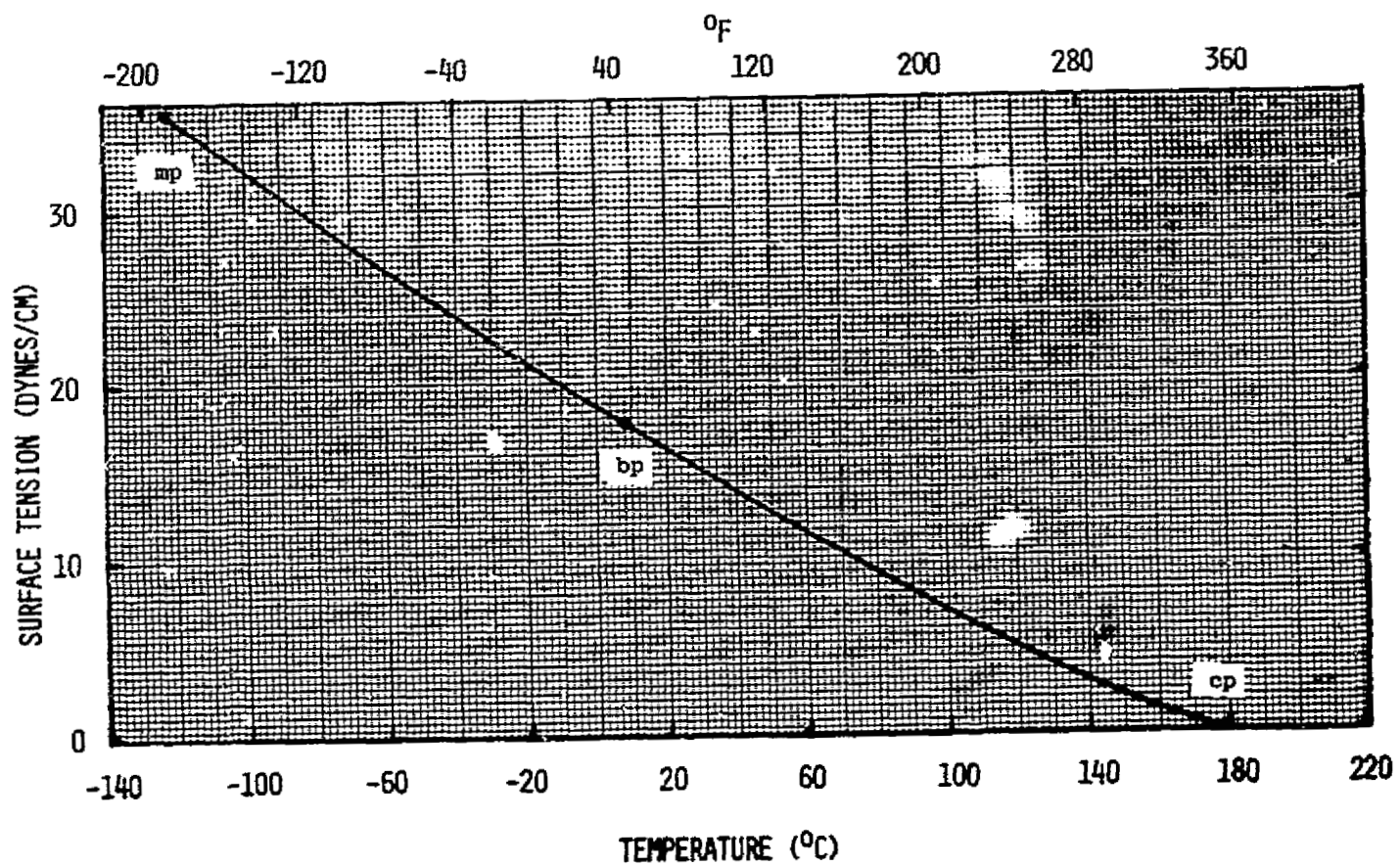

Figure 2.4-6 Surface Tension vs Temperature for Dichlorosilane

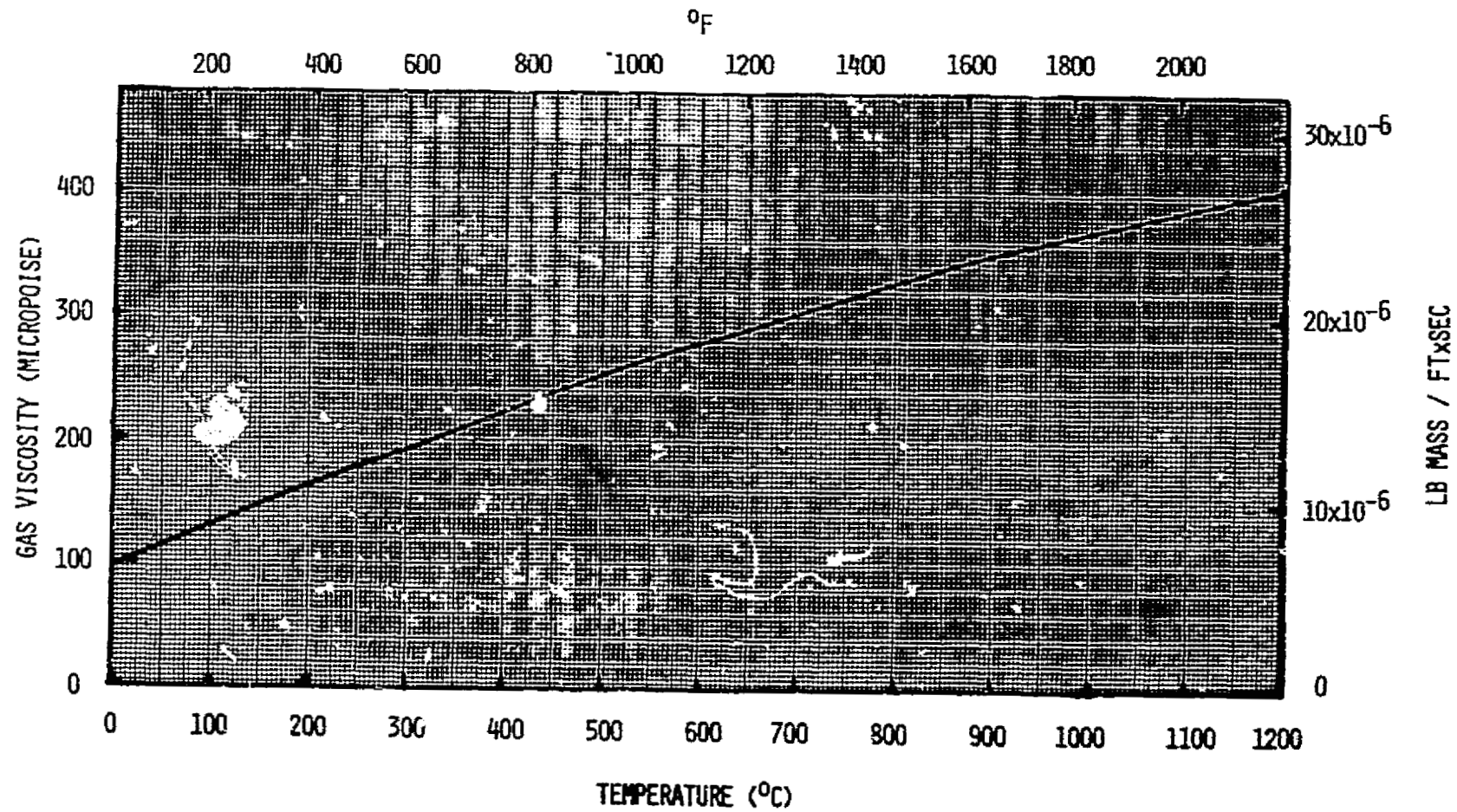

Figure 2.4-7 Gas Viscosity vs Temperature for Dichlorosilane

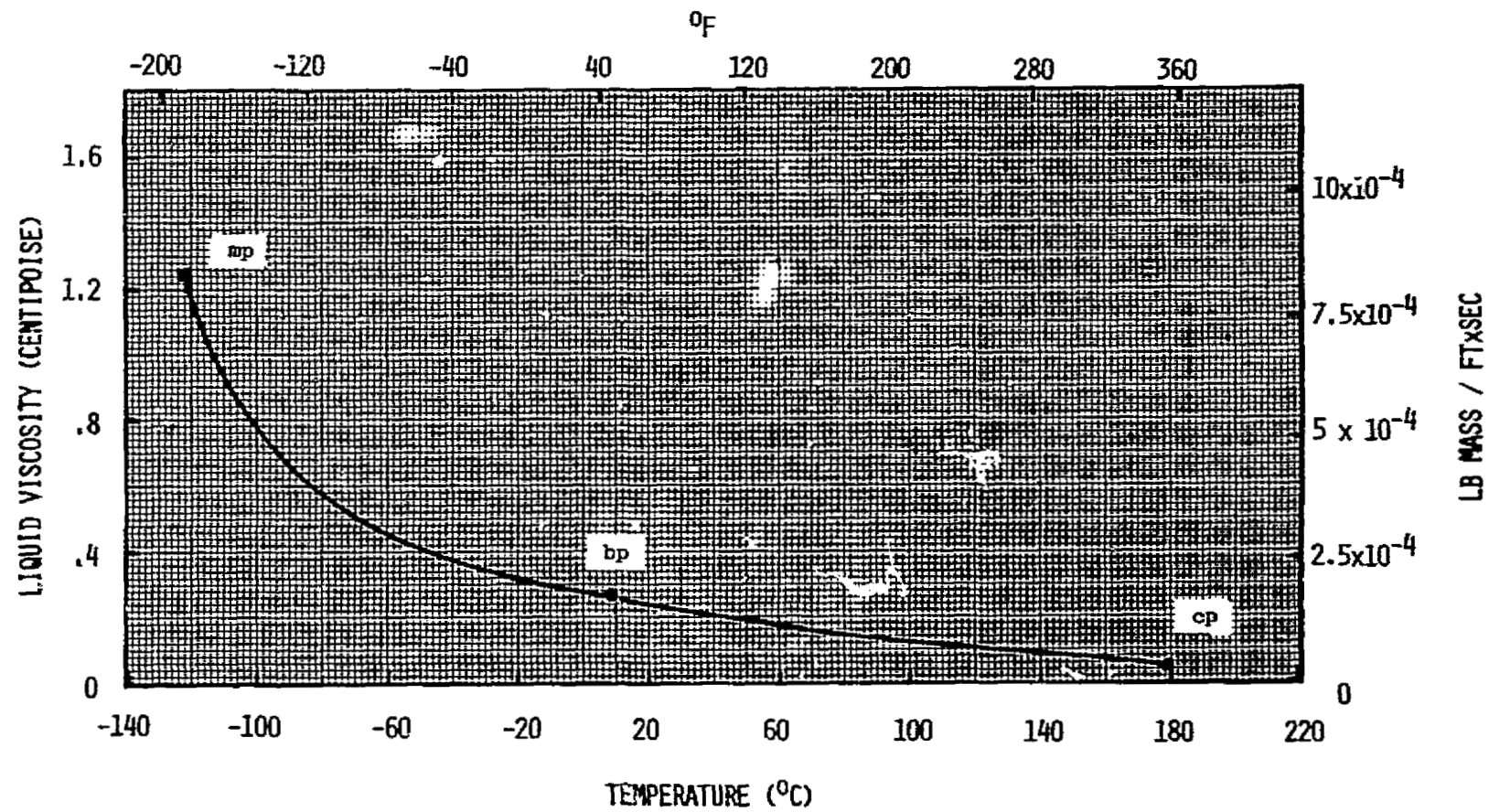

Figure 2.4-8 Liquid Viscosity vs Temperature for Dichlorosilane

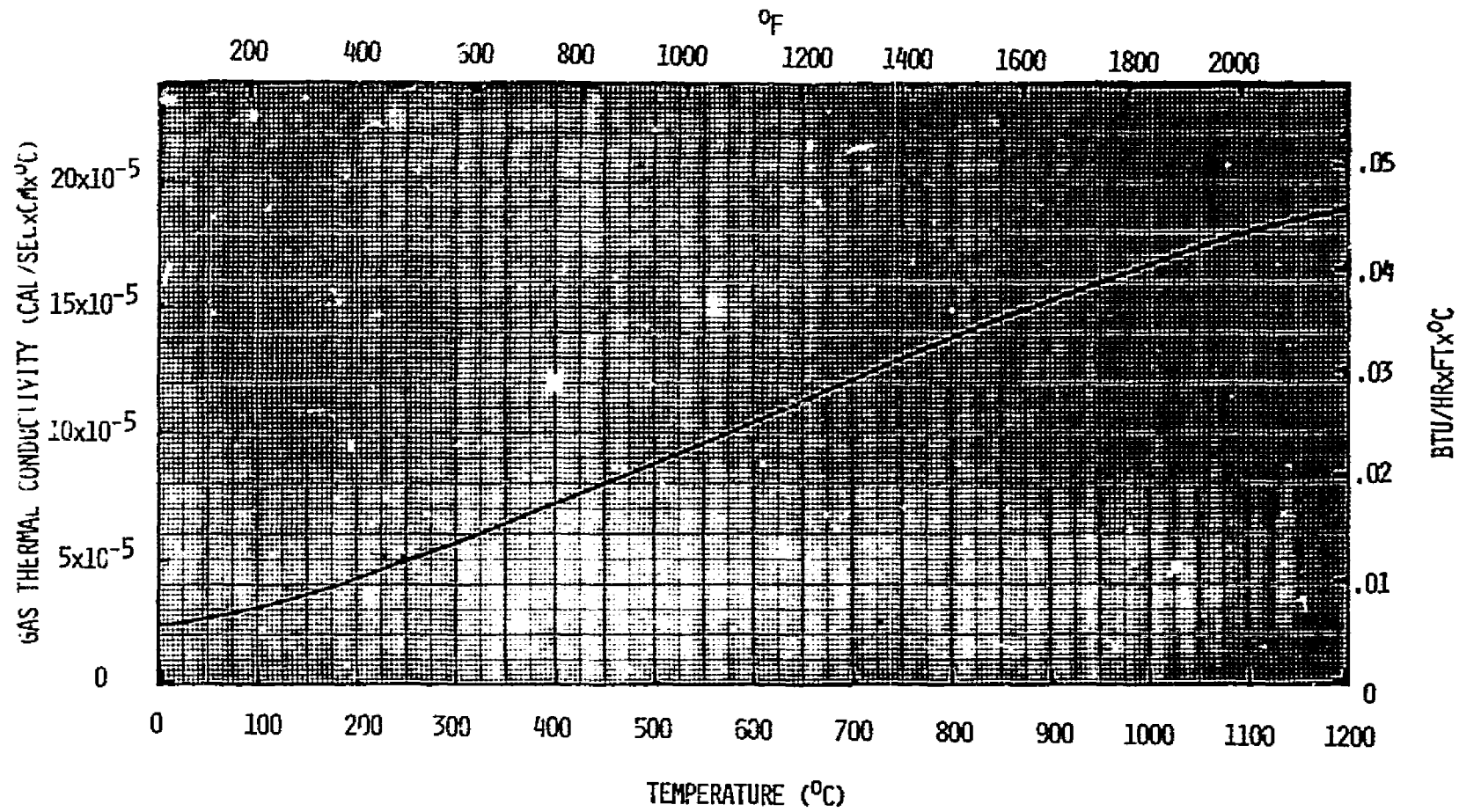

Figure 2.4-9 Gas Thermal Conductivity vs Temperature for Dichlorosilane

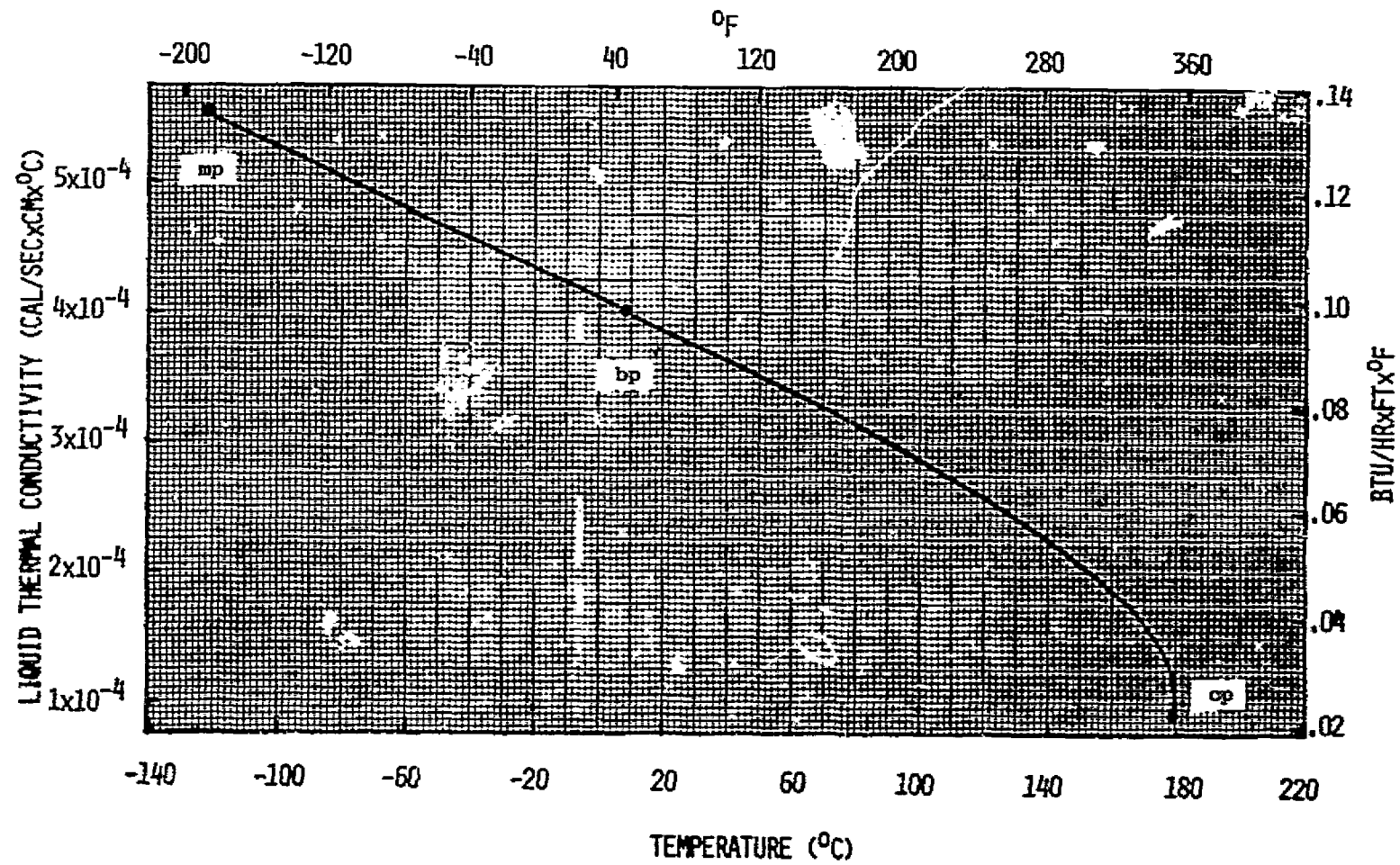

Figure 2.4-10 Liquid Thermal Conductivity vs Temperature for Dichlorosilane

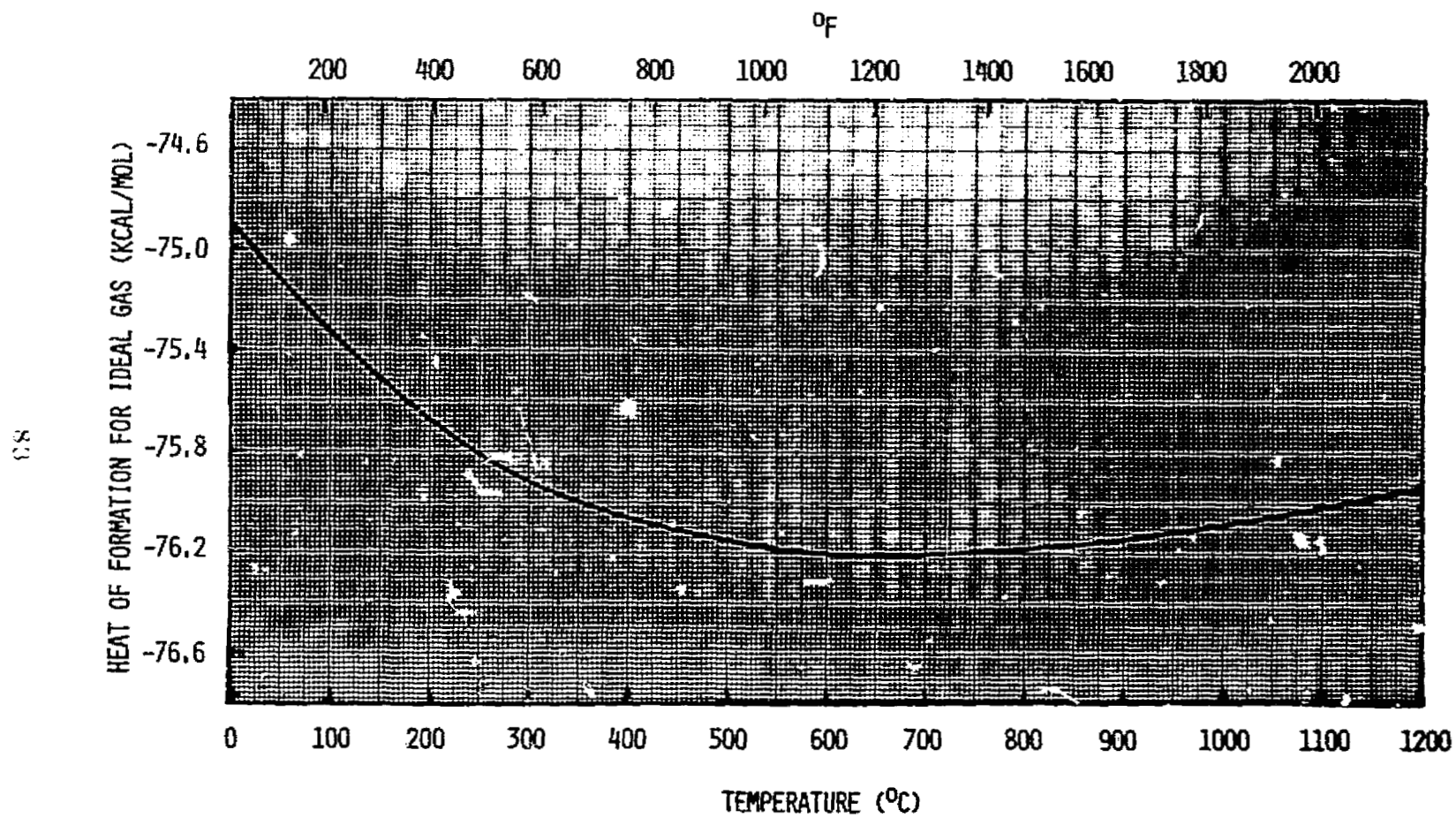

Figure 2.4-11 Heat of Formation vs Temperature for Dichlorosilane

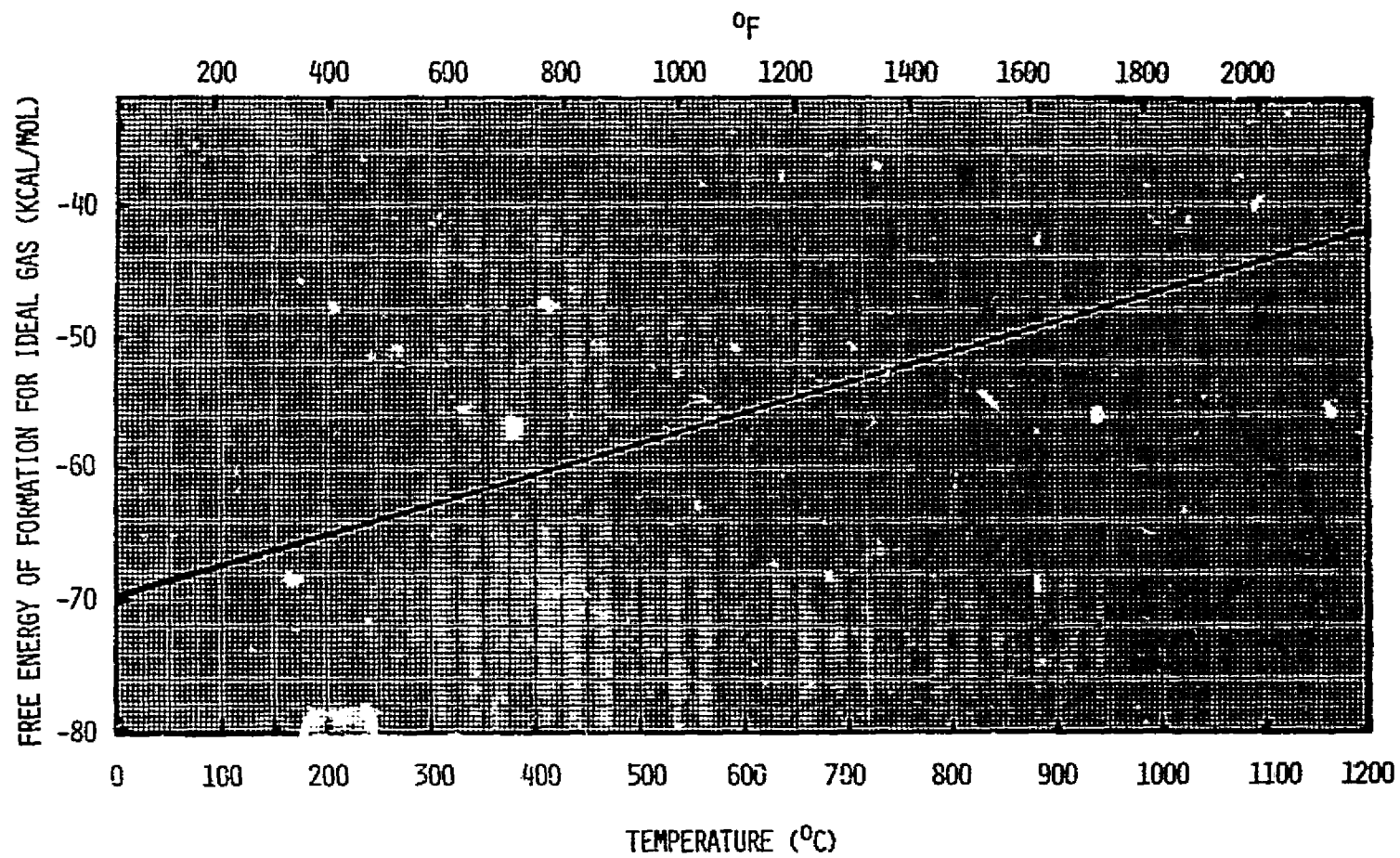

Figure 2.4-12 Free Energy of Formation vs Temperature for Dichlorosilane

REFERENCES FOR DICHLOROSILANE

- H 1. Bailar, Jr., J. C., others, Comprehensive Inorganic Chemistry, Vol. 1, Pergamon Press, Elmsford, New Jersey (1973).
- H 2. Dean, J. A., ed., Lange's Handbook of Chemistry, 11th ed., McGraw-Hill, New York (1973).
- H 3. Ebsworth, E. A., Volatile Silicon Compounds, MacMillan Co., New York (1963).
- H 4., Gmelin, Gmelins Handbüch der Anorganischen Chemie, No. 13, Silicium Part B, Verlag Chemie, GMBH, Weinheim, Bergstrasse (1959).
- H 5. Hunt, L. P., others, J. Electrochem Soc., 119 (12), 1741-5 (1972).
- H 6. Ka pet'yants, M. Kh. and M. L., Thermodynamic Constants of Inorganic and Organic Compounds, Ann-Arbor-Humphrey Science Pub., Ann Arbor, Mich. (1970).
- H 7. Karapet'yants, M. L., Tables of Some Thermodynamic Properties of Different Substances, Trudy MKh TI in Mendeleeva, No. 34, Moscow (1961) Russ.
- H 8. Kirk, R. E., Kirk-Othmer Encyclopedia of Chemical Technology, Vol. 18, Interscience Publishers, New York (1969).
- H 9. Landolt-Bornstein Tables, Original volumes to present, Springer-Verlag, Berlin, Germany (1956-present).
- H10. Lapidus, I. I., others, Thermophysical Properties of Gases and Liquids, No. 1, Rabinovich, V. A., ed., 102, Is _____rogram for Scientific Translation (1970).
- H11. Lapidus, I. I., others, Tepolfiz Vys. Temp. (High Temp.), 6 (1), 60 (1968).
- H12. Lapidus, I. I., others, Izv. Vysshikh. Uchebn., Zavedenii, Tsvetn. Met., 9 (2), 92-96 (1966) Russ.
- H13. O'Neal, H. E. and Ring, M. A., Inorg. Chem., 5 (3), 435 (1966).
- H14. Pedley, J. B., others, Comput. Anal. Thermochem. Data (1972).
- H15. Prostov, V. N. and Popova, O. G., Zh. Fiz. Khim., 49 (3), 631-3 (1975) Russ.
- H16. Reed, R. C., others, The Properties of Gases and Liquids, 3rd ed., McGraw-Hill Publishing Co., New York (1977).
- H17. Reed, R. C. and Sherwood, T. K., The Properties of Gases and Liquids, 2nd ed., McGraw-Hill Book Co., New York (1966).
- H18. Rochow, E. G., An Introduction to the Chemistry of the Silicones, John Wiley and Sons, New York (1946).

- H19. Seifer, A. L., others, *Izv. Vysshikh. Uchebn., Zavedonij. Tsvetn. Met.*, 9 (3), 85 (1966) Russ.
- H20. Shakhparonov, M. I., others, *Zhur. Priklad. Khim.*, 33, 2699-2703 (1960).
- H21. Sneed, M. C. and Brasted, R. C., Comprehensive Inorganic Chemistry, Vol. 7 D. Van Nostrand Co., New York (1958).
- H22. Stock, A., Hydrides of Boron and Silicon, Cornell Univ. Press, New York, (1933) (reissued 1957).
- H23. Stock, A. and Smieski, C., Siliciumwasserstoffe: VI, Chlorierung and Methylierung der Monosilane, 52, 695 (1919).
- H24. Stone, F. G. A., Hydrogen Compounds of Group IV Elements, Prentice-Hall, Inc., Englewood Cliffs, N. J. (1962).
- H25. Stull, D. R., and Prophet, H., JANAF Thermochemical Tables, NSRDS-NBS 37, Nat. Bur. Stds., Washington, D. C. (1971).
- H26. Wagman, D. D., others, "Selected Values of Chemical Thermodynamic Properties", NBS Tech. Note 270-3, Natl. Bur. Stds., Washington, D. C. (1968).
- H27. Weast, R. C., ed., CRC Handbook of Chemistry and Physics, 49th ed., C. R. C. Inc., Cleveland, Ohio (1968-1969).
- H28. Yaws, C. L., Fang, C. S., Hansen, K. C. and Miller, J. W., Jr., Quarterly Technical Progress Report (XI), ERDA/JPL 954343-78/11, Distribution Category UC-63 (June, 1978).
- H29. Yaws, C. L., others, *Solid State Technology*, 16, (1), 39 (1973).
- H30. Yaws, Carl L., Physical Properties, Chemical Engineering, McGraw-Hill Publishing Co., New York (1977).
- H31. Wintgen, R., Ber., 52B, 724-31 (1919).
- H32. Golosova, R. M., others, *Russ. J. Phys. Chem.*, 45 (5), 598 (1971).
- H33. Mikawa, Y., *Nippon Kagaku Zasshi*, 81, 1512 (1960).
- H34. DeLong, D. J. *Solid State Tech.*, 15 (10) 29-34 (1972).
- H35. Yaws, C. L., Miller, J. W., Jr., Lutwack, R., and Hsu, G., "Electricity from Sunlight: Low Cost Silicon For Solar Cells", Fifth National Conference on Energy and the Environment, A.I.Ch.E.-A.P.A.C., Cincinnati (Oct. 31-Nov. 3, 1977).
- H36. Shaulov, Y. K., others, *Zh. Fiz. Khim.*, 40 (8), 893 (1966).

2.5 Silicon Tetrafluoride Properties

Physical Properties and Critical Constants (Table 2.5-1)

Physical properties are listed in Table IA-1 including the boiling point (sublimation temperature, where the vapor pressure of the solid is 760 mm Hg.). Two temperature are given in the literature for the melting point (triple point) of silicon tetrafluoride based on the work of Patnode and Papish (F37) in 1930 and the work of Pace and Mosser (F36) in 1963. The more recent work was selected as the melting point (triple point, where solid, liquid and vapor are in equilibrium).

Experimental data for the critical temperature and critical pressure of silicon tetrafluoride have been determined (F4). The critical compressibility factor, Z_c , was estimated from the Garcia'-Barcena' correlation (F39):

$$Z_c = f(T_b) - g(T_b/M) \quad (2.5-1)$$

where T_b is the normal boiling point, °K, and M is the molecular weight. When this method was applied to sulfur hexafluoride, another subliming inorganic fluoride, the calculated value of the critical compressibility factor only deviated 3.3% from the known value. From the estimated value of Z_c , the critical volume, V_c , was calculated by the rearrangement of the definition of Z_c .

$$V_c = \frac{Z_c RT_c}{P_c} \quad (2.5-2)$$

Vapor Pressure (Figure 2.5-1)

The vapor pressure of silicon tetrafluoride has been determined experimentally from 50° below the sublimation point to near the critical point (F4, F36, F37, F41). The experimental data were extended to cover the liquid range (from triple point to critical point), and for the solid (below the triple point using the YSSP correlation in each case:

$$\log P_v = A + \frac{B}{T} + C \log T + DT \quad (2.5-3)$$

At the higher temperatures the deviation of experimental and correlation results are 2% while the average percent error was 4.8% in the lower temperature range. Much of the deviation is due to rather poor agreement in the literature for the experimental values.

Heat of Vaporization (Figure 2.5-2)

Heat of vaporization data for silicon tetrafluoride are reported near the triple point (F24, F29, F36, F41, F60). Using the selected value (F36), Watson's correlation (F39) was used to extend the heat of vaporization over the entire liquid phase:

$$\Delta H_V = \Delta H_{V_1} \left[\frac{T_c - T}{T_c - T_1} \right]^n \quad (2.5-4)$$

where $n = .38$ and T_1 is the boiling point. The value of H_{V_1} was effectively confirmed using the Clausius-Clayron equation and literature vapor pressure values (F36).

Heat Capacity (Figures 2.5-3 and 2.5-4)

Heat capacity of the ideal gas at low pressure has been calculated from 0°C to 1200°C (F48, F63). These values, including other values covering smaller temperature ranges (F11, F24, F26, F29, F35, F60), were taken from various structural and spectral data and are in close agreement. The JANAF values (F48) were selected.

The liquid heat capacity of silicon tetrafluoride is reported near the sublimation point (F36). The values are extended over all liquid temperatures by the relationship:

$$\text{Heat Capacity} \times \text{Density} = \text{Constant} \quad (2.5-5)$$

The estimated constant was 0.473. Testing of this relationship with available data (4 data points) for silicon tetrafluoride produced an average absolute deviation of 0.8% error.

Liquid Density (Figure 2.5-6)

Liquid density data for silicon tetrafluoride are available only within about 20 degrees of the triple point (F26, F60). The experimental data were extrapolated to the critical point by use of a modification of the Rackett equation (F65, F66):

$$\rho = \rho_c Z^{-(1-T_r)} \quad (2.5-6)$$

where ρ_c is the critical density, T_r is the reduced temperature, and Z is a parameter derived from available data. Comparison of the calculated and experimental values of 5 data points gave 0.57% average absolute error.

Surface Tension (Figure 2.5-6)

Experimental data are not available for the surface tension of silicon tetrafluoride. The Brock and Bird corresponding states technique was used to estimate the surface tension (F39):

$$\alpha = P_c^{2/3} T_c^{1/3} (0.153 \alpha_c - 0.281) (1-T_r)^{11/9} \quad (2.5-7)$$

where α is surface tension, dynes/cm; α_c is the Riedel parameter; P_c is critical pressure, atm; T_c is the critical temperature, °K; and T_r is the reduced temperature. Application of this technique to silicon tetrachloride and sulfur hexafluoride gave results within 4% and 1% absolute deviation with experimental data, respectively.

Viscosity (Figures 2.5-7 and 2.5-8)

Experimental data for the gas viscosity of silicon tetrafluoride are available from about room temperature to above 300°C (F13, F32). The values at higher temperatures were estimated using the relationship:

$$\log \eta_G = A + BT + CT^2 \quad (2.5-8)$$

The average absolute percentage error was 1.74% when correlated values were compared with the 28 experimental data points.

No experimental data are available for the liquid viscosity of silicon tetrafluoride. Estimates were derived applying the Letsou-Stiel high-temperature liquid-viscosity correlation (F65):

$$\eta_L \xi = (\eta_L \xi)^0 + \omega (\eta_L \xi)^1 \quad (2.5-9)$$

where the parameters $(\eta_L \xi)^0$ and $(\eta_L \xi)^1$ are functions of reduced temperature, ω is the acentric factor and $\xi = T_c^{1/6} / M^{1/2} P_c^{2/3}$. This correlations gave results within 17% and 48% absolute deviation for the experimental values of silicon tetrachloride and sulfur hexafluoride, respectively. Since liquid viscosity estimation methods may be grossly inaccurate (F69), these values must be assumed to be order of magnitude estimates only.

Thermal Conductivity (Figures 2.5-9 and 2.5-10)

The gaseous thermal conductivity of silicon tetrafluoride has been reported from about room temperature to 350°C (F9, F68). The experimental values were extended using a modified form of the Misić and Thodos correlation (F66):

$$\lambda_G = \frac{C_p}{T} (10^{-6}) (14.52T_r - 5.14)^n \quad (2.5-10)$$

where $n = .63$, Γ is $T_c^{1/6} M^{1/2} / P_c^{2/3}$, T_r is the reduced temperature and C_p is the gaseous heat capacity. The average percentage error was less than one percent.

No liquid thermal conductivity data are available; however, values were estimated using the Sato-Riedel equation (65):

$$\lambda_L = \frac{2.64 \times 10^{-3}}{M^{1/2}} \frac{3 + 20(1-T_r)^{2/3}}{3 + 20(1-T_{r_b})^{2/3}} \quad (2.5-11)$$

where M is molecular weight, T_r is the reduced temperature, and T_{r_b} is the reduced temperature at the boiling point. This correlation gave 34% error with the single experimental data point for silicon tetrachloride and 24% error for sulfur hexafluoride with the several experimental data points. There is considerable deviation of values among the several different data sources (22% maximum deviation). The present results should be taken only to represent an order of magnitude estimate.

Heat and Free Energy of Formation (Figures 2.5-11 and 2.5-12)

Many American workers (F20, F24, F29, F34, F35, F48, F57, F58) and others (F40, F43) have reported heats of formation as well as Gibb's free energy of formation (F48, F56, F58) for the ideal gas. The JANAF values (F48) were selected.

TABLE 2.5-1

PHYSICAL PROPERTIES AND CRITICAL CONSTANTS OF SILICON TETRAFLUORIDE

<u>Identification</u>	<u>Silicon Tetrafluoride</u>
Formula	SiF ₄
State (std. cond.)	gas (colorless)
Molecular weight, M	104.08
Boiling point, T _b , °C (sublimation point)	-95.7 (760 mm Hg)
Melting Point, T _m , °C (triple point)	-86.8 (1679 mm Hg) *Ref. F36 -90.2 (1318 mm Hg) Ref. F37
Critical Temp, T _c , °C	-14.15
Critical Pressure, P _c , atm	36.66
Critical Volume, v _c , cm ³ /gr mol	165**
Critical Compressibility Factor, Z _c	0.284**
Critical Density, ρ _c , gr/cm ³	0.6308**
Acentric Factor (ω)	0.4086

* Selected Value

**Estimated

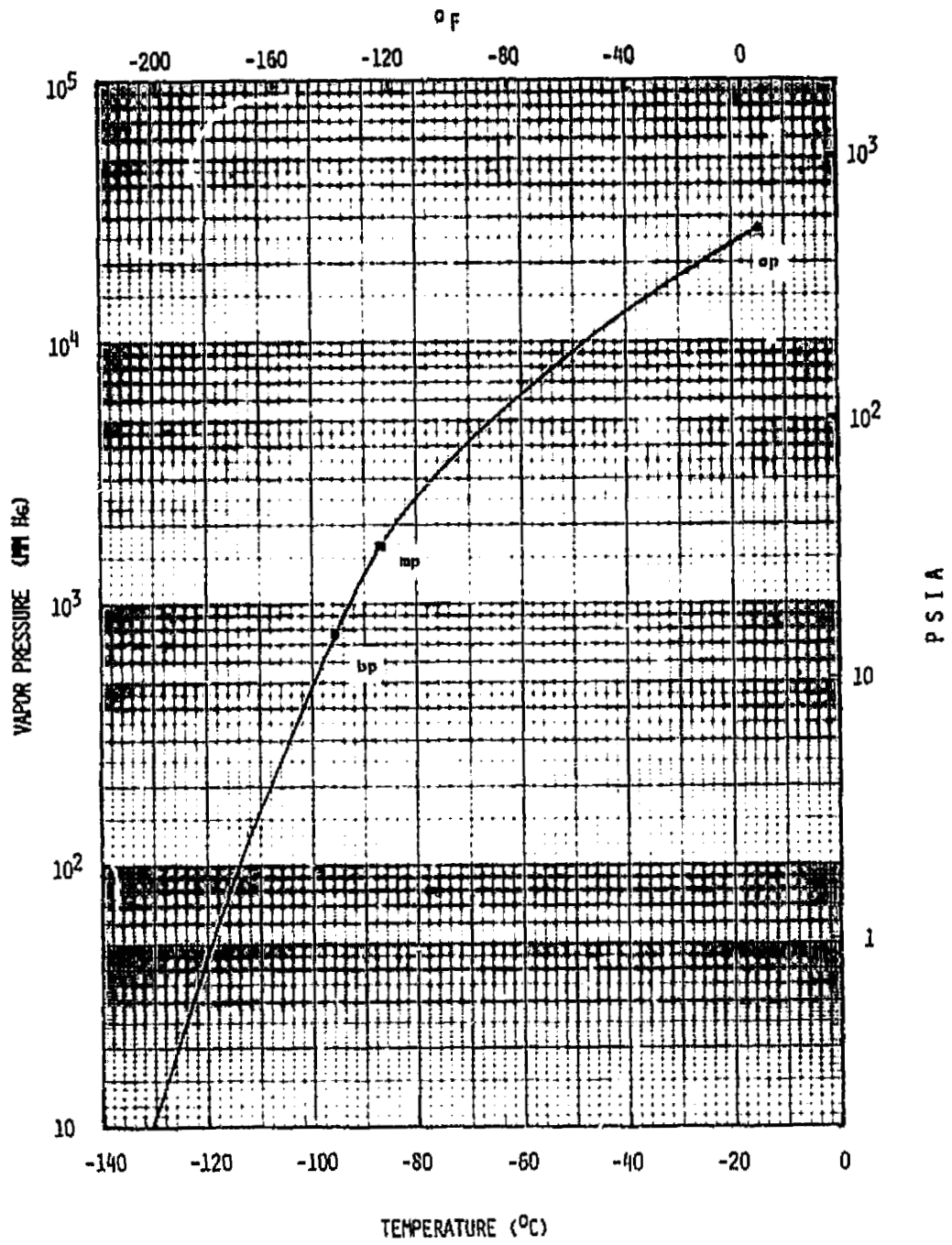

Figure 2.5-1 Vapor Pressure vs Temperature for Silicon Tetrafluoride

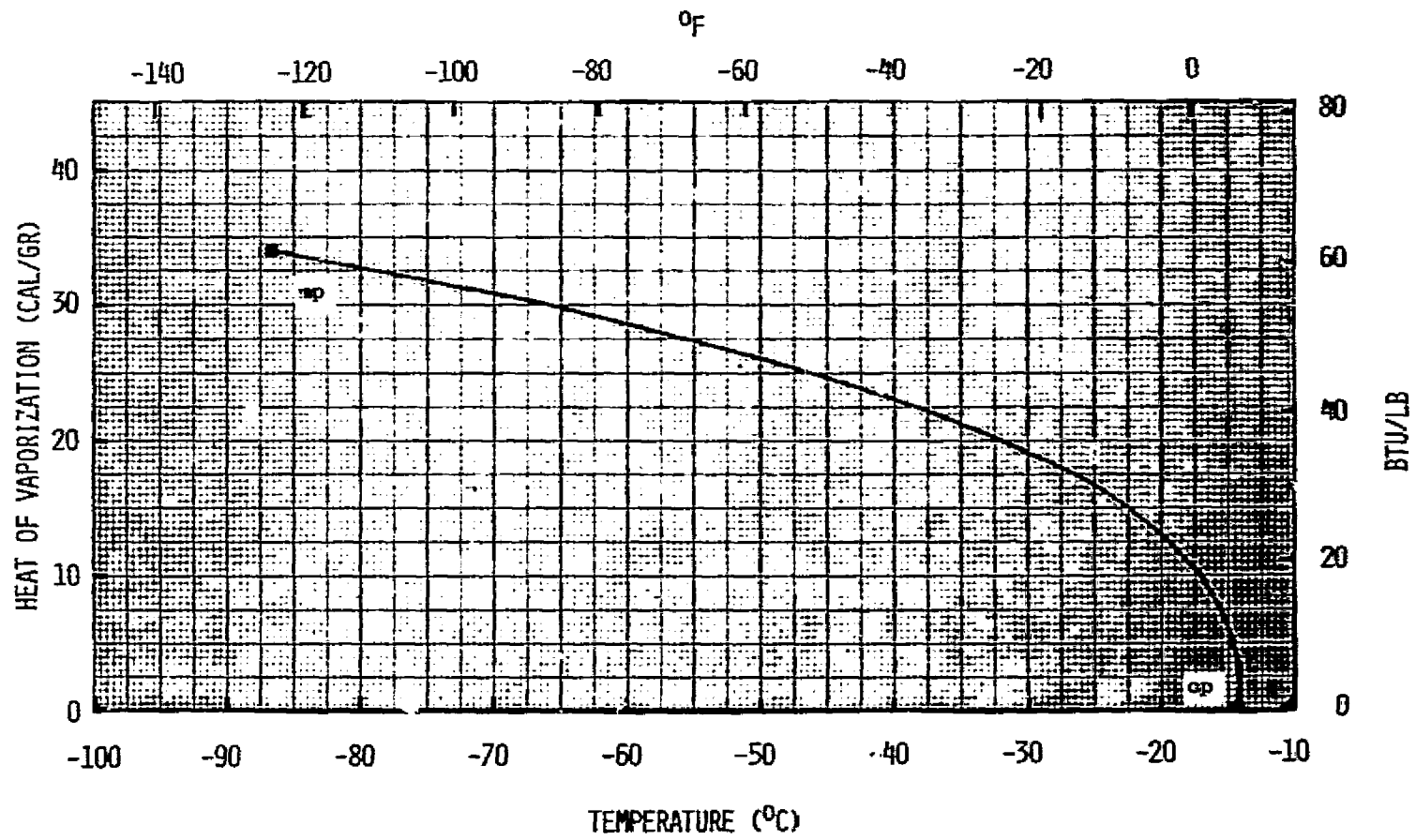

Figure 2.5-2 Heat of Vaporization vs Temperature for Silicon Tetrafluoride

.6

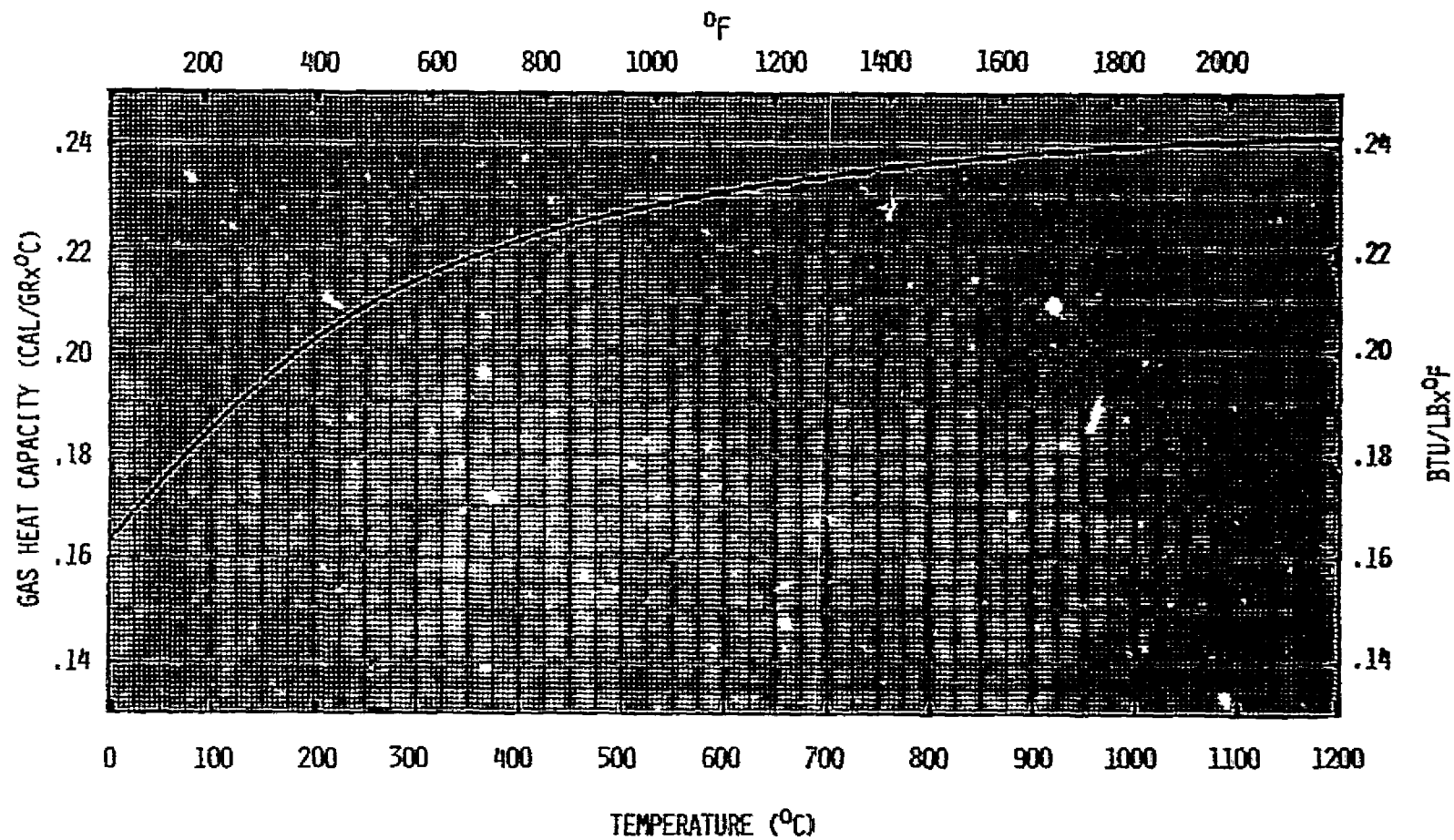

Figure 2.5-3 Gas Heat Capacity vs Temperature for Silicon Tetrafluoride

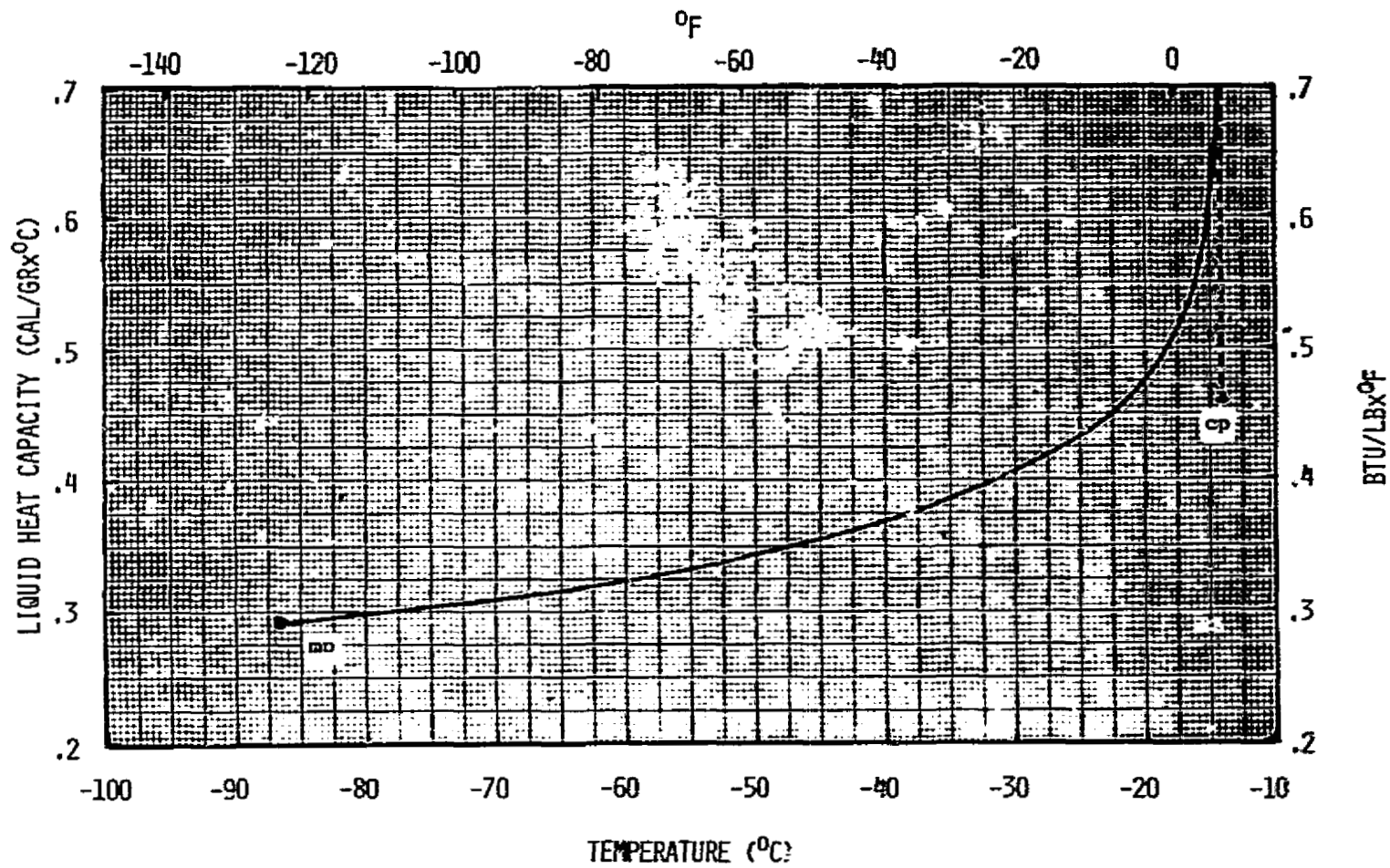

Figure 2.5-4 Liquid Heat Capacity vs Temperature for Silicon Tetrafluoride

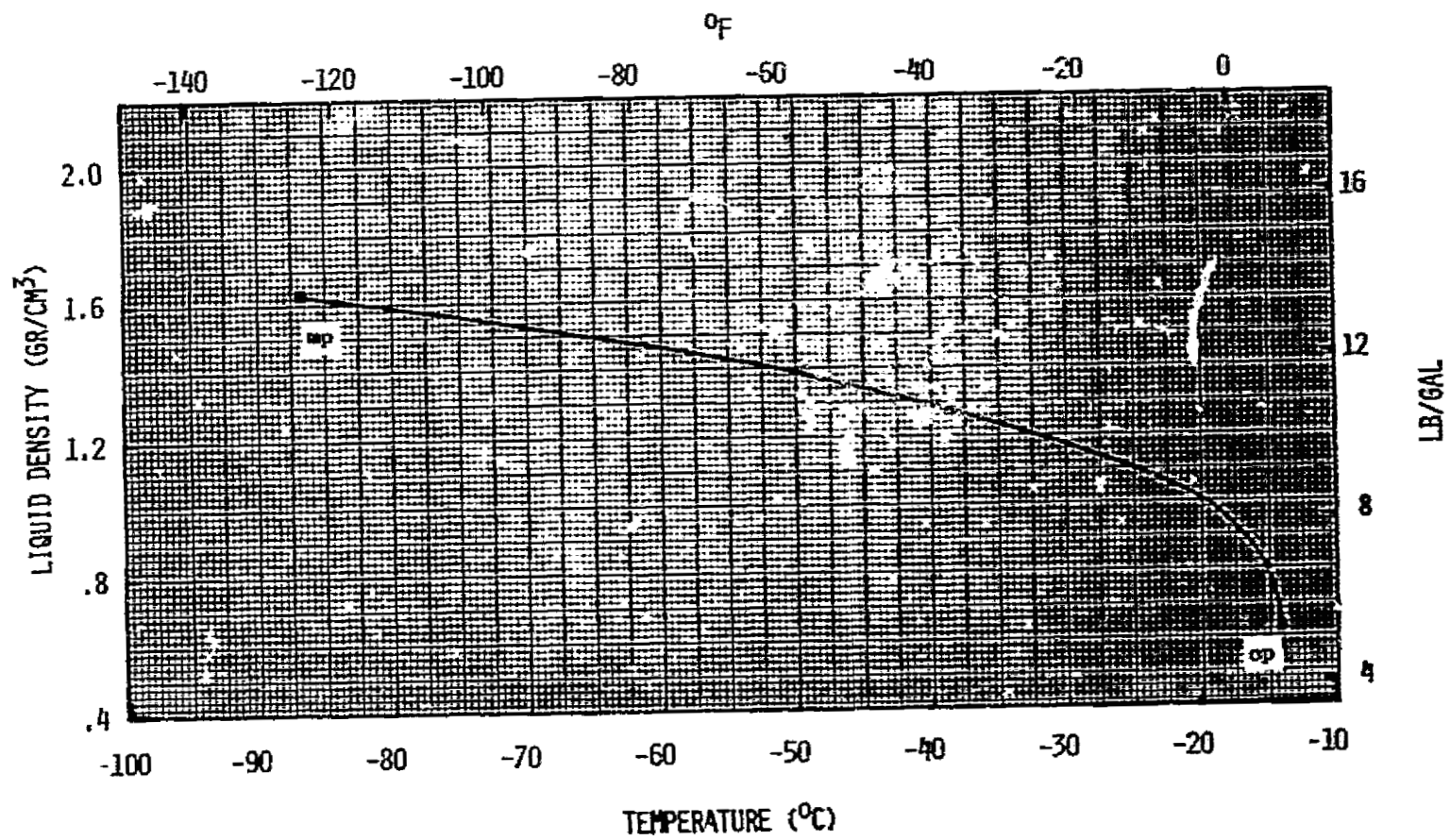

Figure 2.5-5 Liquid Density vs Temperature for Silicon Tetrafluoride

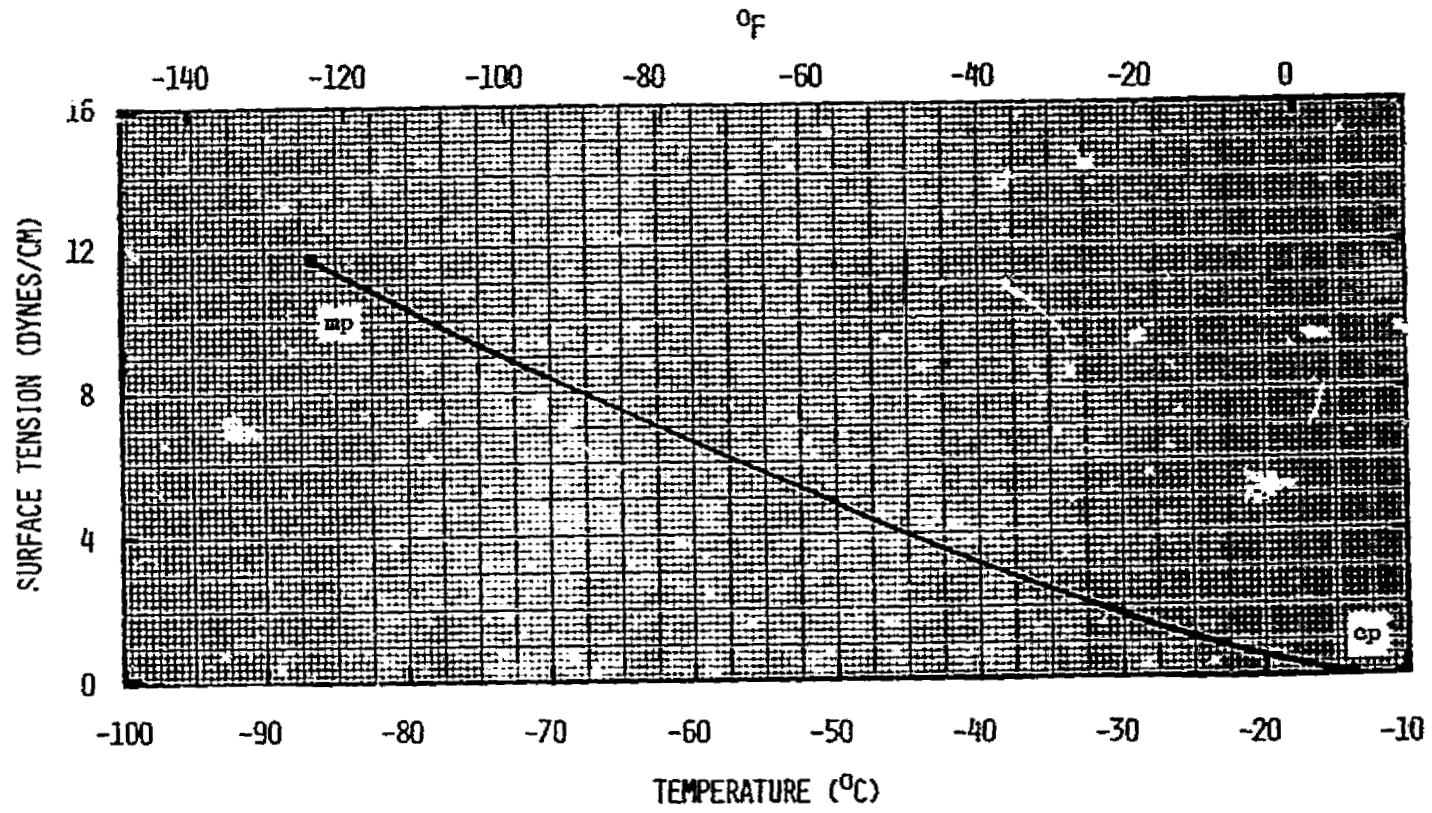

Figure 2.5-6 Surface Tension vs Temperature for Silicon Tetrafluoride

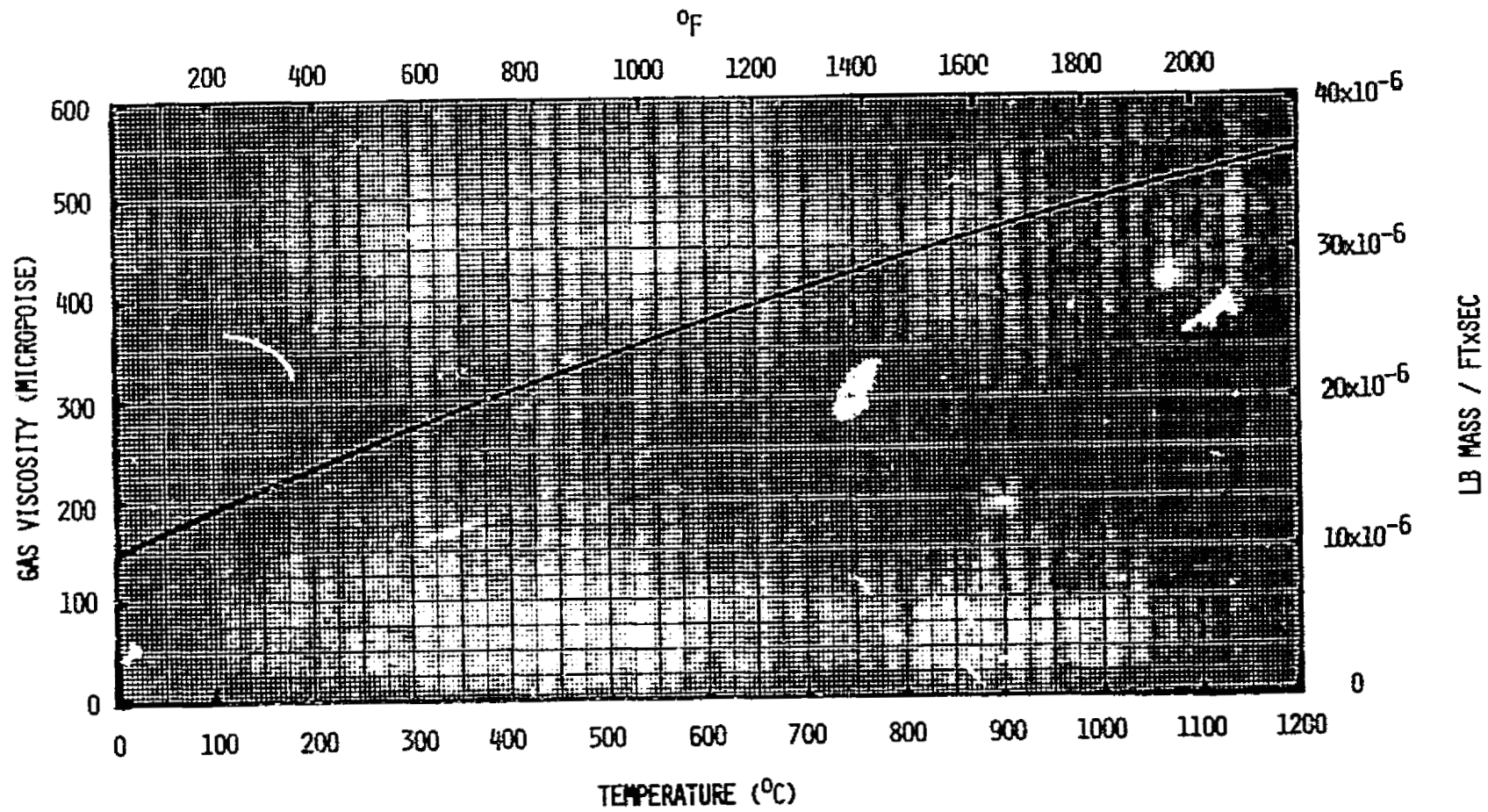

Figure 2.5-7 Gas Viscosity vs Temperature for Silicon Tetrafluoride

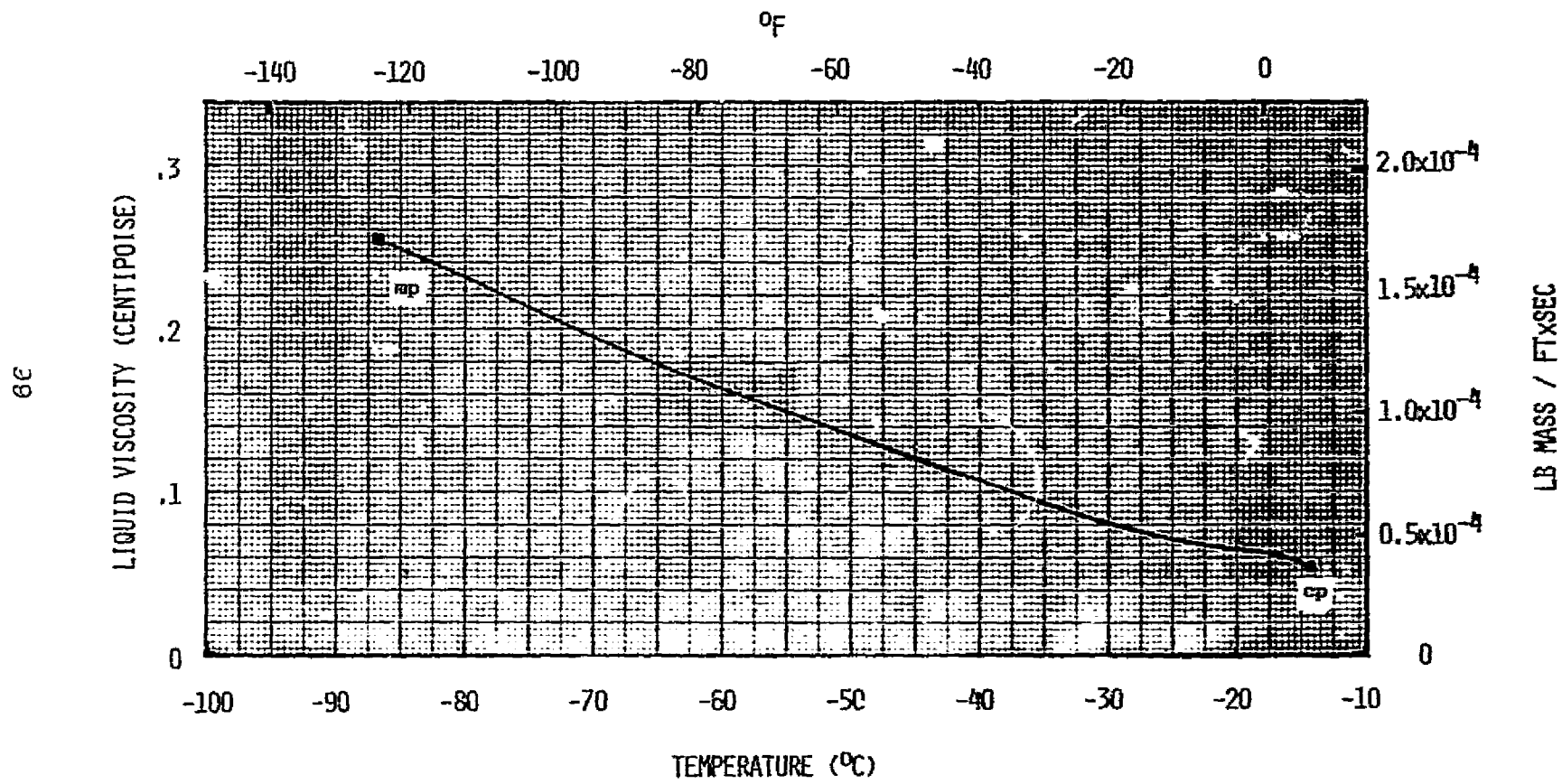

Figure 2.5-8 Liquid Viscosity vs Temperature for Silicon Tetrafluoride

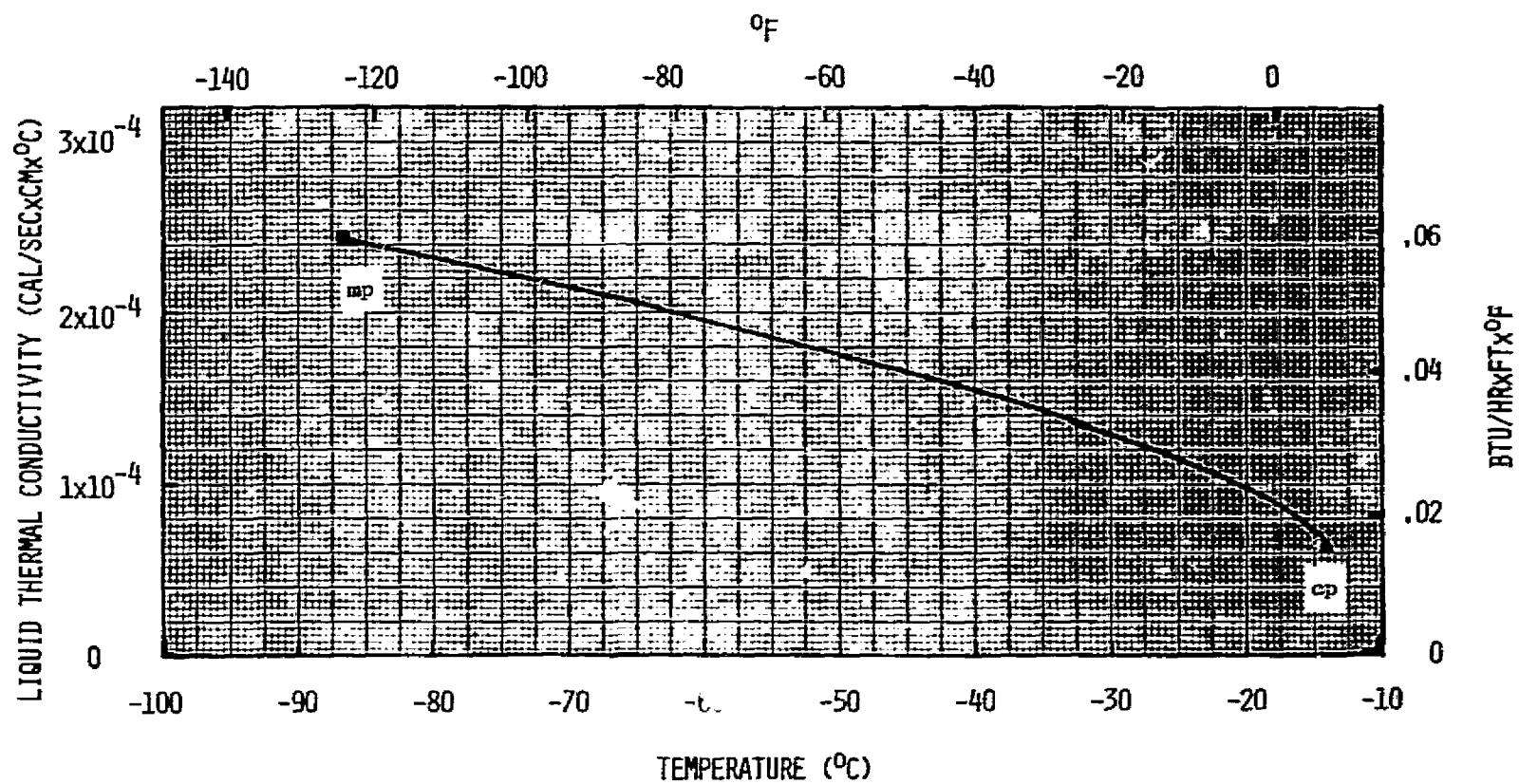

Figure 2.5-10 Liquid Thermal Conductivity vs Temperature for Silicon Tetrafluoride

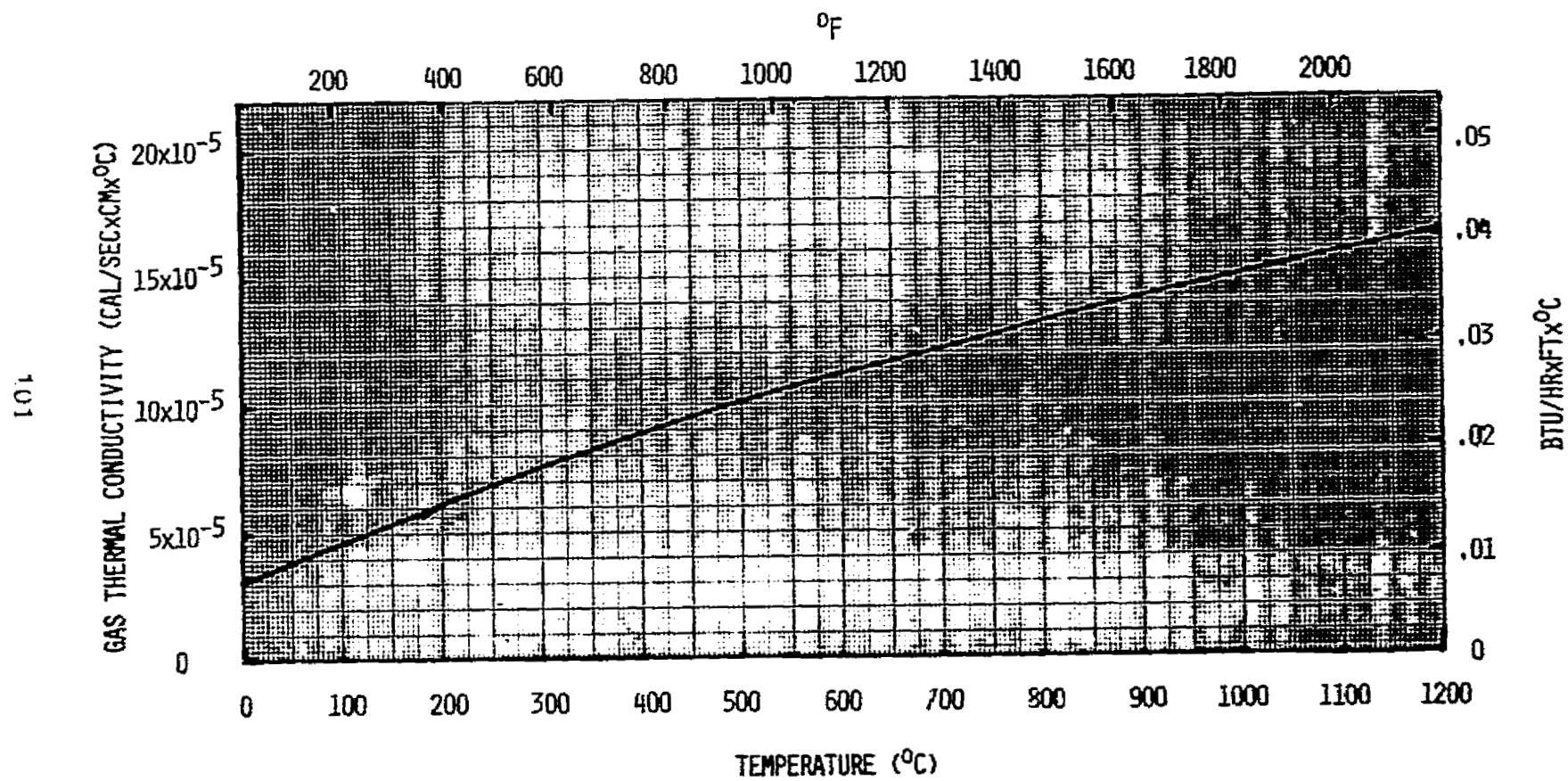

Figure 2.5-9 Gas Thermal Conductivity vs Temperature for Silicon Tetrafluoride

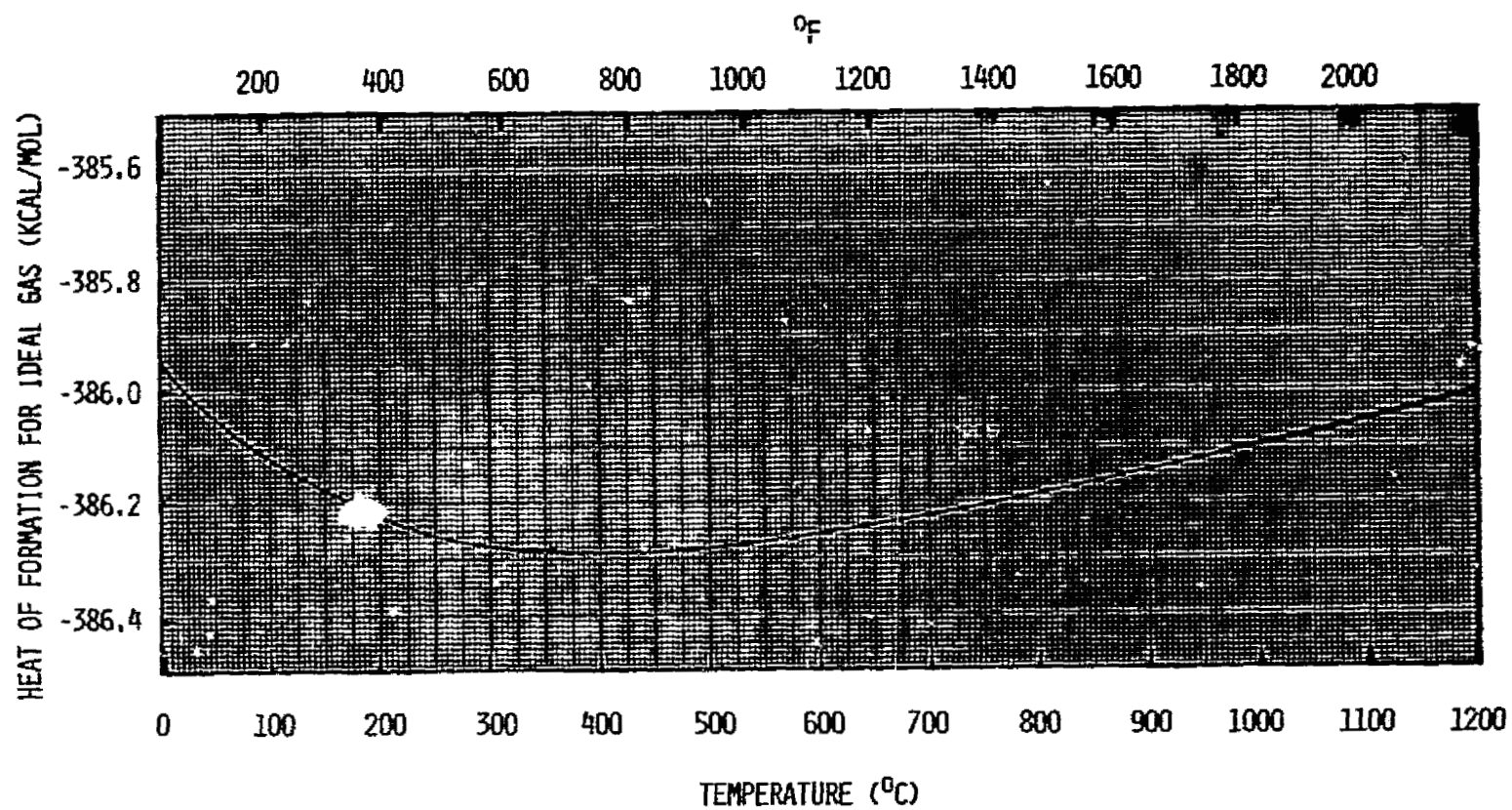

Figure 2.5-11 Heat of Formation vs Temperature for Silicon Tetrafluoride

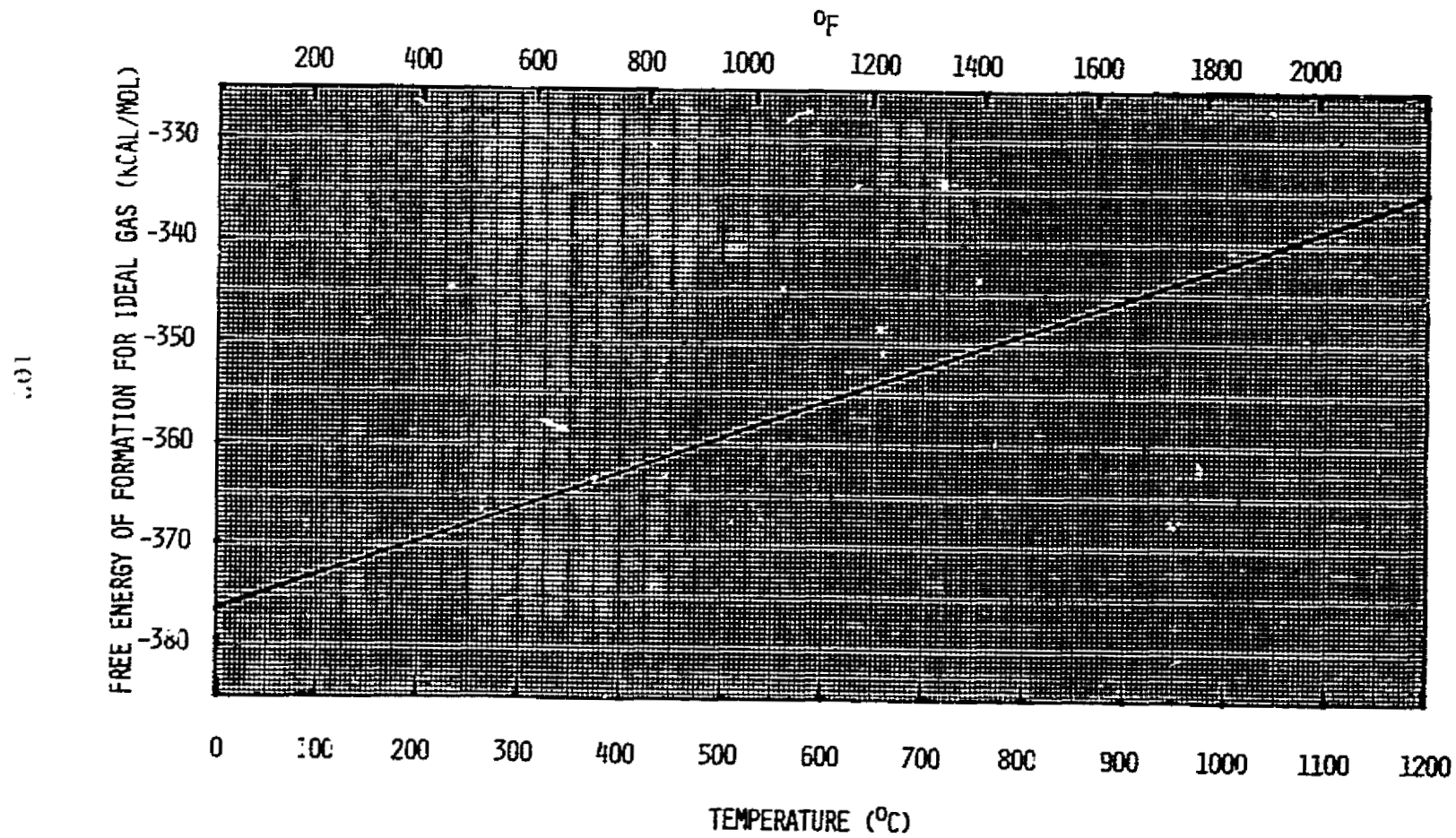

Figure 2.5-12 Free Energy of Formation vs Temperature for Silicon Tetrafluoride

REFERENCES FOR SILICON TETRAFLUORIDE

- F 1. Antonov, A. A. and Maslov, P. G., Zh. Prikl. Khim., 40 (12), 2787 (1976).
- F 2. Boiko, V. V., others, Termodin Termokhim. Konstanty, 224 (1970).
- F 3. Booth, H. S. and Swinehart, C. F., J. Am. Chem. Soc., 57, 1333 (1935).
- F 4. Booth, H. S. and Swinehart, C. F., J. Am. Chem. Soc., 57, 1337 (1935).
- F 5. Bratland, D., others, Acta. Chem. Scand., 24 (3), 864 (1970).
- F 6. Bratland, D., others, Acta. Chem. Scand., 24 (3), 871 (1970).
- F 7. Brokaw, R. S., "Alignment charts for transport properties-viscosity, thermal conductivity, and diffusion coefficients for nonpolar gases and gas mixtures at low density," NASA TR R-81, AD 243 198, Sup. of Doc., Washington, D. C. (1961).
- F 8. Caillat, R., Ann. Chim., 20 367 (1945).
- F 9. Choy, P. G., "Thermal Conductivities of some Polyatomic Gases", Xerox University Microfilms, Ann Arbor, Michigan (1967).
- F10. Choy, P. G. and Raw, C. J. G., J. Chem. Phys., 45 (5), 1413 (1965).
- F11. Dean, J. A., ed., "Lange's Handbook of Chemistry", revised 11th ed., McGraw-Hill, New York (1973).
- F12. Ellis, C. P. and Raw, C. J. G., J. Chem. Soc., 3765 (1956).
- F13. Ellis, C. P. and Raw, C. J. G., J. Chem. Phys., 30, 574 (1954).
- F14. Everett, D. H., J. Chem. Soc., 2566 (1960).
- F15. Fischer, W. and Weidemann, W., Z. Anorg. Allgem. Chem., 213, 106 (1933).
- F16. Glassner, A., "The Thermophysical Properties of the Oxides, Fluorides, and Chlorides, to 2500 °K", ANL-5750, Sup. of Doc., Washington, D. C. (1957).
- F17. Gordon, J. S., "High Performance Solid Rocket Propellents. Thermodynamic Data for Combustion Products", RMD 210-E3, AD 231 995, Sup., of Doc., Washington, D. C. (1960).
- F18. Goryachkin, Yu. N., others, Tr. Mosk. Khim.-Tekhnol. Inst., 67, 76 (1970).
- F19. Hamann, S. D. and Lambert, J. A., Australian J. Chem., 7, 1 (1954).

- F20. Hubbard, W. N., "Thermochemical Studies at Argonne National Laboratory", U. S. At. Energy Comm., TID-15554, Sup. of Do., Washington, D. C. (1962).
- F21. "International Critical Tables", McGraw-Hill, New York (1926).
- F22. Lange, N. A., ed., "Lange's Handbook of Chemistry", Revised 10th ed., McGraw-Hill, New York (1961).
- F23. Khaidukov, N. I., others, J. Applied Chem. (USSR), 9, 439 (1936).
- F24. Kirk, R. E. and Othmar D. F., eds., "Encyclopedia of Chemical Technology", 2nd ed., Interscience Encyclopedia Inc., New York (1970).
- F25. Kostryukov, V. N., others, Zhur, Fiz, Khim., 32, 1354 (1958).
- F26. "Landolt-Börnstein Tables", Original volumes to present, Vol. 2 (pt.1, 2a, 3, 4, 5a, 5b), Springer-Verlag, Berlin, Germany (1956-present).
- F27. Margrave, J. L., U. S. At. Energy Comm., AROD-1428:9, Sup. of Doc., Washington, D. C. (1963).
- F28. Maslov, P. G. others, High Temperature, 5 (2), 245 (1967).
- F29. "Matheson Gas Data Book", 5th ed., Matheson Co., East Rutherford, N. J. (1971).
- F30. Mathews, J. F., Chemical Reviews, 72 (1), 71 (1972).
- F31. Mikawa, Yukio, Nippon Kagaku Zasshi, 81, 1512 (1960).
- F32. McCoubrey, J. C. and Singh, N. M., Trans. Faraday Soc., 53, 877 (1957).
- F33. McCoubrey, J. C. and Singh, N. M., Trans. Faraday Soc., 55 Pt. II 1826 (1959).
- F34. McDonald, J. D., others, Advan. Chem. Ser. No. 72, 261 (1968).
- F35. O'Neal, H. E. and Ring, M. A., Inorg. Chem., 5 (3), 435 (1966).
- F36. Pace, E. L. and Mosser, J. S., J. Chem. Phys., 39 (1), 154 (1963).
- F37. Patnode, W. I. and Papish, J., J. Phys. Chem., 34, 1494 (1930).
- F38. Perry, R. H. and Chilton, C. H., "Chemical Engineer's Handbook", 5th ed., McGraw-Hill, New York (1973).
- F39. Reid, R. C. and Sherwood, T. K., "The Properties of Gases and Liquids", 2nd ed., McGraw-Hill, New York (1966).
- F40. Roth, W. A. and Troitzsch, H., Z. Anorg. Chem., 260, 337 (1949).
- F41. Ruff, O. and Ascher, E., Z. Anorg. Allgem. Chem., 196, 413 (1931).

- F42. Ryss, I. G., J. Phys. Chem. (USSR), 14, 571 (1940).
- F43. Schaefer, J. B., and Morcher, B., Z. Anorg. Allgem. Chem., 352 (3-4), 122 (1967).
- F44. Schramm, B., Ber. Bunsenges. Phys. Chem., 73 (2), 217 (1969).
- F45. Shishkin, G. I. and Bogachev, G. N., Tr. Ural. Nauch.-Issled. Khim. Inst., (17), 108 (1968).
- F46. Sinke, G. C., "Thermodynamic Properties of Combustion Products", AR 18-59, AD-214587, Sup. of Doc., Washington, D. C. (1959).
- F47. Sminova, Z. G., others, Issled. Obl. Neorg. Tekhnol., 202 (1972).
- F48. Stull, D. R. and Prophet, H., JANAF Thermochemical Tables, Cat. No. C13:18-37, Stock No. 0303-0872, NBS-RS-37, Sup. of Doc., Washington, D. C. (1971).
- F49. Svehla, R. A., "Estimated Viscosities and Thermal Conductivities of Gases at High Temperature", NASA TR R-132, Lewis Research Center, Cleveland (1962).
- F50. Touloukian, Y. S., Liley, P. E. and Saxena, S. C., "Thermophysical Properties of Matter", 1st and 2nd eds., IFI/Plenum, New York or Washington, D. C. (1970).
- F51. Voelz, F. L., others, J. Chem. Phys., 19, 1084 (1951).
- F52. Wartenberg, H. von, Z. Anorg. Allgem. Chem., 151, 326 (1926).
- F53. Wartenberg, H. von and Schütte, R., Z. Anorg. Allgem. Chem., 211, 222 (1933).
- F54. Weast, R. C., ed., "CRC Handbook of Chemistry and Physics", 55th ed., Chemical Rubber Co., Cleveland (1974).
- F55. Wiederkehr, R. R., J. Chem. Phys., 37, 1192 (1962).
- F56. Wise, S. S., "Heats of Formation of Some Inorganic Compounds by Fluorine Bomb Calorimetry", U. S. At. Energy Comm., ANL-6472, Sup. of Doc., Washington, D. C. (1962).
- F57. Wise, S. S., others, J. Phys. Chem., 66, 381 (1962).
- F58. Wise, S. S., others, J. Phys. Chem., 67, 815 (1963).
- F59. Youssef, A., others, Z. Phys. Chem. (Leipzig), 243 (1-2), 95 (1970).
- F60. Bailar, J. C., Jr., ed., "Comprehensive Inorganic Chemistry", Vol. 1, Pergamon Press, Oxford (1973).

- F61. Voelz, F. L., others, *J. Chem. Phys.*, 20, 1498 (1952).
- F62. Kobe, K. A. and Lynn, R. E., *Chemical Reviews*, 52, 117 (1953).
- F63. Barin, I. and Knacke, O., "Thermochemical Properties of Inorganic Substances", Springer-Verlag, Berlin, Germany (1973).
- F64. Moissan, H. *Compr. rend.*, 139, 711 (1904); *Ann. chim. phys.*, 8 (8) (1906).
- F65. Reed, R. C., others, "The Properties of Gases and Liquids", Third edition, McGraw-Hill, New York (1977).
- F66. Yaws, Carl L., "Physical Properties", Chemical Engineering, McGraw-Hill, New York (1977).
- F67. Yoon, R. and Thodos, G., *AIChE Journal*, 16 (2), 300 (1970).
- F68. Yaws, Carl L., Fang, C. S., Hansen, K. C., and Miller, J. W., Jr., Quarterly Technical Progress Report (XI), ERDA/JPL 954343-78/11, Distribution Category UC-63 (June, 1978).
- F69. Gambill, W. R., *Chem. Eng.* 66 (1), 127 (1959).
- F70. Yaws, C. L., Miller, J. W., Jr., Lutwack, R. and Hsu, G., Electricity From Sunlight: Low Cost Silicon For Solar Cells, "Proceedings of the Fifth National Conference on Energy and the Environment", A.I.Ch.E.-A.P.C.A., Cincinnati (Oct. 31-Nov. 3, 1977).

2.6 Silicon Properties

PHYSICAL PROPERTIES (TABLE 2.6-1)

Experimental values for the melting point have been reported (1, 32, 49, 67, 110); however, all other values have been calculated. Estimated values for the boiling point range from 2285°C to 3267°C (10, 31, 52, 55, 109, 124, 125, 137). Our value is estimated to give a reasonable computer fit to the available vapor pressure data. Estimated values of critical properties are reported by van Laar's calculation (5, 34, 43, 44, 101, 125), Baibus (4) and Gates and Thodos (31, reported in Table I-1). Solid properties listed in Table I-1 are at room temperature while liquid properties are at the melting point.

VAPOR PRESSURE (FIGURE 2.6-1)

Recent vapor pressure data reported by American (1, 18) and British (6) workers were selected and extended using the YSSP vapor pressure correlation (157):

$$\log P_v = A + \frac{B}{T} + C \log T + DT + ET^2 \quad (2.6-1)$$

where P_v is the vapor pressure of saturated liquid, mm Hg; T is temperature, °K; and A , B , C , D and E are correlation constants derived using a generalized least squares program. Other data (10, 125, 142) were not used because of high percentage error which is reported to be due to extensive reaction of the silicon (54, 135). For the 44 experimental data points used (which are all in the range below 0.2 mm Hg) the average absolute deviation was 17%.

HEAT OF VAPORIZATION (FIGURE 2.6-2)

Heat of vaporization values of about 3850 cal/gm are available (1, 6, 18, 55) as well as older (10, 125a, 147) and Russian (142) values of about 3170 cal/gm. From the vapor pressure data near the melting point, the heat of vaporization was determined using the Clausius-Clapyrin equation. Using these values, Watson's correlation (165) was used to extend the heat of vaporization to the boiling point.

$$\Delta H_v = \Delta H_{v_1} \left[\frac{7500 - T}{7500 - T_1} \right]^n \quad (2.6-2)$$

where $n = 0.38$ and all other terms have their usual meanings. The calculated values give a 1.3% absolute percentage deviation with the five experimental references giving values near 3850 cal/gm near the melting point.

HEAT OF SUBLIMATION (FIGURE 2.6-3)

Heat of sublimation based on limited data have been reported recently in the literature (18, 54, 106). Using the YSSP correlation of vapor pressure data (as described earlier), heats of sublimation were calculated using the Clausius-Clapeyron equation (123):

$$\Delta H_{\text{sub}} = P \Delta V_{\text{sub}} \frac{\delta P}{\delta T} \quad (2.6-3)$$

where ΔH_{sub} is the heat of sublimation, cal/gr-mol; P is the vapor pressure, atm; and $\Delta V_{\text{sub}} = V^{\text{gas}} - V^{\text{solid}}$. The derivative, $\delta P/\delta T$, was determined from differentiation of the YSSP vapor pressure equation. Considering the possible inaccuracy in the extrapolation of very low vapor pressures at low temperatures, these values should be considered only order-of-magnitude calculations below 600°C.

HEAT CAPACITY (FIGURES 2.6-4 and 2.6-5)

Liquid heat capacities have been reported from experiments done in the range from the melting point to about 200°C above the melting point (67, 100). The values of Kantur (67) were selected because the temperature range was significantly greater with the temperatures appearing to be more accurately determined. The average values of heat capacity and temperature were taken as a reference point and the values were extended over the liquid range using the relationship:

$$\text{Liquid Heat Capacity} \times \text{Liquid Density} = \text{constant} \quad (2.6-4)$$

Calculated values agree within two percent of the values published in the experimental work (67).

Solid heat capacities have been reported by many authors (144, 138, 55, 34, 96, 164, 62, 115, and others) which give similar values. The JANAF and Touloukian values (138, 144) were selected.

DENSITY (FIGURES 2.6-6 & 2.6-7)

Several authors (93, 37, 14, 25, 9) have reported measured liquid density values from the melting point to about 400°C above the melting point. The data were extended to the boiling point using a modification of the Rackett equation (106):

$$\rho = \rho_c z^{-(1 - T_r)^{2/7}} \quad (2.6-3)$$

where ρ_c is critical density; T_r is reduced temperature and z is a parameter defined by the experimental data. Calculated values give a 0.5% average absolute deviation from the thirty reported experimental values. The vertical line at the melting point indicates the change in density upon melting.

Solid density measurements of silicon are recorded near room temperature (133, 134) at the melting point (85) and many others give linear thermal expansion data which are summarized by Touloukian (144). Solid densities at various temperatures were calculated using the percentage linear expansions (144) according to the relation:

$$\rho = \rho_1 \times \{1 - [3x(\text{percent linear expansion})]\} \quad (2.6-6)$$

Calculated values gave less than one percent deviation with the measured values over the solid range.

SURFACE TENSION (FIGURE 2.6-8)

Limited data for the surface tension of silicon show a wide range of values (79, 71, 130, 25, 40). From the experimental data in close agreement (79, 71, 130), values were extended to the boiling point using the Othmer relation (123):

$$\sigma = \sigma_1 \left[\frac{7500 - T}{7500 - T_1} \right]^n \quad (2.6-7)$$

where σ is surface tension at T , dynes/cm, and n is the correlation parameter, 1.2. The other parameters have their usual meaning. Calculated values agree with the limited data (5 values) with a 1.5% absolute error.

LIQUID VISCOSITY (FIGURE 2.6-9)

Liquid viscosity data for silicon are available from the melting point to about 400°C above the melting point (9, 81, 127, 163). Values from the melting point to the boiling point were calculated using a $\log \eta_L$ vs $1/T$ linear relationship. Average absolute percentage error was 9.1% on 19 data points, due largely to the wide scatter of the experimental data.

THERMAL CONDUCTIVITY (FIGURE 2.6-10)

An experimental value of the liquid thermal conductivity of silicon has been reported by Russian workers (167). Their research indicates a value of $0.16 (\pm .02)$ cal/cm \times sec \times °C at the melting point. The higher value of the thermal conductivity of liquid silicon compared to solid silicon at the melting point is in agreement with other experimental work (168).

Solid thermal conductivity data has been reported by several authors (104, 23, 83 and others). The recommended values of Touloukian (144) were selected.

TABLE 2.6-1

PHYSICAL PROPERTIES AND CRITICAL CONSTANTS OF SILICON

<u>No.</u>	<u>Identification</u>	<u>Silicon</u>
1.	Symbol	Si
2.	State (std. cond.)	Solid
3.	Atomic Weight	28.086
4.	Boiling Point, b.p., °C	2,878*
5.	Melting Point, m.p., °C	1,412 ± 2
6.	Critical Temperature, T_c , °C	4,886*
7.	Critical Pressure, P_c , atm	530*
8.	Critical Volume, V_c , cm ³ /gr mol	232.6*
9.	Critical Density, ρ_c , gr/cm ³	0.1207*
10.	Vapor Pressure, mm Hg	2.8×10^{-4} (at m.p.)
11.	Heat of Vaporization, cal/gr	3,812 (at m.p.)
12.	Heat of Sublimation, cal/gr	4,075 (at m.p.)
13.	Heat of Fusion, cal/gr	264* (at m.p.)
14.	Liquid Heat Capacity, cal/gr-mol °C	6.755 (at m.p.)
15.	Solid Heat Capacity, cal/gr-mol °C	4.78 (at 25°C)
16.	Liquid Density, gr/cm ³	2.533 (at m.p.)
17.	Solid Density, gr/cm ³	2.329 (at 25°C)
18.	Percent Expansion on Freezing	10% (at m.p.)
19.	Surface Tension, dynes/cm	736 (at m.p.)
20.	Liquid Viscosity, centipoise	0.88 (at m.p.)
21.	Liquid Thermal Conductivity, cal/secxcmx°C	0.16 (at m.p.)
22.	Solid Thermal Conductivity, cal/secxcmx°C	0.353 (at 25°C)

*estimated

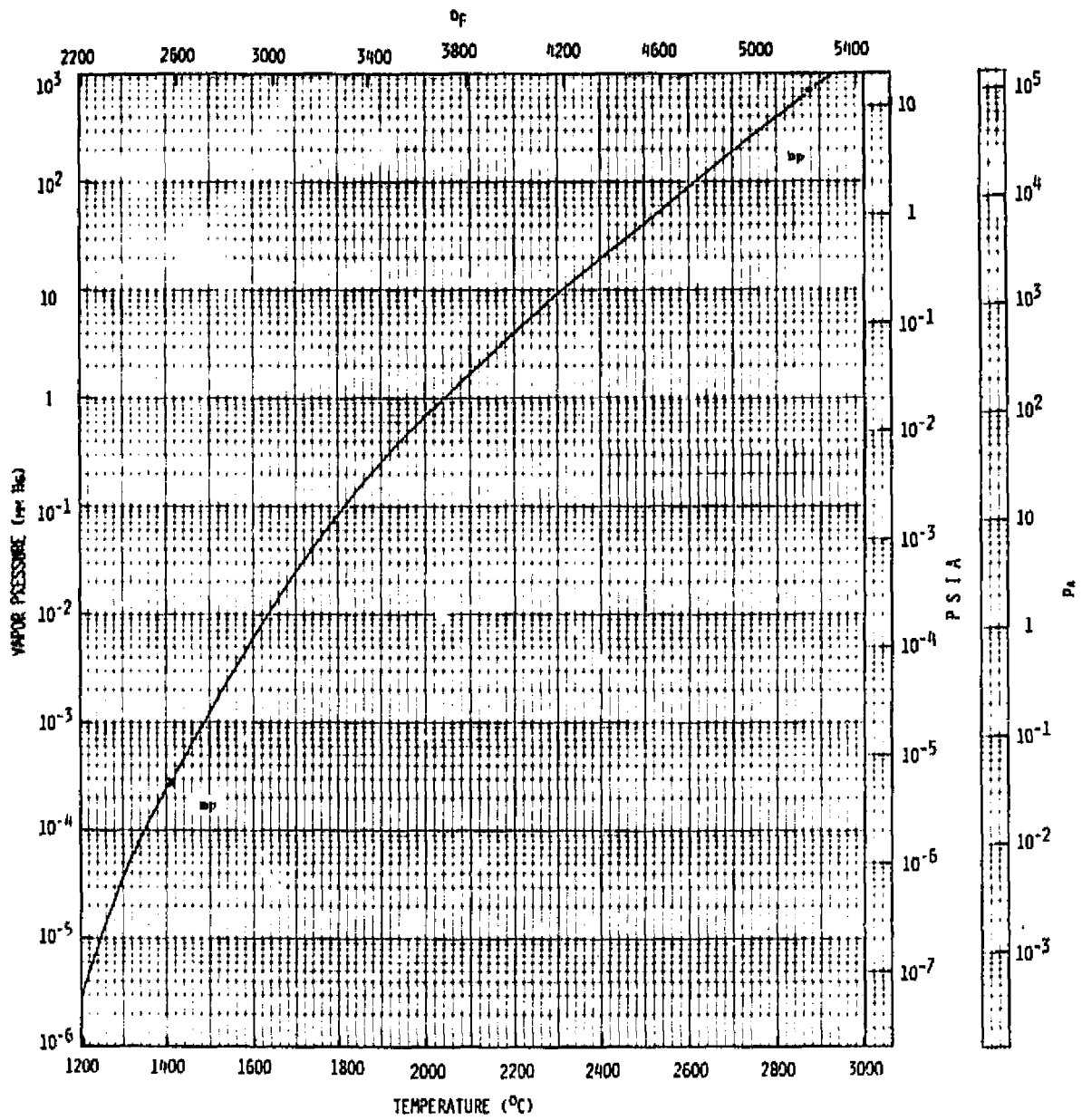

Figure 2.6-1 Vapor Pressure vs Temperature for Silicon

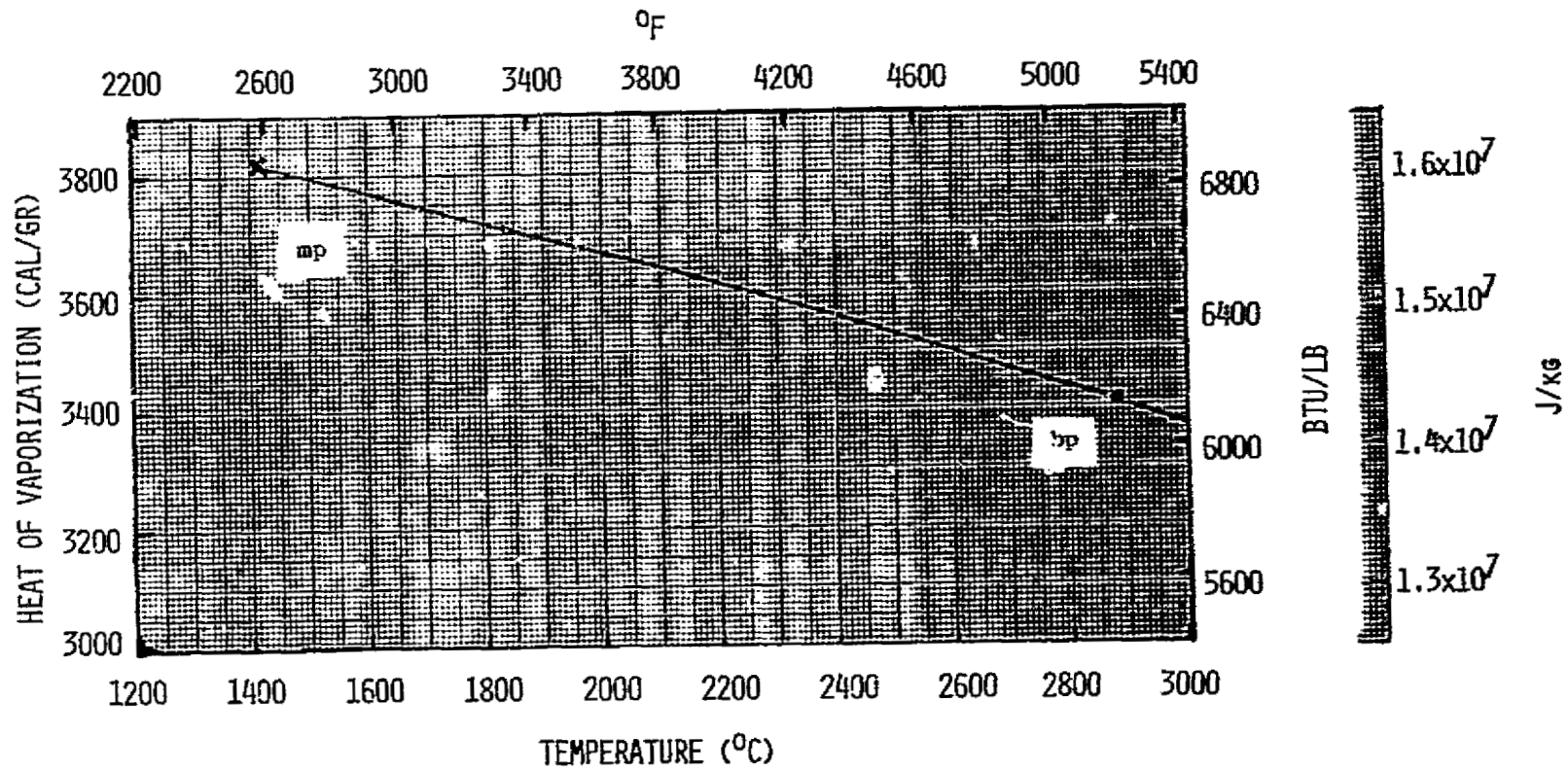

Figure 2.6-2 Heat of Vaporization vs Temperature for Silicon

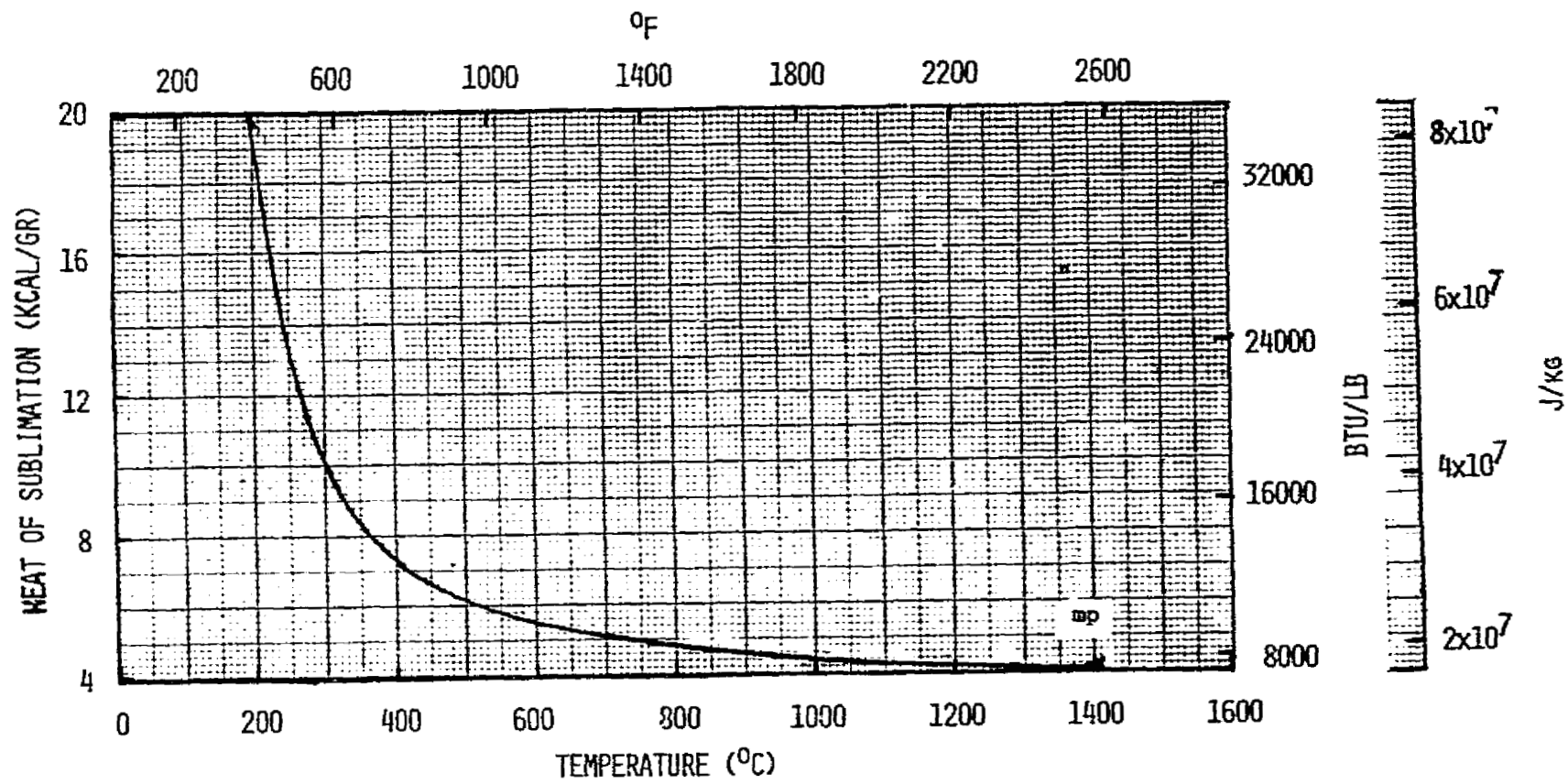

Figure 2.6-3 Heat of Sublimation vs Temperature for Silicon

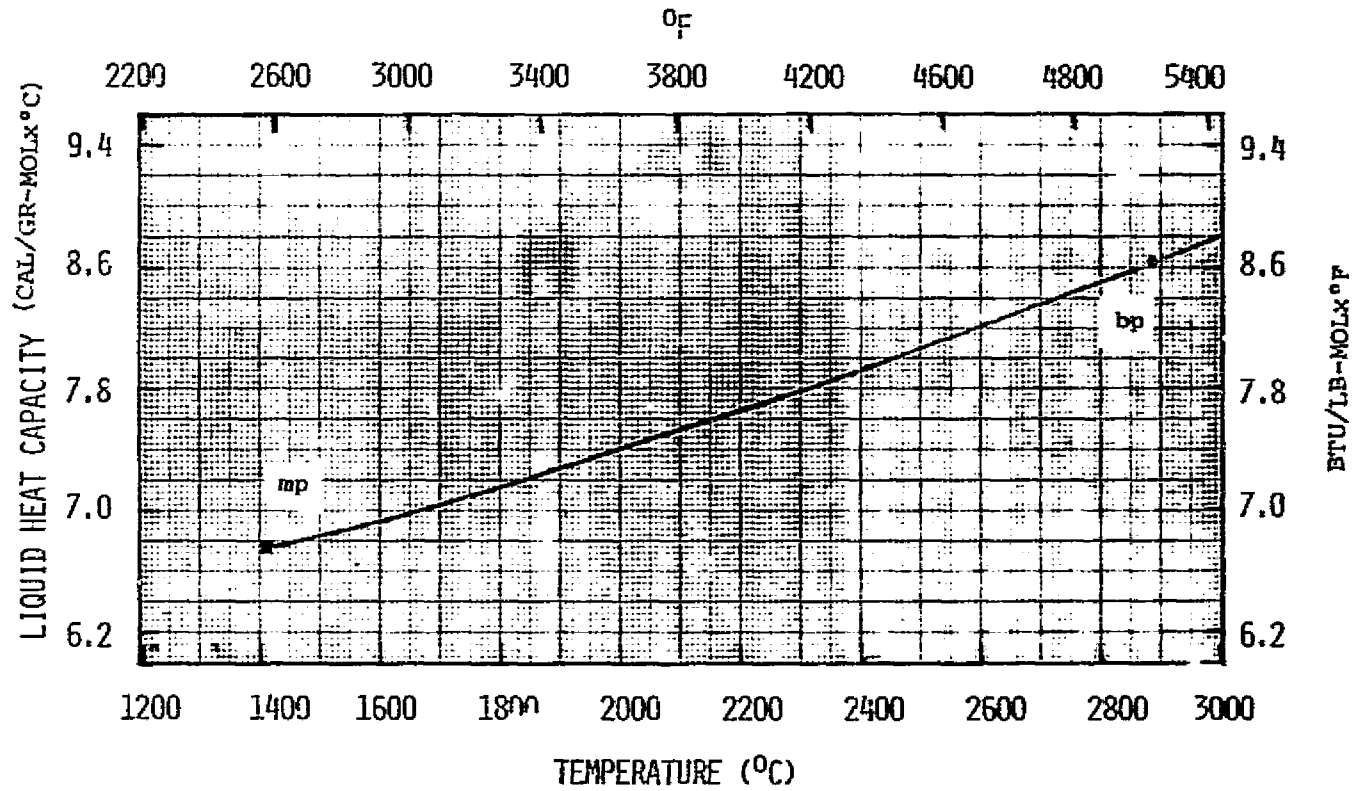

Figure 2.6-4 Liquid Heat Capacity vs Temperature for Silicon

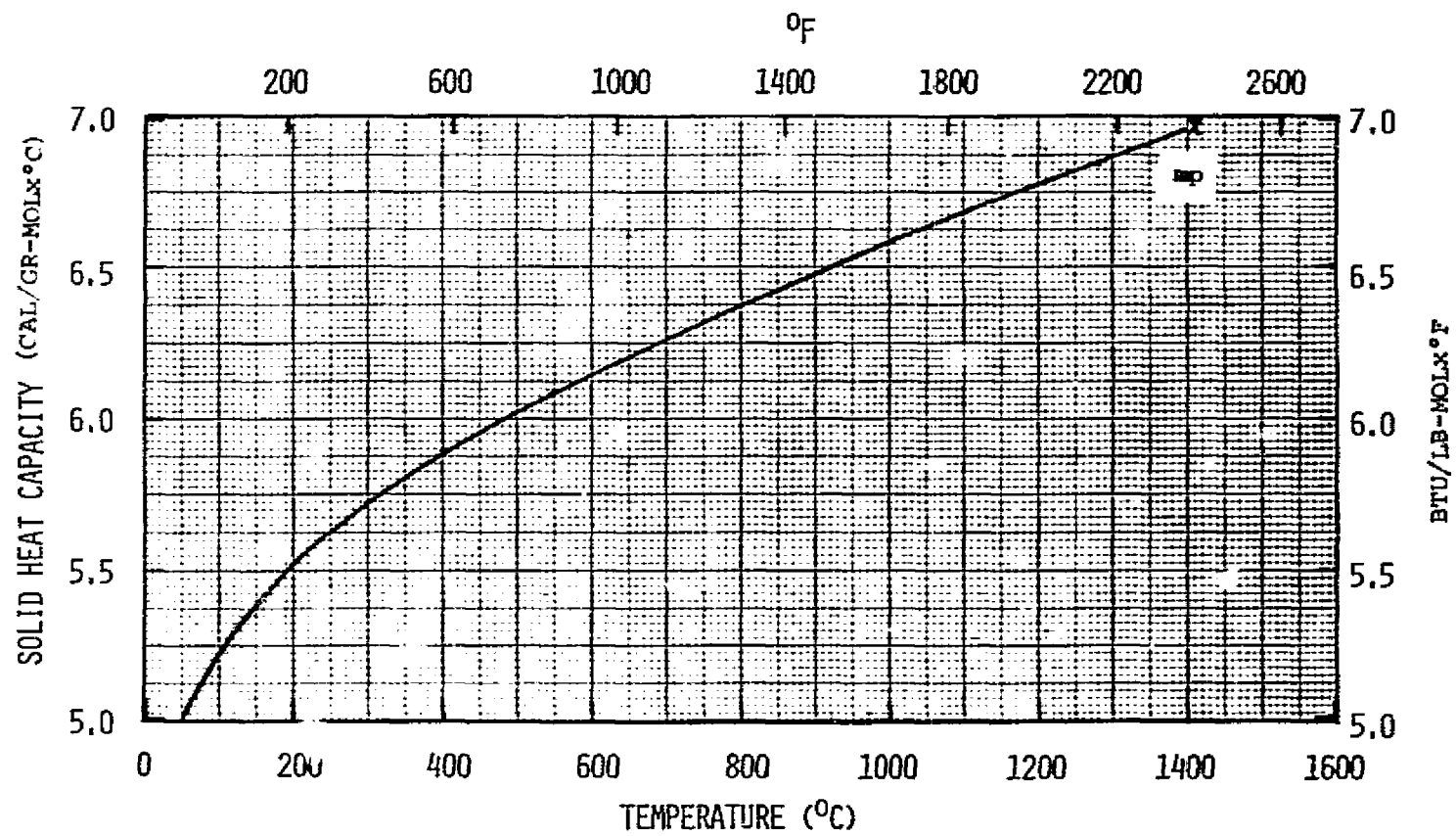

Figure 2.6-5 Solid Heat Capacity vs Temperature for Silicon

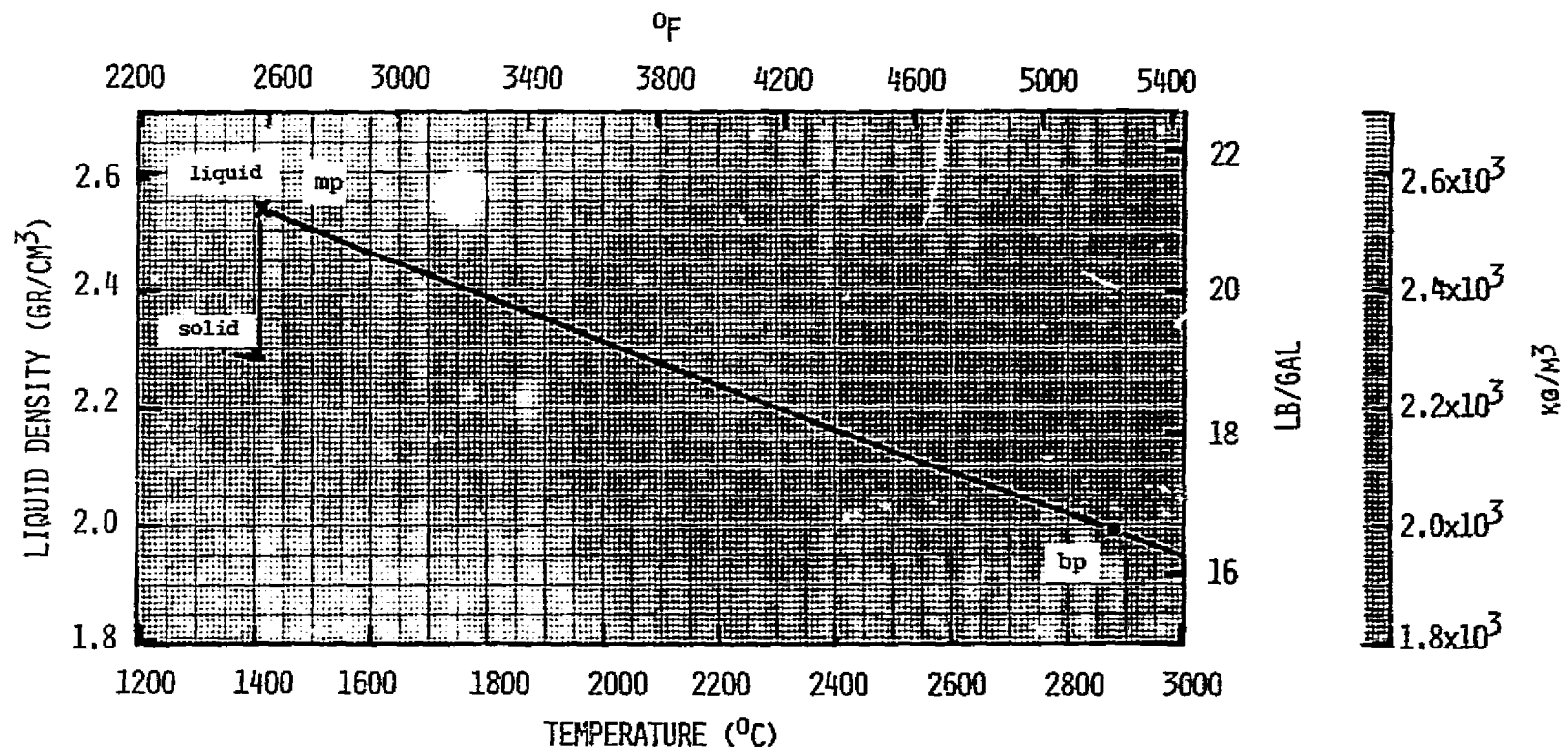

Figure 2.6-6 Liquid Density vs Temperature for Silicon

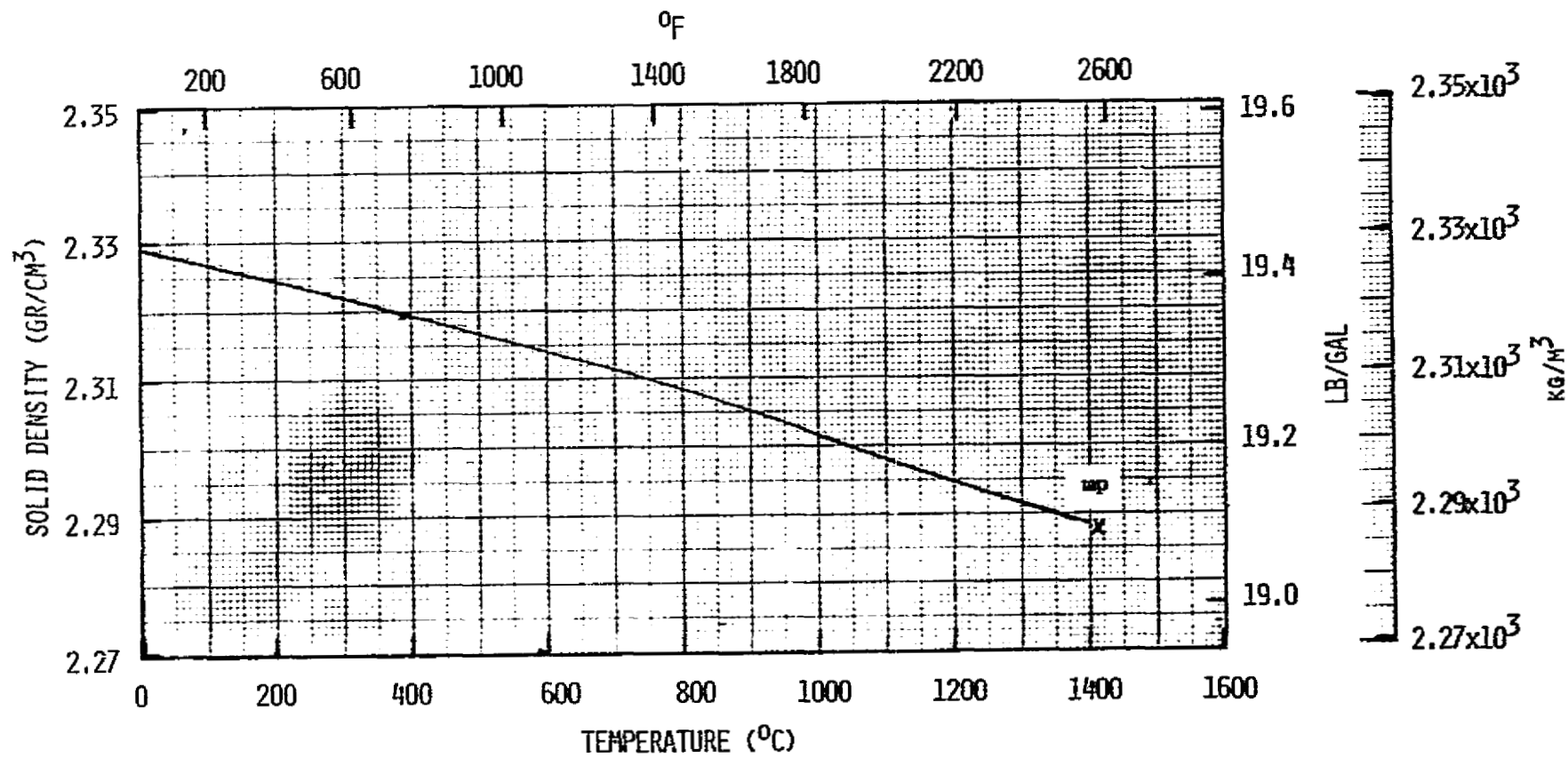

Figure 2.6-7 Solid Density vs Temperature for Silicon

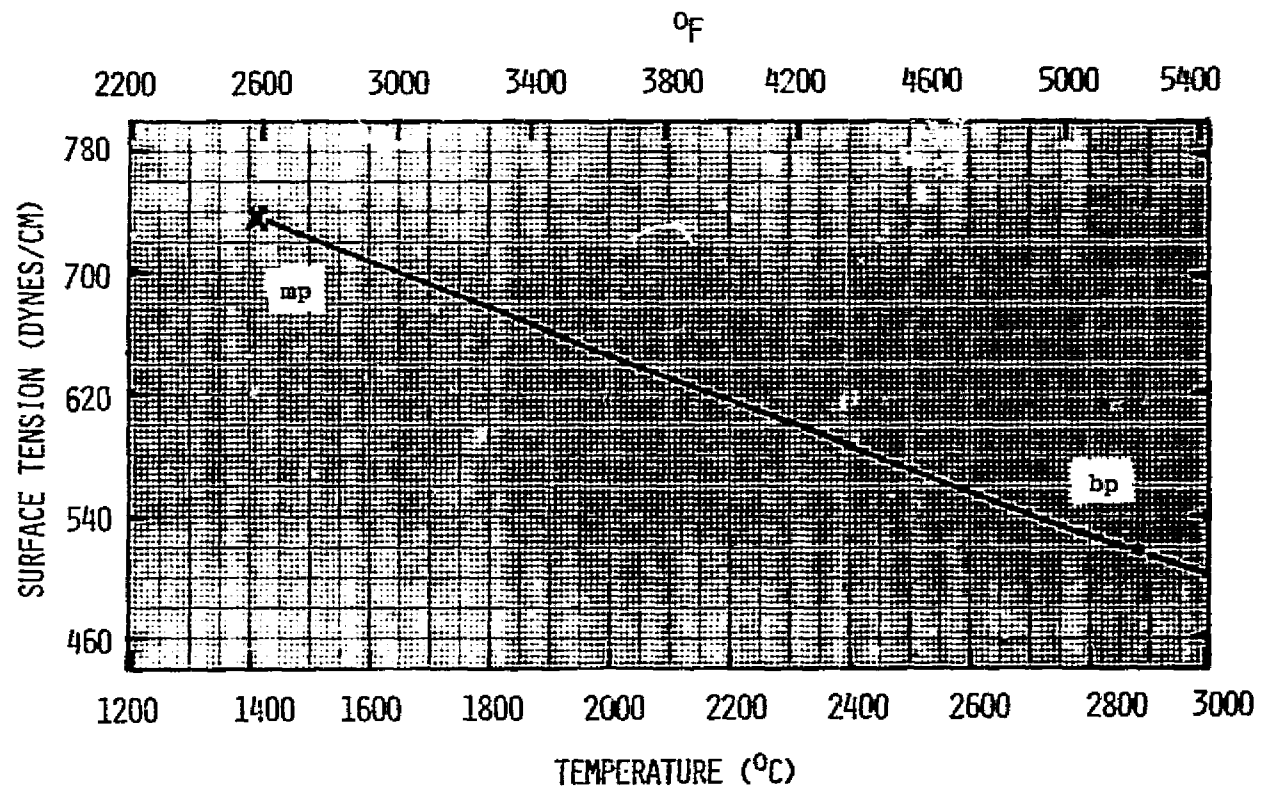

Figure 2.6-8 Surface Tension vs Temperature for Silicon

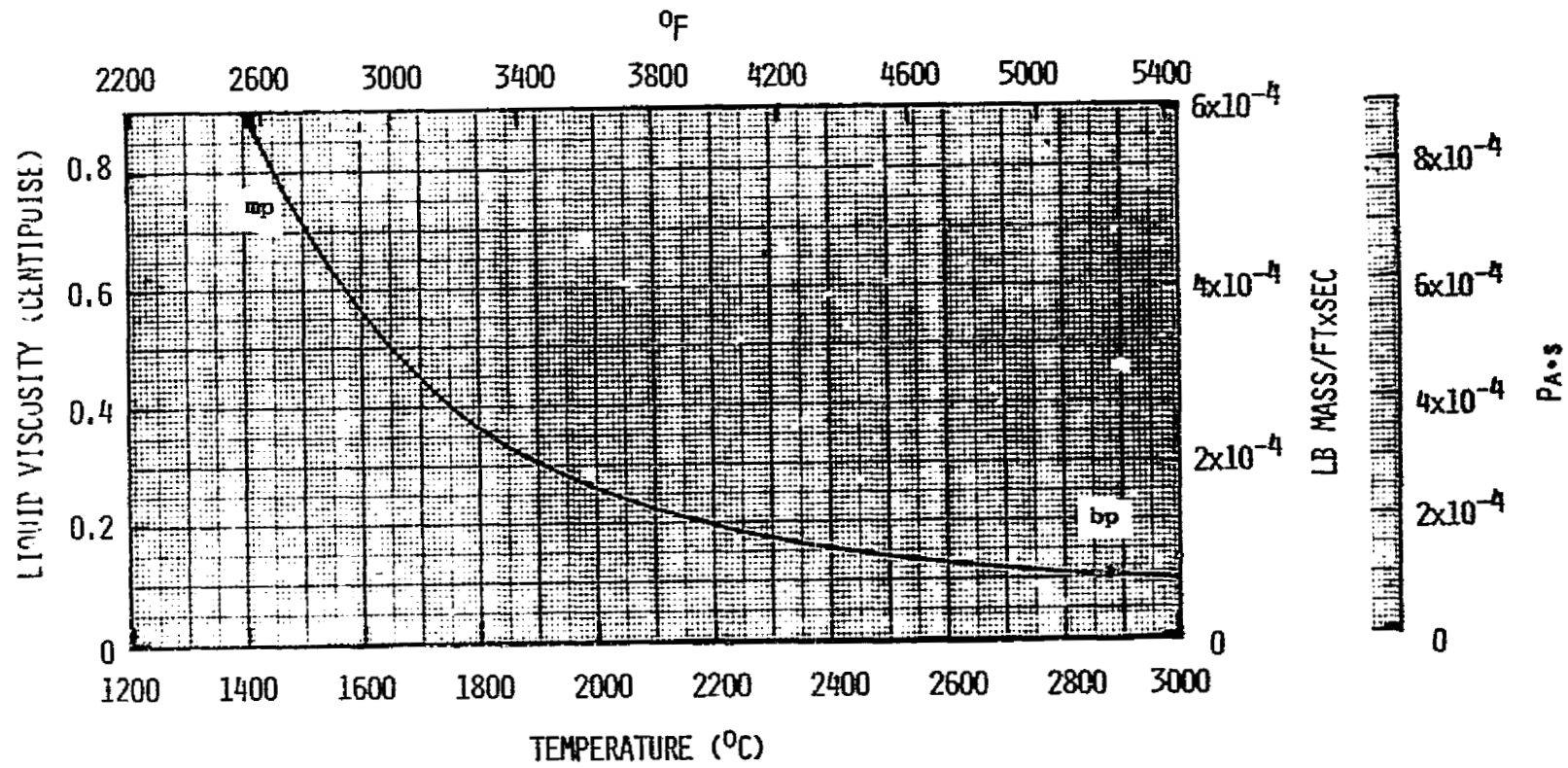

Figure 2.6-9 Liquid Viscosity vs Temperature for Silicon

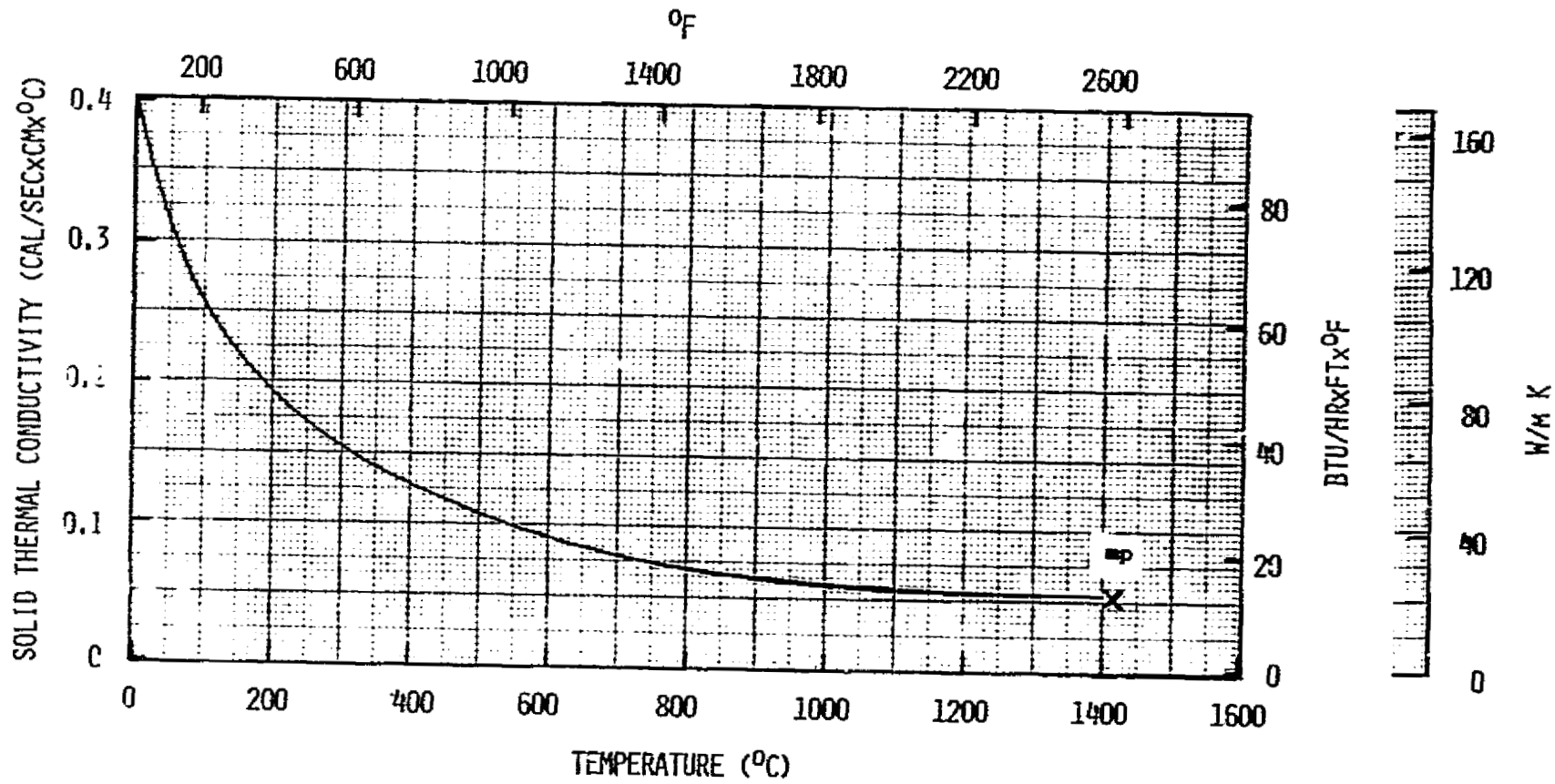

Figure 2.6-10 Solid Thermal Conductivity vs Temperature for Silicon

REFERENCES FOR SILICON

1. Batdorf, R.L. and Smith, F. M., Jour. Appl. Phys., 30, 259 (1959).
2. Akiyama, Kenji, Nat'l Tech, Dept. (Matsushita Elec. Ind. Co., Osaka), 8, 114-20 (1962).
3. Anderson, C. T., J. Am. Chem. Soc., 52, 2301-4 (1930).
4. Baibuz, V. F., Tr. Gos. Inst. Prikl Khim, 49, 113-19 (1962).
5. Bailar, J. C., Jr., Ed., "Comprehensive Inorganic Chemistry", 1, Pergamon Press, Oxford (1973).
6. Grievason, P. and Alcock, C. B., Special Ceramics, P. Popper, ed., Heywood & Co., London (1960).
7. Barin, I. and Knacke, O., Thermochemical Properties of Morg. Substances, 686 (1973).
8. Baughan, E. C., Quant. Rev., 7, 116 (1953).
9. Baum, B. A., others, Izv. Akad Nauk SSSR, Metal, 1967 (1), 62-9, Russ.
10. Baur, E. and Brunner, R., Helv. Chim. Acta, 17, 958 (1934).
11. Pears, D. S., others, Proc. Intern. Conf. Phys. Semicond., Exeter, England, 1962, 41-8.
12. Belogurov, B. B., Zhur. Fiz Khim, 34, 440-3 (1960).
13. Bermann, R. and Foster, E. L., Proc. Roy. Soc. (London), A237, 344-54 (1957).
14. Bobkovski, V. N., others, Konstr. Mater Osn. Grafita, 1970, No. 5, 138-43 (Russ.).
15. Boublik, T., others, "The Vapor Pressure of Pure Substances", Elsevier, N. Y. (1973).
16. Burki, Friedrich, Helvetica Chim. Acta, 2, 27-38 (1919).
17. Carruthers, J. A., others, Proc. Roy. Soc. (London) A238, 502-14 (1957).
18. Davis, S. G., others, J. Chem. Phys., 34, 659-64 (1961).
19. Davydov, K. N., others, Fiz. Kim. Osnovy Proizvodstva Stali, Akad Nauk SSR., Trudy 3-c' Kerf, 1955, 350-69 (1957).
20. Dayal, B., The Sp. Heat's of Metallic Si, Proc. Indian Acad. Sci., 20A, 87-91 (1944).
21. Dean, J. A., Ed., "Lange's Handbook of Chemistry", 11th ed., McGraw-Hill, N. Y. (1973).

REFERENCES (Continued)

22. Ditchburn, R.W. and Gilmour, J. C., *Revs. Modern Phys.*, 13, 310-27 (1941).
23. Dolling, F. and Cowley, R. A., *Proc. Phys. Soc. (London)*, 88, (2), 463-94 (1966) England.
24. Elyutin, V.P. and Pavlov, Y. A., *Silicon*, *Osn. Met*, 1968, 5, 375-84.
25. Elyutin, V. Pl, others, *Fiz. Khim. Poverkh. Yavlenii Rasplavakh*, 1971, 153-6.
26. Erdman, C. A., others, *J. Appl. Phys.*, 1973, 44 (7), 3127-9.
27. Fedoroff, M., *Monogr Met Haute Purete*, 1977, 3, 523-76 (Fr.)
28. Fine, M. E., *J. Chem. Phys*, 21, 1427 (1953).
29. Flubacher, P., others, *Phil. Mag*, (8), 4, 273-294 (1959).
30. Gashenko, S. I., others, *Kremnii Garnamii*, 1970, No. 2, 59-61.
31. Gates, D.B. and Thodos, G., *AIChE Journal*, 6, 50-4, (1960).
32. Gayler, M. L. V., *Nature*, 142, 478 (1938).
33. Gel'd, P. V., others, *Fiz. Metal. i Metallovel. Akad. Nauk, SSSR, Ural. Filial*, 2, 244-53 (1956).
34. Gmelin's Handbook of I. C., System 15, Silicon, Part C.
35. Gibbons, D. F., *Thermal Expansion of Some Crystals with the Diamond Structure*, *Phys. Rev.*, vol 112, pp. 136-140 (1958).
36. Gel'd, P.V. and Gertman, Y. A., *U. S. At. E. Com. AEC-tr-4879*, 181-5 (1960).
37. Gel'd, P.V. and Gertnam, Y. M., *Fiz Metal i Metalloved Akad. Nauk SSSR*, 12, No. 1, 47-50 (1951).
38. Gerlich, D., others, *J. Appl. Phys*, 36, (1), 76-9 (1965).
39. Glassbrenner, C. J., *Univer. Microfilms order No. 64-3533*, 208 pp.
40. Gogiberidze, Y. M., others, *Poverkh. Yavleniya Rasplavakh*, 1968, 114-17, (Russ), Eremko, V. D. (ed.).
41. Goldsmid, H. J., *Proc. Phys. Soc., (London)* 67B, 360-3 (1954).
42. Gullyaev, P.V. and Petrov, A. V., *Soviet Phys. Solid State*, 1, 330-4 (1959).
- 42a. Guertler, W. and Pirani, M., *Z. Metallkunde II*, 1-7 (1919).
43. Hampel, C. A. (ed.), *Rare Metals Handbook*, Reinhold Pub. Co., N. Y. (1954).
44. Hampel, C. A., *The Encyclopedia of the Chemical Elements*, Reinhold Book Co., N. Y. (1968).

REFERENCES (Continued)

45. Hampel, C.A. and Hawley, G. G., The Encyclopedia of Chemistry, 3rd ed., Van Nostrand Reinhold Co., N.Y. (1973).
46. Hamilton, R.A.H. and Parrott, J. E., Phys.Lett. A, 1969, 29 (9), 556-8
47. Hart, M, and Morgan, I.G., At. Masses Fundam. Constants, Proc. Int. Conf. 4th, 1971 (pub. 1972), 505-15.
48. Ho, Cho. Yen and Powell, R.W., Nat. Bur. Stand. Spec. Pub., 1967, No. 302, 33-46 (Eng.).
49. Hoffman, F. and Schulze, A., Physik, Z., 38, 901-5 (1937); Metallwirtschaft, 17, No. 1, 3-6 (1938).
50. Hölbling, R., The Prep. and Some Prop. of Pure Metallic Si, Z. Angew Chem., 40, 655-9 (1927).
51. Holyer, J., AD 62 1152, Avail CPSTI, 44pp.
52. Honig, R. E., V. P. Data for the Solid & Liq. Elements, RCA Rev., vol. 23, pp. 567-586 (1962).
53. Honig, R. E., J. Chem. Phys., 21, 573 (1953).
54. Honig, R. E., J. Chem. Phys., 22, 1610 (1954).
55. Hultgren, Ralph, others, Selected Values of the Thermodynamic Properties of the Elements, American Society for Metals, Metals Park, Ohio (1973).
56. Hsiac, S.N. and Liu, I. H., Wu Li Hsueh Pao, 20 (8) 699-704, 1964 (Ch).
57. Hsieh, Yu-Chang, J. Chem. Phys., 22, 306-11 (1954).
58. Hull, G.W. and Geballe, Tilt, Phys. Rev., 96, 845 (1954).
59. "International Critical Tables", Vol. I-VI, McGraw-Hill, N. Y. (1926-1929).
60. Ioffe, A. F., Doklady Akad. Nauk. SSSR, 27, 369-72 (1952).
61. Ioffe, A.V. and A.F., Zhur. Tekh. Fiz., 24, 1910-11 (1954).
62. Ivanova, L. I., Zhur. Obschchei. Khim., (J. Gen. Chem), 21, 444-52 (1951).
63. Jasper, J. J., J. Phys. Chem. Ref. Data, 1 (4), 841 (1972).
64. Jayaraman, A., others, Phys. Rev, 130, 540-7 (1963).
65. Kalishevich, G. I., others, Zh. Fiz. Khim., 39 (12), 2999-3001 (Russ.) (1965).
66. Kaplun, A.B. and Solov'ev, A. N., Zh. Fiz. Mekhan. i. Tekhn. Fiz., 1966 (?), 139-41 (Russ).
67. Kantur, P. B., others, Ukrain, Fiz. Zhur., 5, 358-62 (1960).

REFERENCES (Continued)

68. Karapet'yants, M. Kh. & M. L., Thermodynamic Constants of Inorganic & Organic Compounds, Ann Arbor Humprey Science Pub., Ann Arbor, Mich. (1970).
69. Karapet'yants, M. L., "Tables of Some Thermodynamic Properties of Different Substances", Trudy MKh TI in Mendeleeva, No. 3, Moscow (1961) (Russ.).
70. Karpov, Yu. S., Sprav. Elektrotekh Mater., Vtoroe, Pererab izd., 1970, 3, 544-67, 669-70, (Russ.).
71. Keck, P.H. and Van Horn, W., The Surface Tension of Liq. Si & Ge, Phys. Rev., Vol. 91, pp. 512-513 (1953).
72. Keenan, J.H. and Pearlman, N., Natl. Bur. Standards Circ., 519, 279-83 (1952).
73. Keenan, J.H. and Seidel, G., Phys. Rev., 113, 33-9 (1959).
74. Kelley, K. K., Bull. Bur. Mines, No. 383 (1935).
75. Kelley, K. K., Contributions to Data on Theoretical Metallurgy, Bur. Mines Bull., No. 477 (1950).
76. Kelley, K. K., Bull. Bur. Mines, No. 584, 159 (1960).
77. Kelley, K. K., Bull. Bur. Mines, No. 592, 113 (1961).
78. Khusanova, B. N., Vestn. Mosk. Univ. Fiz. Astron., 1968, 23 (4), 117-18 (Russ.).
79. Kingery, W.D. and Humenik, M., Jr., J. Phys. Chem., 57, 359-63 (1953).
80. Kirk, R. E. and Othmer, D. F., "Encyclopedia of Chemical Technology", 1st and 2nd ed., Interscience Encyclopedia Inc., N. Y., (1948-1970).
81. Klein, A. H., others, U.S.A. E. C., I. S. 835, 17pp.
82. Kocherov, P. V., others, Tr. Ural'sk Politekhn Inst., No. 144, 139-41 (1965) Russ.
83. Kokkas, A. G., RCA Rev., 1974, 35 (4), 579-81.
84. Korsunskii, A.M. and Bondareva, A. G., Zh. Fiz. Khim., 1973, 47 (11) 2762-4.
85. Krestovnikov, A. N., others, Dokl. Akad. Nauk SSSR, 174 (3) 634-7 (1967) Russ.
86. Krikorian, O. H., U.S.A. E. Comm., UCRL-6132, 7 pp. (1960).
87. Kulin, S., others, U.S. Clearinghouse Fed. Sci. Tech. Infor., A. D. 1970, No. 703275, 43 pp., Avil. CFSTI.
88. Kuprovskii, B. B. & Gel'd, P. V., Fiz. Metal. i Metalloved., 1966, 3 (1966).
89. van Laar, J. J., Proc. Acad. Sci. Amsterdam, 20, 492-504.

REFERENCES (Continued)

90. Landolt - Bornstein, Springer-Verlag, Berlin.
91. Lange, N. A., ed., "Handbook of Chemistry", 10th ed., McGraw-Hill, N. Y. (1961).
92. Lee, J. and Williamson, B. H. J., *Nature*, 208, 50007, 278-9 (1965).
93. Logan, R.A. and Bond, W. L., *Density Change in Silicon on Melting*, *J. Appl. Physics*, vol. 30, 322 (1959).
94. Lucas, L. D., *Mem. Sci. Rev. Met*, 61, 1-24, 97-116 (1964).
95. Lucas, L.D. and Urbain, G., *Compt Rend*, 255, 2414-16 (1962).
96. Magnus, A., *The Specific Heat of C, Si & SiC*, *Ann. Physik*, 70, 303-31 (1923).
97. Manuilov, L. A. & Klyukovskii, G. I., *Fizicheskaya Khimiya i Khimiya Kremniya (Phys. Chem. & Chem. of Si)* 3rd ed., Moscow; "Vysshaya Shkola", 311 p. (1962).
98. Maissel, L., *Thermal Expansion of Silicon*, *J. Appl. Physics*, vol. 31, p. 211 (L) (1960).
99. Mauer, F.A. and Bolz, L. H., *P. B. Rept*, 136066.
100. McSkimin, H. J., others, *Measurement of Elastic Constants of Si Single Crystals & Their Thermal Constants*, *Phys. Rev.*, vol. 83, p. 1080 (L), (1951).
101. Mellor, J. W., "Inorganic and Theoretical Chemistry", (original volumes and supplements), Longmans, Green and Co., London (1956).
102. Mette, H., others, *Phys. Rev.*, 117, 1491-3 (1960).
103. Meyer, F. and Sparnaay, M. J., *Surface Phys Phosphors Semicond.*, 321-410 (1975).
104. Morris, R.G. and Martin, J. J., *J. Appl. Phys.*, 34 (8), 2388-90 (1963).
105. Nakamura, Tetsuro, *Nippon Kagaku Zasshi*, 86 (5), 491-7 (1965).
106. Nesmeyanov, A. N., *Vapor Pressure of the Elements*, Academic Press, N. Y. (1963).
107. Nordmeyer, P. and Bernulli, *Ber. Physik. Ges.*, 5, 175-78.
108. Novikova, S.I. and Strelkov, P. G., *Fiz. Tverdugo Tela*, 1, 1841-3 (1959).
109. Ohe, S., "Computer Aided Data Book of Vapor Pressure", , Data Book Publishing Company, Tokyo, Japan (1976).
110. Olette, M., *Phys. Chem. Steelmaking Proc.*, Dedham, Mass. 1956, 18-26 (1958).
111. Ormont, B. F., *Doklady Akad Nauk SSSR*, 106, 687-90 (1957).
112. Padnos, B. N., *Internations Si Device Technology*, V. Chem/ Metallurgical Prop. of Si, NASA Acc. No. N66 19917.

REFERENCES (Continued)

113. Pawlek, F., *Metall*, 19, (12), 1249-52 (1965) Ger.
114. Pearson, G.L. and Treuting, R. G., *Surface Melt Patterns on Silicon*, *Acta Cryst.*, Vol. 2, 397-399 (1958).
115. Pehlke, R.P. and Elliot, J. F., *Trans AIME*, 215, 781-5 (1959).
- 115a. Perry, R. H., others, "Chemical Engineers' Handbook", 45th ed., McGraw-Hill, N. Y. (1973).
116. Perry, R.H. and Chilton, C. H., "Chemical Engineers' Handbook", 5th ed., McGraw-Hill, N. Y. (1973).
117. Petrov, E. and Kochetkov, A. I., *Radiotekh. Elektron*, 1974, 19, (1), 214-16 (Russ).
118. Phillips, J. C., *Phys. Rev.*, 113, 147-55 (1959).
119. Popel', S. I., others *Zh. Fiz. Khim.*, 1970, 44, (1), 260-1.
120. Redin, R. D., U. S. Clearinghouse Fed. Sci. Tech. Inform., AD 1969, AD 698154, 13 pp. Avail. CFSTI.
121. Reeber, R. R., *Phys. Status Solidi A.*, 1975, 32, (1), 321-31.
122. Reid, R.C. and Sherwood, R. K., "The Properties of Gases and Liquids", 2nd ed., McGraw-Hill, N. Y. (1966).
123. Reid, R. C., others, "The Properties of Gases and Liquids", 3rd ed., McGraw-Hill, N. Y. (1977).
124. Raznjevic', Kuzman, *Handbook of Thermodynamic Tables and Charts*, McGraw-Hill, N. Y. (1976).
125. Runyan, W. R., *Silicon Semiconductor Technology*, McGraw-Hill Book Co., N. Y., (1965).
- 125a. Ruff, O. and Korschak, M., *Z. Elektrochem*, 32, 515-25 (1926).
126. Russell. A. S., *Physik Z.*, 13, 59-65, Measurements of Sp.Ht. at Low Temps.
127. Samsonov, G. V., *Handbook of the Physicochemical Properties of the Elements*, (translated from Russian) IFI/PLENUM, N. Y. (1968).
128. Serebrennikor, N.N. and Gel'd, P. V., *Doklady Akad. Nauk. SSSR*, 87, 1021-4 (1952).
129. Shanks, H. R., *Phys. Rev.*, 130, 1743-8 (1963).
130. Shashkov, Yu.M. and Kolesnikova, T. P., *Zh. Fiz. Khim.*, 37 (6) 1397-9 (1963).
131. Stuckes, A.D. and Chasmar, R. P., *Rept. Meeting on Semiconductors*, Rugby, 1956, 119-25.

REFERENCES (Continued)

132. Slack, G. A., Phys. Rev., 105, 829-31 (1957).
133. Straumanis, M.E. and Aka, E. Z., J. Applied Phys., 23, 330-4 (1952).
134. Smakula, A. and Kalnajs, J., Nuovo Cimento [10], 6, Suppl. 214-20 (1957).
135. Stuckes, A. D., Phil. Mag., 8, 5, 84-99 (1960).
136. Stull, D. R., Ind. Eng. Chem., 39 540 (1947).
137. Stull, D. R. and Prophet, H., Project Directors, "JANAF Thermochemical Tables", 2nd ed., NSRDS-NBS37, Natl. Bur. Stds., Washington, D. C., (1971).
138. Stull, D.R. and Sinke, G. C., "Thermodynamic Properties of the Elements", Adv. in Chem. Series, No. 18, A.C.S., Washington, D. C.
139. Suzuki, K. and Mikoshiba, N., Phys. Rev., B, 1971, [3] 3 (8), 2550-6 (Eng.).
140. Svehla, R. A., Tech. Report R-132 NASA, "Est. Visc. & Thermal Cond. of Gases at High Temps.", NASA, Washington, D. C. (1962).
141. Tavadze, F. N., others, Poverkh Yavleniya Rasplavakh, 1968, 159-62 (Russ).
142. Tseplyawva, A. V., others, Vestnik Moskov Univ. Ser 11, 15, No. 5, 36-8 (1960).
143. Thompson, J.C. and Younglove, B. A., Phys. & Chem. Solids, 20, 146-9 (1961).
144. Touloukian, Y. S. and Makita, T., "Thermophysical Prop. of Matter", Supplement to Vol. 6, 83, IFI/Plenum, New York (1976)
145. Turovskii, B. M., Nauch. Tr. Nauch-Issled Proekt. Inst. Redkometal. Prom., 1971, 33, 41-4 (Russ).
146. Turovskii, B.M. and Ivanova, I.I., Izv. Akad. Nauk. SSSR. Neorg. Mater., 1974, 10 (12) 2108-11.
147. V. Wartenberg, H., Thermochemistry of Si, Nernst's Festschrift (Halle, 1912). 459-63.
148. V. Wartenberg, H., Z. Elektrochem, 19, 482 (1913).
149. V. Wartenberg, H., Z. Anorg. Allgem. Chem., 79, 71-87 (1913).
150. Wagman, D. D., others, "Selected Values of Chemical Thermodynamic Properties", NBS Tech. Note 270-3, Nat., Bur. Stds., Washington, D. C. (1968).
151. Wawra, Hans, Z. Metallkd, 1975, 66 (7), 395-401 (Ger.)
152. Weast, R. C., ed., "CRC Handbook of Chemistry and Physics", 55th ed., CRC Press, Cleveland (1974).
153. White, G.K. and Woods, S. B., Phys. Rev., 103, 569-71 (1956).
154. White, G. K., others, Bull. Inst. Intern. Froid, Annexe, 1956-2, 91-5.

REFERENCES (Continued)

155. White G. K., J. Phys. D., 1973, 6 (17), 2070-8.
156. Wicks, C. E. and Block, F. E., "Thermodynamic Properties of 65 Elements", Bull. 605 Bur. of Mines, U. S. Govt. Printing Off., Washington, D. C (1963).
157. Yaws, C. L., "Physical Properties", McGraw-Hill, N. Y. (1977).
158. Yaws, C. L., Miller, J. W., Jr., Lutwack, R., & Hsu, George, "Electricity from sunlight: Low Cost Silicon For Solar Cells", Fifth National Conference on Energy and the Environment, A.I.Ch.E.-A.P.A.C., Cincinnati (Oct. 31-Nov. 3, 1977).
159. Younglove, B. A., University Microfilm, Mic 61-1381.
160. Zadukin, S. N., Soviet Phys. Solid State, 1, 516-17 (1959).
161. Zhdanova, V. V., others, Izv. Akad Nauk SSSR Neorg. Mater., 3 (7), 1263-4. (1967).
162. Tables Nouvelles Internationales De Constantes et Donnees Numeriques, Herman and Co., Paris, Vol. 12 (1939).
163. Rea, Samuel N., Texas Instruments Report No. 03-78-30, July 1978, DOE/JfL 954887-78/3 Distribution Category UC-63, Dallas, TX.
164. Gel'd, P.V. and Serebrennikov, N. N., Doklady Akademii Nauk SSSR, 87, 1021, (1952) Russ.
165. Reynes, E. G. and G. Thodos, AIChE J., 8, 357 (1962).
166. Rackett, H. G., J. Chem. Eng. Data, 15, 514 (1970).
167. Shaskov, Yu. M. and V. P. Grishin, Soviet Physics - Solid State, 8, 447 (1966).
168. Dr. Khattak, Crystal Systems, Salem, Mass., personal communication, (summer, 1980).

2.7 Thermal Conductivity Investigation

Gas phase thermal conductivity values were experimentally determined between 25°C and 350°C for a variety of silicon source materials which included silane and halogenated silanes. The apparatus used was a hot wire thermal conductivity cell (or catharometer). It consists of two pairs of matched tungsten-rhenium filaments mounted in a stainless steel block. The filaments are connected as elements of a constant current Wheatstone Bridge (Figure 2.7-1). The cell is electrically heated and a constant temperature is maintained with a digital temperature controller and read-out to $\pm 1^\circ\text{C}$. The filaments are positioned in cavities in the steel block into which the gases, of which the thermal conductivity is to be determined, can be introduced. The filaments are heated by a constant current and the heat thus generated is dissipated primarily by conduction through the gas. A change in the thermal conductivity of the gaseous medium results in a change in the rate of dissipation and therefore, a change in the temperature of the filament. The temperature of the hot filament is measured as if it were a resistance thermometer; change in temperature produces a change in filament resistance, which is measured by means of the Wheatstone Bridge circuit.

The thermocouples (type K) used to monitor the temperature of the thermal conductivity cell were calibrated using materials of known melting points throughout the temperature range of the study (25°C to 350°C). The EMF of the thermocouples was measured with a Leeds and Northrup, Model 8686, millivolt potentiometer which was calibrated and certified at the factory. The temperatures reported for the thermal conductivity values are considered to be accurate to $\pm 1^\circ\text{C}$.

Since absolute measurement of thermal conductivity is difficult, a differential method was employed in which the catharometer was divided into two parts where half of the filaments are in contact with a reference gas of known thermal conductivity and the other half contact the sample whose thermal conductivity is to be determined. The Wheatstone Bridge is first balanced by introducing the reference gas into both sides of the cell. The sample to be determined is then introduced into the sample side of the cell and the resultant voltage unbalance (E) is recorded. The catharometer responds to the reciprocal of the thermal conductivities according to equation 2.7-1: (reference 1)

$$E - E_{\text{ref.}} = b\left(\frac{1}{\lambda} - \frac{1}{\lambda_{\text{ref}}}\right) \quad (2.7-1)$$

where E_{ref} is voltage with the reference gas in both sides of the thermal conductivity cell, λ and λ_{ref} are the thermal conductivities of the unknown and reference gas respectively, and b is a constant characteristic of the particular apparatus (cell constant). This cell constant (b) can be determined by using a standardization gas of known thermal conductivity

as the sample and determining the voltage unbalance (E) of it with respect to the reference gas. The cell constant (b) is slightly temperature dependent and must be determined throughout the temperature range in which measurements are to be made.

Before thermal conductivity data could be obtained, the apparatus described above needed to be calibrated. The calibration work included the determination of cell constants for the temperature range 25°C to 350°C, the determination of filament wire temperatures for various filament currents and cell wall temperatures, and the experimental determination of the thermal conductivity of argon and hydrogen in the temperature range 25°C to 350°C.

The cell constant, which is used to calculate thermal conductivity values when the differential method is used, is temperature dependent and therefore needs to be determined for the complete temperature range to be investigated. It was also found that at a given temperature, the cell constant may vary slightly from day to day; therefore cell constants were routinely determined everytime data were collected. This variation may be due to slight changes in the filament current or to slight oxidation or corrosion of the filament with use.

In measuring the thermal conductivity of gases using the "hot wire" method, the gas may not be at a uniform temperature due to differences in the temperature of the cell wall and filament wire. This can be minimized by operating the apparatus at filament currents sufficiently low that this temperature difference is small. In order to do this, a means of monitoring the filament wire temperature was needed. This was accomplished by using the filament as a resistance thermometer. With no current in the filament, the filament resistance as a function of temperature was measured (figure 2.7-2). When thermal conductivity data were being obtained, the filament resistance was routinely calculated by monitoring the current through the filament and the potential across the filament. The filament temperature can then be obtained from figure 2.7-1. The filament current was then adjusted so that the temperature difference between the filament and the cell wall was small.

The thermal conductivity of argon was determined throughout the temperature range 25°C to 350°C. These values were compared to recommended values for the thermal conductivity of argon (reference 2) in order to evaluate the accuracy of data obtained on this apparatus (figure 2.7-3). The recommended values used were those presented in "Thermophysical Properties of Matter", Vol. 3 on Thermal Conductivity (TPRC), and were determined by an evaluation of available published data. It was stated that the published data correlated with the recommended values to within $\pm 5\%$. The thermal conductivity values obtained in this study agree with the recommended values to within $\pm 2\%$ up to 300°C and $\pm 4\%$ from 300°C to 350°C.

The thermal conductivity of hydrogen was determined in the temperature range 25°C to 350°C. These values were compared to previously reported experimental values for thermal conductivity of hydrogen (references 3 and 4) in order to evaluate the accuracy of the data obtained on this apparatus (figure 2.7-4) for gases of relatively high thermal conductivity.

The thermal conductivity of silane (SiH_4) was determined between 25°C and 300°C (Table 2.7-1 and Figure 2.7-5). Values above 300°C were not determined because above that temperature silane is thermally unstable and begins to deposit silicon. There have been no previously reported experimental data for gaseous thermal conductivity of silane. Estimated values have been determined using a modified Eucken Correlation (ref. 5) and these estimated values agree fairly well with the now available experimental values.

The thermal conductivity of dichlorosilane (SiH_2Cl_2) was determined between 25°C and 350°C (Table 2.7-2 and Figure 2.7-6). There have been no previously reported experimental data for gaseous thermal conductivity of dichlorosilane. Estimated values have been reported (reference 39) in the temperature range 0°C to 70°C which were determined by a Eucken approximation. These estimated values are considerably lower than the experimental values now reported.

The thermal conductivity of trichlorosilane (SiHCl_3) was determined between 50°C and 350°C (Table 2.7-3 and Figure 2.7-7). There have been no previously reported experimental data for gaseous thermal conductivity of trichlorosilane.

The thermal conductivity of gaseous silicon tetrachloride was determined between 100°C and 350°C (Table 2.7-4 and Figure 2.7-8). There have been both calculated (ref. 7) and experimental (ref. 8) values for the thermal conductivity of silicon tetrachloride previously reported. The calculated values, in the temperature range 80°C to 335°C, were lower than the values obtained in this study by more than 10%. The experimental values, in the temperature range 70°C to 300°C, were about 10% lower than the values obtained in this study.

The thermal conductivity of silicon tetrafluoride (SiF_4) was determined between 25°C and 350°C (Table 2.7-5 and Figure 2.7-9). The values obtained in this study agree to within +3% with previously reported (reference 9) experimental data for silicon tetrafluoride (figure 2.7-10)

Figure 2.7-11 summarizes all of the experimentally determined values for gaseous thermal conductivity of silane and halogenated silanes reported from this investigation.

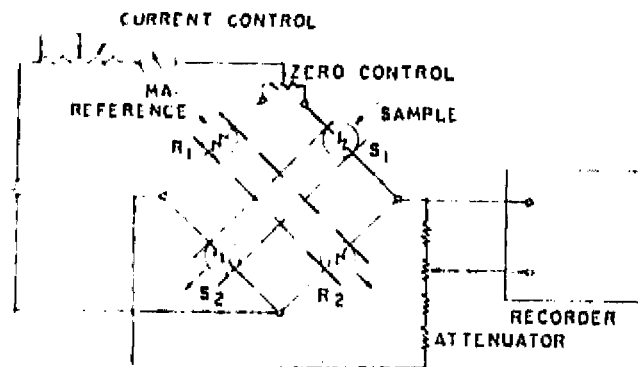

Figure 2.7-1 Wheatstone Bridge Circuit For Thermal Conductivity Cell

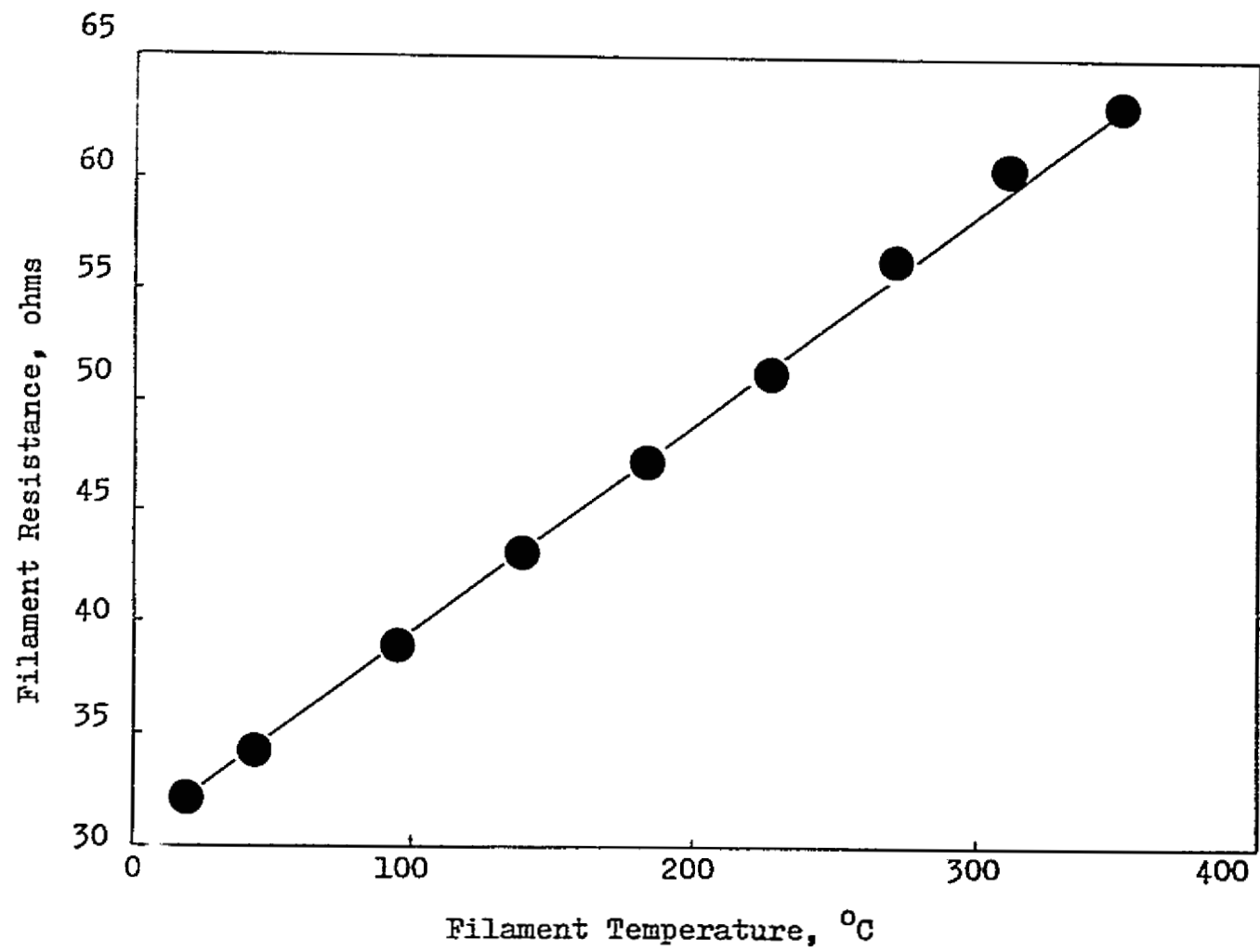

Figure 2.7-2 Filament Resistance as a Function of Temperature

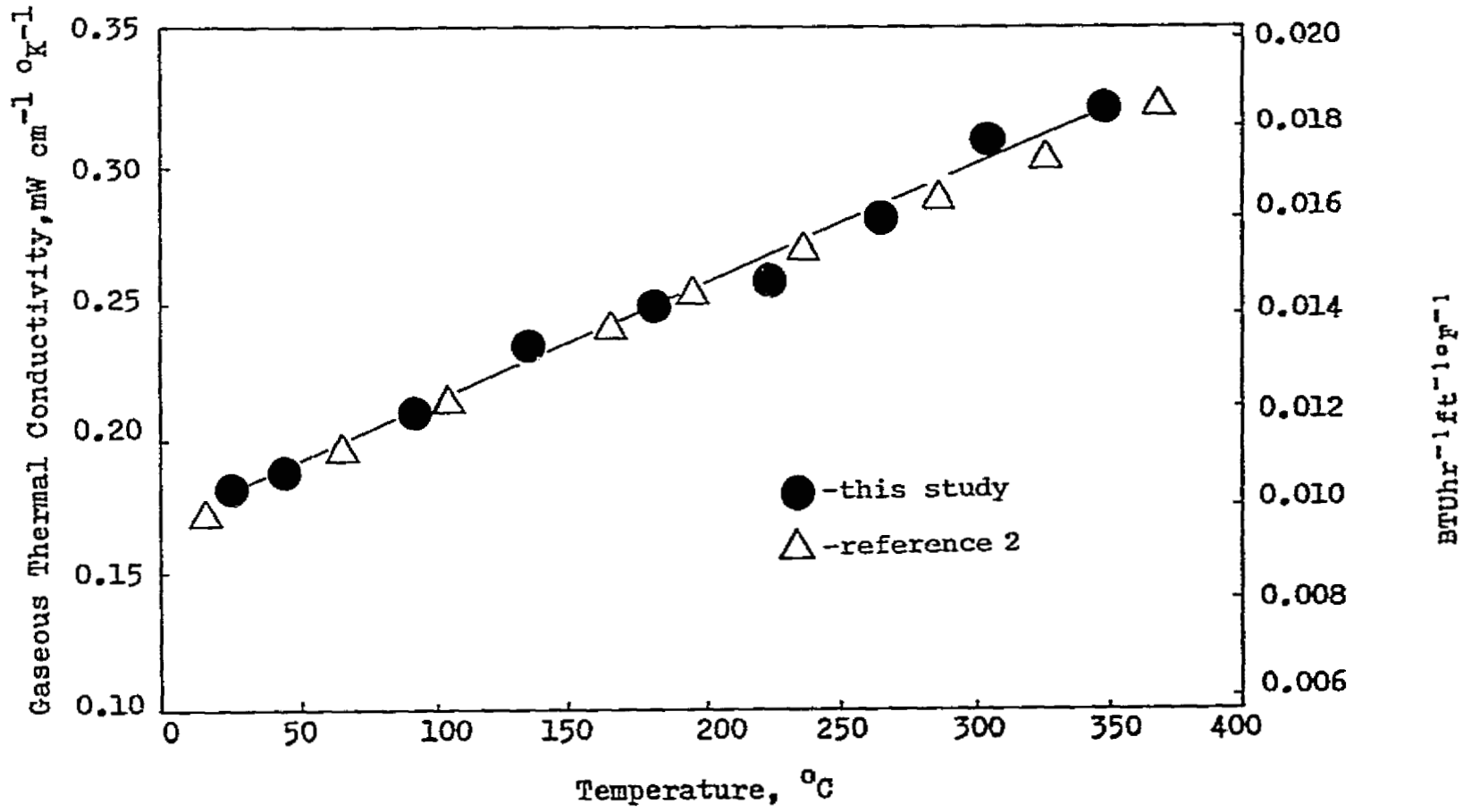

Figure 2.7-3 Comparison of Thermal Conductivity Values for Argon

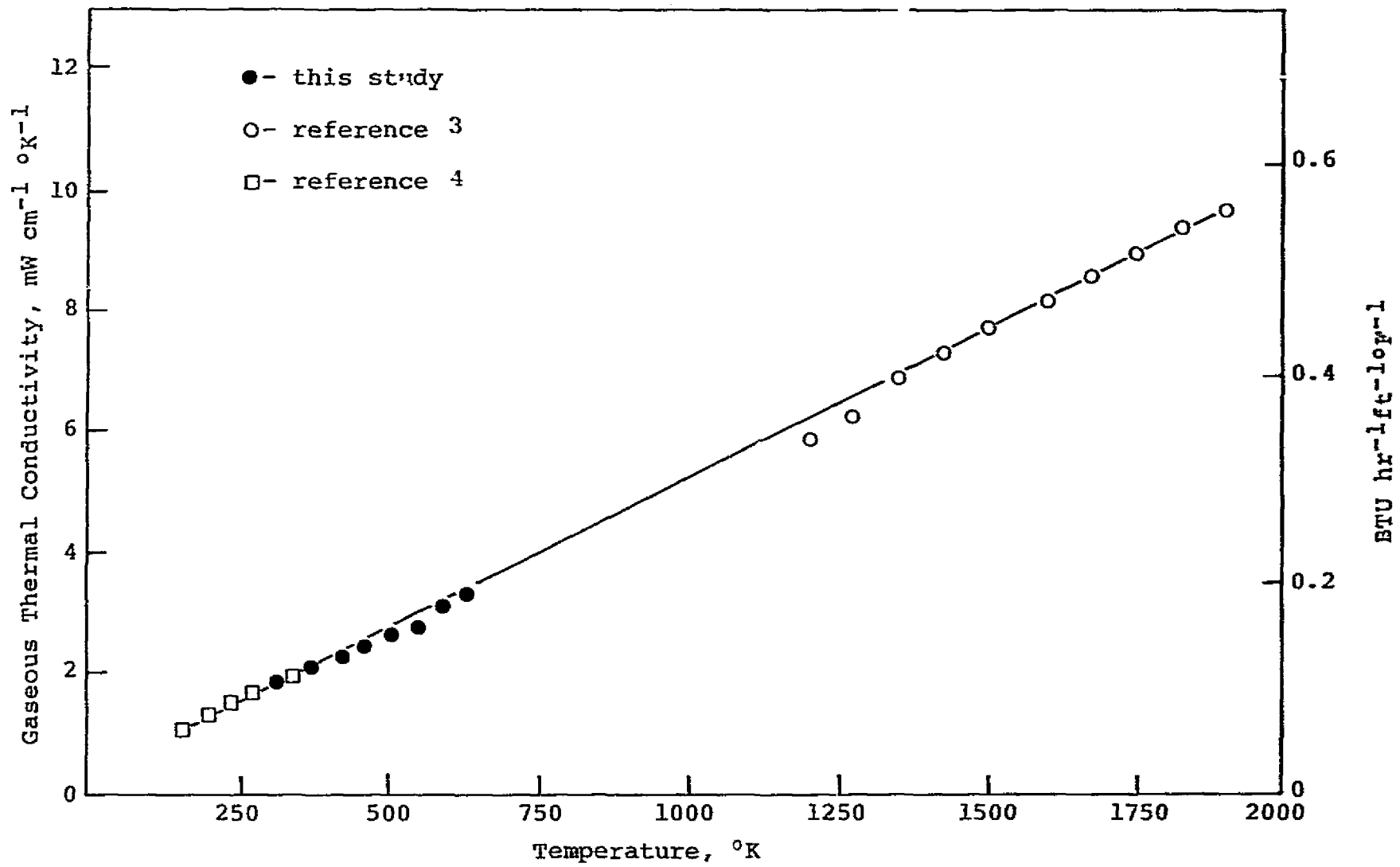

Figure 2.7-4 Comparison of Thermal Conductivity Values for Hydrogen

Table 2.7-1 Gaseous Thermal Conductivity Values of Silane

<u>Temperature</u>	<u>Gaseous Thermal Conductivity</u>		
	<u>°C</u>	<u>mW cm⁻¹ °K⁻¹</u>	<u>Cal cm⁻¹sec⁻¹ °C⁻¹</u>
28.0	0.234	56.02 X 10 ⁻⁶	13.54 X 10 ⁻³
45.7	0.249	59.44 X 10 ⁻⁶	14.37 X 10 ⁻³
94.7	0.297	70.96 X 10 ⁻⁶	17.15 X 10 ⁻³
139.4	0.345	82.34 X 10 ⁻⁶	19.90 X 10 ⁻³
184.1	0.400	95.67 X 10 ⁻⁶	23.13 X 10 ⁻³
227.4	0.449	107.24 X 10 ⁻⁶	25.93 X 10 ⁻³
269.5	0.497	118.86 X 10 ⁻⁶	28.73 X 10 ⁻³

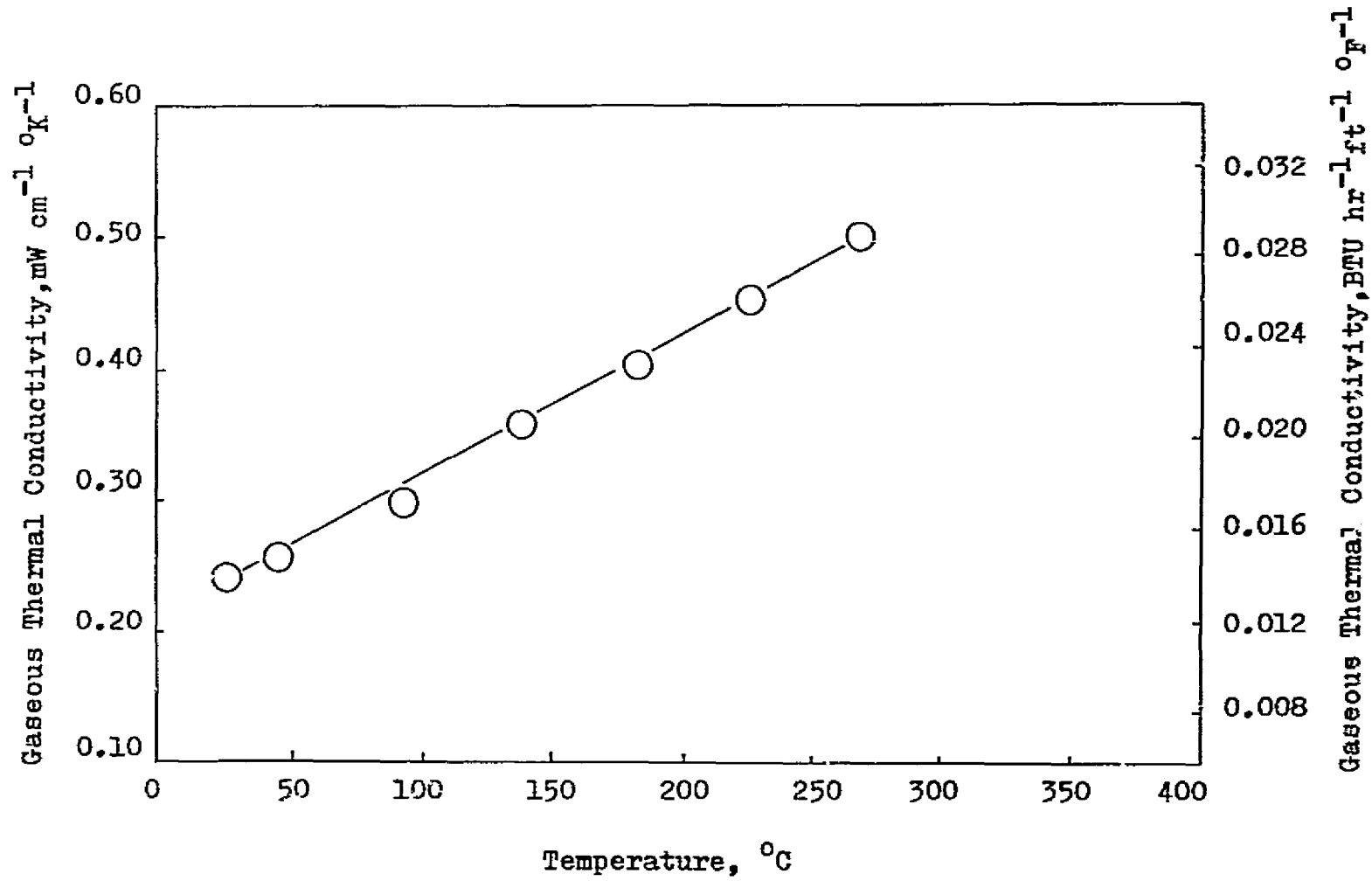

Figure 2.7-5 Gaseous Thermal Conductivity of Silane

Table 2.7-2 Gaseous Thermal Conductivity Values of Dichlorosilane

<u>Temperature</u>	<u>Gaseous Thermal Conductivity</u>		
	<u>°C</u>	<u>mW cm⁻¹ °K⁻¹</u>	<u>Cal cm⁻¹sec⁻¹ °C⁻¹</u>
28.0	0.102	24.43 X 10 ⁻⁶	5.91 X 10 ⁻³
45.7	0.108	25.72 X 10 ⁻⁶	6.22 X 10 ⁻³
94.7	0.129	30.86 X 10 ⁻⁶	7.46 X 10 ⁻³
139.4	0.148	35.42 X 10 ⁻⁶	8.56 X 10 ⁻³
184.1	0.169	40.37 X 10 ⁻⁶	9.76 X 10 ⁻³
227.4	0.194	46.46 X 10 ⁻⁶	11.23 X 10 ⁻³
273.5	0.217	51.79 X 10 ⁻⁶	12.52 X 10 ⁻³
321.3	0.243	58.15 X 10 ⁻⁶	14.06 X 10 ⁻³
350.6	0.267	63.70 X 10 ⁻⁶	15.40 X 10 ⁻³

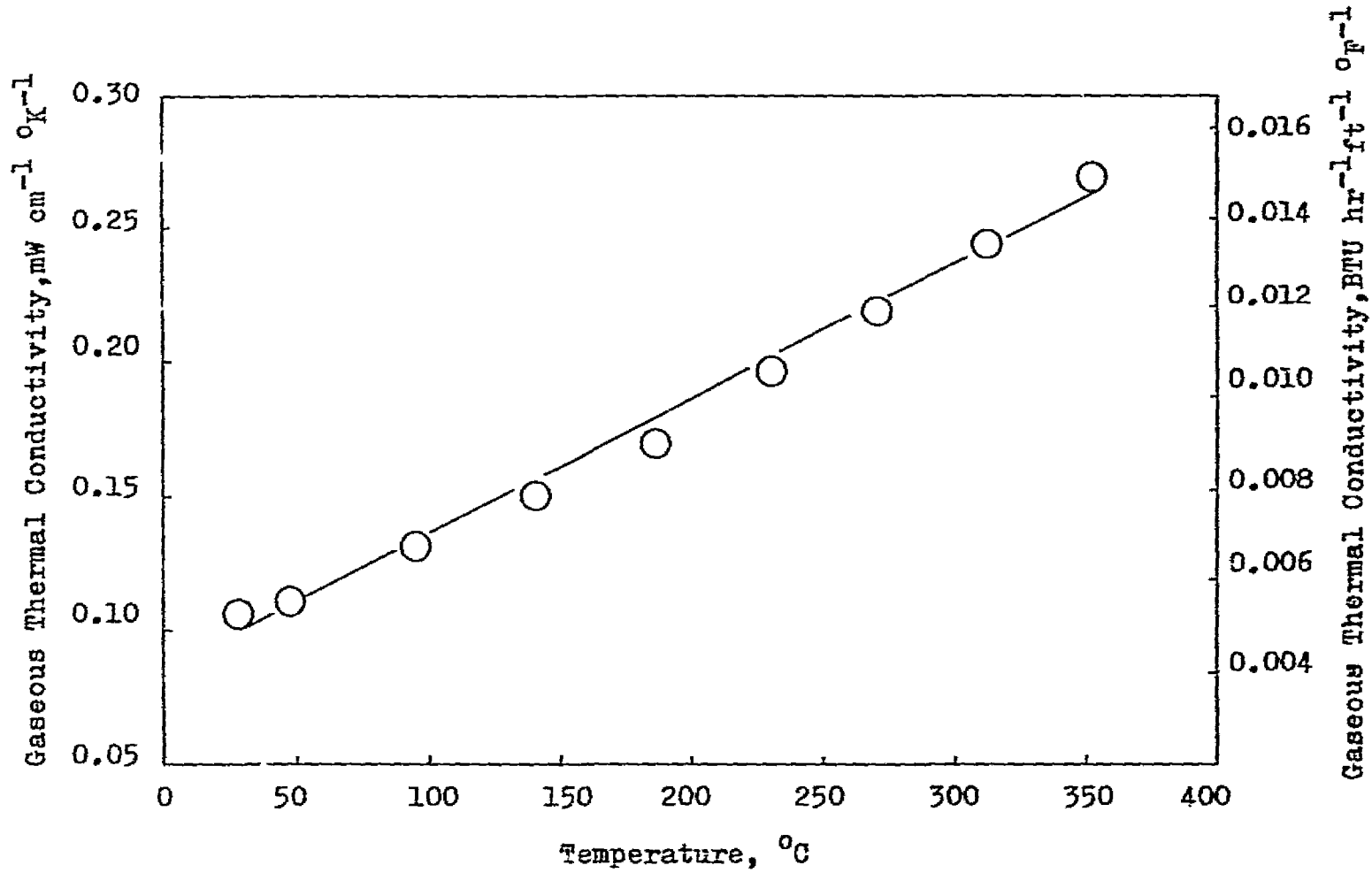

Figure 2.7-6 Gaseous Thermal Conductivity of Dichlorosilane

Table 2.7-3 Gaseous Thermal Conductivity Values of Trichlorosilane

<u>Temperature</u>	<u>Gaseous Thermal Conductivity</u>		
	<u>°C</u>	<u>mW cm⁻¹ °K⁻¹</u>	<u>Cal cm⁻¹sec⁻¹ °C⁻¹</u>
45.7	0.093	22.13 X 10 ⁻⁶	5.35 X 10 ⁻³
94.7	0.110	26.22 X 10 ⁻⁶	6.34 X 10 ⁻³
139.4	0.126	30.16 X 10 ⁻⁶	7.29 X 10 ⁻³
184.1	0.144	34.35 X 10 ⁻⁶	8.30 X 10 ⁻³
227.4	0.161	38.55 X 10 ⁻⁶	9.32 X 10 ⁻³
269.5	0.180	43.05 X 10 ⁻⁶	10.41 X 10 ⁻³
311.3	0.198	47.24 X 10 ⁻⁶	11.42 X 10 ⁻³
350.6	0.216	51.58 X 10 ⁻⁶	12.47 X 10 ⁻³

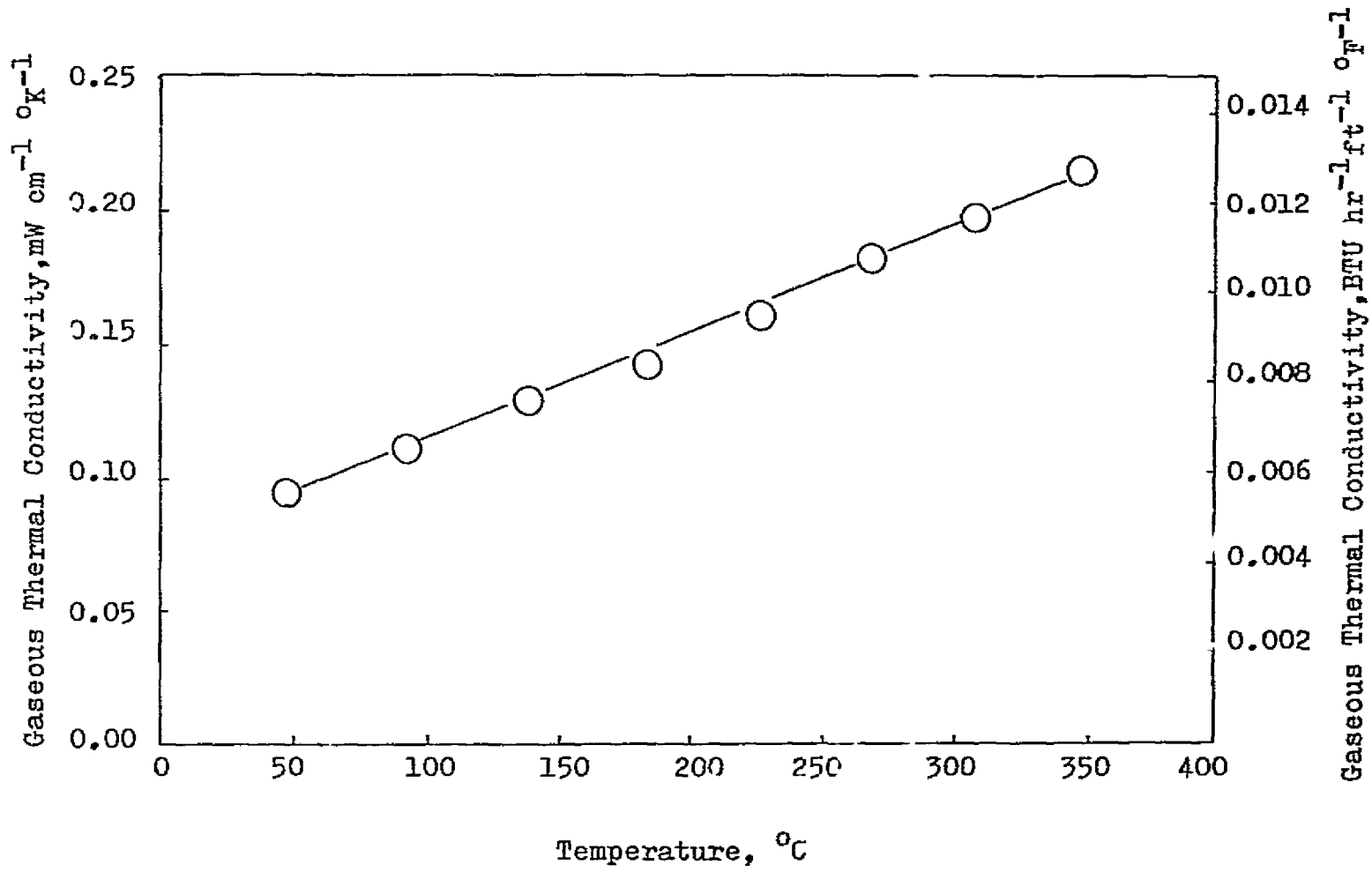

Figure 2.7-7 Gaseous Thermal Conductivity of Trichlorosilane

Table 2.7-4 Gaseous Thermal Conductivity Values of Tetrachlorosilane

<u>Temperature</u>	<u>Gaseous Thermal Conductivity</u>		
	<u>°C</u>	<u>mW cm⁻¹ °K⁻¹</u>	<u>Cal cm⁻¹ sec⁻¹ °C⁻¹</u>
94.7	0.100	23.93 X 10 ⁻⁶	5.78 X 10 ⁻³
139.4	0.111	26.43 X 10 ⁻⁶	6.39 X 10 ⁻³
184.1	0.124	29.59 X 10 ⁻⁶	7.15 X 10 ⁻³
227.4	0.138	32.89 X 10 ⁻⁶	7.95 X 10 ⁻³
269.5	0.153	36.59 X 10 ⁻⁶	8.85 X 10 ⁻³
311.3	0.169	40.39 X 10 ⁻⁶	9.76 X 10 ⁻³
350.6	0.193	46.13 X 10 ⁻⁶	11.15 X 10 ⁻³

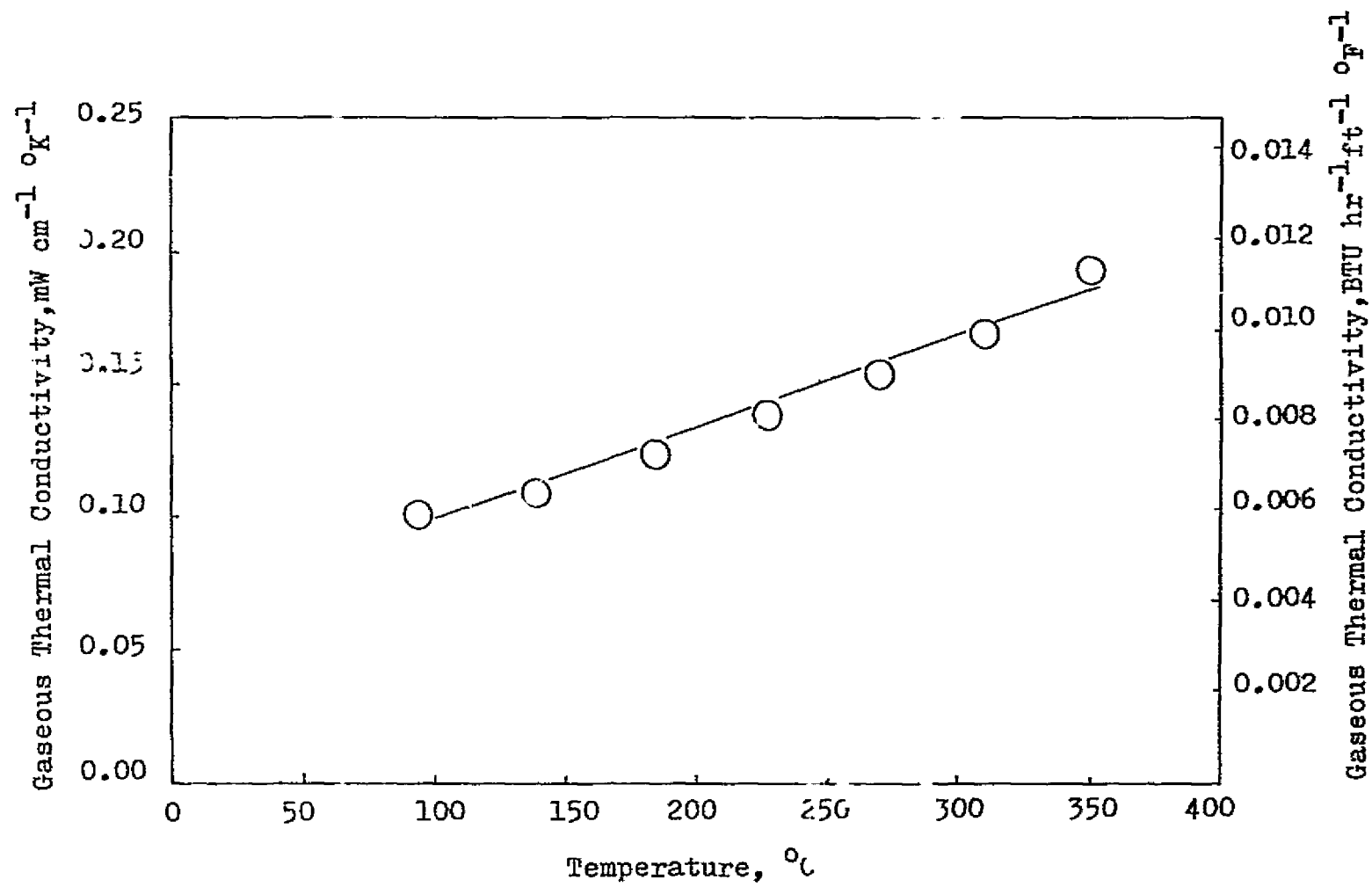

Figure 2.7-8 Gaseous Thermal Conductivity of Tetrachlorosilane

Table 2.7-5 Gaseous Thermal Conductivity Values of Tetrafluorosilane

<u>Temperature</u>	<u>Gaseous Thermal Conductivity</u>		
	<u>°C</u>	<u>mW cm⁻¹ °K⁻¹</u>	<u>Cal cm⁻¹ sec⁻¹ °C⁻¹</u>
29.0	0.150	35.95 X 10 ⁻⁶	8.69 X 10 ⁻³
45.7	0.158	37.79 X 10 ⁻⁶	9.13 X 10 ⁻³
94.7	0.189	45.24 X 10 ⁻⁶	10.94 X 10 ⁻³
139.4	0.215	51.43 X 10 ⁻⁶	12.43 X 10 ⁻³
184.1	0.241	57.67 X 10 ⁻⁶	13.94 X 10 ⁻³
227.4	0.274	65.46 X 10 ⁻⁶	15.83 X 10 ⁻³
269.5	0.291	69.55 X 10 ⁻⁶	16.81 X 10 ⁻³
311.3	0.316	75.55 X 10 ⁻⁶	18.26 X 10 ⁻³
350.6	0.345	82.34 X 10 ⁻⁶	19.90 X 10 ⁻³

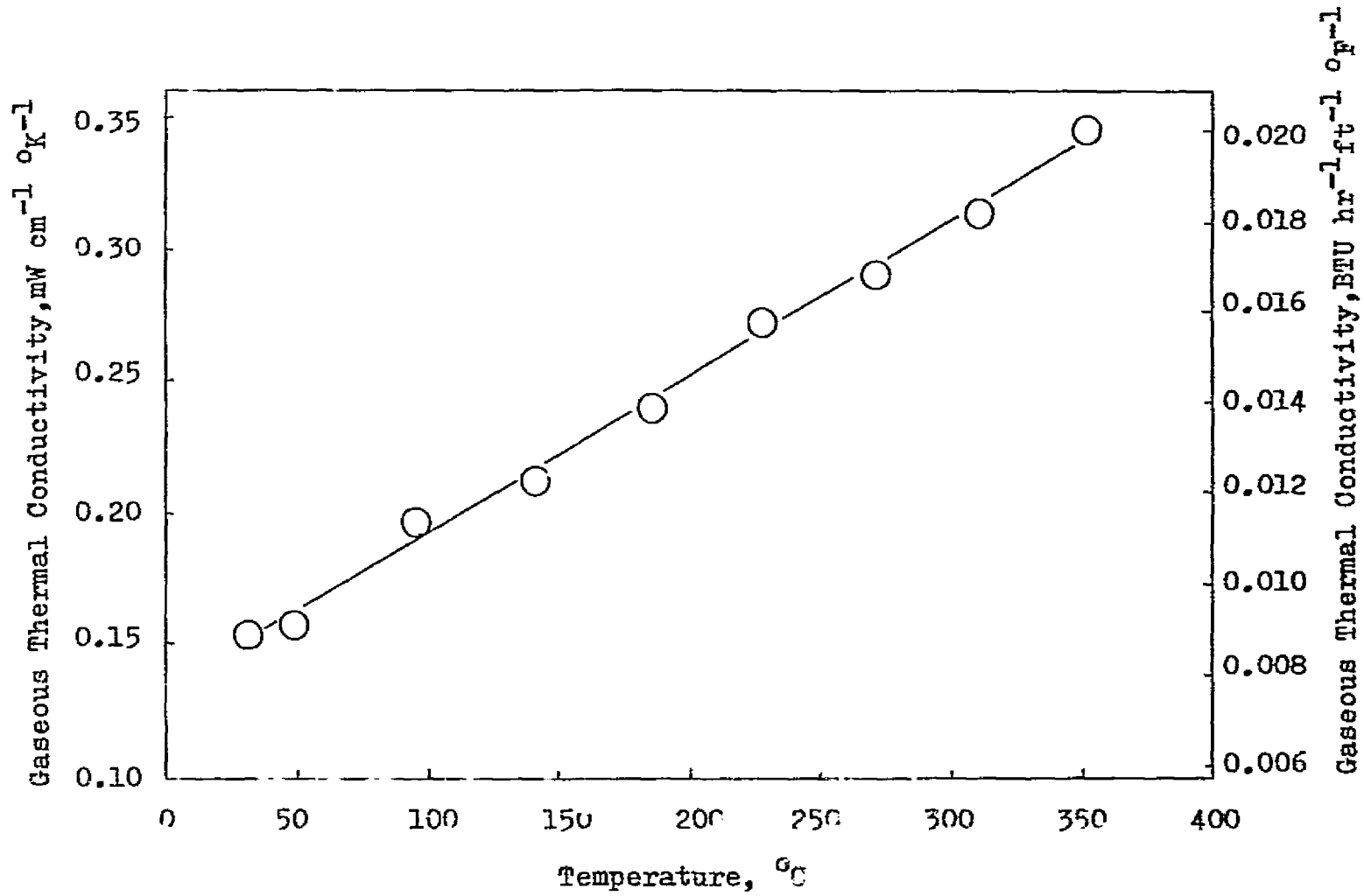

Figure 2.7-9 Gaseous Thermal Conductivity of Tetrafluorosilane

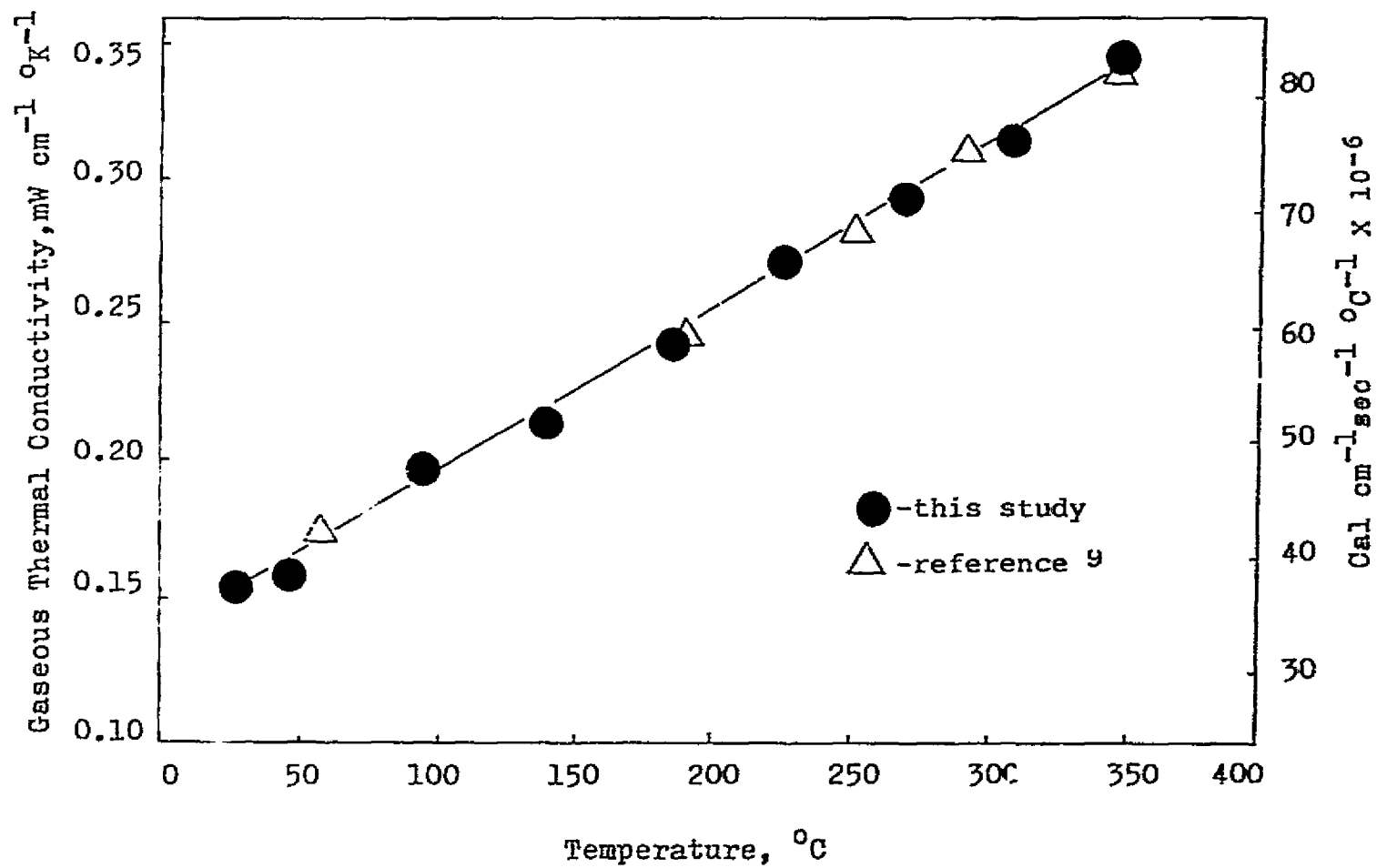

Figure 2.7-10 Comparison of Thermal Conductivity Values for Tetrafluorosilane

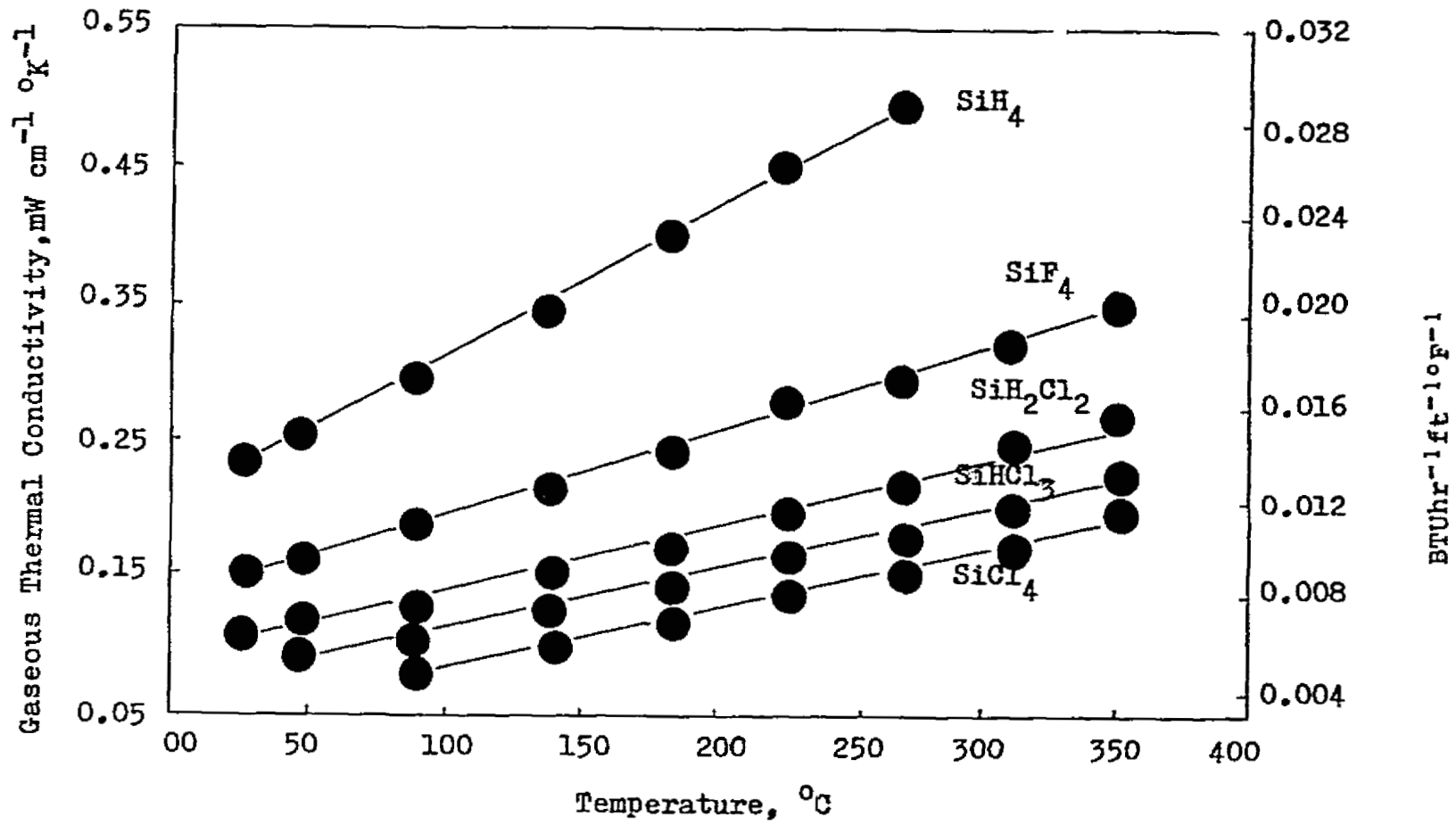

Figure 2.7-11 Gaseous Thermal Conductivity Values for Silane and Halogenated Silanes

References for Thermal Conductivity Investigation

1. C. E. Baker and C. S. Brokaw, J. Chem. Phys., 40, 1523 (1964); J. Chem. Phys., 43, 3519 (1965).
2. Touloukian, T. S. (Series Editor) and Others, "Thermophysical Properties of Matter", Volumes 1-13, 1st and 2nd Editions, IKI/Plenum Press, New York (1970-1976).
3. N. C. Blair and J. B. Mann, J. Chem. Phys., 32, 1459 (1960).
4. H. L. Johnson and E. R. Grilly, J. Chem. Phys., 14, 233 (1946).
5. Hansen, K. C., Miller, J. W., and Yaws, C. L., Quarterly Progress Report, June 1977, JPL Contract 954343.
6. Yaws, C. L. and Others, Solid State Technology, 16, No. 1, 39, January, 1973.
7. Prostov, V. N. and O. G. Popova, Russian Journal of Physical Chemistry, 49 (3), 366 (1975).
8. Timrot, D. L. V. N. Prostov, and V. E. Lyusternik, High Temperature, 1 (5), 824 (1967).
9. Choy, P. G., "Thermal Conductivities of Some Polyatomic Gases at Moderately High Temperatures", Ph D. Dissertation, St. Louis University, 1967.

2.8 Viscosity Investigation

Gas viscosity values of some halogenated silanes were experimentally determined between 40°C and 200°C. The viscosity values were determined by a transpiration method which is based on the rate of flow of the gas through a capillary. In order to determine these gas flow rates, a constant volume, glass viscometer (Figure 2.8-1) was fabricated and assembled. The apparatus is similar to one described by McCoubrey and Singh (1). The apparatus consists of a 1 liter glass bulb which is connected through a glass manifold to a mercury manometer and to a thermostated capillary with a preheater coil. The capillary is 20 cm. in length and has an internal diameter of 0.02 cm. The exit side of the capillary can be continuously evacuated by a two stage mechanical pump.

In order to make a measurement, the viscometer is thoroughly evacuated and then the gas sample is introduced into the bulb up to a pressure of about 18 cm. Hg. The gas sample is then evacuated through the capillary and the resulting rate of flow is monitored by recording the pressure decrease in the bulb with time. The pressure is measured with a standard U tube mercury manometer to ±0.5mm. Hg.

The rate of flow of a gas through a capillary is dependent upon the coefficient of viscosity (η) of the gas. By combining Poiseuille's equation for laminar flow of a gas through a tube and the ideal gas law equation, the relationship between pressure, time, and viscosity of a gas can be derived. Poiseuille's equation (2) for laminar gas flow is:

$$\frac{dV}{dt} = \frac{\pi(P_1^2 - P_2^2)r^4}{16L\eta P_0} \quad (2.8-1)$$

where dV/dt is the volume rate of gas flowing through the capillary, P_1 is the pressure at the capillary inlet, P_2 is the pressure at the capillary outlet, r is the radius of the capillary, L is the length of the capillary, and P_0 is the pressure at which the gas volume is measured. In this method where the gas is continuously evacuated with a pump, P_2 is negligible compared to P_1 and equation 2.8-1 reduces to:

$$\frac{dV}{dt} = \frac{\pi P_1^2 r^4}{16L\eta P_0} \quad (2.8-2)$$

From the ideal gas law, dV , the volume of gas at P_0 , passing through the capillary in unit time can be expressed in terms of dN , the number of molecules of gas flowing through the capillary in unit time (equation 2.8-3).

$$dV = dN(RT/P_0) \quad (2.8-3)$$

Substituting equation 2.8-3 into equation 2.8-2 gives equation 2.8-4:

$$\frac{dN}{dt} = \frac{\pi P_1^2 r^4}{16L\eta RT} \quad (2.8-4)$$

As the gas is evacuated in a constant volume viscometer, the pressure decreases. Again using the ideal gas law,

$$dN = -dP_1(V/RT) \quad (2.8-5)$$

where V is the volume being evacuated. Substituting equation 2.8-5 into equation 2.8-4 gives equation 2.8-6

$$dP_1 = -\frac{\pi P_1^2 r^4}{16L\eta V} dt \quad (2.8-6)$$

The assumptions of the derivations are: constant volume of the system, ideal behavior of the gas, and laminar flow through the capillary. Since the pressure is measured with a U-tube manometer, the volume of the system will change by 10 to 20 ml. during an experiment. However, with a total volume of the viscometer of over 1 liter, this change can be neglected. The gases to be measured do not exhibit ideal behavior, but at pressures of less than 1 atmosphere their deviations should not be large. Laminar flow assumes zero velocity at the wall. A correction may need to be made for slip at the wall.

From equation 2.8-6, the viscosity (η) of a gas can be calculated from the slope of the line obtained by plotting $1/P_1$ versus t . In order to avoid the necessity of careful measurements of the capillary dimensions and the volume of the system, a gas of known viscosity can be used to determine an apparatus constant which includes all the constant terms in equation 2.8-6. Alternatively, the calculation constant can be omitted and the viscosity of the unknown, relative to that of a reference gas, can be computed from the inverse relation of the slopes of the $1/P$ versus t graphs (equation 2.8-7).

$$\frac{\eta}{\eta_{ref}} = \frac{\text{slope}_{ref}}{\text{slope}} \quad (2.8-7)$$

Evaluation and calibration of the gas viscometer was accomplished before data collection began. Using argon as a

reference to determine a viscometer constant, experimental values for gas viscosity of nitrogen have been determined between 40°C and 200°C. These values were compared to recommended values for the gas viscosity of nitrogen (3) in order to evaluate the accuracy of data obtained on this viscometer (figure 2.8-2). The recommended values used were those presented in "Thermophysical Properties of Matter", Vol. 11 on viscosity (TPRC), and were determined by an evaluation of available published data. It was stated that the published data correlated with the recommended values to within ±2%. The viscosity values obtained for gaseous nitrogen in this study deviate from the recommended values by less than 2% from 40°C to 200°C (figure 2.8-2).

The viscosity of trichlorosilane (SiHCl_3) has been determined between 40°C and 200°C (table 2.8-1 and figure 2.8-3). There have been no previously reported experimental values for gas viscosity of trichlorosilane in the temperature range of the study. Values at 0°C and 31°C were reported by Tel'chuk and Tubyanskaya (ref. 5).

The viscosity of dichlorosilane (SiH_2Cl_2) has been determined between 40°C and 200°C (table 2.8-2 and figure 2.8-4). The sample of dichlorosilane used for the measurements was semiconductor grade obtained from Union Carbide Corporation. There have been no previously reported experimental values for the gas phase viscosity of dichlorosilane. One set of calculated values have been reported (ref. 6) in the temperature range of 0°C to 300°C. These calculated values agree with the experimental values determined in this study with deviations of less than ±2% from 40°C to 200°C.

The viscosity of tetrafluorosilane (SiF_4) has been determined between 40°C and 200°C (Table 2.8-3 and Figure 2.8-5). There have been two previous reports of experimentally determined viscosity values for tetrafluorosilane. Ellis and Raw (reference 4) reported values between 23°C and 134°C and McCoubrey and Singh (reference 1) reported values between 18°C and 190°C. The values of McCoubrey and Singh were in close agreement to the values reported in this study with less than 3% deviation through the whole temperature range. The values of Ellis and Raw were lower than the values reported in this study by as much as 7%.

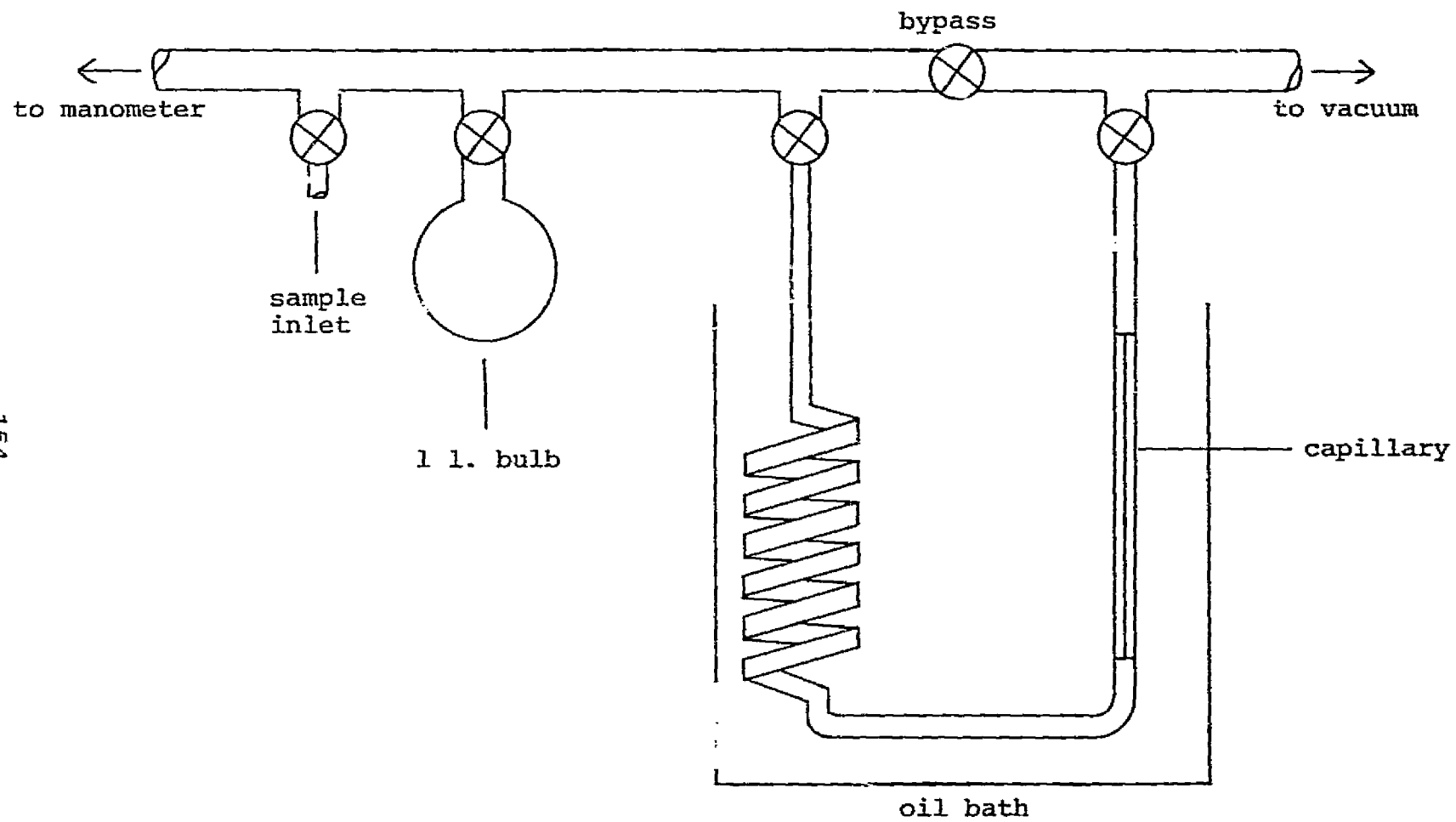

154

Figure 2.8-1 Constant Volume Gas Viscometer

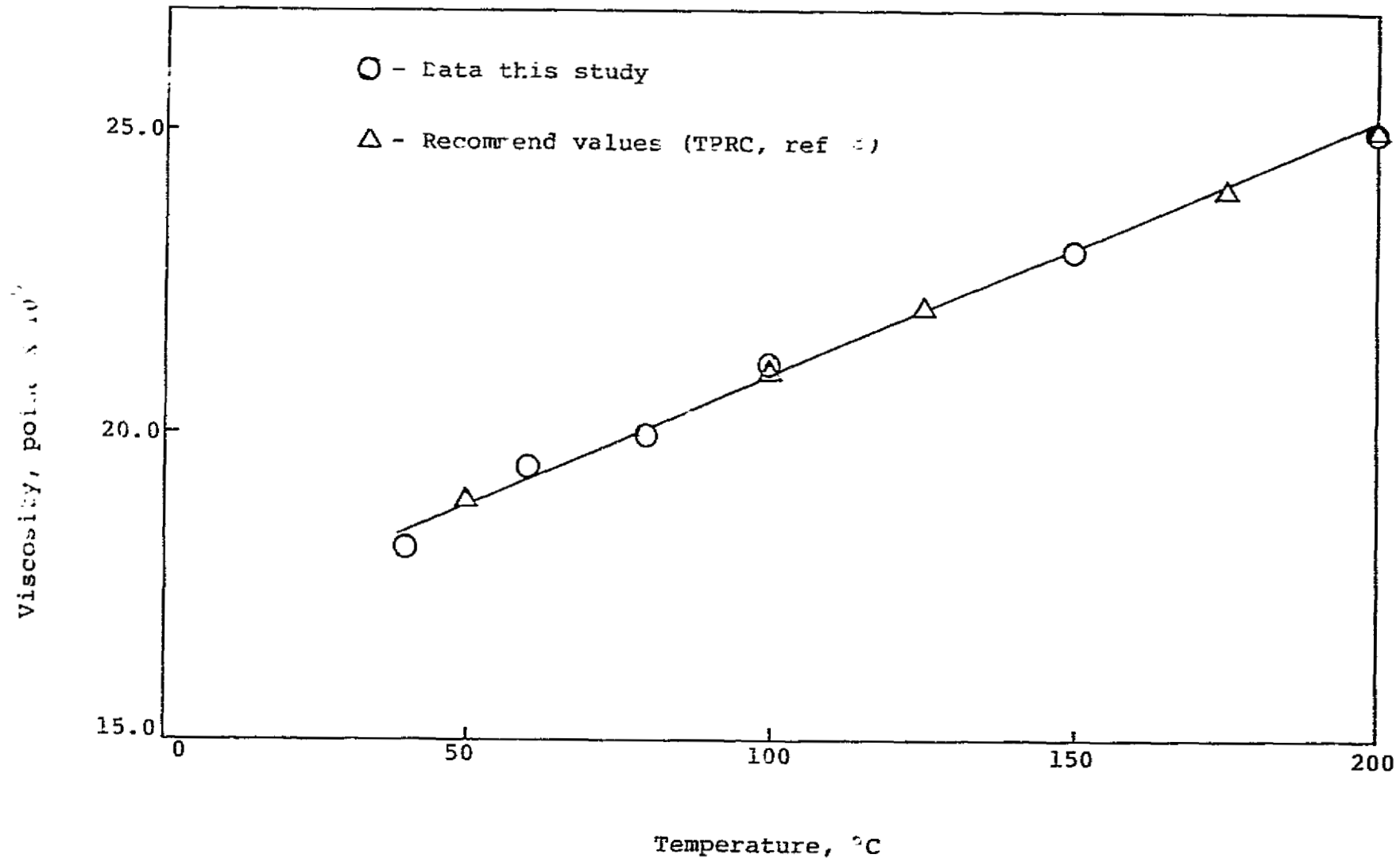

Figure 2.8-2 Viscosity of Nitrogen

Table 2.8-1

Viscosity of Gaseous Trichlorosilane

Temperature °C	Viscosity		
	micropoise	Nsm^{-1}	$\text{lb s}^{-1}\text{ft}^{-1}$ _m
40	122.0	12.20×10^{-6}	8.20×10^{-6}
60	125.9	12.59×10^{-6}	8.46×10^{-6}
80	134.8	13.48×10^{-6}	9.06×10^{-6}
100	140.8	14.08×10^{-6}	9.46×10^{-6}
150	157.3	15.73×10^{-6}	10.57×10^{-6}
200	177.2	17.72×10^{-6}	11.91×10^{-6}

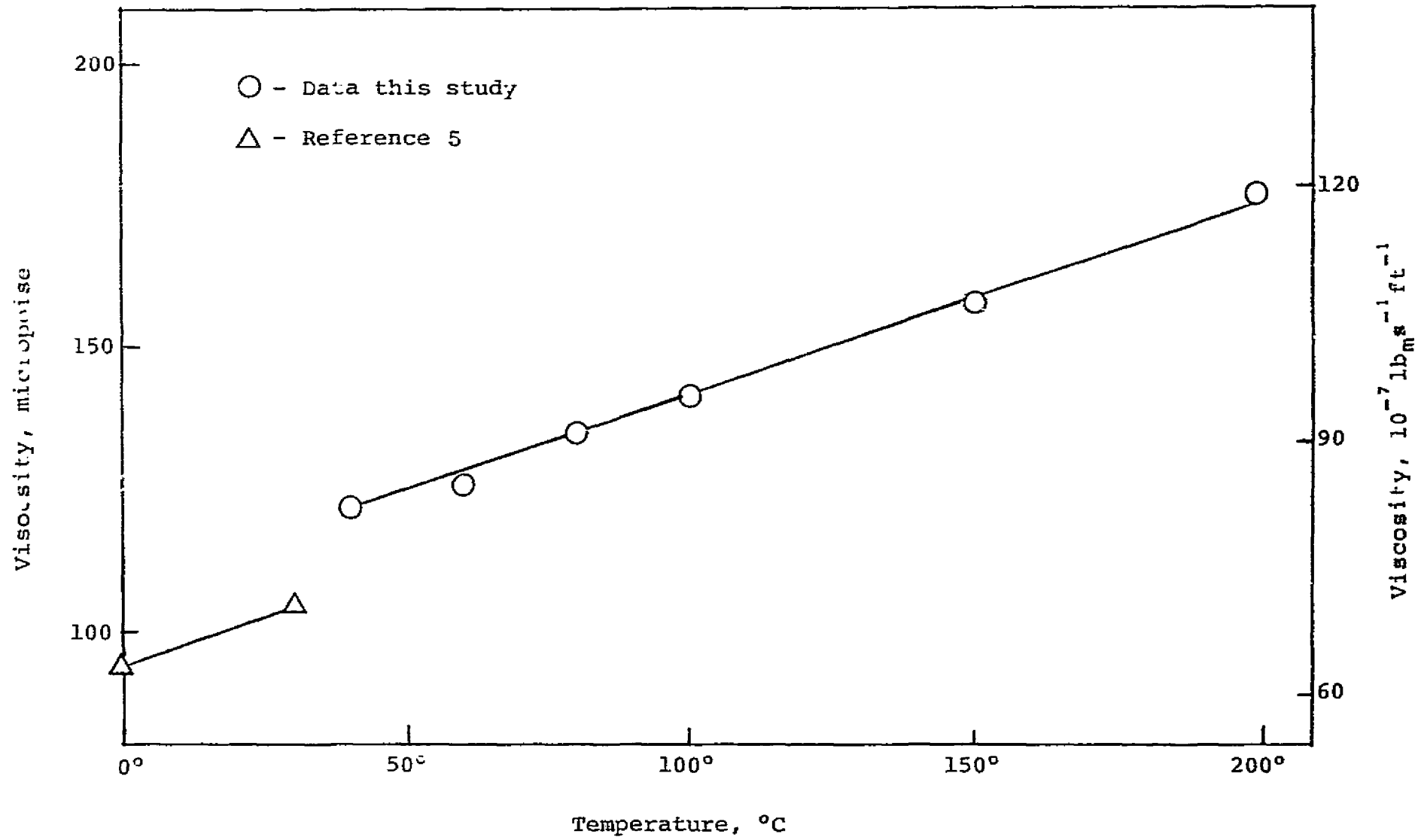

Figure 2.8-3 Viscosity of Gaseous Trichlorosilane

Table 2.8-2

Viscosity of Gaseous Dichlorosilane

Temperature °C	Viscosity		
	micropoise	Nsm^{-1}	$\text{lb}_m\text{s}^{-1}\text{ft}^{-1}$
40	118.7	11.87×10^{-6}	7.98×10^{-6}
60	125.3	12.53×10^{-6}	8.42×10^{-6}
80	134.6	13.46×10^{-6}	9.05×10^{-6}
100	140.2	14.02×10^{-6}	9.42×10^{-6}
150	163.5	16.35×10^{-6}	10.99×10^{-6}
200	181.9	18.19×10^{-6}	12.22×10^{-6}

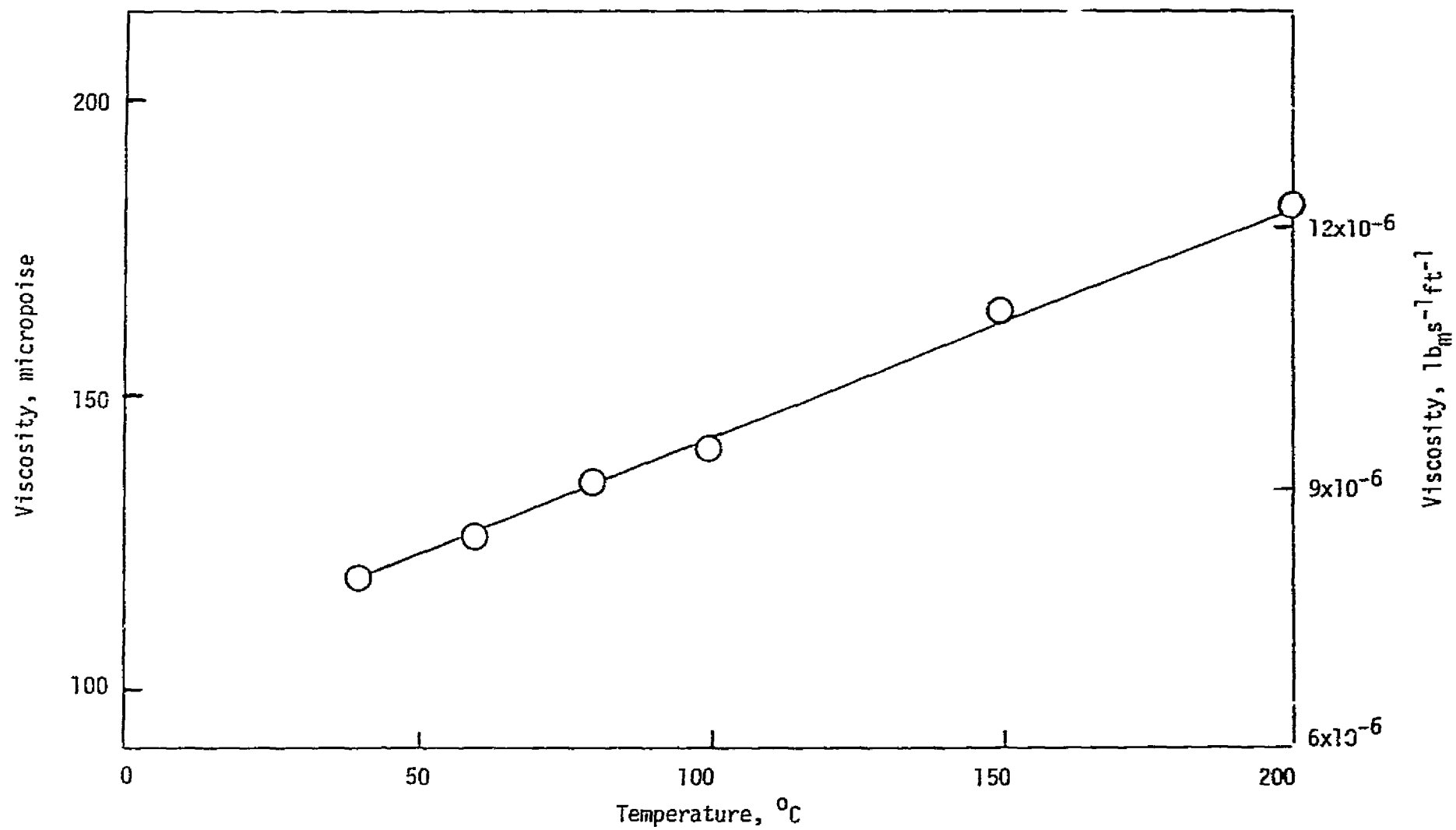

Figure 2.8-4 The Viscosity of Gaseous Dichlorosilane as a Function of Temperature

TABLE 2.8-3

Gaseous Viscosity of Tetrafluorosilane

Temperature °C	Viscosity		
	micropoise	N s m^{-2}	$\frac{\text{lb}}{\text{m}} \text{S}^{-1} \text{ft}^{-1}$
40	169.5	16.96×10^{-6}	11.40×10^{-6}
60	180.7	18.07×10^{-6}	12.14×10^{-6}
100	191.7	19.17×10^{-6}	12.88×10^{-6}
150	208.3	20.83×10^{-6}	14.00×10^{-6}
200	231.2	23.12×10^{-6}	15.54×10^{-6}

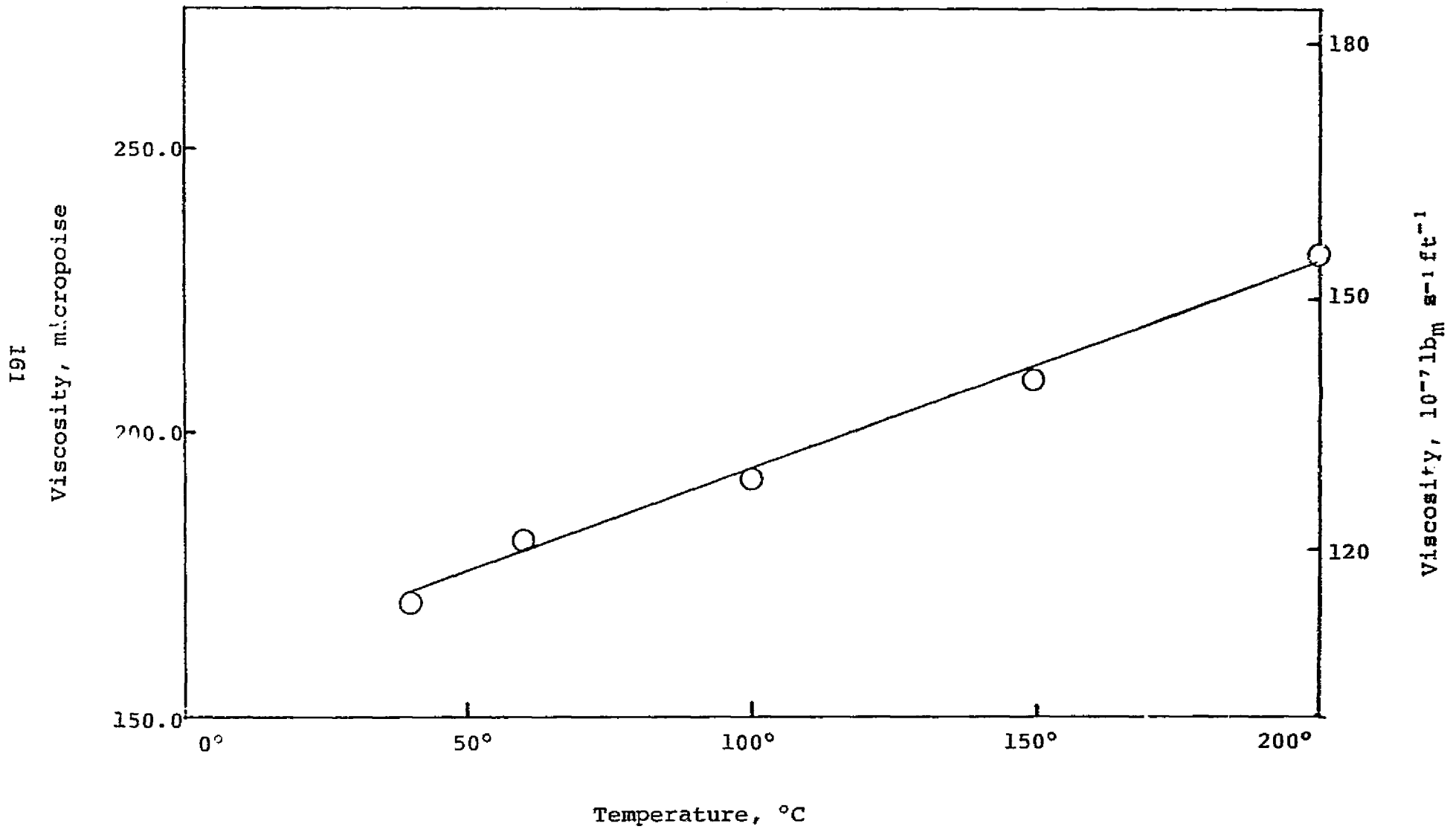

Figure 2.8-5 Viscosity of Gaseous Tetrafluorosilane

References for Viscosity Investigation

1. McCauley, J. C. and N. M. Singh, *Trans. Faraday Soc.*, 53 877 (1957).
2. Moore, W. J., "Physical Chemistry", 3rd ed., Prentice-Hall, Inc. (1964).
3. Touloukian, T. S. (Series Editor) and others, "Thermophysical Properties of Matter", Volumes 1-13, 1st and 2nd editions, IKI/Plenum Press, New York (1970-1976).
4. Ellis, C. P. and C. J. G. Raw, *J. Chem. Soc.*, 3765 (1956).
5. Lel'chek, S. L. and V. S. Tubyanskaya, "Physico-Chemical Properties of Some Silicons", Moskva, Goskhimizdat (1961).
6. Lapidus, I. I. et al, "Thermophysical Properties of Gases and Liquids", No. 1, V. A. Rabinovich, ed., 102, Israel Program for Scientific Translation, Jerusalem (1970).

2.9 Silicon Tetrafluoride Generation

Investigations were conducted toward developing a method to generate silicon tetrafluoride (SiF_4) from an aqueous solution of hexafluorosilicic acid (H_2SiF_6), which is readily available as a product of the phosphate fertilizer industry. The method investigated involved the precipitation of an insoluble salt of hexafluorosilicic acid followed by the thermal decomposition of the salt to produce SiF_4 .

Experiments were conducted in which concentrated aqueous solutions of various salts (NaCl , NaF , NaOH , Na_2CO_3) were reacted with a 23% aqueous solution of H_2SiF_6 at room temperature:

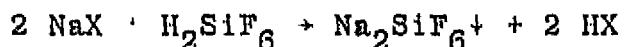

where X = Cl, F, OH or CO_3

Reaction under these conditions resulted in the immediate formation of a precipitate which could be readily filtered and dried. With each salt, several reactions were carried out with differing stoichiometric amounts of the reactant in order to determine the reactant ratio which would give maximum precipitation of Na_2SiF_6 . The results of these investigations are shown in Figures 2.9-1 through 2.9-4.

Figure 2.9-1 shows that the precipitation of Na_2SiF_6 with NaCl solutions gives maximum recovery of the SiF_4 precursor at a reactant ratio of slightly greater than 1:1. Increasing the amount of NaCl does not improve the yield any further. The percent yield of Na_2SiF_6 never rises above the 90-95% region due to its slight solubility in water. The precipitate formed was shown to be Na_2SiF_6 by comparing its infrared spectrum with that of an authentic sample. Air drying of the precipitate was shown to leave approximately 1-2% water.

Figure 2.9-2 shows that precipitation of Na_2SiF_6 with NaF solution gives essentially the same results as was obtained with NaCl up to about 1.25:1 reactant ratio. At higher ratios the calculated percent yield of Na_2SiF_6 rises above 100% which indicates that something else is occurring other than the precipitation of Na_2SiF_6 . Hydrofluoric acid (HF) is a by-product of this reaction and will form an insoluble adduct ($\text{NaF}\cdot\text{HF}$) which results in the greater than 100% calculated yield.

Precipitation using NaOH solutions (Figure 2.9-3) gives completely different results than that obtained with either NaCl and NaF . The calculated yields (based on Na_2SiF_6) are much above 100% and continue to rise up to a reactant ratio of 3:1. The use of NaOH (a strongly basic reagent) resulted in the hydrolysis of the Si-F bond as well as precipitation of Na_2SiF_6 . The hydrolysis of $\text{SiF}_6^{=}$ under basic conditions

results in the formation of silicic acids which are hydrated oxides of silicon and these precipitate along with Na_2SiF_6 . The formation of silicic acids in these reactions was confirmed by infrared analysis of the precipitate which showed characteristic absorptions for both silicic acid and Na_2SiF_6 .

Figure 2.9-4 shows that reaction with Na_2CO_3 (a weakly basic reagent) gives results comparable to those obtained with NaCl solutions. Infrared analysis of the precipitate however, indicated the presence of some silicic acids which showed that hydrolysis was occurring with Na_2CO_3 as well as with NaOH .

Studies were also conducted to determine conditions necessary for the efficient precipitation of BaSiF_6 (another possible precursor for the generation of SiF_4). The use of BaSiF_6 as an alternate precursor to SiF_4 (instead of Na_2SiF_6) was investigated because of several advantages this route may have. BaSiF_6 is less soluble than Na_2SiF_6 by a factor of about 30 which should result in a more efficient recovery of SiF_4 from a solution of H_2SiF_6 . Secondly, if BaF_2 is used to precipitate the BaSiF_6 there should be no co-precipitation of an adduct with HF (use of NaF in the precipitation of Na_2SiF_6 resulted in the co-precipitation of $\text{NaF}\cdot\text{HF}$). Also the thermal decomposition of BaSiF_6 to give SiF_4 may occur at a lower temperature than that observed for Na_2SiF_6 .

The precipitation of BaSiF_6 was effected by the reaction of a 23% aqueous solution of H_2SiF_6 with aqueous solutions of either BaCl_2 or BaF_2 . An immediate precipitate was formed in both

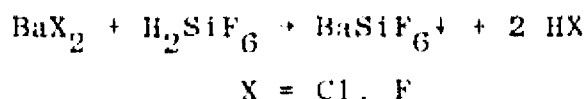

cases which could be readily filtered and dried. With each salt, several reactions were carried out with differing stoichiometric amounts of the reactant in order to determine the reactant ratio which would give maximum precipitation of BaSiF_6 . The results of these investigations are presented in Figures 2.9-5 and 2.9-6.

Figure 2.9-5 shows that the precipitation of BaSiF_6 with BaCl_2 solutions at room temperature gives maximum recovery of the SiF_4 precursor at a reactant ratio of 1:1. Increasing the amount of BaCl_2 does not increase the yield any further and the percent yield never rises above about 97% due to the slight solubility of BaSiF_6 .

Figure 2.9-6 shows the results of the reactions of BaF_2 solutions with H_2SiF_6 at 50°C. Maximum recovery of BaSiF_6 is shown to be at a reactant ratio of 1.5 to 1 with the percent yield about 95%. The higher reactant ratio necessary

for efficient precipitation and slightly lower yields than were observed in the reactions with BaCl_2 is due to the low solubility of BaF_2 which dictated the use of considerably larger volumes of water.

Investigations were conducted for the generation of silicon tetrafluoride (SiF_4) by the thermal decomposition of sodium hexafluorosilicate⁴ (Na_2SiF_6):



Parameters such as temperature, reaction time, and general reaction conditions were examined in order to determine optimum conditions for efficient SiF_4 generation.

Anhydrous sample of Na_2SiF_6 were placed in a quartz tube and heated under various reaction conditions. The amount of SiF_4 generated was determined from the weight loss of the sample after heating based on the stoichiometry in equation 4.

Initially the samples were heated for 1 hour in a closed system of inert gas (N_2) maintained at 1 atmosphere and at constant temperatures ranging from 350°C to 600°C. In no instance was the generation of SiF_4 above 12%. This low yield of the SiF_4 was due to the fact that the thermal decomposition reaction is an equilibrium reaction (eq. 4) and when the decomposition is carried out under conditions which allow an equilibrium to be established, the reaction will proceed no further than the equilibrium point.

As a result of these initial results, the reaction conditions were altered such that a slow stream of N_2 (approximately 200 cc/min) was continuously passed over the sample during the decomposition. Figure 2.9-7 shows the results of these experiments. Heating the samples for 1 hour gave low yields of SiF_4 increased rapidly such that the generation of SiF_4 was essentially quantitative above 550°C.

Based on the above results, it is obvious that the decomposition of Na_2SiF_6 to generate SiF_4 occurs extensively at temperatures above 500°C. Since this data was obtained by heating the samples for an extended period (1 hour at each temperature), the per cent generation of SiF_4 was obtained as a function of reaction time in order to determine the minimum amount of heating required to produce high yields of SiF_4 . Figures 2.9-8, 2.9-9, 2.9-10 show the results of this type investigation at 500°C, 550°C, and 600°C. Figure 2.9-8 indicates that decomposition is not complete at 500°C even upon heating for a period of 1 hour. At 550°C the generation of SiF_4 approaches completion in 30 minutes (figure 2.9-9) and at 600°C the reaction is essentially complete in 15 minutes.

The generation of silicon tetrafluoride (SiF_4) by the thermal decomposition of barium hexafluorosilicate (BaSiF_6) according to equation 9 was investigated. Parameters such

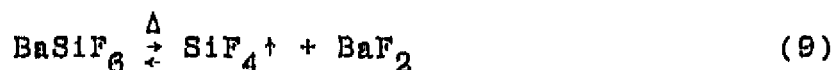

as temperature, reaction time, and general reaction conditions were examined in order to determine optimum conditions for efficient SiF_4 generation by this method.

Samples of anhydrous BaSiF_6 were placed in a quartz tube and heated at various temperatures for a period of one hour during which time a slow stream of N_2 (approximately 200 cc/min) was continuously passed over the sample. The amount of SiF_4 generated was determined from the weight loss of the sample after heating based on the stoichiometry in equation 9. The results of these experiments are shown in figure 2.9-11. Heating for 1 hour at temperatures up to about 400°C gave low yields of SiF_4 . At temperatures above 400°C however, nearly quantitative yields were obtained.

Based on the above results, it can be seen that the decomposition of BaSiF_6 to generate SiF_4 occurs extensively at temperatures above 400°C. Since this data was obtained by heating the samples for an extended period (1 hour at each temperature), the per cent yield of SiF_4 was obtained as a function of time in order to determine the minimum amount of heating required to produce high yields of SiF_4 . Figures 2.9-12, 2.9-13, 2.9-14, 2.9-15 show the results of this type investigation at 400°C, 450°C, 500°C, and 550°C respectively. Figure 2.9-12 shows that at 400°C the decomposition of BaSiF_6 does not approach completion until about 1 hour heating time. Figure 2.9-13 shows that decomposition of BaSiF_6 is essentially complete after 30 minutes heating at 450°C and figures 2.9-14 & 2.9-15 show that decomposition is complete after only a few minutes (5-10 minutes) at 500°C and 550°C.

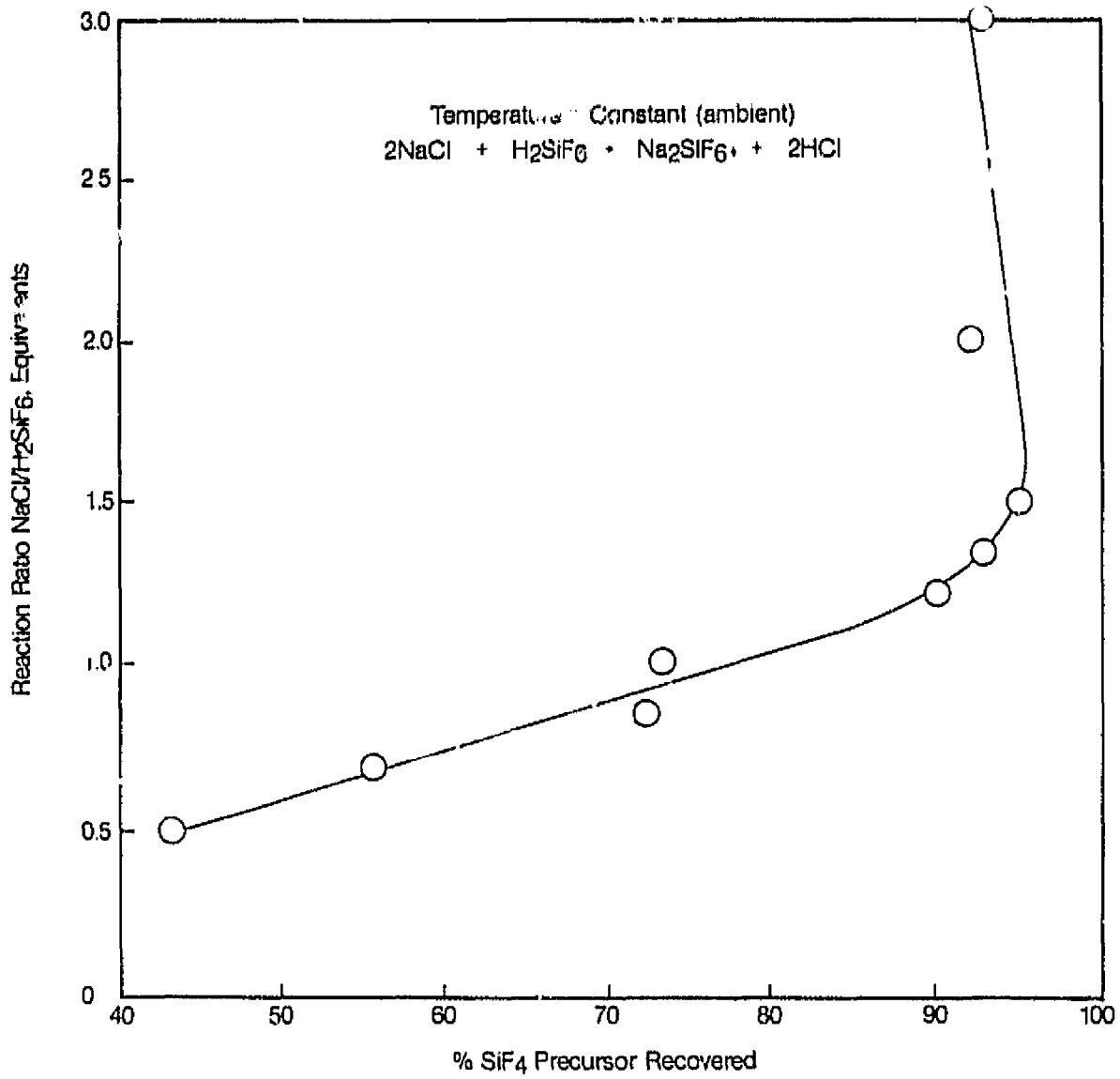

Figure 2.9-1 Variation of SiF₄ Precursor Recovery with Reaction Ratio (NaCl Reaction)

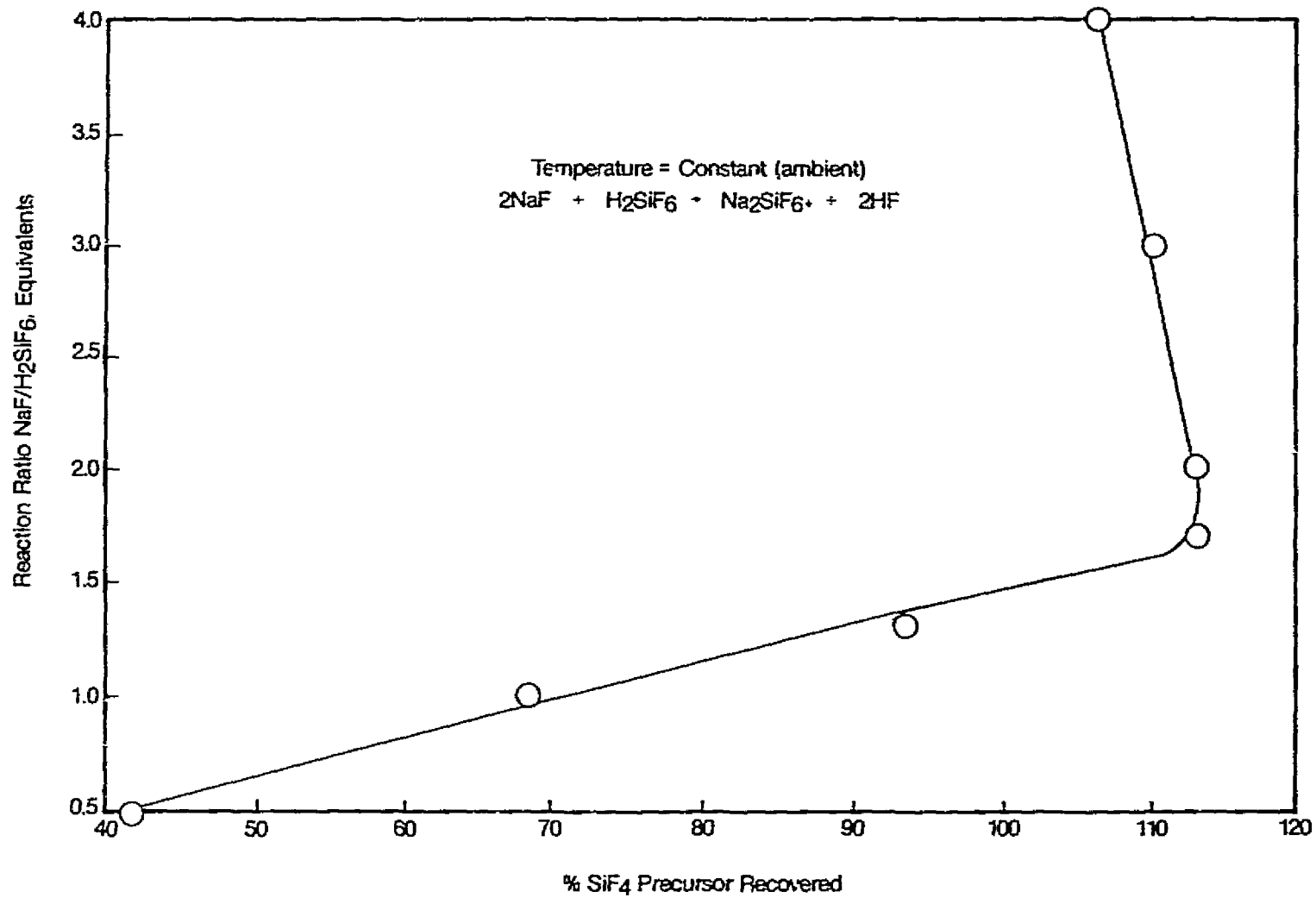

Figure 2.9-2 Variation of SiF₄ Precursor Recovery with Reaction Ratio (NaF Reaction)

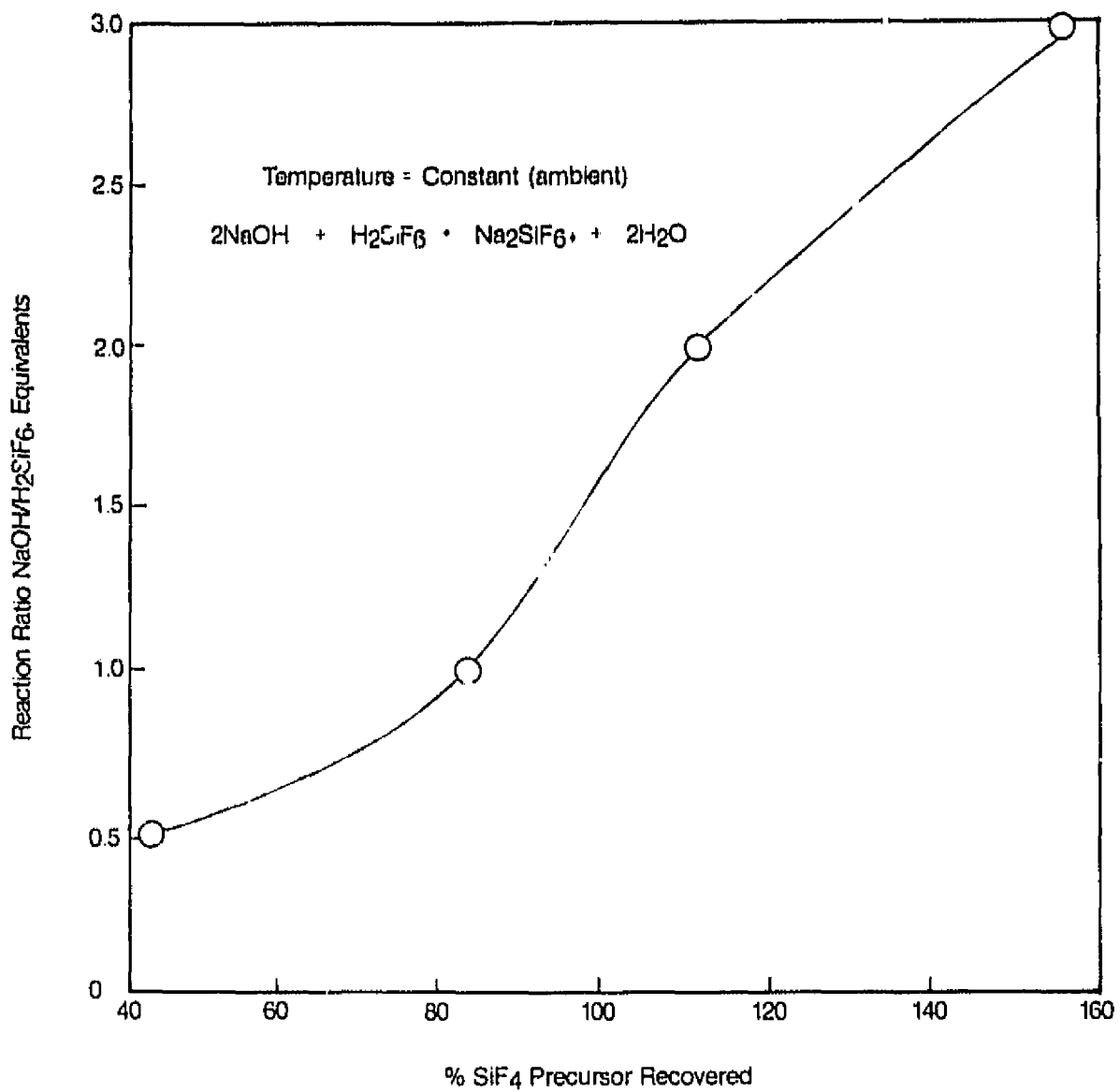

Figure 2.9-3 Variation of SiF₄ Precursor Recovery with Reaction Ratio (NaOH Reaction)

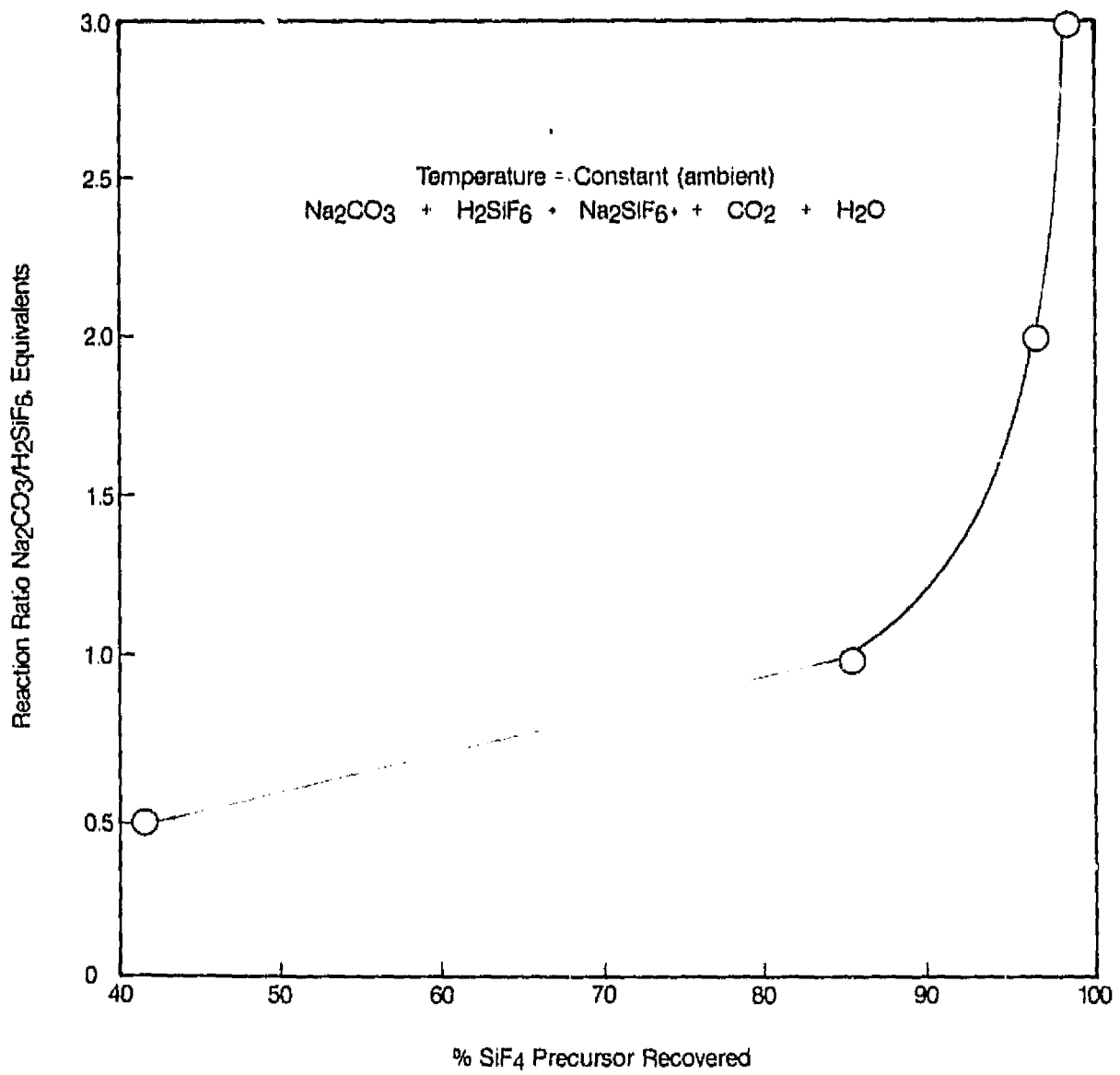

Figure 2.9-4 Variation of SiF_4 Precursor Recovery with Reaction Ratio (Na_2CO_3 Reaction)

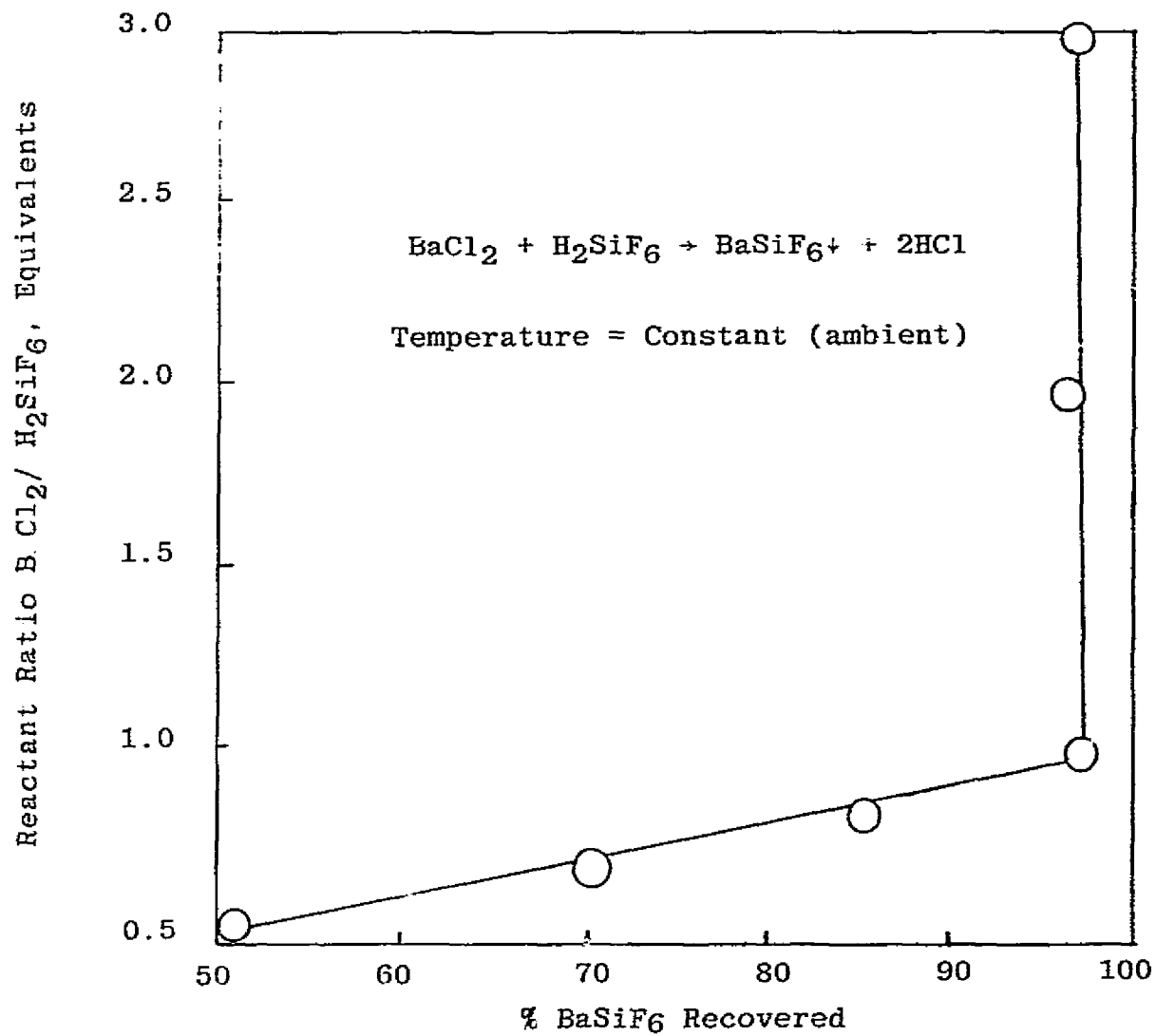

Figure 2.9-5 Variation of $BaSiF_6$ Recovery with Reactant Ratio ($BaCl_2$ Reaction)

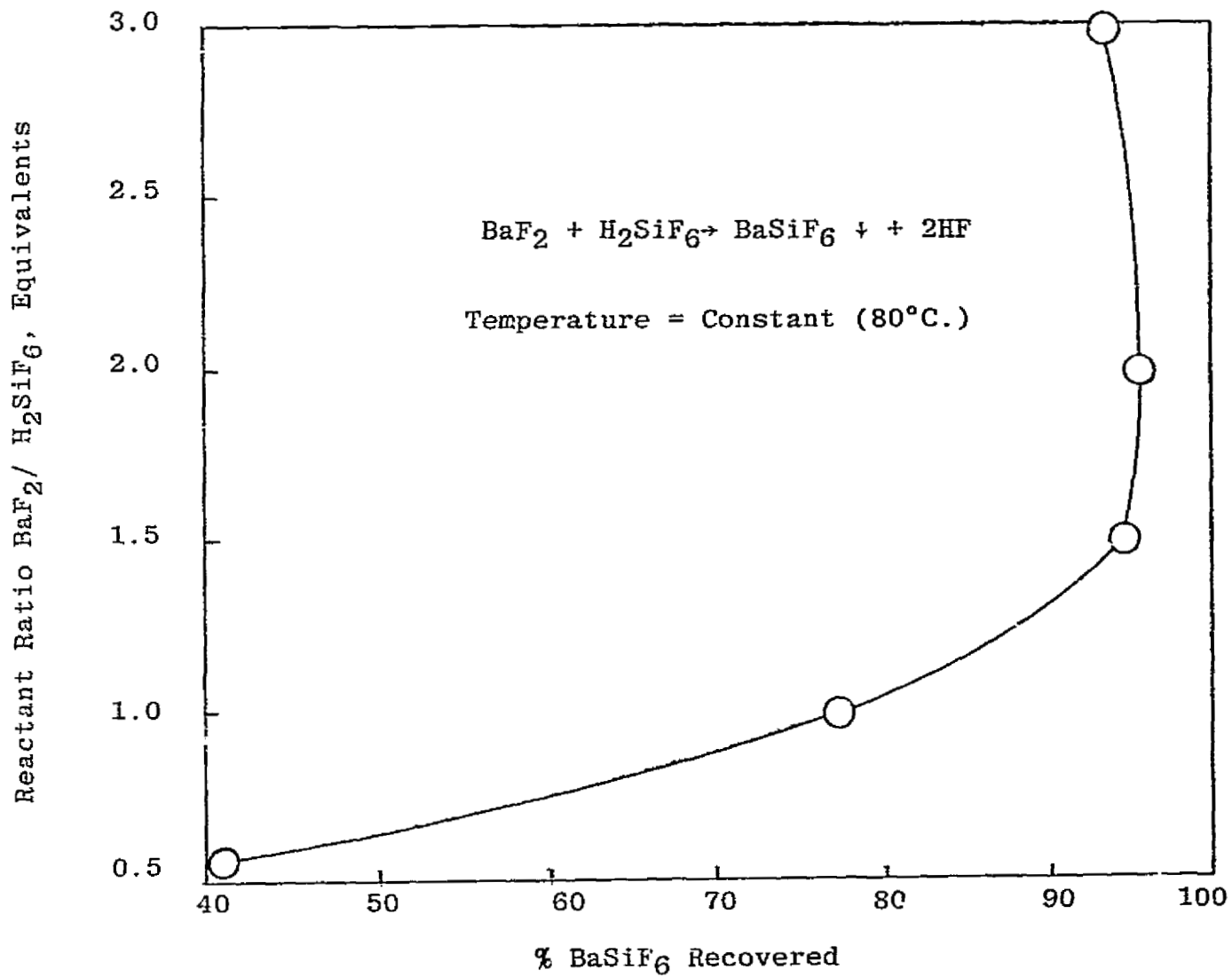

Figure 2. Variation of $BaSiF_6$ Recovery with Reactant Ratio (BaF_2 / H_2SiF_6) at 80°C.

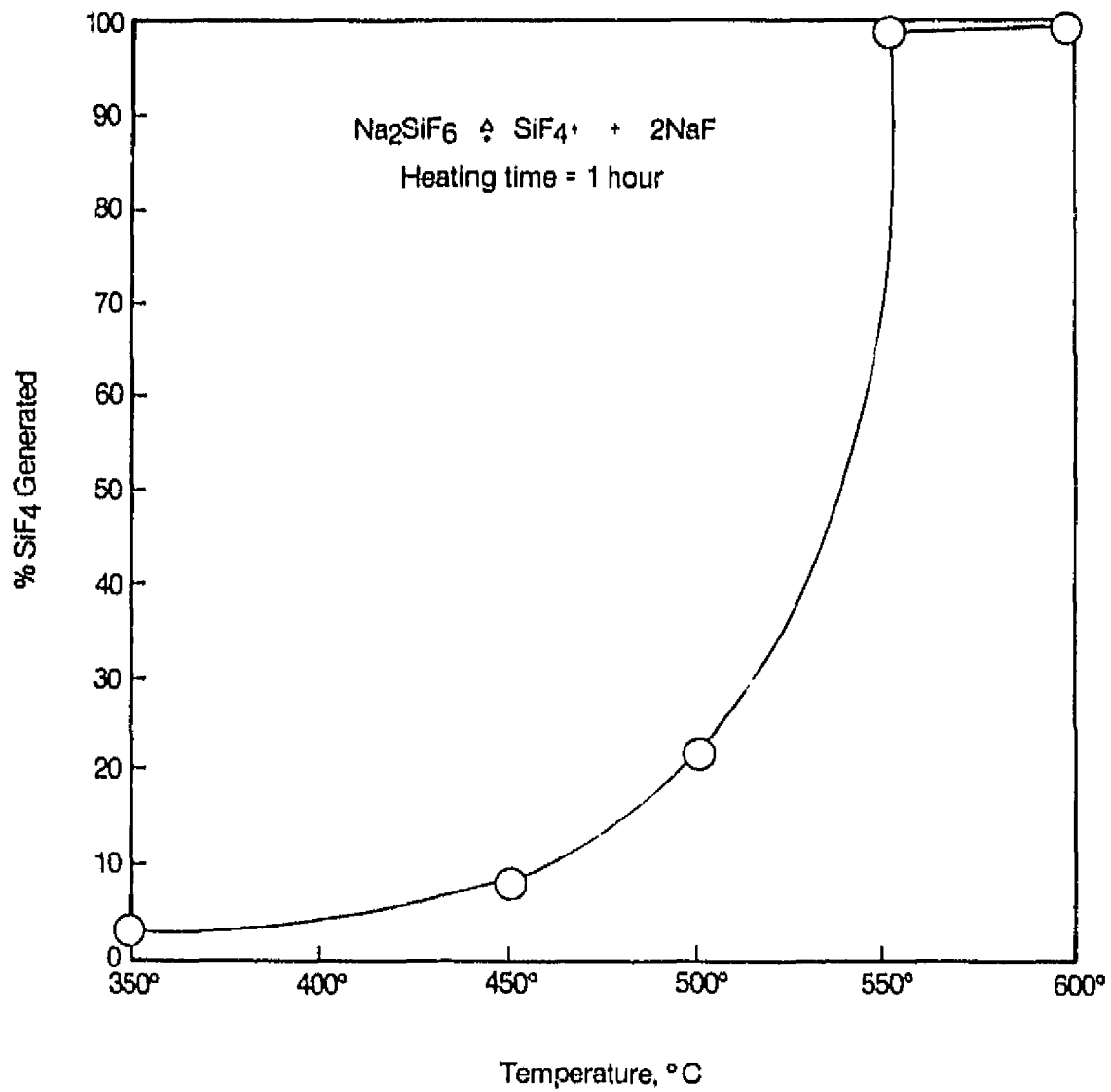

Figure 2.9-7 Variation of % SiF₄ Generated with Temperature

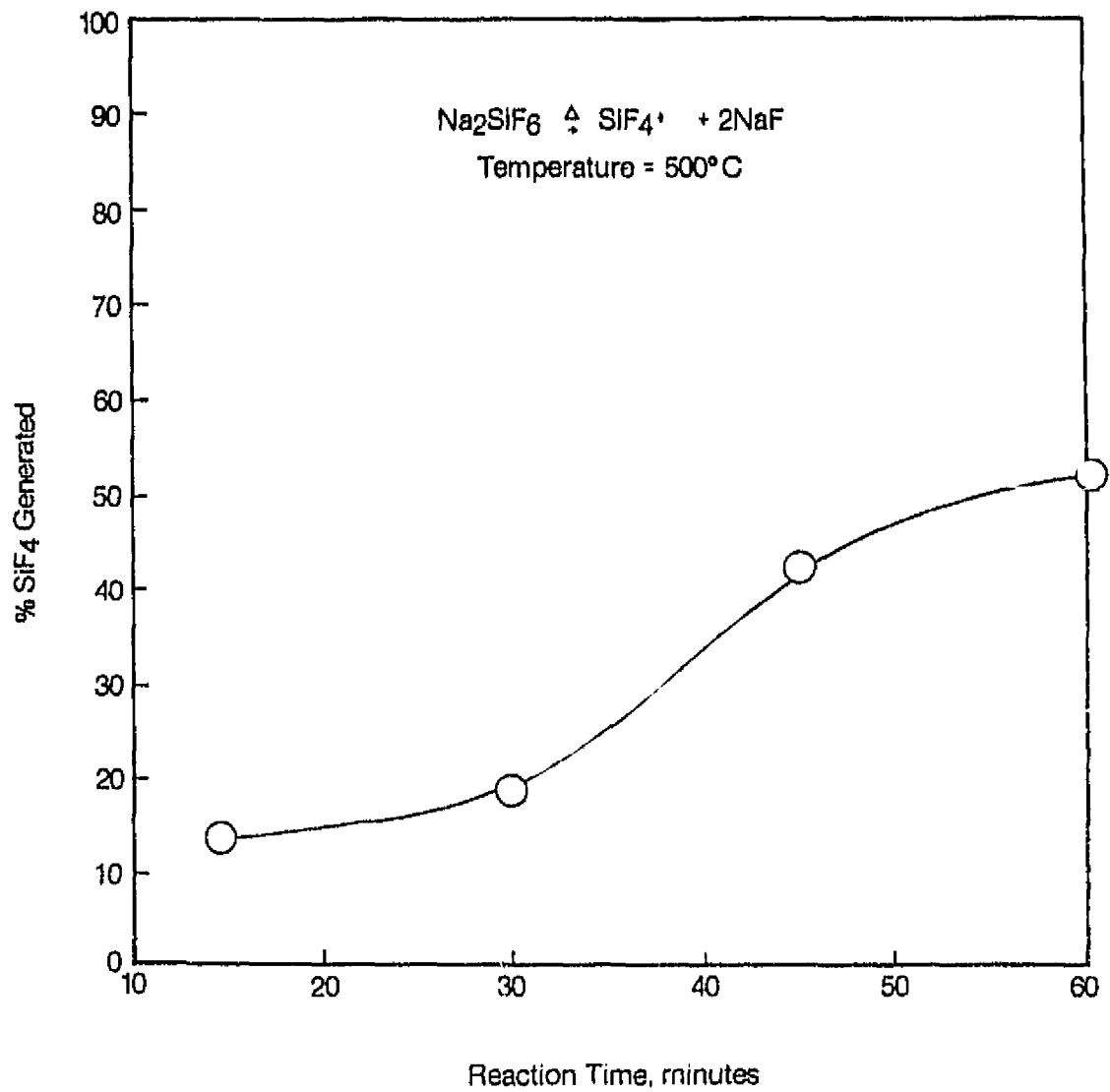

Figure 2.9-8 Variation of % SiF₄ Generated with Reaction Time

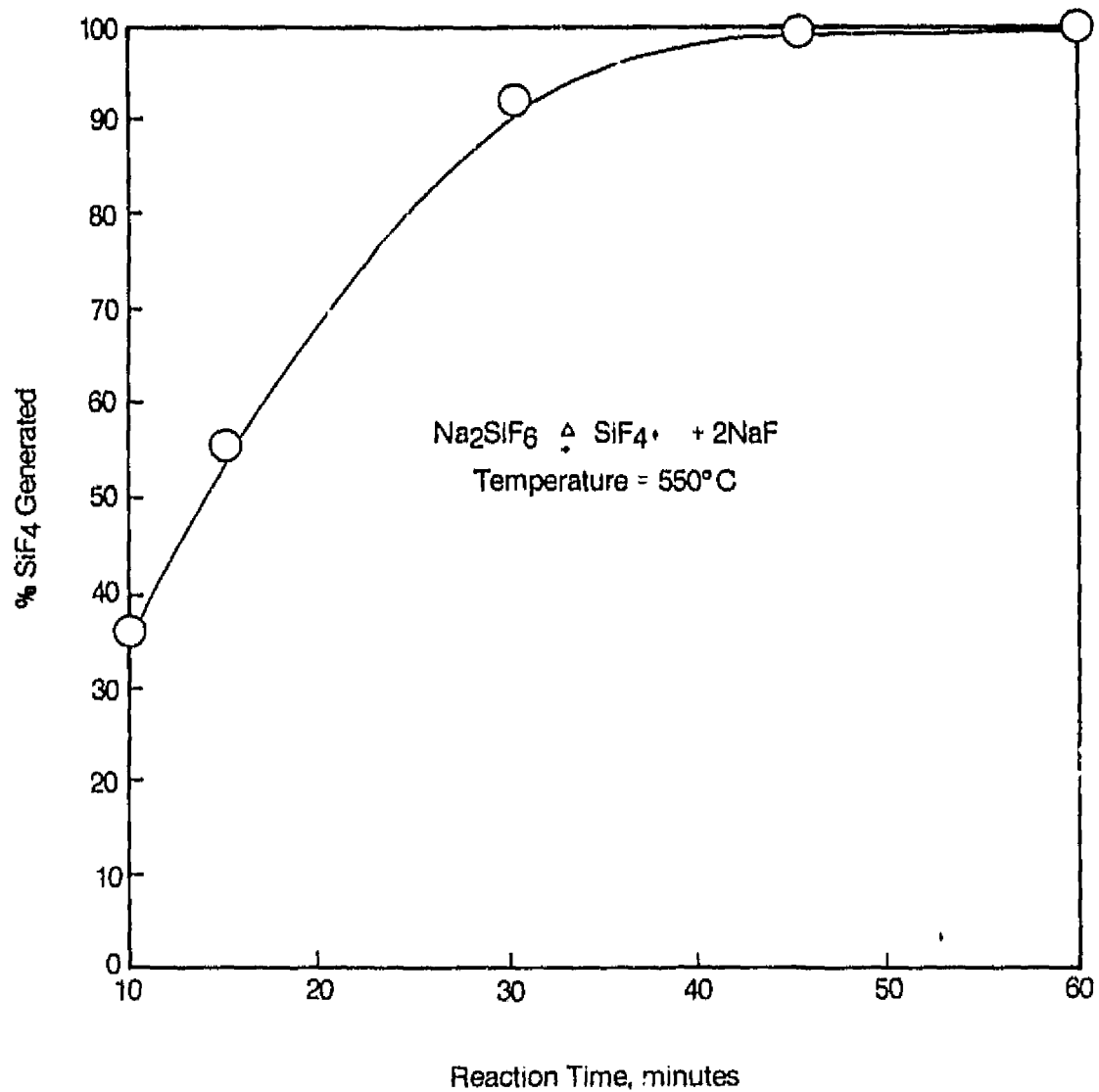

Figure 2.9-9 Variation of % SiF₄ Generated with Reaction Time

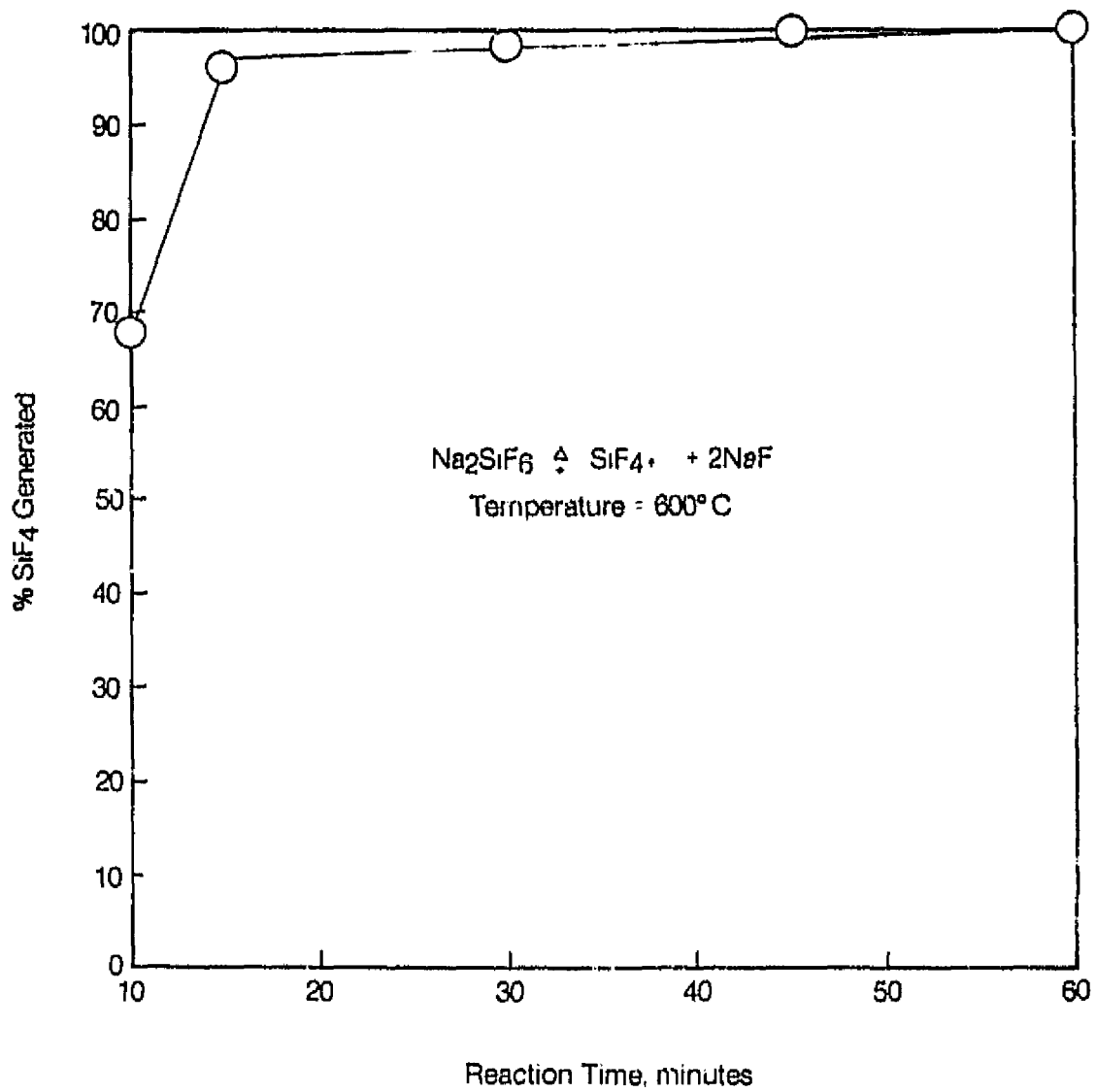

Figure 2.9-10 Variation of % SiF₄ Generated with Reaction Time

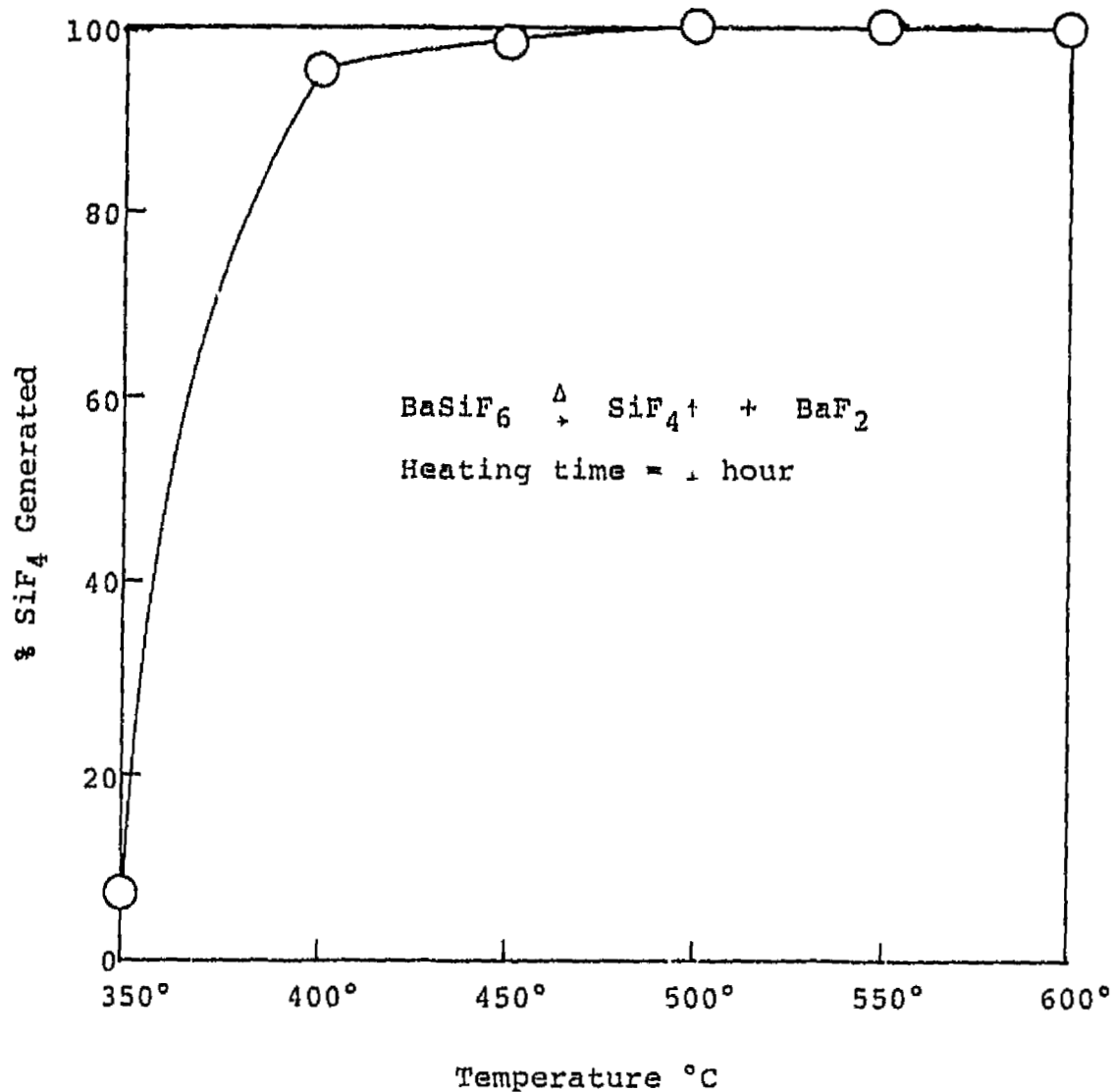

Figure 2.9-11 Variation of % SiF₄ Generated with Temperature

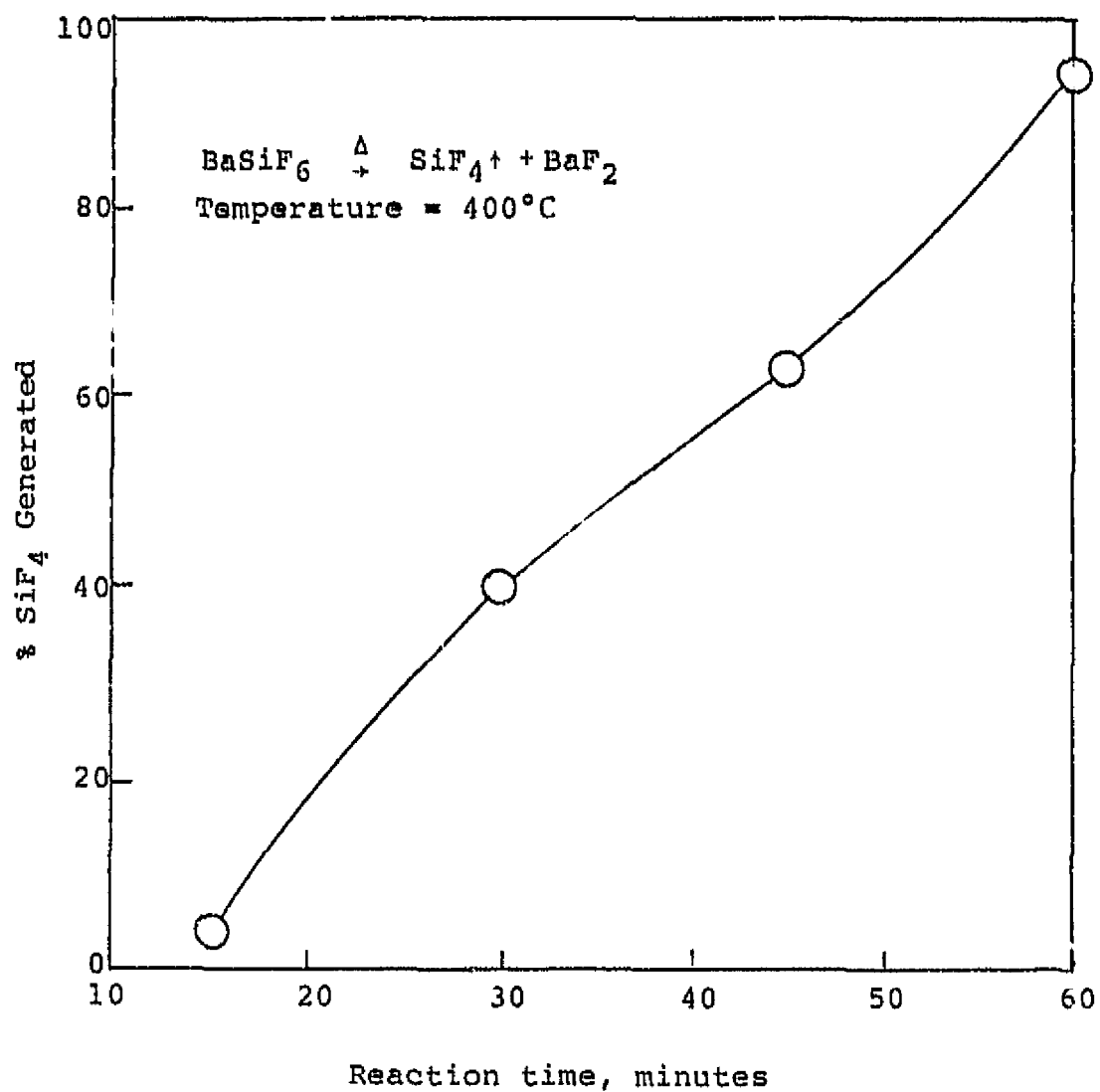

Figure 2.9-12 Variation of % SiF₄ Generated with Reaction Time

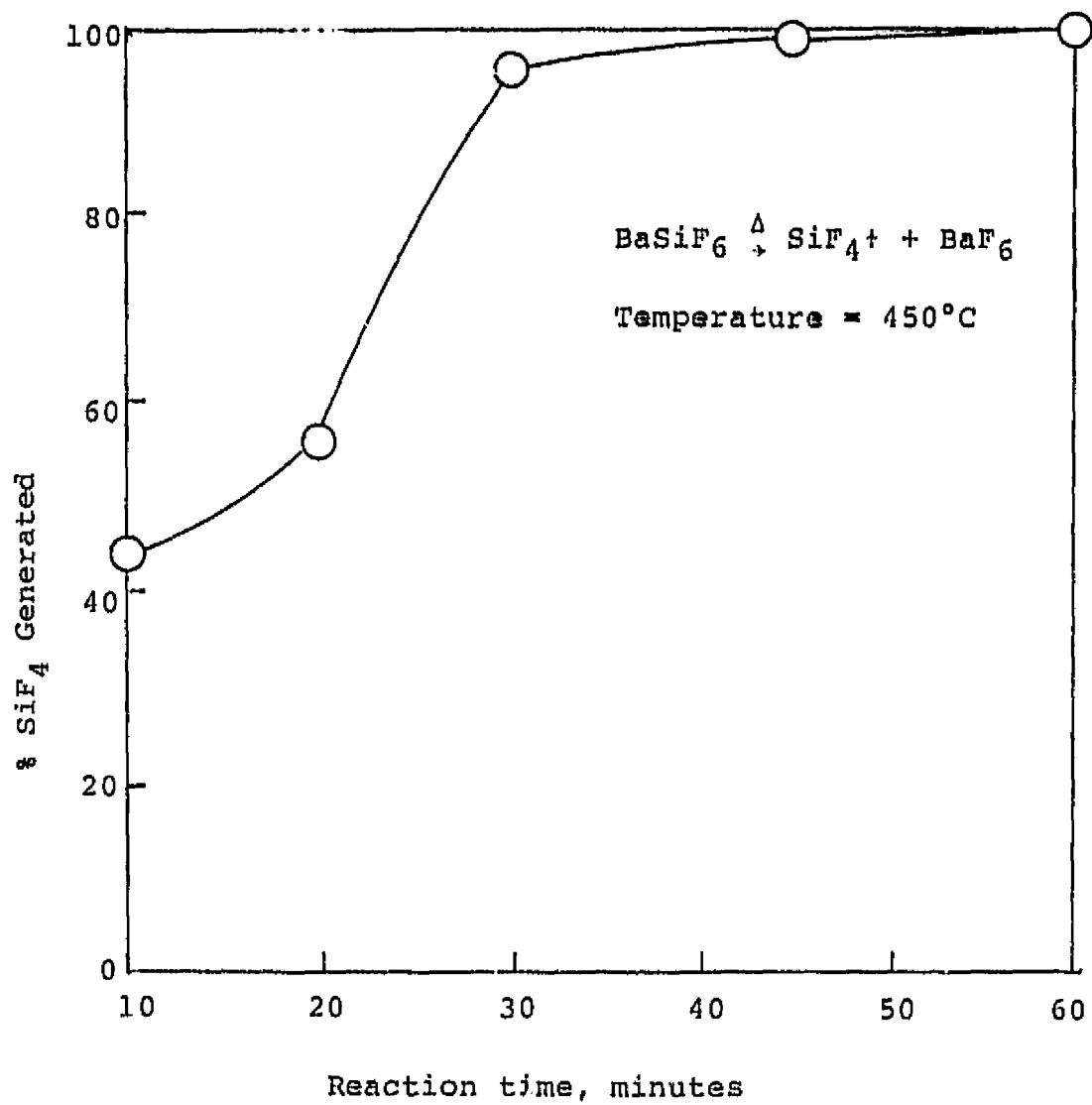

Figure 2.9-13 Variation of % SiF₄ Generated with Reaction Time

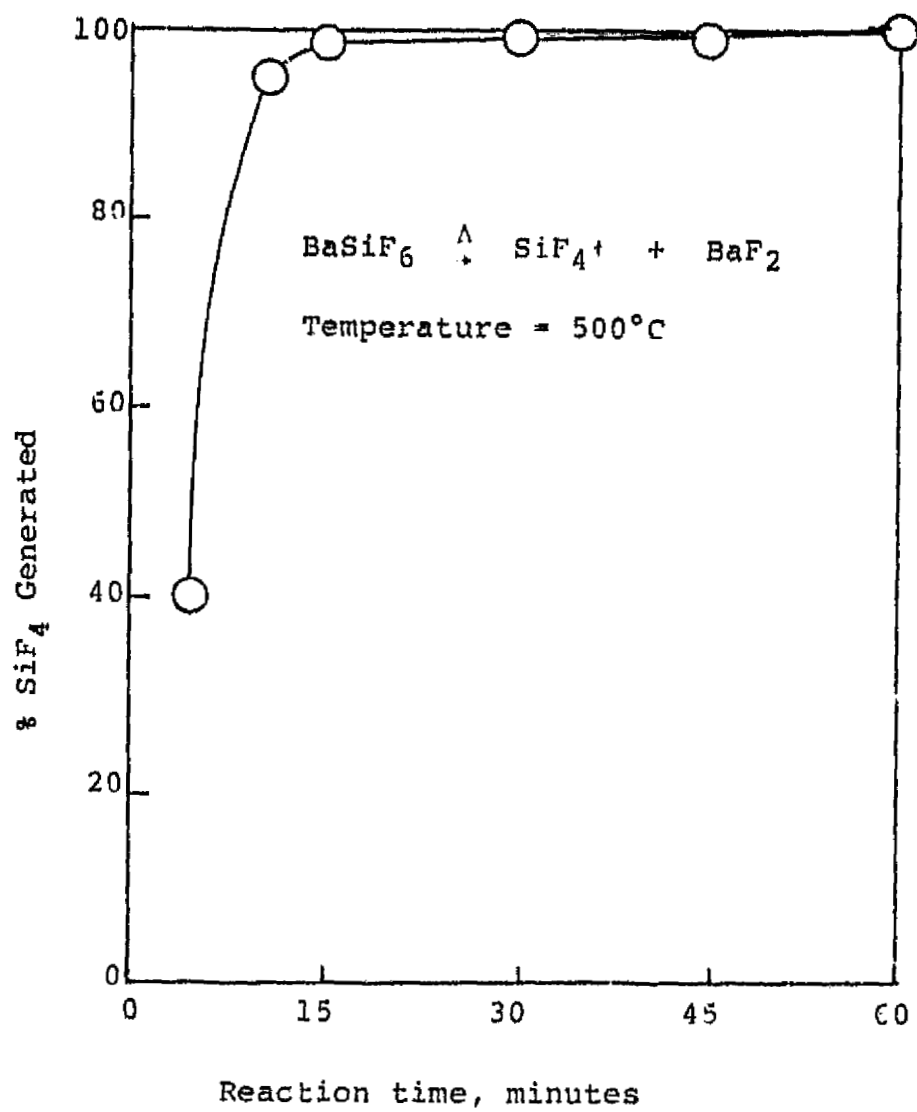

Figure 2.9-14 Variation of % SiF₄ Generated with Reaction Time

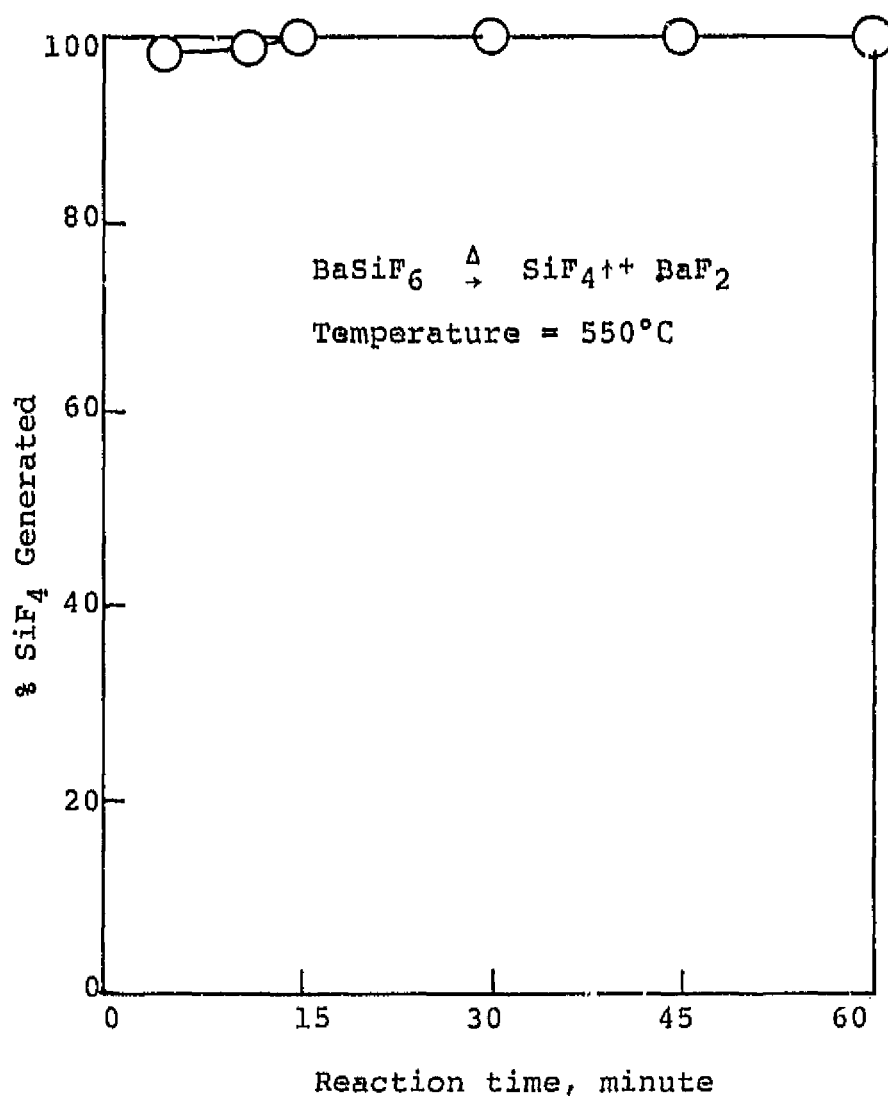

Figure 2.9-15 Variation of % SiF₄ Generated with Reaction Time

3. CHEMICAL ENGINEERING ANALYSES

3.1 SiI₄ Decomposition Process

The chemical engineering analysis activity involves a preliminary process design of a plant to produce silicon via the technology under consideration.

The process flow-diagram for the SiI₄ decomposition process is shown in Figure 3.1-1. This process⁴ involves several major processing operations such as fluidization, distillation, condensation, vaporization and deposition unit.

At the beginning of the process, metallurgical grade silicon (M.G. Si) is reacted with iodine (I₂) in a fluidized bed reactor (100°K) to produce silicon tetraiodide. This gas product is condensed and then purified by distillation process.

This purified SiI₄ is vaporized and introduced into a silicon rod reactor where silicon is deposited according to the following reaction



The reaction temperature is kept at 1300°K.

Unreacted SiI₄ and iodine are condensed and separated by distillation for recycle purpose.

A process design was performed to obtain data for the cost analysis. The design was based on a plant for the production of 1000 metric tons per year of polysilicon via this SiI₄ decomposition process.

The detailed status sheet for the process design package is shown in Table 3.1-1 and is representative of the various sub-items that make up the activity. The summarized results for the preliminary process design are presented in a tabular format to make it easier to locate items of specific interest. The guide for these tables is given below

Base Case Conditions-----	Table 3.1-2
Reaction chemistry-----	Table 3.1-3
Raw Material Requirements-----	Table 3.1-4
Utility Requirements-----	Table 3.1-5
Major Process Equipment-----	Table 3.1-6
Production Labor Requirements--	Table 3.1-7

The process design provides detailed data for raw materials, utilities, major process equipment and production labor requirements which are necessary for polysilicon production

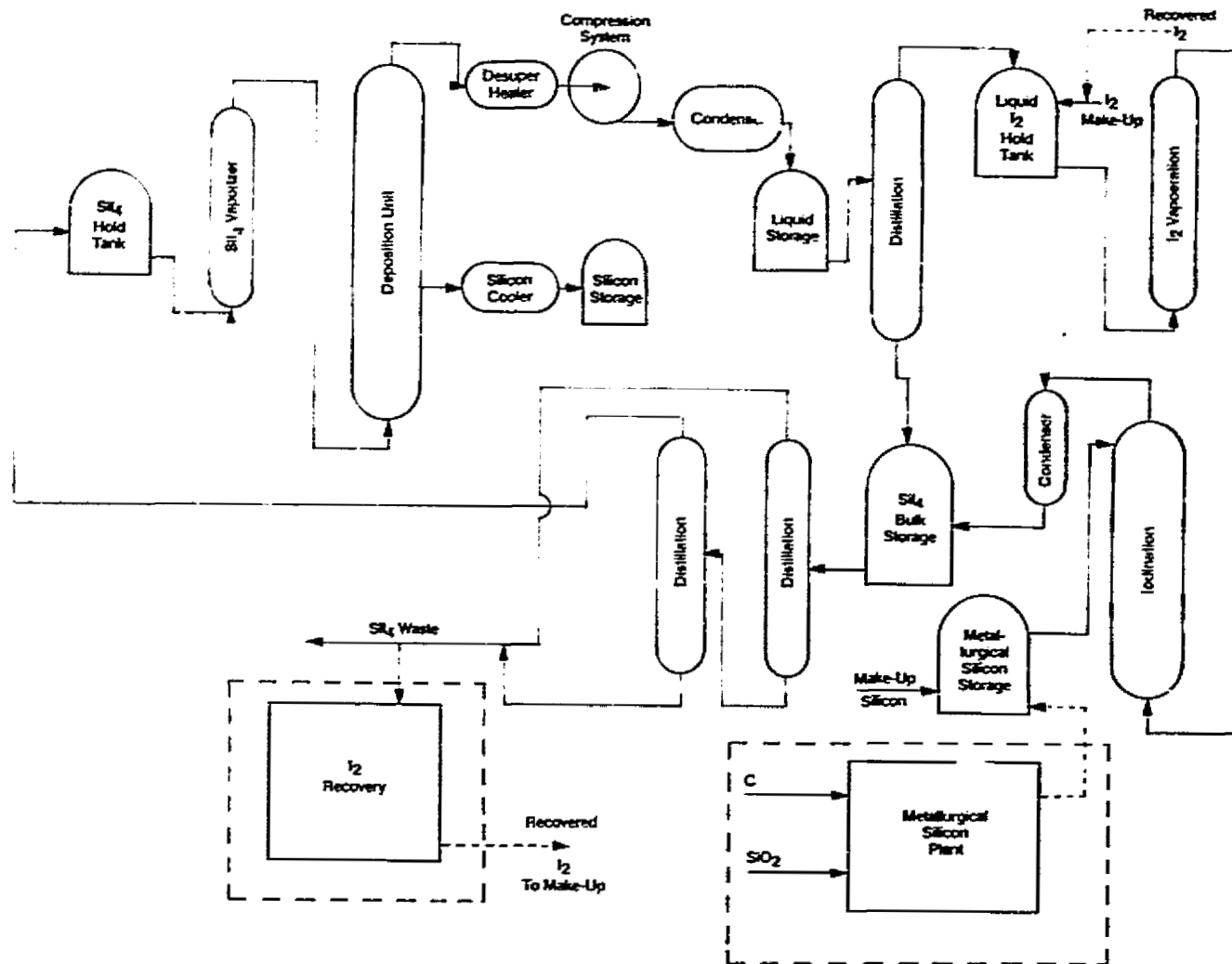

Figure 3.1-1 Process Flow Diagram for SiI_4 Decomposition Process (Battelle)

TABLE 3.1-1 CHEMICAL ENGINEERING ANALYSES:
PRELIMINARY PROCESS DESIGN ACTIVITIES FOR SiH_4 DECOMPOSITION PROCESS

<u>Prel. Process Design Activity</u>	<u>Status</u>	<u>Prel. Process Design Activity</u>	<u>Status</u>
1. Specify Base Case Conditions	●	7. Equipment Design Calculations	●
1. Plant Size	●	1. Storage Vessels	●
2. Product Specifics	●	2. Unit Operations Equipment	●
3. Additional Conditions	●	3. Process Data (P, T, rate, etc.)	●
2. Define Reaction Chemistry	●	4. Additional	●
1. Reactants, Products	●	8. List of Major Process Equipment	●
2. Equilibrium	●	1. Size	●
3. Process Flow Diagram	●	2. Type	●
1. Flow Sequence, Unit Operations	●	3. Materials of Construction	●
2. Process Conditions (T, P, etc.)	●	8a. Major Technical Factors	●
3. Environmental	●	(Potential Problem Areas)	●
4. Company Interaction	●	1. Materials Compatibility	●
(Technology Exchange)	●	2. Process Conditions Limitations	●
4. Material Balance Calculations	●	3. Additional	●
1. Raw Materials	●	9. Production Labor Requirements	●
2. Products	●	1. Process Technology	●
3. By-Products	●	2. Production Volume	●
5. Energy Balance Calculations	●	10. Forward for Economic Analysis	●
1. Heating	●		
2. Cooling	●		
3. Additional	●		
6. Property Data	●	○ Plan	
1. Physical	●	● In Progress	
2. Thermodynamic	●	● Complete	
3. Additional	●		

TABLE 3.1-2

BASE CASE CONDITIONS FOR SiI_4 DECOMPOSITION PROCESS

1. Plant Size
 - Production of 1000 metric tons/year
 - Solar Cell Grade Silicon
2. Iodination Reaction
 - Metallurgical grade silicon and iodine to produce SiI_4
 - Atmospheric, 1000°K
 - 100% conversion (thermodynamic equilibrium)
 - Fluidized bed
3. SiI_4 Purification
 - Recycled and manufactured SiI_4 distilled
 - 10% waste (5% light, 5% heavies)
 - 90% product (heartcut)
4. SiI_4 Decomposition
 - Silicon rod reactor, deposition
 - .001 ATM, 1300°K
 - 59.67% conversion (thermodynamic equilibrium)
5. SiI_4/I_2 Recycle
 - Separated by distillation
 - SiI_4 to purification and decomposition
 - I_2 to iodination
6. Operating Ratio
 - Approximately 80% utilization (79.3%)
 - Approximately 7000 hr/year production
7. Recovery of Waste SiI_4
 - Wet recovery of iodine from SiI_4 wastes
 - 90% recovery
 - \$.70/pound of I_2 recovery cost
 - Recycle I_2 to I_2 makeup
8. Storage Considerations
 - Feed materials (two week supply)
 - Product (two week supply)
 - Process (several days)

TABLE 3.1-3
REACTION CHEMISTRY FOR SiI_4 DECOMPOSITION PROCESS

1. Silicon Deposition

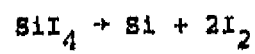

2. Iodination Reaction

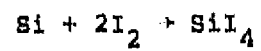

TABLE 3.1-4
RAW MATERIAL REQUIREMENTS FOR
SiI₄ DECOMPOSITION PROCESS

<u>Raw Material</u>	<u>Requirement lb/Kg of Silicon</u>
1. Metallurgical Grade Silicon	2.6194
2. Iodine	7.4954

TABLE 3.1-5
UTILITY REQUIREMENTS FOR
SiI₄ DECOMPOSITION PROCESS

<u>Utility/Function</u>	<u>K watt-hours/ Kg of Silicon Product*</u>
Heating and Cooling (10% losses)	27.55
Compressor Train	1.059
Radiant Losses from Deposition	<u>190.</u>
	218.61

* All utility requirements calculated as electricity. Actual useage would involve cooling water, steam, etc.

TABLE 3.1-6 LIST OF MAJOR PROCESS
EQUIPMENT FOR SiI₄ DECOMPOSITION PROCESS

<u>Item</u>	<u>Function</u>	<u>Duty</u>	<u>Size</u>	<u>Material</u>
1. Purified SiI ₄ Hold Tank	Storage of purified SiI ₄ feed to deposi- tion	One Week	6.254 x 10 ⁴ gallons	316 S.S.
2. Liquid Storage	Cooled overheads from deposition	One Week	5.6 x 10 ⁴ gallons	316 S.S.
3. Silicon Product Storage	Product for sales	Two Weeks	1.097 x 10 ⁴ gallons	C.S.
4. Liquid I ₂ Storage	I ₂ separated from SiI ₄	One Week	2.962 x 10 ⁴ gallons	316 S.S.
5. SiI ₄ Bulk Storage	SiI ₄ separated from I ₂	One Week	6.948 x 10 ⁴ gallons	316 S.S.
6. Metallurgical Silicon Storage	Raw material storage for manufacturing	Two Weeks	1.304 x 10 ⁴ gallons	C.S.
7. Feed Tank	Purification column 2 feed tank	Eight Hours	4.008 x 10 ³ gallons	316 S.S.
8. SiI ₄ Vaporizer	Vaporize SiI ₄ for deposition unit	+29.86 K cal/gmoles Si produced	121.5 ft ²	C.S. with Hastelloy tubes
9. Silicon Cooler	Cool product silicon for storage and ship- ment	-5.7 K cal/gmole Si	1D = 1.85 ft L = 5.67 ft	6 units - Graphite or Quartz
10. Deposition Condenser	Condense overheads for recycle	-37.146 K cal/gmoles Si	1510.8 ft ²	C.S. with Hastelloy tubes

TABLE 3.1-6 (Continued)

<u>Item</u>	<u>Function</u>	<u>Duty</u>	<u>Size</u>	<u>Material</u>
11. Separation Column Preheater	Preheat feed to bubble point for dist.	+3.289 K cal/gmole Si	22.3 ft ²	C.S. with Hastelloy tubes
12. Separation Column O/H Condenser	Provide liquid reflux to column	-36.66	216.2 ft ²	C.S. with Hastelloy tubes
13. Separation Column Calandria	Provide vapor rate to column	+42.86	210 ft ²	C.S. with Hastelloy tubes
14. Separation Column O/H After Cooler	Cool I ₂ at B.P. to 130°C for storage	- 2.1	14.74 ft ²	C.S. with Hastelloy tubes
15. I ₂ Vaporizer	Vaporize I ₂ for iodination unit	+26.91	113 ft ²	C.S. with Hastelloy tubes
16. Iodination O/H Condenser	Condense bulk SiI ₄ vapors from iodina- tion	-33.85	1377.42 ft ²	C.S. with Hastelloy tubes
17. Separation Column Bottoms After Cooler	Cool SiI ₄ at B.P. to 150°C for storage	- 4.2	28.48 ft ²	C.S. with Hastelloy tubes
18. Tet Purification Preheater	Bring SiI ₄ to bubble point for distillation	+11.41	77.38 ft ²	C.S. with Hastelloy tubes
19. Purification Column 1 O/H Condenser	Provide reflux for operation of column	-54.42	221 ft ²	C.S. with Hastelloy tubes
20. Purification Column 1 Calandria	Provide vapor for column operation	54.42	221 ft ²	C.S. with Hastelloy tubes
21. Purification Column 2 O/H Condenser	Provide reflux for operation of column	-52.24	212 ft ²	C.S. with Hastelloy tubes

TABLE 3.1-6 (Continued)

<u>Item</u>	<u>Function</u>	<u>Duty</u>	<u>Size</u>	<u>Material</u>
22. Purification Column 2 Calandria	Provide vapor for operation of column	52.24 K cal/gmole Si	212 ft ²	C.S. with Hastelloy tubes
23. Purification After Cooler	Cool purified SiI ₄ to 150°C for storage	-10.27	69.7 ft ²	C.S. with Hastelloy tubes
24. De-superheater	Cool for compression	-24.03	163 ft ² each	6 units - Quartz or Graphite
25. Purified SiI ₄ Pump	Feed to SiI ₄ vaporizer	6.2 gpm	100 ft of head	316 S.S.
26. Deposition Com- pressor(s)	Return deposition gases to atmospheric pressure	-23.03 K cal/gmole 4.155 x 10 ⁵ ft ³ /min	184.1 horsepower	316 S.S.
27. I ₂ /SiI ₄ Liquid Pump	Pump to I ₂ /SiI ₄ separa- tion	5.56 gpm	100 ft of head	316 S.S.
28. I ₂ /SiI ₄ Separation Column Over- heads Pump	Pump O/H I ₂ for reflux and storage	5.66 gpm	100 ft	316 S.S.
29. I ₂ /SiI ₄ Separation Column Bottoms Pump	Pump bottoms for reboil and SiI ₄ storage	19.48 gpm	150 ft	316 S.S.
30. I ₂ Pump	Pump liquid I ₂ through vaporization and iodina- tion	3.84 gpm	150 ft	316 S.S.
31. SiI ₄ Pump	Pump liquid SiI ₄ to purification	6.89 gpm	100 ft	316 S.S.
32. Tet Purification Column 1 O/H Pump	Pump O/H to reflux and waste	19.75 gpm	100 ft	316 S.S.

TABLE 3.1-6 (Continued)

<u>Item</u>	<u>Function</u>	<u>Duty</u>	<u>Size</u>	<u>Material</u>
33. Tet Purification Column 1 Bottoms Pump	Pump bottoms for reboil and remove product	27.25 gpm	150 ft	316 S.S.
34. Tet Purification Column 2 Feed Pump	Feed to Column 2	1.504 gpm	50 ft	316 S.S.
35. Tet Purification Column 2 O/H Pump	Pump for reflux and to purified stage	18.47 gpm	100 ft	316 S.S.
36. Tet Purification Column 2 Bottoms Pump	Pump bottoms for reboil and waste	19.35 gpm	150 ft	316 S.S.
37. Deposition Unit	Produce Si from $\text{SiI}_4 + \text{Si} + 2\text{I}_2$	144 Kg of Si/hour + 89.82 K cal/gmole Si	6 at 1018 ft ² each	Quartz
38. Iodination Reactor	Produce SiI_4 from met grade Si. $\text{Si} + 2\text{I}_2 \rightarrow \text{SiI}_4$	3263.25 Kg/hr of raw SiI_4 , -44.93 K cal/gmoles	23 inch ID by 10 ft tall	Graphite
39. I_2/SiI_4 Distillation Column	Separate I_2 from SiI_4 for recycle	Separate 1903.36 Kg/hr SiI_4 + 2602.61 Kg/hr I_2	20 ft by 23 inch ID	316 S.S.
40. Purification Column 1	Purify SiI_4 by 5% cut off top to waste	Feed rate 5166.61 Kg/hr SiI_4	47.6 ft by 26.5 inch ID	316 S.S.
41. Purification Column 2	Purify SiI_4 by 5% cut off bottom to waste	Feed rate 4908.28 Kg/hr SiI_4	23.8 ft by 26 inch ID	316 S.S.

TABLE 3.1-7 PRODUCTION LABOR REQUIREMENTS
OF SiI_4 DECOMPOSITION PROCESS

<u>Unit Operation</u>	<u>Type</u>	<u>Skilled Man Hrs/Day Unit</u>	<u>Semiskilled Man Hrs/Day Unit</u>
1. Vaporization	B	23	
2. Deposition Unit	A	36	
3. Compression System	B	23	
4. Vapor Condensation	B	23	
5. I_2/SiI_4 Distillation	C	16	
6. Iodination	B	23	
7. Tet Purification	C	16	
8. Materials Handling	A		36
9. Product Handling	A		<u>36</u>
		160	72

Skilled: .0584 Man-hrs/KgSi

Semiskilled: .0263 Man-hrs/KgSi

TOTAL .0847 Man-hrs/KgSi

NOTES

1. A Batch Process or Multiple Small Units
B Average Process
C Automated Process

2. Manhours/Day Unit from Figure 4-6, Peters & Timmerhaus (7).

3.2 Conventional Process for Polysilicon (Siemens Technology)

The chemical engineering analysis activity involves a preliminary process design of a plant to produce polysilicon through the conventional process (Siemens Technology).

The process flowsheet for the conventional polysilicon process, consisting of several major processing operations of hydrochlorination, condensation, distillation and chemical vapor deposition, is shown in Figure 3.2-1.

Initially, metallurgical grade silicon (MGSi) is reacted with anhydrous hydrogen chloride (HCl) in a fluidized bed (550-650°K) to produce a mixture of chlorosilanes, which is primarily trichlorosilane (TCS) and silicon tetrachloride (TET). Since the reactions are highly exothermic, heat transfer for removal of heat of reaction is required to maintain reaction temperature control. The mixture of chlorosilanes from the reaction is condensed and subjected to a several stage distillation to separate by-products and remove impurities.

The purified TCS is reacted with hydrogen (H₂) in a rod reactor to obtain polysilicon deposition via the representative reaction:

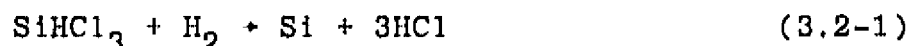

The deposition reaction occurs on the surface of a hot rod (1000-1100°C) which is heated by passage of electrical current through the rod. Large electrical energy requirements are necessary because of the endothermic reaction, radiation heat losses and incomplete conversion of the TCS. Unreacted chlorosilanes and hydrogen are separated and recycled. Silicon tetrachloride is not recycled.

A process design was performed to obtain data for the cost analysis. The design was based on a plant for the production of 1000 metric tons per year of semiconductor grade polysilicon via the conventional Siemens process.

The detailed status sheet for the process design package is shown in Table 3.2-1 and is representative of the various sub-items that make up the activity. The summarized results for the preliminary process design are presented in a tabular format to make it easier to locate items of specific interest. The guide for these tables is given below:

- Base Case Conditions-----Table 3.2-2
- Reaction chemistry-----Table 3.2-3
- Raw Material Requirements-----Table 3.2-4
- Utility Requirements-----Table 3.2-5
- Major Process Equipment-----Table 3.2-6
- Production Labor Requirements----Table 3.2-7

The process design provides detailed data for raw materials, utilities, major process equipment and production labor requirements which are necessary for polysilicon production.

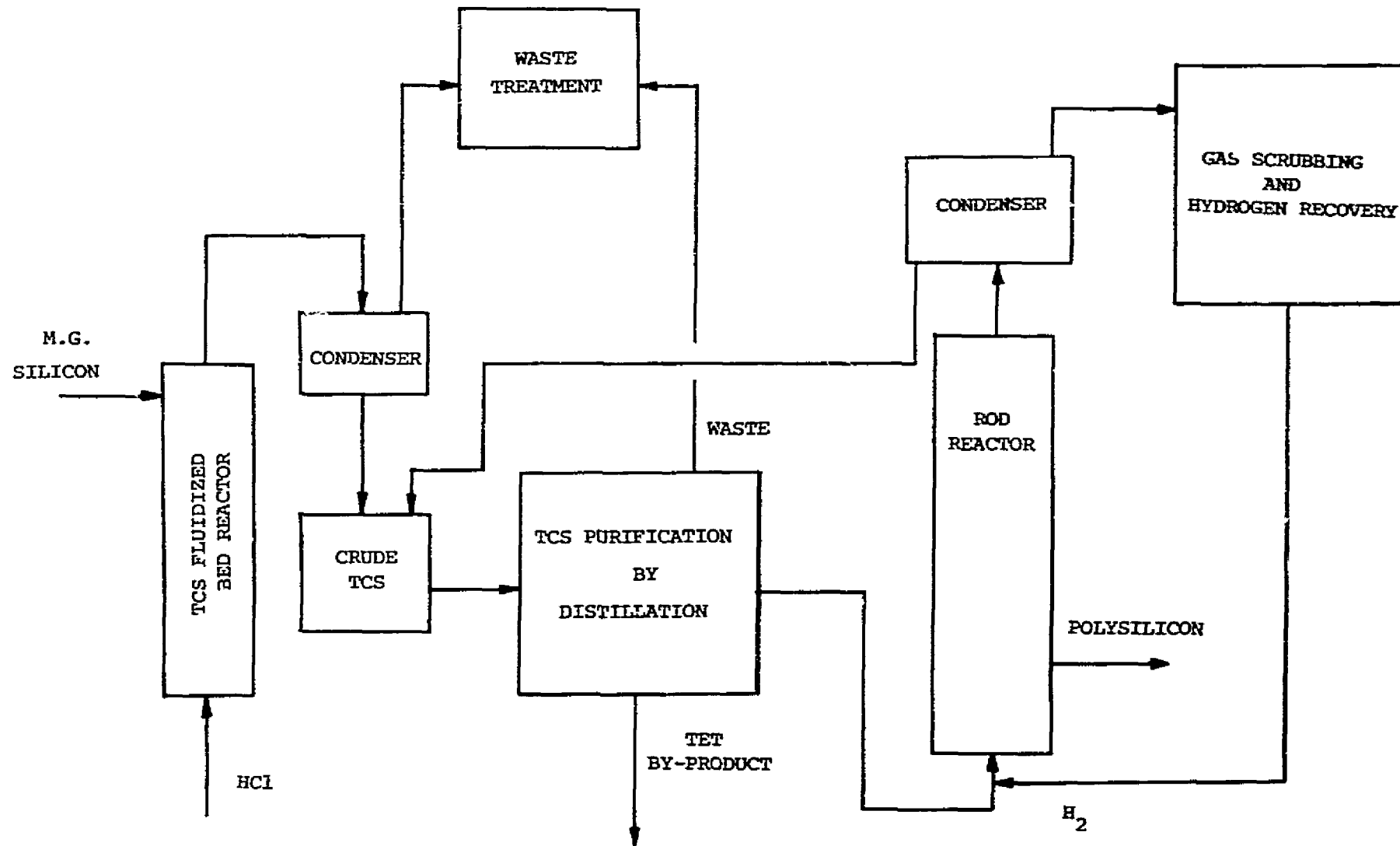

Figure 3.2-1 Preliminary Process Flowsheet for Conventional Polysilicon Process

TABLE 3.2-1 CHEMICAL ENGINEERING ANALYSES:
PRELIMINARY PROCESS DESIGN ACTIVITIES FOR CONVENTIONAL POLYSILICON PROCESS

<u>Prel. Process Design Activity</u>	<u>Status</u>	<u>Prel. Process Design Activity</u>	<u>Status</u>
1. Specify Base Case Conditions	●	7. Equipment Design Calculations	●
1. Plant Size	●	1. Storage Vessels	●
2. Product Specifics	●	2. Unit Operations Equipment	●
3. Additional Conditions	●	3. Process Data (P, T, rate, etc.)	●
2. Define Reaction Chemistry	●	4. Additional	●
1. Reactants, Products	●	8. List of Major Process Equipment	●
2. Equilibrium	●	1. Size	●
3. Process Flow Diagram	●	2. Type	●
1. Flow Sequence, Unit Operations	●	3. Materials of Construction	●
2. Process Conditions (T, P, etc.)	●	8a. Major Technical Factors	●
3. Environmental	●	(Potential Problem Areas)	●
4. Company Interaction	●	1. Materials Compatibility	●
(Technology Exchange)	●	2. Process Conditions Limitations	●
4. Material Balance Calculations	●	3. Additional	●
1. Raw Materials	●	9. Production Labor Requirements	●
2. Products	●	1. Process Technology	●
3. By-Products	●	2. Production Volume	●
5. Energy Balance Calculations	●	10. Forward for Economic Analysis	●
1. Heating	●		
2. Cooling	●	○ Plan	
3. Additional	●	● In Progress	
6. Property Data	●	● Complete	
1. Physical	●		
2. Thermodynamic	●		
3. Additional	●		

TABLE 3.2-2
BASE CASE CONDITIONS FOR CONVENTIONAL POLYSILICON PROCESS

1. Plant Size
 - 1000 metric tons per year
 - Semiconductor grade silicon

2. Production of TCS
 - Fluidized Bed, 600^oK, low pressure (65 PSIA)
 - Metallurgical grade silicon plus HCl gas
 - Chlorosilane content in condensed reactor gas by moles (ref. 32)
 - 91.5% TCS (SiCl₃H)
 - 5.2% TET (SiCl₃H₂)
 - 1.4% DCS (SiCl₂H₂)
 - 1.9% Heavies
 - Slight excess HCl in reactor gas (1%)
 - Hydrogen burned

3. TCS Purification (ref. 31)
 - Distillation
 - 5% lights to waste (5% of TCS & TET)
 - Separate TCS and TET
 - 5% heavies from TCS & TET to waste
 - TET for by-product sales
 - TCS to rod reactor

4. Silicon Production
 - Rod reactor at 1050^oC, 20 PSIA
 - Hydrogen to reduce TCS
 - Entering gas analysis
 - 10% TCS
 - 90% H₂
 - 8.17 moles TCS in/mole of Si; production in an operating reactor
 - Exit gas analysis (ref. 20)
 - 4.339% TET
 - 4.457% TCS
 - .089% DCS
 - 2.197% HCl
 - 88.92% H₂

5. Waste Treatment
 - Light and heavy cuts from distillation to waste treatment
 - Vapors from TCS reactor condenser to scrubber
 - Vapor from rod reactor to scrubber
 - All waste streams neutralized with NaOH

TABLE 3.2-2 (Continued)

6. Recycles
 - H₂ from rod reactor dried and returned, 5% losses
 - Chlorosilanes from rod reactor condensed off gas recycled to purification (distillation)
7. Operating Ratio
 - Approximately 90% utilization
 - Approximately 7880 hour/year production
8. Storage Considerations
 - Feed materials (two week supply)
 - Product (two week supply)
 - Process (several days)
9. Filament Pullers
 - Pull rate of 50-100 inches/hour
 - Average of 72 inches/hour used
 - 1/4" Filaments for silicon deposition needed

TABLE 3.2-3

REACTION CHEMISTRY FOR CONVENTIONAL POLYSILICON PROCESSES

1. TCS Reactor

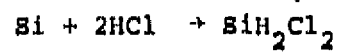
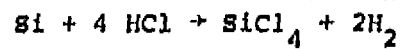
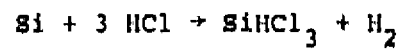

2. Rod Reactor

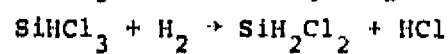
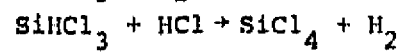
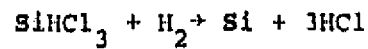

3. Waste Treatment

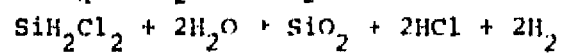
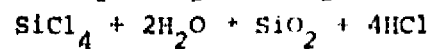
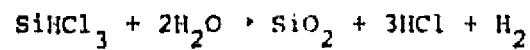

TABLE 3.2-4
 RAW MATERIAL REQUIREMENTS FOR
 CONVENTIONAL POLYSILICON PROCESS

<u>Raw Material</u>	<u>Requirement lb/Kg of Silicon</u>
1. M. G. Silicon	6.72 Kg/Kg
2. Anhydrous HCl	57.96
3. Hydrogen	.828
4. Caustic (50% NaOH)	53.29
5. SiCl ₄ (By Product)	46.12

TABLE 3.2-5

UTILITY REQUIREMENTS FOR
CONVENTIONAL POLYSILICON PROCESS

<u>UTILITY/FUNCTION</u>	<u>REQUIREMENTS/Kg OF SILICON PRODUCT</u>
1. Electricity	384.62 Kw-Hr
1. All pump motors (16 motors)	(.339)
2. 2 compressor motors	(9.243)
3. Polysilicon Rod Reactor	(375)
4. Filament Pullers	(.0244)
2. Steam (250 PSIA)	152 Pounds
1. HCl Vaporizer	(7.07)
2. Caustic Storage Tank	(1.82)
3. #1 Scrubber Vapor Heater	(.276)
4. #1 Distillation Column Calandria	(38.75)
5. #2 Distillation Column Calandria	(47.73)
6. #3 Distillation Column Calandria	(25.24)
7. TCS Vaporizer	(10.79)
8. #2 Scrubber Vapor Heater	(3.4)
9. Liquid Recycle Heater	(5.52)
10. #4 Distillation Column Calandria	(11.3)
11. Rod Reactor	(-1287 generated)
3. Cooling Water	984.5 Gallons
1. TCS Reactor Off Gas Cooler	(13.91)
2. Rod Reactor Off Gas Cooler	(334)
3. #4 Distillation Column Condenser	(37.24)
4. Polysilicon Rod Reactor Cooling End Plates	(473)
5. TCS Reactor Off Gas Compressor	(11.12)
6. Rod Reactor Off Gas Compressor	(115.2)
4. Process Water	320.9 Gallons
1. #2 Gas Scrubber	(31.36)
2. #1 Gas Scrubber	(134.82)
3. To Make Steam In Cooling Rod Reactor Side Walls	(154.7)
5. Refrigerant (-40°F)	42.1 M BTU
1. TCS Reactor Off Gas Condenser	(12.57)
2. Rod Reactor Off Gas Condenser	(29.52)
6. Refrigerant (34°F)	92.3 M BTU
1. #1 Distillation Column Condenser	(34)
2. #2 Distillation Column Condenser	(37.4)
3. #3 Distillation Column Condenser	(20.85)
7. High Temperature Heat Exchange Fluid	582 Pounds
1. TCS Fluidized Bed Reactor	(581)
2. Nitrogen Heater	(0.61)
8. Nitrogen	349.1 SCF
1. Molecular Sieves	(328.5)
2. Polysilicon Rod Reactor Purge	(20.64)

TABLE 3.2-6
LIST OF MAJOR PROCESS
EQUIPMENT FOR CONVENTIONAL POLYSILICON PROCESS

	<u>Type</u>	<u>Function</u>	<u>Duty</u>	<u>Size</u>	<u>Materials of Construction</u>
1.	(T1) M.G. Silicon Storage Hopper	Raw Material Storage	2 Weeks Storage	6.5×10^4 gallons	CS
2.	(T2) Liquid HCl Storage Tank	Raw Material Storage	2 Weeks Storage	2.5×10^5 gallons 250 PSIA	Nickel Steel
3.	(T3) Crude TCS Hold Tanks (3)	Feed for Purification	1 Week Storage	2.77×10^5 gallons (each)	CS
4.	(T4) Waste Hold Tank	Feed For Waste Treatment	1 Week Storage	3.025×10^4 gallons	CS
5.	(T5) TCS Reactor Off Gas Flash Tank	Phase Separation		1 ft. in diameter by 4 ft. tall, 300 PSIA	SS
6.	(T6) Hydrogen Storage Tank	Make-up For Losses	8 Hours Backup for Pipeline Failure	7.24×10^4 gallons Spherical 250 PSIA	CS
7.	(T7) Polysilicon Storage Space	Final Product Storage	2 Weeks Storage	1300 ft. ³ of space	CS
8.	(T8) TET Storage Tanks (2)	Final By-product Storage	2 Weeks Storage	1.62×10^5 Gallons (each)	CS
9.	(T9) TET Feed Tanks (2)	Feed for Distillation Column #4	1 Week Storage	8.83×10^4 Gallons (each)	CS
10.	(T10) TCS Feed Tanks (3)	Feed for Distillation Column #3	1 Day Storage	2.47×10^4 Gallons (each)	CS
11.	(T11) TCS Storage Tanks (3)	Purified TCS Hold-Up Feed to Rod Reactor	1 Week Storage	1.64×10^5 Gallons (each)	CS
12.	(T12) TET/TCS Feed Tanks (3)	Feed for Distillation Column #2	1 Day Storage	3.75×10^4 Gallons (each)	CS

TABLE 3.2-6 (continued)

13. (T13)	Caustic Storage Tank	Raw Material Storage	2 Week Storage 1.91×10^5 BTU/HR	1.92×10^5 Gallons	SS
14. (T14)	#1 Distillation Condenser Flash Tank	Phase Separation		1 Ft. in Diameter by 4 Feet Tall	CS
15. (T15)	Rod Reactor Off Gas Flash Tank	Phase Separation		1 Ft. in Diameter by 4 Feet Tall 300 PSIA	SS
16. (H1)	HCl Vaporizer	Vaporize Feed To TCS Reactor	7.5×10^5 BTU/HR	38.29 Ft. ² 250 PSIA Shell	SS/SS
17. (H2)	TCS Reactor Off Gas Cooler	Cool Reaction Gas	4.4×10^5 BTU/HR	224 Ft. ² 65 PSIA Tubes	CS/SS
18. (H3)	TCS Reactor Off Gas Condenser	Condense Reaction Gas	1.6×10^6 BTU/HR	1423 Ft. ² 300 PSIA Tubes	SS/SS
19. (H4)	#1 Scrubber Vapor Heater	Heat Vapor Wastes to 40°F for Scrubbing	3×10^4 BTU/HR	15.7 Ft. ² 250 PSIA Shell	CS/SS
20. (H5)	#1 Distillation Column Condenser	Condense Overheads for Relux	4.31×10^6 BTU/HR	1540 Ft. ²	CS/SS
21. (H6)	#1 Distillation Column Calandria	Reboiler for Column #1	4×10^6 BTU/HR	311. Ft. ² 250 PSIA Shell	CS/SS
22. (H7)	#2 Distillation Column Condenser	Condense Overheads For Reflux	4.7×10^6 BTU/HR	1555 Ft. ²	CS/CS
23. (H8)	#2 Distillation Column Calandria	Reboiler for Column #2	5×10^6 BTU/HR	402.4 Ft. ² 250 PSIA Shell	CS/SS
24. (H9)	#3 Distillation Column Condenser	Condense Overheads for Reflux	2.64×10^6 BTU/HR	867 Ft. ²	CS/CS

TABLE 3.2-6 (continued)

25. (H10)	#3 Distillation Column Calandria	Reboiler for Column #3	2.64×10^6 BTU/Hr	173 Ft. ² 250 PSIA Shell	CS/SS
26. (H11)	TCS Vaporizer	Vaporize Feed To Rod Reactor	1.13×10^6 BTU/Hr	3 Ft. ² 250 PSIA Shell	CS/CS
27. (H12)	Rod Reactor Off Gas Cooler	Cool Reaction Gas	1.06×10^7 BTU/Hr	2519 Ft. ² 20 PSIA	CS/SS
28. (H13)	Rod Reactor Off Gas Condenser	Condense Reaction Gas	3.74×10^6 BTU/Hr	3341 Ft. ² 300 PSIA Tubes	SS/SS
29. (H14)	#2 Scrubber Vapor Heater	Heat Vapor Wastes to 40°F for Scrubbing	3.56×10^5 BTU/Hr	180 Ft. ² 250 PSIA Shell	CS/SS
30. (H15)	Liquid Recycle Heater	Heat Cold Recycle Liquid (Crude TCS) to 80°F for Storage	5.79×10^5 BTU/Hr	30.6 Ft. ² 250 PSIA Shell	SS/SS
31. (H16)	#4 Distillation Column Condenser	Condenser Overheads for Reflux	1.18×10^6 BTU/Hr	513 Ft. ²	CS/CS
32. (H17)	#4 Distillation Column Calandria	Reboiler for Column #4	1.18×10^6 BTU/Hr	95 Ft. ² 250 PSIA Shell	CS/SS
33. (H18)	Nitrogen Heater	Heat Regenerator Gas for Molecular Sieves	2.46×10^4 BTU/Hr	44.8 Ft. ²	CS/CS
34. (P1)	TCS Reactor Off Gas Compressor	Compress Reaction Gas For Condensation	3.52×10^5 BTU/Hr	138.2 Horsepower	CS
35. (P2)	Caustic Supply Pump	Supply Caustic for Waste Neutralization and Gas Scrubbers		9 gpm 100 Ft. of Head	SS
36. (P3)	#1 Distillation Column Overheads Pump	Supply Reflux and Remove Waste to Waste Hold Tank		62.2 gpm 100 Ft. of Head	CS*

TABLE 3.2-6 (continued)

	37. (P4)	#1 Distillation Column Calandria Pump	Forced Convection Pump		93 gpm 150 Ft. of Head	CS*
	38. (P5)	TET/TCS Feed Pump	Feed #2 Distillation Column		26.1 gpm 100 Ft. of Head	CS*
	39. (P6)	#2 Distillation Column Overheads Pump	Supply Reflux, Pump Overhead to TCS Feed Tank		70 gpm 100 Ft. of Head	CS*
	40. (P7)	TCS Feed Pump	Feed #3 Distillation Column		21 gpm 100 Ft. of Head	CS*
	41. (P8)	#2 Distillation Column Calandria Pump	Forced Convection Pump		104 gpm 150 Ft. of Head	CS*
218	42. (P9)	#3 Distillation Column Overhead Pump	Supply Reflux Pump Overheads to TCS Storage Tank		39 gpm 100 Ft. of Head	CS*
	43. (P10)	Rod Reactor TCS Feed Pump	Feed TCS to Rod Reactor		15 gpm 100 Ft. of Head	CS*
	44. (P11)	#3 Distillation Column Calandria Pump	Forced Convection Pump		39 gpm 150 Ft. of Head	CS*
	45. (P12)	Rod Reactor Off Gas Compressor	Compress Reaction Gas for Condensation	3.65×10^6 BTU/Hr	1434 Horsepower	CS
	46. (P13)	#4 Distillation Column Overheads Pump	Supply Reflux Pump TET by product to TET Storage Tank		21.59 gpm 100 Ft. of Head	CS*
	47. (P14)	#4 Distillation Column Calandria Pump	Forced Convection Pump		22.4 gpm 100 Ft. of Head	CS*

NOTES

*Includes incremental higher cost for special purity requirements.

TABLE 3.2-6 (continued)

48. (P15)	TET Feed Pump	Feed #4 Distillation Column		9.2 gpm 100 Ft. of Head	CS*
49. (P16)	Waste Treatment Pump	Pump from Waste Hold To Waste Treatment		2.8 gpm 50 Ft. of Head	CS
50. (P17)	Crude TCS Feed Pump	Feed Purification Area		28 gpm 100 Ft. of Head	CS*
51. (P18)	Process Water Feed Pump	Feed Process Water to Scrubber and Waste Treatment		350 gpm 100 Ft. of Head	CS
52. (C1)	#1 Gas Scrubber	Scrub Gas Wastes from TCS Reactor Off Gas		43 Ft. Tall D = 3½ Ft.	SS
53. (C2)	#2 Gas Scrubber	Scrub Gas Wastes from H16, H3, H5		40 Ft. Tall D = 2½ Ft.	SS
54. (C3)	#1 Distillation Column	Separate Light Impurities to Waste		29 Trays 24 inches apart 3 ¾ Ft. in Diameter	CS
55. (C4)	#2 Distillation Column	Separate TET and TCS		29 Trays 24 inches apart 4½ Ft. in Diameter	CS
56. (C5)	#3 Distillation Column	Separate Heavies TCS to Waste		15 Trays 20 inches apart 3 Ft. in diameter	CS
57. (C6)	#4 Distillation Column	Separate Heavies TET to Waste		15 Trays 20 inches apart 2½ Feet in Diameter	CS
58. (R1)	TCS Fluidized Bed Reactor	Production of TCS For Rod Reactor	4.552 x 10 ⁶ BTU/hr (Cooling)	D = 2.61 Ft. L = 28.8 Ft. 64, 1" O D Cooling Tubes 9.4' Long	SS

TABLE 3.2-6 (continued)

59. (R2)	Polysilicon Rod Reactors (305)	Production of Polysilicon		Hairpin Reactor (2 hairpins, 3 Ft. long, 6 Inch Dia.)	Quartz
60. (A1)	Molecular Sieves (2)	Dry Out Rod Reactor Off Gas For Hydrogen Recycle		D = 3.5 Ft. L = 14.4 Ft.	CS
61. (A2)	Fines Separator	Remove Solids From Fluidized Bed Reactor Off Gas		12" Cyclone Separator	SS
62. (A3)	Hydrogen Flare	Dispose of Hydrogen Produced in TCS Fluidized Bed Reactor	8.94×10^6 BTU/Hr	30 Feet High Stack 6" diameter	CS
63. (A4)	Filament Pullers	Production of 1/4" filaments for Polysilicon depositon			

TABLE 3.2-7

PRODUCTION LABOR REQUIREMENTS FOR
CONVENTIONAL POLYSILICON PROCESS

<u>Unit Operation</u>	<u>Type</u>	<u>Skilled Labor</u>		<u>Semiskilled Labor</u>	
		<u>Man Hrs/Day</u>	<u>Per Kg Si</u>	<u>Per Day</u>	<u>Per Kg Si</u>
1. TCS Production	A	80	.0292		
2. Vaporization	B	60	.0219		
3. Vapor Compression	B	67	.0219		
4. Vapor Condensation	B	60	.0219		
5. TCS/TET Separation	C	40	.0146		
6. TCS Purification	C	35	.0128		
7. TET Purification	C	30	.011		
8. Filament Pullers		120	.0430		
9. Gas Scrubbing	A	64	.0232		
10. Hydrogen Drying (Molecular Sieves)	B	32	.0117		
11. Crude TCS Recycle System	B	58	.0212		
12. Silicon Fines Sep- aration	B	15	.0055		
13. Material Handling	A			90	.0329
14. Polysilicon Production		732	.2672		
TOTAL		1386	.5059	90	.0329

NOTES:

- A Batch Process or Multiple Small Units
B Average Process
C Automated Process
- Man hours/day Unit from Figure 4-6, Peters and Timmerhaus (7).
- Polysilicon manpower requirements based on batch operation with approximately 1 operator per 10 reactors.
- Filament puller manpower requirements based on 1 operator per puller.

3.3 UCC Silane Process for Silicon (Union Carbide Corporation)

The chemical engineering analysis activity involves a preliminary process design of a plant to produce silicon via the technology under consideration.

The UCC silane process (Union Carbide Corporation) for silicon involves several processing operations of hydrogenation-hydrochlorination reaction, stripping, distillation, redistribution reaction, silane purification, pyrolysis and consolidation of silicon. The process flowsheet is shown in Figure 3.3-1.

Hydrogen, silicon tetrachloride, and metallurgical grade silicon are fed to the hydrogenation reactor (fluidized bed, 500°C, 515 psia, copper catalyst) to produce a mixture of chlorosilanes. The mixture of chlorosilanes from the hydrogenation reaction is condensed and subjected to several stage distillation to separate components and remove impurities.

Initially, the condensed liquid mixture is sent to D-01 stripper (90 psia) to remove inert gases and volatile impurities. The stripper bottoms go to D-02 distillation (55 psia) which separates TCS (trichlorosilane) and STC (silicon tetrachloride). The TCS redistribution reactor (liquid phase, 85 psia, 140°F catalyst) is used to produce DCS (dichlorosilane). The separation of DCS and TCS is achieved in D-03 distillation (320 psia). The overhead goes to DCS redistribution reactor (liquid phase, 510 psia, 140°F, catalyst) to produce silane (SiH₄). The silane is purified by separation from trace impurities (such as B₂H₆) by D-04 distillation (355 psia).

The purified silane is used to produce silicon powder via the pyrolysis reaction:



The hydrogen from the reaction is compressed and recycled to the hydrogenation reactor. The silicon powder from the pyrolysis is consolidated to provide the molten silicon product.

A process design was performed to obtain data for a cost analysis of a plant to produce silicon by this new technology. The design was based on a plant to produce 1000 metric tons/yr of silicon via the UCC silane process.

The detailed status sheet for the process design package is shown in Table 3.3-1, and is representative of the various sub-items that make up the activity. The summarized results for the preliminary process design are presented in a tabular format to make it easier to locate items of specific interest.

The guide for these tables is given below:

- Process Flowsheet-----Figure 3.3-2
- Base Case Conditions-----Table 3.3-2
- Reaction Chemistry-----Table 3.3-3
- Redistribution Equilibrium-----Figure 3.3-3
- Raw Material Requirements-----Table 3.3-4
- Utility Requirements-----Table 3.3-5
- Major Process Equipment-----Table 3.3-6
- Production Labor Requirements----Table 3.3-7

The process design provides detailed data for raw materials, utilities, major process equipment and production labor requirements which are necessary for polysilicon production.

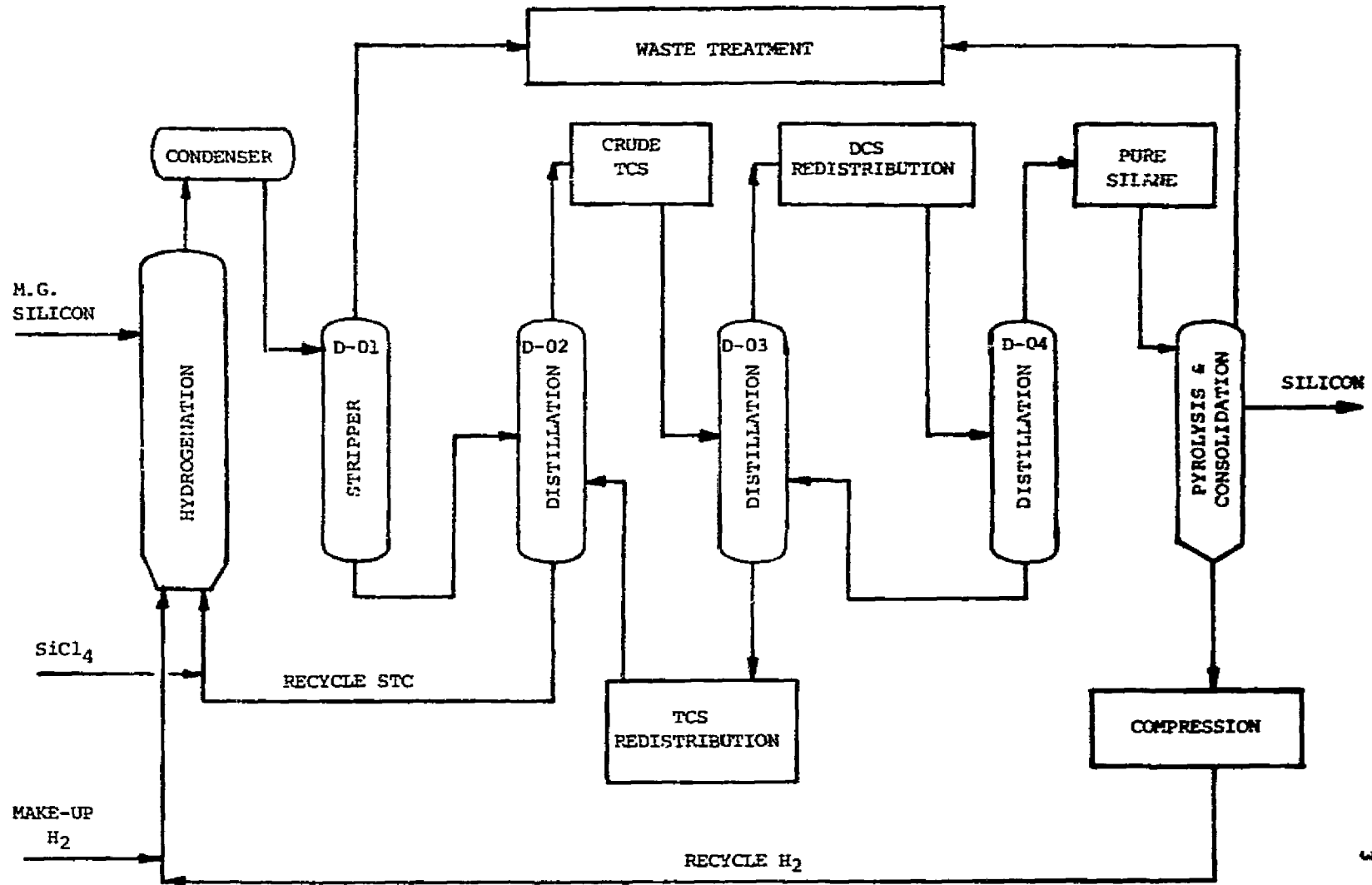

Figure 3.3-1 PROCESS FLOWSHEET FOR UCC SILANE PROCESS

TABLE 3.3-1 CHEMICAL ENGINEERING ANALYSES:
PRELIMINARY PROCESS DESIGN ACTIVITIES FOR UCC SILANE PROCESS

<u>Prel. Process Design Activity</u>	<u>Status</u>	<u>Prel. Process Design Activity</u>	<u>Status</u>
1. Specify Base Case Conditions	●	7. Equipment Design Calculations	●
1. Plant Size	●	1. Storage Vessels	●
2. Product Specifics	●	2. Unit Operations Equipment	●
3. Additional Conditions	●	3. Process Data (P, T, rate, etc.)	●
2. Define Reaction Chemistry	●	4. Additional	●
1. Reactants, Products	●	8. List of Major Process Equipment	●
2. Equilibrium	●	1. Size	●
3. Process Flow Diagram	●	2. Type	●
1. Flow Sequence, Unit Operations	●	3. Materials of Construction	●
2. Process Conditions (T, P, etc.)	●	8a. Major Technical Factors	●
3. Environmental	●	(Potential Problem Areas)	●
4. Company Interaction	●	1. Materials Compatibility	●
(Technology Exchange)	●	2. Process Conditions Limitations	●
4. Material Balance Calculations	●	3. Additional	●
1. Raw Materials	●	9. Production Labor Requirements	●
2. Products	●	1. Process Technology	●
3. By-Products	●	2. Production Volume	●
5. Energy Balance Calculations	●	10. Forward for Economic Analysis	●
1. Heating	●		
2. Cooling	●	○ Plan	
3. Additional	●	● In Progress	
6. Property Data	●	● Complete	
1. Physical	●		
2. Thermodynamic	●		
3. Additional	●		

223

CASE C

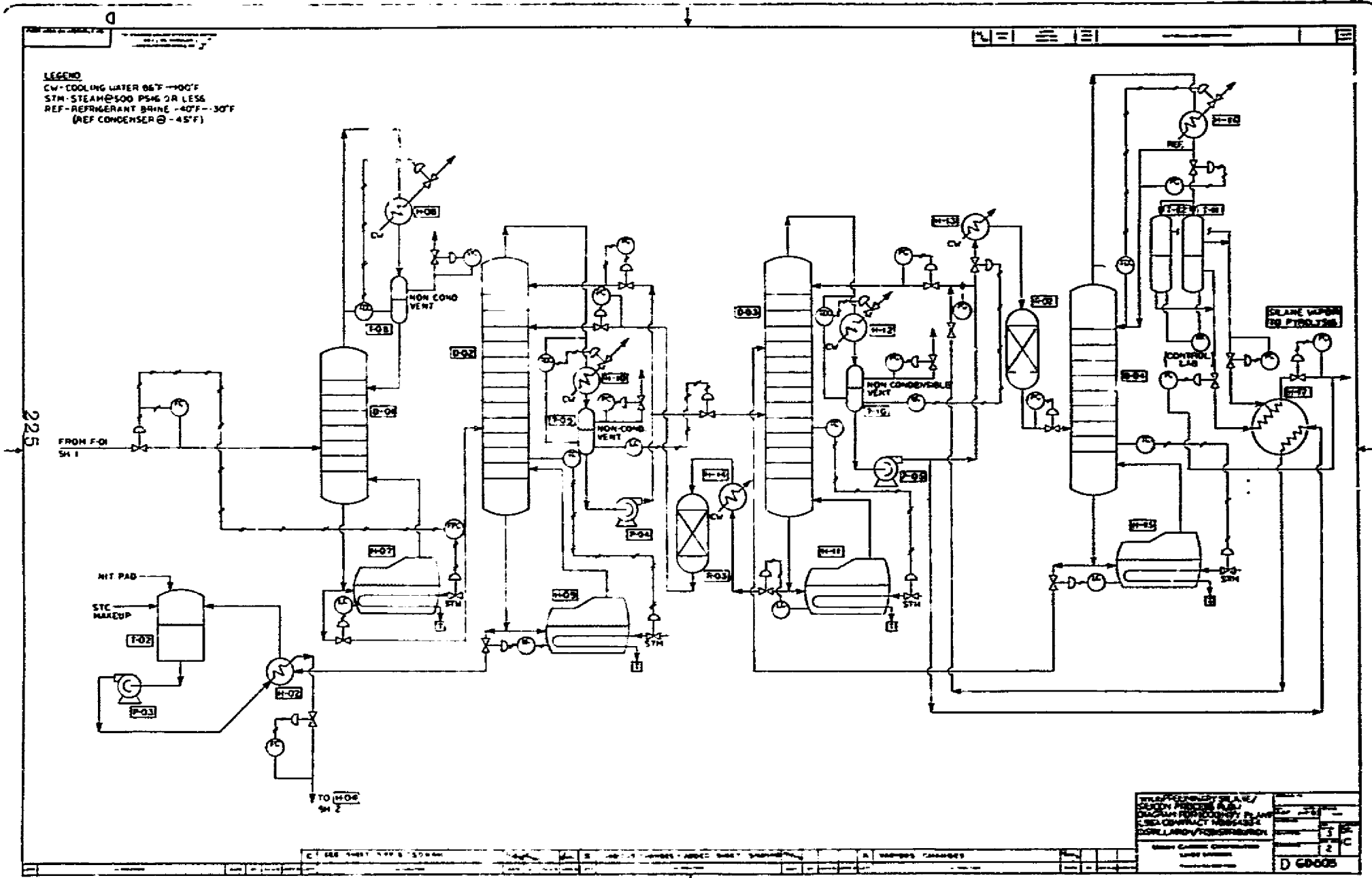

Figure 3.3-2 (Continued)

CASE C

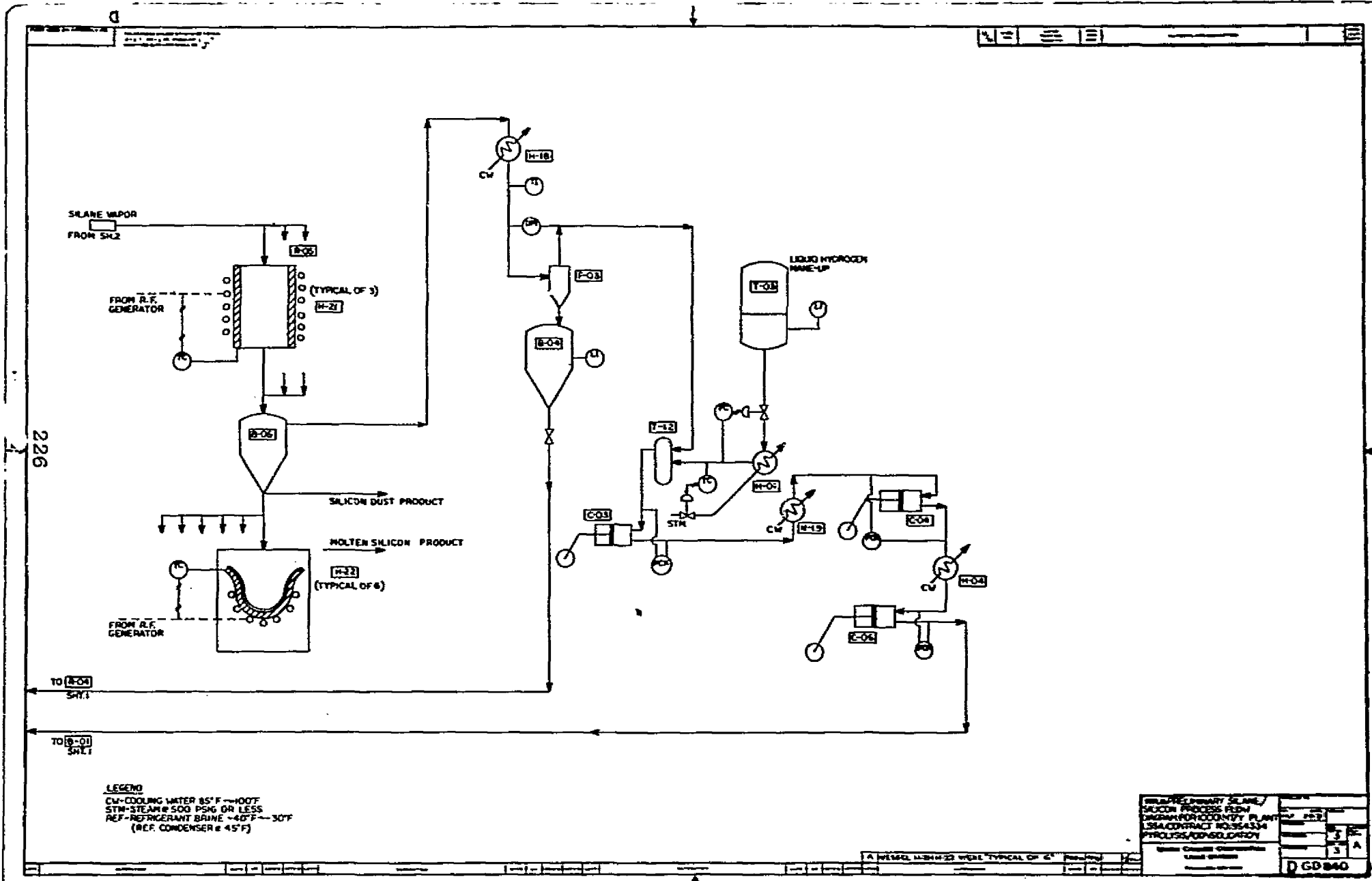
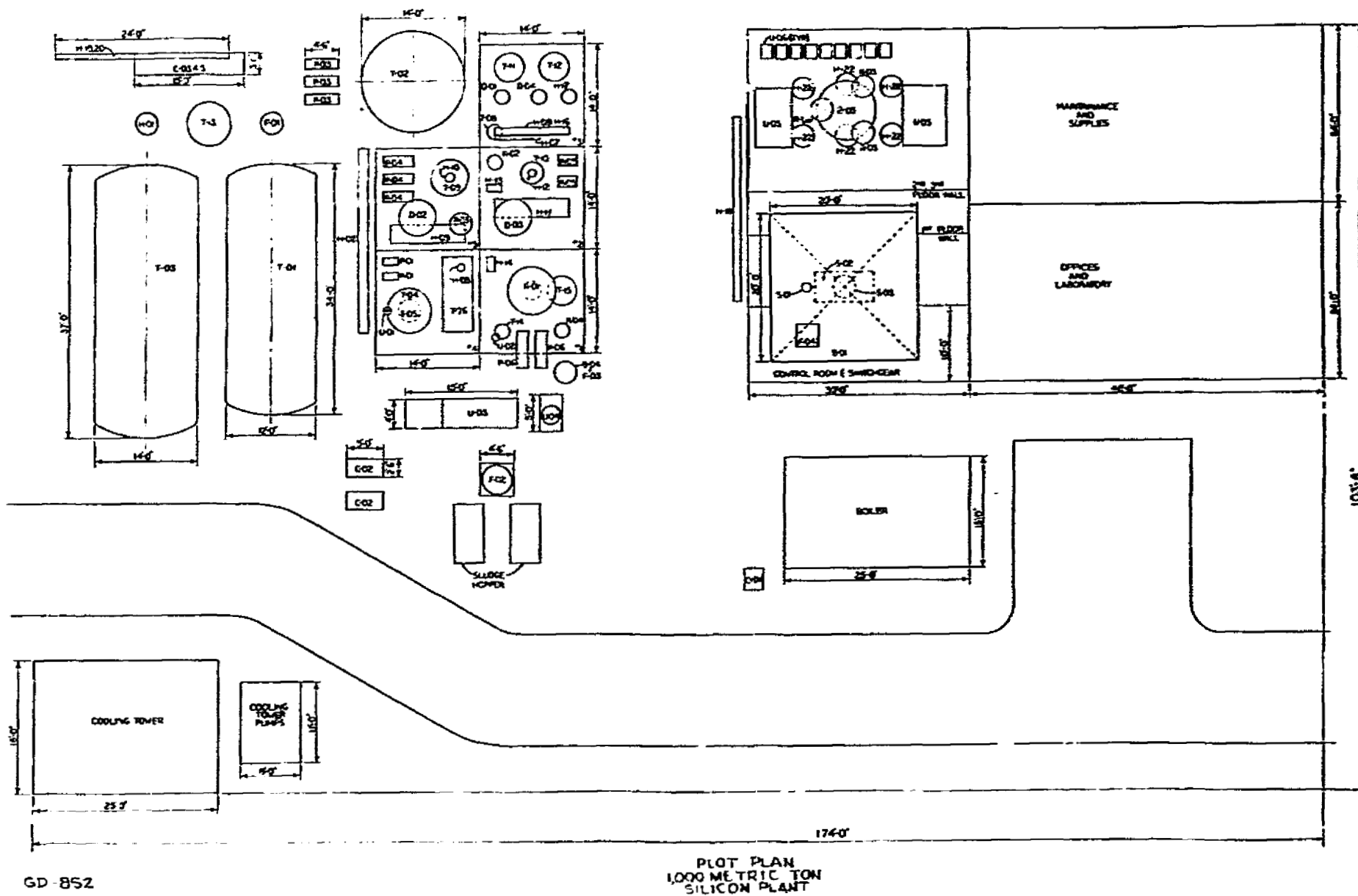

Figure 3.3-2 (Continued)

CASE C



227

Figure 3.3-2 (Continued)

TABLE 3.3-2

BASE CASE CONDITIONS FOR UCC SILANE PROCESS

1. Plant Size
 - Silicon produced from silane
 - 1000 metric tons/year of silicon
 - Solar cell grade silicon
2. Hydrogenation Reaction
 - Metallurgical grade silicon, hydrogen, and recycle silicon tetrachloride (TET) used to produce trichlorosilane (TCS)
 - Copper catalyzed
 - Fluidized bed
 - 500°C, 514.7 psia
 - 20% to 22.5% conversion of $SiCl_4$ (example)
3. TCS Redistribution Reaction
 - TCS from hydrogenation produces dichlorosilane (DCS)
 - Catalytic redistribution of TCS with tertiary amine ion exchange resin
 - Liquid phase 85 psia, 140°F
 - Conversion a function of inlet concentration (Union Carbide equilibrium)
 - Conversion from pure TCS feed is about 9.5% to DCS (example)
4. DCS Redistribution Reaction
 - DCS produces SiH_4 (silane)
 - Catalytic redistribution of DCS with tertiary amine exchange resin
 - Liquid phase 510 psia, 140°F
 - Conversion a function of inlet concentration (Union Carbide equilibrium)
 - Conversion from pure DCS feed is about 14% to Silane (example)
5. Recycles
 - Unreacted chlorosilanes separated by distillation and recycled
6. Silane Purification
 - Final purification by distillation
 - Designed to remove trace impurities (B_2H_6 , example)
7. Operating Ratio
 - Approximately 85% utilization (on stream time)
 - Approximately 7445 hour/year production
8. Storage Consideration
 - Feed materials (several week supply, approx. 1 month)
 - Product (two shifts storage)
 - Process (several hours to 1 shift)

TABLE 3.3-3

REACTION CHEMISTRY FOR UCC SILANE PROCESS

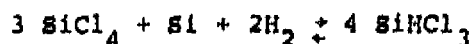
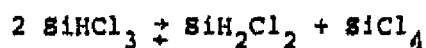
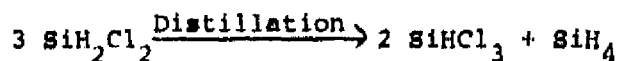
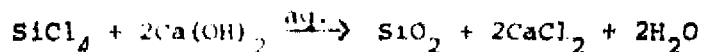
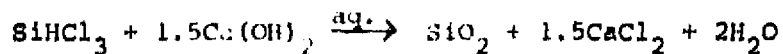
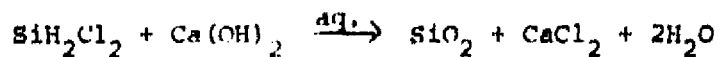
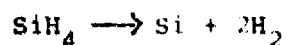
1. Hydrogenation Reaction2. Trichlorosilane Redistribution Reaction3. Dichlorosilane Redistribution Reaction4. Waste Treatment (representative)5. Silane Pyrolysis ReactionNote

1. Reaction 1 product contains H_2 , HCl , SiCl_4 , SiHCl_3 , SiH_2Cl_2 (trace), other trace chlorides
2. Reaction 2 Product contains SiHCl_3 , SiCl_4 , SiH_2Cl_2 , SiH_3Cl
3. Reaction 3 Product contains SiH_2Cl_2 , SiHCl_3 , SiCl_4 , SiH_3Cl , SiH_4

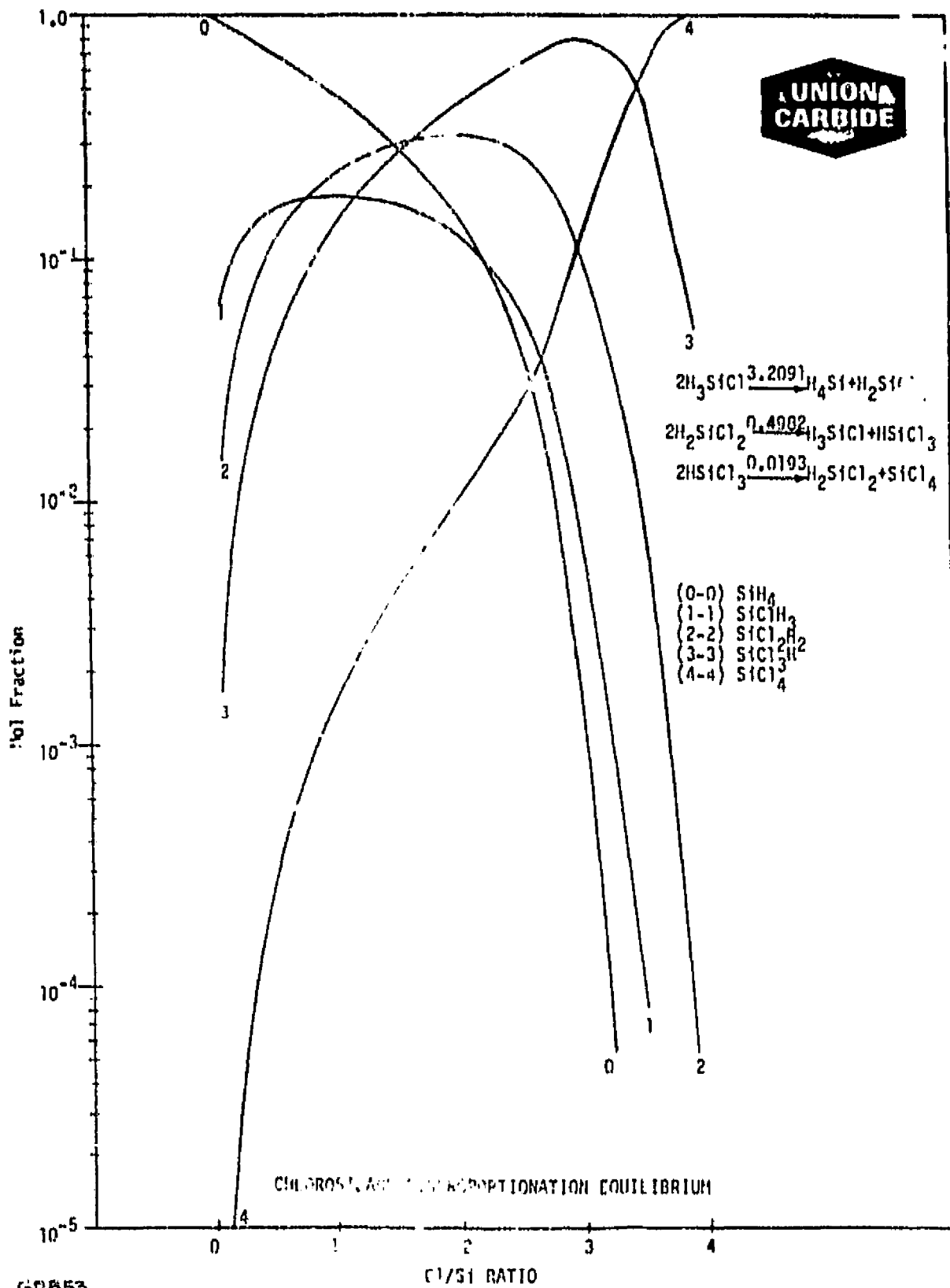

Figure 3.3-3 Redistribution Equilibrium For UCC Silane Process
 (Provided by Union Carbide)

TABLE 3.3-4

RAW MATERIAL REQUIREMENTS FOR UCC SILANE PROCESS

<u>Raw Material</u>	<u>Requirements</u>	
	<u>lb/hr for 1000 MT/yr Silicon</u>	<u>lb/KG of Silicon</u>
1. M. G. Silicon (Si)	348.6	2.60
2. Silicon Tetrachloride (SiCl ₄ , make-up)	370.1	2.76
3. Liquid Hydrogen (H ₂ , make-up)	4.3	0.032
4. Copper Catalyst (Cu)	6.8	0.051
5. Hydrate Lime [Ca(OH) ₂]	326.3	2.43

Note:

Assuming all inert gas from D-01 is H₂

TABLE 3.3-5

UTILITY REQUIREMENTS FOR UCC SILANE PROCESS

<u>Utility/Function</u>	<u>Total Requirement</u>	<u>Requirement/KG Silicon</u>
1. Electricity	409.7 KW	3.050 KW/hr
2. Steam	23113 lb/hr	172.2 lbs.
3. Cooling Water	70,453 gal/hr	525 gallons
4. Process Water	9.52 gal/hr	0.0709 gallons
5. Refrigerant	0.130 MM Btu/hr	968 Btu
6. Fuel	3.640 MM Btu/hr	27,100 Btu

TABLE 3.3-6

LIST OF MAJOR PROCESS
EQUIPMENT FOR UCC SILANE PROCESS

<u>Equipment</u>	<u>Function</u>	<u>Duty/Type</u>	<u>Size</u>	<u>Material of Construction</u>
<u>DISTILLATION COLUMNS</u>				
1. D-01 Crude TCS/STC Stripping Column	To remove inert gases	24929 lb/hr of feed	24" diam. 20' tall, 10 sieve plates	CS
2. D-02 TCS/STC Distillation Column	To remove STC at bottoms	64,213 lb/hr of feeds	4.63' diam., 74' tall, 32 sieve plates	CS
3. D-03 DCS/TCS Distillation Column	To remove DCS at distillates	46,254 lb/hr of feeds	4.30' diam., 77.5' tall, 45 sieve plates	CS
4. D-04 Silane Distillation Column	To purify silane	6967 lb/hr of feed	24" diam., 50'tall, 30 sieve plates	316SS
<u>REACTORS</u>				
5. R-01 Hydrogenation Reactor (Fluidized Bed)	Hydrogenation of Si and SiCl ₄	25,447 lb/hr of feed	6.5' diam. x 6.5' / 2.5' diam. x 10.5' cone	316SS
6. R-02 DCS Redistribution Reactor (Fixed Bed)	To convert DCS to silane	6,967 lb/hr of feed	2' diam., 11.2' tall, with catalyst	316SS
7. R-03 TCS Redistribution Reactor (Fixed Bed)	To convert TCS to DCS and STC	39,287 lb/hr of feed	3' diam., 17.3' tall, with catalyst	316SS
8. & 9. R-04 Sludge Neutralization Reactor	Waste Treatment	Agitated Tank/Column	2' diam., 20' tall	316SS (for pricing)

TABLE 3.3-6 (Continued)

HEAT EXCHANGERS

10.	H-01 Liquid Hydrogen Vaporizer	To provide H ₂ gas	7.22 lb/hr of Liquid H ₂	(Vendor supplied equipment)	
11.	H-02 STC Cooler	Exchange heats of STC streams	7.23 x 10 ⁵ Btu/hr shell-tube H. E.	893 ft. ² 514.7 psia	316SS/CS
12.	H-03 Quench Condenser	To condense chlorosilanes, 100°F	4.69 x 10 ⁶ Btu/hr shell-tube H. E.	676 ft. ² 514.7 psia	316SS/CS
13.	H-04 Recycle STC Vaporizer	To provide STC vapor to reactor	1.71 x 10 ⁶ Btu/hr kettle	65.9 ft. ² 514.7 psia	CS
14.	H-05 Recycle STC Superheater	To heat STC from 234 to 932°F	2.46 x 10 ⁶ Btu/hr Furnace Convection	1603 ft. ² 514.7 psia	316SS
15.	H-06 Recycle H ₂ Heater	To heat H ₂ from 100 to 932°F	6.78 x 10 ⁵ Btu/hr Furnace Convection	331 ft. ² 514.7 psia	316SS
16.	H-07 Stripper Recoiler	Reboiler of D-01, 242°F	9.06 x 10 ⁵ Btu/hr Kettle	39.8 ft. ² 95 psia	CS
17.	H-08 Stripper Condenser	Partial Condenser of D-01, 139°F	86,700 Btu/hr shell-tube H. E.	36.1 ft. ² 90 psia	CS
18.	H-09 TCS/STC Reboiler	Reboiler of D-02 216°F	7.83 x 10 ⁶ Btu/hr kettle	295 ft. ² 55 psia	CS
19.	H-10 TCS/STC Condenser	Total condenser of D-02, 120°F	6.24 x 10 ⁷ Btu/hr shell-tube H. E.	1315 ft. ² 55 psia	316SS/CS

TABLE 3.3-6 (Continued)

20.	H-11 DCS/TCS Reboiler	Reboiler of D-03	3.50×10^6 Btu/hr Kettle	333 ft. ² 320 psia	CS
21.	H-12 DCS/TCS Condenser	Total condenser of D-03, 234°F	3.99×10^6 Btu/hr shell-tube H. E.	429 ft. ² 320 psia	316SS/CS
22.	H-13 DCS Cooler	To cool DCS before redistribution reaction	1.88×10^5 Btu/hr shell-tube H. E.	22.1 ft. ² 550 psia	316SS/CS
23.	H-14 TCS Cooler	To cool TCS before redistribution reaction	2.01×10^6 Btu/hr shell-tube H. E.	161 ft. ² 85 psia	316SS/CS
24.	H-15 Silane Boiler	Reboiler of D-04 278°F	2.71×10^5 Btu/hr Kettle	15.4 ft. ² 360 psia	316SS/CS
25.	H-16 Silane Condenser	Total condenser of -44PF	1.30×10^5 Btu/hr Shell-tube H. E.	81 ft. ² 360 psia	316SS
26.	H-17 Silane Vaporizer/Superheater	To provide silane vapor for pyrolysis, 200°F	25,000 Btu/hr Jacket/tubes	27.3 ft. ³ /12.0 ft. ² 355 psia	316SS/CS
27.	H-18 Pyrolysis Hydrogen Cooler	To cool H ₂ gas from 363 to 100°F	43,000 Btu/hr shell-tube H. E.	80.5 ft. ² 20 psia	316SS/CS
28.	H-19 First Stage H ₂ Intercooler	To cool H ₂ between comp. stages 328 to 100°F	38,570 Btu/hr shell-tube H.E.	72.2 ft. ² 50 psia	316SS/CS
29.	H-20 Second Stage H ₂ Intercooler	To cool H ₂ between comp. stages 328 to 100°F	38570 Btu/hr shell-tube H. E.	72.2 ft. ² 160 psia	316SS/CS

TABLE 3.3-6 (Continued)

PUMPS AND COMPRESSORS

30.	C-01 Pneumatic Conveying Fan	Si feed transport	417 ACFM Centrifugal	5.1 psi Δp 12 BHP	CS
31.	C-02 Recycle H ₂ Blower	H ₂ gas blower	22.8 ACFM Centrifugal	518.7 psia 1.23 BHP	CS
32.	C-03 First Stage H ₂ Compressor	H ₂ gas compressor	164 ACFM; double action, reciprocating	48.1 psia discharge, 19.8 BHP	CS
33.	C-04 Second Stage H ₂ Compressor	H ₂ gas compressor action,	50 ACFM; double action, reciprocating	157 psia discharge, 19.6 BHP	CS
34.	C-05 Third Stage H ₂ Compressor	H ₂ gas compressor	15.3 ACFM; double action, reciprocating	515 psia discharge, 19.8 BHP	CS
35.	P-01 Quench Contactor Pump	Circulating liquid chlorosilanes	100 gpm, centrifugal/motor	36.7' head, 1.56 BHP	316SS
36.	P-03 Recycle STC Pump	To supply STC	33.1 gpm Centrifugal/ Turbine	847' head, 14.2 BHP	CS
37.	P-04 TCS Distillate Pump	D-02 Reflux/ Distillate	144 gpm Centrifugal/ Turbine	589' head, 33.5 BHP	CS
38.	P-05 DCS Distillate Pump	D-03 Reflux/ Distillate	144 gpm Centrifugal/ Motor	759' head, 26.2 BHP	316SS
39.	P-06 Lime Tank Pump	Circulating Lime Slurry	100 gpm Centrifugal/ Motor	103' head, 4. BHP	Cast iron

TABLE 3.3-6 (Continued)

TANKS AND BINS

40.	T-01 Crude TCS/STC Storage Tank	Storage/Feed to Silane production	8 hr. storage, horizontal	12' diam. x 27' 514.7 psia	CS
41.	T-02 STC Storage Tank	Storage/Feed to Hydrogenation	6 hr. storage, Vertical	14' diam. x 13.4' 14.7 psia	CS
42.	T-03 Liq. H ₂ Storage	Liq. H ₂ make-up storage	(Vendor supplied equipment)		
43.	T-04 Waste Settler Tank	To separate solid residues	Vertical cyl/cone bottom	6' diam., 12' tall 514.7 psia	316SS
44.	T-05 Waste Chlorides Tank	To remove solid residues	285 lb/hr Vertical	3' diam., 4' tall 25 psia (aprox.)	316SS
45.	T-06 Quench Condenser Receiver	Gas-liq. separa-	15 min. storage Horizontal	4' diam. x 11.3' 514.7 psia	CS
46.	T-07 Recycle Hydrogen Receiver	H ₂ gas surge tank	Vertical	3' diam. x 6' 514.7 psia	CS
47.	T-08 Stripper Reflux pot	D-01 Distillate/ gas	30 min. storage Vertical	2' diam. x 3.4' 90 psia	CS
48.	T-09 TCS/STC Reflux pot	D-02 Distillate	10 min. storage Vertical	5' diam. x 10' 55 psia	CS
49.	T-10 DCS/TCS Relux pot	D-03 Distillate	10 min. storage Vertical	4' diam. x 12' 320 psia	CS
50.	T-11 A, B Silane Shift Tanks	D-04 Distillate/ Feed to pyrolysis	4 hr. storage, each, Vertical	5' diam. x 9.4' 360 psia	316SS

TABLE 3.3-6 (Continued)

51.	T-13 Pyrolysis H ₂ Receiver	H ₂ Feed to Com- pressor	Vertical 25 psia	6' diam. x 12'	CS
52.	T-14 Lime Make-Up Tank	Lime solu. pre- paration	8 hr. storage Vertical, open	5' diam. x 9.2' 14.7 psia	CS
53.	T-15 Sludge Pump Tank	Sludge-solu. storage	4 hr. storage Vertical	5' diam. x 8'	316SS
54.	B-01 M. G. Silicon Storage Hopper	Feed to hydro- genation reactor	344 lb/hr Si	20' sq. x 5'/10' cone 14.7 psia	CS
55. & 56.	B-04 Pyrolysis Dust Bin	Solid residue	Small	3'diam. x 3' 25 psia	CS

238

FILTERS

57.	F-01 Crude TCS/ STC Filter	In Line Filter	Small solid-liq.	50 gpm x 100μ	CS/316SS
58.	F-02 Waste Hydroxide Filter	Remove solid residues	100 gpm solid-liq.	Filtering area 67 ft. ²	CS/316SS
59.	F-03 Pyrolysis H ₂ Filter	Remove solid residues	Small Bag solid-gas	20 ft. ² x 5μ	CS/cloth
60.	F-04 M. G. Silicon Unloading Filter	Solid-air separa- tion in pneumatic conveyor	Small Bag solid-gas	20 ft. ² x 5μ	CS/cloth

TABLE 3.3-6 (Continued)

SOLID HANDLING EQUIPMENT

61.	S-01 M. G. Silicon Unloading Cyclone	Si feed transport	6" W. C. ΔP	417 ACFM	316SS
62.	S-02 Double Shell Blender	Si feed to reactor	Blending	20 ft. ³ /shroud	304SS
63.	S-03 M. G. Silicon Lock Hopper	Si Feed to reactor	Locking	20 ft. ³	CS

UNCLASSIFIED

64.	U-01 Quench Contactor Ejector	To withdraw gaseous products from reactor	6" W. C. Suction	100gpm 134 ACFM	316SS
65.	U-02 Lime Tank Agitator	Line solution preparation		3/4 HP	316SS
66.	U-03 Vent Gas Combustor	To burn vent gases from various units	20 ft. ³ , 0.5 MM Btu/hr load	1.22 ACFM	316SS
67.	U-04 Vent Gas Ejector	To withdraw gases from combustion chamber	10" W. C. Suction	100gpm 1.0 CFM (STP)	316SS

PYROLYSIS SECTION (Primary)

68.	R-05 Silane Pyrolysis Reactors (six)	To convert silane to silicon	25 KW Power supply	3' diam., 15' tall, cone shape (approx.)	Monel/ quartz (pricing)
69.	X-01 Melters (six)	Melt silicon	60 KW Power supply		Graphite/ Quartz, etc.

TABLE 3.3-6 (Continued)

70.	B-05 Powder Hoppers (six)	Pyrolysis Powder collection	96.1 lb/hr Si	8' diam. x 15' width cone bottom	316SS
71.	X-02 Hydrogen Cooler	Cool Hydrogen	42.4 lb/hr H ₂	See Economic Analysis	CS/Other
72.	X-03 Hydrogen Blower	Blow Hydrogen	127 CFM (STP)	See Economic Analysis	CS/Other
73.	X-04 Dust Filter	Filter Dust	127 CFM (STP)	See Economic Analysis	CS/Other
74.	X-05 Star Valve (six)	Flow Control		See Economic Analysis	CS/Other
75.	X-06 Conveyor	Transport Material	96.1 lb/hr Si and its containers	See Economic Analysis	CS/Other
76.	X-07 Drum Loader	Load Drums		See Economic Analysis	

TABLE 3.3-7

PRODUCTION LABOR REQUIREMENTS FOR UCC SILANE PROCESS

<u>Section/Unit Operation</u>	<u>Skilled Labor man-hr/KG Si (oper/shift)</u>	<u>Semiskilled Labor man-hr/KG Si (oper/shift)</u>
1. Hydrogenation	0.00745 (1)	0.00745 (1)
2. Silane	0.02230 (3)	----
3. Pyrolysis	0.02980 (4)	----
4. Waste Treatment	0.00745 (1)	----
5. Hydrogen Compression	<u>0.00745 (1)</u>	<u>----</u>
TOTAL	0.0745 (10)	0.00745 (1)

Note

Manpower estimate for production labor requirements based on:

1. Dividing plant into sections
 - type of unit operation
 - mark off working area
2. Specify work duties required in each section
3. Estimate operators required to perform work duties in each section
 - type of unit operation
 - size of working area
 - degree of automation (batch, semi-continuous, continuous, etc.)

3.4 BCL Process for Silicon - Case A (Battelle Columbus Laboratories)

The chemical engineering analysis activity involves a preliminary process design of a plant to produce silicon via the technology under consideration.

The process flowsheet for the Case A of BCL process to manufacture silicon is shown in Figure 3.4-1. This process consists of several major processing operations of distillation, vaporization, stripping, condensation and a deposition reaction to produce silicon as well as electrolysis to recover the zinc.

Silicon tetrachloride (SiCl_4), which is the major raw material, is fed to the distillation section for purification, to remove impurities (such as boron and phosphorous). In the deposition section, purified silicon tetrachloride is vaporized and preheated to the reaction temperature, 927°C , before it is introduced into a silicon deposition unit, which is a fluidized bed reactor. Zinc vapor, produced by a specially designed induction-heated vaporizer, is also introduced to the reactor at the same temperature for the reaction. The reaction equation to show the silicon deposition is

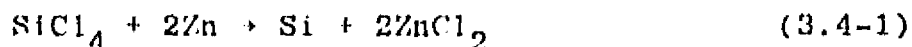

Silicon granules produced by the deposition reaction, which descend to the bottom of reactor, are cooled and collected in containers. A small amount of silicon seed is fed to the reactor to control the particle size of the silicon product. Zinc chloride and unreacted zinc are recovered and fed to the electrolysis section, while unreacted silicon tetrachloride is recycled to the distillation section.

In the electrolysis section, zinc chloride is reduced to zinc by low voltage (4-5 volts) electrolysis cells. Zinc is recycled to the deposition unit, while chlorine gas is collected as the by-product. The deposition and electrolysis sections are purged with inert gas (such as argon). Waste gases from various sections are collected and treated with hydrate lime solution in the waste treatment section.

A process design was performed to obtain data for a cost analysis of a plant to produce silicon by this new technology. The design was based on a plant to produce 1000 metric tons/yr of silicon via the BCL process. In Case A, two deposition reactors and six electrolysis cells are required.

The detailed status sheet for the process design package is shown in Table 3.4-1 and is representative of the various sub-items that make up the activity. The summarized results

for the preliminary process design are presented in a tabular format to make it easier to locate items of specific interest. The guide for these tables is given below:

- Process Flowsheet-----Figure 3.4-1
- Base Case Conditions-----Table 3.4-2
- Reaction Chemistry-----Table 3.4-3
- Raw Material Requirements-----Table 3.4-4
- Utility Requirements-----Table 3.4-5
- Major Process Equipment-----Table 3.4-6
- Production Labor Requirements----Table 3.4-7

The process design provides detailed data for raw materials, utilities, major process equipment and production labor requirements which are necessary for polysilicon production.

TABLE 3.4-1 CHEMICAL ENGINEERING ANALYSES:
PRELIMINARY PROCESS DESIGN ACTIVITIES FOR BCL PROCESS - Case A

<u>Prel. Process Design Activity</u>	<u>Status</u>	<u>Prel. Process Design Activity</u>	<u>Status</u>
1. Specify Base Case Conditions	●	7. Equipment Design Calculations	●
1. Plant Size	●	1. Storage Vessels	●
2. Product Specifics	●	2. Unit Operations Equipment	●
3. Additional Conditions	●	3. Process Data (P, T, rate, etc.)	●
2. Define Reaction Chemistry	●	4. Additional	●
1. Reactants, Products	●	8. List of Major Process Equipment	●
2. Equilibrium	●	1. Size	●
3. Process Flow Diagram	●	2. Type	●
1. Flow Sequence, Unit Operations	●	3. Materials of Construction	●
2. Process Conditions (T, P, etc.)	●	8a. Major Technical Factors	●
3. Environmental	●	(Potential Problem Areas)	●
4. Company Interaction	●	1. Materials Compatibility	●
(Technology Exchange)	●	2. Process Conditions Limitations	●
4. Material Balance Calculations	●	3. Additional	●
1. Raw Materials	●	9. Production Labor Requirements	●
2. Products	●	1. Process Technology	●
3. By-Products	●	2. Production Volume	●
5. Energy Balance Calculations	●	10. Forward for Economic Analysis	●
1. Heating	●		
2. Cooling	●	○ Plan	
3. Additional	●	● In Progress	
6. Property Data	●	● Complete	
1. Physical	●		
2. Thermodynamic	●		
3. Additional	●		

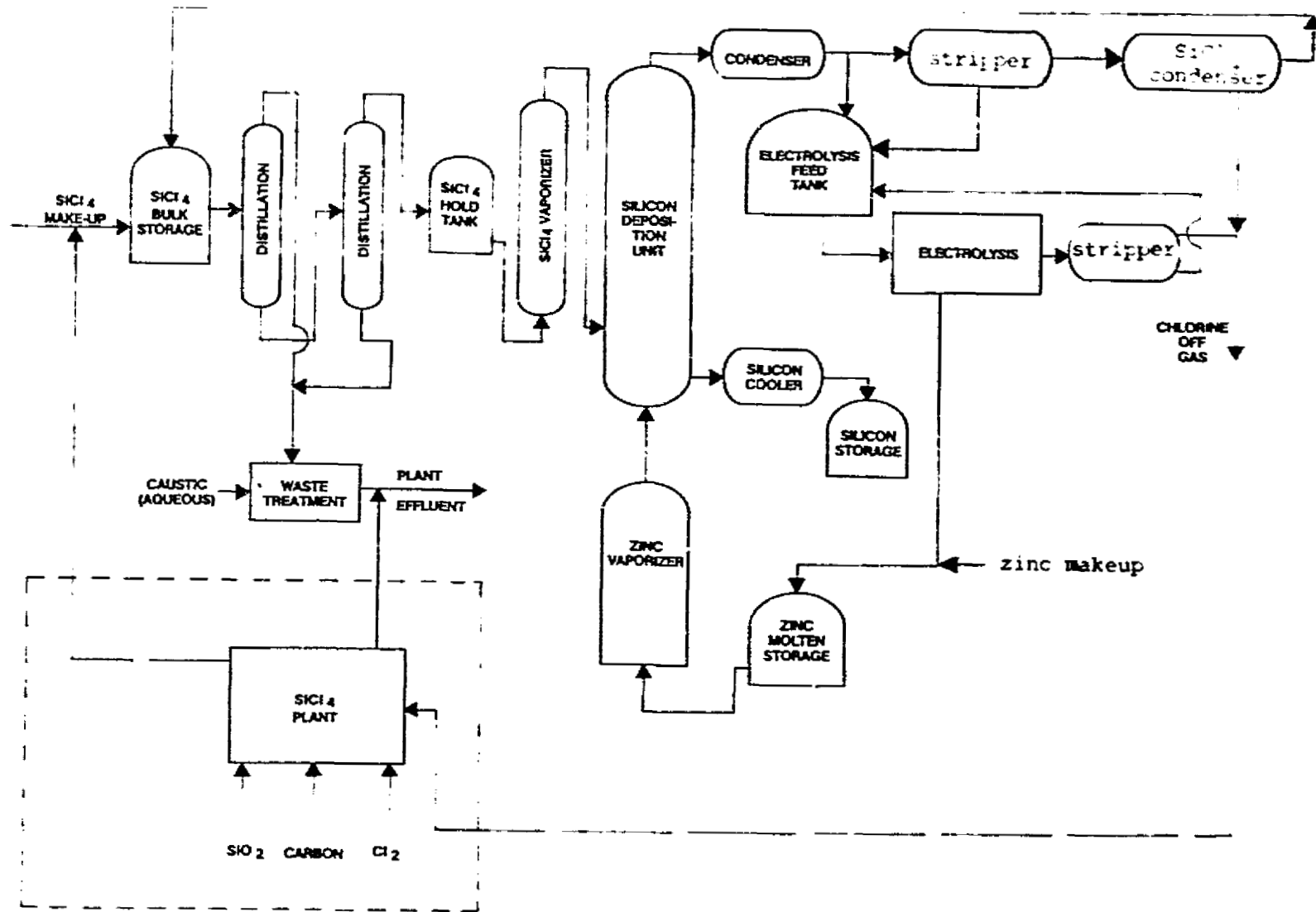

Figure 3.4-1 Process Flow Sheet for BCL Process-Case A

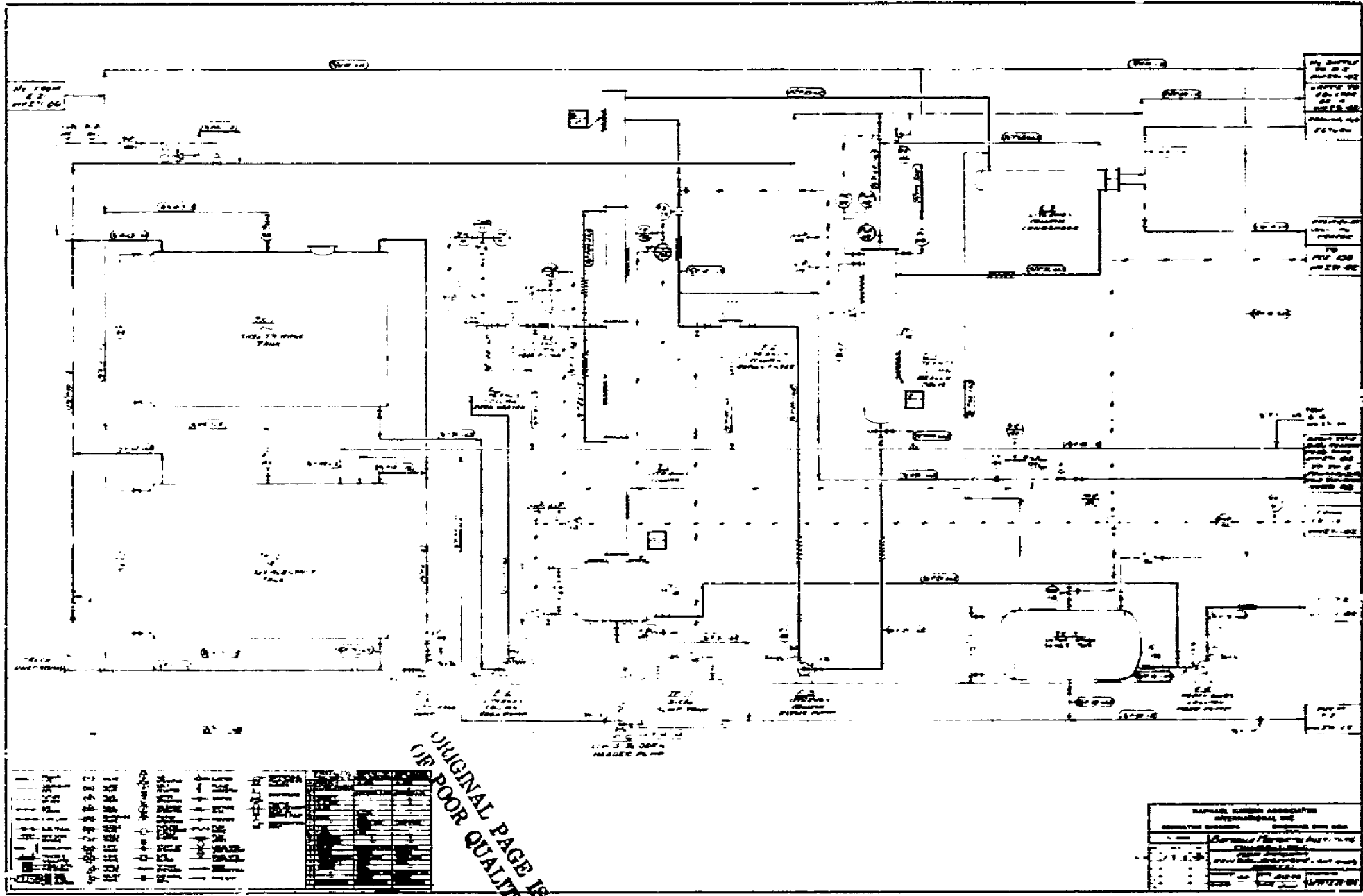

Figure 3.4-2 Process Flow Sheet for BCL Process-Case A

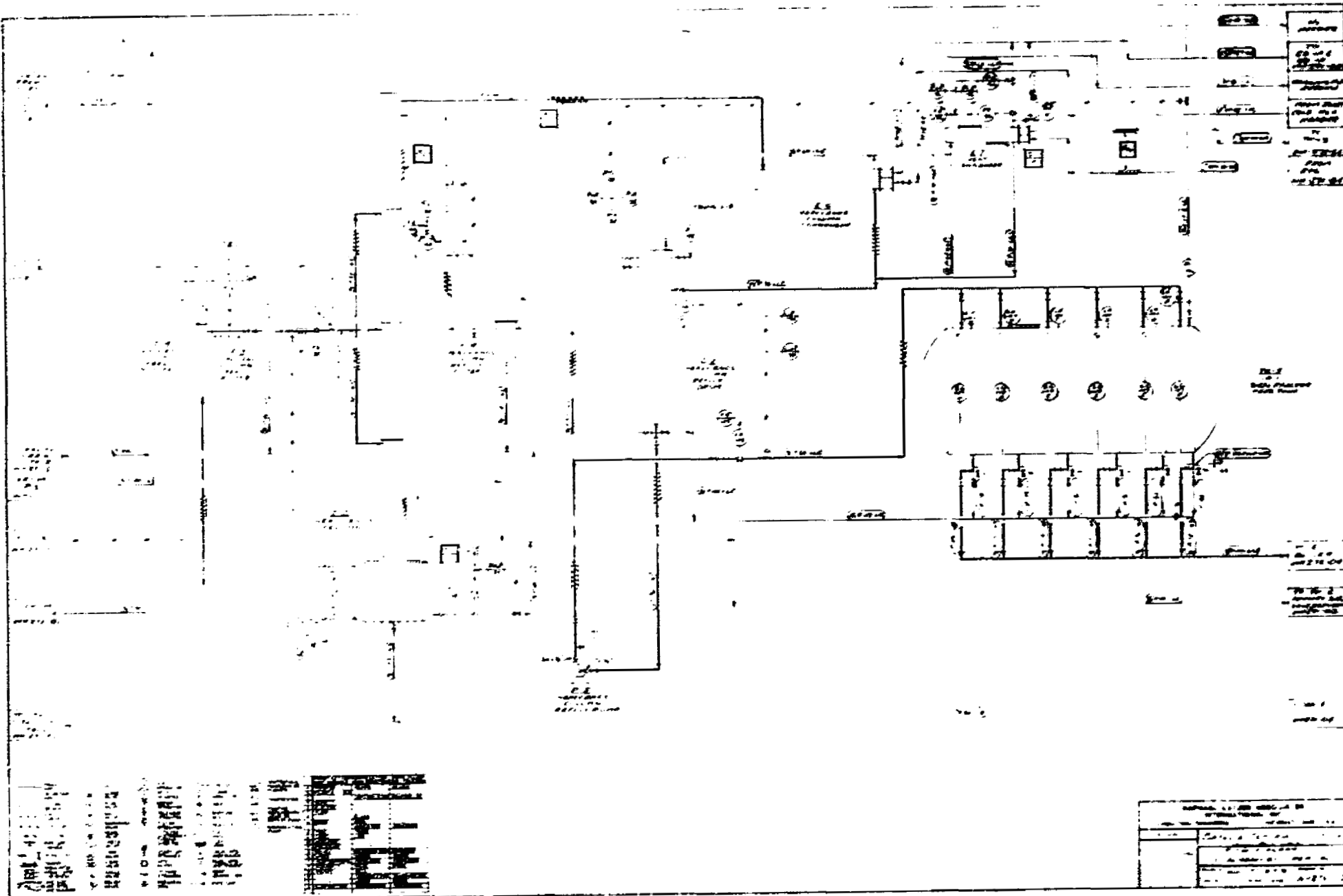

Figure 3.4-2 (Continued)

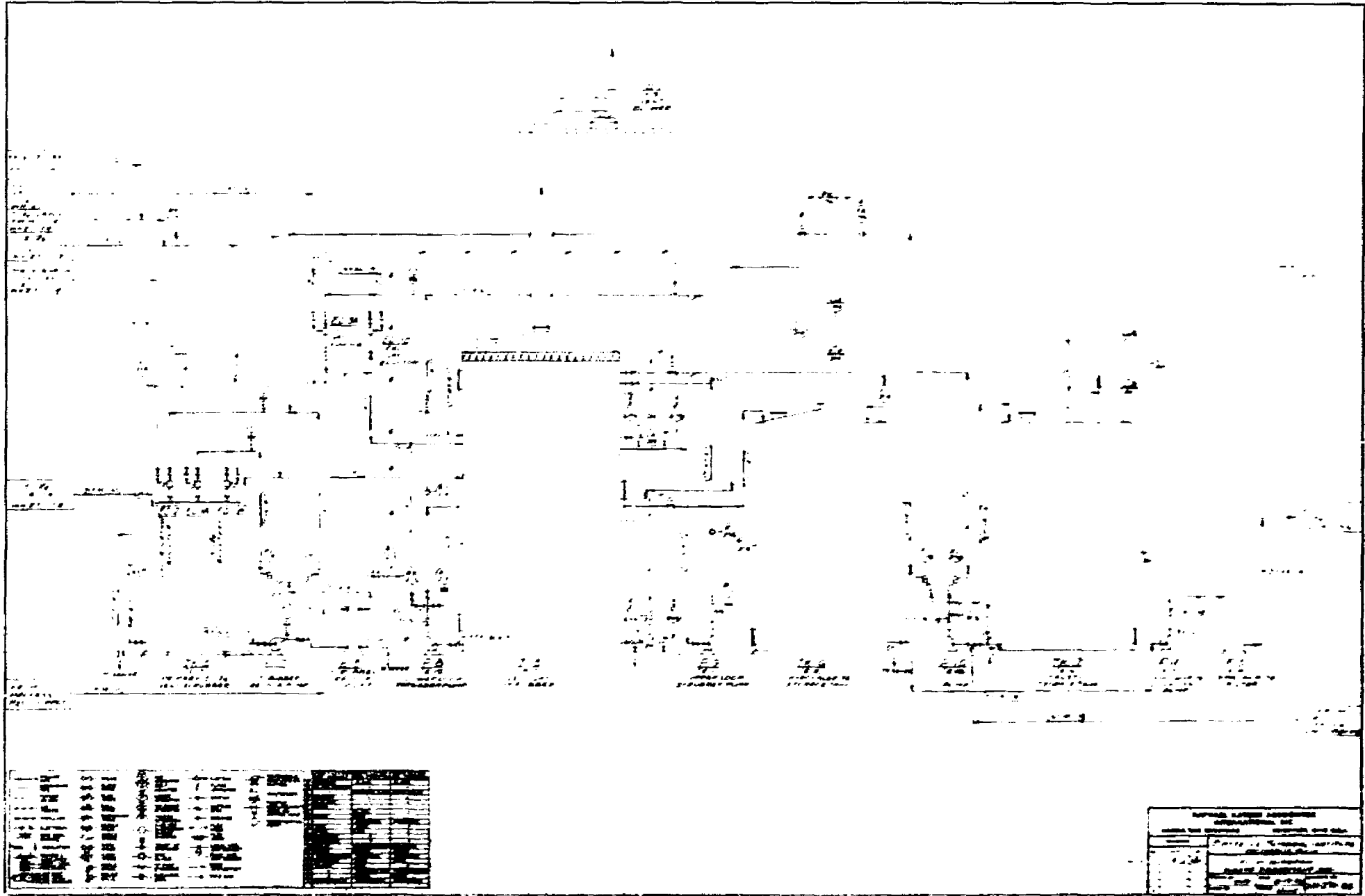

Figure 3.4-2 (Continued)

Note: For 50 MT/yr
Facility...

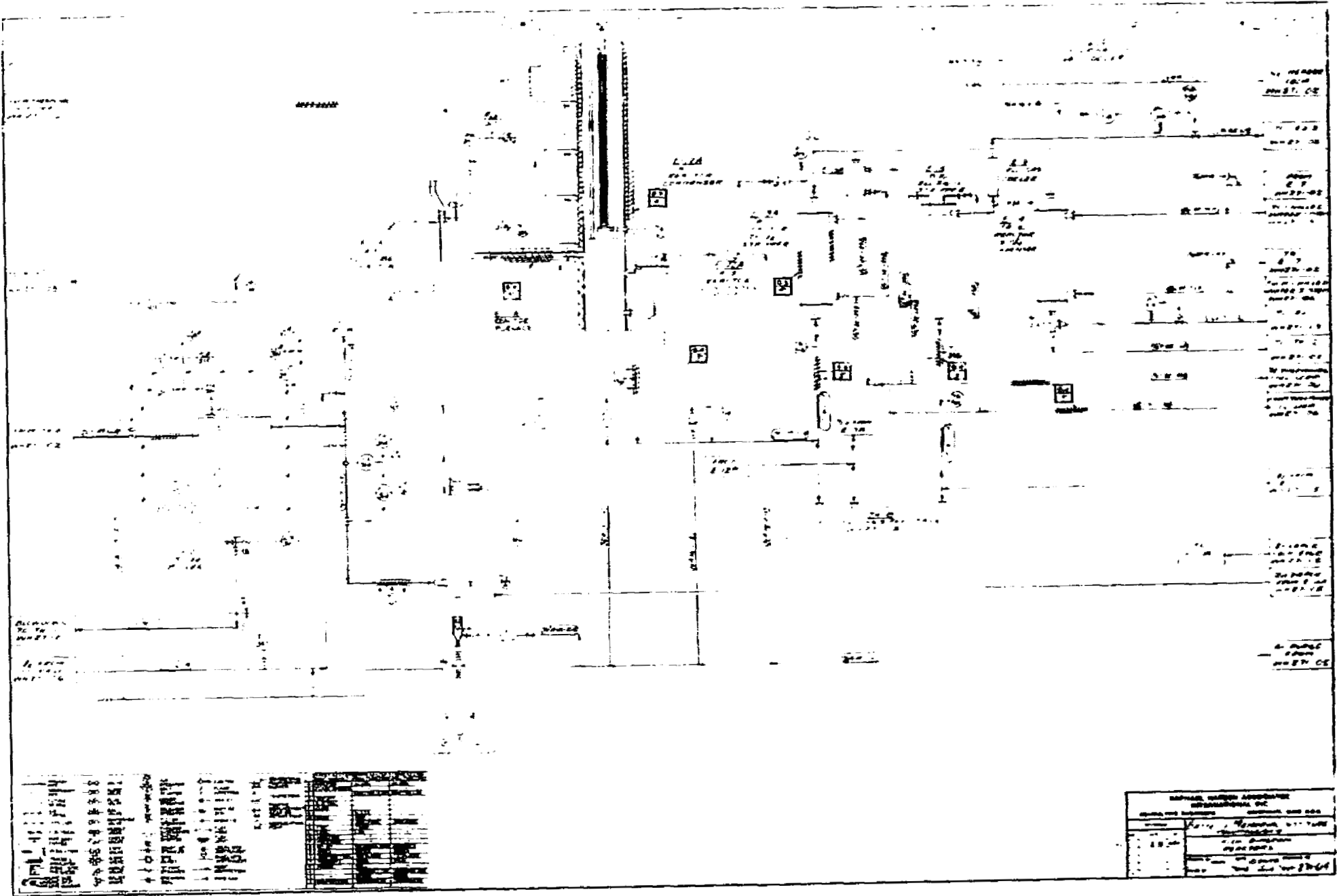

Figure 3.4-2 (Continued)

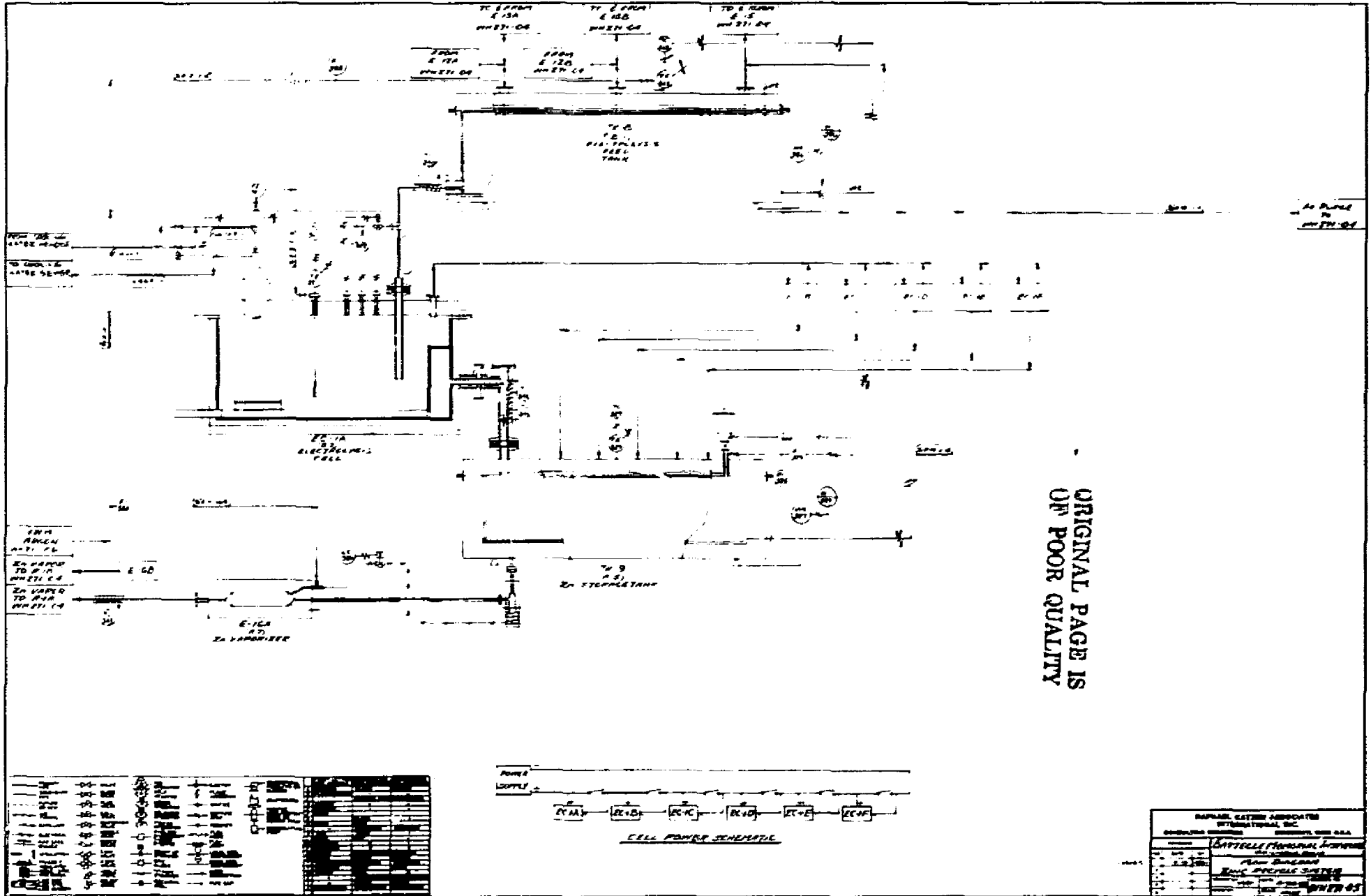
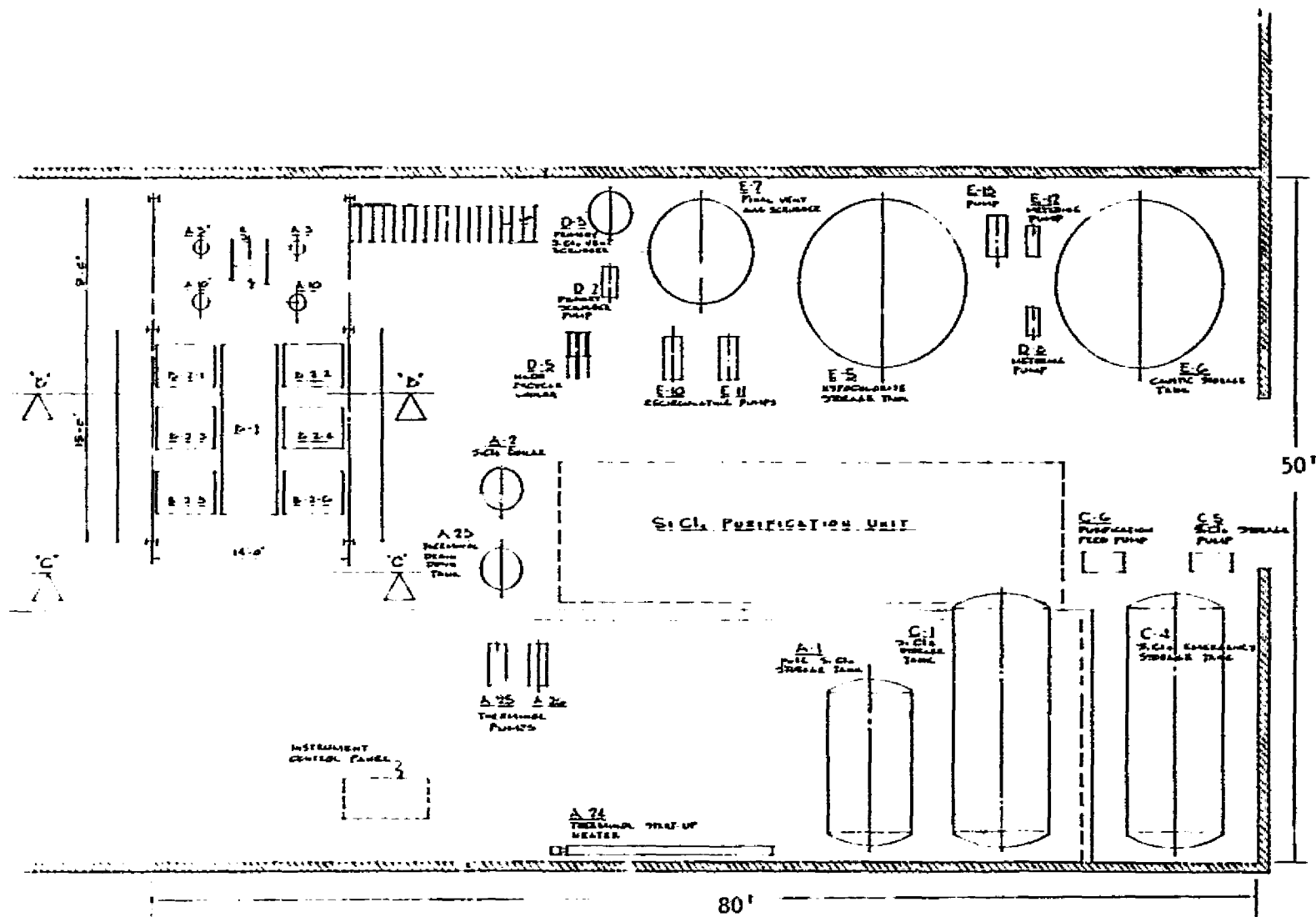

Figure 3.4-2 (Continued)



PLOT PLAN

Figure 3.4-2 (Continued)

TABLE 3.4-2
BASE CASE CONDITIONS FOR BCL PROCESS - Case A

1. Plant Size
 - silicon produced from silicon tetrachloride (TET)
 - 1000 metric tons/yr of silicon
 - solar cell grade silicon
 - solid phase product form (granules)
2. Light End Distillation
 - purification of TET by distillation
 - remove 4% chlorosilanes as the light end
 - 80°C, 10 psig
3. Heavy End Distillation
 - purification of TET by distillation
 - remove 4% impurities as the heavy end
 - 92% over-all yield of TET from both distillations
 - 80°C, 10 psig
4. TET Vaporizer
 - to supply TET vapor for deposition reactor
 - by power input (resistance heater)
 - hold at constant level and constant pressure
 - 164°F
5. Deposition Reactor
 - reduce TET by zinc to produce silicon
 - deposit on pure silicon seed
 - fluid bed
 - 927°C (1700°F, 1 atm)
 - 63% conversion of TET to silicon
6. Reactor Condenser
 - to condense gases from reactor ($ZnCl_2$, unreacted Zn and $SiCl_4$ gases)
 - partial condensation
 - using therminol 66 as the coolant
 - 927°C inlet temperature and 350°C outlet temperature
7. Reactor $ZnCl_2$ Stripper
 - work as partial condenser
 - to condense $ZnCl_2$ gas from $SiCl_4$ gas
 - operating at the temperature right above $ZnCl_2$ melting point (318°C), 350°C
 - using therminol 66 as the coolant
- Cell $ZnCl_2$ Stripper
 - operates as partial condenser
 - to condense $ZnCl_2$ gas from Cl_2 and $SiCl_4$ gases
 - operating at the temperature right above $ZnCl_2$ melting point (318°C), 350°C
 - using therminol 66 as the heat exchange medium

TABLE 3.4-2 (Continued)

9. Reactor SiCl_4 Condenser
 - condense SiCl_4 gas for recycle
 - antifreeze as the coolant
 - 350°C inlet temperature, 20°F outlet temperature.
10. Electrolysis
 - electrolytic recovery of Zn from ZnCl_2
 - Cl_2 gas is by product
 - 95% Zn recovery
 - 500°C, approx. 1 atm
11. Zinc Vaporizer
 - to vaporize Zinc
 - by induction heating
 - 927°C, approx. 1 atm.
12. Wastes Treatment
 - to scrub and neutralize SiCl_4 and chlorosilane gases
 - caustic solution used to neutralize
13. Operating Ratio
 - approximately 80% utilization (on stream time)
 - approximately 7,000 hr/yr production
14. Storage Considerations
 - feed material (two week supply)
 - product (two shifts storage)
 - process (several hours)

TABLE 3.4-3
REACTION CHEMISTRY FOR BCL PROCESS - Case A

1. Silicon Deposition

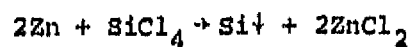

2. Electrolysis

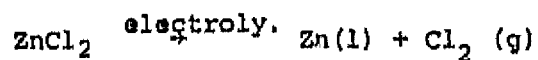

3. Waste Treatment

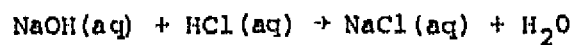
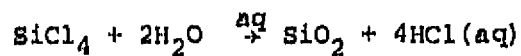

or

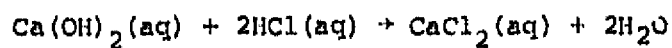

3a. Waste Treatment (50 MT/yr unit)

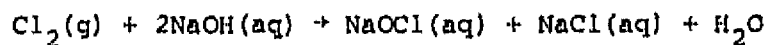

Table 3.4-4

Raw Material Requirements for
BCL Process - Case A

<u>Raw Material</u>	<u>Requirements lb/KG of Silicon</u>
1. Silicon Tetrachloride, SiCl_4	15.68 ¹
2. Zinc, Zn	0.54
3. Caustic (50%), NaOH(aq)	5.23
or	
Lime (99%), Ca(OH)_2	2.85 ²
4. Argon	3.1 scf ³
5. Nitrogen	7.6 scf ³
6. Chlorine, Cl_2 (by-product)	11.12

1. Includes light wastes (4%), heavy wastes (4%) and additional losses (7%).
2. Includes neutralization of distillation section, deposition section, electrolysis section and chlorination losses.
3. Estimate from BCL

TABLE 3.4-5
UTILITY REQUIREMENTS FOR BCL
PROCESS - Case A

<u>Utility/Function</u>	<u>Requirements/Kg of Silicon Product</u>
1. Electricity	30.92 kw-hr
1. Low Voltage D.C. for Electrolysis (20.51)	
2. Zinc Vaporizer Induction Heated (5.62)	
3. Preheat Section of Deposition Unit Induction Heated (1.39)	
4. Electrolysis Feed Tank Heater (0.24)	
5. Molten Zinc Storage Heater (0.10)	
6. SiCl ₄ Vaporizer (0.53)	
7. Pumps, Blowers (2.53)	
2. Steam (50 PSIA)	9.67 pounds
1. #1 Purification Column Reboiler (4.59)	
2. #2 Purification Column Reboiler (4.30)	
3. Caustic Storage Heating (0.29)	
4. #1 Purification Column Preheater (0.49)	
3. Cooling Water	37.88 Gallons
1. #1 Purification Column Condenser (16.94)	
2. #2 Purification Column Condenser (15.88)	
3. Purified Tet Cooler (1.67)	
4. Chlorination Cooler (H-17) (0.53)	
5. Cell Gas Cooler (H-18) (2.86)	
4. Process Water	24.20 Gallons
1. Diluent for Waste Treatment (24.20)	
5. Refrigeration	2.38 kStu
1. Reactor SiCl ₄ Condenser (H-11) (1.28)	
2. SiCl ₄ Vent Condenser (H-07) (1.10)	

Note: k = kilo = 10³

TABLE 3.4-6

LIST OF MAJOR PROCESS EQUIPMENT
FOR BCL - Case A

<u>Equipment</u>	<u>Function</u>	<u>Size/Type</u>	<u>Material of Construction</u>	<u>Capacity Ratio to 1000 MT/yr</u>
<u>PROCESS TOWER AND INTERNALS</u>				
1. D-01 Light End Distillation Column	To purify SiCl ₄	8" dia. x 21', packed 13.5'	Column, CS/packing, SS	20
2. D-02 Heavy End Distillation Column	To purify SiCl ₄	8" dia. x 21', packed 13.5'	Column, CS/packing, SS	20
3. A-01 Primary SiCl ₄ Vent Scrubber	To scrub SiCl ₄ vent gas	3' dia. x 4'4" T/T, 225 gal/flat bottom	FRP	1
4. A-02 Final SiCl ₄ Vent Scrubber	To scrub SiCl ₄ vent gas	7'6" dia. x 17'4" T/T/ 4 pp trays, Teflon dimister	FRP	1
<u>HEAT EXCHANGER</u>				
5. H-01 L.E. Column Feed Heater	To preheat feed to D-01	2' dia. x 5', 15,013 Btu/hr / external heater	CS	20
6. H-02 L.E. Column Reboiler	Reboiler of D-01	2' dia. x 3', 51,522 Btu/hr / external heater	CS	20
7. H-03 L.E. Column Condenser	Total condenser of D-01	47,430 Btu/hr/shell-tube H.E.	CS	20
8. H-04 H.E. Column Feed Heater	To preheat feed to D-02	2' dia. x 5', 14,331 Btu/hr/external heater	CS	20

TABLE 3.4-6 (Continued)

9.	H-05 H.E. Column Reboiler	Reboiler of D-02	2' dia. x 3', 56,641 Btu/hr/external heater	CS	20
10.	H-06 H.E. Column Condenser	Total condenser of D-02	52,292 Btu/hr/shell-tube H.E.	CS	20
11.	H-07 SiCl ₄ Vent Condenser	Condense SiCl ₄ from vent gas	38 ft ² , 18,000 Btu/hr/shell-tube H.E.	CS	20
12.	H-08 SiCl ₄ Vaporizer	To provide SiCl ₄ vapor to reactor	2.75' dia. x 3' T/T. 13,648 Btu/hr/resistance heater	CS	20
13.	H-09 Reactor Condenser	To condense by products from reactor	14" dia. x 6.4', 126,237.2 Btu/hr	Graphite W/SS shell	20
14.	H-10 Reactor ZnCl ₂ Stripper	To condense ZnCl ₂ gas	12 ft ² , 2,652 Btu/hr/shell-tube H.E., finned U-tube	316 SS	20
15.	H-11 SiCl ₄ Condenser	To condense SiCl ₄ gas for recycle	6,401 Btu/hr (x 4.62 = 29,573 Btu/hr)	316 SS	20
16.	H-12 Cell ZnCl ₂ Stripper	To condense ZnCl ₂ vapor	9,841.4 Btu/hr/shell-tube, H.E. (x 0.32)	Inconel 600	20
17.	H-13 Therminol Cooler (cold circuit)	To cool Therminol	68 ft ² , 11,000 Btu/hr/shell-tube H.E., 500 psia	CS	20
18.	H-14 Therminol Cooler (hot circuit)	To cool Therminol	262 ft ² , 120,000 Btu/hr/shell-tube H.E., 500 psia	CS	20
19.	H-15 Start-up Heater	Therminol start up heater	98,950 Btu/hr/U-tube 15', resistance heater	CS	20
20.	H-16 Silicon Product Cooler (two)	To cool the Si product from reactor	5,735 Btu/hr	SiC	20

TABLE 3.4-6 (Continued)

20a.	H-17 Chlorination Cooler		20,000 Btu/hr, Area 200 ft ²	SS	1
20b.	H-18 Cell Gas Cooler		1.08×10^5 Btu/hr, Area 1805 ft ²	CS	1
<u>PROCESS AND STORAGE VESSELS</u>					
21.	T-01 SiCl ₄ Storage Tank	Storage/feed to purification	7' dia. x 16' T/T/ 4,600 gal	CS	20
22.	T-02 SiCl ₄ Emergency Storage Tank	Storage/feed to purification	7' dia. x 16' T/T/ 4,600 gal	CS	20
23.	T-03 L.E. Column Reflux Drum	To hold distillate for reflux	12" dia. x 4'/23 gal	CS	20
24.	T-04 Surge Tank	Surge Tank for D-01 bottom	3' dia. x 4'/200 gal	CS	20
25.	T-05 Sump Tank	Sump for purification unit	3' dia. x 4'/200 gal	CS	20
26.	T-06 H.E. Column Reflux Drum	To hold distillate for reflux	12" dia. x 4'/23 gal	CS	20
27.	T-07 Pure SiCl ₄ Storage Tank	Storage feed to SiCl ₄ Vaporizer	6' dia. x 10' T/T/ 1900 gal	CS	20
28.	T-08 Electrolysis Feed Tank	Storage feed ZnCl ₂ to electrolysis cell	50" x 158" x 38"H/ 7" graphite TH	Graphite/304 SS	20
29.	T-09 Molter Zinc Storage Tank	Storage feed to Zinc vaporizer	W/heater 68,242 Btu/hr	Graphite/304 SS	20
30.	T-10 Therminol Head Tank	Storage Therminol	1.5' dia. x 3.75' T/T/ 49.6 gal	CS	20

TABLE 3.4-6 (Continued)

31.	T-11 Therminol Drain Down Tank	To store drained Therminol	2.75' dia. x 3' T/T/ 133 gal	CS	20
32.	T-12 Chlorine Supply Tank	To supply chlorine gas	1 1/2' dia. x 3' / 37.62 gal	CS	20
33.	T-13 Lime Storage Tank	Storage Lime	12' dia. x 14'6" T/T/ 12,000 gal	FRP	1

PUMPS WITH DRIVERS

34.	P-01 Purification Feed Pump	To feed SiCl_4 to storage tank	30 gpm, 31' head/ centrifugal, 1 1/2 hp	CS	20
35.	P-02 L.E. Column Feed Pump	To supply SiCl_4 to preheater	28.9 gph, $\Delta p = 72$ psia/ 0.5 hp.	CS	20
36.	P-03 L.E. Column Reflux Pump	D-01 Reflux	51.7 gph, $\Delta p = 23$ psia/ 0.5 hp.	CS	20
37.	P-04 Surge Tank Pump	To supply SiCl_4 to H.E. Column	29.4 gph, $\Delta p = 53$ psia/ 0.5 hp.	CS	20
38.	P-05 Sump Pump	To pump SiCl_4 to emergency tank	30 gpm, 31' head/ centrifugal, 1 1/2 hp.	CS	20
39.	P-06 L.E. Column Bottom Pump	To pump SiCl_4 to surge tank	29.4 gph, $\Delta p = 53$ psia/ 0.5 hp.	CS	20
40.	P-07 H.E. Column Reflux Pump	D-02 Reflux	57.1 gph, $\Delta p = 25$ psia/ 0.5 hp.	CS	20
41.	P-08 H.E. Column Bottom Pump	To pump bottom solution to waste treatment	1.3 gph, $\Delta p = 25$ psia/ 0.5 hp.	CS	20
42.	P-09 SiCl_4 Vaporizer Feed Pump	To feed SiCl_4 to Vaporizer	15 gph, 31' head/ 1/2 hp	CS	20

TABLE 3.4-6 (Continued)

43.	P-10 Reactor Con- denser Circulating Pump	To circulate con- densates	2.4 gpm, 30' head/1/2 hp	Graphite	20
44.	P-11 Cold Circuit Pump (two)	Cold Therminol circulation	20 gpm, 85' head/centri- fugal, 2 hp.	CS	20
45.	P-12 Hot Circuit Pump	Hot Therminol circulation	62 gpm, 85' head/centri- fugal, 4 hp.	CS	20
46.	P-13 Primary Scrubber Recircula- tion Pump	Recirculation for Scrubber A-01	20 gpm, 125' head/ centrifugal, 2.5 hp.	Duriron	1
47.	P-14 Primary Scrubber Lower-loop Recirculating Pump	Circulate solution for Lower-loop of Scrubber A-02	100 gpm, 103' head/ centrifugal, 7 1/2 hp.	Duriron	1
48.	P-15 Primary Scrubber Upper-loop Recirculating Pump	Circulate solution for upper-loop of Scrubber A-02	100 gpm, 13' head/ centrifugal, 2 hp.	Duriron	1
49.	P-16 Make up Lime Metering Pump	Lime make up	0.9 gpm, 25' head/ centrifugal, 1/2 hp.	CS	1

FILTERS

50.	F-01 L.E. Column Feed Filter	Remove solids	29 gph, $\Delta p = 5$ psia/ 140 micron	CS	20
51.	F-02 L.E. Column Reflux Filter	Remove solids	30 gph, $\Delta p = 5$ psia/ 140 micron	CS	20
52.	F-03 H. E. Column Feed Filter	Remove solids	52 gph, $\Delta p = 5$ psia/ 140 micron	CS	20
53.	F-04 H.E. Column Reflux Filter	Remove solids	31 gph, $\Delta p = 5$ psia/ 140 micron	CS	20

TABLE 3.4-6 (Continued)

54.	F-05 Therminol Cooler Blower Filter	To filter the solids from air			20
<u>SPECIALIZED EQUIPMENTS</u>					
55.	R-01 Fluidized Bed Reactor (two)	To reduce SiCl_4 to Si by Zn	1830.2 Btu/hr.	6.5" dia. Graphite Lined /SS	20
56.	FN-01 Furnace (two)	To preheat SiCl_4 gas	272,966 Btu/hr		20
57.	B-01 Seed Addition Hopper (two)	To feed Si seed to the reactor		310 SS	20
58.	B-02 Si Product Hopper (four)	To hold Si product	6 gal	310 SS	20
59.	B-03 Zinc Hopper	To hold make up Zinc	40 gal	CS	20
60.	C-01 Therminol Cooler Blower	Therminol system air cooler blower	500 acfm fan/electric, 1 1/2 hp., 12-1/2" wheel	CS	20
61.	C-02 Scrubber Vent Blower	Suck SiCl_4 gas for A-01 & A-02	10,000 acfm/electric, 10 hp. 31-1/2" wheel	FRP	1
62.	E-01 Eductor (two)	SiCl_4 scrubbing (Scrubber D-05)	20 gpm, $\Delta p = 47.4$ psia/ Hydraulic ejector, 1-1/2" NPT	P.V.C.	1
63.	EC-01 Electrolysis Cell (six)	To recover Zn from ZnCl_2	5,000 ~6,000 amp cells	Graphite/SS	20
64.	PW-01 Power Supply	To supply power to electrolysis cell	545,933 Btu/hr.		20
65.	VP-01 Zinc Vaporizer (two)	To provide zinc vapor to reactor	104,128.8 Btu/hr 13.5" dia. x 32"	Quartz	20

TABLE 3.4-6 (Continued)

NOTE:

1. For the 1000 MT/yr plant, items 3, 4, 33, 46, 47, 48, 49, 61, and 62 are used for waste treatment of distillation wastes (light, heavy) and vent gases.
2. In the 50 MT/yr facility, these items are used for hypochlorite manufacture which is not present in the 1000 MT/yr plant.
3. For H-11, the operation conditions were changed from 171°F - 32°F to 662°F - 20°F.
4. For H-12, the operations conditions have been changed from $\Delta T = 855^\circ\text{F}$ to 270°F.

TABLE 3.4-7

PRODUCTION LABOR REQUIREMENTS FOR
BCL PROCESS - Case A

<u>Section</u>		<u>Labor</u> <u>man-hr/KG Si (oper/shift)</u>
1. Purification	(I)	0.01402 (2)
2. Deposition	(II)	0.01402 (2)
3. Electrolysis	(III)	0.02103 (3)
4. Waste Treatment	(IV)	0.00701 (1)
5. Product Handling	(V)	0.00701 (1)
	TOTAL	0.06309 (9)

Note

Manpower estimate for production labor requirements based on:

1. Dividing plant into sections
 - type of unit operation
 - mark off working area
2. Specify work duties required in each section
3. Estimate operators required to perform work duties in each section
 - type of unit operation
 - size of working area
 - degree of automation (batch, semi-continuous, continuous, etc.)

3.5 BCL Process for Silicon - Case B (Battelle Columbus Laboratories)

The chemical engineering analysis activity involves a preliminary process design of a plant to produce silicon via the technology under consideration.

The process flowsheet for the Case B of the BCL process to manufacture silicon is shown in Figure 3.5-1. This process consists of several major processing operations of distillation, vaporization, stripping, condensation and a deposition reaction to produce silicon as well as electrolysis to recover the zinc.

Silicon tetrachloride (SiCl_4), which is the major raw material, is fed to the distillation section for purification, to remove impurities (such as boron and phosphorous). In the deposition section, purified silicon tetrachloride is vaporized and preheated to the reaction temperature, 927°C , before it is introduced into a silicon deposition unit, which is a fluidized bed reactor. Zinc vapor produced by a specially designed induction-heated vaporizer is also introduced to the reactor at the same temperature for the reaction. The reaction equation to show the silicon deposition is

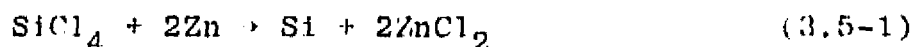

Silicon granules produced by the deposition reaction, which descend to the bottom of reactor, are cooled and collected in containers. A small amount of silicon seed is fed to the reactor to control the particle size of the silicon product. Zinc chloride and unreacted zinc are recovered and fed to the electrolysis section, while unreacted silicon tetrachloride is recycled to the distillation section.

In the electrolysis section, zinc chloride is reduced to zinc by low voltage (4-5 volts) electrolysis cells. Zinc is recycled to the deposition unit, while chlorine gas is collected as the by-product. The deposition and electrolysis sections are purged with inert gas (such as argon). Waste gases from various sections are collected and treated with hydrate lime solution in the waste treatment section.

A process design was performed to obtain data for a cost analysis of a plant to produce silicon by this new technology. The design was based on a plant to produce 1000 metric tons/yr of silicon via the BCL process. In case B, the process contains one deposition reactor and two electrolysis cells as compared with two deposition reactors and six electrolysis cells for Case A which was reported earlier.

The detailed status sheet for the process design package is shown in Table 3.5-1 and is representative of the various sub-items that make up the activity. The summarized results for the preliminary process design are presented in a tabular format to make it easier to locate items of specific interest.

The guide for these tables is given below:

- Base Case Conditions-----Table 3.5-2
- Reaction Chemistry-----Table 3.5-3
- Raw Material Requirements-----Table 3.5-4
- Utility Requirements-----Table 3.5-5
- Major Process Equipment-----Table 3.5-6
- Production Labor Requirements-----Table 3.5-7

The process design provides detailed data for raw materials, utilities, major process equipment and production labor requirements which are necessary for polysilicon production.

TABLE 3.5-1 CHEMICAL ENGINEERING ANALYSES:
PRELIMINARY PROCESS DESIGN ACTIVITIES FOR BCL Process (Case B)

<u>Prel. Process Design Activity</u>	<u>Status</u>	<u>Prel. Process Design Activity</u>	<u>Status</u>
1. Specify Base Case Conditions	●	7. Equipment Design Calculations	●
1. Plant Size	●	1. Storage Vessels	●
2. Product Specifics	●	2. Unit Operations Equipment	●
3. Additional Conditions	●	3. Process Data (P, T, rate, etc.)	●
2. Define Reaction Chemistry	●	4. Additional	●
1. Reactants, Products	●	8. List of Major Process Equipment	●
2. Equilibrium	●	1. Size	●
3. Process Flow Diagram	●	2. Type	●
1. Flow Sequence, Unit Operations	●	3. Materials of Construction	●
2. Process Conditions (T, P, etc.)	●	8a. Major Technical Factors	●
3. Environmental	●	(Potential Problem Areas)	●
4. Company Interaction (Technology Exchange)	●	1. Materials Compatibility	●
4. Material Balance Calculations	●	2. Process Conditions Limitations	●
1. Raw Materials	●	3. Additional	●
2. Products	●	9. Production Labor Requirements	●
3. By-Products	●	1. Process Technology	●
5. Energy Balance Calculations	●	2. Production Volume	●
1. Heating	●	10. Forward for Economic Analysis	●
2. Cooling	●		
3. Additional	●		
6. Property Data	●	○ Plan	
1. Physical	●	● In Progress	
2. Thermodynamic	●	● Complete	
3. Additional	●		

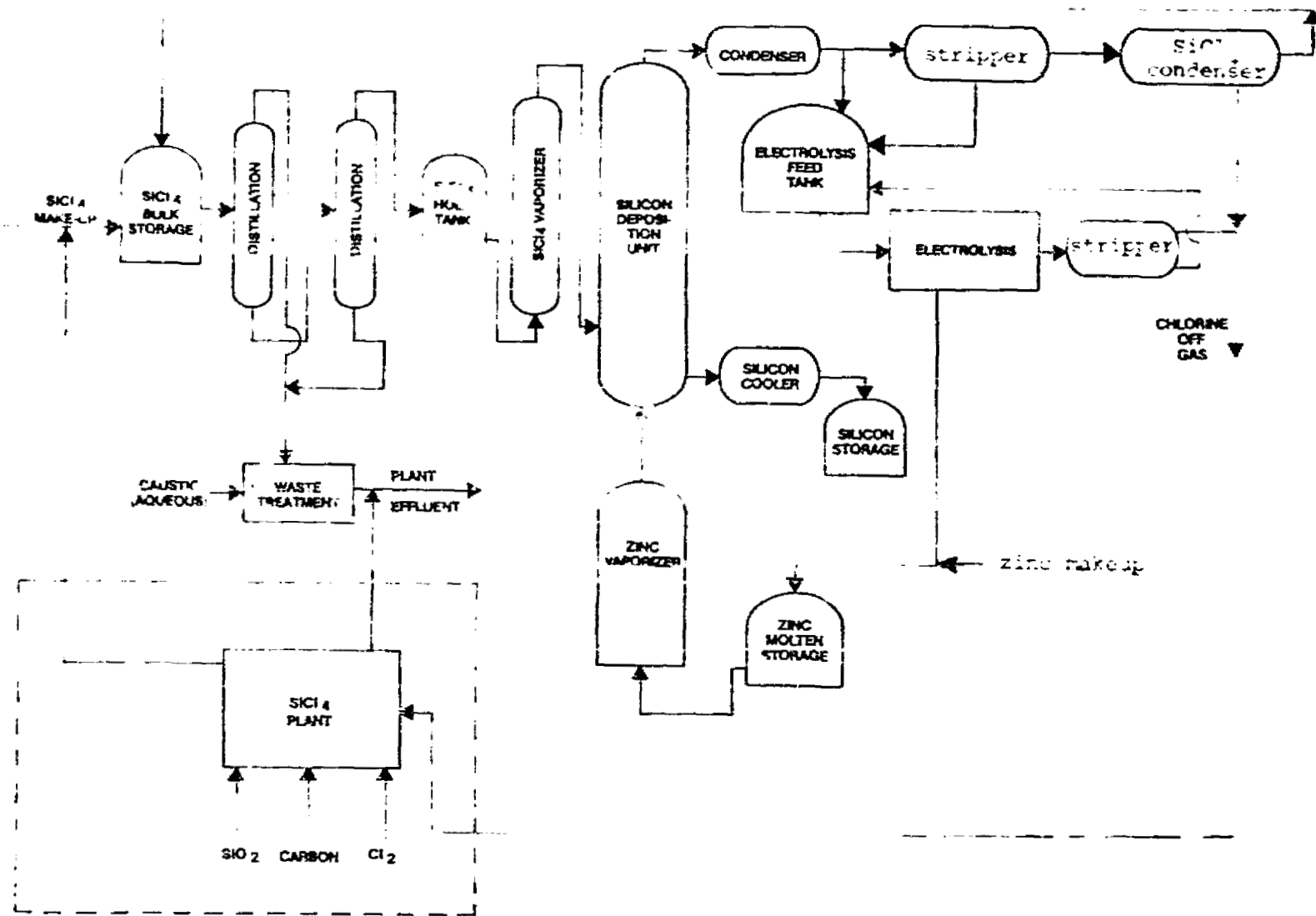

Figure 3.5-1 Process Flow Sheet for BCL Process - Case B

TABLE 3,5-2
BASE CASE CONDITIONS FOR ECL PROCESS (Case B)

1. Plant Size
 - silicon produced from silicon tetrachloride (TET)
 - 1000 metric tons/yr of silicon
 - solar cell grade silicon
 - solid phase product form (granules)
2. Light End Distillation
 - purification of TET by distillation
 - remove 4% chlorosilanes as the light end
 - 80°C, 10 psig
3. Heavy End Distillation
 - purification of TET by distillation
 - remove 4% impurities as the heavy end
 - 92% over-all yield of TET from both distillations
 - 80°C, 10 psig
4. TET Vaporizer
 - to supply TET vapor for deposition reactor
 - by power input (resistance heater)
 - hold at constant level and constant pressure
 - 164°F
5. Deposition Reactor
 - reduce TET by zinc to produce silicon
 - deposit on pure silicon seed
 - fluid bed
 - 927°C (1700°F, 1 atm)
 - 63% conversion of TET to silicon
6. Reactor Condenser
 - to condense gases from reactor (ZnCl₂, unreacted Zn and SiCl₄ gases)
 - partial condensation
 - using therminol 66 as the coolant
 - 927°C inlet temperature and 350°C outlet temperature
7. Reactor ZnCl₂ Stripper
 - work as partial condenser
 - to condense ZnCl₂ gas from SiCl₄ gas
 - operating at the temperature right above ZnCl₂ melting point (318°C), 350°C
 - using therminol 66 as the coolant
8. Cell ZnCl₂ Stripper
 - operates as partial condenser
 - to condense ZnCl₂ gas from Cl₂ and SiCl₄ gases
 - operating at the temperature right above ZnCl₂ melting point (318°C), 350°C
 - using therminol 66 as the heat exchange medium

TABLE 3.5-2 (Continued)

9. Reactor SiCl_4 Condenser
 - condense SiCl_4 gas for recycle
 - antifreeze as the coolant
 - 350°C inlet temperature, 20°F outlet temperature.
10. Electrolysis
 - electrolytic recovery of Zn from ZnCl_2
 - Cl_2 gas is by product
 - 95% Zn recovery
 - 500°C, approx. 1 atm
11. Zinc Vaporizer
 - to vaporize Zinc
 - by induction heating
 - 927°C, approx. 1 atm.
12. Wastes Treatment
 - to scrub and neutralize SiCl_4 and chlorosilane gases
 - caustic solution used to neutralize
13. Operating Ratio
 - approximately 80% utilization (on stream time)
 - approximately 7,000 hr/yr production
14. Storage Considerations
 - feed material (two week supply)
 - product (two shifts storage)
 - process (several hours)

TABLE 3.5-3
REACTION CHEMISTRY FOR BCL PROCESS (Case B)

1. Silicon Deposition

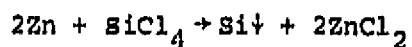

2. Electrolysis

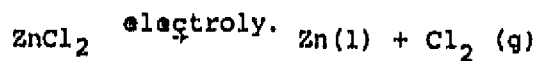

3. Waste Treatment

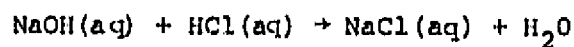
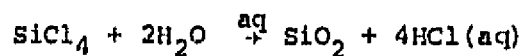

or

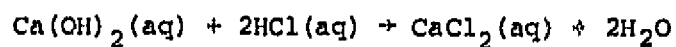

3a. Waste Treatment (50 MT/yr unit)

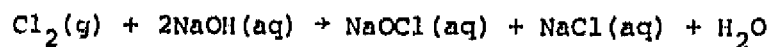

Table 3.5-4

Raw Material Requirements for
BCL Process (Case B)

<u>Raw Material</u>	<u>Requirements lb/KG of Silicon</u>
1. Silicon Tetrachloride, SiCl ₄	15.33
2. Zinc, Zn	0.54
3. Caustic (50%), NaOH(aq)	3.75
or	
Lime (99%), Ca(OH) ₂	1.75
4. Argon	3.1 SCF*
5. Nitrogen	7.6 SCF*
6. Chlorine, Cl ₂ (by-product)	11.12

*Estimate from BCL

TABLE 3.5-5 UTILITY REQUIREMENTS FOR BCL
PROCESS (Case B)

<u>Utility/Function</u>		<u>Requirements/Kg of Silicon Product</u>
1.	Electricity	25.40 Kw-hr
1.	Low Voltage D.C. for Electrolysis	(20.51)
2.	Zinc Vaporizer Induction Heated	(4.37)
3.	Preheat Section of Deposition Unit Induction Heated	(1.12)
4.	Electrolysis Feed Tank Heater	(0.24)
5.	Molten Zinc Storage Heater	(0.10)
6.	SiCl ₄ Vaporizer	(0.53)
7.	Pumps, Blowers	(0.53)
2.	Steam (50 PSIA)	9.67 pounds
1.	#1 Purification Column Calandria	(4.59)
2.	#2 Purification Column Calandria	(4.30)
3.	Caustic Storage Heating	(0.29)
4.	#1 Purification Column Preheater	(0.49)
3.	Cooling Water	34.49 Gallons
1.	#1 Purification Column Condenser	(16.94)
2.	#2 Purification Column Condenser	(15.88)
3.	Purified Tet Cooler	(1.67)
4.	Process Water	10.48 Gallons
1.	Diluent for Waste Treatment	(10.48)
5.	Refrigeration	2.30 MBtu
1.	Reactor SiCl ₄ Condenser (H-11)	(1.28)
2.	SiCl ₄ Vent Condenser (H-07)	(1.10)

TABLE 3.5-6

LIST OF MAJOR PROCESS EQUIPMENT
FOR BCL (Case B)

<u>Equipment</u>	<u>Function</u>	<u>Size/Type</u>	<u>Material of Construction</u>	<u>Capacity Ratio to 1000 MT/yr</u>
<u>PROCESS TOWER AND INTERNALS</u>				
1. D-01 Light End Distillation Column	To purify SiCl_4	8" dia. x 21', packed 13.5'	Column, CS/packing, SS	20
2. D-02 Heavy End Distillation Column	To purify SiCl_4	8" dia. x 21', packed 13.5'	Column, CS/packing, SS	20
3. A-01 Primary SiCl_4 Vent Scrubber	To scrub SiCl_4 vent gas	3' dia. x 4'4" T/T, 225 gal/flat bottom	FRP	1
4. A-02 Final SiCl_4 Vent Scrubber	To scrub SiCl_4 vent gas	7'6" dia. x 17'4" T/T/ 4 pp trays, Teflon dimister	FRP	1
<u>HEAT EXCHANGER</u>				
5. H-01 L.E. Column Feed Heater	To preheat feed to D-01	2' dia. x 5', 15,013 Btu/hr / external heater	CS	20
6. H-02 L.E. Column Reboiler	Reboiler of D-01	2' dia. x 3', 51,522 Btu/hr / external heater	CS	20
7. H-03 L.E. Column Condenser	Total condenser of D-01	47,430 Btu/hr/shell-tube H.E.	CS	20
8. H-04 H.E. Column Feed Heater	To preheat feed to D-02	2' dia. x 5', 14,331 Btu/hr/external heater	CS	20

TABLE 3.5-6 (Continued)

9.	H-05 H.E. Column Reboiler	Reboiler of D-02	2' dia. x 3', 56,641 Btu/hr/external heater	CS	20
10.	H-06 H.E. Column Condenser	Total condenser of D-02	52,292 Btu/hr/shell-tube H.E.	CS	20
11.	H-07 SiCl ₄ Vent Condenser	Condense SiCl ₄ from vent gas	38 ft ² , 18,000 Btu/hr/shell-tube H.E.	CS	20
12.	H-08 SiCl ₄ Vaporizer	To provide SiCl ₄ vapor to reactor	2.75' dia. x 3' T/T, 13,648 Btu/hr/resistance heater	CS	40
13.	H-09 Reactor Condenser	To condense by products from reactor	14" dia. x 6.4', 126,237.2 Btu/hr	Graphite W/SS shell	40
14.	H-10 Reactor ZnCl ₂ Stripper	To condense ZnCl ₂ gas	12 ft ² , 2,652 Btu/hr/shell-tube H.E., finned U-tube	316 SS	20
15.	H-11 SiCl ₄ Condenser	To condense SiCl ₄ gas for recycle	6,401 Btu/hr (x 4.62 = 29.573 Btu/hr)	316 SS	20
16.	H-12 Cell ZnCl ₂ Stripper	To condense ZnCl ₂ vapor	9,841.4 Btu/hr/shell-tube, H.E. (x 0.32)	Inconel 600	20
17.	H-13 Therminol Cooler (cold circuit) 66	To cool Therminol	68 ft ² , 11,000 Btu/hr/shell-tube H.E., 500 psia	CS	20
18.	H-14 Therminol Cooler (hot circuit) 66	To cool Therminol	262 ft ² , 120,000 Btu/hr/shell-tube H.E., 500 psia	CS	20
19.	H-15 Start-up Heater	Therminol start-up heater	98,950 Btu/hr/U-tube 15', resistance heater	CS	20
20.	H-16 Silicon Product Cooler (two)	To cool the Si product from reactor	5,735 Btu/hr	SiC	40

TABLE 3.5-6 (Continued)

20a.	H-17 Chlorination Cooler		20,000 Btu/hr, Area 200 ft ²	SS	1
20b.	H-18 Cell Gas Cooler		1.08 x 10 ⁵ Btu/hr, Area 1805 ft ²	CS	1

PROCESS AND STORAGE VESSELS

21.	T-01 SiCl ₄ Storage Tank	Storage/feed to purification	7' dia. x 16' T/T/ 4,600 gal	CS	20
22.	T-02 SiCl ₄ Emergency Storage Tank	Storage/feed to purification	7' dia. x 16' T/T/ 4,600 gal	CS	20
23.	T-03 L.E. Column Reflux Drum	To hold distillate for reflux	12" dia. x 4'/23 gal	CS	20
24.	T-04 Surge Tank	Surge Tank for D-01 bottom	3' dia. x 4'/200 gal	CS	20
25.	T-05 Sump Tank	Sump for purifica- tion unit	3' dia. x 4'/200 gal	CS	20
26.	T-06 H.E. Column Reflux Drum	To hold distillate for reflux	12" dia. x 4'/23 gal	CS	20
27.	T-07 Pure SiCl ₄ Storage Tank	Storage/feed to SiCl ₄ Vaporizer	6' dia. x 10' T/T/ 1900 gal	CS	20
28.	T-08 Electrolysis Feed Tank	Storage/feed ZnCl ₂ to electrolysis cell	50" x 158" x 38"H/ 7" graphite TH	Graphite/304 SS	20
29.	T-09 Molten Zinc Storage Tank	Storage/feed to Zinc vaporizer	W/heater 68,242 Btu/hr	Graphite/304 SS	20
30.	T-10 Therminol Feed Tank	Storage Therminol	1.5' dia. x 3.75' T/T/ 43.6 gal	CS	20

TABLE 3.5-6 (Continued)

31.	T-11 Therminol Drain Down Tank	To store drained Therminol	2.75' dia. x 3' T/T/ 133 gal	CS	20
32.	T-12 Chlorine Supply Tank	To supply chlorine gas	1 1/2' dia. x 3'/ 37.62 gal	CS	20
33.	T-13 Lime Storage Tank	Storage Lime	12' dia. x 14'6" T/T/ 12,000 gal	FRP	1
<u>PUMPS WITH DRIVERS</u>					
34.	P-01 Purification Feed Pump	To feed SiCl_4 to storage tank	30 gpm, 31' head/ centrifugal, 1 1/2 hp	CS	20
35.	P-02 L.E. Column Feed Pump	To supply SiCl_4 to preheater	28.9 gph, $\Delta p = 72$ psia/ 0.5 hp.	CS	20
36.	P-03 L.E. Column Reflux Pump	D-01 Reflux	51.7 gph, $\Delta p = 23$ psia/ 0.5 hp.	CS	20
37.	P-04 Surge Tank Pump	To supply SiCl_4 to H.E. Column	29.4 gph, $\Delta p = 53$ psia/ 0.5 hp.	CS	20
38.	P-05 Sump Pump	To pump SiCl_4 to emergency tank	30 gpm, 31' head/ centrifugal, 1 1/2 hp.	CS	20
39.	P-06 L.E. Column Bottom Pump	To pump SiCl_4 to surge tank	29.4 gph, $\Delta p = 53$ psia/ 0.5 hp.	CS	20
40.	P-07 H.E. Column Reflux Pump	D-02 Reflux	57.1 gph, $\Delta p = 25$ psia/ 0.5 hp.	CS	20
41.	P-08 H.E. Column Bottom Pump	To pump bottom solution to waste treatment	1.3 gph, $\Delta p = 25$ psia/ 0.5 hp.	CS	20
42.	P-09 SiCl_4 Vaporizer Feed Pump	To feed SiCl_4 to Vaporizer	15 gph, 31' head/ 1/2 hp	CS	20

TABLE 3.5-6 (Continued)

43.	P-10 Reactor Condenser Circulating Pump	To circulate condensates	2.4 gpm, 30' head/1/2 hp Graphite		40
44.	P-11 Cold Circuit Pump (two)	Cold Therminol circulation	20 gpm, 85' head/centrifugal, 2 hp.	CS	20
45.	P-12 Hot Circuit Pump	Hot Therminol circulation	62 gpm, 85' head/centrifugal, 4 hp.	CS	20
46.	P-13 Primary Scrubber Recirculation Pump	Recirculation for Scrubber A-01	20 gpm, 125' head/centrifugal, 2.5 hp.	Duriron	1
47.	P-14 Primary Scrubber Lower-loop Recirculating Pump	Circulate solution for Lower-loop of Scrubber A-02	100 gpm, 103' head/centrifugal, 7 1/2 hp.	Duriron	1
48.	P-15 Primary Scrubber Upper-loop Recirculating Pump	Circulate solution for upper-loop of Scrubber A-02	100 gpm, 13' head/centrifugal, 2 hp.	Duriron	1
49.	P-16 Make up Lime Metering Pump	Lime make up	0.9 gpm, 25' head/centrifugal, 1/2 hp.	CS	1
<u>FILTERS</u>					
50.	F-01 L.E. Column Feed Filter	Remove solids	29 gph, $\Delta p = 5$ psia/140 micron	CS	20
51.	F-02 L.E. Column Reflux Filter	Remove solids	30 gph, $\Delta p = 5$ psia/140 micron	CS	20
52.	F-03 H. E. Column Feed Filter	Remove solids	52 gph, $\Delta p = 5$ psia/140 micron	CS	20
53.	F-04 H.E. Column Reflux Filter	Remove solids	31 gph, $\Delta p = 5$ psia/140 micron	CS	20

TABLE 3.5-6(Continued)

54.	F-05 Therminol Cooler Blower Filter	To filter the solids from air			20
<u>SPECIALIZED EQUIPMENTS</u>					
55.	R-01 Fluidized Bed Reactor (two)	To reduce SiCl_4 to Si by Zn	1830.2 Btu/hr, 6.5" dia.	Graphite Lined /SS	40
56.	FN-01 Furnace (two)	To preheat SiCl_4 gas	272,966 Btu/hr		40
57.	B-01 Seed Addition Hopper (two)	To feed Si seed to the reactor		310 SS	40
58.	B-02 Si Product Hopper (four)	To hold Si product	6 gal	310 SS	20
59.	B-03 Zinc Hopper	To hold make up Zinc	40 gal	CS	20
60.	C-01 Therminol Cooler Blower	Therminol system air cooler blower	500 acfm fan/electric, 1 1/2 hp., 12-1/2" wheel	CS	20
61.	C-02 Scrubber Vent Blower	Suck SiCl_4 gas for A-01 & A-02	10,000 acfm/electric, 50 hp. 31-1/2" wheel	FRP	1
62.	E-01 Eductor (two)	SiCl_4 scrubbing (Scrubber D-05)	20 gpm, $\Delta p = 47.4$ psia/ Hydraulic ejector, 1-1/2" NPT	P.V.C.	1
63.	EC-01 Electrolysis Cell (six)	To recover Zn from ZnCl_2	5,000 ~6,000 amp cells	Graphite/SS	60
64.	PW-01 Power Supply	To supply power to electrolysis cell	545,933 Btu/hr.		20
65.	VP-01 Zinc Vaporizer (two)	To provide zinc vapor to reactor	104,128.8 Btu/hr 13.5" dia. x 32"	Quartz	40

TABLE 3.5-6 (Continued)

NOTE:

1. For the 1000 MT/yr plant, items 3, 4, 33, 46, 47, 48, 49, 61, and 62 are used for waste treatment of distillation wastes (light, heavy) and vent gases.
2. In the 50 MT/yr facility, these items are used for hypochlorite manufacture which is not present in the 1000 MT/yr plant.
3. For 1-11, the operation conditions were changed from 171°F - 32°F to 662°F - 20°F.
4. For 1-12, the operation conditions have been changed from 1T = 855°F to 270°F.

TABLE 3.5-7

PRODUCTION LABOR REQUIREMENTS FOR
BCL PROCESS (Case B)

<u>Section</u>		<u>Labor</u> <u>man-hr/KG Si (oper/shift)</u>
1. Purification	(I)	0.01402 (2)
2. Deposition	(II)	0.01402 (2)
3. Electrolysis	(III)	0.02103 (3)
4. Waste Treatment	(IV)	0.00701 (1)
5. Product Handling	(V)	0.00701 (1)
		<hr/>
	TOTAL	0 06309 (9)

Note

Manpower estimate for production labor requirements based on:

1. Dividing plant into sections
 - type of unit operation
 - mark off working area
2. Specify work duties required in each section
3. Estimate operators required to perform work duties in each section
 - type of unit operation
 - size of working area
 - degree of automation (batch, semi-continuous, continuous, etc.)

3.6 DCS Process (Dichlorosilane)

The chemical engineering analysis activity involves a preliminary process design of a plant to produce dichlorosilane as a silicon source material by using the technology under consideration.

The process flowsheet for the DCS process to produce dichlorosilane consisting several major processing operations of hydrochlorination, condensation, stripping, distillation and redistribution reaction, is shown in Figure 3.6-1.

Metallurgical grade silicon (M.G.Si) is hydrochlorinated at the presence of hydrogen (H_2) and silicon tetrachloride ($SiCl_4$) in a fluidized bed reactor. The product stream from the hydrochlorination is cooled. A settler is then used to remove metal impurities. The chlorosilanes - dichlorosilane (DCS), trichlorosilane (TCS) and silicon tetrachloride (TET) are separated by several distillation units. After separation, the silicon tetrachloride is recycled.

Intermediate in the several distillation units, the TCS is redistributed to DCS and TET by passing through a fixed bed of catalyst. After redistribution, the stream is fed to appropriate distillation unit for separation and purification. The reaction equations to produce DCS are shown

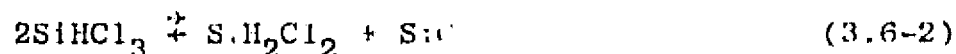
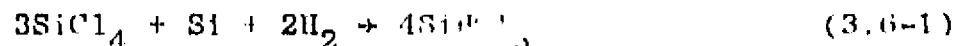

A process design was performed to obtain data for a cost analysis of a plant to produce DCS by this new technology. The design was based on a plant to produce 2,780 metric tons/yr of DCS which is sufficient to produce 1000 metric tons/yr of silicon without recycle.

The detailed status sheet for the process design package is shown in Table 3.6-1 and is representative of the various sub-items that make up the activity. The summarized results for the preliminary process design are presented in a tabular format to make it easier to locate items of specific interest. The guide for these tables is given below:

- Base Case Conditions, Table 3.6-2
- Reactor Chemistry, Table 3.6-3
- Raw Material Requirements, Table 3.6-4
- Utility Requirements, Table 3.6-5
- Major Process Equipment, Table 3.6-6
- Production Labor Requirements, Table 3.6-7

The process design provides detailed data for raw materials, utilities, major process equipment and production labor requirements which are necessary for polysilicon production.

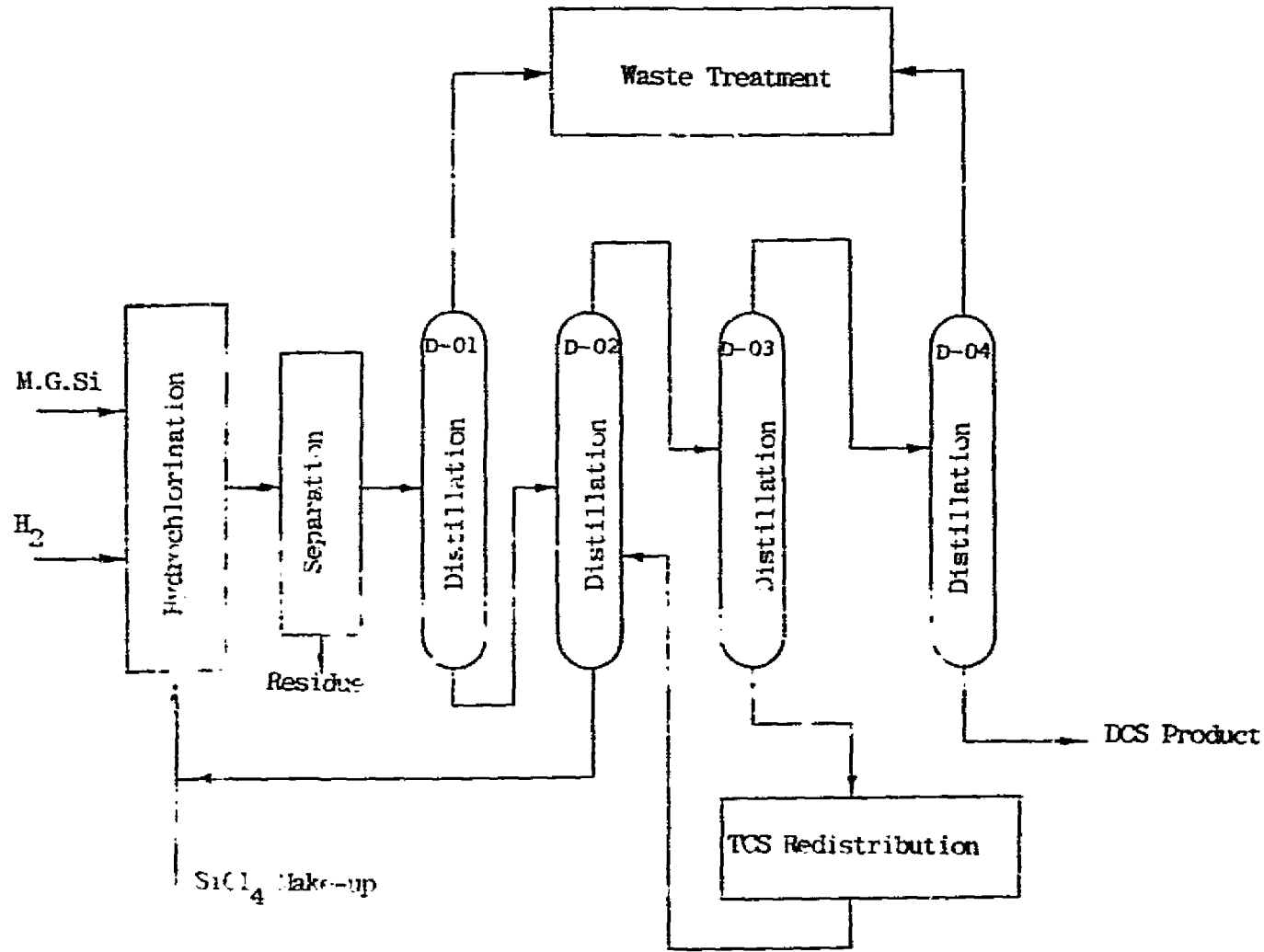

Figure 3.6-1 Process Flowsheet for DCS Process

TABLE 3.6-1 CHEMICAL ENGINEERING ANALYSES:
PRELIMINARY PROCESS DESIGN ACTIVITIES FOR DCS PROCESS

<u>Prel. Process Design Activity</u>	<u>Status</u>	<u>Prel. Process Design Activity</u>	<u>Status</u>
1. Specify Base Case Conditions	●	7. Equipment Design Calculations	●
1. Plant Size	●	1. Storage Vessels	●
2. Product Specifics	●	2. Unit Operations Equipment	●
3. Additional Conditions	●	3. Process Data (P, T, rate, etc.)	●
2. Define Reaction Chemistry	●	4. Additional	●
1. Reactants, Products	●	8. List of Major Process Equipment	●
2. Equilibrium	●	1. Size	●
3. Process Flow Diagram	●	2. Type	●
1. Flow Sequence, Unit Operations	●	3. Materials of Construction	●
2. Process Conditions (T, P, etc.)	●	8a. Major Technical Factors	●
3. Environmental	●	(Potential Problem Areas)	●
4. Company Interaction	●	1. Materials Compatibility	●
(Technology Exchange)	●	2. Process Conditions Limitations	●
4. Material Balance Calculations	●	3. Additional	●
1. Raw Materials	●	9. Production Labor Requirements	●
2. Products	●	1. Process Technology	●
3. By-Products	●	2. Production Volume	●
5. Energy Balance Calculations	●	10. Forward for Economic Analysis	●
1. Heating	●		
2. Cooling	●		
3. Additional	●		
6. Property Data	●	○ Plan	
1. Physical	●	● In Progress	
2. Thermodynamic	●	● Complete	
3. Additional	●		

TABLE 3.6-2

BASE CASE CONDITIONS FOR DCS PROCESS

1. Plant Size
 - Dichlorosilane produced from m.g. silicon and silicon tetrachloride.
 - 2,895 lb/hr dichlorosilane (enough to support 1000 metric tons/year of silicon production)
 - 9,780 metric tons/yr of DCS capacity
2. Hydrochlorination
 - Metallurgical grade silicon, hydrogen, and recycle silicon tetrachloride (TET) used to produce trichlorosilane (TCS)
 - Copper catalyzed
 - Fluidized bed
 - 500°C, 514.7 psia
 - H₂/Cl₂ ration about 2.8
 - 30% conversion of SiCl₄ to SiHCl₃
3. TCS Redistribution Reaction
 - TCS is redistributed to DCS and TET through catalytic reaction
 - Catalytic redistribution of TCS with amine function ion exchange resin
 - Liquid phase 85 psia, 140°F
 - Conversion from pure TCS feed is about 11% to DCS
4. Recycles
 - Unreacted chlorosilanes and hydrogen are separated by distillation and recycled
5. Dichlorosilane Purification
 - Final purification by distillation
 - Designed to remove trace impurities (B₂H₆, example)
6. Operating Ration
 - Approximately 85% utilization (on stream time)
 - Approximately 7446 hour/year production
7. Storage Consideration
 - Feed materials (several week supply, approx. 1 month)
 - Product (two shifts storage)
 - Process (several hours to 1 shift)

TABLE 3.6-3

REACTION CHEMISTRY FOR DCS PROCESS

1. Hydrochlorination Reaction

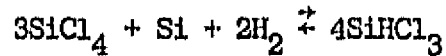

2. Redistribution Reaction

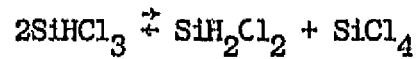

3. Waste Treatment (representative - overall)

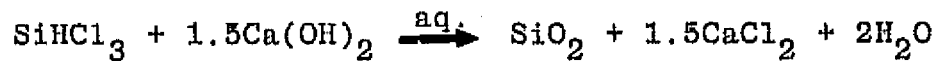

Note:

1. Reaction 1 product contains H₂, HCl, SiCl₄, SiHCl₃, SiH₂Cl₂ (trace), other trace chlorides
2. Reaction 2 product contains SiCl₃, SiCl₄, SiH₂Cl₂, SiH₃Cl

TABLE 3.6-4

RAW MATERIAL REQUIREMENTS FOR DCS PROCESS

	<u>Raw Material</u>	<u>Requirements lb/hr</u>	<u>lb/kg of DCS</u>
1.	M.G. Silicon (Si)	456.6	0.348
2.	Silicon Tetrachloride (SiCl ₄ , make-up)	2609.5	1.987
3.	Liquid Hydrogen	62.5	0.048
4.	Copper Catalyst (Cu)	6.8	0.005
5.	Hydrate Lime (Ca(OH) ₂)	310.0	0.236

TABLE 3.6-5

UTILITY REQUIREMENTS FOR DCS PROCESS

<u>Utilities/Function</u>	<u>Total Requirements</u>	<u>Requirements per Kg of DCS</u>
1. Electricity		
1) Gas Compressions (96bhp)	217 KW	.165 KW-Hr
2) Pumping Liquids (98.5 bhp)	223 KW	.170 KW-Hr
3) Filter Drive (1 bhp)	<u>2.3 KW</u>	<u>.002 KW-Hr</u>
	443 KW	.337 KW-Hr
2. Steam (50 psia, saturated)		
1) Column Reboiler (12.0MM Btu/hr)	3,850 lb/hr	2.93 lb
2) Vaporizer (3.56MM Btu/hr)	<u>12,970 lb/hr</u>	<u>9.88 lb</u>
	16,820 lb/hr	12.81 lb
3. Cooling Water		
1) Coolers and Condensers (21.66MM Btu/hr)	1237 gpm	56.51 gal
4. Process Water		
1) Waste Treatment	6.59 gpm	.301 gal
5. Fuel Oil		
1) Direct-Fired Heater (4.71MM Btu/hr)	33.4 gal/hr	.026 gal
2) Incineration (1.5 x 10 ⁶ MM Btu/hr)	<u>10.6 gal/hr</u>	<u>.008 gal</u>
	44.0 gal/hr	.034 gal

TABLE 3.6-6

LIST OF MAJOR PROCESS EQUIPMENT
FOR DCS PROCESS

<u>Equipment</u>	<u>Function</u>	<u>Duty/Type</u>	<u>Size</u>	<u>Material of Construction</u>
<u>Reactors</u>				
1. R-01 Hydrochlorination Reactor	Hydrochlorination of m.g. Si & SiCl ₄	32,200lb/hr Feed/Fluid. bed	8.54' diam. x 9.75', and 12.25', 30° cone	316SS
2. R-02 TCS Redistribution Reactor	Conversion of TCS to DCS	31,000lb/hr Feed/Fluid Bed, catalyst	2' diam. x 36' 320 psia	316SS
3. R-03 Waste Neutralizer	Waste Treatment	agitated vessel	3' diam. x 20' 14.7 psia	316SS
4. R-04 Waste Com-buster	To incinerate waste vapors	25 SCFM Vapor/Combustion	3' x 3' x 9' 14.7 psia	CS/Brick
<u>Distillation Columns</u>				
5. D-01 Crude TCS Stripping Column	To remove inert gases	31,217lb/hr of feed	24" diam. x 20' tall with 10 sieve plates	CS
6. D-02 TCS/STC Distillation Column	To remove STC at bottom	62,208.4lb/hr of feed	5.2' diam. x 68'tall with 29 sieve plates	CS
7. D-03 DCS/TCS Distillation Column	To remove DCS at distillates	34,001.2lb/hr of feed	4.9' diam. x 102'tall with 46 sieve plates	CS
8. D-04 DCS Distillation Column	To purify DCS	3,009.8lb/hr of feed	1.1' diam. x 70' tall with 40 sieve plates	316SS

TABLE 3.6-6 (continued)

	<u>Equipment</u>	<u>Function</u>	<u>Duty/Type</u>	<u>Size</u>	<u>Material of Construction</u>
	<u>Tanks & Bins</u>				
9.	B-01 Silicon Storage Bin with Feed Lock	To store and feed m.g. Si to reactor	1 week storage/Vertical, with Feed Lock	7'diam. x 22', 60° cone	CS
10.	T-01 Residue Settling Tank	To separate unreacted solid residues	Vertical	8' diam. x 16', 515 psia	316SS
11.	T-02 Residue Withdraw Tank	To remove unreacted solid residues	Vertical	3' diam. x 6', 515 psia	316SS
12.	T-03 Hydrogen Separation Tank	To separate H ₂ gas from chlorosilanes	Vertical, mesh pad	3.75' diam. x 11.25', 515 psia	CS
13.	T-04 Crude TCS Storage Tank	To store crude TCS	8 hr. storage, Horizontal	12'diam. x 33', 100 psia	CS
14.	T-05 TCS Stripper Reflux Drum	Reflux drum for D-01 column	30 min. storage, Vertical	2' diam. x 3.5', 90 psia	CS
15.	T-06 TCS/STC Distillation Reflux Drum	Reflux drum for D-02 column	10 min. storage, Vertical	4.5' diam. x 19', 55 psia	CS
16.	T-07 STC Storage Tank	To store STC	6 hr. storage, Horizontal	10.25' diam. x 3.05', 15 psia	CS
17.	T-08 DCS/TCS Distillation Reflux Drum	Reflux drum for D-03 column	10 min. storage, Vertical	4' diam. x 13', 320 psia	CS
18.	T-09 DCS Distillation Reflux Drum	Reflux drum for D-04 column	10 min. storage, Vertical	1.5' diam. x 4.25', 125 psia	316SS
19.	T-10 DCS Storage Tank	To store purified DCS	8 hr. storage, Horizontal	6' diam. x 16.75', 125 psia	316SS

TABLE 3.6-6 (continued)

	<u>Equipment</u>	<u>Function</u>	<u>Duty/Type</u>	<u>Size</u>	<u>Material Construction</u>
20.	T-11 Flue Gas Separation Tank	To separate flue gas from lime solution	Vertical tank with mesh	2' diam. x 5'	CS
21.	T-12 Lime Solution Preparation Tank	To prepare lime solution	8 hr. storage, Vertical, open top	5' diam. x 9.5'	CS
22.	T-13 Waste Filtrate Storage Tank	To store waste filtrate	4 hr. storage, vertical	5' diam. x 8'	CS
<u>Heaters & Heat Exchangers</u>					
23.	H-01 Crude TCS Condenser	To condense chlorosilanes	8.4MM Btu/Hr. Shell-Tube H.E.	1211 ft ² , 515 psia	316SS
293 24.	H-02 H ₂ Gas Pre-heater ²	To preheat H ₂ Gas for chlorination	500°C discharge, Direct-fired heater	2.59MM Btu/hr, 515 psia	CS/316SS
25.	H-03 STC Vaporizer	To vaporize and superheat STC for chlorination	3.56MM Btu/hr, Kettle	573 ft ² , 515 psia	316SS
26.	H-04 Stripper Condenser	Partial condenser for D-01 column	86,700 Btu/hr Shell-tube H.E.	30 ft ² , 90 psia	CS
27.	H-05 Stripper Reboiler	Stripper reboiler of D-01 column	0.91MM Btu/hr, Kettle	40 ft ² , 95 psia	CS
28.	H-06 TCS Condenser	To condense TCS vapor of D-02 column	7.9MM Btu/hr, Shell-tube H.E.	2,358 ft ² , 55 psia	316SS
29.	H-07 TCS/STC Reboiler	Reboiler for D-02 TCS/STC Distillation column	8.25MM Btu/hr, Kettle	318 ft ² , 55 psia	CS
30.	H-08 STC Heat Exchanger	STC Cooling and Heating	0.824MM Btu/hr, Liq-liq. heat exchanger	742 ft ² , 55 psia	316SS/CS

TABLE 3.6-6 (continued)

	<u>Equipment</u>	<u>Function</u>	<u>Duty/Type</u>	<u>Size</u>	<u>Material of Construction</u>
31.	H-09 DCS Condenser	To condense DCS Vapor from D-03 Column	3.2MM Btu/hr Shell-Tube H.E.	328 ft ² , 320 psia	316SS/CS
32.	H-10 DCS/TCS Reboiler	Reboiler for DCS/TCS distillation column, D-03	2.7MM Btu/hr, Kettle	252 ft ² , 320 psia	CS
33.	H-11 TCS Cooler	To cool TCS before redistribution reaction	1.32MM Btu/hr Shell-Tube H.E.	78.6 ft ² , 85 psia	316SS
34.	H-12 DCS Distillation overhead condenser	To condense overhead of D-04 column	0.183MM Btu/hr Shell-Tube H.E.	23.4 ft ² , 355 psia	316SS/CS
35.	H-13 DCS Distillation Reboiler	Reboiler of DCS Distillation column, D-04	0.12MM Btu/hr	6.8 ft ² , 355 psia	316SS/CS
36.	H-14 Waste stream cooler	To cool waste stream in waste treatment	0.5MM Btu/hr Shell-Tube H.E.	125 ft ² , 60 psia	316SS/CS
37.	H-15 STC Superheater	To heat STC before hydrochlorination	500°C discharge temp. Direct-fired heater	2.12MM Btu/hr, 515 psia	316SS/CS
38.	H-16 H ₂ Compressor Intercooler	To cool H ₂ gas between compression stages	70,000 Btu/hr Shell-Tube H.E.	67.7 ft ² , 90 psia	316SS/CS
<u>Compressors and Pumps</u>					
39.	C-01A Hydrogen Feed Compressor. First stage	Compression of recycle and make-up H ₂ gas	187 SCFM/Recip.comp.	38bhp. discharge press. 87 psia	CS
40.	C-01B Hydrogen Feed compressor, Second stage	Compression of recycle and make-up H ₂ gas	187 SCFM/Recip.comp.	41bhp., discharge press. 515 psia	CS

TABLE 3.6-6 (continued)

	<u>Equipment</u>	<u>Function</u>	<u>Duty/Type</u>	<u>Size</u>	<u>Material of Construction</u>
41.	C-02 Hydrogen Circulation Compressor	Compression of recycle H ₂ gas	2,833 SCFM/centri-	17bhp., ΔP=30 psi	CS
42.	P-01 Feed Tank Blower	To load silicon to its storage bin	Pnumatic transport/centrifugal blower	939ACFM, 32bhp	CS
43.	P-02 Settling Tank Circulation Pump	Circulation and to support ejector	100 gpm centrifugal	37' Head, 1.75bhp	316SS
44.	P-04 TCS Reflux Pump	Pumping TCS for D-02 reflux and feed to D-03	58 gpm centrifugal	12bhp, discharge press. 320 psia	CS
45.	P-05 STC Feed Pump	Pumping STC to Hydro-chlorination reactor	42.2 gpm centrifugal	15bhp, discharge press. 500 psia	CS
46.	P-06 DCS Reflux Pump	Pumping DCS for D-03 reflux and feed to D-04	6.5 gpm centrifugal	½bhp, discharge press. 355 psia	316SS
47.	P-08 DCS Purification Discharge Pump	To withdraw impurities from DCS Purification unit	2.6 gpm centrifugal	½ bhp, discharge press. 355 psia	316SS
48.	P-09 DCS Pump	To pump pure DCS	290 gpm centrifugal	34 bhp	316SS
49.	P-10 Waste Solution Pump	To feed slurry to filter	12.5 gpm centrifugal	1.25 bhp	Cast Iron
50.	P-11 Lime Solution Circulation Pump	To circulate lime solution to neutralizer	12.5 gpm centrifugal	1.25 bhp	Cast Iron
51.	P-12 Fresh Lime Solution Pump	To supply fresh lime solution	6.5 gpm centrifugal	0.75 bhp	Cast Iron

TABLE 3.6-6 (continued)

<u>Equipment</u>	<u>Function</u>	<u>Duty/Type</u>	<u>Size</u>	<u>Material of Construction</u>
<u>Miscellaneous</u>				
52. F-01 Silicon Dust Filter	To retain m.g. silicon dust	Gas-Solid/Bag	20 ft ² x 5μ	CS/cloth
53. F-02 Waste Slurry Filter	To remove waste sludge	12.5 gpm rotary filter	2 ft ²	CS/cloth
54. S-01 Silicon Feed Cyclone	To feed m.g. silicon to storage bin	6" w.c.ΔP	940ACFM	316SS
55. E-01 Quench Contact Ejector	To withdraw and cool effluent of hydrochlorination	6" w.c. suction	100 gpm 134 ACFM	316SS
56. E-02 Flue Gas Ejector	To withdraw flue gas from waste gas combustion	10" w.c. suction	100 gpm 1 SCFM	CS

TABLE 3.6-7

PRODUCTION LABOR REQUIREMENTS FOR DCS PROCESS

<u>Section</u>	<u>Labor</u>	
	<u>man-hr/KG DCS</u>	<u>(oper/shift)</u>
1. Hydrochlorination	0.001294	(2)
2. Purification/Re-distribution	0.00194	(3)
3. Waste Treatment	0.000647	(1)
TOTAL	0.003882	(6)

Note

Manpower estimate for production labor requirements based on

1. Dividing plant into sections
 - type of unit operation
 - mark off working area
2. Specify work duties required in each section
3. Estimate operators required to perform ovrk duties in each section
 - type of unit operation
 - size of working area
 - degree of automation (batch, semi-continuous, etc.)

4. ECONOMIC ANALYSES

4.1 SiI₄ Decomposition Process

The economic analysis activity involves a cost analysis of the process under consideration for the production of silicon. The cost analysis for the particular technology is based on process design results, such as requirements for raw materials and major process equipment necessary to produce the product, from the chemical engineering analysis activity. Primary results issuing from the economic analysis include plant capital investment and product cost which are useful in identification of those processes showing promise for meeting project cost goals.

The cost analysis results for producing silicon by the SiI₄ decomposition process are presented in Table 4.1-1 including costs for raw materials, labor utilities and other items composing the product cost (total cost of producing silicon). The tabulation summarizes all of these items to give a total product cost without profit of \$44.64 (1975 dollars) and \$62.50 (1980 dollars) per kg. This product cost without profit includes direct manufacturing cost, indirect manufacturing cost, plant overhead and general expenses.

The product cost represents all cost associated with producing silicon. On top of these costs a producing company will include some profit. The sales price of the product silicon will actually be the sum of the product cost and a profit for the company. The profit is usually measured in terms of rate of return on the capital investment that the company spent in going into the polysilicon business. Two profitability methods which are commonly used are the return on original investment (per cent ROI) and discounted cash flow rate of return (per cent DCF).

The cost and profitability analysis summary for this process are presented in Table 4.1-2. The sales price of polysilicon at various rates of return for both profitability methods (per cent ROI and DCF) is shown in the lower half of the table. The results indicate a sales price of \$71.48 per kg of silicon (1980 dollars) at 5 per cent DCF return on investment.

These cost and profitability results for the SiI₄ decomposition process indicate that this new technology for producing polysilicon does not show promise for meeting the cost goal of \$14 per kg of silicon material (1980 dollars) for solar cells.

The detailed results for the economic analysis are presented in a tabular format to make it easier to locate cost items of specific interest. The guide for the tabular format is given below:

- Preliminary Economic Analysis Activities..Table 4.1-3
- Process Design Inputs.....Table 4.1-4
- Base Case Conditions.....Table 4.1-5
- Raw Material Cost.....Table 4.1-6
- Utility Cost.....Table 4.1-7
- Major Process Equipment Cost.....Table 4.1-8
- Production Labor Cost.....Table 4.1-9
- Plant Investment.....Table 4.1-10
- Total Product Cost.....Table 4.1-11

TABLE 4.1-1

ESTIMATION OF PRODUCT COST FOR SiI_4 DECOMPOSITION PROCESS

	Cost \$/Kg of Silicon (1975 dollars)	Cost \$/Kg of Silicon (1980 dollars)
1. Direct Manufacturing Cost (Direct Costs).....	23.48	32.87
Raw Materials		
Direct Operating Labor		
Utilities		
Supervision and Clerical		
Maintenance and Repairs		
Operating Supplies		
Laboratory Charge		
2. Indirect Manufacturing Cost (Fixed Cost).....	12.17	17.04
Depreciation		
Local Taxes		
Insurance		
3. Plant Overhead.....	3.17	4.44
4. General Expenses.....	5.82	8.15
Administration		
Distribution and Sales		
Research and Development		
5. Product Cost Without Profit.....	44.64	62.50

TABLE 4.1-2

COST AND PROFITABILITY ANALYSIS SUMMARY FOR SiI_4 DECOMPOSITION PROCESS

1. Process..... SiI_4 Decomposition Process
2. Plant Size.....1,000 Metric Tons/year
3. Plant Product.....Silicon
4. Product Form.....Silicon Ingots (Rods)
5. Plant Investment.....\$107,600,000/\$150,650,000
(1975 dollars) (1980 dollars)

Fixed Capital	\$ 93.57Mega	\$131.00 Mega
Working Capital	\$ 14.03Mega	\$ 19.65 Mega
(15%) Total	\$107.60Mega	\$150.65 Mega
	(1975 dollars)	(1980 dollars)

6. Return on Original Investment, after taxes (%ROI)

	Sales Price \$/Kg of Silicon <u>(1975 dollars)</u>	Sales Price \$/Kg of Silicon <u>(1980 dollars)</u>
0% ROI.....	44.64	62.50
5% ROI.....	54.60	76.45
10% ROI.....	64.57	90.40
15% ROI.....	74.53	104.35
20% ROI.....	84.49	118.30
25% ROI.....	95.46	132.25
30% ROI.....	104.42	146.19
40% ROI.....	124.35	174.09

7. Discounted Cash Flow Rate of Return, after taxes (% DCF)

	Sales Price \$/Kg of Silicon <u>(1975 dollars)</u>	Sales Price \$/Kg of Silicon <u>(1980 dollars)</u>
0% DCF.....	44.64	62.50
5% DCF.....	51.05	71.40
10% DCF.....	58.11	81.36
15% DCF.....	65.74	92.04
20% DCF.....	73.84	103.38
25% DCF.....	82.34	115.28
30% DCF.....	91.16	127.63
40% DCF.....	109.50	153.31

Based on 10 year project life and 10 year straight line depreciation.

8. Tax Rate (Federal).....46%

TABLE 4.1-3

ECONOMIC ANALYSES:
 PRELIMINARY ECONOMIC ANALYSIS ACTIVITIES FOR SiH_4 Decomposition Process

<u>Prel. Process Economic Activity</u>	<u>Status</u>	<u>Prel. Process Economic Activity</u>	<u>Status</u>
1. Process Design Inputs	●	6. Production Labor Costs	●
1. Raw Material Requirements	●	1. Base Cost Per Man Hour	●
2. Utility Requirements	●	2. Cost/Kg Silicon Per Area	●
3. Equipment List	●	3. Total Cost/Kg Silicon	●
4. Labor Requirements	●		
2. Specify Base Case Conditions	●	7. Estimation of Plant Investment	●
1. Base Year for Costs	●	1. Battery Limits Direct Costs	●
2. Appropriate Indices for Costs	●	2. Other Direct Costs	●
3. Additional	●	3. Indirect Costs	●
		4. Contingency	●
3. Raw Material Costs	●	5. Total Plant Investment	●
1. Base Cost/lb. of Material	●	(Fixed Capital)	
2. Material Cost/Kg of Silicon	●	8. Estimation of Total Product Cost	●
3. Total Cost/Kg of Silicon	●	1. Direct Manufacturing Cost	●
4. Utility Costs	●	2. Indirect Manufacturing Cost	●
1. Base Cost for Each Utility	●	3. Plant Overhead	●
2. Utility Cost/Kg of Silicon	●	4. By-Product Credit	●
3. Total Cost/Kg of Silicon	●	5. General Expenses	●
5. Major Process Equipment Costs	●	6. Total Cost of Product	●
1. Individual Equipment Cost	●		
2. Cost Index Adjustment	●		
		○ Plan	
		● In Progress	
		● Complete	

TABLE 4.1-4

PROCESS DESIGN INPUTS FOR
SiI₄ Decomposition Process

1. Raw Material Requirements
-Silicon tetrachloride, zinc, lime, argon and nitrogen
-see table for "Raw Material Cost"
2. Utility
-electricity, steam, cooling water and process water
-see table for "Utility Cost"
3. Equipment List
-41 plus pieces of major process equipment
-process vessels, heat exchangers, reactor, etc.
4. Labor Requirements
-production labor for purification, deposition, etc.
-see table for "Production Labor Cost"

TABLE 4.1-5
BASE CASE CONDITION FOR SiH_4 Decomposition Process

1. Capital Equipment

- January 1975 Cost Index for Capital Equipment Cost
- January 1975 Cost Index Value = 430

2. Utilities

- Electrical, Steam, Cooling Water, Nitrogen
- January 1975 Cost Index (U. S. Dept. Labor)
- Values determined by literature search and summarized in cost standardization work

3. Raw Material Cost

- Chemical Marketing Reporter
- January 1975 Value
- Raw Material Cost Index for Industrial Chemicals
- 1975 Cost Index Value = 100 (Wholesale Price Index, Producer Price Index)

4. Labor Cost

- Average for Chemical, Petroleum, Coal and Allied Industries (1975)
- Skilled \$6.90/hr

5. Update to 1980

- historically cited 1975 dollars (USA project)
- DOE decision to change to 1980 dollars (JPL, 6/22/79)
- reports to reflect both 1975 and 1980 dollars (JPL, 6/22/79)
- inflation factor of 1.4 to be used (JPL, 6/22/79)

TABLE 4.1-6
 RAW MATERIAL COSTS FOR
 SiI_4 DECOMPOSITION PROCESS

<u>Raw Material</u>	<u>Requirement lb/Kg of Silicon</u>	<u>\$/lb of Material</u>	<u>Cost \$/Kg of Silicon</u>
1. Metallurgical Si	2.6194	.454	1.188
2. Iodine*	.7495	2.59	1.94
3. Iodine*	6.746	.20	<u>1.35</u>
		TOTAL COST	4.48

* SiI_4 wastes are recovered as iodine for recycle at \$.20/pound. Assuming 10% losses⁴ in this step, 10% of total iodine must be purchased at \$2.59/pound.

TABLE 4.1-7

UTILITY COST FOR
SiI₄ DECOMPOSITION PROCESS

<u>Utility</u>	<u>Requirements in Kw-hr/ Kg of Silicon</u>	<u>Cost of Utility</u>	<u>Cost \$/Kg of Silicon</u>
Electricity*	218.62	\$.0324/Kw-hr	7.08

* For costing purposes only. Actual utilities would involve cooling water, steam, etc.

TABLE 4.1-8

ESTIMATED COST OF MAJOR PROCESS EQUIPMENT FOR SiI_4 DECOMPOSITION PROCESS

<u>Equipment</u>	<u>Purchased Cost, \$M</u>
1. Purified SiI_4 Hold Tank	63.80
2. Liquid Reactor Overheads Storage	60.50
3. Silicon Product Storage	6.72
4. Liquid Iodine Storage	4.54
5. SiI_4 Bulk Storage	67.19
6. Metallurgical Silicon Storage	8.06
7. Feed Tank for Purification Column 2	6.89
8. SiI_4 Vaporizer	7.87
9. Silicon Cooler	3.16
10. Deposition Condenser	525.4
11. Separation Column Preheater	3.48
12. Separation Column O/H Condenser	15.45
13. Separation Column Calandria	12.19
14. Separation Column O/H After Cooler	3.09
15. Iodine Vaporizer	7.86
16. Iodination O/H Condenser	50.22
17. Separation Column Bottoms After Cooler	3.48
18. Tet Purification Preheater	7.73
19. Tet Purification Column 1 O/H Condenser	15.45
20. Tet Purification Column 1 Calandria	12.39
21. Tet Purification Column 2 O/H Condenser	15.45
22. Tet Purification Column 2 Calandria	12.06
23. Tet Purification After Cooler	7.73

TABLE 4.1-8 (Continued)

<u>Equipment</u>	<u>Purchased Cost, \$M</u>
24. Deposition De-superheaters (6 units)	38.68
25. Purified SiI ₄ Pump	1.76
26. Deposition Compressor System	12090.0
27. I ₂ /SiI ₄ Liquid Pump	1.76
28. I ₂ /SiI ₄ Separation Column O/H Pump	1.76
29. I ₂ /SiI ₄ Separation Column Bottoms Pump	2.15
30. Iodine Pump	2.15
31. SiI ₄ Pump	1.76
32. Tet Purification Column 1 O/H Pump	1.76
33. Tet Purification Column 1 Bottoms Pump	2.12
34. Tet Purification Column 2 Feed Pump	1.25
35. Tet Purification Column 2 O/H Pump	1.76
36. Tet Purification Column 2 Bottoms Pump	2.09
37. Deposition Units (6 units)	1922.0
38. Iodination Reactor	10.75
39. I ₂ /SiI ₄ Distillation Column	16.50
40. Tet Purification Column 1	47.25
41. Tet Purification Column 2	<u>24.44</u>
TOTAL PURCHASED COST	15090.65

TABLE 4.1-9

PRODUCTION LABOR COSTS
 SiI_4 DECOMPOSITION PROCESS

	<u>Skilled Man-Hrs/Kg Silicon</u>	<u>Semiskilled Man-Hrs/Kg Silicon</u>	<u>\$Kg Si</u>
1	.008395	-	.05793
2	.01314	-	.09067
3	.008395	-	.05793
4	.008395	-	.05793
5	.00584	-	.040296
6	.008395	-	.05793
7	.00584	-	.040296
8.	-	.01314	.064386
9.	-	.01314	<u>.064386</u>
			\$.5319/Kg

NOTES

Based on labor costs of \$6.90 skilled, \$4.90 semiskilled.

TABLE 4.1-10
ESTIMATION OF PLANT INVESTMENT FOR SII₄ DECOMPOSITION PROCESS

	<u>Investment</u> <u>\$1000</u>
1. DIRECT PLANT INVESTMENT COSTS	
1. Major Process Equipment Cost	15,090.0
2. Installation of Major Process Equipment	6,488.7
3. Process Piping, Installed	11,166.6
4. Instrumentation, Installed	2,867.1
5. Electrical, Installed	1,509.0
6. Process Buildings, Installed	1,509.0
1a. SUBTOTAL FOR DIRECT PLANT INVESTMENT COSTS (PRIMARILY BATTERY LIMIT FACILITIES)	38,630.4
2. OTHER DIRECT PLANT INVESTMENT COSTS	
1. Utilities, Installed	7,243.2
2. General Service, Site Development, Fire Protection, etc.	1,810.8
3. General Buildings, Offices, Shops, etc.	2,112.6
4. Receiving, Shipping Facilities	3,168.9
2a. SUBTOTAL FOR OTHER DIRECT PLANT INVESTMENT COSTS (PRIMARILY OFFSITE FACILITIES OUTSIDE BATTERY LIMITS)	14,335.5
3. TOTAL DIRECT PLANT INVESTMENT COST, 1a + 2a	52,965.9
4. INDIRECT PLANT INVESTMENT COSTS	
1. Engineering, Overhead, etc.	8,299.5
2. Normal Cont. for Floods, Strikes, etc.	10,713.9
4a. TOTAL INDIRECT PLANT INVESTMENT COST	19,013.4
5. TOTAL DIRECT AND INDIRECT PLANT INVESTMENT COST, 3 + 4a	71,979.3
6. OVERALL CONTINGENCY, % of 5	21,593.8
7. FIXED CAPITAL INVESTMENT FOR PLANT, 5 + 6	<div style="border-top: 1px solid black; padding-top: 5px;"> 93,573. (1975 dollars) x 1.4 inflation 131,002.3 (1980 dollars) </div>

TABLE 4.1-11

ESTIMATION OF TOTAL PRODUCT COST FOR Si_4 DECOMPOSITION PROCESS

	<u>\$/KG of Si</u>
1. Direct Manufacturing Cost (Direct Charges)	
1. Raw Materials	4.48
2. Direct Operating Labor	.58
3. Utilities	7.08
4. Supervision and Clerical	.08
5. Maintenance and Repairs	9.36
6. Operating Supplies	1.87
7. Laboratory Charge	.08
2. Indirect Manufacturing Cost (Fixed Charges)	
1. Depreciation	9.36
2. Local Taxes	1.87
3. Insurance	.94
3. Plant Overhead	3.17
4. By-Product Credit	-----
4a. Total Manufacturing Cost, 1 + 2 + 3 + 4	38.82
5. General Expenses	
1. Administration	2.33
2. Distribution and Sales	2.33
3. Research and Development	<u>1.16</u>
6. Total Cost of Product, 4a + 5	44.64 (1975 dollars)
	<u>x 1.4 inflation</u>
	62.50 (1980 dollars)

4.2 Conventional Polysilicon Process (Siemen's Technology)

The economic analysis activity for the conventional polysilicon process involves a cost analysis for the production of silicon via the Siemen's technology. In the Siemen's technology, trichlorosilane (TCS) is used as the feed source material for semiconductor grade silicon.

Since several existing plants producing semiconductor grade polysilicon in the United States were constructed in the 1960's, the cost analysis is based on a poly plant constructed in the 1960's (1965 or earlier). Operating costs for the plant are applicable to the time period of interest (such as 1975 and 1980).

The cost analysis results for producing silicon by the conventional Siemen's process are presented in Table 4.2-1 including costs for raw materials, labor, utilities and other items composing the product cost (total cost of producing silicon). The tabulation summarizes these items to give a total product cost without profit of \$35.52 - 41.22 (1975 dollars) and \$49.73 - 57.81 (1980 dollars) per kg. This product cost without profit includes direct manufacturing cost, indirect manufacturing cost, plant overhead and general expenses. The range for product cost reflects low and high electrical costs (1.5-3¢/kw hr for 1975 and 2.1-4.2¢/kw hr for 1980).

Electrical costs vary with location (different costs for different states and different costs for different regions in the same state). However, the range (1.5-3¢/kw hr) and intermediate value (2.25¢/kw hr) for 1975 are considered representative based on a recent plant site survey listing industrial power cost in the USA. With respect to the intermediate value, the survey indicated the following typical electrical cost for industrial power: Michigan (2.48), Arizona (2.27), Missouri (2.05) and Texas (1.49).

In Table 4.2-1, the average product cost without profit is given as \$38.41 (1975 dollars) and \$53.77 (1980 dollars) per kg for the conventional polysilicon process. This average product cost corresponds to intermediate electrical costs (2.25¢/kw hr for 1975 and 3.15¢/kw hr for 1980). These cost results for the conventional polysilicon process indicate that this Siemen's technology using trichlorosilane for producing polysilicon does not show promise for meeting the cost goal of \$14 per kg of silicon material (1980 dollars) for solar cells.

When solar cells come into more widespread use, the capacity of existing polysilicon plants will be exceeded necessitating a new poly plant or plants. Higher capital investment costs will be required for new plants to produce polysilicon by the conventional process. The higher capital investment cost for silicon production in new plants will, of course, appear in higher product cost for polysilicon in terms of increased depreciation, taxes, insurance, etc. The profit will also be higher for a reasonable return on investment for the producing company. Thus, the sales price (product cost with profit) for polysilicon from new plants will be considerably higher than the present price for polysilicon of semiconductor grade produced in existing plants.

The detailed results for the economic analysis are presented in a tabular format to make it easier to locate cost items of specific interest. The guide for the tabular format is given below:

- Preliminary Economic Analysis Activities..Table 4.2-2
- Process Design Inputs.....Table 4.2-3
- Base Case Conditions.....Table 4.2-4
- Raw Material Cost.....Table 4.2-5
- Utility Cost.....Table 4.2-6
- Major Process Equipment Cost.....Table 4.2-7
- Production Labor Cost.....Table 4.2-8
- Plant Investment.....Table 4.2-9
- Total Product Cost.....Table 4.2-10

TABLE 4.2-1

ESTIMATION OF PRODUCT COST FOR CONVENTIONAL POLYSILICON PROCESS

	Cost \$/Kg of Silicon (1975 dollars)	Cost \$/Kg of Silicon (1980 dollars)
1. Direct Manufacturing Cost (Direct Costs).....	24.94-30.71	24.92-42.99
Raw Materials		
Direct Operating Labor		
Utilities		
Supervision and Clerical		
Maintenance and Repairs		
Operating Supplies		
Laboratory Charge		
2. Indirect Manufacturing Cost (Fixed Cost).....	1.38	1.93
Depreciation		
Local Taxes		
Insurance		
3. Plant Overhead.....	3.82	5.35
4. General Expenses.....	5.38	7.54
Administration		
Distribution and Sales		
Research and Development		
5. Product Cost Without Profit.....	35.52-41.29	49.73-57.81
6. Average Product Cost Without Profit.....	38.41	53.77

Basis: The above results are based on a plant constructed in the 1960's. (1965 or earlier) which is fully depreciated. The range for product cost without profit reflects low and high electrical costs (1.5-3¢/kw. hr for 1975 and 2.1-4.2¢/kw hr for 1980). The average product cost without profit reflects intermediate electrical costs (2.25¢/kw hr for 1975 and 3.15¢/kw for 1980).

TABLE 4.2-2
 ECONOMIC ANALYSES: PRELIMINARY ECONOMIC ANALYSIS ACTIVITIES
 FOR CONVENTIONAL POLYSILICON PROCESS

<u>Prel. Process Economic Activity</u>	<u>Status</u>	<u>Prel. Process Economic Activity</u>	<u>Status</u>
1. Process Design Inputs	●	6. Production Labor Costs	●
1. Raw Material Requirements	●	1. Base Cost Per Man Hour	●
2. Utility Requirements	●	2. Cost/Kg Silicon Per Area	●
3. Equipment List	●	3. Total Cost/Kg Silicon	●
4. Labor Requirements	●	7. Estimation of Plant Investment	●
2. Specify Base Case Conditions	●	1. Battery Limits Direct Costs	●
1. Base Year for Costs	●	2. Other Direct Costs	●
2. Appropriate Indices for Costs	●	3. Indirect Costs	●
3. Additional	●	4. Contingency	●
3. Raw Material Costs	●	5. Total Plant Investment (Fixed Capital)	●
1. Base Cost/Lb. of Material	●	8. Estimation of Total Product Cost	●
2. Material Cost/Kg of Silicon	●	1. Direct Manufacturing Cost	●
3. Total Cost/Kg of Silicon	●	2. Indirect Manufacturing Cost	●
4. Utility Costs	●	3. Plant Overhead	●
1. Base Cost for Each Utility	●	4. By-Product Credit	●
2. Utility Cost/Kg of Silicon	●	5. General Expenses	●
3. Total Cost/Kg of Silicon	●	6. Total Cost of Product	●
5. Major Process Equipment Costs	●		
1. Individual Equipment Cost	●	○ Plan	
2. Cost Index Adjustment	●	● In Progress	
		● Complete	

SLS

TABLE 4.2-3
PROCESS DESIGN INPUTS FOR
CONVENTIONAL POLYSILICON PROCESS

1. Raw Material Requirements
-M.G. silicon, anhydrous HCl, caustic, hydrogen, silicon tetrachloride (by-product);
-see table for "Raw Material Cost"
2. Utility
-electrical, steam, cooling water, etc.
-see table for "Utility Cost"
3. Equipment List
-63 pieces of major process equipment
-process vessels, heat exchangers, reactor, etc.
-see table for "Major Process Equipment Cost"
4. Labor Requirements
-production labor for deposition, vaporization, product handling, etc.
-see table for "Production Labor Cost"

TABLE 4.2-4
BASE CASE CONDITIONS FOR
CONVENTIONAL POLYSILICON PROCESS

1. Capital Equipment
 - January 1975 Cost Index for Capital Equipment Cost
 - January 1975 Cost Index Value = 430
2. Utilities
 - Electrical, Steam, Cooling Water, Nitrogen
 - January 1975 Cost Index (U.S. Dept. Labor)
 - Values determined by literature search and summarized in cost standardization work
3. Raw Material Cost
 - Chemical Marketing Reporter
 - January 1975 Value
 - Other Sources
4. Labor Cost
 - Average for Chemical Petroleum, Coal and Allied Industries (1975)
 - Skilled \$6.90/hr
 - Semiskilled \$4.90/hr
5. Update to 1980
 - historically cited 1975 dollars (LSA project)
 - DOE decision to change to 1980 dollars (JPL, 6/22/79)
 - reports to reflect both 1975 and 1980 dollars (JPL, 6/22/79)
 - inflation factor of 1.4 to be used (JPL, 6/22/79)

TABLE 4.2-5
 RAW MATERIAL COST FOR
 CONVENTIONAL POLYSILICON PROCESS

<u>Raw Material</u>	<u>Requirement lb/Kg of Silicon</u>	<u>\$/lb of Material</u>	<u>Cost \$/Kg of Silicon</u>
1. M.G. Silicon	6.72 (Kg/Kg)	1.0/Kg	6.72
2. Anhydrous HCl	57.96	.10	5.79
3. Hydrogen	.828	.96	.79
4. Caustic (50% NaOH)	53.29	.0382	2.04
5. SiCl ₄ (By Product)	46.12	.135	<u>-6.23</u> (credit)
TOTAL COST			9.11 (1975 dollars)
			<u>x 1.4</u> inflation
			12.75 (1980 dollars)

TABLE 4.2-6
UTILITY COST FOR CONVENTIONAL
POLYSILICON PROCESS

<u>Utility</u>	<u>Requirements/Kg of Silicon</u>	<u>Cost of Utility</u>	<u>Cost \$/Kg of Silicon</u>
1. Electricity	384.6 kw-hr	\$.03/kw-hr	\$ 11.54
2. Steam	152 Pounds	- *	-
3. Cooling Water	984.5 Gallons	\$.08/M Gal.	.08
4. Process Water	320.9 Gallons	\$.35/M Gal.	.11
5. Refrigerant (-40°F)	42.1 M BTU	\$10.38/MM BTU	.44
6. Refrigerant (34°F)	72.3 M BTU	\$ 3.75/MM BTU	.35
7. High Temperature Coolant	582 Pounds	\$ 2.7/M Pounds	1.57
8. Nitrogen	349 SCF	\$.50/M SCF	<u>.17</u>
TOTAL COST			14.26 (1975 dollars)
			<u>x 1.4</u> inflation
			19.96 (1980 dollars)

NOTES

* All steam produced by cooling jacket on polysilicon rod reactor.

TABLE 4.2-7

PURCHASED COST OF MAJOR PROCESS EQUIPMENT FOR
CONVENTIONAL POLYSILICON PROCESS

<u>Equipment</u>	<u>Purchased Cost, \$M</u>
1. (T1) M.G. Silicon Storage Hopper	24.1
2. (T2) Liquid HCl Storage Tank	435.96
3. (T3) Crude TCS Hold Tank (3)	178.8
4. (T4) Waste Hold Tank	14.9
5. (T5) TCS Reactor Off Gas Flash Tank	7.2
6. (T6) Hydrogen Storage Tank	152.1
7. (T7) Polysilicon Storage Space	10.8
8. (T8) Tet Storage Tanks (2)	85.2
9. (T9) Tet Feed Tanks (2)	57.8
10. (T10) TCS Feed Tanks (3)	42.6
11. (T11) TCS Storage Tanks (3)	127.8
12. (T12) TET/TCS Feed Tanks (3)	54.
13. (T13) Caustic Storage Tank	106.7
14. (T14) #1 Distillation Condenser Flash Tank	.85
15. (T15) Rod Reactor Off Gas Flash Tank	7.2
16. (H1) HCl Vaporizer	2.5
17. (H2) TCS Reactor Off Gas Cooler	7
18. (H3) TCS Reactor Off Gas Condenser	46.3
19. (H4) #1 Scrubber Vapor Heater	.75
20. (H5) #1 Distillation Column Condenser	14.
21. (H6) #1 Distillation Column Calandria	9.25
22. (H7) #2 Distillation Column Condenser	14.6
23. (H8) #2 Distillation Column Calandria	11.92
24. (H9) #3 Distillation Column Condenser	9.1
25. (H10) #3 Distillation Column Calandria	5.8
26. (H11) TCS Vaporizer	1.8
27. (H12) Rod Reactor Off Gas Cooler	49.4
28. (H13) Rod Reactor Off Gas Condenser	27.5
29. (H14) #2 Scrubber Vapor Heater	5.8
30. (H15) Liquid Recycle Heater	2.3
31. (H16) #4 Distillation Column Condenser	6.4
32. (H17) #4 Distillation Column Calandria	3.7
33. (H18) Nitrogen Heater	1.3

TABLE 4.2-7 (Continued)

34.	(P1)	TCS Reactor Off Gas Compressor	53.2
35.	(P2)	Caustic Supply Pump	1.56
36.	(P3)	#1 Distillation Column Overheads Pump	2.64
37.	(P4)	#1 Distillation Column Calandria Pump	3.83
38.	(P5)	TET/TCS Feed Pump	2.04
39.	(P6)	#2 Distillation Column Overhead Pump	2.8
40.	(P7)	TCS Feed Pump	1.8
41.	(P8)	#2 Distillation Column Calandria Pump	3.8
42.	(P9)	#3 Distillation Column Overhead Pump	2.2
43.	(P10)	Rod Reactor TCS Feed Pump	1.7
44.	(P11)	#3 Distillation Column Calandria Pump	2.6
45.	(P12)	Rod Reactor Off Gas Compressor	234.5
46.	(P13)	#4 Distillation Column Overheads Pump	1.87
47.	(P14)	#4 Distillation Column Calandria Pump	1.87
48.	(P15)	TET Feed Pump	1.56
49.	(P16)	Waste Treatment Pump	.77
50.	(P17)	Crude TCS Feed Pump	1.9
51.	(P18)	Process Water Feed Pump	3.7
52.	(C1)	#1 Gas Scrubber	53.2
53.	(C2)	#2 Gas Scrubber	29.
54.	(C3)	#1 Distillation Column	26.1
55.	(C4)	#2 Distillation Column	27.7
56.	(C5)	#3 Distillation Column	8.9
57.	(C6)	#4 Distillation Column	6.7
58.	(R1)	TCS Fluidized Bed Reactor	57.2
59.	(R2)	Polysilicon Rod Reactors (305)	56. (each)
60.	(A1)	Molecular Sieves	16.77
61.	(A2)	Fines Separator	4.8
62.	(A3)	Hydrogen Flare	1.
63.	(A4)	Filament Pullers (5)	<u>15. (each)</u>
TOTAL PURCHASED COST			\$19,307.14 (1975 dollars)
			x 1.4 inflation
			<u>\$27,030.00 (1980 dollars)</u>

TABLE 4.2-8

PRODUCTION LABOR COST FOR
CONVENTIONAL POLYSILICON PROCESS

<u>Unit Operation</u>	<u>Skilled Labor Man-Hrs/Kg Si</u>	<u>Cost \$/Kg Si</u>
1. TCS Production	.0292	.2014
2. Vaporization	.0219	.1511
3. Vapor Compression	.0219	.1511
4. Vapor Condensation	.0219	.1511
5. TCS/TET Separation	.0146	.1007
6. TCS Purification	.0128	.0883
7. TET Purification	.011	.0759
8. Filament Pullers	.0438	.3021
9. Gas Scrubbing	.0232	.1600
10. Hydrogen Drying (Molecular Sieves)	.0117	.0807
11. Crude TCS Recycle System	.0212	.1463
12. Silicon Fines Separation	.0055	.038
13. Materials Handling	.0329*	.1612*
14. Polysilicon Production	.2672	<u>1.8429</u>
	TOTAL COST	\$3.65 (1975 dollars)
		<u>x 1.4</u> inflation
		5.11 (1980 dollars)

*semiskilled

TABLE 4.2-9
ESTIMATION OF PLANT INVESTMENT COST FOR
CONVENTIONAL POLYSILICON PROCESS

	Investment (\$1000)	
	1975 Plant	1960's Plant
1. DIRECT PLANT INVESTMENT COSTS		
1. Major Process Equipment Cost	19,307	11,032
2. Installation of Major Process Equipment	4,699	2,685
3. Process Piping, Installed	8,969	5,125
4. Instrumentation, Installed	924	528
5. Electrical, Installed	1,931	1,103
6. Process Buildings, Installed	3,303	1,889
1a. SUBTOTAL FOR DIRECT PLANT INVESTMENT COSTS (PRIMARYLY BATTERY LIMIT FACILITIES)	39,133	22,362
2. OTHER DIRECT PLANT INVESTMENT COSTS		
1. Utilities, Installed	9,096	5,198
2. General Services, Site Development, Fire Protection, etc.	2,317	1,324
3. General Buildings, Offices, Shops, etc.	5,104	2,917
4. Receiving, Shipping Facilities	4,741	2,709
2a. SUBTOTAL FOR OTHER DIRECT PLANT INVESTMENT COSTS (PRIMARYLY GRESITT FACILITIES OUTSIDE BATTERY LIMITS)	21,258	12,147
3. TOTAL DIRECT PLANT INVESTMENT COST, 1a + 2a	60,391	34,509
4. INDIRECT PLANT INVESTMENT COSTS		
1. Engineering, Overhead, etc.	3,757	2,147
2. Normal Cost. for Floods, Strikes, etc.	9,076	5,186
4a. TOTAL INDIRECT PLANT INVESTMENT COST	12,833	7,333
5. TOTAL DIRECT AND INDIRECT PLANT INVESTMENT COST, 3 + 4a	73,224	41,842
6. OVERALL CONTINGENCY, 3 OF 5.010%	7,322	4,184
7. FIXED CAPITAL INVESTMENT FOR PLANT, 5 + 6	80,546	46,026

1980 CE Plant Cost Index = 253 (March)
1975 CE Plant Cost Index = 182
1965 CE Plant Cost Index = 104
1960 CE Plant Cost Index = 102

Plant Constructed In 1975	Plant Constructed In 1960's (1965 or Earlier)
---------------------------------	---

TABLE 4.2-10

ESTIMATION OF TOTAL PRODUCT COST FOR CONVENTIONAL POLYSILICON PROCESS

	<u>PRODUCT COST, \$/KG Si</u>		
	<u>Low</u> <u>1.5¢/kw hr</u>	<u>High</u> <u>3¢/kw hr</u>	<u>Intermed.</u> <u>2.25¢/kw hr</u>
1. Direct Manufacturing Cost			
1. Raw Materials	15.34	15.34	15.34
2. Direct Operating Labor	3.65	3.65	3.65
3. Utilities	8.49	14.26	11.37
4. Supervision and Clerical	.55	.55	.55
5. Maintenance and Repairs	2.16	2.16	2.16
6. Operating Supplies	.43	.43	.43
7. Laboratory Charge	.55	.55	.55
2. Indirect Manufacturing Cost			
1. Depreciation	-----	-----	-----
2. Local Taxes	.92	.92	.92
3. Insurance	.46	.46	.46
3. Plant Overhead	3.82	3.82	3.82
4. By-Product Credit	(6.23)	(6.23)	(6.23)
4a. Total Manufacturing Cost, 1 + 2 + 3 + 4	30.14	35.91	33.02
5. General Expenses			
1. Administration	2.15	2.15	2.15
2. Distribution and Sales	2.15	2.15	2.15
3. Research and Development	<u>1.08</u>	<u>1.08</u>	<u>1.08</u>
6. Total Cost of Product, 4a + 5	35.52	41.29	38.41 (1975 dollars)
	<u>x 1.4</u>	<u>x 1.4</u>	<u>x 1.4</u> inflation
	49.73	57.81	53.16 (1980 dollars)

Basis: The above results are based on a plant constructed in 1960's (1965 or earlier) which is fully depreciated. The range reflects low and high electrical costs (1.5-3¢/kw hr). Intermediate reflects intermediate electrical cost (2.25¢/kw hr).

4.3 UCC Silane Process for Silicon (Union Carbide Corporation)

The economic analysis activity involves a cost analysis of the process under consideration for the production of silicon. The cost analysis for the particular technology is based on process design results, such as requirements for raw materials and major process equipment necessary to produce the product, from the chemical engineering analysis activity. Primary results issuing from the economic analysis include plant capital investment and product cost which are useful in identification of those processes showing promise for meeting project cost goals.

The cost analysis results for producing silicon by the UCC silane process (Union Carbide Corporation) are presented in Table 4.3-1 including costs for raw materials, labor, utilities and other items composing the product cost (total cost of producing silicon). The tabulation summarizes all of these items to give a total product cost without profit of \$6.90 (1975 dollars) and \$9.66 (1980 dollars) per kg. This product cost without profit includes direct manufacturing cost, indirect manufacturing cost, plant overhead and general expenses.

The product cost represents all cost associated with producing 1 kg of silicon. On top of these costs a producing company will include some profit. The sales price of the product silicon will actually be the sum of the product cost and a profit for the company. The profit is usually measured in terms of rate of return on the capital investment that the company spent in going into the polysilicon business. Two profitability methods which are commonly used are the return on original investment (per cent ROI) and discounted cash flow rate of return (per cent DCF).

The cost and profitability analysis summary for this process are presented in Table 4.3-2. The sales price of polysilicon at various rates of return for both profitability methods (per cent ROI and DCF) is shown in the lower half of the table. The results indicate a sales price of \$13 per kg of silicon (1980 dollars) at 15 per cent DCF return on investment.

These cost and profitability results for the UCC silane process indicate that this new technology for producing polysilicon shows good promise for meeting the cost goal of \$14 per kg of silicon material (1980 dollars) for solar cells.

The detailed results for the economic analysis are presented in a tabular format to make it easier to locate cost items of specific interest. The guide for the tabular format is given below:

- Preliminary Economic Analysis Activities...Table 4.3-3
- Process Design Inputs.....Table 4.3-4
- Base Case Conditions.....Table 4.3-5
- Raw Material Cost.....Table 4.3-6
- Utility Cost.....Table 4.3-7
- Major Process Equipment Cost.....Table 4.3-8
- Production Labor Cost.....Table 4.3-9
- Plant Investment.....Table 4.3-10
- Total Product Cost.....Table 4.3-11

The economic analysis provides detailed cost data for raw materials, utilities, labor and major process equipment which are necessary for polysilicon production.

TABLE 4.3-1

ESTIMATION OF PRODUCT COST FOR UCC Silane Process

	Cost \$/Kg of Silicon <u>(1975 dollars)</u>	Cost \$/Kg of Silicon <u>(1980 dollars)</u>
1. Direct Manufacturing Cost (Direct Costs).....	4.15	5.81
Raw Materials		
Direct Operating Labor		
Utilities		
Supervision and Clerical		
Maintenance and Repairs		
Operating Supplies		
Laboratory Charge		
2. Indirect Manufacturing Cost (Fixed Cost).....	1.19	1.67
Depreciation		
Local Taxes		
Insurance		
3. Plant Overhead.....	0.66	0.92
4. General Expenses.....	0.00	1.26
Administration		
Distribution and Sales		
Research and Development		
5. Product Cost Without Profit.....	6.90	9.66

TABLE 4.3-2

COST AND PROFITABILITY ANALYSIS SUMMARY FOR UCC Silane Process

1. Process.....	UCC Silane Process	
2. Plant Size.....	1,000 Metric Tons/year	
3. Plant Product.....	Silicon	
4. Product Form.....	Liquid Phase	
5. Plant Investment.....	\$10,570,000 /	\$14,800,000
	(1975 dollars)	(1980 dollars)

Fixed Capital	\$9.19 Mega	\$12.87 Mega
Working Capital	\$1.38 Mega	\$1.99 Mega
(15%) Total	\$10.57 Mega	\$14.80 Mega
	(1975 dollars)	(1980 dollars)

6. Return on Original Investment, after taxes (% ROI)

	<u>Sales Price</u> \$/Kg of Silicon (1975 dollars)	<u>Sales Price</u> \$/Kg of Silicon (1980 dollars)
0% ROI.....	6.90	9.66
5% ROI.....	7.88	11.02
10% ROI.....	8.86	12.39
15% ROI.....	9.84	13.75
20% ROI.....	10.81	15.11
25% ROI.....	11.79	16.47
30% ROI.....	12.77	17.84
40% ROI.....	14.73	20.56

7. Discounted Cash Flow Rate of Return, after taxes (% DCF)

	<u>Sales Price</u> \$/Kg of Silicon (1975 dollars)	<u>Sales Price</u> \$/Kg of Silicon (1980 dollars)
0% DCF.....	6.90	9.66
5% DCF.....	7.53	10.54
10% DCF.....	8.22	11.50
15% DCF.....	8.97	12.55
20% DCF.....	9.77	13.65
25% DCF.....	10.60	14.82
30% DCF.....	11.47	16.02
40% DCF.....	13.27	18.53

Based on 10 year project life and 10 year straight line depreciation.

8. Tax Rate (Federal).....46%

Table 4.3-3
ECONOMIC ANALYSES:
PRELIMINARY ECONOMIC ANALYSIS ACTIVITIES FOR UCC Silane Process

<u>Prel. Process Economic Activity</u>	<u>Status</u>	<u>Prel. Process Economic Activity</u>	<u>Status</u>
1. Process Design Inputs	●	6. Production Labor Costs	●
1. Raw Material Requirements	●	1. Base Cost Per Man Hour	●
2. Utility Requirements	●	2. Cost/Kg Silicon Per Area	●
3. Equipment List	●	3. Total Cost/Kg Silicon	●
4. Labor Requirements	●		
2. Specify Base Case Conditions	●	7. Estimation of Plant Investment	●
1. Base Year for Costs	●	1. Battery Limits Direct Costs	●
2. Appropriate Indices for Costs	●	2. Other Direct Costs	●
3. Additional	●	3. Indirect Costs	●
		4. Contingency	●
3. Raw Material Costs	●	5. Total Plant Investment	●
1. Base Cost/lb. of Material	●	(Fixed Capital)	
2. Material Cost/Kg of Silicon	●	8. Estimation of Total Product Cost	●
3. Total Cost/Kg of Silicon	●	1. Direct Manufacturing Cost	●
		2. Indirect Manufacturing Cost	●
4. Utility Costs	●	3. Plant Overhead	●
1. Base Cost for Each Utility	●	4. By-Product Credit	●
2. Utility Cost/Kg of Silicon	●	5. General Expenses	●
3. Total Cost/Kg of Silicon	●	6. Total Cost of Product	●
5. Major Process Equipment Costs	●		
1. Individual Equipment Cost	●		
2. Cost Index Adjustment	●		
		○ Plan	
		● In Progress	
		● Complete	

TABLE 4.3-4
PROCESS DESIGN INPUTS FOR
UCC SILANE PROCESS

1. Raw Material Requirements
 - M.G. Silicon, silicon tetrachloride, hydrogen, copper catalyst, lime
 - see table for "Raw Material Cost"

2. Utility
 - electrical, steam, cooling water, etc.
 - see table for "Utility Cost"

3. Equipment List
 - 93 pieces of major process equipment
 - process vessels, heat exchangers, reactor, etc.

4. Labor Requirements
 - production labor for purification, vaporization, product handling, etc.
 - see table for "Production Labor Cost"

TABLE 4.3-5

BASE CASE CONDITIONS FOR
UCC SILANE PROCESS

1. Capital Equipment

- January 1975 Cost Index for Capital Equipment Cost
- January 1975 Cost Index Value = 430

2. Utilities

- Electrical, Steam, Cooling Water, Nitrogen
- January 1975 Cost Index (U. S. Dept. Labor)
- Values determined by literature search and summarized in cost standardization work

3. Raw Material Cost

- Chemical Marketing Reporter
- January 1975 Value
- Raw Material Cost Index for Industrial Chemicals
- 1975 Cost Index Value = 206.9 (Wholesale Price Index, Producer Price Index)

4. Labor Cost

- Average for Chemical Petroleum, Coal and Allied Industries (1975)
- Skilled \$6.90/hr
- Semiskilled \$4.90/hr

5. Update to 1980

- historically cited 1975 dollars (LSA project)
- DOE decision to change to 1980 dollars (JPL, 6/22/79)
- reports to reflect both 1975 and 1980 dollars (JPL, 6/22/79)
- inflation factor of 1.4 to be used (JPL, 6/22/79)

TABLE 4.3-6

RAW MATERIAL COST FOR UCC SILANE PROCESS

<u>Raw Material</u>	<u>Requirement lb/KG of Si</u>	<u>\$/lb of Material</u>	<u>Cost \$/KG of Si</u>
1. M.G. Silicon (Si)	2.60	0.535	1.391
2. Silicon Tetrachloride (SiCl ₄ , make-up)	2.76	0.135	0.373
3. Liquid Hydrogen (H ₂ , make-up)	0.032	1.84	0.059
4. Copper Catalyst (Cu)	0.051	0.922	0.047
5. Hydrate Lime (Ca(OH) ₂)	2.43	0.015 (33.2\$/ton)	0.036
TOTAL			1.906 (1975 dollars)
			x 1.4 inflation
			<u>2.668</u> (1980 dollars)

TABLE 4.3-7
UTILITY COST FOR UCC SILANE PROCESS

<u>Utility</u>	<u>Requirement, KG of Silicon</u>	<u>Cost of Utility</u>	<u>Cost \$/KG of Silicon</u>
1. Electricity	3.050 KW	0.0324 \$/KW-HR	0.0988
2. Steam	172.200 lbs.	1.35 \$/klb	0.2325
3. Cooling Water	525.000 gallons	0.09 \$/kgal	0.0473
4. Process Water	0.0709 gallons	0.405\$/kgal	0.0001
5. Refrigerant	968.000 Btu	10.50 \$/MBtu	0.0102
6. Fuel	27,100.00 Btu	1.40 \$/MBtu	<u>0.0379</u>
		TOTAL	0.43 (1975 dollars)
			x 1.4 inflation
			<u>0.60 (1980 dollars)</u>

Note:

k = kilo = 10^3
M = mega = 10^6

TABLE 4.3-8

PURCHASED COST OF MAJOR PROCESS EQUIPMENT FOR
UCC SILANE PROCESS

<u>Equipment</u>	<u>Purchased Cost, \$1000</u>
1. (D-01) Crude TCS/STC Stripping Column	5.5
2. (D-02) TCS/STC Distillation Column	32.6
3. (D-03) DCS/TCS Distillation Column	61.6
4. (D-04) Silane Distillation Column	50.3
5. (R-01) Hydrogenation Reactor	87.6
6. (R-) DCS Redistribution Reactor	19.2
7. (R-03) TCS Redistribution Reactor	17.3
8-9. (R-04) Sludge Neutralization Reactor	10.3
10. (H-01) Liquid H ₂ Vaporizer (Provided by Vendor)	-- ----
11. (H-02) STC Cooler	26.4
12. (H-03) Quench Condenser	22.6
13. (H-04) Recycle STC Vaporizer	3.3
14. (H-05) Recycle STC Superheater	35.0
15. (H-06) Recycle H ₂ Heater	10.8
16. (H-07) Stripper Reboiler	1.5
17. (H-08) Stripper Condenser	1.4
18. (H-09) TCS/STC Reboiler	8.6
19. (H-10) TCS/STC Condenser	44.5
20. (H-11) DCS/TCS Reboiler	8.2
21. (H-12) DCS/TCS Condenser	16.2
22. (H-13) DCS Cooler	1.5
23. (H-14) TCS Cooler	3.0

TABLE 4.3-8 (Continued)

24.	(H-15) Silane Reboiler	1.3
25.	(H-16) Silane Condenser	2.6
26.	(H-17) Silane Vaporizer/Superheater	2.4
27.	(H-18) Pyrolysis Hydrogen Cooler	4.1
28.	(H-19) First Stage H ₂ Intercooler	3.6
29.	(H-20) Second Stage H ₂ Intercooler	3.6
30.	(C-01) Pneumatic Conveying Fan	1.6
31.	(C-02) Recycle H ₂ Blower	4.7
32.	(C-03) First Stage H ₂ Compressor	9.7
33.	(C-04) Second Stage H ₂ Compressor	9.7
34.	(C-05) Third Stage H ₂ Compressor	9.7
35.	(P-01) Quench Contactor Pump	2.4
36.	(P-03) Recycle STC Pump	15.0
37.	(P-04) TCS Distillate Pump	19.8
38.	(P-05) DCS Distillate Pump	11.3
39.	(P-06) Lime Tank Pump	2.0
40.	(T-01) Crude TCS/STC Storage Tank	39.0
41.	(T-02) STC Storage Tank	17.0
42.	(T-03) Liquid H ₂ Storage (Provided By Vendor)	_____
43.	(T-04) Waste Settler Tank	27.0
44.	(T-05) Waste Chloride Tank	1.8
45.	(T-06) Quench Condenser Receiver	8.8
46.	(T-07) Recycle H ₂ Receiver	7.2

TABLE 4.3-8 (Continued)

47.	(T-08) Stripper Reflux pot	1.2
48.	(T-09) TCS/STC Reflux pot	6.1
49.	(T-10) LCS/TCS Reflux pot	11.2
50.	(T-11) A, B Silane Shift Tank (two)	20.6 ea.
51.	(T-13) Pyrolysis H ₂ Receiver	7.9
52.	(T-14) Lime Make-up Tank	5.7
53.	(T-15) Sludge Pump Tank	11.3
54.	(B-01) M. G. Silicon Storage Hopper	12.2
55-56.	(B-04) Pyrolysis Dust Bin	1.7
57.	(F-01) Crude TCS/STC Filter	0.7
58.	(F-02) Waste Hydroxide Filter	5.0
59.	(F-03) Pyrolysis H ₂ Filter	0.7
60.	(F-04) M. G. Silicon Unloading Filter	1.6
61.	(S-01) M. G. Silicon Unloading Cyclone	1.4
62.	(S-02) Double Shell Blender	13.0
63.	(S-03) M. G. Silicon Load Hopper	5.8
64.	(U-01) Quench Contactor Ejector	1.3
65.	(U-02) Lime Tank Agitator	1.3
66.	(U-03) Vent Gas Combustor	6.3
67.	(U-04) Vent Gas Ejector	1.3
68.	(R-05) Silane Pyrolysis Reactor (six)	46.8 ea.
69.	(X-01) Melters (six)	53.0 ea.
70.	(B-05) Powder Hoppers (two)	14.9 ea.
71.	(X-02) Hydrogen Cooler	4.1

TABLE 4.3-B (Continued)

72.	(X-03) Hydrogen Blower	2.5
73.	(X-04) Dust Filter	0.8
74.	(X-J5) Star Valve (six)	1.2 ea.
75.	(X-06) Conveyor	8.3
76.	(X-07) Drum Loader	<u>16.6</u>
	TOTAL	1481.9 (1975 dollars) $\times 1.4$ inflation <u>2074.7 (1980 dollars)</u>

TABLE 4.3-9

PRODUCTION LABOR COST FOR UCC SILANE PROCESS

<u>Section/ Unit Operation</u>	<u>Skilled Labor Man-Hrs/KG of Si</u>	<u>Semiskilled Labor Man-Hrs/KG of Si</u>	<u>Cost \$/KG of Si</u>
1. Hydrogenation	0.00745	0.000745	0.0879
2. Silane	0.02230	-----	0.1539
3. Pyrolysis	0.02980	-----	0.2056
4. Waste Treatment	0.00745	-----	0.0514
5. Hydrogen Compression	0.00745	-----	0.0514
		TOTAL	0.55 (1975 dollars) x 1.4 inflation <u>0.77 (1980 dollars)</u>

TABLE 4.3-10

ESTIMATION OF PLANT INVESTMENT FOR UCC SILANE PROCESS

	<u>Investment</u> <u>\$1000</u>
1. DIRECT PLANT INVESTMENT COSTS	
1. Major Process Equipment Cost	1,481.9
2. Installation of Major Process Equipment	637.2
3. Process Piping, Installed	1,096.6
4. Instrumentation, Installed	281.6
5. Electrical, Installed	148.2
6. Process Buildings, Installed	148.2
1a. SUBTOTAL FOR DIRECT PLANT INVESTMENT COSTS (PRIMARILY BATTERY LIMIT FACILITIES)	3,793.7
2. OTHER DIRECT PLANT INVESTMENT COSTS	
1. Utilities, Installed	711.3
2. General Services, Site Development, Fire Protection, etc.	177.8
3. General Buildings, Offices, Shops, etc.	207.5
4. Receiving, Shipping Facilities	311.2
2a. SUBTOTAL FOR OTHER DIRECT PLANT INVESTMENT COSTS (PRIMARILY OFFSITE FACILITIES OUTSIDE BATTERY LIMITS)	1,407.8
3. TOTAL DIRECT PLANT INVESTMENT COST, 1a + 2a	5,201.5
4. INDIRECT PLANT INVESTMENT COSTS	
1. Engineering, Overhead, etc.	815.0
2. Normal Cont. for Floods, Strikes, etc.	1,052.1
4a. TOTAL INDIRECT PLANT INVESTMENT COST	1,867.1
5. TOTAL DIRECT AND INDIRECT PLANT INVESTMENT COST, 3 + 4a	7,068.6
6. OVERALL CONTINGENCY, % of 5	<u>2,120.6</u>
7. FIXED CAPITAL INVESTMENT FOR PLANT, 5 + 6	9,189.2 (1975 dollars)
	x 1.4 inflation
	<u>12,864.9 (1980 dollars)</u>

TABLE 4.3-11

ESTIMATION OF TOTAL PRODUCT COST
FOR UCC SILANE PROCESS

	<u>\$/KG of Si</u>
1. Direct Manufacturing Cost (Direct Charges)	
1. Raw Materials	3.906
2. Direct Operating Labor	0.350
3. Utilities	0.427
4. Supervision and Clerical	0.083
5. Maintenance and Repairs	0.919
6. Operating Supplies	0.184
7. Laboratory Charge	0.083
2. Indirect Manufacturing Cost (Fixed Charges)	
1. Depreciation	0.919
2. Local Taxes	0.184
3. Insurance	0.092
3. Plant Overhead	0.656
4. By-Product Credit	-----
4a. Total Manufacturing Cost, 1 + 2 + 3 + 4	6.003
5. General Expenses	
1. Administration	0.360
2. Distribution and Sales	0.360
3. Research and Development	0.180
6. Total Cost of Product, 4a + 5	<hr/> 6.903 (1975 dollars) x 1.4 inflation 9.664 (1980 dollars)

4.4 BCL Process for Silicon - Case A (Battelle Columbus Laboratories)

The economic analysis activity involves a cost analysis of the process under consideration for the production of silicon. The cost analysis for the particular technology is based on process design results, such as requirements for raw materials and major process equipment necessary to produce the product, from the chemical engineering analysis activity. Primary results issuing from the economic analysis include plant capital investment and product cost which are useful in identification of those processes showing promise for meeting project cost goals.

The cost analysis results for producing silicon by the BCL process-Case A (Battelle Columbus Laboratories) are presented in Table 4.4-3 including costs for raw materials, labor, utilities and other items composing the product cost (total cost of producing silicon). The tabulation summarizes all of these items to give a total product cost without profit of \$8.63 (1975 dollars) and \$12.08 (1980 dollars) per kg. This product cost without profit includes direct manufacturing cost, indirect manufacturing cost, plant overhead and general expenses.

The product cost represents all cost associated with producing silicon. On top of these costs a producing company will include some profit. The sales price of the product silicon will actually be the sum of the product cost and a profit for the company. The profit is usually measured in terms of rate of return on the capital investment that the company spent in going into the polysilicon business. Two profitability methods which are commonly used are the return on original investment (per cent ROI) and discounted cash flow rate of return (per cent DCF).

The cost and profitability analysis summary for this process are presented in Table 4.4-2. The sales price of polysilicon at various rates of return for both profitability methods (per cent ROI and DCF) is shown in the lower half of the table. The results indicate a sales price of \$13.28 per kg of silicon (1980 dollars) at 5 per cent DCF return on investment after taxes.

The detailed results for the economic analysis are presented in a tabular format to make it easier to locate cost items of specific interest. The guide for the tabular format is given below:

- Preliminary Economic Analysis Activities..Table 4.4-3
- Process Design Inputs.....Table 4.4-4
- Base Case Conditions.....Table 4.4-5
- Raw Material Cost.....Table 4.4-6
- Utility Cost.....Table 4.4-7
- Major Process Equipment Cost.....Table 4.4-8
- Production Labor Cost.....Table 4.4-9
- Plant Investment.....Table 4.4-10
- Total Product Cost.....Table 4.4-11

These cost and profitability results for the BCL process-Case A indicate that this new technology for producing polysilicon shows promise for meeting the cost goal of \$14 per kg of silicon material (1980 dollars) for solar cells.

TABLE 4.4-1

ESTIMATION OF PRODUCT COST FOR BCL PROCESS - CASE A

	Cost \$/Kg of Silicon <u>(1975 dollars)</u>	Cost \$/Kg of Silicon <u>(1980 dollars)</u>
1. Direct Manufacturing Cost (Direct Costs).....	5.21	7.29
Raw Materials		
Direct Operating Labor		
Utilities		
Supervision and Clerical		
Maintenance and Repairs		
Operating Supplies		
Laboratory Charge		
2. Indirect Manufacturing Cost (Fixed Cost).....	1.62	2.27
Depreciation		
Local Taxes		
Insurance		
3. Plant Overhead.....	0.68	0.95
4. General Expenses.....	1.12	1.57
Administration		
Distribution and Sales		
Research and Development		
5. Product Cost Without Profit.....	<u>8.63</u>	<u>12.08</u>

TABLE 4.4-2

COST AND PROFITABILITY ANALYSIS SUMMARY FOR BCL PROCESS-CASE A

1. Process.....	BCL Process-Case A
2. Plant Size.....	1,000 Metric Tons/year
3. Plant Product.....	Silicon
4. Product Form.....	Silicon Granules
5. Plant Investment.....	\$14,340,000 / \$20,070,000 (1975 dollars) (1980 dollars)

Fixed Capital	\$12.47Mega	\$17.45 Mega
Working Capital	\$ 1.87Mega	\$ 2.62 Mega
(15%) Total	\$14.34Mega	\$20.07 Mega
	(1975 dollars)	(1980 dollars)

6. Return on Original Investment, after taxes (%ROI)

	<u>Sales Price</u> \$/Kg of Silicon (1975 dollars)	<u>Sales Price</u> \$/Kg of Silicon (1980 dollars)
0% ROI.....	8.63	12.08
5% ROI.....	9.96	13.94
10% ROI.....	11.28	15.80
15% ROI.....	12.61	17.65
20% ROI.....	13.94	19.51
25% ROI.....	15.27	21.37
30% ROI.....	16.59	23.23
40% ROI.....	19.25	26.95

7. Discounted Cash Flow Rate of Return, after taxes (% DCF)

	<u>Sales Price</u> \$/Kg of Silicon (1975 dollars)	<u>Sales Price</u> \$/Kg of Silicon (1980 dollars)
0% DCF.....	8.63	12.08
5% DCF.....	9.48	13.28
10% DCF.....	10.42	14.59
15% DCF.....	11.44	15.91
20% DCF.....	12.52	17.25
25% DCF.....	13.65	18.61
30% DCF.....	14.83	20.00
40% DCF.....	17.27	24.28

Based on 10 year project life and 10 year straight line depreciation.

8. Tax Rate (Federal).....

TABLE 4.4-3

ECONOMIC ANALYSES:
PRELIMINARY ECONOMIC ANALYSIS ACTIVITIES FOR BCL PROCESS-CASE A

<u>Prel. Process Economic Activity</u>	<u>Status</u>	<u>Prel. Process Economic Activity</u>	<u>Status</u>
1. Process Design Inputs	●	11. Production Labor Costs	●
1. Raw Material Req. Limits	●	1. Base Cost Per Man Hour	●
2. Utility Requirements	●	2. Cost/Kg Production Per Area	●
3. Equipment List	●	3. Total Cost/Kg Production	●
4. Labor Requirements	●	Estimation of Plant Investment	●
per Sq Meter Base for Area	●	1. Battery Limits Direct Costs	●
Base Cost for Labor	●	2. General Direct Costs	●
Appropriate Index for	●	3. Indirect Costs	●
Adjustment	●	4. Plant Agency	●
2. Raw Material Cost	●	5. Total Plant Investment	●
1. Base Cost/Kg of Product	●	Fixed Capital	●
2. Labor Cost/Kg of Product	●	Estimation of Total Product Cost	●
3. Total Cost/Kg of Product	●	1. Direct Manufacturing Cost	●
4. Utility Cost	●	2. Indirect Manufacturing Cost	●
1. Base Cost for Utility	●	3. Plant Overhead	●
2. Utility Cost/Kg of Product	●	4. By-Product Credit	●
3. Total Cost/Kg of Product	●	5. General Expenses	●
5. Major Process Equipment Costs	●	6. Total Cost of Product	●
1. Individual Equipment Cost	●		
2. Cost Index Adjustment	●		
		● Plant	
		● In Progress	
		● Complete	

TABLE 4.4-4

PROCESS DESIGN INPUTS FOR
BCL PROCESS - Case A

1. Raw Material Requirements
-Silicon tetrachloride, zinc, lime, argon and nitrogen
-see table for "Raw Material Cost"
2. Utility
-electricity, steam, cooling water and process water
-see table for "Utility Cost"
3. Equipment List
-82 plus pieces of major process equipment
-process vessels, heat exchangers, reactor, etc.
4. Labor Requirements
-production labor for purification, deposition, electrolysis, etc.
-see table for "Production Labor Cost"

TABLE 4.4-5
BASE CASE CONDITION FOR BCL PROCESS-CASE A

1. Capital Equipment

- January 1975 Cost Index for Capital Equipment Cost
- January 1975 Cost Index Value = 430

2. Utilities

- Electrical, Steam, Cooling Water, Nitrogen
- January 1975 Cost Index (U. S. Dept. Labor)
- Values determined by literature search and summarized in cost standardization work

3. Raw Material Cost

- Chemical Marketing Reporter
- January 1975 Value
- Raw Material Cost Index for Industrial Chemicals
- 1975 Cost Index Value = 200 (Wholesale Price Index, Producer Price Index)

4. Labor Cost

- Average for Chemical Petroleum, Coal and Allied Industries (1975)
- Skilled \$6.90/hr

5. Update to 1980

- historically cited 1975 dollars (LSA project)
- DOE decision to change to 1980 dollars (JPL, 6/22/79)
- reports to reflect both 1975 and 1980 dollars (JPL, 6/22/79)
- inflation factor of 1.34 to be used (JPL, 6/22/79)

Table 4.4-6

RAW MATERIAL COST FOR BCI PROCESS-CASE A

<u>Raw Material</u>	<u>Requirement lb/KG of Si</u>	<u>\$/lb of Material</u>	<u>Cost \$/KG of Si</u>
1. Silicon Tetrachloride (SiCl ₄)	15.68	0.135	2.117
2. Zinc (Zn)	0.54	0.38	0.205
3. Hydrate Lime (Ca(OH) ₂)	2.85	0.015	0.043
4. Argon (Ar)	3.1 SCF	0.016/SCF	0.050
5. Nitrogen (N ₂)	7.6 SCF	0.003/SCF	<u>0.023</u>
		Sub Total	2.438
6. Chlorine (Cl ₂)	-10.46 ¹	0.0332	<u>-0.347</u>
		TOTAL	2.091 (1975 dollars)
			<u>x 1.4 inflation</u>
			2.927 (1980 dollars)

Note:

1. This number is the result of by-product rate minus reactor chlorination rate, i.e., 11.12 - 0.66 lb. of Cl₂/KG Si.

Table 4.4-7
UTILITY COST FOR BCL PROCESS-CASE A

<u>Utility</u>	<u>Requirement/KG of Silicon</u>	<u>Cost of Utility</u>	<u>Cost \$/KG of Silicon</u>
1. Electricity	30.92 kw-hr	0.0324 \$/kw-hr	1.0018
2. Steam	9.67 pounds	1.35 \$/klb	0.0131
3. Cooling Water	37.88 Gallons	0.09 \$/kgal	0.0034
4. Process Water	24.20 Gallons	0.405 \$/kgal	0.0098
5. Refrigerant	2.38 MBtu	10.50 \$/MBtu	0.0250
		TOTAL	1.0531 (1975 dollars) x 1.4 inflation 1.4743 (1980 dollars)

Note:

k = kilo = 10^3
M = mega = 10^6

TABLE 4.4-8

ESTIMATED COST OF MAJOR PROCESS EQUIPMENT FOR BCL PROCESS -CASE A

<u>Equipment</u>	<u>Purchased Cost, \$1,000</u>
1. (D-01) Light End Distillation Column	55.6
2. (D-02) Heavy End Distillation Column	55.6
3. (A-01) Primary SiCl ₄ Vent Scrubber	0.8
4. (A-02) Final SiCl ₄ Vent Scrubber	11.1
5. (H-01) L. E. Column Feed Heater	7.8
6. (H-02) L. E. Column Reboiler	2.2
7. (H-03) L. E. Column Condenser	2.3
8. (H-04) H. E. Column Feed Heater	7.8
9. (H-05) H. E. Column Reboiler	2.4
10. (H-06) H. E. Column Condenser	2.3
11. (H-07) SiCl ₄ Vent Condenser	11.8
12. (H-08) SiCl ₄ Vaporizer	6.7
13. (H-09) Reactor Condensers (2)	190.3
14. (H-10) Reactor ZnCl ₂ Strippers (2)	27.9
15. (H-11) SiCl ₄ Condenser	20.5
16. (H-12) Cell ZnCl ₂ Stripper	10.9
17. (H-13) Therminol Cooler (Cold Circuit)	3.8
18. (H-14) Therminol Cooler (Hot Circuit)	9.1
19. (H-15) Start-up Heater	9.6
20. (H-16) Silicon Product Coolers (2)	7.7
20a. (H-17) Chlorination Cooler	15.9
20b. (H-18) Cell Gas Cooler	18.7
21. (T-01) SiCl ₄ Storage Tank	33.6
22. (T-02) SiCl ₄ Emergency Storage Tank	33.6
23. (T-03) L. E. Column Reflux Drum	6.7

TABLE 4.4-8 (Continued)

24.	(T-04) Surge Tank	19.0
25.	(T-05) Sump Tank	19.0
26.	(T-06) H. E. Column Reflux Drum	6.7
27.	(T-07) Pure SiCl_4 Storage Tank	28.8
28.	(T-08) Electrolysis Feed Tank	46.0
29.	(T-09) Molten Zinc Storage Tank	86.9
30.	(T-10) Therminol Head Tank	3.8
31.	(T-11) Therminol Drain Down Tank	5.3
32.	(T-12) Chlorine Supply Tank	2.4
33.	(T-13) Lime Solution Storage Tank	6.8
34.	(P-01) Purification Feed Pump	3.7
35.	(P-02) L. E. Column Feed Pump	8.4
36.	(P-03) L. E. Column Reflux Pump	8.4
37.	(P-04) Surge Tank Pump	9.8
38.	(P-05) Sump Pump	3.7
39.	(P-06) L. E. Column Bottom Pump	12.0
40.	(P-07) H. E. Column Reflux Pump	8.4
41.	(P-08) H. E. Column Bottom Pump	10.9
42.	(P-09) SiCl_4 Vaporizer Feed Pump	4.8
43.	(P-10) Reactor Condenser Circulation Pumps (2)	14.4
44.	(P-11) Cold Circuit Pump	6.7
45.	(P-12) Hot Circuit Pump	13.9
46.	(P-13) Primary Scrubber Recirculation Pump	0.9
47.	(P-14) Primary Scrubber Lower-loop Recirculation Pump	1.4
48.	(P-15) Primary Scrubber Upper-loop Recirculation Pump	1.5
49.	(P-16) Lime Solution Metering Pump	1.4

TABLE 4.4-8 (Continued)

50.	(F-01) L. E. Column Feed Filter	0.9
51.	(F-02) L. E. Column Reflux Filter	0.9
52.	(F-03) H. E. Column Feed Filter	0.9
53.	(F-04) H. E. Column Reflux Filter	0.9
54.	(F-05) Therminol Cooler Blower Filter	0.7
55.	(R-01) Fluidized Bed Reactors (2)	197.1
56.	(FN-01) Furnaces (1)	354.2
57.	(B-01) Seed Addition Hoppers (2)	9.6
58.	(B-02) Si Product Hoppers (4)	14.4
59.	(B-03) Zinc Hopper	2.4
60.	(C-01) Therminol Cooler Blower	4.8
61.	(C-02) Scrubber Vent Blower	5.4
62.	(E-01) Eductors (2)	1.8
63.	(EC-01) Electrolysis Cells (6)	444.0
64.	(PW-01) Power Supply and Bus	105.9
65.	(VP-01) Zinc Vaporizers (2)	<u>144.0</u>
	TOTAL	2,177.7 (1977 dollars) x 1.4 inflation <u>3,048.8 (1990 dollars)</u>

TABLE 4.4-9

PRODUCTION LABOR COST FOR BCL PROCESS-CASE A

<u>Section</u>	<u>Labor Man-Hr/Kg Si</u>	<u>Labor Cost \$/Man-Hr</u>	<u>Cost \$/Kg Si</u>
1. Purification	0.01402	6.90	0.0968
2. Deposition	0.01402	6.90	0.0968
3. Electrolysis	0.02103	6.90	0.1451
4. Waste Treatment	0.00701	6.90	0.0484
5. Product Handling	0.00701	6.90	<u>0.0484</u>
		TOTAL	0.4355 (1975 dollars) x 1.4 inflation <u>0.6097 (1980 dollars)</u>

Note: Costs are 1975 Dollars

TABLE 4.4-10

ESTIMATION OF PLANT INVESTMENT FOR BCL PROCESS-CASE A

	Investment \$1000
1. DIRECT PLANT INVESTMENT COSTS	
1. Major Process Equipment Cost	2,177.7
2. Installation of Major Process Equipment	936.4
3. Process Piping, Installed	1,611.6
4. Instrumentation, Installed	413.8
5. Electrical, Installed	217.8
6. Process Buildings, Installed	212.8
1a. SUBTOTAL FOR DIRECT PLANT INVESTMENT COSTS (PRIMARILY BATTERY LIMIT FACILITIES)	5,574.9
2. OTHER DIRECT PLANT INVESTMENT COSTS	
1. Utilities, Installed	641.3
2. General Service, Site Development, Fire Protection, etc.	100.5
3. General Buildings, Offices, Shops, etc.	304.0
4. Receiving, Shipping Facilities	457.3
2a. SUBTOTAL FOR OTHER DIRECT PLANT INVESTMENT COSTS (PRIMARILY OFFSITE FACILITIES OUTSIDE BATTERY LIMITS)	2,068.8
3. TOTAL DIRECT PLANT INVESTMENT COST, 1a + 2a	7,643.7
4. INDIRECT PLANT INVESTMENT COSTS	
1. Engineering, Overhead, etc.	1,192.7
2. Normal Cont. for Floods, Strikes, etc.	1,546.7
4a. TOTAL INDIRECT PLANT INVESTMENT COST	2,739.4
5. TOTAL DIRECT AND INDIRECT PLANT INVESTMENT COST, 3 + 4a	10,383.0
6. OVERALL CONTINGENCY, % of 5	2,074.5
7. TOTAL INVESTMENT FOR PLANT, 5 + 6	12,457.5 (1975 dollars) x 1.4 inflation 17,440.5 (1980 dollars)

TABLE 4.4-11

ESTIMATION OF TOTAL PRODUCT COST FOR BCL PROCESS - CASE A

	<u>\$/KG of Si</u>
1. Direct Manufacturing Cost (Direct Charges)	
1. Raw Materials	2.091
2. Direct Operating Labor	0.436
3. Utilities	1.053
4. Supervision and Clerical	0.065
5. Maintenance and Repairs	1.247
6. Operating Supplies	0.249
7. Laboratory Charge	0.065
2. Indirect Manufacturing Cost (Fixed Charges)	
1. Depreciation	1.247
2. Local Taxes	0.249
3. Insurance	0.125
3. Plant Overhead	0.675
4. By-Product Credit	-----
4a. Total Manufacturing Cost, 1 + 2 + 3 + 4	7.501
5. General Expenses	
1. Administration	0.450
2. Distribution and Sales	0.450
3. Research and Development	<u>0.225</u>
6. Total Cost of Product, 4a + 5	8.626 (1975 dollars)
	<u>x 1.4</u> inflation
	12.076 (1980 dollars)

4.5 BCL Process for Silicon - Case B (Battelle Columbus Laboratories)

The economic analysis activity involves a cost analysis of the process under consideration for the production of silicon. The cost analysis for the particular technology is based on process design results, such as requirements for raw materials and major process equipment necessary to produce the product, from the chemical engineering analysis activity. Primary results issuing from the economic analysis include plant capital investment and product cost which are useful in identification of those processes showing promise for meeting project cost goals.

The cost analysis results for producing silicon by the BCL process - Case B (Battelle Columbus Laboratories) are presented in Table 4.5-1 including costs for raw materials, labor, utilities and other items composing the product cost (total cost of producing silicon). The tabulation summarizes all of these items to give a total product cost without profit of \$7.91 (1975 dollars) and \$11.07 (1980 dollars) per kg. This product cost without profit includes direct manufacturing cost, indirect manufacturing cost, plant overhead and general expenses.

The product cost represents all cost associated with producing silicon. On top of these costs a producing company will include some profit. The sales price of the product silicon will actually be the sum of the product cost and a profit for the company. The profit is usually measured in terms of rate of return on the capital investment that the company spent in going into the polysilicon business. Two profitability methods which are commonly used are the return on original investment (per cent ROI) and discounted cash flow rate of return (per cent DCF).

The cost and profitability analysis summary for this process are presented in Table 4.5-2. The sales price of polysilicon at various rates of return for both profitability methods (per cent ROI and DCF) is shown in the lower half of the table. The results indicate a sales price of \$13.14 per kg of silicon (1980 dollars) at 10 per cent DCF return on investment.

These cost and profitability results for the BCL process-Case B indicate that this new technology for producing polysilicon shows promise for meeting the cost goal of \$14 per kg of silicon material (1980 dollars) for solar cells.

The detailed results for the economic analysis are presented in a tabular format to make it easier to locate cost items of specific interest. The guide for the tabular format is given below:

- Preliminary Economic Analysis Activities..Table 4.5-3
- Process Design Inputs.....Table 4.5-4
- Base Case Conditions.....Table 4.5-5
- Raw Material Cost.....Table 4.5-6
- Utility Cost.....Table 4.5-7
- Major Process Equipment Cost.....Table 4.5-8
- Production Labor Cost.....Table 4.5-9
- Plant Investment.....Table 4.5-10
- Total Product Cost.....Table 4.5-11

TABLE 4.5-1

ESTIMATION OF PRODUCT COST FOR BCL PROCESS - CASE B

	Cost \$/Kg of Silicon <u>(1975 dollars)</u>	Cost \$/Kg of Silicon <u>(1980 dollars)</u>
1. Direct Manufacturing Cost (Direct Costs).....	4.94	6.52
Raw Materials		
Direct Operating Labor		
Utilities		
Supervision and Clerical		
Maintenance and Repairs		
Operating Supplies		
Laboratory Charge		
2. Indirect Manufacturing Cost (Fixed Cost).....	1.33	1.86
Depreciation		
Local Taxes		
Insurance		
3. Plant Overhead.....	.61	.85
4. General Expenses.....	1.0	1.44
Administration		
Distribution and Sales		
Research and Development		
5. Product Cost Without Profit.....	<u>7.94</u>	<u>11.07</u>

TABLE 4.5-2

COST AND PROFITABILITY ANALYSIS SUMMARY FOR BCL PROCESS- CASE B

- 1. Process.....BCL Process - Case B
- 2. Plant Size.....1,000 Metric Tons/year
- 3. Plant Product.....Silicon
- 4. Product Form.....Silicon Granules
- 5. Plant Investment.....\$11,790,000 /\$16,500,000
(1975 dollars) (1980 dollars)

Fixed Capital	\$10.25Mega	\$14.25Mega
Working Capital	\$ 1.54Mega	\$ 2.15Mega
(15%) Total	\$11.79Mega	\$16.50Mega
	(1975 dollars)	(1980 dollars)

6. Return on Original Investment, after taxes (%ROI)

	<u>Sales Price</u> \$/Kg of Silicon (1975 dollars)	<u>Sales Price</u> \$/Kg of Silicon (1980 dollars)
0% ROI.....	7.91	11.07
5% ROI.....	9.00	12.60
10% ROI.....	10.09	14.13
15% ROI.....	11.18	15.66
20% ROI.....	12.28	17.19
25% ROI.....	13.37	18.71
30% ROI.....	14.46	20.24
40% ROI.....	16.64	23.29

7. Discounted Cash Flow Rate of Return, after taxes (% DCF)

	<u>Sales Price</u> \$/Kg of Silicon (1975 dollars)	<u>Sales Price</u> \$/Kg of Silicon (1980 dollars)
0% DCF.....	7.91	11.07
5% DCF.....	9.01	12.60
10% DCF.....	10.10	14.14
15% DCF.....	11.20	15.67
20% DCF.....	12.30	17.20
25% DCF.....	13.40	18.73
30% DCF.....	14.50	20.26
40% DCF.....	16.68	23.31

Based on 10 year project life and 10 year straight line depreciation.

- 8. Tax Rate (Federal).....40%

TABLE 4.5-3

ECONOMIC ANALYSES:
PRELIMINARY ECONOMIC ANALYSIS ACTIVITIES FOR BCL PROCESS-CASE B

<u>Prel. Process Economic Activity</u>	<u>Status</u>	<u>Prel. Process Economic Activity</u>	<u>Status</u>
1. Process Design Inputs	3	6. Production Labor Costs	3
1. Raw Material Requirements	3	1. Base Cost Per Man Hour	3
2. Utility Requirements	3	2. Cost/Kg Silicon Per Area	3
3. Equipment List	3	3. Total Cost/Kg Silicon	3
4. Labor Requirements	3		
Specify Base Case Conditions	3	7. Estimation of Plant Investment	3
1. Base Year for Costs	3	1. Battery Limits Direct Costs	3
2. Appropriate Indices for Costs Additional	3	2. Other Direct Costs	3
		3. Indirect Costs	3
		4. Contingency	3
		5. Total Plant Investment (Fixed Capital)	3
2. Raw Material Costs	3		
1. Base Cost lb. of Material	3	8. Estimation of Total Product Cost	3
2. Base Cost Kg of Silicon	3	1. Direct Manufacturing Cost	3
3. Total Cost/Kg of Silicon	3	2. Indirect Manufacturing Cost	3
		3. Plant Overhead	3
3. Utility Costs	3	4. By-Product Credit	3
1. Base Cost for Base Unit	3	5. General Expenses	3
2. Unit Cost/Kg of Silicon	3	6. Total Cost of Product	3
3. Total Cost/Kg of Silicon	3		
4. Major Process Equipment Cost	3		
1. Individual Equipment Cost	3		
2. Cost Index Adjustment	3		
		9. Plan	
		0. In Progress	
		1. Complete	

TABLE 4.5-4

PROCESS DESIGN INPUTS FOR
BCL PROCESS - CASE B

1. Raw Material Requirements
-Silicon tetrachloride, zinc, lime, argon and nitrogen
-see table for "Raw Material Cost"
2. Utility
-electricity, steam, cooling water and process water
-see table for "Utility Cost"
3. Equipment List
-70 plus pieces of major process equipment
-process vessels, heat exchangers, reactor, etc.
4. Labor Requirements
-production labor for purification, deposition, electrolysis, etc.
-see table for "Production Labor Cost"

TABLE 4.5-5
BASE CASE CONDITION FOR BCL PROCESS - CASE B

1. Capital Equipment

- January 1975 Cost Index for Capital Equipment Cost
- January 1975 Cost Index Value = 430

2. Utilities

- Electrical, Steam, Cooling Water, Nitrogen
- January 1975 Cost Index (U. S. Dept. Labor)
- Values determined by literature search and summarized in cost standardization work

3. Raw Material Cost

- Chemical Marketing Reporter
- January 1975 Value
- Raw Material Cost Index for Industrial Chemicals
- 1975 Cost Index Value = 206.9 (Wholesale Price Index, Producer Price Index)

4. Labor Cost

- Average for Chemical Petroleum, Coal and Allied Industries (1975)
- Skilled \$6.90/hr

5. Update to 1980

- historically cited 1975 dollars (LSA project)
- DOE decision to change to 1980 dollars (JPL, 6/22/79)
- reports to reflect both 1975 and 1980 dollars (JPL, 6/22/79)
- inflation factor of 1.4 to be used (JPL, 6/22/79)

Table 4.5-6

RAW MATERIAL COST FOR BCL PROCESS-CASE B

<u>Raw Material</u>	<u>Requirement lb/KG of Si</u>	<u>\$/lb of Material</u>	<u>Cost \$/KG of Si</u>
1. Silicon Tetrachloride (SiCl ₄)	15.68	0.135	2.117
2. Zinc (Zn)	0.54	0.38	0.205
3. Hydrate Lime (Ca(OH) ₂)	2.85	0.015	0.043
4. Argon (Ar)	3.1 SCF	0.016/SCF	0.050
5. Nitrogen (N ₂)	7.6 SCF	0.003/SCF	<u>0.023</u>
		Sub Total	2.438
6. Chlorine (Cl ₂)	-10.46 ¹	0.032	<u>-0.347</u>
		TOTAL	2.091 (1975 dollars)
			<u>x 1.4 inflation</u>
			2.927 (1980 dollars)

Notes:

1. This number is the result of by-product rate minus reactor chlorination rate, i.e., 11.12 - 0.66 lb. of Cl₂/KG Si.

Table 4.5-7
UTILITY COST FOR BCL PROCESS-CASE B

<u>Utility</u>	<u>Requirement/KG of Silicon</u>	<u>Cost of Utility</u>	<u>Cost \$/KG of Silicon</u>
1. Electricity	30.92 KW-HR	0.0324 \$/KW-HR	1.0018
2. Steam	9.67 pounds	1.35 \$/Mlb	0.0131
3. Cooling Water	37.88 Gallons	0.09 \$/Mgal	0.0034
4. Process Water	24.20 Gallons	0.405 \$/Mgal	0.0098
5. Refrigerant	2.38 MBtu	10.50 \$/MMBtu	0.0250
		TOTAL	1.0531 (1975 dollars)
			<u>x 1.4 inflation</u>
			1.4743 (1980 dollars)

TABLE 4.5-8

ESTIMATED COST OF MAJOR PROCESS EQUIPMENT FOR BCL PROCESS-CASE B

<u>Equipment</u>	<u>Purchased Cost, \$1,000</u>
1. (D-01) Light End Distillation Column	55.6
2. (D-02) Heavy End Distillation Column	55.6
3. (A-01) Primary SiCl ₄ Vent Scrubber	0.8
4. (A-02) Final SiCl ₄ Vent Scrubber	11.1
5. (H-01) L. E. Column Feed Heater	7.8
6. (H-02) L. E. Column Reboiler	2.2
7. (H-03) L. E. Column Condenser	2.3
8. (H-04) H. E. Column Feed Heater	7.8
9. (H-05) H. E. Column Reboiler	2.4
10. (H-06) H. E. Column Condenser	2.3
11. (H-07) SiCl ₄ Vent Condenser	11.8
12. (H-08) SiCl ₄ Vaporizer	6.7
13. (H-09) Reactor Condensers (2)	144.2
14. (H-10) Reactor SnCl ₂ Strippers (2)	21.1
15. (H-11) SiCl ₄ Condenser	20.5
16. (H-12) Cell SnCl ₂ Stripper	10.9
17. (H-13) Thermal Cooler (Cold Circuit)	3.8
18. (H-14) Thermal Cooler (Hot Circuit)	9.1
19. (H-15) Startup Heater	9.6
20. (H-16) Silicon Product Coolers (2)	5.8
20a. (H-17) Chlorination Cooler	15.9
20b. (H-18) Cell Gas Cooler	18.7
21. (T-01) SiCl ₄ Storage Tank	33.6
22. (T-02) SiCl ₄ Emergency Storage Tank	33.6
23. (T-03) L. E. Column Reflux Drum	6.7

TABLE 4.5-P (Continued)

24.	(T-04) Surge Tank	19.0
25.	(T-05) Sump Tank	19.0
26.	(T-06) H. E. Column Reflux Drum	6.7
27.	(T-07) Pure SiCl_4 Storage Tank	28.8
28.	(T-08) Electrolysis Feed Tank	46.0
29.	(T-09) Molten Zinc Storage Tank	86.9
30.	(T-10) Therminol Head Tank	3.8
31.	(T-11) Therminol Drain Down Tank	5.3
32.	(T-12) Chlorine Supply Tank	2.4
33.	(T-13) Lime Solution Storage Tank	6.8
34.	(P-01) Purification Feed Pump	3.7
35.	(P-02) L. E. Column Feed Pump	8.4
36.	(P-03) L. E. Column Reflux Pump	8.4
37.	(P-04) Surge Tank Pump	9.8
38.	(P-05) Sump Pump	3.7
39.	(P-06) L. E. Column Bottom Pump	12.0
40.	(P-07) H. E. Column Reflux Pump	8.4
41.	(P-08) H. E. Column Bottom Pump	10.9
42.	(P-09) SiCl_4 Vaporizer Feed Pump	4.8
43.	(P-10) Reactor Condenser Circulation Pumps (2)	10.9
44.	(P-11) Cold Circuit Pump	6.7
45.	(P-12) Hot Circuit Pump	13.9
46.	(P-13) Primary Scrubber Recirculation Pump	0.9
47.	(P-14) Primary Scrubber Lower-loop Recirculation Pump	1.4
48.	(P-15) Primary Scrubber Upper-loop Recirculation Pump	1.5
49.	(P-16) Lime Solution Metering Pump	1.4

TABLE 4.5-8 (Continued)

50.	(F-01) L. E. Column Feed Filter	0.9
51.	(F-02) L. E. Column Reflux Filter	0.9
52.	(F-03) H. E. Column Feed Filter	0.9
53.	(F-04) H. E. Column Reflux Filter	0.9
54.	(F-05) Therminol Cooler Blower Filter	0.7
55.	(R-01) Fluidized Bed Reactors	149.4
56.	(FN-01) Furnaces	268.5
57.	(B-01) Seed Addition Hoppers	7.3
58.	(B-02) Si Product Hoppers (4)	14.4
59.	(B-03) Zinc Hopper	2.4
60.	(C-01) Therminol Cooler Blower	4.8
61.	(C-02) Scrubber Vent Blower	5.4
62.	(E-01) Eductors (2)	1.3
63.	(EC-01) Electrolysis Cells (2)	286.5
64.	(PW-01) Power Supply and Bus	105.9
65.	(VP-01) Zinc Vaporizers	<u>109.1</u>
	TOTAL	1,790.7 (1975 dollars)
		<u>x 1.4 inflation</u>
		2,507.0 (1980 dollars)

TAB 4.5-9

PRODUCTION LABOR COST FOR BCL PROCESS-CASE B

<u>Section</u>	<u>Labor Man-Hr/Kg Si</u>	<u>Labor Cost \$/Man-Hr</u>	<u>Cost \$/Kg Si</u>
1. Purification	0.01402	6.90	0.0968
2. Deposition	0.01402	6.90	0.0968
3. Electrolysis	0.02103	6.90	0.1451
4. Waste Treatment	0.00701	6.90	0.0484
5. Product Handling	0.00701	6.90	<u>0.0484</u>
		TOTAL	0.4355 (1975 dollars) <u>x 1.4 inflation</u> 0.6097 (1980 dollars)

Note: Costs are 1975 Dollars

TABLE 4.5-10

ESTIMATION OF PLANT INVESTMENT FOR BCL PROCESS-CASE B

	<u>Investment</u> <u>\$1000</u>
1. DIRECT PLANT INVESTMENT COSTS	
1. Major Process Equipment Cost	1,790.7
2. Installation of Major Process Equipment	770.0
3. Process Piping, Installed	1,325.1
4. Instrumentation, Installed	340.2
5. Electrical, Installed	179.1
6. Process Buildings, Installed	179.1
1a. SUBTOTAL FOR DIRECT PLANT INVESTMENT COSTS (PRIMARILY BATTERY LIMIT FACILITIES)	4,584.2
2. OTHER DIRECT PLANT INVESTMENT COSTS	
1. Utilities, Installed	859.5
2. General Service, Site Development, Fire Protection, etc.	214.9
3. General Buildings, Offices, Shops, etc.	250.7
4. Receiving, Shipping Facilities	376.1
2a. SUBTOTAL FOR OTHER DIRECT PLANT INVESTMENT COSTS (PRIMARILY OFFSITE FACILITIES OUTSIDE BATTERY LIMITS)	1,701.2
3. TOTAL DIRECT PLANT INVESTMENT COST, 1a + 2a	6,285.4
4. INDIRECT PLANT INVESTMENT COSTS	
1. Engineering, Overhead, etc.	984.9
2. Normal Cont. for Floods, Strikes, etc.	1,271.4
4a. TOTAL INDIRECT PLANT INVESTMENT COST	2,256.3
5. TOTAL DIRECT AND INDIRECT PLANT INVESTMENT COST, 3 + 4a	8,541.6
6. OVERALL CONTINGENCY, % of 5	1,708.3
7. FIXED CAPITAL INVESTMENT FOR PLANT, 5 + 6	<u>10,250.0</u> (1975 dollars) <u> x 1.4</u> inflation 14,350.0 (1980 dollars)

TABLE 4.5-11

ESTIMATION OF TOTAL PRODUCT COST FOR BCL PROCESS - CASE 1

	<u>\$/kg of Si</u>
1. Direct Manufacturing Cost (Direct Charges)	
1. Raw Materials	2.091
2. Direct Operating Labor	0.436
3. Utilities	1.053
4. Supervision and Clerical	0.065
5. Maintenance and Repairs	1.025
6. Operating Supplies	0.205
7. Laboratory Charge	0.065
2. Indirect Manufacturing Cost (Fixed Charges)	
1. Depreciation	1.025
2. Local Taxes	0.205
3. Insurance	0.103
3. Plant Overhead	0.608
4. By-Product Credit	-----
4a. Total Manufacturing Cost, 1 + 2 + 3 + 4	7.881
5. General Expenses	
1. Administration	0.413
2. Distribution and Sales	0.413
3. Research and Development	<u>0.206</u>
6. Total Cost of Product, 4a + 5	7.913 (1975 dollars)
	<u>x 1.4</u> inflation
	11.078 (1980 dollars)

4.6 DCS Process (Dichlorosilane)

The economic analysis activity involves a cost analysis of the DCS process - Case A to produce dichlorosilane which is involved in the Hemlock Semiconductor Corporation program for polysilicon.

The cost analysis for the particular technology is based on process design results, such as requirements for raw materials and major process equipment necessary to produce the product from the chemical engineering analysis activity. Primary results issuing from the economic analysis include plant capital investment and product cost which are useful in the analysis of polysilicon production from dichlorosilane.

The cost analysis result for the DCS process (Case A) are presented in Table 4.6-1 including costs for raw materials, labor, utilities and other items composing the product cost (total cost of producing silicon). The tabulation summarizes all of these items to give a total product cost without profit of \$1.39 per kg of DCS (1980 dollars). This product cost without profit includes direct manufacturing cost, indirect manufacturing cost, plant overhead and general expenses.

The product cost represents all cost associated with producing 1 kg of DCS. On top of these costs a producing company will include some profit. The sales price of the product silicon will actually be the sum of the product cost and a profit for the company. The profit is usually measured in terms of rate of return on the capital investment that the company spent in going into the DCS business. Two profitability methods which are commonly used are the return on original investment (per cent ROI) and discounted cash flow rate of return (per cent DCF).

The cost and profitability analysis summary for this process are presented in Table 4.6-2. The sales price of dichlorosilane at various rates of return for both profitability methods (per cent ROI and DCF) is shown in the lower half of the table. The results indicate a sales price of \$1.47 per kg (1980 dollars) at 15 per cent DCF rate of return on investment.

These cost and profitability results for the DCS process will help the analysis of polysilicon production from dichlorosilane.

The detailed results for the economic analysis are presented in a tabular format to make it easier to locate cost items of specific interest. The guide for the tabular format is given

below:

- Preliminary Economic Analysis Activities...Table 4.6-3
- Process Design Inputs.....Table 4.6-4
- Base Case Conditions.....Table 4.6-5
- Raw Material Cost.....Table 4.6-6
- Utility Cost.....Table 4.6-7
- Major Process Equipment Cost.....Table 4.6-8
- Production Labor Cost.....Table 4.6-9
- Plant Investment.....Table 4.6-10
- Total Product Cost.....Table 4.6-11

The economic analysis provides detailed cost data for raw materials, utilities, labor and major process equipment which are necessary for polysilicon production.

TABLE 4.6-1

ESTIMATION OF PRODUCT COST FOR DCS PROCESS

	Cost \$/Kg of DCS (1975 dollars)	Cost \$/Kg of DCS (1980 dollars)
1. Direct Manufacturing Cost (Direct Costs).....	0.6935	0.9709
Raw Materials		
Direct Operating Labor		
Utilities		
Supervision and Clerical		
Maintenance and Repairs		
Operating Supplies		
Laboratory Charge		
2. Indirect Manufacturing Cost (Fixed Cost).....	0.0735	0.1029
Depreciation		
Local Taxes		
Insurance		
3. Plant Overhead.....	0.0355	0.0497
4. General Expenses.....	0.1205	0.1687
Administration		
Distribution and Sales		
Research and Development		
5. Product Cost Without Profit.....	0.9230	1.2922

TABLE 4.6-2

COST AND PROFITABILITY ANALYSIS SUMMARY FOR DCS PROCESS

1. Process.....	DCS process	
2. Plant Size.....	9,780 metric tons/year	
3. Plant Product.....	dichlorosilane	
4. Product Form.....	liquid	
5. Plant Investment.....	6.36 x 10 ⁶	8.90 x 10 ⁶
	(1975 dollars)	(1980 dollars)

Fixed Capital	5.53 Mega	7.74 Mega
Working Capital	0.83 Mega	1.16 Mega
(15%) Total	6.36 Mega	8.90 Mega
	(1975 dollars)	(1980 dollars)

6. Return on Original Investment, after taxes (%ROI)

	Sales Price \$/Kg of DCS (1975 dollars)	Sales Price \$/Kg of DCS (1980 dollars)
0% ROI.....	0.92	1.29
5% ROI.....	0.98	1.38
10% ROI.....	1.04	1.46
15% ROI.....	1.10	1.55
20% ROI.....	1.16	1.63
25% ROI.....	1.22	1.71
30% ROI.....	1.28	1.80
40% ROI.....	1.40	1.97

7. Discounted Cash Flow Rate of Return, after taxes (% DCF)

	Sales Price \$/Kg of DCS (1975 dollars)	Sales Price \$/Kg of DCS (1980 dollars)
0% DCF.....	0.92	1.29
5% DCF.....	0.96	1.35
10% DCF.....	1.00	1.41
15% DCF.....	1.05	1.47
20% DCF.....	1.10	1.54
25% DCF.....	1.15	1.61
30% DCF.....	1.20	1.69
40% DCF.....	1.32	1.84

Based on 10 year project life and 10 year straight line depreciation.

TABLE 4.6-3

ECONOMIC ANALYSES:
PRELIMINARY ECONOMIC ANALYSIS ACTIVITIES FOR DCS PROCESS

<u>Prel. Process Economic Activity</u>	<u>Status</u>	<u>Prel. Process Economic Activity</u>	<u>Status</u>
1. Process Design Inputs	3	6. Production Labor Costs	3
1. Raw Material Requirements	3	1. Base Cost Per Man Hour	3
2. Utility Requirements	3	2. Cost/Kg Silicon Per Area	3
3. Equipment List	3	3. Total Cost/Kg Silicon	3
4. Labor Requirements	3		
		7. Estimation of Plant Investment	3
2. Specify Base Case Conditions	3	1. Battery Limits Direct Costs	3
1. Base Year for Costs	3	2. Other Direct Costs	3
2. Appropriate Indices for Costs	3	3. Indirect Costs	3
3. Additictal	3	4. Contingency	3
		5. Total Plant Investment (Fixed Capital)	3
3. Raw Material Costs	3		
1. Base Cost/lb of Material	3	8. Estimation of Total Product Cost	3
2. Material Cost/Kg of Silicon	3	1. Direct Manufacturing Cost	3
3. Total Cost/Kg of Silicon	3	2. Indirect Manufacturing Cost	3
		3. Plant Overhead	3
4. Utility Costs	3	4. By-Product Credit	3
1. Base Cost for Each Utility	3	5. General Expenses	3
2. Utility Cost/Kg of Silicon	3	6. Total Cost of Product	3
3. Total Cost/Kg of Silicon	3		
5. Major Process Equipment Costs	3		
1. Individual Equipment Cost	3		
2. Cost Index Adjustment	3		
		3 Plan	
		3 In Progress	
		3 Complete	

375

TABLE 4.6-4
PROCESS DESIGN INPUTS FOR DCS PROCESS

1. Raw Material Requirements
-silicon tetrachloride, zinc, lime, argon and nitrogen
-see table for "Raw Material Cost"
2. Utility
-electricity, steam, cooling water and process water
-see table for "Utility Cost"
3. Equipment List
-process vessels, heat exchangers, reactors, etc.
-see table for "Major Process Equipment Cost"
4. Labor Requirements
-production labor for purification, deposition, electrolysis, etc.
-see table for "Production Labor Cost"

TABLE 4.6-5
BASE CASE CONDITION FOR DCE PROCESS

1. Capital Equipment

- January 1975 Cost Index for Capital Equipment Cost
- January 1975 Cost Index Value = 430

2. Utilities

- Electrical, Steam, Cooling Water, Nitrogen
- January 1975 Cost Index (U. S. Dept. Labor)
- Values determined by literature search and summarized in cost standardization work

3. Raw Material Cost

- Chemical Marketing Reporter
- January 1975 Value
- Raw Material Cost Index for Industrial Chemicals
- 1975 Cost Index Value = 206.9 (Wholesale Price Index, Producer Price Index)

4. Labor Cost

- Average for Chemical Petroleum, Coal and Allied Industries (1975)
- skilled \$6.90/hr

5. Update to 1980

- historically cited 1975 dollars (LSA project)
- DOE decision to change to 1980 dollars (JPL, 6/22/79)
- reports to reflect both 1975 and 1980 dollars (JPL, 6/22/79)
- inflation factor of 1.4 to be used (JPL, 6/22/79)

TABLE 4.6-6

RAW MATERIAL COST FOR DCS PROCESS

<u>Raw Material</u>	<u>Requirement lb/kg of DCS</u>	<u>\$/lb of material</u>	<u>Cost \$/kg of DCS</u>
1. M.G. Silicon (Si)	0.348	0.535	0.1862
2. Silicon Tetrachloride (SiCl ₄ , make-up)	1.987	0.135	0.2682
3. Liquid Hydrogen	0.048	1.84	0.0883
4. Copper Catalyst (Cu)	0.005	0.922	0.0046
5. Hydrate Lime (Ca(OH) ₂)	0.236	0.015	<u>0.0036</u>
		TOTAL	0.5509 (1975 dollars)
			<u>x 1.4</u> inflation
			0.7713 (1980 dollars)

TABLE 4.6-7

UTILITY COST FOR DCS PROCESS

<u>Utility</u>	<u>Requirement/kg of DCS</u>	<u>Cost of Utility</u>	<u>Cost \$/kg of DCS</u>
1. Electricity	0.337 KW HR	0.0324\$/kw hr	0.01092
2. Steam	12.81 lb	1.35\$/Mlb	0.01730
3. Cooling water	56.51 gal	0.09\$/M gal	0.00509
4. Process water	0.301 gal	0.405\$/M gal	0.00012
5. Fuel Oil	0.00473 MM Btu	1.40\$/MM Btu	<u>0.00662</u>
		TOTAL	0.04005 (1975 dollars)
			<u>x 1.4</u> inflation
			0.05607 (1980 dollars)

TABLE 4.6-8

PURCHASED COST OF MAJOR PROCESS EQUIPMENT
FOR DCS PROCESS

	<u>Equipment</u>	<u>Purchased Cost, \$1000</u>
1.	R-01 Hydrochlorination Reactor	81.9
2.	R-02 TCS Redistribution Reactor	14.0
3.	R-03 Waste Neutralizer	15.7
4.	R-04 Waste Combustor	8.0
5.	D-01 Crude TCS Stripping Column	5.40
6.	D-02 TCS/STC Distillation Column	40.41
7.	D-03 DCS/TCS Distillation Column	94.43
8.	D-04 DCS Distillation Column	41.22
9.	B-01 Silicon Storage Bin with Feed Lock	18.0
10.	T-01 Residue Settling Tank	55.8
11.	T-02 Residue Withdraw Tank	4.0
12.	T-03 Hydrogen Separation Tank	7.9
13.	T-04 Crude TCS Storage Tank	7.5
14.	T-05 TCS Stripper Reflux Drum	0.8
15.	T-06 TCS/STC Distillation Reflux Drum	4.5

TABLE 4.6-8 (continued)

16.	T-07 STC Storage Tank	13.8
17.	T-08 DCS/TCS Distillation Reflux Drum	6.9
18.	T-09 DCS Distillation Reflux Drum	1.2
19.	T-10 DCS Storage Tank (3)	23.9 ea.
20.	T-11 Flue Gas Separation Tank	0.8
21.	T-12 Lime Solution Pre- paration Tank	0.9
22.	T-13 Waste Filtrate Storage Tank	0.9
23.	H-01 Crude TCS Condenser	35.7
24.	H-02 H ₂ Gas Preheater	27.2
25.	H-03 STC Vaporizer	54.5
26.	H-04 Stripper Condenser	2.0
27.	H-05 Stripper Reboiler	3.6
28.	H-06 TCS Condenser	53.4
29.	H-07 TCS/STC Reboiler	17.7
30.	H-08 STC Heat Exchanger	23.4
31.	H-09 DCS Condenser	13.4
32.	H-10 DCS/TCS Reboiler	14.7
33.	H-11 TCS Cooler	7.2
34.	H-12 DCS Distillation Overhead Condenser	1.6
35.	H-13 DCS Distillation	0.6
36.	H-14 Waste Stream Cooler	6.1
37.	H-15 STC Superheater	26.7
38.	H-16 H ₂ Compressor Intercooler	3.6

TABLE 4.6-8 (continued)

39.	C-01A Hydrogen Feed Compressor, First-stage	26.0
40.	C-01B Hydrogen Feed Compressor, Second-stage	26.0
41.	C-02 Hydrogen Circulation Compressor	16.4
42.	P-01 Feed Tank Blower	8.0
43.	P-02 Settling Tank Circulation Pump	2.4
44.	P-04 TCS Reflux Pump	2.7
45.	P-05 STC Feed Pump	2.7
46.	P-06 DCS Reflux Pump	1.0
47.	P-08 DCS Purification Discharge Pump	0.3
48.	P-09 DCS Pump	6.9
49.	P-10 Waste Solution Pump	0.5
50.	P-11 Lime Solution Circulation Pump	0.5
51.	P-12 Fresh Lime Solution Pump	0.4
52.	F-01 Silicon Dust Filter	1.6
53.	F-02 Waste Slurry Filter	5.0
54.	S-01 Silicon Feed Cyclone	1.4
55.	E-01 Quench Contact Ejector	1.3
56.	E-02 Flue Gas Ejector	<u>1.3</u>
		891.6 (1975 dollars)
		x 1.4 inflation
		<u>1,248.2</u> (1980 dollars)

TABLE 4.6-9

PRODUCTION LABOR COST FOR DGS PROCESS

<u>Section</u>	<u>Labor man-hr/Kg DGS</u>	<u>Labor \$/man-hr</u>	<u>Cost \$/Kg DGS</u>
1. Hydrochlorination	0.001294	6.90	0.008929
2. Purification/Redistribution	0.001941	6.90	0.013393
3. Waste Treatment	0.000647	6.90	<u>0.004464</u>
			0.02879 (1975 dollars)
			<u>x 1.4 inflation</u>
			0.03751 (1980 dollars)

TABLE 4.6-10

ESTIMATION OF PLANT INVESTMENT FOR DCB PROCESS

	Investment <u>\$1000</u>
1. DIRECT PLANT INVESTMENT COSTS	
1. Major Process Equipment Cost	891.6
2. Installation of Major Process Equipment	383.4
3. Process Piping, Installed	659.8
4. Instrumentation, Installed	169.4
5. Electrical, Installed	89.2
6. Process Buildings, Installed	89.2
1a. SUBTOTAL FOR DIRECT PLANT INVESTMENT COSTS (PRIMARILY BATTERY LIMIT FACILITIES)	2,282.5
2. OTHER DIRECT PLANT INVESTMENT COSTS	
1. Utilities, Installed	428.0
2. General Services, Site Development, Fire Protection, etc.	107.0
3. General Buildings, Offices, Shops, etc.	124.8
4. Receiving, Shipping Facilities	187.2
2a. SUBTOTAL FOR OTHER DIRECT PLANT INVESTMENT COSTS (PRIMARILY OFFSITE FACILITIES OUTSIDE BATTERY LIMITS)	847.0
3. TOTAL DIRECT PLANT INVESTMENT COST, 1a + 2a	3,129.5
4. INDIRECT PLANT INVESTMENT COSTS	
1. Engineering, Overhead, etc.	490.4
2. Normal Cont. for Floods, Strikes, etc.	633.0
4a. TOTAL INDIRECT PLANT INVESTMENT COST	1,123.4
5. TOTAL DIRECT AND INDIRECT PLANT INVESTMENT COST, 3 + 4a	4,252.9
6. OVERALL CONTINGENCY, % OF 5	<u>1,275.9</u>
7. FIXED CAPITAL INVESTMENT FOR PLANT, 5 + 6	5,528.8 (1975 dollars)
8. WORKING CAPITAL INVESTMENT FOR PLANT, % OF 6	<u>7,740.3</u> (1980 dollars) x 1.4 inflation
9. TOTAL PLANT INVESTMENT, 7 + 8	

TABLE 4.6-11

ESTIMATION OF TOTAL PRODUCT COST FOR DCS PROCESS

	<u>\$/KG of DCS</u>
1. Direct Manufacturing Cost (Direct Charges)	
1. Raw Materials - from prel. design	0.8319
2. Direct Operating Labor - from prel. design	0.0268
3. Utilities - from prel. design	0.0400
4. Supervision and Clerical	0.0040
5. Maintenance and Repairs	0.0865
6. Operating Supplies	0.0113
7. Laboratory Charge	0.0040
8. Patents and Royalties	
2. Indirect Manufacturing Cost (Fixed Charges)	
1. Depreciation	0.0565
2. Local Taxes	0.0113
3. Insurance	0.0057
3. Plant Overhead	0.0355
4. By-Product Credit - from prel. design	
4a. Total Manufacturing Cost, 1 + 2 + 3 + 4	0.8026
5. General Expenses	
1. Administration	0.0482
2. Distribution and Sales	0.0482
3. Research and Development	<u>0.0241</u>
6. Total Cost of Product, 4a + 5	0.9230 (1975 dollars)
	<u> x 1.4 inflation</u>
	1.2922 (1980 dollars)

5. SUMMARY - CONCLUSIONS

The following summary-conclusions are made as a result of analyses conducted for new technologies and processes being developed for the production of lower cost silicon for solar cells:

1. Analyses of process system properties are important for chemical materials involved in the several processes under consideration for semiconductor and solar cell grade silicon production. Major physical, thermodynamic and transport property data are reported for the following silicon source and processing chemical materials

- Silane
- Silicon Tetrachloride
- Trichlorosilane
- Dichlorosilane
- Silicon Tetrafluoride
- Silicon

The property data are reported for critical temperature, critical pressure, critical volume, vapor pressure, heat of vaporization, heat capacity, density, surface tension, viscosity, thermal conductivity, heat of formation and Gibb's free energy of formation. The reported property data are presented as a function of temperature to permit rapid usage in research, development and production engineering.

2. Chemical engineering analyses involving the preliminary process design of a plant (1000MT/yr capacity) to produce silicon via the technology under consideration were accomplished for the following processes:

- UCC Silane Process for Silicon
- BCL Process for Silicon - Case A
- BCL Process for Silicon - Case B
- Conventional Polysilicon Process (Siemen's Technology)
- SiI_4 Decomposition Process
- DCS⁴ Process (Dichlorosilane)

Major activities in the chemical engineering analyses included base case conditions, reaction chemistry, process flowsheet, material balance, energy balance, property data, equipment design, major equipment list, production labor and forward for economic analysis. The process design package provided detailed data for raw materials, utilities, major process equipment and production labor requirements necessary for polysilicon production in each process.

3. Economic analyses were accomplished for the following processes under consideration for the production of silicon:

- UCC Silane Process for Silicon
- BCL Process for Silicon - Case A
- BCL Process for Silicon - Case B
- Conventional Polysilicon Process (Siemens Technology)
- SiI₄ Decomposition Process
- DCS⁴ Process (Dichlorosilane)

Primary activities in the economic analyses involved process design inputs, base case conditions, raw material costs, utility costs, major process equipment costs and production labor costs in the estimation of plant investment and total product cost.

4. The cost analysis results for producing silicon by the UCC silane process (Union Carbide Corporation) are presented including costs for raw materials, labor, utilities and other items composing the product cost (total cost of producing silicon). The results indicate a total product cost without profit of \$6.90 (1975 dollars) and \$9.86 (1980 dollars) per kg. For profitability analysis, the results indicate a sales price of \$13 per kg of silicon (1980 dollars) at 15 per cent DCF (discounted cash flow) rate of return on investment.

These cost and profitability results for the UCC silane process indicate that this new technology for producing polysilicon shows good promise for meeting the cost goal of \$14 per kg of silicon material (1980 dollars) for solar cells.

5. The cost analysis results for producing silicon by the BCL process - Case A (Battelle Columbus Laboratories) are presented including costs for raw materials, labor, utilities and other items composing the product cost (total cost of producing silicon). The results indicate a total product cost without profit of \$8.63 (1975 dollars) and \$12.08 (1980 dollars) per kg. The profitability analysis results disclose a sales price of \$13.28 per kg of silicon (1980 dollars) at 5 per cent DCF (discounted cash flow) rate of return on investment after taxes.

These cost and profitability results for the BCL process - Case A indicate that this new technology for producing polysilicon shows promise for meeting the cost goal of \$14 per kg of silicon material (1980 dollars) for solar cells. In Case A, the process involves two deposition reactors and six electrolysis cells.

6. The cost analysis results for producing silicon by the BCL process - Case B (Battelle Columbus Laboratories) are presented including costs for raw materials, labor, utilities and other items composing the product cost

(total cost of producing silicon). The results give a total product cost without profit of \$7.91 (1975 dollars) and \$11.07 (1980 dollars) per kg. For profitability, the analysis indicates a sales price of \$13.14 per kg of silicon (1980 dollars) at 10 per cent DCF (discounted cash flow) rate of return on investment.

These cost and profitability results for the BCL process - Case B indicate that this new technology for producing polysilicon shows promise for meeting the cost goal of \$14 per kg of silicon material (1980 dollars) for solar cells. In Case B, the process contains one deposition reactor and two electrolysis cells.

7. For the conventional polysilicon process, the cost analysis is based on a poly plant constructed in the 1960's (1965 or earlier) since several existing plants producing semiconductor grade polysilicon in the United States were constructed in the 1960's. The operating costs for the plant are applicable to the time period of interest (such as 1975 and 1980).

The cost analysis results for producing silicon by the conventional Siemens process are presented including costs for raw materials, labor, utilities and other items composing the product cost (total cost of producing silicon). The results disclose total product cost without profit of \$35.52 - 41.29 (1975 dollars) and \$49.73 - 57.81 (1980 dollars) per kg. The range for product cost reflects low and high electrical costs (1.5-3¢/kw hr for 1975 and 2.1-4.2¢/kw hr for 1980).

The average product cost without profit is estimated at \$38.41 (1975 dollars) and \$53.77 (1980 dollars) per kg for the conventional polysilicon process. This average product cost corresponds to intermediate electrical costs (2.25¢/kw hr for 1975 and 3.15¢/kw hr for 1980). These cost results for the conventional polysilicon process indicate that this Siemens technology using trichlorosilane for producing polysilicon does not show promise for meeting the cost goal of \$14 per kg of silicon material (1980 dollars) for solar cells.

8. The cost analysis results for producing silicon by the SiI_4 decomposition process are presented including costs for raw materials, labor, utilities and other items composing the product cost (total cost of producing silicon). The results give a total product cost without profit of \$44.64 (1975 dollars) and \$62.50 (1980 dollars) per kg. The profitability results indicate a sales price of \$71.48 per kg of silicon (1980 dollars) at 5 per cent DCF (discounted cash flow) rate of return on investment.

These cost and profitability results for the SiH_4 decomposition process indicate that this new technology for producing polysilicon does not show promise for meeting the cost goal of \$14 per kg of silicon material (1980 dollars) for solar cells.

9. Using a hot-wire technique, experimental gas phase thermal conductivity values were determined between 25°C and 350°C for silicon source materials such as silane and halogenated silanes. The accuracy of the values were shown to be $\pm 2\%$ by determining values for argon and hydrogen, compounds whose thermal conductivity values have been previously determined.

10. Experimental gas phase viscosity values were determined for the halogenated silanes; dichlorosilane, trichlorosilane and tetrafluorosilane. The values were determined in the temperature range 40°C to 200°C using a transpiration method. Nitrogen, a compound for which viscosity values are known, was used to calibrate the apparatus. The calibration studies showed that the values obtained were accurate to $\pm 2\%$ throughout the temperature range.

11. Studies were conducted to develop an efficient method for the generation of SiF_4 from hexafluorosilicic acid, a readily available by-product of the phosphate fertilizer industry. This included investigation of such parameters as conditions for precipitation of SiF_4 precursors (Na_2SiF_6 and BaSiF_6), temperature for thermal decomposition of the salts⁶, heating time required and optimum flow rates. Precipitation of the salts, Na_2SiF_6 or BaSiF_6 , with NaCl , NaF , BaCl_2 , or BaF_2 followed by thermal decomposition at temperatures above 500°C proved to be an efficient method for the generation of SiF_4 .

A1. ADDITIONAL CHEMICAL ENGINEERING ANALYSIS

A1.1 Silane Process - Case A

The chemical engineering analysis activity of Silane Process - Case A (Regular Process Storage) involves a preliminary process design of a plant to produce silane for silicon.

The Silane Process- Case A involves several processing operations of hydrogenation, distillation, redistribution reaction, stripping and absorption. The process flowsheet is shown in Figure A1.1-1. This flowsheet was received from Union Carbide.

A summation of the salient features of Case A is shown below:

CASE A

Process.....	Silane (Union Carbide)
Plant Size.....	1270 MT/year of Silane
Process Flowsheet.....	Original received from Union Carbide
Process Chemistry and Equilibrium.....	From Union Carbide
Intermediate Product Storage Considerations...	Regular
Major Process Equipment.....	76 pieces of process equipment

The detailed status sheet is shown in Table A1.1-1, and is representative of the various subitems that make up the preliminary design activity. The results from the preliminary process design are presented in a tabular format similar to previous design results for alternate processes to produce silicon. Note that in this process results are per pound of silane versus other processes represented as per kilogram of silicon. The silane plant size assumes a 90% conversion of silane to silicon.

The guide to the tables for Case A is given below:

Base Case Conditions.....	Table A1.1-2
Reaction Chemistry.....	Table A1.1-3
Raw Material Requirement.....	Table A1.1-4
Utility Requirements.....	Table A1.1-5
Major Process Equipment.....	Table A1.1-6
Production Labor Requirements.....	Table A1.1-7

CASE A

391

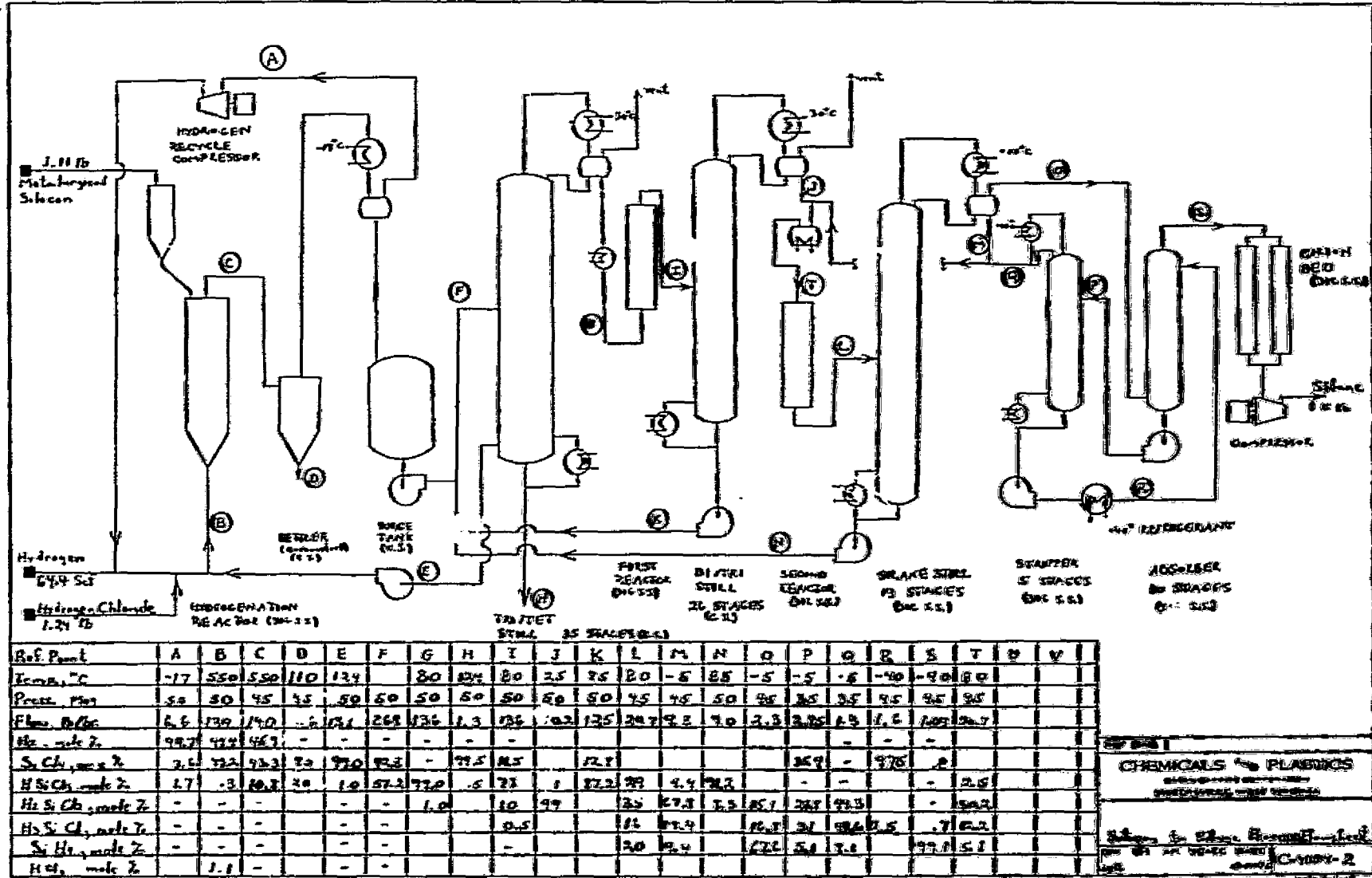

Figure A1.1-1 Process Flow Sheet for Silane Process-Case A
(Provided by Union Carbide)

CASE A

TABLE A1.1-1 CHEMICAL ENGINEERING ANALYSES:
PRELIMINARY PROCESS DESIGN ACTIVITIES FOR SILANE PROCESS - CASE A

<u>Prel. Process Design Activity</u>	<u>Status</u>	<u>Prel. Process Design Activity</u>	<u>Status</u>
1. Specify Base Case Conditions	●	7. Equipment Design Calculations	●
1. Plant Size	●	1. Storage Vessels	●
2. Product Specifics	●	2. Unit Operations Equipment	●
3. Additional Conditions	●	3. Process Data (P, T, rate, etc.)	●
2. Define Reaction Chemistry	●	4. Additional	●
1. Reactants, Products	●	8. List of Major Process Equipment	●
2. Equilibrium	●	1. Size	●
3. Process Flow Diagram	●	2. Type	●
1. Flow Sequence, Unit Operations	●	3. Materials of Construction	●
2. Process Conditions (T, P, etc.)	●	8a. Major Technical Factors	●
3. Environmental	●	(Potential Problem Areas)	●
4. Company Interaction	●	1. Materials Compatibility	●
(Technology Exchange)	●	2. Process Conditions Limitations	●
4. Material Balance Calculations	●	3. Additional	●
1. Raw Materials	●	9. Production Labor Requirements	●
2. Products	●	1. Process Technology	●
3. By-Products	●	2. Production Volume	●
5. Energy Balance Calculations	●	10. Forward for Economic Analysis	●
1. Heating	●		
2. Cooling	●	○ Plan	
3. Additional	●	● In Progress	
6. Property Data	●	● Complete	
1. Physical	●		
2. Thermodynamic	●		
3. Additional	●		

CASE A

TABLE A1.1-2

BASE CASE CONDITIONS FOR SILANE PROCESS - CASE A

1. Plant Size
 - Allow for 10% losses of silane in production of silicon
 - 1270 metric tons/year of silane
 - Solar cell grade silicon
2. Hydrogenation Reaction
 - Metallurgical grade silicon, hydrogen, to produce trichlorosilane (TCS) make-up hydrogen chloride used and recycle silicon tetrachloride (TST)
 - Copper catalyzed
 - Fluidized bed
 - 550°C, 30 psig
 - 15.8% conversion of SiCl_4 (Union Carbide flowsheet)
3. TCS Redistribution Reaction
 - TCS from hydrogenation produces dichlorosilane (DCS)
 - Catalytic redistribution of TCS with tertiary amine ion exchange resin.
 - Liquid phase 30 psig, 80°C.
 - Conversion a function of inlet concentration per Figure IIA-2 (Union Carbide equilibrium)
 - Conversion from pure TCS feed is about 10% to DCS (example)
4. DCS Redistribution Reaction
 - DCS produces SiH_4 (silane)
 - Catalytic redistribution of DCS with tertiary amine ion exchange resin.
 - Gas phase 60-80°C
 - Conversion a function of inlet concentration per Figure IIA-1.1 (Union Carbide equilibrium)
 - Conversion from pure DCS feed is about 14% to silane (example)
5. Recycles
 - Unreacted chlorosilanes separated by distillation and recycled
6. Silane Purification
 - Chlorosilanes removed by absorption in -40°C SiCl_4 (Tet)
 - Trace contaminants removed by carbon adsorption
7. Operating Ratio
 - Approximately 90% utilization
 - Approximately 7880 hour/year production
8. Storage Considerations
 - Feed materials (two week supply)
 - Product (two week supply)
 - Process (several days)

CASE A

TABLE A1.1-3

REACTION CHEMISTRY FOR SILANE PROCESS - CASE A

1. Hydrogenation Reaction

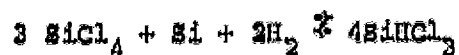

2. Trichlorosilane Redistribution Reaction

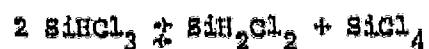

3. Dichlorosilane Redistribution Reaction



Note

1. Reaction 1 Product contains H_2 , SiCl_4 , SiHCl_3 , SiH_2Cl_2 (trace), other trace chlorides
2. Reaction 2 Product contains SiHCl_3 , SiCl_4 , SiH_2Cl_2 , SiH_3Cl
3. Reaction 3 Product contains SiH_2Cl_2 , SiHCl_3 , SiCl_4 , SiH_3Cl , SiH_4

CASE A

TABLE A1.1-4

RAW MATERIAL REQUIREMENTS FOR SILANE PROCESS - CASE A

<u>Raw Material</u>	<u>Requirement lb/lb of Silane</u>
1. Anhydrous HCl	1.239
2. Hydrogen	.362
3. Caustic (50%)	2.448
4. M.G. Silicon	1.11

CASE A

TABLE A1.1-5

UTILITY REQUIREMENTS FOR SILANE PROCESS - CASE A

<u>Utility/Function</u>	<u>Requirements/lb of Silane Product</u>
1. Electricity	.253 KW-HR
1. All pump and compressor motors (24)	(.253)
2. Steam 250 Psia	190.34 lbs
1. #1 Distillation Column Preheater	(6.96)
2. #1 Distillation Column Reboiler	(81.18)
3. #2 Distillation Column Reboiler	(91.77)
4. #2 Redistribution Reactor Preheater	(3.0)
5. #3 Distillation Column Preheater	(3.62)
6. #3 Distillation Column Reboiler	(3.29)
7. #4 Distillation Column Reboiler	(.41)
8. Waste Treatment	(.11)
3. Cooling Water (10-120°F)	168.12 gallons
1. #1 Distillation Column Condenser	(146.12)
2. #2 Distillation Column Condenser	(22.09)
4. Process Water (90°F)	8.22 gallons
1. Waste Treatment	(8.22)
5. Refrigerant (23°F)	27.1 BTU
1. #4 Distillation Column Feed Tank	(27.1)
6. Refrigerant (5°F)	79.1 BTU
1. #3 Distillation Column Overhead Receiver	(79.1)
7. Refrigerant (-7°F)	26.4 BTU
1. #4 Distillation Column Overhead Receiver	(26.4)
8. Refrigerant (-20°F)	2303.2 BTU
1. #3 Distillation Column Condenser	(2058.0)
2. #4 Distillation Column Condenser	(245.2)

CASE A

TABLE A1.1-5 (Continued)

9.	Refrigerant (-30°F)		30788.0 BTU
	1. TCS Reactor Recycle Gas Condenser (30788.0)		
10.	Refrigerant (-40°F)		280.6 BTU
	1. #2 Redistribution Reactor Condensate Receiver (192.2)		
	2. Silane Product Storage (88.4)		
11.	Refrigerant (-50°F)		3503.2 BTU
	1. #2 Redistribution Reactor Gas Condenser (2986.0)		
	2. Product Silane Condenser (137.9)		
	3. Absorbent Cooler (379.3)		
12.	High Temperature Heat Exchange Fluid		3.324 x 10 ⁴ BTU
	1. TCS Reactor Recycle Gas Heater (6.591 x 10 ³)		
	2. HCl Vaporizer (4.466 x 10 ²)		
	3. Tet Vaporizer (2.464 x 10 ⁴)		
	4. Heat Nitrogen to Regenerate Char. Adsorbers (70.95)		
	5. TCS Reactor (1.491 x 10 ³)		
13.	Nitrogen		5.54 BCF
	1. Regenerate Charcoal Adsorbers (5.54)		

CASE A

TABLE A1.1-6

LIST OF MAJOR PROCESS
EQUIPMENT FOR SILANE PROCESS - CASE A

	<u>Type</u>	<u>Function</u>	<u>Duty</u>	<u>Size</u>	<u>Materials of Construction</u>
1.	(T1) M.G. Silicon Storage Hopper	Raw Material Storage	2 weeks storage	1.363 x 10 ⁴ gallons	CS
2.	(T2) Hydrogen Storage Tank	Raw Material Storage	8 hours backup for pipeline failure	9.161 x 10 ⁴ gallons 250 PSIA (spherical)	CS
3.	(T3) Liquid HCl Storage Tank	Raw Material Storage	2 weeks storage	1.612 x 10 ⁴ gallons 250 PSIA, -50°F (spherical)	Michal Steel
4.	(T4) Recycle TBT Storage	For TCS Reactor Feed	2 days storage	1.985 x 10 ⁵ gallons 65 PSIA	CS
5.	(T5) TCS Reactor Off-Gas Flash Tank	Phase Separation		1 ft. diameter by 4 ft. long, 65 PSIA, 0°F 65 PSIA	CS
6.	(T6) TCS/TBT Storage	Feed Distillation Column #1	2 Days hold-up	1.966 x 10 ⁵ gallons 65 PSIA	CS
7.	(T7) #1 Distillation Column Condensate Accumulator	Reflux feed; column Control	20 minutes hold-up	4.88 x 10 ³ gallons 65 PSIA	CS
8.	(T8) #1 Redistribution Reactor Feed Tank	Hold-up and feed Reactor	2 days hold-up	2.266 x 10 ⁵ gallons 65 PSIA	CS
9.	(T9) #1 Redistribution Reactor Product Tank	Hold-up and feed #2 Distillation Column	2 days hold-up	2.21 x 10 ⁵ gallons 65 PSIA	CS

CASE A

TABLE Al.1-6 (continued)

10.	(T10)	#2 Distillation Column Condensate Accumulator	Reflux feed; column Control	20 minutes hold-up	746 gallons 65 PSIA	SS
11.	(T11)	#2 Redistribution Reactor Feed Tank	Hold-up and feed Reactor	2 days hold-up	1.891×10^4 gallons 65 PSIA	SS
12.	(T12)	#2 Redistribution Reactor Product Tank	Hold-up and feed #3 Distillation Column	2 days hold-up 6.8×10^4 BTU/hr	3.46×10^4 gallons -40°F, 60 PSIA	SS
13.	(T13)	#3 Distillation Column Condensate Accumulator	Reflux feed; phase Separation; column control	20 minutes hold-up	194 gallons 5°F, 60 PSIA	SS
14.	(T14)	#3 Distillation Column Condensate Tank	Hold-up and recycle feed to #2 Redistribution Reactor	2 days hold-up 2.81×10^4 BTU/hr	1.7×10^4 gallons 60 PSIA, 5°F	SS
15.	(T15)	#4 Distillation Column Feed Tank	Surge between absorber and distillation	2 days hold-up 9.63×10^3 BTU/hr	4.69×10^3 gallons 60 PSIA	SS
16.	(T16)	#4 Distillation Column Condensate Accumulator	Reflux feed; column control	20 minutes hold-up	16 gallons 50 PSIA, -7°F	SS
17.	(T17)	#4 Distillation Column Condensate Tank	Hold-up and recycle to #2 Redistribution Reactor	2 days hold-up 9.4×10^3 BTU/hr	2.55×10^3 gallons 50 PSIA, -7°F	SS
18.	(T18)	Waste Tank	Collect waste for Treatment and disposal	2 week storage	1.378×10^4 gallons 65 PSIA	CS
19.	(T19)	Absorber Feed Tank	Feed TET to absorber	2 days storage	2.44×10^3 gallons 50 PSIA	SS
20.	(T20)	Silane Storage	Final Product storage	1 week storage 3.14×10^4 BTU/hr	1.522×10^4 gallons -40°F, 250 PSIA	SS

CASE A

TABLE A1.1-6 (continued)

	21.	(T21) Caustic Storage	Raw Material Storage	2 weeks storage	2.304 x 10 ⁴ gallons	SS
	22.	(H1) TCS Reactor Recycle Gas Heater	Heat Recycle gas and Hydrogen to 550°C	2.342 x 10 ⁶ BTU/hr	752 ft ² 65 PSIA	CS
	23.	(H2) HCl Vaporizer	Heat Reactant to 550°C	1.587 x 10 ⁵ BTU/hr	34 ft ² 65 PSIA	CS
	24.	(H3) TET Vaporizer	Heat Reactant to 550°C	8.755 x 10 ⁶ BTU/hr	2381 ft ² 65 PSIA	CS
	25.	(H4) TCS Reactor Re- cycle Condenser	Phase separation; Recycle hydrogen	1.094 x 10 ⁷ BTU/hr	1882 ft ² 65 PSIA	CS/SS
	26.	(H5) #1 Distillation Column Preheater	Preheat distillation feed to bubble point	2.044 x 10 ⁶ BTU/hr	164 ft ² 250 PSIA	CS
400	27.	(H6) #1 Distillation Column Condenser	Provide Reflux to Column	1.296 x 10 ⁷ BTU/hr	3189 ft ² 65 PSIA	CS
	28.	(H7) #1 Distillation Column Reboiler	Provide vapor to Column	2.382 x 10 ⁷ BTU/hr	2818 ft ² 250 PSIA	CS
	29.	(H8) #2 Distillation Column Condenser	Provide Reflux to column	1.96 x 10 ⁶ BTU/hr	956 ft ² 65 PSIA	CS/SS
	30.	(H9) #2 Distillation Column Reboiler	Provide Vapor to Column	2.693 x 10 ⁷ BTU/hr	2514 ft ² 250 PSIA	CS
	31.	(H10) #2 Redistribution Reactor Feed Vaporizer	Vaporize Reactants for Reactor	8.81 x 10 ⁵ BTU/hr	78 ft ² 250 PSIA	CS/SS
	32.	(H11) #2 Redistribution Reactor Product Condenser	Condense Vapor for hold-up storage	1.06 x 10 ⁶ BTU/hr	306 ft ² 60 PSIA	CS/SS
	33.	(H12) #3 Distillation Column Preheater	Vaporize and preheat feed to column	1.06 x 10 ⁶ BTU/hr	66 ft ² 250 PSIA	CS/SS

CASE A

TABLE A1.1-6 (continued)

34.	(H13)	#3 Distillation Column Condenser	Provide Column Reflux (Partial Condenser)	7.312×10^5 BTU/hr	593 ft ² 60 PSIA	CS/SS
35.	(H14)	#3 Distillation Column Reboiler	Provide Vapor to Column	9.64×10^5 BTU/hr	84 ft ² 250 PSIA	CS/SS
36.	(H15)	Silane Condenser	Condenser Final Product for storage	4.9×10^4 BTU/hr	53 ft ² 250 PSIA	CS/SS
37.	(H16)	#4 Distillation Column Condenser	Provide Reflux	8.71×10^4 BTU/hr	84 ft ² 50 PSIA	CS/SS
38.	(H17)	#4 Distillation Column Reboiler	Provide Vapor to Column	1.2×10^5 BTU/hr	13 ft ² 250 PSIA	CS/SS
39.	(H18)	Absorber Pre-cooler	Cool TET for absorption column	1.35×10^5 BTU/hr	35 ft ² 60 PSIA	CS/SS
40.	(H19)	Nitrogen Heater	Heat Nitrogen to regenerate Charcoal Adsorbers	2.52×10^4 BTU/hr	14.1 ft ²	CS
41.	(P1)	TCS Reactor Off Gas Recycle Compressor	Circulate Recycle Gas to Reactor	1.36×10^3 SCFM	26.5 Horsepower 75 PSIA Discharge	CS*
42.	(P2)	#1 Distillation Column Feed Pump	Feed Column	136.5 gpm	106 PSI; 14.5 BHP	CS*
43.	(P3)	#1 Distillation Column Overheads Pump	Provide Reflux and remove overhead product	244 gpm	92.3 PSI; 22.5 BHP	CS*
44.	(P4)	#1 Distillation Column Bottoms Pump	Remove Bottoms Product to TET storage tank	69 gpm	106 PSI; 7.3 BHP	CS*

CASE A

TABLE A1.1-6 (continued)

45.	(P5)	Process Water Feed Pump	Feed Process Water to Waste Treatment	48.6 gpm	82.5 PSI; 4 BHP	CS*
46.	(P6)	Caustic Feed Pump	Feed Raw Material to waste treatment	1 gpm	118 PSI; $\frac{1}{4}$ BHP	SS
47.	(P7)	#1 Redistribution Reactor Feed Pump	Feed TCS to Reactor	79 gpm	106 PSI; 8.4 BHP	SS
48.	(P8)	#2 Distillation Column Feed Pump	Feed TCS/DCS still	76.6 gpm	92.3 PSI; 7.1 BHP	SS
49.	(P9)	#2 Distillation Column Overheads Pump	Provide Reflux and Remove Overhead Product	37.3 gpm	92.3 PSI; 3.4 BHP	SS
50.	(P10)	#2 Distillation Column Bottoms Pump	Remove Bottoms Product to TCS/TET storage tank	66.7 gpm	106.3 PSI; 7.1 BHP	SS
51.	(P11)	#2 Redistribution Reactor Feed Pump	Feed DCS to Reactor	13.4 gpm	130 PSI; 1.7 BHP	SS
52.	(P12)	#3 Distillation Column Feed Pump	Feed Silane Still	12 gpm	87.3 PSI; 1 BHP	SS
53.	(P13)	#3 Distillation Column Overhead Pump	Provide Reflux; Remove Overhead Product	9.7 gpm	87.3 PSI; 1 BHP	SS
54.	(P14)	#3 Distillation Column Bottoms Pump	Remove Bottoms Product to TCS/TET Tank	5.2 gpm	106.3 PSI; $\frac{1}{2}$ BHP	SS
55.	(P15)	#4 Distillation Feed Pump	Feed TET Stripper	1.6 gpm	77.3 PSI; $\frac{1}{4}$ BHP	SS

* Includes incremental higher cost for special purity requirements.

CASE A

TABLE A1.1-6 (continued)

56.	(P16)	#4 Distillation Column Overhead Pump	Provide Reflux, Remove Overhead Product	1 gpm	77.3 PSI; $\frac{1}{4}$ BHP	SS
57.	(P17)	#4 Distillation Column Bottoms Pump	Remove Bottoms Product to Absorber Feed Tank	1 gpm	91.3 PSI; $\frac{1}{4}$ BHP	SS
58.	(P18)	#4 Distillation Condensate Recycle Pump	Recycle Condensate back to #2 Redistribution Reactor	1 gpm	106.3 PSI; $\frac{1}{4}$ BHP	SS
59.	(P19)	Silane Product Compressor	Liquefy Silane for Storage	66 SCPM	250 PSIA Discharge 6.5 HP	SS
60.	(P20)	Waste Feed Pump	Distillation Wastes to Waste Treatment	1 gpm	76.3 PSI; $\frac{1}{2}$ BHP	CS
61.	(P21)	TCS Reactor Feed Pump	Feed TET to Reactor	69 gpm	92.3 PSI; 6.4 BHP	CS*
62.	(P22)	#3 Distillation Condensate Recycle Pump	Recycle Condensate back to #2 Redistribution reactor	5.9 gpm	92.3 PSI; $\frac{1}{2}$ BHP	SS
63.	(P23)	Waste Collection Pump	Distillation Wastes to Waste Tank	1 gpm	87.3 PSI; $\frac{1}{4}$ BHP	CS
64.	(P24)	Absorber Feed Pump	Feed Cold TET to Absorption Column	1 gpm	87.3 PSI; $\frac{1}{4}$ BHP	SS
65.	(C1)	#1 Distillation Column	Separate TET from TCS	95,220 lb/hr of feed	7.56 ft. diameter 100 ft. tall, 50 trays	CS

CASE A

TABLE A1.1-6 (continued)

66.	(C2)	#2 Distillation Column	Separate TCS from DCS	48, 321 lb/hr of feed	10.6 ft. Diameter 136 ft. tall, 68 trays	CS
67.	(C3)	#3 Distillation Column	Separate Silane from other Chlorosilanes	7344 lb/hr of feed	2.01 ft. Diameter 29 ft. tall, 29 trays	SS
68.	(C4)	#4 Distillation Column	Strip TET for use in absorber	1007.7 lb/hr of feed	1.04 ft. Diameter 28.5 ft. tall, 38 trays	SS
69.	(C5)	Silane Absorber	Absorb Chlorosilane from Silane	819.3 lb/hr of vapor feed	0.823 ft. Diameter 12 ft. tall, 16 trays	SS
70.	(C6)	Charcoal Adsorber	Activated Carbon Adsorption of Silane to remove Trace Chlorosilane	366 lb/hr of vapor feed	1 ft. Diameter 7 ft. tall (2), 623 lbs of carbon	SS
71.	(R1)	TCS Fluidized Bed Reactor	Produces TCS from TET M.G.Silicon, and H ₂		6.26 ft. in diameter 26.5 ft. tall, 481 tubes 1", 16' long	SS
72.	(R2)	#1 Redistribution Reactor	Redistribute TCS to DCS		2' Diameter by 15 ft. tall 1042 lbs catalyst	SS
73.	(R3)	#2 Redistribution Reactor	Redistribute DCS to Silane		2.34' Diameter by 35 ft. tall 1667.2 lbs catalyst	SS
74.	(A1)	Fines Separator	Remove Silicon Fines carried over with TCS Reactor Off-gas		Standard design 30" Diameter	SS
75.	(A2)	Waste Treatment	Discharge innocuous effluent		1 column for absorption + 1 heat exchanger to vaporize feed	SS
76.	(A3)	Hydrogen Flare	Dispose of Hydrogen from Waste Treatment		30 ft. stack 6" Diameter	CS

CASE A

TABLE A1.1-7

PRODUCTION LABOR REQUIREMENTS FOR
SILANE PROCESS - CASE A

<u>Unit Operation</u>	<u>Type</u>	<u>Skilled Labor, Man Hours</u>		<u>Semiskilled Labor</u>	
		<u>Per Day</u>	<u>Per lb. Silane</u>	<u>Per Day</u>	<u>Per lb. Silane</u>
1. TCS Production	B	65	.0085		
2. Hydrogen Recycle	C	18	.0023		
3. Raw Material Vaporization	C	50	.0065		
4. TCS Condensation	C	50	.0065		
5. TCS/TET Separation	C	62	.0081		
6. #1 Redistribution Reactor	C	49	.0064		
7. DCS/TCS Separation	C	52	.0068		
8. #2 Redistributon Reactor	C	32	.0042		
9. Silane Distillation	C	32	.0042		
10. Silane Absorption	C	28	.0036		
11. Silane Purification (adsorption)	A	36	.0047		
12. Silane compression	B	23	.003		
13. Silane Condensation	B	23	.003		
14. Materials Handling	A			48	.0063
15. Waste Treatment	B	60	.0078		
16. Silicon Fines Separation	A	15	.002		
	TOTAL	595	.0776	48	.0063

NOTES:

1. A Batch Process of Multiple Small Units
B Average Process
C Automated Process
2. Man hours/day Unit from Figure 4-6, Peters and Timmerhaus (7).

A1.2 Silane Process - Case B

The chemical engineering analysis of the Silane Process - Case B (Minimum Process Storage) involves a preliminary process design of a plant to produce silane for silicon.

The Silane Process - Case B involves several processing operations of hydrogenation distillation, redistribution, distillation, redistribution reaction, stripping and absorption. The flowsheet received from Union Carbide, upon which the design is based, is shown in Figure A1.2-1.

A summation of the important features of CASE B is presented in the following table:

CASE B

Process.....	Silane (Union Carbide)
Plant Size.....	1270 MT/year of Silane
Process Flow Sheet.....	Original Received from Union Carbide
Process Chemistry & Equilibrium.....	From Union Carbide
Intermediate Product Storage Considerations...	Minimum
Major Process Equipment.....	58 pieces of Process Equipment

The results from the preliminary process design (CASE B) are summarized in a tabular format parallel to those representing Case A. These tables are represented by the following guide to enable the reader to quickly locate items of interest.

Base Case Conditions.....	Table A1.2-2
Reaction Chemistry.....	Table A1.2-3
Raw Material Requirement.....	Table A1.2-4
Utility Requirements.....	Table A1.2-5
Major Process Equipment.....	Table A1.2-6
Production Labor Requirements.....	Table A1.2-7

CASE B

407

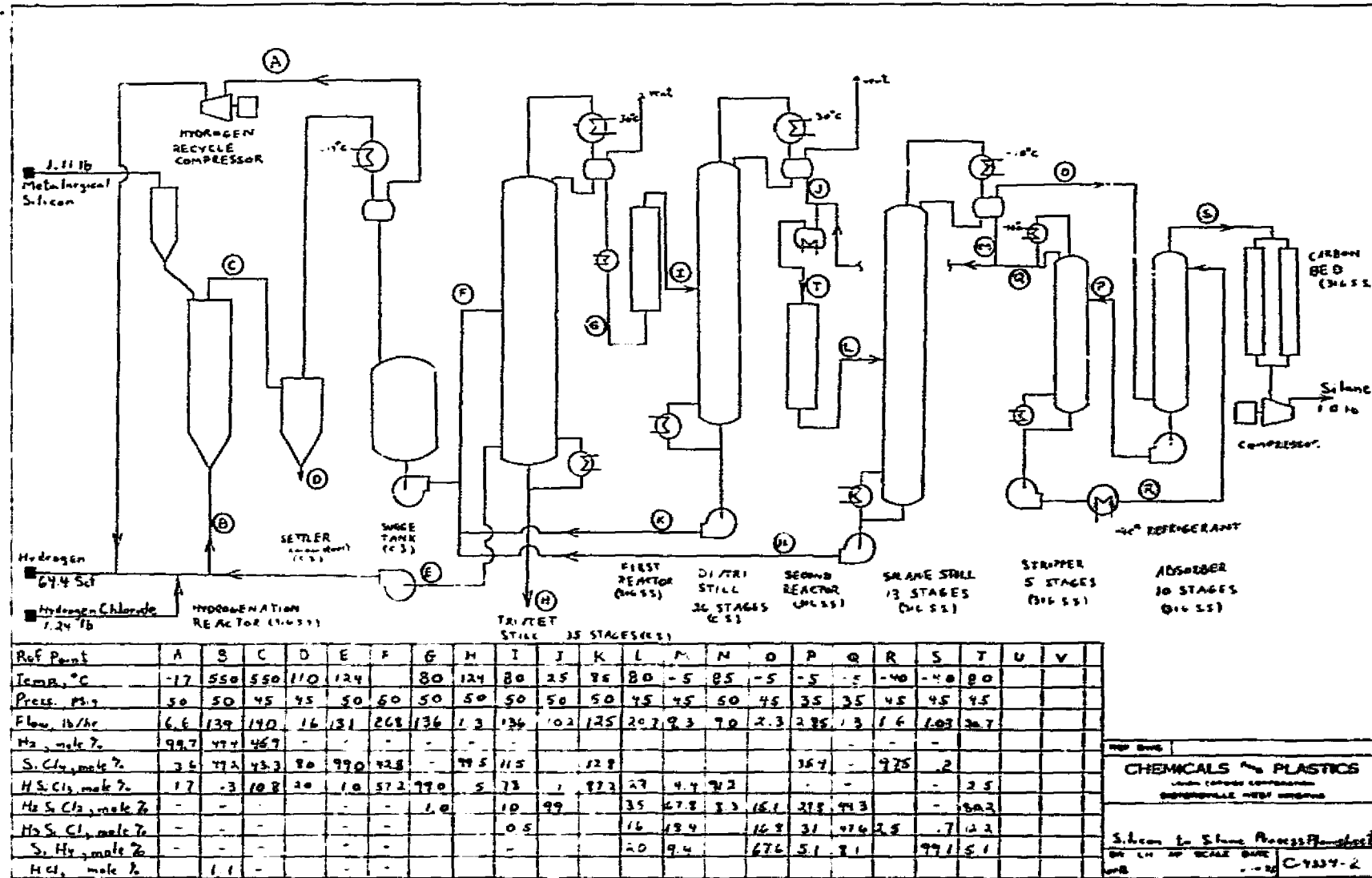

Figure Al.2-1 Process Flow Sheet for Silane Process -CASE B
(Provided by Union Carbide)

CASE B

TABLE A1.2-1 CHEMICAL ENGINEERING ANALYSES:
PRELIMINARY PROCESS DESIGN ACTIVITIES FOR SILANE PROCESS -CASE B

<u>Prel. Process Design Activity</u>	<u>Status</u>	<u>Prel. Process Design Activity</u>	<u>Status</u>
1. Specify Base Case Conditions	●	7. Equipment Design Calculations	●
1. Plant Size	●	1. Storage Vessels	●
2. Product Specifics	●	2. Unit Operations Equipment	●
3. Additional Conditions	●	3. Process Data (P, T, rate, etc.)	●
2. Define Reaction Chemistry	●	4. Additional	●
1. Reactants, Products	●	8. List of Major Process Equipment	●
2. Equilibrium	●	1. Size	●
3. Process Flow Diagram	●	2. Type	●
1. Flow Sequence, Unit Operations	●	3. Materials of Construction	●
2. Process Conditions (T, P, etc.)	●	8a. Major Technical Factors	●
3. Environmental	●	(Potential Problem Areas)	●
4. Company Interaction (Technology Exchange)	●	1. Materials Compatibility	●
4. Material Balance Calculations	●	2. Process Conditions Limitations	●
1. Raw Materials	●	3. Additional	●
2. Products	●	9. Production Labor Requirements	●
3. By-Products	●	1. Process Technology	●
5. Energy Balance Calculations	●	2. Production Volume	●
1. Heating	●	10. Forward for Economic Analysis	●
2. Cooling	●		
3. Additional	●		
6. Property Data	●	○ Plan	
1. Physical	●	● In Progress	
2. Thermodynamic	●	● Complete	
3. Additional	●		

CASE B

TABLE A1.2-2

BASE CASE CONDITIONS FOR SILANE PROCESS-CASE B

1. Plant Size
 - Allow for 10% losses of silane in production of silicon
 - 1270 metric tons/year of silane
 - Solar cell grade silicon
2. Hydrogenation Reaction
 - Metallurgical grade silicon, hydrogen, to produce trichlorosilane (TCS) make-up hydrogen chloride used and recycle silicon tetrachloride (TET)
 - Copper catalyzed
 - Fluidized bed
 - 550°C, 50 PSIG
 - 15.8% conversion of SiCl_4 (Union Carbide flowsheet)
3. TCS Redistribution Reaction
 - TCS from hydrogenation produces dichlorosilane (DCS)
 - Catalytic redistribution of TCS with tertiary amine ion exchange resin.
 - Liquid phase 50 PSIG, 80°C.
 - Conversion a function of inlet concentration per Figure IIA-2 (Union Carbide equilibrium)
 - Conversion from pure TCS feed is about 10% to DCS (example)
4. DCS Redistribution Reaction
 - DCS produces SiH_4 (silane)
 - Catalytic redistribution of DCS with tertiary amine ion exchange resin.
 - Gas phase 60-80°C
 - Conversion a function of inlet concentration per Figure IIA-1.1 (Union Carbide equilibrium)
 - Conversion from pure DCS feed is about 14% to Silane (example)
5. Recycles
 - Unreacted chlorosilanes separated by distillation and recycled
6. Silane Purification
 - Chlorosilanes removed by absorption in -40°C SiCl_4 (Tet)
 - Trace contaminants removed by carbon adsorption
7. Operating Ratio
 - Approximately 90% utilization
 - Approximately 7880 hour/year production
8. Storage Considerations
 - Feed materials (two week supply)
 - Product (two week supply)
 - Process (several days)

CASE B

TABLE A1.2-3

REACTION CHEMISTRY FOR SILANE PROCESS - CASE B

1. Hydrogenation Reaction

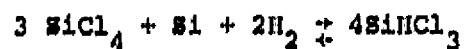

2. Trichlorosilane Redistribution Reaction

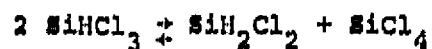

3. Dichlorosilane Redistribution Reaction



Note

1. Reaction 1 Product contains H_2 , SiCl_4 , SiHCl_3 , SiH_2Cl_2 (trace), other trace chlorides
2. Reaction 2 Product contains SiHCl_3 , SiCl_4 , SiH_2Cl_2 , SiH_3Cl
3. Reaction 3 Product contains SiH_2Cl_2 , SiHCl_3 , SiCl_4 , SiH_3Cl , SiH_4

CASE B

TABLE A1.2-4

RAW MATERIAL REQUIREMENTS FOR SILANE PROCESS-CASE B

<u>Raw Material</u>	<u>Requirement lb/lb of Silane</u>
1. Anhydrous HCl	1.239
2. Hydrogen	.362
3. Caustic (50%)	2.448
4. M.G. Silicon	1.11

CASE B

TABLE A1.2-5

UTILITY REQUIREMENTS FOR SILANE PROCESS - CASE B

<u>Utility/Function</u>	<u>Requirements/lb of Silane Product</u>
1. Electricity	.212 KW-HR
1. All pump and Compressor Motors (16)	.212)
2. Steam 250 Psia	186.72 lbs
1. #1 Distillation Column Preheater	(6.96)
2. #1 Distillation Column Reboiler	(81.18)
3. #2 Distillation Column Reboiler	(91.77)
4. #2 Redistribution Reactor Preheater	(3.0)
5. #3 Distillation Column Reboiler	(3.29)
6. #4 Distillation Column Reboiler	(0.41)
7. Waste Treatment	(0.11)
3. Cooling Water (10-120°F)	168.12 gallons
1. #1 Distillation Column Condenser	(146.12)
2. #2 Distillation Column Condenser	(22.09)
4. Process Water (90°F)	8.22 gallons
1. Waste Treatment	(8.22)
5. Refrigerant (-20°F)	2303.2 BTU
1. #3 Distillation Column Condenser	(2058.0)
2. #4 Distillation Column Condenser	(245.2)
6. Refrigerant (-30°F)	30788.0 BTU
1. TCS Reactor Recycle Gas Condenser	(30788.0)
7. Refrigerant (-40°F)	25.26 BTU
1. Silane Product Storage	(25.26)
8. Refrigerant (-50°F)	517.2 BTU
1. Product Silane Condenser	(137.9)
2. Absorbent Cooler	(379.3)
9. High Temperature Heat Exchange Fluid	3.324 x 10 ⁴ BTU
1. TCS Reactor Recycle Gas Heater	(6.591 x 10 ³)
2. HCl Vaporizer	(4.46 x 10 ²)
3. Tet Vaporizer	(2.464 x 10 ⁴)
4. Heat Nitrogen to Regenerate Char. Adsorbers	(70.95)
5. TCS Reactor	(1.491 x 10 ³)

CASE B

TABLE A1.2-5 (Continued)

<u>Utility/Function</u>	<u>Requirements/lb of Silane Product</u>
10. Nitrogen	
1. Regenerate Charcoal Adsorbars	(5.54) 5.54 SCF

CASE B

TABLE A1.2-6

LIST OF MAJOR PROCESS
EQUIPMENT FOR SILANE PROCESS - CASE B

	<u>Type</u>	<u>Function</u>	<u>Duty</u>	<u>Size</u>	<u>Materials of Construction</u>
1.	(T1) M.G. Silicon Storage Hopper	Raw Material Storage	2 weeks storage	1.363 x 10 ⁴ gallons	CS
2.	(T2) Hydrogen Storage Tank	Raw Material Storage	8 hours backup for pipeline failure	9.161 x 10 ⁴ gallons 250 PSIA (spherical)	CS
3.	(T3) Liquid HCl Storage Tank	Raw Material Storage	2 weeks storage	1.612 x 10 ⁴ gallons 250 PSIA, -50°F (spherical)	Nickel Steel
4.	(T4) Recycle TET Storage	For TCS REactor Feed	1 day storage	9.923 x 10 ⁴ gallons 65 PSIA	CS
A15.4	(T5) TCS Reactor Off-Gas Flash Tank	Phase Separation		1 ft. diameter by 4 ft. long, 65 PSIA, 0°F 65 PSIA	CS
6.	(T6) TCS/TET Storage	Feed Distillation Column #1	1 day hold-up	1.966 x 10 ⁵ 65 PSIA	CS
7.	(T7) #1 Distillation Column Condensate Accumulator	Reflux feed; column Control	20 minutes hold-up	4.88 x 10 ³ gallons 65 PSIA	CS
8.	(T8) #2 Distillation Column Condensate Accumulator	Reflux feed; column Control	20 minutes hold-up	746 gallons 65 PSIA	SS
9.	(T9) #3 Distillation Column Condensate Accumulator	Reflux feed; phase Separation; column control	20 minutes hold-up	194 gallons 5°F. 60 PSIA	SS

CASE B

TABLE A1.2-6 (Continued)

10.	(T10)	#4 Distillation Column Condensate Tank	Reflux feed; column control	20 minutes hold-up	18 gallons 50 PSIA, -7°F	SS
11.	(T11)	Waste Tank	Collect waste for Treatment and disposal	2 week storage	1.378×10^4 gallons 65 PSIA	CS
12.	(T12)	Silane Storage	Final Product Storage	2 days storage 8.97×10^3 BTU/hr	4.349×10^3 gallons -40°F, 250 PSIA	SS
13.	(T13)	Caustic Storage	Raw Material Storage	2 weeks storage	2.304×10^4 gallons	SS
14.	(H1)	TCS Reactor	Heat Recycle gas and Hydrogen to 550°C	2.342×10^6 BTU/hr	752 ft ² 65 PSIA	CS
15.	(H2)	HCl Vaporizer	Heat Reactant to 550°C	1.587×10^5 BTU/hr	34 ft ² 65 PSIA	CS
16.	(H3)	TET Vaporizer	Heat Reactant to 550°C	8.755×10^6 BTU/hr	2381 ft ² 65 PSIA	CS
17.	(H4)	TCS Teactor Re-cycle Condenser	Phase separation; Recycle hydrogen	1.094×10^7 BTU/hr	1882 ft ² 65 PSIA	CS/SS
18.	(H5)	#1 Distillation Column Preheater	Preheat distillation feed to bubble point	2.044×10^6 BTU/hr	164 ft ² 250 PSIA	CS
19.	(H6)	#1 Distillation Column Condenser	Provide Reflux to Column	1.296×10^7 BTU/hr	3189 ft ² 65 PSIA	CS
20.	(H7)	#1 Distillation Column Reboiler	Provide vapor to Column	2.382×10^7 BTU/hr	2818 ft ² 250 PSIA	CS

CASE B

TABLE A1.2-6 (Continued)

21.	(H8)	#2 Distillation Column Condenser	Provide Reflux to column	1.96×10^6 BTU/hr	956 ft ² 65 PSIA	CS/SS
22.	(H9)	#2 Distillation Column Reboiler	Provide Vapor to column	2.693×10^7 BTU/hr	2514 ft ² 250 PSIA	CS
23.	(H10)	#2 Redistribution Reactor Feed Vaporizer	Vaporize Reactants for Reactor	8.81×10^5 BTU/hr	78 ft ² 250 PSIA	CS/SS
24.	(H11)	#3 Distillation Column Condenser	Provide Column Reflux (Partial Condenser)	7.312×10^5 BTU/hr	593 ft ² 60 PSIA	CS/SS
25.	(H12)	#3 Distillation Column Reboiler	Provide Vapor to Column	9.64×10^5 BTU/hr	84 ft ² 250 PSIA	CS/SS
26.	(H13)	Silane Condenser	Condense Final Product for storage	4.9×10^4 BTU/hr	53 ft ² 250 PSIA	CS/SS
27.	(H14)	#4 Distillation Column Condenser	Provide Reflux	8.71×10^4 BTU/hr	84 ft ² 50 PSIA	CS/SS
28.	(H15)	#4 Distillation Column Reboiler	Provide Vapor to Column	1.2×10^5 BTU/hr	13 ft ² 250 PSIA	CS/SS
29.	(H16)	Absorber Pre-cooler	Cool TET for absorption column	1.35×10^5 BTU/hr	35 ft ² 60 PSIA	CS/SS
30.	(H17)	Nitrogen Heater	Heat Nitrogen to regenerate Charcoal Adsorbers	2.52×10^4 BTU/hr	14.1 ft ²	CS
31.	(P1)	TCS Reactor Off Gas Recycle Compressor	Circulate Recycle Gas to Reactor	1.36×10^3 SCFH	26.5 Horsepower 75 PSIA Discharge	CS*

CASE B

TABLE A1.2-6 (Continued)

32.	(P2)	#1 Distillation Column Feed Pump	Feed Column	136.5 gpm	106 PSI; 14.5 BHP	CS*
33.	(P3)	#1 Distillation Column Overheads Pump	Provide Reflux and remove overhead product	244 gpm	92.3 PSI; 22.5 BHP	CS*
34.	(P4)	#1 Distillation Column Bottoms Pump	Remove Bottoms Product to TET storage tank	69 gpm	106 PSI, 7.3 BHP	CS*
35.	(P5)	Process Water Feed Pump	Feed Process Water to Waste Treatment	48.6 gpm	82.5 PSI; 4 BHP	CS*
36.	(P6)	Caustic Feed	Feed Raw Material	1 gpm	118 PSI; 1/4 BHP	SS
417 37.	(P7)	#2 Distillation Column Overheads Pump	Provide Reflux and Remove Overhead Product	37.3 gpm	92.3 PSI; 3.4 BHP	SS
38.	(P8)	#2 Distillation Column Bottoms Pump	Remove Bottoms Product to TCS/TET storage tank	66.7 gpm	106.3 PSI; 7.1 BHP	SS
39.	(P9)	#3 Distillation Column Overhead Pump	Provide Reflux; Remove Overhead Product	9.7 gpm	87.3 PSI; 1 BHP	SS
40.	(P10)	#3 Distillation Column Bottoms Pump	Remove Bottoms Product to TCS/TET Tank	5.2 gpm	106.3 PSI; 1/2 BHP	SS

* Includes incremental higher cost for special purity requirements.

CASE B

TABLE A1.2-6 (Continued)

41.	(P11)	#4 Distillation Column Overhead Pump	Provide Reflux, Remove Overhead Product	1 gpm	77.3 PSI; 1/4 BHP	SS
42.	(P12)	#4 Distillation Column Bottoms Pump	Remove Bottoms Product to Absorber Feed Tank	1 gpm	91.3 PSI; 1/4 BHP	SS
43.	(P13)	Silane Product Compressor	Liquefy Silane for Storage	66 SCPM	250 PSIA Discharge 6.5 HP	SS
44.	(P14)	Waste Feed Pump	Distillation Wastes to Waste Treatment	1 gpm	76.3 PSI; 1/4 BHP	CS
45.	(P15)	TCS Reactor Feed Pump	Feed TET to Reactor	69 gpm	92.3 PSI; 6.4 BHP	CS*
46.	(P16)	Waste Collection Pump	Distillation Wastes to Waste Tank	1 gpm	87.3 PSI; 1/4 BHP	CS
47.	(C1)	#1 Distillation Column	Separate TET from TCS	94,220 lb/hr of feed	7.56 ft. diameter 100 ft. tall, 50 trays	CS
48.	(C2)	#2 Distillation Column	Separate TCS from DCS	48,321 lb/hr of feed	10.6 ft. Diameter 136 ft. tall, 68 trays	CS
49.	(C3)	#3 Distillation Column	Separate Silane from other Chlorosilanes	7344 lb/hr of feed	2.01 ft. Diameter 29 ft. tall, 29 trays	SS
50.	(C4)	#4 Distillation Column	Strip TET for use in absorber	1007.7 lb/hr of feed	1.04 ft. Diameter 28.5 ft. tall, 38 trays	SS
51.	(C5)	Silane Absorber	Absorb Chlorosilane from Silane	819.3 lb/hr of vapor feed	0.823 ft. Diameter 12 ft. tall, 16 trays	SS

* Includes incremental higher cost for special purity requirements.

CASE B

TABLE A1.2-6 (Continued)

52.	(C6)	Charcoal Adsorber	Activated Carbon Adsorption of Silane to remove Trace Chlorosilane	366 lb/hr of vapor feed	1 ft. Diameter 7 ft. tall (2), 623 lbs of carbon	SS
53.	(R1)	TCS Fluidized Bed Reactor	Produces TCS from TET, M.G. Silicon, and H ₂		6.26 ft. in Diameter 26.5 ft. tall, 481 tubes 1", 16' long	SS
54.	(R2)	#1 Redistribution Reactor (2)	Redistribute TCS to DCS		2' Diameter by 15 ft. tall 1042 lbs catalyst	SS
55.	(R3)	#2 Redistribution Reactor (2)	Redistribute DCS to Silane		2.34' Diameter by 35 ft. tall 1667.2 lbs catalyst	SS
56.	(A1)	Fines Separator	Remove Silicon Fines carried over with TCS Reactor Off-gas		Standard design 30" Diameter	SS
57.	(A2)	Waste Treatment	Discharge innocuous effluent		1 column for adsorption + 1 heat exchanger to vaporize feed	SS
58.	(A3)	Hydrogen Flare	Dispose of Hydrogen from Waste Treatment		30 ft. stack 6" Diameter	CS

CASE B

TABLE A1.2-7

PRODUCTION LABOR REQUIREMENTS FOR
SILANE PROCESS - CASE B

	<u>Unit Operation</u>	<u>Type</u>	<u>Skilled Labor, Man Hours</u>	
			<u>Per Day</u>	<u>Per lb. Silane</u>
1.	TCS Production	B	65	.0085
2.	Hydrogen Recycle	C	18	.0023
3.	Raw Material Vaporization	C	50	.0065
4.	TCS Condensation	C	50	.0065
5.	TCS/TET Separation	C	62	.0081
6.	#1 Redistribution Reactor	C	49	.0064
7.	DCS/TCS Separation	C	52	.0068
8.	#2 Redistribution Reactor	C	32	.0042
9.	Silane Distillation	C	32	.0042
10.	Silane Absorption	C	28	.0036
11.	Silane Purification (adsorption)	A	36	.0047
12.	Silane Compression	B	23	.003
13.	Silane Condensation	B	23	.003
14.	Materials Handling	A	48*	.0063*
15.	Waste Treatment	B	60	.0078
16.	Silicon Fines Separation	A	15	.002
			-----	-----
		TOTAL	595	.0776

NOTES:

1. A Batch Process of Multiple Small Units
B Average Process
C Automated Process
2. Man Hours Day Unit from Figure 4-6, Peters and Timmerhaus (7).

*semi skilled

A1.3 Silane Process - Case C

Initial results for the Silane Process (Cases A and B) were marginal and indicated process revisions were warranted.

Based on these initial findings, Union Carbide engineering, research development personnel revised their flowsheet for a more optimum arrangement of major process equipment, raw material requirements and operating conditions. A joint meeting with Union Carbide and Lamar was conducted in late January (1978) for initial review of the revised flowsheet and potential lower plant capital investment and lower product cost for silane production.

In the revised silane process, the silicon tetrachloride is hydrogenated in a fluidized bed of silicon which is catalyzed by copper. The hydrogenation reaction is conducted at a higher pressure than originally proposed to increase the yield of desirable trichlorosilane. The gas leaving the fluidized bed reactor is cooled and condensed to recover the liquid chlorosilanes. The hydrogen is recycled.

The condensed liquid chlorosilanes are separated by distillation. The inerts (dissolved gases) are removed in the initial distillation column. The remaining distillation columns separate the liquid chlorosilanes into primarily silicon tetrachloride, trichlorosilane, dichlorosilane and silane. The silicon tetrachloride is recycled back to the hydrogenation reactor. The trichlorosilane and dichlorosilane are sent to the redistribution reactors for rearrangement of chlorine/hydrogen bonds to silicon. The final redistribution reactor product is sent to the silane distillation column. The silane is removed from this distillation and sent to silicon production.

Chemical engineering analysis results for the Silane Process - Case C (Revised Process) are given in Section 3.3- UCC Silane Process for Silicon (Union Carbide Corporation).

A2. ADDITIONAL ECONOMIC ANALYSIS

A2.1 Silane Process - Case A

The economic analysis activity for the Silane Process - Case A (Regular Process Storage) involves a cost analysis to produce silane for silicon. Primary results issuing from the economic analysis include plant capital investment and product cost which are useful in identification of those processes showing promise for meeting project cost goals.

The cost analysis results for producing silane by the Silane Process - Case A are presented in Table A2.1-1 including costs for raw materials, labor, utilities and other items composing the product cost (total cost of producing silicon). The tabulation summarizes all of these items to give a total product cost without profit of \$5.55 (1975 dollars) and \$7.77 (1980 dollars) per lb of silane. This product cost without profit includes direct manufacturing cost, indirect manufacturing cost, plant overhead and general expenses. These results, when expressed in terms of silicon contained in the silane, correspond to \$13.94 (1975 dollars) and \$19.53 (1980 dollars) per kg of silicon.

This cost results for the Silane Process - Case A indicate that this new technology for producing silane for silicon is marginal. Revisions are warranted for meeting the cost goal of \$14 per kg of silicon material (1980 dollars) for solar cells.

The detailed results for the economic analysis are presented in a tabular format to make it easier to locate cost items of specific interest. The guide for the tabular format is given below:

Preliminary Economic Analysis Activities.....	Table A2.1-2
Process Design Inputs.....	Table A2.1-3
Base Case Conditions.....	Table A2.1-4
Raw Material Cost.....	Table A2.1-5
Utility Cost.....	Table A2.1-6
Major Process Equipment Cost.....	Table A2.1-7
Production Labor Cost.....	Table A2.1-8
Plant Investment.....	Table A2.1-9
Total Product Cost.....	Table A2.1-10

TABLE A2.1-1

ESTIMATION OF PRODUCT COST FOR SILANE PROCESS - CASE A

	Cost \$/lb of Silane <u>(1975 dollars)</u>	Cost \$/lb of Silane <u>(1980 dollars)</u>
1. Direct Manufacturing Cost (Direct Costs).....	3.34	4.68
Raw Materials		
Direct Operating Labor		
Utilities		
Supervision and Clerical		
Maintenance and Repairs		
Operating Supplies		
Laboratory Charge		
2. Indirect Manufacturing Cost (Fixed Cost).....	0.89	1.25
Depreciation		
Local Taxes		
Insurance		
3. Plant Overhead.....	0.60	.84
4. General Expenses.....	0.72	1.01
Administration		
Distribution and Sales		
Research and Development		
5. Product Cost Without Profit.....	5.55	7.77

CASE A

Table A2.1-2

ECONOMIC ANALYSES:
PRELIMINARY ECONOMIC ANALYSIS ACTIVITIES FOR SILANE PROCESS
CASE A

<u>Prel. Process Economic Activity</u>	<u>Status</u>	<u>Prel. Process Economic Activity</u>	<u>Status</u>
1. Process Design Inputs	●	6. Production Labor Costs	●
1. Raw Material Requirements	●	1. Base Cost Per Man Hour	●
2. Utility Requirements	●	2. Cost/lb Silane Per Area	●
3. Equipment List	●	3. Total Cost/lb Silane	●
4. Labor Requirements	●		
2. Specify Base Case Conditions		7. Estimation of Plant Investment	●
1. Base Year for Costs	●	1. Battery Limits Direct Costs	●
2. Appropriate Indices for Costs	●	2. Other Direct Costs	●
3. Additional	●	3. Indirect Costs	●
		4. Contingency	●
		5. Total Plant Investment (Fixed Capital)	●
3. Raw Material Costs	●		
1. Base Cost/lb. of Material	●	8. Estimation of Total Product Cost	●
2. Material Cost/lb of Silane	●	1. Direct Manufacturing Cost	●
3. Total Cost/lb of Silane	●	2. Indirect Manufacturing Cost	●
		3. Plant Overhead	●
4. Utility Costs	●	4. By-Product Credit	●
1. Base Cost for Each Utility	●	5. General Expenses	●
2. Utility Cost/lb of Silane	●	6. Total Cost of Product	●
3. Total Cost/lb of Silane	●		
5. Major Process Equipment Costs	●		
1. Individual Equipment Cost	●		
2. Cost Index Adjustment	●		
		○ Plan	
		◐ In Progress	
		● Complete	

TABLE A2.1-3
PROCESS DESIGN INPUTS FOR
SILANE PROCESS - CASE A

1. Raw Material Requirements
 - M.G. Silicon, anhydrous HCl, caustic, hydrogen.
 - see table for "Raw Material Cost"
2. Utility
 - electrical, steam, cooling water, etc.
 - see table for "Utility Cost"
3. Equipment List
 - 76 pieces of major process equipment
 - process vessels, heat exchangers, reactor, etc.
 - see table for "Major Process Equipment Cost"
4. Labor Requirements
 - production labor for purification, vaporization, product handling, etc.
 - see table for "Production Labor Cost"

CASE A

TABLE A2.1-4

BASE CASE CONDITIONS FOR
SILANE PROCESS-CASE A

1. Capital Equipment
 - January 1975 Cost Index for Capital Equipment Cost
 - January 1974 Cost Index Value = 430
2. Utilities
 - Electrical, Steam, Cooling Water, Nitrogen
 - January 1975 Cost Index (U.S. Dept. Labor)
 - Values determined by literature search and summarized in cost standardization work
3. Raw Material Cost
 - Chemical Marketing Reporter
 - January 1975 Value
 - Other Sources
4. Labor Cost
 - Average for Chemical Petroleum, Coal and Allied Industries (1975)
 - Skilled \$6.90/hr
 - Semiskilled \$4.90/hr
5. Update to 1980
 - historically cite 1975 dollars (LSA project)
 - JPL decision to change to 1980 dollars (JPL, 6/22/79)
 - reports to reflect both 1975 and 1980 dollars (JPL, 6/22/79)
 - inflation factor of 1.4 to be used (JPL, 6/22/79)

CASE A

TABLE A2.1-5

RAW MATERIAL COST FOR SILANE PROCESS - CASE A

<u>Raw Material</u>	<u>Requirement lb/lb of Silane</u>	<u>\$/lb of Material</u>	<u>Cost \$/lb of Silane</u>
1. HCl	1.239	.10	.12
2. Hydrogen	.362	.96	.35
3. Caustic (50%)	2.448	.0382	.09
4. M.G. Silicon	1.11	.454	<u>.50</u>
			1.06 (1975 dollar.)
			<u>x 1.4 inflation</u>
			1.48 (1980 dollars)

CASE A

TABLE A2.1-6

UTILITY COST FOR SILANE PROCESS -CASE A

<u>Utility</u>	<u>Requirement/lb of Silane</u>	<u>Cost of Utility</u>	<u>Cost \$/lb of Silane</u>
1. Electricity	.253 Kw-Hr	\$.03/KW hr	.0076
2. Steam	190.34 lbs	1.25/M lb	.2379
3. Cooling Water	168.12 gallons	.08/M gal	.0134
4. Process water	8.22 gallons	.35/M gal	.0029
5. Refrigerant (23°F)	27.1 BTU	4.75/MM BTU	.0001
6. Refrigerant (5°F)	79.1 BTU	6.40/MM BTU	.0005
7. Refrigerant (-7°F)	26.4 BTU	7.50/MM BTU	.0002
8. Refrigerant (-20°F)	2.3 M BTU	8.70/MM BTU	.0200
9. Refrigerant (-30°F)	30.8 M BTU	9.60/MM BTU	.2957
10. Refrigerant (-40°F)	269 BTU	10.50/MM BTU	.0039
11. Refrigerant (-50°F)	3.5 M BTU	11.40/MM BTU	.0400
12. High Temperature Heat Exchange Fluid	3.324 x 10 ⁴ BTU	3.00/MM BTU	.099
13. Nitrogen	5.54 SCF	.50/M SCF	<u>.0028</u>
			.724 (1975 dollars)
			<u>x 1.4 inflation</u>
			1.01 (1980 dollars)

CASE A

TABLE A2.1-7

PURCHASED COST OF MAJOR PROCESS EQUIPMENT FOR
SILANE PROCESS -CASE A

	<u>Equipment</u>	<u>Purchased Cost, \$1000</u>
1.	(T1) M.G. Silicon Storage Hopper	12.05
2.	(T2) Hydrogen Storage Tank	179.2
3.	(T3) Liquid HCl Storage Tank	95.27
4.	(T4) Recycle TET Storage	214.4
5.	(T5) TCS Reactor Off-Gas Flash Tank	0.71
6.	(T6) TCS/TET Storage	214.4
7.	(T7) #1 Distillation Column Condensate Accumulator	8.51
8.	(T8) #1 Redistribution Reactor Feed Tank	241.99
9.	(T9) #1 Redistribution Reactor Product Tank	245.0
10.	(T10) #2 Distillation Column Condensate Accumulator	7.37
11.	(T11) #2 Redistribution Reactor Feed Tank	76.03
12.	(T12) #2 Redistribution Reactor Product Tank	221.17
13.	(T13) #3 Distillation Column Condensate Accumulator	2.76
14.	(T14) #3 Distillation Column Condensate Tank	147.44
15.	(T15) #4 Distillation Column Feed Tank	53.45
16.	(T16) #4 Distillation Column Condensate Accumulator	2.76
17.	(T17) #4 Distillation Column Condensate Tank	34.1
18.	(T18) Waste Tank	17.01
19.	(T19) Absorber Feed Tank	16.59
20.	(T20) Silane Storage	255.9
21.	(T21) Caustic Storage	92.15
22.	(H1) TCS Reactor Recycle Gas Heater	8.12
23.	(H2) HCl Vaporizer	1.15
24.	(H3) TET Vaporizer	18.48
25.	(H4) TCS Reactor Recycle Condenser	38.98

CASE A

TABLE A2.1-7 (continued)

26.	(H5) #1 Distillation Column Preheater	3.24
27.	(H6) #1 Distillation Column Condenser	22.4
28.	(H7) #1 Distillation Column Reboiler	23.7
29.	(H8) #2 Distillation Column Condenser	21.08
30.	(H9) #2 Distillation Column Reboiler	21.16
31.	(H10) #2 Redistribution Reactor Feed Vaporizer	3.67
32.	(H11) #2 Redistribution Reactor Product condenser	8.62
33.	(H12) #3 Distillation Column Preheater	2.86
34.	(H13) #3 Distillation Column Condenser	14.95
35.	(H14) #3 Distillation Column Reboiler	3.88
36.	(H15) Silane Condenser	2.29
37.	(H16) #4 Distillation Column Condenser	3.48
38.	(H17) #4 Distillation Column Reboiler	1.33
39.	(H18) Absorber Pre-cooler	1.79
40.	(H19) Nitrogen Heater	.92
41.	(P1) TCS Reactor Off-gas Recycle Compressor	35.1
42.	(P2) #1 Distillation Column Feed Pump	5.03
43.	(P3) #1 Distillation Column Overheads Pump	6.04
44.	(P4) #1 Distillation Column Bottoms Pump	3.59
45.	(P5) Process Water Feed Pump	2.87
46.	(P6) Caustic Feed Pump	1.25
47.	(P7) #1 Redistribution Reactor Feed Pump	4.02
48.	(P8) #2 Distillation Column Feed Pump	3.59
49.	(P9) #2 Distillation Column Overheads Pump	2.57
50.	(P10) #2 Distillation Column Bottoms Pump	3.59
51.	(P11) #2 Redistribution Reactor Feed Pump	2.09
52.	(P12) #3 Distillation Column Feed Pump	1.77

CASE A

TABLE A2.1-7 (continued)

53.	(P13) #3 Distillation Column Overheads Pump	1.77
54.	(P14) #3 Distillation Column Bottoms Pump	1.47
55.	(P15) #4 Distillation Column Feed Pump	1.23
56.	(P16) #4 Distillation Column Overheads Pump	1.23
57.	(P17) #4 Distillation Column Bottoms Pump	1.23
58.	(P18) #4 Distillation Condensate Recycle Pump	1.23
59.	(P19) Silane Product Compressor	17.55
60.	(P20) Waste Feed Pump	.62
61.	(P21) TCS Reactor Feed Pump	3.31
62.	(P22) #3 Distillation Condensate Recycle Pump	1.47
63.	(P23) Waste Collection Pump	.62
64.	(P24) Absorber Feed Pump	1.23
65.	(C1) #1 Distillation Column	100.66
66.	(C2) #2 Distillation Column	214.08
67.	(C3) #3 Distillation Column	40.19
68.	(C4) #4 Distillation Column	21.14
69.	(C5) Silane Absorber	15.06
70.	(C6) Charcoal Adsorber	18.0
71.	(R1) TCS Fluidized Bed Reactor	155.06
72.	(R2) #1 Redistribution Reactor	13.26
73.	(R3) #2 Redistribution Reactor	33.14
74.	(A1) Fines Separator	2.0
75.	(A2) Waste Treatment	18.72
76.	(A3) Hydrogen Flare	<u>0.10</u>
TOTAL PURCHASED EQUIPMENT COST		\$3079.31 (1975 dollars)
		x 1.4 inflation
		<u>4,311.03 (1980 dollars)</u>

CASE A

TABLE A2.1-8

PRODUCTION LABOR COST FOR SILANE PROCESS - CASE A

<u>Unit Operation</u>	<u>Skilled Labor Man-Hrs/lb silane</u>	<u>Cost \$/lb of Silane</u>
1. TCS Production	.0085	.05865
2. Hydrogen Recycle	.0023	.01587
3. Raw Material Vaporization	.0065	.04485
4. TCS Condensation	.0065	.04485
5. TCS/TET Separation	.0081	.05589
6. #1 Redistribution Reactor	.0064	.04416
7. DCS/TCS Separation	.0068	.04692
8. #2 Redistribution Reactor	.0042	.02898
9. Silane Distillation	.0042	.02898
10. Silane Absorption	.0036	.02484
11. Silane Purification(Adsorption)	.0047	.03243
12. Silane Compression	.003	.0207
13. Silane Condensation	.003	.0207
14. Materials Handling	.0063*	.03097
15. Waste Treatment	.0078	.05382
16. Silicon Fines Separation	.002	.0138
		<u>\$.5663 (1975 dollars)</u>
		<u>x 1.4 inflation</u>
		<u>.7928 (1980 dollars)</u>

NOTES

Based on labor costs of \$6.90 skilled, \$4.90 semiskilled.

* Semiskilled Labor

TABLE A2.1-9

ESTIMATION OF PLANT INVESTMENT FOR SILANE PROCESS - CASE A

	<u>Investment</u> <u>\$1000</u>
1. DIRECT PLANT INVESTMENT COSTS	
1. Major Process Equipment Cost	\$3079.31
2. Installation of Major Process Equipment	1324.10
3. Process Piping, Installed	2278.69
4. Instrumentation, Installed	585.07
5. Electrical, Installed	307.93
6. Process Buildings, Installed	307.93
1a. SUBTOTAL FOR DIRECT PLANT INVESTMENT COSTS (PRIMARYLY BATTERY LIMIT FACILITIES)	7883.03
2. OTHER DIRECT PLANT INVESTMENT COSTS	
1. Utilities, Installed	1478.07
2. General Services, Site Development, Fire Protection, etc.	369.52
3. General Buildings, Offices, Shops, etc.	431.10
4. Receiving, Shipping Facilities	646.66
2a. SUBTOTAL FOR OTHER DIRECT PLANT INVESTMENT COSTS (PRIMARYLY OFFSITE FACILITIES OUTSIDE BATTERY LIMITS)	2925.35
3. TOTAL DIRECT PLANT INVESTMENT COST, 1a + 2a	10808.38
4. INDIRECT PLANT INVESTMENT COSTS	
1. Engineering, Overhead, etc.	1693.62
2. Normal Cont. for Floods, Strikes, etc.	2186.31
4a. TOTAL INDIRECT PLANT INVESTMENT COST	3879.93
5. TOTAL DIRECT AND INDIRECT PLANT INVESTMENT COST, 3 + 4a	14688.31
6. OVERALL CONTINGENCY	4406.49
7. FIXED CAPITAL INVESTMENT FOR PLANT, 5 + 6	19094.80 (1975 dollars)
	x 1.4 inflation
	<u>26732.72 (1980 dollars)</u>

CASE A

TABLE A2.1-10

ESTIMATION OF TOTAL PRODUCT COST FOR SILANE PROCESS- CASE A

	<u>\$/lb of Silane</u>
1. Direct Manufacturing Cost (Direct Charges)	
1. Raw Materials- from prel. design	1.06
2. Direct Operating Labor- from prel. design	.5663
3. Utilities- from prel. design	.724
4. Supervision and Clerical,	.085
5. Maintenance and Repairs,	.682
6. Operating Supplies,	.136
7. Laboratory Charge,	.085
8. Patents and Royalties, costs	----
2. Indirect Manufacturing Cost (Fixed Charges)	
1. Depreciation	.682
2. Local Taxes	.136
3. Insurance	.068
4. Interest	----
3. Plant Overhead	.595
4. By-Product Credit- from prel. design	--
4a. Total Manufacturing Cost, 1 + 2 + 3 + 4	4.819
5. General Expenses	
1. Administration,	.289
2. Distribution and Sales, cost	.289
3. Research and Development, cost	.145
6. Total Cost of Product, 4a + 5	5.55 (1975 dollars)
	x 1.4 inflation
	<u>7.77 (1980 dollars)</u>

A2.2 Silane Process - Case B

The economic analysis activity for the Silane Process -Case B (Minimum Process Storage) involves a cost analysis to produce silane for silicon. Primary results issuing from the economic analysis include plant capital investment and product cost which are useful in identification of those processes showing promise for meeting project cost goals.

The cost analysis results for producing silane by the Silane Process - Case B are presented in Table A2.2-1 including costs for raw materials, labor, utilities and other items composing the product cost (total cost of producing silicon). The tabulation summarizes all of these items to give a total product cost without profit of \$4.58 (1975 dollars) and \$6.41 (1980 dollars) per lb of silane. These results, when expressed in terms of silicon contained in the silane, correspond to \$11.53 (1975 dollars) and \$16.12 (1980 dollars) per kg of silicon.

These cost results for the Silane Process-Case B indicate that this new technology for producing silane for silicon is marginal. Revisions are warranted for meeting the cost goal of \$14 per kg of silicon material (1980 dollars) for solar cells.

The detailed results for the economic analysis are presented in a tabular format to make it easier to locate cost items of specific interest. The guide for the tabular format is given below:

Preliminary Economic Analysis Activities..	Table A2.2-2
Process Design Inputs.....	Table A2.2-3
Base Case Conditions.....	Table A2.2-4
Raw Material Cost.....	Table A2.2-5
Utility Cost.....	Table A2.2-6
Major Process Equipment.....	Table A2.2-7
Production Labor Cost.....	Table A2.2-8
Plant Investment.....	Table A2.2-9
Total Product Cost.....	Table A2.2-10

TABLE A2.2-1

ESTIMATION OF PRODUCT COST FOR SILANE PROCESS - CASE B

	Cost \$/lb of Silane <u>(1975 dollars)</u>	Cost \$/lb of Silane <u>(1980 dollars)</u>
1. Direct Manufacturing Cost (Direct Costs).....	2.95	4.13
Raw Materials		
Direct Operating Labor		
Utilities		
Supervision and Clerical		
Maintenance and Repairs		
Operating Supplies		
Laboratory Charge		
2. Indirect Manufacturing Cost (Fixed Cost).....	0.52	0.73
Depreciation		
Local Taxes		
Insurance		
3. Plant Overhead.....	0.51	0.71
4. General Expenses.....	0.60	0.84
Administration		
Distribution and Sales		
Research and Development		
5. Product Cost Without Profit.....	4.58	6.41

CASE B

TABLE A2.2-2

ECONOMIC ANALYSES:

PRELIMINARY ECONOMIC ANALYSIS ACTIVITIES FOR SILANE PROCESS - CASE B (UNION CARBIDE)

<u>Prel. Process Economic Activity</u>	<u>Status</u>	<u>Prel. Process Economic Activity</u>	<u>Status</u>
1. Process Design Inputs	●	6. Production Labor Costs	●
1. Raw Material Requirements	●	1. Base Cost Per Man Hour	●
2. Utility Requirements	●	2. Cost/lb Silane Per Area	●
3. Equipment List	●	3. Total Cost/lb Silane	●
4. Labor Requirements	●		
2. Specify Base Case Conditions	●	7. Estimation of Plant Investment	●
1. Base Year for Costs	●	1. Battery Limits Direct Costs	●
2. Appropriate Indices for Costs	●	2. Other Direct Costs	●
3. Additional	●	3. Indirect Costs	●
		4. Contingency	●
3. Raw Material Costs	●	5. Total Plant Investment	●
1. Base Cost/lb. of Material	●	(Fixed Capital)	
2. Material Cost/lb of Silane	●	8. Estimation of Total Product Cost	●
3. Total Cost/lb of Silane	●	1. Direct Manufacturing Cost	●
4. Utility Costs	●	2. Indirect Manufacturing Cost	●
1. Base Cost for Each Utility	●	3. Plant Overhead	●
2. Utility Cost/lb of Silane	●	4. By-Product Credit	●
3. Total Cost/lb of Silane	●	5. General Expenses	●
5. Major Process Equipment Costs	●	6. Total Cost of Product	●
1. Individual Equipment Cost	●		
2. Cost Index Adjustment	●		
		○ Plan	
		◐ In Progress	
		● Complete	

CASE B

TABLE A2.2-3

PROCESS DESIGN INPUTS FOR
SILANE PROCESS - CASE B

1. Raw Material Requirements
 - M.G. Silicon, anhydrous HCl, caustic, hydrogen.
 - see table for "Raw Material Cost"
2. Utility
 - electrical, steam, cooling water, etc.
 - see table for "Utility Cost"
3. Equipment List
 - 58 pieces of major process equipment
 - process vessels, heat exchangers, reactor, etc.
 - see table for "Major Process Equipment Cost"
4. Labor Requirements
 - production labor for purification, vaporization, product handling, etc.
 - see table for "Production Labor Cost"

CASE B

TABLE A2.2-4

BASE CASE CONDITIONS FOR
SILANE PROCESS - CASE B

1. Capital Equipment
 - January 1975 Cost Index for Capital Equipment Cost
 - January 1975 Cost Index Value = 430
2. Utilities
 - Electrical, Steam, Cooling Water, Nitrogen
 - January 1975 Cost Index (U.S. Dept. Labor)
 - Values determined by literature search and summarized in cost standardization work
3. Raw Material Cost
 - Chemical Marketing Reporter
 - January 1975 Value
 - Other Sources
4. Labor Cost
 - Average for Chemical Petroleum, Coal and Allied Industries (1975)
 - Skilled \$6.90/hr
 - Semiskilled \$4.90/hr
5. Update to 1980
 - historically cited 1975 dollars (LSA project)
 - DOE decision to change to 1980 dollars (JPL, 6/22/79)
 - reports to reflect both 1975 and 1980 dollars (JPL, 6/22/79)
 - inflation factor of 1.4 to be used (JPL, 6/22/79)

CASE B

TABLE A2.2-5
RAW MATERIAL COST FOR SILANE PROCESS-CASE B

<u>Raw Material</u>	<u>Requirement lb/lb of Silane</u>	<u>\$/lb of Material</u>	<u>Cost \$/lb of Silane</u>
1. HCl	1.239	.10	.12
2. Hydrogen	.362	.96	.35
3. Caustic (50%)	3.448	.0382	.09
4. M.G. Silicon	1.11	.454	<u>.50</u>
			1.06 (1975 dollars)
			<u>x 1.4 inflation</u>
			1.48 (1980 dollars)

CASE B

TABLE A2.2-6

UTILITY COST FOR SILANE PROCESS -CASE B

<u>Utility</u>	<u>Requirement/lb of Silane</u>	<u>Cost of Utility</u>	<u>Cost \$/lb of Silane</u>
1. Electricity	.212 KW-Hr	\$.03/kw hr	.0064
2. Steam	186.72 lbs	1.25/M lb	.2334
3. Cooling Water	168.12 gallons	.08/M gal	.0134
4. Process Water	8.22 gallons	.35/M gal	.0029
5. Refrigerant (-20°F)	2.3 M BTU	8.70/MM BTU	.0200
6. Refrigerant (-30°F)	30.8 M BTU	9.60/MM BTU	.2957
7. Refrigerant (-40°F)	25.3 BTU	10.50/MM BTU	.0003
8. Refrigerant (-50°F)	517.2 BTU	11.42/MM BTU	.0059
9. High Temperature Heat Exchange Fluid	33.24 M BTU	3.0/MM BTU	.0997
10. Nitrogen	5.54 SCF	.50/M SCF	<u>.0028</u>
			.6805 (1975 dollars)
			<u>x 1.4 inflation</u>
			.9527 (1980 dollars)

CASE B

TABLE A2.2-7

PURCHASED COST OF MAJOR PROCESS EQUIPMENT FOR
SILANE PROCESS - CASE B

<u>Equipment</u>	<u>Purchased Cost, \$1000</u>
1. (T1) M.G. Silicon Storage Hopper	12.05
2. (T2) Hydrogen Storage Tank	179.2
3. (T3) Liquid HCl Storage Tank	95.27
4. (T4) Recycle TET Storage	125.55
5. (T5) TCS Reactor Off-Gas Flash Tank	0.71
6. (T6) TCS/TET Storage	214.4
7. (T7) #1 Distillation Column Condensate Accumulator	8.51
8. (T8) #2 Distillation Column Condensate Accumulator	7.37
9. (T9) #3 Distillation Column Condensate Accumulator	2.76
10. (T10) #4 Distillation Column Condensate Accumulator	2.76
11. (T11) Waste Tank	17.01
12. (T12) Silane Storage	82.09
13. (T13) Caustic Storage	92.15
14. (H1) TCS Reactor Recycle Gas Heater	8.12
15. (H2) HCl Vaporizer	1.15
16. (H3) TET Vaporizer	18.48
17. (H4) TCS Reactor Recycle Condenser	38.98
18. (H5) #1 Distillation Column Preheater	3.24
19. (H6) #1 Distillation Column Condenser	22.4
20. (H7) #1 Distillation Column Reboiler	23.7
21. (H8) #2 Distillation Column Condenser	21.08

CASE B

TABLE A2.2-7 (Continued)

22.	(H9) #2 Distillation Column Reboiler	21.16
23.	(H10) #2 Redistribution Reactor Feed Vaporizer	2.67
24.	(H11) #3 Distillation Column Condenser	14.95
25.	(H12) #3 Distillation Column Reboiler	3.88
26.	(H13) Silane Condenser	2.29
27.	(H14) #4 Distillation Column Condenser	3.48
28.	(H15) #4 Distillation Column Reboiler	1.33
29.	(H16) Absorber Pre-cooler	1.79
30.	(H17) Nitrogen Heater	.92
31.	(P1) TCS Reactor Off-gas Recycle Compressor	35.1
32.	(P2) #1 Distillation Column Feed Pump	5.03
33.	(P3) #1 Distillation Column Overheads Pump	6.04
34.	(P4) #1 Distillation Column Bottoms Pump	3.59
35.	(P5) Process Water Feed Pump	2.87
36.	(P6) Caustic Feed Pump	1.25
37.	(P7) #2 Distillation Column Overheads Pump	2.57
38.	(P8) #2 Distillation Column Bottoms Pump	3.59
39.	(P9) #3 Distillation column Overheads Pump	1.77
40.	(P10) #3 Distillation Column Bottoms Pump	1.47
41.	(P11) #4 Distillation Column Overheads Pump	1.23
42.	(P12) #4 Distillation Column Bottoms Pump	1.23
43.	(P13) Silane Product Compressor	17.55
44.	(P14) Waste Feed Pump	.62

CASE B

TABLE A2.2-7 (Continued)

45.	(P15)	TCS Reactor Feed Pump	3.31
46.	(P16)	Waste Collection Pump	.62
47.	(C1)	#1 Distillation Column	100.66
48.	(C2)	#2 Distillation Column	214.08
49.	(C3)	#3 Distillation Column	40.19
50.	(C4)	#4 Distillation Column	21.14
51.	(C5)	Silane Absorber	15.06
52.	(C6)	Charcoal Adsorber	18.0
53.	(R1)	TCS Fluidized Bed Reactor	155.06
54.	(R2)	#1 Redistribution Reactor	26.52
55.	(R3)	#2 Redistribution Reactor	66.28
56.	(A1)	Fines Separator	2.0
57.	(A2)	Waste Treatment	18.72
58.	(A3)	Hydrogen Flare	<u>0.10</u>
TOTAL PURCHASED EQUIPMENT COST			1796.17 (1975 dollars)
			<u> x 1.4</u> inflation
			2515 (1980 dollars)

CASE B

TABLE A2.2-8

PRODUCTION LABOR COST FOR SILANE PROCESS - CASE B

<u>Unit Operation</u>	<u>Skilled Labor Man-Hrs/lb Silane</u>	<u>Cost \$/lb of Silane</u>
1. TCS Production	.0085	.05865
2. Hydrogen Recycle	.0023	.01587
3. Raw Material Vaporization	.0065	.04485
4. TCS Condensation	.0065	.04485
5. TCS/TET Separation	.0081	.05589
6. #1 Redistribution Reactor	.0064	.04416
7. DCS/TCS Separation	.0068	.04692
8. #2 Redistribution Reactor	.0042	.02898
9. Silane Distillation	.0042	.02898
10. Silane Absorption	.0036	.02484
11. Silane Purification (Adsorption)	.0047	.03243
12. Silane Compression	.003	.0207
13. Silane Condensation	.003	.0207
14. Materials Handling		.03087
15. Waste Treatment	.0078	.05382
16. Silicon Fines Separation	.002	<u>.0138</u>
		TOTAL COST .5663 (1975 dollars)
		<u>x 1.4</u> inflation
		.7928 (1980 dollars)

NOTES

Based on labor costs of \$6.90 skilled, \$4.90 semiskilled.

* Semiskilled labor.

CASE B

TABLE A2.2-9

ESTIMATION OF PLANT INVESTMENT FOR SILANE PROCESS - CASE B

	<u>Investment</u> <u>\$1000</u>
1. DIRECT PLANT INVESTMENT COSTS	
1. Major Process Equipment Cost	\$ 1796.17
2. Installation of Major Process Equipment	772.35
3. Process Piping, Installed	1329.17
4. Instrumentation, Installed	341.27
5. Electrical, Installed	179.62
6. Process Buildings, Installed	179.62
1a. SUBTOTAL FOR DIRECT PLANT INVESTMENT COSTS (PRIMARYLY BATTERY LIMIT FACILITIES)	4598.2
2. OTHER DIRECT PLANT INVESTMENT COSTS	
1. Utilities, Installed	862.16
2. General Services, Site Development, Fire Protection, etc.	215.54
3. General Buildings, Offices, Shops, etc.	251.46
4. Receiving, Shipping Facilities	377.20
2a. SUBTOTAL FOR OTHER DIRECT PLANT INVESTMENT COSTS (PRIMARYLY OFFSITE FACILITIES OUTSIDE BATTERY LIMITS)	1706.36
3. TOTAL DIRECT PLANT INVESTMENT COST, 1a + 2a	6304.56
4. INDIRECT PLANT INVESTMENT COSTS	
1. Engineering, Overhead, etc.	987.89
2. Normal Cont. for Floods, Strikes, etc.	1275.28
4a. TOTAL INDIRECT PLANT INVESTMENT COST	2263.17
5. TOTAL DIRECT AND INDIRECT PLANT INVESTMENT COST, 3 + 4a	8567.73
6. OVERALL CONTINGENCY	2570.32
7. FIXED CAPITAL INVESTMENT FOR PLANT, 5 + 6	11138.05 (1975 dollars)
	x 1.4 inflation
	<u>15593</u> (1980 dollars)

CASE B

TABLE A2.2-10

ESTIMATION OF TOTAL PRODUCT COST FOR SILANE PROCESS -CASE B

	<u>\$/ lb of Silane</u>
1. Direct Manufacturing Cost (Direct Charges)	
1. Raw Materials- from prel. design	1.06
2. Direct Operating Labor- from prel. design	.5663
3. Utilities-from prel. design	.6805
4. Supervision and Clerical,	.0849
5. Maintenance and Repairs,	.3976
6. Operating Supplies,	.0795
7. Laboratory Charge,	.0849
8. Patents and Royalties, costs	----
2. Indirect Manufacturing Cost (Fixed Charges)	
1. Depreciation	.3976
2. Local Taxes	.0795
3. Insurance	.0398
4. Interest	-----
3. Plant Overhead	.51
4. By-Product Credit- from prel. design	--
4a. Total Manufacturing Cost, 1 + 2 + 3 + 4	3.9806
5. General Expenses	
1. Administration, cost	.2388
2. Distribution and Sales, cost	.2388
3. Research and Development, cost	.1194
6. Total Cost of Product, 4a + 5	<hr/>
	4.58 (1975 dollars)
	<u>x 1.4</u> inflation
	6.41 (1980 dollars)

A2.3 Silane Process - Case C

Initial cost analysis results for the Silane Process (Cases A and B) were marginal and indicated process revisions were warranted for meeting the project cost goals.

Process revisions were accomplished with favorable cost benefits over the original scheme.

The revised process included operation of the silicon tetrachloride reaction at higher pressure for increased trichlorosilane yield should lower recycle requirements. Lower recycle requirements will lower capital equipment and labor costs. The distillation train as now proposed will operate at several hundred pounds pressure compared to original lower pressure. This higher pressure permits use of cooling water in the condensers and does not require expensive low temperature refrigeration as originally proposed. This will provide lower operating (utilities) cost in 3 of the 4 distillation columns. The higher pressure also permits use of smaller diameter columns (vapor loading, density proportional to pressure). The elimination of hydrogen chloride reduces starting material costs. Also, the use of hydrogen from silane pyrolysis provides additional lower feed material costs.

The revised silane process provided the following cost benefits:

- lower capital costs
- lower raw material costs
- lower operating labor costs

Economic analysis results for the Silane Process - Case C (Revised Process) are given in Section 4.3-UCC Silane Process for Silicon (Union Carbide Corporation).