

APPLICATIONS OF THE DOE/NASA WIND TURBINE ENGINEERING INFORMATION SYSTEM

Harold E. Neustadter and David A. Spera
National Aeronautics and Space Administration
Lewis Research Center
Cleveland, OH 44135, (216)433-4000

ABSTRACT

The NASA Lewis Research Center manages for the Department of Energy, the technology and engineering development of large horizontal axis wind turbines. In support of this activity each wind turbine has a variety of information systems used to acquire, process and analyze data. In general four categories of data systems, each responding to a distinct information need, can be identified. The categories are: Control, Technology, Engineering and Performance.

The focus of this report is on the information that can be extracted by statistical analysis of data obtained from the Technology and Engineering Information Systems. These systems consist of the following elements: (1) sensors which measure critical parameters (e.g., wind speed and direction, output power, blade loads and component vibrations); (2) remote multiplexing units (RMUs) on each wind turbine which frequency-modulate, multiplex and transmit sensor outputs; (3) on-site instrumentation to record, process and display the sensor output; and (4) statistical analysis of data at the NASA-Lewis Research Center in Cleveland, Ohio.

Two examples of the capabilities of these systems are presented. The first illustrates the standardized format for application of statistical analysis to each directly measured parameter. The second shows the use of a model to estimate the variability of the rotor thrust loading, which is a derived parameter.

INTRODUCTION

The U.S. Government has established a Wind Energy Program within the Department of Energy (DOE) to encourage the development and promote commercialization of wind energy systems. One phase of this program is being managed by the NASA Lewis Research Center (LeRC). An agreement with DOE stipulates that LeRC shall manage both the Technology and Engineering Development for large (100 kW) horizontal axis wind turbines (ref. 1). Four wind turbine projects, designated the Mod-0 (ref. 2), Mod-0A (ref. 3), Mod-1 (ref. 4), and Mod-2 (ref. 5), are part of the current development program. In addition to these projects, efforts aimed at achieving lower machine costs have been initiated. These include advanced multi-megawatt (Mod-5) and 200 to 500 kW (Mod-6) wind turbine projects. With regard to all these machines, LeRC has the responsibility to monitor, and report on their performance.

Despite the diverse characteristics of these machines, we can nonetheless identify four distinct information/user categories that are common to all wind turbines; namely, operations/the wind turbine itself; technology/field operations personnel; engineering/system and component designers; performance/dispatchers or investors. The requirements for each category, as seen in Figure 1, are sufficiently disjoint that separate data systems have evolved to meet each need.

At one extreme, with the highest sampling rates, are the computer based control systems which govern the routine operation of each wind turbine generator. The data portion of the control system provides information regarding adequacy of the wind, status of all critical

systems, machine alignment with the wind, etc., and often monitors more than 100 sensors. For certain critical parameters the control system must be capable of responding within milliseconds. This system is considered to be an integral part of the wind turbine and varies significantly from one design to the next.

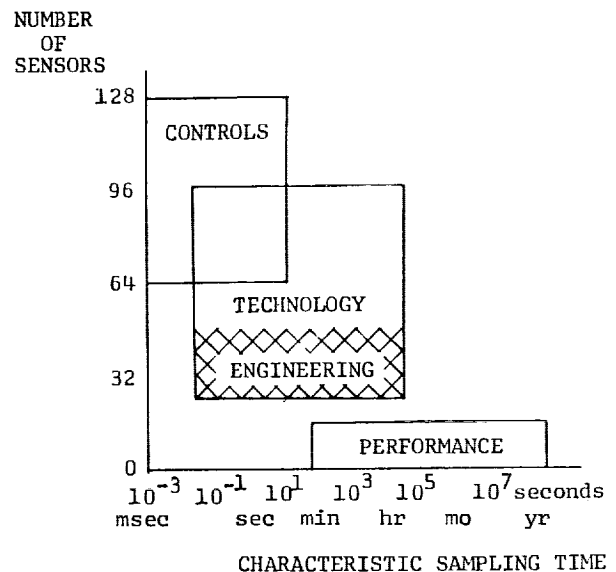

Figure 1 - The approximate relationship between the number of sensors, characteristic sampling time and the function of a data system.

At the other extreme, with the lowest sampling rate, is the performance system to provide information for evaluation of a wind turbine's availability, reliability and energy production. These data requirements are generally limited to meteorological, electrical and structural parameters with time scales ranging from one hour to the lifetime of the machine.

The two remaining information systems, Technology and Engineering, are discussed in greater detail in the remainder of this report. The next section deals with signal conditioning, data acquisition and display and the subsequent routine digital pre-processing. The third section provides an example of the standardized statistical analyses. The fourth section presents a technique to estimate variability in the rotor thrust, which itself is not measured directly but is derived from the flatwise bending moment.

TECNOLOGY AND ENGINEERING INFORMATION SYSTEMS

The Technology Information System has three functionally (and spatially) distinct components, as seen in Figure 2(a). The data signals from the sensors move through the system in the sequence: signal conditioning, acquisition/display, and statistical analysis. Physically, these three functions occur: on the wind turbine, at or near the base of the wind turbine tower and at LeRC, respectively. As was seen in Figure 1(a), the Engineering Information System is a subset of the Technology Information System in that fewer sensors are monitored. In addition, the Engineering System uses significantly less electronic equipment at each wind turbine site. As a consequence, if a statistical analysis is desired, some further processing and display is performed at the Plum Brook Station as illustrated in Figure 2(b).

The wind turbines monitored by LeRC vary considerably in their size, location, blade composition and design. Despite, and to some extent because of, this variability, it was decided that all data system implementations should have the same (or functionally equivalent) hardware and software.

Signal Conditioning

Signal conditioning is performed by a Remote Multiplexing Unit (RMU) (ref. 6). As input, an RMU can accept up to 32 low-level or high-level data signals from a variety of transducers. Each RMU contains reference junctions for thermocouples as well as the necessary electronics for excitation and bridge completion of strain gauges. Each DOE/NASA wind turbine has one RMU located in the hub, another in the nacelle and a third unit at the base of the tower in the control room. A listing of all the transducers monitored during the initial testing of Mod-1 has been reported elsewhere.(ref. 7)

After a signal is received at the RMU it is conditioned (scale and/or offset, amplification or attenuation) to a common range and frequency multiplexed for output. Each RMU can generate

two multiplex groups. Each multiplex group consists of up to 16 FM signals (+ 125 Hz centered at 500 Hz intervals from 1000 Hz thru 8500 Hz) plus a precise reference tone at 9500 Hz. Other significant features of the RMU include a 4-pole active Butterworth low-pass filter, end-to-end system calibration capability (upon command from an external source) and one kilometer signal transmission via coaxial cable.

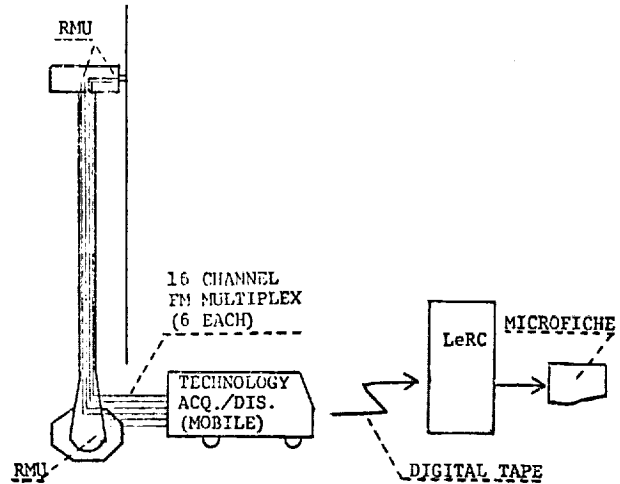

2(a) Technology Information System

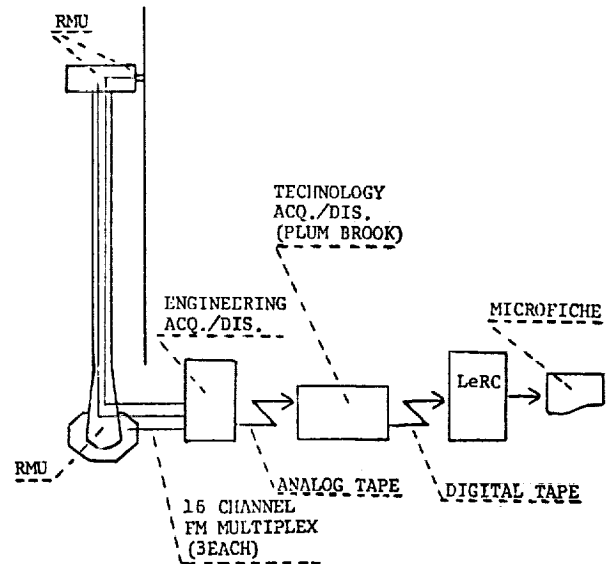

2(b) Engineering Information System

Figure 2 - Schematic representation of the DOE/NASA Wind Energy Technology and Engineering Information Systems.

Acquisition/Display

LeRC has two functionally equivalent Technology Acquisition/Display units. One unit is installed in a mobile van and is used to support field engineers, at wind turbine sites, thru assembly, check-out and initial operation of the first unit of each new wind turbine design. It is presently located at the Mod-2 site in Goodnoe Hills, Washington. The other unit is installed at the LeRC Plum Brook Station, Sandusky, Ohio. In addition to processing analog tapes received from those wind turbine sites equipped with Engineering Acquisition/Display units, it is also used in the Supporting Research and Technology program based on the Mod-0 machine.

A schematic representation of the electronic data processing capability of the mobile unit is shown in Figure 3(a). All RMU-generated FM multiplexes entering this unit are, with the addition of a time code, recorded in direct analog form. This recording capability is independent of any other equipment or processing activity within the unit. Simultaneously, the data can also be routed thru a bank of six sets of 16 discriminators which de-multiplex the signals and generate analog (+5V) signals. Any or all of these 96 analog signals can be digitized and routed thru the mini-computer. From there they can be processed for real-time digital display on the CRT and/or for transmittal on digital tape to LeRC for further analysis. In addition, any 24 of the 96 analog signals may be selected for display on strip charts and any single analog signal may be routed to a spectrum analyzer for frequency content evaluation. All the components shown with a stippling in Figure 3(a) can be set up and run under computer control at the discretion of the unit operator via the control terminal. This unit was designed with sufficient capacity to simultaneously support up to three wind turbines at a single site.

Even after the initial check-out of a new wind turbine design, LeRC retains the responsibility to monitor and report the wind turbine's performance. However, the Technology Acquisition/Display unit is too elaborate and expensive for long term monitoring at each site. Therefore, we have identified a functional subset, the Engineering Acquisition/Display unit, which is installed in the control area of each wind turbine. This latter unit provides on-line analog display on strip chart (eight channels per wind turbine) and continuously records 48 signals (as three FM multiplexes) plus time code on four tracks of analog magnetic tape. The analog magnetic tape recorder operates in either of two modes, depending on local conditions and requirements. At some sites it records until the tape is full (32 hours) and then automatically rewinds (10 minutes) and restarts, erasing old data as new data are recorded. At other sites the recorder operates for 96 hours (by making three passes thru the tape using a total of 12 tracks) and then automatically turns off. It remains off until the tape is replaced and the unit is manually restarted.

Large volumes of data are often of little value in their raw form. Even after processing, they may well be of negligible value if the end product is overwhelmingly voluminous, inadequately disseminated, or excessively delayed. To preclude these occurrences we routinely perform statistical analyses of both the technology and the engineering data. Condensed summaries are provided in both graphic and tabular form, using microfiche as the distribution medium.

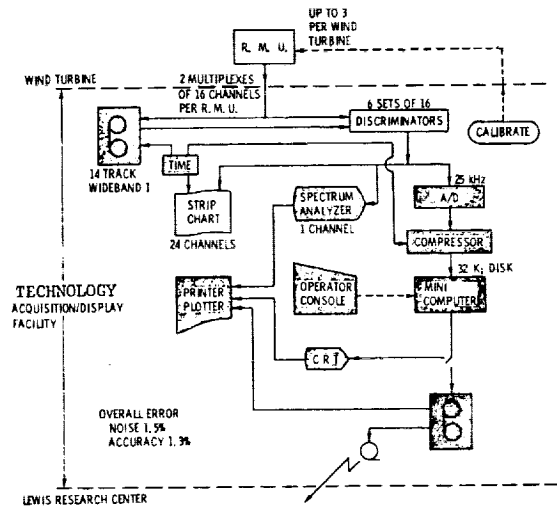

3(a) Technology Acquisition/Display Unit

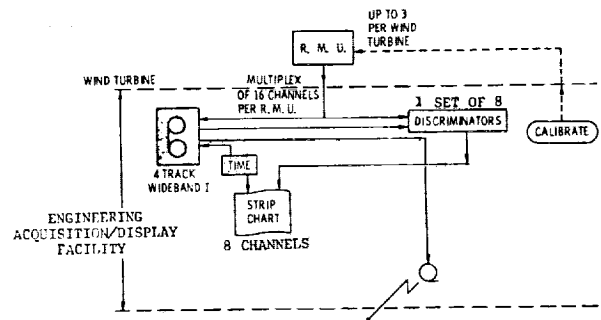

3(b) Engineering Acquisition/Display Unit

Figure 3 - Schematic representation of the electronic data processing in the Technology and Engineering Acquisition/Display Units. In the Technology Unit, each device shown with stippling can be controlled by the operator from the console.

Digital Pre-Processing

Digital magnetic tapes can be generated at either of the Technology Acquisition/ Display units. The digital data consist of 11 readings per parameter per (nominal) revolution and are stored as a tightly packed, randomly sequenced record. Each datum is accompanied by an identifying tag. Time markers (to nearest millisecond) are merged with the data.

As the first step on the LeRC main frame system, these data tapes are transferred to disk for short term storage. During the transfer process, the internal representation is transformed (in software) from ASCII to EBCDIC. The next step compacts this initially large dataset (5×10^6 data values + 5×10^6 tags + 1×10^6 time markers) into a more manageable form, as follows. The rotor shaft position is used to mark the start of each rotation. These markers are then combined with the associated time markers and processed to give rotor speed (rpm) as a function of time. Then, the data from approximately 30 sensors of general interest are screened to yield maximum and minimum values for each parameter for each revolution of the rotor. This smaller data set (5×10^5 data values) is stored on disk and is the data base for all further processing. In the final step, this latter data set is processed onto a microfiche containing the time history and statistical summary of each parameter of general interest. This entire process is shown schematically in Figure 4.

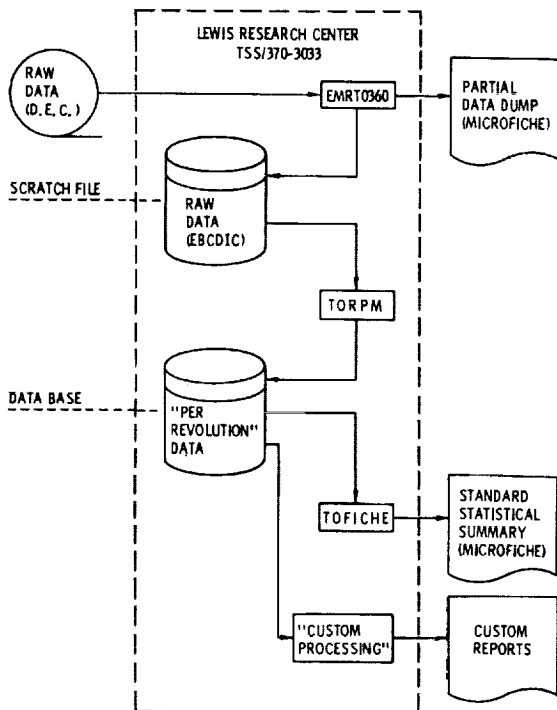

Figure 4 - Schematic representation of the final step in information processing using the LeRC main computer facility.

EXAMPLE 1: STANDARD STATISTICAL ANALYSIS

While the specific set of sensors and their associated scale factors will vary from machine to machine, nevertheless, a single analysis procedure and a common presentation format is applied to all data from all machines.

The data, which are stored in the data base as maximum and minimum values for each revolution, are transformed to represent the midpoint and cyclic values for each revolution. The transformation equations are:

$$\text{midpoint} = (\text{maximum} + \text{minimum}) / 2$$

$$\text{and}$$

$$\text{cyclic} = (\text{maximum} - \text{minimum}) / 2 \times (1 + f(\text{rpm}))$$

$$\text{where,}$$

$$f(\text{rpm}) = 2 \times 10^{-5} (\text{rpm})^2.$$

The correction function, $f(\text{rpm})$, is introduced to compensate for the consistent underestimation of cyclic values resulting from the data sampling rate of 11 per (nominal) revolution.

The results of the analysis of each sensor are displayed as two frames, one graphical and one tabular on the microfiche card. An example of the graphical output is shown in Figure 5 and of the tabular output in Table I. These data were recorded by the on-site Engineering Acquisition/Display unit on January 5, 1981, and cover more than 12,000 consecutive revolutions of continuous machine operation.

The first frame for each sensor contains three graphs. On each graph there are two plots, one of the midpoint values with circles as symbols and the other of the cyclic values with diamonds as symbols. The three graphs are:

1. Time history. The top graph smooths and summarizes the information that one associates with a continuous trace on a strip chart recorder. One plot is of the average, over 30-second intervals, of the midpoint values. The other plot is of the corresponding cyclic values.

2. Partitioned distributions (ref. 8). The abscissa for this center graph is the wind speed midpoint value as measured at hub height. These wind speed values are used as the basis for sorting the data from the sensor of interest. These latter values are grouped into subsets such that for each subset all the sensor data values were obtained at approximately the same measured wind speed. Then the data values within each subset are separately ranked in ascending order. The 16th and 84th percentile for each such sequenced subset are displayed as horizontal tabs at the end of a vertical bar. We also estimate the confidence interval (at the 0.95 level) and display it as an interval (denoted by a pair of circles or diamonds) on the same vertical bar. This entire process is performed separately for the midpoint (circle) and cyclic (diamond) data values.

1981

OAHU, HAWAII

MODOA 4

TAPE START TIME: 12 HRS 5 MIN

02S052 FLAP BENDING STA 40 S

FT LBS

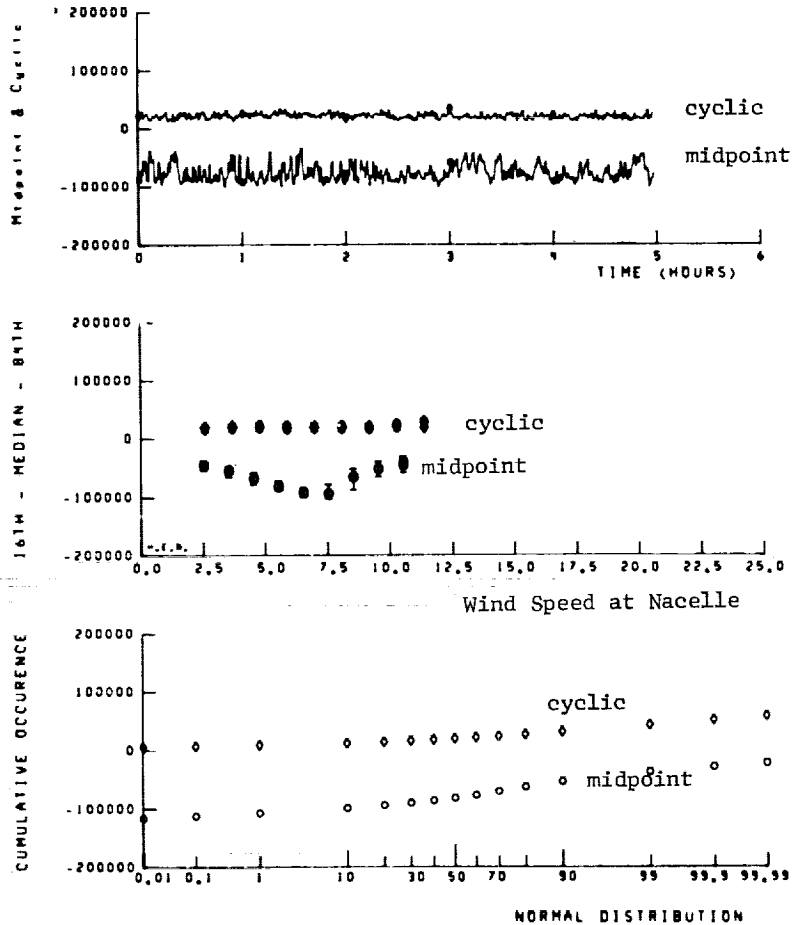

Figure 5. - Sample frame showing the three graphs produced by the standardized statistical processing for each parameter. The above graphs comprise over 12,000 rotor revolutions and were recorded by the on-site Engineering Acquisition/Display Facility. (nt-m = 1.356 ft-lb).

Table I. Distributional Information from Figure 5, in Tabular Form

1981 OAHU, HAWAII
TAPE START TIME: 12 HRS 5 MIN
02S052 FLAP BENDING STA 40 S FT LBS

----- SEGMENTED DISTRIBUTIONS -----						C Y C L I C					
WIND	MINIMUM	16TH PCTL	M I D P O I N T	84TH PCTL	MAXIMUM	WIND	MINIMUM	16TH PCTL	M E D I A N	84TH PCTL	MAXIMUM
2.5	-7.1E 04	-5.3E 04	-4.42E 04	-3.8E 04	-3.0E 04	2.6	8.4E 03	1.3E 04	1.83E 04	2.4E 04	4.2E 04
3.5	-9.1E 04	-6.4E 04	-5.36E 04	-4.6E 04	-2.8E 04	3.7	6.2E 03	1.4E 04	1.97E 04	2.7E 04	5.0E 04
4.5	-1.0E 05	-7.7E 04	-6.63E 04	-5.6E 04	-3.4E 04	4.8	6.5E 03	1.5E 04	2.07E 04	2.9E 04	5.9E 04
5.5	-1.1E 05	-8.7E 04	-7.96E 04	-7.1E 04	-4.7E 04	5.9	5.3E 03	1.3E 04	1.90E 04	2.3E 04	5.7E 04
6.5	-1.1E 05	-9.8E 04	-9.33E 04	-8.3E 04	-4.5E 04	7.0	5.5E 03	1.4E 04	1.99E 04	2.9E 04	5.2E 04
7.5	-1.2E 05	-1.0E 05	-9.20E 04	-7.7E 04	-4.9E 04	8.1	6.0E 03	1.3E 04	1.95E 04	2.8E 04	5.7E 04
8.5	-1.1E 05	-9.5E 04	-6.26E 04	-5.0E 04	-2.8E 04	9.2	6.3E 03	1.4E 04	1.89E 04	2.7E 04	5.9E 04
9.5	-1.1E 05	-6.3E 04	-4.99E 04	-3.8E 04	-1.6E 04	10.3	1.0E 04	1.5E 04	2.25E 04	3.1E 04	4.8E 04
10.5	-7.3E 04	-5.6E 04	-4.12E 04	-3.0E 04	-2.5E 04	11.4	2.0E 04	2.0E 04	2.42E 04	3.6E 04	4.7E 04

----- CUMULATIVE DISTRIBUTION -----					
FREQUENCY	M I D P O I N T	C Y C L I C	MAXIMUM	MINIMUM	
0.0001	-114862.8	5476.3	-52587.0	-156445.8	
0.0010	-111229.9	6500.0	-52587.0	-149613.9	
0.0100	-105859.9	8684.0	-88825.9	-136587.9	
0.1000	-97175.9	12358.0	-78638.9	-120388.9	
0.2000	-92322.9	14529.0	-72793.9	-113875.9	
0.3000	-88157.9	16199.0	-67784.0	-109032.9	
0.4000	-84149.9	17869.0	-63108.0	-104857.9	
0.5000	-80142.0	19706.0	-57931.0	-100683.0	
0.6000	-75293.0	21543.0	-52587.0	-95840.0	
0.7000	-68786.0	23714.0	-46909.0	-89160.0	
0.8000	-61438.0	26553.0	-39895.0	-80643.0	
0.9000	-52253.0	30895.0	-31545.0	-70623.0	
0.9900	-36054.0	42214.5	-13008.0	-53255.0	
0.9990	-27704.0	50447.7	4026.0	-44571.0	
0.9999	-21330.6	57404.9	13337.6	-40255.1	

3. Cumulative distribution. The bottom graph corresponds to a normal distribution, i.e., the abscissa is in units of normalized standard deviations and segmented with tick marks labelled by percentiles. Such a graph has the attribute that if the plotted data have a normal (i.e., gaussian) distribution, the plot will be linear. For this graph the entire set of all midpoint values is sequenced and plotted by percentile. This process is repeated, separately, for the cyclic values.

The second frame (see Table I) for each sensor presents tabular listings of the plotted data points from both distributional graphs. Some additional (non-plotted) data are also tabulated. Because some of these are extreme values (i.e., maxima and minima), these latter tabulated values must be addressed with caution as they might represent spurious noise.

EXAMPLE 2: ROTOR THRUST STATISTICS

As an example of using these data systems to obtain information about non-measured parameters, consider a calculation procedure which can be applied to estimate the variability in the rotor thrust from the measured flatwise bending moment data of a wind turbine blade. First an analysis is made of the changes in the flatwise bending moment, which is a measured parameter. Then the changes in flatwise bending moment are related to changes in rotor thrust, which is a derived parameter, and developed as a normalized "range" (i.e., variability) coefficient.

Flatwise (Midpoint) Moment Range

The first step is to produce a pseudo-spectrum for the flatwise bending moment. The procedure starts with a data set consisting of the midpoint values (as defined in the previous section and as shown in figure 5) of the measured bending moment for each of some large number, n , of rotor revolutions. From these data, the range, i.e., the maximum minus the minimum, is calculated repeatedly over successively doubled time intervals. That is to say, the calculation of range values is made over every two cycles, again over every four cycles, again over every eight cycles, etc. This procedure yields n range values of the midpoint flatwise bending moment.

These range values are sorted in ascending order and plotted as a standard normal probability graph, as shown in Figure 6, using the scale shown to the left. The data for this particular calculation are the same data as seen earlier in Figure 5. The flatwise bending moment was measured near the root end of the blade at approximately five percent of the span, i.e., 100 cm from the axis of rotation. The median of the range of the flatwise bending moment data is 8,800 N-m and the 84th percentile is 24,400 N-m.

These same data are replotted in Figure 6 for the same abscissa, but using as the ordinate the logarithmic scale to the right of the graph. The fit of the straight line to these

data from the 50th to the 99th percentiles indicates a log-normal distribution that is truncated at the very high end. When the same analysis is made on data which include start-up/shut-down sequences, there is no truncation of the distribution and log-normality prevails to the uppermost extent of the data set (ref. 9). In either case the results in the region from the 50th to 99th percentile are essentially the same. Therefore, the information extracted is drawn from the central region of the distribution which is, in statistical jargon, more robust.

Rotor Thrust

The conversion from mean flatwise bending moment to mean rotor thrust is made by using the MOSTAB-WT (ref. 10) simulation program to determine the ratio, C , of the change in thrust to the change in flatwise bending ($N/N\text{-m}$). For wind speeds below the rated wind speed (11 m/s) $C = 0.016$, and for wind speeds above the rated wind speed, $C = 0.011$. Since both conditions occurred during the machine operation and the calculations described above do not distinguish between these two cases, an average of the two cases, $C = 0.013$, is acceptable for this analysis. Applying this average value to the flatwise moment range data in Figure 6, we obtain the average results shown in Table II. The median value of the range of the rotor thrust is 1600 N and the 84th percentile is 4400 N. This information can be normalized by the rotor thrust at rated wind speed (32,000 N) and restated as a dimensionless parameter. This gives the dimensionless values of 0.05 at the 50th percentile and 0.14 at the 84th percentile for the ratio of the range of rotor thrust to the rotor thrust at rated wind speed.

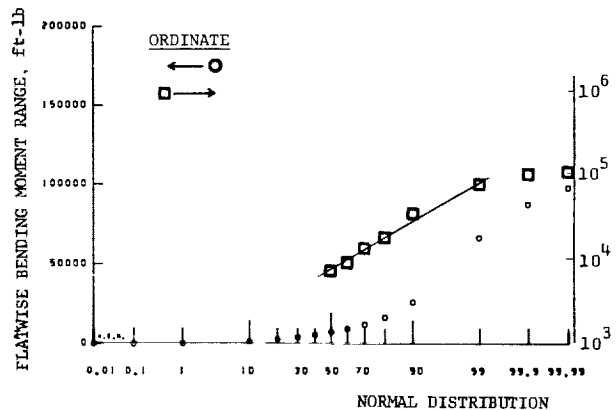

Figure 6 - Normal probability plots for the range of variability in the flatwise bending moment, based on the same data as in Figure 5.

Table II Rotor Thrust Variability for Mod-OA

$\frac{\text{change in rotor thrust}}{\text{change in flatwise bending moment}} = 0.013\text{m}^{-1}$
 rotor thrust at rated wind speed= 32,000 nt

<u>Parameter</u>	<u>Median</u>	<u>84th Percentile</u>
flatwise moment range (midpoint), nt-m	8,800	24,400
rotor-thrust range, nt-m	1600	4400
$\frac{\text{rotor thrust range}}{\text{rotor thrust at rated wind speed}}$	0.05	0.014

CONCLUDING REMARKS

Two related data systems, one for technology development and the other for engineering evaluation, have been identified and described. Typical data, in this instance six consecutive hours of flatwise bending moment data were presented. The description of the extraction of information thru the application of statistical analyses included both the standardized analysis procedure and an analysis specific to evaluating rotor thrust.

REFERENCES

1. Wind Energy Systems Program Summary, Raytheon Service Company, DOE/CS/20097-01, 1980.
2. Glasgow, J. C. and Birchenough, A. G., Design and Operating Experience on the U.S. DOE Experimental Mod-0 100 kW Wind Turbine, NASA TM-78915, 1978.
3. Glasgow, J. C. and Robbins, W. H., Utility Operational Experience on the NASA/DOE Mod-OA 200 kW Wind Turbine, NASA TM-79084, 1979.

4. Puthoff, R. L.; Collins, J. L. and Wolf, R. A.: Installation and Checkout of the DOE/NASA Mod-1 2000 kW Wind Turbine Generator, NASA TM-81444, 1980.
5. Mod-2 Wind Turbine System; Concept and Preliminary Design Report, Boeing Engineering and Construction, NASA CR-159609, 1979.
6. DOE/NASA Wind Turbine Data Acquisition System (Part 1: Equipment), EMR Data Systems, NASA CR-159779.
7. Neustadter, H.: Data Acquisition and Analysis in the DOE/NASA Wind Energy Program, NASA TM-81603, 1980.
8. McGill, R.; Tukey, J. W. and Larsen, W. A.: Variations of Box Plots, The American Statistician, Vol. 32, No. 1, P. 12-16, 1978.
9. Hoffman, J. A.: Wind Turbine Analysis Using the MOSTAB Computer Program, Mechanics Research Incorporated, MRI 2690-1, 1974.
10. Preliminary Calculation of Pseudo-Spectra for Mod-OA Rotor Thrust Loading, Lewis Research Center, Wind Energy Project Office, Internal report, PIR 167, 1980.

QUESTIONS AND ANSWERS

H.E. Neustadter

From: G. McNerney

Q: How extensive is the data base for each site, (sample rates, total time, and channels sampled), and is the data available in raw form for dissemination outside NASA?

A: *The raw form of the data is analog recording of FM encoded data and is not available for general distribution. For digital analysis the sampling rate is 11 times per revolution for up to 48 channels over a six hour duration for each analysis performed. There are about 100 analyses currently on microfiche and the production rate is, nominally, one per machine per week.*

From: W.N. Sullivan

Q: What is the turnaround time on creation of engineering information data sets?

A: *Under ideal circumstances it could be 2 or 3 days. Typical turnaround is 7 to 12 days.*

From: P.C. Klimas

Q: 1) Does your data system measure rotor C_p ? If so, is the data available?

2) What is the time interval used for the measurements which you "bin"?

A: 1) *Not yet, because most sites do not have free-stream wind data available.*

2) *The values which are "binned" are the midpoint and cyclic values for a revolution. The time interval depends on the rotor speed.*