

NASA
CP
2227
c.1

NASA Conference Publication 2227

Meteorological Satellites - Past, Present, and Future



LOAN COPY: RETURN TO
AFWL TECHNICAL LIBRARY
WRIGHT PATTENSON AFB, OHIO

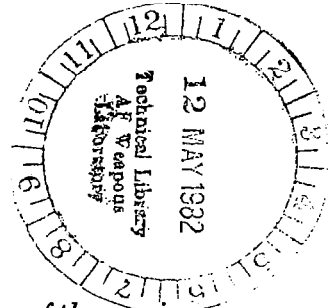

*Proceedings of the session
on Meteorological Satellites at
AIAA 20th Aerospace Sciences Meeting
held in Orlando, Florida
January 11-14, 1982*

NASA



Meteorological Satellites - Past, Present, and Future

Proceedings of the session
on Meteorological Satellites at
AIAA 20th Aerospace Sciences Meeting
held in Orlando, Florida
January 11-14, 1981

NASA

National Aeronautics
and Space Administration

**Scientific and Technical
Information Branch**

PREFACE

Approximately two decades ago the first "meteorological" sensor was flown on a satellite. Since that time, considerable effort has been devoted to developing and promoting programs to obtain the maximum value from the capabilities of sensor systems on board Earth satellites. As with any new measurement system, the initial enthusiasm and projections have been tempered with the real world of results and opportunities for the future. New perspectives of our atmosphere and applications of imagery at global and local scales have resulted from the program accomplishments. The capabilities demonstrated and new technology changes will have a major influence on the future of meteorological satellites. The papers in this report will provide an opportunity for everyone to reflect on the past developments, accomplishments, and potential for the future relative to operational forecasting and atmospheric research needs. The authors and their respective organizations have played important roles in meteorological satellite sensor system development and application activities. Their reviews of past activities and assessments of the current and projected role of satellites will be an important contribution toward efforts to define the nation's future meteorological satellite program.

With one exception, the papers presented in this report were prepared for presentation at the AIAA's 20th Aerospace Sciences Meeting held January 11-14, 1982, in Orlando, Florida. They comprised the session on Meteorological Satellites—Past, Present, and Future. The papers are published with the approval of the authors and the American Institute of Aeronautics and Astronautics. The paper entitled "Defense Meteorological Satellite Program" is published with the approval of the authors and the U.S. Air Force's Space Division.

William W. Vaughan
Session Chairman

TABLE OF CONTENTS

	Page
METEOROLOGICAL SATELLITES — SOME EARLY HISTORY William W. Vaughan	1
THE INITIAL CONCEPTUALIZATION AND DESIGN OF A METEOROLOGICAL SATELLITE Stanley M. Greenfield	3
THE DEVELOPMENT OF THE TIROS GLOBAL ENVIRONMENTAL SATELLITE SYSTEM A. Schnapf	7
THE NIMBUS SATELLITE SYSTEM — REMOTE SENSING R&D PLATFORM OF THE 70'S I. S. Haas and R. Shapiro	17
DEFENSE METEOROLOGICAL SATELLITE PROGRAM (DMSP) James W. Rivers, Jr., and Charles P. Arnold	31
THE DESIGN AND DEVELOPMENT OF GOES L. R. Fermelia	35
SPACE PLATFORMS AND METEOROLOGICAL APPLICATIONS Kenny L. Mitchell and Gregory S. Wilson	43
USER NEEDS AND THE FUTURE OF OPERATIONAL METEOROLOGICAL SATELLITES Donald B. Miller and Joseph R. Silverman	53

METEOROLOGICAL SATELLITES - SOME EARLY HISTORY

William W. Vaughan

Atmospheric Sciences Division

NASA/George C. Marshall Space Flight Center

Huntsville, Ala.

While their projectile was advancing towards the moon in 1860, Jules Verne's intrepid "Lunarnauts" looked back and "saw" cloud systems against the Earth's background. "Some parts brilliantly lighted showed the presence of high mountains, often disappearing behind thick spots, which were never seen on the lunar disc. They were rings of clouds placed concentrically round the terrestrial globe." About a hundred years were to elapse before the real successors to Verne's travellers actually saw the majestic cloud-scape against the terrestrial globe (Fritz, 1946).

Although some pictures of clouds taken from vertical sounding rockets were published as early as 1949 and the feasibility of weather observation from a satellite was discussed by S. M. Greenfield and W. W. Kellogg in a 1951 classified report "Meteorological Satellites" (staff report for Committee on Aeronautical and Space Sciences, U.S. Senate 89th Congress, 2nd. Session, U.S. Government Printing Office, Washington, D. C. 1962) of the Rand Corporation, the first known depiction of what large-scale weather patterns might be expected to look like from high altitudes was that of Dr. Harry Wexler. It was presented as part of a paper, "Observing the Weather from a Satellite Vehicle", given at the Third Symposium on Space Travel at the American Museum, Hayden Planetarium, New York, on May 4, 1954 (Widger, 1961).

Dr. Wexler described what he envisioned as a "Meteorological Satellite" or satellite weather station's primary purpose and properties (Wexler, 1954).

A satellite vehicle travelling about the Earth outside the atmosphere would not assist in portraying the pressure, temperature, humidity, and wind fields by direct measurement. However, by a bird's-eye view of a good portion of the Earth's surface and the cloud structure, it should be possible by inference to identify, locate, and track storm areas and other meteorological features. The vehicle would then serve principally as a "storm patrol." There exists under normal conditions a characteristic cloud condition for a "typical" extra-tropical storm.

In order to reconnoitre the weather most effectively, the satellite weather station should

have the following properties:

- (a) It should be located far enough away to have an instantaneous field of view comparable to North America and adjacent ocean areas - similar to the area covered by the forecaster's "working" chart.
- (b) It should not be so high that cloud areas and geographical features are not readily identifiable.
- (c) It should move in such a manner as to have the same cloud system in the field of view at least twice in a 12-hour period to obtain a track of the storm associated with the cloud system.
- (d) It should not move so fast that individual cloud systems cannot be located accurately with respect to known ground features.
- (e) It should cover the entire earth in daylight at least once daily.
- (f) It should have a westward component of motion relative to the Earth's surface so as to detect quickly new storms which usually move from west to east.

Such a vehicle is one which is located at 2.01 Earth's radii from the Earth's centre or about 4,000 miles from the Earth's surface and which has a period of rotation about the earth of exactly 4 hours.

In the late 1940's and early 1950's, rockets were used for experimental investigations of the atmosphere. In 1947, a V-2 rocket launched at White Sands, New Mexico, took the first successful photographs of the Earth's cloud cover, from an altitude to 110 to 165 kilometers. From 1947 to 1950, additional V-2 and viking rockets carried high altitude cloud-photography experiments which led to the first serious proposal for meteorological satellites. In 1954, a Navy aerobee rocket took pictures over the southwestern United States that emphasized the utility of a meteorological satellite. These pictures showed a storm that had passed onto land from the Gulf of Mexico. The complexity of this storm had remained completely

undetected by conventional means. The presence of multiple-circulation patterns explained previously inexplicable rains that occurred at several inland stations. Thus the ability of high-altitude photography to detect unknown storms was demonstrated. By mid-1958 work had begun in the Advanced Research Projects Agency of the Department of Defense on a meteorological satellite that was to become TIROS. On April 13, 1959, cognizance of this program was transferred to NASA (Anon. 1966).

The first TIROS was flown in April 1960 and demonstrated that cloud cover information provided by a satellite is useful in describing atmospheric motions. It established the value of the spacecraft and supporting ground equipment developed around special sensors, such as cameras and radiation detectors. The successful operation of TIROS I opened the way toward the identification and tracking of fronts and storms from day to day, and the continuous quantitative global observation of the atmosphere. While the accomplishments have exceeded what Dr. Wexler and others envisioned in the early days, without their foresight and persistence the meteorological satellite would not have reached the dimensions it has today.

References

- Anon: 1966, "Satellite Meteorology 1958-1964", NASA SP-96, National Aeronautics and Space Administration, Washington, D. C.
- Fritz, Sigmund: 1964, "Pictures from Meteorological Satellites and their Interpretation". Space Science Reviews 3, 541-580, D. Reidel Publishing Company, Dordrecht, Holland
- Wexler, Harry: 1954, "Observing the Weather from a Satellite Vehicle". British Interplanetary Society 13, 269-276.
- Widger, William: 1961, "Satellite Meteorology - Fancy and Fact". Weather 16, 47-55

THE INITIAL CONCEPTUALIZATION AND DESIGN OF A METEOROLOGICAL SATELLITE

Dr. Stanley M. Greenfield
Systems Applications, Inc.
San Rafael, California

Abstract

The meteorological satellite had its substantive origin in the analytical process that helped initiate America's military satellite program. Its impetus lay in the desire to acquire current meteorological information in large areas for which normal meteorological observational data were not available on a day-to-day basis. High altitude rocket photography had, in the late '40s suggested the potential meteorological usefulness of regional cloud observations. It was not until serious consideration was given to the feasibility of an orbiting vehicle that substantial thought was turned to the potential of a meteorological satellite. This paper provides insight into the conceptualization of a meteorological satellite and the early research that gave substance to the concept.

I. Introduction

From time immemorial, meteorologists have decried the lack of data required to adequately characterize the temporal and spatial variations of the atmosphere. While this plea for more data is not unique to meteorologists, there is some strong justification in the case of those concerned with synoptic weather forecasting. This need to characterize the weather became increasingly apparent once the "frontal theory" of meteorology was advanced about 1918, and the importance of frontal development and movement to forecasting was demonstrated. Based on the frontal theory, the foundation of most weather forecasting systems is the weather-observing network. Whether the forecast is "local" or for the entire Northern Hemisphere, the starting point must be an appraisal of the synoptic weather picture. A meteorologist who does not have good observations from an extensive area is at a disadvantage; and such is often the case for coastal regions, since weather observations over the oceans are often inadequate. This disadvantage was graphically demonstrated during World War II, when military operations on a global scale, frequently suffered from inadequate weather information. This, despite the valient attempts to provide additional data through the use of extensive reconnaissance activities (aircraft, ship, ground). At best, even with great effort, only spotty information could be provided which by its very nature, lacked the one quality of observation most necessary to synoptic meteorology, that of continuity in time and space.

In 1947, the U.S. Air Force initiated a research project at the Rand Corporation to examine the feasibility of conducting military reconnaissance from earth orbiting satellites. Based on known and projected television imaging capabilities, electronics, power supplies, etc., it was possible to demonstrate that useful payloads could be placed in a 300-400 mile orbit with rockets that

were not unreasonable extrapolations from the German V-2.

Based on the information generated by this research study, it was logical to extend it to include an examination of additional uses for this potential capability. My colleague, Dr. William Kellogg and I, took advantage of this unique opportunity to raise and address the question of feasibility and utility of a satellite designed to gather meteorological information.

II. The Conceptualization

Any attempt to explore the usefulness of weather observations from a satellite must start with the questions of what can be seen from such altitudes, and can meteorologically significant information be extracted? With regard to what can be seen from satellites, one must remember that at that point in time, 1949-1950, no satellite had been launched. Our concept of what might be obtainable at that time was limited to essentially non-quantifiable TV images.* The ability to specify what might be seen was limited, therefore, to an examination of what high altitude photography was available, and the projected capabilities of the satellite imaging system.

Available observations from high altitude consisted primarily of limited photography taken from high altitude manned balloons (e.g., Explorer I & II, etc.), and camera sequences shot from vertically fired rockets (e.g., V-2, Aerobee, Viking).

Unfortunately, most high altitude photography was not taken for the purpose of looking at clouds and in fact attempted to deliberately avoid these limitations to its basic mission. Whenever possible, photographs taken from vertically fired rockets were utilized primarily to aid in determining the axial orientations of the vehicle. In addition, considerable effort was made to fire the rocket under fair weather conditions thereby assuring optical tracking, and lowering the probability of photographing extensive cloud formations. Deplorably, this salient point did not emerge until after many dizzying hours were spent watching thousands of feet of film taken from many rapidly spinning rockets. We, however, were ultimately successful in obtaining several photographic sequences that provided excellent photographs of extended cloud systems taken from altitudes ranging from 60-80 miles. These photographs provided a clear sense of large scale cloud patterns and hence, circulation. In addition, it quickly became clear, by carefully defocusing the pictures,

*Non-quantifiable was not quite accurate in that level of brightness if measureable by this system and does provide additional information.

that the ability to resolve structural cloud elements with linear dimensions of the order of 500 feet, would permit one to identify major cloud types. It was felt, and later shown, that cloud identification, even in the absence of other quantitative information, would permit significant interpretation of the broad scale synoptic weather pictures.

Having established the resolution required to provide usable meteorological observations, it was then possible to utilize the reconnaissance satellite system parameters previously derived. The results of this analysis indicated that using television camera technology available at that time it was possible, from an altitude of 350 miles, to achieve a resolution of 500 feet under full sunlight with 25% contrast and an f/10 lens. Further, at a speed of 5 frames/sec, these parameters would permit a transverse strip 350 miles wide to be photographed as a satellite orbited the earth. Finally, if the satellite's orbit were set tangent to latitude 56°N, then these system parameters would permit the entire earth's surface in the vicinity of 40° to 50° latitude to be covered every 24-48 hours with lesser coverage towards the equator.

In essence then, these results indicated that given adequate rocket power, it was feasible to design a satellite system that would produce, temporally and spatially, significant coverage of the earth with television resolution sufficient to identify the cloud forms.* The remaining question was--could useful synoptic information be extracted from these observations?

Two approaches were taken in attempting to answer the above question. Both approaches addressed the question from the standpoint of observations that were only pictorial. Any quantitative information obtained were derived indirectly from the pictorial observations. The first approach accepted the rocket photographs as the only synoptic information available. That is to say, it was assumed that these observations represented the only information available in the area. The question was then, how much of the synoptic picture could be reconstructed? The starting point for this approach had to be an analysis of what qualitative information of standard meteorological parameters was obtainable from cloud photographs. Given adequate ground resolution, it was apparent that wind direction, degree of atmospheric stability, and a sense of the horizontal and vertical wind shear were obtainable from wide spread cloud photographs. Additionally, vertical wind shear could be used to obtain the direction of the horizontal temperature gradient. Moisture and precipitation were inferable from cloud presence and type

*It should be recognized that this cavalier assumption that 500 ft. resolution would permit one to identify clouds is actually based on an in-depth examination of expected contrasts assuming various cloud and ground albedos. The results of this examination indicate that the minimum contrast designed into the system would validate this assumption in the great majority of expected conditions.

as well as surface albedo (e.g., change in albedo due to newly fallen snow, etc.). Taken together, it was felt that this information when combined with frontal theory, continuity, and synoptic information from peripheral areas would permit an experienced analyst to reconstruct the synoptic picture in the unknown area. This approach was attempted using the photographs obtained from three separate rocket flights. While not perfect, the results convinced us that satellite photography was capable of providing an integrated and interpretable view of the wide-spread synoptic weather patterns.

The second approach involved the late Dr. J. Bjerknes. At that time, Dr. Bjerknes was at the Department of Meteorology, University of California at Los Angeles. He had played a role in the development of the polar front theory and at the time of this study, was preeminent in the field of synoptic meteorology. Dr. Bjerknes was asked to analyze the rocket photography in conjunction with all of the available meteorological data for the area in question. What resulted was a truly beautiful analysis in which Dr. Bjerknes was able to demonstrate the beneficial complementarity between wide spread cloud observations taken from high altitude and synoptic weather data. As he wrote in concluding his analysis, "In summary, it may be said that the rocket pictures add a considerable amount of interesting information to the ordinary weather-map analysis and, in addition, that the accumulated knowledge from the maps helps us in the new problem of interpreting what we see from high-level rocket pictures."¹

In essence then, an idea was born, its potential utility was recognized, and its feasibility was demonstrated within the narrow constraints of the information available at the time. What was accomplished and what was concluded from this initial study is best illustrated by quoting directly from the unclassified version of the final report:¹

"A major advantage of satellite weather observations is the repeated broad spatial coverage. Such broad coverage provides the meteorologist with an essential element for his analysis, which is generally referred to as continuity. It permits him to follow a given system as it moves and develops over a period of days. It is a relatively simple matter to identify a system once it is known that such a system is present. Once a weather situation is so identified, it can be earmarked from high-altitude pictures, and not only may it then be tracked across an inaccessible area like an ocean, but any over-all changes or modifications that affect the visible parameters may be almost immediately noticed. It is also likely that, having a complete analysis of the surrounding territory on land, where observations are plentiful, and many satellite observations of the unknown area (through which it is possible to get fixes on systems and to examine visually the over-all weather picture), a complete analysis of the desired region will become a much simpler thing to construct."

and,

"This report has attempted to show what is thought to be necessary in the making of such an analysis. It is obvious, however, that, with the limited data available, many important points may inadvertently have been overlooked. An inquiry of this type can therefore serve only as a guide to a full-scale study of the subject, in which every suggestion and method is put to a full test and is either accepted, modified, or discarded.

The development of all the suggested methods mentioned in this report appears to be feasible. As any analysis depends on its integral parts for its accomplishments, from this standpoint, if from no other, the analysis of synoptic weather from satellite observations is also feasible."

III. Implementation

Having satisfied ourselves as to the feasibility and potential utility of a meteorological satellite, it became useful to consider how it might be implemented. The results of our study had been published as a classified report in 1951.¹ Discussions within the meteorological community, with access to classified information, produced agreement with the feasibility of the concept, and a sense of excitement over its potential utility that evolved over a period of years. This evolved general interest finally helped to declassify the subject of meteorological satellites and starting in 1954, a series of papers began to appear in the open literature discussing the concept.^{1,2,3,4,5,6,7,8,9} This involvement of an interested community of scientists became very important for two basic reasons. First, it quickly moved the concept out of the realm of science fiction and gave it increased respectability. Second, this broader interest kept the subject alive and evolving until the needed launch vehicles had been developed. In addition, what was apparent almost from the start of our original study--the need for quantitative data--developed, during this gestation period, into a rapidly expanding research effort on the use of radiative transfer theory and multi-frequency sensors to probe the atmosphere from satellites. By the time the first meteorological satellite was launched in 1960, many papers had already appeared on the subject and the course had been set for the developments discussed in the companion presentations to this one.^{10,11,12,13,14,15}

By 1956, the nation had made its initial commitment to developing its capabilities in space. RCA, the company that had, under subcontract to the RAND Corporation, carried out the initial studies on satellite television systems, proposed a very simple, small version to be placed in orbit by a Jupiter C rocket. By 1958, the Thor-Able launch vehicle became available and as indicated in the paper by Schnapp¹⁶, the simple satellite quickly was expanded into TIROS-I, the first meteorological satellite, launched in April 1960. While this initial television system did not provide the resolution suggested by our original study, the vehicles orbital characteristics were not very far removed from those concepts.

IV. Conclusion

Roughly ten years elapsed from the emergence and examination of the original idea to its development into a piece of operating hardware. In that period of time, a whole community of interest was developed which quickly began to extend the original ideas into more sophisticated and potentially more useful configurations. By the time the original idea reached the operational test stage (TIROS-I), it was already obsolete. The result has been the development and global acceptance over the last two decades, of a family of meteorological satellites (both geo-stationary and low altitude orbiters) that have made, and continue to make, significant contributions to the well-being of man. The current versions of these satellites have advanced far beyond the simple approach originally conceived of by William Kellogg and myself. But that is as it should be, and only serves to increase our pride in the contribution made by our original proposal.

References

1. Greenfield, S. M., and W. W. Kellogg, "Inquiry into the Feasibility of Weather Reconnaissance from a Satellite Vehicle," R-365, The Rand Corporation, 1960, Unclassified edition of Rand report R-218, dated April, 1951.
2. Greenfield, S. M., "Synoptic Weather Observations from Extreme Altitudes," The Rand Corporation, Paper P-761, Feb., 1956.
3. Greenfield, S. M., and W. W. Kellogg, "Weather Reconnaissance by Satellites," Astronautics, 4, 1959, pp. 32-33 and 77-78.
4. Widger, W. K., and C. N. Touart, "Utilization of Satellite Observations in Weather Analysis," Bulletin of American Meteorological Society, Vol. 38, No. 9, 1957, pp. 531-533.
5. Wexler, H., "Observing the Weather from a Satellite Vehicle," Journal of the British Interplanetary Society, Vol. 13, 1954, pp. 269-276.
6. Glaser, A. H., and J. H. Conover, "Meteorological Utilization of Images of the Earth's Surface Transmitted from a Satellite Vehicle," Harvard University Blue Hill Meteorological Observatory, Oct., 1957.
7. Minutes of the first meeting of the Committee on Meteorological Aspects of Satellites, Space Science Board, National Academy of Sciences, Sept. 26, 1958.
8. Satellites Will Advance Knowledge of Weather, Dept. of Defense, Office of Public Information, News Release 871-58, Sept., 1958.
9. Singer, S. F., "Meteorological Measurements from a Minimum Satellite Vehicle," Trans. Amer. Geophysical Union, 38, 1957, pp. 469-482.
10. Suomi, V. E., "The Radiation Balance of the Earth from a Satellite," Annals of the IGY, Vol. VI, 1957, pp. 331-340.

11. Greenfield, S. M., and W. W. Kellogg, "Calculations of Atmospheric Infrared Radiation as Seen from a Meteorological Satellite", Journal of Meteorology, Vol. 17, No. 3, June, 1960, pp. 283-290.
12. Kaplan, L. D., "On the Inference of Atmospheric Structure from Remote Radiation Measurement," Presented at Meeting of American Optical Society, New York City, April 3, 1959.
13. King, J. I. F., "The Radiative Heat Transfer of Planet Earth," in Scientific Use of Earth Satellites, Ann Arbor, Univ. of Mich. Press, 1956, pp. 133-136.
14. Greenfield, S. M., and W. W. Kellogg, "Meteorological Satellites," in the Space Handbook, Astronautics and its Applications, Random House, New York, 1958, pp. 236-246.
15. Singer, S. F., "A Method for the Determination of the Vertical Ozone Distribution from a Satellite," J. Geophys. Res., 62, 1957, pp. 299-308.
16. Schnapf, A., "The Development of the TIROS Global Environmental Satellite System," presented at 20th Aerospace Sciences Conference, AIAA, Orlando, FL, Jan., 1982.

THE DEVELOPMENT OF THE TIROS GLOBAL ENVIRONMENTAL SATELLITE SYSTEM

A. Schnapf*
Principal Scientist
RCA Astro-Electronics
Princeton, NJ 08540

for presentation
20th Aerospace Sciences Conference
American Institute of Aeronautics and Astronautics
Orlando, Florida
January 11-14, 1982

INTRODUCTION

On April 1, 1960, TIROS-1 (Television Infra-Red Observation Satellite) was orbited successfully from Cape Canaveral, Florida. It was the world's first meteorological satellite, ushering in a new era in meteorological observations. From its very first orbit around the earth, TIROS demonstrated the ability of the satellite to perform global observations on a timely basis. The TIROS meteorological satellite system was designed and built at RCA Astro-Electronics, Princeton, New Jersey, for the National Aeronautics and Space Administration (NASA). With the success of TIROS-1, there followed an orderly growth and evolution of the TIROS family of meteorological satellites over the next two decades. Figure 1 depicts the chronology of the TIROS satellites. A total of 28 TIROS/ESSA/ITOS/(TIROS-N)/NOAA series of satellites was orbited successfully, all meeting or exceeding the mission requirements. Table 1 shows the orbital performance of the TIROS satellites. From 1960 to 1965, ten TIROS Research and Development spin-

stabilized satellites were placed in orbit to provide data for researchers and the U.S. meteorological community. TIROS-VIII, launched in 1963, with its special automatic picture transmission (APT), provided the first real-time direct readout of the satellite's observations to simple ground stations located in various parts of the world.

The world's first operational meteorological satellite (as well as the world's first operational application satellite) was introduced into service in February 1966 with the successful launch of ESSA 1 and 2. The ESSA spin-stabilized satellite series provided two satellite configurations, an ESSA APT for direct real-time readout of observed data to relatively low-cost earth receiving stations located throughout the planet, and a second ESSA-AVCS capable of remote sensing and storage of data and playback to the two principal U.S. Command and Data Acquisition stations. Each satellite viewed the entire planet on a daily basis. A total of nine ESSA satellites was orbited successfully between 1966 and 1969.

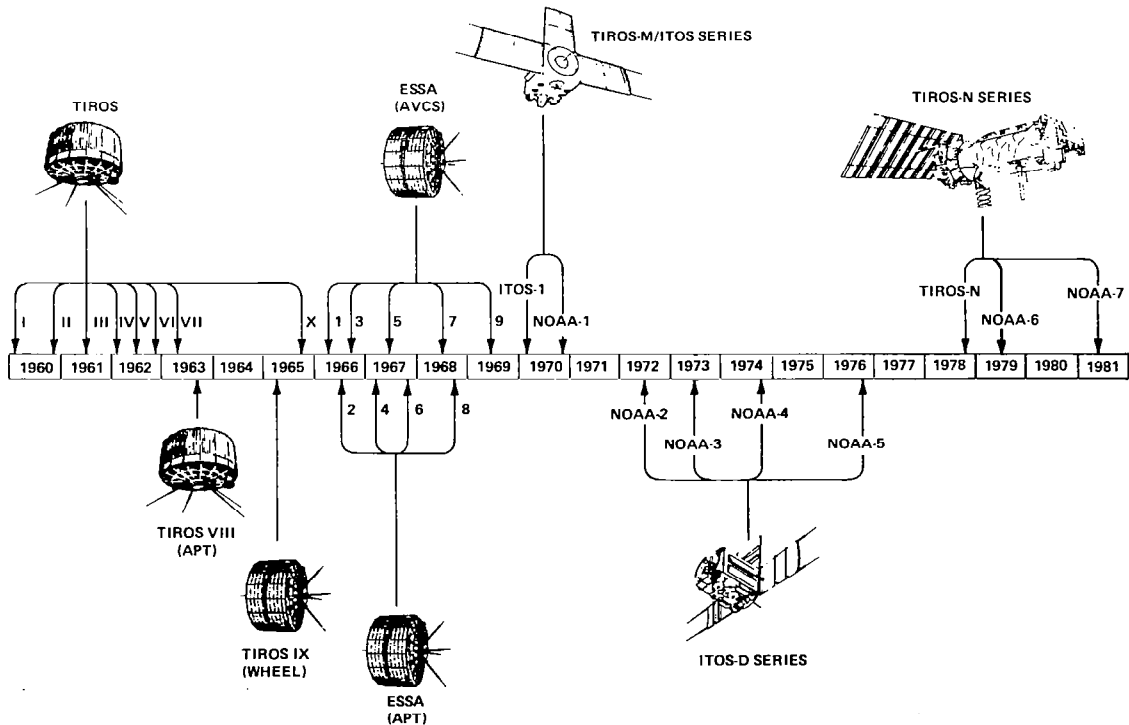

Figure 1. TIROS Polar-Orbiting Global Operational Meteorological Satellite System Evolution

*Fellow

TABLE 1. THE TIROS/ESSA/ITOS/NOAA SATELLITES IN ORBIT

Name	Launched	Weight (lbs)	Period (min)	Perigee (km)	Apogee (km)	Inclination (deg)	Life (days)	Remarks
TIROS I	01APR60	263	99.2	796	867	48.3	89	1 TV-WA and 1 TV-NA
TIROS II	23NOV60	278	98.3	717	837	48.5	376	1 TV-WA, 1 TV-NA, passive & active IR scan
TIROS III	12JUL61	285	100.4	854	937	47.8	230	2 TV-WA, HB, IR, IRP
TIROS IV	08FEB62	285	100.4	817	972	48.3	161	2 TV-WA, IR, IRP, HB
TIROS V	19JUN62	287	100.5	680	1119	58.1	321	1 TV-WA, 1 TV-MA
TIROS VI	18SEP62	281	98.7	783	822	58.2	389	1 TV-WA, 1 TV-MA
TIROS VII	19JUN63	299	97.4	713	743	58.2	1809	2 TV-WA, IR, IP, HB
TIROS VIII	21DEC63	260	99.3	796	878	58.5	1287	1st APT TV direct readout & 1 TV-WA
TIROS IX	22JAN65	320	119.2	806	2967	96.4	1238	First "wheel"; 2 TV-WA global coverage
TIROS X	02JUL65	320	100.6	848	957	98.6	730	Sun synchronous, 2 TV-WA
ESSA 1	03FEB66	320	100.2	800	965	97.9	861	1st operational system, 2 TV-WA, FPR
ESSA 2	28FEB66	290	113.3	1561	1639	101.0	1692	2 APT, global operational APT
ESSA 3	02OCT66	350	114.5	1593	1709	101.0	738	2 AVCS, FPR
ESSA 4	26JAN67	290	113.4	1522	1656	102.0	465	2 APT
ESSA 5	20APR67	350	113.5	1556	1635	101.9	1034	2 AVCS, FPR
ESSA 6	10NOV67	290	114.8	1622	1713	102.1	763	2 APT TV
ESSA 7	16AUG68	350	114.9	1646	1691	101.7	571	2 AVCS, FPR, S-Band
ESSA 8	15DEC68	290	114.7	1622	1682	101.8	1103	2 APT TV
ESSA 9	26FEB69	350	115.3	1637	1730	101.9	1030	2 AVCS, FPR, S-Band
ITOS 1	23JAN70	683	115.1	1648	1700	102.0	510	2 APT, 2 AVCS, 2 SR, FPR, 3-axis stabilization
NOAA 1	11DEC70	683	114.8	1422	1472	102.0	252	2 APT, 2 AVCS, 2 SR, FPR
NOAA 2	15OCT72	750	114.9	1451	1458	98.6	837	2 VHRR, 2 VTPR, 2 SR, SPM
NOAA 3	06NOV73	750	116.1	1502	1512	101.9	1029	2 VHRR, 2 VTPR, 2 SR, SPM
NOAA 4	15NOV74	750	114.9	1447	1461	101.6	1463	2 VHRR, 2 VTPR, 2 SR, SPM
NOAA 5	29JUL76	750	116.2	1504	1518	102.1	1067	2 VHRR, 2 VTPR, 2 SR, SPM
TIROS-N	13OCT78	3127	98.92	849	864	102.3	868	AVHRR, HIRS-2, SSU, MSU, HEPAD, MEPED, DCS, TED
NOAA 6	27JUN79	3127	101.26	807.5	823	98.74	857*	AVHRR, HIRS-2, SSU, MSU, HEPAD, MEPED, DCS, TED
NOAA 7	23JUN81	3127	101.9	845	879	98.9	131*	AVHRR-2, HIRS-2, SSU, MSU, HEPAD, MEPED, TED, DCS
APT	Automatic Picture Transmission TV					MSU	Microwave Scanner Unit	
AVCS	Advanced Vidicon Camera System (1" Vidicon)					SEM	Solar Environmental Monitor, TED, MEPED, HEPAD	
AVHRR	Advanced Very High Resolution Radiometer - 4 ch.					SPM	Solar Proton Monitor	
AVHRR-2	Advanced Very High Resolution Radiometer - 5 ch.					SR	Scanning Radiometer	
DCS	Data Collection System					SSU	Stratospheric Sounding Unit	
FPR	Flat Plate Radiometer					TED	Total Energy Detector	
HB	Heat Budget Instrument					TV	Television Cameras (1/2" Vidicon)	
HEPAD	High Energy Proton and Alpha Particle Detector						NA Narrow Angle - 12°	
HIRS-2	High Resolution Infrared Sounder						MA Medium Angle - 78°	
IP	Ion Probe						WA Wide Angle - 104°	
IR	Infrared 5 Channel Scanner					VHRR	Very High Resolution Radiometer	
IRP	Infrared Passive					VTPR	Vertical Temperature Profile Radiometer	
MEPED	Medium Energy Proton and Electron Detector							
*Still Operational								

The third generation of TIROS satellites, TIROS-M (ITOS), was placed into orbit in December 1970. ITOS, by means of infrared scanning radiometers and television cameras, provided day and night observation of the entire planet. Further improvements were introduced in this 3-axis stabilized satellite with the ITOS-D series. The Very High Resolution Radiometer was added for 1-km (0.6 mi) resolution in visible and IR channels, and the Vertical Temperature Sounding instrument for temperature profiles of the atmosphere from sea level to 30 km. Each of the ITOS satellites was capable of observing the planet every twelve hours. A total of six ITOS/NOAA satellites was placed into operation between 1970 and 1976.

The fourth satellite generation, TIROS-N, was introduced into service in October 1978, and its companion satellite, NOAA-6, in June 1979. A third satellite, NOAA-7, was placed into orbit on June 23, 1981. These new, sophisticated environmental satellites were configured with improved sensors that provided more refined observation, a data collection platform, and a solar energetic particle monitor. The satellites were on station to support the First GARP (Global Atmospheric

Research Program) Global Experiment (FGGE) during 1978-1979. The Advanced TIROS-N (ATN) spacecraft, the last three spacecraft in this series, are under construction to assure continuous global observation into the mid-1980's. These will have additional payloads to monitor the earth's ozone and measure radiation gains and losses to the planet for climatology use. They will also have an experimental search and rescue payload for locating downed aircraft and ships in distress. Figure 2 shows the evolution of the TIROS/ESSA/ITOS/NOAA series of satellites.

NOAA (National Oceanic and Atmospheric Administration) owned and operated the operational ESSA and NOAA satellites. NASA developed the initial spacecraft and managed the procurement of the satellites.

EVOLUTION OF THE TIROS PROGRAM

Early Development Phase of TIROS

Early in this century, aircraft began to gather data to enlarge the knowledge of the atmosphere. In the mid-1930's radiosondes were routinely used

TIROS R & D 1960-1965

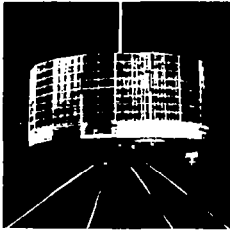

2 FT, 283 LBS

TIROS IX (Wheel) 1965

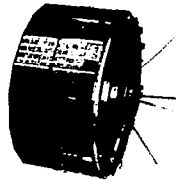

2 FT, 320 LBS

TOS

ESSA-AVCS 1966-1969

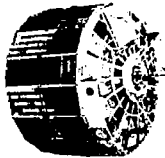

2 FT, 340 LBS

ESSA-APT 1966-1969



2 FT, 300 LBS

ITOS

ITOS-1 1970-1972

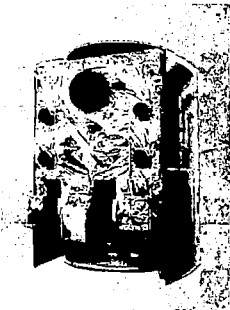

4 FT, 690 LBS

NOAA-2 1972-1976

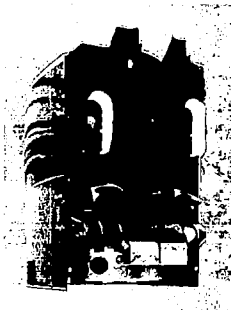

4 FT, 750 LBS

TIROS-N

1978-1984

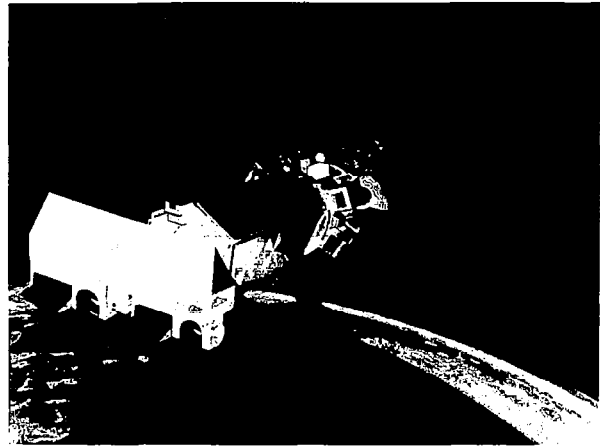

12 FT, 3,127 LBS

Advanced TIROS-N

1982-1986

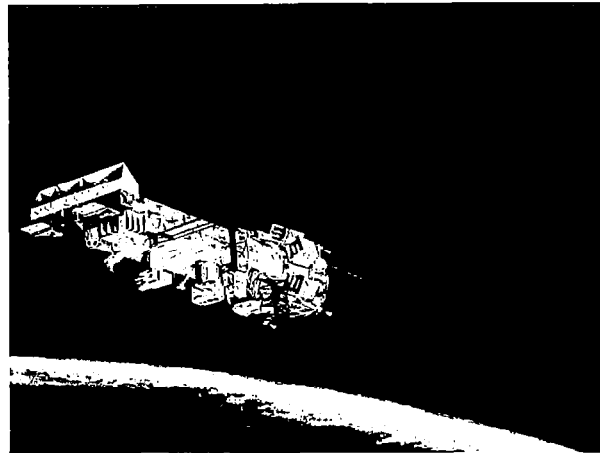

14 FT, 3,800 LBS

Figure 2. TIROS Satellite Evolution

for upper atmosphere observations. Small sounding rockets were used before World War II for upper atmospheric measurements. Following the war, the captured V-2 rockets and Viking rockets were used for further research. The Navy Aerobee rocket returned high altitude motion pictures of the earth and its cloud cover in 1954. Early satellite observations were attempted by Vanguard II in February 1959. However, due to a poor orbit and a large spin-axis nutation, the data was unusable.

The initiation of TIROS I program in mid-1958 and the successful launch and operations of TIROS I on April 1, 1960 opened a new era in earth observations. In its time TIROS I was one of the most sophisticated satellites launched in the U.S. space program. The development that led to the first successful TIROS I, which has gone on to produce four generations of meteorological and environmental satellites totaling 28 in orbit over the past 22 years, has had a very colorful beginning and a number of iterations in design and launch vehicles and Government agencies.

As a result of studies by RCA with the Rand Corporation in the 1950's as to the use of television in space and discussions of weather reconnaissance by satellite by S.M. Greenfield, W.W. Kellogg,

H. Wexler, and S.F. Singer, the concept for meteorological satellites came forth.

The initial development of the TIROS program materialized when the Army Ballistic Missile Agency at Redstone responded favorably to an RCA proposal. RCA's initial award in 1956 was to conceive a TV system for a satellite for weather reconnaissance to be launched by Jupiter C rocket. The program was designated JANUS. The resultant design was a slender rod-shaped 20-lb spacecraft, measuring five inches in diameter and approximately 30 inches long and with a single TV camera. In mid-1958 the configuration was changed with the availability of a larger booster designated JUNO-II. The JANUS-II weight limit increased to 85 pounds and a drum-shaped satellite 18 inches in diameter and 30 inches long was configured. Figure 3 depicts the JANUS and JANUS II spacecraft development.

In late-1958 the Thor-Able rocket was made available and the project, then called Cloud-Cover, finally became the disc-shaped TIROS spacecraft. The TIROS weight limit was set at 270 pounds, and its size increased to 42 inches in diameter and 22.5 inches high plus the extended antenna on top and bottom of the spacecraft. Two complete 1/2-inch vidicon TV cameras, plus two video recorders,

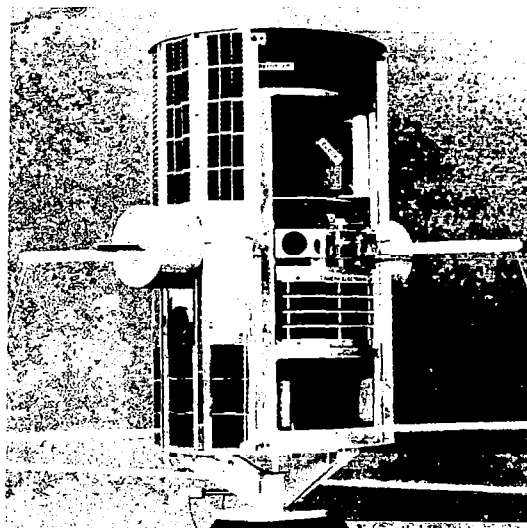
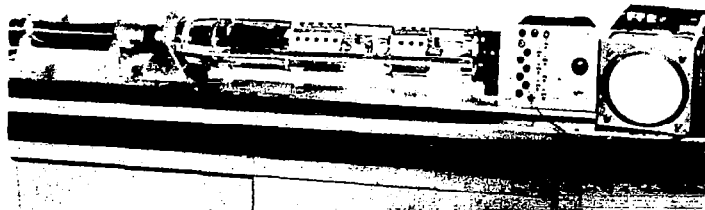

Figure 3. JANUS and JANUS II Spacecraft Development

cylindrical solar array hat, rechargeable batteries, spin-up rockets, nutation dampers, remote command, telemetry, beacons, command receivers, and TV transmitters were included in the spacecraft. During these early development years the management of the program shifted from the Ballistic Missile Agency to ARPA, to the U.S. Signal Corps and finally in early-1959 to NASA/GSFC.

The TIROS I to X System Development

TIROS I, the world's first meteorological satellite, was launched April 1, 1960 by the Thor-Able, as shown in Figure 4, with the primary objective of demonstrating the feasibility of observing the earth's cloud cover by means of slow-scan tele-

vision cameras in an earth-orbiting, spin-stabilized satellite. This satellite included both a wide-angle and a narrow-angle TV camera, and was placed in a circular orbit at an altitude of 400 miles, with the orbit inclined 48 degrees to the equator.

The first, historic television pictures from space were received on the very first orbit of TIROS I, immediately and clearly demonstrating the feasibility of the system. Figure 5 shows the first picture taken on the first orbit, a wide-angle picture showing the earth's cloud cover from space of the northeastern part of the United States and Canada. With the reception of pictures from TIROS I, a new and powerful tool for the meteorological community became a reality.

TIROS II was launched November 23, 1960, to demonstrate, in addition to the wide- and narrow-angle television cameras, an experimental 5-channel scanning IR radiometer and a 2-channel non-scanning IR device. Both of these devices were developed by

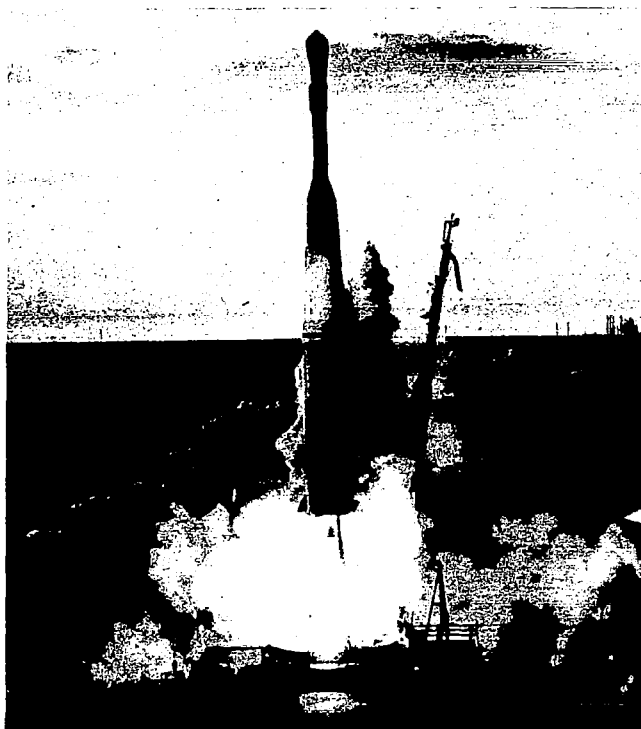

Figure 4. TIROS I - World's First Meteorological Satellite, Launched April 1, 1960

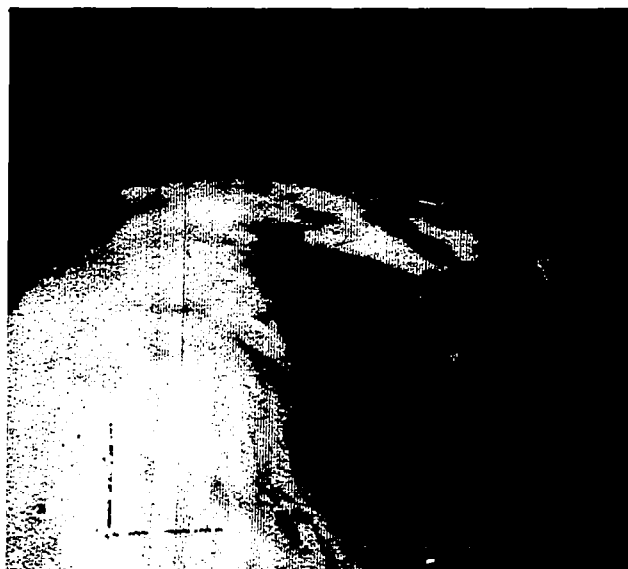

Figure 5. TIROS I Satellite - First Television Picture from Space, April, 1960

the NASA Goddard Space Flight Center. They measured the thermal energy of both the earth's surface and atmosphere in order to provide data on the planet's heat balance and add a new dimension for the understanding of weather. A magnetic torquing coil was added to TIROS II (and all TIROS satellites thereafter) so that a controlled magnetic field about the satellite would interact with the earth's field in space and, hence, provide control of the satellite's attitude. In this way, camera pointing, thermal control, and the use of available solar power were enhanced.

TIROS III, IV, V, VI, and VII were launched between July 1961 and June 1963 to provide continuous observation of the earth's cloud cover for limited operational use. With each of these satellites, particular emphasis was given to provide early warning of severe tropical storms, hurricanes, and typhoons. In addition to cloud-cover observation, the satellites were employed experimentally to detect sea ice and snow cover. The initial 104° wide angle 1/2-vidicon TV camera and 12° narrow angle TV were converted to two wide angle TV on TIROS III and again changed to one wide angle and one 78° medium angle TV on TIROS IV, V, and VI.

TIROS VIII, launched in December 1963, included both a 1/2-inch TIROS camera and a 1-inch Automatic Picture Transmission (APT) camera. This marked the first in-space use of the APT system. The APT camera utilized a very slow-scan vidicon, as compared to the 1/2-inch TV camera. The latter required two seconds to scan its 500 TV-line image; the APT camera required 200 seconds for readout of its 800 TV-line image. By virtue of the 2-kHz bandwidth of the APT system, TIROS VIII was able to transmit direct, real-time television pictures to a series of relatively inexpensive APT ground stations located around the world.

TIROS IX, the first "wheel-mode" satellite, was launched in January 1965 with the objective of expanding the capability of the TIROS satellites to provide complete global weather observation on a daily basis. This represented an increase of four times the daily observation provided by the predecessor TIROS satellites. With its new design, TIROS IX differed from its predecessors in many aspects and was the forerunner of the satellites now used in the TIROS Operational System. A pri-

mary difference was that in TIROS I through VIII, the two TV cameras were mounted on the baseplate of the satellite with the optical axes parallel to the inertially stabilized spin axis. Hence, the camera axes were parallel to the orbit plane and viewed the earth for about 25 percent of each orbit. In the TIROS IX configuration, the TV cameras were mounted radially perpendicular to the spin axes and diametrically opposite one another and looked out through the sides rather than through the baseplate of the satellite. The satellite was injected into a higher inclination orbit with the spin axis in the orbital plane; however, the spin axis was then maneuvered by an improved magnetic-torquing system to an attitude normal to the orbit plane. Thus, the spinning satellite "rolled" along its orbital path and the field of view of each camera passed through the local vertical once during each spin or "roll". At the proper interval in the picture-taking sequence, the camera shutter was triggered to take a photo of the local scene when the camera was looking down at the earth. Hence, throughout the sunlit portion of the orbit, the earth below the satellite could be observed by means of a sequence of overlapping photos. By placing the wheel satellite in a near-polar, sun-synchronous orbit, the entire earth could be observed on a daily basis. Figure 6 is a mosaic of TIROS IX pictures depicting global coverage in a 24-hour period. TIROS IX was the forerunner of the Global Operational ESSA system.

TIROS X, the last of the research and development series of standard TIROS satellites, was launched in July 1965 to provide hurricane and tropical storm observations.

ESSA Global Weather Satellite System

The commitment to provide daily routine worldwide observations without interruption in data was fulfilled by the introduction of the TIROS Operational System (TOS) in February 1966. This system employed a pair of ESSA (Environmental Science Services Administration) satellites, each configured for its specific mission. Through their on-board data storage systems, the odd-numbered satellites (ESSA 1, 3, 5, 7, 9) provided global weather data to the U.S. Department of Commerce's CDA (Command and Data Acquisition) station in

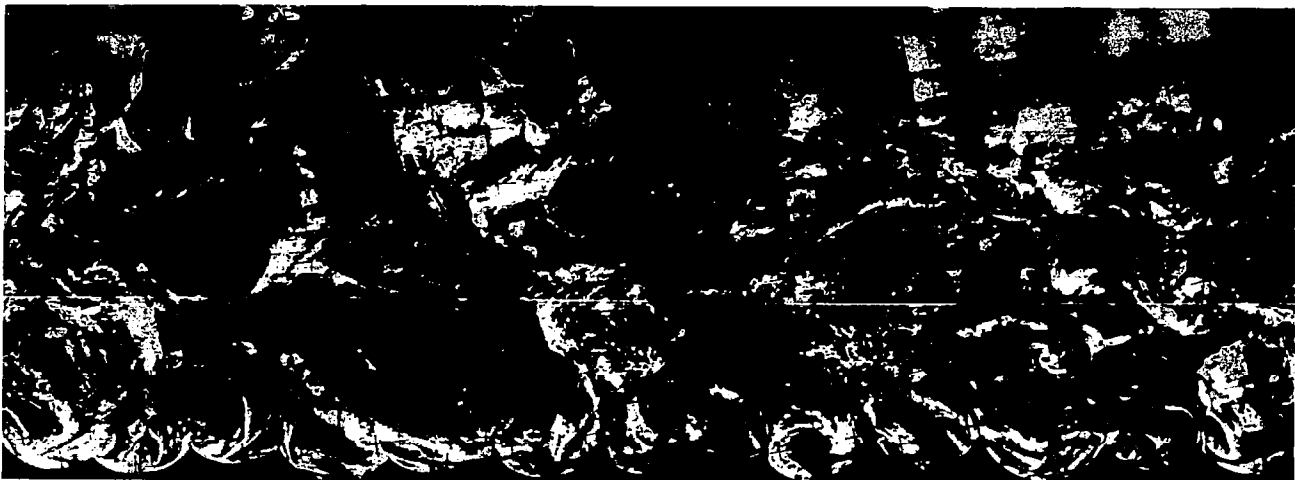

Figure 6. TIROS IX - First Complete View of the World's Weather, February 13, 1965

Wallops Island, Virginia, and Fairbanks, Alaska, and then relayed it to the National Environmental Satellite Service at Suitland, Maryland, for processing and forwarding to the major forecasting centers of the United States and to nations overseas. Nine ESSA satellites were successfully launched between 1966 and 1969. One of them, ESSA-8, remained in operation for over 7 years.

ESSA 1 was launched February 3, 1966 into a 400 nmi near polar sun-synchronous orbit to become the first operational satellite providing global observations on a daily basis. This satellite (like its predecessor, TIROS IX) utilized two 1/2-inch vidicon camera systems, wherein a pair of pictures (one from each camera) produced a picture swath 2200 miles wide and 800 miles long along the orbit track. With the 14.5 orbits completed each day, a total of 450 TV photos were available.

The second ESSA satellite, ESSA 2, was successfully placed in orbit on February 28, 1966. ESSA 2 was actually the first of the TOS-design spacecraft. It was launched into a 750 nautical-mile, sun-synchronous orbit to complement ESSA 1 in the TIROS Operational System by providing direct, real-time readout of APT pictures to the APT ground stations located throughout the world. The pair of ESSA satellites fulfilled the commitment made by the United States to provide an operational meteorological satellite system in the first quarter of 1966. On October 2, 1966, the ESSA 3 satellite was launched. It replaced ESSA 1. ESSA 3 was launched into a 750 nautical-mile, sun-synchronous orbit. This satellite was configured with the Advanced Vidicon Camera System (AVCS), which provided higher resolution and a larger picture area than the 1/2-inch TIROS cameras. To ensure uninterrupted daily global photo-coverage, three additional APT satellites were launched, ESSA 4, 6 and 8. Likewise, three more AVCS were orbited, ESSA 5, 7 and 9, to assure continuous operational service.

ITOS - The Improved TIROS Operational System

TIROS-M Configuration

The ITOS system was designed as a third-generation meteorological satellite system that would meet NOAA's requirements for obtaining systematic, world-wide, day-and-night weather observations routinely and reliably from a single spacecraft. The Delta-launched ITOS satellites operated in a sun-synchronous, near-polar circular orbit at an altitude of 1463 kilometers (908 miles). During the satellite's 115-minute orbital period, the earth rotates 28.5 degrees. The sensor view angles assured contiguity of coverage between adjacent orbits as well as observation in the orbit track; hence, during the 12.5 orbits daily, global imaging was achieved.

The ITOS-1 series of satellites carried redundant television camera subsystems (APT and AVCS) and scanning radiometer subsystems. The ITOS television sensors, proven on the ESSA satellites, provided direct real-time readout of APT pictures to stations anywhere in the world; in addition, the recorded video data from the AVCS TV system provided global data to the U.S.A. CDA (Command and Data Acquisition) stations for retransmission to NESS, the National Environmental Satellite Service, Suitland, Maryland. The dual-channel

scanning radiometer and its associated signal processor and recorders provided for day and night observations, and the recording of surface temperatures of the earth, sea, and cloud tops. The recorded data was played back to the CDA stations; the realtime data was directly read out to APT stations. These satellites were also equipped with a solar proton monitor, which provided NOAA's Space Disturbance Center at Boulder, Colorado, with timely warnings of solar energy bursts in the vicinity of earth. A flatplate radiometer (FPR) on board each spacecraft gathered heat balance data. The ITOS system provided for continuous earth orientation of the spacecraft surface containing the primary sensors and maintained 3-axis orientation of the spacecraft to better than ± 0.5 degree at all times.

The general physical configuration of the ITOS satellite is shown in Figure 7, which shows the similarity between the NOAA-2 (ITOS-D) and ITOS-1 spacecraft. The satellite was a rectangular, box-shaped structure, approximately 101.6 cm (40 inches) by 101.6 cm (40 inches) by 121.9 cm (48 inches) long. On the bottom of the structure, a cylindrical transition section attaches to the 94 cm (37 in.) diameter adapter section of the second stage of the Delta launch vehicle. The ITOS-D series spacecraft weigh approximately 340 kg (750 lb) compared with the 310 kg (683 lb) of the ITOS-1 (TIROS-M) spacecraft. The three solar panels (each measuring 92.7 by 161.3 cm) [36.5 x 63.5 inches] are mounted along the main body of the satellite with their hinge lines at the top of the structure. In the deployed position, the 4.5 square meter array lies in the orbit plane. A total of 10,260 2 by 2 cm silicon cells comprised the solar array that provided an initial power output of over 400 watts. The power system provided an adequate margin of power over a sun-angle range of 30 to 60 degrees. Thermal control was achieved by the application of passive and active thermal-control techniques. Most of the satellite was covered by multilayer insulation blankets, except for the primary sensor openings and the areas used for the active and passive thermal control systems.

ITOS-D Configuration

The second configuration of the ITOS spacecraft series, ITOS-D, expanded the operational capability of the ITOS system and its ability to achieve the long-term objectives of NOAA for sensing the environment of the planet. This system utilized the ITOS basic space bus with a new complement of operational environmental sensors: a redundant, very high resolution radiometer (VHRR); a redundant vertical temperature profile radiometer (VTPR); an improved, redundant, scanning radiometer (SR); and the solar proton monitor (SPM). The APT, AVCS, and FPR systems have been deleted in this new configuration.

The ITOS-D spacecraft series again, as in the ITOS-1 series, provided both real-time direct data to APT-type receiving stations throughout the world and stored data to the two primary NOAA CDA stations. Three types of real-time data were available to the local users: SR over the APT VHF link, VHRR over the S-band link, and VTPR over the beacon link. The SR data, which was similar to that of ITOS-1, provided to local users 0.52 to 0.73-micrometer visible data and 10.5 to 12.5-micrometer IR

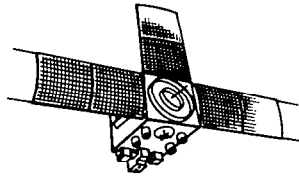

ITOS 1, NOAA 1

- Payload**
- 2 APT TV Cameras
 - 2 AVCS TV Cameras
 - 2 Scanning Radiometers
 - 1 Flat Plate Radiometer
 - 1 Solar Proton Monitor
- 3-Axis Momentum Bias Stabilization
- Mission**
- Global Daytime Direct Readout
 - Global Daytime Stored Data
 - Day & Night VIS and IR Direct and Remote Data
 - Heat Budget Data
 - Electron, Proton Data
- ITOS-1 launched 1/23/70
 NOAA-1 launched 12/11/70
 ITOS-B Launch Vehicle Failure

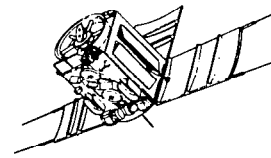

NOAA 2, 3, 4, 5

- Payload**
- 2 Scanning Radiometers
 - 2 Very High Resolution Radiometers
 - 2 Vertical Temperature Profile Radiometers
 - 1 Solar Proton Monitor
- Mission**
- Global Visible and IR Imaging
 - Medium Resolution - Real Time and Remote
 - High Resolution - Real Time and Limited Remote
 - Temperature Sounding Real Time and Stored Global
 - Electron and Proton Flux Data
- NOAA 2 - 10/15/72
 NOAA 3 - 11/6/73
 ITOS E Launch Vehicle Failure
 NOAA 4 - 11/15/74
 NOAA 5 - 7/29/76

Figure 7. ITOS/NOAA Improved TIROS Operational System, 1970-1978

data with a resolution of 3.7 and 7.4 km, respectively. The VHRR two-channel scanning radiometer provides data in two spectral regions to the local user: 0.6 to 0.7-micrometer visible and 10.5 to 12.5-micrometer IR. The resolution at local vertical for the VHRR is 0.9 km, both in the IR and visible channels. The vertical temperature profile radiometer provided sounding of the temperature profile from the surface of the earth to about 30,500 meters (100,000 ft). The temperature sounding was made in the 15-micrometer Q-branch region of the CO₂ spectrum. The soundings are made through eight narrow channels. The NOAA processed VTPR data yielded a global temperature map on a 450 km grid. The Solar Proton Monitor (SPM) continuously measured proton and electron flux at orbit altitude. The SPM monitored the environment with six solid-state detectors.

The Current TIROS-N/NOAA Operational System

The fourth generation polar orbiting environmental satellite system, designated TIROS-N, completed development and was placed into operational service in 1978. Eight spacecraft in this series will provide global operational service from 1978 through 1986. TIROS-N provides NOAA with the global meteorological and environmental data required to support both the operational and the experimental portions of the World Weather Watch Program. This new series has a new complement of data gathering instruments. One of these instruments, the Advanced Very High Resolution Radiometer (AVHRR), increases the amount of radiometric information for more accurate sea-surface temperature mapping and identification of snow and sea ice, in addition to day-and-night imaging in the visible and infrared bands. Other instruments, contained in a subsystem known as the TIROS Operational Vertical Sounder (TOVS), provide improved vertical sounding of the atmosphere. These instruments are the High Resolution Infrared Sounder (HIRS/2), the Stratospheric Sounding Unit (SSU), and the Microwave Sounding Unit (MSU). A Data Collection System (DCS) receives environmental data from fixed or moving

platforms such as buoys or balloons and processes it. A Solar Environmental Monitor is included to measure proton, electron, and alpha particle densities for solar disturbance prediction.

The data collected by the satellite's advanced instrument complement is processed and stored on board for transmission to NOAA's central processing facility at Suitland, Maryland via the CDA station. Data is also transmitted in real time, at VHF and S-band frequencies, to remote stations distributed about the globe. Figure 8 depicts the TIROS-N equipment layout.

The TIROS-N satellite, launched by an Atlas E/F from the Western Test Range, operates in a near-polar circular sun-synchronous orbit with a nominal altitude of either 833 or 870 km. In the operational configuration, two satellites are positioned with a nominal orbit plane separation of 90 degrees.

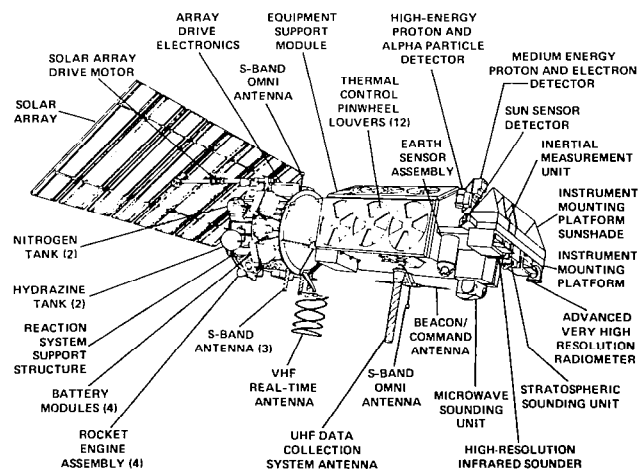

Figure 8. TIROS-N Spacecraft



The instrument payload for TIROS-N consists of:

- (1) The Advanced Very High Resolution Radiometer (AVHRR), initially a four-channel currently a five-channel instrument, cross-track scanning instrument providing image and radiometric data in the visible, near-infrared and far-infrared portions of the spectrum. The instrument is used to observe clouds, land-water boundaries, snow and ice, water vapor, temperature of clouds, and land and sea surface.
- (2) The TIROS Operational Vertical Sounder (TOVS), a subsystem consisting of three instruments, providing temperature profiles of the atmosphere from sea level to 20 miles, water vapor contents, and total ozone content.
 - The High-Resolution Infrared Sounder (HIRS/2), a 20-channel step-scanned, visible and infrared spectrometer, used to produce tropospheric temperature and moisture profiles.
 - The Stratospheric Sounding Unit (SSU), a 3-channel, pulse-modulated, step-scanned, far-infrared spectrometer, used to produce temperature profiles of the stratosphere.
 - The Microwave Sounding Unit (MSU), a 4-channel, step-scanned spectrometer with response in the 60-GHz O₂ band, used to produce temperature profiles in the atmosphere in the presence of clouds.
- (3) The Data Collection System (DCS), a random-access system for the collection of meteorological environmental and scientific data from in-situ platforms, both movable and fixed, such as buoys, balloons, and remote stations.
- (4) The Space Environment Monitor (SEM), a 3-instrument multidetector unit used to monitor solar particulate energies in the vicinity of the satellite. SEM will measure solar proton, alpha particle and electron flux-density energy spectrum in the vicinity of the satellite.

Advanced TIROS-N (NOAA-E, F, G)

The last three spacecraft in the TIROS-N series (NOAA-E, F, and G) are being modified for a larger payload complement to further enhance the TIROS Operational System. In addition to the TIROS-N basic complement, a list of growth sensors anticipated for future requirements was used in developing the requirements for the spacecraft's support subsystem. This resulted in a satellite design with inherent growth capabilities for continued orderly evolution. Thus, NOAA-E, the sixth spacecraft in the TIROS-N series will be an advanced configuration equipped for the Search and Rescue (SAR) mission. The SAR payload will be used in a joint U.S.A.-Canadian, French-Russian program to perform an experimental mission that will provide data for identifying and locating downed aircraft and ships in distress. The NOAA-F and G spacecraft (refer to Figure 9) will also be equipped with a

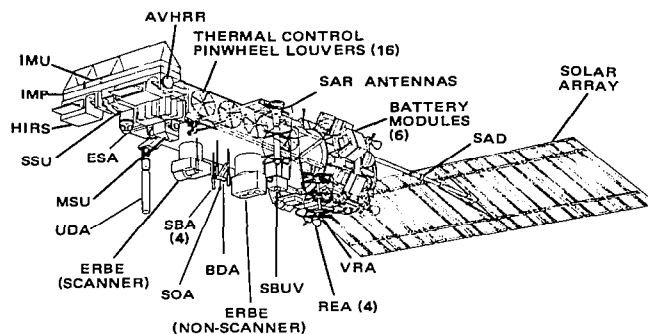

Figure 9. Advanced TIROS-N Spacecraft

SBUV (Solar Backscatter Ultraviolet Instrument) to measure the earth's ozone distribution and the ERBE (Earth Radiation Budget Experiment) will be used to determine the radiation loss and gain to and from the planet. Table 2 depicts the instrument complement for the TIROS-N/NOAA A-G series. Table 3 summarizes the physical characteristics of this series.

Benefits

Over the past 22 years, the U.S. TIROS/ESSA/ITOS/NOAA Meteorological Satellite Systems have evolved where the products, the quantity, quality, and reliability of satellite coverage have improved greatly. Since 1966 the entire earth has been photographed at least once daily on a continuous basis. The photographs are not only used in real-time operations, but are also placed in archives from which they can be retrieved for use in research case studies. From its inception as a new research tool with its potential not fully realized, satellite data has steadily increased in importance. It is now being used by meteorologists and environmental scientists on a widespread basis in routine operations throughout the world and is considered almost indispensable for analyses and short-range forecasts.

The meteorological data from around the earth is received at the National Environmental Satellite Service (NESS) in Washington, transformed into a broad variety of products, and distributed throughout the world. Selected images from several satellites are shown in Figure 10. Although the processing necessary to reduce these images to the

TABLE 2. TIROS-N/NOAA (A-G) INSTRUMENT COMPLEMENT

Payload	TIROS-N	NOAA-6	NOAA-7	NOAA-D	NOAA-E	NOAA-F	NOAA-G
AVHRR 4-Channel 5-Channel	X	X	X	X	X	X	X
TOVS							
HIRS-2	X	X	X	X	X	X	X
MSU	X	X	X	X	X	X	X
SSU	X	X	X	X			X
DCS	X	X	X	X	X	X	X
SEM							
MEPED	X	X	X	X			X
HEPAD	X	X	X				
TED	X	X	X	X			X
SBUV						X	X
ERBE Scanner Non-Scanner						X X	X X
SAR					X	X	X

TABLE 3. TIROS-N/NOAA (A-G) PHYSICAL CHARACTERISTICS

	TIROS-N/ NOAA A-D	ADVANCED TIROS-N (NOAA E-G)
Weight - Lb		
Lift-Off	3,127	3,725
On Orbit	1,640	2,235
Payload	510	810
Size - Inches		
Length - Nondeployed	146	165
Diameter	74	74
Length - Deployed	256	294
Power - Watts		
Array	1,260	1,470
Bus - Load	266	286
Payload	146	263

printed page results in the loss of detail, their scope and potential usefulness are readily apparent.

The satellite information has proven extremely useful in two broad types of situations. First, there are extensive areas of the earth from which conventional reports are sparse, namely: the oceanic regions of the northern and southern hemispheres, deserts, and the polar regions. Satellite information fills these voids by locating the large-scale features depicted by the cloud formations. These features include storm systems, fronts, upper level troughs and ridges, jet streams, fog, stratus, sea ice conditions, area of snow cover, and to some extent upper level wind directions and speeds. The satellite data is also used in conjunction with other data to provide quantitative heights of constant pressure surfaces as inputs to conventional analyses.

The second type of situation to which satellite data is usefully applied is the location and tracking of hurricanes, typhoons, and tropical storms. Coastal and island stations with little or no adjacent conventional weather information can make maximum use of APT data. The satellite data provides information on the presence and the position of frontal patterns, storms, and general

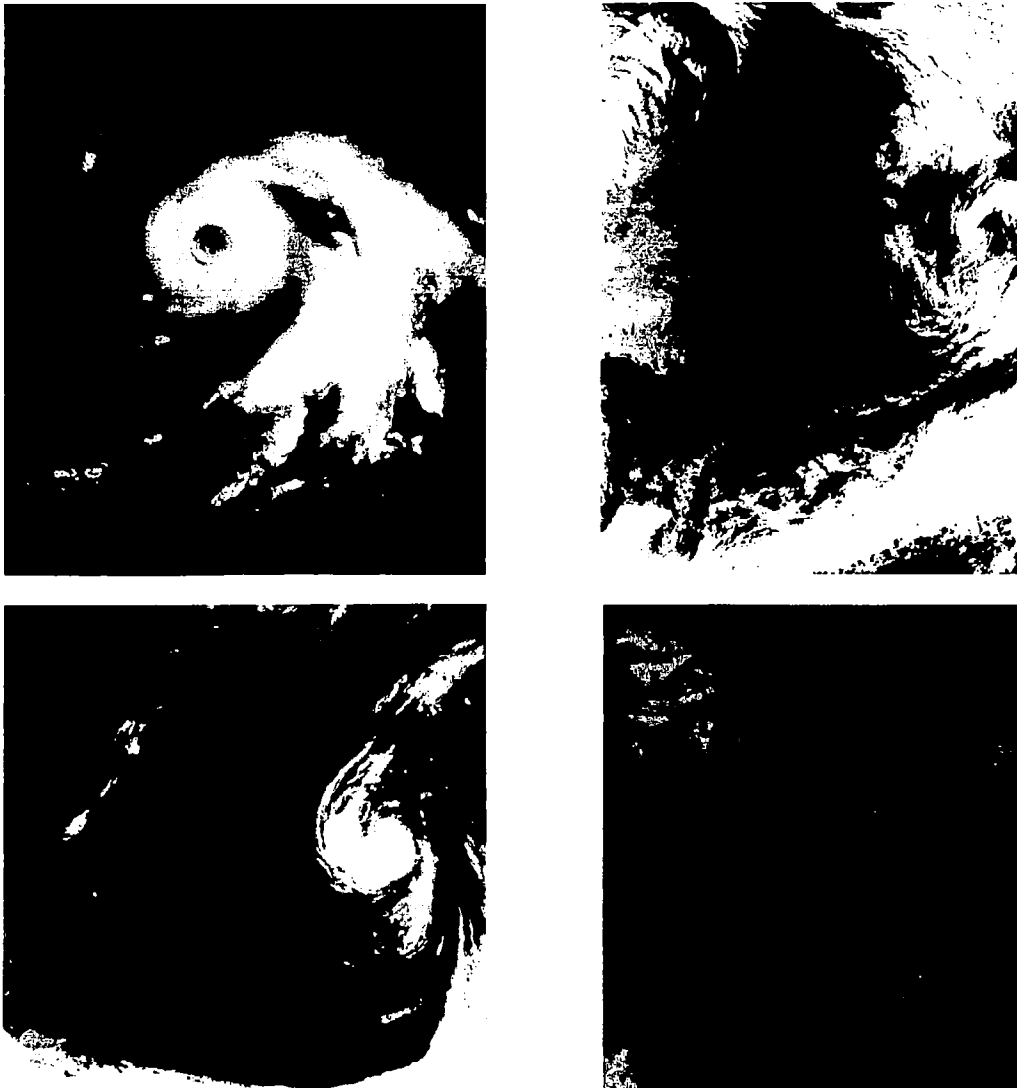

Figure 10. NOAA Meteorological Satellite VHRR Photographs

cloud cover. Storms are usually spotted in their developing states, often beyond the normal range of weather reconnaissance aircraft from their bases of operation. The APT, Direct Readout Infrared (DRIR), and processed-stored visible and infrared data are available at most offices with tropical storm forecast responsibilities. All the tropical regions of the world are completely monitored through satellite data received by the National Environmental Satellite Service.

The infrared data from the TIROS-N/NOAA satellites can be used to produce charts showing the sea-surface temperature over a larger area and with more frequency than is possible from any other source. This information is useful to shipping interests and to the fishing industry, and is a vital input to meteorological forecasts. Satellite pictures display the extent and character of ice fields in the Arctic and Antarctic Seas, and on the Great Lakes, with a frequency and geographic coverage never before approached.

Worldwide atmospheric temperature soundings provided by the satellite result in more complete and

accurate analyses for use in weather forecasts. Soundings by satellite provide coverage over oceans and remote areas not covered by conventional sounding instruments. TIROS direct readout data is received by over 900 ground stations in over 100 countries.

Summary

The TIROS series of satellites will continue to provide beneficial data to the United States and the world community. The meteorological products for this highly successful program have grown. Initially gathering daytime cloud observations in 1960, TIROS today provides data used for atmosphere temperature and moisture profiles, sea surface temperature, and sea ice and snow cover observation. It collects and locates data from fixed or moving platforms, and monitors electron and proton particles emanating from the sun. Its broad international acceptance and use is unmatched. The additional spacecraft in the TIROS series will assure global coverage during most of this decade.

THE NIMBUS SATELLITE SYSTEM - REMOTE SENSING R&D PLATFORM OF THE 70'S

I. S. Haas, Senior Consultant
General Electric Company

R. Shapiro, Department Project Manager OSP-A
NASA/Goddard Space Flight Center

Abstract

Paper No. 82-0384. The Nimbus Satellite System - Remote Sensing R&D Platform of the 70's.

I. S. Haas, Sr. Cons. Gen. Elec. Co. Phila., Pa.
R. Shapiro, Dep. Proj. Mgr. OSP-A, NASA/Goddard

Originally conceived by the United States Weather Bureau (Now NOAA) and the National Aeronautics and Space Administration during the earliest days of the Space Program to be the future operational weather satellite, the Nimbus series of seven satellites became the work horse and experimental backbone of the NASA/NOAA space research program during the next decade and a half. Early problems in developing the Attitude Control System and proving its operational characteristics in the simulated space environment contributed to cost growth and schedule delay, encouraging the federal agencies to reconsider the operational commitment. The resulting program proved itself many times over orbiting more than thirty-five remote sensing instruments; contributing substantially to the scientific knowledge of atmospheric and weather and paving the way for operational sensors on both TIROS and MILMETSATS.

I. Introduction

The Nimbus observatory satellite project, initiated by the National Aeronautics and Space Administration in the early 1960's matured to become the Nation's principal satellite platform for remote-sensing research. Starting with the launch of Nimbus 1 in 1964, the satellites have grown significantly in sophistication, complexity, weight, capability and performance. Each satellite mission has advanced man's understanding of Earth's atmospheric environment and its structure.

Nimbus spacecraft are placed in sun-synchronous, near-polar orbits and provide global coverage twice in every 24-hour period. The spacecraft is butterfly-shaped, 10 feet tall and 5 feet in diameter. See Figure 1, a detailed illustration of Nimbus 7 showing the location of various elements of the satellite including the complement of nine experiments. A circular structure at the base of the satellite houses the major subsystems and experiments. A three-axis active attitude control subsystem mounted above the sensory ring keeps the spacecraft oriented to Earth's center with an accuracy of better than one degree. Two solar paddles track the sun during daylight operation and convert its energy into electrical power for the spacecraft's subsystems.

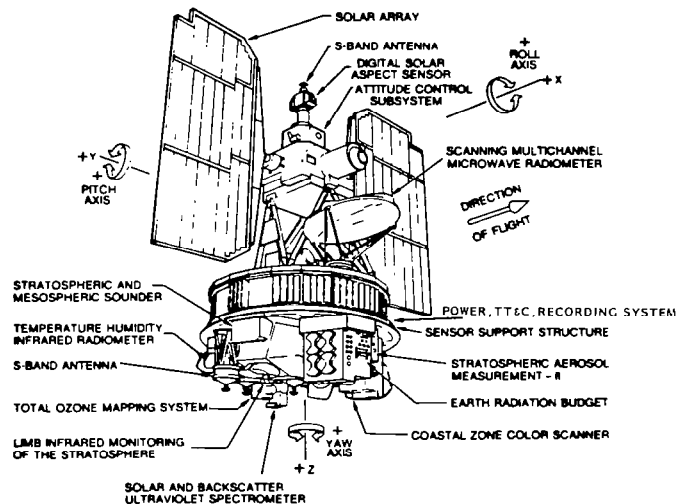

Figure 1. Nimbus 7 Spacecraft

As application/research vehicles, the seven Nimbus spacecraft have been used for the development, test and application of a variety of new and advanced meteorological and geophysical remote-sensing instruments and associated data transmission and processing techniques. A wealth of new data applicable to meteorology, oceanography, geology, geography and hydrology has been transmitted to Earth. Beneficial results are still being obtained from the last three Nimbus which are still operational. See Figure 2 where launch dates and operating lifetimes of both Nimbus and Landsat observatories are displayed.

In spite of an improper orbit, elliptical instead of circular at 575 miles, Nimbus 1, the first three-axis fully stabilized satellite launched by NASA on an Air Force Agena launch vehicle, achieved operational status a few days after its launch on August 28, 1964. On that day, a new era was initiated in the science of meteorology, leading to a worldwide dependence on space for synoptic data to feed the hungry machines used by the world's meteorological community.

To quote a representative of the Weather Bureau who was present at the Nimbus 1 NASA/Press briefing on September 2, 1964, and was asked about the meteorological community dependence on satellite data, (at that time, two TIROS spin

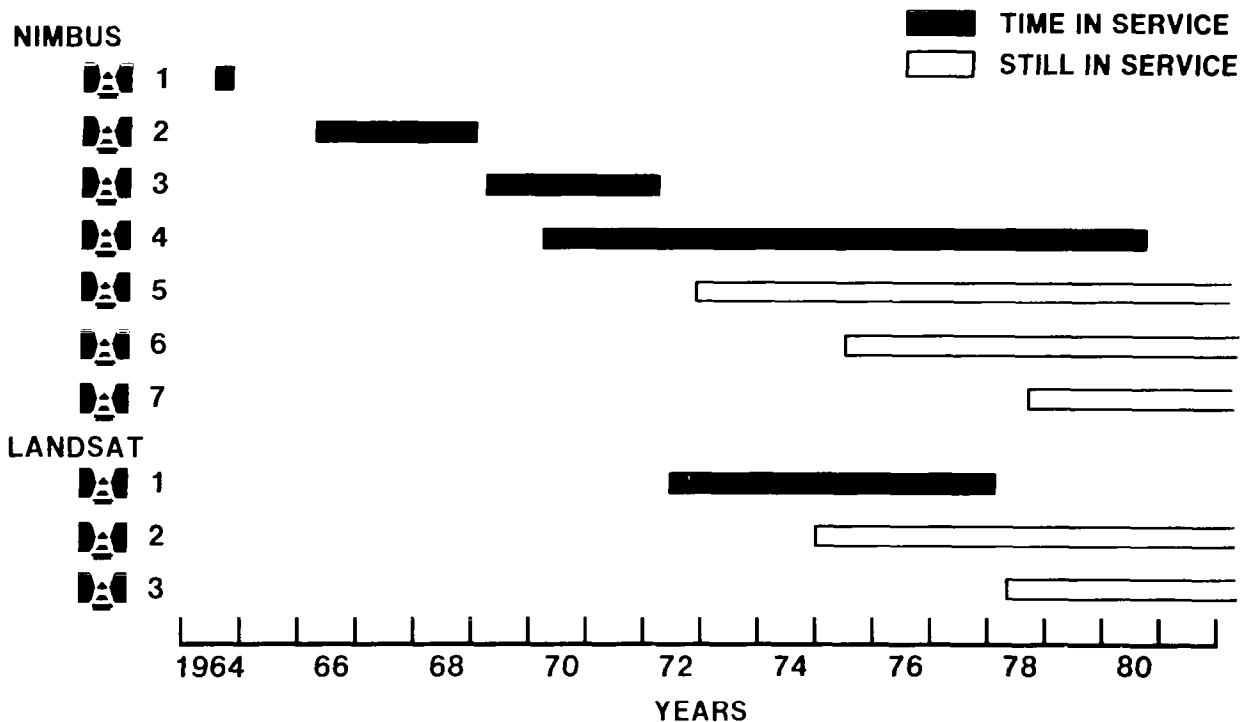

Figure 2. Decades of Experimental Performance, Nimbus/Landsat

stabilized satellites were actively providing image data to the U.S. only.)---"Are we dependent on them? Yes, we certainly are. ---When the world sees the quality of APT (the Automatic Picture Taking vidicon capability on Nimbus 1 - a first) they will be demanding it more and more. As you can see, it's absolutely marvelous. We have been using it every day since Nimbus went up and using it to good advantage."

The continuance of the TIROS and Nimbus Programs, one operational, the other experimental was assured from this point on. Some of the experimental firsts, the quasi operational utilization of the data and the later adaptation of those sensory devices to the operational satellite environment are brought out in this paper. The Nimbus Program, consisting of eight satellite launches, seven of which were successful in achieving orbit, carried a total of 48 sensors and experiments contributing mightily to the fields of earth and atmospheric sciences. In addition, a direct adaptation of the Nimbus satellite, the Earth Resources Technology Satellite Program (ERTS, now called Landsat) resulted in orbiting three satellites carrying both high resolution vidicon cameras and multi-spectral scanners. Both sensor systems evolved from highly successful experimentation results achieved from earlier Nimbus satellites.

To the basic Nimbus bus, were added a wideband recording and transmission system, the RBV (Return Beam Vidicon) and MSS (Multi-Spectral Scanner) sensors. A slight modification to the solar array and attitude control system provided a 9:30 a.m. orbit instead of the standard Nimbus 12:00 noon

orbit. An artist rendition of the Landsat satellite is shown in Figure 3. The data from Landsat, processed through a dedicated high throughput Ground Data Handling System and highly organized cadre of scientific investigators, opened the door to an entirely new set of scientific analyses, techniques and applications. The then current NASA Administrator, Dr. James Fletcher, had this to say about the contribution of the ERTS Program to our society. "If I had to name one space age development to help save the world, I would pick ERTS." - September 1973

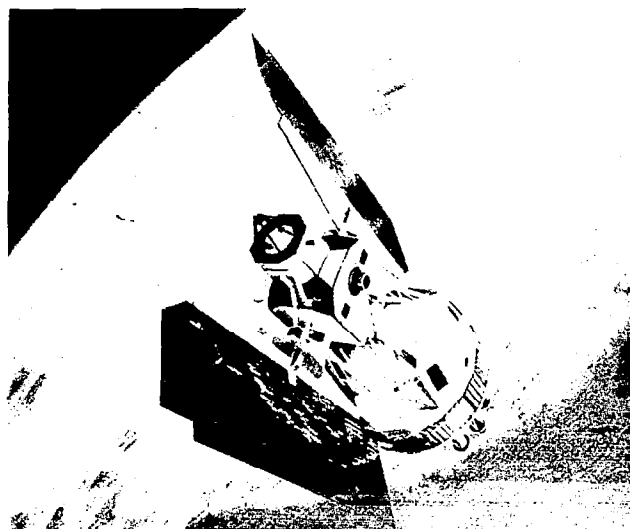

Figure 3. Artist's Rendition of ERTS/Landsat

II. Satellite System Design

The Nimbus Satellite design had its origins very early in the evolutionary development of NASA's Goddard Space Flight Center as a Satellite System designer, implementer and contracting agency responsible for scientific and applications satellites of the 1960's. Originally conceived as an "In-House" project, where subsystems and payloads would be "contracted-out" with final integration at GSFC, the Center Management eventually decided to fund an integrating contractor. This role, together with the Attitude Control Subsystem development was assigned to General Electric Company. Many features of the design resulted from GSFC's early experience with Space Flight and in large part, the eventual long life experienced by almost all the satellites was due to the configuration and conservative nature of the original design. (Life expectancy in the contract was specified to be at least six months). In today's broadened knowledge of the space environment and a generation of experience in reliable/redundant design, the original life requirement sounds overly simplistic and shortsighted. Indeed, by the time the Nimbus configuration was employed for Landsat in the early '70's, the life expectancy was raised to three years. Current technology affords at least 10-year life from similar performing satellites and there is no question that the goals have been raised based on demonstrated performance of the Nimbus satellite and others of similar complexity.

Back at the inception of Nimbus design, several methods of stabilization (in orbit) were known, i.e., Spin Gravity Gradient and Reactive Control. It was decided to combine some features of both Reactive and Gravity Gradient control into Nimbus, explaining to some degree the two mass design, (sensory ring with strut separation of the Attitude Control Subsystem; see Figure 1, where the Nimbus 7 configuration is described.) In fact, on Nimbus 4, the Gravity Gradient feature was actively explored with the addition of a gravity gradient deployable mass installed on the top of the Attitude Control Subsystems and successfully demonstrated in orbit. This feature, combined with the roll, pitch and yaw reaction

wheel has been beneficial in providing Nimbus with very low rotational rates, especially resulting in very reduced data correction requirements for experiment data processing.

Other benefits accrued from the decision to separate the Attitude Control Subsystem from the sensory ring. The Nimbus Program had an extraordinarily high content of government furnished equipment, resulting in a continuing need to integrate a multitude of "black boxes" and remote sensor instruments from various suppliers into a single integrated functioning system. The process of integration, and thereby the cost of integration, was simplified to a great degree by the ability to do separate and parallel integration and test of these elements of the system. The Multi-Mission Satellite, (MMS) later developed by NASA/GSFC had this same concept in the way the program is scoped and the subsystems developed. On Nimbus, this concept was particularly useful since it permitted ease of interchangeability of major system elements between concurrently produced satellites and between Nimbus and Landsat in later years.

As the program progressed in its evolutionary development from its original concept of an operational metsat into a research/experimental observatory system, many and varied upgrades were introduced into the satellite design to accommodate increasingly sophisticated payloads. For Nimbus 3 a new power system was designed, providing increased efficiency solar conversion and a significant increase in electrical power capability during satellite night. Earlier designs carried instruments mainly utilized for daytime sensing. The experiment complement on Nimbus 3 and beyond was to become more focused on remote sensing during the entire orbit, with sensors operating in IR, UV and microwave portions of the spectrum. Table 1 summarizes the significant growth and dramatic changes in operating payloads of all seven Nimbus observatories. The satellite configuration readily adjusted to each successive vehicle in terms of sensor view angle requirements, RFI, thermal isolation and radiation cooling requirements.

Table 1. Growth of Sensor Technology, Nimbus Observatories

	NIMBUS						
	1	2	3	4	5	6	7
NUMBER OF EXPERIMENTS	3	4	9	9	6	9	9
NUMBER OF SPECTRAL CHANNELS	3	8	28	43	34	62	79
SPECTRAL REGIONS							
VISIBLE	X	X	X	X	X	X	X
INFRARED	X	X	X	X	X	X	X
FAR INFRARED		X	X	X	X	X	X
ULTRAVIOLET			X	X		X	X
MICROWAVE					X	X	X

Nimbus 4 provided a significant upgrade in the Attitude Control Subsystem and of equal importance, the addition of the Versatile Information Processor (VIP) which together with the command system clock and tape recorders represented a complete real time and delayed capability to execute, precision clock, sample and hold, store and transmit in a completely flexible and reprogrammable way, experimental data from the differing payload complements carried on each successive observatory.

III. Nimbus Achievements

Growth of Earth Science Applications

Named after the Latin word for raincloud, Nimbus was originally conceived as a meteorological satellite concerned primarily with providing atmospheric data for improved weather forecasting. With the addition of more sophisticated sensing devices on each succeeding vehicle, this applications/research observatory program grew significantly in capability and performance through a total of seven launches and a wide range of earth sciences.

Data produced by the sensing instruments on Nimbus 5, 6 and 7 are still being studied and applied in the following fields:

1. Oceanography (geography of oceans and related phenomena).
2. Hydrology (study of water, especially on surface of the land, in the soil and underlying rocks, and in the atmosphere).
3. Geology (science of the Earth's composition, structure and history as recorded in rocks).
4. Geomorphology (study of the form of the Earth, general configuration of its surface, distribution of land and water, and evolution of land forms).
5. Geography (description of land, sea, and air, and distribution of life, including man and his industries).
6. Cartography (map making and map revision).
7. Agriculture (soil conditions, vegetation patterns, crop production).
8. Meteorology (concerned with global water vapor distribution and temperature profiles as they affect weather forecasting).

The accompanying chart (Table 2) summarizes the experiments, arranged alphabetically, that have been used on one or more of the seven Nimbus observatories. The listing illustrates the wide variety of remote sensing techniques that have contributed to the growth and increased maturity of remote sensing technology.

The Experiments and Their Achievements

The growing list of achievements attained by the Nimbus observatories attests to the success of NASA's satellite program. The technological

growth of the devices flown on the Nimbus spacecraft is a complex story and the following discussion merely summarizes a small portion of what has been accomplished. The continuous flow of sensor data from space and the new quasi-operational techniques that have evolved are contributing greatly toward improved, long-range weather forecasts and further understanding of Earth's complex environment. Selected experiments are described and representative pictures of the many data types and application areas are presented.

Early Nimbus Experiments

Nimbus 1 carried three experiments which successfully demonstrated the design concept, with all sensors performing exceptionally well. The Automatic Picture Transmission (APT) subsystem for the first time from space continuously transmitted photographic data (Figure 4) of synoptic meteorological conditions to local weather stations anywhere in the world that were equipped with relatively inexpensive receiving equipment. The Advanced Vidicon Camera Subsystem (AVCS) recorded three pictures simultaneously with overlapping field of view for subsequent readout. The High Resolution Infrared Radiometer (HRIR) provided nighttime IR coverage of the Earth and cloud cover so that mosaics of worldwide weather conditions could be produced.

The vehicle provided an exceptionally clear photo of Hurricane Cleo during its first day in orbit and subsequently tracked other hurricanes and Pacific typhoons. In addition, the pictures enabled cartographers to correct inaccuracies on relief maps and supplied better definition of the formation of the Antarctic ice front.

At the time of Nimbus 2 launch, the number of APT stations had grown from 65 to over 300, located in 43 countries. The system was modified to enable HRIR data to be read out in real time, another first for space meteorology. Temperature patterns could be obtained of lakes and ocean currents (of vital interest to shipping and fishing industries), and thermal pollution could be identified.

Medium Resolution Infrared Radiometer (MRIR)

A new experiment on Nimbus 2, the MRIR, measured radiation emitted and reflected from the Earth in five wavelength intervals from visible to infrared. The data permitted detailed study of the effect of water vapor, carbon dioxide, and ozone on the Earth's heat balance. A data composite of all five spectral channels together with spacecraft annotated data and a calibrated gray scale, was generated for each orbit. With rapid turnaround at the Nimbus Ground System, these weather annotated data sheets found their way into early experimental operational weather analysis.

Image Dissector Camera Subsystem (IDCS)

On Nimbus 3 and Nimbus 4, both the APT and the AVCS subsystems were replaced by the Image Dissector Camera Subsystem. The IDCS was designed to provide daytime cloud cover pictures in both real time using the Real Time Transmission Subsystem (RTTS) and by stored playback data using

Table 2. Nimbus Experiment Summary

Abbreviation	Experiment Name	Experimenter	Equipment Contractor	Type of Sensor	Scientific Objective
APT	Automatic Picture Taking	GSFC	RCA	Slow Readout Vidicon Camera	Local Cloud Cover Images (pictures)
AVCS	Advanced Vidicon Camera	GSFC	RCA	Wide Angle Multi-vidicon Camera	High Resolution Cloud Cover Images
BUV	Backscatter Ultraviolet Spectrometer	NCAR/GSFC	Beckman	Radiometer/Spectrometer	Spatial Distribution of Atmospheric Ozone
CZCS	Coastal Zone Color Scanner	GSFC	Ball Bros.	Multispectral Imaging Radiometer	Ocean and Coastal Area Measurement of Chlorophyll, Vegetation, Temp. and Geibstoff
ESMR	Electrically Scanning Microwave Radiometer	GSFC	Aerojet	Scanning (imaging) Microwave Radiometer	Thermal Image of the Earth and Ocean Unobscured by Clouds
ESMR-F	Electrically Scanning Microwave Radiometer	GSFC	Aerojet	Two Polarization, Scanning Microwave Radiometer	Map Liquid Water Content of Clouds Sea-Ice Cover, Cross Characteristics of Land.
ERB	Earth Radiation Budget	NOAA	Gulton	Fixed and Scanning Radiometer	Measure Planetary Heat Budget total Solar Radiation and Angular Distribution of Earth Flux
FWS	Filter Wedge Spectrometer	GSFC	ITT	Radiometer/Spectrometer	Vertical Distribution and Temperature Profile of Water Vapor and Carbon Dioxide
HIRS	High Resolution Temperature Sounder	GSFC/NOAA	ITT	Scanning Spectral Radiometer	Vertical Temperature Profile and H ₂ O Distribution
HRIR	High Resolution Infrared Radiometer	GSFC	ITT	IR Imaging Radiometer	Night Cloud Cover
IDCS	Image Dissector Camera	GSFC	ITT	Dual Channel Imaging Radiometer	Day/Night Cloud Cover
IRIS	Infrared Interferometer Spectrometer	GSFC	TI	Imaging Radiometer	Day Cloud Cover
IRLS	Interrogation, Recording, and Location System	GSFC	Radiation Inc	Radiometer/Spectrometer	Vertical Temperature & Moisture Profile and Distribution of Other Atmospheric Gases
ITPR	Infrared Temperature Profile Radiometer	ESSA	Gulton	Radiometer/Spectrometer	Locate, Interrogate and Record Data from Remote Stations (balloons and buoys)
LIMS	Limb Infrared Monitoring of the Stratosphere	LRC	Honeywell	Multispectral Scanning Radiometer	Vertical Temperature Profile (CO ₂)
LRIR	Limb Radiance Inversion Radiometer	NCAR U of Florida	Honeywell	Scanning Spectral Radiometer	Stratospheric Measurement of Temp., Ozone, Water Vapor, Nitric Acid, Nitrogen Dioxide
MRIR	Medium Resolution Infrared Radiometer	GSFC	SBRC	Scanning Spectral Radiometer	Stratospheric Measurements of Temperatures, Water Vapor, and Ozone Profiles
MUSE	Monitor Ultraviolet Solar Energy	GSFC	Adcole	Imaging Radiometer/Spectrometer	Vertical Temperature Profile, Heat Balance, and Distribution of Atmospheric Gases
NEMS	Microwave Spectrometer	JPL/MIT	JPL	Radiometer/Spectrometer	Measurement of Solar Ultraviolet Energy
PMR	Pressure Modulated Radiometer	Oxford	Marconi	Radiometer/Spectrometer	Vertical Temperature Profile Using O ₂ Line Water and Water Vapor Distribution
RMP	Rate Monitoring Package	GSFC	Sperry	Scanning Spectral Radiometer	Vertical Temperature Profiles to 85 KM
RTG	Radioisotope Thermoelectric Generator	AEC	Martin		Measurement of Angular Rate by Gas Bearing Gyro
SAM II	Stratospheric Aerosol Measurement II	LRC	University of Wyoming	Spectral Radiometer	Assess the Usefulness of Radioactive Power Supplies
SAMS	Stratospheric and Mesospheric Sounder	Oxford	Hawker-Siddeley	Pressure Broadening Spectral Radiometer	Measure and Map Global Aerosol Concentration and Optical Properties in Stratosphere and Troposphere
SBUV/TOMS	Solar Backscatter UV Energy and Total Ozone Mapping Spectrometer	GSFC	Beckman	Monochro Monitor Photometer	Global Measurement of Temperature and Select Gaseous Distribution
SCAMS	Scanning Microwave Spectrometer	JPL/MIT	JPL	Scanning Spectral Radiometer	Map Total and Vertical Distribution of Ozone Measure Solar Irradiance
SCMR	Surface Composition Mapping Radiometer	GSFC	ITT	Imaging Radiometer/Spectrometer	Vertical Temperature Using O ₂ line Water Vapor Distribution
SCR	Selective Chopper Radiometer	Reading & Oxford University	Marconi	Imaging Radiometer/Spectrometer	Identification of Surface Minerals (I:RS)
SMMR	Scanning Multichannel Microwave Radiometer	GSFC	JPL	Radiometer/Spectrometer	Vertical Temperature Profile and Distribution of Atmospheric Gases
SIRS	Satellite Infrared Spectrometer	ESSA	ESSA Gulton/SBRC	Scanning Microwave Radiometer	Sea Temp., Surface Winds, Ice Extent, Soil Moisture, Snow Cover, Continental Ice Atmospheric Moisture Water Vapor and Rainfall
T&DRE	Tracking and Data Relay Experiment	GSFC	GSFC/GE/BBC	Radiometer/Spectrometer	Vertical Temperature Profile and Distribution of Atmospheric Gases
THIR	Temperature/Humidity Infrared Radiometer	GSFC	SBRC	S-Band Transponder	Range and Range Rate Measurements, Data Relay
TWERLE	Tropical Winds Energy Conversion Reference Level Experiment	GSFC/Univ of Wisconsin	TI	Imaging Radiometer/Spectrometer	Cloud Cover, and Water Vapor Mapping
				RF Receiver Balloon Transmitter	Measure Large Scale Atmospheric Motions, Conversion of Potential to Kinetic Energy, Provide 150 mb R-reference Level

Table 2. Nimbus Experiment Summary (Continued)

Abbreviation	Special Instrument Technique	Number of Data Channels (Sensor Only)	Spectral Interval	Pointing Direction	Angular Resolution (Degrees)	Scanning	Nimbus Spacecraft
APT	Stored Image Vidicon (slow scan)	1	0.5 to 0.75 μm	Nadir	2.5 nm**	77°	1, 2
AVCS	Vidicon Camera	3	0.5 to 0.75 μm	Nadir	1.0 nm**	107°	1, 2
BUV	Grating Spectrometer	12	2500 to 3888 Å	Nadir	12.0	None	4
CZCS	Mechanically Scanned Radiometer	6	.433 to .800 μm 10.5 to 12.5 μm	Nadir	0.05	Across Track $\pm 40^\circ$ Along Track $\pm 20^\circ$	7
ESMR	Electronically Scanned Phased Array Antenna Dicke Switch	1	19.35 GHz	Nadir	1.4	74°	5
ESMR-F	Electronic Conical Scanned Phased Array Antenna Measure both Horizontal and Vertical Simultaneously, Dicke	2	37 GHz	Nadir	1.1	74°	6
ERB	Two Axis Gimbal Mounted Scanning Radiometer	22	2000 Å - 50 μm	Nadir and Towards the Sun	5 14 \times +0.25 Scan Channels 1.5 Fixed Channels	Horizon to Horizon, Along Track and Across Track	6, 7
FWS	Continuously Variable Interference Filter Disk	1	1.2 - 2.4 μm 3.2 - 6.4 μm	Nadir	2.6	None	4
HIRS	Mechanically Scanned Radiometer with Spectral Selection by Interference Filters Radiation Cooler	17	0.7 - 15 μm	Nadir	1.5	72°	6
HRIR	Mechanically Scanned Imaging Radiometer Spectral Dispersion by Interference Filters	1	3.4 to 4.2 μm	Nadir	0.5	Horizon to Horizon	1, 2
		2	3.4 to 4.2 μm 0.7 to 1.3 μm	Nadir	0.4		3
IDCS	Electrically Scanned Imaging Radiometer	1	0.5 to 0.75 μm	Nadir	1.2 nm**	98.2°	3, 4
IRIS	Michelson Interferometer with Self Calibration	1	5 to 25 μm	Nadir	8.0	None	3
					5.0		4
IRLS				Nadir	120.0 (beamwidth)	None	3, 4
ITPR	Fixed Spectral Filters Mech Step Scan	7	3.8 to 15 μm	Nadir	1.5	76°	5
LIMS	Mechanical Scanning Radiometer	6	6.1 to 15.8 μm	Earth Limb	0.03°	Horizon to Space 12°	7
LRIR	Mechanically Scanned Radiometer, Interference Filters (CH ₃ /NH ₃ Cryo Cooler)	4	8.7 - 25 μm	Towards the Horizon	0.3 \times 0.03	10° Acquisition 2° Track Vertically	6
MRIR	Mechanically Scanned Radiometer with Fixed Interference Filters	5	0.5 to 29 μm	Nadir	2.7	Horizon to Horizon	2, 3
MUSE	Fixed Spectral Filter	5	1120 to 3100 Å	Towards Sun	90	None	3, 4
NEMS	Microwave Radiometer (Dicke Superheterodyne)	5	20 to 60 GHz	Nadir	10.0	None	5
PMR	Pressure Broadening Spectral Filter	2	15 μm	Nadir	4.0 \times 20.0	15°	6
RMP	Hydrodynamic Gas Bearing Gyroscope					None	3
RTG						None	3
SAM II	Mechanically Scanned Radiometer	1	1 μm	Spacecraft Sunrise/Sunset	0.01°	10° Vertical Scan	7
SAMS	Mechanically Scanned Radiometer	9	2.7 to 15 μm 25 to 100 μm	Towards Horizon	16° \times 16°	Horizon 4.5° to -9° \pm 15° About	7
SBUV/TOMS	Fixed and Spectral Scanning Radiometers (TOMS/SBUV)	20	.16 μm to .80 μm	Nadir	SBUV 11° TOMS 3°	Vertical and Cross Track	7
SCAMS	Mechanically Scanned Microwave Radiometer (Dicke Superheterodyne)	5	20 - 60 GHz	Nadir	7.5	86°	6
SCMR	Spectral Filters and Cooled Detector	3	0.8 to 1.1 μm 8.3 to 9.2 μm 10.5 to 11.3 μm (Far IR & Visible)	Nadir	0.03	Horizon to Horizon	5
SCR	Selective Absorption of Gas	6	2 to 200 μm (Near to Very Far IR)	Nadir	3.0 & 5.0	None	4
		16			1.5 & 2.2		5
SMMR	Mechanically Scanned Radiometer	10	6.33, 10.69, 18.00, 21.00, 37.00 GHz	42° Conical Off Nadir	0.8° ~ 4.2°	Conical Forward of Nadir \pm 25°	7
SIRS	Grating Spectrometer	8	11 to 15 μm (Far IR)	Nadir	12.0	None	3
		14	11 to 35 μm (Far IR)				4
TADRE	Doppler Shift			Zenith		- -	6
THIR	Mechanically Scanned Radiometer	2	6.5 μm to 7.5 μm (Far IR)	Nadir	1.2	Horizon to Horizon	4, 5, 6, 7
			10.5 to 12.5 μm (Far IR)		0.4		
TWERLE	Antenna Receiver, and Random Access Computer	8	400 MHz				6

**In Nautical Miles for 600 NM Orbit Altitude



Figure 4. Annotated APT Photograph Returned from Nimbus 1

the High Data Rate Storage Subsystem (HDRSS). Each frame of IDCS provided effective Earth coverage of approximately 1400 nm on a side with a resolution of 800 lines. The average picture resolution was approximately 2.5 statute miles.

After demonstrating the enormous value of visible sensors, like APT, AVCS and IDCS on early Nimbus satellites, the use of visible sensors was discontinued on Nimbus with IDCS (Nimbus 4). For reference purposes, the THIR sensor was evaluated on Nimbus 4 and used operationally on Nimbus 5, 6 and 7.

Temperature Humidity Infrared Radiometer (THIR)

The Nimbus THIR, which replaced the HRIR and MRIR radiometers used on previous Nimbus spacecraft as well as the IDCS, produced data of exceptional quality. The instrument is a two-channel scanning radiometer. The 6.7 micrometer (water vapor) channel, designed to show moisture distribution in the stratosphere and upper troposphere, provided a vivid portrayal of jet streams and large storm systems. Water vapor and ice concentration in the middle and upper tropospheres are strongly influenced by vertical as well as horizontal motion and often appear on THIR data as areas of convergence in the wind-blown patterns, indicating jet stream activity. These jet streams, lying in zones of maximum temperature contrast, often denote regions of greatest storminess.

Figure 5 was taken over central Europe on the night of 12 April 1970. A wind-field analysis has been added showing wind arrows, wind contours for 25 and 50 knots per hour, and locations of two jet streams.

The 10 to 12 micrometer long wave window on THIR, where there is virtually no reflected sunlight, eliminated the problem often seen with data from the HRIR instruments flown previously, and provided pictures of unusual clarity and contrast. Figure 6 shows the coastal region of the United States with the warm water of the Gulf Stream registering much darker than that of the cold water. Improved versions of THIR were successfully carried on Nimbus 5, 6 and 7.

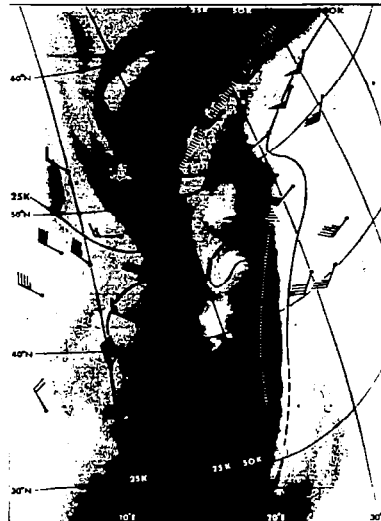

Figure 5. Wind Field Analysis of THIR Photograph Taken Over Europe

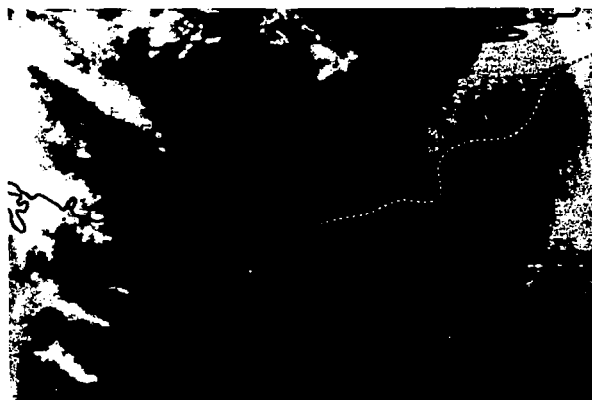

Figure 6. Annotated Photograph of Gulf Stream Transmitted from Nimbus 4 THIR Subsystem

Satellite Infrared Spectrometer (SIRS)

The excellent performance of the Satellite Infrared Spectrometer (SIRS) on Nimbus 3 inaugurated a new era in using satellites for meteorological observations. The device simultaneously measured infrared spectral radiances in narrow intervals of the carbon dioxide absorption band, from which temperature profiles of the Earth's atmosphere can be developed.

The now famous first temperature profile (Figure 7) was constructed from SIRS data on April 14, 1969, and provided excellent correlation with radiosonde measurements from Kingston, Jamaica. Subsequent correlation with data taken over the United States and the Pacific Ocean was also excellent.

The first SIRS instrument, on Nimbus 3, sensed data only along the subsatellite ground track. The Nimbus 4 SIRS had the added capability of making measurements to either side of the subsatellite track so that full global coverage was obtained twice each day.

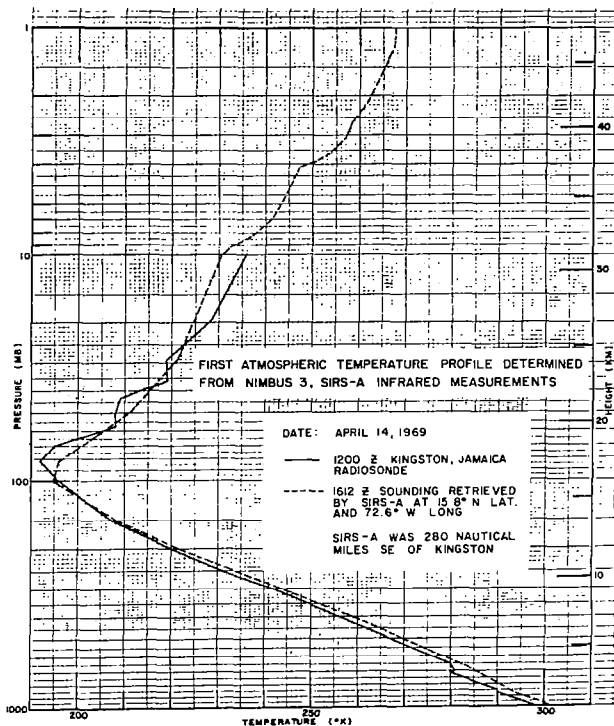

Figure 7. Comparison of Radiosonde and SIRS Data

These satellite-derived profiles have become a part of the total set of meteorological observations used in numerical weather analysis and prediction by the National Weather Service. Early operational utilization of data from Nimbus led the way for smooth adaptation and utilization from TIROS temperature sounding instruments ITPR.

Monitor of Ultraviolet Solar Energy (MUSE)

The MUSE experiment measured solar radiation otherwise undetectable at the Earth's surface because of the atmosphere's screening effect that absorbs all energy below 3000 angstroms. The purpose of the MUSE experiment was to look for changes with time in the ultraviolet solar flux in five broad bands from 1150 Å to 3000 Å (0.115 to 0.300 micrometers), to measure the solar flux in these regions, and to measure the atmospheric attenuation at these wavelengths as the sensor views the setting sun after the spacecraft has crossed the terminator in the northern hemisphere.

Shortly after the Nimbus 3 launch, channels with responses at 2000 Å and 16000 Å suffered severe degradation due to a violent solar proton storm. The most significant finding from these three operating channels of MUSE was that there is pronounced periodic variation in solar UV radiation which corresponds to the 27-day solar rotation period. Nimbus 4 data confirmed the variations. Figure 8 shows sensor currents for 2600, 1800 and 1200 Å channels for the first three months of satellite operation. Such variations affect the rate at which atmospheric oxygen (O₂) is photodissociated into atomic oxygen (O) and could influence the ozone concentrations that control the UV heating of the Earth's upper

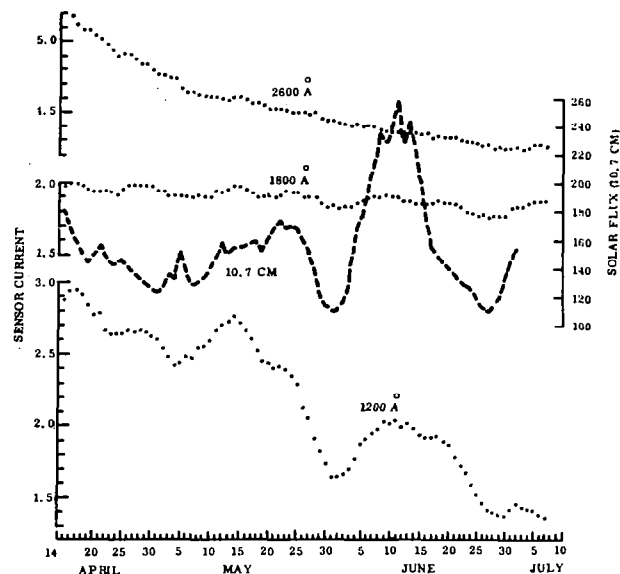

Figure 8. Daily Averages for Three MUSE Sensor Channels (Ordinates for the top two plots are multiplied by 10^{-8} Ampere, and for the bottom plot by 10^{-10} Ampere. The Ordinate for the 10.7 cm (2800 MHz) solar flux is on the right.)

atmosphere. These studies of the Sun, the Earth's heat source, are continuing in order to determine long-range influences on Earth's weather.

Interrogation, Recording and Location System (IRLS)

The IRLS package was used on Nimbus 3 and 4 to demonstrate the feasibility of using polar-orbiting satellites to determine position-location and to collect data from remote instrumented platforms around the globe, either on or above the Earth's surface. Five types of platforms were used: balloons, ships, an ice island in the Arctic, buoys, and land-based packages.

A tropical wind experiment, utilizing approximately 30 constant-altitude balloons conducted with the Nimbus 4 IRLS, revealed that the balloons stay at a fairly constant latitude as they circle the globe (Figure 9). The Nimbus 4 IRLS, which had a greater slant range than that of Nimbus 3, was able to monitor exact location on any given orbital pass to within ± 1 nm. This experiment system was followed by the highly successful TWERLE/RAMS experiment on Nimbus 6.

TWERLE Experiment

The TWERLE experiment, Tropical Wind Energy Conversion and Reference Level Experiment/Random Access Measurement System (RAMS), has had worldwide participation in the evaluation of meteorological circulation, ocean currents and ice movement. At the completion of one year of satellite operation, over 700 platforms had been activated by 31 investigations representing seven worldwide countries.

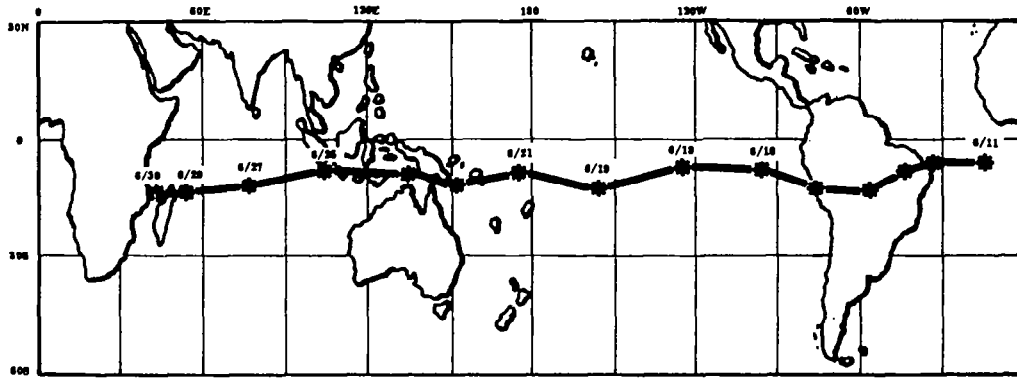

Figure 9. Flight Path of Balloon Interrogation Package Launched From Ascension Island on June 11, 1970

Selective Chopper Radiometer (SCR)

The SCR determined the global temperature of six successive layers of the atmosphere by radiometric measurements of the emission of carbon dioxide in the 15-micrometer band. The refinement of the system enabled high spatial resolution measurements of Earth or cloud-top temperatures to be taken, the field of view being a strip 7 miles long (in the direction of flight) by 70 miles wide. The calibration data was computerized and placed on tape for transformation into temperature profiles similar to those obtained with the IRIS and SIRS experiments.

SCR data was also used to prepare radiance maps which indicate "sudden warmings" of the winter stratosphere near the poles, where the temperature over a small area may rise as much as 50°K in a few days, accompanied by a major circulation change. Radiance maps for 30 December 1970 and 4 January 1971 (Figure 10) illustrates how a warming region developing over central Asia intensified in four days and moved northeast over Siberia.

A much more sophisticated design with 16 channels was flown successfully on Nimbus 5. A British furnished experiment, the SCR data found near operational utility by the British Meteorological Service for several years after Nimbus 5 launch.

ESMR Global Thermal Mapping

The Electrically Scanning Microwave Radiometer (ESMR) on Nimbus 5 provided the first microwave device for globally mapping thermal radiation from the Earth's surface and atmosphere. Differences between snow and ice and between rain and clear areas over oceans are emphasized by using the gray scale to represent sensed temperature between 190 and 250°K.

From polar images reconstructed from ESMR data, ice cover has been measured by the U.S. Geological Survey Ice Dynamics Project. Images of both polar regions have been measured and analyzed (1). A sample reproduction of the images analyzed is presented in Figure 11. The

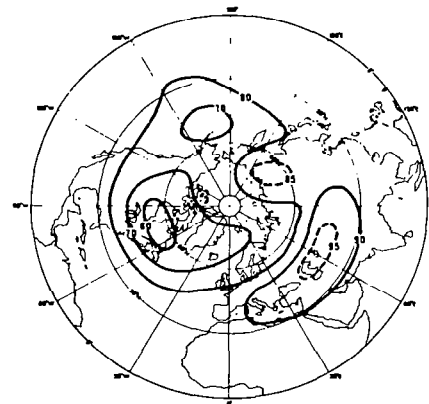

30 December 1970

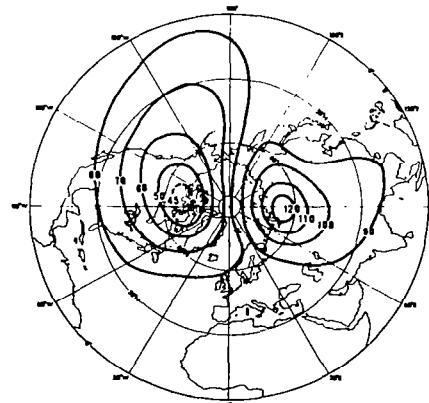

4 January 1971

Figure 10. SCR Radiance Maps Showing Stratospheric Warming of Northern Polar Region

detailed analysis showed differences between earlier ice boundaries taken from the U.S. Navy Atlas and those presented by ESMR. ESMR #5 has proven that large discrepancies exist between long term ice cover depicted in various Atlas and the actual ice canopies. This experiment was continued with excellent results from ESMR F flown on Nimbus 6.

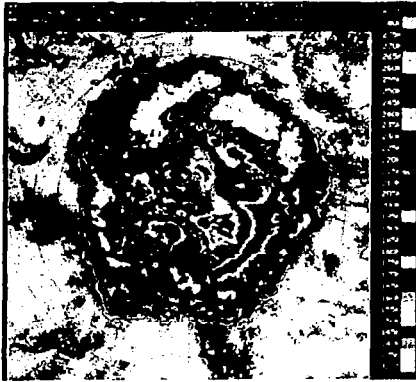

Figure 11. Microwave Image of Antarctic Continent and Sea Ice, Winter of 1974



Figure 12. Water Vapor (top) and Liquid Water (bottom) Images over the Ocean, October 1-14, 1975. (White represents high humidity. Apparent fringes of liquid water around coastline are artifacts of the data processing.)

SCAMS Scanning Microwave Spectrometer

Figure 12 shows global images of water vapor and liquid water obtained from the SCAMS experiment flown on Nimbus 6. The most prominent feature in these images is the intertropical convergence zone. Also prominent are the averaged traces of storms carrying moisture from the western tropical oceans into the mid-latitudes of each hemisphere.

(1) Polar Record, Vol. 18 No. 116, 1977 p. 431-450, Printed in Great Britain, "Passive Microwave Images of the Polar Regions and Research Applications," H. J. Zwally and P. Gloersen.

Nimbus 7 Application Teams

The Nimbus 7 payload complement provided significant departures from a purely meteorological science direction, offering remote sensing coverage over a vast percentage of the electromagnetic spectrum. This is shown schematically in Figure 13.

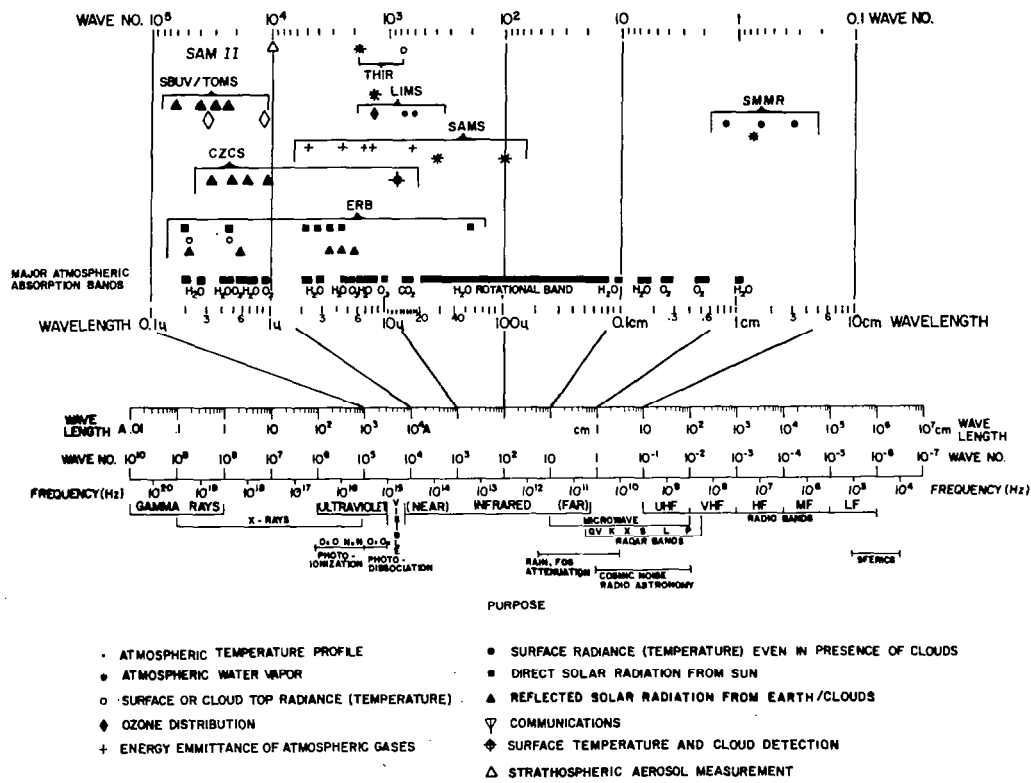

Figure 13. Relation of Nimbus 7 Experiments to the Electromagnetic Spectrum

The complex of remote sensors carried on Nimbus 7, and the interrelationships of certain data types necessitated a slightly different arrangement in the planned data utilization, where previous Nimbus sensor data was generally restricted to the instrument scientist for early proof and analysis, data from Nimbus 7 is distributed to teams of investigators. The principal applications and wide distribution of users working together in evaluation of each of the seven major sensors is summarized in Table 3. The quasi-operational nature of this experimentation has significant advantages in both evaluation techniques advancement and early determination of operational utility. The usefulness of BUUV/SBUV data to the meteorological community has led to plans for incorporation of this technique into the TIROS operational program.

Table 3. Nimbus 7 Data Products and Their Uses

Sensor	File and Tape Output Products	Scientific Parameters	Applications	Users
ERB	Daily, monthly and seasonal world grids Monthly and seasonal contour maps Zonal sections	Earth fluxes Solar fluxes Zonal insolation	Climatology Ocean/atmosphere dynamics Weather modeling Terrestrial reflectance studies	GSFC, NOAA, LARC CSU Dread U of C (Davis) Esperly Lab Cal Tech
SAMR	Orbital observations Bi-daily and monthly color contour maps	SEV/ICE parameters Ocean surface conditions Atmospheric conditions Land parameters Glacial features	Ocean dynamics Ice dynamics Ocean/atmosphere interactions Cryospheric dynamics Climatology and weather modeling	GSFC, MIT, U of Wash. NOAA, JPL U.K., Switzerland Denmark Canada
SAM-11	Daily aerosol profiles Seasonal and annual contour maps and atmospheric cross sections	Aerosol backscatter profiles Optical Properties of atmospheric aerosols	Atmospheric winds Earth radiation budget studies Aerosol injection dynamics	LARC, U of Wyo. NCAR, SRI, U of Ariz. NOAA
LIHR	Daily atmospheric profile Daily, monthly and seasonal contour maps and atmospheric cross sections	Gas concentrations and temperature profiles in the stratosphere	Atmospheric pollution monitoring Photo-chemical studies Atmospheric gas dynamics Climatology	LARC, NCAR, NOAA Dread, U of Wash, JPL UK France
SAMS	Daily atmospheric profile Daily, monthly and seasonal contour maps and atmospheric cross sections	Gas concentrations and temperature profiles in the stratosphere and mesosphere	Atmospheric pollution monitoring Photo-chemical studies Atmospheric gas dynamics Climatology Wind dynamics	Oxford GSFC LARC Dread NCAR
SBUV/TOMS	Daily profiles of O ₃ Daily, monthly and seasonal contour maps Solar spectra Zonal O ₃ statistics	O ₃ profiles Total atmospheric O ₃ Solar irradiances Terrestrial radiances	O ₃ dynamics/modeling Climatology and meteorology O ₃ solar relationships	GSFC, NOAA, MIT, CCC, U of Fla, NSF, LARC Lockheed, Oxford Cal Tech Canada
CZCS	2-minute images	Temperature Spectral radiances Chlorophyll Sediment	Geodynamics of coastal regions Chemical and thermal pollution studies Fishery resources Deep ocean monitoring Oil spill monitoring	GSFC, NOAA, U of Cal (Davis) U of Fla, AMES Tex A&M EURASEP
THIR	Daily message of temperature	Surface temperature Cloud top temperature	Effects of cloudiness or other Nimbus-G instruments data	All sensors

Coastal Zone Color Scanner (CZCS)

One of the most important sensors to be flown on Nimbus 7 is the CZCS. Increasing uses for the data are currently being explored by the experiment team. This image (Figure 14) from the Nimbus 7 CZCS taken in November 1978 shows the area of the Mississippi River Mouth to Mobile Bay, including Mississippi Sound and Lake Pontchartrain. The nutrient-enriched waters with high phytoplankton concentration around the mouth of the Mississippi are shown in this gray scale representative of a color image. The gray scale is labeled in milligrams per cubic meter at the bottom of the image. To the South of the Mississippi Mouth, one sees the clear water of the Gulf of Mexico with chlorophyll concentrations dropping down into the range .05 milligrams per cubic meter. A gradient of pigment concentration is shown by the graph in white, made by scanning between the two cursor marks shown as white crosses. The scan direction is from the Northern cursor to the Southern cursor. The values along the graph in milligrams per cubic meter are shown on the Y axis of the image, ranging from 0 to .5.

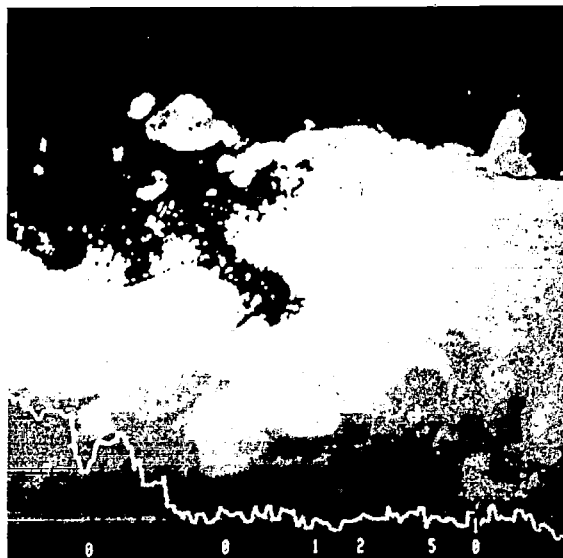

Figure 14. Nimbus 7 CZCS Image of the Mississippi Delta Showing Concentrations of Phytoplankton

Applications Technology Transfer

Table 4 is a summary of those remote sensing instruments that had their beginnings in the Nimbus Program. These experimental sensors became principal elements of the operational program of NOAA and in so doing, are today contributing to the public welfare. A tribute to the high degree of integration that exists in our Nation's Space Program

Table 4. Transfer of Nimbus Technology to Operational Spacecraft

NIMBUS INSTRUMENT		OPERATIONAL INSTRUMENT	
APT	AUTOMATIC PICTURE TRANSMISSION SYSTEM	APT	AUTOMATIC PICTURE TRANSMISSION SYSTEM
AVCS	ADVANCED VIDICON CAMERA SYSTEM	AVCS	ADVANCED VIDICON CAMERA SYSTEM
SIRS	SATELLITE INFRARED SPECTROMETER	ITPR	INFRARED TEMPERATURE PROFILE RADIOMETER
IRLS	INTERROGATION, RECORDING AND LOCATION SYSTEM	DCS	DATA COLLECTION SYSTEMS
		SARR	SEARCH AND RESCUE PROFESSOR AND REPORTER
HIRS	HIGH RESOLUTION TEMPERATURE SOUNDER	HIRS	HIGH RESOLUTION TEMPERATURE SOUNDER
THIR	TEMPERATURE HUMIDITY INFRARED RADIOMETER	AVHRR	ADVANCED VERY HIGH RESOLUTION RADIOMETER
		SR	SCANNING RADIOMETER
NEMS	NIMBUS EXPERIMENT MICROWAVE SPECTROMETER	AMSU	ADVANCED MICROWAVE SOUNDING UNIT
		MSU	MICROWAVE SOUNDING UNIT
PMR	PRESSURE MODULATED RADIOMETER	SSU	STRATOSPHERIC SOUNDING UNIT
BUV	BACKSCATTER ULTRAVIOLET	SBUV	SCANNING BACKSCATTER ULTRAVIOLET
SBUV	SCANNING BACKSCATTER ULTRAVIOLET		

IV. Lessons Learned

The current administration, specifically the Department of Defense, has completed several studies aimed toward a better understanding of the processes involved in what is popularly called P3I or Pre-Planned Product Improvement. While Nimbus was not one of the programs selected for this study (Aircraft and Tanks were better suited to the task at hand), after-the-fact statistics on Nimbus are interesting if viewed in this perspective.

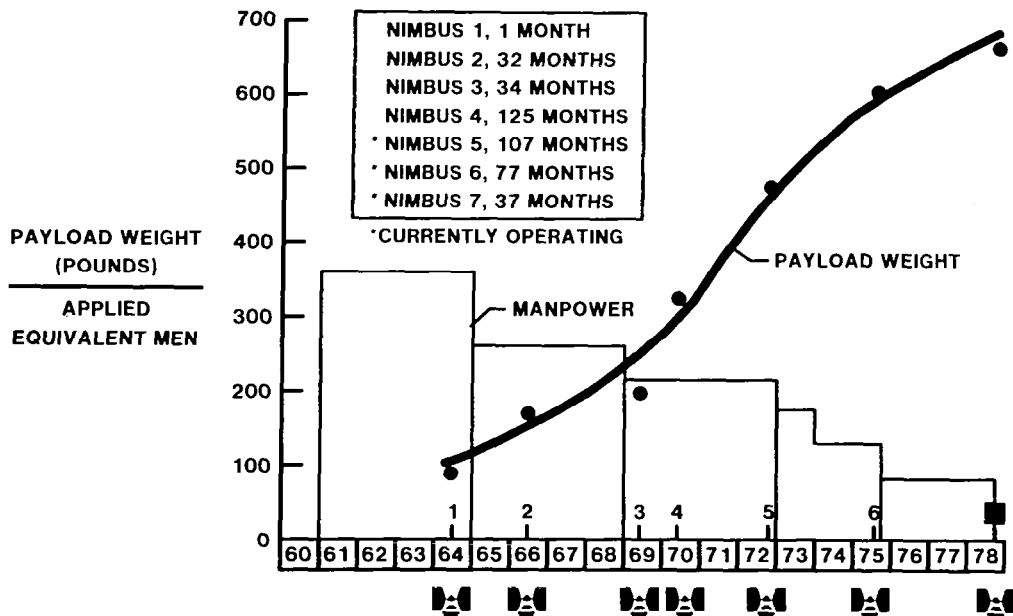

Figure 15. Nimbus Program Efficiencies

While there are many differences in relating one at a time satellites, prepared for launch over a period usually lasting two or more years, to repetitive fabrication of military aircraft, the principal factors involved are pretty much the same; mainly people.

Building, assembling and testing satellites, while it is a one-at-a-time experience, is very dependent on what came before. The first of a kind has only related experience to provide the backdrop and very often the related experience is not as related as originally thought. Engineers find themselves experimenting more often than they are producing. Figure 15 is a good example of how the people related activity can be effectively employed, providing the same degree of skills, turning out a reliable, long lived space vehicle in a repetitive manner, even over a period of years while becoming more and more efficient in the process. It seems to be symptomatic in the space business that people and programs stay pretty much together, and I am sure that the General Electric Company experience with Nimbus has been repeated at other contractor facilities. Figure 16 is related to the Boeing experiences over the years in the repetitive production of 727 airplanes.

Just as the data on Nimbus includes the addition of significant non-recurring cost improvements in the system (new command system, new attitude control system, improved power system, upgraded structure); so too does the data from the 727 Program include approximately a 50% of initial investment non-recurring cost for improvements made. The significance of repetitive activities, and not unexpectedly, the maintenance of a CONTINUOUS technical/cost team is stressed by Boeing as key factors in contributing to this improved performance. The NASA/General Electric continuous technical/cost team was instrumental in providing the results shown for Nimbus.

Figure 17 in a quantitative way, describes the real payoff of P³I. As described, Nimbus became the principal remote sensing research satellite for NASA, and in so becoming, hosted an ever growing list of payload devices, each one more complex than the one previous, each one demanding more power than previous, each one demanding more transmission bandwidth needed to return significantly more data to the experiment community. Yet as the plots and the data show, the ratio of payload to spacecraft in terms of real dollar cost and total payload weight shows an ever increasing capability.

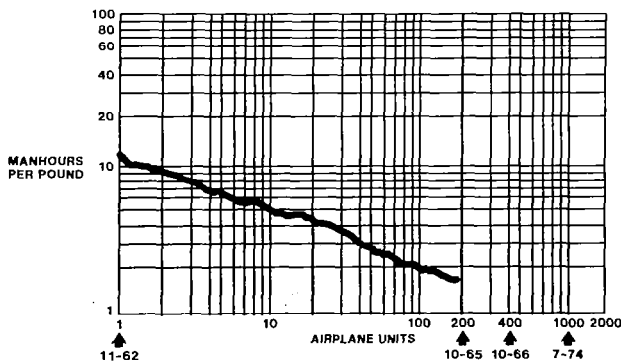

Figure 15. Cost of Non-Recurring Product Improvements (727 Aircraft Program)

The Nimbus Program was indeed fortunate in that the early visionary designers selected a configuration, stuck to the principal of a highly accurate attitude control system and designed an active thermal control system that simplified the individual payload designers task. In addition, as mentioned briefly in this paper, the degree of adaptability of the basic Nimbus spacecraft design was further demonstrated in its direct application to the Earth Resources Technology Satellite (ERTS, now Landsat) Program launches 1, 2 and 3. If similar data for ERTS were examined, it would be seen that the favorable ratios demonstrated for Nimbus 7 were exceeded by all three ERTS satellites.

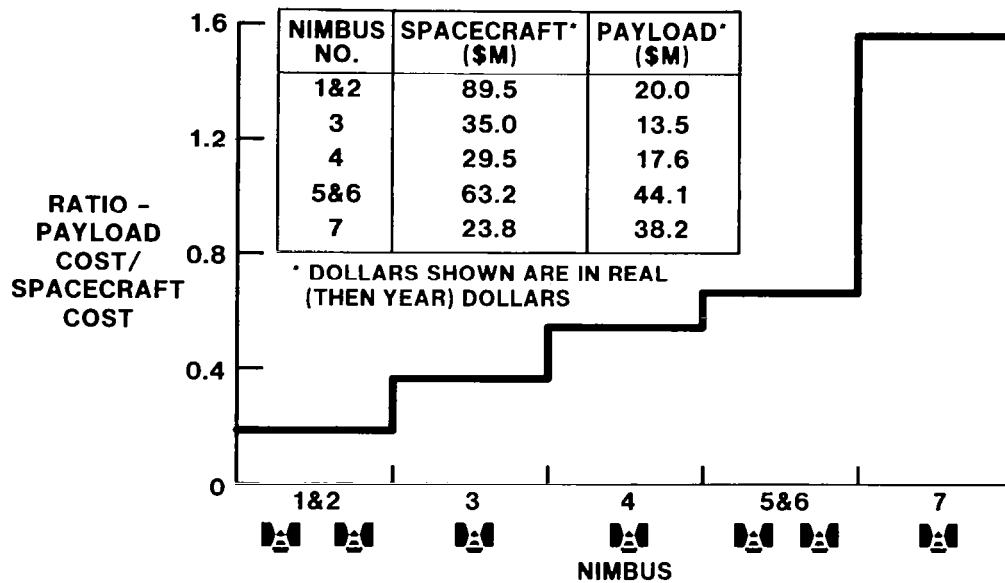

Figure 17. Nimbus Program Cost History and Rate of Information Return

Whether by accident or by design, it would appear that the prerequisites for successful P³I are several and varied:

1. Vision and imagination to believe that the first prototype will be the precursor to a successful new series of flight articles.
2. Hard and fast design principals that demand just a little bit more capability than is really needed to meet the near-in objectives.
3. A qualified and dedicated team that sincerely believes in the product it is busy evolving and a responsible management structure that helps to encourage their continuity.

With all the near-in problems that seem to be plaguing NASA today and the difficulty in initiating new program starts, it would certainly appear that the "Nimbus Experience" could be used to good advantage and help to influence the future United States Space Program Policy in the area of Space Applications.

DEFENSE METEOROLOGICAL SATELLITE PROGRAM (DMSP)

Col James W. Rivers, Jr.¹
and
Lt Col. Charles P. Arnold, Jr.²

ABSTRACT

The DMSP is a total satellite system composed of spacecraft with meteorological sensors, an earth-based command and control network, user stations, launch vehicle and support; with a communication network linking the various segments together.

INTRODUCTION

The mission of DMSP is to provide to the Tri-Service Commanders global meteorological data in support of worldwide military operations, both strategic and tactical, and to advance spaceborne meteorological sensing technology to meet changing Department of Defense requirements. The Space Segment consists of two satellites in 450 nautical mile sun synchronous polar orbits, each carrying a payload of meteorological sensors. The Satellite Operations Center is located at Offutt AFB, Nebraska, with earth terminals located at Loring AFB, Maine, Fairchild AFB, Washington, and the AF Remote Tracking Station, Hawaii. Real-time weather data is transmitted directly from the spacecraft to Air Force and Navy ground terminals and Navy carriers located throughout the world. Stored or playback meteorological data is transmitted to the Air Force Global Weather Central at Offutt AFB, Nebraska, and the Navy's Fleet Numerical Oceanography Center in Monterey, California, for processing and distribution. In support of the command and control data, telemetry and meteorological data, domestic communication satellites and land lines are used to interconnect the various segments in a cohesive and responsive manner.

SPACE SEGMENT

The spacecraft consists of a three-axis stabilized vehicle with an on-orbit weight of 1600 pounds and twelve feet in length exclusive of solar panels. It has a pointing accuracy of 0.01° and a 30-month mean mission duration.

Sensor

The Operational Linescan System (OLS) is the primary meteorological sensor. The OLS is a complete self-contained data collection system consisting of an oscillating scanning radiometer and a data-processing and storage subsystem which provide pictorial meteorological data (cloud cover) on a global basis. The system gathers and outputs in real time and/or stores multi-orbit day and night visual and infrared spectrum data from earth scenes.

1. Deputy for Defense Meteorological Satellite Systems, Headquarters USAF, Space Division, Los Angeles AFS, California
2. Air Weather Service Representative to the DMSP Program Office

Earth scene data is sensed by the OLS in two complementary spectral bands: the visible light and the thermal infrared. In each channel the scene resolution across scan is made nearly constant by use of a variable instantaneous field of view in conjunction with a sinusoidally varying scan motion. For global coverage the nominal smoothed mode resolution in each channel is 2.78 km, and for selected regional coverage of higher resolution a nominal 0.56 km fine mode is provided in each channel.

The visible channel senses scene radiance in the 0.4 to 1.1 micrometer spectral band for scene illuminations from sub-solar to sub-lunar at quarter moon, a range of over ten million to one.

The infrared channel senses scene radiance in the 10 to 13 micrometer spectral band over the scene temperature range from 190°K to 310°K. The output data is made linear with temperature over the dynamic range.

The visible channel detectors are a three-segment silicon photoconductive PIN diode for daytime scenes and a cesiated gallium arsenide opaque photocathode for nighttime scenes.

The infrared detector is a two-segment Mercury-Cadmium-Telluride photoconductive detector cooled to a temperature near 108°K and maintained within +0.1°K of the chosen set point.

The imagery data across the scan path is collected in the form of discrete picture elements (pixels) and converted into one of 64 or 256 grey shades.

The program and data storage for the processor are provided by the OLS memory consisting of 3,072 16-bit words of ROM and 13,312 16-bit words of CMOS RAM. In addition, there is core memory RAM consisting of 12,288 16-bit words and 4090 18-bit words.

Processed meteorological data is stored on four magnetic tape recorders, each with a storage capacity of 1.67×10^9 bits.

In addition to the OLS, the spacecraft has other meteorological sensors. These may include atmospheric sensors such as the multispectral infrared radiometer, the microwave temperature sounder, and space environmental sensors such as the precipitating electron spectrometer.

Communications and Telemetry

For meteorological data transmission the Communications Subsystem incorporates three independent S-band links using PCM/PSK transmission at 1.024 Mbps real time and 2.66 Mbps playback data rates. The transmitters are 5-watt solid state units used in conjunction with

crossed-dipole directive antennas mounted on the earth-facing side of the spacecraft. In addition, there are redundant S-band telemetry links, one using a high gain directive antenna while the other consists of an omnidirectional with two half-turn, half-wave helical antennas. The telemetry link consists of a PCM/PSK/PM modulation.

The uplink command system operates at a 2K baud rate and has tertiary MFSK/AM modulation. The receive L-band antennas are similar to the telemetry omnidirectional units.

The telemetry unit is a solid-state CMOS PCM system under microprocessor control using 4K of PROM and 2K of RAM. With three commandable data rates, 2, 10 and 60 kbps, it also has numerous commandable submodes, i.e., ability to obtain OLS, spacecraft and telemetry memory dumps, sample 1 or 2 analog channels to obtain high sampling rates, and ability to rearrange the entire analog and discrete channel assignments. Eight-bit analog-to-digital conversion is utilized.

Command and Control

The Command and Control Subsystem is the focal point for all spacecraft functions and operations. It consists of a Controls Interface Unit which is an input/output device through which all data and instructions flow. The spacecraft contains computers and memories to control all spacecraft functions, a stable spacecraft clock, and processing to decode and distribute all commands. Two central processing units are used, with each having 28K read/write memories. It multiplexes its own internal telemetry data stream, from memory, composed entirely of Attitude and Control parameters for insertion into the telemetry data format.

The software elements of the Command and Control Subsystem process command messages and data loads, maintain an image of the status of the hardware and generate control signals to all elements of the spacecraft, both hardware and software. The Ascent Guidance Software provides the navigation, upper state thruster control, velocity trim and final orientation maneuvers during ascent through orbital insertion. The Orbit Mode Software provides attitude determination and control after achieving orbit.

Attitude Determination and Control

An extremely accurate (0.01 degree) three-axis attitude determination and control subsystem provides precise pointing of the sensor payload. Three on-board orthogonal gyroscopes measure short-term changes in attitude; long-term drift is measured by a star sensor. An on-board processor stores ephemeris data and computes the spacecraft attitude. To enhance pointing accuracy, extensive star catalogs and ephemeris tables are periodically transmitted to the spacecraft from the ground. Attitude control is provided by three reaction wheels in an active closed-loop configuration (with a fourth for back-up), magnetic coils for unloading excess momentum, and GN₂ thrusters for transient momentum disturbances. In the event of

failure of the Inertial Measurement Unit or Celestial Sensor Assembly, lower-accuracy (0.1 degree) three-axis attitude determination and control is available. It is provided by the Earth Sensor Assembly and the Sun Sensor Assembly.

Other Spacecraft Subsystems

The other subsystems consist of a power system which includes photovoltaic solar cells, two nickel-cadmium secondary batteries and power conditioning electronics, a single-axis sun tracking solar array control system, and both passive and active thermal control systems.

GROUND SUPPORT

The DMSP spacecraft has an extensive worldwide system available to provide support for meeting the mission objectives. In addition to the three earth terminals and domestic communication satellite network described, it has the added resources of the Air Force Satellite Control Facilities worldwide Remote Tracking Stations and the extensive DOD communication satellites network to provide telemetry and command backup. All of these resources are presently linked via terrestrial or satellite links.

Satellite Operations Center

The Satellite Operations Center (SOC) at Omaha is the primary command and control site and contains the personnel and systems necessary to conduct all mission planning, spacecraft commanding, telemetry ingest and post-pass analysis.

Mission planning encompasses all tasks associated with scheduling and data generation for the ground system and satellite operating activities. It synthesizes the user's scheduled data needs, accepts engineering requests for special satellite tests and processes satellite status information to create the operational data files necessary to control the DMSP satellite system.

These requirements and operational constraints are then incorporated into the automated Mission Planning Data Generation and Verification System (PLANS).

The Stored Telemetry Processing System (STPS) provides data analysts with the means to conduct post-pass long-term telemetry analysis of spacecraft anomalies. The system operates either interactively or in the batch mode.

For real-time telemetry the SOC utilizes specially built Decoms to uniquely identify every telemetry step for computer processing. Real-time processing provides engineering units conversion and out-of-limit identification, all displayed on color graphic terminals.

Once the satellite contact period is over, the stored telemetry and the real-time telemetry are merged into the on-line revolution by revolution telemetry data base, and is then accessible for post-pass computer analyses.

Satellite Communications

Weather and telemetry data are multiplexed together with site status data and a digital voice

channel into a single 3.072 Mbps data stream at each Command Readout Station (Washington and Maine). The Hawaii Tracking Station 3.072 Mbps data stream does not contain digital voice. These channels from the three sites are uplinked to the Westar satellite, leased from Western Union by American Satellite Corporation, and relayed to terminals located at AFGWC, Nebraska, and FNOC at California. Both sites receive all of the data contained on all three channels. The command channel from the Omaha Satellite Operations Center to the two CRS's is a single time division multiplexed (TDM) channel that contains a composite of command, control and digital voice at 230.4 kbps. The command data stream is converted from a serial to ternary form at each CRS and uplinked to the spacecraft.

The primary links to the CRS's are backed up by terrestrial lines that are capable of handling the same types of command and telemetry data as Westar but only at a lower data rate. The terrestrial lines do not provide mission data to the AFGWC. In addition, there are command/telemetry back-up links to the Air Force Satellite Control Facility, to RCA (factory) and to Vandenberg AFB for launch and test support.

Command Readout Stations

The Command Readout Stations in Maine and Washington consist of earth terminals for accessing and receiving data from the spacecraft. The antenna system has a 40-foot reflector with a G/T 20.75 dB/°K and uses a pseudomonopulse auto-tracking.

In addition to processing and transmitting commands in real time, the terminals have a local commanding capability by means of command data shipped in advance from the SOC plans computer. The duration of the stand-alone operation is totally dependent upon the quantity of command data resident on the local disc system.

The downlink function receives, stores and forwards all incoming S-band signals to the users.

USER SEGMENT

Global Weather Central

The Air Force Global Weather Central (AFGWC) is the largest military meteorological center in the world and provides worldwide meteorological and space environmental support to not only the Air Force but to the Army and a variety of Defense Department agencies as well. In addition, AFGWC backs up the National Weather Service's National Meteorological Center and the National Severe Storms Forecast Center.

Meteorologists at AFGWC use a combination of conventional (rawinsonde, radar, aircraft, and ships) and satellite (DMSP, GOES, and NOAA) data for both their meteorological and space environmental customers. Conventional data is transmitted into GWC over the Automated Weather Network (AWN) from military bases within the CONUS and from overseas. In Europe and the Pacific the AWN also consists of a vast system of intercept sites which monitor radio broadcasts for environmental information. Global Weather Central also acquires

additional weather data from civilian sources such as the FAA, the National Meteorological Center, and commercial airlines.

All these data sources are fed into GWC which, operating under a build and apply philosophy, devotes as much as 60 percent of its resources to building a variety of data bases. The remaining 40 percent of GWC's resources go toward meteorological applications of these various data bases. Among the many thousands of products created and transmitted from GWC daily are 425 MAC computer flight plans, 190 other computer flight plans, some 90 terminal forecasts, 300 facsimile charts, anywhere from 100 to 150 point weather warnings, and as many as 150 requests for special forecast assistance.

DMSP satellite data is used in a variety of ways at GWC to support both meteorological and space environment customers. Global satellite imagery, visual and infrared, is made available to the forecaster in several different ways. He may receive a positive transparency for use on a light table or as a hardcopy print on which he can conduct an analysis. The imagery is also processed directly into the Satellite Global Data Base (SGDB). With each new dump of stored data into GWC this data base is updated. The meteorologist can then use the SGDB to reconstruct computer-generated images of any area of the globe or can merge this data with conventional data to produce the world's only three-dimensional cloud analysis model. With additional input from numerical forecast models a short-term cloud forecast can be generated.

The tropical meteorologist at AFWC has found DMSP cloud imagery to be particularly useful. In areas of the world where there are virtually no conventional observations, typhoon location and tracking have been traditionally accomplished by aircraft reconnaissance. However, as this resource decreased, DMSP has become increasingly more important to both naval and fixed base forces.

DMSP data has also been found very useful in the construction of hemispheric weather depiction charts. These charts show areas of cloudiness, cloud type, icing, and turbulence. Wind direction vectors can be extracted from DMSP pictures and used for upper-air analyses performed at GWC. The severe weather forecaster also uses cloud imagery to locate areas of potential instability and to assist him in the preparation of point weather warnings.

In addition to cloud imagery, the forecaster now has meteorological data available from a variety of infrared and microwave sounders and imagers. Among the types of information these sensors provide are vertical temperature and moisture profiles. By sensing infrared and microwave radiation transmitted by the earth and by atmospheric gases (CO₂, O₂, H₂O), the meteorologist can reconstruct temperature and moisture profiles. This type of information has long been used as the basis for atmospheric analysis and forecasting. Prior to the advent of satellite remote sensing, temperature and moisture profiles were obtained solely from instrumented balloons, with severely limited coverage. With DMSP we now have worldwide coverage which fills in all the data void regions.

By improving our initial analyses we also improve our numerical forecasts. These forecasts generate large-scale weather systems that ultimately affect the local weather. They also generate the winds and moisture values that are required for computer flight plans, wind trajectory models, and ICBM wind and density forecasts used by SAC.

Navy Fleet Numerical Oceanography Center

The Navy Fleet Numerical Oceanography Center (FNOC) at Monterey, California, receives the identical mission data as Global Weather Central via AMSAT relay. The weather data is transmitted via terrestrial links to secondary facilities at Pearl Harbor, Guam, Norfolk and Spain for detailed processing for local weather reports.

Mobile Terminals

The Mark IV is the latest generation DMSP mobile receive-only ground terminal. It is a compact unit consisting of a 10-foot parabolic antenna, 20-foot van, and an auxiliary power generator. It has automated acquisition and tracking and a GASFET low noise front end with a G/T of 11.3 db/K.

It allows visual or infrared images to be enlarged, enhanced, labeled and gridded within 30 seconds of a satellite pass. Hard-copy data can be provided to at least four remote locations over cable and class C-2 telephone circuits.

The demodulated 1.024 Mbps serial data is formatted for processing and is simultaneously recorded along with time code information using enhanced NRZ-L techniques on a 7-track analog tape recorder. The formatting consists of a serial data synchronization process, a serial-to-parallel data conversion, and a decommutation process. The decommutation process extracts the visual or infrared data and the other auxiliary data. The image data is the primary data input for display generation, with the auxiliary data used for appropriate image correction.

The hard copy is a laser-scanned, dry-processed film transparency suitable for light table viewing and photographic reproduction, while the soft copy is a CRT monitor display.

In the real-time mode, the image data is formatted, corrected for earth curvature and wow/flutter effects, enhanced and overlaid, and sent to the hard and soft copy displays.

The capability to search through the entire pass at normal magnification using the soft copy display is accomplished by commands entered via the operator's console keyboard. The scene is 1655 nmi square at 1:15 million scale for normal magnification. For times two and four, the displayed scene will be 828 and 414 nmi square respectively. From each spacecraft pass, an area up to 4500 nmi long and 1050 nmi wide can be covered. By 1987, there will be 16 of these terminals operational worldwide.

Shipboard Terminals

There are shipboard receiving terminals on the JFK, Enterprise, Independence, Midway, and Kitty Hawk. In the future, they will be installed on nine additional ships, such as the Nimitz,

Coral Sea, Constellation, etc. Their operation is very similar to that of the previously discussed mobile terminals.

FUTURE PLANS

The future of DMSP does not foresee immediate dramatic technological changes but, rather, a deliberate enhancement of the various subsystems, technology permitting. Primarily, these include increasing system lifetime by obtaining parts with improved reliability, that are less susceptible to radiation effects and have increased yields. Error detection and correction will be incorporated into future spacecraft computer systems. There is a definite need to have solid state storage devices for recording the weather data, but at the present time, in the capacity required, there is no immediate relief.

Future efforts will include the study of satellite autonomous operation for up to six months with little or no support from the ground operations centers. This will involve significant changes to the overall spacecraft, including power and redundancy management, data handling and software systems to achieve the stated goals.

Other future considerations include moving out of the crowded S-band RF frequency to the higher EHF band (40 GHz). While not technology limited, such a change would have severe impact on the numerous fixed and mobile terminals and how to transition with minimum operational effects.

As in the past, advanced state-of-the-art special sensors will continue to be flown to provide additional meteorological information and further the sensing technology.

RELATED REFERENCES

W. R. Johnson, "Acquisition, Processing, and Applications of Meteorological Satellite Data at the Air Force Global Weather Central," International Telemetry Conference, Volume XVII, pp. 1001-1010, 1981.

R. W. Lieske, "DMSP Primary Sensor Data Acquisition," International Telemetry Conference, Volume XVII, pp. 1013-1020, 1981.

THE DESIGN AND DEVELOPMENT OF GOES

L. R. Fermelia, GOES Program Manager
Hughes Aircraft Company
Los Angeles, California

Introduction

The Geostationary Operational Environmental Satellite (GOES) provides a wide variety of meteorological satellite services as a part of the network of satellites for the world weather watch program planned by the World Meteorological Organization (WMO). The GOES 4 and 5 Satellites are operating from the two geostationary orbit locations (75°W and 135°W longitude) and have a seven year design lifetime. The primary satellite mission is the transmission of visible and infrared observations of global scale weather, hurricanes and other localized severe storms to an earth based processing center; then it performs time-shared relay of the processed high resolution observation data along with Weather Facsimile (WEFAX) data to field stations. Weather observations are generated in an advanced instrument, the Visible and Infrared Spin Scan Radiometer (VISSR) Atmospheric Sounder (VAS). GOES also provides direct interrogation and simultaneous relay transmission between the command and data acquisition station (CDAS) and multiple, widely dispersed data collection platforms (DCP). The condition of the earth's magnetic field and energetic particle flux in the vicinity of the spacecraft and x-ray emissions from the sun are also monitored. These measurements are made through instruments collectively called the Space Environmental Monitor (SEM) and transmitted directly to a central processing center.

The spacecraft design had its origins in the first spin-stabilized synchronous communications satellite (Syncom). Many of the general design concepts are essentially unchanged from the original design on Syncom including fundamental spin-stabilization, real time, spin synchronous pulsed thruster propulsion system concept, sun-sensor attitude determination concept and IRIG real-time telemetry of attitude, and diagnostic, and spacecraft status data. The GOES design has drawn heavily upon specific designs developed by the Geostationary Meteorological Satellite (GMS) Program. The use of these previous design concepts was an important factor in meeting the ambitious delivery schedule of 35 months from the contract award date to the launch of GOES 4. However, the GOES 4 and 5 spacecraft also use newer technology and have expanded capability relative to their predecessors. The spacecraft provides a new capability for temperature sounding of the atmosphere with the VAS. This instrument has evolved from the first spin-scan cloud camera developed for NASA's Applications Technology Satellite (ATS) Systems. The VAS performs all of the operational visible and infrared imaging functions of its VISSR predecessor as

well as experimental multi-spectral imaging (MSI) and temperature sounding of the atmosphere by processor control of the 12 IR spectral bands.

In addition to the VAS, the GOES has a number of components which were uniquely designed for this system. The S-Band telemetry and command system, including the bicone antenna which provides a $\pm 50 \times 360$ degree angular coverage pattern, was developed for GOES. The system operates at STDN compatible S-Band frequencies and features a processor controlled telemetry system. The SEM has increased capability for high energy proton and alpha particle detection. The spacecraft has special magnetic control and a magnetometer instrument deployment specifically designed for GOES. Full earth coverage high power S-Band and UHF communications service are provided with a light-weight nylon honeycomb mechanically despun antenna array. Earth orientation is maintained via earth or sun sensor references using the despun control electronics. The mechanical despun antenna implementation provides greater EIRP efficiency than the electronically despun antennas used on previous GOES missions.

Other subsystem features designed for this satellite include a fully channelized communications system which provides improved intermodulation performance. Light weight, high performance is achieved with the hybrid microcircuit implementation in the VAS digital multiplexer. The satellite structural design employs beryllium members and a graphite composite apogee motor adapter to achieve weight efficiency. The latest design K-7 solar cells provide efficient light weight power system performance. The use of these weight efficient materials and high efficiency solar cells has enabled the satellite design to provide sufficient fuel, solar panel and battery capacity for a 7 year design life which is substantially longer than previous GOES. This paper summarizes the GOES 4 and 5 development with primary emphasis on the overall spacecraft design and new developments in the payload equipment.

Spacecraft Design Configuration

The GOES (Figure 1) which is approximately 12 feet high and 7 feet in diameter consists of a spinning cylindrical section and a despun, earth oriented antenna assembly. The despun bearing assembly and the non-contacting tri-coaxial rotary joint allows the spinning section to spin freely at 100 rpm thereby maintaining attitude stability, a simple means for passive thermal control, and a means for orientation and orbit control through pulsed thruster operation. The

antenna assembly provides a $\pm 9^\circ$ conical earth coverage pattern with 1) a north-south linearly polarized, dipole fed parabolic reflector for the VAS downlink and for the S-Band uplink and downlink portion of both the DCP service and the multifunction channel, and 2) a right-hand circularly polarized bifilar helix with a cupped reflector to support the UHF uplinks and downlinks of the DCP service. The bicone antenna is used for telemetry, command and ranging.

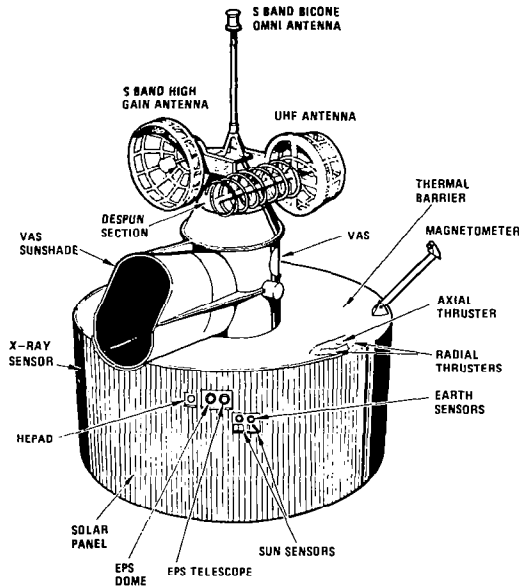

Figure 1. GOES Satellite

The spacecraft spinning section, enclosed by a cylindrical solar panel, contains the electronics equipment shelf, the VAS and SEM instruments, and the propulsion system hydrazine tanks and thrusters. The earth and sun sensors provide timing references to the despun control electronics, which in turn maintain the antenna pointing, as well as timing references for VAS operation and time multiplexing of the communications signals in the multifunction transponder. The GOES significant performance parameters are listed in Table 1.

Table 1. Spacecraft Performance Characteristics

		<u>AT LAUNCH</u>	<u>AT 7 YEARS</u>
• WEIGHT, lb		1841	770
• SOLAR PANEL POWER, watts		400	320
• COMMUNICATIONS	<u>EIRP, dBm</u>	<u>G/T, dB/°K</u>	<u>FREQUENCIES, MHz</u>
UHF	45	-22	402 and 468
S-Band	55	-16	1681 and 2034
• VAS		<u>RESOLUTION, nmi</u>	<u>RESPONSE, μm</u>
VISIBLE		0.5	.55 - .72
IR		3.7, 7.4	3.9 - 14.7
• ENERGETIC PARTICLE SENSOR	<u>RANGE</u>	<u>RANGE, EPS</u>	<u>RANGE, HEPAD</u>
PROTONS		0.8 to 500 MeV	> 370 MeV
ALPHAS		3.2 to 400 MeV	> 640 MeV
ELECTRONS		\geq 2.0 MeV	
• X-RAY SENSOR	0.5 to 3 Å, 1 to 8 Å		
• MAGNETOMETER	$\pm 50 \gamma$ to $\pm 400 \gamma$		

The spacecraft spinning structure consists of seven major assemblies: 1) the apogee boost motor (ABM) adapter, 2) the primary thrust tube which supports the VAS instrument, 3) the solar panel substrate, 4) the despun bearing support assembly, 5) the VAS sunshade/cover, 6) the electronics equipment shelf, and 7) the magnetometer boom assembly. The structural configuration illustrated in the exploded view, Figure 2, is based on the GMS design. The ABM adapter and magnetometer boom assembly are the primary new structural developments for the GOES spacecraft. The ABM adapter is constructed of newer 10 ply graphite fiber composite material for lighter weight. The magnetometer boom is a new design to accommodate the magnetometer payload, which was not required on the GMS design. It consists of a 30 inch x 2.5-inch-diameter graphite tube which is deployed by the spacecraft centrifugal force. A spring damper limits the deployment loads on the magnetometer instrument and boom mounting structure.

The thrust tube is a riveted assembly of machined aluminum rings and rolled magnesium alloy conical skins. The remaining structural elements use aluminum honeycomb sandwich construction with facesheets of appropriate material: the equipment shelf has aluminum facesheets, the solar panel has Kevlar facesheets, and the remaining assemblies employ epoxy fiberglass facesheets. These structural elements are fundamentally of the same design as GMS.

Full structure developmental tests were performed on the GMS spacecraft so the GOES developmental tests were confined to the newly designed structural elements. The magnetometer boom and deployment mechanism integrity was verified by deployment tests over the environmental temperature and spacecraft spin rate extremes. A full static loads test was completed on the ABM adapter prior to spacecraft level assembly. All other structural assemblies were proof loaded prior to spacecraft assembly.

The UHF and S-Band antennas were developed from similar GMS antennas and are one integrated structure composed of polyamide impregnated paper honeycomb core sandwich materials. Multiple layers of preimpregnated fiberglass cloth form the facesheets. Weight reducing holes are cut in this

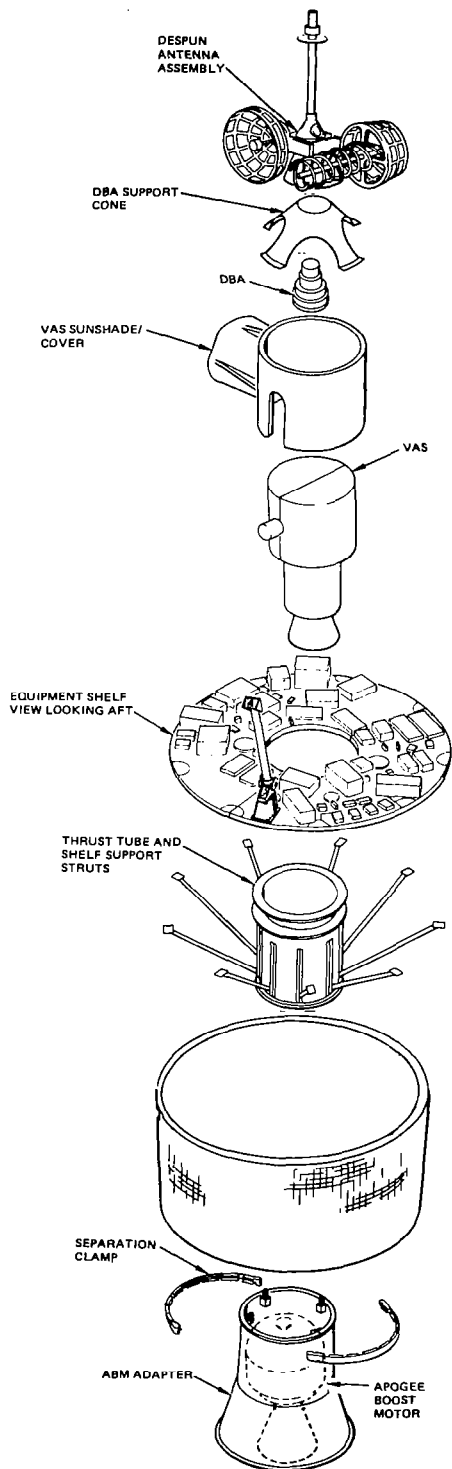

Figure 2. GOES Exploded View

sandwich consistent with structural integrity to reduce weight and solar pressure exerted on the antenna. The bicone antenna assembly, added to the GMS design for the GOES mission, utilizes a beryllium mast to support the aluminum fiberglass bicone radome structure. The developmental test program for the antenna array included individual tests of each of the three antenna assemblies. Complete pattern verification measurements were performed on the antenna range with a simulated spacecraft structure prior to two full-up flight spacecraft tests. Structural tests prior to spacecraft assembly were not required on the antenna array because they had been conducted on the similar GMS spacecraft.

Communications Subsystem

The GOES communications subsystem consists of the despun antenna array connected to the electronics on the spinning side of the satellite through a noncontacting rotary joint as illustrated in Figure 3. For reliability, the subsystem has full redundancy and cross-strapping of all active electronics units; the redundancy details are omitted from Figure 3 for purposes of clarity. The subsystem can be divided into individual systems according to their mission function: 1) the multifunction S-Band system, 2) the UHF system, 3) the telemetry, command, and ranging system.

The multifunction S-Band system contains the communication equipment for transmission and relay of VAS, stretched-VAS (S-VAS), WEFAX, and trilateration mission functions. Analog VAS data are multiplexed and converted to PCM in the VAS digital multiplexer (VDM). The VAS PCM is then QPSK-modulated at 28 Mbps in the S-Band receiver and directly transmitted via the 20 watt S-Band transmitter and the dipole-fed S-Band parabolic antenna. The multifunction relay signals (S-VAS, WEFAX, and trilateration) are received by the S-Band antenna and coupled via the same S-Band transmit path as the direct VAS signal for time-shared transmission. Time-shared transmission between the VAS and S-VAS signals occurs every satellite spin revolution, with direct VAS transmission during the 20 degrees of VAS imaging and S-VAS relay during the remaining 340 degrees. WEFAX or trilateration relay occurs under ground control during periods when VAS imaging has been completed.

The S-Band receiver design is based on the GMS design with upgrades of all RF circuits to microwave integrated circuits (MIC) or surface acoustic wave (SAW) devices. The S-Band driver and transmitter amplifier are stripline based on the GMS design.

The DCP interrogation (DCPI) signals are also received by the earth coverage S-Band antenna and routed to the S-Band receiver, where they are downconverted and separated from the multifunction signals. The signal is then routed through the UHF receiver and transmitted to the earth coverage UHF bifilar helix antenna. DCP report (DCPR) signals uplink in the reverse manner through the UHF antenna and the dedicated 0.5 watt DCPR transmitter. The UHF receiver AGC preserves linearity while providing an essentially constant drive to the DCPR transmitter which is operated linearly to minimize intermodulation

products between the simultaneously transmitted (up to 188) DCPR carriers.

The major development in the GOES communications system included newly designed telemetry and command RF equipment (STDN telemetry transmitter and command/ranging unit) for compatibility with the GOES-ground station interface. In addition, the dedicated DCPR transmitter and command/data acquisition (CDA) telemetry transmitters were designed for GOES to permit channelized separation from the direct VAS/S-VAS transmission channel, thereby improving intermodulation performance over previous designs. The rotary joint and the S-Band triplexer were also major developments for the GOES. The rotary joint is a tricoaxial design, with the innermost channel utilized for telemetry and command operations, the intermediate channel used for S-Band multi-function operation, and the outer coaxial channel used for UHF operation. Developmental testing of the communication system included unit level breadboard assemblies and developmental tests, full performance verification of all flight units at protoflight environmental extremes, and finally an integrated communication subsystem checkout prior to spacecraft level assembly and testing.

The high gain triplexer is a key element of the S-Band and DCPR transmission systems. In addition to separating the transmit and receive frequencies, it permits channelization of the high power, time shared, VAS/multifunction transmission link and the low power continuous DCPR link. Particular attention was devoted to the analysis, design, and development of the S-Band triplexer because of the severe design constraints imposed by the VAS data link transmission requirements. The triplexer is required to 1) minimize the delay variation and distortion in the VAS transmission band; 2) suppress the VAS and SVAS power flux density in the adjacent radio astronomy band (1660 to 1670

MHz) to less than $-240\text{dBw/m}^2/\text{Hz}$; and 3) duplex the VAS and DCPR carriers to the S-Band antenna with minimum insertion loss.

To meet these conflicting requirements, the transmission link was modeled by computer simulation and a number of design configurations were studied. The final design utilizes an eight section VAS transmit filter to band limit the VAS spectrum and provide out-of-band suppression necessary for radio astronomy protection. The VAS filter was turned to give a quasi-elliptic function response with a 3dB bandwidth of 22 MHz and sharp band edge transitions which give large out-of-band rejection. The large rejection at the band edges also provides the isolation required to efficiently sum the DCPR signal in the triplexer. The measured laboratory and in-orbit performance of the VAS transmission link for GOES 4 is shown in Figure 4. The performance is within 4 dB of theoretical and has satisfactorily met all mission requirements.

VAS and VDM Design

Visible and infrared two-dimensional cloud mapping data of high resolution (0.9 km visible and 6.9 km infrared) originate in the VAS. The VAS also obtains radiometric data in the earth's atmospheric water vapor and CO_2 absorption bands to help determine the three-dimensional structure of the atmospheric temperature and water vapor distribution.

The VAS image mapping raster is formed by the combination of the satellite spin motion (spin scan) and the step action of the scanning optics. One raster line in the earth's west-east (W-E) direction is formed for each revolution of the spinning satellite at each north-south (N-S) angular scan step position of the VAS scan mirror. Each 0.192 mr N-S axis scan step corresponds to

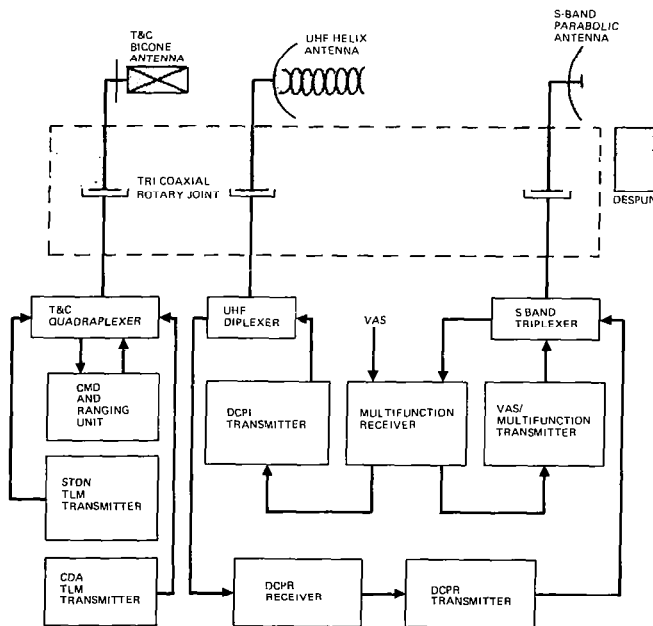

Figure 3. Communications Subsystem Block Diagram

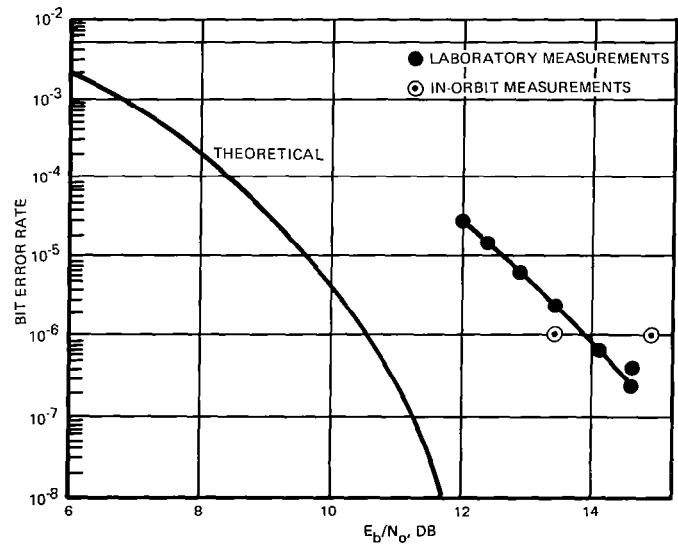

Figure 4. VAS Bit Error Rate Link Performance

the total field of view of the eight visible channel detectors. The 0.9 km resolution in the visible spectrum is obtained by using a linear array of eight detectors aligned so that they sweep out the complete scan line path. The earth is covered in the N-S direction with 1820 successive latitude steps until 20° coverage is obtained.

The VAS has six infrared detectors; two are used primarily for imaging and four for sounding information. Two pairs of infrared detectors are in use during any satellite spin period. The detector pairs are automatically switched into the VDM by the VAS processor depending upon the selected mode of operation. The processor also controls the VAS filter wheel which can selectively position spectral filters into the optical train to provide IR response in 12 different spectral bands.

The primary development in the VAS was the addition of the 4 IR detectors and the spectral filter wheel to implement multispectral imaging and temperature sounding of the atmosphere. Processor control of the MSI and VAS sounding modes was also developed for GOES 4 and 5. The remaining elements of the VAS system are nearly identical to the VISSR flown on the previous SMS and GOES missions. Developmental testing included full optical performance verification of the VAS breadboard and flight instruments, including performance verification and calibration in thermal-vacuum environment. The VAS development, which started prior to the spacecraft development under a separate contract, was completed for use in GOES.

The redundant, cross-strapped VAS digital multiplexer provides high accuracy multiplexing of the VAS visible and infrared data. Implemented primarily with hybrid microcircuits, features differential signal detection and employs four visible and two infrared analog to digital (A/D) converters operating in parallel for relatively low speed operation and reduced power consumption. Figure 5 is a block diagram of one of the redundant VDM units.

Each of the eight visible channels from the VAS is processed through a differential input receiver, a five pole Bessel filter, and a dedicated sample and hold circuit. The use of four A/D converters instead of a single high speed converter provides better timing margins and allows the use of a conservative, simple A/D converter design. The A/D converters are a successive approximation type, operating at 500,000 samples/second, with auto ranging capability using a switchable gain

for higher resolution of low level inputs. The gain mode is controlled by a comparator which determines whether the input signal falls above or below 1/8 full scale. If above, the A/D converter operates as a normal 6 bit linear converter. If below, the signal is multiplied by eight, which provides the required high resolution for low level signals.

The A/D output includes the 6 bits from the converter and a single gain indication bit from the comparator. These 7 bits are processed by a programmable read-only memory which, for each of the 128 possible input words, produces the appropriate 6 bit output to convert the overall conversion transfer function to an approximate square root function. A single PROM performs the square root conversion for all visible A/D converters.

IR channel processing also utilizes different input buffers, active 5 pole Bessel filters, and sample and hold circuitry similar to the visible channel. The IR A/D converter utilizes a dual mode configuration which initially performs the four most significant bit conversions followed by a second conversion which forms the six least significant bits. This implementation allows the use of slower and lower power components for the 4 bit conversion with its attendant advantages of conservative design margins and lower power operations.

The IR A/D converter also features an individual offset correction for each input chain. Once per satellite revolution, during preamble transmission, a calibrated voltage is applied to the input filters. An integrating circuit within the A/D converter is driven to a value which nulls the combined offsets of the filter, track and hold, and the converter itself. This offset correction is held for the ensuing earth scan.

The development verification program for the VDM included the development of proof-of-design assemblies of all hybrids and the assembly and developmental engineering model of the VDM unit. Protoflight testing at the hybrid assembly and unit level over environmental temperature extremes was accomplished prior to flight unit assembly.

VAS atmospheric sounding for GOES 4 and 5 is being performed on an experimental basis. Although full quantitative assessments are not complete, preliminary results described in Reference 1, are promising. Sounding inferences appear to provide accuracies and horizontal and vertical resolutions comparable to lower altitude polar orbiting satellites. Experiments also indicate that small but significant temporal variations can be observed by the geostationary satellite sounder.

SEM Design

The Space Environmental Monitor performs three functions with three sets of instruments. The instruments are depicted in Figure 1.

1. The magnetometer measures the magnetic field strength and direction in the vicinity of the spacecraft. The sensor is a biaxial flux gate magnetometer with one axis parallel to the

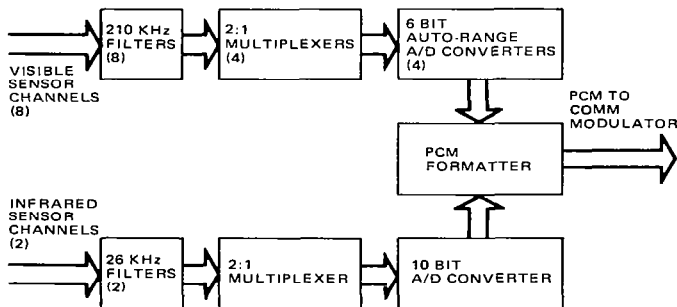

Figure 5. VAS Digital Multiplexer Block Diagram

spacecraft spin axis and a transverse axis parallel to the spin plane. The two coils in the magnetometer are mounted on a 30 inch boom which is deployed by spacecraft centrifugal force after launch.

2. The x-ray sensor monitors solar flare activity in the soft x-ray spectrum. The x-ray radiation travels at the speed of light and its advance warning that slower moving energetic particles may follow. A geared stepper motor can adjust this sensor to track the seasonal relative movement of the sun in steps of 0.125 degrees. The step size corresponds to an average of two steps per day.

3. The energetic particle sensor is designed to detect alpha particles, protons, and electrons resulting from solar flare-associated particle injection events. This instrument has three detector assemblies to cover the broad energy spectrum of penetrating radiation. These units are:

A. Telescope. The telescope utilizes two silicon surface barrier detectors to detect low energy protons (0.8 to 15 MeV) and alpha particles (3.2 to 60 MeV) with half angle field of view of 35 degrees.

B. Dome. The dome utilizes three groups of paired silicon surface barrier detectors (SSBD) to detect electrons (greater than 2 MeV), protons (15 to 500 MeV) in seven channels, and alpha particles (60 to 400 MeV) in six channels within a field of view of 130 degrees.

C. High Energy Particle Detector. The HEPAD is a Cerenkov counter telescope combining a photomultiplier tube and solid state detectors to detect protons (350 to > 850 MeV) and alpha particles (640 to > 900 MeV) within a field of view of 68 degrees.

The SEM design for GOES 4 and 5 is fundamentally the same as that used on previous GOES missions, the HEPAD instrument was not included in previous missions. The HEPAD design is identical to that flown on previous NOAA polar orbit missions. Development verification tests of the SEM included full performance verification over protoflight environmental extremes.

Controls Subsystem Design

The controls subsystem performs antenna pointing VAS/SEM timing, and nutation, attitude, and orbit control as shown in Figure 6. The heart of the system is the phase locked loop (PLL), which generates timing that is accurately phase controlled to the spacecraft rotor spin rate as defined by the sensor reference. The sensor reference supplies a pulse train at spin frequency, ω_s , with pulse positions carrying rotor inertial phase information. The pulse train is then processed by the PLL which has three functions: 1) to quantize the spin cycle into 2^{16} (0.0055 degree) parts, 2) to increase the output phase sample rate to $2^4 \omega_s$, and 3) to filter noise from the input sensor pulse train. The PLL output pulse train is delayed by the earth-to-sun angle by means of the time-of-day (TOD) delay, whose delayed output is at $2^{12} \omega_s$. The TOD delay output is then counted down and delayed in two angle generators to provide independent control reference for antenna pointing and VAS/SEM angle refer-timing.

The antenna angle generator counts the $2^{12} \omega_s$ input train down to $2^4 \omega_s$ and provides for ground commanded pulse additions or subtractions that step the antenna reference in ± 0.88 degree increments. Its output then contains rotor phase information which is compared with the despin bearing assembly generated rotor-to-antenna relative phase to produce an estimate of the antenna pointing error. The resulting error signal is applied as the pointing torque command.

The VAS/SEM angle generator uses the $2^{12} \omega_s$ output of the TOD delay to generate a stream of eight timing signals each spin period in order to synchronize the required mission line scan operations with rotor spin phase. This signal stream can be advanced or retarded in phase by ground command in increments of ± 0.88 degrees over the full ± 180 degree range.

The fully redundant automatic nutation control unit consists of sensing accelerometers, control electronics, and axial thrusters to provide control torque during the transfer orbit when the spacecraft spin to transverse inertia ratio is less than one. After apogee boost motor firing and the achievement of geosynchronous orbit, the ABM/adaptor combination is jettisoned, the inertia

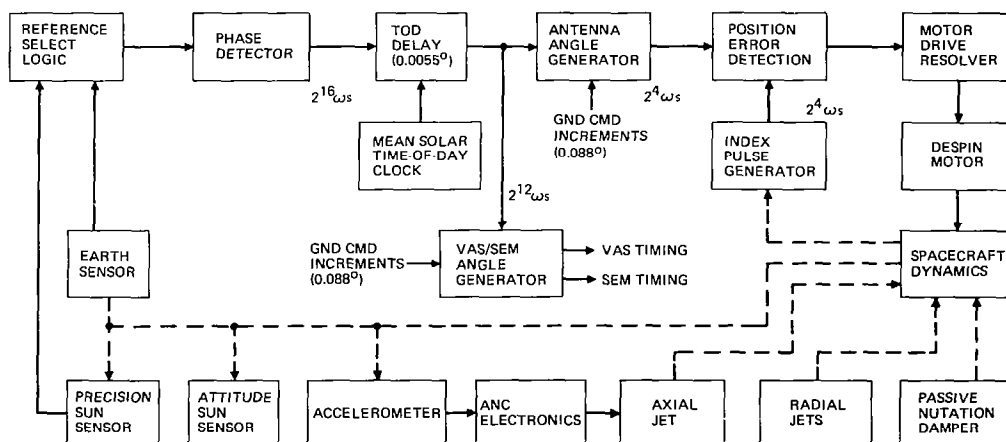

Figure 6. Control Subsystem Block Diagram

ratio becomes greater than one and the ANC is disabled. Orbit control ΔV maneuvers and spin axis attitude precision maneuvers are accomplished by ground commanding axial and radial thrusters in appropriate continuous and pulsed modes. Spin axis attitude determination is implemented by ground processing of telemetered earth chordwidth and sun aspect angle data.

The control subsystem's passive nutation damper was primarily developed on GMS. The damper time constant (less than 1 minute) was verified during GMS developmental testing to be effective for angles below 2 microradians in altitude chamber simulation. The damper fraction-fill was modified for GOES to 10% and its position was offset from the spin-axis to correct for an in-orbit spin-axis/geometric axis misalignment experienced on GMS.

The other design elements of the controls subsystem were based primarily on the GMS design with some timing changes to the despin control electronics to accommodate the SEM and VAS instruments. The despin bearing assembly index pulse generator was changed for GOES to minimize the spacecraft induced magnetic environment and its potential interference with the magnetometer sensor mission measurements. The earth and sun sensors are identical to those used on GMS and many other geostationary satellite designs.

Telemetry and Command

The telemetry and command subsystem, Figure 7, monitors the health of the spacecraft, multiplexes and transmits operational SEM data and spacecraft attitude data, and controls the subsystems via ground command. Commands are received by the bicone antenna and downconverted for baseband processing by the demodulator/decoder. Telemetry is transmitted by both the CDA (1694 MHz) and the STDN (2214 MHz) telemetry transmitters through the bicone antenna.

The central telemetry unit (CTU) contains the basic timing and control functions required to sample and multiplex spacecraft diagnostic and operational analog and digital measurements. It organizes the data into a composite pulse code modulation (PCM) format for transmission to the

ground network. The CTU also time and frequency multiplexes attitude, nutation sensor, and control operational data for transmission in real time. These real time sensor and control data are priority-gated or command-selected to frequency modulate two IRIG channels. The PCM and both real time data streams are routed to the CDA and STDN telemetry transmitters for downlink transmission. The CTU has been designed with processor control which provides flexibility for accommodating changes in payload configuration and telemetry monitoring requirements.

Each remote telemetry unit is capable of sampling 256 totally programmable combinations of analog and bilevel data sources. Sampling of the sources is under control of the CTU via supervisory bus. When interrogated, the remote telemetry unit (RTU) samples the selected data points, multiplexes, encoders, and formats the data into PCM-RZ data, and returns it to the CTU via a data bus.

The demodulator/decoder unit alternately samples the redundant STDN ranging/command receivers and automatically selects one of two on the basis of baseband FSK tone signal level. The demodulator recovers the baseband FSK/AM signal, and the decoder, upon receipt of the execute tone, completes the command execution. Both demodulator/decoders have the capability of executing all 254 pulse commands.

The processor controlled telemetry subsystem was newly designed for GOES to meet the signal capacity, bit rate, and ground station interface requirements. The command system is based on previous designs and has been modified for ground station interface compatibility and greater capacity requirements.

Power and Propulsion Subsystems

The power subsystem comprises solar panel and battery energy sources, solar panel limiters and battery controllers, and a preregulator which furnishes controlled voltage to the VAS. The subsystem design is fundamentally identical to the GMS design. The system uses K-7 solar cells which provide an output power for 350 watts at

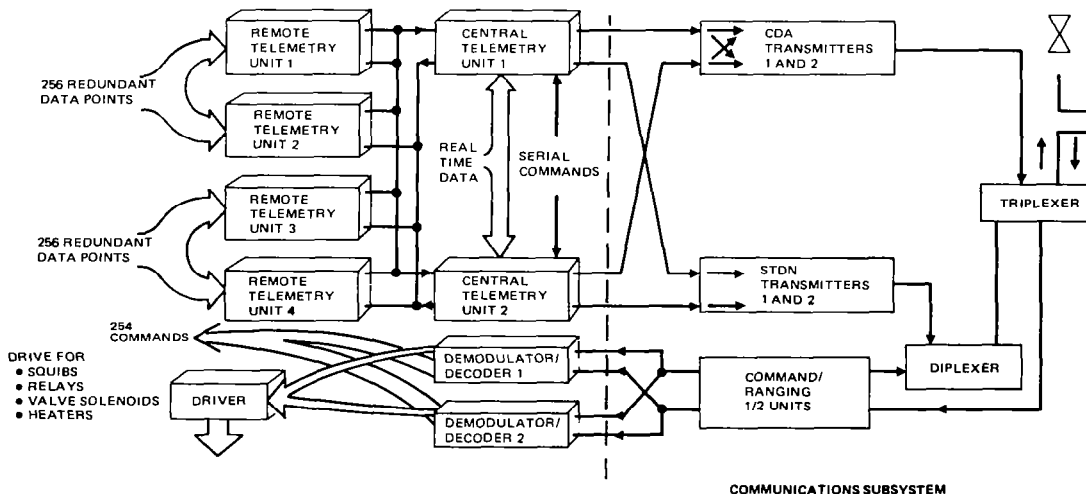

Figure 7. Telemetry and Command Block Diagram

the end of the 7-year mission. The solar panel harness design has been tailored to minimize the spacecraft induced magnetic environment and its potential interference with the magnetometer sensor mission measurements.

The propulsion subsystem consists of an apogee boost motor, which is identical to the GMS design, and a hydrazine reaction control system which is similar to the GMS design but has greater fuel capacity. The RCS system includes redundant axial thrusters for altitude and north-south station keeping. Redundant pairs of radial thrusters arranged to perform east-west station-keeping and spin rate control complete the RCS thruster complement.

Summary

The GOES 4 and 5 spacecraft development has combined proven design concepts with newer technology to provide a system with advanced performance ready for operational service in a timely manner. The program has resulted in the design, development, launch, and successful in-orbit operation of essentially a new spacecraft design within a period of 35 months. The advanced performance of the spacecraft manifests itself in the spacecraft bus and in all payload areas. The use of hybrid microcircuit technology in the VAS digital multiplexer and telemetry subsystems has contributed to the reliability and weight efficiency of the spacecraft. Incorporation of advanced K-7 solar cells provides solar panel power sufficient for increased mission lifetime over previous GOES spacecraft. The microprocessor design in the telemetry subsystem contributes to reliability improvement while providing flexibility for changes in payload or mission requirements of future systems. The weight efficiency afforded in these areas, and the use of lightweight graphite composites and beryllium in the structure, have enabled increased hydrazine fuel capacity necessary to support the 7-year mission lifetime.

Incorporation of the HEPAD into the SEM instrument complement has significantly expanded the range of energetic particle detection. Channelization and efficient filtering in the communication subsystem has minimized the intermodulation products and suppressed undesirable radiation in the radio astronomy band while maintaining the fidelity required for low bit error rate performance. While the increased sounding capability of the VAS is an experimental payload for the GOES 4 and 5, the preliminary results from this instrument are very promising. Its performance to date indicates the possibility for operational measurement and timely distribution of global-scale weather data previously not practical. In conclusion, the GOES 4 and 5 program has successfully met its demanding requirements and provides a sound design for future GOES missions.

Acknowledgement

Programmatic and operational responsibilities for the GOES system are assigned to the National Oceanic and Atmospheric Administration (NOAA) within the Department of Commerce. Procurement and advance developments for GOES are managed for NOAA by the National Aeronautics and Space

Administration at the Goddard Space Flight Center. The GOES 4, 5 and 6 satellites are being built by Hughes Aircraft Company, Space and Communications Group, under Contract NAS 5-24342.

Reference

1. W. L. Smith, et al, First Sounding Results from VAS D, Bulletin of the American Meteorological Society, Volume 62, pp 2322-236, 1981.

SPACE PLATFORMS AND METEOROLOGICAL APPLICATIONS

Kenny L. Mitchell
 Space Platform Project Office
 Marshall Space Flight Center, Alabama 35812

Gregory S. Wilson
 Environmental Applications Branch, Space Sciences Laboratory
 Marshall Space Flight Center, Alabama 35812

Abstract

The National Aeronautics and Space Administration has studied the benefits of utilizing space platforms for low Earth orbit missions. The results of these studies show that the platform is a powerful new concept for space experimentation and is receiving strong support from the scientific community. The space platform allows an evolutionary approach, both in the sophistication of the platform system and in the science to be accomplished. This paper presents an overview of past, current, and future platform activities, with emphasis on implementation of the initial space platform. Utilization of the space platform for meteorological purposes is examined and shown to be practical for both research and operational payloads.

Introduction

The science and application community achieves its space missions through individual free-flying spacecraft which provide long duration flight, stability, low gravity, and little contamination. The advent of the Space Shuttle provides a more cost-effective transportation system for placing these spacecraft into low Earth orbit. The Shuttle will also allow a Spacelab mode of experimentation to accomplish scientific and application space observations for durations longer than the "minute-to-hours" period of suborbital flights (Fig. 1).

The Spacelab sortie mode will accommodate large and complex scientific instruments and facilities (which can be reconfigured from flight to flight to address different scientific objectives). It will support active manned operations in orbit, provide high data rate transmission to the ground, and allow user access to the payload when returned to the ground after the mission. While both of these operational modes will continue to be utilized, the need to provide an approach that encompasses the best of both of these operational modes has been identified (Fig. 2).

The approach under definition is an orbit-based, Shuttle-tended system, which will provide, for extended periods of time, stability, utilities, and access for a variety of replaceable payloads. This system is called the Space Platform. The initial Space Platform (SP) will be capable of accommodating at any one time, as many as three payload elements consisting of such items as a Spacelab pallet complement of instruments or a facility-class payload capable of supporting multiple instruments. It is envisioned that the SP would be visited on approximately 6-month intervals, at which time some of the payload elements would be exchanged. (Some payloads may require on-orbit durations of a year or longer.) Thus, the SP is distinct from a free-flyer spacecraft in emphasis on routine Shuttle servicing and payload exchange. This operation, illustrated in Figure 3, will be elaborated later in this paper.

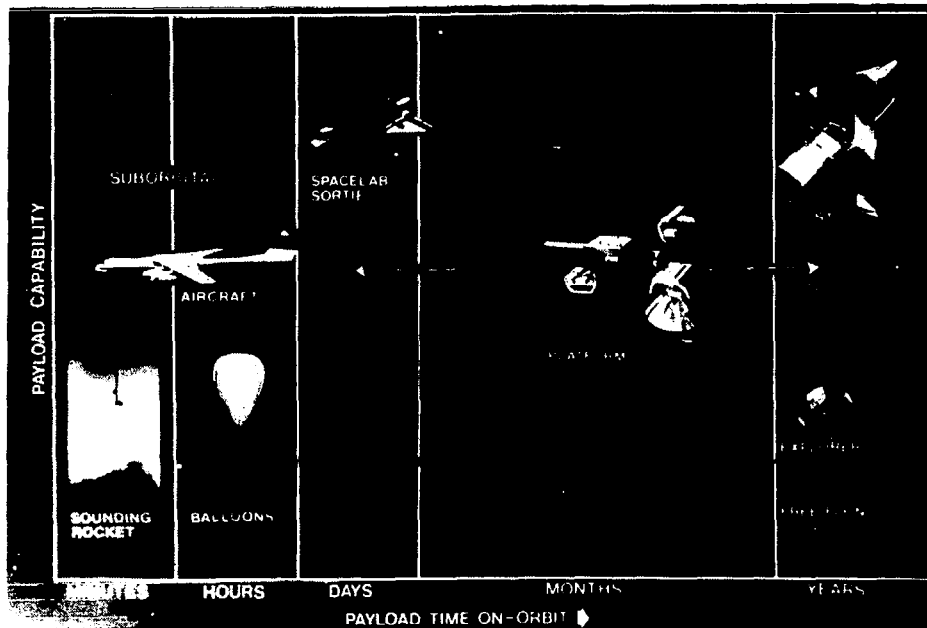

Fig. 1. Payload opportunities for space operations.

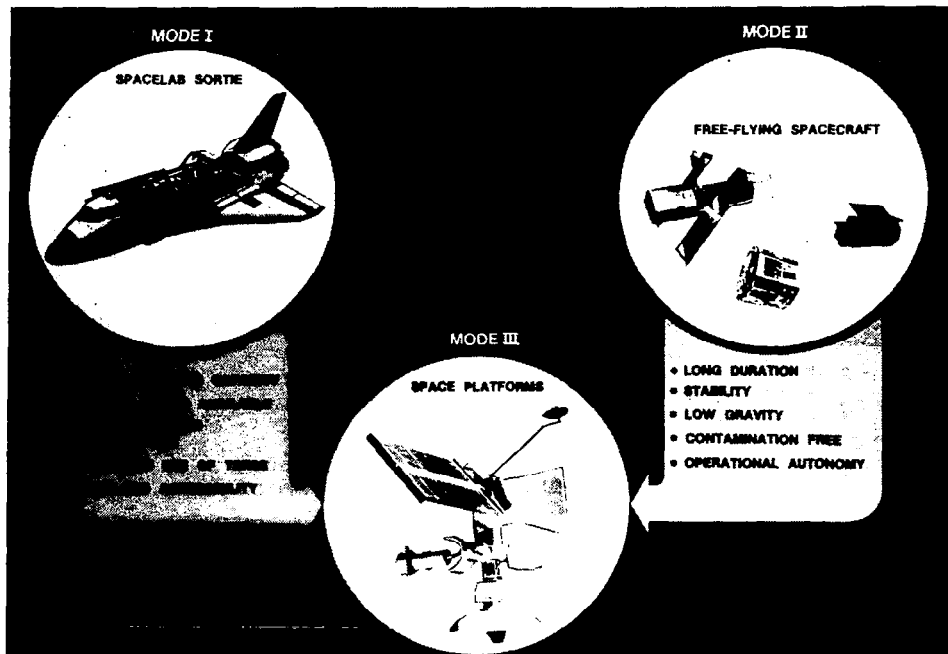

Fig. 2. Payload opportunities for space operations and attendant system design characteristics.

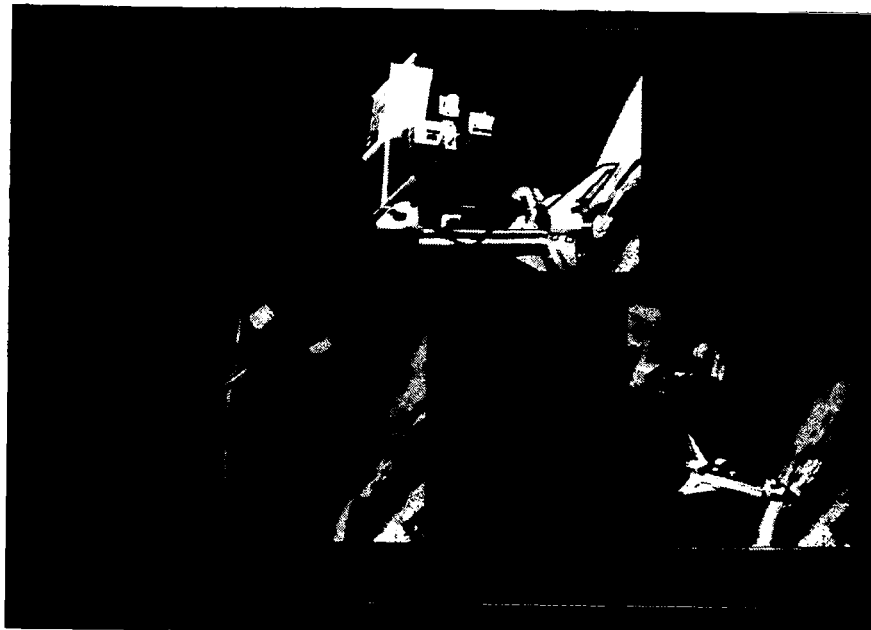

Fig. 3. Routine Shuttle servicing and payload exchange.

Considerable attention has been devoted to this concept by the NASA/Headquarters and the Marshall Space Flight Center over the past 4 years and has been reported on in References 1-14. This paper is designed to update the NASA definition of the Space Platform program and the potential relationship of this operational system with meteorological payloads.

The most critical element in the platform planning and concept definition has been the continued involvement of the science and applications

community in formulating payload needs and assessing the design concepts to satisfy these needs. The merging of early Phase A 25 kW Power Module studies with the Phase A Science and Applications Space Platform (SASP) studies into the Phase B Space Platform studies was a result of the payload community involvement. McDonnell-Douglas Astronautics Company and TRW have recently completed parallel Phase B definition studies on the SP. Following design selection, the SP requirements can be met with a state-of-the-art design using, to a large extent, available hardware design from other

flight programs. This extensive use of previously developed hardware greatly minimizes the SP cost and risk. While the basic system size and configuration has been defined during the Phase B studies, continued payload inputs will be used in the design and implementation of the Space Platform.

Payload Requirements

The payload requirements and mission models for potential incorporation into a platform have been defined by the NASA payload discipline offices in concert with representatives of the user communities. The payload elements, identified for flight in the latter half of the 1980's, have been classified into two major categories: (1) assemblages of instruments and (2) large facility-class instruments. Approximately 80 typical payload elements were used in the early Phase B analysis to assess the accommodation capability of a platform program. A major portion of the payload elements contains pointing-type instruments. The instruments are clustered such that each payload element occupies at least one Spacelab pallet full of equipment. These initial requirements were reviewed by various advisory groups to assure their validity and are defined in References 15 and 16. As the SP design developed, 16 to 20 payloads (see Table 1) were selected as design driver payloads for operation on the Space Platform and grouped into design reference missions (DRM's) for assessing more detailed payload accommodation features of the Space Platform.

In the definition of payload requirements, it is necessary to include not only the instruments but the ancillary equipment necessary for integrating

the instruments together and to the Space Platform (Fig. 4). The payload ancillary equipment includes such items as structural carriers (i.e., Spacelab pallets); thermal control hardware (i.e., coolant pumps and cold plates); fine pointing systems; and other platform interfacing items for power and data management. An assessment of this type equipment for the reference payloads is in process [17]; and early results are summarized for power, mass, and data in Figures 5, 6, and 7, respectively. Ancillary integration equipment can represent a significant percentage of the power and mass for some of the payloads, but almost all of the data requirements are for the instrument.

Space Platform System Description

The two contractor designs for the SP are not presented in this paper because of the competitive nature of the A-109 procurement established for this project. However, a generic description of the Space Platform can be given based upon previous Phase A studies and Phase B system requirements.

The basic Space Platform system features are illustrated in Figure 8. The configuration is sized to fit within the payload bay of the Shuttle Orbiter for delivery to orbit. It weighs approximately 30,000 lb, and the length of 40 ft leaves room in the bay for operational payloads on the initial SP deployment flight. The design operational orbit is nominally 435 km altitude with inclination at either 28.5° or 57°. (Polar orbits are possible on later missions.) However, the SP carries its own altitude adjust capability to make up for orbit decay, and this can be used to provide much higher (i.e., for sun-synchronous orbits) or lower operational

Table 1 Early typical payloads for space platform

DISCIPLINE	PAYLOAD	NAME	GENERAL INTERFACE CHARACTERISTICS
COSMIC RAYS	SCRN	ELEMENTAL COMPOSITION/ENERGY SPECTRA OF COSMIC RAY NUCLEI	<ul style="list-style-type: none"> ● LARGE AND MASSIVE INSTRUMENTS ● COARSE POINTING ● ANTI-EARTH VIEWING ● LOW DATA RATES
	TRIC	TRANSITION RADIATION/IONIZATION COLORIMETER TELESCOPE	
	SUPERMAG	SUPERCONDUCTING MAGNETIC SPECTROMETER	
	HEAVY NUC	HEAVY NUCLEI EXPLORER	
ASTRONOMY	VLBI	VERY LONG BASELINE INTERFEROMETRY	<ul style="list-style-type: none"> ● LARGE VOLUME ● FINE POINTING ● MANY TARGETS IN CELESTIAL SPHERE ● CRYOGENS ● CONTAMINATION SENSITIVE
	SIRTF	SHUTTLE INFRARED TELESCOPE FACILITY	
	STARLAB	STARLAB UV OPTICAL TELESCOPE	
SOLAR PHYSICS	SIC	SOLAR INSTRUMENT CLUSTER	<ul style="list-style-type: none"> ● REAL-TIME GROUND INTERACTION ● LARGE INSTRUMENTS ● FINE POINTING ● SINGLE TARGET ● HIGH DATA RATES
	SOT	SOLAR OPTICAL TELESCOPE	
SPACE PLASMA PHYSICS	SEPAC	SPACE EXPERIMENTS WITH PARTICLE ACCELERATORS	<ul style="list-style-type: none"> ● MULTIPLE PACKAGES ● MAGNETIC FIELD ALIGNMENT ● SIMULTANEOUS SOLAR AND EARTH VIEWING ● HIGH POWER
	WISP	WAVE INJECTION IN SPACE	
MATERIALS PROCESSING	EOS	ELECTROPHORESIS OPERATIONS IN SPACE (COMMERCIAL)	<ul style="list-style-type: none"> ● HEAVY FACILITIES ● LOW GRAVITY REQUIREMENTS ● HIGH POWER ● LOW DATA RATE ● ON-ORBIT SERVICING (SAMP EXCHANGE)
	SES	SOLIDIFICATION EXPERIMENT SYSTEM	
	MEA	MATERIALS EXPERIMENT ASSEMBLY	
ENVIRONMENTAL OBSERVATIONS	QWDS	OCEAN WAVE DIRECTIONAL SPECTROMETER	<ul style="list-style-type: none"> ● EARTH NADIR POINTING ● HIGH DATA RATES ● SOLAR VIEWING
	ALS	ADVANCED LIMB SOUNDER	
	SAR	SYNTHETIC OPERATURE RADAR (LAND OBSERVING RADAR)	
	SUSIM	SOLAR ULTRAVIOLET IRRADIANCE MONITOR	
	ACR	ACTIVE CAVITY RADIOMETER	
AMSU	ADVANCED MICROWAVE SOUNDING UNIT		

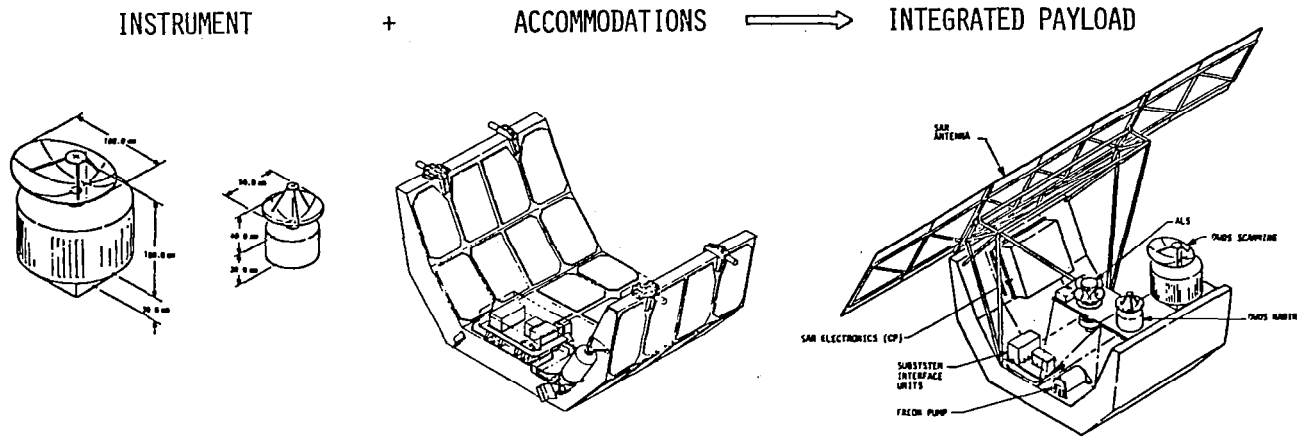

Fig. 4. Definition of integrated payload requirements for a platform port.

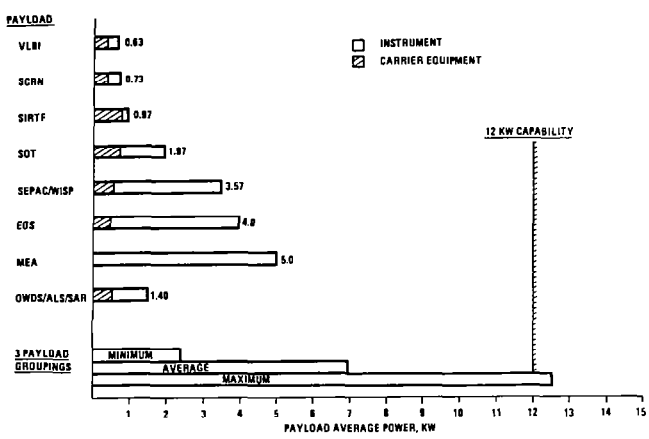

Fig. 5. Electrical power requirements of typical platform payloads.

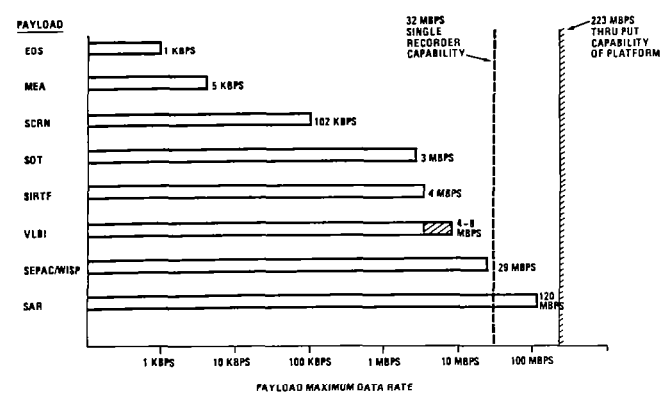

Fig. 7. Range of payload data rates for platform.

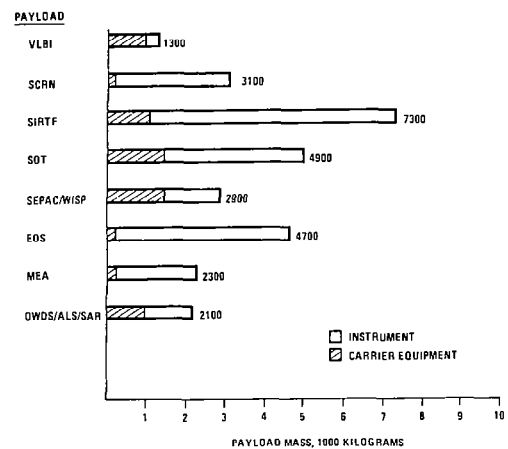
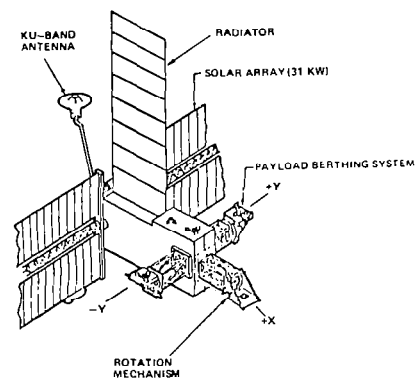

Fig. 6. Mass characteristics of typical platform payloads.



- PAYLOAD PORT RESOURCES AVAILABLE**
- ELECTRICAL POWER: 12KW CONTINUOUSLY
 - HEAT REJECTION: COMMENSURATE WITH POWER LEVEL
 - COMMUNICATION & DATA HANDLING: 223 Mbps TO GROUND VIA TDSS. SPACELAB EQUIVALENT MULTIPLEXING AND DATA STORAGE.
 - STABILITY AND CONTROL: CONTAMINATION FREE CMG STABILIZATION
 - ARC-SECONDS STABILITY AND POINTING
 - LOW g ENVIRONMENT (10⁻⁶ Gs)
- 3 ACTIVE BERTHING PORTS WITH SIMULTANEOUS OPERATION AND MULTIDIRECTIONAL VIEWING
 PERIODIC MANNED INVOLVEMENT FOR PAYLOAD EXCHANGE AND SERVICING
 COMPATIBLE WITH SPACELAB ELEMENTS AND INTERFACES

Fig. 8. Space Platform system features.

altitudes as required. The primary structure is modular in design with the aft section containing three berthing ports for payloads and a fourth port for Orbiter berthing. The forward section of the SP contains the solar array and the reboost module. The central section contains most of the electrical, thermal, attitude control, communications, and data handling subsystems equipment. The equipment is mounted to permit on-orbit replacement.

The SP electrical power subsystem furnishes the power required for both the subsystems and payloads, and has been designed for providing a nominal total power to the payload ports of approximately 12 kW at the end of 5 years on-orbit operations. It is also designed to accommodate on-orbit growth to a 25 kW system by the addition of solar arrays, batteries, and power conditioning equipment. This level of power can be delivered to one port or divided among the payloads as a function of mission requirements. The solar array is a design which is based upon the lightweight, flexible substrate technology developed for the Solar Electric Propulsion Stage (SEPS) arrays. Each wing has a single-degree-of-freedom gimbal capability with $\pm 180^\circ$ rotation capability; thus, slip rings are not required.

The SP thermal control subsystem utilizes a Freon-pumped coolant loop and a deployable radiator for rejecting heat. Extensive use was made of coolant loop components and technology developed for the Shuttle Orbiter. Dual coolant loops will provide needed subsystem redundancy. The thermal control radiator consists of flat panels which are deployable and retractable. Each payload port has a heat exchanger for accepting waste heat from payloads similar to the Shuttle Orbiter approach. Each payload provides its own coolant pump package for collecting and transporting heat to the SP heat exchanger. The SP shall provide a coolant temperature range of 0°C to 10°C to the payload heat exchanger.

The SP communications subsystem provides communications for the SP and for the attached payloads. The total integrated design and the Ku-band subsystems are compatible with the Tracking and Data Relay Satellite System (TDRSS). The S-band subsystem is also compatible with the Ground Space Tracking and Data Network (GSTDN) and the Orbiter Payload Interrogator. The Ku-band capability of the SP permits up to 223 megabits per sec (MBPS) of data to be down linked from the SP to the ground via TDRSS. This capability is normally available 20 min per orbit. The S-band capability of the SP utilizes a TDRSS multiple access (MA) channel to transmit data up to 50 kilobits per sec (KBPS) throughout the orbit (except for brief periods when TDRSS is blocked from view).

The SP data management subsystem provides all data management functions required to support the SP subsystem. It provides executive control over attached payloads, routes commands and data between the SP communication subsystems and attached payloads, and provides a command and data interface with the Orbiter when the two vehicles are attached. A key factor in the SP design has been the desire to simplify integration of payload/platform software. Payload autonomy, interface standardization, and software modularity are of particular importance. Figure 9 shows an example of a candidate interface. For this system, the

individual experimenter would see an interface very similar to Spacelab. In fact, the scientific-data interface with the high rate multiplexer can be identical. The command, housekeeping data, and timing interfaces are different in some details; but these differences can be accommodated by a Spacelab Payload Standard Modular Electronics (SPSME) module as indicated. The SPSME also has provisions for a dedicated experiment processor to support experiment control, data acquisition, and data processing. Because of the desire for autonomy and simplicity, this approach is strongly preferred over payload data processing in a centralized processor on the platform. The platform will have data storage capability equivalent to the Spacelab during those orbital periods when TDRSS communications via the Ku-band is not possible. This capability is 32 MBPS maximum storage rate and 3.8×10^{10} bits of storage [18].

The SP attitude control subsystem provides stabilization, attitude control, and maneuvering functions for the platform and its payloads. In addition to these functions, the subsystem receives position information from and generates rotational control command to the payload port, solar array, and communications antenna gimbal system, and generates thruster firing commands for the reboost module. The basic elements of the subsystem include control moment gyros (CMG's), magnetic torquers, rate gyros, attitude determination sensors, and Sun sensors. This subsystem will provide a very stable, contamination-free base for the attached payloads; and stability and pointing accuracies in the sub-arc-minute range are possible using a payload sensor (Fig. 10). The pointing mount (if required for a payload) would be part of the payload ancillary equipment.

The SP is equipped with an altitude adjust capability (reboost module) to compensate for orbit decay. The module is replaceable on-orbit and is sized to maintain the SP above 370 km for at least 1 year without being resupplied by the Shuttle. The use of the reboost module (frequency and propellant consumption) is a function of operating altitude requirements, payload requirements, and solar flux activity.

Space Platform Systems Operation

As noted earlier, the Space Shuttle is utilized for delivery of the platform and its payload to orbit, for servicing or maintaining them during revisits, and for exchanging payloads as mission requirements for the platform change. The Orbiter Remote Manipulator System (RMS) is used in performing these services. The SP is being designed for unscheduled maintenance on-orbit and is foreseen to have an unlimited life for supporting payload operations. The SP provides the "parking spaces" for locating payloads removed from the Orbiter payload bay while the RMS removes a payload from the berthing port and stows it in the Orbiter bay for return to Earth.

The SP/Orbiter berthing mechanisms, provided by the SP program, are being designed to minimize Orbiter interfaces and any payload bay resources (weight or volume) that reduce the Orbiter capabilities for payload delivery. Contractor designs are not presented for illustrating this SP operational feature, but Figure 3 gives an idea of the

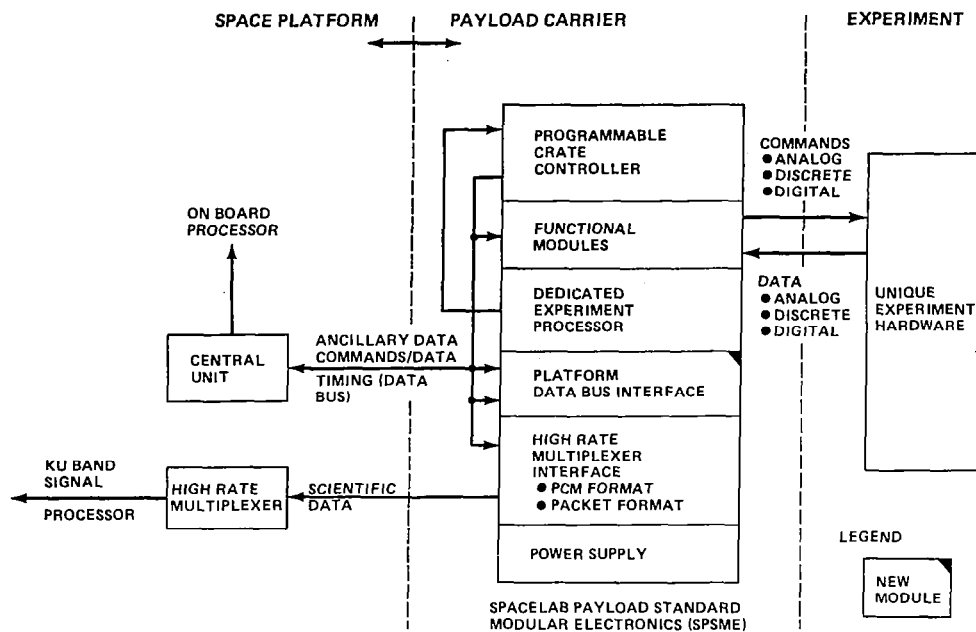

Fig. 9. Typical platform command data flow with payloads.

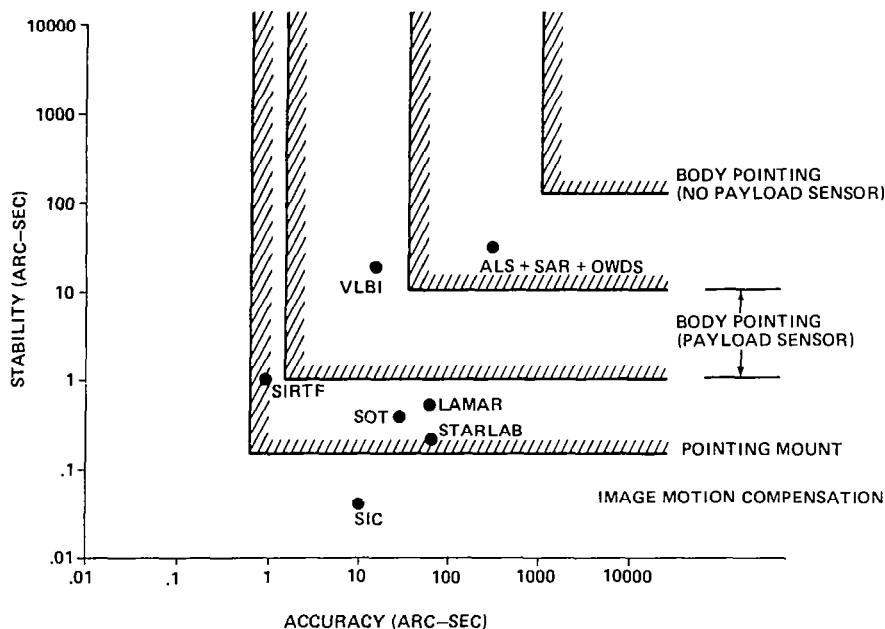

Fig. 10. Payload pointing requirement versus platform and pointing mount capabilities.

location of this berthing adapter and the RMS exchange of SPS payloads.

The potential paths of the SP evolution are illustrated in Figure 11. A growth scenario might proceed from the initial capability to replication of this initial system, copies being dedicated to specific disciplines and/or placed in special orbits (e.g., Sun-synchronous); and to larger platforms accommodating several of the facility-class payloads; and/or evolve to the manned module mission which could evolve from early-manned systems to the all up permanent operations center in space.

Meteorological Applications

The Space Platform design characteristics and capabilities have been molded by discipline-oriented groupings of instruments/payloads. The specific instruments listed in Table 1, under the six major discipline categories, were chosen primarily because they exhibited characteristics (i.e., size, weight, power, data rates, etc.) that have driven the overall SP design capabilities and configuration. Within the discipline category called "Environmental Observations" would fall all payload measurements involved with the atmosphere (ALS), oceans (OWDS), and land surface (SAR) for studies of earth resources, upper-oceanic structure, and atmospheric phenomenon.

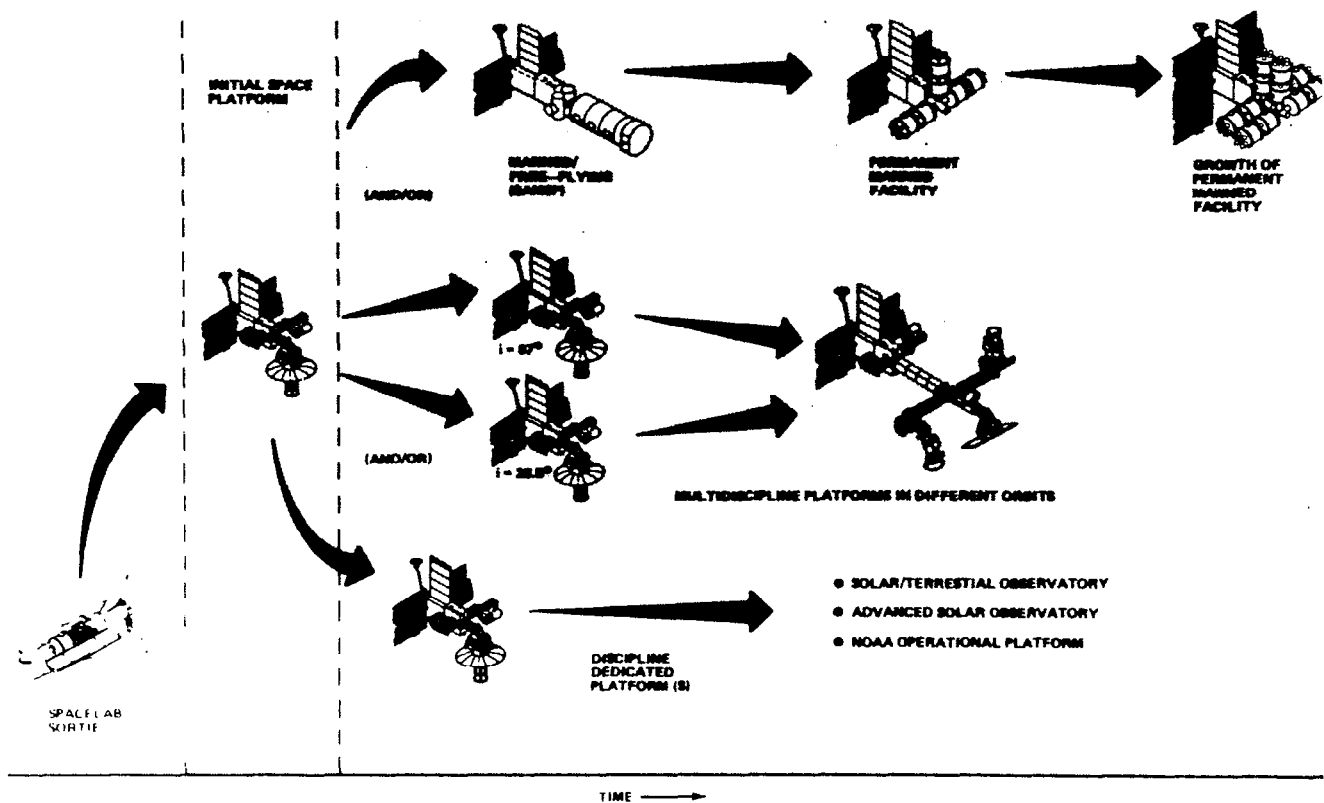

Figure 11. Space Platform evolution scenarios.

Meteorological applications of the SP, as discussed here, will be limited to research activities involved with atmospheric phenomena primarily in the "weather producing" lower-atmosphere (troposphere and lower-stratosphere from about 0-30 km altitude). The primary purpose of this section is not to propose a specific complement of meteorological instrumentation for the SP, but to develop a philosophy and an organized, scientific approach that could eventually be used as a basis for determining those actual groupings of SP instruments best suited for answering high-priority scientific questions concerning the lower atmosphere using space measurements. However, specific instrumentation and their groupings into payloads will be discussed as an example of the type of meteorological instrument-complements that might be proposed to answer a broad, high-priority scientific question using SP capabilities. These activities depend heavily on the research and development strategy of early SP missions that is not dedicated to a specific, long-term (greater than 6 to 12 months) objective. The National Oceanic and Atmospheric Administration has studied the potential for using the SP in a dedicated, operational configuration in the late 1980's and early 1990's and found it highly desirable (see Reference 19 and Figure 11). The research utilization of the SP discussed in this paper would provide, as one advantage, a means by which specific instrumentation could be flown, tested, improved, and eventually used operationally by NOAA if their mission required the space measurement capabilities and performance provided by a given payload or instrument.

Lower Atmospheric Research Satellite Program Concept

The process of defining meteorological applications of the SP is encompassed by a broad range of similar studies under the Lower Atmospheric Research Satellite (LARS) Program Concept [20]. The LARS Program Concept proposes a comprehensive investigation of the energetics, composition, and dynamics of the lower atmosphere to provide a broad-based study of lower atmospheric processes and their interactions using coordinated space-related measurements and theoretical studies closely coupled to ongoing lower atmospheric and solar-terrestrial science as a whole. While LARS activities might cover lower atmospheric research, field measurements, laboratory studies, and theoretical analysis derived from all the "payload capability" versus "payload time on-orbit" activities shown in Figure 1, the emphasis of meteorological applications of the SP under the LARS Program Concept involves only those opportunities, configurations, and resources related to the planned SP, as discussed previously in Figures 1 through 4.

The LARS Concept research areas focus into these three categories:

- 1) coupling among radiative, chemical, and dynamical processes
- 2) interactions between the earth's surface, boundary layer and troposphere

- 3) dynamic and energetic relationships between lower atmospheric processes.

This broad scope of research activity requires a wide range of different and overlapping space-related measurements to help answer some of the key scientific questions in each category. If the LARS concept is used as an approach to determining potential meteorological applications of the SP, then specific scientific questions and issues must be outlined under each of the three broad categories above to:

- establish the role of space technology in answering key questions
- determine data requirements
- develop sensor systems and supporting research programs
- acquire collaborative experiment inputs
- determine the LARS instrument complements for various SP orbital and design configurations.

Meteorological Applications Determined by the LARS Concept

As an example of the type of SP instrument complement that might be proposed under the LARS concept, research area 3), above, was chosen as the major focus of a hypothetical grouping of instrumentation looking at lower atmospheric dynamics and energetics. It is assumed that key scientific questions in this category have been identified relative to their applicability to a space technology solution. Table 2 summarizes the recommended measurements for a hypothetical low-atmospheric dynamics and energetics determination.

Table 2 Summary of Hypothetical Measurements Recommended for Lower-Atmospheric Dynamics and Energetics Determination*

Earth Radiation Budget. Measure incoming and outgoing radiation characteristics of the solar and terrestrial spectrum. (Accuracy: 0.5 percent)

Temperature, Humidity, Pressure.** Height - 0 to 30 km; vertical resolution ≥ 1 km; accuracy: 1°C, 10 percent RH, 1 mb of pressure; horizontal resolution ~ 1 -10 km

Horizontal Winds. Horizontal resolution ~ 1 to 10 km; vertical resolution ~ 1 km; accuracy: ~ 2 -5 ms⁻¹

Precipitation. Horizontal resolution ~ 1 -5 km; precipitation rate accuracy: 10 percent

Lightning Intensity and Distribution. Horizontal resolution ~ 1 -5 km

Surface Properties. Horizontal resolution ~ 1 -10 km

*Coordinated field-of-view desirable on all measurements where possible.

**Multi-spectral imaging in IR, visible, and microwave channels will be part of this measurement activity.

These specific measurement requirements could be met using a wide range of existing and proposed instrumentation focusing on the variables needed to improve our basic understanding of lower-atmospheric dynamics and energetics. Table 3 lists strawman atmospheric instruments for this purpose, including payload accommodation requirements.

Payload Groupings and Accommodations for the SP

The nine instruments proposed in Table 3 could be grouped for mounting on pallets as shown in concept in Figure 4. In addition, the required resources for the entire instrument complement utilize much of the power and data-rate capabilities of the proposed SP design. If the ERBI, AMSU, MPS, LTPMS, and LM were mounted on pallet 1, the LAMMR and/or SMR on pallet 2, and DLS on pallet 3, all or most of the instrumentation could be flown as a dedicated payload activity with each pallet interfaced to the proposed three berthing ports of the SP. However, the exact configuration would depend on an extensive mission and on-orbit operations analysis not presented in this paper.

References

1. Chappell, C. R.: "The Solar Terrestrial Observatory," AIAA Conference on Large Space Platforms: Future Needs and Capabilities, AIAA Paper No. 78-1640, September 1978.
2. Wu, S. T., and Morgan, Samuel H., eds.: Proceedings of the UAH/NASA Workshop on Space Science Platform, University of Alabama in Huntsville, December 1978.
3. Cuneo, William J. Jr., and Williams, Dell P., III: "Space Platforms for NASA - Opportunity or Pitfall," Proceedings of the Sixteenth Space Congress, April 1979.
4. Snoddy, William C., and Nein, Max E.: "Space Platform Concepts," American Astronautical Society, 1979 Annual Meeting, Paper No. 79-264, October 1979.
5. Ballance, J. O.: "Space Platforms: An Evolution from Spacelab Payload Operations," Proceedings of the Seventeenth Space Congress, April 1980.
6. Stofan, Andrew J.: "Space Platforms: A Cost Effective Evolution of Spacelab Operations," XXXI Congress, International Astronautical Federation, Paper Number 80-IAA36, September 1980.
7. DeSanctis, C.: "Science and Applications Space Platforms: A NASA Overview," AIAA 19th Aerospace Sciences Meeting, AIAA Paper No. 18-0339, January 1981.
8. Wu, S. T.; Taylor, William W. L.; Torr, Douglas; and Walker, Arthur B. C.: "Space Platform Science/Application Requirements," AIAA 19th Aerospace Sciences Meeting, AIAA Paper No. 81-0340, January 1981.

Table 3 Strawman Atmospheric Instruments for Lower-Atmospheric Dynamics and Energetics Determination*

Instrument	Characteristics/Function	Weight (kg)	Size	Power (W) ⁺	Data Rate (KBPS)
Earth Radiation Budget Instrument (ERBI)	Measure incoming and outgoing reflected and emitted radiation. Measure solar constant, spectral solar irradiance in spectral bands, albedo, and emitted long-wave radiation.	60	0.5 x 0.5 x 0.5 m	55-P	1.3
Advanced Moisture and Temperature Sounder (AMTS)	28 channel IR spectrometer to measure vertical profiles of temperature and moisture	300	1.0 x 1.4 x 0.8 m	150-P	3.0
Advanced Microwave Sounding Unit (AMSU)	20 channel microwave radiometer to measure vertical profiles of temperature and moisture	80	0.5 x 1.6 x 0.6 m	170-P	3.6
Microwave Pressure Sounder (MPS)	Microwave sensor using up to 6 channels to measure sea-level pressure	50	1.5 x 0.6 x 0.5 m	100-A	1.0
Large Antenna Multi-frequency Microwave Radiometer (LAMMR)	High-resolution microwave radiometer to map surface and atmospheric temperature, water vapor and liquid water, ice coverage, and ocean winds	220	4 meter diameter dish	235-P	50
Lidar Temperature/Pressure/Moisture Sounder (LTPMS)	Visible/IR laser with scan to permit wide coverage of vertical temperature/moisture/pressure sounding from surface into stratosphere.	1300	255 m ³	3000-A	250
Doppler Lidar Wind Sounder (DLS)	CO ₂ laser with scan to permit measurement of horizontal winds (from aerosol backscattering) from surface to ~ 10 km	2300	3.9 x 2.8 x 4.2 m	8500-A	1150
Spaceborne Meteorological Radar (SMR)	Dual-wavelength radar to measure precipitation rates and surface properties (snow depth, ice cover, soil moisture, etc.)	500	5 m dish or array antenna	800-A	200
Lightning Mapper (LM)	Optical array detector for determining the occurrence, location, and intensity of lightning flashes	20	2 m ³	150 P	100

+ P - passive instrument and A - active instrument.

* Information for some instruments from Reference 21 and from Mr. John Theon of NASA Headquarters.

- | | |
|--|--|
| <p>9. Lillie, Charles F.: "Integrated Requirements and Operational Scenarios for Low Altitude Space Platforms," AIAA 19th Aerospace Sciences Meeting, AIAA Paper No. 81-0341, January 1981.</p> <p>10. Nein, Max, and Runge, Fritz: "Science and Applications Space Platform," AIAA 2nd Conference on Large Space Platforms: Toward Permanent Occupancy of Space, AIAA Paper No. 81-0458, February 1981.</p> <p>11. Hauver, R. V.: "Payload Accommodations on Science and Applications Space Platforms," AIAA 19th Aerospace Sciences Meeting, AIAA Paper No. 81-0343, February 1981.</p> <p>12. Crisman, Ronal B., and Wax, Robert L.: "Experiment Design Considerations for Space Platforms," AIAA 19th Aerospace Science Meeting, AIAA Paper No. 81-0344, February 1981.</p> <p>13. Schwartz, Jonas M., and Hilchey, John D.: "The Manned Space Platform as an Evolutionary Means to Achieve a Permanent Manned Orbital Operations Facility," AIAA 2nd Conference on Large Space Platforms: Toward Permanent Manned Occupancy in Space, AIAA Paper No. 81-0462, February 1981.</p> <p>14. Snoddy, William C.: "Space Platforms for Science and Applications," Astronautics and Aeronautics, April 1981.</p> | <p>15. NAS8-33759, "Payload Requirements/Accommodations Assessment Study for Science and Applications Space Platform," Volume II: TRW Technical Report, November 1980.</p> <p>16. MSFC Document PM-006, "25 kW Power System Payload Support Requirements," August 1980.</p> <p>17. NAS8-34586, "Science and Applications Space Platform Payload Accommodations Study," October 1981.</p> <p>18. NAS8-33592, "Conceptual Design Study of a Science and Applications Space Platform," Vol. II Technical Report, October 1980.</p> <p>19. MSFC PD Document, "SP/Sun Synchronous Mission Study for Potential NOAA Applications," May 1981.</p> <p>20. Vaughan, William W.: "Lower Atmospheric Research Satellite (LARS) Program," NASA-Marshall Space Flight Center, December 1980. (presently unpublished).</p> <p>21. NASW-3398, "Handbook of sensor technical characteristics," NASA, September 1981.</p> |
|--|--|

USER NEEDS AND THE FUTURE OF OPERATIONAL METEOROLOGICAL SATELLITES

Drs. Donald B. Miller and Joseph R. Silverman
Advanced Systems Concepts Group
National Oceanic and Atmospheric Administration
National Earth Satellite Service
Washington, D.C. 20233

Introduction

The National Oceanic and Atmospheric Administration's (NOAA's) National Earth Satellite Service (NESS) has, for many years, been operating a system of complementary polar and geostationary satellites to provide a unique source of environmental observations of the earth's surface, oceans, atmosphere, and near space. For over 20 years, data collected from the environmental satellites have contributed significantly to the national environmental monitoring, prediction, and warning services. The polar-orbiting satellites obtain quantitative global environmental data used to derive profiles of atmospheric temperature and moisture, sea surface temperature observations, and snow and ice coverage. Environmental data from fixed and moving remote platforms are relayed through the polar-orbiting satellites. These data and products are used in numerical weather analysis and prediction, oceanographic, hydrologic, agricultural, and solar radiation programs. The geostationary satellites provide the repetitive, around-the-clock images that are needed to detect, track, and monitor the growth and decay of severe weather systems in the temperate and tropical latitudes. They continuously collect environmental data from fixed platforms and are used to retransmit satellite derived products to national and international users via Weather Facsimile. The polar-orbiting and geostationary satellites carry instruments to monitor the state of solar activity at spacecraft altitude.

The polar-orbiting satellite of the present system are of the TIROS-N series; eight operational spacecraft (NOAA A through G) are being built and NOAA H, I, J are to be contracted. In the geostationary case, five geostationary spacecraft have been launched, and three more are under construction. The last of these (GOES F) would be needed in orbit about mid-1983. Purchases of additional GOES (G, H, and I) are being planned.

Polar-Orbiting (TIROS-N Series)

The TIROS-N series of satellites is a cooperative effort of the United States (NOAA and NASA), the United Kingdom, and France. NASA conducted the development and launch of the first flight satellite (TIROS-N) with subsequent satellites procured and launched by NASA using NOAA funds. The operational ground facilities, including the Command and Data Acquisition (CDA) stations, the Satellite Operation Control Center, and the data processing facilities (with the exception of the Data Collection System (DCS) processing facility are procured, funded, and operated by NOAA. The United Kingdom, through its Meteorological Office (Met O), Ministry of

Defense, provided a Stratospheric Sounding Unit (SSU), one of three sounding instruments, for each satellite.

The Centre National d'Etudes Spatiales (CNES) of France provides the DCS instrument for each satellite and the facilities necessary to process and make available to users the data obtained from this system. The Centre d'Etudes de la Meteorologie Spatiale (CEMES) of France provides ground facilities at Lannion, France for receipt of, and for retransmission to NESS via the GOES, the sounder data acquired during those orbits when the satellites are outside the range of the CDA stations in Alaska and Virginia.

The primary environmental sensors for these satellites are:

1. The High Resolution Infrared Sounder (HIRS/2)
2. The Stratospheric Sounding Unit (SSU)
3. The Microwave Sounding Unit (MSU)
4. The Advanced Very High Resolution Radiometer (AVHRR)
5. The Space Environment Monitor (SEM)
6. The Data Collection System (DCS)

Beginning with NOAA E, the operational polar-orbiting satellite system (advanced TIROS-N) will be modified to accommodate the addition of the following missions:

1. A Search and Rescue (S&R) mission
2. The Earth Radiation Budget Experiment (ERBE)
3. Solar Backscatter Ultraviolet (SBUV) Instrument

A list of products and services available from the polar satellites is provided in Table III.

Geostationary Operational Environmental Satellites

The Geostationary Operational Environmental Satellite (GOES) System was developed to provide for continuous viewing of weather features and for collecting and relaying meteorological data from remote platforms such as bouys, ships, automatic stations, aircraft, and balloons. The GOES system performs meteorological observations for the following purposes: continuous storm tracking, cloud analysis-density temperature, height, wind velocity, surface temperature mapping, space environmental

sun/earth interaction, remote sensor data relay (flood, rain, snow, tsunami, earthquake, and air-water pollution monitoring).

The most likely system deployment in the 1980s will be similar to the current two GOES system with one eastern (75°W) and one western (135°W) satellite performing the basic imaging (utilizing the Visible and Infrared Spin-Scan Radiometer), Space Environment Monitoring, Data Collection, and WEFAX missions. An additional middle satellite with a failed imager (107°W) serves as a dedicated WEFAX service and a backup for the DCS.

The primary environmental instruments for these satellites are:

1. The Visible Infrared Spin Scan Radiometer (VISSR) Atmospheric Sounder (VAS)
2. The Space Environment Monitor (SEM)
3. The narrowband weather facsimile (WEFAX)
4. The Data Collection System (DCS)

International Satellite Programs

The international community has implemented and now operate meteorological satellites. For the period of December 1978 to November 1979, the most comprehensive meteorological and oceanographic experiment (first GARP Global Experiment) ever attempted was conducted under the auspices of the World Meteorological Organization (WMO). Polar-orbiting satellites operated by the United States and the U.S.S.R., and geostationary meteorological satellites operated by the United States, the European Space Agency, and Japan contributed greatly to the success of this global weather experiment.

During the decade of the 80s, it is anticipated that six international geostationary meteorological satellite systems will be in operation. (See Table I.) Although the design characteristics of the American, Japanese, European Soviet, and Indian satellite systems differ from one to another, they bear a general resemblance in their mission performance and they have the following mission objectives:

1. High Resolution Imaging of the earth's surface and of its cloud coverage in the visible and thermal infrared spectra, and extraction of meteorological information such as cloudiness, wind vectors, and temperatures from the image data.

2. Dissemination of cloud cover images and other meteorological information to remote Data User Stations.

3. Collection of environmental data from remote fixed or mobile Data Collection Platforms (DCPs) located either on the earth's surface or in the atmosphere.

Since these two missions affect a wide community of users owning Automatic Picture Transmission (APT) stations, Data User Stations, and Data Collection Platforms (DCP), the transmission characteristics and the operational procedures have been standardized. The coverage of the data relay capability extends outward to about 75° of great circle arc around the subsatellite points.

Data, Products, and Services

The present GOES system has been designed to meet a specific set of observational requirements. These were defined by the Department of Commerce in 1970. The meteorological capabilities of the current GOES are keyed to the VISSR, a dual band (VIS and IR) spin-scanned device utilized for day and night cloud cover pictures. Off-line assessments and evaluations are presently underway to determine if the VAS should supersede the VISSR as the operational instrument. The VAS has the VISSR imaging capabilities with an additional 11 IR channels. It is possible to determine not only surface and cloud top temperatures, but also the three-dimensional structure of the atmospheric temperature and water distribution. The VAS can provide time sequences of multi-spectral images from which cloud and water vapor motions can be tracked and from which cloud-top and surface temperatures can be more accurately determined. It can also be programmed (when not in VISSR mode) to obtain atmospheric temperature and moisture profiles. The dwell sounding swaths can be located and timed to obtain data near hurricanes, severe storms, and other targets of opportunity.

TABLE I. INTERNATIONAL GEOSTATIONARY METEOROLOGICAL SATELLITE SYSTEMS

SYSTEM OPERATOR	SATELLITE NAME	LOCATION/ LONGITUDE	LAUNCH DATES
European Space Agency	Meteosat-2	0°	October 1981
Japan	GMS-2	140°E	August 1981
USA	GOES-West	135°W	October 1981
	GOES-East	75°W	June 1981
	GOES-Central	107°W	June 1977
	(WEFAX only)		
USSR	GOMS	76°E	Circa 1983
India	INSAT-1	74°E	1982

Many products are available from GOES, and these are summarized in Table II. The currently available products are listed under Item I. Products that could become operationally available in 1985 (GOES G) are listed under Item II.

Next Generation Meteorological Satellite Systems

The following discussion is based on several long-term analyses which developed, based on the user requirements and system capabilities, scenarios of different systems for the coming years. Current and future budgetary restrictions may significantly modify these plans. This problem is addressed in the later sections of this paper.

The next 20 years in meteorological satellites should be one of enhancement and expansion of existing services. Developing technologies will provide avenues for new techniques; however, these will face stiff competition for the R&D dollars necessary to develop new approaches. Notwithstanding, there should be continuing improvement and refinement in satellite spacecraft and sensors which will proceed apace with advances in space technology. Progress in the optical, electronics, and material sciences has opened new possibilities for the remote sensing of the environment and for the handling of the resulting data. The intent that the reusable Space Shuttle of NASA's Space Transportation System (STS) be employed to launch these meteorological satellites may necessitate a number of significant, abrupt departures in the technological continuity of the program. New developments such as the Tracking and Data Relay Satellite System (TDRSS) and the Global Positioning System (GPS) may enable significant system design changes.

A broad program of cooperative technology development and research generates the new observation techniques and instrumental concepts upon which improved operational capabilities will be based. Promising new instruments and techniques are tested on balloon and aircraft-borne packages in addition to NASA experimental satellites as essential steps in the development programs.

There are also improvements envisioned in the GOES via "GOES-Next." A major direction of such a system would be the ability to provide both images and soundings simultaneously.

In addition to the continuation of existing baseline products and services, the goals for improvement of the geosynchronous system through the 1990s will be:*

Geosynchronous

A. Imaging

1. Increase spatial resolution in the visible and infrared channels to 0.5 km and 1-2 km respectively.

*Authors Note: These items are projected on a "most desirable basis" and are not necessarily realizable under current budget restrictions.

2. Decrease routine full disk imaging time to 15 minutes and 3 minutes for severe storm sectors, with a potential for 30 second severe storm interval imaging over limited sectors.

3. Increase the number of simultaneous multispectral images.

B. Sounding

1. Increase the vertical mean layer temperature resolution in the troposphere to 1-5 km.
2. Improve horizontal sounding resolution (10 km to 100 km range).
3. Perform soundings with flexibility of location, area covered, and increased timeliness.

C. Data Collection System

Improve efficiency, economy of operation, and platform location while maintaining existing data collection platforms.

D. Space Environment Monitor

1. Add the ability to image the solar disk in the x-ray portion of the spectrum.
2. Add the ability to monitor the electron flux density in the ionosphere.
3. Add the ability to detect and monitor low energy plasma.

E. WEFAX

Provide continuous transmissions independent of other spacecraft functions. (A single spacecraft cannot presently provide the imaging and WEFAX functions simultaneously.)

F. Ground System

1. Upgrade the ground system to accommodate separate sounding and imaging functions.
2. Provide ground processing capacity to produce additional quantitative products and services.
3. Provide for near real-time interaction between National Severe Storm Forecast Center (NSSFC) and National Hurricane Center (NHC) and the spacecraft sensors during severe storm episodes.

G. Communications

Decrease the down-link bandwidth and transmission rate to simplify ground acquisition.

Polar

The life of the current polar system could be extended beyond 1990 through improvement and

enhancements of the spacecraft and sensors and adaptation for launch on STS. NOAA I and J will be launched about 1987. Additional buys of the ATN series (e.g., K, L, et. seq.) may further extend the series to the mid-90s or beyond. The actual sensor complement of these later spacecraft may vary. It can be assumed that most of the basic services provided in the 80s will be continued through the 90s.

Potential Future Sensors

In the selection of the sensor complement there are a variety of instruments which are under consideration for the next twenty years which may or may not fly as a function of both technological feasibility and budgetary trade-offs. In practical terms, development work should begin on any system at least five years before the launch date. (Where significant development is required, this period may extend to eight or nine years.)

Typical of these other sensors are:

1. AMSU (Advanced Microwave Sounder) - a multichannel (up to 20 channels) microwave sounding instrument to provide "all weather" atmospheric temperature and moisture soundings.

2. LIDAR - doppler sounder to determine winds through laser/doppler measurements of aerosols.

3. CZCS (Coastal Zone Color Scanner) - a system which produces imagery data used to generate maps of the atmospheric attenuation and oceanic chlorophyll concentration and turbidity.

4. LAMMR (Large Antenna Multi-Frequency Microwave Radiometer) - a sensor to measure brightness temperatures from which sea surface temperatures, wind speed, and ice cover can be derived.

5. ALT (Radar Altimeter) - an active return sensor which surveys the oceans to measure waveheight and mean sea level and to detect tides, currents, and storm surges.

6. SCAT (Scatterometer) - a system to provide a periodic and spatially distributed measure of the radar backscatter coefficient for the determination of wind speed and direction at the sea surface.

Geosynchronous Sensors

Some of the new sensors which would be considered to fill the requirements of a GOES-Next are:

1. Higher Resolution VIS/IR Imager/Sounder
2. Microwave Sounder
3. Lightning Mapper
4. Separate Imager/Sounder
5. Solar X-ray Imager

The Future of the Meteorological Satellite Program - the authors opinion

Notwithstanding the previous discussion of next generation meteorological satellites as

yet undefined, budgetary restrictions may predicate significant restrictions in the degree of expansion available. There is little argument as the validity and requirement for a strong and continuing meteorological satellite problem. However, the severe budgetary restrictions currently being imposed in the federal government will handicap the ability of capital intensive programs such as these to be updated to next generation capability. This process which normally would have been ongoing during this time period (1980-1985) was to have been done for both polar and geosynchronous satellites (e.g., GOES-Next and System 85). A re-evaluation of capabilities versus funding availability predicate a continuation of the satellite portion of the program on "more or less" the same level of technological sophistication and capability that currently exists. Consideration has been redirected to where potential reductions in budget could best be implemented to obtain the maximum benefit from reduced fundings. In the evaluation of cost versus benefits and determination of next generation system configurations, two distinct cases can be made: one for Polar future and the other for GOES future.

Polar Future - The primary mission of the polar orbiting satellites is the global acquisition of vertical temperature profiles (atmospheric soundings) for use by the numerical forecasting models of the National Meteorological Center. The combination of the present infrared sounder, a four-channel microwave sounder, and the infrared stratospheric sounding unit is providing useful data over the portions of the earth that are clear to partly cloudy. The deficiencies in the present sounding capability are in the ability to obtain soundings in cloudy regions near the centers of storm systems and within active weather fronts. Sensor systems tuned to the microwave portion of the spectrum have shown that temperature profiles can be obtained in stormy regions except in areas of heaviest rain.

The development and implementation of multichannel (9 to 20 channels in the 10 to 90 GHz and even 183 GHz) microwave sounders are the highest priority for flight on the future polar-orbiting meteorological satellites. Much of the technology for microwave sounding has been proven on the NASA NIMBUS series of satellites and on aircraft flights. What remains is the development, testing, and flight of operational advanced microwave sounding units.

The Defense Meteorological Satellite Program (DMSF) has developed and flown a seven channel microwave sounder (in the 50-60 GHz range) with a horizontal resolution of 170 km and a vertical resolution of about 5 km in the troposphere. The numerical forecast models of the future will require soundings at a horizontal resolution of 50 km to 100 km and vertical resolutions of 3 km. In order to accomplish this kind of detailed measurements from space, a microwave sounder would need to have a horizontal resolution of at least 50 km and a vertical resolution of 3 km. This leads to a 9 to 12 channel instrument. Measurements at

higher frequencies (90 GHz and 183 GHz) offer the ability to correct for precipitation and the ability to obtain detailed water vapor soundings in addition to temperature soundings.

GOES Future - The utility and value of the GOES system has grown over a seven year operational lifetime. The ability to locate and track storm systems from the imagery has greatly improved short-term local area forecasts. The typical user is becoming educated in the use of GOES, although additional training will be useful.

One of the major difficulties in using the GOES system is that current space technology has outstripped the ability of the user to fully apply the data. Representative of this is lack of utilization of the full potential of the VISSR. For example, the following areas lack full exploration:

- No digital data to the field forecast units.
- Satellite data is primarily treated as a separate data source.
- No blending or melding of imagery with conventional data.
- No interactive computing in the field forecast limits.
- Limited time lapse capability in the field forecast limits.
- Little quantitative use of VISSR data.
- No 24 hour digital data base for quantitative applications.
- In addition, the user also wants more quantitative measures such as:
 - cloud-top heights and growth rates
 - rates of change of cloud systems
 - movements/measures of intensity of storm fronts, etc.

Further, users exhibit some concern over-exploiting the capabilities of an operational VAS when they have yet to exploit the full capabilities of the VISSR. Based on the above, it becomes obvious that the user community has exhibited some reluctance toward the development of new instruments.

This lack of full operational utilization of VISSR data relates less to the instrument and more to the ground processing systems -- major portions of which have been in operation for well over a decade. This along with the users willingness to delay new space technology until maximal use can be made of the existing data (VISSR and VAS) leads to the logical conclusion that limited budgets may best be utilized to upgrade the ground systems. One caution which must be observed in ground system improvements is the cost multiplier factor in NWS; i.e., the large number of field stations (WSFOs and WSOs).

Some of the areas where these improvements may be implemented are to make the configuration of the updated ground data handling system more responsive to user needs and provide near real-time data for diversified operational needs. The ground system should be able to merge satellite data with other conventional observations and provide quantitative data sets for greater synergism. Even with budget restrictions it may be possible to perform some portion of the data handling/processing in space. Interactive processing modes will be an important feature of future ground systems. Data processing and display systems will be by components of the data management system, and they will be required in substantial numbers at the local regional and central levels of the users information processing systems.

Conclusion

NASA and the aerospace industry are capable of producing an impressive array of potential instrument and sensor capabilities that could greatly improve and expand our ability to sense and measure the earth's atmosphere if implemented in next generation meteorological satellite systems. The current budgetary climate, however, affords little opportunity to improve the space segment of the meteorological satellite systems. Any additional capital for improvements and upgrading the system must be justified against the following criteria:

- Will the additional capital investment result in lower operating costs over the next ten years?
- Will the additional capital investment result in substantially greater benefits to the nation at the same operating costs?
- Will additional capital investments result in such large, quantifiable benefits that the nation can ill afford not to make the investment (for national security, public safety, etc.).

TABLE II

I. Product and/or Service Now Done Which is Expected to Continue During GOES G and H Operations

A. Meteorological Products and/or Services

1. GOES Imagery (IR and visible)
2. Movie Loops with Annotation and/or Narrative
3. United Press and Associated Press, Print, and Captions
4. Local Television Support
5. Hurricane Intensity Classification
6. Satellite Interpretation Messages (SIM)
7. SELS and SIGMET Charts
8. Special Message to the Agency for International Development (AID)
9. Local Thunderstorm, High Wind, Icing Warning Service
10. Meteorological Consultation
11. Cloud Motion Winds (Full Disk)
12. Cloud Motion Winds - United States Pacific Coast (200 mile limit)
13. Cloud Motion Winds - Gulf of Mexico
14. Cloud Motion Winds - Gulf of Alaska
15. Computer-Derived Cloud Motion Vectors (Picture/Pair Winds)
16. Cloud Top Height Data
17. Rainfall Estimates (Scofield/Oliver Techniques)
18. Surface Frontal and Pressure Analysis
19. Moisture Analysis
20. NMC Support
21. Satellite Cloud PROGS for NMC Aviation Weather Branch
22. NMC Support (Satellite Cloud PROGS for Quantitative Precipitation)
23. Support to NMC (surface and upper air analyses)

B. Oceanographic and Hydrologic

1. Ocean Current Messages
2. Oceanographic Consultation
3. Flash Flood Precipitation, Amounts, and Estimates
4. Rainfall Estimates
5. Snow Melt Enhanced IR Images
6. Great Lakes Ice Analysis
7. Regional Snow Maps
8. River Basin Snow Maps

C. Agricultural

Experimental: Freezeline Analyses and Tracking
Solar Insolation Estimates

D. Other Products and/or Services

1. Numerical Grid Corrections
2. WEFAX Program
3. EDIS Archive
4. Data Collection System
5. VISSR Data Base

II. Category 1 - Product and/or Service That Is Not Now Done Operationally Which Could Be Developed by The Time of The GOES G Launch

A. Meteorological Products and/or Services

1. GOES-VIS and Multispectral Imagery (MSI)
2. Rapid Scan GOES Imagery
3. Moisture
4. Thickness Fields
5. Thickness Change
6. Geostrophic Vorticity
7. Geostrophic Winds
8. Maximum Convective Activity
9. Low Level Cloud Top Heights - Gulf of Mexico Coastal Zone
10. Coastal Zone Winds
11. Fog Area and Dissipation Maps

TABLE II (CONT'D)

- B. Oceanographic and Hydrologic Products and/or Services
 - 1. Flash Flood Guidance Messages
 - 2. Flash Flood Monitoring Messages
 - 3. Sea Surface Thermal Composite - Coastal Zone of the United States
 - 4. Sea Surface Thermal/Composite - Great Lakes of the United States
 - 5. Sea Surface Thermal Composite - Movable Display
 - 6. River Basin Snow Maps, Digital

 - C. Agricultural Products and/or Services
 - 1. Precipitation Estimates (AgRISTARS)
 - 2. Freeze Warning
 - 3. Insolation (Solar Radiation Incident at the Surface AgRISTARS)

 - D. Other Products and/or Services
 - 1. NWS-TDL Archive
 - 2. Archive of VAS Dwell-Sounding Submode and Multispectral Submode Imagery
 - 3. Archive of VISSR Digital Data and Imagery
- III. Category 2 - Products and/or Services Which Are Feasible but Require Development, Testing, and User Acceptance
- A. Meteorological Products and/or Services
 - 1. GOES Imagery with Conventional Meteorological Data Superposed
 - 2. Cloud Cover Maps
 - 3. Thickness Fields Near Tropical Storms
 - 4. Moisture Convergence
 - 5. Oceanic Temperature/Moisture Soundings from VAS 25°N - 50°N
 - 6. Surface Air Temperature and Changes (3m level)
 - 7. Cloud Cover Analysis
 - 8. Clear Air Turbulence
 - 9. Hurricane Wind Field Estimates
 - 10. Plot of Wind Estimates; High and Low Level

 - B. Oceanographic and Hydrologic Products and/or Services
 - Three-Hourly Global Rainfall Estimates

 - C. Agricultural Products and/or Services
 - 1. Land Surface Temperatures
 - 2. Minimum Surface Temperature - Seven-Day Composite
 - 3. Maximum Surface Temperature - Seven-Day Composite

 - D. Other Products and/or Services
 - 1. VAS Digital Data Base(s)
 - 2. Earth Radiation Budget Maps
 - 3. Aerosol Optical Thickness Maps



TABLE III. POLAR SATELLITE PRODUCTS

Sounding Products

1. Layer-mean temperatures (°K)
 - a. Layer precipitable water (mm)
 - b. Surface-700 mb; 700-500 mb; above 500 mb
 - c. Tropopause pressure (mb) and temperature (°K)
 - d. Total ozone (Dobson Units)
 - e. Equivalent blackbody temperatures (°K) for 20 HIRS/2 stratospheric channels
 - f. Cloud Cover
2. Thickness (m) and layer-mean temperatures (deg.K) between selected standard pressure levels.
 - a. Precipitable water (mm) between
 - b. Tropopause pressure (mb) and temperature (deg.K)
 - c. Cloud cover
3. Clear radiances
 - a. $mW/m^2-sr-cm^{-1}$
4. Earth-located, calibrated radiances from SSU plus selected HIRS/2 and MSU channels.
5. Earth-located sensor output, with calibration parameters appended, for HIRS/2 and MSU (DPSS Level I-b data base).

Oceanographic and Hydrologic Products

Accuracy Goals

- | | |
|---|-------------------------------|
| 1. Sea Surface Temperature Observations | + 1.5°C Absolute |
| | + 1.5°C Relative |
| 2. Sea Surface Temperature
Regional - Scale Analysis | Ibid. |
| 3. Sea Surface Temperature
Global - Scale Analysis | Ibid. |
| 4. Sea Surface Temperature
Climatic - Scale Analysis | Ibid. |
| 5. Sea Surface Temperature
Monthly Observation Mean | Ibid. |
| 6. Weekly Composite
Surface Water Temperature Analysis | 1.5°C Abs
0.5°C Rel |
| 7. Ice Concentration and Coverage Analysis* | +5 km |
| 8. Surface Water Temperature Analysis* | Ibid. |
| 9. Snow and Ice Melting Conditions* | Contour location within +5 km |

Earth Heat Budget Product List

1. Heat Budget Parameters:
 - a. Daytime Longwave Flux.
 - b. Nighttime Longwave Flux.
 - c. Reflected Energy or Equivalent (albedo, absorbed)
 - d. Available Solar Energy (calculated field to be included in output form).
 - e. Angular Data

Mapped/Gridded Initial Imagery Products (NonQuantitative)**

1. Hemispheric Mapped Polar Mosaics IR and VIS
2. Mercator-Mapped Mosaics IR/VIS
3. Polar-Mapped "Chips" IR/VIS
4. Mercator-Mapped "Chips" IR/VIS
5. Polar-Mapped Composites IR/VIS (Minimum Brightness/Maximum Temperature)
6. Pass-by-Pass Gridded Imagery VIS/IR (One Satellite)
7. Imagery from Limited Area Coverage (LAC) Data: Both Recorded & Direct Readout (Ungridded)

*From hand analysis of full-resolution imagery

**From one satellite

1. REPORT NO. NASA CP-2227		2. GOVERNMENT ACCESSION NO.		3. RECIPIENT'S CATALOG NO.	
4. TITLE AND SUBTITLE Meteorological Satellites — Past, Present, and Future				5. REPORT DATE May 1982	
				6. PERFORMING ORGANIZATION CODE	
7. AUTHOR(S)				8. PERFORMING ORGANIZATION REPORT #	
9. PERFORMING ORGANIZATION NAME AND ADDRESS George C. Marshall Space Flight Center Marshall Space Flight Center, Alabama 35812				10. WORK UNIT NO. M-381	
				11. CONTRACT OR GRANT NO.	
12. SPONSORING AGENCY NAME AND ADDRESS National Aeronautics and Space Administration Washington, D.C. 20546				13. TYPE OF REPORT & PERIOD COVERED Conference Publication	
				14. SPONSORING AGENCY CODE	
15. SUPPLEMENTARY NOTES					
16. ABSTRACT <p>The papers contained in this conference proceedings include primarily those presented in the session on Meteorological Satellites during the AIAA's 20th Aerospace Sciences Meeting held January 11-14, 1982, in Orlando, Florida. They provide reviews of past activities and assessments of the current and projected role of meteorological satellites, with emphasis on spacecraft and associated instrumentation.</p>					
17. KEY WORDS Meteorology Meteorological satellites — history Satellite instrumentation Spacecraft			18. DISTRIBUTION STATEMENT Unclassified — Unlimited Subject Category 47		
19. SECURITY CLASSIF. (of this report) Unclassified		20. SECURITY CLASSIF. (of this page) Unclassified		21. NO. OF PAGES 63	22. PRICE A04

National Aeronautics and
Space Administration

Washington, D.C.
20546

Official Business

Penalty for Private Use, \$300

SPECIAL FOURTH CLASS MAIL
BOOK

Postage and Fees Paid
National Aeronautics and
Space Administration
NASA-451



04372 377725
OFFICE OF THE AIR FORCE
WASHINGTON, D.C. 20546
ATTENTION: AIR FORCE (102)
CIVILIAN AIR FORCE

NASA

POSTMASTER: If Undeliverable (Section 158
Postal Manual) Do Not Return