

Potential Availability of Diesel Waste Heat at Echo Deep Space Station (DSS 12)

R. D. Hughes
DSN Engineering Section

Energy consumption at the Goldstone Echo Deep Space Station (DSS 12) is predicted and quantified for a future station configuration which will involve implementation of proposed energy conservation modifications. Cogeneration by the utilization of diesel waste-heat to satisfy site heating and cooling requirements of the station is discussed. Scenarios involving expanded use of on-site diesel generators are presented.

I. Introduction

As part of the Deep Space Network (DSN) effort in energy conservation and energy self-sufficiency at ground-based tracking stations, the on-site availability of low-to-medium-temperature waste heat has been viewed as an important cogeneration energy resource that requires additional investigation. At the Echo Deep Space Station, DSS 12, diesel-driven electric generators presently supply all of the site's electrical needs during "on-peak" daily time periods for the purpose of reducing purchased utility electricity costs. "On-peak" time periods are defined by Southern California Edison Company, the utility company, as 1:00 p.m. to 7:00 p.m. summer weekdays and from 5:00 p.m. to 10:00 p.m. on winter weekdays; where summer commences at 12:01 a.m. on May 1, and winter commences at 12:01 on November 1. During these on-peak periods, waste heat generated in the jacket cooling water and exhaust gases presents an energy and cost savings potential if utilized in place of conventional heat sources.

Since the diesel generators are supplying the entire site's load during generator operating periods, they are in a "load-following" mode, and knowledge of an accurate load profile is necessary in order to predict the available quantity and optimum timing of diesel waste heat. Thus, as a first phase of

the study, this report is devoted to the determination of a "projected" energy consumption profile which takes into account proposed energy saving modifications to the Echo facility. Also, since any available waste heat would be used to satisfy some or all of the space heating and cooling requirements of the station, profiles of projected heating and cooling loads have been constructed for future economic analyses.

An attempt is made in this work to quantify the amount of waste heat available for satisfying given heating and cooling loads. The conceptual design details and economic feasibility of the facility systems necessary for waste heat utilization as well as the waste heat potential at other major DSS stations will be discussed in subsequent articles.

II. Projected Energy Consumption Profiles

A major part of the energy conservation effort at the Goldstone Deep Space Communications Complex (GDSCC) has been directed toward the modification of the heating, ventilating, and air-conditioning (HVAC) systems. Due to the ongoing nature of this effort, a baseline energy profile for the Echo site was constructed which represents the existing conditions (Ref. 1). Then a future projection of the energy

requirements was established depicting the new profile after the proposed modifications have been completed.

The station energy requirements were determined by exercising the JPL-computerized model, ECP, which simulates energy consumption in buildings using a description of building construction and occupancy, exterior weather data, and interior mechanical, lighting, HVAC and electrical systems.

The accuracy of this model was verified by comparing the simulation results to actual energy consumption data which were obtained by recording on-site meter readings. This verification process was performed for the Echo buildings and facilities, as reported in Ref. 1, as they existed before any energy conservation modifications were made. Once the ECP model was verified for existing conditions, various modifications were modeled to determine their energy and cost saving potential. The most effective set of modifications for each building based on relevant economic criteria was then proposed for future building modifications.

Some examples of cost-effective modifications are: add zero energy-band "deadband" thermostat control, add outside air economizers, add timeclocks to air handlers, use automatic reset "floating" setpoints, lower inside design temperatures in winter to 68°F, increase inside design conditions in summer to 78°F, reduce outside air infiltration/exfiltration rates by weatherproofing, replace incandescent lighting with fluorescent, balance air flow rates, and replace some evaporative coolers with packaged vapor-compression units.

To construct the projected Echo site energy profile, the ECP-simulated results for the projected building conditions were modeled and summed for only the major energy-consuming buildings. The summed energy profiles were increased by 5% to account for those miscellaneous minor buildings which consume small amounts of energy and were not modeled separately. The total monthly space heating load, space cooling load, electrical energy consumption by cooling and heating equipment, and overall electrical consumption are shown in Tables 1-4, respectively, where they are itemized by building and summed for the entire station. Also, hourly energy consumption rates for two typical days, one in January and one in August, representing extreme winter and summer ambient conditions, are shown in Tables 5-9.

The loads and consumption values for building G-38 have been scaled from those of building G-21 because of recent major changes in the nature of building G-38 usage. Building G-21 was used as an analogous model for G-38 because the consumption profiles, interiors, and occupancy patterns of the two buildings are similar.

The predicted reductions in energy consumption are found significant when compared to the unmodified, existing conditions summarized in Ref. 1. The total Echo station annual electrical consumption will drop from the present value of 4,468 MWh(e) to 3,382 MWh(e) for a savings of 1,086 MWh(e) or about 24% per year. Since the average cost of electricity at GDSCC for FY '81 was about \$0.06/kWh(e) this represents an annual cost savings of about \$65,000. As expected, the category in which the greatest savings occurred was HVAC electrical consumption, which was reduced from 1,226,680 kWh(e)/yr to 371,265 kWh(e)/yr for a reduction of 70%.

Figure 1 shows a comparison of overall electrical consumption profiles on a monthly basis before and after the proposed modifications. Figure 1 also shows the on-peak diesel generated electrical energy profiles as projected after modifications (overall electrical consumption) and when reduced by assuming that the entire cooling and heating electrical load is met by waste heat (non-HVAC electrical consumption). Thus an upper and lower bound are established on the amount of electrical power generated, and accordingly, on the amount of waste heat available.

Figure 2 shows predicted heating and cooling load profiles on a monthly basis. Figure 3 and 4 show the projected overall electrical consumption profiles with generating periods delineated for a typical day in January and August, respectively.

III. Required vs Available Waste Heat

The questions of how much waste heat is actually available and how to most economically utilize the waste heat were approached in two ways: (1) on the basis of average energy consumption for each month and (2) on the basis of hourly energy consumption rates for a typical day in winter and summer. To help answer those questions, the recoverable portion of the waste heat is calculated as presented below:

A. Recoverable Waste Heat

The effective input thermal energy of the fuel consumed by a diesel generator system is distributed into the following sources of output energy for average operating conditions (Ref. 2):

Mechanical work	30%
Recoverable jacket cooling water heat	27%
Recoverable flue gas heat	15%
Cooling-oil heat, nonrecoverable flue gas heat, radiation	28%

This energy balance (Ref. 2) assumes that 90% of the jacket coolings water heat is recoverable and 70% of the flue gas heat is recoverable. The flowrate of the exhaust gas heat-exchange fluid must be such that the exhaust gas temperature remains above 160°C (325°F) to avoid water vapor condensation and sulphur-related corrosion of the exhaust system.

Thus approximately 72% of the net fuel energy is recoverable from the diesel generator system. The ratio of electrical energy generated to recoverable jacket water heat to recoverable exhaust heat is:

$$1.0: 0.9: 0.5$$

assuming negligible generator losses.

A block diagram of a typical waste-heat recovery system used to augment a conventional HVAC system is shown in Fig. 5. This represents one possible configuration for such a system; other arrangements are possible.

The preceding energy ratio was applied to the projected energy quantities in Tables 1-9. The amount of waste heat available from the generators is compared to that required to satisfy the heating and cooling loads and is shown in Tables 10-12. It was assumed that there was a 10% loss in the hot fluid supply system (piping, etc.) and a 0.67 coefficient of performance for the absorption refrigeration system. Thus the waste heat required to satisfy the heating load is given as (heating load) ÷ 0.9 and the waste heat required to satisfy the cooling load is (cooling load) ÷ (0.9 × 0.67).

Plots of available vs. required thermal energy profiles are shown in Fig. 6 for monthly quantities and in Figs. 7 and 8 for January and August typical-day hourly profiles respectively.

B. Waste Heat Availability and Utilization

The data shown in Table 10 indicate that on the annual basis the amount of waste heat available (taking an average value between the upper and lower bound) is enough to supply all of the heating load and approximately one-half of the cooling load. Such an evaluation, however, implies the existence of an efficient storage system for both hot and cold thermal fluids. Since a chilled-water system with thermal storage capability has been proposed for the Echo site as an economically feasible HVAC modification, the implementation of a waste heat utilization system which requires thermal storage may be quite feasible.

When waste heat availability is analyzed on a monthly basis, Fig. 6 shows that sufficient waste heat is available to satisfy

the heating load every month, or to satisfy the complete cooling load five months out of the year and part of the cooling load for the remainder of the year. When waste heat availability is analyzed on a daily basis it should be noted that Tables 11 and 12 represent conditions for a "weekday" which differ from "weekend" conditions. Thus, for a typical weekday in January, the available waste heat is nearly equal to the total required for both heating and cooling; for an individual weekday, the relative amount of waste heat availability is greater than on a monthly basis, since the monthly total takes into account weekends when no generation usually occurs.

Finally, on an hourly basis, it can be seen that in August almost all of the waste heat can be used without storage and about half of the cooling load per day can be met with waste heat. On the other hand, for conditions in January, if no thermal storage were available, only about 22% of the waste heat would be utilized.

C. Increase Due to Expanded Generator Operation

The possibility exists (depending on detailed economic analysis results) that it may be financially advantageous to expand the periods of diesel generator operation in order to take better advantage of waste heat recovery equipment. For example, if the hours of diesel generator operation in August were expanded to the period 7:00 a.m. to 10:00 p.m., the net amount of waste heat generated would almost double (about 10,000 kWh per day) and would nearly be enough to satisfy the maximum weekday cooling load. In addition, there exist periods of operating the generators in a "spinning reserve" mode during critical tracking maneuvers. When a critical tracking period occurs, electrical power is switched to diesel generation regardless of the time of day, and enough diesel generators are brought on line so that they are only operating at partial load. In this fashion, one or more generators could be dropped from operation in the event of malfunction and the remaining generators would assume the load, thus utilizing "spinning reserve." This mode of operation occurs 10-20% of the time. If critical periods are assumed to be random in the overlap of "on-peak" periods, then the amount of waste heat available is approximately 10% greater than indicated by the projected profiles.

IV. Summary

It has been shown that sufficient waste heat will be produced at the Echo site to satisfy approximately all of the heating and cooling load in the winter and one-half in the summer. This quantification is based on the assumption that diesel generators are only operating during "on-peak" periods and energy consumption is according to projected conditions.

C-3

Also, an efficient thermal storage system would be required to meet these conditions. If expanded diesel operation were implemented, a greater waste heat utility would be realized. A

conceptual design and economic analysis using the results of this report will be necessary in order to determine the technical feasibility of waste heat utilization at the Echo station.

References

1. Guiar, C. N., et al., "Energy Consumption for the Echo Station (DSS 12)," *TDA Progress Report 42-66*, pp. 355-363, Jet Propulsion Laboratory, Pasadena, Calif., Dec. 15, 1981.
2. Caterpillar Tractor Co., "Total Energy Handbook," Aug. 1969.



ORIGINAL PAGE IS
OF POOR QUALITY

Table 1. Monthly heating load at Echo for projected conditions (kWh_e)

Month	Building									Total
	G-21	G-23	G-24	G-26	G-28	G-33	G-34/35	G-38 ^a	Others ^b	
Jan	1,899	8,459	1,266	105	5,916	4,366	59	1,310	1,169	24,549
Feb	779	6,519	281	—	4,295	1,948	—	536	718	15,076
Mar	604	6,373	179	—	4,506	1,749	—	416	691	14,518
Apr	524	5,505	—	—	3,870	1,146	—	363	572	11,980
May	—	5,403	—	—	—	240	—	—	282	5,925
Jun	—	4,002	—	—	—	—	—	—	200	4,202
Jul	—	3,238	—	—	—	—	—	—	162	3,400
Aug	—	3,378	—	—	—	—	—	—	169	3,547
Sept	—	4,474	—	—	—	—	—	—	224	4,698
Oct	217	4,603	—	—	2,992	499	—	149	419	8,799
Nov	926	7,008	249	—	4,515	2,148	—	639	774	16,259
Dec	2,136	8,825	1,553	144	6,308	4,987	155	1,474	1,279	26,861
Annual total	7,085	67,787	3,528	249	32,402	17,003	214	4,887	6,659	139,814
Average monthly load	590	5,649	294	21	2,700	1,417	18	407	555	11,651
Power average, kW	0.81	7.74	0.40	0.03	3.70	1.94	0.02	0.56	0.76	16.0

^aValues scaled from G-21 load.

^bAssumed to be 5% of the total of the buildings listed.



ORIGINAL PAGE IS
OF POOR QUALITY

Table 2. Monthly cooling load at Echo for projected conditions (kWh,)

Month	Building									Total
	G-21	G-23	G-24	G-26	G-28	G-33	G-34/35	G-38 ^a	Others ^b	
Jan	—	788	18,607	—	—	—	—	—	970	20,365
Feb	—	1,487	16,806	—	—	—	376	—	933	19,602
Mar	—	1,807	18,607	—	—	105	580	—	1,055	22,154
Apr	—	2,283	18,385	3,920	—	2,876	6,730	—	1,710	35,903
May	1,150	883	22,513	24,158	1,702	12,710	10,499	9,570	4,159	87,344
Jun	3,519	2,753	28,128	41,594	3,470	26,591	23,616	29,292	7,938	166,701
Jul	4,592	3,892	33,134	55,095	3,882	37,832	34,404	38,219	10,553	221,603
Aug	4,500	3,643	32,948	54,919	3,481	37,304	34,024	37,450	10,414	218,692
Sept	3,210	2,032	25,913	38,570	2,546	27,776	19,570	26,718	7,317	153,652
Oct	1,709	2,799	21,050	12,007	—	6,969	13,839	14,222	3,630	76,225
Nov	—	1,473	18,005	—	—	—	615	—	1,005	21,098
Dec	—	629	18,607	—	—	—	—	—	962	20,198
Annual total	18,680	24,468	272,703	230,263	15,081	152,163	144,253	155,471	50,646	1,063,728
Average monthly total	1,557	2,039	22,725	19,189	1,257	12,680	12,021	12,956	4,221	88,644
Power average, kW	2.13	2.79	31.13	26.29	1.72	17.37	16.47	17.75	5.78	121.43

^aValues scaled from G-21 load.

^bAssumed to be 5% of the total of the buildings listed.

ORIGINAL PAGE IS
OF POOR QUALITY

Table 3. Electrical energy consumed by heating and cooling equipment for projected conditions (kWh_e)

Month	Building									Total
	G-21	G-23	G-24	G-26	G-28	G-33	G-34/35	G-38 ^a	Others ^b	
Jan	—	904	4,449	—	—	—	66	—	271	5,690
Feb	—	1,135	3,659	—	—	—	225	—	251	5,270
Mar	—	1,270	4,052	—	—	247	372	—	297	6,238
Apr	—	1,433	4,134	1,638	—	910	1,858	—	499	10,472
May	2,839	1,492	6,324	8,579	—	4,827	3,038	4,700	1,590	33,389
Jun	4,456	2,108	9,336	15,120	—	10,130	6,570	10,000	2,886	60,606
Jul	4,981	2,510	11,880	20,360	—	15,210	10,020	15,300	4,013	84,274
Aug	4,844	2,421	11,560	20,030	—	14,290	9,639	14,300	3,854	80,938
Sept	4,183	1,888	8,056	13,580	—	8,534	5,183	8,200	2,481	52,105
Oct	1,224	1,656	5,340	4,394	—	2,721	3,298	3,300	1,097	23,030
Nov	—	1,166	3,540	—	—	—	209	—	246	5,161
Dec	—	842	2,881	—	—	—	174	—	195	4,092
Annual total	22,527	18,825	75,211	83,701		56,869	40,652	55,800	17,680	371,265
Average monthly consumption	1,877	1,569	6,268	6,875		4,739	3,388	4,650	1,473	30,939
Power average kW	2.57	2.15	8.59	9.55		6.49	4.64	6.37	2.02	42.38

^aScaled from G-21 values

^bAssumed to be 5% of the total of the buildings listed

ORIGINAL PAGE IS
OF POOR QUALITY

Table 4. Overall electrical consumption at Echo for projected conditions (MWh_e)

Month	Building									Total
	G-21	G-23	G-24	G-26	G-28	G-33	G-34/35	G-38 ^a	Others ^b	
Jan	4.4	1.9	50.9	57.8	6.1	37.5	32.9	36.4	11.4	239.3
Feb	4.1	2.1	45.4	52.4	5.7	33.5	30.1	34.1	10.4	217.8
Mar	4.4	2.3	50.2	57.8	6.1	37.9	33.6	36.3	11.4	240.0
Apr	4.3	2.4	48.4	60.3	6.0	37.4	34.4	35.9	11.5	240.6
May	7.8	2.5	52.4	72.4	6.6	43.9	37.0	65.1	14.4	302.1
Jun	9.6	3.1	54.1	79.9	6.6	48.8	40.1	79.5	16.1	337.8
Jul	10.1	3.5	58.3	87.1	6.7	56.0	44.7	84.2	17.5	368.1
Aug	10.0	3.4	57.9	86.8	6.7	55.8	44.3	83.1	17.4	365.4
Sept	9.3	2.9	52.7	78.4	6.6	46.5	38.8	77.2	15.6	328.0
Oct	5.8	2.7	51.3	66.0	6.1	41.1	37.7	48.4	13.0	272.1
Nov	4.3	2.2	48.5	56.1	6.0	36.1	32.2	36.0	11.1	232.5
Dec	4.4	1.8	51.2	57.8	6.1	35.7	33.0	36.5	11.3	237.8
Annual total	78.5	30.8	621.3	812.8	75.3	510.2	438.8	652.7	161.1	3,381.5
Average monthly consumption	6.5	2.6	51.8	67.7	6.3	42.5	36.6	54.4	13.4	281.8
Power average, kW	8.9	3.6	71.0	92.7	8.6	58.2	50.1	74.5	18.4	386.0

^aValues scaled from G-21

^bAssumed to be 5% of the total of the buildings listed.

**ORIGINAL PAGE IS
OF POOR QUALITY**

Table 5. Echo hourly heating load for a typical day in January for projected conditions (kW_t)

Hour	Building									Total
	G-21	G-23	G-24	G-26	G-28	G-33	G-34/35	G-38 ^a	Others ^b	
1	—	18.2	3.6	—	14.0	7.7	—	—	2.2	45.7
2	—	18.0	4.2	—	15.3	8.0	—	—	2.3	47.8
4	—	18.1	4.8	—	16.5	8.4	—	—	2.4	50.2
6	—	18.1	4.2	—	15.4	7.8	—	—	2.3	47.8
8	22.7	17.9	3.1	1.6	12.7	9.2	—	15.7	4.1	87.0
10	20.2	16.4	—	—	6.7	4.6	—	1.8	2.5	52.2
12	—	15.6	—	—	2.6	0.6	—	—	0.9	19.7
14	—	15.6	—	—	—	—	—	—	0.8	16.4
16	—	16.1	—	—	—	—	—	—	0.8	16.9
18	15.8	17.4	—	—	2.9	2.9	—	10.9	2.5	52.4
20	—	18.5	—	—	5.0	5.0	—	—	1.4	29.9
22	—	18.5	1.1	—	6.2	6.2	—	—	1.6	33.6
24	—	18.3	2.9	—	7.2	7.2	—	—	1.8	37.4
Daily total	117.4	416.9	41.3	3.2	187.8	120.3	—	56.8	47.2	990.9
Average hourly load	4.9	17.4	1.7	0.1	7.8	5.0	—	2.4	2.0	41.3

^aScaled from G-21 values.

^bAssumed to be 5% of the total of the buildings listed.

Table 6. Echo hourly cooling load for a typical day in January for projected conditions (kW_t)

Hour	Building									Total
	G-21	G-23	G-24	G-26	G-28	G-33	G-34/35	G-38 ^a	Others ^b	
1	—	1.1	25.0	—	—	—	—	—	1.3	27.4
2	—	1.1	25.0	—	—	—	—	—	1.3	27.4
4	—	1.1	25.0	—	—	—	—	—	1.3	27.4
6	—	1.1	25.0	—	—	—	—	—	1.3	27.4
8	—	1.1	25.0	—	—	—	—	—	1.3	27.4
10	—	1.8	25.0	—	—	—	—	—	1.3	28.1
12	—	2.1	25.0	—	—	—	—	—	1.4	28.5
14	—	2.1	25.0	—	—	—	—	—	1.4	28.5
16	—	1.8	25.0	—	—	—	—	—	1.3	28.1
18	—	1.1	25.0	—	—	—	—	—	1.3	27.4
20	—	0.7	25.0	—	—	—	—	—	1.3	27.0
22	—	0.7	25.0	—	—	—	—	—	1.3	27.0
24	—	1.1	25.0	—	—	—	—	—	1.3	27.4
Daily total	—	31.6	600.0	—	—	—	—	—	31.6	663.2
Average hourly load	—	1.3	25.0	—	—	—	—	—	1.3	27.6

^aScaled from G-21 values.

^bAssumed to be 5% of the total of the buildings listed.

**ORIGINAL PAGE IS
OF POOR QUALITY**

Table 7. Echo hourly electrical consumption for a typical day in January for projected conditions (kW_e)

Hour	Building									Total
	G-21	G-23	G-24	G-26	G-28	G-33	G-34/35	G-38 ^a	Others ^b	
1	1.7	3.6	71.8	73.6	5.0	40.5	42.9	14.1	12.7	265.9
2	1.7	3.6	72.4	73.6	5.0	40.5	43.4	14.1	12.7	267.0
4	1.7	3.5	72.9	73.6	5.0	40.5	43.4	14.1	12.7	267.4
6	1.7	3.5	72.3	74.7	5.0	40.5	43.4	14.1	12.8	268.0
8	9.3	3.4	69.9	89.2	5.0	73.4	50.7	77.4	18.9	397.2
10	16.5	3.8	56.1	89.0	24.1	76.2	50.7	137.3	23.1	485.8
12	16.3	4.1	65.8	89.0	24.1	78.2	50.7	135.6	23.2	487.0
14	16.3	4.2	66.1	89.0	24.1	75.8	40.7	135.6	22.6	474.4
16	16.3	4.1	66.0	89.0	5.0	73.1	40.7	135.6	21.5	451.3
18	9.3	3.8	65.5	72.6	5.0	40.5	44.4	77.4	15.9	334.4
20	1.7	3.6	65.8	73.6	5.0	40.5	42.9	14.1	12.4	259.6
22	1.7	3.6	69.0	73.6	5.0	40.5	42.9	14.1	12.5	262.9
24	1.7	3.6	71.0	73.6	5.0	40.5	42.9	14.1	12.6	265.0
Daily total	188.4	89.6	1,626.4	1,921.0	234.6	1,320.4	1,073.6	1,567.0	401.9	8,422.9
Average hourly load	7.9	3.7	67.8	80.0	9.8	55.0	44.7	65.3	16.7	351.0

^aScaled from G-21 values.

^bAssumed to be 5% of the total of the buildings listed.

Table 8. Echo hourly cooling load for a typical day in August for projected conditions (kW_t)

Hour	Building									Total
	G-21	G-23	G-24	G-26	G-28	G-33	G-34/35	G-38 ^a	Others ^b	
1	—	6.0	42.9	43.2	—	31.3	45	—	8.4	176.8
2	—	5.6	36.9	35.9	—	29.5	39.7	—	7.4	155.0
4	—	4.9	30.9	16.9	—	26.4	33.8	—	5.6	118.5
6	—	4.6	27.4	5.6	—	24.6	28.5	—	4.5	95.2
8	—	4.9	26.0	41.5	—	42.9	32.3	—	7.4	155.0
10	15.5	6.3	45.7	82.3	2.8	71.7	51.7	128.7	20.2	424.9
12	24.3	7.7	51.0	87.2	3.9	87.9	55.9	201.8	26.0	545.7
14	27.8	8.4	54.1	90.7	12.0	95.3	55.6	231.0	28.7	603.6
16	27.4	9.8	55.6	92.5	12.3	98.4	57.3	228.2	29.1	610.6
18	17.2	9.1	55.6	71.4	13.0	54.1	53.4	143.5	20.9	438.2
20	—	8.1	53.1	70.3	10.5	49.6	51.7	—	12.2	255.5
22	—	7.0	49.6	67.5	5.3	40.4	48.5	—	10.9	229.2
24	—	6.3	45.4	65.4	—	33.1	46.1	—	9.8	206.1
Daily total	224.4	165.1	1,060.1	1,432.2	119.6	1,306.0	1,107.9	1,866.4	364.0	7,645.7
Average hourly load	9.4	6.9	44.2	59.7	5.0	54.4	46.2	77.8	15.2	318.6

^aScaled from G-21 values.

^bAssumed to be 5% of the total of the buildings listed.

ORIGINAL PAGE IS
OF POOR QUALITY

Table 9. Echo hourly electrical consumption for a typical day in August for modified conditions (kW)

Hour	Building									Total
	G-21	G-23	G-24	G-26	G-28	G-33	G-34/35	G-38 ^a	Others ^b	
1	1.7	6.3	77.0	97.2	5.0	57.9	54.9	14.1	15.7	329.8
2	1.7	6.1	75.3	96.1	5.0	57.2	57.5	14.1	15.7	328.7
4	1.7	5.9	73.6	93.5	5.0	56.4	55.2	14.1	15.3	320.7
6	1.7	5.7	69.7	92.7	5.0	55.8	53.1	14.1	14.9	312.7
8	9.1	5.6	68.4	112.9	5.0	91.2	61.6	75.7	21.5	451.0
10	39.7	6.4	76.8	125.3	25.6	107.6	66.5	330.0	38.9	816.8
12	43.5	7.1	79.6	128.9	25.6	115.7	70.5	361.9	41.6	874.4
14	45.3	7.5	83.5	131.3	25.6	116.9	61.1	376.9	42.4	890.5
16	45.8	7.9	84.3	132.4	6.5	115.7	62.6	381.1	41.8	878.1
18	36.4	7.7	84.3	111.6	6.5	65.3	58.3	302.8	33.6	706.5
20	1.7	7.4	81.5	111.1	6.5	63.5	60.5	14.1	17.3	363.6
22	1.7	6.8	79.5	108.2	6.5	60.4	57.6	14.1	16.7	351.5
24	1.7	6.4	77.7	106.1	5.0	58.4	55.5	14.1	16.2	341.1
Daily total	460.0	160.9	1,867.7	2,691.3	255.6	1,927.7	1,439.4	3,826.0	631.3	13,259.9
Average hourly load	19.2	6.7	77.8	112.1	10.7	80.3	60.0	159.4	26.3	552.5

^aScaled from G-21 values.

^bAssumed to be 5% of the total of the buildings listed.

Table 10. Echo site monthly total energy profiles for modified conditions (MWh_e or MWh_t)

Month	Heating load	W-H required for heating ^a	Cooling load	W-H required for heating ^b	Total W-H required	Generated electrical energy	Reduced generation ^c	W-H generated ^d	Reduced W-H generated ^d
Jan	24.5	27.2	20.4	33.8	61.0	29.7	28.9	41.6	40.5
Feb	15.1	16.8	19.6	32.5	49.3	27.0	26.3	37.8	36.8
Mar	14.5	16.1	22.2	36.8	52.9	29.8	29.0	41.7	40.6
Apr	12.0	13.3	35.9	59.5	72.8	29.9	29.1	41.9	40.7
May ^e	5.9	6.6	87.3	144.8	151.4	81.4	63.3	114.0	88.6
Jun	4.2	4.7	166.7	276.5	281.2	91.0	70.8	127.4	99.1
Jul	3.4	3.8	221.6	367.5	371.3	99.1	77.2	138.7	108.1
Aug	3.5	3.9	218.7	362.7	366.6	98.4	76.6	137.8	107.2
Sept	4.7	5.2	153.7	254.9	260.1	88.3	68.8	123.6	96.3
Oct	8.8	9.8	76.2	126.4	136.2	73.3	57.0	102.6	79.8
Nov	16.3	18.1	21.1	35.0	53.1	28.9	28.1	40.5	39.3
Dec	26.9	29.9	20.2	33.5	63.4	29.5	28.7	41.3	40.2
Annual total		155		1,764	1,919			989	817

^aW-H ⇒ waste-heat; 90% efficiency assumed (piping loss).

^bAssumed coefficient of performance = 0.67 and piping losses = 10%.

^cHeating and cooling electrical consumption is subtracted to provide a lower bound on W-H available.

^dBoth jacket and flue gas heat recovery taken into account: W-H generated = 1.4 × electrical energy generated.

^eMay 1 through Oct 31 is "summer"; on-peak is 1:00 p.m. to 7:00 p.m. in "summer" and 5:00 p.m. to 10:00 p.m. in "winter."

ORIGINAL PAGE IS
OF POOR QUALITY

Table 11. Echo site hourly total energy profiles for a typical day in January for modified conditions (kW_e or kW_t)

Hour	Heating load	W-H required for heating ^a	Cooling load	W-H required for heating ^b	Total W-H required	Generated electrical power	Reduced generation ^c	W-H generated ^d	Reduced W-H generated ^d
1	45.7	50.8	27.4	45.4	96.2	—	—	—	—
2	47.8	53.1	27.4	45.4	98.5	—	—	—	—
4	50.2	55.8	27.4	45.4	101.2	—	—	—	—
6	47.8	53.1	27.4	45.4	98.5	—	—	—	—
8	87.0	96.7	27.4	45.4	142.1	—	—	—	—
10	52.2	58.0	28.1	46.6	104.6	—	—	—	—
12	19.7	21.8	28.5	47.3	69.2	—	—	—	—
14	16.4	18.2	28.5	47.3	65.5	—	—	—	—
16	16.9	18.8	28.1	46.6	65.4	—	—	—	—
18 ^e	52.4	58.2	27.4	45.4	103.6	334.4	326.4	468.2	457.0
19	41.2	45.8	27.2	45.1	90.9	297.0	289.0	415.8	404.6
20	29.9	33.2	27.0	44.8	78.0	259.6	251.6	363.4	352.2
21	31.8	35.3	27.0	44.8	80.1	261.3	253.3	365.8	354.6
22	33.6	37.3	27.0	44.8	82.1	262.9	254.3	368.1	356.0
24	37.4	41.6	27.4	45.4	87.0	—	—	—	—
Net energy per day, kWh						1,415	1,375	1,981	1,925

^aW-H ⇒ waste-heat; 90% efficiency assumed (piping losses).

^bAssumed coefficient of performance = 0.67 and piping losses = 10%.

^cHeating and cooling electrical consumption is subtracted to provide a lower bound on W-H available.

^dBoth jacket and flue gas heat recovery taken into account: W-H generated = 1.4 × electrical energy generated.

^e“On-peak” period is 5:00 p.m. to 10:00 p.m.

ORIGINAL PAGE IS
OF POOR QUALITY

Table 12. Echo site hourly total energy profiles for a typical day in August for modified conditions (kW_e or kW_t)

Hour	Heating load	W-H required for heating ^a	Cooling load	W-H required for cooling	Total W-H required	Generated electrical power	Reduced generation ^b	W-H generated ^c	Reduced W-H generated ^c
1	-	-	176.8	293.2	293.2	-	-	-	-
2	-	-	155.0	257.0	257.0	-	-	-	-
4	-	-	118.5	196.5	196.5	-	-	-	-
6	-	-	95.2	157.9	157.9	-	-	-	-
8	-	-	155.0	256.0	257.0	-	-	-	-
10	-	-	424.9	704.6	704.6	-	-	-	-
12	-	-	545.7	905.0	905.0	-	-	-	-
14 ^d	-	-	603.6	1,001.0	1,001.0	890.5	693.2	1,246.7	970.5
15	-	-	607.1	1,006.8	1,006.8	882.5	687.0	1,235.5	961.8
16	-	-	610.6	1,012.6	1,012.6	878.1	683.6	1,229.3	957.0
17	-	-	524.4	869.7	869.7	792.3	616.8	1,109.2	863.5
18	-	-	438.2	726.7	726.7	706.5	550.0	989.1	770.0
19	-	-	346.9	575.3	575.3	535.1	416.6	749.1	583.2
20	-	-	255.5	423.7	423.7	-	-	-	-
22	-	-	229.2	380.1	380.1	-	-	-	-
24	-	-	206.1	341.8	341.8	-	-	-	-
Net energy per day, kWh						4,685	3,647	6,559	5,106

^aW-H ⇒ waste-heat; assumed coefficient of performance = 0.67 and piping losses = 10%.

^bHeating and cooling electrical consumption is subtracted to provide a lower bound on W-H available.

^cBoth jacket and flue gas heat recovery taken into account: W-H generated = 1.4 × electrical energy generated.

^d"On-peak" period is 1:00 p.m. to 7:00 p.m.

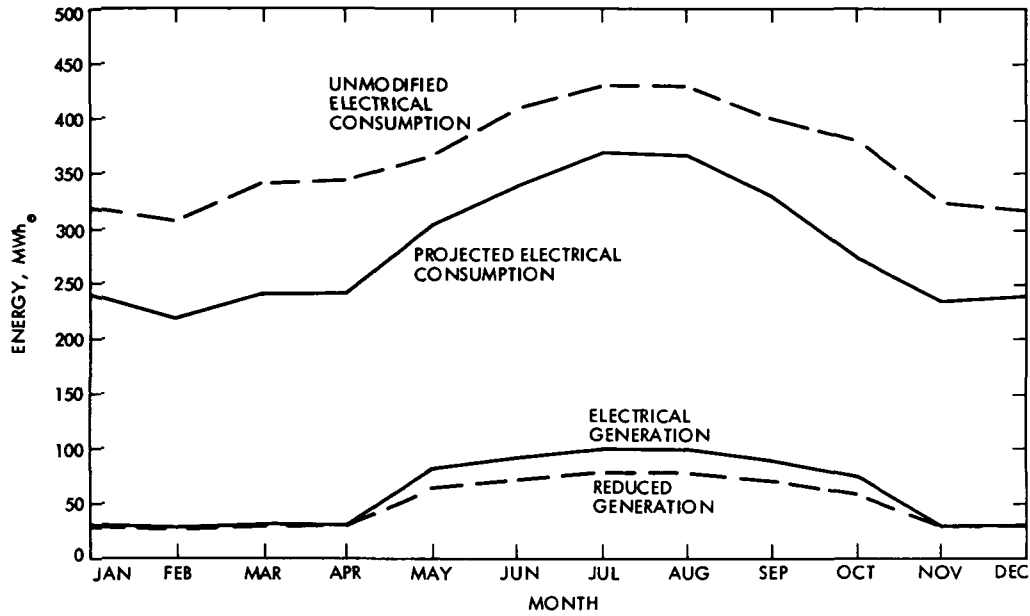

Fig. 1. Overall electrical consumption and generation at Echo site

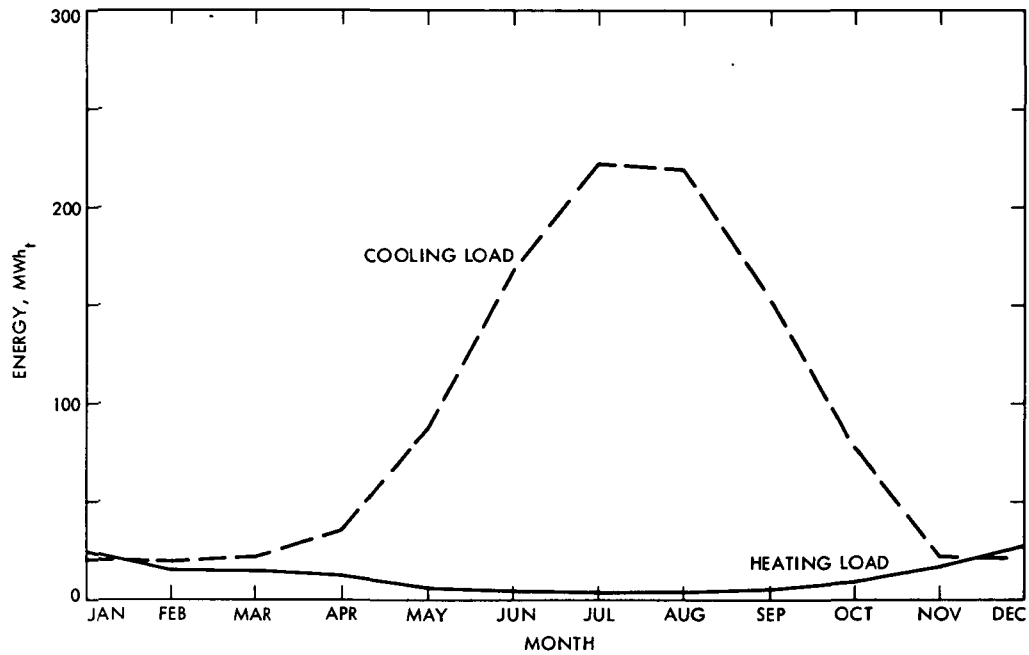

Fig. 2. Echo site heating and cooling loads

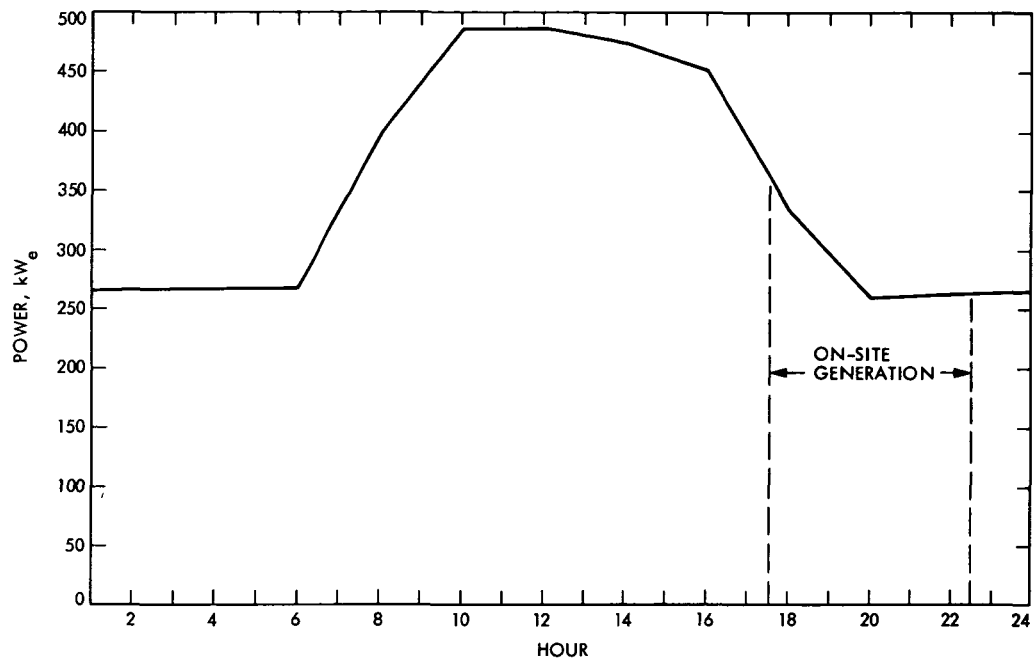

Fig. 3. Hourly electrical power for a typical day in January

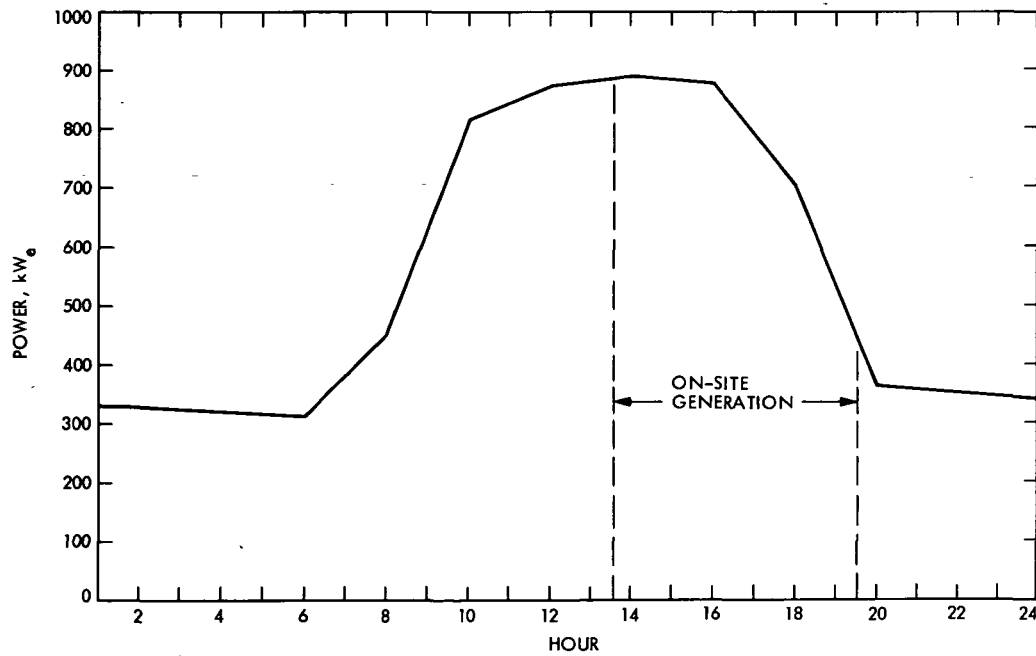
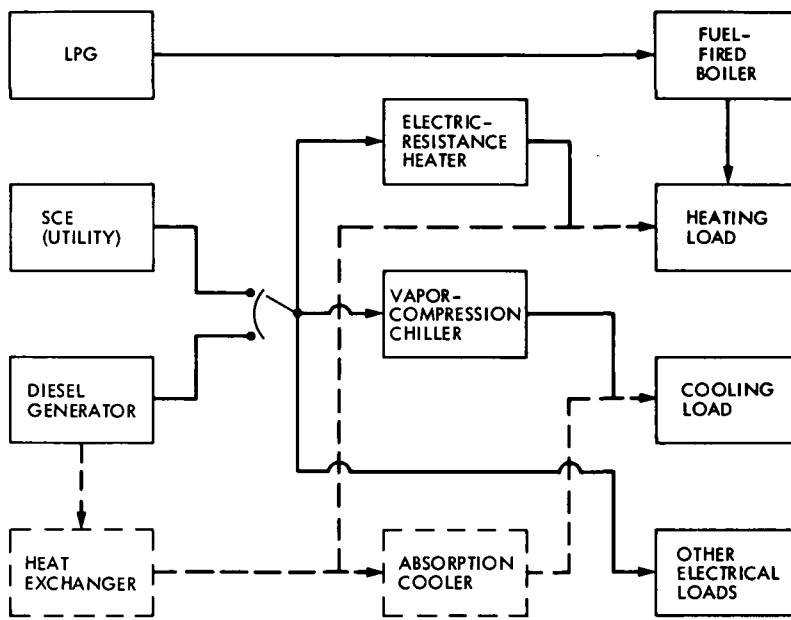

Fig. 4. Hourly electrical power for a typical day in August

ORIGINAL PAGE IS
OF POOR QUALITY



NOTE. DASHED LINES INDICATE COMPONENTS FROM WASTE-HEAT SYSTEM

Fig. 5. Available vs required thermal energy per month

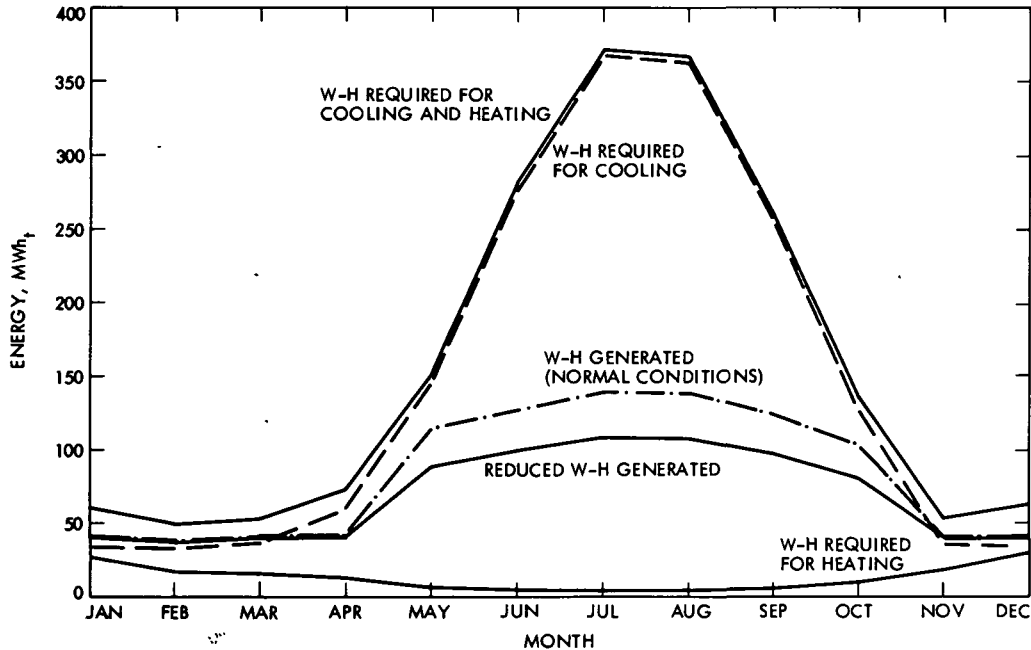

Fig. 6. Available vs required thermal power, January

ORIGINAL PAGE IS
OF POOR QUALITY

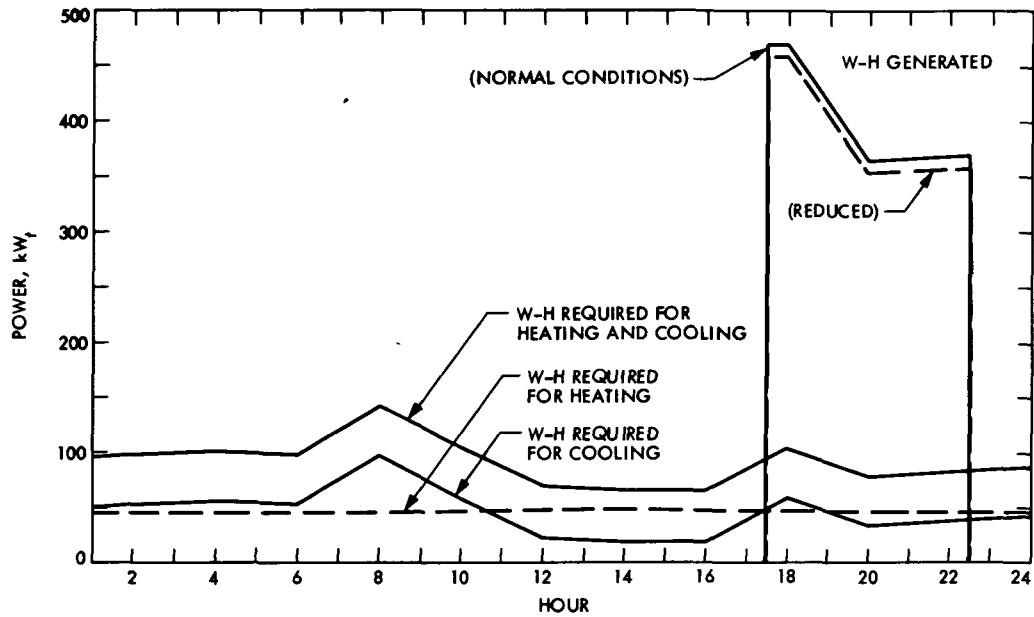

Fig. 7. Available vs required thermal power, August

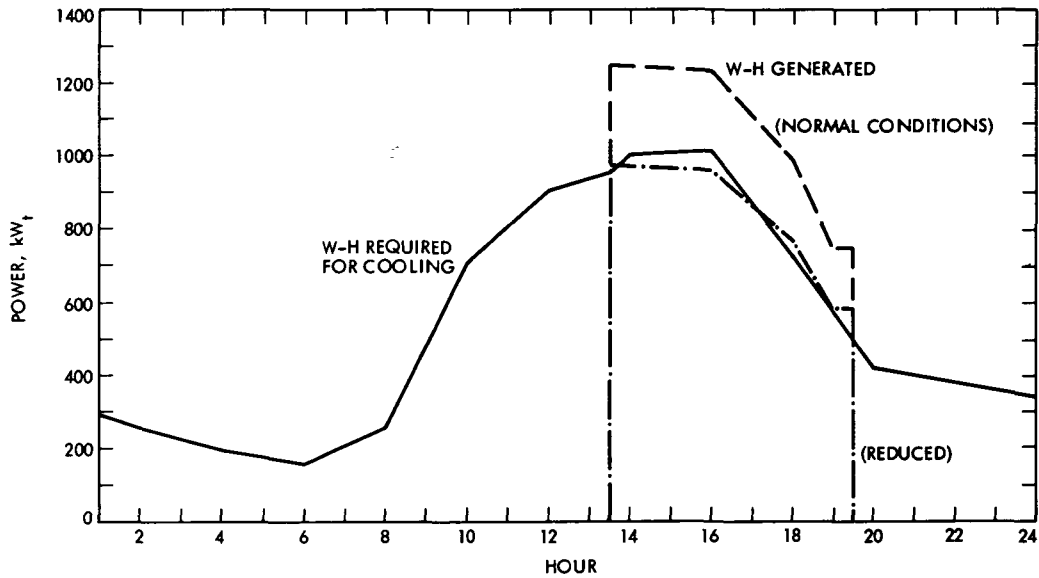

Fig. 8. Block diagram of energy flow in a waste-heat utilization system