

NASA  
Contractor Report 3579

AVRADCOM  
Technical Report 82-A-9

# A Comparative Study of Soviet vs. Western Helicopters

## Part I - General Comparison of Designs

W. Z. Stepniewski  
*International Technical Associates, Ltd.*  
*Upper Darby, Pennsylvania*

Prepared for  
Aeromechanics Laboratory  
AVRADCOM Research and Technology Laboratories  
Ames Research Center  
under Contract NAS2-10062



National Aeronautics  
and Space Administration

Scientific and Technical  
Information Branch

1983

## *Preface*

Even a superficial observation would indicate that there are basic differences in the Soviet and Western design and operational philosophies of rotary-wing aircraft. On the other hand, one should not be surprised to find a lot of commonality in the approach to various technical and operational problems.

In view of this anticipated duality of similarities and dissimilarities, it becomes especially interesting to develop a deeper understanding of the subject. This can be done by showing not only WHAT is either at variance or in agreement in the Soviet design and operational philosophy of helicopters with those in the West, but also WHY.

The need for such a comparative study of Soviet vs. Western helicopters was recognized by the Research and Technology Laboratories of the U.S. Army Aviation R&D Command, especially by Dr. Richard M. Carlson, Director of the Labs. Consequently, a contract to conduct this task was awarded through NASA to International Technical Associates, Ltd., and Mr. Ronald A. Shinn was designated by the Labs as monitor of the project for Part I, "General Comparison of Designs." Mr. Wayne D. Mosher monitored the preparation of Part II, "Evaluation of Weight, Maintainability, and Design Aspects of Major Components."

The results of the tasks performed are presented in this two-part report as outlined below:

**PART I. General Comparison of Designs.** Here basic design aspects of existing Soviet helicopters, as well as hypothetical helicopters representing optimum configurations described in the Soviet book, "Helicopters—Selection of Design Parameters" by M.N. Tishchenko et al<sup>1</sup> are compared with selected Western representatives.

**PART II. Evaluation of Weight, Maintainability and Design Aspects of Major Components.** In this task, a deeper comparative insight into design and operational philosophies is gained by examining (a) weight-prediction methods and weight trends, (b) maintainability, (c) overall merits of component designs, and (d) classification and ranking of helicopter configurations for transport operations.

In preparation for Part I, nine production and four Soviet hypothetical helicopters, and a total of fourteen Western helicopters representing gross-weight classes ranging from under 12,000 to over 100,000 pounds were included in the study. This phase of the work represented a look into the overall design philosophy of Soviet vs. Western helicopters. Also included was a comparison of six production and two hypothetical Soviet engines, and thirteen Western engines, representing powerplants installed in the compared helicopters.

Upon completion of the above work, review copies of the report were printed (courtesy of Boeing Vertol Company) in February 1981, and distributed to the manufacturers of the Western helicopters contained in the study, along with a request that they review and correct the material related to their products, while the material related to Russian helicopters and engines was submitted to the U.S. Army Foreign Science and Technology Center for their comments and suggestions. The response was very good, and valuable additional information, as well as basic up-to-date data was obtained and incorporated into the final report.

In preparation for Part I of the Comparative Study of Soviet vs. Western Helicopters, nine production and four hypothetical Soviet helicopters, and a total of fourteen Western helicopters representing gross weight classes ranging from 12,000 to over 100,000 pounds were included in the study. This phase of the work represented a look into the overall design philosophy of Soviet vs. Western helicopters. A comparison of six production and two hypothetical Soviet engines, and thirteen Western engines, representing powerplants installed in the compared helicopters were also included.

Upon completion of the above work, review copies of the report were printed (courtesy of Boeing Vertol Company) in February 1981, and distributed to the manufacturers of the Western helicopters contained in the study, along with a request that they review and correct the material related to their products, while the material related to Russian helicopters and engines was submitted to the U.S. Army Foreign Science and Technology Center for their comments and suggestions. The response was very good, and valuable additional information, as well as basic up to date data was obtained, and incorporated into the final report.

In the meantime, the Mil Mi-26 heavy-lift transport helicopter with the Lotarev D-136 turboshaft engine was unveiled at the Paris Air Show in June, 1981. A comparison of this helicopter and engine with the corresponding hypothetical machine postulated by Tishchenko et al<sup>1</sup> indicated that the hypothetical aspects contained in his book actually represented milestones and goals for the new generation of Soviet helicopters and engines. Taking advantage of the valuable additional information regarding the Mi-26 and the D-136 turboshaft, the undersigned has included the extra helicopter data along with its 'conceptual prototype' — the hypothetical 52-ton single rotor helicopter (referred in this work as the Hypo 52-SR), while the information available to date on the D-136 turboshaft is contained in the powerplant comparison.

The revision of Part I of 'A Comparative Study of Soviet vs. Western Helicopters' was made possible by the contributions of the manufacturers of Western helicopters as represented by Aero-spaciale, Bell Helicopter Textron, Boeing Vertol Company, Messerschmitt-Boelkow-Blohm GmbH, and Sikorsky Aircraft. Other contributors include Dr. R. M. Carlson who continuously served as a source of inspiration and valuable suggestions, and Mr. R. A. Shinn who, in his capacity as technical and administrative monitor, greatly contributed to the concept formulation of the study and its execution. The editors are grateful to Mr. R. D. Semple of Boeing Vertol, Mr. H. D. Wilsted of the Research and Technology Labs, and Mr. E. R. McInturff for their expert review and valuable suggestions. Our appreciation and sincere thanks are extended to all of the above companies and individuals.

The text of this volume was set by Mrs. W. L. Metz of ITA, who also assisted with editorial aspects.

Upper Darby, Pa., USA  
July 30, 1981

W. Z. Stepniewski

# Contents

	<i>page</i>
<i>Preface</i> . . . . .	iii
<i>List of Symbols</i> . . . . .	ix
 <b>Chapter 1 Introductory Considerations</b>	
1.1 Objectives . . . . .	1
1.2 Helicopter Groups . . . . .	2
1.3 Selection of Gross Weight . . . . .	4
1.4 Design Effectiveness Criteria for Hovering and Vertical Climb . . . . .	4
1.5 Design Effectiveness Criteria for Forward Flight . . . . .	8
1.6 Some Aspects of Design Philosophy . . . . .	19
1.7 Configurational Aspects . . . . .	20
1.8 Concluding Remarks . . . . .	26
 <b>Chapter 2 Powerplants</b>	
2.1 Introduction. . . . .	29
2.2 Auxiliary Relationships . . . . .	30
2.3 Comparison of Engines Installed in Helicopters of up to 12,000-lb Gross Weight Class . . . . .	33
2.4 Comparison of Engines Installed in 12,000 to 30,000-lb Gross Weight Class Helicopters . . . . .	40
2.5 Comparison of Engines Installed in the 30,000 to 100,000-lb and Over 100,000-lb Gross Weight Class Helicopters . . . . .	46
2.6 Concluding Remarks . . . . .	48
 <b>Chapter 3 Helicopters of the Up-to-12,000-lb Class</b>	
3.1 Basic Data . . . . .	55
3.2 Hovering and Vertical Climb Aspects. . . . .	68
3.3 Energy Aspects in Hover. . . . .	79
3.4 SHP Required Aspects in Level Flight at SL, ISA. . . . .	83
3.5 Energy Aspects in Forward Flight . . . . .	89
3.6 Productivity . . . . .	100
3.7 General Discussion and Concluding Remarks . . . . .	100
 <b>Chapter 4 Helicopters of the 12,000 to 30,000-lb Gross Weight Class</b>	
4.1 Basic Data . . . . .	103
4.2 Hovering and Vertical Climb Aspects. . . . .	113



4.3	Energy Aspects in Hover . . . . .	129
4.4	SHP Required Aspects in Level Flight at SL, ISA . . . . .	133
4.5	Energy Aspects in Level Flight, SL, ISA . . . . .	140
4.6	Productivity . . . . .	147
4.7	General Discussion and Concluding Remarks . . . . .	147
	<i>Appendix – Chapter 4</i> . . . . .	153

### Chapter 5 30,000 to 100,000-lb GW Helicopters

5.1	Hypothetical Helicopters . . . . .	154
5.2	Basic Data . . . . .	159
5.3	Hovering and Vertical Climb Aspects . . . . .	168
5.4	Energy Aspects in Hover . . . . .	180
5.5	SHP Required Aspects in Level Flight at SL, ISA . . . . .	184
5.6	Energy Aspects in Level Flight, SL, ISA . . . . .	196
5.7	Productivity . . . . .	204
5.8	General Discussion and Concluding Remarks . . . . .	204

### Chapter 6 Over 100,000-lb Gross Weight Helicopters

6.1	Compared Helicopters . . . . .	210
6.2	Basic Data . . . . .	218
6.3	Hover and Vertical Climb Aspects . . . . .	225
6.4	Energy Aspects in Hover . . . . .	235
6.5	SHP Required Aspects in Level Flight at SL . . . . .	235
6.6	Energy Aspects in Level Flight, SL, ISA . . . . .	242
6.7	Productivity . . . . .	249
6.8	General Discussion and Concluding Remarks . . . . .	253
	<i>Appendix – Chapter 6</i> . . . . .	255

### Chapter 7 Overview of Design Parameters and Performance

7.1	Introduction . . . . .	260
7.2	Principal Design Parameters . . . . .	260
7.3	Weight Aspects . . . . .	265
7.4	Hovering Aspects . . . . .	270
7.5	Forward Flight Aspects . . . . .	270
7.6	Energy Aspects . . . . .	280

	<i>References</i> . . . . .	287
--	-----------------------------	-----

## *Foreword*

Even a superficial observation would indicate that there are basic differences in the Soviet and Western design and operational philosophies of rotary-wing aircraft. On the other hand, one should not be surprised to find a lot of commonality in the approach to various technical and operational problems.

In view of this anticipated duality of similarities and dissimilarities, it becomes especially interesting to develop a deeper understanding of the subject. This can be done by showing not only WHAT is either at variance or in agreement in the Soviet design and operational philosophy of helicopters with those in the West, but also WHY.

The need for such a comparative evaluation and analysis was recognized by the Research and Technology Laboratories of the U.S. Army Aviation R&D Command; especially by Dr. Richard M. Carlson, Director of the Labs. Consequently, a contract to conduct this task was awarded through NASA to International Technical Associates, Ltd., and Mr. Ronald A. Shinn was designated by the Labs as monitor of the project.

The study is divided into several separate tasks, and the results are presented in this report which consists of the three parts outlined below.

### **Part I. General Comparison of Designs**

Here, basic design aspects of existing Soviet helicopters, as well as hypothetical helicopters representing optimum configurations as set forth in Tishchenko's et al studies<sup>1</sup> are compared with selected representatives of the West.

### **Part II. Evaluation of Major Components and Their Weight-Prediction Methods**

In this task, a deeper comparative insight into design and operational philosophies is gained by examining the following aspects of the major components of Soviet and Western helicopters.

- (a) weight trends and weight-prediction methods
- (b) conceptual approach
- (c) producibility and maintainability.

### **Part III. Ranking of Large Single and Multirotor Transport Helicopters**

The final comparison is made of Soviet vs. Western approaches to helicopter design using Tishchenko's method of ranking large helicopters of various configurations with respect to a few selected short and long-haul cargo transport missions. This task will be performed by using both Soviet and Western constraints and minimal performance requirements, and the weight trend prediction methods indicated in Part II.

In the meantime, the Mil Mi-26 heavy-lift transport helicopter with the Lotarev D-136 turboshaft engine was unveiled at the Paris Air Show in June 1981. A comparison of this helicopter and engine with the corresponding hypothetical machine postulated by Tishchenko et al<sup>1</sup> indicated that the hypothetical aspects contained in his book actually represented milestones and goals for the new generation of Soviet helicopters and engines. Taking advantage of the valuable additional information regarding the Mi-26 and D-136 turboshaft, the undersigned has included the extra helicopter data along with its 'conceptual prototype' – the hypothetical 52-ton single-rotor helicopter (referred to in this work as the Hypo 52-SR), while the information available to date on the D-136 turboshaft is contained in the powerplant comparison.

The revision of Part I of "A Comparative Study of Soviet vs. Western Helicopters" was made possible by the contributions of the manufacturers of Western helicopters as represented by Aero-spaciale, Bell Helicopter Textron, Boeing Vertol Company, Messerschmitt-Boelkow-Blohm GmbH, and Sikorsky Aircraft. Other contributors include Dr. R.M. Carlson who continuously served as a source of inspiration and valuable suggestions, and Mr. R.A. Shinn who, in his capacity as technical and administrative monitor, greatly contributed to the concept formulation of the study and its execution. The editors are grateful to Mr. R.D. Semple of Boeing Vertol, Mr. H.D. Wilsted of the Research and Technology Labs, and Mr. E.R. McInturff of the U.S. Army Foreign Science and Technology Center for their expert review and valuable suggestions. Our appreciation and sincere thanks are extended to all of the above companies and individuals. The text of this report was set by Mrs. W.L. Metz of ITA, who also assisted with editorial aspects.

W. Z. Stepniewski

Upper Darby, Pa. USA  
July 30, 1981

## List of Symbols

$A$	total rotor(s) swept area; sq.ft
$AR$	wing aspect ratio
$b$	number of blades
$C_D$	wing drag coefficient
$C_L$	wing lift coefficient
$C_P$	power coefficient: $C_P \equiv 550 \text{ HP} / A \rho V_t^3$
$C_T$	thrust coefficient: $C_T \equiv T / A \rho V_t^2$
$C_W$	gross-weight coefficient: $C_W \equiv W_{gr} / A \rho V_t^2$
$c$	chord, blade or wing; ft
$\bar{c}_d$	average blade profile drag coefficient
$\bar{c}_l$	average blade-lift coefficient: $\bar{c}_l \equiv 6C_T / \sigma$
$D$	diameter; ft
	drag; lb
$D_e$	equivalent helicopter drag: $D_e \equiv 325 \text{ SHP} / V$ ; lb
$f$	equivalent flat-plate area; sq.ft
$FF$	fuel flow; lb/unit of time
$\overline{FF}_w$	fuel required per lb of gross weight & 100 n.mi
$\overline{FF}_{pl_0}$	fuel required per lb of zero-range payload & 100 n.mi
$FM$	rotor figure of merit
$FM_{oa}$	helicopter overall figure of merit: $FM_{oa} \equiv RP_{id} / SP$
$GW$	gross weight; lb
$H$	altitude; ft
$h$	height; ft
$HFF$	hourly fuel flow; lb/hr
$HH$	horizontal hinge
$HP$	horsepower; hp
$k_{blo}$	blocking effect coefficient
$k_{eng}$	engine weight coefficient
$k_{ind}$	rotor induced power coefficient: $k_{ind} \equiv RP_{ind} / RP_{id}$
$k_{pc}$	climb efficiency factor
$k_v$	download coefficient: $k_v \equiv T_{mr} / W_{gr}$
$L$	distance; ft
	lift; lb
$\ell$	length; ft
	distance; n.mi
$M$	Mach number
$NGW$	normal gross weight; lb
$n$	number
$OGE$	out-of-ground effect
$PL$	payload; lb
$PH$	pitch-bearing housing

<i>PI</i>	productivity index: $PI \equiv V_{cr} W_{pl} / W_e$
<i>R</i>	rotor radius; ft
<i>RP</i>	rotor power: ft-lb/sec, or hp
<i>RHP</i>	rotor horsepower; hp
<i>R/C</i>	rate of climb; fps, or fpm
<i>S</i>	area; sq.ft
<i>SP</i>	shaft power; ft-lb/sec, or hp
<i>SHP</i>	shaft horsepower; hp
<i>sfc</i>	specific fuel consumption; lb/hr-hp
<i>T</i>	rotor thrust; lb
<i>t</i>	time; sec, min, or hr
<i>V</i>	speed of flight; kn rate of climb; fps or fpm
<i>V'</i>	total rate of ideal flow through the disc; fps
<i>V<sub>t</sub></i>	rotor tip speed; fps
<i>V<sub>cab</sub></i>	cabin volume; cu.ft
<i>VH</i>	vertical hinge
<i>v</i>	induced velocity; fps
<i>W</i>	weight; lb or kg
<i>w</i>	disc, and area loading; psf
<i>x</i>	tail-rotor distance from main-rotor shaft; ft
$\bar{x}$	relative tail-rotor distance from main-rotor shaft: $\bar{x} \equiv x/R$
<i>y</i>	tail-rotor elevation over main-rotor hub; ft
$\bar{y}$	relative tail-rotor elevation: $\bar{y} \equiv y/R$
$\alpha$	relative fuel flow at idle angle-of-attack; deg or rad
$\beta$	slope of relative fuel flow vs partial power setting
$\Delta$	increment
$\eta_{oa}$	overall rotor-power transmission efficiency: $\eta_{oa} \equiv RP/SP$
$\eta_{xm}$	transmission efficiency
$\lambda$	relative engine power lapse rate with altitude wing-lift to total-lift ratio
$\mu$	rotor advance ratio: $\mu \equiv 1.69 V/V_t$
$\rho$	air density; slugs/cu.ft
$\sigma$	rotor solidity; $\sigma \equiv bc/\pi R$

Subscripts:

<i>act</i>	actual
<i>av</i>	available, or average
<i>c</i>	climb

<i>cont</i>	continuous
<i>cr</i>	cruise
<i>e</i>	empty
	minimum power (approx. maximum endurance)
<i>eng</i>	engine
<i>f</i>	forward
<i>fp</i>	flat plate
<i>fu</i>	fuel
<i>gr</i>	gross
<i>H</i>	altitude
<i>h</i>	hovering
<i>hc</i>	hovering ceiling
<i>id</i>	ideal
<i>ind</i>	induced
<i>mr</i>	main rotor
<i>NR</i>	normal rated
<i>o</i>	initial value
	sea level
<i>pl</i>	payload
<i>ref</i>	reference
<i>req</i>	required
<i>rot</i>	rotor
<i>sc</i>	service ceiling
<i>TO</i>	takeoff
<i>t</i>	time
	tip
<i>tab</i>	tip of advancing blade
<i>tf</i>	trapped fluid
<i>tr</i>	tail rotor
<i>VTO</i>	vertical takeoff
<i>v</i>	vertical; at speed of flight $V$
<i>w</i>	gross weight
	wing
<i>xm</i>	transmission
<i>e</i>	$\epsilon \equiv (W_{gr}/D_{\theta})_{max}$

# Chapter 1

## Introductory Considerations

### 1.1 Objectives

The principal aim of this chapter is to make a general comparison of the state of the art of Soviet helicopter design vs. that of the West (U.S. in particular), and to indicate both commonalities and differences in conceptual design philosophies existing in those two politically, economically, and to some extent, climatically and geographically different groups.

There are two basic aspects of the comparison:

- (1) Presentation of important design parameters, and
- (2) evaluation of the overall design effectiveness according to various criteria.

With respect to the first of these tasks, it is performed by simply presenting, numerically and often graphically, such input parameters as: (a) disc loading, (b) installed (TO) and transmission-limited power loading, (c) tip speeds, (d) number of blades, blade aspect ratios, and rotor solidities, (e) relative location of the tail rotor, and tail-rotor to main-rotor radii ratio, (f)  $C_T/\sigma$  and/or  $\bar{c}_g$  in the considered regimes of flight\*, and (g) cabin dimensions.

As far as task (2) is concerned, again simple listing and suitable graphical presentation of performance would, by itself, provide some clues regarding the success of design. Here, the following items come to one's mind: (a) hovering ceiling, OGE vs. gross weight; (b) rate of vertical climb; (c) forward flight rate of climb, with all engines operating; (d) service ceiling with all engines operating, and one engine out; (e) maximum and cruise speeds of flight; and (f) payload, and corresponding range.

This cursory design evaluation can be further improved by graphically presenting such power-dependent performance items as hovering ceilings, rates of climb, and flight speeds as a function of installed or transmission-limited power loading.

However, in order to gain a still deeper insight into the overall design effectiveness (aerodynamics, weights, and powerplants), more detailed criteria are established and discussed, and particular helicopters are judged according to them.

---

\*Items (a), (c), (d), and (f) refer to both lifting and tail rotors.

Since powerplants represent an important contribution to the success or failure of rotorcraft, one chapter is devoted to the comparison of the most important characteristics of both Soviet and Western engines, and the accumulation of engine performance information necessary for further helicopter evaluation. Consequently, such items are examined as various power ratings; specific weight; specific fuel consumption, and its variation with power setting; and external dimensions. However, the powerplant comparisons are not as indepth as those for the rotorcraft as a whole.

In concluding these general introductory remarks, it should be emphasized that in addition to the comparison of Soviet and Western helicopter designs, supplemental benefits from this study should be acquired through an accumulation (under a single cover) of data representing values and ranges of various design parameters, and acquisition of numerical evaluation of the most important aspects of the overall design efficiency. All this material should be of significant help to the designers of new rotary-wing aircraft as well as to those who teach academic courses on helicopter design.

## 1.2 Helicopter Groups

In order to improve the significance of the comparative process, all examined helicopters are grouped according to their design gross weight as follows:

- (1) Up to 12,000-lb gross weight class
- (2) 12,000 to 30,000-lb gross weight class
- (3) 30,000 to 100,000-lb gross weight class
- (4) Higher than 100,000-lb gross weight class.

Once the above classification was accepted, it was not difficult to properly group existing Soviet helicopters on which published data are available. Also it was possible to incorporate the hypothetical helicopters considered in Tishchenko's et al book<sup>1</sup> into suitable gross weight classes.

As far as Western designs are concerned, it appeared desirable to include both U.S. and European rotorcraft and, in that process, to select representatives of the most recent, as well as earlier designs.

As a result of this approach, the following groups were formed for comparison:

### 1. Up to 12,000-lb Gross Weight Class

#### A. Soviet:

Mil Mi-2 (original version as produced by PZL, Swidnik, Poland)

Mil Mi-2-A (with 2 Allison 250-C20B engines (PZL))

Kamov Ka-26



**B. Western:**

Aerospatiale SA-365N

Sikorsky S-76

Bell UH-1H

MBB BO-105

Bell Model 222

**2. 12,000 to 30,000-lb Gross Weight Class**

**A. Soviet:**

Mil Mi-8

Mil Mi-24D

Kamov Ka-25

**B. Western:**

Aerospatiale SA330J Puma

Boeing Vertol CH-46E Sea Knight

Boeing Vertol YUH-61A (UTTAS)

Sikorsky CH-3E (S-61R)

Sikorsky UH-60A Black Hawk (UTTAS)

**3. 30,000 to 100,000-lb Gross Weight Class**

**A. Soviet:**

Mil Mi-6

Mil Mi-10

Hypothetical 15 metric-ton S.R. helicopter<sup>1</sup>

Hypothetical 24 metric-ton S.R. helicopter<sup>1</sup>

**B. Western:**

Boeing Vertol CH-47D Chinook

Sikorsky CH-53D

Sikorsky CH-53E

**4. Over 100,000-lb Gross Weight Class**

**A. Soviet:**

Mil Mi-12

Hypothetical 52 metric-ton S.R. helicopter<sup>1</sup> and Mil Mi-26

Hypothetical 52 metric-ton S.b.S. helicopter<sup>1</sup>

**B. Western:**

Boeing Vertol HLH

### 1.3 Selection of Gross Weight

Absolute performance of helicopters as well as their relative rating can be strongly affected by their flying gross weight values. Consequently, it becomes important to establish a common ground for the selection of gross weights to be used in this comparative study.

Normal gross weight appears as one of the possibilities, since performance figures published in such reference texts as Jane's<sup>2</sup>, Blue Book<sup>3</sup> and manufacturers brochures are often quoted for this gross weight value. Unfortunately, this weight is often determined around some specific missions, which may be different for various helicopters and thus the normal gross weight may not represent a truly common ground for this comparative evaluation.

Maximum operational flying weight as specified by the manufacturer and usually quoted in such references as 2 and 3, as well as helicopter brochures, forms a somewhat better gross weight basis since it is directly associated with the practical maximum load-carrying capacity of the rotorcraft. Hence, it will be selected as the principal flying gross weight in this study.

However, one may object to this approach on the ground that helicopters are, first of all, VTO aircraft, and as such should have the capability to take off vertically and/or hover OGE under specified pressure altitudes and ambient temperature conditions. In order to satisfy these aspects, the following is proposed:

VTO gross weight will be defined as a gross weight corresponding to hovering OGE at 3000 ft, ISA. Should the so-defined VTO gross weight of a helicopter be lower than its maximum operational value, then some of the comparative performance items will be recalculated for that supplemental gross weight in order to show how adherence to the VTO capabilities would alter the relative standing of that helicopter with respect to the others.

### 1.4 Design Effectiveness Criteria for Hovering and Vertical Climb

Overall Figure of Merit. Overall aerodynamic and configurational effectiveness of design in hover can be evaluated through the Overall Figure of Merit ( $FM_{oa}$ ) which can be defined as a ratio of the ideal power required in hovering ( $HP_{id} \equiv W_{gr}\sqrt{w/2\rho_h}/550$ ) to the actual shaftpower delivered by the engines in that regime of flight OGE.

$$FM_{oa} = HP_{id}/SHP_{req} \quad (1.1)$$

The ideal power is easily determined, as the disc loading ( $w$ ) of lifting rotor(s) and air density ( $\rho_h$ ) in hovering are readily obtainable. As to the total engine  $SHP$  required under these circumstances, in some cases, flight test results will be available which either give the desired relationship of  $SHP_{req_h} = f(W_{gr})$  directly, or in a coefficient form as  $C_p = f(C_T)$ . Should such direct relationship be not available, then this difficulty can be surmounted by assuming that the hovering ceiling is associated with the  $TO$  power

rating. Consequently, once the manufacturer's or assumed lapse-rate for the engines is known, the  $SHP_{TO}$  at hovering ceiling can be obtained. From this, the shaft horsepower per pound of gross weight ( $SHP/W_{gr}$ ) at the hovering ceiling can be calculated, and Eq (1.1) is rewritten as follows:

$$FM_{oa} = \sqrt{w/2\rho_{hc}/550(SHP/W_{gr})_{hc}} \quad (1.1a)$$

For the compared helicopters the above quantity can be tabulated as well as presented graphically.

**Determination of VTO Gross Weight.** Once the  $FM_{oa}$  values are found, their knowledge can greatly facilitate establishment of the VTO gross weight:

Assuming that the  $FM_{oa}$  value remains approximately constant within possible gross weight (main rotor thrust) and density variation limits, the shaft horsepower required to hover OGE at 3000 ft, ISA by a single-rotor helicopter can be expressed as

$$SHP_{req_h} = W_{gr} \sqrt{W_{gr}/2\pi R_{mr}^2 \rho_{3000}/550 FM_{oa}}$$

where  $R_{mr}$  is the main rotor radius and air density  $\rho_{3000} = 0.002175$  slugs/ft<sup>3</sup>.

On the other hand, knowing the lapse rate ( $\lambda_{3000}$ ) of the takeoff power at 3000 ft, the TO shaft horsepower available at that altitude becomes

$$SHP_{av_h} = \lambda_{3000}(SHP_{TO})_o$$

where  $SHP_{TO}$  is the takeoff power at SL, ISA. Should the so-obtained power be higher than the transmission limit, then the latter becomes the power available.

Equating the right sides of the above equations and solving for  $W_{gr}$ , the sought VTO gross weight is obtained: \*

$$(W_{gr})_{VTO} = 16.05[(SHP_{TO})_o \lambda_{3000} R_{mr} FM_{oa}]^{2/3} \quad (1.2)$$

**Hourly Fuel Consumption in Hover at SL, ISA per Pound of Payload.** The Overall Figure of Merit permits one to judge only some aspects of the success of design of a helicopter as a hover vehicle. Such important aspects of design effectiveness as the ability to carry the highest possible payload (at a given gross weight) and, when doing that, use as little energy (fuel) as possible per pound of payload and unit of time are not reflected through the  $FM_{oa}$  values. In order to eliminate those shortcomings, the following criterion is proposed: hourly fuel flow in hover at SL, ISA per pound of payload.

It is suggested that the above quantity be computed for the range of hypothetical payloads starting with that corresponding to zero and ending at one hour of hover time.

Since weight empty and crew number are known for all helicopters being compared, the zero hover time payload can be determined as

\*For tandems and side-by-side configurations, a constant coefficient of 20.22 would replace the 16.05 in Eq (1.2).

$$(W_{pl})_{t=0} = W_{gr} - W_e - W_{crew} - W_{tf} \quad (1.3)$$

where  $W_{gr}$  is the gross weight selected as a basis for comparison; i.e, either  $(W_{gr})_{max}$  or  $(W_{gr})_{VTO}$ ;  $W_e$  is the weight empty;  $W_{crew}$  is the crew weight; and  $W_{tf}$  is the weight of trapped fluids.

It should be noted that in addition to the  $W_e/W_{gr}$  ratio, the  $(W_{pl})_{t=0}/W_{gr}$  ratio also represents an interesting criterion of the weight effectiveness of design and thus both relationships should be shown in tabulated and graphical form.

In regard to the relative hourly fuel consumption in hover ( $HFF/W_{pl}$ ), it is suggested that in order to apply this criterion under uniform conditions, the  $HFF/W_{pl}$  quantity should be computed for hover OGE at SL/ISA, either at the maximum flying weight,  $(W_{gr})_{max}$ , or at the VTO gross weight should the latter be lower than  $(W_{gr})_{max}$ .

Once the  $FM_{oa}$  values are known, the hourly fuel flow can be obtained as follows:

$$HFF = (W_{gr} \sqrt{W/2\rho_o} / 550 FM_{oa}) sfc \quad (1.4)$$

However, in order to complete the calculations indicated by Eq (1.4), the power required in hover as given by the expression in the parenthesis in Eq (1.4) must be computed first, which would permit one to find the partial power setting and the corresponding sfc values.

The needed  $(W_{pl})_{t=0}$  value is computed from Eq (1.3), while for time (hours) in hovering  $t > 0$ , the payload is calculated as

$$(W_{pl})_t = (W_{pl})_{t=0} - HFFt \quad (1.5)$$

The  $(HFF/W_{pl}) = f(t)$  curve can be obtained from Eqs (1.4) and (1.5). This relationship for the compared helicopters can be graphically presented as in Fig. 1.1.

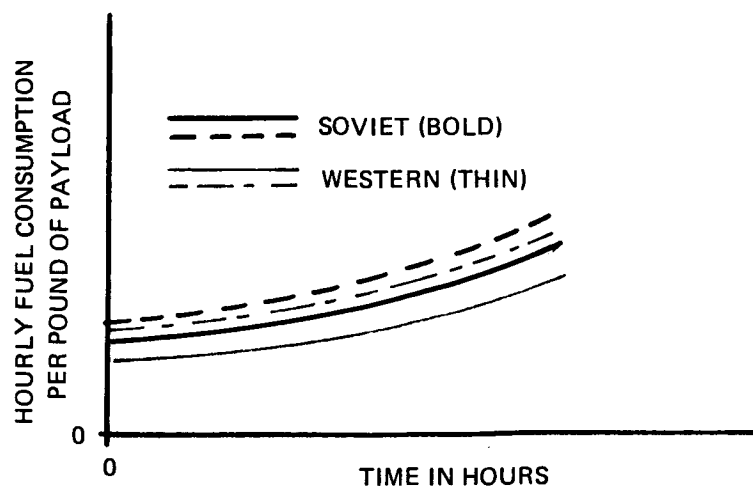

Figure 1.1 Relative hourly fuel flow vs. hover time for the compared helicopters

**Vertical Rate of Climb at SL, ISA.** Values of vertical R/C at SL, ISA are not always given in published literature, but knowledge of that performance item may be desirable when comparing various helicopters. Here, again, knowledge of the  $FM_{oa}$  values can greatly facilitate quick estimates of the vertical rate of climb.

As indicated in Ch II of Ref 4, the total rate of the ideal flow through the disc  $V'$  in fps is

$$V' = 550 RHP_{id}/W_{gr} \quad (1.6)$$

but

$$RHP_{id} = SHP FM_{oa}$$

and

$$V' = 550 FM_{oa}/(W_{gr}/SHP) \quad (1.6a)$$

This total flow rate is, in turn, equal to the sum of the ideal induced velocity  $v_{id}$  and rate of vertical climb ( $V_{cv}$ ):

$$V' = v_{id} + V_{cv} \quad (1.7)$$

or

$$V_{cv} = V' - v_{id} \quad (1.7a)$$

In turn,  $v_{id}$  can be expressed as follows:

$$v_{id} = w/2\rho V' \quad (1.8)$$

or, in light of Eq (1.6a)

$$v_{id} = w(W_{gr}/SHP)/1100\rho FM_{oa} \quad (1.8a)$$

Substituting Eqs (1.6a) and (1.8a) for  $V'$  and  $v_{id}$  respectively, into Eq (1.7a), and expressing the rate of climb in fpm, the following is obtained:

$$V_{cv} = 60 \left\{ [550 FM_{oa}/(W_{gr}/SHP)] - [w(W_{gr}/SHP)/1100\rho FM_{oa}] \right\} \quad (1.9)$$

It can be seen from this equation that knowing the overall figure of merit ( $FM_{oa}$ ) and power loading ( $W_{gr}/SHP$ )—in this case, at the T.O or transmission-limited rating—the vertical rate of climb can readily be computed and properly tabulated for the purpose of comparison.

**Hovering Ceiling.** Hovering ceiling (OGE and IGE) in itself represents an important performance item. However, when plotted on the abscissa of the T.O power loading, it may be considered as a design efficiency criterion, showing how well the available power is actually utilized for achieving various hover altitudes. A scheme of graphical presentation of the hovering ceilings for the purpose of comparison is depicted in Fig. 1.2.

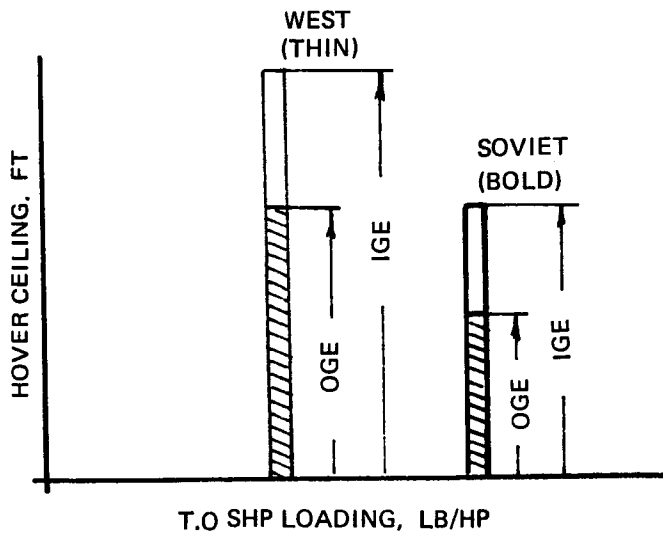

Figure 1.2 Hovering ceiling vs. power loading of the compared helicopters

### 1.5 Design Effectiveness Criteria for Forward Flight

Shaft Horsepower per Pound of Gross Weight vs Flight Speed. Shaft horsepower per pound of gross weight computed at a selected altitude (say, SL, ISA) and gross weight values (in our case, maximum) and presented vs. speed of flight can be taken as a valuable criterion for comparing aerodynamic and configurational effectiveness of various helicopters. An auxiliary grid of the weight to the equivalent drag,  $(W/D_e) = const$ , lines would permit one to assess at a glance the  $(W/D_e)_{max}$  values of the compared aircraft.

As for the comparison of the Soviet vs. Western helicopters, graphical presentation of the  $(SHP/W_{gr}) = f(V)$  curves will be such that referring to the Soviet machines will be plotted in heavy, while the Western machines will be plotted in thin, lines; thus providing a background for the candidate helicopters (Fig 1.3).

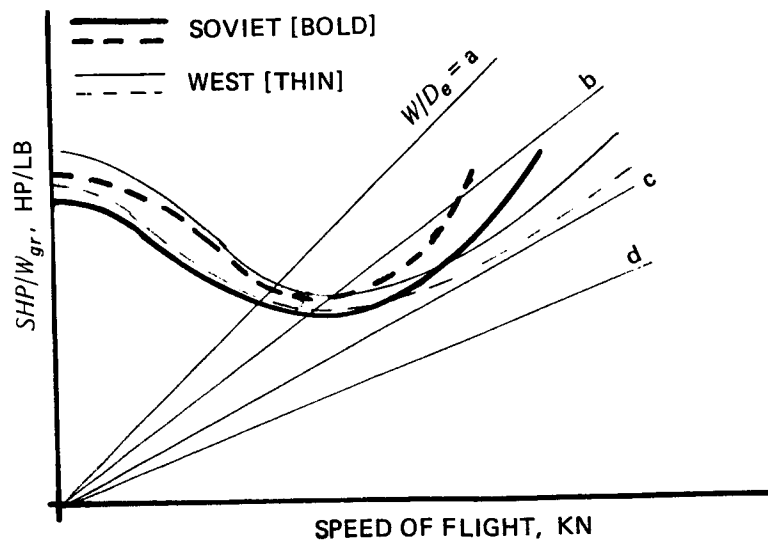

Figure 1.3 Comparison of  $(SHP/W_{gr}) = f(V)$  curves for the Soviet and Western helicopters

**Establishment of the  $(SHP/W_{gr}) = f(V)$  Relationship.** For some Western helicopters, actual flight test data on SHP vs. flying speed, or manufacturers' predicted figures are available. However, this information could be for a different gross weight and/or altitude than required for this comparative study. For Soviet rotorcraft, the  $SHP = f(V)$  relationships are not available as a rule. Consequently, there is a need for (a) the ability to recalculate the  $(SHP/W_{gr}) = f(V)$  relationships from one altitude and gross weight condition to another, and (b) to reconstruct the  $(SHP/W_{gr}) = f(V)$  curve from obtainable officially published figures on flying speed at various gross weights and altitudes, and only generally defined power settings (e.g., cruise, economic cruise). Additional information can be provided by the (usually given) maximum rate of climb at SL, ISA and presumably, maximum continuous power setting.

An analytical basis for accomplishment of tasks (a) and (b) is provided by the following equation, derived from Eqs (3.106) and (3.107) of Ref. 4.

$$(SHP/W_{gr}) = \left[ 2.413 \rho \frac{V^3}{w_{fp}} + 0.296 \frac{k_{vf}^2 k_{indf} w}{\rho V} + 0.75(1 + 4.7\mu^2) \left( \frac{\bar{c}_d}{\bar{c}_l} \right) V_t \right] / 550 \eta_{oa} \quad (1.10)$$

where  $V$  is the flight speed in kn;  $k_{vf}$  is the download factor;  $k_{indf}$  is the induced power factor;  $w$  is the disc loading in psf;  $w_{fp} \equiv W_{gr}/f$  is the equivalent flat-plate area ( $f$ ) loading in psf;  $\mu \equiv 1.69V/V_t$  is the advance ratio;  $V_t$  is the tip speed in fps;  $\rho$  is the flight air density in slugs/cu.ft;  $(\bar{c}_d/\bar{c}_l)$  is the ratio of the average profile drag to the average lift coefficient in hover; and  $\eta_{oa}$  is the overall rotor power transmission efficiency representing the ratio of the rotor to shaft power.

Actually, in Eq (1.10) there are five unknowns ( $w_{fp}$ ,  $k_{vf}$ ,  $k_{indf}$ ,  $(\bar{c}_d/\bar{c}_l)$ , and  $\eta_{oa}$ ). It is evident hence, that in order to determine all of them, five pairs of  $(SHP, V)$  points should be known. However, not all of these unknowns are equally important for a correct reconstruction of the  $(SHP/W_{gr}) = f(V)$  curve. For instance, it may be safely assumed that for conventional helicopters,  $k_{vf} < 1.03$  and probably an assumption of  $k_{vf} \approx 1.02$  would constitute a good representative value. Also, from an inspection of the configuration, the overall power transmission efficiency coefficient in forward flight can be estimated. For this flight regime,  $0.88 < \eta_{oa} < 0.93$  would probably represent a good practical value of that coefficient\*.

It appears hence that it would be desirable to determine the values of the  $w_{fp}$ ,  $(\bar{c}_d/\bar{c}_l)$ , and  $k_{indf}$  unknowns. Also, at first glance, it appears that the information needed to work the 3 necessary equations can usually be provided by: (1) SHP required in hover OGE at SL, ISA (see Page 5); (2)  $SHP_{min}$ , corresponding to the maximum rate of climb in forward flight at a speed  $V_e$  whose value can be estimated (see below); and (3) SHP at either  $V_{max}$  or maximum cruising speed ( $V_{cr,max}$ ), both usually quoted for the maximum continuous power setting, or that corresponding to the transmission limit.

But values of  $k_{ind}$  in hover and in forward flight may be considerably different. Consequently, the validity of using the hovering point in conjunction with the two remaining points representing forward flight at  $V \geq V_e$  is somewhat doubtful.

\*This subject is more thoroughly examined later, in subsection on Configurational Aspects.

It appears, hence, that if one wants to use the 3-equation approach, all of the equations should be written around the  $SHP, V$  information available at the following speed range,  $V_e \leq V \leq V_{max}$ . An actual attempt to use this approach indicated that one may obtain unreasonable values of the induced power coefficient; for instance,  $k_{ind} < 1.0$ . Therefore, a decision was made to use the two-equation approach, based on information available regarding  $SHP$  required at  $V_{max}$  or  $V_{cr.max}$  and  $SHP_{min}$ , while assuming  $k_{indf} = 1.12$  to  $1.15$ , and solving for the  $w_{fp}$  and  $(\bar{c}_d/\bar{c}_l)$  values.

A test case is shown in Fig. 1.4, where actual flight test data<sup>5</sup> for the UH-1H helicopter flown at  $W_{gr} = 8560$  lb and air density  $\rho = 0.00205$  was used as inputs for ( $V_e = 64$  kn,  $SHP = 500$  hp) and ( $V_e = 128$  kn,  $SHP = 1000$  hp), while for the other unknowns the following values were assumed:  $\eta_{oa} = 0.89$  and  $k_{indf} = 1.12$ .

Introducing the above values into Eq (1.10), a set of two linear equations in  $w_{fp}$  and  $(\bar{c}_d/\bar{c}_l)$  was obtained, whose solution yielded  $w_{fp} = 282.5$  psf ( $f = 30.3$  ft<sup>2</sup>) and  $(\bar{c}_d/\bar{c}_l) = 1/57$ . When the above values were reintroduced into Eq (1.10) along with the previously assumed  $\eta_{oa}$  and  $k_{indf}$  values;  $(SHP/W_{gr})$  and then  $SHP = (SHP/W_{gr})W_{gr}$  were calculated for several flying speeds, thus resulting in a perfect fit of the test points (see Fig. 1.4).

Once all the unknowns in Eq (1.10) are either found, or assumed, it is possible to use that equation for determining, with some confidence, the  $(SHP/W_{gr}) = f(V)$  curves of the compared helicopters at the specified gross weights (say, maximum flying) and altitude (SL, ISA). It should be recalled at this point that when dealing with different gross weights, new values of  $w_{fp}$  should be used:  $w_{fp} = w_{fp0}(W_{gr}/W_{gr0})$ .

As an example of this procedure, the  $(SHP/W_{gr}) = f(V)$  curve was recomputed for the UH-1H helicopter at  $W_{gr} = 9500$  lb and SL, ISA, and the so-obtained figures compared with those obtained from the generalized flight test data presented in Fig 67 of Ref. 6. It can be seen from Fig. 1.5 that the above-described method of recalculating the  $(SHP/W_{gr}) = f(V)$  values for other gross weights and altitudes appears to be quite satisfactory.

In the reconstruction of the  $(SHP/W_{gr}) = f(V)$  relationship from published performance data by the two-equation method, the coordinates of the high speed point ( $V_{max}, SHP$ ) or ( $V_{cr.max}, SHP$ ) should usually be directly given. But as far as the other point ( $V_e, SHP_{min}$ ) is concerned, neither the speed nor the power coordinate is directly available.

The  $(SHP_{min}/W_{gr})$  values can be estimated from the usually published maximum rate of climb  $(V_{cf})_{max}$  at SL, ISA and the generally accepted convention that  $(R/C)_{max}$  is related to the known maximum continuous power setting ( $SHP_{max.cont}$ ), or transmission limit.

Assuming that the so-called climb efficiency factor ( $k_{pc}$ ) (see Sect. 5, Ch. III, Ref. 7) can be taken as  $k_{pc} = 0.85$ , and  $(V_{cf})_{max}$  is in fpm, the  $(SHP_{min}/W_{gr})$  can be expressed as follows:

$$(SHP_{min}/W_{gr}) = (SHP_{max.cont}/W_{gr}) - [(V_{cf})_{max}/33,000 k_{pc}] \quad (1.11)$$



DATA SOURCE: USAASTA FINAL REPORT

PROJECT No. 66-04

November 1970

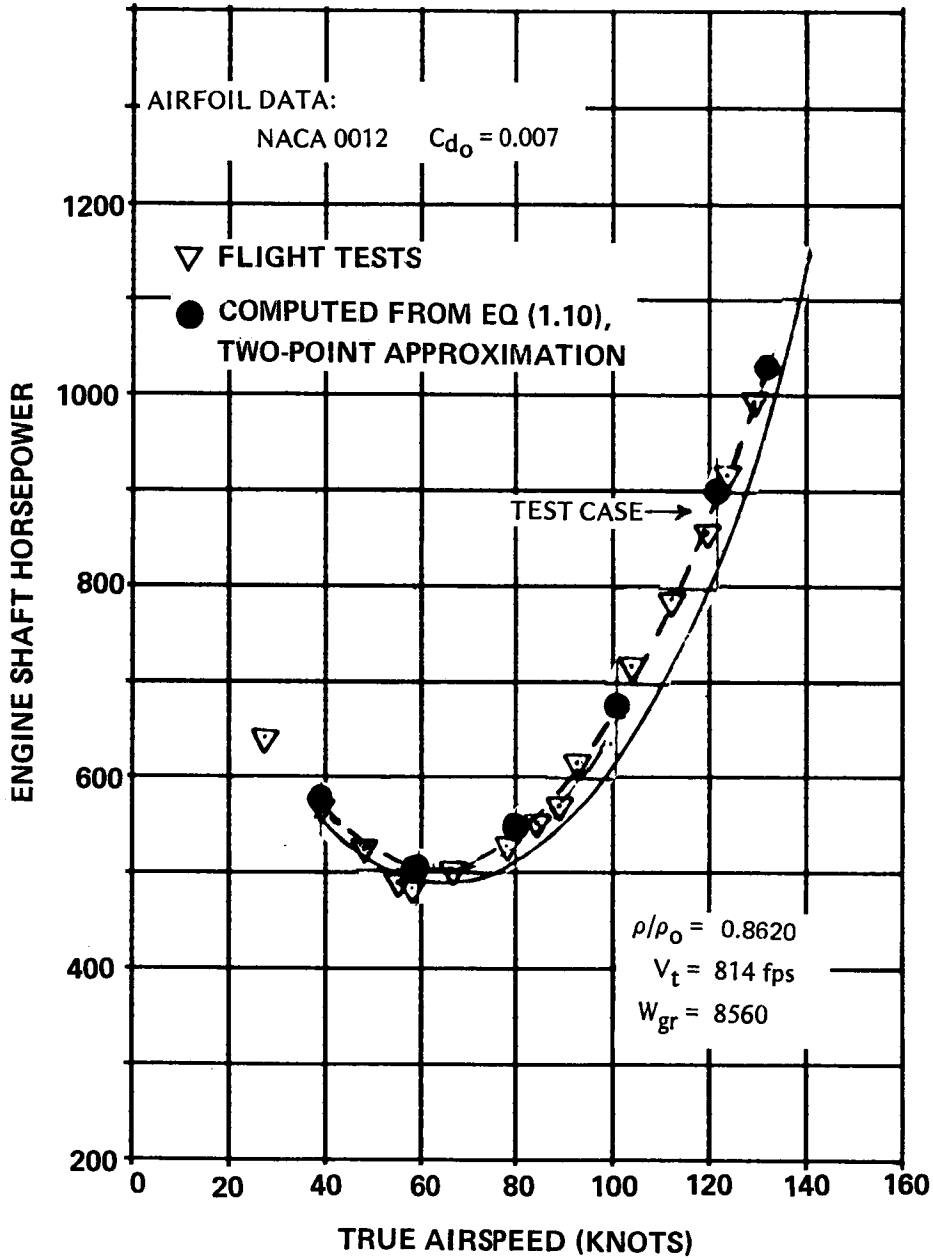

Figure 1.4 Two-point approximation of measured level flight power required vs. speed of flight—Model UH-1H<sup>5</sup>

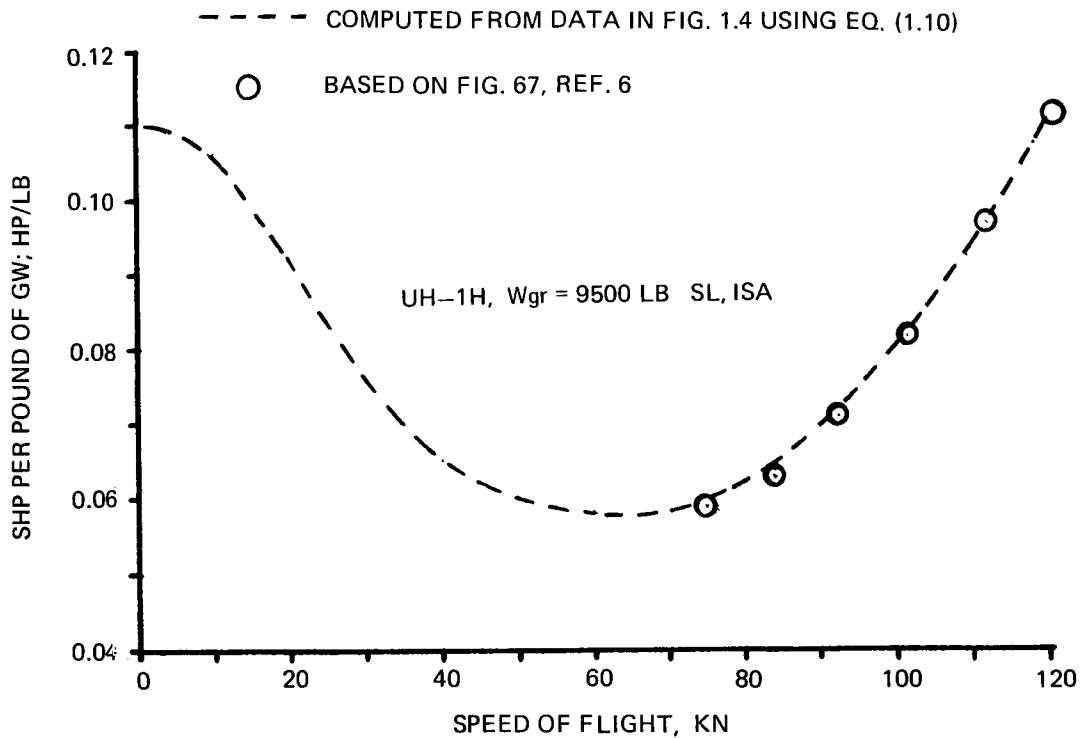

Figure 1.5 Comparison of  $(SHP/W_{gr}) = f(V)$  deduced from flight tests at higher altitude and lower gross weight with flight test data for  $W_{gr} = 9500$  and SL, ISA.

From Eq (1.11) the ordinate of the  $[V_e, (SHP_{min}/W_{gr})]$  point can be obtained, but the abscissa ( $V_e$ ) is still missing. However, this situation can be remedied through the so-called first approximation approach, based on the single high speed point, say  $[V_{max}, (SHP_{max.cont}/W_{gr})]$ . In this case, in Eq (1.10)  $k_{vf}$ ,  $k_{indf}$ ,  $\eta_{oa}$  and  $(\bar{c}_d/\bar{c}_l)$  values are all assumed, and the equation is solved for  $w_{fp}$  only.

Differentiating Eq (1.10) with respect to  $V$ , while assuming that the last term in that equation is constant, and equating the result to zero, one finds that an approximate value of the speed  $V_e$  corresponding to  $(SHP_{min}/W_{gr})$  can be obtained in knots as:

$$V_e = 0.448 \sqrt[4]{k_v^2 k_{ind} w_{fp} / \rho^2} \quad (1.12)$$

Figure 1.6 and Table 1.1 was prepared in order to find to what extent the variation in the assumed  $k_{vf}$ ,  $k_{indf}$ ,  $\eta_{oa}$  and  $\bar{c}_d/\bar{c}_l$  values would affect the  $V_e$  value. Here, the  $(SHP/W_{gr}) = f(V)$  curve, based on manufacturer's data<sup>8</sup> was reasonably approximated by assuming that  $\eta_{oa} = 0.88$ ,  $k_{indf} = 1.15$ ,  $k_{vf} = 1.02$  and  $(\bar{c}_d/\bar{c}_l) = 1/45$  (Fig. 1.6). Then the influence of a single parameter variation was investigated (Table 1.1) and then all the parameters were taken at either their maximum or minimum values (Fig. 1.6). It can

SHAFT HORSEPOWER PER LB OF GROSS WEIGHT  
VS SPEED OF FLIGHT

SA-365N, SL, ISA, GW = 7055 LB

ASSUMED

COMPUTED FROM EQ (1.10)

$\eta_{oa} = 0.88; k_{indf} = 1.15; \bar{c}_d/\bar{c}_l = 1/45$

$w_{fp} = 366.2 \text{ psf}$

$\eta_{oa} = 0.93; k_{indf} = 1.10; \bar{c}_d/\bar{c}_l = 1/50$

$w_{fp} = 322.2 \text{ psf}$

$\eta_{oa} = 0.83; k_{indf} = 1.20; \bar{c}_d/\bar{c}_l = 1/40$

$w_{fp} = 429.3 \text{ psf}$

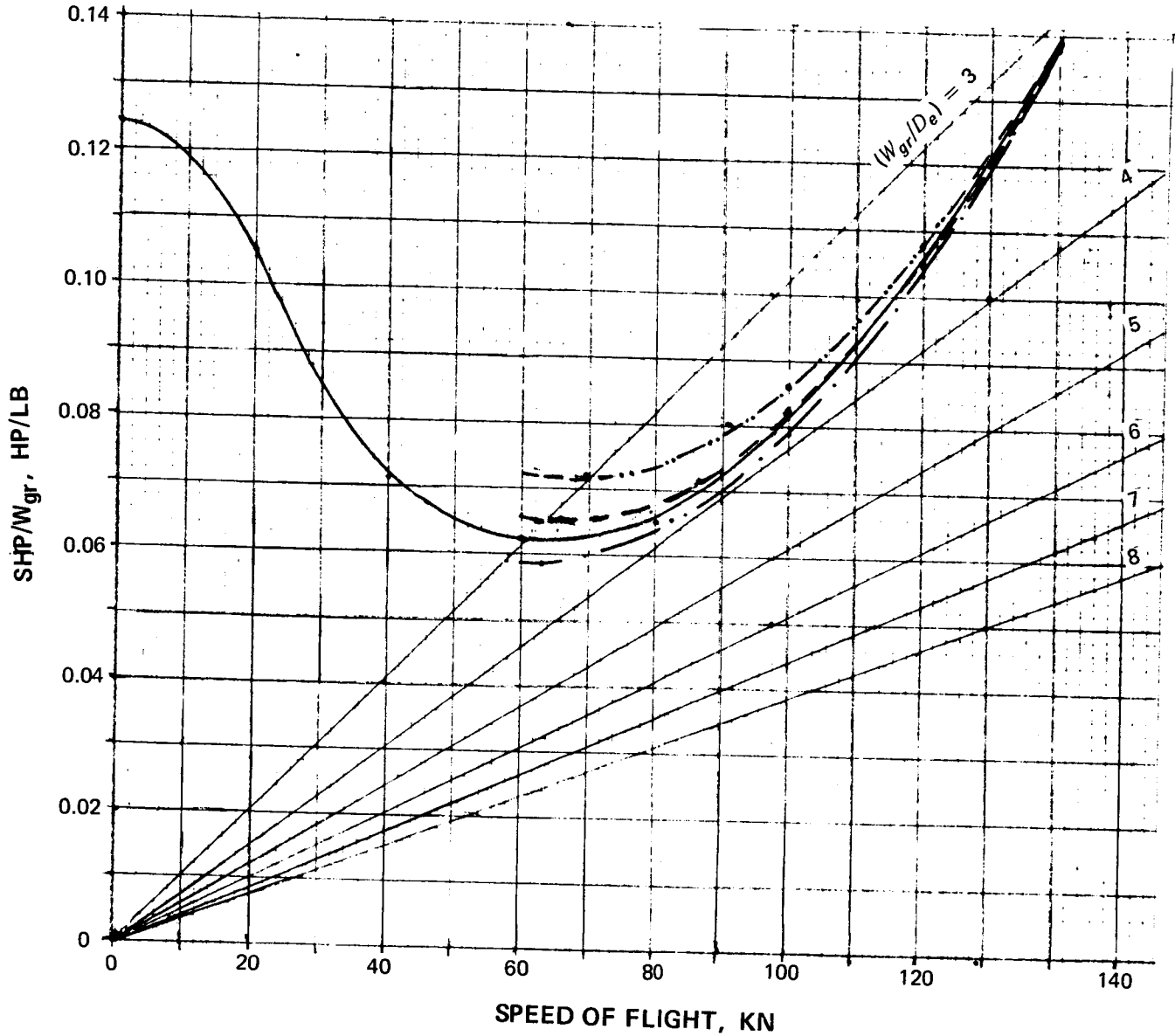

Figure 1.6 Example of approximating a given  $(SHP/W_{gr}) = f(V)$  curve through the single-point approach and various assumed values of  $\eta_{oa}$ ;  $k_{ind}$  and  $\bar{c}_d/\bar{c}_l$

ITEM	PARAMETRIC VALUES FOR A "GOOD FIT"	SINGLE PARAMETER VARIES AS INDICATED, WHILE ALL OTHERS REMAIN AS IN COLUMN 2				
		$\eta_{oa} = 0.93$	$\eta_{oa} = 0.83$	$k_{ind} = 1.10$	$k_{ind} = 1.20$	$\bar{c}_d/\bar{c}_q = 1/50$
$w_{fp}$ ; psf	$\eta_{oa} = 0.88$ $k_{indf} = 1.15$ $k_{vf} = 1.02$ $\bar{c}_d/\bar{c}_q = 1/45$	336.4	402.0	363.9	368.7	386.2
$V_e$ ; kn	66.1	64.7	65.3	66.9	65.4	67.0
$(SHP/W_{gr})_e$ ; hp/lb	0.0650	0.0615	0.0632	0.0656	0.0620	0.0671

Table 1.1 Example of the importance of varying a single parameter, while others retain values assuring a "good fit"

be seen from this figure and the table that even large excursions from the "good fit values" result in a relatively minor variation of the  $V_e$  value, while somewhat greater differences can be noted in the  $(SHP_{min}/W_{gr})$  levels. However, this fact is of little significance for the two-point method of the  $(SHP/W_{gr}) = f(V)$  relationship reconstruction since the  $(SHP_{min}/W_{gr})$  values are obtained from the maximum rate of climb considerations.

Small variations of  $V_e$  with rather large fluctuations of the assumed values of the parameters is encouraging as far as the two-point approach is concerned, because it permits one to use with confidence the  $V_e$  values computed from Eq (1.12) based on the results of the "first approximation."

#### Fuel Consumption Related to Gross Weight.

Although the  $(SHP/W_{gr}) = f(V)$  curves can be used in the evaluation and comparison of the aerodynamic and configurational effectiveness of various designs, they do not contribute to one's knowledge regarding the effectiveness of the airframe-powerplant combination. In the latter respect, plots of fuel consumption per hour and pound of gross weight can be quite instructive.

Knowing the sfc variation versus engine power setting and having the previously established  $(SHP/W_{gr}) = f(V)$  curves, the hourly fuel flow (HFF) per pound of gross weight can readily be computed for the whole speed range as

$$(HFF/W_{gr}) = (SHP/W_{gr})sfc \quad (1.13)$$

and the  $(HFF/W_{gr}) = f(V)$  plotted.

As far as the comparative study is concerned, it is again suggested that the above curves for the Soviet helicopters be plotted in bold lines, while those of Western rotorcraft, presented in thin lines,

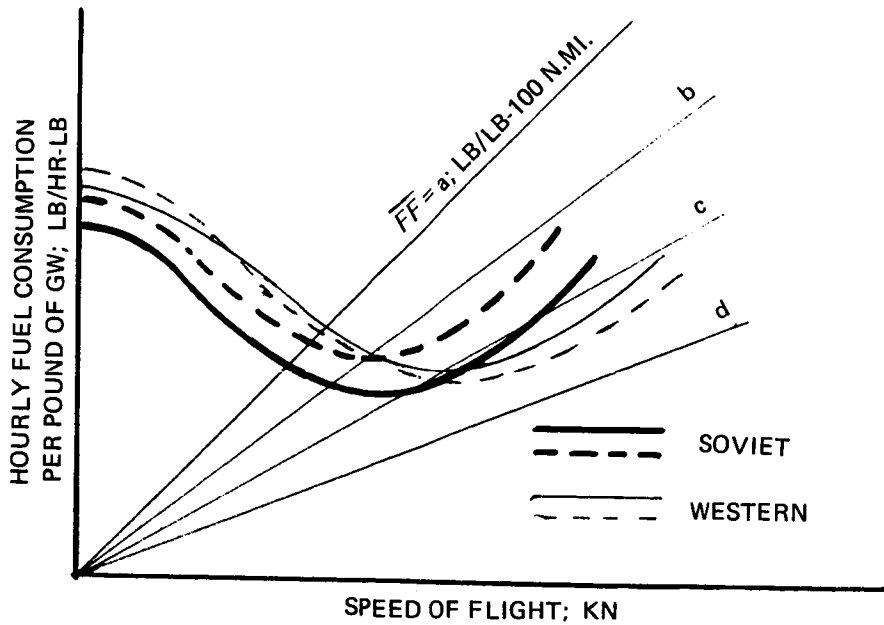

Figure 1.7 Scheme for comparing hourly fuel consumption.

would form the background (Fig. 1.7). As in the preceding case, this comparison is also limited to the SL/ISA conditions.

An auxiliary grid of straight lines expressing various constant values of fuel consumed per pound of gross weight and say, 100 n.mi, would permit one to judge at a glance those values for various machines. However, in order to provide a means for a more precise comparison of the  $\overline{FF} \equiv (HFF/W_{gr}V)100$  levels for the compared helicopters, separate plots of  $\overline{FF} = f(V)$  are provided (Fig. 1.8).

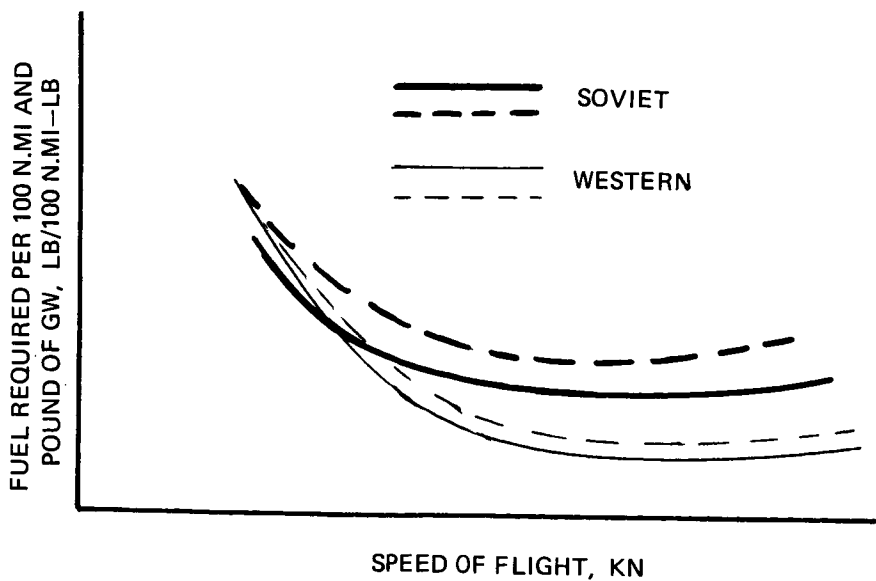

Figure 1.8 Scheme for comparing fuel required per lb of gross weight and 100 n.mi of Soviet and Western Helicopters

**Fuel Consumption Related to Payload.** The fuel utilization aspects discussed in the preceding subsection still fail to serve as a criterion for a comparison of design effectiveness with respect to the aerodynamics-configuration-powerplant-weights design combination. In order to obtain tools for a more complete design comparison, both hourly fuel flow and fuel required per 100 n.mi and one pound of the zero-range (time) payload can be used. Graphs reflecting these values (plotted vs speed of flight) can be readily obtained by dividing the data shown in Figs. 1.7 and 1.8 by the  $(W_{pl})_{\ell=0}/W_{gr}$  ratio; where the zero range ( $\ell$ ) payload  $(W_{pl})_{\ell=0} \equiv (W_{pl})_{t=0}$  is as defined by Eq (1.3).

However, it is more interesting to see how the fuel weight to payload ratio would vary with the distance flown. Strictly for comparative purposes, this can be done as follows:

Defining payload at zero range as  $(W_{pl})_0$ ; the payload for distance  $\ell$  (neglecting reserves and fuel for takeoff and maneuvers) can be expressed as

$$(W_{pl})_{\ell} = (W_{pl})_0 - (W_{fu})_{\ell}$$

where  $(W_{fu})_{\ell}$  is the weight of fuel required for distance  $\ell$ .

Dividing both sides of the above equation by  $(W_{pl})_{\ell}$  and rearranging, one obtains

$$\frac{(W_{fu})_{\ell}}{(W_{pl})_{\ell}} = \frac{(W_{pl})_0}{(W_{pl})_{\ell}} - 1 \quad (1.14)$$

Further assuming that for short distances, the hourly fuel flow at a given speed remains constant,  $HFF \approx const$ ; the  $(W_{pl})_{\ell}$  can be expressed as follows:

$$(W_{pl})_{\ell} = (W_{pl})_0 - (HFF/V)\ell$$

and Eq (1.14) can be rewritten as

$$\frac{(W_{fu})_{\ell}}{(W_{pl})_{\ell}} = \frac{(W_{pl})_0}{(W_{pl})_0 - (HFF/V)\ell} - 1 \quad (1.14a)$$

Dividing the numerator and denominator of the first term on the right side of Eq (1.14a) by  $(W_{pl})_0$ , one obtains

$$\frac{(W_{fu})_{\ell}}{(W_{pl})_{\ell}} = \frac{1}{1 - \frac{100 HFF}{(W_{pl})_0 V} \frac{\ell}{100}} - 1 \quad (1.15)$$

In analogy to the  $\overline{FF}$  quantity discussed in the preceding subsection,  $100 HFF/(W_{pl})_0 V$  can be called the relative fuel consumption per one pound of the zero-range payload and one hundred nautical miles, and designated by the symbol  $\overline{(FF_{pl})_0}$ , Eq (1.14) can now be written as

$$\frac{(W_{fu})_{\ell}}{(W_{pl})_{\ell}} = \frac{1}{1 - (\overline{FF}_{pl})_o \ell / 100} - 1 \quad (1.16)$$

Using the optimal values of the  $(\overline{FF}_{pl})_o$  quantity (which is readily obtainable as  $(\overline{FF}_{pl})_{o_{opt}} = (\overline{FF})_{opt} / [(W_{pl})_o / W_{gr}]$  from graphs such as that in Fig. 1.8 for the compared helicopters), a graph showing the  $(W_{fu})_{\ell} / (W_{pl})_{\ell} = f(\ell)$  relationship can be prepared for the Soviet and Western helicopters (see Fig. 1.9).

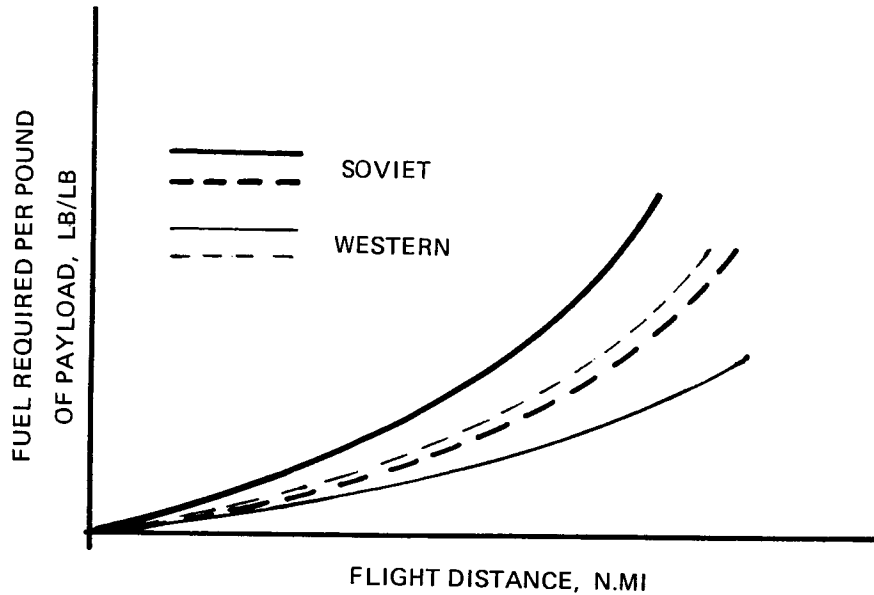

Figure 1.9 Comparison of Soviet vs Western fuel weight-to-payload ratios, shown as a function of flight distance.

Using the presently described methods for forward flight, plus those discussed in subsection 1.4 for the hovering case, the important energy aspects of Soviet and Western helicopters can be examined and compared.

**Productivity Index, PI.** In a comparative evaluation of various helicopters it is of importance to know not only the cost in fuel at which a unit weight of payload can be delivered over a given distance, but also how fast this task can be accomplished. To establish some yardstick in that respect, the notion of the productivity index  $(PI)_{\ell}$  is introduced by defining that quantity as follows:

$$(PI)_{\ell} = [(W_{pl})_{\ell} / W_e] V \quad (1.17)$$

where  $(W_{pl})_{\ell}$  is the maximum theoretical payload corresponding to flight distance  $\ell$ ,  $V$  is the speed of flight in knots, and  $W_e$  is the weight empty (in the same units as  $W_{pl}$ ).

But

$$W_{pl} = (W_{pl})_o - \overline{FF}(\ell/100)W_{gr}$$

and Eq (1.17) can be rewritten as follows:

$$(PI)_\ell = \{ [(W_{PI})_o / W_{gr}] - (\overline{FF}\ell / 100) \} V / (W_e / W_{gr}) \quad (1.17a)$$

where  $\overline{FF}$  is (as before) the fuel required per pound of gross weight and 100 nautical miles, and distance  $\ell$  is in nautical miles.

Using Eq (1.17a), the  $(PI)_\ell$  values are computed first for the compared helicopters for several flight distances (say, 0, 100, 200, and 300 n.mi) and then, the whole range of speeds from 0 to  $V_{max}$ . The result of this phase can be graphically presented as in Fig. 1.10.

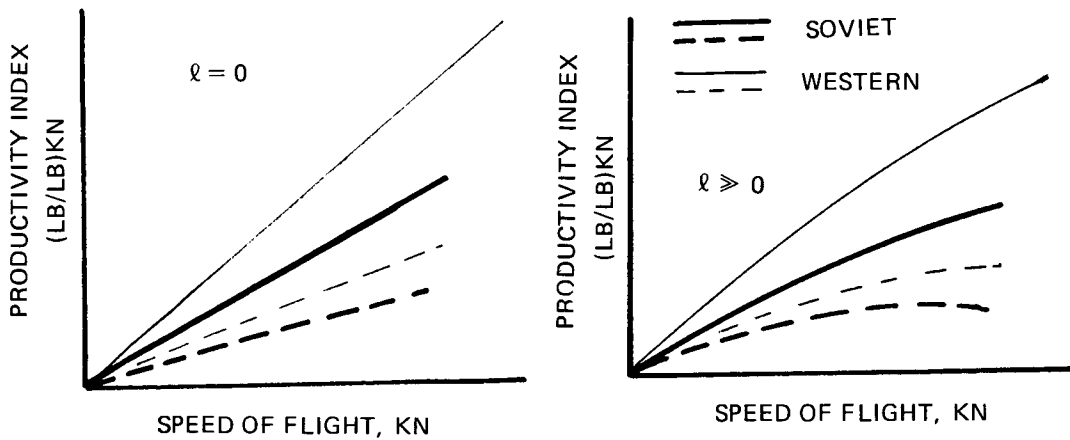

Figure 1.10 Proposed scheme for comparing productivity index vs speed for selected flight distances of Soviet and Western helicopters.

Now the maximal values of the productivity index corresponding to various selected flight distances can be plotted vs distance as schematically indicated in Fig. 1.11.

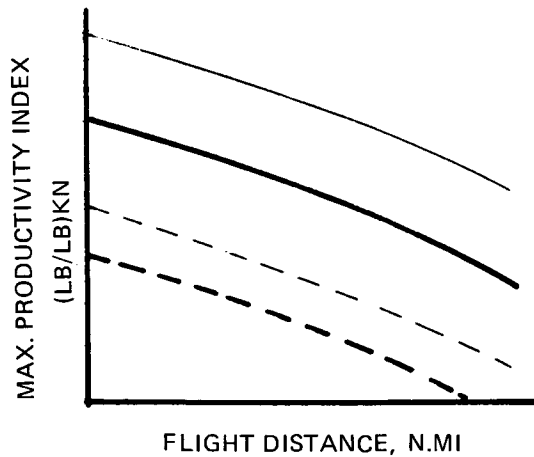

Figure 1.11 Maximal productivity index values vs distance scheme for Soviet and Western helicopters.



## 1.6 Some Aspects of Design Philosophy

Merely listing side-by-side, and graphically presenting the most important design parameters of Soviet and Western helicopters should give one some idea regarding the design philosophy trends of the two groups.

However, in order to get a deeper insight into some particular aspects of design philosophy, additional considerations may be indicated.

**Power Loading Aspects.** It appears that helicopters designed in the West generally have much better hovering performance under high altitude-elevated temperature conditions than their Soviet counterparts; to a large extent, due to the climatic and geographic conditions of their anticipated operations. This trend can be predicted from a plot (Fig. 1.12) showing actual shaft takeoff power per pound of gross weight compared with the ideal horsepower required per pound of gross weight in hover at SL/ISA.

$$(HP/W_{gr})_{id_h} = \sqrt{w/2\rho_0}/550$$

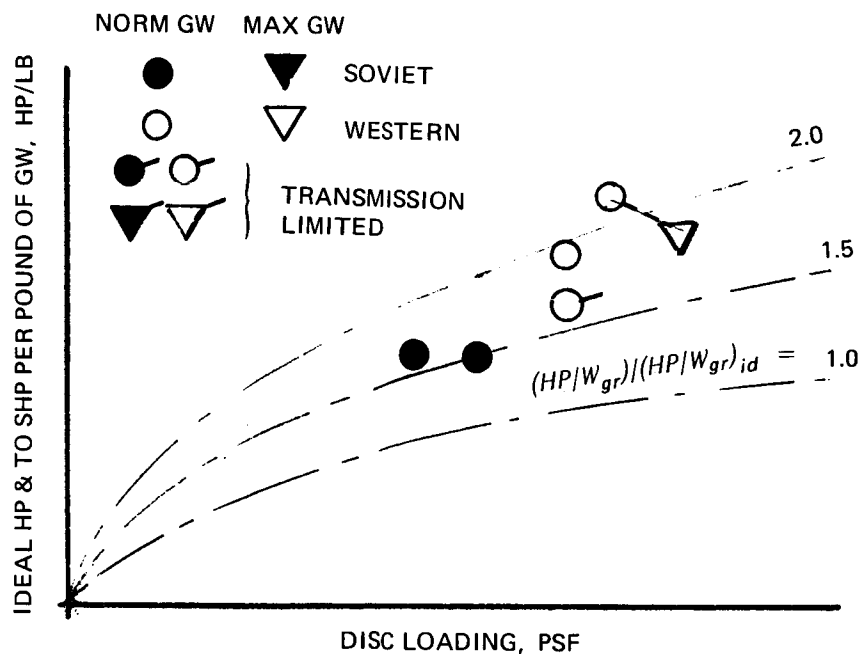

Figure 1.12 Comparison of takeoff and ideal specific powers for Soviet and Western helicopters.

**Disc Loading and Tip Speed.** Lifting rotor disc loadings and tip speed represent design parameters whose values may be considered as important imprints on the helicopter design philosophy. These quantities are listed hence in the comparative tables and simply presented in graphical form.

**Average Lift (or  $C_T/\sigma$ ) Coefficient.** Values of the average lift ( $\bar{C}_l$ ) or  $C_T/\sigma$  coefficients corresponding to maximum flight and normal or VTO gross weights also represent an important aspect of design philosophy. If these values are low under SL/ISA conditions, it obviously means that greater controllability

(maneuverability) margins would be available for operations under high altitude and/or ambient temperature conditions. Also blade stall aspects at higher flying speeds and altitudes would be more favorable. However, on the other hand, low  $\bar{c}_l$  ( $C_T/\sigma$ ) values could lead to less favorable ( $\bar{c}_d/\bar{c}_l$ ) ratios; thus resulting in higher profile power levels. This aspect may be especially important for hovering capabilities of rotorcraft with low ratios of the takeoff specific power to its ideal value.

For comparative purposes, the average lift coefficient in hovering will be defined here as

$$\bar{c}_l = 6C_T/\sigma = 6k_v w/\sigma \rho_o V_t^2$$

where  $k_v$  is the download factor.

Using two scales, the magnitudes of both  $\bar{c}_l$  and  $C_T/\sigma$  will be presented for the Soviet and Western helicopters in the manner shown in Fig. 1.13.

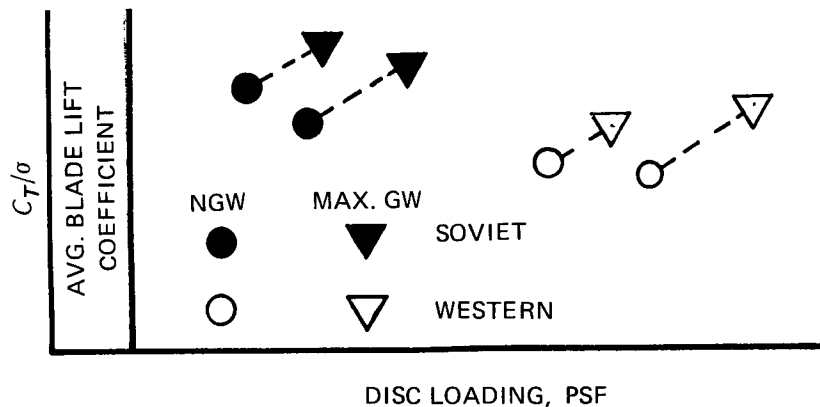

Figure 1.13 A scheme for comparing  $\bar{c}_l$  and  $C_T/\sigma$  of Soviet and Western helicopters.

**Producibility and Maintainability.** Producibility and maintainability, including some indications regarding the skill-level of servicing and manufacturing personnel, definitely represent two important aspects of helicopter design philosophy. It would be hence desirable for the compared helicopters to provide either actual statistical figures in this respect or, at least, operational-handbook or sales-brochure projections. Unfortunately, with very few exceptions, this type of information is not available on the Soviet rotorcraft. Consequently, it became necessary to limit the main considerations of this subject to a general discussion (which will be conducted in Part II) of such trends and goals as, for instance, those presented in Tishchenko's work, while limiting actual quantitative comparisons to those few cases wherein the necessary data is available.

## 1.7 Configurational Aspects

There are many configurational aspects wherein comparison may be important in assessing commonalities and differences of Soviet vs Western design philosophies. Obviously, one of them is the selection of

the overall helicopter configuration (single-rotor, tandem, coaxial, and side-by-side). However, this aspect will be thoroughly considered in Part III of this study. Consequently, in this part, attention will be called only to some configurational topics of the single-rotor scheme, especially those which affect aircraft performance. The location of the tail rotor and management of the main-rotor torque compensation, with emphasis on minimization of the tail-rotor power/main-rotor power ratio through the proper selection of the related design parameters, can be cited as one such topic.

As shown in Fig. 1.14, the location of the tail rotor can be defined by two coordinates ( $x$  and  $y$ ) whose values should be registered in absolute as well as relative ( $\bar{x} = x/R$ ), ( $\bar{y} = y/R$ ) forms.

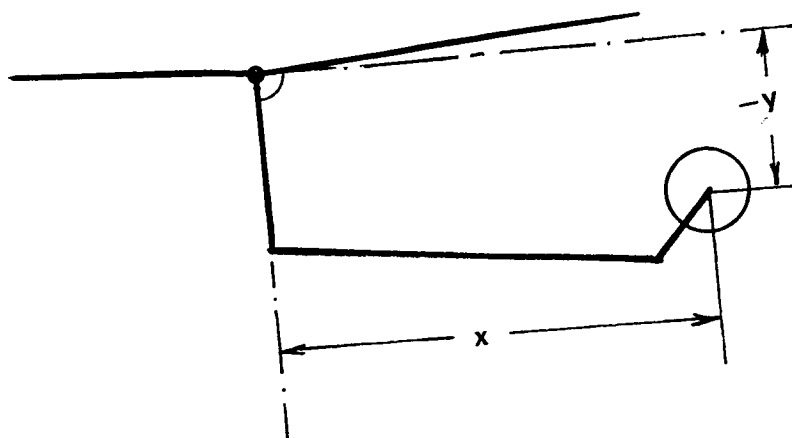

Figure 1.14 Tail rotor Coordinates.

With respect to the main-rotor torque compensation aspects, it would be of interest to indicate which design parameters have the most important influence on the tail-rotor to main-rotor power ratio; as well as to establish a simple method for finding numerical values of that ratio, since it may be needed for performance comparisons. To achieve this goal, the following approximate relationships are developed.

**Ratio of Tail-Rotor ( $RP_{tr}$ ) to Main-Rotor ( $RP_{mr}$ ) Powers in Hover at SL/ISA.** The tail-rotor thrust in pounds ( $T_{tr}$ ) required to compensate the main-rotor torque can be expressed as follows:

$$T_{tr} = (RP_{mr}/V_{t_{mr}})(R_{mr}/x_{tr}) \quad (1.18)$$

or denoting  $x_{tr}/R_{mr} \equiv \bar{x}_{tr}$ ,

$$T_{tr} = RP_{mr}/V_{t_{mr}}\bar{x}_{tr} \quad (1.18a)$$

where  $V_{t_{mr}}$  and  $R_{mr}$ , respectively, are the tip speed (fps), and radius (ft) of the main rotor, and  $x_{tr}$  is the distance of the tail rotor center from the main-rotor shaft axis (ft), while  $RP_{mr}$  is in ft-lb/sec.

The power required by the tail rotor of the open-aircrew type at SL/ISA can, in turn, be written (ft-lb/sec) as:

$$RP_{tr} = (T_{tr}^{3/2} / \sqrt{2\pi R_{tr}^2 \rho_o}) FM_{tr} k_{blo} \quad (1.19)$$

where  $R_{tr}$  is the tail-rotor radius (ft),  $FM_{tr}$  is the tail-rotor figure of merit and  $k_{blo}$  is a coefficient accounting for the blocking effect of the structure on which the tail rotor is mounted.

For the Fenestron — assuming that there is no contraction of the slipstream,

$$(RP_{tr})_F = \frac{1}{2} T_{tr}^{3/2} / \sqrt{\pi R_{tr}^2 \rho_o} FM_{tr} \quad (1.19a)$$

In turn,  $RP_{mr}$  appearing in Eq (1.18) can be presented as follows:

$$RP_{mr} = k_{vh}^{3/2} W_{gr} \sqrt{w_{mr}/2\rho_o} / FM_{mr} \quad (1.20)$$

where  $k_{vh}$  is the helicopter download factor in hover;  $W_{gr}$  is the helicopter gross weight; and  $FM_{mr}$  is the main-rotor figure of merit.

Substituting Eq (1.20) into Eq (1.18a) and the latter, in turn, into Eqs (1.19) and (1.19a), the following expressions for the  $RP$  of the open-aircrew tail rotor is obtained:

$$RP_{tr} = (k_{vh}^{3/2} W_{gr} \sqrt{w_{mr}/2\rho_o} / V_{t_{mr}} FM_{mr} \bar{x}_{tr})^{3/2} k_{blo} / \sqrt{2\pi R_{tr}^2 \rho_o} FM_{tr} \quad (1.21)$$

and for the Fenestron-type

$$(RP_{tr})_F = \frac{1}{2} (k_{vh}^{3/2} W_{gr} \sqrt{w_{mr}/2\rho_o} / V_{t_{mr}} FM_{mr} \bar{x}_{tr})^{3/2} / \sqrt{\pi R_{tr}^2 \rho_o} FM_{tr} \quad (1.21a)$$

Writing  $W_{gr}/\pi R_{mr}^2$  instead of  $w_{mr}$  in Eq (1.20) and then dividing Eq (1.21) and (1.21a) by the so-modified Eq (1.20), the sought power ratio for the open aircrew becomes

$$(RP_{tr}/RP_{mr}) = k_{vh}^{3/2} k_{blo} (\sqrt{w_{mr}/2\rho_o} / V_{t_{mr}} \bar{x}_{tr})^{3/2} (R_{mr}/R_{tr}) / FM_{tr} \sqrt{FM_{mr}} \quad (1.22)$$

and for the ducted one,

$$(RP_{tr}/RP_{mr})_F = (k_{vh} \sqrt{w_{mr}/2\rho_o} / V_{t_{mr}} \bar{x}_{tr})^{3/2} (0.707 R_{mr}/R_{tr}) / FM_{tr} \sqrt{FM_{mr}} \quad (1.22a)$$

It can be seen from Eqs (1.22) and (1.22a) that the most important parameters influencing the  $(RP_{tr}/RP_{mr})$  values are: the ratio of the ideal induced velocity at the main rotor disc to its tip speed and the ratio of the tail-rotor distance to the main-rotor radius ( $\bar{x}_{tr}$ ), as both these quantities appear to the 3/2 power; next in importance are the main-to-tail-rotor radii and the tail-rotor figure of merit (both to the first power). Of lesser significance is the main-rotor figure of merit as it appears to the 1/2 power. One can see hence that in comparing design philosophies of various helicopters, it may be of interest to

present such configurational aspects as the  $(\bar{x}_{tr}/R_{mr})$  and  $(R_{mr}/R_{tr})$  ratios as well as to indicate the  $(v_{id_{mr}}/V_{t_{mr}})$  values, where  $v_{id_{mr}}$  is the ideal induced velocity of the main rotor.

This can be done in tabular, as well as graphical form.

The  $(\bar{x}_{tr}/R_{mr})$ ;  $(R_{tr}/R_{mr})$  and  $(v_{id_{mr}}/V_{t_{mr}})$  ratios can readily be computed from data usually available in the published material on various helicopters. However, in order to complete the calculations indicated by Eqs (1.22) and (1.22a), the values of  $FM_{mr}$  and  $FM_{tr}$  are required. They can be assumed, or still better, approximated in the manner described below.

Estimate of Rotor  $FM \equiv RP_{id}/RP$ . There are available results of many tower and/or stand tests giving a relationship between rotor thrust  $T$  (lb) and rotor power  $RP$  (ft-lb/sec) for full-scale lifting and tail rotors:  $RP = f(T)$  or  $C_p = f(C_T)$  under static conditions OGE.

Rotor thrust can be expressed in terms of the average blade lift coefficient  $\bar{c}_l$ ,

$$T = (1/6)\sigma\pi R^2 \rho V_t^2 \bar{c}_l \quad (1.23)$$

while the rotor power can be given in terms of the total blade drag coefficient ( $\bar{C}_D$ ):

$$RP = (1/8)\sigma\pi R^2 \rho V_t^3 \bar{C}_D \quad (1.24)$$

With respect to the ideal rotor power, it can be expressed as a function of the blade average lift coefficient and rotor solidity ratio. Remembering that

$$RP_{id} = T\sqrt{T/2\pi R^2 \rho}$$

and substituting it into the above equation (1.23) for  $T$ , and simplifying, one obtains

$$RP_{id} = 0.048(\sigma\bar{c}_l)^{3/2}\pi R^2 \rho V_t^3 \quad (1.25)$$

Dividing Eq (1.25) by Eq (1.24), the expression for the figure of merit becomes:

$$FM = 0.385\sqrt{\sigma}(\bar{c}_l^{3/2}/\bar{C}_D) \quad (1.26)$$

From available test-established  $RP = f(T)$  or  $C_p = f(C_T)$  relationships at various blade tip Mach numbers, blade airfoil sections, and blade Reynolds numbers,  $FM = f(\bar{c}_l)$  curves can be drawn for the given rotor solidities. For instance at  $\sigma = 0.0996$ , at which tower tests of the UH-61A rotor were performed (Fig. 1.16). The question is how to transfer the available results to other solidities.

The influence of various rotor solidity ratio values can be accounted for by assuming that for a given type of rotor (similar blade Reynolds and Mach numbers, airfoils, twist, and planform distribution) at any given  $\bar{c}_l$  value, the difference between the actual and ideal total drag coefficients remains constant:

$$\Delta\bar{C}_D|_{\bar{c}_l = const} = \bar{C}_D - \bar{C}_{D_{id}} = const$$

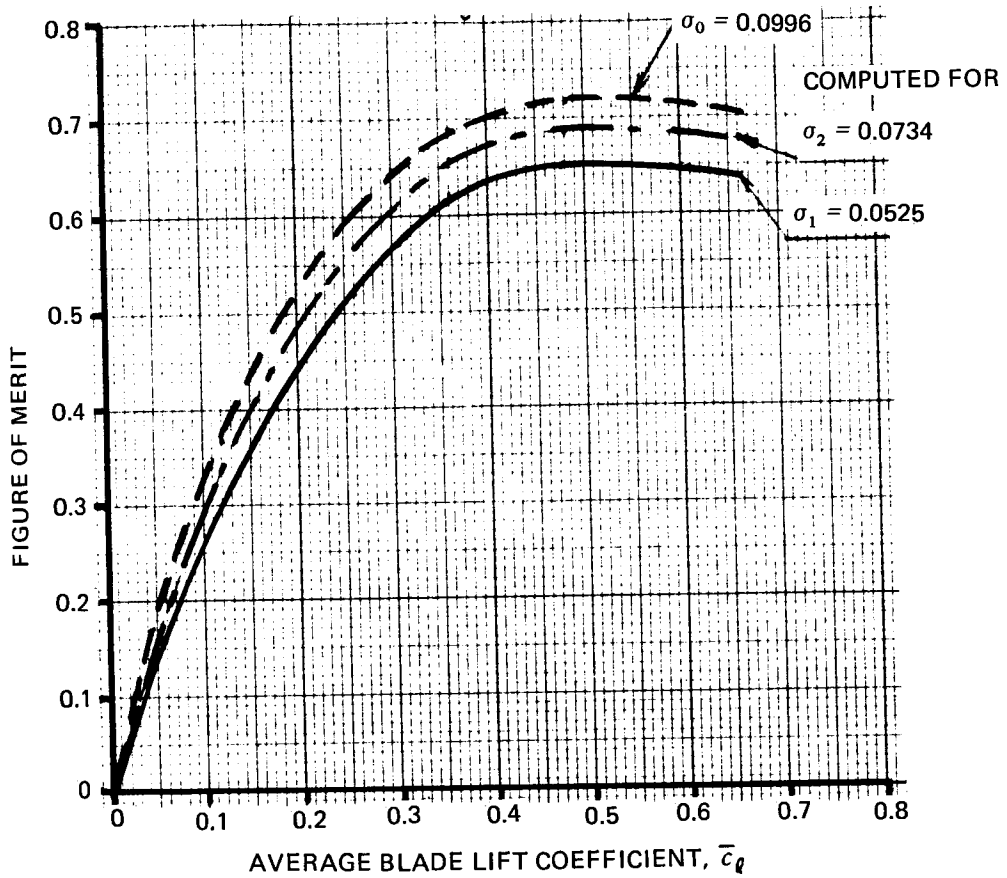

Figure 1.16 Example of the  $FM = f(\bar{c}_l)$  relationships at various rotor solidities.

In turn, making  $FM = 1$  in Eq (1.26),  $\bar{C}_{D_{id}}$  can be expressed as follows:

$$\bar{C}_{D_{id}} = 0.385 \bar{c}_l^{3/2} \sqrt{\sigma}$$

Assigning  $\sigma$  subscripts to the available  $\bar{C}_D = f(\bar{c}_l)$  relationships, and 1, 2, 3, ... to those representing different  $\sigma$  values, the total drag coefficient at this new, say,  $\sigma_1$  value, but with the same  $\bar{c}_l$ , can be written

as

$$\bar{C}_{D_1} = \bar{C}_{D_{id_1}} + \Delta \bar{C}_D = 0.385 \bar{c}_l^{3/2} \sqrt{\sigma_1} + \bar{C}_{D_o} - 0.385 \bar{c}_l^{3/2} \sqrt{\sigma_o}$$

Substituting the above into Eq (1.26), the following is obtained:

$$FM_1 = \frac{0.385 \bar{c}_l^{3/2} \sqrt{\sigma_1}}{\bar{C}_{D_o} + 0.385 \bar{c}_l^{3/2} (\sqrt{\sigma_1} - \sqrt{\sigma_o})}$$

Dividing the numerator and denominator of the above equation by  $\bar{C}_{D_o}$ , while multiplying by  $\sqrt{\sigma_o}$ , the figure of merit for a new rotor solidity ratio value ( $\sigma_1$ ) can be expressed as

$$FM_1 = \frac{FM_o}{\sqrt{\sigma_o/\sigma_1}(1 - FM_o) + FM_o} \quad (1.26a)$$

**Determination of Overall Rotor-Power Transmission Efficiency.** Once the approximate values of the  $(RP_{tr}/RP_{mr})$  ratio are computed by the above described methods, then the overall rotor-power transmission efficiency factor ( $\eta_{oa} \equiv RHP/SHP = RP/SP$ ) in hover can be determined with some confidence as

$$\eta_{oa} = \eta_{xm_{tot}}/[1 + (RP_{tr}/RP_{mr})] \quad (1.27)$$

where  $\eta_{xm_{tot}}$  is the total mechanical transmission efficiency accounting for the actual transmission (gear) losses and power utilized for running the accessories, and  $\eta_{xm_{tot}} = 0.96$  would represent a good average value.

**Determination of the Overall Figure of Merit.** Knowing  $\eta_{oa}$ ,  $k_{vh}$ , and  $FM_{mr}$  the overall figure of merit can be computed as

$$FM_{oa} = \eta_{oa} FM_{mr} / k_{vh}^{3/2}$$

and the so-obtained values may be used for checking those resulting from the OGE hovering data, as previously described in Section 1.

**Ratio of Tail-Rotor to Main-Rotor Power in Forward Flight at SL/ISA.** Assuming that the tail-rotor hub and attachment drag is accounted for in the estimates of the whole helicopter flat plate area ( $f$ ) and there is no "help" in the main-rotor torque compensation in forward flight from a fixed vertical empennage; the rotor power of the tail rotor in that regime of flight at SL/ISA becomes

$$RP_{trf} = T_{tr} \left[ \frac{T_{tr}}{2\pi R_{tr}^2 \rho_o V} + \frac{3}{4} (1 + 4.7\mu_{tr}^2) \left( \frac{\bar{c}_d}{\bar{c}_l} \right)_{tr} V_{ttr} \right] \quad (1.28)$$

while  $T_{tr}$  is given by Eq (1.18a) as in hovering and  $V$  and  $V_{ttr}$  are both in fps.

Substituting the right-hand side of Eq (1.18a) for  $T_{tr}$  in Eq (1.28), the following expression for the power ratio is obtained:

$$\left( \frac{RP_{tr}}{RP_{mr}} \right)_f = \left[ \frac{RP_{mr}}{2\pi R_{tr}^2 \rho_o V V_{tmr}^2 \bar{x}_{tr}} + \frac{3}{4} (1 + 4.7\mu_{tr}^2) \left( \frac{\bar{c}_d}{\bar{c}_l} \right)_{tr} \left( \frac{V_{ttr}}{V_{tmr}} \right) \right] \quad (1.29)$$

Further assuming that  $V_{tmr} = V_{ttr} = V_t$  and hence  $\mu_{tr} = \mu$ , Eq (1.29) becomes

$$\left( \frac{RP_{tr}}{RP_{mr}} \right)_f = \left[ \frac{RP_{mr}}{(2\pi R_{tr}^2 \rho_o V_t^3) \mu \bar{x}_{tr}} + \frac{3}{4} (1 + 4.7\mu^2) \left( \frac{\bar{c}_d}{\bar{c}_l} \right)_{tr} \right] \quad (1.29a)$$

It should be noted that the expression in the parentheses in the denominator of the first term of Eq (1.29a) represents a hypothetical power which remains constant for unvarying  $\rho$  and  $V_t$ .

In order to get some idea regarding the magnitude of the tail-rotor power losses in forward flight, the values of the  $(RP_{tr}/RP_{mr})_f$  ratio may be calculated at  $V_e$  corresponding to  $SHP_{min}$  and  $V_{crmax}$  ( $V_{max}$ ) achievable at the maximum continuous engine power setting.

Once the  $\eta_{oa}$  values in forward flight are estimated, they may be used in the  $(SHP/W_{gr}) = f(V)$  determination.

The actual procedure is facilitated by the fact that  $SHP$  corresponding to  $V_{crmax}$  is usually directly available, hence by using the assumed  $\eta_{oa}$  values, the approximate  $RP_{mr}$  can be readily calculated as

$$RP_{mr} = 550 SHP_{max cont} \eta_{oa}$$

and substituted into Eq (1.29a).

Having the so-refined  $(RP_{tr}/RP_{mr})_f$  values,  $\eta_{oa}$  in forward flight can be computed from Eq (1.27).

**Cabin Volume and Cabin Floor Area Loading.** With respect to configurational aspects of design philosophy, it may be of interest to look into such aspects as volume and floor area of the cargo/passenger cabin. In order to permit one to investigate these aspects on a common basis, it is suggested to graphically present figures regarding  $(W_{pl})_o/V_{cab}$  and  $(W_{pl})_o/S_{cab}$  where  $(W_{pl})_o$  corresponds to the maximum flying weight;  $V_{cab}$  is the cabin volume in cu.ft; and  $S_{cab}$  is the cabin floor area in sq.ft.

## 1.8 Concluding Remarks

The introductory considerations presented in this chapter provided an outline for various aspects of the general comparison of the Soviet vs Western helicopters. Various design parameters and performance items were singled out as special entities facilitating a quantitative comparison of the two design philosophies. This, in turn, led to the identification of basic data necessary for that procedure. Consequently, for each of the considered gross-weight classes, tables of principal characteristics and performance were constructed in such a way as to include all the necessary information (see Table 1.2).



TABLE 1.2  
 PRINCIPAL CHARACTERISTICS & PERFORMANCE

G.W. CLASS

ITEM	HELICOPTER							
	SOVIET 1	SOVIET 2	SOVIET 3	WESTERN 1	WESTERN 2	WESTERN 3	WESTERN 4	WESTERN 5
CONFIGURATION								
POWERPLANT								
Number of Engines								
Output Shaft rpm								
Total T.O. SHP								
Total Max. Cont. SHP								
Transmission Limit, HP								
MAIN ROTOR R, ft								
Dir. of Rotation								
rpm								
Number of Blades								
Blade 0.7R Chord, ft								
Airfoil								
Articulation								
TAIL ROTOR R, ft								
Type								
x, ft								
y, ft								
rpm								
Number of Blades								
Blade 0.7R Chord, ft								
Airfoil								
Articulation								
EXTERNAL DIMENSIONS								
Overall Length, ft								
Fuselage, ft								
Overall Height, ft								



# Chapter 2

## Powerplants

### 2.1 Introduction

A comprehensive comparison of the state of the art of the Soviet helicopter powerplants with those of the West is outside the present study. However, there are some engine characteristics about which some approximate knowledge is required in order to perform the general comparison of the two helicopter technologies as outlined in the preceding chapter.

The two most important engine characteristics for that comparison are (1) variation of the sfc with partial power setting, and (2) power lapse rate with altitude and temperature. Both these characteristics are usually not available for Soviet engines and for some Western engines as well. Consequently, a methodology had to be developed for even approximate estimates of these two items.

Engine power ratings are also important, but usually they can be directly found in published literature.

Although, as mentioned above, this study is not directed toward comparison of engine technologies, there are some additional readily-available powerplant characteristics about which some knowledge may be of interest to the rotorcraft designer, and whose comparative presentation may shed some light on the engine state of the art of the two groups. Two such items may be (1) engine specific weight ( $W_{eng}/SHP_{TO}$ ) and (2) compactness, which may be defined as  $SHP_{TO}/(\text{length} \times \text{width} \times \text{height})$ .

Similar to the proceedings discussed in the preceding chapter, all engines are also grouped according to their application to the helicopters belonging to the four gross weight classes. Consequently the following groups of engines are considered.

1. Engines installed in the up to 12,000-lb gross weight helicopters.

Soviet

- (1) Isotov/PZL GTD-350
- (2) Vedeneev M-14V-26 (reciprocating)

Western

- (1) Allison 250-C20B
- (2) Allison 250-C30
- (3) Turbomeca Arriel 1C
- (4) Lycoming T53-L-13
- (5) Lycoming LTS 101-650C-2

## 2. Engines installed in 12,000 to 30,000-lb gross weight helicopters

### Soviet

- (1) Isotov TV-2-117A
- (2) Glushenkov GTD-3F – Similar to TVD-10

### Western

- |                                      |                                  |
|--------------------------------------|----------------------------------|
| (1) Turbomeca Turmo IVC & Makila 1.A | (3) General Electric T58-GE-16   |
| (2) General Electric T58-GE-5        | (4) General Electric T700-GE-700 |

## 3. Engines installed in 30,000 to 100,000-lb gross weight helicopters

### Soviet

- (1) Soloviev D-25V (TV-2BM)
- (2) Hypothetical

### Western

- (1) Lycoming T55-L-712
- (2) General Electric T64-GE-415
- (3) General Electric T64-GE-413

## 4. Engines installed in the over 100,000-lb gross weight helicopters

### Soviet

- (1) Soloviev D-25VF
- (2) Hypothetical

### Western

- (1) Allison T701

Tables of the principal engine characteristics were prepared for each of the above groups (for example, see Table 2.1). Graphs of sfc variation with partial power setting, power lapse rate vs ISA altitude, specific weights, and TO power to the overall volume ratio are presented separately.

## **2.2 Auxiliary Relationships**

Estimates of sfc Variation vs Partial Power Setting. Even in the case of rather incomplete information on engine characteristics where values of sfc are given at two SHP levels only, a relationship of  $sfc = f(SHP/SHP_{TO})$  can be established.

Assuming that the engine fuel flow is linear with SHP, and at least two points of (sfc, SHP) are given (one of them being for the takeoff power setting), a relationship between  $(FF/FF_{TO}) = f(SHP/SHP_{TO})$ ,

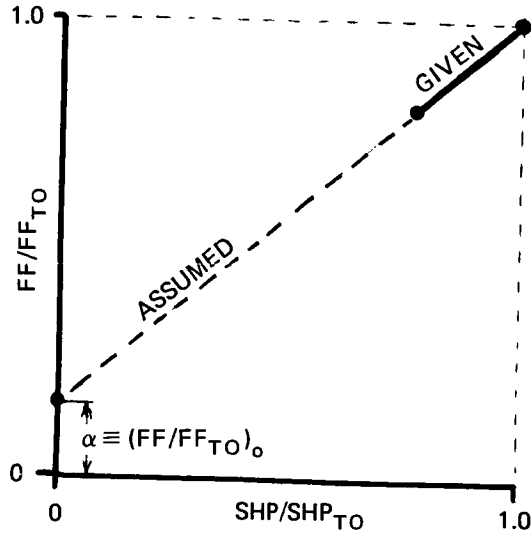

Figure 2.1 Basic relationship between relative fuel flow and power setting.

as illustrated in Fig. 2.1 can be developed and the  $(FF/FF_{TO})$  ratio for idle,  $(FF/FF_{TO})_0$ , can be established.

Calling the relative fuel flow at idle  $(FF/FF_{TO})_0 \equiv \alpha$ , and the slope of the straight line  $\beta$ , the relative fuel flow as a function of the power ratio can be expressed as

$$FF/FF_{TO} = \alpha + \beta(SHP/SHP_{TO})$$

while

$$sfc \equiv FF/SHP = FF_{TO}[\alpha + \beta(SHP/SHP_{TO})]/SHP \quad (2.1)$$

Dividing the numerator and denominator in the right-hand side of Eq (2.1) by  $SHP_{TO}$  and remembering that  $\beta \equiv 1 - \alpha$ , while  $FF_{TO}/SHP_{TO} \equiv sfc_{TO}$ , the following is obtained:

$$sfc = sfc_{TO} \left[ 1 + \alpha \left( \frac{1}{SHP/SHP_{TO}} - 1 \right) \right] \quad (2.2)$$

Using Eq (2.2), comparative graphs of  $sfc = f(SHP/SHP_{TO})$  for the Soviet and Western engines can be prepared for each of the engine groups and presented as in Fig. 2.2 (Soviet in bold, Western in thin lines).

**Relative Lapse Rate in ISA.** For a detailed comparison of the powerplant technology levels, it would be interesting to investigate the lapse rate with both pressure altitude and ambient temperature. However, since in the present study performance is compared under standard conditions only, the lapse rate aspects will be limited to the altitude ( $H$ ) variation at ISA only.

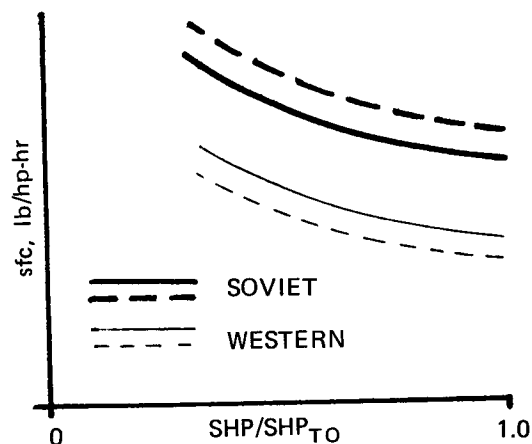

Figure 2.2 sfc variation vs partial power setting for Soviet and Western helicopter engines.

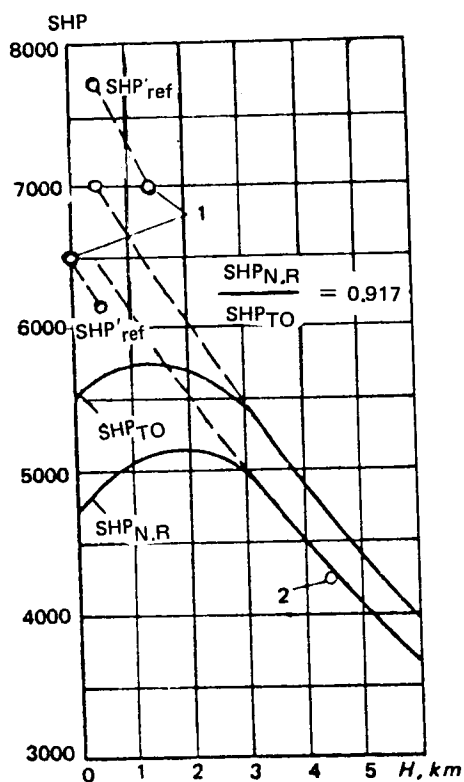

Figure 2.3 Power variation with altitude of the Mi-6 helicopter engines and values of referred rated power: (1) power required in hover; (2) power required for flight at  $H = 4500$  m. (Fig. 2.62, Ref. 1).

Whenever manufacturers' data on  $SHP_{TO} = f(H)$  is available, it will be used to compute and graphically present the relative lapse rate as a function of the ISA altitude

$$\lambda \equiv (SHP_{TO})_H / (SHP_{TO})_0 = f(H)$$

In addition, the trends in  $\lambda = f(H)$  deduced from Tishchenko's Fig. 2.62<sup>1</sup> (reproduced here as Fig. 2.3) are also indicated on Fig. 2.4.

It can be anticipated (solid lines, Fig. 2.3) that at least the large Soviet turboshafts (in this case, the D-25V installed in the Mi-6) have a higher thermodynamic than mechanical capacity. Consequently, at lower altitudes ( $H < 3000$  m), their output is restricted (perhaps due to material temperature limit) through fuel flow limitation.

Should there be no such limitations, then the TO power would increase at lower altitudes as indicated by the broken line in Fig. 2.3.

Lapse rate based on the so-extended Tishchenko's curve will also be marked in the comparative drawings. When actual data on Soviet powerplants are available, they will be shown in bold lines in addition to the two trend curves based on Fig. 2.3. Lapse rates of the

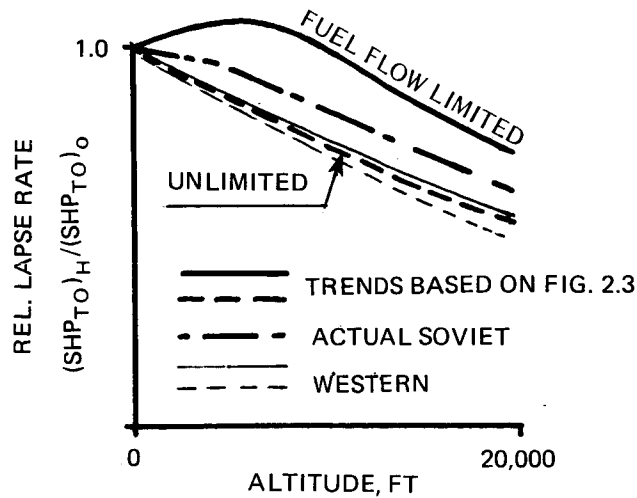

Figure 2.4 Scheme for presentation of the relative lapse rate for Soviet and Western helicopter engines.

Western turboshafts will be plotted in thin lines (Fig. 2.4).

### 2.3 Comparison of Engines Installed in Helicopter of up to 12,000-lb Gross Weight Class

**Basic Data.** The principal characteristics and performance at SL/ISA of the Soviet and Western engines utilized in the up to 12,000-lb gross weight helicopter class are shown in Table 2.1.

The variation of sfc with partial power setting at SL/ISA is shown in Fig. 2.5, the lapse rate in Fig. 2.6, and specific weights in Fig. 2.7.

The relationship between the external dimensions of an engine and its power-producing capacity (say, takeoff power) may be of interest to the helicopter designer. Although, in every case of a particular design, a careful examination of the principal engine dimensions (length, width, and height) is required, at least some general idea regarding the relative bulk of the engines can be acquired by comparing their takeoff shaft horsepower to the external volume ratios. Where the external volume is defined in general as a product of the overall dimensions; an exception is made for powerplants having a distinctly circular front view. Here, the overall volume is taken as  $(\pi D^2/4) \times \text{length}$ . These  $(SHP_{TO}/\text{overall volume})$  ratios are shown in Fig. 2.8.

**Discussion.** The Isotov PZL GTD-350 engine is the sole representative of Soviet turboshafts installed in helicopters of up to 12,000-lb gross weights. It is obvious from the presented material that the specific weight of that engine is approximately twice as high as that of its Western counterpart (Fig. 2.7). Also its specific fuel consumption is decisively inferior to that of the comparative group of Western powerplants (Fig. 2.5). The same refers to power extraction per unit of the overall engine volume, where the GTD-350 engine appears to be on a lower level than those of the West (Fig. 2.8).

From the available data on the power lapse rate with the ISA altitude, it appears that the GTD-350 at SL has a slightly higher thermodynamic than mechanical capacity (420 vs. 395 hp). For this reason, its  $\lambda = f(H)$  curve is located between the two limiting Tishchenko curves, but closer to that showing no excess in the thermodynamic capacity. While up to  $H = 1000m$ , the lapse rate of the Soviet engine is somewhat lower than for the Western counterpart; from that altitude on, the slope of the curve is quite similar to those of the Western counterparts.

In view of the above-discussed specific weight and sfc characteristics, it should be of no surprise (as will be seen in Ch. 3) that replacement of the GTD-350 by the Allison 250-C20-B in the Mi-2 helicopter resulted in a dramatic improvement in the performance of that helicopter. It should also be noted that the presently-recommended TBO for the GTD-350 engine is 1000 hours, while for the Allison, the TBO is 3500 hours.

However, actual operators of the Mi-2 helicopters have indicated to this investigator that the GTD-350 engine is really "rugged" and can successfully operate under arctic as well as sandy-desert conditions in the presence of abrasive agents, and that it does not require highly skilled personnel to perform the little on-the-spot maintenance that may be deemed necessary.

Utilization of the two Vedenev M-14V-26 reciprocating engines on the Kamov Ka-26 helicopter is definitely an exception to the general trend of using turboshafts on contemporary multiengine helicopters.

The contrast in specific weights of these two types of powerplants is quite evident from Figs. 2.7 and 2.17.

Some compensation of that high engine weight can be obtained through a more favorable sfc which, in the case of M-14V-26 engines is indeed low, even in comparison with the Western turboshafts (Fig. 2.5).

Another argument for the utilization of reciprocating engines may be cost. Unfortunately, no comparative data on that subject for the Vedenev engine is available.



TABLE 2.1  
 PRINCIPAL CHARACTERISTICS AND PERFORMANCE AT SL/ISA OF ENGINES  
 INSTALLED IN HELICOPTERS OF UP TO 12,000-LB G.W. CLASS

ITEM	ENGINE						Lycoming LTS 101-650C
	Isotov/PZL GTD-350	Vedeneev M-14V-26 (Recipr.)	Allison 250-C20B	Allison 250-C30	Turbomeca Arriel 1C	Lycoming T53-L-13	
SERVICE DATE			1974	1978	1980	1966	1978
POWER, SHP							
Maximum Contingency	—	—	—	700 (2½ min)	700	—	650 (2½ min)
Immediate Contingency	—	—	420 (30 min)	—	686	—	—
Takeoff	395	320	420 (5 min)	650 (5 min) <sup>Δ</sup>	660	1400	600
Max. Continuous	315	271	400 (limited)	650	536	1250	550
Max. Cruise	—	—	370 (unlimited)	557	—	(1250)	(550)
Cruising II* or A †	281 (II)	187	333 (A)	501 (A)	—	1167 (A)	495 (A)
Cruising I** or B ††	232 (I)	143	278 (B)	418 (B)	—	975 (B)	415 (B)
WEIGHT (DRY), LB	304	540	158	235	260	549	232
SPEC. FUEL CONS., LB/HR-SHP							
Takeoff	0.827		0.650	0.592	0.590	0.580	0.584
Max. Continuous	0.885		0.648	0.592	0.605	0.600	0.589
Cruising II	0.939 (II)	0.46	0.665 (A)	0.624 (A)	—	0.620 (A)	0.601 (A)
Cruising I	1.006 (I)		0.709 (B)	0.657 (B)	—	0.663 (B)	0.628 (B)
OVERALL DIMENSIONS, FT							
Length	4.43	3.66	3.23	3.60	3.58	3.97	2.575
Width	1.71		1.58	1.83	1.41		1.333
Height	2.07	D = 3.23	1.93	2.09	1.87		D = 1.92
TO SHP/Overall Vol. HP/FT <sup>3</sup>	23.38	10.62	42.64	47.21	67.91	121.82	110.42
SPECIFIC WEIGHT							
Engine Weight/TO SHP, LB/SHP	0.770	1.687	0.376	0.362	0.375	0.392	0.377
Output RPM	5904	2800-2350	6016	6016	6000	6300	9265

\* 87.5% gas generator rpm

† 90% of max. cruise power

\*\*84.5% gas generator rpm

†† 75% of max. cruise power

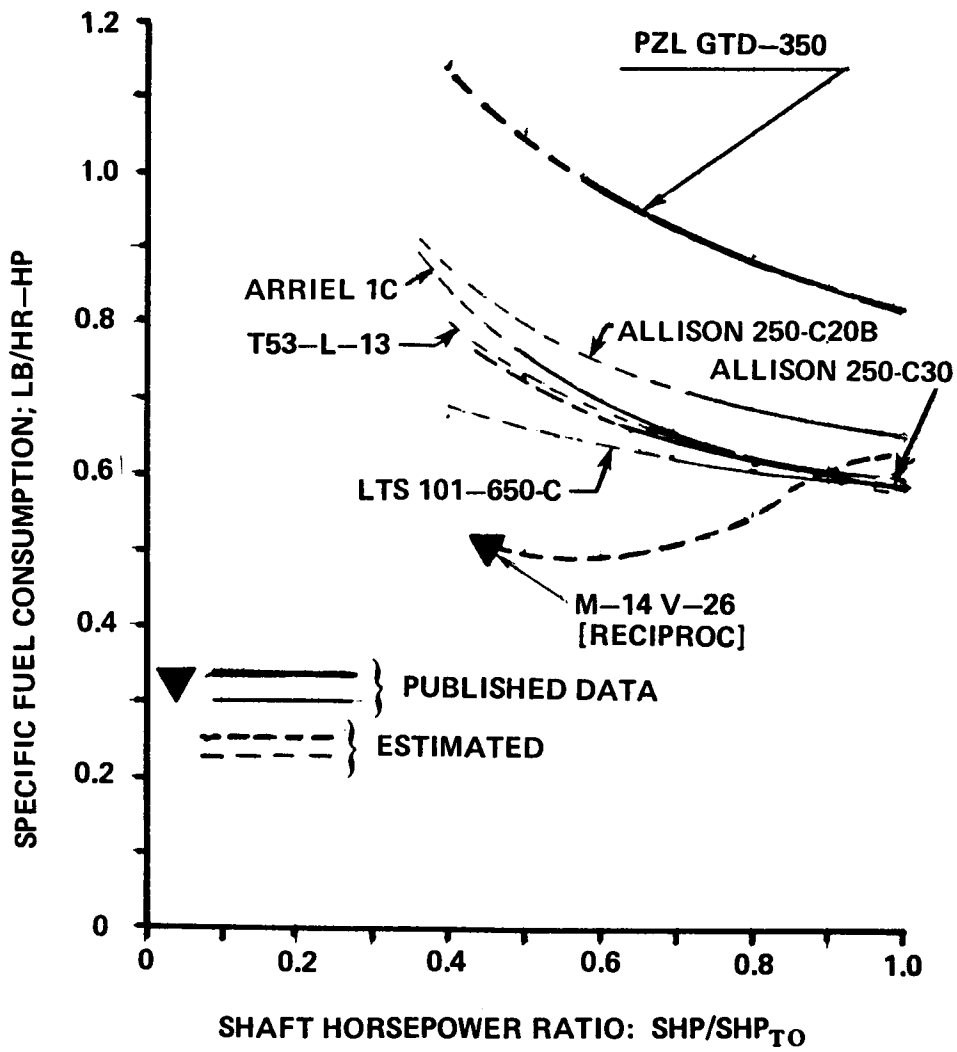

Figure 2.5 Variation of sfc vs power setting for Soviet and Western engines installed in the up to 12,000-lb gross weight class helicopters.

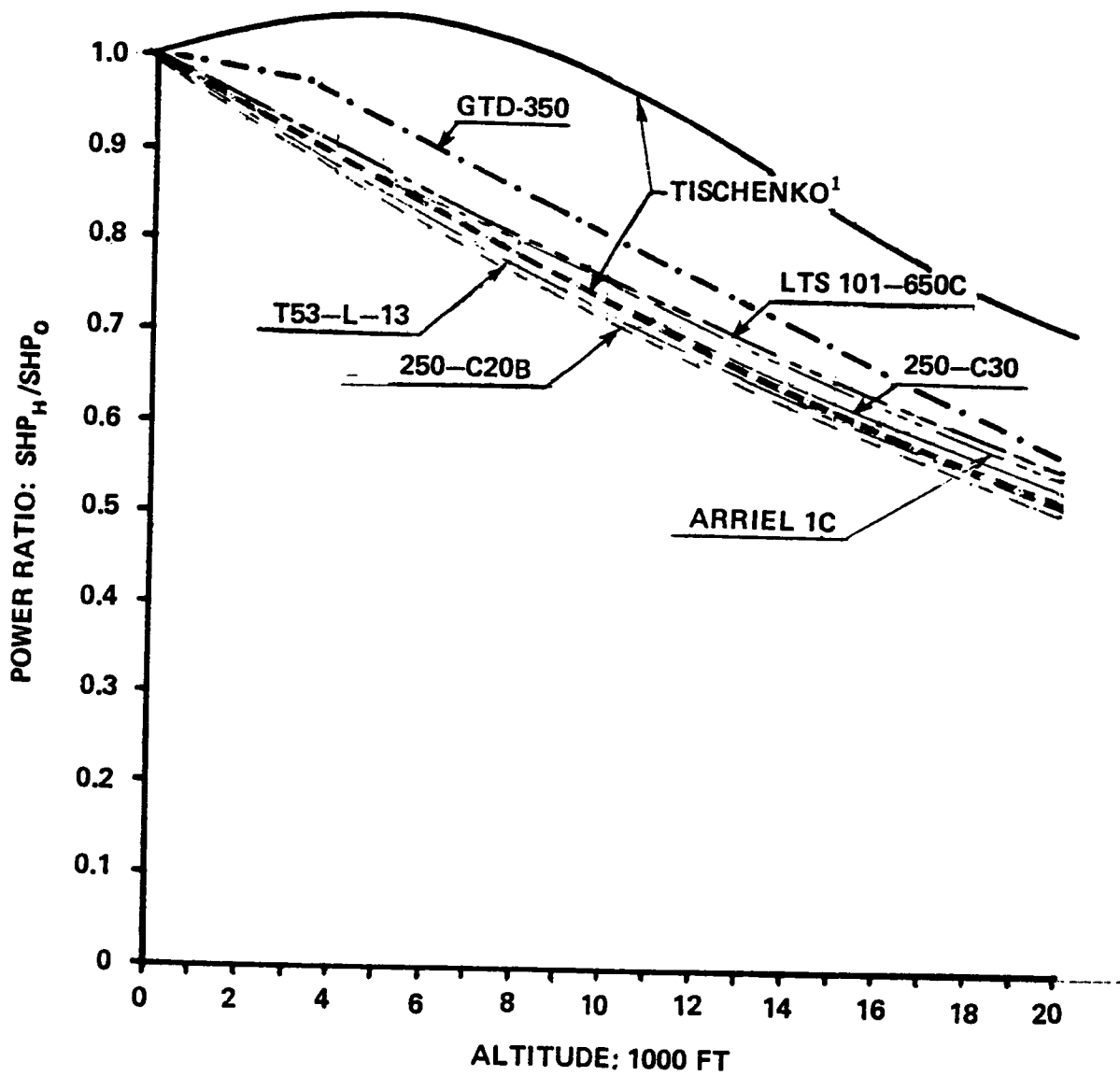

Figure 2.6 Relative lapse rate in ISA for takeoff and military powers of Soviet and Western engines, installed in the up to 12,000-lb gross weight class helicopters.

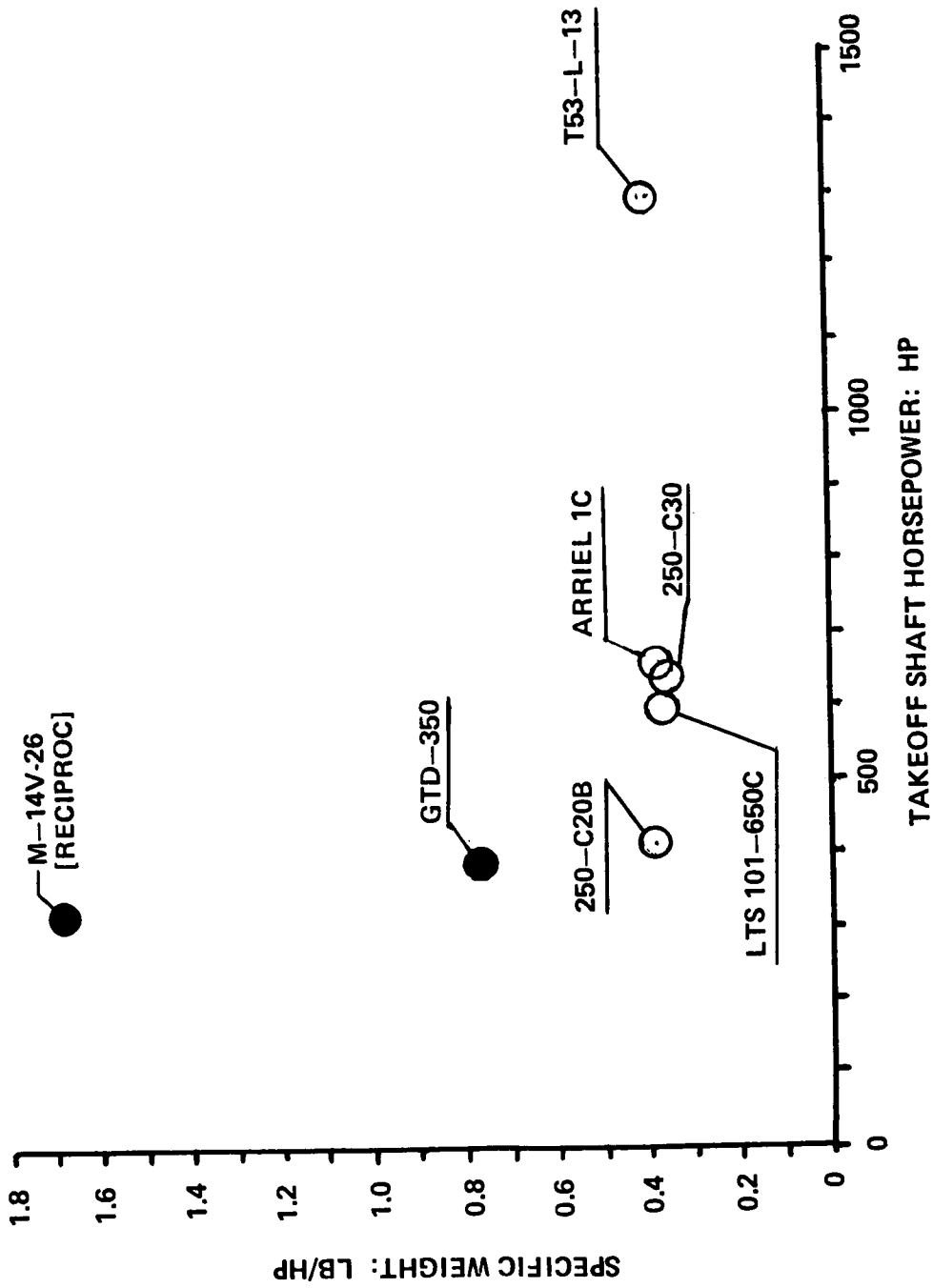

Figure 2.7 Specific weights of Soviet and Western Engines

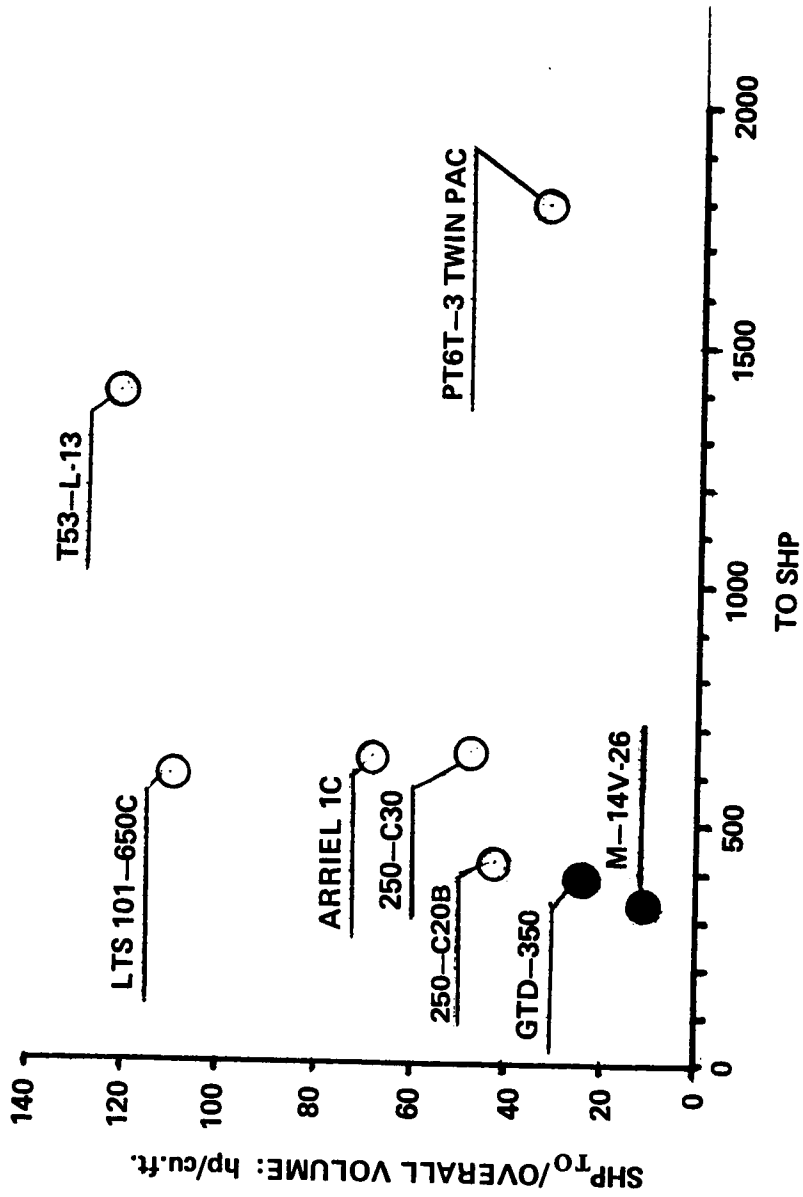

Figure 2.8 Takeoff SHP for overall engine volume ratio of Soviet and Western powerplants

## 2.4 Comparison of Engines Installed in the 12,000 to 30,000-lb Gross Weight Class Helicopters

**Basic Data.** The principal characteristics and performance at SL/ISA of the Soviet and Western turboshafts utilized in the 12,000 to 30,000-lb gross weight class helicopters are shown in Table 2.2.

The variation of sfc with partial power setting, also at SL/ISA, is given in Fig. 2.9, the lapse rate is given in Fig. 2.10, specific weights in Fig. 2.11, and the ratio of the S/L takeoff power to overall engine volume is shown in Fig. 2.12.

**Discussion.** With respect to the Isotov TV-2-117A turboshaft, one should note that in contrast to the GTD-350 engine, its sfc is much lower and is on the level of the older Western powerplants of the same power class (Fig. 2.9).

As can be seen from Fig. 1.10 showing  $\lambda = f(H)$ , the thermodynamic capacity of the TV-2-117A engine is higher than its fuel flow-restricted power limit (at SL,ISA, 1775 hp vs 1480 hp). This characteristic leads to a more favorable lapse rate with the ISA altitude than for the Western counterparts.

However, perhaps due to material temperature limitations, the specific weight of Soviet engines is much higher than for the Western turboshafts (Fig. 2.11). It can be seen from this figure that this remains true, even when specific weight is based on the thermodynamic capacity horsepower (single-flagged symbol in Fig. 2.11). In addition, the Soviet engine appears relatively much more bulky than its Western counterparts (Fig. 2.12).

It should be emphasized at this point that all the above-discussed aspects of the TV-2-117A engine apply to the civilian version only.

When the absolute helicopter speed record was established by the Mil A-10 (specialized version of the Mi-24) in 1978, the TV3-117 engine rating of 2170 was used<sup>2</sup>. However, this turboshaft is probably not an updated TV2-117, but the standard Mi-24 powerplant rated at 2170 hp.

In order to provide an example of more recent Western powerplants suitable for helicopters of the 12,000 to 30,000-pound gross weight class, the basic data on the Aerospatiale Makila 1A engine powering the AS332L Super-Puma helicopter was added to Table 2.2, as well as to the appropriate graphs.

TABLE 2.2  
 PRINCIPAL CHARACTERISTICS AND PERFORMANCE AT SL/ISA OF ENGINES  
 INSTALLED IN 12,000 TO 30,000-LB GROSS WEIGHT HELICOPTERS

ITEM	ENGINE							
	Isotov TV-2-117A	Glushenkov GTD-3F	Gen. Electric T58-GE-5	Gen. Electric T58-GE-16	Gen. Electric T700-GE-700	Turbomeca Turmo IVC	Turbomeca Makila 1.A	
SERVICE DATE			1959	1959	1976	1974	1980	
POWER, SHP								
Maximum Contingency						1555	1725	
Intermediate Contingency					1561	1474	1693	
Takeoff/Military	1480	900	1500	1870	1258	1495	1693	
Max. Continuous/Normal	1185 <sup>†</sup>			1770		1287	1338	
Max. Cruise	985		1250	1593				
Cruising I*				1328	~900			
Cruising I**								
WEIGHT (DRY). LB	727		335	443	415	500	536	
SPEC. FUEL CONS. LB/HR-SHP								
Takeoff/Military	0.614		0.610	0.530	0.464	0.641	0.498	
Maximum Continuous	0.66		0.610	0.540	0.474	0.645	0.505	
Cruising I*				0.555	~0.52			
Cruising I**				0.590				
OVERALL DIMENSIONS, FT								
Length	7.85		4.92	5.32	3.92	6.07	6.91	
Width	1.79			1.96	D = 2.08	2.00	1.73	
Height	2.44		D = 1.725	1.87		2.35	2.23	
TO SHP/OVERALL VOL, HP/FT <sup>3</sup>	43.75		130.48	95.90	117.21	52.27	63.51	
SPECIFIC WEIGHT								
Engine Wt/TO SHP, lb/shp	0.491		0.223	0.237	0.266	0.335	0.317	
Output RPM	12,000		19,500	19,500	21,000	22,840	22,850	

\* 90% of maximum cruise power

\*\* 75% of maximum cruise power

† 60 minutes

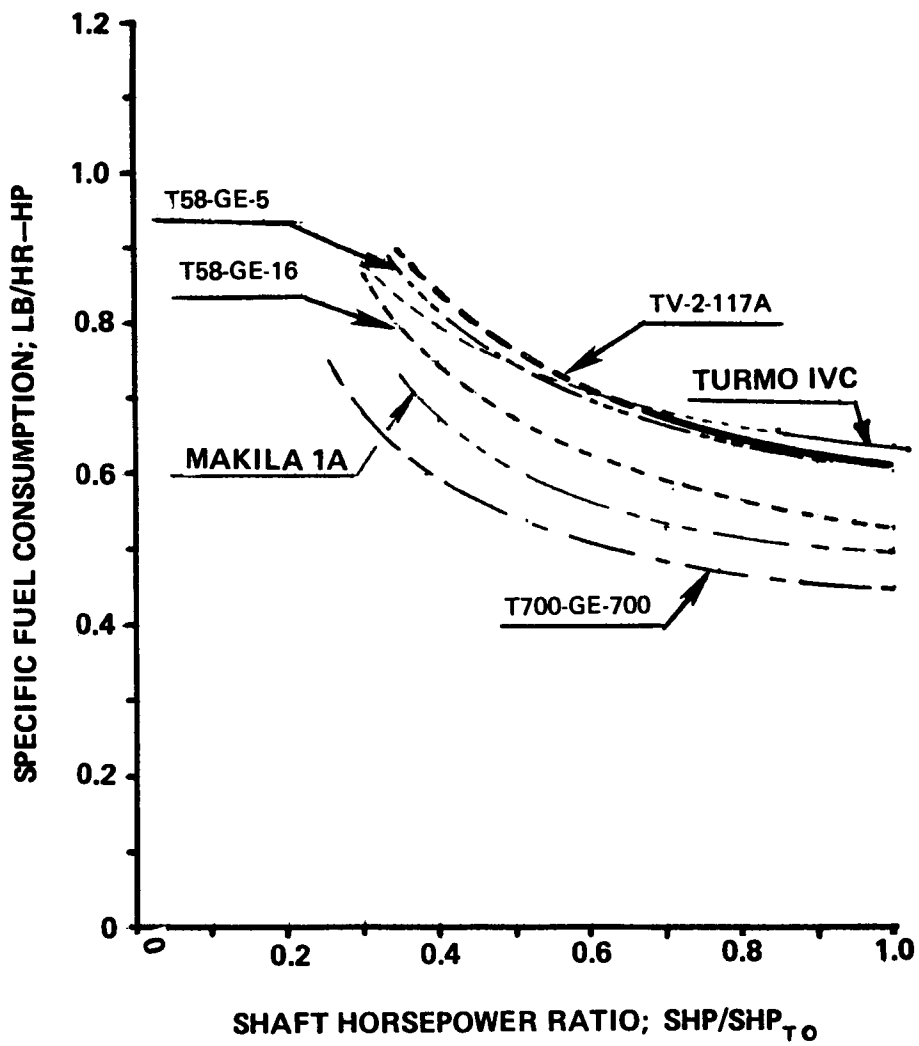

Figure 2.9 Variation of sfc vs power setting for Soviet and Western engines installed in the 12,000 to 30,000-lb gross weight class helicopters.



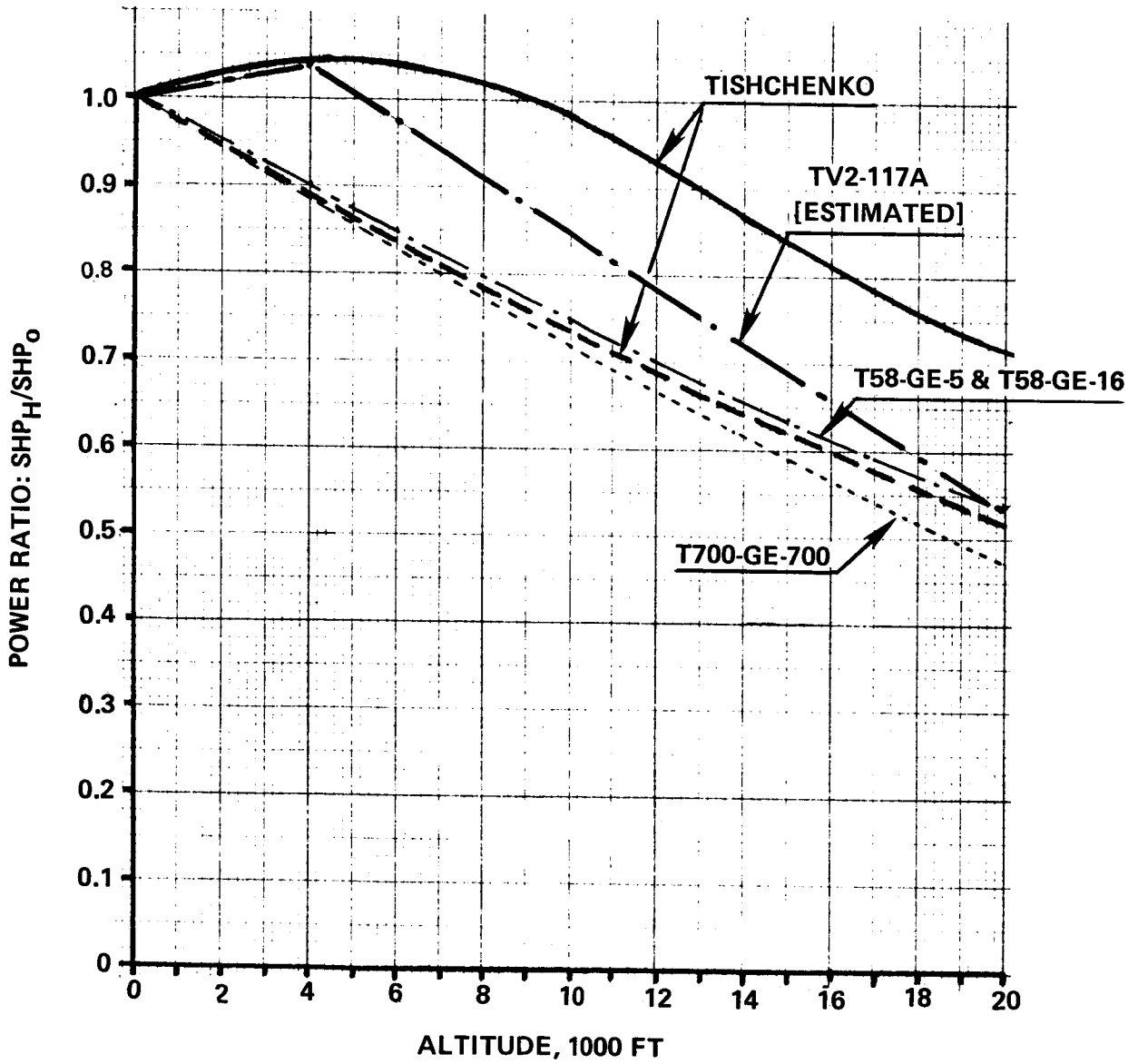

Figure 2.10 Relative lapse rate in ISA for takeoff and military powers for Soviet and Western engines installed in the 12,000 to 30,000-lb gross weight class helicopters.

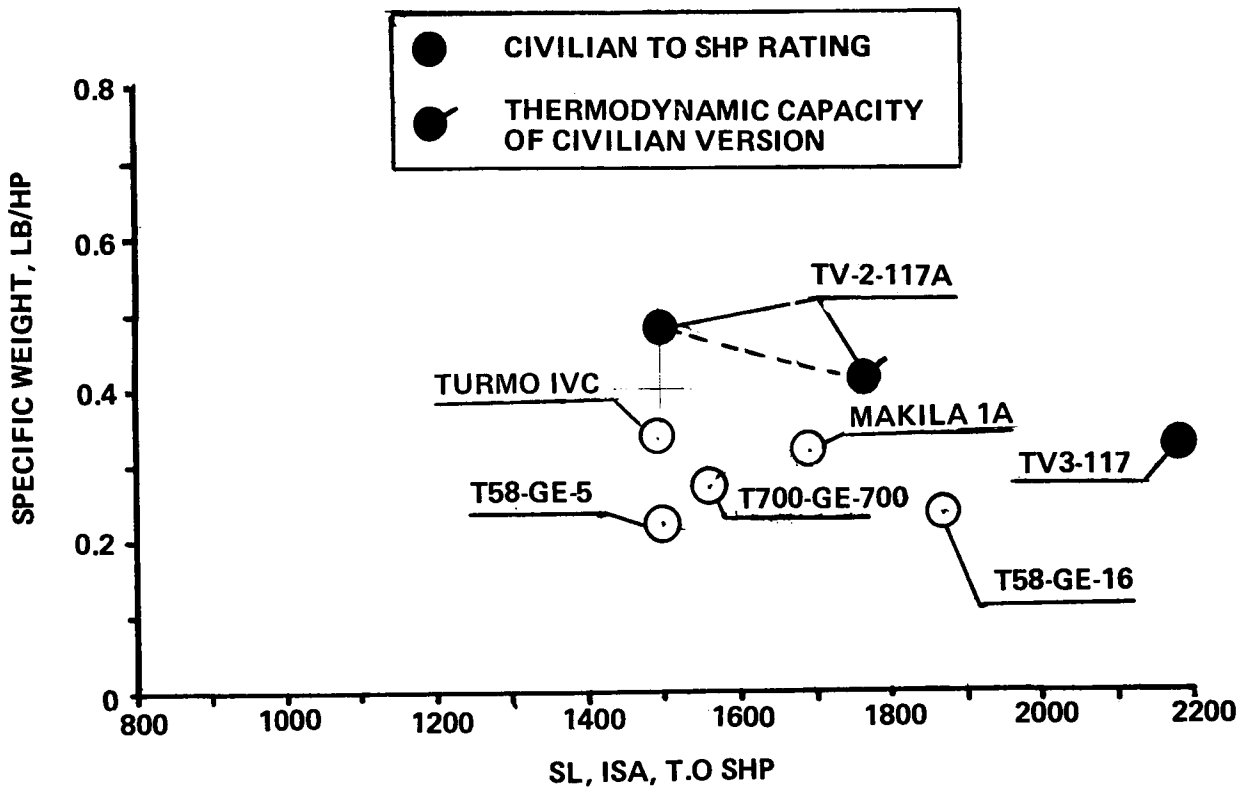

Figure 2.11 Specific weight of Soviet and Western turboshafts for 12,000 to 30,000-lb gross weight helicopters.

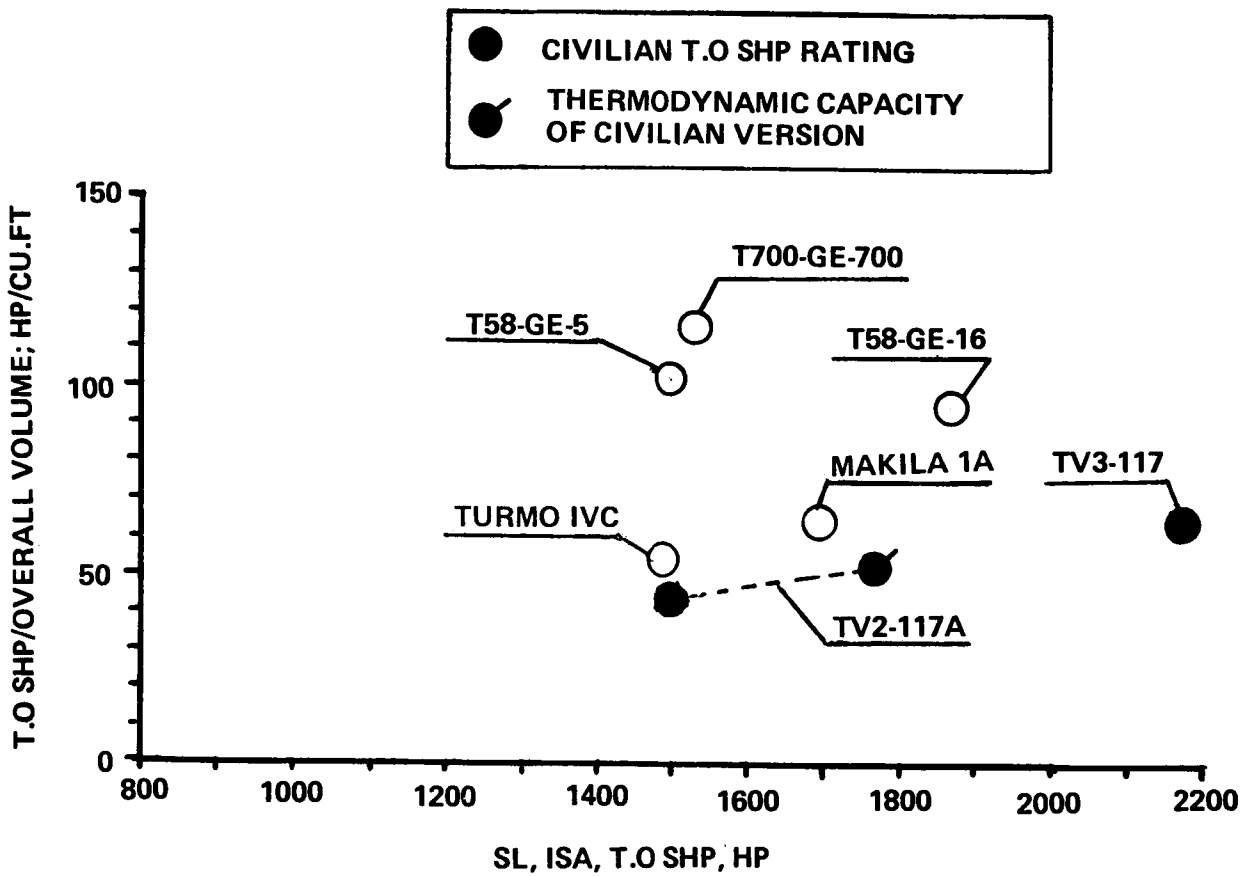

Figure 2.12 Takeoff SHP to overall engine volume of Soviet and Western turboshafts for 12,000 to 30,000-lb gross weight helicopter class.

## 2.5 Comparison of Engines Installed in the 30,000 to 100,000-lb and over 100,000-lb Gross Weight Class Helicopters

Combination of Two Engine Groups. Since, in the over 100,000-lb gross weight class helicopters, there is only one nonhypothetical engine (T701) that does not appear in the 30,000 to 100,000 gross weight class, powerplants from both categories are combined into a single study group.

Hypothetical Engines. In addition to the actual turboshafts, two hypothetical engines “constructed” on the basis of some of the characteristics and performance assumed in the book by Tishchenko et al<sup>1</sup> are included in the present study. The overall picture of the so-reconstructed powerplants is far from being complete; for instance, there is no indication regarding the physical shape of the engines and output rpm. Nevertheless, it is believed that incorporation of even these very sketchy “hypothetical powerplants” may shed some light on the Soviet projected trends (or at least on the desires of the Soviet helicopter designers) in regard to their design philosophies concerning turboshafts for rotary-wing applications.

Formulation of these sketchy engine concepts is done as follows:

It is clearly stated in Ref. 1 that all 12 to 24 metric ton gross weight helicopters are of the twin-engine type. It appears that the 44 to 60 metric ton gross weight helicopters may be of either twin, or 3-engine type. It is also stated that for the single-rotor configuration, selected here as a test case, the so-called installed reference power (i.e., engine T.O SHP available at 500 m) per kg of gross weight should be (see Fig. 2.63<sup>1</sup>)

$$SHP_{ref}/W_{gr} = 0.45 \text{ hp/kg}$$

Consequently, the installed takeoff SHP related to SL, ISA would be

$$(SHP_{TO})_o/W_{gr} = 0.45/\lambda_{500m} \text{ hp/kg}$$

where  $\lambda_{500m}$  is the takeoff power lapse rate corresponding to 500 m = 1640 ft. Assuming Tishchenko's curve of  $\lambda = f(H)$  for engines with matched mechanical and thermodynamic capacities (broken line in Fig. 2.10),  $\lambda_{500m} = 0.965$ . Remembering that the SI\* horsepower (75 kg-m/s) amounts to 0.986 of the 550 ft-lb/sec horsepower, the nominal SL, ISA takeoff SHP per engine can be expressed in English units as

$$(SHP_{TO})_o = 0.21 W_{gr}/n_{eng} \tag{2.3}$$

where  $n_{eng}$  is the number of engines.

The  $(SHP_{TO})_o$  values as given by Eq (2.3) are shown in Table 2.3.

---

\*International System (SI) of Units.

TABLE 2.3  
T.O SHP AT SL, ISA PER ENGINE FOR HELICOPTERS OF 12 TO 24  
AND 44 TO 60 METRIC TON GROSS WEIGHTS

GROSS WEIGHT		No. OF ENGINES	T.O SHP; SL, ISA PER ENGINE, HP
Metric Tons	lb.		
12	26,460	2	2778
16	35,280	2	3704
20	44,100	2	4630
24	52,920	2	5556
44	97,020	2	10,187
52	114,660	2	12,039
52	114,660	3	8026
60	132,300	3	9261

Two engines are selected from this table: (1) hypothetical engine A with takeoff power at SL, ISA assumed to be  $(SHP_{TO})_o = 5500$  hp (same as for the D-25V), and (2) hypothetical engine B with  $(SHP_{TO})_o = 8080$  hp (same as that for the T701). The referred shaft horsepower (in SI units) for these engines would be 5383 hp and 7908 hp, respectively.

The weights of the engines in kilograms according to Eq (2.57)<sup>1</sup> can be expressed as

$$W_{eng} = k_{eng}(SHP_{ref})^{0.7}$$

Assuming an average value of  $k_{eng} = 1.1$ , the weight of hypothetical engine A would be 901.8 lb and that of engine B, 1170 lb. Specific fuel consumption at takeoff rating (p. 123<sup>1</sup>) in gr/hp-hr would be

$$sfc_{TO} = k_{ce}/(SHP_{ref})_{max}^{0.1}$$

Taking an average value of  $k_{ce} = 495$  gr/hp<sup>0.9</sup>-hr, the following is obtained: for engine A,  $sfc_{TO} = 0.462$  lb/hp-hr, and for engine B,  $sfc_{TO} = 0.445$  lb/hp-hr.

Variation of sfc with partial power setting is given by the following formula (Eq (2.161<sup>1</sup>)), where the results are in kg/hp-hr, and  $sfc_{TO}$  is given in the same units:

$$sfc = \{sfc_{TO} - 0.16[1 - (SHP/SHP_{TO})]\}/(SHP/SHP_{TO})$$

The normal rated power is assumed as

$$SHP_{N.R} \approx 0.92SHP_{TO} \quad (p.119^1)$$

**Basic Data.** The principal characteristics and performance of the real and hypothetical powerplants at SL, ISA are given in Table 2.4. The sfc consumption as a function of partial power setting (also at SL, ISA) is shown in Fig. 2.13; lapse rate in Fig. 2.14; specific weights in Fig. 2.15; and TO SHP per cu.ft of the engine volume (defined by its external dimensions) is shown for real engines in Fig. 2.16.

**Discussion.** It can be seen from Fig. 2.13 that similar to the previously discussed engine classes, the specific fuel consumption of the D-25V (TV-2BM) turboshaft is higher than that of its Western counterparts. However, for Tishchenko's hypothetical engines, it is practically the same as for the advanced powerplants and is even better for the new D-136 disclosed at the Paris Air Show in 1981.

As can be seen from Fig. 2.14, the previously mentioned design philosophy of providing a larger thermodynamic than mechanical engine capability at low altitudes and then restricting the power through fuel flow limitation is even more visible in the D-25V (YB-2BM) engine than in the other Soviet turboshafts. By contrast, the so-called hypothetical engines apparently would have matched thermodynamics and mechanical capabilities; thus their relative power lapse rate vs ISA altitude should be similar to those of the American turboshafts. Unfortunately, in this respect, there is no available data in regard to the D-136. However, the goals regarding specific weights as set up in Fig. 2.15 have been closely approached in the D-136 turboshaft.

Fig. 2.16 clearly shows that, as may be expected, the D-25V (TV-2BM) engine is much more bulky than the Western ones. Again, no data is available as yet on the D-136.

## 2.6 Concluding Remarks

From the comparative material presented in this chapter, it appears that from the performance point of view, Soviet helicopter powerplants have been definitely inferior to their Western counterparts. Whether those performance and weight deficiencies are compensated, if at all, by such aspects as ruggedness, ease of maintenance, and operational reliability, are outside of the scope of this part of the comparative study.

It appears that Soviet helicopter designers realize that their present powerplants are inferior to those of the West (which is clearly discernable from such comparisons as depicted in Fig. 2.17) and thus, in their hypothetical concepts, they assume performance and weight characteristics representing the current Western state of the art. Characteristics of the D-136 turboshaft tend to indicate that the general goals of the hypothetical engines served as milestones of the actual development program.

TABLE 2.4  
 PRINCIPAL CHARACTERISTICS AND PERFORMANCE AT SL, ISA OF ENGINES INSTALLED IN  
 30,000 TO 100,000-LB GROSS WEIGHT CLASS HELICOPTERS

ITEM	ENGINE							
	Soloviev D-25V (TV-2BM)	Tishchenko Hypothetical A	Tishchenko Hypothetical B	Allison T701	General Electric T64-GE-413	General Electric T64-GE-415	Lycoming T55-L-712	
SERVICE DATE		1976 <sup>d</sup>	1976 <sup>d</sup>		1969		1978	
POWER, SHP								
Maximum Contingency				8080	3925 <sup>e</sup>		4500	
Intermediate Contingency				8080	3695		3750	
Takeoff/Military	5425	5500	8080	7305	4380 <sup>f</sup>		3400	
Max. Continuous	4635	5060 <sup>c</sup>	7434 <sup>c</sup>		3230		3000	
Max. Cruise	3945				2905 <sup>†</sup>		2250 <sup>a</sup>	
Cruising II* or A <sup>†</sup>				5478 <sup>a</sup>	2420 <sup>††</sup>		1200 <sup>b</sup>	
Cruising I* or B <sup>††</sup>				3648 <sup>b</sup>				
WEIGHT (DRY); LB	2921	902	1170	1179	712	720	750	
SPEC. FUEL CONS.; LB/HR-SHP								
Takeoff	0.634	0.462	0.445	0.471	0.479	0.466	0.543	
Max. Continuous	0.670 <sup>g</sup>	0.471 <sup>c</sup>	0.453 <sup>c</sup>	0.462	0.488	0.476	0.562	
Cruising II				0.468 <sup>a</sup>	0.496		0.610 <sup>a</sup>	
Cruising I				0.506 <sup>b</sup>	0.517			
OVERALL DIMENSIONS; FT								
Length	8.98	-	-	5.275	6.57	6.58	3.88	
Width	3.56	-	-	2.375	D = 1.98	D = 1.667	D = 2.33	
Height	3.78	-	-	3.0	143.5	188.1	205.6	
TO SHP/Overall Vol; hp/ft <sup>3</sup>	44.9	-	-	215.0				
SPECIFIC WEIGHT								
Engine Weight/TO SHP; lb/shp	0.538	0.164	0.145	0.146	0.193	0.164	0.221	
Output RPM		-	-	11,500	13,600	14,280		

NOTES:

\*86.5% gas generator rpm

\*\*83.5% gas generator rpm

<sup>†</sup>90% of max. cruise power

<sup>††</sup>75% of max. cruise power

<sup>a</sup>75% max. continuous power

<sup>b</sup>50% max. continuous power

<sup>c</sup>normal rated power equal to 0.92 SHP/TO<sup>1</sup>

<sup>d</sup>publication date, ref. 1

<sup>e</sup>10-minute rating

<sup>f</sup>10-minute rating  
<sup>g</sup>30-minute rating @ 4115 hp

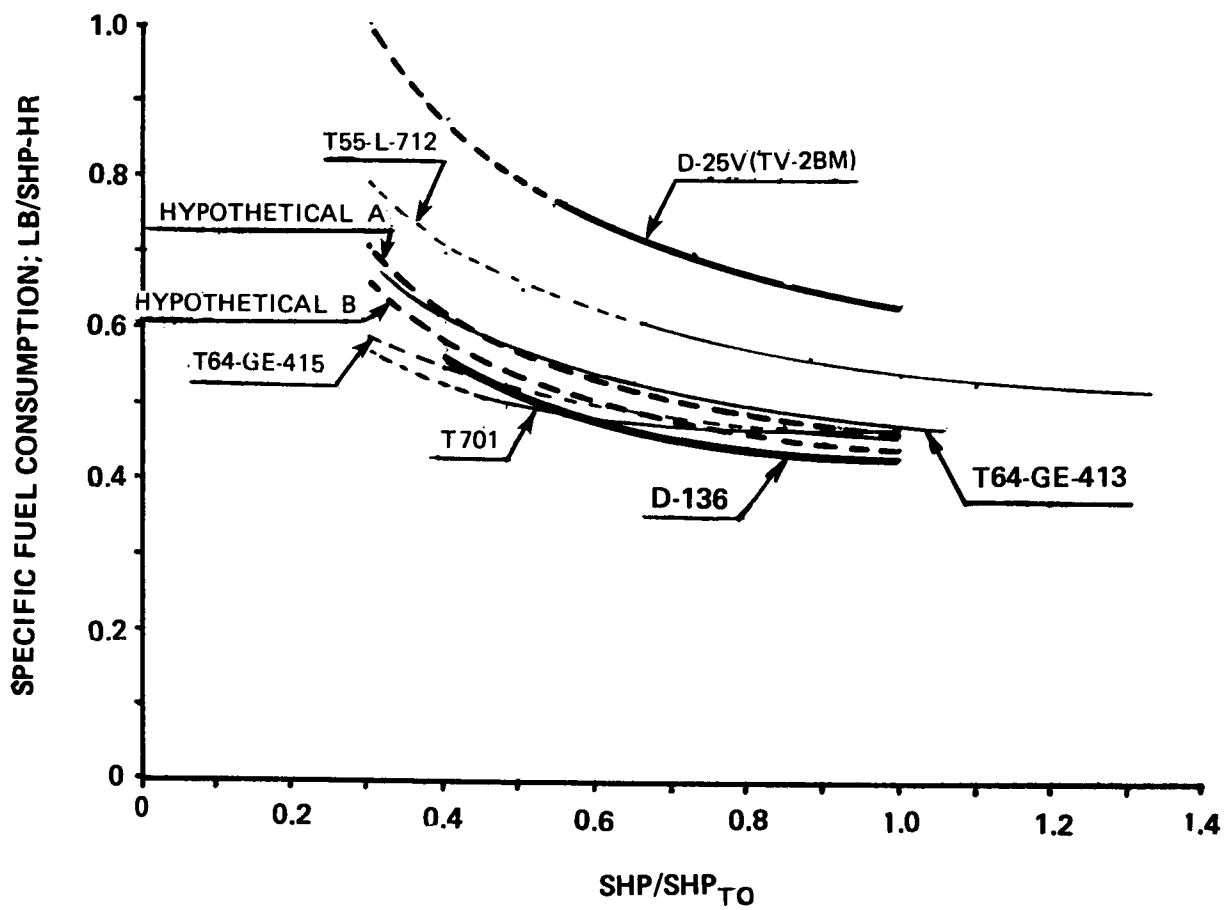

Figure 2.13 The sfc vs partial power setting of Western and Soviet turboshafts for 30,000 to 100,000, and over 100,000-lb gross weight class helicopters.



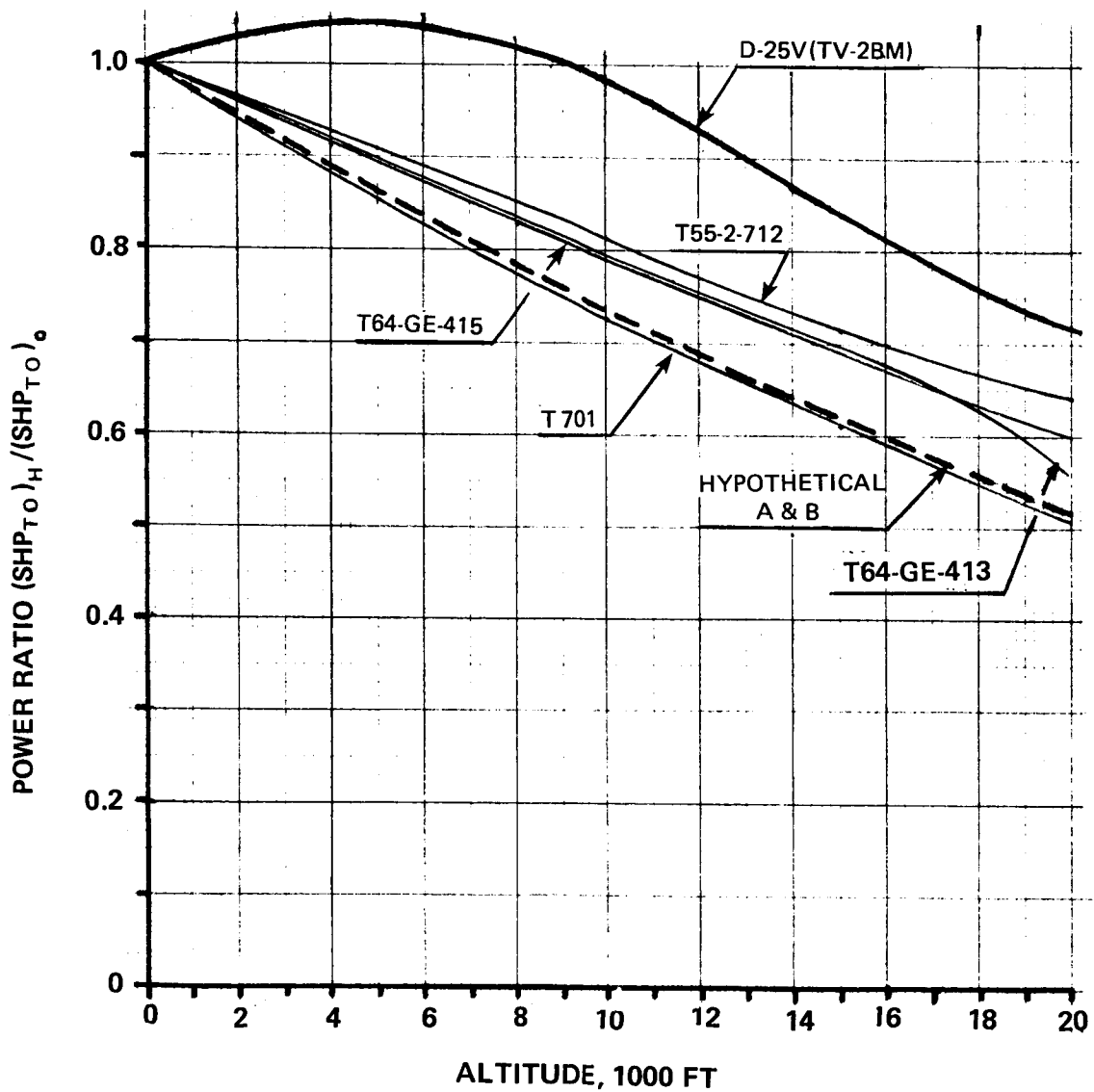

Figure 2.14 Relative lapse rate for TO SHP, ISA of Soviet and Western turboshafts for 30,000 to 100,000, and over 100,000-lb gross weight class helicopters.

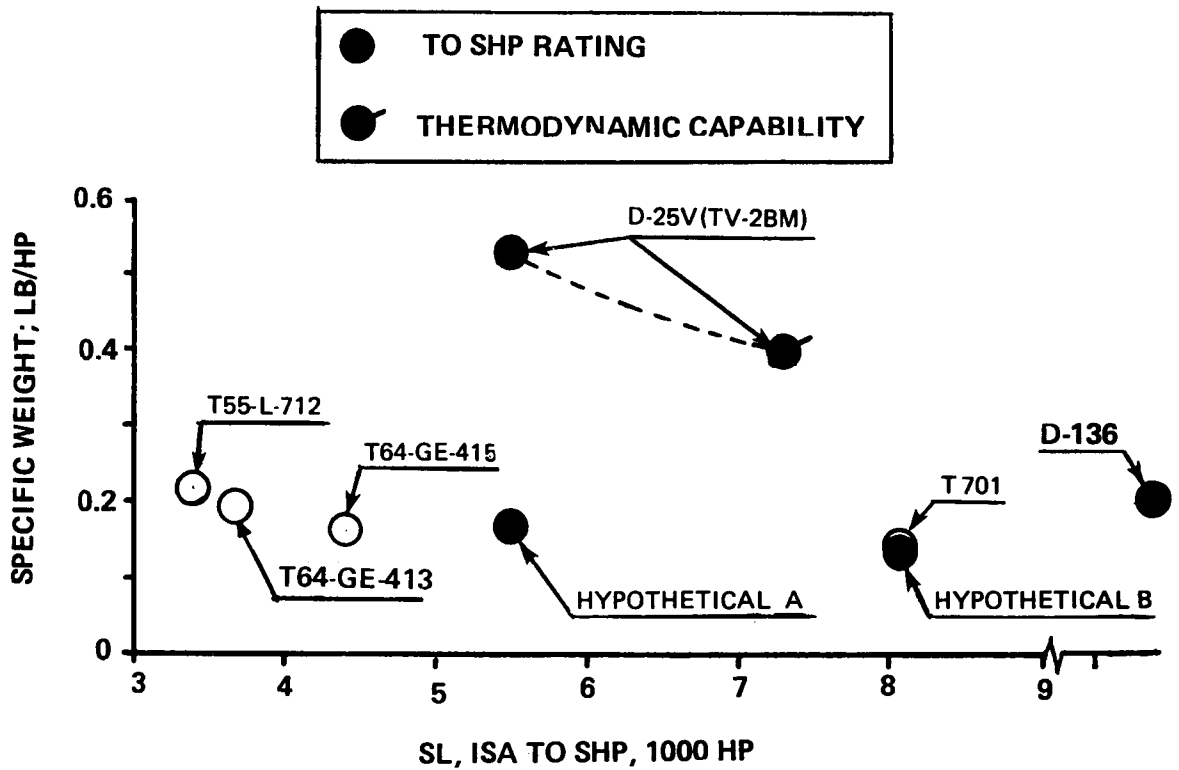

Figure 2.15 Specific weights of Soviet and Western turboshafts for helicopters of 30,000 to 100,000, and over 100,000-lb gross weights.

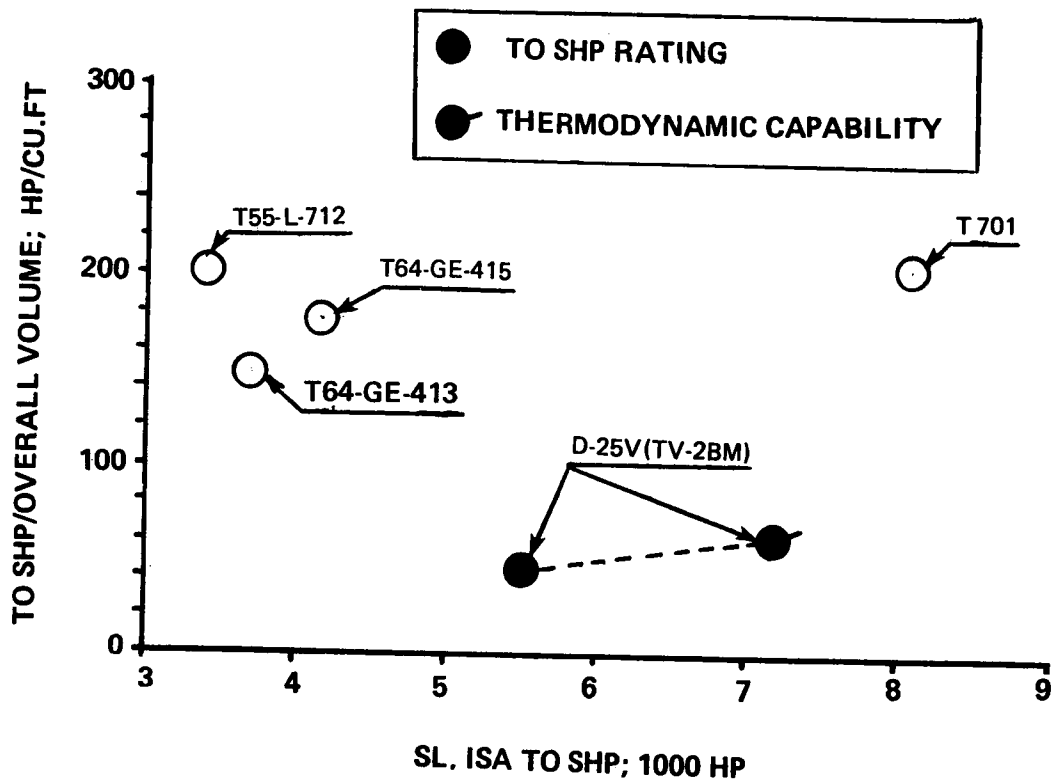

Figure 2.16 SL, ISA Takeoff SHP to overall engine volume for Soviet and Western turboshafts for 30,000 to 100,000, and over 100,000-lb gross weight helicopters

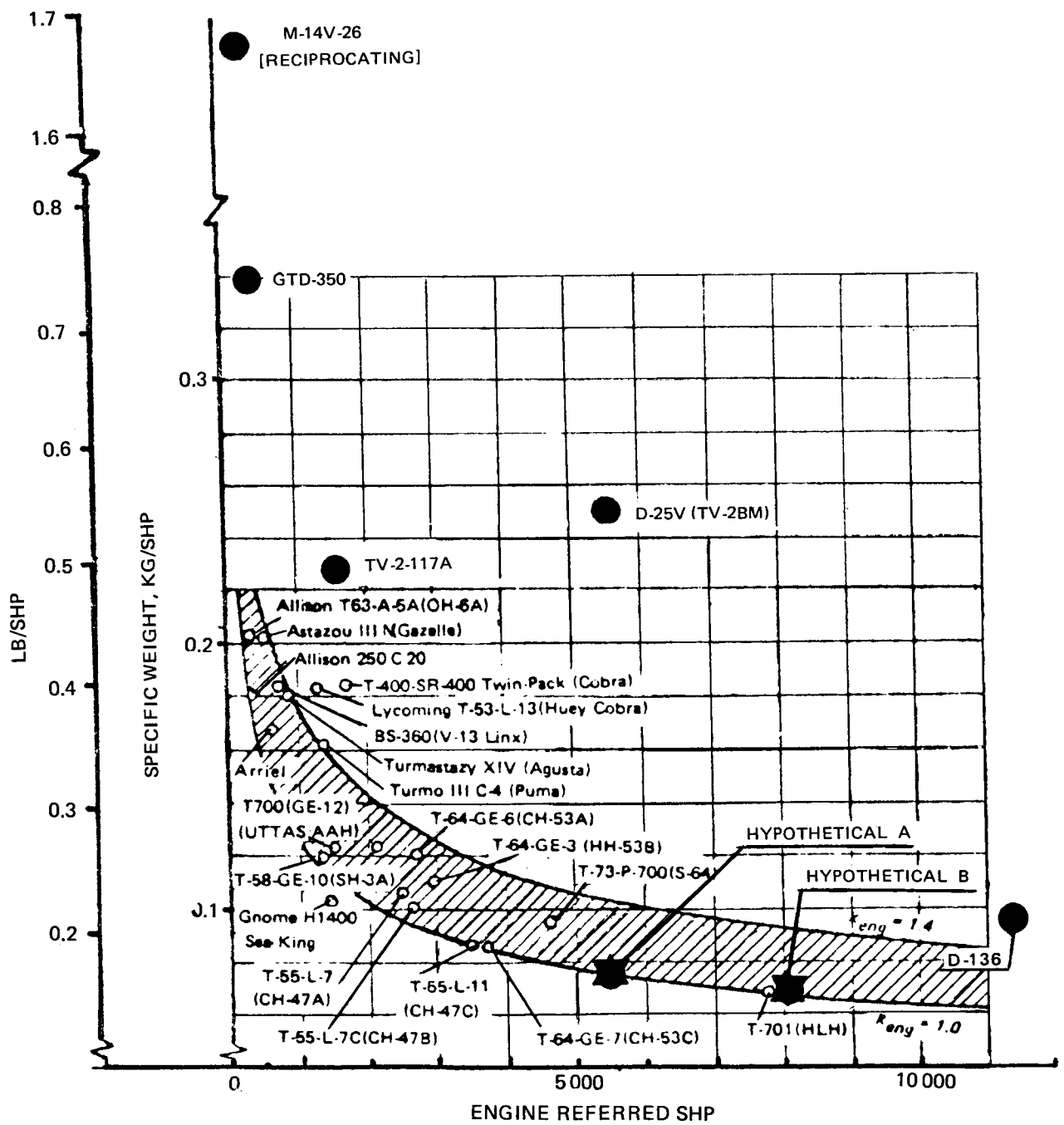

Figure 2.17 General comparison of specific weights of Soviet and Western helicopter engines.

## Chapter 3

# Helicopters of the Up-to-12,000-lb Class

### 3.1 Basic Data

Three-view drawings of the compared helicopters are shown in Figs. 3.1a through 3.1h, while their principal characteristics are given in Table 3.1. Some of the data contained in this table are graphically presented in Figs. 3.2 through 3.7.

**Disc Loading** (Fig. 3.2). From this figure it can be seen that the disc loading of Soviet helicopters belonging to the up to 12,000-lb gross weight class is not only much lower than that of the more recent Western helicopters of the same class, but is also lower than the disc loading of the older types represented here by the UH-1H helicopter.

**Power Loading** (Fig. 3.3). In contrast to the disc loading, the power loading of the Soviet rotorcraft is much higher than that based on the takeoff power installed (unflagged symbols), but is also higher than the Western power loading associated with transmission limits, or engine flat rating (flagged symbols).

**Main Rotor Tip Speed** (Fig. 3.4). Main rotor tip speeds of the Soviet helicopters of the considered class are of slightly over 600 fps magnitude, while those of the Western helicopters are usually in the 700 fps class, with some Bell helicopters reaching, or even exceeding, the 800 fps limit.

**Tail-Rotor to Main-Rotor Radii Ratio and Relative Tail-Rotor Distance** (Fig. 3.5). It can be seen from this figure that the rotor radii ratio of the Soviet helicopters is only slightly higher than the corresponding ratios of Western counterparts. SA-365N represents an exception to this rule, since the radii ratio is significantly lower for the Fenestron tail-rotor configuration.

The relative distance ( $\bar{x}$ ) of the Mi-2 tail-rotor location is practically the same as those of Western helicopters.

**Weight Empty and Zero-Range Payload to Gross Weight Ratios** (Fig. 3.6). Trends visible from this figure indicate that the weight empty to gross weight ratios of Soviet helicopters are higher for both normal and maximum flying gross weights than for their Western counterparts. Consequently, the zero-range (or time) payload to gross weight ratios of the Soviet helicopters are lower than those of Western helicopters.

**Cabin Volume Loading at Zero-Range Payload** (Fig. 3.7). It can be seen from this figure that with respect to the provision of cabin volume for the possible maximum payload (as expressed by the zero-range payload), there is no common trend in the Soviet helicopters of the considered gross-weight class. While the Mil designs provide a large cabin volume for the possible payload (resulting in a cabin loading way below Western practice), Kamov's design is more consistent with the Western trend, with the exception of the BO-105.

TABLE 3.1  
 PRINCIPAL CHARACTERISTICS & PERFORMANCE  
 UP TO 12,000-LB GROSS WEIGHT CLASS HELICOPTERS

ITEM	HELICOPTER									
	MIL Mi-2	MIL Mi-2 Allison	Kamov Ka-26	Aerospatiale SA-365N	Sikorsky S-76	Bell UH-1H	MBB BO-105CB	Bell		
CONFIGURATION	S.R.	S.R.	Co-Axial	S.R.	S.R.	S.R.	S.R.	S.R.	S.R.	S.R.
POWERPLANT	Isotov/PZL GTD-350	Allison 250-C20B	Vedenev M-14V-26	Turbomeca Arriel 1C	Allison 250-C30	Lycoming T53-L-13	Allison 250-C20B	Lycoming 101-650C-3		
Number of Engines	2	2	2	2	2	1	2	2		
Output Shaft rpm	5904	6016	2800-2350	6000	6016	6600	6016	9540		
Total T.O SHP	789	840	640	1320	1300	1400	840	1236		
Total Max. Cont. SHP	630	800	541	1172	1300	1134	800	1184		
Transmission Limit, HP	—	—	—	1207	1300	1134	690	1029 <sup>a</sup>		
MAIN ROTOR R, ft	23.88	23.88	21.33	19.57 <sup>#</sup>	22.0	24.0	16.14	19.87		
Direction of Rotation	C.W	C.W	Upper C.W	C.W	CC.W	CC.W	CC.W	CC.W		
rpm	246	246	3	350	293	294-324	424	348		
Number of Blades	3	3	2 X 3	4	4	2	4	2		
Blade 0.7R Chord, ft	1.312	1.312	0.82	1.329	1.29	1.75	0.89	2.38		
Airfoil	NACA 0012	NACA 0012	OA2	OA2	SC 1095	NACA 0012	NACA 23012	Wortmann 080		
Articulation	Full	Full	Semi-Rigid	Semi-Rigid	Uniball Elastom	See-Saw	Hingeless	See-Saw		
Tip Speed, fps	615	615	[580]	717	675	739-814	716.5	724		
TAIL ROTOR R, ft	4.43	4.43		1.476	4.0	4.25	3.115	3.25		
Type & Dir. of Rotation	P & CC.W	P & CC.W	Distance between rotors	Fenestron	P & CC.W	P & CC.W	P & C.W	P & C.W		
x, ft	29.2	29.2	3.83	21.1	26.71	28.86	19.52	23.3		
y, ft	-4.0	-4.0		—	-1.32	-0.35	~0	-4.01		
rpm	1450	1450		4693	1609	1654	2220	1881		
Number of Blades	2	2		13	4	2	2	2		
Blade 0.7R Chord, ft	0.721	0.721		0.143	0.54	0.70	0.59	0.83		
Airfoil				—	SC 1095	See-Saw	See-Saw	See-Saw		
Articulation				—	F.P	See-Saw	See-Saw	See-Saw		
$R_{tr}/R_{mr}$	0.186	0.186		0.0754	0.182	0.177	0.193	0.164		
$x/R_{mr}$	1.223	1.223		1.078	1.214	1.202	1.209	1.173		
EXTERNAL DIMENSIONS										
Overall Length, ft	57.17	57.17	42.66 (2R)	43.59	52.5	57.1	38.92	47.5		
Fuselage, ft	39.17	39.17	25.42	37.33	43.37	41.9	24.35	41.0		
Overall Height, ft	12.29	12.29	13.0	13.16	14.48	14.5	9.83	11.5		

<b>INTERNAL DIMENSIONS</b>													
Cabin Length, ft	13.35	13.35/8.5	6.0	7.54	8.08								6.3
Maximum Width, ft	4.9	4.9	4.1	6.29	6.33								4.8
Maximum Height, ft	4.95	~5.0	4.6	4.59	4.42								4.75
Volume, cu.ft	274.32	274.32	113.2	177	242 <sup>‡</sup>								129.2
<b>CREW</b>	2/1	2/1	2/1	1/2	2/1								2/1
<b>WEIGHTS</b>													
Maximum Gross Weight, lb	8175	7826	7165	8488	10,000								7850
Normal Gross Weight, lb	7826	7386	6780	—	10,000								7200
Empty Weight, lb	5229	4718	4300	4277	5600								4860
Payload at Zero Range, lb	2519	2689	2445	4041*	3978								2565
$W_e/(W_{gr})_{max}$	0.640	0.603	0.600	0.504	0.560								0.619
Max. $(W_{pl})_0/W_{gr}$	0.308	0.344	0.341	0.476	0.398								0.327
Max. $(W_{pl})_0/Cabin Vol, lb/ft^3$	9.18	9.80	21.55	21.39	16.44								19.85
<b>PERFORMANCE</b>													
Flt. Speed, Max/VNE, kn	113	VNE 135	91	165	155								@ Max. GW
Fast Cruise*, kn	108	113	81	153	145								141
Economic Cruise*, kn	102	105	49-59	140	125								141
R/C, Vertical*, fpm													130
R/C Forward*, fpm	885	1319		1614	1350								680
Hover*, OGE, ft	3280	1575	2625 <sup>†</sup>	3280	2800								1590
Service Ceiling, ft	13,125	13,123	9840	> 13,100	15,000								4600
Ceiling: 1-Engine Out, ft			1640	3200	6200								12,800
Avg. Fuel Consumption, lb/h		340		—	490								5200
Normal Fuel, lb	1017	1017	794	1984	1883								1275
Maximum Range, N.Mi.	147 <sup>††</sup>	268	215	455	404								329
<b>DISC LOADING</b>													
Normal GW, psf	4.37	4.12	4.75	—	6.58								6.33
Maximum GW, psf	4.56	4.37	5.01	7.05	—								—
<b>POWER LOADING</b>													
Normal GW, lb/shp	9.92	8.79	10.43	—	7.69								Trans. Limit
Maximum GW, lb/shp	10.36	9.32	11.02	7.03	—								7.63

NOTES: \*SL, ISA \*\*ISA †6615-lb GW ††1320-lb Payload + 983-lb of Fuel ‡with Blade Tip Cap †incl. Cargo Compartment  
<sup>a</sup>based on 875 hp to Main Rotor Mast

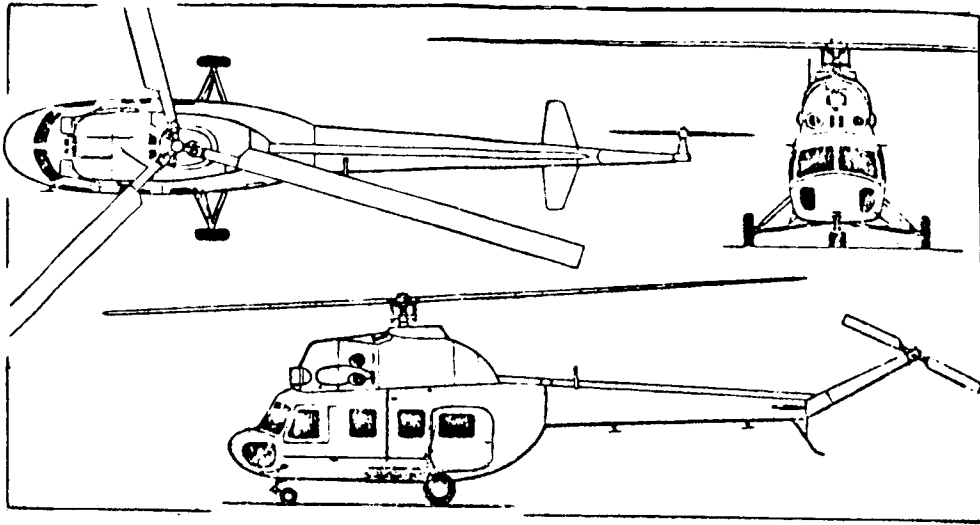

(a) PZL-Swidnik (Mil) Mi-2 twin-turbine general-purpose light helicopter (*Pilot Press*)

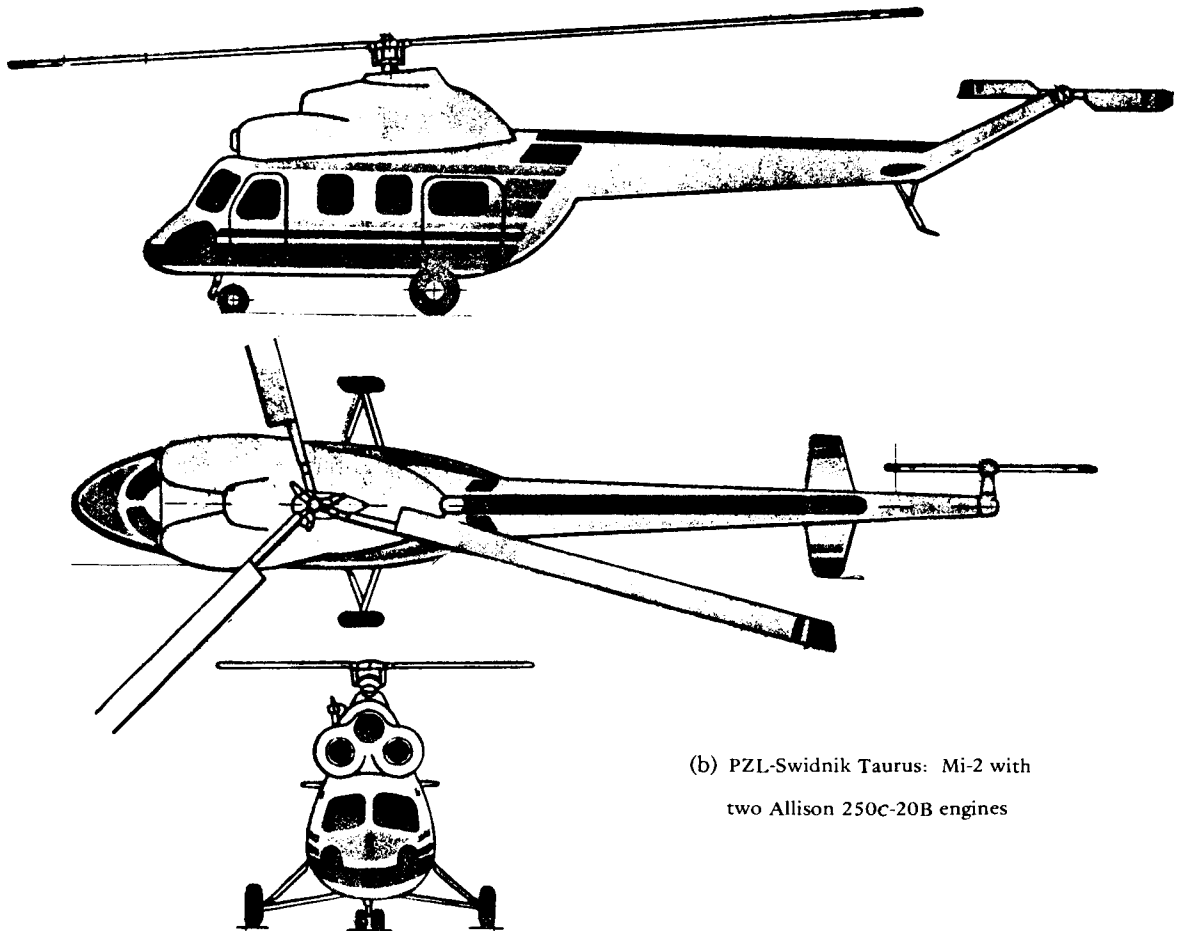

(b) PZL-Swidnik Taurus: Mi-2 with two Allison 250C-20B engines

Figure 3.1 Three-view drawings of Soviet and Western helicopters of the up to 12,000-lb GW class.



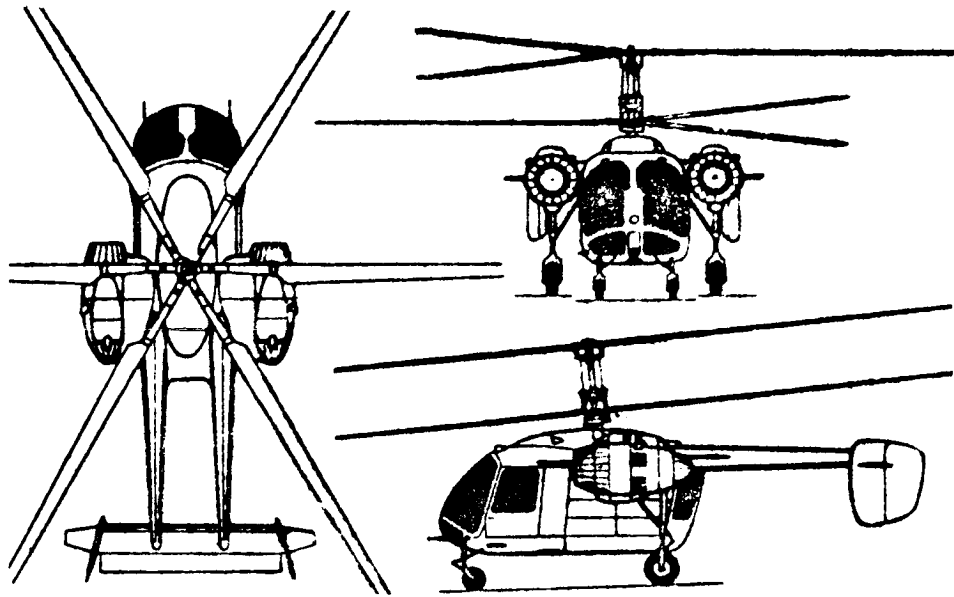

(c) Kamov Ka-26 twin-engined flight general-purpose helicopter in passenger-carrying form (*Pilot Press*).

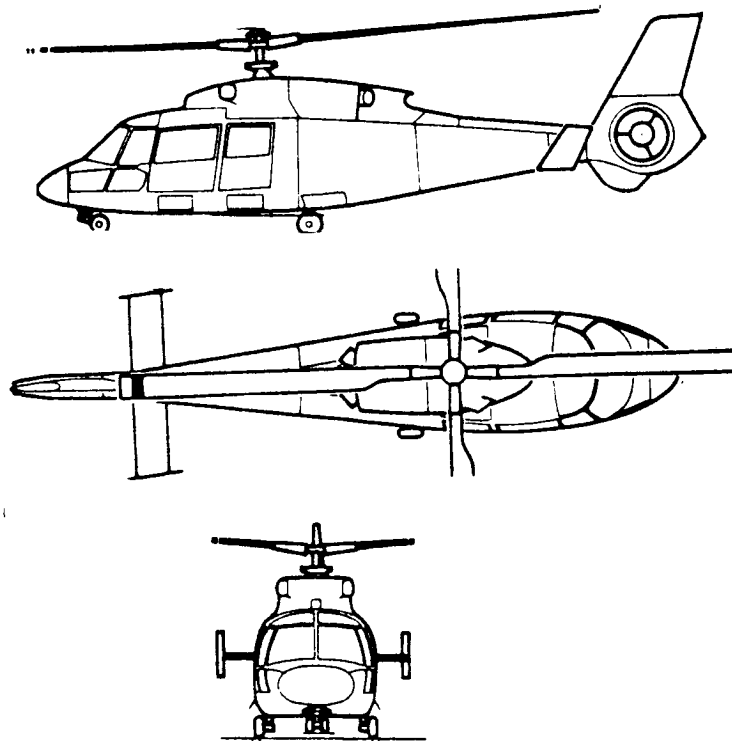

(d) Aerospatiale SA-365N Dauphin 2

Figure 3.1 Three-view drawings of Soviet and Western helicopters of the up to 12,000-lb GW class (Cont'd).

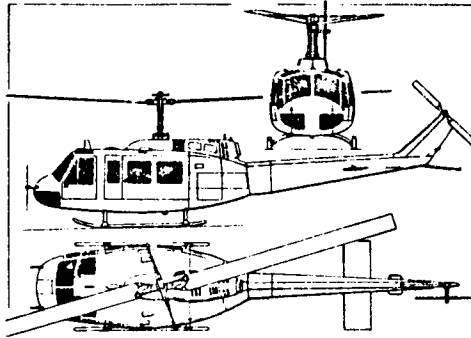

(e) Bell UH-1H Iroquois.

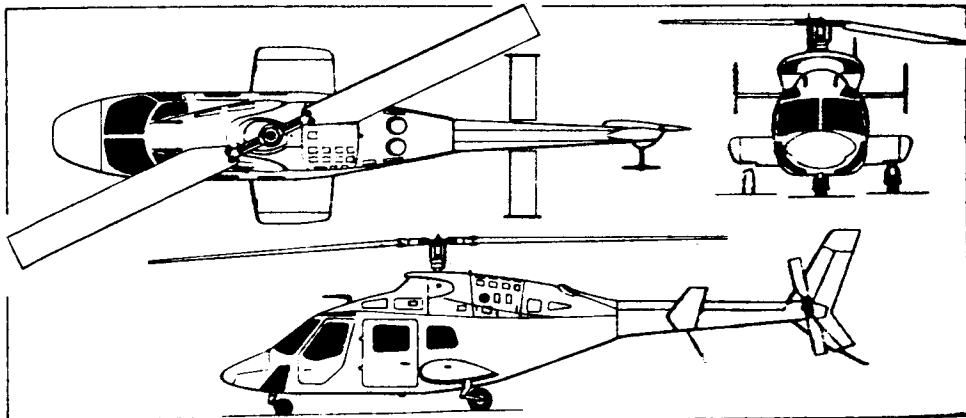

(f) Bell Model 222 (two Avco Lycoming LTS 101 turboshaft engines) (*Pilot Press*).

Figure 3.1 Three-view drawings of Soviet and Western helicopters of the up to 12,000-lb GW class (Cont'd).

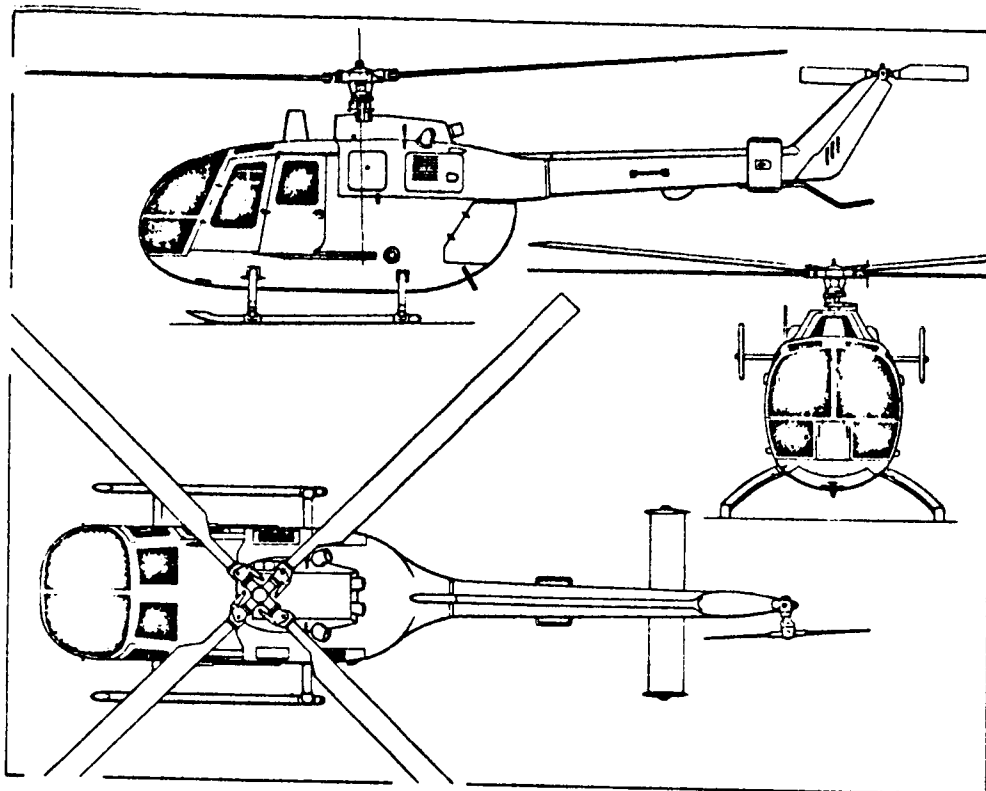

(g) BO 105 CB five-seat light helicopter (two Allison 250-C20B turboshaft engines) (*Pilot Press*).

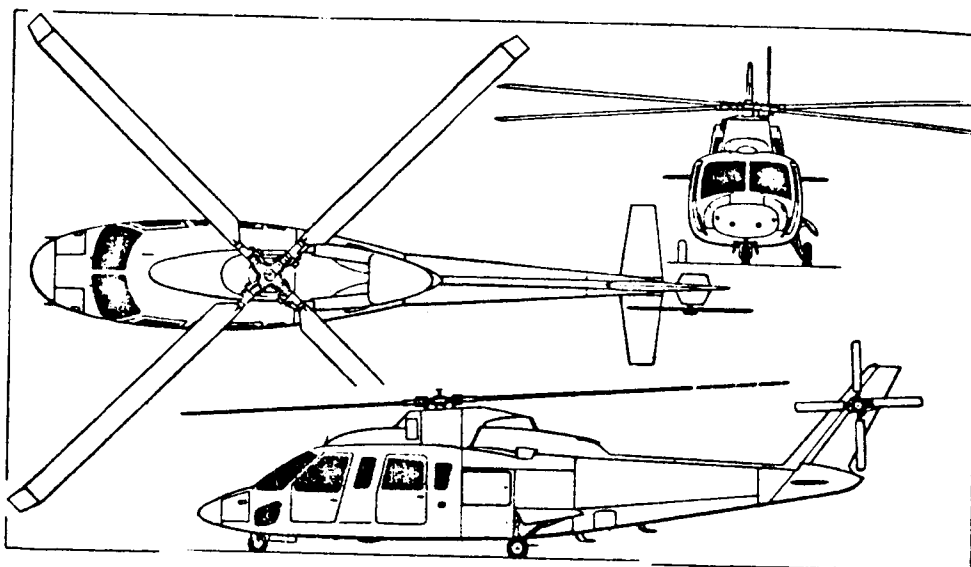

(h) Sikorsky S-76 eight/twelve-passenger commercial transport helicopter (*Pilot Press*).

Figure 3.1 Three-view drawings of Soviet and Western helicopters of the up to 12,000-lb GW class (Cont'd).

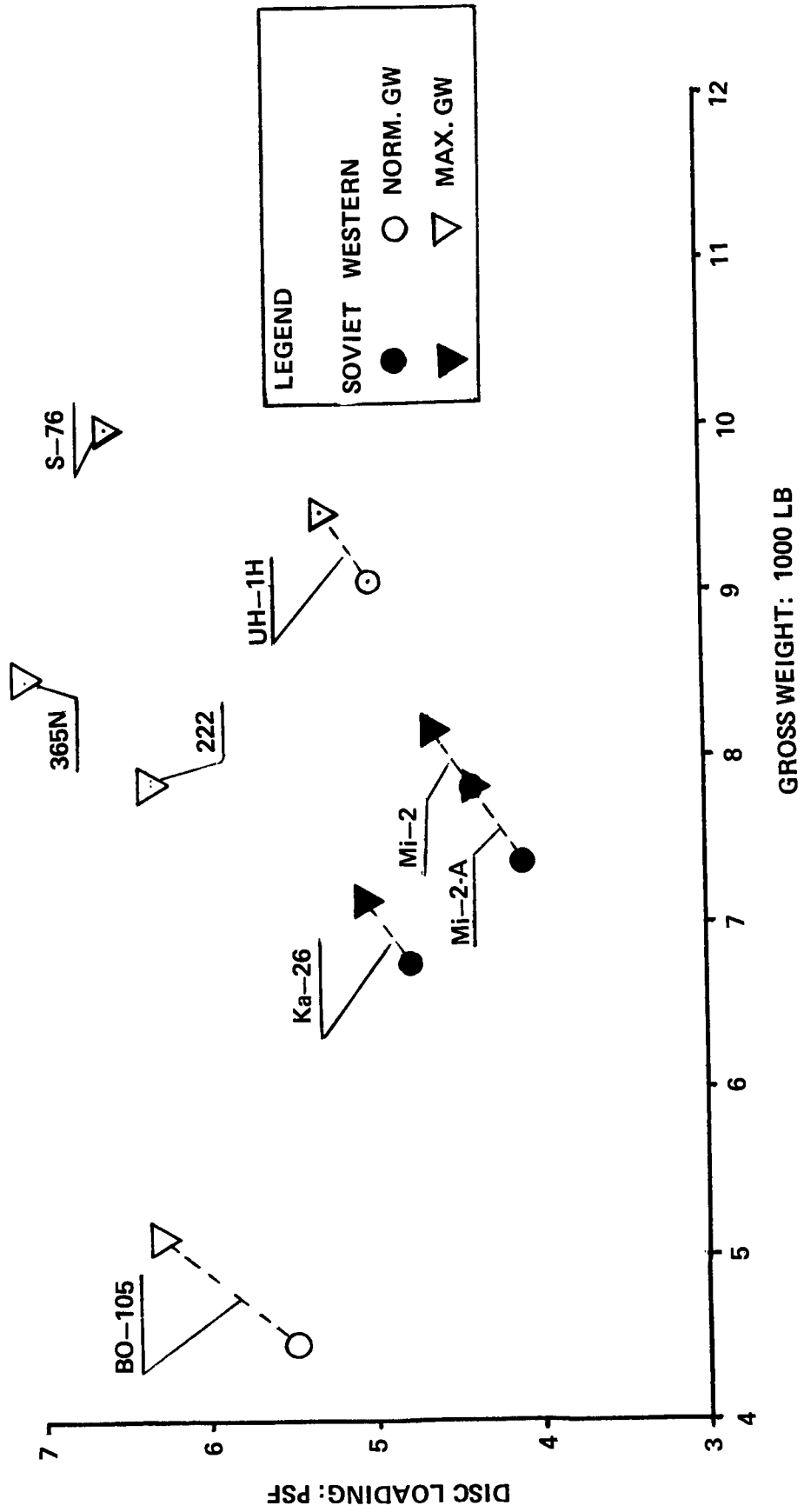

Figure 3.2 Disc loading comparison of Soviet & Western helicopters of up to 12,000-lb gross weights.

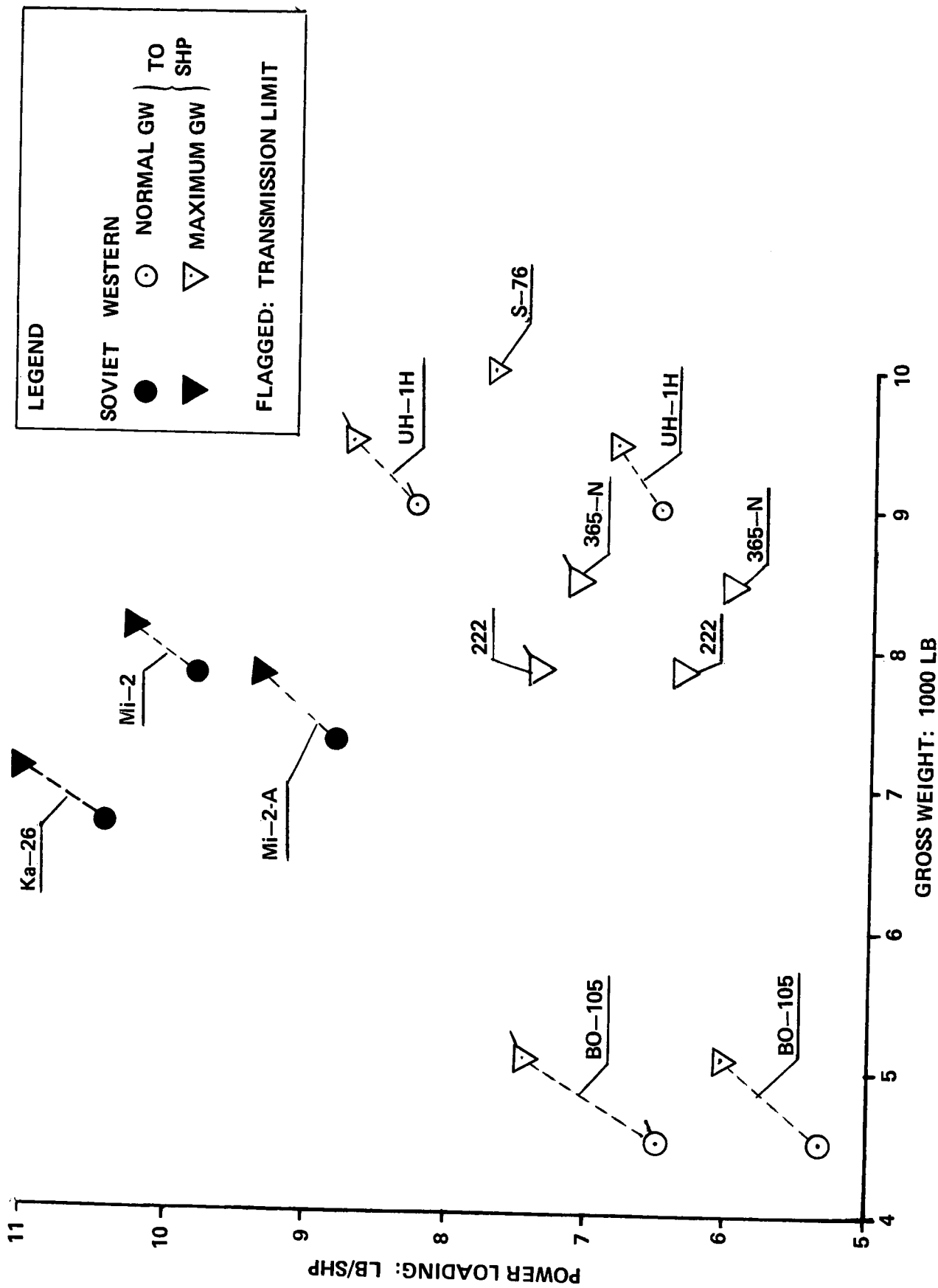

Figure 3.3 Comparison of power loading of normal & maximum gross weights of Soviet & Western helicopters of up to 12,000-lb gross weights.

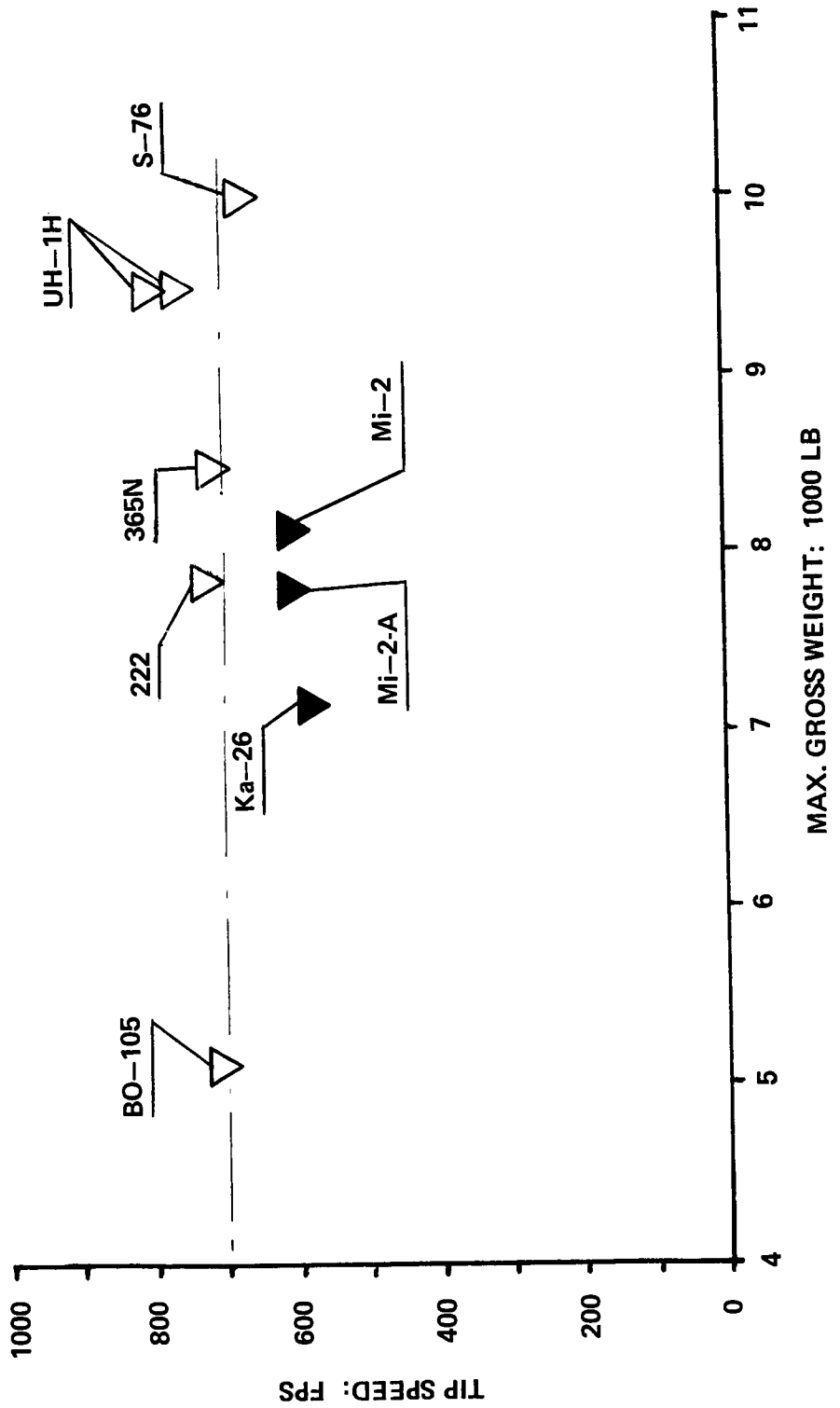

Figure 3.4 Comparison of main-rotor tip speed of Soviet & Western helicopters of up to 12,000-lb gross weight.

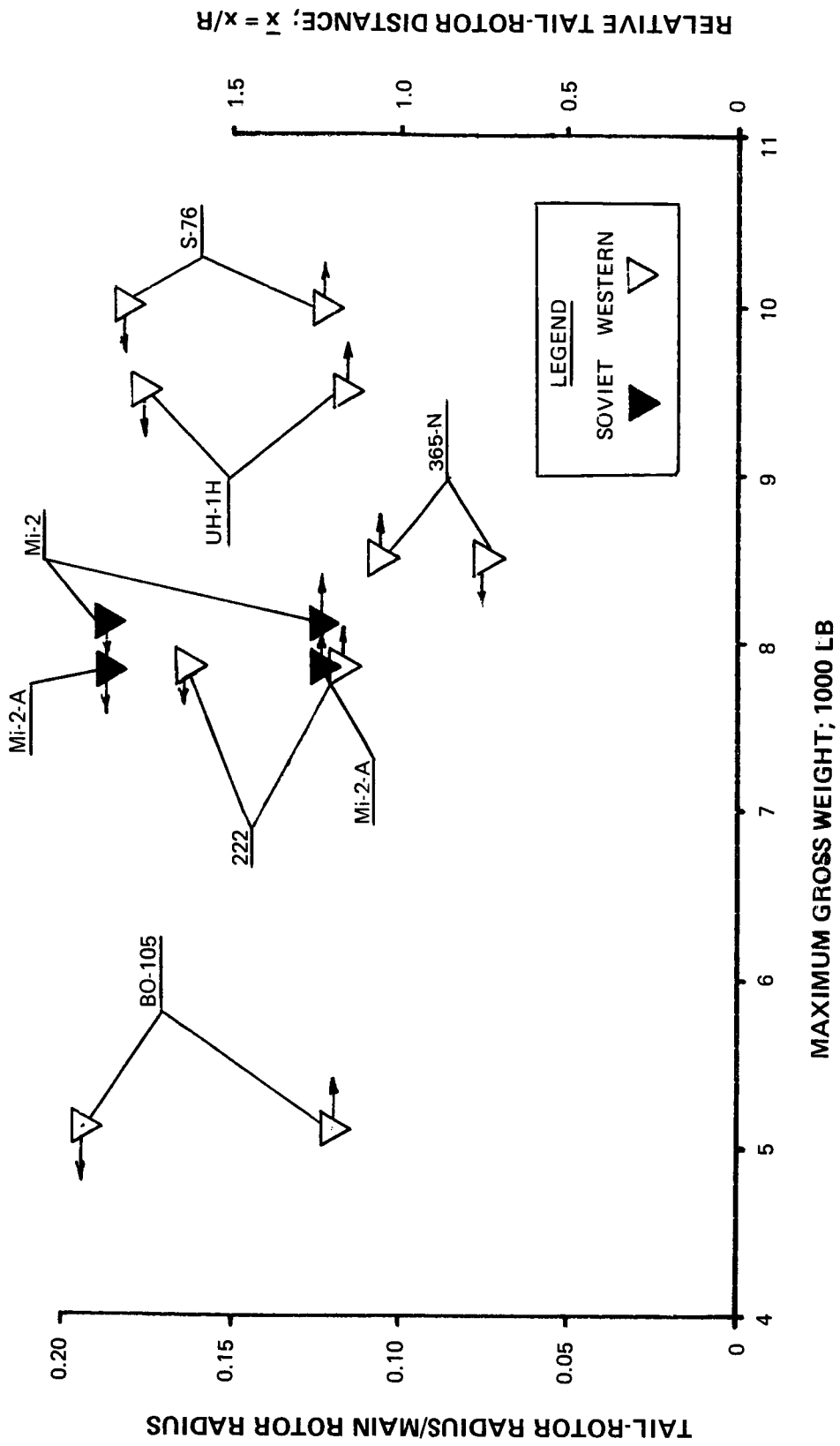

Figure 3.5 Comparison of the tail-rotor to main-rotor radii ratios and relative tail-rotor location of Soviet & Western helicopters of up to 12,000-lb gross weights

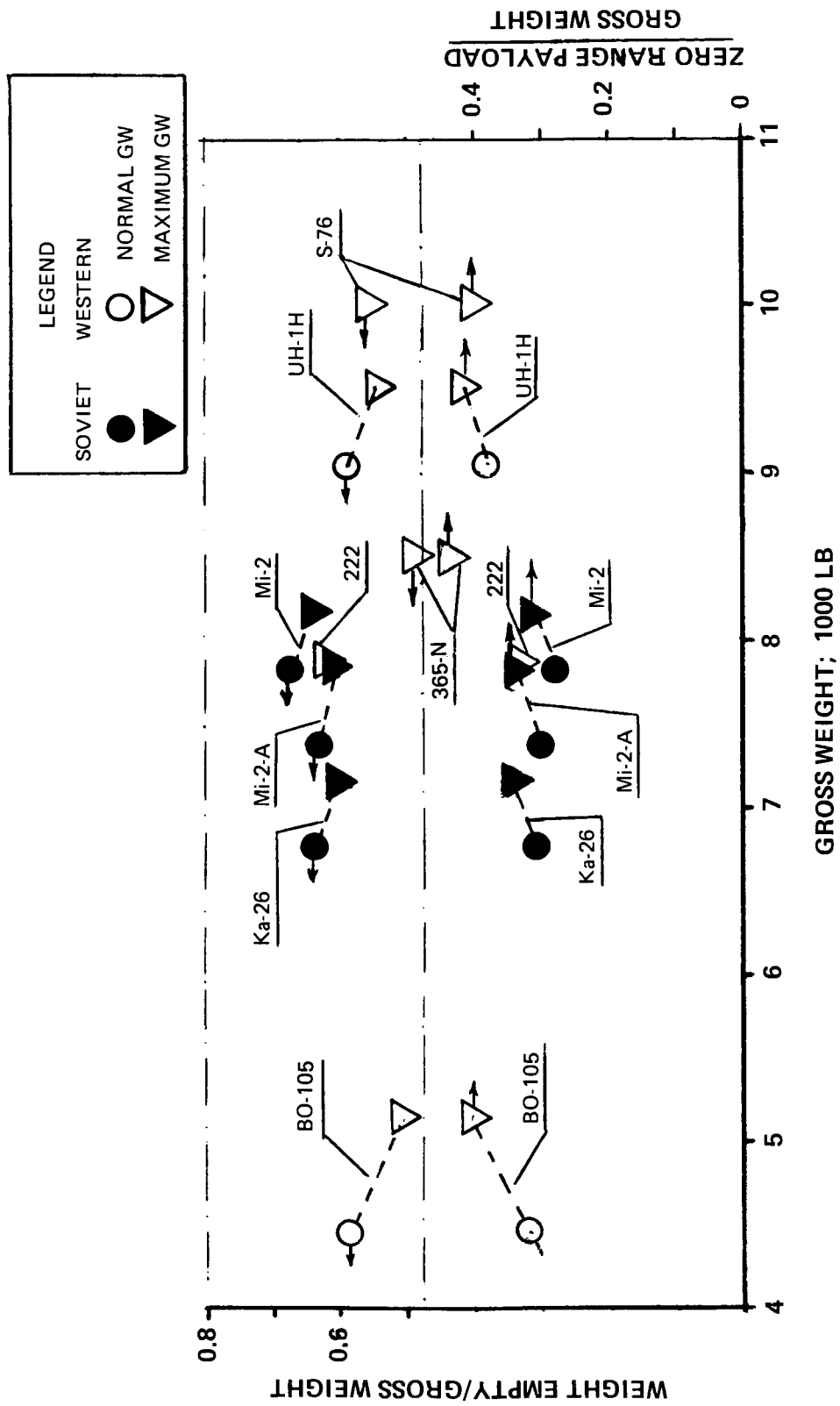

Figure 3.6 Comparison of weight-empty and zero-range payload to gross weight ratios of Soviet & Western helicopters of up to 12,000-lb gross weights.



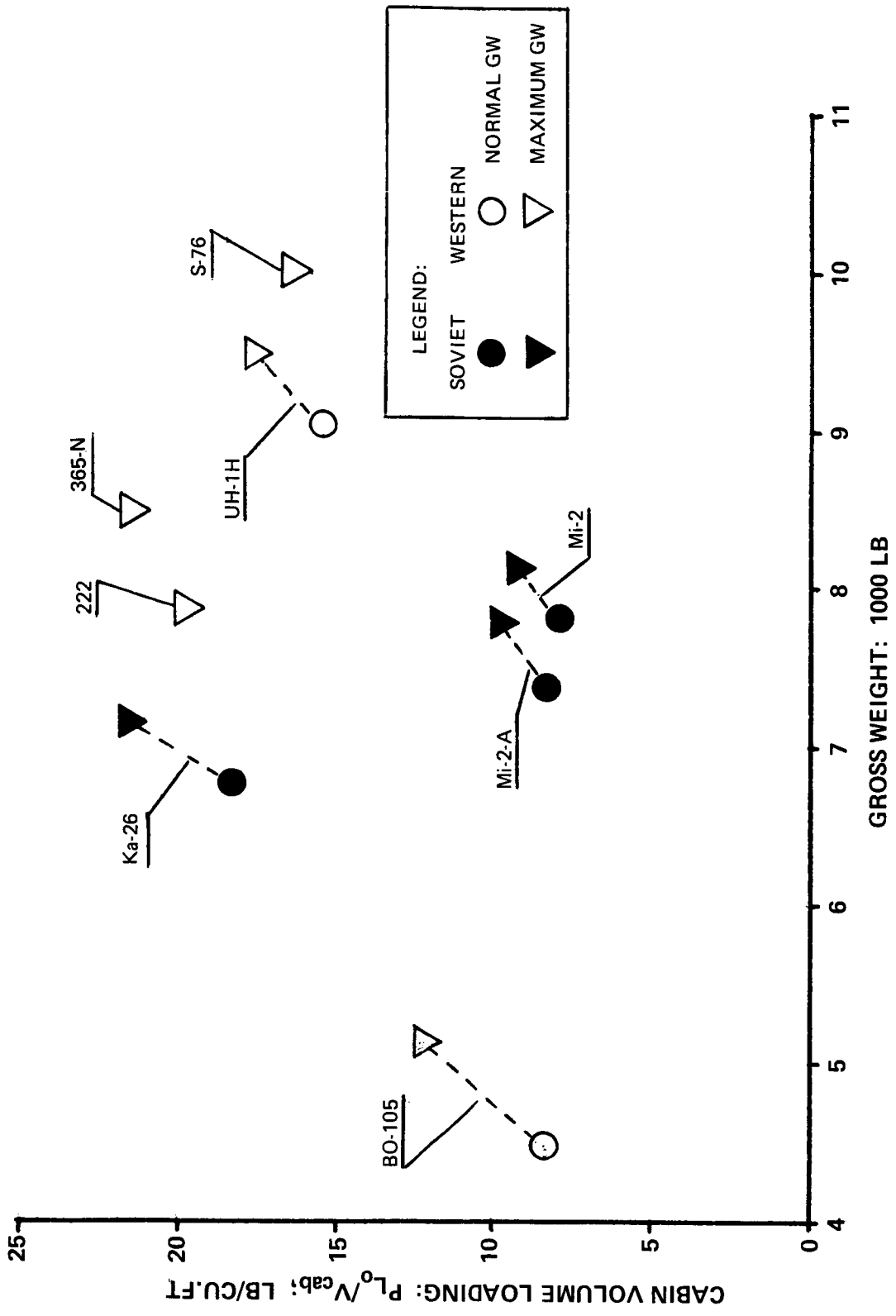

Figure 3.7 Comparison of cabin-volume loading at zero-range (time) payload of up to 12,000-lb gross weight class.

## 3.2 Hovering and Vertical Climb Aspects

Table 3.2 was prepared using the data contained in Table 3.1. This was done by selecting those gross weights for which the largest number of hovering and vertical climb performance terms could be found in published documentation.

It can be seen from this table that, following the approaches outlined in Ch. 1; first, the main-rotor and then the tail-rotor aspects are considered. Once the figure of merit of the main rotor and the power ratio of the tail to main rotor is estimated, the overall transmission efficiency, as well as the overall helicopter figure of merit, is computed.

Next, the estimated values of the overall figure of merit of the helicopter are compared with those resulting from the published hovering OGE data and engine characteristics, including the power lapse rate.

The obtained  $FM_{oa}$  values are compared with the estimated values, and arithmetic means of both are given as average overall  $FM$  in Table 3.2.

Assuming that the so-compared overall figures of merit are more nearly correct than either the estimated ones or those computed from published hovering OGE data, the vertical rate of climb at S/L, ISA and TO power rating is computed from Eq (1.9), and the so-called VTO gross weight determined from Eq (1.2).

Some of the items either directly appearing in, or easily obtainable from, Table 3.2 are graphically presented in Figs. 3.8 through 3.14.

**Power per Pound of GW in Comparison with the Ideal Power (Fig. 3.8).** It can be seen from this figure that Soviet helicopters in general exhibit a lower ratio of takeoff specific power to ideal specific power than their Western counterparts. This is true at both normal and maximum gross weights. However, for those Western helicopters which encounter transmission limits, or have flat-rated engines (flagged symbols), the takeoff to ideal power ratios become similar to those of the Mi-2A helicopters.

**Average Blade Lift Coefficient (or  $C_T/\sigma$ ) in Hover at SL, ISA (Fig. 3.9).** The trend indicated in this figure shows that all Soviet helicopters (in the up to 12,000-lb GW class) operate in hover at SL, ISA at higher average blade lift coefficients ( $C_T/\sigma$ ) than the Western ones. This aspect of their design philosophy probably reflects two facts: (1) lesser concern of the Soviets regarding operations at high altitudes and/or high ambient temperatures; and (2) a desire to operate at the  $\bar{c}_p$  values as close as possible to those corresponding to the maximum  $FM$  values. This latter aspect becomes a necessity because of their higher than Western power loadings which, in turn, may reflect the fact that Soviet engines exhibit much higher specific weights than their Western counterparts.

These high  $\bar{c}_p$  ( $C_T/\sigma$ ) values may be detrimental as far as controllability margins are concerned, especially at higher altitudes and/or elevated ambient temperatures.

**Main-Rotor Figures of Merit (Fig. 3.10).** Except for the manufacturer-given  $FM$  value for the 365N, all other  $FM$  values were estimated, trying to match airfoil sections, tip Mach, and representative Reynolds numbers of the investigated rotorcraft with available tower test measurements on isolated rotors; resulting in the  $FM_o = f(\bar{c}_\rho)$  relationships. This basic data was then corrected to the actual rotor solidity ratios using Eq (1.26a).

It can be seen from Fig. (3.10) that the so-estimated Mi-2 helicopter figure of merit values in hover are approximately the same as those of American machines of the same vintage (UH-1H), but lower than those of modern helicopters. The figure of merit of the Ka-26 was estimated as being on the modern Western level, due to the counter-rotating rotors.

**Tail-Rotor Thrust to Gross Weight, and Power to Rotor-Power Ratios (Fig. 3.11).** A glance at Fig. 3.11 would indicate that the tail-rotor thrust to gross-weight ratios of the Mi-2 helicopters are quite similar to those of Western helicopters (about 0.065). However, the power ratios appear slightly lower than those of conventional Western helicopters and considerably lower than that of the Fenestron-equipped 365N helicopter.

**Overall Figures of Merit (Fig. 3.12).** For the compared helicopters (excluding the BO-105 and UH-1H), the overall figures of merit were computed as an average between those estimated independently and those deduced from the published hovering ceiling OGE data.

However, test data showing a relationship between gross weight and shaft horsepower required in hover OGE at SL, ISA was obtained for the BO-105, courtesy of Boeing Vertol (Fig. 3.13). This enabled one to compute  $FM_{oa}$  directly from Eq (1.1), and the so-obtained value was taken as the “actual” overall figure of merit.

Fig. 3.13 also made possible the plot of  $FM_{oa} = f(\bar{c}_\rho)$  as shown in Fig. 3.14, from which one can see that the  $FM_{oa}$  value derived in Table 3.2 is very close to that obtained from flight tests.

Generalized hovering data on the relationship between SHP required in hover OGE and gross weight for the UH-1H helicopter are given in Fig. A-9 of Ref. 8, in the form of engine power coefficient  $C_{PE} = f(C_w)$ , where  $C_w$  is the weight coefficient. Using those coefficients,  $W_{gr}$  and  $SHP$  can be expressed as follows:

$$W_{gr} = \pi R^2 \rho V_t^2 C_w \quad (3.1)$$

and

$$SHP = \pi R^2 \rho V_t^3 C_{PE} / 550 \quad (3.2)$$

Using Eq (3.1), the ideal power can be expressed as

$$RHP_{id} = 0.707 \pi R^2 \rho V_t^3 C_w^{3/2} / 550 \quad (3.3)$$

Dividing Eq (3.3) by Eq (3.2), the sought overall figure of merit is obtained:

TABLE 3.2

HOVERING AND VERTICAL CLIMB ASPECTS, ISA  
UP TO 12,000-LB GROSS WEIGHT CLASS

ITEM	HELICOPTER									
	Mil Mi-2	Mil M-2 Allison	Kamov Ka-26	Aerospatiale SA-365N	Sikorsky S-76	Bell UH-1H	MBB BO-105	Bell 222		
GROSS WEIGHT, lb	7826	7826	6615*	8488	10,000	9500	5114	7850		
MAIN ROTOR R, ft	23.88	23.88	21.32	19.57	22.0	24.0	16.14	19.87		
Disc Loading, psf	4.37	4.37	4.63	7.05	6.58	5.25	6.25	6.33		
Ideal Ind. Velocity; $v_{id}$ , fps	30.30	30.30	31.19	38.53	37.18	33.21	36.24	36.5		
Tip Speed; $V_t$ , fps	615.0	615.0	580	717	675	814	716.5	724		
$v_{id}/V_t$	0.049	0.049	0.054	0.054	0.055	0.043	0.051	0.050		
Solidity	0.0525	0.0525	0.0734	0.0821	0.0747	0.0464	0.0702	0.0763		
Download Factor	[1.025]	[1.025]	[1.025]	[1.05]	[1.025]	[1.025]	[1.025]	[1.030]		
Avg. Blade Lift Coefficient	0.569	0.569	0.485	0.422	0.500	0.485	0.437	0.41		
FM	[0.63]	[0.63]	[0.66]	0.75 <sup>‡</sup>	[0.71]	[0.625]	[0.625]	[0.71]		
TAIL ROTOR R, ft	4.43	4.43		1.476	4.0	4.25	3.115	3.25		
$R_{tr}/R_{mr}$	0.186	0.186		0.075	0.182	0.177	0.193	0.164		
Distance $x$ , ft	29.2	29.2		21.1	26.71	28.86	19.52	23.28		
Relative distance $\bar{x}$	1.223	1.223		1.078	1.214	1.203	1.207	1.172		
$T_{tr}/W_{gr}$	0.064	0.064		0.072	0.067	0.062	0.067	0.064		
Disc Loading, psf	8.18	8.18		89.9	13.29	10.54	11.16	15.14		
Tip Speed; fps	672.5	672.5		725.4	674	736	717.5	643		
Solidity	0.104	0.104		0.40	0.172	0.105	0.121	0.163		
Blocking Factor	1.0	1.0		—	1.1	0.467	0.45	1.1		
Average Blade-Lift Coefficient	0.44	0.44		—	[0.60]	[0.60]	[0.60]	0.623		
Estimated FM	[0.60]	[0.60]		0.65 <sup>‡</sup>	0.114	0.097	0.093	[0.63]		
Power Ratio ( $RP_{tr}/RP_{mr}$ )	0.088	0.088		0.20	0.86	0.875	0.878	0.116		
OVERALL EFFICIENCY, $\eta_{0a}$	0.88	0.88	0.091	0.80	0.86	0.875	0.878	0.869		
OVERALL FM	0.54	0.54	0.58	0.55	0.58	0.527	0.556	0.59		

Hover Ceiling OGE, ft	2100	1575	2625	3300	2800	4000	6500 <sup>†</sup>	4600
Hover Ceiling IGE, ft	5600	4331			6200	13,600	9514 <sup>†</sup>	7700
SL TO: $W_{gr}/SHP$ , lb/hp	9.78	9.32	10.18	6.43	7.69	8.63**	7.41	7.63
Rel Lapse @ Hover Ceiling OGE	0.985	0.94	0.95	0.91	0.93	0.88		0.89
Overall FM	0.555	0.56	0.63	0.520	0.583	0.553**	0.562 <sup>††</sup>	0.550
AVERAGE OVERALL FM	0.550	0.550	0.605	0.535	0.582	0.540	0.562 <sup>††</sup>	0.570
RATE OF CLIMB, fpm	[80]	[250]	[180]	[415]	[510]	[210]	[615]	680 <sup>‡</sup>
Hover GW; OGE @ SL, lb	[7870]	[8200]	[6760]	[9000]	[10,800]	[9930]	[5620]	[8480]
Hover GW; OGE @ 3000 ft, lb	[7670]	[7470]	[6225]	[8700]	[9900]	[9600]	[5452]	[8230]

NOTES:

\* Hover Ceiling OGE is given at this GW only

\*\* Based on Transmission Limit

<sup>†</sup> at  $W_{gr} = 4405$  lb

<sup>††</sup> from Flight Tests

<sup>‡</sup> from Manufacturer's Data

Assumed or rough estimated values are shown in brackets [ ].

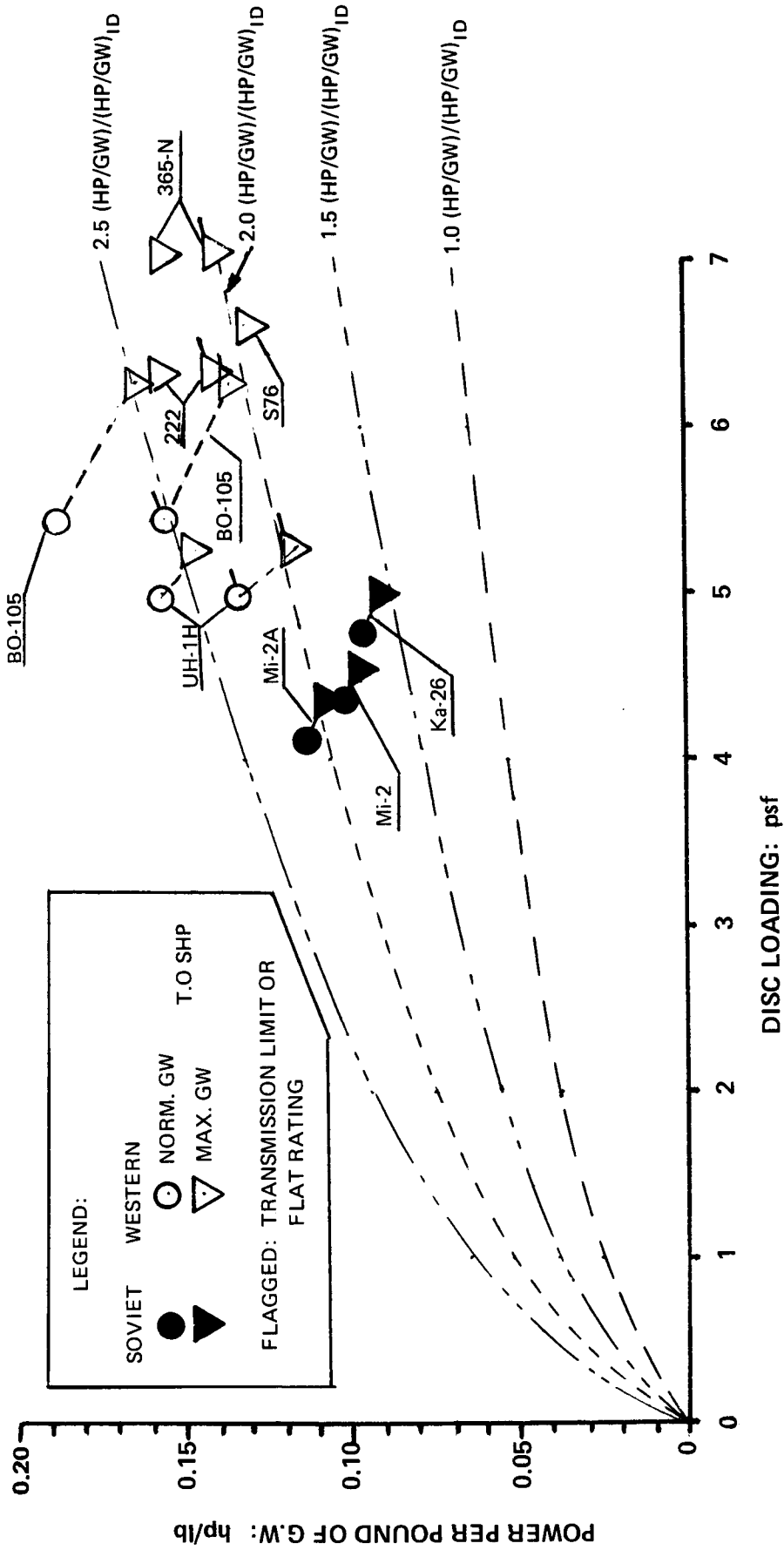

Figure 3.8 Power per pound of gross weight in comparison with ideal power, shown vs disc loading for Soviet & Western helicopters of up to 12,000-lb gross weight.

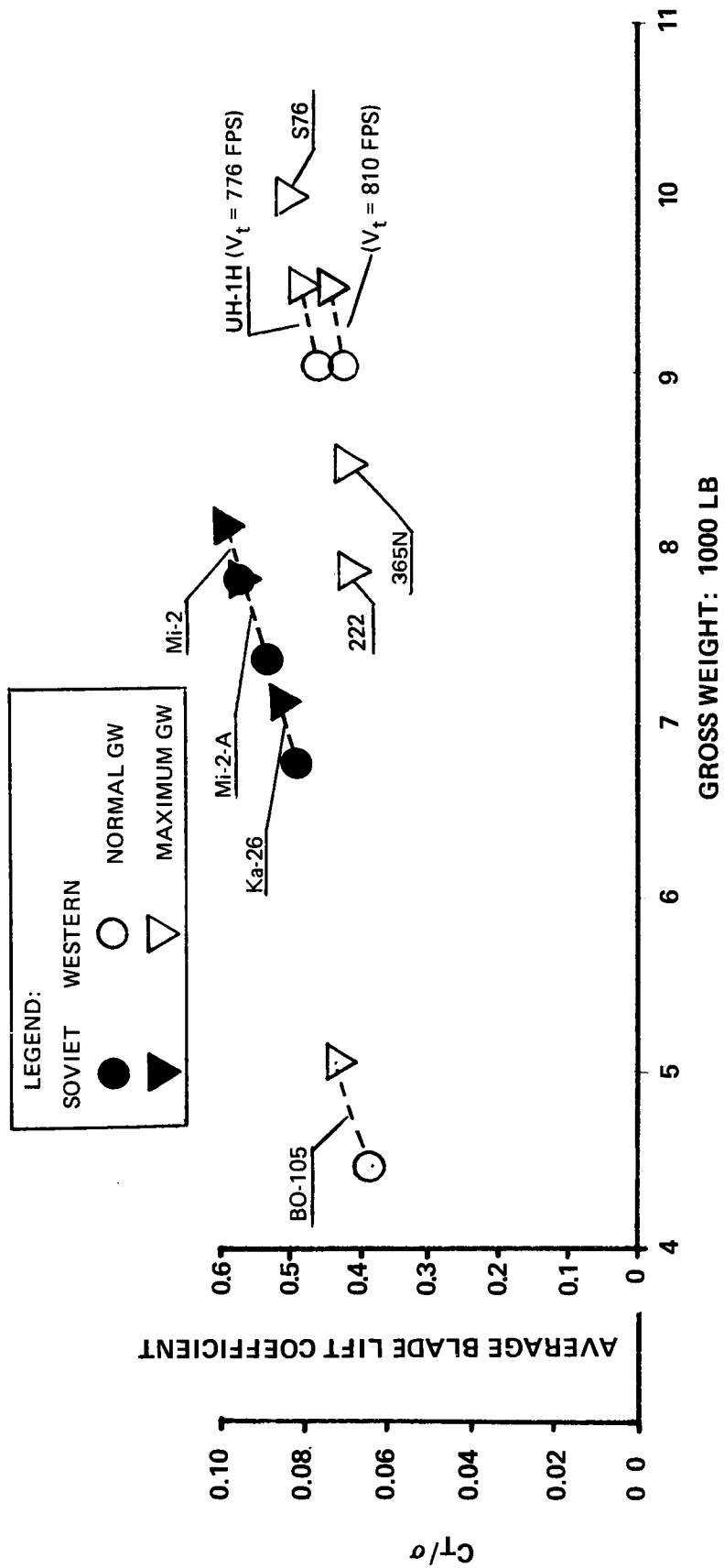

Figure 3.9 Average blade lift coefficients &  $C_T/\sigma$  in OGE hover at SL, ISA of Soviet & Western helicopters of up to 12,000-lb gross weight

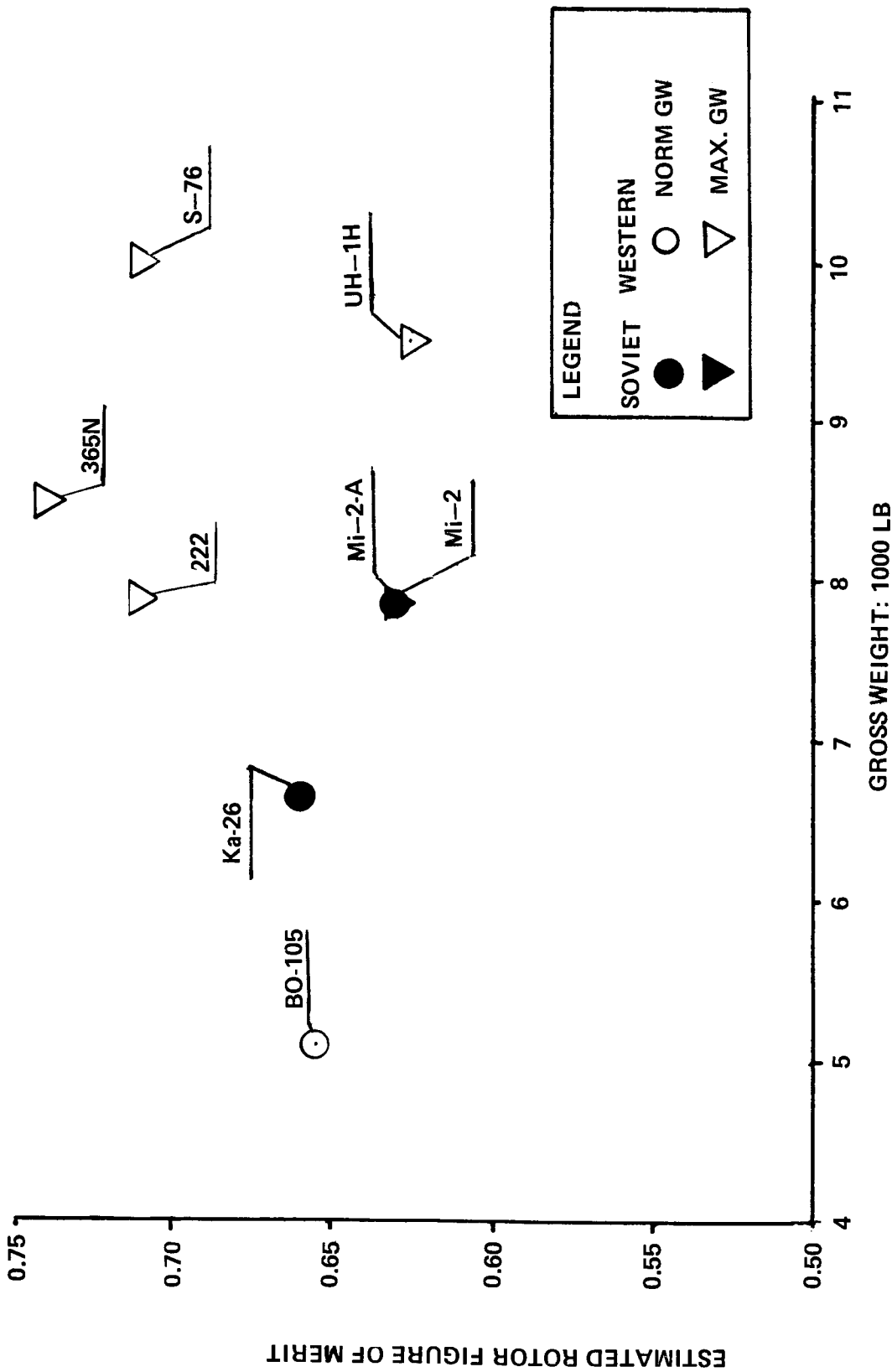

Figure 3.10 Estimated main-rotor figures of merit in OGE hover, at SL, ISA of Soviet and Western helicopters of up to 12,000-lb gross weight.



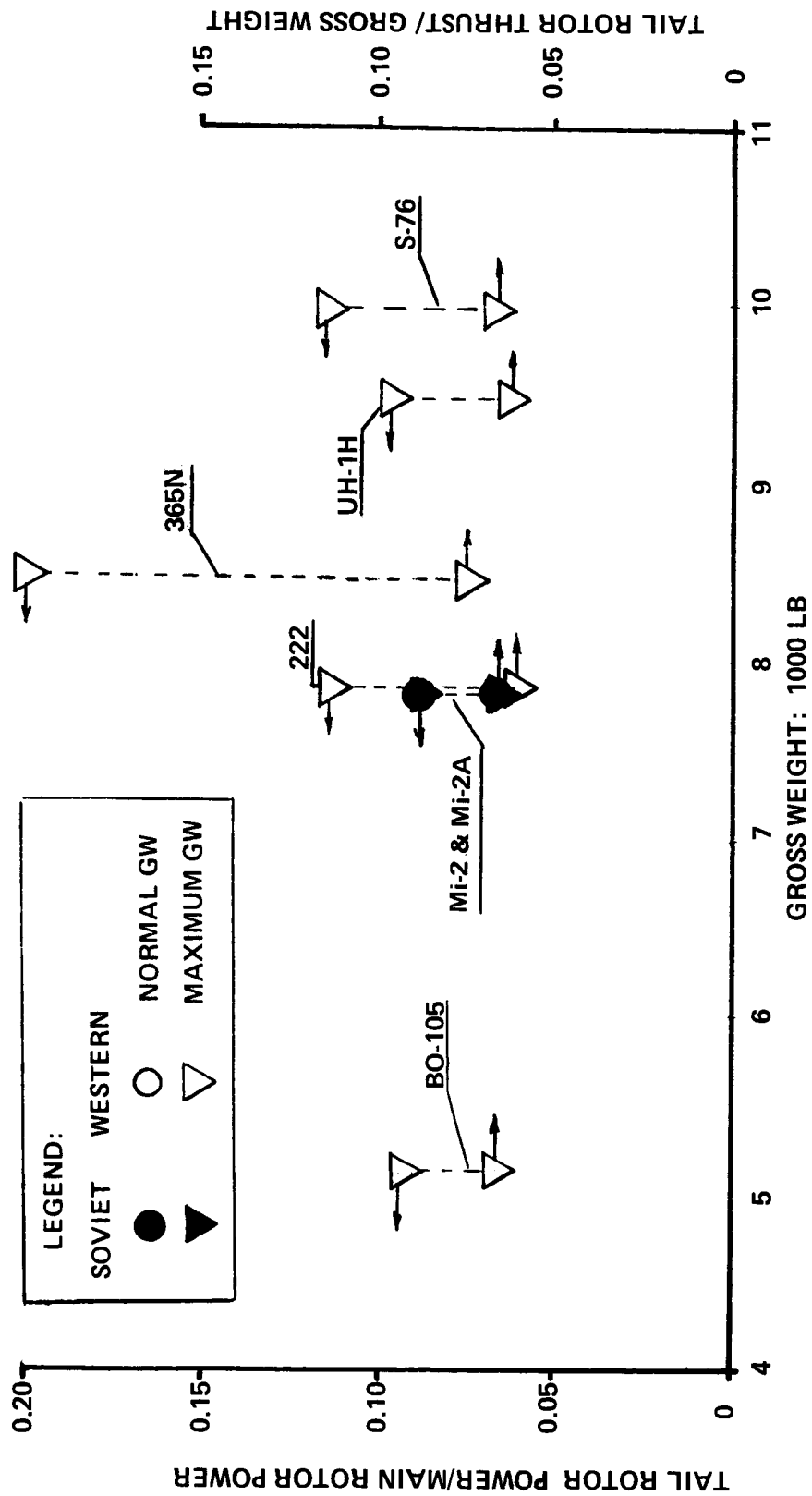

Figure 3.11 Tail-rotor thrust to gross weight & power to main-rotor power ratios of Soviet & Western helicopters of up to 12,000-lb gross weight.

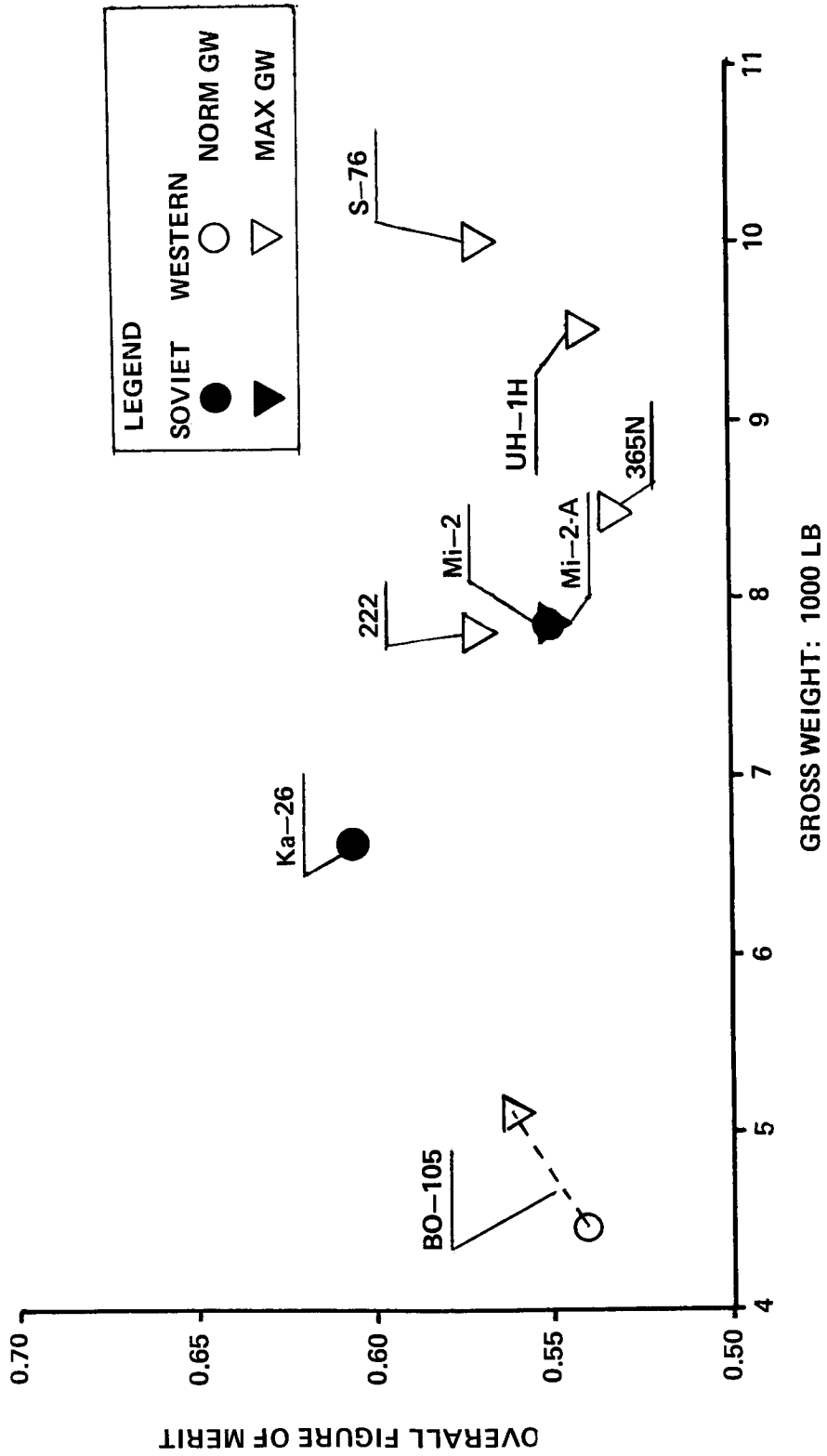

Figure 3.12 Comparison of overall figure of merit of Soviet & Western helicopters of up to 12,000-lb gross weight.

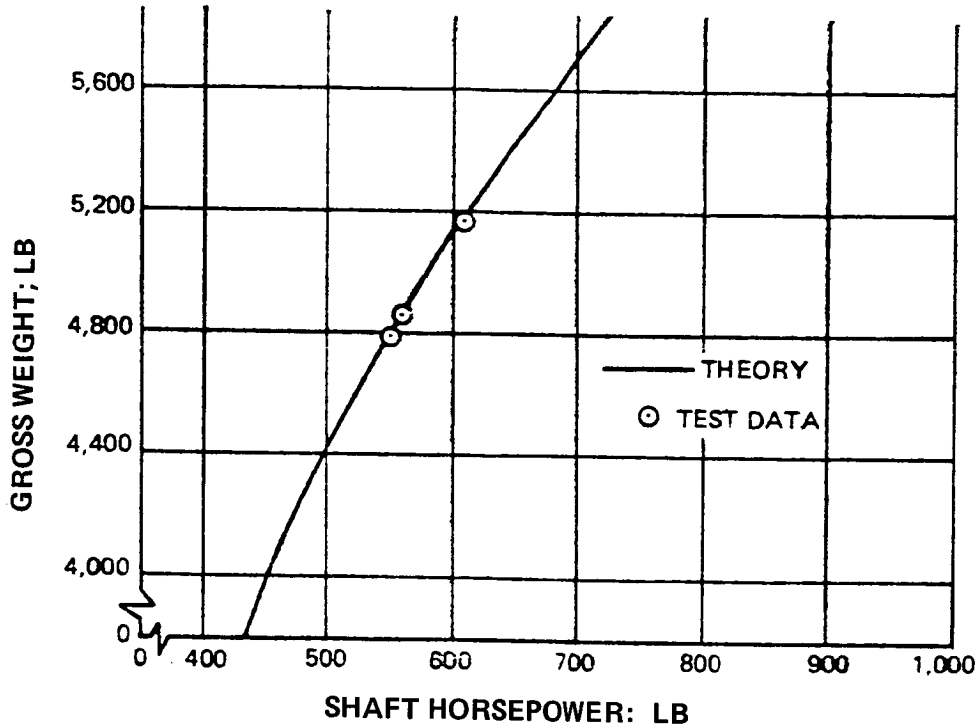

Figure 3.13 Correlation of theory with BO-105 flight-test data in hover (Courtesy of Boeing Vertol Co.)

$$FM_{oa} = 0.707C_w^{3/2}/C_{PE} \quad (3.4)$$

An expression for the average blade lift coefficient based on  $C_w$  can also be obtained from Eq (3.1) as

$$\bar{c}_p = k_{vh} 6C_w/\sigma \quad (3.5)$$

Using the data presented in Fig. A.9<sup>8</sup>, the  $FM_o = f(\bar{c}_p)$  curve was calculated for the UH-1H, and the results are shown in Fig. 3.14. Here, it can be seen that, as in the case of the BO-105, the value of the overall figure of merit as obtained in Table 3.2 is very close to those resulting from flight tests.

In the case of the 365N helicopter, a  $SHP = f(V)$  curve as SL, ISA is shown in Fig. 5 of Ref. 9 for  $W_{gr} = 7055$  lb. Taking advantage of this data,  $FM_{oa}$  was computed from Eq (1.1). The so-obtained  $FM_{oa} = 0.523$  is somewhat lower than the average value of 0.534 shown in Table 3.2; but this may be expected since  $FM_{oa} = 0.534$  corresponds to  $\bar{c}_p = 0.534$ , while  $FM_{oa} = 0.523$  corresponds to  $\bar{c}_p = 0.72$ .

The above three cases should give some degree of confidence in the accepted method of providing the  $FM_{oa}$  values of the compared helicopters.

Going back to Fig. 3.12, it can be seen that the  $FM_{oa}$  values for the Mi-2 helicopters are approximately on the same level as those of the BO-105 and UH-1H, lower than for the S-76 and 222, but higher than for the 365N. As far as the Ka-26 is concerned, its overall figure of merit (due to the counter-rotating configuration) is higher than those of Western helicopters.

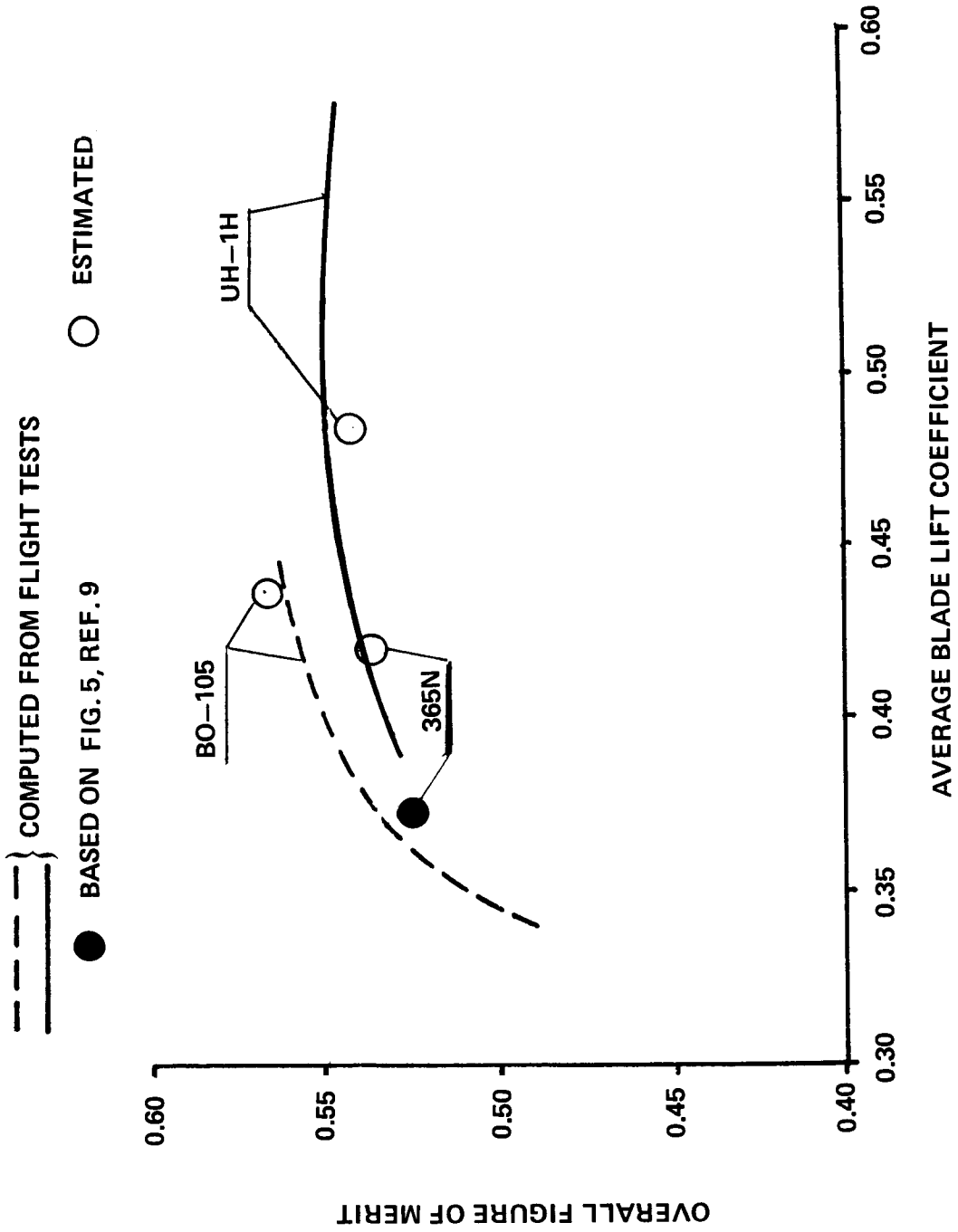

Figure 3.14 Comparison of estimated  $FM_{0g}$  values with those resulting from flight tests or manufacturer's data

**VTO Gross Weight.** VTO gross weights (defined here as the  $W_{gr}$  corresponding to hovering OGE at 3000-ft altitude ISA) were calculated for the compared helicopters using Eq (1.2) and listed in the last row of Table 3.2. Here, it can be seen that for Soviet Mi-2 and Ka-26 helicopters the so-called VTO gross weights are lower than their normal gross weights, and are below the maximum flying weight of the Mi-2-A helicopter. By contrast, the VTO gross weights of the Western rotorcraft either exceed the maximum flying weights (BO-105, Bell 222, UH-1H, and SA-365N) or, at least, are almost equal to the maximum gross weight values (S-76).

**Vertical Rates of Climb.** Vertical rates of climb at SL, ISA and T.O engine power setting as computed from Eq (1.9) are listed in the third row from the bottom of Table 3.2. These values refer to the gross weights indicated in the first row, and are plotted in Fig. 3.15.

In addition, the vertical rates of climb were also calculated for the VTO gross weights and indicated on this figure. It is interesting to note that for helicopters having transmission-limited power inputs (BO-105, 222, and UH-1H) or flat rated engines (Mi-2), the vertical rate of climb at  $(W_{gr})_{VTO}$  is about 180 fpm; while for powerplants exhibiting a continuous decrease of power with altitude, the vertical rate of climb at the VTO gross weight is about 500 fpm.

### 3.3 Energy Aspects in Hover

**Table 3.3.** The most important inputs required in the study of energy aspects in hover, as well as numerical values of hourly fuel consumption per pound of gross weight and zero-time payload are indicated in Table 3.3. The results are also graphically presented in Figs. 3.16 and 3.17.

**Hourly Fuel Consumption per Pound of GW in Hover, OGE, SL, ISA (Fig. 3.16).** It is interesting to note that with the original GTD-350 engine, the Mi-2 helicopter has one of the highest relative hourly fuel consumption of all compared helicopters. Through installation of the Allison 250-C20B turbines, this consumption is brought to a lower level than that of the Western counterparts. One's attention should also be called to the low relative fuel consumption of the Ka-26—resulting from its high  $FM_{OB}$  values, and from the utilization of reciprocating engines.

**Hourly Fuel Consumption per Pound of Payload in Hover, OGE, SL, ISA (Fig. 3-17).** This figure clearly indicates that the original Mi-2 helicopter exhibits much larger fuel consumption related to the payload than any other compared helicopter. Installation of the Allison turbine in that aircraft results in a very considerable improvement, placing that machine on the same level of hovering fuel economy as several Western helicopters.

It should be noted that the hovering fuel economy of the Ka-26 aircraft remains close to that of the Western representatives, in spite of its low  $W_{p/O}/W_{gr}$  ratio.

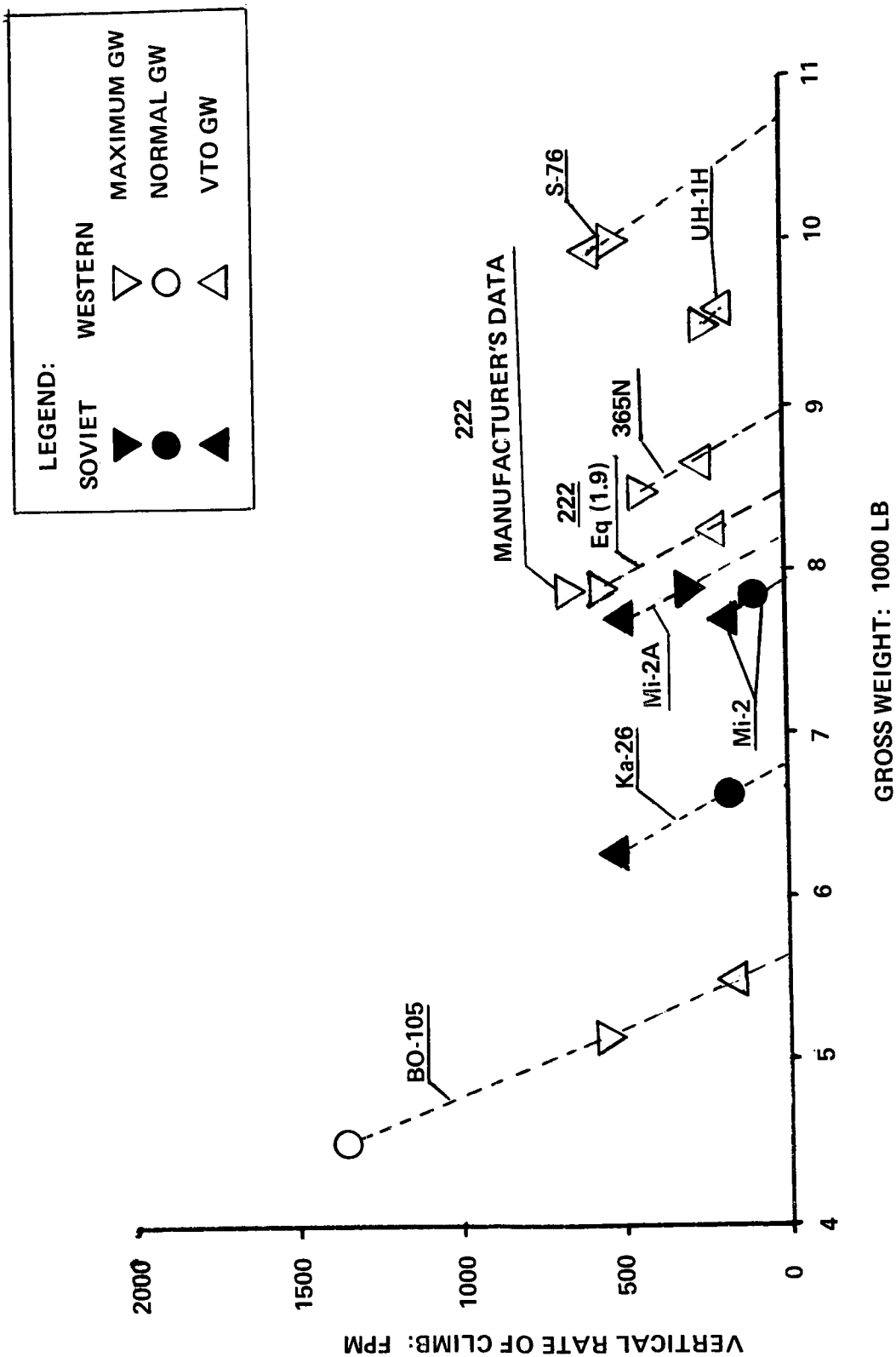

Figure 3.15 Vertical rates of climb at SL, ISA and T.O. or transmission-limit power settings, for various gross weights of Soviet & Western helicopters weighing up to 12,000 lb.

TABLE 3.3  
ENERGY ASPECTS IN HOVER, S/L, ISA  
UP TO 12,000-LB GROSS-WEIGHT CLASS

ITEM	HELICOPTER							
	Mil Mi-2	Mil Mi-2 Allison	Kamov Ka-26	Aerospatiale SA-365N	Sikorsky S-76	Bell UH-1H	MBB BO-105	Bell 222
GROSS WEIGHT, LB	7826	7826	6615	8488	10,000	9500	5114	7850
Overall Figure of Merit	0.550	0.550	0.605	0.535	0.582	0.540	0.562	0.570
SHP Required in Hover, hp	777	777	610	1130	1158	1053	605	914
T.O SHP Installed; hp	800	840	650	1320	1300	1400	840	1350
$SHP_{req}/SHP_{TO}$	0.97	0.925	0.94	0.86	0.89	0.75	0.72	0.67
sfc, lb/hp-hr	0.810	0.635	0.595	0.613	0.610	0.625	0.71	0.620
Hourly Fuel Flow per Pound of GW; lb/hr-lb	0.0804	0.0630	0.0549	0.0821	0.0706	0.0692	0.0840	0.0720
Ratio of Zero-Time PL ( $PL_0$ ) to GW	0.322	0.344	0.286	0.476*	0.398	0.407	0.405	0.327
Hourly Fuel Flow per Lb of PL for $t = 0$ ; lb/lb-hr	0.250	0.183	0.192	0.172	0.177	0.170	0.207	0.220
$t = 1/3$ hr	0.272	0.195	0.202	0.183	0.186	0.182	0.229	0.233
$t = 2/3$ hr	0.300	0.209	0.220	0.195	0.197	0.192	0.241	0.251
$t = 1$ hr	0.333	0.224	0.239	0.208	0.209	0.205	0.262	0.270

\*One Pilot

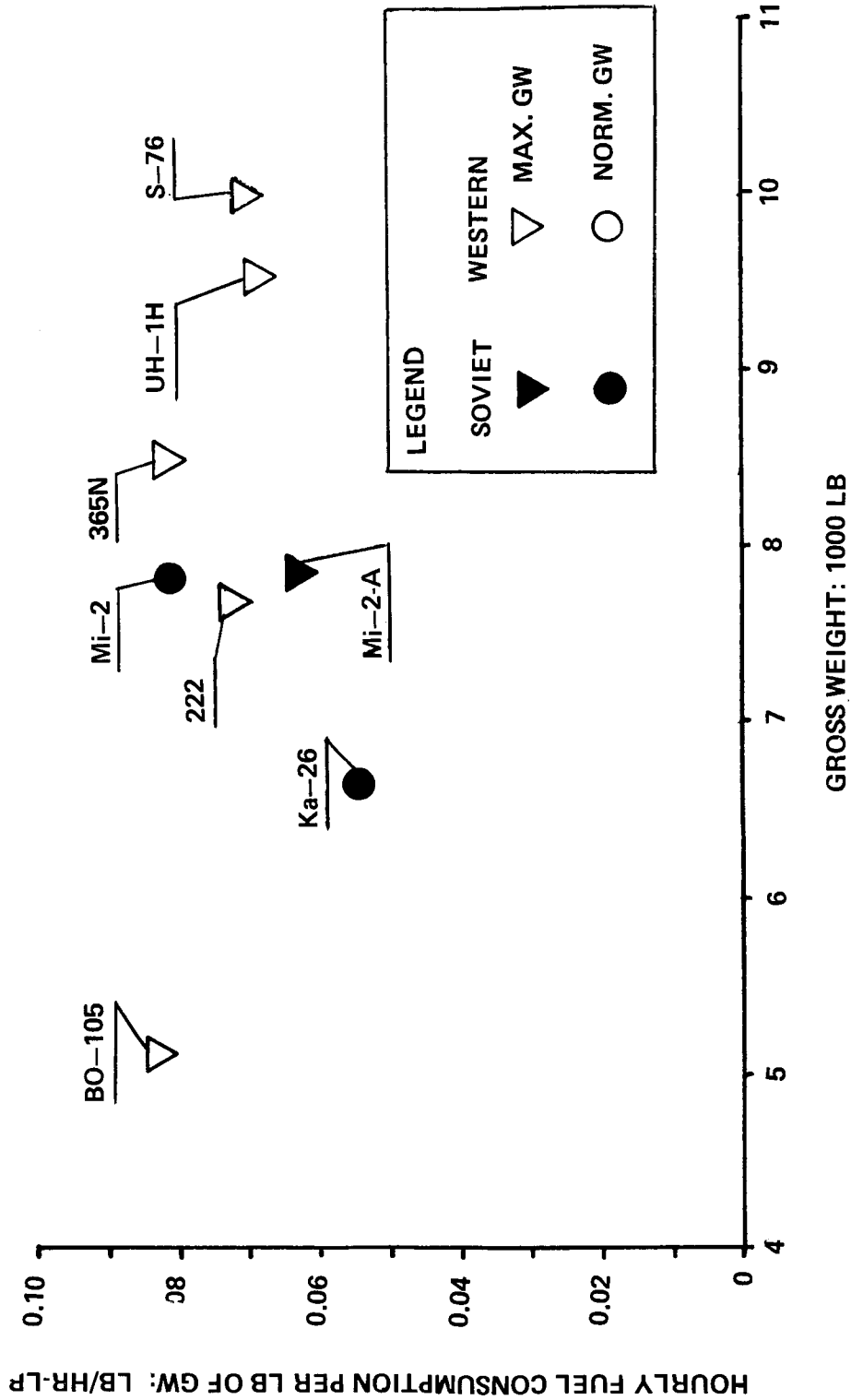

Figure 3.16 Hourly fuel consumption per pound of GW in OGE hover at SL, ISA of Soviet & Western helicopters of the up to 12,000-lb GW class



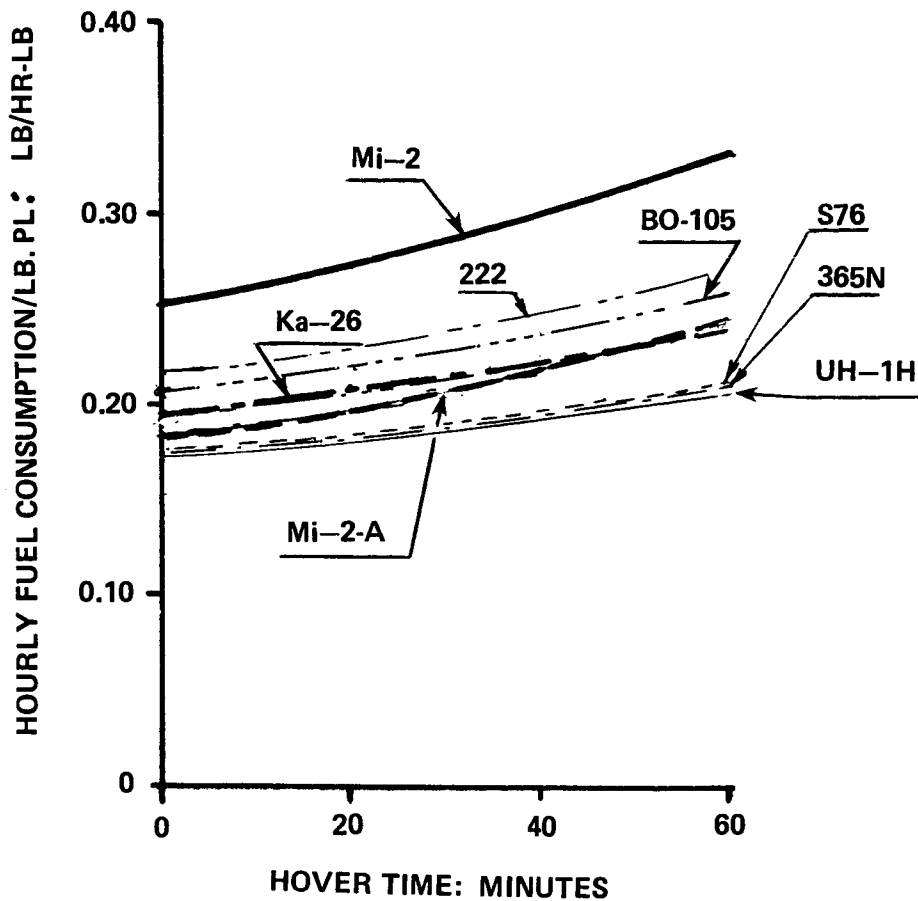

Figure 3.17 Variation with time of hourly fuel consumption per pound of maximum payload in hover OGE at SL, ISA for Soviet & Western helicopters of up to 12,000-lb gross weights.

### 3.4 SHP Required Aspects in Level Flight at SL, ISA

$(SHP/W_{gr}) = f(V)$  Relationship. As indicated in Section 1.5, the  $(SHP/W_{gr}) = f(V)$  relationship for the compared helicopters is established on the basis of the  $SHP = f(V)$  data obtained from flight tests, manufacturer's publications, or published performance figures (e.g., Refs. 2 and 3). In the case of helicopters having gross weights of up to 12,000 lb, the manufacturer's data under the form of the  $(SHP/W_{gr}) = f(V)$  relationship at SL, ISA was directly given by Aerospatiale Company for the 365N helicopter at  $W_{gr} = 8488$  lb, and by the Sikorsky Company for the S76 at  $W_{gr} = 10,000$  lb. These inputs are shown in columns 4 and 5 of Table 3.4, and were later used for the  $w_{fp}$  and  $f$  estimates.

Published flight test results can be found for the UH-1H helicopter under the form of generalized  $C_p = f(C_T)$  graphs from which the  $(SHP/W_{gr}) = f(V)$  relationship at the desired gross weight ( $W_{gr} = 9500$  lb) and flight altitude (SL, ISA) can be directly calculated.

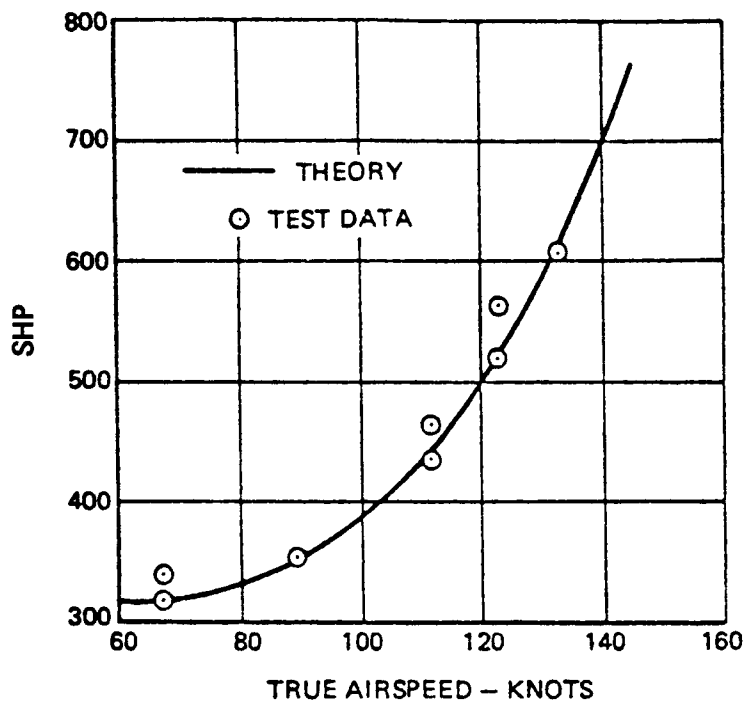

Figure 3.18  $SHP = f(V)$  for the BO-105 helicopter in level flight at air density  $\rho = 0.00199$  slugs/cu.ft., and average  $W_{gr} = 5005$  lb.

Flight test data for the BO-105 helicopter (courtesy of Boeing Vertol Company) are shown in Fig. 3.18, where the  $SHP = f(V)$  curve is given for  $W_{gr} = 5005$  lb, and air density  $\rho = 0.00199$  slugs/cu.ft. Here, as in the case of the SA-365N helicopter, using inputs from Fig. 3.18,  $w_f$  and  $\bar{c}_d/\bar{c}_\rho$  values were computed and then the  $(SHP/W_{gr}) = f(V)$  curve was established for  $W_{gr} = 5114$  lb and SL, ISA conditions.

For the remaining helicopters, the procedure based on the known  $V_{max}$  or  $(V_{cr})_{max}$  and maximum rate of climb in forward flight values, as outlined in Sect. 1.5 was used.

Various steps leading to the establishment of the  $(SHP/W_{gr}) = f(V)$  relationship are clearly visible in Table 3.4. It can be seen that the computational procedures consisted first of determining the overall "transmission" efficiency values ( $\eta_{oa}$ ) at  $V_{max}$ , or the maximum flying cruise speed on the basis of the known power at those speeds. Check calculations performed at the speed ( $V_e$ ) corresponding to  $SHP_{min}$  indicated that under those conditions, the  $(RHP_{tr}/RHP_{mr})$  ratios remained very close to those established at  $V_{max}$  and  $V_{cr,max}$ . Consequently, only the  $\eta_{oa}$  values computed for  $V_{max}$  and  $V_{cr,max}$  were used in the subsequent  $(SHP/W_{gr}) = f(V)$  calculations.

TABLE 3.4  
FORWARD FLIGHT ASPECTS AT SL, ISA  
UP TO 12,000-LB GROSS WEIGHT CLASS

ITEM	HELICOPTER									
	Mil Mi-2	Mil-Mi-2 Allison	Kamov Ka-26	Aerospatiale SA-365-N	Sikorsky S-76	Bell UH-1H	MBB BO-105	Bell		
GROSS WEIGHT: lb	7826	7826	7165	8488	10,000	9500	5005**	7850		
$\eta_{oa}$ Estimate at $V_{max}$ or $V_{cr}$ : kn	113	113	91	140	145	110	132**	141		
SHP: hp	630	740	550	1153	1114	1100	610**	1029		
~Main Rotor RHP: hp	554	666	-	1084	958	962	549	875		
Main Rotor $V_t$ : fps	615	615	580	733.7	675	780	716.5	724		
Torque Compensating Thrust: lb	405.4	512.4			613.0	587.1	348	567		
Tail Rotor Disc Loading: psf	6.576	8.313			12.198	10.348	11.44	17.0		
Tail Rotor $\bar{c}_d$	0.421	0.532			0.357	0.408	0.463	0.536		
Tail Rotor $\bar{c}_d/\bar{c}_g$	[0.0105]	[0.011]			[0.010]	[0.010]	[0.011]	[0.012]		
Tail Rotor $\bar{c}_d/\bar{c}_g$	[1/40]	[1/48]			[1/35]	[1/40]	[1/42]	[1/44]		
Tail Rotor Power: hp	18.49	25.41			39.84	34.14	19.63	35.0		
RHP <sub>tr</sub> /RHP <sub>mr</sub>	0.03	0.038			0.04	0.035	0.036	0.04		
$\eta_{oa}$ at $V_{max}$ or $V_{crmax}$	0.932	0.925	0.89	0.95	0.923	0.928	0.927	0.923		
$(SHP/W_{gr}) = f(V)$ : 1st Approx.										
$M_{toa}$ at $V_{max}$ or $V_{crmax}$	0.722	0.722	0.658	0.907	0.825	0.8655	0.842	0.862		
$\mu$ at $V_{max}$ or $V_{crmax}$	0.3105	0.3105	0.265	0.338	0.363	0.238	0.311	0.329		
Main Rotor Disc Loading: psf	4.37	4.37	$w' = 4.5^*$	7.05	6.58	5.25	6.12	6.33		
Main Rotor $\bar{c}_g$	0.569	0.569	0.512	0.42	0.487	0.485	0.512	0.436		
Main Rotor $\bar{c}_d$	[0.011]	[0.011]	[0.010]	[0.008]	[0.0085]	[0.0095]	[0.010]	[0.008]		
Main Rotor $\bar{c}_d/\bar{c}_g$	[1/50]	[1/50]	[1/50]	[1/52.5]	[1/57]	[1/51]	[1/48.5]	[1/54.5]		
$k_{vf}$	[1.02]	[1.02]	[1.02]	[1.02]	[1.02]	[1.02]	[1.02]	[1.02]		
$k_{indf}$	[1.15]	[1.15]	[1.12]	[1.15]	[1.15]	[1.15]	[1.15]	[1.15]		
Computed $w_f$ : psf	286.0	286.0	222.5	345.0	493.0	286.0	286.0	360.0		
Computed $V_e$ : kn	57.1	57.1	53.7	67.5	71.9	67.9	67.9	66.4		
Computed $SHP_{min}$ : hp	391.3	391.3	377.6	525	550	324.4	324.4	515.3		

(Cont'd)

Table 3.4 (Cont'd)

$(SHP/M_{gr}) = f(V)$ : 2nd Approx.																				
Max. R/C at SL, ISA: fpm	885	1319	—	—	—	—	—	—	—	—	—	—	—	—	—	—	—	—	1590	
Excess SHP: hp	246.9	368	—	—	—	—	—	—	—	—	—	—	—	—	—	—	—	—	460	
$SHP_{min}$	383.1	372	320	320	515	530	770	770	530	320*	320*	—	—	—	—	—	—	569	—	
$(SHP/M_{gr})$ at $V_{max}$ or $V_{crmax}$	—	0.0946	0.0768	0.0768	0.1359	0.095	0.095	0.095	0.095	0.1218*	0.1218*	—	—	—	—	—	—	0.1311	—	
$(SHP/M_{gr})$ at $V_e$	—	0.0475	0.045	0.045	0.0605	0.053	0.053	0.053	0.053	0.0639*	0.0639*	—	—	—	—	—	—	0.0723	—	
$f$ : sq.ft	29.27	29.27	40.6	40.6	22.8	17.9	17.9	17.9	17.9	18.0	18.0	—	—	—	—	—	—	17.0	—	
$wfp$ : psf	267.4	267.4	176.4	176.4	372.2	560	560	560	560	277.9	277.9	—	—	—	—	—	—	462	—	
main Rotor $\bar{c}_d/\bar{c}_g$	1/59	1/59	1/86 (?)	1/86 (?)	1/45	1/55.6	1/55.6	1/55.6	1/55.6	1/58.3	1/58.3	—	—	—	—	—	—	1/33 (?)	—	
main Rotor $\bar{c}_d$	0.0096	0.0096	0.0059 (?)	0.0059 (?)	0.0093	0.0088	0.0088	0.0088	0.0088	0.00926	0.00926	—	—	—	—	—	—	0.014 (?)	—	
$(SHP/M_{gr})$ : hp/lb at $V$ : kn, <u>SL, ISA</u>																				
0	0.0993	0.0993	0.096	0.096	0.1335	0.1150	0.1150	0.1150	0.1150	0.1108	0.1108	—	—	—	—	—	—	0.1164	—	
40	0.0513	0.0513	0.056	0.056	0.0735	0.0660	0.0660	0.0660	0.0660	0.0642	0.0642	—	—	—	—	—	—	0.0735	—	
60	0.0478	0.0478	0.054	0.054	0.0608	0.0540	0.0540	0.0540	0.0540	0.0580	0.0580	—	—	—	—	—	—	0.0633	—	
80	0.0565	0.0565	0.066	0.066	0.0637	0.0530	0.0530	0.0530	0.0530	0.0640	0.0640	—	—	—	—	—	—	0.0656	—	
100	0.0759	0.0759	0.091	0.091	0.0730	0.0590	0.0590	0.0590	0.0590	0.0801	0.0801	—	—	—	—	—	—	0.0765	—	
120	0.1069	0.1069	—	—	0.0916	0.0720	0.0720	0.0720	0.0720	0.1069	0.1069	—	—	—	—	—	—	0.0962	—	
140	—	—	—	—	0.1359	0.0950	0.0950	0.0950	0.0950	0.1507	0.1507	—	—	—	—	—	—	0.1250	—	

NOTES:

\* Taken from flight tests

\*\* Flight tests at  $\rho = 0.00199$  slug/cu.ft

(a) Manufacturer's data

(b) Average of the 2 single and 2 two-point computations

(c) Based on  $wfp$  and  $\bar{c}_d$  averaged from 1st and 2nd approximations  
Assumed or rough estimated values are shown in brackets [ ] .

This  $\eta_{oa}$  estimate was done through the so-called "first approximation" based on a single data point of  $SHP_{req}$  at  $V_{max}$  or  $V_{crmax}$ , and assumed values of  $k_{vf}$ ,  $k_{indf}$ , and  $\bar{c}_d/\bar{c}_f$ . Here, Eq (1.10) was solved for  $w_{fp}$  and then the flying speed  $V_e$  was computed from Eq (1.12), and the corresponding  $SHP_{min}$  obtained again from Eq (1.10).

In the "second approximation",  $SHP_{min}$  was estimated by calculating the excess  $SHP$ , using the known rate of climb at SL, ISA, and assuming climb efficiency  $\eta_{climb} = 0.85$ . The so-obtained  $SHP_{min}$  values were next compared with those from the first approximation.

It can be seen from Table 3.4 that for the Mi-2 helicopters, both results are close. It should be noted at this point that in developing the  $(SHP/W_{gr}) = f(V)$  relationship for Mi-2 and Mi-2-Allison helicopters, the performance data of the latter (as given in Ref. 10) were used in preference to those given in Jane's for the Mi-2. This was done because of a better consistency of the performance figures in Ref. 10.

With respect to the Ka-26 helicopter, this investigation could not find any data on the rate of climb at SL, ISA. However, a service ceiling of 500 m (1640 ft) at 7165-lb gross weight, and one engine inoperative is given in Jane's<sup>2</sup>. Assuming that the remaining engine operates at its takeoff power of 320 hp, and neglecting the power lapse, the minimal power-to-weight ratio of  $(SHP/W_{gr})_e = 0.045$  hp/lb was obtained.

When estimating the overall transmission efficiency of the Ka-26 in forward flight, engine cooling losses of 24.6 hp per engine had to be accounted for. Further assuming that  $\eta_{xm} = 0.96$  (to cover the actual transmission and accessory power losses), the following is obtained:

$$\eta_{oa} = [(640 - 49.2)/640] 0.96 = 0.89$$

It should also be noted that due to vertical separation of the rotors (3.83 ft), the slipstream cross-section area loading instead of the disc loading must be used in Eq (1.10). This slipstream cross-section loading ( $w$ ) becomes  $w' = 4.5$  psf.

With the above outlined additional inputs, further calculations of the  $w_{fp}$  and  $\bar{c}_d/\bar{c}_f$  values follow the two-point procedure outlined in Table 3.4 as a second approximation.

However, the so-obtained results, based on the assumption that the Ka-26 can be flown in horizontal flight at a gross weight of 7165 using only 320 shp, appear too optimistic ( $\bar{c}_d/\bar{c}_f = 1/86$ ), and somewhat pessimistic regarding the equivalent flat plate area loading ( $w_{fp} = 176$  psf). This means that the published performance figures should probably either be related to a lower gross weight (perhaps 6615 lb, given for hovering), or that the engines can operate at an emergency rating higher than 320 shp. Consequently, for this and the 222 helicopter (where large differences also appeared in  $w_{fp}$  and  $\bar{c}_d/\bar{c}_f$  values computed in the "first" and "second" approximations), the averages of the two computations were used in establishing the  $(SHP/W_{gr}) = f(V)$  relationship appearing in the last 7 rows of Table 3.4, and shown graphically in Fig. 3.19. The direct manufacturer's data for the 365N and S-76 helicopters is also shown in this figure.

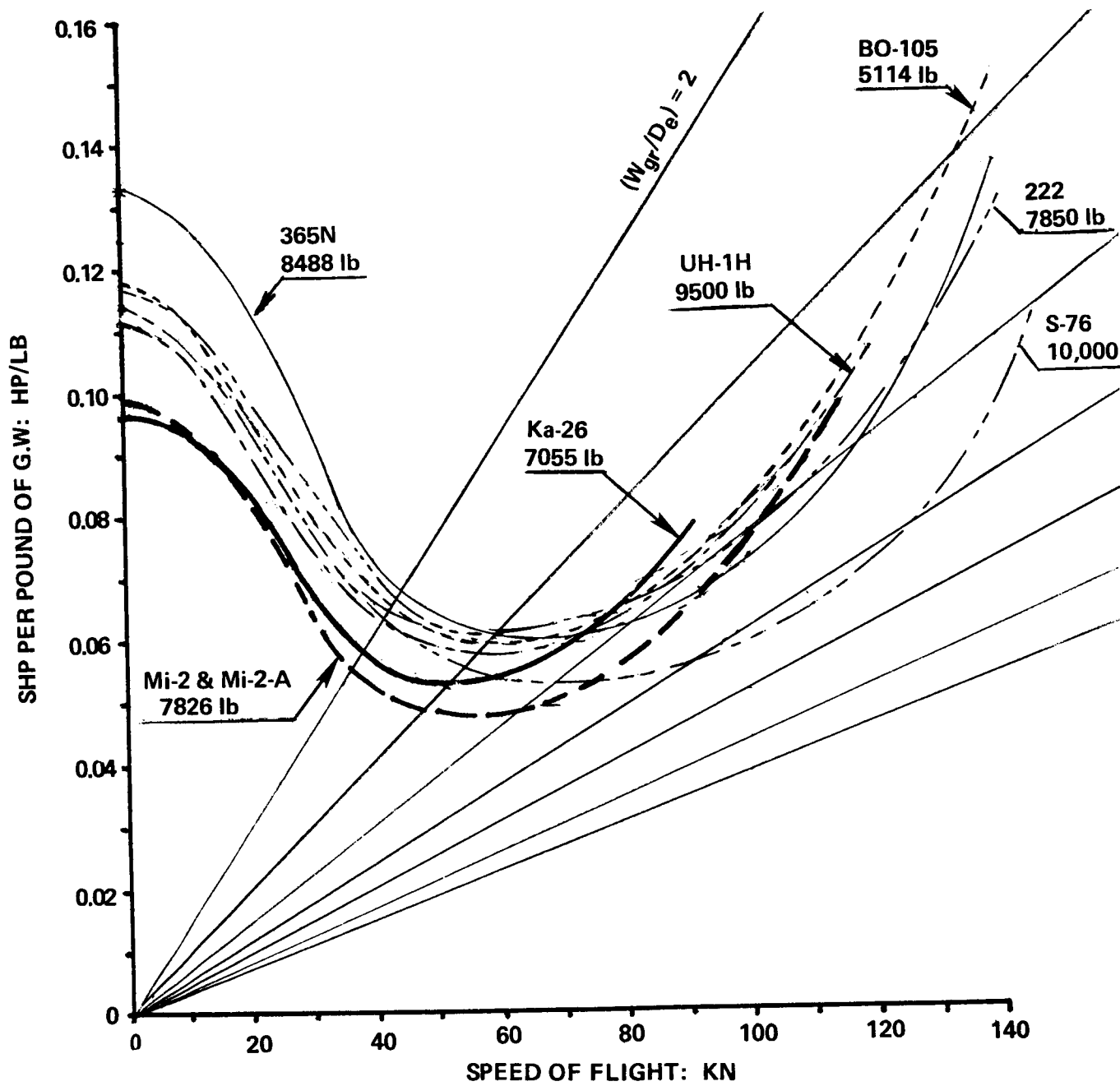

Figure 3.19 Comparison of shaft horsepower per pound of gross weight vs speed of level flight at SL, ISA of Soviet and Western helicopters of up to 12,000-lb gross weight class.

Because of the lower disc loading of Soviet helicopters, the power requirements per pound of gross weight in the low-speed flight regime are below those of their Western counterparts, as shown in Fig. 3.19. However, at high speeds, the  $(SHP/W_{gr})$  values of the Ka-26 helicopters rise sharply because of its relatively large flat-plate area as witnessed by the level of equivalent flat area loading of  $w_{fp} \approx 200$  psf (taken as an average of the first and second approximations).

The high speed  $(SHP/W_{gr})$  values of the Mi-2 helicopters are approximately on the same level as for the UH-1H and BO-105, but are above those of the 365N, 222 and, especially, S-76 helicopters.

With respect to  $(W_{gr}/D_e)_{max}$ , a glance at this figure would indicate that the Mi-2 helicopters achieve a maximum gross weight to the equivalent drag ratio of  $(W_{gr}/D_e)_{max} \approx 4.5$ , which is one of the highest for the considered gross-weight class. In contrast to the Mi-2, the Ka-26 represents the lowest level of about 3.75. Of the Western helicopters, only the S-76 attains a level of  $(W_{gr}/D_e)_{max} \approx 5.2$ .

$(SHP/W_{gr})$  Values at High Velocities. In Fig. 3.20, the  $SHP/W_{gr}$  values at high  $V$ 's are shown vs corresponding speeds. The third-degree parabolas representing the so-called cubic law of power dependence on speed are also marked in this figure. It is interesting to note that the points for the Mi-2 and UH-1H helicopters lie on the same parabola, the Ka-26 is above it, while the parabola passing through the S-76 lies well below the other one. Points representing the BO-105, 365N, and 222 are approximately half way between the two parabolas. This distribution of points reflects the degree of aerodynamic cleanness as given by the  $w_{fp}$  values (see Table 3.4) which, for the S-76 helicopter, reaches 560 psf, while they are approximately at one-half of that level for Mi-2 and UH-1H helicopters.

### 3.5 Energy Aspects in Forward Flight

Fuel Requirements per Pound of Gross Weight. The numerical inputs needed for a determination of fuel requirements per pound of gross weight and one hour; or 100 nautical miles, are shown in Table 3.5. This table was prepared for the gross weights shown in the first row of Table 3.4, and the  $(SHP/W_{gr}) = f(V)$  values as listed in the last seven rows of that table. All the gross weights considered in Tables 3.4 and 3.5 represent maximum flying weights.

The resulting fuel flow per pound of gross weight and hour for the compared helicopters is shown in Fig. 3.21. The auxiliary grid in this figure permits one to judge at a glance how those helicopters compare from the point of view of fuel utilization per pound of gross weight and distance flown (selected here as 100 n.mi). In addition, this fuel consumption per pound of gross weight and 100 n.mi is shown as a function of flying speed in a separate graph (Fig. 3.22).

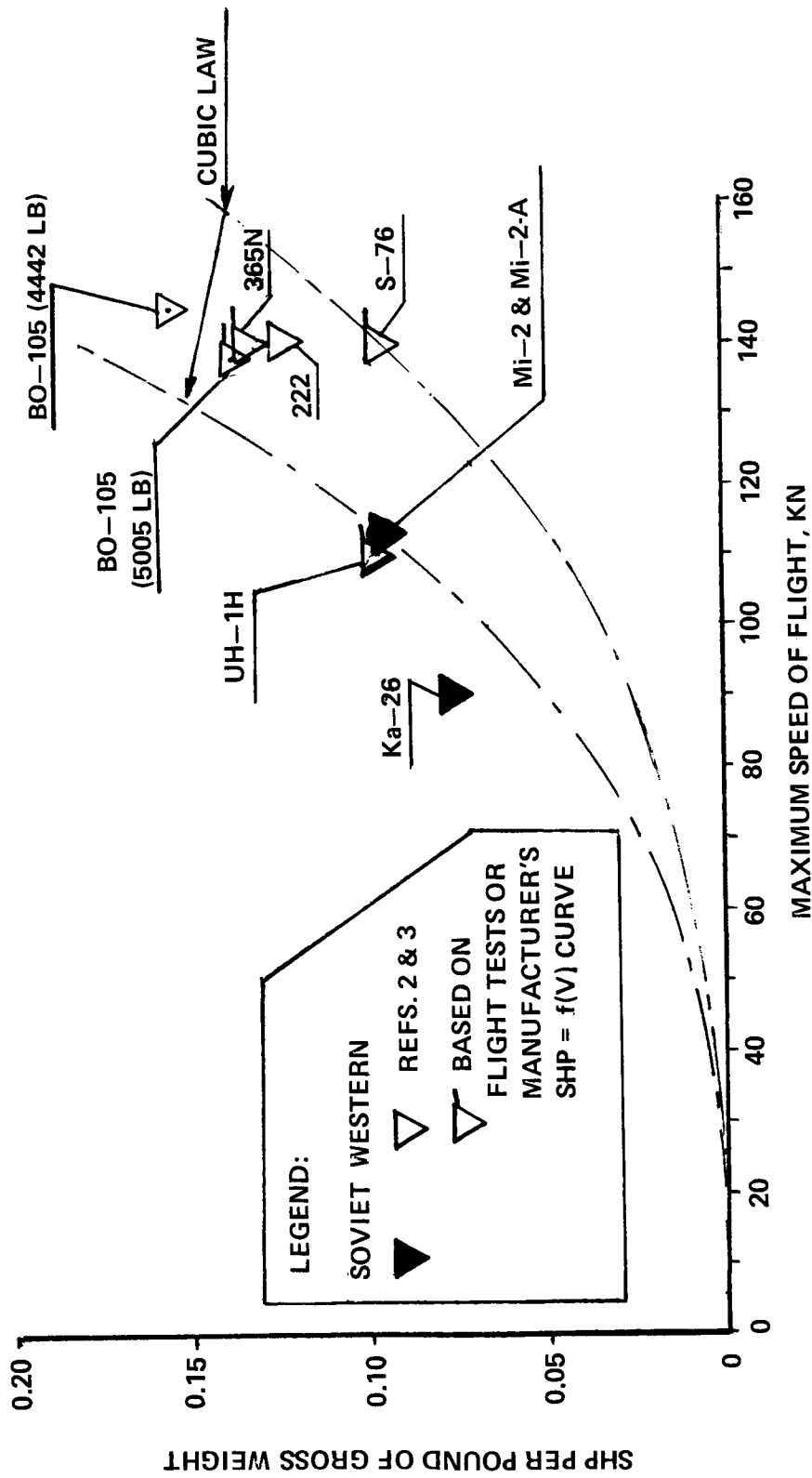

Figure 3.20 Shaft horsepower per pound of gross weight at  $V_{max}$  vs speed of flight of Soviet & Western helicopters of up to 12,000-lb GW class.



TABLE 3-5  
RELATIVE FUEL REQUIREMENTS WITH RESPECT TO GROSS WEIGHT  
UP TO 12,000-LB GROSS WEIGHT CLASS

ITEM	HELICOPTER							Bell UH-1H	MBB BO-105	Bell 222
	Mil Mi-2	Mil Mi-2 Allison	Kamov Ka-26	Aerospatiale SA-363N	Sikorsky S-76					
(SHP/TO/W <sup>2</sup> ): hp/lb	0.1022	0.1073	0.0907	0.1555	0.1300	0.1474	0.1643	0.1574		
Speed of Flight; kn	RATIO OF SHP REQUIRED TO T.O.; SHP									
0	0.972	0.925	1.058	0.859	0.885	0.752	0.714	0.740		
40	0.502	0.478	0.617	0.473	0.508	0.436	0.414	0.467		
60	0.468	0.445	0.595	0.391	0.415	0.393	0.364	0.402		
80	0.553	0.526	0.728	0.403	0.408	0.434	0.397	0.417		
100	0.743	0.707	1.003	0.469	0.454	0.543	0.498	0.486		
120	1.046	0.996	—	0.589	0.554	0.725	0.670	0.611		
140	—	—	—	0.874	0.731	—	0.917	0.794		
Speed of Flight; kn	SPECIFIC FUEL CONSUMPTION; LB/SHP-HR									
0	0.82	0.66	0.635	0.61	0.61	0.64	0.710	0.61		
40	1.005	0.815	0.480	0.77	0.74	0.76	0.870	0.67		
60	1.03	0.835	0.465	0.82	0.82	0.80	0.915	0.69		
80	0.97	0.785	0.500	0.80	0.84	0.76	0.875	0.68		
100	0.88	0.710	0.620	0.73	0.79	0.70	0.800	0.66		
120	0.81	0.65	—	0.68	0.73	0.64	0.735	0.63		
140	—	—	—	0.60	0.64	—	0.670	0.60		
Speed of Flight; kn	FUEL CONSUMPTION PER HOUR AND POUND OF GROSS WEIGHT; LB/HR-LB									
0	0.0814	0.0665	0.0610	0.0814	0.0702	0.0726	0.0833	0.0710		
40	0.0515	0.0418	0.0269	0.0566	0.0488	0.0488	0.0592	0.0492		
60	0.0492	0.0399	0.0251	0.0499	0.0443	0.0464	0.0547	0.0430		
80	0.0548	0.0444	0.0330	0.0510	0.0445	0.0486	0.0571	0.0446		
100	0.0664	0.0539	0.0564	0.0533	0.0466	0.0561	0.0655	0.0505		
120	0.0866	0.0695	—	0.0623	0.0526	0.0684	0.0808	0.0606		
140	—	—	—	0.0815	0.0608	—	0.1010	0.0750		
Speed of Flight; kn	FUEL REQUIRED PER POUND OF GROSS WEIGHT AND 100 N.M.									
40	0.128	0.1045	0.0673	0.1415	0.1221	0.1220	0.1480	0.1230		
60	0.082	0.0665	0.0418	0.0831	0.0738	0.0773	0.0912	0.0716		
80	0.0685	0.0555	0.0413	0.0637	0.0557	0.0607	0.0714	0.0558		
100	0.0664	0.0539	0.0564	0.0533	0.0466	0.0561	0.0655	0.0505		
120	0.0721	0.0579	—	0.0519	0.0438	0.0570	0.0673	0.0505		
140	—	—	—	0.0582	0.0434	—	0.0721	0.0535		

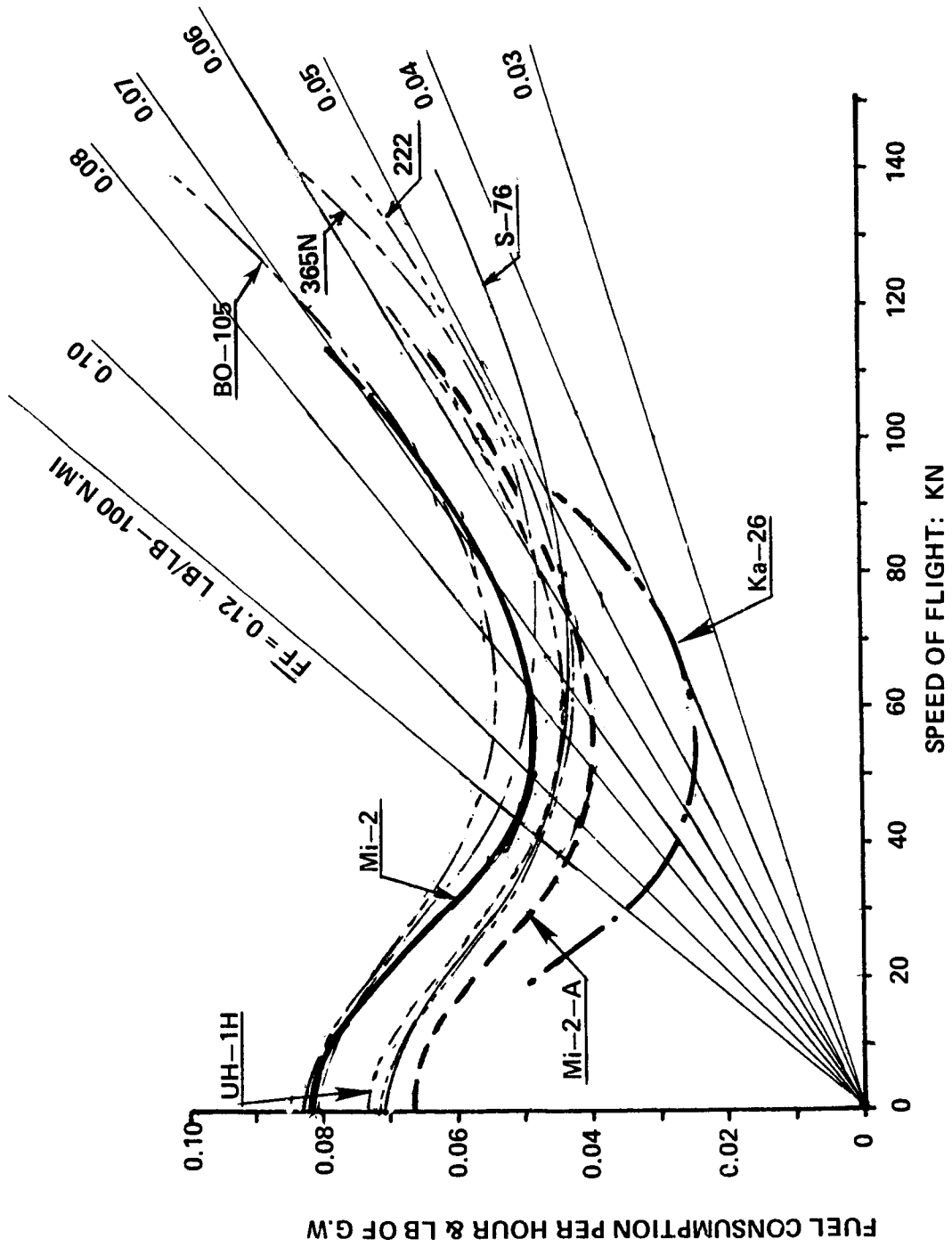

Figure 3.21 Fuel required per hour and pound of gross weight of Soviet & Western helicopters of the up to 12,000-lb gross weight class.

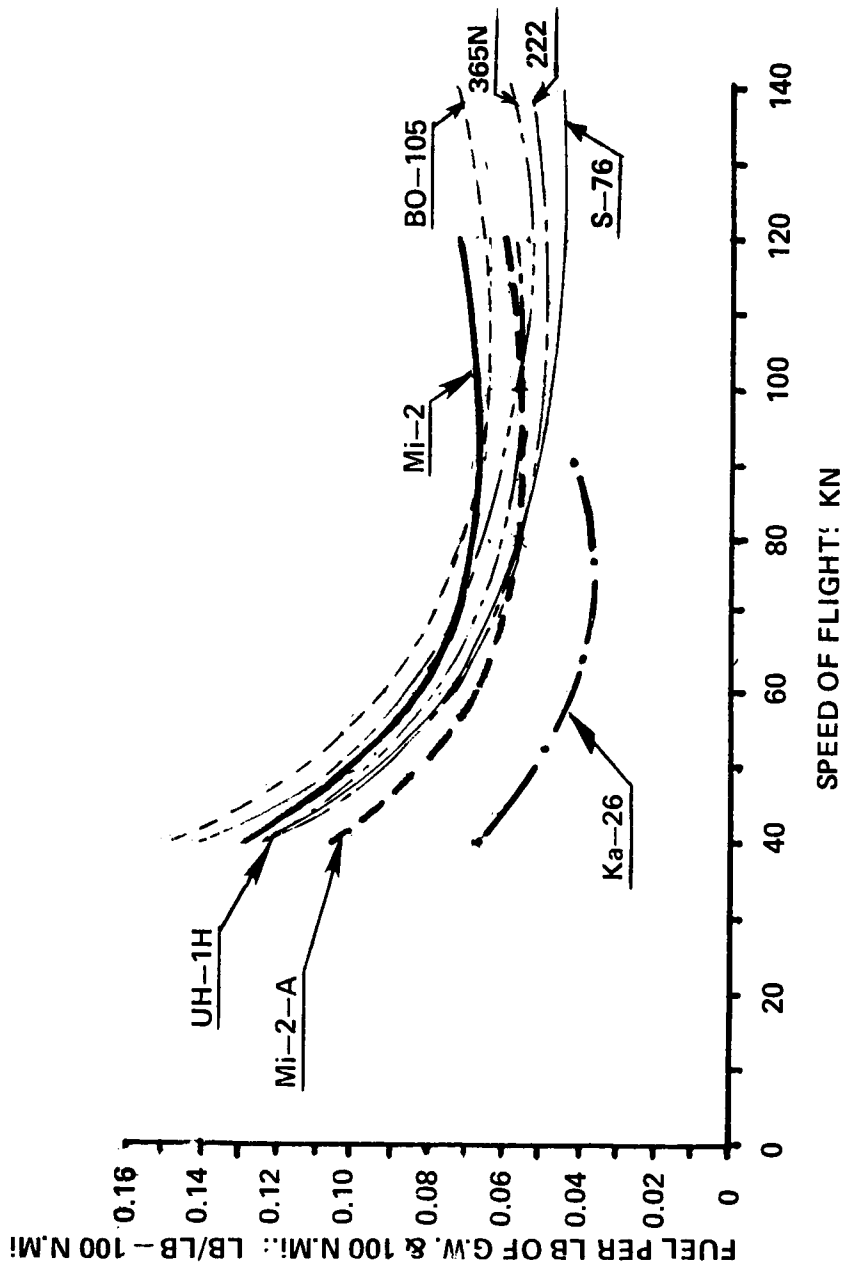

Figure 3.22 Fuel required per pound of gross weight & 100 n.mi for Soviet & Western helicopters of the up to 12,000-lb gross weight class

Looking at Figs. 3.21 and 3.22, one would note that the original Mi-2 helicopter shows one of the higher relative fuel measurements per pound of gross weight with reference to time and distance. Through installation of the Allison 250-C20B turboshafts, these fuel requirements improve considerably, and in the low-speed regime become one of the lowest.

The Ka-26 helicopter appears as especially interesting with respect to energy aspects related to pound of gross weight. It can be seen from these figures that thanks to the reciprocating engines installed in that helicopter, it becomes a champion as far as low fuel requirements per pound of gross weight with respect to time and distance are concerned. It should be noted, however, that the optima occur at low flying speeds (about 50 and 70 knots, respectively) which, in some operations, may represent a serious drawback (low productivity).

**Fuel Requirements per Pound of Zero-Range Payload.** The numerical inputs required for the determination of fuel required per pound of zero-range payload and one hour, and a hypothetical distance of 100 n.mi. are shown in Table 3.6. As in the preceding case, all calculations are performed for the maximum flying weight. The results are shown in Figs. 3.23 and 3.24. These figures indicate that when the fuel consumption is related to the hypothetical zero-range payload, the Mi-2 helicopter shows decisively the worst energy characteristics of all the compared helicopters. However, through the installation of Allison engines, these characteristics are approximately on the same level as the Western rotorcraft. The Ka-26 still remains the champion of low energy utilization in the low-speed regimes of flight. It should be emphasized at this point that the favorable energy characteristics of the Ka-26 helicopter are achieved at the maximum flying gross weight, which is not only higher than the VTO gross weight, but even exceeds the hovering gross weight OGE at SL, ISA. The importance of the influence of increasing the operational gross weight of a given helicopter with respect to energy aspects related to payload should not be overlooked.

**Fuel Required per Pound of Payload vs Distance.** Even approximate values of fuel required to fly one pound of payload over various distances can provide an important insight regarding energy aspects of the compared helicopters. Using the approach outlined in Section 1.5, the numerical inputs required in that evaluation are given in Table 3.7, while the results are graphically presented in Fig. 3.25.

It can be seen from this figure that the Mi-2 with the original engines represents the highest energy requirements for transportation of a unit weight of payload over any distance. Installation of the Allison turboshafts leads to considerable improvements, making the fuel requirement practically identical to that of the BO-105 and 222.

It should be remembered, however, that a change in the ground rules for selecting gross weight (say, making it equal to the so-called VTO gross weight) may considerably affect the relative position of Soviet helicopters vs their Western counterparts. This will be especially true in the case of the Ka-26, for the already mentioned reasons of a large discrepancy between its VTO and maximum flying gross weight.

TABLE 3.6  
 FUEL REQUIREMENTS WITH RESPECT TO ZERO-RANGE PAYLOAD  
 UP TO 12,000-LB GROSS WEIGHT CLASS

ITEM	HELICOPTER									
	Mil Mi-2	Mil Mi-2 Allison	Kamov Ka-26	Aerospatiale SA-365N	Sikorsky S-76	Bell UH-1H	MBB BO-105	Bell		
GROSS WEIGHT: Lb	7826	7826	7165	8488	10,000	9500	5114			
Weight Empty	5229	4718	4300	4277	5600	5210	2622			
Weight of Crew	[397]	[397]	[397]	[397]	[397]	[397]	[397]			
Trapped Fuel	[25]	[25]	[25]	[25]	[25]	[25]	[25]			
Payload Zero Range	2175	2686	2443	3789	3978	3868	2070			
Payload Zero/GW	0.278	0.343	0.338	0.446	0.398	0.407	0.405			
FUEL CONSUMPTION PER HOUR AND POUND OF ZERO RANGE PAYLOAD										
SPEED OF FLIGHT, Kn	0.293	0.194	0.1805	0.1825	0.176	0.178	0.206			
40	0.185	0.122	0.0796	0.1269	0.123	0.120	0.146			0.217
60	0.177	0.116	0.0743	0.1119	0.111	0.114	0.135			0.150
80	0.197	0.129	0.0976	0.1143	0.112	0.119	0.141			0.131
100	0.239	0.157	0.1757	0.1195	0.117	0.138	0.162			0.136
120	0.312	0.203	-	0.1397	0.132	0.168	0.200			0.154
140				0.182	0.153	0.249	0.200			0.185
							0.249			0.229
FUEL REQUIRED PER POUND OF ZERO RANGE PAYLOAD AND 100 N.M.										
SPEED OF FLIGHT, Kn	0.460	0.307	0.1990	0.317	0.306	0.300	0.365			
40	0.295	0.194	0.1238	0.186	0.186	0.190	0.225			0.376
60	0.246	0.162	0.1222	0.143	0.140	0.149	0.176			0.219
80	0.239	0.157	0.1757	0.119	0.117	0.138	0.162			0.170
100	0.259	0.169	-	0.116	0.110	0.140	0.166			0.154
120				0.130	0.109	0.140	0.166			0.154
140							0.178			0.164

NOTE: Assumed or rough estimated values are shown in brackets [ ].

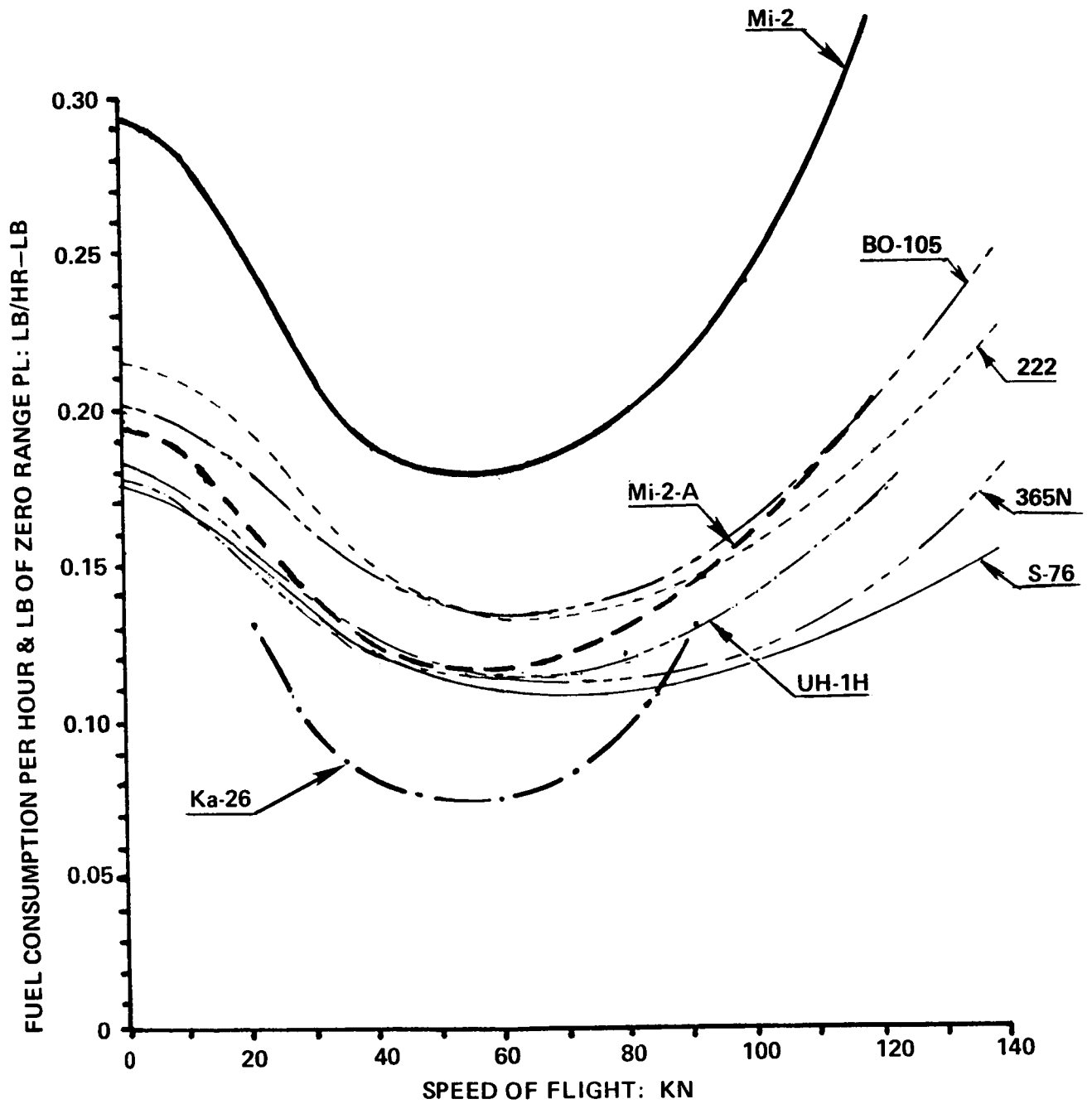

Figure 3.23 Fuel required per hour and pound of zero-range payload of Soviet & Western Helicopters of the up to 12,000-lb gross weight class

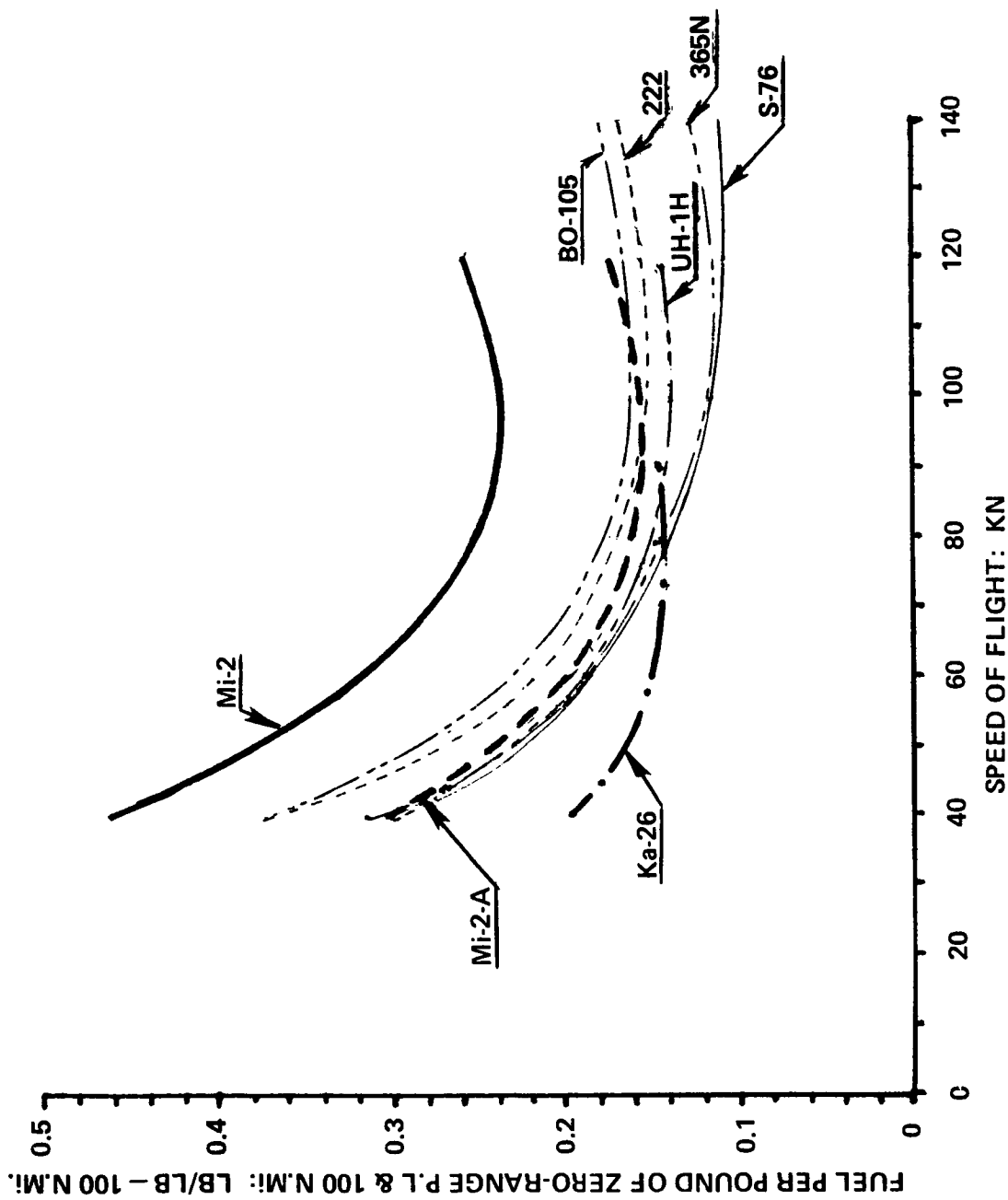

Figure 3.24 Fuel required per pound of zero-range payload and 100 n.mi of Soviet & Western helicopters of the up to 12,000-lb gross weight class

TABLE 3.7  
 FUEL REQUIRED PER POUND OF PAYLOAD AT VARIOUS DISTANCES  
 UP TO 12,000-LB GROSS WEIGHT CLASS

ITEM	HELICOPTER							
	Mil Mi-2	Mil-Mi-2 Allison	Kamov Ka-26	Aerospatiale SA-365N	Sikorsky S-76	Bell UH-1H	MBB BO-105	Bell 222
GROSS WEIGHT: lb	7826	7826	7165	8488	10,000	9500	5114	7850
Opt. Fuel Consumed per One Pound of Zero-Range Payload and 100 N.Mi.	0.239	0.157	0.120	0.116	0.109	0.138	0.160	0.154
FUEL REQUIRED PER POUND OF PAYLOAD								
DISTANCE: N.Mi	0	0	0	0	0	0	0	0
50	0.154	0.085	0.064	0.062	0.057	0.074	0.087	0.083
100	0.314	0.186	0.136	0.131	0.122	0.160	0.190	0.182
150	0.559	0.308	0.220	0.210	0.195	0.261	0.316	0.300
200	0.915	0.458	0.316	0.302	0.278	0.381	0.471	0.445
250	1.481	0.646	0.429	0.408	0.375	0.527	0.667	0.626



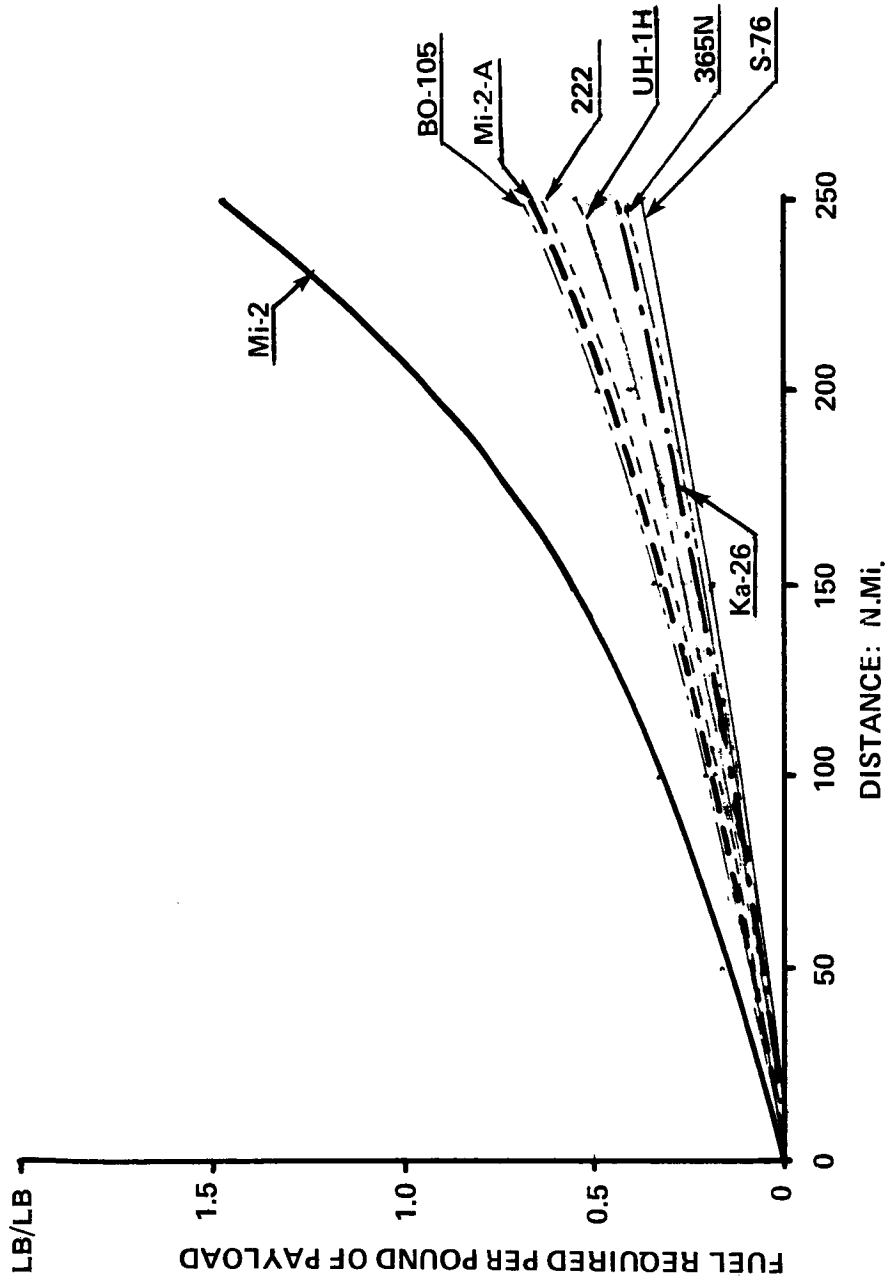

Figure 3.25 Fuel required per pound of payload vs. flight distance for Soviet & Western helicopters of the up to 12,000-lb gross weight class.

### 3.6 Productivity

**Productivity Index.** Productivity index values were computed from Eq (1.17a) for various distances and flying speeds from 40 knots to  $V_{cr_{max}}$ . Auxiliary plots made of  $PI = f(V)$  indicated that maximum productivity occurs at the maximum operational flying speed, which is assumed to be the maximum cruise speed as listed in published specifications of the compared helicopters. Consequently only the PI values corresponding to  $V_{cr_{max}}$  were computed in Table 3.8, and graphically presented in Fig. 3.26. This figure indicates that the productivity index of all three Soviet helicopters is below that of their Western counterparts; the Mi-2 showing the lowest PI values. Installation of Allison engines made a considerable improvement in the productivity index, but still failed to make it comparable to an even older Western helicopter such as the UH-1H.

### 3.7 General Discussion and Concluding Remarks

The original Mi-2 helicopter appears to have well-selected basic design parameters. However, chiefly because of the high specific weight and high specific fuel consumption of the GTD-350 turboshaft plus higher than the Western weight empty to gross weight ratio, the performance of the Mi-2, when referred to payload, becomes much inferior to that of its Western counterparts (e.g., Figs. 3.23 and 3.24).

Installation of Allison 250-C20B engines considerably improve the energy aspects with respect to gross weight, but especially to payload, and makes the relative fuel requirements per pound of payload and either hour or unit of distance similar to that of Western helicopters. Nevertheless, when it comes to the productivity referred to weight empty, the values of the so-called productivity index, including the Allison version of the Mi-2 are below those of the Western counterparts.

A comparison of the Mi-2-A and BO-105 helicopters may be of special interest, as both have the same powerplants, but represent different design philosophies (e.g., disc loading at maximum flying weight of 4.37 psf for the Mi-2-A vs 6.25 psf for the BO-105), resulting in the Mi-2-A being larger, heavier, and with greater zero-range payload capacity (2689 lb vs 2070 lb), but slower than the BO-105. In spite of the lower maximum cruise speed of the Mi-2 derivation, because of a higher  $(W_{pl})_o$ , its absolute productivity  $[(W_{pl})_o \times V_{cr_{max}}]$  at zero-range would be 303,857 lb-kn/hr vs 273,240 for the BO-105. However, the productivity index of the Mi-2-A is much lower than for its German counterpart (Fig. 3.26). The hourly fuel consumption per pound of zero-range payload in hover is quite similar for both helicopters. This is also true with respect to the energy consumed per pound of payload in forward flight (Fig. 3.25).

The Ka-26 represents an interesting departure from the general design philosophy of the entire range of helicopters having gross weights of up to 12,000 lb; not only because of its coaxial configuration, but also because of the utilization of reciprocating engines.

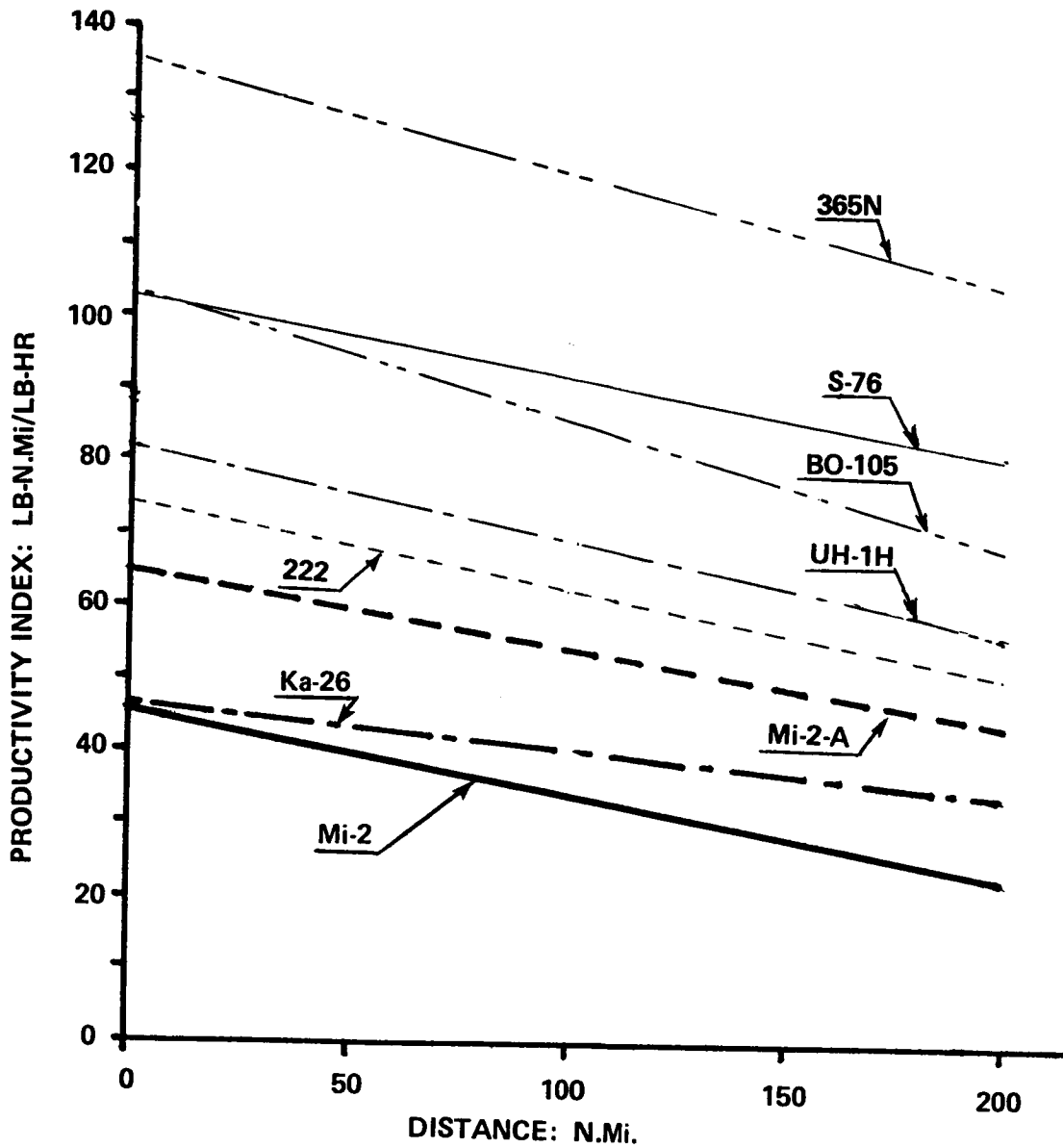

Figure 3.26 Productivity index at maximum cruise speed of Soviet and Western helicopters of the 12,000-lb gross weight class.

TABLE 3.8  
PRODUCTIVITY INDEX AT  $V_{crmax}$   
UP TO 12,000-LB GROSS WEIGHT CLASS

ITEM	HELICOPTER							
	Mil Mi-2	Mil Mi-2-A	Kamov Ka-26	Aerospatiale SA-365N	Sikorsky S-76	Bell UH-1H	MBB BO-105	Bell 222
$W_{gr}$ : lb	7826	7826	7165	8488	10,000	9500	5114	7850
$W_e W_{gr}$	0.668	0.602	0.600	0.504	0.560	0.548	0.513	0.619
$(W_{pil}/W_{gr})$	0.278	0.343	0.338	0.446	0.398	0.407	0.405	0.327
$V_{crmax}$ : kn	108	113	81	153	145	110	132	141
$\overline{FF}$ at $V_{crmax}$ : lb/lb-100 n.mi.	0.069	0.058	0.041	0.051	0.044	0.057	0.070	0.054
PI: lb-kn/lb	55.95	64.38	45.63	135.4	103.1	81.70	104.21	74.5
Zero Distance	33.50	54.00	40.05	119.9	91.7	70.00	85.05	62.2
100 n.mi.	22.5	43.0	34.6	104.4	80.3	57.5	68.2	49.9
200 n.mi.								

At first glance one may expect that such a helicopter would have no chance at all in competition with turbine-equipped rotorcraft. However, it appears that in applications requiring low speeds only, this helicopter can find an operational niche because of its favorable energy aspects with respect to payload. But should those applications require hovering at elevated altitudes and/or ambient temperatures, the relative advantage of the Ka-26 may disappear.

At this point it should again be emphasized that under accepted ground rules, all comparisons were carried out at gross weights either equal, or almost equal, to maximum flying gross weights. All of the compared Soviet helicopters exhibit a hovering altitude-elevated temperature performance inferior to that of their Western counterparts. Consequently, should the ground rule emphasize the requirement of OGE hover at high altitudes and/or temperatures, then the gross weight of the Soviet machine used in the comparative study would go down; resulting in a worsening of their comparative position with respect to Western rotorcraft.

## Chapter 4

### Helicopters of the 12,000 to 30,000-lb GW Class

#### 4.1 Basic Data

Three-view drawings of the compared helicopters are shown in Figs 4.1a through 4.1b, while their principal characteristics are given in Table 4.1.

Of all the compared helicopters, the least is known about the Mi-24-D. However, there are indications that this rotorcraft represents an evolutionary development of the Mi-8; having similar powerplants (TV-3-117), although possibly higher rated (to 2170 hp), and apparently having a similar rotor system, but of smaller radius. There also appear to be some differences in the blade root section, as can be seen when comparing Figs 4.1a and 4.1b. Because of the many uncertainties regarding the Mi-24-D, its characteristics and performance are listed in the last column of Table 4.1.

Some of the data contained in Table 4.1 is graphically presented in Figs 4.2 through 4.7.

**Disc Loading (Fig. 4.2).** The disc loading of the Mi-8 helicopter is somewhat lower than that of its modern Western counterparts, but not much different from that of the older CH-3E. By contrast, the estimated disc loading of the Mi-24-D<sup>2</sup> appears on the same level as that for the UTTAS-type helicopters, and even higher when the normal gross weights are compared. The disc loading of the Ka-25 is not much different from the disc loading of the contemporary single-rotor Western helicopters. As for the tandem configuration – represented here by the CH-46E – it should be noted that its disc loading based on the swept area is quite low ( $w = 5.7$  psf) even at its maximum flying weight of 23,300 lb.

**Power Loading (Fig. 4.3).** As in the case of the Ka-26 in the up to 12,000 gross weight class, the power loading of the Ka-25, based on the “official” takeoff SHP, appears the highest of all the compared helicopters. Since, at this writing, little is known about the characteristics of GTD-3F turboshafts, it is also unknown whether the thermodynamic capabilities of that engine exceeds its mechanical capabilities. By contrast, as discussed in Ch. 2, the TV2-117A turboshafts have higher thermodynamic than mechanical capabilities. It is also known that under record-establishing conditions<sup>2</sup> the TV-3-117 engines operate at ratings of 2200 cv (metric horsepower), which is approximately equal to 2170 hp. Consequently, when these higher thermodynamic capabilities for the Mi-8, and higher ratings of the Mi-24-D engines are taken into account, the power loading of the Mi-8 would be closer to its Western counterparts, and that of the Mi-24-D would be on the level of the U.S. UTTAS machines.

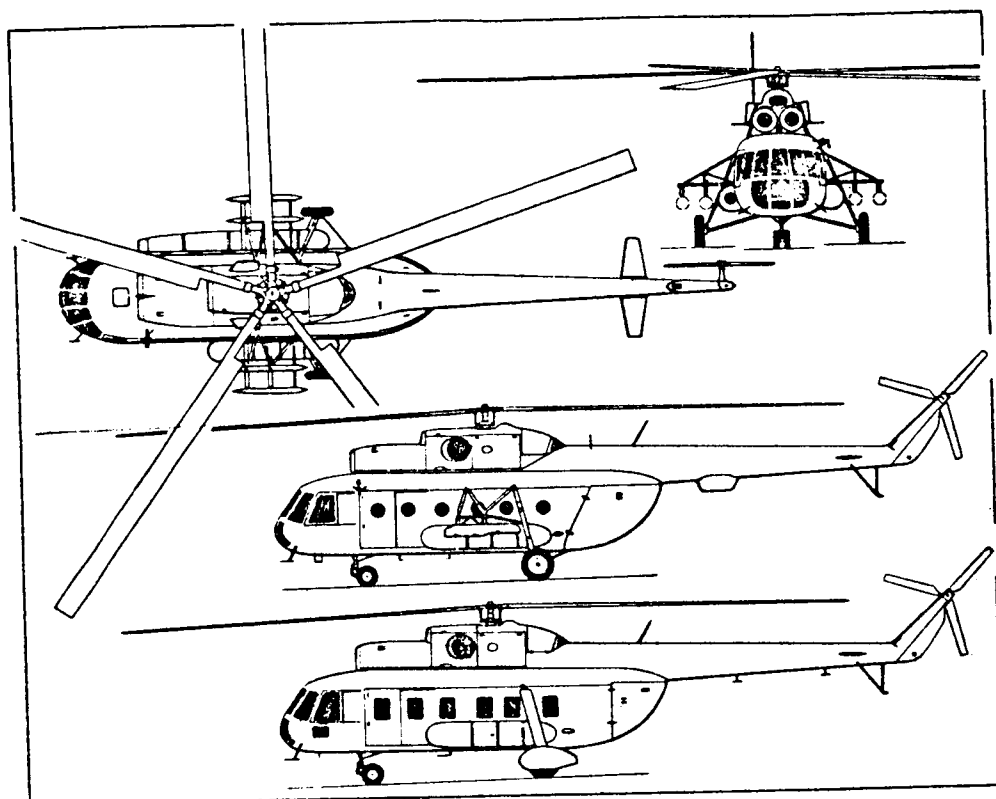

(a) 'Hip-C' military version of Mil Mi-8 twin-turbine helicopter, with additional side view (bottom) of commercial version (*Pilot Press*).

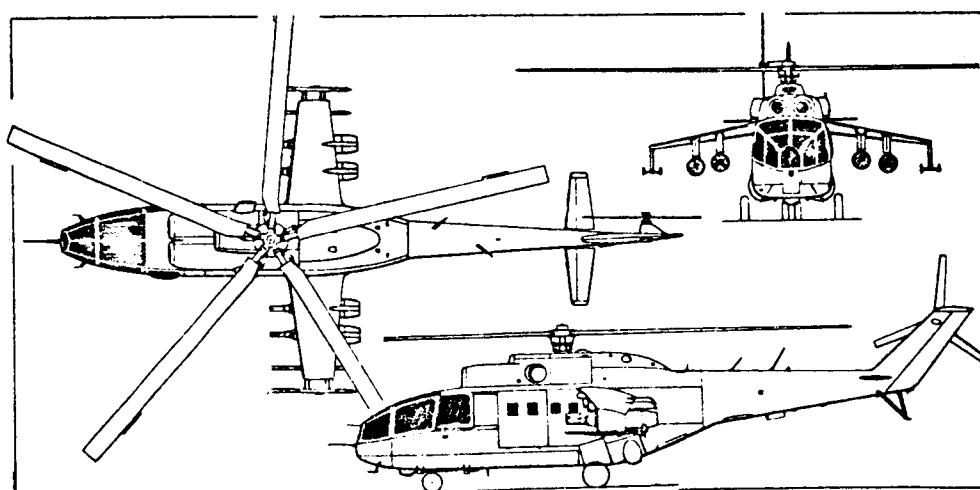

(b) Mil Mi-24 assault helicopter, in the form known to NATO as 'Hind-A', with original tail rotor (*Pilot Press*).

Figure 4.1 Three-view drawings of Soviet and Western helicopters of 12,000 to 30,000-lb GW class.

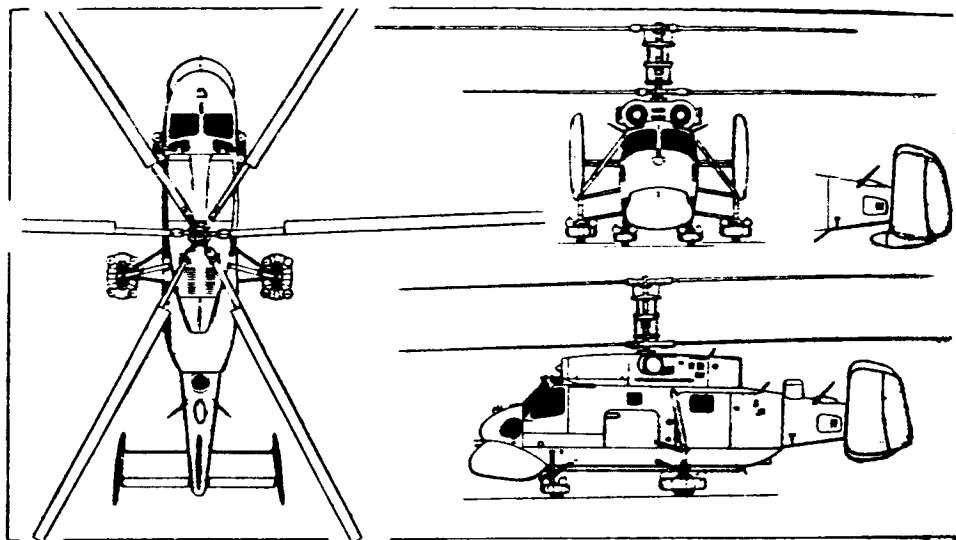

(c) 'Hormone-A' anti-submarine version of the Kamov Ka-25 helicopter. Scrap view shows option of blisters at base of central tail-fin (*Pilot Press*).

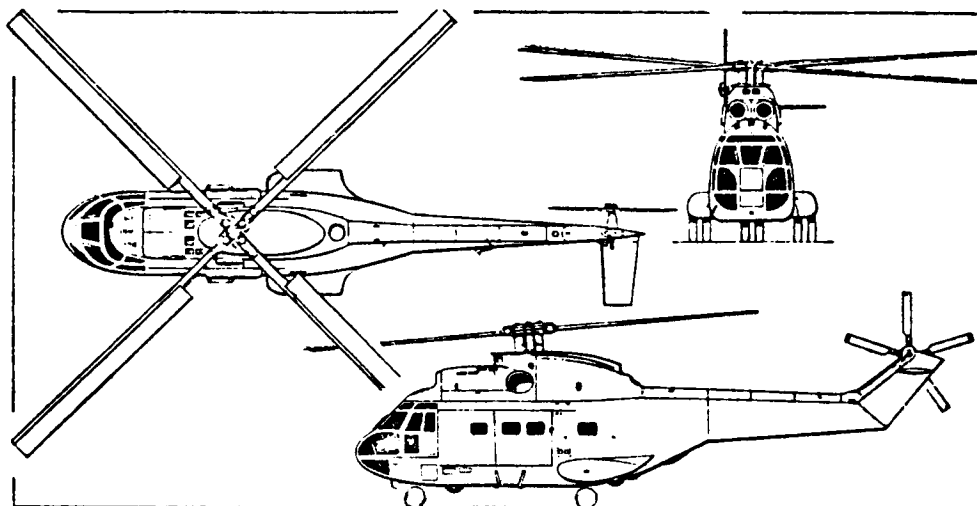

(d) Aerospatiale SA 330 Puma transport helicopter (*Pilot Press*).

Figure 4.1 Three-view drawings of Soviet and Western helicopters of 12,000 to 30,000-lb GW class. (Cont'd).

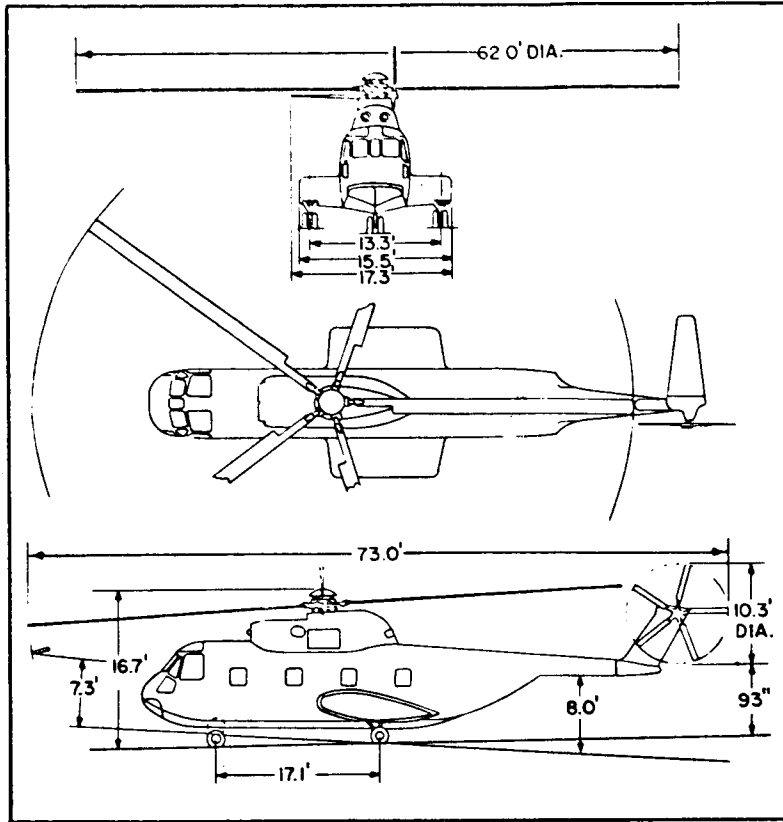

(e) Sikorsky CH-3E twin-turbine engine transport helicopter.

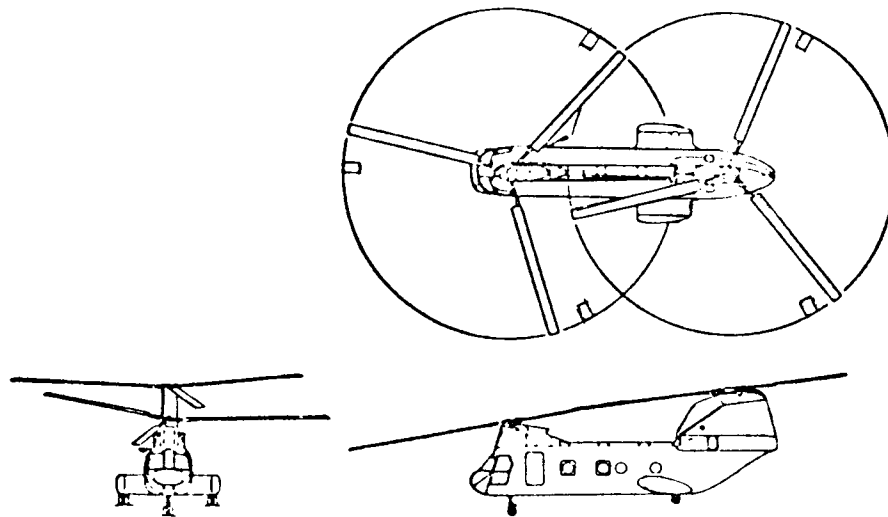

(f) Boeing Vertol CH-46E (Sea Knight) combat assault helicopter.

Figure 4.1 Three-view drawings of Soviet and Western helicopters of 12,000 to 30,000-lb GW class. (Cont'd)



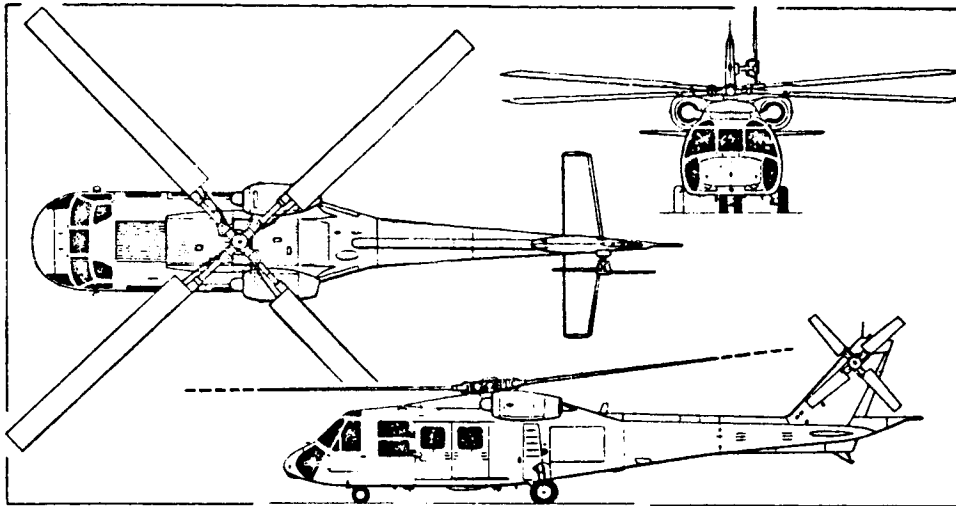

(g) Boeing Vertol YUH-61A Utility Tactical Transport Aircraft System (UTTAS) (*Pilot Press*).

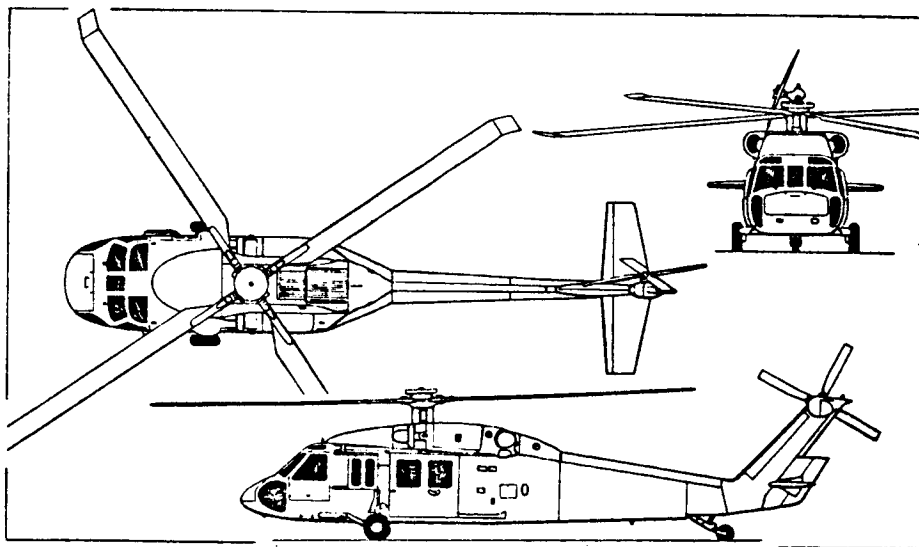

(h) Sikorsky UH-60A Black Hawk combat assault helicopter (*Pilot Press*).

Figure 4.1 Three-view drawings of Soviet and Western helicopters of 12,000 to 30,000-lb GW class

TABLE 4.1  
 (A) PRINCIPAL CHARACTERISTICS & PERFORMANCE  
 12,000 TO 30,000-LB GROSS WEIGHT CLASS

ITEM	HELICOPTER									
	Mil Mi-8	Kamov Ka-25K	Aerospatiale SA330J Puma	Sikorsky CH-3E (S-61R)	Boeing-Vertol CH-46E Sea Knight	Boeing Vertol YUH-61A UTTAS	Sikorsky UH-60A Black Hawk	Mil Mi-24-D		
CONFIGURATION	S.R.	CO-AX	S.R.	S.R.	TANDEM	S.R.	S.R.	S.R.		
POWERPLANT	Isotov TV2-117A	Glushenkov GTD-3F	Turbomeca Turmo IVC	T58-GE-5	T58-GE-16	T700-GE-700	T700-GE-700	Isotov TV3-117		
Number of Engines	2	2	2	2	2	2	2	2		
Output Shaft rpm	12,000	1800	22,840	19,500	19,500	3000	3120	4340		
Total T.O. SHP	3000		2990	3000	3740	3000				
Total Max. Continuous SHP	2000	No	2521	2500	3540	2500				
Transmission Limit, HP	No	No	2212	2575	2800	No	2827			
MAIN ROTOR R: ft	34.94	25.83	24.74	31.0	25.5	24.5	26.83	27.89		
Direction of Rotation	C.W	C.W	C.W	C.C.W	C.C.W*	C.C.W	C.C.W	C.W		
rpm	192		265	203	264	286	258			
Number of Blades	5	2 X 3	4	5	2 X 3	4	4	5		
Blade 0.7R Chord: ft	1.71	[1.01]	1.97	1.52	1.56	1.92	1.73	1.585		
Airfoil	NACA 230		Evolutionary	NACA 0012	B-V 23010.6-1.31	B-V VR7, 8, 9	SC 1095 (mod)			
Articulation	Full		Full	Full	Full	Nonarticulated	Full			
TAIL ROTOR R: ft	6.41	Distance between Rotors	4.99	5.17	Distance between rotors	5.5	5.5	6.4		
Type	Pusher		Pusher			Pusher	Tractor	Tractor		
x: ft	41.14		30.02	36.83	33.35	29.1	32.5	36.43		
y: ft	-0.68	4.72			Overlap 34.6%	-0.46	-1.28	0		
rpm	1130		1278							
Number of Blades	3		5	5		4	4	3		
Blade 0.7R Chord: ft	0.89		0.612	0.61			0.81			
Airfoil			NACA 0012				SC 1095			
Articulation	Univers. Susp		Full			Flex Strap	Flex Strap			
EXTERNAL DIMENSIONS										
Overall Length: ft	82.82	32.25	59.4	73.0	84.33	60.7	64.83	55.75		
Fuselage: ft	60.07	31.65	46.0	57.25	45.67	52.5	50.06			
Overall Height: ft	18.34	17.62	16.86	18.08	16.67	15.5	16.83	14.00		

NOTE:

\*Front Rotor

Assumed or rough estimated values are shown in brackets [ ] .

Table 4.1 (Cont'd)

<b>INTERNAL DIMENSIONS</b>													
Cabin Length: ft	17.52		19.875	25.83	24.67*	12.67	12.58						
Maximum Width: ft	7.69		5.92	6.50	6.0	7.17	7.08						
Maximum Height: ft	5.98		5.08	6.25	6.0	4.5	4.5						
Volume: cu.ft	812	[280]	403	1051	865	412	387						[700]
<b>CREW</b>	2	2	2	2+1	2	2	2						2
<b>WEIGHTS</b>													
Gross Maximum: lb	26,455	16,100	16,315	22,050	23,300	19,700	20,250						22,000
Normal: lb	24,470	15,650		19,500		15,157	16,260						
Empty: lb	15,026	9700	8303	13,255	15,198	9750	10,624						
Payload @ Zero Range: lb	11,002	5973	7600	8373	7675	9523	9199						
<b>PERFORMANCE</b>													
Flt Speed, Max/VNE: kn	@ 24,470 lb	@ 15,650 lb	@ 16,315 lb	@ 19,500 lb	@ 23,300 lb		@ 16,450 lb						198.9*
Fast Cruise*: kn	135	119	142	143	139/144	155	167/195						
Economic Cruise*: kn	122	104	139	134	139	145	164						
R/C, Vertical*: fpm			134	134	137	664*	147						
R/C Forward*: fpm			1200	1520	360		2460						
Hover**, OGE: ft	2625	1700	5575	5900	1590	6450	10,400						
Service Ceiling: ft	6233	11,500	15,750	13,600	15,700	7130	19,100						
Ceiling, 1-Engine Out: ft			7220		2200								
Avg. Fuel Consumption: lb/h			—	4325	1574								
Normal Fuel: lb	3210	351*	2690	404*	2421	321**	243*						
Maximum Range: N.Mi.	259*		297*		182**								
<b>DISC LOADING</b>													
Normal Gross Weight: psf	6.39	7.46	8.48	6.46	5.70	8.04	7.19						9.00
Maximum Gross Weight: psf	6.83	7.68		7.30		10.47	8.95						
<b>POWER LOADING</b>													
Normal Gross Weight: lb/shp	8.15	8.69	5.46/7.38	6.50	6.23/8.32	5.05	5.21/5.75						5.07
Maximum Gross Wt: lb/shp	8.82	8.94		7.35		6.56	6.49/7.16						

NOTES: \*SL/ISA      \*with 5% res.      \*with reserves      \*no reserves      \*with 10% res.      \*incl. flight deck      \*@ 4000 ft, 95% of power      \*max TO wt w/30 min. reserves      \*record flight w/4340 total hp  
 \*\*ISA      \*\*at 4000 ft w/30-min res.

TABLE 4.1 (CONT'D)  
 (B) ADDITIONAL HELICOPTER CHARACTERISTICS  
 12,000 TO 30,000-LB GROSS WEIGHT CLASS

ITEM	HELICOPTER									
	Mil Mi-8	Kamov Ka-25K	Aerospatiale SA330J Puma	Sikorsky CH-3E (S-61R)	Boeing-Vertol CH-46E Sea Knight	Boeing-Vertol YUH-61A UTTAS	Sikorsky UH-60A Black Hawk	Mil Mi-24-D		
Tip Speed: fps	702.4	[650]	687	659	704.8	734	725	[705]		
$R_{tr}/R_{mr}$	0.183	—	0.202	0.167	—	0.224	0.205	0.229		
$x/R_{mr}$	1.176	—	1.213	1.188	—	1.188	1.211	1.302		
Maximum Gross Wt: lb	26,455	16,100	16,315	22,050	23,300	19,700	20,250	22,000*		
$W_e/W_{gr}/max$	0.568	0.602	0.509	0.601	0.652	0.495	0.525			
$(W_{p1}/O)/W_{gr}/max$	0.416	0.371	0.465	0.380	0.329	0.483	0.455			
$(W_{p1}/O)/Cabin Vol: lb/ft^3$	13.55	[21.33]	18.82	7.97	8.87	23.11	23.81			

NOTE:

\*Estimated N. GW<sup>2</sup>

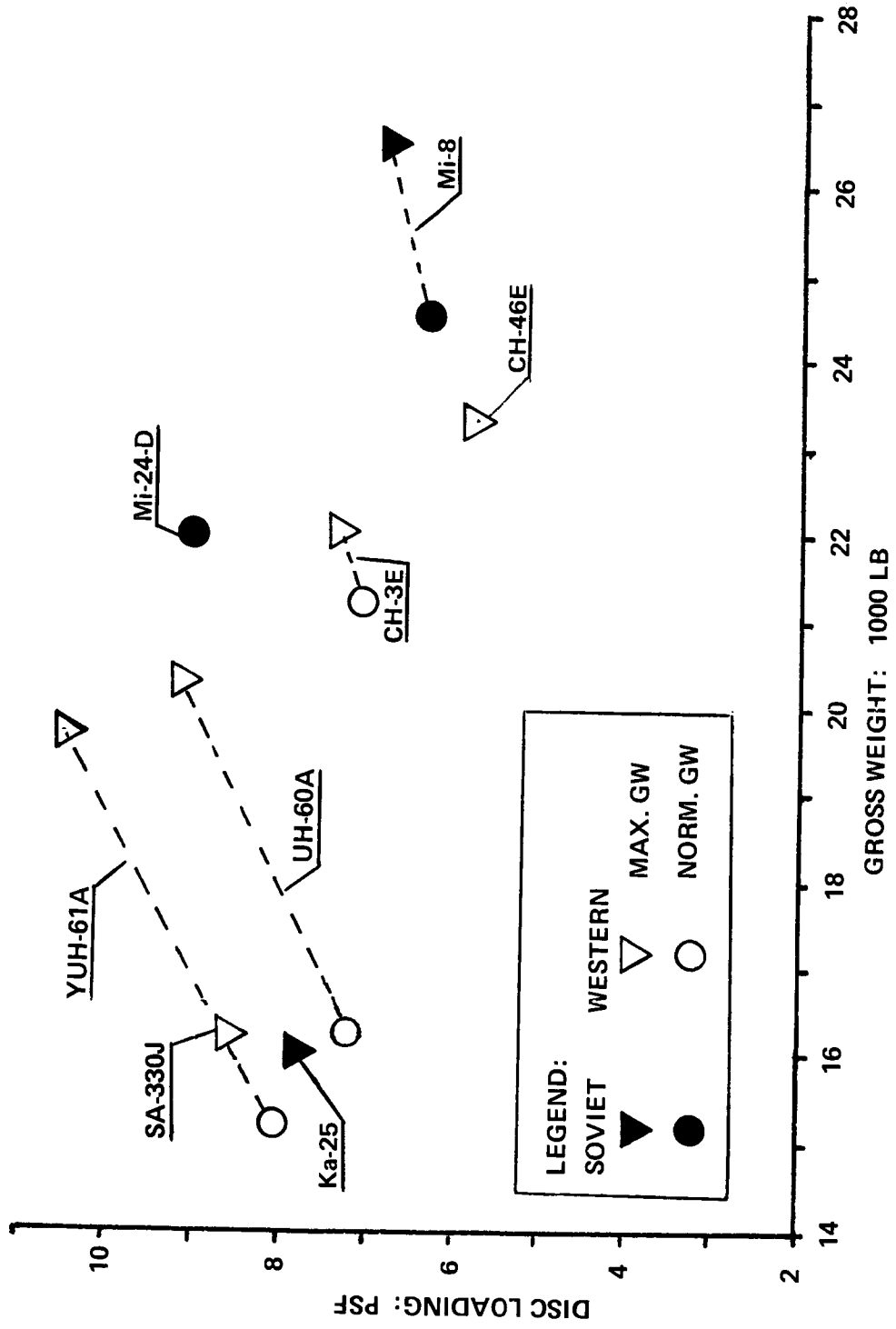

Figure 4.2 Disc loadings of Soviet and Western helicopters of the 12,000 to 30,000-lb gross weight class

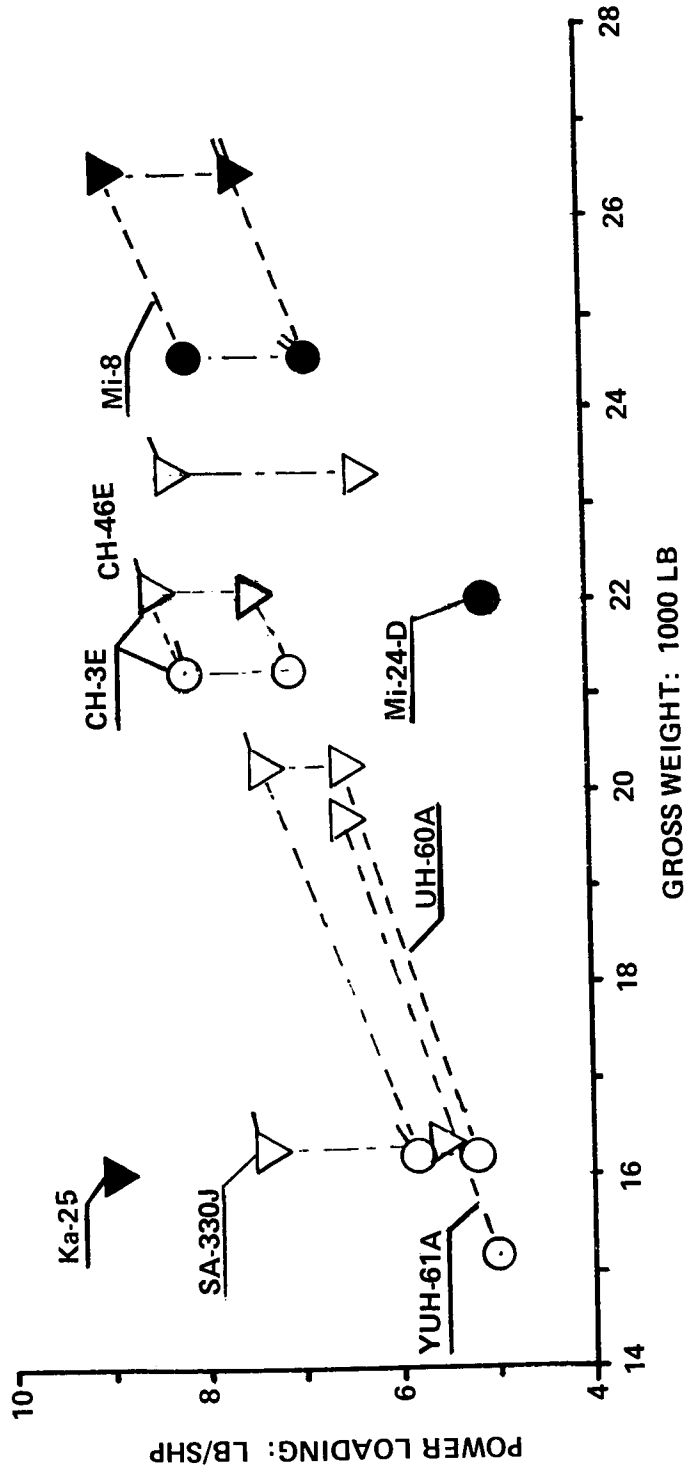
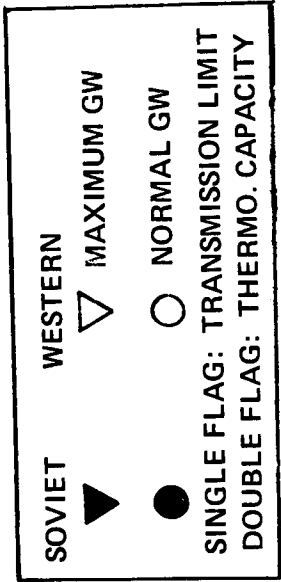

Figure 4.3 Power loading of Soviet and Western helicopters of the 12,000 to 30,000-lb gross weight class

**Main Rotor Tip Speed (Fig. 4.4).** The main rotor tip speed of the Mi-8 helicopter appears on the same level as that of the Western rotorcraft of the same gross weight class (about 700 fps). There is no data available to this writer regarding the tip speed of the Mi-24-D, but it is probably close to that of the Mi-8; thus  $V_t \approx 700$  fps is assumed for the Mi-24-D. For the Ka-25,  $V_t = 650$  fps is postulated.

**Tail-Rotor to Main-Rotor Radii Ratio and Relative Tail-Rotor Distance (Fig. 4.5).** In general, the tail-rotor to main-rotor radii ratio of the Soviet helicopters and their Western counterparts are of similar magnitudes; with the Mi-24-D showing the highest values of that ratio:  $(R_{tr}/R_{mr}) = 0.229$ .

The relative distances ( $\bar{x}$ ) of all the compared helicopters appear to quite uniformly within the limits  $1.176 \leq \bar{x} \leq 1.305$  with the lowest value represented by the Mi-8 and the highest by the Mi-24-D.

**Weight Empty and Zero-Range Payload to Gross Weight Ratios (Fig. 4.6).** The weight ratios shown in Fig. 4.6 are related to the maximum flying gross weight. A glance at this figure indicates that the weight-empty and zero-range payload to gross weight ratios of the Mi-8 helicopter roughly represent an average of the Western counterparts; while for the Ka-25 those ratios are close to the extremes of the Western designs in spite of the fact that the considered version of the Kamov helicopter represents the crane configuration. The CH-46E appears to exhibit the least favorable  $(W_e/W_{gr})$  and  $(W_{pl})_o/W_{gr}$  ratios of all the compared helicopters of the 12,000 to 30,000-lb gross weight class. However, it should be emphasized at this point that the CH-46E is the only one of the compared rotorcraft that is equipped with automatic blade folding and other special equipment which is counted as weight empty. For instance, for the CH-46D,  $(W_e/W_{gr}) = 13,067/23,000 = 0.568$  and  $(W_{pl})_o/W_{gr} = 0.413$ .

**Cabin Volume Loading at Zero-Range Payload (Fig. 4.7).** Similar to the preceding gross weight group, the Mil Mi-8 helicopter appears to have provisions of larger cabin volume with respect to maximum payload than the Kamov Ka-25 design. In comparison with the Western helicopters, the relative roominess of the Ka-25 is on practically the same level as the UTTAS class, while the cabin of the Mi-8 appears slightly less spacious with respect to maximum payload weight than that of the CH-3E and CH-46E, but more spacious than that of the UTTAS helicopters.

## 4.2 Hovering and Vertical Climb Aspects

**Table 4.2.** Similar to the procedure established in Ch. 3, the first estimates of  $FM_{oa}$  in Table 4.2 were performed using the primary data related to maximum gross weights contained in Table 4.1. In the second estimate, computations were performed using the best hovering data available related to gross weights.

First, the figures of merit for all helicopters except the YUH-61A and SA-330J were estimated using Fig. 1.16 as a basis, and deviations from that relationship due to such factors as airfoil sections and Reynolds numbers were also estimated. The influence of the rotor solidity was computed with the help of Eq. (1.26a). For the YUH-61A, Fig. 1.16 obviously represents the tower-tested and established  $FM_{mr} = f(\bar{c}_{l_n})$  relationship, while the manufacturer's figure was used for the SA-330J.

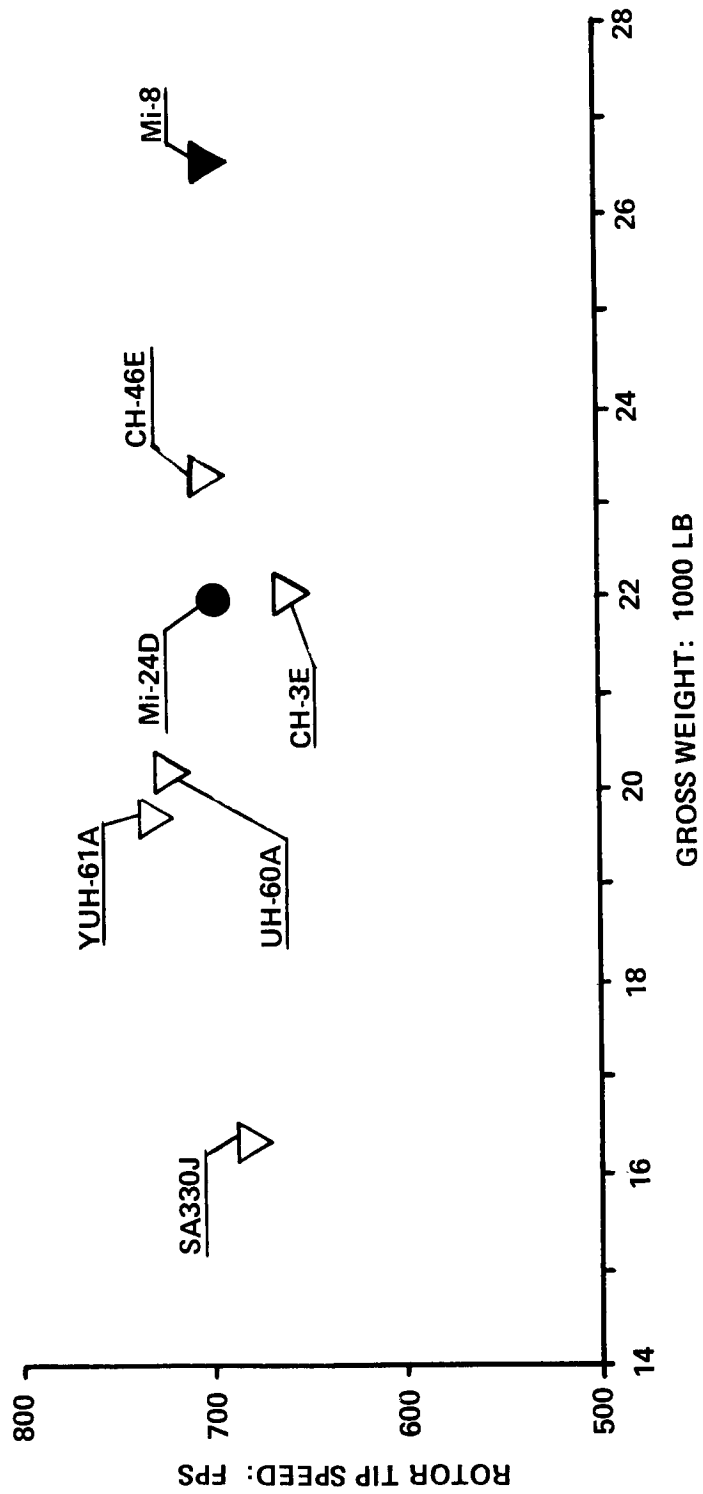

Figure 4.4 Main-rotor tip speed of Soviet and Western helicopters of the 12,000 to 30,000-lb gross weight class.



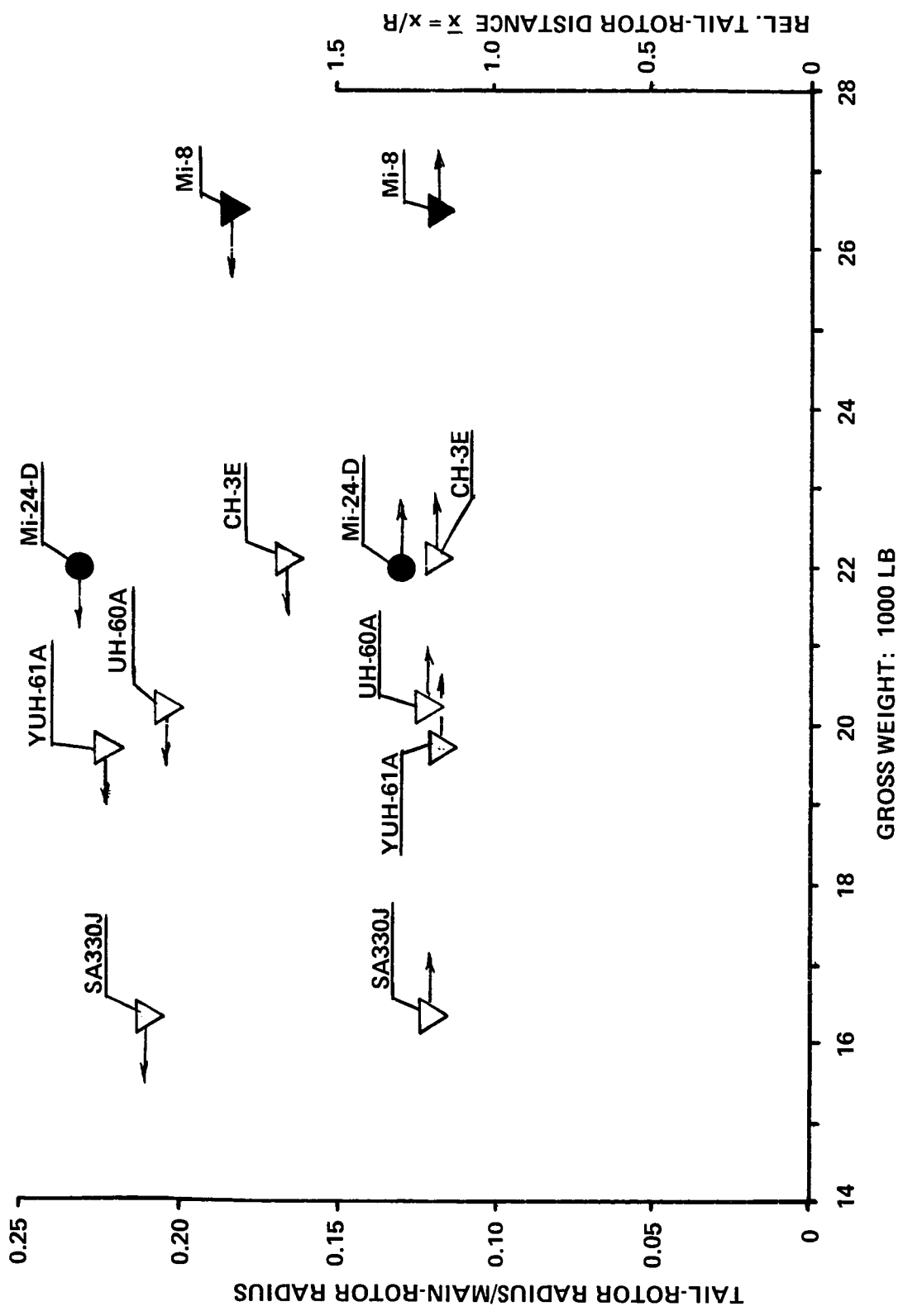

Figure 4.5 Tail-rotor to main-rotor radii ratio and relative tail-rotor distance of Soviet & Western helicopters of the 12,000 to 30,000-lb gross weight class.

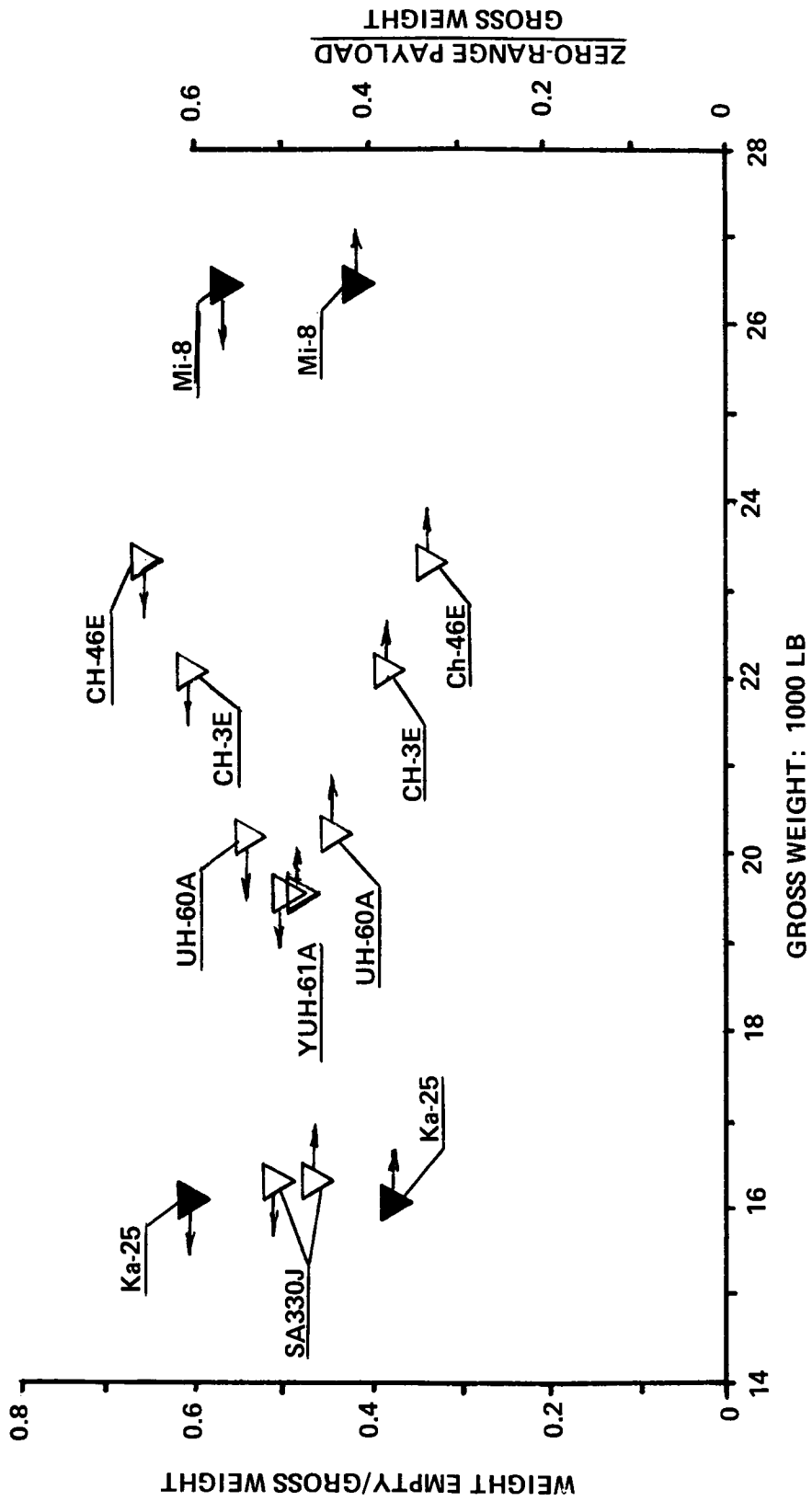

Figure 4.6 Weight empty and zero-range payload to gross weight ratio for Soviet & Western helicopters of the 12,000 to 30,000-lb gross weight class

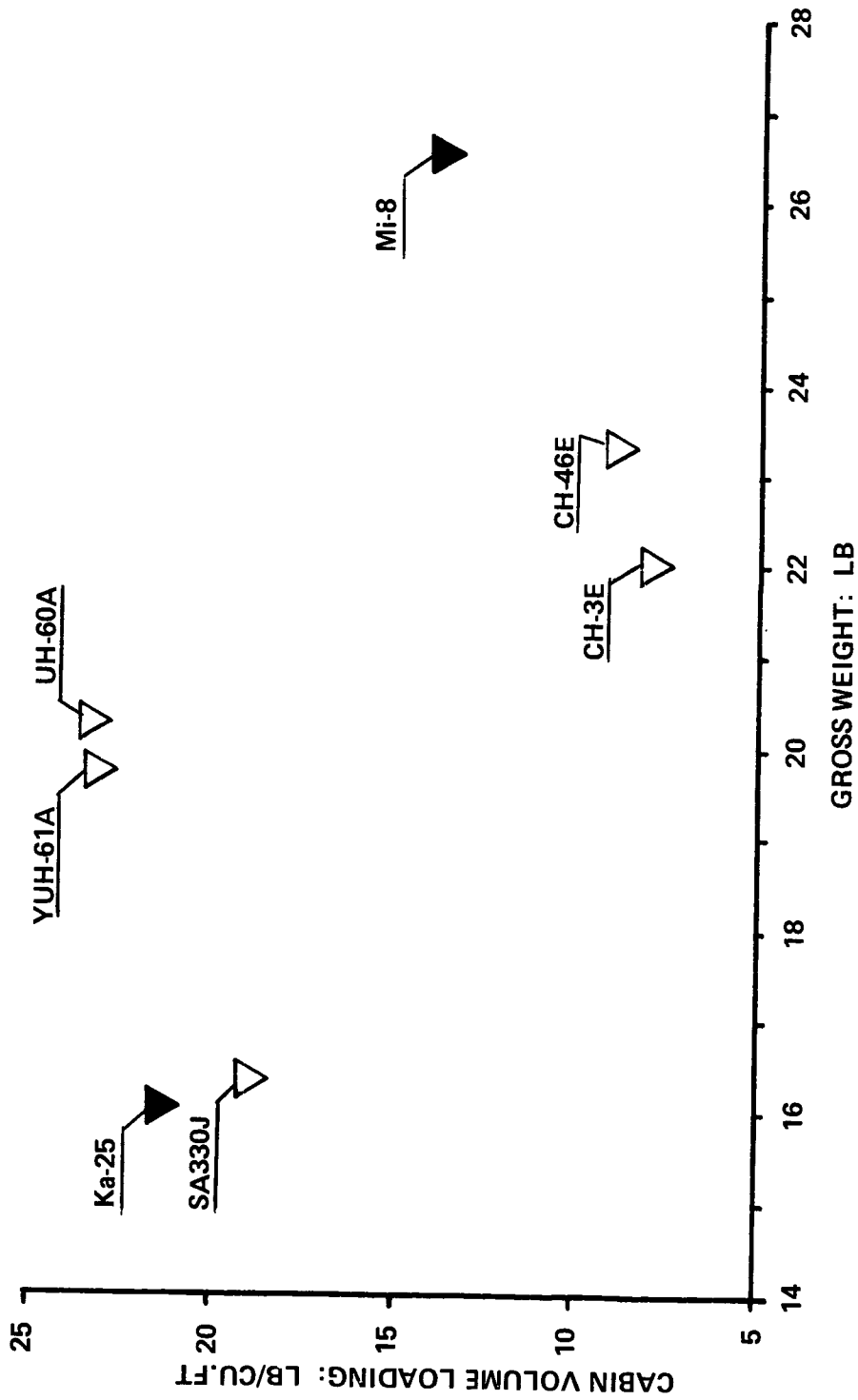

Figure 4.7 Zero-range cabin volume loading for Soviet and Western helicopters of the 12,000 to 30,000-lb gross weight class.

TABLE 4.2

HOVERING AND VERTICAL CLIMB ASPECTS, ISA  
12,000 TO 30,000-LB GROSS WEIGHT CLASS

ITEM	HELICOPTER							
	Mil Mi-8	Kamov Ka-25	Aerospatiale SA330J	Sikorsky CH-3E	Boeing-Vertol CH-46E	Boeing-Vertol YUH-61A	Sikorsky UH-60A	Mil Mi-24-D
GROSS WEIGHT, LB	26,455	16,100	16,315	22,050	23,300	19,700	20,250	22,000*
<b>MAIN ROTOR</b>								
Disc Loading, $w$ : psf	6.83	7.68	8.48	7.30	5.70	10.47	8.95	9.00
Ideal Induced Velocity, $v_{id}$ : fps	37.88	40.17	42.23	39.16	34.60	46.90	43.39	43.48
Tip Speed, $V_t$ : fps	692.1	[650]	687.0	659.0	704.8	734.0	725.0	[705.0]
$v_{id}/V_t$	0.055	[0.062]	0.062	0.059	0.049	0.064	0.060	[0.062]
Solidity, $\sigma$	0.0533	[0.074]	0.101	0.078	0.058	0.0996	0.0821	0.0905
Download Factor, $k_{vh}$	1.025	1.025	1.025	1.025	1.060	1.025	1.025	1.070
Average Blade Lift Coeff., $\bar{c}_l$	0.67	[0.63]	0.46	0.56	0.53	0.50	0.53	[0.52]
$FM$	[0.64]	[0.68]	(a) 0.70	[0.66]	[0.67]	0.72**	[0.72]	[0.70]
<b>TAIL ROTOR</b>								
Tail Rotor Thrust: lb	2069.7		1170	1735		1530.0	1450	1656.5
$T/Mgr$	0.078		0.072	0.078		0.078	0.071	0.075
Disc Loading, $w$ : psf	16.04		15.02	20.67		16.10	15.26	12.88
Ideal Induced Velocity, $v_{id}$ : fps	58.0		56.2	65.9		58.2	56.6	52.0
Tip Speed, $V_t$ : fps	758.4		667.3					
Solidity, $\sigma$	0.133		0.195					
Blocking Factor, $k_{blo}$	[1.0]		1.07					
Avg. Blade Lift Coefficient: $\bar{c}_l$	0.53		0.435	[0.6]				[0.6]
$FM$	[0.6]		0.48	0.135				0.101
Power Ratio, $(RP_t/RP_m)^j$	0.119		0.15					

(a) Manufacturer's Data

NOTE: \*@ Normal Gross Weight

\*\*From Figure 1.16

Assumed or rough estimated values are shown in brackets [ ].

Table 4.2 (Cont'd)

$\eta_{Og}$	0.858	[0.95]	0.85	0.846	[0.91] <sup>a</sup>	0.864	0.866	0.872
$FM_{Og}$ (1st Estimate)	0.529	0.622	0.578	0.538 <sup>b</sup>	0.560	0.599	0.599	0.555
GROSS WEIGHT, LB	24,470	15,650	16,315	19,500	23,300	19,700	20,250	22,000
Hover Ceiling OGE: ft	2615*	1700	5575	3000	5900			
SL Takeoff SHP/GW: hp/lb	0.123*	0.115	0.136 <sup>†</sup>	0.120 <sup>†</sup>	0.120 <sup>†</sup>			
Rel. Lapse at Hovering Ceiling OGE	1.03	[1.0]	0.86	1.0	0.85 (N/A)			
$FM_{Og}$ (2nd Estimate)	0.528	0.644	0.612	0.530	0.574	0.605 <sup>††</sup>	0.590 <sup>†††</sup>	
Average $FM_{Og}$	0.529	0.633	0.595	0.534	0.568 <sup>c</sup>	0.605 <sup>††</sup>	0.590	0.555
Lapse Rate $\lambda_{3000}$	1.035	[1.0]	0.93	0.925 (N/A)	0.925 (N/A)	0.915	0.915 (N/A)	[1.0]
VTO Gross Weight: lb	23,804	15,300	16,680 <sup>†</sup>	19,500	23,950 <sup>d</sup>	19,125	20,250	26,500
Vert. R/C at VTO GW: fpm	~70	210	220	200	210	660	220	260
Vert. R/C at NGW: fpm	-120	60	-	-340	-	2250	1530	1725
Vert. R/C at Max. GW: fpm	-	-148	400	-	340	440	220	-

NOTES:

\*at normal gross weight (NGW)

\*\*Reference Fig. 1.16

<sup>†</sup> transmission limit

<sup>††</sup> flight test results from Fig. A-13, Ref. 8

<sup>†††</sup> flight test results from Fig. 3, Ref. 12

<sup>a</sup> overlap effect

<sup>b</sup> Reference 11

<sup>c</sup> Reference Fig. 4.8

<sup>d</sup> from Fig. 4.8

Since it was difficult to establish values of all the parameters which could influence the tail-rotor figures of merit levels, it was decided to assume a common value of  $FM_{tr} = 0.6$  for all single-rotor helicopters. It is believed that this approach is justified by the fact that possible practical deviations from the assumed figures of merit level would have little influence on the results of the comparative rating of the helicopters studied.

The overall power transmission efficiency ( $\eta_{oa}$ ) for the single-rotor helicopters was computed from Eq. (1.27), assuming  $\eta_{xmtot} = 0.96$ , which would cover the actual transmission and accessory losses. For the coaxial configuration of the Ka-25,  $\eta_{oa} = 0.95$  was assumed, while for the tandem represented by the CH-46E, the  $\eta_{oa} = 0.92$  value included the overlap losses ( $\eta_{op} = 0.95$ ).

As in Ch. 3, the overall figure of merit values computed by the step-by-step procedure are compared either with those deduced from the hovering ceiling data or those obtained from flight test results. In the first case, an average of the step-by-step and hovering ceiling results are shown in Table 4.2 as "official"  $FM_{oa}$  values. In the second case, the values computed from flight test data were assumed to be correct, while the closeness of the step-by-step obtained  $FM_{oa}$ 's to those resulting from flight tests seems to strengthen one's confidence in the established procedure (see CH-46E, UH-60A, and YUH-61A).

It should be added at this point that the gross weight-rotor thrust relationship from which the  $FM_{oa}$  of the CH-46 was computed [ $FM_{oa} = SHP_{id} / (RHP / \eta_{xm})$ ] is shown in Fig. 4.8.

Having the  $FM_{oa}$  values established, the VTO gross weight was computed from Eq. (1.2), and the vertical R/C at SL, ISA was calculated from Eq. (1.9).

**Power per Pound of Gross Weight in Comparison with the Ideal Power (Fig. 4.9).** Based on the so-called civilian rating of 1500 SHP of the TV2-117A turboshaft, the ratio of the maximum and normal gross weights for the Mi-8 helicopter appears to be lower than for its Western counterparts. By contrast, the power ratio for the Mi-24D with TV3-117 engines rated at 2170 hp would be on the Western level. The  $[(SHP_{TO})_o / (W_{gr})_{max}] / [SHP_{id} / (W_{gr})_{max}]$  ratio for the Ka-25 helicopter appears to be the lowest of all the compared helicopters of this gross weight class (about 1.5). Whether the assumed rating of the GTO-3 engine of  $(SHP_{TO})_o = 900$  hp is routinely exceeded is not known.

It should be noted that such recent Western helicopter designs as the SA330J, UH-60A, and YUH-61A exhibit, at normal gross weight, a power ratio of about 2.5 (based on transmission-limited power), and about 1.75 at the maximum flying gross weight.

**Average Blade Lift Coefficient (or  $C_T/\sigma$ ) in Hover OGE at SL, ISA (Fig. 4.10).** Similar to the previously discussed gross weight class, the majority of the Soviet helicopters depicted here also appear to operate in hover OGE, even at SL, ISA, at higher average blade-lift coefficients than their Western counterparts. However, in the Mi-24D, the  $\bar{c}_l$  value (at least at NGW and assumed  $V_t = 700$  fps) appears to be closer to those of the older Western rotorcraft, but is still above those of the UTTAS and Puma (later developed into the so-called European UTTAS-Super Puma) types.

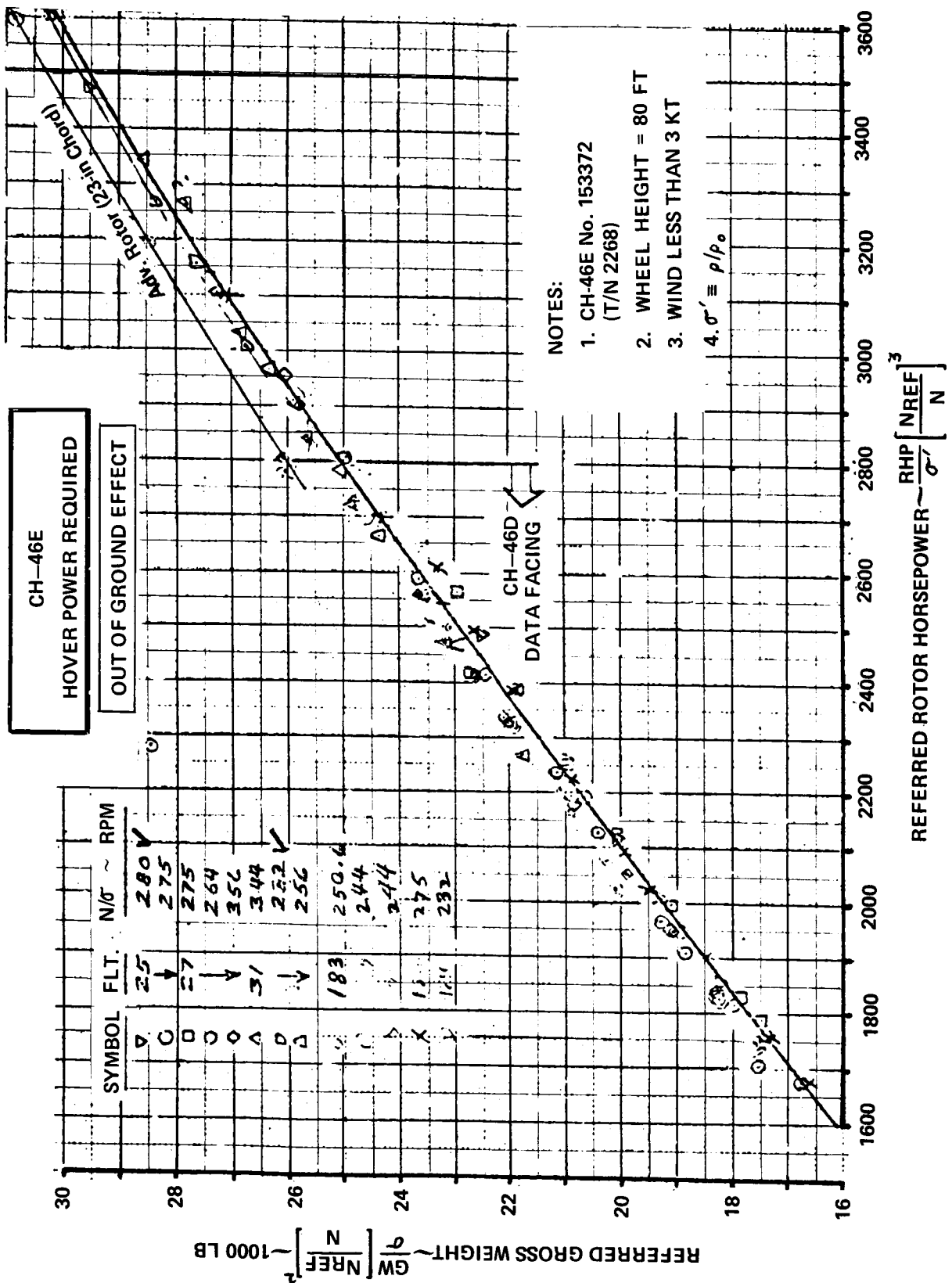

Figure 4.8 Referred rotor horsepower - referred gross weight relationship in hover OGE for the CH-46E helicopter. (Courtesy of Boeing Vertol Company)

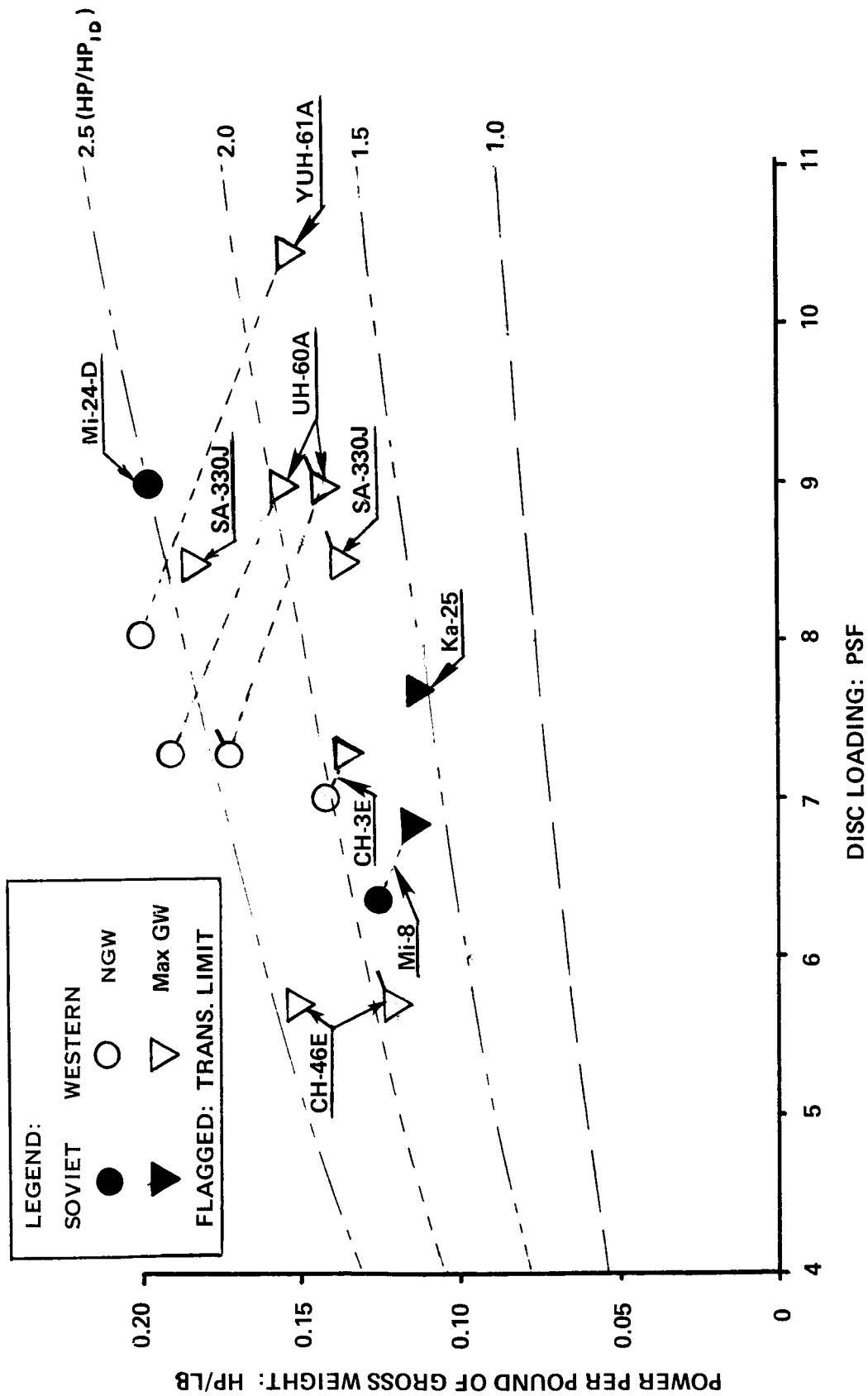

Figure 4.9 Power per pound of gross weight in comparison with ideal power, shown vs disc loading for Soviet & Western helicopters of 12,000 to 30,000-lb gross weight class



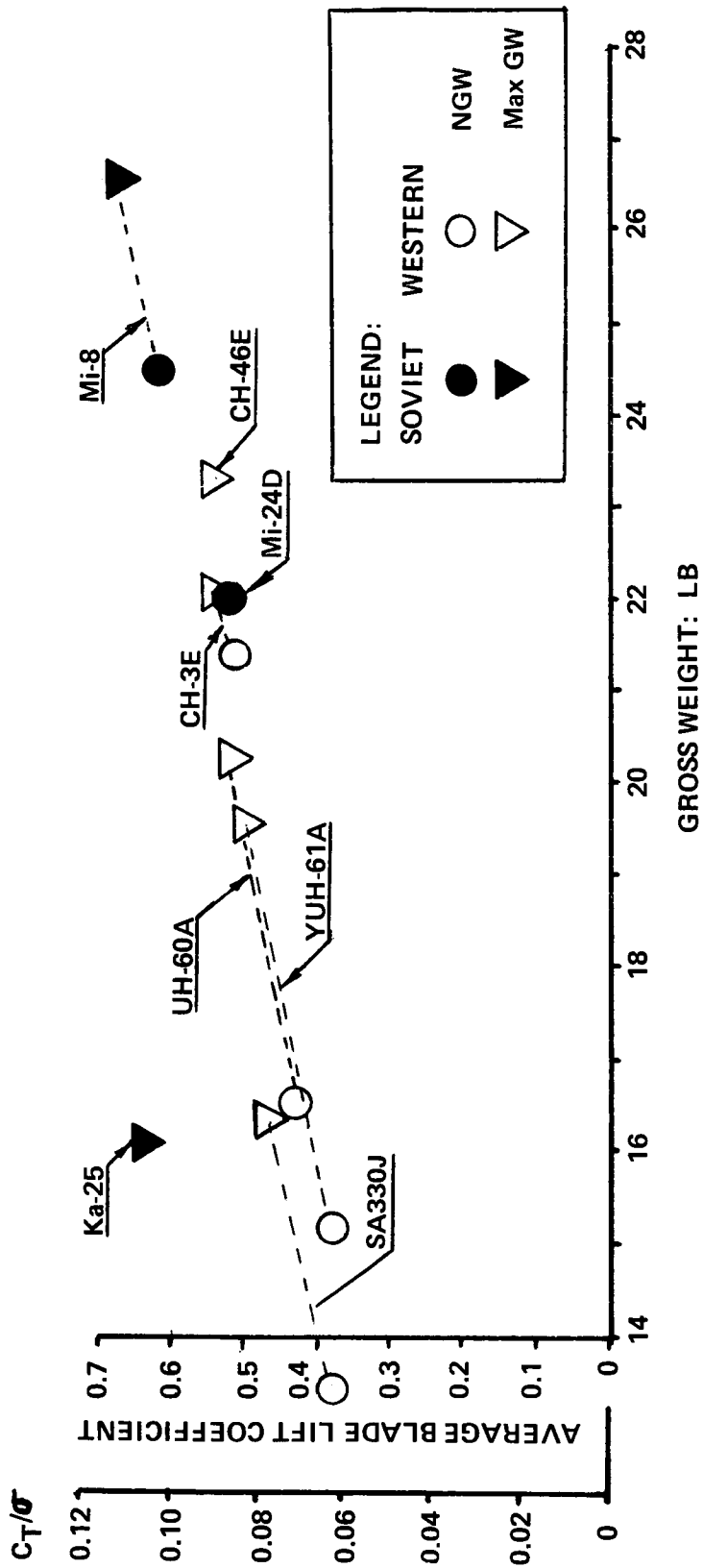

Figure 4.10 Average blade lift coefficient and  $C_T/\sigma$  in hover OGE SL, ISA of Soviet and Western helicopters of the 12,000 to 30,000-lb gross weight class.

**Main Rotor Figures of Merit (Fig. 4.11).** As previously mentioned, the main rotor figure of merit of the YUH-61A helicopter was computed from tower test data<sup>8</sup>. The  $FM_{mr}$  value was supplied by the manufacturer for the SA330J, while for all other helicopters the values were estimated. A glance at Fig. 4.11 indicates that the Mi-8 probably exhibits the lowest  $FM_{mr}$  of the whole group, while that of the Mi-24D has the potential of attaining the same level as the UTTAS-Puma type. The  $FM_{mr}$  of the Ka-25 would probably be higher than for the CH-3E, but below the UTTAS type.

**Tail-Rotor Thrust to Gross Weight and Power to Rotor-Power Ratios (Fig. 4.12).** It can be seen from Fig. 4.12 that in hover OGE at SL, ISA, all of the compared single-rotor helicopters of the presently investigated gross weight class exhibit surprisingly uniform tail-rotor thrust to gross weight ratios of  $T_{tr}/W_{gr} \approx 0.076$ .

With respect to the power ratios, the Mi-8 with  $RP_{tr}/RP_{mr} \approx 0.12$  at  $W_{gr_{max}}$  is on the same level as Western helicopters having the same type of operational gross weight. The Mi-24D appears to exhibit the lowest power ratio of approximately 0.10, but it is emphasized that this occurs at the assumed normal gross weight and furthermore, that all inputs on this helicopter are (at this writing) highly speculative.

**Overall Figure of Merit (Fig. 4.13).** The overall figures of merit for the YUH-61A, UH-60A, and CH-46E helicopters were obtained from flight test results (Refs. 8 and 12, and Fig. 4.8); for the other compared helicopters, the  $FM_{oa}$  values were estimated. Fig. 4.13 shows that the Ka-25 probably has the highest overall figure of merit because of its coaxial configuration. The UTTAS and Puma, but especially the UTTAS represent the next highest  $FM_{oa}$  level. The Mi-8 and CH-3E appear on the same level, while the Mi-24D is on a somewhat higher level.

**VTO Gross Weight.** The lapse rate of takeoff power at 3000-ft altitude, ISA, was read from Fig. 2.10 and the engine power available at that altitude was computed. The obtained values were then compared with the transmission limits and the lower of the two powers was used in calculating the VTO gross weight from Eq. (1.2) for single-rotor helicopters. For the tandem configuration, a constant coefficient of 20.22 was used in Eq. (1.2) instead of 16.05. The so-calculated VTO gross weight values are listed in Table 4.2, which shows that for the SA330J and CH-46E, the VTO gross weights are higher than their maximum gross weights, while for the CH-3E and YUH-61A they are lower, and for the UH-60A the weights are equal. The VTO gross weights for the Mi-8 and Ka-25 are even lower than even their normal gross weights. This is in contrast to the Mi-24-D where the VTO gross weight is much higher than the assumed normal gross weight.

**Vertical Rates of Climb at SL, ISA (Fig. 4.14).** Using the VTO gross weights, as well as the maximum flying and normal gross weights, the corresponding vertical rates of climb at SL, ISA were computed for the compared helicopters. The results are shown in Table 4.2, and plotted in Fig. 4.14.

A glance at this figure indicates that the vertical rate of climb of the TV2-117A-equipped Mi-8 helicopter at its VTO gross weight is very low. This is due to the character of the lapse-rate curve of this

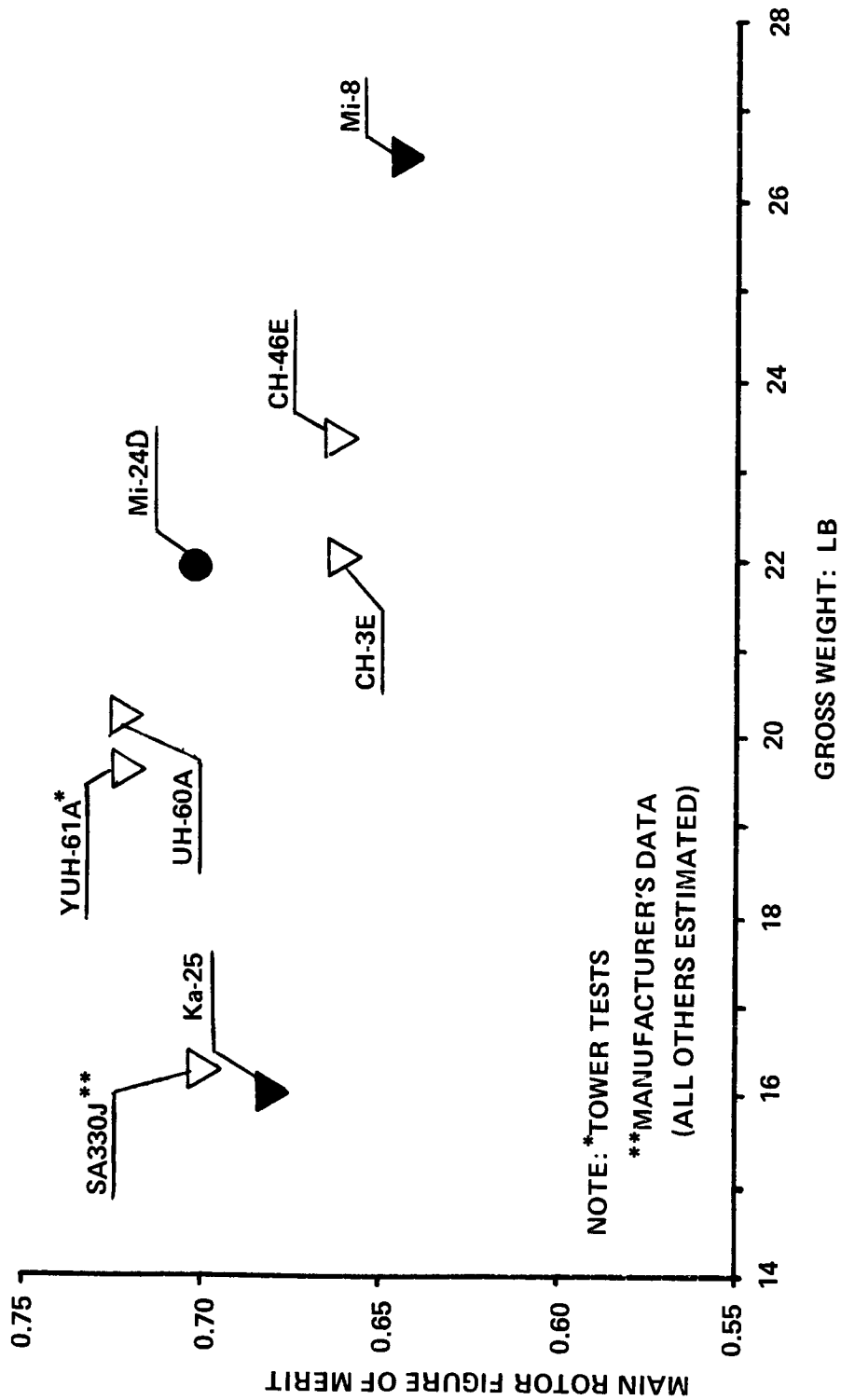

Figure 4.11 Main rotor figures of merit in hover OGE, SL, ISA of Soviet and Western helicopters of 12,000 to 30,000-lb gross weight class.

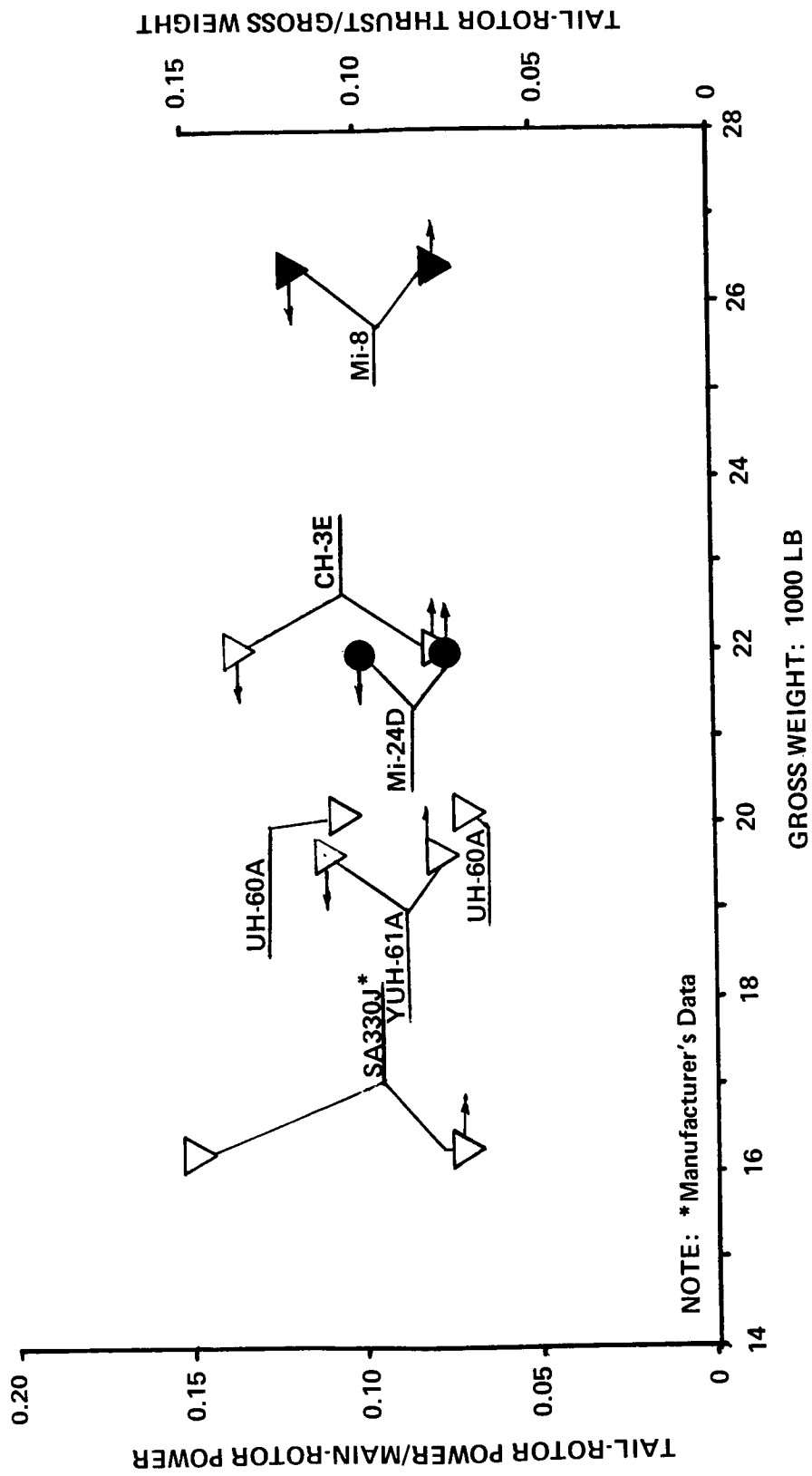

Figure 4.12 Tail-rotor thrust to gross weight and tail-rotor power to main-rotor power ratios in hover OGE, SL, ISA for Soviet and Western helicopters of the 12,000 to 30,000-lb gross weight class.

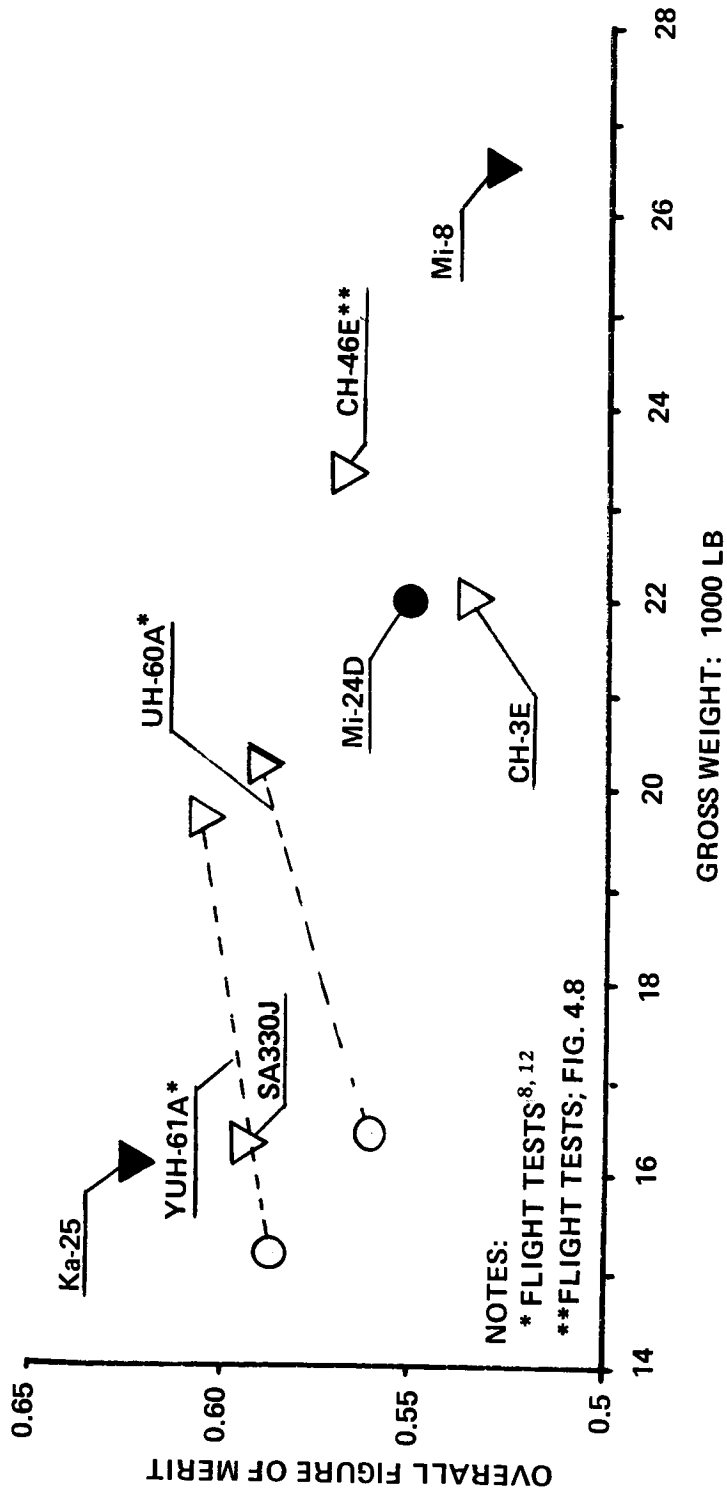

Figure 4.13 Overall figures of merit of Soviet and Western helicopters of the 12,000 to 30,000-lb gross weight class.

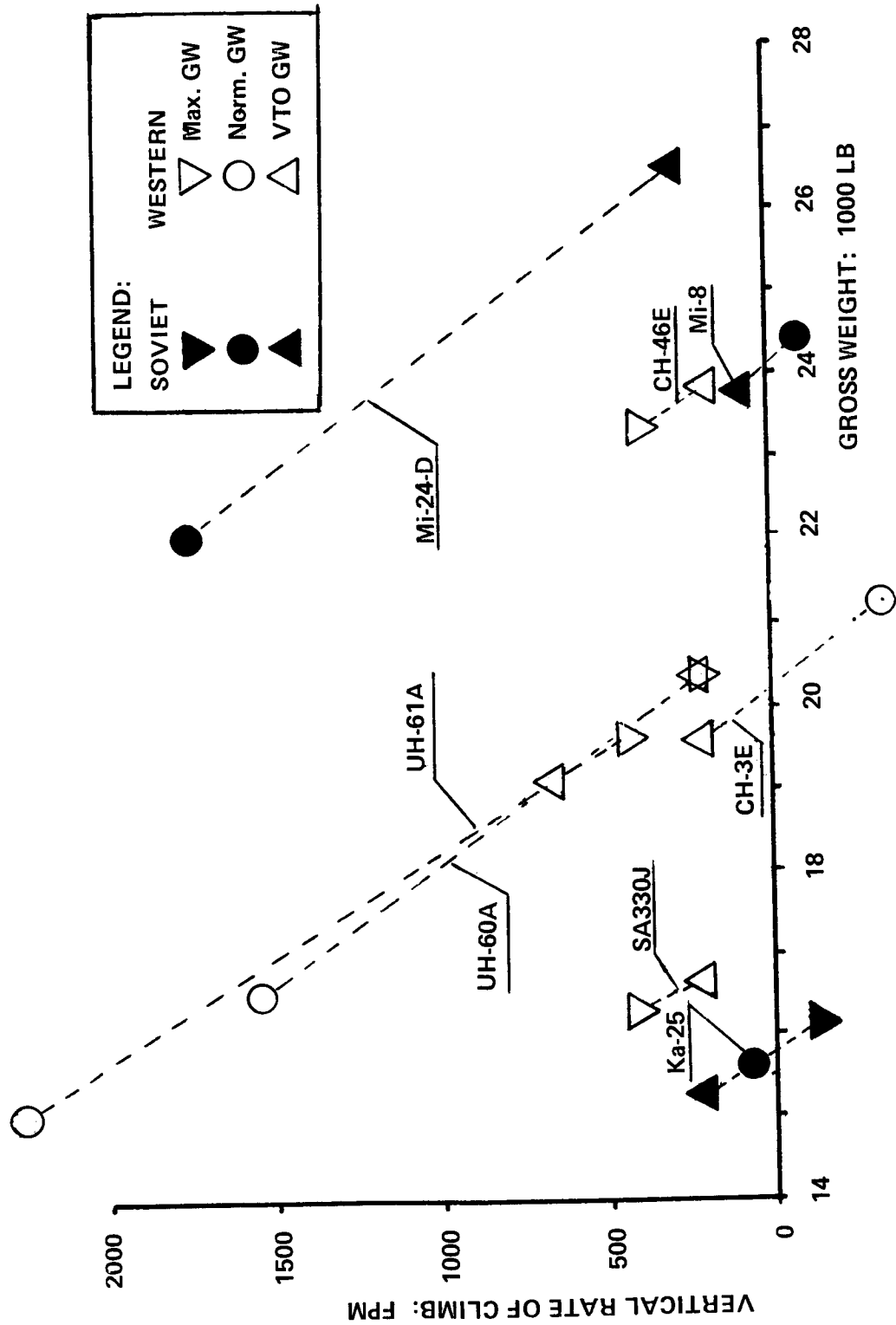

Figure 4.14 Vertical rates of climb at SL, ISA at TO, or transmission-limited power for various 12,000 to 30,000-lb gross weight Soviet & Western helicopters.

engine – showing an increase of power with altitude (up to about 4000 ft). For rotorcraft having transmission-limited takeoff power, the vertical rates of climb at the VTO gross weight are also low ( $V_{vc} \approx 200$  fpm).

With respect to Soviet helicopters, it should be noted that the Mi-8 and Ka-25 at SL, ISA have no vertical climb capability at either their maximum or normal gross weights. By contrast, the TV3-117-equipped Mi-24D at its assumed normal gross weight would have a vertical climb capability similar to that of the UTTAS types at their normal gross weights.

With the exception of the CH-3E, all of the compared Western helicopters show some vertical climb capability at their maximum flying weights. The UTTAS-type helicopters show very high rates of climb at their normal gross weights.

### 4.3 Energy Aspects in Hover

**Table 4.3.** The most important inputs required in the study of energy aspects in hover, as well as numerical values of hourly fuel consumption per pound of gross weight and zero-time payload are indicated in Table 4.3.

For all of the Western helicopters, with the exception of the CH-3E, the calculations were performed at maximum gross weights since, at these flying weights, they have not only OGE capabilities at SL, ISA, but also at 3000-ft altitude (definition of the VTO gross weight).

By contrast, the Soviet Mi-8 and Ka-26 helicopters at their maximum gross weights can not hover at SL, ISA (at least at the accepted "civilian" ratings of the TV2-117A engines). Consequently, the VTO gross weights for these two helicopters were taken as a basis for the comparative study of energy aspects in hover performed in Table 4.3. For the Mi-24-D, the fuel required per pound of gross weight and one hour was computed at its normal gross weight, assuming the same sfc variation as for the TV2-117A engine.

The results of these studies are graphically presented in Figs. 4.15 and 4.16.

**Hourly Fuel Consumption per Pound of Gross Weight in Hover OGE at SL, ISA (Fig. 4.15).** It can be seen from Fig. 4.15 that the Soviet Mi-24-D and Ka-25, and the Western SA330J helicopters show the highest fuel consumption per unit of gross weight in the hover regime of flight. It should be noted however, that an error may be present in the estimates of the lb/hr-lb values of the Ka-25 and Mi-24-D helicopters since, at this writing, no "official" data for the fuel consumption of the GTD-3F and TV3-117 turboshafts were available.

In spite of the somewhat inferior sfc of the TV2-117A engine, the Mi-8 appears to have a good fuel consumption per unit of gross weight.

The T700-GE-700-equipped UTTAS helicopters exhibit the lowest lb/hr-lb values of the entire group.

TABLE 4.3

ENERGY ASPECTS IN HOVER, S/L, ISA  
12,000 TO 30,000-LB GROSS WEIGHT CLASS

ITEM	HELICOPTER							
	Mil Mi-8	Kamov Ka-25	Aerospatiale SA 330J	Sikorsky CH-3E	Boeing-Vertol CH-46E	Boeing-Vertol YUH-61A	Sikorsky UH-60A	Mil Mi-24D
GROSS WEIGHT: LB	23,800*	15,300*	16,315**	19,500*	23,300**	19,700**	20,250**	22,000***
Overall Figure of Merit	0.529	0.633	0.595	0.534	0.568	0.605	0.590	0.555
SHP Required in Hover: hp	2931.7	1720	2011 <sup>a</sup>	2446	2655	2776.6	2600 <sup>a</sup>	3133.7
TO SHP Installed: hp	3000	1800	2990	3000	3740	3000	3120	4340
<i>SHP<sub>req</sub>/SHP<sub>TO</sub></i>	0.98	0.96	0.67	0.82	0.71	0.93	0.83	0.72
sfc: lb/hp-hr	0.61	[0.75]	0.69	0.64	0.59	0.45	0.46	[0.66]
Hourly Fuel Flow per Pound of GW: lb/hr-lb	0.0751	[0.0853]	0.0860	0.0804	0.0672	0.0634	0.0531	0.0940
Zero-Time Payload: lb	8347	5043	7600	5820	7675	9523	9199	
Ratio of Zero-Time PL to GW	0.351	0.334	0.466	0.298	0.329	0.483	0.454	
Hourly Fuel Flow per Lb of PL for t = 0: lb/lb-hr	0.214	[0.250]	0.185	0.269	0.204	0.131	0.117	
t = 1/3 hr	0.231	[0.280]	0.198	0.291	0.219	0.137	0.122	
t = 2/3 hr	0.250	[0.308]	0.212	0.323	0.236	0.144	0.127	
t = 1 hr	0.273	[0.344]	0.228	0.362	0.256	0.151	0.132	

NOTES:

\*VTO Gross Weight

\*\*\*Normal Gross Weight

\*\*Maximum Gross Weight

<sup>a</sup>Manufacturer's Data

Assumed or rough estimated values are shown in brackets [ ].



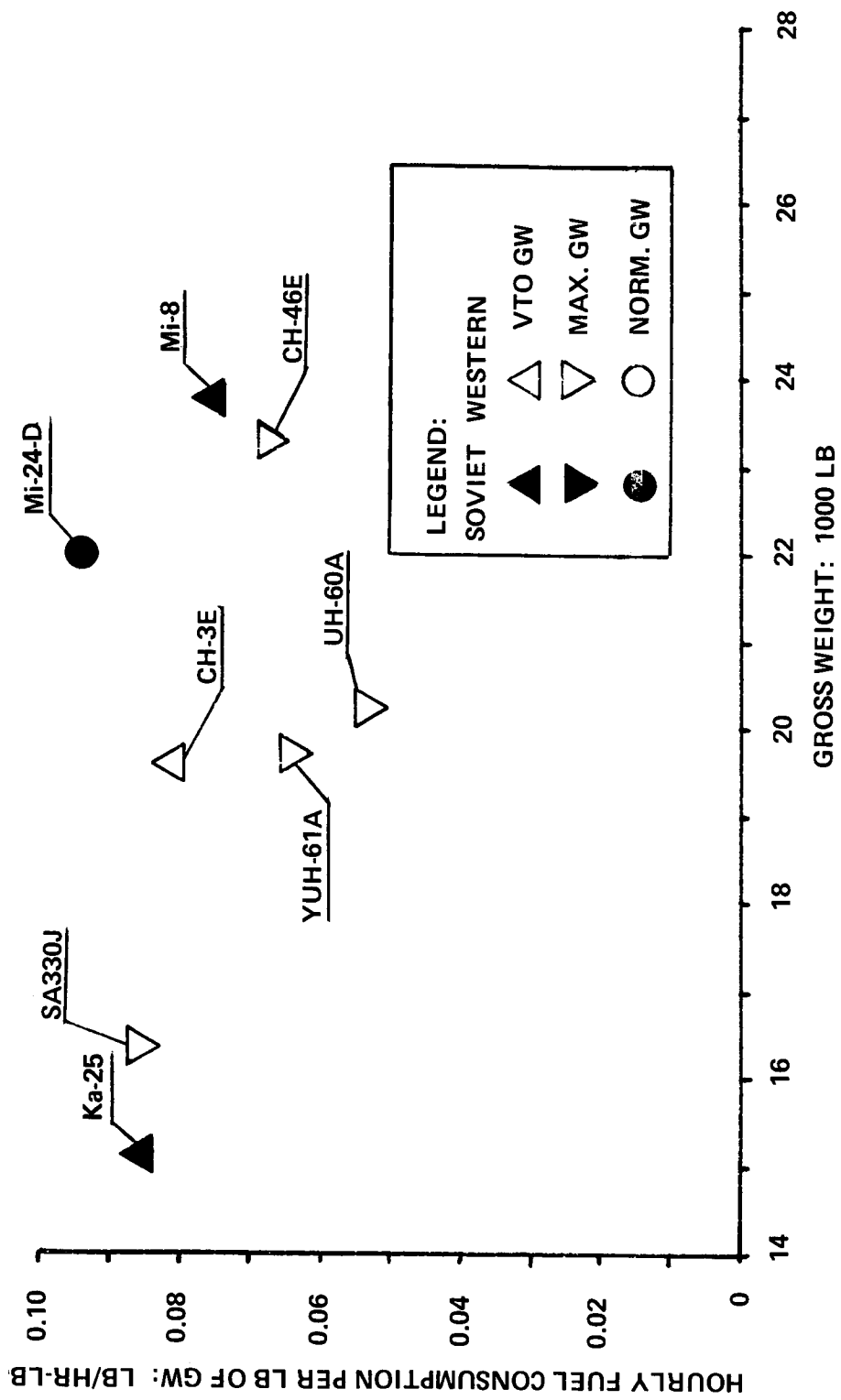

Figure 4.15 Hourly fuel consumption per pound of gross weight in hover OGE, SL, ISA of Soviet & Western helicopters of the 12,000 to 30,000-lb gross weight class.

Fuel Consumption per Pound of Payload in Hover OGE, SL, ISA (Fig. 4.16). Unfortunately, there is insufficient data regarding the Mi-24-D helicopter to include it in this comparison. As far as the other two Soviet helicopters are concerned, the Ka-25 appears to have a higher fuel consumption per unit weight of payload (based on the assumed sfc) than its Western counterparts, with the exception of the CH-3E. The Mi-8 also shows slightly higher fuel requirements per unit weight of payload than those of the CH-46E and SA330J helicopters. The UTTAS-type helicopters, due to the low sfc of their engines and favorable structural weight aspects, exhibit by far the lowest fuel requirements with respect to payload of all the compared helicopters. It should once more be pointed out that should the CH-46 be configured for land operations, as are the rest of the compared rotorcraft, its relative fuel consumption referred to payload would be lower.

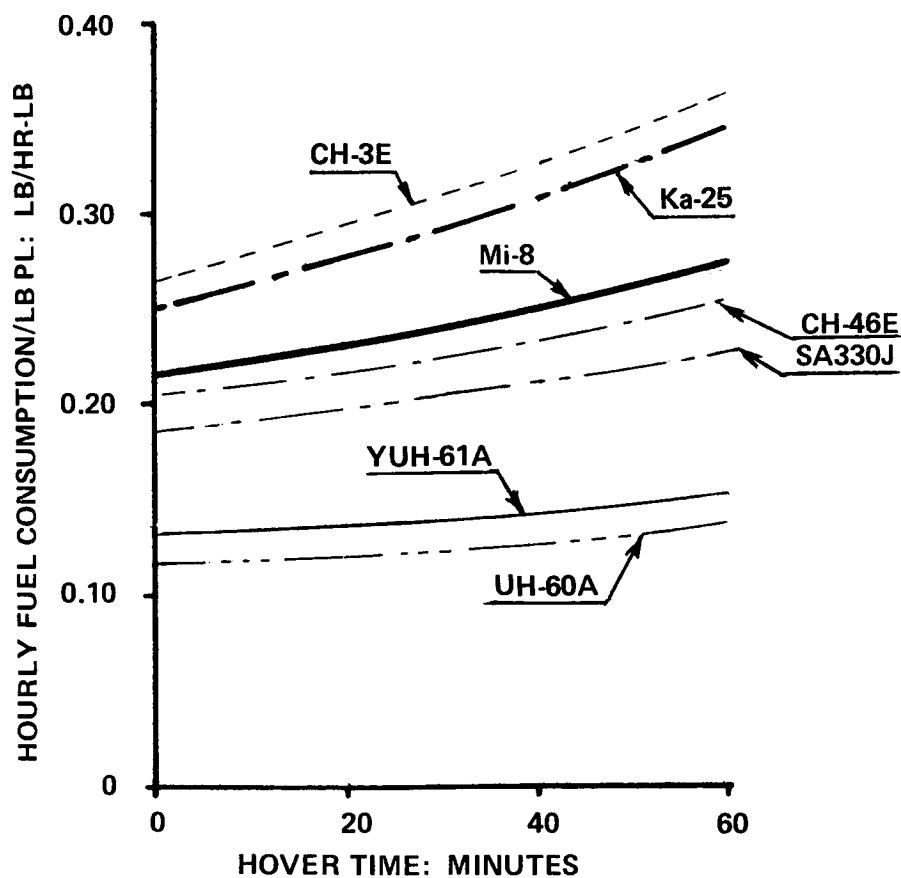

Figure 4.16 Variation with time of hourly fuel consumption per pound of maximum payload in hover OGE, SL, ISA for Soviet and Western helicopters of the 12,000 to 30,000-lb gross weight class.

#### 4.4 SHP Required Aspects in Level Flight at SL, ISA

Establishment of the  $(SHP/W_{gr}) = f(V)$  Relationship. Flight test results (Fig. 4.17) were directly used to establish the  $(SHP/W_{gr}) = f(V)$  relationship for the CH-46E helicopter in level flight at SL, ISA.

Flight test data was also available for the YUH-61A helicopter (Fig. A-8, Ref. 5); but at gross weights different than the  $(W_{gr})_{max}$  and in two cases, at air densities lower than that at SL, ISA. Furthermore, the results were referred to the rotor and not shaft horsepower. In view of these facts, the two-point approach (Sect. 1.5), modified for  $(RHP/W_{gr}) = f(V)$  relationships, was used to find the  $w_{fp}$ ,  $f$ , and  $\bar{c}_d/\bar{c}_d$  from the curves shown in Fig. A-8<sup>5</sup>.

The results of those calculations and the average values assumed for establishment of the  $SHP/W_{gr} = f(V)$  relationship at SL, ISA and  $W_{gr} = 19,700$  lb are shown in Table 4.4.

The  $(SHP/W_{gr}) = f(V)$  for the UH-60A was directly computed from the  $C_p = f(C_T)$  curves in Ref. 12, and was given by the manufacturer for the SA330J.

TABLE 4.4

VALUES OF VARIOUS PARAMETERS COMPUTED FROM FLIGHT TEST RESULTS<sup>5</sup>

$W_{gr}$ : lb	$\rho$ , slug/cu.ft	$\bar{c}_d/\bar{c}_d$	$\bar{c}_d$	$\bar{c}_d$	$w_{fp}$ , psf	$f$ , sq.ft.
18,720*	0.00208*	1/51.5	0.513	0.010	436.8	42.85
16,572*	0.00238*	1/43	0.413	0.0096	462.0	35.83
19,700	0.00238	1/50	0.50	0.010	500.0	39.36

\*See Fig. A-8<sup>5</sup>

For the remaining helicopters (both Soviet and Western), an approach based on performance figures (see Sections 1.5 and 3.4) was used.

It should be noted at this point that no reliable data regarding the maximum rate of climb in forward flight at SL is available for the Mi-8 helicopter at this writing. Consequently, the single-point approach was taken to determine the  $f$  and  $\bar{c}_d$  values at  $W_{gr} = 24,470$  at which  $V_{max}$  is quoted. The so-established equivalent flat plate area and average blade drag coefficient values were taken to calculate the  $(SHP/W_{gr}) = f(V)$  relationship at  $W_{gr} = 26,455$  lb at SL, ISA.

No data at all regarding rates of climb could be found for the Ka-25 helicopter at this writing; hence, the single-point approach was also used in this case.

As far as the Mi-24D is concerned, no performance figures are known to this writer.

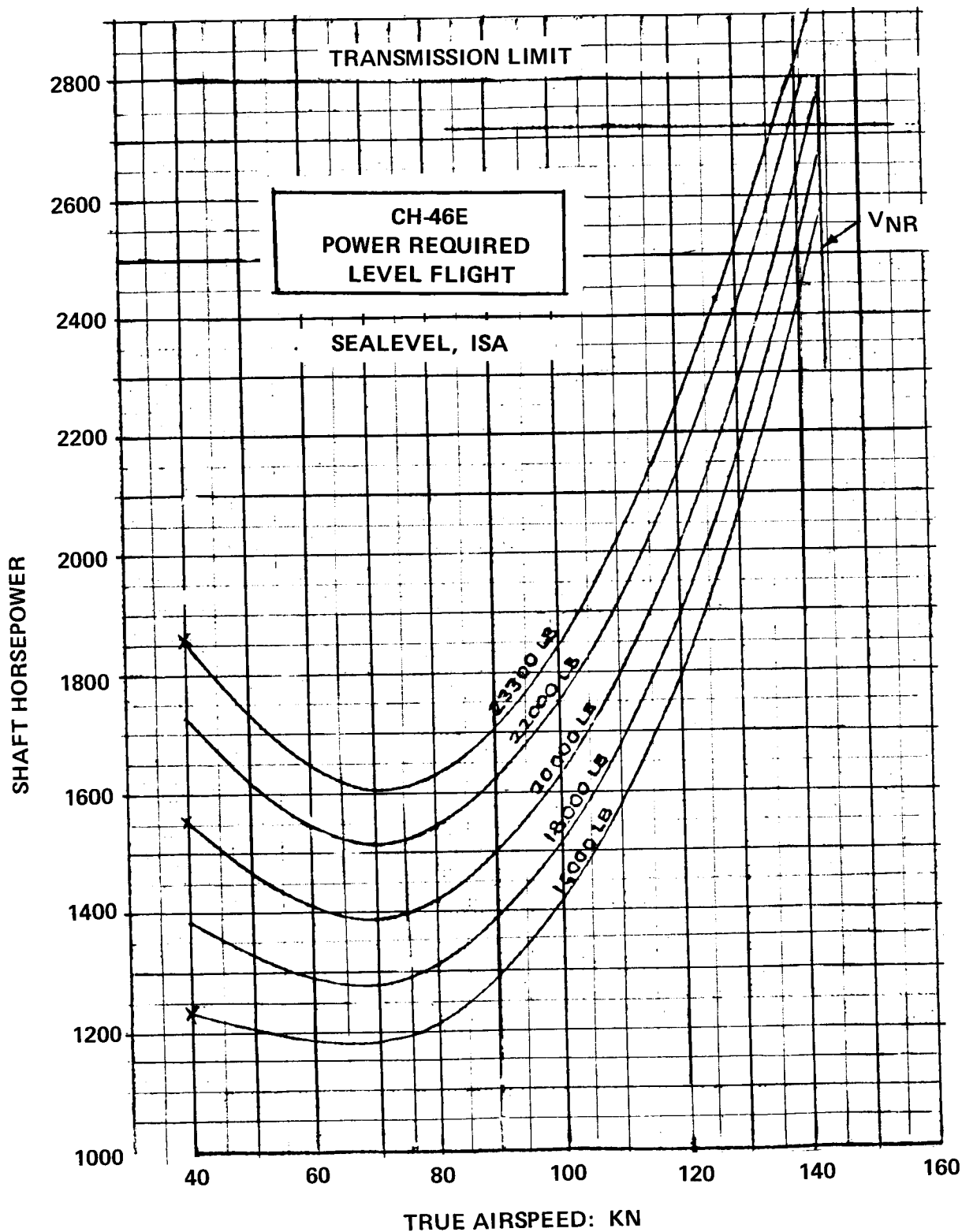

Figure 4.17  $SHP = f(V)$  relationship in level flight at SL, ISA for the CH-46E helicopter. (Courtesy of Boeing Vertol Co.)

The computations indicated in Table 4.5 as the 1st Approximation were performed for the SA330J using manufacturer's figures regarding the SHP required at 134 knots. Then, taking advantage of the  $(SHP/W_{gr}) = f(V)$  relationship, the two-point technique was used to determine the  $w_{fp}$ ,  $f$ , and  $\bar{c}_d$  values shown in the 2nd Approximation.

In the 1st Approximation for the UH-60A, the single-point results produced a  $(SHP/W_{gr}) = f(V)$  relationship very close to those based on flight tests<sup>1,2</sup>. Then using the manufacturer's figures for SHP required at 155 knots, and  $SHP_{min}$ , the two-point technique was used to determine the  $w_{fp}$ ,  $f$ , and  $\bar{c}_d$  values shown in the 2nd Approximation.

In the case of the CH-3E helicopter, the two-point approach was applied in the calculations of  $f$  and  $\bar{c}_d$  at  $W_{gr} = 21,247$  lb, and the results were used to establish the  $(SHP/W_{gr}) = f(V)$  curve at  $W_{gr} = 22,050$  lb at SL, ISA.

All of the above-described calculations are indicated in Table 4.5, and the results are graphically shown in Fig. 4.18.

**Fig. 4.18.** A glance at Fig. 4.18 indicates that similar to the up-to-12,000-lb gross weight class, the Kamov helicopter shows the lowest power per pound of gross weight requirements in the low-speed range of level flight at SL, ISA. However, as the flying speed becomes higher than 70 kn, the  $(SHP/W_{gr})_{max}$  requirements begin to increase quite sharply.

The Mi-8 helicopter appears to exhibit generally good characteristics with respect to the  $(SHP/W_{gr})_{max} = f(V)$  relationship. It also appears that this helicopter, together with the SA330J and CH-3E show the highest gross weight to equivalent drag ratios (approximately 4.4).

It is also noted that, in general, all of the  $(SHP/W_{gr})_{max} = f(V)$  curves for the compared helicopters in this gross weight class are included within a relatively narrow band. It should be recalled that for the CH-46E, UH-60A, and YUH-61A helicopters, the results shown in Fig. 4.18 were based on flight tests. The  $(SHP/W_{gr}) = f(V)$  curve for the SA330J represents a fit into the points representing the manufacturer's  $SHP/W_{gr}$  and  $V$  values shown in Table 4.5. The curves for all of the other helicopters were deduced from published performance figures; keeping in mind the uncertainties as to a precise knowledge of engine power at the quoted speed of flight, and the rate of climb values in forward flight.

$(SHP/W_{gr})$  Values at  $V_{max}$ . In Fig. 4.19, the  $SHP/W_{gr}$  values at  $V_{max}$  or  $V_{cr,max}$  are shown vs corresponding speeds. The third-degree parabolas representing the so-called cubic law of power dependence on speed are also marked in this figure. It is interesting to note that the points for the YUH-61A, UH-60A and SA330J helicopters lie on the same parabola. Another parabola passes through the point representing the Ka-25 helicopter. The Mi-8 point lies close to the lower parabola. It should also be noted that, contrary to Fig. 3.20, the scatter of points in the 12,000 to 30,000-lb gross weight class appears much smaller than for the previously considered gross weight class of up to 12,000 lb.

TABLE 4.5  
FORWARD FLIGHT ASPECTS AT SL, ISA  
12,000 TO 30,000-LB GROSS WEIGHT CLASS

ITEM	HELICOPTER							
	Mil Mi-8	Kamov Ka-25	Aerospatiale SA 330J	Sikorsky CH-3E	Boeing-Vertol CH-46E	Boeing-Vertol YUH-61A	Sikorsky UH-60A	Mil Mi-24D
GROSS WEIGHT: LB	24,470	16,100	16,315	21,247	23,300		16,450	22,000
$\eta_{0a}$ Estimate at $V_{max}$ or $V_{cr}$	[0.92]	[0.95]	[0.92]	[0.92]	[0.96]	[0.92]	[0.92]	
$V_{max}$ or $V_{cr}$ : kn	135	119	134	141	139	145	164	
SHP: hp	[2550] <sup>r</sup>	[1550]	1609 <sup>a</sup>	2500	2800		2827	
~Main Rotor RHP: hp	2346	N.A.	1389	2300	—		2602	
Main Rotor $V_t$ : fps	692.1	[650]	687	677.4	700.4	734	725	
Torque Compensating Thrust: lb	1437		978	1571.7			1630	
Tail Rotor Disc Loading: psf	11.14		12.5	18.72			17.16	
Tail Rotor $\zeta_d$	0.37		0.37				0.47	
Tail Rotor $\bar{c}_d$	0.0105		0.01				0.011	
Tail Rotor $\bar{c}_d/\bar{c}_z$	1/35		1/37				1/43	
Tail Rotor Power: hp	91.34		60.7	[105]			~120	
$RHP_{tr}/RHP_{mr}$	0.039		0.0437	[0.0456]			0.046	
$\eta_{0a}$ at $V_{max}$ or $V_{crmax}$	0.92	[0.95]	0.92	0.92	[0.96]		~0.92	
$(SHP/M_{gr}) = f(V)$ : 1st Approx.								
$M_{tab}$ at $V_{max}$ or $V_{crmax}$	0.825	0.763	0.818	0.821	0.834	0.880	0.898	
$\mu$ at $V_{max}$ or $V_{crmax}$	0.330	0.309	0.330	0.352	0.331	0.332	0.382	
Main Rotor Disc Loading: psf	6.39	$w_s = 6.91^*$	8.58	7.08	5.7	10.45	7.27	
Main Rotor $\zeta_d$	0.64	0.63	0.47	0.50	0.525	0.496	0.42	
Main Rotor $\bar{c}_d$	0.011	[0.012]	0.009	0.01	0.0095		0.0092	
Main Rotor $\bar{c}_d/\bar{c}_z$	1/58	1/52	1/52	1/50	1/55		1/45.3	
$k_{vf}$	1.02	1.02	1.02	1.02	1.04	1.02	1.02	
$k_{indf}$	1.15	1.15	1.15	1.15	1.80	1.15	1.15	
Computed $w_f$ : psf	438.8	344.4	541	442.6	379	39.4	420.5	
Eq. Flat Plate $f$ : sq.ft	55.77	46.75	30.1	48.0	61.45		39.1	
Computed $V_e$ : kn	69.9	67.0	79.0	71.7	74.0		71.4	
Computed $SHP_{min}$ : hp	1361	957	1060	1304	1534		1090	

Cont'd

NOTE: \*Slipstream cross-section loading.

Table 4.5 (Cont'd)

GROSS WEIGHT: LB	16,315	21,247	23,300	19,700	20,250	
$(SHP/W_{gr}) = f(V)$ 2nd Approx. Max. R/C at SL, ISA: fpm Excess SHP: hp $SHP_{min}$ $(SHP/W_{gr})$ at $V_{max}$ or $V_{crmax}$ $(SHP/W_{gr})$ at $V_e$ $f$ : sq.ft $w_f$ : psf Main Rotor $\epsilon_d/\epsilon_e$ Main Rotor $\epsilon_d$	1200	1310 1054 1446	1600*	1415*	1900	
	985 <sup>a</sup>	0.1177 0.0689 40.7	0.1202* 0.0687* 58.18	0.1225*† 0.0716*	1310 <sup>a</sup> 0.1259 <sup>b</sup> 0.0647 <sup>b</sup>	
		522.3 1/37	400.5 1/48	38.71 508.9 1/48.8	32.7 619 1/42.6	
		0.0127	0.0109	0.0102	0.0120	
	GROSS WEIGHT: LB	16,315	22,050	23,300	19,700	20,250
	$(SHP/W_{gr})$ : hp/lb at $V$ : kn SL, ISA 0 40 60 80 100 120 140 160	0.1233	0.1338	0.1166*	0.1409*	0.1336*
		0.1179	0.0785	0.0796*	0.1010*	0.1336*
		0.0697	0.0611	0.0708*	0.0799*	0.0730*
		0.0595	0.0611	0.0700*	0.0718*	0.0682*
		0.0622	0.0747	0.0790*	0.0806*	0.0740*
0.0752		0.0910	0.0966*	0.0949*	0.0897*	
0.0976		0.1154	0.1286*	0.1166*	0.1129*	
0.1301	—	—	—	—	22,000	
0.0836	0.1179	0.1179	0.1179	0.1179	0.1429	
0.0678	0.0697	0.0697	0.0697	0.0697		
0.0655	0.0595	0.0595	0.0595	0.0595		
0.0720	0.0622	0.0622	0.0622	0.0622		
0.0877	0.0752	0.0752	0.0752	0.0752		
0.115	0.0976	0.0976	0.0976	0.0976		
—	—	—	—	—		

NOTE: \*Taken from flight tests  
 † at 145 kn.  
 †† at 155 kn.  
<sup>a</sup>Manufacturer's data

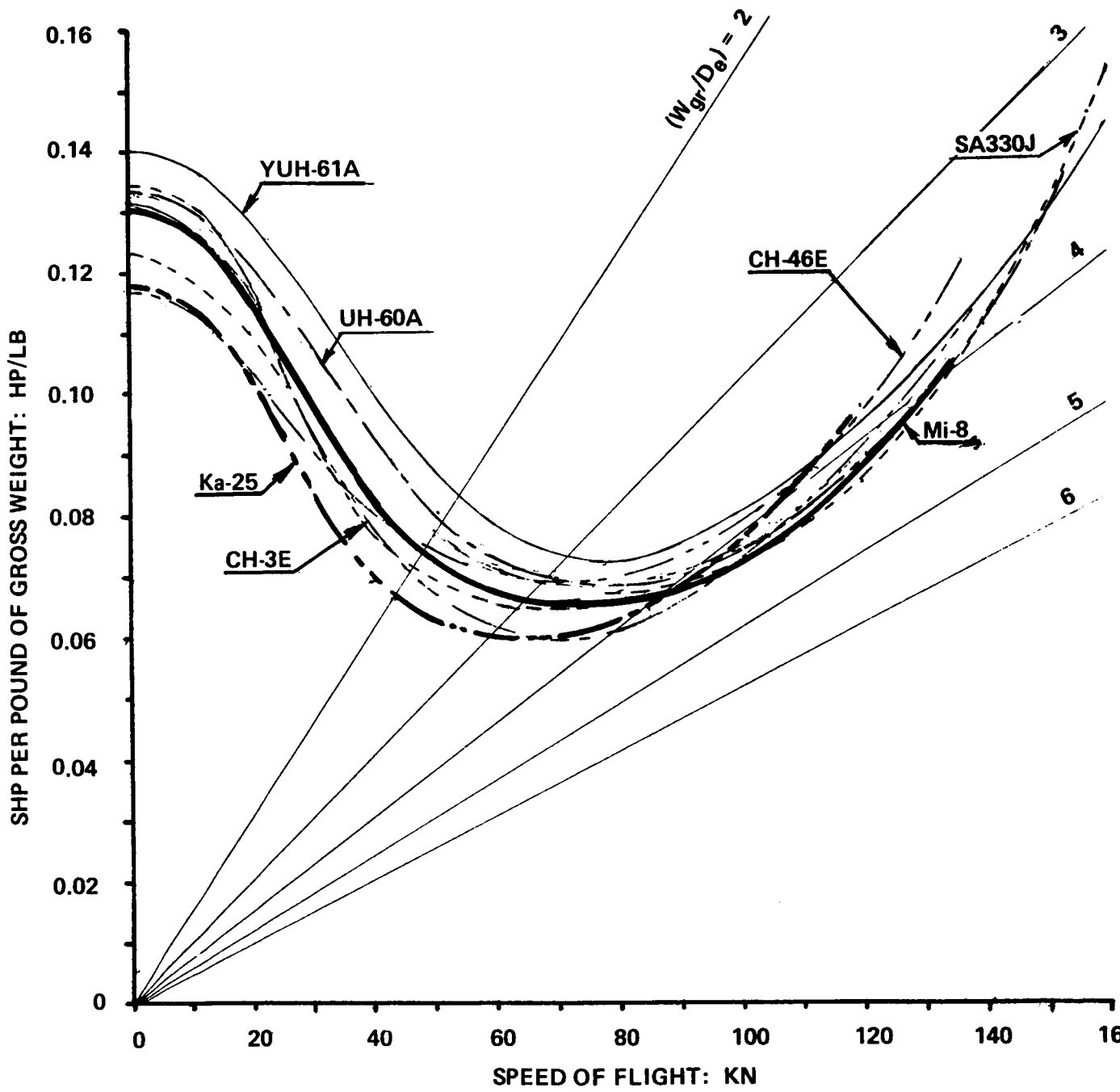

Figure 4.18 Comparison of shaft horsepower per pound of gross weight vs speed of level flight at SL, ISA of Soviet and Western helicopters of the 12,000 to 30,000-lb gross weight class.



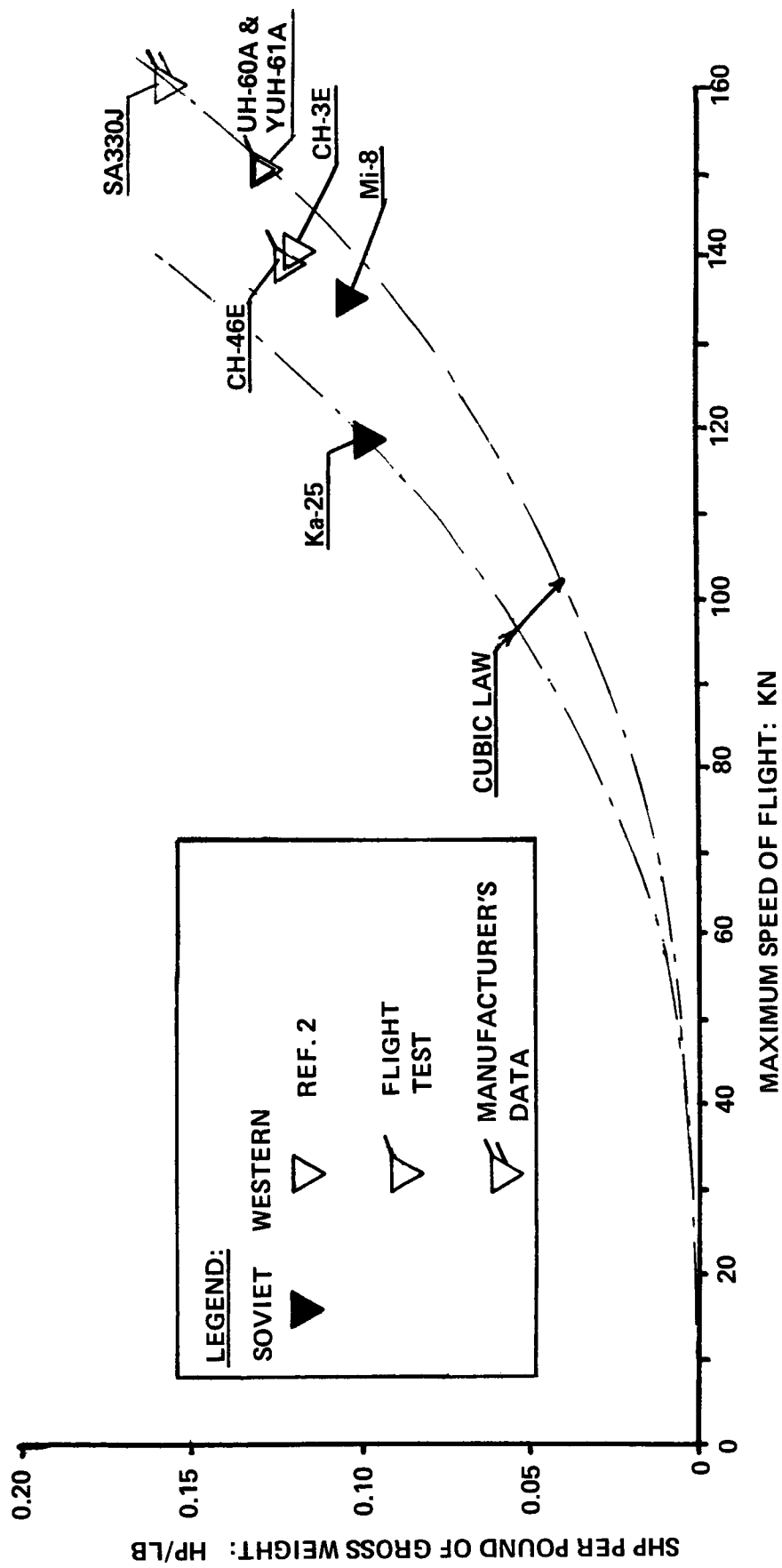

Figure 4.19 Shaft horsepower per pound of gross weight at  $V_{max}$  vs speed of flight of Soviet & Western helicopters of the 12,000 to 30,000-lb gross weight class.

## 4.5 Energy Aspects in Level Flight at SL, ISA

Fuel Required per Pound of Gross Weight in Level Flight at SL, ISA. The numerical inputs needed for determination of fuel required per pound of gross weight and one hour, or pound of gross weight and 100 n.mi in level flight at SL, ISA are shown in Table 4.6. It should be noted that at this writing, there was no data available to the investigators regarding the sfc of the GTD-3 engines installed in the Ka-25 helicopter, nor the performance figures necessary for determination of the  $(SHP/W_{gr}) = f(V)$  curves of the Mi-24D helicopter. Consequently, for these two helicopters, no fuel requirements in forward flight could be determined at this time.

It should also be emphasized that all considerations of energy aspects of all the compared helicopters were performed at their maximum flying weight.

The resulting fuel flow per pound of gross weight and hour for the compared helicopters is shown in Fig. 4.20. The auxiliary grid in this figure permits one to judge at a glance how these helicopters compare from the point of view of fuel utilization per pound of their gross weight and distance flown (selected here as 100 n.mi). In addition, this fuel consumption per pound of gross weight and 100 n.mi is shown as a function of flying speed in Fig. 4.21.

Looking at Figs. 4.20 and 4.21, one would note that the fuel consumption of the Mi-8 helicopter per pound of gross weight and hour, and pound of gross weight and 100 n.mi. is very similar to that of the CH-46E and CH-3E helicopters. Furthermore, it appears better than that of the SA330J, and is only inferior to the latest U.S. UTTAS helicopters (YUH-61A and UH-60A). It should also be pointed out that for the Super-Puma equipped with the Makila engine, the relative fuel consumption figures are approximately 15 to 20 percent better than for the SA330J.

Fuel Requirements per Pound of Zero-Range Payload. The numerical inputs required for the determination of fuel required per pound of zero-range payload and one hour, and a hypothetical distance of 100 n.mi. are shown in Table 4.7. As in the preceding case, all calculations are performed for the maximum flying weight. The results are shown in Figs. 4.22 and 4.23.

A glance at these figures would indicate that when the fuel consumption is related to the hypothetical zero-range payload, the Mi-8 helicopter shows one of the best energy characteristics of all the compared helicopters, and is surpassed only by the UTTAS types.

However, it should be recalled at this point that although the present comparison is carried out on the common basis of maximum flying weight, the Mi-8 and the CH-3E at their gross weights do not have OGE hover capabilities (Fig. 4.14). In order to get a better balanced picture, the fuel requirements should be recalculated and compared; say, for the VTO gross weight. In the case of the CH-3E and especially, the CH-46E helicopters, some special equipment is incorporated into the weight empty, thus leading to low  $(W_{pl})_0/W_{gr}$  ratios. Here, again, a revision of the weight empty values of these two helicopters might be desired.

TABLE 4.6  
RELATIVE FUEL REQUIREMENTS WITH RESPECT TO GROSS WEIGHT  
12,000 TO 30,000-LB GROSS WEIGHT CLASS

ITEM	HELICOPTER							
	Mil Mi-8	Kamov Ka-25	Aerospatiale SA-330J	Sikorsky CH-3E	Boeing-Vertol CH-46E	Boeing Vertol YUH-61A	Sikorsky UH-60A	Mil Mi-24D
(SHP TO $W_{gr,max}$ ): hp/lb	0.1134	0.1118	0.1833	0.1361	0.1605	0.1523	0.1541	0.1972*
RATIO OF SHP REQUIRED TO TAKEOFF: SHP								
SPEED OF FLIGHT: KN								
0	1.15	1.05	0.67	0.98	0.73	0.93	0.85	
40	0.74	0.62	0.42	0.58	0.50	0.66	0.57	
60	0.60	0.53	0.35	0.45	0.44	0.52	0.46	
80	0.58	0.56	0.35	0.45	0.44	0.45	0.44	
100	0.63	0.67	0.41	0.55	0.49	0.53	0.49	
120	0.77	0.87	0.47	0.67	0.60	0.62	0.58	
140	1.01	—	0.60	0.85	0.80	0.76	0.73	
SPECIFIC FUEL CONSUMPTION: LB/SHP-HR								
SPEED OF FLIGHT: KN								
0	0.60		0.69	0.61	0.59	0.45	0.46	
40	0.67		0.81	0.70	0.68	0.49	0.52	
60	0.71		0.88	0.78	0.71	0.54	0.57	
80	0.73		0.88	0.78	0.72	0.57	0.58	
100	0.70		0.82	0.73	0.67	0.54	0.55	
120	0.65		0.78	0.68	0.63	0.50	0.51	
140	0.61		0.71	0.63	0.57	0.47	0.48	
FUEL CONSUMPTION PER HOUR AND POUND OF GROSS WEIGHT								
SPEED OF FLIGHT: KN								
0	0.078		0.084	0.082	0.069	0.063	0.060	
40	0.0656		0.062	0.055	0.054	0.049	0.046	
60	0.048		0.056	0.048	0.050	0.043	0.040	
80	0.048		0.056	0.048	0.050	0.041	0.040	
100	0.050		0.061	0.054	0.053	0.040	0.041	
120	0.057		0.067	0.062	0.061	0.045	0.045	
140	0.070		0.078	0.073	0.073	0.055	0.054	
FUEL REQUIRED PER POUND OF GROSS WEIGHT AND 100 N.MI								
SPEED OF FLIGHT: KN								
40	0.140		0.153	0.1375	0.135	0.1225	0.115	
60	0.080		0.093	0.080	0.083	0.072	0.0666	
80	0.060		0.070	0.060	0.0625	0.051	0.050	
100	0.050		0.061	0.054	0.053	0.040	0.041	
120	0.0475		0.056	0.052	0.051	0.0375	0.038	
140	0.050		0.056	0.053	0.052	0.039	0.039	

NOTE: \*at NGW

\*\*based on Fig.4.18

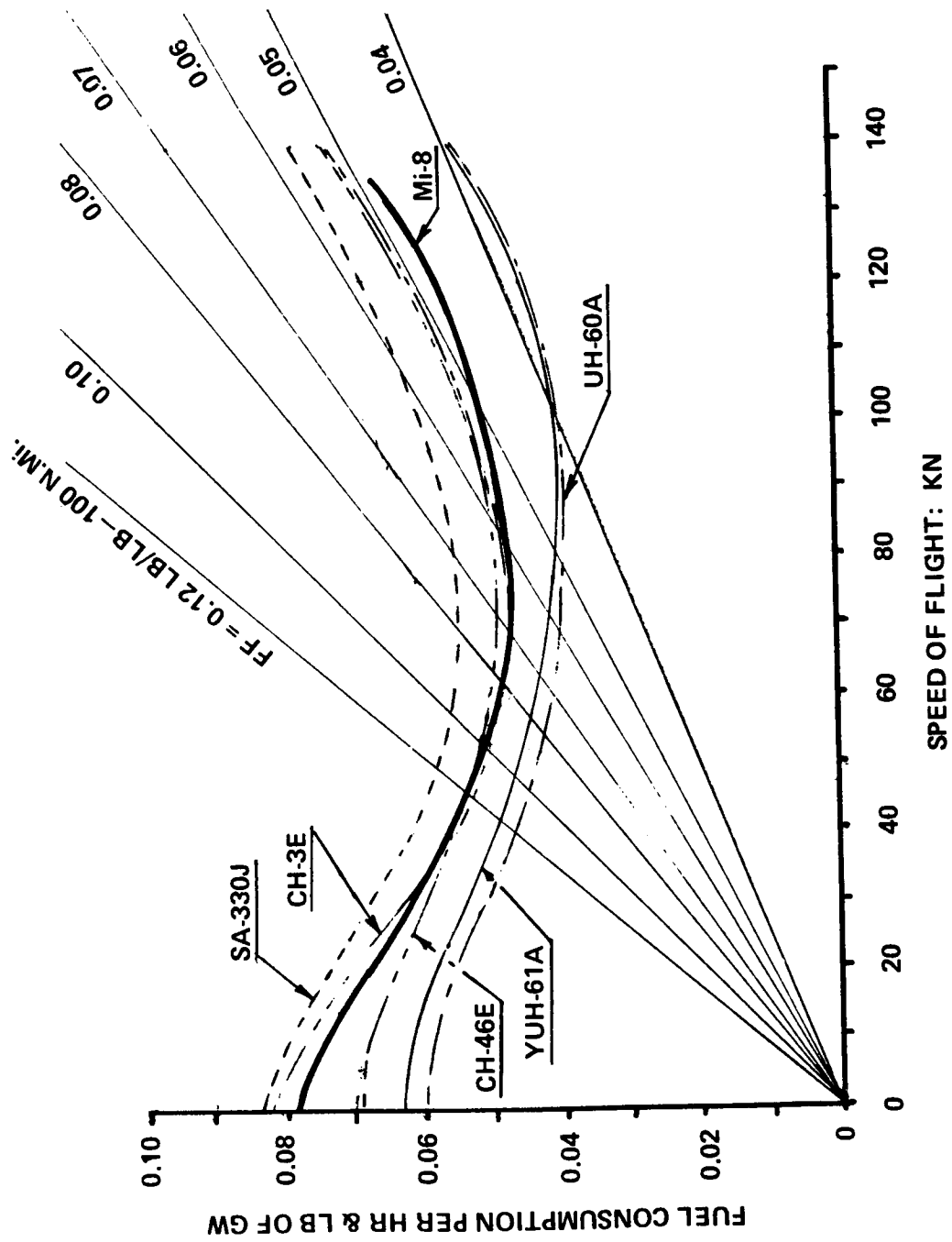

Figure 4.20 Fuel required per hour and pound of gross weight in level flight at SL, ISA of Soviet & Western helicopters of the 12,000 to 30,000-lb gross weight class.

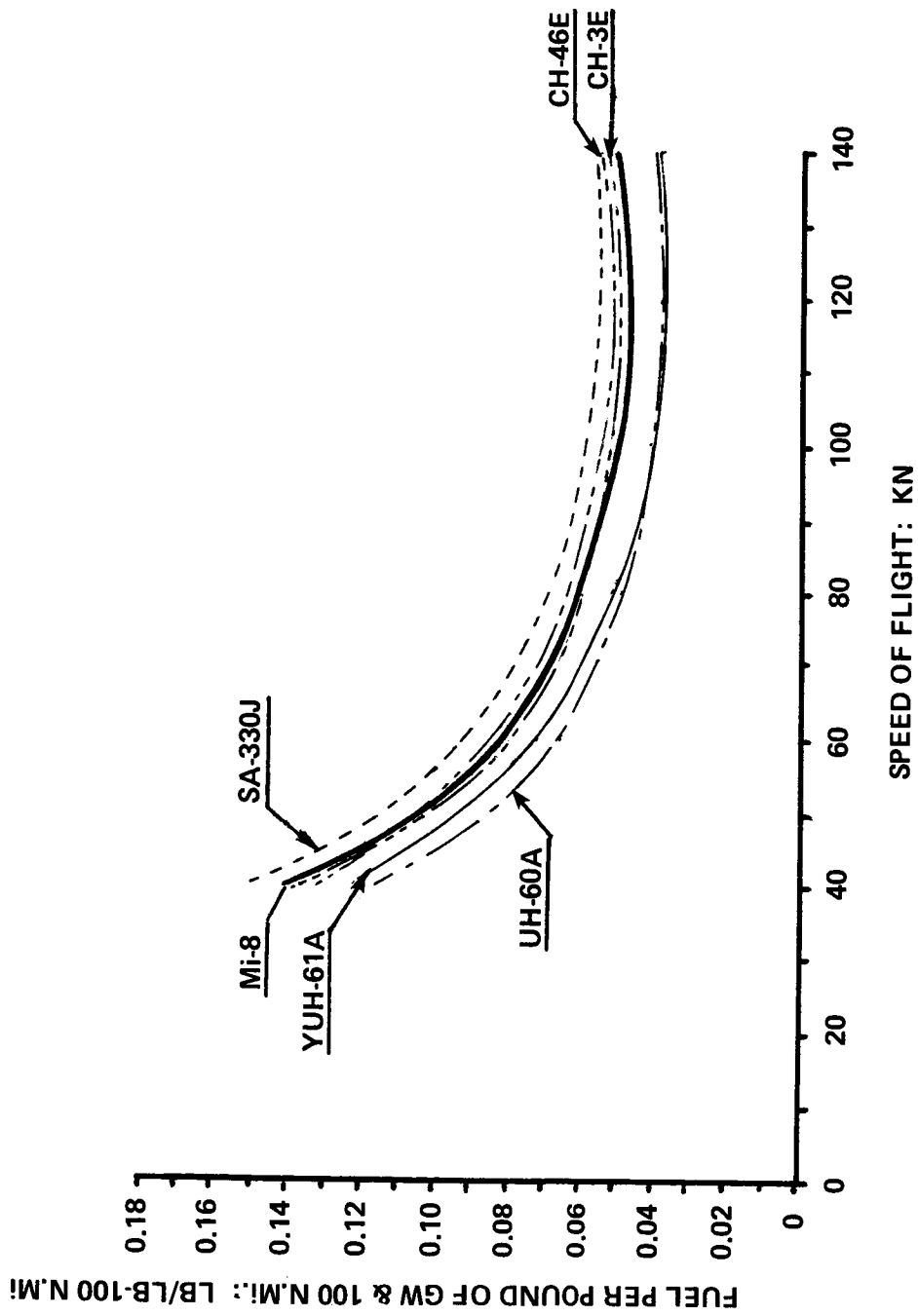

Figure 4.21 Fuel required per pound of gross weight and 100 n.m.i. at SL, ISA of Soviet & Western helicopters of the 12,000 to 30,000-lb gross weight class

TABLE 4.7  
 FUEL REQUIREMENTS WITH RESPECT TO ZERO-RANGE PAYLOAD  
 12,000 TO 30,000-LB GROSS WEIGHT CLASS

ITEM	HELICOPTER							
	Mil Mi-8	Kamov Ka-25	Aerospatiale SA-330J	Sikorsky CH-3E	Boeing-Vertol CH-46E	Boeing-Vertol YUH-61A	Sikorsky UH-60A	Mil Mi-24D
Max. Gross Weight: lb Payload Zero Range/GW	26,455 0.416	16,100 0.371	16,315 0.465	22,050 0.380	23,300 0.329	19,700 0.483	20,250 0.454	
FUEL CONSUMPTION PER HOUR AND POUND OF ZERO-RANGE PAYLOAD								
SPEED OF FLIGHT: KN								
0	0.1875		0.1806	0.2158	0.2097	0.1304	0.132	
40	0.1346		0.1333	0.1447	0.1641	0.1014	0.1011	
60	0.1154		0.1204	0.1263	0.1520	0.0890	0.0880	
80	0.1154		0.1204	0.1263	0.1520	0.0849	0.0880	
100	0.1202		0.1312	0.1427	0.1611	0.0828	0.0901	
120	0.1370		0.1441	0.1632	0.1854	0.0932	0.0989	
140	0.1683		0.1677	0.1921	0.2219	0.1139	0.1187	
FUEL CONSUMPTION PER POUND OF ZERO-RANGE PAYLOAD AND 100 N.Mi								
SPEED OF FLIGHT: KN								
40	0.3366		0.3339	0.3618	0.4103	0.2536	0.2528	
60	0.1923		0.2007	0.2105	0.2523	0.1491	0.1465	
80	0.1442		0.1505	0.1579	0.1900	0.1056	0.1100	
100	0.1202		0.1312	0.1421	0.1611	0.0828	0.0959	
120	0.1142		0.1201	0.1368	0.1550	0.0776	0.0836	
140	0.1202		0.1198	0.1394	0.1581	0.0807	0.0857	

NOTE: Assumed or rough estimated values [ ] .

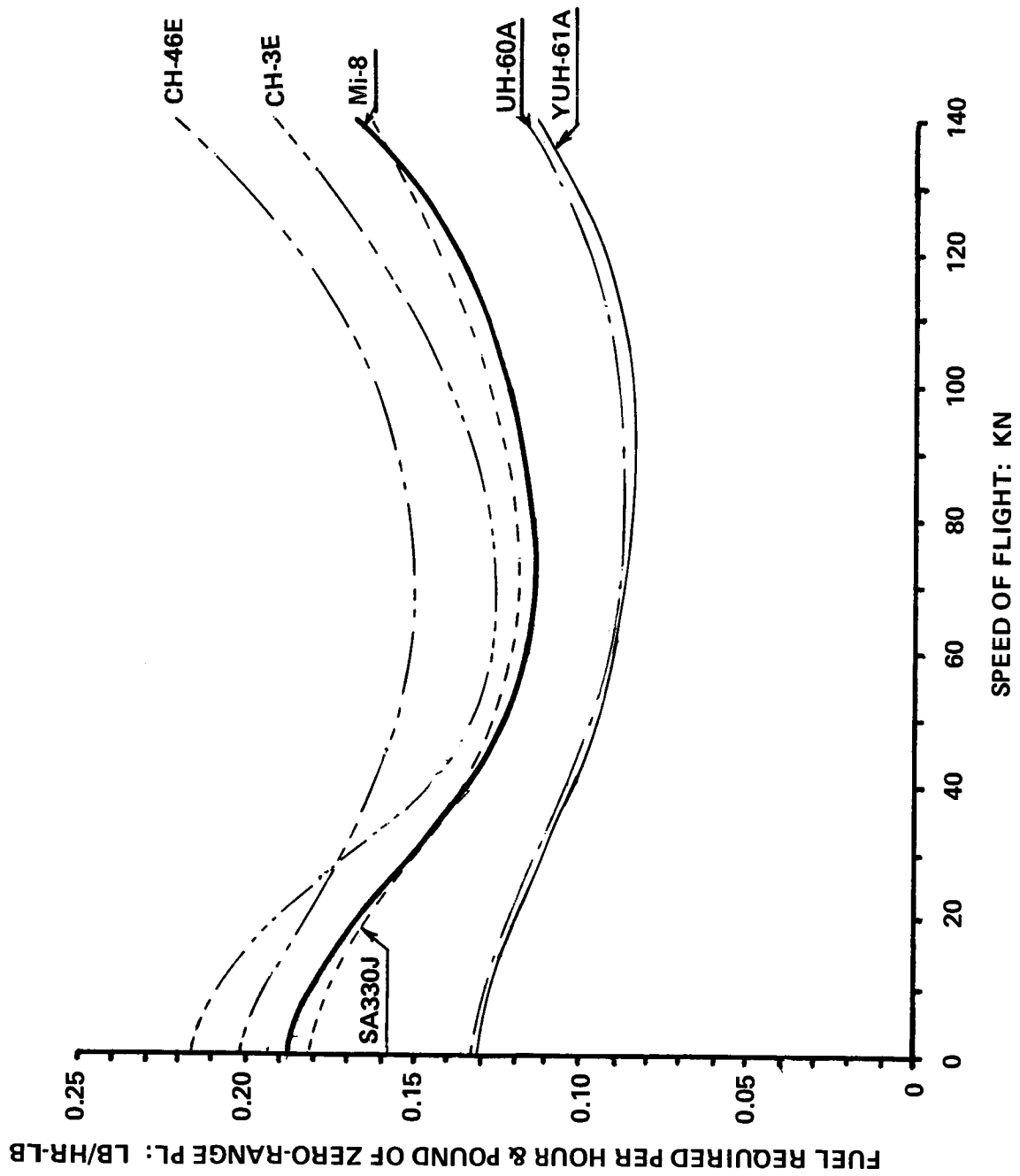

Figure 4.22 Fuel required per hour and pound of zero-range payload at SL, ISA of Soviet & Western helicopters of the 12,000 to 30,000-lb gross weight class.

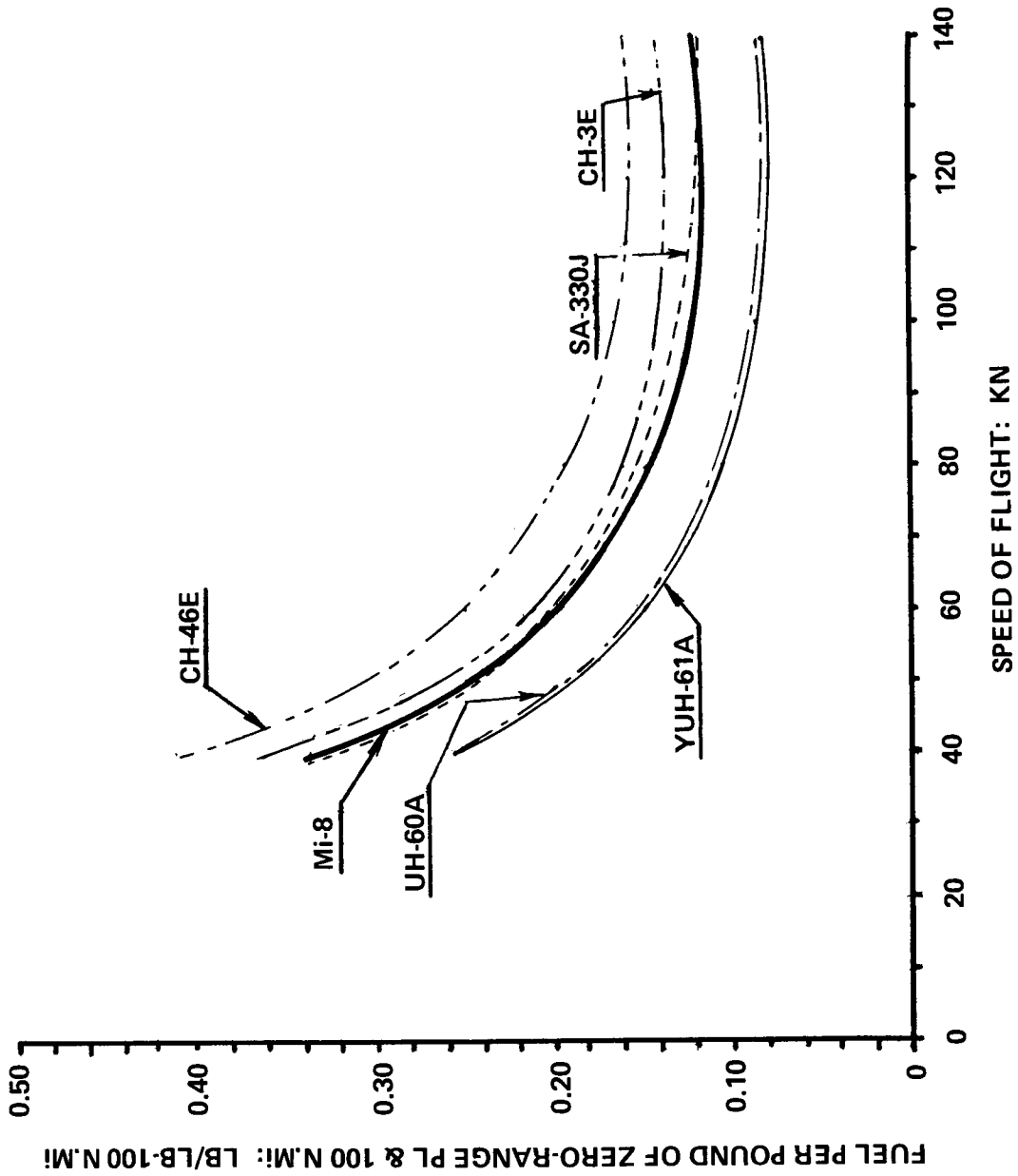

Figure 4.23 Fuel required per pound of zero-range payload and 100 n.mi at SL, ISA of Soviet & Western helicopters of the 12,000 to 30,000-lb gross weight class.



**Fuel Required per Pound of Payload vs Distance.** Using the approach outlined in Sect. 1.5 and applied in Sect. 3.5 for helicopters in the up to 12,000-lb gross weight class, the numerical inputs required in that evaluation are given in Table 4.8, while the results are graphically presented in Fig. 4.24.

It can be seen from this figure that in contrast to the original Mi-2 (Fig. 3.25), the Mi-8 represents one of the lowest energy requirements for transportation of a unit weight of payload over any distance; surpassed only by the U.S. UTTAS type helicopters.

Remarks made in the preceding subsection regarding the gross weight basis for comparison ( $W_{gr_{max}}$  vs  $W_{gr_{VTO}}$ ), as well as observations about unfavorable results of the type of weight-empty bookkeeping of the CH-46E and CH-3E helicopters also apply to the comparison shown in Fig. 4.24.

## 4.6 Productivity

**Productivity Index.** The inputs necessary to calculate the productivity index from Eq (1.17a) are indicated in Table 4.9. However, in light of the experience gained in Sect. 3.6, the PI evaluation in this case was limited to the specified maximum cruise speed only. The so-obtained PI values are listed in Table 4.9, and graphically presented in Fig. 4.25. A glance at this figure would indicate that the productivity index of the Mi-8 is below that of the UTTAS types and the SA-330J; but above that of the CH-46E and CH-3E.

## 4.7 General Discussion and Concluding Remarks

At this writing, an indepth discussion of design aspects of Soviet helicopters of the 12,000 to 30,000-lb gross weight class must, unfortunately, be limited to the Mi-8 helicopter only, since there is a lack of engine characteristics for the Ka-25 engine, and incomplete data on weights and performance of the Mi-24D helicopter.

However, on the basis of the presently available limited information, the following general remarks can be made with respect to the latter two rotorcraft.

Similar to the Ka-26 helicopter discussed in the preceding chapter, the Ka-25 appears to be underpowered by Western standards, resulting in limited hovering and vertical climb capabilities. Consequently, its VTO gross weight of 15,300 lb is below its maximum flying weight of 16,100 lb. Again, similar to the Ka-26, the same design philosophy is visible in the case of the Ka-25: take advantage of the coaxial configuration and derive as much performance as possible from the limited power installed in the rotorcraft. Therefore, although its average blade lift coefficient may be favorable for a high rotor figure of merit in hover, it appears to be too high to provide a comfortable margin for maneuvers, especially at elevated altitudes and ambient temperatures. The power required per pound of gross weight in forward flight appears one of the lowest in the low-speed region ( $V < 70$  kn), but grows rapidly at higher flying speeds, due to low  $w_{fp}$  values. Lack of engine data unfortunately prevents any discussion of energy aspects in all regimes of flight.

TABLE 4.8  
 FUEL REQUIRED PER POUND OF PAYLOAD AT VARIOUS DISTANCES  
 12,000 TO 30,000-LB GROSS WEIGHT CLASS

ITEM	HELICOPTER							
	Mil Mi-8	Kamov Ka-25	Aerospatiale SA-330J	Sikorsky CH-3E	Boeing-Vertol CH-46E	Boeing-Vertol YUH-61A	Sikorsky UH-60A	Mil Mi-24D
Max. Gross Weight: lb	26,455	16,100	16,315	22,050	23,300	19,700	20,250	
Opt. Fuel Consumed per One Pound of Zero-Range Payload and 100 N. Mi.	0.114		0.119	0.136	0.155	0.078	0.083	
FUEL REQUIRED PER POUND OF PAYLOAD								
DISTANCE: N.Mi								
0	0	0	0	0	0	0	0	0
50	0.061		0.063	0.073	0.084	0.040	0.043	
100	0.129		0.135	0.158	0.183	0.084	0.091	
150	0.207		0.218	0.258	0.303	0.132	0.142	
200	0.296		0.312	0.377	0.449	0.184	0.199	
250	0.399		0.423	0.520	0.633	0.241	0.262	

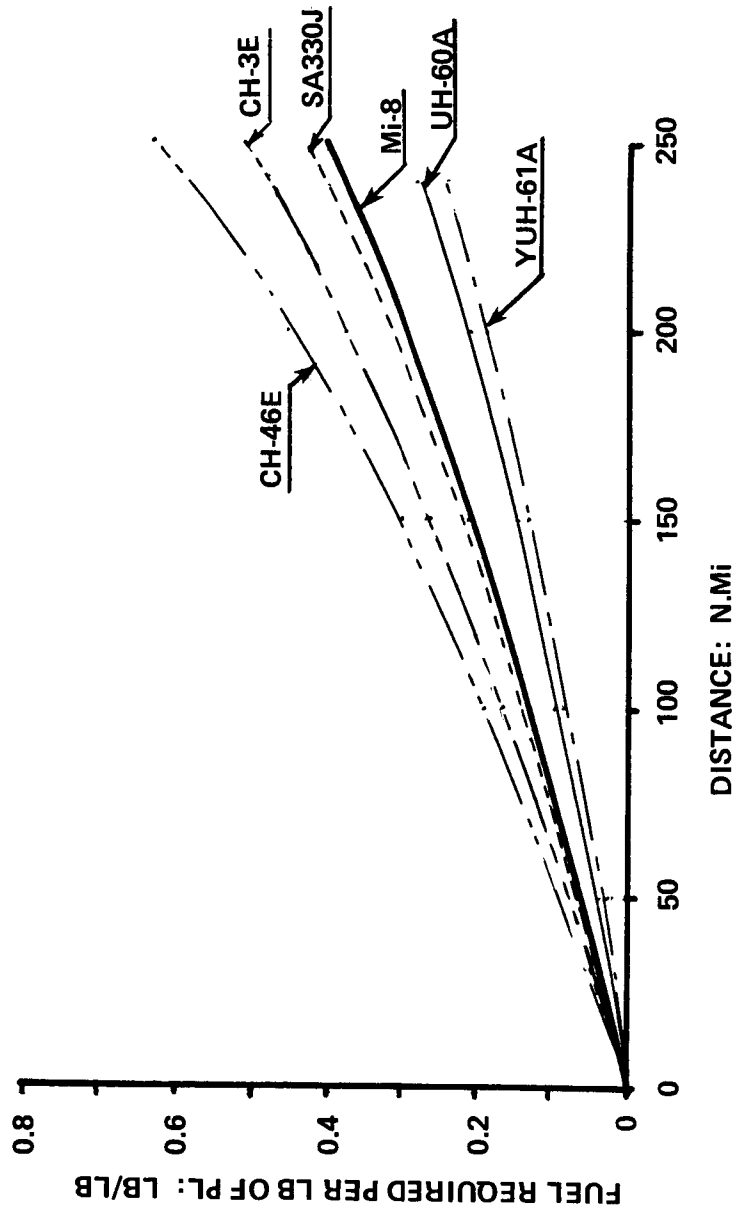

Figure 4.24 Fuel required per pound of payload vs flight distance at SL, ISA of Soviet & Western helicopters of the 12,000 to 30,000-lb gross weight class

TABLE 4.9  
 PRODUCTIVITY INDEX AT  $V_{crmax}$ , SL, ISA  
 12,000 TO 30,000-LB GROSS WEIGHT CLASS

ITEM	HELICOPTER									
	Mil Mi-8	Kamov Ka-25	Aerospatiale SA-330J	Sikorsky CH-3E	Boeing-Vertol CH-46E	Boeing Vertol YUH-61A	Sikorsky UH-61A	Mil Mi-24D		
Max Gross Weight: lb	26,455	16,100	16,315	22,050	23,300	19,700	20,250			
$W_e/W_{gr}$	0.568	0.602	0.509	0.601	0.652	0.495	0.525			
$(W_{pl})_0/W_{gr}$	0.416	0.371	0.465	0.380	0.329	0.483	0.455			
$V_{crmax}$ : kn	122	104	139	[135]	139	[145]	147			
$\overline{FF}$ at $V_{crmax}$ : lb/lb-100 n.mi	0.048		0.056	0.053	0.052	0.041	0.041			
PRODUCTIVITY INDEX AT $V_{crmax}$ : LB-N.Mi/LB-HR										
FLIGHT DIST: N.Mi										
0	89.35		127.23	85.36	70.14	141.48	127.28			
100	79.04		111.93	73.45	59.05	129.47	115.80			
200	68.73		96.64	61.55	47.97	117.46	104.31			

NOTE: Assumed or rough estimated values are shown in brackets [ ] .

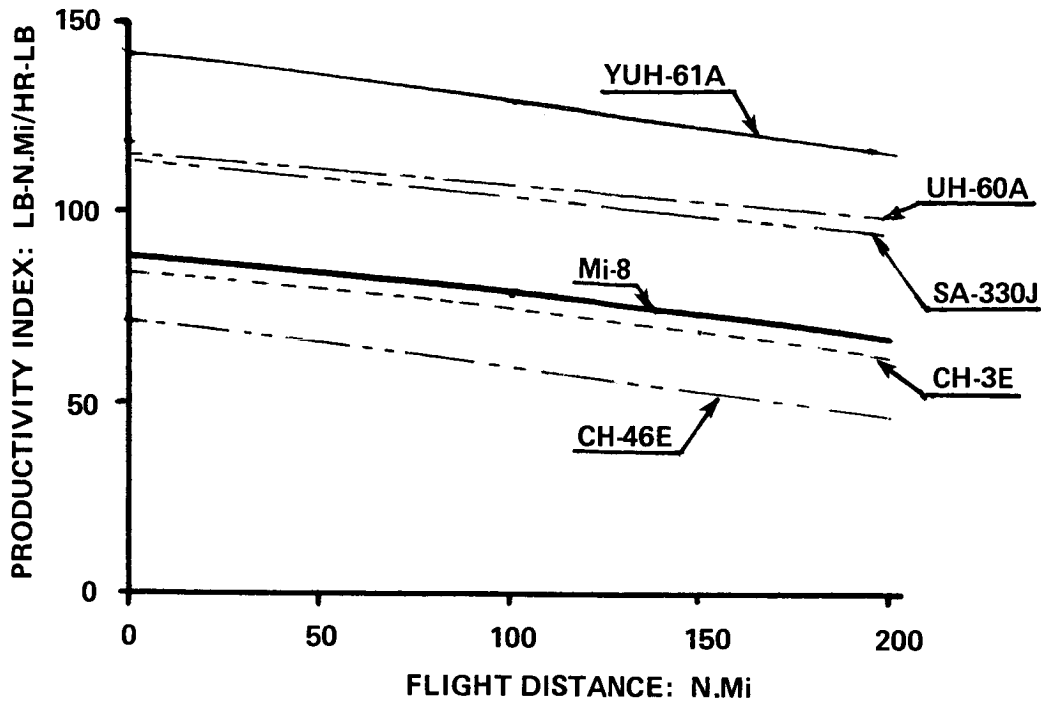

Figure 4.25 Productivity index at  $V_{crmax}$ , SL, ISA vs flight distance for Soviet & Western helicopters of the 12,000 to 30,000-lb gross weight class.

From the limited information available, it appears that the design philosophy of the Mi-24D is more in line with current Western trends, as reflected in the UTTAS types. Its estimated disc loading of  $w = 9$  psf at normal gross weight represents a departure from  $w = 6.39$  psf of the Mi-8 at its normal gross weight. Consequently, the rotor solidity of the Mi-24D ( $\sigma \approx 0.09$ ) becomes closer to that of the UTTAS types and the Puma ( $\sigma = 0.0821$  to  $0.101$ ).

Unfortunately, the tip speed of the Mi-24D is not known to these investigators, but it is probably at least slightly higher than the  $V_t = 692.1$  fps of the Mi-8. The higher solidity and higher tip speed should result in lower average blade lift coefficients (in spite of the higher disc loading) than those of the Mi-8 or Ka-25.

The TV3-117 turboshaft installed in the Mi-24D helicopters has a rating of 2170 hp, which is much higher than the  $SHP_{TO} = 1480$  rating of the Mi-8 engines. Consequently, the power loading of the Mi-24D should be similar to that of the UTTAS types.

With respect to aerodynamic characteristics, the Mi-8 helicopter appears quite similar to the CH-3E, although the Mi-8 disc loading is slightly lower and the power loading (based on the "civilian" engine rating) is somewhat higher than that of the CH-3E. The  $(SHP/W_{gr})_{max} = f(V)$  for both helicopters are quite similar in spite of the disc loading differences. This is also true with respect to the fuel required per pound of gross weight and hour, and pound of gross weight and 100 n.mi.

When comparing the energy aspects of the two helicopters, one would note that the hourly fuel consumption per pound of zero-time payload of both helicopters is quite similar. However, in forward flight, (probably due to the weight-empty bookkeeping of the CH-3E), the energy aspects per pound of zero-range payload of the Mi-8 appear somewhat superior to those of the CH-3E.

In general, it may be stated that when comparing the basic design aspects of the Mi-8 helicopter with its Western counterparts, in many respects the Soviet machine appears to be on the same level as its Western counterparts, seemingly being only inferior to the UTTAS types.

The only area where the Mi-8 is probably inferior is in its hovering OGE and vertical climb capabilities at its maximum or even normal gross weights. However, it should be noted that this inferiority stems chiefly from the high power loading based on the "civilian" rating of the TV2-117A engines. Should a higher rating be permitted in some operations, then the VTO performance aspects of the Mi-8 would improve.

## APPENDIX – CHAPTER 4

Mr. W. Coffee, Test Pilot, Boeing Vertol Company, gave the following pilot's impressions of flying the Mil-8. His evaluation is being included as a supplement to the general design comparison of the Mi-8 helicopter with its Western counterparts.

### MIL-8 FLIGHT EVALUATION

On June 4, 1971, Mr. Coffee was given a 30-minute flight in the Mil-8 aircraft. This aircraft did not differ from the Mil-8 that has been seen in previous years except that it was fitted out with a VIP interior. His report follows:

- A. He flew with Mr. Pelevin who had flown the Chinook with Mr. Coffee at the 1967 Paris Air Show.
- B. The Mil-8 pilot seats are very comfortable but do not have arm rests.
- C. The rudder pedals are mounted on a bar with approximately 3 X 5-inch pads that incorporate a foot-operated switch for releasing the autopilot when coming into a hover or in the event of a hard-over signal. A similar arrangement is installed in the Mil B-12.
- D. As reported earlier, the cyclic and collective sticks each have centering springs that function like those installed in the Chinook. However, their position is strange and does not appear as practical as the Chinook.
- E. The control breakout forces with the centering springs engaged are estimated to be about 4 to 5 times higher than the Chinook. It was an uncomfortable feature to Mr. Coffee when holding the centering spring button down, the cyclic stick motion is very "sloppy." The Russian pilot agreed with Mr. Coffee that the breakout forces are too high on all the Mil helicopters.
- F. The cockpit was very quiet and engine noise was not annoying even though the engines are located directly above the aft of the cockpit.
- G. A six-inch diameter fan is provided above each pilot's head.
- H. The aircraft flown had a strong 1 per rev vibration in hover but the pilot stated that this was due to blade tip damage from a parking accident. We can verify this because there was a minor collision between the C-5 Galaxy, the Mil B-12, and the Mil-8 while parking the aircraft on one of the early days of the Air Show. In cruise the one per rev vibration and high frequency vibration was very low and the instrument panel was steady. The aircraft cruised comfortably at 120 knots IAS.
- I. The transition to hover revealed strong to moderate high frequency vibrations in the last 10 knots of forward speed. The instrument panel shook very little but the autopilot on the center of the cockpit showed movement.
- J. The pilots are separated by about 3 feet of open space. A flight engineer sits between and operates the engine and other switches. Most of the switches are located overhead.
- K. The instrument panel is not extended across the cockpit. The pilot and copilot have individual instrument panels with a clear opening forward in between.
- L. The visibility forward and to the sides was very good in straight and level flight, but the pilot on the high side of a bank has poor cross vision to clear himself in the direction of a turn. This is due to the wide cockpit and lack of high windshield such as is provided in the Chinook.
- M. Power response to thrust movements was very positive.
- N. Wheel brakes are controlled by a long bicycle handle bar type brake grip located on the forward side of the pilot cyclic grip.

## Chapter 5

# 30,000 to 100,000-lb GW Helicopters

### 5.1 Hypothetical Helicopters

**Selection of Models for Comparison.** An analysis of the hypothetical helicopters discussed by Tishchenko, et al<sup>1</sup> should provide an additional insight into the current design philosophy of what is probably the most important group of Soviet rotary-wing designers. Types and configurations which emerge as being the most successful from the comparative study discussed in Ref. 1 would most likely serve as conceptual "prototypes" for current or near-future design efforts of the former Mil group.

Within a study of the 12 to 24 metric-ton gross weight helicopters presented in pp. 129 to 134 of Ref. 1, only single-rotor and tandem configurations were examined, and the conclusion was reached that under the accepted ground rules, the single-rotor helicopters were superior to the tandems.

This decision clearly indicates the preference of the Tishchenko design team for single-rotor configurations. Consequently, only this type of configuration was selected to represent the hypothetical helicopters in this comparative study.

With respect to size, it appeared advantageous to select two helicopters; one being close to the lower, and another close to the upper limit of the gross weight scale. For a 15 metric-ton helicopter, there is a detailed weight statement included in Ref. 1, which makes this rotorcraft especially suitable to represent the lower gross weight in the current comparative study. The 24 metric-ton helicopter was selected as another representative of the 12 to 24 metric-ton gross weight class.

All single-rotor helicopters of that weight class are of the twin-engine type and are configured similarly to the Mi-8 (Fig. 5.1c) and the Mi-6 (Fig. 5.1a), while the dimensions of their cargo compartments are approximately  $2 \times 2 \times 8$  m.

The performance requirements for all the considered helicopters at their nominal gross weights are (p. 117<sup>1</sup>):

Hovering ceiling	$H_h = 1500\text{m} \approx 4900\text{ ft.}$
Service ceiling	$H_s = 4500\text{m} \approx 14,750\text{ ft.}$
Range	$\ell = 370\text{ km} \approx 200\text{ n.mi.}$

At 500 m,  $V_{max} = 250$  to  $300$  km/h  $\approx 135$  to  $162$  kn. Later in Ref. 1 when various rotary-wing configurations are compared, a fast cruise speed of  $260$  km/hr (about  $140$  kn) is mentioned for the pure hypothetical helicopters. On this basis, it will be assumed here that the speed requirement is  $V_{crmax} = 140$  kn.



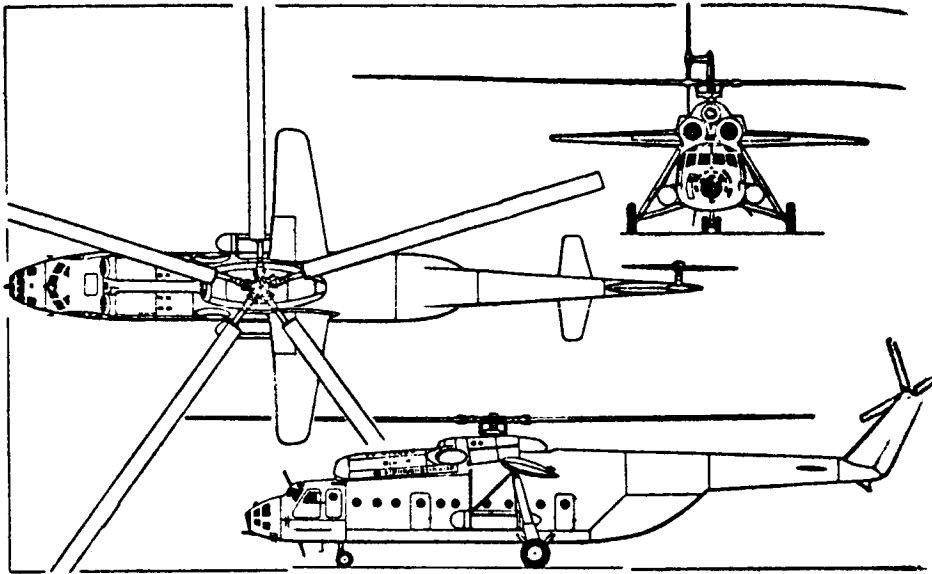

(a) Military version of Mil Mi-6 heavy general-purpose helicopter (*Pilot Press*)

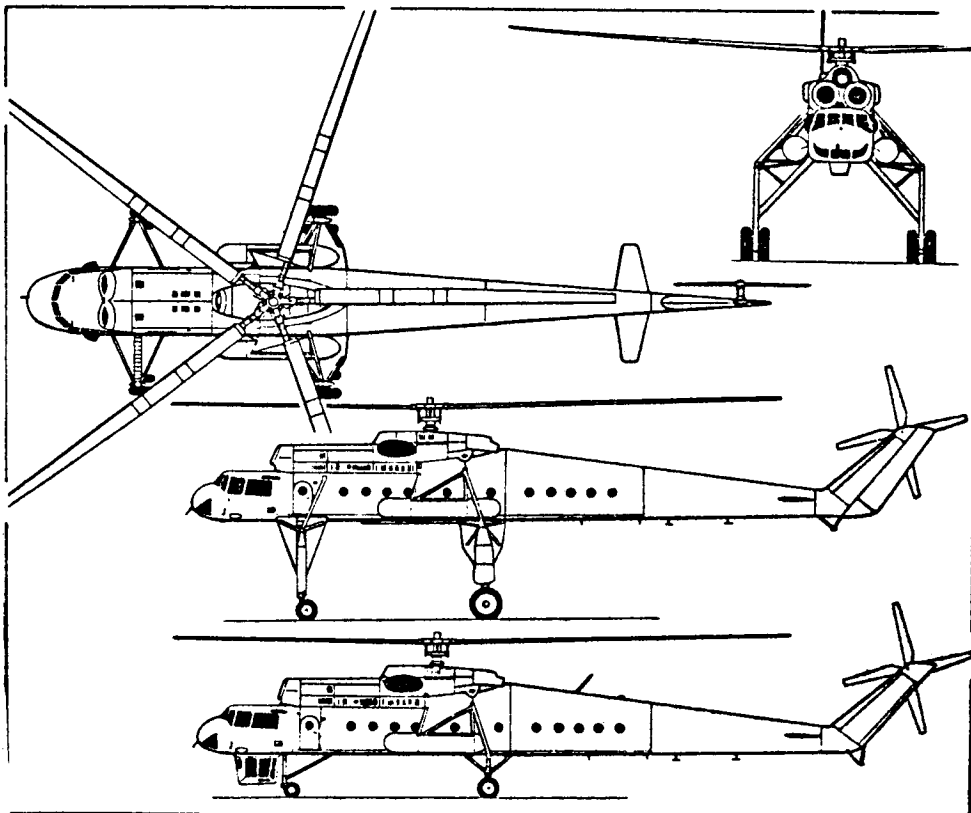

(b) Mil Mi-10 flying crane derivative of the Mi-6, with additional side view (bottom) of Mi-10K (*Pilot Press*)

Figure 5.1 Three-view drawings of Soviet and Western helicopters of the 30,000 to 100,000-lb GW class

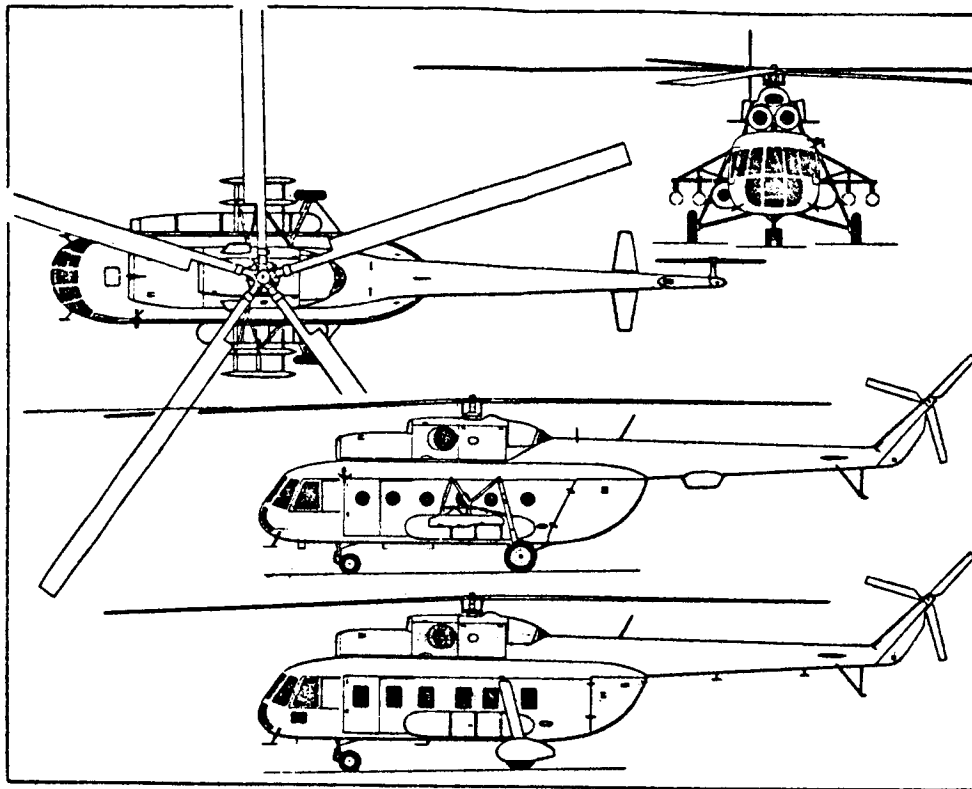

(c) General configuration of the hypothetical 15 and 24 metric-ton helicopters (similar to the above Mi-8).

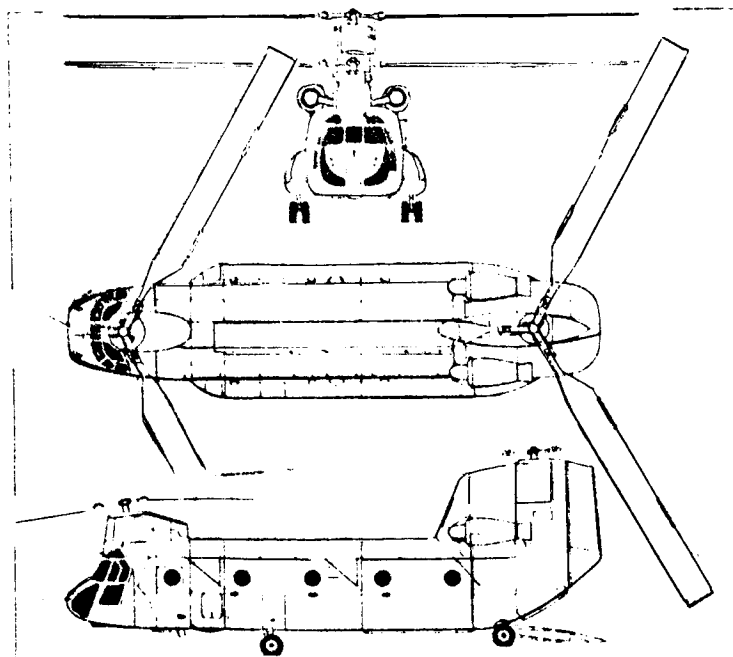

(d) Boeing-Vertol CH-47D (Chinook)

Figure 5.1 Three-view drawings of Soviet and Western helicopters of the 30,000 to 100,000-lb GW class (Cont'd).

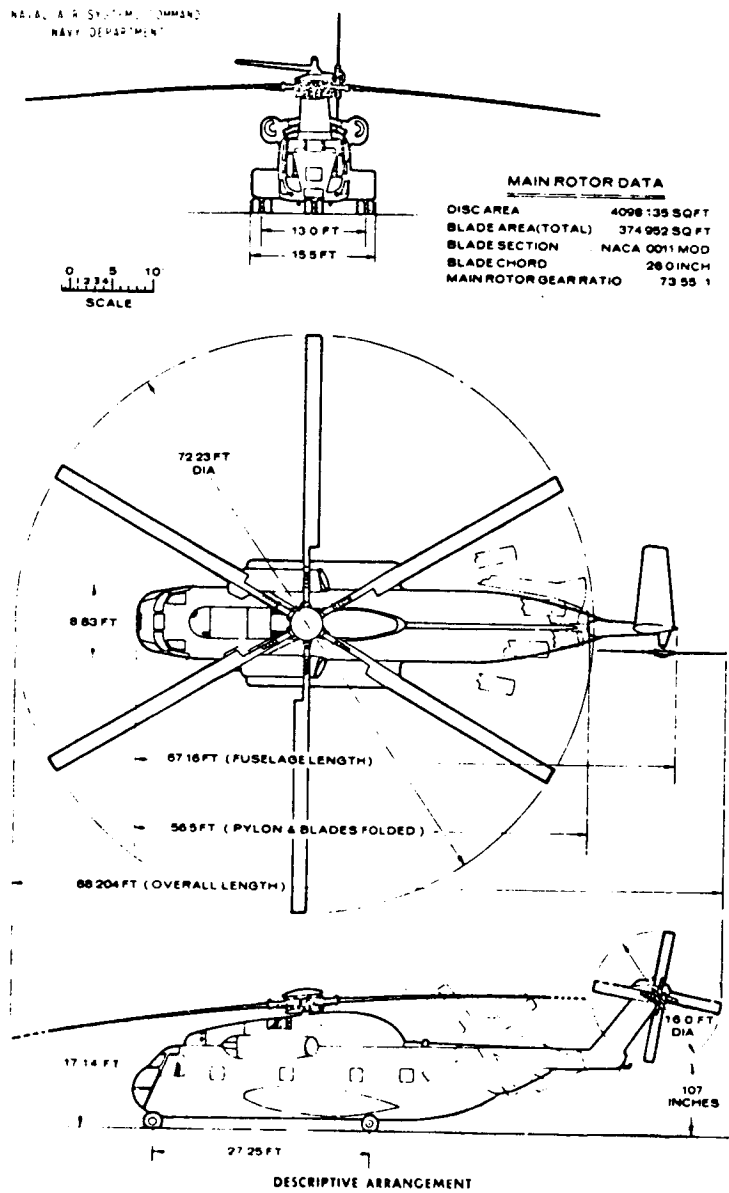

(e) Sikorsky CH-53D Assault Transport Marine Helicopter

Figure 5.1 Three-view drawings of Soviet and Western helicopters of the 30,000 to 100,000-lb GW class (Cont'd).

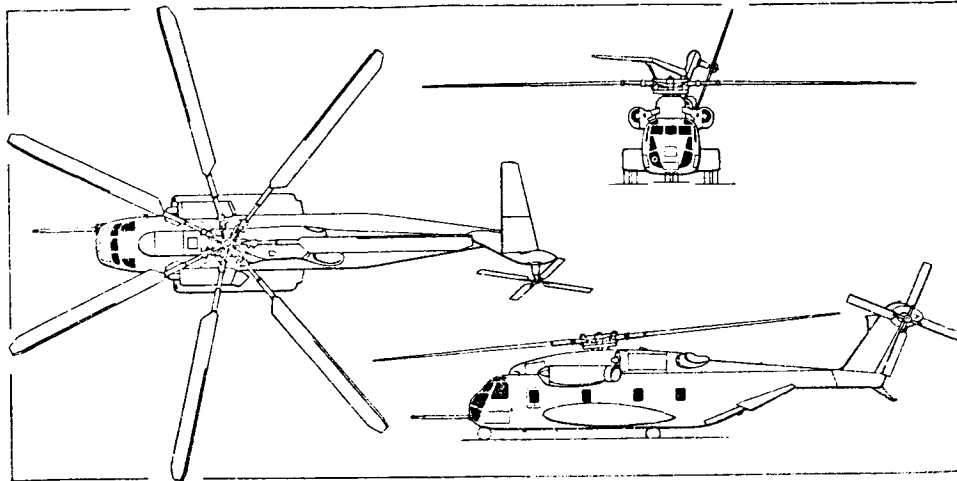

(f) Sikorsky CH-53E heavy-duty multi-purpose helicopter (*Pilot Press*)

Figure 5.1 Three-view drawings of Soviet and Western helicopters of the 30,000 to 100,000-lb GW class

In view of the above given high performance requirements, the specified gross weights (15 and 24 m.ton) of the hypothetical helicopters should be considered as **normal** rather than maximum flying weights.

Other important characteristics of the hypothetical helicopters are:

Tip speed	$V_t = 220 \text{ m/s} \approx 720 \text{ fps.}$
Blade thrust coefficient (SL, ISA)	$t_{v_o} = 0.155, \text{ or } \bar{c}_{l_o} = 0.465$
Crew of 3 at 90 kg	198.5 lb each.

The weight and powerplant aspects of the two hypothetical helicopters are discussed later.

**15 Metric-Ton Helicopter.** A detailed weight breakdown for this helicopter is given in Table 2.8<sup>1</sup>; but later in the text, it is stated that in the actual comparative study, an increase of 10 percent in structural weight was assumed. Taking this fact into account, the weight empty of the 15 metric-ton helicopter becomes  $W_e = 8180 \text{ kg} \approx 18,040 \text{ lb}$  instead of  $7490 \text{ kg} \approx 16,515 \text{ lb}$ , while the payload for a 370-km range is reduced from  $W_{p/370} = 5890 \text{ kg} \approx 12,990 \text{ lb}$  to  $W_{p/370} = 5100 \text{ kg} \approx 11,245 \text{ lb}$ . The so-obtained payload checks well with that given in Fig. 2.73<sup>1</sup>. Consequently,  $W_e = 18040 \text{ lb}$  is entered in Table 5.1, while the resulting zero-range payload becomes  $(W_{pl})_o = 33,075 - 18,040 - 595.5 - 39.5 = 14,400 \text{ lb}$ .

On the basis of Figs. 2.71, 2.72, and 2.73<sup>1</sup>, a seven-bladed rotor of  $R_{mr} = 10.25 \text{ m} = 33.63 \text{ ft}$  is assumed as assuring a maximum payload capacity of  $W_{p/370} = 5100 \text{ kg}$ . With the assumed SL, ISA blade lift coefficient of  $\bar{c}_{l_o} = 0.465$ , the resulting main-rotor blade chord would be  $c_{mr} = 1.47 \text{ ft}$ , and  $\sigma_{mr} = 0.0974$ .

The so-called referred power installed (TO power at 500 m ISA) can be estimated from the assumed engine installed weight of 790 kg, and a weight coefficient of 0.140 kg/hp<sub>ref</sub>:  $SHP_{ref} = 790/0.140 = 5642.9$  hp. This would correspond to  $(SHP_{TO})_o = 5880$ , or  $(SHP_{TO})_o = 2940$  hp per engine in SI units, and 2900 hp in British units.

**24 Metric-Ton Helicopter.** Similar to the above-discussed case, the weight empty of the 24 metric-ton helicopter is deduced using an optimal payload (Fig. 2.71<sup>1</sup>) of  $W_{p/370} = 9400$  kg, assuming the weight of fuel to increase proportionally to gross weight from  $W_{fu} = 1450$  kg for the 15-ton helicopter to  $W_{fu} = 2320$  kg for the 24-ton helicopter, and taking the crew weight at  $W_{crew} = 270$  kg. This results in  $W_e = 12,010$  kg  $\approx$  26,480 lb, while the zero-range payload becomes 25,800 lb.

It is estimated from Fig. 2.71 that the main-rotor diameter should be  $D = 24.8$  ( $R_{mr} = 40.68$  ft); have 7 blades and, as before, operate at SL, ISA at  $\bar{c}_{\rho_o} = 0.465$ , which would require a blade chord of  $c_{mr} = 1.94$  ft; resulting in a solidity ratio of  $\sigma_{mr} = 0.1065$ .

Fig. 2.63<sup>1</sup> can be interpreted that flat-rated engines (with constant power up to 2000 m altitude) are visualized for transport helicopters. The so-interpreted installed power per kg of gross weight amounts to  $N_{eng} \approx 0.39$  hp/kg, which would result in the total takeoff power installed:  $SHP_{TO} = 0.39 \times 24,000 = 9360$  hp in SI units, or  $SHP_{TO} \approx 9230$  hp; i.e., 4615 hp per engine in British units. Normal rated power is estimated to amount to 92 percent of the takeoff value; i.e.,  $SHP_{n.rat.} \approx 8490$  hp.

## 5.2 Basic Data

Three-view drawings of the compared helicopters are shown in Fig. 5.1a through 5.1f. It should be noted at this point that in Fig. 5.1c the three-view drawing of the Mi-8 is reproduced, since this aircraft is supposed to most closely represent the base configuration of the hypothetical 15 and 24 metric-ton helicopters.

The principal characteristics of the compared helicopters are given in Table 5.1, while some of the data contained therein is graphically presented in Figs. 5.2 through 5.7.

**Disc Loading (Fig. 5.2).** It can be seen from this figure that the real Soviet helicopters (Mi-6 and Mi-10) of the considered gross weight class have a maximum disc loading no higher than about 9 psf. The design trend of the future, as is probably evidenced by the design optimization process of the hypothetical helicopters, seems to indicate only moderate increases in disc loading in the next generation of Soviet single-rotor helicopters in the 12 to 24 metric-ton gross weight class.

In contrast to the Soviet approach, the disc loading of the CH-53E is much higher, as it reaches  $w = 15$  psf at the maximum flying weight (probably the highest value of all presently flying transport helicopters).

TABLE 5.1A  
 PRINCIPAL CHARACTERISTICS AND PERFORMANCE  
 30,000 TO 100,000-LB GROSS WEIGHT HELICOPTERS

ITEM	HELICOPTER						
	Mil Mi-6	Mil Mi-10K	Hypothetical 15 M.Ton	Hypothetical 24 M.Ton	Boeing-Vertol CH-47D	Sikorsky CH-53D	Sikorsky CH-53E
CONFIGURATION	S.R	S.R	S.R	S.R	Tandem	S.R	S.R
POWERPLANT	Soloviev D-25V (TV-28M)	Soloviev D-25V	Hypothetical	Hypothetical	Lycoming T55-L-712	General Electric T64-GE-413	General Electric T64-GE-416
Number of Engines	2	2	2	2	2	2	3
Output Shaft rpm	11,000*	11,000*	[5800]	[9230]	15,066	13,600	14,280
Total T.O or Mil. SHP	9400	11,000*	[5363]	[8490]	7500	7850	13,140
Total Max. Cont. SHP					5974	6460	11,088
Transmission Limit, HP					7500	7560	13,140/11,570**
MAIN ROTOR R, ft	57.42	57.42	33.63	40.68	30.00	36.12	39.50
Direction of Rotation	CW	CW	CW	CW	FR: CCW	CCW	CCW
rpm	120.0	120.0	204.5	169	225	184.9	179
Number of Blades	5	5	7	7	2 X 3	6	7
Blade 0.7R Chord, ft	3.28	3.28	1.47	1.94	2.67	2.17	2.44
Airfoil	HH, VH, PH	HH, VH, PH	HH, VH, PH	HH, VH, PH	VR-7 & VR-8	NACA 0011 Mod	SC 1095
Articulation					HH, PH, VH	HH, VH, PH	HH, VH, PH
TAIL ROTOR R, ft	10.99 <sup>1</sup>	10.99	6.8	8.70	Distance between rotors	8.00	10.00
Type	Pusher	Pusher				Pusher	Pusher
x, ft	69.20	69.67			39.17	[44.30]	[49.12]
y, ft (see Fig. 1.14)	[3.5]	[-3.6]	41.25	50.20	Overlap	[-2.8]	[-2.0]
rpm	675	675			35%	791	699
Number of Blades	4	4				4	4
Blade 0.7R Chord, ft	1.48 <sup>1</sup>	1.48 <sup>1</sup>				1.28	1.28
Airfoil						NACA 0012	NACA 0015
Articulation							
EXTERNAL DIMENSIONS							
Overall Length, ft	136.96	137.46			99.00	88.25	99.00
Fuselage, ft	108.875	107.81			51.00	67.17 <sup>a</sup>	73.33
Overall Height, ft	32.33	25.58			18.58	24.92	28.42

a) Folded, 56.5  
 Cont'd

\* Also 13,000 1.2  
 \*\*10 sec/30 min

Table 5.1A (Cont'd)

INTERNAL DIMENSIONS	39.375	46.06	26.25	26.25	30.17	30.00	30.00
Cabin Length, ft							
Max. Width, ft	8.64	8.21	6.56	6.56	7.50	7.50	7.50
Max. Height, ft	F: 6.58, R: 8.21	5.5	6.56	6.56	6.50	6.50	6.50
Volume, cu.ft	2825	2120	1129.32	1129.32	1474	1500	1500
CREW	3	2/3	3	3	2	3	3
WEIGHTS							
Max. Gross Weight, lb	93,700	83,776 <sup>ΔΔ</sup>	[38,760]	[60,100]	50,000	42,000	73,500
Normal, lb	89,285	33,075	33,075	52,920	42,700	36,693	56,000
Empty, lb	60,055	54,410	18,040	26,480	23,162	23,485	33,226
Payload at Zero Range, lb <sup>†</sup>	32,760	28,720	[20,080]	[32,980]	26,400	17,880	39,640
PERFORMANCE	at 82,765 lb	83,776	Norm. GW	Norm. GW	Max. GW	Norm. GW	Norm. GW
Flt. Speed, Max/VNE, kn	162.0	135.0	140.0	140.0	142.0	164	170.0
Fast Cruise*, kn	135.0				142.0	150.0	150
Economic Cruise*, kn					140.0	138	132
Vertical R/C*, fpm					4200 <sup>b</sup>	1740 <sup>d</sup>	
Forward R/C*, fpm					1100	2510	2800
Hover**, OGE, ft			4920	4920	6000	8000	8200
Service Ceiling, ft	14,760	9850	14,760	14,760	8500	17,000	18,500
Ceiling, 1-Engine Out, ft					950 <sup>c</sup>	2112	
Avg. Fuel Consumption, lb/hr	13,922	15,220	3197	5116	3295	2150	
Normal Fuel, lb	350 <sup>Δ</sup>	428	200	200		4338	
Range, N.Mi.						~250	1120
DISC LOADING							
Normal GW, psf	8.62	-	9.30	10.18	7.55	8.95	11.43
Max. GW, psf	9.05	8.09	[10.91]	[11.56]	8.84	10.25	15.00
POWER LOADING							
Normal GW, lb/shp	8.12	-	[5.70]	[5.73]	5.69	4.67/4.85	4.26
Max. GW, lb/shp	8.52	7.62	[6.68]	[6.51]	6.67	5.35/5.56	5.59

NOTES:

\*SL, ISA

\*\*ISA

<sup>†</sup> Based on Max. GW

<sup>Δ</sup>With  $W_{fU} = 29,312$  lb, 781 n.mi.

<sup>ΔΔ</sup>With sling load

<sup>a</sup> Avg. of 3 missions

<sup>b</sup> 33,000 lb GW

<sup>c</sup> Emergency power, 4420 hp

<sup>d</sup> 1590 at NRP

TABLE 5.1B  
 ADDITIONAL HELICOPTER CHARACTERISTICS  
 30,000 TO 100,000-LB GROSS WEIGHT CLASS

ITEM	HELICOPTER						
	Mil Mi-6	Mil Mi-10K	Hypothetical 15 M.Ton	Hypothetical 24 M.Ton	Boeing-Vertol CH-47D	Sikorsky CH-53D	Sikorsky CH-53E
Tip Speed, fps	721.4	721.4	720	720	706.7	699.8	740
Main Rotor Solidity	0.0909	0.0909	0.0974	0.1063	0.0850	0.1143	0.136
$R_{tr}/R_{mr}$	0.191	0.191	0.202	0.214	—	0.221	0.253
$x/R_{mr}$	1.205	1.213	1.227	1.234	—	[1.226]	1.244
Maximum GW, lb	93,700	83,776	[38,760]	[60,100]	50,000	42,000	73,500
$W_e/(W_{gr})_{max}$	0.641	0.649	0.465	0.441	0.463	0.559	0.452
$(W_{pl})_0/(W_{gr})_{max}$	0.350	0.343	0.518	0.549	0.528	0.426	0.539
$(W_{pl})_0/\text{Cabin Vol, lb/ft}^3$	11.60	13.55	[17.78]	[29.20]	17.91	11.92	26.43
Normal or VTO GW, lb	82,675		33,075	52,920	42,700	36,693	56,000
$W_e/(W_{gr})_{norm}$	0.726		0.546	0.500	0.542	0.640	0.593
$(W_{pl})_0$ at NGW, lb	21,980		14,400	25,800	19,100	12,570	22,140
$(W_{pl})_0/(W_{gr})_{norm}$	0.266		0.435	0.488	0.447	0.343	0.395
$(W_{pl})_0/\text{Cabin Vol, lb/ft}^3$	7.78		12.75	22.85	12.96	8.38	14.76



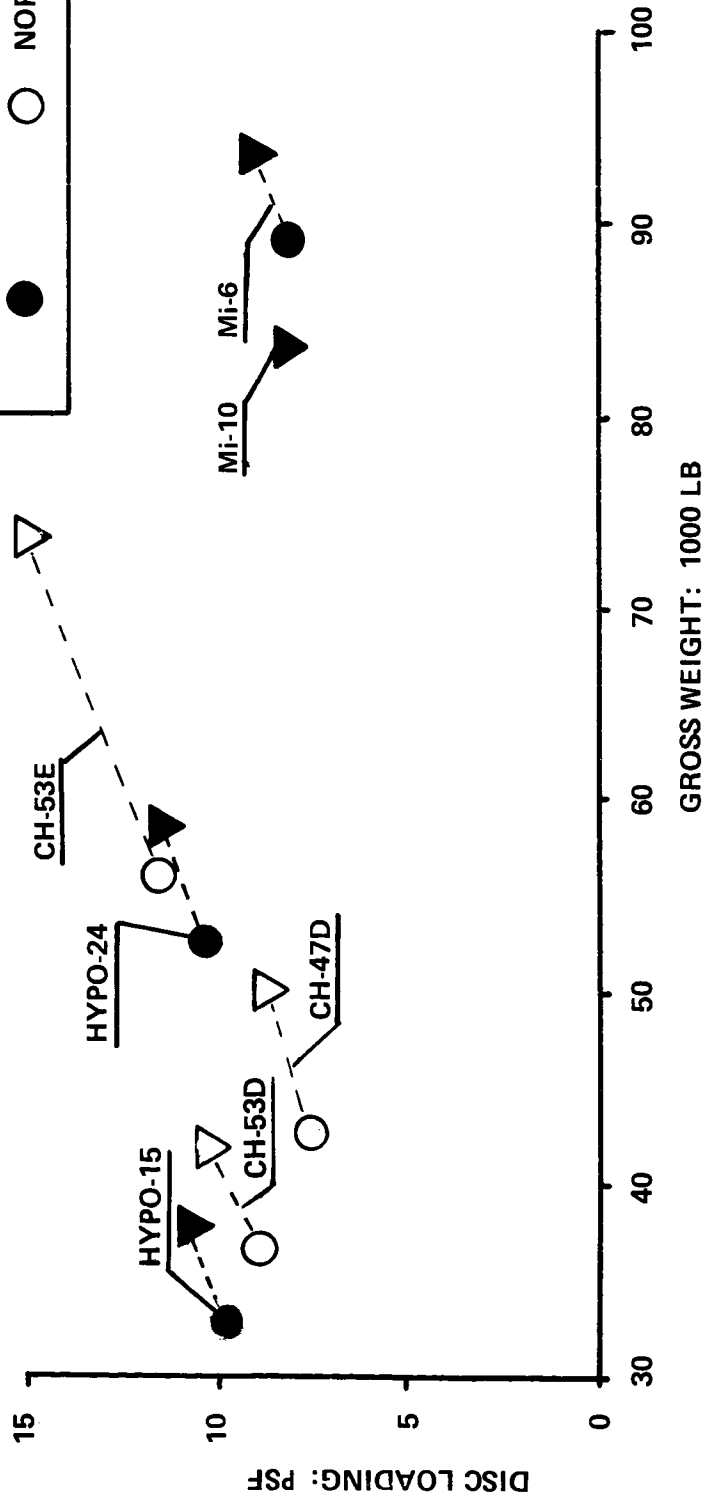
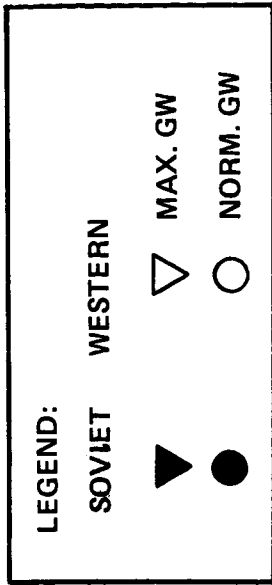

Figure 5.2. Disc loadings of Soviet and Western helicopters of the 30,000 to 100,000-lb gross weight class.

As may be expected for a tandem configuration, the disc loading of the CH-47D is lower than that of the single-rotor types.

**Power Loading (Fig. 5.3).** A glance at this figure would indicate that the power loading of the actual Soviet helicopters of the considered weight class is higher than that of their Western counterparts. However, power loading (based on TO power) of the hypothetical helicopters is on the same level as that of the CH-47D and CH-53E. It should also be remembered that the hypothetical powerplant assumed in the hypothetical helicopters are flat rated. Consequently, the power loading based on SL, ISA thermal capacity of the hypothetical engines would amount to about 83 percent of the power loading shown in Fig. 5.3 and listed in Table 5.1. These power loading values would be below those of the CH-47D and CH-53E.

**Main-Rotor Tip Speed (Fig. 5.4).** It can be seen from this figure and Table 5.1B that the actual, as well as the hypothetical Soviet helicopters, have practically the same tip speed  $V_t \approx 720$  fps—while those of their U.S. counterparts vary from 699.8 (CH-53D) to 740 fps (CH-53E).

**Tail-Rotor to Main-Rotor Radii Ratio and Relative Tail-Rotor Distance (Fig. 5.5).** It can be seen from this figure that the tail-rotor to main-rotor radii ratio of existing Soviet helicopters is lower than those of the CH-53D and CH-53E. However, the relative longitudinal location ( $\bar{x}$ ) of the tail rotors is practically the same for all four helicopters.

For the hypothetical helicopters, the tail-rotor radius can be computed from Eq (2.141)<sup>1</sup> which, in the present notations, can be written as follows:

$$R_{tr}^3 + (R_{mr} + \delta)R_{tr}^2 - [(M_Q)_{mr}/\pi w_{tr}] = 0 \quad (5.1)$$

where  $\delta$  is the gap separating the main-rotor tip radius from the tail-rotor tip radius. (In Ref. 1, it is assumed that  $\delta = 0.25$  m = 0.82 ft.)  $(M_Q)_{mr}$  is the main-rotor torque which, in turn, in hovering may be expressed as  $(M_Q)_{mr} = R_{mr}(R_{vh}^3 W_{gr} V_{id_{mr}})/FM_{mr} V_{t_{mr}}$ .

Using the above-outlined procedure and the indicated tail-rotor disc-loading values, the tail-rotor values of the hypothetical helicopters were found as shown in Table 5.1A. Their  $x$  and  $\bar{x}$  values are also given in this table.

It can also be seen from Table 5.1A and Fig. 5.5 that the so-determined  $R_{tr}/R_{mr}$  ratios are between the Mil Mi-6 and Mi-10, and the Sikorsky CH-53D and CH-53E helicopters; while the  $\bar{x}$  distances are practically the same as for all single-rotor helicopters of the same class; i.e.,  $\bar{x} \approx 1.2$ .

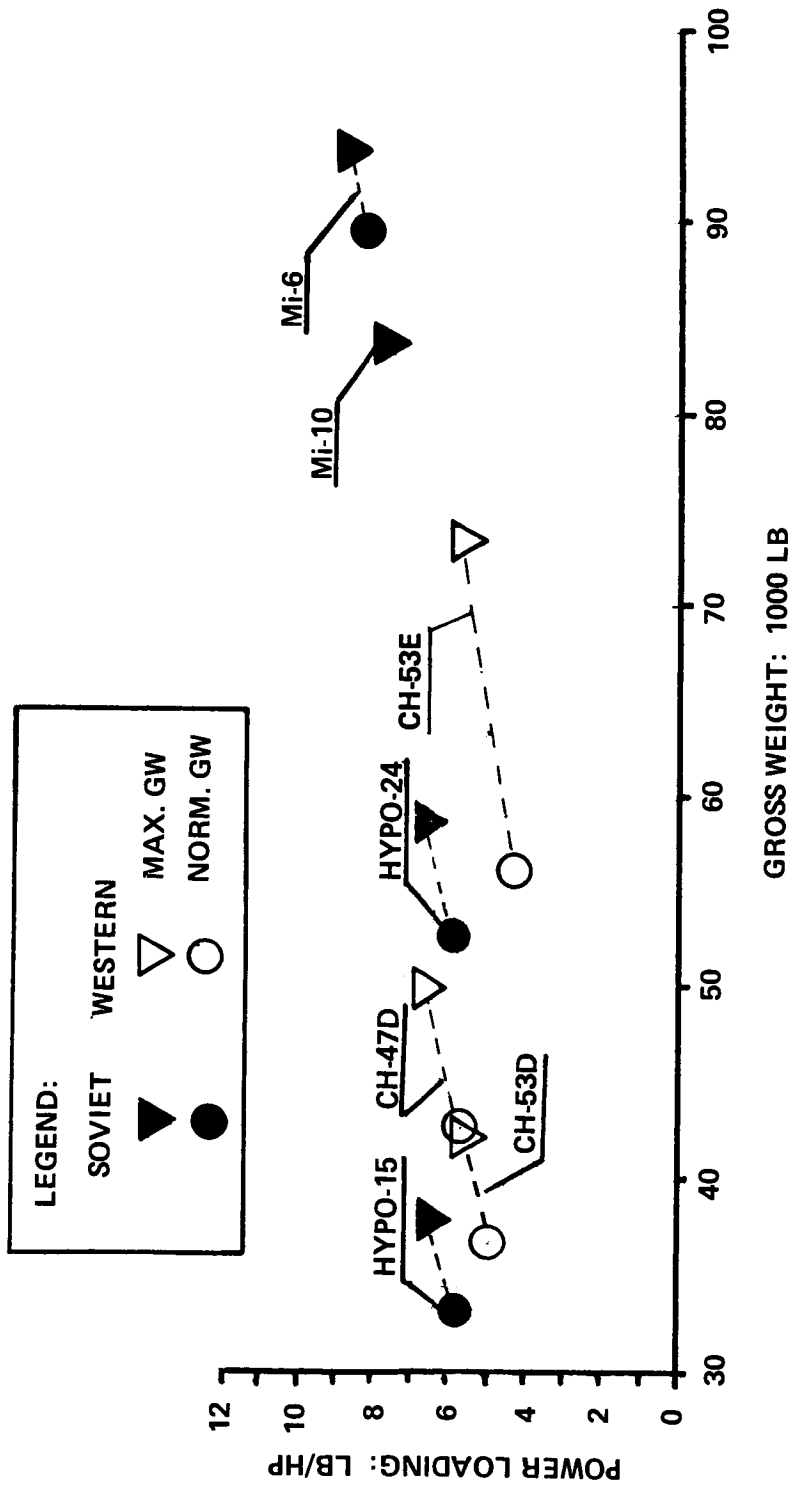

Figure 5.3 Power loading of Soviet and Western helicopters of the 30,000 to 100,000-lb gross weight class

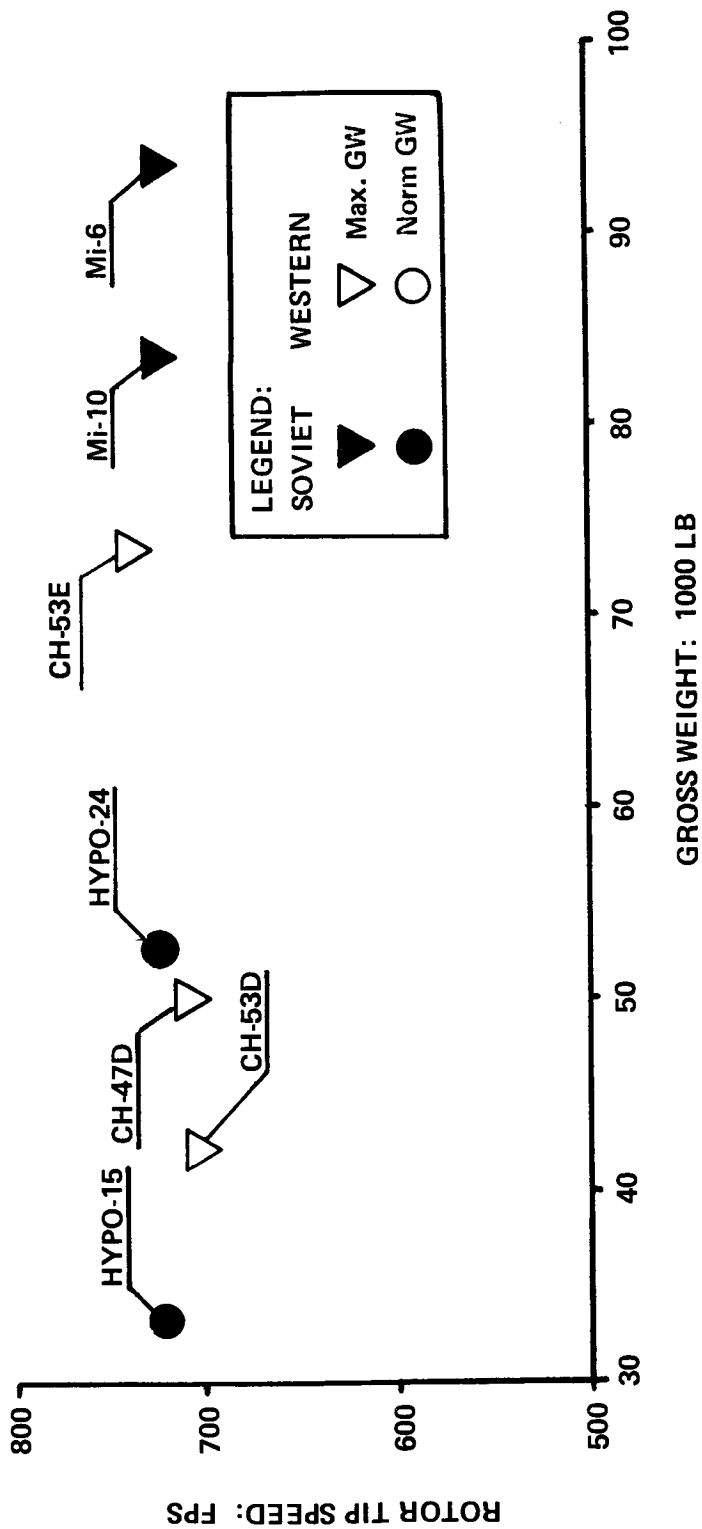

Figure 5.4 Main-rotor tip speed of Soviet and Western helicopters of the 30,000 to 100,000-lb gross weight class.

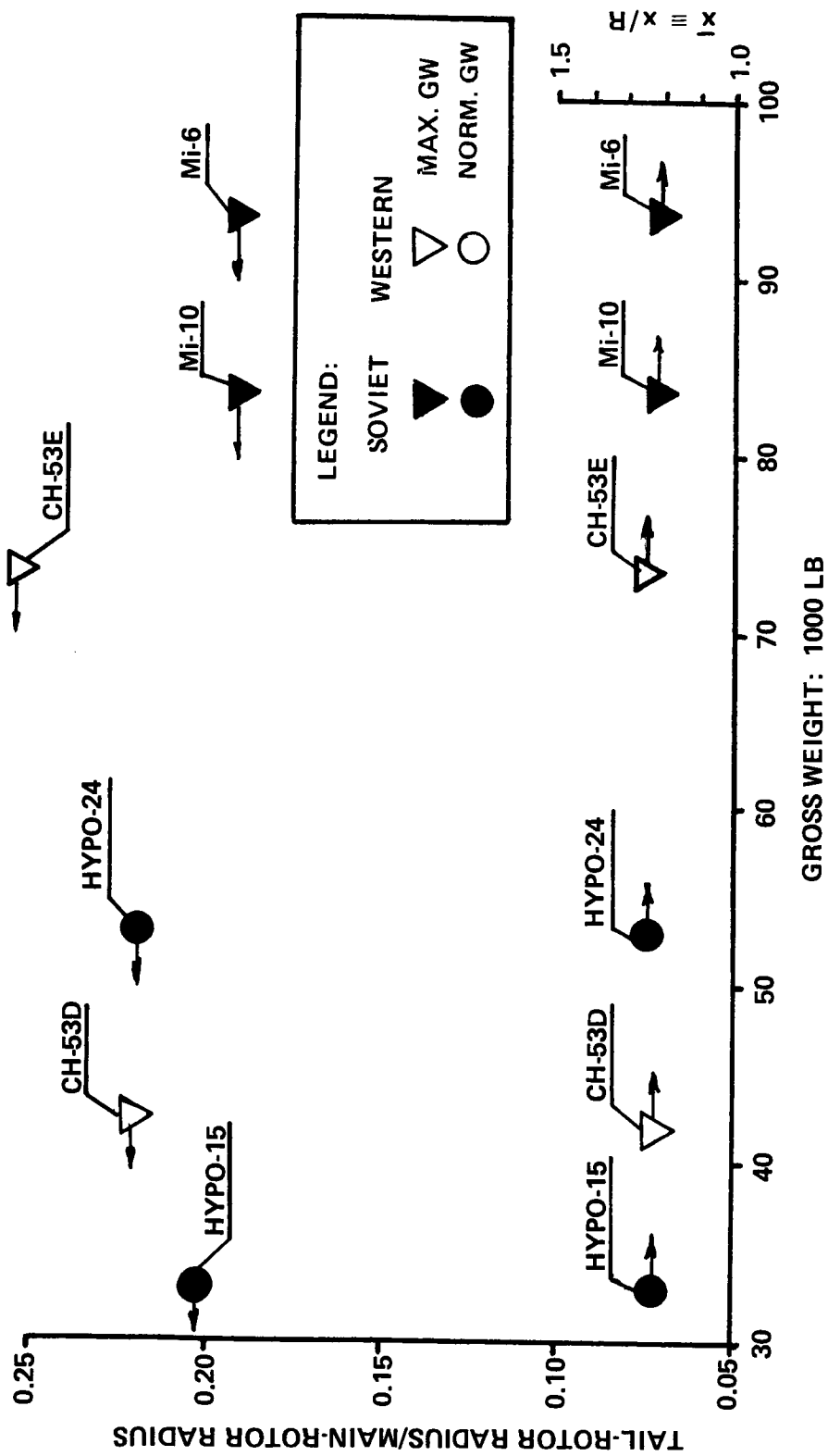

Figure 5.5 Tail-rotor to main-rotor radii ratio and relative tail-rotor distance of Soviet and Western helicopters of the 30,000 to 100,000-lb gross weight class.

Weight Empty and Zero-Range Payload to Gross Weight Ratios (Figs. 5.6 and 5.6A). It can be seen from Fig. 5.6 that the weight empty to maximum gross weight, and the weight empty to normal gross weight ratios of the Mi-6 and Mi-10 helicopters are higher than those of the CH-47D, CH-53E, and CH-53D.

Contrary to the trend represented by existing Soviet helicopters of the considered weight class, the so-called hypothetical helicopters reflect at least a possibility that the weight empty to gross weight ratios of the new generation of Soviet helicopters can be equal to, or better than, their Western counterparts.

Fig. 5.6A supplements Fig. 5.6 by showing zero-range payload to normal gross weight ratios. It can be seen from this figure that the ratio for existing Soviet helicopters is considerably lower than for the CH-47D, CH-53E, and is still below that of the CH-53D, but their hypothetical helicopters at their normal gross weights are expected to have a  $(W_{pl})_o/(W_{gr})$  that is better than their Western counterparts.

Cabin Volume Loading (Fig. 5.7). A glance at this figure would indicate that similar to the previously discussed gross weight classes, the existing Soviet helicopters of the 30,000 to 100,000-lb gross weight class have relatively more spacious cargo cabins than the CH-47D, and especially the CH-53E model; but similar space to that of the CH-53D. This roominess of the cabin is even present in the Mi-10K, in spite of the fact that it is a crane type primarily designed to carry external cargo loads.

The trend of the hypothetical helicopters in that respect is not consistent, since the same cabin dimensions (2 X 2 X 8 m) were assumed for the entire 12 m.ton to 24 m.ton gross weight class. This assumption obviously leads to much more cabin volume with respect to the maximum possible payload of a 15-ton gross weight helicopter than a 24-ton helicopter.

### 5.3 Hovering and Vertical Climb Aspects

A graph of  $V_{cv} = f(W_{gr})$  was available for the CH-53D<sup>13</sup>, as was data giving  $SHP_{req} = f(W_{gr})$  in hovering OGE, SL, ISA for the CH-47D (courtesy of Boeing-Vertol Company). This allowed one direct calculation of  $FM_{oa}$  values (Fig. 5.8). The overall figures of merit were computed for all of the other helicopters discussed in this chapter by following the procedures previously used in Sections 3.2 and 4.2, and shown in detail in Table 5.2.

Once the  $FM_{oa}$  values were determined, the VTO gross weights were computed from Eq (1.2), and the vertical rate of climb at that, and other gross weights, were computed from Eq (1.9).

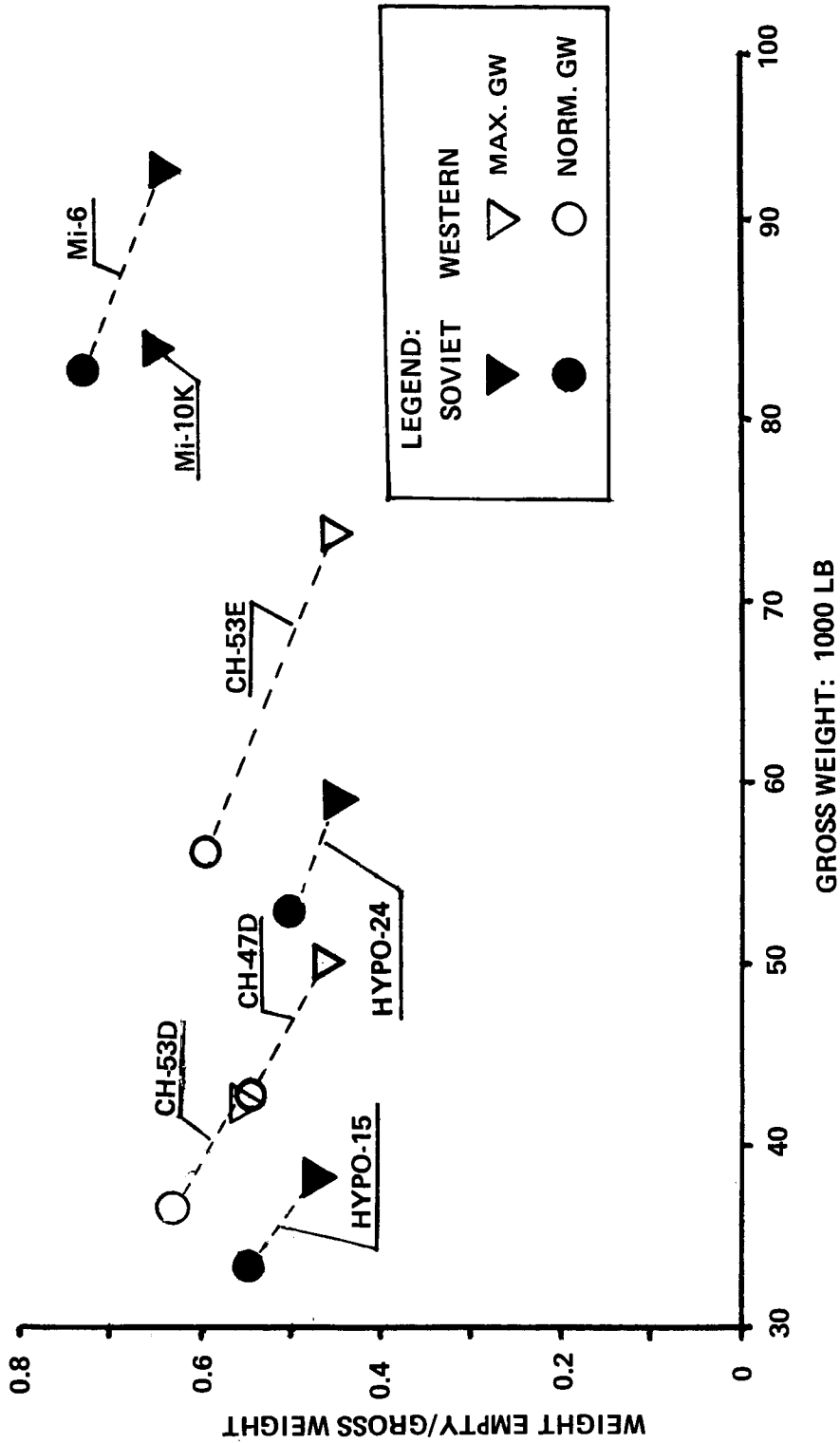

Figure 5.6 Weight empty to gross weight ratios of Soviet and Western helicopters of the 30,000 to 100,000-lb gross weight class.

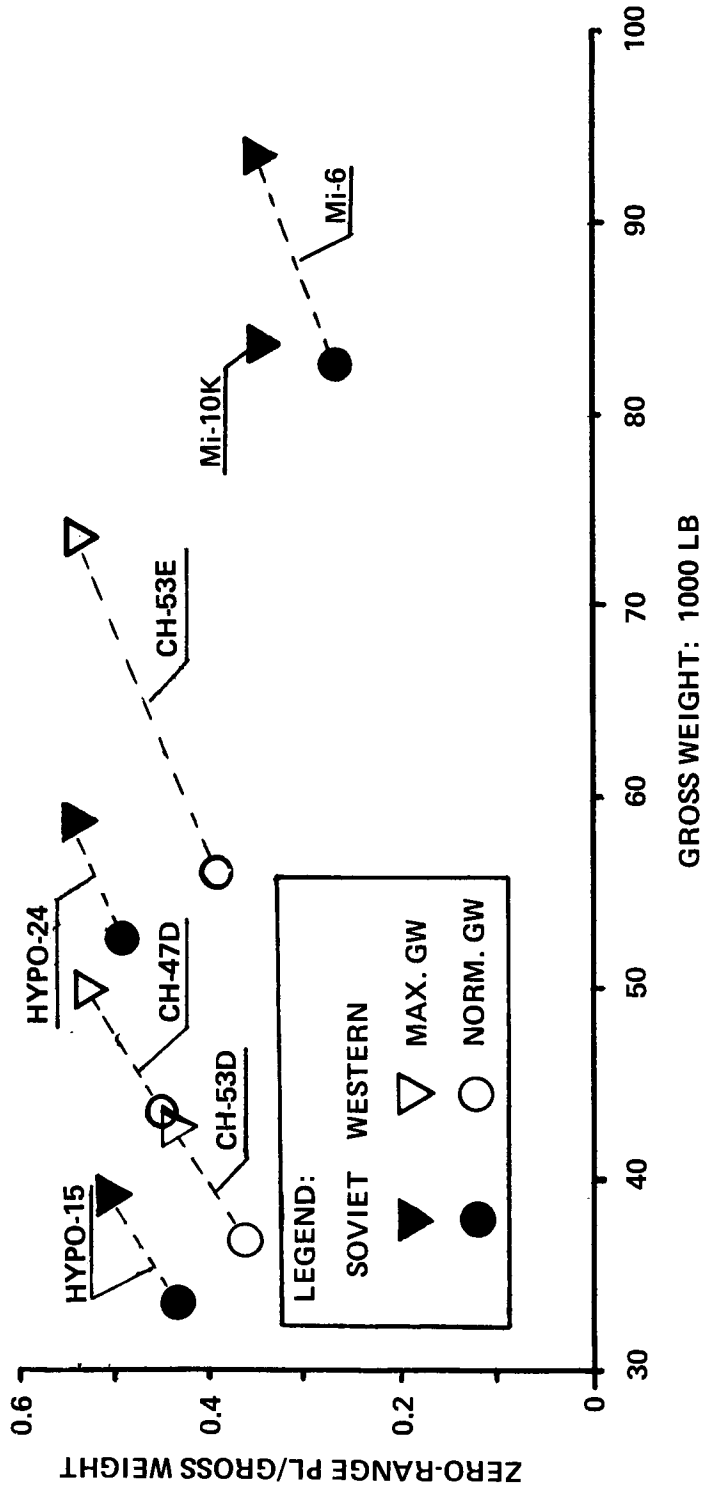

Figure 5.6A Zero-range payload to gross weight ratios of Soviet and Western helicopters of the 30,000 to 100,000-lb gross weight class.



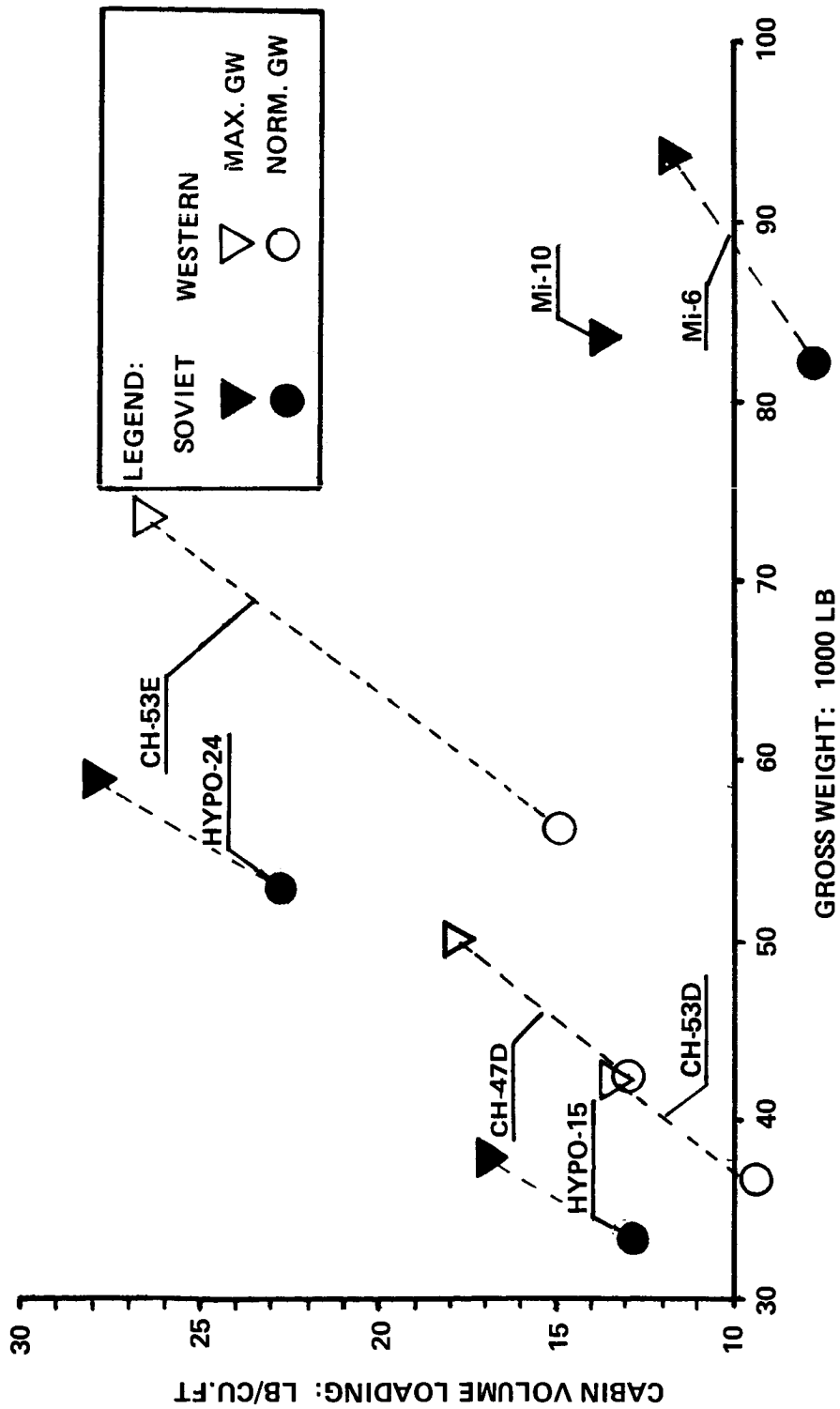

Figure 5.7 Cabin volume loading at zero-range payload of Soviet and Western helicopters of the 30,000 to 100,000-lb gross weight class.

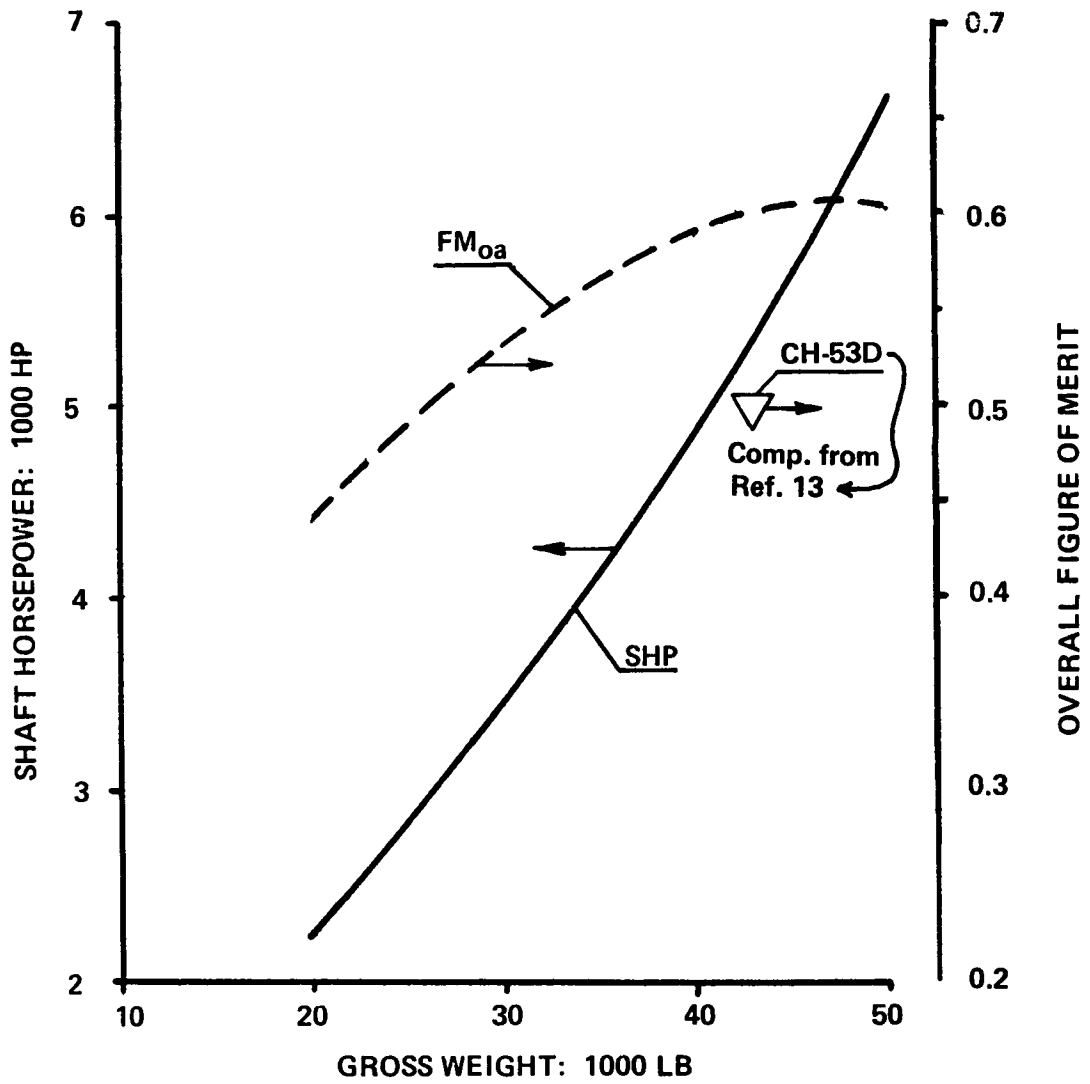

Figure 5.8 SHP required in hover OGE, SL, ISA (courtesy of Boeing-Vertol Co.) and overall figure of merit of the CH-47D & CH-53D helicopters.

TABLE 5.2  
HOVERING AND VERTICAL CLIMB ASPECTS, ISA  
30,000 TO 100,000-LB GROSS WEIGHT CLASS

ITEM	HELICOPTER						
	Mil Mi-6	Mil Mi-10K	Hypothetical 15 M.Ton	Hypothetical 24 M.Ton	Boeing Vertol CH-47D	Sikorsky CH-53D	Sikorsky CH-53E
GROSS WEIGHT, LB	82,675	83,776	33,075	52,920	50,000	42,000	56,000
MAIN ROTOR							
Disc Loading, $w$ ; psf	7.98	8.09	9.30	10.18	8.84	10.25	11.43
Ideal Induced Velocity, $v_{id}$ ; fps	40.94	41.23	44.20	46.25	43.09	46.40	49.00
Tip Speed, $V_t$ ; fps	721.4	721.4	720.0	720.0	706.7	699.2	740
$v_{id}/V_t$	0.0568	0.0571	0.0614	0.0642	0.0610	0.0664	0.0669
Solidity, $\sigma$	0.0909	0.0909	0.0974	0.1063	0.0850	0.1143	0.136
Download Factor, $k_{vh}$	[1.07]	[1.025]	1.025	1.025	[1.055]	[1.035]	[1.035]
Average Blade Lift Coeff., $\bar{c}_l$	0.455	0.442	0.465	0.465	0.55	0.46	0.40
$FM$	0.695 <sup>1</sup>	0.694 <sup>1</sup>	0.701 <sup>1</sup>	0.709 <sup>1</sup>	0.75 <sup>a</sup>	[0.69]	[0.72]
TAIL ROTOR							
Tail Rotor Thrust, lb	6130	6025	2436	4027		3394	4140
$T/W$ , gr	0.0741	0.0719	0.0737	0.0761		0.0808	0.0739
Disc Loading, $w$ ; psf	16.16	15.88	16.77	16.90		16.88	13.18
Ideal Induced Velocity, $v_{id}$ ; fps	58.26	57.76	59.36	59.95		59.55	52.62
Tip Speed, $V_t$ ; fps	776.7	776.7	[770]	[770]		791	732
Solidity, $\sigma$	0.171	0.171	0.170	0.171		0.186	0.1633
Blocking Factor, $k_{blo}$	[1.0]	[1.0]	[1.0]	[1.0]		[1.0]	[1.0]
Avg. Blade Lift Coefficient, $\bar{c}_{l tr}$	0.39	0.39	0.42	0.42		0.37	0.38
$FM_{tr}$	[0.6]	[0.6]	[0.6]	[0.6]		[0.6]	[0.56]
Power ratio, $(RP_{tr}/RP_{mr})$	0.099	0.1025	0.1120	0.116		0.116	0.097

Cont'd

Table 5.2 (Cont'd)

$\eta_{Oa}$	0.874	0.871	0.863	0.86	0.875	0.86	0.875
$FM_{Oa}$ (1st Estimate)	0.549	0.582	0.585	0.589	0.605	0.560	0.598
Hover Ceiling OGE; ft					6000	3600 <sup>a</sup>	8200
SL Takeoff SHP/GW; hp/lb	0.133	0.131			0.15	0.189	0.207 <sup>c</sup>
Rel. Lapse Rate at Hover Ceiling OGE					0.89	0.93	0.820
$FM_{Oa}$ (2nd Estimate)					0.642	0.512	0.526
Average $FM_{Oa}$	0.549	0.582	0.585	0.589	0.604 <sup>b</sup>	0.506 <sup>d</sup>	0.562
Lapse Rate $\lambda_{3000}$	1.035	1.035	1.0	1.0		0.94	0.945
VTO Gross Weight; lb	81,100	84,300	37,800	58,720	> ( $W_{gr}^{max}$ )	42,200	67,980
Vert. R/C at VTO GW; fpm	~60	~60	210	260	NA	NA	660
Vert. R/C at NGW; fpm	[-690]	~110	1310	1130	1870	1800 <sup>13</sup>	2370
Vert. R/C at Maximum GW; fpm	-				750	700 <sup>13</sup>	~90

NOTE:

<sup>a</sup>Manufacturer's Data

<sup>b</sup>From Fig. 5.8

<sup>c</sup>Based on 30-min Transmission Limit

<sup>d</sup>Average of Fig. 5.8 and 2nd Estimate

**Installed Power per Pound of Gross Weight in Comparison with Ideal (SHP/GW) Values in Hover OGE, ISA (Fig. 5.9).** It can be seen from this figure that similar to the previously considered gross weight classes, the ratio of the installed power (at a rating of 5500 hp per engine) per pound of gross weight to the ideal values of the Mi-6 and Mi-10K helicopters is lower than for most of their Western counterparts. Only the CH-53E at its maximum flying weight of 73,600 lb has an  $(SHP_{TO}/W_{gr})/(SHP/W_{gr})_{id} \approx 1.75$  similar to that of the Mi-10K.

By contrast, the ratio of the installed flat-rated power loading to the ideal values of the so-called Soviet hypothetical helicopters tends to be similar to that of the Western helicopters.

**Average Blade Lift Coefficient (or  $C_T/\sigma$ ) in Hover OGE at SL, ISA (Fig. 5.10).** A glance at Fig. 5.10 would indicate that in the presently considered gross weight class, the average blade-lift coefficients of existing Soviet (Mi-6 and Mi-10K) helicopters and their Western counterparts appear to be quite similar for the same type of operational gross weights. The same seems to be true regarding the two hypothetical helicopters.

**Main Rotor Figure of Merit in Hover OGE at SL, ISA (Fig. 5.11).** Figures of merit of Soviet helicopters (both existing and hypothetical) were determined from the curve marked "Tests" in Fig. 2.60<sup>1</sup>, and then corrected to the proper  $\bar{c}_\rho = 3 \times t_\gamma$  values using the following equation given on p. 113 of Ref. 1 which, using present notation, becomes:

$$FM_1 = FM_o - 0.3(1/3 \bar{c}_\rho - 0.185)$$

where  $FM_1$  is the sought figure of merit at a given  $\bar{c}_\rho$ , and  $FM_o$  represents the  $FM$  value shown in Fig. 2.60<sup>1</sup>.

The figure of merit of the CH-47D was given by the manufacturer. For the other Western helicopters, Fig. 1.16 was used as a starting base, and deviations from the values shown in this figure were estimated, taking into consideration blade airfoils, and Reynolds and Mach numbers. Then, final  $FM$  values were calculated for the proper rotor solidities using Eq. (1.26a).

It can be seen from Fig. 5.11 that the so-obtained figures of merit of the compared helicopters are close to 0.7. The CH-53E rotor, due to its high solidity value reaches  $FM = 0.74$  at the helicopter's maximum gross weight, which is similar to the manufacturer's given  $FM = 0.745$  for the CH-47D.

**Tail-Rotor Thrust to Gross Weight, and Power to Rotor-Power Ratios (Fig. 5.12).** The rotor-thrust to gross weight ratios, being slightly higher than 0.07, are very similar for all the considered helicopters shown in Fig. 5.12.

The tail-rotor to main-rotor power ratios are also approximately the same, amounting to 0.097 to 0.116.

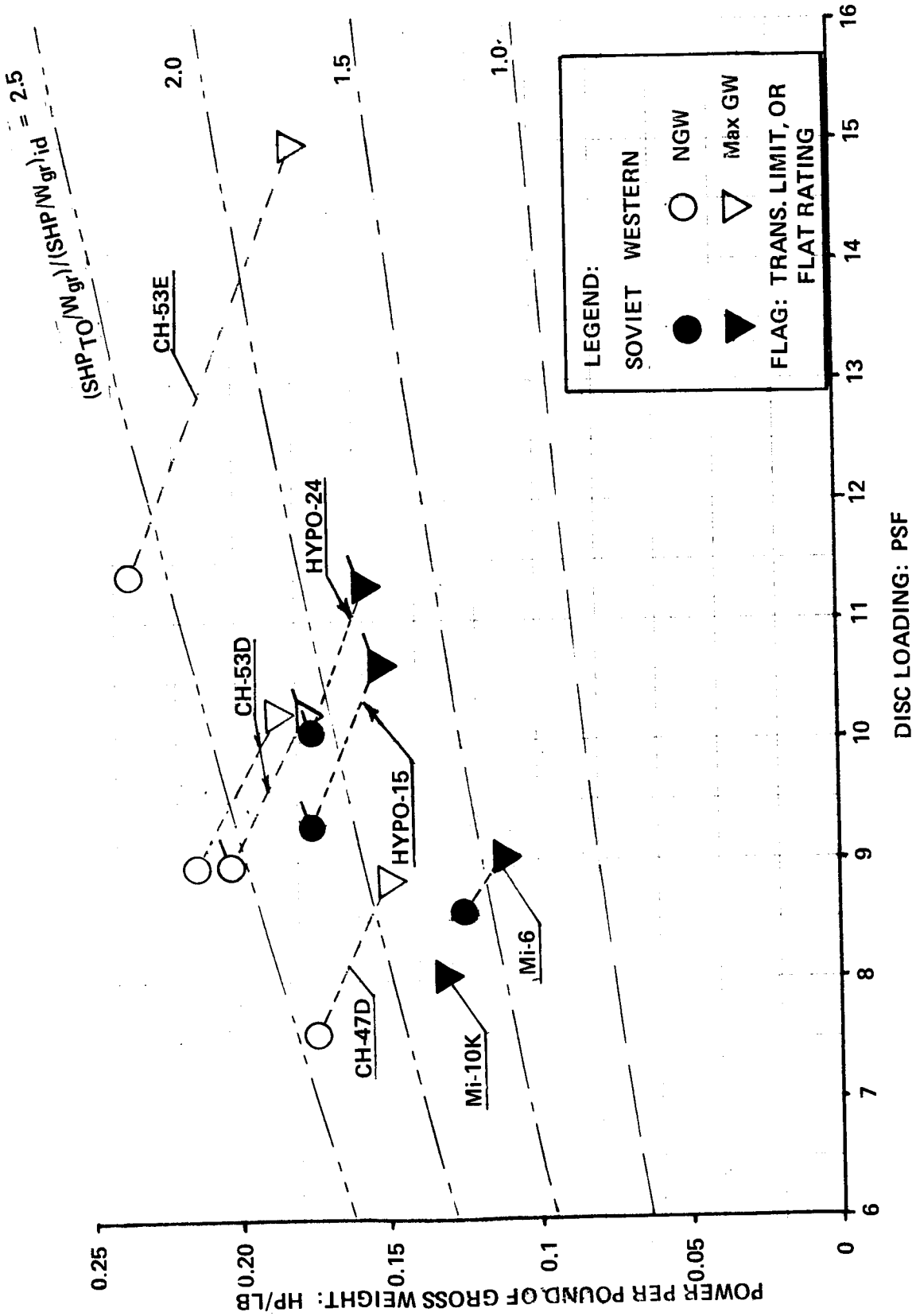

Figure 5.9 Installed power per pound of gross weight in comparison with ideal values for Soviet and Western helicopters of the 30,000 to 100,000-lb gross-weight class

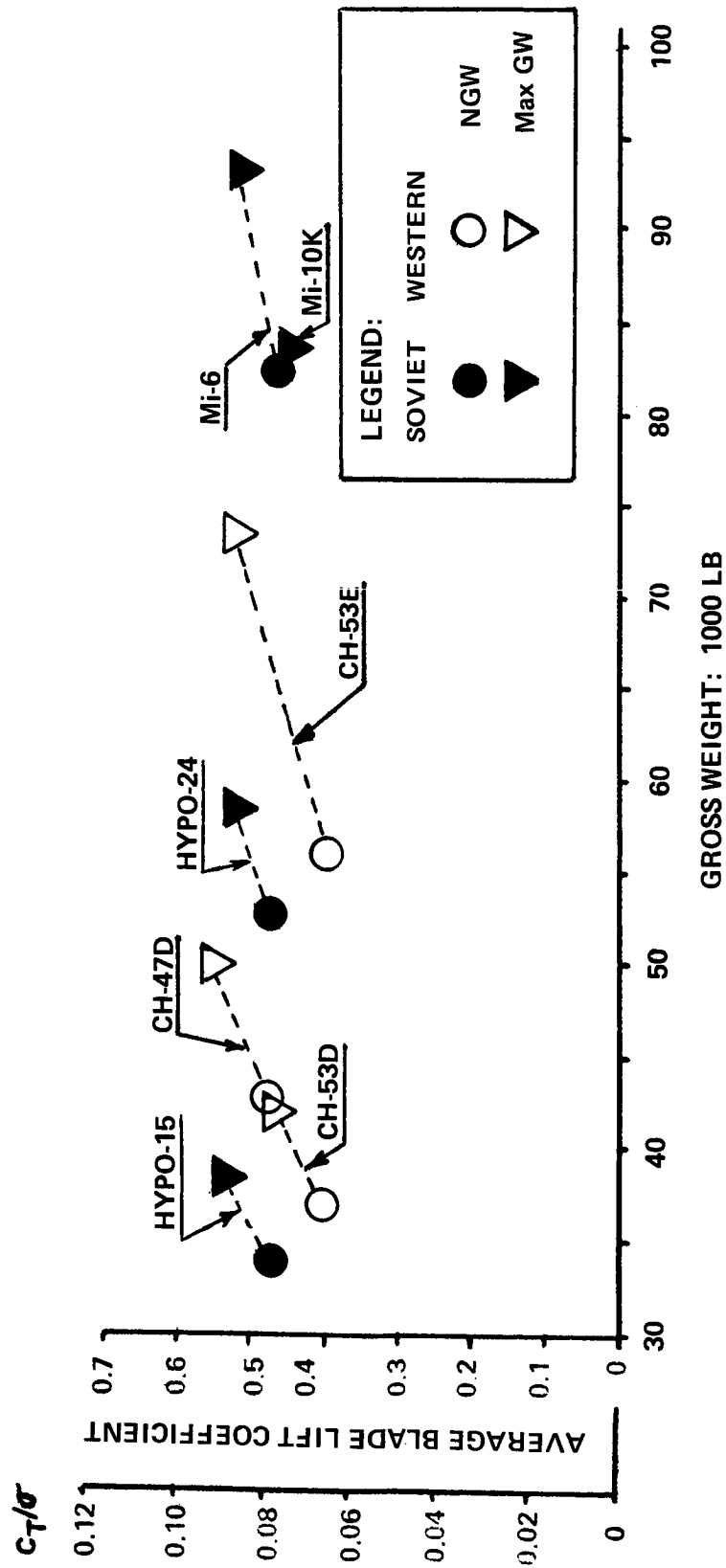

Figure 5.10 Average blade lift coefficient and  $C_T/\sigma$  in hover OGE SL, ISA of Soviet and Western helicopters of the 30,000 to 100,000-lb gross weight class

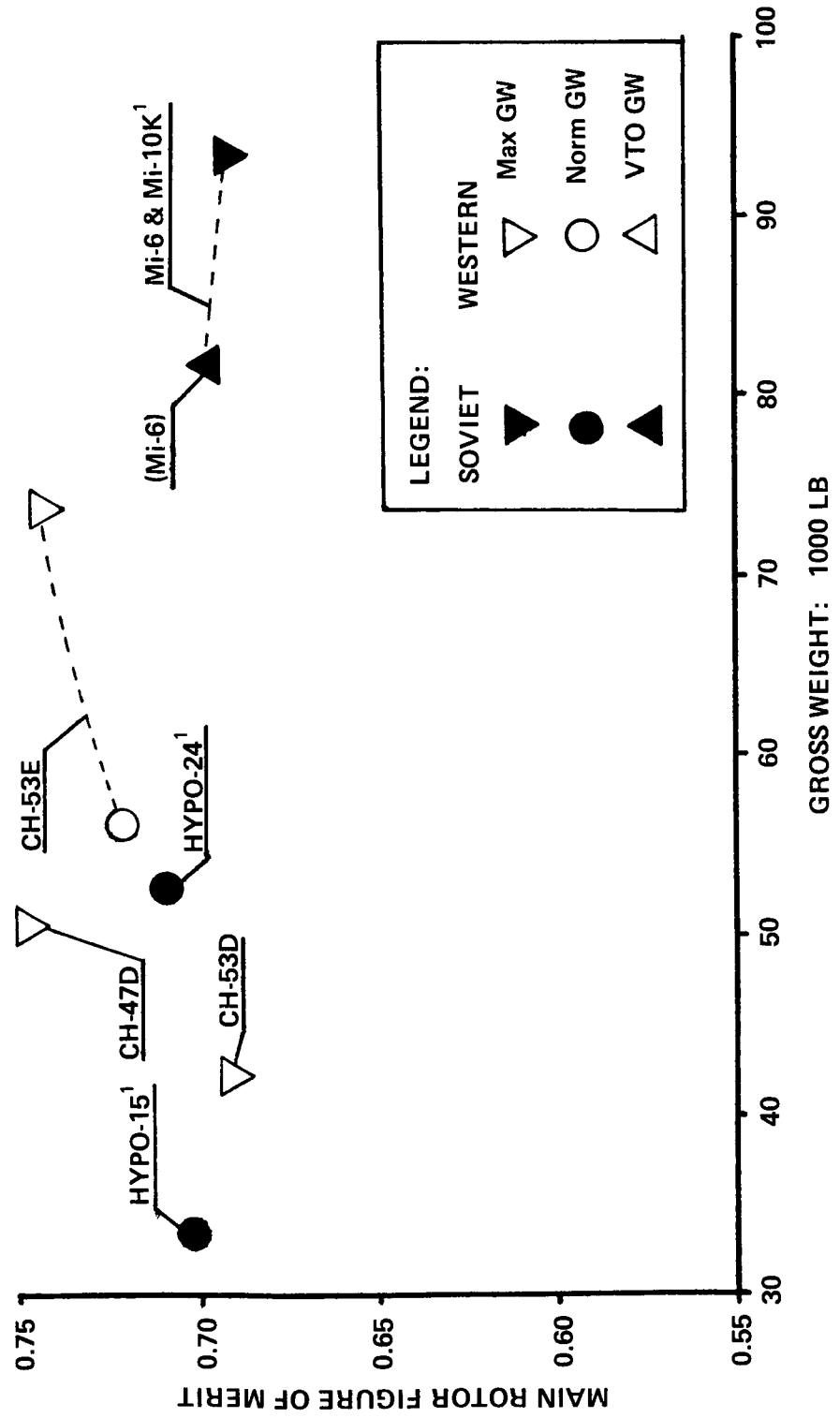

Figure 5.11 Main-rotor figure of merit of Soviet and Western helicopters of the 30,000 to 100,000-lb gross weight class



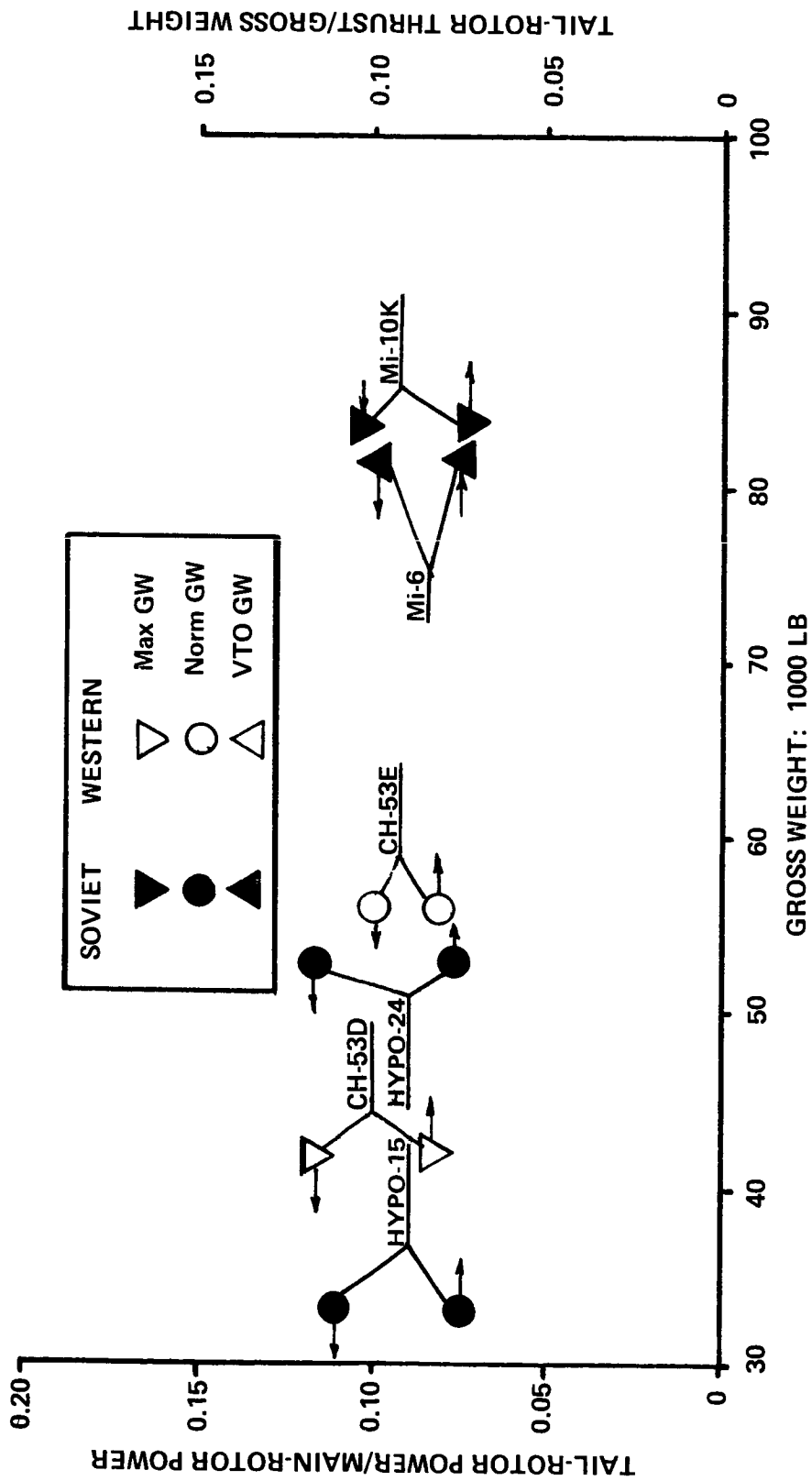

Figure 5.12 Tail-rotor thrust to gross weight and tail-rotor power to main-rotor power ratios in hover OGE, SL, ISA of Soviet and Western helicopters of the 30,000 to 100,000-lb gross weight class.

**Overall Figure of Merit (Fig. 5.13).** The  $FM_{Oa}$  of the CH-47D is based on  $SHP = f(W_{gr})$  flight test results (Fig. 5.8). The  $FM_{Oa}$  values for all of the other helicopters shown in Fig. 5.13 were obtained through the indirect estimates outlined in Table 5.2. The hovering ceilings OGE are given for the CH-53D and CH-53E<sup>2, 13</sup> and the hovering weight OGE at SL, ISA is also known for the CH-53D<sup>13</sup>. This information was not available for the Mi-6 and Mi-10K, while the hovering ceiling values for the hypothetical helicopters shown in Table 5.1 represent spec-required levels – not the performance-prediction figures. For this reason, the  $FM_{Oa}$  values for all of the Soviet helicopters shown in Fig. 5.13 were obtained through the so-called “first approximation” only. As can be seen from the examples of the CH-53E and CH-53D, this procedure tends to lead to somewhat optimistic  $FM_{Oa}$  values. Consequently, the actual overall figure-of-merit levels of the Soviet helicopters shown in this figure may be a few percentage points lower than the ones indicated.

**Vertical Rates of Climb at SL, ISA (Fig. 5.14).** Using VTO weights computed from Eq. (1.2), as well as maximum flying and normal gross weights, the corresponding vertical rates of climb at SL, ISA were computed for the compared helicopters. The results are shown in Table 5.2 and are plotted in Fig. 5.14.

A glance at this figure would indicate that the vertical rates of climb of existing Soviet helicopters (Mi-6 in the winged, and Mi-10K in the short landing-gear versions) at their maximum flying weights are either low, as for the Mi-10K, or have no positive value at all, as in the case of the Mi-6 with wings. Without wings, the gross weight at which the latter would have some capability to climb vertically would be close to 85,000 lb – still below the maximum (93,700 lb), and even normal (89,285 lb) gross weights.

The situation is different with respect to Western helicopters which have some vertical climb capabilities, even at their maximum flying weights and, in the case of the CH-53E, the ability to hover OGE.

With respect to the Soviet hypothetical helicopters, it appears that their designers would like to provide vertical climb capabilities similar to those of their Western counterparts.

## 5.4 Energy Aspects in Hover

**Table 5.3.** The most important inputs required in the study of energy aspects in hover, and numerical values of hourly fuel consumption per pound of gross weight and zero-time payload, are indicated in Table 5.3.

In order to perform this comparison on a common basis, maximum gross weights were used for the Mi-10K, CH-47D, CH-53D, and CH-53E helicopters, as their  $(W_{gr})_{max}$  is lower than or equal to

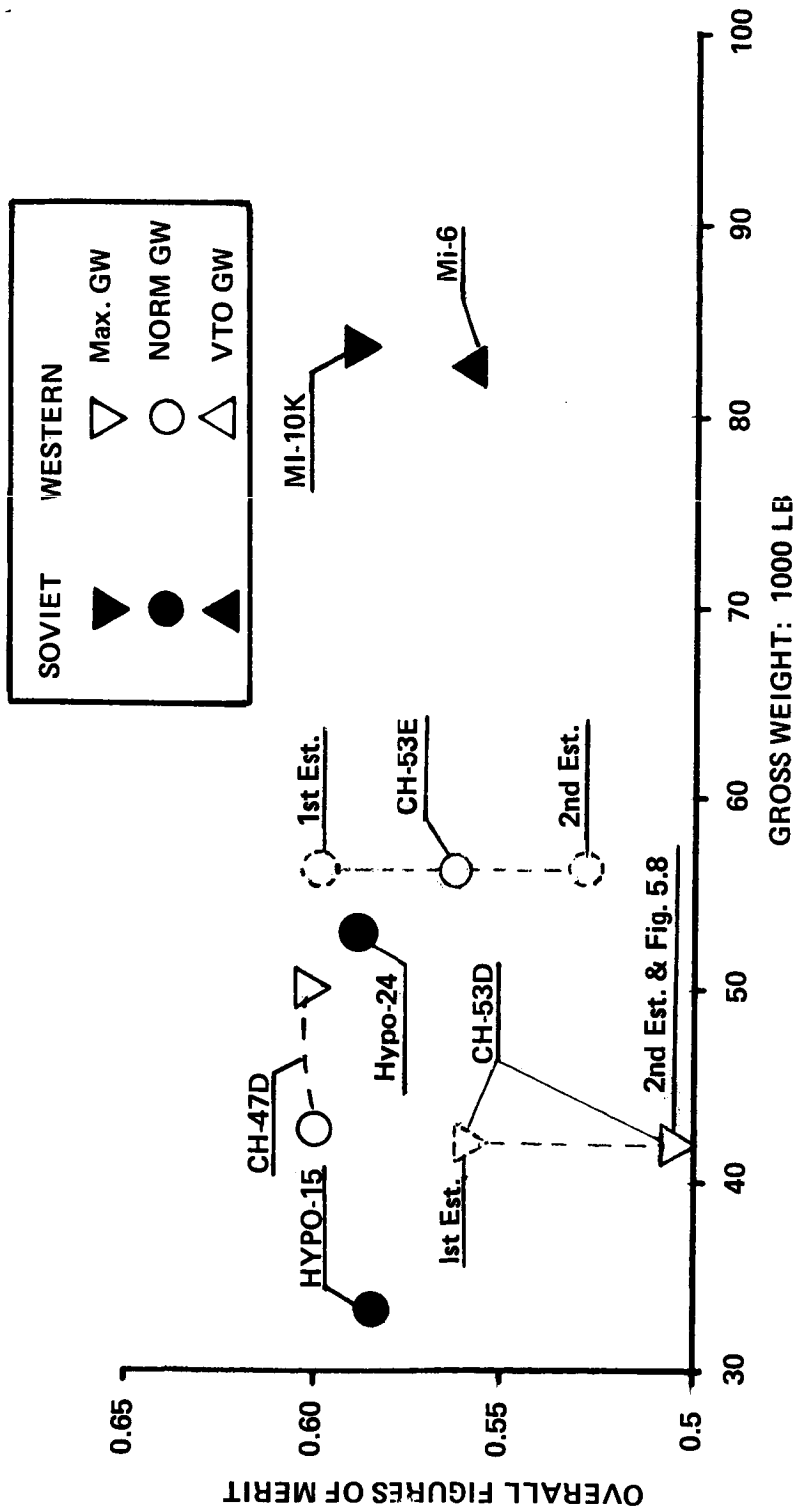

Figure 5.13 Overall figure of merit in hover OGE at SL, ISA of Soviet and Western helicopters of the 30,000 to 100,000-lb gross weight class.

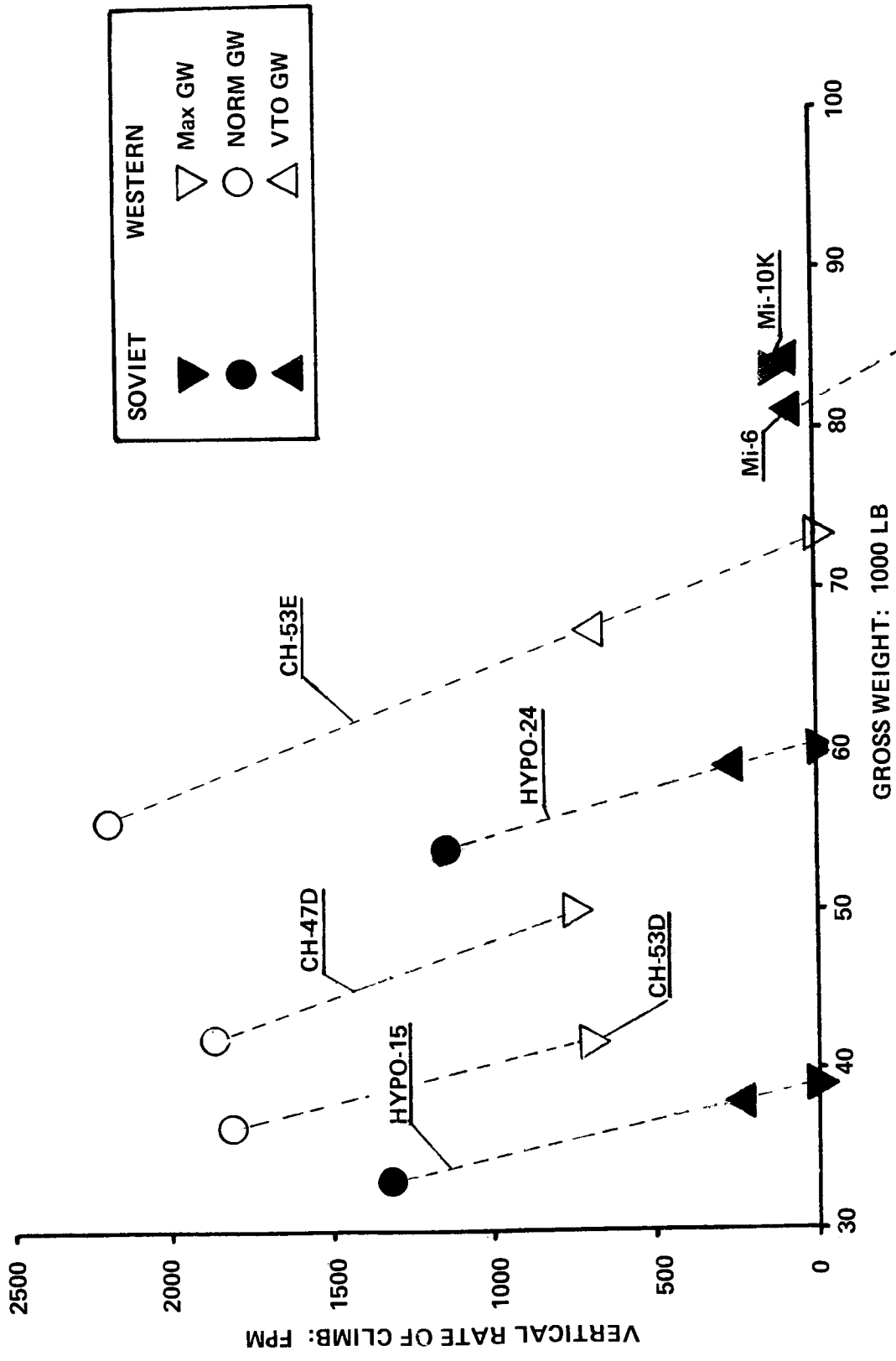

Figure 5.14 Vertical rate of climb at SL, ISA of Soviet and Western helicopters of the 30,000 to 100,000-lb gross weight class.

TABLE 5.3

ENERGY ASPECTS IN HOVER AT SL, ISA  
30,000 TO 100,000-LB GROSS WEIGHT CLASS

ITEM	HELICOPTER						
	Mil Mi-6	Mil Mi-10K	Hypothetical 15 m.ton	Hypothetical 24 m.ton	Boeing-Vertol CH-47D	Sikorsky CH-53D	Sikorsky CH-53E
GROSS WEIGHT: LB	81,800 <sup>a</sup>	83,776 <sup>b</sup>	38,760 <sup>a</sup>	60,100 <sup>a</sup>	50,000 <sup>b</sup>	42,000 <sup>b</sup>	73,500 <sup>b</sup>
Overall Figure of Merit	0.549	0.582	0.585	0.589	0.604	0.506	0.562
SHP Required in Hover: hp	11,000	10,790	5765	9244	6650	7002	~13,140
TO SHP Installed: hp	11,000	11,000	6990 <sup>c</sup>	10,410 <sup>c</sup>	7500	7850	13,140
SHP <sub>req</sub> /SHP <sub>TO</sub>	1.0	0.931	0.825	0.888	0.887	0.892	1.0
sfc: lb/hp-hr	0.62	0.63	0.50	0.47	0.55	0.49	0.45
Hourly Fuel Flow per Pound of GW: lb/hr-lb	0.0833	0.0812	0.0743	0.0723	0.0734	0.0817	0.0793
Zero Time Payload: lb	21,150	28,720	20,080	32,980	26,400	17,880	39,640
Ratio of Zero Time PL to GW	0.258	0.343	0.518	0.549	0.528	0.426	0.539
Hourly Fuel Flow per Lb of PL for t = 0: lb/lb-hr	0.323	0.237	0.143	0.131	0.139	0.192	0.147
t = 1/3 hr	0.362	0.257	0.150	0.137	0.146	0.205	0.155
t = 2/3 hr	0.412	0.281	0.158	0.144	0.153	0.220	0.163
t = 1 hr	0.477	0.311	0.167	0.151	0.161	0.237	0.172

NOTES:

<sup>a</sup>SL, ISA OGE Hover Gross Weight

<sup>b</sup>Maximum Gross Weight

<sup>c</sup>Equivalent SL Rating

their hovering weight OGE at SL, ISA. Calculations were performed for the Mi-6 at  $(W_{gr})_{VTO} = 81,800$  lb since, at higher gross weights, the winged version of the Mi-6 can not hover OGE at SL, ISA. For the hypothetical helicopters, gross weights corresponding to hovering OGE at SL, ISA were computed, and arbitrarily assumed to be their maximum flying gross weights. Therefore, these higher gross weight values were used in the considerations of the energy aspects of the two helicopters.

#### Hourly Fuel Consumption per Pound of Gross Weight in Hover OGE, SL, ISA (Fig. 5.15).

Both Soviet and Western helicopters appearing in Fig. 5.15 exhibit a similar rate of fuel consumption per pound of gross weight in this regime of flight. The highest is for the Mi-6 (0.0833 lb/hr-lb) and the lowest for the hypothetical 24-ton helicopter (0.0723 lb/hr-lb), and the CH-47D (0.0734 lb/hr-lb).

Hourly Fuel Consumption per Pound of Payload in Hover OGE, SL, ISA (Fig. 5.16). The picture changes radically when hourly fuel consumption in hover per pound of payload instead of gross weight is calculated. It can be seen from Fig. 5.16 that in this respect, existing Soviet helicopters (especially the Mi-6 with wings) perform rather poorly when compared with their Western counterparts.

By contrast, the Soviet hypothetical helicopters exhibit a low hourly fuel consumption per pound of payload — comparable with that of the CH-47D, representing the best performance in that respect of all considered Western helicopters of the same class.

### **5.5 SHP Required Aspects in Level Flight at SL, ISA**

Establishment of the  $(SHP/W_{gr}) = f(V)$  Relationship. Flight-test substantiated manufacturers' data on  $SHP = f(V)$  at SL, ISA were available for the CH-47D (Fig. 5.17, courtesy of Boeing-Vertol Company). Consequently, these inputs were directly used to calculate  $(SHP/W_{gr}) = f(V)$  at the maximum flying gross weight of 50,000 lb. The "two-point technique" for  $W_{gr} = 50,000$  and 33,000 lb was employed to determine the equivalent plate area ( $f$ ) and the average blade profile drag coefficient ( $\bar{c}_d$ ). The results of the calculations are shown in Table 5.4.

In this table the  $\bar{c}_d$  values obtained for the two considered gross weights are quite similar, while the values of the equivalent flat-plate area differ by about 10 percent. This difference can result from variation in trim drag at the widely different gross weights, and could also reflect an error in the induced drag coefficient level (assumed in both cases as  $k_{indf} = 1.8$  at  $V_{max}$  and 1.7 at  $V_\theta$ ). In order to take into account those possible errors, an average value of  $f = 98.5$  sq.ft. was

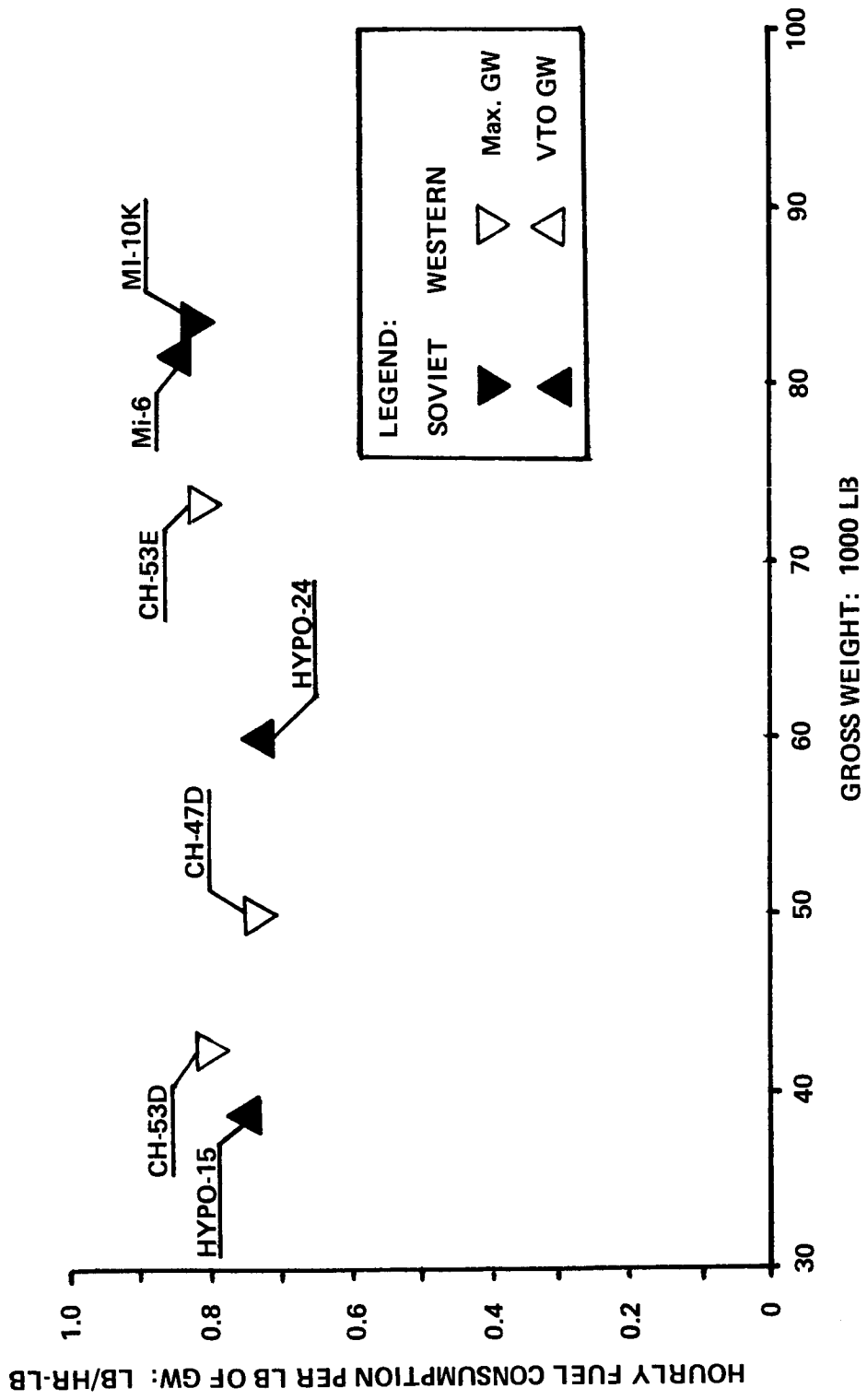

Figure 5.15 Hourly fuel consumption per pound of gross weight in hover OGE, SL, ISA of Soviet and Western helicopters of the 30,000 to 100,000-lb gross weight class

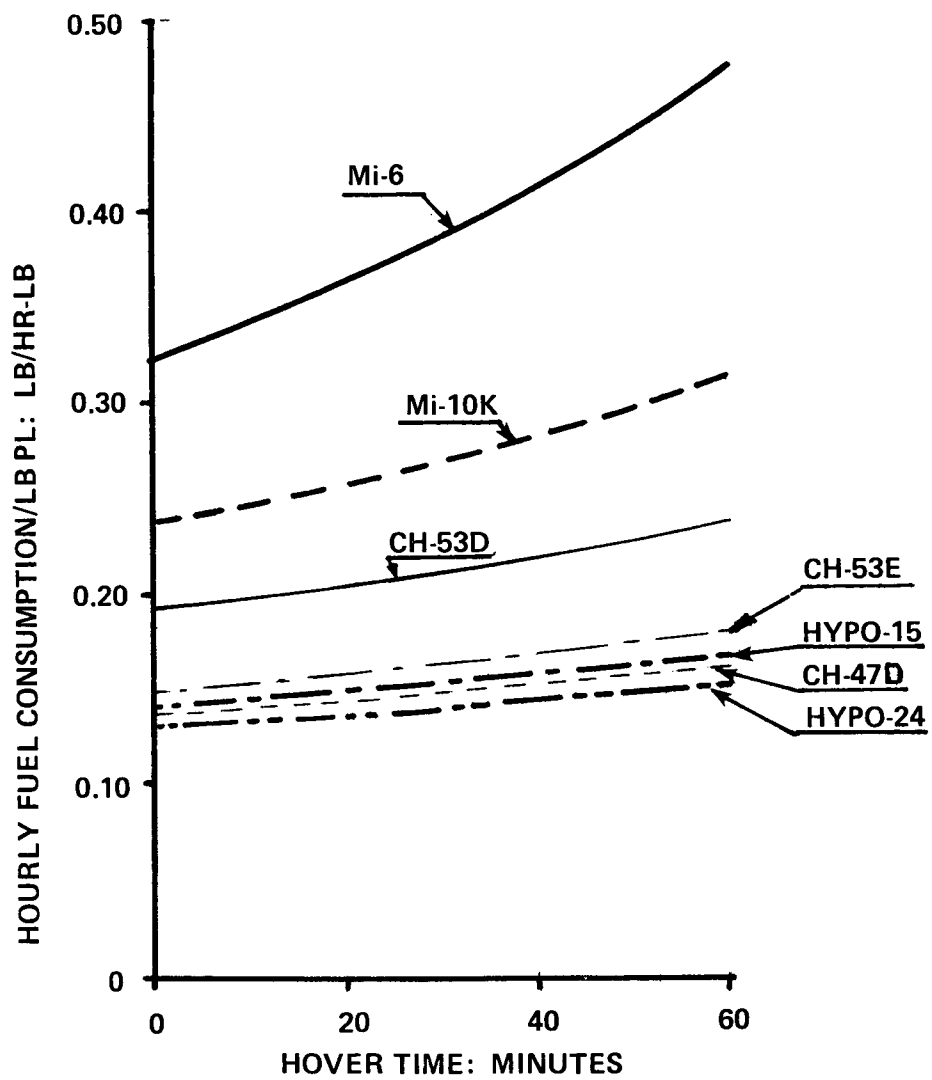

Figure 5.16 Variation with time of hourly fuel consumption per pound of maximum payload in hover OGE, SL, ISA for Soviet and Western helicopters of the 30,000 to 100,000-lb gross weight class.



SL/ISA 225 RPM

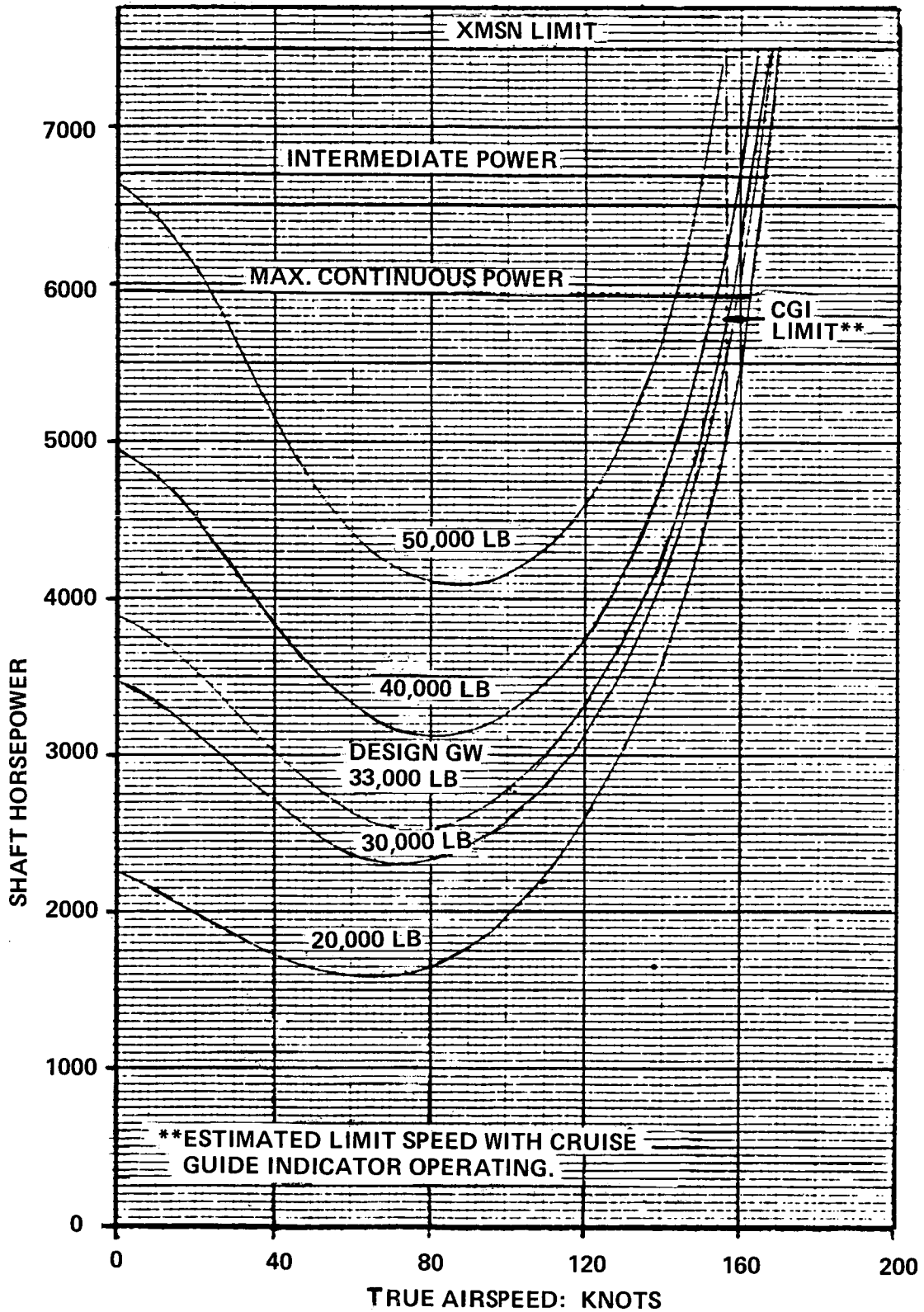

Figure 5.17 Level flight shaft horsepower required by the CH-47D at SL, ISA with no external load (courtesy of Boeing Vertol Company).

ITEM	GROSS WEIGHT: LB		
	50,000	33,000	
	ASSUMED VALUES		
$k_{ind_f}$ at $V_{max}$	1.8	1.8	
$k_{ind_f}$ at $V_e$	1.7	1.7	
$k_{v_f}$ at $V_{max}$	1.03	1.03	
$k_{v_f}$ at $V_e$	1.04	1.04	
$\eta_{oa}$	0.96	0.96	
	COMPUTED VALUES		
	$w_{fp}$ : psf	487.2	353.2
	$f$ : sq.ft	103.7	93.42
	$\bar{c}_d/\bar{c}_\ell$	1/58.5	1/39.0
	$\bar{c}_\ell$	0.55	0.362
	$\bar{c}_d$	0.0094	0.0093

Table 5.4. Equivalent flat plate area and average blade-profile drag coefficients computed for two gross-weight values, using data from Fig. 5.17.

assumed as being correct, and is shown in Table 5.5 with the corresponding equivalent flat-plate area loading level of  $w_{fp} = 507.1$  psf. The  $(SHP/W_{gr}) = f(V)$  curves for gross weights of 50,000 and 33,000 lb, computed directly from the data in Fig. 5.17, are plotted in Fig. 5.18.

Published performance figures for the CH-53E and CH-53D helicopters permitted one to first apply the single-point technique for the original estimation of  $w_{fp}$  and hence  $f$  values, and then to check them vs the two-point approach where, in addition, the  $\bar{c}_d/\bar{c}_\ell$  and  $\bar{c}_d$  values were obtained.

In the case of the CH-53E, where performance figures are known, and  $SHP_{min}$  is given by the manufacturer for  $W_{gr} = 56,000$  lb, both the single and two-point approaches were used at that gross weight as shown in Table 5.5. It can be seen from this table that through the single-point approach,  $f = 124$  sq.ft; and through the two-point approach,  $f = 140$  sq.ft. For calculations of  $(SHP/W_{gr}) = f(V)$  at  $W_{gr} = 73,500$  lb, the single-point  $f$  value was judged as more representative; thus resulting in  $w_{fp} = 592.7$  psf.

With respect to the  $\bar{c}_d$  levels, a relative difference between the assumed  $\bar{c}_d = 0.0098$  in the first approximation and that resulting from the two-point approach is significant ( $\bar{c}_d = 0.0098$  vs  $\bar{c}_d = 0.0067$ ). In order to reduce possible errors in calculations of  $(SHP/W_{gr}) = f(V)$  at  $W_{gr} = 73,500$  lb, an average of the above two profile drag coefficients was assumed; i.e.,  $\bar{c}_d = 0.0083$ , resulting in  $\bar{c}_d/\bar{c}_\ell = 1/56$  at  $\bar{c}_\ell = 0.47$ . The results of the  $(SHP/W_{gr}) = f(V)$  calculations are plotted in Fig. 5.18.

For the CH-53D, the performance figures given for  $W_{gr} = 36,693$  lb<sup>2, 13</sup> served as a basis of the  $f$  and  $\bar{c}_d$  estimates. In this case, the results of both the single and two-point approaches showed some

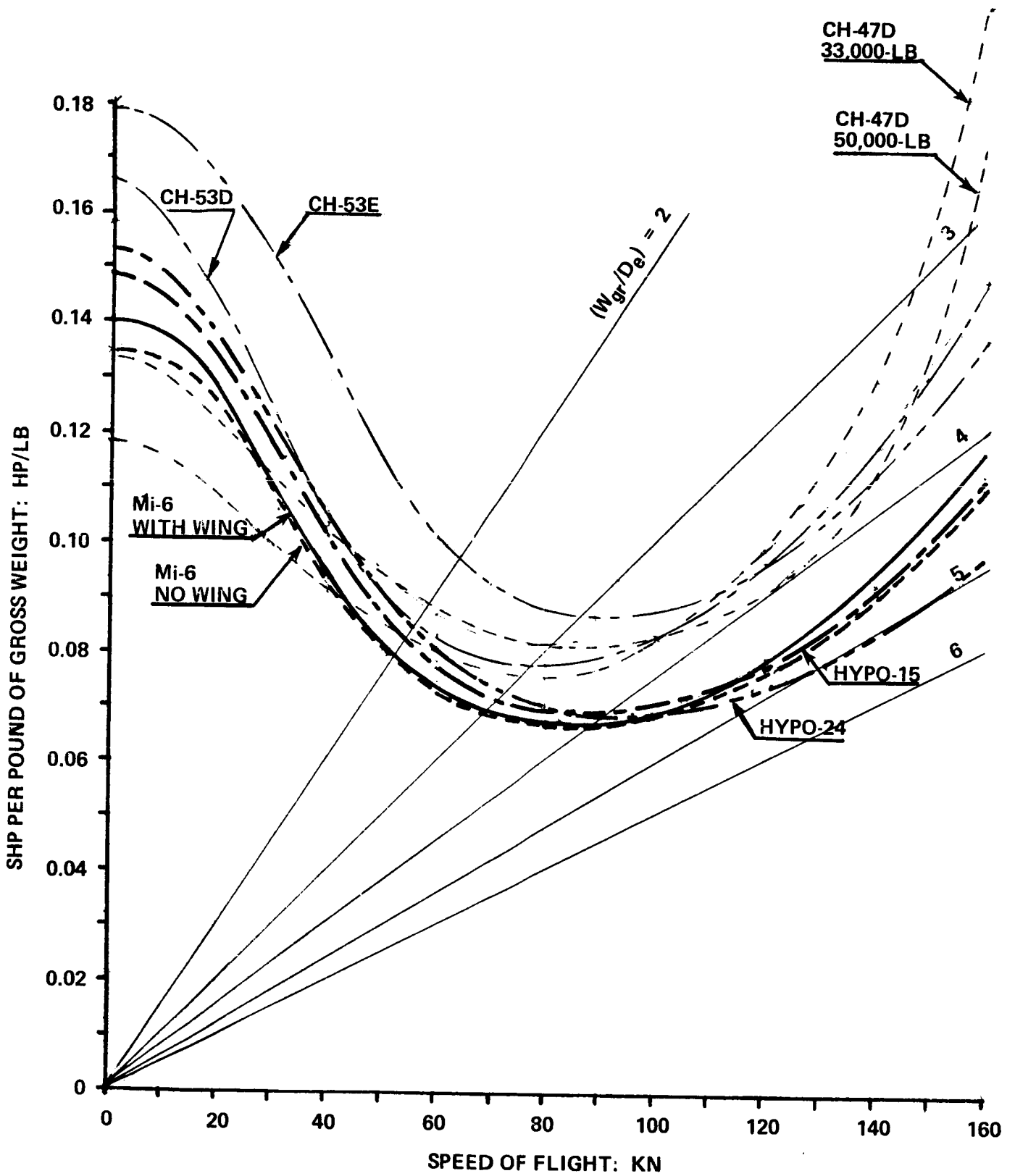

Figure 5.18 Comparison of shaft horsepower per pound of gross weight vs speed of level flight at SL, ISA of Soviet and Western helicopters of the 30,000 to 100,000-lb gross weight class.

TABLE 5.5  
FORWARD FLIGHT ASPECTS AT SL, ISA  
30,000 to 100,000-LB GROSS WEIGHT CLASS

ITEM	HELICOPTER						
	Mil Mi-6	Mil Mi-10K	Hypothetical 15 m.ton	Hypothetical 24 m.ton	Boeing-Vertol CH-47D	Sikorsky CH-53D	Sikorsky CH-53E
GROSS WEIGHT; LB	93,700		38,760	60,100	50,000	36,693	56,000
$\eta_{0a}$ Estimate at $V_{max}$ or $V_{cr}$	[0.92]		[0.92]	[0.92]	[0.96]	[0.92]	[0.92]
$V_{max}$ or $V_{cr}$ ; kn;	162		[162]	[162]	143	166	170
SHP; hp	9400		N/A	N/A	5974	6460	10,850
~Main Rotor RHP; hp	8650		N/A	N/A		5943	10,200
Main Rotor $V_t$ ; fps	721.4		720	720		699.2	732.0
Torque Compensating Thrust; lb	5472		N/A	N/A		3813	6161.3
Tail Rotor Disc Loading; psf	14.42		N/A	N/A		18.97	19.62
Tail Rotor $\bar{c}_h$	0.35		N/A	N/A		0.48	0.47
Tail Rotor $\bar{c}_d$	0.011		N/A	N/A		[0.0115]	[0.011]
Tail Rotor $\bar{c}_d/\bar{c}_h^2$	1/32		N/A	N/A		1/42.2	1/42.8
Tail Rotor Power; hp	413.6		N/A	N/A		265.7	432.6
RHP <sub>tr</sub> /RHP <sub>mr</sub>	0.048		N/A	N/A		0.0447	0.0424
$\eta_{0a}$ at $V_{max}$ or $V_{crmax}$	0.92		[0.92]	[0.92]	[0.96]	0.92	0.92
$(SHP/W_{gr}) = f(V)$ ; 1st Approximation	0.89		0.89	0.89	0.85	0.88	0.91
$M_{tab}$ at $V_{max}$ or $V_{crmax}$	0.38		0.38	0.38	0.34	0.40	0.39
$\mu$ at $V_{max}$ or $V_{crmax}$	8.52		10.91	11.56	8.84	8.95	11.43
Main Rotor Disc Loading; psf	0.46		0.55	0.54	0.55	0.40	0.36
Main Rotor $\bar{c}_h$	0.01		[0.01]	[0.01]		[0.01]	0.0098
Main Rotor $\bar{c}_d$	1/46		1/55	1/54		1/40	1/36.7
Main Rotor $\bar{c}_d/\bar{c}_h^2$	1.02		1.02	1.02	[1.03]	[1.025]	[1.03]
$k_{vf}$	1.15		1.15	1.15	[1.80]	[1.15]	[1.15]
$k_{indf}$	765.9		775.2 <sup>1</sup>	[1045.2]		444.0	451.5
Computed $w_f$ ; psf	122.3		50 <sup>1</sup>	[57.5]		82.6	124.0
Equivalent Flat Plate $f$ ; sq.ft	87.6		92.1	100.7		76.5	81.8
Computed $V_e$ ; kn							
Computed SHP <sub>min</sub> ; hp						2776	~5000

NOTES: \* Assuming no lift on the wing.  
Assumed or rough estimated values are shown in brackets [ ].

Table 5.5 (Cont'd)

$(SHP/W_{gr}) = f(V)$ ; 2nd Approximation Max. R/C at $SL, ISA$ ; fpm Excess SHP; hp $SHP_{min}$ $(SHP/W_{gr})$ at $V_{max}$ or $V_{crmax}$ $(SHP/W_{gr})$ at $V_e$ $f$ ; sq.ft $w_f$ ; psf Main Rotor $\bar{c}_d/\bar{c}_g$ Main Rotor $\bar{c}_d$	$f_{-w} = 111.05$ 843.76 1/46 0.010					93,700 NO WING	38,760 60,100 50,000	42,000 73,500	2510* 3400 3060 0.176 0.0834 75.2 488 1/31.5 0.0127	2825* 6438* 4650* 0.194 0.0830 140 400 1/54 0.0067
$(SHP/W_{gr})$ ; hp/lb at $F$ ; kn $SL, ISA$	0	0.1344	0.1488	0.1530	0.1330	0.1667	0.1788			
	40	0.0916	0.1013	0.1059	0.1025	0.1038	0.1337			
	60	0.0726	0.0778	0.0807	0.0882	0.0831	0.1008			
	80	0.0672	0.0702	0.0711	0.0820	0.0787	0.0889			
	100	0.0693	0.0711	0.0697	0.0834	0.0839	0.0883			
	120	0.0773	0.0787	0.0792	0.0920	0.0974	0.0968			
	140	0.0909	0.0923	0.0838	0.1130	0.1190	0.1135			
	160	0.1103	0.1122	0.0986	[0.1660]	0.1493	0.1382			

NOTES: † based on Fig. 5.17

†† directly computed from Fig. 5.17.

\* Manufacturer's data

differences in the  $f$  (82.6 vs 75.2 sq.ft) and  $\bar{c}_d$  (0.01 vs 0.0127) values. Consequently, mean values of  $f$  and  $\bar{c}_d$  resulting from the two approaches were used to calculate the  $(SHP/W_{gr}) = f(V)$  for  $W_{gr} = 42,000$  lb shown in Fig. 5.18.

In the case of the 15-m.ton hypothetical helicopter, the equivalent flat plate area is given on p. 132 of Ref. 1 as  $f = 4.5m^2 \approx 50$  sq.ft. At the VTO gross weight of  $W_{gr} = 38,760$  lb, this leads to  $w_{fp} = 775.2$  psf. In addition, assuming that  $\bar{c}_d = 0.01$ , the  $(SHP/W_{gr}) = f(V)$  relationships at that gross weight were computed and plotted in Fig. 5.18.

For the 24-m.ton hypothetical helicopter, the assumed flat-plate area was obtained by arbitrarily increasing the  $f$  value of the 15-m.ton helicopter by 15 percent, resulting in  $f = 57.5$  sq.ft which, at the VTO gross weight of 60,100 lb, resulted in  $w_{fp} = 1045.2$  psf. As in the preceding case, it was assumed that  $\bar{c}_d = 0.01$ . Using the above inputs and assuming other values as shown in Table 5.5, the  $(SHP/W_{gr}) = f(V)$  values were computed and plotted in Fig. 5.18.

The  $(SHP/W_{gr}) = f(V)$  relationship for the Mi-10K (short landing-gear configuration) is probably quite similar to that of the Mi-6 without the wing. Should some differences in that respect exist, it would be difficult to ascertain them at this writing, since the available performance data is not sufficiently detailed to evaluate any potential differences.

The Mi-6 represents a special case, since it is equipped with a relatively large wing (estimated total projected area:  $S_w \approx 400$  sq.ft), representing the area ratio of  $S_w/\pi R^2 \approx 0.039$ . According to Ref. 2, this wing carries about 20 percent of the total lift in cruising flight. In order to account for this fact, the following simplified analysis is made.

Denoting by  $\lambda$  the fraction of the gross weight times the download factor which is carried by the wing ( $\lambda = L_w/k_{vf}W_{gr}$ ); making small-angle assumptions; further assuming that the wing is located in the rotor flow field where the rotor induced velocity is equal to its ideal value; and neglecting the aerodynamic influence of the wing on the rotor, the following two-force equations, along the vertical and horizontal axes, can be written for the steady level-flight case (see Fig. 5.19a):

$$W_{gr} k_{vf} = \overbrace{W_{gr} k_{vf} (1 - \lambda)}^{T_{mr}} + \overbrace{W_{gr} k_{vf} \lambda}^{L_w}, \text{ and}$$

$$W_{gr} k_{vf} (1 - \lambda) \gamma = D_{-w} + W_{gr} k_{vf} \lambda \left[ \frac{v_{idf}}{1.69V} + \frac{1}{(L/D)_w} \right]$$

where  $v_{idf}$  is the ideal induced velocity at speed  $V$ , in knots:

$$v_{idf} = 0.296 k_{vf} (1 - \lambda) w / \rho V$$

( $w$  being, as before, the nominal main-rotor disc loading at the considered gross weight) and  $(L/D)_w$  is the lift-to-drag ratio of the wing carrying the  $L_w = k_{vf}\lambda W_{gr}$  load.

Examining the above two equations, one should note that the total SHP required by the helicopter in horizontal flight can be expressed as a sum of power required by a wingless helicopter flying at  $W'_{gr} = (1 - \lambda)W_{gr}$  and additional shaft horsepower due to the wing, which can be expressed as:

$$\Delta SHP_w = W_{gr} k_{vf} \lambda \left\{ k_{vf} 0.296 (1 - \lambda) w / V^2 \rho + [1 / (L/D)_w] \right\} 1.69 V / 550 \eta_{oa} \quad (5.1)$$

or, rewriting the equation in terms of additional power per pound of gross weight, it becomes

$$(\Delta SHP_w / W_{gr}) = 1.69 k_{vf} \lambda V \left\{ 0.296 k_{vf} (1 - \lambda) w / \rho V^2 + [1 / (L/D)_w] \right\} / 550 \eta_{oa} \quad (5.1a)$$

and the equation for the total power required per pound of gross weight in a steady-state level flight now becomes:

$$(SHP / W_{gr}) = \left\{ 2.413 \rho_o \frac{V^3}{w_{fp}} + 0.296 \frac{k_{vf}^2 k_{indf} (1 - \lambda) w}{\rho V} + 0.75 (1 + 4.7 \mu^2) \left( \frac{\bar{c}_d}{\bar{c}_q} \right) V_t + 1.69 k_{vf} \lambda V \left[ 0.296 k_{vf} (1 - \lambda) \frac{w}{\rho V^2} + \frac{1}{(L/D)_w} \right] \right\} / 550 \eta_{oa} \quad (5.2)$$

Similar to Eq (1.10), Eq (5.2) can be used in the single as well as in the two-point approach. In both cases, knowledge of the  $(L/D)_w$  values is required. For the Mi-6 wing  $L/D = f(\bar{C}_L)$  characteristics were obtained taking this relationship as the basis for a wing of  $AR = 4.5$  as given in Fig. 2.101<sup>1</sup>, and recalculating it for  $AR = 6.3$  of the Mi-6 helicopter wing (Fig. 5.19b).

Since no data regarding the forward rate of climb of the Mi-6 helicopter is available at this writing, the single-point approach was used, assuming a gross weight of 93,700 lb and  $V_{max} = 162$  kn. Twenty percent of the load is carried by the wing. Based on the total projected wing area, this results in a nominal wing loading of  $w_w = 47.79$  psf and the corresponding  $\bar{C}_L = 0.54$  at SL, ISA. From Fig. 5.19b, one finds that  $(L/D)_w = 18.8$ .

The main-rotor disc loading in this case would be  $w' = 0.8 \times w = 7.24$ , and the blade average lift coefficient would be  $\bar{c}_l = 0.40$ . Assuming that  $\bar{c}_d = 0.0096$  and hence,  $\bar{c}_d / \bar{c}_l = 1/42$ , Eq (5.2) was solved for  $w_{fp}$ , resulting in  $(w_{fp})_{-w} = 902.5$  psf and  $f_{-w} = 103.8$  sq.ft.

As shown in Table 5.5, the total equivalent plate area loading  $(w_{fp})_{tot}$  and the total equivalent flat plate area  $f_{tot}$  values were calculated through a single-point technique, assuming that the wing carries no load.

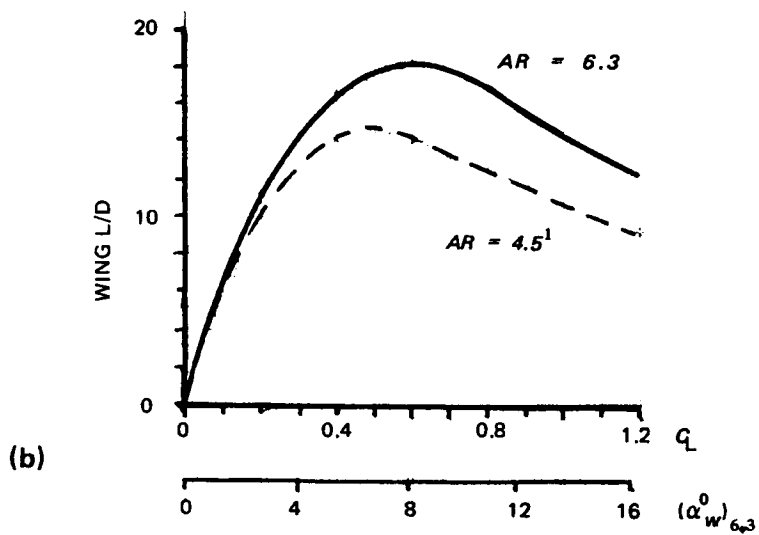
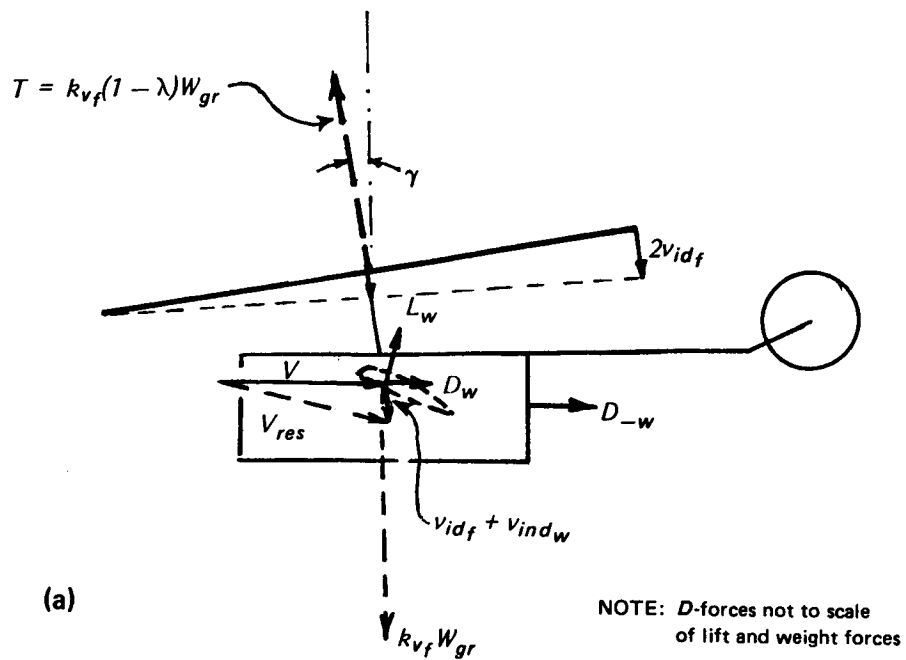

Figure 5.19 Scheme of velocities and forces of winged helicopter, and (b) wing lift-to-drag ratio vs wing-lift coefficient for  $AR = 4.5$  (Ref. 1) and  $AR = 6.3$ .



TABLE 5.6  
DETERMINATION OF (SHP/W<sub>gr</sub>) FOR Mi-6 WITH A WING

Speed of Flight V; kn	$\tan^{-1} \left( \frac{V_{if}}{1.69V} \right)$ deg	Wing Angle-of-Attack $\alpha_w$ deg	$C_{Lw}$	Wing Lift $L_w$ lb	Wing Lift Gross Weight $\lambda$	Wing L/D.	$\frac{SHP - W}{W_{gr}}$ hp/lb	$\frac{\Delta SHP - W}{W_{gr}}$ hp/lb	Total SHP/W <sub>gr</sub> hp/lb
160	-1.24	7.5	0.54	18,740	0.200	18.8	0.1106	0.0082	0.1188
120	-1.65	7.1	0.51	9960	0.106	17.6	0.0763	0.0037	0.0800
80	-6.17	2.6	0.19	1650	0.018	10.0	0.0666	0.0010	0.0676
40	-23.7	-15.0	[-0.9]	-1950	-0.021	[-10.0]	0.0945	-0.0008	0.0937
0	-90.0	~ -90.0	[ $C_{Dw} = 1.2$ ]	-3900	-0.042	0	0.1344	0.0056	0.1400

The so-obtained figures were  $(w_{fp})_{tot} = 765.9$  psf and  $f_{tot} = 122.3$  sq.ft. Assuming that the non-lifting wing contributes about 4 sq.ft of parasite drag ( $S_w \times C_{D0} = 400 \times 0.01$ ), the flat-plate area of the helicopter minus the wing would be  $f_{-w} = 118.3$  sq.ft.

The average of the quantities obtained through the non-lifting and 20%-lifting wing assumption, amounting to  $f_{-w} = 111.05$  sq.ft, was used to calculate the  $(SHP/W_{gr}) = f(W)$  relationship for the Mi-6 helicopter without a wing as shown in Table 5.5 and Fig. 5.18.

The  $(SHP/W_{gr}) = f(V)$  for the winged version was computed using Eq (5.2). Because of the limited technical information, the main thrust of the comparison was directed toward indicating incremental differences in the  $(SHP/W_{gr})$  values of the two versions, rather than to try to assess, with a high degree of accuracy, their absolute values. In order to achieve this goal, the procedure was performed in steps as shown in Table 5.6. In addition, the following assumptions were made: Since the wing has apparently no flaps nor angle-of-incidence adjusting mechanism, it was assumed that the attitude of the aircraft as a whole remains constant in all regimes of flight; thus the angle-of-attack of the wing at various flight speeds varies solely due to the changing angle of the flow generated by the main rotor. It was further assumed that the fixed angle of incidence of the wing with respect to the fuselage is such that in horizontal flight at 160 kn, it provides a lift equal to 20 percent of the gross weight of the aircraft.

Values of the total  $SHP/W_{gr}$  were plotted in Fig. 5.18. By comparing this latter curve with that for the Mi-6 helicopter minus a wing, one can see that the differences between the two curves (at least at SL, ISA, and the considered gross weight) are small. Consequently, in further considerations of forward flight aspects, no distinction will be made between the two versions.

$SHP/W_{gr} = f(V)$ , Fig. 5.18. The impression one gets from this figure is that the Mi-6 helicopters at speeds of flight  $V > 40$  kn require less power per pound of gross weight than their Western counterparts. As a result, their  $(W/D_e)$  values are also better [ $(W/D_e)_{max} > 4.5$ ] than those of the Western helicopters [ $(W/D_e)_{max} \leq 4.0$ ].

It should be emphasized, however, that the Mi-6 ( $SHP/W_{gr} = f(V)$ ) curves are predicated on the validity of information<sup>2</sup> regarding gross weight (93,700 lb), and total engine power (11,000 hp) corresponding to the quoted  $V_{max} = 162$  kn. But even accepting some possible errors in that data, it can still be concluded that the Mi-6 helicopter represents a case of well-selected design parameters leading to forward flight aerodynamic characteristics which, probably, are at least on the level of those of the corresponding Western helicopters.

It can also be seen from Fig. 5.18 that the so-called hypothetical helicopters represent a goal, or at least a desire, to achieve low ( $SHP/W_{gr}$ ) values at both moderate ( $40 < V < 100$  kn) and high ( $V > 100$ ) speeds of flight.

With respect to the ( $SHP/W_{gr} = f(V)$ ) curves of Western helicopters, it should be pointed out that only in the case of the CH-47D are those relationships based on flight-test-supported  $SHP = f(V)$  data, while for the CH-53D and CH-53E, previously discussed indirect methods were applied, using published performance figures<sup>2,13</sup> and manufacturer's data.

( $SHP/W_{gr}$ ) Values at  $V_{max}$ . Figure 5.20 supports the previous statement that if one accepts the performance data and engine ratings as given in Ref. 2, then the aerodynamic cleanness of the Mi-6 helicopter should be better than that of its Western counterparts. With respect to the future design trend of Soviet helicopters as reflected in the hypothetical rotorcraft, it is clear that the Soviet designers will try to maintain, or improve, the degree of aerodynamic cleanness of their large transport helicopters.

## 5.6 Energy Aspects in Level Flight, SL, ISA

Fuel Required per Pound of Gross Weight. The numerical inputs required for determination of the fuel required per pound of gross weight are given in Table 5.7, while the results of the calculations are shown in Figs. 5.21 and 5.22.

It is evident from these figures that the Mi-6 helicopter appears to have an hourly fuel consumption per pound of gross weight similar to those of Western helicopters of the same gross weight class. The same is true regarding the fuel required per pound of gross weight and 100 nautical miles.

By contrast, in the hypothetical helicopters, one can detect the desire and hope of Soviet designers to develop machines with a better basic fuel economy than that of their own existing as well as Western helicopters.

Fuel Requirements per Pound of Zero-Range Payload (Table 5.8 and Figs. 5.23 and 5.24. Because of the relatively higher structural weight (as expressed by the  $W_e/W_{grmax}$  ratios) of the Mi-6 and Mi-10K helicopters, their fuel requirements per pound of payload (and either one hour or 100 n.mi) are much higher than those of Western helicopters. However, here again with respect to the hypothetical helicopters, one can detect a desire to create rotorcraft with superior fuel economy characteristics related to payload.

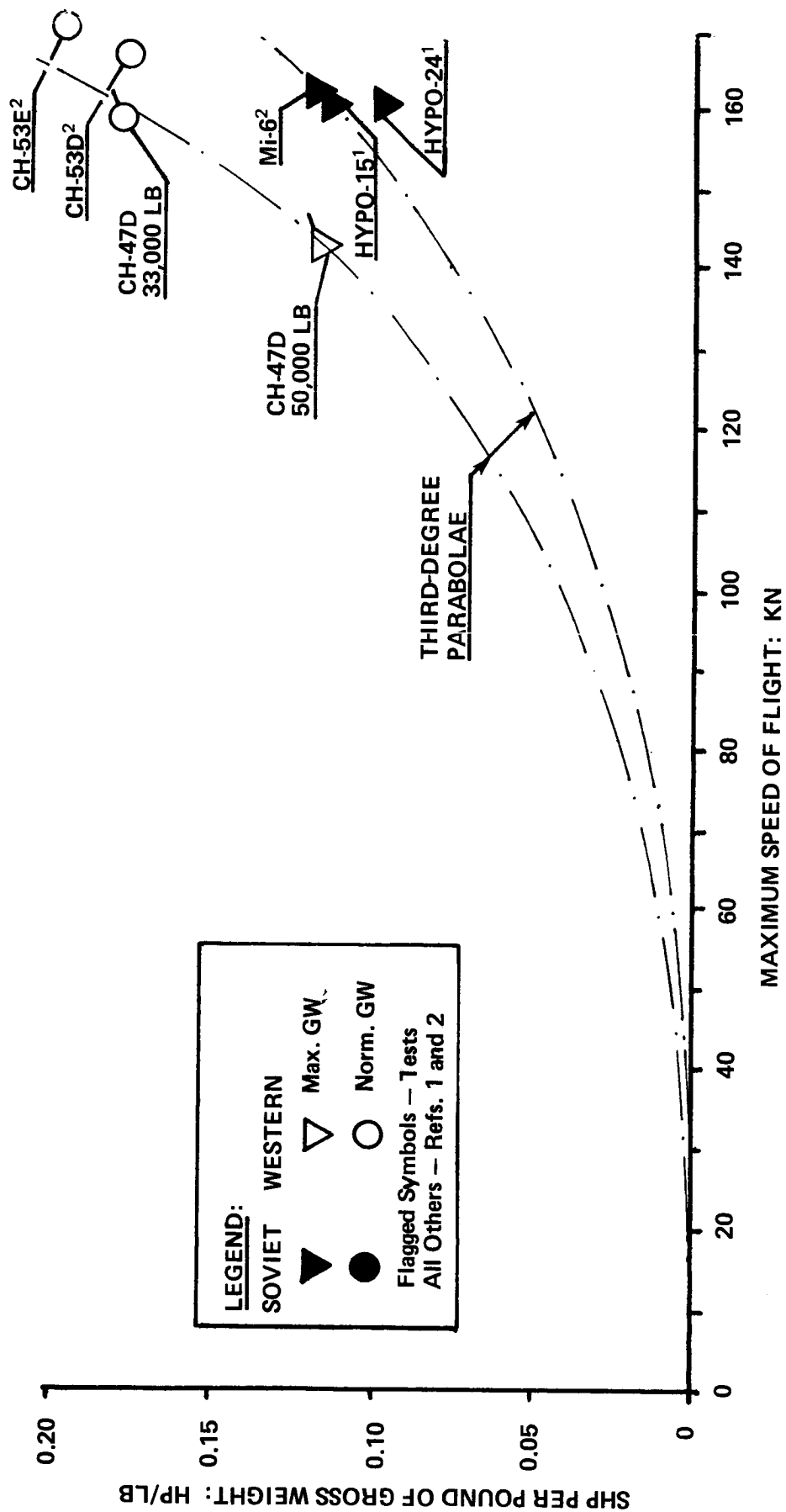

Figure 5.20 Shaft horsepower per pound of gross weight at  $V_{max}$  vs. speed of flight at SL, ISA of Soviet and Western helicopters of the 30,000 to 100,000-lb gross weight class

TABLE 5.7  
RELATIVE FUEL REQUIREMENTS WITH RESPECT TO GROSS WEIGHT  
30,000 TO 100,000-LB GROSS WEIGHT CLASS

ITEM	HELICOPTER						
	Mil Mi-6	Mil Mi-10K	Hypothetical 15 M.Ton	Hypothetical 24 M.Ton	Boeing-Vertol CH-47D	Sikorsky CH-53D	Sikorsky CH-53E
( $SHP_{TO}/W_{gr_{max}}$ ): hp/lb	0.1174	0.1313	0.1496	0.1536	0.1500	0.1760	0.1788
RATIO OF SHP REQUIRED TO TAKEOFF SHP							
SPEED OF FLIGHT: KN							
0	1.19		0.99	0.99	0.89	0.93	1.0
40	0.80		0.68	0.69	0.68	0.58	0.75
60	0.62		0.52	0.53	0.59	0.46	0.56
80	0.58		0.47	0.46	0.55	0.44	0.49
100	0.59		0.48	0.45	0.56	0.47	0.49
120	0.68		0.53	0.48	0.61	0.54	0.54
140	0.77		0.62	0.55	0.75	0.66	0.63
160	1.00		0.75	0.64	—	0.83	0.77
SPECIFIC FUEL CONSUMPTION: LB/HP-HR							
SPEED OF FLIGHT: KN							
0	0.62		0.46	0.46	0.56	0.48	0.47
40	0.67		0.51	0.51	0.60	0.54	0.48
60	0.73		0.56	0.55	0.63	0.59	0.51
80	0.75		0.58	0.58	0.64	0.60	0.52
100	0.74		0.58	0.59	0.64	0.59	0.52
120	0.71		0.56	0.58	0.62	0.57	0.51
140	0.68		0.53	0.55	0.58	0.53	0.50
160	0.62		0.50	0.52	—	0.50	0.48
FUEL CONSUMPTION PER HOUR AND POUND OF GROSS WEIGHT							
SPEED OF FLIGHT: KN							
0	0.087		0.068	0.070	0.074	0.080	0.084
40	0.063		0.052	0.054	0.061	0.056	0.064
60	0.053		0.044	0.044	0.056	0.049	0.051
80	0.051		0.041	0.041	0.052	0.047	0.046
100	0.051		0.041	0.041	0.053	0.050	0.046
120	0.057		0.044	0.043	0.057	0.056	0.049
140	0.062		0.049	0.046	0.066	0.063	0.057
160	0.074		0.056	0.051	—	0.075	0.066
FUEL REQUIRED PER POUND OF GROSS WEIGHT AND 100 N.MI.							
SPEED OF FLIGHT: KN							
40	0.157		0.129	0.135	0.152	0.140	0.160
60	0.088		0.073	0.073	0.093	0.082	0.086
80	0.063		0.051	0.052	0.066	0.059	0.057
100	0.051		0.041	0.041	0.053	0.050	0.046
120	0.048		0.037	0.036	0.047	0.046	0.041
140	0.044		0.035	0.033	0.047	0.045	0.041
160	0.046		0.036	0.032	—	0.047	0.041

NOTE: Maximum gross weights are assumed in the above calculations.

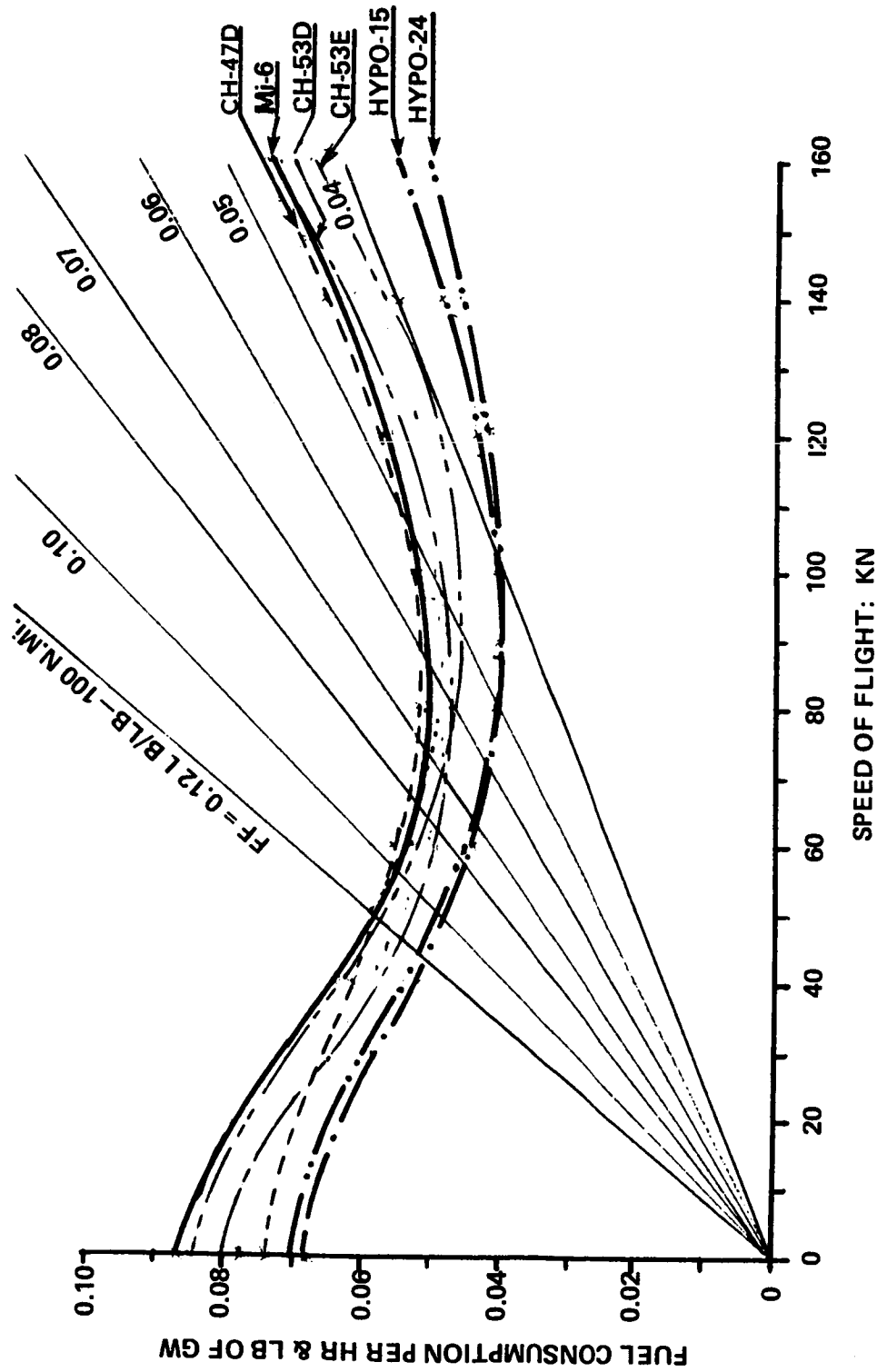

Figure 5.21 Fuel required per hour and pound of gross weight in level flight at SL, ISA of Soviet and Western helicopters of the 30,000 to 100,000-lb gross weight class.

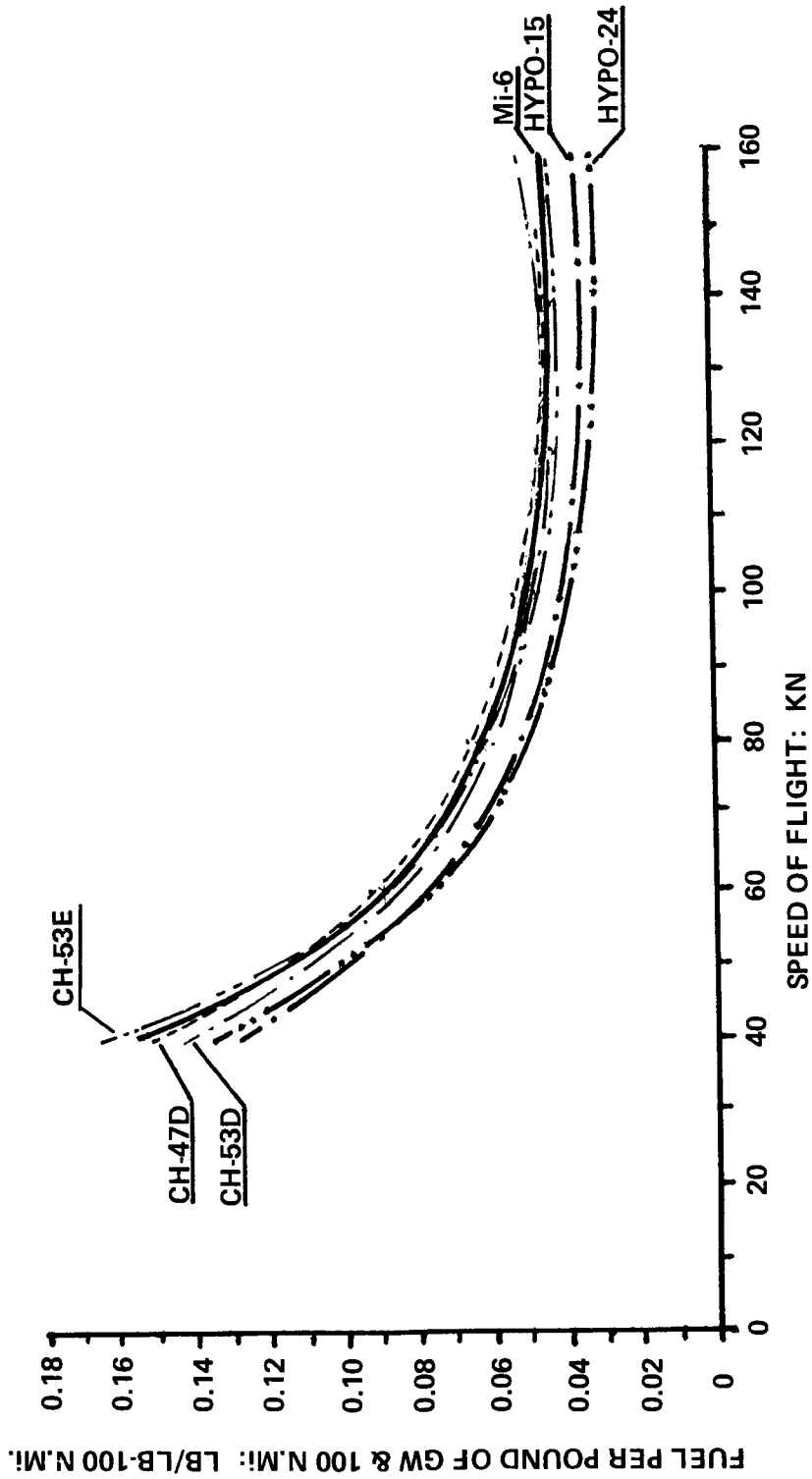

Figure 5.22 Fuel required per pound of gross weight and 100 n.mi. at SL, ISA of Soviet and Western helicopters of the 30,000 to 100,000-lb gross weight class.

TABLE 5.8  
 FUEL REQUIREMENTS WITH RESPECT TO ZERO-RANGE PAYLOAD  
 30,000 TO 100,000-LB GROSS WEIGHT CLASS

ITEM	HELICOPTER						
	Mil Mi-6	Mil Mi-10K	Hypothetical 15 M.Ton	Hypothetical 24 M.Ton	Boeing-Vertol CH-47D	Sikorsky CH-53D	Sikorsky CH-53E
Max. Gross Weight: lb Payload Zero Range/GW	93,700 0.350	83,776* 0.343	[ 38,760 0.518 ]	[ 60,100 0.548 ]	50,000 0.528	42,000 0.426	73,500 0.539
FUEL CONSUMPTION PER HOUR OF ZERO-RANGE PAYLOAD							
SPEED OF FLIGHT; KN							
0	0.249	0.237	[ 0.131 ]	[ 0.128 ]	0.140	0.188	0.156
40	0.180	0.178	[ 0.100 ]	[ 0.099 ]	0.116	0.131	0.119
60	0.151	[ 0.155 ]	[ 0.085 ]	[ 0.080 ]	0.106	0.115	0.095
80	0.146	[ 0.149 ]	[ 0.079 ]	[ 0.075 ]	0.098	0.110	0.085
100	0.146	[ 0.149 ]	[ 0.079 ]	[ 0.075 ]	0.100	0.117	0.085
120	0.163	[ 0.166 ]	[ 0.083 ]	[ 0.079 ]	0.108	0.131	0.091
140	0.177	[ 0.181 ]	[ 0.095 ]	[ 0.084 ]	0.125	0.148	0.106
160	0.211	[ - ]	[ 0.098 ]	[ 0.093 ]	-	0.176	0.123
FUEL CONSUMPTION PER POUND OF ZERO-RANGE PAYLOAD AND 100 N.MI.							
SPEED OF FLIGHT; KN							
40	0.449	0.445	[ 0.250 ]	[ 0.246 ]	0.289	0.328	0.297
60	0.251	[ 0.257 ]	[ 0.141 ]	[ 0.134 ]	0.177	0.192	0.158
80	0.180	[ 0.184 ]	[ 0.098 ]	[ 0.094 ]	0.123	0.138	0.107
100	0.146	[ 0.149 ]	[ 0.079 ]	[ 0.075 ]	0.100	0.117	0.085
120	0.137	[ 0.140 ]	[ 0.071 ]	[ 0.065 ]	0.090	0.109	0.076
140	0.126	[ 0.128 ]	[ 0.068 ]	[ 0.060 ]	0.090	0.106	0.076
160	0.131	[ - ]	[ 0.069 ]	[ 0.058 ]	-	0.110	0.077

NOTES: Assumed or rough estimated values [ ]

\* Assuming fuel consumption per pound of gross weight at  $V \geq 60$  kn (same as for the Mi-6).

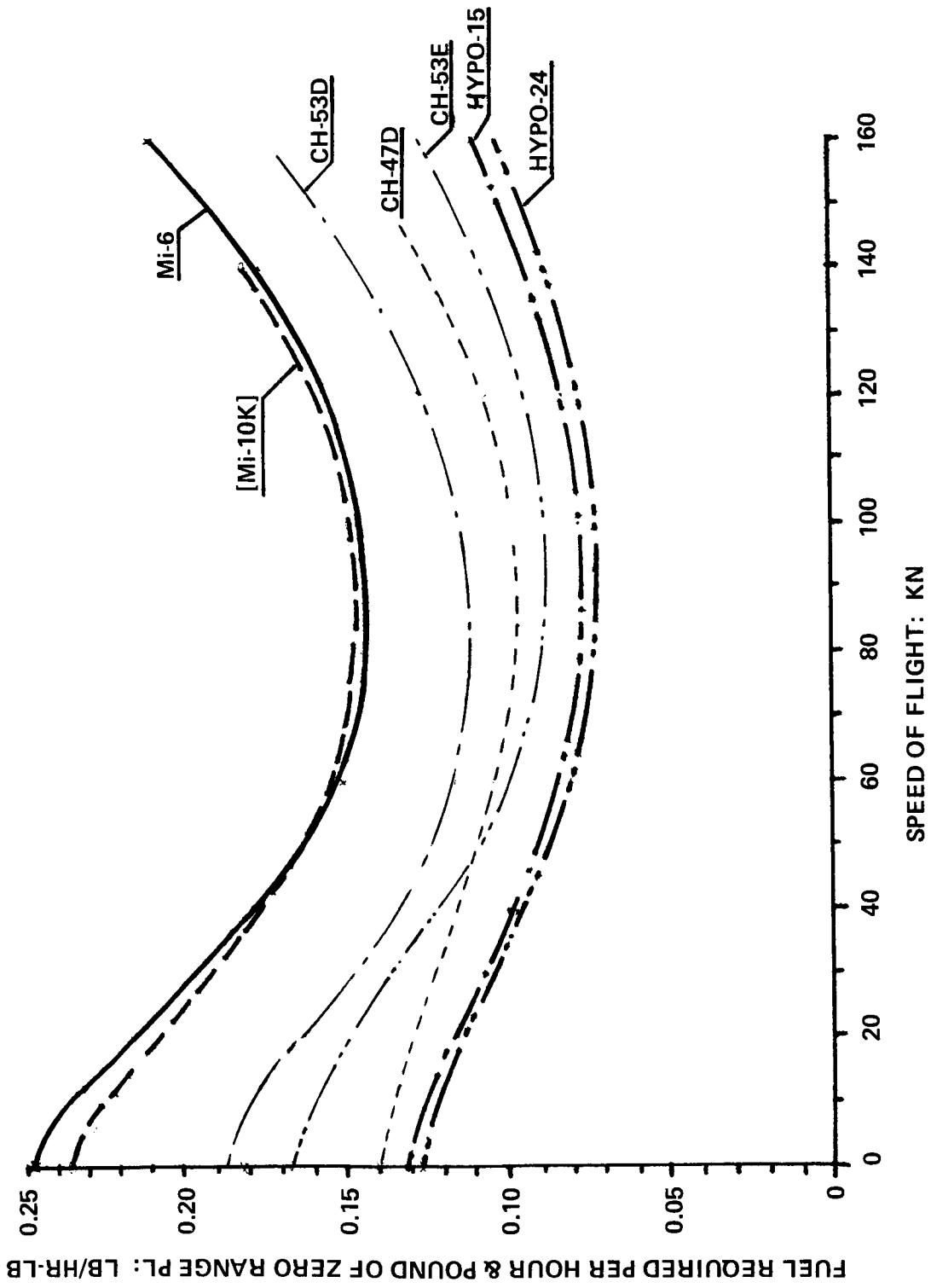

Figure 5.23 Fuel required per hour and pound of zero-range payload at SL, ISA of Soviet and Western helicopters of the 30,000 to 100,000-lb gross weight class.



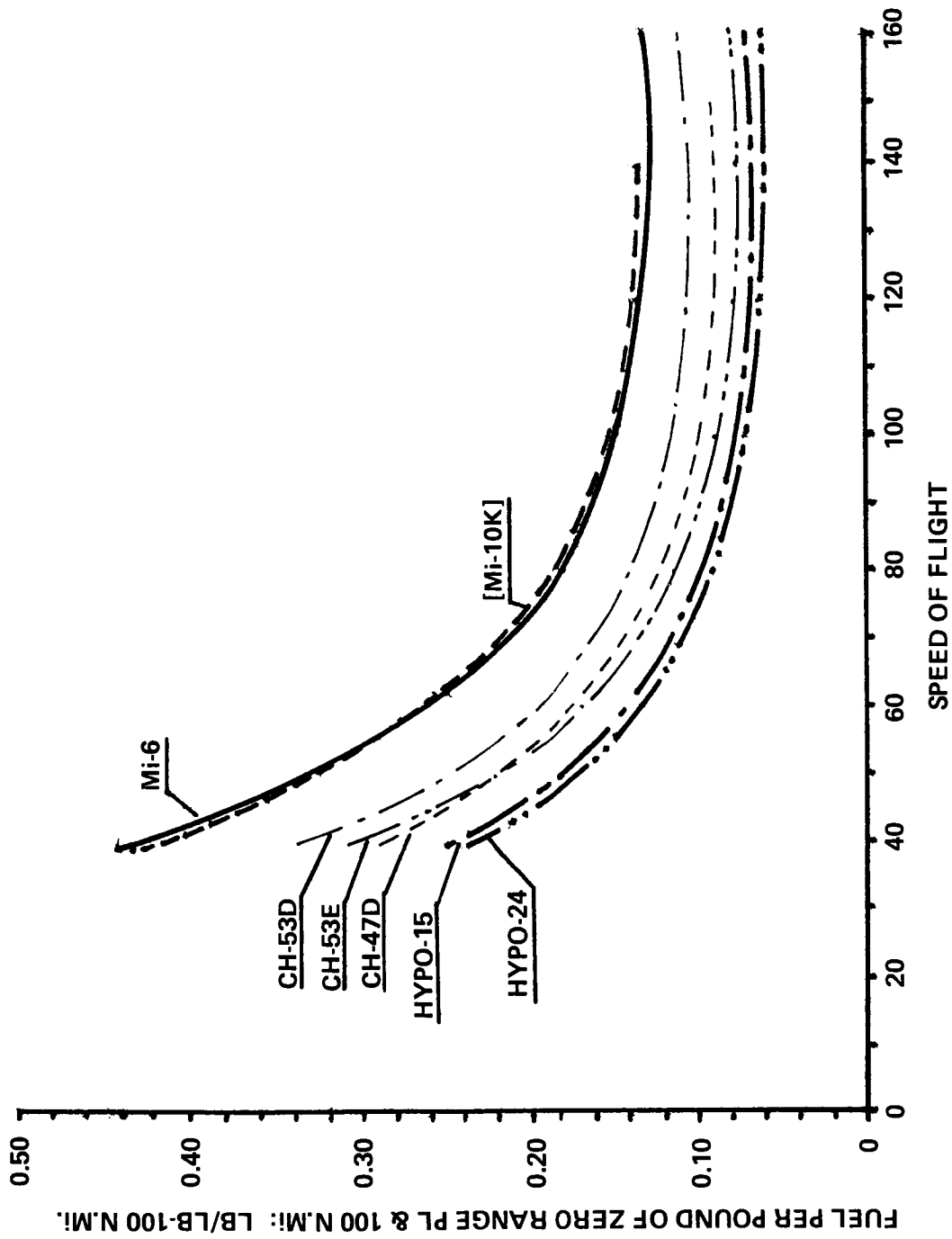

Figure 5.24 Fuel required per pound of zero-range payload and 100 n.m.i. at SL, ISA of Soviet and Western helicopters of the 30,000 to 100,000-lb gross weight class.

**Fuel Required per Pound of Payload vs Distance (Table 5.9).** The above-established trend in fuel economy with respect to unit of weight of the zero-range payload is further confirmed in the computations shown in Table 5.9, and the fuel required to carry one pound of payload over various flight distances is graphically presented in Fig. 5.25. Here, again, the Mi-6 and Mi-10K helicopters exhibit the highest, and the hypothetical helicopter, the lowest fuel requirements.

## 5.7 Productivity

**Productivity Index.** The inputs necessary to calculate the productivity index from Eq (1.17a) are indicated in Table 5.10. Similar to Section 4.6, the PI evaluation was also limited to the specified  $V_{crmax}$  only. The results are graphically presented in Fig. 5.26. The Mi-6 and Mi-10K helicopters also exhibit the lowest relative productivity of the whole considered gross weight class, while the highest PI values are predicted for the 24 m.ton hypothetical helicopter. The relative productivity of the 15 m.ton helicopter would be on the same level as that of the CH-47D and CH-53E.

## 5.8 General Discussion and Concluding Remarks

Because of its size and large quantity of aircraft in both military and civilian use, the Mi-6 helicopter is the most important representative of existing Soviet helicopters in the 30,000 to 100,000-lb gross weight class. Unfortunately, at this writing, the lack of reliable performance figures defining gross weight, engine rating, and flight altitude corresponding to the quoted maximum flying speed<sup>2</sup>, as well as a complete lack of information on the maximum rate of climb in forward flight, makes it difficult to carry the forward flight analysis to the precise level one would like to achieve for this important machine. Consequently, an element of uncertainty is present, not only in the  $(SHP/W_{gr}) = f(V)$  relationship, but in the following relationships for both the Mi-6 and its sister design, the Mi-10K helicopter.

Based on the limited data, even if the calculated  $w_{fp} \approx 800$  psf for the Mi-6 at its maximum gross proved to be optimistic when compared with  $w_{fp} \approx 500$  to 600 psf for its Western counterparts, both it and the Mi-10K (the short-landing gear version) should be considered as aerodynamically clean rotorcraft.

Other aerodynamically important parameters such as disc loading, tip-speed, and rotor solidity ratio, appear to be well selected, resulting in the operational levels of the average blade-lift coefficients ( $C_T/\sigma$ ), rotor advance ratios, and blade tip Mach numbers being, in various regimes of flight, similar to those of the Western designs.

However, there are areas where the design philosophy of the Mi-6 and Mi-10K departs from that of the West. For instance, the power loading of both helicopters, but especially that of the Mi-6 at its maximum gross weight ( $W_{gr} = 93,700$  lb, and an officially-stated engine rating of  $SHP_{TO} = 5500$  hp) is markedly higher than that of the American CH- types. This results in inferior hovering and vertical climb characteristics of the Mi-6; especially of its winged version. Although  $W_{gr} = 93,700$  lb is quoted in Ref. 2 as the maximum gross weight, still allowing vertical takeoff at SL, ISA, this statement probably refers to

TABLE 5.9  
 FUEL REQUIRED PER POUND OF PAYLOAD AT VARIOUS DISTANCES  
 30,000 TO 100,000-LB GROSS WEIGHT CLASS

ITEM	HELICOPTER						
	Mil Mi-6	Mil Mi-10K	Hypothetical 15 M.Ton	Hypothetical 24 M.Ton	Boeing-Vertol CH-47D	Sikorsky CH-53D	Sikorsky CH-53E
Max. Gross Weight: lb	93,700	83,776	[38,760]	[60,100]	50,000	42,000	73,500
Opt. Fuel Consumed per One Pound of Zero-Range Payload and 100 N.Mi.	0.126	[0.128]	[0.068]	[0.058]	0.090	0.106	0.076
DISTANCE: N.MI							
0	0	0	0	0	0	0	0
50	0.067	0.068	0.035	0.030	0.047	0.055	0.040
100	0.144	0.147	0.073	0.062	0.099	0.116	0.083
150	0.233	0.238	0.114	0.095	0.156	0.185	0.131
200	0.337	0.244	0.157	0.131	0.220	0.263	0.182
250	0.460	[0.471]	[0.205]	[0.170]	0.290	0.351	0.238

NOTE: Assumed or rough estimated values are shown in brackets [ ].

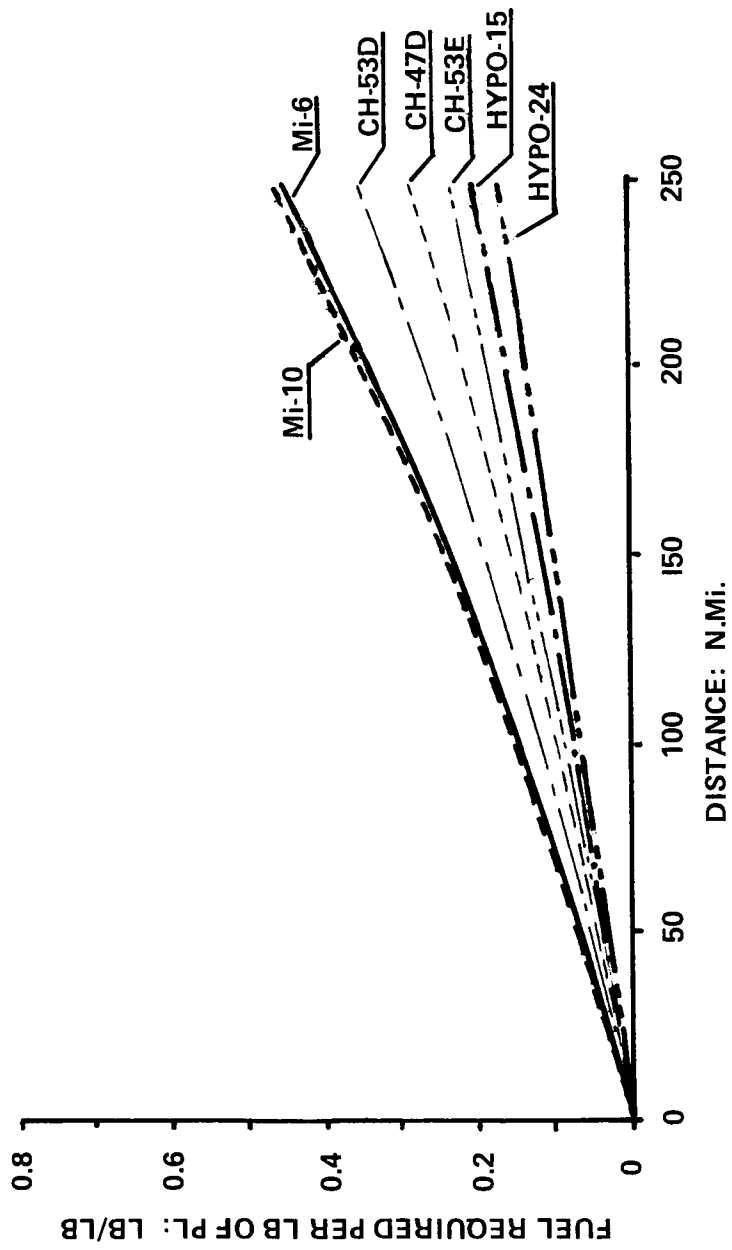

Figure 5.25 Fuel required per pound of payload vs flight distance at SL, ISA of Soviet and Western helicopters of the 30,000 to 100,000-lb gross weight class

TABLE 5.10

PRODUCTIVITY INDEX AT  $V_{cr,max}$ , SL, ISA  
30,000 TO 100,000-LB GROSS WEIGHT CLASS

ITEM	HELICOPTER						
	Mil Mi-6	Mil Mi-10K	Hypothetical 15 M.Ton	Hypothetical 24 M.Ton	Boeing-Vertol CH-47D	Sikorsky CH-53D	Sikorsky CH-53E
Max. Gross Weight: lb	93,700	83,776	38,760	60,100	50,000	42,000	73,500
$W_e/W_{gr}$	0.641	0.649	0.465	0.440	0.463	0.559	0.452
$(W_{pl}/O)/W_{gr}$	0.350	0.343	0.518	0.548	0.528	0.426	0.539
$V_{cr,max}$ : kn	135	135	145	145	142	140	135
FF at $V_{cr,max}$ : lb/lb-100 n.mi.	0.045	0.045	0.035	0.023	0.047	0.052	0.042
FLIGHT DIST: N.MI	PRODUCTIVITY INDEX AT $V_{cr,max}$ : LB-N.MI/LB-HR						
0	73.7	71.3	156.0	174.4	161.9	106.7	160.9
100	64.2	61.9	145.4	163.8	147.5	93.7	148.4
200	54.8	52.6	134.9	153.3	134.2	80.6	135.9

NOTE: Assumed or rough estimated values are shown in brackets [ ].

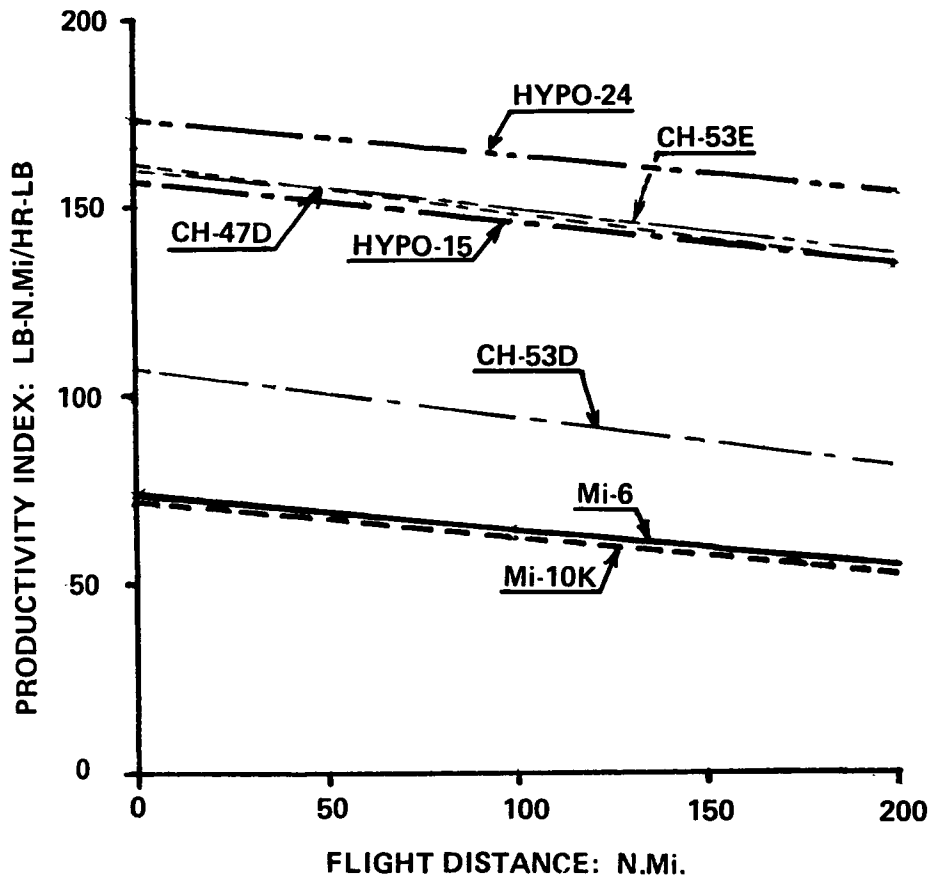

Figure 5.26 Productivity index at  $V_{cr_{max}}$  at SL, ISA vs flight distance of Soviet and Western helicopters of the 30,000 to 100,000-lb gross weight class.

hovering and limited vertical climb in ground effect only. Remarks in Ref. 1 seem to support this suggestion, as on p. 118 it is stated that the Mi-6 in normal operations either takes off in ground effect or with a ground run, while Fig. 2.62<sup>1</sup> shows the total power for HOGE at SL, ISA as 13,000 hp\*.

The purpose of using a wing having a fixed angle of incidence, and with no flaps appears unclear. In hovering and vertical climb, the wing produces a download amounting to about 4 percent of the gross weight and, in flight at low altitudes and standard temperatures, provides no apparent benefit. However, performance benefits may be present in flights close to service-ceiling altitudes. Also, at elevated or even intermediate altitudes, the wing may contribute to an achievement of maneuver load factors higher than for the wingless configuration.

In general, it may be stated that when performance effectiveness criteria is referred to units of gross weight, both of the Mil helicopters exhibit design effectiveness levels similar to those of the American helicopters of the same gross weight class.

By contrast, because of the higher structural weights and inferior specific fuel consumption characteristics of the Mi-6 and Mi-10K helicopters, all of the performance effectiveness criteria referred to units of payload rather than gross weight indicate large unfavorable differences from those of the American CH-types.

With respect to the hypothetical helicopters, it is interesting to note that they reflect the desire and, probably, the hope of the Soviet designers to surpass the American designs; not only in the areas of overall performance reflected in various indices referred to units of gross weight, but also in those referred to the weight units of the payload.

---

\*This value checks very well with  $SHP_{req} = 13,118$  hp resulting from  $(SHP/W_{gr})_{V=0} = 0.14$  as shown in Fig. 5.18 for the winged version, and with  $W_{gr} = 93,700$  lb.

## Chapter 6

# Over 100,000-lb GW Class Helicopters

### 6.1 Compared Helicopters

Composition of the Group. In the class of helicopters with gross weights exceeding 100,000 pounds, the Mi-12 (Mil V-12; Fig. 6.1a) represents the helicopter type that has been in limited operational service. The Boeing Vertol heavy-lift (HLH) helicopter (XCH-62A, Fig. 6.1b) was developed through the prototype stage, but this development ceased several years ago. The two other helicopters included in this group were purely hypothetical: one of the single-rotor (Fig. 6.1c) and another of the side-by-side (Fig. 6.1d) configuration. Both are of the 52 m.ton design (normal) gross weight and, similar to the Hypo-15 and Hypo-24 of the preceding chapter, were reconstructed from inputs provided in Ref. 1. Also, as in the case of the previous hypothetical machines, they may be considered as forerunners of the conceptual designs of new heavy-lift Soviet helicopters.

This assumption appears to be correct since, after completion of the review copies of this report, the Mi-26 helicopter was officially unveiled at the Paris Air Show on June 4 - 14, 1981. The available characteristics of the aircraft suggest strong similarities to the Hypothetical 52 single-rotor machine. It therefore appeared desirable to include the Mi-26 in the comparisons performed in this chapter, even on the limited basis of the available technical characteristics.

It should be noted at this point that in spite of the fact that in Ref. 1, tandems were considered for heavy-lift operations, there is no hypothetical Soviet tandem among the compared helicopters. This is because their studies of the 44 to 60-m.ton gross weight class helicopters<sup>1</sup> showed a definite preference for the single-rotor configuration with the side-by-side as a close competitor.

Hypothetical Helicopters. Hypothetical helicopters of the 44 to 60-m.ton gross weight range were considered in Section 2.5.4 of Ref. 1. However, most of the information on design details and weight aspects applied to the 52-m.ton design gross weight machines. Consequently, this particular gross weight was selected for the present study. The baseline data which appear as the most important for comparative evaluation were selected from Table 2.11<sup>1</sup>, and presented (in English units) in Table 6.1. It should be remembered, however, that in the optimization process of Ref. 1, the rotor-radius and number of blades become the most important parameters. Hence, in the optimal versions, the rotor radii are different from the baseline values of Table 6.1.

With respect to the configuration, it is stated in Ref. 1 that the single-rotor helicopters are configured similarly to the Mi-6, while the side-by-side types have non-intermeshing rotors supported by the truss-type



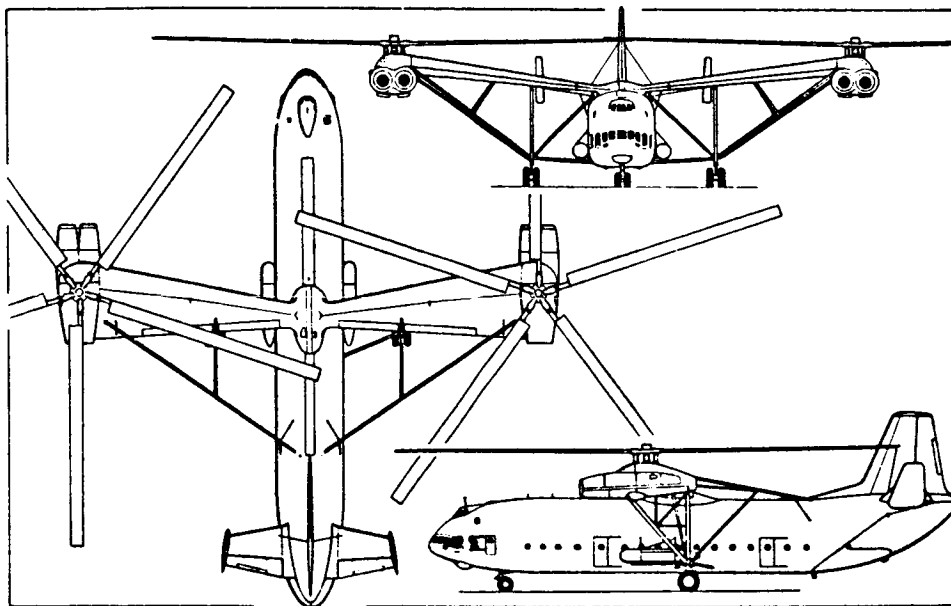

(a) Mil V-12 four-turboshaft heavy-duty freight-carrying helicopter (*Pilot Press*).

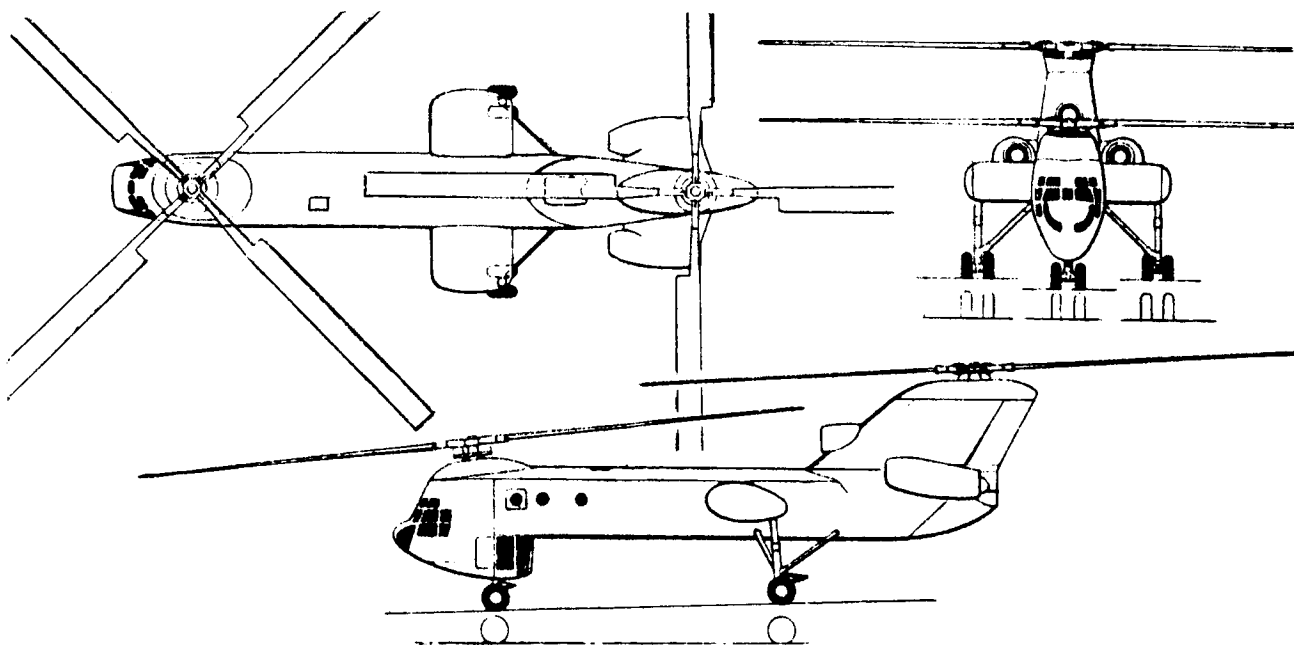

(b) Boeing Vertol XCH-62A heavy-lift helicopter

Figure 6.1 Drawings of Soviet and Western helicopters of the over 100,000-lb gross weight class.

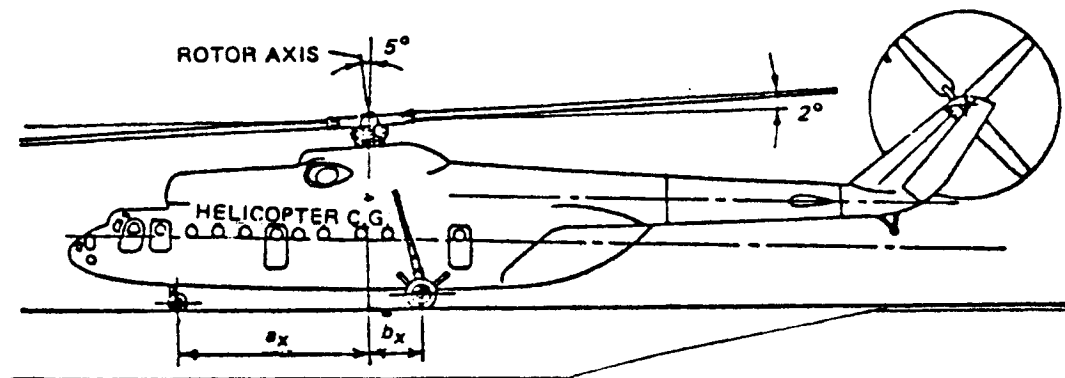

(c) Side-view drawing of the hypothetical 52-m. ton single-rotor helicopter (similar to the Mi-6)

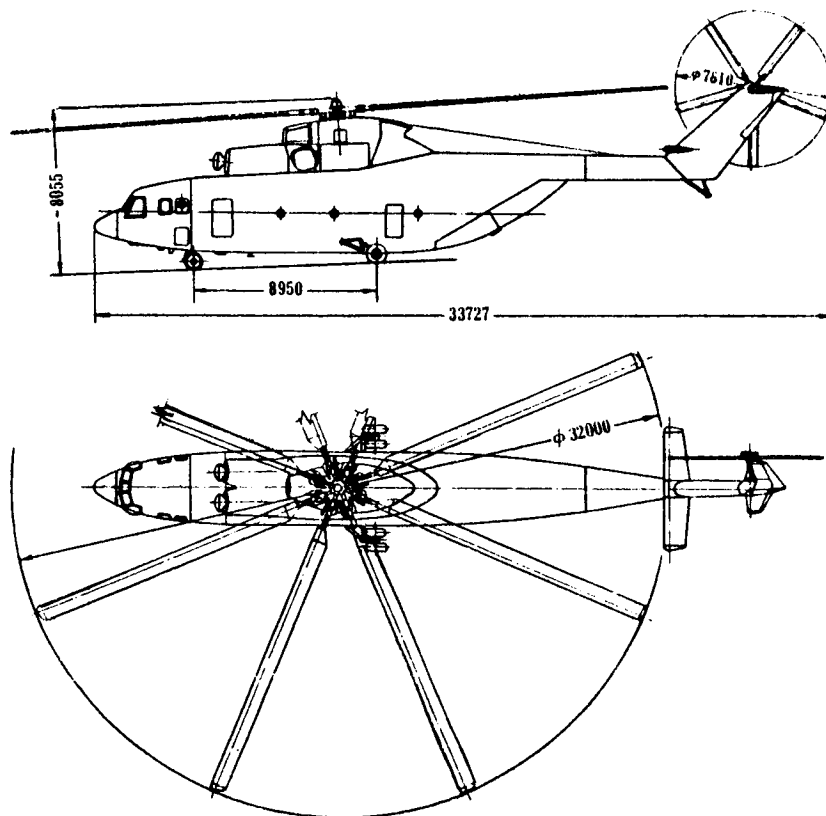

(d) Two-view drawing of the Mil Mi-26 heavy-lift helicopter

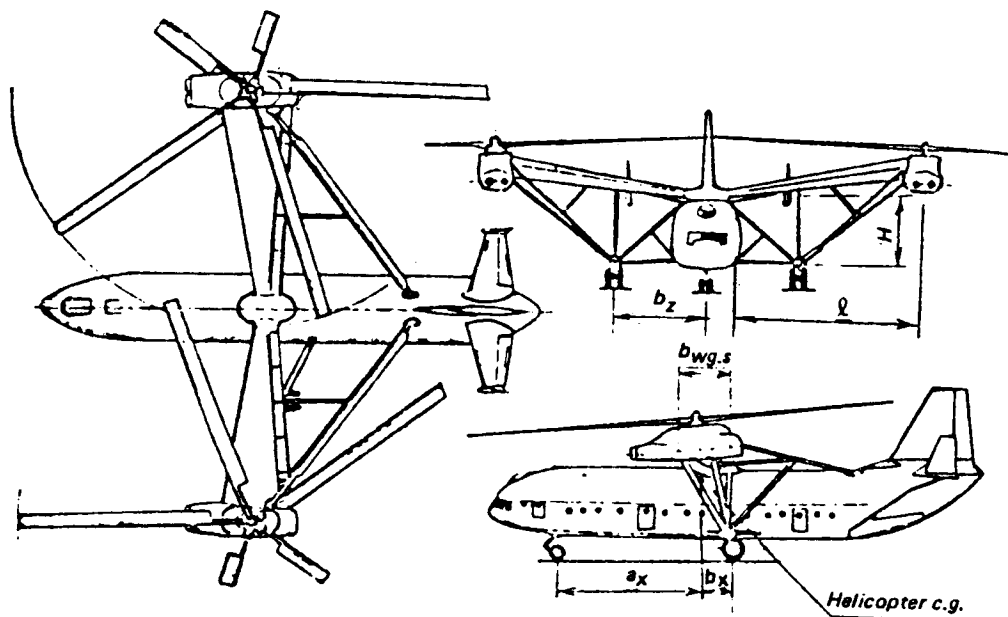

(e) Three-view drawing of the hypothetical 52-metric-ton side-by-side helicopter (similar to the Mil V-12)

Figure 6.1 Drawings of Soviet and Western helicopters of the over 100,000-lb gross weight class (Concluded)

TABLE 6.1  
BASIC DATA ASSUMED FOR THE HYPOTHETICAL 52-M.TON HELICOPTERS

BASIC PARAMETER USED IN CALCULATIONS	HELICOPTER	
	SINGLE ROTOR	SIDE-BY-SIDE*
Main-Rotor Radius of Baseline Variant: ft	52.5	36.1
Tip Speed of Main and Tail Rotor: fps at		
$H_h$	721.8	721.8
$V_{cr}$	689.0	689.0
Average Blade Lift Coefficient; $\bar{c}_{l_o}$	0.465	0.513
Airframe Download Coefficient for Baseline Version of Configuration: $k_{vh}$	1.030	1.065
FM of Isolated Rotor at $H = H_h$ and Solidity $\sigma_o = 0.217$	0.707	0.689
Coefficient of Power Utilization in Hover; $\eta_{oah}$	0.83	0.95
Coefficient of Power Utilization at $V_{cr}$ ; $\eta_{oacr}$	0.89	0.95
Distance between Rotor Shafts in the Original Layout; $L$ : ft	66.4	72.2
Wetted Area of Fuselage in the Original Layout; $S_\phi$ : ft <sup>2</sup>	3443	2542
Parasite Drag Eq. Flat-Plate Area: ft <sup>2</sup>	80.7	133.4

\*No overlap.

outriggers, as in the case of the Mi-12. The cargo cabin volume was assessed as  $41 \times 10 \times 10$  ft—similar to the dimensions of the Mi-6 (Scheme B of Fig. 2.64<sup>1</sup>).

**Hypothetical 52-m.ton Single-Rotor Helicopter (Hypothetical 52-SR).** It is shown in Figs. 2.86 and 2.87<sup>1</sup> that the optimal number of blades of the main rotor of the single-rotor configuration (Hypo-52-SR), as well as the side-by-side hypothetical 52-m.ton single-rotor helicopters, is  $n_{bl} = 8$ . Fixing the number of main-rotor blades at 8, it appears from Figs. 2.76 through 2.79<sup>1</sup> that the rotor diameter of  $D = 33$ m; i.e.,  $R = 54.14$  ft, represents a good compromise for flight distances from  $L = 50$  to 800 km. For this diameter, the referred total engine power (in SI units) is  $SHP_{ref} = 22,500$  hp (Fig. 2.79<sup>1</sup>). This corresponds to the SL, ISA  $SHP_{TO_o} = 23,250$  hp (in English units), which is assumed to be delivered by three 7750-hp engines.

The weight empty (in kg) is derived as follows:

$$W_e = W_{gr} - (W_{pl} + W_{fu} + W_{crew} + W_{t,fluid})$$

Taking the flight distance as 800 km, the payload becomes  $W_{pl} = 12,800$  kg (Fig. 2.78<sup>1</sup>); the weight of fuel as  $W_{fu} = 9200$  kg (Fig. 2.79<sup>1</sup>); assuming a crew of three at 90 kg each,  $W_{crew} = 270$  kg; and the weight of trapped fluids as  $W_{t.fluids} = 20$  kg, the weight empty becomes  $W_e = 29,710$  kg, or 65,510 lb.

Similar to the previously discussed cases of the Hypo-15 and Hypo-24, here also, the nominal 52 m.ton gross weight is assumed to be normal [ $(W_{gr})_{norm} = 114,660$  lb]. However, in order to be able to conduct a meaningful comparison of the performance of the hypothetical helicopters with that of the Mi-12 and XCH-62A at their maximum flying gross weights, the same weights should also be determined or assumed for the hypothetical machines.

It is not known at this writing if the quoted maximum flying gross weight of the Mi-12 ( $W_{grmax} = 231,500$  lb)<sup>2</sup> was established on the basis of performance or on structural considerations, but both factors probably had an effect on this determination.

In the case of the XCH-62A, the selection of  $W_{grmax} = 148,000$  lb was solely based on structural criteria: maneuver load factor = 2.0, instead of 2.5 at the design (normal) gross weight. This established  $W_{grmax}$  is approximately 10 percent higher than the  $W_{gr} = 134,300$  lb, permitting hovering OGE at SL, ISA, with the transmission limited to 17,700 hp.

Since there is no information regarding maneuvering load factors of the hypothetical helicopters, it is suggested that their maximum flying gross weight would correspond to the hovering ability OGE at SL, ISA.

Using the same approach as in the case when establishing the VTO gross weight in Section 1.4, the following formula (analogous to Eq. (1.2)) for the maximum OGE hovering weight at SL, ISA,  $(W_{gr})_{maxh}$ , is obtained for single-rotor helicopters:

$$(W_{gr})_{maxh} = 16.54 [(SHP_{TO})_{av} R_{mr} FM_{oa}]^{2/3} \quad (6.1)$$

where  $(SHP_{TO})_{av}$  is the total nominal takeoff power of all engines or, in the case of transmission restriction, the transmission-limited total power.

For twin-rotor configurations, Eq (6.1) becomes



$$(W_{gr})_{maxh} = 20.84 [(SHP_{TO})_{av} R_{mr} FM_{oa}]^{2/3} \quad (6.2)$$

Assuming that there is no transmission limit, as seems to be implied by Table 2.10<sup>1</sup>, and  $FM_{oa} = 0.543$  (see Section 6.3), the maximum flying weight of the Hypo-52-SR, based on the hovering ability as computed from Eq (6.1) would be  $(W_{gr})_{maxh} \equiv (W_{gr})_{max} = 131,375$  lb.

This gross weight brings the disc loading to  $w = 14.26$  psf, or  $69.6$  kg/m<sup>2</sup>, which is slightly less than the constraining value<sup>1</sup> of  $w_{max} = 70.0$  kg/m<sup>2</sup>.

The helicopter characteristics established above were entered into Table 6.2.

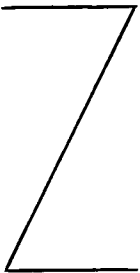
TABLE 6.2A  
 PRINCIPAL CHARACTERISTICS AND PERFORMANCE  
 OVER 100,000-LB GROSS WEIGHT HELICOPTERS

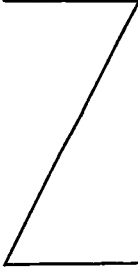
ITEM	HELICOPTER				
	Mil Mi-12	Hypothetical Hypo 52-SR	Mil Mi-26	Hypothetical Hypo 52-SBS	Boeing Vertol XCH-62A
CONFIGURATION	SBS	SR	SR	SBS	Tandem
POWERPLANT	Soloviev D-25VF	Hypothetical 7750 hp	Lotarev D-136	Hypothetical 5000 hp	Allison T701-AD-700
Number of Engines	4	3	2	4	3
Output Shaft rpm		—	8300	—	11,500
Total T.O or Mil. SHP	26,000	[23,250]	22,480	[20,000]	24,240
Total Max. Continuous SHP	[22,200]	[21,500]		[18,500]	21,915
Transmission Limit, HP				—	17,700
MAIN ROTOR R, ft	57.42	54.14	52.50	39.37	46.00
Direction of Rotation	CW Right	[CW]	CW	[CW Right]	CW Front
rpm	[120]	127.3		175.1	156.0
Number of Blades	2 X 5	8	8	2 X 8	2 X 4
Blade 0.7R Chord, ft	3.28	2.75	[2.73]	1.72	3.33
Airfoil		—	—	—	VR-7 & VR-8
Articulation	HH, VH, PH	HH, VH, PH		HH, VH, PH	Elastomeric
TAIL ROTOR R, ft		[11.26] — [66.22]	12.48 Pusher [65.63] ~0		
Type					
x, ft					
y, ft (see Fig. 1.14)					
rpm			5		
Number of Blades			[1.56]		
Blade 0.7R Chord, ft					
Airfoil					
Articulation					
EXTERNAL DIMENSIONS					
Overall Length, ft	219.83 (span)	[127.14]	130.8	[158.0 (span)]	162.25
Fuselage, ft	121.375	—		—	89.25
Overall Height, ft	41.00	—	26.43*	—	38.625
INTERNAL DIMENSIONS					
Cabin Length, ft	92.33	[41.0]	[40.0]	[41.0]	[60.0]
Max. Width, ft	14.42	10.0	10.8	10.0	8.80
Max. Height, ft	14.42	10.0	10.0	10.0	6.25
Volume, cu.ft	[19,000]	[4100]	[4320]	[4100]	[3000]
CREW	6	[3]	5	[3]	3

Note:

\*Including hub

Cont'd

Table 6.2A (Cont'd)

WEIGHTS					
Max. Gross Weight, lb	231,500	131,375	123,480	129,210	148,000
Normal Gross Weight, lb	213,850	114,660	109,148	114,660	118,000
Weight Empty, lb	[142,000]	65,510	62,181	69,480	64,880
Payload at Zero Range, lb <sup>†</sup>	[88,200]	65,210	60,270	59,080	82,470
PERFORMANCE					
	Normal GW	Normal GW	Normal GW	Normal GW	Normal GW
Flight Speed, Max/VNE, kn	140		159.2		147
Fast Cruise*, kn	130	140	137.6	140	130
Economic Cruise*, kn					
Vertical R/C*, fpm					1390
Forward R/C*, fpm					2300
Hover**, OGE, ft		4920	5900	4920	8630
Service Ceiling, ft	11,500	14,760	15,090	14,760	
Ceiling, 1-Engine Out, ft					
Avg. Fuel Consumption, lb/hr					
Normal Fuel, lb					
Range, n.mi					1,515 (ferry)
DISC LOADING					
Normal Gross Weight, psf	10.32	12.45	12.61	11.78	8.88
Maximum Gross Weight, psf	11.18	14.26	14.26	13.27	11.13
POWER LOADING					
	T.O SHP <sub>o</sub>	T.O SHP <sub>o</sub>	T.O SHP <sub>o</sub>	T.O SHP <sub>o</sub>	T.O SHP <sub>o</sub>
Normal Gross Weight, lb/shp	8.22	4.93	4.86	5.73	4.87
Maximum Gross Weight, lb/shp	8.90	5.65	5.49	6.46	6.11

NOTES: \*SL, ISA \*\*ISA †Based on maximum gross weight

TABLE 6.2B  
ADDITIONAL HELICOPTER CHARACTERISTICS

Tip Speed, fps	721.4	721.8	[721.0]	721.8	750
Main Rotor Solidity	0.0909	0.130	[0.132]	0.1111	0.0923
$R_{tr}/R_{mr}$	—	0.208	0.238	—	—
$x/R_{mr}$	—	1.223	[1.250]	—	—
MAX' GROSS WEIGHT, lb					
$W_e/(W_{gr})_{max}$	[0.613]	0.499	0.504	0.538	0.438
$(W_{pl})_o/(W_{gr})_{max}$	[0.381]	0.496	0.488	0.457	0.557
$(W_{pl})_o/\text{Cabin Vol. lb/ft}^3$	[4.640]	15.90	[13.95]	14.10	27.49
NORMAL OR VTO GW, lb					
$W_e/(W_{gr})_{norm}$	[0.664]	0.571	0.570	0.606	0.550
$(W_{pl})_o$ at NGW, lb	[60,550]	48,500	45,940	44,530	52,470
$(W_{pl})_o/(W_{gr})_{norm}$	[0.329]	0.423	0.421	0.388	0.445
$(W_{pl})_o/\text{Cabin Vol. lb/ft}^3$	[3.71]	11.83	[10.63]	10.86	17.49

**Hypothetical 52-m.ton Side-by-Side Helicopter (Hypothetical 52-SBS).** Figures 2.83, 2.84, and 2.85<sup>1</sup> indicate that  $D = 24$  m; i.e.,  $R = 39.37$  ft appears as optimal. The so-called referred shaft power dictated by hovering requirements OGE at 1500 m, ISA (Fig. 2.85<sup>1</sup>) is 19,375 hp, which corresponds to the  $SHP_{TO_0} \approx 20,000$  hp (in English units) assumed to be delivered by four engines with a rating of  $SHP_{TO_0} = 5000$  hp each.

Similar to the preceding case, weight empty is established by first finding  $W_{pl}$  for the 800-km flight distance by plotting  $W_{pl_{max}}$  values corresponding to  $n_{bl} = 8$ , and the three gross weights (40, 48, and 60 m.ton; Fig. 2.84<sup>1</sup>), and finding the payload for  $W_{gr} = 52$  m.ton. This amounts to  $W_{pl} = 11,300$  kg\*, while the weight of the fuel is 8900 kg (Fig. 2.85<sup>1</sup>). Assuming crew and trapped fluids weights as for the single-rotor configuration,  $W_e = 31,510$  kg, or 69,480 lb.

The maximum flying gross weight, calculated from Eq. (1.2), assuming no transmission limit, and  $FM_{oa} = 0.620$  (see Section 6.3) is  $W_{gr_{max_h}} \equiv W_{gr_{max}} = 129,210$  lb.

As in the case of the single rotor, the above established helicopter characteristics were entered into Table 6.2.

**Mil Mi-26 Heavy-Lift Transport Helicopter.** As previously mentioned, the Mi-26 helicopter was unveiled at the 1981 Paris Air Show, where a Russian language brochure giving some characteristics and a two-view drawing of the aircraft was obtained, as well as a French brochure on the D-136 turboshaft powering that helicopter. Although the material was rather incomplete, it still served as a basis for entering the Mi-26 into the comparative evaluation. In all tables, the Mi-26 is shown next to the 52-ton hypothetical helicopter as the latter served as a "conceptual prototype" of the actual machine. It appears that many of the design goals set up for transport helicopters of that class, as reported in Ref. 1, have been achieved in the Mi-26. The same appears true with respect to the powerplants, where the sfc even exceeded the goals represented by the hypothetical engines, while the specific weight level came close to the established goals.

## 6.2 Basic Data

The principal characteristics of the compared helicopters are given in Table 6.2, while some of the data contained therein are graphically presented in Figs. 6.2 through 6.6.

**Disc Loading (Fig. 6.2).** The disc loading of the Mi-12 is on the same level as that of the Boeing Vertol HLH. However, should the optimization process aimed at maximization of the payload outlined in Ref. 1 serve as a guide for future Soviet design of heavy-lift helicopters, the trend would be toward higher

---

\* Value reconfirmed by Fig. 2.86<sup>1</sup>.



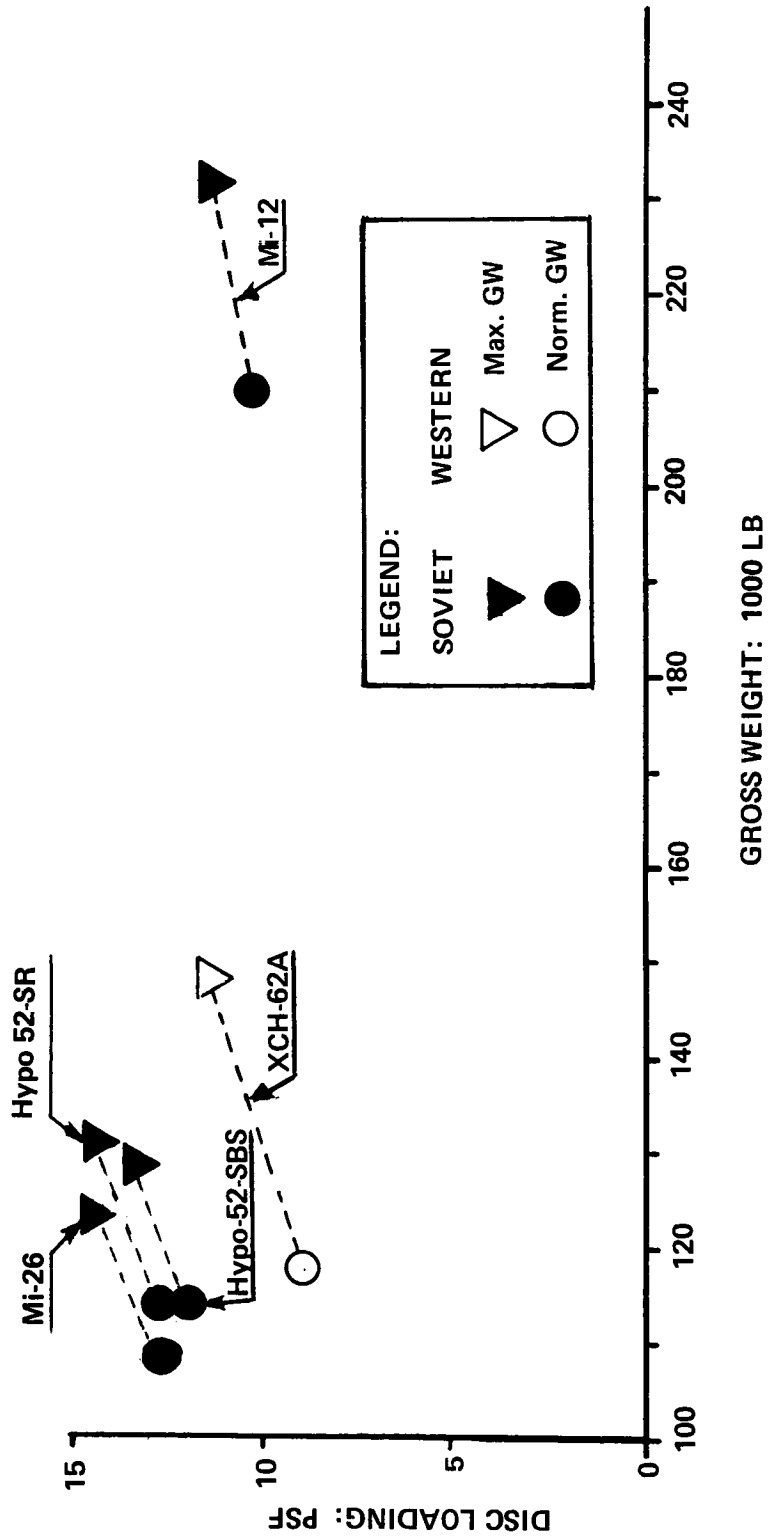

Figure 6.2 Disc loading of Soviet and Western helicopters of the over 100,000-lb gross weight class.

disc loadings. For the alternate (maximum flying) gross weight, the disc loading of the hypothetical single-rotor helicopter may go as high as 14.26 psf — close to that of the CH-53E at its maximum flying weight — and for the side-by-side configuration,  $w_{max} \approx 13.3$  psf. It can be seen that the Mi-26 almost perfectly matches the disc loading values of the Hypo 52-SR.

**Power Loading (Fig. 6.3).** The trend exhibited in all previous Soviet helicopters; i.e., the power loading based on  $SHP_{TO_0}$  being higher than the power loading of the Western counterparts, has extended to include the Mi-12. It appears, however, that this design philosophy will reverse in the future models, as witnessed by the trend exhibited by the hypothetical helicopters, where the  $W_{gr}/SHP_{TO_0}$  is practically on the same level as for the XCH-62A, and even lower than those associated with the transmission limit. This trend toward lower power loadings was fully confirmed by the  $W_{gr}/SHP_{TO_0}$  values for the Mi-26.

**Main-Rotor Tip Speed (Fig. 6.4).** Since the Mi-12 helicopter has the same main rotors as the Mi-10, the rotors of both aircraft probably have the same tip speed; i.e.,  $V_t \approx 720$  fps. A similar tip speed is postulated for the hypothetical helicopters in hover, and slightly lower ( $V_t \approx 690$  fps) in cruise<sup>1</sup>. This is probably also true for the Mi-26. The tip speed of the XCH-62A, amounting to 750 fps, is the highest for the compared gross weight class.

**Tail-Rotor to Main-Rotor Radii Ratio and Relative Tail-Rotor Distance.** There are only two representatives of the single-rotor configuration in the considered gross weight class. Consequently, there is no figure to show the comparative  $R_{tr}/R_{mr}$  and  $x/R_{mr}$  values. It should be mentioned here only that  $R_{tr}/R_{mr} = 0.208$  was assumed as the average of the corresponding values for the hypothetical helicopters in the preceding chapter. This resulted in  $R_{tr} = 11.26$  ft and  $\bar{x} = 1.223$ . For the Mi-26, the corresponding values are  $R_{tr}/R_{mr} = 0.238$  and  $\bar{x} = 1.250$ .

**Weight Empty and Zero-Range Payload to Gross-Weight Ratios (Figs. 6.5 and 6.5A).** At this writing it was not possible to locate published figures regarding weight empty of the Mi-12. However, during the 1971 Paris Air Show, representatives of the Mi-12 crew cited 40 metric ton (88,200 lb) as useful load at  $W_{gr_{max}} = 231,500$  lb. With a crew of six, and an assumed weight of 100 lb of trapped fluids, this would result in  $W_e = 142,000$  lb.

Assuming this figure as approximately correct, the  $W_e/W_{gr}$  and  $(W_{pl})_0/W_{gr}$  ratios were computed (Table 6.2A), and plotted in Figs. 6.5 and 6.5A, showing that the weight empty to both maximum and normal gross weight ratios are appreciably higher than for the XCH-62A, and also higher than for the single-rotor and the side-by-side hypothetical helicopters.

Although the Hypo 52-SBS helicopter is of the same configuration as the Mi-12, the Soviet designers expect to achieve structurally lighter side-by-side configurations in the future than in the past. This aspect

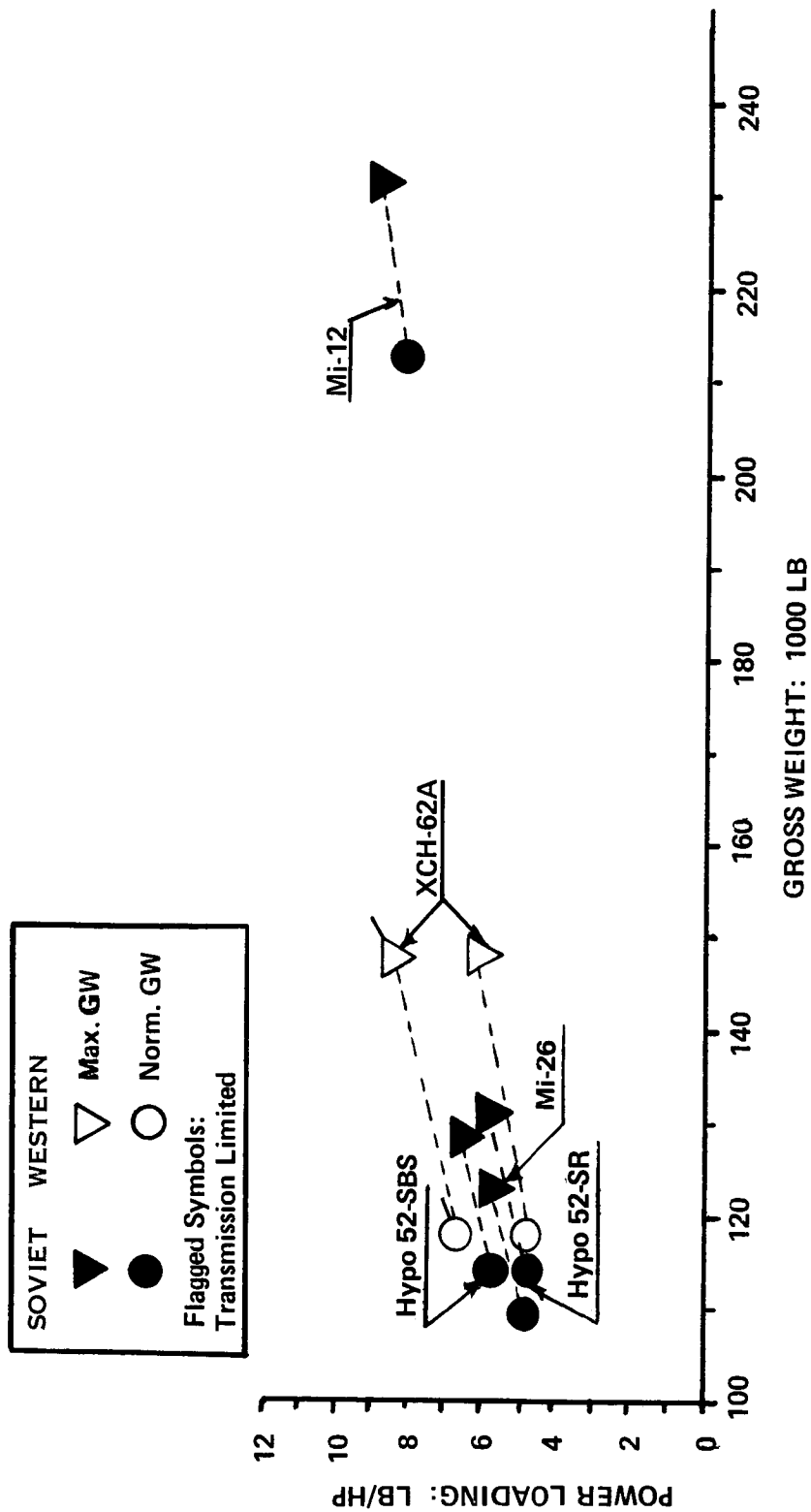

Figure 6.3 Power loading of Soviet and Western helicopters of the over 100,000-lb gross weight class.

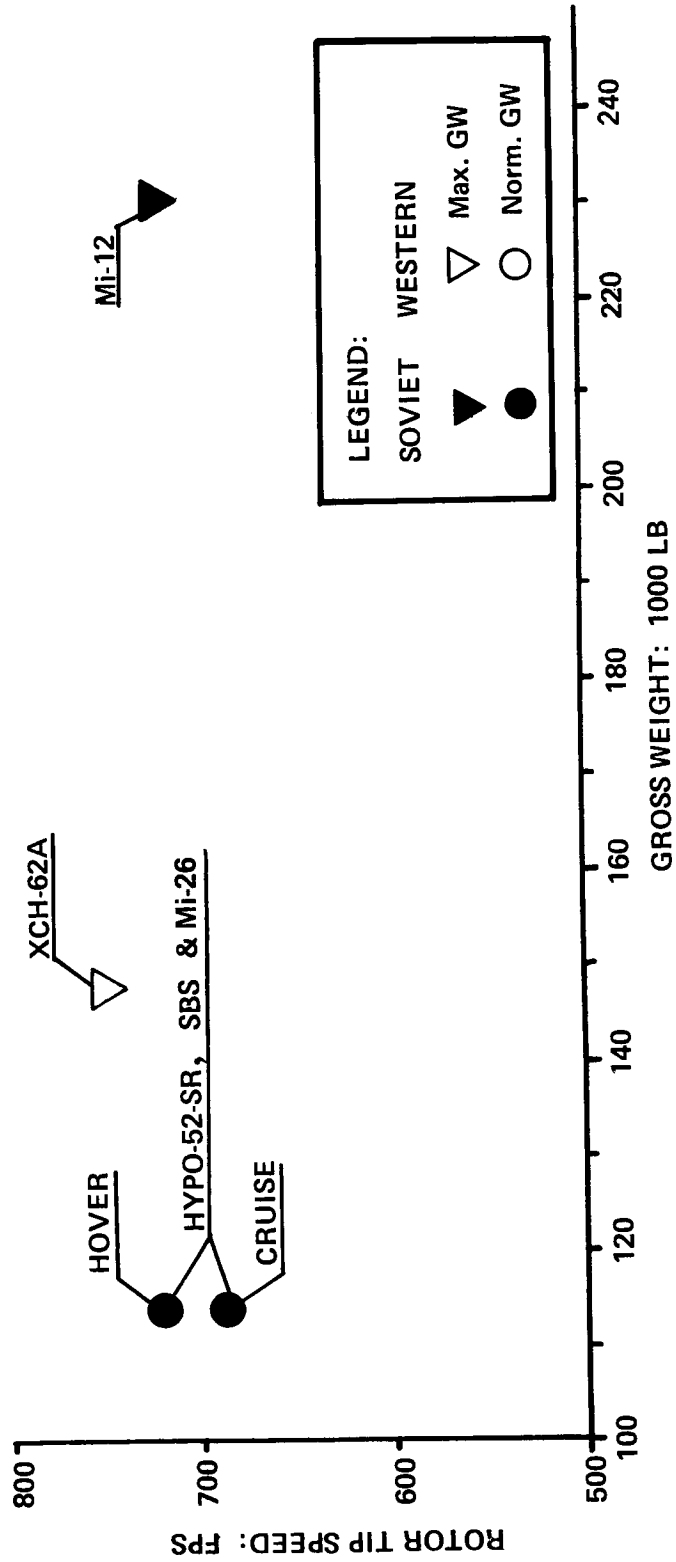

Figure 6.4. Main-rotor tip speed of Soviet and Western helicopters of the 100,000-lb gross weight class.

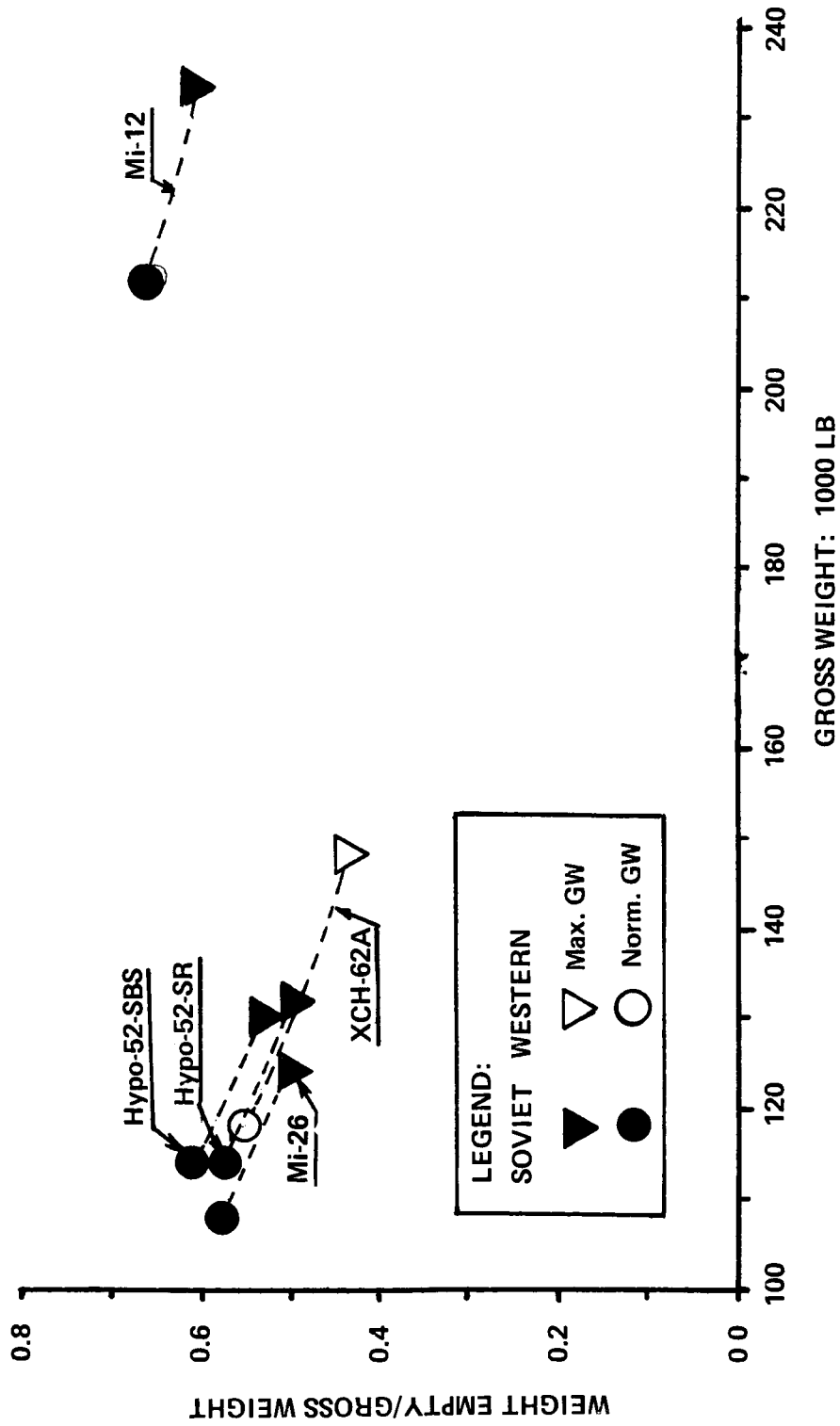

Figure 6.5 Weight empty to gross weight ratios of Soviet and Western helicopters of the over 100,000-lb gross weight class.

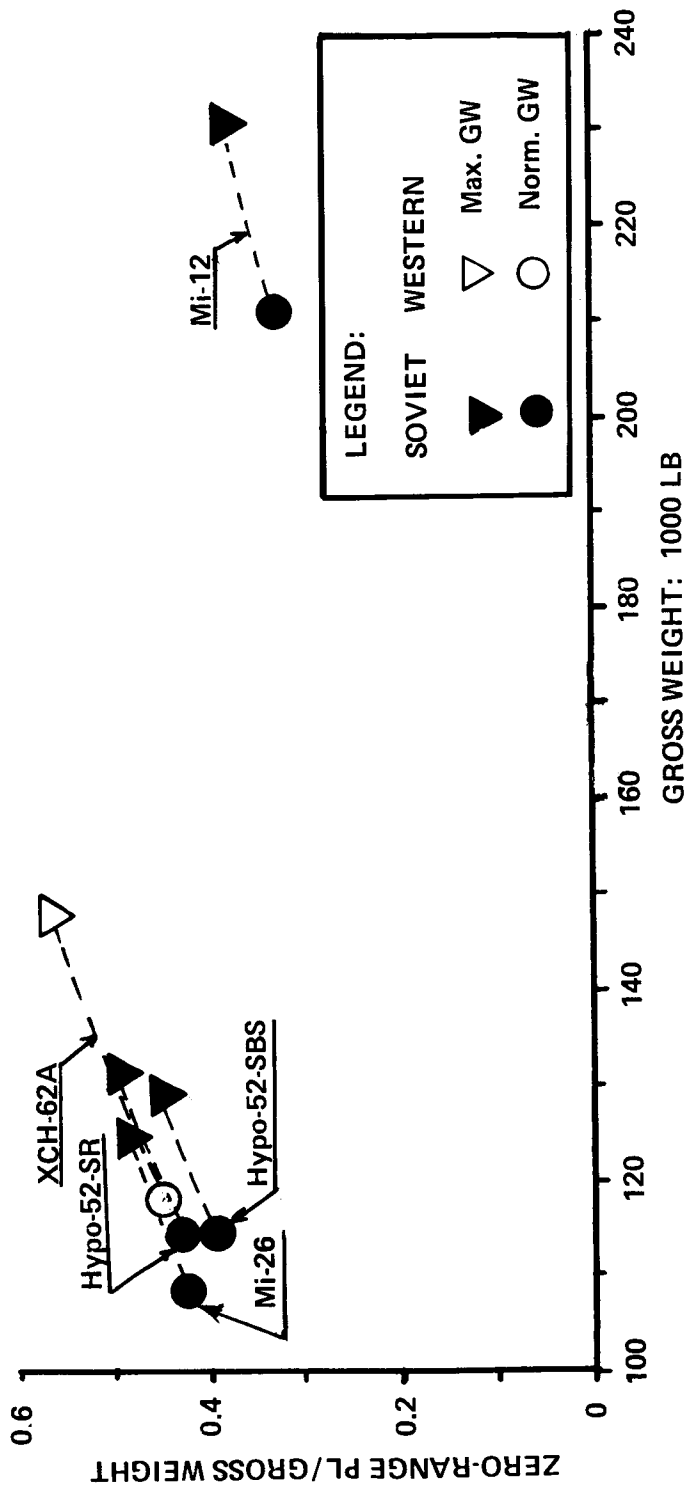

Figure 6.5A Zero-range payload to gross-weight ratios of Soviet and Western helicopters of the over 100,000-lb gross weight class.

is frequently discussed in Ref. 1, where it is indicated that the Mi-12 was their first venture into this size and configuration; thus leading to a higher degree of conservatism in the design and load estimate than may be expected in the future. The weight-empty to gross-weight ratio for the Mi-26 is quite close to the targets indicated by the Hypo 52-SR figures.

The above discussed weight empty aspects are further supplemented by the zero-range payload to the gross-weight ratios shown in Fig. 6.5A.

**Cabin Volume Loading (Fig. 6.6).** Although, at this point, the figures regarding zero-range payload of the Mi-12 may not be completely accurate, it may still be safely assumed that a very large cabin ( $28 \times 4.4 \times 4.4$  m) is provided for possible payload. This results in  $(W_{pl})_0/V_{\text{cabin}}$  values way below those of the XCH-62A.

As to the hypothetical helicopters, it should be remembered that their cabin volume was only assumed to correspond to Scheme B of Fig. 2.64<sup>1</sup>. Should this assumption prove to be correct, the cabin volume loading values would be about one-third lower than those of the XCH-62A helicopter. The estimated cabin dimensions and volume of the Mi-26 appear to be quite close to those assumed for the hypothetical helicopters, leading to a similar cabin volume loading.

### 6.3 Hovering and Vertical Climb Aspects

**Table 6.3.** The most important part of the calculations performed in this table is the determination of the overall figure-of-merit values. In the case of the XCH-62A, this can be done on the basis of the manufacturer's performance data; supported by wind-tunnel tests and flight experience with similar configurations, thus providing a high confidence level regarding the quoted figures.

In Prime Item Description Document, Vol. 1 – Heavy-Lift Helicopter, Code Ident. No. 77272, it is stated that at a transmission-limited power of 17,700 hp, the hovering gross weight OGE at SL, ISA is 134,300 lb.

The overall figure of merit, computed directly from Eq. (1.1a) is 0.635. A continuous checking of the indirect methods of calculating  $FM_{oa}$  values, as indicated in Table 6.3, was carried out; leading to  $FM_{oa} = 0.617$ , which is quite close to the Boeing-Vertol data-based value.

Using  $FM_{oa} = 0.635$ ,  $(W_{gr})_{VTO} = 130,300$  lb is computed from Eq. (6.2), which is in complete agreement with the Boeing-Vertol data of the gross weight – hovering ceiling relationship. The vertical rate of climb at  $(W_{gr})_{VTO}$ , computed from Eq. (1.9) is, again, in very good agreement with Boeing-Vertol data.

Unfortunately, in the case of the Mi-12, there is no published data on either hovering ceiling or vertical rate of climb. Consequently, only the speculative so-called first-estimate procedure shown in Table 6.3 could be used; resulting in  $FM_{oa} = 0.594$ . This was done, neglecting any beneficial aerodynamic

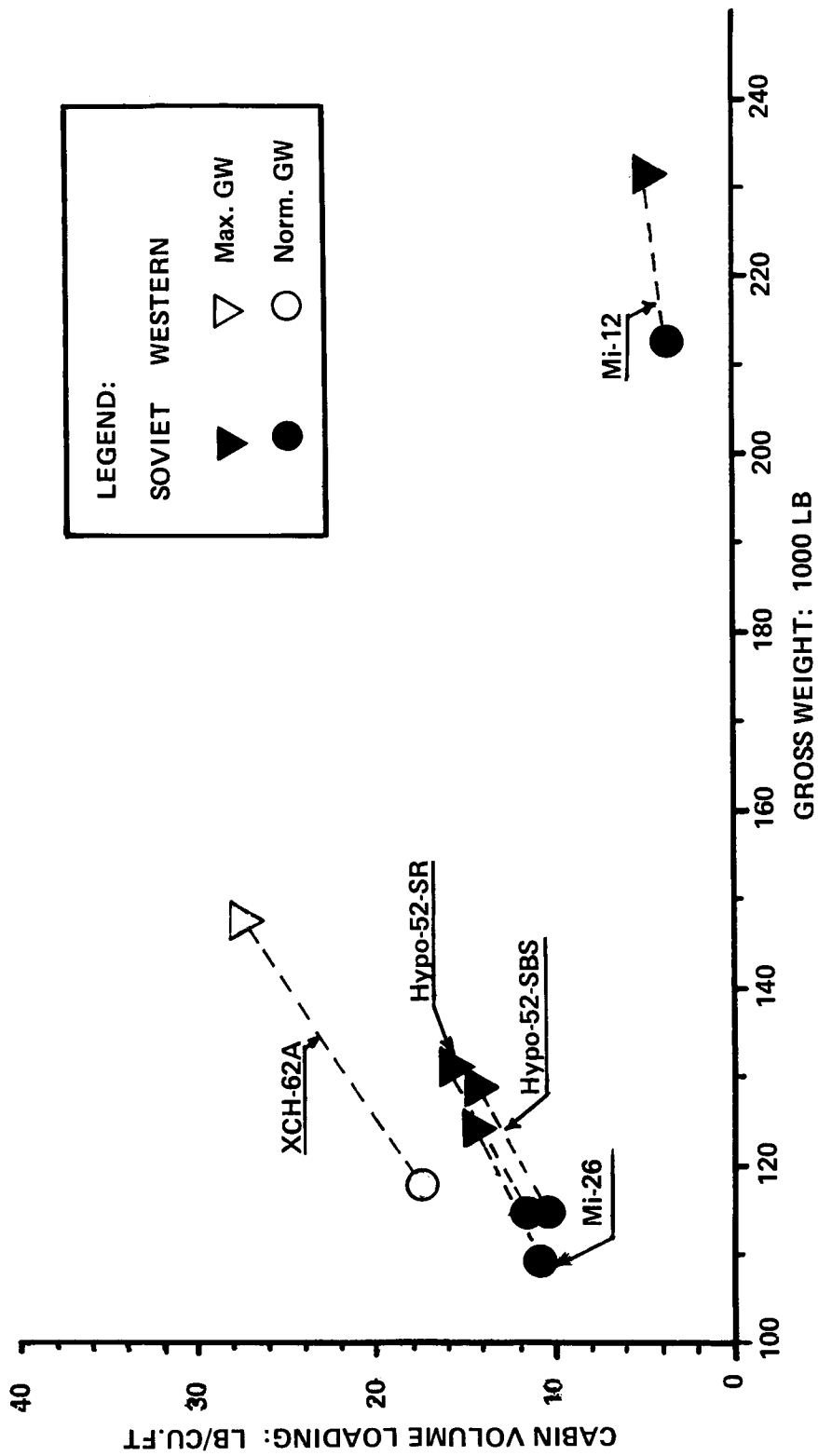
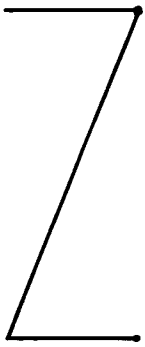
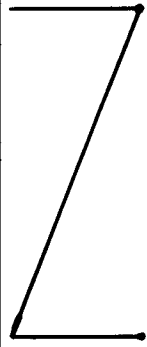
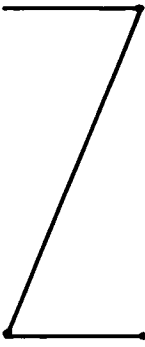

Figure 6.6 Zero-range payload cabin volume loading of Soviet and Western helicopters of the over 100,000-lb gross weight class.



TABLE 6.3  
HOVERING AND VERTICAL CLIMB ASPECTS, ISA  
OVER 100,000-LB GROSS WEIGHT CLASS

ITEM	HELICOPTER				
	Mil Mi-12	Hypothetical Hypo 52-SR	Mil Mi-26	Hypothetical Hypo 52-SBS	Boeing-Vertol XCH-62A
GROSS WEIGHT, LB	213,850	114,660	109,148	114,660	118,000
<b>MAIN ROTOR</b>					
Disc Loading, $w$ ; psf	10.32	12.45	12.61	11.78	8.88
Ideal Induced Velocity, $v_{id}$ ; fps	46.56	51.14	51.15	49.75	93.19
Tip Speed, $V_t$ ; fps	721.4	721.8	[721.8]	721.8	750.0
$v_{id}/V_t$	0.0645	0.0709	0.0709	0.0689	0.0576
Solidity, $\sigma$	0.0909	0.130	[0.132]	0.1111	0.0923
Download Factor, $k_{vh}$	1.065 <sup>1</sup>	1.03 <sup>1</sup>	1.03	1.065 <sup>1</sup>	1.055
Average Blade Lift Coefficient, $\bar{c}_l$	0.59	0.484	0.476	0.513	0.467
FM	0.688	0.703 <sup>1</sup>	[0.703] <sup>1</sup>	0.680 <sup>1</sup>	0.725
<b>TAIL ROTOR</b>					
Tail Rotor Thrust; lb		9874.0	9242.0		
$T/W_{gr}$		0.086	0.085		
Disc Loading, $w$ ; psf		24.79	18.89		
Ideal Induced Velocity, $v_{id}$ ; fps					
Tip Speed, $V_t$ ; fps					
Solidity, $\sigma$					
Blocking Factor, $k_{blo}$					
Avg. Blade Lift Coefficient, $\bar{c}_l$					
FM					
Power Ratio, $(RP_{tr}/RP_{mr})$					
$\eta_{oa}$	0.95 <sup>1</sup>	0.83 <sup>1</sup>	[0.83] <sup>1</sup>	0.95 <sup>1</sup>	0.95
$FM_{oa}$ (1st Estimate)	0.594	0.558	0.558	0.610 <sup>†</sup>	0.617*
Hover Ceiling OGE: ft		4920	5900	4920	8630
SL Takeoff SHP/GW; hp/lb		0.2027	0.2060	0.1744	
Rel. Lapse Rate at Hover Ceiling OGE		0.87	[0.82]	0.87	
$FM_{oa}$ (2nd Estimate)		0.567	0.552	0.630	0.635**
Average $FM_{oa}$	0.594	0.562	0.555	0.620	0.635**
Lapse Rate $\lambda_{3000}$	1.035	0.920	[0.920]	0.920	$X_{man}$ Limit
VTO Gross Weight; lb	195,500	120,600	114,560	118,640	130,300
Vertical R/C @ VTO GW; fpm	~ 80	800	805	780	260**
Vertical R/C @ NGW; fpm	—	1260	1240	1060	1390**
Vertical R/C @ Max. GW; fpm	—	0	105	0	—

NOTES:

<sup>†</sup> Includes thrust augmentation coefficient  $k_T > 1.04$  (Table 2.11<sup>1</sup>).

\* Including overlap correction factor;  $\eta_{ol} = 0.96$ .

\*\* Based on Boeing-Vertol data

effects of the side-by-side configuration. However, as indicated in Ref. 1, the hypothetical side-by-side helicopter should experience thrust augmentation in hover, and the value of the proper coefficient is given in Table 2.11<sup>1</sup> as  $k_T = 1.04$ . Taking into consideration the thrust augmentation effect, the overall figure of merit for the Mi-12 would be 0.618.

For the other representative of the side-by-side configuration; namely, the Hypo 52-SBS, the  $FM_{Oa} = 0.610$  obtained through the first estimate was checked against the second estimate, based on 1500 m (4920 ft), ISA hovering ceiling requirements for all hypothetical helicopters considered in Ref. 1. The so-obtained  $FM_{Oa} = 0.630$  is not much different from the previously computed value.

For the single-rotor hypothetical helicopter, the so-called speculative  $FM_{Oa} = 0.558$  and that resulting from hovering requirements (0.567) are quite close, thus indicating at least a consistency in the hovering and vertical climb performance estimates.

The first estimate for the Mi-26 resulted in  $FM_{Oa} = 0.558$ . The second estimate was based on a Russian leaflet which contained data on the hovering ceiling and assumed lapse rate of the D-136 engine. The result was similar to the first estimate – leading to  $FM_{Oa} = 0.552$ . The average of the two estimates (0.555) was assumed for computing the VTO gross weight and rates of climb.

The results of the above-discussed  $FM_{Oa}$  estimates, and those obtained at the intermediate steps, are shown in Figs. 6.7 through 6.11.

Installed Power per Pound of Gross Weight in Comparison with Ideal (SHP/GW) Values in Hover OGE, ISA (Fig. 6.7). For the Mi-12 helicopter, the ratio of installed (takeoff) power to the ideal power is quite low for  $W_{grmax}$  and  $W_{grnorm}$ . This is reflected in the need of using running takeoffs at maximum gross weight, even at SL, ISA. By contrast the hypothetical and the Mi-26 helicopters at their normal gross weights exhibit power ratios similar to the normal gross weight of the XCH-62A (with transmission limit).

Average Blade-Lift Coefficient (or  $C_T/\sigma$ ) in Hover OGE, ISA (Fig. 6.8). The average blade-lift coefficient of the Mi-12 helicopter is higher than for the XCH-62A, Mi-26, and the hypothetical machines. It should also be noted that the  $\bar{c}_l$  values of the hypothetical side-by-side machine are slightly higher than for the single-rotor configuration. Since the Soviet designers are the only ones having any significant design and operational experience related to side-by-side configurations, one should have no reason to doubt a statement contained in Ref. 1 that the nominal design rotor thrust coefficients,

$$t_{y_o} = 2W_{gr}/\rho_o \sigma S_{rot} V_t^2 = 2C_T/\sigma$$

may be approximately 10 percent higher for the side-by-side configurations than for either the single-rotors or the tandems (Table 2.11<sup>1</sup>). It is also shown in this table that in calculating the actual rotor thrust coefficient of the side-by-side helicopters at hovering ceiling, a thrust augmentation coefficient,  $k_T = 1.04$  is incorporated which reduces the rotor  $t_y$  values by about 4 percent.

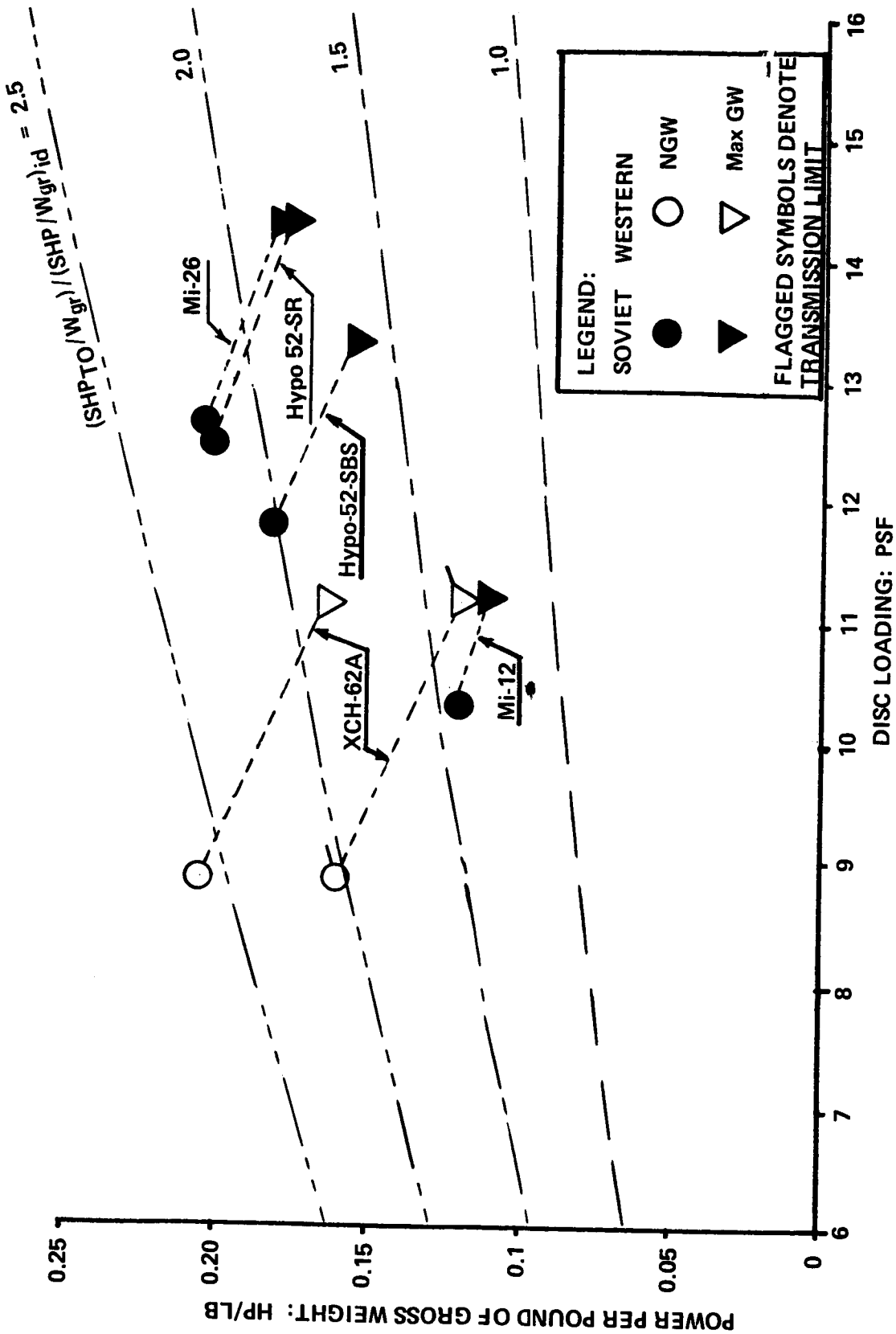

Figure 6.7 Installed, or transmission limited power per pound of gross weight in comparison with ideal power for Soviet and Western helicopters of the over 100,000-lb class.

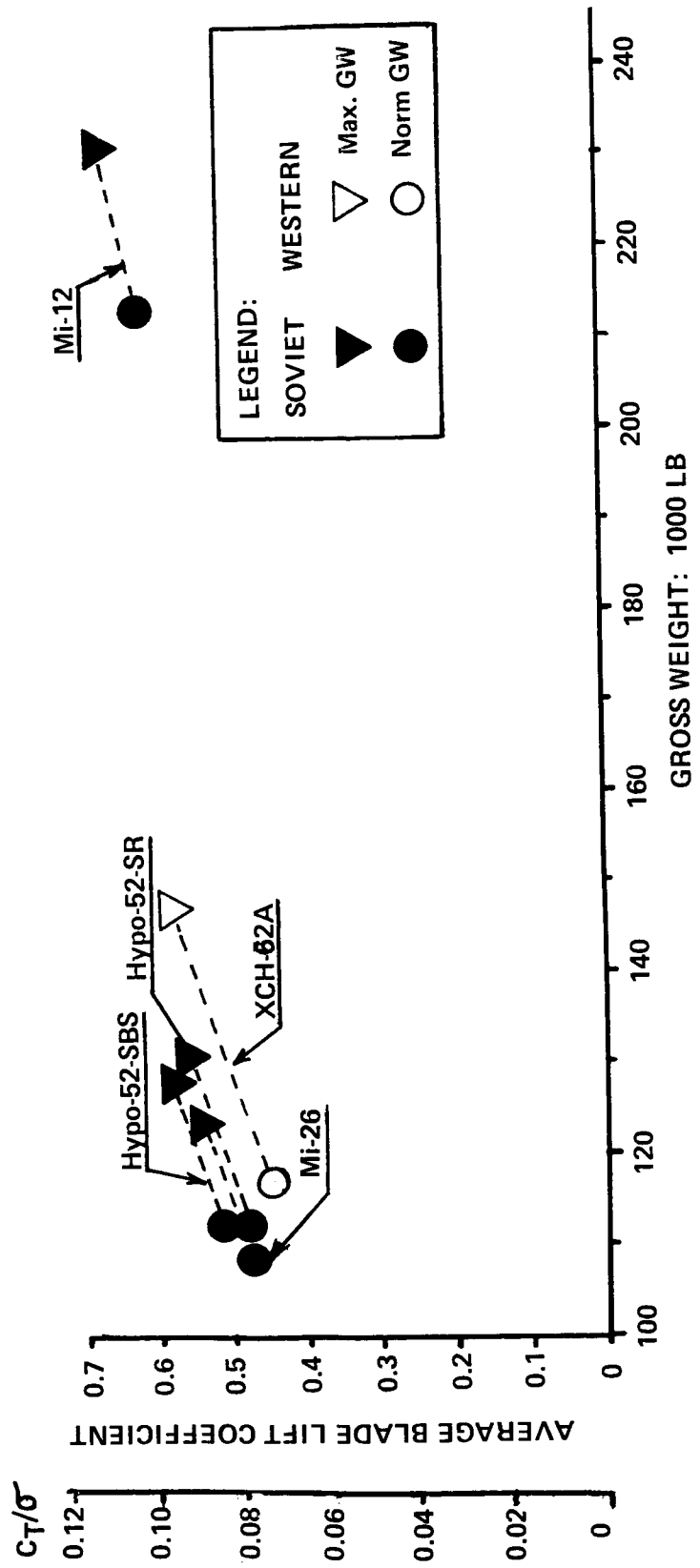

Figure 6.8 Average blade lift coefficient, and  $C_T/\sigma$  in hover OGE at SL, ISA of Soviet and Western helicopters of the over 100,000-lb gross weight class.

Main-Rotor Figure of Merit in Hover OGE at SL, ISA (Fig. 6.9). Figures of merit of the Mi-12 and XCH-62A helicopters were estimated, while those of the hypothetical machines and the Mi-26 were read from the graphs in Figs. 2.79 and 2.85<sup>1</sup>. There are no striking differences in the lifting-rotor FM values of the compared helicopters. However, it appears that due to the advanced blade airfoil sections (VR-7 and VR-9) and proper twist distribution, the figure of merit of the Boeing Vertol heavy-lift helicopter is the highest.

Tail-Rotor Thrust to Gross Weight, and Power to Rotor-Power Ratios. Since there are only two representatives of the single-rotor configuration in the considered gross weight class, no detailed studies were conducted of the tail-rotor thrust to gross weight, and power to rotor-power ratios.

Overall Figure of Merit (Fig. 6.10). Derivation of the overall figures of merit was discussed in the subsection entitled, 'Table 3'. Consequently, only the most important features of Fig. 6.10 are indicated here. Two  $FM_{oa}$  values for the Mi-12 are shown, the more conservative with no credit toward beneficial airframe-rotor interaction; and the higher one incorporating the  $k_T = 1.04$  thrust augmentation factor. Assuming that the latter approach is correct, the overall figure of merit of the Mi-12 would be quite similar to that of the Hypo 52-SBS ( $FM_{oa} = 0.618$  vs  $FM_{oa} = 0.620$ ).

The figure of merit of the XCH-62A appears to be about 2 percent higher than for the side-by-side configurations. It should also be noted that all twin-rotor configurations exhibit considerably higher  $FM_{oa}$  values (about 11 percent) than the single-rotor schemes.

Vertical Rates of Climb at SL, ISA (Fig. 6.11). The Mi-12 helicopter has no positive rate of climb in vertical ascent at either its maximum flying gross weight of 231,500 lb or normal gross weight of 213,850 lb, since its maximum gross weight to hover OGE at SL, ISA is 197,600 lb. The VTO gross weight of 195,500 lb, corresponding to hovering OGE at 3000 ft ISA, was computed from Eq. (1.2)\*. Assuming that the lapse rate at this altitude is  $\lambda = 1.03$ ; i.e., of the same character as for the D-25VF engine rated at 5500 shp, the VTO gross weight is not much different from the  $(W_{gr})_{hmax}$  value. This, of course, results from the peculiar lapse rate of the Mi-12 engines, which also accounts for the quite low sea level vertical rate of climb (80 fpm) at  $(W_{gr})_{VTO}$ .

It should be recalled at this point that the maximum flying weight of the hypothetical helicopters was arbitrarily defined as that corresponding to hovering OGE at SL, ISA. Obviously, at this gross weight, the vertical rate of climb would be zero. At  $(W_{gr})_{VTO}$  (120,600 lb for the single-rotor, and 118,640 lb for the side-by-side configuration), the vertical rate of climb of both hypothetical helicopters is about 800 fpm; while at their normal (design) gross weights, the vertical climb rate is about 1250 fpm for the single, and about 1100 fpm for the side-by-side configurations.

---

\*With fixed coefficient 20.22 instead of 16.05.

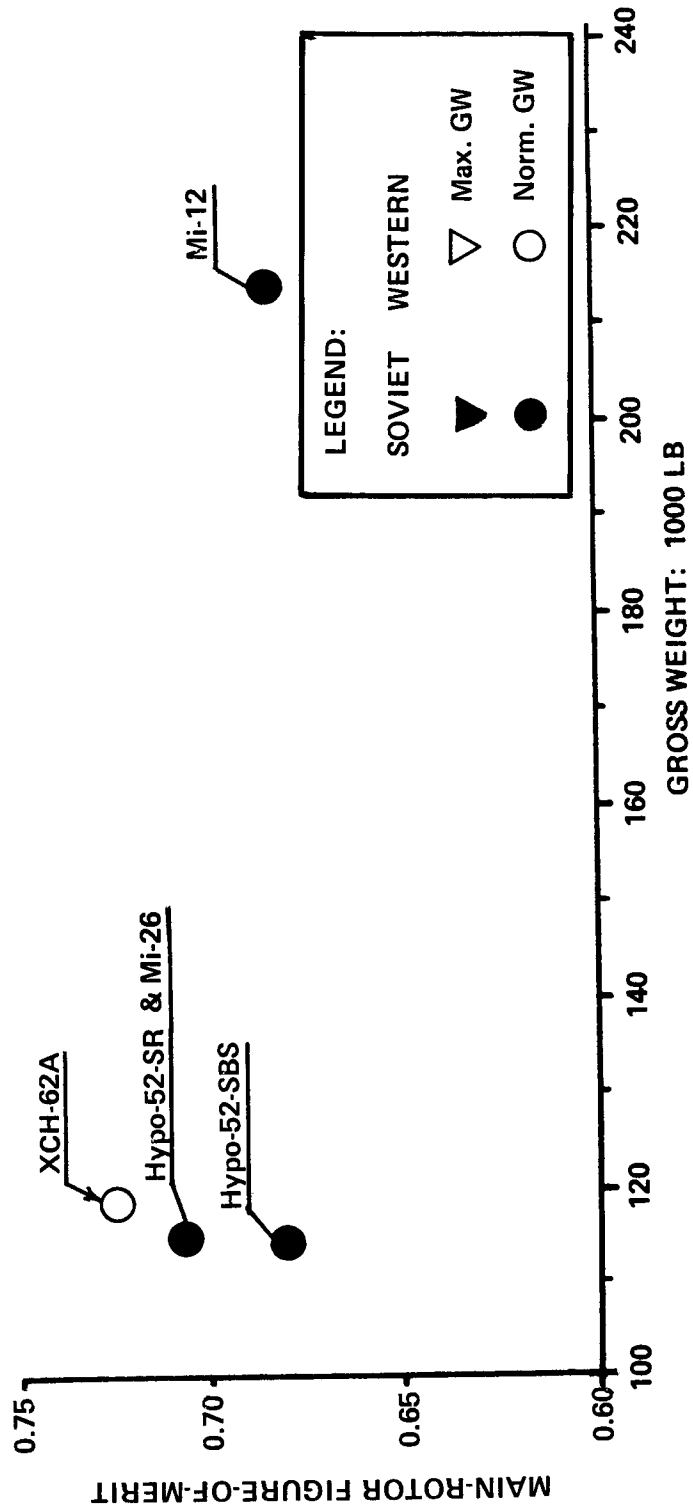

Figure 6.9 Main-rotor figure of merit in hover OGE at SL, ISA of Soviet and Western helicopters of the over 100,000-lb gross weight class.

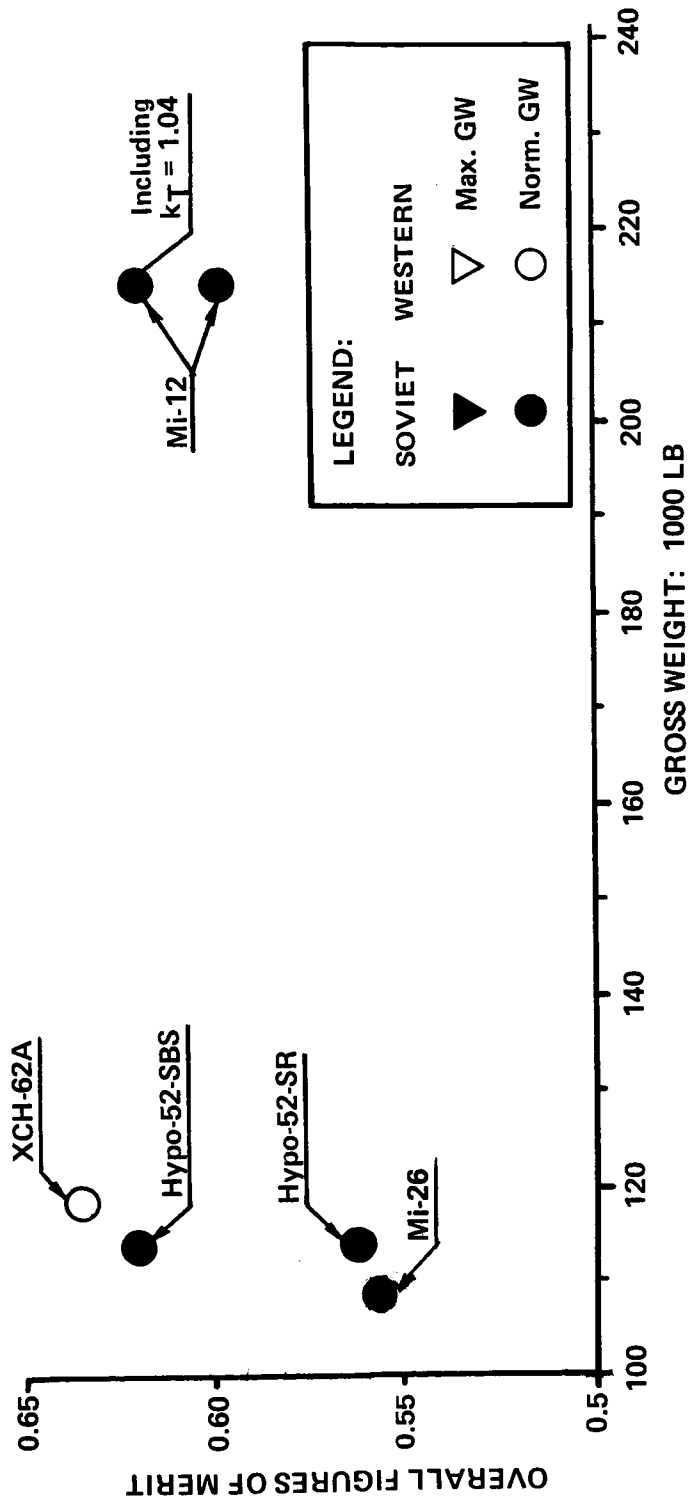

Figure 6.10 Overall figures of merit in hover OGE at SL, ISA of Soviet and Western helicopters of the over 100,000-lb gross weight class.

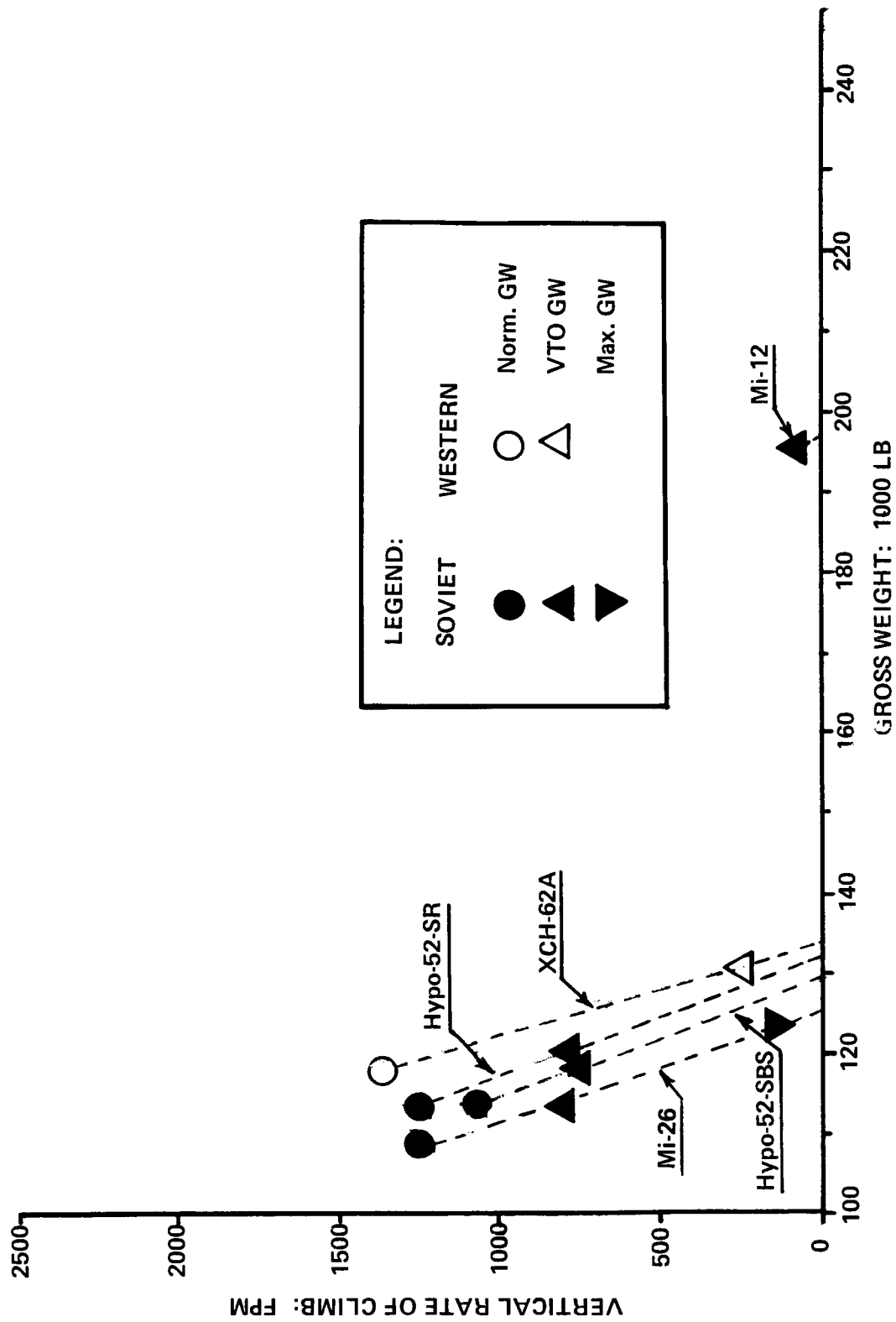

Figure 6.11 Vertical rate of climb at SL, ISA of Soviet and Western helicopters of the over 100,000-lb gross weight class.



The vertical climb performance of the Mi-26 appears to be almost identical to that of the Hypo 52-SR (Table 6.3 and Fig. 6.11).

According to Boeing Vertol data, the  $(W_{gr})_{h_{max}}$  for the XCH-62A helicopter is 134,300 lb. This is below the maximum flying gross weight of the aircraft. The  $(W_{gr})_{VTO} = 130,300$  lb, and the vertical climb rate corresponding to this weight is about 260 fpm. This rate of climb is lower than for the hypothetical helicopters because of the constancy of the transmission limited power available up to the VTO altitude of 3000 ft. At normal gross weight,  $V_{c_v} = 1390$  fpm, which is slightly higher than for the hypothetical and the Mi-26 helicopters.

Looking at Fig. 6.11, one would get the impression that as far as vertical climb performance is concerned, the Soviet helicopter designers actually improved the vertical performance capabilities of their heavy-lift models, making them comparable to those expected for the U.S. HLH.

## 6.4 Energy Aspects in Hover

**Table 6.4.** In order to provide a common basis for the compared helicopters, the investigation of energy aspects in hover was performed at their maximum OGE hovering gross weights at SL, ISA, except for the Mi-26, where the maximum flying weight is lower than the SL, OGE hovering weight. As in the preceding chapters, all of the important information required to compute the variation of hourly fuel consumption with the indicated hovering time per pound of ideal maximum payload is indicated in Table 6.4.

Hourly Fuel Consumption per Pound of Payload in Hover OGE, at SL, ISA (Fig. 6.12). It is evident from Fig. 6.12 that with respect to the important criterion of energy consumption per unit weight of payload in hover, the Mi-12 helicopter definitely shows poor performance. This is especially visible when compared with the XCH-62A curve.

Similar to other comparisons, as witnessed by the Hypo 52-SR and Hypo 52-SBS models, it is also evident that Soviet designers have been striving to achieve energy consumption per unit of payload comparable to that of their Western counterparts and, in the case of the Mi-26, have succeeded.

## 6.5 SHP Required in Level Flight at Sea Level

Establishment of the  $(SHP/W_{gr}) = f(V)$  Relationship. Since comparison of forward flight aspects is performed at maximum flying weights, the  $(SHP/W_{gr}) = f(V)$  relationship must be established for all of the compared helicopters at that particular gross weight. For the XCH-62A helicopter with no external load, the  $SHP = f(V)$  curves at sea level, 95°F were available (Fig. 6.13). Using an approach identical to that applied to the CH-47D in Section 5.5, the basic inputs needed for calculating  $(SHP/W_{gr}) = f(V)$  at SL, ISA were found (Table 6.5). From this table it can be seen that the  $f$  and  $\tilde{c}_d$  values computed for both

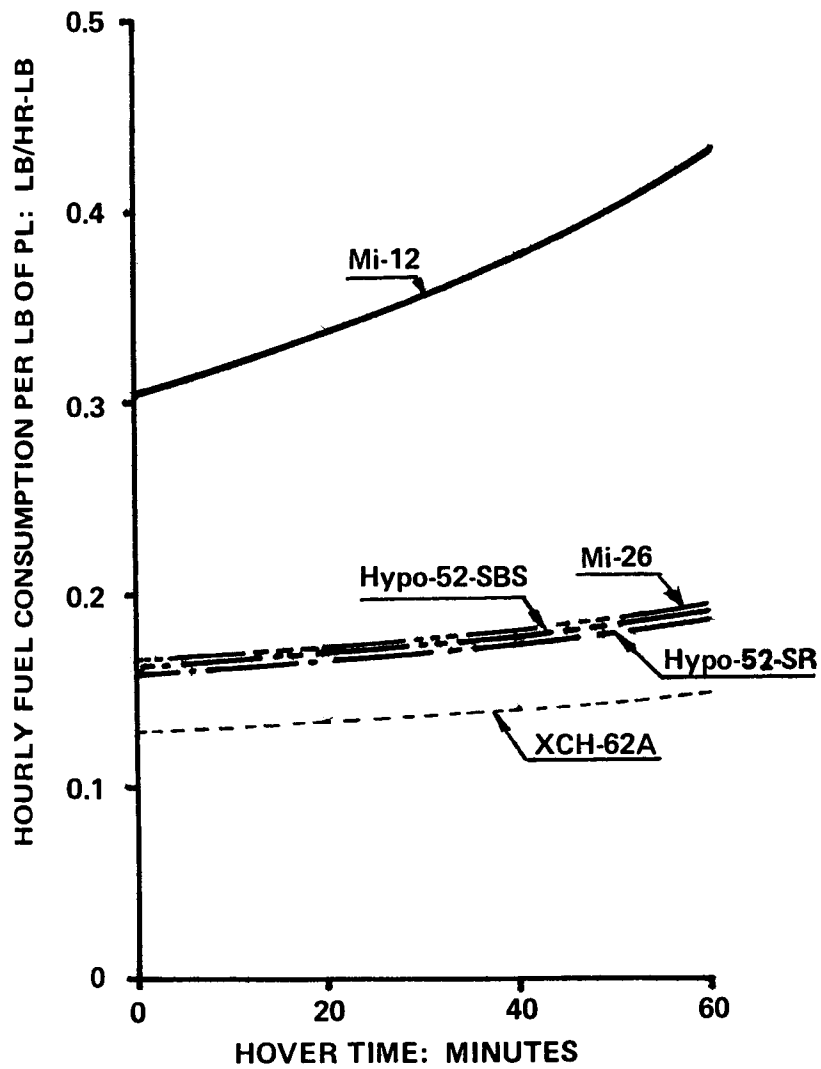

Figure 6.12 Variation with time of hourly fuel consumption per pound of ideal maximum payload in hover OGE at SL, ISA for Soviet and Western helicopters of the over 100,000-lb gross weight class.

TABLE 6.4  
ENERGY ASPECTS IN HOVER AT S/L, ISA  
OVER 100,000-LB GROSS WEIGHT CLASS

ITEM	HELICOPTER				
	Mil V-12 Mi-12	Hypothetical Hypo 52-SR	Mil Mi-26	Hypothetical Hypo 52-SBS	Boeing Vertol XCH-62A
GROSS WEIGHT: LB	197,600	131,375	123,480	129,210	134,300
Overall Figure of Merit	0.618	0.562	0.555	0.620	0.635
SHP Required in Hover: hp	26,000	23,250	22,140	20,000	17,700
T.O SHP Installed: hp	26,000	23,250	22,480	20,000	24,240
SHP <sub>req</sub> /SHP <sub>T.O</sub>	1.0	1.0	0.98	1.0	0.73
sfc: lb/hp-hr	0.63	0.44	0.44	0.47	0.50
Hourly Fuel Flow per Pound of GW: lb/hr-lb	0.0831	0.0779	0.0782	0.0727	0.0659
Zero Time Payload: lb	54,300	65,200	60,270	59,050	68,750
Ratio of Zero Time PL to GW	0.275	0.496	0.488	0.457	0.512
Hourly Fuel Flow per Lb of PL for t = 0: lb/hr-lb	0.302	0.157	0.160	0.159	0.129
t = 1/3 hr	0.336	0.166	0.171	0.168	0.135
t = 2/3 hr	0.378	0.175	0.181	0.178	0.141
t = 1 hr	0.432	0.186	0.193	0.188	0.148

TABLE 6.5  
EQUIVALENT FLAT PLATE AREAS AND AVERAGE BLADE PROFILE COEFFICIENTS  
(BASED ON FIGURE 6.13)

ITEM	GROSS WEIGHT: LB	
	148,000	118,000
	ASSUMED VALUES	
$k_{ind_f}$ at $V_{max}$	1.8	1.8
$k_{ind_f}$ at $V_e$	1.7	1.7
$k_{v_f}$ at $V_{max}$	1.03	1.03
$k_{v_f}$ at $V_e$	1.04	1.04
$\eta_{oa}$	0.96	0.96
	COMPUTED VALUES	
$w_{fp}$ : psf	612.0	514.2
$f$ : sq.ft	241.8	229.5
$\bar{c}_d/\bar{c}_l$	1/71.7	1/58.4
$\bar{c}_l$	0.60	0.48
$\bar{c}_d$	0.0084	0.0082

gross weights are close. However, instead of taking their averages in computing  $(SHP/W_{gr}) = f(V)$  for  $W_{gr} = 148,000$  lb at SL, ISA, the figures obtained in the first column of Table 6.5 were used. This was done because the gross weight shown in Fig. 6.13 and that being of interest are now identical, while the ambient conditions differ only slightly (SL, 95°F vs SL, ISA).

At this writing, no data is available on the forward rate of climb of the Mi-12 helicopter. Consequently, only the single-point approach based on  $V_{max}$  could be used for the determination of the  $(SHP/W_{gr}) = f(V)$  relationship.

In the case of the hypothetical helicopters, the normal process of establishing the  $(SHP/W_{gr}) = f(V)$  dependence is reversed;  $V_{max}$  is not known, but the equivalent flat plate areas for the baseline configurations are given in Table 6.1.

Since the main-rotor radii of the Hypo 52-SR and Hypo 52-SBS are larger than those of the baseline machines, the equivalent flat plate area values in Table 6.1 were arbitrarily increased by 5 percent. Furthermore, the average blade profile drag coefficients were assumed as  $\bar{c}_d = 0.0095$  for both helicopters.

The input data for the Mi-26 helicopter are not certain, since the SHP required at the maximum flying speed of 159.2 kn is not known. In this respect, it was assumed that  $V_{max}$  corresponds to the maximum continuous power rating which, in turn, was postulated (following indications in Ref. 1) as amounting to  $0.925 SHP_{TO}$ ; i.e., 20,790 hp. There is no information available as to the rate of climb in forward flight. Consequently, the single-point approach was used to determine  $w_{fp}$  and  $f$  at NGW. However, the so-obtained values of  $w_{fp} = 352$  psf and the corresponding  $f = 310$  sq.ft appear too pessimistic. Were they correct, it would mean that the very ambitious goal of aerodynamic cleanness, as represented by  $w_{fp} = 1550$  psf and  $f = 84.74$  sq.ft of the Hypo 52-SR was completely missed, which does not appear to be feasible, as inspection of the photographs of the Mi-26 generally suggests a relatively aerodynamically clean design except for the landing gear and the main and tail-rotor hubs.

Therefore, for determination of the  $(SHP/W_{gr}) = f(V)$  relationship at maximum flying gross weight, the equivalent flat plate area value of 197 sq.ft was used (representing an average of that obtained through the single-point procedure and that of the Hypo 52-SR). In this estimate  $\bar{c}_d/\bar{c}_q = 1/55$  was assumed.

Using the above and previously discussed inputs, the  $(SHP/W_{gr}) = f(V)$  relationships of the compared helicopters were computed in Table 6.6, and plotted in Fig. 6.14.

$(SHP/W_{gr}) = f(V)$  Relationships (Fig. 6.14). It can be seen from Fig. 6.14 that in the low-speed range ( $10 < V < 90$  kn), the Mi-12 helicopter exhibits the lowest power required per pound of maximum gross weight of all five of the compared helicopters. However, at flight speeds higher than 90 kn, the required power increases rapidly, due to the relative high parasite drag.

The hypothetical helicopters seem to represent a trend toward aerodynamically clean designs, especially the single-rotor configuration, with low power requirements per unit weight in the high-speed regimes

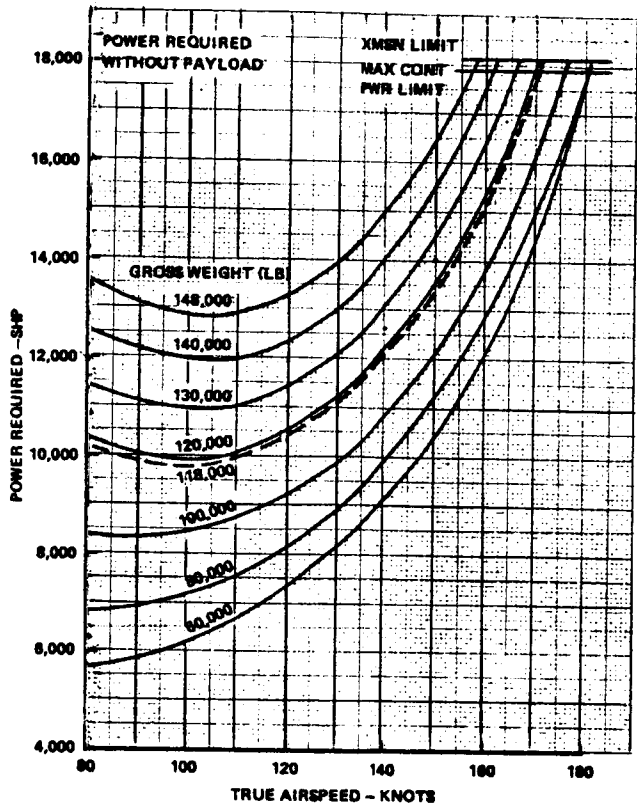

Figure 6.13 Shaft horsepower required vs speed at SL/95° F for the XCH-62A helicopter with no external load (Courtesy of Boeing Vertol Co.).

TABLE 6.6  
FORWARD FLIGHT ASPECTS AT SL, ISA  
OVER 100,000-LB GROSS WEIGHT CLASS

ITEM	HELICOPTER				
	Mil V-12 Mi-12	Hypothetical Hypo 52-SR	Mil Mi-26	Hypothetical Hypo 52-SBS	Boeing-Vertol XCH-62A
GROSS WEIGHT; LB	213,850	131,375	109,148	129,210	148,000
$\eta_{oa}$ Estimate at $V_{max}$ or $V_{cr}$					
$V_{max}$ or $V_{cr}$ ; kn	140.0		159.2		157.0 <sup>†</sup>
SHP; hp	[22,200]	[21,500]	[20,794]	[18,500]	17,700
~Main Rotor RHP; hp					
Main Rotor $V_f$ ; fps	721.4	690	[690]	690	750
Torque Compensating Thrust; lb					
Tail Rotor Disc Loading; psf					
Tail Rotor $\bar{c}_l$					
Tail Rotor $\bar{c}_d$					
Tail Rotor $\bar{c}_d/\bar{c}_l$					
Tail Rotor Power; hp					
RHP <sub>tr</sub> /RHP <sub>mr</sub>					
$\eta_{oa}$ at $V_{max}$ or $V_{crmax}$	0.95 <sup>1</sup>	0.89 <sup>1</sup>	[0.89]	0.95 <sup>1</sup>	[0.95]
<u><math>(SHP/W_{gr}) = f(V)</math>: 1st Approximation</u>					
$M_{tab}$ at $V_{max}$ or $V_{crmax}$	0.858		0.859		0.910
$\mu$ at $V_{max}$ or $V_{crmax}$	0.320		0.390		0.354
Main Rotor Disc Loading; psf	11.18	14.26	12.61	13.27	11.13
Main Rotor $\bar{c}_l$	0.595	0.55	0.52	0.60	0.60
Main Rotor $\bar{c}_d$	[0.0095]	[0.0092]	[0.0092]	0.0095]	0.0084
Main Rotor $\bar{c}_d/\bar{c}_l$	1/62.7	1/60	1/56.5	1/63.4	1/71.7
$k_{vf}$	1.02	1.02	1.02	1.02	1.04 to 1.03
$k_{indf}$	1.10	1.15	1.15	1.10	1.5 to 1.8
Computed $w_f$ ; psf	508	1550 <sup>1</sup>	352 (?)	922.9 <sup>1</sup>	612
Equivalent Flat Plate $f$ ; sq.ft	420	84.74 <sup>1</sup>	310 (?)	140.1 <sup>1</sup>	241.8
Computed $V_e$ ; kn	81.4		—		97.1
Computed SHP <sub>min</sub> ; hp	13,790		—		12,880
MAX. GROSS WEIGHT; LB	231,500	131,375	123,480	129,210	148,000
$(SHP/W_{gr})$ ; hp/lb at $F$ ; kn					
SL/ISA					
0	0.1426	0.1770	0.1793	0.1548	0.1385
40	0.0949	0.1268	0.1296	0.1081	0.1076
60	0.0739	0.0932	0.0974	0.0806	0.0932
80	0.0685	0.0785	0.0864	0.0700	0.0880
100	0.0729	0.0734	0.0867	0.0685	0.0871
120	0.0849	0.0759	0.0954	0.0731	0.0940
140	0.1056	0.0787	0.1121	0.0831	0.1093
160		0.0878	0.1367	0.0981	0.1320

NOTES:

\* Based on Figure 6.13

<sup>†</sup> At SL, 95°F

\*\*Based on  $f = 197$  sq.ft, and  $\bar{c}_d/\bar{c}_l = 1/55$

Assumed or rough estimated values are shown in brackets [ ].

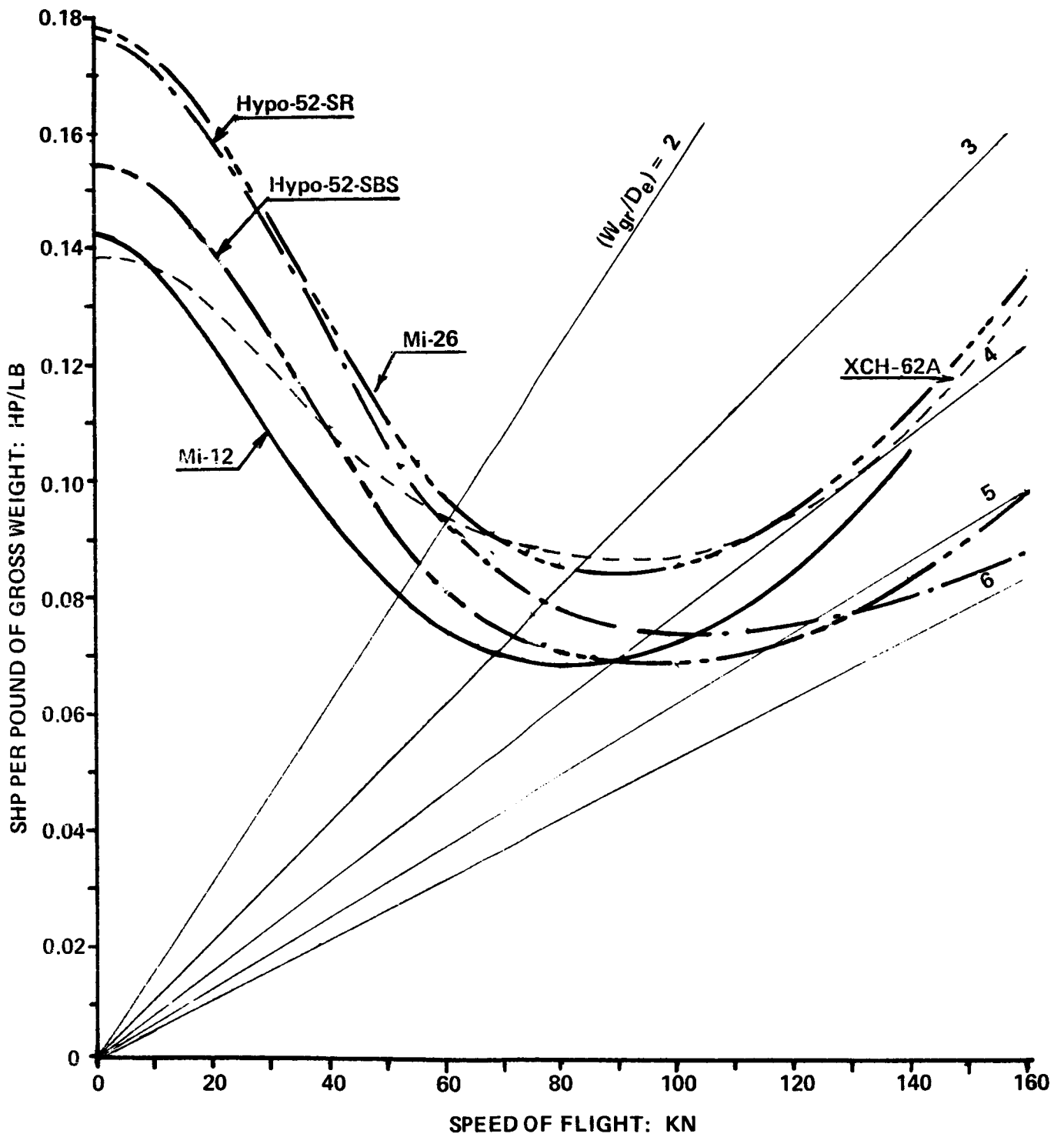

Figure 6.14 Comparison of shaft horsepower per pound of gross weight vs speed of level flight at SL/ISA of Soviet and Western helicopters of the over 100,000-lb gross weight class.

of flight. Also, their  $(W/D_e)_{max}$  values appear to be the highest for the considered class. By contrast, in the very low-speed regimes of horizontal flight, the high disc loading of the hypothetical machines (especially at their maximum flying weights) leads to more elevated per-unit-weight power requirements than for the Mi-12 and XCH-62A helicopters.

Because of the previously discussed uncertainty regarding the SHP required at  $V_{max}$  for the Mi-26, the  $(SHP/W_{gr}) = f(V)$  curve should be considered as approximate. However, the goal of aerodynamic cleanness set up in the Hypo 52-SR has probably not been achieved and consequently, at  $V > 60$  kn, the power required per pound of gross weight of the Mi-26 begins to deviate from that of the hypothetical single-rotor helicopter and becomes similar to that of the XCH-62A.

With respect to the comparison of the  $(SHP/W_{gr}) = f(V)$  curves of the XCH-62A and Mi-12 helicopters, it should be recalled that the curve of the XCH-62A was based on wind-tunnel supported manufacturer's data, while that of the Mi-12 was reconstructed from a single, and not even completely certain, pair of  $SHP$ ,  $V_{max}$  values. The  $(SHP/W_{gr}) = f(V)$  relationship of the hypothetical helicopters appear to be more as design objectives than characteristics of actual rotorcraft.

## 6.6 Energy Aspects in Level Flight at SL, ISA

**Fuel Required per Pound of Gross Weight.** The numerical inputs required for a determination of fuel required per pound of gross weight and hour, and 100 n.mi are given in Table 6.7, while the results are graphically shown in Figs. 6.15 and 6.16.

One can see from Fig. 6.15 that the high specific fuel consumption of the Mi-12 engines overbalances any advantages in the  $(SHP/W_{gr})$  levels, even in the low-speed region, resulting in the highest hourly fuel requirements per pound of gross weight throughout the whole speed range.

It is evident from Fig. 6.16 that this fuel requirement per unit of gross weight of the Mi-12 when referred to 100 n.mi of flight distance also remains higher than that of the other compared helicopters.

The fuel requirements of the hypothetical helicopters at  $V > 50$  kn, referred to both time of flight and distance, seem to be approximately on the same level as those of the XCH-62A model, while for the Mi-26, they are even closer to those of the U.S. HLH type.

**Fuel Requirements per Pound of Zero-Range Payload.** Similar to the preceding case, the numerical inputs are shown in Table 6.8, while the results are graphically presented in Figs. 6.17 and 6.18. It can be seen from the first of these figures that due to a less favorable weight-empty to gross-weight ratio of the Mi-12 helicopter, the gap between the fuel requirements per pound of zero-range payload and hour for this machine and those of the others becomes even wider than that shown in Fig. 6.15. In General, the XCH-62A helicopter represents the lowest fuel requirements per pound of zero-range payload and hour.



**TABLE 6.7**  
**RELATIVE FUEL REQUIREMENTS WITH RESPECT TO GROSS WEIGHT**  
**OVER 100,000-LB GROSS WEIGHT CLASS**

ITEM	HELICOPTER				
	Mil V-12 Mi-12	Hypothetical Hypo 52-SR	Mil Mi-26	Hypothetical Hypo 52-SBS	Boeing-Vertol XCH-62A
$(SHP_{TO}/W_{gr})$ : hp/lb	0.1123	0.1770	0.1821	0.1548	0.1638
SPEED OF FLIGHT: KN	RATIO OF SHP REQUIRED TO T.O: SHP				
0	[1.270]	1.0	[0.985]	1.0	0.846
40	0.845	0.716	0.712	0.698	0.556
60	0.658	0.527	0.535	0.521	0.569
80	0.586	0.445	0.474	0.454	0.538
100	0.649	0.415	0.476	0.443	0.532
120	0.756	0.429	0.524	0.472	0.579
140	0.940	0.445	0.616	0.537	0.643
160	-	0.496	0.751	0.634	0.813
SPEED OF FLIGHT: KN	SPECIFIC FUEL CONSUMPTION: LB/SHP-HR				
0	[0.62]	0.44	0.44	0.47	0.47
40	0.66	0.48	0.45	0.51	0.48
60	0.725	0.525	0.50	0.55	0.49
80	0.75	0.56	0.52	0.59	0.495
100	0.73	0.58	0.52	0.595	0.49
120	0.69	0.565	0.50	0.58	0.485
140	0.64	0.56	0.47	0.545	0.48
160	-	0.54	0.45	0.52	0.47
SPEED OF FLIGHT: KN	FUEL CONSUMPTION PER HOUR AND POUND OF GW: LB/HR-LB				
0	[0.0884]	0.0779	0.0782	0.0728	0.0651
40	0.0626	0.0609	0.0583	0.0551	0.0516
60	0.0536	0.0489	0.0487	0.0414	0.0457
80	0.0514	0.0441	0.0451	0.0431	0.0436
100	0.0532	0.0426	0.0451	0.0408	0.0422
120	0.0586	0.0429	0.0477	0.0424	0.0456
140	0.0676	0.0441	0.0523	0.0453	0.0525
160	-	0.0474	0.0615	0.0510	0.0620
SPEED OF FLIGHT: KN	FUEL REQUIRED PER POUND OF GW AND 100 N.Mi				
40	0.1566	0.1521	0.1458	0.1378	0.1290
60	0.0893	0.0816	0.0812	0.0739	0.0761
80	0.0642	0.0562	0.0564	0.0517	0.0545
100	0.0532	0.0426	0.0451	0.0408	0.0422
120	0.0488	0.0357	0.0398	0.0353	0.0380
140	0.0483	0.0315	0.0376	0.0324	0.0375
160	-	0.0296	0.0385	0.0319	0.0388

NOTE: Assumed or rough estimated values are shown in brackets [ ].

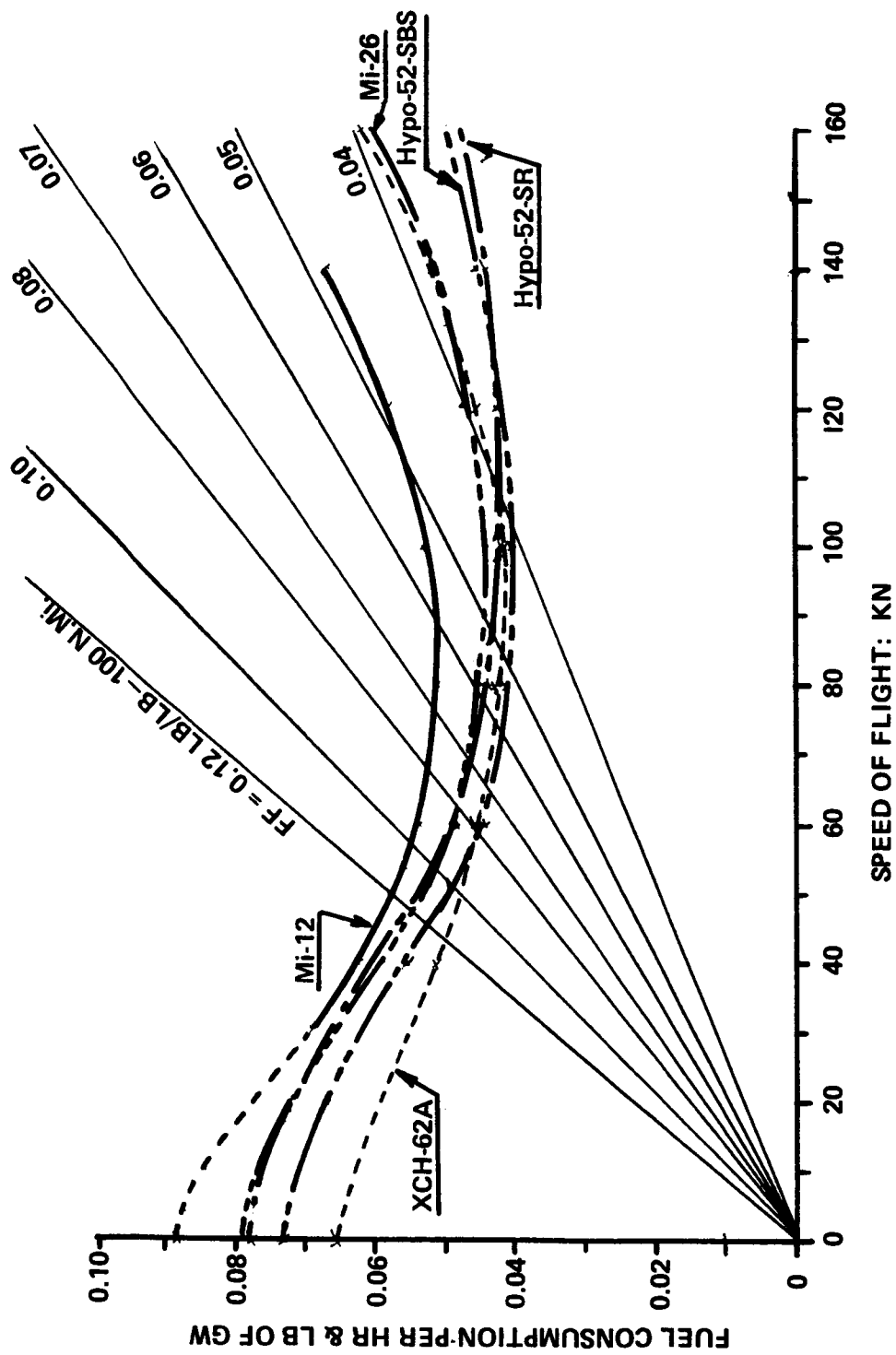

Figure 6.15 Fuel required per hour and pound of gross weight in level flight at SL, ISA of Soviet and Western helicopters of the over 100,000-lb gross weight class.

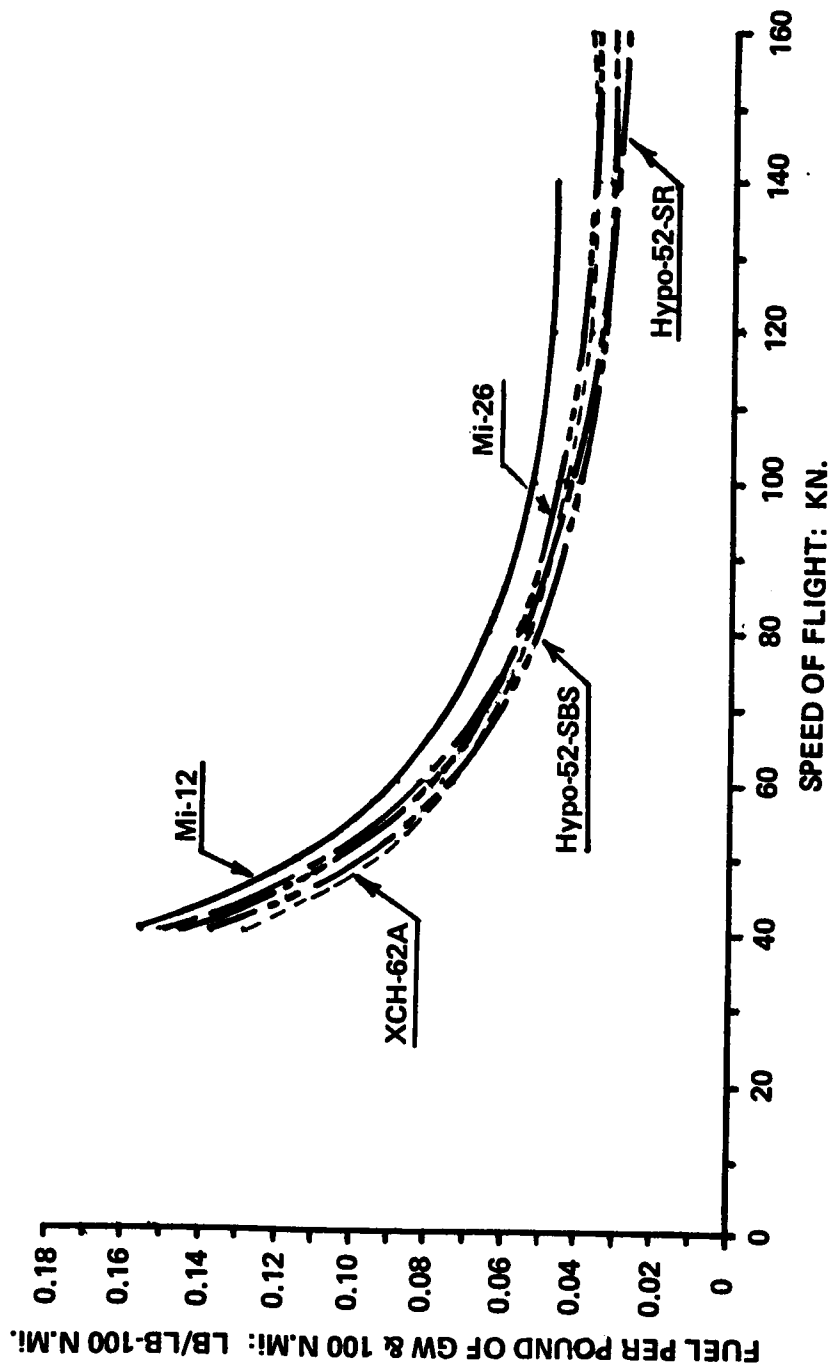

Figure 6.16 Fuel required per pound of gross weight and 100 n.mi. at SL, ISA of Soviet and Western helicopters of the over 100,000-lb gross weight class.

TABLE 6.8  
 FUEL REQUIREMENTS WITH RESPECT TO ZERO-RANGE PAYLOAD  
 OVER 100,000-LB GROSS WEIGHT CLASS

ITEM	HELICOPTER				
	Mil V-12 Mi-12	Hypothetical Hypo 52-SR	Mil Mi-26	Hypothetical Hypo 52-SBS	Boeing-Vertol XCH-62A
MAXIMUM GROSS WEIGHT: LB	231,500	131,375	123,480	129,210	148,000
PAYLOAD ZERO RANGE/GW	[0.381]	[0.496]	0.488	[0.457]	0.557
SPEED OF FLIGHT: KN	FUEL CONSUMPTION PER HOUR OF ZERO-RANGE PAYLOAD				
0	0.2320	0.1570	0.1602	0.1593	0.1169
40	0.1643	0.1228	0.1195	0.1206	0.0926
60	0.1409	0.0986	0.0998	0.0969	0.0820
80	0.1349	0.0889	0.0924	0.0906	0.0783
100	0.1396	0.0859	0.0924	0.0893	0.0758
120	0.1538	0.0865	0.0977	0.0928	0.0819
140	0.1774	0.0889	0.1072	0.0991	0.0943
160	—	0.0952	0.1260	0.1116	0.1113
SPEED OF FLIGHT: KN	FUEL CONSUMPTION PER LB OF ZERO-RANGE PAYLOAD & 100 N.Mi				
40	0.4107	0.3070	0.2987	0.3014	0.2316
60	0.2345	0.1643	0.1663	0.1615	0.1367
80	0.1686	0.1111	0.1155	0.1132	0.0978
100	0.1396	0.0859	0.0924	0.0893	0.0758
120	0.1282	0.0721	0.0815	0.0773	0.0682
140	0.1267	0.0635	0.0766	0.0708	0.0673
160	—	0.0595	0.0788	0.0698	0.0696

NOTE: Assumed or rough estimated values are shown in brackets [ ].

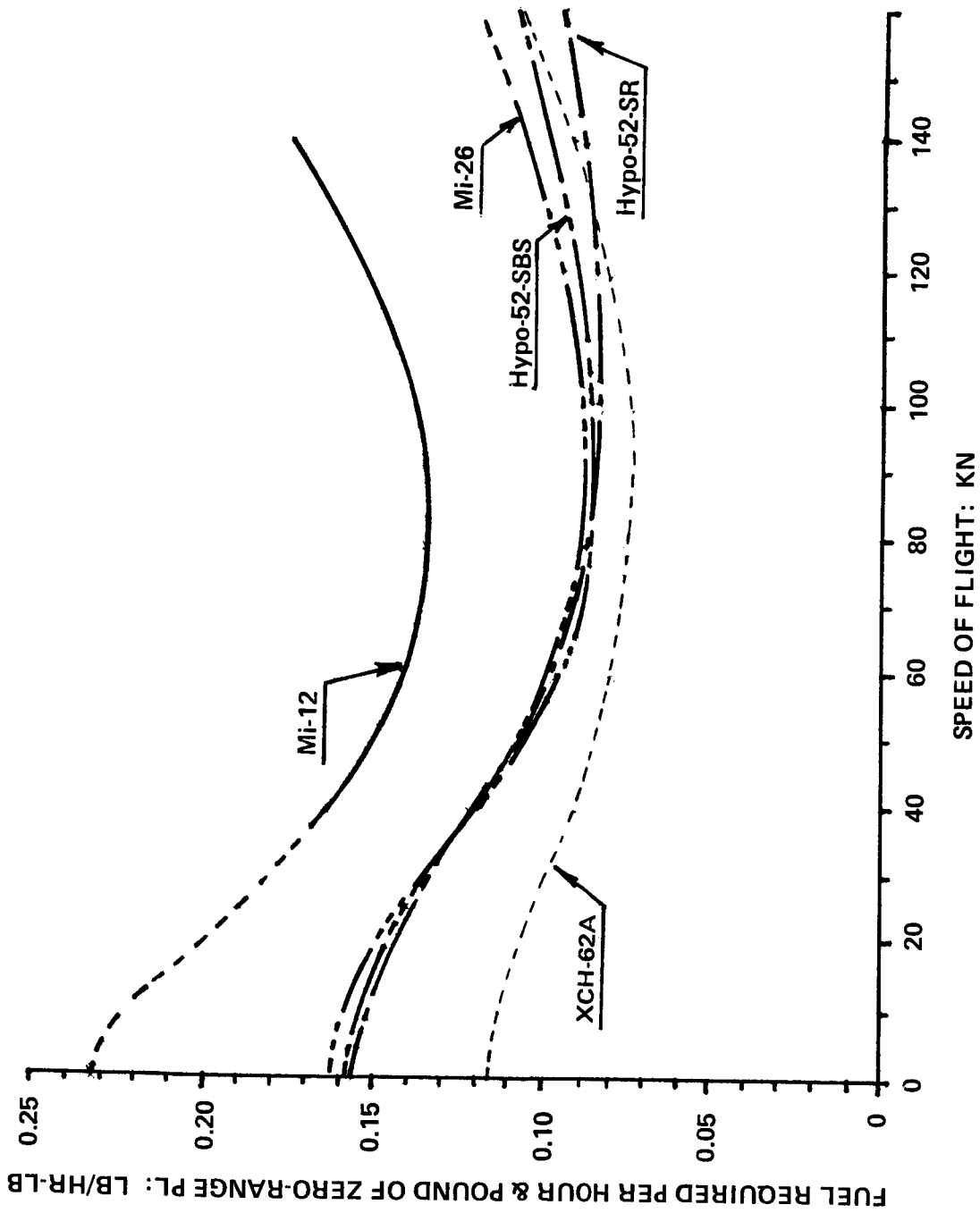

Figure 6.17 Fuel required per hour and pound of zero-range payload at SL, ISA of Soviet and Western helicopters of the over 100,000-lb gross weight class.

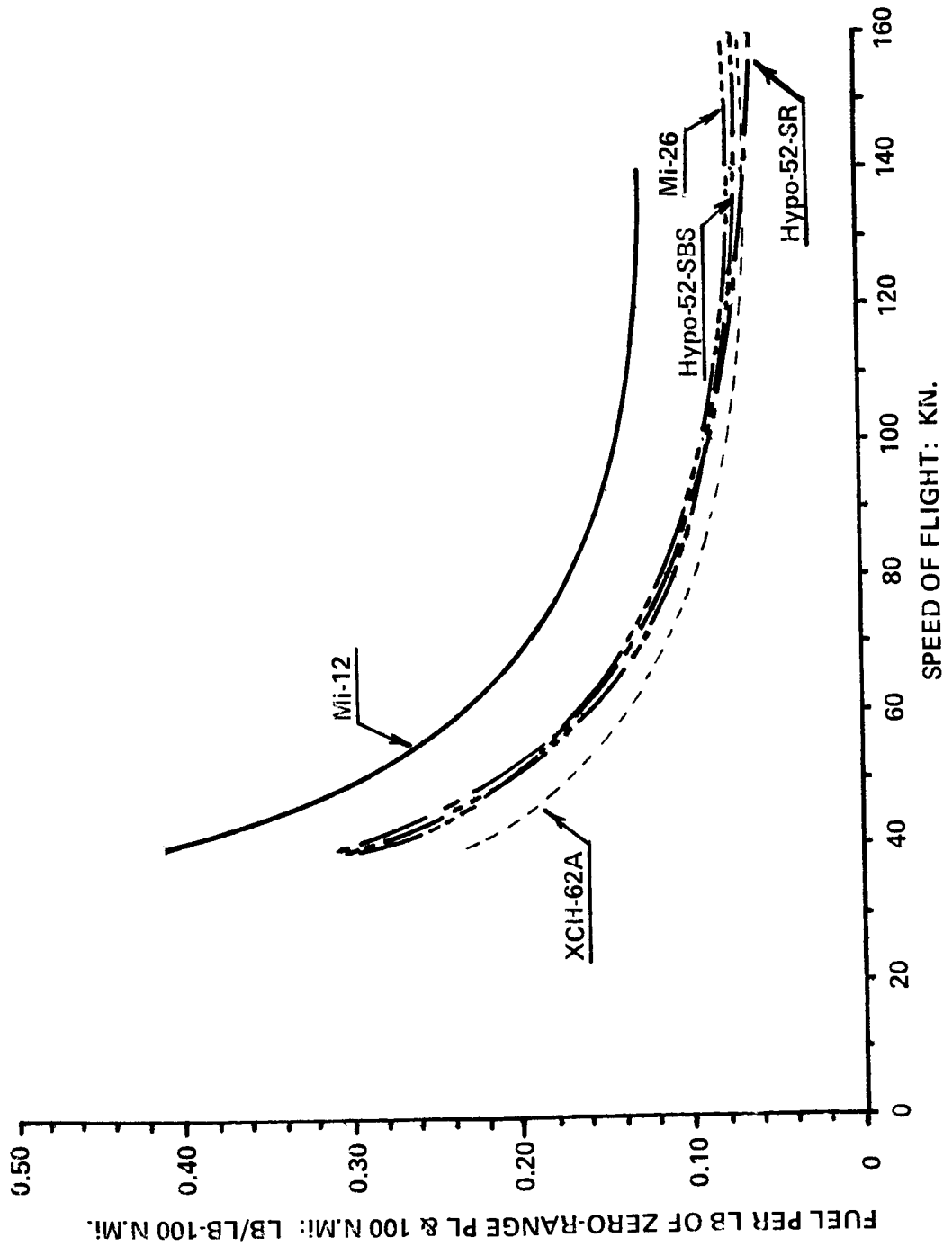

Figure 6.18 Fuel required per pound of zero-range payload and 100 n.mi at SL, ISA of Soviet and Western helicopters of the over 100,000-lb gross weight class.

The hypothetical helicopters exhibit appreciably higher payload-related fuel requirements than those of the XCH-62A in the low-speed regimes of flight; but at high flying speeds, their energy expenditure per pound of payload appear almost as good, and in the case of the hypothetical single-rotor configuration, even slightly better than those of the American HLH.

With respect to the Mi-26, it appears that the payload-related fuel consumption goals, as set by the Hypo 52-SR, were closely met except for some possible deviations in the high cruise speed area.

The above-mentioned observations are further supported by the graphs of payload-related fuel requirements referred to flight distance shown in Fig. 6.18.

Fuel Required per Pound of Payload vs Distance (Table 6.9). The trend in fuel requirements with respect to unit of weight of the zero-range payload is also confirmed by the calculations presented in Table 6.9, and graphically depicted in Fig. 6.19.

A glance at this figure would indicate that the energy requirements for transporting a pound of payload in the Mi-12 over various distances is twice as high as those of the two hypothetical helicopters, the Mi-26, and the XCH-62A.

## 6.7 Productivity

Productivity Index. Similar to Sections 4.6 and 5.7, the productivity index, calculated from Eq. (1.17a), is based on either specified (Mi-12, Mi-26, and XCH-62A) or assumed (hypothetical helicopters) maximum cruising speed values. The necessary inputs for those calculations are shown in Table 6.10, with the results presented in Fig. 6.20. It can be seen from this figure that the PI values (at maximum flying gross weights) of the XCH-62A helicopter are the highest, while those of the Mi-12 are the lowest (about one-third that of the HLH level). The hypothetical helicopters, although clearly superior to the Mi-12 in this respect, appear inferior to the XCH-62A. It should be remembered, however, that in the determination of PI values, the payload level is of prime importance and this, in turn, depends on the maximum flying weight determination. The maximum gross weight of 148,000 lb for the HLH was solely based on the maneuvering factor level of  $n = 2.0$ . Therefore at the transmission limit of 17,700 hp, this helicopter has no hovering capability at SL, ISA; while for the hypothetical helicopters,  $W_{gr\max}$  was arbitrarily established as maximum gross weights corresponding to hovering OGE at SL, ISA. For this reason, the PI values for the XCH-62A are also shown at its maximum hovering weight of 134,300 lb. It can be seen from Fig. 6.20 that the productivity index of the HLH becomes almost identical with that of the single-rotor hypothetical helicopter.

The productivity index of the Mi-26 at its maximum flying weight (which is lower than the SL, OGE hovering weight) appears to be slightly below that of the Hypo 52-SR.

TABLE 6.9  
 FUEL REQUIRED PER POUND OF PAYLOAD AT VARIOUS DISTANCES  
 OVER 100,000-LB GROSS WEIGHT CLASS

ITEM	HELICOPTER				
	Mil V-12 Mi-12	Hypothetical Hypo 52-SR	Mil Mi-26	Hypothetical Hypo 52-SBS	Boeing-Vertol XCH-62A
MAXIMUM GROSS WEIGHT: LB	231,500	131,375	123,480	129,210	148,000
Opt. Fuel Consumed per Lb of Zero- Range PL and 100 N.Mi	0.1267	[0.0595]	0.0766	[0.0698]	0.0696
DISTANCE: N.Mi	FUEL REQUIRED PER POUND OF PAYLOAD				
0	0	[ 0 ]	[ 0 ]	[ 0 ]	0
50	0.0678	[ 0.0309 ]	[ 0.0398 ]	[ 0.0363 ]	0.0360
100	0.1455	[ 0.0638 ]	[ 0.0829 ]	[ 0.0753 ]	0.0748
150	0.2353	[ 0.0989 ]	[ 0.1129 ]	[ 0.1173 ]	0.1166
200	0.3405	[ 0.1364 ]	[ 0.1809 ]	[ 0.1628 ]	0.1617
250	0.4652	[ 0.1765 ]	[ 0.2368 ]	[ 0.2121 ]	0.2110

TABLE 6.10  
 PRODUCTIVITY INDEX AT  $V_{crmax}$  AT SL, ISA  
 OVER 100,000-LB GROSS WEIGHT CLASS

ITEM	HELICOPTER				
	Mil V-12 Mi-12	Hypothetical Hypo 52-SR	Mil Mi-26	Hypothetical Hypo 52-SBS	Boeing-Vertol XCH-62A
MAXIMUM GROSS WEIGHT: LB	231,500	[131,375]	123,480	[129,210]	148,000
$W_e/W_{gr}$	0.613	[ 0.499 ]	0.504	[ 0.538 ]	0.438
$(W_{pl})_0/W_{gr}$	0.381	[ 0.496 ]	0.488	[ 0.457 ]	0.557
$V_{crmax}$ : kn	130	[ 145 ]	137.6	[ 145 ]	135
$\overline{FF}$ at $V_{crmax}$ (lb/lb-100 N.Mi)	0.063	0.045	0.052	0.046	0.050
FLIGHT DISTANCE: N.Mi	PRODUCTIVITY INDEX AT $V_{crmax}$ : LB-N.Mi/LB-HR				
0	80.8	144.2	133.4	123.2	171.6
100	67.4	131.1	119.2	110.8	156.3
200	54.1	118.0	105.0	98.4	140.9

NOTE: Assumed or rough estimated values are shown in brackets [ ].



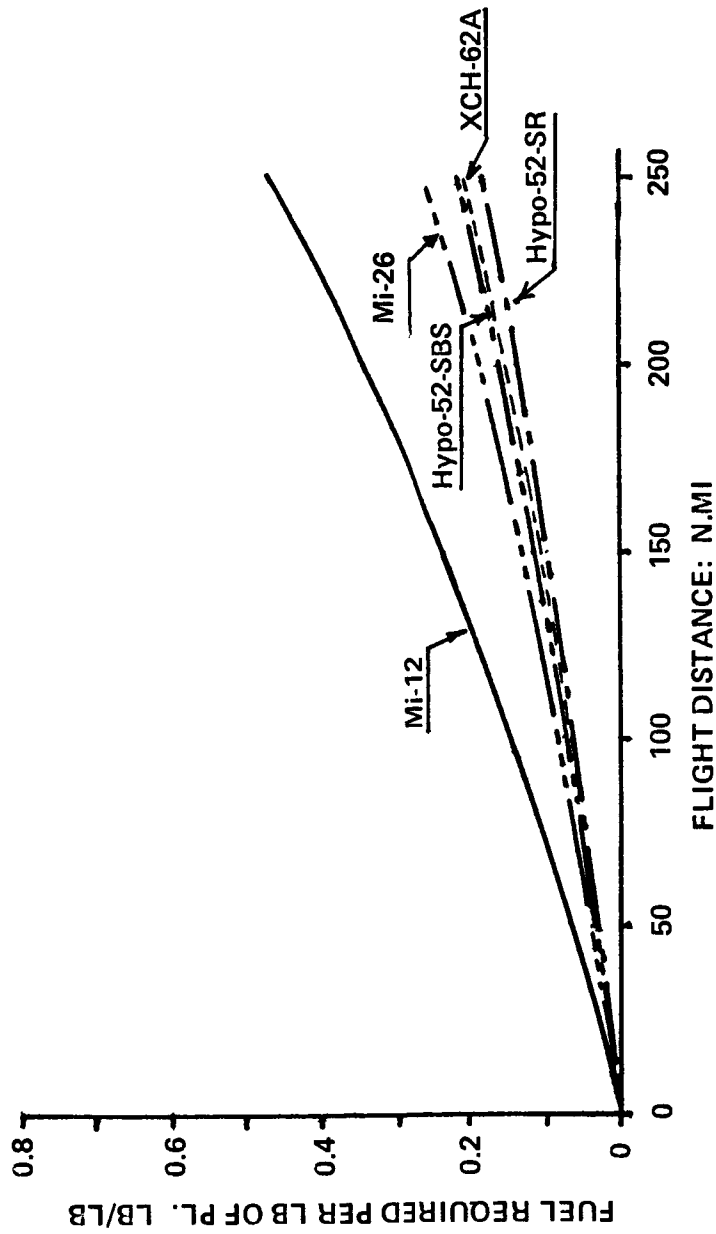

Figure 6.19 Fuel required per pound of payload vs flight distance at SL, ISA of Soviet and Western helicopters of the over 100,000-lb gross weight class.

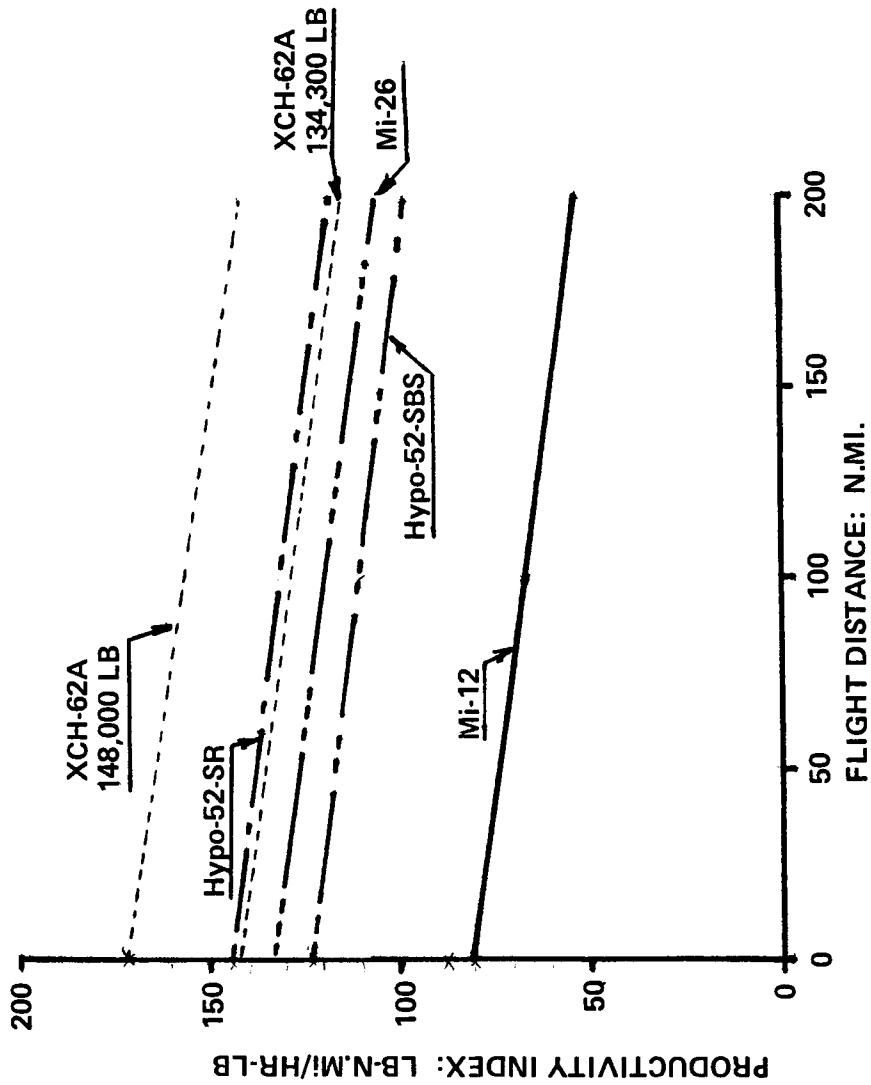

Figure 6.20 Productivity index at  $V_{cr_{max}}$  at SL, ISA vs flight distance of Soviet and Western helicopters of the over 100,000-lb gross weight class.

## 6.8 General Discussion and Concluding Remarks

It should be emphasized that as of this writing, some important uncertainties regarding the principal characteristics and performance of the Mi-12 and Mi-26 still exist.

For instance, the Mi-12 weight empty of 142,000 lb was based on the statement (see Appendix to this chapter) by the chief pilot of the Mi-12 that at 105 m.ton gross weight (231,480 lb), the aircraft has a useful load of 40 tons (88,180 lb). The weight-empty value, computed from the record flight to 2250 meters with a crew of six and 88,633 lb of payload, is somewhat lower. This record flight was presumably accomplished at  $W_{grmax} = 105 \text{ m.ton} = 231,500 \text{ lb}$  using a running takeoff (see Appendix to this chapter, and Ref. 1). Also assuming that the amount of fuel at takeoff was for one-half hour at maximum continuous power; i.e., about 6700 lb, the weight empty would amount to 134,850 lb. However, it is not clear whether the aircraft was loaded above its maximum gross weight, taking advantage of "something better than standard day conditions" (see Appendix). Because of these uncertainties, the weight empty of 142,000 lb was assumed for the Mi-12 in this study.

One should also remember that for the sake of simplicity, the rotor unloading by the wing in high-speed flight was neglected. This appears to be permissible in view of other uncertainties and relatively small differences in the  $(SHP/W_{gr}) = f(V)$  values obtained for the winged and pure helicopter configurations of the Mi-6.

There are also some uncertainties regarding the VTO gross weight. Tishchenko indicated (see Appendix to this chapter) that "The nominal 20 m.ton (44,092 lb) payload is based on HOGE at 1000 m (3,280 ft) standard day conditions; fuel for 510 km (275.2 n.mi); and 5 percent fuel reserve."

Assuming  $\bar{F}_w = 0.05 \text{ lb/lb-100 n.mi}$  (Fig. 6.16) and an average gross weight of 190,000 lb, the fuel required for 275 n.mi, with 5 percent reserve, would be 24,880 lb. For the specified crew of six, and an assumed weight empty of 134,850 lb, the gross weight allowing the helicopter to hover OGE at 1000 m ISA would still be 205,150 lb, while the VTO gross weight (corresponding to hover OGE at 3000 ft ISA—close to 1000 m) determined in Section 6—amounts to 195,000 lb. Should the  $W_{grVTO} = 195,500 \text{ lb}$  (Table 6.3) be correct, then the corresponding weight empty would amount to only 125,200 lb.

It is obvious that the difference of  $142,000 - 125,200 = 16,800 \text{ lb}$  would have a noticeable influence on all figures related to payload in general; for instance, the fuel requirements per pound of zero-range payload would be lower by about 19 percent, while the relative productivity would be higher by about 35 percent. This, of course, would make the Mi-12 somewhat more attractive with respect to other helicopters considered in the over 100,000-lb gross weight class. Nevertheless, it would not alter the overall conclusions derived below on the basis of the assumed weight empty of 142,000 lb.

From the comparison of the Mi-12 helicopter with the XCH-62A, it appears that the overall design effectiveness of the Soviet machine is not as high as its American counterpart, in spite of the fact that

aerodynamically, in the approximate 10 to 145-kn flying speed interval, the Mi-12 shows advantages over the American HLH as witnessed by the SHP required per pound of gross weight (Fig. 6.14).

However, these advantages are offset by the higher structural weight of the Mi-12. For instance, at its 'official' maximum flying weight of 231,500 lb, the zero-range payload of the Mi-12 is 88,200 lb, which is practically the same as that of the XCH-62A (88,470 lb) at a flying gross weight of only 148,000 lb. As a further consequence of the high structural weight aspects, the Mil helicopter when operating close to its maximum flying weight is underpowered, in spite of the total installed takeoff power of 26,000 hp. In order to hover OGE at SL, ISA, its gross weight must be reduced to about 198,000 lb, with the zero-range payload dropping to about 54,500 lb; while under the same circumstances, the XCH-62A helicopter with its transmission-limited power of 17,700 hp, should have a zero-range payload of about 74,800 lb.

The consequences of the high structural weight of the Mi-12 are visible in all subsequent comparisons of this aircraft with the American HLH when energy requirements are related to the unit weight of the payload (see corresponding figures); and is equally visible in the comparison of the productivity index (Fig. 6.20).

Apparently, the Soviet designers realized the above-mentioned deficiencies of the Mi-12 and tried to eliminate them in their future designs of heavy-lift helicopters. This trend is clearly visible in the so-called hypothetical helicopters of the 52-m.ton design gross weight (very similar to the design gross weight of approximately 53.5-m.ton for the XCH-62A), and was fully confirmed in the manufacturer's figures for the Mi-26.

As previously mentioned, although there are some uncertainties regarding the Mi-26 SHP value required at  $V_{max}$ . This in turn casts some doubt with respect to the  $(SHP/W_{gr}) = f(V)$  relationship and thus, on all subsequent computations as well. Nevertheless, on the basis of 'solid' manufacturer's figures regarding weights and hovering performance, plus the more speculative ones related to forward flight aspects, it may be determined that most of the weight and performance objectives as represented by the single-rotor 52-ton hypothetical helicopter have been met.

The new D-136 turboshaft, with its Western-level sfc and specific weight values, undoubtedly represents one of the most important factors in the success of the Mi-26 in attaining the design goals set for the hypothetical helicopters.

Should the operational and flying qualities aspects of the Mi-26 be as good as its weights and performance aspects, then the Soviets will have a helicopter that could prove highly competitive with the American HLH.

APPENDIX – CHAPTER 6

EXERPTS FROM BOEING-VERTOL REPORT No. D210-10301-1

“A DESCRIPTION OF THE Mil V-12 TRANSPORT HELICOPTER”

by T. R. Pierpoint

June 30, 1971

INTRODUCTION

The USSR brought a MIL B-12 helicopter (sometimes referred to as the Mil V-12) to the 1971 Paris Air Show which took place at Le Bourget Airport, Paris, France, between 27 May and 6 June. This report has been prepared to summarize what was learned from examinations of the helicopter and from discussion with various USSR personnel.

Through Mr. Igor S. Gouriev who was the Director of the USSR Exposition at the Air Show, contact was made with Mr. Marat Tishchenko who is the new chief designer and head of the Moscow helicopter plant MIL because he replaced Mr. Mil as Chief Designer upon Mr. Mil's death in January 1971.

Two extended sessions were held. The first consisted of a several hour long inspection of the aircraft itself on 1 June 1971.

A. From the USSR:

Mr. Marat N. Tishchenko . . . . . Chief of the M.L. Mil Moscow Helicopter Plant  
Mr. B. A. Koloshenko . . . . . Mil V-12 Chief Test Pilot  
Mr. Leonid Maslov . . . . . Chief, Rotor Head Design  
Mr. Nicolay Drobroljubov . . . . . Automatic Systems Designer  
Mr. Anatoly A. Sokolov . . . . . Mil-6, 8 & 10 Test Pilot  
Mr. Pelevin . . . . . Mil-8 Pilot  
and several others

B. From Boeing and Agusta:

Mr. Howard N. Stuverude . . . . . Vice President & General Manager  
Vertol Division, The Boeing Company  
Mr. Bruno Lovera . . . . . Chief Design Engineer  
Construzioni Aeronautiche Agusta  
Mr. Fred Doblhoff . . . . . Director of Engineering  
Boeing International Corp., Europe  
Mr. William Coffee . . . . . Boeing-Vertol Pilot  
Mr. T. R. Pierpoint . . . . . Director Current Programs  
Boeing-Vertol

The second session occurred on 4 June 1971 and consisted of a three to four hour technical discussion with the following persons in attendance:

A. From the USSR:

Mr. Marat N. Tishchenko . . . . . Chief of the M.L. Mil Moscow Helicopter Plant  
Mr. Leonid Maslov . . . . . Chief, Rotor Head Design  
Mr. Anatoly A. Sokolov . . . . . Test Pilot  
Mr. Nicolay Drobroljubov . . . . . Automatic Systems Engineer  
Mrs. Nina Artamonova . . . . . Interpreter

B. From the USA:

Mr. Howard N. Stuverude . . . . . Vice President & General Manager  
Vertol Division, The Boeing Company  
Mr. Tadeusz Tarczynski . . . . . Design Specialist, Vertol Division  
Mr. T. R. Pierpoint . . . . . Director Current Programs  
Vertol Division

The Contents of this report have been compiled from notes provided to the writer by each of the American participants in addition to his own. What has been written herein has been reviewed by each of the participants for accuracy and completion and therefore represent a summary of the recollections of all participants.

In the 7 or 8 hours spent with the Russians, there appeared to be absolutely no constraint on their part to discuss technical aspects of the aircraft as well as their thoughts with respect to the future and other aspects of VTOL aircraft. They would not however discuss how many Mil V-12 aircraft have been or will be constructed, how many hours have been flown, the number of hours on the aircraft at the Air Show, nor future plans. They were also vague as to whether or not the aircraft would be placed on the worldwide commercial market and would not give an indication of its selling price. However, Mr. Bart Kelley, of the Bell Helicopter Company was told by them that 20 helicopters are under construction, and Aviation Week (June 7, 1971) reported that one other Mil V-12 is flying and that several hundred will be built incorporating final design features not incorporated in the aircraft described herein.

OVERALL DESCRIPTION OF THE MIL V-12

The Mil V-12 helicopter is a giant aircraft with an overload gross weight of 105 metric tons (231,483 pounds), and a normal gross weight of 97 metric tons (213,846 pounds). It is a side by side (lateral) rotor configuration with approximately 8.5% overlap between the 5-bladed rotors.

Each rotor is supported on a pylon-wing arrangement that is braced by large struts interconnecting to both the landing gear and fuselage. At the end of each pylon-wing there is located a nacelle housing two engines, rotor transmission and rotor. Each rotor is powered by two Soloviev D-25VF turboshaft engines of 6500 shaft horsepower connected to a 13,000+ hp transmission (approximately 1500 hp additional is required for control differential purposes, so it is probable each transmission is capable of transmitting 14,500 hp) which is directly connected to the rotor.

The rotors are 35 meters in diameter (114.83 ft) Mil-10 rotors with modified blades. The rotors are connected by a cross shaft extending from each nacelle rotor transmission to a mixing transmission located in the upper center fuselage. This transmission permits power to be transmitted from one nacelle package to the other in the event of a loss of one or both engines on either side.

The aft fuselage is equipped with large clam shell doors and ramp both of which are hydraulically operated. The internal clear fuselage cross section is 4.4 meters by 4.4 meters (14.44 ft X 14.44 ft) which is the same dimension as the Anatov 22 large turboprop transport. The Mil V-12 was specifically developed to be used in conjunction with the AN-22.

Thus, the cabin is capable of clear straight in-loading of objects up to 28.15 meters (92.36 ft) long. Located in the top of the fuselage shell are two I beams running the length of the cabin to which is mounted an overhead crane electrically operated that is capable of lifting ten metric tons (22,046 pounds). Tie-down fittings are provided generously throughout the cabin floor. A single row of troop seats that fold up against the cabin are located on each side of the cabin. No soundproofing was mounted in the cabin area, but the cockpit and crew areas forward were soundproofed.

The landing gear is of conventional tricycle design, with dual wheels employed for both the nose and main wheel locations. The nose wheel swivels 360 degrees. Located on the bottom aft fuselage just ahead of the ramp are four boggie wheels apparently installed for tail low landing purposes. Hydraulically operated pads extend down when loading in order to provide tipping support to the fuselage. No cargo hook was installed in the aircraft demonstrated and when questioned, the Russian engineers replied that they did not intend to install one on this aircraft. (Conflicting information was given to Mr. Coffee by the Mil V-12 Chief Pilot, Koloshenko, who claimed there is a 16 metric ton (35,274 pound) hook available.)

The aircraft is fully equipped for instrument flight and flight under icing conditions.

It is generally accepted that this helicopter has been developed principally for the movement of military and civil equipment up to 500 km (269.70 n.mi) from airports capable of accepting the AN-22 large turbo-prop transport aircraft to isolated sites.

In flight, the aircraft was very quiet and it was maneuvered as one would expect with a very large aircraft, demonstrating gentle turns (less than 30° bank angles), high-speed flight of approximately 260 kilometers per hour (140.30 knots), and a quite slow reduction in air speed to a hover followed by rearward flight of approximately 15 knots. It was flown twice during the Air Show for approximately 10 minutes each flight. The pre-flight was observed to be several hours in length before each flight. The only thing unusual noted in the flight was that upon starting, the No. 3 engine had a tendency to torch for quite a period of time. It appeared to take about three minutes from the start for the rotors to come to their normal rotational speed of 120 rpm.

Although flown at light gross weights, the rotors appeared to have more coning than would be expected at low gross weights. From a close observation of the second slow down to hover maneuver, the aircraft demonstrated a tendency to porpoise thus appearing to require constant longitudinal stick correction by the pilot. Overall performance as given by the Russians is shown below.

A. Published USSR data given out freely at the Paris Air Show:

	Metric	U.S.
Maximum Gross Weight	105 tons	231,483 lbs
Normal Gross Weight	87 tons	213,846 lbs
Rotor Diameter	35 meters	114.8315 ft
Installed Power (4 turbines @ 6500 hp)	26,000 hp	26,000 hp
Length (less rotors)	37 meters	121.3933 ft
Length (with rotors turning)	67 meters	219.8203 ft
Height of Vertical Tail	12.5 meters	41.0112 ft
Cabin Dimensions:		
Length (including ramp open)	28.15 meters	92,3573 ft
Width (clear )	4.4 meters	14,4359 ft
Height (clear – w/o internal crane)	4.4 meters	14,4359 ft
Maximum Speed	260 km/hr	161.5580 mph
Cruise Speed	240 km/hr	149.1305 mph
Maximum Operational Altitude	3500 meters	11,483.15 ft
Crew	6	6

The Mil V-12 established a world-wide helicopter payload lifting record by lifting a 40,204 kilogram (88,633 lbs) load to an altitude of 2250 meters (7,382 ft).

B. Detailed discussions with Mr. Tishchenko revealed:

1. The 40,204 kilogram (88,633 lbs) record flight was accomplished in something better than standard day conditions, and a rolling takeoff was employed.
2. The nominal 20 metric ton (44,092 lbs) payload is based on:
  - HOGS @ 1,000 meters (3,280.9 feet), standard day conditions.
  - Fuel for 510 km (275.1979 n.mi)
  - 5% Fuel Reserve
3. Specific fuel consumption of the Soloviev D-25DV engine is “approximately”:
  - 0.258 kilograms/hp/hour which = 0.5688 pounds/hp-hour.

C. Discussions between Mil V-12 Chief Pilot, Koloshenko, and Boeing-Vertol pilot, Coffee, revealed:

1. Total ferry fuel load is approximately 38,000 lbs carried in the pylon/wings, 2 external auxiliary tanks and two internal auxiliary tanks.
2. At 105 metric tons (231,483 pounds), the aircraft has a useful load of 40 metric tons (88,184 pounds).



## WHY THE CONFIGURATION

Mr. Tishchenko advised that the side by side configuration was selected after considerable study on their part for the following reasons:

- A. In order to reduce development costs a decision was made at the highest level to mate two Mil-10 rotors in order to obtain an overload payload of 30 metric tons (66,138 pounds) with a normal payload of 20 metric tons (44,092 pounds).
- B. When saddled with this requirement, their studies showed that 5-bladed rotors of the Mil-10 type when placed in tandem would result in fuselage length and pylon height of such size that it would weigh considerably more than the current design. Further, the increased drag resulting from this configuration is, in their opinion, offset by the minimum power gains resulting from span effect as well as from the wing which provides approximately 15–20 percent of the lift in cruise.

Incidentally, early in the first session when discussing "Why the Configuration," Tishchenko pointed out that minimum power required for forward flight was 40% of hovering power for a lateral arrangement, 50% for a single rotor arrangement, and 80% for a tandem. We objected that a tandem would be as high as 80% and he then admitted it could be as low as 65%.

- C. They also favored this configuration because of the relative ease by which they could tune the pylon structures. When first constructed, the natural frequency of the pylon structures was close to one per rotor rpm, and by adding additional struts they were able to tune the structure to approximately 1.5 rotor rpm. Tishchenko opined that this would have been much more difficult to accomplish with the fuselage and pylons of a tandem configured aircraft.

When questioned whether he would have selected a tandem configuration if he were permitted to utilize rotors optimized for the desired payload and range, his reply was that only one company in the world had been able to consistently develop successful tandem aircraft, and that was Boeing-Vertol. He cited the YAK-24, the Bristol Belvedere and the Bell ASW tandem aircraft as examples of unsuccessful tandem designs and therefore he feels there must be special techniques employed in the construction of tandem helicopters which he and other USSR designers do not possess. He did not say he would not try again, however.

He also commented on the fact that he felt that the Chinook utilized too much overlap between the rotors and that he personally would not employ more than about 18 or 20 percent overlap with a 4-bladed rotor tandem. He noted that we had reduced overlap with our Model 347 from the 32% overlap in the current 3-bladed CH-47C Chinook helicopter to about 26% with increased vertical separation on the 4-bladed Model 347 helicopter.

He felt that was a step in the right direction and probably was one of the principal reasons why the 347 is showing itself to have superior flying characteristics. The Mil V-12 employs approximately 8.5% overlap with its 5-bladed rotors.

## Chapter 7

# Overview of Design Parameters and Performance

### 7.1 Introduction

**Objectives and Presentation.** As the comparative study progressed, it became apparent that in order to obtain a clear picture of design trends and performance capabilities of the compared helicopters, it would be advantageous to present each of the important comparison parameters in a specific graph, showing the variation of each parameter throughout the investigated gross-weight range. Consequently, a logarithmic gross-weight scale was selected as an abscissa, while the investigated parametric values were plotted as ordinates to the usually linear and, in some cases, also logarithmic scale.

In these summary graphs, points representing individual aircraft are no longer designated by model, but only through easy recognizable graphic symbols as shown in Tables 7.1 and 7.2 identifying the helicopter configuration, type of gross weight (i.e., maximum, normal, or VTOL), and type (i.e., Soviet production, hypothetical, or Western machines).

### 7.2 Principal Design Parameters

**Disc Loading (Fig. 7.1).** The trends in disc loading values shown in Fig. 7.1 increase with gross weight and, for the largest Western single-rotor helicopter, reaches a level of 15 psf at its maximum flying gross weight. The disc loadings of Western tandems also exhibit growth with gross weights but, in general those values remain below those of single-rotor machines. Soviet production helicopters, regardless of their configuration, are characterized by lower disc loadings than their Western counterparts. By contrast, the disc loadings of Soviet hypothetical helicopters become closer to the upper limit of the Western trend. It is apparent that this new design philosophy is followed in actual new designs as exemplified by the Mi-26 helicopter, whose disc loading goes up to 14.26 psf at its maximum flying weight.

**Power Loading.** A study of installed power loading (Fig. 7.2) would clearly indicate that values of this design parameter in earlier Soviet helicopters are, in general, above those adopted by Western designers. However, in the more recent models as the Mi-24 and Mi-26 they appear on the same level as in their Western counterparts. In this respect, they seem to closely follow the trend established by the Tishchenko team in their studies of hypothetical helicopters.

TABLE 7.1

SOVIET ACTUAL AND HYPOTHETICAL HELICOPTERS











ACTUAL HELICOPTERS	APPROX. MAX. GW (LB)	SYMBOLS			
		MAX. GW	NORM. GW	VTO GW	
KAMOV Ka-26	7,150				
Mil Mi-2 W/Allison Engines	7,800	}			
Mil Mi-2	8,150				
KAMOV Ka-25	16,100				
Mil Mi-24D	22,000		●	▲	
Mil-8	26,450	}			
Mil Mi-10K	83,800				
Mil Mi-6 W/Wings	93,700				
Mil Mi-26	123,480				
Mil Mi-12	231,500				
HYPOTHETICAL HELICOPTERS	NGW/MAX. GW (LB)	SYMBOLS			
		MAX. GW	NORM. GW	VTO GW	
S.R 15 M.Ton	33,050/[ 37,800]	}			
S.R 24 M.Ton	52,900/[ 58,700]				
S.R 52 M.Ton	114,700/[131,350]				
S.B.S 52 M.Ton	114,700/[129,200]				

TABLE 7.2

WESTERN HELICOPTERS

HELICOPTERS	APPROX. MAX. GW (LB)	SYMBOLS		
		MAX. GW	NORM. GW	VTO GW
MBB Bo-105CB	5,100	}		
BELL 222	7,850			
AEROSPATIALE SA-365N	8,500			
BELL UH-1H	9,500			
SIKORSKY S-76	10,000			
AEROSPATIALE SA-330J	16,300	}	○	△
BOEING-VERTOL YUH-61A	19,700			
SIKORSKY UH-60A	20,250			
SIKORSKY CH-3E	22,050			
BOEING VERTOL CH-46E	23,300			
SIKORSKY CH-53D	42,000	▽		
BOEING VERTOL CH-47D	50,000	▽		
SIKORSKY CH-53E	73,500	▽		
BOEING VERTOL XCH-62A	148,000	▽		

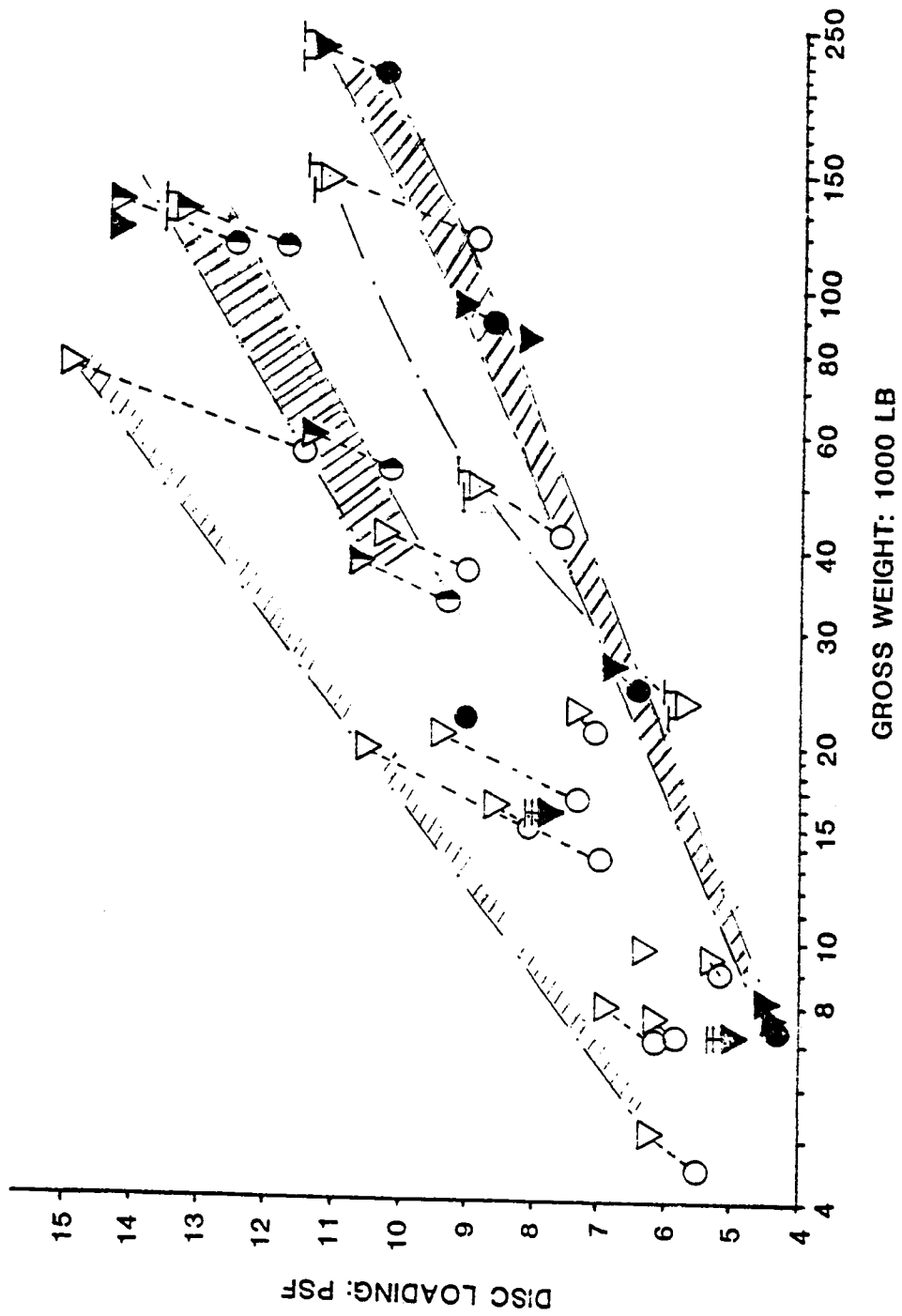

Figure 7.1 Disc loading vs gross weight

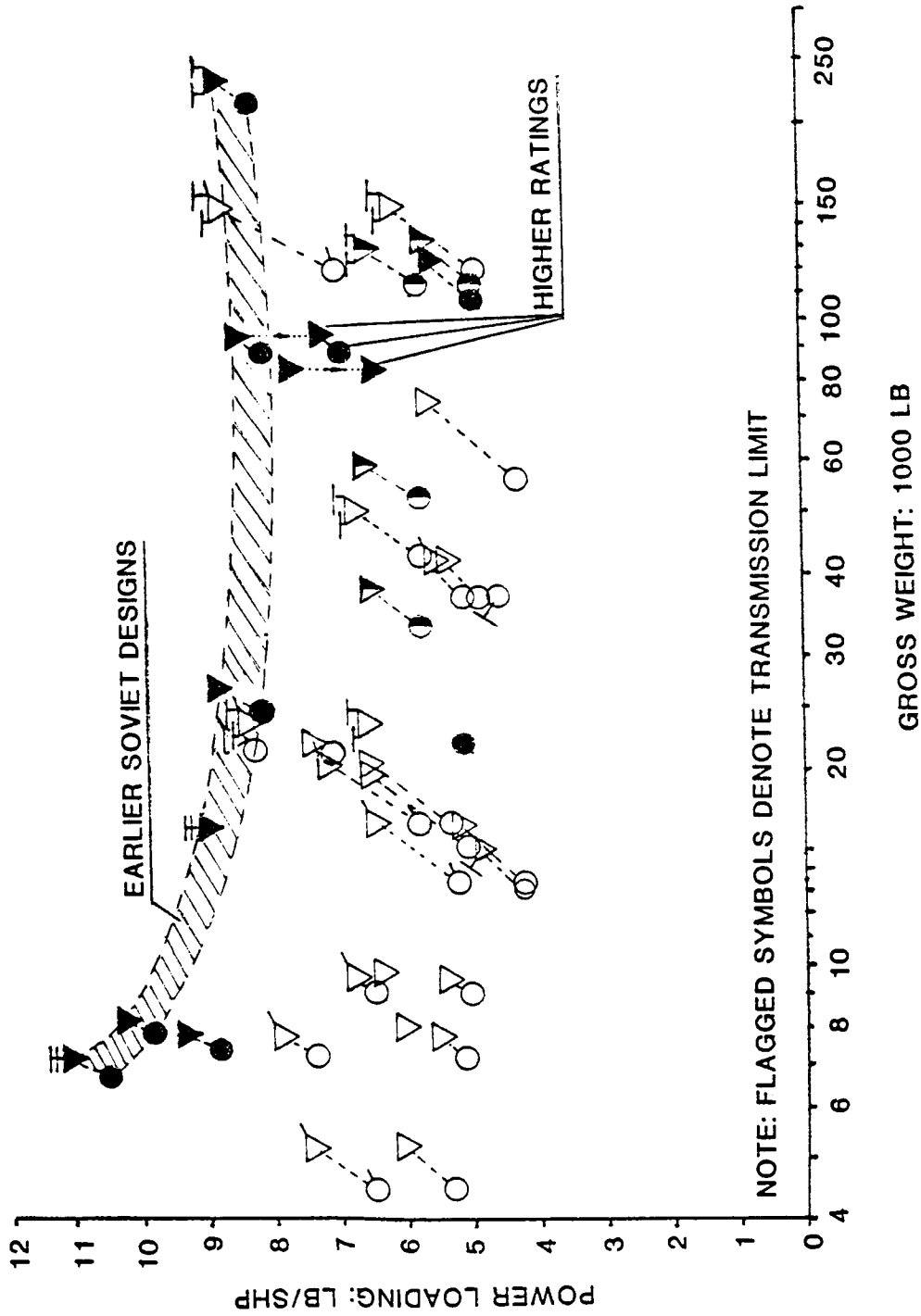

Figure 7.2 Installed power loading vs gross weight

**Tip Speed.** It appears that a tip speed of about 700 fps represents an average value for both Soviet and Western designs (Fig. 7.3). However, for smaller helicopters, Western designers seem to favor tip speeds values slightly higher than 700 fps, while those of Soviet designers appear to be noticeably lower. For large helicopters, both design schools seem to agree that tip speeds of 720 to 750 fps are most feasible.

**Advancing-Tip Mach Numbers and Advance Ratios.** It can be seen from Fig. 7.4 that conventional helicopters – regardless of their national origin – still encounter the old  $M_{tab} - \mu$  barrier. At fast cruise, the advancing tip Mach number does not usually go above the  $M = 0.9$  level, while almost all of the advance ratio values appear to be included within the 0.3 to 0.4 band.

**Equivalent Flat Plate Area Loading.** The absolute values of the equivalent flat plate area loading indicated in Fig. 7.5 may be somewhat conservative as they may, to some extent, reflect both compressibility and incipient stall effects encountered under the high advancing tip Mach number and  $\mu$  conditions; but the general trend should be correct, as well as the relative ranking of the compared helicopters regarding their aerodynamic cleanness. As may be expected, this aerodynamic cleanness improves with size (gross weight) of the helicopters; but still remains disappointingly low for the production machines when compared with fixed-wing aircraft of the same gross-weight class. It should also be noted that in their new designs, the Soviet designers hope to achieve much higher  $w_{fp}$  values than those representing the current state of the art.

Unfortunately, at this time, it is impossible to evaluate the extent that those goals of aerodynamic cleanness set up in the hypothetical machines have been achieved in the actual design represented by the Mi-26 helicopter. As previously mentioned in Chapter 6, there is no reliable available information regarding the SHP required at  $V_{max}$ . Consequently, the  $w_{fp} = 627$  psf value noted in Fig. 7.5 should be considered as preliminary. Nevertheless, it appears that the ambitious goal of  $w_{fp} = 1460$  psf shown for the Hypo 52-SR has not been approached.

**Average Blade Lift and Profile Drag Coefficients.** It is apparent from Fig. 7.6 that the average blade lift coefficients ( $C_T/\sigma$ ) exhibited by Soviet production helicopters are, in general, higher than those of the Western counterparts. Again, as far as the hypothetical and Mi-26 helicopters are concerned, their  $\bar{c}_l$ 's are more in line with those of the West.

The  $\bar{c}_d$ 's were evaluated from the known  $\bar{c}_l$  and  $(\bar{c}_l/\bar{c}_d)$  values computed from the two-point approach. It can be seen from the lower part of Fig. 7.6 that the so-obtained  $\bar{c}_d$  level appears to be quite uniformly close to the 0.01 mark for all of the considered helicopters.

### 7.3 Weight Aspects

**Weight Empty and Zero-Range Payload to Gross-Weight Ratios.** As in the preceding chapters, the maximum flying gross weight (symbolized by the inverted triangle) specified by the manufacturer of

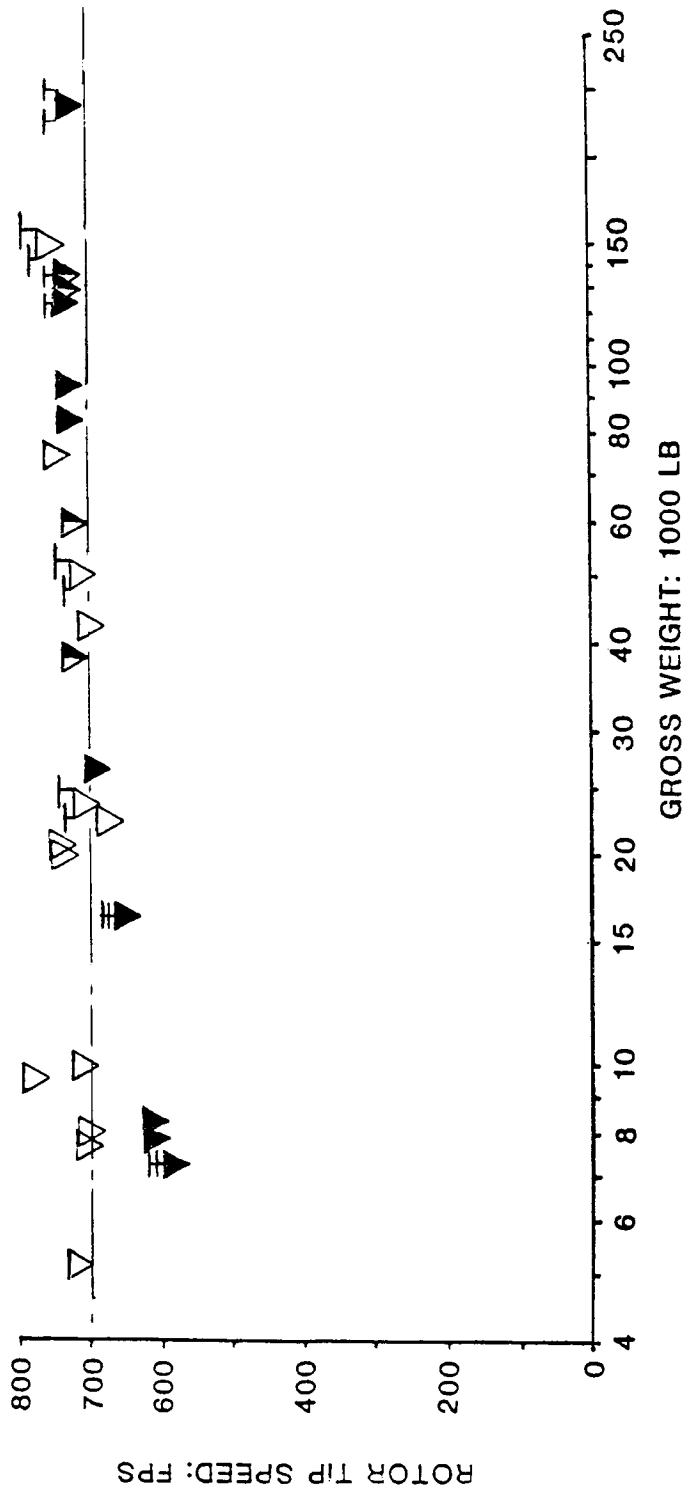

Figure 7.3 Tip speed vs maximum gross weight



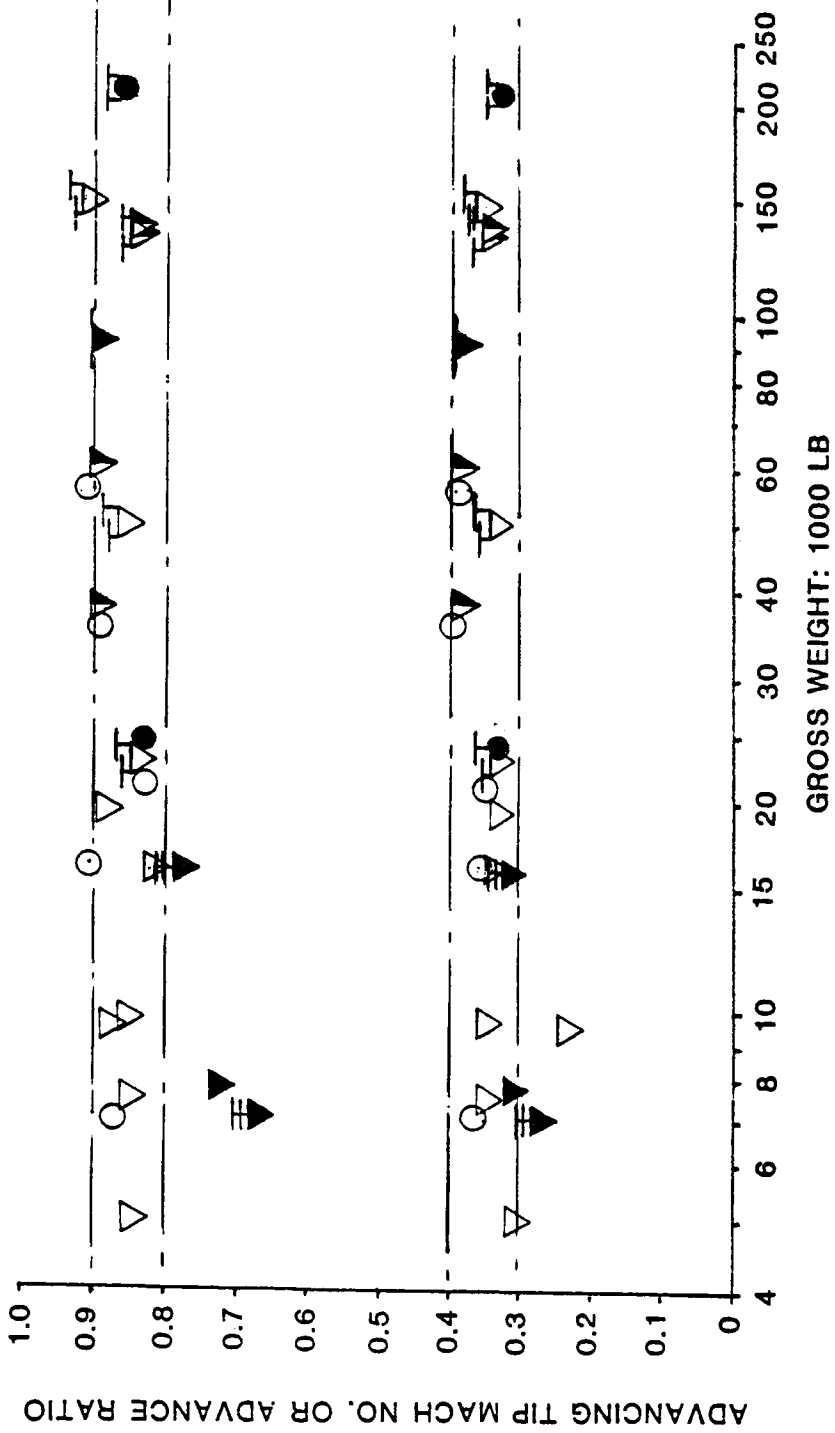

Figure 7.4 Advancing tip Mach number and advance ratio at maximum flying or fast cruise speed at SL, ISA

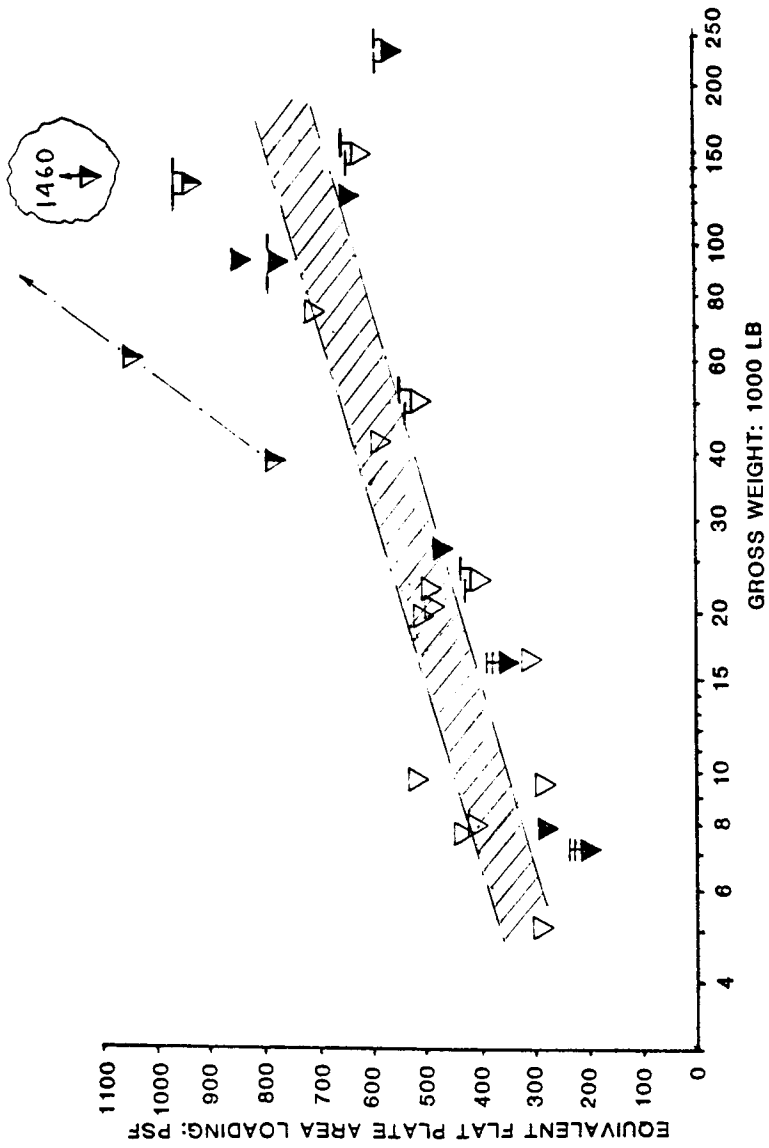

Figure 7.5 Equivalent flat plate area loading

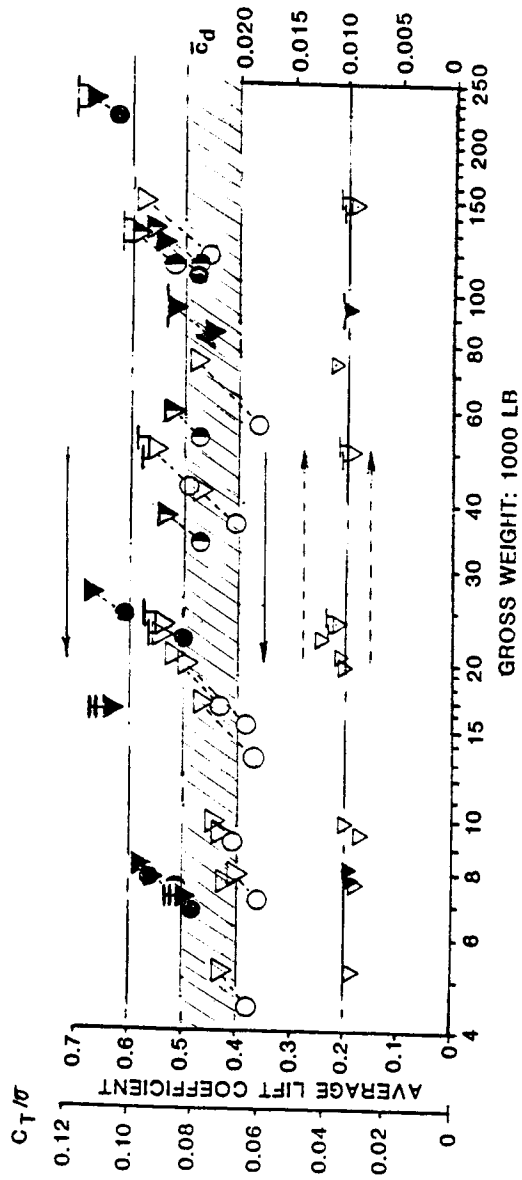

Figure 7.6 Average blade lift and profile drag coefficients at SL, ISA

each aircraft was selected whenever possible as a basis for computing the weight empty and zero-range payload to gross-weight ratios (Figs. 7.7 and 7.8). Values related to normal gross weights are also shown. From these figures, one can see that weight-wise, the Soviet production helicopters are generally less efficient than their Western counterparts. But, judging from the trends established by the hypothetical machines, they expect to have their new designs on the optimal boundary of the Western helicopters. Furthermore, it is apparent that the rather ambitious weight goals represented by the hypothetical helicopters have actually been achieved in the Mi-26 helicopter.

#### 7.4 Hovering Aspects

Overall Figure of Merit. It can be seen from Fig. 7.9 that all twin-rotor configurations (i.e., coaxial, side-by-side, and tandem) exhibit the highest overall figures of merit, generally in excess of the 0.6 level. Single-rotor helicopters show lower values of the overall figure of merit, with noticeable scatter. As far as the comparison of Soviet and Western helicopters is concerned, there seems to be no established pattern of differences.

SHP per Pound of Gross Weight Required in Hover OGE at SL, ISA. Figure 7.10 indicates that the SHP per pound of gross weight required to hover OGE at SL, ISA increases as the size, with the corresponding disc loading, becomes larger. Older Soviet and Western designs seem to form the lower boundary of the hovering power required per unit of gross weight, while in more recent designs of both schools, including the Mi-26; this expenditure of power becomes higher.

Ratio of Maximum OGE, SL Hovering to Maximum Flying Gross Weights. It is interesting to take a look at the relationships of the maximum OGE at SL, ISA hovering gross weights and maximum flying gross weights specified by the manufacturers. A glance at Fig. 7.11 would indicate that definite differences exist between production Soviet and Western helicopters. In the latter case – in contrast to the Soviet approach – the SL, ISA maximum hovering weight is almost always higher than the permissible maximum flying weight. For the Soviet hypothetical machines, this ratio is one since, as previously mentioned, the maximum flying gross weight used in this presentation was arbitrarily established as that corresponding to hover OGE at SL, ISA, and for the Mi-26, it is close to one (1.007). For the Mi-24-D at its normal gross weight, it would probably be quite high; amounting to about 1.24.

#### 7.5 Forward Flight Aspects

$\frac{SHP}{W_{gr}} = f(V)$ . A single graph showing this relationship for all of the compared helicopters would be too crowded. Consequently, the reader is referred back to the  $\frac{SHP}{W_{gr}} = f(V)$  plots for each of the four considered gross-weight classes; i.e., Figs. 3.19, 4.18, 5.18, and 6.14.

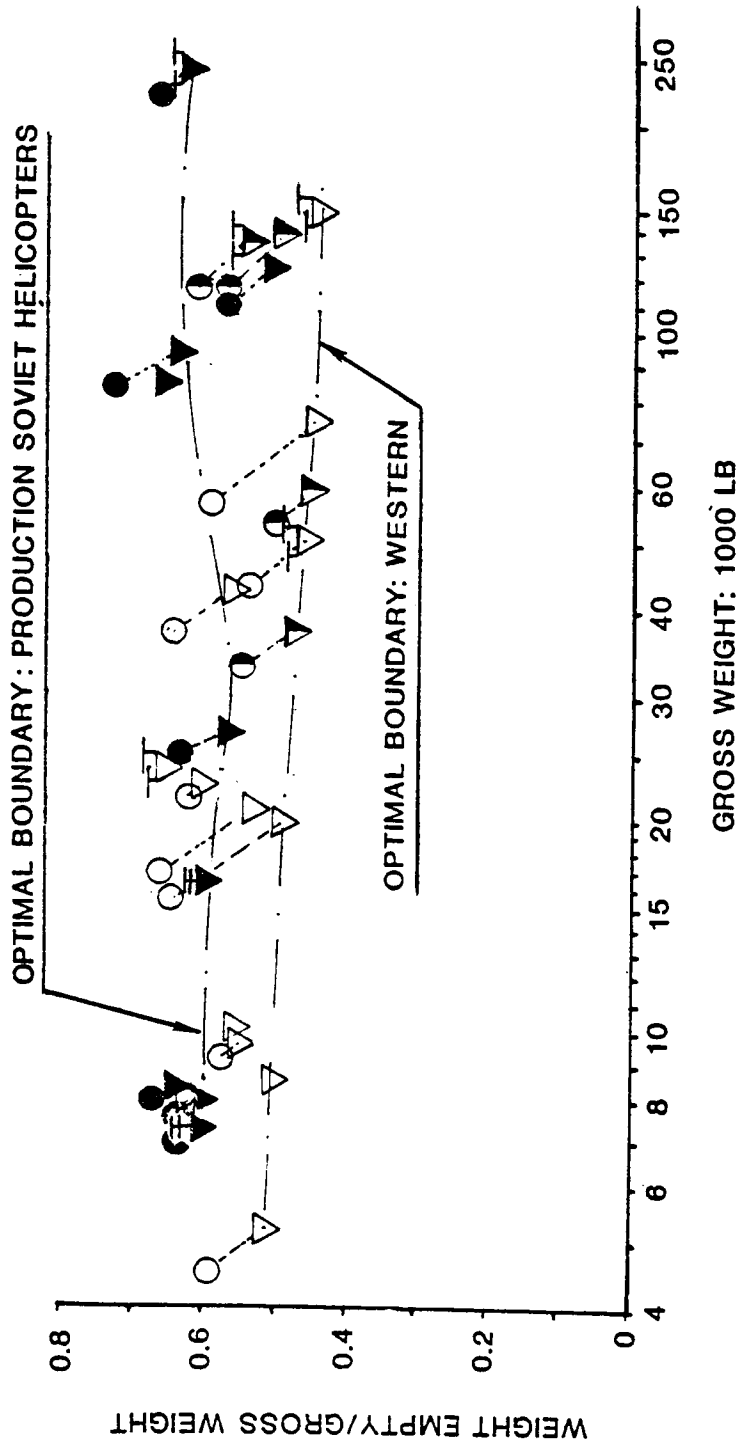

Figure 7.7 Weight-empty to gross-weight ratios

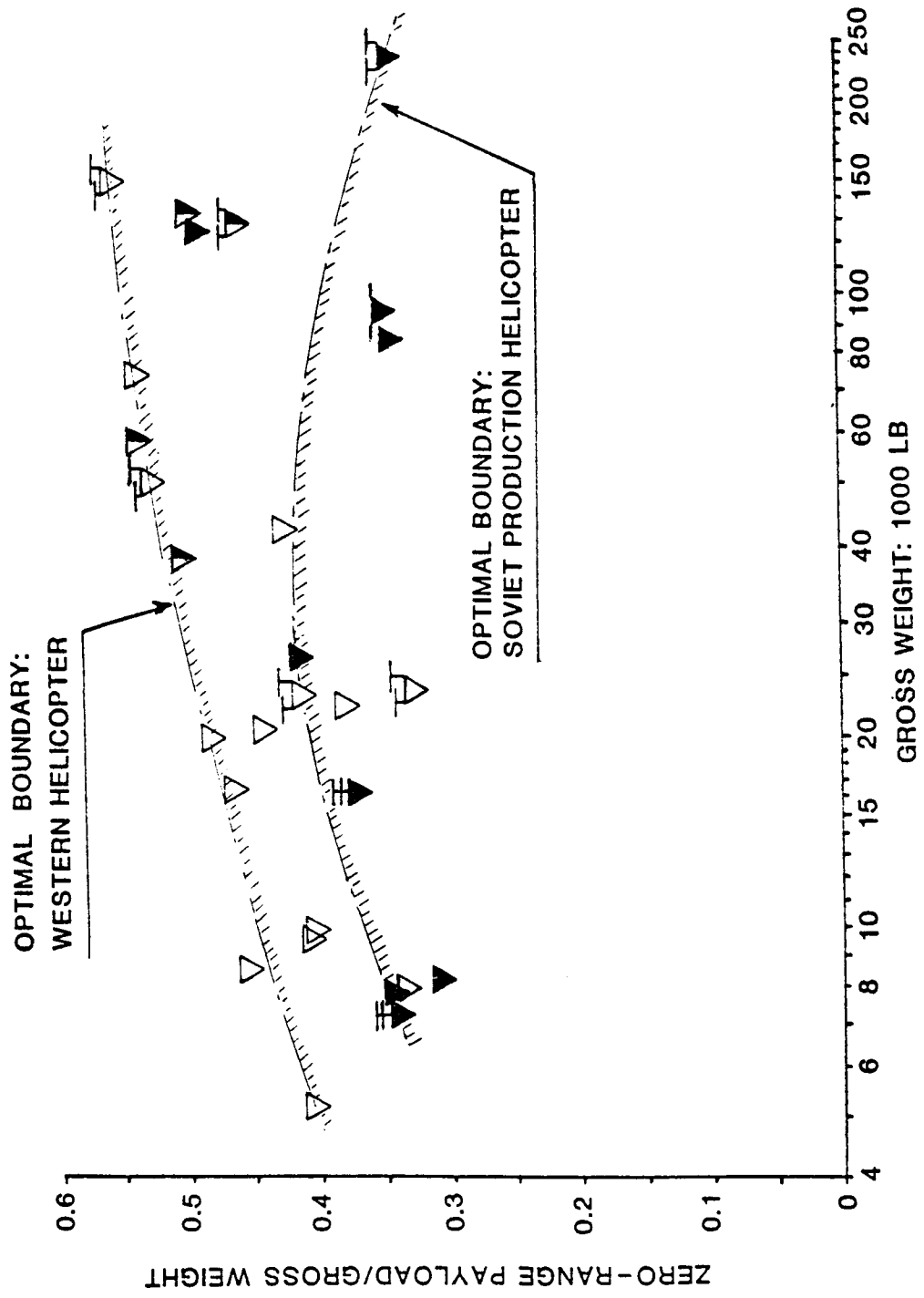

Figure 7.8 Zero-range payload to gross-weight ratios

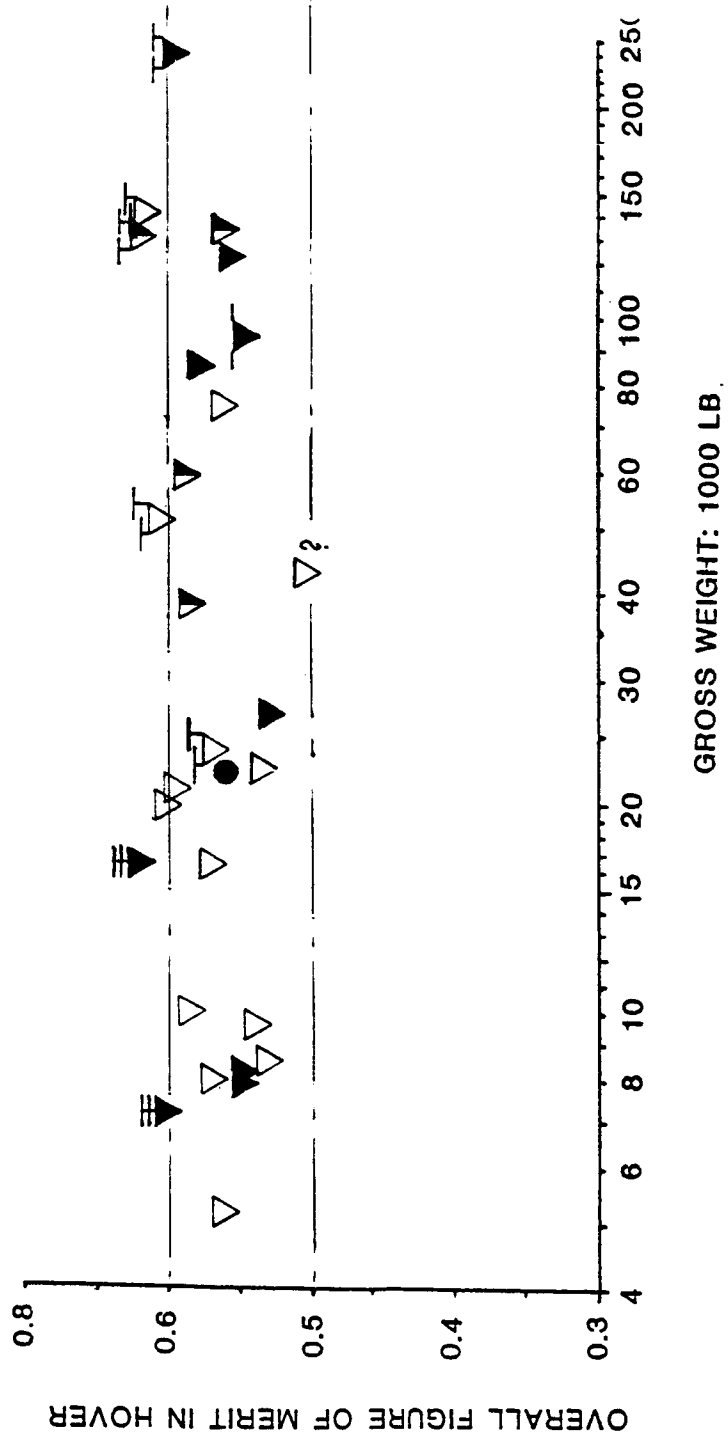

Figure 7.9 Overall figure of merit

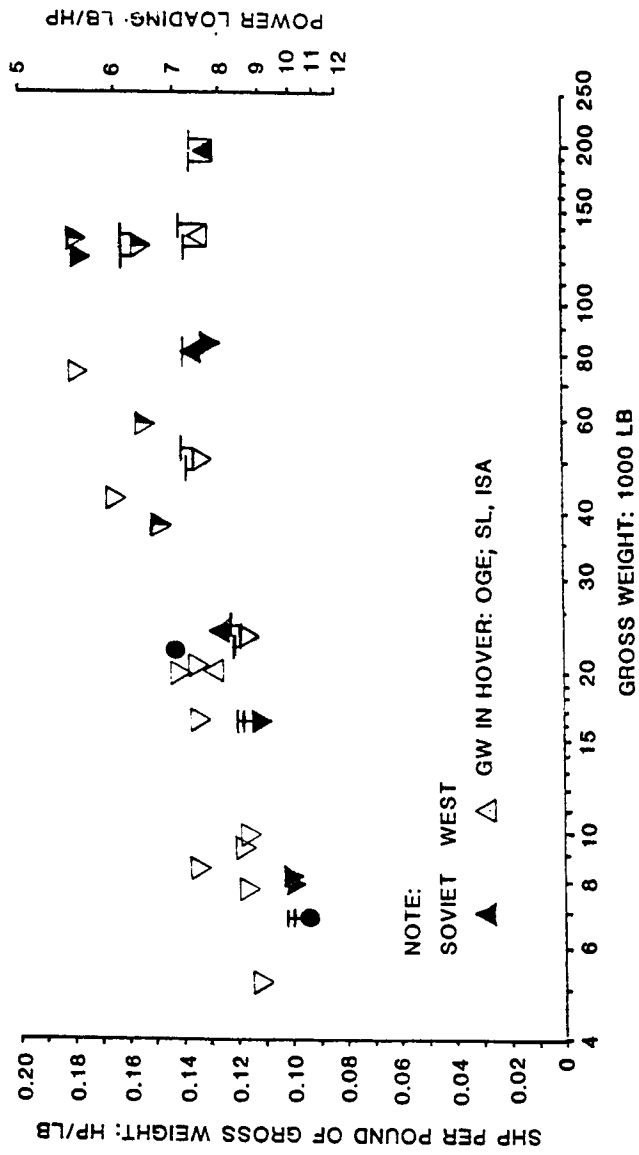

Figure 7.10 SHP required per pound of gross weight in hover OGE at SL, ISA



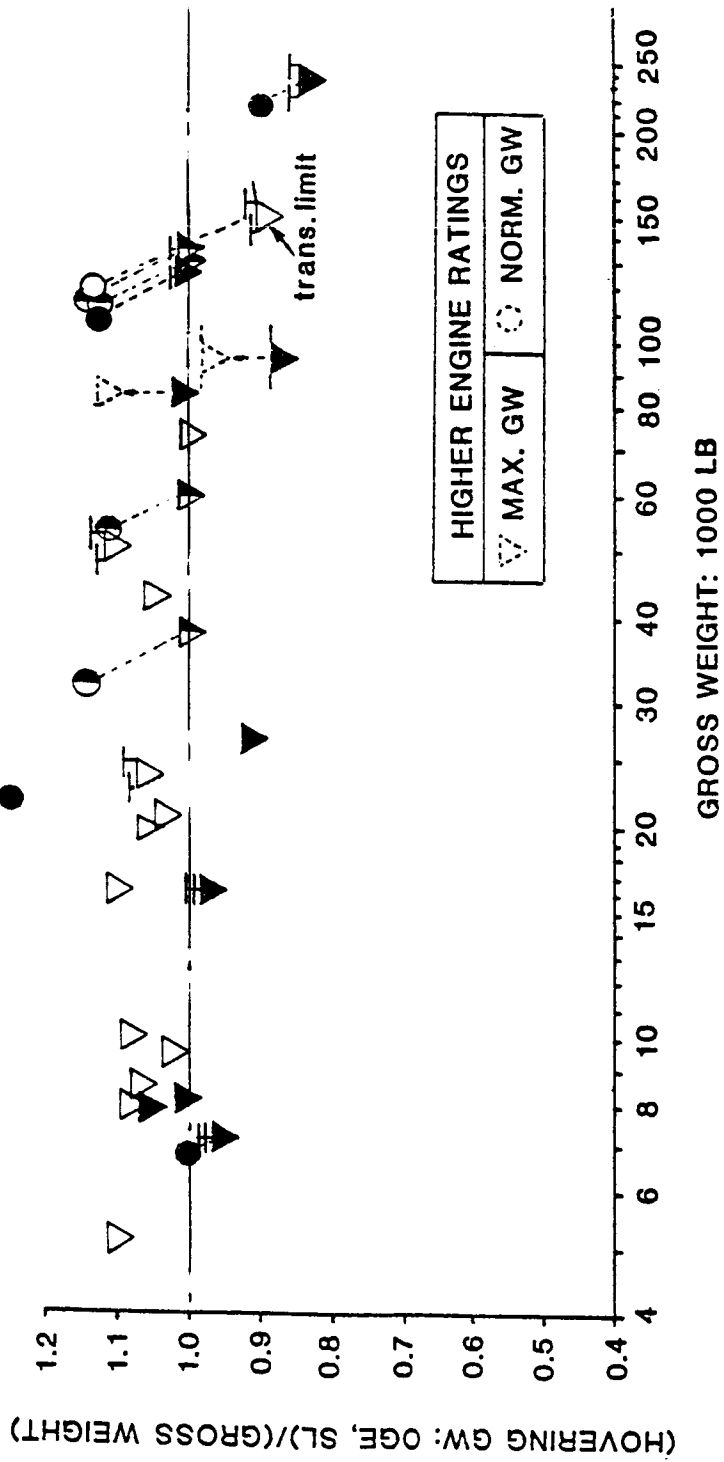

Figure 7.11 Ratio of SL, ISA, OGE hovering gross weight to maximum, or normal, gross weight

Looking at rotary-wing aircraft having gross weights of up to 12,000 pounds (Fig. 3.19) and those weighing 12,000 to 30,000 pounds (Fig. 4.18), one can see that in the low-speed range, Soviet helicopters of both classes exhibit lower power requirements than their Western counterparts. It should also be noted that with the exception of the S-76, which slightly exceeds the  $(W_{gr}/D_e) = 5$  value, the gross-weight to the equivalent drag ratios of all the other helicopters are disappointingly low.

In the higher gross-weight classes, the following should be noted: in the 30,000 to 100,000-pound gross-weight class (Fig. 5.18), the Mi-6 appears to exhibit a higher  $(W_{gr}/D_e)$  than the compared Western helicopters, as well as relatively low power requirements throughout the whole range of flight speeds. The Soviet designers expected to improve the high-speed power requirements over those of the Mi-6, as exemplified by the hypothetical 15 and 25-ton helicopters.

The same expectation of improved aerodynamic cleanness is also visible for Soviet hypothetical helicopters having gross weights over 100,000 pounds; especially, for the Hypo 52-SR helicopter (Fig. 6.14). However, on the basis of the information presently available, it appears from the  $SHP/W_{gr} = f(V)$  curve of the Mi-26 that the Soviet designers were not as successful in achieving aerodynamic cleanness as they were in reaching their structural weight and hovering performance goals.

**Optimal Gross-Weight to Equivalent Drag Ratios.** The maximum  $(W_{gr}/D_e)$  values are summarized once more in Fig. 7.12. Looking at the design parameters appearing in the formula included with this figure, one should realize that minimization of the  $w/w_{fp}$  ratio would have the greatest effect as far as betterment of maximum weight to the equivalent drag ratio is concerned. But going too far down with respect to the disc loading is not very practical because of the weight empty and overall aircraft dimensional aspects. Greatly improved aerodynamic cleanness of design – as represented by the high equivalent flat-plate area loadings – seems to be the most profitable way of improving the  $(W_{gr}/D_e)_{max}$  ratio. Apparently, the Soviet designers intended to follow that line in the past, and probably will continue to try in the future.

**Fast Cruise.** It can be seen from Fig. 7.13 that fast cruise is usually performed at about 140 kn for most Western helicopters, as well as for the large production and hypothetical Soviet helicopters. For the Mi-26, fast cruise is given as 255 km/h; i.e., 137.6 kn. Small Soviet helicopters, especially the coaxial configurations, appear to have fast cruise speeds much lower than their Western counterparts.

**Ideal Absolute Productivity.** Assuming the fast cruise values as shown in Fig. 7.13, the ideal absolute productivity was computed for payloads corresponding to the 100 n.mi range (Fig. 7.14). Here, it can be seen that the ideal absolute productivity of production Soviet helicopters remains below that of the corresponding Western machines. The points of hypothetical helicopters are on the Western-trend line, while the Mi-26 is close to that line.

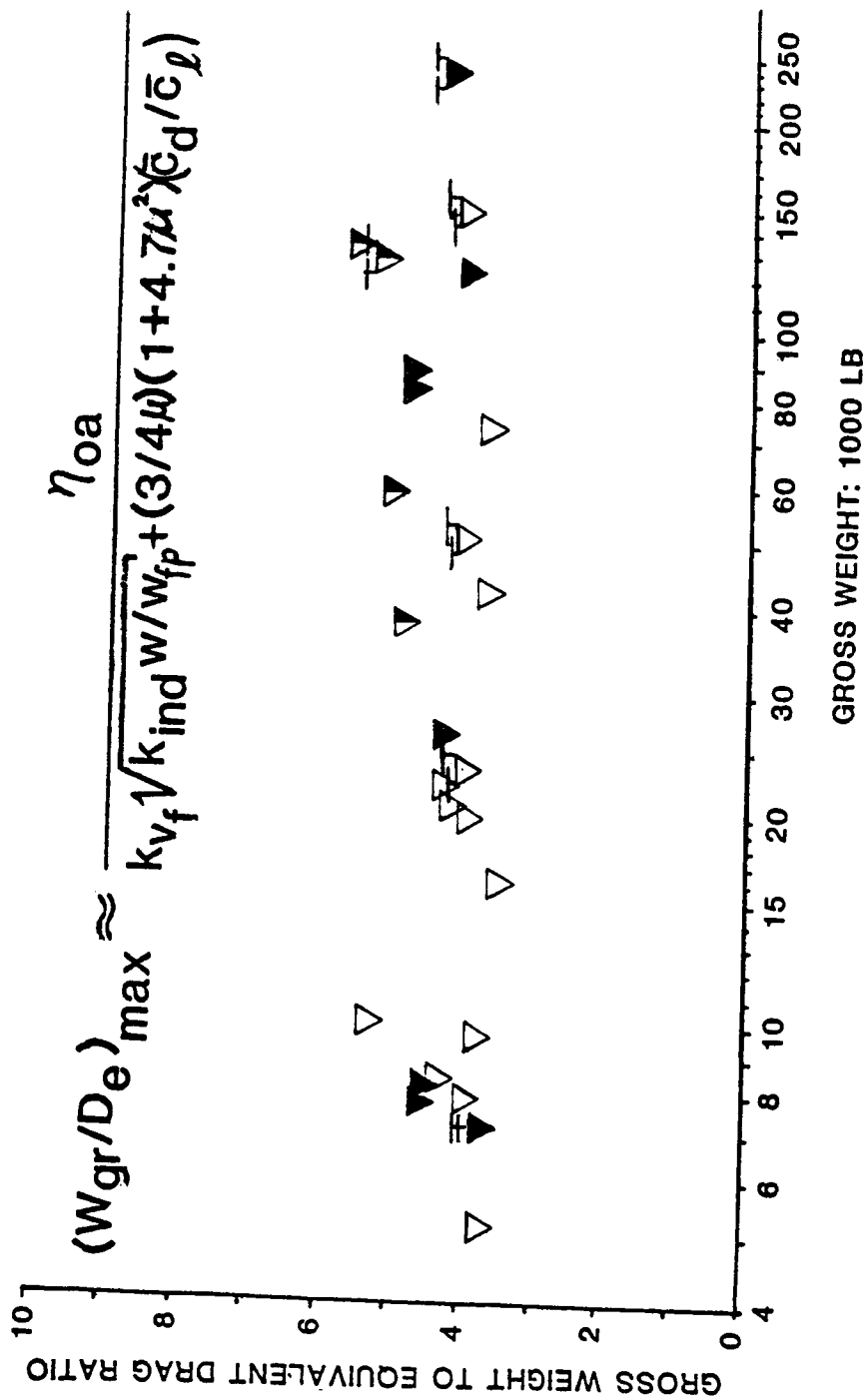

Figure 7.12 Optimal gross-weight to equivalent drag ratios

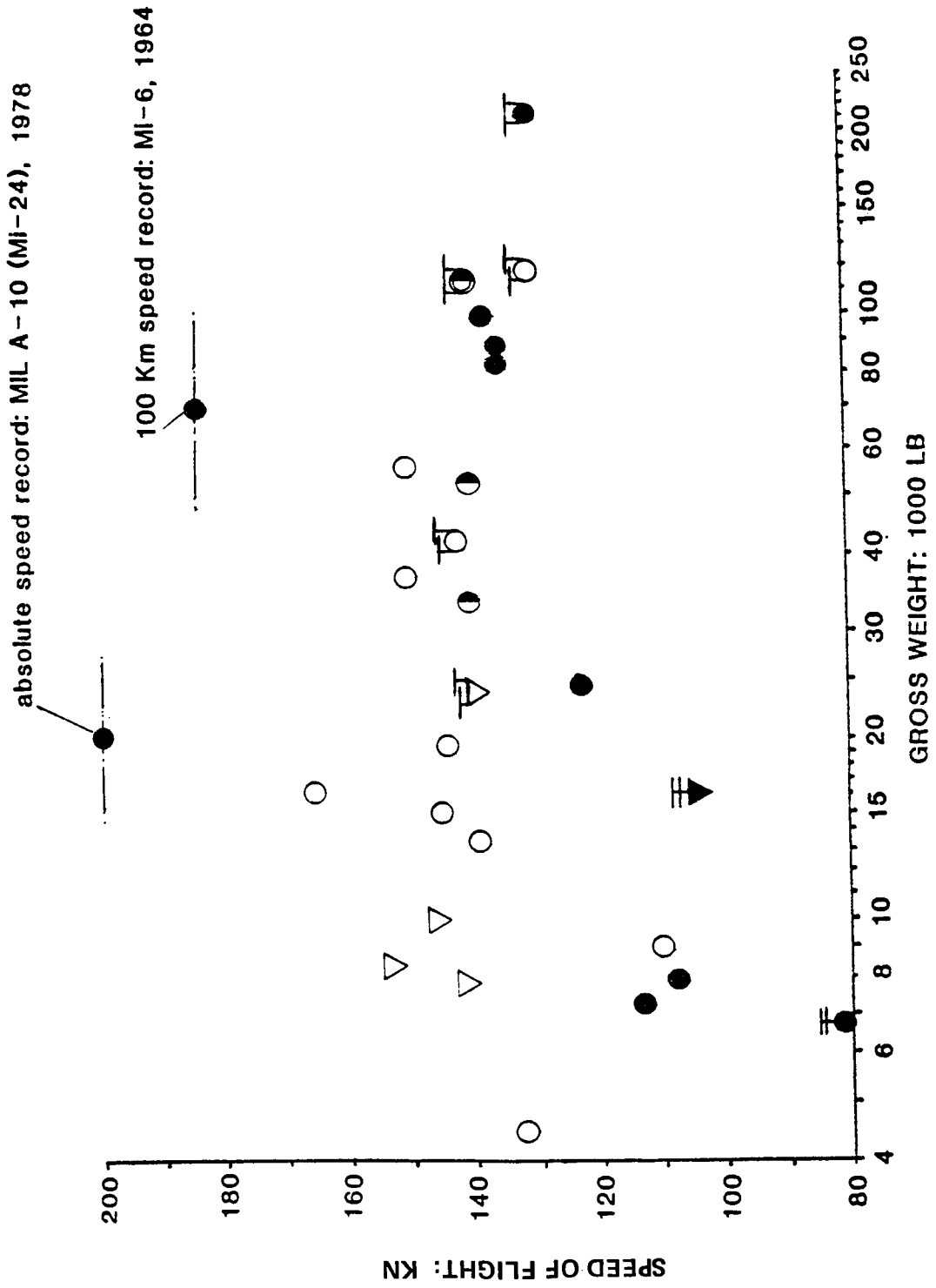

Figure 7.13 Fast Cruise

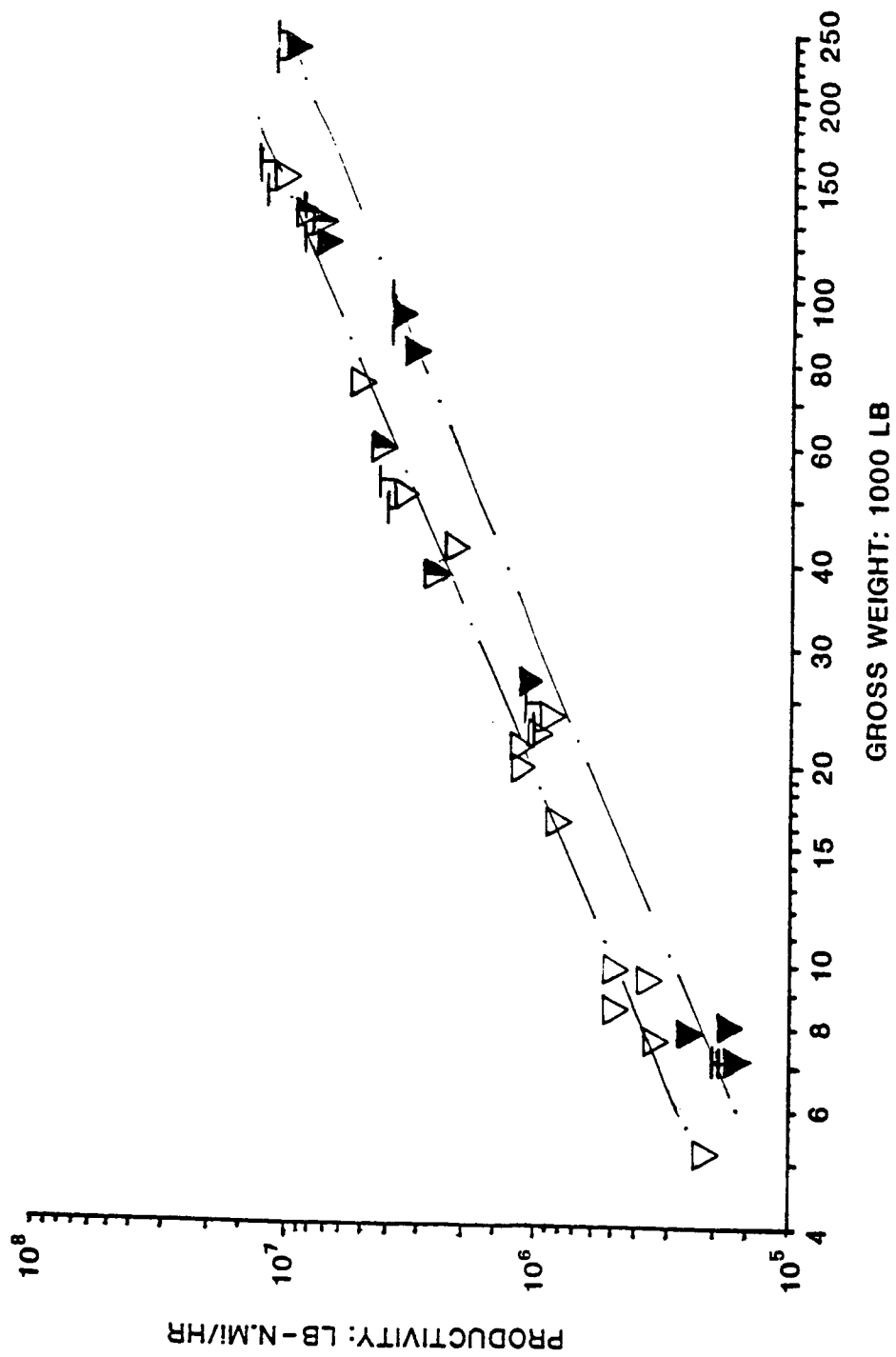

Figure 7.14 Ideal absolute productivity at 100 n.mi

**Productivity Index (Ideal Relative Productivity).** The ideal relative productivity (also called productivity index – Eq (1.17)) is shown in Fig. 7.15. Using this criterion, the Soviet production helicopters are considerably below the optimal boundary of the Western counterparts. However, the so-called hypothetical helicopters are close to the optimal boundary. It also appears that the relative productivity goals visualized for the Hypo 52-SR were actually met in the Mi-26 helicopter.

**Ideal Ferry Range.** Assuming for the sake of simplicity that the fuel required per pound of gross weight and 100 n.mi remains constant ( $\overline{FF}_w = \text{const}$ ) in spite of the changing gross weight due to the burned fuel, the elementary gross weight change associated with travel over a distance  $d\ell$  can be expressed as follows:

$$dw = -\overline{FF}_w W_{gr} d\ell / 100 \quad (7.1)$$

Eq (7.1) can now be integrated within limits of the initial takeoff gross weight and the same weight minus fuel. Assuming that in the ideal case, fuel is equal to the zero-range payload (with no penalty for additional tankage) the following expression (similar to Breguet's formula) for the ideal range is obtained:

$$l_{id} = \frac{100}{\overline{FF}_{w_{opt}}} \ln \frac{1}{1 - (W_{pl_o} / W_{gr_{max}})} \approx \frac{100(W_{pl_o} / W_{gr_{max}})}{\overline{FF}_{w_{opt}} [1 - \frac{1}{2}(W_{pl_o} / W_{gr_{max}})]} \quad (7.2)$$

The ideal ferry ranges of the compared helicopters are shown to complete the picture of forward flight aspects (Fig. 7.16). Here, one may note a considerable gap between the optimal boundaries of Western and Soviet production helicopters. One can find an explanation of this gap by looking at the expression for the ferry range given by Eq (7.2). It has already been shown in Fig. 7.8 that the zero-range payload to gross-weight ratios of Western helicopters are, in general, higher than those of the Soviet production counterparts. It will be shown later that the fuel required per pound of gross weight and 100 n.mi (symbol  $\overline{FF}_w$  in the formula) is also more favorable for Western rotorcraft.

However, the trend implied by the Soviet hypothetical helicopters indicates that the dual disadvantage of low payloads and high fuel consumption will be eliminated in future Soviet designs. Consequently, the hypothetical machines appear either close to, or above, the optimal boundary, while the ideal ferry range of the Mi-26 is slightly below that optimal boundary.

## 7.6 Energy Aspects

**Energy Consumption in Hover.** Energy consumption per pound of gross weight and hour in hover can be expressed as follows:

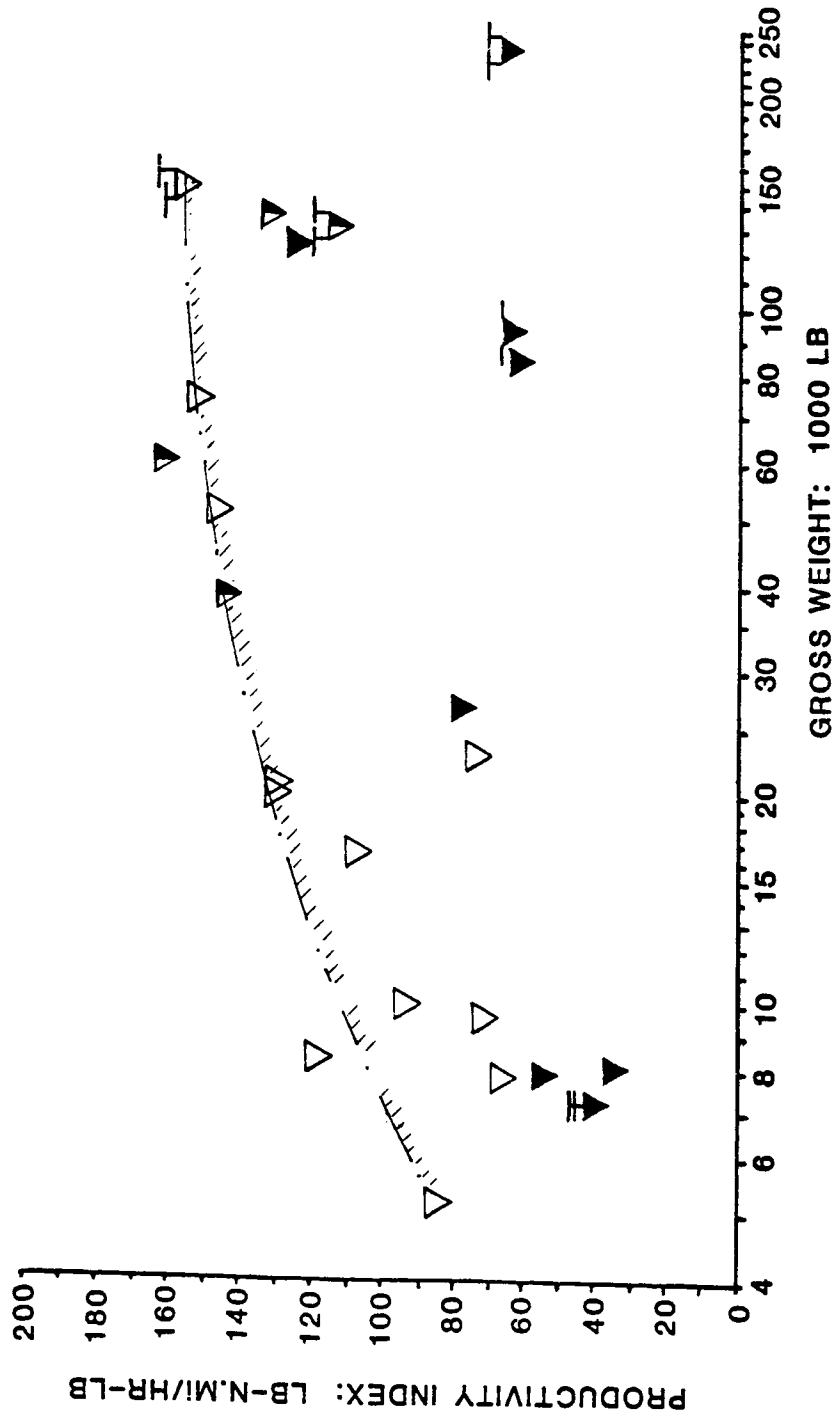

Figure 7.15 Ideal productivity index for 100 n.mi

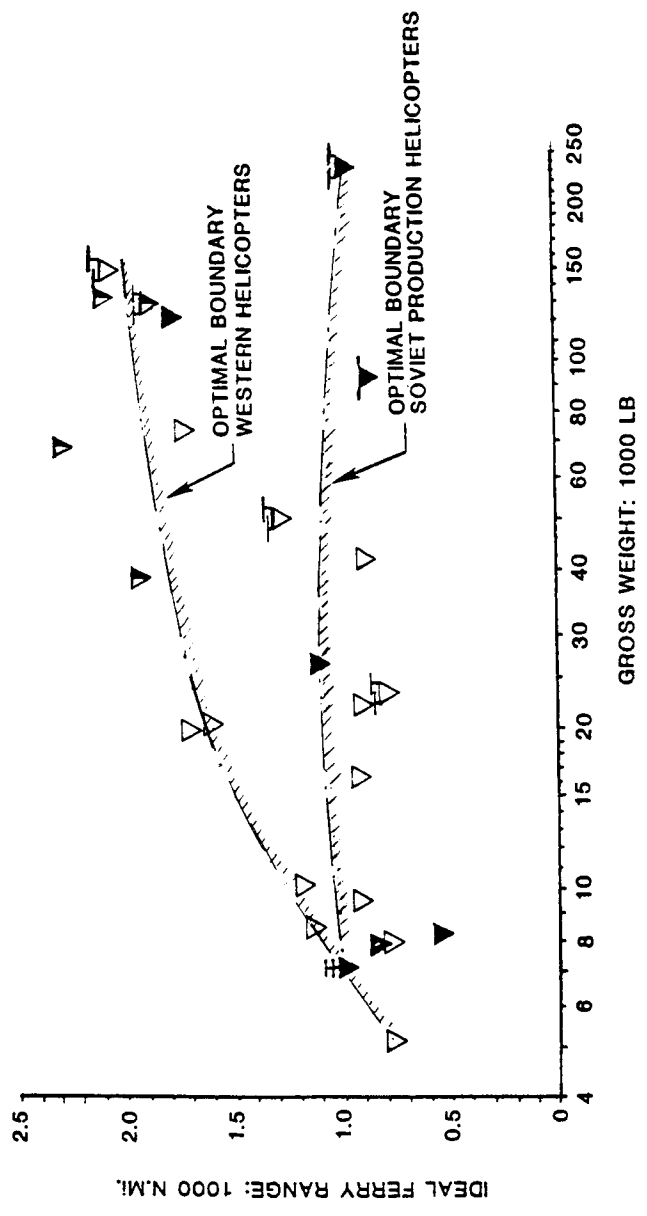

Figure 7.16 Ideal ferry range



$$\overline{FF}_{wh} = \frac{sfc\sqrt{w/2\rho}}{550 FM_{oa}} \quad (7.3)$$

and fuel required per pound of payload and hour would be:

$$\overline{FF}_{plh} = \frac{sfc\sqrt{w/2\rho}}{550 FM_{oa} (W_{pl}/W_{gr})} \quad (7.4)$$

Looking at Eq (4.3), one would realize that factors contributing to the betterment of fuel required per pound of gross weight and hour are: (1) low sfc of the engines; (2) low disc loading—although this may be in conflict with other requirements; and (3) high overall figure of merit. In the case of minimizing fuel per pound of payload and hour, as shown in Eq (7.4), a new factor appears under the form of high payload to gross-weight ratio.

Figure 7.17 clearly indicates that while the band of fuel required per pound of gross weight and hour is relatively narrow for all the considered helicopters, this fuel consumption when referred to pound of payload becomes highly scattered. Here, advanced Western and Soviet hypothetical helicopters gravitate toward the lower boundary of this band, while Soviet production helicopters are grouped toward the upper limit. Spotting the Mi-26 point in this figure, one would see that this new transport shows hourly fuel consumption per pound of gross weight and payload very close to those of the Hypo 52-SR. It should also be noted that the  $\overline{FF}_{plh}$  value of the Mi-26 is close to the optimal boundary of energy utilization per pound of payload in hover.

Energy Consumption in Cruise. Energy consumption referred to, say, 100 n.mi and pound of gross weight for all types of powered vehicles is as follows:

$$\overline{FF}_{wf} = \frac{(sfc)_v}{3.25 (W_{gr}/D_e)_v} \quad (7.5)$$

where  $(sfc)_v$  and  $(W_{gr}/D_e)_v$  respectively, mean engine specific fuel consumption, and gross weight to the equivalent drag ratio at speed of flight  $V$ .

When the reference base is changed to pound of payload and 100 n.mi, the corresponding fuel consumption equation for cargo vehicles becomes:

$$\overline{FF}_{plf} = \frac{(sfc)_v}{3.25 (W_{gr}/D_e)_v (W_{pl}/W_{gr})} \quad (7.6)$$

A glance at the above expression indicates that the requirement for favorable energy consumption is governed by a low sfc, high gross weight to the equivalent drag ratio, and a payload to gross-weight ratio as high as possible.

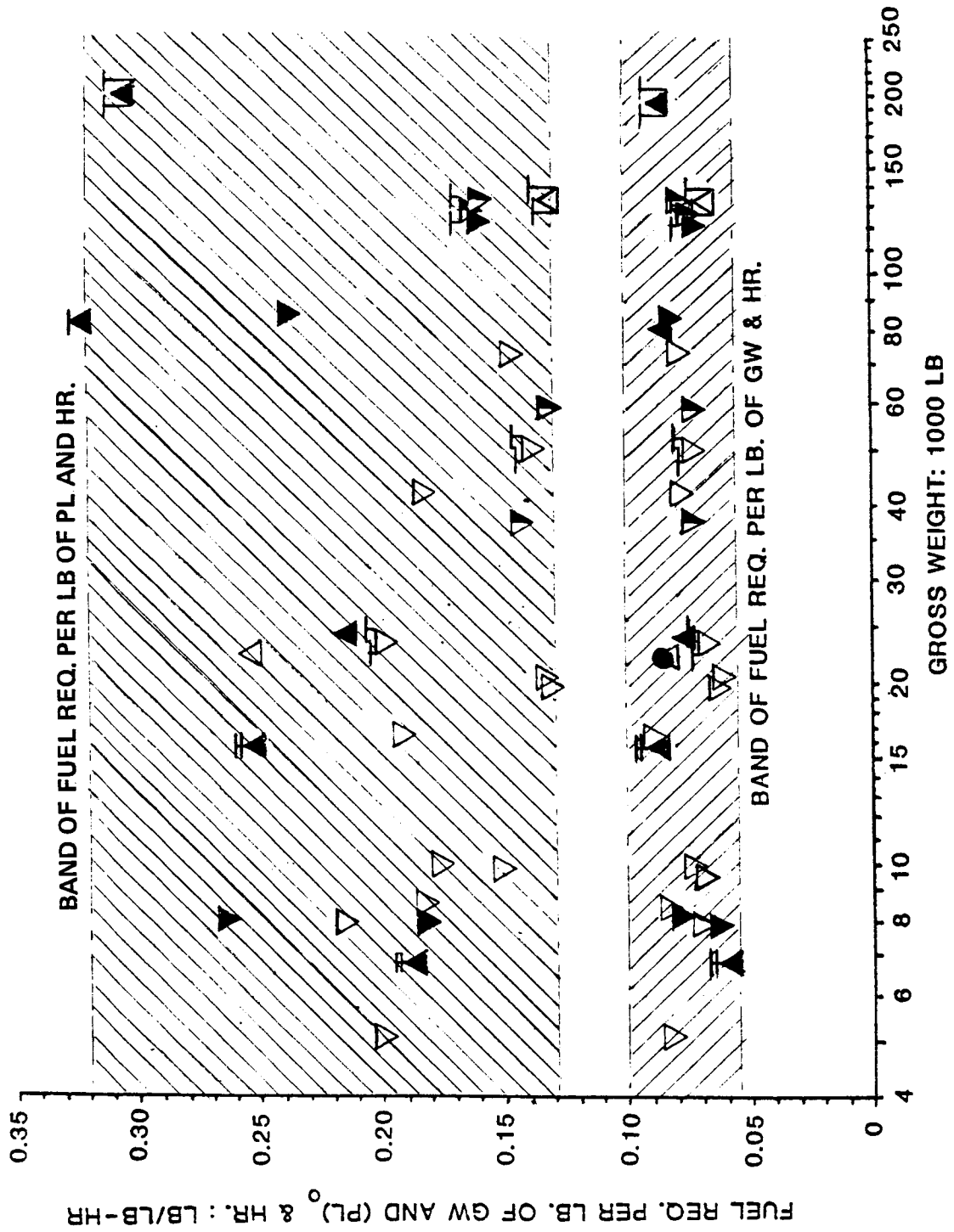

Figure 7.17 Fuel required per pound of gross weight and zero-range payload and hour in hover OGE at SL, ISA

Optimal fuel requirements per 100 n.mi and pound of gross weight, and zero payload of actual and hypothetical helicopters can be judged from Fig. 7.18.

In this figure, one may note a picture somewhat similar to that in hover. Here, also, the band of fuel requirements referred to a unit of gross weight is relatively narrow for all considered helicopters.

When optimal fuel consumption per 100 n.mi is referred to the zero-range payload, the band containing points representing actual helicopters becomes somewhat broader, but for the Western helicopters, still indicates a definite trend of this quantity, decreasing with the increasing size of the rotorcraft.

Some of the Soviet production helicopters appear within, and some above those boundaries, while the points representing the hypothetical concepts are located at the bottom of the Western trend. Spotting the Mi-26 helicopter on those graphs, one would see that in both aspects of fuel consumption in cruise, the characteristics of the actual machine are quite close to those postulated for the hypothetical concepts.

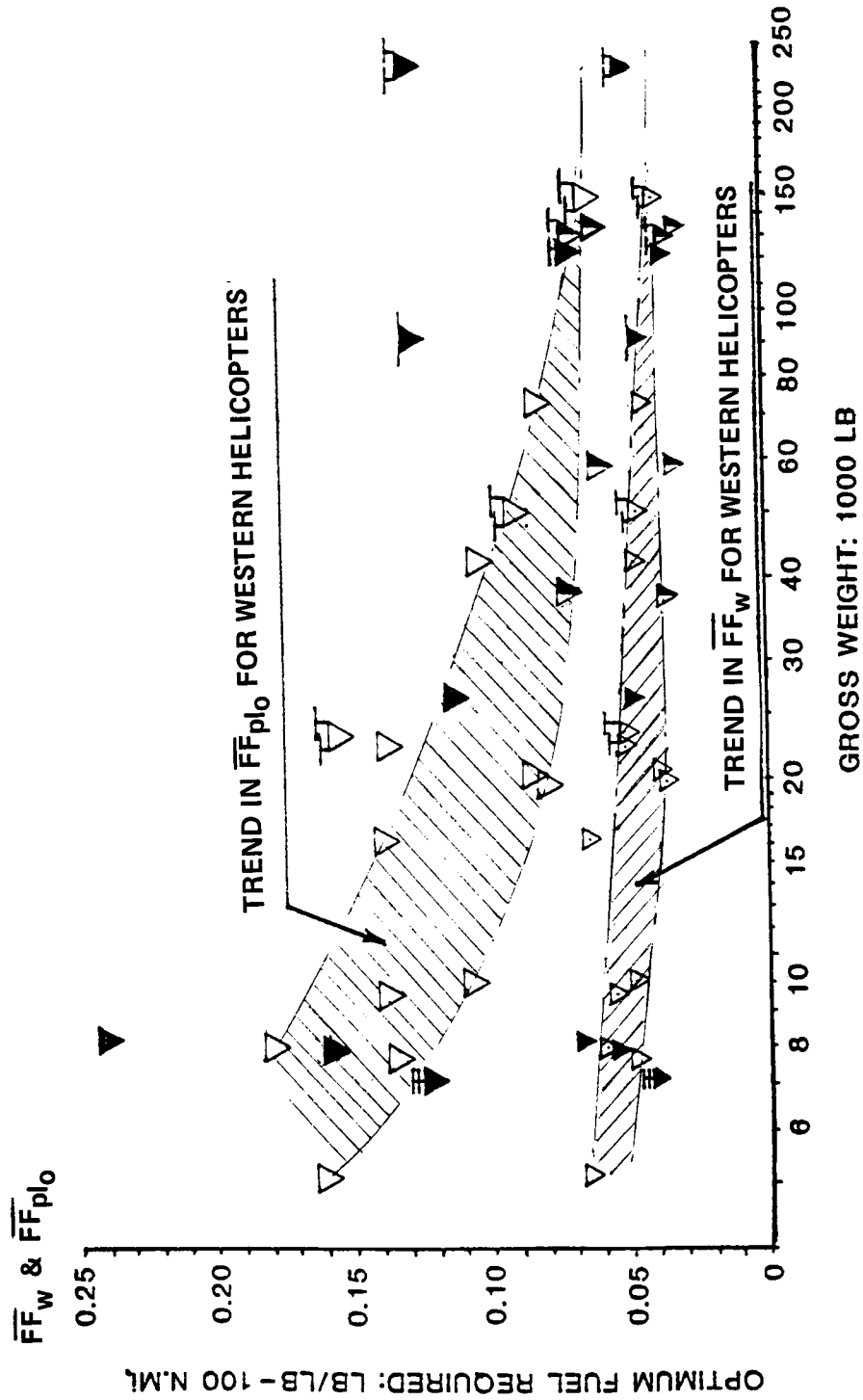

Figure 7.18 Optimal fuel requirements per 100 n.mi and pound of gross weight, or pound of zero-range payload

## REFERENCES

1. Tishchenko, M.N., A.V. Nekrasov, and A.S. Radin. *Viertolety, vybor parametrov pri proektirovaniy: Helicopters, Selection of Design Parameters*. Mashinostroyeniye Press, Moscow, 1976.
2. Jane's Yearbooks. *Jane's All the World's Aircraft*. London, 1980.
3. Helicopter Financial Services, Inc. *Helicopter Blue Book*. 1979.
4. Stepniewski, W.Z. *Rotary-Wing Aerodynamics*. Vol. 1, NASA CR 3082. 1979.
5. Harris, F.D.; J. D. Kocurek, T.T. McLarty; and T.J. Trept, Jr. *Helicopter Performance Methodology at Bell Helicopter Textron*. 35th National AHS Forum, Paper 79-2. May 1979.
6. Dominick, F., and E.E. Nelson. *Engineering Flight Tests, YUH-1H Helicopter, Phase D*. USAASTA Project No. 66-04. Nov. 1970.
7. Keys, C.N. *Rotary-Wing Aerodynamics*. Vol. II, NASA CR 3083. 1979.
8. Kocurek, J.D.; L.F. Berkowitz; and F.D. Harris. *Hover Performance Methodology at Bell Helicopter Textron*. 36th National AHS Forum Paper 80-3. May 1980.
9. Green, D. *Aerospatiale's Remarkable SA-365N Dauphin 2*. Rotor and Wing, Int., pp. 54-59, Feb. 1980.
10. Anon. *PZL Kania - Kite*. Pezetel. Swidnik, Poland.
11. Anon. *CH-3E*. AGF, Vol. 2, Addn. 50. Sept. 1971.
12. Nagata, J.I., et al. *Government Comparative Tests, Utility Tactical Transport Aircraft System (UTTAS) Sikorsky YUH-60A Helicopter*. U.S. Army Aviation Engineering Flight Activity, Edwards Airforce Base, Ca. 93523. Nov. 1976.
13. Anon. *CH-53D Standard Aircraft Characteristics*, pp. 235-239. Naval Air Systems Command, Navy Dept. Sept. 1971.

1. Report No. NASA CR-3579 AVRADCOM TR 82-A-9		2. Government Accession No.		3. Recipient's Catalog No.	
4. Title and Subtitle A COMPARATIVE STUDY OF SOVIET VS. WESTERN HELICOPTERS PART 1 - GENERAL COMPARISON OF DESIGNS				5. Report Date March 1983	
				6. Performing Organization Code	
7. Author(s) W. Z. Stepniewski				8. Performing Organization Report No.	
				10. Work Unit No.	
9. Performing Organization Name and Address International Technical Associates, Ltd. 1728 State Road Upper Darby, PA 19082				11. Contract or Grant No. NAS2-10062, Mod. 1	
				13. Type of Report and Period Covered Contractor Report	
12. Sponsoring Agency Name and Address National Aeronautics and Space Administration Washington, D.C. 20546  and U.S. Army Aviation Research and Development Command St. Louis, MO 63166				14. Sponsoring Agency Code	
15. Supplementary Notes Point of Contact: W.D. Mosher, MS:207-5, Ames Research Center, Moffett Field, CA 94035 FTS 448-5578 or 415-965-5578 Reviewer R. Shinn See CR - 3580:TM84261					
16. Abstract  This document provides a general comparison of the state of the art of Soviet helicopter design vs. that of the West (U.S. in particular). It includes both commalities and differences in conceptual design philosophies by addressing design parameters and design effectiveness according to accepted criteria. The baseline for comparison is by design gross weight which is presented in four categories: under 12,000 lb, 30-100,000 lb, greater than 100,000 lb.					
17. Key Words (Suggested by Author(s)) Helicopters - Soviet Comparison - design Weight Helicopters - Western			18. Distribution Statement Unclassified - Unlimited  Subject Category 01		
19. Security Classif. (of this report) Unclassified		20. Security Classif. (of this page) Unclassified		21. No. of Pages 300	22. Price* A13

\*For sale by the National Technical Information Service, Springfield, Virginia 22161