

TURBULENT COMBUSTOR FLOWFIELD INVESTIGATION

David G. Lilley
School of Mechanical and Aerospace Engineering
Oklahoma State University
Stillwater, Oklahoma 74078

Experimental and theoretical research is being undertaken on 2-D axisymmetric geometries under low speed, nonreacting, turbulent, swirling flow conditions. The flow enters the test section and proceeds into a larger chamber (the expansion ratio $D/d = 2$) via a sudden or gradual expansion (side-wall angle $\alpha = 90$ and 45 degrees). Inlet swirl vanes are adjustable to a variety of vane angles with values of $\phi = 0, 38, 45, 60$ and 70 degrees being emphasized. The objective is to determine the effect of these parameters on isothermal flowfield patterns, time-mean velocities and turbulence quantities, and to establish an improved simulation in the form of a computer prediction code equipped with a suitable turbulence model. This is a prerequisite to the prediction of more complex turbulent reacting flows, and successful outcomes of the work can be incorporated into more combustion- and hardware-oriented activities, including incorporating the modeling aspects into already existing comprehensive numerical solution procedures.

New features of the present year's study are: the turbulence measurements are being performed on **swirling** as well as nonswirling flow; and all measurements and computations are also being performed on a confined jet flowfield with realistic **downstream blockage**. Recent activity in the research program falls into three categories:

1. Time-mean flowfield characterization by five-hole pitot probe measurements and by flow visualization.
2. Turbulence measurements by a variety of single- and multi-wire hot-wire probe techniques.
3. Flowfield computations using the computer code developed during the previous year's research program.

In the experimental approach, flow visualization is accomplished by still and movie photography of helium-filled soap bubbles and smoke produced by an injector and a smoke wire.¹ Time-mean velocities have been measured with a five-hole pitot probe at low swirl strengths,² and this has recently been extended to higher swirl strengths, including the effect of size and location of a downstream blockage of area ratio 2 and 4.³ Turbulence measurements have recently been completed on swirling (up to $\phi = 45$ degrees) as well as nonswirling flows using a six-orientation single-wire hot-wire technique.⁴ Although all Reynolds stresses are deducible by this technique, a new cross-wire probe is currently being used for more accurate shear stress evaluation. A series of hot-wire measurements are also in progress, using a three-wire hot-wire probe with direct computer interface and data reduction. These data will enable turbulent viscosity components to be deduced (from the turbulence stress vs. mean velocity spatial gradients) and will aid the turbulence modeling aspects of the study.

In the computational approach, an advanced computer code has been developed to predict corresponding confined swirling flows to those studied experimentally.⁵ Tentative predictions were given earlier.¹ Predictions have now been made which include **realistic** inlet conditions for a complete range of swirl strengths. Predictions of **downstream blockage** (two blockage sizes at two axial locations) have also been completed and these are being assessed in the light of the experimental data.⁶ Advanced versions of the code will incorporate modification in the form of state-of-the-art turbulence models, deduced from the experiments and elsewhere, so as to accommodate better the physics of swirling recirculating flows.

Proposed future studies include: expansion ratio $D/d = 1.5$, correspondingly predictions using advanced turbulence models, inlet turbulence level effects to be clarified, turbulence length scales to be measured, and turbulence model developments to be made. The completion of these tasks will make a substantial contribution to the understanding and predictive capability of complex turbulent swirling recirculating flows.

References

1. Rhode, D. L., Lilley, D. G., and McLaughlin, D. K., "On the Predictions of Swirling Flowfields Found in Axisymmetric Combustor Geometries", ASME Symposium on Fluid Mechanics of Combustion Systems, Boulder, CO, June 22-24, 1981, pp. 257-266. Journal of Fluids Engng., 1982 (in press).
2. Rhode, D. L., Lilley, D. G., and McLaughlin, D. K., Mean Flowfields in Axisymmetric Combustor Geometries with Swirl, AIAA Paper No. 82-0177, Orlando, Florida, Jan. 11-14, 1982. AIAA Journal, 1983 (in press).
3. Lilley, D. G., and Rhode, D. L., A Computer Code for Swirling Turbulent Axisymmetric Recirculation Flows in Practical Isothermal Combustor Geometries, NASA CR-3442, Feb. 1982.
4. Janjua, S. I., McLaughlin, D. K., Jackson, T. W., and Lilley, D. G., Turbulence Measurements in a Confined Jet Using a Six-Orientation Hot-Wire Probe Technique. Paper AIAA 82-1262, Cleveland, OH, June 21-23, 1982.
5. Yoon, H.K., and Lilley, D. G. Five-Hole Pitot Probe Time-Mean Velocity Measurements in Confined Swirling Flows. AIAA Paper, Reno, NV, Jan. 10-13, 1983.
6. Abujelala, M. T., and Lilley, D. G. Swirler Performance and Confined Swirling Flow Predictions. AIAA Paper, Reno, NV, Jan. 10-13, 1983.

1. Introduction

1.1 The Test Facility

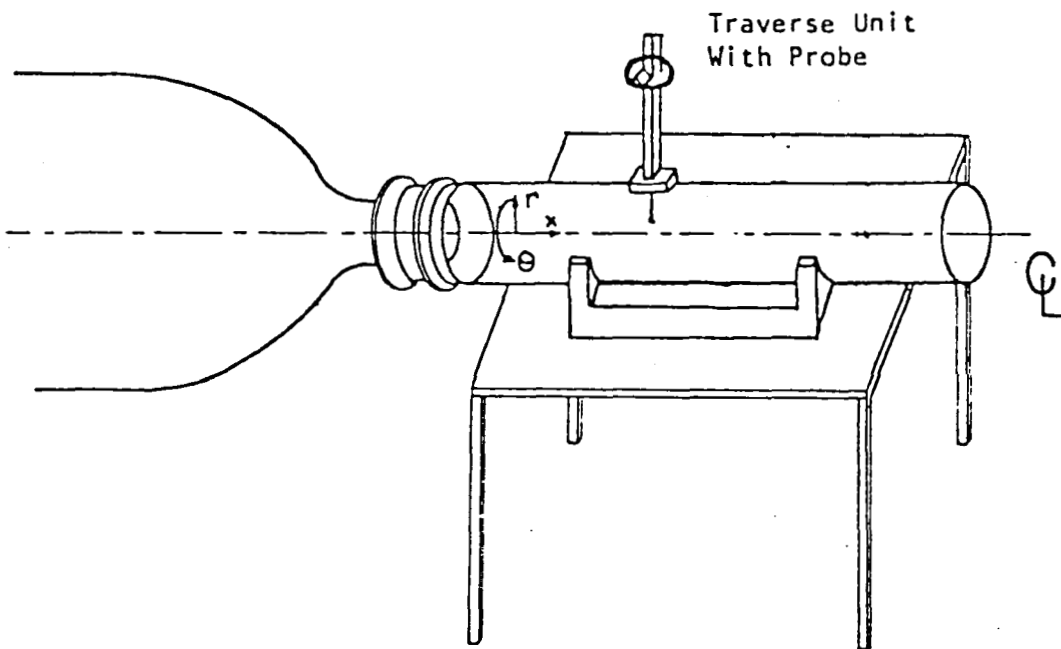

1.2 Research Objectives

1. To determine the effect of:

- * swirl vane angle ϕ
- * side-wall angle α
- * downstream blockage area ratio AR
and location L/D

on:

- * isothermal flowfield patterns
- * time-mean velocities
- * turbulence quantities

2. To establish an improved simulation in the form of:

- * computer prediction code
- * suitable turbulence model

1.3 Research Approach

1. Time-mean flowfield characterization by five-hole pitot probe measurements and by flow visualization.
2. Turbulence measurements by a variety of single- and multi-wire hot-wire probe techniques.
3. Flowfield computations using the computer code developed during the previous year's research program.

1.4 Progress During First Year (1980-1981)

1. Test facility - design and construction, including variable angle swirler and expansion blocks.
2. Experimental techniques - flow visualization, five-hole pitot probe and reduction computer code.
3. Computational code development - advanced version of a primitive-variable solution procedure - STARPIC.
4. Flowfield characterization - emphasis on time-mean flow character, using flow visualization, five-hole pitot probe and tentative predictions.

1.5 Progress During Second Year (1981 - 1982)

1. Higher swirl strengths - flow visualization and five-hole pitot probe measurements.
2. Swirler effectiveness - exit profiles of u , v , w , and p accurately established.
3. Flowfield predictions - the need for specifying the inlet conditions very precisely.
4. Downstream blockage - effects of area ratio and axial location studied by flow visualization, five-hole pitot probe and corresponding computer predictions.
5. Turbulence measurements - in nonswirling and swirling flow via one-wire, two-wire and three-wire hot-wire methods.

1.6 Present Studies (1982 - 1983)

1. Expansion ratio $D/d = 1.5$
2. Corresponding predictions
3. Turbulence measurements at higher swirl strengths, with and without downstream blockage.
4. Turbulence length scale being measured
5. Turbulence model developments

2. Swirler Performance

2.1 Swirl Effect on Axial and Swirl Velocities

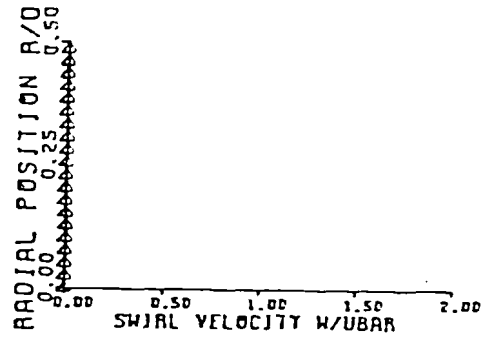
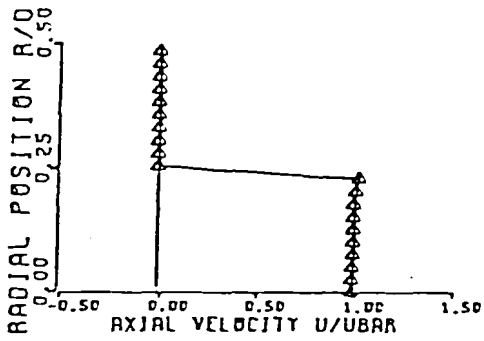

(a) $\phi = 0^\circ$ (No Swirler)

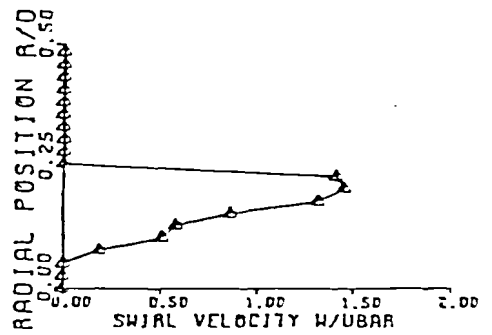
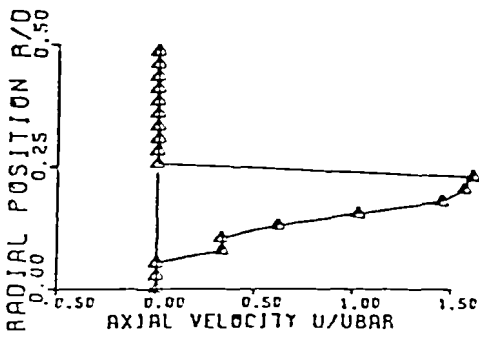

(b) $\phi = 45^\circ$

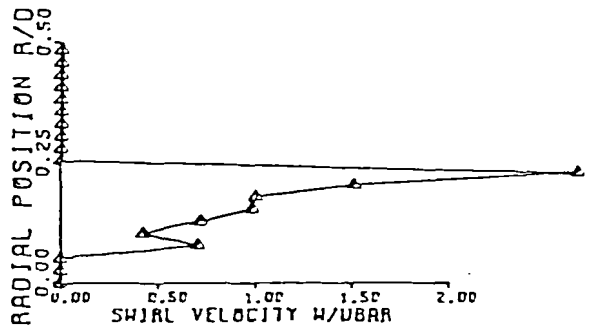
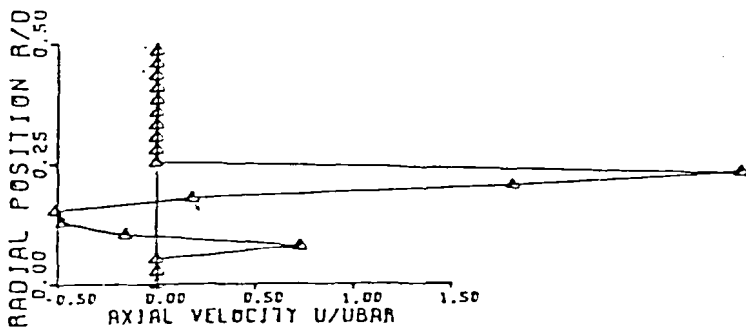

(c) $\phi = 70^\circ$

3. Time-Mean Velocity Measurements

3.1 Swirl Effect on Axial and Swirl Velocity Fields

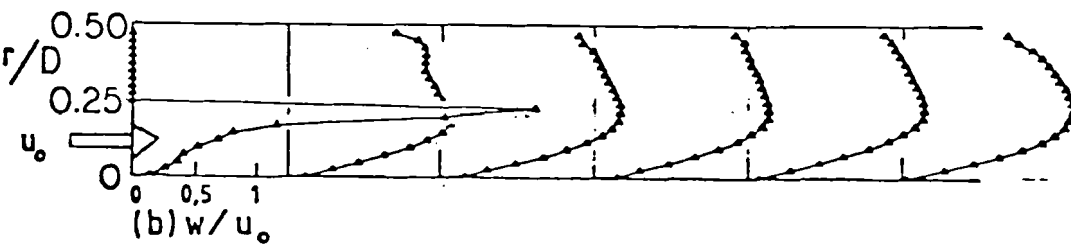
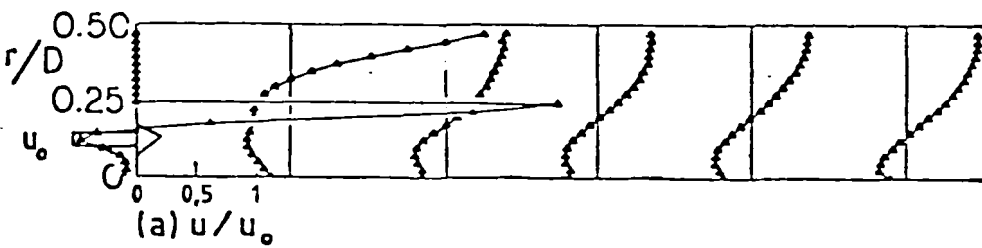
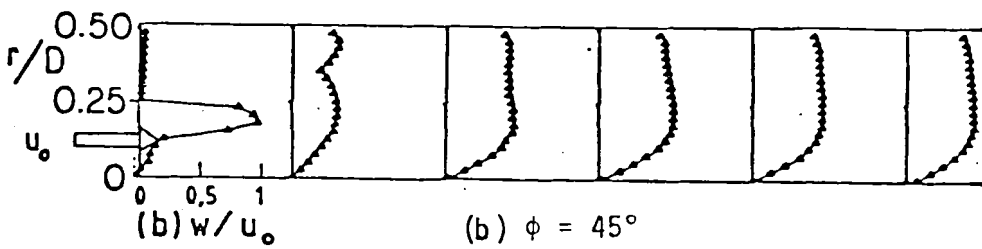
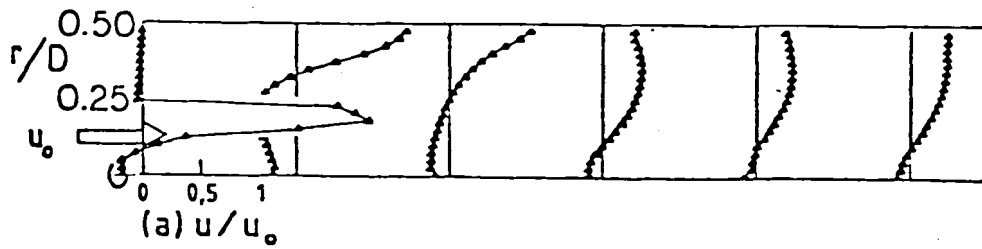
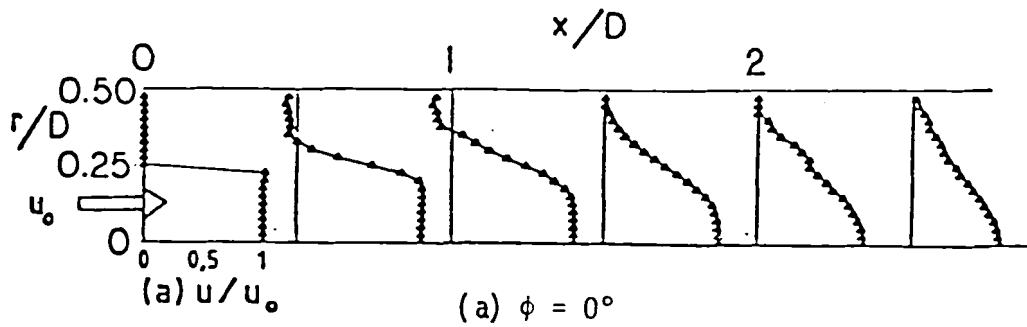

(c) $\phi = 70^\circ$

3.2 Contraction Block (AR = 2) Effect on $\phi = 45^\circ$

Degree Flowfield

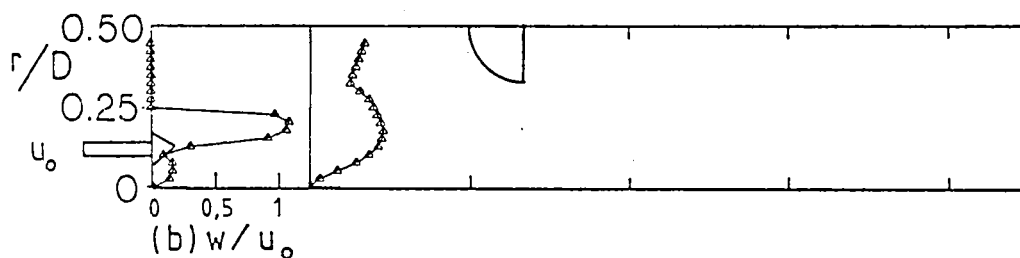
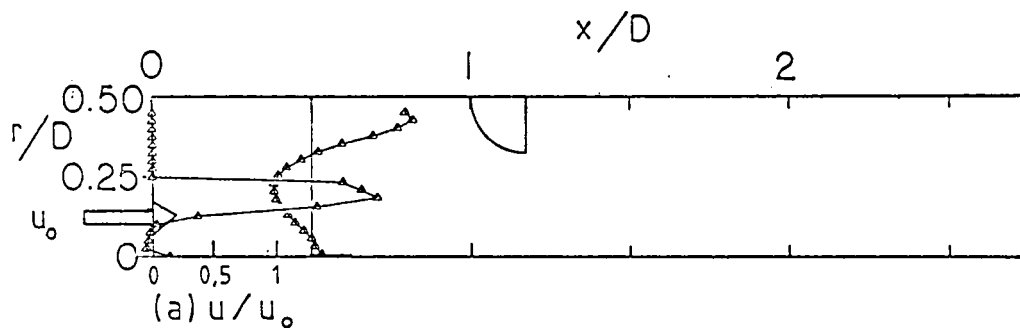

(a) $L/D = 1.0$

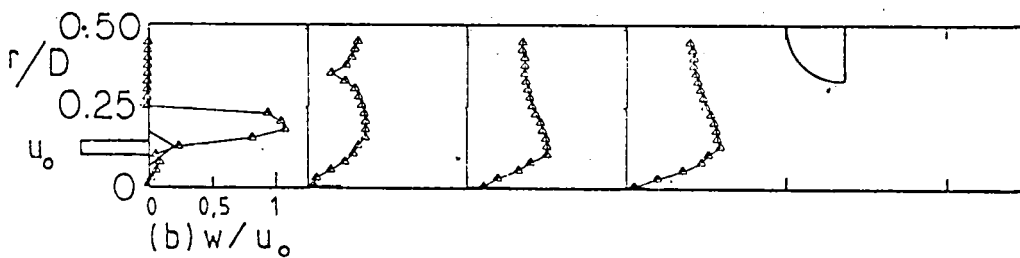
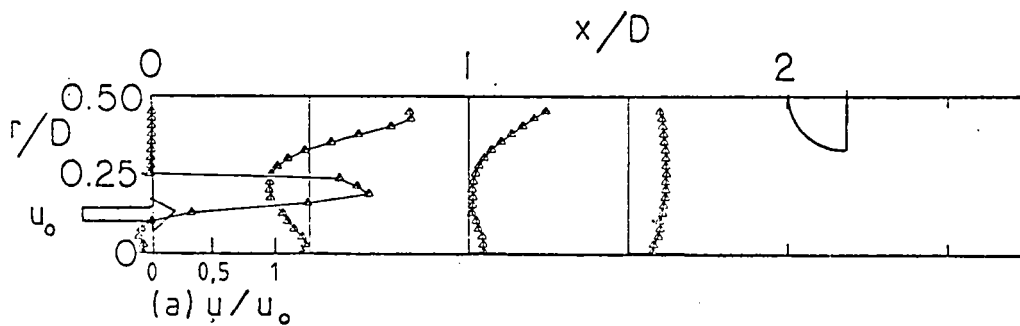

(b) $L/D = 2.0$

3.3 Contraction Block (AR = 4) Effect on $\phi = 45$ Degree Flowfield

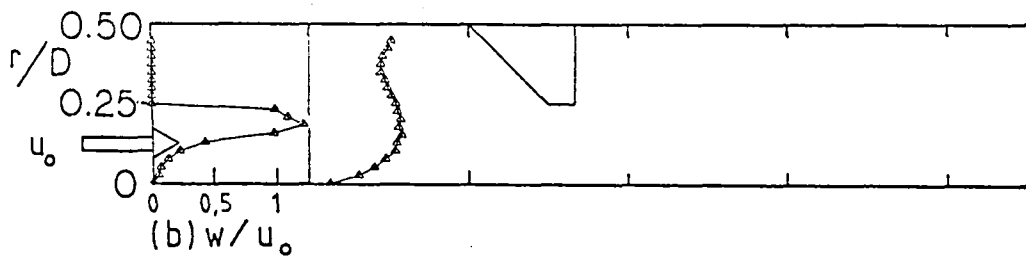
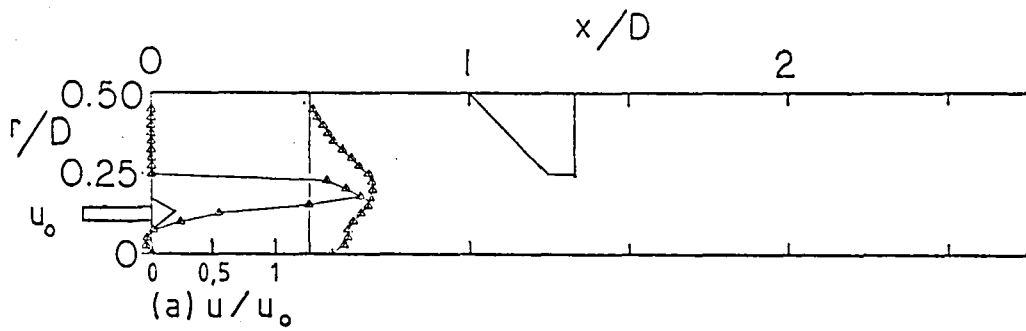

(a) $L/D = 1.0$

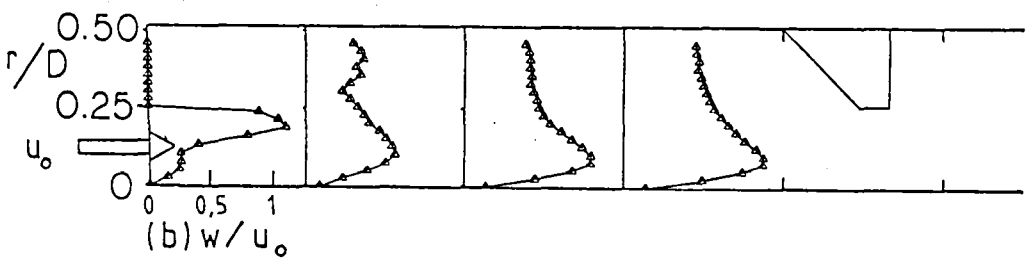
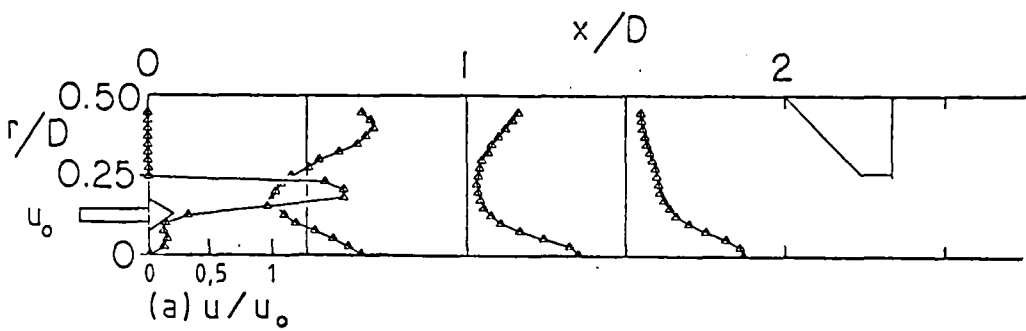

(b) $L/D = 2.0$

3.4 Swirl Effect on Streamlines: No Downstream Blockage

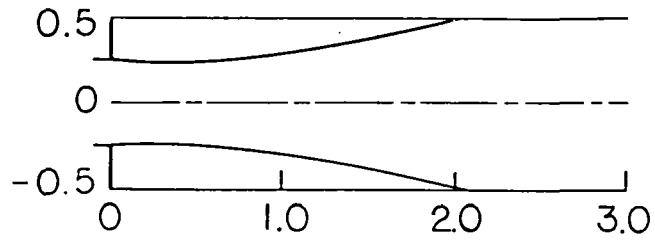

(a) $\phi = 0^\circ$

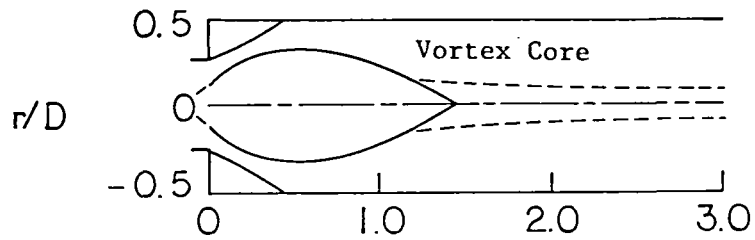

(b) $\phi = 45^\circ$

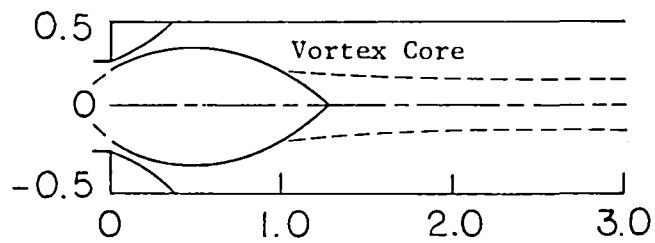

(c) $\phi = 70^\circ$

x/D

3.5 Swirl Effect on Streamlines: Weak Downstream
Blockage at $L/D = 2.0$

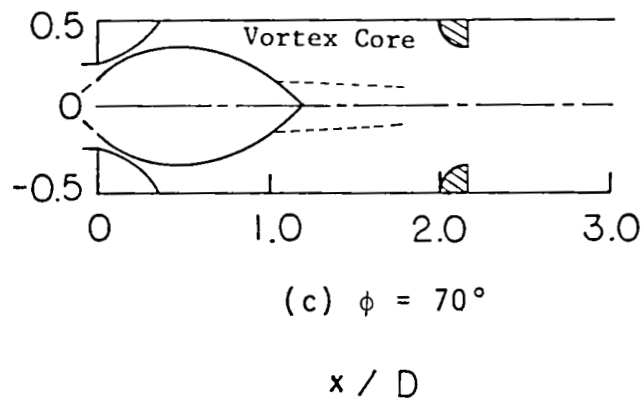
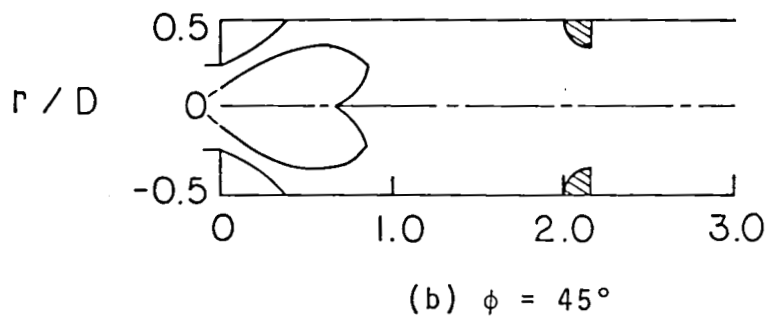
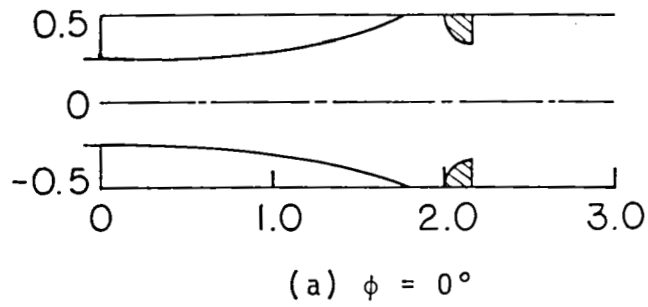

3.6 Swirl Effect on Streamlines: Strong Contraction
Blockage at $L/D = 2.0$

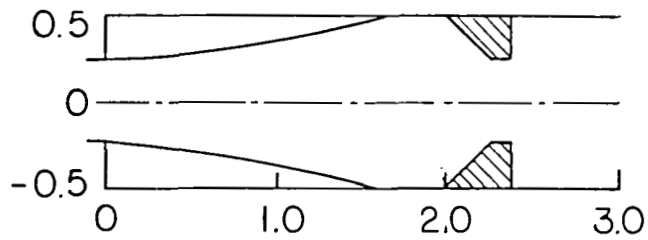

(a) $\phi = 0^\circ$

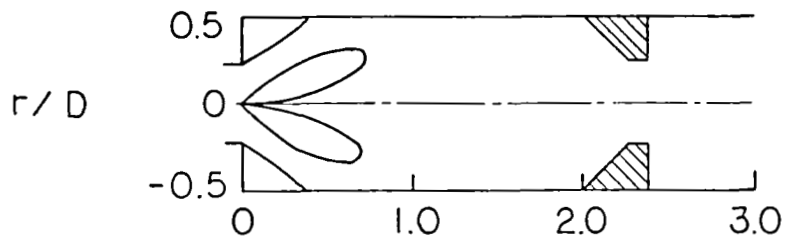

(b) $\phi = 45^\circ$

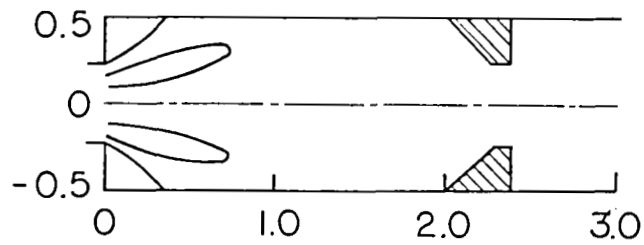

(c) $\phi = 70^\circ$

x / D

4. Computational Studies

4.1 Predicted Axial and Swirl Velocity Fields for

$\phi = 45$ Degree Flowfield

Measured inlet u , v and w profiles.

Standard $k-\epsilon$ turbulence model.

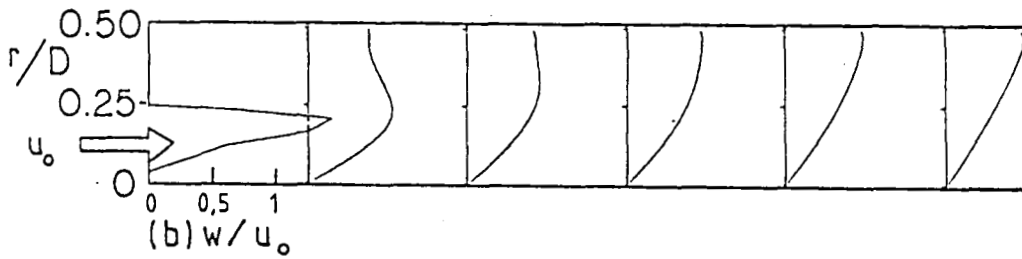
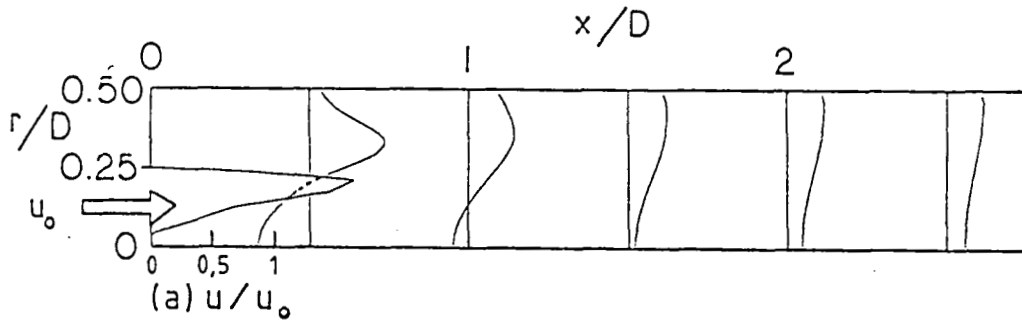

4.2 Swirl Effect on Streamlines: No Downstream Blockage

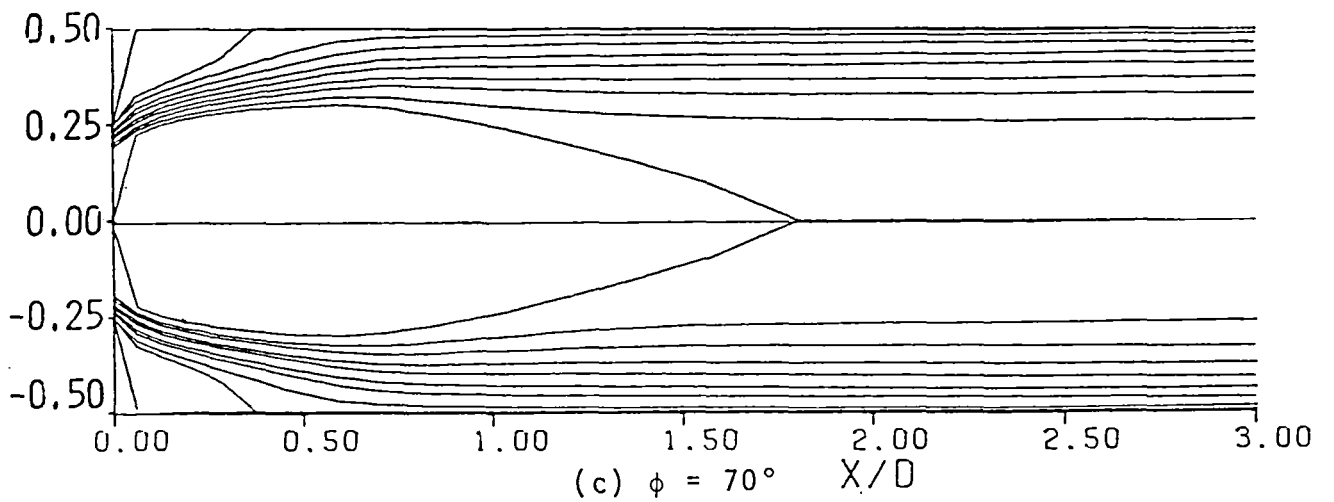
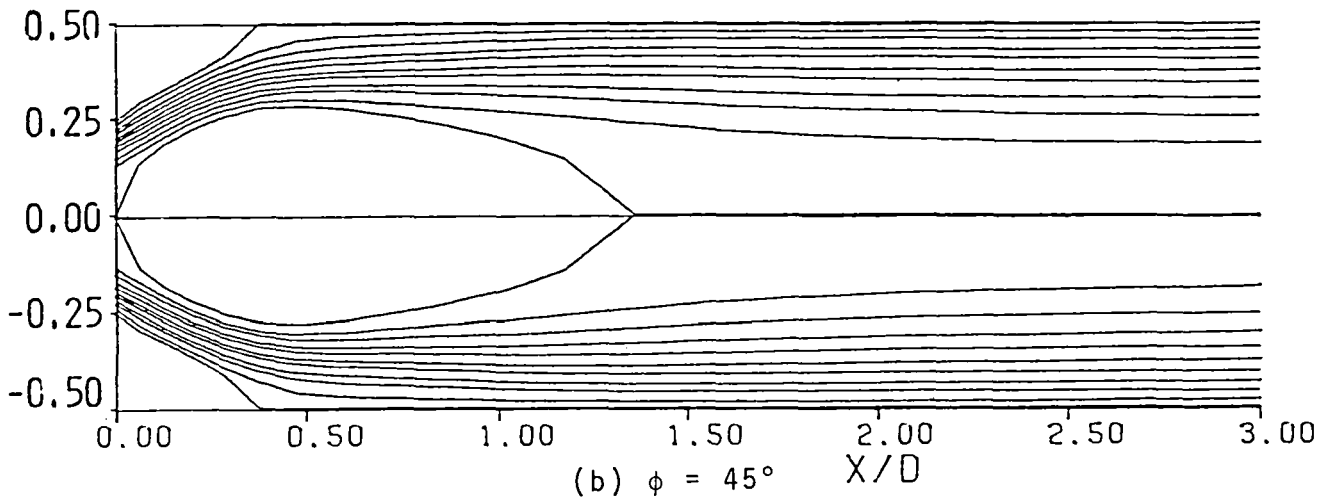
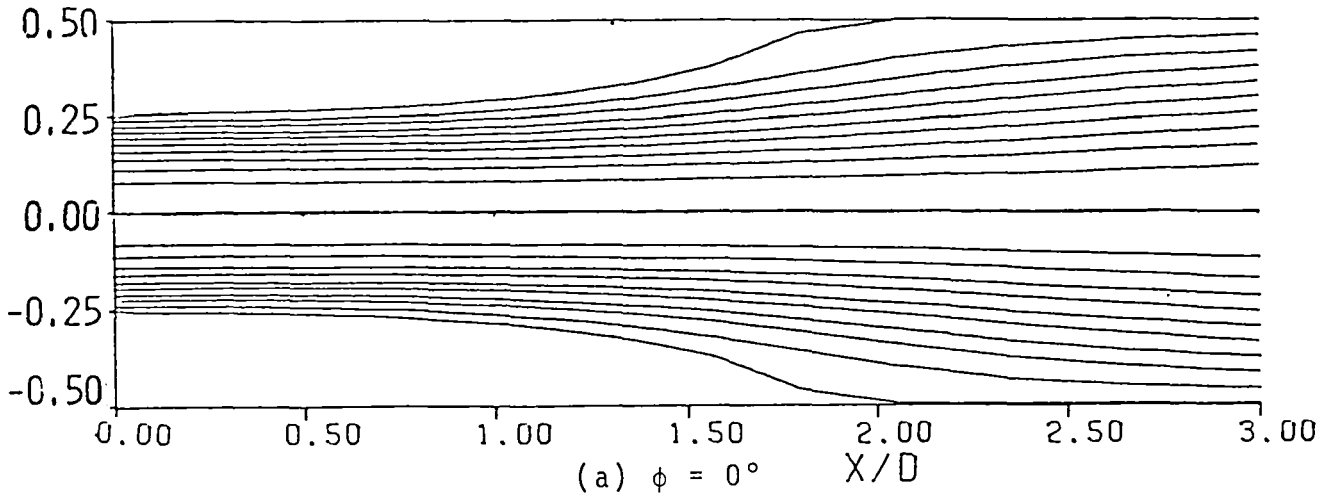

4.3 Swirl Effect on Streamlines: Strong Contraction

Blockage at $L/D = 2.0$

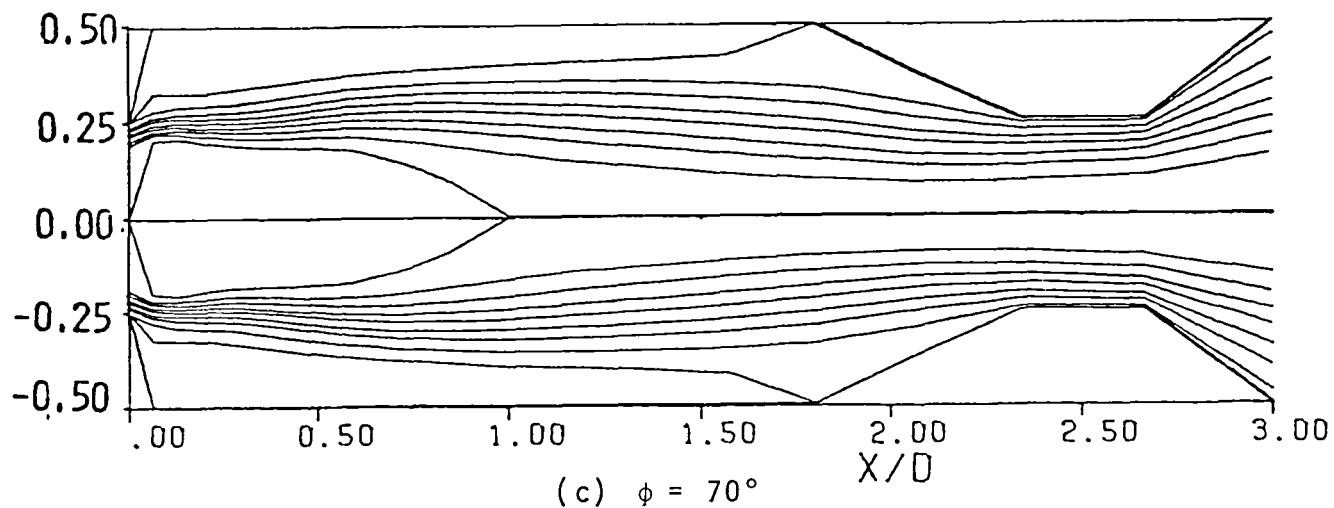
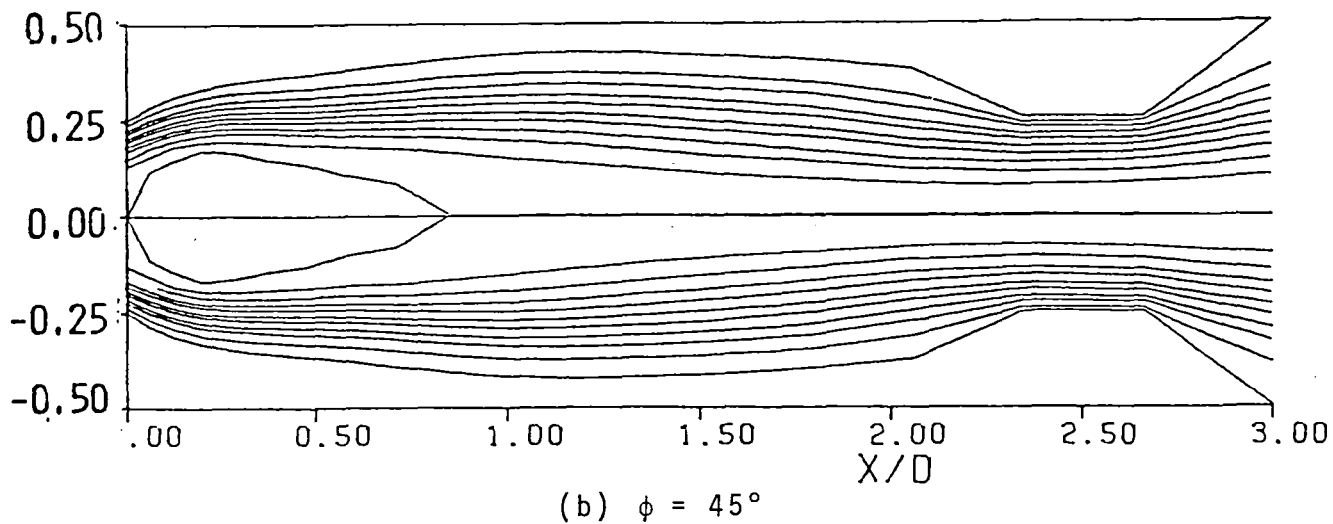
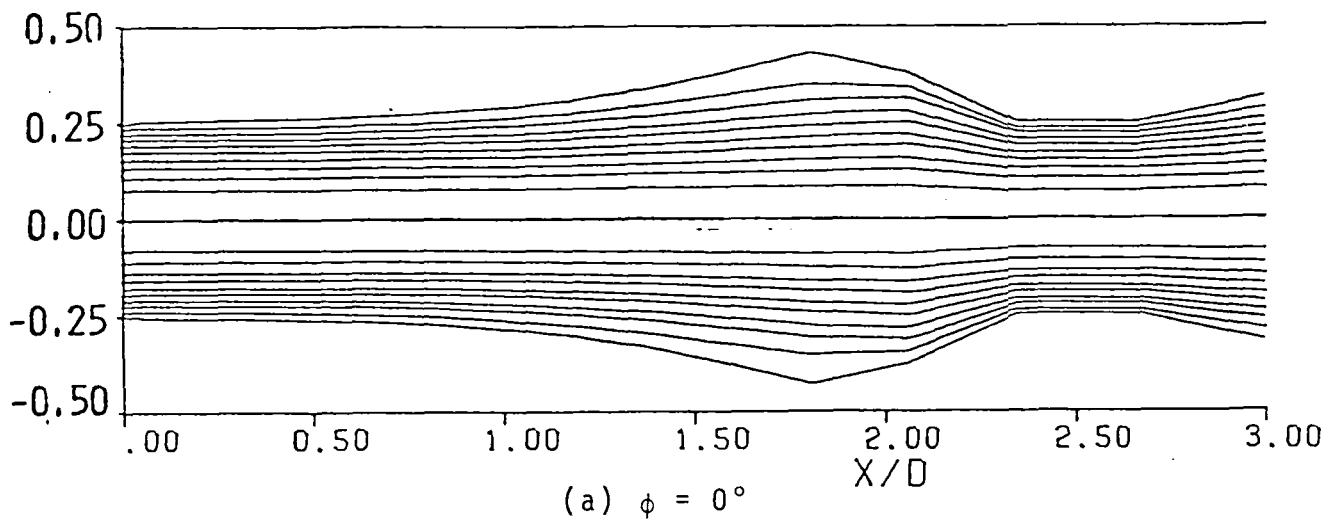

5. Hot-Wire Anemometry

5.1 Turbulence Measurements: Nonswirling Flow

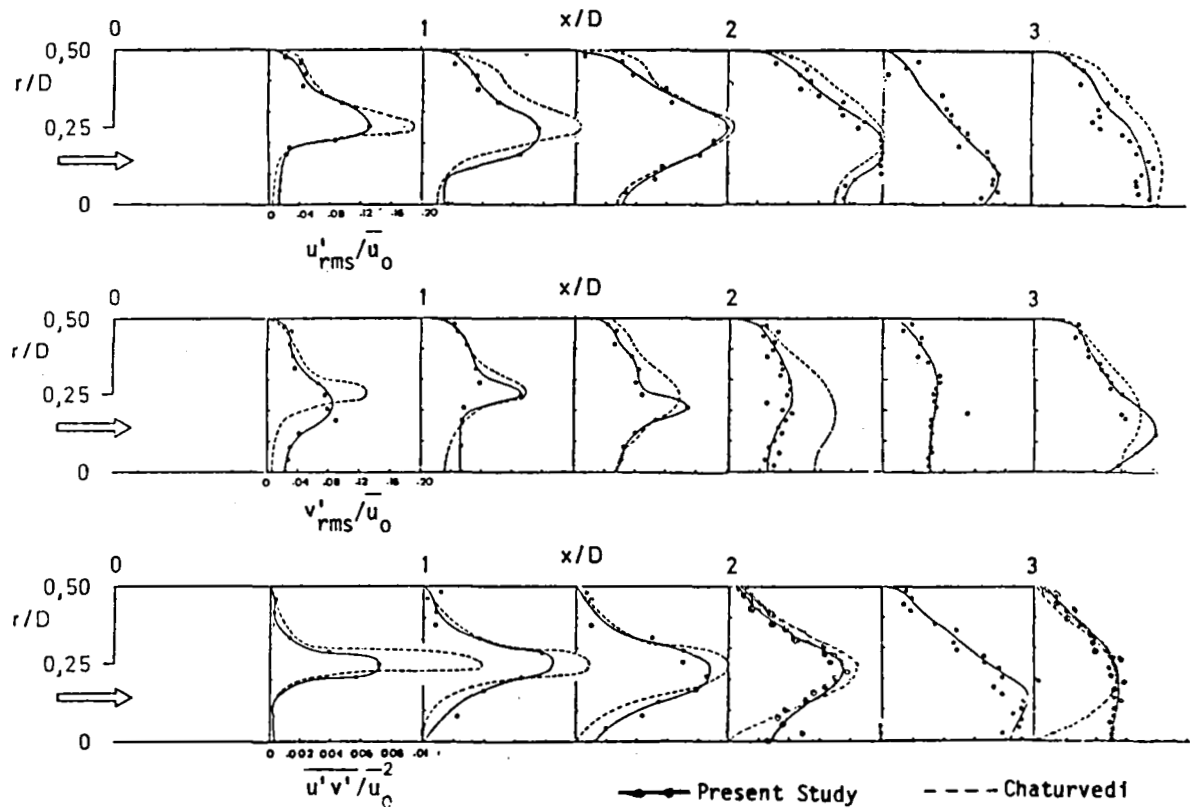

5.2 Turbulence Measurements: Swirling Flow $\phi = 38$ Degrees

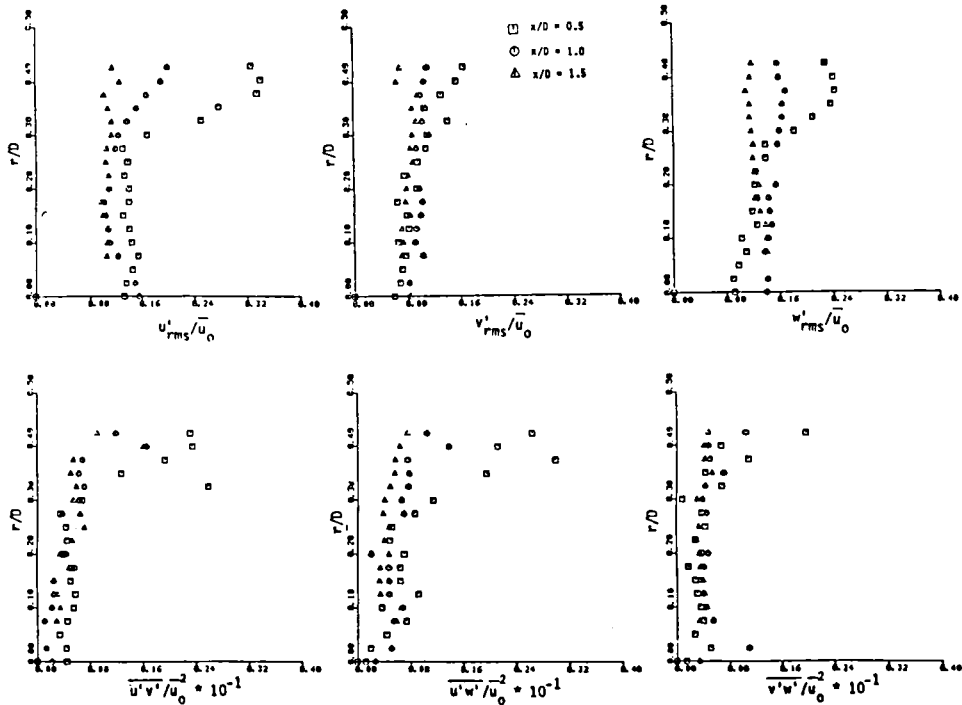

6. Closure

1. Measurements of effect of swirl, expansion angle and contraction blockage on flowfield patterns, time-mean velocities and turbulence quantities.
2. Computer prediction studies of associated phenomena.
3. Turbulence model developments for the simulation of swirling recirculating flow.