

General Disclaimer

One or more of the Following Statements may affect this Document

- This document has been reproduced from the best copy furnished by the organizational source. It is being released in the interest of making available as much information as possible.
- This document may contain data, which exceeds the sheet parameters. It was furnished in this condition by the organizational source and is the best copy available.
- This document may contain tone-on-tone or color graphs, charts and/or pictures, which have been reproduced in black and white.
- This document is paginated as submitted by the original source.
- Portions of this document are not fully legible due to the historical nature of some of the material. However, it is the best reproduction available from the original submission.

(10)

ADA130144

DOT/FAA/CT-82/132

Optimization of Aircraft Seat Cushion Fire Blocking Layers

D.A. Kourtides
J.A. Parker
A.C. Ling
W.R. Hovatter

National Aeronautics and Space Administration
Ames Research Center
Moffett Field, California 94035

March 1983

Final Report

This document is available to the U.S. public through the National Technical Information Service, Springfield, Virginia 22161.



U.S. Department of Transportation
Federal Aviation Administration
Technical Center
Atlantic City Airport, N.J. 08405

DTIC
JUL 6 1983
A

DTIC FILE COPY

83_07_6_020

NOTICE

The United States Government does not endorse products or manufacturers. Trade or manufacturer's names appear herein solely because they are considered essential to the object of this report.

This document is disseminated under the sponsorship of the Department of Transportation in the interest of information exchange. The United States Government assumes no liability for the contents or use thereof.

1. Report No. DOT/FAA/CT-82/132		2. Government Accession No.		3. Recipient's Catalog No.	
4. Title and Subtitle OPTIMIZATION OF AIRCRAFT SEAT CUSHION FIRE BLOCKING LAYERS				5. Report Date March 19	
				5. Performing Organization Code	
7. Author(s)				8. Performing Organization Report No. 505-44-21	
9. Performing Organization Name and Address National Aeronautics and Space Administration AMES Research Center Moffett Field, CA 94305				10. Work Unit No. (TRAIS)	
				11. Contract or Grant No. DTFA03-81-A00149	
12. Sponsoring Agency Name and Address U.S. Department of Transportation Federal Aviation Administration Technical Center Atlantic City Airport, NJ 08405				13. Type of Report and Period Covered TM Final 7/81-7/82	
				14. Sponsoring Agency Code	
15. Supplementary Notes					
16. Abstract This report describes work completed by the National Aeronautics and Space Administration - Ames Research Center under Interagency Agreement No. DTFA03-A00149 for the Federal Aviation Administration Technical Center. The purpose of this work was to examine the potential of fire blocking mechanisms for aircraft seat cushions in order to provide an optimized seat configuration with adequate fire protection and minimum weight. Aluminized thermally stable fabrics were found to provide adequate fire protection when used in conjunction with urethane foams, while maintaining minimum weight and cost penalty. ←					
17. Key Words Aircraft Seats Flammability Fire Blocking Layer Foams			18. Distribution Statement This document is available to the U.S. public through the National Technical Information Service, Springfield, Virginia 22161		
19. Security Classif. (of this report) Unclassified		20. Security Classif. (of this page) Unclassified		21. No. of Pages	22. Price

METRIC CONVERSION FACTORS

Approximate Conversions to Metric Measures

Symbol	When You Know	Multiply by	To Find	Symbol
LENGTH				
in	inches	2.5	centimeters	cm
ft	feet	30	centimeters	cm
yd	yards	0.9	meters	m
mi	miles	1.6	kilometers	km
AREA				
m ²	square inches	6.5	square centimeters	cm ²
ft ²	square feet	0.09	square meters	m ²
yd ²	square yards	0.8	square meters	m ²
mi ²	square miles	2.6	square kilometers	km ²
	acres	0.4	hectares	ha
MASS (weight)				
oz	ounces	28	grams	g
lb	pounds	0.45	kilograms	kg
	short tons (2000 lb)	0.9	tonnes	t
VOLUME				
tsp	teaspoons	5	milliliters	ml
Tbsp	tablespoons	15	milliliters	ml
fl oz	fluid ounces	30	milliliters	ml
c	cups	0.24	liters	l
pt	pints	0.47	liters	l
qt	quarts	0.95	liters	l
gal	gallons	3.8	liters	l
ft ³	cubic feet	0.03	cubic meters	m ³
yd ³	cubic yards	0.76	cubic meters	m ³

TEMPERATURE (exact)

°F	Fahrenheit temperature	5/9 (after subtracting 32)	Celsius temperature	°C
----	------------------------	----------------------------	---------------------	----

Approximate Conversions from Metric Measures

When You Know	Multiply by	To Find	Symbol
LENGTH			
millimeters	0.04	inches	in
centimeters	0.4	inches	in
meters	3.3	feet	ft
meters	1.1	yards	yd
kilometers	0.6	miles	mi
AREA			
square centimeters	0.16	square inches	in ²
square meters	1.2	square yards	yd ²
square kilometers	0.4	square miles	mi ²
hectares (10,000 m ²)	2.5	acres	ac
MASS (weight)			
grams	0.036	ounces	oz
kilograms	2.2	pounds	lb
tonnes (1000 kg)	1.1	short tons	st
VOLUME			
milliliters	0.03	fluid ounces	fl oz
liters	2.1	pints	pt
liters	1.06	quarts	qt
liters	0.26	gallons	gal
cubic meters	35	cubic feet	ft ³
cubic meters	1.3	cubic yards	yd ³

TEMPERATURE (exact)

°C	Celsius temperature	9/5 (then add 32)	Fahrenheit temperature	°F
----	---------------------	-------------------	------------------------	----

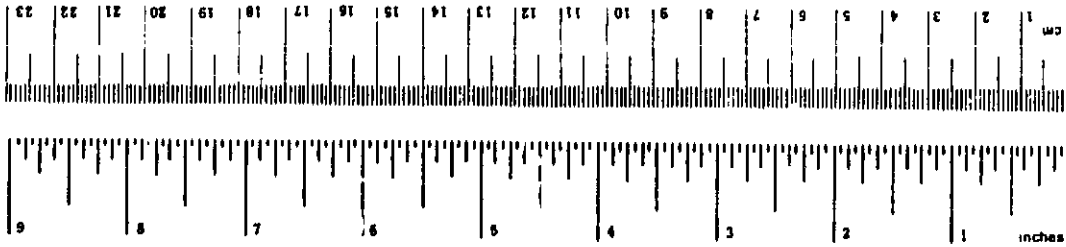

*1 in = 2.54 exactly. For other exact conversions and more detailed tables, see NBS Mon. Pub. 446, Units of Weights and Measures, Price \$2.25, SD Catalog No. C13.10-286.

PREFACE

The Special Aviation Fire and Explosion Reduction Advisory Committee (SAFER) (Reference 1), recognized that aircraft seat cushions represented a potentially important fire source. The SAFER committee recommended that fire blocking layers should be evaluated for seat construction.

The Federal Aviation Administration (FAA), acting on this recommendation, evaluated Vonar[®], a neoprene foam blocking layer, in a full-scale cabin fire test facility to examine its effect on postcrash fire propagation in the aircraft (Reference 2). The use of a Vonar fire blocking layer with conventional seats significantly decreased the flammability of the seats and increased the survivability time (Reference 2). The additional weight associated with the use of Vonar-3, with a weight of 0.918 kg/m³ (27.0 oz/yd³), in the U.S. fleet, amounted to a cost of approximately \$31,000,000 per year averaged over a 10 year period (see Appendix E-1).

The Chemical Research Projects Office, Ames Research Center, under an Interagency Agreement with the FAA, was charged with the responsibility of optimization of the seat blocking layer design with regard to fire performance, wear, comfort, and cost.

To achieve the above goal, various fire blocking materials were characterized in terms of their (a) fire protection, (b) wear, (c) comfort, and (d) cost as compared with currently used seats.

From our studies (see Appendices B and C), it has been shown that a number of improved fireworthy seats can be made by protecting the cushion with a variety of fire blocking layers.

The optimum material is Norfab[®] 11HT-26-A1, an aluminized fabric which will cost \$11,600,000 over the baseline cushion and provide approximately similar fire performance as the Vonar-3 wrapped seat under small-scale fire test conditions (Appendices B-1 and C-1).

This optimization program showed that some fire blocking layers such as Norfab 11HT-26-A1 gave better fire protection when used with non-fire retarded urethane. Thus, it is possible to use non-fire retarded urethane with a density of 19.2 kg/m³ (1.2 lb/ft³) with the Norfab 11HT-26-A1 at a cost of only \$7,880,000 over the baseline. This represents a fourfold improvement over the cost with the Vonar-3 material.

This report is presented in two parts - Sections 1-7 which describe the work completed under the Interagency Agreement, and Section 8, the Appendices, where individual studies may be found.

Vonar[®] is registered trade mark of E.I. du Pont de Nemours Co., Inc.
Norfab[®] is a registered trademark of the Norfab Corp.

TABLE OF CONTENTS

	<u>Page</u>
1. INTRODUCTION	1
2. SELECTION AND FIRE TESTING OF CANDIDATE FIRE BLOCKING LAYERS	4
2.1 Mechanistic Aspects of Fire Blocking Behavior	4
2.2 Rationale for the Selection of Test Materials	5
2.3 Materials Selected	7
2.3.1 Decorative Cover Materials	7
2.3.2 Foam Cushioning Materials	8
2.3.3 Fire Blocking Layers (FBL)	8
2.4 Fire Testing of Candidate Seat Cushion Configurations	10
2.4.1 NASA-Ames T-3 Burner Test Results	10
2.4.2 Thermal Characterization of Materials	10
2.4.3 Mass Injection Studies into the Environment	11
2.4.4 Cabin Fire Simulator Test Results	12
3. DEVELOPMENT OF WEIGHT AND ECONOMICS ALGORITHMS FOR SELECTED SEAT CUSHIONS	18
3.1 Development of a Weight Algorithm	18
3.2 Comparative Economics of Use for Selected Seat Cushion Configurations	20
4. MECHANICAL WEAR TESTING AND ASSOCIATED COMFORT FACTORS	22
4.1 ILD Test Results	22
4.2 Wear Tests	23
5. SUMMARY	25
6. CONCLUSIONS	26
7. REFERENCES	27

8. APPENDICES

Appendix A-1

"NASA Burn Tests of Seat Cushions", NASA Final Report, Contract NAS2-11064, Scientific Services, Inc., Redwood City, California, February 1982.

Appendix B-1

"Optimization of Fire Blocking Layers for Aircraft Seating", J.A. Parker and D.A. Kourtidis, Presented at the 7th International Conference on Fire Safety, SRI International, Menlo Park, California, January 11-15, 1982.

Appendix C-1

"Test Methodology for Evaluation of Fireworthy Aircraft Seat Cushions", D.A. Kourtidis and J.A. Parker, Presented at the 7th International Conference on Fire Safety, SRI International, Menlo Park, California, January 11-15, 1982, and the 41st Annual Conference of Allied Weight Engineers, May 19, 1982.

Appendix D-1

"Study for the Optimization of Aircraft Seat Cushion Fire Blocking Layers - Full Scale Test Description and Results", NASA Final Report, Contract NAS2-11095, Kenneth J. Schutter and Fred E. Duskin, McDonnell Douglas Corporation, May 1982.

Appendix E-1

"Seat Cushion Design Users Manual", NASA Final Report, Contract 7110-654, Linda Gay Thompson, Informatics, Inc., March 1982.

Appendix F-1

"Development of an Algorithm and Data Gathering for Aircraft Seats", NASA Final Report, P.O. # A84863B, EXON, Inc., August 1981.

Appendix G-1

"Fire Protection Studies of Aircraft Seats", NASA Final Report, NASA-SJSU Cooperative Agreement No. NCC-2-56, A.C. Ling, San Jose State University, January 1982.



EXECUTIVE SUMMARY

The purpose of this study, conducted under an interagency agreement between the Federal Aviation Administration (FAA) and the National Aeronautics and Space Administration (NASA), was to select and evaluate low-weight fire blocking layers for aircraft seat cushions to minimize the cabin hazards created by a postcrash fire.

The general approach was to evaluate the fire hazard characteristics and mechanical properties of a series of candidate seat cushion fire blocking layers, and accurately compute the weight differential and manufacturing cost of each candidate system as well as the impact on airline operating costs for the U.S. Fleet over a period of 10 years. From this work, a number of blocking layer configurations, optimized for fire hazard reduction and minimal weight penalty, have been derived for full-scale fire test evaluation at the FAA Technical Center.

A series of eleven seat fire blocked configurations was evaluated using various fire test methods and laboratory tests. From these tests, it was concluded that seat cushions constructed with such fire blocking materials as Norfab 11HT-26-A1 in combination with non-fire retarded urethane foam provided a definite reduction in the fire hazards with a minimum weight penalty.

1. INTRODUCTION

Among existing commercially used cushioning polymers, there is probably no better material from mechanical aspects and cost (ca. \$0.15 per board foot) than conventional flexible polyurethane foams, and, unfortunately, none more thermally sensitive. These polymers, because of their easily pyrolyzed urethane groups and thermally oxidizable aliphatic linkages, exhibit polymer decomposition temperatures of ca. 250° C (508° F), maximum pyrolysis rates at 300° C (598° F), with a total yield of pyrolysis vapor of about 95%, most of which is combustible. One would expect these materials to ignite easily with a low power energy source, and when ignited, effect sustained flame propagation even after removal of the heat source.

This report examines the possibility of increasing the available egress time for passengers from aircraft exposed to a large fire, by providing fire protection for the polyurethane cushioning.

At the present time, all commercial transport aircraft are fitted with fire retarded flexible polyurethane seat cushions (bottoms, backs, and head rests) with an average foam density of 29.9 kg/m³ (1.87 lbs/ft³). With average seat construction, there are about 2.72 kg (6 lbs) of foam per seat. For 2,000 aircraft with an average of 200 seats per aircraft, this amounts to 91,000 kg (2 million lbs) of flexible polyurethane foam in use. The options one might consider as seating alternatives to effect improvement in the fireworthiness of aircraft interiors, and their limitations, are use of the following:

- § fire resistant non-metallic (polymeric) materials
 limitations: high cost, difficult processability, low durability and comfort factors
- § plastics and elastomers with fire retardant additives
 limitations: not effective for postcrash fires
- § fire blocking layers (FBL)
 limitations: essentially none; although compromises will have to be made in the choice of an FBL with respect to ultimate performance as a function of cost and weight, and the costs of labor involved in assembling a composite seat cushion.

The same classes of high char yield polymers that are known to be outstanding ablative materials (sacrificial materials designed to be consumed in order to protect other components) such as phenolics, polyimides, and polybenzimidazoles (PBI), can be made fire resistant enough to inhibit both propagation and flash-over when used as replacements for polyurethane in seats. However, when so designed, they all suffer serious limitations because of cost, processability, comfort, and durability (brittleness).

No fire retardant additive known to date can suppress production of combustible vapor from polyurethane foams under sustained heat fluxes. The only real option that exists at present with commercially available components seems to be the fire blocking approach; that is, to provide cost and weight optimized ablative materials in the form of foams, or fabrics, which will expend and dissipate the heat flux incident on the seats by producing non-toxic non-combustible residues. Eventually, however, the ablating FBL will be consumed, and attack on the polyurethane foam will occur. The time needed for ablation of the FBL, which is then the protection interval for the polyurethane foam, should be optimized as a function of cost, weight, durability, and other contributing factors, to provide the requisite egress time for aircraft passengers.

One of the largest contributors to the development of a hostile environment inside an aircraft cabin during a fire is the production of flammable and toxic vapors from soft fabrics and furnishings, the bulk of which are contained in the seats. The flammable vapors produced by thermal decomposition of the urethane foam cushions are assumed to be the largest single factor contributing overtly to this hostility factor during such a fire. Thus, it is deemed necessary to find an FBL to minimize the hazards created in the post-crash aircraft fire. Preliminary studies (Reference 2) have shown that Vonar-3, 0.48 cm (3/16 in) thick, is a good ablative FBL, but it carries a heavy weight penalty producing significantly increased operating costs. This study was performed to find an FBL which will provide greater cost benefits and comparable, if not better, heat blocking performance than 0.48 cm (3/16 in) thick Vonar.

The main purpose of this investigation is to evaluate the fire hazard characteristics and mechanical properties of a series of candidate seat cushion FBLs, to accurately compute the weight differential and manufacturing costs of each candidate system, and to provide a quantitative assessment of the effect of these factors on airline operating costs for the U.S. fleet over a period of ten years. From these data, FBL configurations will be characterized and ranked for fire hazard reduction and minimal weight penalty, and will be recommended in rank for full-scale fire test evaluation at the Federal Aviation Administration (FAA) Technical Center.

Initial interest in this problem of passenger survivability time, and the development of severely hostile cabin environments, began when it was shown that a Vonar-3 FBL over normal polyurethane foam cushioned seats provided a significant reduction in fire hazard in a full-scale fire test (the C-133 wide-body test facility at the FAA Technical Center). Preliminary data from the FAA Technical Center indicated that the Vonar-3 blocking layer, when encasing a conventional fire retardant (FR) urethane cushion, appeared equivalent in fire protective performance to full-cushion LS-200 neoprene, and superior in performance to full-cushion polyimide, full-cushion FR urethane, and 0.48 cm (3/8 in) LS-200 neoprene blocking layer over FR urethane (Reference 5). However, use of a Vonar-3 blocking layer resulted in an estimated weight penalty of 1.8 kg (4 lbs) per seat. Thus, due to ever

increasing fuel costs, the Vonar-3 blocking layer may not be cost effective (see Appendix E-1). An FBL is then needed which affords fire protection as well as cost effectiveness (both in terms of weight penalties and intrinsic costs of manufacturing and assembly) for the U.S. fleet.

With this background, a work statement and interagency agreement was developed between the Federal Aviation Administration and the National Aeronautics and Space Administration (NASA). The studies described above indicated that an FBL configuration must be found which best fits four often conflicting criteria:

- first, it must be a suitable FBL;
- second, it must be light-weight to minimize fuel costs;
- third, it must be comfortable, and
- fourth, it must have reasonable manufacturing and processing costs via normal commercial sources.

The work statement in the interagency agreement between the FAA and NASA delineates three specific tasks aimed at accomplishing this goal:

1. Selection and fire tests of candidate FBL materials
2. Development of a weight and economics algorithm for aircraft seat cushion configurations to determine cost effectiveness
3. Mechanical tests of optimum FBL configurations.

This report is the culmination of a group effort to accomplish these goals. In the following section of this report, each of these three tasks will be defined in detail, with results and discussion of the work performed in accomplishing these tasks. Individual contributions may be found in the Appendices at the end of this report.

2. SELECTION AND FIRE TESTING OF CANDIDATE FIRE BLOCKING LAYERS

2.1 MECHANISTIC ASPECTS OF FIRE BLOCKING BEHAVIOR: There are various fire blocking mechanisms thought to occur with existing materials that are possible candidates for blocking layers. These are described briefly below:

Transpirational cooling occurs via emission of water vapor to cool the heated zone. Vonar, a family of low density and high char yield foams, usually doped with $Al(OH)_3$ powder, contains a large fraction of water of hydration, and is one of the best candidates in this class. It is available in three thicknesses, Vonar-1 0.16 cm (1/16 in), Vonar-2 0.32 cm (2/16 in), and Vonar-3 0.48 cm (3/16 in). Materials which depend on transpirational cooling by mass injection into the environment can be very efficient at high heat fluxes. Unfortunately, these systems are less efficient on a weight basis than those using other fire protection mechanisms.

High temperature resistant fabrics such as PBI and Preox® (registered trademark of Gentex Corporation), with char yields in excess of 60%, are excellent candidates that utilize a re-radiative fire protection mechanism. Suitable felt fabrics, which are also good insulators, have been prepared from these polymers in fiber form. These potential fire blocking materials exhibit high temperature stability with low thermal conductivity. Fabrics, mats, and mats with excellent high temperature insulation properties can also be obtained from inorganic materials such as silica and alumina. Also to be considered are the highly reflective continuous surfaces, such as aluminum foils, which function by distributing the incident radiant energy and thus reducing local heat loads.

Another mechanism which may be important in controlling the effective mass injection rate is the ability of the material to initiate vapor phase cracking of the combustible vapor species generated by the low temperature pyrolysis of the polyurethane substrate. The action of the FBL itself in inducing these endothermic processes can be a very important contribution to overall fire protection abilities. All of these materials in sufficient thicknesses, in combination or individually, can provide the required degree of thermal protection necessary for fire safe polyurethane cushioning.

Examination of the heat conduction and thermal radiation properties of the seat cushion materials has led to the development of a simple cushion model based on six identifiable layers. This model cushion consists of the following six layers:

1. the wool-nylon decorative fabric layer
2. the re-radiative char layer (formed from the heat blocking layer by thermal degradation of a suitable fabric or foam)
3. the transpiration layer (allowing vapor exchange)
4. the air gap layer
5. the reflective layer (to assist in controlling radiant energy)
6. the cushioning foam (the primary component which requires thermal protection).

In some cases, for example LS-200 neoprene and polyimide, the FBL and cushion are a single substance, with no need for any additional FBL component. Re-radiation can be effected by either reflection from an emissive surface of aluminum or from a hot char surface formed. The use of aluminum covering on high temperature stable and/or char forming interlayers is important in redistributing the local incident radiation, and the hot char or carbonized layers formed can dominate the re-radiation process. Thus, aluminized char forming high temperature materials, such as Preox 1100-4 or Norfab 11HT-26-Al provide the best combination of mechanisms. Nevertheless, it should be noted at this point that efficient FBLs are by no means limited to these kinds of materials.

A major danger in aircraft fires is what is termed "flash-over", where flammable vapors trapped high up towards the ceiling of the cabin will suddenly ignite and propagate the fire across the whole upper interior of the aircraft like a wave. A suspected major source of flammable vapors leading to this condition is the decomposition of polyurethane foam.

In ablative (sacrificial) protection of a flammable substrate such as the flexible polyurethane foam, wherein a limited amount of controlled pyrolysis by the FBL is not only allowable but encouraged, secondary internal char formation by thermal cracking of the urethane pyrolysis vapor is additionally beneficial. Firstly, that part of the evolving combustible gas which is fixed as a char cannot participate in the external flame spread and the flash-over process. Secondly, the additional char layer assists in insulating the remainder of the foam from further pyrolysis. Venting of the seat cushion is necessary to prevent sudden release of combustible gases, and can allow additional cooling via mass exchange processes.

2.2 RATIONALE FOR THE SELECTION OF TEST MATERIALS: In delineating the rationale for materials selection, one must remember that there is a wide range in radiant heating rates to which the seat sections are exposed in an aircraft fire. In exposing the seats in the C-133 test aircraft to a large pool fire through an opening the size of a door in zero wind conditions, one encounters an actual heating rate of 14 W/cm^2 ($12.3 \text{ Btu/ft}^2 \cdot \text{sec}$). This decays to 1.7 W/cm^2 ($1.5 \text{ Btu/ft}^2 \cdot \text{sec}$) at the center line of the aircraft (Reference 6). Thus, one of the apparent problems in trying to define the thermal environment, which is necessary before one can consider the materials response, is the highly geometrically variable distribution of heating rates, ranging from values as high as 14 to as little as 1.7 W/cm^2 . One must recognize also that the seat presents an oblique and irregular view angle to the incoming radiation. Under such fixed wind conditions, the seat will undergo pyrolysis to generate a 90% (by weight) yield of combustible gases from the urethane cushion core. At nominal heating rates of $1-2 \text{ W/cm}^2$, this pyrolysis rate is not influenced by the presence of contemporary incorporated chemical fire retardants. The possibility of modifying the standard state-of-the-art polyurethane seats via the incorporation of chemical fire retardants was eliminated from further consideration. Bricker

(Reference 4), using tests in the 737 at NASA-Johnson Space Center, showed clearly that at heating rates above $4-5 \text{ W/cm}^2$ there was little or no difference in suppression of fire propagation from seat to seat for chemically retarded polyurethane compared to untreated polyurethane.

The primary objective in modifying the seats to increase their fire resistance is simply to reduce the rate of production of flammable vapors from the urethane core cushion, and prevent the injection of such flammable gases into the passenger environment - a critical issue. Under the conditions that exist in postcrash fires, it is quite clear that nothing can be done to influence vapor production from the polyurethane. An alternate option is to replace the polyurethane with materials that do not yield flammable vapors on pyrolysis. Under the enormous heat fluxes that exist, such materials will still pyrolyze, however, the pyrolysis process should produce a non-flammable char, leading to self-protection of the remaining foam. The polyimide foams represent an example of this kind, providing a high char yield on pyrolysis, and not releasing flammable vapors into the environment. Unfortunately, the cross-link density and aromaticity required to achieve the level of char yield was inconsistent with the mechanical properties, comfort factors, resiliency, and durability of the seat, and these materials were eliminated from further consideration.

Thus, since we cannot replace the polyurethane core itself with another foam that will not pyrolyze to a flammable vapor, then we must use an insulating layer to provide the requisite protection. This FBL will provide ablative (sacrificial) protection of the polyurethane foam core. Even with the FBL present, it is still deemed necessary to prevent localized attack on the polyurethane cushion, necessitating some form of secondary protection (or protective layer) that will allow dissipation of the heat flux over as large an area as possible. The obvious method is to use a "wrap" made from highly conductive aluminum sheet (aluminum minimizes any weight penalty, and has one of the best thermal conductivity coefficients available for any common metal), such that the lateral conduction capabilities will reduce local hot spots, and further enhance the action of the FBL. There are several of these heat resistant, not easily pyrolyzed, low volatility woven fabric materials: Nomex® and Kevlar® (registered trademarks of the E. I. du Pont de Nemours Corporation), and Kynol® (registered trademark of American Kynol Corporation). Two that are commercially available as aluminized carbon-fibre based fabrics are Panox® (registered trademark of RK Textiles Composite Fibres, Ltd.) and Celiox® (registered trademark of Celanese Corporation), and the aluminized-Norfab materials containing Kynol, Kevlar, and Nomex.

One surprising factor emerged on examination of these aluminum protected fabric FBL systems. Since they are thin, it was not possible to maintain a zero temperature change between front and back face of the FBL, and thus necessarily some degradation of the surface of the polyurethane foam cushion will occur. However, the back-surface of these FBL systems behaves as an efficient (and hot) catalytic surface, producing rapid pyrolysis of the

potentially flammable vapor (and thus curtailment of their escape into the environment). Secondly, this endothermic pyrolysis action produces an intrinsic fire ablation mechanism, and finally, yet a third protective mechanism ensues, in that the pyrolysis process produces a thin (but effective) char layer from the polyurethane itself, strengthening the overall ablative mechanism from the FBL, and further protecting the remainder of the foam. This three-fold bonus action, which is non-operative in the absence of the FBL itself, provides a considerable degree of synergism between FBL and central foam cushion. More interestingly, this synergism seems to be stronger with NF foam (a lighter and more desirable core cushion) than with PR foam! Finally, a fourth advantage is apparent, since it should be noted that the aluminum layer provides a degree of impermeability to the FBL wrapped around the foam core. This helps to prevent liquefied urethane vapor from dripping out of the cushion onto the floor, and forming small secondary pool fires underneath the banks of seats. This in itself is a valuable contributing factor in preventing the attainment of a lethal environment in the passenger cabin of an aircraft.

We may summarize the various factors contributing to our rationale for materials selection, and limiting the cushion configurations tested:

- (1) Chemical modification of polyurethanes to provide fire retardant properties was eliminated based on Bricker's work which showed lack of effectiveness in suppressing the pyrolysis rate.
- (2) There are no commercially available foam cushion systems which have all the qualities needed for a seat such as comfort and durability and yet provide sufficient fire protection.
- (3) The most efficient method for ablative protection at high heating rates ($5-14 \text{ W/cm}^2$) is to use a transpirational mechanism ablater. The most efficient transpirational ablater we know is neoprene highly loaded with Al(OH)_3 , which gives about 50% (by weight) injection rate of water into the environment (essentially, the ablater is spent completely before the foam cushion begins to decompose at all).

It has been determined previously (Reference 2) that seat arrays heat blocked with a neoprene FBL transpirational ablater at 1.0 kg/m^3 (30 oz/yd^3) was able to effect an increase of approximately 1 minute in the egress time when tested under large scale conditions. The major problem was that use of such an FBL produced an increase of 1.8 kg (4 lbs) in the seat, and is considerably more expensive to use.

2.3 MATERIALS SELECTED: In formulating our restricted set of cushion configurations, the following components were selected:

2.3.1 DECORATIVE COVER MATERIALS: The upholstery material selected was a blue-colored standard wool/nylon blended fabric currently in use by a commercial airline company.

2.3.2 FOAM CUSHIONING MATERIALS: Two types of cushioning foam were used in these studies, a fire-retarded polyurethane (FR, with density of 29.9 kg/m³, 1.87 lb/ft³) and a non-fire retarded polyurethane (NF, density of 23.2 kg/m³, 1.45 lb/ft³). A second form of NF foam was used for one test, involving a low density foam (16.1 kg/m³, 1.0 lb/ft³). Composition of the NF polyurethane is given in Table 1. Composition of the FR polyurethane is not known (commercially controlled proprietary information), but it is assumed to contain chemically incorporated organo-halide and/or organo-phosphorus components as the fire retardant.

Table 1: Contents of Non-Fire Retarded Polyurethane Foam

Component	Parts by Weight
Polyoxypropylene glycol (3000 M.W.)	100.0
Toluene diisocyanate (80:20 isomers)	105.0
Water	2.9
Silicone surfactant	1.0
Triethylenediamine	0.25
Stannous octoate	0.35

2.3.3 FIRE BLOCKING LAYERS (FBL): This is not a materials development study, but merely an experimental comparison of "off the shelf" materials. Potential candidates are listed in Table 2 and are all commercially available. As stated above, the optimum fire blocking seat should give equivalent or better fire blocking performance than Vonar-3 with no increase in contemporary seat weight or price.

Criteria were established to screen potential fire blocking materials prior to inclusion in this study. These criteria included:

- (a) fire blocking efficiency as it relates to weight,
- (b) mechanical properties with respect to comfort,
- (c) wear of the FBL, and
- (d) cost.

Any FBL that did not perform adequately in each of the above categories was disqualified. Several FBLs possessing optimum fire blocking efficiency under laboratory tests were also tested by the FAA in full-scale tests (C-133) to determine fire propagation under the simulated postcrash fire conditions. Wear properties were not evaluated in detail and only preliminary and partial results are given in the report. Complete test results will be provided in a separate report.

TABLE 2: SEAT CUSHION CONFIGURATIONS SELECTED FOR EVALUATION

Config-uration	Foam†	Fire-Blocking Layer (FBL)	FBL Weight kg/m ² oz/yd ²		Suppliers of Fire Blocking Layers
1	PR urethane*	none			
2	PR urethane*	Vonar-3, 0.48 cm (3/16 in)	0.91	27.07	Chris Craft Industries 1980 East State St. Trenton, NJ 08619
3	PR urethane*	Vonar-2, 0.32 cm (2/16 in)	0.67	19.97	Chris Craft Industries 1980 East State St. Trenton, NJ 08619
4	PR urethane	LS-200 neoprene 0.95 cm (3/8 in)	3.0	84	Toyad Corporation 16 Creole Drive Pittsburg, PA 15239
5	PR urethane	Preox 1100-4 aluminized Preox fabric, plain weave, neoprene CTD, P/N 1299013	0.39	11.53	Genex Corporation P.O. Box 315 Carbondale, PA 18407
6	PR urethane	Norfab 11HT-26-A1 aluminized on one side, 25% Nomex, 70% Kevlar 5% Kynol, weave structure ixi plain	0.40	11.8	Amatex Corporation 1032 Stonebridge St. Morristown, PA 19404
7	PR urethane	181 E-Glass, Satin Weave	0.30	9.2	Uniglass Industries Statesville, NC
8	NP urethane*	Vonar-3, 0.48 cm (3/16 in)	0.92	27.07	Chris Craft Industries 1980 East State St. Trenton, NJ 08619
9	NP urethane	Norfab 11HT-26-A1	0.40	11.8	Amatex Corporation 1032 Stonebridge St. Morristown, PA 19404
10	LS-200 Neoprene	none			
11	Polyimide	none			
12	NP urethane light	Norfab 11HT-26-A1	0.40	11.8	Amatex Corporation 1032 Stonebridge St. Morristown, PA 19404

Notes on Table 2:

All decorative upholstery is a wool/nylon blend fabric (R76423 Sun Eclipse, Azure Blue, 78-3680) by Collins & Aikman, Albemarle, NC.

† Suppliers of Foams:

PR urethane (No. 2043 PA foam, density of 29.9 kg/m³ or 1.87 lb/ft³):
North Carolina Foam, P.O. Box 1112, Mt. Airy, NC 27030.

NP urethane (medium firm, ILD32, density of 23.4 kg/m³ or 1.45 lb/ft³):
Foam Craft, Inc., 11110 Business Circle Dr., Cerritos, CA 90701.

NP urethane light (16.1 kg/m³ or 1.0 lb/ft³):
Foam Craft, Inc., 11110 Business Circle Dr., Cerritos, CA 90701

Polyimide foam (19.2 kg/m³ or 1.2 lb/ft³):
International Harvester, 701 Fargo Ave., Elk Grove Village, IL 60007

LS-200 neoprene foam: Toyad Corporation.

* These polyurethane foams were covered by a cotton/muslin fire-retarded scrim cloth, weighing 0.08 kg/m² (2.6 oz/yd²).

2.4 FIRE TESTING OF CANDIDATE SEAT CUSHION CONFIGURATIONS: The second task described in the agreement was to evaluate candidate seat-cushion/FBL configurations using a series of fire tests ranging from small sample tests to large scale tests on full banks of seats.

2.4.1 NASA-AMES T-3 BURNER TEST RESULTS: A series of initial screening tests for potential candidate blocking layers was conducted by Scientific Services, Inc. (Redwood City, CA) for NASA. The objective of these tests was to compare the effects of thermal exposure on the standard seat cushion (the baseline reference seat was taken to be FR polyurethane covered by a wool-nylon blended decorative fabric) and a number of candidate FBL configurations, by measuring the time that it took to raise the temperature of the surface of the foam material in each sample to the degradation temperature (typically 300° C or 598° F). The test procedures used are delineated in Appendix A-1. Basically, 22.9 x 22.9 cm (9 x 9 in) areas of the various seat cushion configurations were exposed to heat fluxes of 11.3 W/cm² (9.95 Btu/ft²/sec) and 8.5 W/cm² (7.49 Btu/ft²-sec) in the NASA-Ames T-3 brick furnace. Thermocouples were placed at various depths in the foam. The FBLs tested are listed in order of descending time for the foam to reach 300° C.

LS-200 neoprene - 0.95 cm (3/8 in) thickness
 Vonar-3 - 0.48 cm (3/16 in) thickness
 Vonar-2 - 0.32 cm (2/16 in) thickness
 Norfab 11HT-26-A1
 Preox 1100-4
 181 E-Glass
 no FBL

Unfortunately, the heat flux in the T-3 burner test is too high to discriminate between small differences in test results.

2.4.2 THERMAL CHARACTERIZATION OF MATERIALS: The physical characteristics under thermal stress of the candidate cushions were determined using thermogravimetric analysis (TGA), differential scanning calorimetry (DSC), and the NASA-Ames NBS Smoke Density Chamber. The NBS smoke chamber gave the most conclusive data. In TGA, the samples are heated at a constant heating rate, usually under a nitrogen atmosphere, and the weight loss recorded as a function of temperature. The polymer decomposition temperature (PDT), the temperature where the mass loss rate is the highest, the temperature of complete pyrolysis, and the final char yield in percent, are determined as characteristic parameters. In DSC, the electrical energy required to maintain thermal equilibrium between the sample and an inert reference is measured as a function of temperature. By calculating the peak area on the chart, and the direction of energy flow, the endo- or exo-thermicity of transitions can be determined. Appendix G-1 contains more complete data on the thermal characteristics of the materials used in these tests.

2.4.3 MASS INJECTION STUDIES INTO THE ENVIRONMENT: The primary purpose of these experimental determinations was to determine the extent with which the polyurethane foam decomposed on pyrolysis and gave rise to mass injection into the environment of the highly flammable urethane vapors suspected of causing flash-over and other fire related phenomena. This investigation was done for NASA by San Jose State University (Appendix G-1) to determine the weight loss factors sustained by the urethane foam cushioning material, as well as the other seat components, both as a function of time, and as a function of the thermal flux incident on the front face of seat cushions.

The NBS smoke chamber was modified to measure weight loss as well as smoke density, as a function of time, at a specific heat flux in the range from 1.0 W/cm^2 ($0.88 \text{ Btu/ft}^2/\text{sec}$) to 7.5 W/cm^2 ($6.61 \text{ Btu/ft}^2/\text{sec}$). Two burning conditions were simulated by the chamber:

- radiant heating in the absence of ignition
- flaming combustion in the presence of supporting radiation.

Test samples ("mini-cushions") are approximately $7.62 \times 7.62 \text{ cm}$ ($3 \times 3 \text{ in}$) in size and 1.27 cm (0.5 in) to 2.54 cm (1.0 in) thick, composed of urethane foam wrapped and protected by a heat blocking layer, and wrapped and secured by wool/nylon upholstery. Each component of the seat configuration is weighed individually. The samples are suspended from the balance and subjected to a known heat flux in the NBS chamber. Mass readings are taken every two seconds via an automated balance. After the test, the sample cushions are opened carefully, and the remaining urethane foam is weighed to determine weight loss of the foam itself.

It was assumed initially that fire protection performance for each of the components would yield a final additive effect; this hypothesis was tested by use of single component samples thermolyzed under identical procedures to that used for the composite mini-cushion. No correlation was found. As mentioned before, in some cases, use of the highly flammable NF foam (and not FR foam) actually improved the overall performance of the sample. These results were based on mass injection measurements. The decorative fabric proved to have little influence on the performance of the heat blocking layer, although previous testing established that this component contributed markedly to the smoke content of the environment. After initial testing, it was determined that the amount of gas originating from the urethane foam injected into the air would be the best criterion to choose in following the thermal degradation of the seating material. However, much of the urethane foam was seen to decompose to a liquid rather than direct vapor, seen also in the McDonnell Douglas full scale testing procedure (see Appendix D-1), and overall mass loss could not be partitioned between direct vapor injection into the environment, and this liquid phase injection from the polyurethane foam.

The specific mass injection rate for Vonar-3 protected seat cushions was found to be over half that measured for the baseline system of wool/nylon decorative cover over FR foam alone. This in itself is a substantial reduction, albeit with a weight penalty. However, Preox 1100-4 and Norfab 11HT-26-A1 gave lower mass injection rates than Vonar, with the added bonus of an even lower weight penalty than Vonar.

The mass injection rate into the environment is predicated on the mass lost by the urethane foam itself, an assumption that is empirically reasonable. A relative Figure of Merit (FOM) is defined in terms of the mass injected into the environment for any thermal flux, the seat cushion size (surface area exposed) and time of exposure to the fire source.

$$FOM = \frac{[q] \cdot [Area Exposed] \cdot [Exposure Time]}{[Weight Loss by Polyurethane Foam]}$$

Samples which exhibited superior performance have been arbitrarily defined as those which have an FOM greater than 5×10^4 watts·sec/gram at 2.5 W/cm^2 . Thus, the larger the FOM, the greater the fire blocking performance exhibited by the sample. Of the configurations exhibiting an $FOM > 5 \times 10^4$, it is important to note that 80% utilize Preox 1100-4 as the heat blocking layer over NF foam. Moreover, samples with ventilation holes punched through the heat blocking layer to allow "breathing" (merely an increased possibility of dissipative cooling effects) by the foam showed the best heat blocking performance.

2.4.4 CABIN FIRE SIMULATOR TEST RESULTS: The Douglas Aircraft Company performed full scale seat bank tests on 13 different seat cushion configurations (Appendix D-1). Fire blocking layers, when present, covered all sides of the cushion. The 13 configurations used are listed in Appendix D-1. Dimensions of the top cushions were 43.2 x 60.9 x 5.1 cm (17 x 24 x 2 in) and of the bottom cushions were 45.7 x 50.8 x 5.1 cm (18 x 20 x 2 in). The tests were performed in a Cabin Fire Simulator (CFS) which is a double-walled steel cylinder 365 cm (144 in) in diameter and 1219 cm (480 in) long. A view port allowed photographs (closed circuit television) to be taken during testing. Chromel-alumel thermocouples were placed inside the seats to monitor temperatures, and heat flux calorimeters were installed to monitor the heat flux from an array of 46 quartz heating units, which produced 10 W/cm^2 ($8.8 \text{ Btu/ft}^2\text{-sec}$) at 15.2 cm (6 in) from the surface of the panels. The seat cushions were weighed prior to the tests. A propane gas lighter was ignited just as the heat flux was switched on. This ensured reproducible ignition of the urethane vapor, and produced a severe fire test configuration. The radiant heat panels remained on for 5 minutes. After 15 minutes, the tests were complete. The residue was removed from the seat frame and weighed.

Characteristically, the polyurethane foam thermally decomposes under the extreme heat into a fluid form and subsequently to a gas. In the fluid form, the urethane drips from the seat cushion onto the floor, forming a puddle or pool. This pool of urethane fluid gives off gases which are ignited by burning debris falling from the seat. This results in a very hot pool fire engulfing the seat in a matter of minutes, and must be controlled in some manner if realistic egress times are to be achieved.

Of the fire blocking layers tested, the ones which showed less than 25% weight loss, and therefore gave the best performance as a fire blocking layer are:

LS-200 neoprene
 polyimide with polyester
 Norfab 11HT-26-A1 (FR foam)
 Preox 1100-4 (FR foam)
 Vonar-3 (NF foam)

Detailed results may be found in Figure 1. LS-200 neoprene and polyimide

Figure 1: WEIGHT LOSS OF VARIOUS CUSHION CONFIGURATIONS

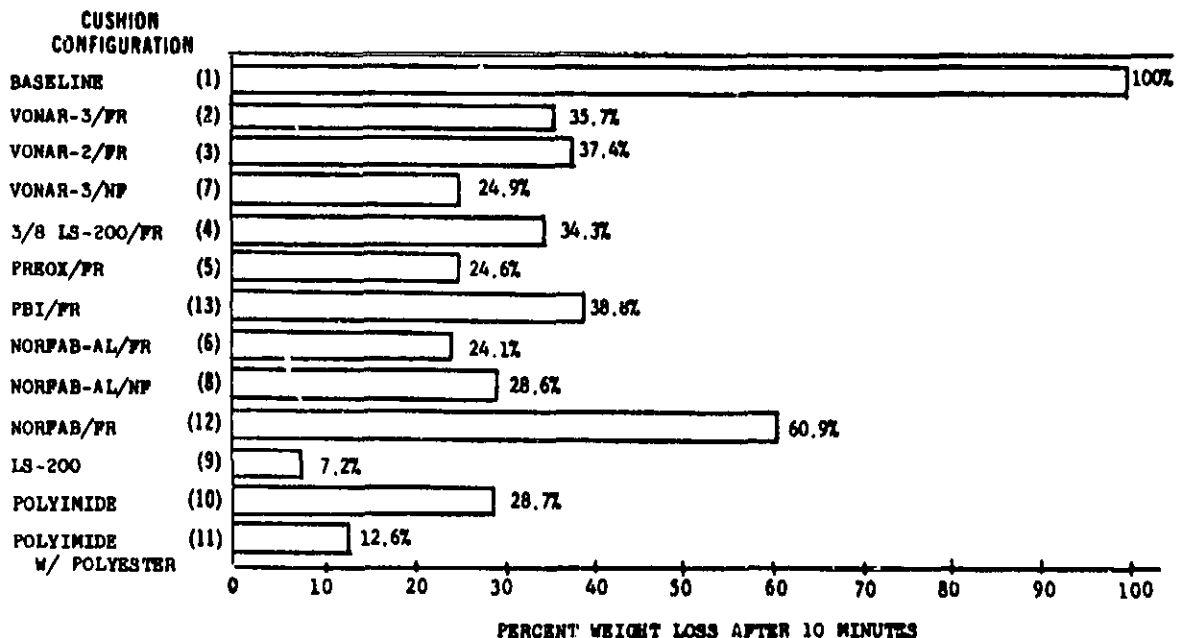

are advanced foams which are used as both the fire blocking layer and the central cushion itself. They are superior to the fire blocked systems tested in fire protection performance. The major disadvantage of LS-200 neoprene is a large weight penalty. Equally, polyimide foam provides good fire protection, but the foam is extremely hard and uncomfortable, and essentially fails the "comfort index" criterion. This is discussed further under "Mechanical Tests".

When the fire blocking layer is able to contain the decomposing urethane by-products (as in those FBL configurations using aluminized fabrics that are impermeable to liquid products), the cushions closest to the heat source burn with less intensity, generating a minimum of heat. More importantly, they are unable to ignite adjacent cushions. However, when the decomposing urethane fluid is able to escape from the fire blocking envelope and form a pool on the floor, an uncontrolled fire erupts which results in total burning of all cushion materials. The aluminized fire blocking layers, both Norfab 11HT-26-A1 and Preox 1100-4, provide significant fire blocking both via their aluminum reflective coating, and their non-permeability. Seam constructions significantly affected results of these tests. Had the seams held, not allowing liquid by-products to pour out onto the floor, the overall seat degradation process may have been even less severe. Seam design is a factor which needs further examination.

Tests were performed with both Norfab 11HT-26-A1 and Norfab without the aluminum backing, and indicated that aluminized materials provide a great deal more fire protection, presumably (as stated before) involving both radiant reflective effects and obviation of localized heating effects.

The Figure of Merit comparisons derived by normalizing the efficiency of the blocking layers tested with respect to Vonar-3 over FR urethane are listed in Table 3, along with other pertinent data to determine the most efficient

Table 3: MASS LOSS DATA AS A CRITERION OF HEAT BLOCKING PERFORMANCE
AT 2.5 W/cm²

CODE	DESCRIPTION OF HEAT BLOCKING LAYER (HBL)	THICKNESS OF HBL cm	SURFACE DENSITY* OF HBL g/cm ²	SPECIFIC MASS INJECTION RATE [†] g/cm ² .sec	FIGURE OF MERIT [‡] $\epsilon_s = \dot{q} / \dot{m}$ watts.sec/g	RELATIVE FIGURE OF MERIT ^{***} $\epsilon/\epsilon_0 \times 100\%$	RANK	ESTIMATED SEAT WEIGHT	
								NF Foam (grams)	FR Foam (grams)
291	None/Wool-Nylon/NF Urethane	0.0	0.0	12×10^{-5}	2.1×10^4	45	7	1040	1542
3	Vonar 1/Wool-Nylon/NF Urethane	0.152	0.055	7.3×10^{-5}	3.4×10^4	51	6	1721	2113
15	Vonar 3/Wool-Nylon/NF Urethane	0.463	0.111	5.1×10^{-5}	4.9×10^4	104	4	2035	2426
369	100 Al(up) Cellon/Wool-Nylon/NF Ure.	0.089	0.039	3.3×10^{-5}	7.6×10^4	162	2	1699	2090
372	101 Al(up) Cellon-Wool-Nylon/NF Ure.	0.071	0.053	2.8×10^{-5}	8.9×10^4	189	1	1528	1919
375	Norfab/Wool-Nylon/NF Urethane	0.088	0.040	4.5×10^{-5}	5.5×10^4	117	3	1539	1930
17	Vonar 3/Wool-Nylon/FR Urethane	0.463	0.111	5.3×10^{-5}	4.7×10^4	100	5	2035	2426

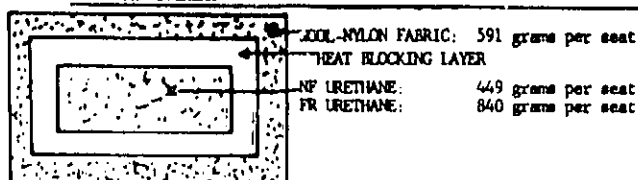

*Densities can be calculated from these values and the indicated HBL thickness data.

†Density = Surface Density/Thickness"

** \dot{q} is a standard heat flux of 2.5 watts/cm²

*** Scaled relative to ϵ_s for Vonar III heat blocking layer with ϵ_s value of 100.

fire blocking layers. It is true that Vonar-3 performs better at the higher heat flux level of 7.5 W/cm^2 ($6.6 \text{ Btu/ft}^2\text{-sec}$), but at the heat level of interest, 5.0 W/cm^2 ($4.4 \text{ Btu/ft}^2\text{-sec}$), it was approximately equal to the other heat blocking layers. However, complete data at 5 W/cm^2 are not available at this time. Both Preox and Norfab perform well as fire blocking layers, with no great difference in performance between the two. It can also be seen from Table 3 that Vonar performs equally well with both non-fire retarded and fire retarded flexible polyurethane foams. Plots have been made of the FOM versus heat flux for both types of foams with various fire blocking layers, and they may be found in Figures 2 and 3.

Figure 2: THERMAL EFFICIENCY (COMPARISON OF HEAT BLOCKING LAYERS FOR PR URETHANE AS A FUNCTION OF HEAT FLUX AT 2 MINUTES ELAPSED TIME

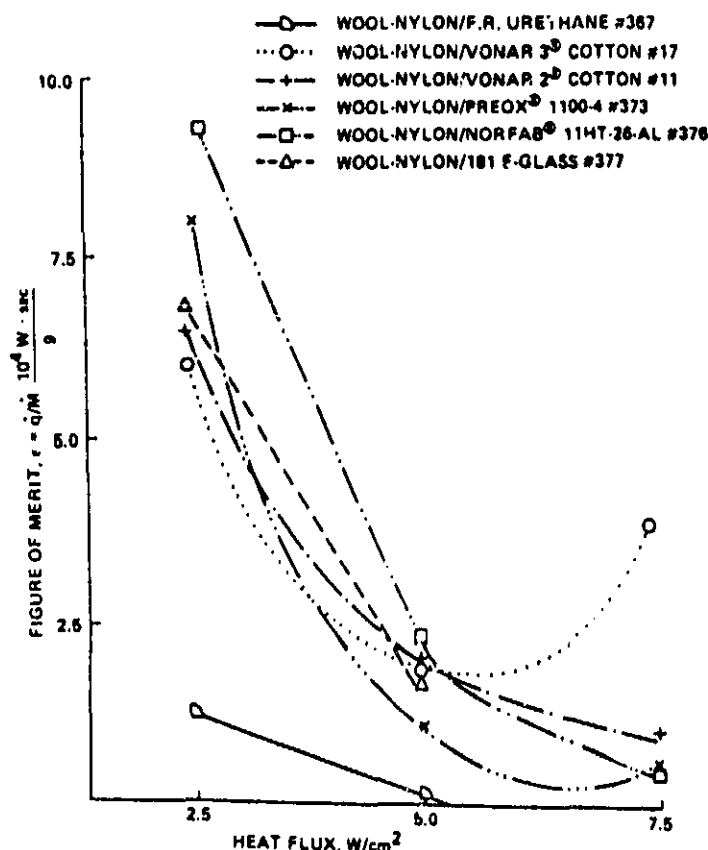

The 181-F Glass fabric exhibited the lowest fire protection at 5.0 W/cm^2 ($4.4 \text{ Btu/ft}^2\text{-sec}$) when the exposure time was averaged over a 5 minutes period, and intuitive reasons would indicate that these inert inorganic materials, which are unable to provide ablation protection, probably will not prove to be worth-while FBI materials.

A cost/weight penalty study of the different blocking layers shows that the re-radiation cooling systems (in general, aluminized fabrics) provide far better cost-efficiency than the transpirational and dissipative cooling systems such as Vonar-3. These results, and the comparability of the fire

Figure 3: THERMAL EFFICIENCY COMPARISON OF HEAT BLOCKING LAYERS FOR
 NF URETHANE AS A FUNCTION OF HEAT FLUX AT 2 MINUTES ELAPSED TIME

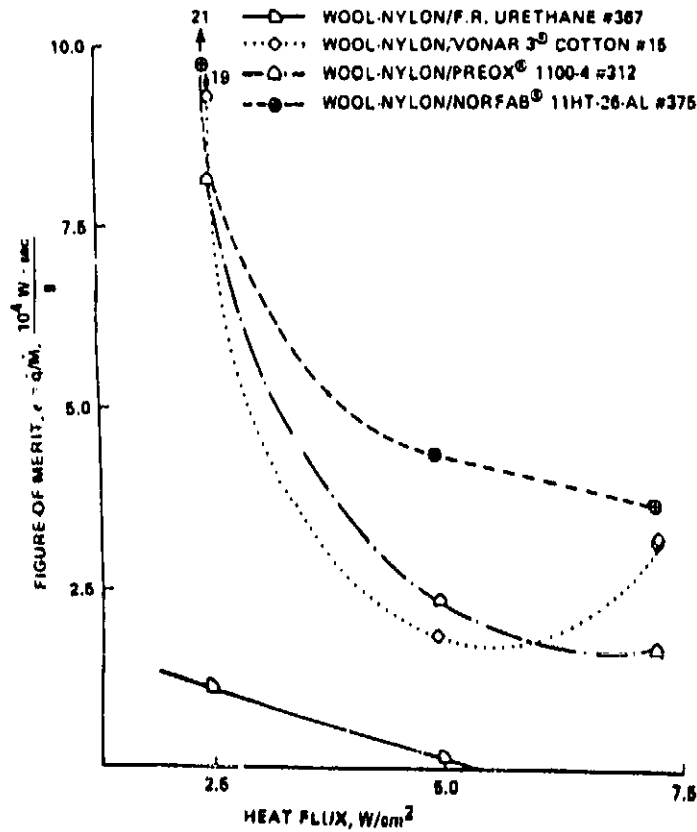

protection performance shown in this study, point in favor of aluminized fabrics for possible use as cost efficient heat protection systems for the polyurethane foams.

For clarity in presentation of thermal performance as a function of weight, the plot shown in Figure 4 is most useful. It can be seen that the Vonar systems do not meet the desired performance criteria. Vonar-3 is too heavy and Vonar-1 is not sufficiently protective. Preox 1100-4 easily meets both of these criteria.

Results of these studies are summarized in terms of a standard tourist-class aircraft seat in Table 4. Again, these results show that on a weight basis both candidate ablative fire blocking layers are about three times more cost effective than Vonar-3. These figures are conservative. Seats can probably be manufactured and used without the cotton/muslin seat cover, and other weight savings can probably be realized in practice.

Finally, it should be stated that, although Preox 1100-4 offers slightly superior fire protection performance when compared to Norfab 11HT-26-Al, it is seen that non-fire retarded polyurethane foam with aluminized Norfab

1HT-26-A1 as a blocking layer comes closest to meeting the target goal of this study, namely, equivalent fire performance to Vonar-3 and the smallest increase in seat weight.

Figure 4: RELATIVE FIGURES OF MERIT FOR SELECTED HEAT BLOCKING MATERIALS USED TO PROTECT NF URETHANE FOAM VERSUS ESTIMATED SEAT WEIGHTS

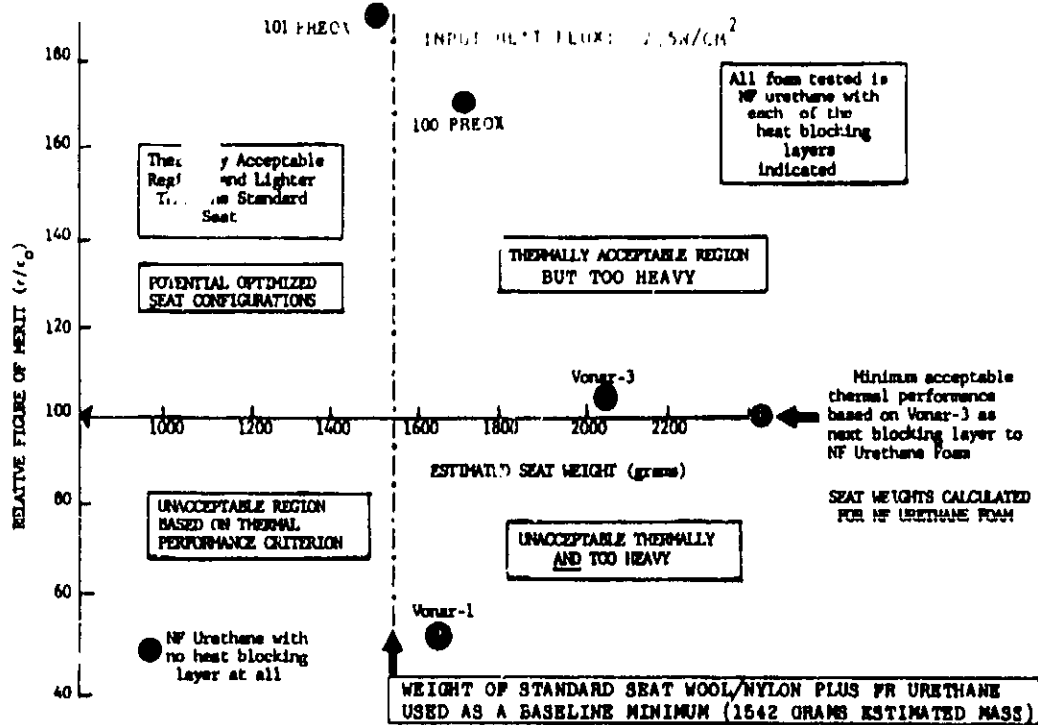
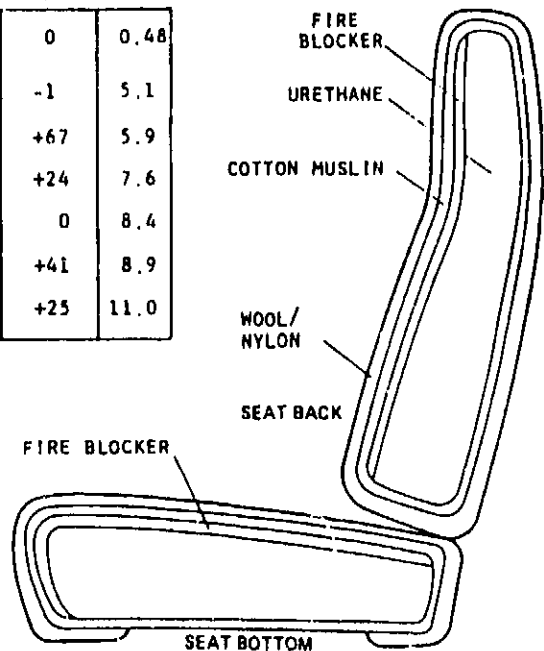

Table 4: RELATIVE RANKING OF CANDIDATE FIRE BLOCKED SEAT CONFIGURATIONS IN TERMS OF THERMAL PERFORMANCE

FIRE BLOCKER	FOAM	SEAT WT KG	% WT	c*
NONE	F.R. URETHANE (BASELINE)	1.54	0	0.48
PREOX	N.F. URETHANE	1.52	-1	5.1
VONAR-3	F.R. URETHANE	2.57	+67	5.9
PREOX	F.R. URETHANE	1.91	+24	7.6
NORPAB	N.F. URETHANE	1.53	0	8.4
VONAR	N.F. URETHANE	2.18	+41	8.9
NORPAB	F.R. URETHANE	1.93	+25	11.0

* $c = \frac{\text{HEAT FLUX}}{\text{SPECIFIC MASS INJECTION RATE}} \cdot \frac{W_s}{G}$
 INPUT HEAT FLUX: 2.5W/CM²
 EXPOSURE TIME: 2 MIN.



3. DEVELOPMENT OF WEIGHT AND ECONOMICS ALGORITHMS FOR SELECTED SEAT CUSHIONS

Among the specific tasks outlined in the NASA/FAA agreement was to provide accurate weight differentials, manufacturing and operating cost information, pertaining to each of the seat configurations for the projected U.S. fleet over a 10-year period. This information was to be provided by a computer program developed in a suitable manner for use by the FAA.

3.1 DEVELOPMENT OF A WEIGHT ALGORITHM: The problem has been addressed for NASA by ECON, Inc. and Informatics, Inc. (Appendices E-1 and F-1). They have developed a methodology to calculate estimated costs of the manufacture and use of advanced aircraft seat cushion configurations. The primary focus was to evaluate the cost impact associated with manufacturing and flying various seat configurations on the U.S. Fleet. The data has been organized into the following groups or files which allows for great versatility by the program user:

- \$ cushion dimensions data: allows varying dimensions in the seat height, width, and depth
- \$ cushion materials data: lists all materials used in the various configurations and a brief description of each material, including estimated costs
- \$ cushion configurations: defines seats comprised of six possible layers (upholstery, scrim cover, heat blocking layer, airgap layer, reflective layer, and foam), taking into account the cost and weight of each component
- \$ reference cushion configuration: allows generation of comparative costs, as compared to absolute costs, by allowing for changes in data on the reference cushion
- \$ aircraft fleet projection data: allows changes in the projected U.S. fleet size as given by the FAA
- \$ 'new' aircraft delivery schedule data: allows for changes in the estimated on-line aircrafts coming into use in the U.S. fleet
- \$ fuel cost projections data: allows change in the projected fuel costs.

A detailed logical flow of the program, taking into account all of the above parameters, is given in Appendix F-1. An outline of the algorithm for the current cost model of these seat modifications is shown in Figure 5.

Figure 5: MODEL CONFIGURATION OF THE COMPUTER ALGORITHM FOR DETERMINING COST/WEIGHT EFFECTIVENESS OF SEAT CUSHION BLOCKING LAYERS

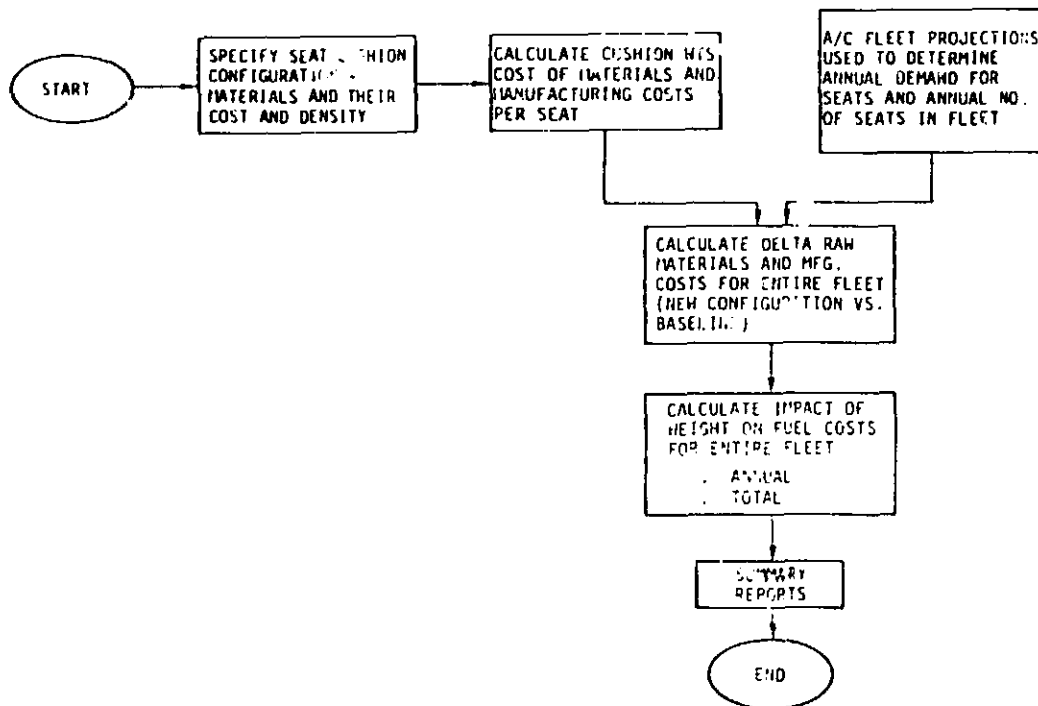

The results of applying this program to Vonar-3, Norfab 11HT-26-A1, and Preox 1100-4 FBLs are shown in Figure 6. Average cost to manufacture and

Figure 6: ALGORITHM COST EVALUATION OF CURRENTLY AVAILABLE FOAMS AND FIRE BLOCKING LAYERS AT EQUIVALENT FIRE PERFORMANCE AND COMFORT

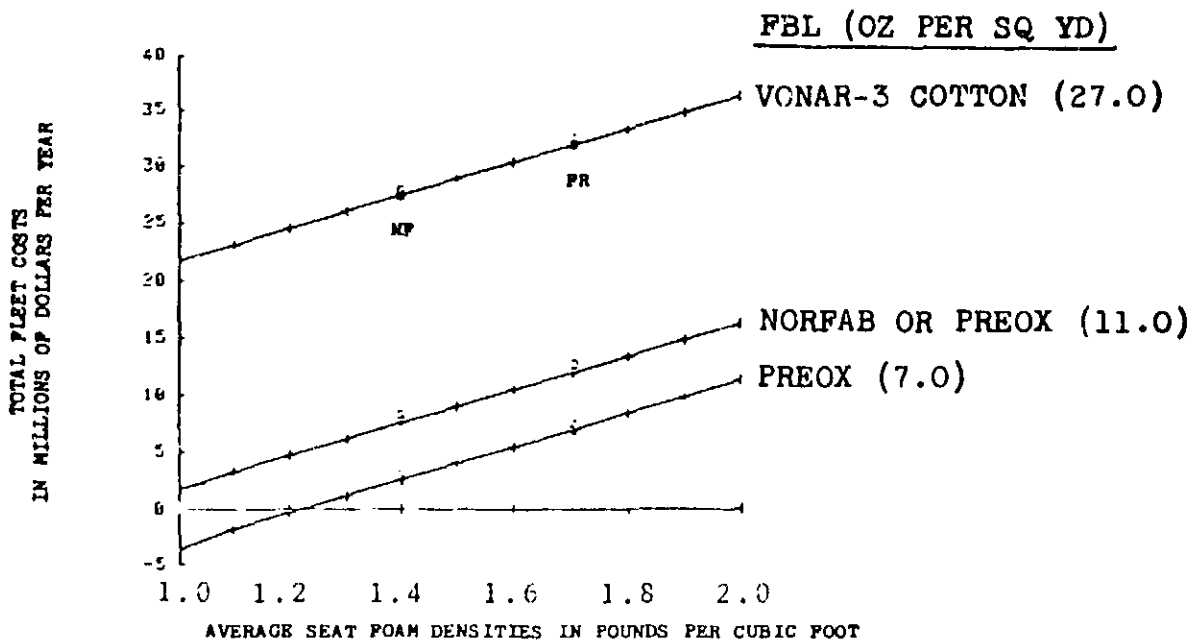

fly per year for a five year period with FBLs, each with a wear life of five years, are plotted as a function of average seat foam density. The average seat foam densities of fire-retarded and non-fire-retarded flexible polyurethane foam have been indicated as 27.2 kg/m³ and 22.4 kg/m³ (1.7 and 1.4 pounds per cubic foot), respectively. The use of non-fire-retarded polyurethane foam is considered to be a viable option for this application.

It is not certain at this point what the lower density limit is for the use of non-fire-retarded polyurethane foam while still maintaining the necessary durability and comfort parameters.

It is shown in Figure 6 that Preox 1100-4 and Norfab 11HT-26-AJ as candidate FBLs with non-fire-retarded polyurethane foam could cost as little as \$6 million dollars, whereas the Vonar-3 modification could amount to about five times as much, or \$28 million dollars.

3.2 COMPARATIVE ECONOMICS OF USE FOR SELECTED SEAT CUSHION CONFIGURATIONS:

Informatics, Inc., (Appendix E-1) implemented the set of programs based on the weight methodology developed by ECON, Inc., with an interactive computer process to compute costs to build and fly various aircraft seat configurations. These programs allow the user to tell the computer to store information about costs and characteristics of seat materials, material suppliers, fleet composition, aircraft characteristics, fuel prices, and seat designs. The user inputs test results, costs to make the seats, seat composition, and seat life in the computer for each design, then directs the computation of seat weight and costs. Costs are projected for ten years, based on annual demand/use demographics for seats. The frequency and method of seat replacement, route/usage information, as well as the composition of the fleet each year, determine the overall seat demand.

The complete program, along with the user's manual, may be found in Appendix E-1. A typical Cost Summary Report given by this program is found in Table 5 below.

Table 5: PROJECTED COSTS THROUGH 1986 FOR THE PURCHASE AND FLYING OF SOME SELECTED SEAT CONFIGURATIONS USING ONE PARTICULAR METHOD OF SEAT REPLACEMENT

METHOD SEATLIFE	VONARS	NORFAB	NORFAB LIGHT	
	CODEN 001	CODEN 002	CODEN 009	CODEN 012
	GRAD	GRAD	GRAD	GRAD
	3 YRS	3 YRS	3 YRS	3 YRS
COST TO FLY(1986)	51566.	84199.	57196.	50089.
COST TO BUY(1986)				
MATERIAL	6986.	7694.	13312.	13312.
MANUFACTURING	11799.	11799.	11799.	11799.
TOTAL COSTS(1986)	78351.	103571.	82307.	75208.
DELTA COST-FLY(1986)	0.	32572.	5630.	-1477.
DELTA COST-BUY(1986)	0.	648.	6326.	6326.
DELTA COSTS(1986)	0.	33220.	11956.	4849.

- * Costs in Table 5 are given in thousands of dollars.
 CODE# 001 - unprotected FR urethane (used as our baseline reference cost)
 CODE# 002 - Vonar-3 protected FR urethane
 CODE# 009 - Norfab protected NF urethane
 CODE# 012 - Norfab protected low-density NF urethane foam

In Appendix E-1 are cost summaries using the three replacement methods for the 12 configurations indicated in Table 2 on page 9. Three methods of seat replacement are used in calculating the replacement costs involved: a "gradual" (GRAD) replacement of the seats, depicting the present attrition rate of used seats, a "no replacement method" (NORP) which is replacement of seats in new aircraft only, as they are introduced in the fleet, and an "immediate" (IMMD) replacement of all seats in the present fleet. Table 5 gives costs for a gradual (GRAD) method of replacement of aircraft seats over a 3 year period.

Table 5 presents comparison costs (relative to baseline figures based on a wool/nylon covered FR foam seat) of some selected seat configurations, for one particular replacement method. It is pertinent to note the change in (delta) costs for each configuration (purchase/manufacturing costs, and flying costs associated with heavier or lighter (negative) seat configurations). Note that configuration 12 in the column CODE# 012 is 1.31b/ft³ NF foam plus an FBL of light-weight Norfab is actually lighter than unprotected FR foam, and produces a lesser operating cost (\$1.5 million less) than our baseline.

4. MECHANICAL WEAR TESTING AND ASSOCIATED COMFORT FACTORS

Optimum fire blocking layers evaluated in the Cabin Fire Simulator at Douglas Aircraft Company were to be further tested by a major seat manufacturer for selected mechanical properties. The tests include wear durability, indentation load deflection, tear resistance, and any others selected by the seat manufacturer.

4.1 ILD TEST RESULTS: Preliminary load deflection test results are found in Table 6. For a baseline comparison, Configuration Number 1 may be used. Note carefully the 25% load deflection weight for polyimide foam. A figure of 77.0 pounds to cause a deflection of only 25% points to an extremely inflexible and, therefore, uncomfortable seat.

Table 6: SEAT CUSHION ASSEMBLIES
Load Deflection Test Results Per ASTM-D-1564-71-Method A

Config- uration Number	Description	Load 75% Prestress	Thickness with 1 lb. Preload	Load 25% Deflection (1 minute)	ILD 25	Load at 65%	ILD 65	ILD 65 ILD 25
	N.P. Urethane, 2 in.		2.738	19.0		41.0		
	F.R. Urethane, 2 in.		1.965	32.2		63.0		
1	W/N; F.R. Urethane, 3 in.	165	3.174	44	0.88	91	1.82	2.07
2	W/N; Vonar-3, 3/16"; F.R. Urethane, 3 in.	196	3.553	46	0.92	100	2.00	2.17
5	W/N; Preox 1100-4; F.R. Urethane, 3 in.	182	3.210	55	1.1	97	1.94	1.76
8	W/N; Vonar-3, 3/16"; N.P. Urethane, 2.7 in.	135	3.248	31	0.62	69	1.38	2.23
11	Polyimide Foam, 2 in. W/N; Preox 1100-4; N.P. Urethane, 3 in.	100	3.096	77.0	0.59	57	1.14	1.93

W/N: Wool/Nylon Fabric

ILD: Indentation Load Deflection

This factor alone disqualifies the polyimide foam seat, which otherwise is a fine candidate, showing promising fire protection properties as shown in Figure 1, as well as being a remarkably lightweight seating material.

All other data from the fire blocking layers tested here show acceptable indentation load deflection. An acceptable range is considered a load 25% deflection (1 minute) of 29 to 55.

4.2 WEAR TESTS: Preliminary wear tests were conducted by Boeing Commercial Airplane Company using the apparatus shown in Figure 7. Results from these tests are shown in Table 7. As can be seen, the Norfab 11HT-26-Al material showed a minimum of 50 hours of wear stress under these testing conditions. Additional tests will be conducted in the near future to compare the 11 different seat configurations used in this study. Results of the wear testing will be given in a later report.

Figure 7: WEAR TESTING APPARATUS USED BY THE BOEING COMMERCIAL AIRPLANE COMPANY TO TEST WEAR DURABILITY OF SEATING MATERIALS

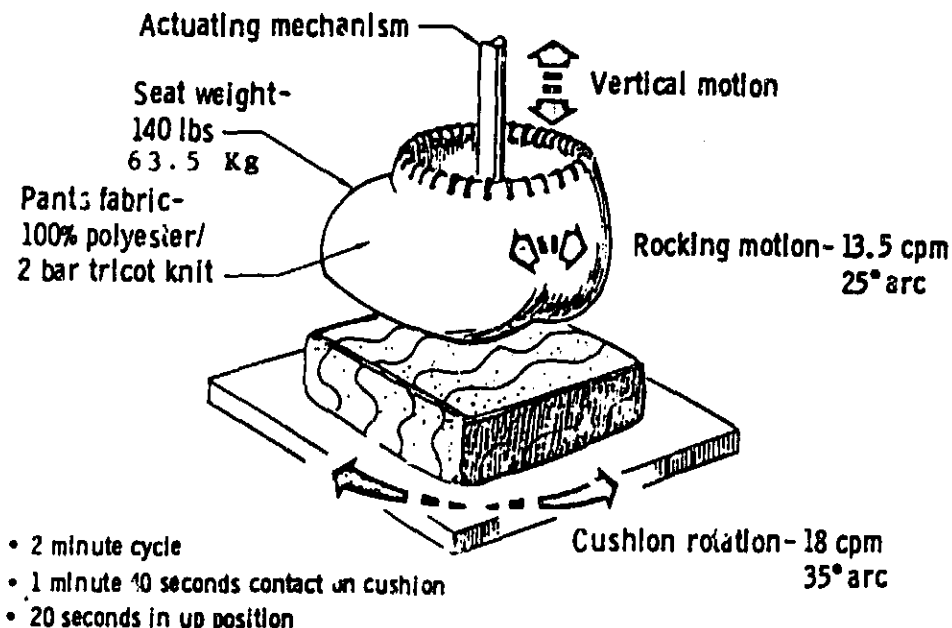

Table 7: WEAR DURABILITY OF VARIOUS SEAT CONFIGURATIONS

MATERIAL DESCRIPTION	WEIGHT		SEAT WEAR TEST RESULTS
	oz/sq yd	kg/m ²	
Morfab (aluminum up)	11	0.37	50 hours minimum wear
Preox (aluminum up)	18	0.61	25 hours, incipient failure
Preox (aluminum up) plus 5 oz PBI	23	0.78	No test performed
Piretux (bonded to decorative upholstery)	6	0.20	50 hours, very poor
Piretux (bonded to decorative upholstery) plus 5 oz PBI	11	0.37	No test performed
Dunlop Tereax 181 9 mm	28	0.95	50 hours minimum wear
LS200 - 3/8 in	38	1.29	50 hours minimum wear
Vonar-3 (cotton)	24	0.81	50 hours minimum wear
9 oz PBI	9	0.31	No test performed

5. SUMMARY

Major accomplishments from this program are listed below.

- § A complete model and computer based algorithm have been developed to determine the cost/weight effectiveness of the foams and fire blocking layers tested. Detailed reports are given in Appendices E-1 and F-1.
- § The NASA T-3 burner test results described in Appendix A-1 were inconclusive in determining the fire protection afforded by various fire blocking layers and foams, and does not appear to offer a viable small-scale testing procedure for these purposes.
- § Full scale laboratory testing has been performed at Douglas Aircraft, and is shown to be a viable test methodology for comparison of the fire performance of complete seat banks. This testing is described in Appendix D-1.
- § A convenient and accurate laboratory based test method of measuring the fire performance of seat configurations has been developed. This test has been graphically described in Appendices C-1 and G-1.

From these studies, the two most effective methods of seat cushion fire protection have been examined and are described below.

- (1) Those which use transpirational cooling, typically composed of $\text{Al}(\text{OH})_3$, perform best in high heat fluxes. The doped neoprene foams work by dehydrating in the case of a fire, cooling by dissipative emission of water vapor. Their major drawback is the weight needed in such ablative materials. Due to this weight penalty, they would be quite costly for use by the U.S. fleet.
- (2) Aluminized thermally stable fabrics work by re-radiation and/or lateral conduction of the heat produced by the fire and provide excellent high temperature insulation. These are the most desirable types of blocking layers to use for these purposes because they show satisfactory fire performance and carry very little weight penalty.

6. CONCLUSIONS

Re-examining the experimental facts given in Section 2.4, we may draw some meaningful conclusions concerning the best choices for fire protection of aircraft seats following a postcrash fire.

In order to increase survivability of passengers, best described quantitatively in terms of the available egress time needed to vacate the passenger cabin in the event of a fire, the seat surfaces must be protected from the intense radiant heat fluxes. It has already been shown that no present technology is available to protect the polyurethane foam by internal chemical molecular modifications, thus, external physical protection is the only viable method. The following points need delineation:

- * No outstanding improvements are seen in fire blocking layer protection capabilities when fire retarded urethane foams are used. In fact, FR foam actually is inferior in performance to NF foam when used in conjunction with some FBL materials under certain test conditions.
- * NF foam has distinct beneficial weight saving attributes.
- * All requirements are presently met with Norfab 11HT-26-A1 at 0.38 kg/m^2 (11 oz/yd²). This material provides equivalent, if not better, thermal protection performance based on small scale tests to Vonar-3, and improves the weight penalty aspects by more than 4-fold. In small scale testing of aluminized fabrics, no differences were noted in seat cushion fire protection with the aluminized coating turned inward towards the foam or outward towards the wool/nylon fabric. However, significant differences were noted when aluminized FBL materials were used with NF versus FR urethane foam. This is shown in Appendix G-1.
- * Vent holes may be required on the under side of the seat cushions to permit venting of the pyrolysis gases produced from the urethane foam, thus reducing the risk of a sudden and immediate release of these gases and larger flame propagation.

7. REFERENCES

1. "Final Report of the Special Aviation Fire and Explosion Reduction (SAFER) Advisory Committee", Federal Aviation Administration, Volume I, Report FAA-ASF-80-4, June 26, 1980.
2. C. P. Sarkos, R. G. Hill, and W. D. Howell: The Development and Application of a Full-Scale Wide Body Test Article to Study the Behavior of Interior Materials During a Postcrash Fuel Fire, North Atlantic Treaty Organization (NATO), Advisory Group for Aerospace Research and Development (AGARD) Lecture Series No. 123 - Aircraft Fire Safety, presented on June 7-8, 1982, Oslo, Norway; June 10-11, 1982, London, UK; and June 15-16, 1982, Washington, D.C.
3. J. A. Parker and D. A. Kourtides: Optimization of Fire Blocking Layers for Aircraft Seating, presented at the 7th International Conference on Fire Safety, SRI International, Menlo Park, California, January 11-15, 1982.
4. R. W. Bricker and F. Duskin: 737 Aircraft Flammability Testing, NASA-Technical Memorandum 78523, 1978.
5. R. B. Hill and C. P. Sarkos, Postcrash Fuel Fire Hazard Measurements in a Wide Body Aircraft Cabin, Journal of Fire and Flammability, Vol. II, pp. 151-163. April 1980.

APPENDIX A-1

NASA Burn Tests of Seat Cushions

Final Report, Contract NAS2-11064, Scientific Services, Inc.

Editor's Note: Sections of this Appendix have been deleted for the sake of brevity. A complete copy of the original manuscript may be obtained upon request.

8133-6

February 1982

**NASA BURN TESTS
OF SEAT CUSHIONS**

prepared for
NASA Ames Research Center
Moffett Field, CA 94035

Contract NAS2-11064

Scientific Service, Inc.
517 East Bayshore
Redwood City, CA 94063

NASA BURN TESTS OF SEAT CUSHIONS

INTRODUCTION

This report presents the results of a series of tests on candidate aircraft seat blocking layers conducted by Scientific Service, Inc., for the NASA-Ames Research Center, under Contract No. NAS2-11064. A total of 109 tests on 19 candidate NASA-supplied samples were performed.

The objective of these tests was to compare the effects of thermal exposure on the standard seat cushion (which uses a wool-nylon blend fabric covering and an FR urethane filler) and on a number of candidate seat cushion configurations by measuring the time that it took to raise the temperature of the surface of the foam material in each sample to the value that could cause degradation of the foam (typically less than 300° Celsius).

TEST ARRANGEMENT AND INSTRUMENTATION

This test series was conducted using the NASA-Ames T-3 furnace (see Fig. 1). The furnace, which has been in use for many years at NASA, is a firebrick-lined box that uses a forced air JP-4 fueled burner. See sketch in Fig. 2. This furnace is coupled to an air scrubber and filter system to prevent the combustion products from being released into the atmosphere. A schematic of the filter system is shown in Fig. 3.

Since the T-3 furnace had not been used for several months, a calibration was performed to determine the length of burn time required to achieve a steady-state condition. Approximately 1½ hours were required to obtain this steady-state condition, which was defined as a constant flux reading (using a slug calorimeter) maintained over a period of 15 minutes.

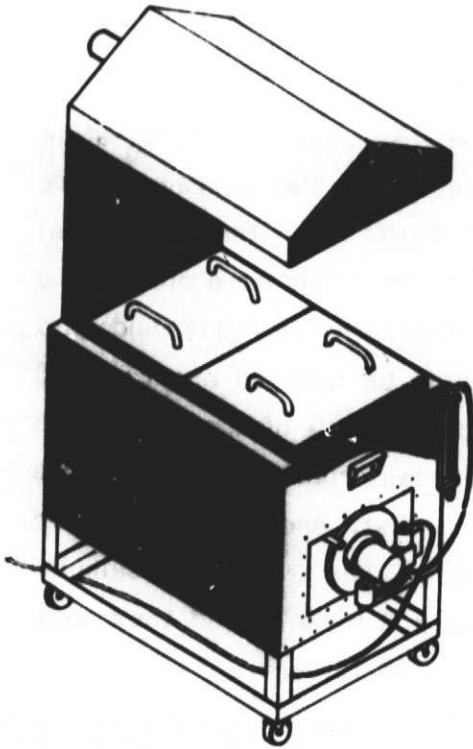

Fig. 1. The NASA-Ames T-3 Furnace.

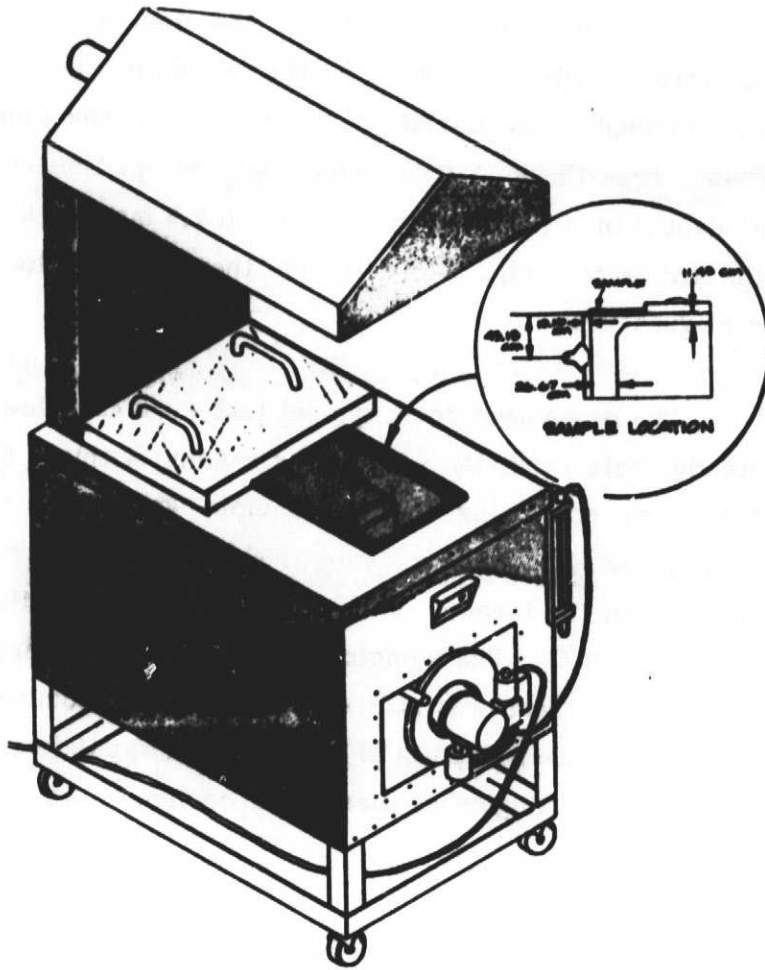

Fig. 2. Detail of T-3 Furnace.

During the test program the furnace was allowed to reach this steady-state condition at the desired flux prior to insertion of the samples. Two exposures were used -- 11.3 W/cm^2 ($10 \text{ Btu/ft}^2\text{s}$) and 8.47 W/cm^2 ($7.5 \text{ Btu/ft}^2\text{s}$) -- that are typical of what might be expected in an aircraft cabin fire. The materials were placed in a steel frame that prevented edge effects from influencing the tests and also furnished support for the test objects so that they could be inserted and removed from the furnace safely and easily. (Fig. 4 presents photographs of the frame with a sample ready to test and one posttest.) The candidate materials were put into the support frame with the wool-nylon blend material* first, and then the other materials were layered according to the specific test case. The area of the samples exposed to the fire was $22.8 \text{ cm} \times 22.8 \text{ cm}$ (9 inches \times 9 inches), and they were burned from the bottom because of the nature of the T-3 furnace.

The instrumentation included the slug calorimeter, noted above, and from one to three thermocouples on the samples. On samples using Fiberfrax, one thermocouple was placed on the surface of the Fiberfrax. On samples containing foam, three thermocouples were used, one at the surface of the foam, and one each at depths of 4.7 mm (3/16 inches) and 7.9 mm (5/16 inches) from the surface toward the exposure. Fig. 5 shows the thermocouple locations for the various sample configurations.

The procedures for a typical test were as follows: Once the furnace reached a steady-state condition with a flux reading within ± 5 per cent of the required value, the frame containing the test sample was moved next to the lid of the furnace. This lid was moved quickly to the side and replaced with the sample. The sample was left in the furnace until the thermocouple at the foam (or Fiberfrax) interface reached 300°C . The sample was then placed on top of the furnace lid because, in most cases, there was still smoke and flame coming from the sample and the hood above the furnace captured the smoke and put it through the filter system. After the sample extinguished itself and cooled, it was removed and photographed.

* In this case the material used by Pan American Airlines, which is similar to the the seat covering of all commercial aircraft.

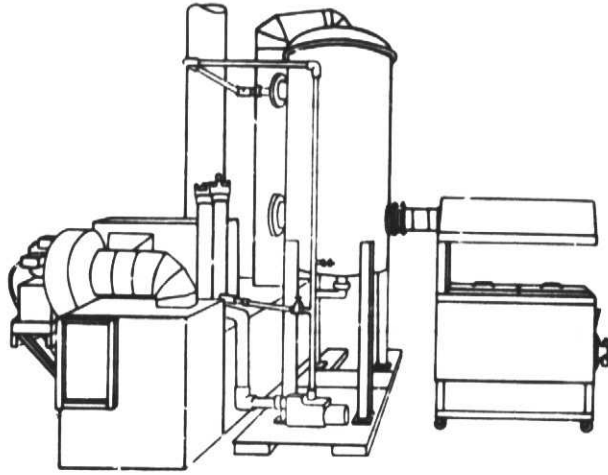

Fig. 3. Schematic of Filter System.

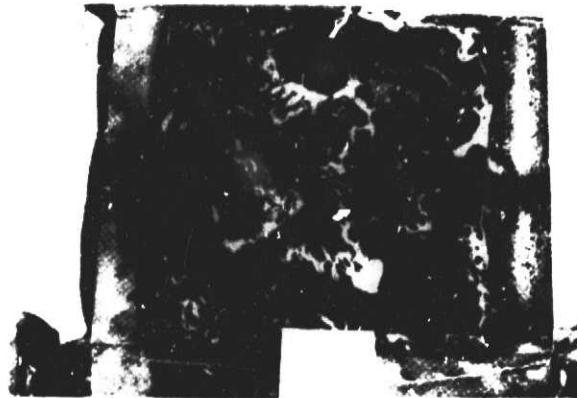
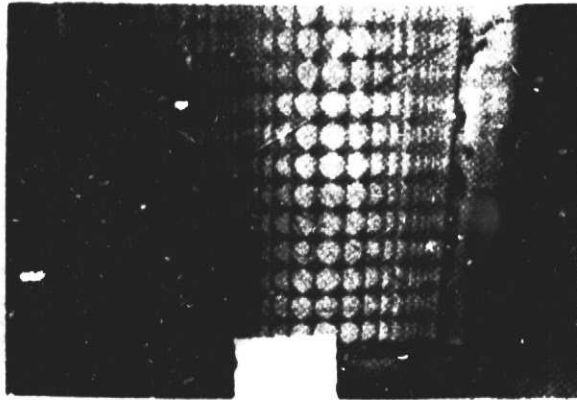

Fig. 4. Samples, Pre- and Post-Test.

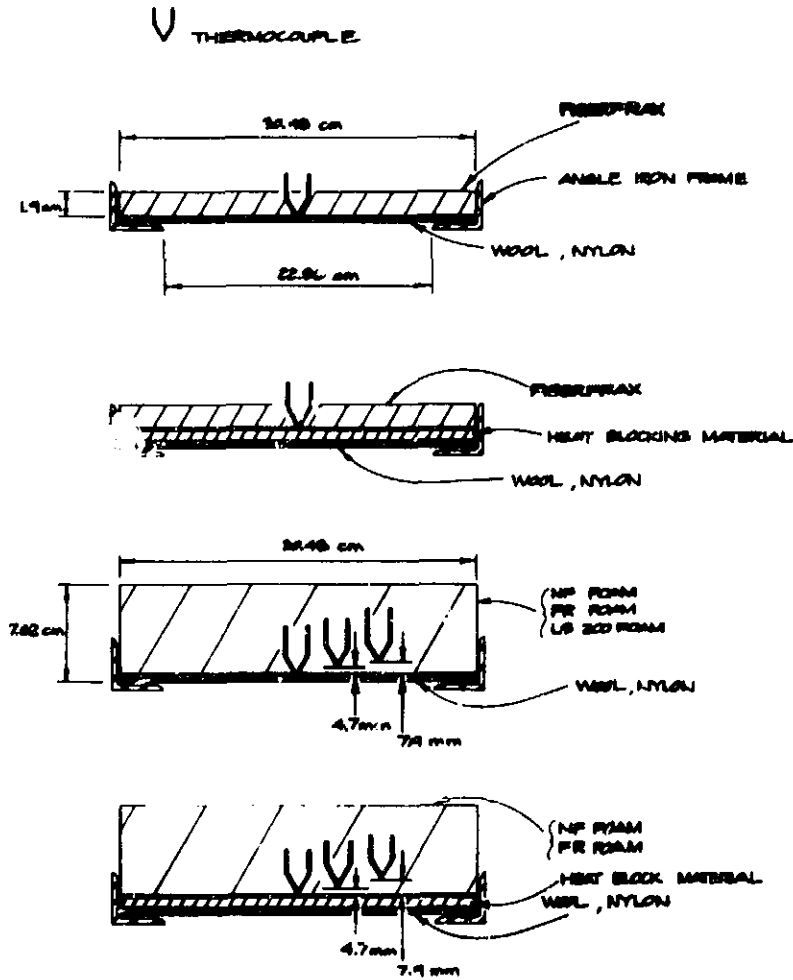

Fig. 5. Placement of Thermocouples.

TABLE I: RESULTS OF THE CANDIDATE HEAT-BLOCKING MATERIALS

Fire block	Fiber	Test #	Test #	Time Range (s)	
		11.3 W/cm ²	8.5 W/cm ²	11.3	8.5
LS200 3/8"	Frax	104,105,106		75-85	
Vonar 3	Frax	10,11,12,17	71,72,73	51-71	95-113
Vonar 3	FR Foam	32,38,39,48	84,85	43-60	57-66
Vonar 3	NF Foam	47,48,49	84,85	50-63	65-66
Vonar 2	Frax	22,23,24,25	74,75	53-68	58-84
Vonar 2	FR Foam	34,35,36	88,87	41-60	45-47
Vonar 2	NF Foam	30,51,52	88,87	60-76	57-77
Norfab	Frax	65,66,67	78,77	30-36	28-30
Norfab	FR Foam	53,54,55	88,89	18-20	31-33
Norfab	NF Foam	62,63,64	88,89	20-25	31-34
Al C ¹¹ x 101	Frax	2,7,8,9	80,81	20-26	23-30
Al C ¹¹ 101	FR Foam	56,57,58	82,83	23-24	24-25
Al C ¹¹ 101	NF Foam		102,103		25-27
E-Glass 181	Frax	29,30,31	78,79	19-23	35-37
E-Glass 181	FR Foam	41,42,43	90,81	17-24	23-27
E-Glass 181	NF Foam		100,101		25-30
None	Frax	1,26,27,28	88,89,70	10-17	16-17
None	FR Foam	44,45,46	82,83	10-13	23-24
None (Note 1)	LS-200	107,108,109		46-93	

Note 1: Show temperature range 3/16" from surface of foam

TEST RESULTS

A summary of the test results is presented in Table 1. The various blocking materials investigated are listed in this table in order of descending time to reach 300°C at the filler interface. Time-temperature plots for each test are presented in Appendix A.

It had originally been planned to make weight measurements of the samples and to measure char thickness. Since many of the samples continued to burn after removal from the furnace it was decided that such measurements would be of little value.

Photographs were taken of each test and these have been delivered to NASA separately.

WOOL-NYLON/FR URETHANE

TEST 44

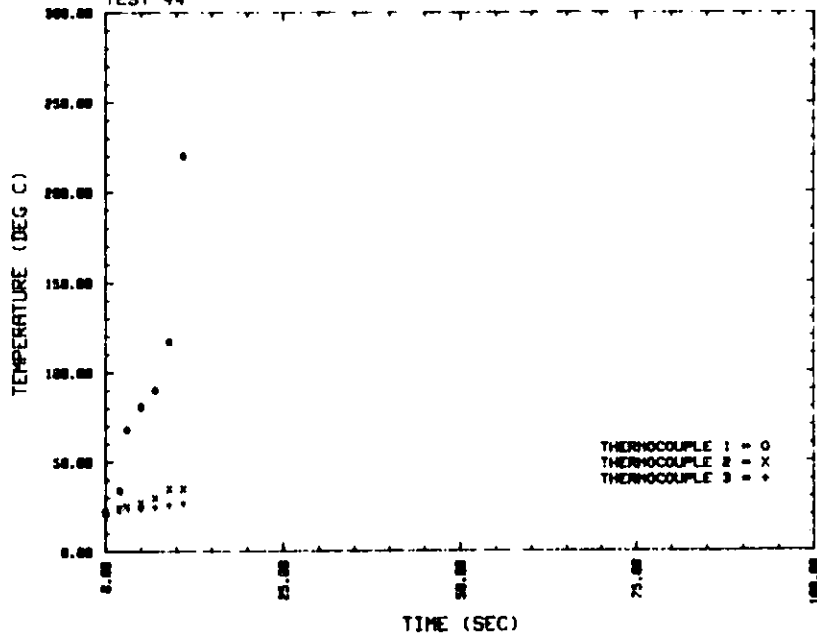

WOOL-NYLON, VONAR 3/FR URETHANE

TEST 38

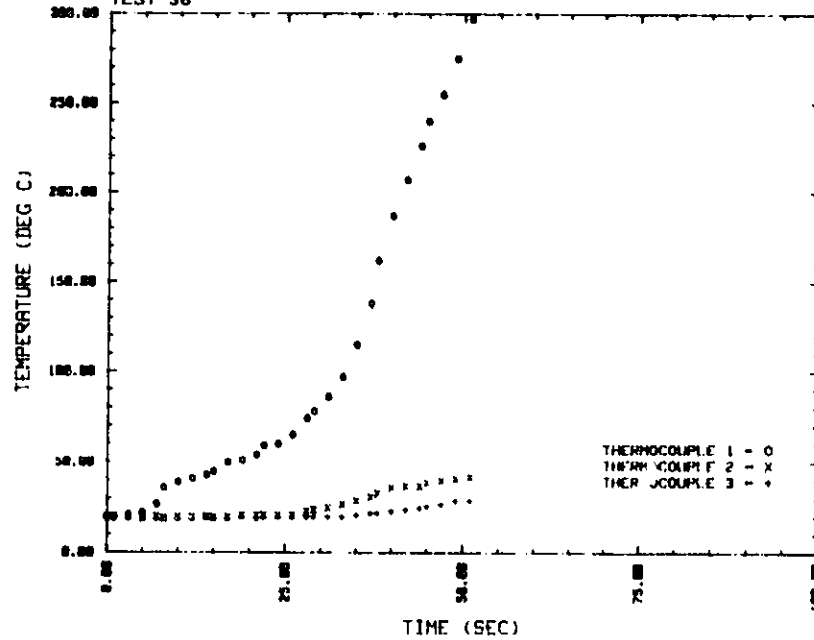

WOOL-NYLON, VONAR 27FR URETHANE

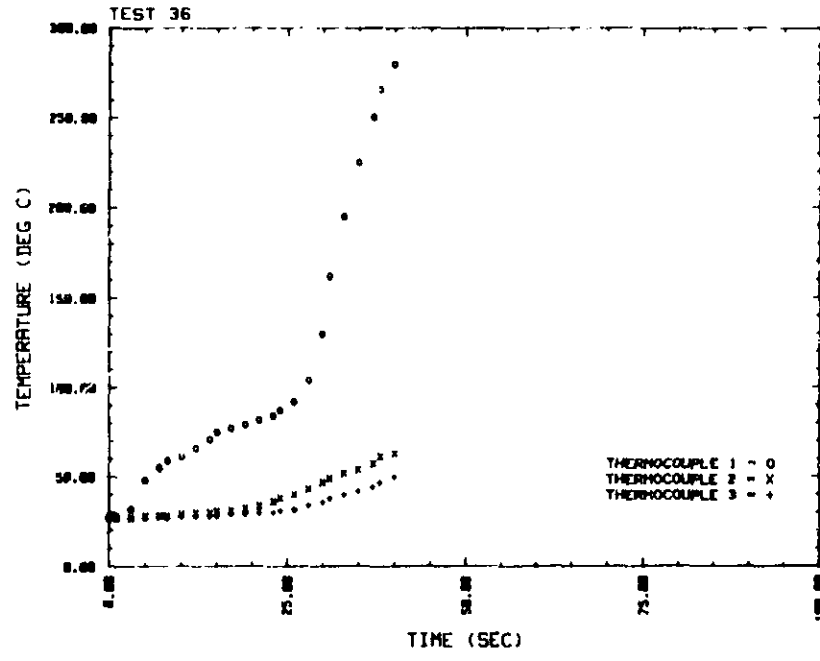

WOOL-NYLON, LS 200 2 INCH

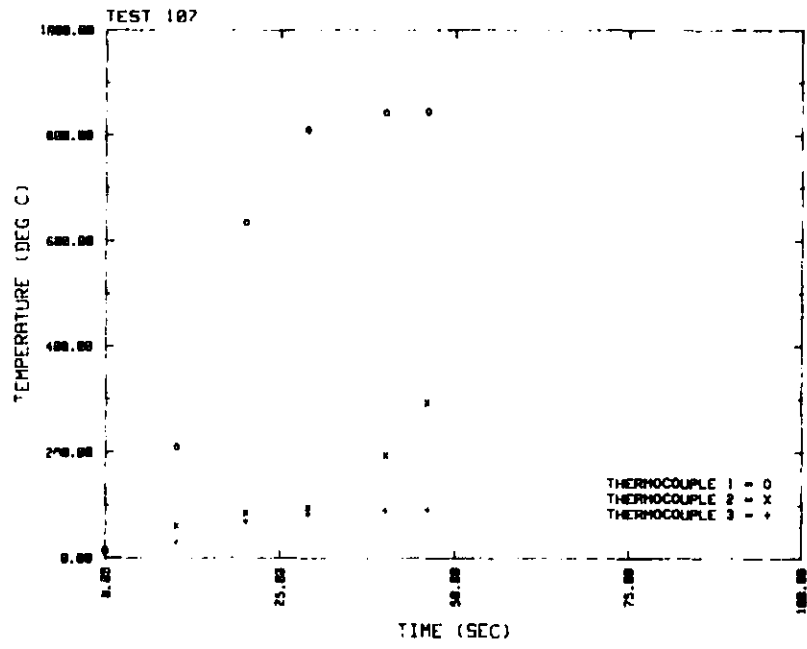

WOOL-NYLON, NORFAB/FR URETHANE

TEST 57

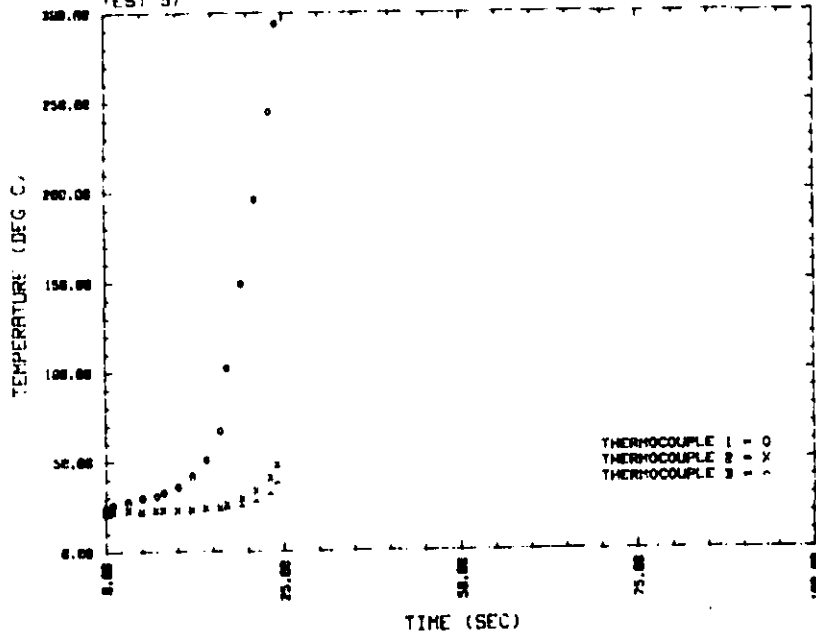

WOOL-NYLON, NORFAB/FR URETHANE

TEST 55

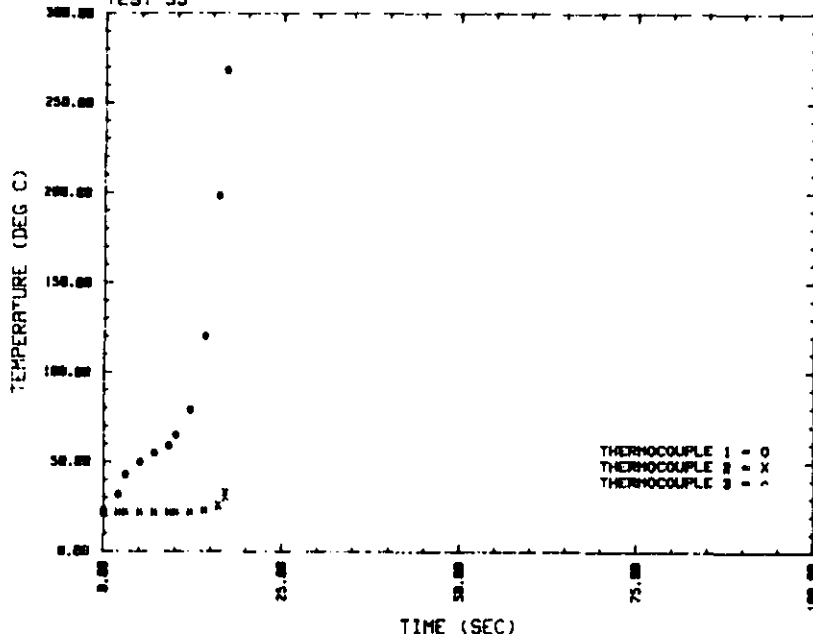

WOOL-NYLON, 181 E. GLASS/FR URETHANE

TEST 41

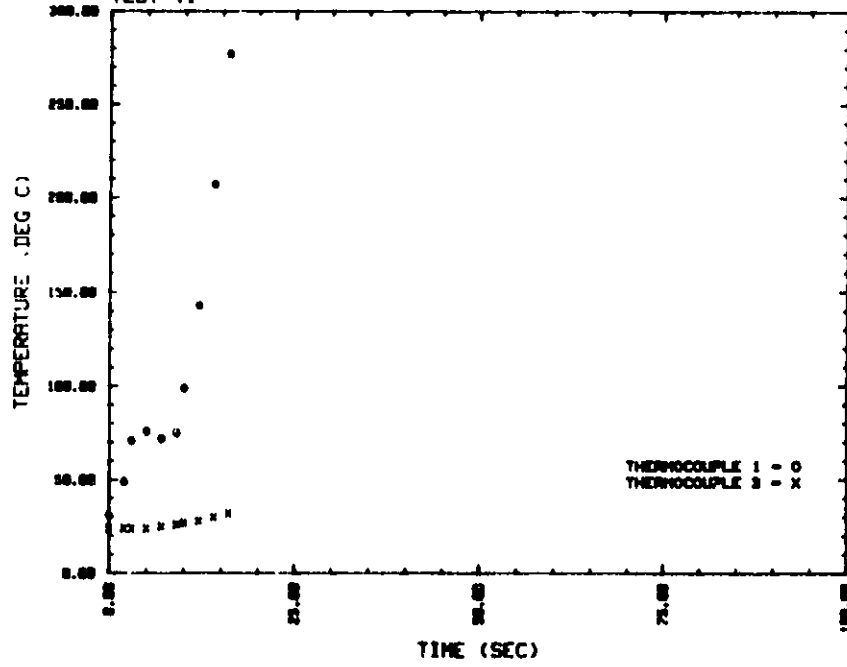

WOOL-NYLON, VONAR 3/NF URETHANE

TEST 47

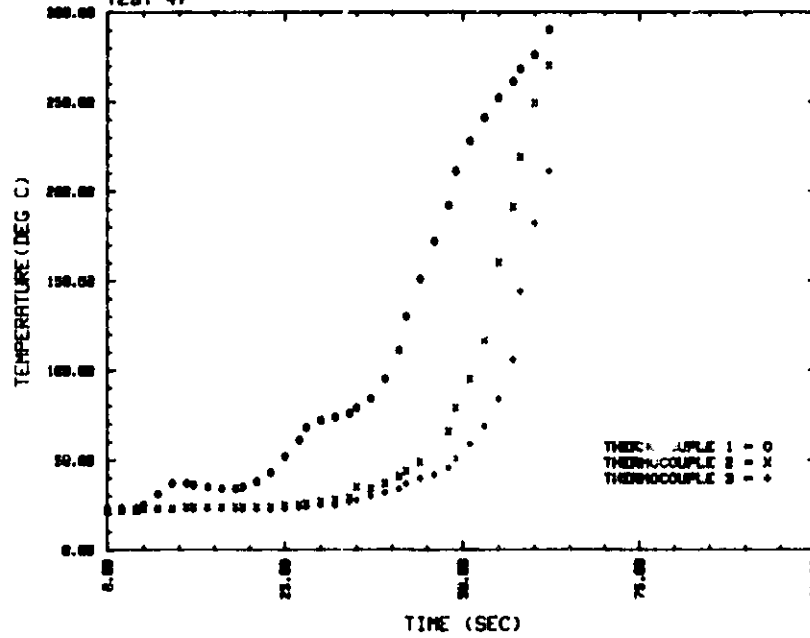

WOOL-NYLON, NORFAB/11F URETHANE

TEST 64

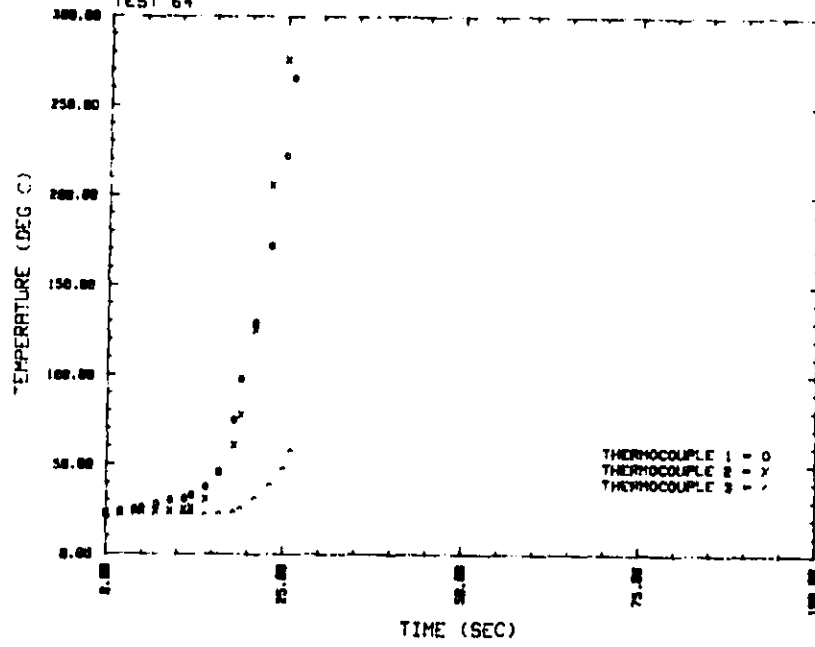

WOOL-NYLON, LS 200 2 INCH

TEST 100

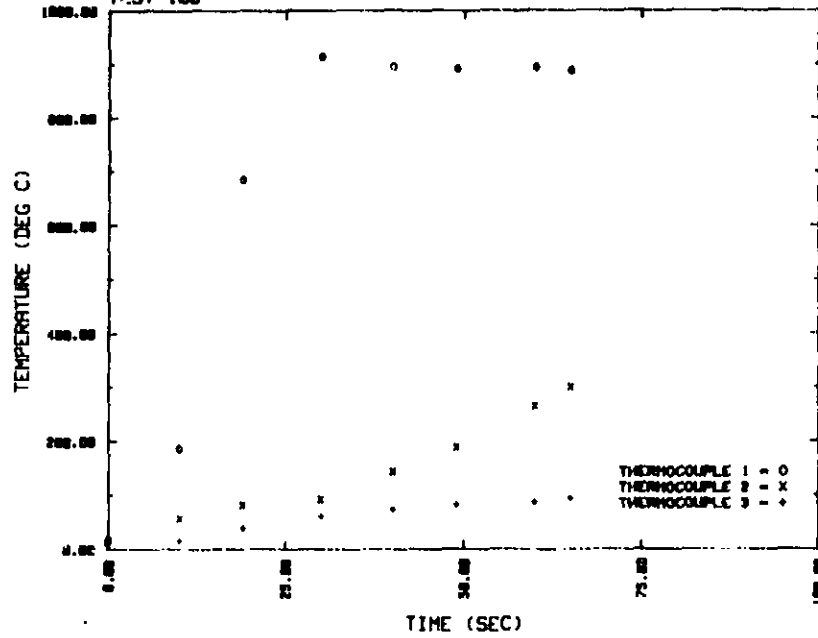

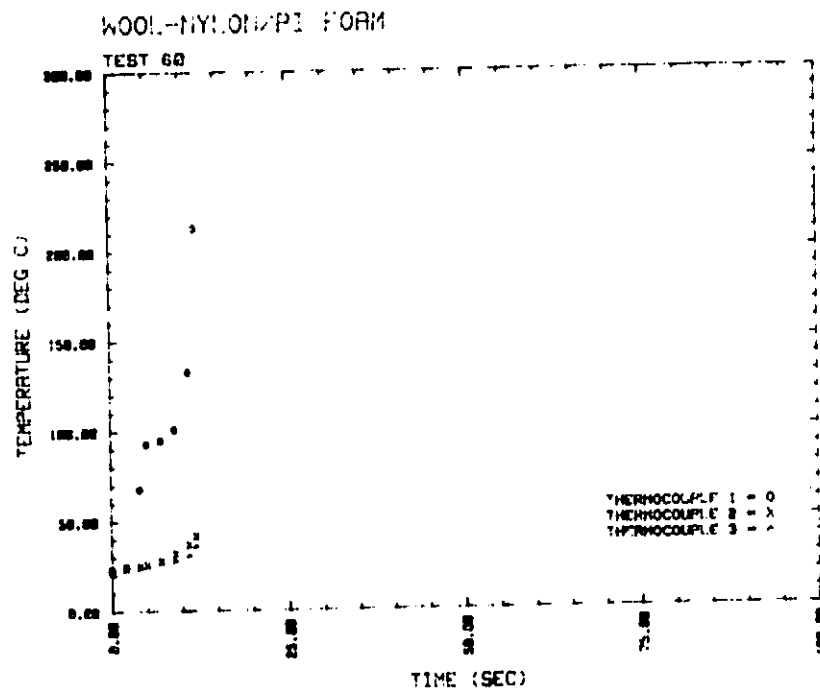

APPENDIX B-1

"Optimization of Fire Blocking Layers for Aircraft Seating"

J.A. Parker and D.A. Kourtides

Presented at the 7th International Conference on Fire Safety, SRI International, Menlo Park, California, January 11-15, 1982.

OPTIMIZATION OF FIRE BLOCKING LAYERS
FOR AIRCRAFT SEATING

John A. Parker and Demetrius A. Kourtides
National Aeronautics and Space Administration, Ames
Research Center
Moffett Field, CA 94035

Presented at the 7th International Conference on Fire Safety
SRI International
Menlo Park, California
January 11-12, 1982

The use of ablative materials in various forms, such as cellular structures, coatings and films to provide thermal protection for heat sensitive substrates against the action of large jet fuel fires is well established (1). Low density foam polymers with low thermal conductivity, high temperature stability and high thermochemical char yields or high transpirational cooling rates, such as those foams fabricated from isocyanurates, phenolics, imides and hydrated chloroprenes, all have been found to be effective in extending the times required for fuel tank cook off and fire penetration to the structures of transport aircraft immersed in large fuel fires. Char forming ablative coatings, are widely used in extending the time before detonation of military ordinance exposed to similar fire threats. The use of functional fabrics as ablatives is new.

Among existing, commercial polymers, one would be hard pressed to find a more thermally sensitive substrate than conventional flexible polyurethane foams, and probably from a mechanical point of view no better cushioning material with a cost of something like \$0.15 per board foot. These polymers because of their easily pyrolyzed urethane groups and thermally oxidizable aliphatic linkages exhibit polymer decomposition temperatures of the order of 250°C, and encounter a maximum pyrolysis rate at 300°C with a total yield of pyrolysis vapor of about 95%, most of which is combustible. One should expect these materials to ignite easily with low power energy sources of 2.5 watts/cm² or less and when ignited effect sustained flame propagation even after removal of heat source. To be sure all non-fire retarded flexible urethane foams that we have examined to date confirm these expectations. From thermogravimetric studies (2), it is evident that the addition of standard fire retardant additives have little or no effect on the maximum decomposition rate, the temperature at which it occurs or the vapor production yield. In fact, one observes the same average mass injection rates of combustible gases under a sustained radiant heating rate from flexible polyurethane foams whether fire retarded or not. This gas production rate can amount to as much as 10-20x10⁻⁵ grams per cm² per second at heating rates of 2.5 watts/cm² even when covered with contemporary upholstery. Kourtidis has shown that this flammable gas production rate increases almost linearly with the applied heating rate up to about six watts/cm², heating rates which are fairly typical of the usual trash or jet fuel fire. A value of 4x10⁻⁴g/cm²/sec for hydrocarbon injection at surfaces has been found to effect sustained propagation and flame spread.

A sustained heating rate of approximately 5 watts/cm² applied to one seat of a three seat transport array comprising flexible polyurethane foam, fire retarded or not, will produce flame spread and ignition to the adjacent seat in less than one minute, resulting in sufficient fire growth to permit flames to impinge on the aircraft ceiling in less than two minutes. The time required to produce these events and the resulting increases in cabin air temperatures should be expected to fix the allowable egress times for passengers attempting to escape the aircraft in a post crash fuel fire.

This paper then examines the question of the possibility of increasing the available egress time for passengers, from a transport aircraft, in which the flexible polyurethane seating is exposed to the action of a large pool fire which we must assume can provide at least 5 watts/cm² radiant heat flux to the seats, by providing sufficient ablative protection for polyurethane cushioning. These fire blocking layers must suppress the combustible mass injection rates of the polyurethane below the somewhat critical values of 4x10⁻⁴ gm/cm²/sec at 5 watts/cm² as a performance criteria to prevent flame spread and subsequent flashover.

All commercial transport aircraft are, at this moment, fitted with fire retarded flexible polyurethane seat cushions, bottoms, backs and head rests with an average foam density of 1.7 lbs/cu ft. With average seat construction, there are about five pounds of foam per seat. For 2000 aircraft with an average of 200 seats per aircraft, this amounts to about two million pounds of flexible polyurethane foam in use.

The options that one might consider as seating alternatives to effect improvement in the fireworthiness of aircraft interiors through modifications of existing cushioning materials are outlined in Figure 1. The same classes of high char yield polymers that are known to be outstanding ablative materials such as phenolics, imides, polybenzimidazoles, etc., can be made fire resistant enough to prevent propagation and flashover as replacements for polyurethane in seats. As indicated, when they are designed to be fire resistant enough, they all suffer in varying degrees from serious limitations because of cost, processability, comfort and durability (brittleness). For example, polyimides in general are about 50 to 100 times more expensive than basic flexible polyurethanes which might result in a replacement cost of 50 to 100 million dollars for the existing U. S. fleet.

There may be some fire retardant additives for flexible polyurethane foams that could improve their thermal stability and suppress the combustible gas production rates at sustained high heating rates. We do not know of any.

The only real option that exists at present with commercially available components seems to be the fire blocking approach that is to provide cost and weight optimized ablative foams, coatings or fabrics. It is believed that the limitations in comfort, decore, durability, & increases in ship set weight penalty may be overcome by the approach taken in this study.

The objectives for this study are re-stated specifically in Figure 2. The key property requirements for an acceptable blocking layer for aircraft seating fall into two important categories as shown in the figure, namely fire performance objectives, and seating performance requirements. In this study, only those materials that possessed only the fire blocking efficiency necessary to prevent fire propagation from seat to seat under the simulated post crash fire conditions conducted by the FAA in full scale tests in a C-133 fuselage were evaluated for durability, comfort, wear and manufacturability. Only those cushion systems that approached state-of-the-art performance in seating performance were evaluated with regard to cost. These screening gates, the controlling algorithms and materials data base have been reported separately (3).

The various ablative or fire blocking mechanisms available from existing materials systems that are possible candidates for blocking layer design are outlined in Figure 3. Vonars, a family of low density, high char yield foams containing a large fraction of water of hydration is perhaps the best candidate of this class currently available. It is available in two practical thicknesses from 3/16" to 1/16". The high temperature resistant polymers with decomposition temperatures in excess of 400°C, and high char yield polymers such as the PBI's, Cellox, & Kynol with char yields in excess of 60% are excellent candidates for re-radiation protection. Suitable ablative felt fabrics which are also good insulators have been prepared from these polymers in fiber form.

The action of the ablative matrix to induce vapor phase cracking of the combustible gas generated from the slow pyrolysis at low temperature of the substrate can be very important especially in applying ablative materials as fire blocking layers. All of these materials in sufficient thicknesses in combination or individually can provide the required degree of thermal protection necessary for fire safe polyurethane cushioning. The question to be answered is which combination provides the correct amount of protection to keep the vapor production rate of polyurethane foam somewhat less than $10 \cdot 20 \times 10^{-5}$ grams/cm²/sec under an incident heating rate of 2.5 watts/cm².

Fabrics, felts and mats with excellent high temperature insulation properties can be obtained as indicated from non-ablative, inorganic, dielectrics such as silica and Fiberfrax. Highly reflective continuous surfaces, which also function to distribute the incident radiant energy and thus reduce the local heat loads, such as aluminum foils must also be considered.

Another ablative mechanism which becomes exceedingly important in controlling the effective mass injection rate, is the ability of the ablative matrix to initiate vapor phase cracking of the combustible vapor species generated by the low temperature pyrolysis of the polyurethane substrate.

All of the mechanisms listed and any of the material examples indicated can alone or in combination provide the required degree of thermal protection necessary for securing fire safe polyurethane cushioning capable of defeating the action of large aircraft fuel fires when used in sufficient thickness. The first question that the research reported here attempts to answer is what mechanism and material or combination provide just the amount of protection required at a minimum weight of ablative material per unit area.

Materials which depend on transpiration cooling by mass injection can be very efficient at high heating rates. Their efficiency increases monotonically with the incident heating rate above 7 watts/cm². As will be shown, transpirational systems are less efficient on a weight basis than systems based on the other mechanisms discussed, in the fire environment of the post crash aircraft fuel fire. To date, material systems that combine one or more combinations of heat rejection mechanisms, such as 2, 3, 4 and 5 provide the most efficient ablation systems for designing blocking layers for contemporary polyurethane seats.

A generalized schematic for the kinds of optimum fire blocking layers to be discussed in this paper, indicating the main heat blocking mechanisms is shown in Figure 4. Earlier studies on the internal isotherm recession rates of char forming ablative foams (4) exposed to the typical aircraft fuel fire environment demonstrated that re-radiation from the non-receding fire stable char surface and the low thermal diffusivity of virgin foam dominated the minimization of the pyrolysis isotherm rate. Re-radiation can be effected by either reflection with an emissive surface of aluminum or a hot char surface. At present, we understand that the use of aluminum surfacing on high temperature stable and or char forming interlayers is important in redistributing the local incident radiation, and the hot char or carbonized interlayers dominates the re-radiation process. Thus, aluminized char forming high temperature materials such as Gentex's Celiox or Amatex's Norfab, provide the best combination of mechanisms. Efficient fire blocking layers are by no means limited to these kinds of materials.

In the case of the ablative protection of a flammable substrate, such as a flexible polyurethane, wherein a limited amount of controlled pyrolysis is allowable, internal char formation by thermal cracking of the urethane pyrolysis vapor is extremely beneficial. That part of the evolving combustible gas which is fixed as char does of course not participate in the external flame spread and the flashover processes. To avoid rupture of the fire blocking layer, it is safe to provide some venting as indicated to manage the pressure drop within the cushion structure.

The results obtained with mini test cushions at 4 minutes and 2.5 watts/cm² incident thermal flux are shown in Figure 5. It can be seen that the anaerobic pyrolysis of the flexible polyurethane foam has produced a stable char residue from the virgin foam and also by thermal cracking on the hot surface of the aluminum layer. When the aluminum layer is external to the blocking inner layer, it still forms inside the porous blocking layer.

Based on the results obtained to date, the two commercial products shown in Figure 6 provide the required degree of fire protection, to prevent propagation due to aircraft seats in a simulated post crash fire at the lowest weight penalty and lower blocking layer costs. It is our opinion that these blocking layers can be used with any weight effective resilient cushioning foam without regard to the foam's inherent flammability.

It is of interest to examine a means of quantitatively characterizing the efficiency of fire blocking layers in laboratory fire durability tests to predict their performance in full scale tests.

In Figure 7, the efficiency of any fire blocking layer has been defined as the ratio of the incident radiant heating rate, to the rate of production of combustible gas produced per unit area per second, generated by the pyrolysis of the substrate polyurethane foam. This efficiency should be able to be measured experimentally by any one of three methods indicated in equation two by the recession rate of the pyrolysis isotherm into the substrate, by equation three by measuring the actual amount of gas generated per unit area per unit time and finally with a knowledge of the heat of combustion of the specific gases generated from the substrate, from heat release calorimeter measurements. Measurement of recession velocities is extremely difficult experimentally. Both methods 3 and 4 give good reproducible results and efficiencies measured by both methods give acceptable agreement. One should note, as pointed out above, that the mass injection rate of the substrate increases monotonically with heating rate, and that the efficiency as defined here should decrease with increased heating rate up to about 7 watts/cm². This has been found to be the case as reported by Kourtidis (2). It is clear that heat blocking efficiencies must be compared at identical heating rates.

An empirical relationship between these laboratory measured efficiencies and the thermal performance of a particular kind of fire blocking system is shown in Figure 8. An allowable egress time in minutes has been plotted as a function of the fire blocking efficiency as defined for three different fire conditions used in the C-133 full scale test article, a zero wind, 2 mph and 3 mph. The fire severity as measured by the average heating rate in the vicinity of seats increasing accordingly. With the Vonar converted seats, the average heating rate of seats is about 5 watts/cm² at zero condition, and could amount up to 10-12 watts/cm² in the most severe conditions with 3 mph wind.

It is clear from this figure that either Vonar 3 or LS-200 both non-metallized components which provide protection by ablative transpirational cooling alone give as much as 5 minutes of available egress time. The unprotected flexible polyurethane seat gave something less than two minutes whereas the empty aircraft gave survival times in terms of temperature only well in excess of ten minutes. One pressing matter these preliminary results put to rest is the question of the role of interior materials in the postcrash fire, namely that the interior materials fireability, in this case the seat array exposed to the post crash fire, is a major factor in post crash fire survivability under the conditions of FAA's average design fire (5). These of course are seat only tests. These test results permit one to calibrate fire performance in terms of Vonar 3, a performance that is considered to provide an acceptable benefit in the post crash fire. In these tests, Vonar 3 with a cotton scrim replacing the usual cotton batting gave an increase of about 26 oz per sq yd of seat covering material. It is the primary objective of this investigation to see if it is possible to achieve equivalent fire blocking layer performance from other materials at reduced weight and hence costs.

In Figure 9, a simple relationship has been developed between the allowable egress time and the efficiency and density of a fire blocking layer. Equation 8 approximates the allowable egress time in terms of the specific fire blocking layer efficiency, the aerial density and the applied heating rates. Of course, this determines weight of the fire blocking layer per seat by equation 10. It should be clear that the higher the efficiency of the fire blocking layer (specific), the longer the available egress time. The design equation 8 permits one to select a predetermined egress time and tailor the ablative to give a maximum efficiency at a minimum aerial density.

Since this is not a materials development study but rather a short term comparison of off the shelf items, we have elected to compare fire blocking efficiencies of candidate materials with Vonar 3's performance, as a standard of comparison, and then compute the effect of their use on the average seat weight. Ideally, the optimum fire blocked seat should give equivalent fire blocking performance to Vonar 3 with no increase in contemporary seat weight.

The specific mass injection rates obtained for both fire retarded and non-fire retarded flexible polyurethane foams in the form of mini cushions described by Kourtidis are shown in Figure 10. These values were obtained at 2.5 watts/cm^2 . It can be seen that the mass injection rate for the Vonar 3 covered foams is about one-half the value for that of the unprotected sample, and also these configurations with Vonar gave acceptable performance in the C-133 test. It can also be seen that both Gentex's Celiox and Norfab gave lower mass injection rates than the Vonar at much lower aerial densities.

This amounts to a weight penalty of something less than half of that for the ablative fire-blockers as compared with the Vonar 3 system. Also in Figure 10, a relative figure of merit for the ablative fire blocking layers has been developed by normalizing the efficiency of the fire blocking layers with respect to Vonar 3, a relationship which seems to hold up to applied heating rates of as much as seven watts/cm^2 , at which rate Vonar begins to be somewhat more efficient. It can also be seen that the low density Celiox (six ounces per sq yd), is the most efficient fire blocker studied so far.

It can also be deduced from Figure 10 that the fire blockers perform equally well with both non-fire retarded and fire-retarded flexible polyurethane foam as predicted.

The non-fire retarded polyurethane foam with Callox 100, in this test comes very close to meeting the target goals of this study, namely equivalent fire performance and the smallest increase in seat weight. It can also be seen it is about twice as efficient as it needs to be even at this low aerial density.

The mass injection rates as a function of fire blocking layer thickness are plotted in Figure 11. Again these results have been base-lined with respect to Vonar 3's performance at 2.5 watts/cm², at 5x10⁻⁵ grams per cm² per sec. It can be seen that the efficiency of Vonar decreases monotonically with thickness, whereas the ablative fire blocking layers increase with decreasing thickness. However, at present durability and wear become limiting factors for currently available fabrics at thickness much less than 0.1 cm. It is believed that a lower limit of about 6 oz per sq yd is the lower thermal limit for that class of fabrics, and one should expect a rapid loss in thermal efficiency below this value.

For convenience of optimization with respect to thermal performance and weight, a plot as shown in Figure 12 is useful. Here we have plotted the relative figure of merit as defined with respect to Vonar 3 as a function of average seat weight. It can be seen that the Vonar systems do not meet the desired performance criteria. Vonar 3 is too heavy and Vonar 1 is not sufficiently protective. Both the Norfab and Callox's easily meet both of these criteria. The Callox based system can be seen to give a somewhat better fire performance margin than the Norfab.

These results are summarized in terms of a standard tourist class aircraft seat in Figure 13. Again these results show that on a weight basis both of the candidate ablative fire blocking layers are about three times more cost effective than the Vonar's on a cost to fly basis. The figures are conservative because the seats can probably be manufactured and used without the cotton muslin seat cover.

The outline of the algorithm for the current cost model of these seat modifications is shown in Figure 14. In this paper only the element which addresses the calculation of relative increase in costs to manufacture and fly these new heat blocked seats for an average U.S. fleet of 2000 aircraft with an average of 200 seats per aircraft will be discussed.

This program searches the data base for candidate heat blocking layers, with the minimum, thermal protection values, and the wear and comfort limits shown in Figure 15. The algorithm then requires the inputs as outlined and outputs the cost difference to fabricate and fly a fire blocked seat per one year compared to the standard seat.

The results of applying this program to Vonar 3 and the ablative fire blocking layers now considered optimum are shown in Figure 16, Cost to manufacture and fly per year for a five year period with fire blocking layers, each with a wear life of five years are plotted as a function of average seat foam density and the aerial density of acceptable fire blocking layers. The average seat foam densities of fire retarded and non fire retarded flexible polyurethane foam have been indicated as 1.7 and 1.4 pounds per cubic foot. The use of non-fire retarded flexible polyurethane foam is considered to be a viable option for this application.

In Figure 16, it can be seen that currently available ablative fire blocking layers with non-fire retarded polyurethane foam amount to about 6×10^6 dollars per year whereas the Vonar 3 modification could amount to about five times as much, about 28×10^6 million dollars.

Further optimization is also indicated in Figure 16, if a 6-7 oz per sq Celliox based fabric could be developed with a five year wear. This could amount to as little as 1.5×10^6 million dollar per year for five years.

Concluding Remarks

All known flexible polyurethane foams suitable as aircraft seating are about equally flammable and provide approximately the same thermal risk to survivability under the conditions of the design fire established for the post crash simulation scenario in the C-133 full scale tests.

All presently known and acceptable flexible cushioning foams require about the same degree of fire blocking protection to suppress this threat.

Adequate fire blocking protection can be achieved through replacement of cotton batting slip covers with a wide variety of fire blocking layers.

Of all of the known fire blocking layers investigated, the Vonar series is the least efficient on a cost/weight basis for fire protection of domestic transport aircraft.

Among the known fire blocking layers the metallized high temperature resistant char forming ablatives appear to be optimum. At the present this practical optimization is limited to aerial densities in the range of 10-12 oz per sq yd. Further developmental work could drive these down to 4 to 6 oz per sq yd which might provide an equivalent cost to build and fly to current seats.

On the basis of both radiant panel testing, heat release calorimetric tests and limited C-133 tests, (correlation among these laboratory test methods and with limited full scale tests in the FAA's C-133 are good to excellent), show that both Norfab and Gentex Celiox are far superior to Vonars and provide a cost effective degree of fire protection for polyurethane products heretofore not available.

CURRENT MATERIALS OPTIONS FOR IMPROVEMENT OF THE FIREWORTHINESS OF
DOMESTIC TRANSPORT AIRCRAFT INTERIORS IN POST-CRASH FUEL FIRES

1. FIRE RESISTANT NON-METALLIC (POLYMERIC) MATERIAL COMPONENTS LIMITATIONS: HIGH COSTS, DIFFICULT PROCESSABILITY, BRITTLE,
2. MODIFICATION OF SEATS OR THE ARI COMBUSTIBLE PLASTIC AND ELASTOMERS WITH FIRE RETARDANT ADDITIVES, LIMITATIONS: NOT EFFECTIVE UNDER CONDITIONS OF POST CRASH FIRE,
3. COVERING FIRE SENSITIVE SUBSTRATE (PANELS, SEATS, ETC.) WITH ABLATIVE COATINGS OR FIRE BLOCKING LAYERS LIMITATIONS: DECOR, DURABILITY (WEAR), & INCREASE IN SHIPSET,

WEIGHT PENALTY

FIGURE 1

SHORT TERM
OPTIMIZATION OF POST CRASH FIRE PERFORMANCE AND
COSTS OF TRANSPORT AIRCRAFT SEATING

- PROJECT OBJECTIVES -

1. PROVIDE EFFICIENT HEATING BLOCKING MATERIAL COMPONENTS FOR CONTEMPORARY AIRCRAFT CUSHIONING:
 - (A) TO REDUCE THE RATE OF FIRE SPREAD THROUGH CONTEMPORARY CABIN INTERIORS INITIATED BY A FULLY DEVELOPED POST CRASH FUEL FIRE
 - (B) TO INCREASE THE EGRESS TIME LIMITED BY CONTEMPORARY INTERIORS IN SUCH FIRES
2. PROVIDE A MINIMUM INCREASE IN SHIP SET WEIGHT FOR CONTEMPORARY TRANSPORT AIRCRAFT
 - (A) TO MAINTAIN EQUIVALENT CUSHIONING EFFICIENCY
 - (B) TO UTILIZE COMMERCIALY AVAILABLE HEAT BLOCKING MATERIAL AND REASONABLE CONSTRUCTION METHODS AND MANUFACTURING COSTS,

FIGURE 2

FIRE BLOCKING MECHANISMS
AVAILABLE FOR PRODUCT DESIGN

1. TRANSPIRATION COOLING (VONARS)
2. RERADIATION { HIGH TEMPERATURE STABLE } (PBI & CELIOX)
 { LOW CONDUCTIVITY } (KYNOL)
3. INSULATION { LOW DENSITY } (SILICA, PANOX)
 { CLOSED CELL } (FIBERFAX, NOMEX)
 { THERMALLY STABLE } (PHENOLIC-MICROBALLONS)
4. REFLECTION { HIGHLY REFLECTIVE } ALUMINUM
 { SURFACES }
5. VAPOR PHASE-CRACKING TO CHAR { DENSE } (ALUMINUM)
 { NON-POROUS } (CELIOX)
 { CATALYTIC SURFACES } (PBI, CARBON LOADED POLYMERS)

2, 3, 4 AND 5 - MOST EFFICIENT COMBINATIONS FOR FIRE BLOCKING

FIGURE 3

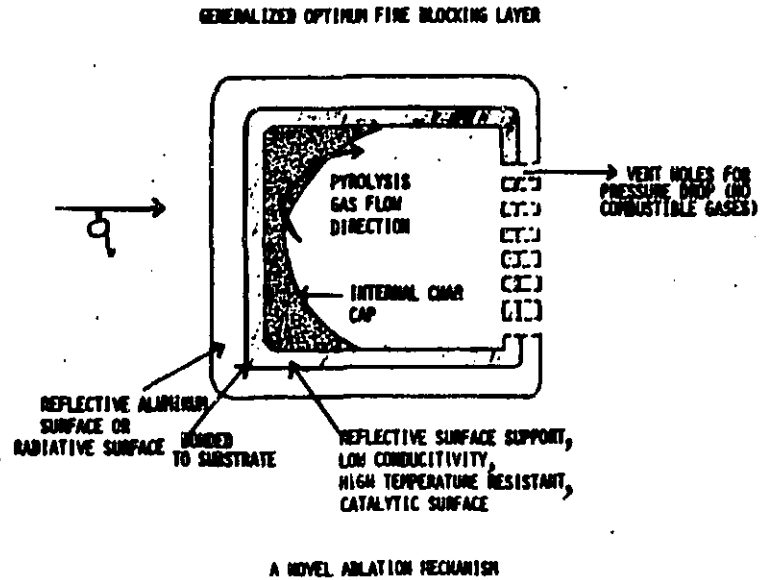

Figure 4

TYPICAL EXAMPLES
OF
OPTIMUM FIRE BLOCKING LAYER

GENTEX COMMERCIALLY AVAILABLE EXAMPLES
ALUMINUM CELLOX -- 11-16 oz/yd² -- COST \$15-18/80 YD
MORFAB (ALUMINUM-SILICA +) 11-12 oz/yd² -- COST \$20 +/-80 YD

MANY OTHER ANALOGS SYSTEMS POSSIBLE
AT SIMILAR COST, WEIGHT & PERFORMANCE

ALUMINUM-PAROX)
ALUMINUM-KYNOL) ANY HIGH ABLATIVE EFFICIENCY SUPPORT FOR
ALUMINUM-PBI) GOOD ALUMINUM WEAR SURFACE
ALUMINUM-CARBON FILLED POLYURETHANE)

(CAN BE USED WITH ANY WEIGHT EFFECTIVE RESILIENT WITHOUT REGARD TO FLEXIBLE
FOAM FLAMMABILITY)

FIGURE 6

GOVERNMENT EQUATIONS
TO EVALUATE THERMAL PERFORMANCE

1. $E = \frac{\text{INPUT ENERGY}}{\text{MASS MATERIAL REACTED}}$ (BASIC EFFICIENCY EQUATION)

2. EFFICIENCY FROM T-3 TEST (FOAM RESSION VELOCITY)

$$E_1 = \frac{q_{\text{RAD}}}{\dot{x}e}$$

q_{RAD} = INPUT HEATING RATE
 \dot{x} = RESSION VELOCITY
 e = FOAM DENSITY

3. EFFICIENCY FROM RADIATION-MASS-LOSS TEST

$$E_2 = \frac{q_{\text{RAD}}}{\dot{M}}$$

\dot{M} = MASS INJECTION RATE

4. EFFICIENCY FROM HEAT RELEASE CALORIMETER TEST

$$E_3 = \frac{q_{\text{RAD}}h}{\frac{\partial H}{\partial t}}$$

h = SPECIFIC HEAT COMBUSTION

ALL TESTS COMPARABLE BY E₁-E₂-E₃

FIGURE 7

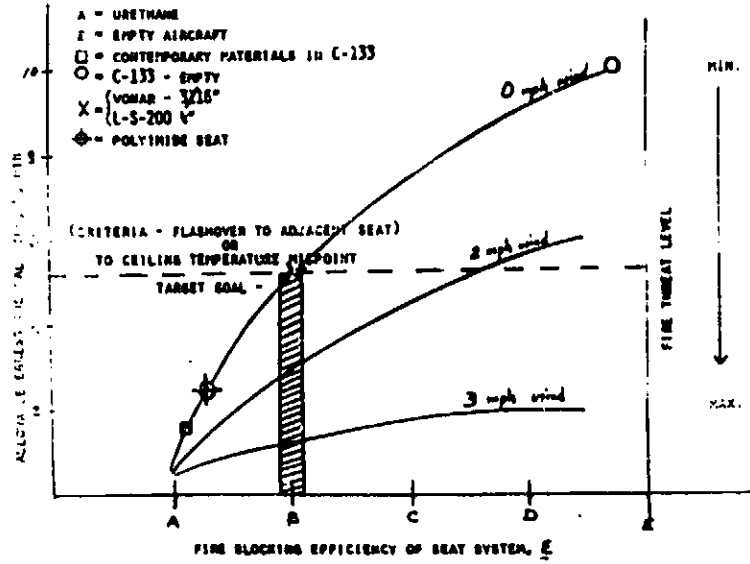

Figure 8

GOVERNING EQUATIONS FOR EMPIRICAL CORRELATION WITH C-133 TEST

- (1) t_e Available egress time desired (time propagation flashover with blocking layer (time or 300°-10' at ceiling)
- (2) t_e^* Available egress time with non-blocking layer
- (3) q_r Average input heating rate to seat
- (4) P_b Density of heat blocking layer
- (5) t Thickness of heat blocking layer
- (6) $P_b t - P_A$ Aerial Density
- (7) k Front factor for test configuration
- (8) $t_e = \frac{PkPA}{q \text{ rad}} + t_e^*$
- (9) $PA = \frac{(t_e - t_e^*)^2}{2k} q \text{ rad} = \text{Weight blocking/unit area}$
- (10) $M_{bb} = A_s \cdot PA$ Seat Area

Figure 9

MASS LOSS DATA AS A CRITERION OF HEAT BLOCKING PERFORMANCE

CODE	DESCRIPTION OF HEAT BLOCKING LAYER (OIL)	THICKNESS OF FILM, cm	SURFACE DENSITY OF FILM, g/cm ²	SPECIFIC MASS DIRECTION, g/cm ² mm	FILM OF HEAT, $\frac{A}{E}$ watts, mm ² /g	RELATIVE PERCENTAGE OF HEAT LOSS, +/- a LOCK	ATTACHED HEAT METER		
							NO. PANS	WT. Pans (grams)	
291	Mono/Mylar/Mylar/UF Urethane	0.0	0.0	1.2×10^{-5}	2.1×10^6	45	7	1040	1547
5	Womer 1/Mylar-Mylar/UF Urethane	0.152	0.055	7.3×10^{-5}	3.4×10^6	51	6	1721	2111
15	Womer 3/Mylar-Mylar/UF Urethane	0.463	0.111	3.1×10^{-5}	4.9×10^6	104	5	2035	2626
369	100 Al (sp) Cellon/Mylar-Mylar/UF Urethane	0.089	0.039	3.3×10^{-5}	7.8×10^6	162	2	1499	2081
172	100 Al (sp) Cellon-Mylar-Mylar/UF Urethane	0.071	0.053	2.8×10^{-5}	8.9×10^6	169	1	1528	1915
175	Moridin/Mylar-Mylar/UF Urethane	0.086	0.040	4.3×10^{-5}	3.5×10^6	117	3	1539	1930
17	Womer 3/Mylar-Mylar/UF Urethane	0.463	0.111	3.1×10^{-5}	4.7×10^6	100	4	2035	2626

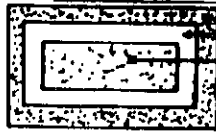

HEAT BLOCKING LAYER: 991 grams per sq. ft.
 HEAT BLOCKING LAYER: 449 grams per sq. ft.
 PF URETHANE: 840 grams per sq. ft.

Densities can be calculated from these values and the indicated film thickness data.
 Density = Surface Density/Thickness
 q is a standard heat flux of 2.5 watts/cm²
 based relative to c. for Womer III heat blocking layer with a value of 100.

Figure 10

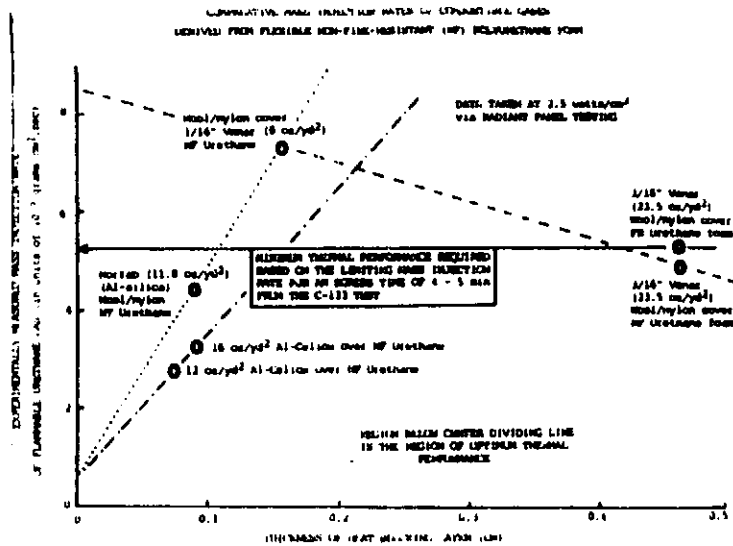

Figure 11

FARE DIRECTION MATS (F) as a Measure of Seat Fire Resistance Performance
 Relative Figures of Merit for Various Heat Blocking Materials
 Used to Protect HF Structures from Stand Burns

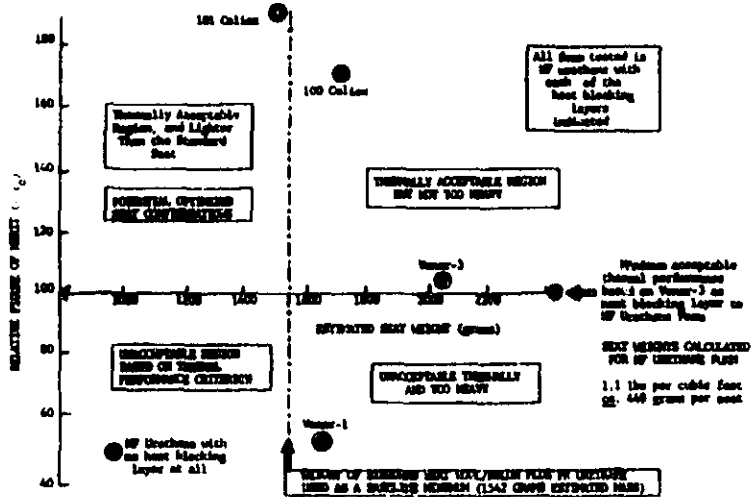

Figure 12

RELATIVE RANKING OF CANDIDATE FIRE BLOCKED SEAT CONFIGURATIONS IN TERMS OF THERMAL PERFORMANCE

FIRE BLOCKER	FOAM	SEAT WT. GR	% WT	α^*
NONE	F.R. URETHANE (BASELINE)	1.54	0	0.48
CELIOX	N.F. URETHANE	1.52	-1	5.1
VONAR 3	F.R. URETHANE	2.57	+67	5.9
CELIOX	F.R. URETHANE	1.91	+24	7.6
NORFAR	N.F. URETHANE	1.53	0	8.4
VONAR	N.F. URETHANE	2.18	+41	8.9
NORFAR	F.R. URETHANE	1.93	+25	11.0

$\alpha^* = \frac{\text{HEAT FLUX}}{\text{SPECIFIC MASS INJECTION RATE}} \frac{M \cdot A}{G}$

INPUT HEAT FLUX: $2.5W/CH^2$

EXPOSURE TIME: 4 MIN.

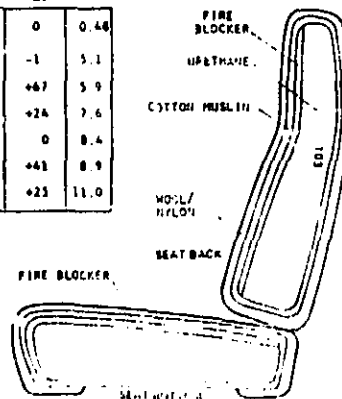

Figure 13

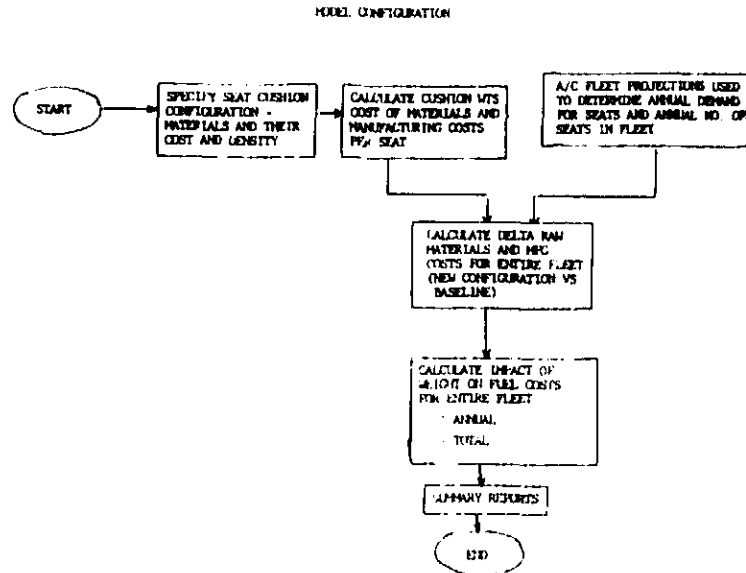

Figure 14

OPTIMIZATION METHODOLOGY FOR
FIRE BLOCKING SEAT CONSTRUCTION

1. SEARCH DATA BASE FOR FIRE BLOCKING EFFICIENCIES
 $E \geq 4.0$ WATT-SEC/GRAM
2. SEARCH DATA BASE FOR ALL OF (1) WITH WEAR EQUAL TO GREATER THAN 5 YEARS
 $L \geq 5$ YEARS
3. SEARCH DATA BASE ALL FOAMS WITH IDENTATION LOAD DEFLECTION AT 25% 55-10 PSI

INPUTS TO CALCULATE OPERATIONAL FLEET COSTS

- | | |
|-----------------------------|-------------------------------|
| 1. SEAT GEOMETRIES | 5. MATERIALS COSTS |
| 2. FOAM DENSITIES | 6. SEAT MANUFACTURING COSTS |
| 3. AREA DENSITIES | 7. AVERAGE ANNUAL SEAT DEMAND |
| 4. FLYING WEIGHT FUEL COSTS | |

OUTPUTS

1. VARIATION IN COST DIFFERENCE TO FABRICATE AND FLY FIRE-BLOCKED SEAT COMPARED TO STANDARD SEAT FOR ONE YEAR

FIGURE 15

ALGORITHM COST EVALUATION OF CURRENTLY AVAILABLE FOAMS AND FIRE BLOCKING LAYERS AT EQUIVALENT FIRE PERFORMANCE AND COMFORT

TOTAL CELL COST IN MILLIONS OF DOLLARS PER YEAR

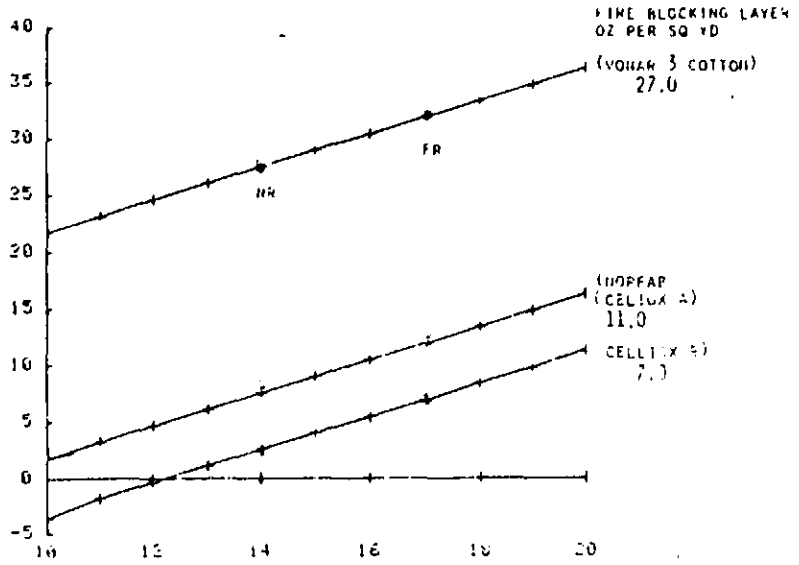

AVERAGE SEAL FOAM DENSITIES IN POUNDS PER CUBIC FOOT x 10²
Figure 16

APPENDIX C-1

"Test Methodology for Evaluation of Fireworthy Aircraft Seat Cushions"

D.A. Kourtides and J.A. Parker

Presented at the 7th International Conference on Fire Safety,
SRI International, Menlo Park, California, January 11-15, 1982, and
the 41st Annual Conference of Allied Weight Engineers, May 19, 1982.

TEST METHODOLOGY FOR EVALUATION OF FIREWORTHY AIRCRAFT SEAT CUSHIONS

D. A. Kourtidis and J. A. Parker
National Aeronautics and Space Administration
Moffett Field, California 94035

Presented at the 7th International Conference on Fire Safety

SRI International
Menlo Park, California
January 11-15, 1982

Abstract

Aircraft seat materials were evaluated in terms of their thermal performance. The materials were evaluated using (a) thermogravimetric analysis, (b) differential scanning calorimetry, (c) a modified NBS smoke chamber to determine the rate of mass loss and (d) the NASA T-3 apparatus to determine the thermal efficiency. In this paper, the modified NBS smoke chamber will be described in detail since it provided the most conclusive results. The NBS smoke chamber was modified to measure the weight loss of materials when exposed to a radiant heat source over the range of 2.5 to 7.5 W/cm². This chamber has been utilized to evaluate the thermal performance of various heat blocking layers utilized to protect the polyurethane cushioning foam used in aircraft seats. Various kinds of heat blocking layers were evaluated by monitoring the weight loss of miniature seat cushions when exposed to the radiant heat. The effectiveness of aluminized heat blocking systems was demonstrated when compared to conventional heat blocking layers such as neoprene. All heat blocking systems showed good fire protection capabilities when compared to the state-of-the-art, i.e., wool-nylon over polyurethane foam.

Introduction

One of the major fire threat potentials in commercial passenger aircraft is the nonmetallic components in the passenger seats. The major components of aircraft passenger seats are the polymeric cushioning material and, to a lesser degree, the textile fabric covering; together they represent a large quantity of potentially combustible material. Each aircraft coach type passenger seat consists of about 2.37 kg of non-metallic material, the major component being the seat cushion. Since modern day wide-body passenger aircraft have from 275 to 500 passenger seats, the total amount of combustible polymeric material provides a severe threat to the environment in the cabin in case of either on-board interior fire or post-crash type fire which in addition involves jet fuel.

A major complication in research to develop fire resistant aircraft passenger seats, is to assure the laboratory method chosen simulates real life conditions in case of a fire scenario onboard an aircraft or a post-crash fire. In this study, a non-flaming heat radiation condition was simulated. 7.6 cm x 7.6 cm samples made to resemble full-size seat cushions were tested for weight loss when exposed to different heat fluxes from an electrical heater. The measurements were conducted in a modified NBS smoke density chamber.

It has been shown (1,2,3,4) that the extremely rapid burning of aircraft seats is due to the polyurethane cushions of the seats. In order to protect the urethane foam from rapid degradation when exposed to heat, three different heat blocking layers were tested.

Two were aluminized fabrics and one was neoprene type of material in two thicknesses. In all cases, urethane foam was enveloped in a wool-nylon fabric.

Fabrics and foams put under a thermal load show a very complex behavior. Figure 1 illustrates the thermal behavior of a seat cushion with a heat blocking layer. When a heat blocking layer is introduced between the fabric and the foam, the complexity is expected to increase, especially if the heat blocking layer is an aluminized one as in some cases in this study. The protective mechanism for the urethane foam involves both conduction of the heat along the aluminum surface and heat re-radiation.

Description of Equipment

The test equipment for recording and processing of weight-loss data is shown in Figure 2. It consists of an NBS smoke chamber modified by the installation of an internal balance (ARBOR model #1206) connected to a HP 5150A thermal printer, providing simultaneous print-outs of weight remaining and time elapsed. Data recorded on the printer was manually fed into a HP 9835 computer, processed and eventually plotted on a HP 9872 plotter (i.e., weight remaining versus time elapsed). Also used was a HP 3455A millivoltmeter for the calibration of the chamber.

The NBS smoke chamber was modified two fold: (a) to permit a heat flux of 2.5-7.5 W/cm² and (b) to monitor weight loss of a sample on a continuous basis.

The NBS test procedure (5) employs a nichrome wire heater to provide a nominal exposure on the spectrum surface of 2.5 W/cm², which corresponds to the radiation from a black-body at approximately 540°C. To simulate thermal radiation exposure from higher temperature sources, a heater capable of yielding a high radiant flux on the face of the sample was utilized. This heater is available from Deltach Inc. This heater is capable of providing a heat flux of 2.5-10 W/cm².

Two burning conditions are simulated by the chamber: radiant heating in the absence of ignition, and flaming combustion in the presence of supporting radiation. During test runs, toxic effluents may be produced; therefore an external exhaust system was connected to the chamber. In order to provide protection against sudden pressure increases, the chamber is equipped with a safety blowout panel. Also, for added safety, a closed air breathing system was installed for use while operating and cleaning the chamber.

In this study, only the radiant heating condition was being simulated, using this electrical heater as the radiant heat source. The heater was calibrated at least once a week using a water-cooled calorimeter connected to a millivoltmeter. Using the calibration curve provided by the manufacturer, the voltages which provided the desired heat fluxes (2.5, 5.0 and 7.5 W/cm²), were determined.

When the chamber was heated up to the desired temperature (and heat flux), an asbestos shield was slid in front of the heater. This prevented the adjacent chamber wall from overheating and thus affecting the data. As mentioned earlier, this NBS smoke chamber was modified for recording of weight loss data by the installation of an electronic balance. The balance was mounted on top of the chamber with its weighing "hook" entering the chamber through a small opening. The chamber was then re-sealed by enclosing the balance in a metal container which was tightly fitted to the chamber roof. This balance was well suited to perform this particular task, because of several of its features. It provides a digital output to allow weighing results to be transferred to external electronic equipment (in this case, the thermal printer), below the balance weighing, which was essential, since the severe conditions inside the chamber during test runs were likely to corrode or otherwise destroy any weighing apparatus mounted inside the chamber. Also, the fact that it ascertains weight by measuring the electrical energy required to maintain equilibrium with the weight of the mass being measured, instead of by measuring mechanical displacement, makes it well suited to measure a continuous weight loss.

A desktop computer was used for data acquisition and storage. It provided an enhanced version of BASIC which includes an extensive array of error messages to simplify programming. The computer was equipped with an 80 by 24-character CRT (Cathode Ray Tube) display and a 16-character thermal printer for hard-copy printouts. One program written and used during the weight loss testing was PLOT wt. The program collected data from any test run stored on a data-file (the computer has a tape cartridge which reads the files from cassette tapes), calculated the weight remaining in %, and plotted the results versus time on a plotter hooked up to the computer.

Description of Materials

The materials used in this study are shown in Tables 1 and 2. Three types of foams were used and four types of heat blocking layers. The densities of the foams and the fire blocker layers are also shown in Tables 1 and 2, with an estimate of the seat weight when constructed from these materials. Two flexible polyurethane foams were used, a fire-retarded and a non-fire-retarded. The composition of the non-fire retarded was as follows.

Component	Parts By Weight
Polyoxypropylene glycol (a.w.)	100.0
Toluene diisocyanate (10:10 isomers)	105
Water	2.9
Silicone surfactant	1.0
Triethylenediamine	0.25
Stannous octoate	0.35

The composition of the fire retarded was not known but it may have contained an organo-halide compound as a fire-retardant. The composition of the polyimide foam used has been described previously (6).

The fire blocking materials used are shown in Table 3.

The Norfab^R 11 NT-26-A is a woven mixture of poly(p-phenylene terephthalamide), an aromatic polyamide and a modified phenolic fabric. The fabric was aluminized on one side. The Preox^R 1100-4 was based on heat stabilized polyacrylonitrile which was woven and aluminized on one side.

The mechanisms of fire protection of these materials depends on heat re-radiation and thermal conduction along the aluminum layer. The Vonar^R 2, and 3 layers used, are primarily transpirational-cooling heat blocking layers. This compound is a neoprene foam with added Al (OH)₃ as a fire-retardant, attached to a cotton backing. The mechanism by which the foam works is based on the heat vaporization of the foam absorbed, thereby cooling its surroundings.

Thermal Characterization

In order to thermally characterize the materials tested, Thermogravimetric Analysis (TGA) and Differential Scanning Calorimetry (DSC) were performed.

In TGA, the samples are heated at a constant heating rate in either oxygen or nitrogen atmosphere and the weight loss recorded. The polymer decomposition temperature (PDT), the temperature where the mass loss rate is the highest ($\max \frac{d}{dt}(\text{wt})$), the temperature of complete pyrolysis and the char yield in % are then determined as shown in Figure 4. The results are shown in Table 4.

In DSC, the electrical energy required to maintain thermal equilibrium between the sample and an inert reference, is measured. By calculating the peak area on the chart, the endo- or exothermicity of transitions can be determined. This was done automatically on the analyzer used which was equipped with a micro-processor and a floppy-disc memory. One analysis is shown in Figure 5 and the results in Table 5.

Both TGA's and DSC's were performed on DuPont thermal analyzers.

Radiant Panel Test Results

All of the configurations shown in Table 1 were tested in the modified NBS smoke chamber to determine the rate of mass loss. Prior to performing the weight loss experiments (radiant panel tests) on the complete sandwich cushions, weight loss experiments on individual components such as fabric, heat blocking layer and foam, were made. No detailed results of these tests will be reported in this paper, but a few observations might be worthwhile to report.

When, assuming that fire performance of the components were additive phenomena, the total weight loss of the components were added together and compared with a sandwich tested under the same conditions, no correlation was found. In some cases, testing with the highly flammable foam actually improved the performance of the sample compared to testing the heat blocking layer alone. The decorative fabric proved to have little influence on the performance of the heat blocking layer. Heat readily went through and the fabric burned off rapidly.

After performing these initial experiments, it was clear that the weight loss profile of the samples could not alone provide a good criteria to determine the efficiency of the heat block. The criteria chosen was the amount of gas originating from the urethane foam injected into the air. The possible steps for the thermal degradation of the flexible urethane foam are shown in Figure 6.

After extensive initial testing, it was determined to test the sandwich configurations shown in Tables 1 and 2. Configuration #367 represents the state-of-the-art, i.e., the seat configuration presently used in the commercial fleet.

All samples shown in Tables 1 and 2, were sandwich structures made up as miniature seat cushions. The sandwiches consisted of a cushioning foam inside a wrapping of a heat blocking layer and a wool-nylon fabric as shown in Figure 3. To simplify the assembly, the heat blocking layer and the fabric were fixed together with a stapler followed by wrapping them around the foam and then fixed in place by sewing the edges together with thread.

Prior to assembly, the individual components were weighed on an external balance and the results, together with other relevant data were recorded. The samples were mounted in the chamber as shown in Figure 3. In order to prevent the heat from the heater from reaching the sample before the start of the test, a special asbestos shield was made. The shield slides on a steel bar and can be moved with a handle from the outside, which also enables the operator to terminate the test without opening the chamber door and exposing himself to the toxic effluents.

The test was initiated by pushing the asbestos shield into its far position, thus exposing the sample to the heat flux from the heater and by starting the thermal printer. The test then ran for the decided length of time (1, 2, 3, 4 or 5 minutes) and was terminated by pulling the asbestos shield in front of the sample. When a stable reading on the printer was obtained (indicating that no more gases originating from the foam were injected into the chamber from the sample), the printer was shut off. After the chamber was completely purged from smoke the sample was taken out and allowed to cool down to room temperature.

The burned area on the side of the sample facing the heater was subsequently measured in order to standardize the test. This area was normally around 5 cm x 5 cm and since the sample size was 7.5 cm x 7.5 cm, this was thought to minimize edge effects (that is, changes in the heat spread pattern through the sample caused by the heat blocking layer folded around the sides of the foam cushion).

Finally, the sample was cut open and the remainder of the foam scraped free from the heat blocking layer and weighed on the external balance. This was done to determine the amount of foam that had been vaporized and injected into the surroundings.

Results and Discussion

The samples shown in Tables 1 and 2 were exposed to heat flux levels of 2.5, 5.0 and 7.5 W/cm². After the weight loss of the urethane foam was determined, as described previously, the specific mass injection rate was calculated as follows:

$$\dot{m} = \frac{(\text{weight loss})}{(\text{area of sample exposed to heat}) \times (\text{time elapsed})} \left[\frac{\text{g}}{\text{cm}^2, \text{s}} \right]$$

The area exposed to heat was brought into the equation in an effort to standardize the test runs in terms of how much radiant energy that had actually been absorbed by the sample.

Then the figure of merit was calculated as follows:

$$\epsilon = \frac{(\text{heat flux})}{(\text{specific mass injection rate})} \left[\frac{\text{W, s}}{\text{g}} \right]$$

The objective was to determine a heat blocking system showing equal or better performance than the Vonar^R 3 system. Therefore, the ϵ -value at every test condition for Vonar^R 3 was assigned to ϵ_0 . Then the relative figure of merit was calculated as follows:

$$\epsilon_{\text{rel}} = \frac{\epsilon}{\epsilon_0}$$

The mass loss data for the fire retarded and non-fire retarded urethane is shown in Tables 6 and 7, respectively.

The rationale for ranking materials at the 2 minute exposure time is related to full scale tests conducted previously (1, 2, 3, 4) and is a critical time at which evacuation must occur in an aircraft in case of a post crash fire.

In case of a post crash fire outside the passenger compartment (e.g., a fire in the fuel system), the seat system inside the cabin will be exposed to severe heat radiation. The foam cushions will start to inject toxic gases into the cabin as simulated in this study. 2 minutes is thought to be an accurate time limit for the survivability of the passengers exposed to these conditions. Data at

2 minutes are also displayed graphically in Figures 7 and 8. Figures 9 and 10 show the figure of merit as a function of heat flux at 2 minutes exposure. It can be seen in Figure 9 that the figure of merit at a heat flux of 2.5 W/cm^2 for the aluminized fabrics (Preox^R 1100-4 and Norfab^R 11HT-26-A1) is higher than either the Vonar^R 2 and 3, at 5.0 W/cm^2 , they are approximately equal, and at 7.5 W/cm^2 that both Vonar^R 2 and 3 show a higher figure of merit than the aluminized fabric.

The method of protection for the urethane foam changes as the heat flux increases whereby the transpirational cooling effect of the Vonar^R is more effective at the higher heat flux range. The mode of urethane protection using the aluminized fabric is primarily due to re-radiation and thermal conduction. At 5 W/cm^2 , all heat blocking materials were approximately equally effective, but, it should be remembered that the weight penalty of the Vonar^R materials is excessive as shown in Table 1. The aluminized fabrics were equally effective in protecting both the fire retarded and non-fire retarded urethane foams as shown in Figures 9 and 10.

To obtain a general view of the heat blocking performance of different heat blocking layers, the average mass injection rates of experiments with 1, 2, 3, 4 and 5 minutes elapsed time was calculated and is shown in Tables 8 and 9. Figures 11 and 12 show the figure of merit as a function of heat flux at average exposure time. Essentially the same results are observed as the measurements indicated at 2 minutes.

The usage of a heat blocking layer in aircraft seats, significantly improves the performance of the seat when exposed to heat radiation. This is true at all heat flux ranges tested. Samples representing the state-of-the-art (#367) were completely burned after only a short exposure time and it was not possible to test these samples at 7.5 W/cm^2 . When it comes to ranking between the different heat blocking layers, the results are more ambiguous. It is true that Vonar^R R performed better at the higher heat flux level (7.5 W/cm^2) but at the heat level of most interest (5.0 W/cm^2), it was approximately equal to the other heat blocking layers. The heat flux of 5.0 W/cm^2 is considered an average heat flux level in the interior of the aircraft as shown in simulated full scale fire tests conducted previously (2). There were no significant differences observed in the fire blocking efficiency of the layers whether a non-fire retarded or a fire retarded urethane foam was used. At 5.0 W/cm^2 , the efficiency of the Vonar^R 3 was higher with the non-fire retarded foam while the aluminized fabric showed a higher efficiency with the same foam at 7.5 W/cm^2 as shown in Figures 9 and 10. It is not precisely known whether this difference is due to the differences between the two foams or is due to the different mechanisms of the heat blocking layers, i.e. transpiration or re-radiation cooling. Neither one of the two aluminized fabrics show outstanding performance in comparison with each other. When the complexities of the effect of the underlying foam are taken into consideration, it is reasonable to rank them as giving equal fire protection. For example, in the case of the fire-retarded foam, the Norfab^R gives

excellent fire protection at the low (2.5 W/cm^2) heat flux in comparison with Preox^R 1100-4 fabric as shown in Figure 11. At 5.0 W/cm^2 , they are equal and at 7.5 W/cm^2 , the situation is reversed when using the non-fire retarded urethane foam. The Norfab^R 11HT-26-A1 fabric exhibited better performance at all heat flux levels when tested with the non-fire retarded foam as shown in Figure 12.

The 181-E glass fabric indicated the lowest fire protection at 5.0 W/cm^2 when the exposure time is averaged over 5 min as shown in Figure 10. At the (2) minute interval, its performance was approximately the same as the other fabrics as shown in Figure 9.

A study of the cost/weight penalty of different heat blocking systems (7) shows that the re-radiation-cooling systems or aluminized fabrics provide far better cost-efficiency than the transpirational-cooling systems such as Vonar^R 3. These results and the equality in fire protection performance shown in this study, points in favor of aluminized fabrics for possible use as cost efficient heat protection system for the urethane foam.

Several difficulties were encountered when conducting the radiant panel tests. The major complications were: (a) the experiments were designed to measure the amount of gas, originating from the urethane foam, injected into the air. To really determine how much gas due to urethane decomposition that is produced, the gases need to be analyzed (preferably by GC-MS methods). This could not be done at the time of this study; (b) some of the gas produced from combustion of urethane foam may be trapped in the heat blocking layer. The amount of gas trapped is extremely difficult to measure. The initial experiments showed that, in some cases, the difference in the weight loss of the HBL (with and without a urethane foam core) was greater than the weight of foam loss; hence the weight of gas trapped could not be measured. This problem was corrected by perforating the fabric on the back surface to allow venting of the gas and, (c) there was a problem with the quenching period. At 7.5 W/cm^2 this might well be the dominant mechanism for weight loss of the urethane foam for shorter test runs. It is desirable that a method to instantly quench the sample be developed for testing at heat fluxes of 7.5 W/cm^2 and higher.

Thermal Efficiency

The NASA-Ames T-3 thermal test (8) was used to determine the fire endurance of the seat configurations shown in Tables 1 and 2. In this test, specimens measuring $25 \text{ cm} \times 25 \text{ cm} \times 5.0 \text{ cm}$ thick were mounted on the chamber and thermocoupled on the backface of the specimen. The flames from an oil burner supplied with approximately 5 liters/hour of JP-4 jet aviation fuel provided heat flux to the front face of the sample in the range of $10.4\text{--}11.9 \text{ W/cm}^2$. The test results were inconclusive since the temperature rise in most of the specimens was extremely rapid and it was very difficult to determine small differences in fire blocking efficiency of the various layers. Additional work will be performed to reduce the level of heat flux in the chamber in order to be able to differentiate easier among the samples.

Conclusions

It is understood that a great number of mechanisms govern the performance of fabrics and foams when exposed to heat radiation. Finding these mechanisms and measuring their individual parameters, is extremely difficult. In this study efforts were directed towards determining the heat protection provided by different heat blocking layers, relative to one another.

Some specific conclusions may be drawn from this study:

(a) Modified NBS smoke chamber provides a fairly accurate method for detecting small differences in specimen weight loss over a range of heat fluxes and time.

(b) Aluminized thermally stable fabrics provide an effective means for providing thermal protection to flexible urethane foams.

(c) Vonar^R 2 or 3 provided approximately equal thermal protection to F.R. urethane than the aluminized fabrics but at a significant weight penalty.

(d) No significant differences were observed in the use of F.R. or N.F. urethane when protected with a fire blocking layer.

(e) The efficiency of the foams to absorb heat per unit mass loss when protected with the heat blocking layer decreases significantly in the heating range of 2.5-5.0 W/cm², but remains unchanged or slightly increases in the range of 5.0-7.5 W/cm².

The results showed that the heat blocking systems studied provides significant improvement of the fire protection of aircraft seats compared to the state-of-the-art (i.e. the seats presently used in the commercial fleet).

The results indicated that transpiration- and re-radiation-cooling systems provided approximately equal fire protection. However, the high weight/cost penalty of the transpiration system favored the re-radiation systems (7).

The T-3 test is not suitable at its present operation to detect minor differences in heat blocking efficiency. Additional methods must be utilized in evaluating these and similar materials in order to establish a good correlation between these weight loss experiments and other more established or standard test methodologies.

References

1. Hill, R. G., and Sarkos, C. P., Postcrash Fuel Fire Hazard Measurements in a Wide Body Aircraft Cabin, Journal of Fire Flammability, Vol. II, pp. 151-163, April 1980
2. Hill, R. G., Johnson, G. R., and Sarkos, C. P., Postcrash Fuel Fire Hazard Measurements in a Wide Body Aircraft Cabin, Federal Aviation Administration, NAFEC, Report FAA-NA-79-42, December 1979
3. Brown, L. J., Cabin Hazards from a Large External Fuel Fire Adjacent to an Aircraft Fuselage, Federal Aviation Administration, NAFEC, Report FAA-RD-79-65, August 1979
4. Nicholas, E. B., Johnson, R. M., and Sarkos, C. P., Flammability Tests of Used Aircraft Interior Materials, Federal Aviation Administration, NAFEC, Letter Report NA-78-71-LR, November 1978
5. Standard Test Method for Measuring the Smoke Generation by Solid Materials, NFPA 258-1976, National Fire Protection Association (1976)
6. Cagliani, G., Flexible Polyimide Foam for Aircraft Material, NASA Technical Memorandum TMS 73144 (August 1976)
7. Parker, J. A. and Kourtidis, D. A., Optimization of Blocking Layers for Aircraft Seating, Presented at the 7th International Conference on Fire Safety, San Francisco, California (January 1982)
8. Riccitiello, S. R., Fish, R. H., Parker, J. A., and Gustafson, E. J., Development and Evaluation of Modified Polyisocyanurate Foams for Low-Heating Rate Thermal Protection, Journal of Cellular Plastics, Vol. 7, No. 2, 91-96, March/April 1971

List of Figures

- Fig. 1 Behavior of Aluminized Fabric/Foam Assembly under Thermal Loads
- Fig. 2 Equipment for Weight-Loss Data
- Fig. 3 Sample Configuration
- Fig. 4 Typical Thermogram
- Fig. 5 Differential Scanning Calorimetry of Vonar^R 2.
- Fig. 6 Thermal Degradation of Flexible Polyurethane Foams
- Fig. 7 Specific Mass Injection Rate of F.R. Urethane at Various Heat Flux Levels at 2 Min.
- Fig. 8 Specific Mass Injection Rate of N.F. Urethane at Various Heat Flux Levels at 2 Min.
- Fig. 9 Figure of Merit Comparison of Heat Blocking Layers - F.R. Urethane as a Function of Heat Flux at 2 Min.
- Fig. 10 Figure of Merit Comparison of Heat Blocking Layers of N.F. Urethane as a Function of Heat Flux at 2 Min.
- Fig. 11 Figure of Merit Comparison of Heat Blocking Layers of F.R. Urethane as a Function of Heat Flux Averaged Over Time
- Fig. 12 Figure of Merit Comparison of Heat Blocking Layers of N.F. Urethane as a Function of Heat Flux Averaged Over Time

List of Tables

- Table 1 Composite Aircraft Seat Configurations with F.R. Urethane
- Table 2 Composite Aircraft Seat Configurations with N.F. Urethane and Polyimide
- Table 3 Candidate Heat Blocking Layers for Seat Cushions
- Table 4 Thermogravimetric Analysis
- Table 5 Different Scanning Calorimetry
- Table 6 Mass Loss Data of F.R. Urethane at 2 Min. from Radiant Panel Test
- Table 7 Mass Loss Data of N.F. Urethane at 2 Min. from Radiant Panel Test
- Table 8 Mass Loss Data of F.R. Urethane Averaged Over Time from Radiant Panel Test
- Table 9 Mass Loss Data of N.F. Urethane Averaged Over Time from Radiant Panel Test

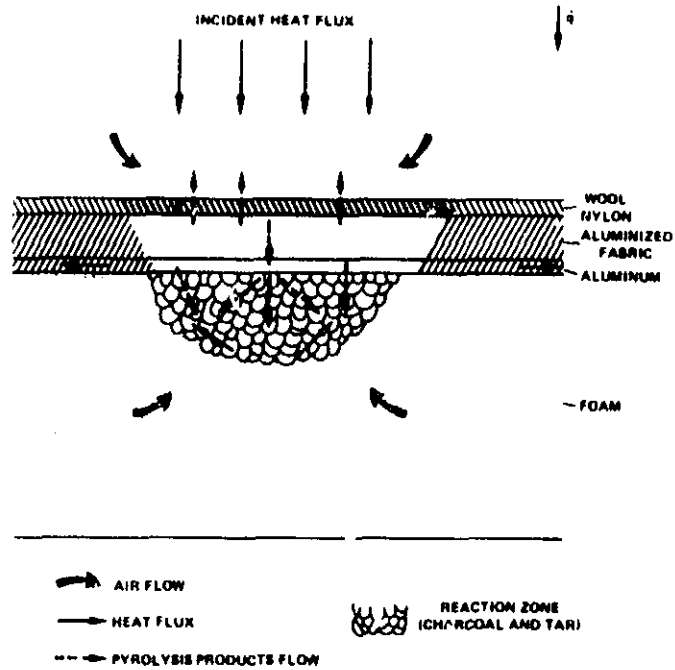

Figure 1: Behavior of Aluminized Fabric/
Foam Assembly Under Thermal Loads

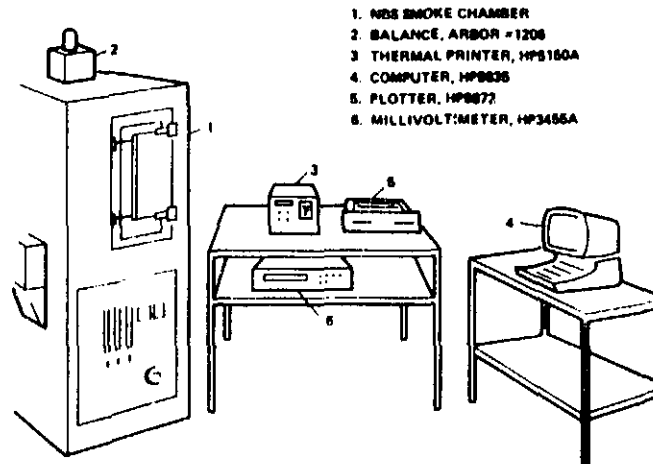

Figure 2: Equipment for Weight-Loss Data

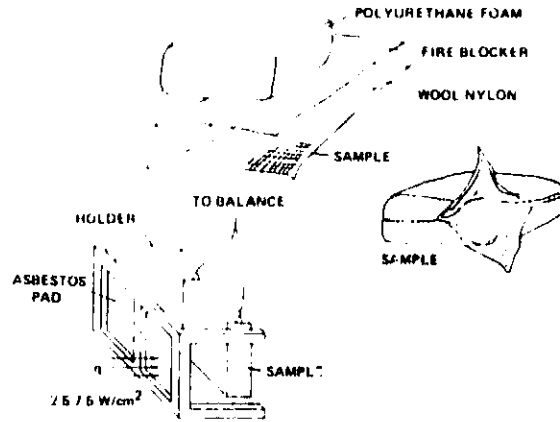

Figure 3: Sample Configuration

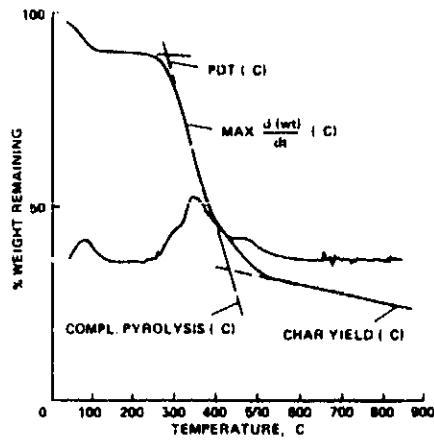

Figure 4: Typical Thermogram

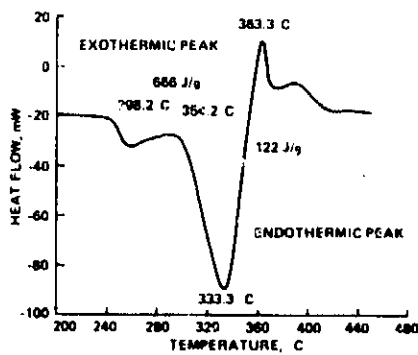

Figure 5: Differential Scanning Calorimetry of Vonar^R 2

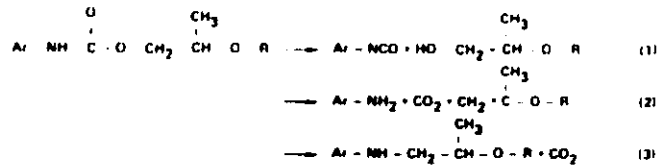

Figure 6: Thermal Degradation of Flexible Polyurethane Foams

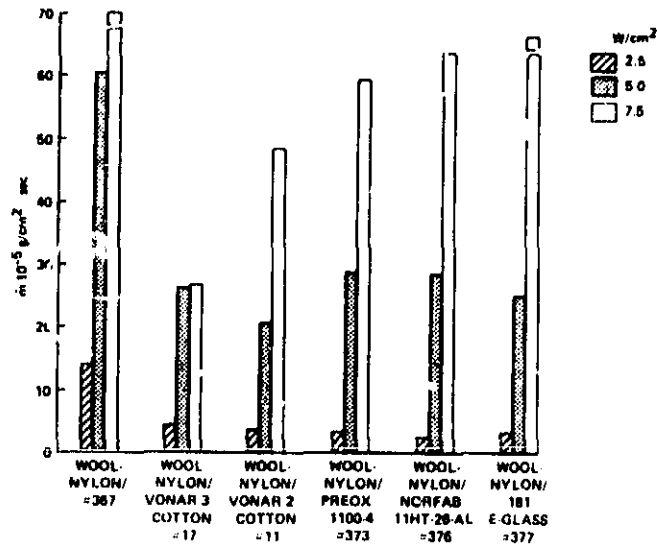

Figure 7: Specific Mass Injection Rate of F.R. Urethane at Various Heat Flux Levels at 2 Min.

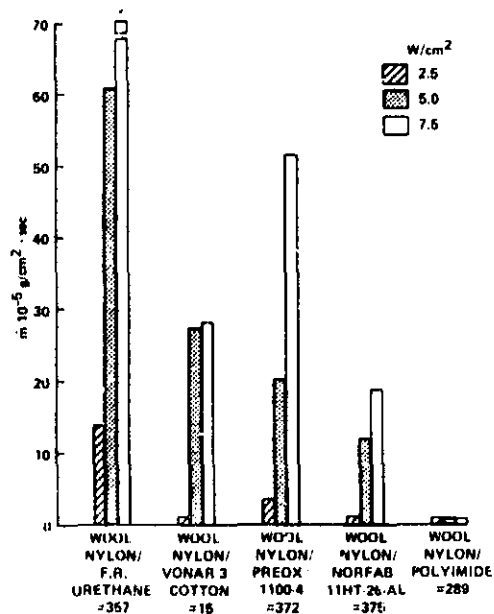

Figure 8: Specific Mass Injection Rate of N.F. Urethane at Various Heat Flux Levels at 2 Min.

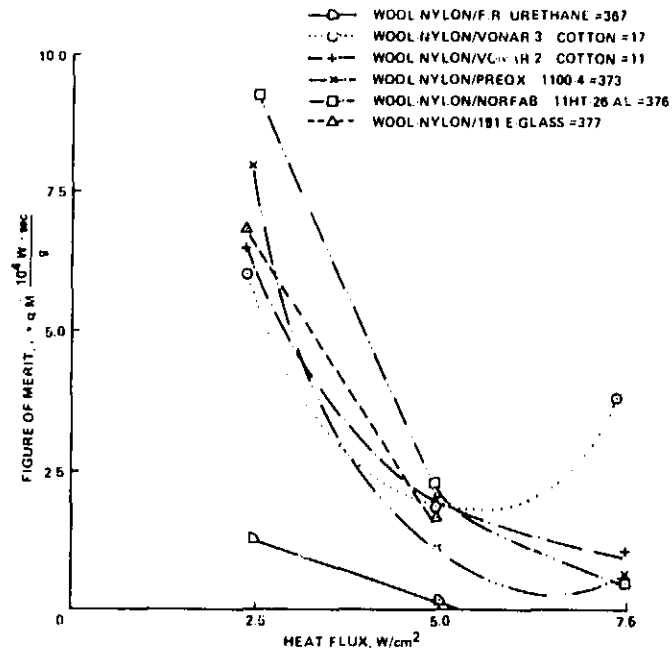

Figure 9: Figure of Merit Comparison of Heat Blocking Layers - F.R. Urethane as a Function of Heat Flux at 2 Min.

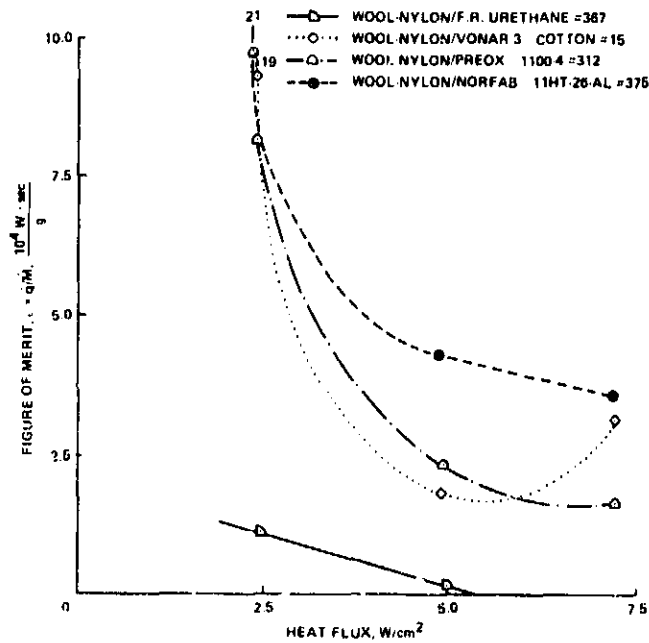

Figure 10: Figure of Merit Comparison of Heat Blocking Layers - N.F. Urethane as a Function of Heat Flux at 2 Min.

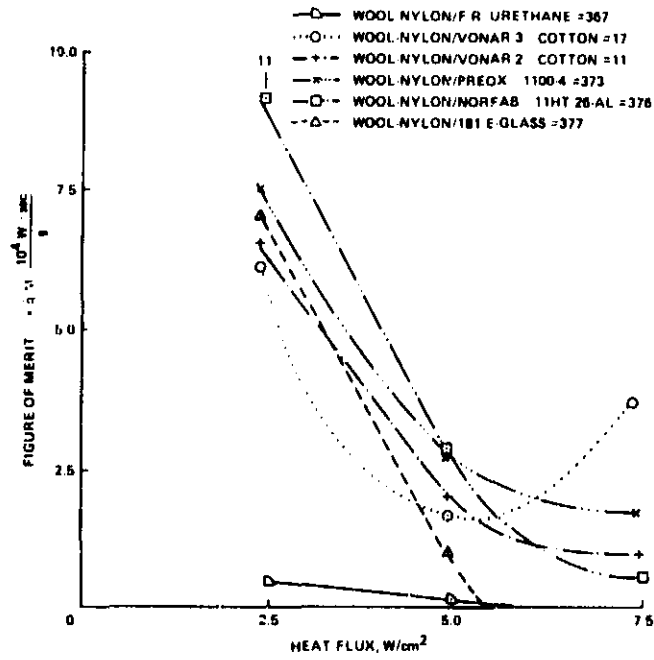

Figure 11: Figure of Merit Comparison of Heat Blocking Layers of F.R. Urethane as a Function of Heat Flux Averaged Over Time

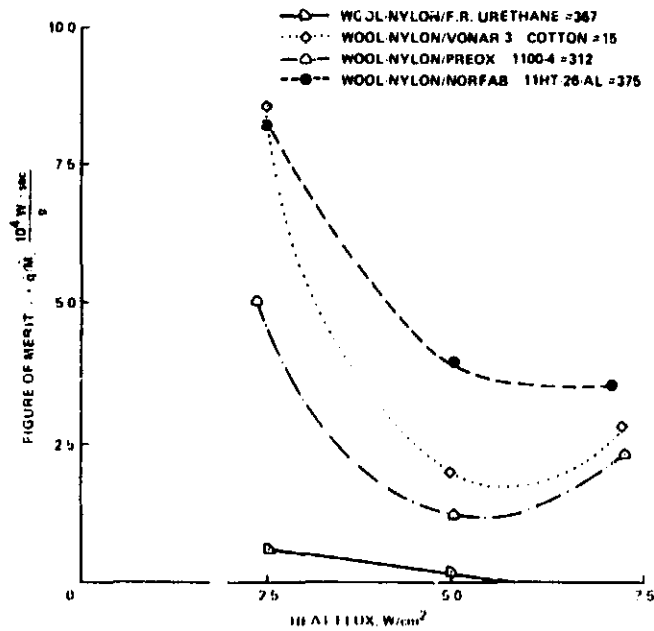

Figure 12: Figure of Merit Comparison of Heat Blocking Layers of N.F. Urethane as a Function of Heat Flux Averaged Over Time

SAMPLE NO (1)	FIRE BLOCKING MATERIAL	AREAL DENSITY, Kg/m ²	FOAM	DENSITY, Kg/m ³	SEAT WEIGHT, g (2)	% Δ
367	NONE		F.R. URETHANE	29.9	2374	0
17	VONAR 3 COTTON	0.91	F.R. URETHANE	29.9	3935	+66
11	VONAR 2 COTTON	0.67	F.R. URETHANE	29.9	3525	+48
373	PREOX 1100-4	0.39	F.R. URETHANE	29.9	3039	+28
376	NORFAB 11HT 26 AL	0.40	F.R. URETHANE	29.9	3055	+29
377	181 E GLASS	0.30	F.R. URETHANE	29.9	2888	+22

(1) ALL CONFIGURATIONS COVERED WITH WOOL-NYLON FABRIC, 0.47 Kg/m²

(2) ESTIMATED WEIGHT OF COACH SEAT CONSISTING OF BOTTOM CUSHION (50.8 · 55.9 · 10.2 cm), BACK CUSHION (45.7 · 50.8 · 5.1 cm) AND HEAD REST (45.7 · 20.3 · 12.7 cm)

Table 1: Composite Aircraft Seat Configuration with F.R. Urethane

SAMPLE NO (1)	FIRE BLOCKING MATERIAL	AREAL DENSITY, Kg/m ²	FOAM	DENSITY, Kg/m ³	SEAT WEIGHT, g (2)	% Δ
15	VONAR 3 COTTON	0.91	N.F. URETHANE	18.0 (23.2)	3206 (3583)	+36 (+51)
372	PREOX 1100-4	0.39	N.F. URETHANE	18.0 (23.2)	2300 (2686)	-2.7 (+13)
375	NORFAB 11HT 26 AL	0.40	N.F. URETHANE	18.0 (23.2)	2325 (2703)	-2.1 (+14)
289	NONE		POLYIMIDE	19.2	1812	-24

(1) ALL CONFIGURATIONS COVERED WITH WOOL-NYLON FABRIC, 0.47 Kg/m²

(2) ESTIMATED WEIGHT OF COACH SEAT CONSISTING OF BOTTOM CUSHION (50.8 · 55.9 · 10.2 cm), BACK CUSHION (45.7 · 50.8 · 5.1 cm) AND HEAD REST (45.7 · 20.3 · 12.7 cm)

Table 2: Composite Aircraft Seat Configuration with N.F. Urethane

FIRE BLOCKER	AREAL DENSITY, Kg/m ²	COMPOSITION	TYPICAL STRUCTURE
NORFAB 11HT 26-AL ALUMINIZED	0.40	70% KEVLAR 26% NOMEX 5% KYNOL	POLY (p-PHE-IVYLENE TEREPHTHALAMIDE) 
PREOX 1100-4 ALUMINIZED	0.39	HEAT STABILIZED POLYACRYLONITRILE	
VONAR 2 COTTON VONAR 3 COTTON	0.67 0.91	POLYCHLOROPRENE	
181 E GLASS FABRIC	0.30	GLASS	SiO ₂

Table 3: Candidate Heat Blocking Layers for Seat Cushions

SAMPLE NAME	TDI C		MAX $\frac{d(\text{wt})}{dt}$ C		COMPL. PYROLYSIS, C		CHAR YIELD, %	
	AIR	N ₂	AIR	N ₂	AIR	N ₂	AIR	N ₂
WOOL NYLON	272	273	405	339	538	440	3	23
PREOX 1100 4	276	315	610	350	667	447	8	58
NORFAB 11H, 26 AL	440	440	590	560	612	610	34	61
VONAR 2, 3	278	276	385	352	600	517	36	47
N.F. URETHANE	278	263	320	33A	340	410	2	5
F.R. URETHANE	268	250	331	380	381	401	11	6
POLYIMIDE	384	450	563	585	659	596	8	48

Table 4: Thermogravimetric Analysis

SAMPLE NAME	AIR		N ₂	
	ΔH , J/G	PEAK TEMP., C	ΔH , J/G	PEAK TEMP., C
WOOL NYLON	137 48	200 299	273	199
PREOX 1100-4	188	366	174	351
NORFAB 11HT 26 AL	-	-	-	-
VONAR 2, 3	-300 317	350 377	-666 122	333 383
N.F. URETHANE	4970	386	2105	408
F.R. URETHANE	2264	356	-	-
POLYIMIDE	366	386	-	-

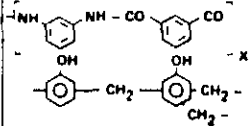
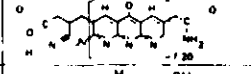
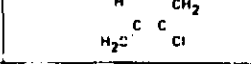
COMMENTS: POSITIVE ΔH VALUES INDICATE EXOTHERMIC REACTIONS (i.e. HEAT EVOLVED IN THE TRANSITION), NEGATIVE ΔH VALUES INDICATE ENDOTHERMIC REACTION (i.e. HEAT ABSORBED IN THE TRANSITION).
 "-" INDICATES THAT NO TRANSITIONS WERE OBSERVED WITHIN THE RANGE OF THIS DSC CELL (0-550 C)

Table 5: Differential Scanning Calorimetry

CONFIGURATION NUMBER	DESCRIPTION OF SAMPLE	SPECIFIC MASS INJECTION RATE $M \frac{10^{-5} \text{ g}}{\text{cm}^2 \text{ sec}}$			FIGURE OF MERIT $\frac{q}{M} \frac{10^4 \text{ W sec}}{\text{g}}$			RELATIVE FIGURE OF MERIT (1) $\frac{q}{q_0} \cdot 100\%$		
		2.5	5.0	7.5	2.5	5.0	7.5	2.5	5.0	7.5
		W/cm ²	W/cm ²	W/cm ²	W/cm ²	W/cm ²	W/cm ²	W/cm ²	W/cm ²	W/cm ²
367	WOOL NYLON/F R URETHANE	13	61	-	1.9	0.8	N/A	32	42	N/A
17	WOOL NYLON/VONAR 3 COTTON/F R URETHANE	4.1	27	28	6.0	1.9	2.7	100	100	100
11	WOOL NYLON/VONAR 2 COTTON/F R URETHANE	4.0	21	50	6.3	2.3	1.5	106	121	66
373	WOOL NYLON/PREOX 1100-4/F R URETHANE	3.3	29	59	7.7	1.7	1.3	128	89	48
376	WOOL NYLON/NORFAB 11HT 26 AL/F R URETHANE	2.7	24	66	9.4	2.1	1.1	155	111	0.41
377	WOOL NYLON/181 E GLASS F R URETHANE	4.0	25	-	6.3	2.0	N/A	105	105	N/A

(1) SCALED RELATIVE TO q_0 FOR VONAR 3 HEAT BLOCKING LAYER WITH A VALUE OF q_0 AS 100

Table 6: Mass Loss Data of F.R. Urethane at 2 Min. from Radiant Panel Test

CONFIGURATION NUMBER	DESCRIPTION OF SAMPLE	SPECIFIC MASS INJECTION RATE $M \frac{10^{-5} \text{ g}}{\text{cm}^2 \text{ sec}}$			FIGURE OF MERIT $\frac{q}{M} \frac{10^4 \text{ W sec}}{\text{g}}$			RELATIVE FIGURE OF MERIT (1) $\frac{q}{q_0} \cdot 100\%$		
		2.5	5.0	7.5	2.5	5.0	7.5	2.5	5.0	7.5
		W/cm ²	W/cm ²	W/cm ²	W/cm ²	W/cm ²	W/cm ²	W/cm ²	W/cm ²	W/cm ²
15	WOOL NYLON/VONAR 3 COTTON/N.F. URETHANE	15	27	28	19	1.9	2.7	317	100	100
372	WOOL NYLON/PREOX 1100-4/N.F. URETHANE	3.3	20	52	7.7	2.5	1.4	128	132	52
375	WOOL NYLON/NORFAB 11HT 26 AL/N.F. URETHANE	1.2	11	20	21	4.5	3.8	350	240	140
289	WOOL NYLON POLYIMIDE	0	0	0	N/A	N/A	N/A	N/A	N/A	N/A

(1) SCALED RELATIVE TO q_0 FOR VONAR 3 HEAT BLOCKING LAYER WITH A VALUE OF q_0 AS 100

Table 7: Mass Loss Data of N.F. Urethane at 2 Min. from Radiant Panel Test

CONFIGURATION NUMBER	DESCRIPTION OF SAMPLE	SPECIFIC MASS INJECTION RATE $M \frac{10^{-5} g}{cm^2 sec}$			FIGURE OF MERIT $\frac{q/M}{g} \frac{10^4 W sec}{g}$			RELATIVE FIGURE OF MERIT (1) $\frac{1}{10} \cdot 100\%$		
		2.5 W/cm ²	5.0 W/cm ²	7.5 W/cm ²	2.5 W/cm ²	5.0 W/cm ²	7.5 W/cm ²	2.5 W/cm ²	5.0 W/cm ²	7.5 W/cm ²
367	WOOL NYLON/F.R. URETHANE	50	66	N/A	0.48	0.76	N/A	8	35	N/A
17	WOOL NYLON/VONAR 3 COTTON/F.R. URETHANE	4.2	23	27	5.9	2.2	2.8	100	100	100
11	WOOL NYLON VONAR 2 COTTON/F.R. URETHANE	3.9	21	47	6.4	2.3	1.6	108	104	57
373	WOOL NYLON/PREOX 1100-4/F.R. URETHANE	3.3	17	35	7.6	3.0	2.1	128	136	75
376	WOOL NYLON/MORFAB 11HT 26-AL/F.R. URETHANE	2.2	16	55	11	3.1	1.4	186	141	50
377	WOOL NYLON/101 E-GLASS/F.R. URETHANE	3.5	33	N/A	7.1	1.5	N/A	120	68	N/A

(1) SCALED RELATIVE TO \dot{q}_0 FOR VONAR 3 HEAT BLOCKING LAYER WITH A VALUE OF \dot{q}_0 AS 100

Table 8: Mass Loss Data of F.R. Urethane Averaged Over Time from Radiant Panel Test

CONFIGURATION NUMBER	DESCRIPTION OF SAMPLE	SPECIFIC MASS INJECTION RATE $M \frac{10^{-5} g}{cm^2 sec}$			FIGURE OF MERIT $\frac{q/M}{g} \frac{10^4 W sec}{g}$			RELATIVE FIGURE OF MERIT (1) $\frac{1}{10} \cdot 100\%$		
		2.5 W/cm ²	5.0 W/cm ²	7.5 W/cm ²	2.5 W/cm ²	5.0 W/cm ²	7.5 W/cm ²	2.5 W/cm ²	5.0 W/cm ²	7.5 W/cm ²
15	WOOL NYLON/VONAR 3 COTTON/N.F. URETHANE	2.8	22	28	6.9	2.3	2.7	149	105	98
372	WOOL NYLON/PREOX 1100-4/N.F. URETHANE	4.9	29	30	5.1	1.7	2.5	85	77	89
375	WOOL NYLON/MORFAB 11HT 26-AL/N.F. URETHANE	3.0	12	19	8.4	4.1	3.9	142	186	140
289	WOOL NYLON/POLYIMIDE	0	0	0	N/A	N/A	N/A	N/A	N/A	N/A

(1) SCALED RELATIVE TO \dot{q}_0 FOR VONAR 3 HEAT BLOCKING LAYER WITH A VALUE OF \dot{q}_0 AS 100

Table 9: Mass Loss Data of N.F. Urethane Averaged Over Time from Radiant Panel Test

APPENDIX D - 1

Study for the Optimization of Aircraft Seat Cushion Fire Blocking
Layers - Full Scale Test Description and Results

Final Report, Contract NAS2-11095, Kenneth J. Schutter
and Fred E. Duskin, Douglas Aircraft Company.

NASA Contractor Report

Final Report

**Study for the Optimization of Aircraft
Seat Cushion Fire-Blocking Layers — Full Scale —
Test Description and Results**

Kenneth J. Schutter and Fred E. Duskin

**McDonnell Douglas Corporation
Douglas Aircraft Company
Long Beach, California 90846**

**CONTRACT NASA 2-11095
MAY 1982**



**National Aeronautics and
Space Administration**

**Ames Research Center
Moffet Field, California 94035**

1 Report No	2 Government Accession No	3 Recipient's Catalog No	
4 Title and Subtitle STUDY FOR THE OPTIMIZATION OF AIRCRAFT SEAT CUSHION FIRE BLOCKING LAYERS - FULL SCALE - TEST DESCRIPTION AND RESULTS		5 Report Date May, 1982	6 Performing Organization Code
7 Author(s) Kenneth J. Schutter Fred E. Duskin		8 Performing Organization Report No MDC J2525	10 Work Unit No
9 Performing Organization Name and Address Douglas Aircraft Company 3855 Lakewood Blvd. Long Beach, Ca. 90846		11 Contract or Grant No NAS2-11-095	13 Type of Report and Period Covered Final Report 9-81 to 9-82
12 Sponsoring Agency Name and Address Ames Research Center Moffet Field, Ca. 94035		14 Sponsoring Agency Code	
15 Supplementary Notes Technical Monitor: Demetrious A. Kourtides			
16 Abstract This report describes the work done by Douglas Aircraft Company under contract to the National Aeronautic and Space Agency, Ames Research Center (NASA ARC) to determine the burn characteristics of presently used and proposed seat cushion materials and types of constructions. These tests were conducted in the Douglas Cabin Fire Simulator (CFS) at the Space Simulation Laboratory, Huntington Beach, California. Thirteen different seat cushion configurations were subjected to full-scale burn tests. The fire source used was a quartz lamp radiant energy panel with a propane pilot flame. During each test, data were recorded for cushion temperatures, radiant heat flux, rate of weight loss of test specimens, and cabin temperature. When compared to existing passenger aircraft seat cushions, the test specimens incorporating a fire barrier and those fabricated from advance materials, using improved construction methods, exhibited significantly greater fire resistance. Results of these tests were similar to those obtained from tests conducted by Douglas Aircraft Company under contract to NASA Johnson Space Center, Contract NAS9-16062.			
17 Key Words (Suggested by Author(s)) Aircraft Fire Safety, Fires, Aircraft Passenger Seats		18 Distribution Statement Unlimited	
19 Security Classif. (of this report) Unclassified	20 Security Classif. (of this page)	21 No. of Pages 229	22 Price*

SECTION I
INTRODUCTION

Aircraft passenger seats represent a high percentage of the organic materials used in a passenger cabin. These organics can contribute to a cabin fire if subjected to a severe ignition source such as post-crash fuel fire. Since 1976, programs funded by NASA have been conducted at Douglas Aircraft Company to study and develop a more fire-resistant passenger seat. The first program dealt with laboratory screening of individual materials (Report No. NASA CR-152056, Contract No. NAS 2-9337). The second program continued laboratory screening of individual materials, conducted laboratory burn tests of multilayer materials, developed a full-scale standard fire source and prepared a preliminary fire-hardened passenger seat guideline (Report No. NASA CR-152184, Contract No. NAS 2-9337). The third program consisted of additional laboratory burn testing of multilayer materials, fabricating a fire-hardened three-abreast tourist class passenger seat, and a design guideline for fire-resistant seats (Contract No. NASA 2-9337, Report No. NASA CR-152408). The fourth program fabricated and burn tested full-scale seat cushions utilizing the fire blocking concept for protecting the inner cushion (Contract No. NASA 9-16026).

The tests documented in this report involve a continuation of full-scale burning of seat cushions utilizing the fire-blocking concept.

SECTION 3 TEST ARTICLES

3.1 Test Specimens

Thirteen different seat cushion constructions were tested (Table 1). Fire blocking, when incorporated, covered all sides of the cushion. All seams were sewn with nylon thread. The overall dimensions for the back cushions were 43 by 61 by 5 centimeters (17 by 24 by 2 inches). The bottom cushions dimensions were 46 by 50 by 8 centimeters (18 by 20 by 3 inches).

3.2 Materials

The 13 test specimens were fabricated using a combination of materials shown in Table 2. These materials were selected and supplied for use in this program by NASA-AMES Research Center.

All cushions were fabricated by Expanded Rubber and Plastics Corporation in Gardena, California.

TABLE 1
SEAT CONSTRUCTIONS

Construction Number	Decorative Upholstery	Slip Cover	Fire Blocking	Foam
1	Wool-Nylon	None	None	F. R. Urethane*
2	Wool-Nylon	Cotton-Muslin	Vonar-3	F. R. Urethane
3	Wool-Nylon	Cotton-Muslin	Vonar-2	F. R. Urethane
4	Wool-Nylon	None	3/8 LS 200	F. R. Urethane
5	Wool-Nylon	None	Celiox 101	F. R. Urethane
6	Wool-Nylon	None	Norfab 11 HT-26-AL	F. R. Urethane
7	Wool-Nylon	Cotton-Muslin	Vonar-3	N. F. Urethane*
8	Wool-Nylon	None	Norfab 11 HT-26-AL	N. F. Urethane
9	Wool-Nylon	None	None	LS 200 Neoprene
10	Wool-Nylon	None	None	Polyimide
11	Polyester	None	None	Polyimide
12	Wool-Nylon	None	Norfab 11 HT-26	F. R. Urethane
13	Wool-Nylon	None	PBI	F. R. Urethane

*F. R. Urethane (Fire Retarded Urethane)

N. F. Urethane (Non-Fire Retarded Urethane)

TABLE 2
TABLE 2
MATERIAL

Material	Source
#2043 urethane foam, fire-retardant (FR), 0.032 g/cm ³ (2.0 lb/ft ³) 43 ILD	North Carolina Foam Ind. Mount Airy, NC
Urethane foam, non-fire retardant (NF), 0.022 g/cm ³ (1.4 lb/ft ³) 24-35 ILD	CPR Division of Upjohn Torrance, Ca.
Vonar-3, 3/16-inch thick with Osaburg cotton scrim (23.5 oz/yd ²) .079 g/cm ²	Chris Craft Industries Trenton, NJ
Norfab 11HT26-aluminized (12.9 oz/yd ²) .044 g/cm ² , aluminized one side only	Amatex Corporation Norristown, Pa
Gentex preox (celiox) (10.9 oz/yd ²) .037 g/cm ² , aluminized one side only	Gentex Corporation Carbondale, Pa
Wool nylon (0.0972 lb/ft ²) .0474 g/cm ² , 90% wool/100% nylon, R76423 sun eclipse, azure blue 78-3080 (ST7427-115, color 73/3252)	Collins and Aikem Albermarle, NC
Vonar 2, 2/16 inch thick, .068 g/cm ² , (19.9 oz/yd ²) osaburg cotton scrim	Chris Craft Industries Trenton, NJ
LS-200 foam, 3/8" thick (33.7 oz/yd ²) .115 g/cm ²	Toyad Corporation Latrobe, Pa
LS-200 foam, 3-4 inches thick (7.7 lb/ft ³) 0.12 g/cm ³	
Polyimide Foam (1.05 lb/ft ³) .017 g/cm ³	Solar San Diego, Ca
100% polyester (10.8 oz/yd ²) .037 g/cm ² 4073/26	Langenthal Corporation Bellevue, Wa
Norfab 11HT26 Approximately (11.3 oz/yd ²) .038 g/cm ²	Gentex Corporation Carbondale, Pa
PBI Woven Cloth Approximately (10.8 oz/yd ²) .037 g/cm ²	Calanese Plastic Company Charlette, NC

SECTION 4 TEST PROGRAM

4.1 Test Setup

All tests were conducted within the Cabin Fire Simulator (CFS). The CFS is a double-walled steel cylinder 12 feet in diameter and 40 feet long, with a double-door entry airlock at one end and a full-diameter door at the other. It is equipped with a simulated ventilation system and, for environmental reasons, all exhaust products are routed through an air scrubber and filter system. A view port in the airlock door allows the tests to be monitored visually. The radiant heat panels used in these tests were positioned as shown in Figures 1 and 2.

The radiant panels consisted of 46 quartz lamps producing a 10 watt/square centimeter heat flux at 6 inches from the surface of the panels. Prior to testing, the heat flux upon the cushion surface was mapped using calorimeters. Figure 3 shows the positions at which heat flux measurements were taken and their recorded values.

4.2 Instrumentation

The relative location of instrumentation for the tests is shown in Figure 4.

4.2.1 Post test still photographs were taken for each seat construction. These photographs are located in Appendix A. In addition, a video recording was made during each test.

4.2.2 Thermal Instrumentation

Temperatures were obtained using chromel-alumel thermocouples placed within the seat constructions. The number of thermocouples varied between 2 and 3 per cushion depending on whether or not a fire blocking layer was used (Figure 5). In the CFS, chromel-alumel thermocouples were located along the ceiling and at the cabin air exhaust outlet. Two heat flux sensors were installed facing the seat assembly. The upper calorimeter was used to monitor the heat flux given off by the radiant panels to insure consistency among tests. The thermocouple and calorimeter signals were fed through a Hewlett-Packard 3052A Automatic Data Acquisition System which provided a real-time printout of data (Figure 6).



FIGURE 1 TEST SETUP

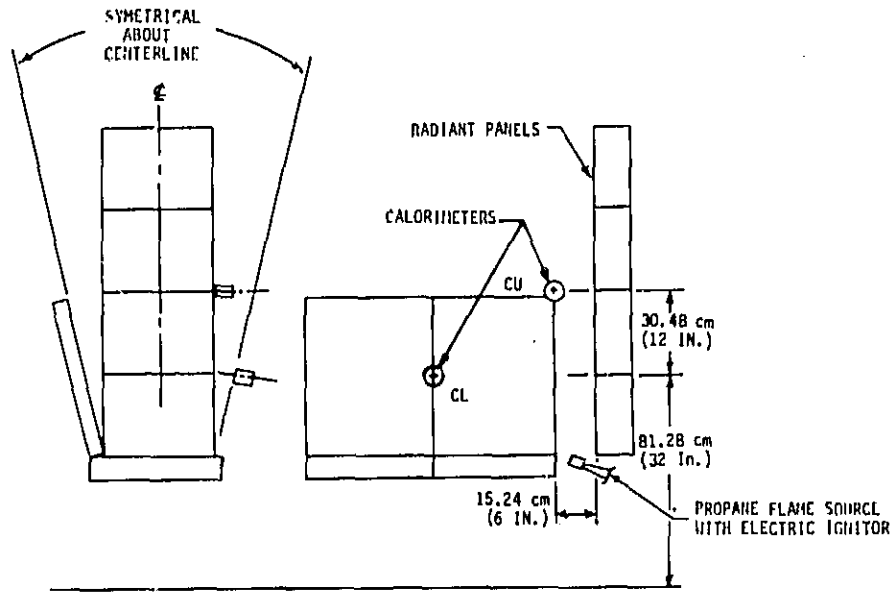

FIGURE 2. FUEL SOURCE AND CALORIMETER LOCATION

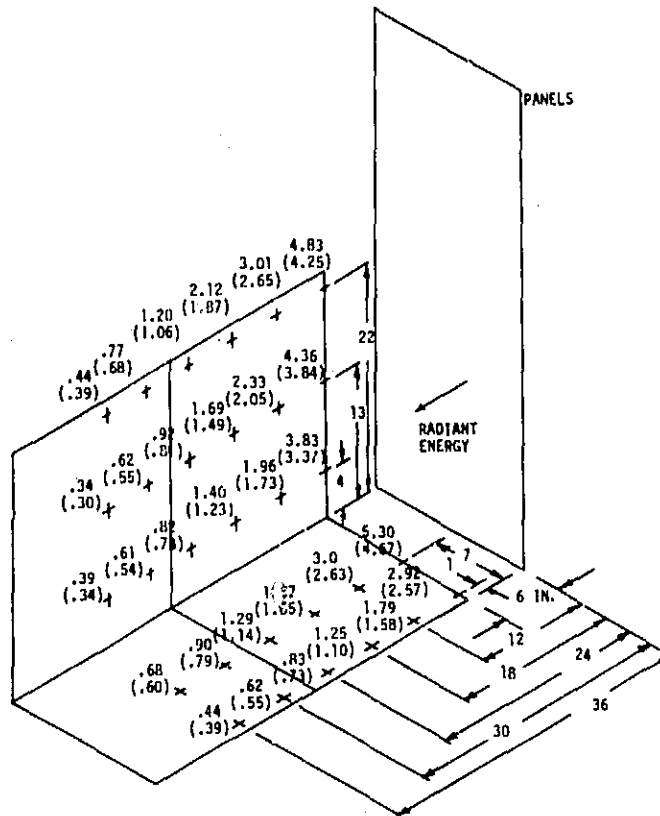
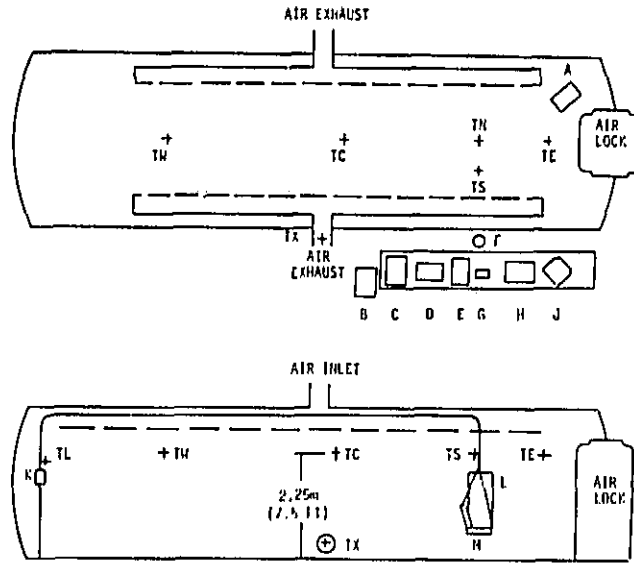

FIGURE 3. HEAT FLUX MAPPING w/cm^2 (Btu/ft²-SEC)



- LEGEND: A = VIDEO CAMERA
 B = HEWLETT PACKARD SCANNER AND DIGITAL VOLTMETER
 C = HEWLETT PACKARD CALCULATOR
 D = HEWLETT PACKARD PLOTTER
 E = HEWLETT PACKARD PRINTER
 F = PROPANE ON/OFF VALVE
 G = VARIABLE TRANSFORMER
 H = VIDEO CASSETTE RECORDER
 J = VIDEO MONITOR
 K = 100 LB. LOAD CELL
 L = RADIANT ENERGY PANELS
 M = SEAT FRAME
 T = THERMOCOUPLE

FIGURE 4. CFS INSTRUMENTATION

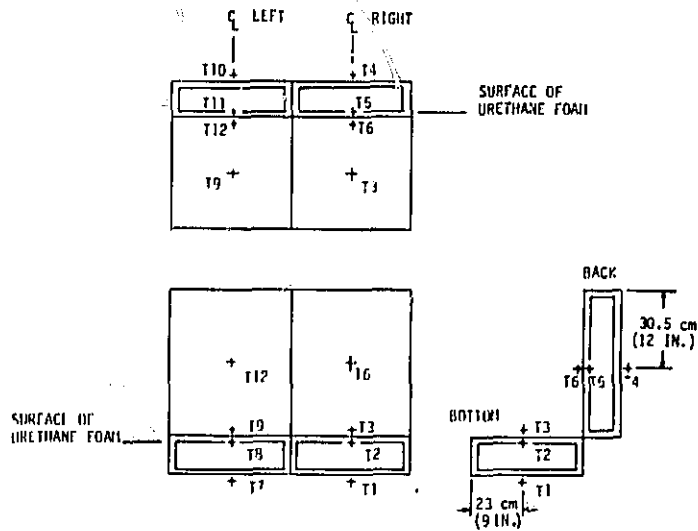

FIGURE 5. CUSHION THERMOCOUPLES (LOCATION AND IDENTIFICATION)

4.1 Test Procedures

Cushions instrumented with thermocouples were weighed, then positioned on the seat frame. The seat frame was rigged with suspension cables and hung from one end of a rod located in the ceiling of the CFS. The other end of the ceiling cable was attached to a load cell. Thermocouples, heat flux sensors, and load cells were checked for proper operation and calibration. The computer and video were started, the propane gas was ignited, and then the radiant panel was switched on. The radiant panels remained on for five minutes. After fifteen minutes, the tests were complete and post-test photos were taken of the cushion residue. The residue was removed from the seat frame and weighed.



FIGURE 6. DATA ACQUISITION

SECTION 5 TEST RESULTS

A total of 23 full-scale cushion burn tests were conducted. Each seat construction listed in Table 1 was tested twice with the exception of constructions 8, 11, 12 and 13. For these constructions, only enough material for one test was available. However, when two tests of the same construction were made, the results were identical and therefore a third test was considered unnecessary.

The purpose of these tests was to investigate the burning characteristics of cushion employing fire resistant designs. It was the peculiar designs and how the materials were used which were evaluated and not so much the individual materials themselves. To give an example, construction number 2 was designed to employ one layer of Vonar-3 as a fire blocking layer. The evaluation of the performance of this cushion was not so much decided on what material was used, Vonar-3, as the way in which it was used, one layer as fire blocking.

5.1 General

The constructions tested can be classified in four groups. These groups are standard cushion construction, standard cushion construction with a protective covering enveloping the urethane foam core, standard cushion construction with a protective covering enveloping non-fire retarded urethane foam core and standard cushion construction with the urethane foam core replaced by an advance fire resistant foam.

The test results of these constructions is graphically provided in plots presented in Appendix B. To aid in comparison of these constructions, the peak values for each test and the time at which they occurred were taken from the respective plots and are presented in Table 3. The weight loss results are in Table 4. Post-test photographs for each construction are located in Appendix B.

5.2 Standard Seat Construction

Construction number 1 is representative of the type of materials most commonly used in the construction of aircraft passenger seat cushions. These cushions were totally consumed by the fire in a matter of minutes.

Characteristically, the fire-retarded urethane foam thermally decomposes under the extreme heat into a fluid form and subsequently to a gas. In the fluid form, the urethane drips from the seat cushion onto the floor forming a puddle or pool. This pool of urethane fluid gives off gases which are ignited by burning debris falling from the seat. This results in a very hot pool fire engulfing the seat in a matter of minutes.

TABLE 3
TEST DATA PEAK VALUES

C = CALORIMETER T = THERMOCOUPLE S = SECONDS

CUSHION CONSTRUCTION	CL	BTU/FT ² -SEC	T1 °F	T2 °F	T3 °F	T4 °F	T5 °F	T6 °F	T7 °F	T8 °F	T9 °F	T10 °F	T11 °F	T12 °F	T5 °F	TM °F	BEFORE °F	AFTER °F	DELTA °F	TI °F	TC °F	TE °F	DP °F	
1 TEST 1	4.0	1494	1666	1309	1218	1526	1690	912	1341	747	750	7.4	0	7.4	293	308	368	11.11						
	2005	1505	1505	1645	1525	2025	2225	3225	2285	2225	1805	2405	2325	2345	1605									
1 TEST 17	3.40	1779	1303	1376	1652	1762	1800	1111	1491	943	1216	7.5	0	7.5	181	359	386	15.77						
	1525	1345	1265	1225	1185	1755	1745	2265	1785	1725	1265	2165	1805	1865	1245									
2 TEST 2	1.40	652	820	1380	108	199	372	98	155	384	264	379	12.75	8.20	4.55	156	163	187	5.24					
	1065	8985	3045	5125	6545	5085	3185	8525	6025	3165	1645	3145												
2 TEST 4	1.62	517	800	1505	1008	724	1170	157	170	418	324	281	392	11.97	8.3	3.67	111	172	191	3.01				
	1025	9985	3145	1265	4765	2905	1185	8985	5265	3225	8725	4785	3205	1205	3085									
3 TEST 11	1.64	917	964	1380	1531	1213	1131	234	188	391	114	326	232	268	437	11.5	7.2	4.3	121	183	216	5.72		
	1125	5405	2825	985	5705	5445	1045	8905	5485	3205	8885	3205	3965	2625	2085									
3 TEST 12	1.66	291	872	1399	1372	1157	1231	233	245	407	112	232	367	282	496	11.5	7.2	4.3	126	196	229	6.0		
	1025	3845	3105	1025	7165	2585	1565	8365	4705	3185	8465	4065	3185	3195	3085									
4 TEST 3	1.54	329	1327	1242	1038	1647	1448	235	265	396	108	129	460	302	414	11.65	7.65	4.0	111	183	214	5.3		
	605	4505	3945	1305	3375	3185	1725	6865	4065	3165	9605	8845	3145	2865	3185									
4 TEST 10	1.50	1106	1310	1682	1225	1461	1294	180	264	432	129	244	478	265	472	11.95	7.8	4.15	115	186	206	5.43		
	1145	3605	3105	1205	5825	3605	1225	8745	3885	3165	8985	4205	3145	3165	3125									
5 TEST 7	1.57	375	958	1314	711	1209	1230	143	375	408	120	409	419	267	439	9.05	6.62	2.23	122	190	209	5.76		
	1045	3745	3165	925	3725	3065	1645	3465	3265	3185	5825	3305	3185	2165	1945									
5 TEST 13	1.65	1098	975	1425	767	1070	1165	150	323	415	122	306	401	272	477	9.20	6.50	2.70	118	191	222	6.26		
	965	3465	1505	1285	3445	2425	1125	3645	3505	3165	5685	3445	2165	2885	2105									
6 TEST 6	1.70	660	1034	1495	867	979	1599	127	331	458	113	239	388	274	498	9.4	7.13	2.27	121	194	217	5.81		
	1005	4225	2785	985	3865	2285	1045	4465	3525	3165	6165	3705	3225	3065	2765									

5.3 Protected Fire-Blocked Standard Cushions

The purpose of the fire-blocking layer surrounding the urethane foam core is to thermally isolate the foam from the heat source by either conducting the heat laterally away and by providing an insulative char layer.

5.3.1 Aluminized Fabric

The celiox and norfab fire blocking constructions employed a reflective aluminum coating bonded to their outer surface.

All three constructions resulted in identical test results. These constructions were unable to protect the urethane foam in the cushions closest to the radiant heat source. They were able to slow down the burn rate of the urethane thus producing a less severe fire. This fire was unable to penetrate the adjacent cushions also protected by these materials.

Characteristically, in these constructions the urethane thermally decomposes within the fire-blocking layer and produces fluids and gases. The gas leaks through the cushion seams, ignites, burn and continues to open the seams. This results in a small controlled pool fire burning within the fire-blocking envelope with flames reaching through the seam areas. The radiant heat source in combination with the controlled pool fire, is adequate to thermally decompose the urethane foam on the closest side of the adjacent cushions. The heat source is not adequate to ignite these gases.

Reversing the edges at which the seams were located, i.e, placing the seams at the bottom edge instead of the top edge of the cushion, made no appreciable difference for the cushions adjacent to the fire source. Placing the seam on the bottom edge of the cushions farthest from the radiant panel helped to prevent the escaping gases from igniting, and the seam from opening. All cushions using this fire-blocking material were vented in the back to prevent ballooning of the cushions by the gas generated within them. However, the decomposed urethane tended to plug the vent and restrict the out-gasing. The overall final appearance of the cushion closest to the radiant panels showed a fragile, charred, empty fire-blocking envelope with its seams burned open.

The final appearance of the cushions farthest from the radiant panels showed a partially charred upholstery cover. The urethane cushion had some minor hollow spots. When the seams were placed on the bottom edge of the cushion, a fully intact fire-blocking envelope remained.

The percent weight loss between the fire and non-fire retarded urethane cushions was small, as shown by Figure 7.

TABLE 4
WEIGHT DATA

Cushion Construction	Weight Before kg (LB)	Weight After kg (LB)	Weight Loss kg (LB)
1 Test 1	3.36 (7.4)	0 (0)	3.36 (7.4)
1 Test 17	3.40 (7.5)	0 (0)	3.40 (7.5)
2 Test 2	5.78 (12.75)	3.72 (8.20)	2.06 (4.55)
2 Test 4	5.43 (11.97)	3.76 (8.3)	1.67 (3.67)
3 Test 11	5.22 (11.5)	3.27 (7.2)	1.95 (4.3)
3 Test 12	5.22 (11.5)	3.27 (7.2)	1.95 (4.3)
4 Test 3	5.28 (11.65)	3.47 (7.65)	1.81 (4.0)
4 Test 10	5.42 (11.95)	3.54 (7.8)	1.88 (4.15)
5 Test 7	4.11 (9.05)	3.00 (6.62)	1.11 (2.23)
5 Test 13	4.17 (9.20)	2.95 (6.50)	1.22 (2.70)
6 Test 5	4.26 (9.40)	3.23 (7.13)	1.03 (2.27)
6 Test 14	4.23 (9.32)	3.18 (7.0)	1.05 (2.32)
7 Test 15	5.10 (11.25)	3.8 (8.45)	1.30 (2.80)
7 Test 16	5.00 (11.03)	3.67 (8.10)	1.33 (2.93)
8 Test 18	3.84 (8.47)	2.74 (6.05)	1.10 (2.42)
9 Test 8	8.89 (19.6)	N/A	--
9 Test 19	8.62 (19.01)	8.0 (17.65)	.62 (1.36)
10 Test 9	2.29 (5.05)	1.63 (3.60)	.66 (1.45)
10 Test 6	2.94 (6.48)	1.68 (3.70)	1.26 (2.78)
11 Test 20	1.91 (4.20)	1.66 (3.67)	.25 (.53)
12 Test 21	4.13 (9.10)	1.66 (3.66)	2.47 (5.54)
13 Test 22	4.45 (9.80)	2.72 (6.00)	1.73 (3.80)

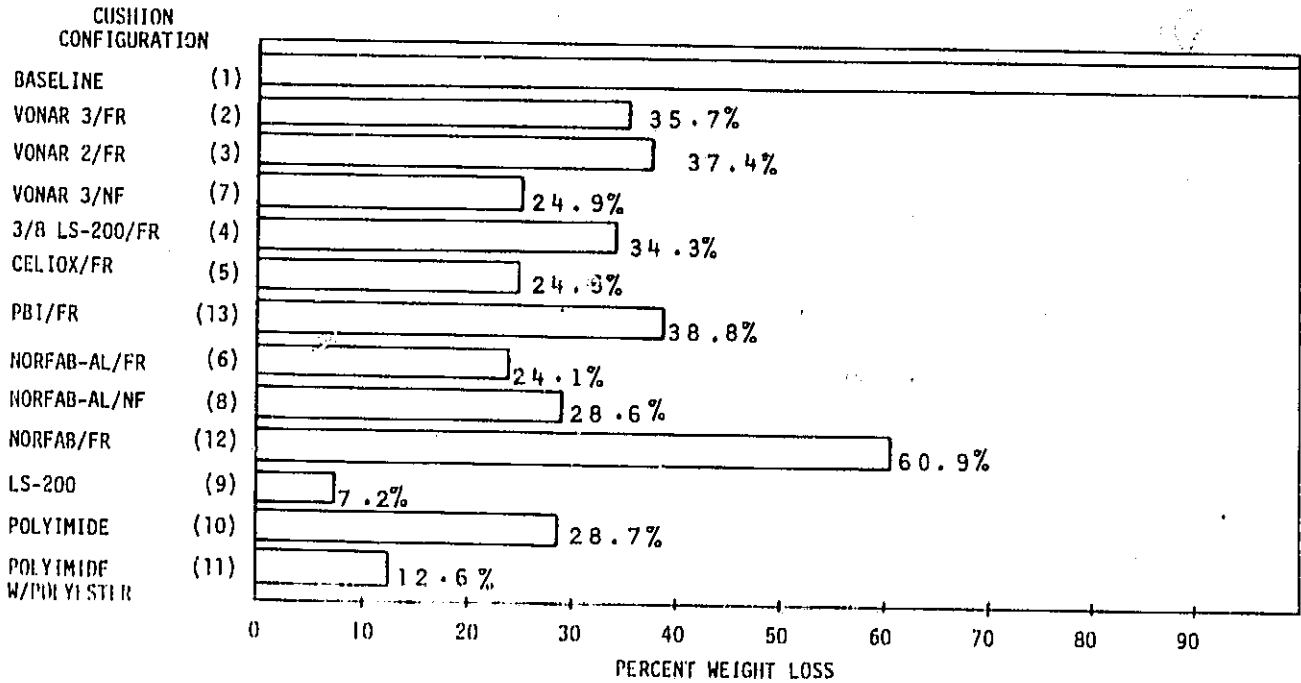

FIGURE 7. PERCENT WEIGHT LOSS

5.3.2 Non-Aluminized Fire Blocking

Constructions 2, 3 and 7 used Vonar foam, construction 4 used LS-200 foam, construction 12 used non-aluminized norfab fabric and construction 13 used PBI fabric.

The constructions were unable to protect the urethane foams in the cushions closest to the radiant panels. However, they did slow down the burn rate of the urethane thus subjecting the adjacent cushion to a less intense fire.

The fire-blocking foams performed much like the aluminized fabric fire-blocking in that even though the heat was intense enough to thermally decompose the urethane into a fluid and gas, the fire blocking layer was able to contain and subdue the burning urethane. Flames exited where the fire-blocking char layer had fallen away.

The non-aluminized norfab fabrics were unable to contain the decomposed urethane. The urethane fluid dripped onto the floor where it pooled and ignited. The cushions were completely consumed when this floor fire engulfed it. The overall final appearance of the cushion remains closest to the radiant panels for foam fire blocking constructions 2, 3, 4 and 7 was thoroughly charred fire-blocking material void of all urethane foam.

The final appearance of the cushions farthest from the radiant panels were very similar. They varied in the amount of thermal decomposition of the urethane foam core, i.e., the size of the void or hollowing of the urethane. Construction number 2 using Vonar-3 material produced the smallest amount of urethane decomposition. It was followed by construction number 4, 3/8 LS 200 neoprene, and construction number 3, Vonar-2. Construction number 7 used a non-fire retarded urethane with Vonar-3. It did not fair as well as construction number 2 employing fire retarded urethane.

Typically, the foam fire-blocking layer adjacent to the urethane hollow spots were completely charred but intact.

5.4 Advanced Foam

Construction numbers 9, 10 and 11 used advanced foams in place of the urethane foam.

Construction number 9, LS 200 neoprene, produced a deep seated fire which did not produce a significant amount of heat or flames. It smoldered long after the test was completed and required total emersion in water to extinguish. This cushion had the lowest weight loss as shown by Figure 7. However, an all LS-200 neoprene seat cushion would result in a large aircraft weight impact because of its high density.

The foam in the seat cushion closest to the radiant panels was completely charred with the upholstery burned off of all surfaces except the bottom and back.

The foam in the seat cushions farthest from the radiant panels had a thick char on the edge closest to the heat source. This char gradually diminished halfway across the cushions. The upholstery on the back and bottom of these cushions was not burned.

Constructions 10 and 11, polyimide foam, had different upholstery materials. Construction 10, 90/10 wool-nylon upholstery, performed identically to a previous test program. The cushions closest to the radiant panels shrunk to one-half inch in thickness or less with a char of one-quarter inch or greater.

The cushion farthest from the radiant panels shrank to within one-half inch thickness with a char of one-quarter inch or less.

Characteristically, the polyimide foam thermally decomposes by giving off gases, and produces a char layer as it decreases in size.

The decomposing of the foam beneath the upholstery on the seat farthest from the radiant panel creates a pocket or void where the gases generated by the foam accumulates. When these trapped gases burn, the foam further thermally decomposes. Construction number 11, polyester upholstery, reacted differently from that characteristic of construction number 10. When the radiant panel was turned on, the polyester upholstery on the cushion farthest from the heat source rapidly decomposed into a liquid which dripped off the seat cushions.

With the upholstery gone, the majority of the gas from the decomposing polyimide foam escaped without igniting. These cushions decomposed less as exemplified by the small weight loss and a thinner char layer.

SECTION 6 CONCLUSIONS

Urethane foam decomposes into a volatile gas when exposed to a severe heat source. If this generated gas can be contained in such a manner as to prevent its igniting or to control the rate at which it burns, the severity of the fire will be reduced. This was clearly shown in the testing of standard cushion constructions with a protective covering, "fire-blocking", enveloping the urethane foam.

When the fire blocking was able to contain the decomposing urethane by-products, i.e., fluid and gas, the cushions closest to the heat source burned with less intensity, generated a minimum of heat and were unable to ignite the adjacent cushions. However, when the decomposing urethane fluid was able to escape from the fire-blocking envelope and pool on the floor, an uncontrolled fire erupted which resulted in total burning of all cushion materials.

Some of the Norfab and Celiox materials utilized aluminum coatings. It was not the aluminums reflecting properties which made the cushions perform well as it was its non-permeable properties. This coating helped contain the decomposed by-products and prevented propagation to the adjacent cushion.

Had the seams held and all the gases vented out the back of the cushions and away from the heat, the decomposing of the cushions may have been even less severe. Undoubtedly, the reflective properties had an effect in slowing down the decomposing of the urethane, but only by a few seconds. The reason being the emissivity and thermal conductivity of the aluminum coating was inadequate to resist the severe radiant energy being applied to the surfaces.

The charred foam fire-blocking layers did not act primarily as a heat barrier as they did a liquid and gas barrier. In the cushions farthest from the radiant source, the urethane foam still thermally decomposed. It formed a pocket of gas behind the intact charred envelope. This was verified in post test inspection. However, the gas escaped slowly and only created a small pilot flame. The flame extinguished itself when the radiant energy source was switched off.

The polyimide cushions are examples of a foam which thermally decomposes at high temperatures and generates gas and char but no noticeable liquids. The wool-nylon upholstery trapped gases between itself and the foam. When these gases ignited, the foam decomposed rapidly. The polyester upholstery decomposed from the cushions fast enough to prevent the trapping of these gases. Subsequently, the foam in the cushions decomposed at a slower rate. From these tests, it is concluded that no matter the foam used as a core for the cushion, if the gases generated by the foam can be expelled or contained in such a manner as to prevent their burning or reduce the rate at which they burn, a severe fire can be avoided or delayed. It is further concluded that if the thermal decomposition characteristics can be altered so as to slow down the generation of gas, the time before a fire becomes severe can be extended to the point where appropriate extinguishment of the fire may be possible.

SECTION 7 RECOMMENDATIONS

It is recommended that a study be made to incorporate cushion designs and fire-blocking materials which are thermally stable and nonpermeable to urethane fluids and gases to prevent or reduce the rate at which a seat cushion burns.

This study should include considerations for wearability of fire blocking layers, fatigue life of cushion foams and methods of venting decomposition gases from the cushion assembly. Test results from this program have shown that seam constructions significantly affect cushion burn performance. Therefore, seam constructions previously studied by the NASA seat program should be reconsidered in future cushion designs.

It is also recommended to use these studies as a basis to develop a design standard for a fire resistant passenger seat. This standard must be supported by inexpensive laboratory burn test methods that can verify these standards are being met.

Construction Number	Decorative Upholstery	Slip Cover	F.B.	Foam
1	Wool-Nylon	None	None	F.R. Urethane
2	Wool-Nylon	Cotton Muslin	Vonar 3	F.R. Urethane
3	Wool-Nylon	Cotton Muslin	Vonar 2	F.R. Urethane
4	Wool-Nylon	None	3/Y LS 200	F.R. Urethane
5	Wool-Nylon	None	Celiox 101	F.R. Urethane
6	Wool-Nylon	None	Norfab 11 HT-26-A1	F.R. Urethane
7	Wool-Nylon	Cotton Muslin	Vonar 3	N.F. Urethane
8	Wool-Nylon	None	Norfab 11 HT-26-A1	N.F. Urethane
9	Wool-Nylon	None	None	LS200 Neoprene
10	Wool-Nylon	None	None	Polyimide
11	Polyester	None	None	Polyimide
12	Wool-Nylon	None	Norfab 11 HT-26-A1	F.R. Urethane

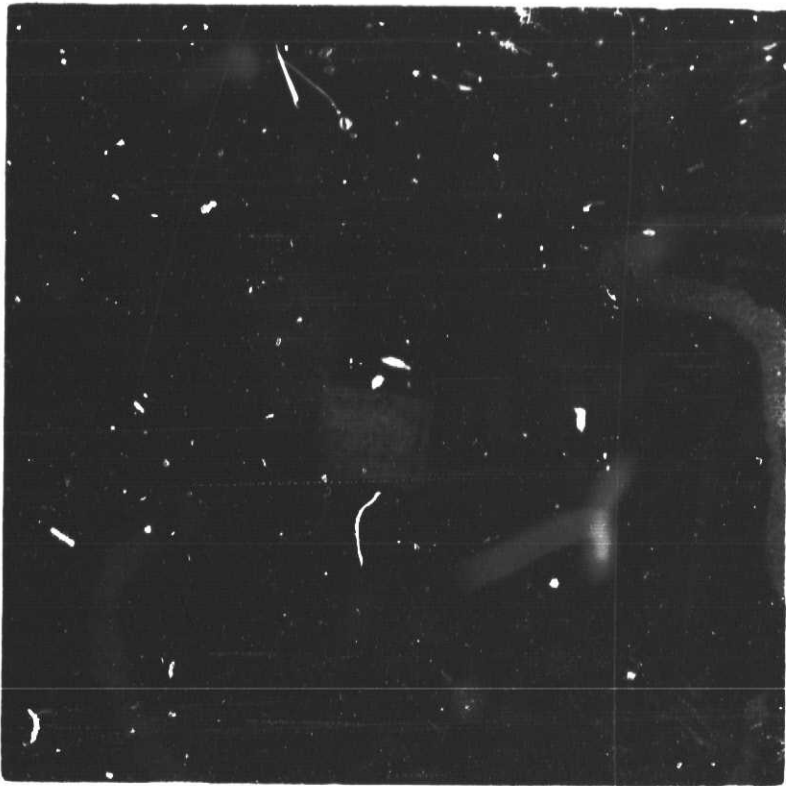

Configuration 1



Configuration 2



Configuration 3



Configuration 4

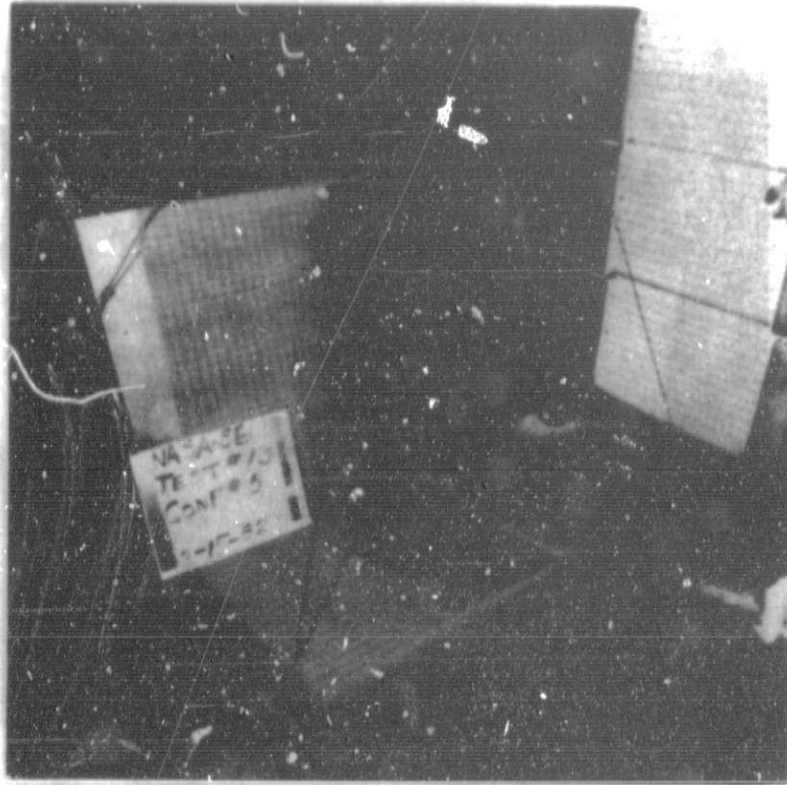

Configuration 5

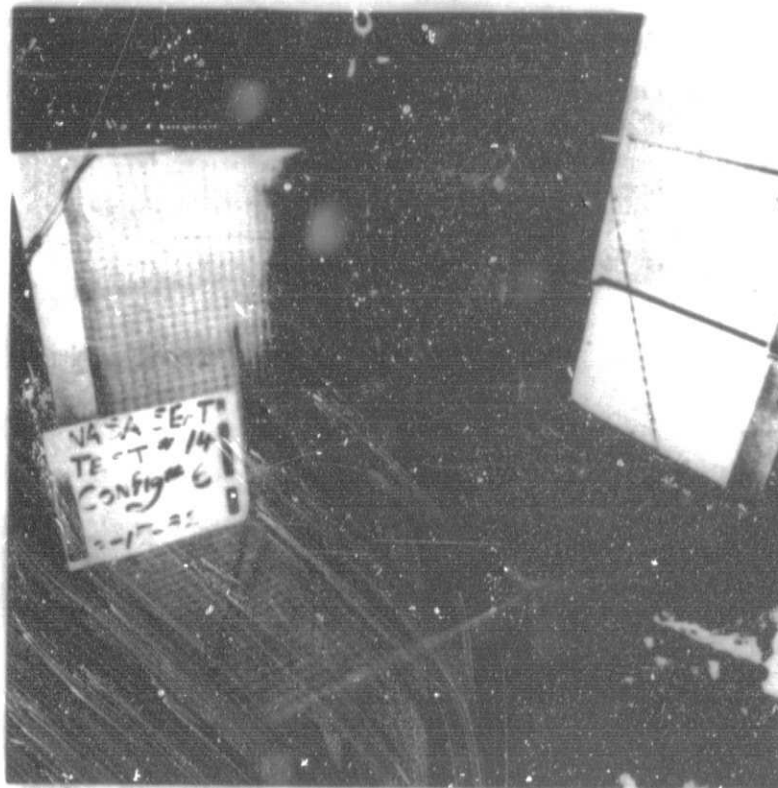

Configuration 6

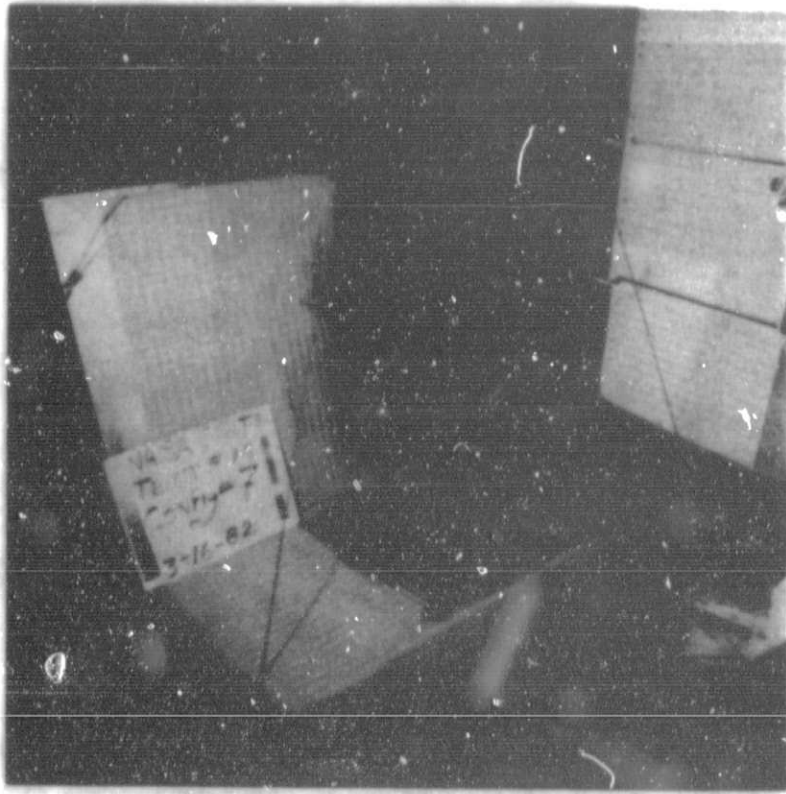

Configuration 7

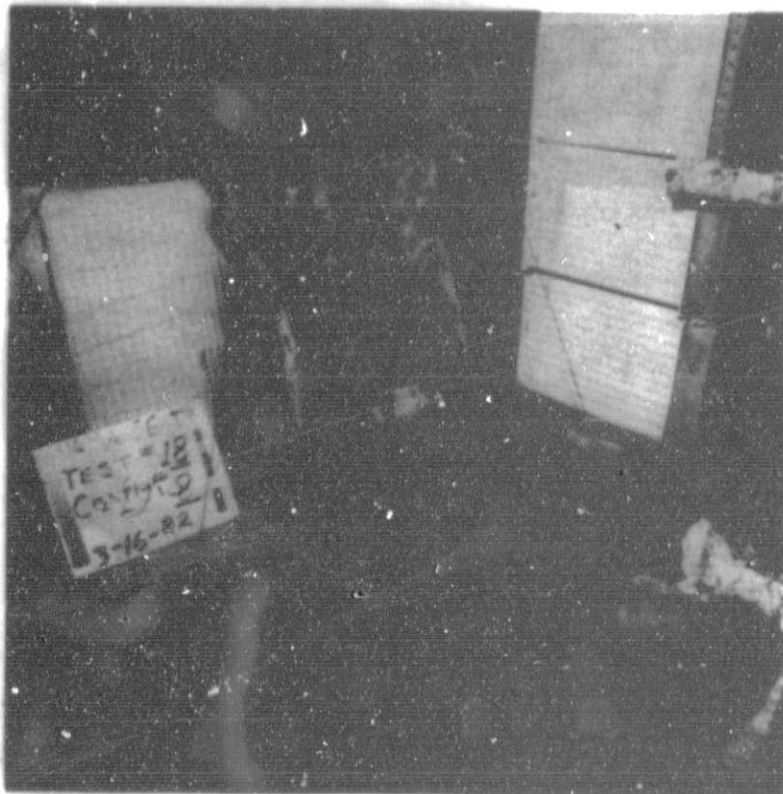

Configuration 8



Configuration 9



Configuration 10



Configuration 11

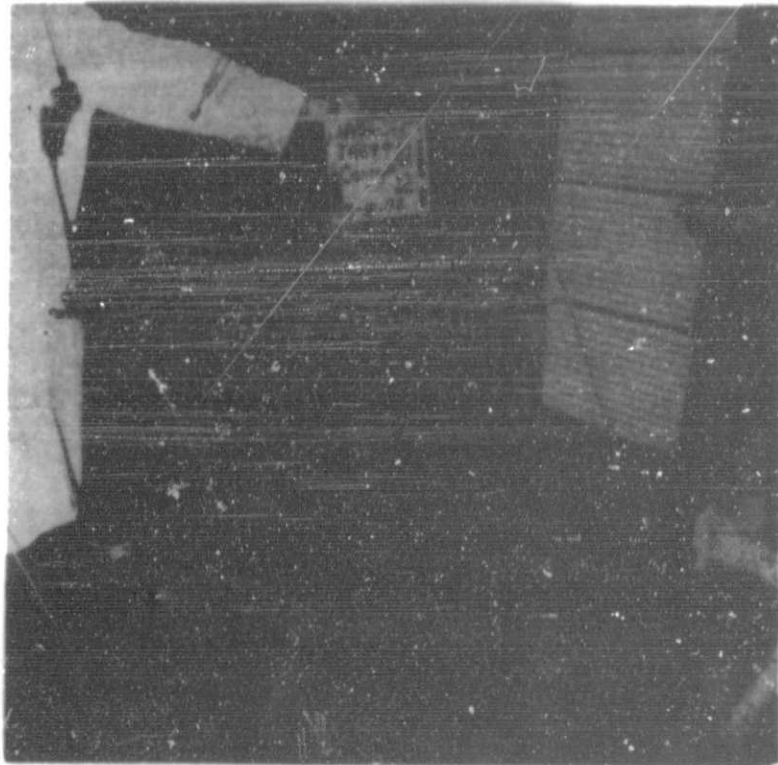

Configuration 12



NASA SEAT PROGRAM

PHASE I

- MATERIAL SCREENING TESTS

PHASE II

- MULTIPLE-LAYER OSU TESTS
- ONBOARD FIRE SOURCE DEVELOPMENT

PHASE III

- DESIGN STUDY
- ADDITIONAL MATERIALS SCREENING TESTS
- ADDITIONAL MULTIPLE-LAYER OSU TESTS
- SEAT DESIGN GUIDELINE
- DISPLAY SEAT FABRICATED

PHASE IV

- CFS CUSHION BURN TESTS

PHASE V

- CFS OPTIMIZED CUSHION BURN TESTS

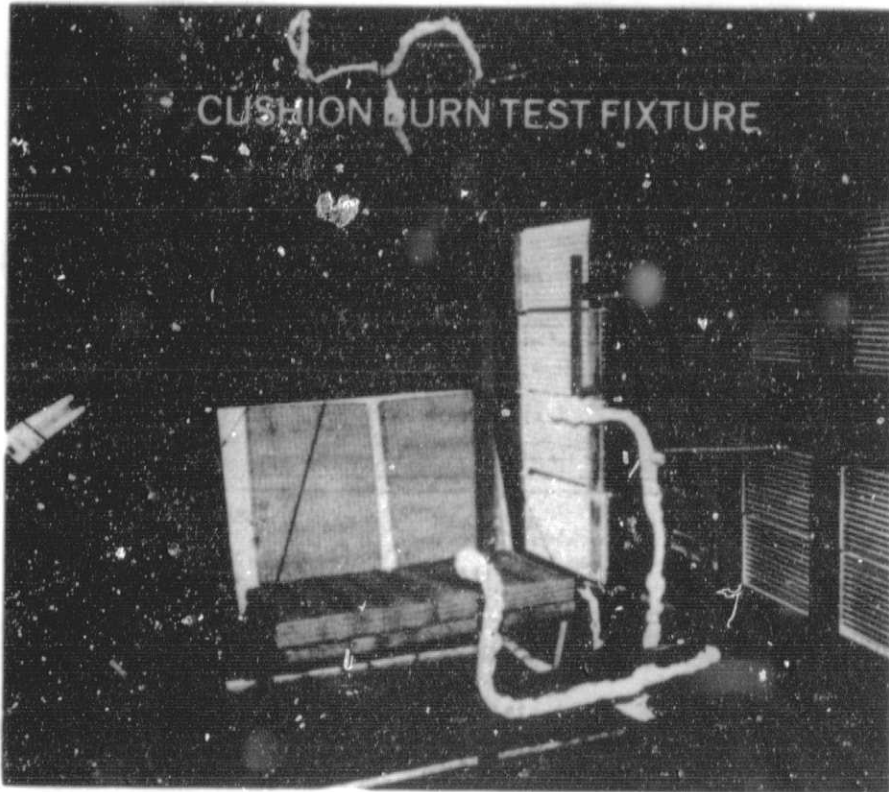
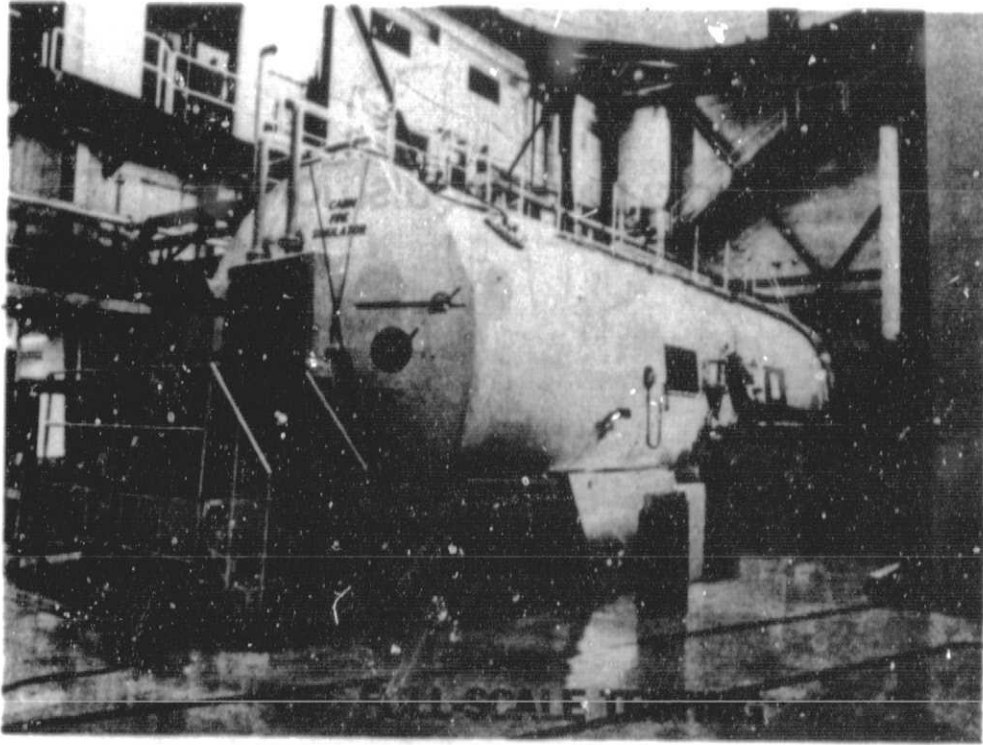

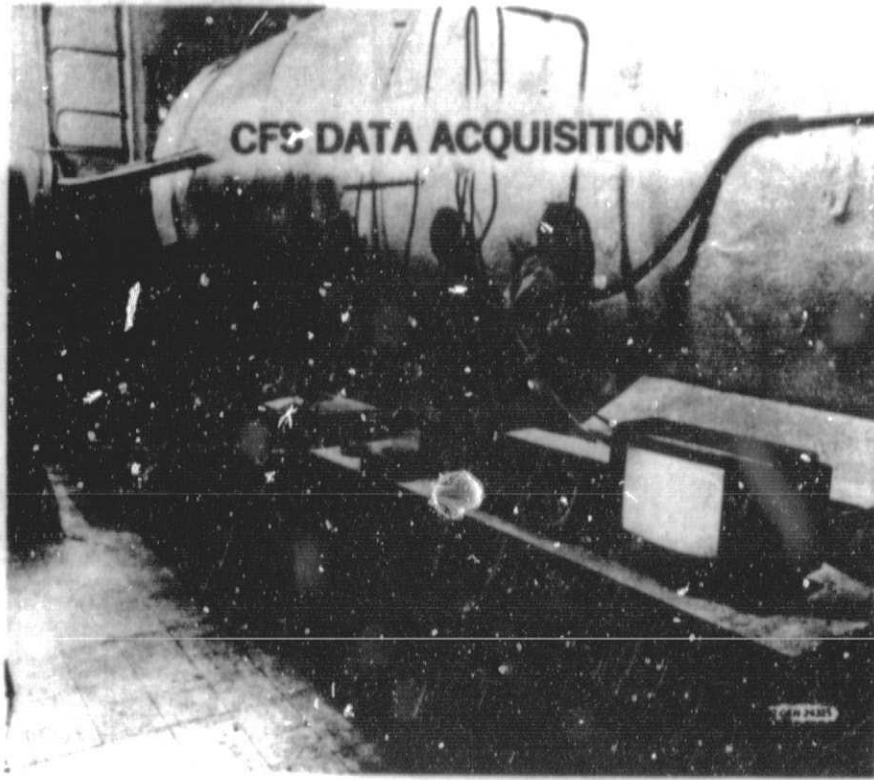

CFS INSTRUMENTATION

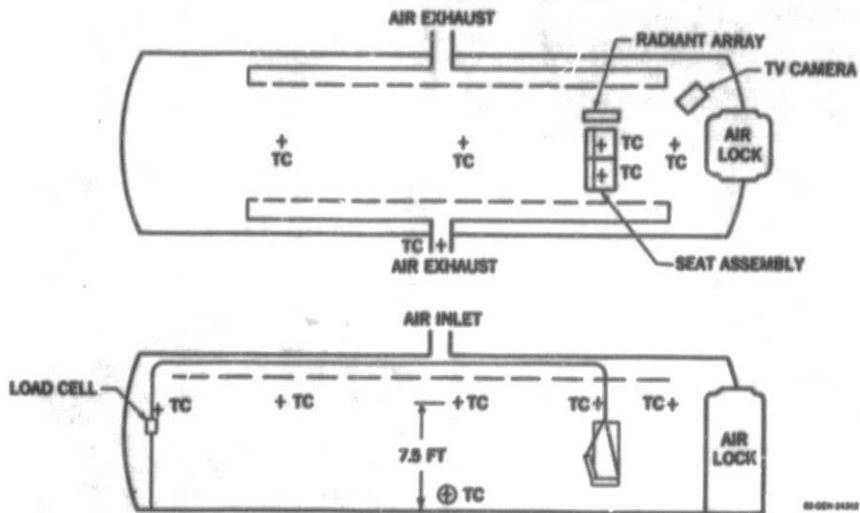

SEAT CUSHION CONSTRUCTIONS

CONF NO.	FIRE BLOCKING	CUSHION FOAM	REMARKS
1	NONE	FR URETHANE	WOOL-NYLON UPHOLSTERY (ALL EXCEPT NO. 1)
2	VONAR 3	FR URETHANE	SLIP COVER COTTON-MUSLIN
3	VONAR 2	FR URETHANE	
7	VONAR 3	NF URETHANE	
4	3/8 LS-200	FR URETHANE	
5	CELIOX 101		
13	PBI W/O ALUM		
6	NORFAB		
8	W/ALUM		
12	NORFAB W/O ALUM	FR URETHANE	ALL FR 2.0 PCF
9	NONE	LS-200	ALL LS 200 7.5 PCF
10		POLYIMIDE	ALL PI 1.0 PCF
11		POLYIMIDE	POLYESTER UPHOLSTERY

TYPICAL FIRE INVOLVEMENT

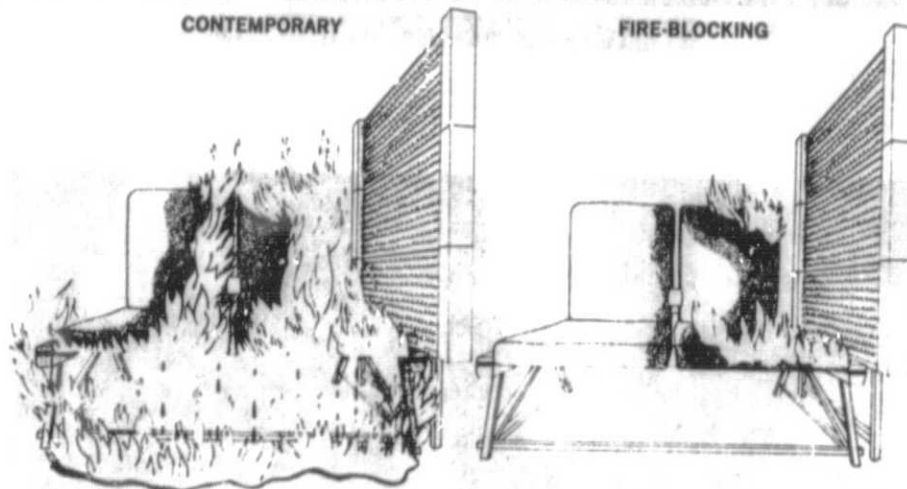



TEST RESULTS COMPARISON



TEST RESULTS COMPARISON
POLYIMIDE FOAM

TEMPERATURES ABOVE SEAT

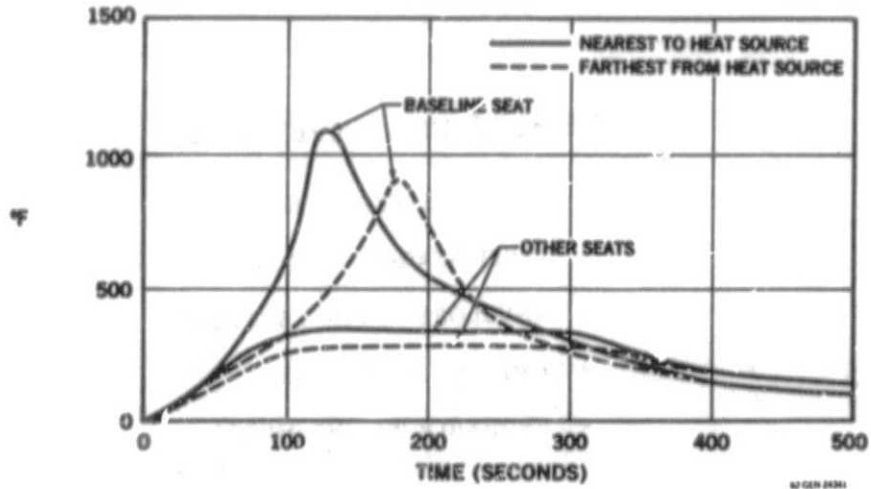

WEIGHT LOSS

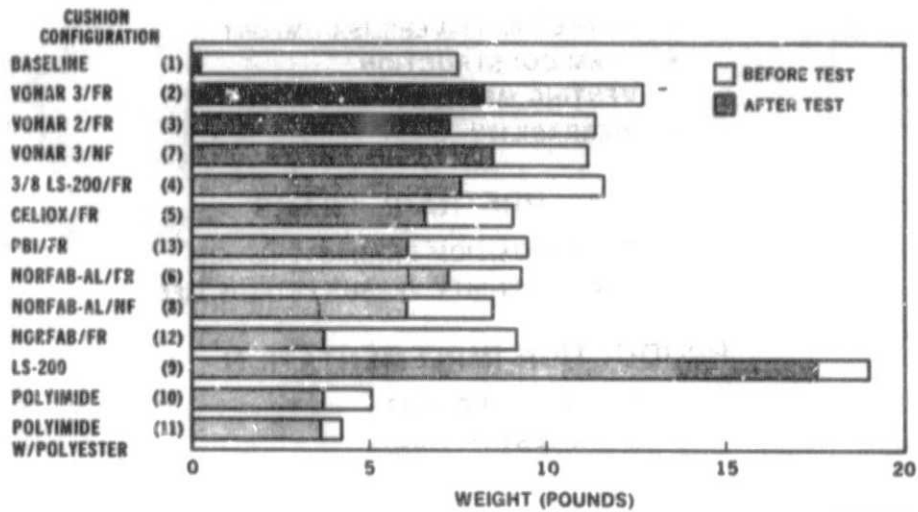

CONCLUSIONS

FIRE-BLOCKING ENVELOPES

- **PROVEN EFFECTIVENESS**
- **IMPERMEABLE FABRICS**
- **ENVELOPE VENTING SYSTEMS**
- **FIRE-RESISTANT SEAMS**
- **PROBABLE WEIGHT IMPACT**
1.0 POUNDS PER SEAT

RECOMMENDATIONS

FIRE-BLOCKING-DESIGN INVESTIGATION

- **PERMEABILITY VERSUS COMFORT**
- **SEAM CONSTRUCTION**
- **VENTING METHODS**
- **WEARABILITY**

URETHANE FOAMS

- **DECOMPOSITION CHARACTERISTICS**
- **LOWER DENSITY VERSUS FATIGUE LIFE**

PRODUCTION IMPLEMENTATION

- **DESIGN STANDARDS**
- **BURN TEST METHODS**

APPENDIX E-1

Seat Cushion Design Manual

NASA Final Report, Contract 7110-654, Linda Gay Thompson, Informatics, Inc.

Editor's Note: Sections of this Appendix have been deleted for the sake of brevity. A complete copy of the original manuscript may be obtained upon request.

Project: 7110-654
Technical Note No.

Date: March 19, 1982

Originator: Linda Gay Thompson

Subject: Seat Cushion Design
User's Manual

Prepared by

Informatics Inc.
1121 San Antonio Road
Palo Alto, California 94303
(415) 964-9900

TABLE OF CONTENTS

- 1.0 INTRODUCTION
- 2.0 SPECIFICATIONS
- 3.0 OPERATING PROCEDURE
 - 3.1 How to: Get started
 - 3.1.1 BUZZ WORDS
 - 3.1.2 ORDER OF PROGRAM EXECUTION
 - 3.2 How to: Create an aircraft character record
 - 3.3 How to: Create a seat dimension
 - 3.4 How to: Create a layer material record
 - 3.5 How to: Create a design
 - 3.6 How to: Create a material supplier record
 - 3.7 How to: Compute costs to make and fly seat
 - 3.8 How to: Create Fleet Projection record
 - 3.9 How to: Create gas price record
 - 3.10 How to: Compute the weight of a seat
 - 3.11 How to: Create a New Aircraft Delivery Schedule
 - 3.12 How to: Compute seat demand
- 4.0 SUMMARY OF YOUR SOFTWARE TOOLS
 - 4.1 ACCHRC
 - 4.2 ADDIM
 - 4.3 ADDMAT
 - 4.4 ADDSGN
 - 4.5 ADDSUP
 - 4.6 COSTS
 - 4.7 FLTPRJ
 - 4.8 GASCST
 - 4.9 LBS
 - 4.10 NEWACD
 - 4.11 SEATDM
- 5.0 ERROR MESSAGES
- APPENDIX A EQUATIONS
- APPENDIX B DATA BASE RECORDS

1.0

INTRODUCTION

INFORMATICS INC. has implemented an interactive computer process, to calculate estimated costs for the manufacture and use of advanced aircraft seat cushion configurations that are being evaluated by NASA-AMES, CRPO for improved fire performance characteristics. The methodology was originally developed by ECON, Inc., and later, adapted to computer processing by INFORMATICS Inc.

2.0

SPECIFICATIONS

The cost set algorithm methodology has been developed to:

- . Provide user interactive computer processing.
- . Serve as a storage facility for cushion configuration weight, cost and fire performance information.
- . Generate cost information for the manufacture and raw materials of each candidate cushion configuration on a U.S. fleetwide basis.
- . Derive the weight impact and resulting fuel consumption sensitivity of each candidate cushion configuration on a U.S. fleetwide basis.

SEAT CUSHION DESIGN SYSTEM
DATA FLOW

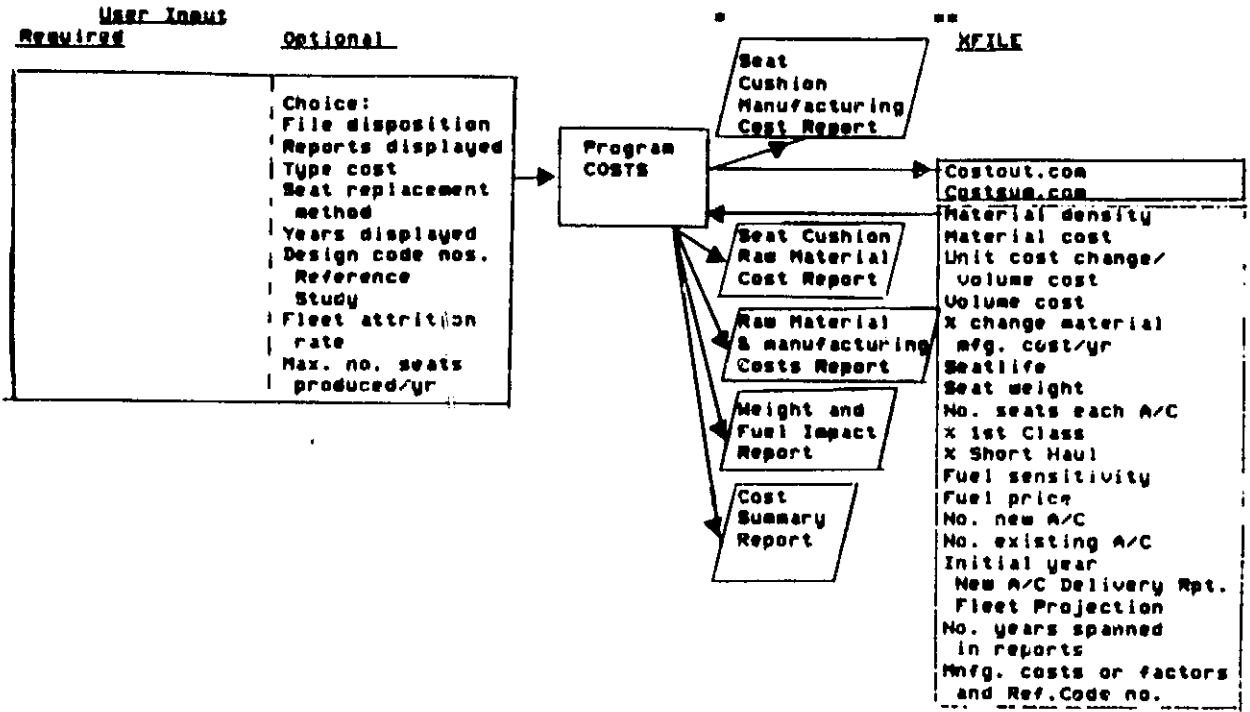

* Reports described in User Manual Section 4
 ** XFILE records name.com described in User Manual Appendix B

SEAT CUSHION DESIGN SYSTEM
DATA FLOW

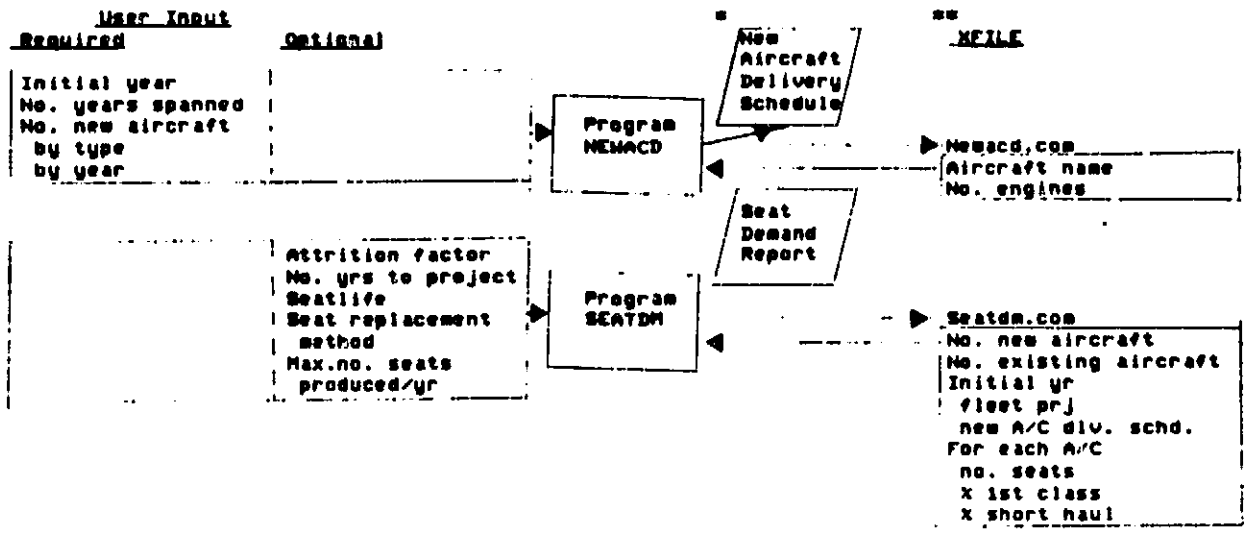

* Reports described in User Manual Section 4
 ** XFILE records name.com described in User Manual Appendix B

SEAT CUSHION DESIGN SYSTEM
DATA FLOW

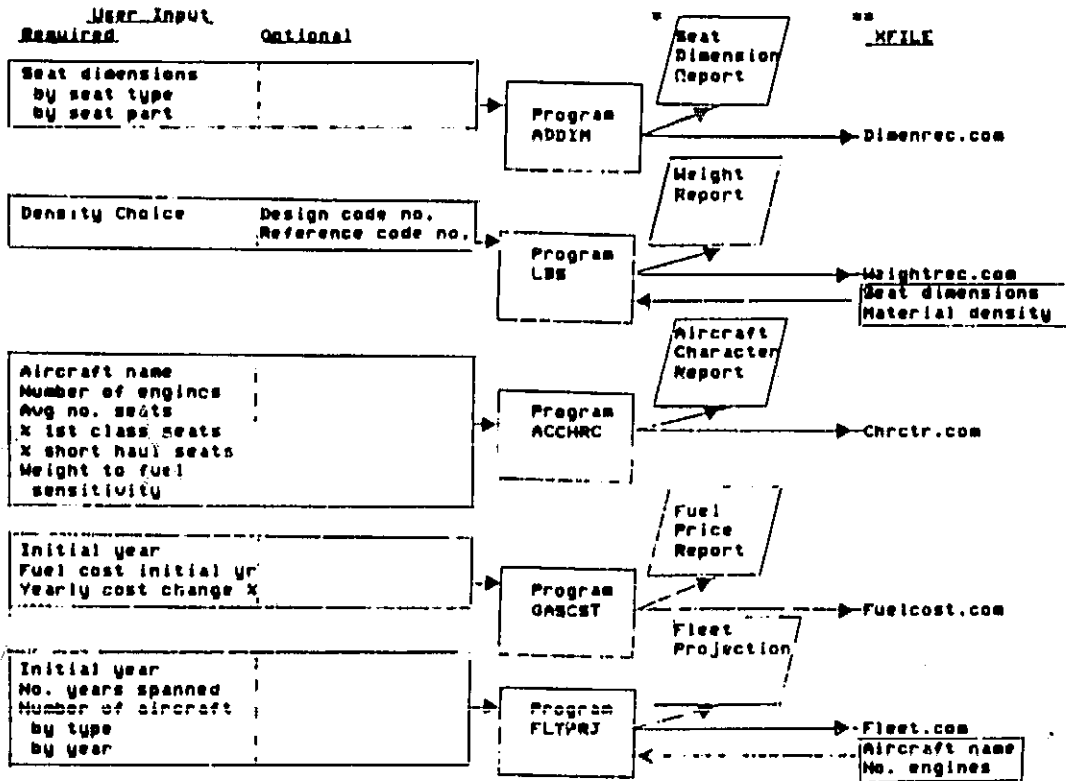

* Reports described in User Manual Section 4
** XFILE records name.com described in User Manual Appendix B

SEAT CUSHION DESIGN SYSTEM
DATA FLOW

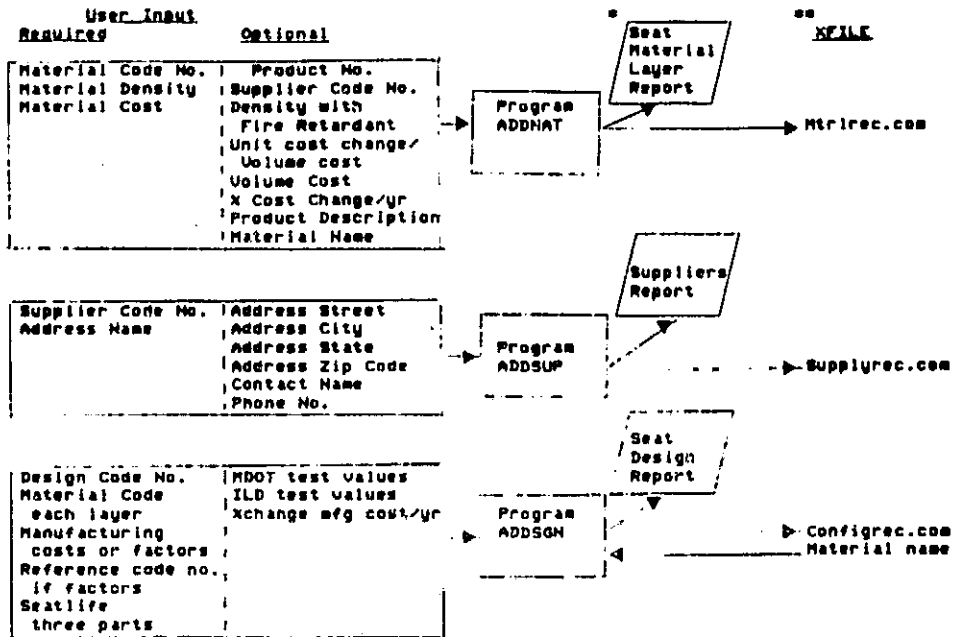

* Reports described in User Manual Section 4
** XFILE records name.com described in User Manual Appendix B

DECISION CHART
FOR SEAT DESIGN
SYSTEM

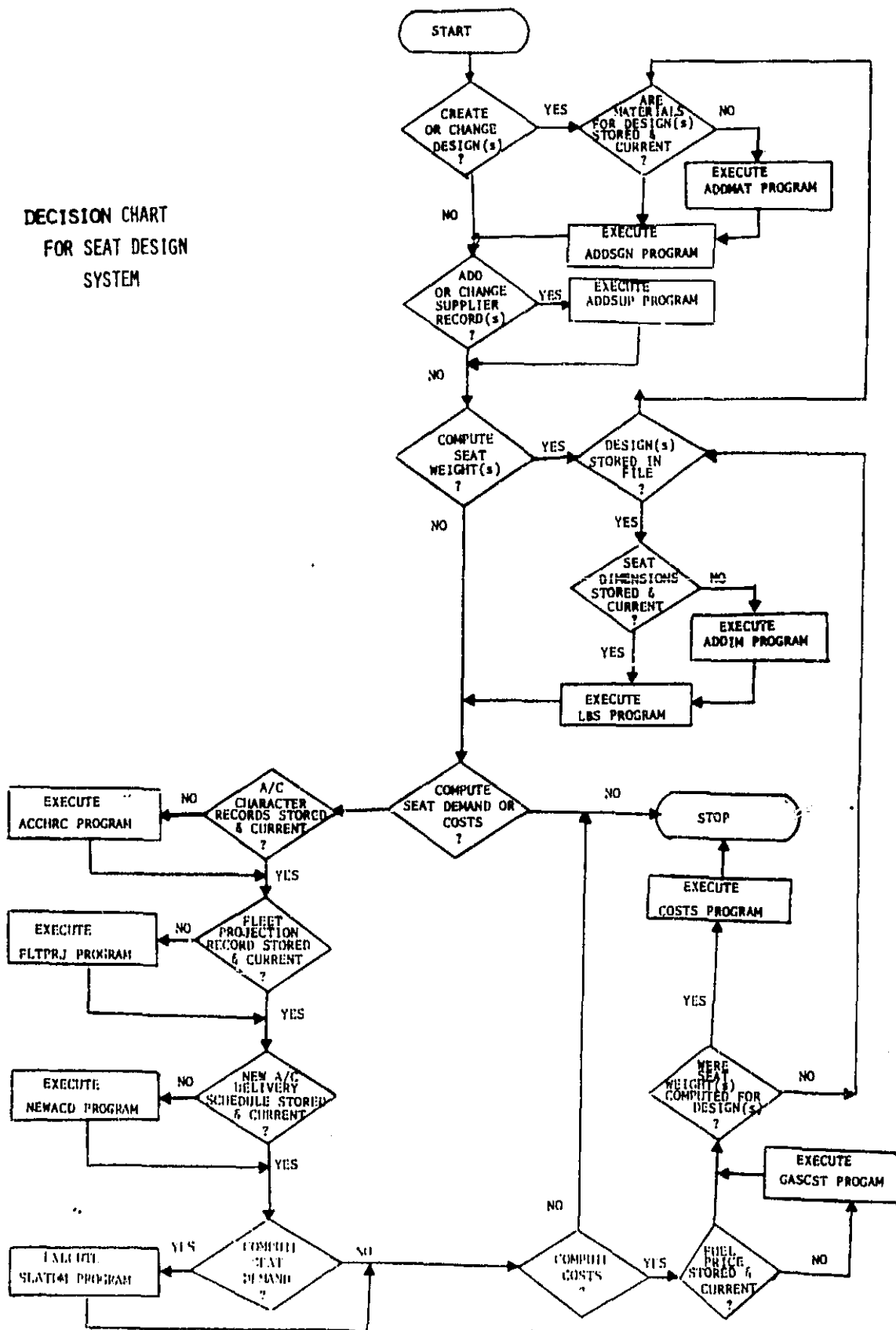

SEAT CUSHION DESIGN SYSTEM

SEQUENCE OF EXECUTION

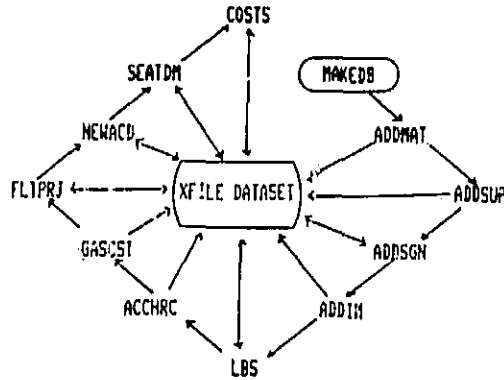

FIGURE 3.1.2

ADDH PROGRAM

$$\text{VOLUME} = \text{LENGTH} \times \text{WIDTH} \times \text{DEPTH}$$

$$\text{SURFACE AREA} = 2 \times (\text{LENGTH} \times \text{WIDTH} + \text{WIDTH} \times \text{DEPTH} + \text{LENGTH} \times \text{DEPTH})$$

GASCST PROGRAM

$$\text{COST NEW} = \text{COST OLD} + (\text{COST OLD} \times \text{YEARLY INCREASE}/100)$$

LBS PROGRAM

$$\text{SURFACE AREA} = (1.23 \times \text{AREA}) + \text{AREA}$$

$$\text{WEIGHT} = \text{DENSITY} \times \text{AREA}$$

$$\text{WEIGHT} = \text{DENSITY} \times \text{VOLUME}$$

ADDSGN

$$\text{EFFICIENCY} = \text{FLUX RATE} / \text{MDOT}$$

$$\text{ADJUSTED ILD} = \text{ILD} + (\text{FACTOR} \times \text{ILD})$$

ADDH PROGRAM

$$\text{VOLUME} = \text{LENGTH} \times \text{WIDTH} \times \text{DEPTH}$$

$$\text{SURFACE AREA} = 2 \times (\text{LENGTH} \times \text{WIDTH} + \text{WIDTH} \times \text{DEPTH} + \text{LENGTH} \times \text{DEPTH})$$

GASCST PROGRAM

$$\text{COST NEW} = \text{COST OLD} + (\text{COST OLD} \times \text{YEARLY INCREASE}/100)$$

LBS PROGRAM

$$\text{SURFACE AREA} = (1.23 \times \text{AREA}) + \text{AREA}$$

$$\text{WEIGHT} = \text{DENSITY} \times \text{AREA}$$

$$\text{WEIGHT} = \text{DENSITY} \times \text{VOLUME}$$

ATTRITION

OPTION

...DIRECT INPUT
...PROGRAM COMPUTES

$$\begin{aligned} \#A/C \text{ ATTRITIONED} &= \#A/C(\text{YEAR}) + \#NEW \ A/C(\text{YEAR}) - \#A/C(\text{YEAR}+1) \\ \#SEATS &= \#A/C \times \#SEATS \ \text{PER} \ A/C \\ \text{ATTRITION RATE} &= \#SEATS \ \text{ATTRITIONED} / \text{TOTAL} \ \#SEATS(\text{YEAR}) \end{aligned}$$

COST OF MATERIALS

$$\begin{aligned} \text{COST/SEAT} &= \text{SEAT AREA} \times \text{COST/UNIT AREA} \\ \text{YEARLY COST} &= \text{SEAT DEMAND} \times \text{COST/SEAT} \end{aligned}$$

MANUFACTURING COSTS

$$\begin{aligned} \text{COST/SEAT} &= 3 \times \text{COST/CUSHION} \\ \text{YEARLY COST} &= \text{SEAT DEMAND} \times \text{COST/SEAT} \end{aligned}$$

PROJECTIONS

$$\text{COST}(\text{YR}+1) = \text{COST}(\text{YR}) \times (1 - \% \text{YEARLY COST CHANGE}/100)$$

MATERIAL COST SELECTION

$$Y = MX + B$$

where Y = # seats
X = unit cost

#SEATS FOR 1 UNIT COST BREAK(CHANGE # SEATS)

$$\#SEATS \ \text{OF} \ 1 \ \text{UNIT} \ \text{MTRL} = \text{VOL COST} / (\text{BASE UNIT COST} - \text{CHANGE UNIT COST})$$

SLOPE

$$\text{SLOPE}(M) = \text{CHANGE} \ \# \ \text{SEATS} / \text{CHANGE UNIT COST}$$

INTERCEPT

$$\text{INTERCEPT}(B) = -(\text{SLOPE} \times (\text{BASIC UNIT COST} - \text{CHANGE UNIT COST})) + \#SEAT$$

where #seats = # SEATS OF 1 UNIT MTRL

COMPUTE UNIT COST

$$X = (Y-B)/M$$

$$\text{UNIT COST} = (\#SEATS - \text{INTERCEPT}) / \text{SLOPE}$$

where #seats = #seats demand x #units material

FULL IMPACT

INITIAL CONDITION HOLD SEATS(YEAR) = ALL

MIX OF OLD AND NEW

... NO REPLACEMENT OLD SEATS

$$\text{HOLD SEATS(YEAR+1)} = \text{HOLD SEATS(YEAR)} \times (1 - \text{ATTRITION}/100)$$

... GRADUAL REPLACEMENT OLD SEATS

$$\text{HOLD SEATS(YR+1)} = \text{HOLD SEATS(YR)} \times (1 - \text{ATTRITION}/100) \times (\text{YRS LIFE REMAIN(YR+1)}/\text{YRS LIFE REMAIN(YR)})$$

... IMMEDIATE REPLACEMENT OLD SEATS

... UNRESTRICTED

$$\text{HOLD SEATS(YR+1)} = \text{NONE}$$

... RESTRICTED BY PRODUCTION RATE

$$\text{HOLD SEATS(YR+1)} = \text{HOLD SEATS(YR)} - \text{MAX NSEATS / YR}$$

$$\text{NEW SEATS} = \text{TOTAL NSEATS} - \text{HOLD SEATS}$$

$$\text{SEAT WEIGHT} = \text{NSEATS} \times \text{WEIGHT/SEAT}$$

$$\text{AVG WEIGHT} = (\text{WEIGHT(YEAR)} + \text{WEIGHT(YEAR+1)}) / 2$$

$$\text{GALLONS OF FUEL/YEAR} = \text{WEIGHT} \times \text{GALLONS PER UNIT WEIGHT/YEAR}$$

$$\text{FULL COST} = \text{GALLONS} \times \text{COST/GALLON}$$

SEAT DEMAND

INITIAL CONDITION

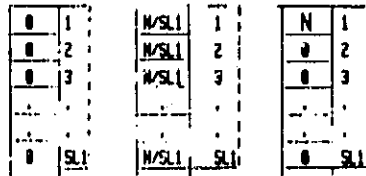

REPLACE- NONE

GRADUAL

IMMEDIATE

COMPUTE

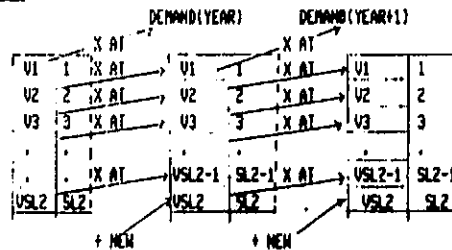

WHERE:

VECTOR LENGTH = MAX(SL1, SL2)

SL1 = SEATLIFE OLD SEAT

SL2 = SEATLIFE NEW SEAT

N = NSEATS AT TIME OF NEW DESIGN INTRODUCTION

h1 = (1 - ATTRITION/100)

DEMAND = 1/2 X AT

NEW = 1/2 X AT - HOLD TO NEW AIRCRAFT

SEAT DEMAND DATE: 6/31/82

YEAR	COACH	SHORT HAUL	1ST CLASS
1982	74842	0	4680
1983	84944	0	7558
1984	83587	0	7264
1985	83848	0	7285
1986	75034	0	4523
1987	80454	0	7009
1988	87390	0	7594
1989	85009	0	7387
1990	89404	0	7748
1991	83319	0	7240

*Method used for demand was GRAD

NEW AIRCRAFT DELIVERY TO U.S. AIR CARRIER FLEET

AS OF DATE: 3/17/82

A/C	78	79	80	81	82	83	84	85	86	87	88	89	90	91	92
2-ENGINE:															
B-737	0	0	20	15	10	10	10	10	10	0	0	0	0	0	0
DC-9	0	0	11	20	10	20	10	10	10	10	10	10	10	10	10
A300	0	0	2	5	1	4	3	5	5	5	5	5	5	5	5
B-757	0	0	0	0	0	0	0	20	20	20	20	20	20	20	20
B-767	0	0	0	0	0	48	42	45	10	13	14	7	10	11	12
TOTAL	0	0	39	40	21	82	47	90	55	48	49	42	45	44	47
3-ENGINE:															
B-727	0	0	61	40	50	50	50	40	30	10	0	0	3	0	0
L1011	0	0	10	0	2	4	5	5	5	5	0	0	0	0	0
DC-10	0	0	15	2	2	7	5	5	0	0	0	0	0	0	0
TOTAL	0	0	106	42	54	41	40	50	35	15	0	0	0	0	0
4-ENGINE:															
B-707	0	0	0	0	0	0	0	0	0	0	0	0	0	0	0
B-720	0	0	0	0	0	0	0	0	0	0	0	0	0	0	0
B-747	0	0	8	2	2	0	2	0	4	5	5	4	6	10	8
DC-8	0	0	0	0	0	0	0	0	0	0	0	0	0	0	0
TOTAL	0	0	8	2	2	0	2	0	4	5	5	4	6	10	8

U. S. AIRCRAFT FLEET PROJECTIONS

AS OF DATE: 4/ 9/82

A/C	78	79	80	81	82	83	84	85	86	87	88	89	90	91	92
2-ENGINE:															
B-737	135	154	152	160	162	166	171	177	177	177	177	177	177	177	177
DC-9	349	345	370	389	390	404	414	421	423	423	423	425	430	430	430
A300	7	7	15	20	21	25	30	35	40	45	50	55	60	65	70
B-757	0	0	0	0	0	0	0	20	40	60	80	100	120	140	160
B-767	0	0	0	0	0	48	90	135	145	158	172	179	189	200	212
TOTAL	511	528	537	569	573	643	705	788	825	843	902	936	976	1012	1049
3-ENGINE:															
B-727	899	970	1042	1050	1059	1070	1084	1098	1095	1094	1093	1091	1090	1088	1086
L1011	90	84	94	94	94	100	105	110	112	112	112	112	112	112	112
DC-10	132	140	149	151	151	158	160	162	162	162	162	162	162	162	162
TOTAL	1121	1214	1285	1295	1306	1328	1349	1370	1369	1368	1367	1365	1364	1362	1360
4-ENGINE:															
B-707	211	178	142	140	124	100	79	60	60	60	60	55	55	50	50
B-720	9	6	0	0	0	0	0	0	0	0	0	0	0	0	0
B-747	103	117	128	130	132	132	134	134	138	143	144	150	151	161	163
DC-8	123	138	105	105	105	105	105	98	98	98	98	98	98	98	96
TOTAL	446	439	375	375	341	337	314	292	294	301	302	303	304	307	309

FUEL COST PROJECTION (\$/GAL) DATE: 4/21/82

B1	B2	B3	B4	B5	B6	B7	B8	B9	B0
1.00	1.05	1.10	1.14	1.22	1.26	1.34	1.41	1.48	1.55
91	92	93	94	95					
1.63	1.71	1.80	1.89	1.98					

DATE: 4/21/82

AIRCRAFT CHARACTERIZATION FILE

	AVG NO. SEATS	X 1ST CLASS	X SHORT HAUL	ESTIMATED WEIGHT TO FUEL SENSITIVITY
2-ENGINE:				
B-737	149	0	0	9.32
DC-9	120	0	0	10.80
A300	200	0	0	15.00
B-757	174	0	0	13.00
B-747	200	0	0	14.00
3-ENGINE:				
B-727	120	0	0	17.34
L1011	325	0	0	15.50
DC-10	315	0	0	15.37
4-ENGINE:				
B-707	140	0	0	10.00
B-720	0	0	0	0.00
B-747	455	0	0	17.75
DC-8	175	0	0	20.15

* Additional gallons fuel consumed to carry
 1 lb. of excess weight on one airplane for
 one year.

SEAT CUSHION WEIGHT PER CUSHION DATE: 4/21/82

SEAT CUSHION DESIGN NUMBER: 009
 US,
 SEAT DESIGN REFERENCE NUMBER: 001

BACK		BOTTOM		HEADREST		TOTAL	
LBS	SLBS	LBS	SLBS	LBS	SLBS	LBS	SLBS
COACH:							
1.94	0.30	3.34	0.24	1.44	0.12	6.72	0.64
SHORT HAUL:							
1.94	0.30	3.34	0.24	1.44	0.12	6.72	0.64
1ST CLASS:							
2.12	0.33	3.42	0.25	1.73	0.13	7.47	0.71

* DELTA WEIGHT
 END OF THE WEIGHT REPORT

SEAT CUSHION DIMENSIONS DATE: 4/21/82

COACH SEAT:

LENGTH	WIDTH	DEPTH	LENGTH	WIDTH	DEPTH	LENGTH	WIDTH	DEPTH
BACK:			BOTTOM:			HEADREST:		
(18.0 X 20.0 X 2.0 IN)			(20.0 X 22.0 X 4.0 IN)			(18.0 X 8.0 X 5.0 IN)		
AREA: 872.0 SQ IN			AREA: 1216.0 SQ IN			AREA: 548.00 SQ IN		
VOLUME: 720.0 CU IN			VOLUME: 1760.0 CU IN			VOLUME: 720.00 CU IN		

SHORT HAUL SEAT:

(18.0 X 20.0 X 2.0 IN)			(20.0 X 22.0 X 4.0 IN)			(18.0 X 8.0 X 5.0 IN)		
AREA: 872.0 SQ IN			AREA: 1216.0 SQ IN			AREA: 548.00 SQ IN		
VOLUME: 720.0 CU IN			VOLUME: 1760.0 CU IN			VOLUME: 720.00 CU IN		

1ST CLASS SEAT:

(18.0 X 22.0 X 2.0 IN)			(20.0 X 24.0 X 4.0 IN)			(18.0 X 10.0 X 5.0 IN)		
AREA: 952.0 SQ IN			AREA: 1312.0 SQ IN			AREA: 440.00 SQ IN		
VOLUME: 792.0 CU IN			VOLUME: 1920.0 CU IN			VOLUME: 900.00 CU IN		

END OF SEAT CUSHION DIMENSION REPORT

 SEAT LAYER DESIGN REPORT

SEAT DESIGN NUMBER: 009

LAYER	NAME	CODE NO.	* MANUFACTURER'S COST FACTORS
A	WOOL/NYLON	005	- LABOR - FABRICATION 1.00
B	NORFAB AL	011	- PLANNING 1.00
C	-----	-0-	- ASSEMBLY 1.00
D	-----	-0-	- INSPECTION 1.00
E	-----	-0-	- TOOLING 1.00
F	NFR URETHANE	BK 004	- DEVELOPMENT
	NFR URETHANE	BM 004	- DESIGN 1.00
	NFR URETHANE	HD 004	- ENGINEERING 1.00
			- SUST. ENGINEERING 1.00
* FIRE PERFORMANCE PARAMETERS			- OVERHEAD
	ILD(BK) = 0	ILD(MT) = 0	ILD(HR) = 0
			- TOOLING 1.00
			- MISC. 1.00
			APPLY TO DESIGN# 001
	2.5 FLUX: MDT = 0.69E-04	E = 34231.88	MFG X/YR INCREASE 0.
	5.0 FLUX: MDT = 0.28E-03	E = 17857.14	
	7.0 FLUX: MDT = 0.34E-03	E = 20833.33	
* LIFETIME IF A SEAT MEASURED IN NUMBER OF YEARS			
	BOTTOM = 2.5	BACK = 5.0	HEADREST = 5.0

 SUPPLIER'S FILE

SUPPLIER CODE: 5

ADDRESS: AMATEX CORP
 1032 STONABRIDGE ST.
 NORRISTOWN
 PA
 19404

CONTACT:
 PHONE:

SEAT CUSHION LAYER MATERIAL

MATERIAL CODE NUMBER: 011
 PPRODUCT NO. : NORFAB 11H7-26-AL

MATERIAL NAME: NORFAB AL
 DESCRIPTION : NORFAB FABRIC, WEAVE STRUCTURE 1X1 PLAIN
 ALUMINIZED ONE SIDE, 25%NOMEX/SXKYHEL

SUPPLIER'S NUMBER: 5
 DENSITY: 0.082 LB/FT2 OR FT3
 DENSITY FIRE RETARDANT FOAM: 0.000 LB/FT2 OR FT3

COST: \$ 2.090/FT2 OR FT3
 YEARLY COST INCREASE: 0%
 UNIT COST CHANGE/VOL. COST: \$ 0.000/ 0.

END OF SEAT CUSHION MATERIAL REPORT

SEAT CUSHION RAW MATERIALS COST '82

Seat Design Number: 009 Date: 6/22/82

Raw material cost based on seat demand method: GRAD

	BACK COST	DCOST	BOTTOM COST	DCOST	HEADREST COST	DCOST	TOTAL CUST	DCOST
COACH:								
30.17	14.53		42.71	20.69	19.19	9.20	92.87	44.50
SHORT HAUL:								
30.17	14.53		42.71	20.69	19.19	9.20	92.87	44.50
1ST CLASS:								
32.95	75.87		46.10	22.34	22.46	10.00	101.51	49.00

* Delta cost is calculated with respect to Reference Seat Cushion 001 cost.

SEAT CUSHION MANUFACTURING COST '82

Seat Design Number: 009 Date: 6/22/82
Reference Design Number: 001

	DESIGN # 009	REFER. DESIGN	DELTA
LABOR	15.	15.	0.
DEVELOPMENT	6.	6.	0.
OVERHEAD	6.	6.	0.
TOTAL	27.	27.	0.

*Note: Cost to manufacture assumed same for Coach, Short Haul and 1st Class, and Back, Bottom and Headrest cushions.

Costs for study design 009 DATE: 6/22/82

RAW MATERIAL AND MANUFACTURING COSTS
***** METHOD: GRAD

YEAR	COACH RH	COACH MFG	SHORT HAUL RH	SHORT HAUL MFG	1ST CLASS RH	1ST CLASS MFG	TOT RH	TOT MFG	TOTAL
1982	11184.	9039.	0.	0.	1072.	856.	12256.	10094.	22950.
1983	11997.	10551.	0.	0.	1150.	917.	13143.	11468.	24611.
1984	11572.	10100.	0.	0.	1109.	885.	12681.	11066.	23747.
1985	12337.	10052.	0.	0.	1103.	944.	13519.	11797.	25316.
1986	12339.	10055.	0.	0.	1103.	944.	13522.	11799.	25320.
1987	11604.	10455.	0.	0.	1139.	909.	13073.	11364.	24907.
1988	12779.	11242.	0.	0.	1225.	970.	14004.	12220.	26224.
1989	12030.	11294.	0.	0.	1231.	902.	14060.	12275.	26344.
1990	12541.	11032.	0.	0.	1202.	959.	13743.	11992.	25735.
1991	13550.	11927.	0.	0.	1300.	1037.	14850.	12963.	27822.

*Costs in thousands of dollars

WEIGHT AND FUEL IMPACT

Design no. 009 Date: 6/22/82

Year	Weight	Gallons	Cost
1982	48291.	745.	702.
1983	143890.	2289.	2435.
1984	233793.	3684.	4172.
1985	288968.	4323.	5254.
1986	287851.	4411.	5638.
1987	292742.	4492.	6328.
1988	297981.	4568.	6428.
1989	303135.	4642.	6859.
1990	309812.	4728.	7334.
1991	314986.	4815.	7743.

*Seat demand based on GRAD method.
 *Delta cost with respect to reference design 001
 *Costs in thousands of dollars.
 *Gallons in thousands of gallons.

COST SUMMARY REPORT

METHOD SEATLIFE	UONARS		NORFAB		NORFAB LIGHT	
	CODEN 001	CODEN 002	CODEN 009	CODEN 012	CODEN 009	
	GRAD 3 YRS	GRAD 3 YRS	GRAD 3 YRS	GRAD 3 YRS	GRAD 3 YRS	
COST TO FLY(1986)	51566.	84139.	57196.	58889.	57196.	
COST TO BUY(1986)						
MATERIAL	6986.	7624.	13522.	13312.	13522.	
MANUFACTURING	11799.	11799.	11799.	11799.	11799.	
TOTAL COSTS(1986)	78351.	103571.	82516.	75208.	82516.	
DELTA COST-FLY(1986)	0.	32570.	5638.	-1477.	5638.	
DELTA COST-BUY(1986)	0.	648.	6536.	6326.	6536.	
DELTA COSTS(1986)	0.	33228.	12166.	4849.	12166.	
AUG'D OVER PROJECTION:						
TOTAL COSTS	72621.	103791.	84413.	77544.	84413.	
DELTA COSTS	0.	31178.	11792.	4923.	11792.	

*Costs in thousands of dollars.

COST SUMMARY REPORT

METHOD SEATLIFE	VONARS		NORFAS		NORFAS LIGHT	
	CODES 001 0RAD 3 YRS	CODES 002 0RAD 3 YRS	CODES 009 0RAD 3 YRS	CODES 012 0RAD 3 YRS	CODES 001 0RAD 3 YRS	CODES 002 0RAD 3 YRS
COST TO FLY(1986)	51564.	84129.	57196.	58889.	51564.	
COST TO BUY(1986)						
MATERIAL	6986.	7634.	13312.	13312.	6986.	
MANUFACTURING	11799.	11799.	11799.	11799.	11799.	
TOTAL COSTS(1986)	78851.	18371.	82387.	75208.	78851.	
DELTA COST-FLY(1986)	0.	32572.	5638.	-1477.	0.	
DELTA COST-BUY(1986)	0.	648.	6326.	6326.	0.	
DELTA COSTS(1986)	0.	33220.	11964.	4849.	0.	
AUG'S OVER PROJECTION:						
TOTAL COSTS	72621.	183791.	84284.	77544.	72621.	
DELTA COSTS	0.	2,178.	11583.	4923.	0.	

*Costs in thousands of dollars.

COST SUMMARY REPORT

METHOD SEATLIFE	VONARS		NORFAS		NORFAS LIGHT	
	CODES 001 0RAD 3 YRS	CODES 002 0RAD 3 YRS	CODES 009 0RAD 3 YRS	CODES 012 0RAD 3 YRS	CODES 002 0RAD 3 YRS	CODES 002 0RAD 3 YRS
COST TO FLY(1986)	51564.	84129.	57196.	58889.	84129.	
COST TO BUY(1986)						
MATERIAL	6986.	7634.	13312.	13312.	7634.	
MANUFACTURING	11799.	11799.	11799.	11799.	11799.	
TOTAL COSTS(1986)	78851.	18371.	82387.	75208.	18371.	
DELTA COST-FLY(1986)	0.	32572.	5638.	-1477.	32572.	
DELTA COST-BUY(1986)	0.	648.	6326.	6326.	648.	
DELTA COSTS(1986)	0.	33220.	11964.	4849.	33220.	
AUG'S OVER PROJECTION:						
TOTAL COSTS	72621.	183791.	84284.	77544.	183791.	
DELTA COSTS	0.	21178.	11583.	4923.	21178.	

*Costs in thousands of dollars.

COST SUMMARY REPORT

METHOD SEATLIFE	VONARS		NORFAS		NORFAS LIGHT	
	CODES 001 0RAD 3 YRS	CODES 002 0RAD 3 YRS	CODES 009 0RAD 3 YRS	CODES 012 0RAD 3 YRS	CODES 002 0RAD 3 YRS	CODES 002 0RAD 3 YRS
COST TO FLY(1986)	51564.	84129.	57196.	58889.	74758.	
COST TO BUY(1986)						
MATERIAL	6986.	7634.	13312.	13312.	7278.	
MANUFACTURING	11799.	11799.	11799.	11799.	11799.	
TOTAL COSTS(1986)	78851.	18371.	82387.	75208.	93819.	
DELTA COST-FLY(1986)	0.	32572.	5638.	-1477.	23184.	
DELTA COST-BUY(1986)	0.	648.	6326.	6326.	284.	
DELTA COSTS(1986)	0.	33220.	11964.	4849.	23468.	
AUG'S OVER PROJECTION:						
TOTAL COSTS	72621.	183791.	84284.	77544.	94438.	
DELTA COSTS	0.	21178.	11583.	4923.	22889.	

*Costs in thousands of dollars.

COST SUMMARY REPORT

METHOD SEATLIFE	UNHARS		NORFAS		NORFAS LIGHT	
	CODES 001 GRAB 3 YRS	CODES 002 GRAB 3 YRS	CODES 009 GRAB 3 YRS	CODES 012 GRAB 3 YRS	CODES 004 GRAB 3 YRS	
COST TO FLY(1986)	51566.	84139.	57196.	58009.	163079.	
COST TO BUY(1986)						
MATERIAL	6906.	7634.	13312.	13312.	7130.	
MANUFACTURING	11799.	11799.	11799.	11799.	11799.	
TOTAL COSTS(1986)	78351.	183571.	82307.	73200.	182013.	
DELTA COST-FLY(1986)	0.	32372.	3430.	-1477.	111812.	
DELTA COST-BUY(1986)	0.	640.	8326.	6326.	152.	
DELTA COSTS(1986)	0.	32229.	11966.	4849.	111665.	
AUG'D OVER PROJECTION:						
TOTAL COSTS	72621.	183791.	87204.	77544.	177872.	
DELTA COSTS	0.	31178.	15823.	4923.	184882.	

*Costs in thousands of dollars.

COST SUMMARY REPORT

METHOD SEATLIFE	UNHARS		NORFAS		NORFAS LIGHT	
	CODES 001 GRAB 3 YRS	CODES 002 GRAB 3 YRS	CODES 009 GRAB 3 YRS	CODES 012 GRAB 3 YRS	CODES 005 GRAB 3 YRS	
COST TO FLY(1986)	51566.	84139.	57196.	58009.	61446.	
COST TO BUY(1986)						
MATERIAL	6906.	7634.	13312.	13312.	13493.	
MANUFACTURING	11799.	11799.	11799.	11799.	11799.	
TOTAL COSTS(1986)	78351.	183571.	82307.	73200.	86697.	
DELTA COST-FLY(1986)	0.	32372.	5630.	-1477.	11879.	
DELTA COST-BUY(1986)	0.	640.	8326.	6326.	647.	
DELTA COSTS(1986)	0.	32229.	11966.	4849.	18347.	
AUG'D OVER PROJECTION:						
TOTAL COSTS	72621.	183791.	84204.	77544.	79881.	
DELTA COSTS	0.	21178.	11523.	4923.	17,81.	

*Costs in thousands of dollars.

COST SUMMARY REPORT

METHOD SEATLIFE	UNHARS		NORFAS		NORFAS LIGHT	
	CODES 001 GRAB 3 YRS	CODES 002 GRAB 3 YRS	CODES 009 GRAB 3 YRS	CODES 012 GRAB 3 YRS	CODES 006 GRAB 3 YRS	
COST TO FLY(1986)	51566.	84139.	57196.	58009.	63029.	
COST TO BUY(1986)						
MATERIAL	6906.	7634.	13312.	13312.	13235.	
MANUFACTURING	11799.	11799.	11799.	11799.	11799.	
TOTAL COSTS(1986)	78351.	183571.	82307.	73200.	80082.	
DELTA COST-FLY(1986)	0.	32372.	3430.	-1477.	12263.	
DELTA COST-BUY(1986)	0.	640.	8326.	6326.	6269.	
DELTA COSTS(1986)	0.	31730.	11966.	4849.	18132.	
AUG'D OVER PROJECTION:						
TOTAL COSTS	72621.	183791.	84204.	77544.	93322.	
DELTA COSTS	0.	31178.	11523.	4923.	17742.	

*Costs in thousands of dollars.

COST SUMMARY REPORT

METHOD SEATLIFE	UNIFAB2		HMFAB		HMFAB LIGHT	
	CODED 001 3 YRS	CODED 002 3 YRS	CODED 003 3 YRS	CODED 012 3 YRS	CODED 007 3 YRS	CODED 007 3 YRS
COST TO FLY(1986)	5166.	64139.	57196.	50009.	50009.	50009.
COST TO BUY(1986)						
MATERIAL	6006.	7634.	12312.	12312.	12312.	12312.
MANUFACTURING	11799.	11799.	11799.	11799.	11799.	11799.
TOTAL COSTS(1986)	76251.	122571.	62207.	73200.	64000.	64000.
DELTA COST-FLY(1986)	0.	32372.	5630.	-1477.	6239.	6239.
DELTA COST-BUY(1986)	0.	640.	6326.	6326.	6326.	6326.
DELTA COSTS(1986)	0.	32228.	11956.	4849.	12747.	12747.
AUG'D OVER PROJECTION:						
TOTAL COSTS	72621.	122791.	64204.	77544.	69234.	69234.
DELTA COSTS	0.	31170.	11903.	4923.	12613.	12613.

*Costs in thousands of dollars.

COST SUMMARY REPORT

METHOD SEATL7K	UNIFAB2		HMFAB		HMFAB LIGHT	
	CODED 001 3 YRS	CODED 002 3 YRS	CODED 003 3 YRS	CODED 012 3 YRS	CODED 007 3 YRS	CODED 007 3 YRS
COST TO FLY(1986)	5166.	64139.	57196.	50009.	77206.	77206.
COST TO BUY(1986)						
MATERIAL	6006.	7634.	12312.	12312.	7601.	7601.
MANUFACTURING	11799.	11799.	11799.	11799.	11799.	11799.
TOTAL COSTS(1986)	76251.	122571.	62207.	73200.	96995.	96995.
DELTA COST-FLY(1986)	0.	32372.	5630.	-1477.	25040.	25040.
DELTA COST-BUY(1986)	0.	640.	6326.	6326.	706.	706.
DELTA COSTS(1986)	0.	32228.	11956.	4849.	25643.	25643.
AUG'D OVER PROJECTION:						
TOTAL COSTS	72621.	122791.	64204.	77544.	97632.	97632.
DELTA COSTS	0.	31170.	11903.	4923.	25012.	25012.

*Costs in thousands of dollars.

COST SUMMARY REPORT

METHOD SEATLIFE	UNIFAB2		HMFAB		HMFAB LIGHT	
	CODED 001 3 YRS	CODED 002 3 YRS	CODED 003 3 YRS	CODED 012 3 YRS	CODED 007 3 YRS	CODED 007 3 YRS
COST TO FLY(1986)	5166.	64139.	57196.	50009.	57196.	57196.
COST TO BUY(1986)						
MATERIAL	6006.	7634.	12312.	12312.	12312.	12312.
MANUFACTURING	11799.	11799.	11799.	11799.	11799.	11799.
TOTAL COSTS(1986)	76251.	122571.	62207.	73200.	62207.	62207.
DELTA COST-FLY(1986)	0.	32372.	5630.	-1477.	5630.	5630.
DELTA COST-BUY(1986)	0.	640.	6326.	6326.	6326.	6326.
DELTA COSTS(1986)	0.	32228.	11956.	4849.	11956.	11956.
AUG'D OVER PROJECTION:						
TOTAL COSTS	72621.	122791.	64204.	77544.	64204.	64204.
DELTA COSTS	0.	31170.	11903.	4923.	11903.	11903.

*Costs in thousands of dollars.

COST SUMMARY REPORT

METHOD SEATLIFE	USMARS		NORFAB		NORFAB LIGHT	
	CODES 001 00AD 3 YRS	CODES 002 00AD 3 YRS	CODES 009 00AD 3 YRS	CODES 012 00AD 3 YRS	CODES 018 00AD 3 YRS	
COST TO FLY(1986)	5166.	84139.	57196.	50009.	137009.	
COST TO BUY(1986)						
MATERIAL	6986.	7634.	13312.	13312.	8167.	
MANUFACTURING	11799.	11799.	11799.	11799.	11799.	
TOTAL COSTS(1986)	78361.	102971.	82307.	73200.	156996.	
DELTA COST-FLY(1986)	0.	32572.	5630.	-1477.	85463.	
DELTA COST-BUY(1986)	0.	640.	6326.	6326.	1102.	
DELTA COSTS(1986)	0.	32228.	11956.	4049.	86645.	
AUG'S OVER PROJECTION:						
TOTAL COSTS	72621.	103791.	84204.	77544.	153000.	
DELTA COSTS	0.	31170.	11503.	4923.	81267.	

*Costs in thousands of dollars.

COST SUMMARY REPORT

METHOD SEATLIFE	USMARS		NORFAB		NORFAB LIGHT	
	CODES 001 00AD 3 YRS	CODES 002 00AD 3 YRS	CODES 009 00AD 3 YRS	CODES 012 00AD 3 YRS	CODES 018 00AD 3 YRS	
COST TO FLY(1986)	5166.	84139.	57196.	50009.	37536.	
COST TO BUY(1986)						
MATERIAL	6986.	7634.	13312.	13312.	22300.	
MANUFACTURING	11799.	11799.	11799.	11799.	11799.	
TOTAL COSTS(1986)	78361.	102971.	82307.	73200.	71721.	
DELTA COST-FLY(1986)	0.	32572.	5630.	-1477.	-14030.	
DELTA COST-BUY(1986)	0.	640.	6326.	6326.	15410.	
DELTA COSTS(1986)	0.	32228.	11956.	4049.	1301.	
AUG'S OVER PROJECTION:						
TOTAL COSTS	72621.	103791.	84204.	77544.	74500.	
DELTA COSTS	0.	31170.	11503.	4923.	2217.	

*Costs in thousands of dollars.

COST SUMMARY REPORT

METHOD SEATLIFE	USMARS		NORFAB		NORFAB LIGHT	
	CODES 001 00AD 3 YRS	CODES 002 00AD 3 YRS	CODES 009 00AD 3 YRS	CODES 012 00AD 3 YRS	CODES 018 00AD 3 YRS	
COST TO FLY(1986)	5166.	84139.	57196.	50009.	50009.	
COST TO BUY(1986)						
MATERIAL	6986.	7634.	13312.	13312.	13312.	
MANUFACTURING	11799.	11799.	11799.	11799.	11799.	
TOTAL COSTS(1986)	78361.	102971.	82307.	73200.	73200.	
DELTA COST-FLY(1986)	0.	32572.	5630.	-1477.	-1477.	
DELTA COST-BUY(1986)	0.	640.	6326.	6326.	6326.	
DELTA COSTS(1986)	0.	32228.	11956.	4049.	4049.	
AUG'S OVER PROJECTION:						
TOTAL COSTS	72621.	103791.	84204.	77544.	77544.	
DELTA COSTS	0.	31170.	11503.	4923.	4923.	

*Costs in thousands of dollars.

COST SUMMARY REPORT

METHOD SEATLIFE	UNMARS		MORFAS		MORFAS LIGHT	
	CODES 001 3 YRS	CODES 002 3 YRS	CODES 003 3 YRS	CODES 012 3 YRS	CODES 003 3 YRS	CODES 002 3 YRS
COST TO FLY(1986)	51966.	59418.	52922.	51211.	59418.	
COST TO BUY(1986)						
MATERIAL	6986.	7147.	6948.	6948.	7147.	
MANUFACTURING	11799.	11799.	11799.	11799.	11799.	
TOTAL COSTS(1986)	78861.	78366.	78281.	71249.	78366.	
DELTA COST-FLY(1986)	0.	7844.	1364.	-354.	7844.	
DELTA COST-BUY(1986)	0.	161.	1374.	1374.	161.	
DELTA COSTS(1986)	0.	8005.	2938.	1219.	8005.	
AUG'S OVER PROJECTION:						
TOTAL COSTS	78821.	80961.	78543.	73757.	80961.	
DELTA COSTS	0.	8348.	2922.	1126.	8348.	

*Costs in thousands of dollars.

COST SUMMARY REPORT

METHOD SEATLIFE	UNMARS		MORFAS		MORFAS LIGHT	
	CODES 001 3 YRS	CODES 002 3 YRS	CODES 003 3 YRS	CODES 012 3 YRS	CODES 003 3 YRS	CODES 002 3 YRS
COST TO FLY(1986)	51966.	59418.	52922.	51211.	57149.	
COST TO BUY(1986)						
MATERIAL	6986.	7147.	6948.	6948.	7856.	
MANUFACTURING	11799.	11799.	11799.	11799.	11799.	
TOTAL COSTS(1986)	78861.	78366.	78281.	71249.	76054.	
DELTA COST-FLY(1986)	0.	7844.	1364.	-354.	5583.	
DELTA COST-BUY(1986)	0.	161.	1374.	1374.	78.	
DELTA COSTS(1986)	0.	8005.	2938.	1219.	5463.	
AUG'S OVER PROJECTION:						
TOTAL COSTS	78821.	80961.	78543.	73757.	78515.	
DELTA COSTS	0.	8348.	2922.	1126.	5894.	

*Costs in thousands of dollars.

COST SUMMARY REPORT

METHOD SEATLIFE	UNMARS		MORFAS		MORFAS LIGHT	
	CODES 001 3 YRS	CODES 002 3 YRS	CODES 003 3 YRS	CODES 012 3 YRS	CODES 004 3 YRS	CODES 003 3 YRS
COST TO FLY(1986)	51966.	59418.	52922.	51211.	78421.	
COST TO BUY(1986)						
MATERIAL	6986.	7147.	6948.	6948.	7623.	
MANUFACTURING	11799.	11799.	11799.	11799.	11799.	
TOTAL COSTS(1986)	78861.	78366.	78281.	71249.	87243.	
DELTA COST-FLY(1986)	0.	7844.	1364.	-354.	26855.	
DELTA COST-BUY(1986)	0.	161.	1374.	1374.	37.	
DELTA COSTS(1986)	0.	8005.	2938.	1219.	26892.	
AUG'S OVER PROJECTION:						
TOTAL COSTS	72621.	80961.	78443.	73757.	106689.	
DELTA COSTS	0.	8348.	2922.	1126.	28863.	

*Costs in thousands of dollars.

COST SUMMARY REPORT

METHOD SEATLIFE	UOMAR2		NORFAB		NORFAB LIGHT	
	CODES 001 ORAD 3 YRS	CODES 002 NORP 3 YRS	CODES 009 NORP 3 YRS	CODES 012 NORP 3 YRS	CODES 005 NORP 3 YRS	CODES 008 NORP 3 YRS
COST TO FLY(1906)	51566.	59418.	52922.	51211.		54427.
COST TO BUY(1906)						
MATERIAL MANUFACTURING	6906. 11799.	7147. 11799.	8568. 11799.	8568. 11799.	8568. 11799.	8568. 11799.
TOTAL COSTS(1906)	78551.	78556.	73281.	71569.		74821.
DELTA COST-FLY(1906)	0.	7844.	1356.	-356.		2861.
DELTA COST-BUY(1906)	0.	161.	1574.	1374.		1618.
DELTA COSTS(1906)	0.	8005.	2930.	1219.		4478.
AUG'D OVER PROJECTION:						
TOTAL COSTS	72621.	88961.	75543.	73757.		77147.
DELTA COSTS	0.	8348.	2922.	1136.		4527.

*Costs in thousands of dollars.

COST SUMMARY REPORT

METHOD SEATLIFE	UOMAR2		NORFAB		NORFAB LIGHT	
	CODES 001 ORAD 3 YRS	CODES 002 NORP 3 YRS	CODES 009 NORP 3 YRS	CODES 012 NORP 3 YRS	CODES 005 NORP 3 YRS	CODES 008 NORP 3 YRS
COST TO FLY(1906)	51566.	59418.	52922.	51211.		54519.
COST TO BUY(1906)						
MATERIAL MANUFACTURING	6906. 11799.	7147. 11799.	8568. 11799.	8568. 11799.	8568. 11799.	8568. 11799.
TOTAL COSTS(1906)	78551.	78556.	73281.	71569.		74864.
DELTA COST-FLY(1906)	0.	7844.	1356.	-356.		2933.
DELTA COST-BUY(1906)	0.	161.	1574.	1374.		1568.
DELTA COSTS(1906)	0.	8005.	2930.	1219.		4513.
AUG'D OVER PROJECTION:						
TOTAL COSTS	72621.	88961.	75543.	73757.		77196.
DELTA COSTS	0.	8348.	2922.	1136.		4576.

*Costs in thousands of dollars.

COST SUMMARY REPORT

METHOD SEATLIFE	UOMAR2		NORFAB		NORFAB LIGHT	
	CODES 001 ORAD 3 YRS	CODES 002 NORP 3 YRS	CODES 009 NORP 3 YRS	CODES 012 NORP 3 YRS	CODES 005 NORP 3 YRS	CODES 007 NORP 3 YRS
COST TO FLY(1906)	51566.	59418.	52922.	51211.		55578.
COST TO BUY(1906)						
MATERIAL MANUFACTURING	6906. 11799.	7147. 11799.	8568. 11799.	8568. 11799.	8568. 11799.	8357. 11799.
TOTAL COSTS(1906)	78551.	78556.	73281.	71569.		73786.
DELTA COST-FLY(1906)	0.	7844.	1356.	-356.		1984.
DELTA COST-BUY(1906)	0.	161.	1574.	1374.		1371.
DELTA COSTS(1906)	0.	8005.	2930.	1219.		3355.
AUG'D OVER PROJECTION:						
TOTAL COSTS	72621.	88961.	75543.	73757.		76884.
DELTA COSTS	0.	8348.	2922.	1136.		3383.

*Costs in thousands of dollars.

COST SUMMARY REPORT

METHOD SEATLIFE	UOMAR2		NORFAB	NORFAB LIGHT	
	CODEN 001	CODEN 002	CODEN 009	CODEN 012	CODEN 008
	GRAB 3 YRS	NORP 3 YRS	NORP 3 YRS	NORP 3 YRS	NORP 3 YRS
COST TO FLY(1986)	51866.	59410.	52922.	51211.	57813.
COST TO BUY(1986)					
MATERIAL	6906.	7147.	8568.	8568.	7161.
MANUFACTURING	11799.	11799.	11799.	11799.	11799.
TOTAL COSTS(1986)	78351.	78356.	73281.	71569.	76772.
DELTA COST-FLY(1986)	0.	7844.	1356.	-356.	6247.
DELTA COST-BUY(1986)	0.	161.	1574.	1574.	175.
DELTA COSTS(1986)	0.	8085.	2930.	1219.	6422.
AUG'D OVER PROJECTION:					
TOTAL COSTS	72621.	80961.	75543.	73757.	79300.
DELTA COSTS	0.	8340.	2922.	1136.	6687.

*Costs in thousands of dollars.

COST SUMMARY REPORT

METHOD SEATLIFE	UOMAR2		NORFAB	NORFAB LIGHT	
	CODEN 001	CODEN 002	CODEN 009	CODEN 012	CODEN 008
	GRAB 3 YRS	NORP 3 YRS	NORP 3 YRS	NORP 3 YRS	NORP 3 YRS
COST TO FLY(1986)	51866.	59410.	52922.	51211.	58922.
COST TO BUY(1986)					
MATERIAL	6906.	7147.	8568.	8568.	8568.
MANUFACTURING	11799.	11799.	11799.	11799.	11799.
TOTAL COSTS(1986)	78351.	78356.	73281.	71569.	73281.
DELTA COST-FLY(1986)	0.	7844.	1356.	-356.	1356.
DELTA COST-BUY(1986)	0.	161.	1574.	1574.	1574.
DELTA COSTS(1986)	0.	8085.	2930.	1219.	2930.
AUG'D OVER PROJECTION:					
TOTAL COSTS	72621.	80961.	75543.	73757.	75543.
DELTA COSTS	0.	8340.	2922.	1136.	2922.

*Costs in thousands of dollars.

COST SUMMARY REPORT

METHOD SEATLIFE	UOMAR2		NORFAB	NORFAB LIGHT	
	CODEN 001	CODEN 002	CODEN 009	CODEN 012	CODEN 010
	GRAB 3 YRS	NORP 3 YRS	NORP 3 YRS	NORP 3 YRS	NORP 3 YRS
COST TO FLY(1986)	51866.	59410.	52922.	51211.	123714.
COST TO BUY(1986)					
MATERIAL	6906.	7147.	8568.	8568.	7280.
MANUFACTURING	11799.	11799.	11799.	11799.	11799.
TOTAL COSTS(1986)	78351.	78356.	73281.	71569.	142792.
DELTA COST-FLY(1986)	0.	7844.	1356.	-356.	28901.
DELTA COST-BUY(1986)	0.	161.	1574.	1574.	294.
DELTA COSTS(1986)	0.	8085.	2930.	1219.	28979.
AUG'D OVER PROJECTION:					
TOTAL COSTS	72621.	80961.	75543.	73757.	148273.
DELTA COSTS	0.	8340.	2922.	1136.	21761.

*Costs in thousands of dollars.

COST SUMMARY REPORT

METHOD SEATLIFE	LUMBER		NORFAB	NORFAB LIGHT	
	CODED 001 3 YRS	CODED 002 3 YRS	CODED 003 3 YRS	CODED 012 3 YRS	CODED 011 3 YRS
COST TO FLY(1986)	51566.	59418.	52922.	51211.	48108.
COST TO BUY(1986)					
MATERIAL	6966.	7147.	6966.	6966.	10822.
MANUFACTURING	11799.	11799.	11799.	11799.	11799.
TOTAL COSTS(1986)	73365.	70266.	73361.	71569.	70000.
DELTA COST-FLY(1986)	0.	7844.	1356.	-356.	-3379.
DELTA COST-BUY(1986)	0.	161.	1574.	1574.	3036.
DELTA COSTS(1986)	0.	8005.	2930.	1219.	487.
AUG'D OVER PROJECTION:					
TOTAL COSTS	73365.	80961.	75549.	73787.	73787.
DELTA COSTS	0.	8348.	2922.	1126.	147.

*Costs in thousands of dollars.

COST SUMMARY REPORT

METHOD SEATLIFE	LUMBER		NORFAB	NORFAB LIGHT	
	CODED 001 3 YRS	CODED 002 3 YRS	CODED 003 3 YRS	CODED 012 3 YRS	CODED 011 3 YRS
COST TO FLY(1986)	51566.	59418.	52922.	51211.	51211.
COST TO BUY(1986)					
MATERIAL	6966.	7147.	6966.	6966.	6966.
MANUFACTURING	11799.	11799.	11799.	11799.	11799.
TOTAL COSTS(1986)	73365.	70266.	73361.	71569.	71569.
DELTA COST-FLY(1986)	0.	7844.	1356.	-356.	-356.
DELTA COST-BUY(1986)	0.	161.	1574.	1574.	1574.
DELTA COSTS(1986)	0.	8005.	2930.	1219.	1219.
AUG'D OVER PROJECTION:					
TOTAL COSTS	73365.	80961.	75549.	73787.	73787.
DELTA COSTS	0.	8348.	2922.	1126.	1126.

*Costs in thousands of dollars.

COST SUMMARY REPORT

METHOD SEATLIFE	UONARS		NORFAS	NORFAS LIGHT	
	CODES 001 ORAD 3 YRS	CODES 002 IMMD 3 YRS	CODES 003 IMMD 3 YRS	CODES 012 IMMD 3 YRS	CODES 002 IMMD 3 YRS
COST TO FLY(1906)	51566.	84139.	57196.	50009.	84139.
COST TO BUY(1906)					
MATERIAL	6906.	1901.	3314.	3314.	1901.
MANUFACTURING	11799.	2930.	2930.	2930.	2930.
TOTAL COSTS(1906)	70351.	88977.	63440.	56341.	88977.
DELTA COST-FLY(1906)	0.	32572.	5630.	-1477.	32572.
DELTA COST-BUY(1906)	0.	-13946.	-12533.	-12533.	-13946.
DELTA COSTS(1906)	0.	18626.	-4903.	-14818.	18626.
AUG'D OVER PROJECTION:					
TOTAL COSTS	72621.	109172.	68530.	61350.	109172.
DELTA COSTS	0.	36551.	15909.	8737.	36551.

*Costs in thousands of dollars.

COST SUMMARY REPORT

METHOD SEATLIFE	UONARS		NORFAS	NORFAS LIGHT	
	CODES 001 ORAD 3 YRS	CODES 002 IMMD 3 YRS	CODES 003 IMMD 3 YRS	CODES 012 IMMD 3 YRS	CODES 003 IMMD 3 YRS
COST TO FLY(1906)	51566.	84139.	57196.	50009.	74750.
COST TO BUY(1906)					
MATERIAL	6906.	1901.	3314.	3314.	1810.
MANUFACTURING	11799.	2930.	2930.	2930.	2930.
TOTAL COSTS(1906)	70351.	88977.	63440.	56341.	79490.
DELTA COST-FLY(1906)	0.	32572.	5630.	-1477.	23184.
DELTA COST-BUY(1906)	0.	-13946.	-12533.	-12533.	-14037.
DELTA COSTS(1906)	0.	18626.	-6903.	-14818.	9147.
AUG'D OVER PROJECTION:					
TOTAL COSTS	72621.	102172.	60530.	61350.	92270.
DELTA COSTS	0.	29551.	15909.	8737.	26657.

*Costs in thousands of dollars.

COST SUMMARY REPORT

METHOD SEATLIFE	UONARS		NORFAS	NORFAS LIGHT	
	CODES 001 ORAD 3 YRS	CODES 002 IMMD 3 YRS	CODES 003 IMMD 3 YRS	CODES 012 IMMD 3 YRS	CODES 004 IMMD 3 YRS
COST TO FLY(1906)	51566.	84139.	57196.	50009.	162079.
COST TO BUY(1906)					
MATERIAL	6906.	1901.	3314.	3314.	1777.
MANUFACTURING	11799.	2930.	2930.	2930.	2930.
TOTAL COSTS(1906)	70351.	88977.	63440.	56341.	167793.
DELTA COST-FLY(1906)	0.	32572.	5630.	-1477.	111512.
DELTA COST-BUY(1906)	0.	-12546.	-12533.	-12533.	-14878.
DELTA COSTS(1906)	0.	18626.	-6903.	-14818.	97443.
AUG'D OVER PROJECTION:					
TOTAL COSTS	72621.	109172.	68530.	61350.	182264.
DELTA COSTS	0.	36551.	15909.	8737.	115644.

*Costs in thousands of dollars.

COST SUMMARY REPORT

METHOD SEATLIFE	UOHARS		NORFAB		NORFAB LIGHT	
	CODEN 001	CODEN 002	CODEN 003	CODEN 012	CODEN 005	
	GRAD 3 YRS	INHD 3 YRS	INHD 3 YRS	INHD 3 YRS	INHD 3 YRS	
COST TO FLY(1986)	51566.	84129.	57196.	50009.	63446.	
COST TO BUY(1986)						
MATERIAL	6906.	1901.	3214.	3214.	2249.	
MANUFACTURING	11799.	2920.	2920.	2920.	2920.	
TOTAL COSTS(1986)	78251.	86977.	63440.	56241.	69733.	
DELTA COST-FLY(1986)	0.	32572.	5620.	-1477.	11079.	
DELTA COST-BUY(1986)	0.	-13946.	-12533.	-12533.	-12497.	
DELTA COSTS(1986)	0.	18626.	-6907.	-14010.	-618.	
AUG'D OVER PROJECTION:						
TOTAL COSTS	72621.	109172.	80520.	81358.	94999.	
DELTA COSTS	0.	36551.	15909.	8737.	22379.	

*Costs in thousands of dollars.

COST SUMMARY REPORT

METHOD SEATLIFE	UOHARS		NORFAB		NORFAB LIGHT	
	CODEN 001	CODEN 002	CODEN 003	CODEN 012	CODEN 005	
	GRAD 3 YRS	INHD 3 YRS	INHD 3 YRS	INHD 3 YRS	INHD 3 YRS	
COST TO FLY(1986)	51566.	84129.	57196.	50029.	63020.	
COST TO BUY(1986)						
MATERIAL	6906.	1901.	3214.	3214.	3200.	
MANUFACTURING	11799.	2923.	2920.	2920.	2920.	
TOTAL COSTS(1986)	78251.	86977.	63440.	56241.	70065.	
DELTA COST-FLY(1986)	0.	32572.	5620.	-1477.	12262.	
DELTA COST-BUY(1986)	0.	-13946.	-12533.	-12533.	-12547.	
DELTA COSTS(1986)	0.	18626.	-6903.	-14010.	-204.	
AUG'D OVER PROJECTION:						
TOTAL COSTS	72621.	109172.	80520.	81353.	95107.	
DELTA COSTS	0.	36551.	15909.	8737.	22337.	

*Costs in thousands of dollars.

COST SUMMARY REPORT

METHOD SEATLIFE	UOHARS		NORFAB		NORFAB LIGHT	
	CODEN 001	CODEN 002	CODEN 003	CODEN 012	CODEN 007	
	GRAD 3 YRS	INHD 3 YRS	INHD 3 YRS	INHD 3 YRS	INHD 3 YRS	
COST TO FLY(1986)	51566.	84129.	57196.	50009.	59005.	
COST TO BUY(1986)						
MATERIAL	6906.	1901.	3214.	3214.	3111.	
MANUFACTURING	11799.	2920.	2920.	2920.	2920.	
TOTAL COSTS(1986)	78251.	86977.	63440.	56241.	45853.	
DELTA COST-FLY(1986)	0.	32572.	5620.	-1477.	8229.	
DELTA COST-BUY(1986)	0.	-13946.	-12533.	-12533.	-12733.	
DELTA COSTS(1986)	0.	18626.	-6903.	-14010.	-4497.	
AUG'D OVER PROJECTION:						
TOTAL COSTS	72621.	109172.	80520.	81350.	90220.	
DELTA COSTS	0.	36551.	15909.	8737.	17509.	

*Costs in thousands of dollars.

COST SUMMARY REPORT

METHOD SEATTLE	UOMARS		MORFAB		MORFAB LIGHT	
	CODES 001 3 YRS	CODES 002 3 YRS	CODES 003 3 YRS	CODES 012 3 YRS	CODES 009 3 YRS	CODES 008 3 YRS
COST TO FLY(1986)	81866.	84139.	87186.	80809.	77806.	
COST TO BUY(1986)						
MATERIAL	8908.	1981.	3314.	3314.	1918.	
MANUFACTURING	11799.	2930.	2930.	2930.	2930.	
TOTAL COSTS(1986)	78261.	80977.	83440.	86341.	82368.	
DELTA COST-FLY(1986)	0.	32572.	5430.	-1477.	25940.	
DELTA COST-BUY(1986)	0.	-12946.	-12933.	-12933.	-12932.	
DELTA COSTS(1986)	0.	18626.	-6993.	-14010.	12907.	
AUG'D OVER PROJECTION:						
TOTAL COSTS	72621.	109172.	80930.	81350.	102544.	
DELTA COSTS	0.	36551.	15909.	8737.	29244.	

*Costs in thousands of dollars.

COST SUMMARY REPORT

METHOD SEATTLE	UOMARS		MORFAB		MORFAB LIGHT	
	CODES 001 3 YRS	CODES 002 3 YRS	CODES 003 3 YRS	CODES 012 3 YRS	CODES 009 3 YRS	CODES 008 3 YRS
COST TO FLY(1986)	81866.	84139.	87186.	80809.	87186.	
COST TO BUY(1986)						
MATERIAL	8908.	1981.	3314.	3314.	3314.	
MANUFACTURING	11799.	2930.	2930.	2930.	2930.	
TOTAL COSTS(1986)	78261.	80977.	83440.	86341.	83440.	
DELTA COST-FLY(1986)	0.	32572.	5430.	-1477.	5430.	
DELTA COST-BUY(1986)	0.	-12946.	-12933.	-12933.	-12933.	
DELTA COSTS(1986)	0.	18626.	-6993.	-14010.	-6993.	
AUG'D OVER PROJECTION:						
TOTAL COSTS	72621.	109172.	80930.	81350.	80930.	
DELTA COSTS	0.	36551.	15909.	8737.	15909.	

*Costs in thousands of dollars.

COST SUMMARY REPORT

METHOD SEATTLE	UOMARS		MORFAB		MORFAB LIGHT	
	CODES 001 3 YRS	CODES 002 3 YRS	CODES 003 3 YRS	CODES 012 3 YRS	CODES 010 3 YRS	CODES 010 3 YRS
COST TO FLY(1986)	81866.	84139.	87186.	80809.	137829.	
COST TO BUY(1986)						
MATERIAL	8908.	1981.	3314.	3314.	2930.	
MANUFACTURING	11799.	2930.	2930.	2930.	2930.	
TOTAL COSTS(1986)	78261.	80977.	83440.	86341.	142000.	
DELTA COST-FLY(1986)	0.	32572.	5430.	-1477.	85433.	
DELTA COST-BUY(1986)	0.	-12946.	-12933.	-12933.	-12916.	
DELTA COSTS(1986)	0.	18626.	-6993.	-14012.	71647.	
AUG'D OVER PROJECTION:						
TOTAL COSTS	72623.	109175.	80930.	81350.	163163.	
DELTA COSTS	0.	36552.	15907.	8735.	90540.	

*Costs in thousands of dollars.

COST SUMMARY REPORT

METHOD SEATLIFE	UOHAR3		NORFAB		NORFAB LIGHT	
	CODEN 001 QWAD 3 YRS	CODEN 002 IHMD 3 YRS	CODEN 009 IHMD 3 YRS	CODEN 012 IHMD 3 YRS	CODEN 011 IHMD 3 YRS	
COST TO FLY(1986)	51566.	84139.	57196.	50009.	27536.	
COST TO BUY(1986)						
MATERIAL	6900.	1981.	3314.	3314.	5576.	
MANUFACTURING	11799.	2938.	2938.	2938.	2938.	
TOTAL COSTS(1986)	70353.	88977.	63448.	56341.	46858.	
DELTA COST-FLY(1986)	0.	32572.	5638.	-1477.	-14838.	
DELTA COST-BUY(1986)	0.	-13940.	-12535.	-12535.	-10273.	
DELTA COSTS(1986)	0.	18624.	-6985.	-14012.	-24303.	
AUG'D OVER PROJECTION:						
TOTAL COSTS	72623.	109175.	88530.	81350.	79165.	
DELTA COSTS	0.	36552.	15987.	8735.	6542.	

*Costs in thousands of dollars.

COST SUMMARY REPORT

METHOD SEATLIFE	UOHAR3		NORFAB		NORFAB LIGHT	
	CODEN 001 QWAD 3 YRS	CODEN 002 IHMD 3 YRS	CODEN 009 IHMD 3 YRS	CODEN 012 IHMD 3 YRS	CODEN 012 IHMD 3 YRS	
COST TO FLY(1986)	51566.	84139.	57196.	50009.	50009.	
COST TO BUY(1986)						
MATERIAL	6900.	1981.	3314.	3314.	3314.	
MANUFACTURING	11799.	2938.	2938.	2938.	2938.	
TOTAL COSTS(1986)	70353.	88977.	63448.	56341.	56341.	
DELTA COST-FLY(1986)	0.	32572.	5638.	-1477.	-1477.	
DELTA COST-BUY(1986)	0.	-13940.	-12535.	-12535.	-12535.	
DELTA COSTS(1986)	0.	18624.	-6985.	-14012.	-14012.	
AUG'D OVER PROJECTION:						
TOTAL COSTS	72623.	109175.	88530.	81350.	81350.	
DELTA COSTS	0.	36552.	15987.	8735.	8735.	

*Costs in thousands of dollars.

SEAT CUSHION LAYER MATERIAL

MATERIAL CODE NUMBER: 004B
PRODUCT NO. 1

MATERIAL NAME: NFR URETHANE
DESCRIPTION : POLYURETHANE FOAM, NON-FIRE RETARDED,
MEDIUM FIRM,ILD32

SUPPLIER'S NUMBER: 2
DENSITY: 1.200 LB/FT2 OR FT3
DENSITY FIRE RETARDANT FOAM: 0.000 LB/FT2 OR FT3

COST: \$ 0.680/FT2 OR FT3
YEARLY COST INCREASE: 0%
UNIT COST CHANGE/VOL. COST: \$ 0.000/% 0.

END OF SEAT CUSHION MATERIAL REPORT

SEAT LAYER DESIGN REPORT

SEAT DESIGN NUMBER: 013

LAYER	NAME	CODE NO.	* MANUFACTURER'S COST FACTORS
			- LABOR - FABRICATION 1.00
A	WOOL/NYLON	005	- PLANNING 1.00
B	NORFAB AL	011	ASSEMBLY 1.00
C	-----	-0-	- INSPECTION 1.00
D	-----	-0-	- TOOLING 1.00
E	-----	-0-	- DEVELOPMENT
F	NFR URETHANE	NK 004B	- DESIGN
	NFR URETHANE	BH 004B	ENGINEERING 1.00
	NFR URETHANE	HD 004B	- SUST.
			ENGINEERING 1.00
			- OVERHEAD
			- TOOLING 1.00
			- MISC. 1.00
			APPLY TO DESIGN# 001
			MFG %/YR INCREASE 0.
* FIRE PERFORMANCE PARAMETERS			
	ILD(BK) = 0	ILD(BT) = 0	ILD(HR) = 0
	2.5 FLUX: MDDT = 0.00E+00	E = 0.00	
	5.0 FLUX: MDDT = 0.00E+00	E = 0.00	
	7.0 FLUX: MDDT = 0.00E+00	E = 0.00	
* LIFETIME OF A SEAT MEASURED IN NUMBER OF YEARS			
	BOTTOM = 2.5	BACK = 5.0	HEADREST = 5.0

SEAT CUSHION WEIGHT PER CUSHION Date: 6/22/82

SEAT CUSHION DESIGN NUMBER: 013
VS.
SEAT DESIGN REFERENCE NUMBER: 001

	BACK		BOTTOM		HEADREST		TOTAL	
	LBS	#LBS	LBS	#LBS	LBS	#LBS	LBS	#LBS
COACH:								
	1.83	0.70	3.08	-0.02	1.34	0.02	6.25	0.20
SHORT HAUL:								
	1.93	0.20	3.08	-0.02	1.34	0.02	6.25	0.20
1ST CLASS:								
	2.01	0.21	3.34	-0.03	1.60	0.00	6.95	0.19

* DELTA WEIGHT

END OF THE WEIGHT REPORT

COST SUMMARY REPORT

METHOD BEATLIFE	UONAR3		NORFAB		NORFAB LIGHT	
	CODEN 001	CODEN 002	CODEN 009	CODEN 012	CODEN 013	
	GRAD 3 YRS	GRAD 3 YRS	GRAD 3 YRS	GRAD 3 YRS	GRAD 3 YRS	
COST TO FLY(1986)	51566.	84139.	57196.	58889.	53248.	
COST TO BUY(1986)						
MATERIAL	6988.	7636.	13312.	13312.	13312.	
MANUFACTURING	11799.	11799.	11799.	11799.	11799.	
TOTAL COSTS(1986)	78353.	103574.	82387.	75288.	78358.	
DELTA COST-FLY(1986)	0.	32572.	5638.	-1477.	1682.	
DELTA COST-BUY(1986)	0.	648.	6324.	6324.	6324.	
DELTA COSTS(1986)	0.	33220.	11953.	4847.	8005.	
AUG'D OVER PROJECTION:						
TOTAL COSTS	72623.	103793.	84284.	77544.	88584.	
DELTA COSTS	0.	31178.	11581.	4921.	7881.	

*Costs in thousands of dollars.

COST SUMMARY REPORT

METHOD BEATLIFE	UONAR3		NORFAB		NORFAB LIGHT	
	CODEN 001	CODEN 002	CODEN 009	CODEN 012	CODEN 013	
	GRAD 3 YRS	NORP 3 YRS	NORP 3 YRS	NORP 3 YRS	NORP 3 YRS	
COST TO FLY(1986)	51566.	59418.	52922.	51211.	51971.	
COST TO BUY(1986)						
MATERIAL	6988.	7149.	8562.	8562.	8562.	
MANUFACTURING	11799.	11798.	11798.	11798.	11798.	
TOTAL COSTS(1986)	78353.	78358.	73283.	71571.	72332.	
DELTA COST-FLY(1986)	0.	7844.	1356.	-356.	485.	
DELTA COST-BUY(1986)	0.	161.	1574.	1574.	1574.	
DELTA COSTS(1986)	0.	8005.	2938.	1218.	1979.	
AUG'D OVER PROJECTION:						
TOTAL COSTS	72623.	88963.	75545.	73759.	74552.	
DELTA COSTS	0.	8348.	2922.	1136.	1929.	

*Costs in thousands of dollars.

COST SUMMARY REPORT

METHOD BEATLIFE	UONAR3		NORFAB		NORFAB LIGHT	
	CODEN 001	CODEN 002	CODEN 009	CODEN 012	CODEN 013	
	GRAD 3 YRS	IMMD 3 YRS	IMMD 3 YRS	IMMD 3 YRS	IMMD 3 YRS	
COST TO FLY(1986)	51566.	84139.	57196.	58889.	53248.	
COST TO BUY(1986)						
MATERIAL	6988.	1981.	3314.	3314.	3314.	
MANUFACTURING	11799.	2938.	2938.	2938.	2938.	
TOTAL COSTS(1986)	78353.	88977.	63448.	56341.	59588.	
DELTA COST-FLY(1986)	0.	32572.	5638.	-1477.	1682.	
DELTA COST-BUY(1986)	0.	-13948.	-12535.	-12535.	-12535.	
DELTA COSTS(1986)	0.	18624.	-6985.	-14812.	-18853.	
AUG'D OVER PROJECTION:						
TOTAL COSTS	72623.	109175.	88538.	81358.	84545.	
DELTA COSTS	0.	36552.	15987.	8735.	11922.	

*Costs in thousands of dollars.

APPENDIX F-1

Development of an Algorithm and Data Gathering for Aircraft Seats
NASA Final Report, P.O. # A84863B, ECON, Inc.

Editor's Note: Sections of this Appendix have been deleted for the sake of brevity. A complete copy of the original manuscript may be obtained upon request.

DEVELOPMENT OF AN ALGORITHM AND DATA GATHERING
FOR AIRCRAFT SEATS

FINAL REPORT

ECON, INC.

August 31, 1981

*Distribution of this report is provided in the interest of
information exchange. Responsibility for the
contents resides in the author or
organization that prepared it.*

Prepared under P.O. NO. A84863 B (EAF) by

ECON, INC.

San Jose, California

for

AMES RESEARCH CENTER

NATIONAL AERONAUTICS AND SPACE ADMINISTRATION

1. Report No.	2. Government Accession No.	3. Recipient's Catalog No.	
4. Title and Subtitle DEVELOPMENT OF AN ALGORITHM AND DATA GATHERING FOR AIRCRAFT SEATS		5. Report Date AUGUST 31, 1981	6. Performing Organization Code SC
7. Author(s) K. LEARY, J. SKRATT		8. Performing Organization Report No.	
9. Performing Organization Name and Address ECON, INC. 4020 MOORPARK AVE., SUITE 216 SAN JOSE, CA. 95117		10. Work Unit No. 505-44-21	11. Contract or Grant No. P.O. A 84863 B (EAF)
12. Sponsoring Agency Name and Address CHEMICAL RESEARCH PROJECTS OFFICE AMES RESEARCH CENTER, MOFFETT FIELD, CA. 94035		13. Type of Report and Period Covered FINAL	
		14. Sponsoring Agency Code SC	
15. Supplementary Notes TECHNICAL MONITOR - D. CAGLIOSTRO, CHEMICAL RESEARCH PROJECTS OFFICE, NASA - AMES RESEARCH CENTER, MOFFETT FIELD, CA.			
16. Abstract ECON, Inc. has developed a methodology to calculate estimated costs for the manufacture and use of advanced aircraft seat cushion configurations that are being evaluated by NASA-AMES, CRPO for improved fire performance characteristics. The methodology has been appropriately designed and documented for easy adaption to computer processing. The cost algorithm methodology has been developed to: <ul style="list-style-type: none">. Provide user interactive computer processing.. Serve as a storage facility for cushion configuration weight, cost and fire performance information.. Generate cost information for the manufacture and raw materials of each candidate cushion configuration on a U.S. fleetwide basis.. Derive the weight impact and resulting fuel consumption sensitivity of each candidate cushion configuration on a U.S. fleetwide basis.			
17. Key Words (Suggested by Author(s)) Materials, Aircraft Seats		18. Distribution Statement UNLIMITED	
19. Security Classif. (of this report) UNCLASSIFIED	20. Security Classif. (of this page) UNCL	21. No. of Pages 103	22. Price*

FOREWORD

This final report has been prepared for the Chemical Research Projects Office at Ames Research Center of NASA, Moffett Field, California, under P.O. NO. A84863 B (EAF).

This report consists of documentation for the work performed under the four contract tasks and serves to specifically direct the computer application of the aircraft seats algorithm. The report is organized as follows:

I. OVERVIEW OF AIRCRAFT SEATS ALGORITHM

II. DATA ORGANIZATION

CUSHION DIMENSIONS DATA FILE

CUSHION MATERIALS DATA FILE

CUSHION CONFIGURATIONS DATA FILE

REFERENCE CUSHION CONFIGURATION DATA FILE

AIRCRAFT FLEET PROJECTION DATA FILE

'NEW' AIRCRAFT DELIVERY SCHEDULE FILE

FUEL COST PROJECTIONS FILE

III. LOGICAL PROGRAM FLOW

DETAILED PROGRAM FLOW

OUTPUT REPORTS

I. OVERVIEW OF AIRCRAFT SEATS ALGORITHM

ECON, Inc. has developed a methodology to calculate estimated costs of the manufacture and use of advanced aircraft seat cushion configurations that are being evaluated by the Chemical Research Projects Office (CRPO) at NASA-Ames for improved fire performance characteristics. The methodology has been appropriately designed and documented for easy adaptation to computer processing.

The primary focus of this effort has been on the evaluation of the cost impact associated with manufacturing and flying various seat configurations on a U.S. aircraft fleet-wide basis. In addition, the approach developed will provide a logical framework for the storage of physical properties data and fire performance indicators for each seat configuration. Figure 1 illustrates the significant parameters that influence the seat manufacturing cost and the weight impact on fuel consumption of flying heavier or lighter aircraft seats. Each of these parameters are discussed in detail in the second section of this report.

Figure 2 provides a top-level, logical view of the proposed model flow. This is expanded upon in the last section of this report in a detailed, step-by-step, presentation of the model methodology. In addition, the summary reports have been specifically defined and are provided in conjunction with the detailed flow.

The development of the approach documented herein was significantly influenced by the nature and availability of pertinent data. In areas

where data is severely limited, as much flexibility in the data structure as possible has been suggested. For example in the area of calculating seat cushion manufacturing costs, there is currently very little insight into the major cost components and how they will be affected by new materials. The methodology developed allows the user to work with data at several levels of detail, depending upon what is available to him. Discussions between ECON and CRPO are currently in progress to find means to expand upon this data base through NASA - funded contracts with seat manufacturers to actually build seats with alternative cushion configurations and track costs in an appropriate manner. Once a good baseline set of manufacturing cost data has been provided, cost estimating tools such as the RCA Price model could be used to generate costs of future cushion designs.

Because the Ames program is focused on cushion configuration alternatives, other components of the seat structure are not considered at this time. Furthermore, the methodology presented reflects a very simplified approach to cushion design and dimensions in which both the bottom and back cushions are rectangular in shape with uniform distribution of all materials across the rectangle. The dimensions of the bottom and back cushions may be specified individually, but it is assumed that they will be comprised of the same materials.

Despite the simplifying assumptions and limitations outlined above, the methodology developed can provide a valuable tool for the comparison of one seat cushion configuration with another and to assess its impact on the cost to manufacture and fly an improved aircraft seat.

II. DATA ORGANIZATION

The data required by the aircraft seats algorithm, as configured by ECON, has been organized into the following logical groupings:

- . cushion dimensions data
- . cushion materials data
- . cushion configurations data
- . reference cushion configuration data
- . aircraft fleet projection data
- . 'new' aircraft delivery schedule data
- . fuel cost projections data

Each of these data groupings is referred to as a data file in the following pages. The contents of the data files and the manner in which the data are used in the algorithm are discussed. An initial set of data is documented, based on the data gathering efforts under this effort. In addition, a sample display format for each data file is provided.

The detailed program flow in Section III of this report refers to the types of data stored in each of the data files as the data is required by the algorithm for computational or display purposes.

FIGURE 1
MODEL APPLICATION

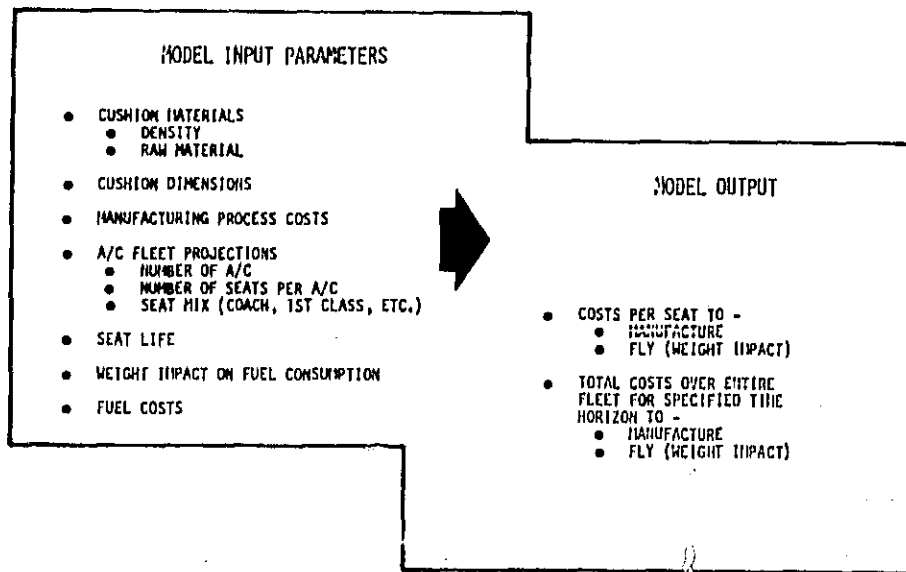
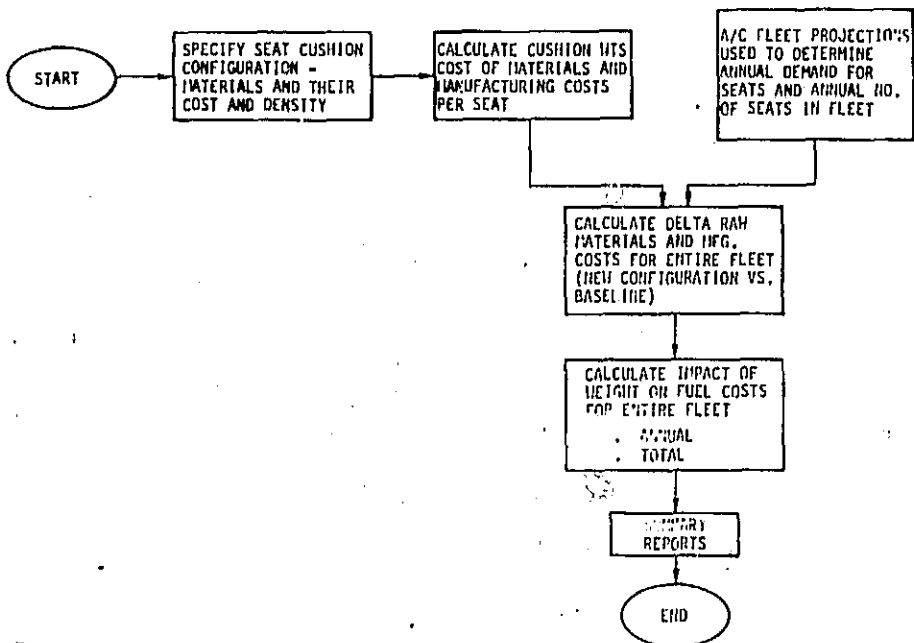

FIGURE 2
MODEL CONFIGURATION



CUSHION DIMENSIONS FILE (DIMEN)

The user of the aircraft seats algorithm may vary the dimensions of the aircraft seat cushions to reflect an actual change in typical cushion dimensions, or to examine the impact of a proposed change in cushion dimensions. The dimensions to be used are stored in the cushion dimensions file, in terms of the length, width and thickness of both the bottom and back seat cushions. Different sets of dimensions may be stored for coach and 1st class category seats. These data serve to approximate the size of the cushions and do not take into account any seat contouring or irregular seat shapes.

The initial data set for this file contains the dimensions used by CRPO in their initial work to determine typical coach seat cushion weights:

- . BACK CUSHION: 26 in. x 17 in. x 1.5 in.
- . BOTTOM CUSHION: 18.5 in. x 18.9 in. x 3.0 in.

It has been assumed that the primary difference between coach and 1st class seats is the seat width. Thus, the initial data for 1st class seats width is 2 inches greater than that specified for coach seats.

The user may also bypass the calculations of seat area and volume using seat cushion dimensions, and directly input the cushion area and volume. This option may be desirable when area and volume information is available and better reflects a seat cushion size, with its various contours and irregular shapes, than dimensions data can provide. Area and volume data would be input to the cushion dimensions file in lieu of length, width and thickness data for back and bottom cushions for both coach and 1st class seats.

The display format for the cushion dimensions data file (DIMEN) is provided on the following page.

SEAT CUSHION MATERIALS FILE (MATERL)

The file of seat cushion materials contains all materials that are used to create seat cushion configurations for the aircraft seats algorithm. Each material is numerically coded, with materials currently included in the file identified by the code established by the CRPO. In addition this file contains: the material name; product number; a brief description; the material supplier, the density; and several estimates of a unit cost. In some cases, one material may be available in a variety of thicknesses, in which case a lower-case alpha character will follow the 3-digit material code to differentiate between thickness.

The initial data set for the seat cushion materials file has been provided by the CRPO and is shown in Table 1 . The material prices currently listed are those quoted to CRPO for their purchase of a limited quantity of materials. The user may enter other price estimates to more accurately reflect the material price in a large scale market.

The display format for an entry in the materials file (MATERL) is also provided.

TABLE 1 : INITIAL DATA SET FOR SEAT CUSHION MATERIALS FILE

MATERIAL CODE: 001 NEOPRENE FOAM
 PRODUCT NO.: VONAR NO. 1
 DESCRIPTION: 1/16 IN. NEOPRENE FOAM WITH 6.9×10^{-3} TO 1.4×10^{-2} LB./FT² COTTON SCRIM
 SUPPLIER: CHRIS CRAFT INDUSTRIES, INC.
 DENSITY: .112 LB/FT²
 COST: PRICE TO CRPO = 0.107 \$/FT²
 HI -
 LO -
 MED -
 OTHER -

MATERIAL CODE: 002 NEOPRENE FOAM
 PRODUCT NO.: VONAR NO. 2
 DESCRIPTION: 2/16 IN. NEOPRENE FOAM WITH 6.9×10^{-3} TO 1.4×10^{-2} LB./FT² COTTON SCRIM
 SUPPLIER: CHRIS CRAFT INDUSTRIES, INC.
 DENSITY: .139 LB/FT²
 COST: PRICE TO CRPO = 0.251 \$/FT²
 HI -
 LO -
 MED -
 OTHER -

MATERIAL CODE: 0914 NFR URETHANE
 PRODUCT NO.: BT 150
 DESCRIPTION: RESILIENT URETHANE FOAM; 2 IN. THICK

SUPPLIER: SCOTT PAPER CO. - FOAM DIV.
 DENSITY: 1.500 LB/FT³
 COST: PRICE TO CRPO = 10.00 \$/FT³
 HI -
 LO -
 MED -
 OTHER -

TABLE 1 : INITIAL DATA SET FOR SEAT CUSHION MATERIALS FILE

MATERIAL CODE: 009 NEOPRENE FOAM
 PRODUCT NO.: VONAR NO. 3
 DESCRIPTION: 3/16 IN. NEOPRENE FOAM WITH 6.9×10^{-3} TO 1.4×10^{-2} LB./FT² COTTON SCRIM
 SUPPLIER: CHRIS CRAFT INDUSTRIES, INC.
 DENSITY: .227 LB/FT²
 COST: PRICE TO CRPO = 0.367 \$/FT²
 HI -
 LO -
 MED -
 OTHER -

MATERIAL CODE: 010 PBI BATTING
 PRODUCT NO.: 40-4010-1
 DESCRIPTION: HEAT STABILIZED
 SUPPLIER: CELANESE FIBERS MFG. CO.
 DENSITY:
 COST: PRICE TO CRPO =
 HI -
 LO -
 MED -
 OTHER -

MATERIAL CODE: 014 POLYIMID FOAM
 PRODUCT NO.:
 DESCRIPTION: RESILIENT, 2 IN. THICK
 SUPPLIER: INTERNATIONAL HARVESTER - SOLAR DIV.
 DENSITY: 1.200 LB/FT³
 COST: PRICE TO CRPO =
 HI -
 LO -
 MED -
 OTHER -

TABLE 1 : INITIAL DATA SET FOR SEAT CUSHION MATERIALS FILE

MATERIAL CODE: 0946 NFR URETHANE
 PRODUCT NO.: BT 150
 DESCRIPTION: RESILIENT URETHANE FOAM; 3 IN. THICK
 SUPPLIER: SCOTT PAPER CO. - FOAM DIV.
 DENSITY: 1.500 LB/FT³
 COST: PRICE TO CRPO = 16.647 \$/FT³
 HI -
 LO -
 MED -
 OTHER -

MATERIAL CODE: 0946 NFR URETHANE
 PRODUCT NO.: BT 150
 DESCRIPTION: RESILIENT URETHANE FOAM; 1/2 IN. THICK
 SUPPLIER: SCOTT PAPER CO. - FOAM DIV.
 DENSITY: 1.500 LB/FT³
 COST: PRICE TO CRPO = 8.571 \$/FT³
 HI -
 LO -
 MED -
 OTHER -

MATERIAL CODE: 005 WOOL/NYLON
 PRODUCT NO.: S17427-115
 DESCRIPTION: R76423 SUN-ECLIPSE BLUE/REG; COLOR 7173252; 95% WOOL/10% NYLON

SUPPLIER: LDP CORP.
 DENSITY: .097 LB/FT²
 COST: PRICE TO CRPO = 1.1756 \$/FT²
 HI -
 LO -
 MED -
 OTHER -

TABLE 1 : INITIAL DATA SET FOR SEAT CUSHION MATERIALS FILE

MATERIAL CODE: 0146 POLYIDE FOAM
 PRODUCT NO.:
 DESCRIPTION: RESILIENT, 3 IN. THICK

SUPPLIER: INT'L HARVESTER - SOLAR DIV.
 DENSITY: 1.200 LB/FT³
 COST: PRICE TO CRPO = 40.00 \$/FT³
 HI -
 LO -
 MED -
 OTHER -

MATERIAL CODE: 0146 POLYIDE FOAM
 PRODUCT NO.:
 DESCRIPTION: RESILIENT, 1/2 IN. THICK

SUPPLIER: INT'L HARVESTER - SOLAR DIV.
 DENSITY: 1.200 LB/FT³
 COST: PRICE TO CRPO =
 HI -
 LO -
 MED -
 OTHER -

MATERIAL CODE: 0174 FR URETHANE FOAM
 PRODUCT NO.: 2041
 DESCRIPTION: 2 IN. THICK

SUPPLIER: NO. CAROLINA FOAM IND.
 DENSITY: 1.870 LB/FT³
 COST: PRICE TO CRPO = 10.00 \$/FT³
 HI -
 LO -
 MED -
 OTHER -

TABLE 1 : INITIAL DATA SET FOR SEAT CUSHION MATERIALS FILE

MATERIAL CODE: 017b FR URETHANE FOAM
 PRODUCT NO.: 2043
 DESCRIPTION: 3 IN. THICK

SUPPLIER: NO CAROLINA FOAM INC.
 DENSITY: 1.870 LB/FT3
 COST: PRICE TO CRPO = 16.667 \$/FT3
 HI -
 LO -
 MED -
 OTHER -

MATERIAL CODE: 017c FR URETHANE FOAM
 PRODUCT NO.: 2043
 DESCRIPTION: 1/2 IN. THICK

SUPPLIER: NO. CAROLINA FOAM INC.
 DENSITY: 1.870 LB/FT3
 COST: PRICE TO CRPO = 8.571 \$/FT3
 HI -
 LO -
 MED -
 OTHER -

MATERIAL CODE: 018 PBI FABRIC
 PRODUCT NO.:
 DESCRIPTION: WOVEN PBI FABRIC HEAT STABILIZED; 2 x 1 TWILL MADE FROM THERMALLY STABILIZED PBI YARN

SUPPLIER: CCLANESSE FIBERS MFG. CO.
 DENSITY:
 COST: PRICE TO CRPO -
 HI -
 LO -
 MED -
 OTHER -

TABLE 1 : INITIAL DATA SET FOR SEAT CUSHION MATERIALS FILE

MATERIAL CODE: 022 NEOPRENE FOAM
 PRODUCT NO.: YONAR NO. 3
 DESCRIPTION: 3/16 IN. NEOPRENE FOAM WITH 6.9×10^{-3} TO 1.4×10^{-2} LB/FT2 PBI SCRIM

SUPPLIER: CHRIS CRAFT INDUSTRIES, INC.
 DENSITY: .257 LB/FT2
 COST: PRICE TO CRPO = 0.367 \$/FT2
 HI -
 LO -
 MED -
 OTHER -

MATERIAL CODE: 023 NEOPRENE FOAM
 PRODUCT NO.: YONAR 3 INTERLINER
 DESCRIPTION: 3/16 IN. NEOPRENE FOAM WITH 6.9×10^{-3} TO 1.4×10^{-2} LB/FT2 POLYESTER SCRIM

SUPPLIER: CHRIS CRAFT INDUSTRIES, INC.
 DENSITY: .227 LB/FT2
 COST: PRICE TO CRPO = 0.394 \$/FT2
 HI -
 LO -
 MED -
 OTHER -

MATERIAL CODE: 024 COTTON KNIT
 PRODUCT NO.:
 DESCRIPTION: FABRIC; 44 x 40 THREAD COUNT

SUPPLIER: LANGENTHAL INT'L CORP.
 DENSITY: .018 LB/FT2
 COST: PRICE TO CRPO = 0.222 \$/FT2
 HI -
 LO -
 MED -
 OTHER -

TABLE 1 : INITIAL DATA SET FOR SEAT CUSHION MATERIALS FILE

MATERIAL CODE: 019 BLACK BATTING
 PRODUCT NO.:
 DESCRIPTION:

SUPPLIER: CCLANESSE FIBERS MFG. CO.
 DENSITY:
 COST: PRICE TO CRPO -
 HI -
 LO -
 MED -
 OTHER -

MATERIAL CODE: 020 LS200
 PRODUCT NO.:
 DESCRIPTION: 1/2 IN. THICK NEOPRENE FOAM 7.5 PCF

SUPPLIER: TOYAD CORP.
 DENSITY: .234 LB/FT2
 COST: PRICE TO CRPO = .703 \$/FT2
 HI -
 LO -
 MED -
 OTHER -

MATERIAL CODE: 021 ALUMINUM FOIL
 PRODUCT NO.:
 DESCRIPTION: 0.002 IN.

SUPPLIER: REYNOLDS ALUMINUM
 DENSITY: .000 LB/FT2
 COST: PRICE TO CRPO = 0.011 \$/FT2
 HI -
 LO -
 MED -
 OTHER -

TABLE 1 : INITIAL DATA SET FOR SEAT CUSHION MATERIALS FILE

MATERIAL CODE: 025 LS 200
 PRODUCT NO.:
 DESCRIPTION: 3/8 IN. THICK

SUPPLIER: TOYAD CORP.
 DENSITY:
 COST: PRICE TO CRPO -
 HI -
 LO -
 MED -
 OTHER -

MATERIAL CODE: 026 FR COTTON KNIT
 PRODUCT NO.:
 DESCRIPTION: FABRIC; 44 x 40 THREAD COUNT; FIRE RETARDANT TREATED

SUPPLIER: LANGENTHAL INT'L CORP.
 DENSITY: .018 LB/FT2
 COST: PRICE TO CRPO = 0.417 \$/FT2
 HI -
 LO -
 MED -
 OTHER -

MATERIAL CODE: 029 MOMEK III
 PRODUCT NO.:
 DESCRIPTION:

SUPPLIER:
 DENSITY: .050 LB/FT2
 COST: PRICE TO CRPO = 1.333 \$/FT2
 HI -
 LO -
 MED -
 OTHER -

SEAT CUSHION CONFIGURATION FILE (CONFIG)

The seat cushion configuration file may contain up to 1000 combinations of available seat materials (from the materials file) for evaluation in the aircraft seats algorithm. As new materials are added to the materials file, new configurations can be specified. A cushion configuration, as currently defined, can be comprised of all or a subset of the following layers:

- LAYER A - Upholstery
- LAYER B - Scrim
- LAYER C - Heat Blocking Layers
- LAYER D - Airgap Layer
- LAYER E - Reflective Layer
- LAYER F - Foam

The cushion configuration code has already been generated by the CRPO for over 300 configurations, as listed in Table 2. These codes are maintained in this data file. Any additional configurations can be added to the file and will be assigned the next available numeric code.

In addition to a definition of the configuration by code and the materials used for each layer, this file contains information about the cushion configurations wear life, cost and fire performance. The cushion wear life will probably be different for the bottom and back cushions, and is tracked separately throughout the algorithm. However, due to the limited information currently available, the manufacture and fire performance in bottom and back cushions are treated the same for the purpose of this exercise.

Manufacturing costs can be handled by the seats algorithm in several fashions, to allow for the variability in the data available. The most

simple approach, Method A, is the direct input of the total cushion price. If greater insight into the cushion price is available, a price breakdown that includes labor cost, development cost, and overhead and profit rates may be used. The algorithm will then generate a total price based on the sum of labor and development costs, multiplied times the overhead and profit rates:

$$\text{TOTAL \$} = (\text{LABOR \$} + \text{DEVEL \$}) \times \text{OVERHEAD \%} \times \text{PROFIT \%}$$

Alternatively, using Method B, there may be no actual cost data available for a particular configuration, but only educated judgements on how the manufacturing process will differ in reference to a known seat configuration. The Reference Configuration (REFRNC) file contains the information on the costs to manufacture a selected reference seat, broken down as follows:

LABOR:	DEVELOPMENT:	OVERHEAD:	OTHER:
FABRICATION	DESIGN ENGR	TOOLING	
PLANNING	SUSTAINING ENGR	FRINGES	
ASSEMBLY		OTHER	
TOOLING			

The data may be available at the category level (i.e., labor, development, overhead, other) or at the sub-category level (i.e., fabrication, planning, etc). Data is entered and stored for the new configuration to indicate that, for example, fabrication costs are estimated to be 25% higher than the reference, and design engineering 10% lower. These differences are stored as factors in the configuration file. The seats algorithm will use these to generate total seat cushion costs.

Finally, the seat cushion configuration file will contain the fire performance characteristics of a specific configuration. At this point, these are not directly used by the algorithm, but merely stored in a convenient location for reference by the algorithm user. There are

many potential measures of fire performance that could eventually be included in this file. However, under this effort only three will be addressed:

- . Radiant panel test results
- . Modified heat release calorimeter test results
- . C-133 test, derived egress time

The initial data set for the configuration file is largely comprised of the definition of configurations established by the CRPO. Two of these configurations contain an amplified set of data to include seat wear life and manufacturing costs, as presented in Table 3. There is no fire performance data available at this time.

A display format for individual entries in the configuration file (CONFIG) is also provided.

TABLE 3 - SELECTED ENTRIES IN SEAT CONFIGURATIONS DATA FILE

CONFIGURATION # 0017	LAYER A	005	WOOL/NYLON
	LAYER B	---	
	LAYER C	009	VONAR NO. 3
	LAYER D	---	
	LAYER E	---	
	LAYER F	017	FR URETHANE

SEAT CUSHION LIFE - BOTTOM: 2.5 YRS.
BACK: 5.0 YRS.

MANUFACTURING COST (\$ PER SEAT CUSHION)

METHOD A - TOTAL MFG \$: LABOR \$: 6.25
DEVELOPMENT \$: 4.00
OVERHEAD RATE: 90%
PROFIT RATE: 10%

METHOD B - (BASED ON REFERENCE CASE SEAT CUSHION)

LABOR	DEVELOPMENT
FABRICATION	DESIGN ENGR
PLANNING	SUSTAINING ENGR
ASSEMBLY	
TOOLING	
OVERHEAD	OTHER
TOOLING	
FRINGES	
OTHER	

FIRE PERFORMANCE CHARACTERISTICS

RADIANT PANEL TEST RESULTS: HEAT SOURCE AT xx BTU/CH2
{SOURCE: }
{DATE: }

- DATA NOT YET AVAILABLE -

MODIFIED HEAT RELEASE CALORIMETER TEST RESULTS:
{SOURCE: } TEST CONDITIONS - W/CH2 CFM AIRFLOW IN. SAMPLE
{DATE: }

- DATA NOT YET AVAILABLE -

C-133 TEST, DERIVED EGRESS TIME: MINUTES
{SOURCE: }
{DATE: }

- DATA NOT YET AVAILABLE -

TABLE 3 (Continued) - SELECTED ENTRIES IN SEAT CONFIGURATIONS DATA FILE

CONFIGURATION # 0376	LAYER A	005	WOOL/NYLON
	LAYER B	129	MORFAG
	LAYER C	---	
	LAYER D	---	
	LAYER E	---	
	LAYER F	017	FR URETHANE

SEAT CUSHION LIFE - BOTTOM: 2.5 YRS.
BACK: 5.0 YRS.

MANUFACTURING COST (\$ PER SEAT CUSHION)

METHOD A - TOTAL MFG \$: LABOR \$: 6.25
DEVELOPMENT \$: 5.00
OVERHEAD RATE: 90%
PROFIT RATE: 10%

METHOD B - (BASED ON REFERENCE CASE SEAT CUSHION)

LABOR	DEVELOPMENT
FABRICATION	DESIGN ENGR
PLANNING	SUSTAINING ENGR
ASSEMBLY	
TOOLING	
OVERHEAD	OTHER
TOOLING	
FRINGES	
OTHER	

FIRE PERFORMANCE CHARACTERISTICS

RADIANT PANEL TEST RESULTS: HEAT SOURCE AT xx BTU/CH2
{SOURCE: }
{DATE: }

- DATA NOT YET AVAILABLE -

MODIFIED HEAT RELEASE CALORIMETER TEST RESULTS:
{SOURCE: } TEST CONDITIONS - W/CH2 CFM AIRFLOW IN. SAMPLE
{DATE: }

- DATA NOT YET AVAILABLE -

C-133 TEST, DERIVED EGRESS TIME: MINUTES
{SOURCE: }
{DATE: }

- DATA NOT YET AVAILABLE -

DISPLAY FORMAT

PROGRAM	SEAT CUSHION CONFIGURATION FILE (CONIG)	DATE	AUGUST 1971
PROGRAMMER	BOON, MC (RL)	PAGE	7 OF 2
STATEMENT LABEL	FORTRAN STATEMENT		STATEMENT SEQUENCE
	SEAT CUSHION CONFIGURATION FILE		
	CONFIGURATION # XXXX		
	LAYER A	AAAAAAAAAAAAAAAAAAAA	XXXX
	LAYER B	AAAAAAAAAAAAAAAAAAAA	XXXX
	LAYER C	AAAAAAAAAAAAAAAAAAAA	XXXX
	LAYER D	AAAAAAAAAAAAAAAAAAAA	XXXX
	LAYER E	AAAAAAAAAAAAAAAAAAAA	XXXX
	LAYER F	AAAAAAAAAAAAAAAAAAAA	XXXX
	SEAT CUSHION LIFE -		
	FRONT	XXX YRS	
	BACK	XXX YRS	
	MANUFACTURING COST (\$ PER SEAT CUSHION)		
	METHOD A - TOTAL MFG. COST	XXXX	
		LABOR %	XXXX%
		DEVELOPMENT %	XXXX%
		OVERHEAD RATE %	XX %
		PROFIT RATE %	XX %
	METHOD B - (BASED ON REFERENCE CASE SEAT CUSHION)		
	LAYER	DEVELOPMENT	XXXX
	FABRICATION	DESIGN ENGR	XXXX
	PLANNING	ESTIM. ENGR	XXXX
	ASSEMBLY	OTHER	XXXX
	TOOLING		
		OVERHEAD	XXXX
		TOOLING	XXXX
		FRINGS	XXXX
		OTHER	XXXX
	FIRE PERFORMANCE CHARACTERISTICS		
	ABANDON PANEL TEST RESULTS: HEAT SOURCE AT XX BTU/HR		



PRODUCT NO 5905

100

DISPLAY FORMAT

PROGRAM	SEAT CUSHION CONFIGURATION FILE (CONIG) - Continued	DATE	AUGUST 1971
PROGRAMMER	BOON, MC (RL)	PAGE	8 OF 2
STATEMENT LABEL	FORTRAN STATEMENT		STATEMENT SEQUENCE
	(SOURCE: AAAAAAAAAAAAAA)		
	(DATE: XX/XX/XX)		
	NOTE #		
	MODELED HEAT RELEASE CALORIMETER TEST RESULTS:		
	(SOURCE: AAAAAAAAAAAAAA) TEST CONDITIONS -		
	(DATE: XX/XX/XX) XX W/GM		
	XX CM. AIRFLOW		
	XX XX SAMPLE		
	NOTE #		
	C-150 TEST, VARYED PRESS. TIME: XXXX MINUTES		
	(SOURCE: AAAAAAAAAAAAAA)		
	(DATE: XX/XX/XX)		



PRODUCT NO 5905

100

REFERENCE SEAT CUSHION CONFIGURATION FILE (REFRNC)

The aircraft seats algorithm generates comparative costs, as opposed to absolute costs, by comparing associated costs for the introduction of a new seat cushion to those costs associated with a reference or baseline seat cushion. The reference cushion will usually be one that is currently in use in commercial aircraft. The seats algorithm then can be used to determine the impact of changing the seat cushion to an alternative cushion configuration. The reference seat cushion configuration file specifies the configuration to be used as a reference by the configuration code and the code for the material used in each layer. It also includes data on the seat cushion life and manufacturing costs.

In this file, manufacturing costs are entered as dollar amounts broken into the following categories: labor, development, overhead and other. If data is available, each of these categories can be further broken down into sub-categories to provide more insight into the contribution of various manufacturing cost elements to the total price. The costs in this file do not include material costs, which are added in the algorithm to generate a total seat cushion price.

The initial data set for the reference file specifies a fire retardant urethane foam cushion, encased in cotton muslin and covered with the wool/nylon upholstery. The seat cushion life and manufacturing cost data is preliminary in nature and has been derived from conversations with a variety of seat manufacturers, airline operators, and NASA personnel.

A display format for this file and its initial data set are provided on the following page.

AIRCRAFT FLEET PROJECTION DATA (FLEET)

The aircraft seats algorithm has been structured to handle data for three categories of jet aircraft: 2 - engine, 3 - engine, and 4 - engine. This structure has been employed to correspond to the format of U.S. fleet projection data presented in the annual FAA Aviation Forecasts (See Table 4). The FAA forecasts have been developed with the aid of sophisticated modelling tools that consider economic indicators, market trends, and policy issues to generate the best available projection of U.S. air carrier activity.

Within each engine category, data may be further broken down by specific aircraft type. This additional breakdown provides the capability to capture variations in seating capacity and the sensitivity to changes in aircraft weight from one aircraft type to another. There may be a range of three to ten aircraft types within each Engine category. It is expected that some current aircraft types will be replaced by new aircraft types in the time period under consideration, therefore altering the composition of the fleet.

The seats algorithm uses the fleet projection data and the 'new' aircraft delivery schedule data (described later in this section) to generate an annual requirement for aircraft seats. Following the introduction of an improved seat configuration, the assumption is made that all 'new' aircraft will contain the improved seats. It is also assumed that seats in aircraft that are already in operation prior to the introduction of the improved seat will be replaced as old seats wear out. Figure 3 depicts this transition from current to improved seats over the aircraft fleet, as it is treated in the methodology developed for the seats algorithm.

ECON, Inc. has created an initial data set of U.S. aircraft fleet projections to be used in the exercise of the seats algorithm. As

new or different information becomes available, new data sets can be created. The initial data set includes only jet aircraft flown by U.S. Air Carriers, excluding cargo transports which fly no passenger seats. Historical data pertaining to the number of aircraft by type in actual operation by U.S. trunk carriers, local carriers, and supplemental air carriers for the years 1978 to 1980 was obtained from the World Aviation Directories, Nos. 79-82. Table 5 summarizes this data. This data corresponds fairly well to the historical data included in the FAA Aviation Forecasts provided for 2 - engine, 3 - engine, and 4 - engine category aircraft. However, because the FAA aircraft forecasts include cargo transports, it was necessary to adjust those projections accordingly for use in the seats algorithm fleet projection. Without the inclusion of cargo aircraft the annual fleet size was assumed to be approximately 85% of that shown in the FAA forecast for both 2 - engine and 4 - engine aircraft. An 85% adjustment approximates the difference in the FAA historical data and the historical data recorded in the World Aviation directory. The number of 3 - engine aircraft used for cargo transport is currently very small and was assumed to continue to be so, therefore the no. of 3 - engine aircraft in the initial data set corresponds very closely to the FAA forecasts.

The World Aviation Directories were also the source for data on the number of aircraft on order by different U.S. air carriers. The initial data set created by ECON, only specifies two new aircraft types by name, Boeing's 767 and 757, with first deliveries expected in 1983 and 1985, respectively. This reflects the information currently available about orders placed for new aircraft. In addition, other new aircraft may be in operation during the time period under consideration, but they are not specifically cited in the initial data set. It is assumed that the reduction in the 4 - engine aircraft fleet as projected in the FAA forecasts reflects the retirement of a significant portion of the B-707 type aircraft. The initial data set reflects this as a gradual retirement. Otherwise, the distribution of aircraft

types within an Engine category has been done somewhat arbitrarily, using the number of aircraft currently in operation and currently on-order as a guide.

Table 6 documents the initial data set for U.S. aircraft fleet projections by Engine category, by aircraft type, by year.

The display format for the aircraft fleet projection data file (FLEET) is also provided.

TABLE 4 - JET AIRCRAFT IN THE SERVICE OF U.S. AIR CARRIERS BY AIRCRAFT TYPE*

Historical*	Jet		
	2 Engine	3 Engine	4 Engine
1975	541	926	627
1976	514	1,003	619
1977	536	1,025	593
1978	563	1,074	551
1979	618	1,164	509
1980	665	1,262	501
Forecast			
1981	669	1,284	459
1982	674	1,306	425
1983	757	1,328	397
1984	829	1,349	369
1985	927	1,370	344
1986	970	1,369	349
1987	1,015	1,368	354
1988	1,061	1,367	355
1989	1,105	1,365	356
1990	1,148	1,364	357
1991	1,191	1,362	361
1992	1,235	1,360	364

* DATA SOURCE: FAA AVIATION FORECASTS, Fiscal Years 1981-1992, September 1980.

FIGURE 3

A/C FLEET TRANSITION TO NEW CUSHIONS

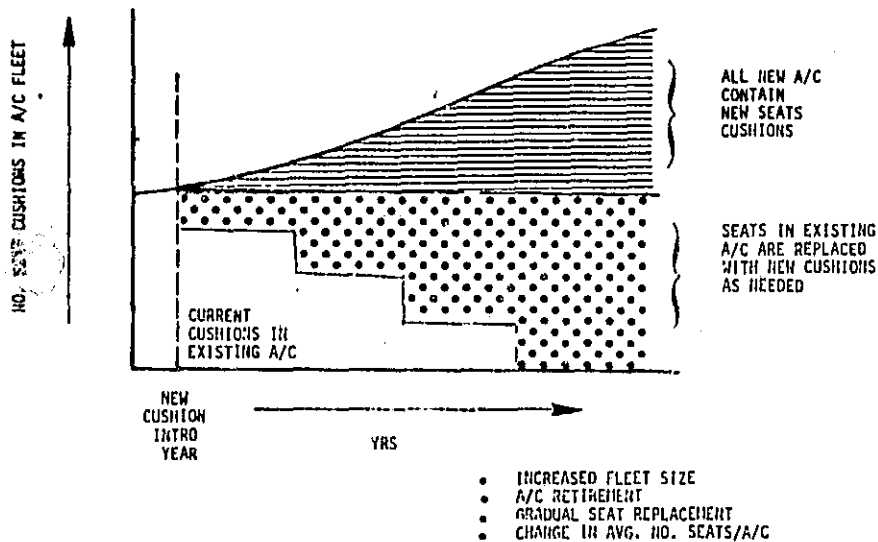

TABLE 5 - U.S. AIRCRAFT FLEET DISTRIBUTION - AIRCRAFT IN OPERATION*

AIRCRAFT TYPE	1978					1979					1980				
	TRUNK	LOCAL	CARGO	SUPPLE.	TOTAL	TRUNK	LOCAL	CARGO	SUPPLE.	TOTAL	TRUNK	LOCAL	CARGO	SUPPLE.	TOTAL
B-707	211		2		213	178				178	142				142
B-720	9				9	6				6					
B-727	479	74	1		554	231	56	1		288	364	57	1	1	1043
B-747	81	54			135	77	79			156	59	93			152
B-747	103		9		112	117		10		127	125		19	3	147
DL-8	92		30	31	153	106		35	32	173	75		32	30	137
DL-9	147	219		3	369	130	224		3	357	116	249		5	370
DC-10	126		1	6	133	131		1	9	141	130		1	11	150
L-1011	90				90	84				84	31				94
A300	7				7	7				7	15				15

* DATA SOURCE: WORLD AVIATION DIRECTORY, SUMMER 1981 (NO. 82) AND WINTER 1980-81 (NO. 81)

TABLE 6: INITIAL DATA SET FOR U.S. AIRCRAFT FLEET PROJECTIONS

AIRCRAFT	78	79	80	81	82	83	84	85	86	87	88	89	90	91	92
	(ACTUAL)			(PROJECTED)											
2-ENGINE:															
B-727	135	154	152	160	162	156	171	177	177	177	177	177	177	177	177
DC-9	369	365	370	389	390	404	414	421	423	423	423	425	430	430	430
A300	7	7	15	20	21	25	30	35	40	45	50	55	60	65	70
B-757	0	0	0	0	0	0	0	20	40	60	80	100	120	140	160
B-767	0	0	0	0	0	48	90	135	145	153	172	179	189	203	212
TOTAL	511	528	537	569	573	643	705	788	825	863	902	939	976	1012	1049
3-ENGINE:															
B-727	892	990	1042	1050	1059	1070	1084	1098	1095	1094	1093	1091	1090	1088	1076
L1011	90	84	94	94	96	100	105	110	112	112	112	112	112	112	112
DC-10	132	140	149	151	151	158	160	162	162	162	162	162	162	162	162
TOTAL	1112	1214	1284	1295	1306	1328	1349	1370	1369	1362	1367	1365	1364	1362	1360
4-ENGINE:															
B-707	211	178	142	140	124	100	75	60	60	60	60	55	55	59	50
B-720	9	6	0	0	0	0	0	0	0	0	0	0	0	0	0
B-747	103	117	128	130	132	132	134	134	138	143	144	150	151	161	163
DC-8	123	133	105	105	105	105	105	98	90	98	98	98	98	96	96
TOTAL	446	439	375	375	261	337	314	292	296	301	302	303	304	307	307

DISPLAY FORMAT

PROGRAM ... AG FLEET PROJECTION FILE (FLEET) - INITIAL DATA SET DATE APR 27 1971
 PROGRAMMER RCM, INC. (ALL) PAGE 1 OF 2

STATEMENT LABEL	CORTRAN STATEMENT										STATEMENT REFERENCE
	1971	1972	1973	1974	1975	1976	1977	1978	1979	1980	1981
2- FUEL:											
B757	185	154	152	140	131	124	117	111	107	102	97
DC9	142	145	170	189	202	211	219	224	227	229	231
A300	17	18	18	20	21	25	30	35	40	45	50
B747	0	0	0	0	0	0	0	0	0	0	0
B747	0	0	0	0	0	0	0	0	0	0	0
TOTAL	344	317	340	349	371	380	366	372	376	376	377
3- ENGINE:											
B727	109	100	102	105	105	107	108	109	109	109	109
L1011	190	194	192	188	184	180	176	172	168	164	160
DC10	13	14	14	15	15	15	15	15	15	15	15
TOTAL	312	308	308	308	304	302	298	294	292	288	284
4- ENGINE:											
B707	111	111	112	110	108	106	105	104	103	102	101
B720	9	9	9	9	9	9	9	9	9	9	9
B747	10	10	10	10	10	10	10	10	10	10	10
DC9	12	12	12	12	12	12	12	12	12	12	12
TOTAL	142	142	143	141	139	137	136	135	134	133	132



PRODUCT NO 3905

168

DISPLAY FORMAT

PROGRAM ... AG FLEET PROJECTION FILE (FLEET) - INITIAL DATA SET (CHECKED) DATE APR 27 1971
 PROGRAMMER RCM, INC. (ALL) * IF THERE IS AN ED COLUMN MAX REPORT WIDTH, BREAK THIS REPORT PAGE 2 OF 2

STATEMENT LABEL	CORTRAN STATEMENT AS SHOWN BELOW										STATEMENT REFERENCE
	1979	1980	1981	1982							
2- FUEL:											
B757	172	177	177	177							
DC9	125	130	130	130							
A300	35	36	36	36							
B747	108	110	110	110							
B747	179	182	180	182							
TOTAL	439	465	463	469							
3- ENGINE:											
B727	109	109	108	108							
L1011	112	112	112	112							
DC10	16	16	16	16							
TOTAL	137	137	136	136							
4- ENGINE:											
B707	25	25	25	25							
B720	9	9	9	9							
B747	15	15	15	15							
DC9	14	14	14	14							
TOTAL	63	63	63	63							



PRODUCT NO 3905

169

"NEW" AIRCRAFT DELIVERY SCHEDULE (DELIV)

In addition to the aircraft fleet projections previously discussed, the aircraft seats algorithm also utilizes data regarding the projected deliveries of "new" aircraft to characterize the operational air carrier fleet. It is assumed that, once improved seat cushion criteria have been decided upon, all "new" aircraft will contain improved seats, while aircraft currently in operation will replace existing seats only when they are worn out or the aircraft undergoes a decor refurbishment. Therefore it is necessary to differentiate between the number of "existing" and "new" aircraft in any given year.

The "new" aircraft delivery schedule will, obviously, correspond to the projection of aircraft fleet size. If the total number of 2 - engine aircraft flying in a given year has increased from the previous year by 20 aircraft, it can be assumed that at least 20 "new" aircraft have been added to the fleet. However, in examination of actual fleet size and aircraft delivery data for 1980 one learns that other factors must also be considered. For example, according to the World Aviation Directory (Summer 1981, No. 82), there were a total of 52 more B-727 aircraft in operation in the U.S. air-separate carrier fleet in 1980 than 1979. However, 81 "new" B-727's were delivered to U.S. air carriers. Some of those "new" aircraft were used to replace existing aircraft that were retired or sold to non-U.S. air carriers. The "new" aircraft delivery schedule data is required for the algorithm to provide insight into this occurrence.

An initial data set for the "new" aircraft delivery schedule has been created by ECON, Inc. is shown in Table 7. Alternate or improved aircraft delivery schedules may be created with the assistance of the FAA or airlines themselves and used in its stead. Assumptions

about aircraft retirement from the U.S. fleet were made somewhat arbitrarily, but in keeping with the general trends reflected in the projections of fleet size.

The display format for the "new" aircraft delivery schedule data file (DELIV) is also provided.

TABLE 7 : INITIAL DATA SET FOR 'NEW' AIRCRAFT DELIVERY TO U.S. AIR CARRIER FLEET

AIRCRAFT	78	79	80	81	82	83	84	85	86	87	88	89	90	91	92
2-ENGINE:															
B-737			20	15	10	10	10	10	10	0	0	0	0	0	0
DC-9			1	20	10	20	10	10	10	10	10	10	10	10	10
A300			8	5	1	4	5	5	5	5	5	5	5	5	5
B-757			0	0	0	0	0	20	20	20	20	20	20	20	20
B-767			0	0	0	48	42	45	10	13	14	7	10	11	12
TOTAL															
3-ENGINE:															
B-727			81	60	50	50	50	40	30	10	0	0	0	0	0
L1011			10	0	2	4	5	5	5	5	0	0	0	0	0
DC-10			15	2	2	7	5	5	0	0	0	0	0	0	0
TOTAL															
4-ENGINE:															
B-707			0	0	0	0	0	0	0	0	0	0	0	0	0
B-720			0	0	0	0	0	0	0	0	0	0	0	0	0
B-747			8	2	2	0	2	0	4	5	5	6	6	10	8
DC-8			0	0	0	0	0	0	0	0	0	3	0	3	0
TOTAL															

DISPLAY FORMAT

PROGRAM: 'NEW' AIRCRAFT DELIVERY TO U.S. AIR CARRIER FLEET (DELIV) DATE: AUG 81 1981
 PROGRAMMER: EFM, JMC (JLL) PAGE: 1 OF 1

LINE NO.	STATEMENT	78	79	80	81	82	83	84	85	86	87	88	89	90	91	92
	NEW AIRCRAFT DELIVERY															
		78	79	80	81	82	83	84	85	86	87	88	89	90	91	92
	2-ENGINE:															
	B737			20	15	10	10	10	10	10	0	0	0	0	0	0
	DC9			1	20	10	20	10	10	10	10	10	10	10	10	10
	A300			8	5	1	4	5	5	5	5	5	5	5	5	
	B757			0	0	0	0	0	20	20	20	20	20	20	20	
	B767			0	0	0	48	42	45	10	13	14	7	10	11	
	TOTAL															
	3-ENGINE:															
	B727			81	60	50	50	50	40	30	10	0	0	0	0	0
	L1011			10	0	2	4	5	5	5	5	0	0	0	0	0
	DC10			15	2	2	7	5	5	0	0	0	0	0	0	0
	TOTAL															
	4-ENGINE:															
	B707			0	0	0	0	0	0	0	0	0	0	0	0	0
	B720			0	0	0	0	0	0	0	0	0	0	0	0	0
	B747			8	2	2	0	2	0	4	5	5	6	6	10	8
	DC8			0	0	0	0	0	0	0	0	0	3	0	3	0
	TOTAL															

AIRCRAFT CHARACTERIZATION FILE (ACCHAR)

The aircraft seats algorithm requires data from the Aircraft Characterization File to generate information from the aircraft operations portion of the algorithm. This file contains three basic kinds of data for each aircraft type included in the fleet projection and "new" aircraft delivery schedule:

- . average number of seats
- . percent of total seats that are 1st class
- . estimated weight to fuel sensitivity

The initial data set for this file contains numbers for the average number of passenger seats per aircraft type primarily based on information provided by Jane's Pocket Book of Commercial Transport Aircraft (Taylor, John W., Collier Books, 1978). In some cases there are different number of seats for different versions of aircraft types, such as the DC-8 Series 30-40 verses the DC-8 Series 60-70. In such cases, these differences were averaged to derive one number representing a specific aircraft type. Information for the B-757 and B-767 was obtained from Boeing Commercial Airplane Company's Public Relations.

The data on 1st class seating is necessary to distinguish between 1st class and coach seating because the size of seats in these sections will most likely differ. The seat size influences manufacturing costs, raw material costs and seat weight. At this time, the initial data set was constructed such that each aircraft type contains 1st Class seats for 8% of the total seating. This number was taken from the available information regarding the B-757 and is considered to approximate the split between each coach and First class seats for all commercial air transport.

The approach taken in the aircraft seats algorithm to generate the impact of additional weight on the aircraft fuel consumption is only one

of many approaches. The algorithm is structured so that additional approaches could be incorporated at a later time, if desired. This approach was selected because of its simplicity and because of the supporting data available from the United Airlines' publication, "The Engineering Connection", April 28, 1980. In this approach an estimate is used for the number of gallons additional fuel required to fly one additional pound of weight on one aircraft for one year. The estimate should represent, as much as possible, the varying route structures across the U.S. It is assumed that there will be no significant change in aircraft utilization over the years, as there is currently no mechanism in the algorithm to allow for variations in route structures from one year to the next.

The initial data set includes estimates for the weight to fuel sensitivity, as described above, referenced by United Airlines for the following aircraft: B-747, B-737, B-727, DC8-61, and DC-10. The estimates used for the other aircraft types in the file were approximated using the United estimates as a reference. The data generated for the initial data set is provided in Table 8.

The display format for the aircraft characterization data file (ACCHAR) is also provided.

TABLE B : INITIAL DATA SET FOR AIRCRAFT CHARACTERIZATION FILE

	AVG. NO. SEATS	% 1ST CLASS	ESTIMATED WEIGHT TO FUEL SENSITIVITY 1
2-ENGINE:			
B-737	109	8.	9.02 ²
DC-9	128	8.	19.00
A300	200	8.	15.00
B-757	174	8.	13.00
B-767	200	8.	14.00
3-ENGINE:			
B-727	120	8.	17.54 ²
L1011	325	8.	17.50 ²
DC10	310	8.	15.37 ²
4-ENGINE:			
B-707	140	27.	10.00
B-720	131	27.	10.00
B-747	455	8.	17.75 ²
DC-3	175	8.	20.15 ²

- 1 Additional gallons fuel consumed to carry 1 lb. of excess weight on the airplane for one year.
- 2 No. of gallons based on estimates provided by United Airlines. "The Fuelweight Connection", March 22, 1977. Estimates are based on route structure, but are considered representative and the best estimates currently available.

DISPLAY FORMAT

PROGRAM AIRCRAFT CHARACTERIZATION FILE (ACCHAR) DATE AUGUST 1981

PROGRAMMER WCAO, WCAO (215) PAGE 1 OF 1

STATEMENT LABEL FORTRAN STATEMENT

STATEMENT LABEL	AIRCRAFT NO. SEATS	% 1ST CLASS	WT. TO FUEL SENSITIVITY	STATEMENT NUMBER
2-ENGINE:				
B737	109	8.	9.02	
DC9	128	8.	19.00	
A300	200	8.	15.00	
B757	174	8.	13.00	
B767	200	8.	14.00	
3-ENGINE:				
B727	120	8.	17.54	
L1011	325	8.	17.50	
DC10	310	8.	15.37	
TOTAL				
4-ENGINE:				
B707	140	27.	10.00	
B720	131	27.	10.00	
B747	455	8.	17.75	
DC3	175	8.	20.15	
TOTAL				



San Francisco CA Branch (408) 537 2777
 Palo Alto CA Branch (415) 767 3621
 Berkeley CA Branch (415) 865 2342
 San Diego CA Branch (619) 594 7272

PRODUCT NO. 5905

Form

FUEL COST PROJECTION FILE (FUEL)

The cost of jet aircraft fuel is expected to increase over the time horizon under consideration for the development of the aircraft seats algorithm. The algorithm has been designed to allow the user to specify annual fuel costs based on projections available at the time. An initial data set for the fuel cost projection file has been defined by ECON that reflects an annual increase over 1981 actual fuel costs of 5% per year, as shown below:

<u>YEAR</u>	<u>FUEL COST (\$1 GAL.)</u>
1981	\$1.00
1982	1.05
1983	1.10
1984	1.16
1985	1.22
1986	1.28
1987	1.34
1988	1.41
1989	1.48
1990	1.55
1991	1.63
1992	1.71

The display format for the fuel cost projection data file (FUEL) is also provided.

DISPLAY FORMAT

PROGRAM	FUEL COST PROJECTION (FUEL)												DATE	
PROGRAMMER													PAGE 1	OF 1
STATEMENT NAME	FORTRAN STATEMENT												STATEMENT NUMBER	
FUEL COST PROJECTION (FUEL)														

	81	82	83	84	85	86	87	88	89	90	91	92	(Allow for '93)*	
	1.00	1.05	1.10	1.16	1.22	1.28	1.34	1.41	1.48	1.55	1.63	1.71		
* NOTE: CHECK TO DETERMINE LAST YEAR FOR WHICH DATA HAS BEEN ENTERED. DO NOT PRINT YEAR WITHOUT DATA.														

III. LOGICAL PROGRAM FLOW

This section of ECON's documentation of the methodology for an aircraft seats algorithm to assess manufacturing and operating costs contains a detailed logical flow of the program. This flow indicates the sequence of the necessary calculations, the series of questions that should be posed to the program user, and the nature of the user response. It specifies when the contents of particular data file are required for a calculation. It also indicates the kinds of summary reports that can be generated. Each summary report is sequentially numbered in the logical program flow, and a sample report format is provided in the pages following the logical flow.

The detailed program flow documents the sequence of calculations and steps of program execution as seen by the user of the program. It does not dictate the internal structure of data organization and program design. However, the methodology was developed with the understanding that there were no data base management systems available for use and, therefore, any manipulation of the data would need to occur within the structure of the program itself. Accordingly, the methodology reflects an attempt to keep additions and changes to the data as simple for the user as possible, while still providing a capability to upgrade the data as required.

Each step in the program execution as outlined in the following pages is numbered for documentation purposes only, to clarify the sequence and allow references to previous steps or indicate a 'skip' to a future step.

PROGRAM FLOW BY STEP

STEP	PURPOSE	MESSAGE	CALCULATION	STOP	DISPLAY
1		ENTER PROGRAM			
2	REVIEW EXISTING FILE?	IF NO, SKIP TO (1) IF YES, CONTINUE			
4	SPECIFY FILE NAME	MATERIAL MATERIALS CONCRETE SEAT CONCRETE REINFORC. REINFORC. CONCRETE PILE# - SEE PILE# PAGE PILE# - NEW BUT BELIE REINFORC. PILE ENHANCER PILE# - PILE # PAGE			USE INPUT COMMANDS FOR EACH FILE
5	ANOTHER FILE?	IF NO, SKIP TO (5) IF YES, BACK TO (2)			
6	CONTINUE?	IF NO, QUIT IF YES, CONTINUE			READ SEAT DIMENSIONS FILE
12	SPECIFY SEAT DIMENSIONS - SHOWN ON MAP	IF STOPPED, SKIP TO (13) IF NEW, CONTINUE			
13	(CALCULATED) FOR (BACK SET DATA)	LENGTH x WIDTH x THICK (IN INCHES)			

PROGRAM FLOW BY STEP

STEP	PURPOSE	MESSAGE	CALCULATION	STOP	DISPLAY
16	START NEW DIMENSIONS?	IF YES, OPERATION END IF NO, CONTINUE			
18	DISPLAY SEAT DIMENSIONS	IF NO, SKIP TO (20) IF YES, CONTINUE	AREA = LENGTH * WIDTH * THICK = SEE LET POINT, SET DATA, BY BACK/BOTTOM		RESULTS OF (16)
21	REVIEW SEAT CONFIGURATION - LENGTH AND AREA	IF STOPPED, SKIP TO (17) IF NEW, CONTINUE			REPORT NO. 1 SEAT DIMENSIONS
22	REVIEW SEAT CONFIGURATION - LENGTH AND AREA	IF STOPPED, SKIP TO (17) IF NEW, CONTINUE			
23	MATERIAL DATA FROM THE FOLLOWING	NAME CONCRETE NO. 2 REINFORCING SUMMIT CONCRETE PILE# - ACTUAL PILE# PILE# PILE#			

PROGRAM FLOW BY STEP

STEP	PURPOSE	MESSAGE	CALCULATION	STOP	DISPLAY
26		ENTER APPROPRIATE DATA			
28	ANOTHER MATERIAL (YES, NO)?	IF YES, BACK TO (27) IF NO, CONTINUE			AND TO MATERIAL FILE
32	DEFINE NEW SEAT CONCRETE LAYER BY LAYER BY LAYER BY LAYER BY	ENTER MATERIAL CODE AT LAYER PROMPT			
34	ENTER SEAT DIMENSION OR MEASUREMENT FOR NEW CONCRETE - BOTTOM	IF YES, SKIP TO STEP NO. (26)			AND TO CONCRETE FILE
36	SPECIFY EXISTING CONCRETE, NO?	ENTER NO. 22			AND TO MATERIAL FILE
42	REVIEW (YES, NO)?	IF NO, SKIP TO (12) IF YES, CONTINUE			REPORT NO. 2 - SEAT CONFIGURATION DATA

PROGRAM FLOW BY STEP

STEP	PURPOSE	MESSAGE	CALCULATION	STOP	DISPLAY
44		COMPUTE WEIGHT BY LAYER A = CONCRETE * AREA B = REINFORCE * AREA C = REINFORCE * AREA D = CONCRETE * AREA E = CONCRETE * AREA F = CONCRETE * AREA G = CONCRETE * AREA H = CONCRETE * AREA			RESULTS OF (26) AND (28)
46		SUM WEIGHTS TOTAL = A + B + C + D + E + F + G + H			RESULTS OF (26)
48		WEIGHT DIFFERENCE NEW - PRESENT BY BACK BOTTOM, BY CONCRETE CLASS			RESULTS OF (26)
52		REPORT NO. 2 - SEAT CONFIGURATION DATA			RESULTS OF (26)
54	REVIEW AND EDIT COST DESIGN	(CONCRETE CLASS) 1-1-1 1-1-1 1-1-1 1-1-1 1-1-1			RESULTS OF (26) AND (28)

PROGRAM FLOW BY STEP

STEP	PURPOSE	MESSAGE	CALCULATION	STOP	DISPLAY
56		IF COST DATA IS AVAILABLE FOR EACH MAT'L IN CONCRETE STEP IS (26). IF DATA IS NOT AVAILABLE FOR 1 OR MORE MAT'L'S, CONTINUE			
58	COST DATA FOR OPTION SELECTED IS NOT AVAILABLE FOR ALL MATERIALS IN CONCRETE ENTER "Y" TO VIEW TO MAT'L'S NEW COST OPTION ENTER "N" TO ENTER COST DATA	IF "Y", RETURN TO (26) IF "N", CONTINUE			
60	SPECIFY SEAT DATA FOR OPTION SELECTED SEE HOW MANY MAT'L'S IN CONCRETE. RECORDS COST DATA TO SEAT DATA REPORT (12) AND (13)	AND DATA ENTERED TO (12) TO MATERIAL FILE			RESULTS OF (26)
62		COMPUTE MAT'L COST PER LAYER LAYER WT x LAYER COST (BY BOTTOM/BACK, BY CONCRETE CLASS)			
64		SUM MAT'L COSTS PER LAYER BASED TOTAL = SUM OF COSTS (BY BOTTOM/BACK, BY CONCRETE CLASS)			

PROGRAM FLOW BY STEP

STEP	PURPOSE	MESSAGE	CALCULATION	STOP	DISPLAY
66		REPORT NO. 2 - SEAT CONFIGURATION DATA			RESULTS OF (26)
68		REPORT NO. 2 - SEAT CONFIGURATION DATA			RESULTS OF (26)
70		REPORT NO. 2 - SEAT CONFIGURATION DATA			RESULTS OF (26)
72		REPORT NO. 2 - SEAT CONFIGURATION DATA			RESULTS OF (26)
74		REPORT NO. 2 - SEAT CONFIGURATION DATA			RESULTS OF (26)
76		REPORT NO. 2 - SEAT CONFIGURATION DATA			RESULTS OF (26)
78		REPORT NO. 2 - SEAT CONFIGURATION DATA			RESULTS OF (26)
80		REPORT NO. 2 - SEAT CONFIGURATION DATA			RESULTS OF (26)
82		REPORT NO. 2 - SEAT CONFIGURATION DATA			RESULTS OF (26)
84		REPORT NO. 2 - SEAT CONFIGURATION DATA			RESULTS OF (26)
86		REPORT NO. 2 - SEAT CONFIGURATION DATA			RESULTS OF (26)

PROGRAM 1100 BY STEP

STEP	PROMPT	RESPONSE	CALCULATION	STORE	DISPLAY
75	[(cont)]		[(LAWRENCE) DEVELOPMENT] & OVERHEAD 1) & 2) PUMP	RESULTS OF (75)	
76					
77			W.C. COST DIFFERENCE: NEW TOTAL - NET TOTAL	RESULTS OF (77)	
78					
79					
80	RETURN 0 = COMPUTATION ERROR AND STORING FACTORS ON INPUT				
81					
82	ENTER COST FACTORS RELATIVE TO REFERENCE COMPLETION (LAWRENCE) OR FABRICATION? (MINIMUM) ASSUMED? (MINIMUM) DEVELOPMENT COSTS? (MINIMUM) MATERIALS (MINIMUM) MAINTENANCE (MINIMUM) OPERATING COSTS? (MINIMUM) FUELING? (MINIMUM) OTHER? (MINIMUM)				
83			ENTER FACTOR FOR EACH ALL NUMBER ELEMENTS IN ALL SUB-ELEMENTS		
84					

PROGRAM 1101 BY STEP

STEP	PROMPT	RESPONSE	CALCULATION	STORE	DISPLAY
85			FOR EACH ELEMENT IN ELEMENTS NEW W.C. COSTS DIFFERENCE 55 & FACTOR		
86			INITIAL W.C. COSTS SUM 55 IN ELEMENTS	RESULTS OF (85)	
87					
88			W.C. DIFFERENCE NEW TOTAL - NET TOTAL	RESULTS OF (88)	
89					
90					
91	RETURN FLEET PERFORMANCE CHARACTERISTICS FOR COMPLETION (YES, NO)				REPORT NO 5 - W.C. COST PER EXPAN.
92					
93					
94	ENTER NEW FLEET PERFORMANCE CHARACTERISTICS FOR COMPLETION (YES, NO)				DISPLAY LAST PORTION OF COMPLETION FILE
95					
96					
97	ENTER FLEET PERFORMANCE CHARACTERISTICS FOR COMPLETION (YES, NO)				
98					
99					
100					
101					
102					
103					
104					
105					
106					
107					
108					
109					
110					

PROGRAM 1102 BY STEP

STEP	PROMPT	RESPONSE	CALCULATION	STORE	DISPLAY
111	[(cont)] DATE? (MIN, MAX) DATE? (MIN, MAX) DATE? (MIN, MAX)				
112					
113					
114					
115					
116					
117					
118					
119					
120					
121					
122					
123					
124					
125					
126					
127					
128					
129					
130					

AIRCRAFT OPERATIONS ANALYSIS

STEP NO.	PROMPT	RESPONSE	CALCULATION	STORE	DISPLAY
101	SPECIFY DURING USE OF NEW SEAT CONFIG.				
102					
103	SPECIFY FLEET HORIZON FOR OPS ANALYSIS				
104					
105					
106	SPECIFY FLEET PRODUCTION SCENARIO 1-6 OR OTHER				
107					
108					
109					
110					
111					
112					
113					
114					
115					
116					
117					
118					
119					
120					
121					
122					
123					
124					
125					
126					
127					
128					
129					
130					

AIRCRAFT OPERATIONS ANALYSIS

STEP NO.	PROMPT	RESPONSE	CALCULATION	STORE	DISPLAY
131	ENTER NEW FLEET PRODUCTION BY A/C TYPE: A/C TYPE 1: 1000? 2000? A/C TYPE 2: (ETC.)				
132					
133					
134	ENTER 'NEW' AIRCRAFT DELIVERY SCHEDULE: A/C TYPE 1: 1000? (ETC.)				
135					
136					
137					
138					
139					
140					
141					
142					
143					
144					
145					
146					
147					
148					
149					
150					

AIRCRAFT OPERATIONS ANALYSIS

STEP NO.	PROMPT	RESPONSE	CALCULATION	STORE	DISPLAY
110					
120					
130					
140					
150					
160					
170					
180					
190					
200					
210					
220					
230					
240					
250					
260					
270					
280					
290					
300					

AIRCRAFT OPERATIONS ANALYSIS

STEP NO.	PROMPT	RESPONSE	CALCULATION	STORE	DISPLAY
128					
129			TOTAL # A/C IN EXISTING FLT. = # FLT + NEW A/C (BY YR. BY A/C TYPE)	RESULTS OF (127)	
130				RESULTS OF (129)	
131			NO. SEATS IN EXISTING FLT. IMPLACED = # EXISTING A/C * SEAT LIFE (BY YR. BY A/C TYPE - BY BACKS & NOTIONS)	RESULTS OF (131)	
132			NO. REPLACED SEATS 1ST CLASS = # SEATS IMPLACED # 1ST CLASS	RESULTS OF (132)	
133			NO. REPL. SEATS COMB. + TOTAL REPL. # 1ST CLASS	RESULTS OF (133)	
134				RESULTS OF (134)	
135				RESULTS OF (135)	
136				RESULTS OF (136)	

AIRCRAFT OPERATIONS ANALYSIS

STEP NO.	PROMPT	RESPONSE	CALCULATION	STORE	DISPLAY
137			TOTAL REPAIR SEATS = NEW 1ST CLASS, COMB. (BY YEAR) (COMB) REPAIR 1ST CLASS, COMB. (BY YEAR) (COMB)	RESULTS OF (137)	
138					
139	DISPLAY (YES, NO)?				
140		IF NO, SKIP TO (142) IF YES, CONTINUE			
141					SEAT DEMAND REPORT # 6
142			RAW FUEL COSTS = RAW FUEL # PER SEAT # # SEATS (BY YEAR, BY COMPOSITE CLASS, BY BACK/NOTIONS)	RESULTS OF (142)	
143					
144			WFO COSTS = FUG # PER SEAT # # SEATS (BY YEAR, BY COMPOSITE CLASS, BY BACK/NOTIONS)		

AIRCRAFT OPERATIONS ANALYSIS

STEP NO.	PROMPT	RESPONSE	CALCULATION	STORE	DISPLAY
145				RESULTS OF (145)	
146	DISPLAY (YES, NO)?				
147		IF NO, SKIP TO (149) IF YES, CONTINUE			
148					RAW FUEL # PER SEAT # # SEATS (BY YEAR, BY COMPOSITE CLASS, BY BACK/NOTIONS)
149			WT. FUELING PER YEAR = WT. PER SEAT # # SEATS FUELING (BY YEAR, BY COMPOSITE CLASS BY A/C TYPE)	RESULTS OF (149)	
150					
151	SPECIFY FUEL TO WHICH SENSITIVITY STORED OR NEW?				
152		IF STORED, SKIP TO (154) IF NEW, CONTINUE			
153	SPECIFY NEW FUEL TO WHICH SENSITIVITY FOR EACH A/C TYPE: TYPE #1 ETC.				
154		FROM # ADDITIONAL LB. ON 1 GAL FOR # LB. # GALS. OF ADDITIONAL FUEL IS CONSUMED			

AIRCRAFT OPERATIONS ANALYSIS

STEP NO.	PROMPT	RESPONSE	CALCULATION	STORE	DISPLAY
155	STORE NEW SENSITIVITY (YES, NO)?				
156		IF NO, SKIP TO (159) IF YES, CONTINUE			
157					STORE NEW SENSITIVITY - DO NOT ACCUMULATE DEFICITS IN A/C CHARACTERISTICS FILE
158			GALS FUEL PER YEAR = WT # # GALS PER 1 LB. ADDITIONAL WEIGHT (BY YEAR, BY A/C TYPE)	RESULTS OF (158)	
159			GALS. BY A/C TYPE (BY YEAR)		
160					
161					
162	SPECIFY FUEL LOST PER YEAR STORED OR NEW?				

AIRCRAFT OPERATIONS ANALYSIS

STEP NO.	PROMPT	RESPONSE	CALCULATION	STORE	DISPLAY
163		IF STORED, SKIP TO (171) IF NEW, CONTINUE			
164	SPECIFY FUEL COST PER YEAR (\$/GAL), (\$/WT) ETC.				
165		\$/GAL. FOR EACH YEAR			
166	STORE (YES, NO)?				
167		NO. SKIP TO 171 IF YES, CONTINUE			
168				STORE NEW FUEL COSTS - DO NOT OVERWRITE DATA IN FUEL COST PROG. FILE	
169					
170					CALC FUEL COST PROG. FILE
171			FUEL COST PER YEAR = GALS. TIME = FUEL # (BY YEAR, BY A/C TYPE)		

AIRCRAFT OPERATIONS ANALYSIS

STEP NO.	PROMPT	RESPONSE	CALCULATION	STORE	DISPLAY
169		YES = RETURN TO (171) NO = CONTINUE			
170	RETURN TO BEGINNING OF PROGRAM?				
171		YES = RETURN TO (171) NO = CONTINUE			

FORTRAN CODING FORM

PROGRAM REPORT NO. 1 - SEAT CUSHION DIMENSIONS DATE AUGUST 1961
PROGRAMMER SCOU - ING. (ALL) PAGE 1 OF 1

STATEMENT LABEL	FORTRAN STATEMENT				STATEMENT SEQUENCE
	REPORT NO. 1 - SEAT CUSHION DIMENSIONS				

	SEAT CUSHION				
	BACK (SR IN	BOTTOM (SR IN	
	VOLUME	CU IN	VOLUME	CU IN	
	1ST CLASS SEAT				
	BACK (SR IN	BOTTOM (SR IN	
	VOLUME	CU IN	VOLUME	CU IN	

FORTRAN CODING FORM

PROGRAM REPORT NO. 2 - SEAT CONFIGURATION DATA DATE AUGUST 1961
PROGRAMMER SCOU, ING. (ALL) PAGE 1 OF 1

STATEMENT LABEL	FORTRAN STATEMENT				STATEMENT SEQUENCE
	(SAME FORMAT AS SEAT CUSHION CONFIGURATION FILE)				

FORTRAN CODING FORM

PROGRAM REPORT NO. 3 - SEAT CUSHION WEIGHT DATE AUGUST 1961
 PROGRAMMER ECOM, INC. (MIL) PAGE 1 OF 1

STATEMENT NO.	STATEMENT	STATEMENT NO.
1	REPORT NO. 3 - SEAT CUSHION WEIGHT	
2	CUSHION CONFIGURATION W:	
	BACK ACOST BOATAN TOTAL	
	COST ACOST COST ACOST COST ACOST	
3	CORCH:	
4	1ST CLASS:	
	* DELTA WEIGHT IS CALCULATED WITH RESPECT TO REFERENCE SEAT CUSHION CONFIGURATION.	



Supplies Division, 44-111111
 Naval Air Station, 33000
 Norfolk, VA 23504

PRODUCT NO. 5705

182

FORTRAN CODING FORM

PROGRAM REPORT NO. 4 - SEAT CUSHION RAW MATERIAL COST DATE AUGUST 1961
 PROGRAMMER ECOM, INC. (MIL) PAGE 1 OF 1

STATEMENT NO.	STATEMENT	STATEMENT NO.
1	REPORT NO. 4 - SEAT CUSHION RAW MATERIAL COST	
2	CUSHION CONFIGURATION WXXX:	
	RAW MATERIAL COST BASED ON OPTION 1 ESTIMATES:	
	BACK BOATAN TOTAL	
	COST ACOST COST ACOST COST ACOST	
3	CORCH:	
4	1ST CLASS:	
	* DELTA COST IS CALCULATED WITH RESPECT TO REFERENCE SEAT CUSHION CONFIGURATION COST.	



Supplies Division, 44-111111
 Naval Air Station, 33000
 Norfolk, VA 23504

PRODUCT NO. 5705

182

FORTRAN CODING FORM

PROGRAM REPORT NO. 5 - SEAT CUSHION MANUFACTURING COST DATE APRIL 1961
 PROGRAMMER ROHN, MS. (HL) PAGE 1 OF 1

STATEMENT LABEL: 1 FORTRAN STATEMENT STATEMENT NUMBER

REPORT NO. 5 - SEAT CUSHION MANUFACTURING COST
CUSHION CONTRIBUTION #
MATERIAL A HAS BEEN SELECTED TO REPRESENT COSTS

	<u>CANES</u>	<u>REPAIR</u>	<u>REPAIR</u>
<u>LABOR</u>	<u>XXXXXX</u>	<u>XXXXXX</u>	<u>XXXXXX</u>
<u>DEVELOPMENT</u>	<u>XXXXXX</u>	<u>XXXXXX</u>	<u>XXXXXX</u>
<u>OVERHEAD</u>	<u>XXXXXX</u>	<u>XXXXXX</u>	<u>XXXXXX</u>
<u>OTHER</u>	<u>XXXXXX</u>	<u>XXXXXX</u>	<u>XXXXXX</u>
<u>TOTAL</u>	<u>XXXXXX</u>	<u>XXXXXX</u>	<u>XXXXXX</u>

OTHER COST TO MANUFACTURE ASSIGNED NAME FOR CONCH AND EXT.
GLASS, AND TUBES AND ROCK CUSHIONS.



San Jose CA Branch 408-751-7777
 Hayward CA Branch 415-763-5001
 Los Angeles CA Branch 213-747-5001

PRODUCT NO. 5905

FORTRAN CODING FORM

PROGRAM REPORT NO. 6 - SEAT DYNAMO DATE APRIL 1961
 PROGRAMMER ROHN, MS. (HL) PAGE 1 OF 1

STATEMENT LABEL: 1 FORTRAN STATEMENT STATEMENT NUMBER

	<u>CONCH</u>	<u>1ST GLASS</u>
<u>LABOR</u>	<u>XXXXXX</u>	<u>XXXXXX</u>
<u>DEVELOPMENT</u>	<u>XXXXXX</u>	<u>XXXXXX</u>
<u>OVERHEAD</u>	<u>XXXXXX</u>	<u>XXXXXX</u>
<u>OTHER</u>	<u>XXXXXX</u>	<u>XXXXXX</u>
<u>TOTAL</u>	<u>XXXXXX</u>	<u>XXXXXX</u>



San Jose CA Branch 408-751-7777
 Hayward CA Branch 415-763-5001
 Los Angeles CA Branch 213-747-5001

PRODUCT NO. 5905

APPENDIX G -1**Fire Protection Studies of Aircraft Seats**

Final Report NASA Cooperative Agreement NCC 2-56,
Dr. A.C. Ling, San Jose State University.

Editor's Note: Sections of this Appendix have been deleted for the sake of brevity. A complete copy of the original manuscript may be obtained upon request.

FIRE PROTECTION STUDIES OF AIRCRAFT SEATS

I. MASS INJECTION STUDIES INTO THE ENVIRONMENT CAUSED BY THERMAL DEGRADATION OF URETHANE FOAM AND OTHER CONSTRUCTIONAL MATERIALS IN AIRCRAFT SEATS.

Investigators: Demetrius Kourtides, Alan Campbell Ling,
Wai Lee, Tom Atchison, Donna Davidson, & Sharyn Jupp

1. INTRODUCTION

The purpose of the project is to develop a superior fire resistant aircraft seat involving a compromise between absolute fire protection producing a seat that is too heavy with respect to payload considerations, and too costly from a materials viewpoint, and a light weight inexpensive seat that offers no fire resistance at all.

The initial method of investigation involves the examination and development of a heat blocking layer for the protection of the urethane foam, the primary cushioning material. One criterion for the acceptability of a superior heat blocking layer is that it must provide both a greater cost benefit and better heat blocking performance than the current 3/16" layer of Vonar® presently used in domestic aircraft.

It is postulated that one of the largest contributors in the development of a hostile environment inside an aircraft cabin during a fire is the production of flammable and toxic vapors from soft fabrics and furnishings, the majority of which form the seating facilities in an aircraft. In particular, the flammable vapors derived from thermal decomposition of the urethane foam cushions. Thus a primary objective of this phase of the investigation was to determine quantitatively the effects of a fire on such foam materials, and to develop methods that will reduce production of such flammable vapors.

This initial investigation has therefore concentrated on determining the apparent weight loss sustained by the central cushioning material (fire-retarded fire-resistant urethane foam, and non-fire protected foam), together with determining weight loss factors sustained by the other components that comprise a typical seat cushion, both as a function of time, and as a function of the thermal flux incident on the front face of the seat cushion.

Parallel investigations involving theoretical and semi-empirical modelling of the heat conduction and thermal radiation properties of various materials, has led to the development of a simple model based on six identifiable layers in a typical seat cushion. This model cushion (see Figure 1) consists of the following six layers:

1. The Wool-Nylon fabric layer (outer decorative cover).
2. The reradiative char layer (formed from the heat blocking layer by thermal degradation of suitable fabric or foam).
3. The transpirational layer (allowing vapor interchange).
4. The air gap layer.
5. The reflective layer (to assist in controlling radiant energy).
6. The cushioning foam (solely present for comfort factors, and the primary agent that requires thermal protection).

Table 1 lists the materials that have been chosen via a conflicting set of criteria (cost, comfort, availability, thermal safety, constructional viability, toxicity factors, weight/density factors, and aesthetics) for the construction of current and future aircraft seat cushions.

As a preliminary study, small scale tests of the heat blocking efficiency of candidate cushions were conducted using the NBS Smoke Density Chamber. The NBS Smoke Density Chamber has been modified to measure weight loss as well as smoke density, as a function of time, at a specific heat flux (range of 1.0 W.cm^{-2} to more than 7.5 W.cm^{-2}).

FIGURE 1 THERMAL PROTECTION MODEL FOR FIRE BLOCKED SEAT

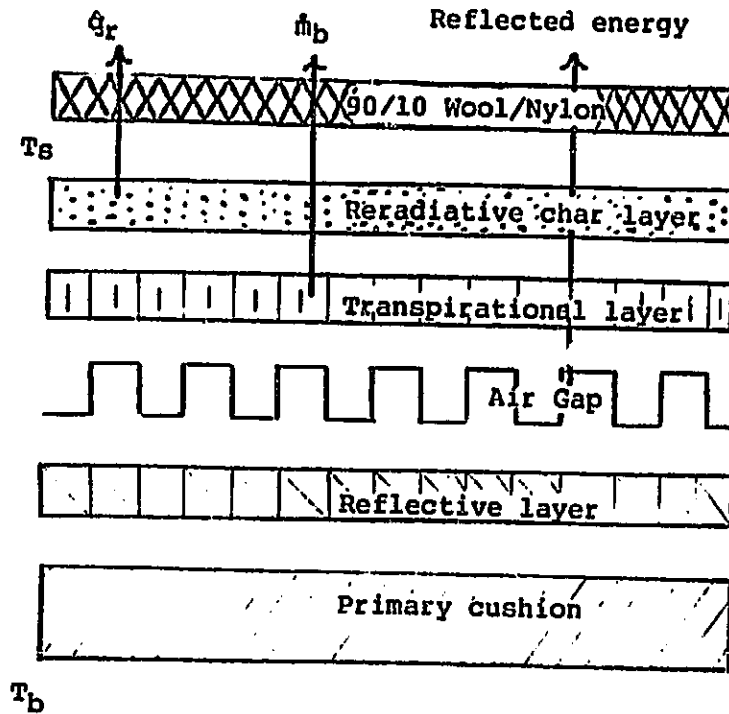

T_s = Surface temperature
 T_b = Backface temperature

MODEL CONFIGURATION FOR OPTIMUM SEAT CUSHION

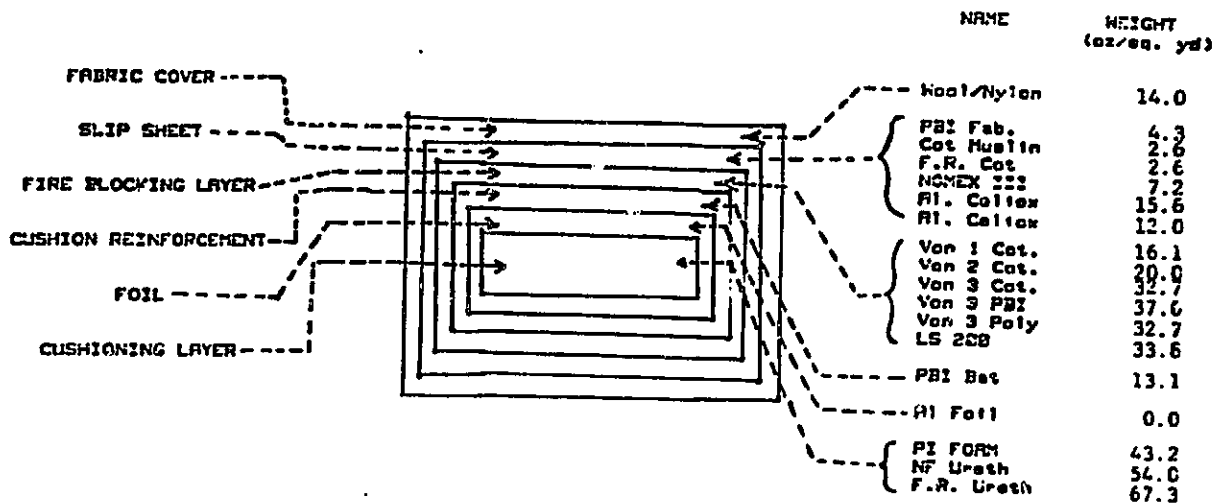

TABLE 1. LIST OF MATERIALS, AND THE PHYSICAL CONSTANTS OF THE MATERIALS, CHOSEN FOR CONSTRUCTIONAL COMPONENTS IN CONTEMPORARY AND NEXT GENERATION AIRCRAFT SEATS.

NAME	MATERIAL DESCRIPTION PHYSICAL CONSTANTS	TRADE NAME	SUPPLIER
Vonar 1 Cotton (Vonar 1)	1/16 inch Neoprene Foam with Cotton Scrim interliner 0.11 lb/ft ²	Vonar 1® Cotton In- terliner	DuPont De Nemours
Vonar 2 Cotton (Vonar 2)	2/16 inch Neoprene Foam with Cotton Scrim interliner 0.18 lb/ft ²	Vonar 2® Cotton In- terliner	DuPont De Nemours
Vonar 3 Cotton (Vonar 3)	3/16 inch Neoprene Foam with Cotton Scrim interliner	Vonar 3® Cotton In- terliner	DuPont De Nemours
Non-Fire-Retarded Urethane Foam (NF Urethane)	Polyurethane Foam 1.1 lb/ft ³	#BT 150 Urethane Foam	Scott Paper
Wool-Nylon Fabric (W-N Fabric)	90% Wool/10% Nylon Fabric 0.097 lb/ft ²	R76423 Sun Eclipse	Collins & Aikman Corp.
Polyimide Foam (PI Foam)	Polyimide Foam 1.2 lb/ft ³	Polyimide Foam	Solar Turbines International
Fire-Retarded Urethane Foam (FR Urethane)	Polyurethane Foam 1.87 lb/ft ³	#2043 Urethane Foam	E. R. Carpenter & Co., Inc.
Aluminized Celiox (Al Celiox)	Heat Stabilized Polyacrylonitrile 0.079 lb/ft ²	Preox® 1100-4	Gentex Corp.
Aluminized Norfab (Al Norfab)	70% Kevlar® 25% Nomex® 5% Kynol® 0.079 lb/ft ²	Norfab 11HT-26-AL Aluminized	Gentex Corp.
Glass	SiO ₂ 0.061 lb/ft ²	181 E-Glass Fabric Satin Weave	Gilwee (NASA)

2. THE SMOKE DENSITY CHAMBER

The NBS Smoke Density Chamber is an approximately 3' x 3' x 2' (18 ft³, ca. 500L) enclosed test chamber, connected to a manometer and an exhaust system to purge smoke from the chamber. If kept open, the exhaust vent can be used to provide continuous purging of the chamber while in use. In case of sudden pressure increases in excess of six inches of water, the chamber is equipped with an aluminum blow-out panel pressure relief outlet. A chromel-alumel wire electrical furnace is used as a heat source. The furnace is calibrated at least once every two week to ensure that the correct heating rate is applied. To minimize the effect of smoke stratification a vertical photometric system with a collimated light beam is used to measure smoke density. The amount of smoke production is recorded via a Photomultiplier-Microphotometer which registers the relative intensity of light transmittance. The NBS Smoke Density Chamber has presently been modified via the installation of a balance (Arbor Model #1206, reading to 0.01 g). This modification allows measurement of the rate of mass loss as a function of time at any one heating rate.

3. CONSTRUCTION OF TEST SAMPLES

The test samples are approximately 3" x 3" by approximately 0.5 to 1.0" in thickness; they are constructed by wrapping the heat blocking layer around approximately 0.5" of the urethane foam to resemble a miniature seat cushion (Figure 2). Each component of the miniature cushion is first weighed, then neatly sewn together using needle and thread. The cushion is then suspended from the balance and placed directly in front of the heater.

4. TEST PROCEDURE

After the electrical furnace has been brought to the desired heat flux, the balance is checked by weighing a small weight (usually, a small piece of urethane foam approximately 0.05 grams in mass). The sample is then suspended from the balance via thread and a wire frame (Figure 3). To prevent the sample from being exposed to the heat source while mounting the sample in preparation for the test, the sample is mounted behind an asbestos heat shield. After the sample has been mounted, the balance is checked again to ensure that the sample is hanging freely, and that the suspension cord is not binding. To start the test, the heat shield is removed, and the lister connected to the balance output initiated. The weight of the sample during the test is measured by the balance and recorded via a Hewlett Packard 5150A Thermal Printer; readings are taken every two seconds. After the test, the sample cushion is cut apart and the remaining urethane foam weighed to determine the weight loss of the foam center itself.

As an additional check, the weight of the sample cushion is determined before and after the test on a second static balance to determine the weight loss.

5. CHAMBER OPERATION AND CALIBRATION

5.1 HEATER CALIBRATION

The heater is calibrated at least once every two weeks using a water cooled calorimeter connected to a millivoltmeter. The heating rate is calculated from the millivolt output using a calibration curve supplied by the manufacturer. The calibration is done by increasing the applied voltage five volts every five minutes (starting at 25 volts) until a heat flux of 7.5 watts per square centimeter is achieved. A plot of applied voltage versus heat flux then provides the operating calibration curve for the furnace.

5.2 TEST FOR CHAMBER LEAKAGE

Before the chamber is warmed each day, the chamber is tested for any leakage. This is done to prevent exposure by personnel to toxic effluents that may be produced during a test. The chamber is pressurized to four inches of water and the pressure drop is timed. The chamber should be sealed sufficiently to provide a decrease in pressure from 4" to 3" (of water) in no less than three minutes.

5.3 WARM-UP PROCEDURES

The electrical furnace is brought to the desired heat flux slowly to maximize the life of the furnace. Starting at 25 volts, the voltage is increased no faster than five volts every five minutes. To prevent the opposite chamber wall from overheating, an asbestos heat shield should be placed in front of the furnace. The asbestos heat shield should be no closer than 1.5 inches from the furnace opening.

6. DISCUSSION

A major danger in an aircraft fire is what is termed "flash-over", where flammable vapors trapped high up towards the ceiling of the cabin will suddenly ignite, and propagate the fire across the whole interior of the aircraft like a wave. A suspected major source of flammable vapors leading to this condition is the decomposition of urethane foam. By measuring the rate that combustible vapors are injected into the environment from the urethane, one may be able to approximate the time required to reach flash-over point. If this time can be extended long enough, by making a more fire resistant seat and/or a seat that does not release large quantities of flammable vapor, then it might be possible to evacuate the aircraft cabin of personnel prior to the flash-over time.

Our test results will be used to calculate the time required to reach such a condition of flash-over, assuming for simplicity that the following assumptions may be taken:

1. The amount of combustible material ejected into the air comes from the decomposition of the urethane foam.
2. The mass lost by the urethane foam is equal to the amount of decomposed vapor ejected into the air

The first assumption is an idealization. It is acceptable only if the major portion of combustible vapors in the air comes from the seat cushions. The second condition is more in the nature of a limitation, since our experimental procedure does not presently allow us to determine the exact amount of combustible material injected into the air from the urethane foam.

6.1 NOTES & COMMENTS:

It is obvious from prima facie considerations that not all vapor from the decomposition of the urethane foam is ejected into the air. Some of the vapor must be trapped by the heat blocking layer. Firstly, there are small but finite amounts of material adsorbed onto the fibres and surfaces of the heat blocking material(s). Experimentally, using the technique outlined above, this seems to be a very small effect, and can be neglected. Secondly, at low heating rates, the urethane foam melts rather than vaporizing. This "liquid" urethane foam will then seep into the heat blocking material and be retained, either as an adsorbed liquid, or after solidification, within the heat blocking layer. Thirdly, for those cases where the heating rate is very high, the urethane foam may decompose so rapidly that an endothermic cooling effect will be noted, enough to cool its surroundings sufficiently to allow vapors to condense inside the heat blocking layer. This effect exhibits itself directly by a mass gain for the heat blocking layer.

The endothermic decomposition (in situ pyrolysis of urethane vapors) induced cooling effect from the urethane foam tends to improve the thermal protection efficiency of the heat blocker, and of the seat cushion as a whole. A cyclic protection process is induced, whereby the foam itself protects the heat-blocking layer, which in turn provides better thermal protection for the foam cushion. Because decomposition of the urethane foam cools the sample, less mass is lost when urethane foam is present. In point of fact, it was found advantageous to use non-fire resistant foam with many heat blocking layers, since the overall effect was quantitatively better than when using fire-resistant foam with the same heat blocking layer. Further, by punching holes in the back of the sample cushions to vent the cooling vapors back into the foam, we can decrease the rate of mass loss by the urethane foam even further, allowing transpiration effects to assist in the overall fire protection mechanism.

It should be noted carefully, that individual fire resistance by the components themselves do not necessarily confer good overall fire resistance on the sandwich itself. There are distinct synergistic effects noted, where the contributions from each component in the whole package are superior to their individual contributions.

The heat blocking materials tend to protect the urethane foams by two different mechanisms. Materials with aluminum, such as aluminized Celiox® and aluminized Norfab®, tend to disperse and/or reflect radiant portions of the heat flux. Materials containing Neoprene®, such as Vonar®, tend to absorb the heat, emit water vapor, and thus cool the urethane foam. At low heating rates, materials that will disperse the heat tend to perform better. At high heating rates, materials that absorb the heat and create some form of endothermic process (such as water vapor emission) perform better.

One of the practical difficulties of this form of testing is that at the conclusion of the test procedure, decomposition of the urethane foam continues after the removal of the heating source by shielding of the sample cushion. At low heating rates (2.5 w.cm^{-2}), this effect is small and can be

neglected. At heating rates of 5.0 w.cm^{-2} the effect is noticeable. At high power, with heating fluxes of 7.5 w.cm^{-2} the amount of urethane foam decomposing during this after-test quenching period can be a major contributor to total decomposition.

A second shortcoming in this experimental procedure is that the precision achievable from nominally identical samples is poor. Thus, many samples must be tested, and average properties (mass injection rate and figure of merit) determined. Single determinations, or the use of data from one sample in a set, can be misleading.

6.2 SUGGESTIONS

To determine the exact fraction of the mass lost from the urethane foam that ends up in the environment as flammable vapor, it is necessary to determine the qualitative content of the gaseous effluent from the foam as the model seat is heated. Gas samples can be taken at various times during the test using a conventional industrial "sniffer", and subjected to analysis via routine GC/MS methods. This will also allow determination of the contributions made by the heat-blocking layer and wool/nylon decorative cover and/or other components to the flammable vapor reservoir injected into the environment of the burning seat.

A more exact measure of the temperature profile across the seat cushion would allow determination of the times and relative decomposition rates of the components in the seat cushion. Small (to avoid local thermal reservoir effects) thermocouples could be implanted into the sample to measure the temperature at different depths into the foam cushion. The actual temperature required for significant decomposition of the urethane foam can be determined directly by TGA, measurement of the temperature of the foam at different depths (measured from the surface subjected to the heat flux) will indicate when any particular layer reaches decomposition, and thus an indirect but valuable measure of the effective mass lost from the foam itself, without resort to mass measurements that are suspect due to several contributing and often conflicting factors. Among other advantages, this

indirect measure of mass loss would obviate problems from "after-test" termination errors caused by the so-called quenching period.

7. EXPERIMENTAL RESULTS AND DATA SUMMARIES

The following calculations and definitions are used in presenting the data in the tables and figures that follow. The mass injection rate into the environment is based on the mass lost by the urethane foam, and calculated from the surface area presented to the thermal flux, and the time required to produce the observed weight loss. A relative figure of merit can be defined in terms of the mass injected into the environment for any defined thermal flux.

7.1 CALCULATIONS

- W₀** ----- Weight of the sample. (The sum of the component weights)
Wt(0) ----- Weight of the sample at the start of the test plus any tare weight. (The weight of the sample registered by the balance at the start of the test)
Wt(T) ----- Weight of the sample at time T plus any tare weight (the weight of the sample registered by the balance at time T into the test)
Wf₀ ----- Weight of the urethane foam before the test (in grams)
Wf_f ----- Weight of the urethane foam after the test (in grams)
Te ----- Total Elapsed time of test (in seconds)
Area ----- Area of sample exposed to electrical furnace (cm²)
Q ----- Heating rate (in watts per centimeter square)
M ----- Mass injection rate.
E ----- Figure of merit.

$$\% \text{ WEIGHT REMAINING} = (W_0 - [Wt(0) - Wt(T)]) / W_0 * 100$$

$$\% \text{ WEIGHT LOSS} = [Wt(0) - Wt(T)] / W_0 * 100$$

$$\text{Mass injection rate} = M = [Wf_0 - Wf_f] / Te * \text{Area}$$

$$\text{Figure of merit} = E = Q / M$$

7.2 DISCUSSION OF DATA AND CONCLUSIONS:

A full listing of all data, more than 300 samples were tested, is given in Appendix A (blue colored sheets). It is useful to select from this listing those samples that exhibited superior performance, defined arbitrarily here as those model cushions that have a Figure of Merit (FOM) in excess of 10 (in arbitrary units).

The Figure of Merit is calculated from the quotient":

$$\text{Figure of Merit} = \text{FOM} = \frac{\text{Heat Flux Incident on Model Seat Surface}}{\text{Mass Injection into Environment}}$$

Thus, the higher the FOM, the better is the performance of the heat blocking layer in protecting the urethane foam core of the seat cushion (less mass lost and potentially injected into the environment for higher heat fluxes).

A listing of the best performing cushions is given in Table 2. It should be noted that the precision of data gathering from sample to sample, and the errors generated, do not allow this figure of merit to be precise measurement of performance. In selecting the best performing cushions, 25 such samples were noted with FOM values exceeding 10, however, several sample cushions occurred only once, even though tested more than once. These were deleted from the listing, and only those samples that had frequency factors greater than unity were retained. For example, one cushion utilizing Vonar®-1 as the heat blocking layer exhibited an FOM value of 150! Similarly, one cushion that did not have any heat blocking layer at all, merely fabric covered foam exhibited a single value of 24 for the FOM value.

It is important to note, that of the 20 samples appearing in Table 2, 16 of them (80%) are samples utilizing aluminized-Celiox® as the heat blocking layer. Moreover, 18 of the 20 samples are ones with ventilation holes cut through the back of the heat blocking layer, to allow "breathing" by the

interior, and thus convective/transpirational heat exchange effects to assist the thermal protection mechanism. One final point is worth noting, of the 20 top performing sandwiches, all but two of them utilized non-fire retarded foam.

Table 2. Model Seat Cushions Exhibiting Figures of Merit Exceeding 10 Arbitrary Units at 2.5 Watts per square centimetre with Respect to their Mass Injection Rates into the Environment

CONFIGURATION OF CUSHION SANDWICH	FIGURE OF MERIT
	Mean \pm S.D. (# of samples)
Fabric/Al-Celiox/NF Foam*	14.8 \pm 5.7 (4)
Fabric/Al-Celiox/NF Foam	15.5 \pm 3.5 (2)
Fabric/Celiox-Al/NF Foam*	13.4 \pm 2.8 (8)
Fabric/Celiox-Al/FR Foam*	19.5 \pm 3.5 (2)
Fabric/Norfab-Al/NF Foam*	18.5 \pm 1.5 (2)
Fabric/Vonar-3/NF Foam	20.5 \pm 3.5 (2)

"S.D." = Standard Deviation

* Vent holes through back of heat blocking layer.

7.3 OTHER DATA

Abridged summaries of the data collected for this project are given in Appendix A (blue colored sheets), and include the following:

Table 1. Sample identification codes and compositions of the sandwiches tested in this program to date.

Table 2. Abridged weight loss data for all samples tested.

Table 3. Mass injection rates and figures of merit for all sandwiches tested to date at 2.5 watts per square centimetre.

Table 4. Thermogravimetric data for various materials used in the construction of aircraft seats.

Table 5. Physical constants for some high performance materials used for heat blocking layers, and for the selected wool/nylon decorative cover.

Table 6. Smoke emission and heat release data for urethane foam alone.

Table 7. Smoke emission and heat release data for Vonar® foams used as heat blocking layers in these studies.

Table 8. Smoke emission data for polyurethane foams protected by Vonar® foams in sandwich samples.

Table 9. Smoke emission data for various heat blocking layer protected foam samples.

Table 10. Smoke emission and heat release data for sandwiches of foam and various heat blocking layers.

Table 11. Heat release data for individual materials for aircraft seats.

Graphical representations of these data, in the form of fractional weight loss as a function of time, are given in Appendix B (pink colored sheets).

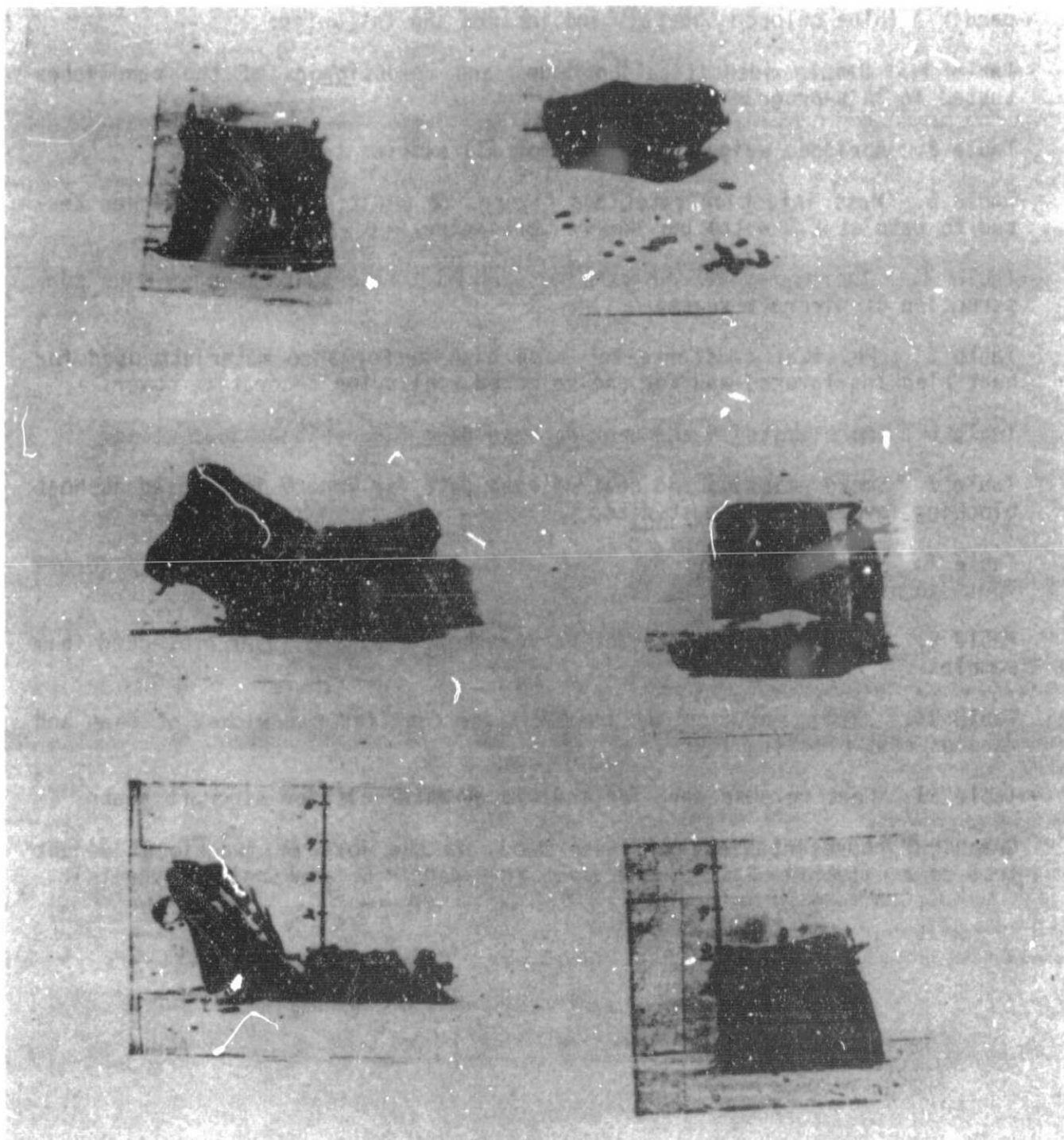

MODEL SEAT CUSHIONS AFTER THERMAL TESTING

Miniature cushions are approximately 3.5" square,
and approximately 0.5" in thickness.

After testing, they are broken open to examine for mass loss
and overall damage to the center poly-urethane foam cushion.

TABLE 4. THERMOGRAVIMETRIC ANALYSIS DATA FOR MATERIALS USED IN THE CONSTRUCTION OF AIRCRAFT SEATS.

SAMPLE NAME	PDT (°C)		MAX $\frac{d(MASS)}{dt}$ (°C)		Pyrolysis Endpoint (°C)		Char Yield (%)	
	Air	N ₂	Air	N ₂	Air	N ₂	Air	N ₂
W-N Fabric	272	273	405	339	538	440	3	23
Al Cellon	276	315	610	350	657	447	6	58
Worlth	440	440	590	560	612	610	34	61
Vnnar	278	276	305	352	600	517	36	47
W Urethane	278	263	320	338	330	410	2	5
W Urethane	260	250	331	380	381	401	11	6
Polyamide	384	450	563	585	659	596	8	48
Neoprene	229	328	370	364	532	495	68	54

'PDT' = Polymer Decomposition Temperature

TABLE 5. PHYSICAL CONSTANTS FOR SOME HIGH PERFORMANCE MATERIALS USED AS HEAT BLOCKING LAYERS AND FOR THE DECORATIVE WOOL/NYLON COVER.

MATERIAL	WEIGHT oz/yd ²	(grams/m ²)	epi	ppi	WARP COUNT WEAVE FILLING Worsted Count (WC)	WEAVE/KNIT STRUCTURE	
Cellon [®] Series D	10.0	(337.50)	12	12	1/10 _s (WC)	Raschel Knit	
Worlth [®] (70% Kevlar/ 25% Nomex/5% Kevlar Wrap)	8.3	(280.12)	20	27	E Glass 150 1/0 Dref Soun	1 x 1 Plain	
Worlth-Aluminized	11.3	(381.37)	20	17	E Glass 150	1 x 1 Plain	
Decorative Upholstery 7% wool 1% Nylon	12.6	(425.24)	81.0	56.0	2/25 _s (WC)	2/27 _s (WC)	Jacquard Double Cloth

** In each series, the heat treated fabrics weighed approximately 2 oz/yd² (6.50 g/m²), less than the loom stated weight cited above.

TABLE 1. SMOKE EMISSION AND HEAT RELEASE DATA FOR POLYURETHANE FOAM ALONE.

MATERIAL DESCRIPTION	SMOKE EMISSION					HEAT RELEASE				
	HEAT FLUX (w/cm ²)	TIME OF INITIAL RISE (sec)	TIME OF MAXIMUM (sec)	VALUE OF MAXIMUM dS/dt (gprt/ft ² -sec)	VALUE OF MAXIMUM dS/dt (gprt/ft ² -sec)	TOTAL SMOKE D _s	TIME OF INITIAL RISE (sec)	VALUE OF MAXIMUM dQ/dt (J/cm ² -sec)	TIME OF MAXIMUM (sec)	TOTAL Q (J/cm ²)
N.C.F.1.- HOSACA- Fire Retarded polyurethane foam	3.5	2.0	18.0	100	1076.43	98.0	2.0	44.0	19.0	2350 - 3000
	5.0	1.0	15.0	150	1614.64	80.0	1.0	66.0	20.0	2200.0
	7.5	0 - 1	6.0	125 - 150	1346 - 638	59.0	0.0	68.0	18.0	2600.0

TABLE 2. SMOKE EMISSION AND HEAT RELEASE DATA FOR VONAR® FOAMS USED AS HEAT BLOCKING LAYERS.*

MATERIAL DESCRIPTION	SMOKE EMISSION					HEAT RELEASE				
	HEAT FLUX (w/cm ²)	TIME OF INITIAL RISE (sec)	TIME OF MAXIMUM (sec)	VALUE OF MAXIMUM dS/dt (gprt/ft ² -sec)	VALUE OF MAXIMUM dS/dt (gprt/ft ² -sec)	TOTAL SMOKE D _s	TIME OF INITIAL RISE (sec)	VALUE OF MAXIMUM dQ/dt (J/cm ² -sec)	TIME OF MAXIMUM (sec)	TOTAL Q (J/cm ²)
Vonar 1 - Cotton*	3.5	8.0	23.0	10.0	107.64	13.0	8.0	2.0	10 - 25	0.0
	5.0	4.0	8 - 16	73 - 40	786 - 431	15.0	2.0	3.5	8.0	20.0
Vonar 2 - Cotton*	3.5	2.0	10.0	71.0	764.26	35.0	2.0	11.0	13.0	250.0
	5.0	2.0	8.0	100.0	1076.43	40.0	0.0	19.0	8.0	300.0
	7.5	0.0	5.0	51.0	548.98	30.0	0.0	11.0	5.0	100.0
Vonar 3 - Cotton*	3.5	9.0	10 - 70	15 - 5	162 - 54	5 - 10	9.0	2.0	11.0	0.0
	5.0	3.0	7 - 40	62 - 17	668 - 163	20.0	2.0	3.0	10.0	100.0

* Cotton scrim cover sheet wrapped around foam as in real seats.

TABLE 3. SMOKE EMISSION DATA FOR POLYURETHANE FOAM PROTECTED BY VONAR® FOAM HEAT BLOCKING LAYERS*

MATERIAL DESCRIPTION	HEAT FLUX (w/cm ²)	TIME OF INITIAL RISE (sec)	TIME OF MAXIMUM (sec)	VALUE OF MAXIMUM dS/dt (gprt/ft ² -sec)	VALUE OF MAXIMUM dS/dt (gprt/ft ² -sec)	TOTAL SMOKE D _s
Vonar®-1*	3.5	5.0	11.0	18.0	194.76	260.0
	5.0	2.0	5.0	61.0	656.62	270.0
	7.5	2.0	5.0	100.0	1076.43	230.0
Vonar®-2*	3.5	4.0	20.0	100.0**	1076.43	210.0
	5.0	2.0	15.0	100.0**	1076.43	210.0
	7.5	1.0	15.0	100.0**	1076.43	---
Vonar®-3*	3.5	6.0	10.0	25.0	269.11	250.0
	5.0	4.0	7.0	86.0	925.73	270.0
	7.5	3.0	6.0	100.0	1076.43	330.0

* Urethane foam wrapped in a cotton scrim cover sheet, heat blocking layer (Vonar® foam) wrapped around this central cushioning package.

TABLE 9. SMOKE EMISSION CHARACTERISTICS FOR SANDWICHES OF FR-FOAM PROTECTED BY VARIOUS HEAT BLOCKING LAYERS (WITH AND WITHOUT FABRIC COVERS).

MATERIAL DESCRIPTION	VALUE OF FOAM MAXIMUM (part/ft ² -sec)	VALUE OF FOAM MAXIMUM (part/m ² -sec)	TIME OF FOAM INVOLVEMENT (sec)	TIME OF FOAM MAXIMUM
Wool-Nylon Fabric/Foam (12.6 oz/sq. yard)	45.0	484.39	12.0	35.0
	64.0	688.91	5.0	10.0
	99.0	1065.68	2.0	15.0
Yonar®-1/FR Foam	100.0*	1076.43	15.0	30.0
	100.0*	1076.43	10.0	15.0
	100.0*	1076.43	5.0	20.0
Al-Norfab®/FR Foam	53.0	570.51	90.0	130.0
	55.0	592.03	50.0	90.0
Fabric/Al-Norfab®/Foam	52.0	555.74	55.0	135.0
	50.0	538.21	50.0	70.0
	39.0	419.81	30.0	45.0

TABLE 10. SMOKE EMISSION DATA AND \dot{m}^2/\dot{Q} RELEASE DATA FOR SANDWICHES OF FR FOAM AND VARIOUS HEAT BLOCKING LAYERS (WITH AND WITHOUT A WOOL-NYLON FABRIC COVER).

MATERIAL DESCRIPTION	HEAT FLUX (w/cm ²)	TIME OF INITIAL RISE (sec)	TIME OF MAXIMUM (sec)	VALUE OF MAXIMUM \dot{m}^2/\dot{Q} (part/ft ² -sec)	VALUE OF MAXIMUM \dot{m}^2/\dot{Q} (part/m ² -sec)	TOTAL SMOKE \dot{Q}_s
Fabric/FR Foam (12.6 oz/sq. yard)	3.5	12.0	35.0	45.0	484.3	60.0
	5.0	5.0	30.0	64.0	688.9	85.0
	7.5	2.0	15.0	99.0	1065.6	105.0
Yonar®-2/FR 5.0	1.0	20.0	210.0	3700.0	13.5	455.6
Yonar®-3/FR 5.0	30.0	65.0	270.0	4050.0	23.5	793.1
Al-Norfab®/Foam	3.5	90.0	130.0*	53.0	570.51	200.0
	5.0	20.0	No Peak	---	---	120.0
Fabric/Al-Norfab®/Foam	3.5	5.0	26.0	26.0	279.8	185.0
	5.0	7.0	20.0	32.0	344.4	130.0
	7.5	2.0	20.0	13.0	139.9	90.0

TABLE 11. HEAT RELEASE DATA FOR VARIOUS MATERIALS USED FOR AIRCRAFT SEATS

MATERIAL DESCRIPTION	TIME OF INITIAL RISE (sec)	TIME OF MAXIMUM (sec)	VALUE OF MAXIMUM \dot{Q} (J/cm ² -sec)	TOTAL \dot{Q}_s (J/cm ²)
Wool-Nylon Fabric/FR Foam	1.0 - 2.0	41.0	27.0	1500.0
	4.0	35.0	21.0	1000.0
	1.0	35.0	23.0	1300.0
Al-Norfab®/FR Foam	110.0	120 - 250	16.0	1750.0
	40.0	90.0	22.0	1500.0
Fabric/Al-Norfab®/FR Foam	4.0	140.0	32.0	4650.0
	5.0	8.0	10.0	1600.0
	0.0	50.0	21.0	1500.0

PART NO 994261-003

DuPont Instruments

Sample ALCELEX02
 Size 16.8 MG
 Rate RAMP HEATING
 Program Interactive DSC v3.8

DSC

Date 18-Jul-81 Time 16:18:03
 File ALCELEX02.D1
 Operator PK
 Plotted 18-Jul-81 11:15:30

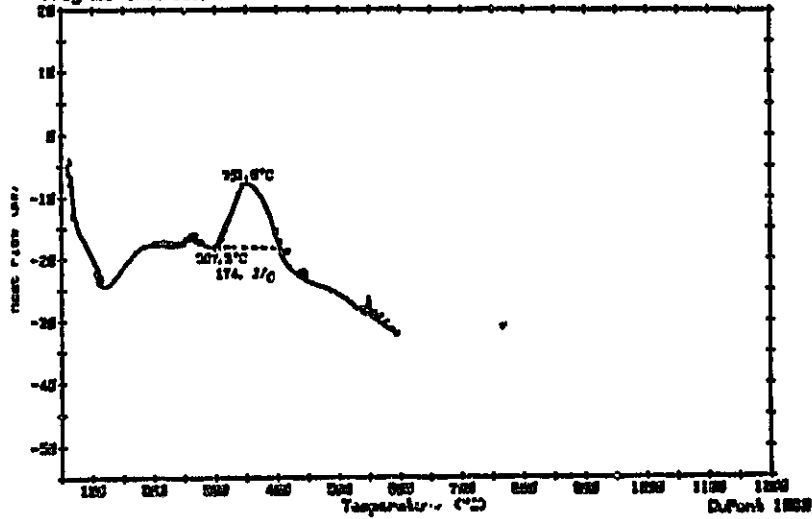

PART NO 994261-003

DuPont Instruments

Sample ALCELIX
 Size 6.8 MG
 Rate RAMP HEATING

DSC

Date 8-Jul-81 Time 12:16:48
 File ALCELIX.D2
 Operator PK

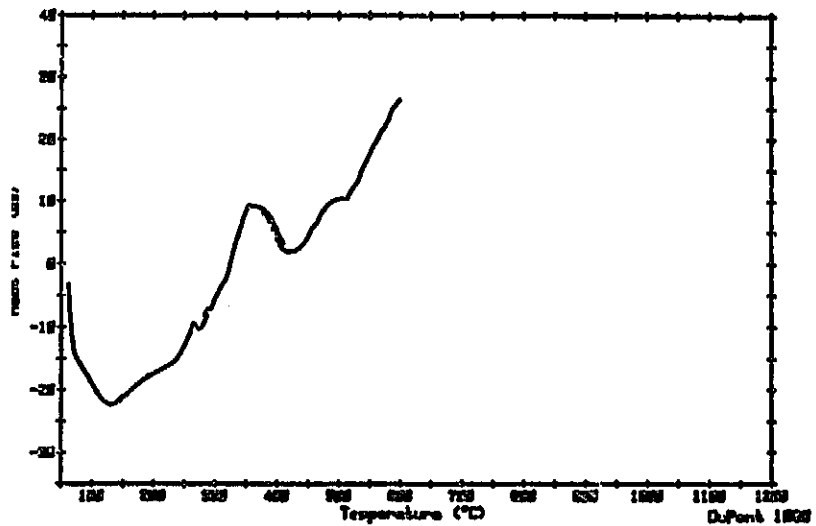

PART NO 994261-003

DuPont Instruments

Sample FRURETH2
 Size: 3.0 MG
 Rate: RAMP HEATING

DSC

Date: 10-Jul-81 Time: 0:17:24
 File: FRURETH2.D2
 Operator: PK

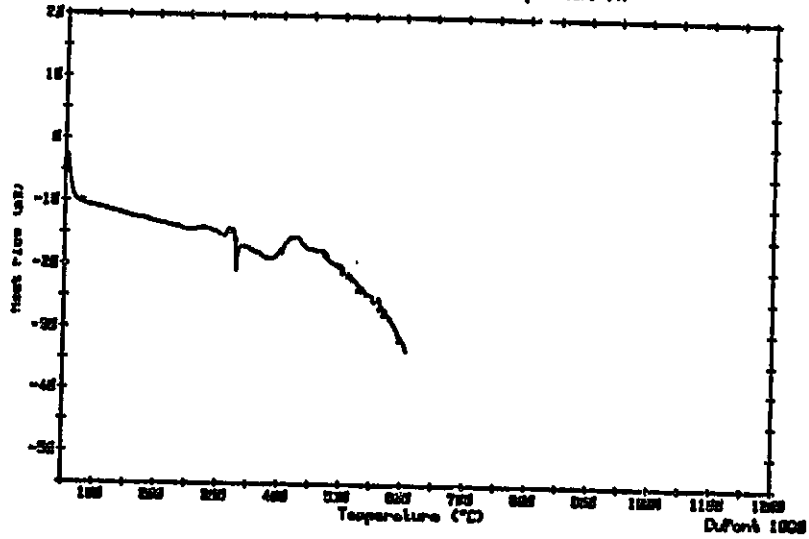

PART NO 994261-003

DuPont Instruments

Sample FR URETH1
 Size: 3.4 MG
 Rate: RAMP HEATING
 Program Interactive DSC v1.8

DSC

Date: 7-Jul-81 Time: 14:50:40
 File: FRURETH1.D1
 Operator: PK
 Plotted: 8-Jul-81 0:32:30

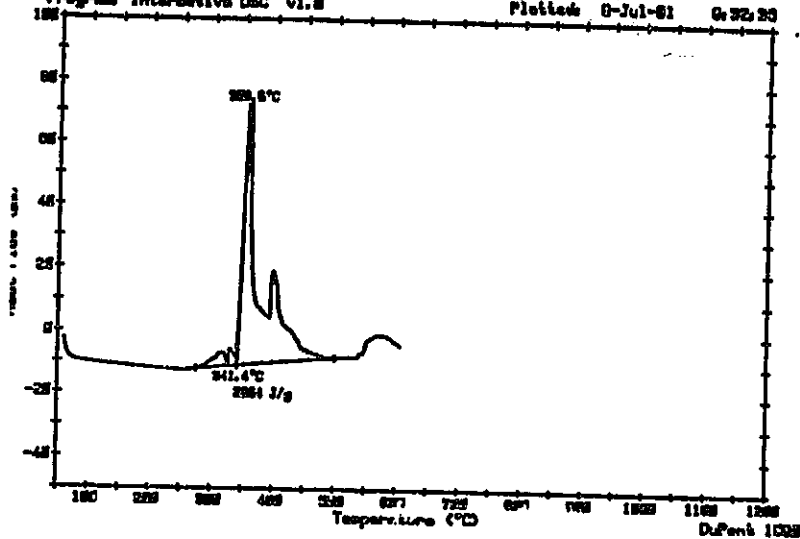

PART NO. 994261-003

DuPont Instruments

Sample NFMETH2
Size 1.8 MG
Rate RAMP HEATING
Program Interactive DSC v1.6

DSC

Date 9-Jul-81 Time 14:45:18
File NFMETH2.D1
Operator PH
Plotted 9-Jul-81 14:45:45

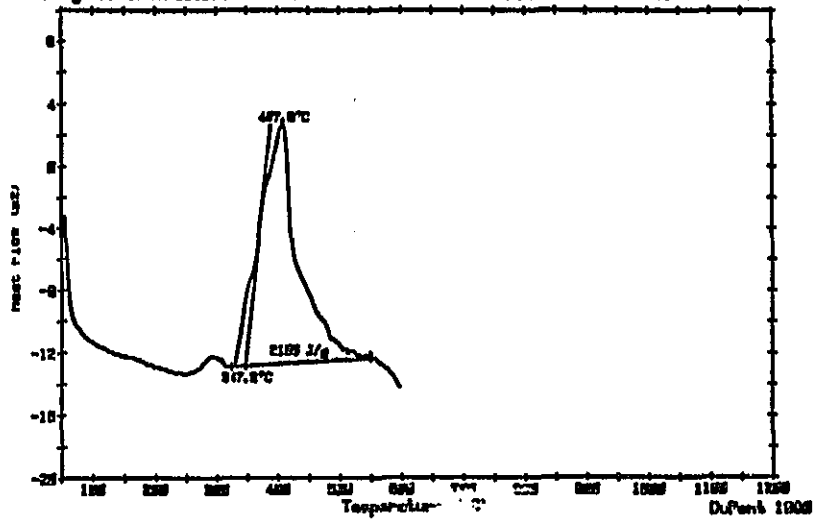

PART NO. 994261-003

DuPont Instruments

Sample NFMETH
Size 1.7 MG
Rate RAMP HEATING
Program Interactive DSC v1.6

DSC

Date 9-Jul-81 Time 15:24:18
File NFMETH.D3
Operator PH
Plotted 9-Jul-81 15:24:00

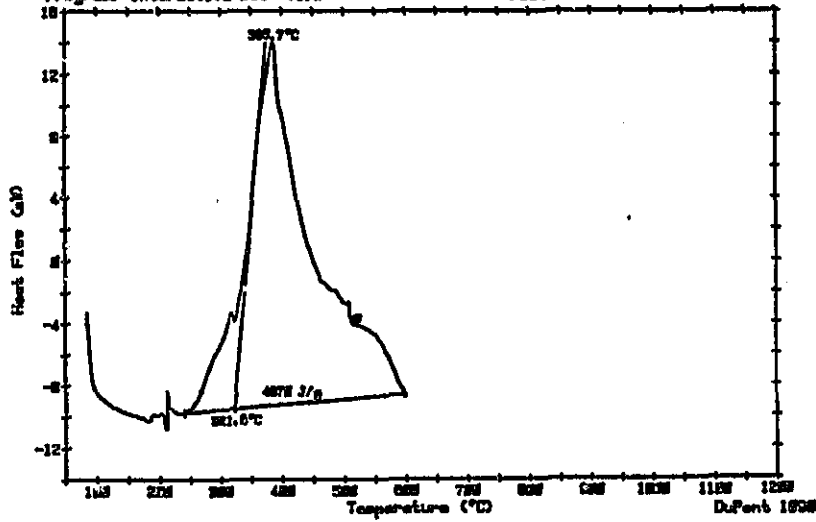

PART NO. 994261-011

DuPont Instruments

Sample: PIFDAMZ
Size: 1.0 MG
Rate: RAMP HEATING

DSC

Date: 18-Jul-81 Time: 19:02:00
File: PIFDAMZ.01
Operator: PK

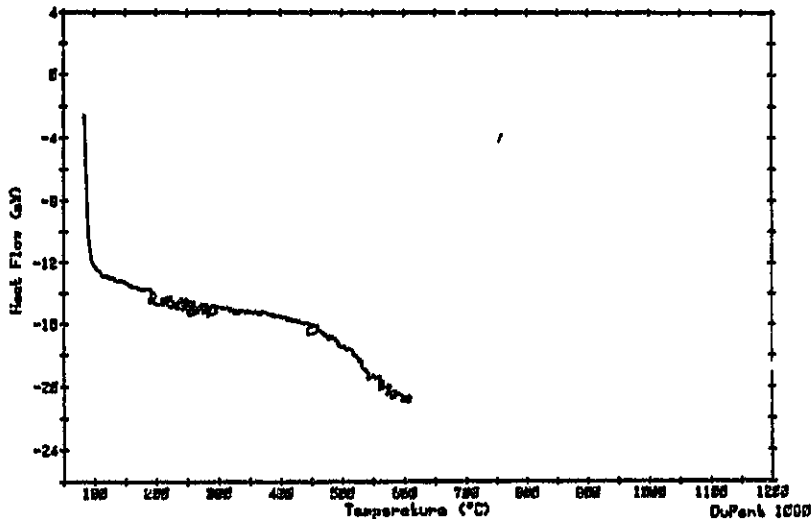

PART NO. 994261-003

DuPont Instruments

Sample: PIFDAM
Size: 2.0 MG
Rate: RAMP HEATING

DSC

Date: 8-Jul-81 Time: 0:48:16
File: PIFDAM.01
Operator: PK

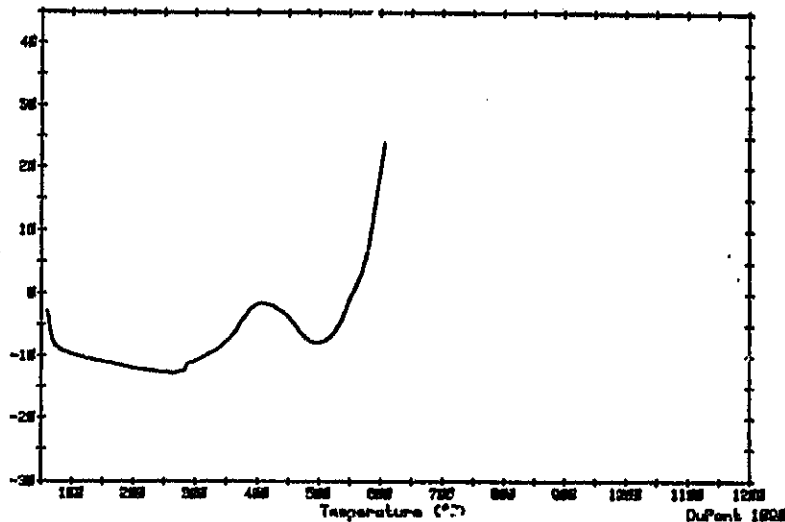

Sample VQIARN2
 Size 19.1 MG
 Rate RAMP HEATING
 Program Interactive DSC v1.0

DSC

Date 9-Jul-81 Time 15:45:50
 File VQIARN2.S1
 Operator PK
 Plotted 20-Jul-81 11:51:03

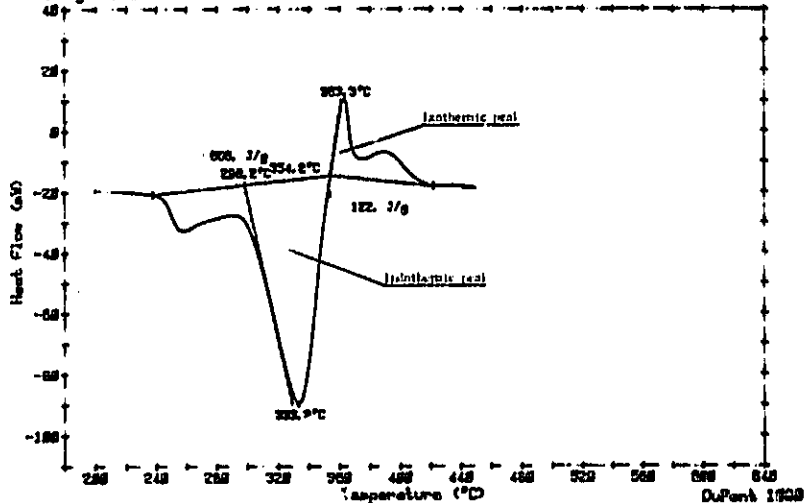

PART NO 994261-003

DuPont Instruments

Sample VQIAR
 Size 11.8 MG
 Rate RAMP HEATING

DSC

Date 8-Jul-81 Time 8:32:03
 File VQIAR.S1
 Operator PK

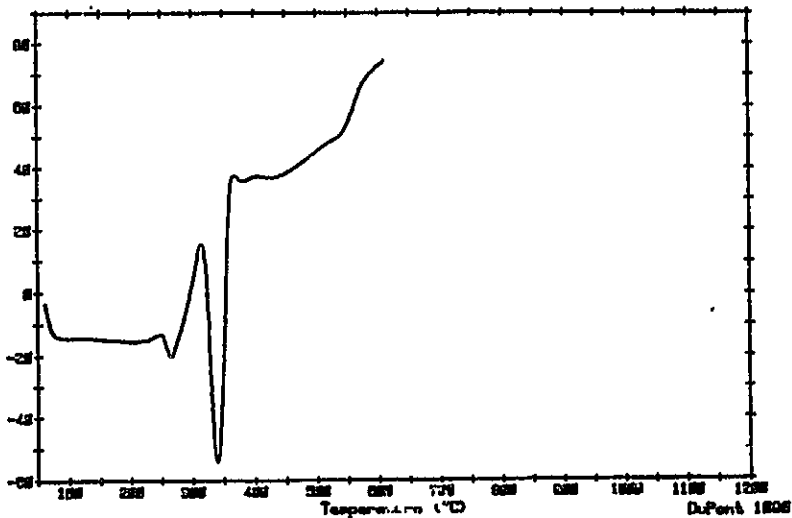

PART NO. 994261-003

DuPont Instruments

Sample: WOOLNYL2
Size: 4.2 MG
Rate: RAMP HEATING

DSC

Date: 18-Jul-81 Time: 11:35:17
File: WOOLNYL2.D1
Operator: PK

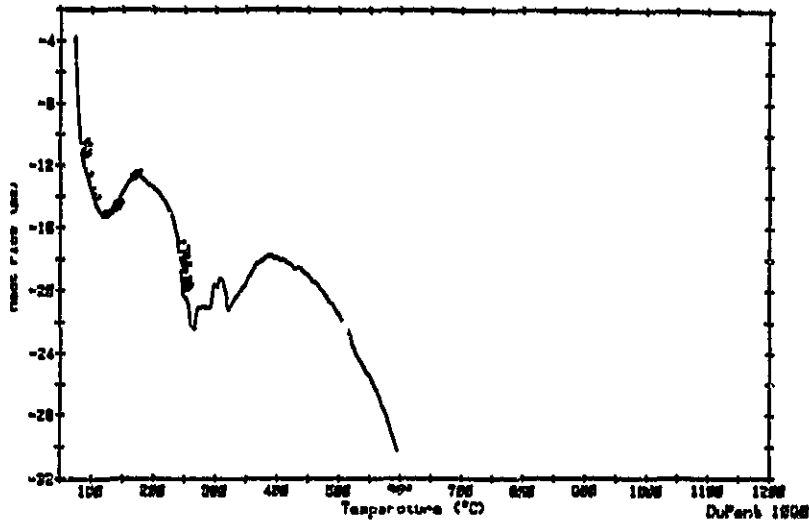

PART NO. 994261-003

DuPont Instruments

Sample: W-CO-FABRIC
Size: 5.5 MG
Rate: RAMP HEATING

DSC

Date: 8-Jul-81 Time: 16:28:52
File: WOOLNYL.D1
Operator: PK

