

FREE STREAM TURBULENCE AND DENSITY RATIO EFFECTS ON THE  
INTERACTION REGION OF A JET IN A CROSS FLOW<sup>1</sup>

C.E. Wark<sup>2</sup> and J.F. Foss  
Department of Mechanical Engineering  
Michigan State University

Jets of low temperature air are introduced into the aft sections of gas turbine combustors for the purpose of cooling the high temperature gases and quenching the combustion reactions. Research studies, motivated by this complex flow field, have been executed by introducing a heated jet into the cross stream of a wind tunnel. The investigation by Kamotani and Greber stands as a prime example of such investigations and it serves as the principal reference for the present study.

The low disturbance level of the cross stream, in their study and in similar research investigations, is compatible with an interest in identifying the basic features, of this flow field. The influence of the prototypes' strongly disturbed cross flow is not, however, made apparent in these prior investigations. The present study provides a direct comparison of the thermal field properties for a low ( $\bar{u}/U_\infty = 0.67\%$ ) and a high ( $\bar{u}/V_\infty = 34\%$ ) disturbance level condition.

A novel technique was used for the data acquisition (Figure 1). Sixty-four fast response ( $\lambda \approx 4\text{msec}$ ) thermocouples were simultaneously sampled (and corrected for the time constant effect) at a downstream plane close to the jet exit ( $x/d=3-4$ ). Various measures were used to characterize the thermal fields for the disturbed and undisturbed conditions, for two different momentum flux ratios ( $J = \rho_j V_j^2 / \rho_\infty V_\infty^2 = 16, 64$ ), and for three overheat conditions ( $T_j = 22.2, 47.1$  and  $61.1$ ).

Two forms of data acquisition were used for this study. Stochastic values were obtained from triplet values:  $T_k(t-\delta t)$ ,  $T_k(t)$  and  $T_k(t+\delta t)$ , where  $K=1 \dots 64$  is the thermocouple designation and the  $\delta t$  ( $\delta t = 0.64\text{msec}$ ) values were used to form the central difference time derivative from which the corrected temperature value:  $\{T_k(t)\}_c$ , was determined. These values were retained for  $t, t+\Delta t, t+2\Delta t \dots t+N\Delta t$  where  $N=5,000$  for the undisturbed and  $10,000$  for the disturbed condition and  $\Delta t=100\text{ms}$  which ensured the statistical independence from its neighboring value. Instantaneous samples:  $\Delta t = 0.64\text{ms}$  and  $N=1,225$  were stored for  $J=16, 64$  and  $T_j = 61.1^\circ\text{C}$ .

<sup>1</sup> Supported by NASA Grant NAG 3-245

<sup>2</sup> M.S. 1984, presently at Illinois Institute of Technology

RESULTS

Histograms, formed from the independent samples, were sufficiently smooth to approximate a probability density function; examples are shown in Figure 2 for a thermocouple from the central region of the jet. A striking result, from all such histograms, is that the peak (non-dimensional) temperature did not exceed 0.25. Hence, even at the relatively close  $x/d$  locations of the present study, molecular diffusivity has played a dramatic role in the reduction of the temperature for the fluid elements of the jet.

The individual histograms, and the isothermal patterns that are fit to the mean values of the corrected temperatures, both reveal that the magnitude of the overheat exerts a significant dynamic effect on the jet in a cross flow problem; see Figures 3 and 4. It is pertinent to note that the increasing distance of the thermal center of gravity, from the source plate with increasing jet temperature, is opposite to that which would be expected from buoyancy and enhanced entrainment effects. The former agrees with the Kamotani and Greber results, the latter is in disagreement. The physical reasons for this unexpected behavior are not apparent; the consistency of the trend: an increased penetration of the thermal field with an increased jet temperature, is consistently observed and serves as a primary focus for further study. A further comparison with the results from Kamotani and Greber (see Figure 5) reveals a substantial difference between the jet penetration for the two studies. This difference is (at least in part) attributed to the present use of a sharp-edge nozzle and to the large ( $\delta/d \approx 1.3$ ) boundary layer for the present study.

One clearly apparent effect of the large disturbance condition is the migration of the centroid of the thermal field; see figure 6. Similar data for all of the instantaneous scans (6 disturbed, 3 undisturbed) are summarized in Table I; note:  $K_{st}$  is the normalized correlation coefficient between the vertical (s) and transverse (t) displacements of the thermal center of gravity.

TABLE I. Cross stream disturbance effect  
on centroid of temperature field

	J	$\sigma_{s \text{ c.g.}}$	$\sigma_{t \text{ c.g.}}$	$K_{st}$
undisturbed c.f.	16	.341	.253	.067
undisturbed c.f.	64	.233	.233	-0.13
disturbed c.f.	16	1.84	1.45	-0.33
disturbed c.f.	64	1.16	1.12	-0.45

The lower mean values, of the disturbed cross stream mean isotherms, are apparently caused by these large centerline migrations; figure 7 shows an instantaneous isotherm pattern that reveals maximum temperature values of the same order as those for the undisturbed case.

ORIGINAL PAGE IS  
OF POOR QUALITY

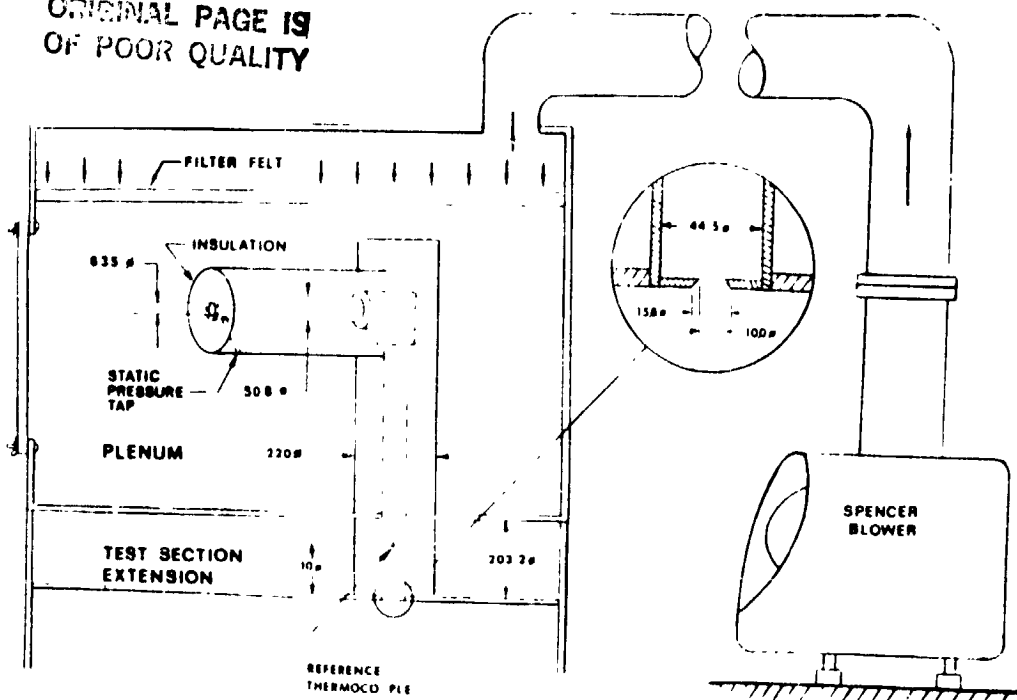

Figure 1a. Schematic of Jet Supply and Exit Conditions  
Note: Lateral (i.e.,  $z$ ) position of the jet corresponds to the undisturbed position. The jet exit was moved into the low speed portion of the shear layer:  $u/U_0 = 0.25$ , for the disturbed flow condition.

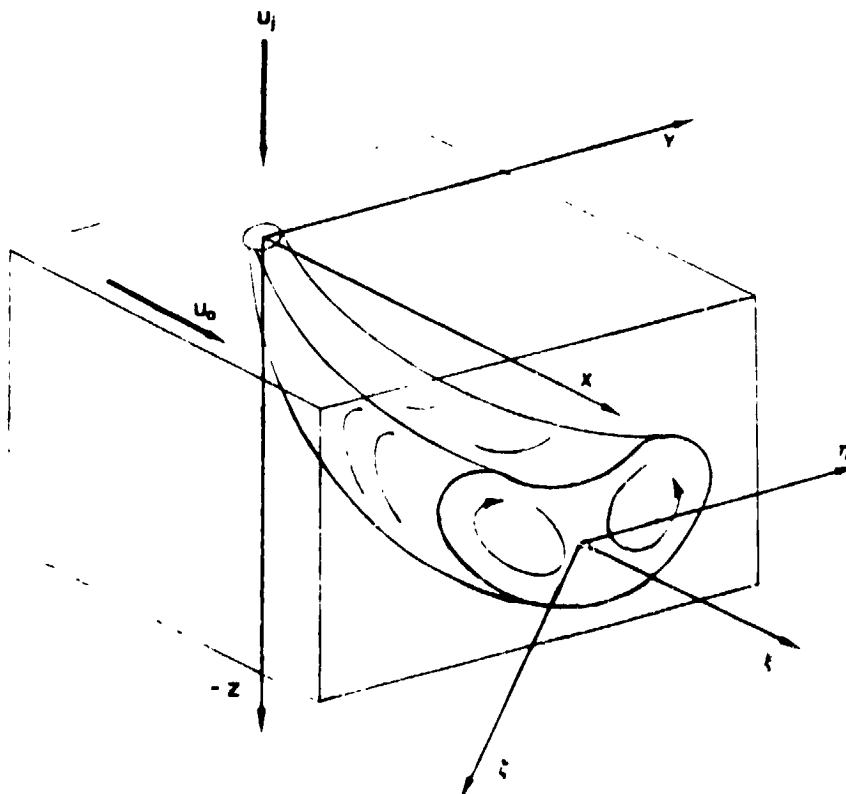

Figure 1b. Schematic Representation of Jet Trajectory, Showing Lab coordinates ( $x, y, z$ ) and Jet Coordinates ( $\xi, \eta, \zeta$ )  
Note: Thermocouples were located in the  $y-z$  plane at  $x=3.5$  (for  $J=64$ ) and  $3.85$  ( $J=16$ ).

ORIGINAL PAGE IS  
OF POOR QUALITY

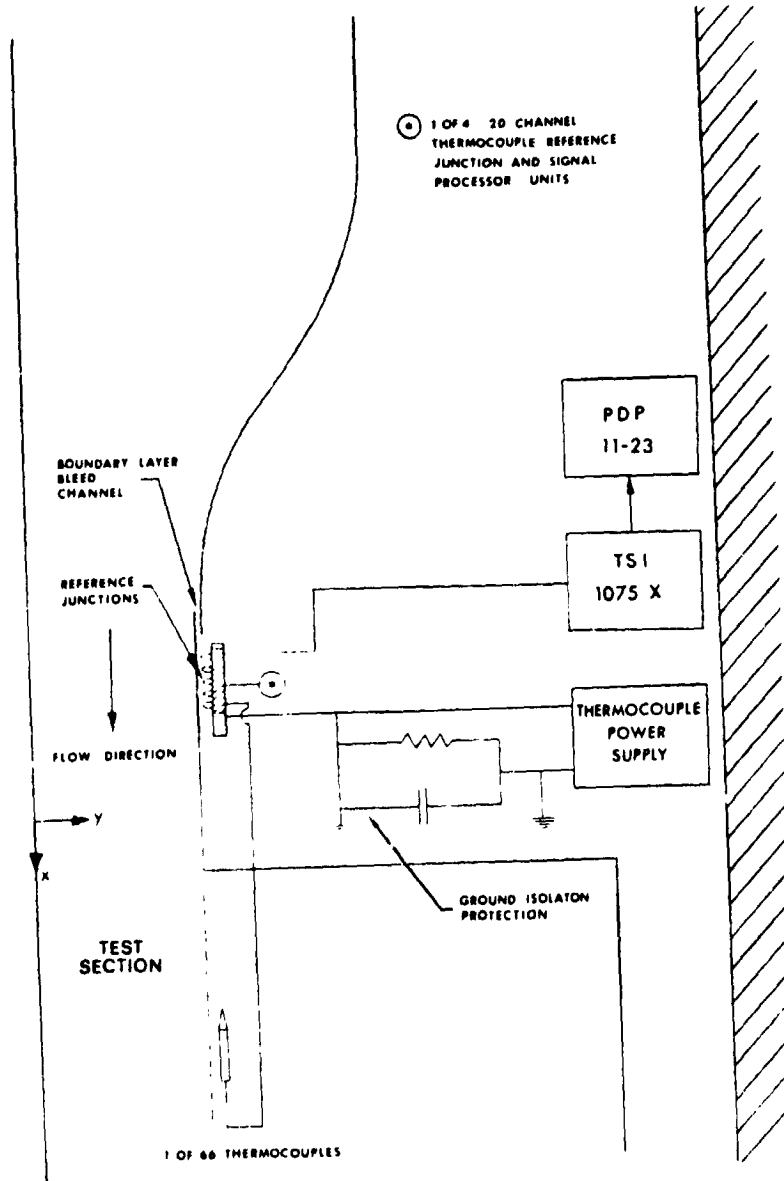

Figure 1c. Schematic Representation of the Temperature measurement system

ORIGINAL PAGE IS  
OF FOUR (QUALITY)

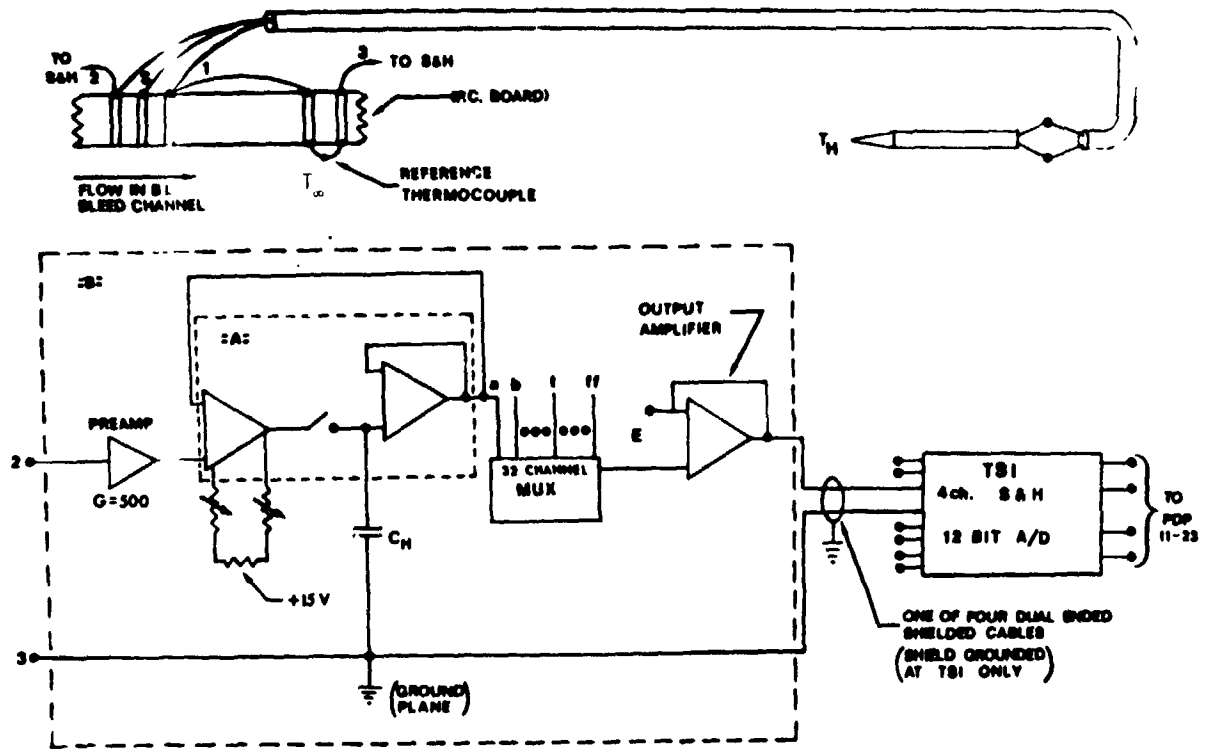

Figure 1d. Detail of a Sample and Hold Circuit.

ORIGINAL PAGE IS  
OF POOR QUALITY

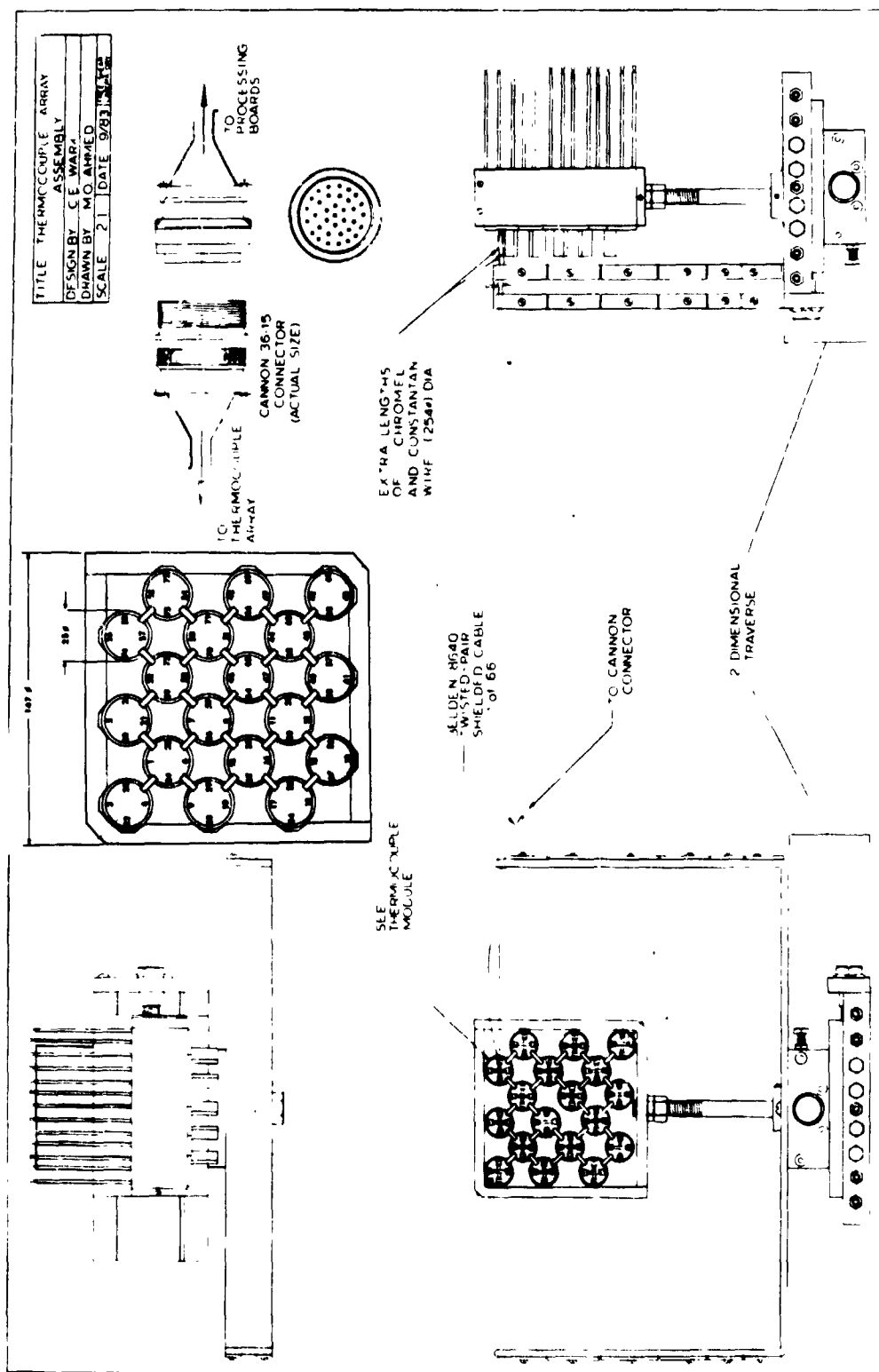

Figure 1e. Thermocouple Array Assembly

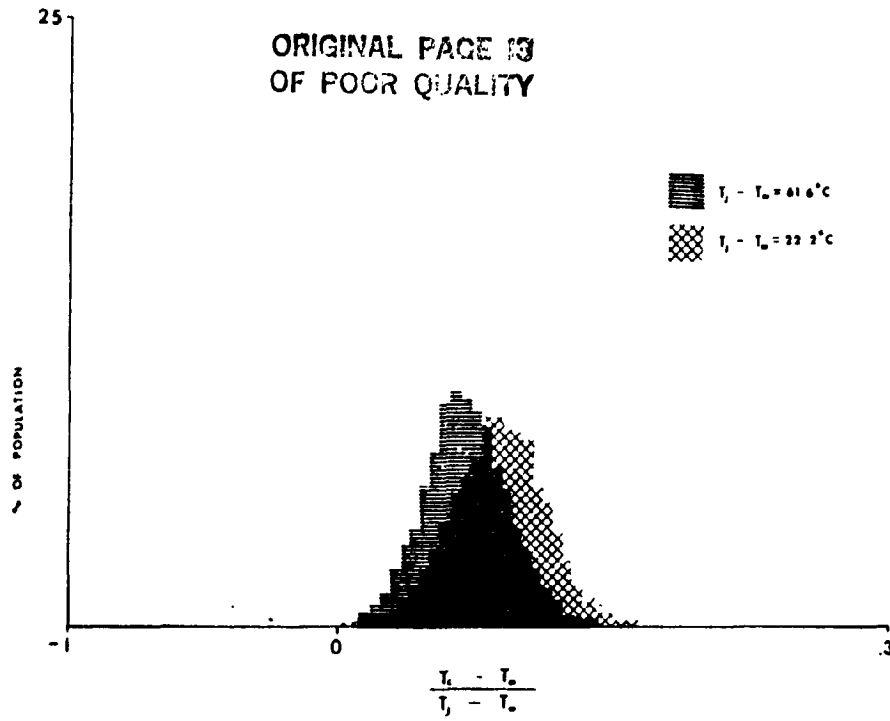

Figure 2a. Temperature Histogram for u.c.f.: J = 16,  
Thermocouple at s/d = 4.79, t/d = 4.73

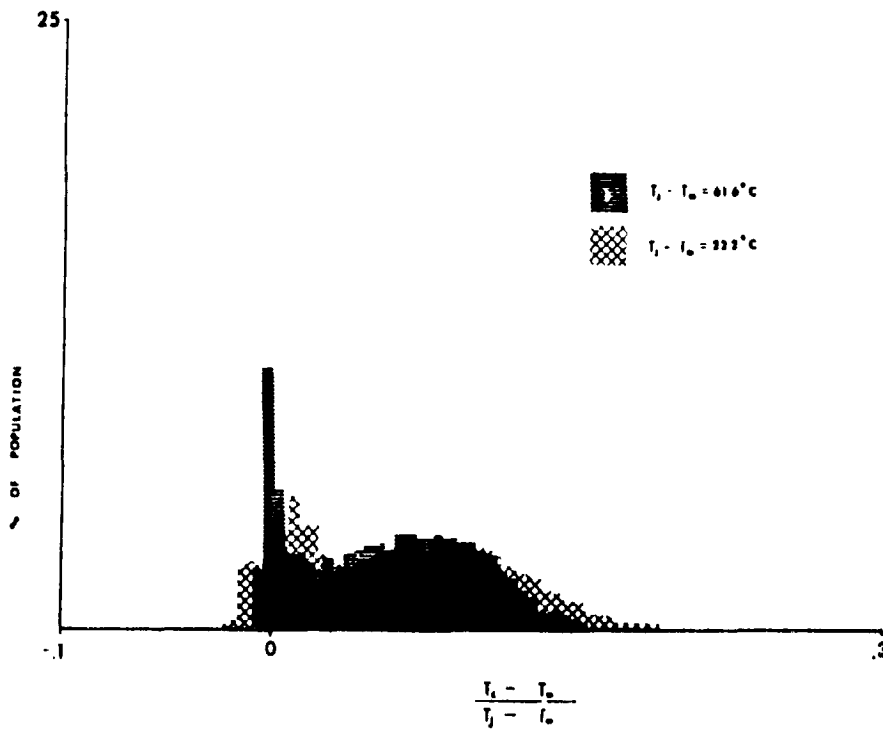

Figure 2b. Temperature Histogram for d.c.f.: J = 16,  
Thermocouple at s/d = 5.64, t/d = 3.64

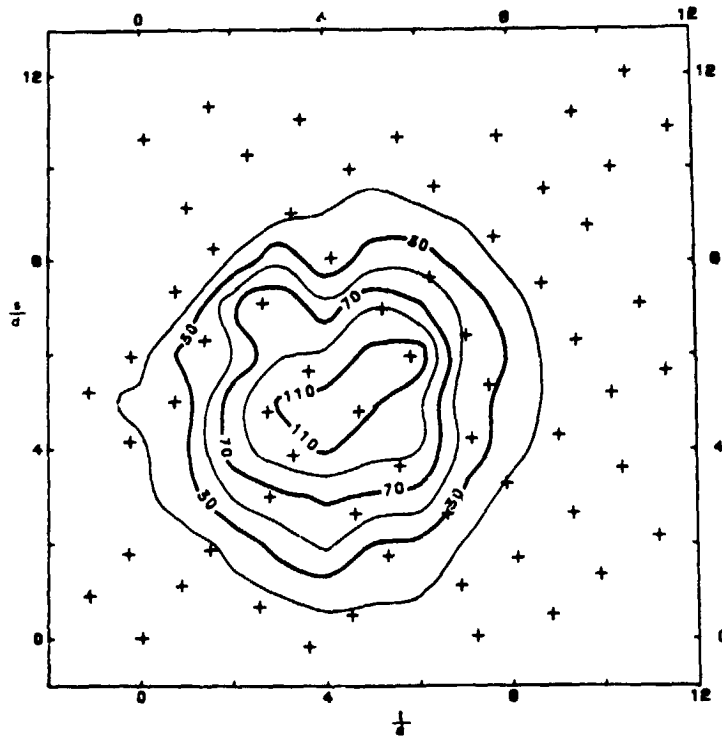

Figure 3a. Undisturbed Cross Flow (u.c.f.) Mean Temperature Isotherms:  $J = 16$ ,  $T_{jet} - T_{\infty} = 22.2^{\circ}\text{C}$

NOTE: Contours shown are  $\frac{T - T_{\infty}}{T_{jet} - T_{\infty}} \times 1000$   $s/d = 14.1 (\pm .7) - z/d$ ,  
 $t/d = 4.3 (\pm .5) - y/d$

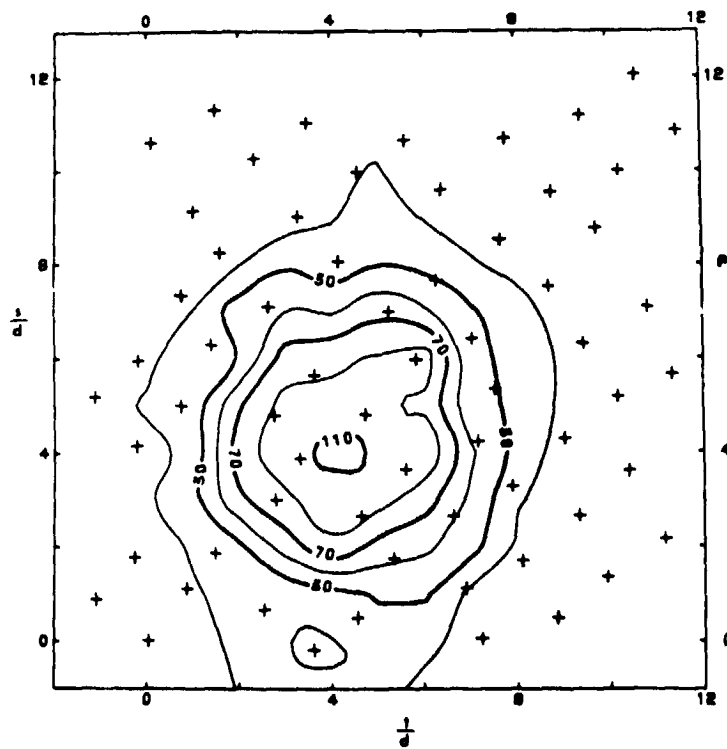

Figure 3b. u.c.f. Mean Temperature Isotherms:  $J = 16$ ,  $T_{jet} - T_{\infty} = 61.1^{\circ}\text{C}$

NOTE:  $s/d = 14.1 (\pm .7) - z/d$ ,  $t/d = 4.3 (\pm .5) - y/d$



ORIGINAL PAGE IS  
OF POOR QUALITY

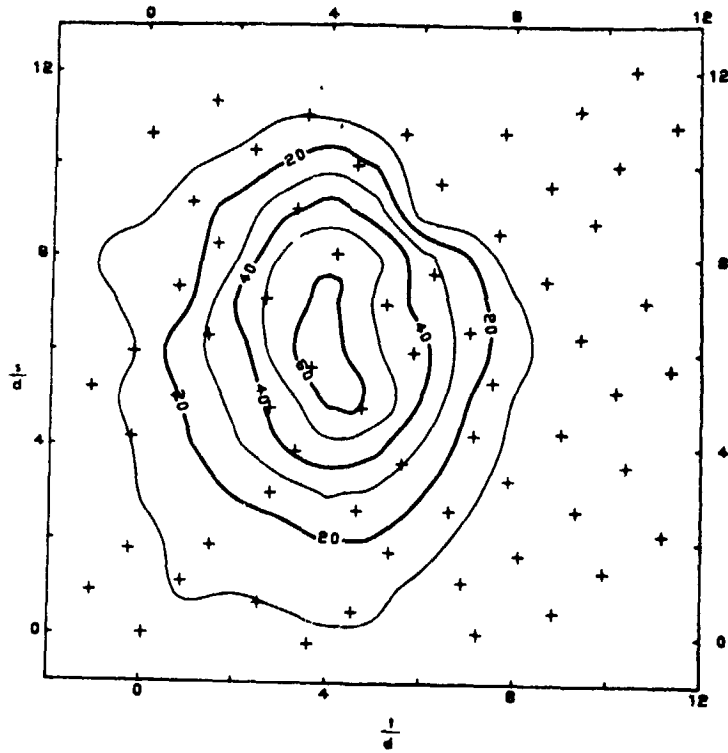

Figure 3c. Disturbed Cross Flow (d.c.f.) Mean Temperature Isotherms  
 $J = 16, T_{jet} - T_{\infty} = 22.2^{\circ}\text{C}$

NOTE:  $s/d = 14.1(\pm .7) - z/d, t/d = 4.2(\pm .5) - y/d$

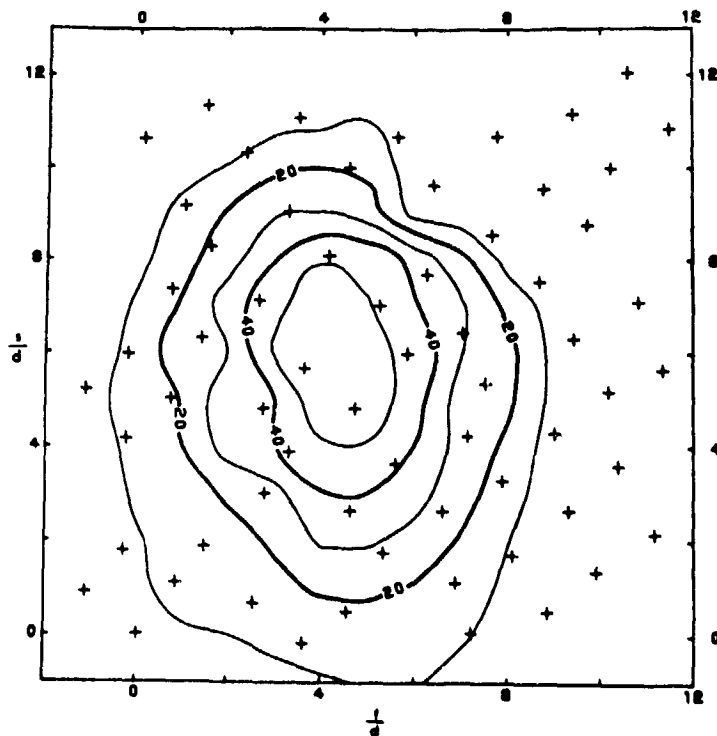

Figure 3d. d.c.f. Mean Temperature Isotherms:  $J = 16, T_{jet} - T_{\infty} = 61.1^{\circ}\text{C}$

NOTE:  $s/d = 14.1(\pm .7) - z/d, t/d = 4.2(\pm .5) - y/d$

ORIGINAL PAGE IS  
OF POOR QUALITY

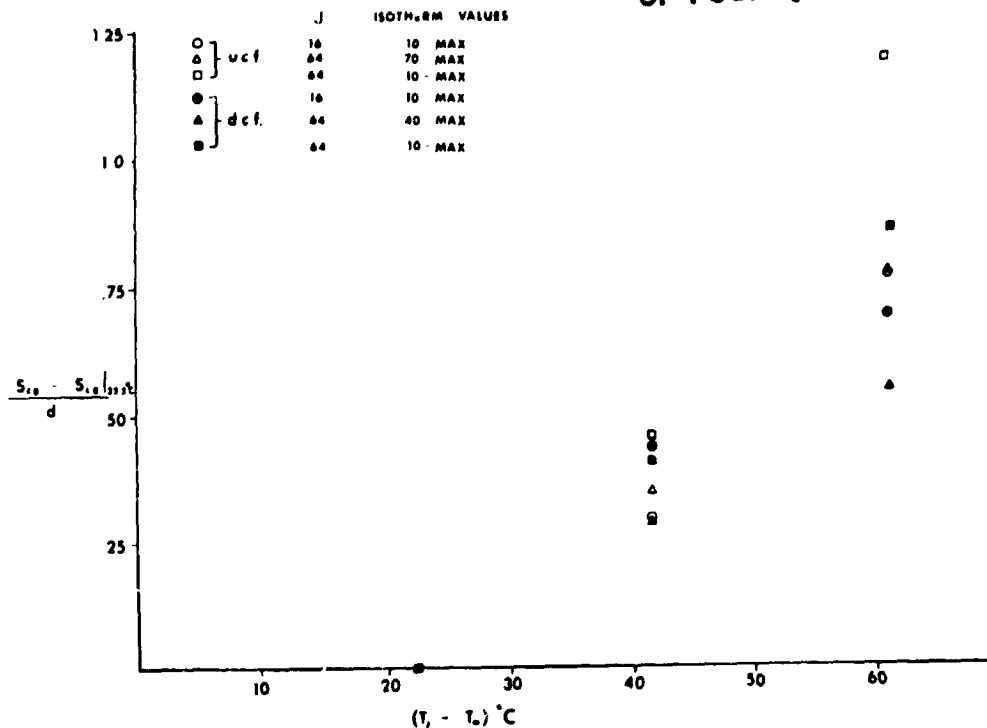

Figure 4. Overheat Influence on s Component Centroid  
(calculated using isotherm contours)

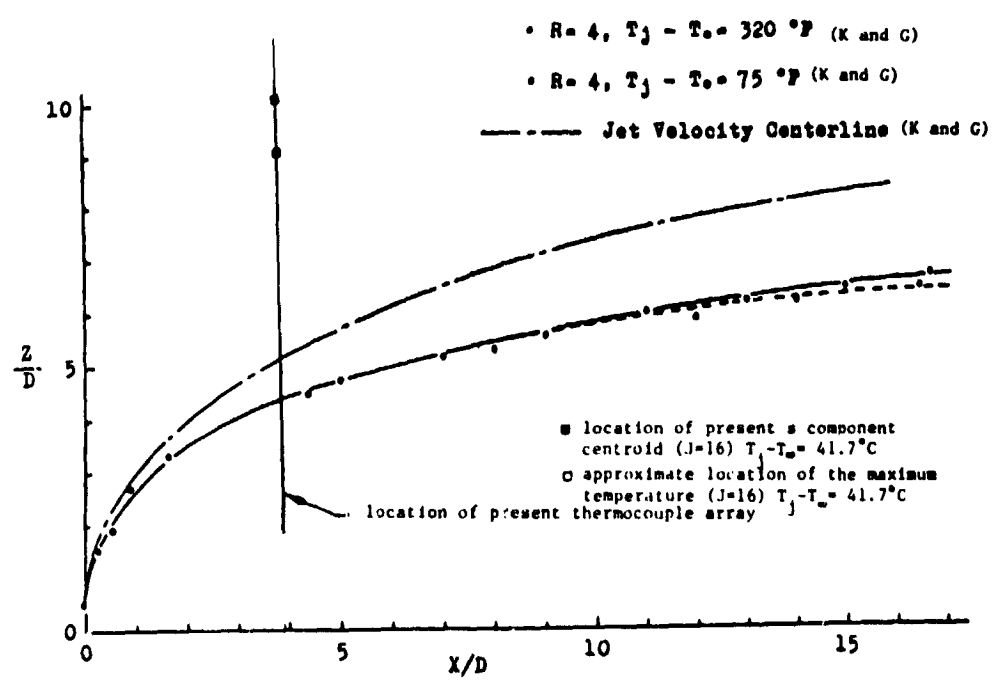

Figure 5a. Location of Temperature Centerline ( $R=4$ )  
from Kamotani and Greber (1971)

ORIGINAL PAGES  
OF EXPERIMENTAL DATA

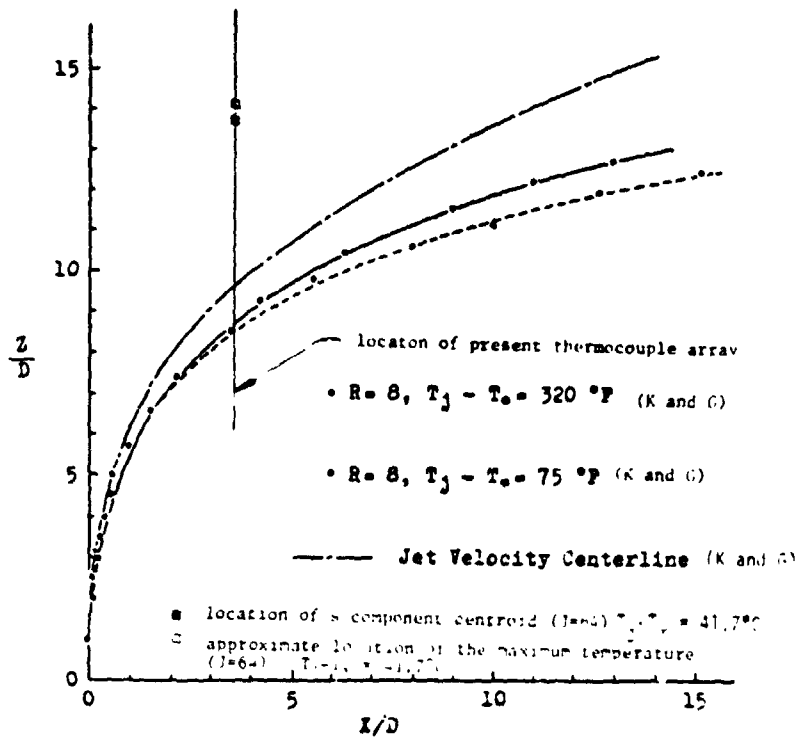

Figure 5b. Location of Temperature Centerline (R=8) from Kamotani and Greber (1973)

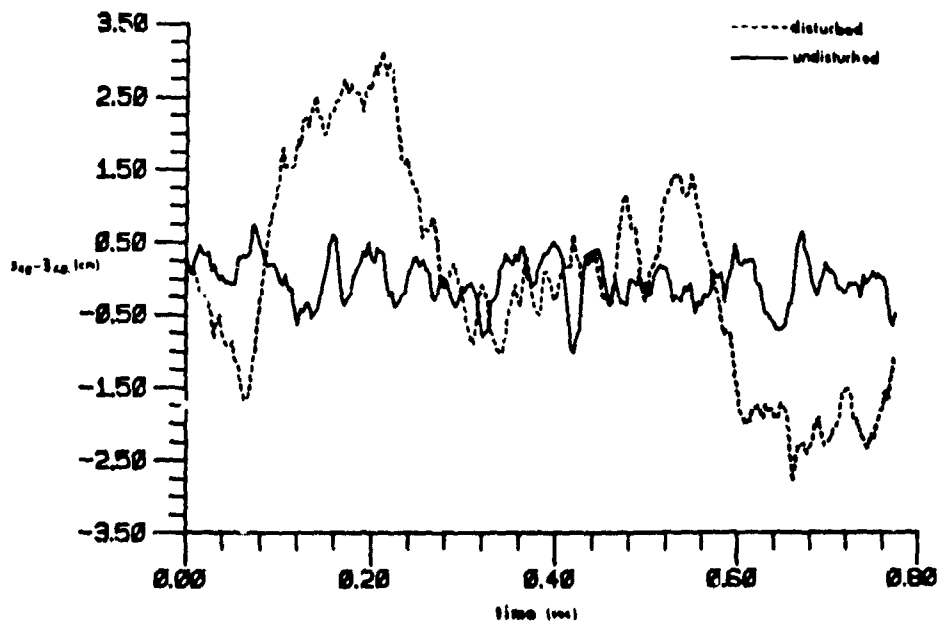

Figure 6. Variation of s Component of Centroid with Time  
 $J = 16, T_{jet} - T_{\infty} = 61.1^{\circ}\text{C}$

Note:  $(z_{c.g.} - z_{c.g.})$  distribution draws a similar fluctuation level.

ORIGINAL PAGE IS  
OF POOR QUALITY

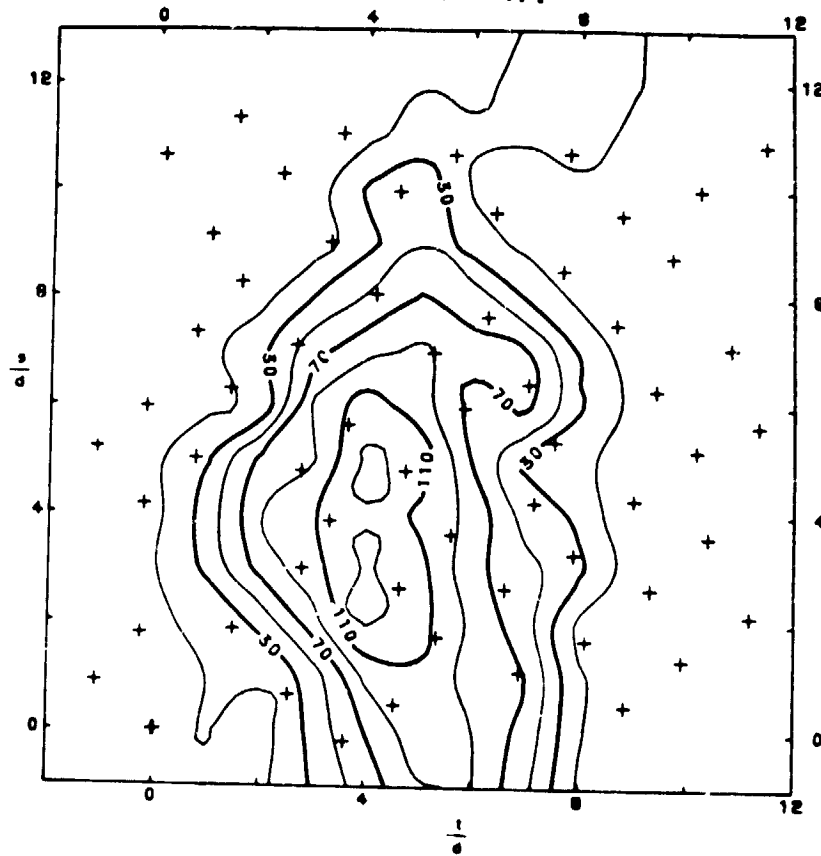

Figure 7. d.c.f. Instantaneous Temperature Isotherms  
 $J = 16$ ,  $T_{jet} - T_{\infty} = 61.1^{\circ}\text{C}$ , Time = .65 sec

NOTE Contours are  $\frac{T - T_{\infty}}{T_{jet} - T_{\infty}} = 1000$ , s/d and  $\frac{1}{d}$ , defined by  
the mean temperature isotherms