

FOREIGN TECHNOLOGY SUMMARY
OF
FLIGHT CRUCIAL FLIGHT CONTROL SYSTEMS

H. A. Rediess
H. R. Textron, Inc.
Irvine, California

First Annual NASA Aircraft Controls Workshop
NASA Langley Research Center
Hampton, Virginia
October 25-27, 1983

INTRODUCTION

A survey of foreign technology in flight crucial flight controls is being conducted for NASA Langley Research Center as a data base for planning future research and technology programs. Only Free World countries were surveyed, and the primary emphasis was on Western Europe because that is where the most advanced technology resides. The survey includes major contemporary systems on operational aircraft, R&D flight programs, advanced aircraft developments, and major research and technology programs. The information was collected from open literature, personal communications, and a tour of several companies, government organizations, and research laboratories in the United Kingdom, France, and the Federal Republic of Germany. This paper provides a summary of the survey results to date.

Some of the figures are taken from a briefing to the NASA Administrator by Mr. Kenneth Szalai from Ames Research Center, Dryden Flight Research Facility, on the technology tour of Europe that Mr. Szalai and the author conducted in 1983. These figures are used with the permission of Mr. Szalai.

This survey was conducted under contract NAS1-17403, and the Technical Representative of the Contracting Officer was Mr. Cary Spitzer, NASA Langley Research Center. The material presented herein solely represents the findings and opinions of the author and is not to be construed as being endorsed by the U.S. Government or representatives of the National Aeronautics and Space Administration.

FLIGHT CONTROL SYSTEMS EVOLUTION

Flight controls technology has undergone tremendous evolution over the past three decades. Figure 1 illustrates many of the key milestones in the evolution as represented by major R&D systems and operational systems. The term "nonflight critical fly-by-wire" refers to systems that are commanded by electric or optical signals, but loss of those signals is not likely to cause the aircraft to crash. Typically, there is also a mechanical/hydraulic path for primary control or as a backup system. Flight critical fly-by-wire means that loss of that system is likely to cause the aircraft to crash.

Although the chart emphasizes U.S. aircraft, several key developments in Europe are included, and those of current interest are discussed subsequently. The Concorde had a very profound effect on European flight controls technology in two ways. It represented the first, and as yet only, high authority SAS/CAS in commercial transports and provided a very important experience base for the UK and France technologists and managers. That has helped influence an early commitment to fly-by-wire in the Airbus. Secondly, it accelerated the development of the technology in France because the French engineers gained valuable experience working directly with the Marconi engineers on the Concorde system. There is now a solid base of DFBW technology in Europe and wide-spread commitment to DFBW for military aircraft and in some cases, commercial transports.

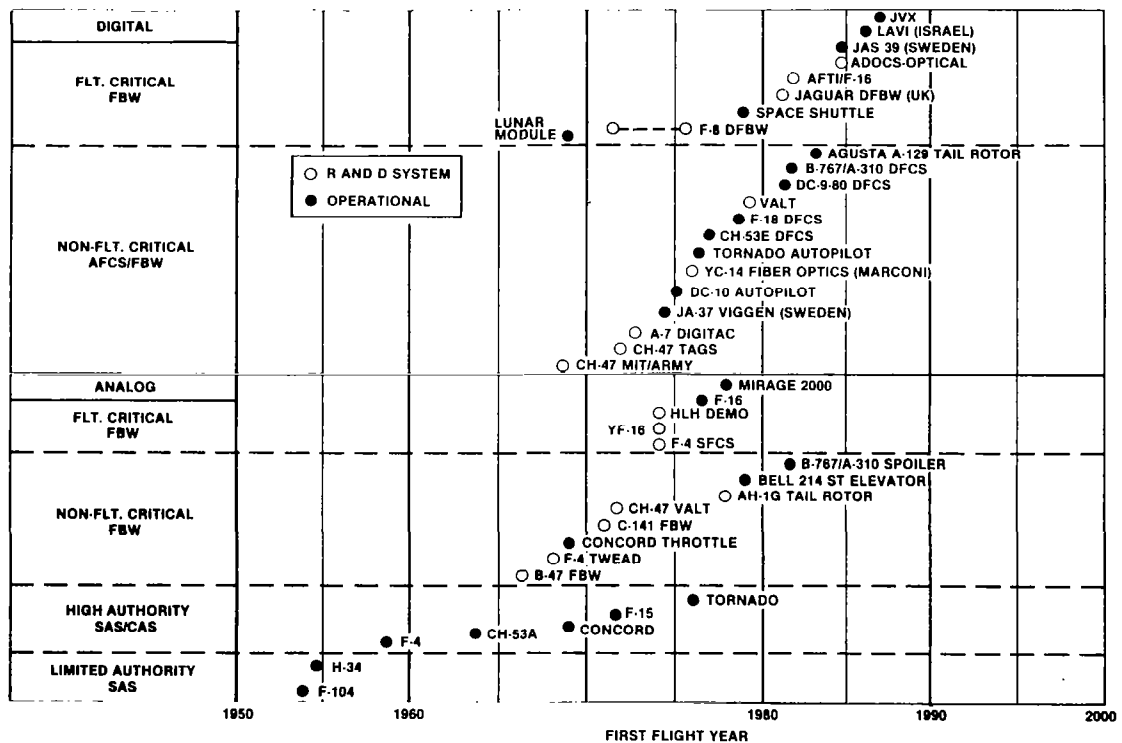

Figure 1

JA-37 AND AIRBUS A-310

The Swedish JA-37 Viggen fighter aircraft (Figure 2) developed by Saab-Scania underwent its first flight in 1974. The aircraft design features a single-channel high-authority digital automatic flight control system (DAFCS) provided by Honeywell and mechanical primary FCS. Functions provided by the DAFCS include a control augmentation system, attitude hold (pitch, roll, heading, and control stick steering), altitude hold, and automatic airspeed control. The aircraft contains three primary control surfaces (right/left elevon and rudder) which are controlled by the pilot via the mechanical PFCS, by the DAFCS via secondary series servo, and via automatic or manual parallel and series trim actuators.

The Airbus A-310 transport, currently in production, was first flight tested in 1982, and features a mechanical primary flight control system, DFBW spoilers, and a digital automatic flight control system. The spoiler system is dual-channel fail safe with identical active and monitor channels and uses dissimilar hardware (processors) and software.

Operational Aircraft

JA-37

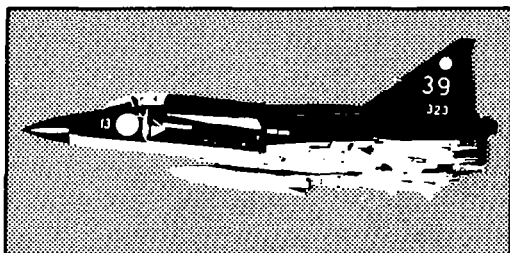

- Swedish (SAAB-Scania)
- First flight 1974
- Single-channel full-authority digital automatic FCS, mechanical reversion

Airbus A310

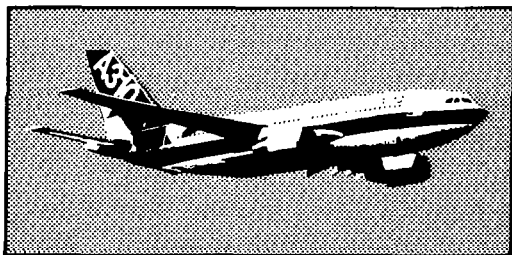

- Multinational (Fr, FRG, Spain, UK)
- First flight 1982
- Mech primary controls, DFBW spoilers, digital autopilot

Figure 2

AIRBUS A-320

Airbus Industries (AI) is in the detailed design stage in the development of a 150-seat, short/medium range A-320 transport (Figure 3) featuring a quadruplex DFBW flight control system (FCS). Mechanical control rudder and mechanical backup pitch trim are retained to permit safe landing in the event of power loss. Tests in the Airbus A-300 flight test aircraft have verified that it is possible to land in this configuration. The system design includes dissimilar redundancy in both hardware and software of the same general type used in the A-310 spoilers. The A-320 will also incorporate relaxed static stability to at least the neutral point and possibly negative static stability.

A flight test program is underway using the A-300 test bed aircraft to evaluate the use of RSS and a side-stick controller on the A-320. The evaluations will determine the engineering operational and certification issues of such systems on civil aircraft. The engines will incorporate full-authority digital engine control integrated with the flight management system.

Operational Aircraft Under Development

Airbus A320

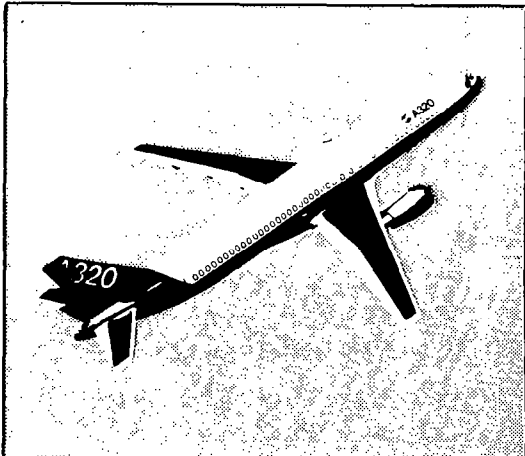

- Multinational (Fr, FRG, Spain, UK)
- Detailed design in progress
- First flight 1986
- Quad DFBW — dissimilar redundancy hardware and software
- Mech backup on rudder and pitch trim
- ACT: relaxed static stability
- Side-stick controller

Figure 3

A-320 DFBW SYSTEM

A more detailed description of the A-320 DFBW system design features is shown in Figure 4. All primary flight control surfaces (elevators, horizontal stabilizer, ailerons, and roll spoilers) are quadruplex digital fly-by-wire using dissimilar redundancy in both hardware and software. The rudder control is mechanical, and the tail plane trim has a mechanical backup to provide emergency landing capability. The secondary controls (slats, trim, speed brakes, and lift dumpers) are commanded electrically.

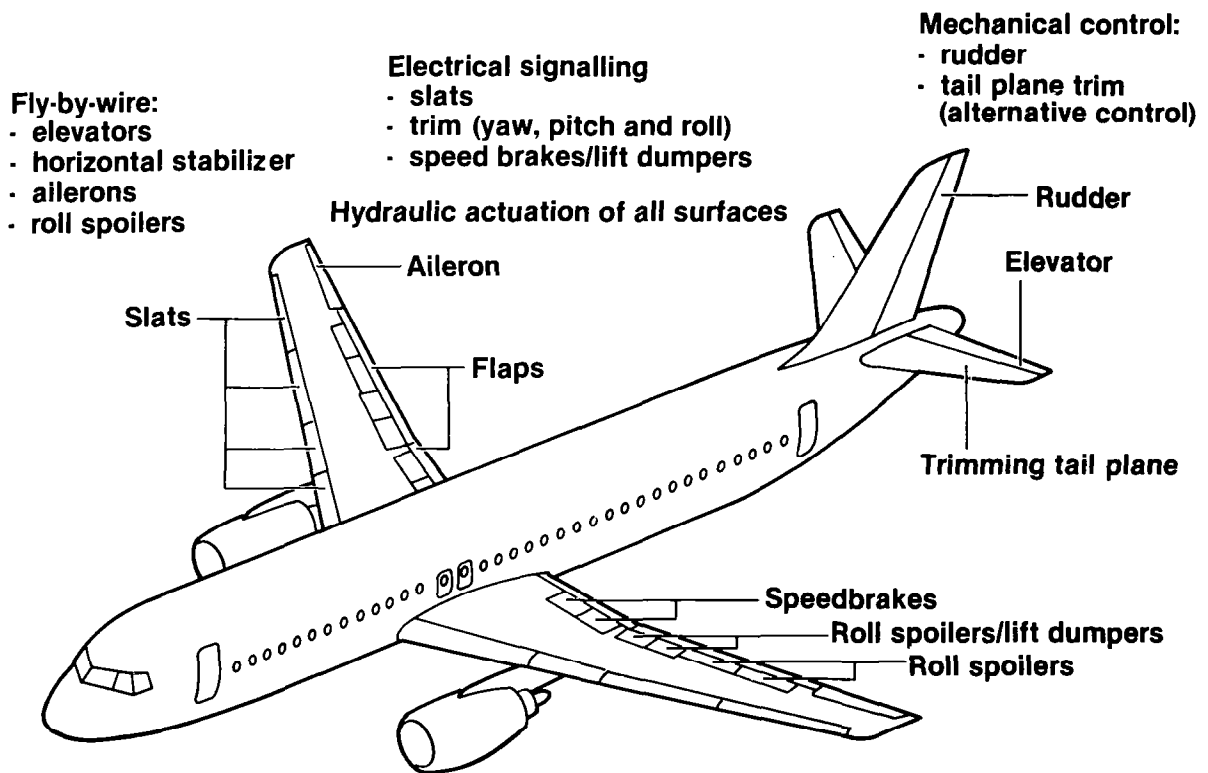

Figure 4

AIRBUS INDUSTRIES FLIGHT CONTROL SYSTEM EVOLUTION

Airbus Industries (AI) planned development of a transport family is illustrated in Figure 5. Based on a continued, vigorous research and development program, including full-scale experimental testing, advanced technologies are progressively introduced in aircraft designs providing practical, evolutionary changes rather than revolutionary. The next transport is the 150-seat A-320 described previously. A series of wide-body aircraft is in the preliminary design stage: a two-engine short/medium range TA-9; a four-engine long-range TA-11; and, a two-engine medium/long range TA-12. The first two of these, TA-9 and TA-11, are expected to incorporate full-authority digital fly-by-wire systems on all surfaces, extensive use of active controls, and reduced energy systems.

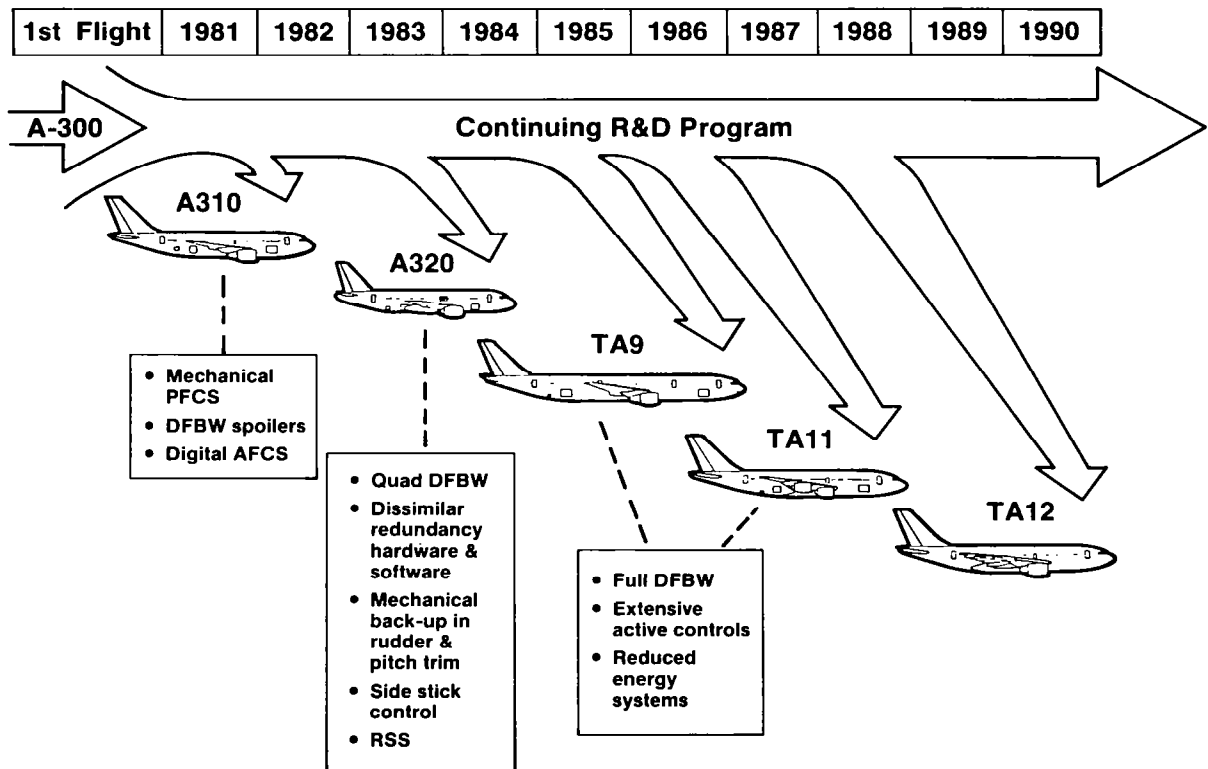

Figure 5

TORNADO AND MIRAGE

Figure 6 illustrates basic characteristics of the multinational Tornado and French Mirage 2000/4000 aircraft currently in production.

The Tornado, a joint UK, FRG, and Italian project, underwent its first flight in 1976. The flight control system includes both analog and digital computing. The primary flight control function is performed by a command/stability augmentation system (CSAS) which is a triplex analog FBW maneuver demand system (Ref. 1). While no mechanical reversion is provided for the rudder and spoilers, it is retained for the ailerons for safe return upon loss of CSAS computing. A dual digital autopilot/flight director (AFDS) integrated with the CSAS provides outer loop control. The AFDS uses cross-comparison techniques for failure detection and a signal consolidation scheme to provide triplex commands to the CSAS. It also provides a fail operational flight director capability to enable the pilot to monitor the autopilot performance and fly the aircraft manually if the autopilot malfunctions.

The first flights of the Dassault-Breguet Mirage 2000 and 4000 were conducted in 1978 and 1979, respectively. With no mechanical reversion capability, both include a flight-critical analog FBW flight control system with digital autopilot. The 2000N version is nuclear hardened fitted with terrain-following radar. The Mirage 4000 features relaxed static stability and automatic variable camber to optimize performance.

Operational Aircraft

Tornado

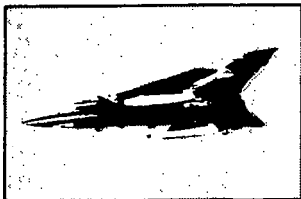

- Multinational (UK, FRG, Italy)
- First flight 1976
- Analog CSAS, dual digital autopilot, mechanical reversion

Mirage 2000/4000



- French (Dassault-Breguet)
- First flight 1978, 1979
- Analog FBW, digital autopilot, no mechanical reversion
- Relaxed static stability/auto variable camber (4000)

Figure 6

JAS-39 AND LAVI

Flight critical DFBW flight control systems designs are under development for operational fighter aircraft in both Sweden and Israel (Fig. 7). Saab-Scania of Sweden is developing the JAS-39 Gripen advanced strike fighter. Lear Siegler, Inc., will design, develop, and manufacture the flight control system. Under subcontracts, Moog Aerospace in cooperation with Saab Combitech will design the primary flight actuators, and Lucas Aerospace will supply the maneuvering-flap control actuation system. The JAS-39 will be a flight-critical triplex DFBW system and, thus, contains no mechanical backup capability. The fighter, scheduled for first flight in 1987, is being developed for specific mission needs of Sweden and may not favorably compete for an international market.

The Israeli Aircraft Industries is developing the LAVI tactical fighter to replace the A-4 and Kfir C2 aircraft with first flight scheduled for 1986. The flight controls, to be designed by Lear Siegler (Moog), will be a digital fly-by-wire system with relaxed static stability and include an analog but no mechanical backup system. Advanced digital avionics systems will be incorporated to operate with interactive multifunction displays/controls, fire control integrated with internal and external sensors, and enhanced active/passive self-defensive systems. As planned, much of the design and systems would be supplied by U.S. companies.

Operational Aircraft Under Development

JAS-39

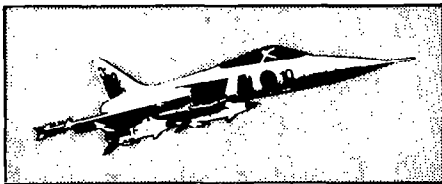

- Swedish (SAAB-Scania)
- First flight 1987
- Triplex DFBW (Lear Siegler), no mechanical backup

LAVI

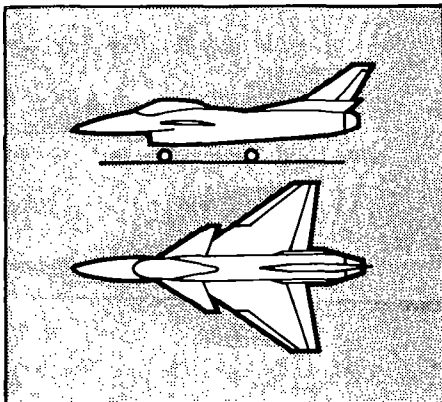

- Israel (IAI)
- First flight 1986
- Triplex DFBW (Lear Siegler), analog backup, no mechanical reversion
- ACT: relaxed static stability

Figure 7

SKYSHIP 600

In the UK, Marconi Avionics, under contract to Airship Industries, is developing a digital fly-by-light (DFBL) flight control system for application to the Skyship 600 (see Figure 8). High inherent immunity to EM interference is achieved by a 1553 optical data bus between the FCC and the actuator drive system (ADS) and by providing dedicated electrical power at the ADS from a hydraulically driven electronic generator. The ADS includes a microprocessor to locally handle the failure detection and isolation. The actuators are duplex electric incorporating two samarium cobalt DC servomotors mounted on a common shaft, each fed by separate power. Torque is supplied by only one motor; the second is activated after failure of the first.

Operational Airship Under Development

Skyship 600

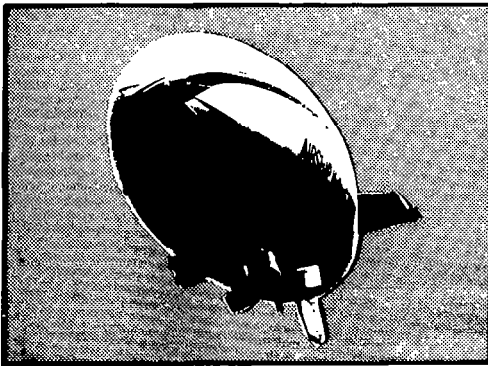

- UK (Airship Industries, Marconi)
- First flight 1983 (with DFBL)
- Digital fly-by-light (DFBL)
 - All four tail surfaces
 - Active/standby with pilot select
 - Microprocessor-based FCS computer
 - 1553 optical data bus

Figure 8

TIAWAN F-104

The Aeronautical Research Laboratories of the Aeronautical Industry Development Center (AIDC) of the Republic of China in Tiawan has initiated a program to develop a modern digital flight control system to upgrade 100 F-104 aircraft (Fig. 9). The system will be a half-authority dual digital command augmentation system (CAS) and stability augmentation system (SAS) for pitch, roll, and yaw. The existing mechanical system and a new direct electrical command system will provide emergency backup capability. The prototype development contract for five aircraft systems is now under competition, and the first flight is expected to be early in 1987.

Operational Aircraft FCS Upgrade

F-104

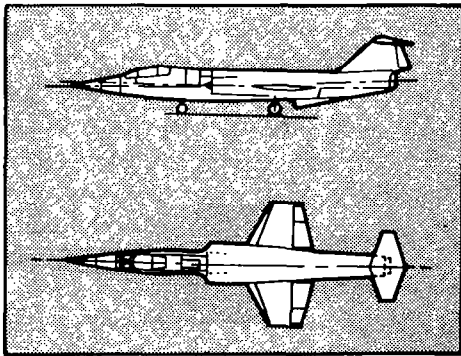

- Republic of China-Taiwan (AIDC)
- FCS under competition
- First flight 1987
- Dual digital CAS/SAS, mechanical and direct electrical backups

Figure 9

F-104 CCV AND JAGUAR DFBW

Among the European R&D flight programs are the German F-104CCV and the United Kingdom's Jaguar DFBW aircraft shown in Figure 10. The purpose of the German demonstration program was to investigate stability and control characteristics of a supersonic aircraft (Ref. 2). A single-seat F104G was modified as a control-configured vehicle (CCV) with a newly developed full-authority quadruplex system while retaining the original system as a mechanical backup. After initial flights starting in December 1977 to evaluate the DFBW system, various degrees of destabilization were achieved by adding aft ballast and a canard. The highest instability reached in normal flight was up to 22% mean aerodynamic chord at an angle of attack of 11 degrees. The flight tests were highly successful in demonstrating aircraft controllability in a highly unstable configuration.

The Jaguar program was initiated to demonstrate a safe, practical, full-authority DFBW flight control system. This activity is of interest since it represents the first pure digital fly-by-wire system with no dissimilar backup. The program was initiated in 1977 under the technical sponsorship of the RAE and under contract to British Aerospace. Marconi Avionics furnished the flight control system. While more descriptions will follow, basically the FSC is a full-authority quadruplex DFBW system with optically coupled data transmission. The initial flight of aircraft was conducted in October 1981.

R & D Flight Programs

F-104 CCV



- German (MBB)
- First flight 1977
- Quad DFBW, full-authority, mechanical reversion
- Relaxed static stability

Jaguar

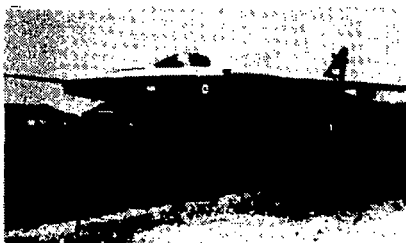

- UK (RAE/BAe, Marconi)
- First flight 1981
- Quad DFBW, no mechanical reversion
- Optical interchannel data links

Figure 10

JAGUAR DFBW SYSTEM ARCHITECTURE

The overall system architecture is shown schematically in Figure 11 (Ref. 3). Quadruplex computers and primary sensors were used to satisfy specifications requiring survival of any two electrical failures in the system and reliance on majority voting rather than self monitoring within each redundant element. Sensors of lower redundancy were used for those functions not necessary for safety of flight. A sextuplex or duo-triplex first-stage actuation scheme was selected to conform with stringent redundancy specifications. The two additional actuator channels are driven by the actuator drive and monitor computers which were independently voted versions of the FCC's outputs. Comprehensive built-in-test features were included to measure the system functional characteristics. While designed to run synchronously, the system has been operated asynchronously for continued periods without observable degradation.

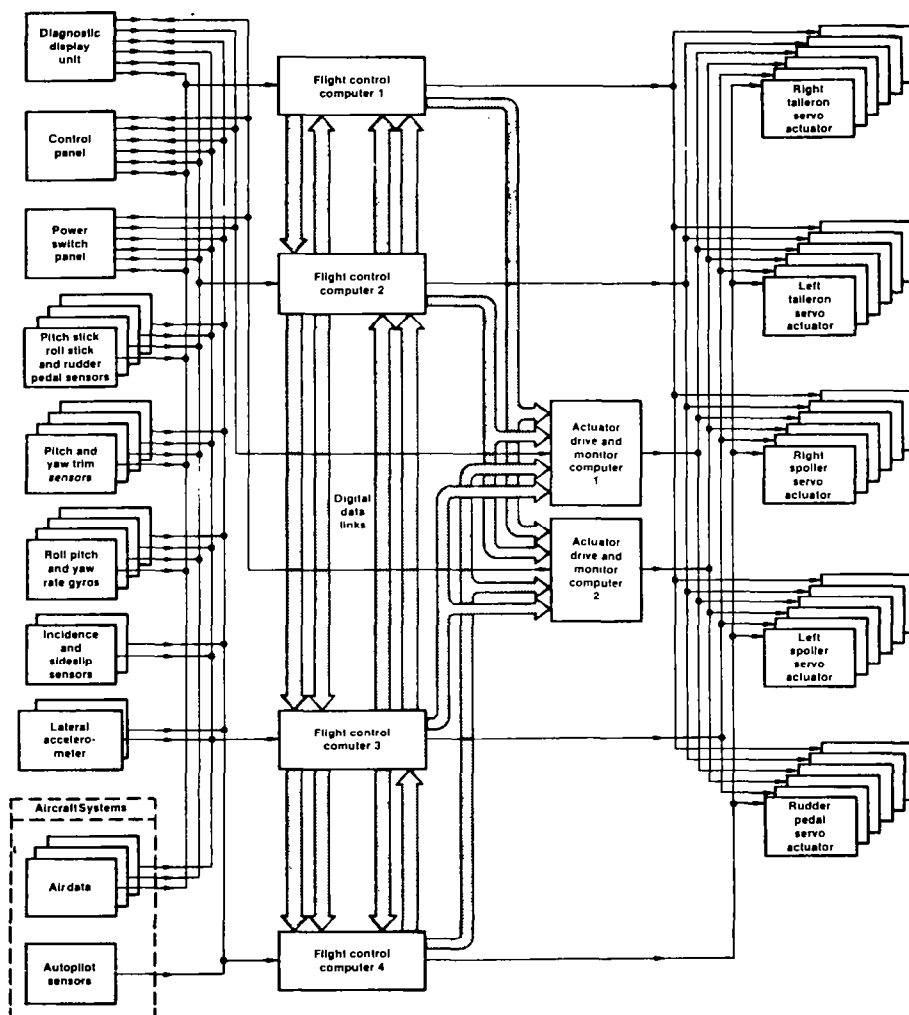

Figure 11

JAGUAR DFBW - COMPUTING AND MONITORING ARCHITECTURE

The basic system computing and monitoring architecture is presented in Figure 12 which illustrates a simplified primary control path (Ref. 4). Quadruplex primary sensors, those necessary for flight safety, are interfaced with four identical flight control computers (FCC) which process these as well as less critical sensor signals into commands for control of the actuators. Cross-channel data transmission is achieved by optically coupled serial data links. This scheme enables each computer to carry out bit for bit identical control law implementation. Voting and failure rejection logic contained in each computer satisfies the requirement for surviving two sequential failures of all critical sensors. The actuation architecture required six independent servo drive signals. To avoid the cost and complexity of a full six-channel system, the four FCC's were augmented by dual analog actuator drive and monitor computers (ADMC) which utilize independently voted versions of the FCC output signals to drive the additional two channels. Failed FCC channels are detected and latched out, and then the ADCM averages the remaining good FCC channels. These additional channels are mechanized to eliminate any interchannel failure propagation between the six parallel redundant output interfaces.

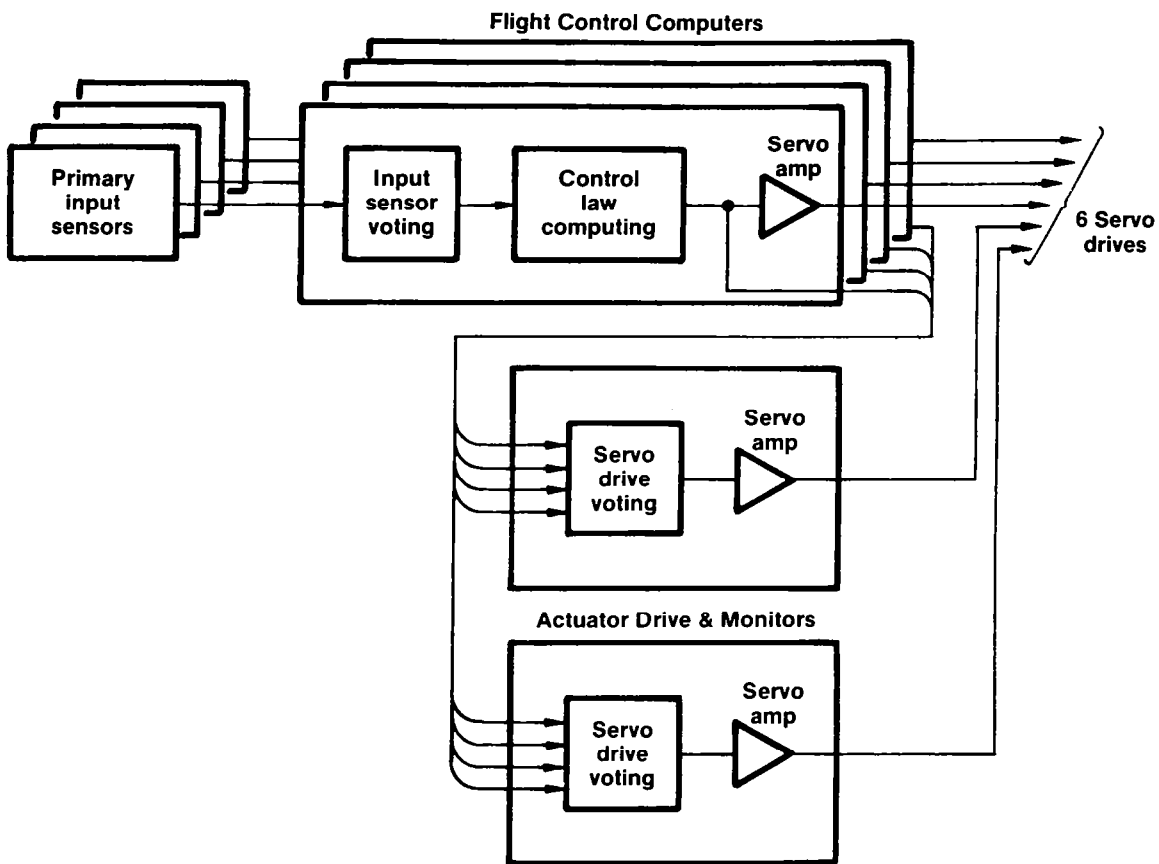

Figure 12

JAGUAR DFBW-DUO-TRIPLEX ACTUATOR SCHEME

The basic specifications requiring that first-stage actuation has only two independent hydraulic supplies with no interconnect and that the system survives a hydraulic failure followed by an electrical system failure or the converse, led to the selection of duo-triplex first-stage actuation system design. While a quadruplex configuration would have offered an attractive one-to-one interface with the FCC's, designers were concerned with mechanizing some form of fast reaction actuator monitoring and channel isolation scheme to prevent uncontrolled surface movement in the event of an electrical followed by a hydraulic failure. Each of the five control surface actuation systems is similar, and Figure 13 illustrates the operation (Ref. 4). Each system contains six servovalves. An interactor mechanical link assures that the spools move uniformly, which effectively sums the six servovalve outputs. Thus, failures in two channels are overridden by the other four. A separate hydraulic supply feeds each trio of servovalves and is also routed to the corresponding jack of the conventional tandem power control unit. A hydraulic supply failure is absorbed because the three associated servovalves are unable to oppose the correctly operating channels.

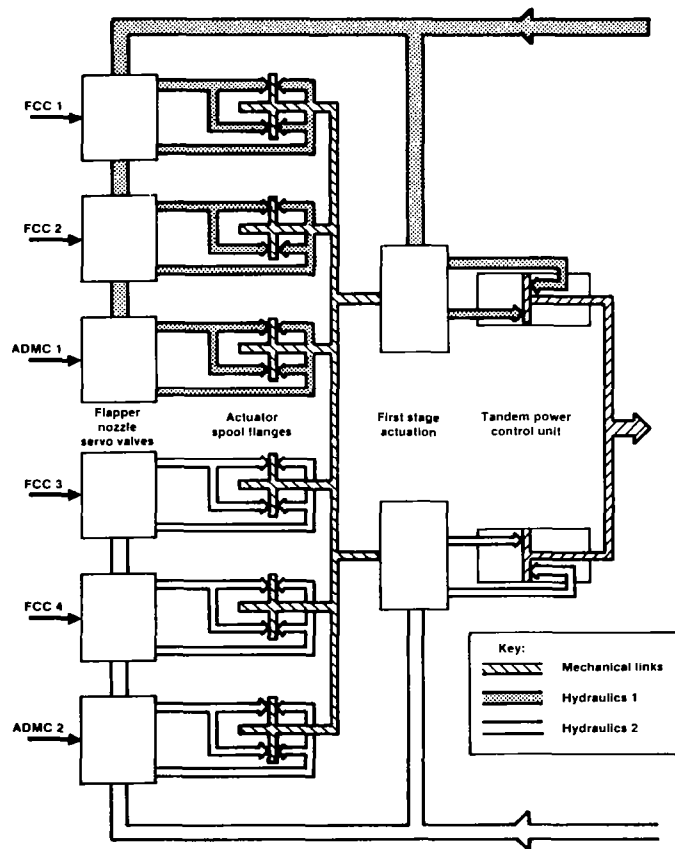

Figure 13

JAGUAR DFBW - SOFTWARE DEVELOPMENT PROCESS

The use of common software in the flight control system presented the potential of a generic error leading to a safety critical loss of control. Therefore it was necessary to provide maximum software visibility to facilitate thorough testing and functional auditing during the design phase, supplemented by clear requirements definition, detailed documentation, and stringent production and configuration control procedures (Ref. 5). The key documents controlling the software design are the System Requirements Document (SRD), which controls the design implementation, and the Software Structure Development (SSD). The SSD defines the running order of the modules within each program segment and is designed to assure strict sequential data flow.

The overall software development process is depicted in Figure 14. The SRD's are interpreted to produce software module design specifications which in turn are used for module coding. A module test specification is written by an independent programmer to minimize error carry-over. The module code is tested, and the results are documented. Senior programmers audit all module documentation to assure that the design requirements are satisfied, the design rules observed, and the test process followed. When the module coding is completed, the modules are assembled and loaded into the hardware for integration tests. All of the software documentation is subjected to strict configuration control with changes authorized only through a formal change request process.

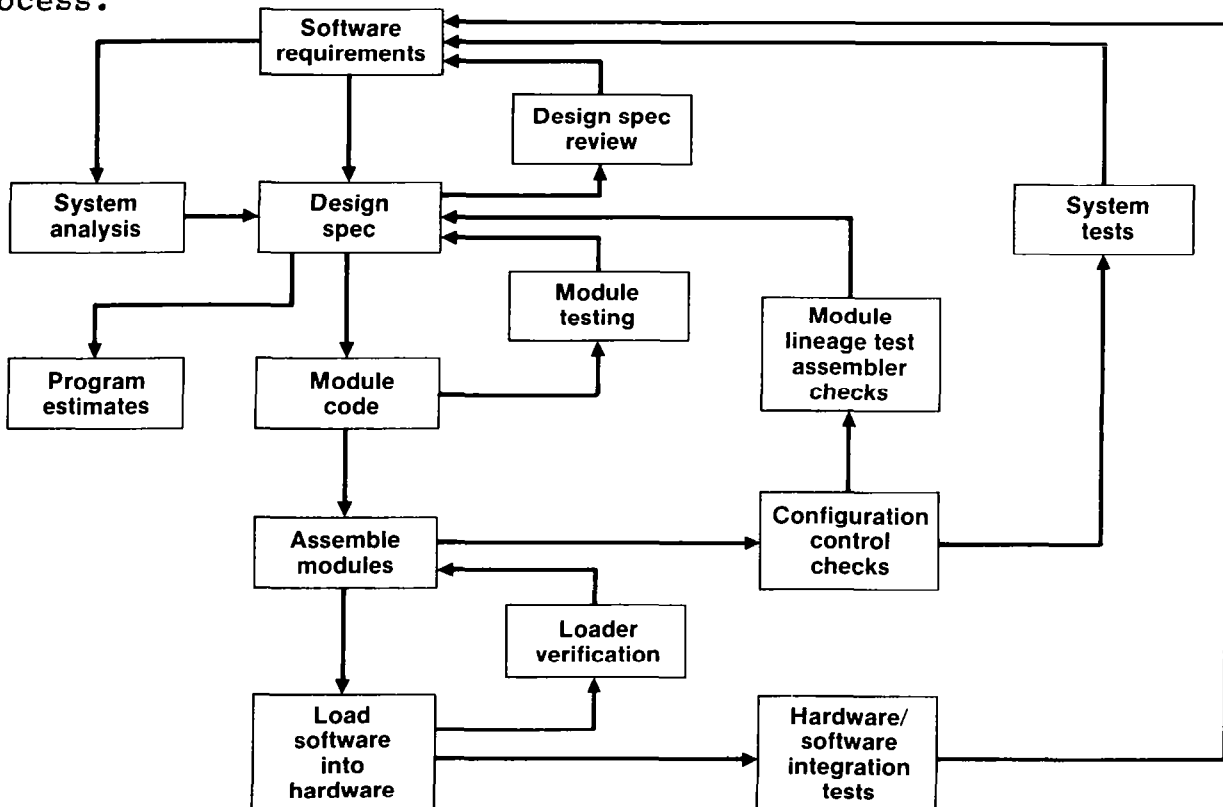

Figure 14

JAGUAR DFBW - SYSTEM INTEGRITY APPRAISAL

The basic integrity of the system was achieved by the selection of the system architecture in conjunction with standard design practices, performance testing, and assessments of operational/safety considerations. For the Jaguar DFBW program, these procedures were extended to include an integrity appraisal or system audit as outlined in Figure 15. The main elements (Ref. 5) were:

- 100% coverage single-fault FMEA
- Multiple-fault FMEA for specific combinations
- Flight resident software integrity appraisal
- Appraisal of specific functions
- Configuration inspection
- Qualification program
- Burn-in program

These were supplemented by secondary analyses shown below the main elements in the figure. As part of the integrity appraisal, various functions and features of the system were subjected to technical evaluations as required from the results of mainstream failure mode and effects analysis (FMEA) and/or engineering findings. While the appraisal was conducted by a team knowledgeable in the specific design, they reported to senior engineers.

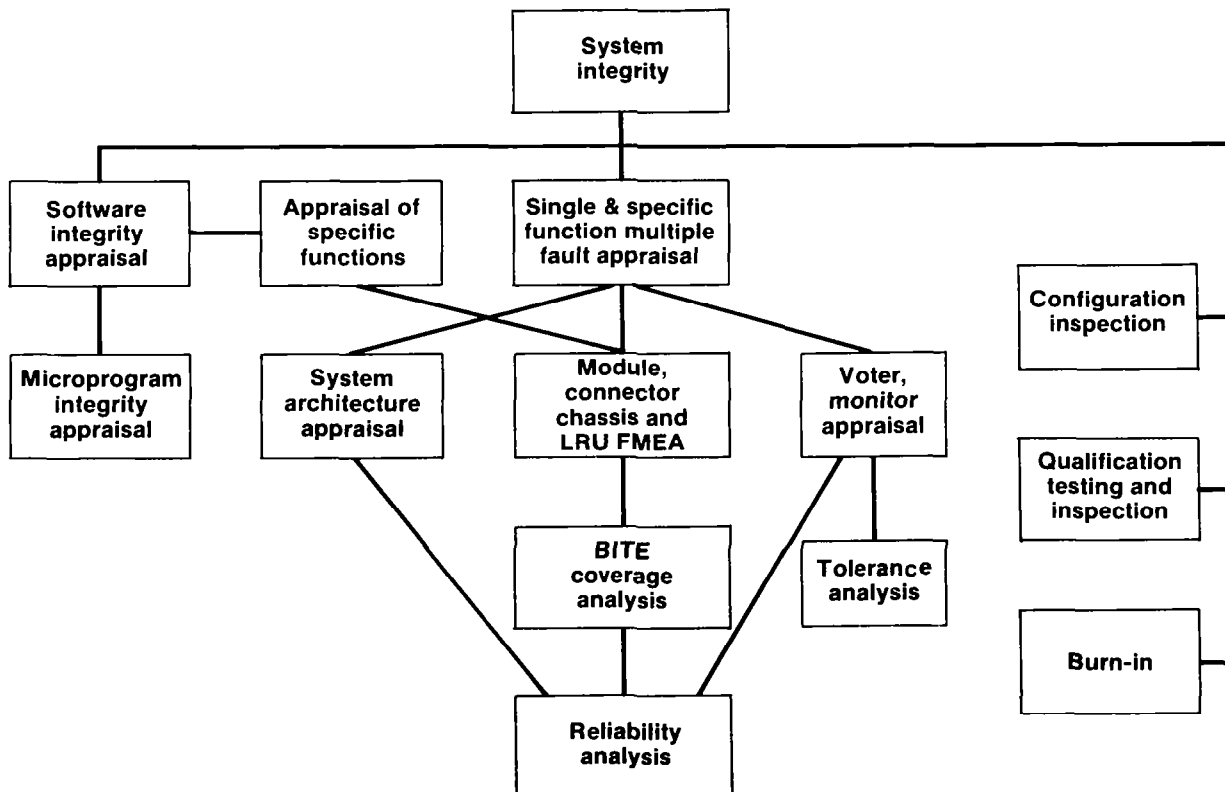

Figure 15

JAGUAR DFBW - SYSTEM QUALIFICATION PROCESS

Once the design objectives had been specified as subsystem or elements, such as the FCS, it was necessary to integrate these elements into a functional system exhibiting the characteristics of the basic design requirement while assuring that no adverse intersystem reactions were present and verifying that the common software used contained no generic or other design defects. These tasks were conducted using a ground test rig, the aircraft, and an independent software audit, interrelated as shown in Figure 16 (Ref. 5).

The ground test rig was used to (1) verify the control laws by pilot assessment, (2) integrate the hardware, software, and ancillary equipment, (3) validate the final software before flight, and (4) gain overall system confidence. In addition, it served as a pilot training aid and as a preflight test bed.

The aircraft ground tests included complete checkout and test of the installed flight control system, electro-magnetic compatibility testing, aircraft systems testing, and simulated lightning tests.

It was considered essential that an independent software test by a disinterested group be used to supplement the rig and aircraft tests. The group was responsible for emulation of the flight control computer using a general purpose machine and for manual code analysis.

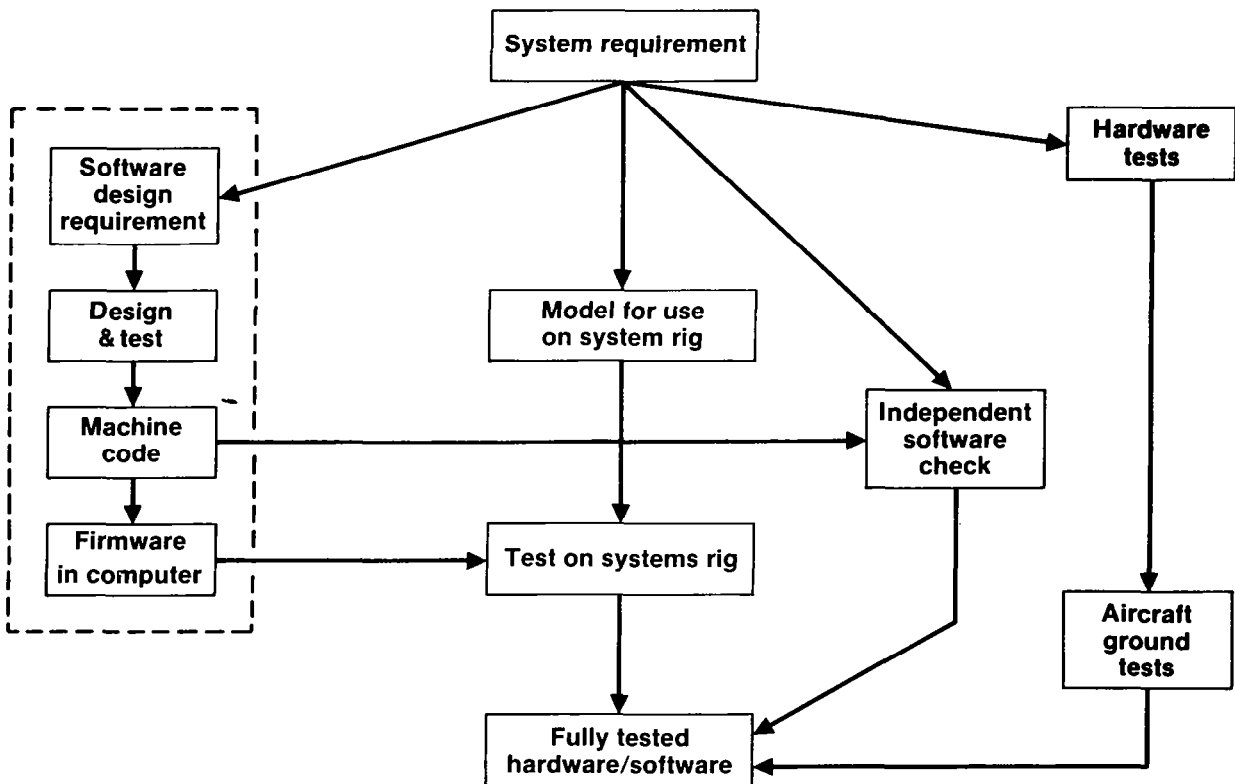

Figure 16

AUGUSTA A-129 AND T-2 CCV

Flight test programs are being conducted by both Italy and Japan (Figure 17).

The Italian Augusta A-129 helicopter has been undergoing tests, and five prototype vehicles are to be manufactured in anticipation of production. The A-129 features a DFBW tail rotor (nonflight critical) but retains other mechanical controls. The design includes a digital autopilot and an integrated multiplexing system using microprocessors for aircraft/firing systems control.

Under contract to the Japanese Defense Agency, Mitsubishi has built a control-configured vehicle version of the T-2 advanced trainer for use as a research aircraft. The T-2 CCV has composite all-flying canards located on the inlets ahead of the wing leading edge and a composite ventral fin located on the fuselage center line. The flight control system is triplex digital with mechanical backup. The first flight was conducted in August 1983, and the aircraft is scheduled for a two-year experimental flight test program by the Japanese Air Self Defense Force.

R & D Flight Programs

Agusta A-129



- Italy
- First flight 1983
- DFBW tail rotor, digital autopilot, mechanical rotor controls
- Multiplex data bus/integrated avionics/flight control

T2 CCV

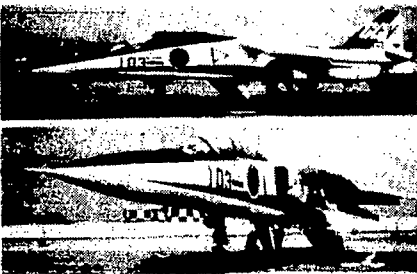

- Japan (Mitsubishi)
- First flight 1983
- Triplex DFBW, mechanical reversion
- All moving canard/RSS

Figure 17

ADVANCED AIRCRAFT DEVELOPMENT

Britain and France are currently competing for leadership of a new generation European combat aircraft advance development program which may lead to a joint development with Germany for 1990's fighter aircraft (Fig. 18).

Led by British Aerospace, a seven-member industrial consortium has an agreement with the British Ministry of Defense for government funding up to and including first flight for the development of an Agile Combat Aircraft (ACA) technology demonstrator called an experimental aircraft program (EAP). Both West German and Italian aerospace companies have contributed some funding, and while not committed, the West German and possibly the Italian governments may fund a second demonstrator aircraft. The ACA flight control system design by Marconi Avionics would be quadruplex digital fly-by-wire (DFBW) with no mechanical backup and no dissimilar redundancy. (Marconi considers that, while not required for military application, dissimilar redundancy is necessary in commercial aircraft for certification purposes.)

France has a comparable program since Dassault-Breguet (D-B) has begun manufacture of one technology demonstration aircraft, Avion de Combat Experimental (ACX). It will be a DFBW design with no mechanical backup and include electrical and fiber optics data busing, voice control system, holographic displays, and provision for antiturbulence ride control in the automatic computer-controlled flight control system.

The Federal Republic of Germany has need for a fast-reaction fighter, and their special requirements are prompting them to consider an entirely new fighter airframe called the TKF-90 which would employ existing avionics technologies to minimize costs. Two German companies, Messerschmitt-Boelkow-Blohm (MBB) and Dornier, are pursuing test programs to satisfy the German Air Force needs but neither is committing to a flying demonstrator. MBB is using a modified Saab Viggen as a test bed to investigate various performance envelopes and is testing vectoring nozzle canards and other advanced control features. MBB has considerable experimental background in fire and flight control systems resulting from their F-104 CCV test bed.

Dornier in conjunction with Northrop has an ND-102 design and is using a modified Alpha jet to test a new transonic wing and to experiment with direct side force controls and maneuvering flaps/slats.

Thus, at the time of this writing, there are three fighter design plans among the UK, France, and FRG. Considering the economics involved, it is likely that more than one or possibly two will be fully developed. Both the UK and France seek partnership with the FRG, and it

is likely that at least the TFK-90 will be a compromise between the ACA and ACX programs. MBB of West Germany is, in fact, a partner on the ACA and is being actively pursued as a partner in France's ACX program. MBB could become the catalyst for a European-wide project with British Aerospace and Dassault-Berquet and themselves as principals. While specific mission requirements would be compromised, such a triumvirate would create an attractive production market and serve as a formidable obstacle for U.S. competitors.

Italy (Aeritalia-Macchi) and Brazil (Embraer) are jointly developing the AMX fighter with first flight scheduled for 1984 and delivery in 1987. Initial production is expected to provide 185 aircraft for Italy and 80 for Brazil. The electronic flight control system designed by Marconi provides duplex analog fly-by-wire control of the tail plane, spoilers, and rudder together with mechanical elevators and ailerons. The design also incorporates automatic pitch, roll, and yaw stabilization. The equipment comprises two dual-redundant flight control computers based on 16-bit microprocessors organized for specially developed fail-safe software. To optimize hardware requirements, analog computing is used for the actuator control loops, pilot command path, and rate damping computations. Digital computing is used to handle gain schedules, electronics trim, and airbrake integrators. System performance is monitored by redundant processors in the flight control computers.

Advanced Aircraft Development

ACA, ACX

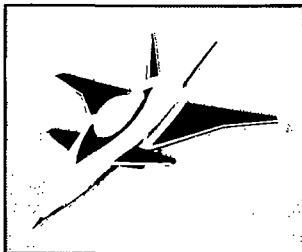

- UK/FRG (BAe, MBB, Marconi)
- First flight 1986
- Quad DFBW, no mechanical reversion, no dissimilar redundancy
- Fr, FRG (Dassault-Breguet, MBB?)
- First flight 1986
- DFBW, no mechanical reversion, fiber optic data bus
- Ride control, voice command, holographic HUD

AM-X

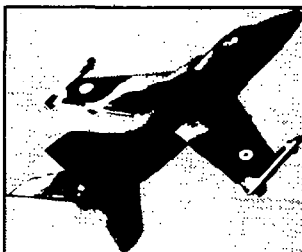

- Italy, Brazil (Aeritalia/Marcchi, Embraer, Marconi)
- First flight 1984
- Duplex analog FBW, digital gain sched/monitoring (tailplane, spoilers, rudder)

Figure 18

REFERENCES

1. Corney, J. M.: The Development of Multiple Redundant Flight Control Systems for High Integrity Applications. *Aeronautical Journal*, vol. 84, no. 837, Oct. 1980, pp. 327-338.
2. Korte, U.: Flight Test Experience with a Digital Integrated Guidance and Control System in a CCV Fighter Aircraft. AGARD CP-321, Lisbon, Portugal, October 1982, pp. 22-1 to 22-11.
3. Smith, T. D., et al.: Ground Flight Testing on the Fly-by-Wire Jaguar Equipped with a Full-Time Quadraplex Digital Integrated Flight Control System. AGARD-CP-321, Lisbon, Portugal, October 1982, pp. 23-1 to 23-20.
4. Marshall, R. E. W., et al.: Jaguar Fly-by-Wire Demonstrator Integrated Flight Control System. Paper presented at the 1981 Advanced Flight Control Symposium, Colorado Springs, CO, August 5-7, 1981.
5. Daley, E. and Smith R. B: Flight Clearance of the Jaguar Fly-by-Wire Aircraft. Proceedings of the Royal Aeronautical Society Symposium, Certification of Avionic Systems, April 27, 1982.