

1985 000 5977

SALT-GRADIENT SOLAR PONDS: SUMMARY OF U.S. DEPARTMENT
OF ENERGY SPONSORED RESEARCH

By
R. L. French
D. H. Johnson
G. F. Jones
F. Zangrando

August 1984

Work Performed Under Contract No. AI03-82SF11592

LIBRARY COPY

JUN 20 1985

Jet Propulsion Laboratory
Pasadena, California

LANGLEY RESEARCH CENTER
LIBRARY, NASA
HAMPTON, VIRGINIA

Technical Information Center
Office of Scientific and Technical Information
United States Department of Energy



Energy

S
O
L
A
R

DISCLAIMER

This report was prepared as an account of work sponsored by an agency of the United States Government. Neither the United States Government nor any agency thereof, nor any of their employees, makes any warranty, express or implied, or assumes any legal liability or responsibility for the accuracy, completeness, or usefulness of any information, apparatus, product, or process disclosed, or represents that its use would not infringe privately owned rights. Reference herein to any specific commercial product, process, or service by trade name, trademark, manufacturer, or otherwise does not necessarily constitute or imply its endorsement, recommendation, or favoring by the United States Government or any agency thereof. The views and opinions of authors expressed herein do not necessarily state or reflect those of the United States Government or any agency thereof.

This report has been reproduced directly from the best available copy.

Available from the National Technical Information Service, U. S. Department of Commerce, Springfield, Virginia 22161.

Price: Printed Copy A09
Microfiche A01

Codes are used for pricing all publications. The code is determined by the number of pages in the publication. Information pertaining to the pricing codes can be found in the current issues of the following publications, which are generally available in most libraries: *Energy Research Abstracts (ERA)*; *Government Reports Announcements and Index (GRA and I)*; *Scientific and Technical Abstract Reports (STAR)*; and publication NTIS-PR-360 available from NTIS at the above address.

DISPLAY 15/2/11

85N14286** ISSUE 5 / PAGE 667 CATEGORY 44 RPT#: NASA-CR-174183
JPL-PUB-84-74 NAS 1.26:174183 DOE/SF-11592/2 DE85-004581 CNT#:
DE-AI03-82SF-11592 84/08/00 165 PAGES UNCLASSIFIED DOCUMENT

UTTL: Salt-gradient solar ponds: Summary of US Department of Energy sponsored
research

AUTH: A/FRENCH, R. L.; B/JOHNSON, D. H.; C/JONES, G. F.; D/ZANGRANDO, F.
PAA: B/(Solar Energy Research Inst.); C/(Los Alamos National Lab.);
D/(Solar Energy Research Inst.)

CORP: Jet Propulsion Lab., California Inst. of Tech., Pasadena.; Department of
Energy, Washington, D. C. AVAIL.NTIS

SAP: HC A08/MF A01

COI: UNITED STATES Prepared for DOE, Washington, D.C.

MAJS: /*DESIGN ANALYSIS/*FLUID DYNAMICS/*HEAT TRANSFER/*SOLAR PONDS (HEAT
STORAGE)/*THERMAL CONDUCTIVITY

MINS: / COMPUTERIZED SIMULATION/ FINITE ELEMENT METHOD/ HEAT EXCHANGERS/
SALINITY/ SOLAR ENERGY CONVERSION/ TECHNOLOGY ASSESSMENT

AMN: The solar pond research program conducted by the United States Department
of Energy was discontinued after 1983. This document summarizes the
results of the program, reviews the state of the art, and identifies the
remaining outstanding issues. Solar ponds is a generic term but, in the
context of this report, the term solar pond refers specifically to
saltgradient solar pond. Several small research solar ponds have been

ENTER:

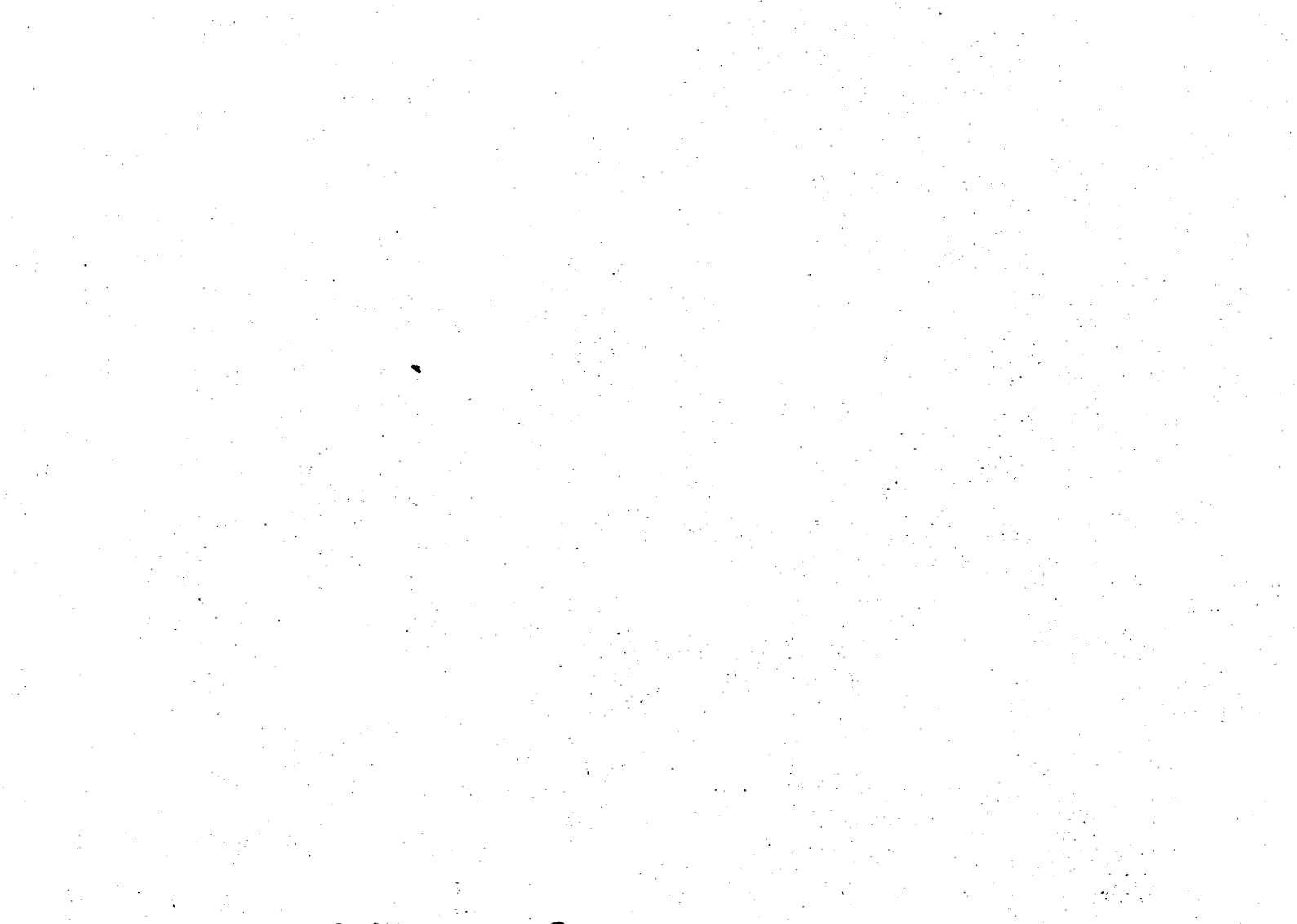

5107-6
Solar Pond Project

DOE/SF/11592-2
(JPL-PUB-84-74)
(DE85004581)
Distribution Category UC-62b

Salt-Gradient Solar Ponds: Summary of U.S. Department of Energy Sponsored Research

R.L. French
D.H. Johnson (Solar Energy Research Institute)
G.F. Jones (Los Alamos National Laboratory)
F. Zangrando (Solar Energy Research Institute)

August 1984

Prepared for
U.S. Department of Energy
Through an Agreement with
National Aeronautics and Space Administration
by
Jet Propulsion Laboratory
California Institute of Technology
Pasadena, California

JPL Publication 84-74

N85-142864
10

ABSTRACT

The solar pond research program conducted by the United States Department of Energy was discontinued after 1983. This document summarizes the results of the program, reviews the state of the art, and identifies the remaining outstanding issues.

Solar ponds is a generic term but, in the context of this report, the term "solar pond" refers specifically to salt-gradient solar pond. Several small research solar ponds have been built and successfully tested. Procedures for filling the pond, maintaining the gradient, adjusting the zone boundaries, and extracting heat have been developed. Theories and models have also been developed and verified. The major remaining unknowns or issues involve the physical behavior of large ponds; i.e., wind mixing of the surface, lateral range or reach of horizontally injected fluids, ground thermal losses, and gradient zone boundary erosion caused by pumping fluid for heat extraction. These issues cannot be scaled and must be studied in a large outdoor solar pond.

This report has been subdivided into three parts. Part One presents the results of the DOE research program. The major contributing institutions include Solar Energy Research Institute, Los Alamos National Laboratory, and Jet Propulsion Laboratory. Part Two presents related independent research conducted by universities. Part Three is a selected bibliography with abstracts.

ACKNOWLEDGMENTS

This document is the work of many people. Federica Zangrando and Dave Johnson of SERI, G. Jones of LANL, and Robert French of JPL all made major contributions. Samuel Schweitzer from the DOE Office of Solar Heat Technologies conceived the idea for the report and provided encouragement and guidance. The task was managed by Mike Lopez from the DOE San Francisco office.

GLOSSARY

AEY	annual energy field
ANL	Argonne National Laboratory
ASES	American Solar Energy Society
ASME	American Society of Mechanical Engineers
BEC	breakeven energy costs
CEC	California Energy Commission
CRF	capital recovery factor
DOE	U.S. Department of Energy
ERTEC	Earth Technology Company
ha	hectare, unit of measurement (2.471 acres, or 10,000 m ²)
IPH	industrial process heat
ISES	International Solar Energy Society
JPL	Jet Propulsion Laboratory
LANL	Los Alamos National Laboratory
LCC	life-cycle cost
LCZ	lower convective zone
mgd	million gallons per day
MIT	Massachusetts Institute of Technology
NCZ	non-convective zone
NTIS	National Technical Information Service
O&M	operation and maintenance
ORC	organic Rankine cycle
OTEC	Ocean Thermal Energy Conversion
PE	potential energy
PVC	polyvinyl chloride

RSGSP Research Salt-Gradient Solar Pond
RTD resistance thermometers
SCE Southern California Edison
SERI Solar Energy Research Institute
SGSP Salt-Gradient Solar Pond
SIC Standard Industrialization Classification
SMSA Standard Metropolitan Statistical Areas
SOLPOND solar pond computer model
SPPP Solar Pond Power Plant
TKE turbulent kinetic energy
TVA Tennessee Valley Authority
UCZ upper convective zone
USAFA U.S. Air Force Academy

CONTENTS

PART ONE. U.S. DEPARTMENT OF ENERGY

I. SOLAR POND OVERVIEW 1-1

II. SOLAR POND FLUID DYNAMICS AND HEAT TRANSFER 2-1

III. REVIEW OF SERI POND WORK 3-1

IV. SALTON SEA SOLAR POND POWER PLANT DESIGN STUDY
AND REGIONAL APPLICABILITY 4-1

PART TWO. UNIVERSITY RESEARCH

V. SOLAR POND RESEARCH AT ARGONNE NATIONAL LABORATORY . 5-1

VI. SUMMARY OF SALT-GRADIENT SOLAR POND RESEARCH AT
UTAH STATE UNIVERSITY 6-1

PART THREE. SELECTED BIBLIOGRAPHY WITH ABSTRACTS 7-1

SECTION I

SOLAR POND OVERVIEW

**R. L. French, Editor
F. Zangrando
D. H. Johnson
G. Jones**

SECTION I

CONTENTS

A. INTRODUCTION 1-5

B. PROGRAM PERSPECTIVE 1-9

C. STATE OF THE ART 1-10

 1. Thermal Performance 1-11

 2. Construction 1-11

 3. Stability 1-13

 4. Gradient Establishment 1-13

 5. Maintenance 1-14

 6. Applications 1-15

 7. Economics 1-16

D. RESEARCH NEEDS AND RECOMMENDATIONS 1-17

E. REFERENCES 1-19

Figure

1-1. Solar Pond Schematic 1-6

Table

1-1. Natural and Artificial Salt-Gradient Solar Ponds . . . 1-7

SECTION I

SOLAR POND OVERVIEW

A. INTRODUCTION

The term "solar pond" is used in this document in specific reference to a salt-gradient solar pond. Shallow ponds, saltless ponds, membrane ponds, and gel ponds are also solar ponds, but they are not discussed in this document. All solar ponds are solar energy collectors; some combine energy collection with energy storage.

A salt-gradient solar pond is a body of saline water with a vertical salt concentration profile that creates horizontal stratification and a non-convective zone. Radiant energy from the sun that penetrates into the pond is absorbed and transformed to thermal energy. In the bottom, or storage zone, this thermal energy can be stored for hours, days or months. Figure 1-1 illustrates the basic construction of a solar pond.

The pond containment structure is built of earth embankments with an impervious clay or synthetic liner to prevent water and brine leakage. The pond itself consists of three aqueous layers: the bottom storage zone, the non-convective zone, and the upper convective or surface zone. A high concentration of salt in the storage zone creates a high density brine. The non-convective zone is the key to the operation of a solar pond and is constructed with a density profile that increases continuously from the upper boundary downward to the lower boundary. Because of the continuous density profile, convective currents are eliminated and a stable layer is formed. Radiant energy passes through, but upward convective circulation is suppressed. The upper convective layer forms naturally and tends to slowly grow and degrade overall pond performance. It must be controlled and minimized to optimize pond performance.

Solar radiation which penetrates into the pond will be absorbed and converted to thermal energy. The brine which warms in the bottom zone does not become buoyant and rise to the surface because of the counteracting effect of the imposed density profile. Energy is trapped and temperatures in the storage zone build to values over 65°C and as high as boiling in warm, sunny climates. The extraction of the thermal energy can be accomplished by circulating the storage brine through a heat exchanger.

Salt-gradient solar ponds have occurred naturally and discovery of lakes with a cold surface and warm lower zone stimulated the initial interest. Table 1-1 lists lakes where natural conditions have allowed formation of a salinity gradient. Man, through study and research, has attempted to understand

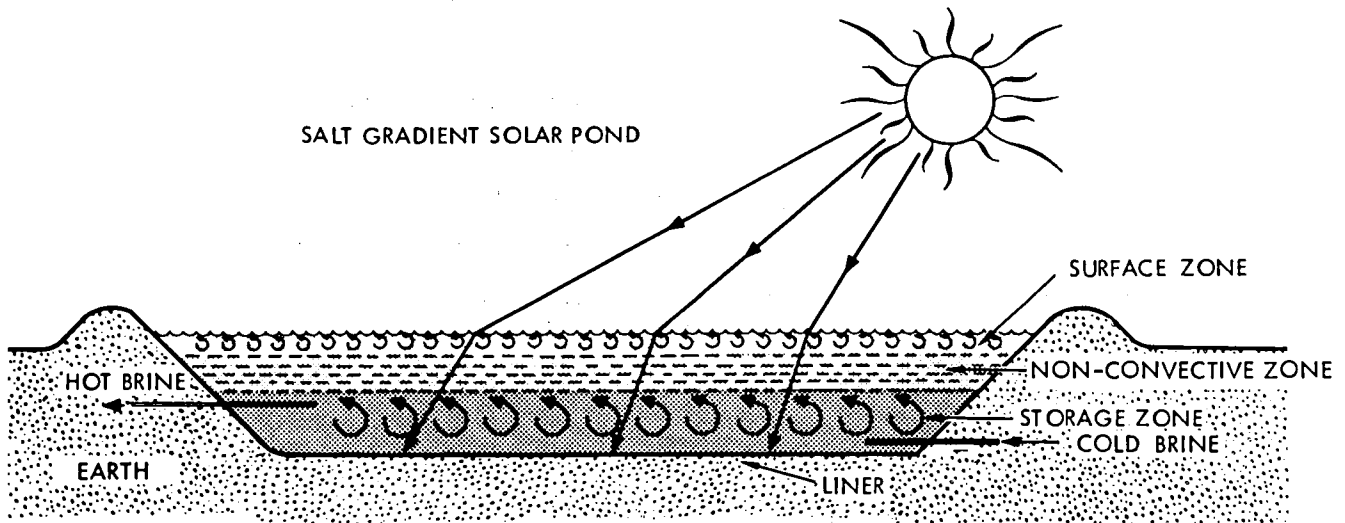

Figure 1-1. Solar Pond Schematic

these natural lakes and to build and manage artificial ponds to actually produce useable energy. Israel spearheaded the research on artificial ponds in the 1950s and, after a 10-year interruption, is again at the forefront of pond technology with a set of two ponds with 4 ha and 21 ha surface areas that intermittently supply thermal energy to Rankine power cycles using water vapor (2.5 MW) and an organic fluid (5 MW). The Israeli effort has always been oriented toward engineering development and commercialization of large-scale, electricity-producing solar ponds with some laboratory research support. The solar pond development in Israel is a joint venture between a private organic Rankine cycle (ORC) turbine manufacturer and a public research foundation that receives a substantial fraction of its funding from their government.

The U.S. effort began around 1974, supported primarily by Federal Government energy agencies with some occasional state funding, and has concentrated on developing small- and medium-scale ponds primarily for heating applications. For the purpose of this discussion, we consider ponds that are less than 1 ha as small scale, and those around 100 ha as large scale. The U.S. program has addressed basic research on hydrodynamical stability, development of modeling and performance prediction tools, broad concept application studies, site-specific designs, economic studies, and evaluation of potential in the United States. The majority of this work was performed in universities and national laboratories across the country with limited interest and involvement from industry.

Most of the operational ponds in the world are listed in Table 1-1. Small salt-gradient solar ponds work well and can be maintained in operation for many years when designed, constructed, and carefully monitored by researchers (e.g., Ohio

Table 1-1. Natural and Artificial Salt Gradient Solar Ponds

Naturally Occurring Ponds				
Lake Medve, Transylvania (Kalecsinski, 1902)				
Hot Lake, Washington State (Anderson, 1958)				
Lake Vanda, Antarctica (Wilson and Wellman, 1962)				
Lake Mahega, Africa (Melack and Kilham, 1972)				
Los Roques Island Lagoon, Venezuela (Hudec and Sonnefeld, 1974)				
Artificial Ponds				
Location (Reference)	Year	Physical Dimensions		
		Area(m ²)	Depth(m)	Salt
<u>United States</u>				
Ohio State University, Columbus, Ohio (Nielsen, 1976)	1975	200	2.5	NaCl
Univeristy of New Mexico, Albuquerque, New Mexico (Zangrando, 1979)	1975	175	2.5	NaCl
Agricultural R&D Center, Wooster, Ohio (Fynn, et al, 1981)	1975	155	3.0	NaCl
Living History Farms, Ames, Iowa (Hull, 1979)	1978	80	3.6	NaCl
Mound Laboratory, Miamisburg, Ohio (Wittenberg and Harris, 1979)	1978	2000	3.0	NaCl
Ohio State University, Columbus, Ohio (Nielsen, 1980a)	1979	400	3.0	NaCl
Argonne National Laboratory, Chicago, Illinois (Hull, et al, 1981)	1980	1000	3.7	NaCl
Tennessee Valley Authority, Chattanooga, Tennessee (Chinery and Siegel, 1983)	1981	4000	3.0	NaCl

Table 1-1. Natural and Artificial Salt Gradient Solar Ponds
(cont 'd)

Artificial Ponds				
Location (Reference)	Year	Physical Dimensions		
		Area(m ²)	Depth(m)	Salt
<u>United States (cont 'd)</u>				
Transportation Department, Flagstaff, Arizona	1981	1000	2.5	NaCl
Los Alamos National Laboratory, Los Alamos, New Mexico (Jones, et al. 1983)	1982	230	2.5	NaCl
<u>Other Countries</u>				
Israel (Tabor, 1981), Dead Sea Potash Works	1975	1100	< 2	End Brines
Eilat	1975	1100	< 2	MgCL ₂
Ormat Turbines Inc., Yavne	1977	1500	< 2	MgCl ₂
Ein Bokek	1978	7500	2.6	Dead Sea Brine
North Shore, Dead Sea	1981	4x(1000)	4.5	Brine
North Shore, Dead Sea	1982	40,000	4.5	Brine
North Shore, Dead Sea	1983	210,000	4.5	Brine
Tata Energy Research Institute, Pondicherry, India	1980	100	2.0	NaCl
University of Petroleum and Minerals, Dahrnan, Saudi Arabia	1980	1000	2.5	NaCl?
Australian Solar Ponds, Inc. Alice Springs, Australia	1981	2000	< 3	Mixed Brines

Table 1-1. Natural and Artificial Salt Gradient Solar Ponds
(cont'd)

Artificial Ponds				
Location (Reference)	Year	Physical Dimensions		
		Area(m ²)	Depth(m)	Salt
<u>Other Countries (cont'd)</u>				
University of Salta, Salta, Argentina	1982	600	2.4	na ₂ SO ₄
Portugal	1983	1000	?	NaCl?

State University, New Mexico, and Ein Bokek-Israel). Some ponds get very hot (Ein Bokek) and even sustain boiling temperatures (New Mexico), although others have operated at low useful temperatures with minimal maintenance (Argentina). Problems have been encountered in some of the ponds. These problems include leaks, liner tears, wind, poor transmissivity, flooding, and high thermal losses to the ground.

Even though the concept of operation is simple and small experimental ponds have been successfully constructed, fundamental questions of operation and maintenance remain. Many different physical processes are involved and interact in complex ways. The non-convective or gradient zone boundaries generally tend to erode as a result of salt and thermal diffusion, surface layer diurnal heating and cooling, wind generated surface waves, and brine circulation in the storage zone when thermal energy is extracted. Solar pond performance will be highly sensitive to the maintenance of water and brine clarity and unrecoverable heat losses to the ground. The use of clay as an impervious pond liner will be economically attractive in some locations, but questions involving outgassing and long-term sealing performance in a hot brine environment have not been answered. In the west, evaporation exceeds rainfall; in the east, annual rainfall exceeds evaporation; and in the northern climates, surface freezing adds a new variable. Therefore, certain regional differences in pond operation and control will also be necessary.

B. PROGRAM PERSPECTIVE

The U.S. Department of Energy (DOE) solar pond program has placed strong emphasis on developing a fundamental understanding

of the physical behavior of the pond while also addressing questions of cost and potential. Theoretical studies, laboratory experiments, and small-scale outdoor ponds have been key elements in the research thrust. Important also are the engineering questions of large system design and operation, and investment costs and economics. Another major area of concern involves the suitability of solar ponds in the U.S. and their market potential. Regardless of how enthused and dedicated the research community became, an attempt was made to balance the program and to keep a point of view toward a final product. Technical feasibility, cost competitiveness, resource availability, and need are all factors that must be addressed. A technically proven pond that produces economical energy will be of no value if construction resources are scarce or no market exists for that energy. Thus, in addition to technical research, the program attempted to maintain a balance and perspective and periodically re-evaluate, update, and improve system cost design studies and estimates of potential.

The purpose and intent of the DOE solar pond program has been to develop the technology and validate a data base which can be used by the private sector. This does not mean that all technical issues must be resolved or that optimum system designs will be created. It does mean that concepts must be proven and valid design parameters established.

Research to date has pursued technical feasibility. An understanding of the basic physical processes within a pond has been developed from laboratory and small research pond experiments. System conceptual layouts, preliminary cost estimates, and performance estimates of commercial scale ponds have been developed. A first order assessment of raw material resource availability and possible market applications has been conducted.

Basic technical questions which remain involve scaling from the small laboratory ponds to large commercial ponds. Some phenomena, i.e., wind affects, and hydrodynamics of heat extraction cannot be studied on other than full-scale systems. Real costs, performance, and economic data will require building and testing a large outdoor pond.

C. STATE OF THE ART

The following paragraphs present a brief discussion of the critical issues of pond construction, operation and performance, a summary of the state of knowledge acquired in solar ponds, and recommendations for future work that must be undertaken before this technology can be fully evaluated and applied commercially.

1. Thermal Performance

Thermal performance of solar ponds can be estimated by assuming a one-dimensional, steady-state model (Reference 1-1) and performing an energy balance between average incident sunlight, energy storage, and conductive losses through the gradient. Analytical predictions can also be obtained by assuming sinusoidal solar input, ambient temperature, and load, all with a 1-year period and different phases (Reference 1-2). In these approximations, the pond is assumed infinite in lateral extent. Thus, all the energy conducted into the ground during one part of the year is returned to the pond during the other, resulting in no net loss. In reality, the pond does have finite edges and finite conduction losses to the ground. These can be taken into account separately by estimating the heat transfer due to soil conditions. One-, two-, and three-dimensional computer codes of varying complexity have been developed (Reference 1-3 and 1-4) to solve the governing equations with variable climatic and load conditions. Results show that geometry and climatic conditions are very important parameters; if these are fixed, the performance of the pond is very sensitive to brine transparency, heat losses to ground, and load distribution over the year. These models have been validated from data obtained with operating solar ponds in the United States and no further development appears necessary, except to update these models on the basis of new and more extensive data.

2. Construction

The construction of a solar pond is similar to that of earth containment systems and water reservoirs, except that the temperature of the fluid can reach 100°C. As the pond contains large quantities of salt (between 0.5 and 1 tons/m² of surface area), the embankment must be sealed to prevent contamination of surrounding ground and the water table. Little research has been done in evaluating the performance of synthetic liners at expected pond temperatures and almost none has been done on processes to impermeabilize the soil. Of the solar ponds built in the United States, some have operated for many years without problems (References 1-2, 1-5, 1-6) and others have run into costly problems due primarily to construction errors that caused liner leakages. The pond in Miamisburg leaked due to settling of the containment berm which apparently had not been sufficiently compacted (Reference 1-7) and resulted in large stresses applied to the liner. The Tennessee Valley Authority (TVA) pond leaked due to failure of factory seams in the primary liner (Reference 1-8).

Even rodents and vegetation have created problems in the solar ponds in Portugal and Australia, and the Australian pond was plagued by torrential rains which saturated the surrounding

soil and increased the heat loss to the ground. In addition, the Los Alamos National Laboratory (LANL) pond and one of the earlier Israeli ponds were disrupted by formation of gas under the pond that either lifted the liner or bubbled violently through the pond. Therefore, chemical composition of the soil must also be scrutinized before selecting a site, and appropriate measures must be taken to ensure that chemical reactions or biological growth does not occur.

For construction of small- and medium-scale ponds, a balanced cut and berm construction is preferred, i.e., part of the pond is dug and the fill is used to construct a berm above ground level, sloped away from the pond to drain rainwater away from the pond sides. A cheap liner (e.g., polyethylene or PVC) may also be buried under the embankment to prevent water from reaching the pond walls. Depending upon the composition of the soil, a slope between 1:1 and 3:1 may be necessary to stabilize and compact the soil and prevent subsequent shifting. Generally, after compaction and removal of protrusions, a thin layer of sand is spread at the bottom of the pond to provide a bed for the liner and the corners are widened and smoothed to minimize stresses on the liner. Occasionally, a tiled drainage system is also buried under the liner to collect any brine that may have leaked. Monitoring this drainage system may thus be used to detect a leak. Construction details are described in more detail in References 1-8 and 1-9.

The liner manufacturer should suggest an approved contractor or installation techniques best suited to their liner. Care must be taken to ensure sufficient slack in the liner, especially at corners, so that it will not be stressed under operation. Several synthetic liners have been used in ponds; the most successful have been Hypalon, Butyl rubber, and Shelterite XR-5 (New Mexico, Ohio, Argonne), although their success may be due primarily to careful soil preparation and liner installation more than durability of the material. In fact, the Miamisburg and TVA ponds used XR-5. The new Dead Sea ponds use an inexpensive, unseamed, overlapping, buried liner in conjunction with impermeable clay that has apparently performed very well, although little product and performance information is available.

For construction of large-scale ponds for electric power generation, synthetic liners add an expensive element and feasibility studies have proposed use of natural or treated clays and soils. The dependence of soil permeability on salt content and temperature is an area of big unknowns and a research study is needed. Some analyses of the salinity dependence have been conducted (Reference 1-10) and the results are not encouraging. A laboratory study of site-specific clay from the Salton Sea also produced a negative result (see Section IV).

3. Stability

The performance of salt-gradient solar ponds is strongly dependent on maintaining a stable nonconvective or gradient zone with controlled and fixed dimensions. Internal mixed layers or erosion of the boundaries can substantially reduce pond performance; for example, a 10 cm decrease in gradient thickness can lead to a 10°C drop in operating temperature, with perhaps a 10% drop in average efficiency.

Stability criteria for the interior of the gradient region have been developed for linear temperature and salinity distributions (Reference 1-11) and for non-uniform gradients, typical of operating solar ponds (Reference 1-12). These criteria predict pond stability reasonably well and are useful engineering tools. The physical mechanisms and the development of instabilities are still not well understood and some further basic research is warranted, but is not necessary for engineering applications.

Stability of the boundaries is still under analysis and requires further work. A research program that included laboratory experiments and theoretical studies was undertaken at LANL (see Section II) to obtain an in-depth understanding of the mechanisms of non-convective zone boundary movement and control. Other efforts have been directed at correlating the dependence of boundary motion with convection in the mixed layers (Reference 1-13) to determine the structure of the boundary layers (SERI subcontract with Purdue University, see Section III), to analyze the effect of wind shear on the surface layer growth (SERI subcontract with the Massachusetts Institute of Technology (MIT), see Section III), and to analyze the effect of extracting heat and mass from the storage layer (Reference 1-14).

Wind-driven surface mixing appears to be the most potentially destructive phenomenon and some ponds have been fitted with surface nets or pipe grids (Israel, Ohio) in an attempt to reduce wave formation on the surface. There are no published data on the usefulness of this technique, but it appears to at least partially suppress wind-mixing effects. Verification tests need to be conducted at full scale since wind fetch cannot be properly scaled; therefore, this issue can only be resolved once a large pond is in operation. Energy extraction can also erode the gradient from below if the extraction system is not designed and located properly. Preliminary engineering criteria exist (Reference 1-15), but must be verified and extended in operating ponds.

4. Gradient Establishment

Several techniques have been developed and tested in operational solar ponds to establish the concentration gradient

in the nonconvective zone. One of the best techniques is called the scanning injection method (Reference 1-16). This method uses a vertical moving diffuser to inject low or high concentrate brine into a fluid body. An issue needing resolution is the horizontal reach of a single diffuser. In the 21 ha Dead Sea pond, a single diffuser was not sufficient to affect the entire pond and large horizontal concentration gradients developed. Three diffusers, moving more or less simultaneously, apparently resolved the problem. This implies that at some pond size between 4 and 21 ha, multiple diffusers will be required.

Two techniques have been used to remove unwanted mixed layers in the interior of the gradient. Either the fluid is pumped out, which is wasteful of salt and can create an environmental hazard, or fluid is injected at high or low flow rates while moving the injection nozzle up or down (References 1-16 and 1-17). Intermittent injection at a fixed level has also been used to adjust the position of the upper boundary (Reference 1-18).

All of the above techniques have been used with success in small- and medium-scale ponds, but may not be the definitive answer. There is little understanding of what actually happens when fluid is injected or withdrawn from the gradient layer. Studies under controlled laboratory conditions are needed to gain this understanding. Also, tests in large ponds are needed to verify application of these techniques over a large area.

5. Maintenance

Once the pond system is constructed, the gradient established and stabilized, and the operation temperature is attained, then periodic maintenance must still be performed. The diffusion of salt to the surface must be countered by flushing the surface and replenishing the storage layer. Various techniques have been used and proposed, depending on local conditions and availability of salt. The surface brine can be concentrated and reinjected at the bottom (Reference 1-2) or new dry salt can be added (Reference 1-19). If circumstances are as favorable as those at the Dead Sea or Great Salt Lake, the surface brine can be discharged and new high salinity brine can be added to the storage layer with no environmental problems.

The clarity of the brine must also be maintained as high as possible to ensure maximum performance. This may be as simple as skimming debris from the surface and occasionally adding some common algicide (Reference 1-2, 1-9) or as complex as applying activated charcoal filtering of the brine (Reference 1-20) and strongly depends on local climatic, biological, and chemical conditions.

If surface wind breakers are used, they also must be cleaned periodically. At the Dead Sea, an air boat with front scrubbers is used to effectively vacuum the nets and surface, but the process is labor and time intensive. New materials and/or new techniques may be required once the effect of the surface grids has been established.

The containment must be monitored for structural integrity; if leaks develop, they must be corrected. No satisfactory technique has yet been developed to repair a liner under hot brine and no thought has been given to what may be required if no synthetic liner is used. Ancillary equipment such as pumps, pipes, heat exchangers, power systems, etc., must also be serviced periodically, depending on the equipment and materials used.

6. Applications

Solar ponds supply heat at temperatures from somewhat above ambient up to 100°C. They have potential application wherever heat at these temperatures can be used. The obvious applications are to supply hot water or heat for buildings or for processes which use heat directly such as crop drying, food processing, drying or concentrating chemicals. Solar ponds are not economically suitable for heating single residential units, but they are likely to be economical sources of heat for residential districts or large commercial buildings. The solar pond potential for space heating is limited by the availability of land, not by need. The total U.S. pond potential in the building sector is estimated to be 3 quads/year by the year 2000 (Reference 1-21). About 3 quads/year of energy are used at this time in this country for industrial processes at temperatures below 100°C (Reference 1-22). This amount of energy is expected to more than double by the year 2000. A large fraction of this energy could potentially be supplied by solar ponds. Solar ponds appear particularly well suited to supplying heat to agricultural processes because land is available on farms and energy for crop drying is usually needed in the fall when the energy yield from a solar pond is highest. Total national pond potential for agricultural processes is estimated at 0.8 quads/year by the year 2000 (Reference 1-21). All of these heating applications will eventually require engineering studies and demonstrations, but there do not appear to be any significant research and development issues connected with them.

The heat from a solar pond can also be used to drive a heat engine to produce electrical or mechanical energy. The national electric power pond potential is estimated to be 3 quads/year by the year 2000 (Reference 1-21). A Rankine cycle using a high vapor pressure organic fluid has been the preferred power conversion device. The heat exchangers to evaporate and condense the

fluid are very large because heat must be transferred over very small temperature differences. Conventional shell and tube heat exchangers are estimated to be 50% of the capital cost of the conversion equipment (25% of the capital cost of the plant if the pond is included). Heat exchanger costs can be cut in half by using a direct-contact heat exchanger to evaporate the working fluid. Studies have shown that the concept is feasible (Reference 1-23) and experiments are supplying the basic data required to design such a heat exchanger (SERI Subcontract No. XP-3-03001). A direct-contact heat exchanger large enough to service a typical power plant has not yet been built.

The need for desalination of water is projected to increase substantially during the next two decades, growing from the current 273 million gallons per day (mgd) to 2500 mgd in the year 2000. The energy required for desalination is estimated to be 0.62 quads/year by the year 2000. Solar ponds can efficiently supply thermal energy for distillation desalination processes (Reference 1-24). Solar ponds could also supply electrical or mechanical power to reverse osmosis or electrodialysis processes. Very little work has been done on this potentially important application of solar ponds. System studies are needed to determine the optimum desalination technology to combine with a solar pond energy source.

There are other potential solar pond applications which have received very little attention. One possibility is the use of solar ponds for space cooling. The heat from a solar pond is at the right temperature for regenerating desiccant material used in a desiccant cooling system. In general, research on ways of effectively using low temperature heat sources (such as improved heat pumps) will benefit solar pond applications.

7. Economics

The cost of energy from any system is dependent on many factors: capital costs, operation and maintenance (O&M) costs, and performance and financial parameters. For a solar pond, local climatic and geological conditions also become important. The Solar Energy Research Institute (SERI) has estimated current pond capital costs between \$60 and \$100/m² for small, lined ponds (see report summaries in Section VII). JPL has conducted a parametric economic study (Section IV) that shows estimated capital costs for lined solar ponds to be \$67/m² in 1980, decreasing to \$43/m² for a mature technology. These estimates were extrapolated from the actual costs of the TVA pond. In the economic study estimates of \$2.5/m²-yr for O&M costs, a 20-year lifetime, 10% investment tax credit, 48% tax rate, 12% discount rate, 6% inflation, 6% O&M escalation, and 6% capital escalation were included. This results in thermal energy costs of \$0.02 to

\$0.028/kWh for the southwest in the range of current gas and oil heating costs, and \$0.06 to \$0.08/kWh for the Great Lakes area.

For electricity-producing ponds (without a synthetic liner), SERI has estimated a combined pond and power generating system cost of \$20/m² for a specific location in Texas based on construction estimates provided by the U.S. Army Corps of Engineers (Reference 1-25).

The JPL group based their preliminary estimates on the Salton Sea Study and predicted combined system capital costs of \$30/m² for a 1 km² pond (5 MW), decreasing to \$12/m² for a 100 km² pond (600 MW). Using the same financial parameters as above, the buss-bar electricity costs in the southwest would be \$0.15/kWh for the 5 MW plant, and \$0.08/kWh for the 600 MW plant. However, these estimates assume that it is possible to operate an unlined pond; if a liner were required, the electricity costs would increase by 0.06 to 0.07 \$/kWh.

D. RESEARCH NEEDS AND RECOMMENDATIONS

As can be seen from the brief review of the state of the art, salt-gradient solar ponds can work and they show promise of becoming economical in regions where land, salt, brackish water, and sunshine are available. Based on the results obtained in laboratory tanks and small-scale ponds, some theories and procedures have been developed. The next step must be operating and monitoring a large pond to verify theories and procedures to ensure that scale dependence does not affect the results and to develop new techniques which are appropriate for large ponds.

Specifically, the critical areas of research that need to be undertaken can be divided into two groups. First, some scale-dependent hydrodynamic issues require testing in the field in a pond large enough to exhibit three-dimensional effects. This stepup in pond size is critical for phenomena such as wind-driven mixing of the surface layer, erosion of the gradient's lower boundary due to energy extraction, and overall maintenance of the gradient clarity and stability, since these are scale-dependent phenomena. The research areas are:

- (1) Evaluation of surface mixing effects and their correlation with climatic conditions.
- (2) Evaluation of the performance of surface grids to suppress deepening of the surface mixed layer.
- (3) Evaluation of the application of gradient boundary maintenance techniques developed in small ponds.

- (4) Determination of the horizontal range of influence of localized injection or extraction of fluid which may be used to maintain the gradient layer and its boundaries.
- (5) Determination of the performance of multiple injection ports for gradient establishment and maintenance.
- (6) Evaluation of energy extraction geometries and erosion of the gradient layer from below due to a recirculation flow in the storage layer.
- (7) Evaluation of the overall thermal performance of a large pond, including ground heat losses.

Second, additional research is needed on scale-independent issues that can be resolved in the laboratory or small ponds prior to verification in large ponds. These involve long-term material performance, operational procedures, instrumentation, and chemistry of brines and soils. The research areas are:

- (1) Determination of the lifetime properties of synthetic liners under pond conditions.
- (2) Development of suitable leak detection and repair techniques.
- (3) Evaluation of biochemical processes affecting water clarity.
- (4) Evaluation of pond to ground heat transfer mechanisms.
- (5) Development of ground heat loss monitoring instrumentation.
- (6) Determination of soil permeability under pond conditions.
- (7) Development of soil impermeabilization techniques.
- (8) Development of an understanding of the mechanisms which cause erosion of the gradient layer from above or below.
- (9) Characterization of the flow patterns and temperature distribution in the storage layer as determined by the discharge diffuser parameters.
- (10) Development of an understanding of the effects of injecting or withdrawing fluid on the gradient layer.

Future research efforts are recommended on two fronts: (1) the construction of a medium-scale pond of around 25 ha in surface area where various scale-dependent experiments can be conducted by research groups active and experienced in this technology, and (2) the selection of a few laboratory and small-scale ponds among the existing facilities where tests can be conducted on those scale-independent issues that need to be investigated to support the field tests.

E. REFERENCES

- 1-1. Kooi, C.F., "The Steady State Salt Gradient Solar Pond," Solar Energy, No. 23, Vol. 1, pp. 37-45, 1979.
- 1-2. Zangrando, F., Observations and Analysis of a Full-Scale Experimental Salt Gradient Solar Pond, Ph.D. Dissertation, University of New Mexico, New Mexico, 1979.
- 1-3. Henderson, J. and Leboeuf, C.M., "SOLPOND - A Simulation Program for Salinity Gradient Solar Ponds," SERI/TP-351-559, 1980. Presented at the Second Annual Systems Simulation and Economics Analysis Conference, Bahia Hotel, San Diego, California, January 23-25, 1980.
- 1-4. Hull, J.R., "Computer Simulation of Solar Pond Thermal Behavior," Solar Energy, No. 25, Vol. 1, pp. 33-40.
- 1-5. Nielsen, C.E., "Design and Initial Operation of a 400 m² Solar Pond," Solar Jubilee, 20 Years of the Sun at Work. Proceedings of the 1980 Annual Meeting of the American Section of the International Solar Energy Society; Phoenix, Arizona; June 2-6, 1980, Newark, DE, as of ISES; Vol. 3.1, pp. 381-385.
- 1-6. Hull, J.R., Cha, Y.S., Sha, W.T., and Schertz, W.W., "Construction and First Year's Operational Results of the ANL Research Salt Gradient Solar Pond," Progress in Solar Energy: The Renewable Challenge, Proceedings of the 1982 Annual Meeting of the American Solar Energy Society, Houston, Texas, June 1-5, 1982. Edited by Gregory E. Franta and Keith Haggard.
- 1-7. Wittenberg, L.J., Harris, M.J., "Miamisburg Salt-Gradient Solar Pond: Mid-1980 Status Report," Miamisburg Mound Facility, MLM-2739 (OP), Miamisburg, Ohio.

- 1-8. Chinery, G.T., and Siegel, G.R., "Design, Construction, and Cost of TVA's 4000 m² (1-Acre) Nonconvecting Salt Gradient Solar Pond," Solar Engineering - 1983, Proceedings of the ASME Solar Energy Division Fifth Annual Conference; Orlando, Florida, April 18-21, 1983. Edited by Lawrence M. Murphy, New York: American Society of Mechanical Engineers, pp. 150-156.
- 1-9. Nielsen, C.E., "Chapter 11: Nonconvective Salt-Gradient Solar Ponds," Solar Energy Technology Handbook, Part A: Engineering Fundamentals, edited by W.C. Dickinson and P.N. Cheremisinoff, New York, Marcel Dekker, pp. 345-376.
- 1-10. Ridley, K.J.D., Bewtra, J.K., and McCorquodale, "Impact of Brine on the Behavior of Compacted Fine Grained Soils," Proceedings of the Canadian Society for Civil Engineers Annual Conference, Municipal Environment Division, Ottawa, Canada.
- 1-11. Weinberger, H., "The Physics of the Solar Pond," Solar Energy, No. 8, Vol. 2, pp. 45-46.
- 1-12. Zangrando, F., and Bertram, L.A., "Double Diffusive Linear Stability with Nonconstant Gradients," SERI/TR-252-2052, 1984.
- 1-13. Bergman, T.L., Munoz, D.R., Incropera, F.P., and Viskanta, R., "Correlation for Entrainment of Salt-Stratified Fluid by a Thermally Driven Mixed Layer," The American Society of Mechanical Engineers," Paper No. 83-WA/HT-76, Engineering Societies Library, 345 E. 47th Street, New York, New York 10017.
- 1-14. Zangrando, F., "Laboratory Experiments on Heat and Mass Extraction from Solar Ponds," Second Quarterly Report, July 1, 1981 to September 30, 1981, SERI/PR-252-1461.
- 1-15. Zangrando, F., Green, J., and Fisher, E., "On Heat and Mass Exchange in a Partially Stratified Fluid," 22nd ASME/AIChE National Heat Transfer Conference, Niagara Falls, New York, August 1984, SERI/TP-252-2295.
- 1-16. Zangrando, F., "A Simple Method to Establish Salt Gradient Solar Ponds," Solar Energy, No. 25, Vol. 5, pp. 467-470, 1980.
- 1-17. Nielsen, C.E., "Salt Transport and Gradient Maintenance in Solar Ponds," Progress in Solar Energy: The Renewable Challenge; Proceedings of the 1982 Annual Meeting of the American Solar Energy Society, Houston, Texas, 1982. Edited by G.E. Franta and K. Haggard, Boulder, Colorado, ASES, pp. 179-184.

- 1-18. Nielsen, C.E., "Surface Zone Behavior in Solar Ponds," The American Society of Mechanical Engineers, No. 82-WA/Sol-25, New York, 1982.
- 1-19. Azbarzadeh, A., MacDonald, R.W.G., "Introduction of a Passive Method for Salt Replenishment in the Operation of Solar Ponds," Solar Energy, No. 29, Vol. 1, pp. 71-76, 1982.
- 1-20. Marsh, H.E., DeFranco, D.M., Haack, R.F., McMurrin, J.C., Reilly, W.W., Singer, M.J., Wu, Y.C., "Salt Gradient Solar Ponds in the Salton Sea: Brine Optical Quality and Performance," Technology for the Transition, Proceedings of the 16th Intersociety Energy Conversion Engineering Conference, Atlanta, Georgia, August 1981. New York, the American Society of Mechanical Engineers, Vol. 2, pp. 1720-1725, 1981.
- 1-21. Lin, E.I.H., French, R.L., Singer, M.J., Wu, Y.C., McMurrin, J.C., Barbieri, R.H., Walton, A.L., Jones, S.C., Hurick, M.G., Levine, N., Richter, P.H., Regional Applicability and Potential of Salt-Gradient Solar Ponds in the United States, Jet Propulsion Laboratory, DOE/JPL-1060-50, 1982.
- 1-22. Iannucci, J.J., "Survey of U.S. Industrial Process Heat Usage Distribution," Sandia National Laboratory, SAND 80-8234, Albuquerque, New Mexico, 1981.
- 1-23. Wright, J.O., "Selection of a Working Fluid for an Organic Rankine Cycle Coupled to a Salt-Gradient Solar Pond by Direct-Contract Heat Exchange," Journal of Solar Energy Engineering, Vol. 104, pp. 286-292, 1982.
- 1-24. Johnson D., Leboeuf, C.M., and Waddington, D., "A Solar Pond-Driven Distillation and Power Production System," SERI/TR-631-1248, 1981.
- 1-25. May, E.K., Leboeuf, C.M., and Waddington, D., Conceptual Design of a 20-Acre Salt Gradient Solar Pond System for Electric Power Production at Truscott, Texas, SERI/TR-253-1868, 1983.

SECTION II

SOLAR POND FLUID DYNAMICS AND HEAT TRANSFER

G. F. Jones

Los Alamos National Laboratory

ACKNOWLEDGMENTS

This section has been condensed from a comprehensive report which reviews the solar pond research of the LANL (Reference 2-1). The material presented here reflects the work of many people. K. A. Meyer developed the initial theories. D. P. Grimmer performed many of the experiments and did instrumentation research. D. A. Neeper provided insight and suggestions. J. C. Hedstrom worked with the data acquisition system at the pond and provided graphics. K. Hedstrom, C. Bates and J. Dreicer worked with the experiments.

This study was funded in part by the U.S. Department of Energy, Division of Solar Thermal Energy Systems and Active Heating and Cooling Division, Office of Solar Heat Technologies and Office of Solar Applications for Buildings. It was also funded in part by an internal supporting research grant from Los Alamos National Laboratory.

SECTION II

CONTENTS

A.	NOMENCLATURE	2-9
B.	PROGRAM DESCRIPTION	2-10
C.	THE THEORY OF SOLAR PONDS	2-10
	1. Oceanographic Studies	2-11
	2. Mechanistic Model	2-11
	3. Boundary Stability	2-12
D.	DYNAMIC PERFORMANCE MODEL DESCRIPTION	2-13
E.	LABORATORY EXPERIMENTS	2-14
	1. Phase 1: One-Dimensional Simulation	2-15
	2. Phase 2: Flow Visualization	2-16
	3. Phase 3: Full-Scale Outdoor Pond	2-16
F.	RESULTS AND DISCUSSION	2-19
	1. Flow Visualization	2-19
	2. Validation of Dynamic Performance Code	2-21
	3. Outdoor Pond	2-29
G.	DISPOSITION OF EXPERIMENTAL EQUIPMENT	2-32
H.	REFERENCES	2-34

Figures

2-1.	Point Conductivity Probe Schematic Diagram . . .	2-15
2-2.	Solar Pond Salinity Profile	2-18
2-3.	Isosalinity Planes	2-18
2-4.	Flow Pattern Below Gradient Zone, Bottom Heater On	2-20
2-5.	Flow Pattern Below Gradient Zone, Bottom Heater Off	2-20

Figures (Cont'd)

2-6.	Time Variation of Layer Position	2-22
2-7.	Temperature of Convective Zone	2-22
2-8.	Comparison of the Measured and Calculated Interface Position for the Miamisburg Solar Pond	2-23
2-9.	Comparison of Observed and Calculated Results for Laboratory Tank Experiment, Experiment No. 1, Lower Interface	2-25
2-10.	Comparison of Observed and Calculated Results for Laboratory Tank Experiment, Experiment No. 5, Lower Interface	2-25
2-11.	Comparison of Observed and Calculated Results for Laboratory Tank Experiment, Experiment No. 2, Upper Interface	2-26
2-12.	Comparison of Observed and Calculated Results for Laboratory Tank Experiment, Experiment No. 2, Lower Interface	2-26
2-13.	Comparison of Observed and Calculated Results for Laboratory Tank Experiment, Experiment No. 3, Upper Interface	2-27
2-14.	Comparison of Observed and Calculated Results for Laboratory Tank Experiment, Experiment No. 3, Lower Interface	2-27
2-15.	Comparison of Observed and Calculated Results for Laboratory Tank Experiment, Experiment No. 4, Upper Interface	2-28
2-16.	Comparison of Observed and Calculated Results for Laboratory Tank Experiment, Experiment No. 4, Lower Interface	2-28
2-17.	Temperature Profiles in Pond During Run-Down Experiment	2-30
2-18.	Salinity Profiles in Pond During Run-Down Experiment	2-30

Figures (Cont 'd)

2-19. Zone Boundary Locations in the Solar Pond During Run-Down	2-33
2-20. Dimensionless Salt-to-Heat-Flux Ratio Versus Heat Flux for Pond Experiment	2-33

Tables

2-1. Result of Los Alamos Laboratory Tank Tests . . .	2-24
2-2. Results of Los Alamos Solar Pond Experiment . .	2-31

SECTION II

SOLAR POND FLUID DYNAMICS AND HEAT TRANSFER

A. NOMENCLATURE

c_p	specific heat (J/g-°C)
d	depth of upper convecting zone (cm)
F_s	salt flux (g/cm ² -s)
F_H	heat flux (w/cm ²)
g	acceleration of gravity (cm/s ²)
k_t	thermal conductivity (w/cm-°C)
L	energy extracted at depth x (W/cm ³)
q	solar energy absorbed at depth x
R_p	density-stability ratio
S	salinity (wt %)
T	Temperature (°C)
U_e	entrainment velocity (cm/s)
x	vertical distance from bottom of pond (cm)
α	coefficient of thermal expansion (1/°C)
β	salinity expansion coefficient (cm ³ /g)
k	thermal diffusivity (cm ² /s)
k	salt diffusivity (cm ² /s)
μ	kinematic viscosity (cm ² /s)
ρ	fluid density (g/cm ³)
ρ_s	solute density (g/cm ³)

B. PROGRAM DESCRIPTION

The primary objective of the solar pond research conducted at the Los Alamos National Laboratory (LANL) was to obtain an in-depth understanding of solar pond fluid dynamics and heat transfer. The key product of the research program was the development of a validated one-dimensional computer model with the capability to accurately predict time-dependent solar pond temperatures, salinities, and interface motions.

When the program began, little was understood about the mechanisms of non-convective zone boundary movement or control. A research program that included laboratory experiments, theoretical studies, literature surveys of oceanography, and real pond testing was pursued. Laboratory scale flow visualization experiments were conducted to better understand layer motion. Two laboratory small-scale ponds and a large-scale outdoor solar pond were designed and built to provide quantitative data. This data provided a basis for validating the model and enhancing the understanding of pond dynamic behavior.

C. THE THEORY OF SOLAR PONDS

A salt-gradient solar pond will exist with three distinct zones: an upper convective zone (UCZ), a non-convective or diffusive zone (NCZ), and a lower convective or thermal energy storage zone (LCZ). Solar radiant energy is absorbed in each zone. Only the radiant energy that reaches the lower convective zone contributes to the useful output of the pond. The energy absorbed in the upper two zones will propagate toward the pond surface and transfer into the atmosphere. Also, thermal energy from the LCZ will transfer by conduction through the NCZ and also dissipate into the atmosphere. The NCZ, however, is an effective insulator and the upward conduction of energy from the LCZ can be controlled by the NCZ thickness.

As seen from the discussion above, the productivity of a solar pond is directly influenced by the thicknesses of the layers. The UCZ absorbs solar radiation (References 2-1, 2-2, and 2-3) and dissipates that energy into the atmosphere. It contributes nothing to the insulative value of the non-convective or diffusive core and is therefore an undesirable element of the pond. Minimizing the thickness of the UCZ improves pond performance. The NCZ is an insulative barrier that helps to contain the thermal energy stored in the LCZ. A greater thickness increases insulative value and undesirably also increases radiant energy absorption. An obvious design trade-off for any given application is the insulative value vs the radiant energy transmittance.

The boundaries separating the upper and lower mixed convective zones and the diffusive core are not stationary, but move in response to forces acting at the boundaries. When there is an imbalance between the effects of convective stirring in the mixed zones and the diffusive flux of salt and heat through the boundaries, the mixed zones can encroach upon the non-convecting zone, reducing its thickness, and decreasing pond performance. These movements occur even though the diffusive core itself is hydrodynamically stable.

The physical process that governs interfacial motion in the region of the boundary between the LCZ and the NCZ is double-diffusive convection. This process also occurs at the upper interface separating the UCZ and the NCZ, but wind-induced surface zone convection and diurnal heating and cooling are additional strong factors that dominate the upper zone boundary motion.

Double-diffusive convection may occur in any fluid composed of at least two elements with different molecular diffusivities that make opposing contributions to density. Here, salt and heat are the two elements and the diffusivity difference is about 80 (salt diffusivity being smaller). A good overview of ongoing research in the area of double-diffusive convection is presented by Huppert and Turner (Reference 2-4).

1. Oceanographic Studies

Researchers in the oceanographic community have done extensive work in the area of double-diffusive convection in thermohaline systems. Instead of the three-zone system, which is of interest to solar pond researchers, the system studied by oceanographers consists of two convective zones which are separated by an interface. The interface varies in thickness from a few millimeters to about five centimeters (References 2-5 and 2-6) and is characterized by a step change in salinity and temperature. Thicker interfaces exhibit a non-convecting core in which molecular diffusion dominates. This core is separated from the convecting zones by regions of intermittent turbulent fluctuations. These fluctuating regions can be regarded as interface-boundary layers. Empirical relations have been obtained for fluxes of salt and heat through the interface as a function of the salinity and temperature steps across the interface.

2. Mechanistic Model

A simple mechanistic model of the interfacial boundary layers in which salt and heat transport are driven by thermally induced convection has been independently proposed by Lindberg

and Haberstroh (Reference 2-7) and Linden and Shirtolifte (Reference 2-8). The proposed model ensures the simultaneous growth of a thermal boundary layer and a salinity boundary layer from the interface (separating the intermittently turbulent LCZ and the diffusive core) into the LCZ. Because the ratio of the molecular diffusivities of heat and salt is about 80, the thermal boundary layer outdistances the salinity boundary layer. Thus, the density distribution within most of the thermal layer is unstable and, at some thickness, the layer will break down and release a buoyant element. This element, which is called a plume or thermal (Reference 2-9), is cooler and less salty than the bulk of the LCZ and gives rise to the turbulent mixing within the LCZ. Correspondingly, as the boundary layers thicken, mass and energy conservation require that heat and salt pass into the diffusive core where they are transported upwards by diffusion. Assuming complete mixing of both boundary layers into the LCZ at the time of breakdown (Reference 2-10), the ratio of the increase in potential energy of the system (caused by an increase in the elevation of salt-mass) to the thermal energy transported through the interface may be estimated. This is the ratio of salt-to-heat flux and oceanographic-model predictions of this are in relatively good agreement with laboratory-measured values. The salt-to-heat flux ratio plays a major role in predicting pond thermal performance and it will be seen that it is the correlating parameter used in the dynamic performance model described in Section II.C.

3. Boundary Stability

The issue of stability in thermohaline columns was considered by Weinberger (Reference 2-11) and Veronis (References 2-12 and 2-13). Stability within a thermohaline column requires that both static and the more stringent dynamic stability requirement be satisfied (References 2-11, 2-12, 2-13):

Static requirement:

$$\frac{d\rho}{dx} < 0 \quad (1)$$

Dynamic requirement:

$$(\nu + K_t) \alpha \frac{\partial T}{\partial x} + (\nu + K_s) \beta \frac{\partial \rho_s}{\partial x} \geq 0 \quad (2)$$

Instability in the core caused by infinitesimal disturbances occur first as overstable oscillatory motions (wind-induced wave motion in the UCZ and thermal expansion affects are two examples

of perturbations that cause infinitesimal disturbances). In a system where the temperature and salinity are increasing downward, if a fluid particle is displaced an infinitesimal distance upward to a cooler, less-saline region, it will lose heat and salt by diffusion. Because of the large difference in diffusivities, it will cool rapidly, become more dense, and be driven downward by its body force. Should viscosity effects be insufficient to dissipate the kinetic energy of this motion, the particle overshoots its equilibrium position and is directed back upward. This action can develop into a growing oscillation that leads to convection.

Stability in the region of inclined sidewall boundaries has received little attention in the past. In the thermohaline case, the salt gradient must be zero at the impermeable sidewall. Lateral density gradients within the core are thus formed which tend to drive the otherwise stable core fluid up at the walls (Reference 2-14) and outward toward the center of the core. A system of interleaving convecting and non-convecting layers is formed (Reference 2-15). Disturbances from this motion could lead to the generation of local convective cells within the diffusive core and thus reduce its insulating value.

D. DYNAMIC PERFORMANCE MODEL DESCRIPTION

The primary thrust of the solar pond research effort at LANL has been to develop an understanding of the pond fluid dynamics and heat transfer. To assist in this effort, a numerical model was developed to solve the one-dimensional time-dependent equations for salt and heat transport in the pond.

Heat transport:

$$\rho C_p \frac{\partial T}{\partial t} = \frac{\partial}{\partial x} \left[h_T \frac{\partial T}{\partial x} \right] + g(x,t) - L(x,t) \quad (3)$$

Salt transport:

$$\frac{\partial \rho_s}{\partial t} = \frac{\partial}{\partial x} \left[K_s \frac{\partial \rho_s}{\partial x} + K_{st} \frac{\partial T}{\partial x} \right] \quad (4)$$

The last term in Equation (4) is the Soret term which accounts for the transport of salt due to a temperature gradient. K_{st} is the Soret diffusion coefficient. Values of the Soret coefficient given by Rothmeyer (Reference 2-16) are used in this work. In the diffusive core, the molecular diffusivity is used in Equations (3) and (4). In regions with convection, an eddy diffusivity is substituted. The value of the eddy diffusivity is always selected to be large enough to ensure complete mixing. Salinity

changes caused by evaporation and precipitation are not included in the present model.

The model functions are based on the hypothesis that boundary-layer behavior (see discussion of theory) exists in ponds in the regions of the interfaces between the mixed zones and the diffusive core. The boundary layers above and below the diffusive core are two halves of the thin interface layer that occurs at the temperature and salinity step of interest to oceanographers. Support for this conjecture comes from the observation of plumes descending from the LCZ boundary layer region in the laboratory tank simulations of solar ponds (Reference 2-17).

Observers also speculate that the salt-to-heat-flux relation obtained across the thin interface of the oceanographic studies also apply across a boundary layer separating the mixed zones and the core in solar ponds.

Static and dynamic stability criteria are incorporated into the model in the following way: If Equation (2) is not satisfied in a portion of the diffusive core, that portion is flagged as convecting and the appropriate eddy diffusivity is used. If Equation (1) is not satisfied across a boundary between a convecting region and the diffusive core, the convecting region encroaches on the core.

The numerical model includes a system of equations that account for wind-driven entrainment. Wind-driven entrainment acts in conjunction with double-diffusive convection at the boundary between the UCZ and the diffusive core.

The equations in the model are written in finite difference form and solved simultaneously. The equation set becomes a system of linear algebraic equations whose solution is obtained by an implicit method. The mesh size used in the finite difference scheme is one centimeter.

A more detailed description of the model is given by Meyer in Reference 2-18.

E. LABORATORY EXPERIMENTS

A series of laboratory experiments were conducted to better understand the fluid motion in the region of the boundary layers and within the mixed zone of solar ponds. These experiments were conducted in three phases using two fully instrumented laboratory tanks and one fully instrumented full-scale outdoor pond. Data from the experiments were used to validate the dynamic performance model.

1. Phase 1: One-Dimensional Simulation

The first phase of the laboratory program involved the development of a pond simulation tank to obtain quantitative data for code validation. It consisted of a glass dewar, 29 cm-I.D. and 75 cm-deep with a bottom heater and a thermoelectrically-cooled heat exchanger on top to establish the desired temperature gradient. The outside wall was heated and insulated to minimize radiation heat losses. A rake supporting two, 100-ohm platinum resistance thermometers (RTDs) and two platinum point conductivity probes was used to measure temperature and salinity.

The point conductivity probe used in the experiments was developed at LANL. The probe development was undertaken because of the need for accurate, high-spatial resolution, in situ salinity measurements over a broad salinity range (Reference 2-19). A schematic diagram of the point conductivity probe is shown in Figure 2-1. Basically, the probe consists of a length of platinum wire, 0.51 mm in diameter, encased in a 2 mm O.D. glass tube and exposed at the tip. This assembly is covered with an RTV fluorosilicone which is sealed from salt water intrusion by a length of shrink tubing. A spiral-wound secondary electrode of large surface area surrounds the platinum tip. Point conductivity measurements are obtained as a small electric current

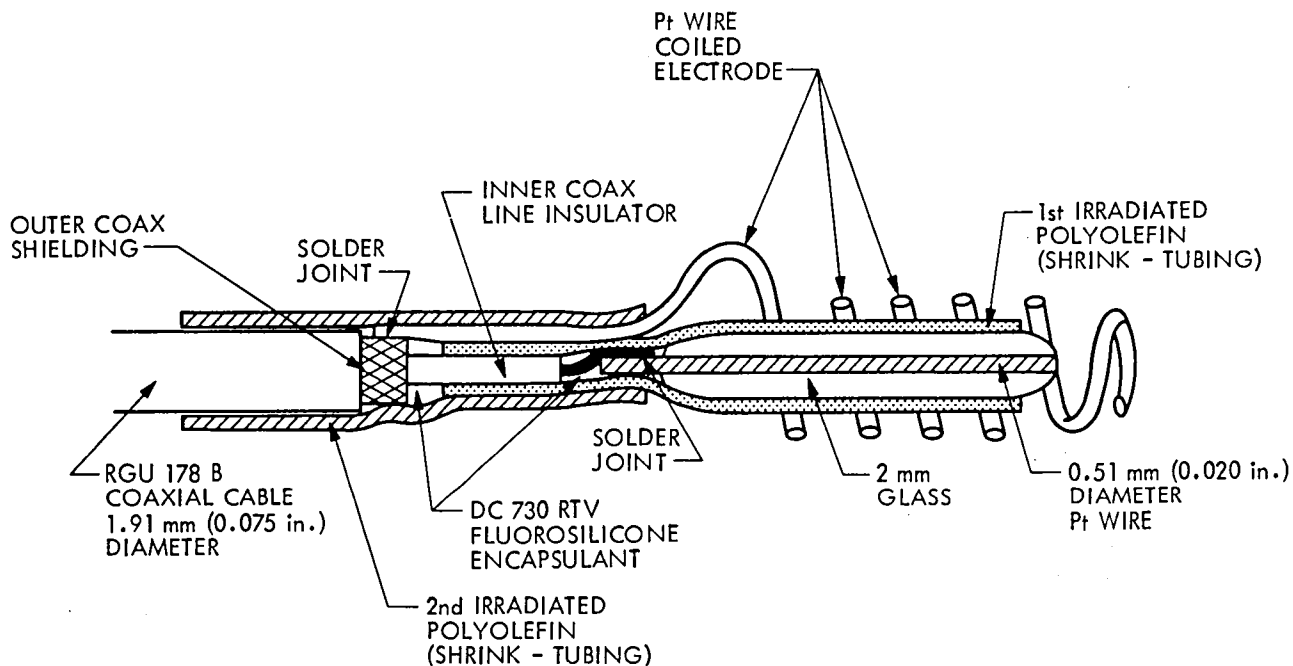

Figure 2-1. Point Conductivity Probe Schematic Diagram

flows between the two electrodes. The current density at the probe tip is much greater than that at the secondary electrode because of the large difference in surface areas. The resulting electrical conductivity measurement is thus heavily weighted to the region of the tip. During each experiment, the probe was calibrated in situ by measuring the specific gravity of extracted samples.

2. Phase 2: Flow Visualization

The second phase of the laboratory experimental program consisted of flow visualization experiments which provided a detailed understanding of the flow patterns near the boundary layers. Also, quantitative measurements were obtained to supplement those from the Phase 1 dewar experiments.

This study was carried out in a bottom-heated plastic tank of approximate dimensions 30 cm x 30 cm x 75 cm-deep (Reference 2-51). The sides and bottom of the tank were insulated, but side sections were removable to permit observation and photographing.

A search for an appropriate flow-visualization technique resulted in the selection of thymol blue as a fluid particle tracer (Reference 2-20). Thymol blue is a pH indicator and solutions containing small concentrations can be made to change color locally by the creation of ions at a charged electrode. A grid electrode (about 10 cm square), made of fine tungsten wires, was suspended about 1 cm below the LCZ interface for experiments performed in the LCZ and immediately above the UCZ for experiments performed in the upper zone.

3. Phase 3: Full-Scale Outdoor Pond

The primary purpose of the outdoor experiment pond was to provide a mechanism for full-scale validation (under controlled, but realistic conditions) of the numerical model. A detailed description of the pond design and construction is given by Jones, et al (Reference 2-21) and Jones and Meyer (Reference 2-22). Only a brief summary of the pond is presented here.

A unique feature of the pond is the construction in a lightweight porous rock known as "tuff," rather than the more typical sand or clay of other ponds. Tuff forms the major fraction of the LANL area surface geology. Tuff has a relatively small thermal conductivity which implies that little, if any, insulation is necessary to reduce perimeter heat losses. Also, because tuff is relatively strong, it was possible to build a pond with

vertical sidewalls and eliminate the problem of localized convection that occurs if the sidewalls slope. Because of these features, the salt and heat transport in the pond was expected to be truly one dimensional.

The construction of the 232 m² x 3.5 m deep pond began in October 1981. After excavation, the pond walls were covered with an 8-cm-thick layer of polyurethane insulation, mostly to smooth the rock surface and prevent a possible liner tear. A backup liner of 0.5-mm-thick rolled-on hypalon (on the walls) and a 0.5-mm-thick sheet of PVC (on the bottom) was installed after 15 cm of smooth plaster sand was spread evenly on the rock floor. Another layer of sand with four imbedded electric resistance leak detectors covered the PVC. The main liner of 1.2 mm thick fiberglass reinforced hypalon was installed in three pieces and joined in the field. To accommodate settling, the edges of the main liner were not anchored in the ground until the pond was filled. Six perimeter heat flux meters were installed in the tuff prior to beginning insulation work.

Instrumentation at the pond consisted of an underwater pyranometer (Epply Model 8-48) and traversing and fixed salinity and temperature measuring probes. The traversing device consists of a wheeled-trolley driven vertically and carrying two platinum RTDs, an induction salinometer (Beckman CEL-RAS7 and RIS5 indicator), and a platinum point conductivity probe.

The initial gradient of 120 cm was established on August 4, 1982. The initial LCZ and UCZ thicknesses were 120 cm and 20 cm, respectively. The pond began warming rapidly with the LCZ initially at 25°C and 18.5% salinity. The rate of temperature increase in the LCZ was 1.2°C/day for the first month of operation, reducing to 0.25°C/day for the second month.

At the end of the first week in September, an abnormal drop in the surface level of the pond was noticed. A leak was suspected. A graph of the salinity profiles over the period when the leak began is shown in Figure 2-2.

In Figure 2-2, note that the thickness of the core is the same for August 31 and September 21, however, the location is about 13 cm lower on the later day. Further, evidence of a leak is evident in Figure 2-3 where the depths of various isosalinity planes are shown as a function of time. After September 1, each isosalinity plane had a negative slope. The leak was judged to be from the LCZ. Subsequent calculations of salt inventories within the pond indicated a leak rate of about 1.8 m³/day.

After cooling the pond, divers found a "dime-sized" hole in the crease of the liner at the intersection of the north wall and floor. The tear is believed to have been caused by excessive stress during settling of the pond bottom. Two independent

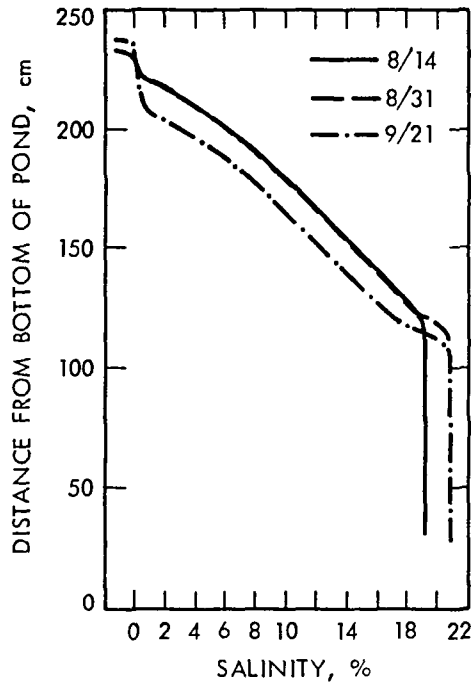

Figure 2-2. Solar Pond Salinity Profile

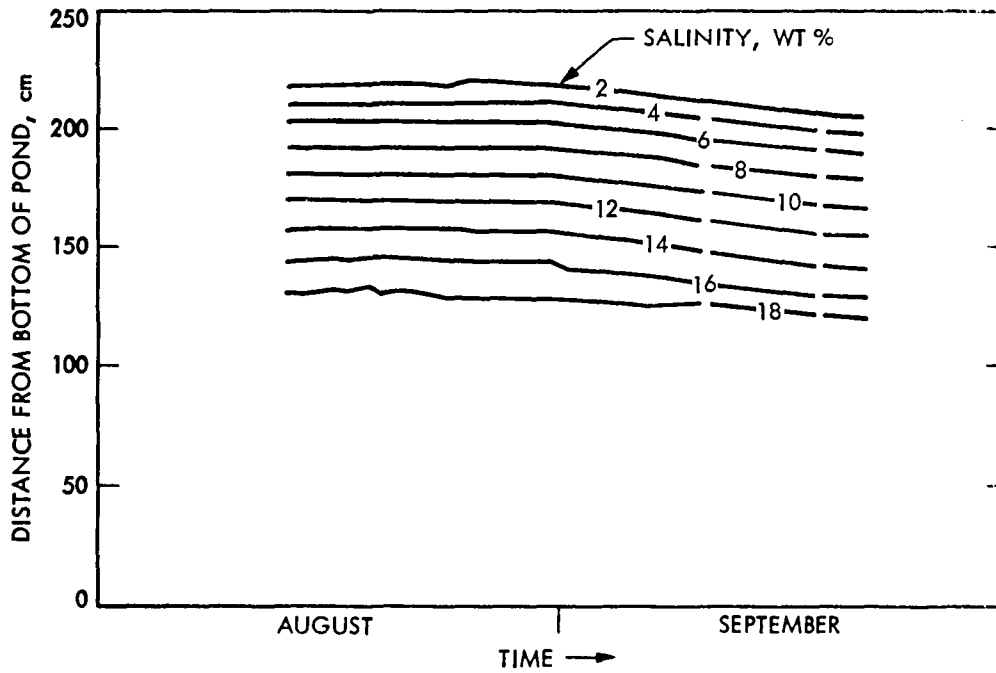

Figure 2-3. Isosalinity Planes

effects may have led to the high stress in the liner. First, the combination of hydrostatic pressure and high temperature from the large solar radiation intensities on the north wall caused the backup and main hypalon liners to stick together. The needed slippage of the main liner was thus prevented and large stresses at the bottom resulted. A similar stress tear had occurred on the west wall above the waterline and was repaired. Sticking was evident along that wall also. Second, because of the harsh environment, the supplier of the liner recommended fiberglass reinforcing for additional strength. Polyester is the standard reinforcement. Fiberglass, however, has very little ductility compared to polyester. The lack of ductility may have contributed to the liner failure. A successful repair was achieved using hypalon patches and a "5-minute" epoxy bonding agent.

A second problem became evident early in June 1983. For some reason, gas began to seep from the rock beneath the pond forcing the main liner upwards toward the surface. About a dozen gas bubbles of various sizes appeared under the liner.

All of the large bubbles were removed mechanically by pushing them down and working them toward a corner. At the corner, the gas escaped through a small incision in the liner made on the bank above the water line. The origin of the gas is uncertain. A gas analysis showed nitrogen-rich air. This air was possibly displaced from the porous tuff by unusually large mountain runoff earlier in the year or from the air displaced by the brine from the liner leak 6 months earlier. The appearance of the few smaller bubbles that were left under the liner has not changed since the end of June 1983.

One unfortunate result of the gas problem was another liner tear. It again occurred at the base of the north wall. An attempt was made to patch the hole from above the water using a double-sided tar-like tape supplied by L. Wittenberg of the Mound Facility, Miamisburg, Ohio. The tape was applied to the bottom of a stainless steel plate, lowered into place, tamped and weighted with sandbags. The liner had been previously cleaned with steel wool. The location of the pond surface stabilized after this patch was applied.

F. RESULTS AND DISCUSSION

1. Flow Visualization

Figure 2-4 shows the flow patterns immediately below the interface separating the LCZ and the diffusive core. Plumes of cool, less-salty dyed water are clearly visible as they descend from the interface. Patterns of this type were repeatedly observed when bottom heating rates were low. A structure such as

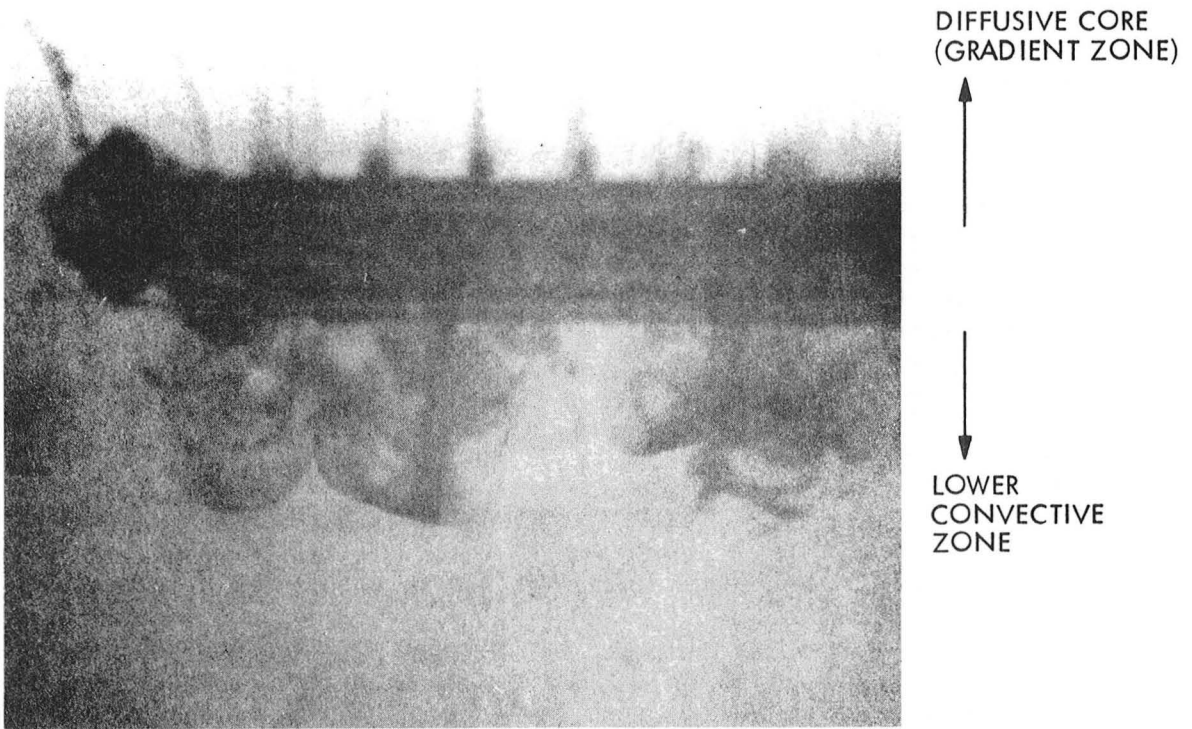

Figure 2-4. Flow Pattern Below Gradient Zone, Bottom Heat Off

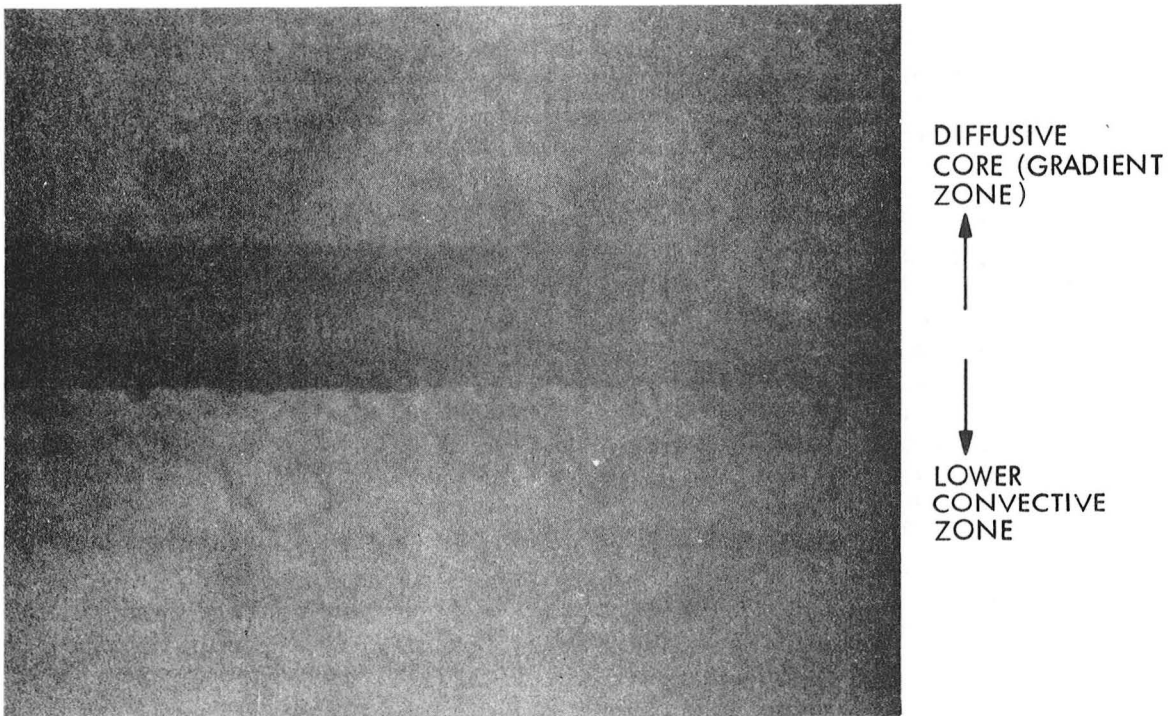

Figure 2-5. Flow Pattern Below Gradient Zone, Bottom Heat On

that shown in Figure 2-4 agrees very well with the breakdown processes assumed in the mechanistic model.

At large rates of bottom heating, the convection generated at the heating plate directly influences the flow patterns at the interface separating the LCZ and the core. The flow patterns immediately below this interface under the condition of large bottom heating are shown in Figure 2-5. Note in Figure 2-5 that the plume structure has been replaced by wisps of fluid being swept away by the convective stirring within the LCZ. This influence may cause an increase in the rate of salt transport through the boundary and result in an increased salt-to-heat-flux ratio. The oceanographic model for the interface assumes that the convective motions in the neighborhood of the interface are caused solely by the effect of heat transport through the interface.

Quantitative measurements with thymol blue have proved difficult. During observations made with heat fluxes in the range of 50 to 90W/m², plume velocities ranged between 0.1 and 0.2 cm/s. The average plume velocity appeared to increase with heat flux. Plume spacing ranged from 3 to 6 cm.

2. Validation of Dynamic Performance Code

The first attempt at validation was to use the numerical model to reproduce the experimental results obtained by Purdue University investigators (Reference 2-23) in a bottom-heated, solar pond simulation experiment. Details of the comparison are presented in Meyer (Reference 2-18). Figures 2-6 and 2-7 compare calculations with experimental data. Agreement is good.

The dynamic model, including wind-entrainment, was used to mathematically simulate the performance of the Miamisburg, Ohio, solar pond over a 3 month period. A brief discussion is presented here; more details of the comparison are described in Meyer et al (Reference 2-17).

The two computed solutions presented in Figure 2-8 reflect two independent sets of empirically determined constants used in the wind entrainment expression (References 2-24, 2-25). The constants from Reference 2-24 produce a better correlation.

A series of laboratory tank experiments were also performed and the data correlated with the model. The correlating coefficient in the numerical model is the salt-to-heat-flux ratio which is computed and input to the model (Reference 2-26).

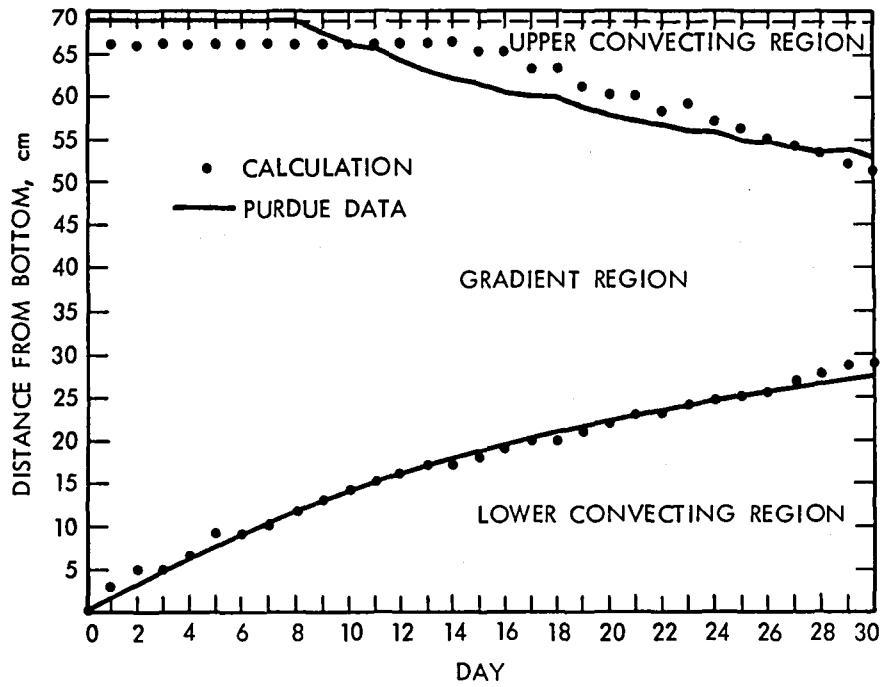

Figure 2-6. Time Variation of Layer Position

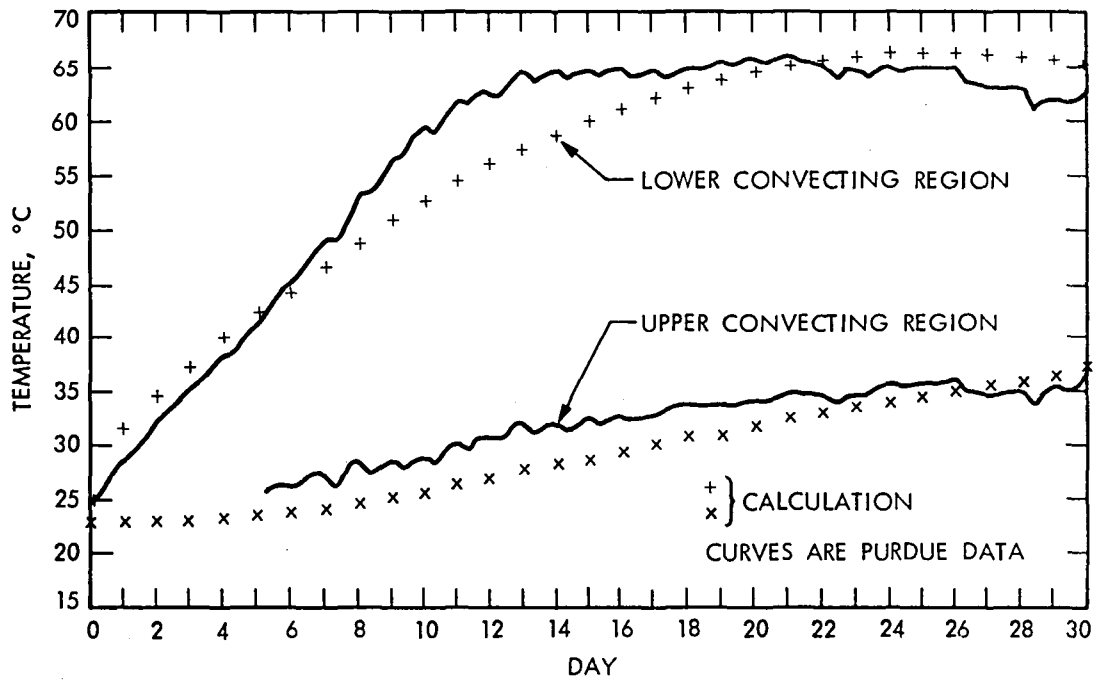

Figure 2-7. Temperature of Convective Zones

Table 2-1 summarizes the conditions of the experiments and Figures 2-9 through 2-16 present comparisons of the observed and calculated results. The error range in the flux ratio, Table 2-1, arises from uncertainties in the location of the interfaces (upper and lower) and the value of the temperature gradient. The salinity profile data were scattered, whereas the temperature profiles were smooth and rounded in the interface regions. The interface was therefore defined to be at the intersection of the straight-line extension of the temperature profile in the core and the constant temperature line of the mixed zone.

The duration of the experiments ranged from 12 to 22 days and heat fluxes from 8.5 to 61.2 W/m². Included on each figure are the heat flux and the dimensionless flux ratio used in the model to produce the plotted calculated results. In all cases, the heat flux and flux ratio used in the model fall within the error range of the data and produce good agreement between the calculated and experimental results.

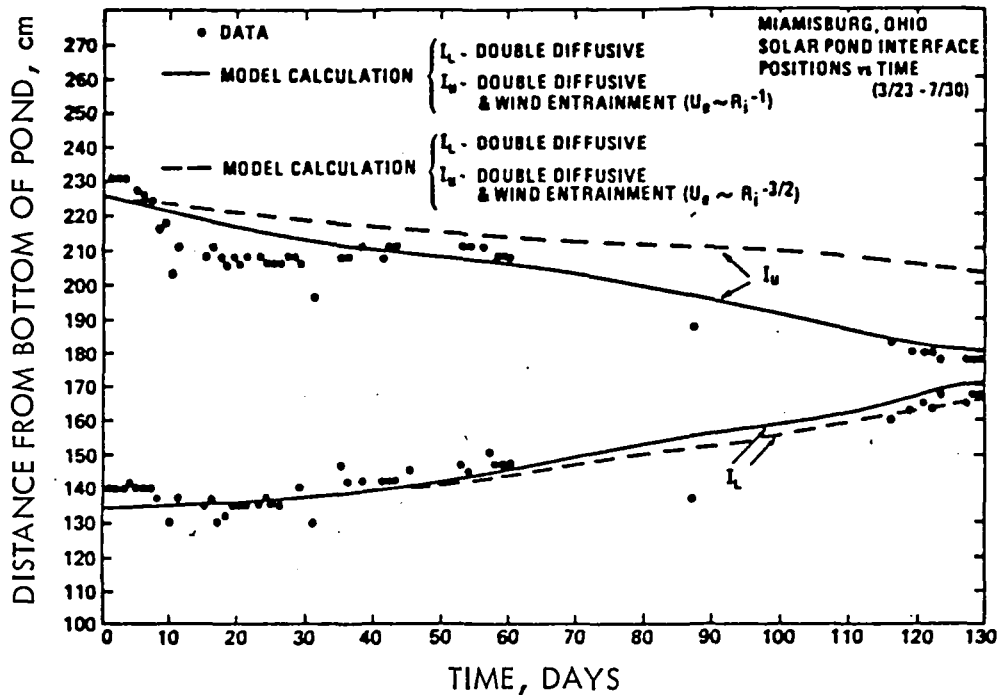

Figure 2-8. Comparison of the Measured and Calculated Interface Position for the Miamisburg Solar Pond

Table 2-1. Results of Los Alamos Laboratory Tank Tests

Experiment Number	Interface or Zone (lower/upper)	Duration (days)	Mixed Zone So(%)	Mixed Zone S/ t(%/day)	FH (W/m ²)	Interface Velocity (cm/day)	pcp F FH
1	<i>l</i>	19.00	12.95	0.072	35.2 ± 3.0	0.42	0.26 ± 0.03
2	<i>l</i>	19.04	12.39	0.094	43.2 ± 3.0	0.55	0.35 ± 0.05
2	<i>u</i>	19.04	0.93	-0.084	46.2 ± 3.0	-0.35	0.15 ± 0.04
3	<i>l</i>	22.00	16.30	0.084	61.2 ± 4.0	0.33	0.25 ± 0.03
3	<i>u</i>	22.00	4.27	-0.110	61.2 ± 4.0	-0.15	0.23 ± 0.05
4	<i>l</i>	13.00	18.75	0.126	49.2 ± 3.0	0.45	0.33 ± 0.04
4	<i>u</i>	13.00	1.84	-0.104	49.2 ± 3.0	-0.22	0.16 ± 0.04
5	<i>l</i>	11.80	11.97	0.115	8.8 ± 0.2	0.017	0.30 ± 0.09

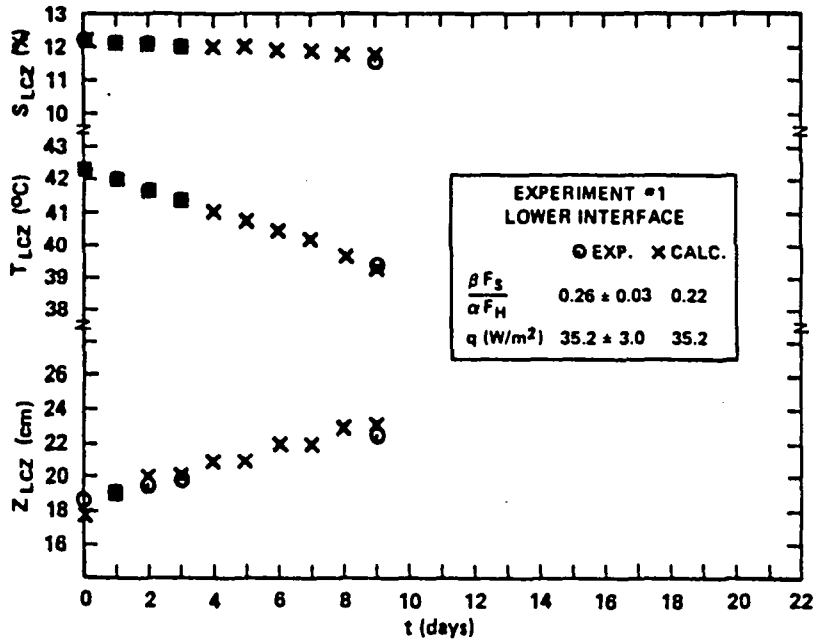

Figure 2-9. Comparison of Observed and Calculated Results for Laboratory Tank Experiment, Experiment No. 1, Lower Interface

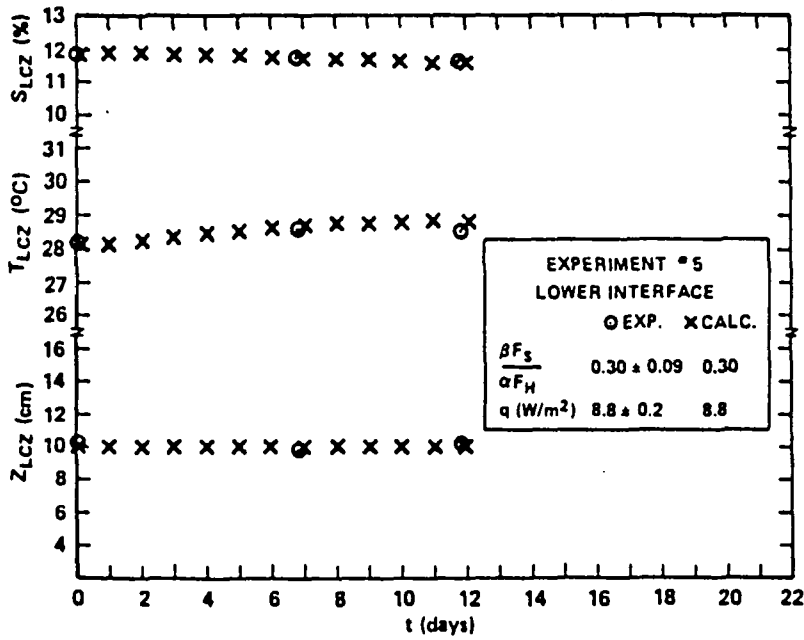

Figure 2-10. Comparison of Observed and Calculated Results for Laboratory Tank Experiment, Experiment No. 5, Lower Interface

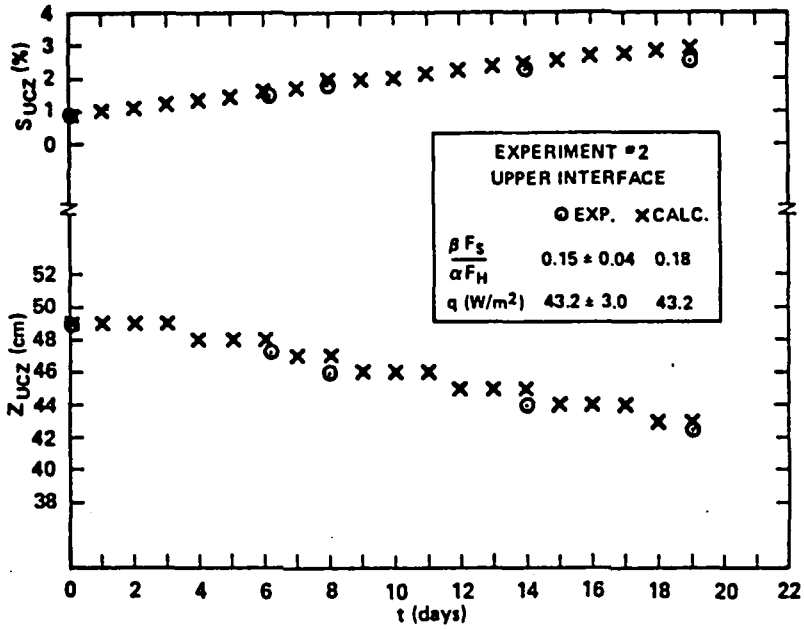

Figure 2-11. Comparison of Observed and Calculated Results for Laboratory Tank Experiment, Experiment No. 2, Upper Interface

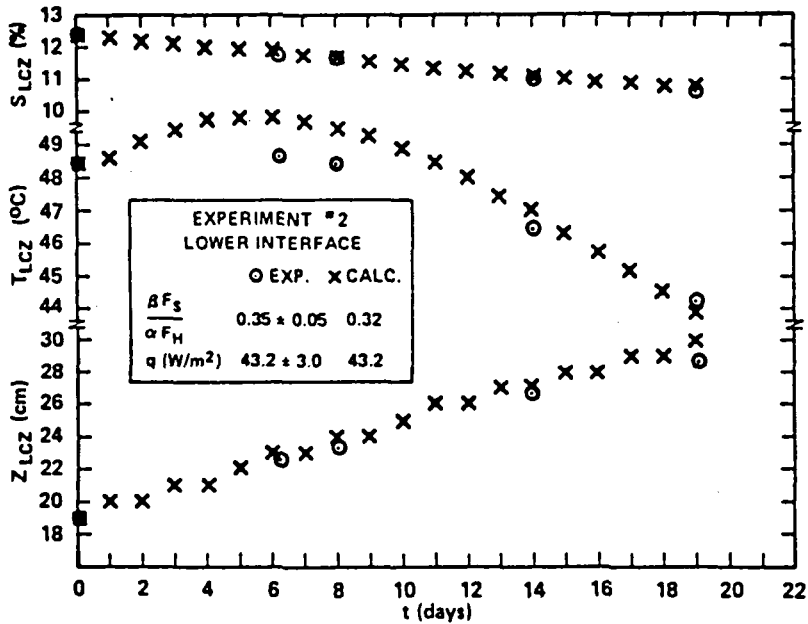

Figure 2-12. Comparison of Observed and Calculated Results for Laboratory Tank Experiment, Experiment No. 2, Lower Interface

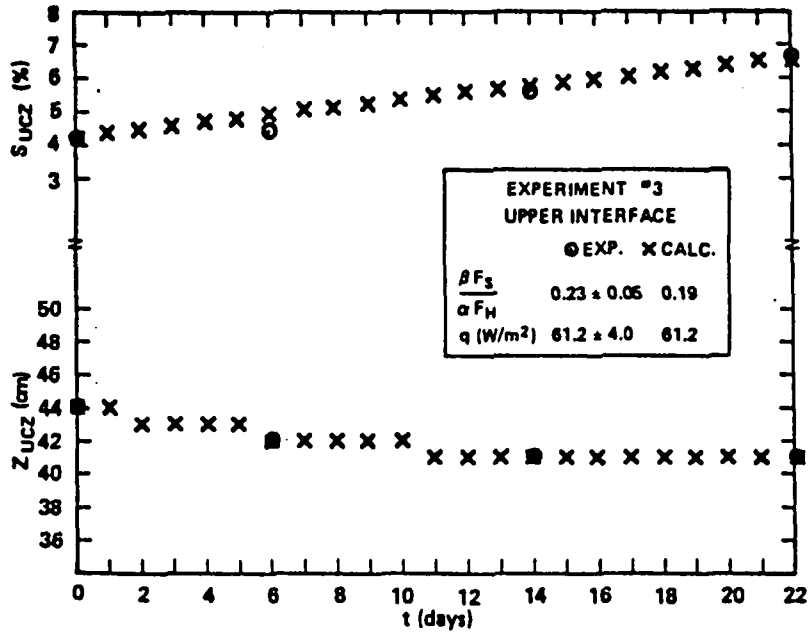

Figure 2-13. Comparison of Observed and Calculated Results for Laboratory Tank Experiment, Experiment No. 3, Upper Interface

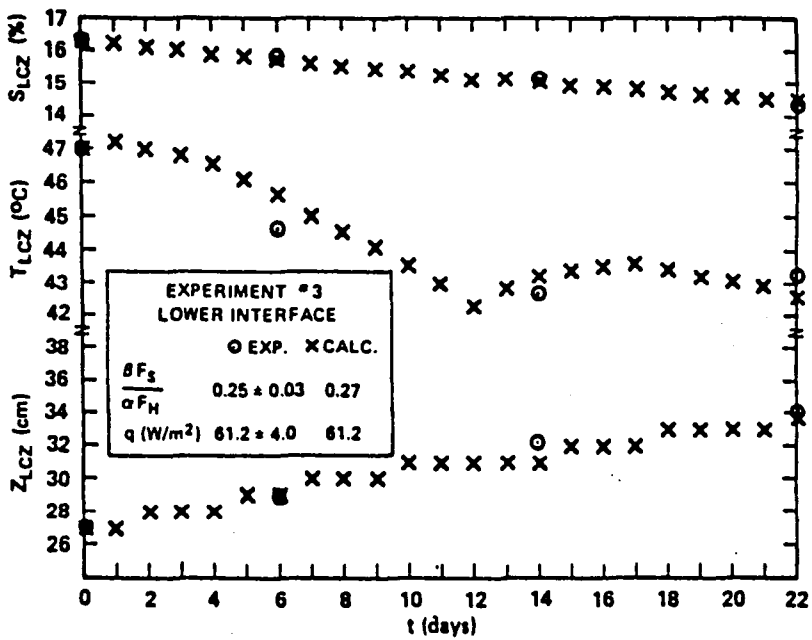

Figure 2-14. Comparison of Observed and Calculated Results for Laboratory Tank Experiment, Experiment No. 3, Lower Interface

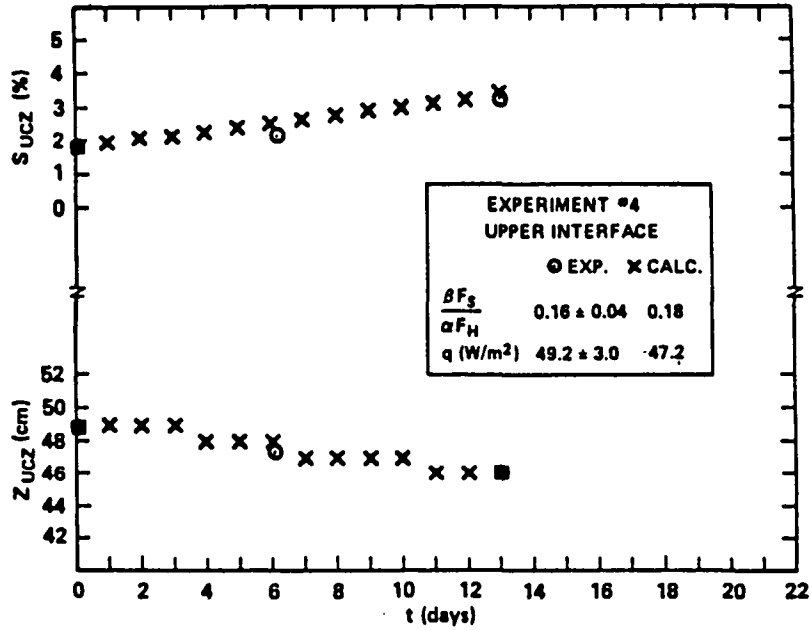

Figure 2-15. Comparison of Observed and Calculated Results for Laboratory Tank Experiment, Experiment No. 4, Upper Interface

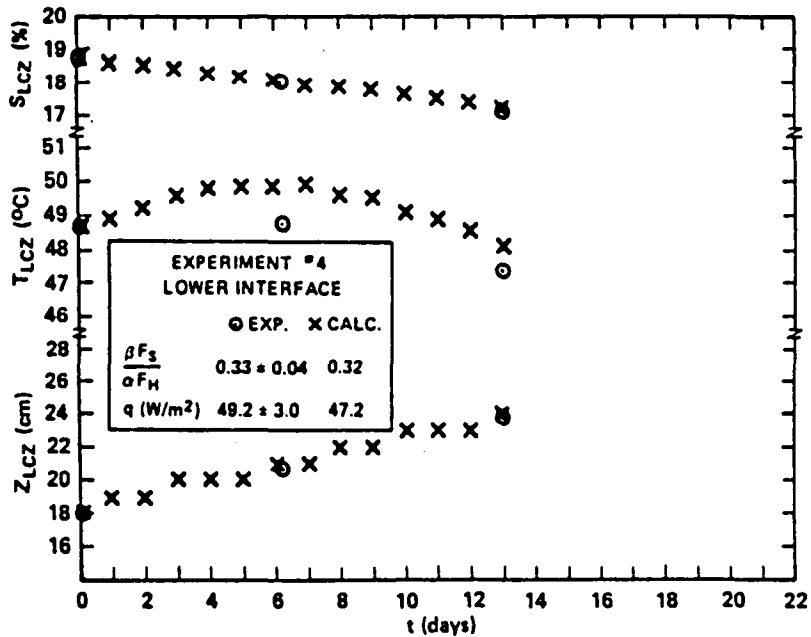

Figure 2-16. Comparison of Observed and Calculated Results for Laboratory Tank Experiment, Experiment No. 4, Lower Interface

The anomalous behavior of the LCZ temperature history in Figure 2-14 occurred when, in error, a technician increased the rate of bottom heating slightly on the twelfth day of the experiment. The discontinuity in heating was included as input to the model and the results are in good agreement with the measured values.

From the good agreement between calculated and predicted results in Figures 2-9 through 2-16, it appears that the model contains the features necessary to predict time-dependent salinity, temperatures, and motion of the mixed layers.

3. Outdoor Pond

The 232 m² solar pond was operated in a run-down mode (no heat extraction or gradient maintenance) for a 57 day period beginning June 22, 1983. In the context of this test, run-down means setting the pond up in an initial state and then allowing the pond to function without external intervention while monitoring heat gains or losses and movements of the zone boundaries. The primary purpose of the experiment was to obtain data on flux ratios from a full-size pond in order to compare to similar data obtained from the small-scale laboratory experiments. The experiment was not fully funded and model validation effort was unfortunately limited to spare time status.

The pond was cooled and otherwise prepared for the test by mid-June. Temperature and salinity profiles in the pond for 4 days during the experiment are shown in Figures 2-17 and 2-18. The fluctuations noted in the salinity profiles in the LCZ are not believed to be real, but caused by a deteriorating platinum coating on the point conductivity probe tip. Fortunately, the salinity values for the LCZ used in the salt flux calculations are from extracted samples and not from probe readings.

Salt-to-heat-flux ratios and other pertinent results from the run-down experiment are presented in Table 2-2. Observe that the rate of run-down was rapid (on the average, about 1 cm/day was lost from the core). This is seen more clearly in Figure 2-19 where the interface locations are graphically displayed. A possible explanation for the rapid run-down is obtained by considering the relatively small values of the overall density-stability ratios shown in Table 2-2. Newell (Reference 2-27) indicates that the operational limit of solar ponds corresponds to an R_{ρ} value of about 7 to 8. Based on this criterion and an R_{ρ} of 5 for most of the experiment, the salinity gradient was not large enough to support the temperature gradient and a rapid run-down transpired.

The average salt flux from the LCZ over the first 23 days of the experiment was about 76 kg/m²/year and for the second 18

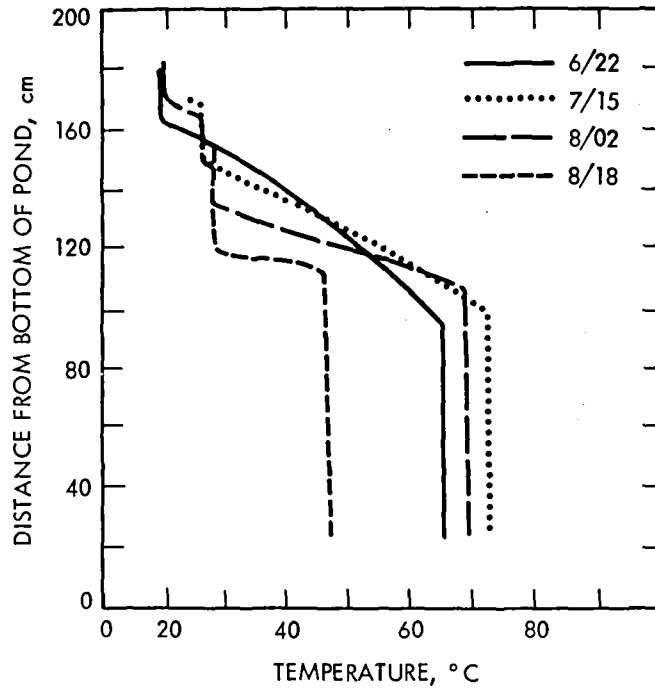

Figure 2-17. Temperature Profiles in Pond During Run-Down Experiment

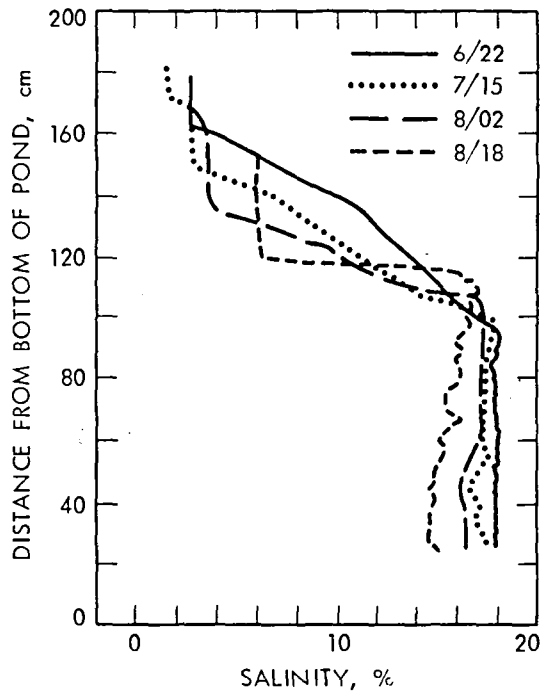

Figure 2-18. Salinity Profiles in Pond During Run-Down Experiment

Table 2-2. Results of Los Alamos Laboratory Solar Pond Experiment

Day of Experiment	Core Thickness (cm)	Average Boundary Salt Flux (g/cm ² -day)		Boundary Heat Flux (w/m ²)		Flux Ratio		Boundary Velocity (cm/day)		Density Stability Ratio-R _ρ
		LCZ	UCZ	LCZ	UCZ	LCZ	UCZ	LCZ	UCZ	
		0	70.0	0.0207		37.73 2.74		0.29 ±0.02		
23	54.0	0.0430	0.020	65.71 ±1.94	101.00 ±1.88	0.33 ±0.01	0.220 ±0.004	0.41	-0.73	4.61
41	29.2	0.0719	121.82 ±3.91			0.30 ±0.01		0.25	-0.89	4.66
57	10.8									8.22

*R_ρ is the density stability ratio, which is equal to $\frac{\beta \Delta S}{\alpha \Delta T}$
 where: β = salinity expansion coefficient (cm³/g)
 S = salinity, wt %
 α = coefficient of thermal expansion (1/°C)
 T = temperature (°C)

$$\text{Flux Ratio} = \frac{\rho C_p \beta F_S}{\alpha F_H}$$

where: ρ = fluid density (g/cm³)
 c_p = specific heat (J/g.°C)
 β = salinity expansion coefficient (cm³/g)
 F_S = salt flux (g/cm²-s)
 α = coefficient of thermal expansion (1/°C)
 F_H = heat flux (w/cm²)

days, it was about twice this amount. The smaller number is about three-and-a-half times the maximum measured value of Nielsen and Rabl (Reference 2-28). More data and study are necessary to provide an explanation for this discrepancy.

Figure 2-20 shows the dimensionless salt-to-heat-flux ratio as a function of heat flux for the laboratory and pond experiments. Also included in the figure are results from Broughton (Reference 2-29) and Marmarino and Caldwell (Reference 2-6). Nielsen's correlation (Reference 2-30) is expressed in a form compatible with the Marmarino and Caldwell results and plotted as a solid curve in Figure 2-20. Also, the correlation used by Meyer (Reference 2-16) to match the predictions from his numerical model to the Purdue data is shown as a dotted curve. For the LANL data, the partially shaded boxes refer to the results obtained for the LCZ interface results. The results presented in Figure 2-20 are in relatively good agreement and support the conjecture that the same physical phenomena are present in both thermohaline columns and solar ponds. Although the data is scattered, the trend toward a smaller flux ratio at larger heat fluxes is perceptible from Figure 2-20. The correlation using Nielsen's solar pond data appears to establish a lower bound. The correlation based on Meyer's work is in much better agreement with the data than the Nielsen correlation in the moderate-to-large heat flux range. The relatively good agreement between the flux ratios for the laboratory tank experiments and those from the pond indicates that the effects of convective mixing from bottom heating on salt transport through the LCZ boundary may not be as significant as originally thought. More flux-ratio data for large ponds are needed to answer this question.

G. DISPOSITION OF EXPERIMENTAL EQUIPMENT

Both tanks and associated hardware are still intact and may be used again without much preparation. The data acquisition system for the dewar experiment is on permanent loan to another group in the laboratory. It will be difficult to retrieve.

The pond needs work. If there is a leak in the liner, it is suggested that a new liner be installed on the top of the old one which could first be patched and used as a backup. More salt will be needed. The underwater pyranometer and the Beckman salinometer both need repair. Other instrumentation at the pond remains intact. The data acquisition system was removed from the pond site, but is still available if needed. The traversing mechanism should be modified to eliminate a sticking problem.

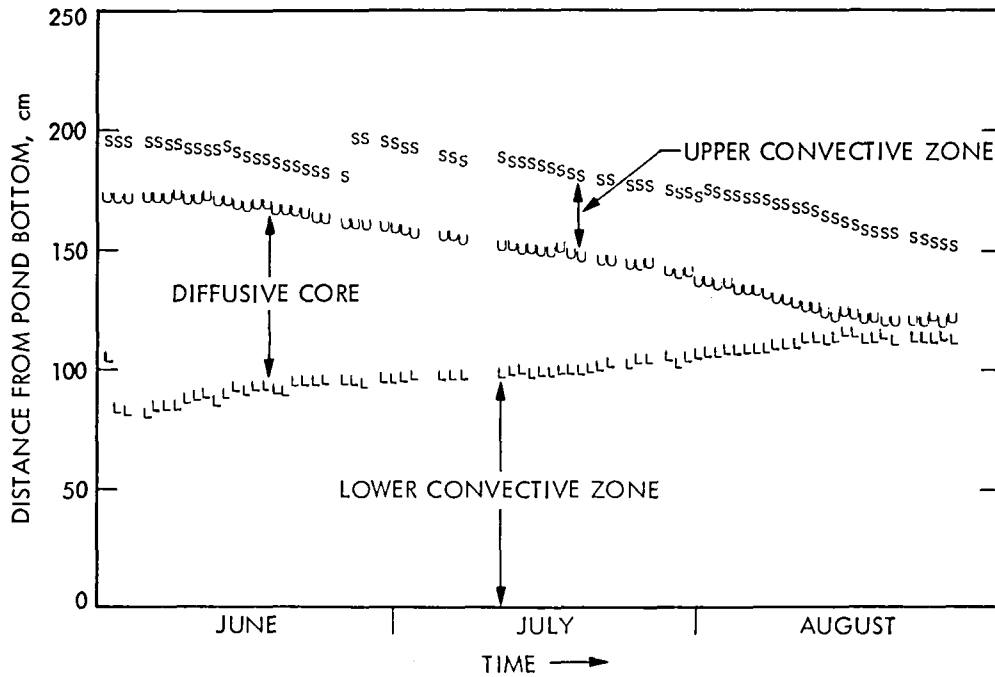

Figure 2-19. Zone Boundary Locations in the Solar Pond During Run-Down

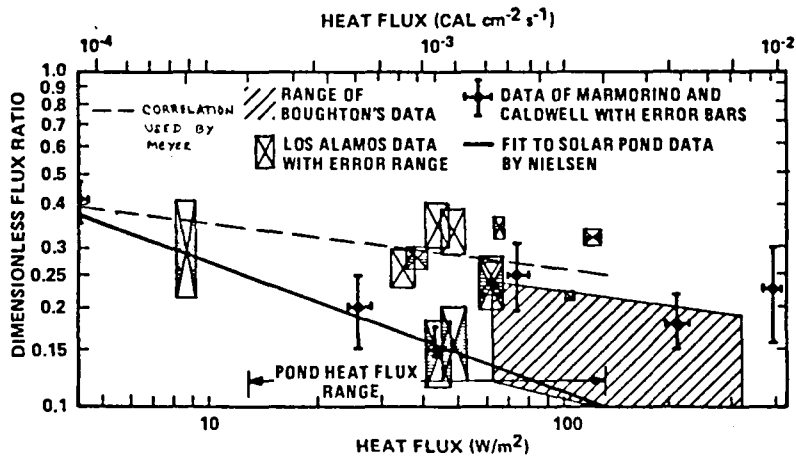

Figure 2-20. Dimensionless Salt-to-Heat-Flux Ratio Versus Heat Flux for Pond Experiment

H. REFERENCES

- 2-1. Jones, G.F., et al, TBD remainder.
- 2-2. Viskanta, R., and Toor, J.S., "Absorption of Solar Radiation in Ponds," Journal of Solar Energy, Vol. 21, p. 59, 1978.
- 2-3. Rabl, A., and Nielsen, C.E., "Solar Ponds for Space Heating," Journal of Solar Energy, Vol. 17, p. 1, 1975.
- 2-4. Hawlader, M.N.A., "The Influence of the Extinction Coefficient," Journal of Solar Energy, Vol. 25, p. 461, 1980.
- 2-5. Huppert, H.E., and Turner, J.S., "Double Diffusive Convection," Journal of Fluid Mechanics, Vol. 106, p. 299, 1981.
- 2-6. Crapper, P.E., "Measurements Across a Diffusive Interface," Deep Sea Research, Vol. 22, p. 537, 1975.
- 2-7. Marmorino, G.O., and Caldwell, D.R., "Heat and Salt Transport Through a Diffusive Interface," Deep Sea Research, Vol. 23, p. 59, 1976.
- 2-8. Lindberg, W.R., and Haberstroh, R.D., "A Thermohaline Convection Model," Office of Naval Research Project NR-083-250, Tech. Report No. 1, November 1971.
- 2-9. Linden, W.R., and Shirtcliffe, T.G.L., "Diffusive Interface in Double Diffusive Convection," Journal of Fluid Mechanics, Vol. 87, p. 417, 1978.
- 2-10. Sparrow, E.M., Husar, R.B., and Goldstein, R.J., "Observations and Other Characteristics of Thermals," Journal of Fluid Mechanics, Vol. 41, p. 793, 1970.
- 2-11. Howard, L.N., "Convection at High Raleigh Number," Proc. 11th International Congress of Applied Mechanics, Munich, Springer-Verlag, Berlin, 1964.
- 2-12. Weinberger, H., "The Physics of the Solar Pond," Journal of Solar Energy, Vol. 8, p. 45, 1964.
- 2-13. Veronis, G., "On Finite Amplitude Instability in Thermohaline Convection," Journal of Fluid Mechanics, Vol. 34, p. 315, 1968.
- 2-14. Turner, J.S., "Double Diffusive Phenomena," Ann. Rev. of Fluid Mechanics, Vol. 6, p. 37, 1974.

- 2-15. Turner, J.S., Lecture presented at the Double-Diffusive Convection Conference, Santa Barbara, California, March 14-18, 1983.
- 2-16. Rothmeyer, M., "The Soret Effect and Salt-Gradient Solar Ponds," Journal of Solar Energy, Vol. 25, p. 567, 1980.
- 2-17. Meyer, K.A., Grimme, D.P., and Jones, G.F., "An Experimental and Theoretical Study of Salt-Gradient Solar Pond Interface Behavior," Proc. International Solar Energy Society Meeting, Houston, Texas, 1982.
- 2-18. Meyer, K.A., "A Numerical Model to Describe the Layer Behavior in Salt-Gradient Solar Ponds," Journal of Solar Energy Engineering, Vol. 105, p. 341, 1983.
- 2-19. Grimme, D.P., Jones, G.F., Tafoya, J., and Fitzgerald, T.J., "Development of a Point-Electrode Conductivity Salinometer with High Spatial Resolution for Use in Very Saline Solutions," Los Alamos National Laboratory, Report No. LA-96554-MS, 1983.
- 2-20. Baker, D.J., "A Technique for the Precise Measurement of Small Fluid Velocities," Journal of Fluid Mechanics, Vol. 87, p. 417, 1978.
- 2-21. Jones, G.F., Meyer, K.A., Hedstrom, J.C., Dreicer, J.S., and Grimmer, D.P., "Design, Construction, and Initial Operation of the Los Alamos National Laboratory Salt-Gradient Solar Pond," Proc. ASME-SED Meeting, Orlando, Florida, April 19-21, 1983.

SECTION III

REVIEW OF SERI SOLAR POND WORK

F. Zangrando

D.H. Johnson

Los Alamos National Laboratory

Solar Energy Research Institute

SECTION III

CONTENTS

A.	INTRODUCTION	3-5
B.	MODEL DEVELOPMENT	3-5
C.	APPLICATION ANALYSIS	3-6
D.	DIRECT CONTACT HEAT EXCHANGERS	3-7
E.	HEAT AND MASS EXTRACTION EFFECTS	3-8
F.	GRADIENT LAYER AND INTERFACE INSTABILITIES	3-9
G.	MISCELLANEOUS	3-11
H.	REFERENCES	3-11

SECTION III

SUMMARY OF SERI SOLAR POND WORK

A. INTRODUCTION

SERI staff have been working since 1979 under funding by the DOE Active Heating and Cooling Program, the DOE Solar Thermal Technology Program, the U.S. Department of Interior, Bureau of Reclamation, and the U.S. Army Corps of Engineers, on many of the problems discussed in Section I. Work has been done in the following areas:

- (1) Development of models of pond thermal performance.
- (2) Analysis of solar pond use for building space heat and hot water production.
- (3) Use of low-temperature pond-produced heat for industrial processes, desalination, and electricity production.
- (4) Development of direct-contact heat exchanger to reduce conversion equipment cost.
- (5) Determination of effects of extracted heat and mass from the storage layer on pond performance.
- (6) Investigation of factors which determine gradient layer stability and the stability of this interface between this level and the upper and lower convecting layers.
- (7) Miscellaneous others.

This work has resulted in papers published in engineering journals, SERI technical reports, and a few unpublished documents. Each of these reports is summarized in Part Three and is listed in Section III.G. The following summarizes the work done in each area, with emphasis on the analytical and experimental tools developed at SERI and available for use by others.

B. MODEL DEVELOPMENT

One of the earliest institute efforts was the development of models of the thermal performance of a solar pond. An analytic model (easily programmed on a hand calculator) was first developed, based on the assumption that load and solar input are sinusoidal functions of time with phases determined by the user (Reference 3-1). A numeric model, based on the lumped parameter electrical circuit analogy to heat transfer, was also created

(Reference 3-2 and 3-3). This is called SOLPOND and is available from SERI in either a one or two dimensional form. Over the years, it has been expanded by adding subroutines. One subroutine calculates the performance of a pond driven multi-effect distillation plant (Reference 3-4); another subroutine calculates the performance of a pond-driven Rankine cycle engine which uses an organic working fluid and produces electrical power (Reference 3-5). The deVries model of soil thermal conductivity as a function of temperature, moisture content, porosity, and constituent materials has been programmed as a SOLPOND subroutine (References 3-6 and 3-7). It can be used to calculate the heat lost to the ground from a solar pond.

C. APPLICATION ANALYSIS

Over the years, SOLPOND has been used to determine the performance of solar ponds at many locations and for many applications. These calculations have often formed the basis for cost estimates. Such studies are perhaps most useful for the methodologies they illustrate, although some conclusions which are likely to be of lasting validity can be drawn. A study of solar ponds used to produce space heat and hot water for houses has shown that this is usually not economical for single homes, but can be economically competitive with solar collectors today for districts of homes (Reference 3-8). Other work has pointed out the benefits of converting existing artificial ponds into solar ponds (Reference 3-9) and of replacing old heating plants with solar ponds (Reference 3-10).

A report on the use of solar ponds to supply low-temperature industrial process heat (IPH) has shown that, in their temperature range, ponds are far more cost effective than any other solar IPH technology (Reference 3-11); in favorable circumstances solar ponds can currently compete with natural gas (Reference 3-12).

A study of solar pond use to supply heat for desalination made the point that multieffect, rather than multistage, distillation processes are best matched to the characteristics of a solar pond heat source (Reference 3-4).

It was pointed out in a study of the application of solar ponds to the mining industry that mining operations develop tailing beds which could be used as support for a lined pond and which may be suitable as containment material for unlined ponds (Reference 3-13). Mining operations are often carried out in remote regions where power is at a premium. These factors reduce the cost of solar ponds and increases the value of the energy they collect for this application.

An application analysis performed at SERI which deserves special mention is that of converting part of the Truscott, Texas brine lake into solar ponds to produce electrical power (References 3-5, 3-14, and 3-15). The Truscott brine lake is being created by the Army Corp of Engineers as part of a project to control the salinity of the Red River. Highly saline tributaries of the Red River are being diverted to the brine lake by pumping their water through pipes to the site of the lake where the water will be held while it evaporates. The brines created by evaporation could be used to build solar ponds, with the heat from the ponds used to power a heat engine to drive the pumps. The three SERI reports dealing with this subject analyze various scenarios for accomplishing this and they thoroughly cover every aspect of designing, constructing, and operating an organic working fluid Rankine cycle engine for converting low-temperature thermal energy into electrical (or mechanical) energy.

D. DIRECT CONTACT HEAT EXCHANGERS

Conversion of the low-temperature heat from a solar pond into electrical (or mechanical) energy requires the transfer of large quantities of heat across small temperature differences. This is typically accomplished using shell and tube heat exchangers with large surface areas. The material in such heat exchangers is expensive. The evaporating and condensing heat exchangers together typically represent 50% of the capital cost of the power conversion equipment. The use of direct contact heat exchangers might substantially reduce this cost. SERI has made an intensive investigation of this substitution.

The possibility of using a direct-contact preheater/evaporator was investigated (References 3-16 and 3-17). A problem usually encountered with direct-contact heat exchangers is loss of working fluid through absorption by the heat transfer fluid. This is avoided with the solar pond/organic Rankine cycle preheater/evaporator because saturated brine absorbs very little organic fluid and because once the brine in the storage layer becomes saturated, loss of working fluid occurs only by diffusion through the gradient layer, a very slow process. Using volumetric heat transfer and flooding correlations from the literature, a direct-contact preheater/evaporator was sized and costed for a 5 MW solar pond power plant (Reference 3-18). It was found that the direct contactor was negligible in cost compared to the alternative of a shell and tube heat exchanger. However, the existing correlations exhibit wide scatter over the range of conditions for a solar pond. A laboratory apparatus to obtain accurate volumetric heat transfer and flooding correlations was designed (Reference 3-19). Measurements to obtain these correlations are being carried out by a group at the University of Utah (Reference 3-20).

The possibility of using a direct-contact condenser was also investigated (Reference 3-21). It was found that the cost of equipment to deaerate the working fluid as it left, almost offset the reduced cost of the direct-contact condenser compared to a shell and tube heat exchanger. The significant point to note is that direct contact has great advantages for evaporation, but is not recommended for the condensation process.

E. HEAT AND MASS EXTRACTION EFFECTS

In order to use a solar pond, heat must be extracted from the storage layer. This could be done by placing a heat exchanger in the storage layer and circulating a heat transfer fluid through it. This approach has several severe disadvantages. One is that heat transfer on the brine side will be limited by natural convection, leading to very large heat exchangers. Another is that the heat exchanger will not be easily accessible for repair. The preferred approach is to withdraw brine from the storage layer, pass it through an external heat exchanger, and return it to the storage layer. There will now be a horizontal flow of brine within the storage layer from the return port to the withdrawal port. This flow will cause a shear force at the interface between the storage and gradient layers which could destabilize the interface and cause erosion of the gradient layer from below, resulting in increased heat losses from the pond.

SERI has conducted an experimental study of the conditions under which this will occur. First, the existing literature on shear flows in stratified fluids was reviewed (Reference 3-22). Then, an apparatus was designed and constructed to investigate this problem (References 3-23, 3-24, and 3-25). This apparatus, called the solar pond simulator, is a tank, 1 m wide x 2 m deep x 10 m long. It can be divided in half, lengthwise, by a removable partition so that length effects can be studied, and it has windows along one side so that flow patterns can be observed. The simulator is heated from below by electrical heaters and is designed to withstand solar pond operating temperatures. Polystyrene, 66 cm thick, insulates against horizontal heat loss. Inlet and outlet manifolds are located at opposite ends of the tank. The solar pond simulator is instrumented to measure vertical temperature and brine density profiles. These measurements can be combined to infer vertical salinity profiles. Brine recirculation rate and inlet and outlet temperatures are also measured. A preliminary set of measurements has been made with this apparatus (Reference 3-24). It was found that the interface between the storage and gradient layer will be stable if the bulk flow in the storage is low enough such that:

$$Ri_b = \frac{g \frac{d\rho}{dz} H^4}{\rho g^2} > 10^9 \quad (1)$$

and the outlet port is far enough below the interface such that:

$$Ri_d = \frac{g \frac{d\rho}{dz} h^4}{\rho g^2} > 500 \quad (2)$$

where Ri_b is the bulk Richardson number, Ri_d is the outlet diffuser Richardson number, g is the acceleration of gravity, $d\rho/dz$ the density gradient at the bottom of the gradient layer, ρ the density of the storage layer, H the depth of the storage layer, h the outlet diffuser distance below the interface between the storage and gradient layer, and q the bulk volumetric flow per unit width.

F. GRADIENT LAYER AND INTERFACE INSTABILITIES

In order for a solar pond to continue to operate, the gradient layer must remain stable. Instabilities can occur due to a variety of forces which act on the boundaries and internal bulk of the gradient layer. SERI has conducted extensive studies of the conditions under which instabilities occur. An upward flow of fluid will occur at the sides of the gradient layer whenever the walls of the pond are sloping (Reference 3-26). This effect may explain the anomalously high upward flux of salt observed in some small ponds, but it is probably not strong enough to be significant in large ponds.

The mechanisms which cause erosion of the upper or lower boundaries are of more general interest. The forces which act on the interface between the upper convecting layer and the gradient layer are due to fluid motions in the mixed layer caused by wind-driven waves and currents and by surface cooling due to evaporation and radiation to the night sky. The wind-driven effects are being investigated experimentally by a group at the Massachusetts Institute of Technology (MIT) under contract to SERI (Reference 3-27). They have incorporated their results into a model which predicts the depth of the surface mixed layer in a solar pond as a function of wind speed. This model has been programmed for solution by a computer and is available at SERI.

The forces which act on the interface between the gradient layer and storage layer are due to convective currents in the storage layer caused by radiative heating or flow in the storage layer due to heat and mass extraction. The latter cause has been discussed in detail above. A group at Purdue University under contract to SERI is investigating the former cause (Reference 3-28).

The force of gravity acts on the internal bulk of the gradient layer. The gradient layer is heated from below, which causes destabilizing gravitational buoyant forces. Normally, the pond is stabilized by the counteracting effect of a salinity distribution which increases with depth. The opposing effects of salt and heat in the gradient layer can give rise to so-called double-diffusive instabilities. The conditions for the onset of these instabilities have been extensively investigated for the case of a linear vertical distribution of salt and temperature. The vertical distribution of salt and temperature in the gradient layer of a solar pond is never linear. SERI initiated theoretical and experimental efforts to determine the conditions for the onset of double diffusive instabilities when the distribution of salt and temperature are not linear. A theoretical study has been completed of the occurrence of double-diffusive instabilities when the temperature distribution is linear, but the salt distribution has a cubic "kink" (Reference 3-29, 3-30). This study predicts that an instability will first occur at the location of the "kink" when the local salt and temperature gradients at the "kink" satisfy the conditions for the occurrence of an instability in a system with linear distributions of salt and heat. The fluid motions due to the instability are strongly localized at the position of the "kink."

Personnel from SERI and Colorado State University have performed experiments to check the essential features of this theory (Reference 3-31). A "stratified fluid test tank," 2 ft long x 2 ft in cross sectional area and 4 ft deep, was built. This tank is constructed of glass and insulated on the sides by a foot of polyurethane foam. The tank is heated by an array of solar simulators located above. It is instrumented with a platinum resistance thermometer which can be scanned vertically to obtain the temperature distribution, a rake of 10 thermistors which can be positioned across the region of the salinity "kink" to obtain a detailed local temperature profile, an array of sampling ports from which small samples of brine may be withdrawn and weighed to obtain density, and a shadowgraph which may be used to observe the effects of an instability. Results obtained with this apparatus show good agreement with the theory of Zangrando and Bertram if the length scale associated with the salinity "kink" is properly chosen.

The conditions for the instabilities discussed above depend, in part, on the physical properties of the particular salt used to form the gradient layer. The stability of linear distributions of several highly soluble and potentially inexpensive salts heated from below has been determined at SERI (Reference 3-32).

G. MISCELLANEOUS

Several reports have been written over the years discussing topics which do not fit in the broad categories previously considered in this section. Perhaps the most important of these is the solar pond bibliography (Reference 3-34). This bibliography has recently been updated and a revised version will soon appear. Another report surveys density measurement techniques for application in stratified fluids (Reference 3-34). Density measurement is not only important in its own right, but combined with a simultaneous temperature measurement, can be used to infer salinity, which is very difficult to measure directly with sufficient accuracy to resolve features of the gradient layer. SERI has also studied saltless or convecting solar ponds. This concept consists of a body of saltless water to absorb and store solar energy. The body of water is insulated against heat loss by a glazing.

H. REFERENCES

- 3-1. Edesess, M., Henderson, J., Jayadev, T.S., A Simple Design Tool for Sizing Solar Ponds, SERI/PR-351-347, 1979.
- 3-2. Jayadev, T.S., Henderson, J., Salt Concentration Gradient Solar Ponds--Modeling and Optimization, SERI/TP-351-277, presented at the Annual Meeting of the International Solar Energy Society (ISES), Atlanta, Georgia, May 28-June 1, 1979.
- 3-3. Henderson, J., Leboeuf, C.M., SOLPOND - A Simulation Program for Salinity Gradient Solar Ponds, SERI/TP-351-559, presented at the Second Annual Systems Simulation and Economics Analysis Conference, Bahia Hotel, San Diego, California, January 23-25, 1980.
- 3-4. Johnson, D., Leboeuf, C.M., and Waddington, D., A Solar Pond-Driven Distillation and Power Production System, SERI/TR-631-1248, 1981.
- 3-5. SERI Truscott Brine Lake Task Force, Conceptual Design of the Truscott Brine Lake Solar Pond System: Volume 1 - Utility Independent Scenario, SERI/TR-731-1202, 1981.
- 3-6. Leboeuf, C., and Johnson, D.H., A Study of Thermal Interaction between Solar Ponds and Underlying Soils, SERI/TR-253-1825, 1984.

- 3-7. Leboeuf, C.M., and Johnson, D.H., Effect of Soil Conditions on Solar Pond Performance, SERI/TP-253-2157, presented at the Sixth Annual Technical Conference of the American Society of Mechanical Engineers, Las Vegas, Nevada, April 8-12, 1984.
- 3-8. Leboeuf, C.M., Application of Solar Ponds to District Heating and Cooling, SERI/TR-731-1036, 1981.
- 3-9. Leboeuf, C.M., Boulder Solar Pond Feasibility Study, Final Report to the SERI Director for Task 2700.39, October 1981, unpublished.
- 3-10. Waddington, D., and Leboeuf, C.M., Solar Pond Study for the Air Force Academy, SERI Memorandum #731-CML-1009, 1981, unpublished.
- 3-11. Brown, K.C., Edesess, M., Jayadev, T.S., Solar Ponds for Industrial Process Heat, SERI/TP-351-460, presented at the Solar Industrial Process Heat Conference at the Oakland Hyatt House, Oakland, California, October 31 to November 2, 1979.
- 3-12. May, E.K., Green, J.H., Schlepp, D.R., Solar Industrial Process Heat: Case Studies, SERI/TR-733-1024, 1981, unpublished.
- 3-13. Woodward-Clyde Consultants, Salt Gradient Solar Ponds and their Applications in the Mining Industry, Final Report for SERI Subcontract XG-1-1066-1, November 1981, unpublished.
- 3-14. May, K.E., Leboeuf, C.M., and Waddington, D., Conceptual Design of the Truscott Brine Lake Solar Pond System, SERI/TR-253-1833, 1982.
- 3-15. May, E.K., Leboeuf, C.M., and Waddington, D., Conceptual Design of a 20-Acre Salt Gradient Solar Pond System for Electric Power Production at Truscott, Texas, SERI/TR-253-1868, 1983.
- 3-16. Wright, J.D., 1981, An Organic Rankine Cycle Coupled to a Solar Pond by Direct-Contact Heat Exchange - Selection of a Working Fluid, SERI-TR-1122R, revised June 1982.
- 3-17. Wright, J.D., "Selection of a Working Fluid for an Organic Rankine Cycle Coupled to a Salt-Gradient Solar Pond by Direct-Contact Heat Exchange", Journal of Solar Energy Engineering, Vol. 104, pp. 286-292, November 1982.

- 3-18. Wright, J.D., Sizing of Direct-Contact Preheater/Boilers for Solar Pond Power Plants, SERI/TR-252-1401, 1983.
- 3-19. Wright, J.D., Design and Rationale for a Pilot-Scale Direct-Contact Preheater/Boiler Experiment, SERI/PR-252-1877, 1983.
- 3-20. Boehm, R. and Jacobs, R., Laboratory Measurements of a Direct Contact Heat Exchange, SERI Subcontract No. XP-3-03001 with the University of Utah, Department of Mechanical and Industrial Engineering. January 1, 1983 to June 30, 1984, summary of internal monthly reports to SERI, unpublished.
- 3-21. Fisher, E., Direct Contact Condensers for Solar Pond Power Production, SERI/TR-252-2164, 1984.
- 3-22. Jaluria, Y., Heat Rejection and Energy Extraction Within Solar Ponds, SERI/RR-252-1393, 1982.
- 3-23. Zangrando, F., Laboratory Experiments on Heat and Mass Extraction from Solar Ponds: First Quarterly Report, SERI/PR-252-1394, April 1, 1981 to June 30, 1981.
- 3-24. Zangrando, F., Laboratory Experiments on Heat and Mass Extraction from Solar Ponds: Second Quarterly Report, SERI/P-252-1461, July 1, 1981 to September 20, 1981.
- 3-25. Zangrando, F., Heat and Mass Extraction from Solar Ponds: Analysis and Development of a Laboratory Facility, SERI/TR-252-1569, 1982.
- 3-26. Roache, P.J., A Study of the Steady Pumping Along Inclined Walls in a Salt Gradient Solar Pond, SERI Subcontract No. AF-0-9381-1 with Ecodynamics Research Associates, Inc., Final Report dated September 30, 1981, unpublished.
- 3-27. Harleman, D.R.F., and Adams, E.E., Wind Mixing in Salt Gradient Solar Ponds, SERI Subcontract No. XX-3-03066-1 with MIT, Department of Civil Engineering, Parsons Laboratory, May 1, 1983 to July 30, 1984, summary of Internal Monthly Reports to SERI, unpublished.
- 3-28. Incropera, F.P., and Viskanta, R., Study of Solar Pond Gradient Layer Interface Dynamics, SERI Subcontract No. XP-3-03047 with Purdue University, School of Mechanical Engineering, March 1, 1983 to May 31, 1984, summary of internal monthly reports to SERI, unpublished.

- 3-29. Zangrando, F., and Bertram, L.A., Doubly Diffusive Linear Stability with Nonconstant Gradients, SERI/TR-252-2052, 1984.
- 3-30. Zangrando, F., and Bertram, L.A., "The Effect of Variable Stratification on Linear Doubly Diffusive Stability," accepted for publication in the Journal of Fluid Mechanics, SERI/TR-252-2246, 1984.
- 3-31. Kirkpatrick, A., Assembly of Instrumentation to Measure Physical Properties of a Stratified Fluid, SERI Subcontract No. XP-3-03043 with Colorado State University, Department of Mechanical Engineering. January 1, 1983 to March 31, 1984, summary of Monthly Reports to SERI, unpublished.
- 3-32. Schell, D., and Leboeuf, C.M., The Behavior of Nine Solar Pond Candidate Salts, SERI/TR-253-1512, 1983.
- 3-33. SERI, Solar Ponds: A Selected Bibliography, SERI/TR-752-711, SEIDB Information Module 8211, 1981.
- 3-34. Zangrando, F., Survey of Density Measurement Techniques for Application in Stratified Fluids, SERI/TR-252-2221, 1984.

SECTION IV

SALTON SEA SOLAR POND POWER PLANT DESIGN STUDY
AND REGIONAL APPLICABILITY

R.L. French

Jet Propulsion Laboratory

SECTION IV

CONTENTS

A. SALTON SEA SOLAR POND POWER PLANT 4-5

 1. Phase 1: Feasibility Study, Concept Design 4-5

 2. Phase 1a: Preliminary Design 4-8

 3. Environmental Assessment 4-11

 4. Site Specific Research 4-12

B. REGIONAL APPLICABILITY 4-15

 1. Residential, Commercial, and Institutional
 Building Sector 4-16

 2. Industrial Process Heat Sector 4-17

 3. Agriculture Process Heat Sector 4-17

 4. Electric Power Sector 4-18

 5. Desalination Sector 4-18

 6. Summary of Economics 4-18

C. SOLAR POND ECONOMICS 4-19

 1. Introduction 4-19

 2. Economic Model 4-19

 3. Thermal Energy 4-20

 4. Electrical Energy 4-23

 5. Conclusions and Recommendations 4-28

D. REFERENCES 4-30

Figures

4-1. Artist Concept, 5 MW_e Plant 4-7

4-2. Life-Cycle Power Costs 4-29

Tables

4-1. Solar Pond Cost Analysis Based on TVA Experience	4-21
4-2. Solar Pond Construction Cost Estimate for a Mature Technology	4-22
4-3. Input Parameters to Energy Cost Model, U.S. Environment	4-23
4-4. Solar Pond Thermal Energy Cost and Comparison to Other Sources	4-24
4-5. Preliminary Cost Estimate for a Solar Pond Plant at the Salton Sea, California (1980\$)	4-25
4-6. Input Parameters to Energy Cost Model (Electricity, U.S. Environment)	4-26
4-7. Cost of Generating Solar Pond Electrical Power (Parametric Study)	4-27
4-8. Sensitivity Analysis, Financial Parameters . . .	4-27

SECTION IV

SALTON SEA SOLAR POND POWER PLANT DESIGN STUDY AND REGIONAL APPLICABILITY

A. SALTON SEA SOLAR POND POWER PLANT

In FY 1981, DOE in cooperation with the Southern California Edison Company (SCE) and the California Energy Commission (CEC), initiated sponsorship of a feasibility study for a solar pond power plant at the Salton Sea in California. The study focused on a 5 MW_e proof-of-concept experiment and a conceptual design of a commercial 600 MW_e plant. The primary site was chosen to be on the shore of the Salton Sea ("wet site") with a secondary site at an inland desert dry lake ("dry site"). The results of the feasibility study pointed out some technical concerns and a large uncertainty relative to the cost of dike construction in the lake at the wet site.

The Phase 1 feasibility study was performed by a team composed of SCE, the Jet Propulsion Laboratory (JPL), Ormat Turbines, Ltd. (Ormat), and WESTEC Services, Inc. (WESTEC). Ormat collected and organized the data base and conducted conceptual plant design, performance, and cost analysis. JPL conducted site-specific studies related to solar pond chemistry, soil biological activity, and dike design and construction. WESTEC conducted environmental investigation studies and performed an environmental assessment. SCE provided planning support for licensing and permitting and technical evaluations of the system design and cost estimate. Contractually, Ormat's work was funded by SCE and CEC, and DOE funded JPL and WESTEC through a JPL subcontract. By mutual agreement, project management was performed by SCE and technical management by JPL. All results were shared without reservation.

One of the major conclusions of the Phase 1 feasibility or concept study was the uncertainty of the geological conditions at the primary site and the impact on dike design and cost. As a follow-on, DOE initiated a Phase 1a study to gather geotechnical data and generate a total plant preliminary design to achieve a $\pm 20\%$ cost estimate. This activity was terminated before completion and only partial results are available.

1. Phase 1: Feasibility Study, Concept Design

Two sites in Southern California were evaluated. The primary site is within the Salton Sea Naval Test Base on the southwestern shore of the Salton Sea. The secondary site is Bristol Lake, an inland dry desert lake. The climatological data for both sites are similar and good solar pond performance can be

expected at either site. A 250-acre solar pond will support year-round baseload operation and achieve a 66% load factor with a power profile that lies within a $5 \text{ MW}_e \pm 15\%$ band. Full details can be found in References 4-1 and 4-2.

At the primary Salton Sea site, saline water from the lake will be used for pond filling and surface flushing. Brine can be obtained from geothermal wells or produced on site from concentrating Salton Sea water by evaporation. Soils adequate for the dike foundation seem to be available although, on the surface, they are covered with sediments of inferior engineering properties.

An artist's concept of the 5 mw_e experimental plant at the Salton Sea site is shown in Figure 4-1. A 250 acre solar pond (right foreground) and power station (center portion) are shown constructed in the lake. Brine required to establish the proper salinity levels in the solar pond would be obtained using evaporation ponds and Salton Sea water. After the solar pond has been filled with the required brine, a smaller area brine makeup pond will be used to supply the brine makeup required for salinity maintenance. A settling pond area (left foreground) is part of the water treatment process for the flushing and evaporation makeup supply. The power station contains all of the equipment needed to convert the thermal energy stored in the pond to electrical power. This includes heat exchangers, pipes, pumps, valves, turbine, generator, switchgear, instrumentation, controls, alarms, purge system, pressurized air, and lubricating systems (Reference 4-2). Ranges in costs which reflect alternate construction techniques were generated in the feasibility study. These cost estimates range from \$25 to \$30 million (1980 dollars) at the Salton Sea Naval Base site and from \$20 to \$30 million at the Bristol Dry lake site.

An evaluation of the feasibility of commercial power generation up to 600 MW_e was made for both sites. The optimum size of a commercial module appears to be 50 MW_e . A 50 MW_e solar pond power module will require a solar pond net area of approximately 2200 acres to generate baseload power with operation at 5500 hours per year. Generation of power at the 600 MW_e level using 12 50-MW_e modules requires an area of approximately 50 mi^2 for the 12 solar ponds, brine makeup ponds, water treatment facilities, power generating units, and all of the associated auxiliary equipment. A pond depth of approximately 16.5 ft, including an 11.5 ft deep heat storage zone, provides seasonal storage capability. The average power output is 600 MW_e with a maximum winter to summer power variation of approximately $\pm 15\%$.

On the basis of available information, commercial 600 MW_e level power generation is not feasible at Bristol Dry lake. An insufficient quantity of contiguous land is available and water would have to be imported for initial fill and maintenance.

4-7

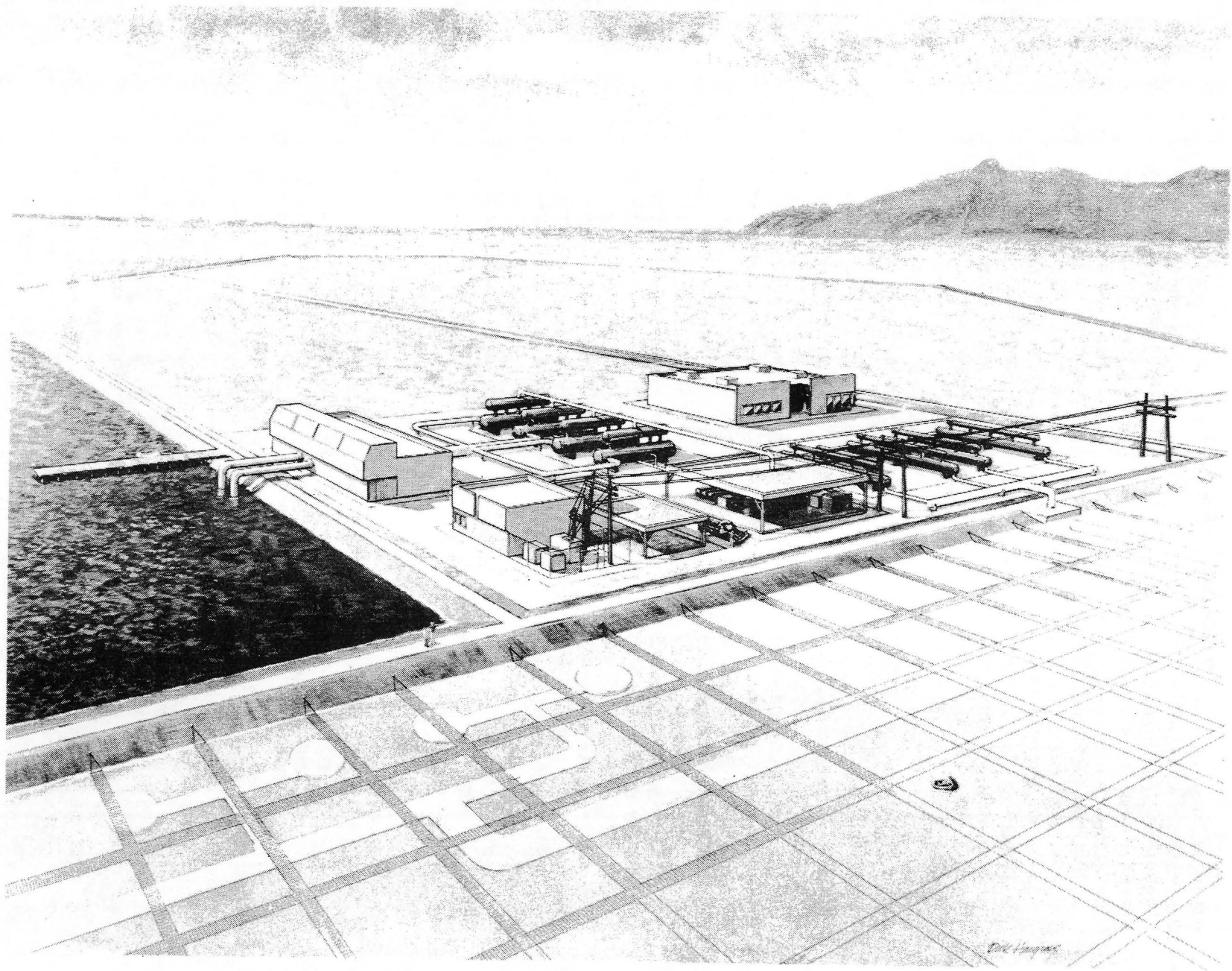

Figure 4-1. Artist Concept, 5MW_e Plant

In contrast, there are sufficient water, brine, and area resources available at the Salton Sea for the construction and operation of commercial solar pond power modules 600 MW_e and even higher. Although many areas of the Salton Sea are suitable for locating the commercial plant, a 50 mi² region in the southeastern end of the lake was tentatively selected for describing the site physical and construction features. This region has been previously identified by the U.S. Department of the Interior and the Resources Agency of California as being suitable to serve as a diked evaporation pond into which Salton Sea water would flow and evaporate to effect a form of salinity control for the remainder of the lake. Solar ponds are completely compatible with the salinity control scheme and could provide a means of converting unproductive areas into productive areas.

2. Phase 1a: Preliminary Design

The difficulty (and, consequently, the cost) of constructing a solar pond in the lake at the wet site is greater than at the dry site. However, because the real commercial potential (abundant water supply and land area) exists at the wet site, the primary focus remained at the Salton Sea site. The greatest area of uncertainty in the design concept from Phase 1 involved dikes. To improve upon the design concept of Phase 1, DOE initiated a preliminary design phase to be conducted by an experienced engineering design/construction firm. JPL, under contract to DOE, awarded a preliminary design contract to the Ralph M. Parsons Company and the Parsons Company selected The Earth Technology Company (ERTEC) for conducting a geotechnical investigation. The Parsons contract was terminated early and only limited results were produced.

The following is a summary of the results of the geotechnical investigation (Reference 4-3):

- (1) The northern half of the site is better suited for siting the ponds. Natural clay deposits are typically found within approximately 20 ft of the ground surface. These soils have low permeability and potentially could act as natural barriers to seepage from the bottom of the ponds. Lateral seepage can be controlled by constructing an impervious barrier, such as a slurry wall, around the perimeter of the pond. Such a seepage barrier should extend from the top of the perimeter dike to depths below the top of the clay. Although this preliminary investigation indicated that the clay layers are probably continuous over large areas in the northern half of the site, more detailed studies will be needed to verify the continuity of the clay deposits. Clays are found, but at greater depths over

most areas in the southern half of the site. Therefore, the bottom of the ponds sited in the southern portions of the site will need to be lined with impervious liners in order to prevent seepage.

- (2) The site is located in a seismically active zone. Therefore, the potential effects of strong earthquake shaking should be considered in the design of the facility. Major faults in the area are capable of producing large earthquakes that can result in maximum ground accelerations of up to 0.4 g (maximum credible level). For design lives of 5 and 30 years, there is a 50% probability of experiencing acceleration levels in excess of 0.15 and 0.30 g (probable levels), respectively. The majority of the site soils are expected to remain stable under the probable levels of earthquake shaking. However, some liquefaction and dynamic settlement may occur in loose recent sediments of limited thickness found near the shoreline.
- (3) The near surface site soils can be used as fill for constructing dike embankments. Approximately 50,000 cubic yards of rock would also be available from on-site sources for use as riprap or offshore starter dike material. Additional rock sources are available in the site region.
- (4) The site soils generally have adequate bearing capacity for supporting the proposed facilities. Loose and/or soft soils were found only at very shallow depths.
- (5) The on-land portions of the site are covered with sand dunes which are dissected by drainage features. Earthwork recommendations addressing cleaning and grubbing, leveling, drainage diversion, erosion protection, and fill placement and compaction are presented in the main text of Reference 4-3.
- (6) The thermal conductivity of the site soils, as measured by laboratory tests, was in the range of 8 to 12 Btu/°F/in. ft² hr (0.012 to 0.027 W/°C cm).
- (7) The preliminary investigation was aimed at providing information for assessment of economic feasibility and preliminary design. More detailed geotechnical studies will be needed before the design of the facility is finalized. Future studies should include field investigations to verify the continuity of the clay layers, field and laboratory tests to assess soil permeability under simulated operating conditions (high salt concentration and temperatures), detailed dike

stability analyses under static and seismic conditions, and detailed evaluations of construction methods.

Reference 4-4 presents the results of the limited design study conducted by Parsons. Subjects covered in the report include interpretation of the geotechnical data; pond design factors (seepage losses, evaporation, water and salt balances, relative locations, sizes, depths, and sealing) for the solar pond, maintenance pond and brine production ponds; dike design factors (soils, dike crest elevation, methods of slope protection, seismic effects, and sealing); plant layouts; and sizing of mechanical equipment and heat exchangers.

Although the Parsons study was foreshortened by withdrawal of the budgeted funds and none of the planned engineering tasks were completed, considerable understanding and insight into the problems and technology of constructing a solar pond were gained.

Calculations made for sizing the ponds show that providing a 2-ft concentrated brine layer in the solar pond for partial operation within 1 year and a full depth brine layer in 2 years requires an evaporation pond that is nearly five times as large as the solar pond, in surface area. This is based on an unlined solar pond, but a fully lined evaporation pond. If the solar pond could also be lined to reduce seepage loss, the size of the evaporation pond would be reduced from 300 to approximately 230 acres. It was necessary to base the pond sizing on an unlined solar pond because it was a requirement to construct the pond, at least partially, in the Salton Sea and no method was devised in the short study time available to dry out the pond for installation of a liner.

The pond sizing calculations also vividly demonstrated the need to reduce seepage loss to the absolute minimum or eliminate it completely. Seepage loss requires the continuous production of additional brine which results in a considerable increase in maintenance and evaporation pond surface area.

The difficulties in locating a suitable, impermeable clay layer under the pond sites, the relatively steep average land slope, ragged surface contours, and poor soil for construction all add up to a relatively poor choice of a site for a solar pond. If effort is ever resumed on the solar pond, it is recommended that some relocation of the site be considered. The ready availability of water from the Salton Sea and free use of the site remain as plus factors.

Contrary to impressions received prior to the study effort, turbine generators using the organic working fluid, R-114, are available in the United States from multiple sources and the technology is neither new nor experimental.

3. Environmental Assessment

The environmental assessment for the proposed site at the Salton Sea was performed by WESTEC under contract to JPL (Reference 4-5). In the performance of this contract, WESTEC efforts included the following:

- (1) Collection of available site data.
- (2) Performance of an environmental screening of selected sites at Salton Sea.
- (3) Preparation of an environmental setting report.
- (4) Preparation of an environmental impact assessment for the proof-of-concept 5MW_e plant.
- (5) Preparation of an environmental feasibility report of the 600MW_e commercial plant.

The WESTEC effort was directed toward a number of studies aimed at determining the environmental feasibility of implementing a solar pond power plant at the Salton Sea. The results of WESTEC's environmental studies for the 5MW_e proof-of-concept plant can be grouped into three categories:

- (1) Anticipated impacts which have been recently well defined.
- (2) Identified data gaps involving the design, construction, or operation of the 5MW_e proof-of-concept plant.
- (3) Areas of potential impact that cannot be fully defined until the data gaps identified in item 2, above, have been resolved; until further fieldwork has been accomplished; or, in some cases, until the 5MW_e proof-of-concept plant is actually operating.

Based on these results, and despite the fact that a lack of data in some areas precludes a full and detailed analysis of all impacts at this time, it currently appears that the 5-MWe proof-of-concept plant could be constructed and operated without incurring significant adverse environmental effects. This conclusion is based on the assumption that final resolution of the project data gaps will not result in an unacceptable set of related impacts and that adequate mitigation of certain identified impacts can be accomplished.

In conclusion:

- (1) The 5MW_e project appears to be completely feasible and following receipt of the necessary permits can be constructed and operated as an experimental project with little or no adverse effect on the environment.
- (2) The feasibility of the 600MW_e facility will depend in part on the results of operating the smaller experimental pond. Considerable additional data regarding the project itself, plus further environmental baseline studies, appear to be necessary in order to complete a full evaluation of the 600MW_e project. To date, a number of potentially adverse environmental effects have been identified for the larger commercial facility; however, most of these can be effectively mitigated through appropriate project design, construction, and operation. The others can probably be resolved through a careful and sensitive location and siting effort within the Salton Sea. None of the impacts identified so far would make the project totally infeasible, provided that the aforementioned mitigation and siting efforts are carried out.

4. Site Specific Research

A distinction can be made between ponds that are built with imported and relatively clean ingredients (man-made ponds) and ponds that are built from the materials at the site (natural ponds). In the former case, the pond will be lined with a synthetic material, sodium chloride will probably be the salt of choice and clean, clear water will be used. In contrast, a "natural pond" will be constructed with available materials: (1) brine, which is usually a mix of many salts; and (2) clay to form the base and seal the walls. The brine or water is typically turbid and contaminated. Under such conditions, behavior unique to the site can occur.

A number of laboratory investigations to examine site-specific issues was undertaken in support of the Salton Sea feasibility study. The primary objectives of the laboratory investigations were to examine carefully the site-specific physical, chemical, and biological factors which could impact construction, durability, and performance of the proposed 5MW_e solar pond system at the Salton Sea. These investigations concentrated on the interactions of the water, salt, and soil of the site and on material compatibility. Potential interactions of the water/brine and soil are particularly important since the pond will use the naturally occurring clays as a bottom seal.

In setting up the laboratory investigations, an attempt was made to look first at the most critical items. Some of the studies proceeded to logical end points and others were terminated early because of limited resources. More work should be done in certain areas to provide more accurate design data, but with respect to water, salt, and soil, the overall system appears technically feasible.

a. Salton Sea Water - Light Transmission and Treatment

Spectrophotometric measurements of light transmission were made on Salton Sea water samples and brine made from Salton Sea water (References 4-6 and 4-7). In-pond precipitation, turbidity and color were identified in laboratory tests to be factors that would reduce the radiance reaching the storage zone. A variety of water clarification experiments were conducted, but only activated carbon and ozone treatments proved to be effective. Solar pond performance estimates based on the laboratory data indicated that without treatment the thermal efficiency of the solar pond would be only 8%, but with carbon treatment the efficiency would increase to 24%.

Considerable uncertainty exists in the above efficiency values because of unavoidable errors in measurements and the extrapolation from samples of small dimensions. Light transmission measurements were made with a Cary 14 spectrophotometer. The major sources of error are the exclusion of forward-scattered light and the multiplying effects of the mathematics needed to extrapolate from laboratory data to real ponds. Nevertheless, spectrophotometric measurements and data analysis have the potential of being developed into a procedure that will yield accurate estimates quickly and at low cost (Reference 4-7).

Light attenuation in Salton Sea water is produced by in-pond precipitation turbidity and color. Turbidity is caused by particles that can be removed by proper filtration. Much of the color passes through a 0.45 micron millipore filter which indicates it is less than colloidal size. Analysis indicates the type and concentration of salts present in the water could not impart color, therefore, the color must be due to organics. For the Salton Sea, the following were determined:

- (1) Decolorizing charcoal removes color.
- (2) Ozone removes color.
- (3) In-pond precipitation settles quickly and will not create a significant problem.
- (4) Natural settling overcomes turbidity.

- (5) Many flocculating agents have been tested, none removed color.

b. Soil Bio-Activity Evaluation

The generation of non-soluble gas under a solar pond could be very disruptive. The gas can physically lift membrane liners or bubble through clay sealing materials and through the pond causing mixing. A series of laboratory experiments were conducted to determine if hydrogen sulfide (H_2S) would be a potential problem at the Salton Sea site.

The ingredients necessary for producing H_2S (water, sulfate ions, organic carbon, and sulfide-producing microorganisms) were found to be present in soil samples taken from the Salton Sea site. Low levels of H_2S were generated in one laboratory experiment, but the concentration never exceeded the solubility limit and, thus, no bubbles formed. The limiting factor appears to be organic carbon whose concentration on a dry weight basis is low at only 0.2%.

Methane is another common gaseous product of anaerobic microorganisms. Methane may well be more critical than hydrogen sulfide because the solubility and transport by diffusion is much lower than hydrogen sulfide. In the laboratory experiments, tests were made for methane, but none were detected. All tests for gas-producing reactions using Salton Sea soil and water samples have produced negative (i.e., no gas) results.

c. Soil Permeability

The baseline plan for the Salton Sea solar pond relied upon using in-situ clays for bottom and side wall sealing. A seepage rate of 1.2×10^{-6} cm/s (0.04 in./day) was selected as a design limit. This translates to a permeation coefficient of 1.96×10^{-7} cm/s which will require a very good sealing clay. Also, some sealing clays are known to degrade in the presence of high concentrated brine (Reference 4-8).

Clay is present at the Salton Sea site in large quantities. Samples were obtained and a permeation test was conducted in a special fixture which allowed exposure to brine while in a gradually increasing temperature environment (Reference 4-7). Initially, the permeation coefficient was measured to be 7.3×10^{-8} cm/s. However, this value quickly deteriorated in the brine and increasing temperature environment. After three days at $93^\circ C$, the permeation coefficient exceeded 1×10^{-6} cm/s.

There may be design options to mitigate the above negative test results (placement of pond in hydrostatic balance with the

adjacent Salton Sea or sealing to a very thick clay strata), but the concept of using naturally occurring clays for pond sealing remains unverified.

d. Corrosion

Laboratory tests on material samples were conducted to obtain data for material selection. Of particular interest was the long-term durability of heat exchanger tubing in the vaporizer, preheater, and condenser of the power conversion subsystem. Mild (1020) and stainless (321) steel coupons were exposed to a variety of salt concentrations in different temperature environments approximating solar pond conditions.

The results (Reference 4-7) were not surprising. Mild steel corroded in all cases and stainless remained unaffected. Mild steel corroded 10 times more rapidly in the simulated upper convecting layer than in the simulated storage layer. The reason offered is that corrosion in aqueous salt solutions is controlled by the availability of oxygen. Since the solubility of oxygen in salt solutions decreases with both rising salt concentration and rising temperature, corrosion in the lower convecting zone should be less severe than in the upper convective zone.

These tests did not confirm or totally refute the notion that mild steel is a suitable material for the hot brine heat exchanger. Such a concept was proposed in the Salton Sea feasibility study. Further studies will be required.

B. REGIONAL APPLICABILITY

A major study and a first step toward assessing the solar pond potential in the United States was completed in March of 1982 (Reference 4-9). A complete evaluation of potential involves such factors as technical feasibility, resource availability on a regional and local level, market needs, economic competitiveness, compliance with zoning, land use development planning, and general public acceptance. The Regional Applicability study addressed a portion of these factors: technical feasibility, regional performance expectations, salt and water availability on a regional basis, land availability within and near metropolitan development areas, energy consumption by various market sector categories, and best case economic comparisons to conventional energy sources. In planning the effort, the factor that seemed most limiting to solar pond deployment for thermal energy applications was availability of suitable land near the end use. To concentrate on this question, a subcontract was awarded to The Benham Group to determine land availability and value for solar pond applications (Reference 4-10). Solar

pond performance estimates were determined by Ormat Turbines, Ltd., (Reference 4-11).

The study proceeded by first conducting a nation-wide survey of the four natural resources essential to solar ponds (i.e., sunshine, land, water, and salts/brine) and the various meteorological and hydrogeological conditions affecting pond performance (e.g., ambient temperature, evaporation, soils, and winds). Locations possessing abundant resources and favorable conditions were identified. Twelve geographic regions were defined, based on patterns of insolation level, water and salts/brine availability, ambient temperature distribution, and other climatic variables. This regional assessment approach allowed comprehensive coverage of the entire United States while neglecting site-specific details.

Five major potential market sectors were addressed: the residential, commercial and institutional buildings sector, the industrial process heat sector, the agricultural process heat sector, the electric power sector, and the desalination sector. Technical and energy-consumption characteristics of each market sector were scrutinized, and solar pond applicability and suitability in each sector were examined.

1. Residential, Commercial, and Institutional Building Sector

With the exception of Alaska, solar ponds can provide thermal energy at sufficiently high temperatures for building space heating and domestic water heating in all regions. Alaska's low insolation and low ambient temperatures prevent uninsulated solar ponds, which are not equipped with reflectors to enhance solar collection, from producing thermal energy at temperatures higher than 45°C. Space cooling using solar ponds is feasible in principle, but requires further research and development to improve its performance.

Because of heat loss considerations, a very small pond serving an average-size single-family dwelling is not practical. However, a one-half to several acre pond serving a group of single-family houses, a multi-family dwelling complex, a sizable commercial or institutional building, or a district comprising a large number of various building types is more appropriate.

Solar-pond potential in the residential, commercial, and institutional buildings sector is limited by land, not need. An estimate of pond potential has been made based upon the pond-suitable land acreage obtained by the Benham Group for the to-be-developed areas (as determined by the local zoning ordinances). The total U.S. pond potential in the buildings sector is estimated to be 3.3 quads/yr which amounts to less than 12% of the

projected energy needs for space heating/cooling and water heating in the year 2000.

2. Industrial Process Heat Sector

Need for thermal energy below 200°F within the manufacturing sector [Standard Industrial Classification (SIC) Code Categories 20-39] is concentrated in the states of California and Washington, most of the Red River region, Gulf Coast and Atlantic Northeast regions, part of the Tennessee Valley region, and all of the Great Lakes region. Food, furniture, paper, chemicals, leather, stone/clay/glass, and primary-metals processing are among the major industries to which solar ponds can be suitable energy suppliers. Using solar ponds for preheating in the higher-temperature processes has not been considered in this study as appropriate conservation measures such as waste heat usage may be more readily and economically implemented.

The majority of solar ponds in the industrial sector will be relatively small. Hence, salts and water resources are not expected to be as limiting as land. Land limitation will likely result in fewer ponds constructed in Standard Metropolitan Statistical Areas (SMSAs) than in non-SMSAs. Many of the more than 176,000 existing impoundments may be suitable for conversion into solar ponds.

Assuming that all of the manufacturing thermal energy needs (less than 200°F) in the non-SMSAs (and only half of those in the SMSAs) are to be met by solar ponds, industrial pond potential in the United States is estimated to be 0.8 quads/yr by the year 2000.

3. Agricultural Process Heat Sector

Agricultural activities take place throughout most of the country. Only a few states have limited agricultural production due to geological or climatic restrictions. Solar ponds can supply thermal energy to a number of agricultural processes: crop drying, livestock brooding, livestock waste disposal, space and water heating for livestock shelters, greenhouse conditioning, farmhouse space, and water heating. Irrigation pumping also consumes a significant fraction of agricultural energy and solar ponds should be able to provide electricity or shaft power for this purpose.

Farm ponds are expected to be moderately sized. A one-acre pond will be able to supply most of the thermal energy needs of a several-hundred-acre farm. Locally occurring salt resources are not a crucial factor. Demand on water resources will not be overly severe. Locating a several-acre pond on a large farm

should not constitute a problem. Appropriate pond liner or groundsealer will be required in most cases, however, to guard against possible contamination of productive land.

4. Electric Power Sector

Solar pond application in the electric power sector is perceived to be limited by resources rather than need. Most of the United States is or can become connected to utility grids and the grids, presumably, can absorb any amount of power that is generated by solar ponds. Solar ponds which generate electric power will be constructed mostly on a large scale (tens or hundreds or thousands of acres in area) and on sites where the essential natural resources (sunshine, land, salts, and water) are available at low or no cost. Many of these sites are likely to be situated away from population centers. The design, construction, operation, and maintenance of these ponds will be significantly different from those of thermal ponds. For a commercial size solar pond power plant (e.g., 600MW_e), present or near-term economic viability is attainable in the southwest, Puerto Rico, Hawaii, Salt Lake, Red River, and Gulf Coast regions. Estimated on the basis of exploitation of the available resources, the national electric power pond potential is 3.5 quads/yr. A significant fraction of this is contributed by the Red River (Texas, Oklahoma) region.

5. Desalination Sector

The current desalination market for solar ponds is small, but the need for desalination is projected to increase substantially during the next two decades. The demand on desalted water has been projected to grow from 273 mgd in 1981 to 2500 mgd in the year 2000.

Solar ponds are perceived to be capable of providing thermal energy to the distillation desalination process and electric or mechanical power to the reverse osmosis and electrodialysis processes. To date, limited studies have been performed on this particular application and further research and development efforts need to be conducted.

6. Summary of Economics

Costs of delivered energy from solar ponds (1981 dollars) vary dramatically as a function of location, construction technique, anticipated performance, and end use. In a very favorable climate (i.e., southwest), thermal energy cost projections range from 6 to 20 \$/mBtu. In a less favorable climate, (i.e., Great Lakes region), costs of solar pond thermal energy

vary from 16 to 55 \$/mBtu. In the electric market, power generation makes sense only in southern latitudes. Cost estimates vary from 8 to 35 cents/kwh. Three factors emerge as the important cost parameters: pond capital cost, discount rate, and energy yield or performance. Doubling the capital cost can increase the pond energy cost by 40 to 70%. Doubling the discount rate can increase the pond energy cost by 33 to 102%. (Discount rates of 11 and 20% were used in computing the energy cost estimates, above.) Doubling the pond energy output can decrease the energy cost by about 50%. These numbers point out the importance of siting, enhancement of pond performance, reduction of up-front construction cost, and financing arrangements.

C. SOLAR POND ECONOMICS

Information and data from a number of sources were collected and used in preparing this analysis. A clear distinction is drawn between ponds for thermal applications and ponds coupled to power conversion units for the generation of electricity. The value of the following analysis is in providing a common basis of comparison and a perspective on sensitivities. The material presented here has been taken from an unpublished paper.

1. Introduction

Solar ponds will become a viable energy resource only after the cost of energy delivered by the pond can be proven to be cost competitive with other options, both conventional and renewable. The cost of energy from a pond is dependent upon many factors which include: first cost, operation and maintenance costs, level of performance, climate (solar input), and financial parameters that are time variable. Because the technology is not fully developed, most of these factors are themselves not well known. Energy cost estimates are therefore subject to future revisions and refinement.

2. Economic Model

The economic analysis uses a model to compute breakeven energy costs (BEC). BEC is the cost that the producer must recover in order to offset all capital and operational costs. BEC applies equally to both thermal and electrical energy. BEC is calculated as follows:

$$BEC = \frac{LCC * CRF}{AEY}$$

where,

BEC = Breakeven energy cost

LCC = Life-cycle cost

CRF = Capital recovery factor

AEY = Annual energy yield

LCC and CRF are discussed more fully in Reference 9, but it is basically through these terms that capital investment, tax credits, recurrent costs, income tax payments, miscellaneous expenses, and cost of money are converted to an annualized cost.

For purposes of ready comparison, all size-dependent parameters have been normalized to a unit of pond area. Thus, system costs are shown as $\$/m^2$ and energy production is presented as kW/m^2 . Energy costs are reported as $\$/kWh_t$ for thermal energy and $\$/kWh_e$ for electrical energy.

3. Thermal Energy

The cost of thermal energy has been computed parametrically as a function of initial capital cost and site location. Table 4-1 summarizes the basis of a capital cost estimate of 67 $\$/m^2$. This value results from an interpretation and extrapolation of real costs experienced in the building of the TVA research pond (Reference 4-12). Table 4-2 is an estimate (Reference 4-9) of capital cost that might be attainable after the technology matures. Table 4-3 summarizes all of the input parameters to the energy cost model.

The results of the calculations are presented in Table 4-4 along with comparative costs of energy from other sources. Solar pond energy costs can be seen to be strongly dependent upon capital cost and location. In the southwest where insolation is greatest, energy costs are projected to be as low as 2 $\$/kWh_t$ for the case using 43 $\$/m^2$ as the initial capital cost. For comparison, energy costs from oil and natural gas are also shown in the table.

The actual costs and comparisons shown in Table 4-4 will vary with climatic region. The numbers presented reflect a California environment. Natural gas may not be a choice in many other locations and the cost of oil will likely increase in future years. Caution and judgments should be used in drawing hard conclusions.

In Tables 4-1 and 4-2, the cost of the salt and the liner are the two largest cost elements. Very significant reductions in the cost of solar pond energy can be achieved if salt or brine

Table 4-1. Solar Pond Cost Analysis Based on TVA Experience

Cost Item	TVA Actual	Eliminate Extras ^a
TVA		
Design and Detailed Engineering	28,367	
Drafting	4,363	
Engineering Procurement	1,021	13,000 ^b
Construction Supervision	1,445	
Project Cost Estimating	706	
Construction Labor	27,506	14,000 ^c
Travel	1,575	
Major Equipment		
Clearing	7,482	7,482
Excavation	30,985	30,985
Gravel Road	9,060	- ^d
Survey	929	929
Testing	1,690	1,690
Thermo-Borings	864	864
Sand Blanket	39,131	-
Find Grading for Hypalon	1,725	1,725 ^e
Sterilization	1,935	- ^d
Underdrains	10,196	- ^e
Mobilization	2,392	2,392 ^e
Hypalon Underliner	27,258	- ^e
Hypalon Evaporation Pond Liner	23,020	23,020
XR-5 8130 Liner	46,879	46,879
Bonding	3,941	3,941
Piping, Valves, etc.	12,948	12,948
Electrical	5,349	5,349 ^d
Concrete	2,500	- ^d
Freight	131	131
Miscellaneous (Fence)	13,846	13,846
Salt	68,000	68,000
	\$375,249	247,181
Private Contractor Profit @10%	-0-	24,000
Total	\$375,249	271,181
Normalized cost, \$/m²	93 \$/m²	67 \$/m²

67\$/m² represents an estimate of a simplified second pond that might be built by a private contractor. These costs are still reflective of an immature technology and the first-of-a-kind article. Further cost reductions will be achieved as more experience is achieved.

Table 4-1. Solar Pond Cost Analysis Based on TVA Experience
(Cont'd)

-
- ^aReduce or eliminate costs for those elements that are clearly extras or over-design options. Basically, this means eliminate second liner and underpond drain system.
 - ^bEstimate engineering design at more conventional 6% of total construction cost.
 - ^cConstruction labor involved in installing two liners and underpond drain system. Take 50% of labor for a design that has one liner and no underpond drain system.
 - ^dSite specific requirement, located on uncleared area and away from existing facilities.
 - ^eReduce to one liner, eliminate sand blanket between liners, and underpond drain.
-

Table 4-2. Solar Pond Construction Cost Estimate for a Mature Technology^a (Normalized to \$/M²)

Item	\$/m ²
Land	1.25 ^a
Excavation	9.90 ^a
Salt	14.80
Liner	11.00
Instrumentation & Misc.	6.20
Total Pond Construction	\$43/m²

^aSolar pond at 10.0 ft deep, 1 acre or larger.

Table 4-3. Input Parameters to Energy Cost Model, U.S. Environment

Thermal Energy Yield from the Pond, Regional Variation

Southwest	63.2	Wt/m ²
TVA (Tennessee)	38.6	Wt/m ²
Great Lakes	22.3	Wt/m ²

Capital Cost	67 \$/m ² and 43 \$/m ²
Maintenance	2.50 \$/m ² /year

Financial Factors

Life	20 years	Discount rate, 1%
Depreciation	Sum-of-yr digits	Inflation rate, 6%
Misc. expenses	2.25%	O&M escalation, 6%
Investment Tax Credit	10%	Capital escalation, 6%
Tax rate	48%	

is free and if the construction site has an impervious soil that can function as a liner. Under such conditions, the thermal energy cost can drop to one half or one quarter of the Table 4-4 costs.

4. Electrical Energy

Economical production of electricity using solar ponds is a much more difficult problem than the economical production of thermal energy. This problem comes about because of two primary reasons: (1) the power conversion equipment requires a significant capital investment, and (2) the efficiency of converting the low grade thermal energy of the pond to electricity is low. In order to achieve acceptable electric energy costs, several favorable factors must be present: (1) a location with a nearly zero cost, and (3) a large system to take advantage of economy of scale.

Real cost and performance data for large solar pond electric power systems do not exist. Preliminary design and analysis of systems at the Salton Sea, California, is the best information available. Table 4-5 presents cost estimates for 5 MW_e and 600 MW_e systems. For the 5 MW_e system, both a wet and a dry site have been examined. A wet site implies locating the solar pond in the lake, and a dry site reflects construction on a dry lake bed in an area near the Salton Sea. Certain cost factors are

Table 4-4. Solar Pond Thermal Energy Cost and Comparison to Other Sources

Energy Source		Energy Cost \$/kWh _t
Solar Ponds		
Southwest	Capital Cost 67 \$/m ² & 43 \$/m ²	0.028 & 0.020
TVA (Tennessee)	Capital Cost 67 \$/m ² & 43 \$/m ²	0.046 & 0.034
Great Lakes	Capital Cost 67 \$/m ² & 43 \$/m ²	0.080 & 0.059
Oil (30 \$/bbl & 80% Burner Eff.)		0.0202 ^a
Natural Gas (0.62 \$/therm & 80% burner eff.)		0.0265 ^a
Flat Plate Collectors (20 yr life & 10 yr life)		0.044 & 0.092 ^a
Conservation (Range of options from weather stripping to double glazed windows)		0.027 & 0.17 ^{a, b}

^aThese costs reflect a California environment. Actual costs will vary on a regional basis.

^b"Retrofit Energy Conservation in Residential Buildings in Southern California," Turner, Birur and Davis, JPL Publication 82-55, June 1982.

different for the two sites. At the dry site, a brine and water production facility must be created, but basic construction is easier and less costly.

Table 4-6 summarizes cost, performance, and the financial factors that were used in evaluating the levelized cost of electricity at the Salton Sea sites. Table 4-7 presents the results of the economic analysis and Table 4-8 shows some estimates made by the local utility for alternate forms of generation. All costs reflect 1980 dollars and care must be exercised in extrapolating to current conditions. Nevertheless, the concept of comparing the economics of various generation technologies is valid and useful.

Several interesting and expected observations can be made from Table 4-7. The significance of weather is readily seen in comparing cases 2, 3 and 4. When the solar radiation diminishes, the power cost climbs dramatically. The effect of first cost is illustrated in comparing case 1 to case 2. Case 2 reflects a dry site and easier construction. A synthetic or plastic liner that costs 10 \$/m² will add approximately 6 ¢/kWh to the electricity

Table 4-5. Preliminary Cost Estimate for a Solar Pond Plant at the Salton Sea, California (1980\$)

Item	Cost (1,000 \$)		
	5 MWe (Wet Site)	5 MWe (Dry Site)	600 MWe (Wet Site)
Solar Pond System			
Geotechnical Survey	220	96	1,000
Solar Pond Construction	7,500	2,409	100,000
Construction of Evaporation Ponds	5,206	472	199,400
Brine Circulation System	752	752	28,800
Cooling System/Water Makeup	510		
Water Makeup System		365	
Water Flushing System	140	1,420	68,400
Water Treatment Plant	1,000	750	36,000
Brine and Water Production		1,000	
Gradient Control System	650	650	70,200
Instrumentation and Control	72	72	1,200
Power Station Yard Development	128	47	2,400
Engineering and Design	1,294	643	30,400
Management, Supervision, and Administration	600	400	20,200
Sub Total	18,072	9,076	558,000
Power Generating Unit			
Plant Equipment	4,650	4,650	311,000
Construction Materials	1,550	1,550	145,000
Construction and Installation	800	880	60,000
Engineering and Design	700	700	17,000
Management and Administration	400	400	7,000
Sub Total	8,100	8,100	540,000
Total	26,172	17,176	1,098,000
Contingencies (15%)	3,926	2,576	164,700
Grand Total	30,098	19,752	1,262,700
Total Solar Pond Area	1.01 $10^6 m^2$	1.01 $\times 10^6 m^2$	1.07 $\times 10^8 m^2$
Normalized Cost \$/m ²	29.74	19.52	11.82

Table 4-6. Input Parameters to Energy Cost Model (Electricity, U.S. Environment)

Electrical Output - kWh_e/m²/yr

	5 MW _e Plant	600 MW _e Plant
Southwest	26.8	27.22
TVA (Tennessee)	13.8	14.1
Great Lakes	7.3	7.3

Capital Cost

5 MW _e (Wet Site)	29.74	\$/m ²
5 MW _e (Dry Site)	19.52	\$/m ²
600 MW _e (Wet Site)	11.82	\$/m ²

Maintenance Cost

5 MW _e (Wet Site)	0.51	\$/m ²
5 MW _e (Dry Site)	0.45	\$/m ²
600 MW _e (Wet Site)	0.13	\$/m ²

Financial Factors

Life - 20 years	Inflation Rate - 6%
Depreciation - Sum-of-year-digits	O&M Escalation Rate - 6%
Misc. Expenses - 2.25%	Capital Escalation Rate - 6%
Investment Tax Credit - 10%	
Tax Rate - 48%	
Discount Rate - 12%	

Table 4-7. Cost of Generating Solar Pond Electrical Power,
(Parametric Study)

Case	Plant Nameplate Rating - MWe	Site Location	Wet/Dry	Liner	Energy Cost \$/kWh
1	5	Southwest	Wet	Clay	0.22
2	5	Southwest	Dry	Clay	0.15
3	5	TVA	Dry	Clay	0.30
4	5	Great Lakes	Dry	Clay	0.56
5	5	Southwest	Dry	Synthetic	0.21
6	600 ^a	Southwest	Wet	Clay	0.08
7	600 ^a	TVA	Wet	Clay	0.16
8	600 ^a	Great Lakes	Wet	Clay	0.30
9	600 ^a	Southwest	Wet	Synthetic	0.15

^a600 MWe plant is constructed from 12 50 MWe modules

Table 4-8. Sensitivity Analysis Financial Parameters

Independent Parameter Each varied + 10%	Effect on Dependent Variable Cost of Power
Initial Capital	8%
Discount rate	7.4%
Lifetime	0
Investment Tax Credit	- 1%
Tax Rate	4.8%
Annual Recurrent Costs	2%
Escalation Rate of Recurrent Cost	1%
Miscellaneous	1%
Rate of Energy Production	- 9%

cost (compare case 2 to case 5). The last four cases reflect a large 600 MW_e plant that is made up of 50 MW_e modules and most of the scaling effect should be achieved at the lower, 50 MW_e size.

Table 4-8 presents the results of a sensitivity study. Input parameters to the cost model were independently varied by plus 10% and the effect on cost of power was noted. Capital cost, discount rate, and pond energy yield have the strongest influence on output power cost. Plant life, investment tax credit, recurrent costs, and escalation rate have relatively small effects.

The competitive posture of solar ponds with alternate energy sources can be appraised by examining Figure 4-2. Figure 4-2 was generated by a Southern California Utility and shows life-cycle power costs for several generating options. Only large solar pond power plant systems appear to be in a competitive range with coal and nuclear. Figure 4-2 is now several years old and recent events will likely have produced some important changes; therefore, hard conclusions should not be drawn.

5. Conclusions and Recommendations

- a. Favorable economics will be more readily achieved in solar pond thermal applications than in electrical applications.
- b. In locations where salt is free, thermal energy from a pond has the potential of being lower in cost than any conventional option.
- c. Economic solar pond electric power production requires a site that has low cost or free construction material resources: land, water, salt, and good soil characteristics.
- d. A solar pond power plant will benefit from economy of scale.

Southern California Edison Company
LIFE-CYCLE POWER COSTS (1980 PRICE LEVEL)

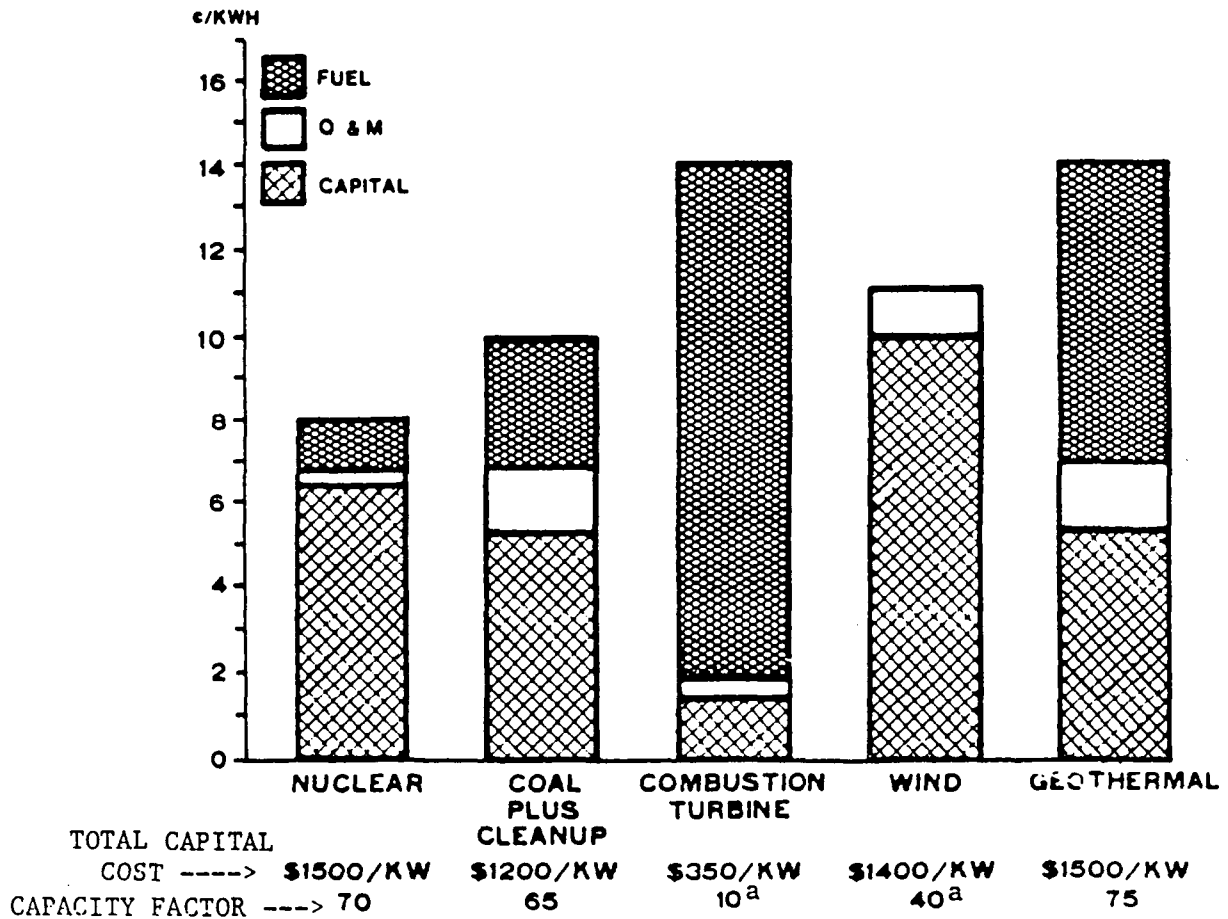

^aFor economic comparison. Life-cycle costs calculated assuming energy production at a 65% capacity factor with make-up energy from system oil-firing generation.

Figure 4-2. Life-Cycle Power Costs

D. REFERENCES

- 4-1. Peelgren, M.L., Salton Sea Project, Phase 1, Jet Propulsion Laboratory, JPL 5107-2, January 1982.
- 4-2. Ormat Turbines, Ltd., A Study of the Feasibility of a Solar Salt Pond Generating Facility in the State of California, U.S.A. Final Study Report, Vol. I and II, prepared by Ormat Turbines, Ltd., Yavne Israel for the Southern California Edison Company, under P.O. No. MOO 79003, May 1981.
- 4-3. Ertec Western, Inc., Report, Phase 1A Geotechnical Investigation, Salton Sea Solar Pond Project, prepared for The Ralph M. Parsons Co., Project No. 83-173, April 26, 1983.
- 4-4. The Ralph M. Parsons Company, Final Report, Salton Sea Solar Pond Power Plant, Preliminary Design/Cost Estimate Study, Prepared for the California Institute of Technology, Jet Propulsion Laboratory, Contract No. 956462, October 1983.
- 4-5. WESTEC Services, Inc., Final Report, Solar Pond Project, Salton Sea, California, prepared for Jet Propulsion Laboratory, California Institute of Technology, September 1981.
- 4-6. Marsh, H.E., DeFranco, D.M., Haack, R.F., McMurrin, J.C., Reilly, W.W., Singer, M.J., Wu, Y.C., "Salt Gradient Solar Ponds in the Salton Sea: Brine Optical Quality and Performance," Technologies for the Transition; Proceedings of the 16th Intersociety Energy Conversion Engineering Conference, Atlanta, Georgia. New York: The American Society of Mechanical Engineers, Vol. 2, pp. 1720-1725, August 9 to 14, 1981.
- 4-7. French, R.L., Marsh, H.E., Roschke, E.J., Wu, W.C., Site Specific Research Conducted in Support of the Salton Sea Solar Pond Project - FY 1982 Report, Jet Propulsion Laboratory, JPL 5107-5, September 1983.
- 4-8. Ridley, K.J.D., Bewtra, J.K., and McCorquodale, "Impact of Brine on the Behavior of Compacted Fine Grained Soils," Proceedings of the Canadian Society for Civil Engineers Annual Conference, Municipal Environment Division, Ottawa, Canada, 1983.
- 4-9. Lin, E.I.H., et al, Regional Applicability and Potential of Salt-Gradient Solar Ponds in the United States, Volume 1 and Volume 2, Jet Propulsion Laboratory, JPL 5107-1, March 1982.

- 4-10. The Benham Group, Land Availability and Land Value Assessment for Solar Ponds in the United States, prepared for the Jet Propulsion Laboratory, California Institute of Technology, JPL Contract No. 955978, May 1982.
- 4-11. Ormat Turbines Ltd., Determination of Solar Pond Design and Performance Parameters on a Regional Basis, prepared for the Jet Propulsion Laboratory, California Institute of Technology, JPL Contract No. 955975, November 1981.
- 4-12. Chinery, G.T., Siegel, G.R., "Design, Construction and Cost of TVA's 4000 m² (1-Acre) Nonconvecting Salt Gradient Solar Pond," Solar Engineering, proceedings of the ASME Solar Energy Division Fifth Annual Conference, Orlando, Florida. Edited by Lawrence M. Murphy. New York, American Society of Mechanical Engineers, pp. 1550-1-56, April 18-21, 1983.

In an attempt to provide a complete summary of solar pond research, invitations to contribute were issued to all institutions that were conducting studies. The material presented in Part II of this report have been provided by institutions that were not directly funded by DOE.

SECTION V

SOLAR POND RESEARCH AT ARGONNE
NATIONAL LABORATORY

John R. Hull

Argonne National Laboratory

SOLAR POND RESEARCH AT ARGONNE NATIONAL LABORATORY

by

John R. Hull
Argonne National Laboratory
Argonne, IL 60439

1. OBJECTIVES AND APPROACH

The objective of solar pond research at Argonne National Laboratory (ANL) is to advance the basic knowledge of solar pond technology. The work focuses on applications that utilize the seasonal heat-storage capability of the solar pond for low-temperature thermal processes, however the results of the research are directly applicable to electricity-generating and other applications.

Experimental and theoretical research is centered around the 1080 m² ANL Research Salt Gradient Solar Pond (RSGSP), which has been operating since Nov. 1980. Close collaboration also exists with a number of researchers from universities within the region. In addition to basic solar pond studies, these collaborators have conducted experiments at the RSGSP to aid understanding of basic oceanographic and double-diffusive convection phenomena.

2. EXPERIMENTAL FACILITY

The ANL RSGSP is 43 by 25 m at the top with sides tapered at 45° to a depth of 4.3 m. The heavy clay soil around the pond is compacted enough to be stable at the 1-to-1 slope. Investigation of either shallow or deep heat-storage zones is accomplished by regulating the depth that the pond is filled. The berms slope slightly away from the pond and are covered with polyethylene plastic to drain rainfall away from the pond. The pond proper is lined with XR-5 plastic, manufactured by Shelter Rite in Millersburg, Ohio. A drainage tile line that leads to a sump is located underneath the pond liner for leakage detection.

The ANL RSGSP is equipped with 165 underground thermocouples. A vertical scanning system, suspended from a cable that passes over the pond, measures the temperature and salinity profiles within the pond. Salinity is measured with an electrodeless conductivity probe. Insolation and weather data are collected at the RSGSP site, as well as several other locations at the laboratory.

The method of data collection varies with the details of the particular experiment, but usually the data are channeled through a data logger, with direct printout and cassette tape storage. Information from the tapes is regularly transmitted to a mainframe computer. The information is accessible by other institutions through several different computer networks. Further details of the construction and operation of the ANL RSGSP may be found in Refs. 1 and 2.

3. DESCRIPTION OF PROJECTS

A variety of theoretical and experimental solar pond projects have been conducted at ANL. The detailed results from most of the projects are described in the references, and only a brief summary of each activity is given here.

Early in the ANL research, it was recognized that understanding of basic solar pond phenomena could greatly benefit by the availability of a computer model of solar pond fluid dynamics. ANL researchers had previously developed COMMIX-1A, a very powerful three-dimensional thermalhydraulic computer code, which solves a first order approximation of the complete Navier-Stokes equations. The investment of many man-years of development in COMMIX-1A has resulted in a code that has been very successful in modeling very difficult fluid problems in nuclear reactors. A subroutine for salt conservation was added to this code to obtain a solar pond fluid model. To test the limits of this computer model, it was applied to the very difficult problem of predicting instability in a double-diffusive system, in a geometry for which an analytical solution was available (3). The computer code was successfully able to predict both the qualitative and quantitative aspects of the instability. The critical parameters were correctly predicted to an accuracy within that expected, given the numerical diffusion limits of a first-order approximation.

It was also recognized that relatively simple models of solar pond thermal performance were needed as design tools. Computer models of pond thermal behavior have been available for some time (4), and it was known that the most sensitive parameters in these models are brine transparency and ground heat loss. The optical part of the solar pond model was improved by a careful theoretical analysis of the effects of reflectivity from the pond bottom (5). The ground heat loss from solar ponds was investigated both theoretically and experimentally (6, 7) in collaboration with researchers at the Ohio State University. The effects of different perimeter insulation strategies were also investigated. A recent theoretical advance in this area has been the development of a method to calculate the ground heat loss to a moving water table (8). The availability of solar pond thermal performance models allows the study of system performance for any location. One unusual study of this type was the combination of a solar pond heat source with an OTEC cold-water pipe for an electricity generating plant (9).

Another important factor in determining solar pond thermal performance is the depth of the upper convecting zone. Currently, no complete understanding of the dynamical behavior of this zone is available. A one-dimensional model of this zone was developed (10) using models that had previously been used in oceanography and limnology. This model was then used to compare the effects of wind, night cooling, and evaporation on the growth of the upper convective zone. It is expected that data from the RSGSP can be used to improve this model.

Analysis of data from the ANL RSGSP has produced several important results. The temperature and salinity profiles have been used to verify an empirical relationship, developed by Prof. C. E. Nielsen of the Ohio State University, governing the growth and erosion of gradient zones (2). A depth sounding instrument has been used to examine sound-reflecting structures in

the solar pond (11). These measurements, coupled with analysis of the salinity and temperature profiles, have demonstrated that salt piles can be effectively used to automatically control the position of the lower boundary of the gradient zone. Prof. I. A. Newell of the University of Illinois has used data from the RSGSP to partially verify a theory of gradient-zone constraint (12) and to extend laboratory results of diffusive-interface behavior to larger scales (13).

Potential environmental degradation due to salt runoff from solar ponds is an important factor in an agricultural area, such as the Midwest region surrounding ANL. The need for the development of inexpensive nonsalt solar ponds has long been recognized, and several theoretical studies have explored this topic (14, 15). In addition, several small-scale experiments using very viscous silicone oil to suppress convection have been conducted.

The ANL RSGSP has also served as a facility for the training of other solar pond researchers. In addition to the many scientists who have visited the facility for shorter periods of time, researchers from Taiwan, Togo, and Egypt have studied at the RSGSP for periods greater than one week. Students from the Illinois Institute of Technology, University of Illinois, University of Iowa, and Purdue University have also studied for extended periods of time at the RSGSP.

4. IMPORTANT RESULTS

This section briefly summarizes several important technical results from the solar pond research at ANL.

- o Reflectivity from the pond bottom is an important factor in pond thermal performance. A general way to incorporate this factor into thermal efficiency calculations is presented in Ref. 5.
- o Night cooling at the surface plays an equal role to wind effects in the erosion of the upper gradient zone boundary. Thus, even with a perfect wave suppression system, there is a minimum size attainable for the thickness of the upper convecting zone (Ref. 10).
- o The effective thermal conductivity of clay soils around solar ponds is significantly higher than most handbook values would indicate (Refs. 6 and 7).
- o Sloping side walls yield less ground heat loss than vertical side walls, even though the side wall area is much greater. Heat loss from sloping side walls is approximately equal to well-insulated vertical side walls (Ref. 6).
- o The presence of a moving water table plays a significant role in determining the thermal efficiency of a solar pond. A method to calculate ground heat loss to a moving water table is presented in Ref. 8.
- o Salt piles in the heat-storage zone form an effective method of stabilizing the position of the lower boundary of the gradient zone (Ref. 11).

- o Simple depth-sounding instruments are valuable tools for determining the position of gradient zones in solar ponds. They are also capable of identifying debris layers that may not be visible to the eye (Ref. 11).
- o In some locations the combination of solar pond and OTEC may be more cost-effective for generating electricity than either solar pond or a shore-based OTEC facility by itself (Ref. 9).

5. STATUS OF EXPERIMENTAL FACILITY

The ANL RSGSP continues to operate as an experimental facility, available for use by outside researchers. A series of heat-extraction experiments will be conducted in 1984 and 1985 to compare the effects on the solar pond of brine withdrawal versus natural convection from a submerged plastic heat exchanger. These experiments are funded in part by the State of Illinois, Dept. of Energy and Natural Resources.

6. REFERENCES

1. Y. S. Cha, W. T. Sha, and J. R. Hull. "Design, Construction, and Initial Operation of the ANL Research Salt Gradient Solar Pond." Report ANL-81-55 (Aug. 1981).
2. J. R. Hull, Y. S. Cha, W. T. Sha, and W. W. Schertz. "Construction and First Year's Operational Results of the ANL Research Salt Gradient Solar Pond." Proc. Am. Solar Energy Soc., pp. 197-202, Houston (June 1982).
3. J. R. Hull et al. "Solar Pond Salt Gradient Instability Prediction by Means of a Thermohydraulic Computer Code." Proc. Am. Sec. of Int. Solar Energy Soc., pp. 812-816, Philadelphia (May 1981).
4. J. R. Hull. "Computer Simulation of Solar Pond Thermal Behavior." Solar Energy 25, 33-40 (1980).
5. J. R. Hull. "Calculation of Solar Pond Thermal Efficiency with a Diffusely Reflecting Bottom." Solar Energy 29, 385-389 (1982).
6. J. R. Hull et al. "Dependence of Ground Heat Loss upon Solar Pond Size and Perimeter Insulation: Calculated and Experimental Results." To be published in Solar Energy (1984). Preliminary results published in Proc. Int. Solar Energy Soc., pp. 661-666, Brighton, England (Aug., 1981).
7. J. R. Hull, J. Kamal, and C. E. Nielsen. "Time Dependence of Ground Heat Loss from Solar Ponds." Proc. Am. Solar Energy Soc., pp. 381-385, Minneapolis (May 31-June 4, 1983).
8. J. R. Hull. "Solar Pond Ground Heat Loss to a Moving Water Table." Submitted to Solar Energy (Feb. 1984).
9. D. Hillis et al. "A Study of Small Scale Solar Pond/OTEC (SPOTEC) Power Systems." Proc. Am. Solar Energy Soc., pp. 443-446, Minneapolis (May 31-June 4, 1983).

10. Y. S. Cha, W. T. Sha, and W. W. Schertz. "Modeling of the Surface Convective Layer of Salt-Gradient Solar Ponds." J. Solar Energy Eng. 104, 293-298 (1982).
11. T. A. Newell and J. R. Hull. "Depth Sounding Diagnostic Measurements of Salt Gradient Solar Ponds." Submitted to J. Solar Energy Eng. (Oct. 1983).
12. T. A. Newell and R. F. Boehm. "Gradient Zone Constraints in a Salt-Stratified Solar Pond." J. Solar Energy Eng. 104, 280-285 (1982).
13. T. A. Newell. In preparation (1984).
14. J. R. Hull. "Membrane Stratified Solar Ponds." Solar Energy 25, 317-325 (1980).
15. Y. S. Cha, W. T. Sha, and S. L. Soo. "Effects of Friction and Extraction on the Stability of Solar Ponds." J. Solar Energy Eng. 105, 356-362 (1983).

SECTION VI

SUMMARY OF SALT-GRADIENT SOLAR
POND RESEARCH AT UTAH STATE UNIVERSITY

J. Clair Batty

J. Paul Riley

Utah State University

Summary of Salt Gradient Solar

Pond Research

at

Utah State University

Prepared by

J. Clair Batty and J. Paul Riley

November 1983

The unique combination of resources existing at the Great Salt Lake has fostered an interest in and commitment to salt gradient solar pond research and Utah State University. In 1978 the Utah Water Research Laboratory sponsored a 3-month study of the Great Salt Lake by Dr. Gad Assaf, a distinguished scientist working on solar ponds in Israel. Dr. Assaf concluded the potential for energy development at the Great Salt Lake was substantial and that further study was warranted.

Researchers at Utah State University then began a modest solar pond research effort progressing from small laboratory scale experiments with stratified brine under lights to computer modeling of solar pond performance. In 1981 and 1982 a solar pond research facility consisting of two identical 3.5 m deep ponds each having a surface area of 250 m². Heat from the ponds is used to warm an experimental greenhouse.

It is hoped that funding can be developed to establish a major solar pond research facility at the Great Salt Lake to further enhance understanding of this promising technology.

Compiled here are abstracts and summaries of 18 different studies of various aspects of solar pond design and operation completed or in progress to date. If further information is needed on any of the studies summarized herein, contact the authors at the:

Utah Water Research Lab.
Utah State University
UMC-82
Logan, Utah 84322
(801) 750-3156

Table 6-1. Summary of Solar Pond Studies at Utah State University
Project Status

Title	Time	Thesis	Paper	Report	Journal	Source of Accompanying Abstract
1. Solar Energy Conversion Strategies Utilizing Salt and Water	1979 - 1980	Joseph Yip MS, ME Completed Jan '80	AWRA Las Vegas September '79		Article	Thesis
2. The Potential for Solar Pond Development in Utah	1980 -			(a) J.P. Riley & J.C. Batty to JPL, Nov. '81 (b) UWRL Report Nov. '83		UWRL Report
3. Experimental and Theoretical Investigation of Solar Pond Behavior	1980 -	M.A. Okpara MS, ME Completed June '81				Thesis
4. One Dimensional Finite Element Computer Model to Simulate the Performance of Salinity Gradient Solar Ponds	1980 - 1982	Zahra Panahi PHD 1981 Completed June '82	ASME 82-WA/SOL 103rd Winter Annual Meeting Phoenix, AZ 1982	UWRL Report Nov. '83 Zahra Panahi J.C. Batty & J.P. Riley		ASME Paper
5. USU Solar Pond Research Facility	1981 - 1982	Conrad Taysom MS, ME Completed June '82		Quarterly Progress Reports to DOE J.C. Batty & J.P. Riley		Thesis
6. An Experimental Study of Strategies for Suppressing Wind-Cause Mixing in Salt Gradient Solar Ponds	1981 - 1982	Allan T. Twede MS, ME Completed June '82				Thesis
7. A Water Use Model for Salt Gradient Solar Ponds			AWRA San Antonio, TX Oct. '83		Proceedings AWRA	AWRA paper
8. Effect and Control of Wind Caused Set-up, Seiche and Return Currents in Salt Gradient Solar Ponds	1983	S.S. Prakash MS, ME estimated completion date Dec. '83				Thesis
9. Theoretical and Experimental Investigation of Heat Extraction from Salt Gradient Solar Ponds	1982 - 1983	Masood Amirfathi MS, ME Completion date Dec. '83				Thesis

Table 6-1. Summary of Solar Pond Studies at Utah State University (Cont'd)
Project Status

Title	Time	Thesis	Paper	Report	Journal	Source of Accompanying Abstract
10. Thermal to Electrical Conversion Technologies for Salt Gradient Solar Ponds	1982 - 1983	Nitin Phase MS, ME Estimated completion date Dec '83				
11. Optimal Thickness of the Gradient Zone in Solar Ponds						
12. Finite Element Computer Model of Two Phase Mass and Energy Exchange Between Solar Ponds and Groundwater	1982 - 1983			Warren F. Phillips, David A. Bell & J. Clair Batty		Report
13. Two-Dimensional Model of Mass and Energy Exchange Between Solar Ponds and Groundwater	1982 - 1984	Arsalan Dadkhah PhD, CEE Estimated completion date April '84	Anticipated during '84	Anticipated June '84		Thesis
14. Measuring of Wave Length Specific Solar Radiation in Solar Ponds	1982 - 1983	Roger Carter MS, Physics Estimated completion date June '84				Thesis
15. Groundwater Flows at Potential Solar Pond Sites Near the Great Salt Lake	1981 - 1984	Frank Roberts MS, CEE Estimated completion date				Thesis
16. Economic and Legal Aspects of Solar Pond Development at the Great Salt Lake	1981 - 1984	Kelly Stevens MS, CEE Estimated completion date				Thesis
17. Effect and Control of Bio-Growth in Great Salt Lake Brines	1983 - 1984			Fred Post, J. Clair Batty, & J. Paul Riley Anticipated completion date March '84		Report
18. Soil Characteristics of Potential Sites for Solar Pond Development Near the Great Salt Lake	1983 - 1984			Abe Jenab, J. Clair Batty, & J. Paul Riley Anticipated completion date June '84		Report

ABSTRACT

Solar Energy Conversion Strategies Utilizing
Salt and Water

by

Yip, Mui-Tong Joseph, Master of Science, 1980
Utah State University

Major Professor: Dr. J. Clair Batty
Department: Mechanical Engineering

The purpose of this study was to discuss the possibility of converting solar energy into more useful forms whenever salt, water, and sunshine are simultaneously available.

Four methods of electrical power production utilizing this combination of resources are discussed in this report. The four methods are:

1. The closed Rankine cycle, utilizing a number of possible working fluids heated by solar ponds.
2. The vapor pressure open cycle, utilizing vapor from solar pond brine themselves as a working fluid.
3. Reverse electrodialysis in which charges are separated by selective membranes, and electricity is produced directly without the necessity of rotating equipment.
4. Osmotic pressure energy conversion, in which fresh water flows through semi-permeable membranes to brine at higher pressure.

Although the capital investment for implementing these technologies seem to be quite high, all are technically feasible. It is concluded that a substantial research effort, aimed at developing the energy potential of the resources available at the locations as Great Salt Lake of Utah, is warranted.

This report also treats the possibility of increasing osmotic pressure by imposing a temperature gradient across the membrane. The difficulty of computing osmotic pressure in a non-isothermal system is circumvented by developing an extension of a well accepted model for isothermal systems. If the non-isothermal model is valid, the osmotic pressure would be tremendously increased by a membrane temperature gradient. It remains to demonstrate the phenomenon physically.

(66 pages)

ABSTRACT

The Potential for Solar Pond Development in Utah

by

J. P. Riley and J. C. Batty

The primary purpose of this report is to present a preliminary evaluation of the energy potential from salt gradient solar ponds in Utah. Various sources of brine and/or pond locations are considered in the study, including (1) the Great Salt Lake, (2) the West Desert, (3) sources within the Upper Colorado River basin, (4) power plant cooling waters, (5) geothermal sources, (6) oil shale brines, (7) discharges from coal gasification and liquification plants, and (8) sites to which salt must be transported.

Computer models are utilized that predict the solar energy storage potential of ponds at various locations throughout the state. Estimates are based on climatological and hydrologic inputs, including the quantity and salinity of the source waters.

Throughout the study, the potential energy available from salt gradient solar ponds in Utah is considered to be limited by the primary physical resources of land, water, salt, and solar energy. Of those resources, water is found to be the most limited in Utah to the development of solar ponds. Other important limiting factors, such as political, economic, environmental, and social considerations have, in the main, been neglected. It will be necessary to consider these factors on a site-by-site basis as development proceeds. It is expected that these factors will limit the potential for salt gradient solar pond development in Utah at levels considerably less than those predicted by this study. Even so, the potential is real and seems sufficiently large to justify in-depth feasibility studies for large scale development.

ABSTRACT

Experimental and Theoretical Investigation of Solar Pond Behavior

by

Nnawuihe Michael A. Okpara, Master of Science
Utah State University, 1981

Major Professor: Dr. J. Clair Batty
Department: Mechanical Engineering

The abundance of salt, water, and an adequate amount of sunshine at the Great Salt Lake in Utah provides a unique combination of resources essential to the harnessing of solar energy using salt gradient solar ponds. This favorable situation was responsible for the initiation of a small scale solar pond project at Utah State University.

Problems paramount to the efficient operation of a full scale solar pond were addressed. Firstly, a reliable and efficient method of monitoring the concentration profiles was improvised using custom designed plexiglass hydrometers.

In the fifteen months duration of this study, various aspects of the operation of solar ponds were also investigated. Alternative methods of restratifying a mixed salt gradient pond was also investigated. Diffusion rates for NaCl were measured. Attempts to obtain boiling temperatures in the bottom of the solar ponds were met with frustrations and failure as a result of the high long-wavelength content of incandescent lamps. Emissive characteristics of incandescent and quartz lamps were also compared.

The effects of an evaporation suppressant on the temperature and concentration gradients of a solar pond were studied. In the tests conducted, evaporation suppressants were generally found to reduce energy loss through evaporation.

The rate of propagation of the upper convective zone (UCZ) and its attendant problems also were addressed. Models of this phenomenon were proposed and the rates of propagation were measured for ponds both with and without evaporation suppression systems. Results indicate evaporation suppressants tended to retard growth of the UCZ. The effects of day and night were simulated by cycling the radiation input. This increased propagation of the UCZ thus tended to confirm the propagation model presented in this paper. It also was observed that as the top surface of the UCZ receded due to evaporation the lower surface propagated downward. Methods were instituted in an attempt to retard this growth with successful results.

The Weinberger stability criterion was modified to a more useful form that facilitates stability analysis in solar pond design and operation. In general, this project provided an initial experience in the design, establishment and maintenance of small laboratory scale salt gradient ponds.

(145 pages)

ABSTRACT

A One-Dimensional Finite Element Computer Model to Simulate the Performance of Salinity Gradient Solar Ponds

by

Zahra Panahi, J. Clair Batty, and J. Paul Riley

A one-dimensional mathematical model which simulates the dynamic performance of stratified solar saline ponds is described. The model simulates the upper convection zone, the middle non-convective zone, and the lower convective zone. In addition to the energy flux, the model simulates the varying brine densities as a function of temperature and salt concentration, and thus is able to examine various pond stability criteria. On the basis of model operational studies, the following results are presented:

1. A study of overall pond efficiency in terms of the upper convective layer.
2. An optimization study of the thickness of the non-convective zone in terms of net energy transmission to the lower convective zone.
3. An investigation of the heat storage efficiency and of the overall pond efficiency as a function of pond loading rate for a particular depth of storage zone.

ABSTRACT

A Water Requirement Model for Salt Gradient Solar Ponds

by

J. Clair Batty, J. Paul Riley, and Zahra Panahi

Salt Gradient Solar Pond (SGSP) technology offers promise as a cost effective method of collecting and storing solar energy. However, one concern is the rather large amounts of water required per unit of energy produced. Consequently, a detailed water requirements model was developed that predicts the SGSP area that can be maintained from a given water source in a given location, together with the evaporation pond area required to recycle the salt and the size of the water storage reservoir needed to accommodate fluctuations in source water flows. For example, the model predicts a 125,000 acre freshwater storage reservoir, 480,000 acres of SGSP, and 250,000 acres of evaporation pond could be maintained by the surface water inflow to the Great Salt Lake as source water. These results are based on average data for a 31 year period.

The study further indicates that as the salinity of the source water increases the area of SGSP of a specified design that can be maintained tends to decrease. Assuming make up water salinity of 10 g/l, salt gradient solar ponds in the intermountain climate are expected to require about 4.6 acre-feet of make up water per year for each acre of SGSP. Further calculations suggest that approximately 490 acre-feet of make up water are required per MW-year of electricity produced from solar pond. This is more than 30 times the amount of water required per MW-year of electricity produced from coal fired power plants. Before concluding that this quantity is excessive, however, it is observed that evaporative water losses from reservoirs such as Lake Mead on the Colorado River amount to nearly 2500 acre-feet per MW-year of electrical energy generated. Furthermore, the SGSP will utilize saline water that otherwise might be considered a liability.

ABSTRACT

Design, Construction, and Operation of a Salt Gradient Solar Pond

by

Conrad O. Taysom, Master of Science
Utah State University, 1982

Major Professor: J. Clair Batty
Department: Mechanical Engineering

The abundance of fresh water, salt, and large available solar collecting area provides a unique setting for solar ponds at the Great Salt Lake and an incentive for studying this important solar technology. This paper discusses the design, construction, and initial operation of a small scale salt gradient solar pond complex at Utah State University. Construction began in April of 1981 and the first pond was in operation by October of that same year. A second solar pond and two evaporation ponds were in operation by June of 1982. The ponds each have an average collecting area of 250 m², containing approximately 115,000 gallons of brine and are each about 3.5 meters deep.

Valuable experience was gained in initially stratifying and in operating solar ponds. An improved method for diffuser control for continuously establishing the concentration gradient was devised and implemented. Biological growth in the ponds was controlled by copper sulfate. Pond pH was maintained between 5 and 6 by adding hydrochloric acid.

During winter operation it was found that about 5 percent of the incident solar energy penetrated 10 inches of ice and snow. Sand and salt was successfully used to increase the rate at which the ice and snow melted from the pond in early spring. Wave suppression devices were effective in reducing the waves on the pond. Diffusers were designed and built using Weinberger velocity criteria.

Several methods of repairing the salinity gradient were tried, including fresh water injection into the convective cells, fresh water and brine injected to reestablish the entire gradient, and extraction of local convective cells. Attempts to use the same method as was used to initially stratify the pond to thicken the gradient zone failed.

Salt that diffused to the surface was successfully recycled to the storage zone by adding salt to the top brine before it was injected into the storage zone. The recycling of diffused salt was used to reduce the top convective zone and to thicken the gradient in one operation.

The first pond was monitored for eight months and temperature of 62°C (18°C less than expected) was obtained in late June. The dis-

appointing rise in temperature was caused by difficulties in maintaining the salinity gradients in the pond. The hot brine in the solar pond was circulated through a greenhouse for a short time in late spring.

The two pond facilities at Utah State University provides a unique experimental facility not found anywhere in this country. The successful initial operation of the second pond indicated that the problems encountered can be solved. Solar ponds will some day provide a valuable source of renewable energy.

(78 pages)

ABSTRACT

An Experimental Study of Strategies for Suppressing
Wind-Caused Mixing for Application in
Salt Gradient Solar Ponds

by

Allan T. Twede, Master of Science
Utah State University, 1982

Major Professor: Dr. J. Clair Batty
Department: Mechanical Engineering

A salt gradient solar pond can collect and store solar energy. The pond collects energy and retains it in a lower storage layer by means of a salt gradient. The gradient prevents the stored energy from escaping to the surface by convection. Disturbances which cause a breakdown of the salt gradient thus allow this energy to escape.

Previous work of other researchers was examined to analyze and understand the process of mixing due to wind effects. Information from this previous work was used to determine additional needed research concerning suppression of mixing in a salt gradient solar pond.

Research was conducted in a laboratory wind-water flume (12.2m long x 0.61m wide x 0.61m deep) for an unstratified water system and also for a system with a density interface. Various methods were tested for effectiveness in controlling wind effects. The Froude number squared and the reciprocal of the Richardson number each were used as the independent variable in correlating data.

Barriers extending both above and below the water surface produced the best suppression results among those methods tested in this research. These barriers were spaced at selected intervals along the length of the flume. Floating wood strips and floating containers also showed promise of being effective in suppressing wave propagation.

More research is almost certainly needed to investigate ways of controlling the gravity circulation due to set-up or seiche on large salt gradient solar ponds. The results obtained from this study indicate that the mixing problems may be the limiting phenomenon in scaling up salt gradient solar ponds, and that mixing due to gravity circulation currents flowing along a density interface will be more difficult to control in solar ponds than mixing due to wave disturbances propagating downward from the surface.

(114 pages)

ABSTRACT

Effect and Control of Wind-Caused Set-Up, Seiche and Return Current in Salt Gradient Solar Ponds

by

S. S. Prakash, Master of Science
Utah State University

Major Professor: Dr. J. Clair Batty
Department: Mechanical Engineering

One of the significant problems facing salt gradient solar pond research is the mixing of the layers in the gradient or non-convective zone due to wind caused set-up and gravity return currents. A review of literature revealed that work has been done towards suppressing mixing due to wave-action but the problem of wind induced drift and return currents resulting from seiche on large ponds had not been addressed. A system that returns these currents to the windward end through pipes was therefore devised and tested through both theoretical and physical models. The theoretical model predicted that in order to produce a significant return of water by pipes (and hence a significant reduction in the gravity return current) a pump would be required. The theoretical model also predicted the change in the velocity profile within an unstratified pond for both partial and complete return through pipes of the wind induced currents. The concept was tested experimentally in a wind tunnel using a channel 35 feet long filled with water 6 inches deep. Set-up measurements and photographs of the velocity profile were taken at wind speeds of 16, 34, 44 and 50 km/hr for cases (i) without the return pipes, (ii) with the return pipes but without a pump, and (iii) with the return pipes incorporating a pump. It was found that theory and experiment matched well and that the circulation current was reduced very substantially. The theoretical model also was applied to ponds with a density gradient. It was found that a return of 55 to 70 percent return of the circulation current through pipes would be optimal in minimizing mixing. A brief economic analysis is included for the application of this kind of system on large ponds.

ABSTRACT

Analytical and Experimental Modeling of Storage Zone Behavior in Salt Gradient Solar Ponds

by

Masood Amirfathi, Master of Science
Utah State University, 1983

Major Professor: Dr. J. Clair Batty
Department: Mechanical Engineering

The behavior of the lower convective storage zone in salt gradient solar ponds with energy extraction is considered in this work. There were two main tasks performed: (1) an analytical model to predict the storage zone temperature profile was formulated and the governing partial differential equation solved numerically to investigate the effect of heat extraction and heat losses from the storage zone on the temperature profiles, (2) an experimental investigation was carried out at the USU solar ponds for two different methods of heat extraction to obtain some useful information about the temperature stratification process. The data obtained were analyzed and compared with the numerical results.

The analytical model is based on energy balance in a differential element of the storage zone, including all losses through the sides, top and bottom, incident radiation, diffuse radiation from the bottom surface, and energy extraction. An explicit finite difference solution gives the temperature in the storage zone as a function of vertical position and time. The iteration matrix is checked for stability, and the necessary and sufficient conditions for stability are specified.

The experimental work was carried out with two methods of energy extraction. In the end-to-end configuration, the cooled brine was returned to the bottom of the storage zone at the opposite side of the pond from which the hot brine was extracted from near the top storage zone. In the top-to-bottom configuration the returning cooled brine was returned to the bottom of the storage zone on the same side of the pond from which the hot brine was extracted near the top of the storage zone. The temperature profiles of the storage zone were simultaneous measured at two locations on opposite sides of the pond.

The experimental results show that the storage zone is rapidly stratified with energy extraction and more importantly, no short circuiting effect (transfer of part of the brine in a loop between inlet and outlet without mixing with the rest of the storage zone) was provoked by either of the two energy extracting methods. There also was no difference detected in the temperature profiles on opposite sides of the pond for the two energy extraction methods (end-to-end, and top-to-bottom), further substantiating the one dimensional assumption made in

formulating the analytical model. Either the end-to-end or top-to-bottom configuration seems to be suitable for heat extraction in solar ponds of this size.

Comparison of the numerical results with the experimental results show some interesting similarities and differences. While the analytical model clearly predicts the general features of the temperature profile, a major difficulty in application to salt gradient solar ponds became apparent. In solar ponds the ratio of M , the mass of the storage zone to m , the extraction mass flow rate, is typically very large. Stability criteria for the solution technique used and the physics of the model require unreasonably large time steps in the numerical procedure.

The results obtained in this investigation show that with some limitation the numerical model presented here can predict the effect of energy extraction in the stratified temperature profile of the storage zone (LCZ) in salt gradient solar ponds. Hence, the numerical model can be used to simulate behavior of solar ponds storage zones provided the ratio of M/m is sufficiently small (< 2000). This condition would generally attain for ponds operated on daily or even weekly extraction cycles. For ponds operated on seasonal heat extraction cycles, wherein the ratio of M/m is larger than 2000 the solution technique employed in the study would need to be modified.

(131 pages)

ABSTRACT

Thermal to Electrical Conversion Technologies for Salt
Gradient Solar Ponds

by

Nitin K. Bhise, Master of Science
Utah State University, 1983

Major Professor: Dr. J. Clair Batty
Department: Mechanical Engineering

The need for a comprehensive overview of appropriate technologies for converting the thermal energy stored in the saline brines of salt gradient solar ponds into electricity was perceived after failing to find such a study in the literature. Four candidate techniques selected for comparative review were: (i) the Rankine cycle (ii) thermo-electric direct conversion, (iii) the Nitinol heat engine, and (iv) the concentration difference engine. Costs of electrical energy (\$/kW h) were calculated from estimates of capital costs of the pond and equipment and conversion efficiencies for each method based on information available in the literature. While the results are preliminary, the study concludes that of the four methods analyzed thermoelectric generators could potentially produce the lowest cost electricity from solar ponds.

ABSTRACT

Optimal Thickness of the gradient Zone in Solar Ponds

by

Nitin K. Bhise, Master of Science
Utah State University, 1983

Major Professor: Dr. J. Clair Batty
Department: Mechanical Engineering

The non-convective gradient zone in salt gradient solar ponds serves both as a "window," through which incident solar radiation passes into the storage brines, and as a "cover" which insulates those same warm storage brines from the cooler environment. A relatively thin gradient zone functions more effectively as a window while a relatively thick gradient zone functions more effectively as an insulating cover. Therefore, there exists an optimum thickness for which the amount of energy collected and retained is maximized. Using the USU solar pond computer model and an iterative procedure, the gradient zone thickness was optimized with respect to the 24 hour increase in storage zone temperature.

For a large pond having a total depth of 3.3 m located near the south end of the Great Salt Lake and subjected to the climatic conditions and solar insolation recorded for that site during 1981, the optimum thickness varied from 85 cm in January to 71 cm in July. It is probably not yet practical to attempt to change the thickness of the gradient zone of an operating pond on a daily basis, but monthly or seasonal adjustments should be possible. The computer simulation model suggests that for ponds at the Great Salt Lake maintaining the gradient zone thickness at the average optimum value for each month would substantially increase the maximum amount of energy extracted from the pond over the year compared to maintaining the thickness at a uniform value all year.

ABSTRACT

Solar Pond - Groundwater Heat Transfer

by

Warren F. Phillips, David A. Bell and J. Clair Batty

Under certain conditions much of the energy collected in a salt gradient solar pond can be lost through an interaction between the solar pond and the soil-groundwater beneath and adjacent to the pond. The mechanism of this pond-soil-groundwater interaction was not well understood and had not been adequately modeled. Accordingly, the objective of the research reported here was to develop a one-dimensional computer model that would accurately predict the mass and energy transport which takes place in the soil beneath a solar pond.

The transport mechanism in the soil beneath a solar pond is very similar to that which takes place in a heat pipe. Because of the temperature gradient between the groundwater and the solar pond, a vapor pressure gradient is established causing water vapor to diffuse from the hot region near the solar pond to the cooler region near the groundwater table. The vapor condenses in the cool soil near the water table and the liquid is drawn upward by capillary forces to replace that which is evaporated in the warm soil directly beneath the solar pond. Because of the large latent heat of vaporization, this flow can transport large quantities of energy from the solar pond to the groundwater.

Previous attempts to model the transport of heat and mass in soil-water systems have treated the water as a simple compressible substance and have neglected the effects of surface tension on the vapor pressure. The present study has established that the surface tension which exists in most soils can cause a significant reduction in the vapor pressure in the soil. Furthermore, this reduction in vapor pressure can have a tremendous effect on the energy transport between the solar pond and the groundwater. In fact, the present study has shown that under proper conditions, surface tension can be used to substantially reduce this type of energy loss from a solar pond.

A computer model has been developed which predicts the energy transfer between a solar pond and the groundwater beneath the pond. This model accounts for both conduction and vapor transfer in the soil and the effects of surface tension are fully included. The model will be used in the selection of sites for solar ponds at the Great Salt Lake and should prove particularly useful in the design of lined salt gradient solar ponds throughout the world.

ABSTRACT

Heat Transfer From a Solar Pond Through Saturated
Groundwater Flow

by

Arsalan Dadkhah, Doctor of Philosophy
Utah State University, 1983

Major Professor: Dr. J. Paul Riley
Department: Civil and Environmental Engineering

The primary objective of this study is to model the processes involved in the transfer of heat from the energy storage zone of a salt gradient solar pond to the groundwater system. Heat is transferred by the two processes of conduction and the downward seepage of brines from the pond. These processes are expressed in mathematical form and incorporated into a computer model which is capable of representing the heat transfer under various assumed groundwater conditions and boundary temperatures. The two-dimensional form of the Laplace Equation

$(\frac{\partial^2 \phi}{\partial X^2} + \frac{\partial^2 \phi}{\partial Y^2} = 0)$ is used to represent the seepage rate from the pond.

The velocities (in two directions) found from the solution of this equation are used in a two-dimensional, time dependent energy equation of the form:

$$e c_y \left(\frac{\partial T}{\partial t} + u \frac{\partial T}{\partial X} + v \frac{\partial T}{\partial Y} \right) = K \left(\frac{\partial^2 T}{\partial X^2} + \frac{\partial^2 T}{\partial Y^2} \right)$$

The solution of this relationship provides estimates of the temperature distribution under the pond at different time steps. The model has practical application in the design, construction, and operation of solar ponds for various known on-site conditions.

ABSTRACT

by

Roger Carter, Physics
Utah State University, June 1984

Major Professor: John K. Wood
Department: Physics

The performance of salt gradient solar ponds depends on effectively transmitting solar radiation through surface and gradient layers to the dense brines near the bottom. If one is to diagnose the problems of an operational pond, the measurement of radiation attenuation becomes important. Because the transmissivity of the pond is highly wave length dependent, it is also important to make wave length specific measurements using some type of monochromometer.

No reports in the literature could be found of successful attempts to make such measurements in operating ponds. Perhaps this is because the hot corrosive brines are a rather hostile environment in which to immerse sophisticated and expensive equipment. Accordingly, the objective of this study was to design, fabricate, test, and evaluate a system to measure the intensity of solar radiation of any given wave length band at any given depth in an operating solar pond.

The system reported here is based on the concept that a computer controlled monochromometer is attached through optical fiber tubes to two identical lenses. The monochromometer and one lens remains above the pond surface while the other lens is lowered to the desired level in the pond. By comparing near simultaneous intensities measured by the lens at the surface and by the immersed lens the attenuation can be determined.

A system was designed and fabricated. A number of practical difficulties were encountered in making field measurements. For example, the immersed lens must be very nearly horizontal at each level in the pond where measurements are taken. The scanning of intensities across the wave length spectrum cannot be accomplished instantaneously. The reading on the immersed lens is dependent on the smoothness of the pond surface and the angle of refraction so that a number of factors other than the depth below the surface may change during the time required to make measurements at several levels throughout the pond. In spite of these difficulties it is believed that this type of equipment permits more accurate determination of wave length specific radiation extinction coefficients in operating solar ponds than have previously been achieved.

ABSTRACT

Criteria for the Selection of Solar Pond Sites Adjacent
to the Great Salt Lake, Utah

by

Frank L. Roberts, Master of Science
Utah State University, 1984

Major Professor: Dr. J. Paul Riley
Department: Civil and Environmental Engineering

The objectives of this study are twofold, namely:

1. To formulate criteria for the selection of solar pond sites adjacent to the Great Salt Lake.

2. To examine by means of a computer model the effects on pond operation of heat losses from the solar pond to the ground system.

Studies were conducted at several locations near the Great Salt Lake to determine.

1. Direction and velocity of groundwater movement.
2. Depth to the water table.
3. Soil water temperature.
4. Hydraulic conductivity.
5. Thermal conductivity.
6. Soil characteristics, organic content, and soil surface reflectivity.

A mathematical model was formulated to represent the heat losses from solar ponds, and the model is used to test the relative importance of the various site characteristics listed above. Results of the model studies are given by the thesis.

ABSTRACT

Economic Size and Site Selection Criteria for Salt Gradient
Solar Ponds Near the Great Salt Lake, Utah

by

Kelly G. Stevens, Master of Science
Utah State University

Major Professor: Dr. J. Paul Riley
Department: Civil and Environmental Engineering

The main objective of this thesis is to present economic size and site selection criteria for salt gradient solar ponds at the Great Salt Lake. The analysis includes construction, operation, and maintenance costs of operational solar ponds, and an estimate of the benefits from the ponds. On the basis of this analysis a physical/economic model is proposed for optimizing (in economic terms only) solar pond development near the Great Salt Lake.

PART THREE

SELECTED BIBLIOGRAPHY WITH ABSTRACTS

PART THREE

CONTENTS

A.	INTRODUCTION	7-5
B.	SOLAR POND REFERENCES	7-5
C.	INTRODUCTION TO SOLAR PONDS	7-6
D.	THERMAL PERFORMANCE PREDICTIONS	7-8
E.	THEORETICAL AND EXPERIMENTAL ANALYSIS OF PHYSICAL BEHAVIOR	7-9
	1. Stability of the Gradient Zone	7-9
	2. Stability of the Interfaces	7-10
	3. Heat and Mass Exchange	7-13
	4. Heat Loss to Ground	7-15
F.	MEASUREMENT OF PROPERTIES AND INSTRUMENTATION	7-16
G.	OTHER CONSIDERATIONS	7-18
	1. Health and Safety	7-18
	2. Solar Pond Liners	7-18
	3. Components	7-20
H.	EXPERIMENTAL SOLAR PONDS	7-23
I.	APPLICATIONS	7-24
	1. Regional Applicability and Suitability	7-24
	2. Space and Hot Water Heating	7-25
	3. Industrial Process Heat	7-26
	4. Electricity Production	7-26
	5. Desalination	7-33

PART III

SELECTED BIBLIOGRAPHY WITH ABSTRACTS

A. INTRODUCTION

The salt-gradient solar pond literature has grown significantly in the past 8 years. Researchers unfamiliar with solar ponds would likely spend a significant effort in obtaining and digesting all of the printed material. This bibliography has been selected and organized with the intent of minimizing duplication of information and eliminating outdated information. Unpublished or difficult to obtain references have not been included.

The referenced documents in this bibliography can be obtained from:

National Technical Information Service (NTIS)
U.S. Department of Commerce
5285 Port Royal Road
Springfield, VA 22161

or:

Solar Energy Research Institute (SERI)
1617 Cole Blvd.
Golden, CO 80401

B. SOLAR POND REFERENCES

ERI, 1981. "Solar Ponds: A Selected Bibliography," SERI/TR-752-711, SEIDB Information Module 8211.

This bibliography was compiled through an extensive literature search and is divided into three sections: (1) Solar Ponds, with 207 references; (2) Shallow Solar Ponds, with 44 references; and (3) Patents, with 17 patent titles. References have been included in the bibliography if the documents are available through libraries, bookstores, or other sources. Additional references were located in the literature search, but were not included in this bibliography if the documents were unpublished or copies of them were not easily obtainable as of March 1981.

Zangrando, F., Johnson, D.H., Review of SERI Solar Pond Work, SERI/TR-252-2322, June 1984.

This is SERI's perspective on the maturity of the solar pond technology with a summary of all SERI research and reports.

Discussed are the technical state-of-the-art of salt-gradient solar ponds, the state of knowledge of pond design, the estimated cost ranges for various locations and applications, and the perceived barriers to commercial development. All SERI reports dealing with solar ponds or related system components, including unpublished reports and technical subcontracts, are summarized.

This SERI document was a major input to the current document. Much of the information contained has been repeated herein.

C. INTRODUCTION TO SOLAR PONDS

Jayadev, T.S., Edesess, M., and Henderson, J., 1979. "Solar Pond Concepts: Old and New," SERI/TP-315-208. Presented at the 14th Intersociety Energy Conversion Engineering Conference, Boston, Massachusetts, August 5-10, 1979.

Different types of solar ponds have been considered since the early 1900s. Salty ponds use salt to create a nonconvecting pond. Shallow solar ponds were investigated by Shuman and Willsie in 1906 and 1907 and have been studied by Lawrence Livermore Laboratories. Swedish investigators are studying a combination of solar collectors and water storage in a pond-cover configuration. In addition, there are thermoclines created in large bodies of water such as reservoirs. This paper surveys the various types of solar ponds, classifies them, and then tries to combine the best of the ideas to synthesize new concepts. It presents a new solar pond concept (the deep convecting pond with a transparent surface cover) which combines the good features of shallow convecting and nonconvecting (salty) ponds.

Edesess, M., Benson, D., Henderson, J., and Jayadev, T.S., 1979. "Economic and Performance Comparisons of Salty and Saltless Solar Ponds." SERI/TP-35-213. Presented at the 14th Intersociety Energy Conversion Engineering Conference, Boston, Massachusetts, August 5-10, 1979.

The optimum solar pond design is site dependent and application dependent. Foremost of the design decisions is the choice of a salty (nonconvecting) pond or a saltless (convecting) pond. The decision variables are local availability and cost of salt, type of salt available and its properties, and possible environmental factors such as the effects of salt run-off and the existence of groundwater. The availability of salt is an important factor in determining the economics of salty ponds. For example, sodium sulfate is a potentially low-cost substitute for sodium chloride and is expected to be plentiful and widely distributed in the near future as a waste product of flue gas desulfurization at coal-fired utility plants. This paper discusses

the potential supply of such salts and estimates the breakpoint in net cost of salt at which a convecting pond becomes economically competitive with the salty pond.

Jayadev, T.S. and Edesess, M., 1980. "Solar Ponds." SERI/TR-731-587.

This report describes the different types of solar ponds, including the nonconvecting salt-gradient pond and various saltless pond designs. It also discusses the availability and cost of salts for salt-gradient ponds and compares the economics of salty and saltless ponds as a function of salt cost. A simple computational model is developed to approximate solar pond performance. This model is later used to size solar ponds for district heating and industrial process heat applications. For district heating, ponds are sized to provide space conditioning for groups of homes in different regions of the United States. Size requirement is on the order of 1 acre for a group of 25 to 50 homes. An economic analysis is performed of solar ponds used in two industrial process heat applications. The analysis finds that solar ponds are competitive when conventional heat sources are priced at about \$5/GJ and expected to rise in price 10% per year. The application of solar ponds to the generation of electricity is also discussed. Total solar pond potential for displacing conventional energy sources is estimated in the range of 1 to 6 x 10¹⁸J/yr in the near and intermediate future.

Nielsen, Carl E., "Nonconvective Salt Gradient Solar Ponds," Chapter 11, pp. 345-376 of the Solar Energy Technology Handbook, Part A, edited by W.C. Dickinson & P.N. Cheremisinoff, published by Marcel Dekker Inc., 1980.

This chapter presents a good and concise introduction to solar ponds and is well suited as a first exposure to the technology. The material is subdivided into the following sections: overview, history, basic physical processes, construction and operating procedures, further research needed, pond performance calculations, and further comments and references. Theoretical and practical aspects of operation and performance are discussed.

Lin, E.I.H., "A Review of the Salt-Gradient Solar Pond Technology," Jet Propulsion Laboratory, JPL 5107-3, January 1982.

The state of the salt-gradient solar pond technology is reviewed. Highlights of findings and experiences from existing ponds to date are presented and the behavior, energy yield, operational features, and economics of solar ponds are examined. It is concluded that salt-gradient solar ponds represent a technically feasible, environmentally benign, and economically

attractive energy producing alternative. In order to bring this emerging technology to maturity, however, much research and development effort remains to be undertaken. Specific R&D areas requiring the attention and action of technical workers and decision-makers are discussed, both from the perspectives of smaller, thermally-oriented ponds and larger, electricity generating ponds.

D. THERMAL PERFORMANCE PREDICTIONS

Jayadev, T.S. and Henderson, J., 1979. "Salt Concentration Gradient Solar Ponds--Modeling and Optimization." SERI/TP-351-277. Presented at the Annual Meeting of the International Solar Energy Society (ISES), Atlanta, Georgia, May 28-June 1, 1979.

A computer simulation design tool, SOLPOND, has been developed to simulate dynamic thermal performance for salinity-gradient solar ponds with a lumped-parameter thermal network. Dynamic programming techniques are applied to allow significant user flexibility in analyzing pond performance under realistic load and weather conditions. Circularly symmetric, two-dimensional, finite-element techniques describe conduction heat transfer through the pond, earth, and edges. Results are presented that illustrate typical thermal performance of salt-gradient ponds. Sensitivity studies of salty pond thermal performance with respect to geometry, layer depths, load, and optical transmission are included and a simplified method to optimize pond design is presented.

Henderson, J., and Leboeuf, C.M., 1980. "SOLPOND--A Simulation Program for Salinity Gradient Solar Ponds," SERI/TP-351-559. Presented at the Second Annual Systems Simulation and Economics Analysis Conference, Bahia Hotel, San Diego, California, January 23-25, 1980.

Predictions of the dynamic thermal performance of a salt-gradient solar pond obtained from the SERI computer simulation design tool, SOLPOND, are compared to experimental data obtained from the Miamisburg pond for July to November 1979. The Miamisburg solar pond is rectangular with a surface area of 1000 m²; SOLPOND is circular, therefore a circular pond with a surface area equivalent to that of the Miamisburg pond was modeled. SOLPOND predictions show good agreement to the data for high soil conductivity values.

Edesess, M., Henderson, J., and Jayadev, T.S., 1979. "A Simple Design Tool for Sizing Solar Ponds," SERI/PR-351-347.

After a start-up period ranging from a few months to one year, the solar pond achieves quasi-steady-state operation; given an annual load profile and required output temperatures, a solar pond may be sized to meet temperature and load requirements. The start-up period is necessary to heat the pond water and the ground surrounding it due to the large thermal masses involved. This report provides simple formulas in "cookbook" form to calculate the required pond surface area and depth. These formulas will enable a potential user to determine the approximate size solar pond needed for the contemplated application and location. In addition, examples are given of solar pond sizes at various locations in the United States. An errata, dated October 19, 1983, accompanies this document.

E. THEORETICAL AND EXPERIMENTAL ANALYSIS OF PHYSICAL BEHAVIOR

1. Stability of the Gradient Zone

Schell, D., and Leboeuf, C.M., 1983, "The Behavior of Nine Solar Pond Candidate Salts," SERI/TR-253-1512.

Several highly soluble salts were tested for their suitability as solar pond materials in a laboratory salt-gradient pond. Each of these salts has the potential to become a cheap, widely available resource and could favorably impact the economics of ponds. The behavior of the laboratory pond was monitored during testing of each alternative salt, and each salt's performance was compared with the performance of sodium chloride, the most commonly used salt in ponds. Predictions of stability were made and compared with experimentally determined stability. Good agreement between experimental and theoretical ranking of each salt's stability was observed. Sodium sulfate, sodium carbonate, magnesium chloride, and calcium chloride exhibited greater stability than sodium chloride at the same concentration gradient.

Zangrando, F., and Bertram, L.A., 1984b, "The Effect of Variable Stratification on Linear Double Diffusive Stability." Accepted for publication in the Journal of Fluid Mechanics, SERI/TP-252-2052.

The results obtained in SERI report TR-252-2052 are summarized in the journal article which describes the results obtained from a numerical analysis of the effect of variable stratification on the linear bifurcations of a double-diffusive plane parallel layer, with emphasis on the overstable modes. The exchange-of-stability results and the description of the numerical procedure used in the study are omitted here.

Zangrando, F., and Bertram, L.A., 1984a, "Double Diffusive Linear Stability with Nonconstant Gradients," SERI/TR-252-2052.

The effect of variable stratification on the linear bifurcations of a double-diffusive plane parallel layer are examined numerically by ending in a Fourier series. Because the motivation is analysis of solar pond stability, a Prandtl number of 7 and ratio of diffusivities of 1/80 is used in the study with (large) solute Rayleigh numbers (R_s) ranging from 104 to 1012. Stratification of solute is cubic antisymmetric about midlayer; because temperature has a higher diffusivity, it is given a linear stratification. The numerical procedure used is described in detail in the two appendices. The numerical results approach Walton's perturbation solution at large R_s but differ significantly at smaller R_s (<108). Although exchanges of stabilities and overstable modes both display an expected tendency to localize about the point of minimum solute gradient, the overstable modes behave in other nonintuitive ways. Sublayers of reversed salinity gradient, if small enough, can be stable. Above $R_s = 1012$, computations become prohibitively expensive as a continuous spectrum is approached. A simple sublayer scaling rule defines an infinite family of R_s and stratification parameters on which the localized eigen solution is invariant for easy field evaluation of gradient stability conditions.

2. Stability of the Interfaces

Meyer, K.A., Grimmer, D.P., Jones, G.F., "An Experimental and Theoretical Study of Salt-Gradient Pond Interface Behavior," Los Alamos National Laboratory, LA-UR-82-834, American Section of the International Solar Energy Society, Proceedings, 1982.

This paper describes an extension of the LANL numerical model to include the effect of wind shear on upper convective region growth. Laboratory experiments designed to investigate interface motion in salt-gradient ponds are reported and a comparison of the numerical model prediction with an experimental result is presented.

A brief review of the numerical model treatment of the double diffusive effects at the interfaces between convecting and nonconvecting regions in solar ponds is included along with a description of an approach that incorporates wind-generated turbulent entrainment into the interface treatment. Agreement of the calculated behavior with observations made on a solar pond is obtained.

Two kinds of interface experiments are discussed. The first kind consists of tank experiments designed to give information on

interface motion, and on salt and heat transport across interfaces. Numerical model predictions are compared with experimental data. The second type of experiments combine flow-visualization techniques with temperature and salinity measurements. These experiments reveal the flow structure in the neighborhood of the interface.

Meyer, Kenneth, A., "A Numerical Model to Describe the Layer Behavior in Salt-Gradient Solar Ponds," Los Alamos National Laboratory, LA-UR-82-1351 (Revised).

A numerical model has been developed to describe the time-dependent behavior of the interfaces between the convecting and nonconvecting regions of a salt-gradient solar pond. Salinity and temperature profiles, as a function of time, are also determined by the model. The model uses empirical correlations from the oceanographic literature that describe the heat and salt fluxes across the interfaces. The model also contains a treatment of entrainment caused by wind-generated turbulence. The calculated behavior agrees with observations made on laboratory-scale solar pond simulation experiments. The model is used to determine pond performance under various operating conditions.

Meyer, K.A., Grimmer, D.P., Jones, G.F., "An Experimental and Theoretical Study of Salt-Gradient Pond Interface Behavior."

This report describes an extension of the numerical model to include the effect of wind shear on upper convective region growth. Also reported are laboratory experiments designed to investigate interface motion in salt-gradient ponds and a comparison is presented of the numerical model prediction with an experimental result.

Two kinds of interface experiments are discussed. The first consists of tank experiments designed to give information on interface motion and on salt and heat transport across interfaces. Numerical model predictions are compared with experimental data. The second type of experiments combine flow-visualization techniques with temperature and salinity measurements. These experiments reveal the flow structure in the neighborhood of the interface.

Grimmer, D.P., and Jones, G.F., "Preliminary Evidence for Internal Wave Motion at Boundaries of Convecting and Nonconvecting Zones in Layered Thermohaline Columns," Los Alamos National Laboratory, LA-UR-84-1080.

Various examples of fluid motion and questions of boundary stability exist. If a heavier fluid is suspended over a lighter

fluid, the upper fluid will fall into the lower one in a set of narrow penetrating spikes and the lower fluid will float up in round-topped, mushroom-like bursts. This is an example of a Rayleigh-Taylor instability.

Visualization experiments in the laboratory have confirmed the existence of Rayleigh-Taylor instabilities in thermohaline columns. This report presents experimental results and develops a mathematical description of the phenomenon.

Harleman, D.R.F., and Adams, E.E., 1983-1984, "Wind Mixing in Salt Gradient Solar Ponds," SERI Subcontract No. XX-3-033066-1 with Massachusetts Institute of Technology (MIT), Department of Civil Engineering, Parsons Laboratory. May 1, 1983 to July 30, 1984. Summary of Monthly Reports to SERI. A final report will be published.

The objective of this subcontract was to develop, calibrate, and verify a transient numerical model capable of describing the vertical heat and mass transfers in large solar ponds under time-varying meteorological conditions. The model was developed by making improvements to an existing one-dimensional wind-mixing model of reservoirs stratified with one diffusing component and by examining how double-diffusive processes interact with the entrainment mechanisms. The model performs calculations in three basic steps: (1) it computes the profiles of temperature and salinity, based on the equations governing heat and salt fluxes in the absence of any input of turbulent kinetic energy (TKE); (2) the wind-mixing algorithm is applied to evaluate the change in potential energy (PE) in the surface mixed layer and the resulting surface heat flux, which modifies slightly the surface temperature; and (3) the density profile is checked for dynamic stability, using the classic linear stability condition for double-diffusive systems.

The wind-mixing model uses a previously developed entrainment relation based on a parametrization of the turbulent kinetic energy budget evaluated at a density interface. This relation accounts for transient storage of TKE in the mixed layer to maintain homogeneity as well as dissipation by internal waves; both these processes reduce the amount of TKE available for entrainment. However, this parametrization was validated for stratification with a single diffusing component (temperature). Experimental results obtained with turbulence-generating grids have shown that the entrainment is a strong function of the stratifying agent. In order to validate the wind-mixing model and to understand the interaction of double-diffusive mechanisms with wind shear, several experiments are being carried out in a portion of an existing flume (30 m long) at the MIT Parsons Laboratory. The test volume is 0.8 m x 1 m x 3 m long; it has been

insulated, bottom heated, and covered to create a wind tunnel with maximum velocity capability of 15 m/s.

The simplest case is analyzed experimentally: a density step of temperature and salinity is formed by establishing two layers of differing density in the range expected in solar ponds. The air blower is then turned on and the downward motion of the interface is recorded visually and by temperature and electrical conductivity scans. The flow structure was observed to start as a two-dimensional recirculation flowing along the "wind" direction at the surface and returning at the interface. However, after several minutes, flow in both directions begins to appear in the horizontal interface plane, the core moves along the wind direction while the fluid near the walls moves in the opposite direction. A second reversal has also been observed, confirming the three-dimensional nature of flow patterns as was evidenced in the storage layer heat and mass extraction tests at SERI. The structure of the interface region not only shows the expected tilt (seiche) but also appears to develop a second upwind wedge below the main interface. Significant drift was also observed in the bottom layer. Entrainment rates are computed from observations of interface position at three locations as a function of time as well as correlation of temperature scans. The water surface friction velocity is computed from pressure drop measurements along the wind tunnel, assuming a logarithmic wind-speed profile. Experiments conducted so far have shown no difference between salt-stratified and double-diffusive cases. However, the speeds used were relatively high (8 m/s), thus the entrainment timescale was at least one order of magnitude greater than that of double-diffusive processes. These tests will be continued through the subcontract period and will be used in the computer model for validation with laboratory and operating solar pond results.

3. Heat and Mass Exchange

Zangrando, F., 1981, "Laboratory Experiments on Heat and Mass Extraction from Solar Ponds: First Quarterly Report, April 1, 1981 to June 30, 1981," SERI/PR-252-1394.

This is the first in a series of progress reports on an analytical and experimental investigation of heat and mass extraction from a salt-gradient solar pond by recirculation of hot brine from the storage layer of the pond through an external heat exchanger. This report introduces the problem to be analyzed, describes the various energy extraction techniques, discusses the operation of the extraction system, and presents the parameter ranges applicable to operating solar ponds. The literature on double-diffusive convection, stratified fluids, and related topics is reviewed, and preliminary conclusions are drawn on the experimental methods to be followed. Analysis of the phenomena

and results of laboratory tests are discussed in subsequent reports.

Zangrando, F., 1982a, "Laboratory Experiments on Heat and Mass Extraction from Solar Ponds: Second Quarterly Report, July 1, 1981 to September 30, 1981," SERI/PR-252-1461.

This second report of the series discusses the equations that govern the response of an initially mixed layer that is bounded above by a stratified fluid and below by a heated, rigid surface; it identifies the relevant non-dimensional parameters, analyzes simplified models, and defines the experimental goals and the required measurement accuracy.

Jaluria, Y., 1982, "Heat Rejection and Energy Extraction within Solar Ponds," SERI/RR-252-1393.

This report details the basic heat transfer and fluid flow mechanisms governing heat rejection to the surface layer and energy extraction from the storage zone of a salt-gradient solar pond and describes the effects of these recirculating flows on the performance of the solar pond in terms of the disturbance to the gradient layer and the resulting temperature distribution in the pond. Simplified analytical models are considered to determine the thermal and fluid where the gradient layer can be maintained at a fixed depth in the presence of two recirculating flows, one above, one below the gradient. A more detailed analysis of the heat and mass extraction process is presented in a subsequent report.

Zangrando, F., 1982b, "Heat and Mass Extraction from Solar Ponds: Analysis and Development of a Laboratory Facility," SERI/TR-252-1569.

This third report of the series updates and summarizes the literature search and analytical work performed during the first year of this project. It also details the design of the laboratory test facility and the experimental apparatus to be built. The test facility consists of a 1-m x 2-m x 10-m-long tank open to ambient at the surface and heavily insulated on the sides and bottom. Electric heaters under the tank provide a heat flux into the tank up to 100 W/m². Cascading flow-line diffusers with adjustable position and slot size are used to recirculate the fluid. The tank is well instrumented for typical temperature, flow, and heat flux measurements. The density distribution is monitored by recording the buoyancy of a known object suspended from a scanning platform that is computer controlled.

Zangrando, F., Green, J., and Fisher, E., 1984, "On Heat and Mass Exchange in a Partially Stratified Fluid," to be presented at the 22nd ASME/AICHE National Heat Transfer Conference, Niagara Falls, New York, August 5-8, 1984. SERI/TP-252-2295.

Laboratory experiments were conducted to investigate the process of heat and mass exchange in a partially stratified fluid that contains gradients of temperature and salinity. The stably stratified region (gradient was established over approximately one half the depth of the tank, while the remaining depth was initially at a constant, high-density storage or mixed region). Fluid from the mixed region was withdrawn, recirculated through an external heat exchanger, and returned at a lower temperature. Tests were primarily aimed at identifying the effects of the recirculating flow on the interface between the gradient and storage regions and determining the maximum rate at which energy can be extracted from such systems with direct application to salt-gradient solar ponds. Results obtained are presented in terms of the governing nondimensional parameters over a broad range of conditions. Critical conditions and parameter ranges in which no erosion of the interface (no entrainment) was observed are also discussed.

4. Heat Loss to Ground

Leboeuf, C., and Johnson, D.H., 1984a, "A Study of Thermal Interaction between Solar Ponds and Underlying Soils," SERI/TR-253-1825.

This report reviews the available methods to assess heat lost to the ground from a solar pond, uses one of these to determine the effect of soil conditions on solar pond performance, and suggests a laboratory-scale experiment to check out both the instrumentation to measure soil conductivity below a full-scale solar pond and the application of existing theories to the high temperatures that exist below a solar pond. The de Vries model of soil thermal conductivity is used with an existing thermal model of a solar pond (SOLPOND) to determine the effect of soil conditions on the temperature of the SOLPOND storage layer during the year, the average annual collection efficiency, and the average temperature profiles below the bottom of the pond. The Philip and de Vries model of coupled heat and moisture transport is used to assess the possibility that the temperature gradient set up in the soil by the presence of a solar pond might cause a redistribution of the soil moisture content from that which existed before the pond was in place. The analysis shows that soil conditions, in general, have an important effect on pond performance and that the temperature gradient below a SOLPOND may cause redistribution of moisture in some cases.

Leboeuf, C.M., and Johnson, D.H., 1984, "Effect of Soil Conditions on Solar Pond Performance," SERI/TP-253-2157. Presented at the Sixth Annual Technical Conference of the American Society of Mechanical Engineers, Las Vegas, Nevada, April 8-12, 1984.

The results obtained in SERI/TR-253-11825 are summarized in this report that examines existing models of heat and mass transport in soils under imposed temperature gradients to assess their potential applicability to solar pond performance models. A computer simulation code, developed at SERI that incorporates the soil thermal conductivity model, was used for a parametric analysis illustrating the impact of this property on pond behavior and the importance of experimental model verification for the range of soil temperatures experienced in solar ponds. Implications of the combined heat and moisture movement theory on solar pond performance are presented.

Meyer, K.A., and Hedstrom, J.C., "Estimates of Ground Conductivity for the DOE-USAFA Experimental Solar Pond," Los Alamos National Laboratory, LA-UR-82-2904.

Soil thermal conductivity must be known in order to determine pond heat loss through the soil. Direct measurement of the conductivity of the undisturbed soil is quite difficult. An analytic model was used to obtain soil conductivity based on soil composition, density, moisture content, and temperature. The critical parameter in this approach is moisture content which, in turn, was estimated assuming a homogeneous soil medium. This paper points out the difficulties and uncertainties of estimating soil conductivity.

F. MEASUREMENT OF PROPERTIES AND INSTRUMENTATION

Webb, J., 1981, "Optical Transparency of Inexpensive Salt Solutions for Construction of Density-Gradient Solar Ponds." SERI/RR-641-615.

A major barrier to the commercialization of density-gradient solar ponds is the high cost of the salt used to produce the gradient. This cost is a function of purchase and transportation prices. Recently, new sources of salts, available in bulk as industrial waste, have been found near sites proposed for solar ponds. The purpose of this work was to establish a rapid laboratory measurement procedure to evaluate the solar transmittance of solutions of candidate salt and to estimate the solar transmittance of a given density gradient constructed using the candidate salt. Extinction coefficients were measured in 10-cm quartz sample cells of a dual-beam spectrophotometer. An error analysis of the measurement protocol and an analysis of the effect of some trace contaminants on the transmittance of the salt solution are

also presented. A flue gas desulfurization by-product containing mainly sodium sulfate was found to be too low in transmittance to be useful as received, but several options for improving the performance of the salt solution in situ are discussed.

Zangrando, F., 1984, "Survey of Density Measurement Techniques for Application in Stratified Fluids," SERI/TR-252-2221.

This report evaluates various techniques for density measurement in stratified fluids, where the fluid density changes rapidly as a function of position, with specific interest in applying these techniques to measurement in salt-gradient solar ponds. The measurement accuracy requirements and the physical constraints of the application are discussed and 11 techniques are reviewed in this report. Conclusions are that hydrometer, vibrating U-tube, magnetic float, and speed of sound measurements have the greatest potential, depending on the accuracy requirements. The first two techniques are commercially developed; the last two require further development for application in solar ponds.

Grimmer, D.P., Jones, G.F., Tafoya, J., Fitzgerald, T.J., "Development of a Point-Electrode Conductivity Salinometer with High Spatial Resolution for Use in Very Saline Solutions," Los Alamos National Laboratory, LA-9654-MS, March 1983.

A conductivity probe and circuit were developed to measure salinities in sodium chloride salt-gradient solar ponds. A point-electrode salinometer design was chosen to give a spatial resolution of approximately 1 mm (0.039 in.). (Such high spatial resolution was necessary to study the behavior of thermohaline columns in the vicinity of convective/conductive zone interfaces.) The point-electrode conductivity instrument was designed for use in up to 25 wt % salinities with immersion times of about 0.1/yr or longer. Drift in the instrument, caused principally by changes in the surface condition of the platinum probe tip and reflected by changes in the probe cell constant, required periodic in situ calibration against the measured specific gravity of withdrawn fluid samples. Other methods of salinity/density measurement are discussed.

G. OTHER CONSIDERATIONS

1. Health and Safety

Ullman, Alan Z., Sokolow, Bart B., Broutman, Marlene, Worker Health and Safety in Solar Thermal Power Systems VI. Solar Ponds, Environmental Science and Engineering, University of California, DOE Contract DE-AN03-87-SF00012, UC 12/1216, UC 62.

The design of solar pond electric power generation systems is reviewed to delineate factors which may affect worker health and safety. Materials handling problems are identified, including brine production and circulation hazards. Toxicity of microorganisms and of pond additives is considered as well as salt intrusion and dispersal. Each appears to have a potential negative health effect. An effect of the water supply quality on worker health may arise from impurities in the water and from waste disposal. This is of major importance if agricultural runoff waters are used. Other hazards identified include fire and reduced visibility hazards.

2. Solar Pond Liners

Boegli, W.J., Dahl, M.M., Remmers, H.E., Preliminary Study of Solar Ponds for Salinity Control in the Colorado River Basin, U.S. Department of Interior, Bureau of Reclamation, GR-82, May 1982.

Appendix B, Pond Liners, of this report presents a survey of flexible membrane liners. Pond lining systems presently in use can be classified as thermoplastics (PVC, CPE, HDPE), thermoplastic elastomers (Hypalon), and elastomers (butyl, EPDM-cured). Liner materials that have been used are briefly discussed along with field experience and costs.

The main body of this document reports on a study that was performed in support of the Saline Water Use and Disposal Opportunities Study, an investigation of alternative plans for collecting, treating, and transporting saline water by pipeline in the Colorado River Basin for disposal and/or energy development use. The options investigated included:

- (1) Collection and transport of the saline water to nearby powerplants for cooling purposes.
- (2) Collection and export of the saline water to dry lakebeds for disposal by evaporation.
- (3) Collection of the saline water for use as a medium for transporting coal in a pipeline to Southern California.

- (4) Multiple uses of the saline water for coal transport, industrial waste-water collection, powerplant cooling, and salt-gradient solar pond development.

For purposes of this study, it was assumed that the saline water would be available for a solar pond as a result of the construction of a salinity control/coal transport project. Approximately 86,450 acre-ft/yr of saline water (at a concentration of 8300 mg/L) would be transported from the basin to one of two terminus points: Danby Dry Lake in southern California or Sevier Dry Lake in western Utah. This report discusses the technical and economic feasibility of constructing solar ponds at these locations for electric power generation and desalination.

Jones, C.W., Effects of Brine on the Soil Lining of an Evaporation Pond, U.S. Department of Interior, Bureau of Reclamation, Advanced Energy Applications Program, Project No. DE-28, August 1983.

Information is needed on the long-term effects of brine on the permeability of clay linings for salt-gradient solar and waste-salt ponds. A case history is presented for the soil lining at Anderson Lake, New Mexico, which was operated as a brine evaporation pond from 1963 to 1976. The soil lining was sampled and tested in March 1982. At that time, the brine level was below the deposited salt surface and near the top of the lined area in the lake. From a comparison of the 1982 tests on the lining and preconstruction tests in 1962, the soil density appears to have increased due to effects of the brine on the soil. From approximate measurements of brine surface elevations in 1982, the seepage through the lining appeared to be very low and was approximately one order of magnitude below the seepage determined during the first year of pond operation. Although the reasons for the apparent changes in soil density and pond seepage have not yet been determined, possible reasons causing changes are given.

Ridley, K.J.D., Bewtra, J.K., McCorquodale, J.A., "Impact of Brine on the Behavior of Compacted Fine Grained Soil," University of Windsor, Windsor, Ontario.

The use of fine grained soil, as an engineering material, will probably never be as exact as concrete, metals and plastic. However, some of the problems encountered with fine grained soils can be reduced with improved knowledge of their behavior under different environments. These soils can no longer be routinely treated as impervious and their hydraulic conductivity should be reliably determined.

It is shown in this study that the hydraulic conductivity and engineering properties of compacted fine grained soils change with time when exposed to a 30% NaCl brine environment. It is important to reproduce field conditions in the laboratory and use representative samples of permeant and not water over longer periods of time for reliable estimations of hydraulic conductivity. Fine grained soils, high in montmorillonite, are prone to alteration in engineering properties when soaked in a 30% NaCl brine. However, brine soaking had little effect on soils rich in illite-kaolinite.

Ridley, Kevin J.D., and Bewtra, J.K., "Breakthrough of Brine Through Compacted Fine Grained Soils," University of Windsor, Windsor, Ontario, Canada.

Compacted fine grained soils, particularly those with high clay fractions, are generally considered to be effectively impervious. However, because of increased concern about long term environmental effects associated with the storage of certain materials, compacted fine grained soils can no longer be routinely treated as impervious barriers. These soils are only capable of retarding the passage of solutes through their pores when a driving force such as a hydraulic, chemical, and/or thermal gradient is imposed.

This study demonstrates that the breakthrough phenomenon is inevitable and occurs in compacted soils of diverse physical and chemical properties, all classified as clays. Furthermore, the anionic pollutant, Cl^- , is transported through such soils much faster than the rate that seepage theory predicts.

3. Components

Wright, J.D., 1981 (revised June 1982), "An Organic Rankine Cycle Coupled to a Solar Pond by Direct-Contact Heat Exchange--Selection of a Working Fluid," SERI/TR-631-1122R.

The objective of the report is to choose the optimum working fluid for use in an organic Rankine cycle coupled to a solar pond by direct-contact boiler and to show the method developed. Due to the inherently low thermal efficiency of low-temperature power cycles, the amount of heat that must be transferred is large relative to the electrical output. For solar ponds, the ratio is approximately 10:1 compared with 3:1 for fossil or nuclear plants. Therefore, the bulk of the capital cost of an organic Rankine cycle plant is in the heat exchangers for heat addition and rejection. Using a direct-contact boiler in place of a conventional shell-and-tube unit may reduce the plant cost by about 25%. In a direct-contact boiler, the organic fluid is bubbled through the pond brine in a column, absorbing heat and vaporizing

as it rises. Plant efficiency, turbine cost, and the rate at which working fluid is lost from the cycle are all affected by the choice of working fluids. Pentane was identified as the best working fluid because it shows the highest net cycle efficiency, has the lowest solubility in the pond, and results in turbines of reasonable size. The hydrocarbons with higher vapor pressure are equally insoluble, but yield lower cycle efficiencies. The halogenated hydrocarbon showed lower cycle efficiencies, somewhat higher loss rates, and adverse environmental effects. The sizing of a direct-contact preheater boiler is described in a subsequent report.

Wright, J.D., 1982a, "Selection of a Working Fluid for an Organic Rankine Cycle Coupled to a Salt-Gradient Solar Pond by Direct-Contact Heat Exchange," Journal of Solar Energy Engineering, Vol. 104, pp. 286-292 (November 1982),

The results described in SERI/TR-631-1122R are summarized in this journal article describing the analysis conducted on power production by an organic Rankine cycle engine coupled to a solar pond with direct-contact heat exchange. Use of a direct-contact boiler reduced the projected plant cost by 25%. The choice of a working fluid affects plant efficiency, turbine size, and working fluid losses. Pentane was shown to be the working fluid best suited to this application.

Wright, J.D., 1982b, "Sizing of Direct-Contact Preheater/Boiler for Solar Pond Power Plants," SERI/TR-252-1401.

The objective of this report is to review the methods available for sizing direct-contact preheater/boiler for an organic Rankine cycle coupled to a solar pond, to develop conceptual designs for the heat exchanger, and to determine what areas will require further research. Preliminary design and cost figures derived for a 50-MW_t plant indicate that in all cases the direct-contact heat exchanger costs much less than an equivalent shell-and-tube boiler. However, further research is required to ensure that an installed direct-contact preheater/boiler will work in the manner intended and to determine the effect of off-design conditions. Design of a pilot-scale experiment is described in a subsequent report.

Wright, J.D., 1983, "Design and Rationale for a Pilot-Scale Direct-Contact Preheater/Boiler Experiment," ARI/PR-252-1877.

This report reviews the literature on direct-contact heat exchangers, describes the rationale for conducting experiments to predict the heat transfer performance of a direct-contact boiler, and describes the experimental apparatus proposed. The survey of

sizing methods points out that several methods exist for estimating the height and diameter of the preheater, but that the methods do not agree well with each other. Currently, data are not available to predict heat transfer or flooding characteristics in the boiling zone. Because the boiling zone determines the design of the heat exchanger, this lack of data provides an impetus for developing and testing theories on direct-contact vaporization. The experimental apparatus consists of a 15-cm diameter, 2.5-m tall, direct-contact glass heat exchanger and the heaters and condensers required to provide a flux of up to 30kW_t through the exchanger. The water loop contains a brine consisting of 20% by weight sodium chloride, while the organic loop uses pentane. Results of tests are discussed below.

Fisher, E., 1984, "Direct Contact Condensers for Solar Pond Power Production," SERI/TR-252-164.

The use of a direct-contact condenser as a way of reducing the cost of electricity from an organic Rankine-cycle power plant coupled to a solar pond is examined. Three possible direct-contact heat exchangers are considered: drop-type, bubble-type, and packed-bed. Each condenser is designed to operate with a deaerator and a degasser to reduce contamination and loss of working fluid. Appropriate calibrations and models from the literature for heat and mass transfer, particle terminal velocity, and particle production are presented. Each piece of equipment is sized and costed. Finally, the cost of the entire power plant is compared with that of a plant using a conventional shell-and-tube condenser. For two of the three direct-contact designs, a reduction in the cost of electricity is estimated. However, the reduction is not significant enough to compensate for the uncertainties involved in the relatively new technology of direct-contact heat transfer.

If salt is expensive, then a saltless solar pond may be cheaper to construct than a salt-gradient solar pond. The break-even point for the two concepts has been investigated for different salts (Edesess, Benson, Henderson, and Jayadev, 1979). Their performance of different glazing materials has also been measured in the laboratory (Leboeuf 1980). SERI has also published two reviews of solar ponds that describe the various solar pond concepts without using scientific jargon (Jayadev, Edesess, and Hendeson 1979; Jayadev and Edesess, 1980).

H. EXPERIMENTAL SOLAR PONDS

Jones, G.F., Meyer, K.A., Hedstrom, J.C., Dreicer, J.S., Grimmer, D.P., "Design, Construction and Initial Operation of the Los Alamos National Laboratory Salt-Gradient Solar Pond," LA-UR-83-0012, ASME Solar Energy Division Meeting, April 1983.

A 232 m² solar pond was constructed at LANL to study pond hydrodynamics on a large scale and to complement the flow visualization and one-dimensional pond simulator experiments that are ongoing at the Laboratory. Design methods, construction techniques, and instrumentation (some of which are unique to this pond) are described in detail. Instrumentation in the pond consists of traversing and fixed probes including platinum resistance thermometers (RTD) and salinometers, an underwater pyranometer, and a weather station. About 127 tons of sodium chloride has been introduced. A 120-cm-thick salinity gradient was established and the pond is heating. Preliminary results indicate a lower-convective-zone heating rate of 1.2°C/day during the pond's first month of operation. Recommendations on pond design, construction, instrumentation, and a preliminary summary of pond major costs are presented.

Hedstrom, J.C., Jones, G.F., Meyer, K.A., "Daily Results of the Initial Operation of the Los Alamos Salt Gradient Solar Pond," Los Alamos National Laboratory, LA-UR-83-325, January 1983.

This report presents the results of our analysis of the initial data obtained on the Los Alamos National Laboratory salt gradient solar pond and a 232 m² pond constructed for the primary purpose of studying pond hydrodynamics. The pond and the data acquisition system were complete and in full operation by August 14, 1982. By September 21, 1982, the lower convecting zone had reached a temperature of 56°C. An energy balance was performed over this period and is presented in this report. As a result of a leak discovered in the pond in September, a method of determining the leak rate was developed and the results are included.

Chinery, Glenn T., Siegel, Graham R., "Design, Construction, and Cost of TVA's 4000 m² (1-Acre) Nonconvecting Salt-Gradient Solar Pond," Tennessee Valley Authority.

Design criteria, construction specifications, and a detailed breakdown of actual costs incurred in the construction of TVA's 4000 m² (1-acre) nonconvecting salt-gradient solar pond are documented. The documented capital costs and labor expenses allow calculation of 1982 unit area and unit energy prices for similar sized and configured ponds. Using this data, different components and component costs may be substituted to calculate costs for different pond designs. An appropriate scale factor would

need to be used to scale up to larger size ponds. The cost data is compared to actual costs at other U.S. ponds as well as previous estimates of pond costs presented in several studies.

Cha, Y.S., Sha, W.T., Hull, J.R., Design, Construction and Initial Operation of the ANL Research Salt Gradient Solar Pond, Argonne National Laboratory, ANL-81-55, August 1981.

The design consideration of a 1/4 acre research salt-gradient solar pond is described. Experience learned during the construction of the solar pond is presented. Initial operation of the pond indicates that the construction of the pond is sound and no leakage has occurred. The pond began to warm up during March of 1981. The maximum pond temperature reached 63°C at the end of July and was still rising. All signs indicate that the operation of the well instrumented pond will be a success and the performance of the pond will be as expected, if not better.

I. APPLICATIONS

1. Regional Applicability and Suitability

Lin, E.I.H., "Regional Applicability and Potential of Salt-Gradient Solar Ponds in the United States," Jet Propulsion Laboratory, JPL 5107, 2 Vols., March 1, 1982.

A comprehensive assessment is made of the regional applicability and potential of salt-gradient solar ponds in the United States. The assessment is focused on the general characteristics of 12 defined geographic regions, while neglecting site-specific details, and includes: a survey of natural resources essential to solar ponds; an examination of meteorological and hydrogeological conditions affecting pond performance; the identification of potentially favorable pond sites; calculation of regional thermal and electrical energy output from solar ponds; a study of selected pond design cases; an evaluation of five major potential market sectors in terms of technical and energy-consumption characteristics, and solar-pond applicability and potential; a detailed economic analysis considering relevant pond system data and financial factors; and a comparison of solar pond energy costs with conventional energy costs.

The assessment concludes that, excepting Alaska, ponds are applicable in all regions for at least two market sectors. Compared with conventional energies, solar ponds will generally be able to attain near-term economic viability in several southern, high-insolation regions. Total solar pond energy supply potential in the five market sectors examined is estimated to be 8.94 quad/yr by the year 2000, approximately 7.2% of the projected total national energy demand.

The Benham Group, "Land Availability and Land Value Assessment for Solar Ponds in the United States," prepared by the Benham Group for the Jet Propulsion Laboratory, May 1982.

The purpose of this investigation is to assess the land availability and land values for solar ponds in the United States as they concern the residential, commercial, and institutional land-use categories. Solar ponds have been identified as efficient and economical means for collecting and storing direct and diffuse solar energy. Innovative methodologies have been applied to arrive at regional projections regarding the amount of land that might potentially be available for retrofit or future solar pond applications. Regional land values have also been documented and analyzed. Much of the data presented is based on general assumptions and can be perceived as theoretical, although the data base representing the case study cities is based on specific input from each of the cities.

In general, the study revealed that there is potentially more land available for solar pond applications east of the Mississippi River, but the best suited applications could be in the expanding and dynamic western part of the country. Land prices have been affected by this growth because the west reflects higher overall land values. Future in-depth, site-specific studies are recommended as a follow-up to this report and to the comprehensive solar pond applicability studies developed by the Jet Propulsion Laboratory.

2. Space and Hot Water Heating

Leboeuf, C.M., 1981a, "Application of Solar Ponds to District Heating and Cooling," SERI/TR-731-1036.

This study examines the application of solar ponds to community-scale district thermal energy supply (including space heating, cooling, and domestic hot water) for new subdivisions in Fort Worth, Texas, and Washington, D.C. Solar ponds were sized to meet the thermal loads of several community sizes using the computer program SOLPOND. Parameters such as storage layer temperature, pond geometry, and storage depth versus surface area were varied to determine the most effective approach to solar pond utilization. A distribution system was designed including sizing of heat exchangers, piping, and pumps. Cost estimates for pond and distribution systems showed that this system is competitive with flat-plate collector systems with delivered energy costs as low as \$16/GJ.

Meyer, K.S., Diamond, S.C., and Hedstrom, J.C., "Preliminary Design and Cost Estimates for the DOE-USAFA Experimental Solar Pond," Los Alamos National Laboratory, LA-UR-82-2169, August 1982.

This report presents the results of a preliminary analysis dealing with thermal performance, design, and costs of a solar pond for winter space heating at the U.S. Air Force Academy at Colorado Springs, Colorado.

A combined pond-building load model was used to perform parameter studies and develop a rationale for selecting a pond area and zone thicknesses. A concept design was developed that included a salt reclamation system, heat extraction equipment, configuration layouts, and all necessary mechanical equipment to supply heat to the building and maintain the pond. A construction cost breakdown was generated and is presented.

3. Industrial Process Heat

Brown, K.C., Edesess, M., and Jayadev, T.S., 1979, "Solar Ponds for Industrial Process Heat," SERI/TP-351-460. Presented at the Solar Industrial Process Heat Conference at the Oakland Hyatt House, Oakland, California, October 31 to November 2, 1979.

Solar ponds offer perhaps the simplest technique for conversion of solar energy to thermal energy which can be used for IPH. This paper presents detailed calculation of solar ponds in two specific applications: providing hot water for aluminum can washing in a manufacturing plant and hot water for washing in a large, commercial laundry. With the help of computer codes developed at SERI for other solar IPH systems, it is shown that solar ponds are far more cost effective than any other solar IPH technology for these applications.

4. Electricity Production

SERI Truscott Brine Lake Task Force, 1981. "Conceptual Design of the Truscott Brine Lake Solar Pond System: Volume I--Utility Independent Scenario," SERI/TR-731-1202.

This report documents a conceptual design for a system of salt-gradient solar ponds requested by the U.S. Army Corps of Engineers. The ponds, which would use a brine lake at Truscott, Texas, are to be constructed as part of a chloride control project in the Red River Valley of Texas where briny waters are diverted so as not to pollute potable water. Heat will be extracted from the ponds and used to drive ORC turbine generators. The electricity produced will serve the pumping needs of the chloride control project, pump brine from the natural source to

the evaporation ponds, pump concentrated brine from the evaporation ponds to the solar ponds, maintain the solar ponds, and supply all system parasitic loads. In Volume 1, the approach requested by the U.S. Army Corps of Engineers was to assume virtually total independence from the utility grid.

The conceptual design presented in this report includes a performance analysis, a layout of the evaporation and solar ponds, the powerhouse, piping and heat exchangers, and operational strategy, specifications for major components, a cost estimate for the pond-related components and construction, and as an estimate of operation and maintenance costs. A system of 7 evaporation ponds totaling 98 ha in area, 5 solar ponds totaling 54 ha, and 1 cooling pond of 6 ha was designed. With eight 300 kW ORC turbine generators in parallel/series configuration, this system will satisfy the pumping power needs (peak as well as average) of the chloride control pumping stations as they come on line. The estimated cost of this system is \$10.3 million exclusive of earth work, contingency, and contractor's fees. Trade-offs under alternative scenarios have been considered in detail in subsequent reports.

May, K.E., Leboeuf, C.M., and Waddington, D., 1982, "Conceptual Design of the Truscott Brine Lake Solar Pond System," SERI/TR-253-1833.

This report documents the second phase of a conceptual design study for a system of electricity-producing salt-gradient solar ponds performed at the request of the U.S. Army Corps of Engineers for the Truscott Brine Lake chloride control project. This study has a format equivalent to that of report TR-731-1202 and considers: (1) a base-load system operating over the year, and (2) a summer-peaking system producing electricity from June through September only. The study resulted in six 10.5-ha solar ponds with three ORC turbines. The base-load system would use 550-kW turbines and deliver 9.8 GWh/yr at a net output of 1120 kW to the utility electric grid for an estimated capital expenditure of \$12.8 million. This includes excavation and soil treatment costs. The summer-peaking system would use 1540 kW turbines and deliver 7.7 GWh/yr at a net output of 2640-kW from June to September for an estimated cost of \$21.1 million.

May, E.K. Leboeuf, C.M. and Waddington, D., 1983, "Conceptual Design of a 20-Acre Salt-Gradient Solar Pond/System for Electric Power Production at Truscott, Texas," SERI/TR-253-1868.

This report documents the final phase of a study performed for the U.S. Army Corps of Engineers regarding the technical feasibility of solar pond technology to produce electricity at Truscott, Texas. A conceptual design of an 8 ha solar pond

system is described including: the layout and design of the solar, cooling, and evaporating ponds; the preliminary specifications of mechanical equipment and instrumentation; and operational and maintenance procedures. According to the ground rules established by the Corps, the system was to provide at least enough energy to meet the annual energy requirements of Area VIII pumping station (1.6 GWh/yr) at a 15% capacity factor. Design net annual output is 1.9 GWh/yr and gross power output from the generator varies from 1.5 MW in April to 2.0 MW in November for an average of 1.7 MW. Parasitic power amounts to 0.3 MW. A major effort was undertaken to minimize system capital costs, resulting in a cost estimate of \$5.7 million for the 2-MW peaking system. Due to the low capacity factor, the mechanical equipment is the major cost constituent.

Peelgren, M.L., Salton Sea Project, Phase 1, Jet Propulsion Laboratory, JPL 5107-2, January 1982.

This report presents the results of a feasibility study made for a salt-gradient solar pond power plant in or near the Salton Sea in southern California. The feasibility study was performed by a team composed of Southern California Edison Company, Jet Propulsion Laboratory, Ormat Turbines, Ltd., and WESTEC Services, Inc. This report summarizes the results of the entire team. References which follow present more detailed information.

Two candidate sites were evaluated for a 5 MW_e proof-of-concept experiment. The primary site is located on the Salton Sea within the U.S. Navy test range on the western shore. This site is called the "wet" site. A secondary site, called the "dry" site, is located at Bristol Lake (a dry inland desert lake). The initial major requirements of the 5 MW_e concept were to produce 5 MW_e gross baseload power 12 months of the year using the energy derived from a salt gradient solar pond. Performance estimates at both the wet and dry sites are similar. A 250-acre solar pond will support year-round baseload operation and achieve a 66% load factor and a power profile that lies within a 5 MW_e + 15% band. The difficulty (and, consequently, the cost) of constructing a solar pond in the lake at the wet site is greater than at the dry site. However, because the real commercial potential (abundant water supply) is at the wet site, the primary focus remained at the Salton Sea site.

The commercial plant will be constructed of modules. Each module will consist of a 50 MW_e power conversion unit coupled to a 2200-acre solar pond. A 600 MW_e plant will therefore be composed of 12 modules.

One of the important factors influencing performance at the Salton Sea is upper zone water clarity. The Salton Sea water has

high turbidity and color which must be reduced or removed. Activated charcoal treatment has been found to be effective.

Solar pond brine will be created from the evaporation of Salton Sea water. For the initial plant, brine production becomes an important cost, space, and time issue. For a 250-acre solar pond, 625 acres of evaporation ponds and 5 years are required to produce a full (11.5-ft) solar pond storage zone. Fortunately, power plant operation can begin with a partially filled storage zone after 2 years of brine production. In the long term, the relatively low salinity of the Salton Sea (3.8%) is more a benefit than a liability. After a pond has been established, direct use of the Salton Sea water as the pond surface flushing water is practical.

Environmentally, the benefits of a large solar pond complex in the Salton Sea are significant. Operating ponds will take saline water from the lake and stabilize the salt concentration.

The major environmental concerns relative to a solar pond involve disposal of dredge bottom surplus, temporary stirring of lake bottom muds and settled debris, displacement of possible fish spawning grounds, and disposal of long-term salt and brine byproducts of solar pond operation. All of these concerns appear manageable at this time.

The major conclusions from the Phase I feasibility study are as follows:

- (1) Solar pond power plants in the Salton Sea are judged to be technically and environmentally viable.
- (2) Baseload electric power generation is achievable from solar ponds.
- (3) The greatest cost drivers for the 5-MWe proof-of-concept experiment are the lake dike construction and pond sealing.
- (4) Salton Sea water has high turbidity and color content and must be treated before use in a solar pond.
- (5) Production of brine from Salton Sea water for the first solar pond unit will require space (evaporation ponds) and time.
- (6) All environmental problems appear to be manageable.

Ormat Turbines, Ltd., A Study of the Feasibility of a Solar Salt Pond Generating Facility in the State of California, U.S.A., Vols. 1 & 2, Ormat Turbines, Ltd., Yavne, Israel, Prepared for the Southern California Edison Company, under P.O. M0079003, May 1981.

This report presents the work performed by Ormat Turbines Ltd. to study the feasibility of a solar salt pond electric power generating facility in Southern California. The climatological, hydrological and physio-chemical boundaries and constraints were determined within which a 5 MW Demonstration Solar Pond Power Plant (SPPP) and 50 MW modules, generating up to 600 MW of power, are feasible at the Salton Sea and at an inland "dry" site. Existing climatic, geotechnical, and solar pond characteristics were compiled and, on the basis of analyses of solar pond response as well as design and operational conditions, the Salton Sea site was determined to be suitable for both a 5 MW Demonstration SPPP and a 600 MW commercial facility composed of 12 50-MW modules. Operation of such a facility at the Salton Sea provides a unique opportunity to combine commercial electric power generation while simultaneously improving the environmental state of the Sea by absorbing its excess salinity. The Bristol Dry Lake site was found to be suitable for a 5 MW Demonstration SPPP, but not for a 20 to 50 MW unit, nor for a 600 MW commercial facility.

Optimization studies were performed to define the solar ponds and power generating equipment for base load operation based on the minimum installed cost of electricity per kW. The installed cost of electricity for a 600 MW SPPP at the Salton Sea is estimated to be approximately \$1,830/kW (gross output) installed, in 1980 dollars, and the base load factor is 0.63.

WESTEC Services, Inc., Final Report, Solar Pond Project Salton Sea, California, WESTEC Svcs, prepared for Jet Propulsion Laboratory, 1981.

This document contains the results of a number of studies aimed at determining the environmental feasibility of implementing a solar pond power plant in the Salton Sea. A 5 MW experimental demonstration plant and a 600 MW commercial facility provided the baseline designs for this evaluation.

The 5 MW project appears to be completely feasible and can be constructed and operated with little or no adverse effect on the environment. The feasibility of the 600 MW facility will depend, in part, on the results of operating the smaller experimental plant. Considerable additional data regarding the project itself, plus further environmental baseline studies, appear to be necessary in order to complete a full evaluation of the 600MW project. A number of potentially adverse environmental effects

have been identified with regard to the larger commercial facility; however, most of these can be effectively mitigated through appropriate design, construction, and operation. The others can probably be resolved through a careful and sensitive location and siting effort within the Salton Sea. None of the impacts identified so far would make the project totally infeasible.

The Ralph M. Parsons Company, Final Report, Salton Sea Solar Pond Power Plant, Preliminary Design/Cost Estimate Study, Prepared by The Ralph M. Parsons Co. for the Jet Propulsion Laboratory, Contract No. 956462, October 1983.

This study was foreshortened by withdrawal of the budgeted funds and the planned engineering tasks were not completed. Nevertheless, considerable understanding and insight into the problems and technology of constructing a solar pond were gained.

Calculations made for sizing the brine production (evaporation) ponds show that providing a 2-ft concentrated brine layer in the solar pond for partial operation within 1 year and a full depth brine layer in 2 years requires an evaporation pond that is nearly five times as large as the solar pond in surface area. This is based on an unlined solar pond, but a fully lined evaporation pond. If the solar pond could also be lined to reduce seepage loss, the size of the evaporation pond would be reduced from 300 to approximately 230 acres. It was necessary to base the pond sizing on an unlined solar pond because it was a requirement to construct the pond, at least partially, in the Salton Sea and no method was devised in the short study time available to dry out the pond for installation of a liner.

The pond sizing calculations also vividly demonstrated the need to reduce seepage loss to the absolute minimum or eliminate it completely. Seepage loss requires the continuous production of additional brine which results in a considerable increase in maintenance and evaporation pond surface area.

The difficulties in locating a suitable, impermeable clay layer under the pond sites, the relatively steep average land slope, ragged surface contours, and poor soil for construction all add up to a relatively poor choice of a site for a solar pond. If effort is ever resumed on the solar pond, it is recommended that some relocation of the site be considered. The ready availability of water from the Salton Sea and free use of the site remain as plus factors.

Contrary to impressions received prior to the study effort, turbine generators using the organic working fluid, R-114, are available in the United States from multiple sources and the technology is neither new nor experimental.

ERTEC, Report, Phase 1a Geotechnical Investigation, Salton Sea Solar Pond Project, prepared by ERTEC Western, Inc. for The Ralph M. Parsons Co., Proj. No. 83-173, April 1982.

A preliminary geotechnical investigation of the proposed solar pond site on the Salton Sea was conducted in the fall of 1982. Based on the results of the investigation, the following are concluded:

- (1) The northern half of the site is better suited for siting the ponds. Natural clay deposits are typically found within approximately 20 ft of the ground surface.
- (2) The site is located in a seismically active zone. For design lives of 5 and 30 years, there is a 50% probability of experiencing acceleration levels in excess of 0.15 and 0.3 g, respectively.
- (3) The near surface site soils can be used as fill for constructing dike embankments.
- (4) The site soils generally have adequate bearing capacity for supporting the proposed facilities.
- (5) The thermal conductivity of the site soils as measured by laboratory tests was in the range of 8 to 12 Btu/°F/in. ft² hr.

French, R.L., Marsh, H.E., Roschke, E.J., and Wu, W.C., Site Specific Research conducted in Support of the Salton Sea Solar Pond Project - FY 1982 Report, Jet Propulsion Laboratory, September 1983.

Laboratory experiments and analytical analyses were conducted to examine site-specific physical, chemical, and biological factors which could impact construction, durability, and performance of a 5 MW_e solar pond system at the Salton Sea. Laboratory experiments included: (1) experiments to validate spectrophotometric light transmission measurements, (2) a continuation of the search for suitable Salton Sea water treatment methods, (3) an evaluation of the suitability of formulating water clarity specifications in terms of standard commercial procedures, (4) a more in-depth investigation into soil-brine interactions, and (5) a preliminary examination into material corrosion potentials.

An experimental approach was selected to validate the extrapolation of small sample spectrophotometric measurements. Two test fixtures of differing size were constructed. Preliminary results produced promising results, the test approach proved to

be good, and the test results displayed the expected shape and sensitivity.

Investigations to find methods for removing color and turbidity from the Salton Sea water continued. Ozone treatment appeared to be as good as activated carbon treatment and carbon plus ozone in a series process produced the very best results. A wide spectrum of flocculents were tested and all produced negative results.

Spectrophotometric measurements produce very useful research data, but such data are difficult to incorporate into water quality process design specifications. In the search for a more suitable quality descriptor, water samples were submitted to standard commercial analyses. Standard colorimeter analysis correlated with the spectrophotometric results while standard turbidity tests produced no correlation. A Salton Sea water clarification process design specification was formulated based on industry acceptable colorimeter measurements.

The potential for soil-brine interactions that could be damaging to solar pond operation has been recognized and briefly studied in earlier work. During this reporting period, more sophisticated laboratory investigations were performed to determine the effects of temperature, evolve a more efficient test method, and examine the potential for the soil to cause light-attenuating contamination. Although hydrogen sulfide gas has been produced in some tests, no pond damaging free gas bubbles were formed. A theory has evolved that Salton Sea soils contain an insufficient supply of organic carbon for sustained high production of hydrogen sulfide. In separate tests, Salton Sea soils were found to degrade the light transmission characteristics of clarified waters and brines.

A preliminary test to examine material corrosion potential was conducted. Coupons of stainless steel and low carbon steel were immersed in both brine and Salton Sea water. Low carbon steel corrosion is most pronounced in Salton Sea water, but also occurs in brine. Stainless steel did not corrode in either liquid.

5. Desalination

Johnson, D., Leboeuf, C.M., and Waddington, D., 1981. "A Solar Pond-Driven Distillation and Power Production System," SERI/TR-631-1248.

Production of fresh water and electric power are described in this report which analyzes the performance of a solar pond-driven multi-effect distillation system coupled to a Claude open-cycle power-production system. The storage layer of the solar

pond serves as the holding tank for the concentrated brine effluent from the distillation process as well as the collector and storage medium or solar energy used to heat incoming salty river water. Steam from the distillation process expands through a turbine/generator combination to provide power for the water circulation and vacuum pumps of the system. A thermodynamic analysis of the energy and mass balances of the system was performed and a performance model of the system developed. This model was used to compute the requirements for desalting several saline tributaries of the Colorado River and resulted in a pond of $2.3 \times 10^7 \text{ m}^2$ to process $1.9 \times 10^3 \text{ kg/s}$ of brackish water in 6 multieffects. The closely integrated distillation and power production system converts up to 65% of the incoming stream of brackish water into an outlet stream of the required purity.



United States Department of Energy
Office of Scientific and Technical Information
Post Office Box 62
Oak Ridge, Tennessee 37831

OFFICIAL BUSINESS
PENALTY FOR PRIVATE USE, \$300

POSTAGE AND FEES PAID
DEPARTMENT OF ENERGY
DOE-350



528 FS- 1
NATIONAL AERONAUTICS AND SPACE ADMINISTRATION
ATTN LIBRARY
LANGLEY RESEARCH CENTER
HAMPTON, VA 23665

1988

1988