

NASA-CR-175,481

NASA-CR-175481
19850012124

Middle Atmosphere Program

HANDBOOK FOR MAP VOLUME 5

Edited by
C. F. Sechrist, Jr.

LIBRARY COPY

MAR 18 1992

LANGLEY RESEARCH CENTER
LIBRARY NASA
HAMPTON, VIRGINIA

ICSU
International Council of Scientific Unions

SCOSTEP

Scientific Committee on Solar-Terrestrial Physics

Officers: K. D. Cole, President
J. W. King, Vice President
C. H. Liu, Scientific Secretary

MIDDLE ATMOSPHERE PROGRAM STEERING COMMITTEE

S. A. Bowhill, SCOSTEP, Chairman
K. Labitzke, COSPAR, Vice Chairman

R. D. Bojkov, WMO	L. R. Megill, IUGG/IAGA
A. D. Danilov, COSPAR	R. J. Murgatroyd, IUGG/IAMAP
J. C. Gille, COSPAR	T. Nagata, SCAR
J. B. Gregory, SCOSTEP	P. C. Simon, IAU
I. Hirota, IUGG/IAMAP	J. Taubenheim, IUGG/IAGA
J. W. King, URSI	T. E. VanZandt, URSI
M. Wada, IUPAP	

PRE-MAP PROJECTS

PMP-1 Coordinated Study of the Behavior of the Middle Atmosphere in Winter, K. Labitzke, Chairman
PMP-2 Equatorial Wave Dynamics, I. Hirota, Chairman
PMP-3 Study of Photochemical Processes in the Upper Stratosphere and Mesosphere by Complementary Spacecraft, *in situ*, and Ground Measurements, J. C. Gille, Chairman
PMP-4 Presentation of Meteorological and Chemical Variables in the Format of Monthly Mean Zonal Cross Sections, J. Barnett, Chairman
PMP-5 Solar Spectral Irradiance Measurements, P. C. Simon, Chairman

MAP STUDY GROUPS

MSG-1 Tropospheric-Stratospheric Coupling, Chemical and Dynamical, J. R. Holton, Chairman
MSG-2 Transport of Trace Constituents, J. D. Mahlman, Chairman
MSG-3 Tides, Gravity Waves and Turbulence, M. A. Geller, Chairman
MSG-4 Electrodynamics of the Middle Atmosphere, H. Volland, Chairman
MSG-5 Ions and Aerosols, F. Arnold, Chairman

MAP COMMITTEES

Data Management - G. Hartmann, Chairman
Dynamics Calendar - T. E. VanZandt, Chairman
Publications - C. F. Sechrist, Jr., Chairman

APPROVED MAP PROJECTS

WINE (Winter in Northern Europe) - U. von Zahn, Coordinator
GLOBUS (Global Budget of Stratospheric Trace Constituents) - W. Seiler, Coordinator
AMA (Antarctic Middle Atmosphere) - T. Hirasawa, Coordinator
CAMP (Cold Arctic Mesopause Project) - L. Bjorn, Coordinator

M I D D L E
A T M O S P H E R E
P R O G R A M

HANDBOOK FOR MAP

VOLUME 5

Edited by

C. F. Sechrist, Jr.
Chairman
MAP Publications Committee

May 1982

Published for the ICSU Scientific Committee on Solar-
Terrestrial Physics (SCOSTEP) with financial assistance
in part from UNESCO Subventions-1980-DG/2.1/414/48 and
1981-1983-DG/7.6.2/Sub 13 (SC), and in part from the
World Meteorological Organization.

Copies available from SCOSTEP Secretariat, University of
Illinois, 1406 W. Green Street, Urbana, Illinois 61801

N85-20434 #

A CATALOGUE OF DYNAMIC PARAMETERS
DESCRIBING THE VARIABILITY OF THE MIDDLE STRATOSPHERE
DURING THE NORTHERN WINTERS

K. Labitzke and B. Goretzki

Institut für Meteorologie
Freie Universität Berlin
FEDERAL REPUBLIC OF GERMANY

CONTENTS

CONTENTS	iii
PART 1 INTRODUCTION TO THE CATALOGUE	1
PART 2 ANNEX A: LONG-TERM MONTHLY MEAN 30-MBAR MAPS: GEOPOTENTIAL HEIGHTS, TEMPERATURES AND STANDARD DEVIATIONS (15-YEAR AVERAGES); LATITUDINAL PROFILES OF MEAN ZONAL WINDS AND TEMPERATURES	31
PART 3 ANNEX B: MERIDIONAL TIME SECTIONS OF DERIVED QUANTITIES FOR THE 16 WINTERS 1965/66 - 1980/81	45

Part 1. Introduction to the Catalogue	Page
Introduction	1
Data and Definition of Winter Events	1
Interannual Variability during the Northern Winters	3
Long-Term Monthly Mean 30-mbar Maps	9
Discussion of the Dynamic Parameters Presented for 16 Winters in Annex B	13
Concluding Remarks	28
Acknowledgements	28
References	28

INTRODUCTION

At the beginning of the Middle Atmosphere Program (MAP) we considered it to be useful to prepare a catalogue of already available parameters for the middle stratosphere, i.e., for the 30-mbar level. This catalogue consists of derived parameters based on hemispheric daily and monthly mean 30-mbar maps prepared by the Stratospheric Research Group, Free University Berlin.

It is the purpose of this HANDBOOK FOR MAP to give information on the variability of the stratosphere during the northern winters. The book consists of three parts:

1. A discussion of: a) the interannual variability, based on 30 winters; b) long-term monthly mean maps, average over 15 years; and c) dynamic parameters which are presented for 16 winters.
2. An Annex A which contains the long-term monthly mean maps.
3. An Annex B which gives meridional time sections of several dynamic parameters.

DATA AND DEFINITION OF WINTER EVENTS

(a) Data

The material presented in this catalogue is based mainly on daily stratospheric maps for the Northern Hemisphere. These analyses were carried out by members of the Stratospheric Research Group of the Free University Berlin. The daily maps are published together with the derived monthly mean maps in the "Meteorologische Abhandlungen, F.U. Berlin", and a listing of the different volume (Band) numbers is given in Table 1. In April 1964 the USSR began to transmit radiosonde data above 100 mbar. Since that time more reliable analyses became possible and therefore most of the derived parameters given here start with the winter 1964/65. The information on earlier years is based on monthly mean maps, either from Muench and Borden (1962) or from our group. Most of the data are available on magnetic tape, on a latitude/longitude grid. The monthly mean maps given in Annex A and described in the section titled "Long-term monthly mean 30-mbar maps" are based on the data of the period July 1964 - June 1979, i.e., 15 years of data for each month.

(b) Definition of Winter Events

Canadian Warmings, C.W., are characterized by an intensification of the Aleutian anticyclone, i.e., an amplification of the planetary-scale height-wave 1 (Labitzke, 1977) and a reversal of the temperature gradient poleward of 60 N is possible. These warmings occur most often during early winter.

Major midwinter warmings, *, are defined as such events during

Table 1 Listing of volume (Band) numbers of Meteor. Abhandl. in which the various daily and monthly maps are published. (Tabulations of height and temperature are given in the underlined volumes; years with asterisk are without temperature analyses; MT = available on magnetic tape only).

	100-mb Maps		50-mb Maps		30-mb Maps		10-mb Maps	
	Daily	Monthly	Daily	Monthly	Daily	Monthly	Daily	Monthly
1957	-	-	42/1,2 *	42/7 *	42/3,4 *	42/7 *	42/5,6 *	42/7 *
1958	-	-	12 *	28/2 *	10 *	28/2 *	13 *	28/2 *
1959	-	-	29 *	29 *	30 *	30 *	31 *	31 *
1960	-	-	15 *	86/1 *	16 *	134/1 *	17 *	134/1 *
1961	-	-	18 *	86/1 *	19	19 *	20	20 *
1962	23 *	23 *	24 *	24 *	25 *	134/1 *	26 *	134/1 *
1963	37	37	38	38 *	39	39 *	40	40 *
1964	46	46	47/1	47/1	48	48	49	49 *
1965	55	55	56	56	57	57	58	58
1966	65	65	66	66	67	67	68	68
1967	80	<u>80</u>	80	<u>80</u>	81	<u>81</u>	82	<u>82</u>
1968	94	<u>94</u>	94	<u>94</u>	95	<u>95</u>	96	<u>96</u>
1969	106	<u>106</u>	106	<u>106</u>	107	<u>107</u>	108	<u>108</u>
1970	116	<u>116</u>	116	<u>116</u>	117	<u>117</u>	118	<u>118</u>
1971	123/1	<u>134/2</u>	123	<u>123</u>	124	<u>124</u>	125	<u>125</u>
1972	-	<u>134/2</u>	131	<u>131</u>	132	<u>132</u>	B/11(1)	<u>B/11(1)</u>
1973	-	<u>134/3</u>	137	<u>137</u>	138	<u>138</u>	-	-
1974	-	<u>134/3</u>	143	<u>143</u>	144	<u>144</u>	-	-
1975	-	MT	B/3	<u>B/3</u>	B/4	<u>B/4</u>	-	-
1976	-	MT	B/8	<u>B/8</u>	B/9	<u>B/9</u>	-	-
1977	-	MT	B/14	<u>B/14</u>	B/15	<u>B/15</u>	-	-
1978	-	MT	B/20	<u>B/20</u>	B/21	<u>B/21</u>	-	-
1979	-	MT	MT	MT	B/25	<u>B/25</u>	-	-
1980	-	MT	MT	MT	B/29	<u>B/29</u>	-	-
1981	-	MT	MT	MT	B/33	<u>B/33</u>	-	-

(single winter months available on request)

which at the 10-mbar level or below the latitudinal mean temperature increases poleward from ~ 60 N latitude and an associated circulation reversal is observed (i.e., net mean easterly winds poleward of ~ 60 N latitude).

Final Warmings, F.W., are the transition into summer conditions; a F.W. is called "early" if the monthly mean 30-mbar North Pole temperature is $\geq -51^\circ\text{C}$ in March, or $\geq -44^\circ\text{C}$ in April (cf. Table 2); "late" denotes a delayed F.W. due to the "late winter cooling" which follows a major midwinter warming, and "C" marks a month which belongs to the coldest months due to the "late winter cooling" effect. If the major warmings take place late in the winter, they may turn directly into a F.W., denoted here as * F.W.; in this instance the late winter cooling is less effective than the heating due to the returning sun (Labitzke, 1982a).

THE INTERANNUAL VARIABILITY DURING THE NORTHERN WINTERS

It has been shown (Labitzke, 1977, 1981b, 1982a; Naujokat, 1981) that the interannual variability of the middle stratosphere during the northern winters is very large. This is demonstrated convincingly by Figure 1 which shows a frequency distribution of monthly mean 30-mbar temperatures over the North Pole during the past 26 years.

The monthly mean temperatures over the North Pole can be considered to be representative for the arctic region north of ~ 80 N. The frequency distribution in Figure 1 shows at first glance two facts: during the summer months July-August the variability of the temperatures is very small, $\zeta < 1^\circ\text{C}$, while during the winter and spring months December-April the variability is very large, largest in February when ζ amounts to 10.9°C . This difference in temperature variability is due to the fact that in summer the prevailing easterly winds prohibit the propagation of the planetary-scale waves from the troposphere into the stratosphere (Charney and Drazin, 1961), while the opposite is the case in winter. The large variability of the stratospheric temperatures in winter reflects the occurrence of stratospheric warmings or cold midwinter periods which all depend on the varying intensity of the planetary-scale waves, originating in the troposphere. The interannual variability of these waves in the troposphere as well as in the stratosphere is not fully understood. In the following some features related to the large variability will be discussed.

For the period November-May the values given in the frequency distribution (Figure 1) are listed in Table 2 for the winters 1955/56 - 1980/81, i.e., 26 winters. The 11 or 12 coldest months (for April and May only the 8 coldest) are denoted with C.

In Table 2 are further marked winter events such as Canadian Warmings, major warmings, and major Final Warmings (see previous sec-

Table 2

MONTHLY MEAN 30-mbar NORTH POLE TEMPERATURES [°C]

YEAR	R _j	NOV	DEC	JAN	FEB	MAR	APR	MAY	F. W.
1951/52	41	C.W.			*				[late]
1952/53	27	C.W.							early
1953/54	0					* F.W.			early
1954/55	23		C.W.	*					[late]
1955/56	74	-68	-79 C	-76 C	-71 C	-61 C	-45	-46 C	late
1956/57	165	-68	-73	-74	-38 *	-58	-53 C	-47 C	[late]
1957/58	203	-70 C	-79 C	-71	-49 *	-61 C	-57 C	-44 C	[late]
1958/59	217	-58 C.W.	-67 C.W.	-74	-73 C	-51 * F.W.	-43	-42	early
1959/60	146	-71 C	-69 C.W.	-60	-70 C	-69 C	-41	-39	early
1960/61	58	-64	-65 C.W.	-65	-72 C	-42 * F.W.	-47	-44 C	early
1961/62	39	-67	-80 C	-79 C	-67	-65 C	-57 C	-42	late
1962/63	20	-69 C.W.	-74	-74	-52 *	-61 C	-54 C	-44 C	[late]
1963/64	15	-72 C	-81 C	-78 C	-77 C	-47 * F.W.	-44	-41	early
1964/65	18	-70 C C.W.	-77 C	-76 C	-73 C	-62 C	-45	-39	late
1965/66	28	-68	-59 C.W.	-76 C	-60 *	-56	-48	-41	[late]
1966/67	111	-65	-73 C.W.	-80 C	-78 C	-72 C	-48	-37	late
1967/68	122	-71 C C.W.	-75	-58 *	-68	-67 C	-52 C	-36	[late]
1968/69	104	-63 C.W.	-62	-72	-74 C	-57	-47	-43	late
1969/70	112	-71 C	-73	-49 *	-62	-67 C	-47	-40	[late]
1970/71	91	-71 C	-78 C	-54 *	-66	-56	-51 C	-44 C	[late]
1971/72	62	-72 C	-78 C	-79 C	-70 C	-56	-44	-42	early
1972/73	43	-69 C.W.	-79 C	-73	-44 *	-56	-52 C	-45 C	[late]
1973/74	28	-71 C	-78 C C.W.	-78 C	-79 C	-50 * F.W.	-44	-42	early
1974/75	19	-65 C.W.	-74	-65	-68	-48 * F.W.	-46	-42	early
1975/76	8	-71 C	-77 C	-80 C	-78 C	-65 C	-34 * F.W.	-39	early
1976/77	16	-63 C.W.	-68	-60 *	-69	-60 C	-40	-40	early
1977/78	52	-68 C.W.	-77 C	-74	-66	-49	-44	-42	early
1978/79	167	-74 C	-74 C.W.	-75 C	-60 * F.W.	-51	-49	-42	early
1979/80	162	-64 C.W.	-72	-80 C	-70 C	-46 * F.W.	-45	-42	early
1980/81	114	-68 C.W.	-82 C	-81 C	-56 *	-54	-54 C	-44 C	[late]
C ⁽ⁿ⁾		≤-70 ⁽¹¹⁾	≤-77 ⁽¹²⁾	≤-75 ⁽¹²⁾	≤-70 ⁽¹²⁾	≤-60 ⁽¹¹⁾	≤-51 ⁽⁸⁾	≤-44 ⁽⁸⁾	
[T] _{n-26}		-68.1	-74.0	-71.6	-65.8	-57.2	-47.3	-41.9	
6		3.7	5.9	8.9	10.9	7.8	5.4	2.6	

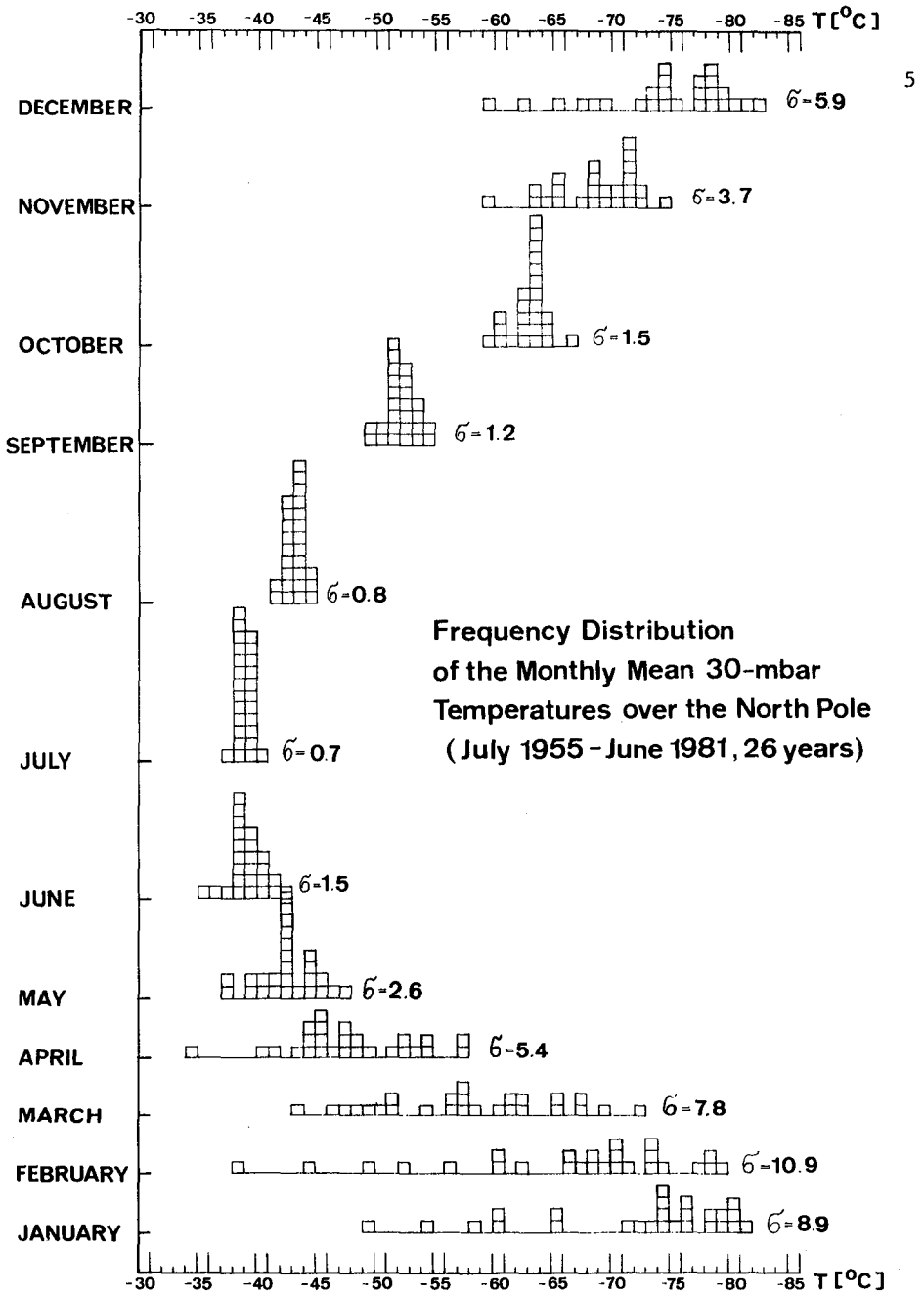

Figure 1 Frequency distribution of monthly mean 30-mbar temperatures [°C] at the North Pole (update of Fig. 1 of (Naujokat, 1981).

tion). These events are also given for the 4 winters 1951/52 - 1954/55, but monthly mean polar temperatures are not available for these early winters. In the column R_J the relative sunspot numbers are listed for January (Swiss Federal Observatory, Zurich). In the last column "F.W." the timing of the transition into summer conditions is grouped into late or early (see previous section).

In a recent paper, Holton and Tan (1980) have shown strong evidence that the equatorial quasi-biennial oscillation (QBO) modulates the global circulation at 50 mbar. Holton and Tan showed: "that in the Northern Hemisphere the zonal mean geopotential at the pole is lower during the westerly phase of the equatorial QBO, both in summer and in winter; that during November-December the stationary planetary wave number 1 is substantially stronger during the easterly phase of the equatorial QBO (at 50 mbar), but that there is little evidence of a QBO in wave number 2 during early winter. In the January-March period wave number 2 is stronger during the westerly phase of the equatorial QBO, and there is little evidence of a QBO in wave number 1. However, the wave number 2 signal may be a result of sampling fluctuations."

Following the idea of Holton and Tan, Labitzke (1982a) has grouped the winters of Table 2 into a "westerly" and an "easterly" category, based on the 50-mbar winds in November-December over the equatorial zone (Figure 2). The two different groups are shown in Table 3.

Looking at Table 3, two facts are obvious at once:

1. Most of the cold winter months denoted with C are to be found in the "westerly" category, in agreement with the results of Holton and Tan that the geopotential over the pole is lower during the "westerly" phase of the QBO. Still, it was not expected that almost all of the coldest months of the observational period belong in this group. This is true also for November and December, although during half of the 16 winters of the "westerly" category Canadian Warmings have been observed. Obviously those C.W.s were less intense and the polar region was less disturbed than during the C.W.s of the "easterly" group. As regards the C-months, Labitzke (1982a) has shown that during the midwinter months December-February (of the winters 1964/65 - 1980/81) out of the 24 months denoted with C (cf. Table 2) 21 months were governed by the "normal" height wave 2 pattern, i.e., an elongated cold polar vortex with two minima, one over Asia and one over Canada. During this situation the cold tropospheric trough over Canada (between about 100 and 40 W) continues uncompensated into the stratosphere.
2. The frequency of major midwinter warmings is much higher in the "easterly" category: major warmings took place during 8 out of 13 winters in contrast to 4 out of 16 winters in the "westerly" category. During the "easterly" phase of the equatorial QBO there exists a tendency for an enhanced development of the quasi-stationary height-wave 1 already in early winter (Holton and Tan,

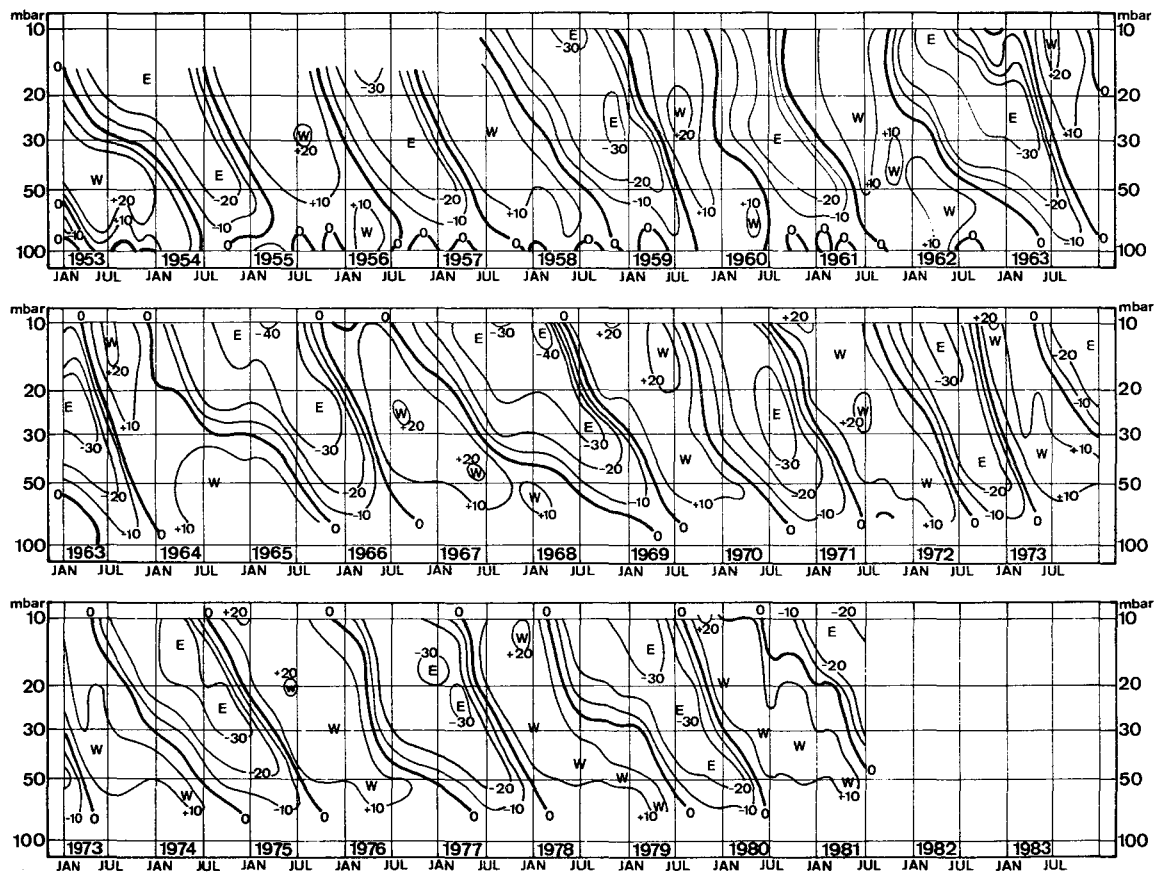

Figure 2 Time-height section of monthly mean zonal winds [m sec^{-1}] at equatorial stations. January 1953 - August 1967, Canton Island, 3S/172W; September 1967-December 1975, Gan/Maledive Islands, 1S/73E; January 1976 - July 1981, Singapore, 1N/104E (from Labitzke, 1982a).

Table 3

WESTERLY CATEGORY										EASTERLY CATEGORY									
n-16	YEAR	NOV	DEC	JAN	FEB	MAR	APR	MAY	F.W.	YEAR	NOV	DEC	JAN	FEB	MAR	APR	MAY	F.W.	n-13
	1952/53	C.W.							early	1951/52	C.W.			*				[late]	
	1953/54					*FW			early	1954/55		C.W.	*					[late]	
n-14 ↓	1955/56		C	C	C	C		C	late	1956/57				*	[C]	[C]		[late]	n-11 ↓
	1957/58	C	C		*	[C]	[C]	[C]	[late]	1958/59	C.W.	C.W.		C	*FW			early	
	1959/60	C	C.W.		C	C			early	1960/61		C.W.		C	*FW	[C]		early	
	1961/62		C	C		C	C		late	1962/63	C.W.			*	[C]	[C]	[C]	[late]	
	1963/64	C	C	C	C	*FW			early	1965/66		C.W.	C	*				[late]	
	1964/65	C.C.W.	C	C	C	C			late	1968/69	C.W.			C				late	
	1966/67		C.W.	C	C	C			late	1970/71	C	C		*		[C]	[C]	[late]	
	1967/68	C.C.W.		*		[C]	[C]		[late]	1972/73	C.W.	C		*		[C]	[C]	[late]	
	1969/70	C		*		[C]			[late]	1974/75	C.W.				*FW			early	
	1971/72	C	C	C	C				early	1976/77	C.W.	C		*	[C]			early	
	1973/74	C	C.C.W.	C	C	*FW			early	1979/80	C.W.		C	C	*FW			early	
	1975/76	C	C	C	C	C	*FW		early										
	1978/79	C	C.W.	C	*FW				early										
	1980/81	C.W.	C	C	*		[C]	[C]	[late]										
	Σ C	10 ⁽¹¹⁾	9 ⁽¹²⁾	10 ⁽¹²⁾	8 ⁽¹²⁾	9 ⁽¹¹⁾	4 ⁽⁸⁾	3 ⁽⁸⁾		Σ C	1 ⁽¹¹⁾	3 ⁽¹²⁾	2 ⁽¹²⁾	4 ⁽¹²⁾	2 ⁽¹¹⁾	4 ⁽⁸⁾	5 ⁽⁸⁾		
	Σ *			2	2					Σ *			3	5					
n-16 ↓	Σ *FW				1	3	1			Σ *FW					4				

1980; Labitzke, 1982a). This development leads often to major warmings in January and February and results in a generally warmer polar region. Some of the major warmings are connected, during the breakdown phase, with the "disturbed" height-wave 2. As pointed out by Labitzke (1982b), the two different height-wave 2 patterns must not be confused.

The 4 major warmings in the "westerly" category occurred in 1957/58, 1967/68, 1969/70, and 1980/81. A comparison with the information given in Table 2 reveals that these winters are all winters near the sunspot maximum. In other words, major warmings did not occur in the "westerly" category, except during winters near the sunspot maxima. Of course, no significance can be attributed to this result, as only three maxima and three minima of the sunspot cycle are covered by the 30 years for which observations are available.

No system could be found for the timing of the F.W.s. From Table 2 it is evident that these warmings can be late several years after another, and then several years with early F.W.s may follow. There is no evidence for a correlation with the sunspot cycle nor with the QBO.

LONG-TERM MONTHLY MEAN 30-MBAR MAPS

Monthly mean maps have been averaged for the 15 year period July 1964 - June 1979 in order to receive a relatively "long-term" mean. These 15-year averages of the heights and temperatures are given in Annex A together with the respective standard deviations for the winter period November-April. The standard deviations reflect the interannual variability.

(a) Description of the Monthly Mean Winter Circulation

During November, A/4 and A/5, the cold polar vortex is already well established. Its center is shifted from the North Pole to the European sector of the Arctic. The Aleutian anticyclone, the prominent feature of the stratospheric winter circulation, is also already well pronounced, especially obvious in the temperature field. This asymmetry reflects the quasi-stationary wave 1. The march of the amplitudes of this wave through the year is given, together with the amplitudes of wave 2, in Figures 3 and 4, for the heights and the temperatures, respectively. In these graphs several features are easy to spot: both waves reach their maximal amplitudes between 60 and 70 N; while the height waves are reaching their maximum between January and February (Figure 3), the temperature waves are reaching their maximum already between December and January (Figure 4).

As regards November, the temperature-wave 1 has already reached amplitudes close to the maximum and the height-wave 1 reaches 75% of the maximal amplitude values. The standard deviations are still only half

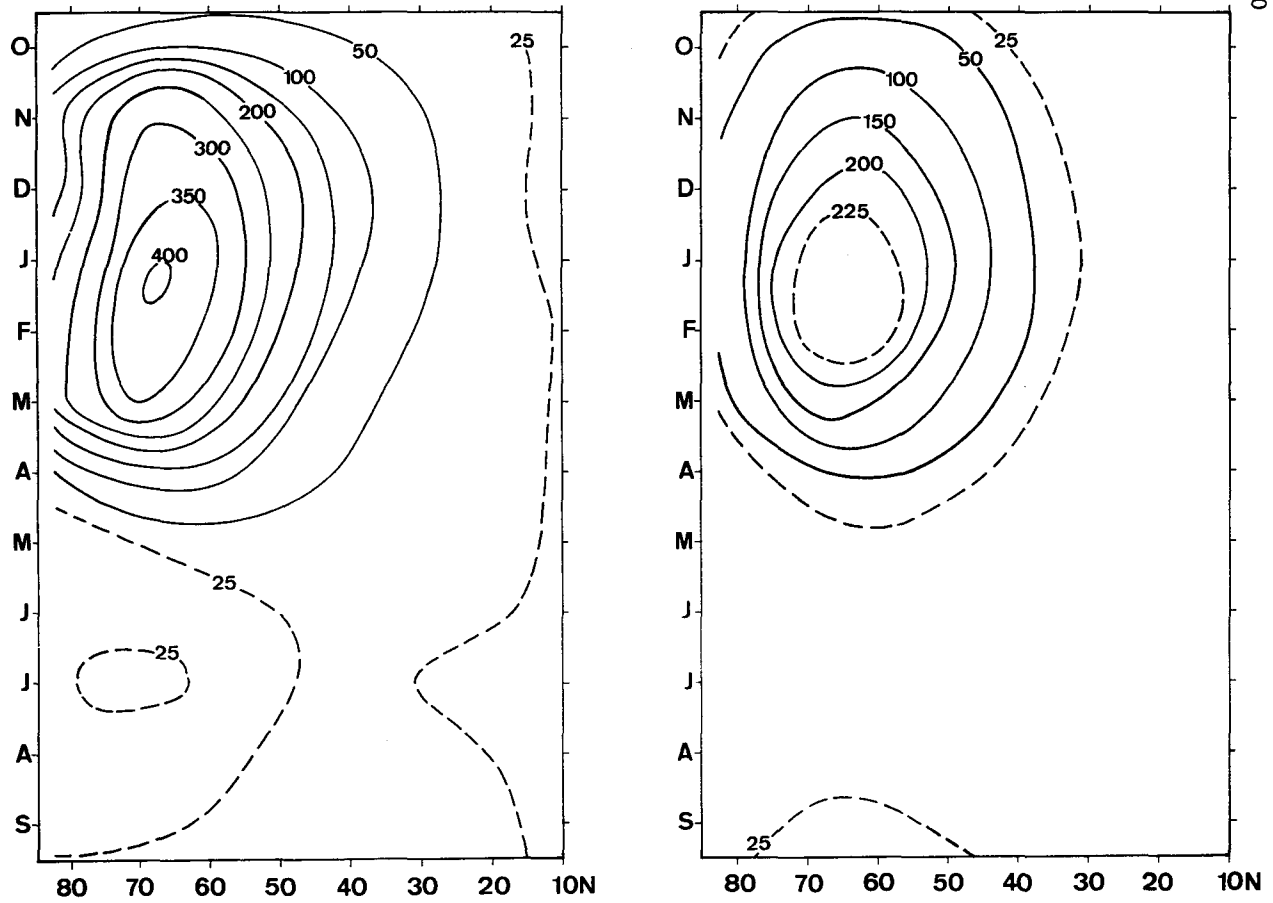

Figure 3 Annual march of the amplitudes [geopot. m] of the quasistationary height-waves 1 and 2, derived from monthly mean data.

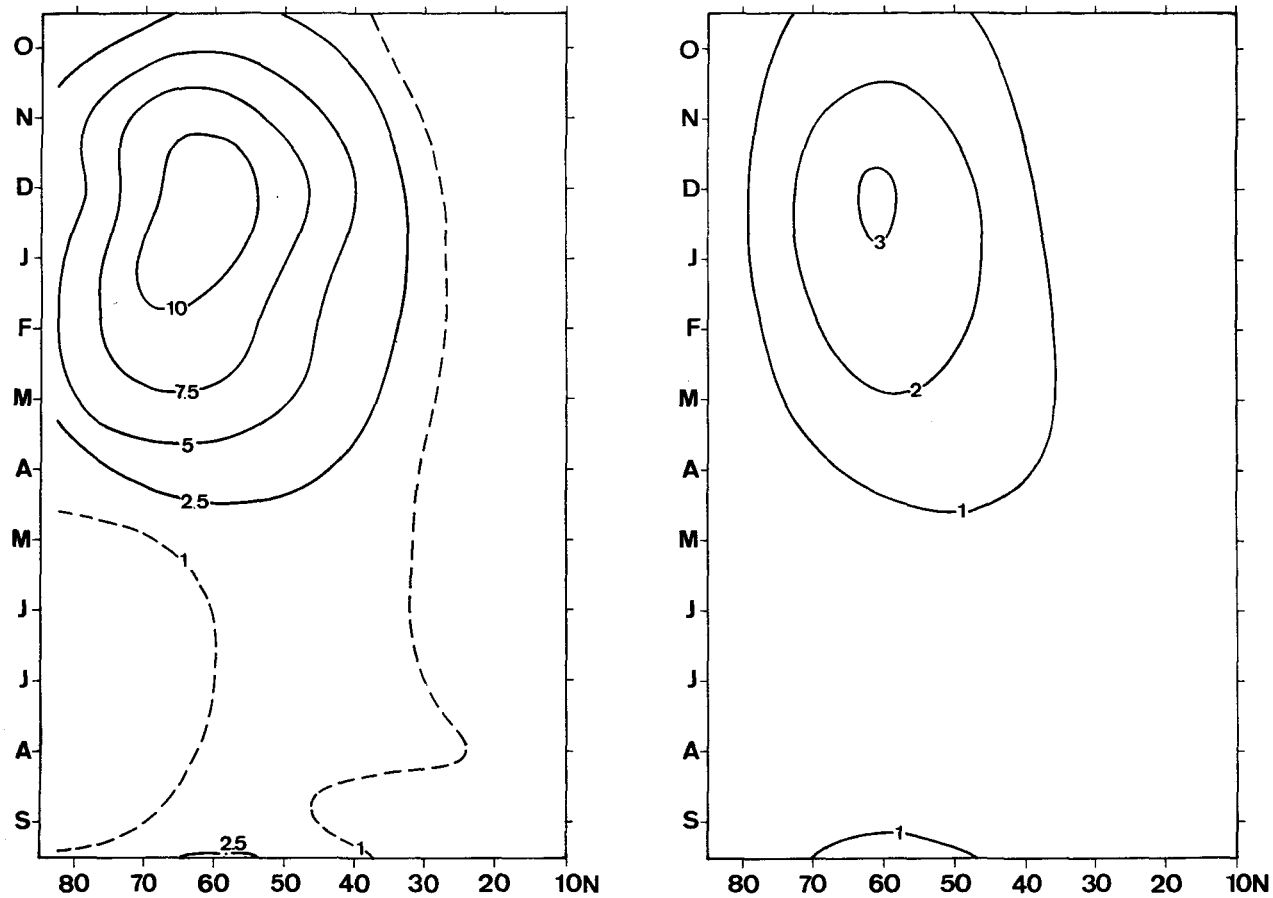

Figure 4 Annual march of the amplitudes [K] of the quasi-stationary temperature-waves 1 and 2, derived from monthly mean data.

of those in January and the maximum of the standard deviations, i.e., the interannual variability, is connected with the Aleutian anticyclone during November; this reflects the occurrence (or non-occurrence) of the Canadian Warmings, as pointed out in the previous section.

The lowest temperatures are reached in December, A/7; the standard deviations increase only slowly and the center of variability is shifted towards Canada, A/6 and A/7.

In January, A/8 and A/9, the vortex reaches its maximal intensity, as well as height-waves 1 and 2 (Figure 3). The interannual variability of the winter is largest in January. It is centered over the polar region, reflecting the variability induced by the major warmings.

Not much change is noticeable in February, A/10 and A/11.

In March, A/12 and A/13, the transition into summer starts with general warming and weakening of the polar vortex. The standard deviations have their maximum over the polar region.

In April, A/14 and A/15, the transition to summer conditions is well in progress, especially in regard to the temperature. The amplitudes of the waves 1 and 2 decrease accordingly (cf. Figures 3 and 4).

The amplitudes of the waves 1 and 2 are very weak during summer, i.e., during the period of prevailing winds from the east, as this condition prohibits the upward propagation of the long waves (Charney and Drazin, 1961). The weak wave 1 during summer reflects the tidal wave. Small day-night differences exist and the maps have been constructed for 00 GMT.

(b) Discussion of the Mean Zonal Wind

On page A/3 meridional profiles of the mean zonal winds are shown for selected months, together with the mean zonal temperatures. The connection between steep temperature gradients and strong winds is obvious in December and February. In March, however, the strong winds reflect the intense polar vortex of the lower stratosphere (below the 30-mbar level), while the spring warming is already noticeable at the 30-mbar level with a much weakened temperature gradient. In April, the temperature gradient is already reversed, with very weak easterly winds over high latitudes. The weak westerlies over middle latitudes are again due to the remains of the polar vortex, which is still more pronounced in the lower stratosphere.

(c) Comparison Between the Zonal Mean Temperatures of Two Different Time Periods

The zonal mean temperatures of the 10-year average (July 1964 - June 1975) are added to the graphs of T on page A/3 to facilitate a comparison. During midwinter the differences are smaller than 1/2 C in most cases over high latitudes, and negligible over middle and low latitudes. Larger differences exist only in spring over high latitudes, cf. the curves for March and April. A comparison with the information given in Table 2 shows clearly that the Final Warmings were always early during each of the 5 winters which have been added to the 10-year average.

DISCUSSION OF THE DYNAMIC PARAMETERS PRESENTED FOR 16 WINTERS IN ANNEX B

(a) Content of Annex B

In Annex B the 16 winters 1965/66 - 1980/81 are presented by means of meridional time sections of the following parameters (all for the 30-mbar level): a) the mean zonal wind; b) the mean zonal temperature; c) the amplitudes of height-wave 1; d) the amplitudes of temperature-wave 1; e) the amplitudes of height-wave 2; f) the amplitudes of temperature-wave 2; g) the momentum flux of waves 1-6; h) the heat flux of waves 1-6; i) the efficiency of the momentum flux by waves 1-6; j) the efficiency of the heat flux by waves 1-6; k) the momentum flux of wave 1; l) the heat flux of wave 1; m) the momentum flux of wave 2; n) the heat flux of wave 2; o) the efficiency of the momentum flux by wave 1; p) the efficiency of the heat flux by wave 1; q) the efficiency of the momentum flux by wave 2; r) the efficiency of the heat flux by wave 2. There is a general agreement that the varying activity of the planetary-scale waves 1 and 2 is responsible for the interannual variability discussed in the section titled "The interannual variability during the northern winters". Therefore, the emphasis of the parameters shown in Annex B is put on waves 1 and 2.

To describe and monitor the different winters, the momentum flux and the heat flux have also been computed, both for the sum of wave 1-6 (plots (g) and (h) in Annex B) and for wave 1 and wave 2 separately (plots (k)-(n)). Further, the efficiency of the meridional momentum and heat transport has been calculated for the sum of the waves 1-6 and for both waves 1 and 2 separately (plots (j), (k), (o)-(r)). The efficiency is used here in the sense of Oort and Rasmussen (1971). The efficiency of the meridional transport of a property is the correlation coefficient between the meridional velocity and the property to be transported. This correlation reaches values between plus and minus 1, respectively. It is a normalized flux of a property where positive values indicate northward flux (Goretzki, 1981). Further, for single waves the efficiency gives insight in the phase differences between the geo-

potential and the temperature waves. In regions of very weak wave amplitudes a calculation of the efficiency was suppressed and all values were set to zero.

(b) A Condensed Survey Over the Last 17 Winters

To provide a condensed survey of the respective winters Figure 5 has been prepared. As the amplitudes of the daily height-waves 1 and 2 generally reach their maximum between 60 and 70 N (cf. plots (c) and (e) in Annex B), the amplitudes are plotted for 60 N in Figure 5, together with the mean zonal wind at 60 N which during the undisturbed winter periods also has its maximum between 60 and 70 N (cf. plots (a) in Annex B). The temperature difference between 80 and 50 N is also given in Figure 5, as this temperature contrast correlates well with the zonal kinetic energy KZ (Labitzke, 1977), with large negative values reflecting a strong, cold polar vortex and positive values indicating a reversal of the temperature gradient. The winter events as defined in "Data and definition of winter events" and as discussed in "The inter-annual variability during the northern winters" (cf. Tables 2 and 3) have been added to the graphs of Figure 5, and are marked in Annex B.

This survey over the last 17 northern winters indicates that at least during these winters amplification of height-wave 1 concurrently with a minimum of height-wave 2 was observed as a characteristic precondition before the onset of a major warming (Labitzke, 1977; 1981a). Often, the amplification of height-wave 1 starts in the troposphere, e.g., with a blocking situation over the area near Iceland, and a few days later the maximum of height-wave 1 is reached in the stratosphere and also in the mesosphere (Labitzke, 1981a). It should be noted that height-wave 1 is often already rather large in the stratosphere when the pulse which leads to the strong intensification arrives, propagating upwards from the troposphere. This indicates that both in the stratosphere and in the troposphere the right conditions must be met to lead to the development of a major warming. The breakdown (circulation reversal) of the polar vortex sometimes follows the period of large amplitudes of height-wave 1 (i.e., values above 700 gpm at 60 N, 30-mbar level) immediately, like in January 1973, but it may take two weeks until the reversal of the temperature gradient is achieved, like in January 1968 or February 1979. The breakdown is often accompanied by a concurrent development of height-wave 2 (the "disturbed" wave 2; Labitzke, 1982b), reflecting the split of the vortex. But there are also major warming cases without the development of wave 2, like, e.g., in January 1970 and 1977, or in March 1980 (cf. Figure 5).

(c) Description of Two Characteristically Different Winters

It is beyond the scope of this book to describe all the winters in detail. Therefore, we shall concentrate on the description of two winters which contain the characteristics of: an undisturbed, cold

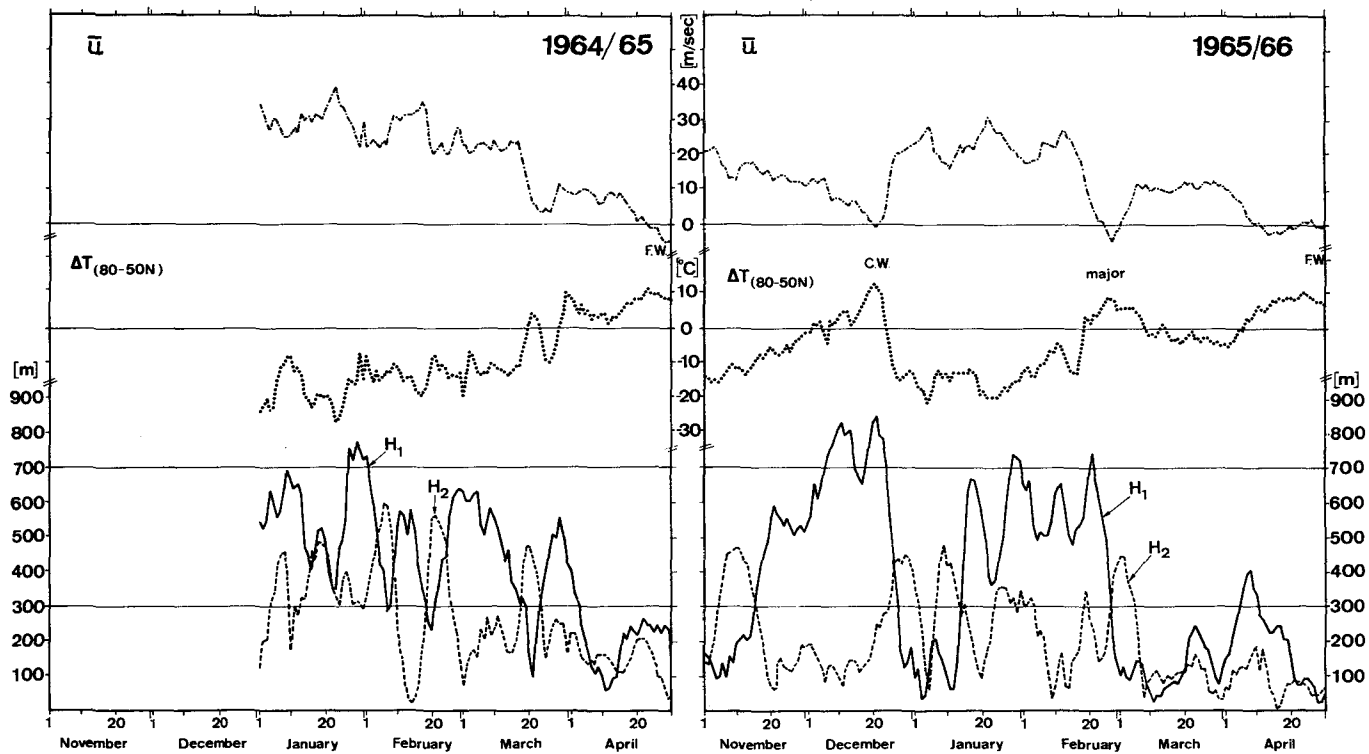

Figure 5 For the winters 1964/65 - 1980/81, at the 30-mbar level: daily values of the mean zonal wind [m sec^{-1}] at 60 N; daily values of the temperature difference [$^{\circ}\text{C}$] between 80 and 50 N; daily values of the amplitudes [geopot. m] of the zonal harmonic height-wave 1 (solid lines) and height-wave 2 (broken lines), at 60 N.

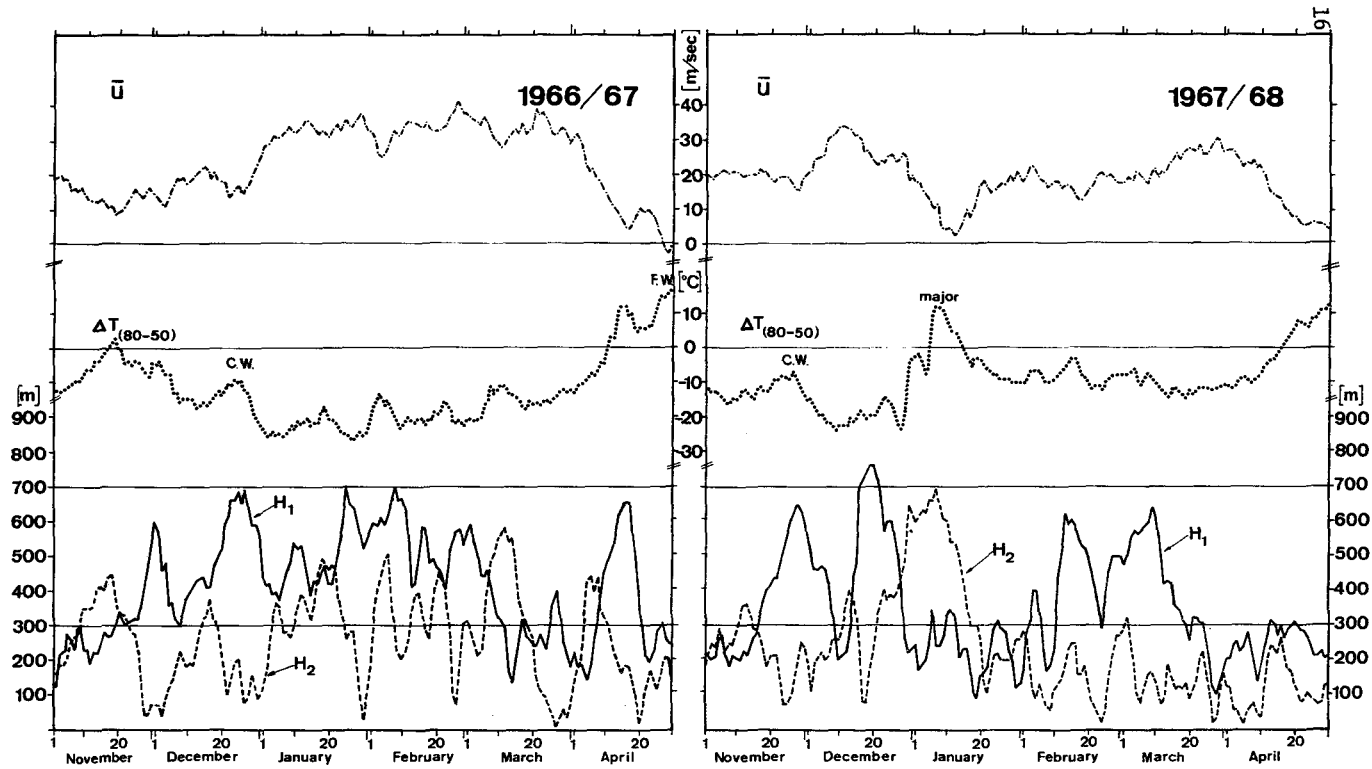

Figure 5 (continued)

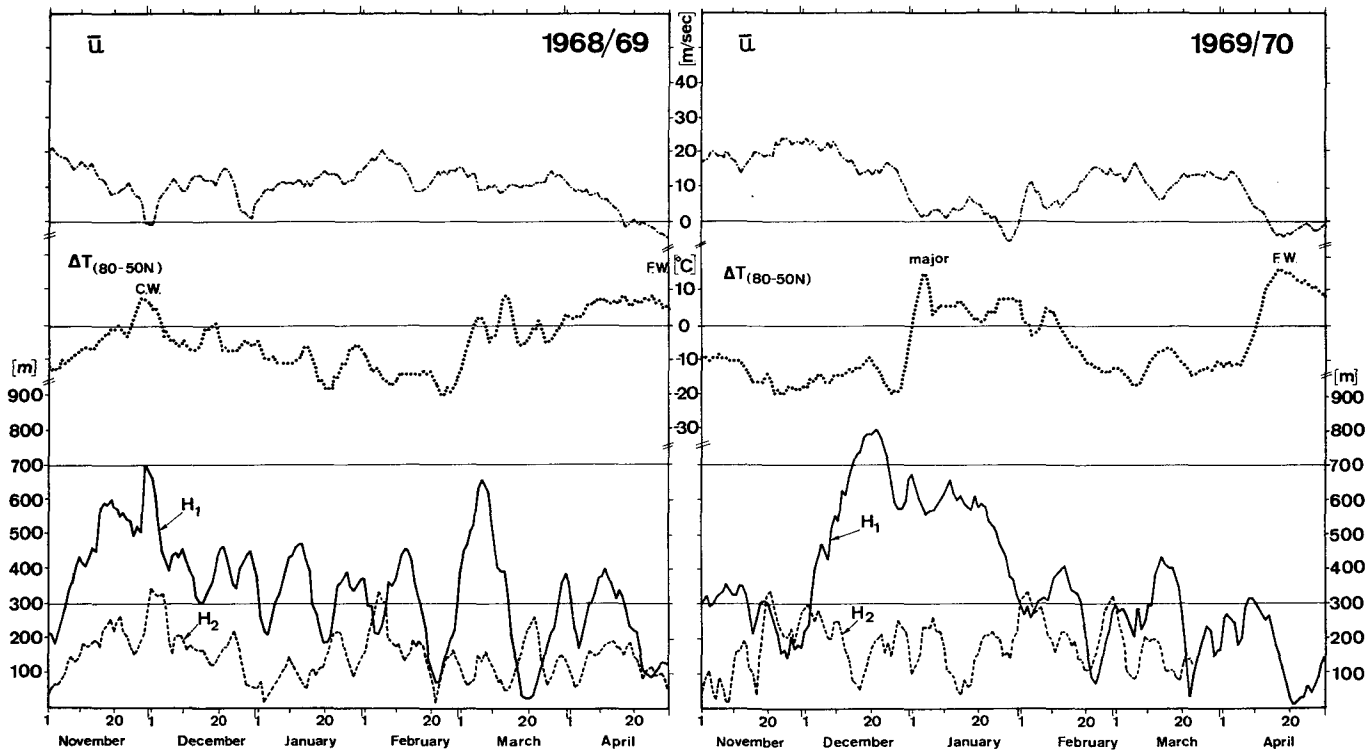

Figure 5 (continued)

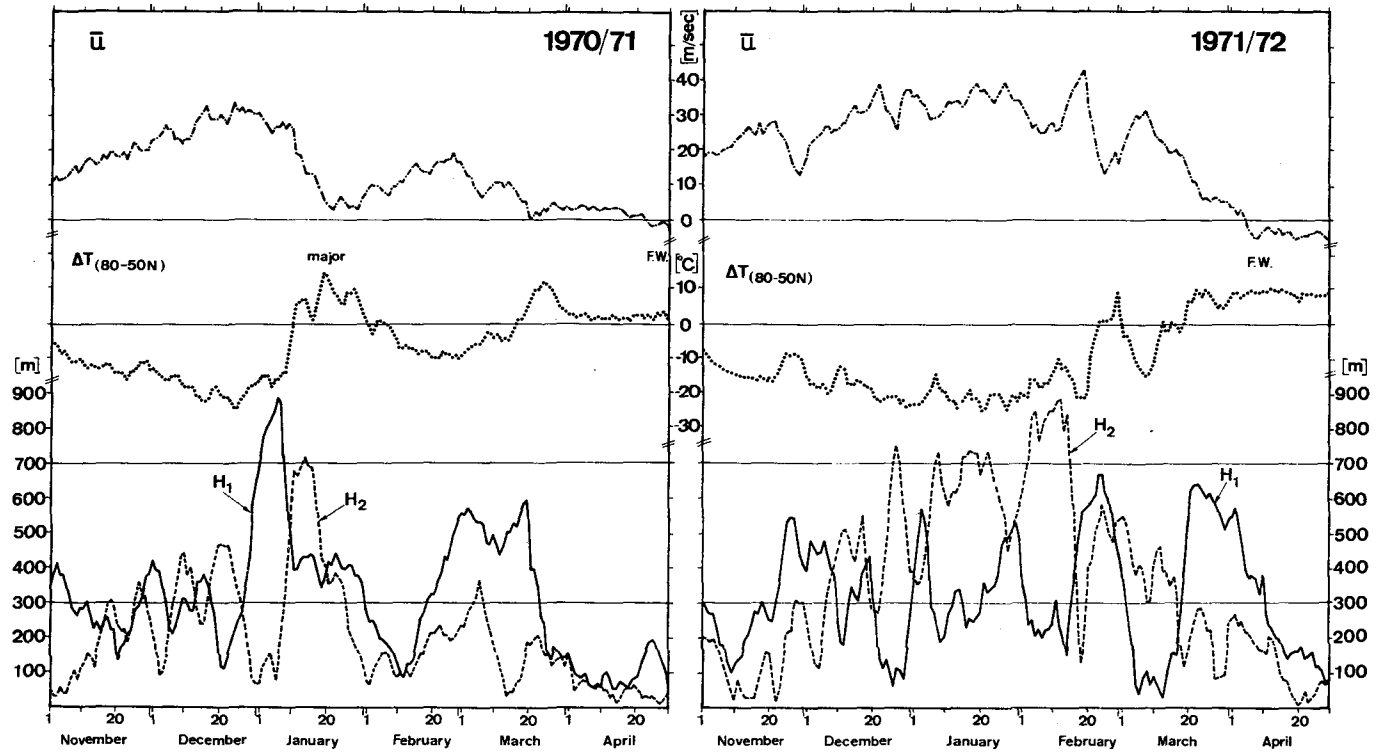

Figure 5 (continued)

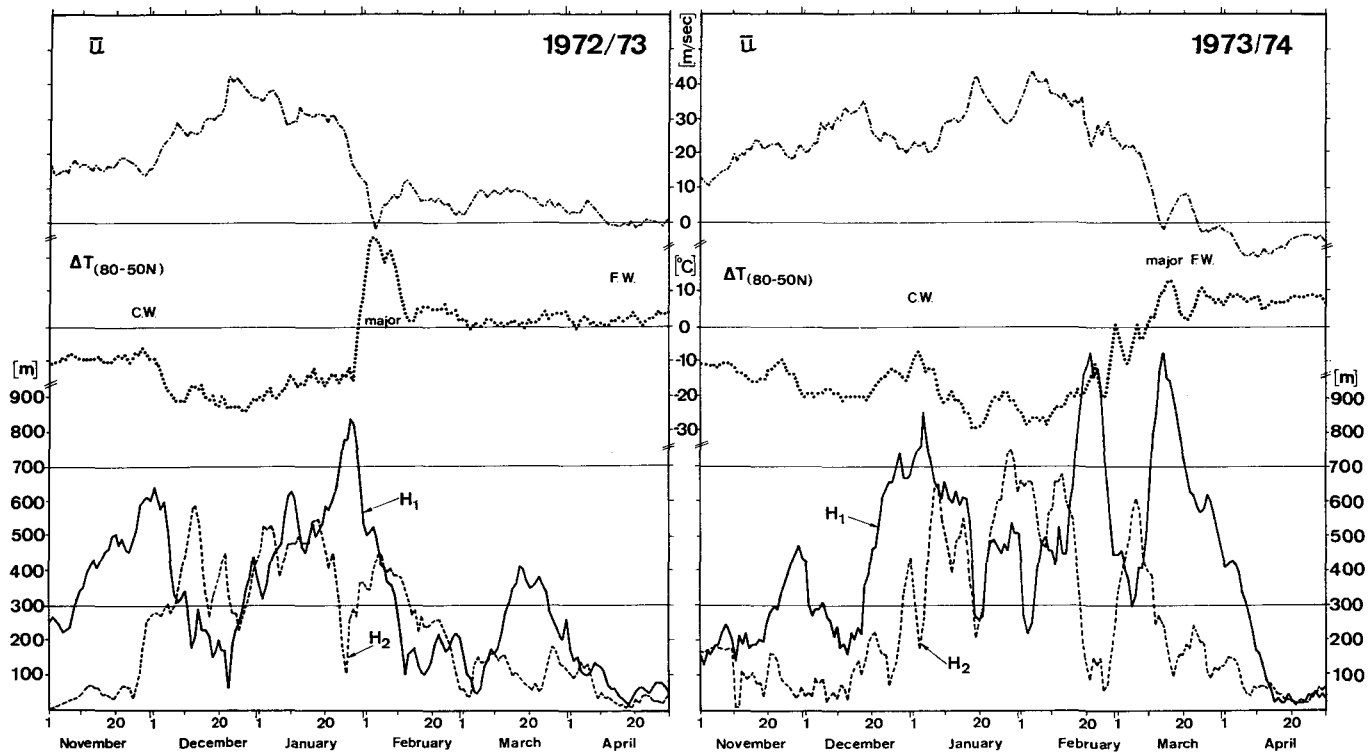

Figure 5 (continued)

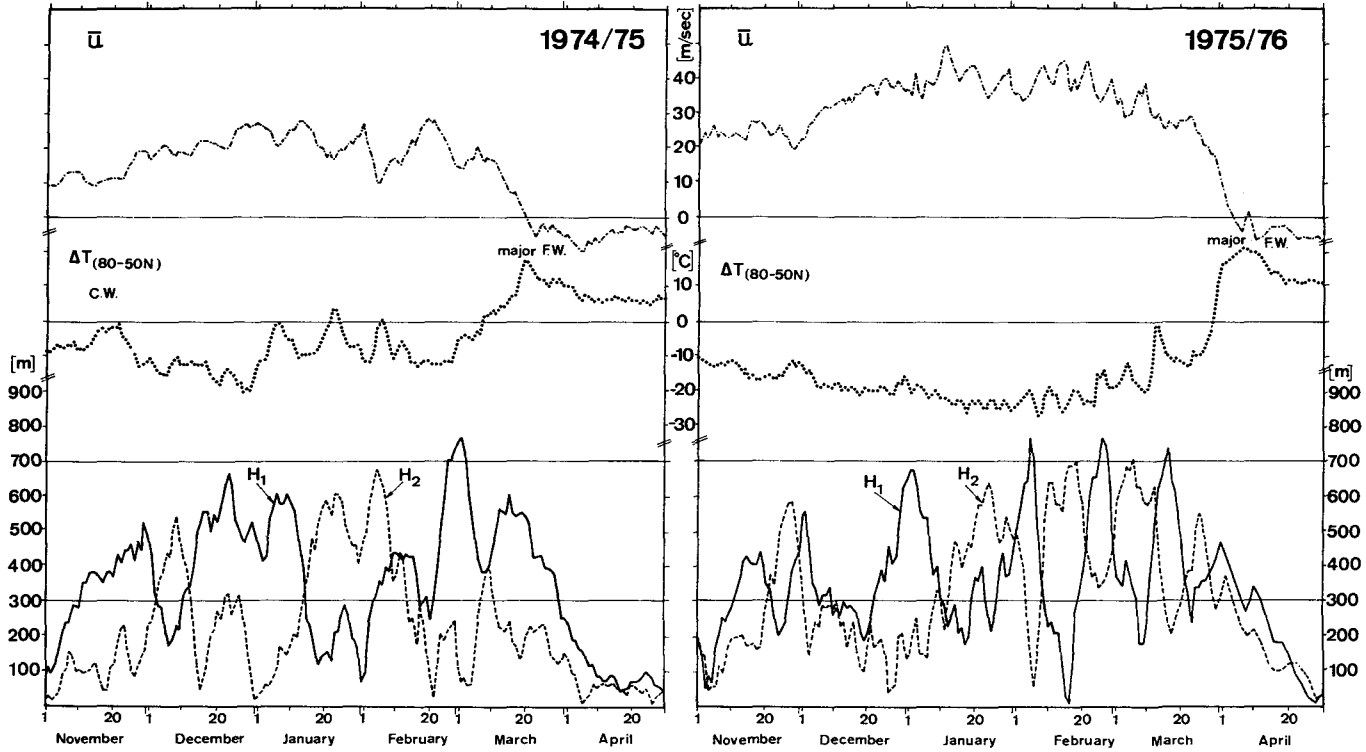

Figure 5 (continued)

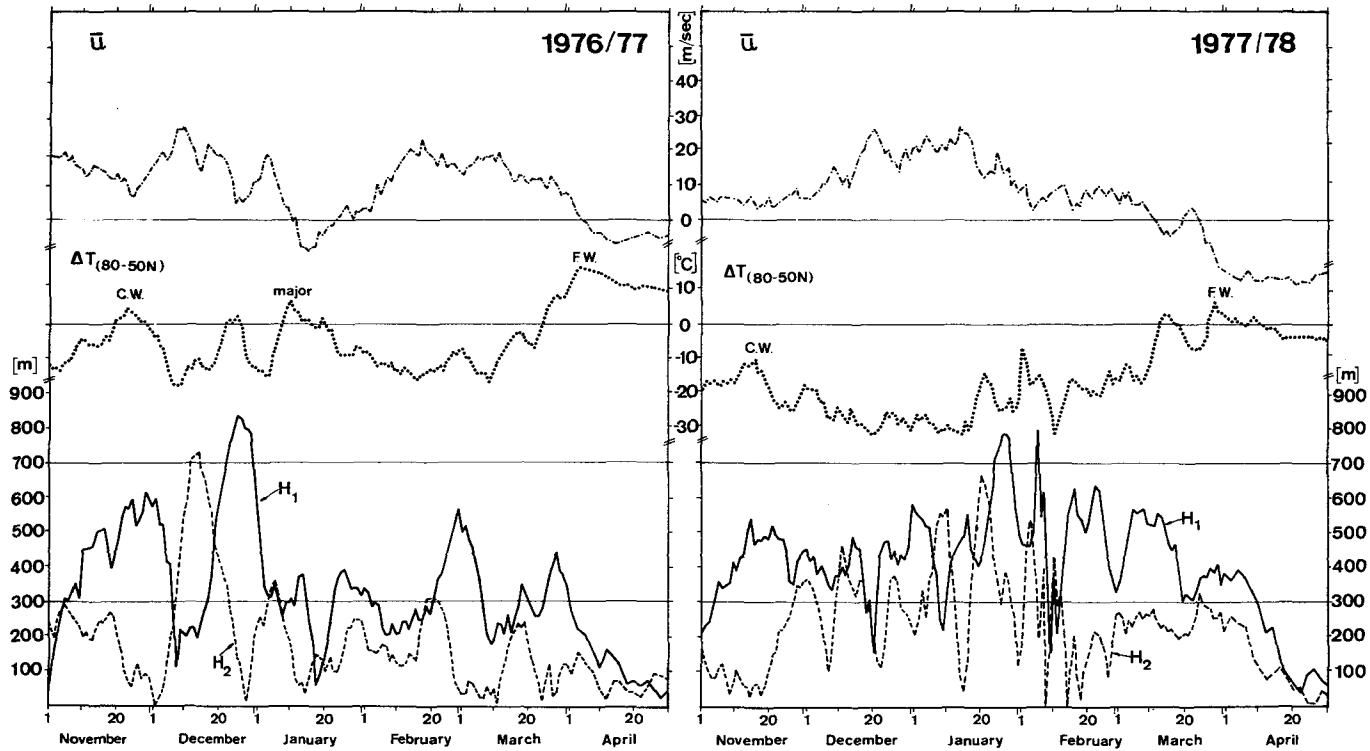

Figure 5 (continued)

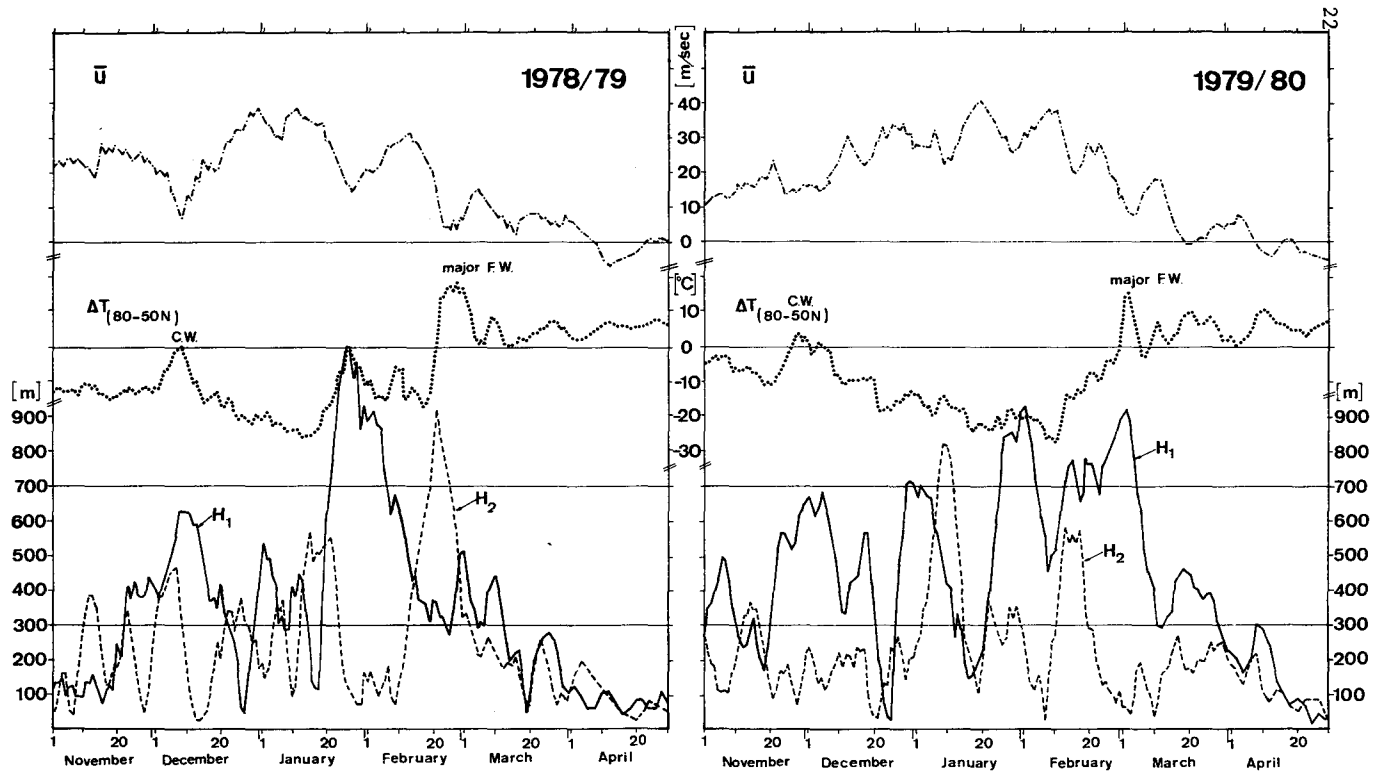

Figure 5 (continued)

winter, 1975/76; and a winter perturbed by a major warming, 1980/81.

The Winter 1975/76

The information given in Table 2 classifies the winter 1975/76 as a cold winter, with the 5-month period November-March belonging to the group of C-months (cf. "The interannual variability during the northern winters"). Only during one other winter of the observational period, i.e., during the winter 1964/65, the whole 5-month period belonged to the group of C-months. It is of interest to note that during both winters (1964/65 and 1975/76) the sunspot numbers reached a minimum. It was further discussed that the C-months are dominated by an elongation of the polar vortex, resulting in a strong development of the "normal" height-wave 2, which is connected with a well developed stratospheric polar jet stream and a strong temperature gradient between 50 N and the North Pole (Labitzke, 1982b). These features can be found in Figure 5 (page 20) for selected latitudes, but in much more detail in Annex B; pages 135-143.

ad plot (a), page 135: During most of the winter the maximum of the jet was situated between 60 and 70 N; the mean zonal winds were strong, with values larger than 40 m/sec during several longer periods. A comparison with the other winters given in Annex B shows that actually during no other winter the number of days with wind speeds above 40 m/sec was as large as during the winter 1975/76 (see also Table 4): 53 days in 1975/76, 30 days in 1966/67, 16 days in 1973/74, and 27 days in 1980/81. All these winters belong to the "westerly" category and are connected with C-months (cf. Table 3).

ad plot (b), page 135: The mean zonal temperatures show remarkable small variations; the polar region was colder than -75 C from December-February and for this region the winter period November-March was the coldest of all 16 winters given in Annex B; but it was also the coldest winter since 1955/56 (cf. Table 2).

ad plot (c)-(f), pages 136-137: The amplitudes of the height and temperature-waves 1 and 2 are of opposite intensity most of the time; the maxima show very little variation with latitude, they stayed between 60 and 70 N; the temperature-wave 2 (plot (f) on page 137) was developed strongest with respect to the other winters in Annex B: for 10 days the temperature wave was larger than 12K, a value which can be compared only with 9 days during the winter 1971/72 (cf. also Table 4). This strong development of the temperature-wave 2 was due to an elongation of the polar vortex, i.e., it was clearly a development of the "normal" wave 2, typical for the C-months. The same feature is, of course, reflected in the amplitudes of height wave 2, plot (e) on page 137. A comparison with the other winters shows that the amplitudes were larger than 640 meters on 14 days, a value surpassed only during the winter 1971/72, with 36 days (cf. Table 4).

Table 4

	Intense Wave 1	Intense Wave 2		Polar Jet		
	$H_1 \geq 960$ [m] cf. plots (c) and (d) $T_1 \geq 24$ [K] heat flux (1) ≥ 144 [K·m·sec ⁻¹], cf. (l) efficiency (1) ≥ 60 , cf. (p)	$H_2 \geq 640$ [m] cf. plots (e) and (f) $T_2 \geq 12$ [K] heat flux (2) ≥ 144 [K·m·sec ⁻¹], cf. (n) efficiency (2) ≥ 60 , cf. (r)	disturbed	normal	$\bar{u} \geq 40$ [m·sec ⁻¹] cf. plots (a)	\bar{u}_{\max} ~28 [m·sec ⁻¹]
Winter					the 2 most intense	the 2 weakest
78/79	$H_1 \geq 960$, 15d $H_1 \geq 1120$, 6d $T_1 \geq 24$, 5d heat flux (1) · 192, eff. ≥ 60 , 7d 80, 2d	before $H_2 \geq 640$, 10d $H_2 \geq 800$, 5d $T_2 \geq 12$, 3d heat flux (2) · 216, eff. ≥ 60 , 8d 80, 5d		* F.W.		
80/81	$H_1 \geq 960$, 13d $H_1 \geq 1120$, 5d $T_1 \geq 24$, 13d $T_1 \geq 28$, 1d heat flux (1) · 216, eff. ≥ 60 , 10d	heat flux (2) · eff. > 60 , 3d		*		
73/74	$H_1 \geq 960$, 15d $T_1 \geq 24$, 7d heat flux (1) · 144, eff. > 60 , 3d			* F.W.	$H_2 \geq 640$, 11d February · C	
79/80	$H_1 \geq 960$, 5d $T_1 \geq 24$, 7d heat flux (1) · 144, eff. > 60 , 5d	$T_2 \geq 12$, 1d heat flux (2) · eff. > 60 , 4d		* F.W.	$H_2 \geq 640$, 6d January · C	
70/71	$H_1 \geq 960$, 3d heat flux (1) · eff. > 60 , 6d	$H_2 \geq 640$, 7d heat flux (2) · eff. > 60 , 2d		*	split of vortex	
77/78	$H_1 \geq 960$, 10d heat flux (1) · eff. > 60 , 20d					
67/68	heat flux (1) · eff. > 60 , 4d	$H_2 \geq 640$, 7d heat flux (2) · eff. > 60 , 4d		*	split of vortex	
69/70	heat flux (1) · 192, eff. > 60 , 12d > 80, 9d			*		\bar{u} (max) ~ 28 m/sec *
72/73	heat flux (1) · 168, eff. > 60 , 11d > 80, 6d			*		
65/66	heat flux (1) · 144, eff. > 60 , 8d			*		
76/77	heat flux (1) · eff. > 60 , 7d			*	$H_2 \geq 640$, 5d December · C	\bar{u} (max) ~ 28 m/sec *
74/75	heat flux (1) · eff. > 60 , 9d > 80, 2d			* F.W.	$H_2 \geq 640$, 3d heat flux (2) · eff. > 60 , 3d	
71/72		$H_2 \geq 640$, 36d $H_2 \geq 800$, 11d $T_2 \geq 12$, 9d heat flux (2) · 144, eff. > 60 , 8d minor warming			4·C	
75/76		$H_2 \geq 640$, 14d $T_2 \geq 12$, 10d			5·C	$\bar{u} \geq 40$, 53d 5·C
66/67	$T_1 \geq 24$, 3d heat flux (1) · eff. > 60 , 5d				January C	$\bar{u} \geq 40$, 30d 3·C
68/69	heat flux (1) · eff. > 60 , 34d > 80, 4d					

As regards the derived quantities, we should like to concentrate the discussion on the heat flux. During the cold, relatively undisturbed winters the highest values of the heat flux in waves 1-6 (plots (h)) are usually between 100 and 150 km/sec. The heat flux by wave 1 (plots (l)) was sometimes larger than by wave 2 (plots (n)), but in 1975/76 both waves transported equally large amounts of heat northward, i.e., up to 72 units. During the winter 1971/72 twice as much heat was transported by wave 2 (i.e., 144 units) as by wave 1.

The Winter 1980/81

The winter 1980/81 was a winter with several extremes. The data in Table 2 show that over the polar region it was the coldest midwinter, December-January, since the winter 1955/56. Concurrent with these low temperatures (page 180, plot (b)), the polar night jet was very strong (page 180, plot (a)) and on 27 days the wind speed was stronger than 40 m/sec. This is typical for the cold, undisturbed winter months, as pointed out in the description of the winter 1975/76.

At the end of January height and temperature-wave 1 developed extreme intensities: with an amplitude of more than 1120 meters (page 181, (c)), height-wave 1 reached values which are comparable only to the winter 1978/79. The amplitude of the temperature wave reached 28 K (page 181, plot (d)), which has not been observed before during the 16 winters discussed here. This development led to a major warming during February. Wave 2 remained weak throughout the winter, page 182. During most of the winters with "major" events the heat flux of wave 1 was much stronger than during the undisturbed winters. During February 1981 the heat flux by waves 1-6 reached 240 km/sec (page 183) and by wave 1 216 units (page 185). These are the largest values observed during the winters discussed here. Of comparable intensity were only the winters 1969/70, 1972/73, and 1978/79 (cf. Table 4). During the 12 winters with "major" events wave 1 transported generally much more heat northward than wave 2. The only, very remarkable exception was the January/February 1979 event, when wave 2 transported up to 216 units northward (page 168), more than the also very active wave 1 (page 167). As regards wave 2, this value is indeed exceptional for the whole period under consideration here (cf. Table 4). The efficiency of wave 1 (plots (n)) was usually larger than of wave 2 (plots (p)), except for the above-mentioned January/February 1979 event.

(d) Summary of the Extremes Observed during the Winters Given in Annex B

To summarize the extremes of the 16 winters, Table 4 has been prepared. In the first column the development of height- or temperature-wave 1 is listed as "intense", if the amplitudes (contours in the plots (c) and (d)) reached values of 960 geopot. meters or 24 K, respectively. The duration of the intense developments is given in days (d), as well

as the type of winter events, if any.

Secondly, the amplitudes of the "disturbed" wave 2 (contour plots (e) and (f)) are listed: given are the number of the days during which the values reached 640 geopot. meters or 12 K, respectively. The five strongest developments of wave 1 are all coupled with "major" events, and two of them with the "disturbed" wave 2. It is puzzling that height-wave 1 appears to be strongest during the latter part of the observational period, with the exception of 1973/74. The "major" warming 1967/68 is listed only with the "disturbed" wave 2, as wave 1, though strongly developed (Figure 5b) did not reach the values observed later.

Thirdly, the "normal" wave 2 is given for the periods when the amplitudes reached 640 meters or 12 K, respectively. Typically, these cases are connected with C-months. In the fourth and fifth column the two years with the most intense polar jet and the two years with the weakest jet are given. It is of great interest to compare the structure of the strong jet, e.g., 1975/76 (page 135) with the structure of the the weak jet, e.g., 1976/77 (page 144). While the jet was well developed already in November 1975 and remained intense with its maximum remaining between 60 and 70 N, the jet was weak already in November 1976 and did not develop to any noticeable size before the "major" warming in January 1977. At first, Table 4 has been compiled in listing the number of days when certain maximal values of the amplitudes of height- and temperature-waves 1 and 2, or of the heat flux by waves 1 or 2 had been reached. Later, the number of days has been added when the efficiency (/100) of the heat flux (by the respective waves) reached 60 or more. It is not surprising that during all periods with strong heat transport (values larger than 144 units) the efficiency was also large. But it is of interest that the efficiency of the heat flux was also large during some "major" warmings which did not reach the pre-selected maximal values of the amplitudes of the waves, like, e.g., in 1967/68 or 1976/77, as regards wave 1.

It is important to note that during most winters, periods with high efficiency of both waves are linked with "major" events. As regards wave 1, only two exceptions must be mentioned: 1) In 1977/78 the heat flux by wave 1 was very efficient during several periods which were connected with large amplitudes of height-wave 1 and intense "minor" warmings, which have not been dealt with in this text; 2) In 1968/69 the heat flux by wave 1 was very efficient during several periods, again in connection with "minor" warmings in the upper stratosphere, although wave 1 was only weakly developed most of the time. As regards wave 2, the heat flux by the "normal" wave 2 was efficient only during February 1972, again in connection with a "minor" warming, and during 3 days in February 1975.

CONCLUDING REMARKS

We tried to demonstrate the variability of the northern winters in the middle stratosphere. As can be seen in the comprehensive material presented, the midwinter disturbances are important events, and their occurrence or non-occurrence characterizes the type of the winter. There appears to be an indication that the QBO modulates the winters, and some facts hint also to a modulation by the sunspot cycle. We hope that the material given here will be of use for climatologists as well as for modellers who have ample opportunities to compare their results with the ever changing nature. Hopefully, some of the questions raised here can be answered through the joint efforts within MAP.

ACKNOWLEDGEMENTS

We thank the members of the Stratospheric Research Group for professional and technical assistance: Mrs. B. Mitschke did most of the drawings, Miss S. Vortmüller organized all the plots for Annex B; Figure 5 is taken from the Ms. Thesis of Mrs. R. Wohlfart (1981). This research was supported by the Deutsche Forschungsgemeinschaft (La 372/9-3). Mrs. M. Scholz typed the manuscript.

REFERENCES

- Charney, J. G., and P. G. Drazin (1961), Propagation of planetary-scale disturbances from the lower into the upper atmosphere, *J. Geophys. Res.*, 66, 83-109.
- Goretzki, B., (1981), Der normierte warmefluß in der stratosphäre als Maß für den wirkungsgrad der planetarischen wellen, Diplom-Arbeit, F.B. 24, F.U. Berlin.
- Holton, J. R., and H. C. Tan (1980), The influence of the equatorial quasi-biennial oscillation on the global circulation at 50 mbar, *J. Atmos. Sci.*, 37, 2200-2208.
- Labitzke, K., (1977), Interannual variability of the winter stratosphere in the northern hemisphere, *Mon. Wea. Rev.*, 105, 762-770.
- Labitzke, K., (1981a), The amplification of height-wave 1 in January 1979: A characteristic precondition for a major warming in February *Mon. Wea. Rev.*, 109, 983-989.
- Labitzke, K., (1981b), Stratospheric-mesospheric midwinter disturbances: A summary of observed characteristics, *J. Geophys. Res.*, 86, 9665-
- Labitzke, K., (1982a), On the interannual variability of the middle stratosphere during the northern winters, *J. Japan. Met. Soc.*, 60, Centennial Issue.

- Labitzke, K., (1982b), A note on the different height-wave 2 patterns in the stratosphere, Mon. Wea. Rev., 110, (submitted for publication).
- Muench, H. S., and T. S. Borden (1962), Atlas of monthly mean stratospheric charts, 1955-1959, Air Force Surv. Geophys., 141.
- Naujokat, B., (1981), Long-term variations in the stratosphere of the northern hemisphere during the last two sunspot cycles, J. Geophys. Res., 86, (in press).
- Oort, A. H., and E. M. Rasmusson (1971), Atmospheric circulation statistics, NOAA Prof. Paper, 5, 323 pp.
- Wohlfart, R.-C. (1981), Darstellung charakteristischer kenngrößen der mittleren stratosphäre im nordwinter, unter besonderer berucksichtigung des "Final Warmings", Diplom-Arbeit, F.B. 24, F.U. Berlin.

Part 2. Annex A: Long-Term Monthly Mean 30-mbar Maps: Geopotential Heights, Temperatures and Standard Deviations (15-Year Averages); Latitudinal Profiles of Mean Zonal Winds and Temperatures	Page
Latitudinal Profiles of Mean Zonal Winds and Temperatures	31
Long-Term Monthly Mean 30-mbar Maps: Geopotential Heights, Temperatures and Standard Deviations (15-Year Averages)	32

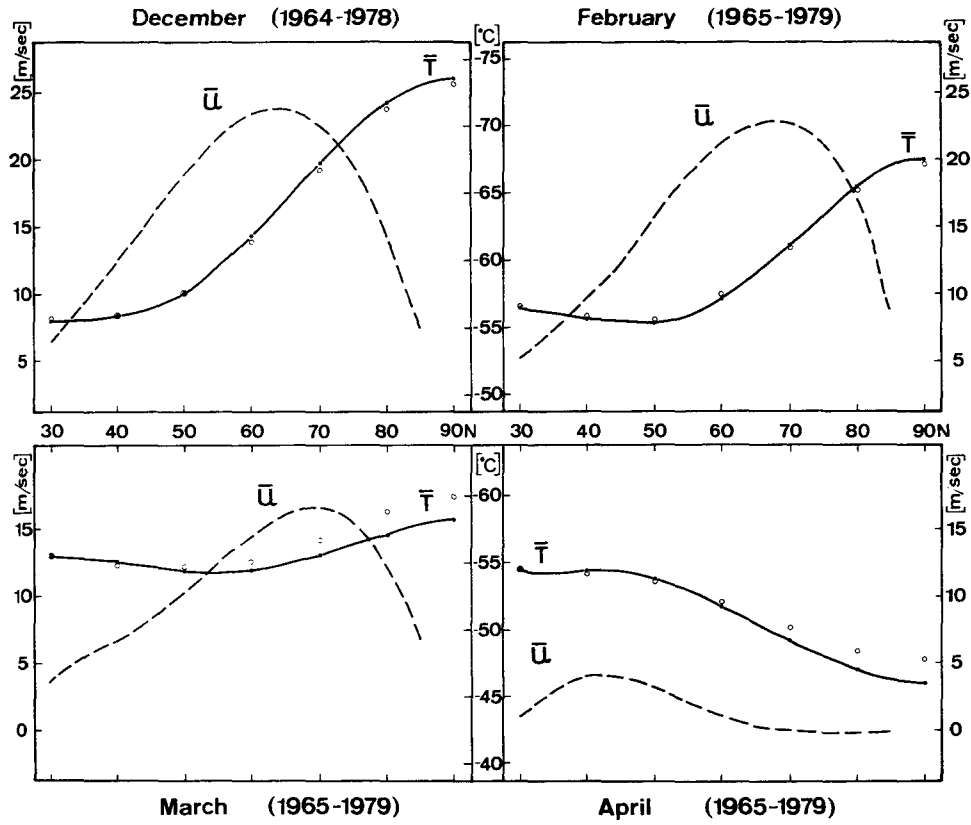

Figure A.1 Meridional profiles of the zonal mean winds (m/sec) and temperatures (°C), at the 30-mbar level averaged over 15 years. (o are zonal mean temperatures of a 10-year average.)

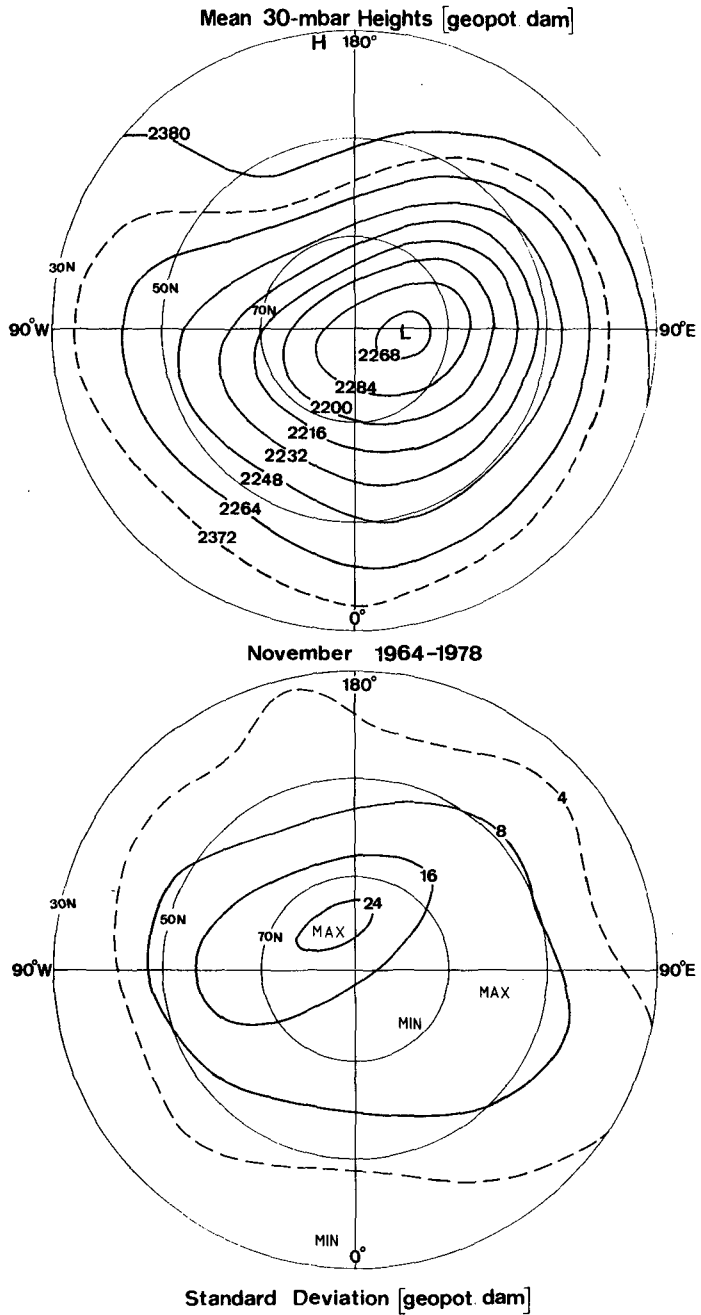

Figure A.2

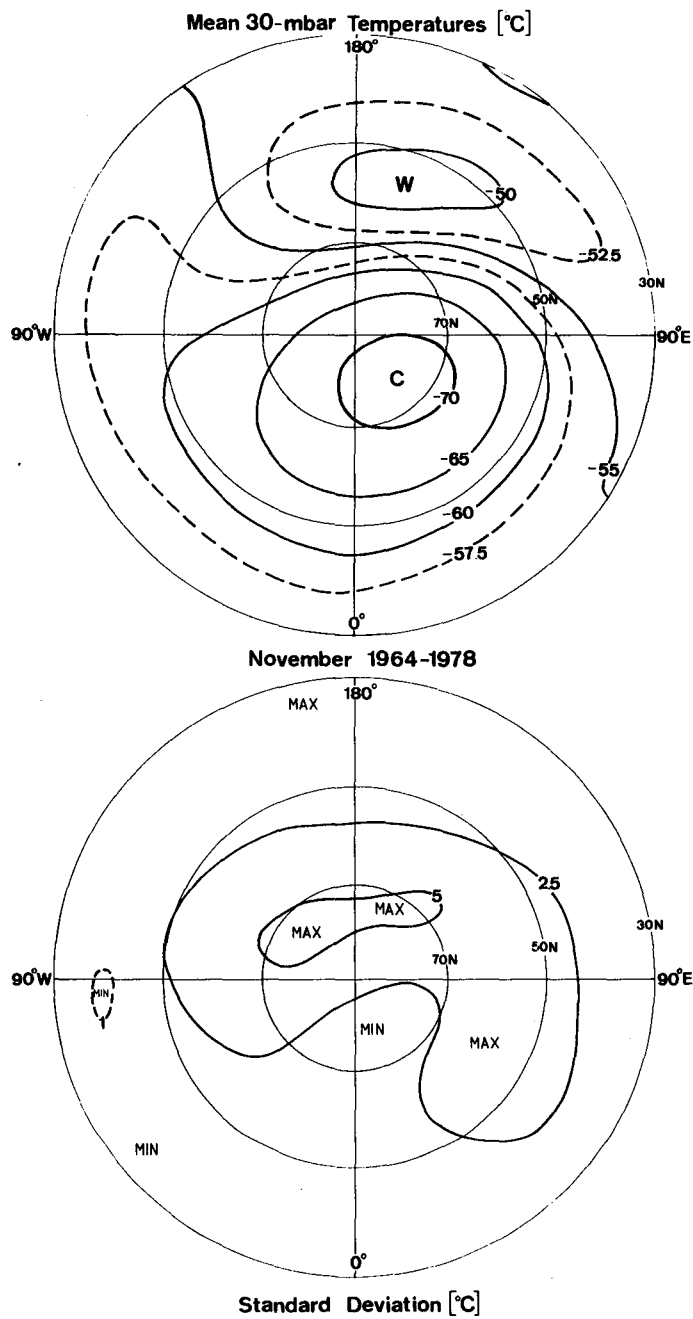

Figure A.3

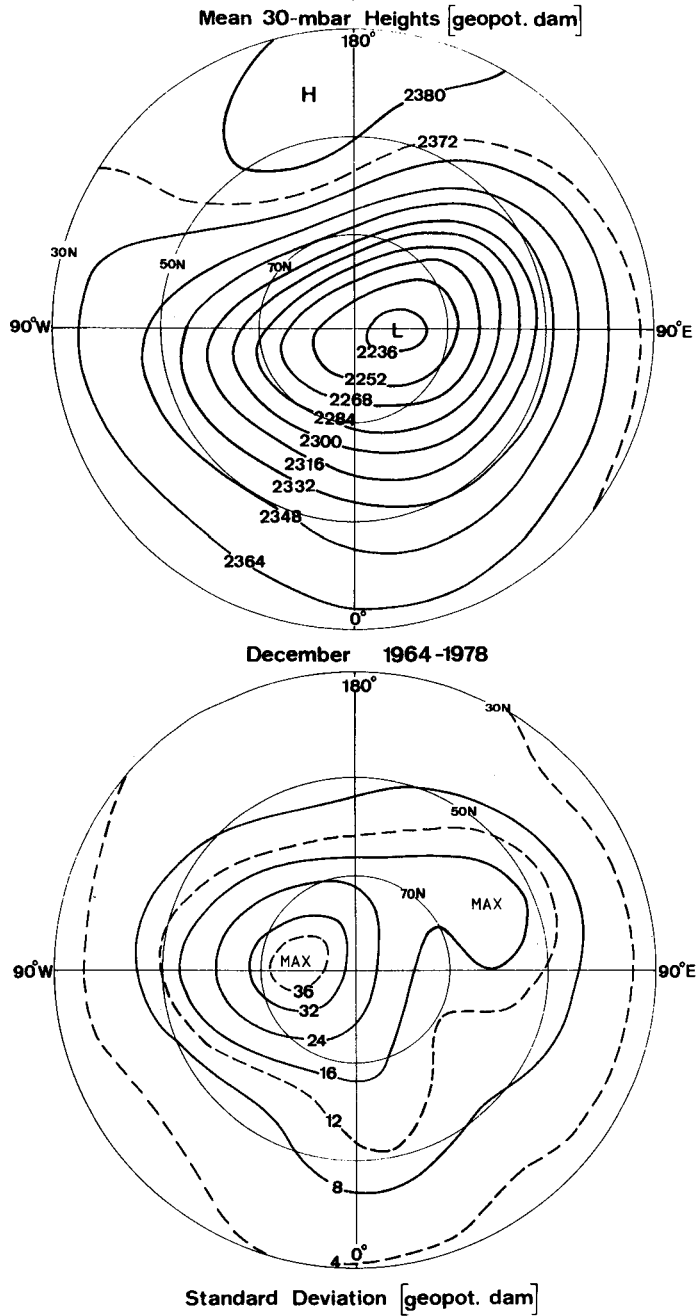

Figure A.4

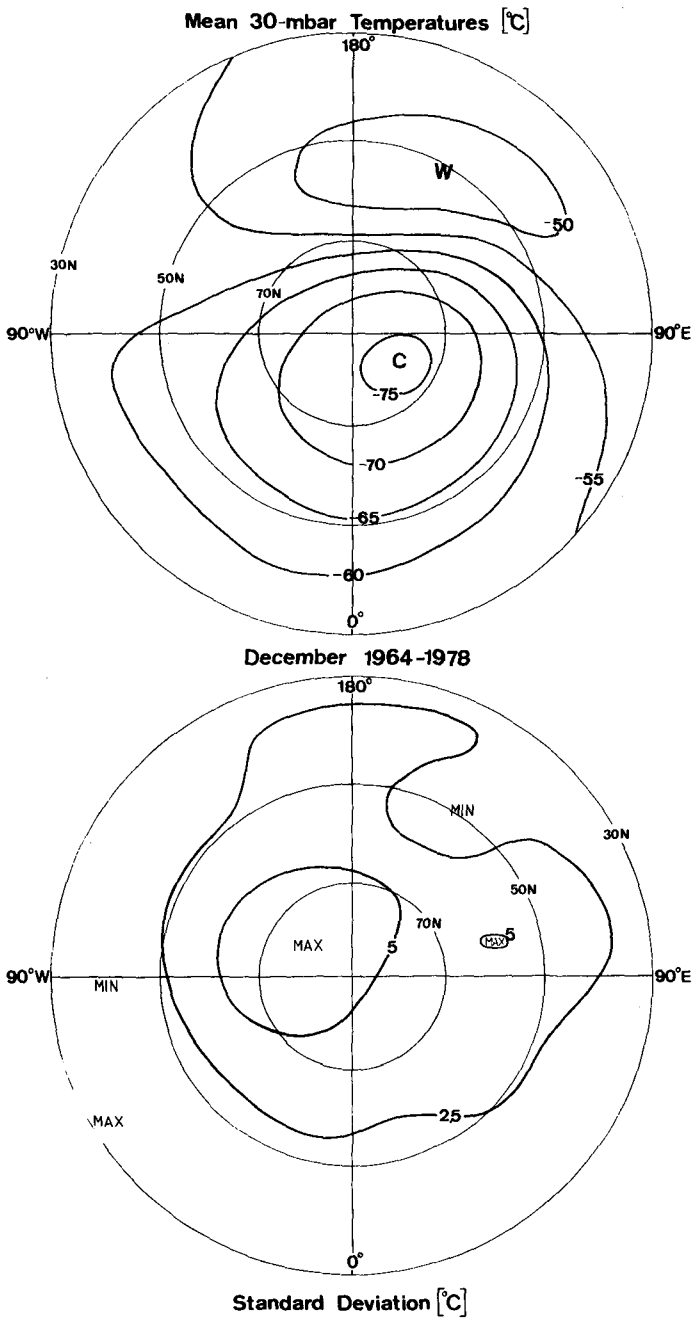

Figure A.5

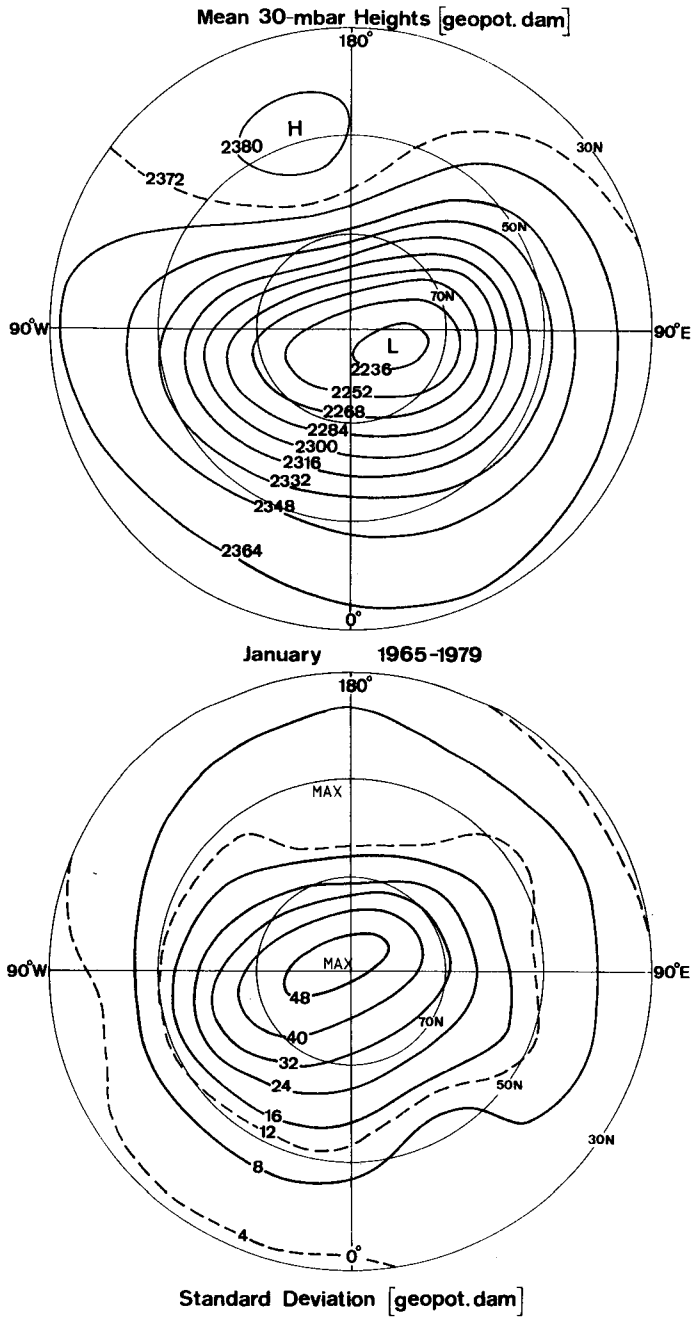

Figure A.6

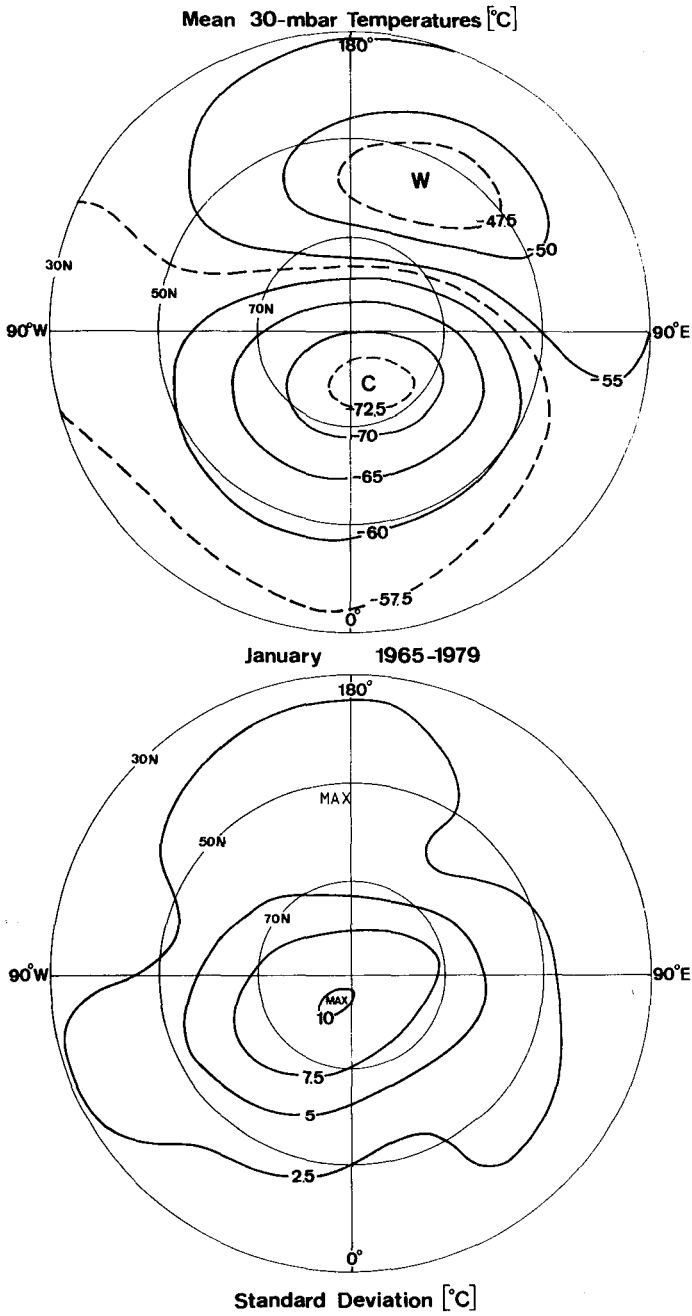

Figure A.7

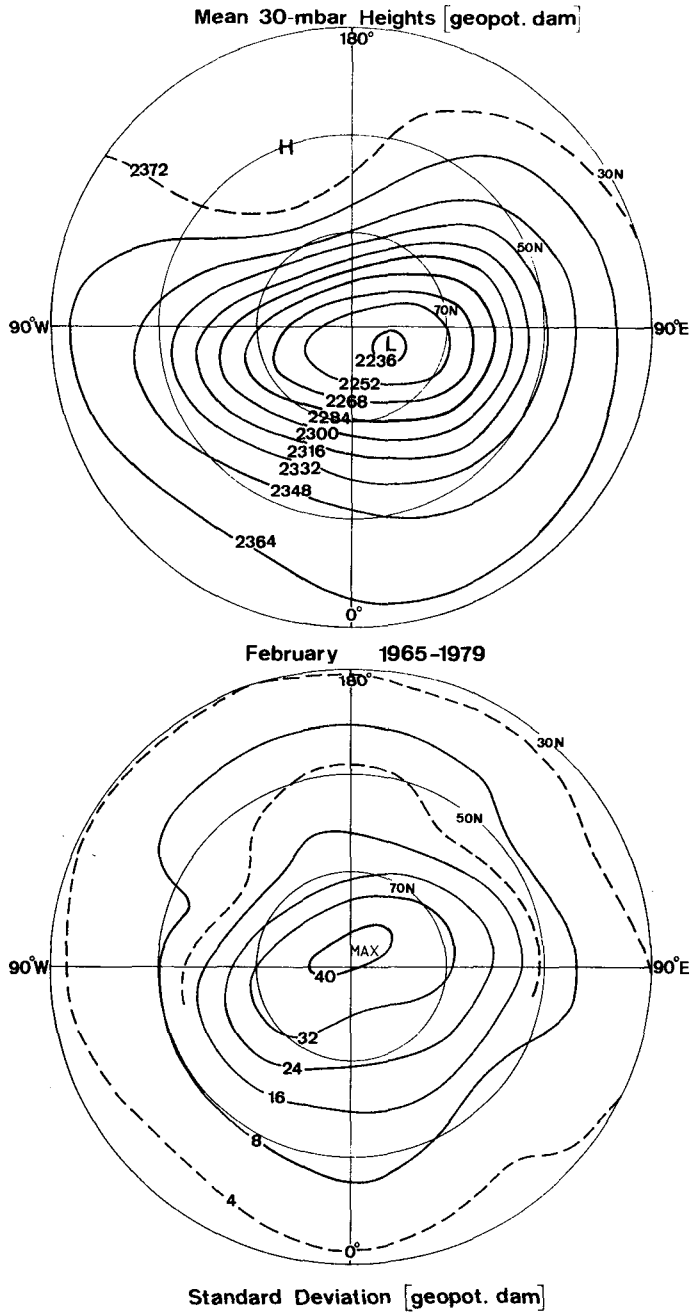

Figure A.8

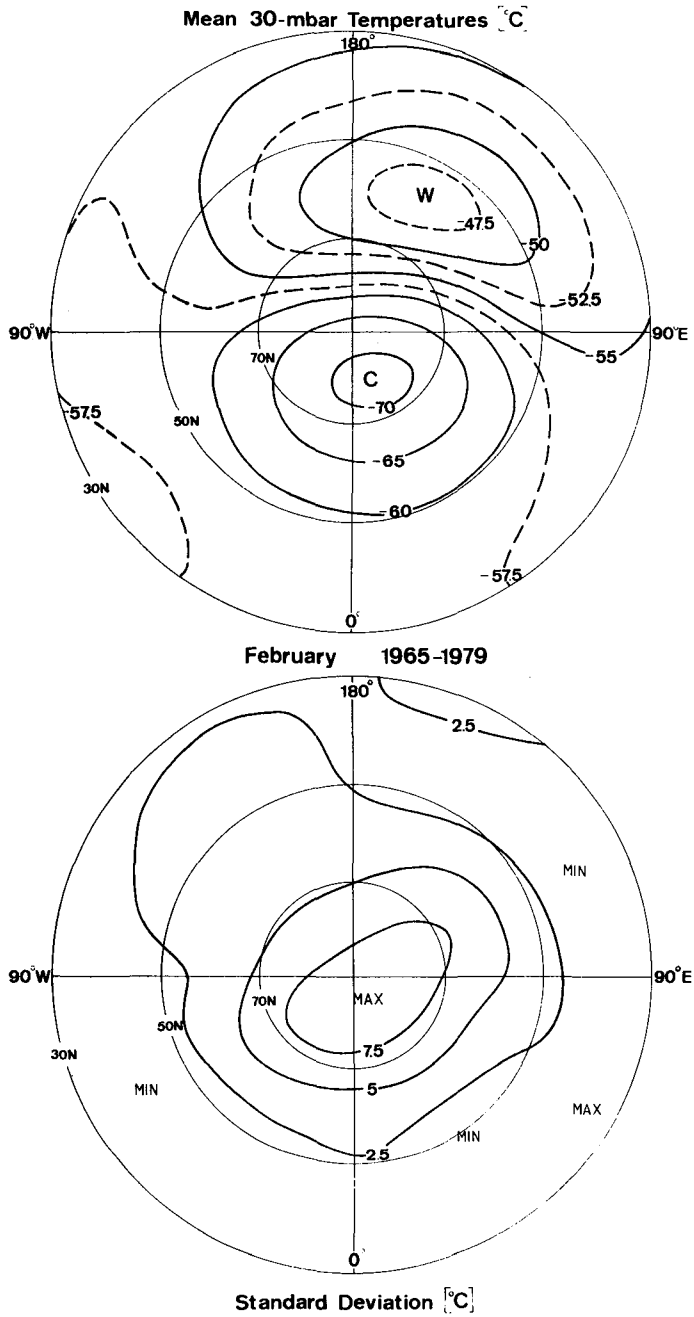

Figure A.9

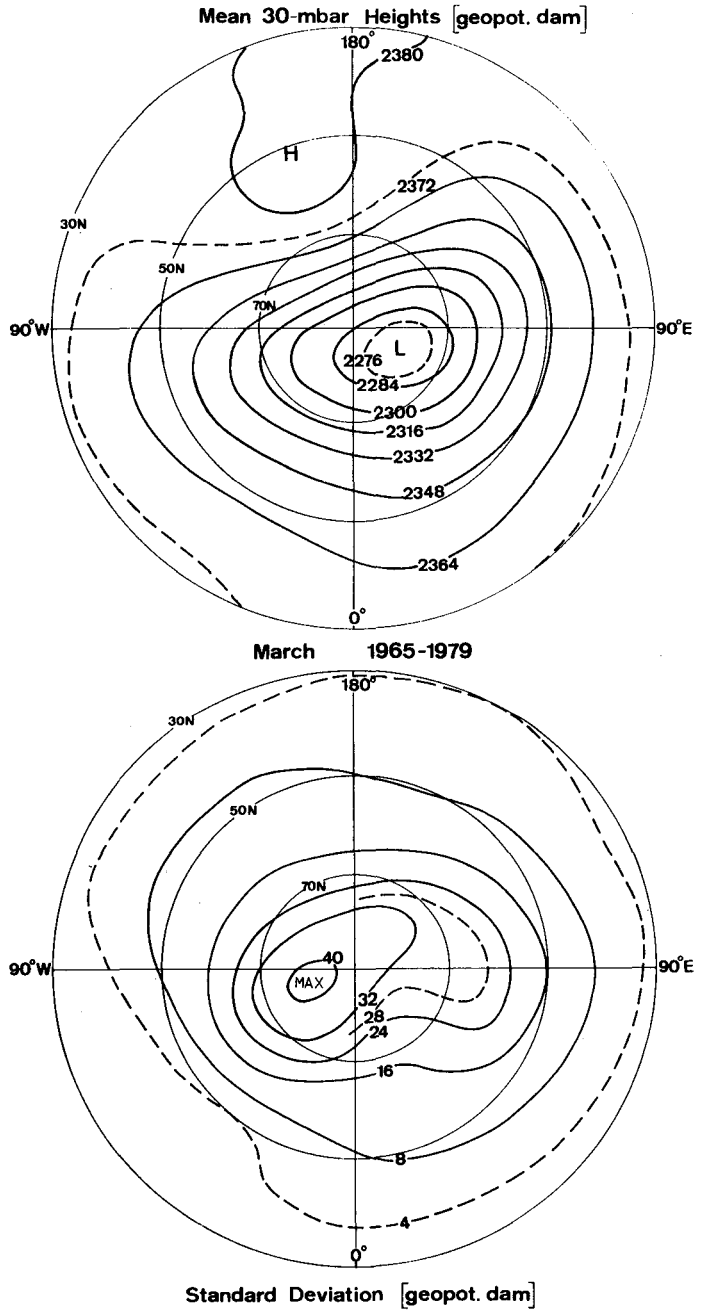

Figure A.10

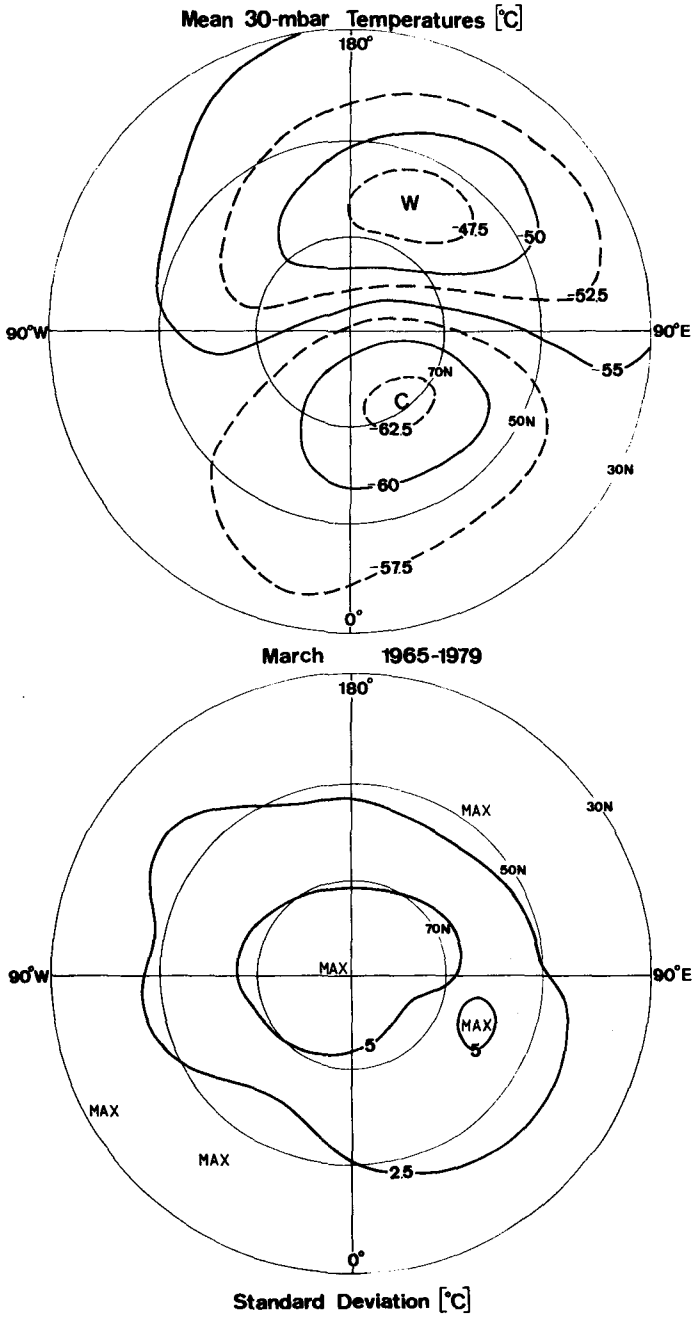

Figure A.11

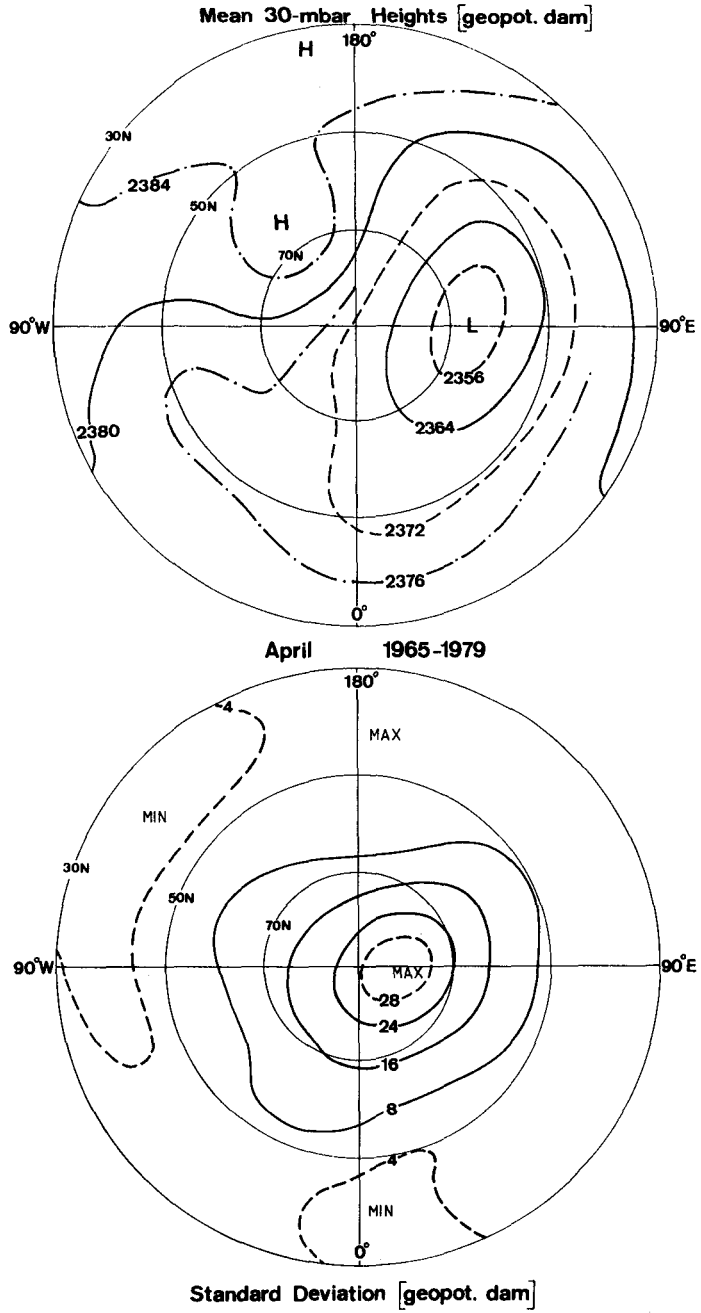

Figure A.12

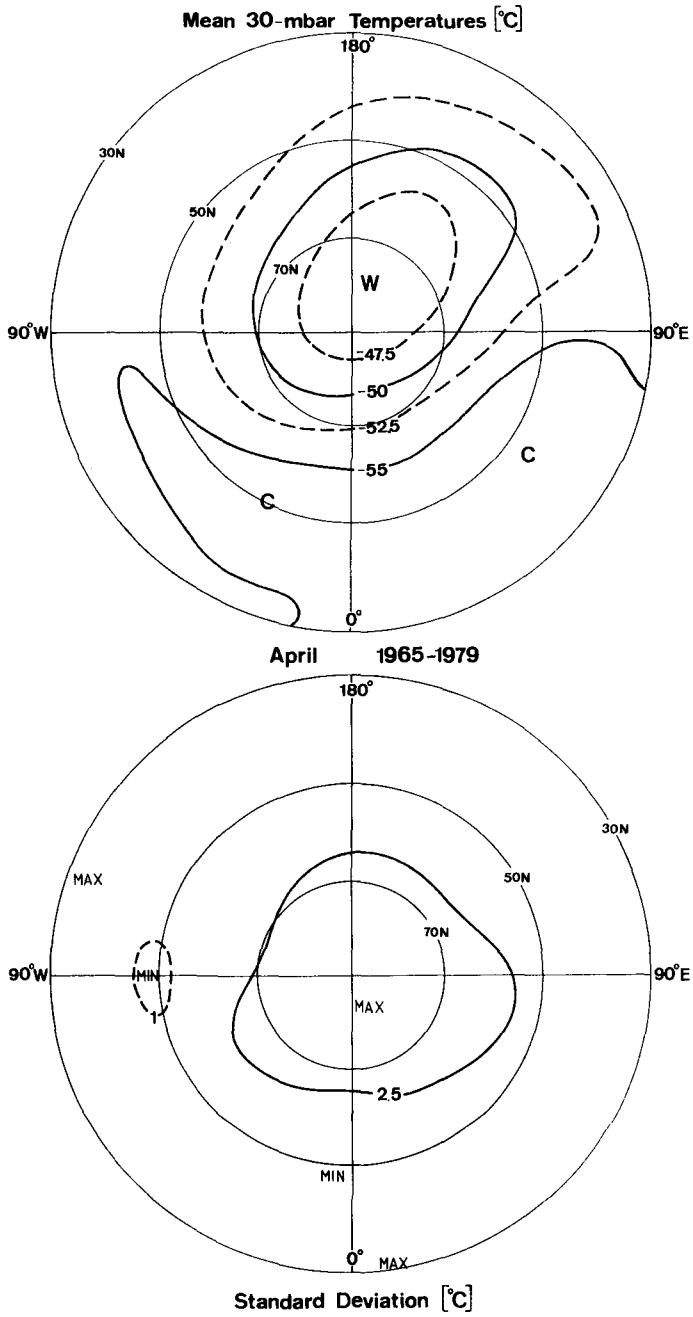

Figure A.13

Part 3. Annex B: Meridional Time Sections of Derived Quantities for the 16 Winters 1965/66 - 1980/81	Page
1965/66	45
1966/67	54
1967/68	63
1968/69	72
1969/70	81
1970/71	90
1971/72	99
1972/73	108
1973/74	117
1974/75	126
1975/76	135
1976/77	144
1977/78	153
1978/79	162
1979/80	171
1980/81	180

- a) Mean zonal winds (m/sec)
- b) Mean zonal temperatures ($^{\circ}\text{C}$)
- c) Amplitudes of height-wave 1 (geopot. m)
- d) Amplitudes of temperature-wave 1 (K)
- e) Amplitudes of height-wave 2 (geopot. m)
- f) Amplitudes of temperature-wave 2 (K)
- g) Momentum flux of waves 1-6 (m^2/sec^2)
- h) Heat flux of waves 1-6 ($\text{K}\cdot\text{m}/\text{sec}$)
- i) Efficiency of the momentum flux by waves 1-6; (/100)
- j) Efficiency of the heat flux by waves 1-6; (/100)
- k) Momentum flux of wave 1 (m^2/sec^2)
- l) Heat flux of wave 1 ($\text{K}\cdot\text{m}/\text{sec}$)
- m) Momentum flux of wave 2 (m^2/sec^2)
- n) Heat flux of wave 2 ($\text{K}\cdot\text{m}/\text{sec}$)
- o) Efficiency of the momentum flux by wave 1 (/100)
- p) Efficiency of the heat flux by wave 1; (/100)
- q) Efficiency of the momentum flux by wave 2; (/100)
- r) Efficiency of the heat flux by wave 2; (/100)

(Note that for clearness the zero-lines have been omitted in (g)-(r).)

1965/66

MEAN ZONAL WIND

MEAN ZONAL TEMP.

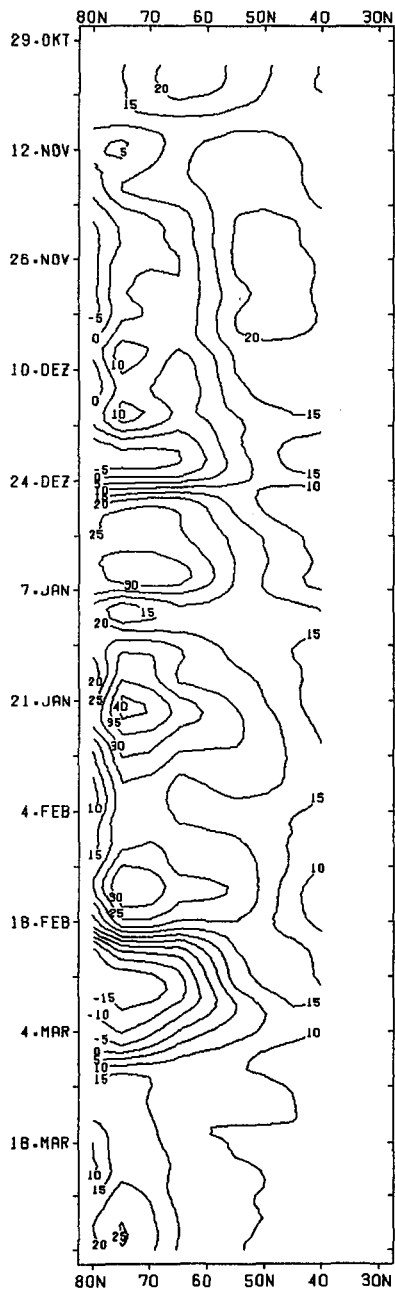

a

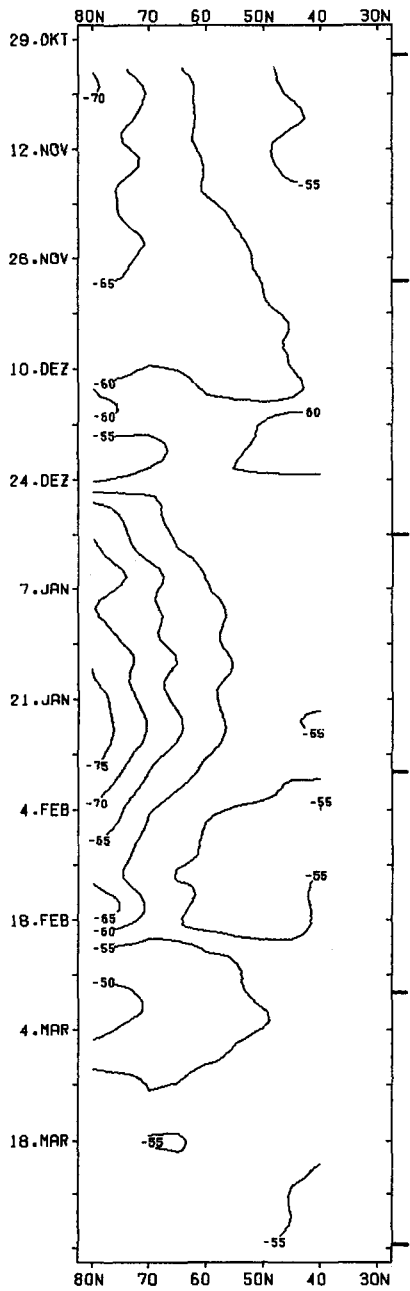

b

C.W.

*

C

Figure B.1

HEIGHT WAVE 1

TEMP. WAVE 1

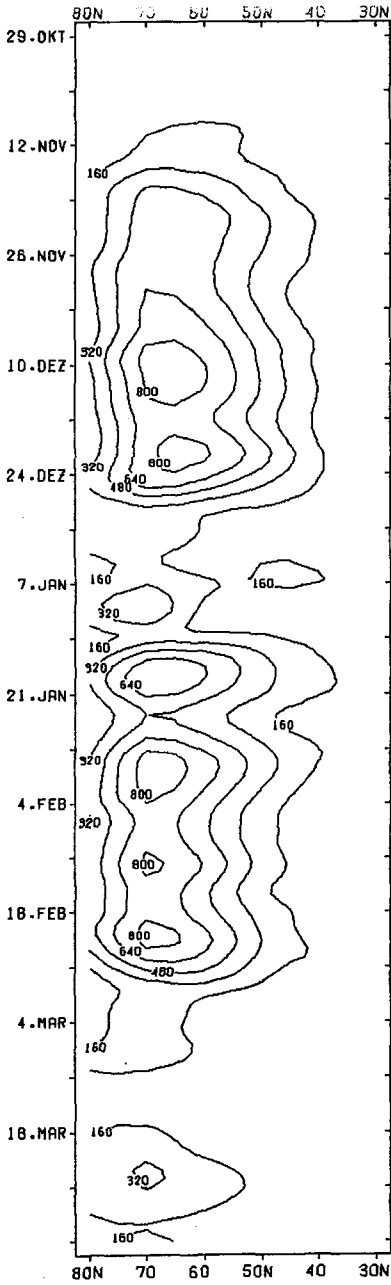

c

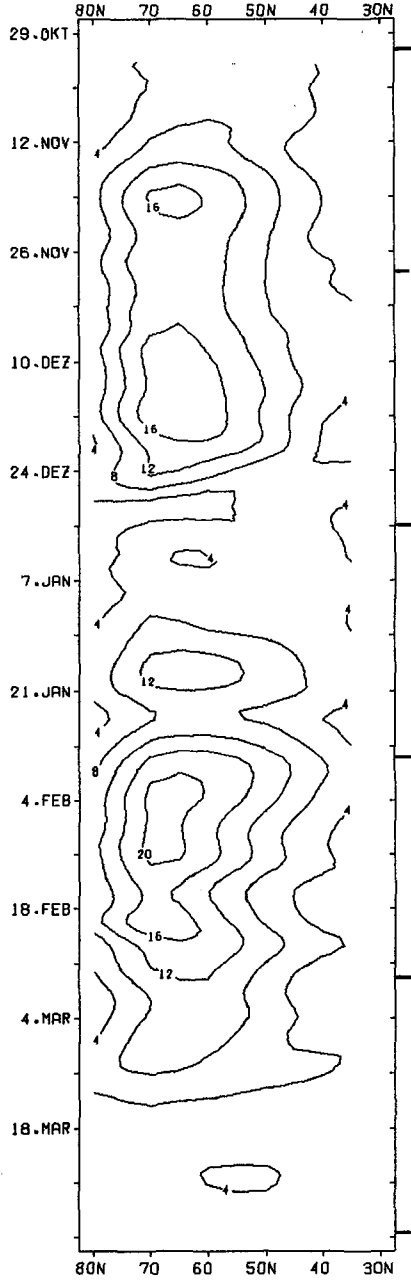

C.W.

*

d

Figure B.2

HEIGHT WAVE 2

TEMP WAVE 2

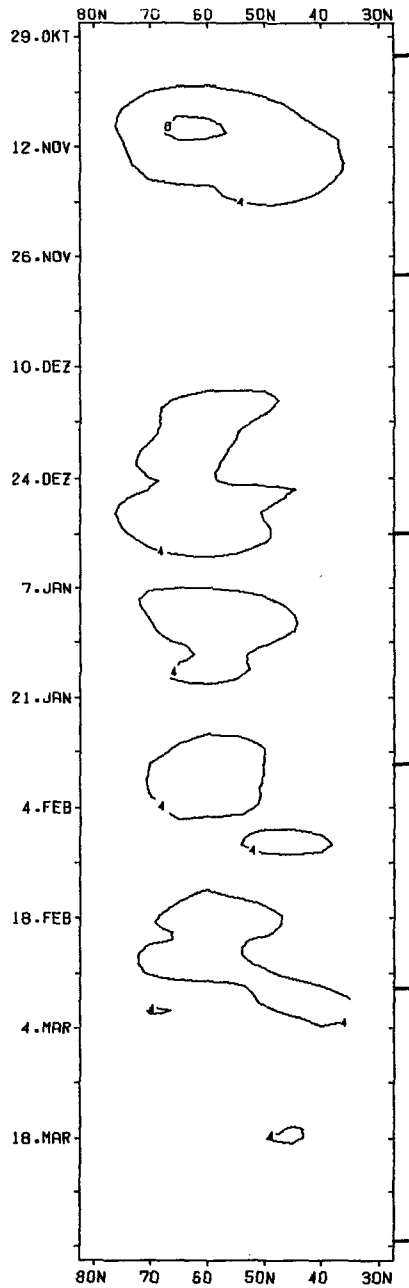
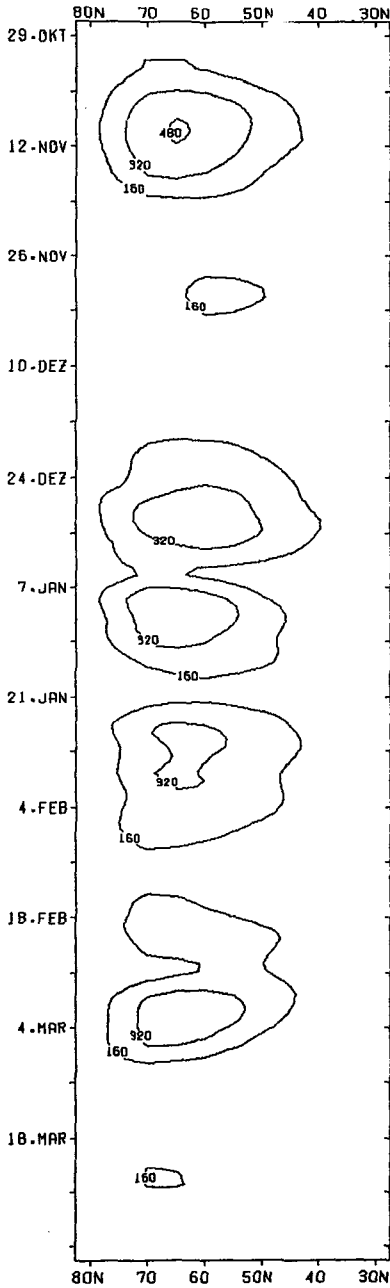

C.W.

C

*

e

f

Figure B.3

MOMENTUM FLUX

1965/66
WAVES 1-6

HEAT FLUX

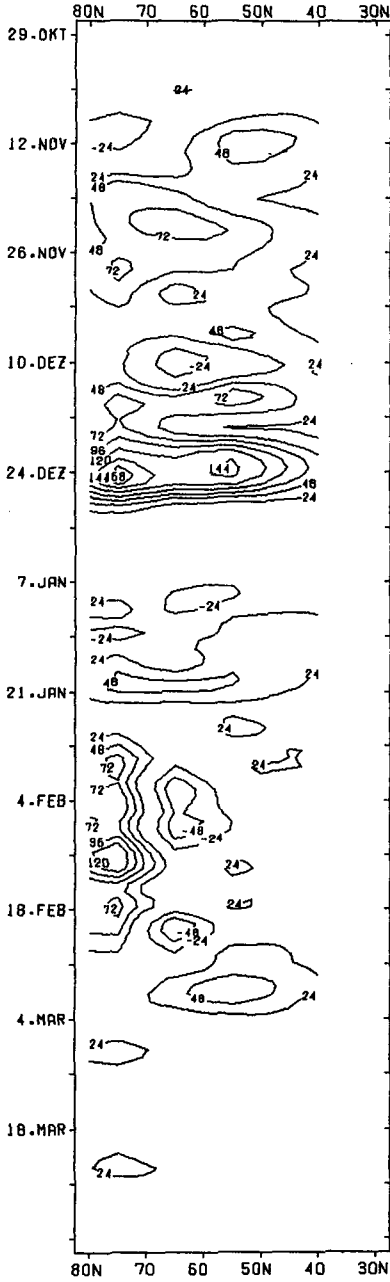

g

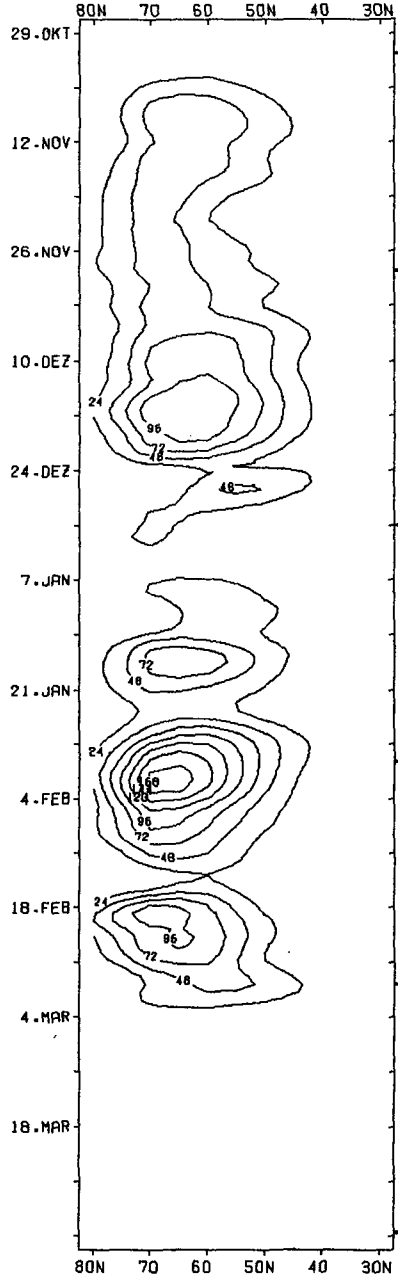

h

C.W.

C

*

Figure B.4

1965/66

EFFICIENCY
MOMENTUM FLUX

EFFICIENCY
HEAT FLUX

WAVES 1-6

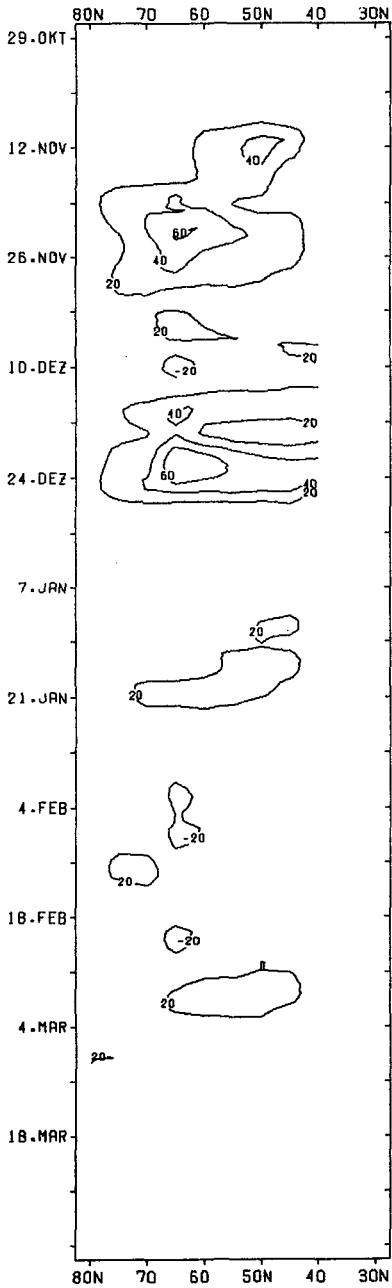

i

C.W.

*

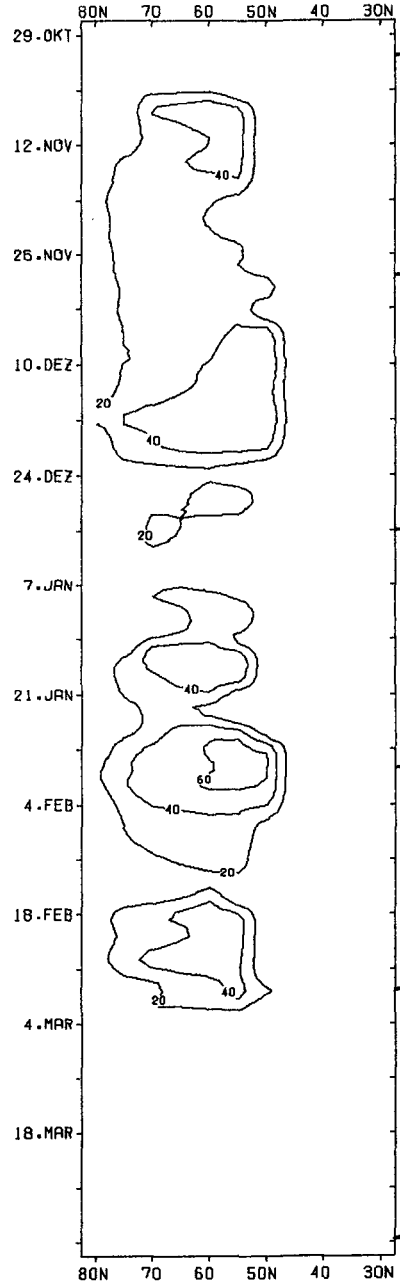

C

j

Figure B.5

MOMENTUM FLUX

1965/66

WAVE 1

HEAT FLUX

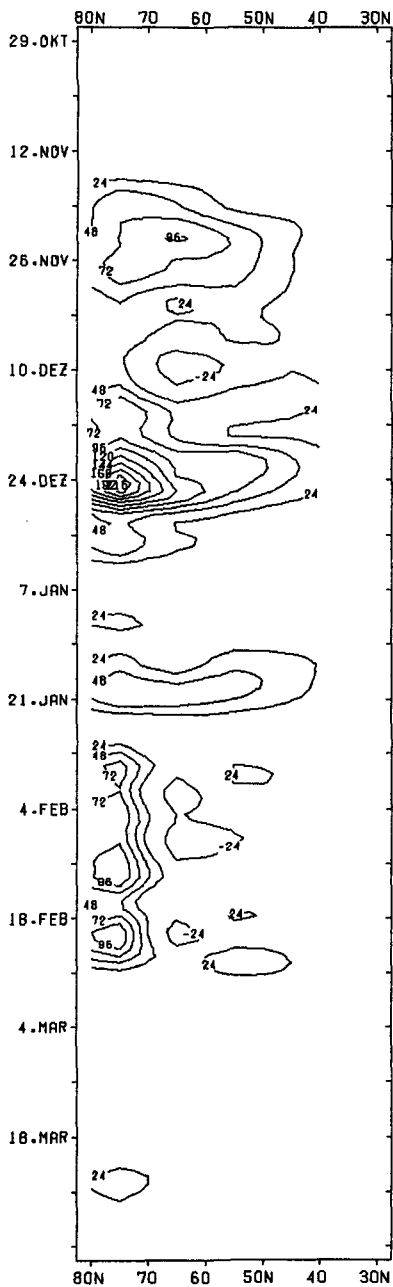

k

C.W.

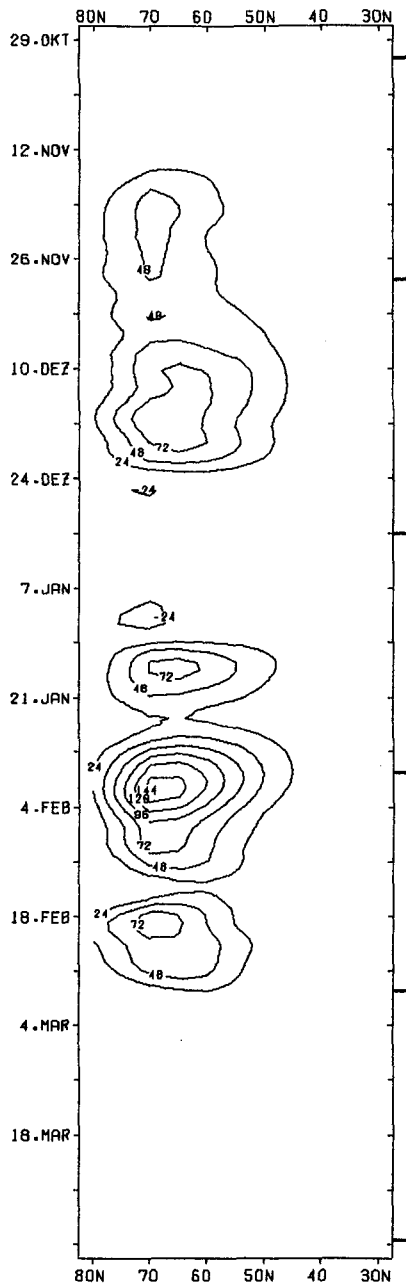

C

*

l

Figure B.6

1965/66

MOMENTUM FLUX

HEAT FLUX

WAVE 2

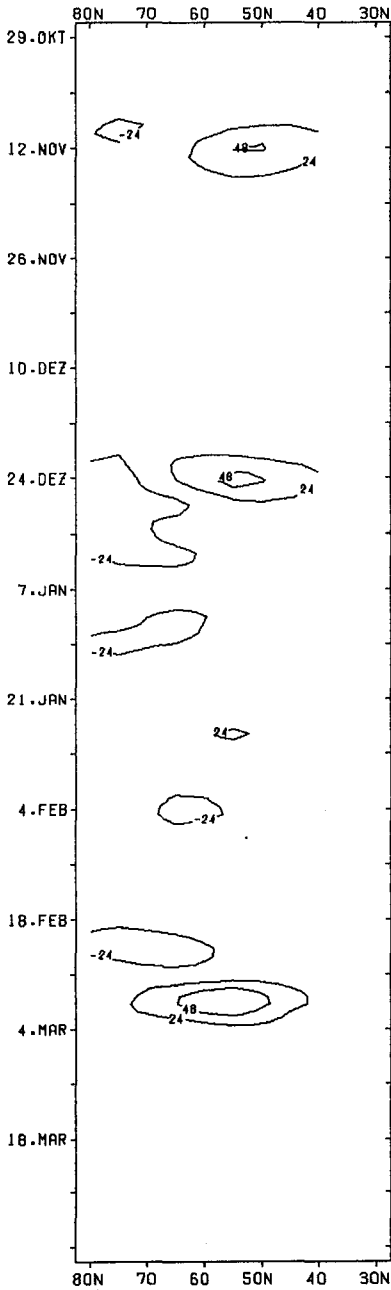

m

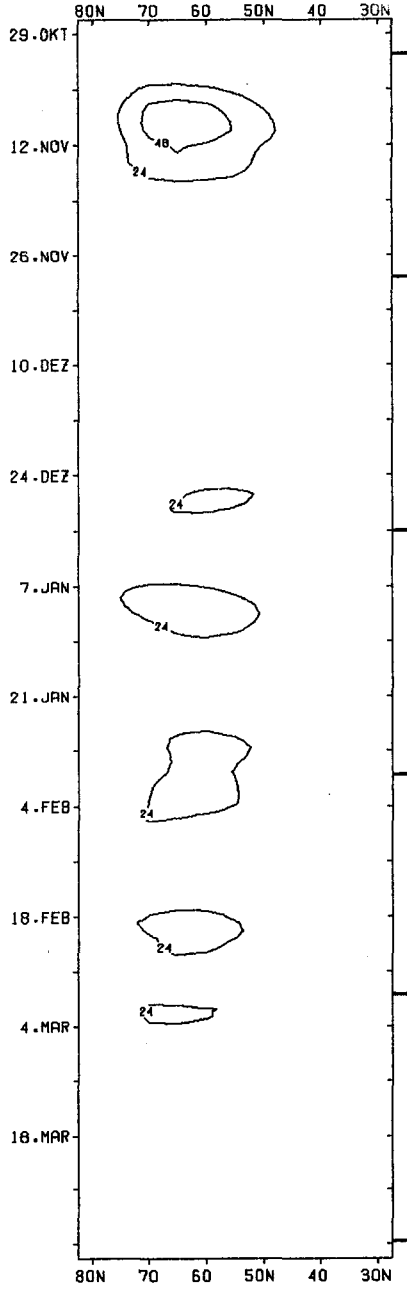

n

C.W.

*

C

Figure B.7

1965/66

52

EFFICIENCY
MOMENTUM FLUX

EFFICIENCY
HEAT FLUX

WAVE 1

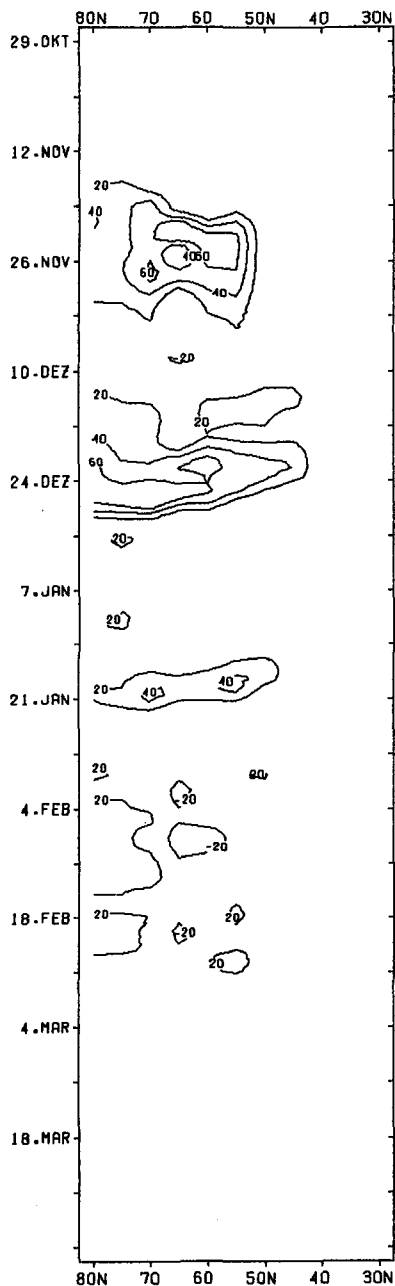

o

C.W.

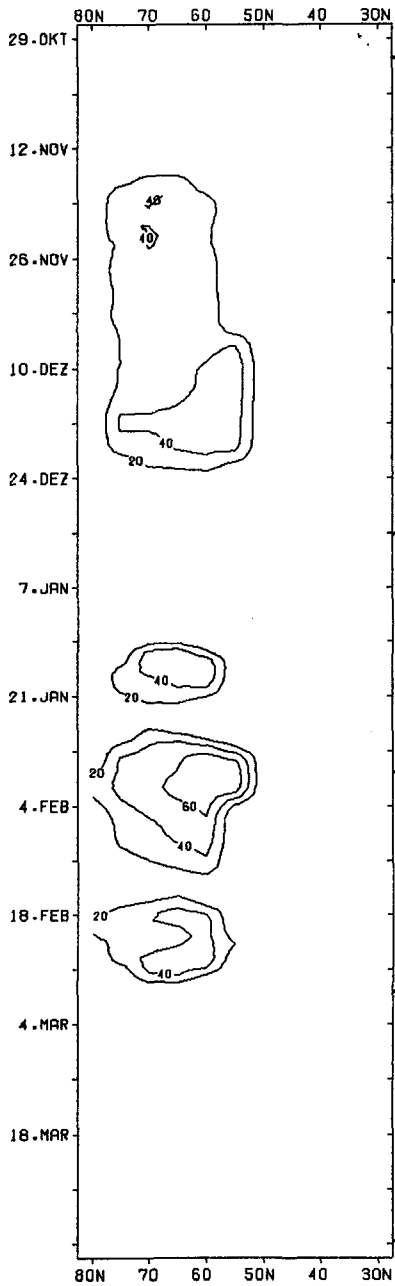

C

*

p

Figure B.8

1965/66

EFFICIENCY
MOMENTUM FLUX

EFFICIENCY
HEAT FLUX

WAVE 2

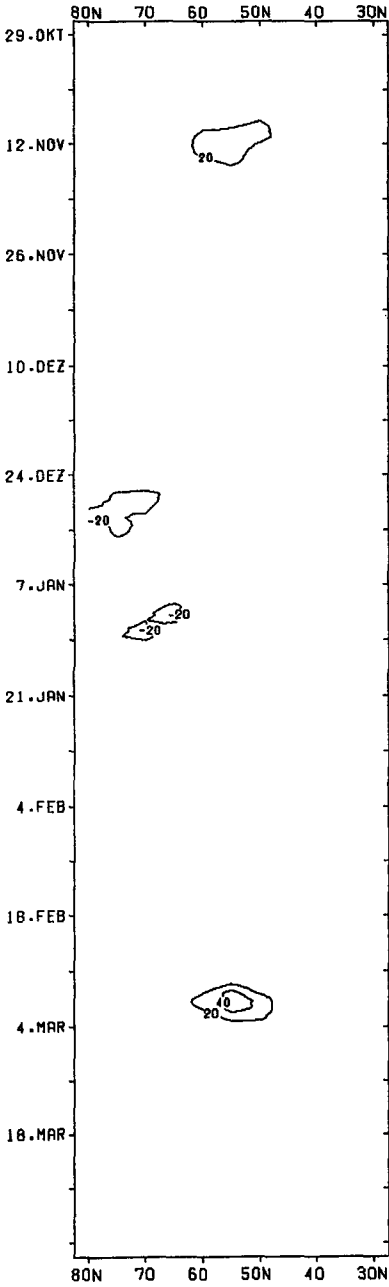

q

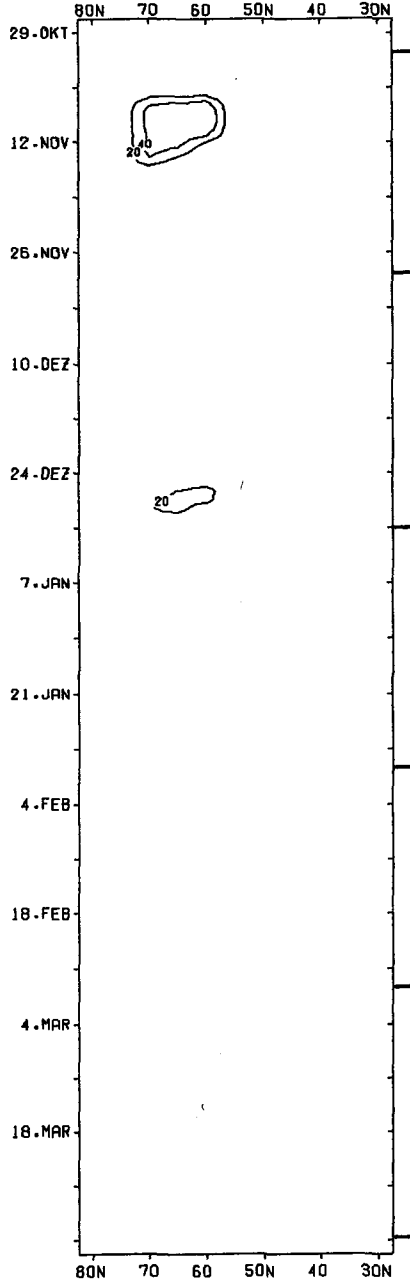

r

Figure B.9

MEAN ZONAL WIND

MEAN ZONAL TEMP.

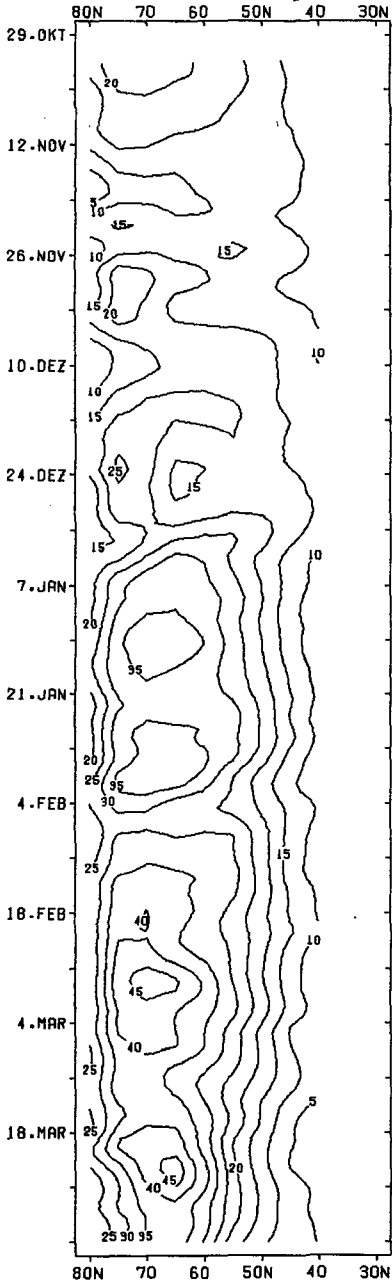

a

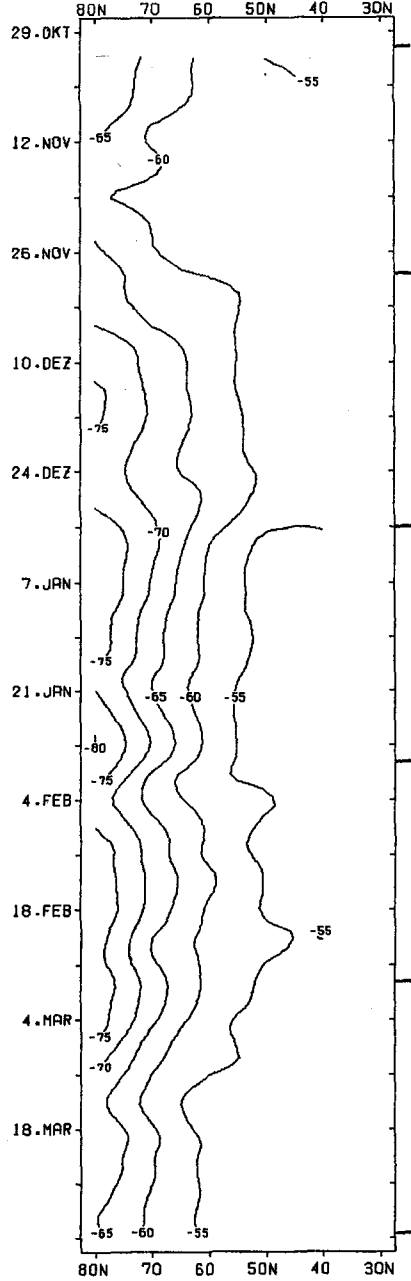

b

Figure B.10

HEIGHT WAVE 1

TEMP. WAVE 1

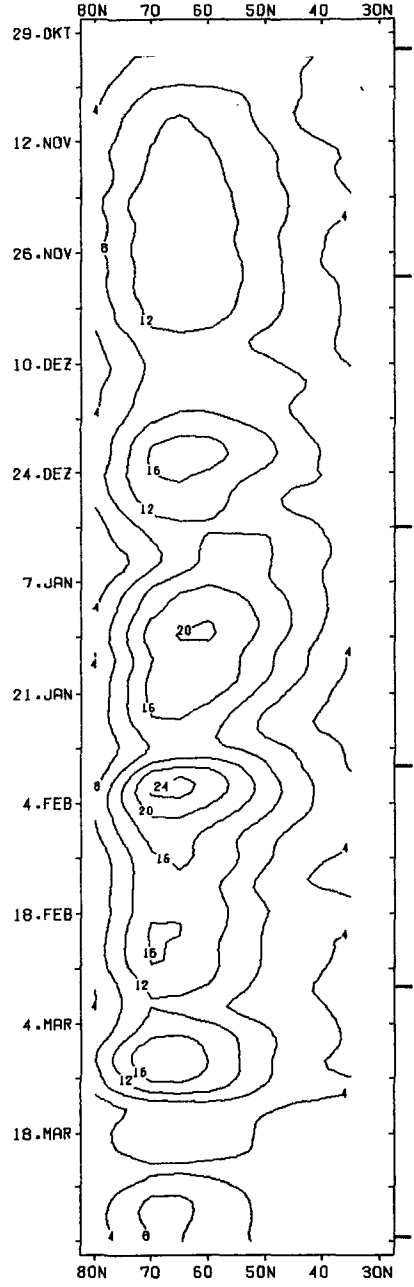
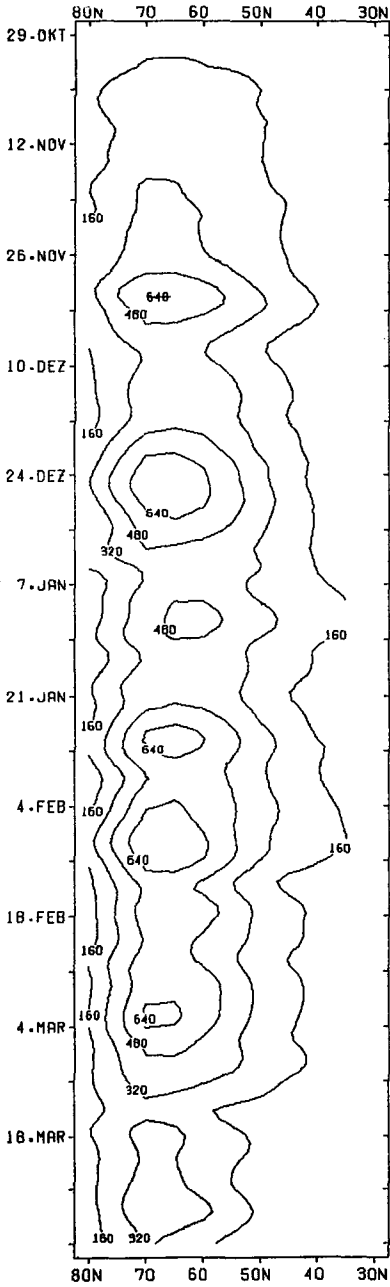

C.W.

C

C

C

c

d

Figure B.11

1966/67

HEIGHT WAVE 2

TEMP WAVE 2

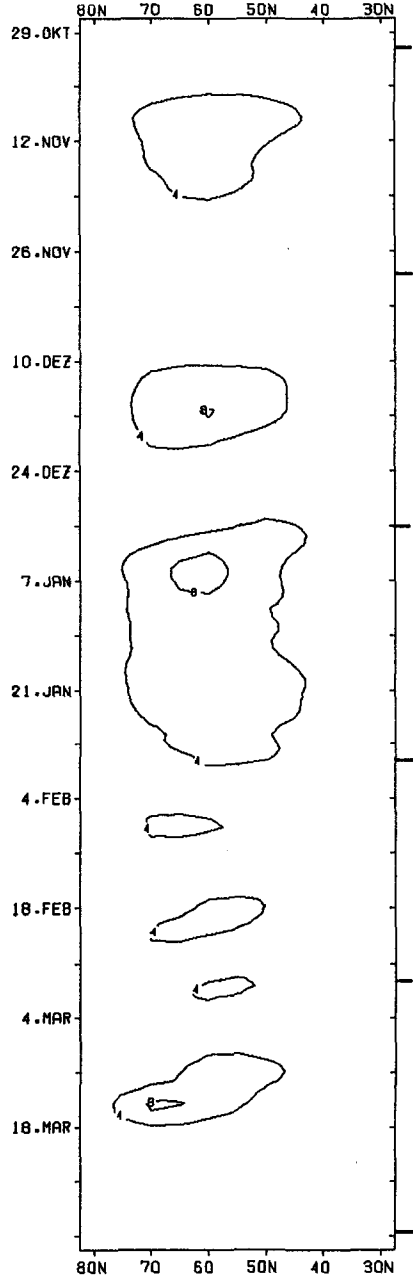
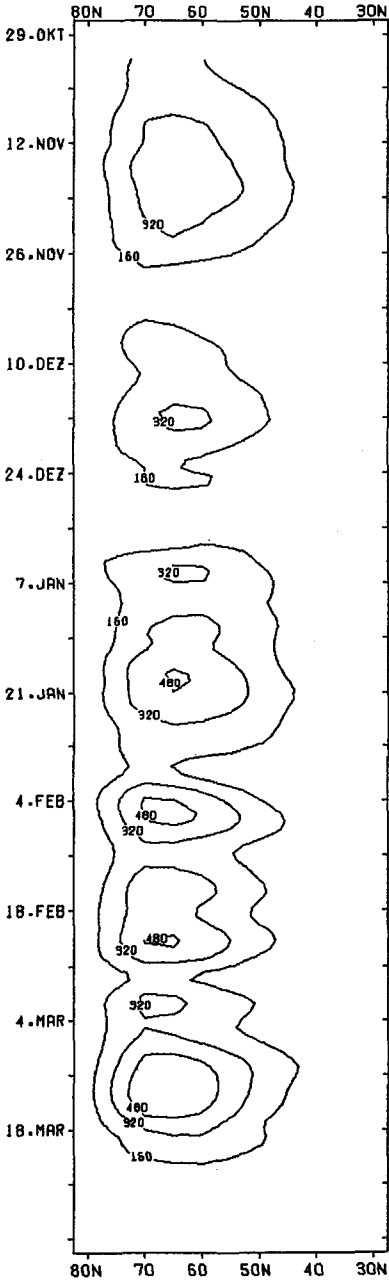

C.W.

C

C

C

e

f

Figure B.12

1966/67

MOMENTUM FLUX

HEAT FLUX

WAVES 1-6

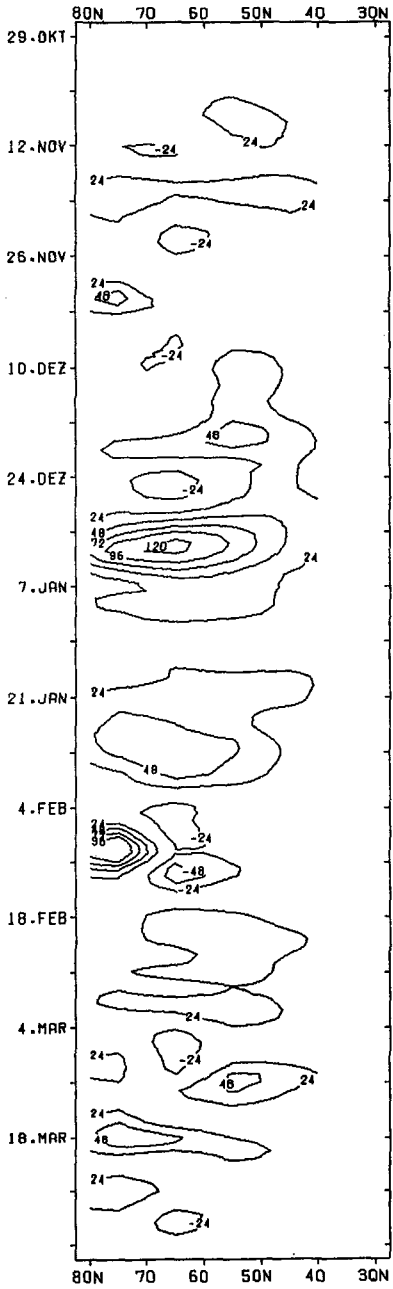

g

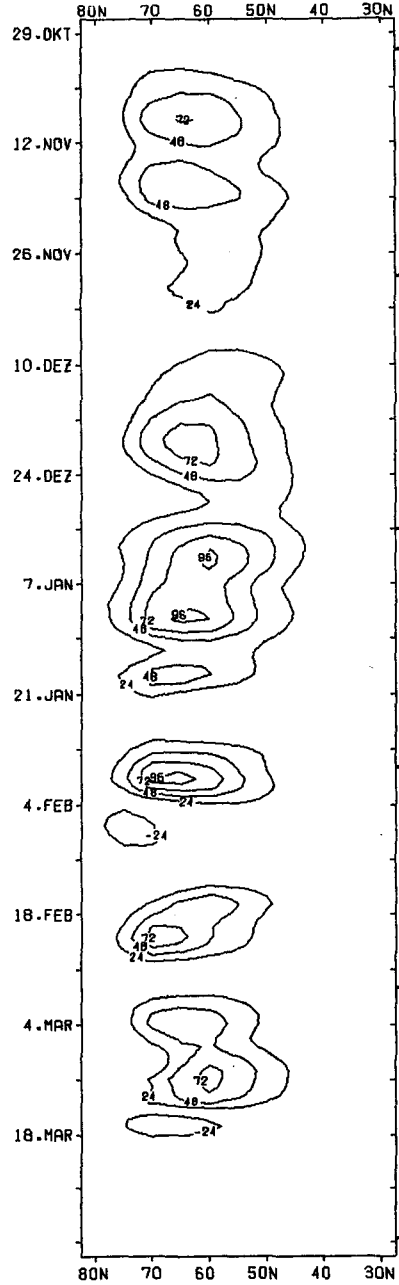

C

C

C

h

Figure B.13

EFFICIENCY
MOMENTUM FLUX

1966/67

WAVES 1-6

EFFICIENCY
HEAT FLUX

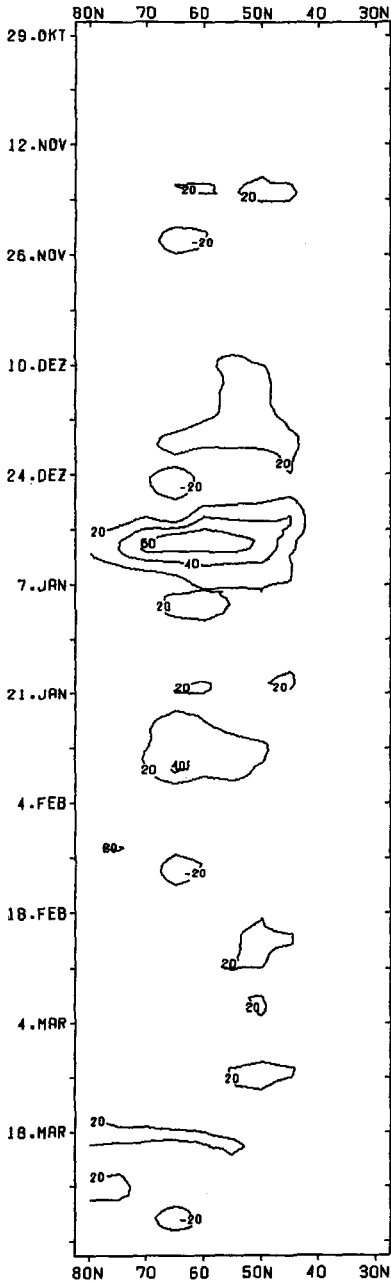

i

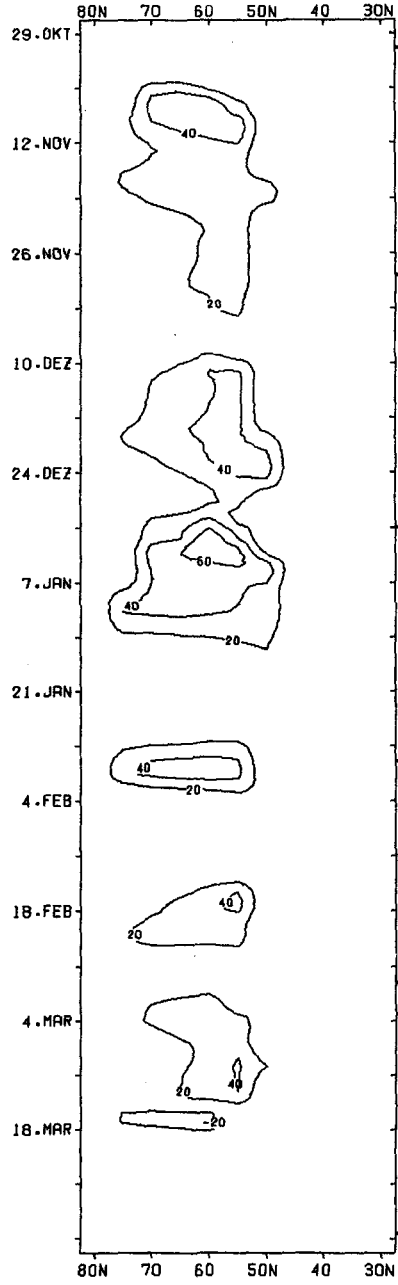

j

C.W.

C

C

C

Figure B.14

MOMENTUM FLUX

HEAT FLUX

WAVE 1

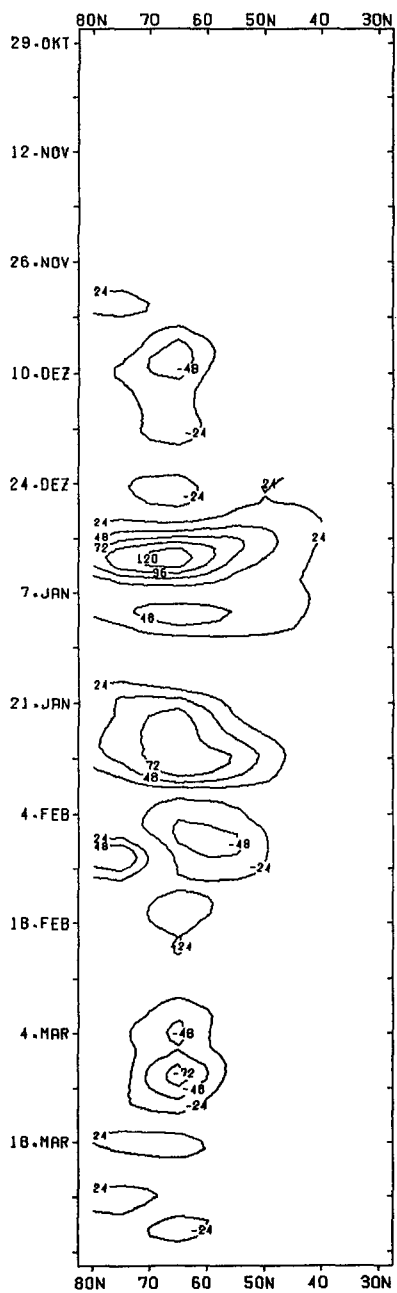

k

C.W.

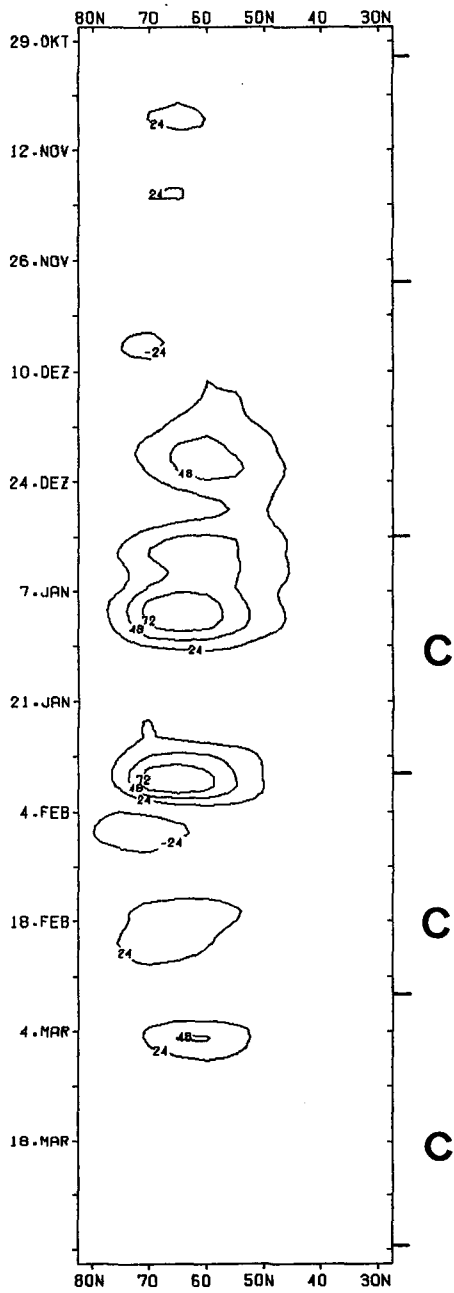

l

Figure B.15

1966/67

MOMENTUM FLUX

HEAT FLUX

WAVE 2

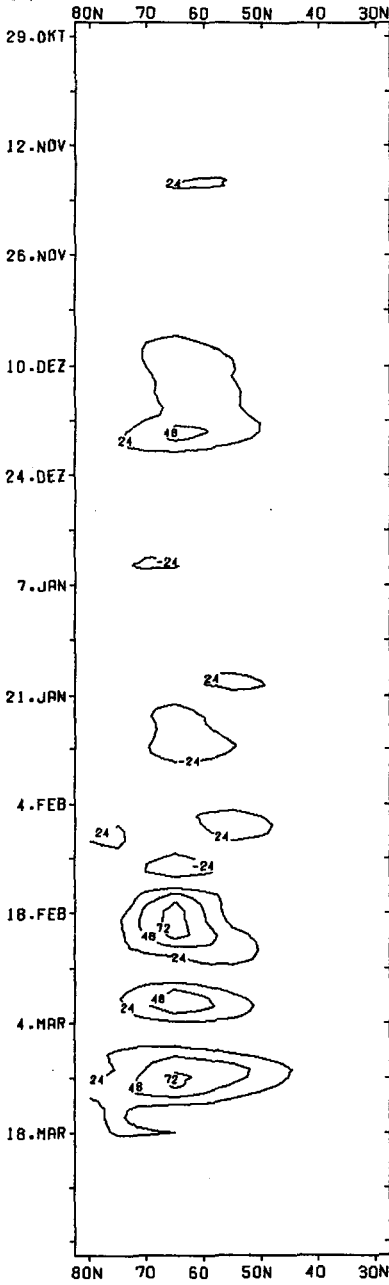

m

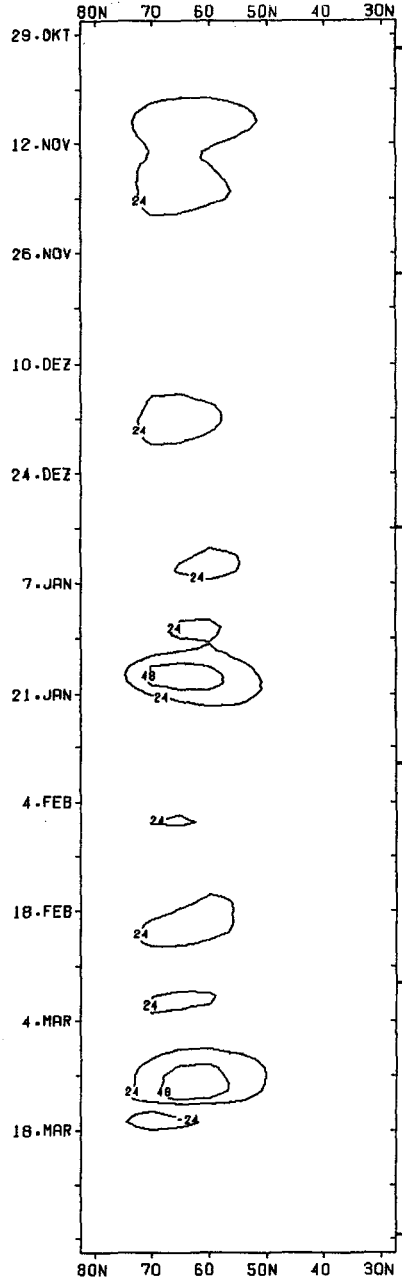

n

C.W.

C

C

C

Figure B.16

1966 / 67

EFFICIENCY
MOMENTUM FLUX

EFFICIENCY
HEAT FLUX

WAVE 1

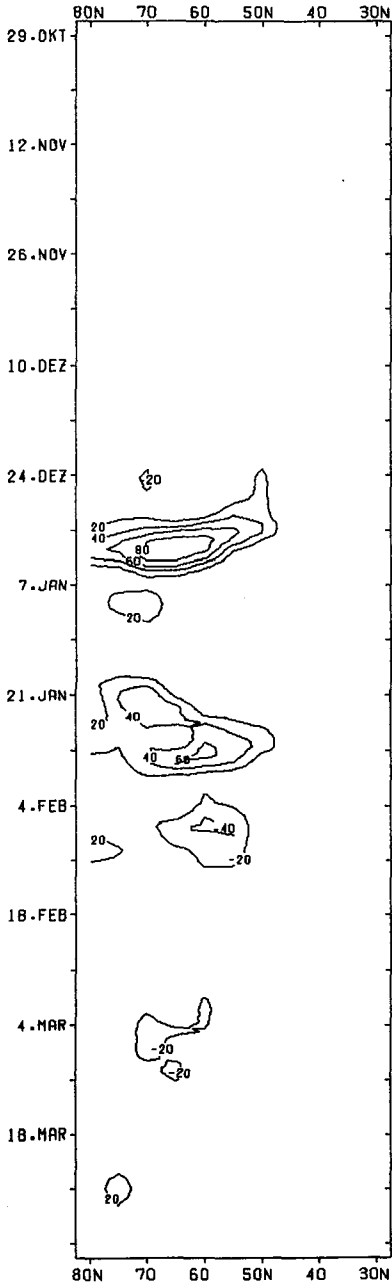

o

C.W.

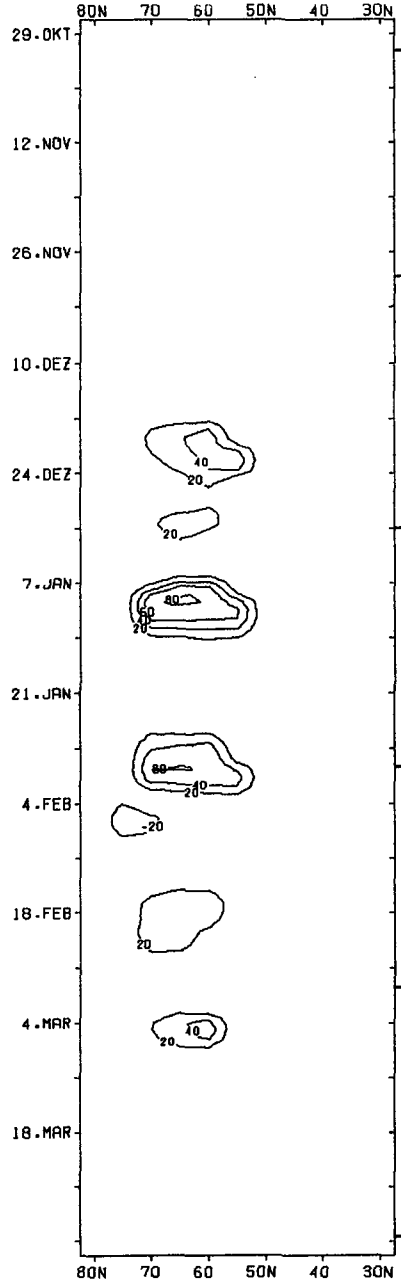

p

Figure B.17

1966 / 67

62

EFFICIENCY
MOMENTUM FLUX

EFFICIENCY
HEAT FLUX

WAVE 2

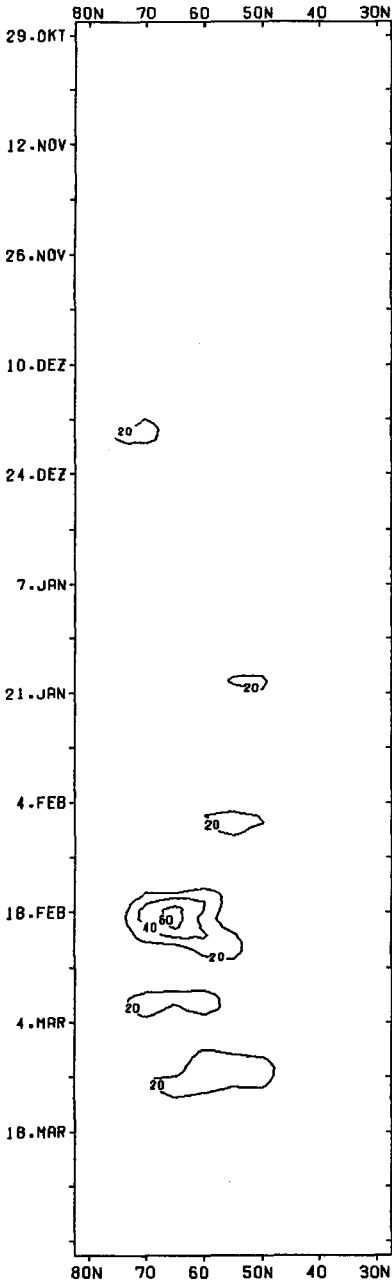

q

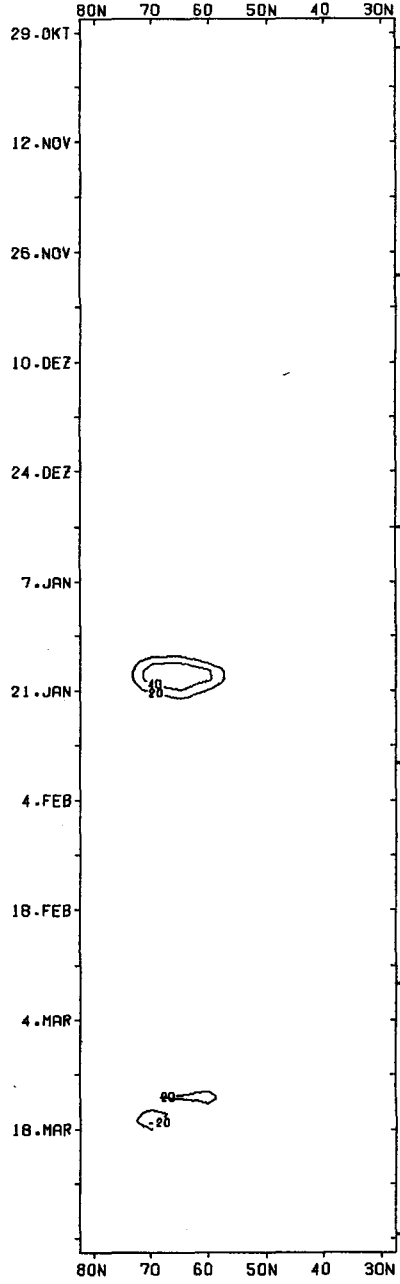

r

Figure B.18

1967/68

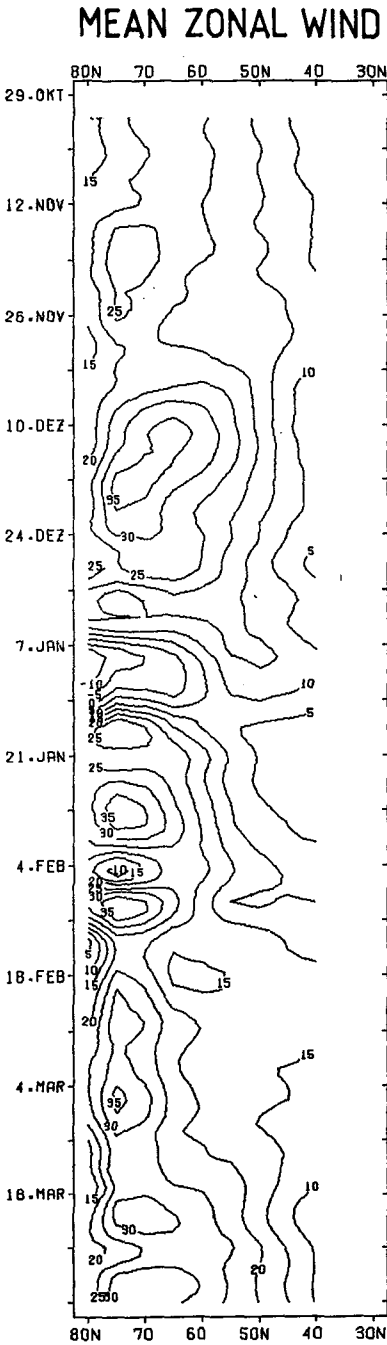

a

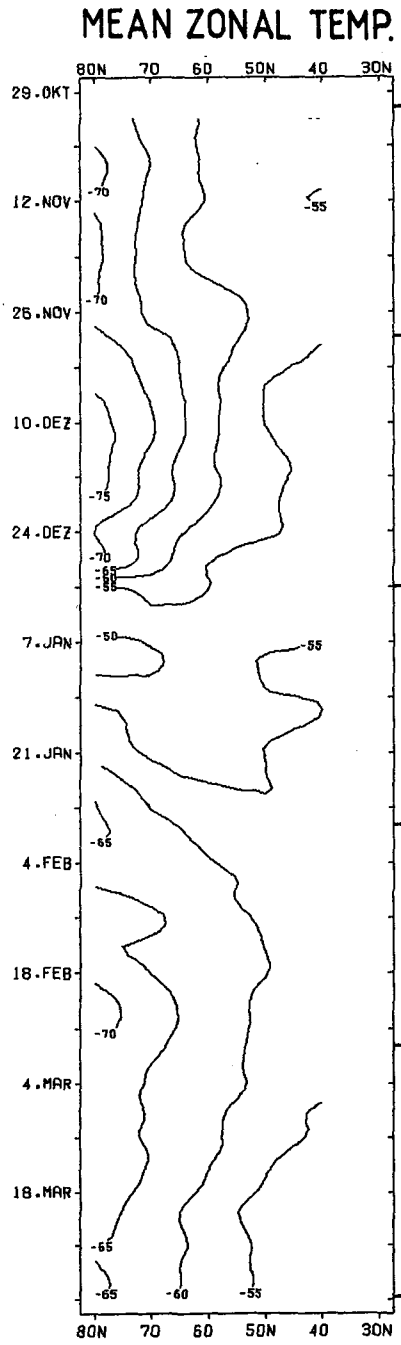

b

C.W.

*

C

C

Figure B.19

HEIGHT WAVE 1

TEMP. WAVE 1

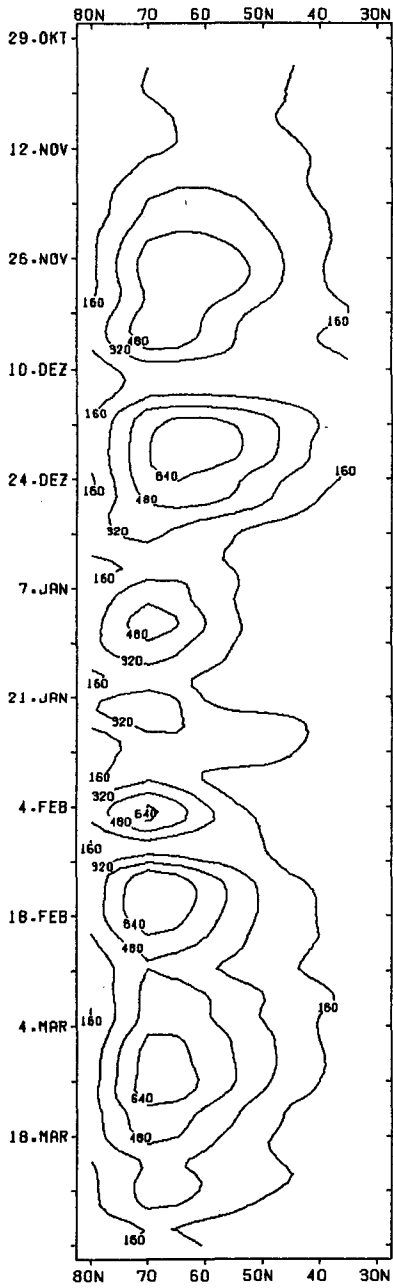

c

C.W.

*

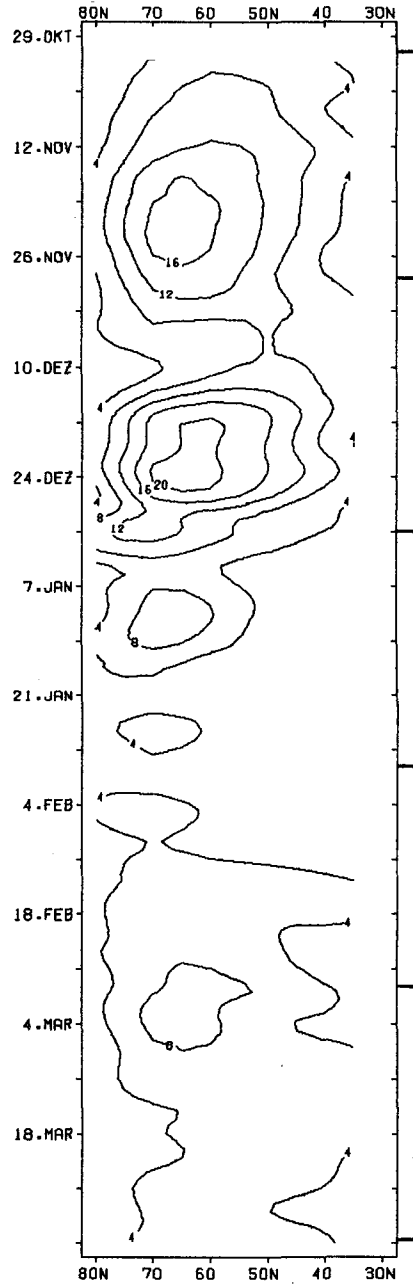

C

C

d

Figure B.20

1967/68

HEIGHT WAVE 2

TEMP WAVE 2

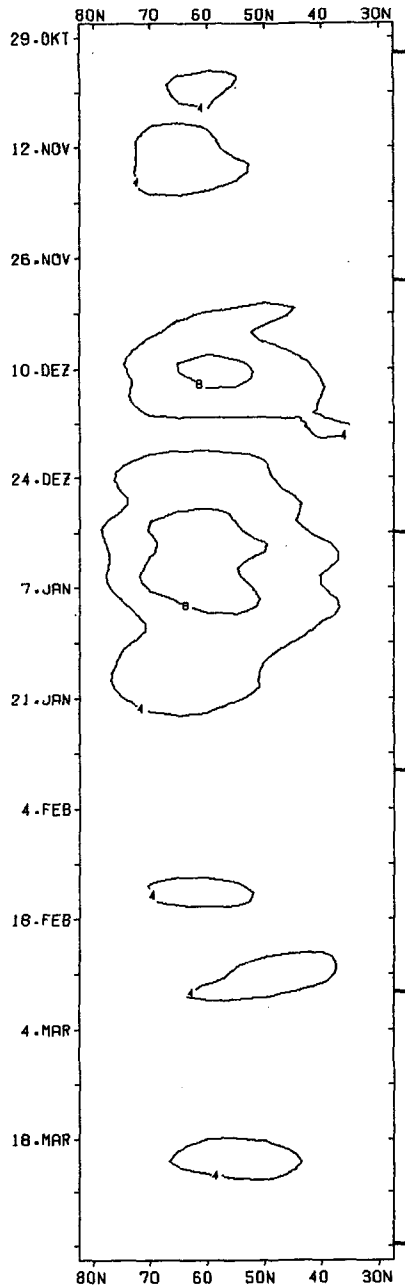
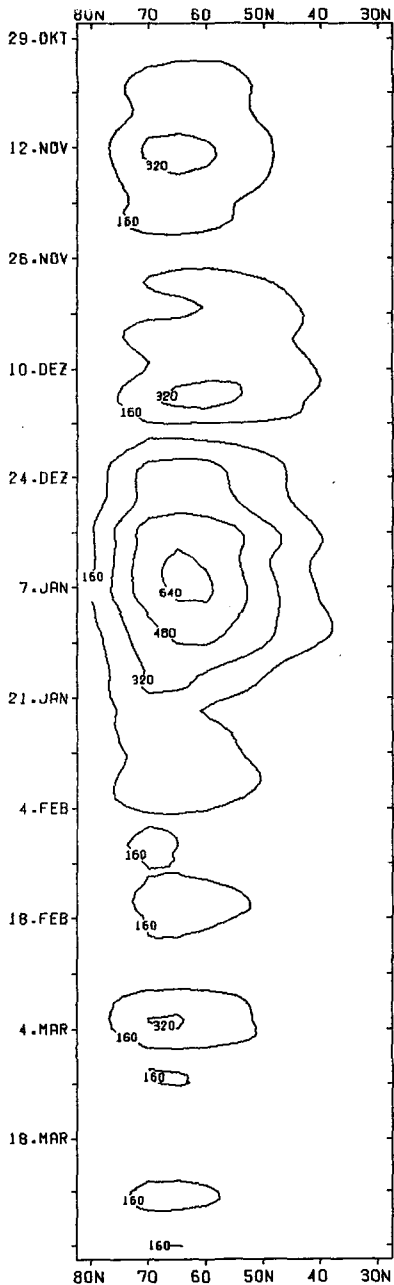

C.W.

*

C

C

e

f

Figure B.21

1967/68

MOMENTUM FLUX

HEAT FLUX

WAVES 1-6

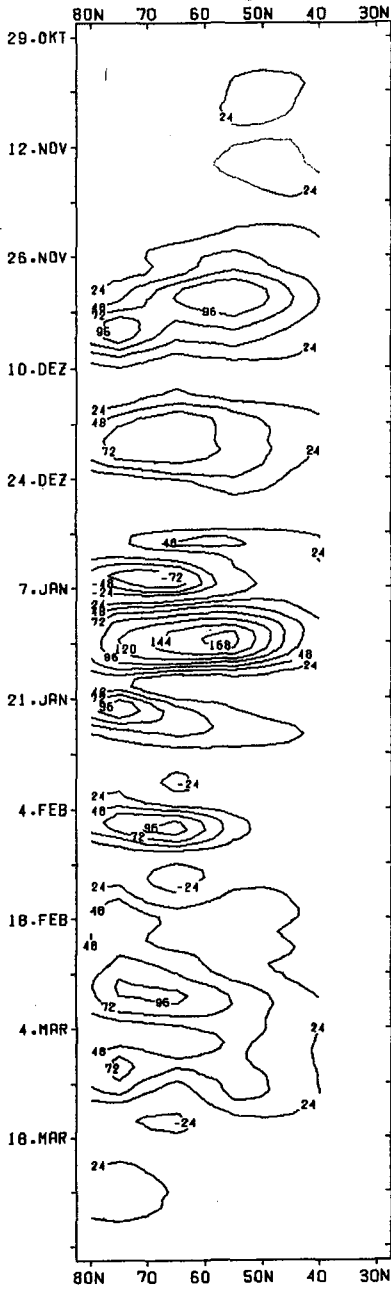

g

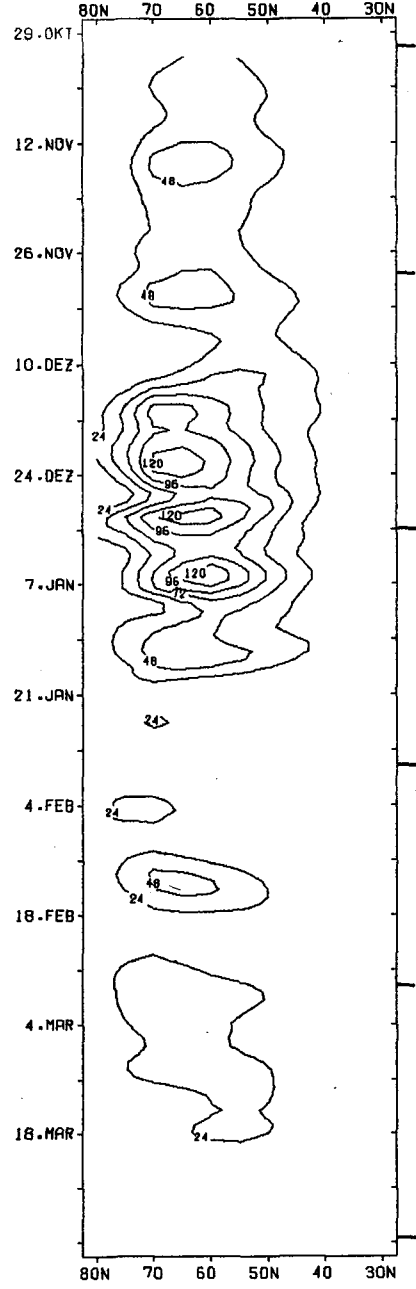

h

Figure B.22

1967/68

EFFICIENCY
MOMENTUM FLUX

EFFICIENCY
HEAT FLUX

WAVES 1-6

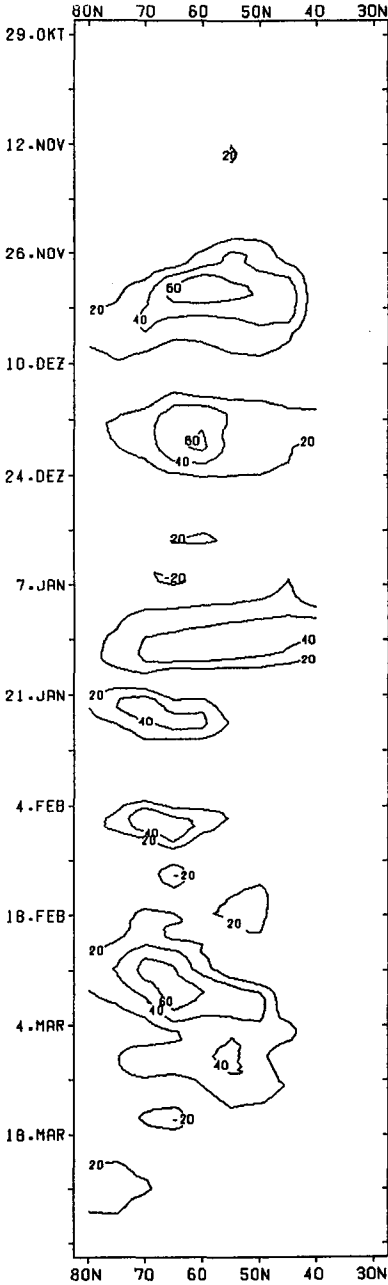

i

C.W.

*

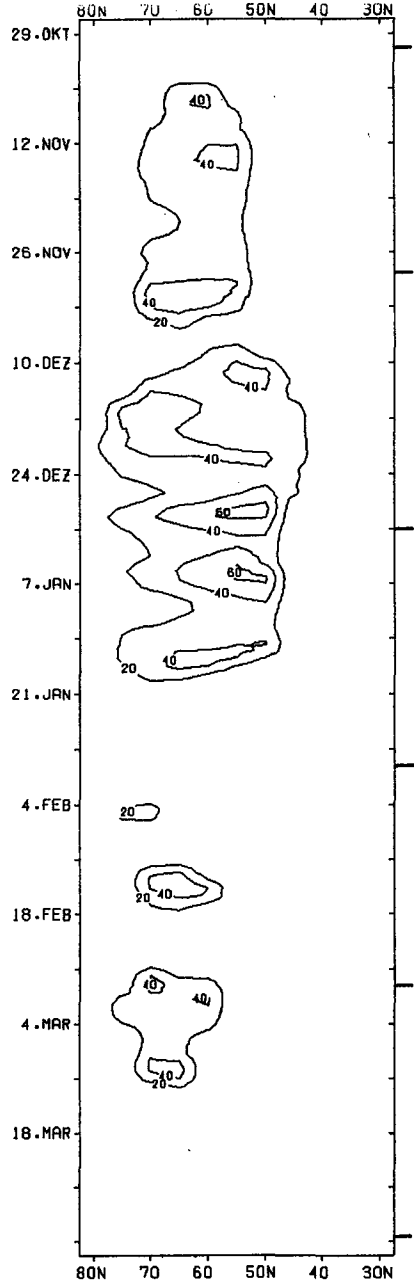

j

Figure B.23

1967/68

MOMENTUM FLUX

HEAT FLUX

WAVE 1

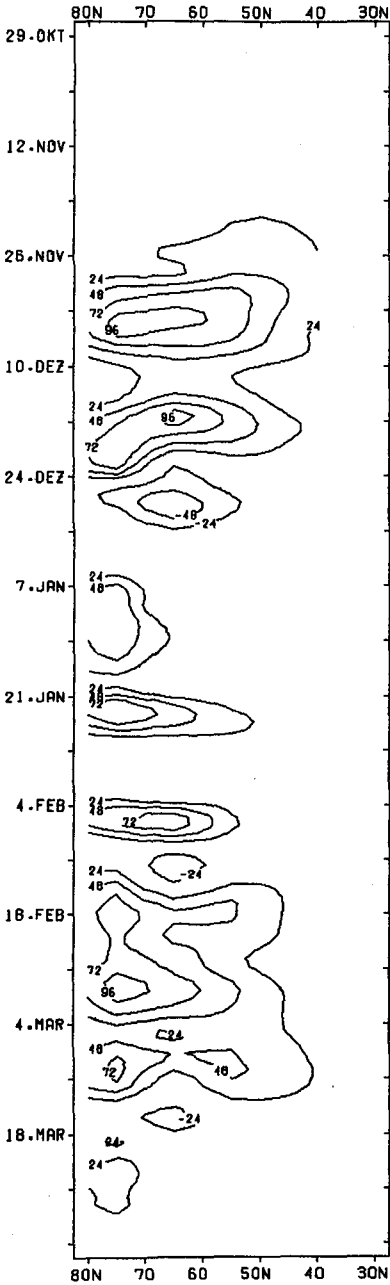

k

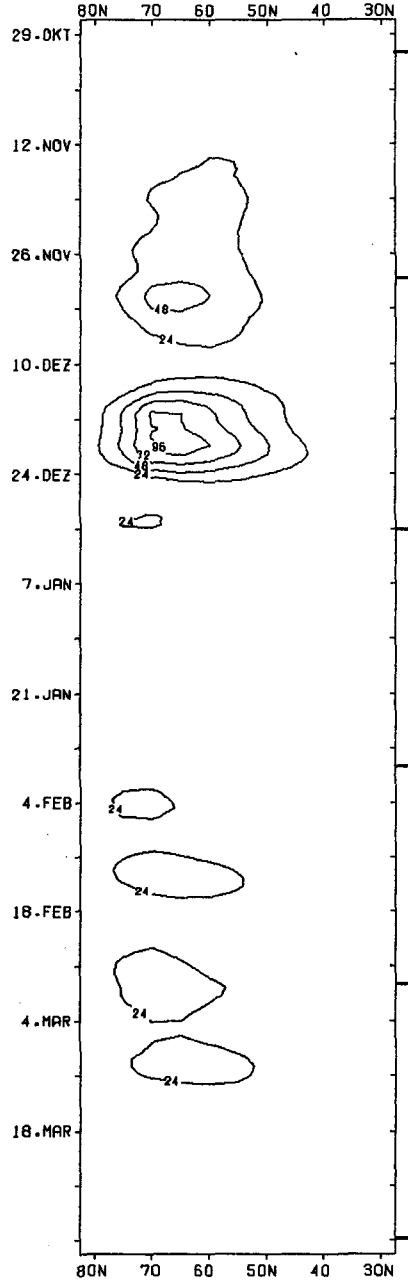

C

C.W.

*

C

l

Figure B.24

MOMENTUM FLUX

WAVE 2

HEAT FLUX

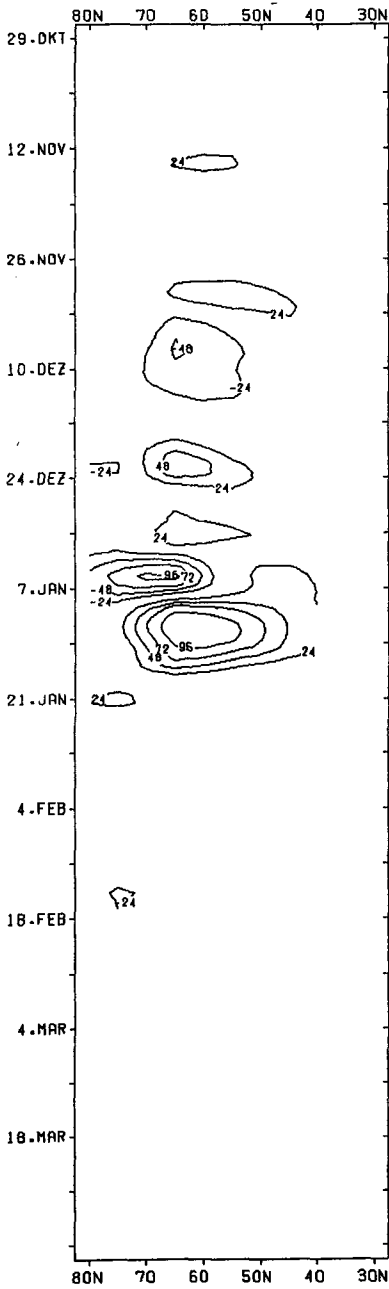

m

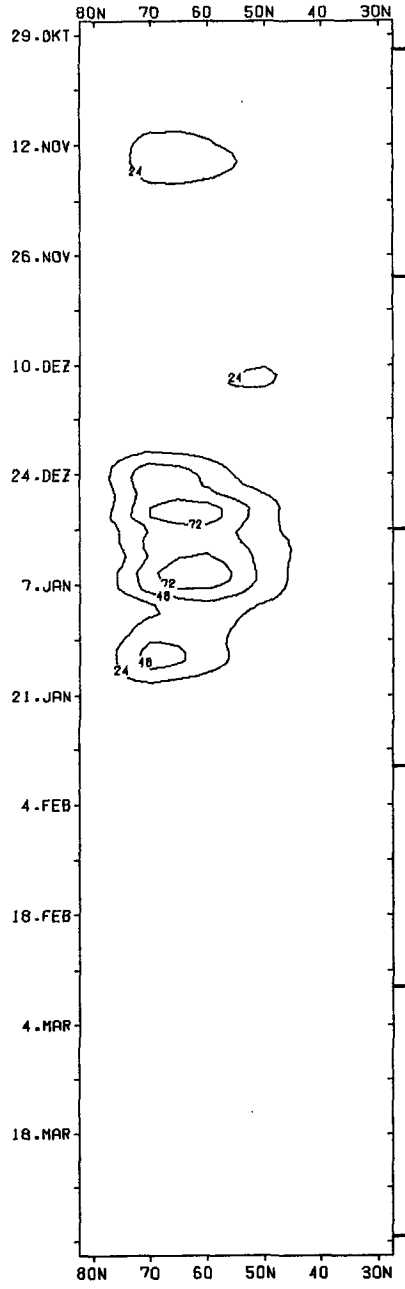

n

Figure B.25

1967/68

70

EFFICIENCY
MOMENTUM FLUX

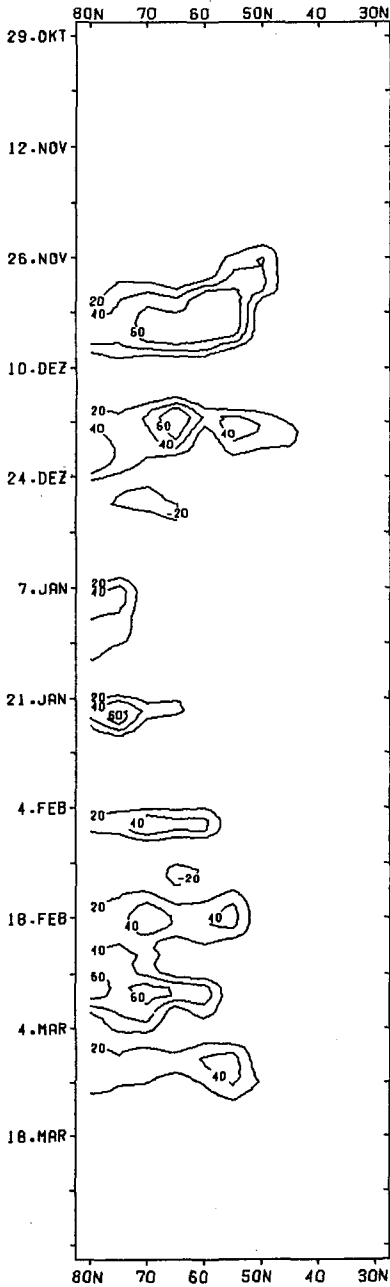

o

EFFICIENCY
HEAT FLUX

WAVE 1

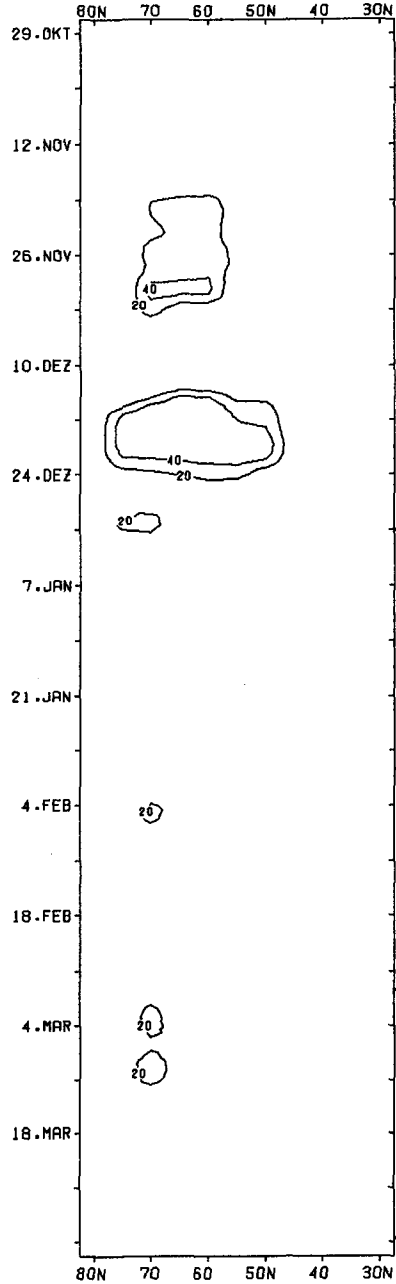

C.W.

C

C

p

Figure B.26

1967/68

EFFICIENCY
MOMENTUM FLUX

EFFICIENCY
HEAT FLUX

WAVE 2

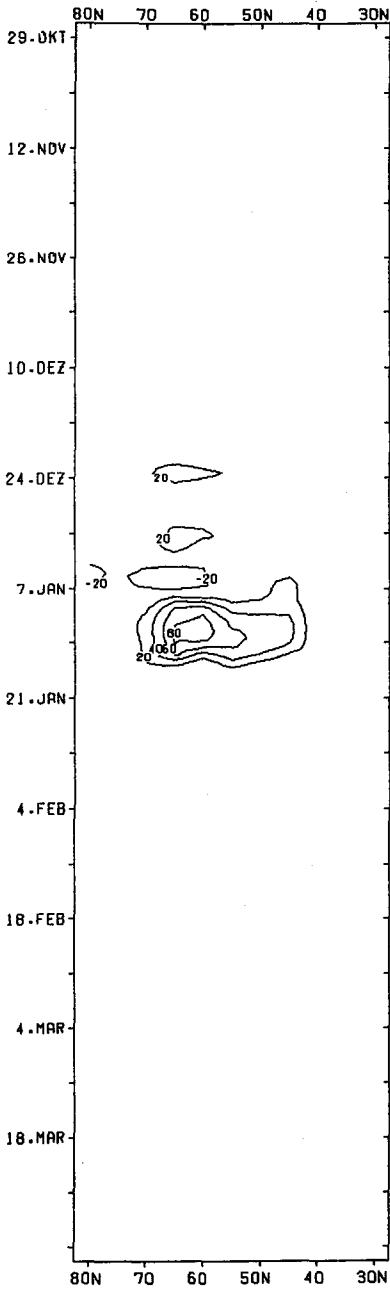

q

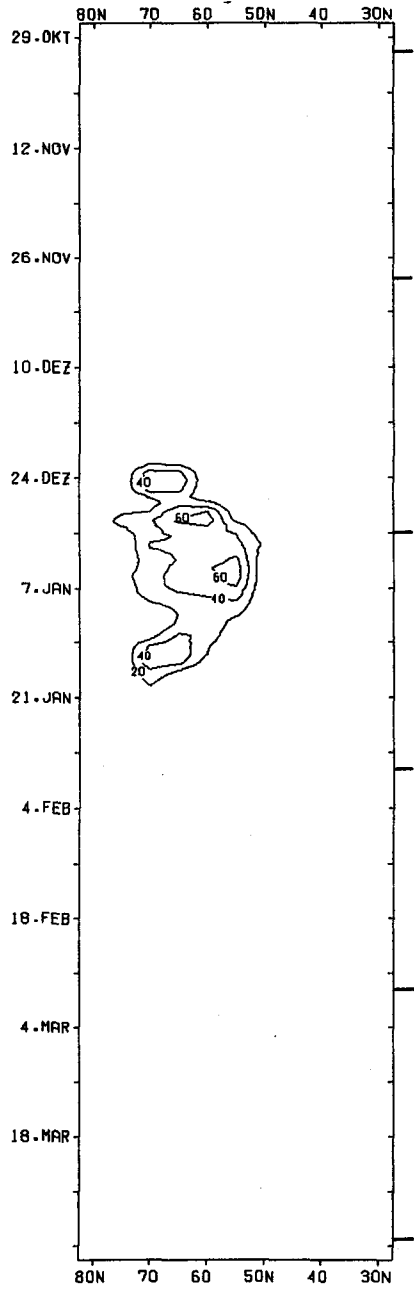

r

Figure B.27

MEAN ZONAL WIND

MEAN ZONAL TEMP.

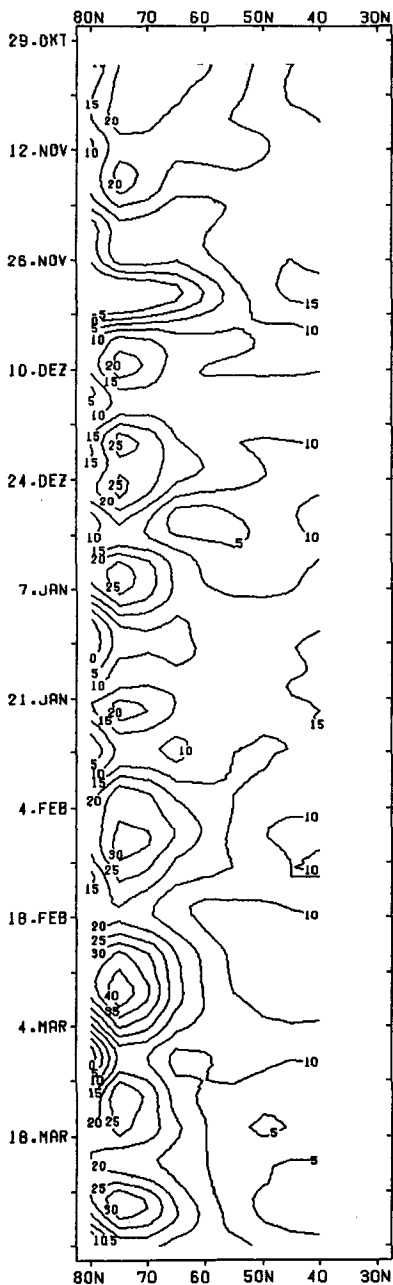

a

C.W.

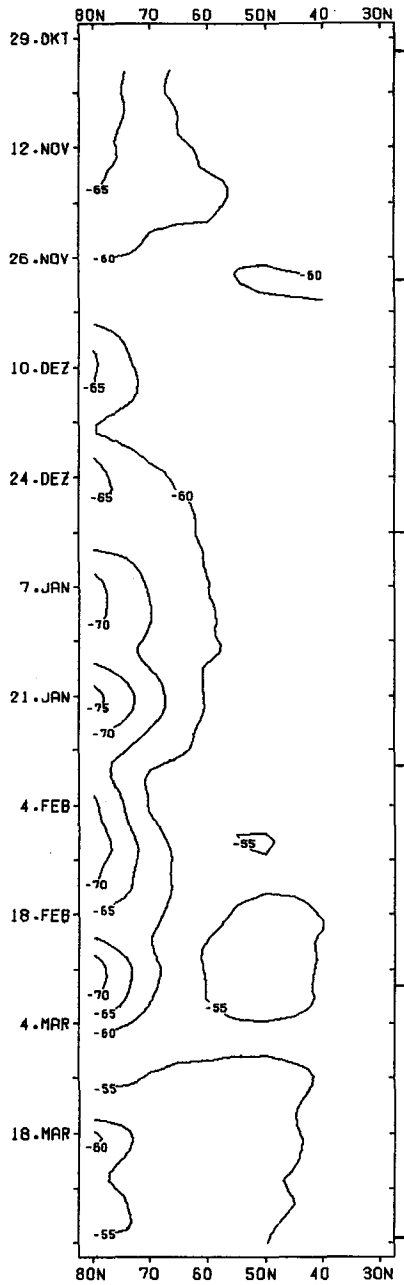

b

C

Figure B.28

HEIGHT WAVE 1

TEMP. WAVE 1

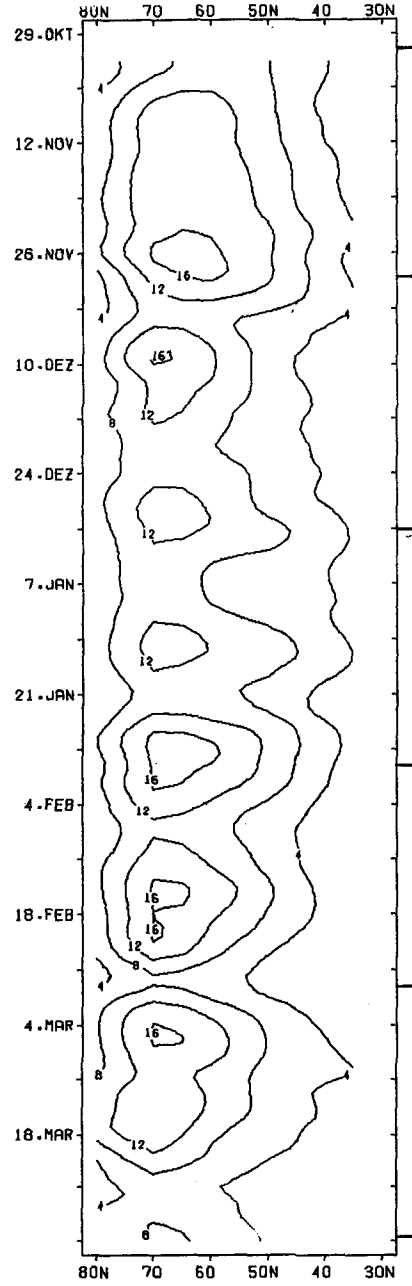
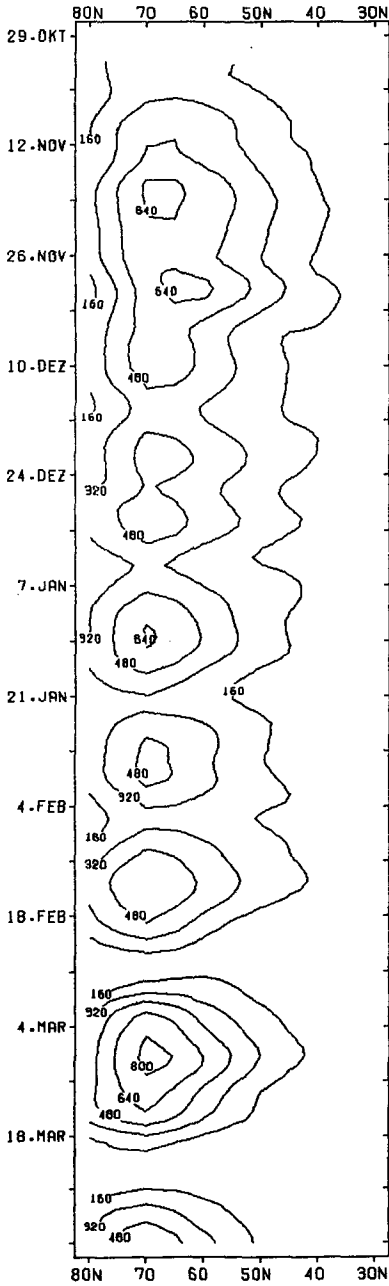

C.W.

C

c

d

Figure B.29

1968 / 69

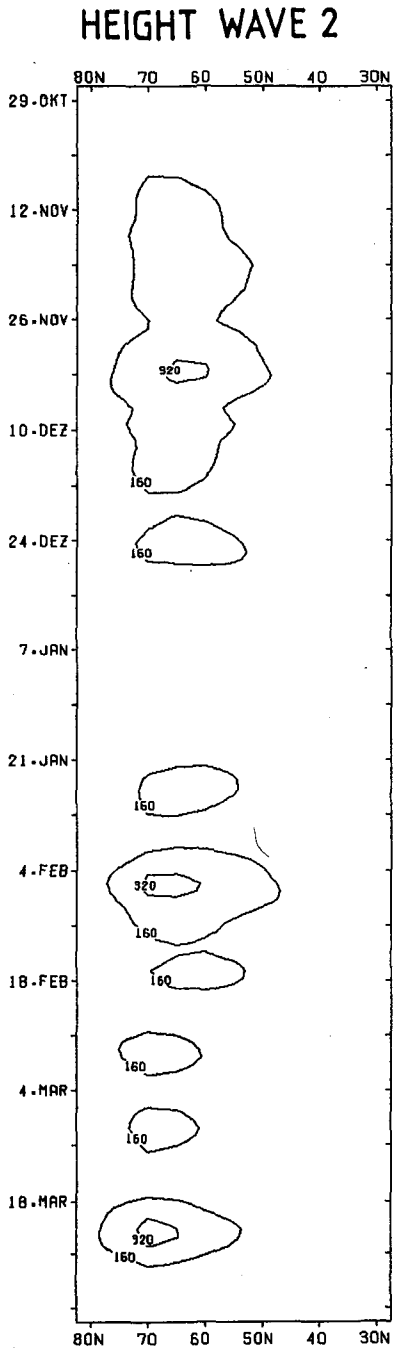

e

C.W.

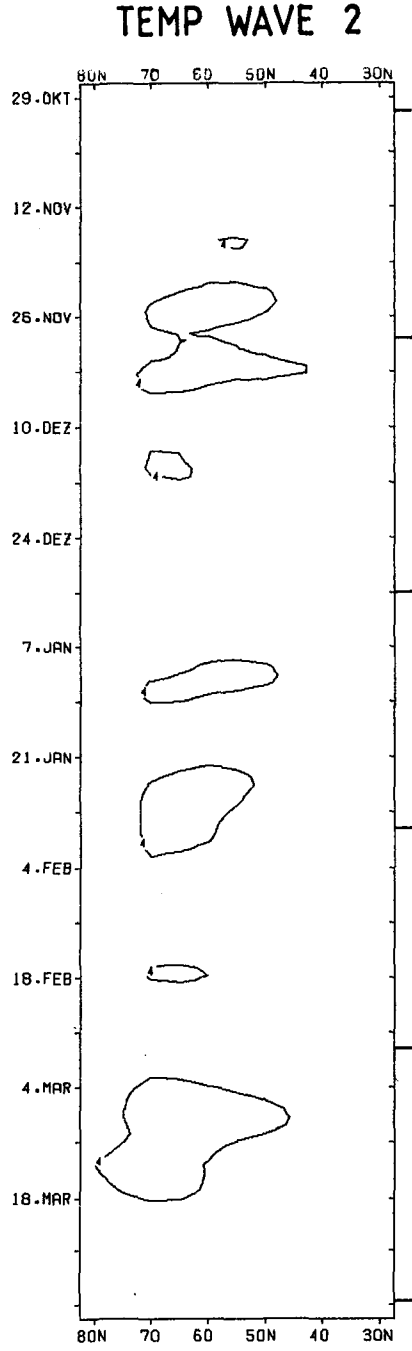

f

C

Figure B.30

1968 / 69

76 EFFICIENCY
MOMENTUM FLUX

EFFICIENCY
HEAT FLUX

WAVES 1-6

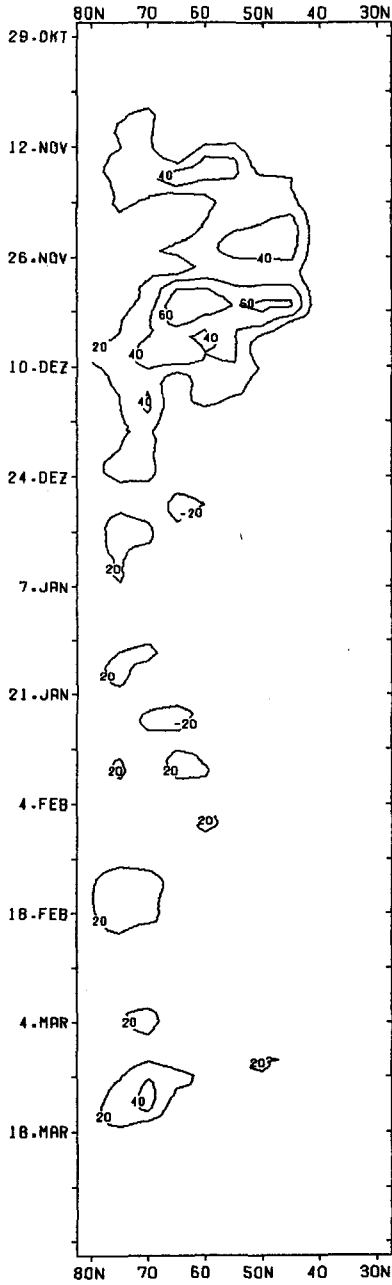

i

C.W.

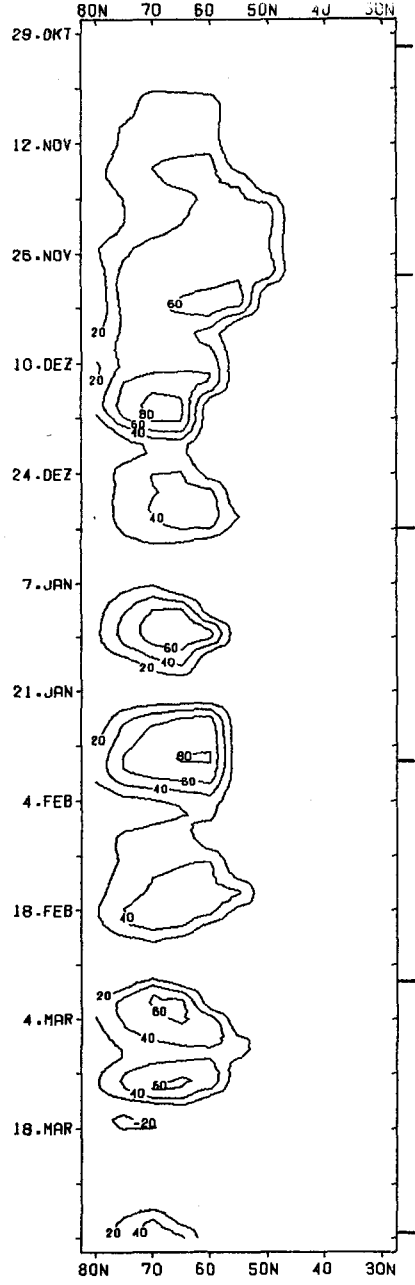

j

C

Figure B.32

MOMENTUM FLUX

HEAT FLUX

WAVE 1

C.W.

C

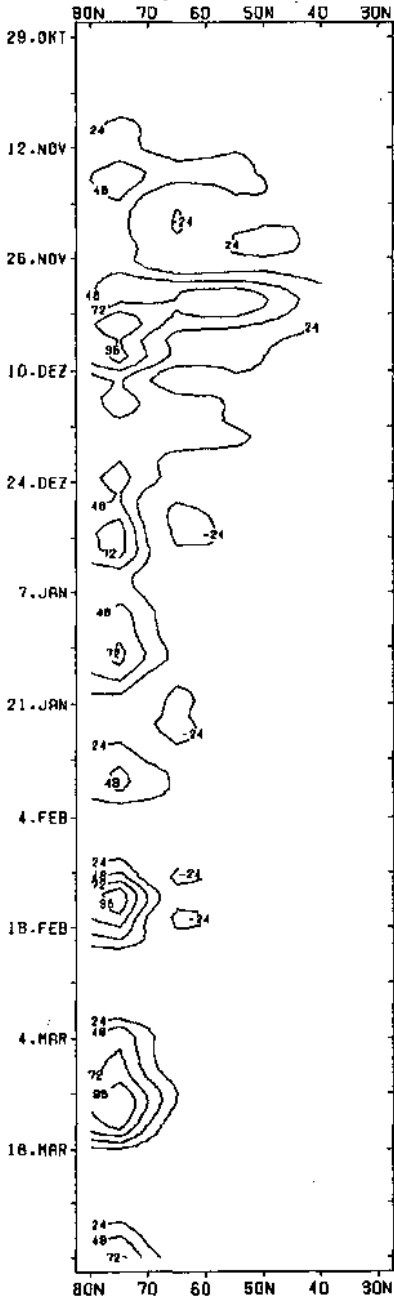

k

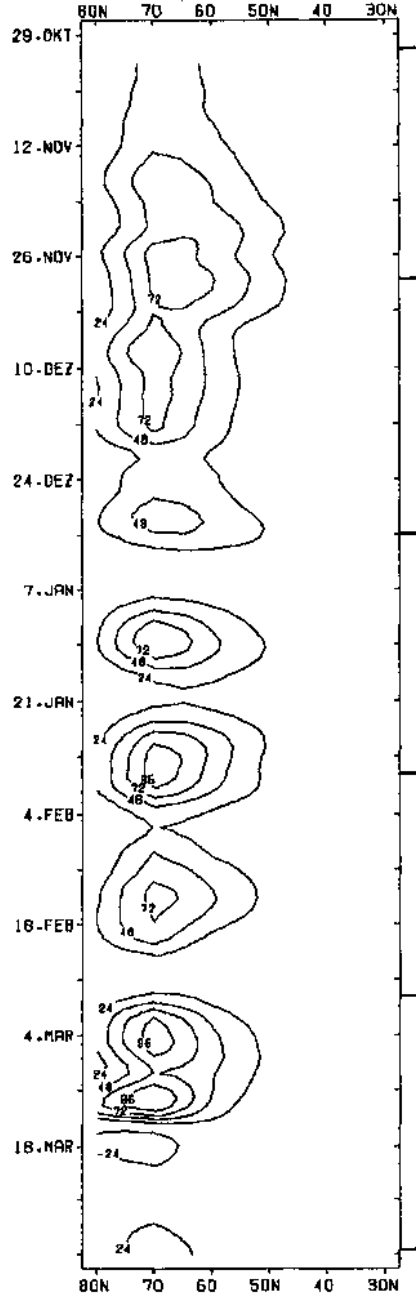

l

Figure B.33

1968 / 69

MOMENTUM FLUX

HEAT FLUX

WAVE 2

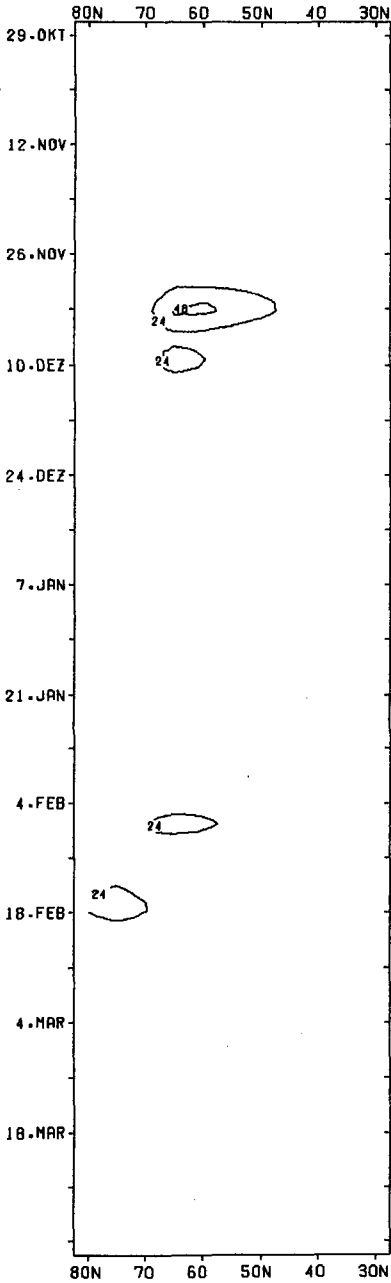

m

C.W.

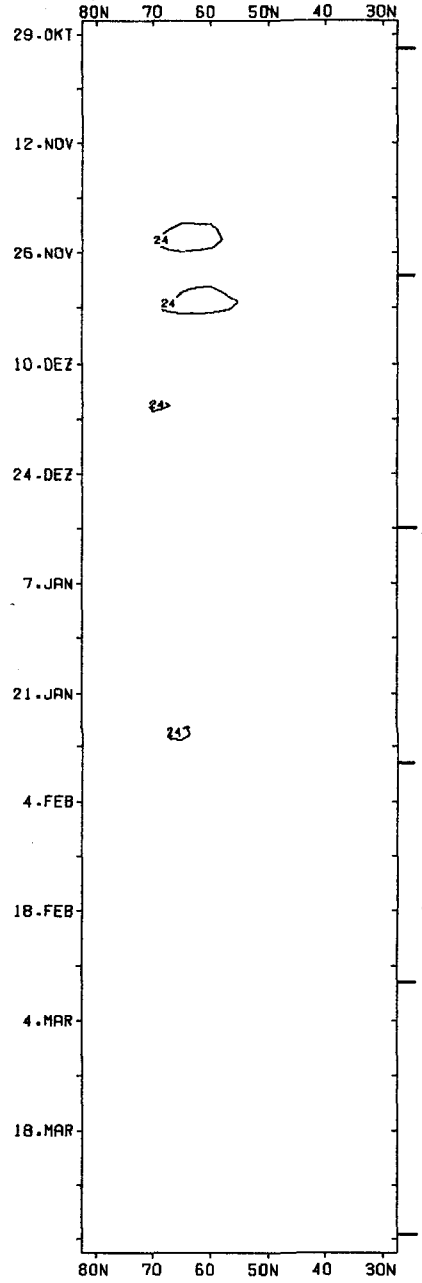

n

Figure B.34

1968 / 69

EFFICIENCY
MOMENTUM FLUX

EFFICIENCY
HEAT FLUX

WAVE 1

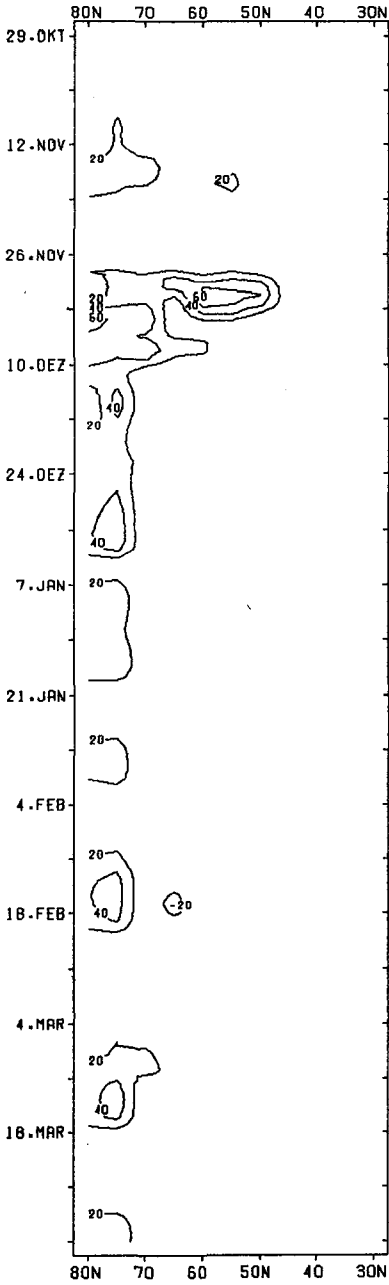

o

C.W.

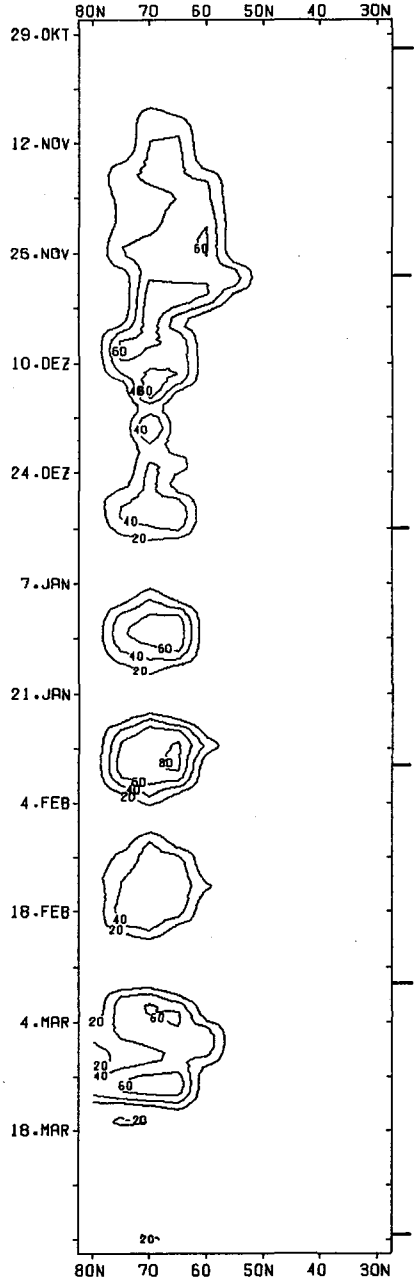

C

p

Figure B.35

1968 / 69

80

EFFICIENCY
MOMENTUM FLUX

EFFICIENCY
HEAT FLUX

WAVE 2

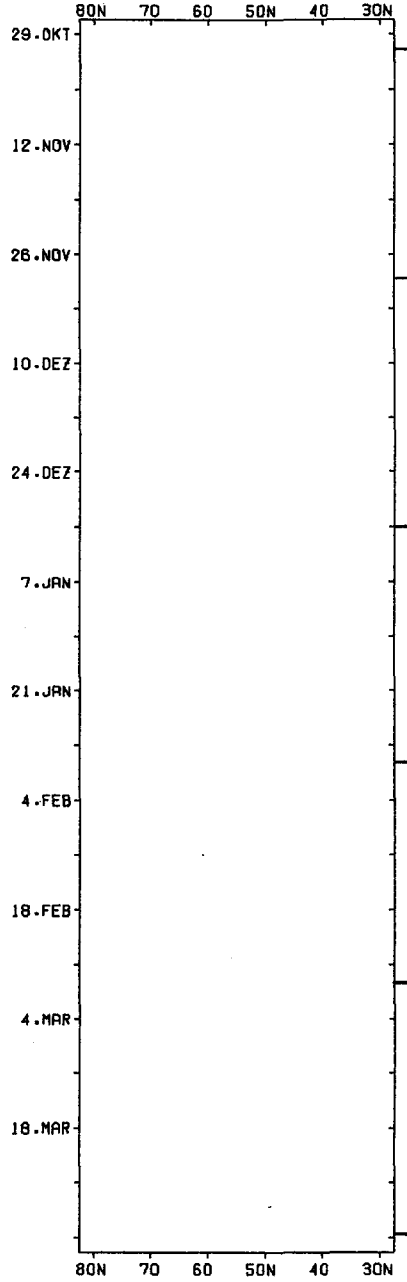
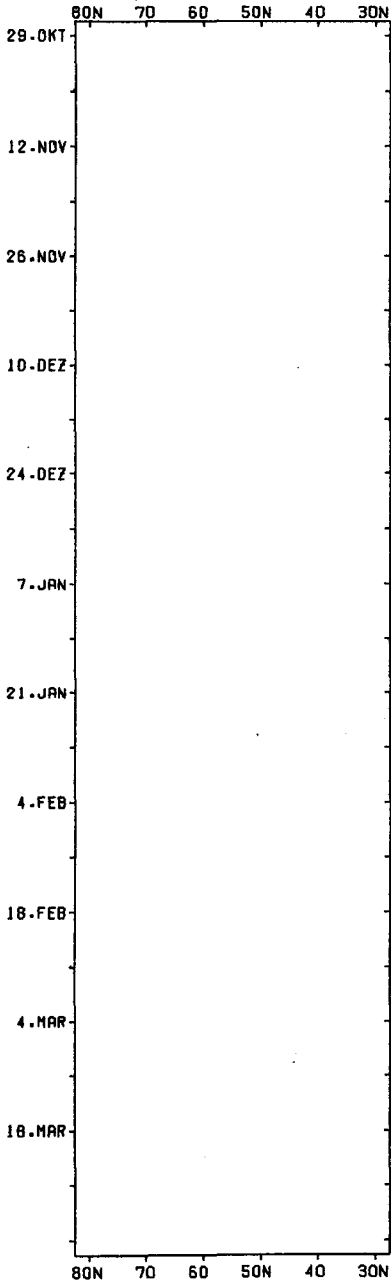

C.W.

C

q

r

Figure B.36

MEAN ZONAL WIND

MEAN ZONAL TEMP.

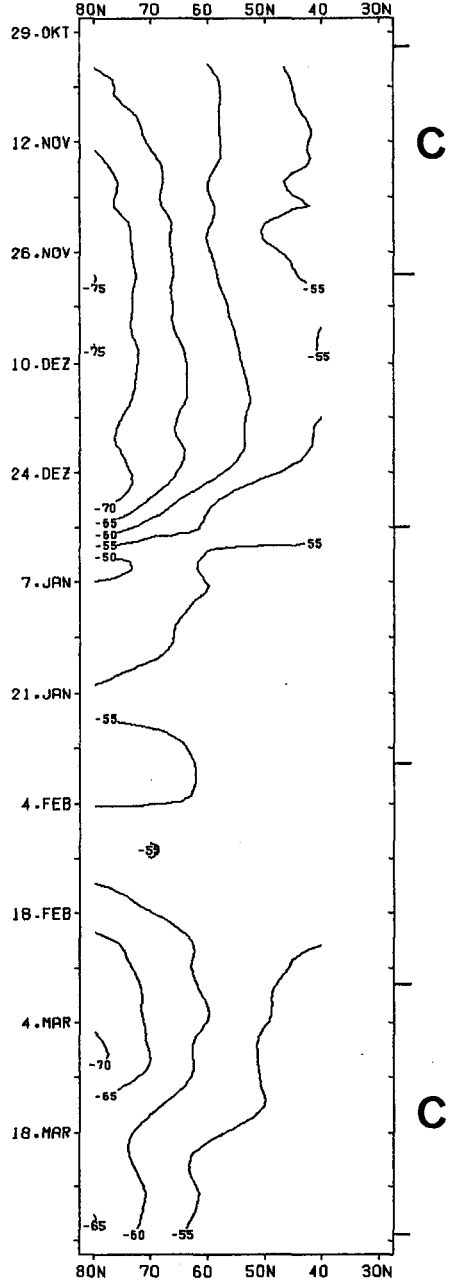
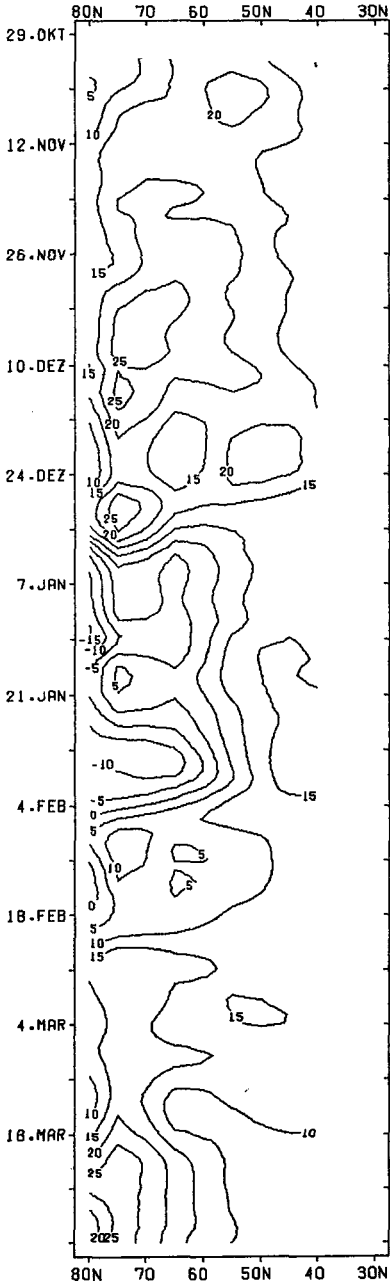

a

b

Figure B.37

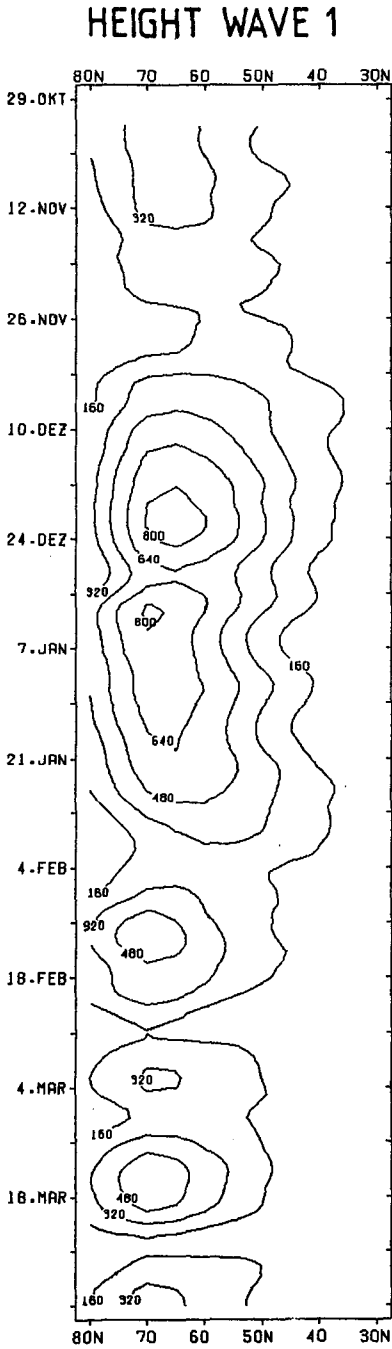

c

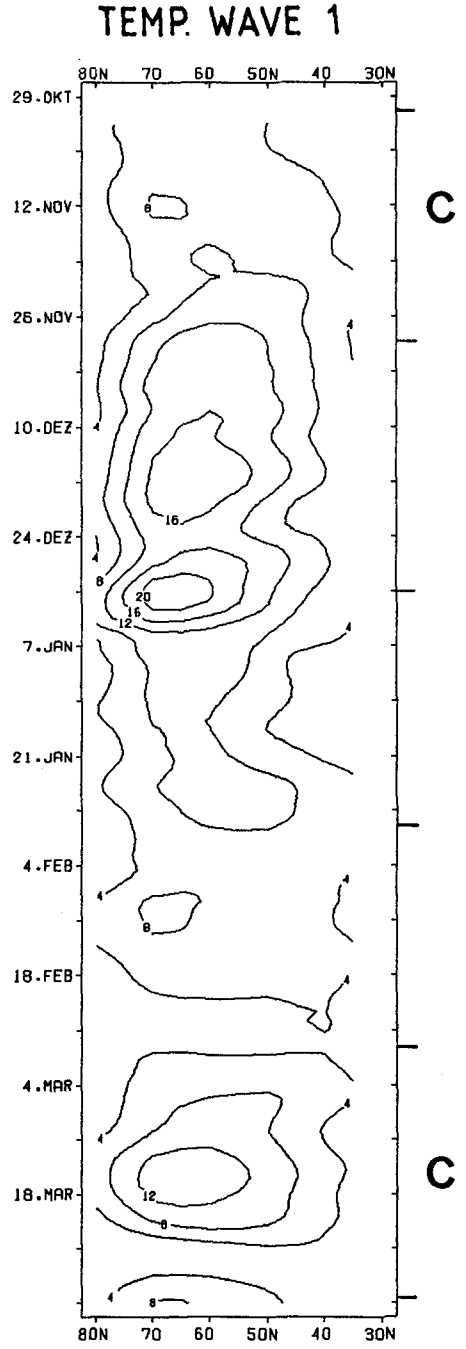

d

*

C

C

Figure B.38

HEIGHT WAVE 2

TEMP WAVE 2

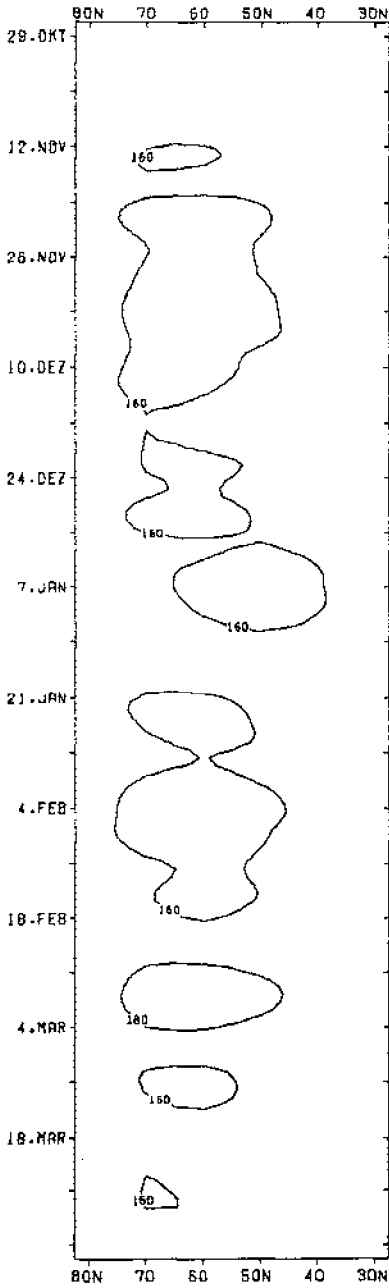

e

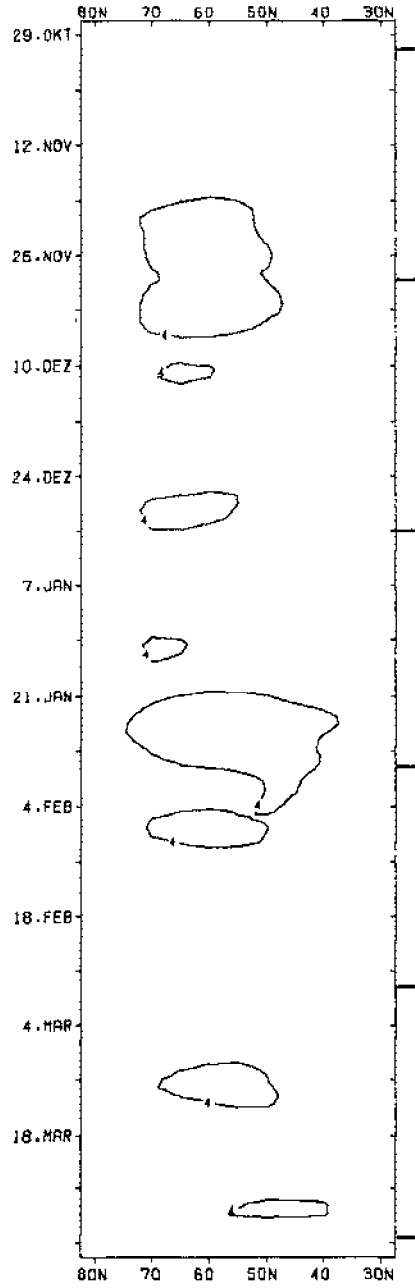

f

Figure B.39

1969/70

MOMENTUM FLUX

HEAT FLUX

WAVES 1-6

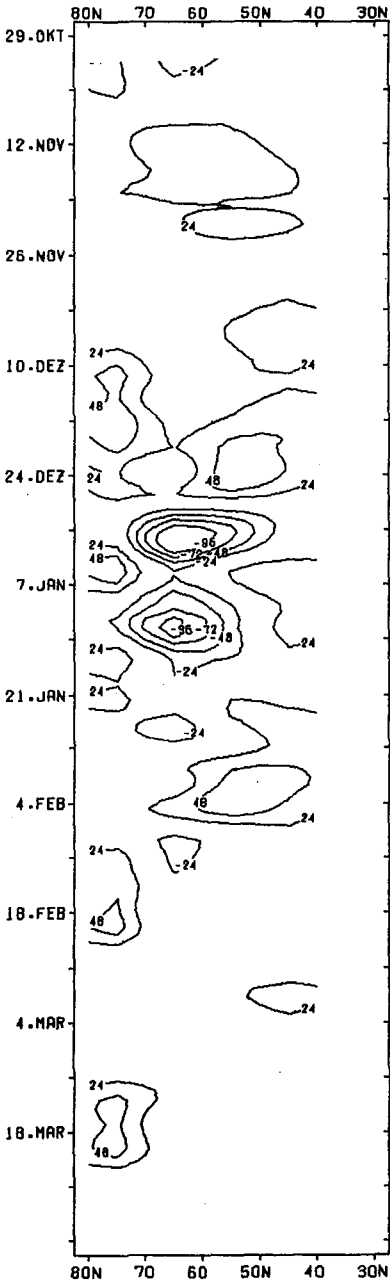

g

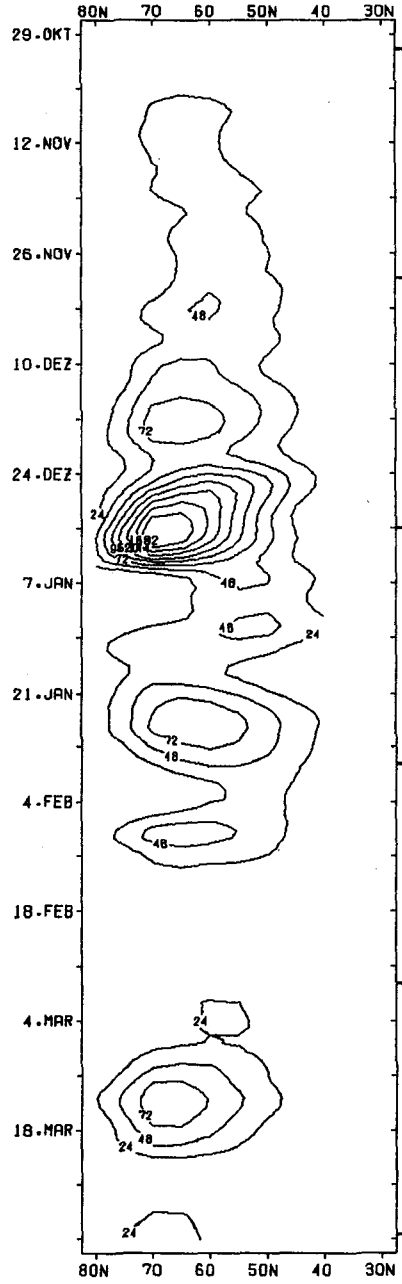

h

*

Figure B.40

1969/70

EFFICIENCY
MOMENTUM FLUX

EFFICIENCY
HEAT FLUX

WAVES 1-6

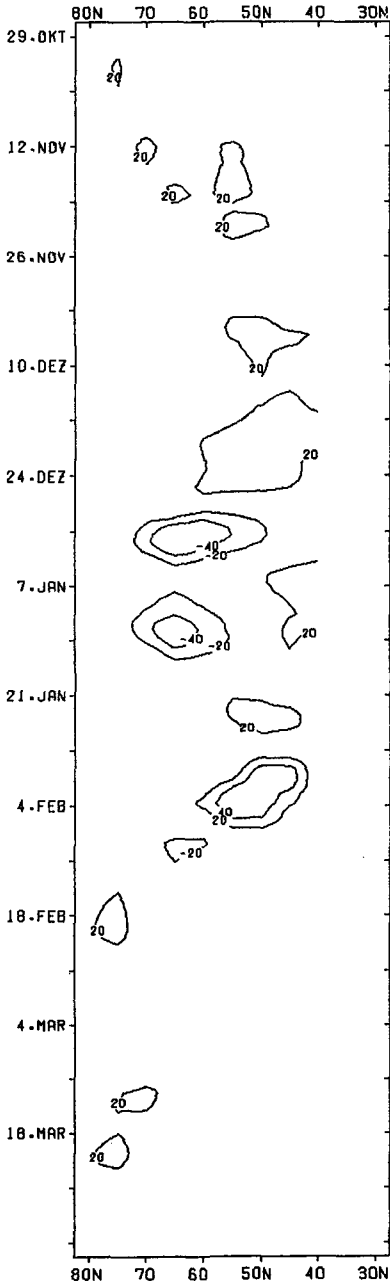

i

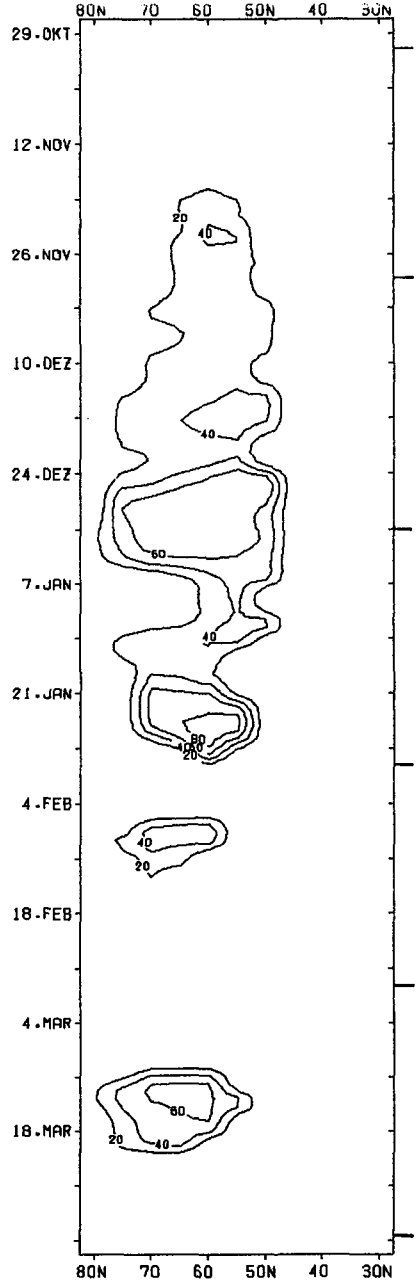

j

Figure B.41

1969/70

MOMENTUM FLUX

HEAT FLUX

WAVE 1

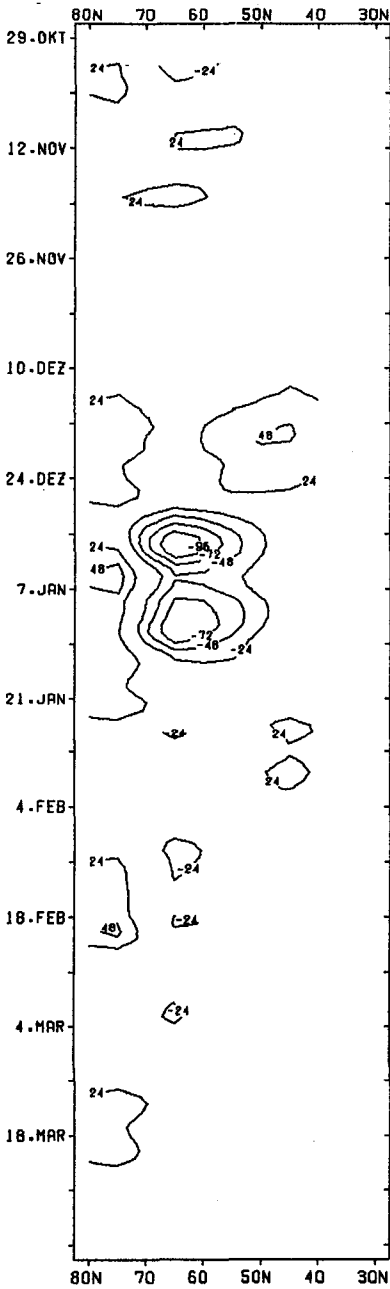

k

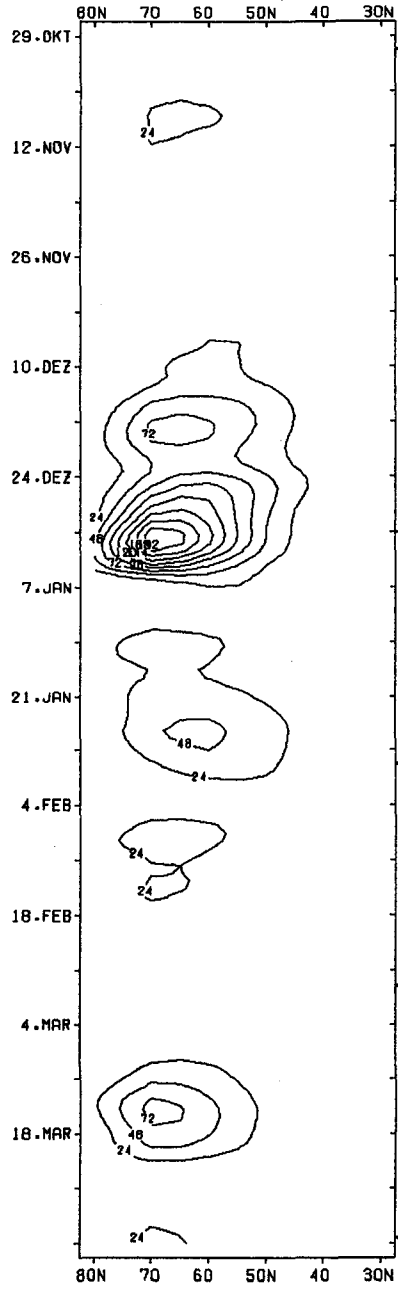

l

Figure B.42

1969/70

WAVE 2

MOMENTUM FLUX

HEAT FLUX

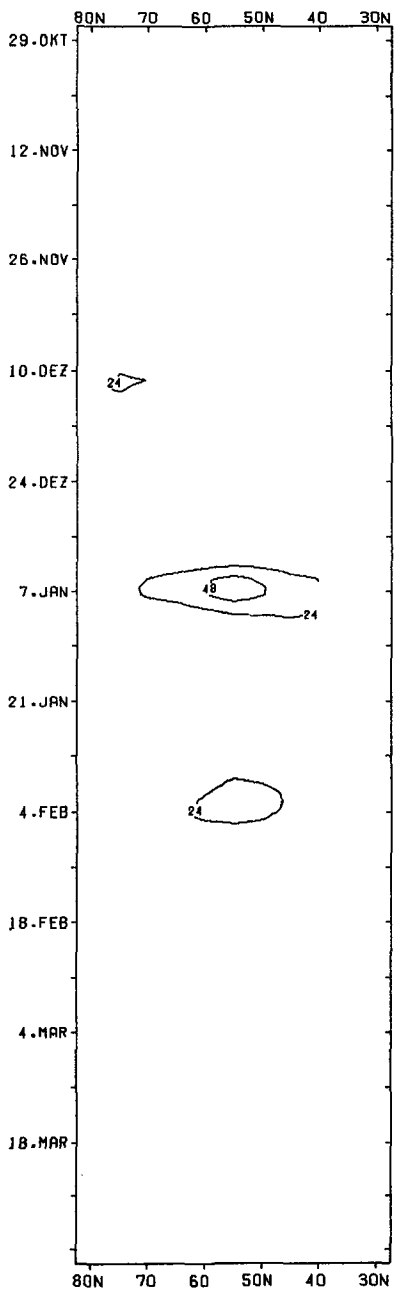

m

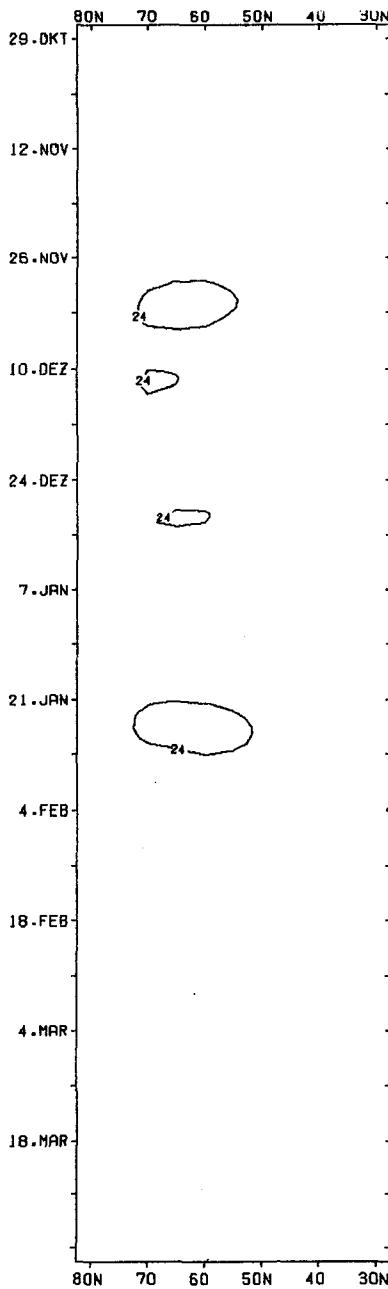

n

C

C

Figure B.43

EFFICIENCY
MOMENTUM FLUX

1969/70

WAVE 1

EFFICIENCY
HEAT FLUX

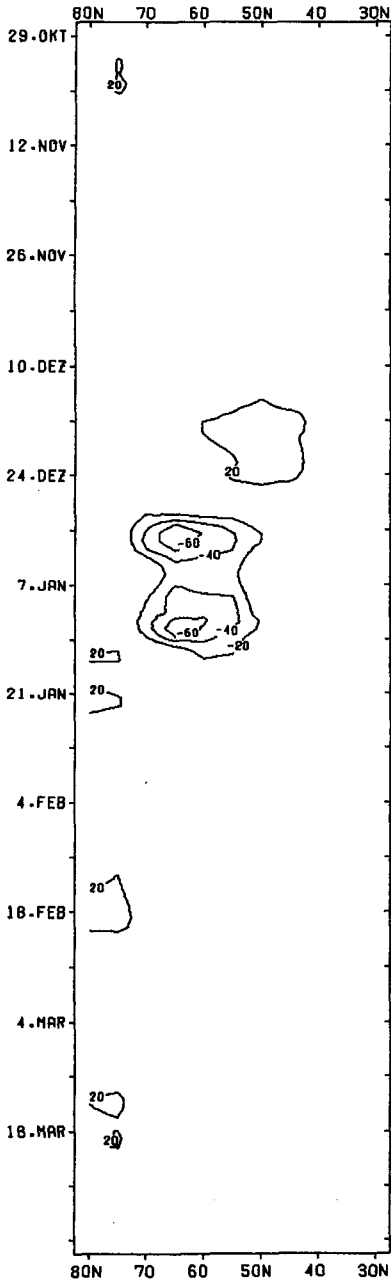

o

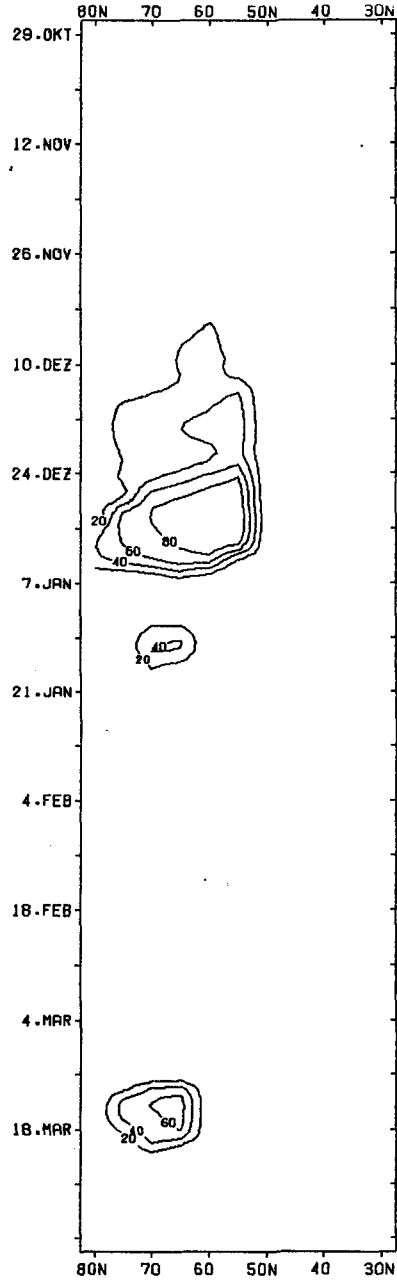

p

Figure B.44

1969/70

EFFICIENCY
MOMENTUM FLUX

EFFICIENCY
HEAT FLUX

WAVE 2

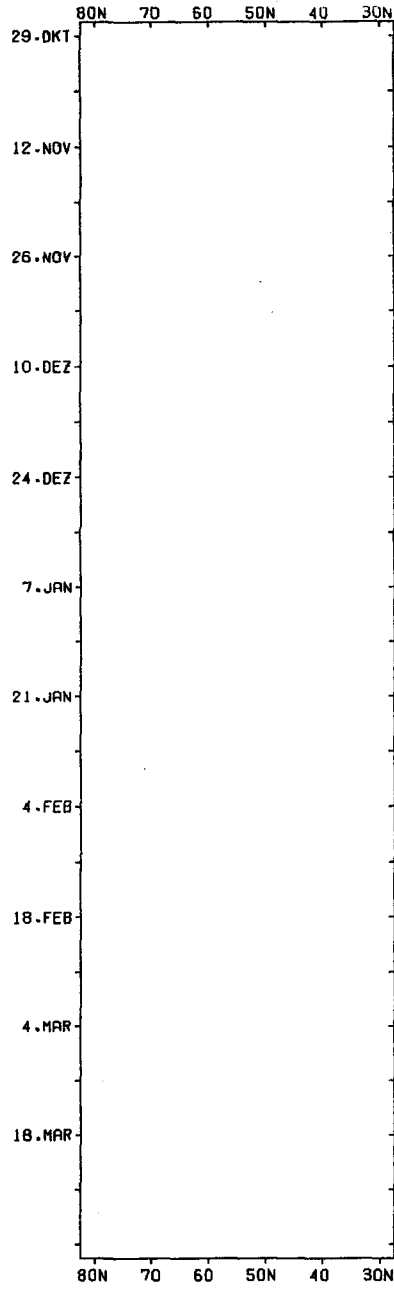
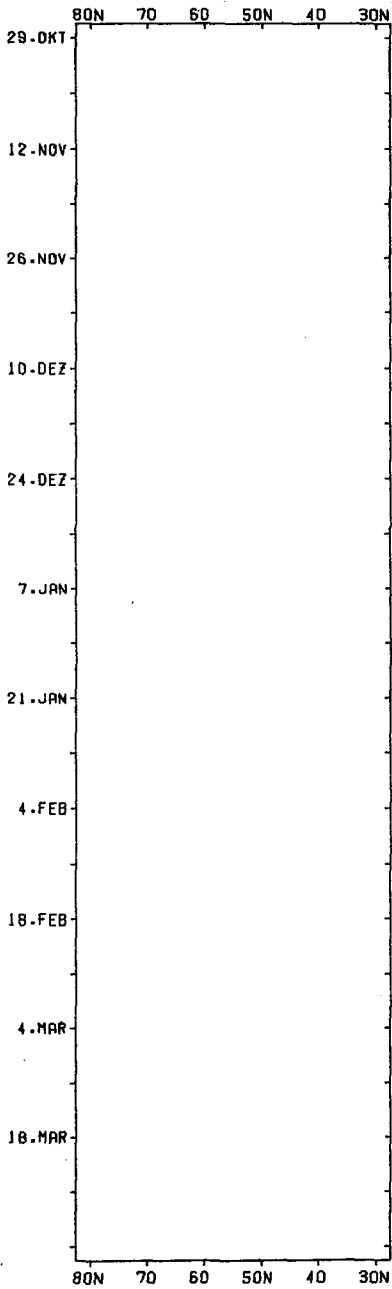

*

q

r

Figure B.45

MEAN ZONAL WIND

MEAN ZONAL TEMP.

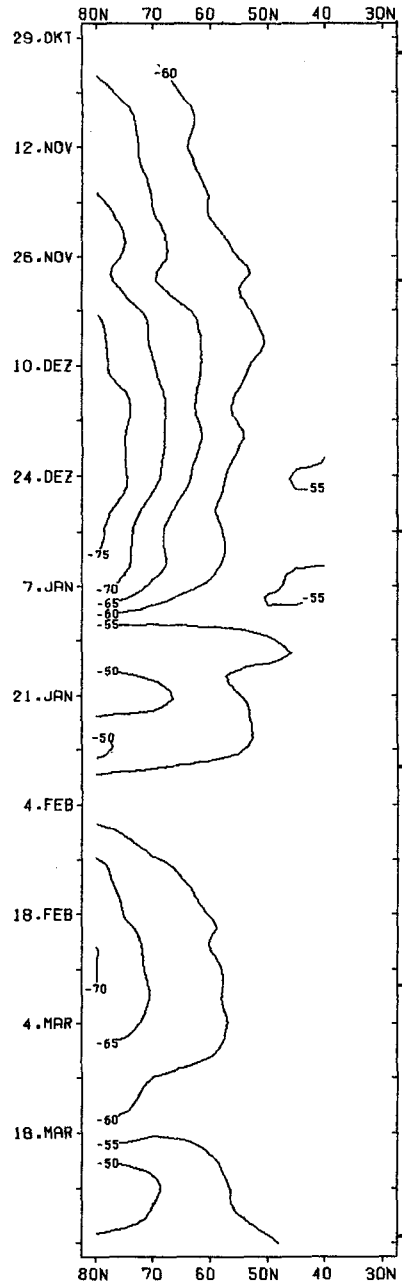
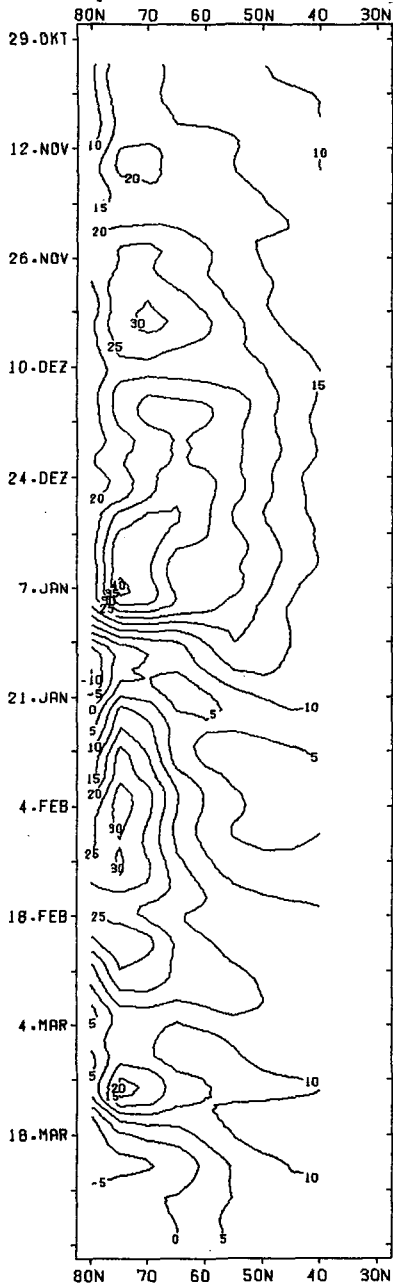

C
C

a

b

Figure B.46

HEIGHT WAVE 2

TEMP WAVE 2

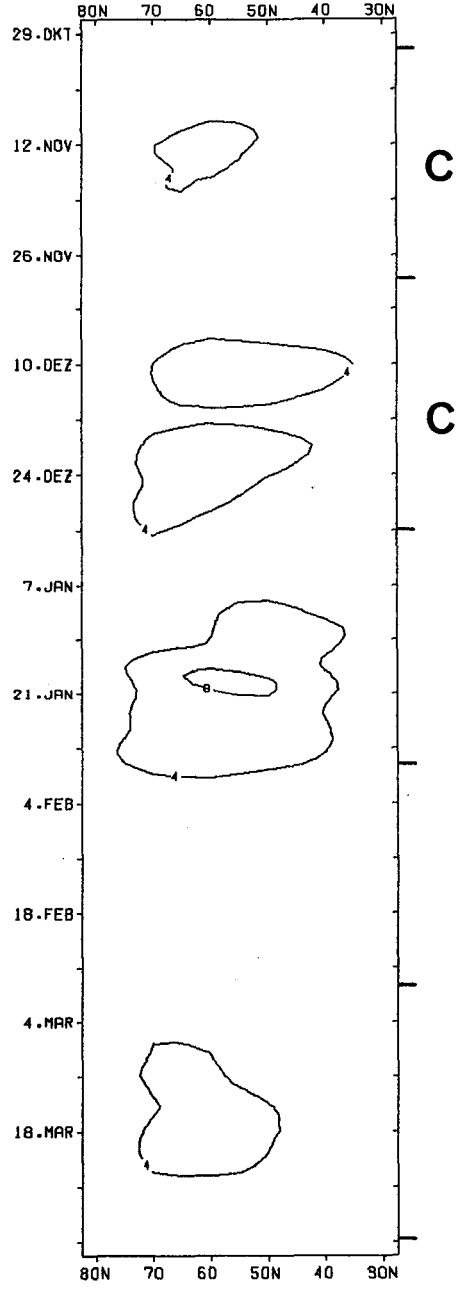
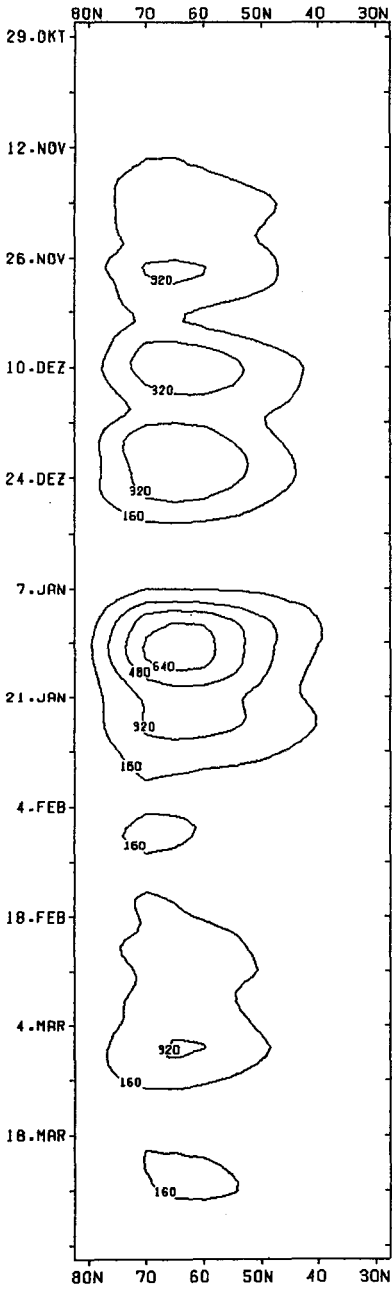

*

e

f

Figure B.48

1970/71
WAVES 1-6

MOMENTUM FLUX

HEAT FLUX

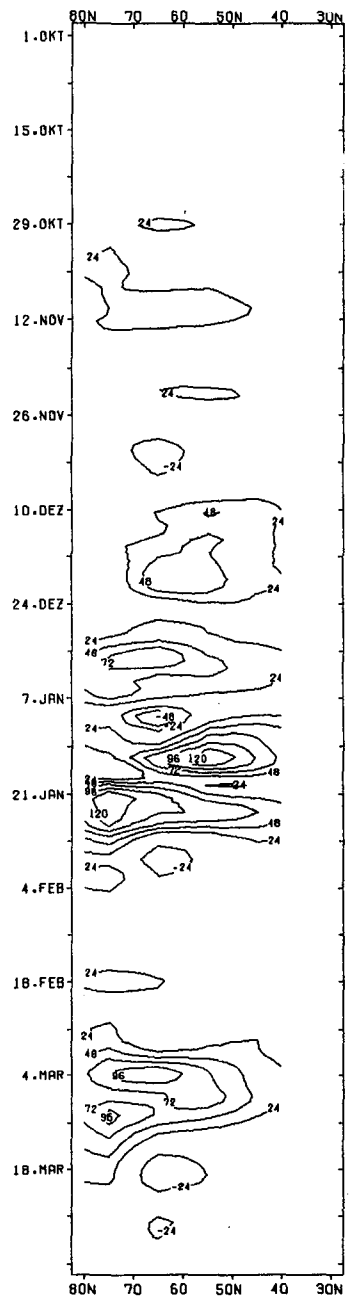

g

*

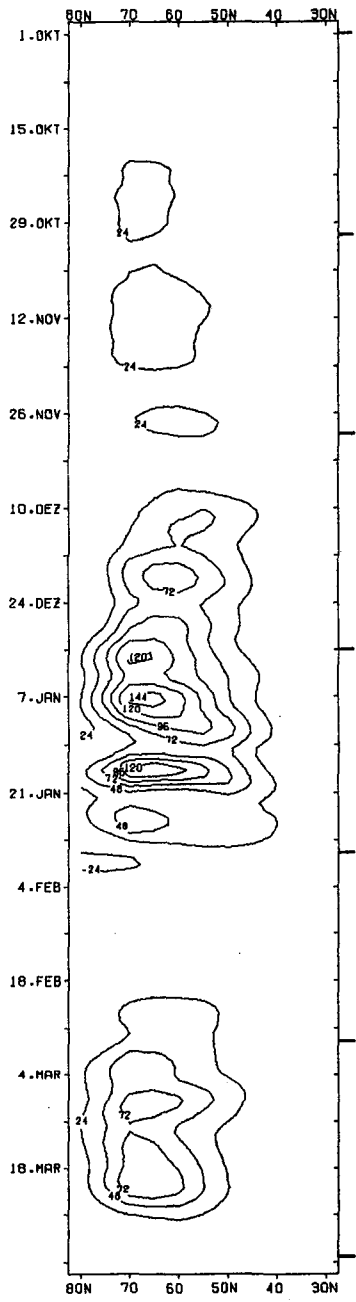

h

Figure B.49

EFFICIENCY
MOMENTUM FLUX

1970/71

EFFICIENCY
HEAT FLUX

WAVES 1-6

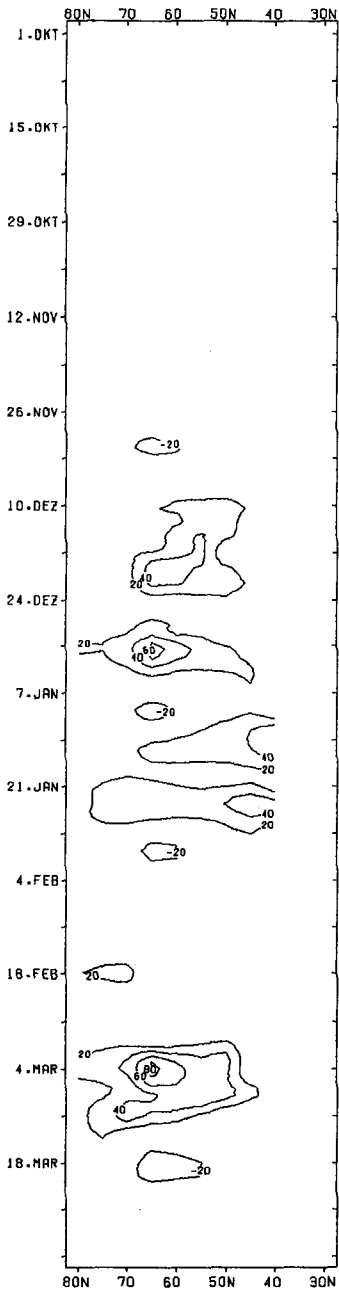

i

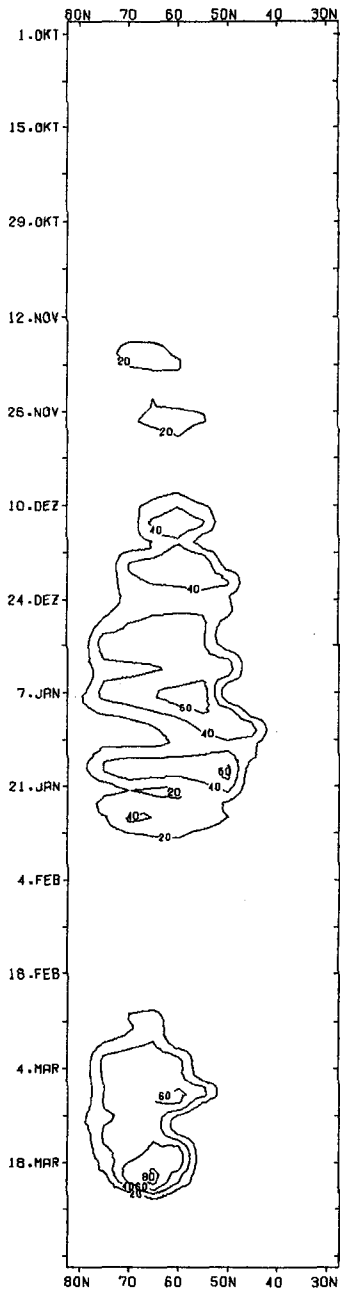

j

Figure B.50

1970/71
WAVE 1

MOMENTUM FLUX

HEAT FLUX

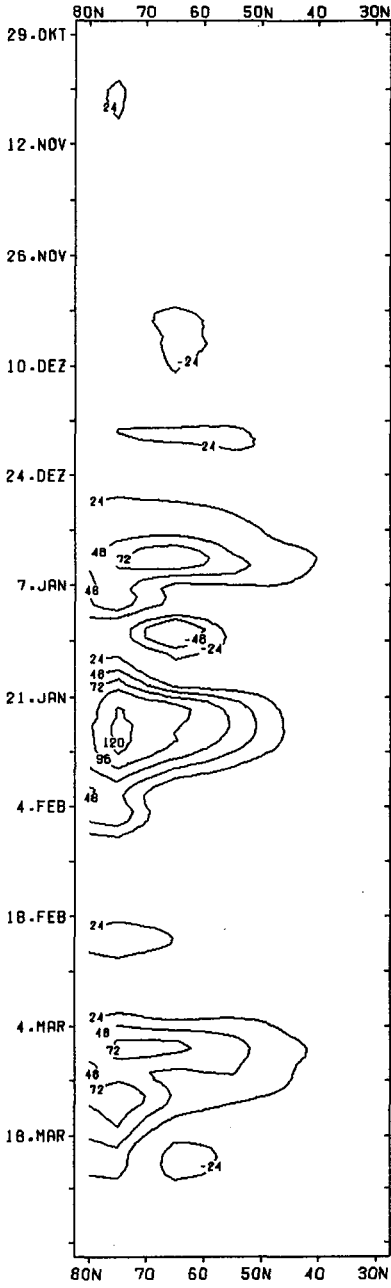

k

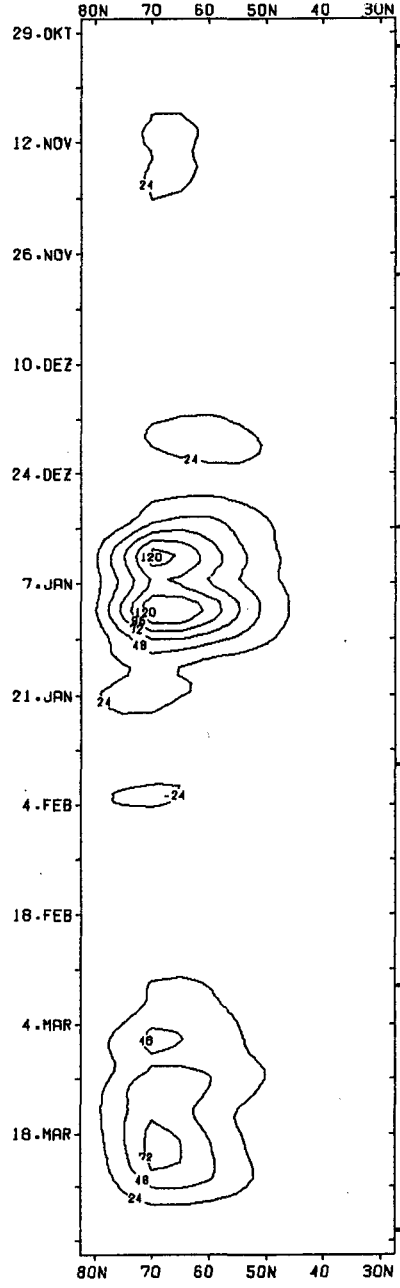

C

C

*

l

Figure B.51

1970/71
WAVE 2

MOMENTUM FLUX

HEAT FLUX

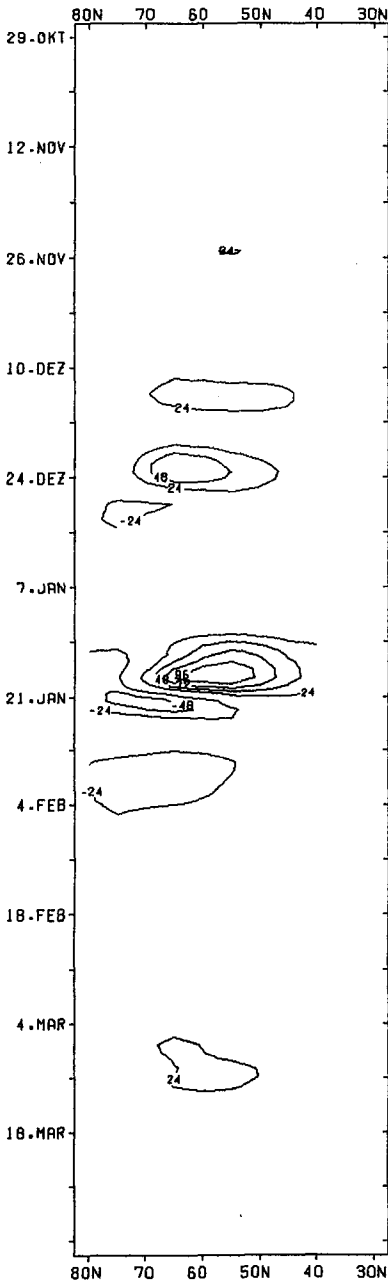

m

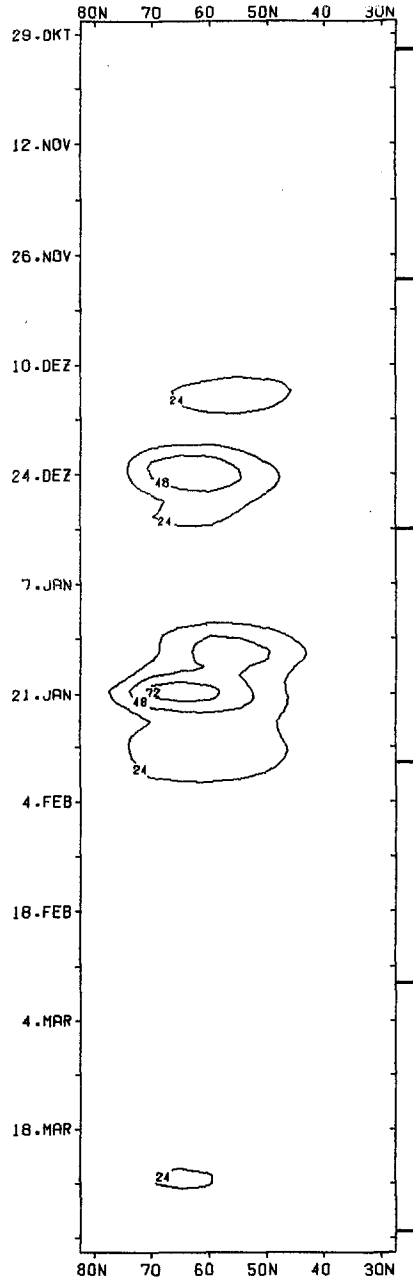

n

*

Figure B.52

1970/71

EFFICIENCY
MOMENTUM FLUX

EFFICIENCY
HEAT FLUX

WAVE 1

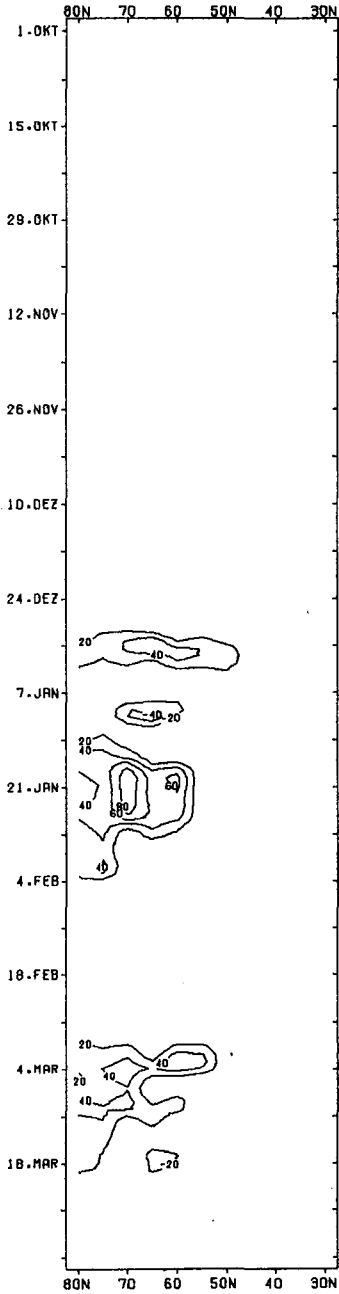

o

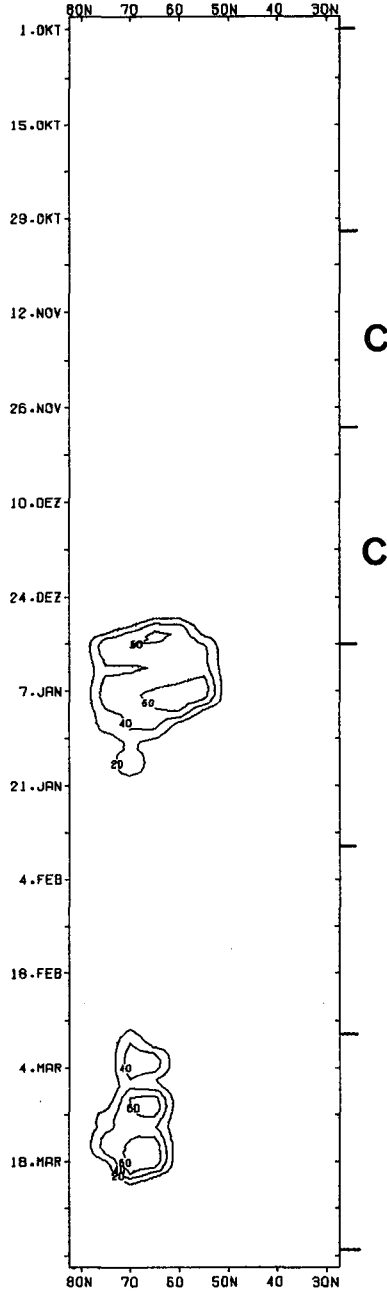

p

*

C

C

Figure B.53

1970/71

EFFICIENCY
MOMENTUM FLUX

EFFICIENCY
HEAT FLUX

WAVE 2

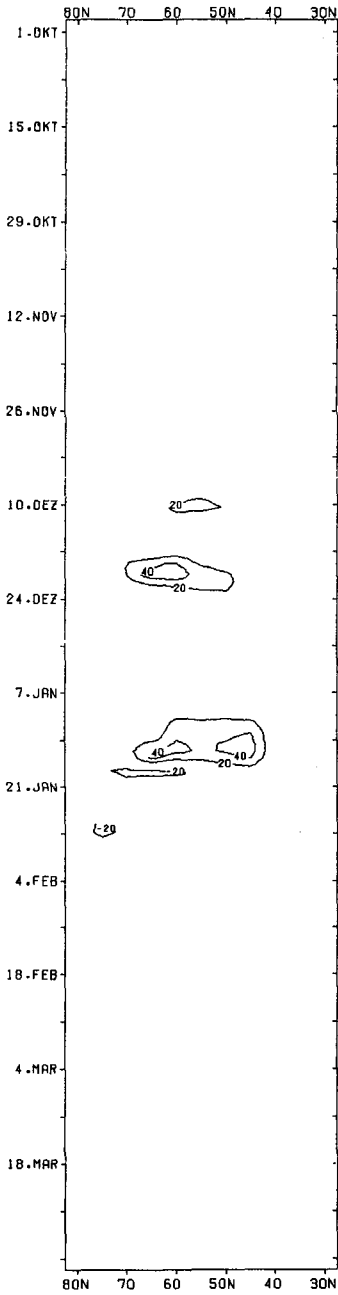

q

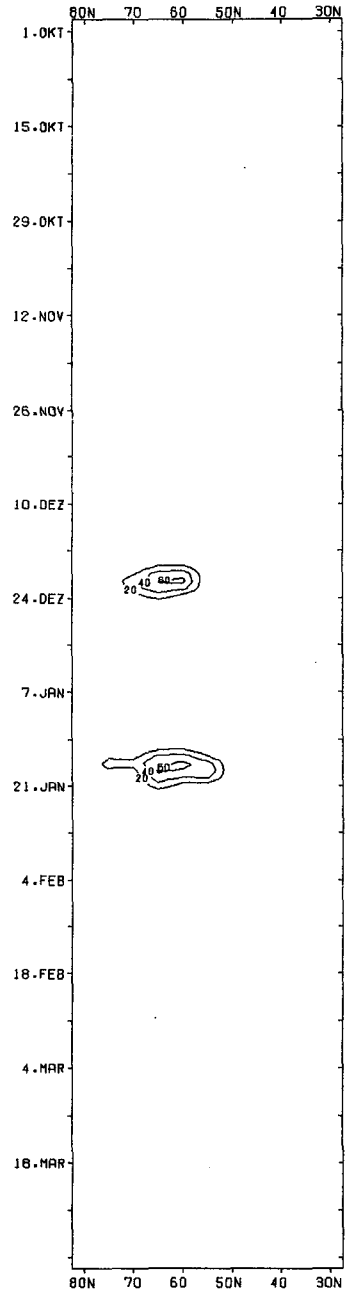

r

Figure B.54

1971 / 72

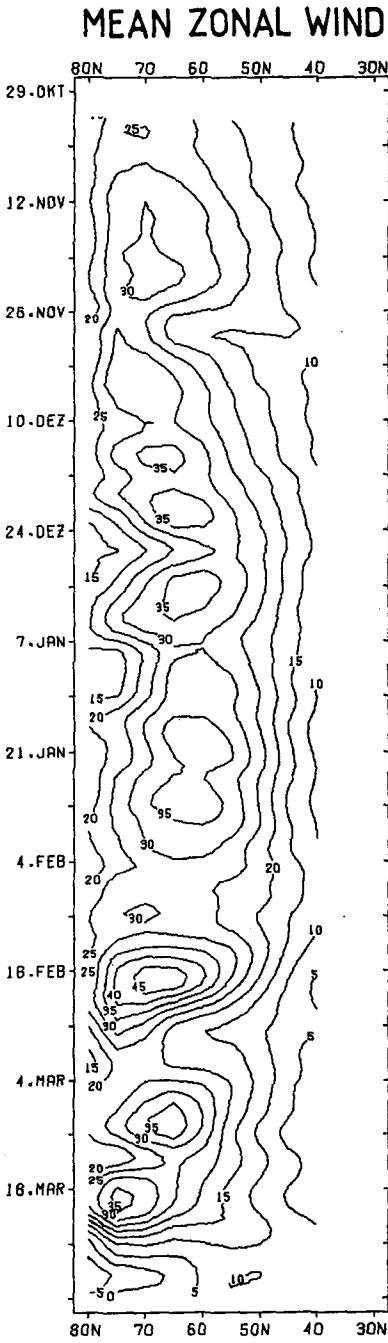

a

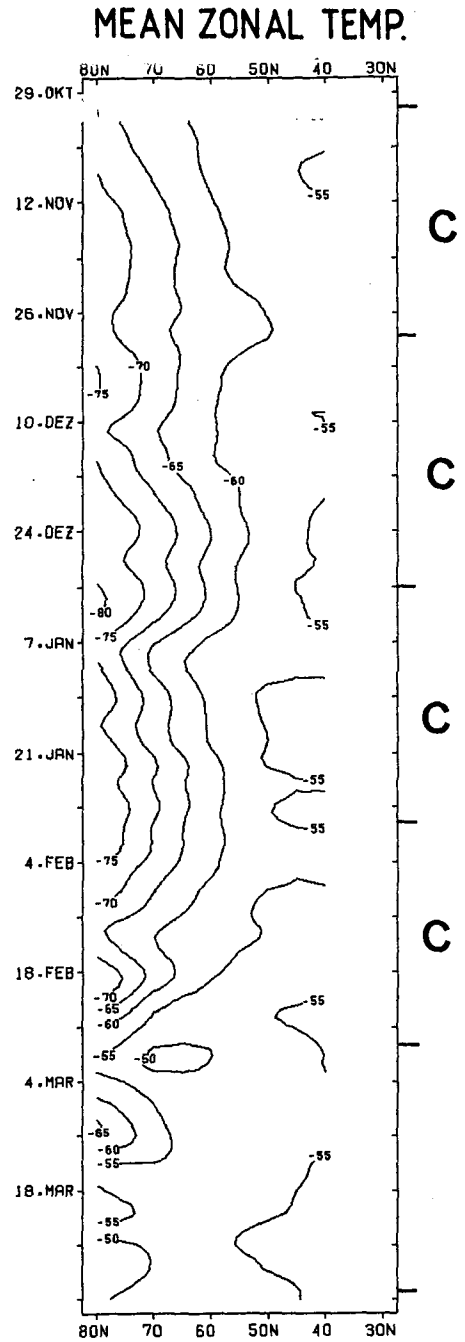

b

Figure B.55

1971 / 72

HEIGHT WAVE 1

TEMP. WAVE 1

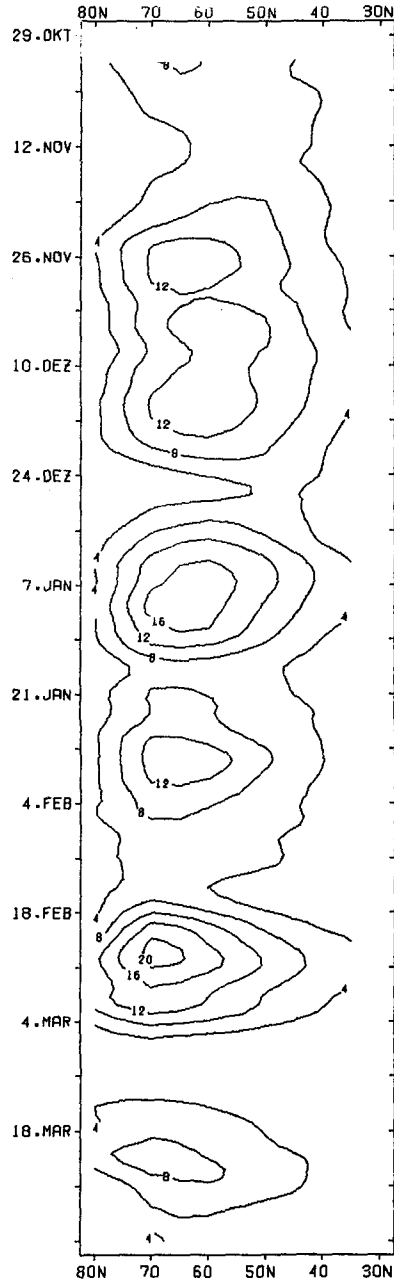
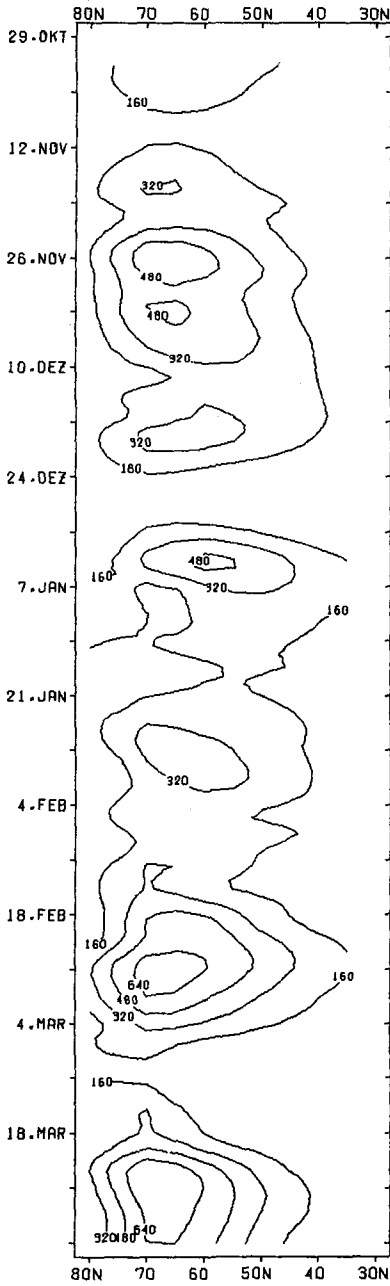

C
C
C
C

c

d

Figure B.56

1971 / 72

HEIGHT WAVE 2

TEMP WAVE 2

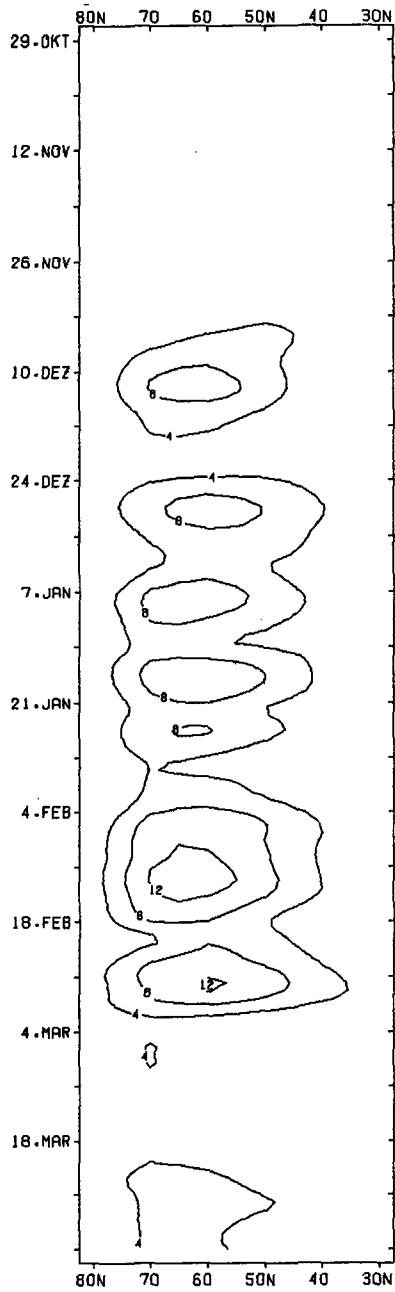
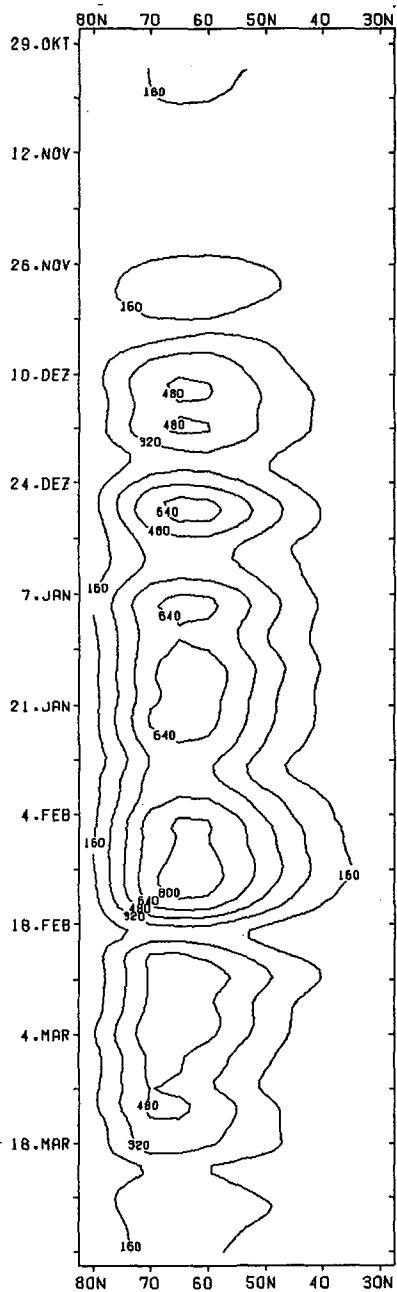

C

C

C

C

e

f

Figure B.57

1971 / 72

WAVES 1-6

MOMENTUM FLUX

HEAT FLUX

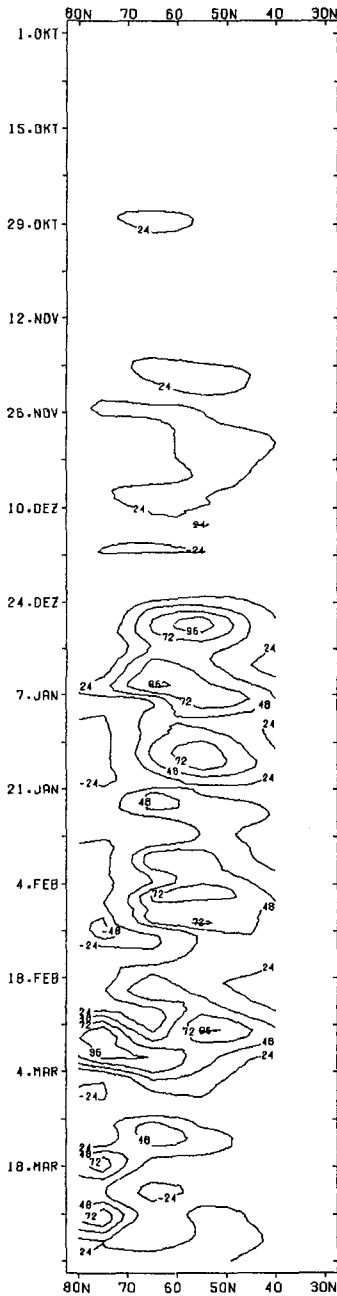

g

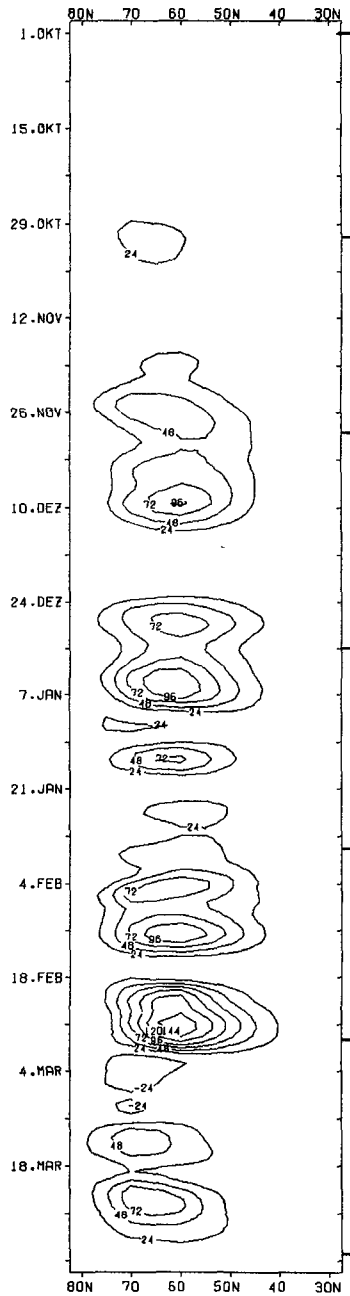

h

Figure B.58

1971 / 72

EFFICIENCY
MOMENTUM FLUX

EFFICIENCY
HEAT FLUX

WAVES 1-6

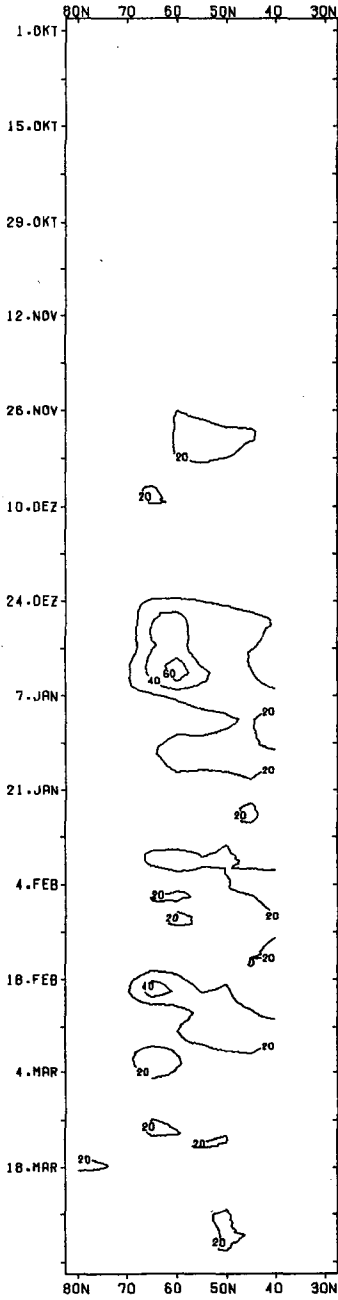

i

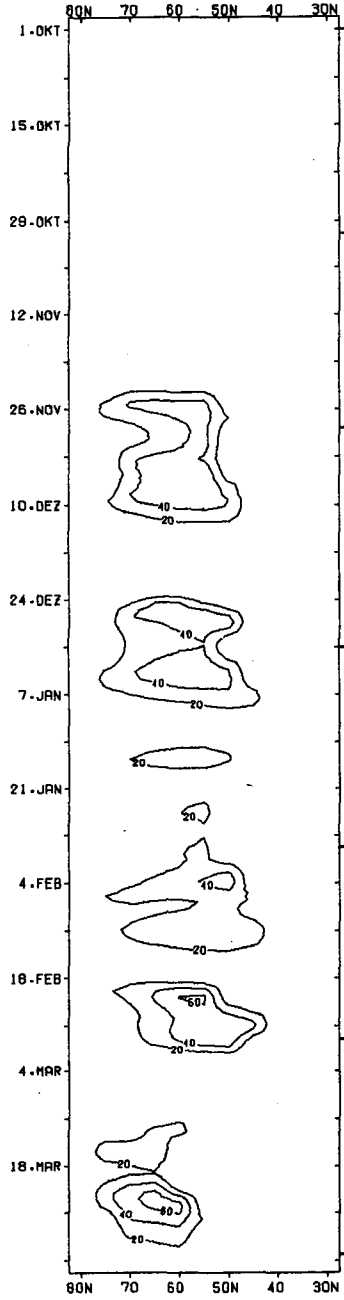

j

Figure B.59

1971 / 72

WAVE 1

MOMENTUM FLUX

HEAT FLUX

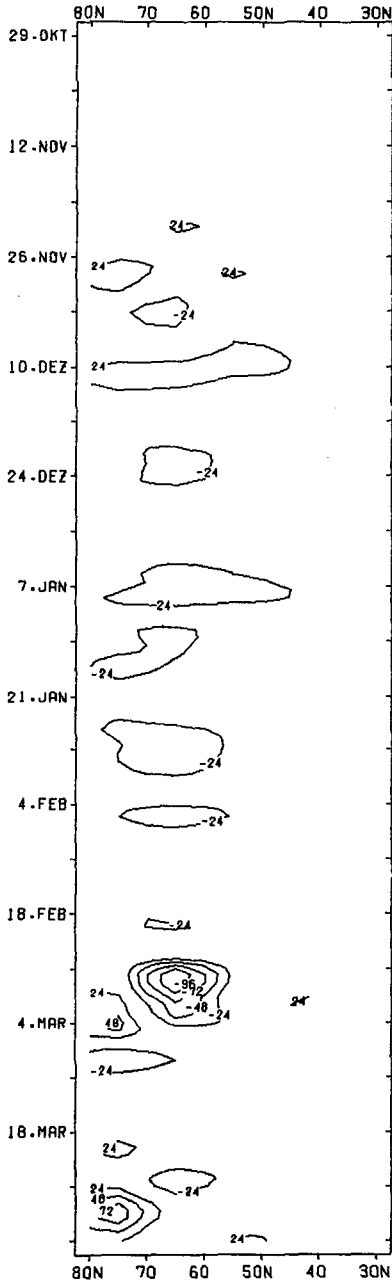

k

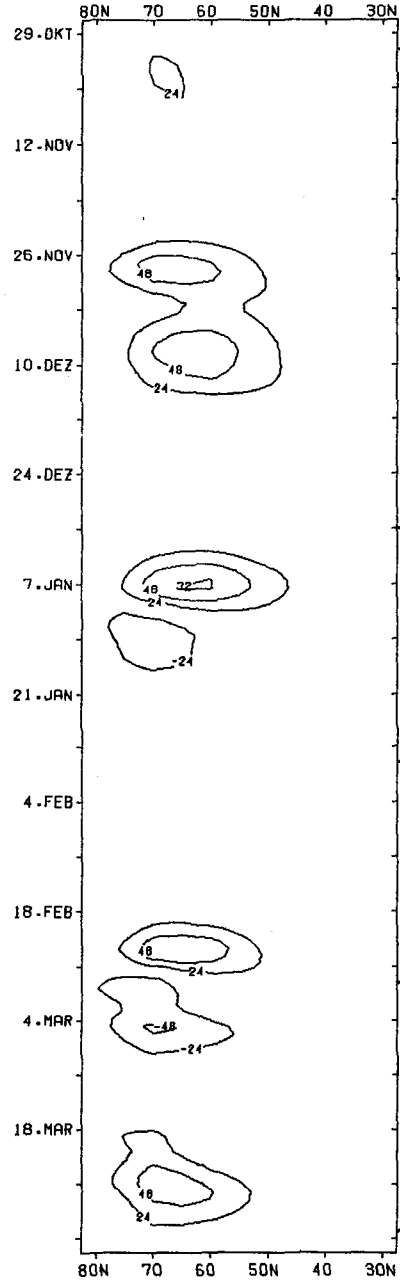

C

C

C

C

l

Figure B.60

1971 / 72

MOMENTUM FLUX

HEAT FLUX

WAVE 2

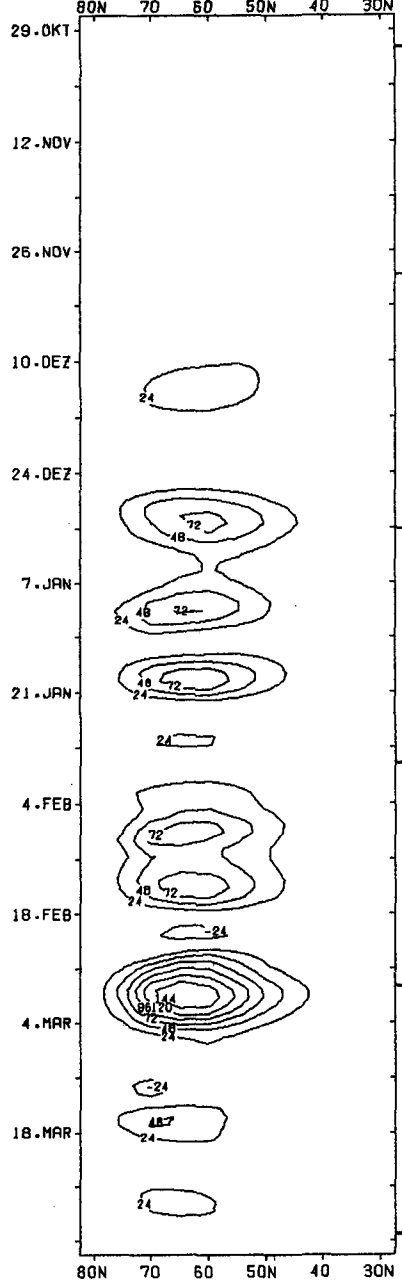
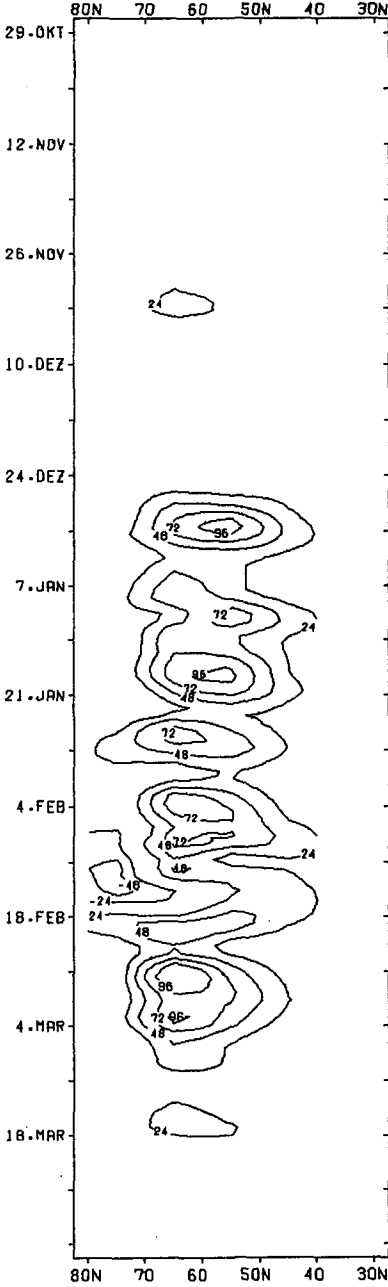

C
C
C
C

m

n

Figure B.61

EFFICIENCY
MOMENTUM FLUX

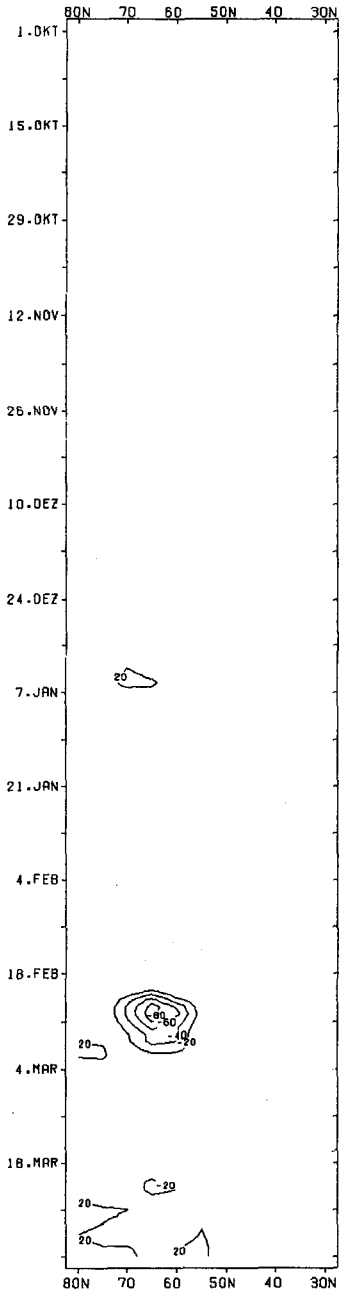

o

1971 / 72

EFFICIENCY
HEAT FLUX

WAVE 1

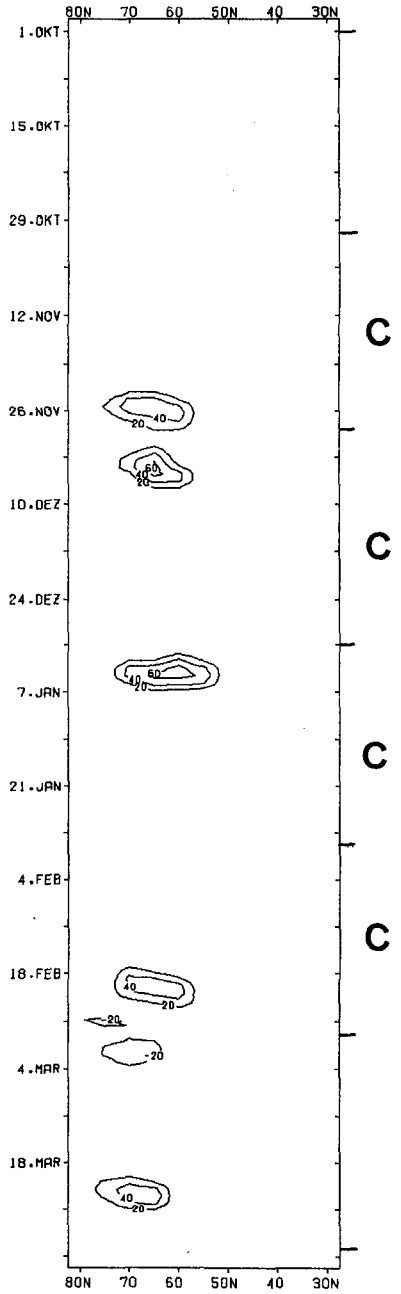

p

Figure B.62

1971 / 72

EFFICIENCY
MOMENTUM FLUX

EFFICIENCY
HEAT FLUX

WAVE 2

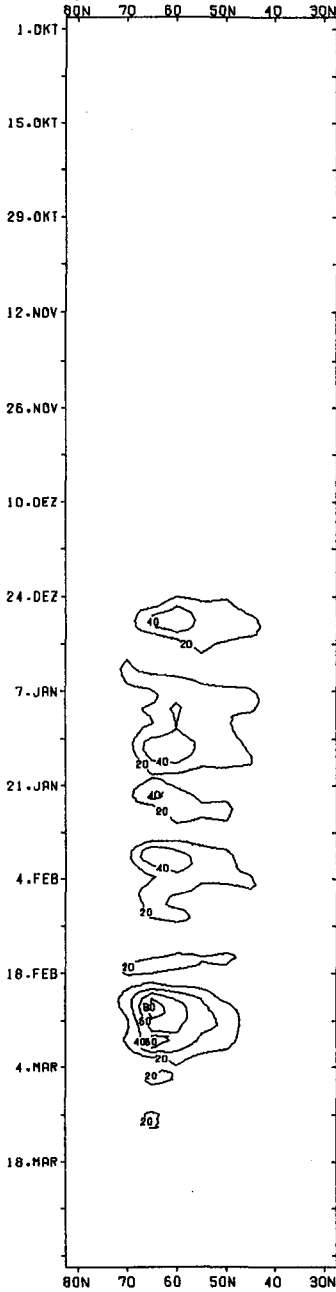

q

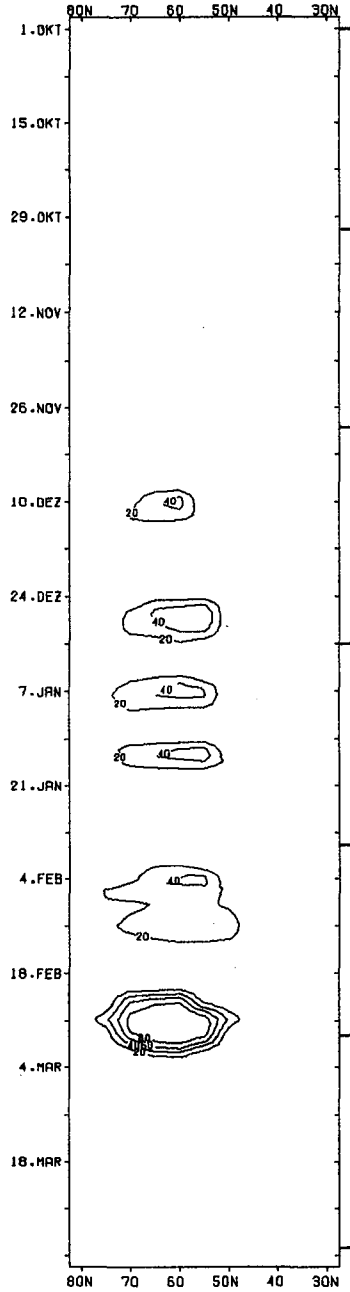

r

Figure B.63

1972 / 73

MEAN ZONAL WIND

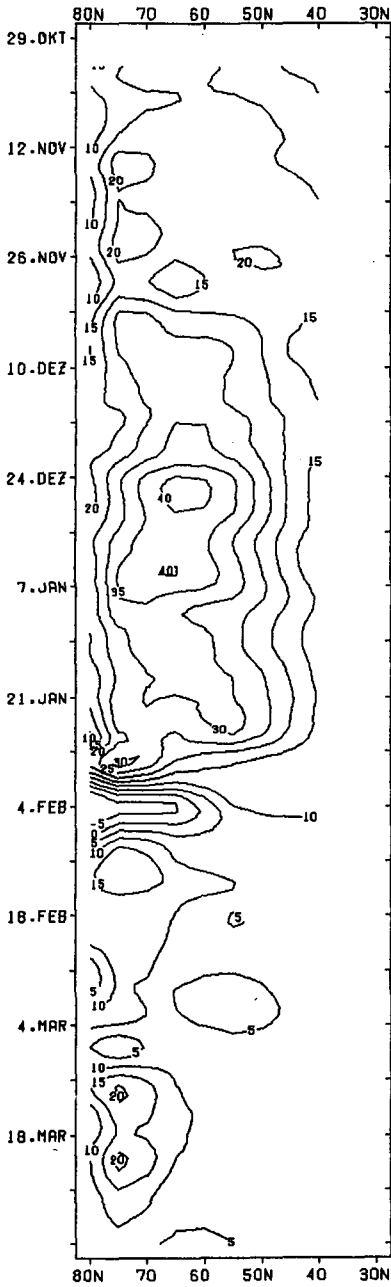

a

MEAN ZONAL TEMP.

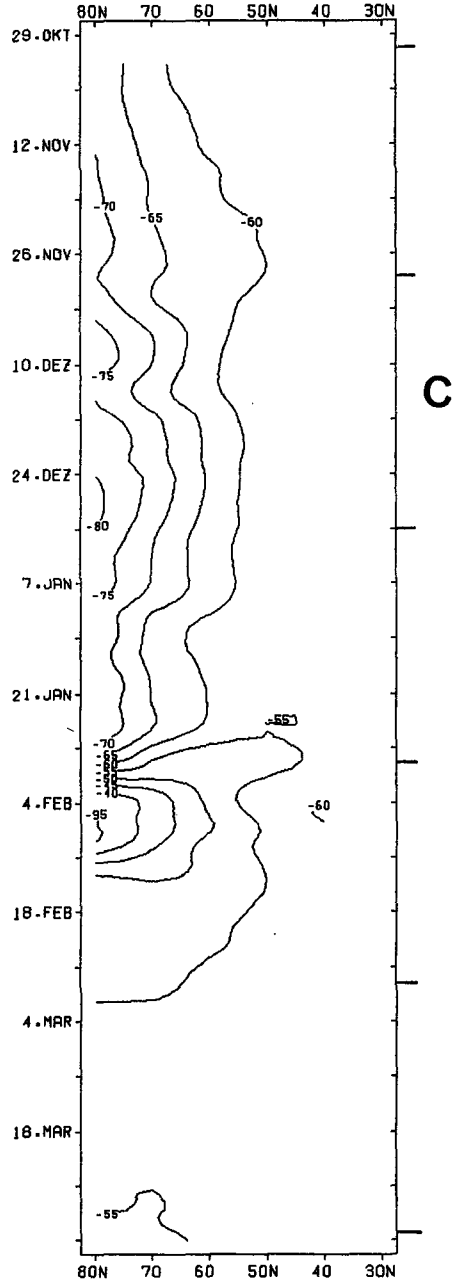

C.W.

C

*

b

Figure B.64

1972 / 73

HEIGHT WAVE 1

TEMP. WAVE 1

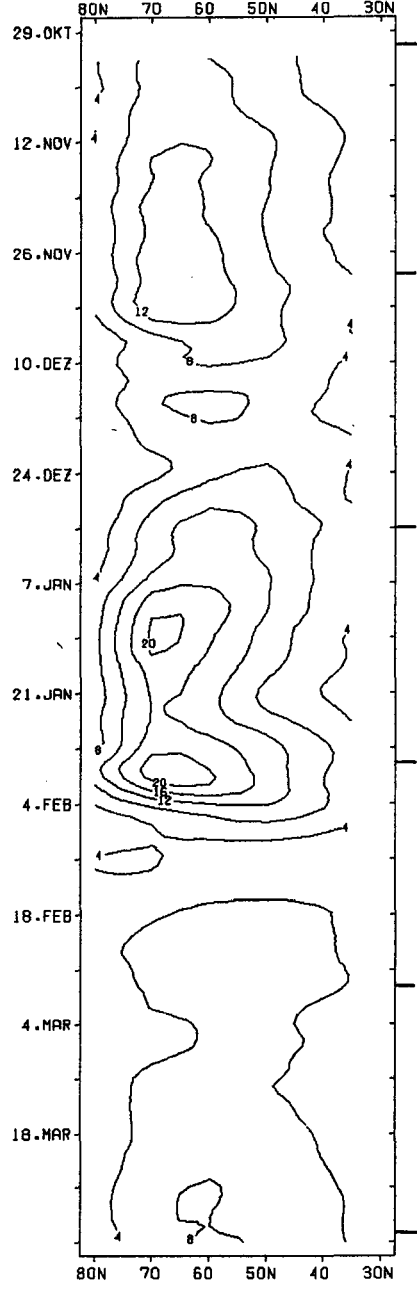
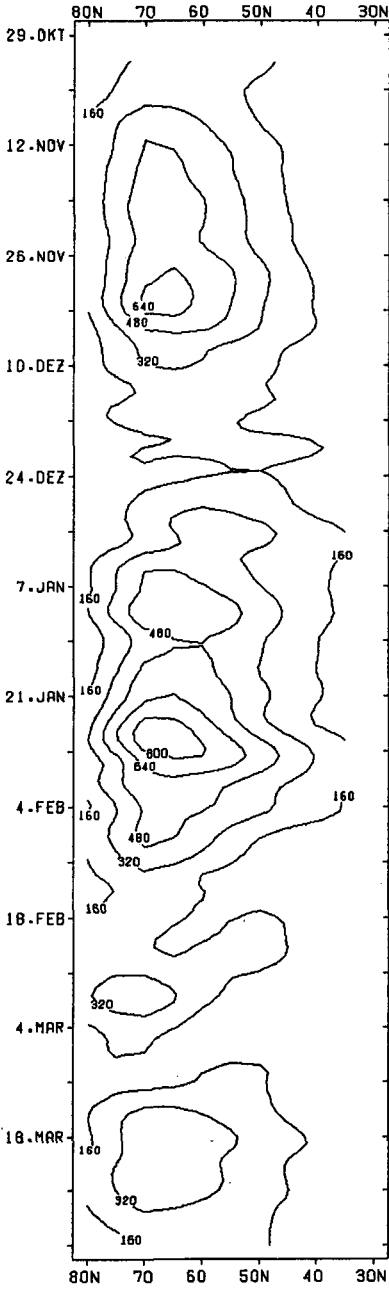

C.W.

C

*

c

d

Figure B.65

1972 / 73

HEIGHT WAVE 2

TEMP WAVE 2

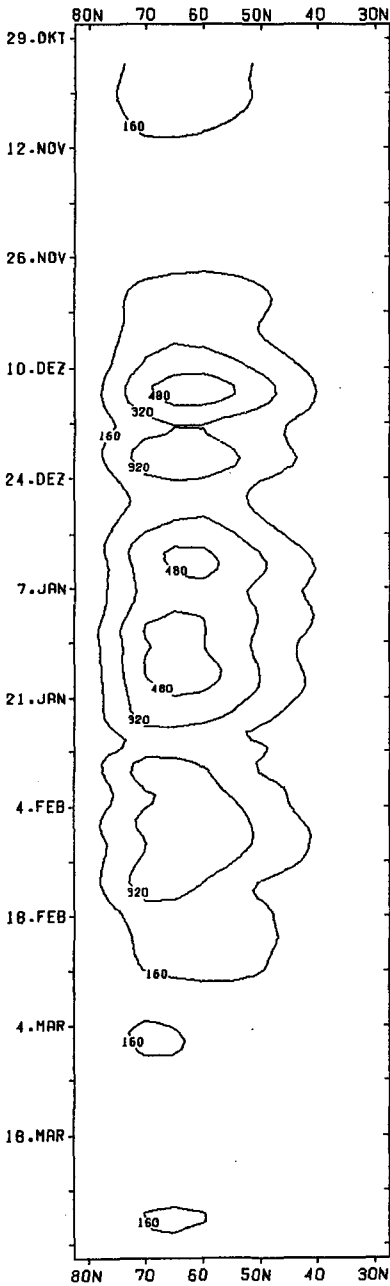

e

C.W.

*

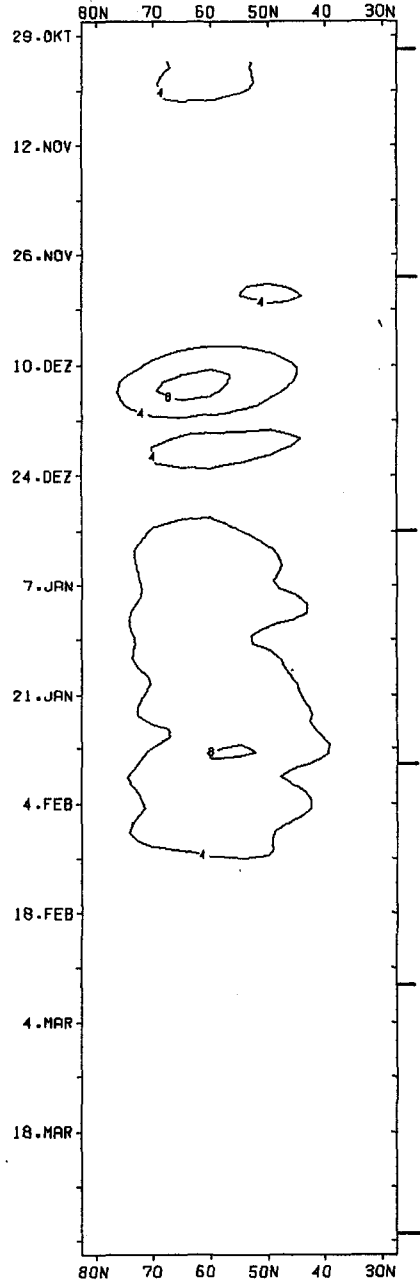

C

f

Figure B.66

MOMENTUM FLUX

HEAT FLUX

WAVES 1-6

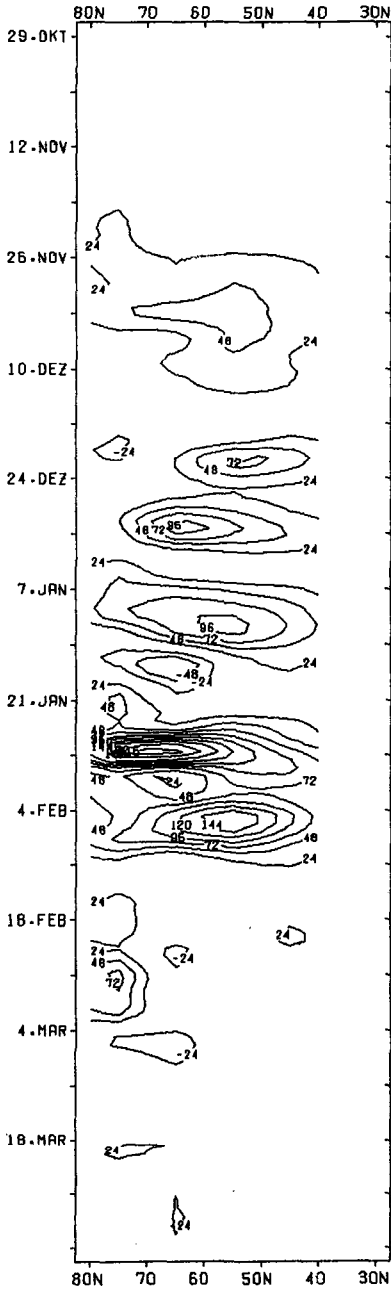

g

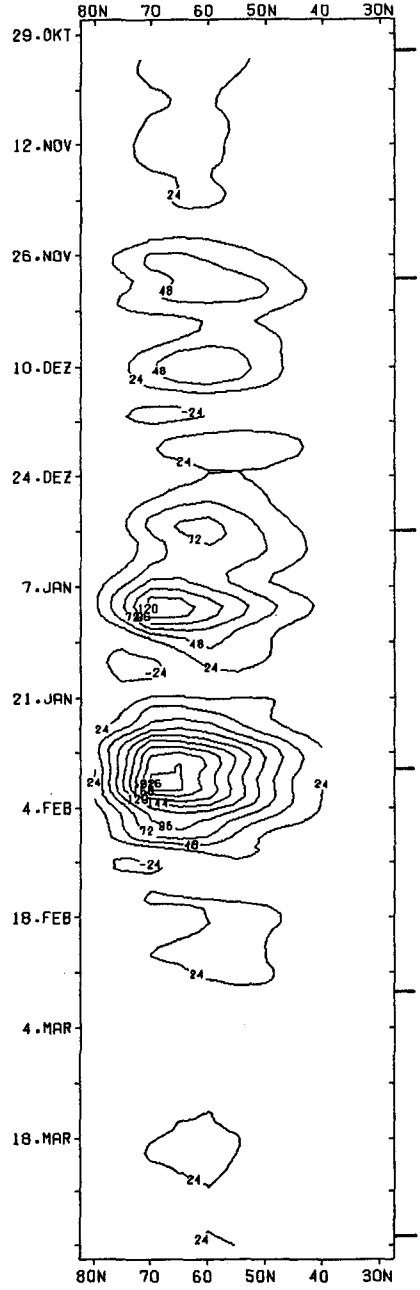

h

C.W.

C

*

Figure B.67

1972 / 73

112 EFFICIENCY
MOMENTUM FLUX

EFFICIENCY
HEAT FLUX

WAVES 1-6

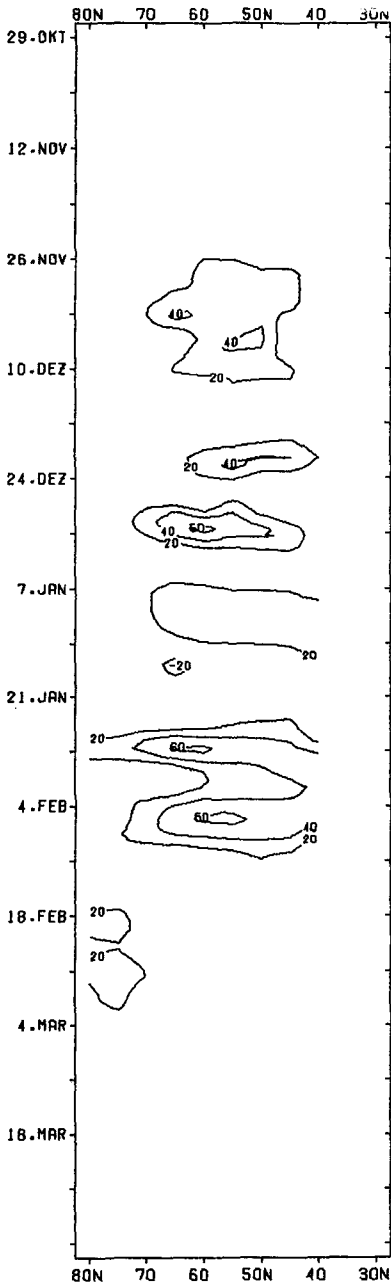

i

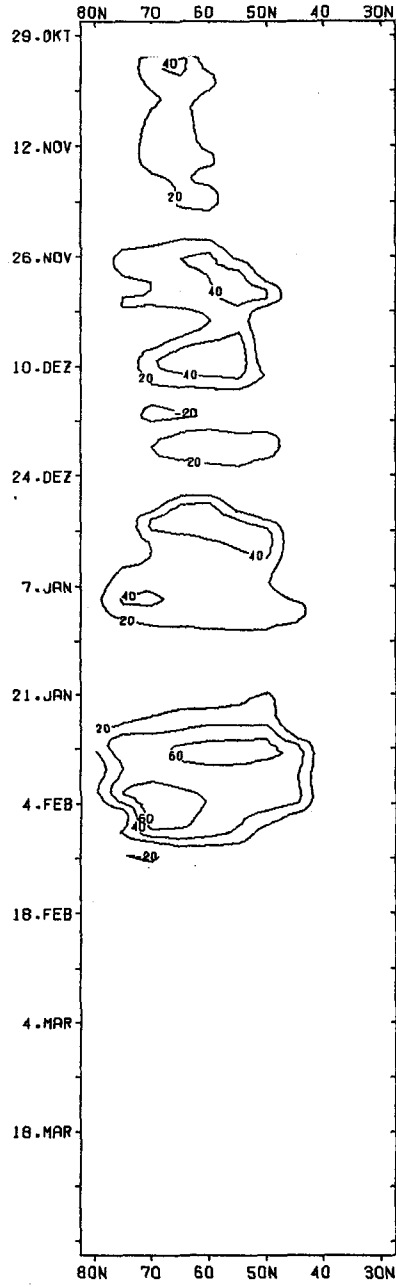

j

C.W.

*

C

Figure B.68

MOMENTUM FLUX

HEAT FLUX

WAVE 1

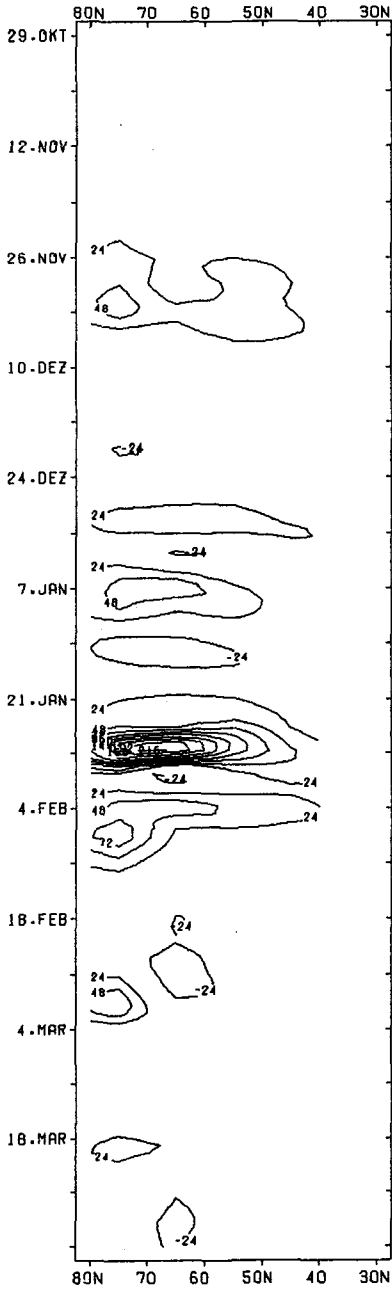

k

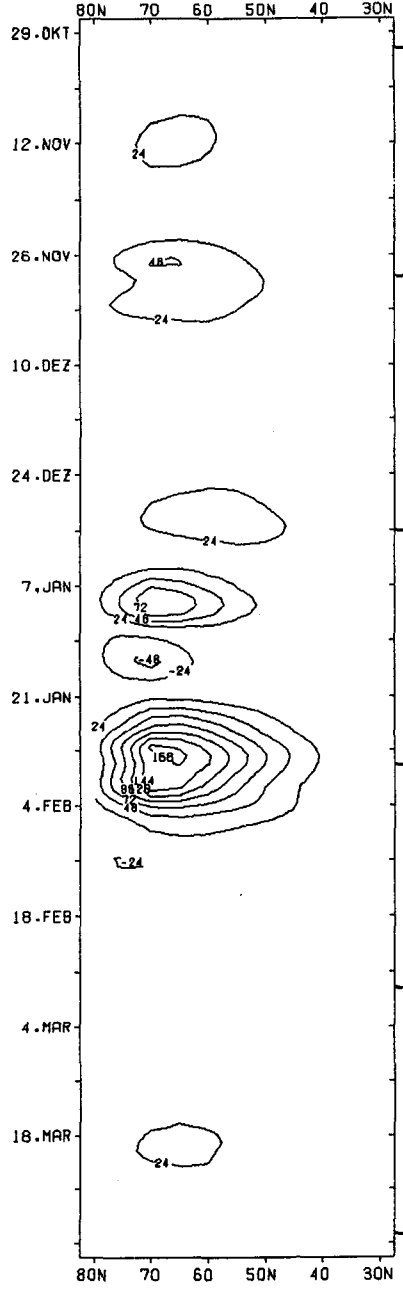

l

C.W.

*

C

Figure B.69

1972/73

WAVE 2

MOMENTUM FLUX

HEAT FLUX

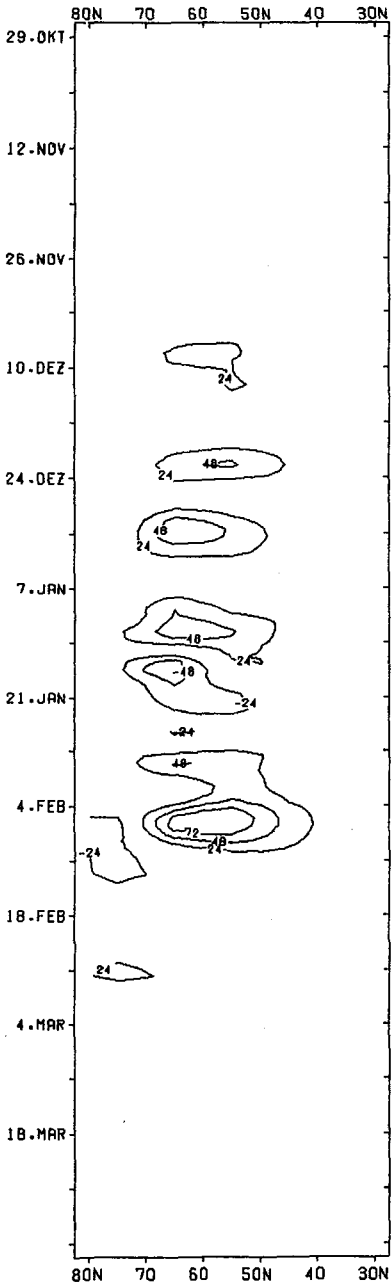

m

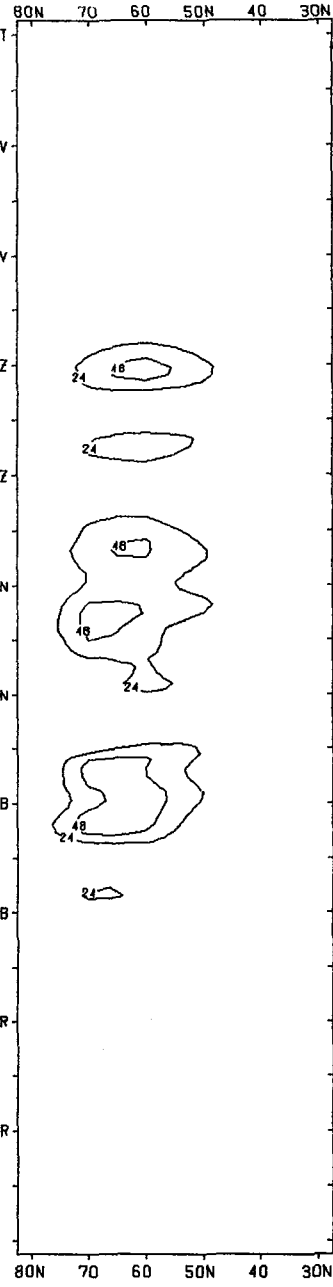

n

C.W.

*

C

Figure B.70

EFFICIENCY
MOMENTUM FLUX

EFFICIENCY
HEAT FLUX

WAVE 1

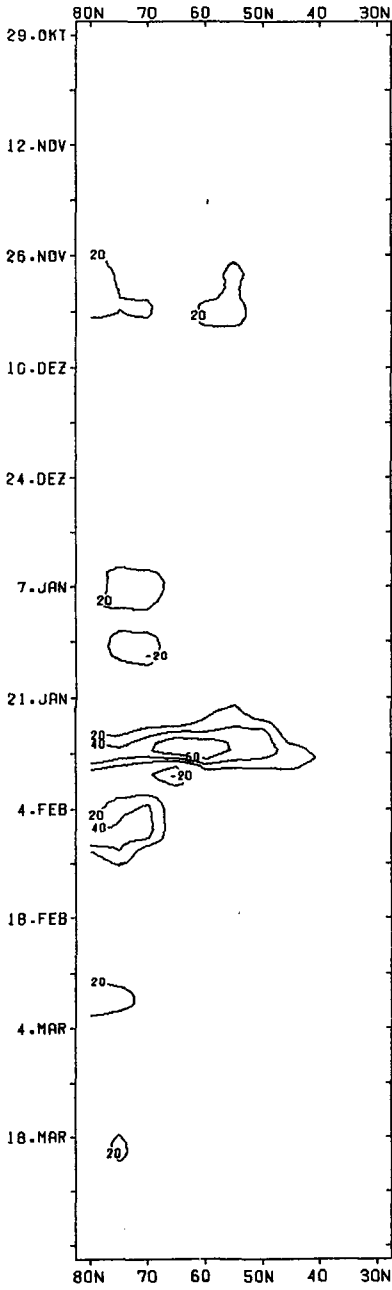

o

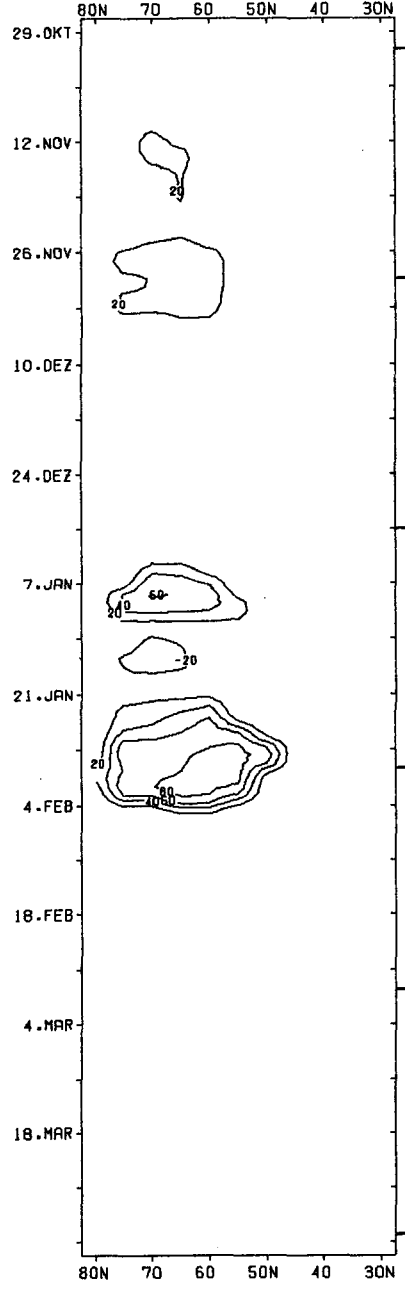

p

C.W.

C

Figure B.71

1972/73

116

EFFICIENCY
MOMENTUM FLUX

EFFICIENCY
HEAT FLUX

WAVE 2

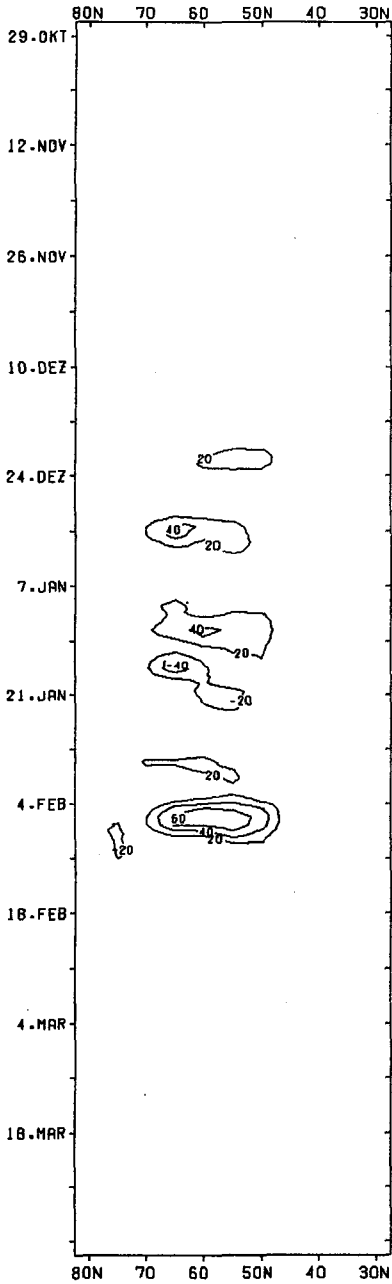

q

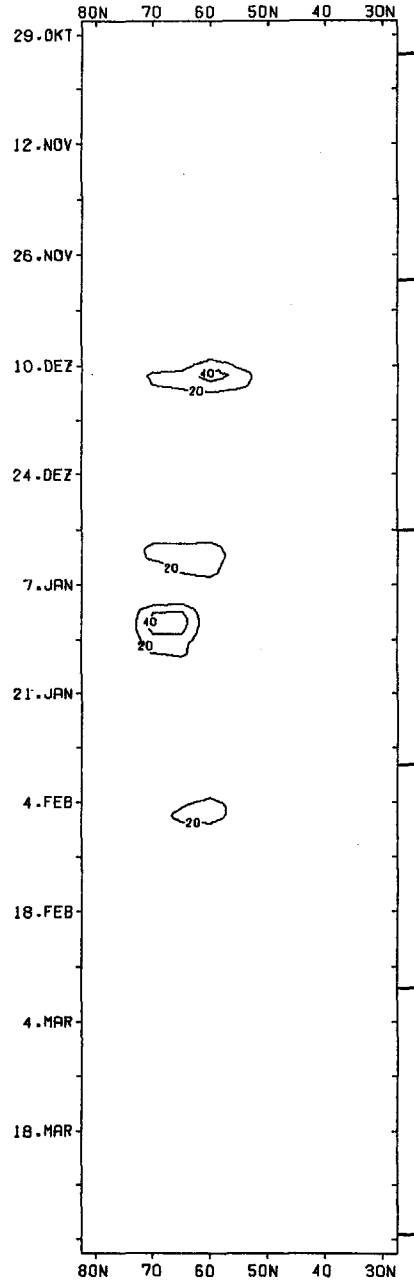

r

C.W.

*

C

Figure B.72

1973 / 74

MEAN ZONAL WIND

MEAN ZONAL TEMP.

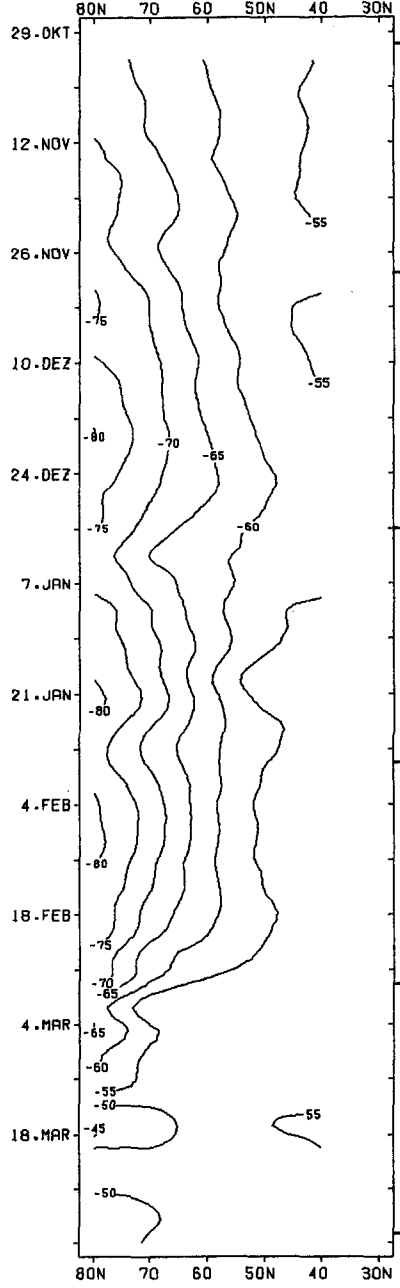
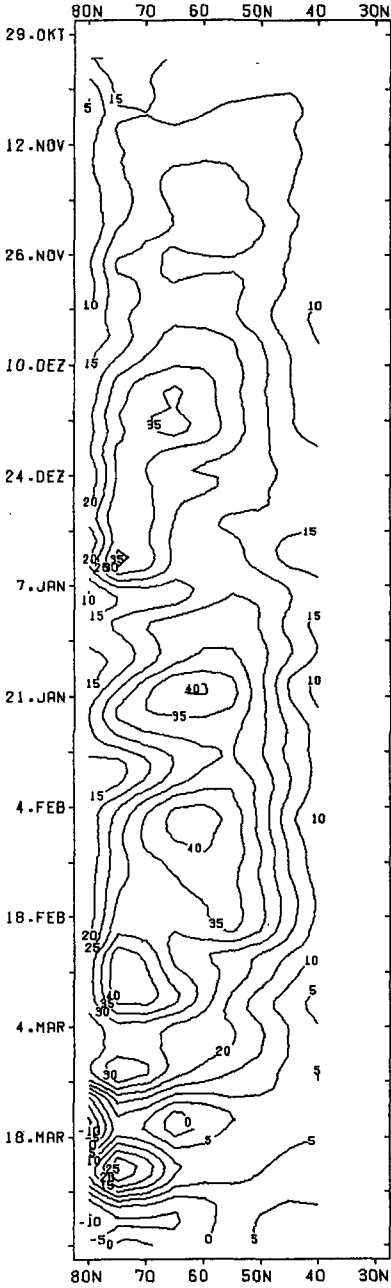

C.W.

* F.W.

C

C

C

C

a

b

Figure B.73

1973 / 74

HEIGHT WAVE 1

TEMP. WAVE 1

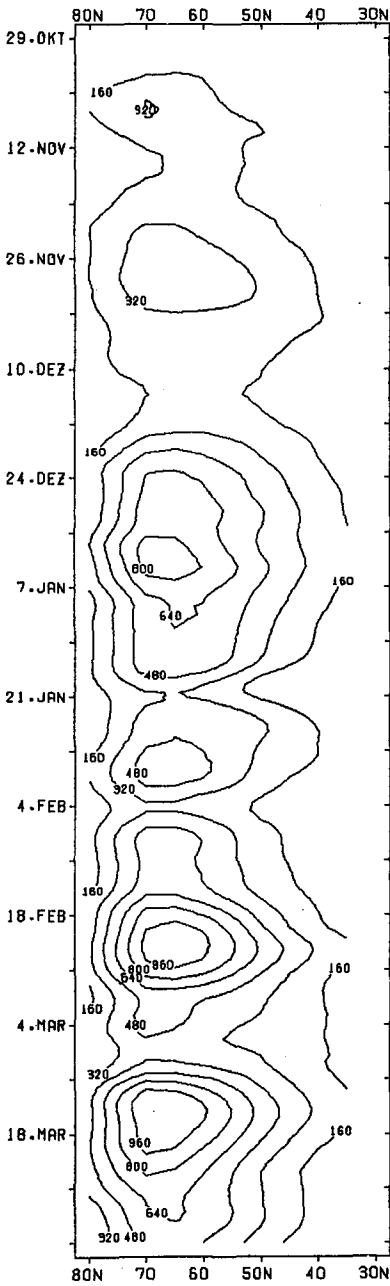

c

C.W.

* F.W.

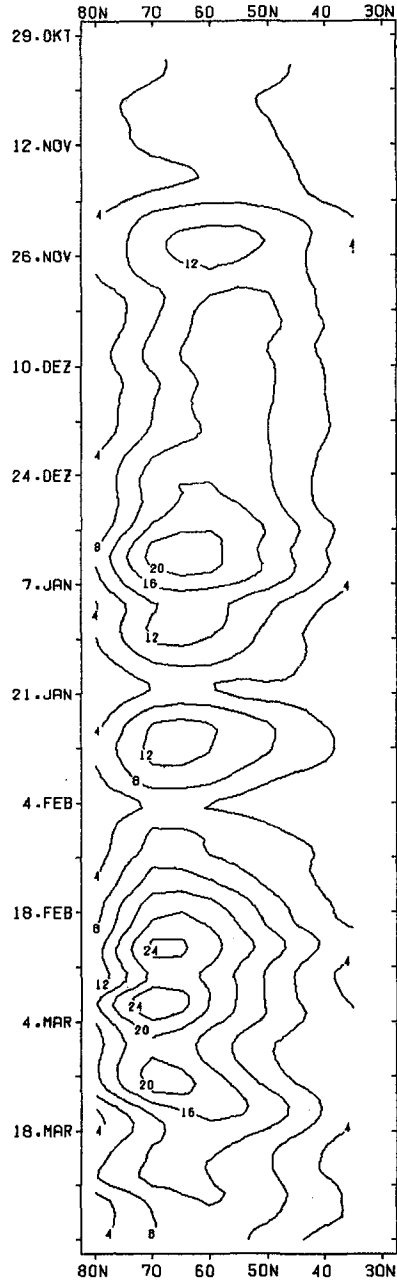

d

Figure B.74

1973 / 74

HEIGHT WAVE 2

TEMP WAVE 2

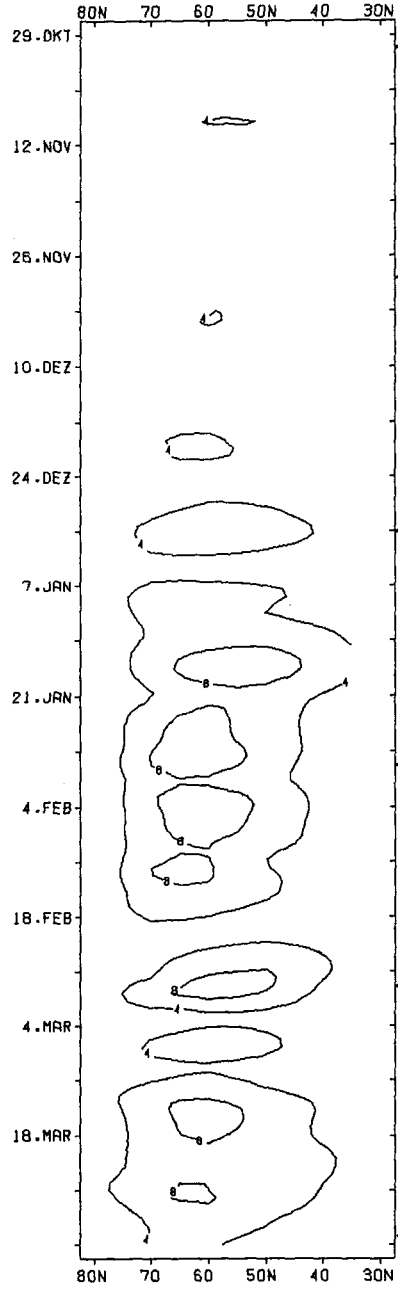
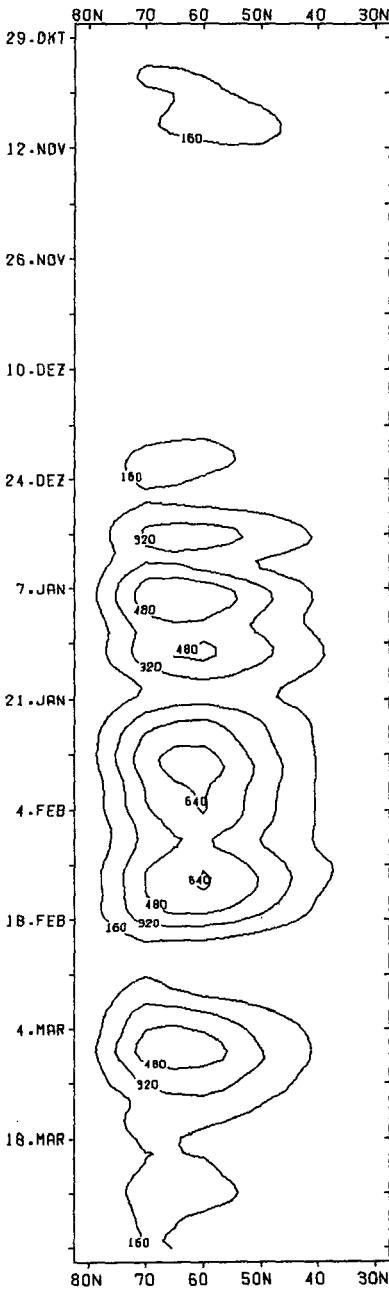

CW.

* F.W.

e

f

Figure B.75

1973 / 74

MOMENTUM FLUX

HEAT FLUX

WAVES 1-6

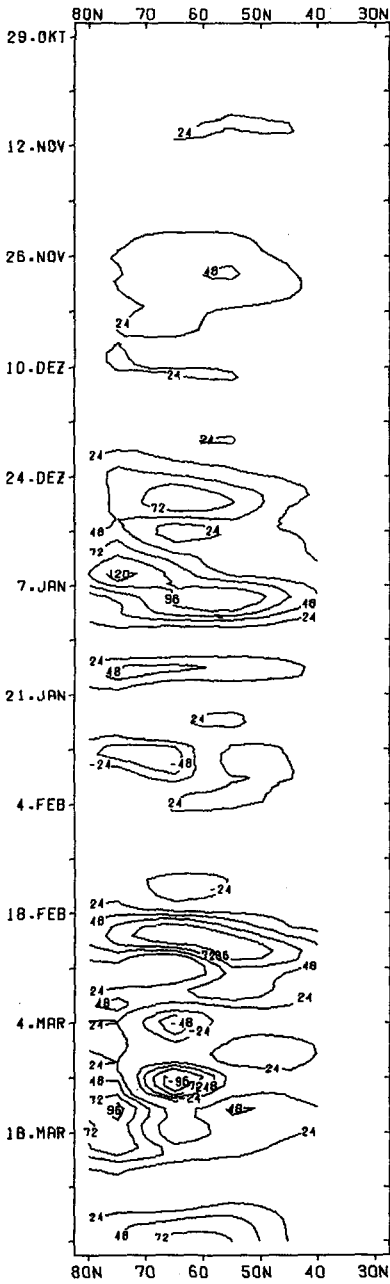

g

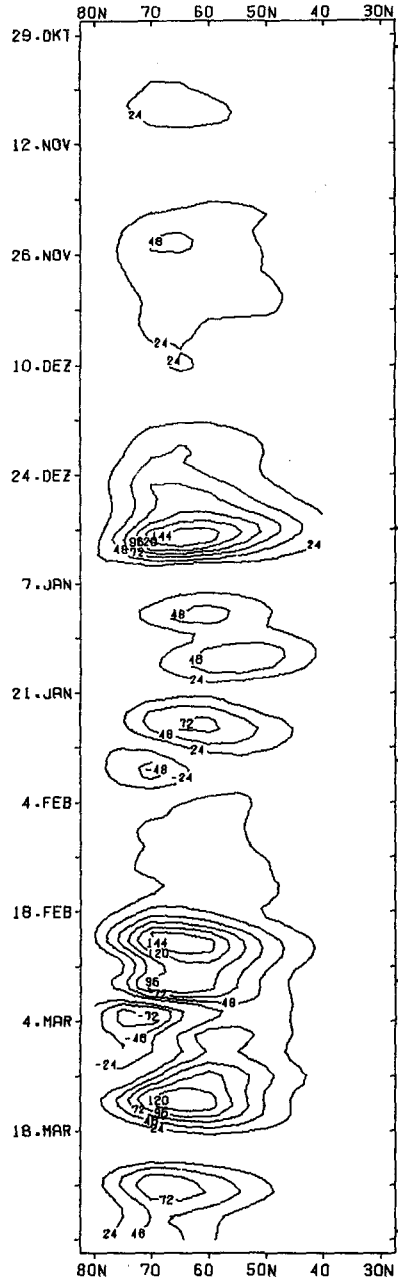

h

Figure B.76

1973 / 74

EFFICIENCY
MOMENTUM FLUX

EFFICIENCY
HEAT FLUX

WAVES 1-6

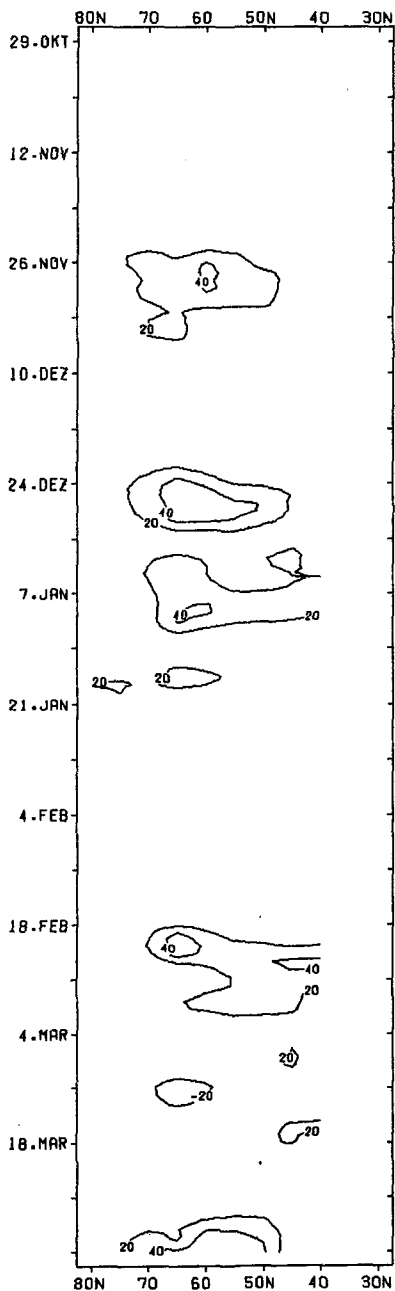

i

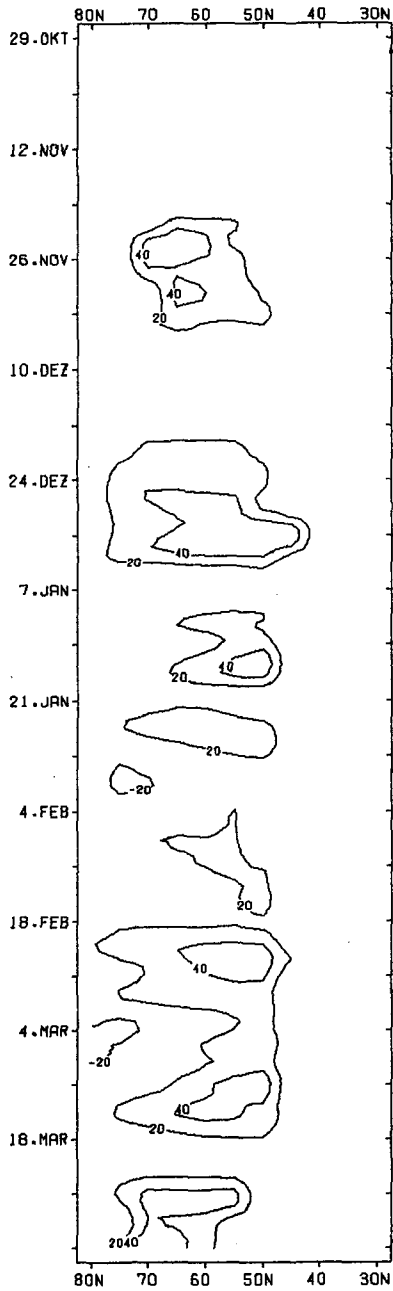

j

Figure B.77

1973 / 74

MOMENTUM FLUX

HEAT FLUX

WAVE 1

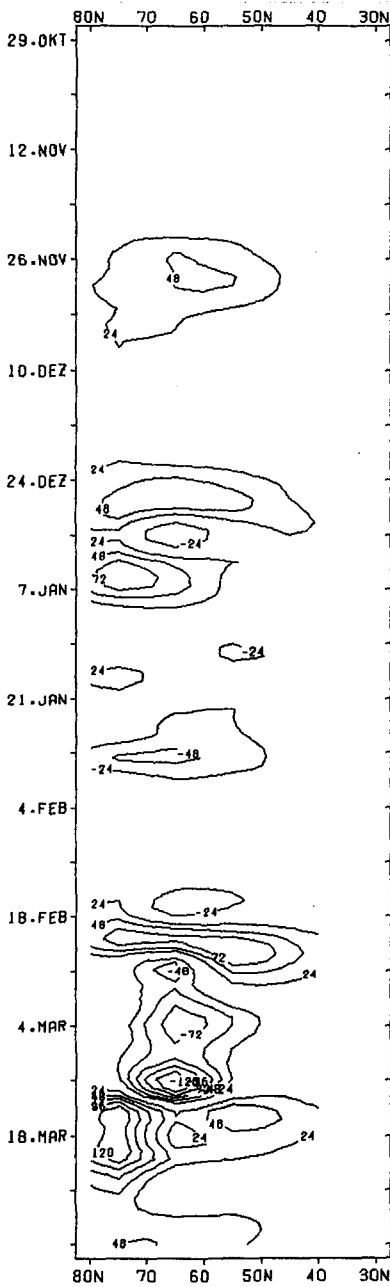

k

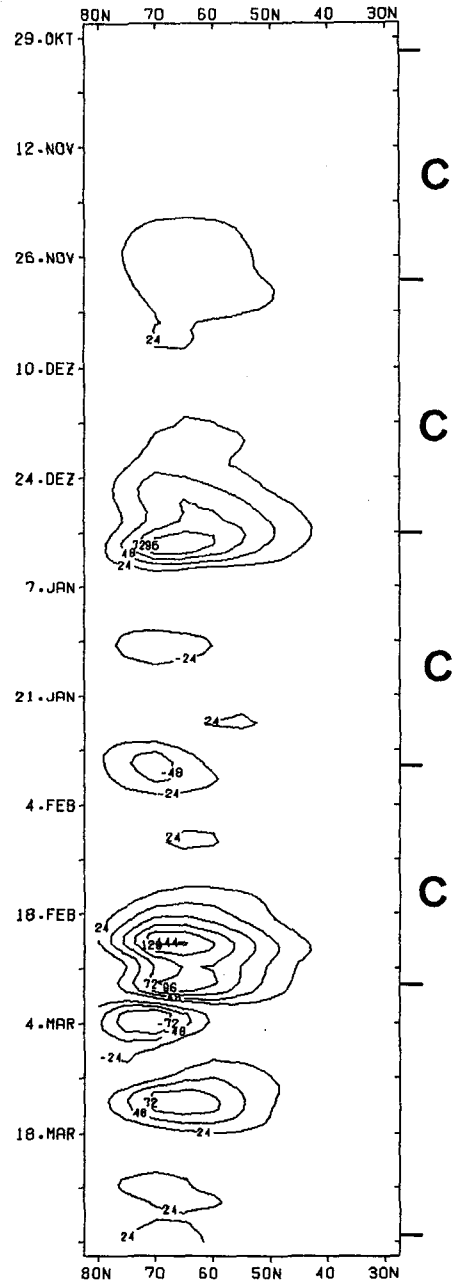

I

Figure B.78

MOMENTUM FLUX

HEAT FLUX

WAVE 2

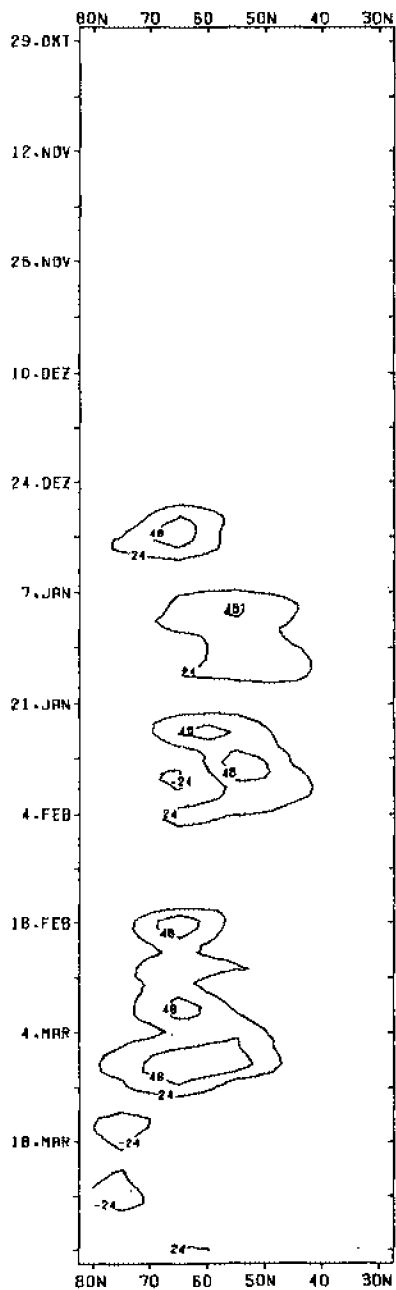

m

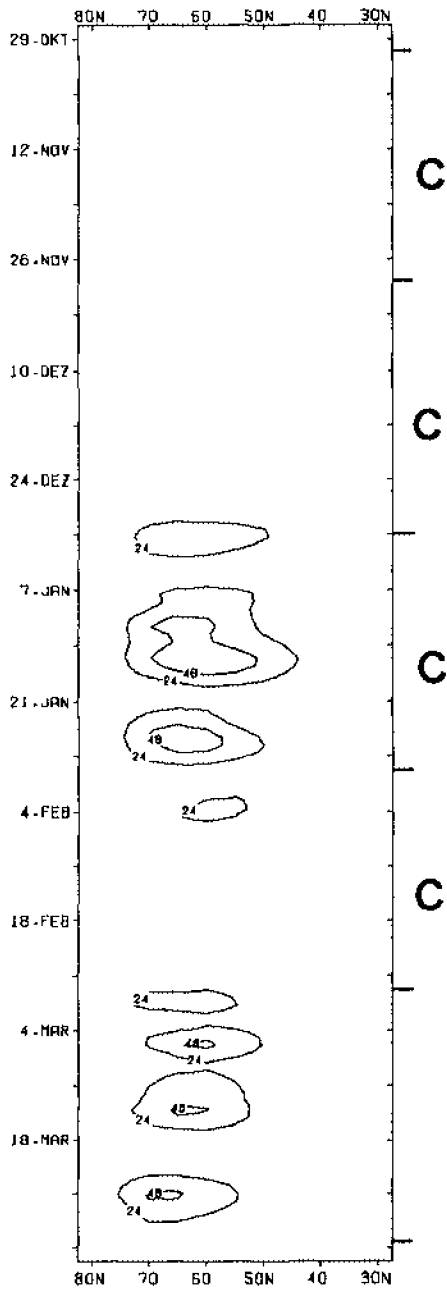

C.W.

* F.W.

n

Figure B.79

EFFICIENCY
MOMENTUM FLUX

1973 / 74

EFFICIENCY
HEAT FLUX

WAVE 1

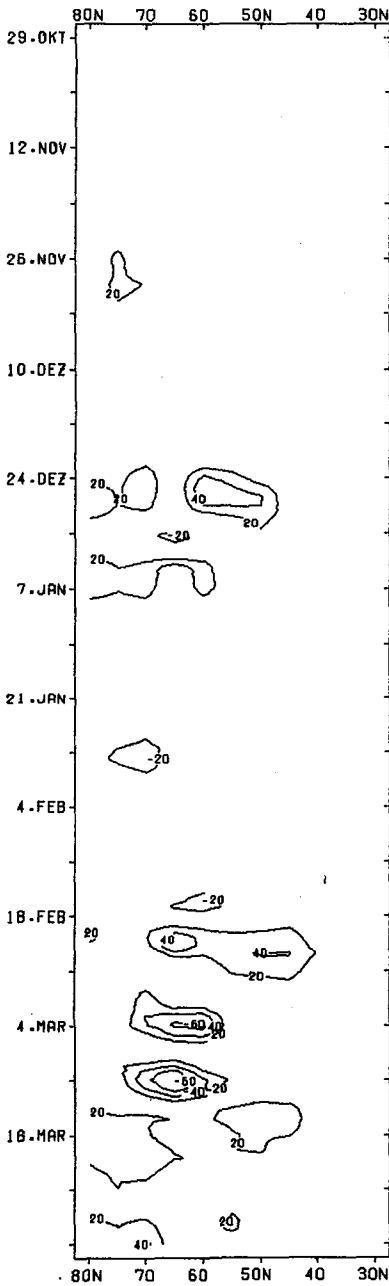

o

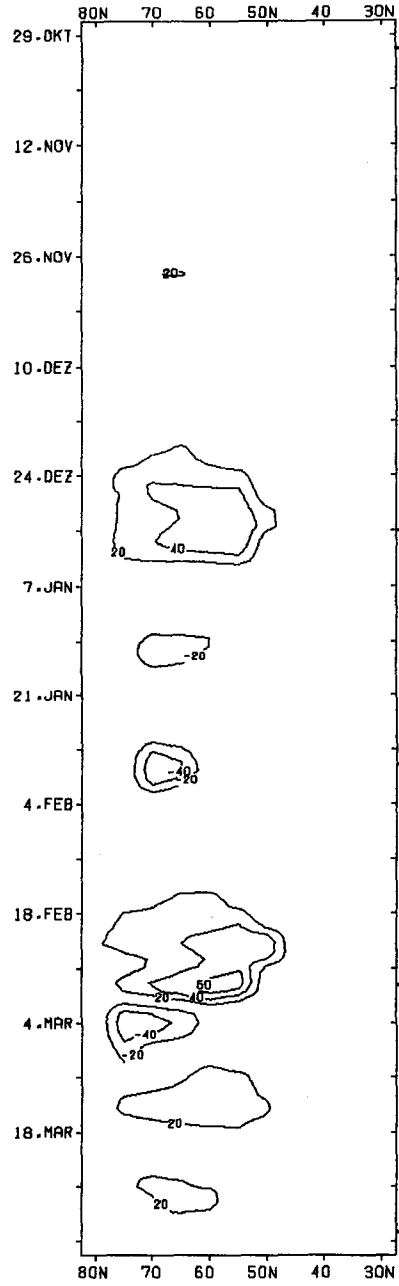

p

Figure B.80

1973 / 74

EFFICIENCY
MOMENTUM FLUX

EFFICIENCY
HEAT FLUX

WAVE 2

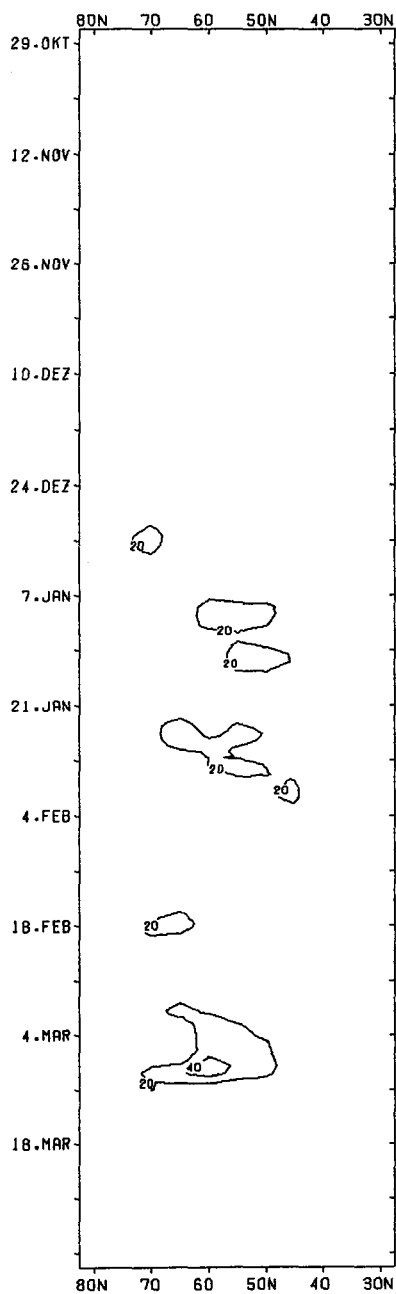

q

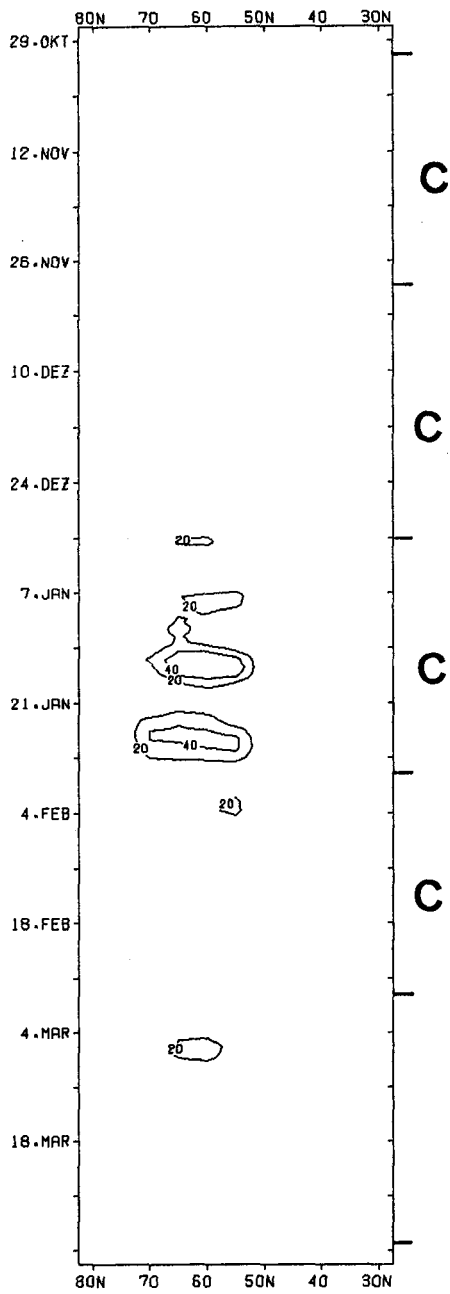

C.W.

* F.W.

C

C

C

C

r

Figure B.81

1974 / 75

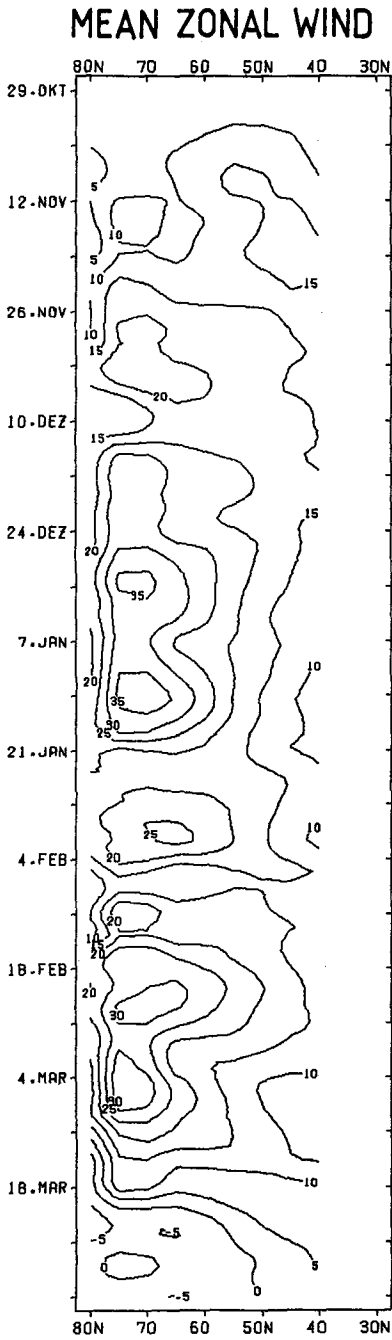

a

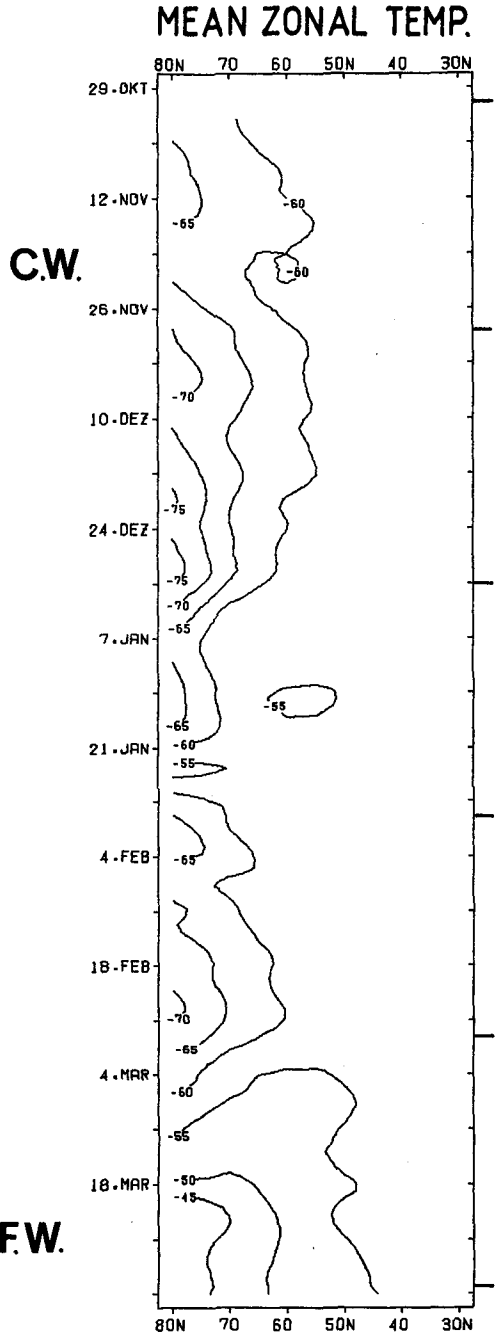

b

Figure B.82

1974/75

HEIGHT WAVE 1

TEMP. WAVE 1

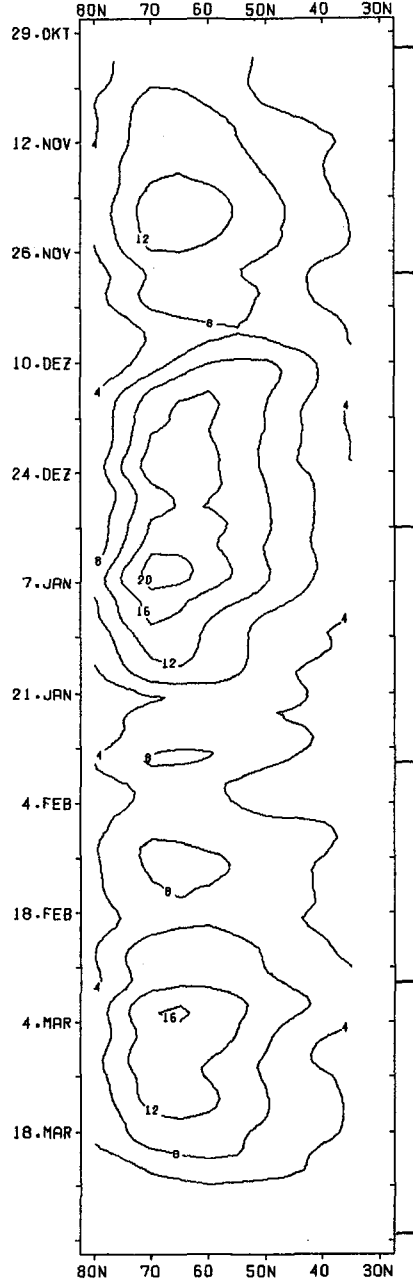
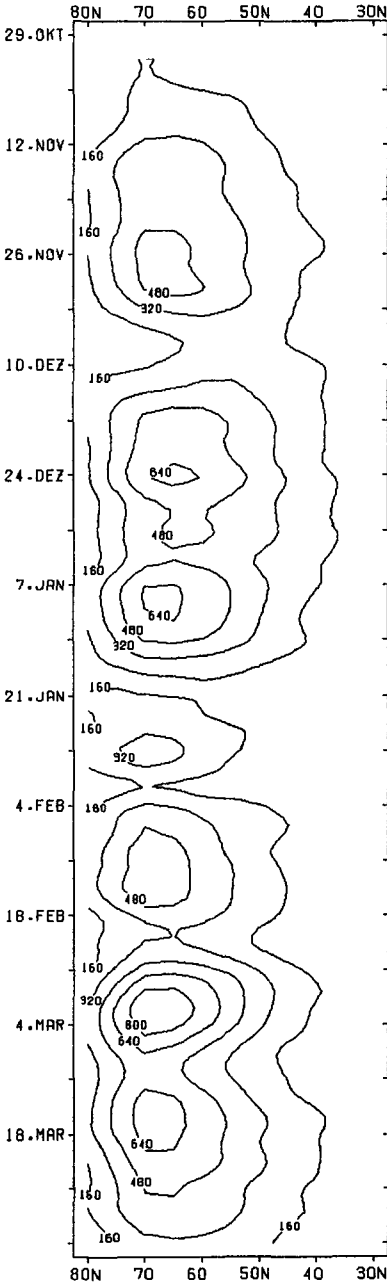

C.W.

* F.W.

c

d

Figure B.83

HEIGHT WAVE 2

TEMP WAVE 2

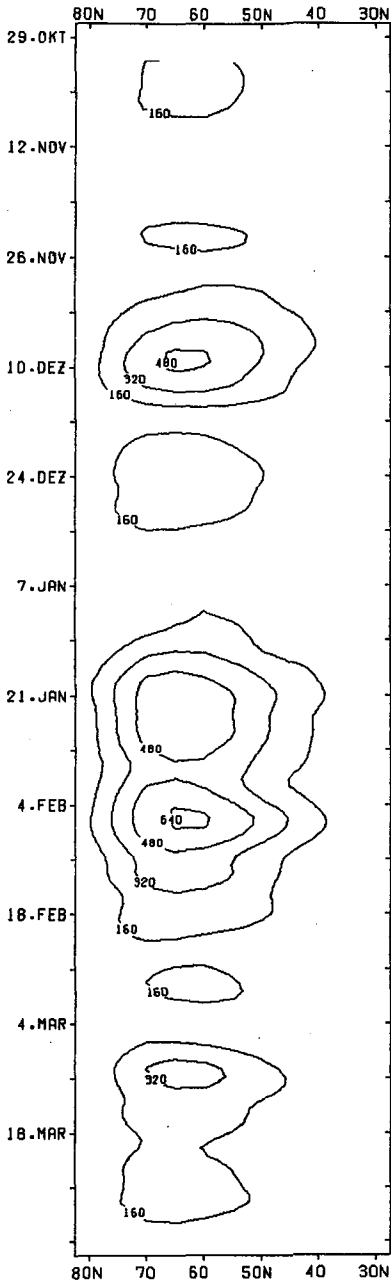

e

C.W.

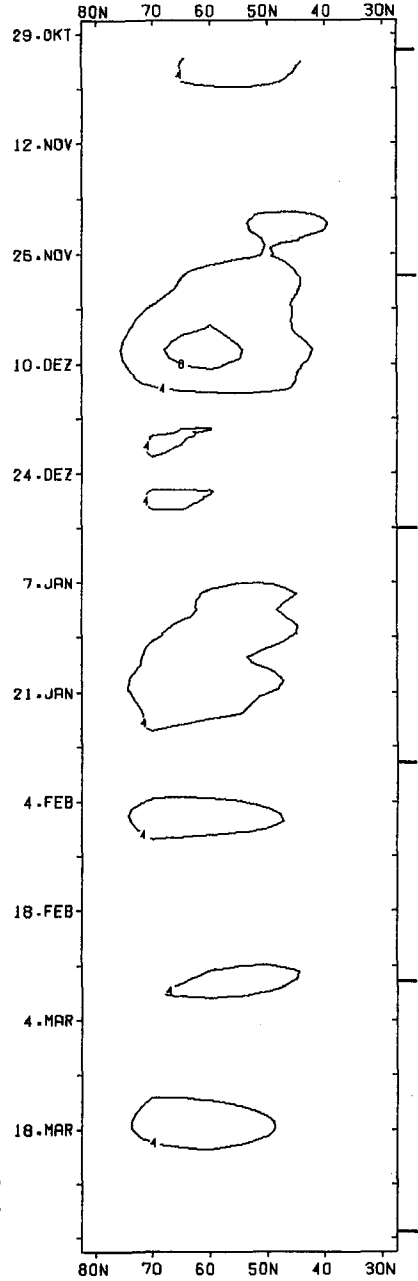

* F.W.

f

Figure B.84

1974 / 75

MOMENTUM FLUX

HEAT FLUX

WAVES 1-6

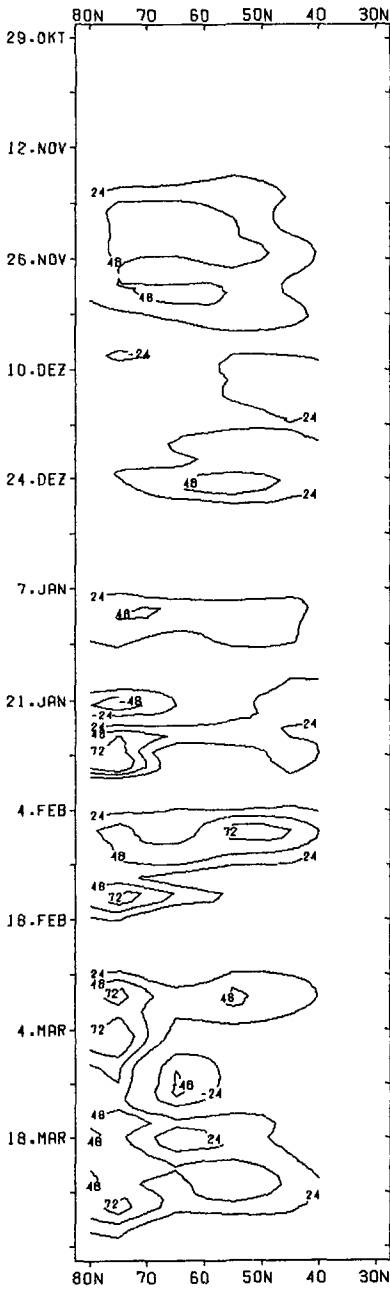

g

C.W.

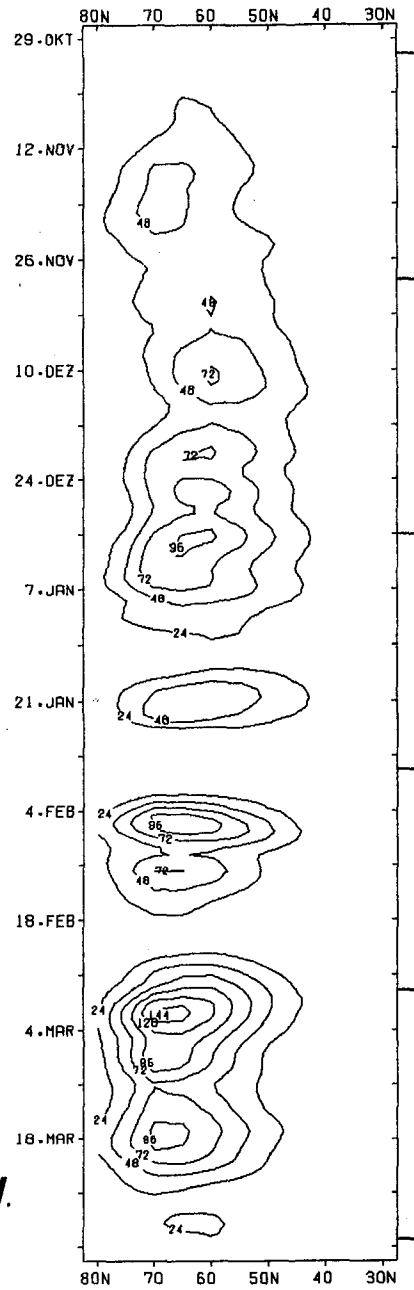

* F.W.

h

Figure B.85

1974 / 75

130

EFFICIENCY
MOMENTUM FLUX

EFFICIENCY
HEAT FLUX

WAVES 1-6

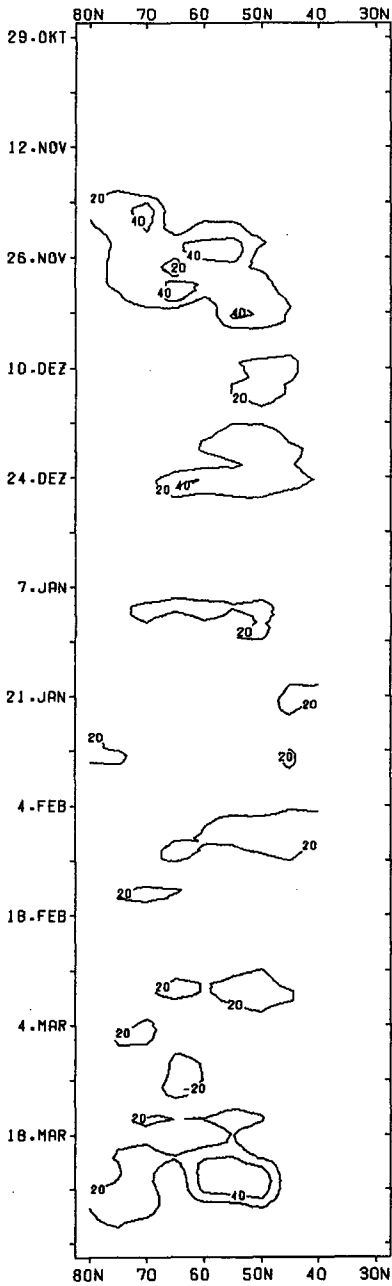

i

C.W.

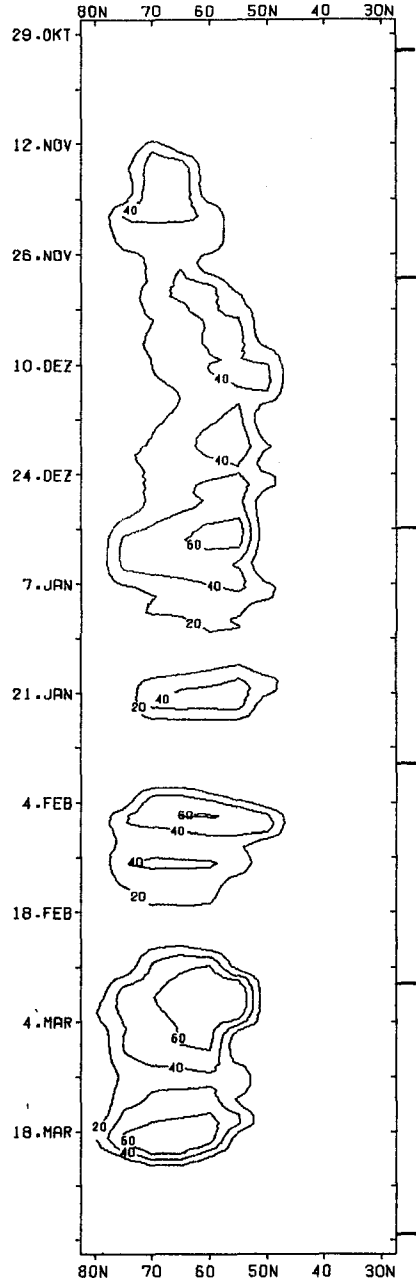

j

* F.W.

Figure B.86

1974/75

MOMENTUM FLUX

HEAT FLUX

WAVE 1

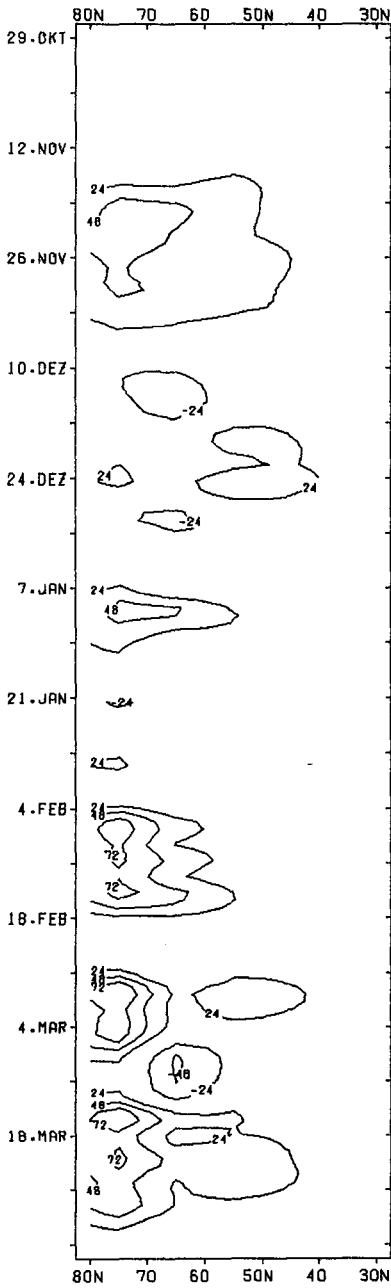

k

C.W.

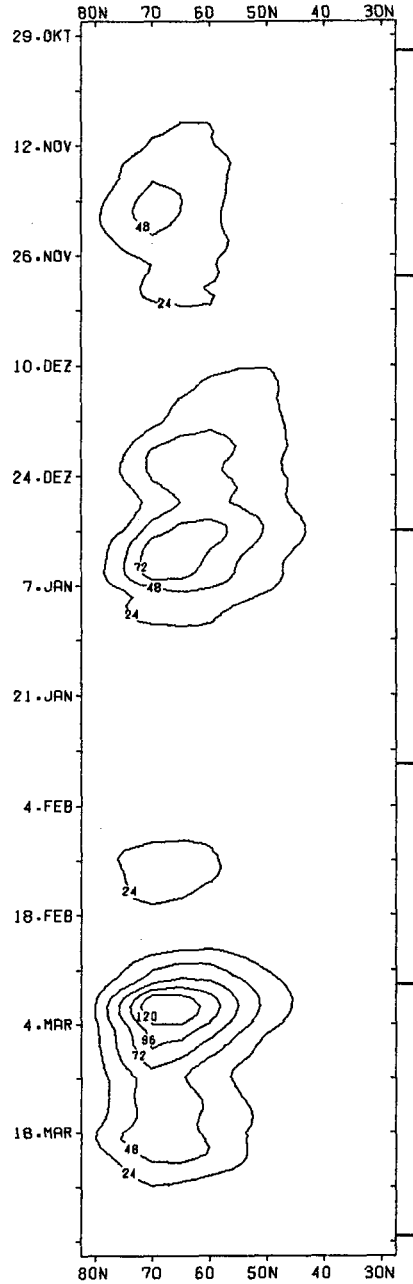

*** F.W.**

I

Figure B.87

1974/75
WAVE 2

MOMENTUM FLUX

HEAT FLUX

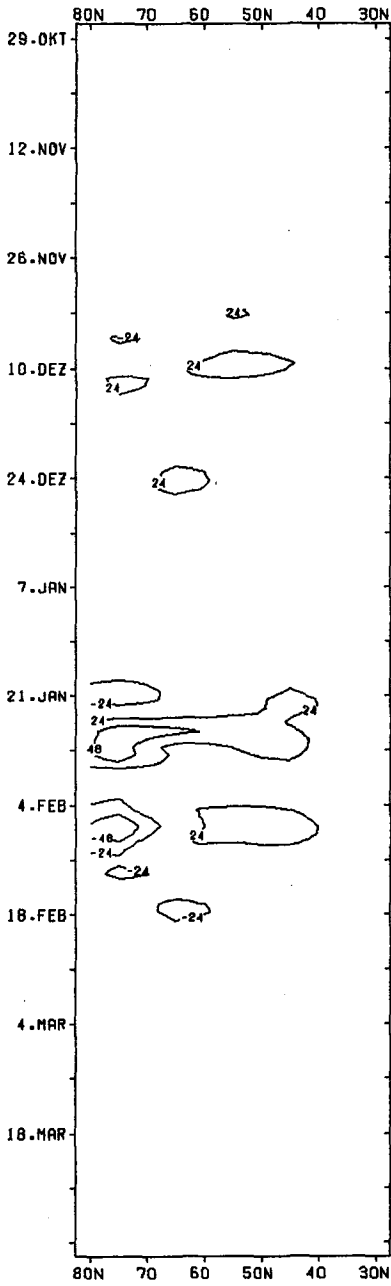

m

C.W.

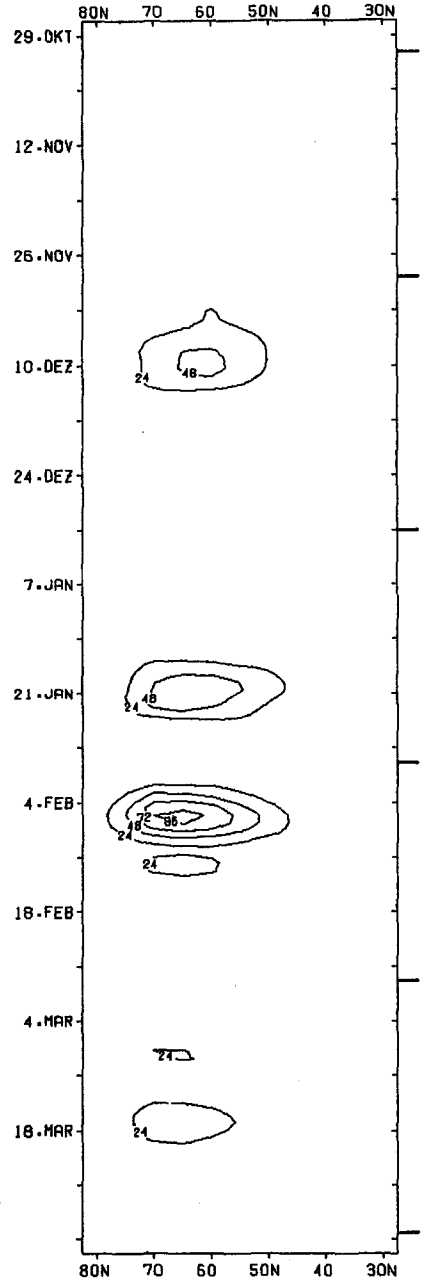

n

* F.W.

Figure B.88

1974 / 75

EFFICIENCY
MOMENTUM FLUX

EFFICIENCY
HEAT FLUX

WAVE 1

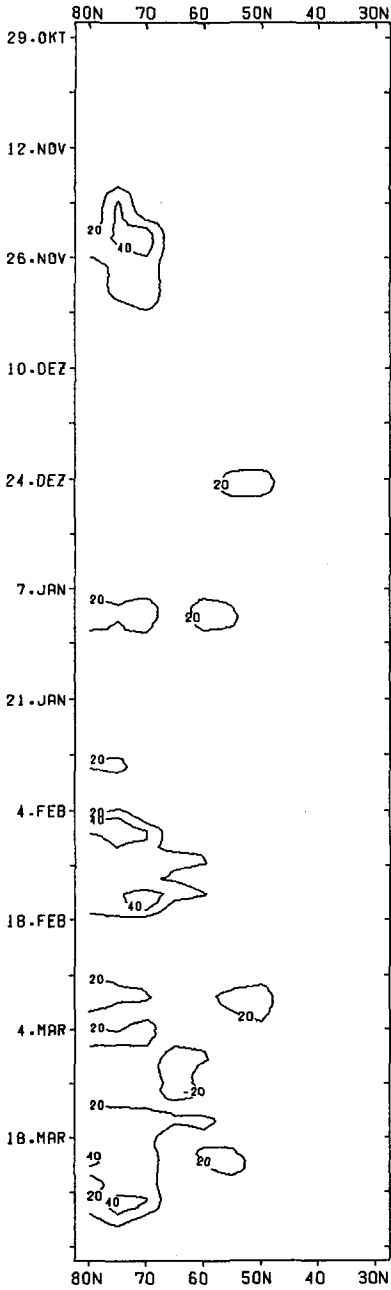

o

C.W.

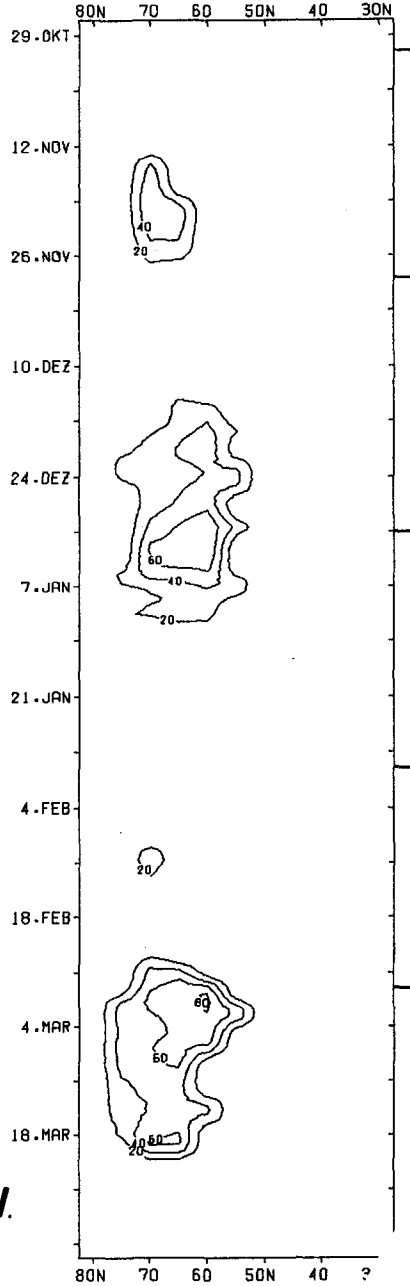

*** F.W.**

p

Figure B.89

1974/75

EFFICIENCY
MOMENTUM FLUX

EFFICIENCY
HEAT FLUX

WAVE 2

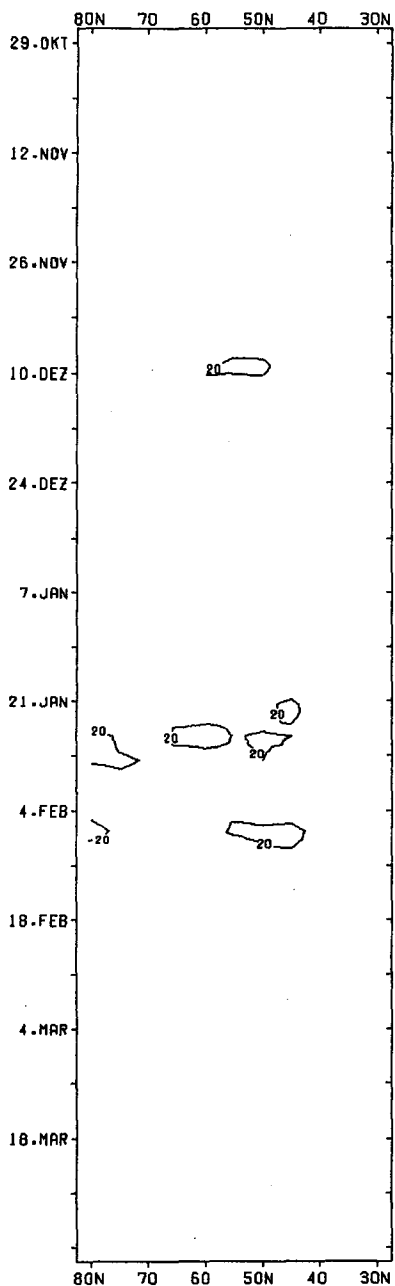

q

C.W.

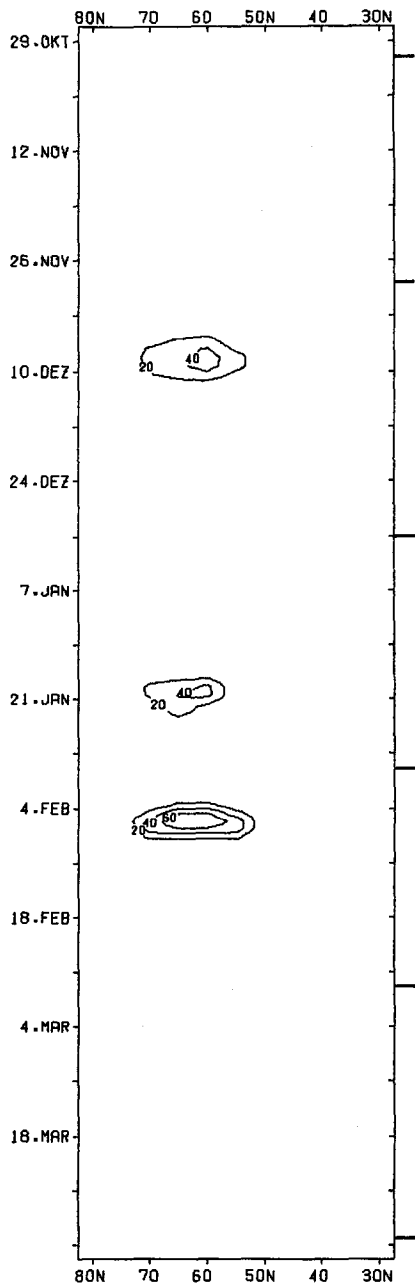

r

* F.W.

Figure B.90

1975 / 76

MEAN ZONAL WIND

MEAN ZONAL TEMP.

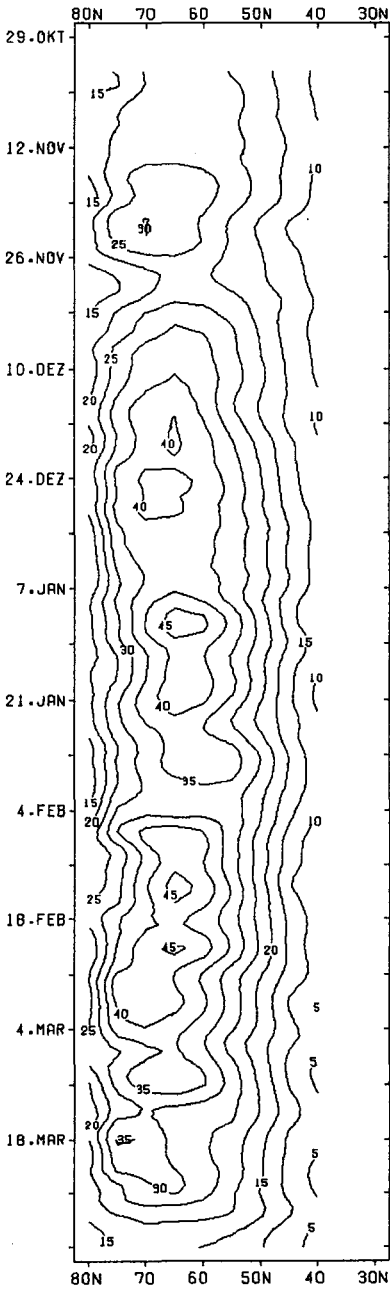

a

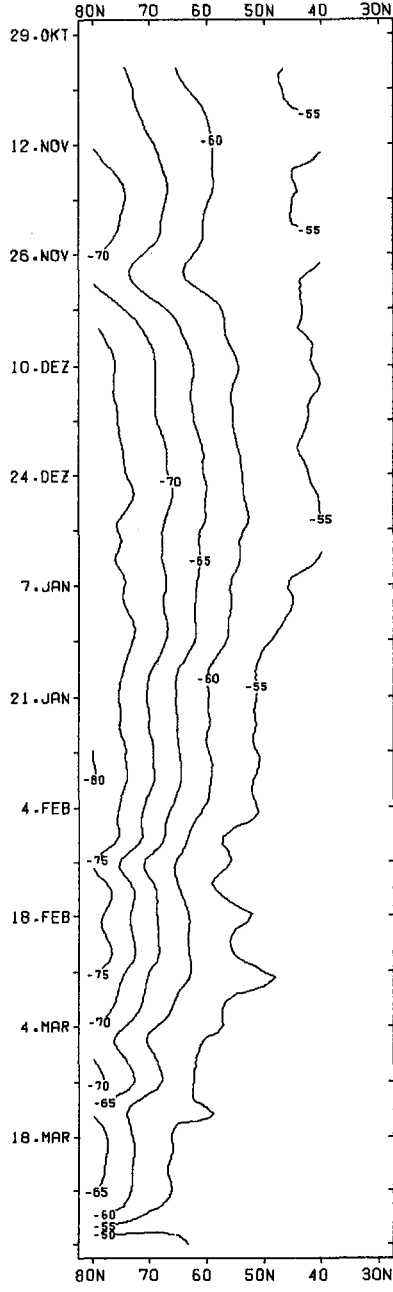

b

Figure B.91

1975 / 76

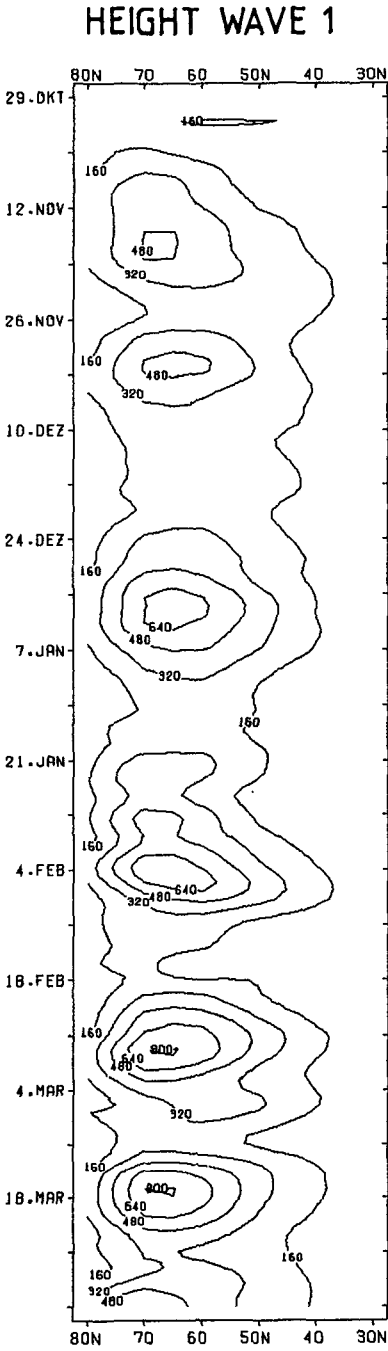

c

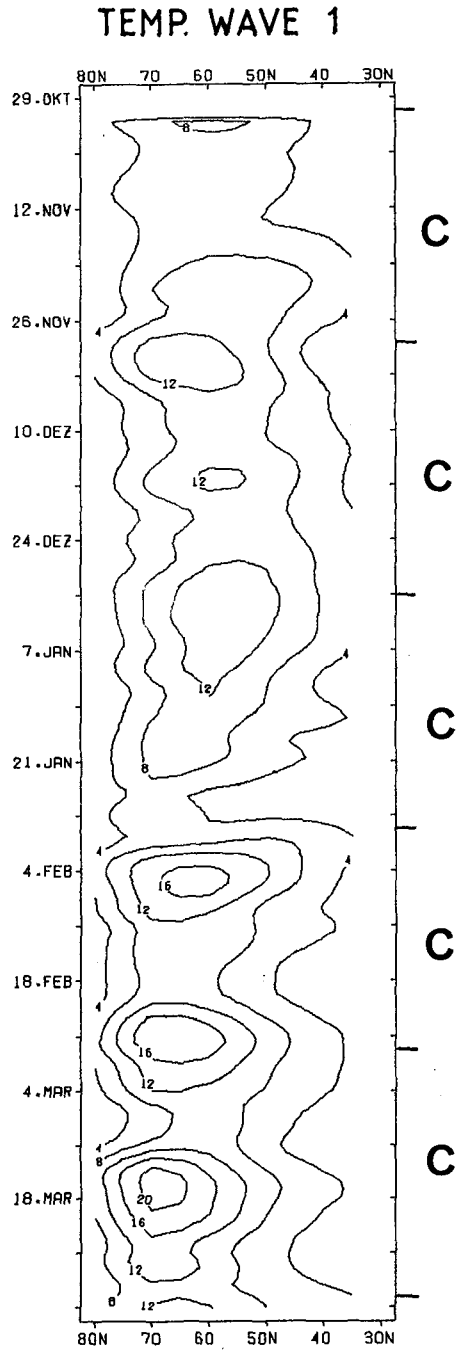

d

Figure B.92

1975 / 76

HEIGHT WAVE 2

TEMP WAVE 2

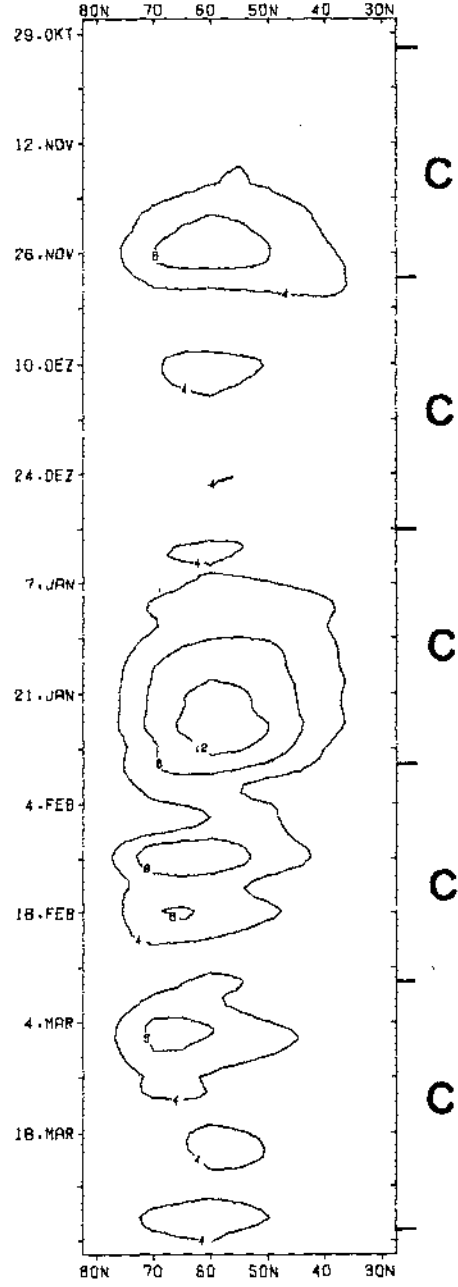
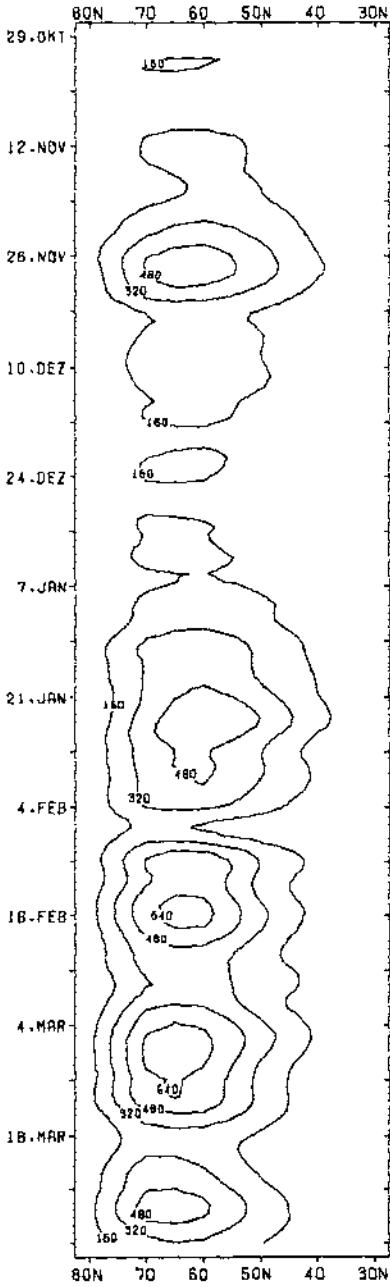

e

f

Figure B.93

1975 / 76
WAVES 1-6

MOMENTUM FLUX

HEAT FLUX

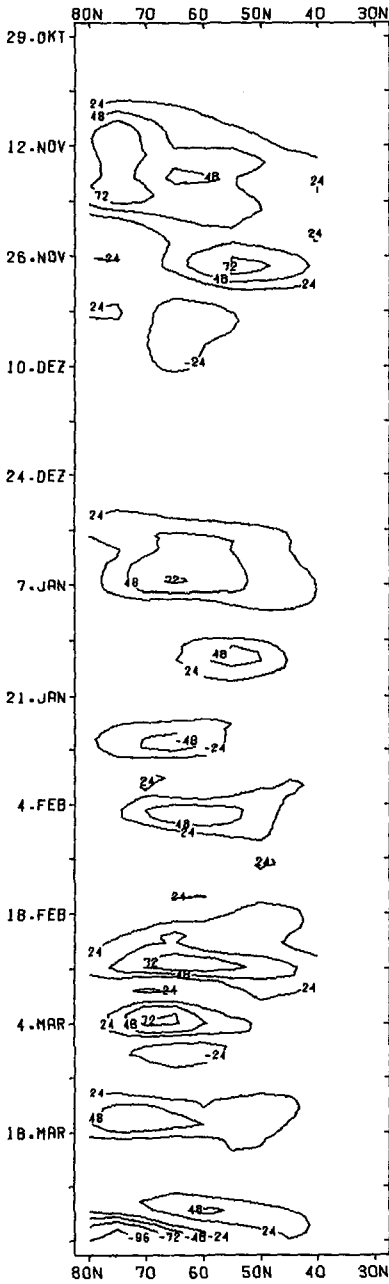

g

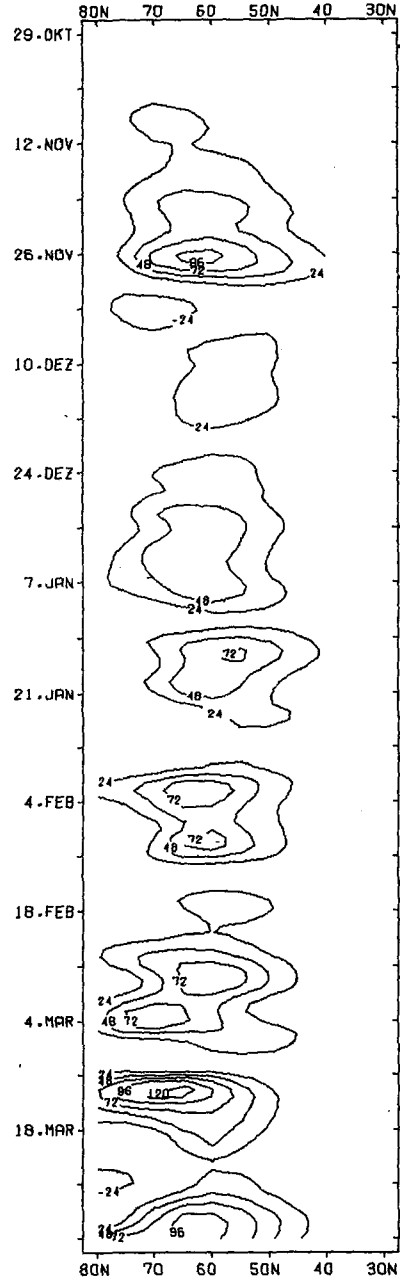

C
C
C
C

h

Figure B.94

1975 / 76

EFFICIENCY
MOMENTUM FLUX

EFFICIENCY
HEAT FLUX

WAVES 1-6

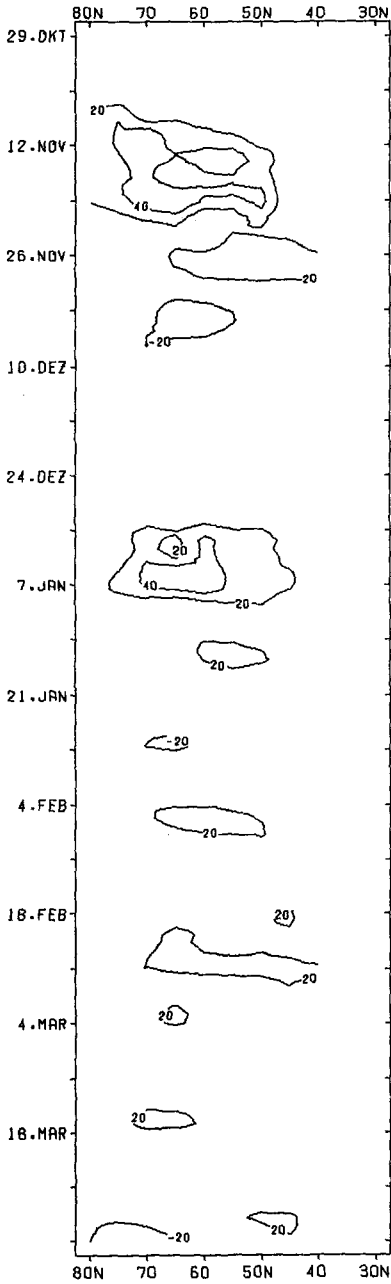

i

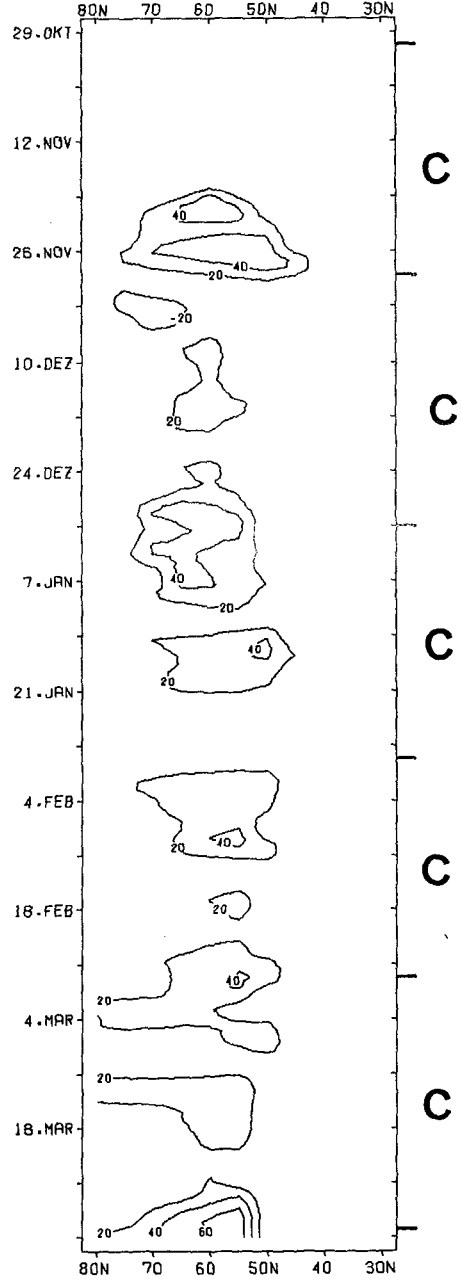

j

Figure B.95

1975 / 76

WAVE 1

MOMENTUM FLUX

HEAT FLUX

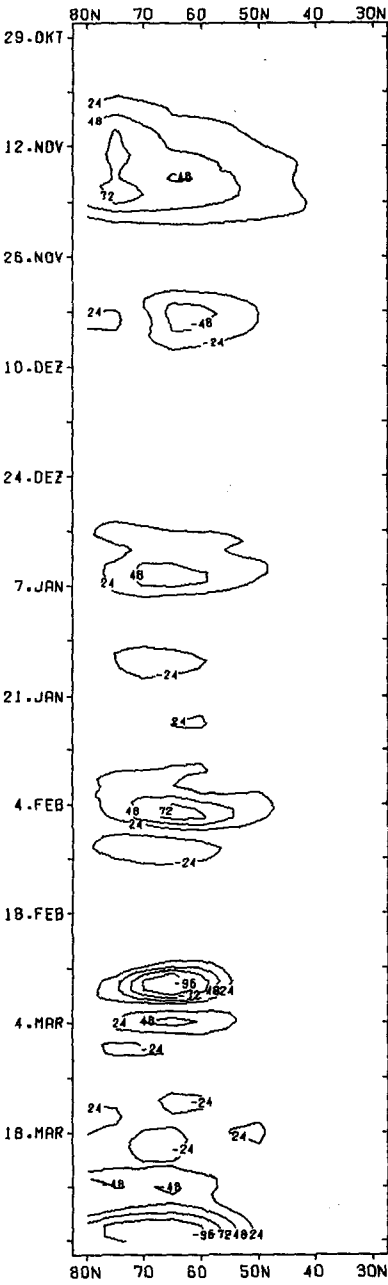

k

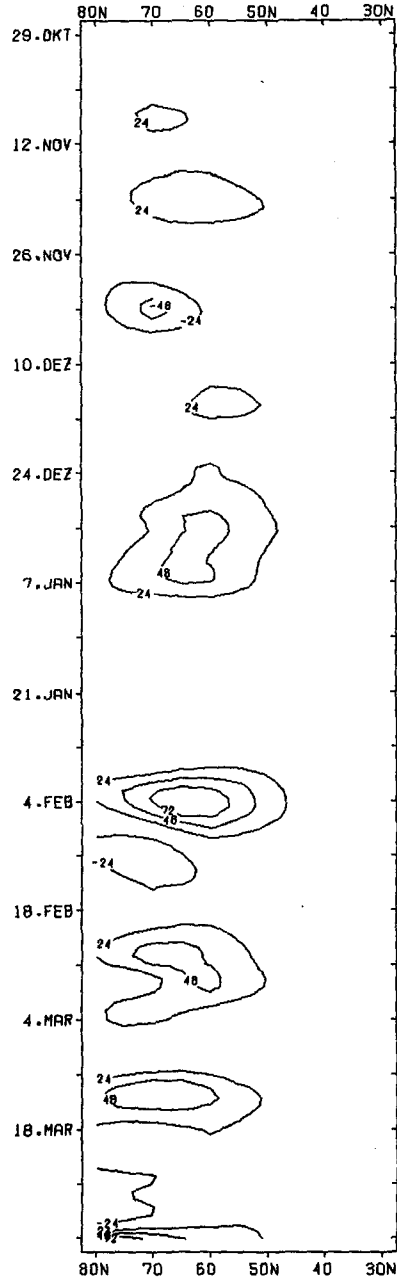

C
C
C
C
C

l

Figure B.96

1975 / 76

MOMENTUM FLUX

HEAT FLUX

WAVE 2

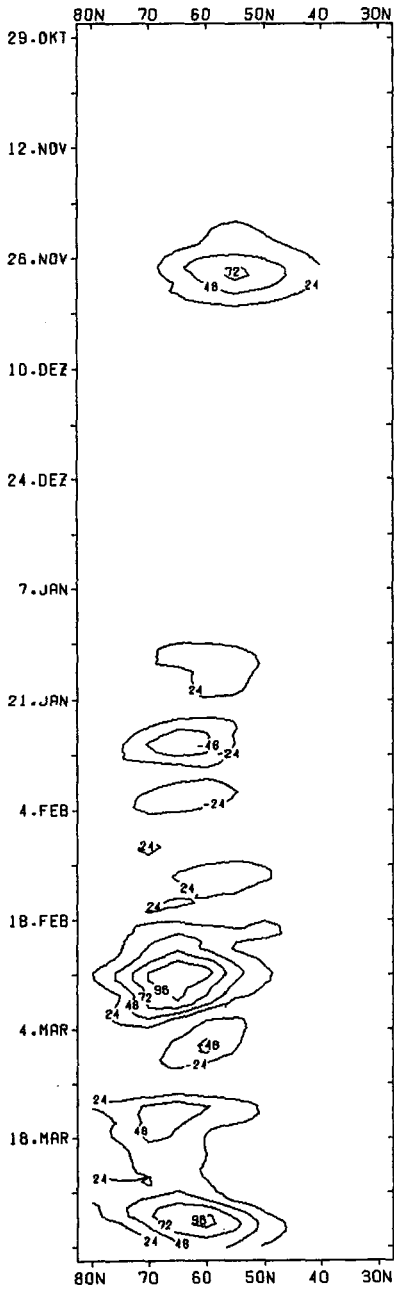

m

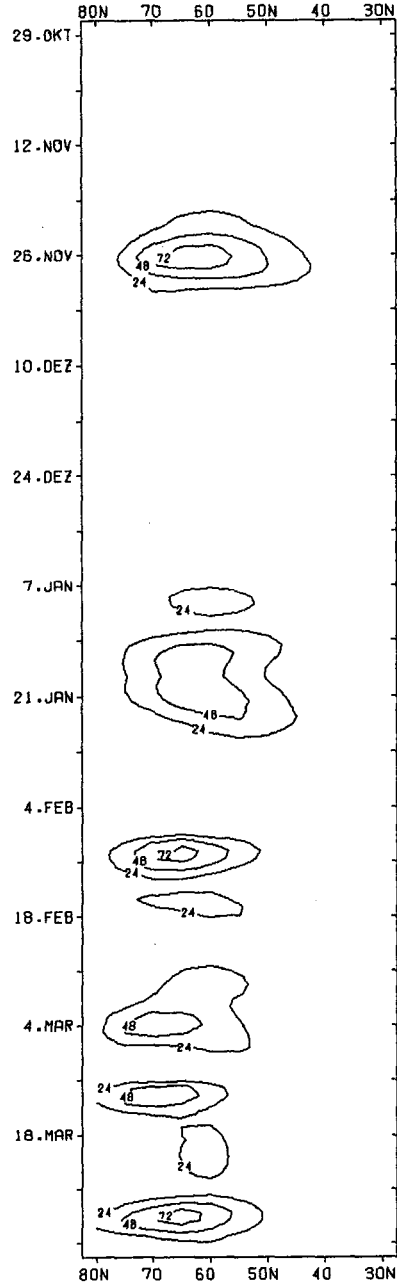

n

Figure B.97

EFFICIENCY
MOMENTUM FLUX

1975 / 76

EFFICIENCY
HEAT FLUX

WAVE 1

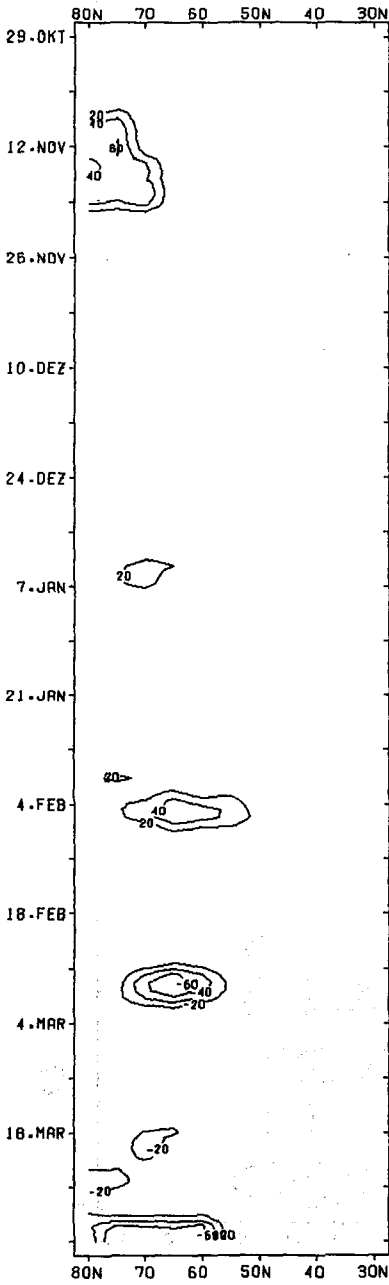

o

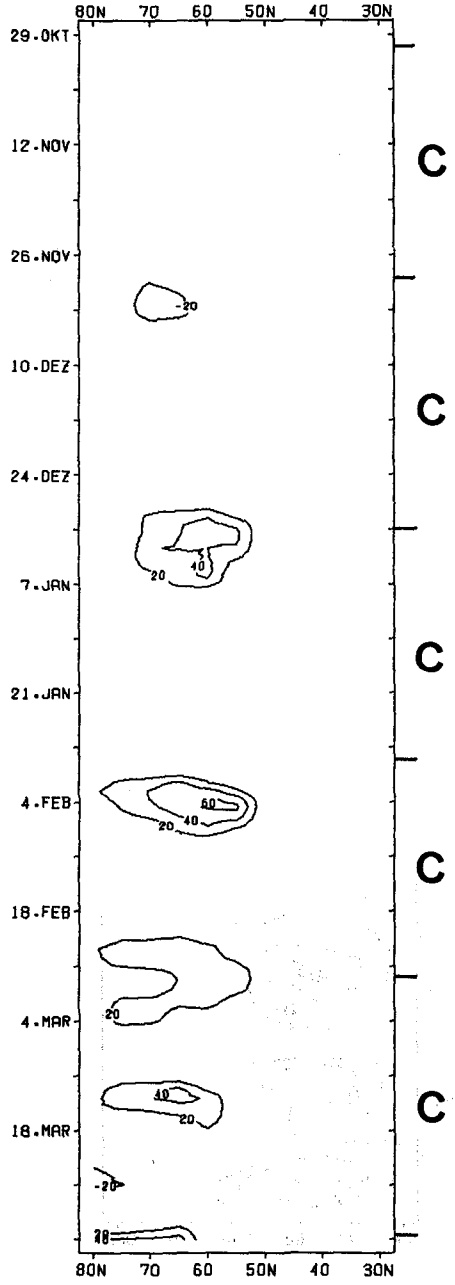

p

Figure B.98

1975 / 76

EFFICIENCY
MOMENTUM FLUX

EFFICIENCY
HEAT FLUX

WAVE 2

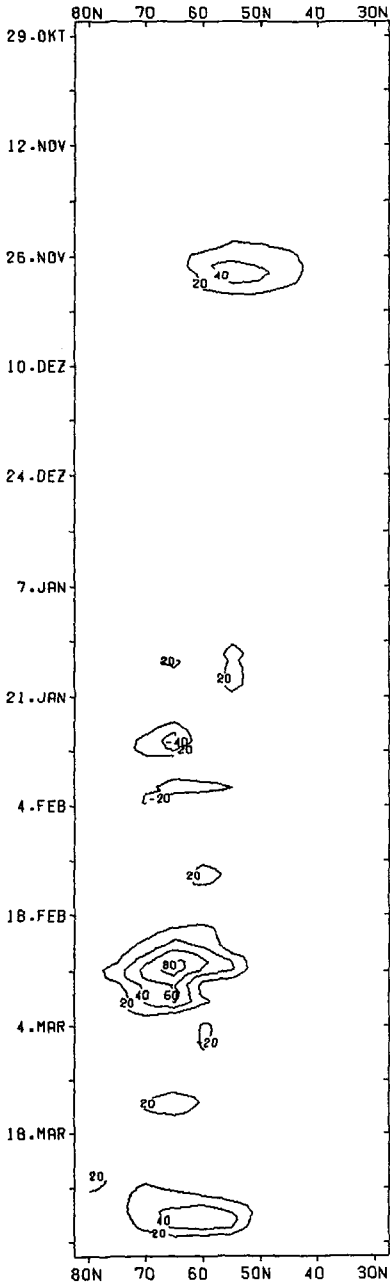

q

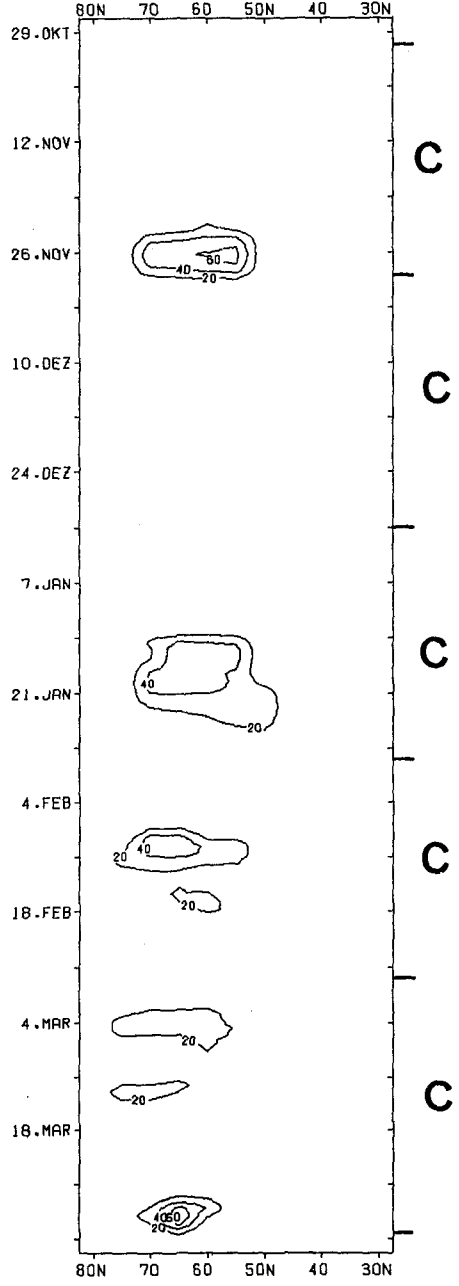

r

Figure B.99

1976 / 77

MEAN ZONAL WIND

MEAN ZONAL TEMP.

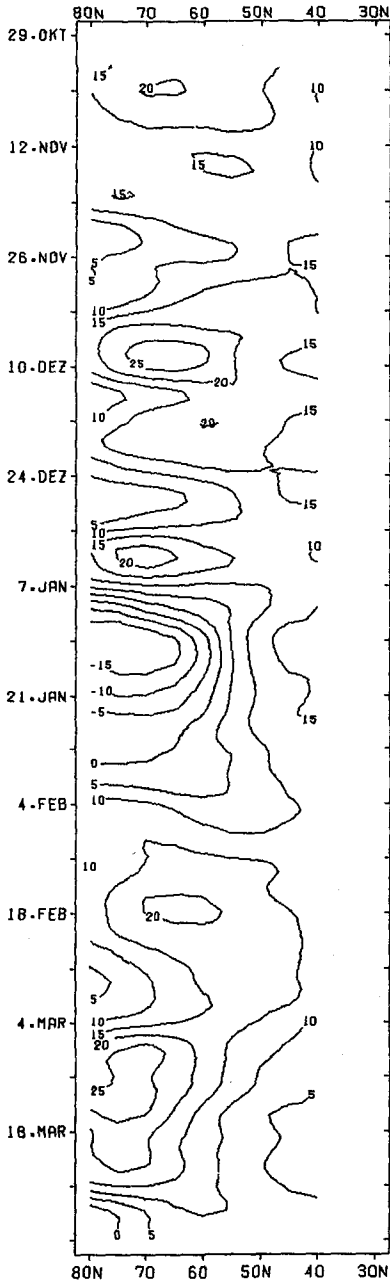

a

C.W.

*

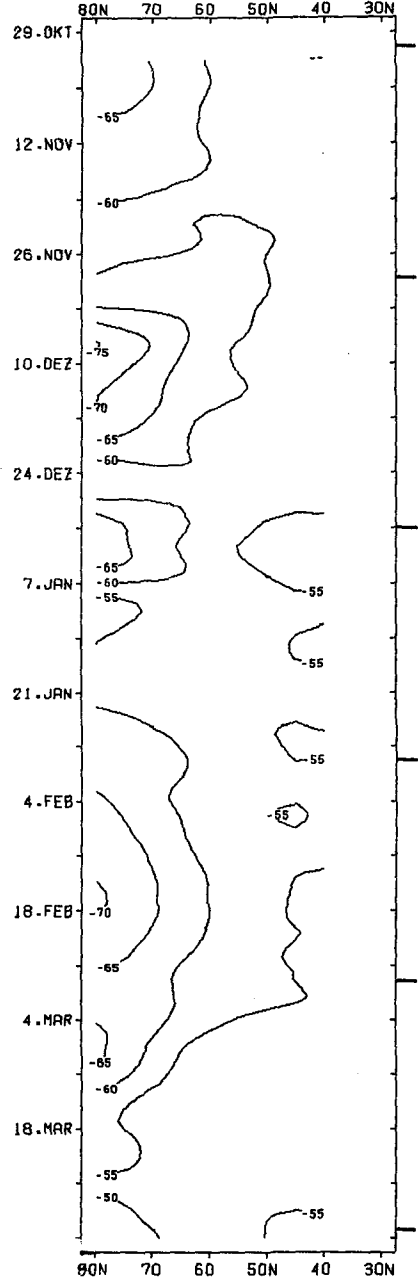

b

C

Figure B.100

1976 / 77

HEIGHT WAVE 1

TEMP. WAVE 1

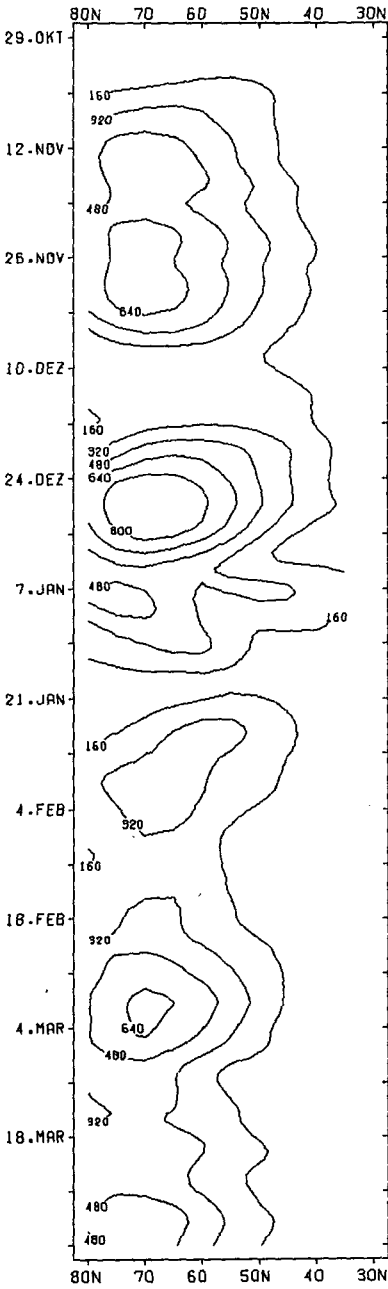

c

C.W.

*

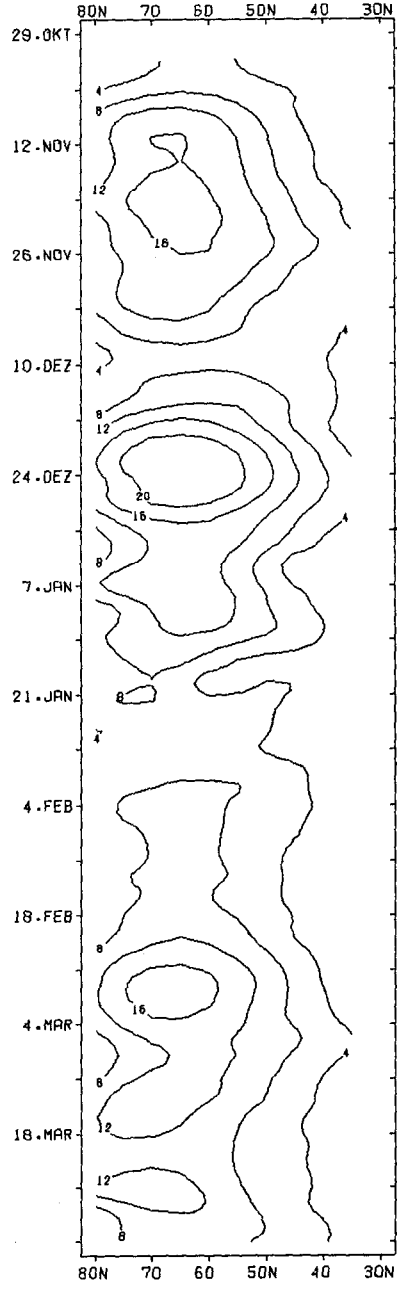

C

d

Figure B.101

1976 / 77

HEIGHT WAVE 2

TEMP WAVE 2

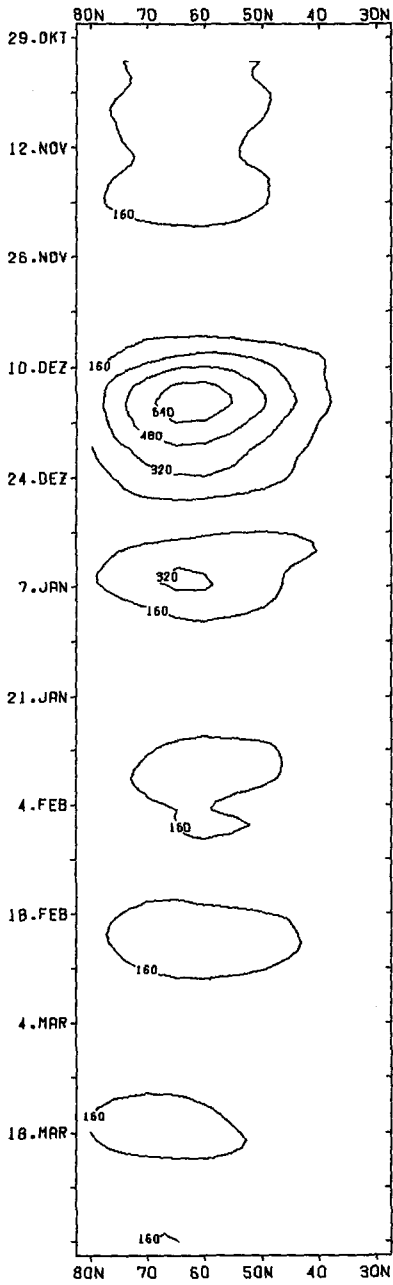

e

C.W.

*

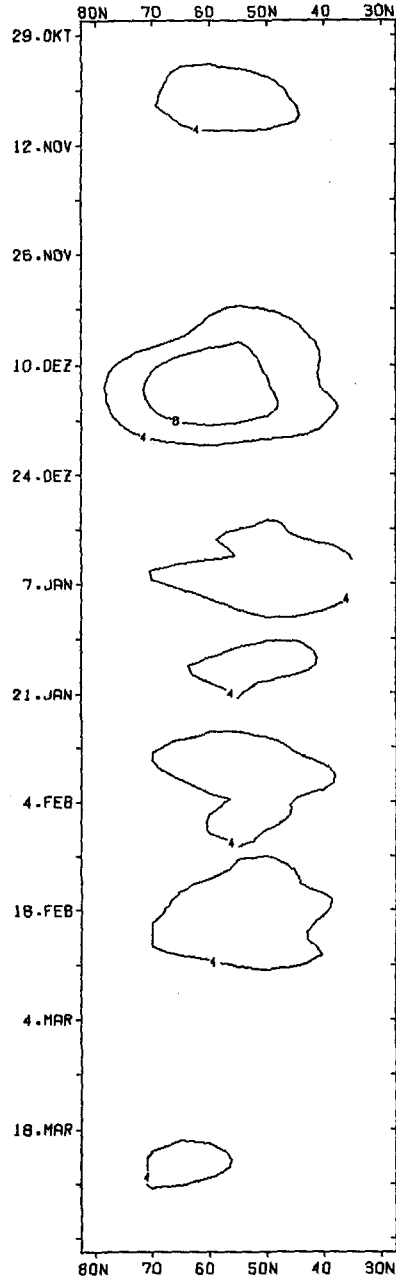

f

C

Figure B.102

1976 / 77
WAVES 1-6

MOMENTUM FLUX

HEAT FLUX

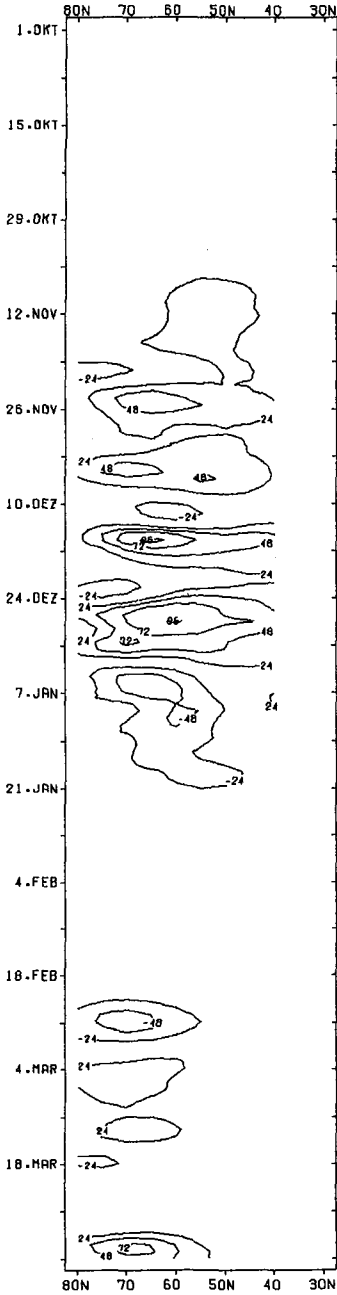

g

C.W.

*

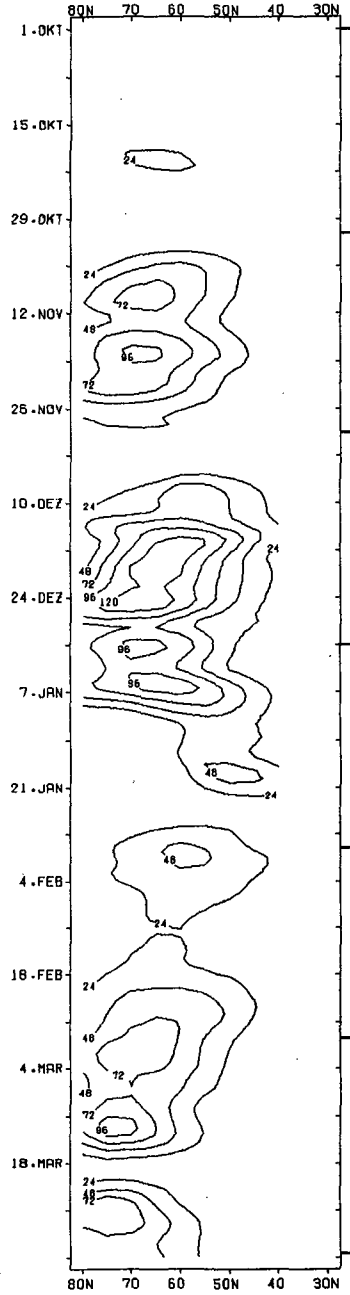

h

C

Figure B.104

EFFICIENCY
MOMENTUM FLUX

1976 / 77

EFFICIENCY
HEAT FLUX

WAVES 1-6

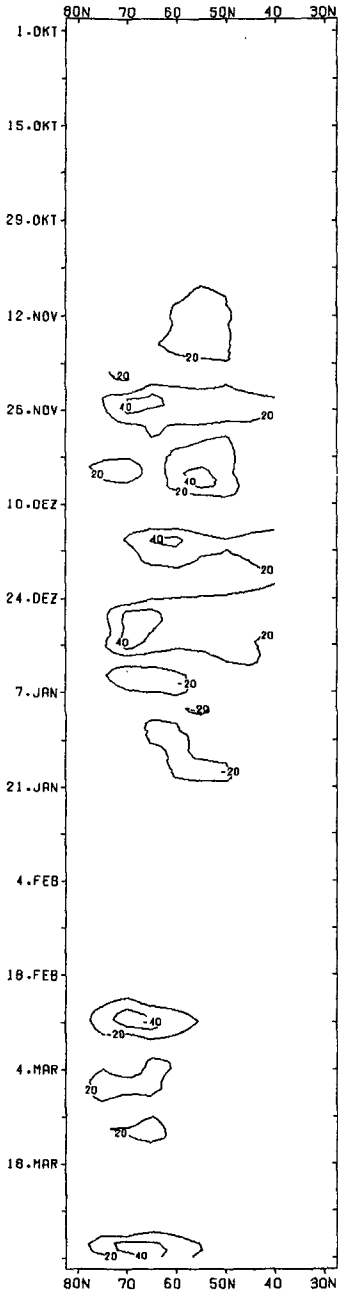

i

CW.

*

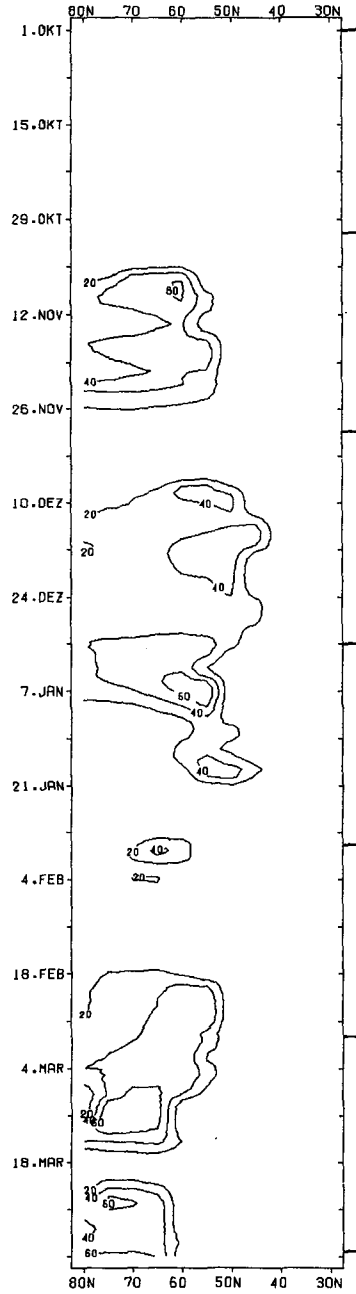

j

C

Figure B.103

MOMENTUM FLUX

HEAT FLUX

WAVE 1

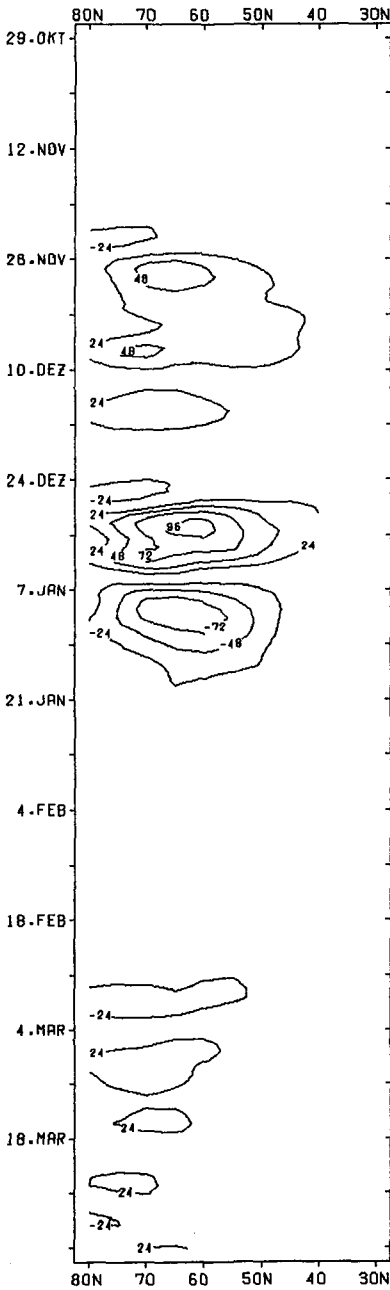

k

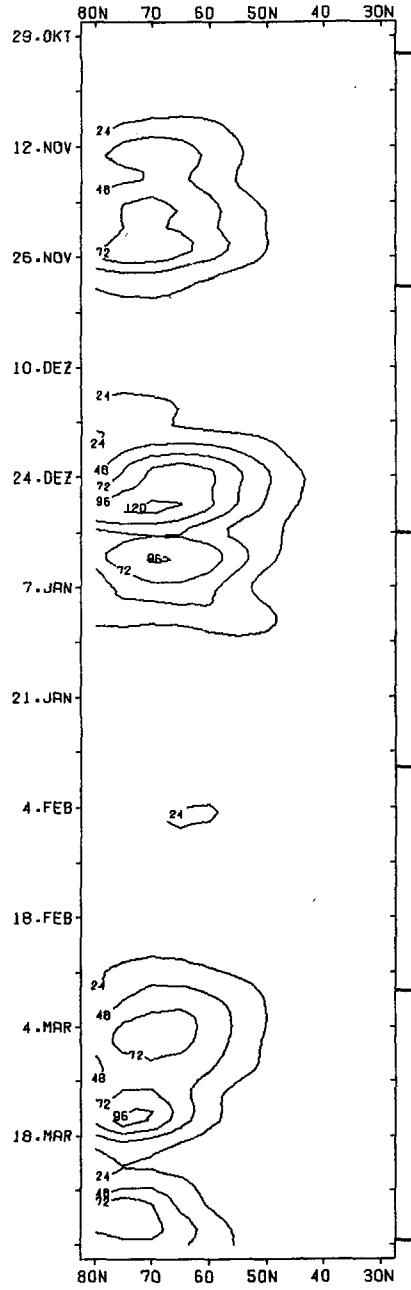

I

C.W.

*

C

Figure B.105

1976 / 77

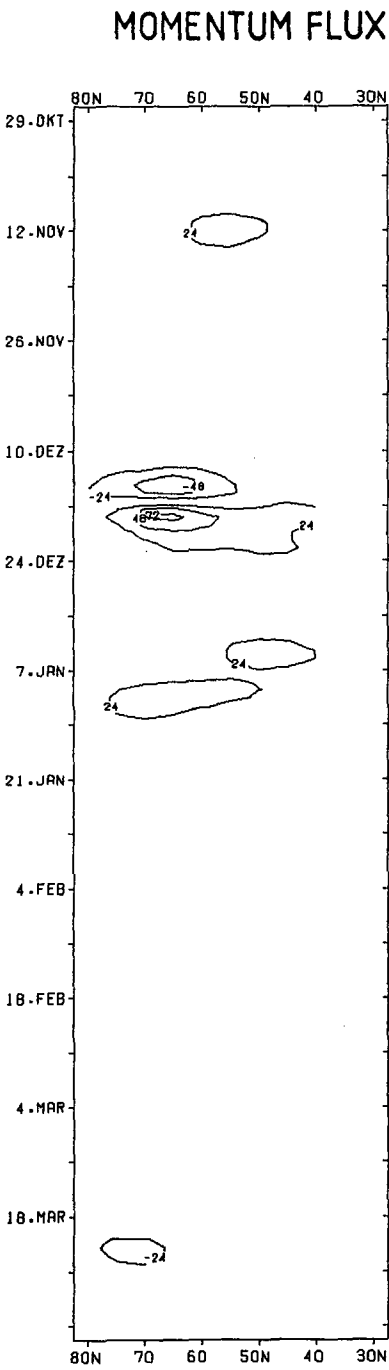

m

HEAT FLUX

WAVE 2

C.W.

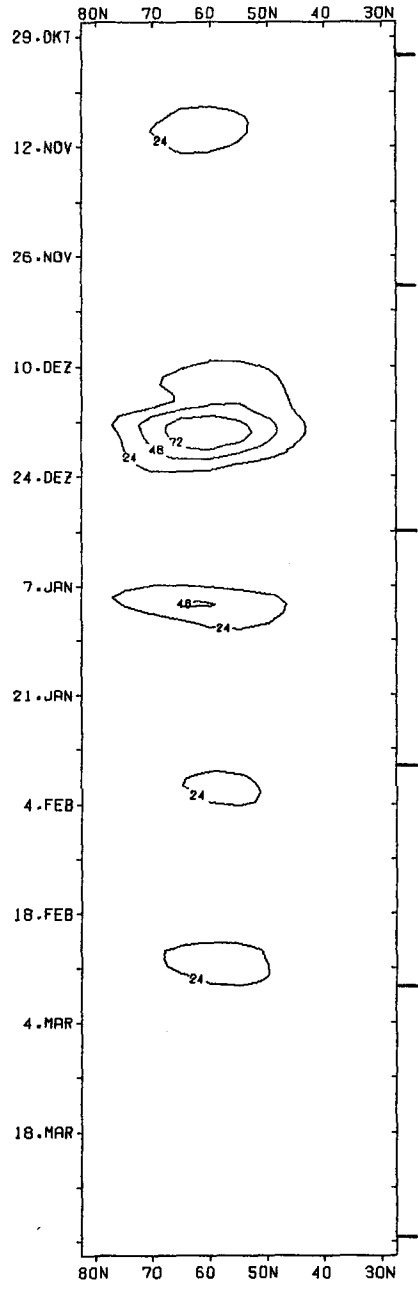

n

C

Figure B.106

1976/77

EFFICIENCY
MOMENTUM FLUX

EFFICIENCY
HEAT FLUX

WAVE 1

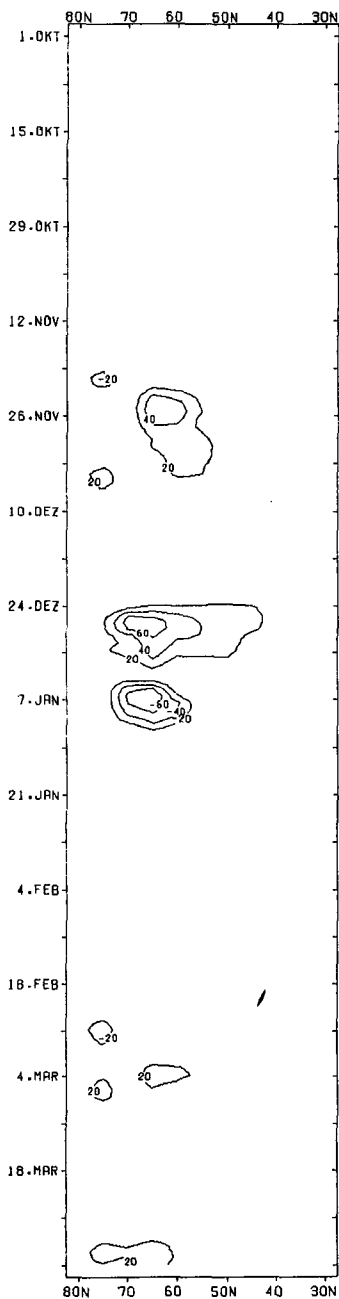

o

C.W.

*

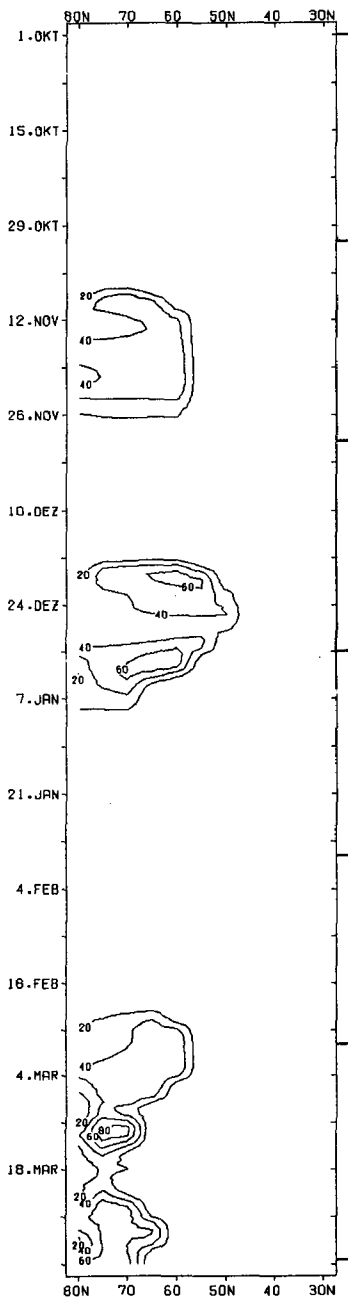

p

C

Figure B.107

EFFICIENCY
MOMENTUM FLUX

1976 / 77

EFFICIENCY
HEAT FLUX

WAVE 2

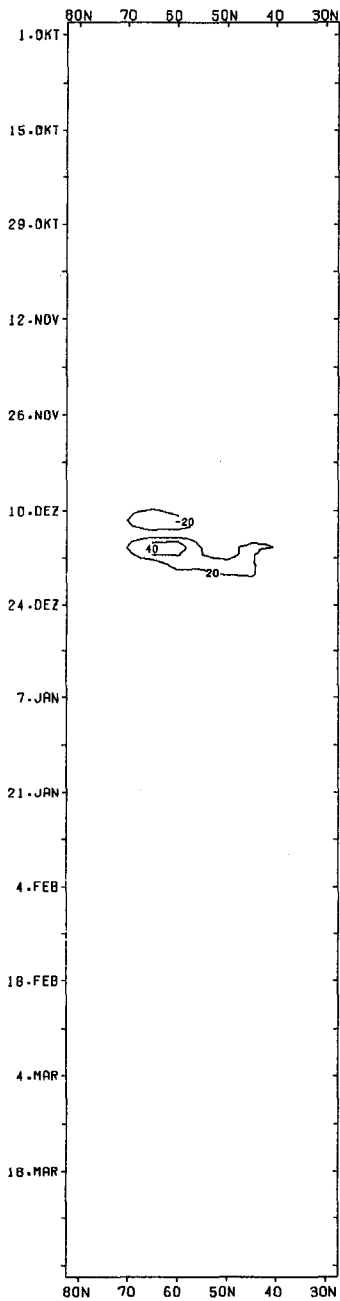

q

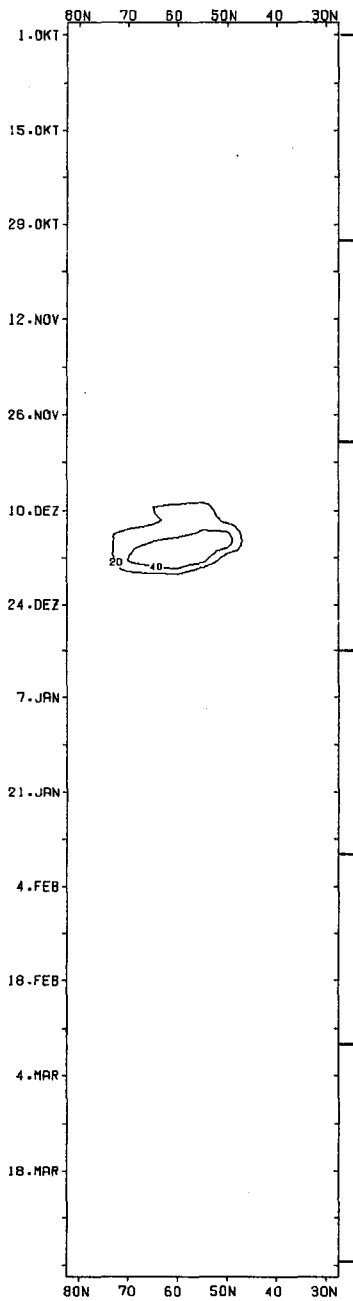

r

C.W.

*

C

Figure B.108

MEAN ZONAL WIND

MEAN ZONAL TEMP.

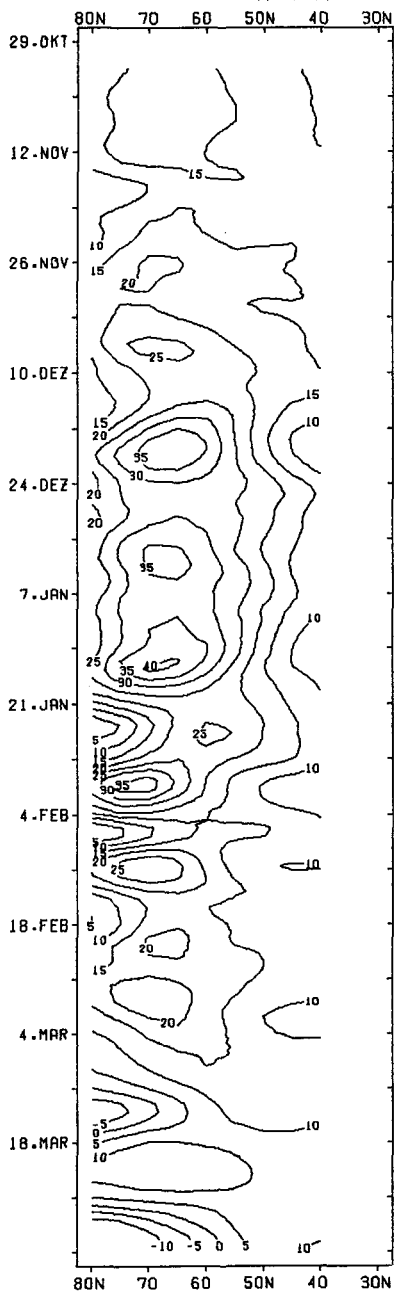

a

C.W.

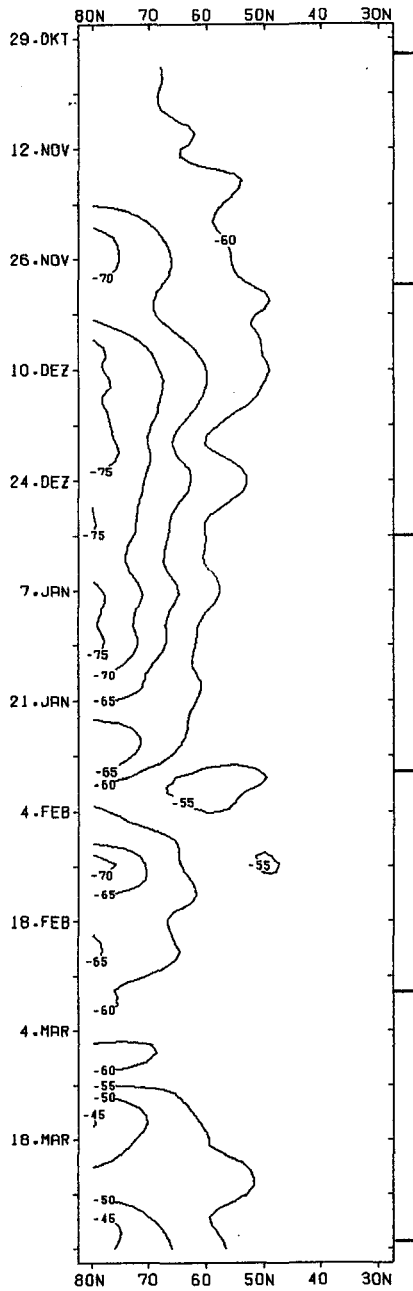

b

Figure B.109

1977 / 78

HEIGHT WAVE 1

TEMP. WAVE 1

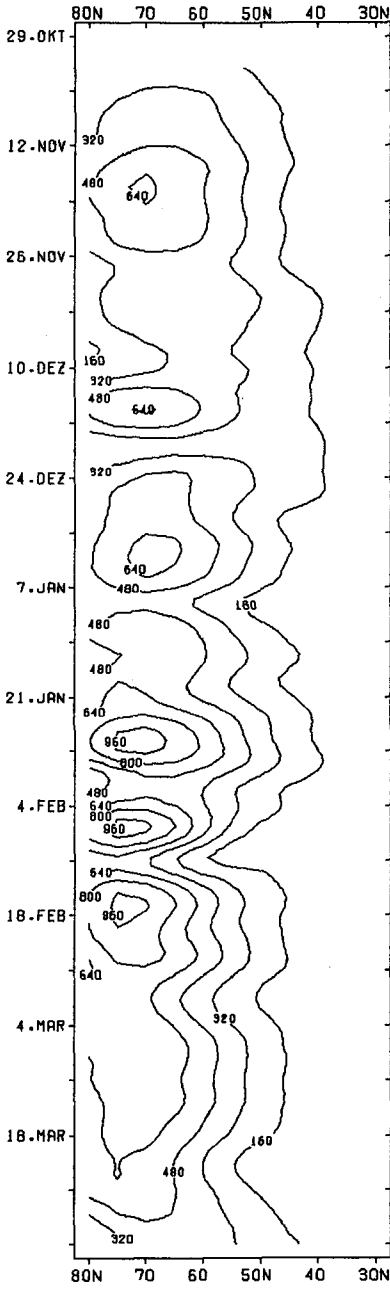

c

C.W.

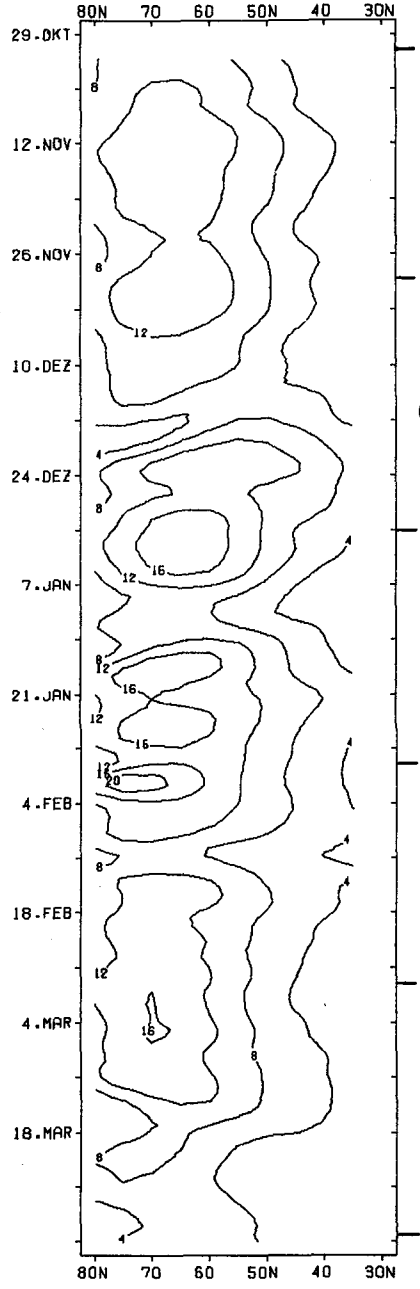

C

d

Figure B.110

1977/78

HEIGHT WAVE 2

TEMP WAVE 2

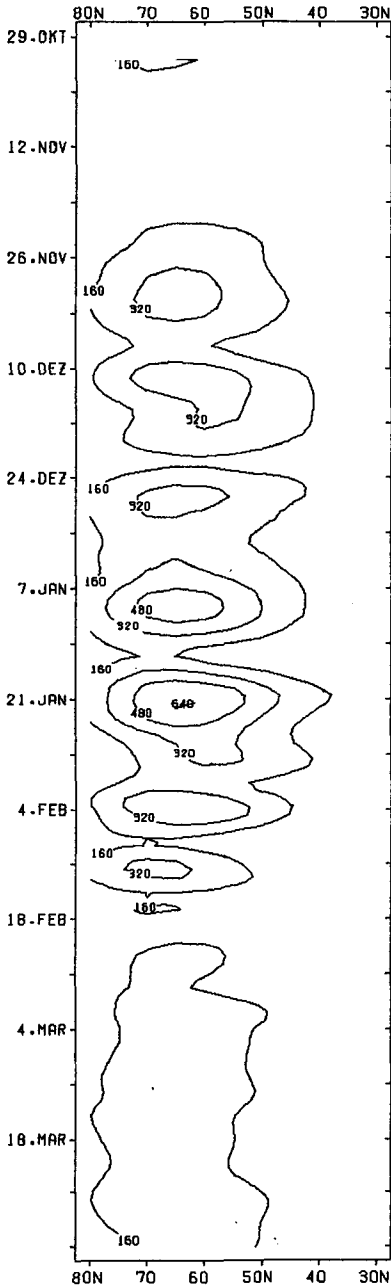

e

C.W.

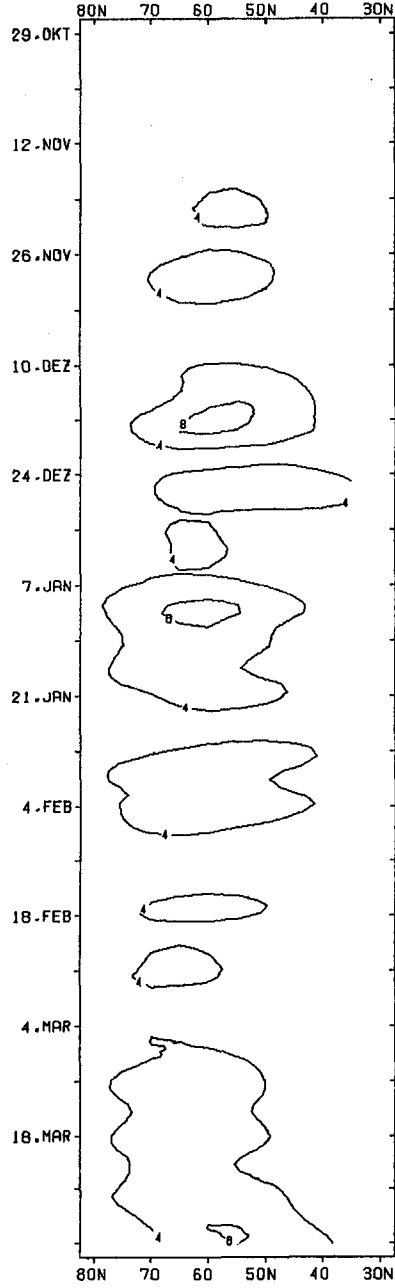

f

Figure B.111

1977/78

WAVES 1-6

MOMENTUM FLUX

HEAT FLUX

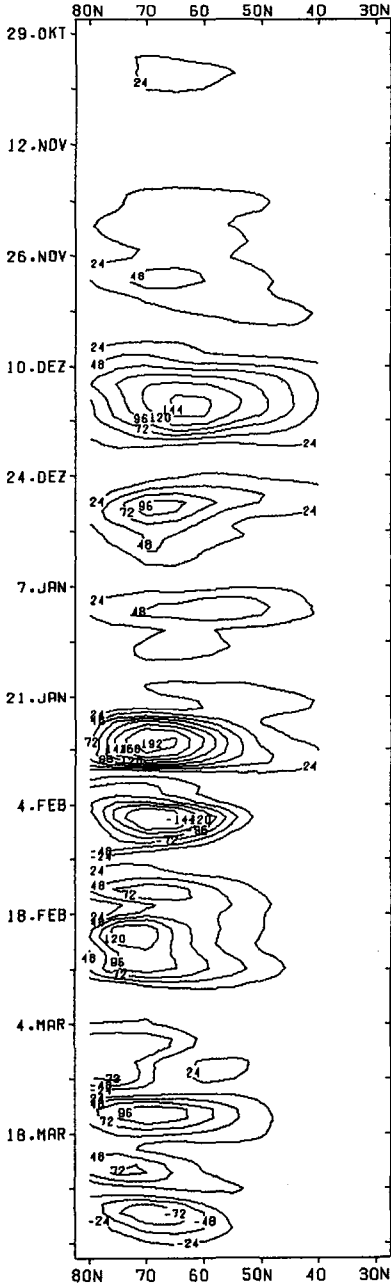

g

C.W.

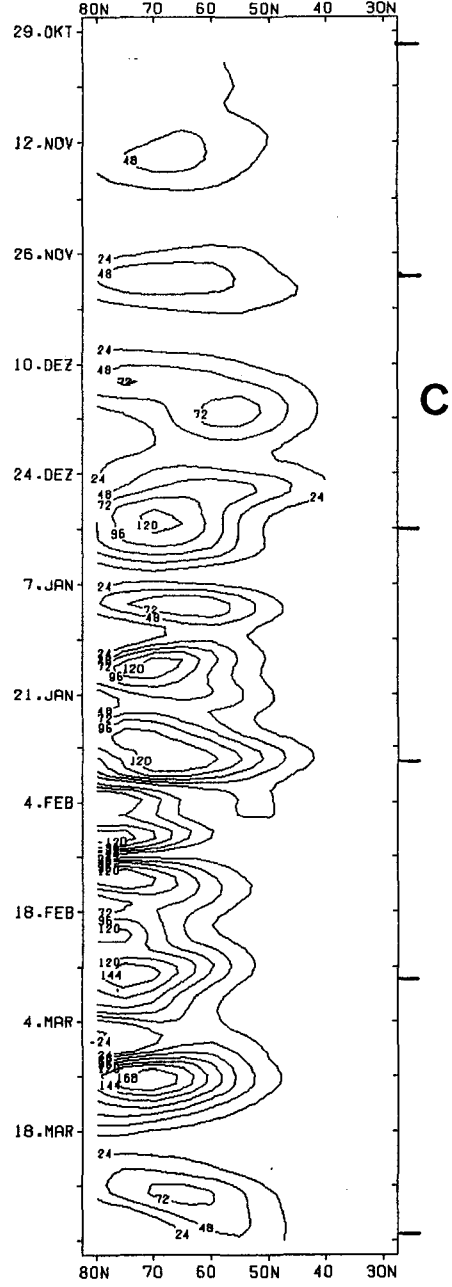

h

Figure B.112

1977 / 78

EFFICIENCY
MOMENTUM FLUX

EFFICIENCY
HEAT FLUX

WAVES 1-6

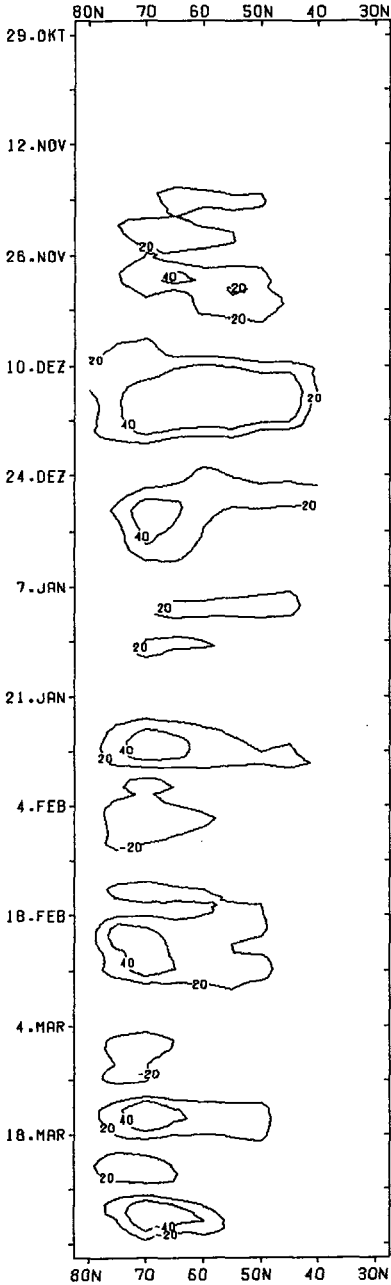

i

C.W.

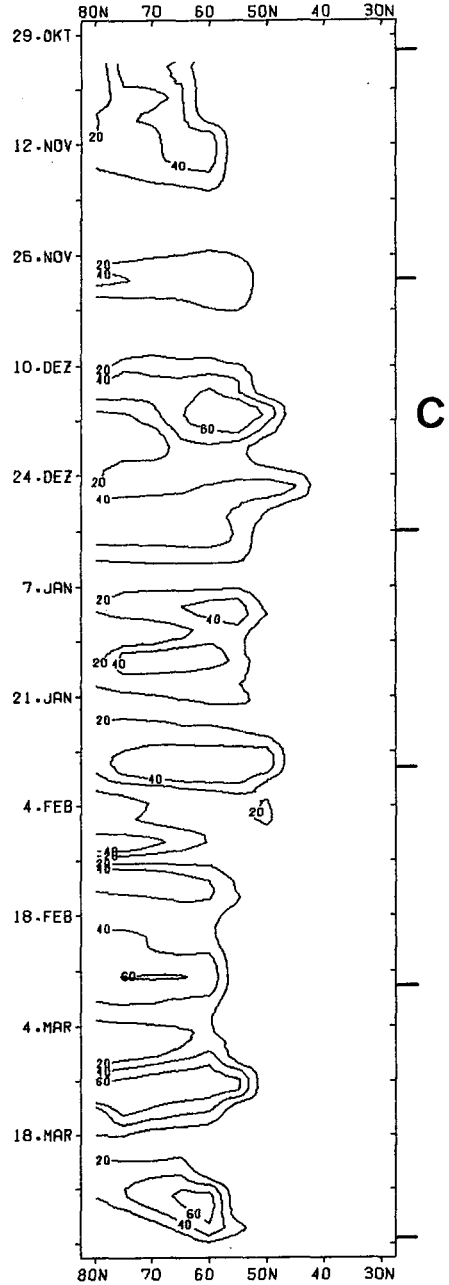

j

Figure B.113

1977/78

MOMENTUM FLUX

HEAT FLUX

WAVE 1

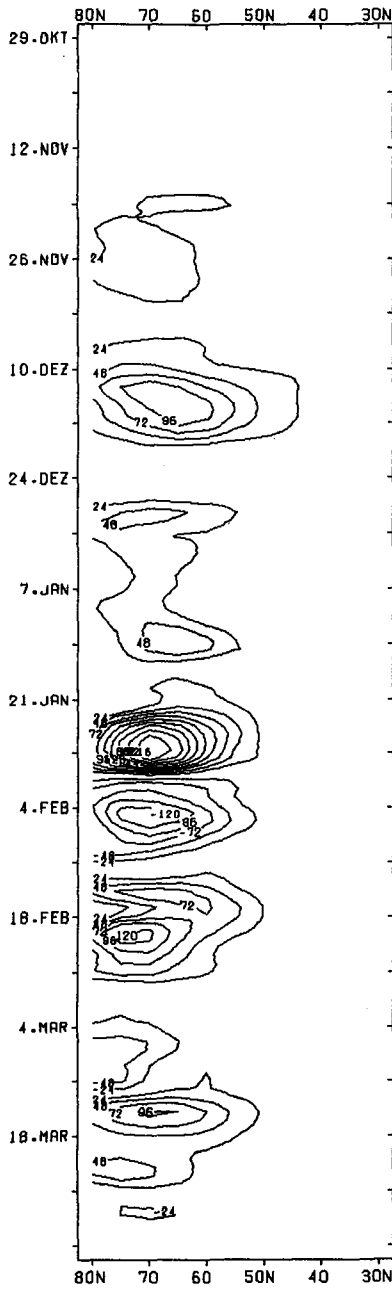

k

C.W.

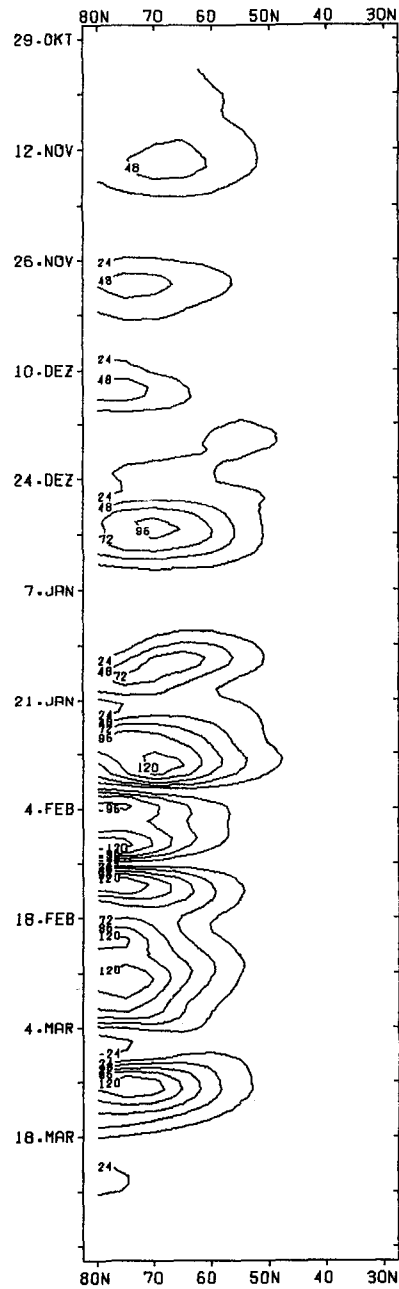

l

Figure B.114

1977/78

MOMENTUM FLUX

WAVE 2

HEAT FLUX

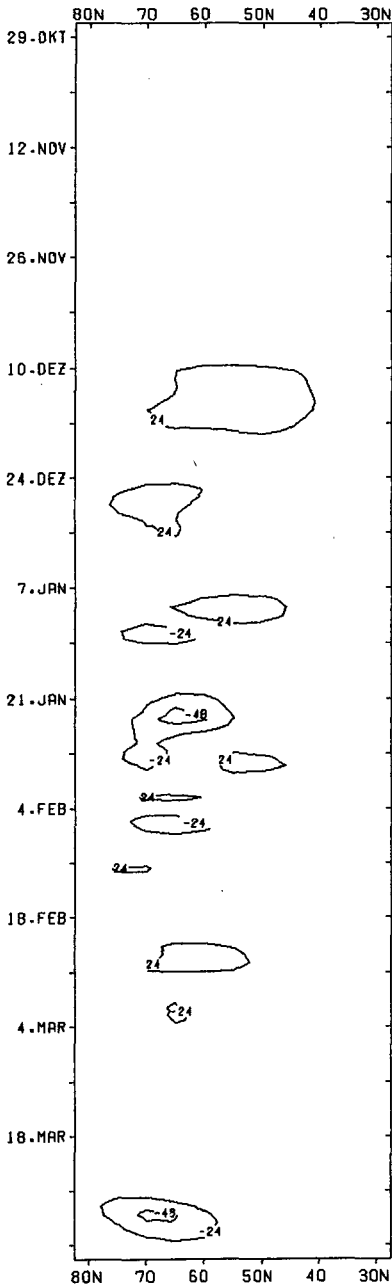

m

C.W.

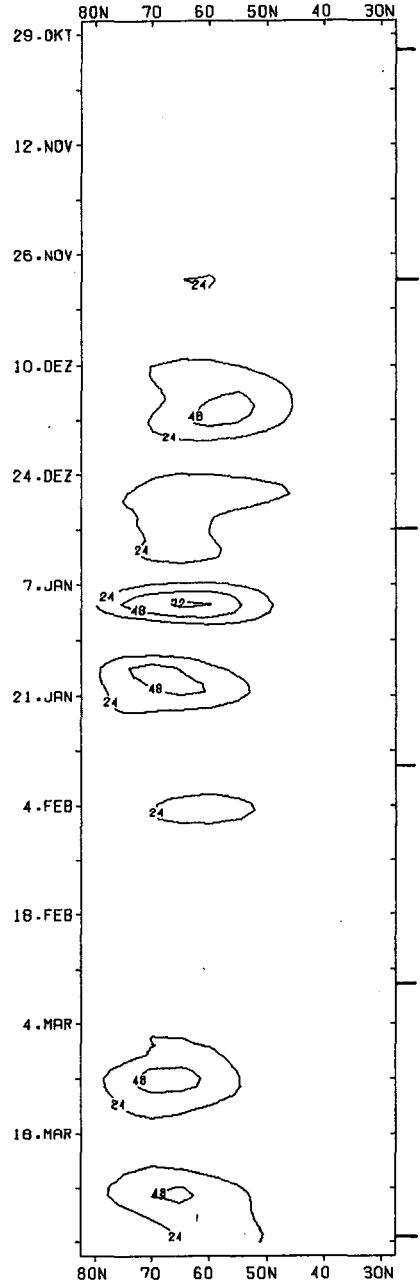

C

n

Figure B.115

EFFICIENCY
MOMENTUM FLUX

1977 / 78

WAVE 1

EFFICIENCY
HEAT FLUX

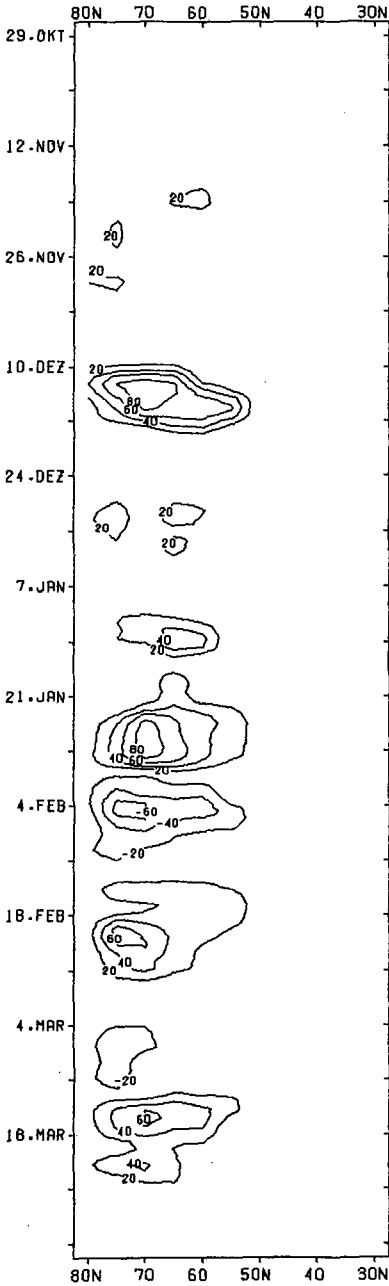

o

C.W.

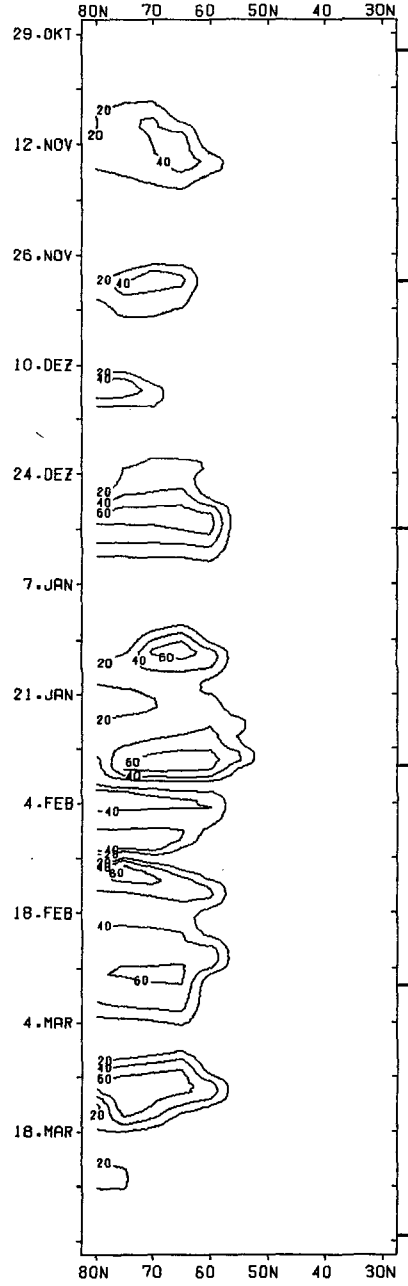

p

C

Figure B.116

1977/78

EFFICIENCY
MOMENTUM FLUX

EFFICIENCY
HEAT FLUX

WAVE 2

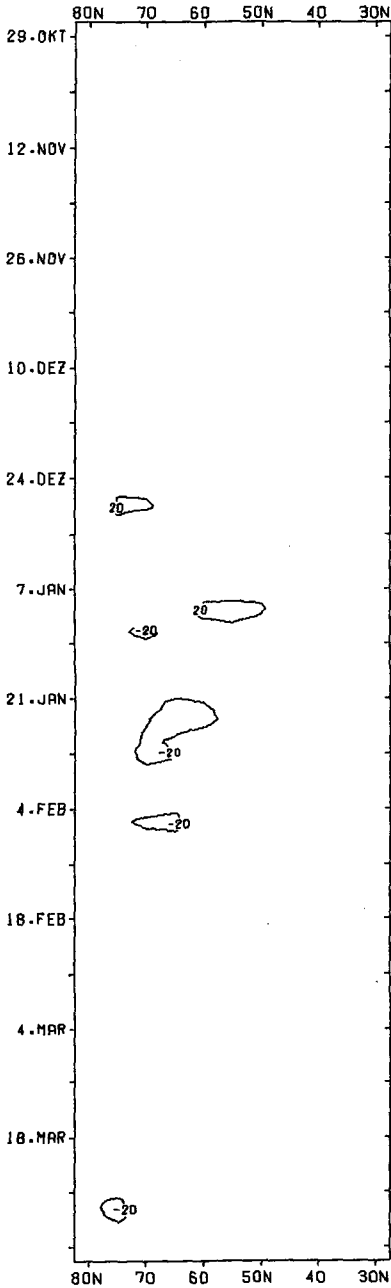

q

C.W.

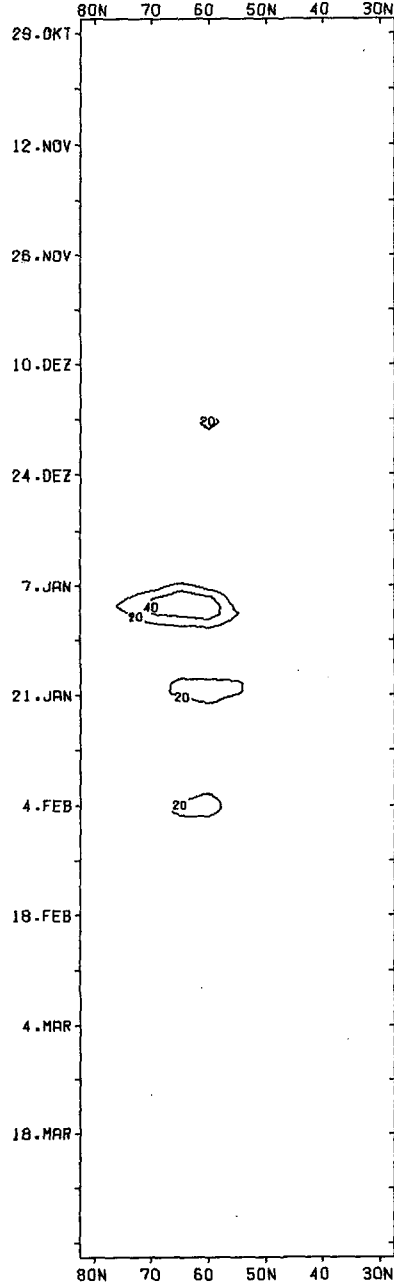

r

Figure B.117

1978/79

MEAN ZONAL WIND

MEAN ZONAL TEMP.

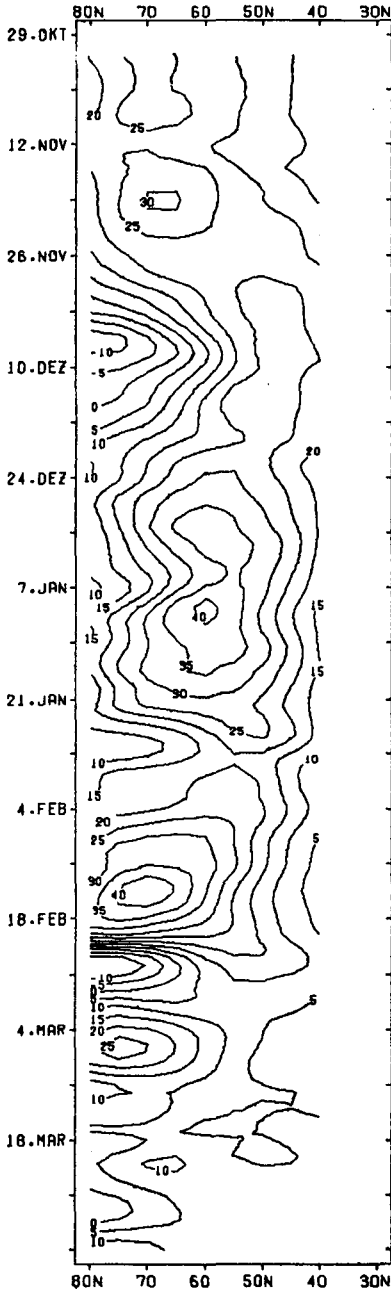

a

C.W.

* F.W.

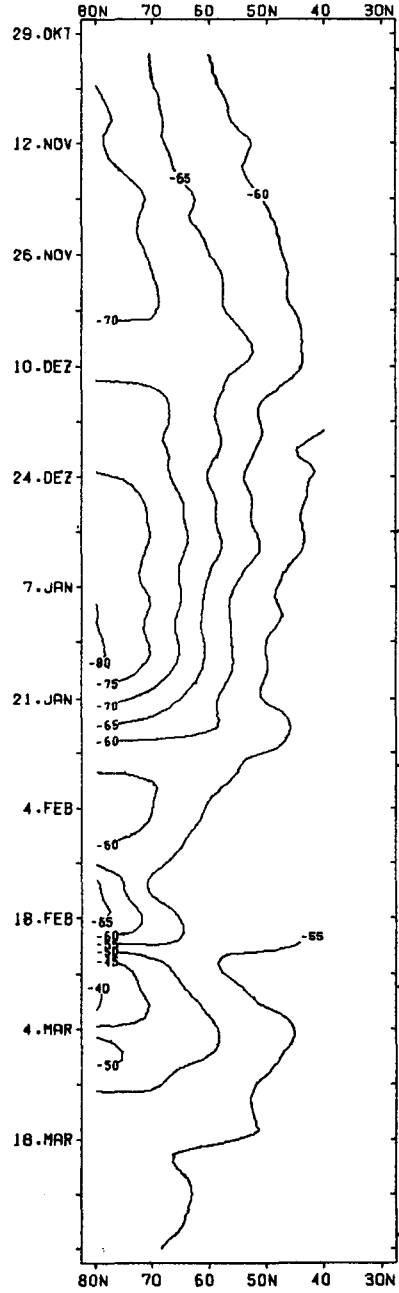

b

C

C

Figure B.118

1978/79

HEIGHT WAVE 1

TEMP. WAVE 1

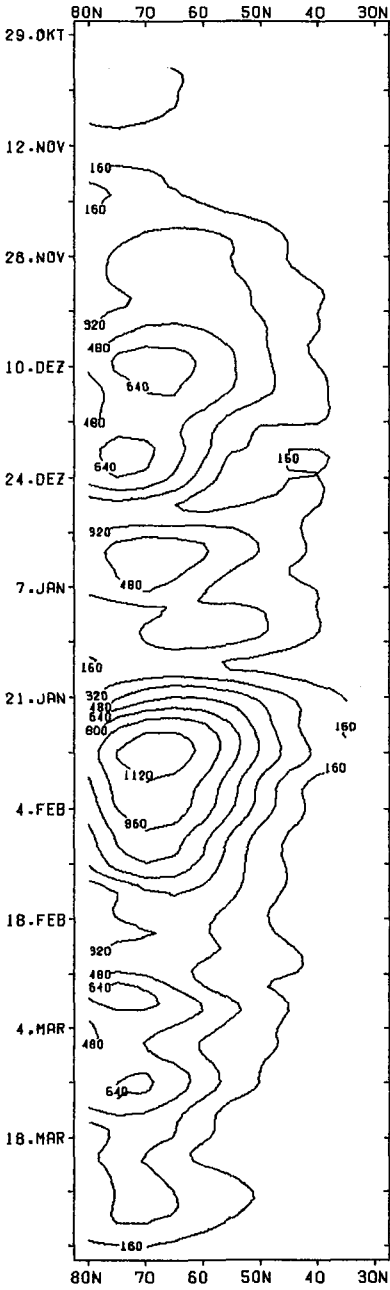

c

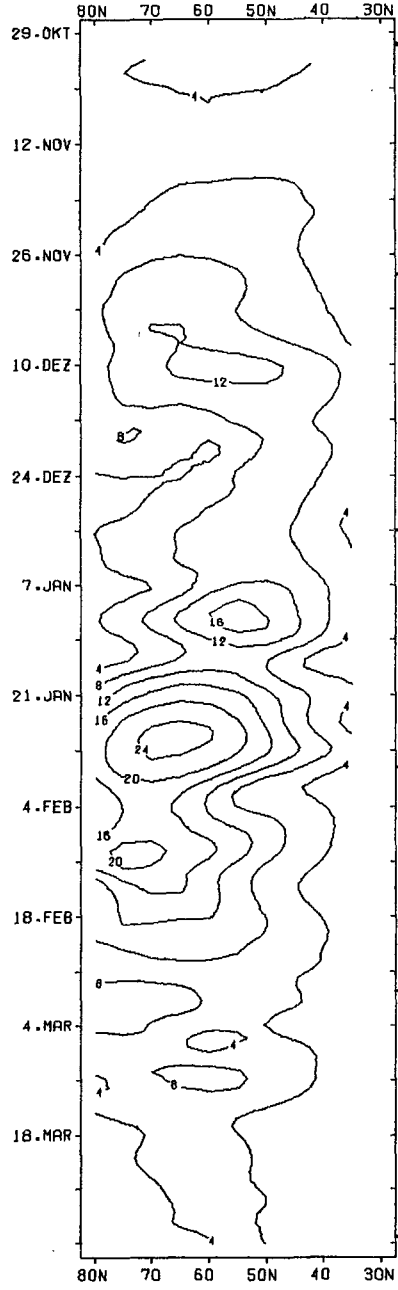

d

C.W.

*** F.W.**

C

C

Figure B.119

1978/79

HEIGHT WAVE 2

TEMP WAVE 2

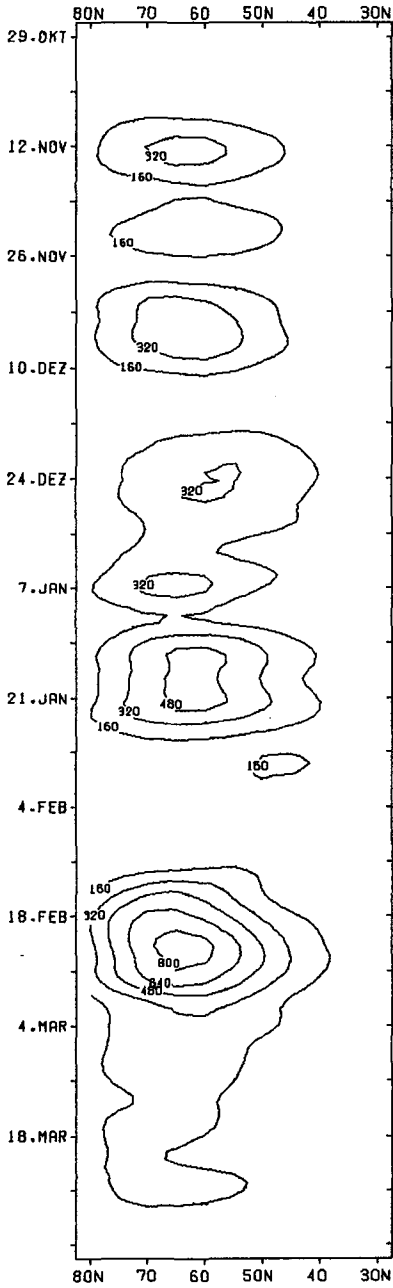

e

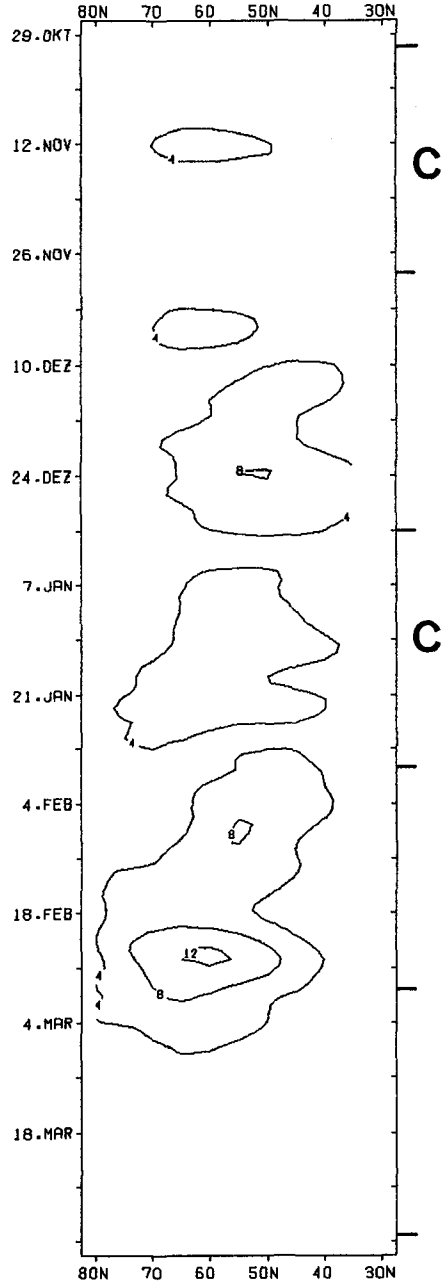

f

C.W.

* F.W.

Figure B.120

1978/79
WAVES 1-6

MOMENTUM FLUX

HEAT FLUX

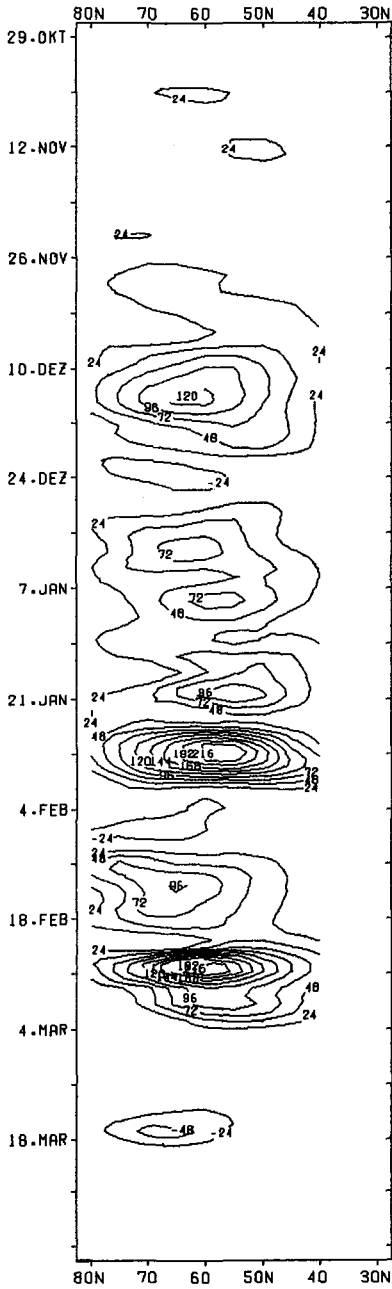

g

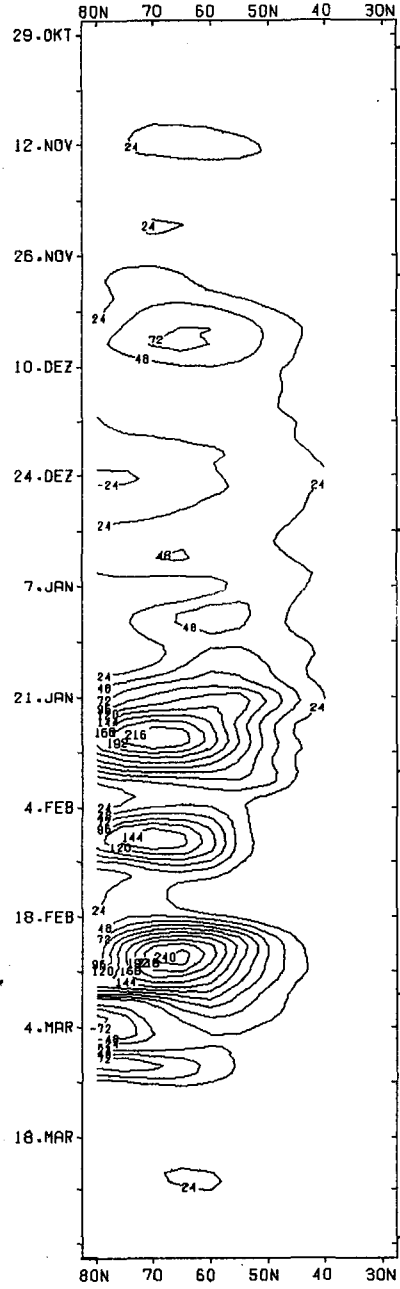

h

Figure B.121

166 EFFICIENCY
MOMENTUM FLUX

1978/79
WAVES 1-6

EFFICIENCY
HEAT FLUX

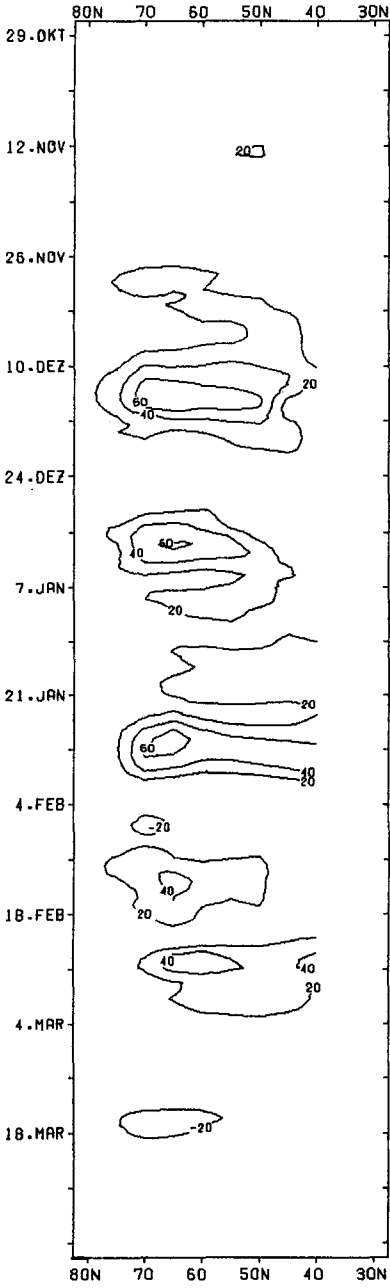

i

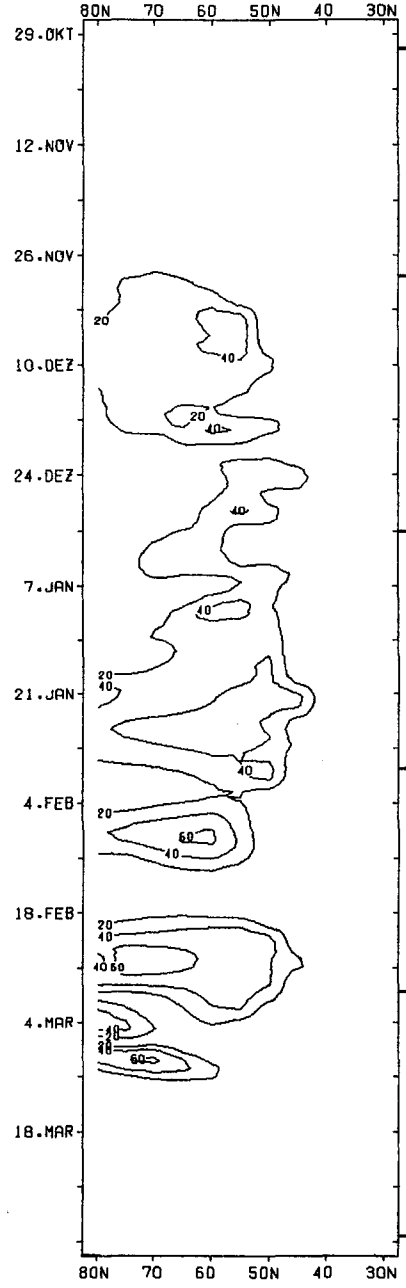

j

C.W.

* F.W.

C

C

Figure B.122

MOMENTUM FLUX

HEAT FLUX

WAVE 1

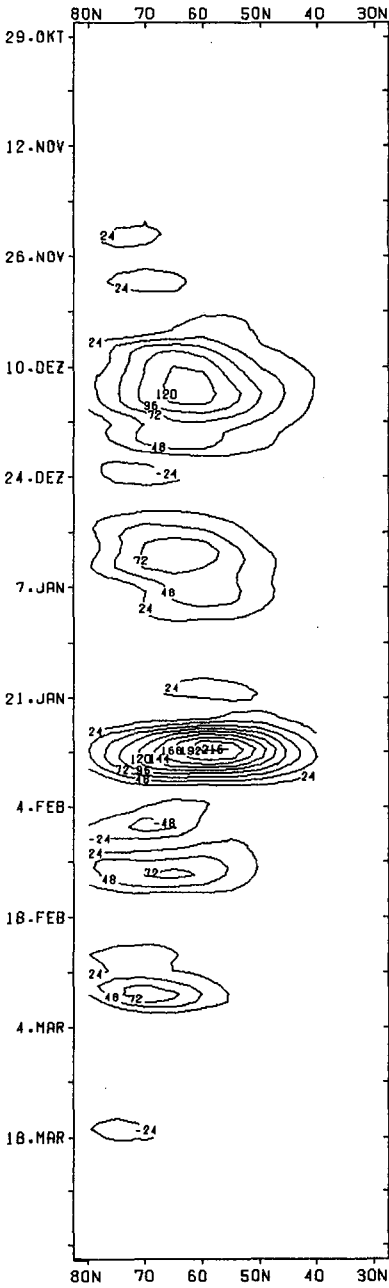

k

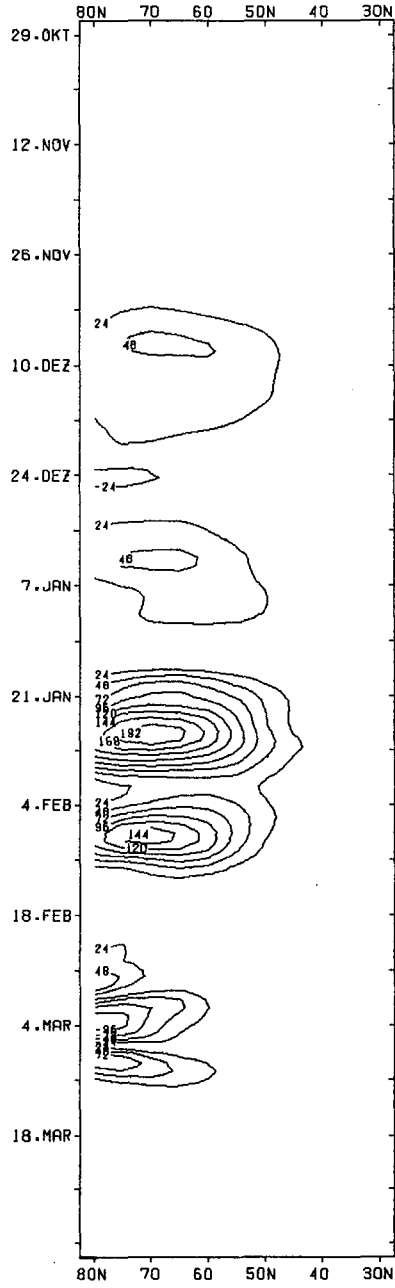

l

Figure B.123

1978 / 79
WAVE 2

MOMENTUM FLUX

HEAT FLUX

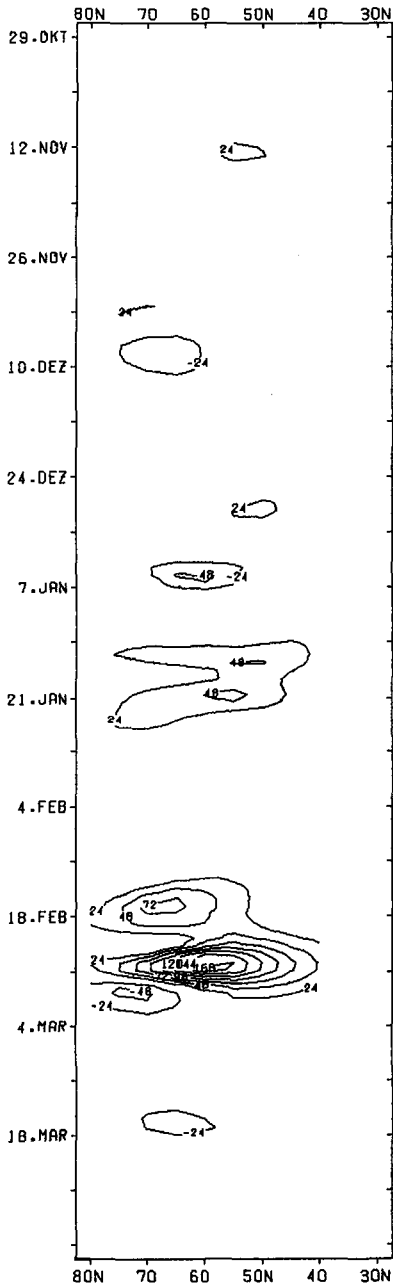

m

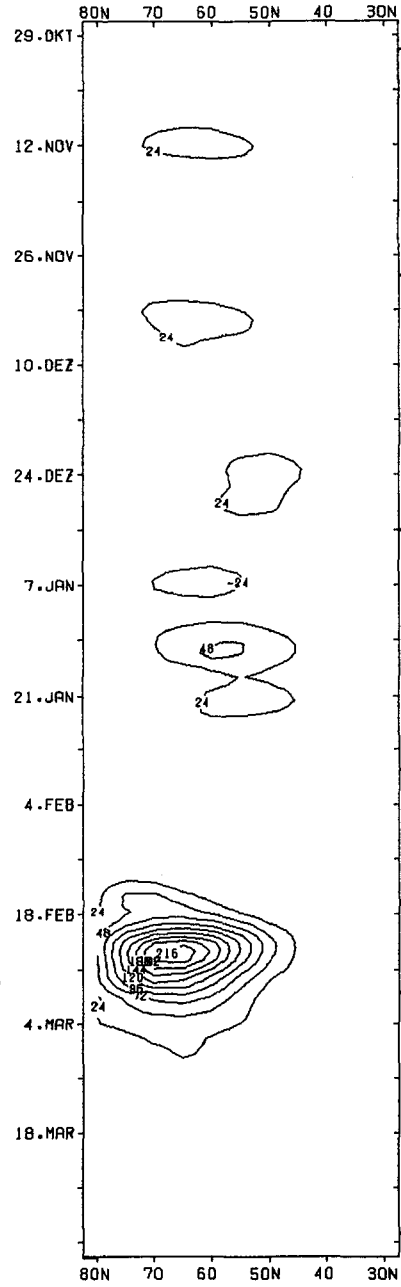

n

C.W.

* F.W.

Figure B.124

1978/79

EFFICIENCY
MOMENTUM FLUX

EFFICIENCY
HEAT FLUX

WAVE 1

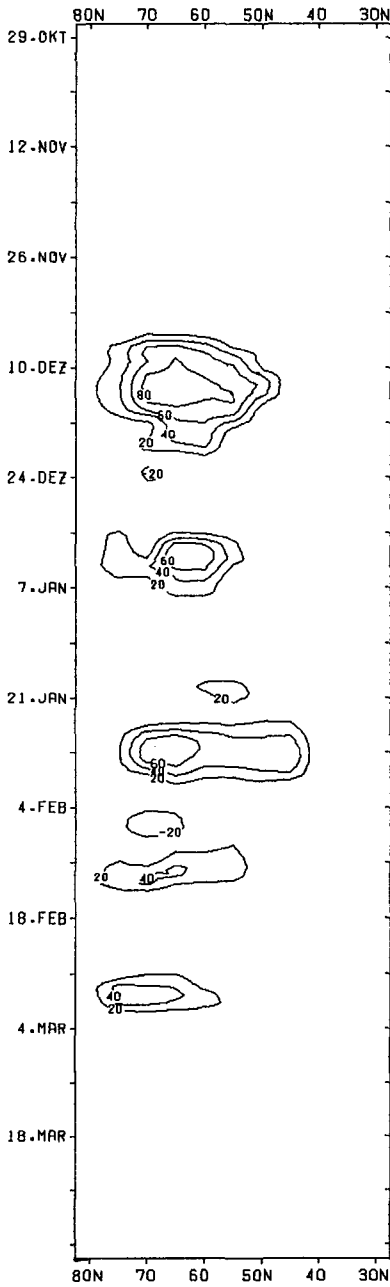

o

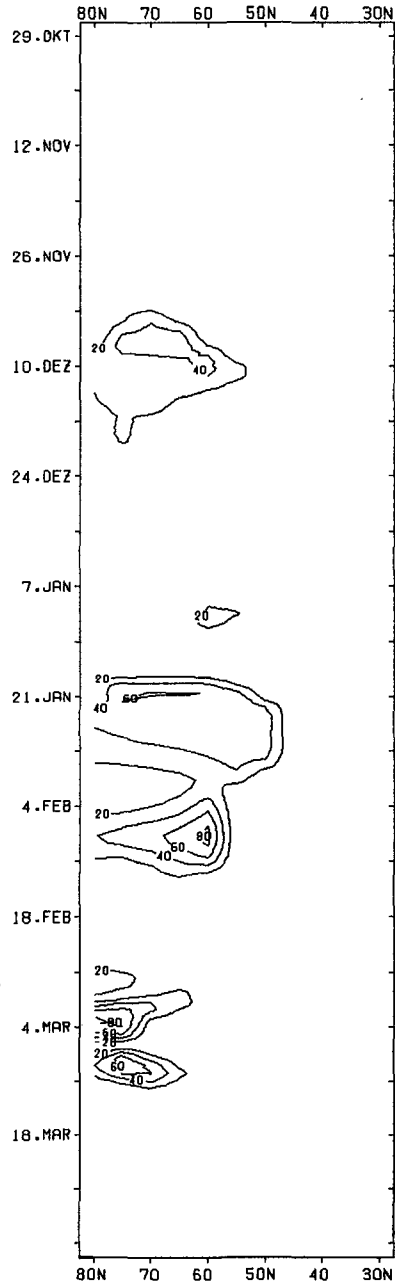

p

Figure B.125

1978/79

170
EFFICIENCY
MOMENTUM FLUX

EFFICIENCY
HEAT FLUX

WAVE 2

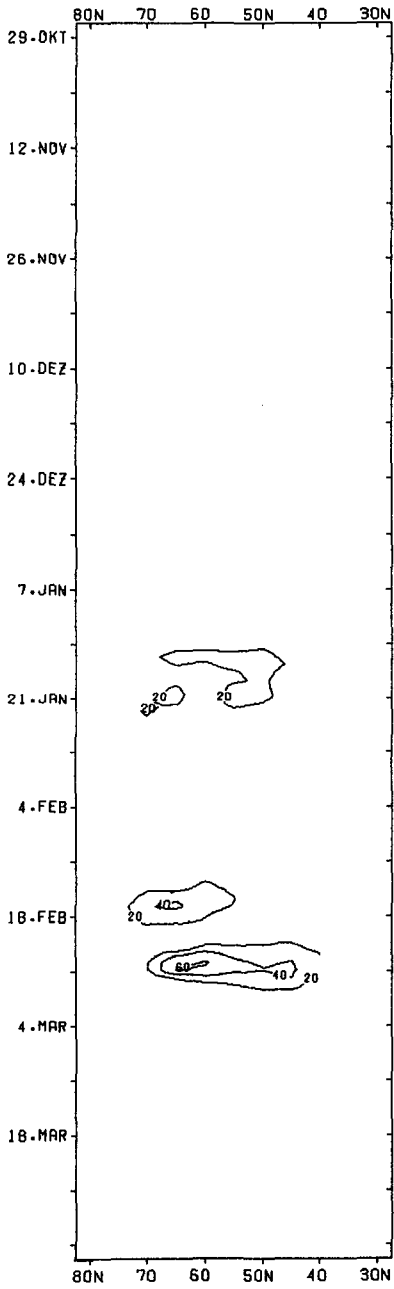

q

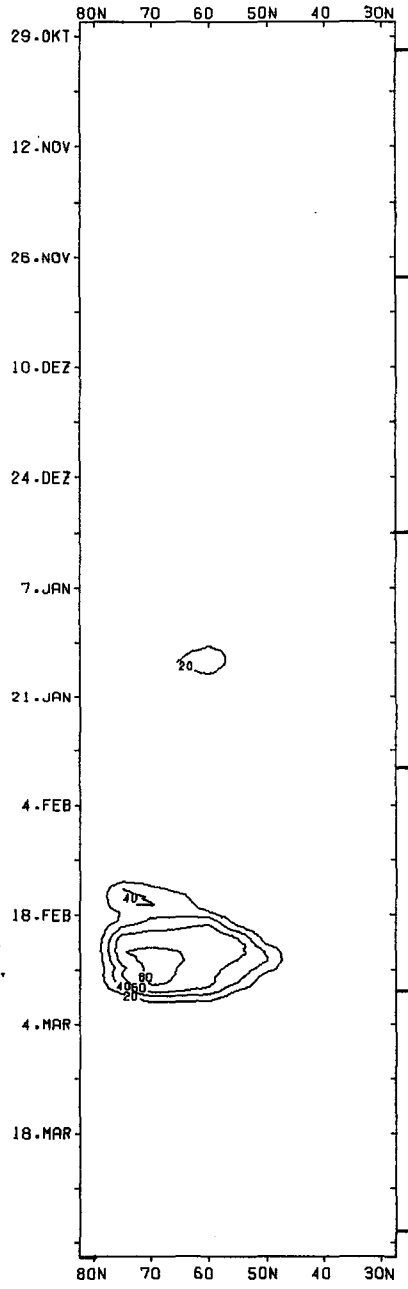

r

Figure B.126

MEAN ZONAL WIND

MEAN ZONAL TEMP.

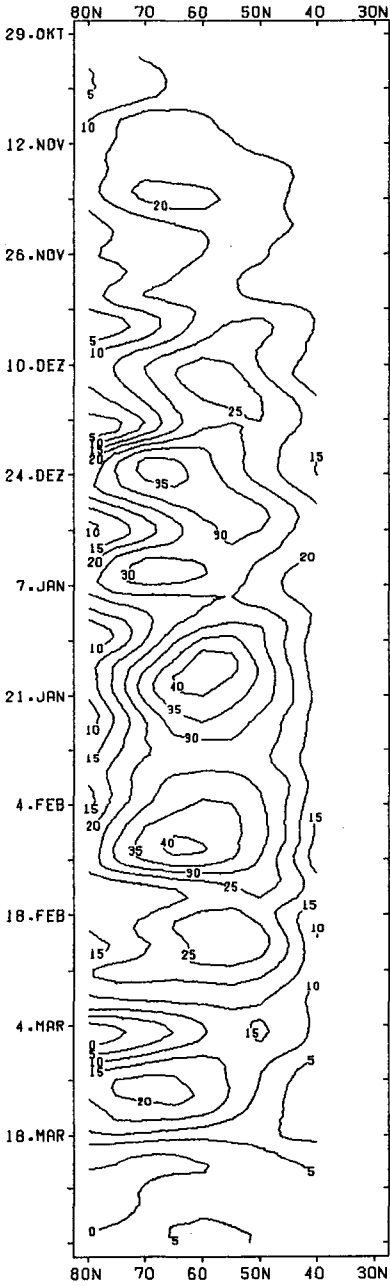

a

C.W.

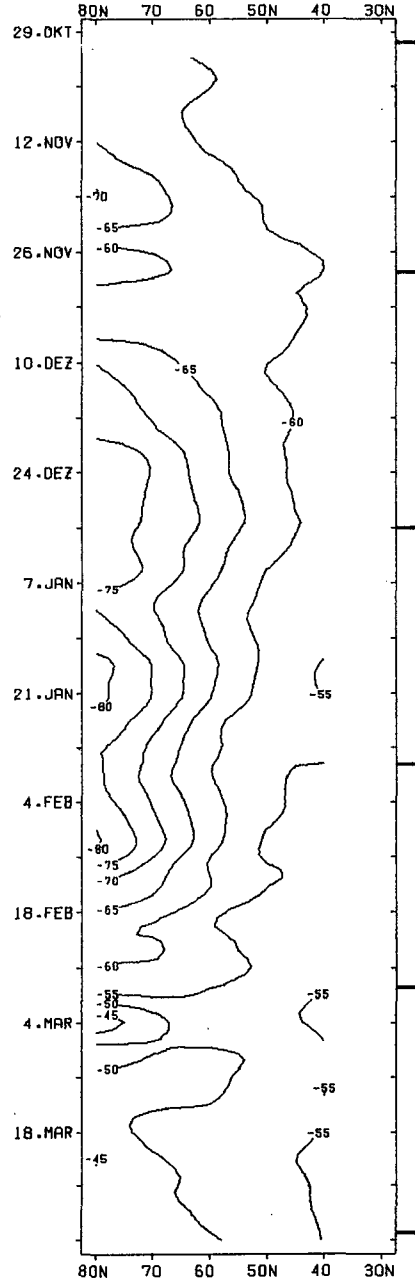

* F.W.

b

Figure B.127

HEIGHT WAVE 1

TEMP. WAVE 1

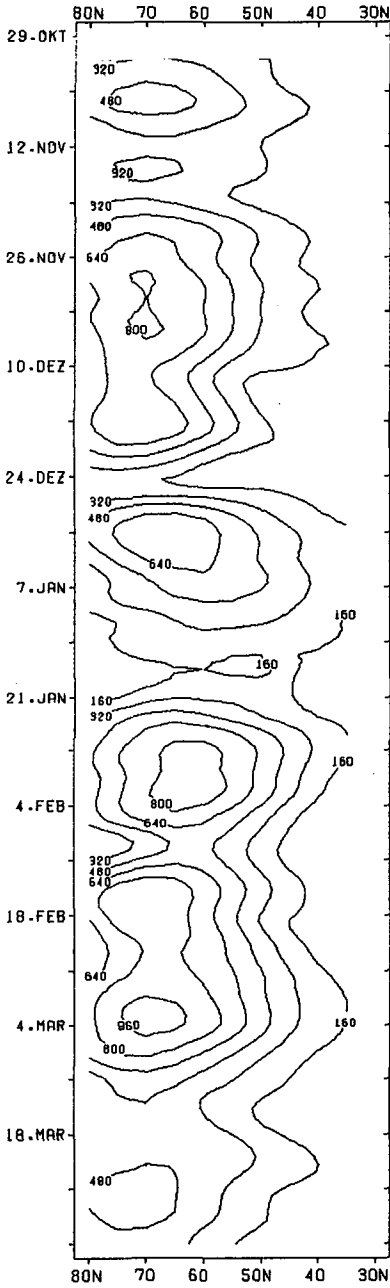

c

C.W.

*** F.W.**

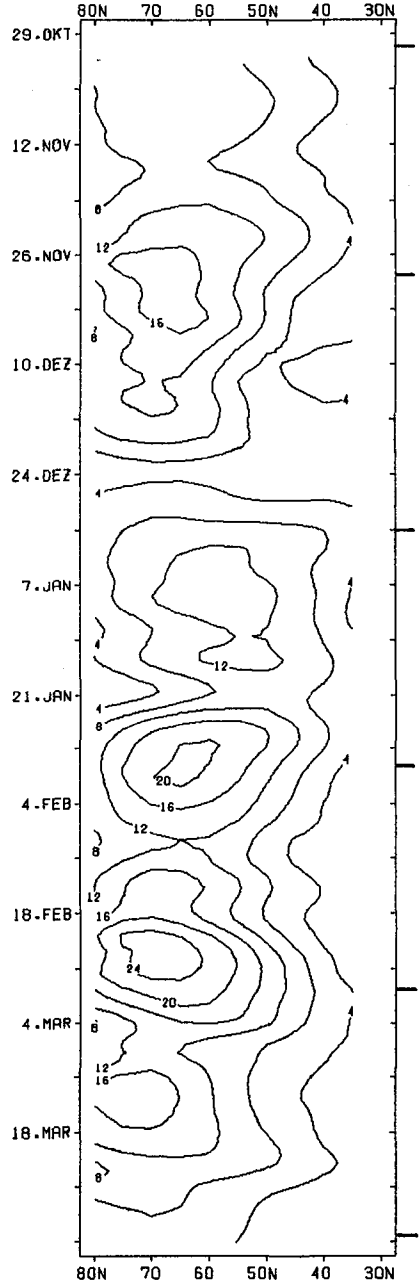

d

Figure B.128

HEIGHT WAVE 2

TEMP WAVE 2

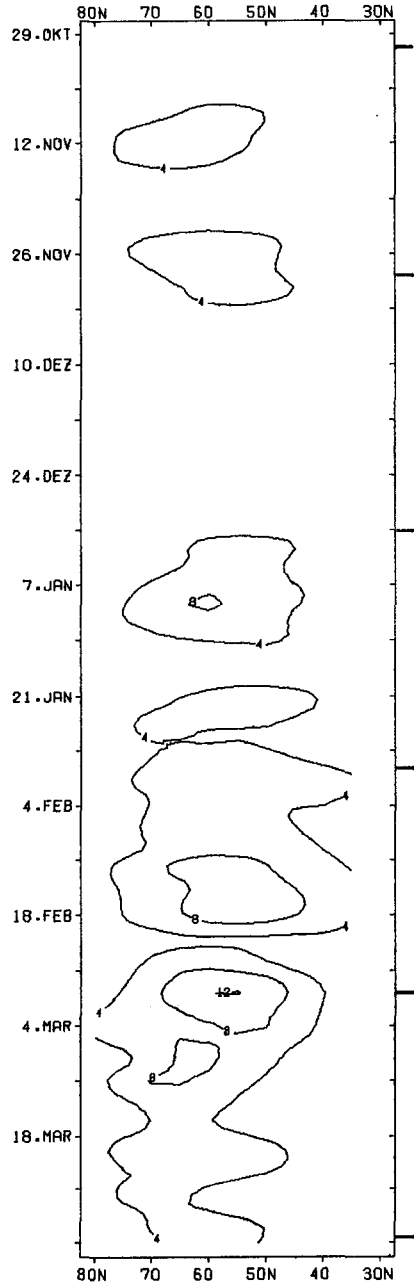
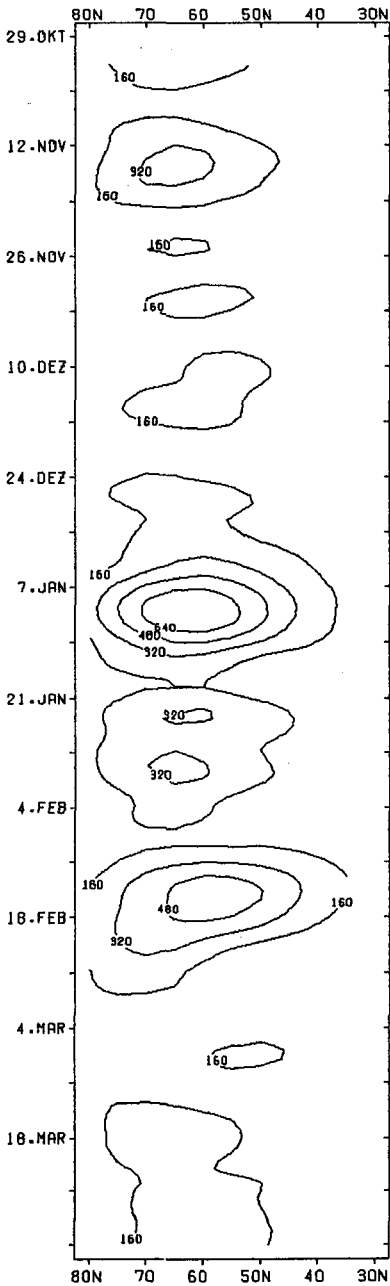

C.W.

* F.W.

C

C

e

f

Figure B.129

MOMENTUM FLUX

1979/80

WAVES 1-6

HEAT FLUX

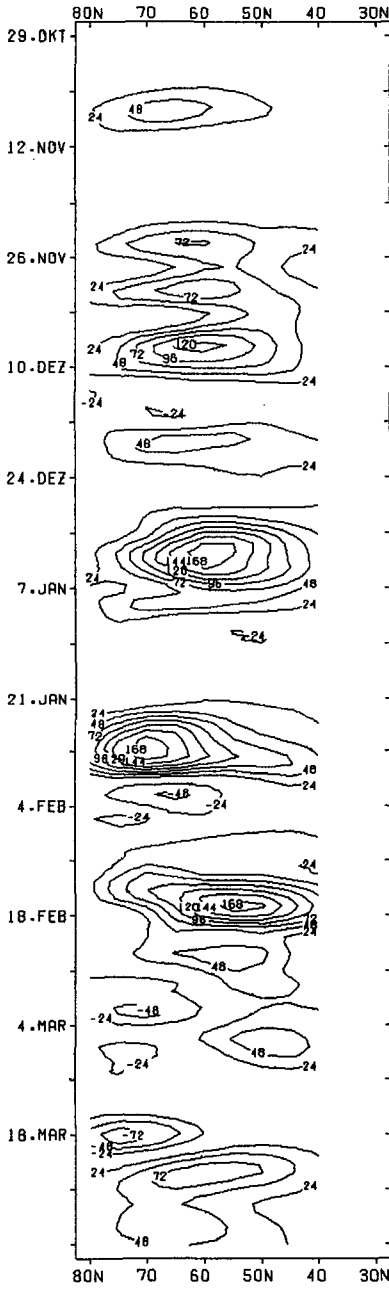

g

C.W.

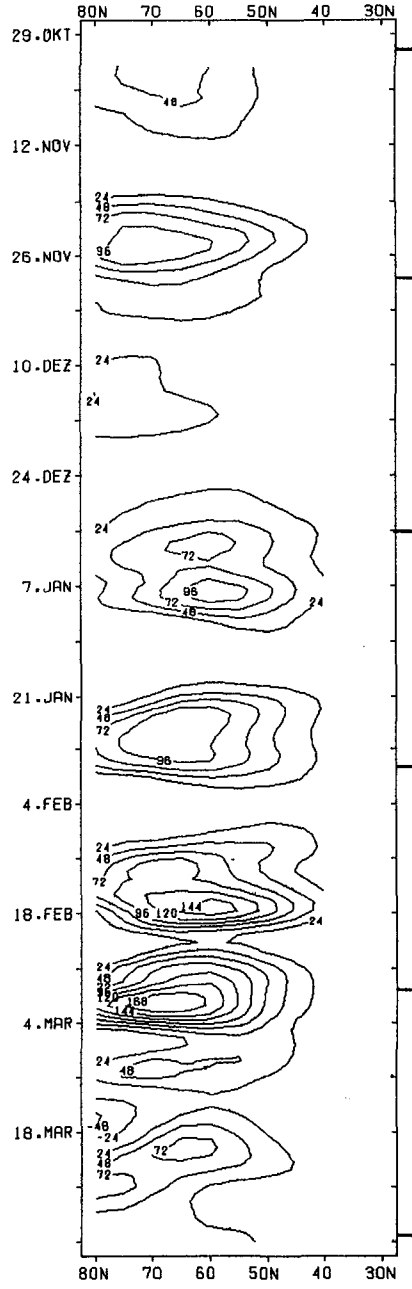

h

* F.W.

Figure B.130

1979/80

EFFICIENCY
MOMENTUM FLUX

EFFICIENCY
HEAT FLUX

WAVES 1-6

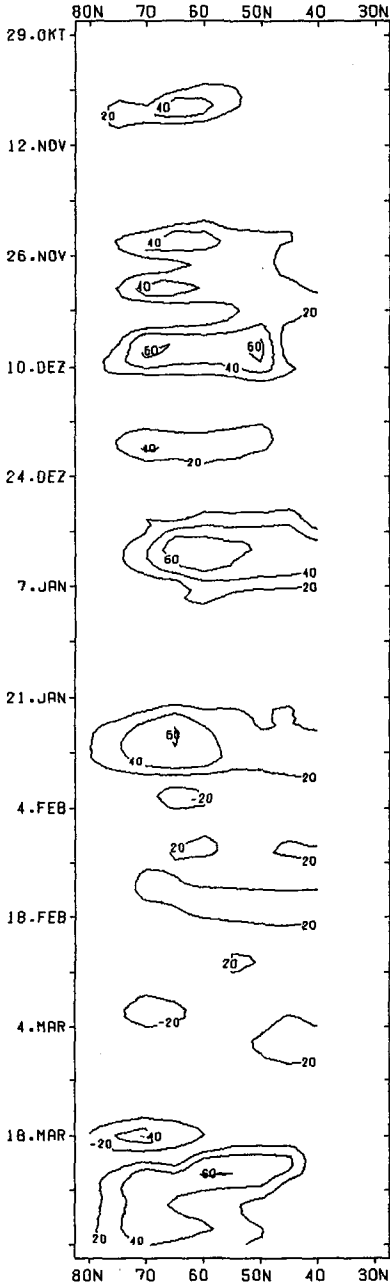

i

C.W.

* F.W.

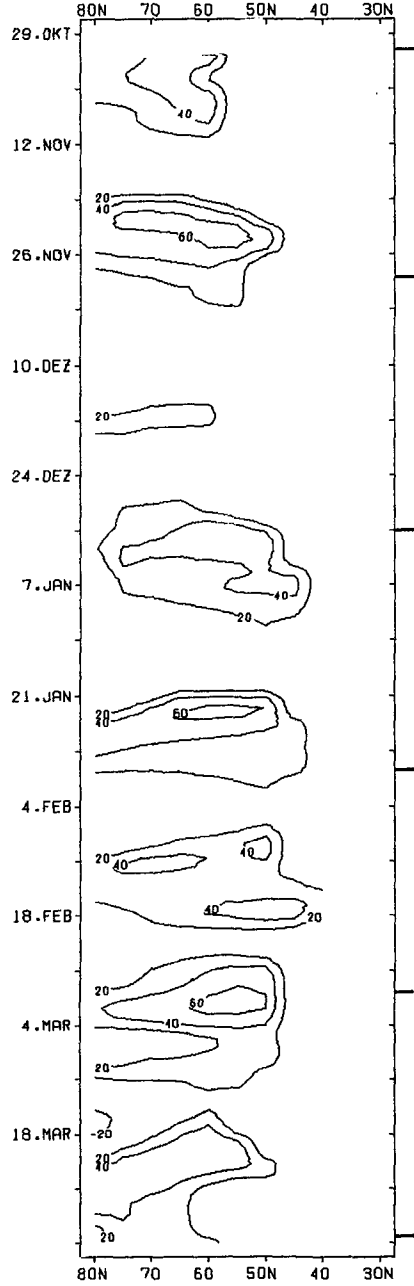

j

Figure B.131

MOMENTUM FLUX

HEAT FLUX

WAVE 1

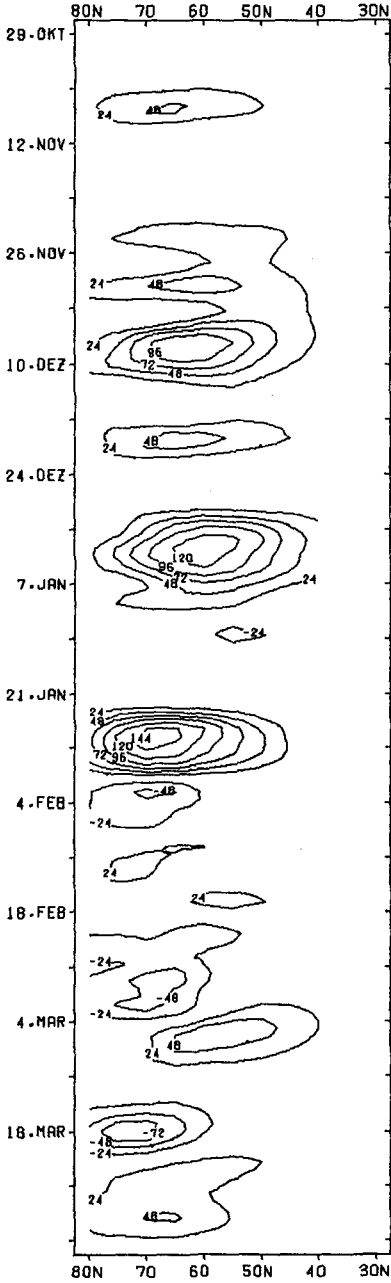

k

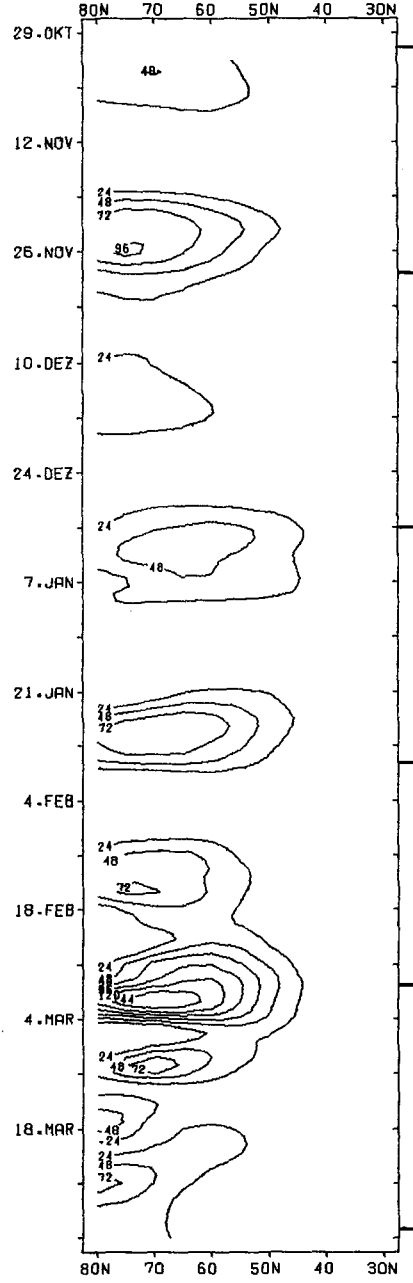

l

Figure B.132

MOMENTUM FLUX

HEAT FLUX

WAVE 2

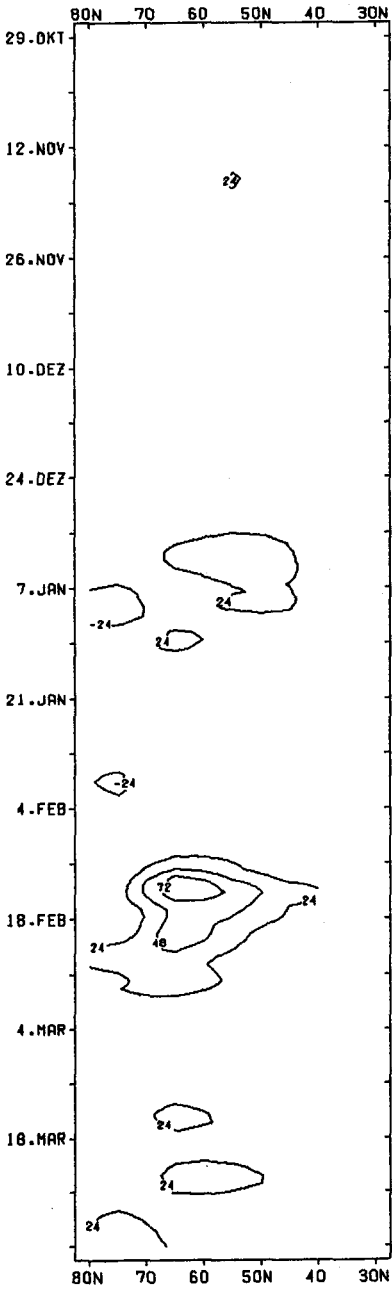

m

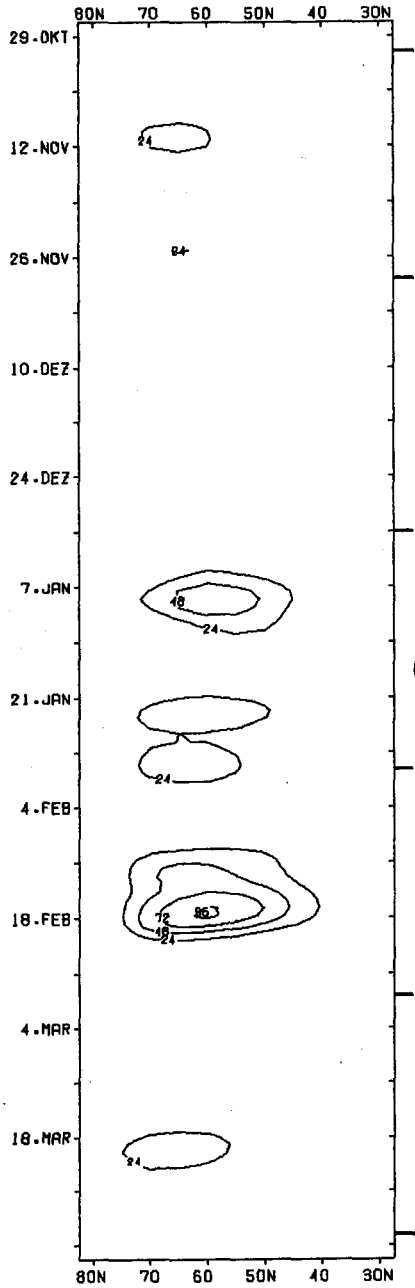

n

C.W.

* F.W.

Figure B.133

1979/80

178 EFFICIENCY
MOMENTUM FLUX

EFFICIENCY
HEAT FLUX

WAVE 1

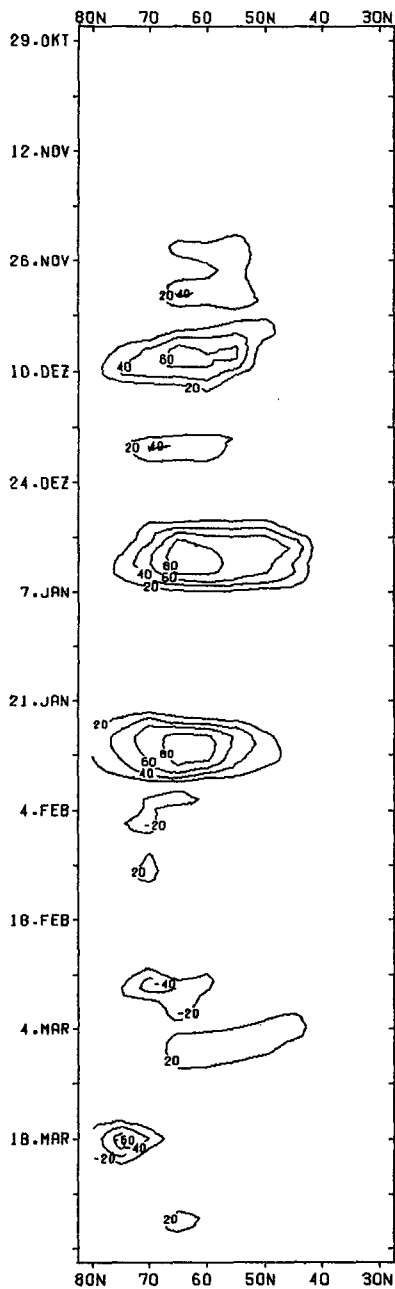

o

C.W.

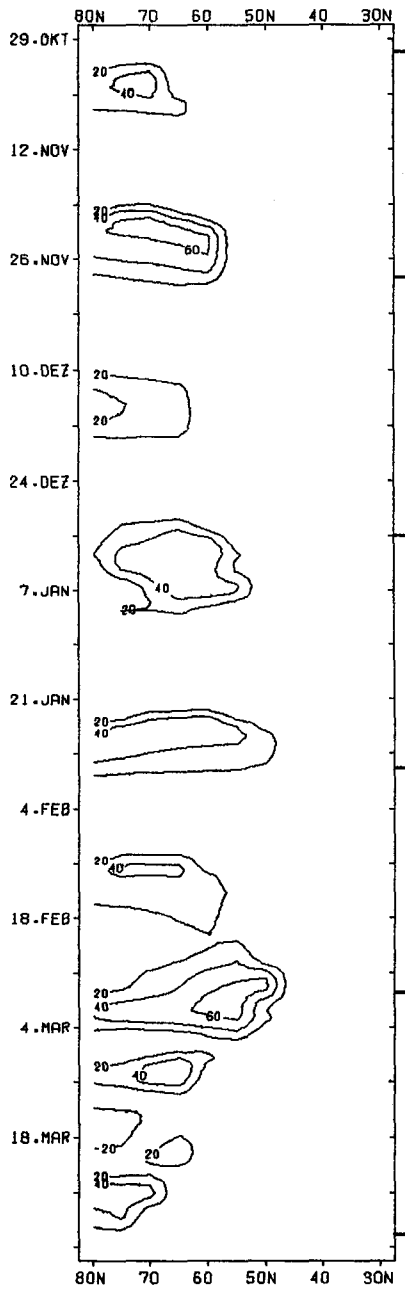

C

C

***F.W.**

p

Figure B.134

1979/80

EFFICIENCY
MOMENTUM FLUX

EFFICIENCY
HEAT FLUX

WAVE 2

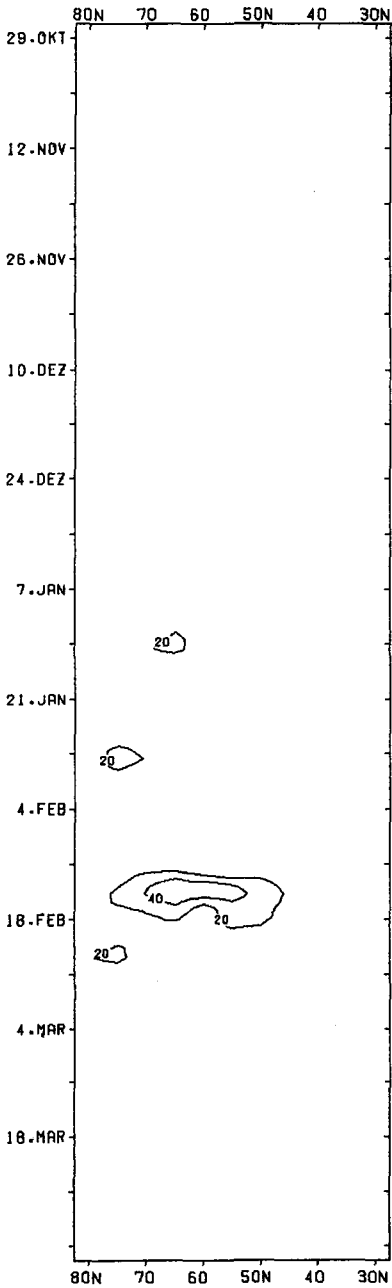

q

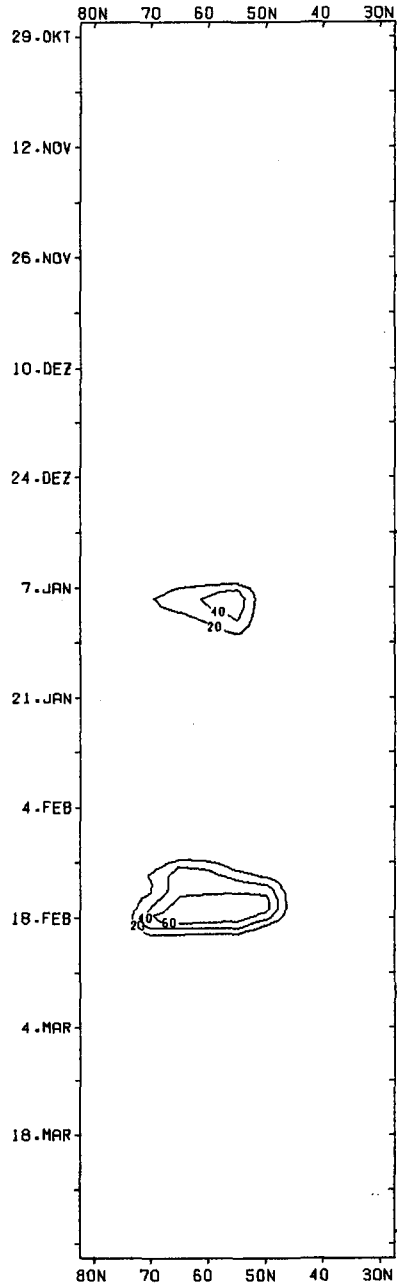

r

Figure B.135

MEAN ZONAL WIND

MEAN ZONAL TEMP.

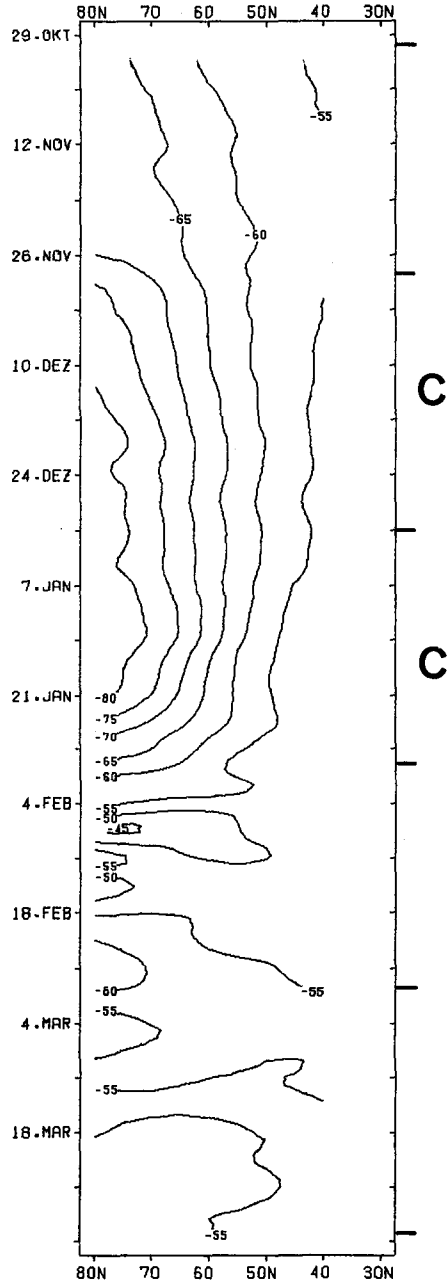
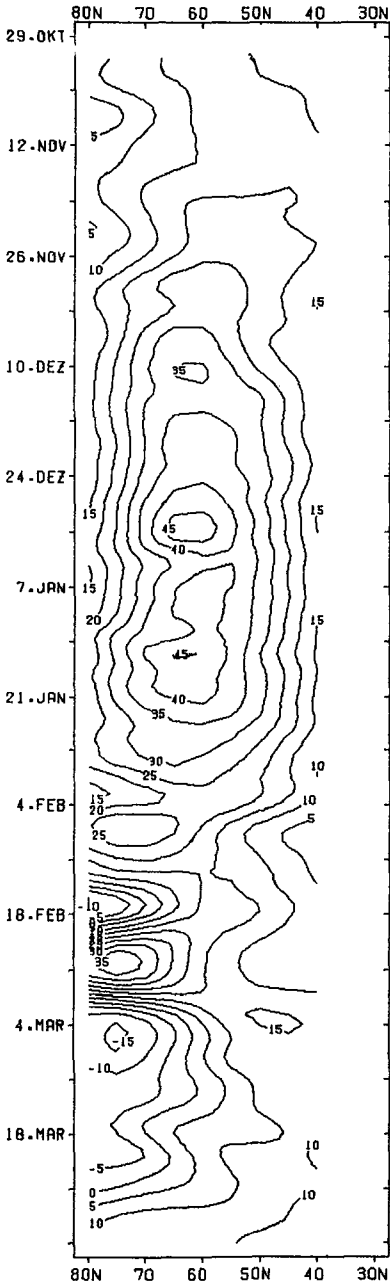

a

b

Figure B.136

HEIGHT WAVE 1

TEMP. WAVE 1

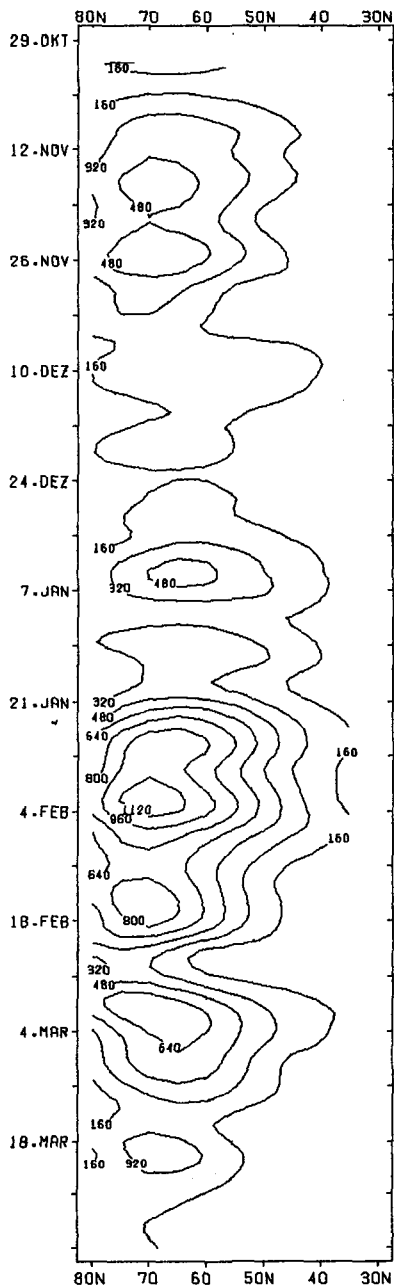

c

C.W.

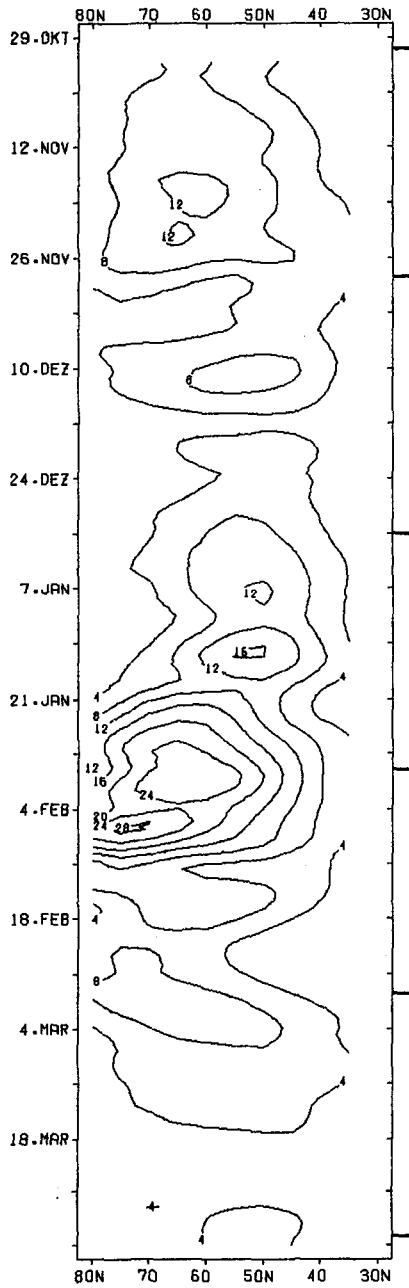

d

*

C

C

+

Figure B.137

1980 / 81

HEIGHT WAVE 2

TEMP WAVE 2

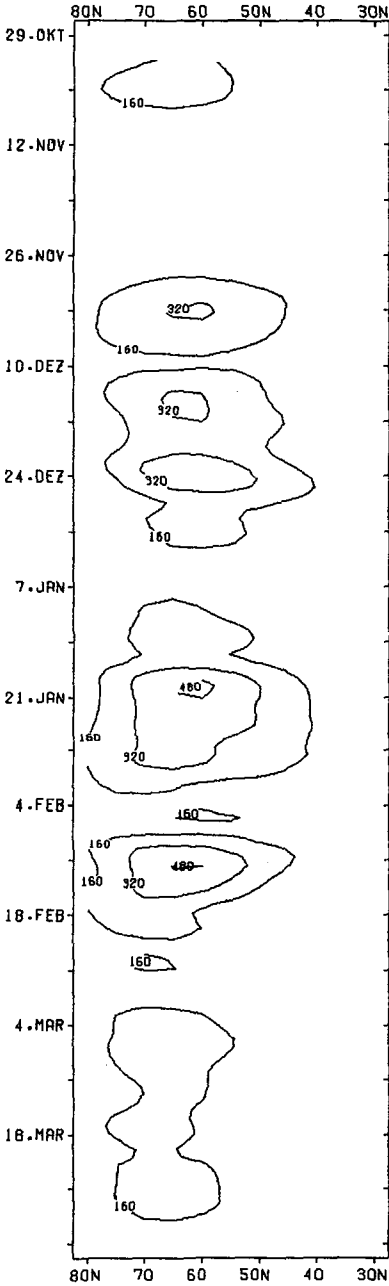

e

C.W.

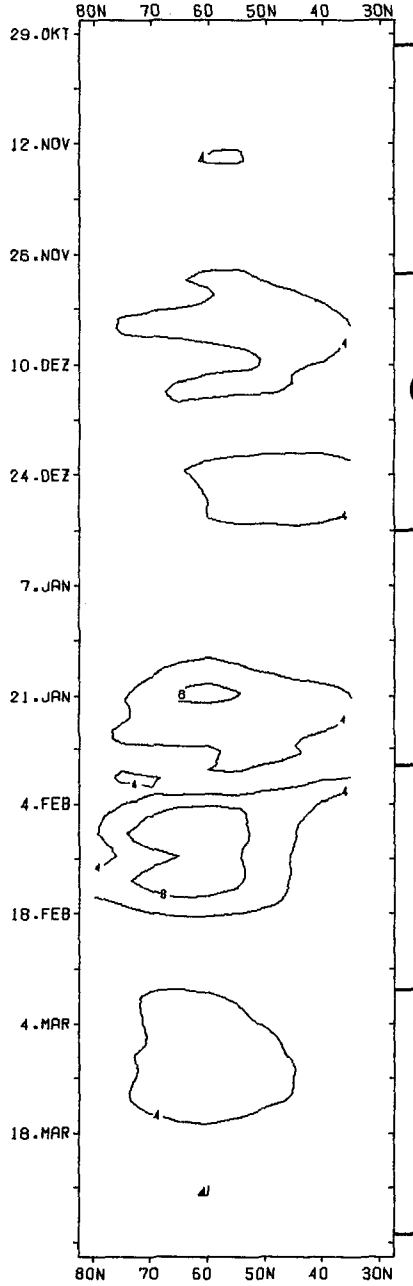

f

Figure B.138

MOMENTUM FLUX

WAVES 1-6

HEAT FLUX

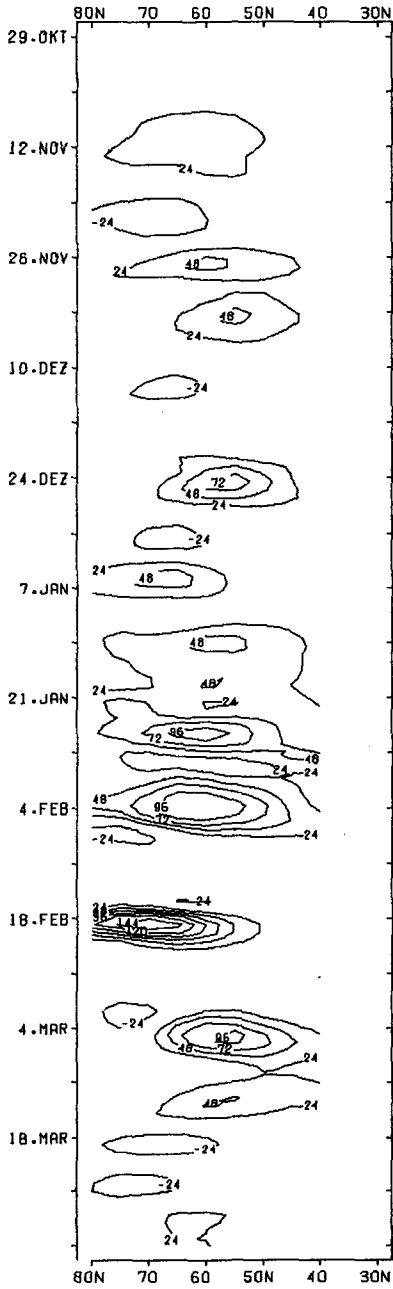

g

C.W.

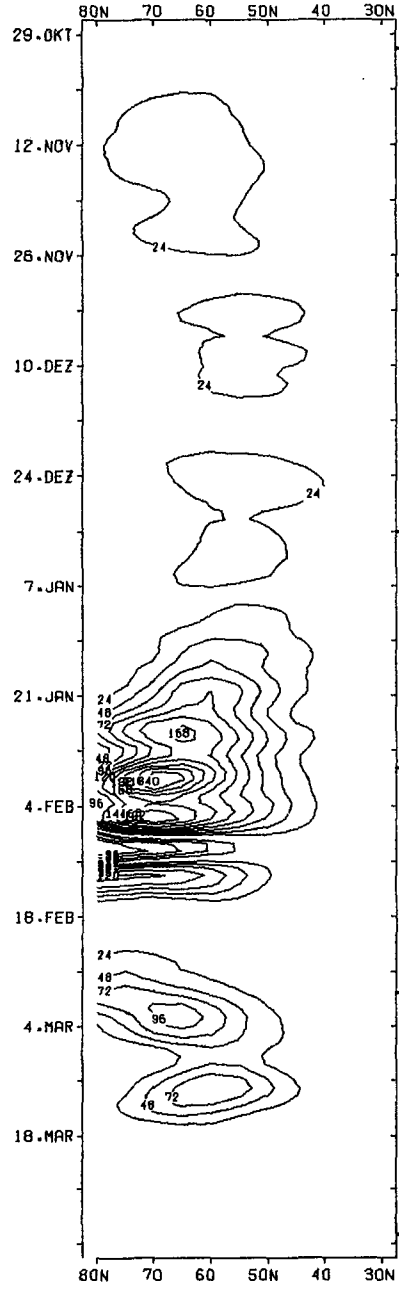

h

Figure B.139

EFFICIENCY
MOMENTUM FLUX

1980 / 81

EFFICIENCY
HEAT FLUX

WAVES 1-6

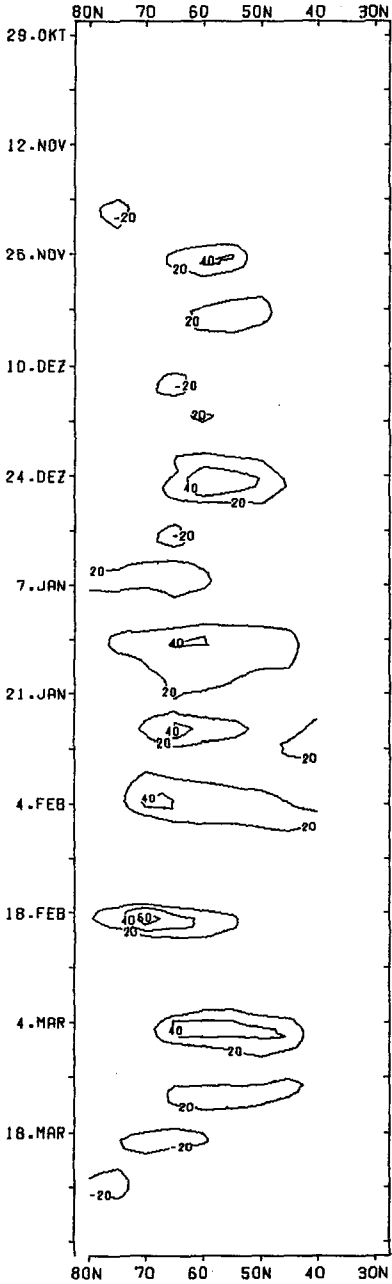

i

C.W.

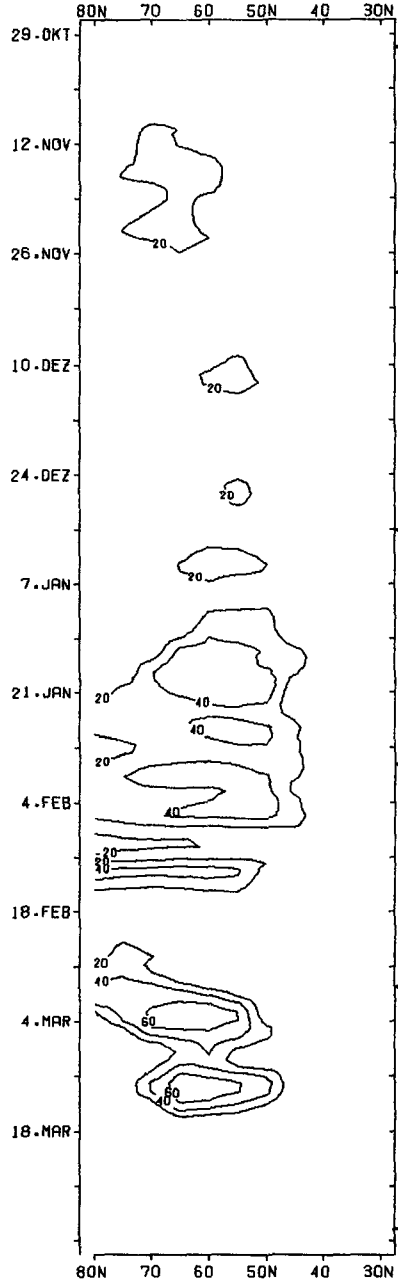

j

Figure B.140

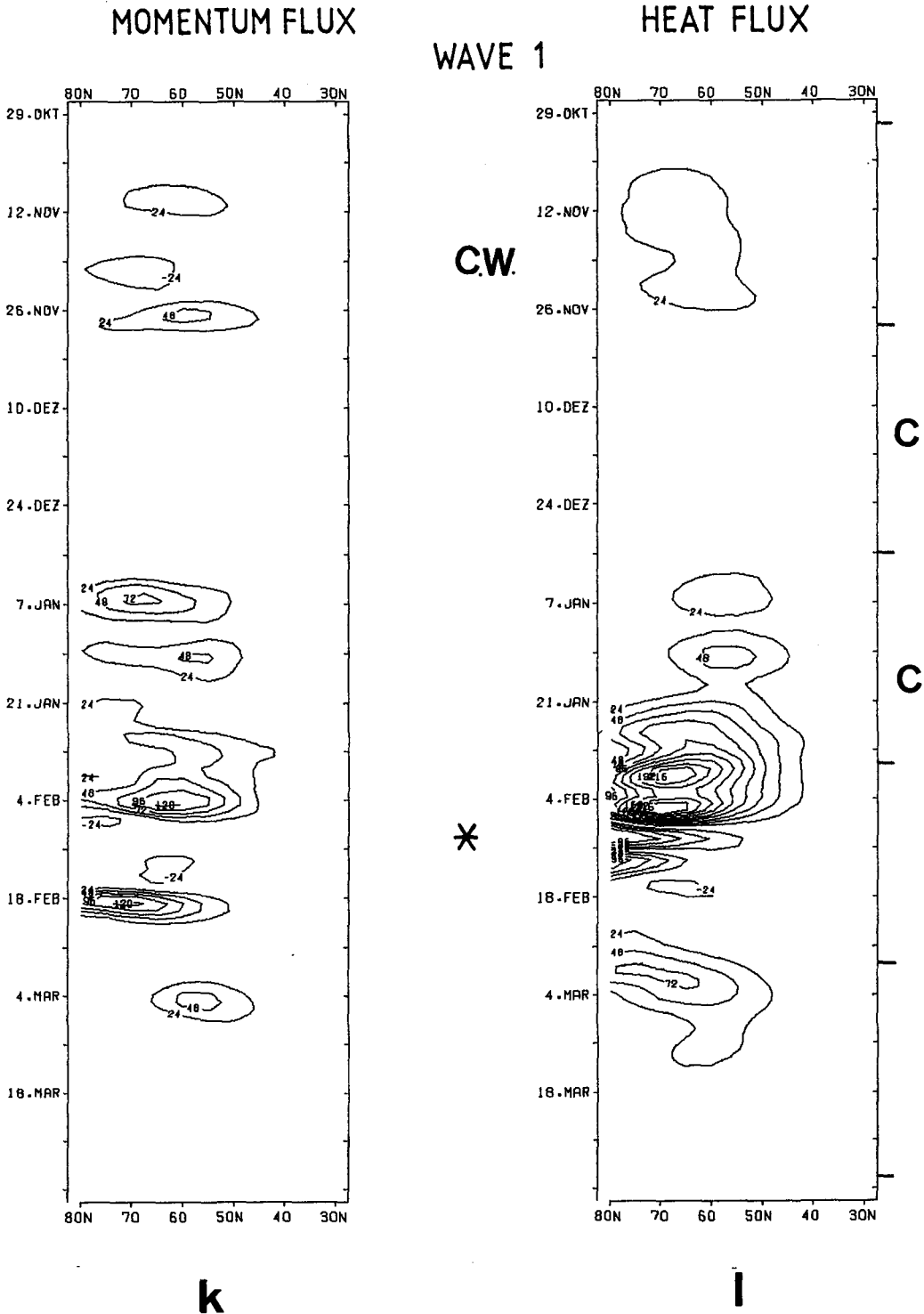

Figure B.141

1980 / 81

WAVE 2

MOMENTUM FLUX

HEAT FLUX

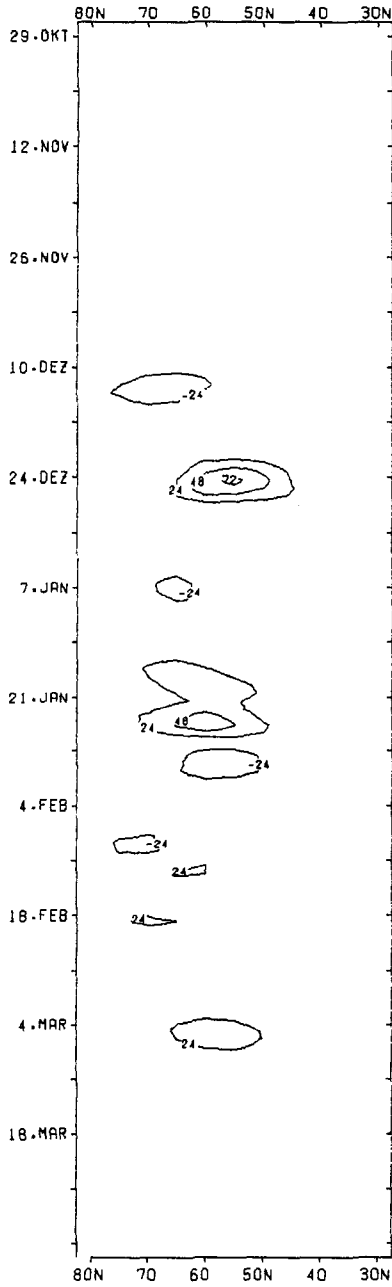

m

C.W.

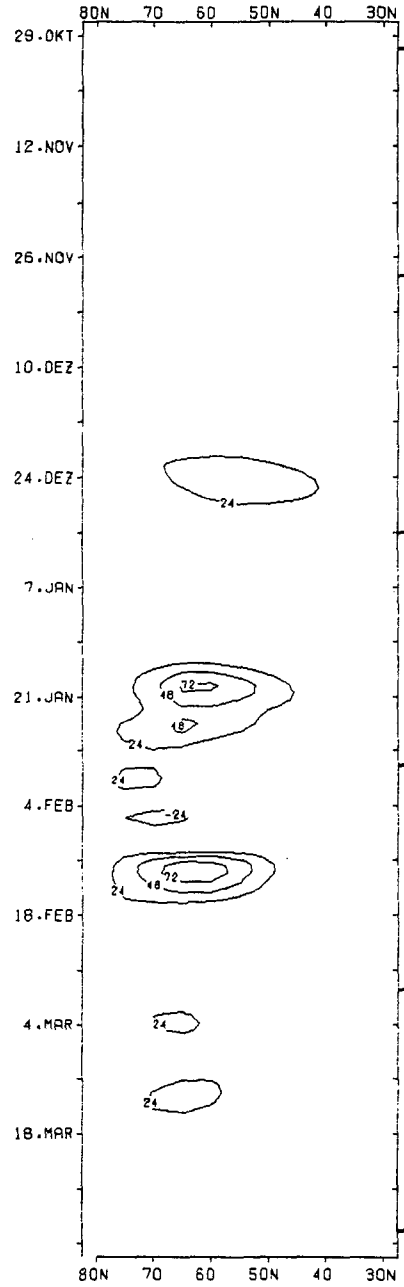

n

Figure B.142

1980 / 81

EFFICIENCY
MOMENTUM FLUX

EFFICIENCY
HEAT FLUX

WAVE 1

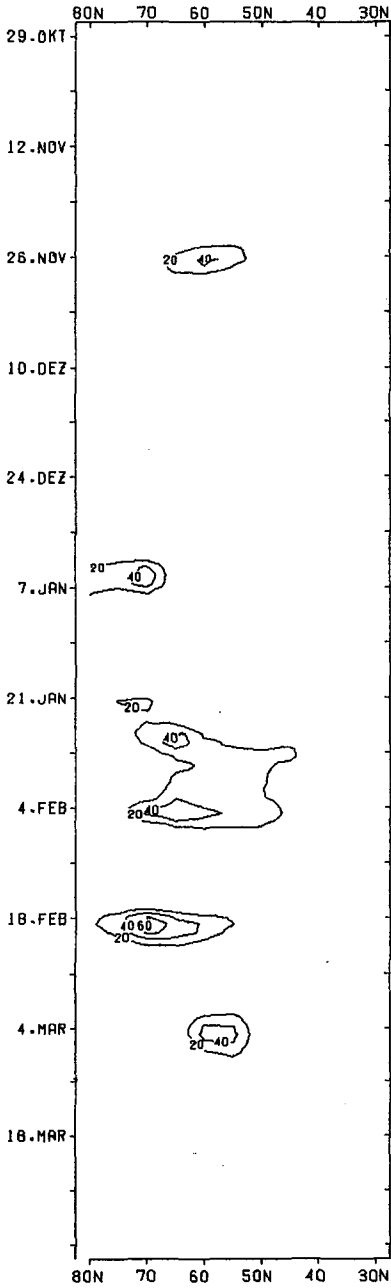

o

C.W.

*

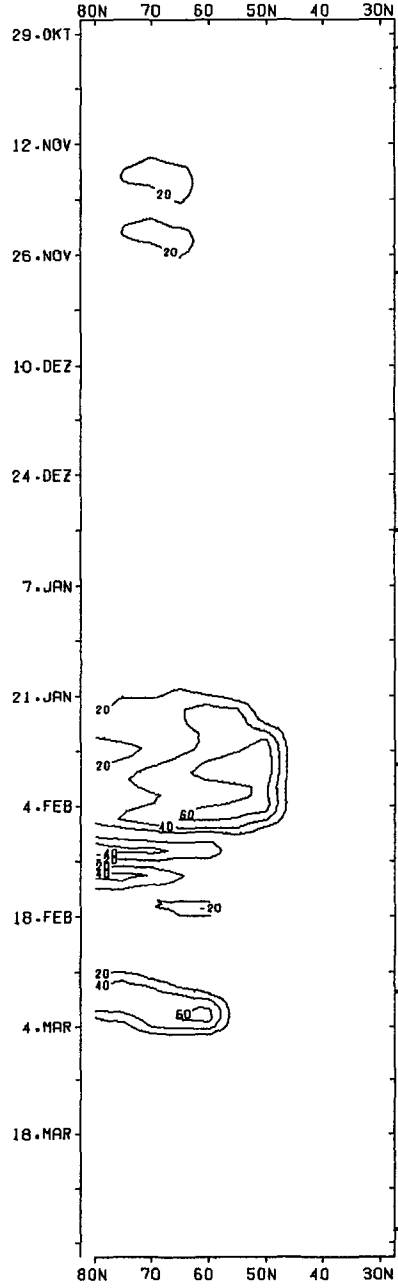

p

Figure B.143

EFFICIENCY
MOMENTUM FLUX

1980 / 81

EFFICIENCY
HEAT FLUX

WAVE 2

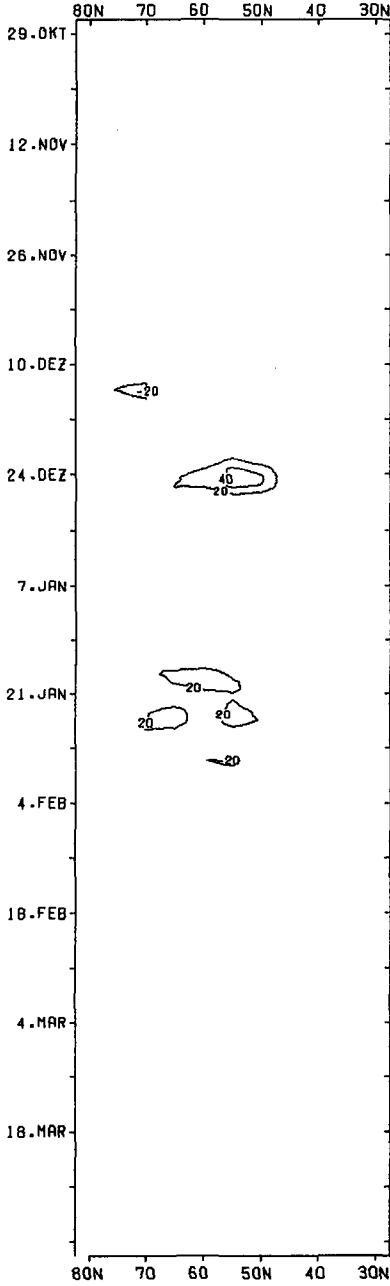

q

C.W.

*

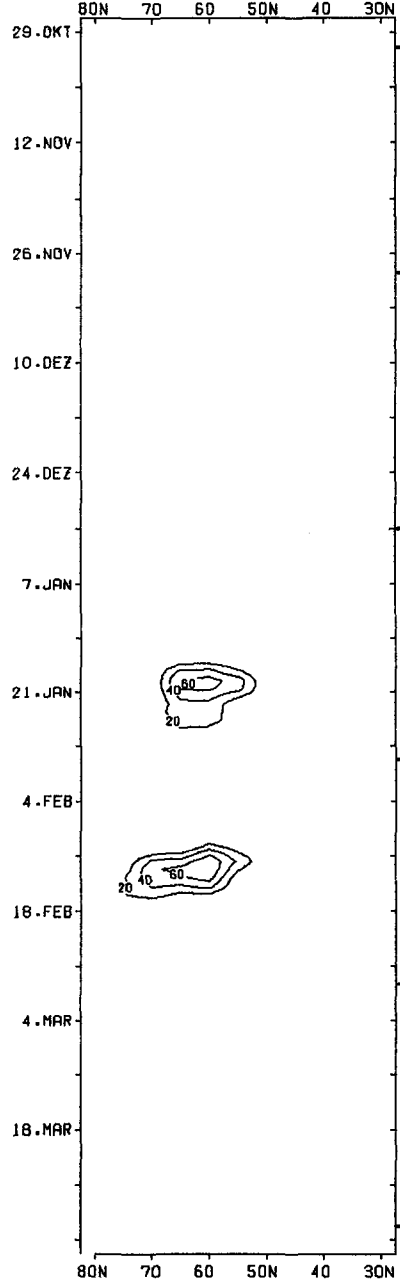

r

Figure B.144

CUMULATIVE LISTING FOR THE MAP HANDBOOK

Volume	Contents	Date of Publication
1	National Plans, PMP-1 Report, PMP-2 Report, PMP-3 Report, MSG-4 Report, Approved MAP Projects	June 1981
2	Symposium on Middle Atmosphere Dynamics and Transport (extended abstracts)	June 1981
3	PMP-5 Report, MSG-1 Report, MSG-2 Report, MSG-3 Report, Antarctic Middle Atmosphere Project (AMA), EXOS-C Scientific Observations, WMO Report No. 5, Updated Chapter 2 of MAP Planning Document, Condensed Minutes of MAPSC Meetings	November 1981
4	Proceedings of MAP Assembly held in Edinburgh, 14-15 August 1981, Condensed Minutes of MAP Steering Committee Meetings held in Edinburgh, Proceedings of MAP Open Meeting held in Hamburg, 19 August 1981	April 1982
	A Catalogue of Dynamic Parameters Describing the Variability of the Middle Stratosphere during the Northern Winters	May 1982

A CATALOGUE OF DYNAMIC PARAMETERS
DESCRIBING THE VARIABILITY OF THE MIDDLE STRATOSPHERE
DURING THE NORTHERN WINTERS

K. Labitzke and B. Goretzki

Institut für Meteorologie
Freie Universität Berlin
FEDERAL REPUBLIC OF GERMANY

CONTENTS

PART 1	INTRODUCTION.	1
	DATA AND DEFINITION OF WINTER EVENTS.	1
	INTERANNUAL VARIABILITY DURING THE NORTHERN WINTERS . .	3
	LONG-TERM MONTHLY MEAN 30-MBAR MAPS	9
	DISCUSSION OF THE DYNAMIC PARAMETERS PRESENTED FOR 16 WINTERS IN ANNEX B	13
	CONCLUDING REMARKS.	28
	ACKNOWLEDGEMENTS.	28
	REFERENCES.	28
PART 2	ANNEX A: LONG-TERM MONTHLY MEAN 30-MBAR MAPS: GEOPOTENTIAL HEIGHTS, TEMPERATURES AND STANDARD DEVIATIONS (15-YEAR AVERAGES): LATITUDINAL PROFILES OF MEAN ZONAL WINDS AND TEMPERATURES.	31
PART 3	ANNEX B: MERIDIONAL TIME SECTIONS OF DERIVED QUANTITIES FOR THE 16 WINTERS 1965/66 - 1980/81	45