

AUTOMATIC FASTENING LARGE STRUCTURES - A NEW APPROACH

Donald F. Lumley
Senior Staff Engineer
Production Engineering
Martin Marietta Aerospace
New Orleans, LA.

ABSTRACT

The External Tank (ET) for the Space Shuttle is produced by Martin Marietta Aerospace at the NASA - Michoud Assembly Facility in New Orleans, Louisiana. The assembly of the ET Intertank Structure, a 27.5 ft. diameter 22.5 ft. long externally stiffened mechanically fastened skin-stringer-frame structure, was a labor intensive manual build on a modified Saturn tooling position.

A new approach was developed based on half-section subassemblies. The heart of this manufacturing approach will be 33 ft. high vertical automatic riveting system with a 28 ft. rotary positioner coming on-line in mid 1985.

The Automatic Riveting System incorporates many of the latest

automatic riveting technologies. Key features include: vertical columns with two sets of independently operating CNC drill-riveting heads; capability to drill, insert and upset any one piece fastener up to 3/8 inch diameter including slugs without displacing the workpiece; offset bucking ram with programmable rotation and deep retraction; vision system for automatic parts program re-synchronization and part edge margin control; automatic rivet selection/handling system permits stack height sensor or parts program selection from 16 feeders; riveting cycle control by servo upset force or head height; automatic tool changer; automatic hole inspection; and printout capability for hole size, upset force, and head height.

INTRODUCTION

The Space Shuttle is America's economical and effective Space Transportation System (STS) developed by the National Aeronautics and Space Administration (NASA) to conduct space missions for projected national and international space program activities. The Space Shuttle vehicle consists of three major elements: a reusable manned Orbiter, an expendable External Tank (ET) containing the Orbiter propellant, and two reusable Solid Rocket Boosters (SRBs). The External Tank, built by Martin Marietta Aerospace at the NASA Michoud Assembly Facility in New

Orleans, Figure 1, is the largest element of the Space Shuttle. It serves as the backbone structure for attachment of the Orbiter and SRBs and also contains and delivers propellants for the three Orbiter main engines. The External Tank accommodates the complex stresses created by its own weight and that of the Orbiter prior to launch, then the thrust generated by the Orbiter and the SRBs during launch. The overall Shuttle has a gross lift-off weight of 4.5 million pounds. Fuel can be supplied from the External Tank to the three main engines at the rate of 45,283 gallons of liquid hydrogen (LH₂) per minute and 16,800 gallons of liquid oxygen (LO₂) per minute.

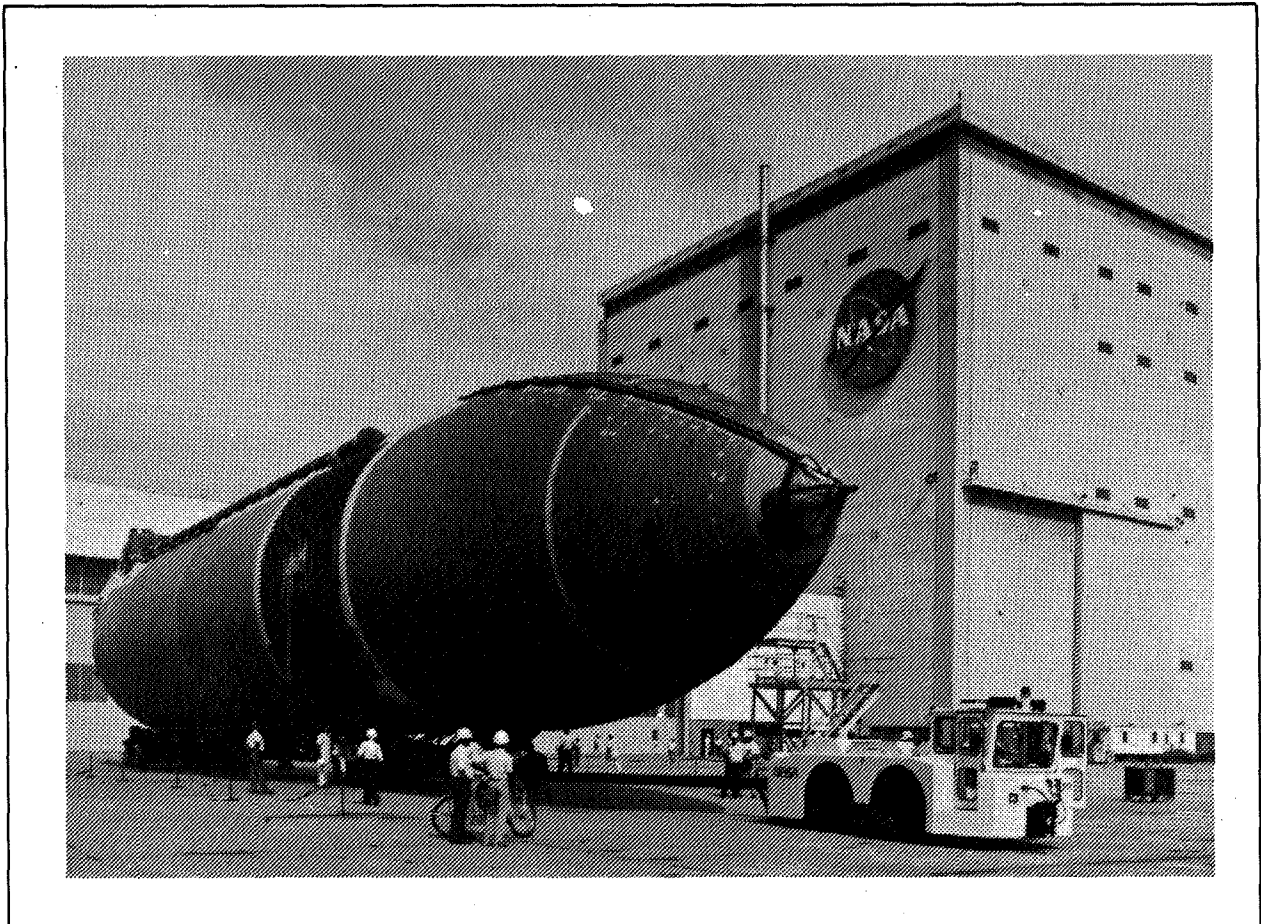

Figure 1.

Completed External Tank Being Transported From Michoud Assembly Facility.

The External Tank is 153.8 feet long and 27.6 feet in diameter. It weighs approximately 69,000 pounds empty and when loaded with propellants at launch weighs approximately 1,660,000 pounds. Three primary structures make up the ET; a LO₂ Tank, an Intertank, and a LH₂ Tank. Both propellant tanks are constructed of aluminum alloy skins with support or stability frames as required, and their skins are butt fusion welded to provide reliable sealed joints. The Intertank aluminum structure utilizes mechanically fastened skins and stringers with stabilizing frames. The External Tank primary structure is shown in Figure 2.

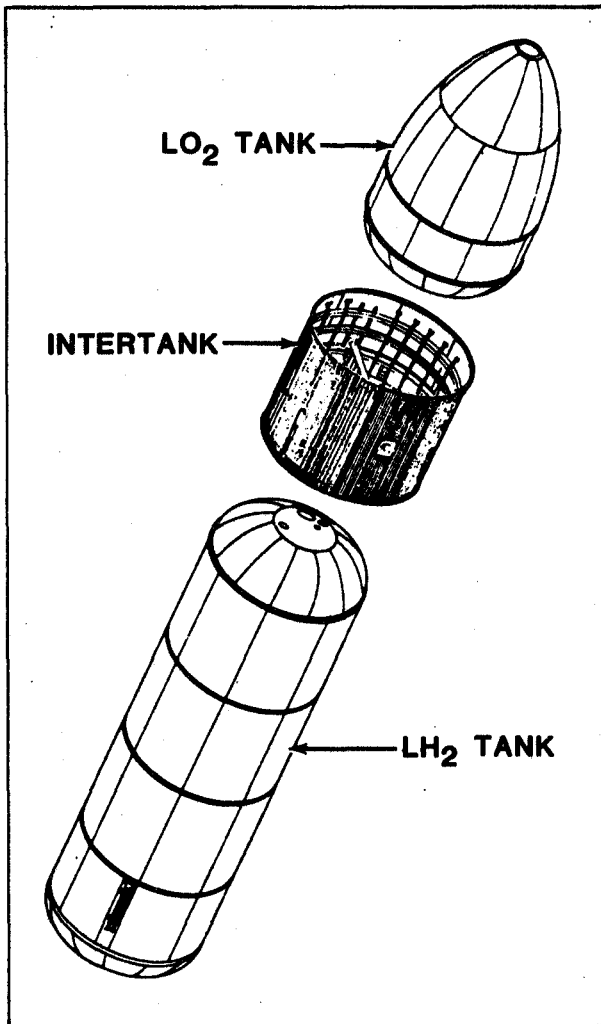

Figure 2.
External Tank Primary Structure.

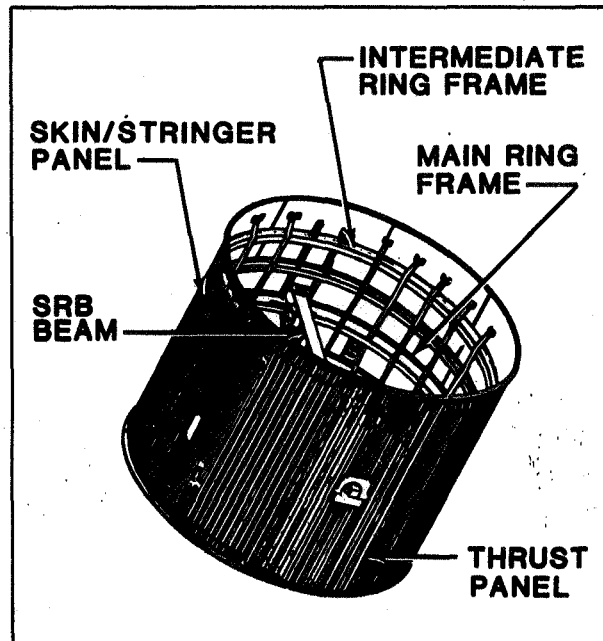

Figure 3.
Intertank Structure

DISCUSSION

The Intertank, Figure 3, is the ET structural connection that joins with both the LO₂ and LH₂ tanks to provide structural continuity between these assemblies. Its primary functions are to receive and distribute all thrust loads from the SRBs and transfer loads between propellant tanks. The Intertank also functions as a protective compartment for housing instrumentation, range safety components, and other subsystems.

The Intertank cylindrical structure consists of two integrally machined thrust panels and six mechanically fastened stringer stiffened panels. It is 27.6 feet in diameter and 22.5 feet long. The two thrust panels distribute the concentrated axial SRB thrust loads to the LO₂ and LH₂ tanks and adjacent skin panels. The thrust panels are selectively machined with tapered skin thicknesses and external integral ribs. The six stringer stiffened panels are similar to each other except for penetrations, system

installation provisions, and an access door. Each panel is 10.8 feet wide and 22.5 feet long and includes a forward and aft chord for attachment to the L02 and LH2 tanks.

The skin/stringer panels are each made of two aluminum skins mechanically spliced longitudinally by internal and external butt straps. Skin doublers provide necessary reinforcement for areas where the skin is penetrated and localized reinforcements to distribute thrust loads. There are 18 aluminum hat section stringers mechanically fastened to each skin/stringer panel.

The six stringer stiffened panels and two thrust panels are mechanically spliced using longitudinal butt splices to form the Intertank skin shell.

One main frame is employed to transmit the transverse SRB thrust loads and the intermediate ring frames stabilize the cylindrical shell. The main frame is constructed of machined outer and inner chords joined to webs to form an I-beam 20 inches deep. The four intermediate ring frames are constructed similar to main frame and are 12 inches deep.

The SRB beam assembly running through the middle of the Intertank is a rectangular box beam. It is 42.95 inches deep at the center, tapers to 26 inches at the ends, and is 15 inches wide. Two SRB thrust fittings, machined aluminum forgings, are attached at either end of the beam and provide for SRB attachment.

The Intertank structural assembly is performed at the NASA Michoud Assembly Facility (MAF) in New Orleans, Louisiana. Major components including thrust panels, stringer panels, frame quadrant

sections, and the SRB beam are subcontracted.

The Development and early production Intertanks were built on modified Saturn S-1C tooling remaining from the previous Saturn/Apollo program at Michoud. A new Intertank manufacturing approach was developed utilizing a half section subassembly. New tooling was designed and built and implemented in a manual mode in the fourth quarter of 1983. The heart of the half section manufacturing approach will be a new and unique Automatic Riveting System for large structures. The new riveting system is being built by GEMCOR and is currently in preliminary checkout at their facility. It will go into operation at Michoud in the third quarter 1985.

The Intertank half section, Figure 4, consists of three skin/stringer panels, 180 degree sections of the five frames, butt splices, and miscellaneous items. The components are joined using blind fasteners (under hat section stringers), 1/4 inch diameter A286 Hi-Sets, and Hi-Loc fasteners.

The first position in the half section family of tooling is the panel and frame tack fixture. In this fixture, the four 180 degree intermediate frame segments, 180 degree main frame segment, the three 45 degree skin/stringer panels are positioned and located for tack fastening. Blind fasteners located under the hat section stringers are the primary tack fasteners.

The third position is for finish, inspection, repair and bracket and subsystem support structure installation. In the current manual mode, fasteners that will be installed by the Automatic Riveting System are installed in this fixture or the tacking fixture.

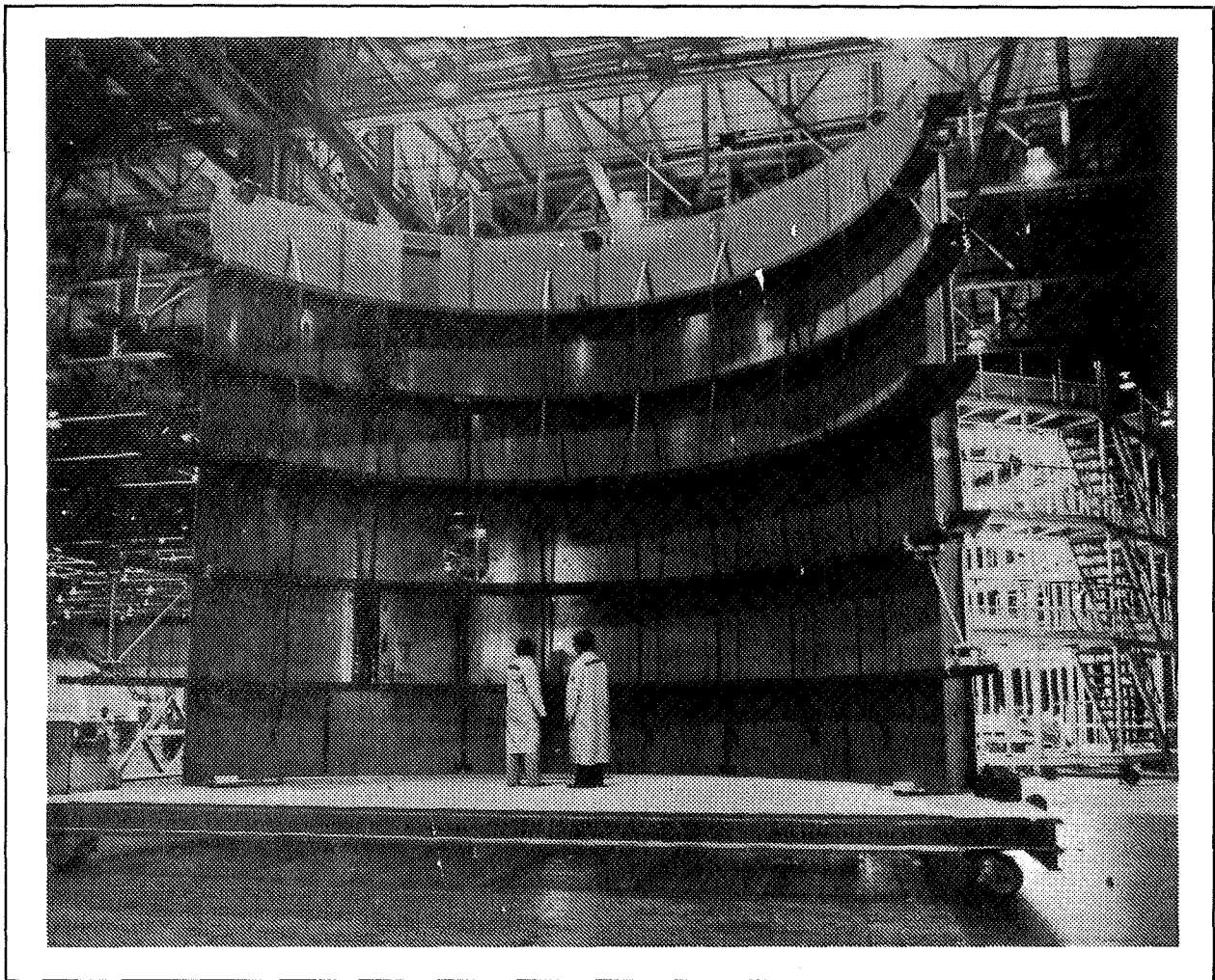

Figure 4.
Intertank Half Section On Transportation Dolly.

These two tooling positions as well as the foundation foot-print for the Automatic Riveting System are shown in Figure 5.

The second position in the family will be the Automatic Riveting System which will install the fasteners to secure the skin panels to the frames and complete the butt splices. The majority of the fasteners used in this operation are 1/4 inch A286 Hi-Sets.

SYSTEM DESCRIPTION

The Automatic Riveting System utilizes a new and unique system of driving the drill/rivet heads under computer numerical control on vertical inner and outer columns with the work piece rigidly supported on a 360 degree rotary positioner. This Vertical Drivmatic is capable of installing any one piece fastener, including slugs, up to 3/8 inch diameter without displacing the workpiece. The inner

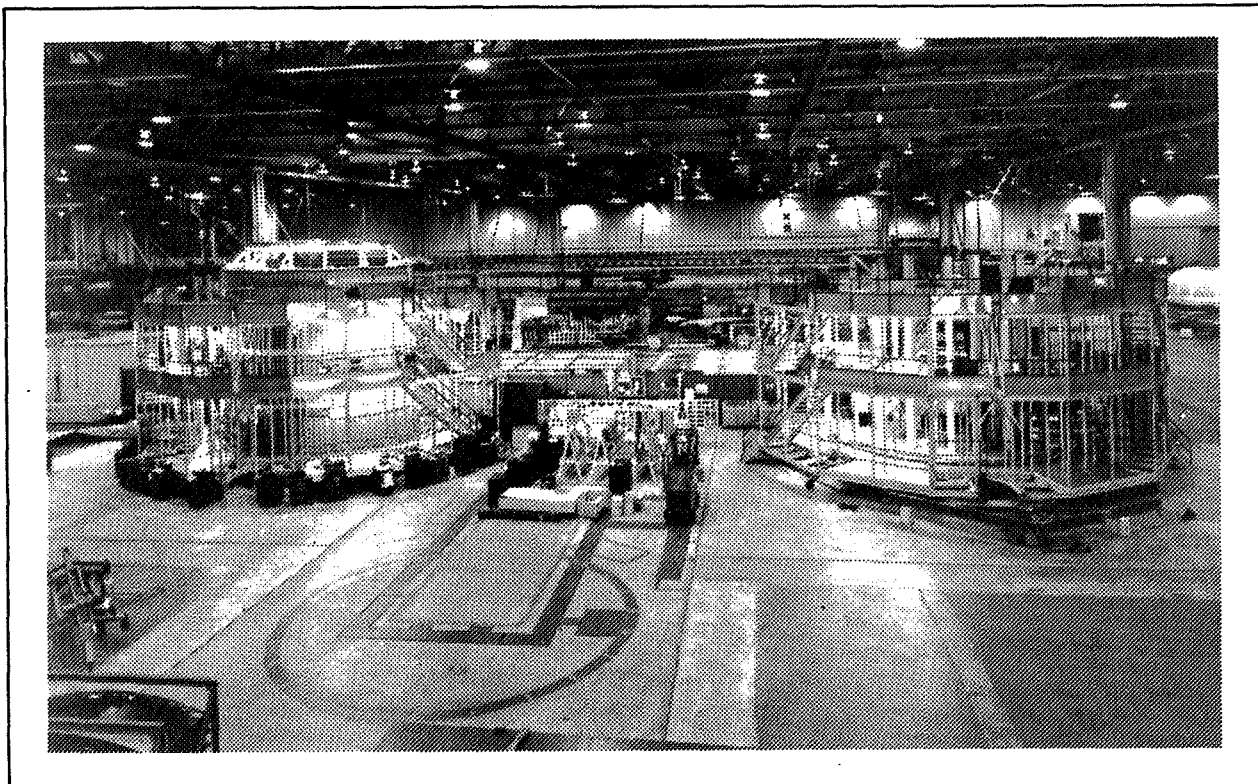

Figure 5.

*Footprint For Intertank Automatic Riveting System
Shown Between First and Third Tooling Positions.*

to outer head load bias to the workpiece is limited to a maximum of 50 pounds under the heaviest riveting conditions.

The system is capable of riveting structures with both internal and external stiffening. The rivet installation rate exceeds twelve fasteners per minute in the Dual head mode and seven per minute in the single head mode. The key features of the system are described in the following paragraphs.

Vertical Drill/Rivet Columns -
Rotary Positioner

The columns are 33 feet high and measure eight feet by ten feet at the base. Two sets of opposing carriages, Z axis, are positioned by electro servomotor rack and pinion drives with dual hydraulic motor counterbalances. This arrangement

permits 28.5 feet of vertical travel or 20.7 feet of working range with either set of carriages parked. Each pair of carriages are controlled by separate CNC systems. The inner column carriages (slaves) provide synchronous movement to the outer carriages and are positioned accordingly. See Figure 6.

The outer Z-axis carriage houses the Y-axis carriage which, in turn, houses the transfer head. The transfer head carries the drill spindle, hole inspection system, and bucking ram and is actuated by the transfer cylinder. The outer Z-axis carriage also mounts the automatic tool changer, automatic injector changer, vision system and TV camera. Six inches of in and out head travel, Y axis, is provided for clearing external stiffeners and accommodating work plane variations.

The inner column carriage contains the upset ram which has 24 inches of programmable retraction and programmable rotation of 350 degrees about the rivet centerline.

Plus or minus one-half inch X - axis translation is provided in each

carriage to permit independent edge margin control.

The CNC rotary positioner, C axis, is a 28 foot diameter ring shaped rotary table which positions the part holding fixture and work piece for the drill rivet operations.

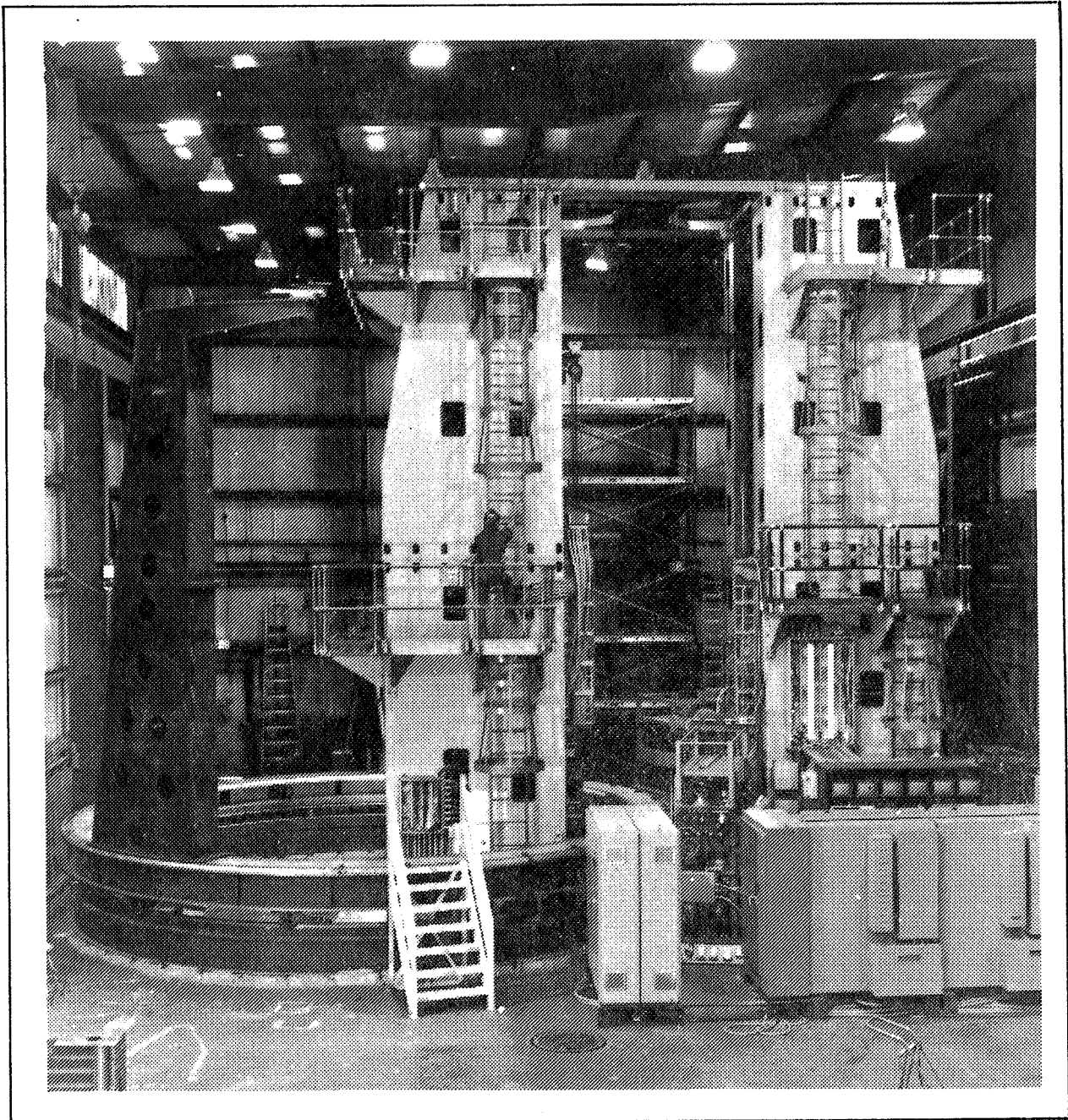

Figure 6.
GEMCOR Automatic Riveting System During Preliminary Checkout.

Control System

The Control system includes the operator's console; two Allen-Bradley 7320 Computerized Numerical Controls (CNC); three Allen-Bradley Programmable Logic Controllers (PLC 2/30); and the General Electric Vision System. The controls are interfaced to permit independent and simultaneous operation of both sets of heads. The control system block diagram is shown in Figure 7.

Primary control of the Vertical Drivmatic is accomplished through utilization of two CNC controllers. One controls the Upper Head, while the other controls Lower Head movement. With the dual CNC system

one will be considered the master, which controls the 'C' Axis programming and is responsible for locking out any head motion that could cause workpiece damage. Either CNC can have the capability of controlling the C Axis, but only one at a time will do so.

Head functions will be controlled by two PLC's in communication with the CNC. In addition a third PLC will be used to control both ARS Systems. The Tack Resynchronization Visual System provided for each head will interact with its associated CNC.

The Operator's console houses all operator controls in a single main control panel. The two

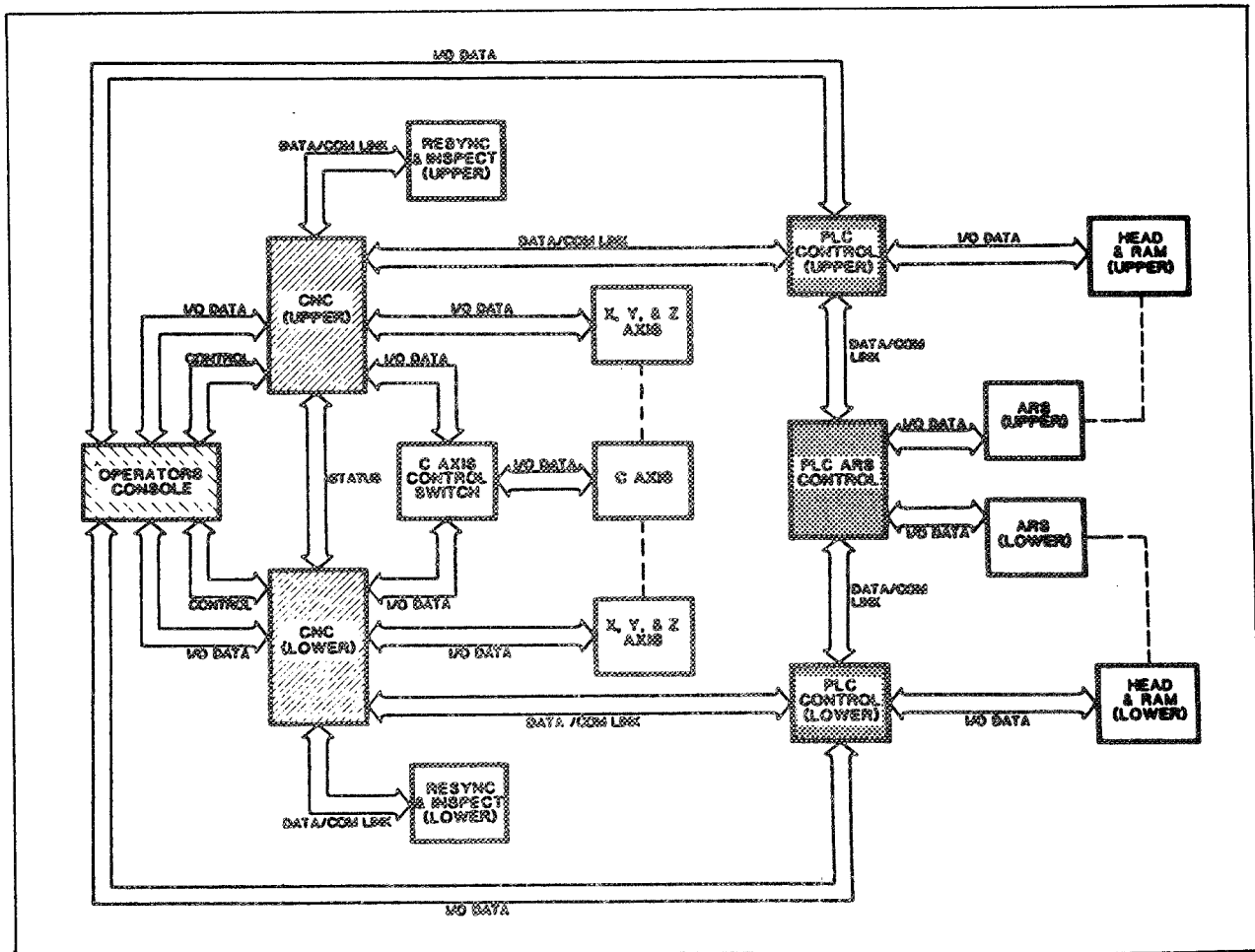

Figure 7.
Control Systems Block Diagram.



*Figure 8.
Operator's Console Provides Independent Control of Dual Drill/Riveting Systems.*

Allen-Bradley CNC main control panels with the CRT display and alpha-numeric keyboard are located in the operator's console along with all controls and indicators necessary for the operation of the system and riveting process. The Operator's Console, shown in Figure 8, also houses the color TV monitors and vision system displays for each set of heads.

The system is capable of controlling the riveting process by either servo upset force or head height control. The mode of operation as well as the

upset force or head height can be selected from the console or the parts program.

Rigid Workpiece Location And Clamp

The Automatic Riveting System locates the work plane of the rigidly mounted Intertank half section and completes the riveting process without displacing the work piece. The following explains the GEMCOR developed method of applying rivet upset forces while putting less than fifty pounds of bias force

on the workpiece. The Y-Axis carriage moves in under system pressure. When the pressure foot, which is at low pressure, touches the work surface and collapses, the pressure foot encoder senses movement and stops the Y-Axis carriage. The Y-Axis then retracts until the encoder indicates home position. The pressure foot is now fully extended and can be pressurized with system pressure.

The inner ram now advances until the clamp makes contact with the work surface. The clamp then switches from low to high pressure and the work piece is fully clamped. The Drivmatic Drill and riveting process is then initiated.

Edge Margin And Tooling Hole Resynchronization Vision System

The vision system has the capability to detect the edge of a part and shift rivet location for a single hole or group of holes using X-axis translation so that a predetermined minimum margin is maintained. This mode of operation will be used to locate the edge of hat sections when riveting Intertank panels to frames. In the hole resynchronization mode, the vision system has the capability of resynching the parts program to a tooling hole. The resynchronization is accomplished by means of X-axis translation and/or Z-axis move. The system also has the capability of resynching on a second tooling hole, computing the offsets for intermediate fasteners, and shifting the fastener locations accordingly.

Automatic Tool Changer

An Automatic Tool Changer on each outer carriage changes the drill and bucking anvil by means of the CNC parts program or operator console input. The tool changer has the

capability of accomplishing the tool change without moving the workpiece. The GEMCOR developed Automatic Tool Changer has 18 tool positions comprising six bucking anvil positions and 12 drill positions. An Automatic Injector Changer accommodates up to five injectors.

The Automatic Tool Changer can complete a drill change in less than 30 seconds and a bucking anvil and injector change in 30 seconds. The Automatic Tool Changer is shown in Figure 9.

Automatic Rivet Selection System

An independent Automatic Rivet Selection System (ARS) is provided for each set of riveting heads. Each ARS has a floor mounted feed station containing 16 vibratory bowl feeders for unscrambling and aligning the rivets. The rivet selection is controlled by the CNC using a miscellaneous (M) function, an automatic stock thickness measurement system, or through the operator console. Selected rivets are automatically dispensed one at a time, blown through the injector tube to the injector and fed into the drilled holes as part of the automatic riveting cycle. A backup or reserve feed capability is included to permit manual feed from three individual drop tubes for each riveting head. The ARS, which can be expanded to include additional feeders, is shown in Figure 10.

Automatic Inspection

A programmable probe type hole inspection system is incorporated in the outer head which performs a plug gage type inspection. A precision conical probe is inserted into the drilled hole and its displacement measured with a Linear Variable Displacement Transducer (LVDT).



*Figure 9.
Automatic Tool Changer Holds 12 Drills and 6 Bucking Anvils.*

From the linear displacement data, the hole diameter is computed and compared to the established tolerances prior to rivet insertion. The system is interfaced with the CNC system to provide the capability of interrupting the drill/rivet cycle and displaying an operator message on the CRT when a drill change becomes necessary to maintain hole tolerance.

A rivet process data system provides real time hard copy printout of sequence number, upset force, hole size, and rivet head height. The frequency of printout is

programmable to provide data as desired from every rivet cycle down to an exception only (out of tolerance) basis.

The system is capable of programming the hole size, upset force, and head height tolerances and the frequency of hole size inspection. The basic programming of the frequency of hole inspection is not accessible from the operator's console; however, the operator has the capability to selectively add inspection of any holes without changing the basic program.

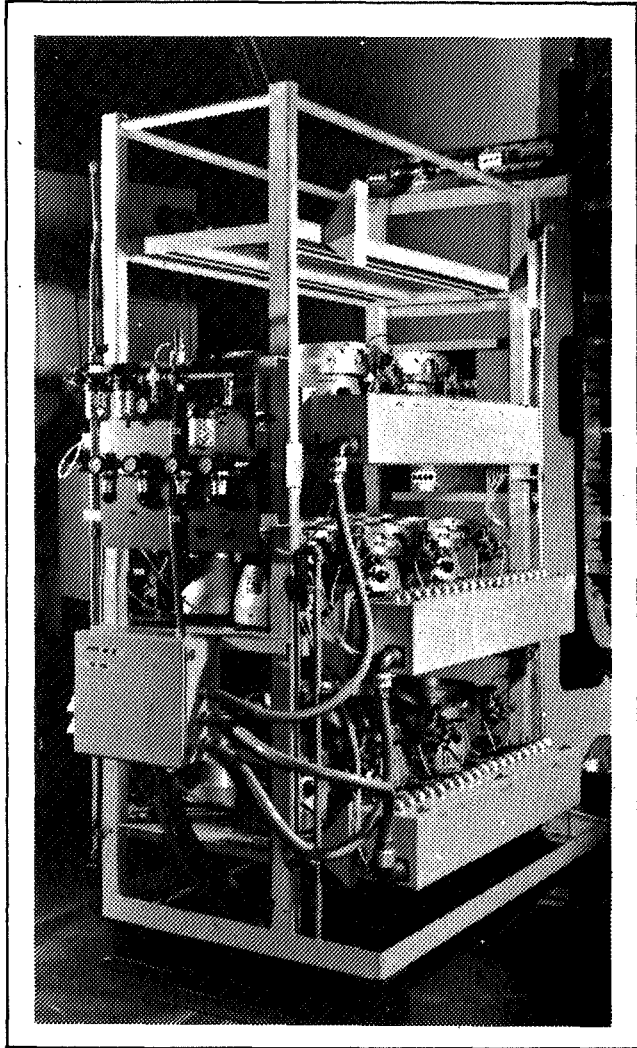

SUMMARY

This Automatic Riveting System, being procured from GEMCOR by Martin Marietta Aerospace for NASA, will incorporate a new and unique automatic riveting system approach. It will bring to the Michoud Assembly Facility and External Tank Program the latest automatic riveting technology permitting further ET cost reductions and capability for low cost production of large structures for future space programs.

*Figure 10.
Automatic Riveting Selection System
Selects & Feeds Fasteners From 16
Vibratory Bowl Feeders.*