

N86-11447

RECENT EXPERIENCE IN SEEDING
TRANSONIC/SUPERSONIC FLOWS AT AEDC

Fred L. Heltsley
Calspan Corporation, AEDC Division
Arnold Air Force Station, Tennessee

INTRODUCTION

The laser velocimeter has been utilized for several years at AEDC as a flow diagnostics tool. Most applications, following the initial proof-of-concept experiments, have involved relatively complex "unknown" flow fields in which the more conventional, intrusive techniques had either not been attempted or had yielded unsatisfactory results. The blunt-base nozzle-afterbody base flow study listed in Figure 1 will be discussed as a representative example of such applications. A wide variety of problems have been encountered during these tests, many of which have proven to be closely related to the size and/or size distribution of the seeding material within the fluid. Resulting measurement uncertainties could often not be conclusively resolved because of the "unknown" nature of the flow field. The other experiments listed in Figure 1 were conducted to provide "known" aerodynamic conditions for comparison with the velocimeter results.

TESTS

<u>CONFIGURATION</u>	<u>FACILITY</u>
BLUNT-BASE NOZZLE-AFTERBODY	AEDC/PWT TUNNEL 1T
7-DEG HALF-ANGLE CIRCULAR CONE	AEDC/VKF TUNNEL A
2-DIMENSIONAL CIRCULAR CYLINDER	AEDC/VKF TUNNEL A

Figure 1

BLUNT-BASE NOZZLE-AFTERBODY TEST

Figure 2 presents some details of the blunt-base nozzle-afterbody test.

- **MODEL CONFIGURATION**
 - 2.5 IN DIA CIRCULAR CYLINDER
 - 0.5 IN EXIT DIA, MACH 2.7 NOZZLE AT CENTER

- **TEST CONDITIONS**
 - **EXTERNAL STREAM**
 - MI = 1.4, RE = 4.75×10^6 /FT
 - **JET (COLD NITROGEN)**
 - MJE = 2.7, NPR = 50 AND 150 (UNDEREXPANDED)

- **CONFIGURATION CHARACTERISTICS:**
 - LARGE BASE FLOW SEPARATION REGION

- **LDV SYSTEM:**
 - 2-COMPONENT BACKSCATTER/COUNTER PROCESSORS
 - 2-COMPONENT BACKSCATTER/FOURIER PROCESSORS

Figure 2

BLUNT-BASE NOZZLE-AFTERBODY INSTALLED IN AEDC/PWT TUNNEL 1T

Figure 3 is a photograph of the blunt-base nozzle-afterbody installed in the AEDC/PWT Tunnel 1T.



Figure 3

NOZZLE-AFTERBODY VELOCITY VECTORS

Mean velocity vectors obtained in the nozzle-afterbody flow field are presented in Figure 4. Flow features, i.e., shocks, expansion fans, Mach disc and shear layers obtained from shadowgraphs, are superimposed. The absence of vectors in the outer edge of the jet plume reflects the absence of seed particles in that region large enough to provide a signal processable by the LDV counter processors. The signals observed were strong enough, however, for processing by the discrete Fourier processor (DFT). These data are not included on the plot since the analysis is not complete at this time.

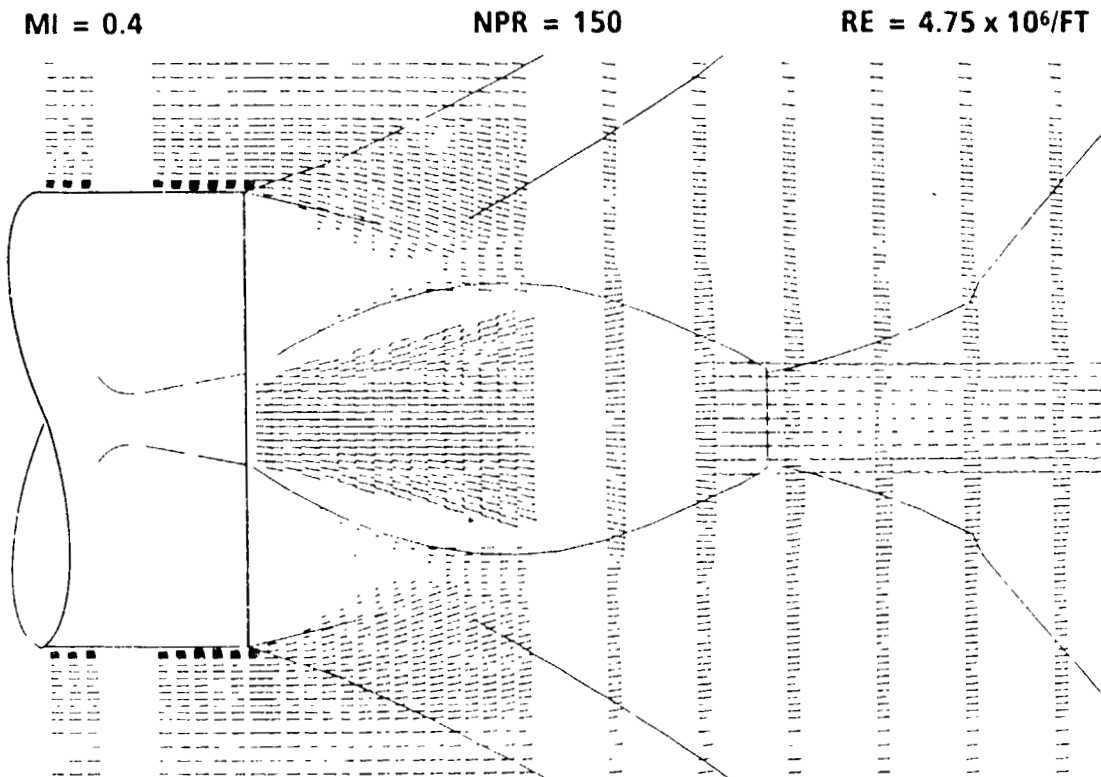

Figure 4

BLUNT-BASE TEST SEEDING

Seed material was added to the tunnel flow (external stream) in the stilling chamber approximately ten feet upstream of the test article. Seed were also injected into the tube which provided high pressure gas for the test article exhaust jet. The redistribution of seed particles within the flow field by the severe aerodynamic conditions resulted in an extremely low particle number density within the separation region near the model base. Seed were introduced into the region from a manifold within the model. Although no difference was observed in the base pressure with the base seeder on or off, other measurements, presented in Reference 1, cast some doubt upon the conclusion that the seeding induced flow disturbance was negligible. The types of aerosol generators and the seed materials used during the test are presented in Figure 5.

- **EXTERNAL FLOW (STREAM TUBE):**
 - **FLUIDIZED BED/0.3 MICRON ALUMINUM OXIDE PARTICLES**

- **JET PLUME:**
 - **FLUIDIZED BED/0.3 MICRON ALUMINUM OXIDE PARTICLES**

- **SEPARATED BASE FLOW (INTERNAL MANIFOLD):**
 - **FLUIDIZED BED/0.3 MICRON ALUMINUM OXIDE PARTICLES**
 - **COLLISON NEBULIZER/MINERAL OIL**
 - **COLLISON NEBULIZER/GLYCEROL AND RHODAMINE 590 FLUORESCENT DYE**

Figure 5

PARTICLE SIZE ESTIMATION

A comparison of particle velocity computed by Nichols (Ref. 2) with LDV measurements at the jet exit of the blunt-base model is presented in Figure 6. The apparent mean particle diameter of 1.7 microns is significantly larger than the nominal 0.3 microns advertised by the manufacturer. The same aluminum oxide powder was found by Crosswy (Ref. 3) to be quite polydisperse, with a significant number of particles or agglomerates larger than 2.0 microns.

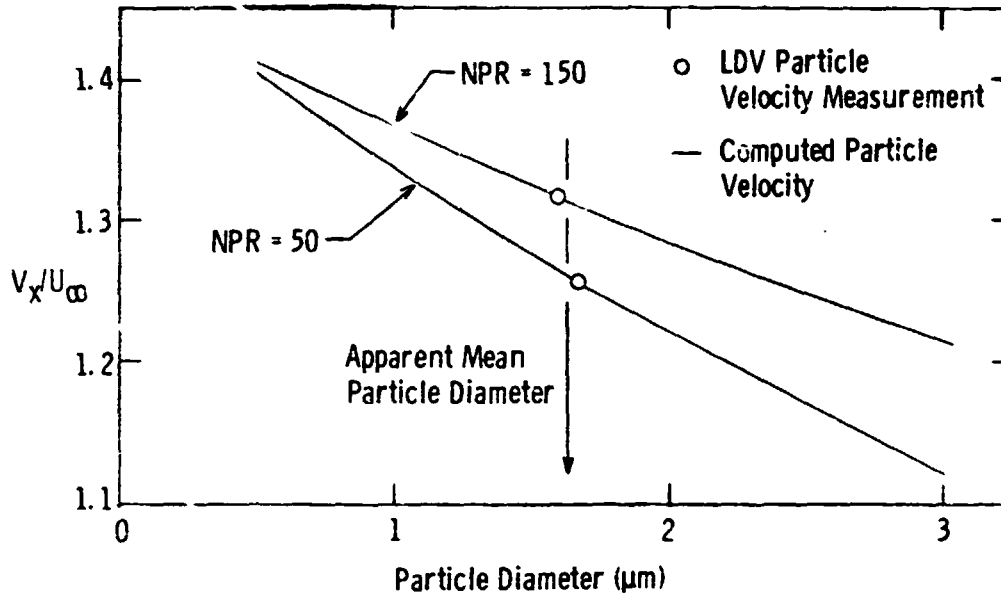

Figure 6

7.0 DEG HALF-ANGLE CONE TEST

Cone models have been studied extensively and provide a well-known reference for assessing the ability of the laser velocimeter to obtain boundary layer measurements in low density, supersonic flow. Pitot probe surveys were obtained during the test for three Reynolds numbers selected to produce laminar, transitional and turbulent boundary layers at the survey station (Fig. 7). In addition theoretical calculations were made for the same test conditions. The test was designed for comparison of forward and backscatter collection as well as counter and Fourier type processors.

A schematic of the cone model installed in the tunnel is presented in Figure 8. All surveys were obtained thirty five inches downstream of the cone nose.

- **MODEL CONFIGURATION**
 - 40.0 IN LONG, SHARP CIRCULAR CONE

- **TEST CONDITIONS**
 - $MI = 4.0$
 - $RE = 0.6 \times 10^6/FT, 1.0 \times 10^6/FT, \text{ and } 3.0 \times 10^6/FT$

- **CONFIGURATION CHARACTERISTICS:**
 - FORWARD-FACING SURFACE, ATTACHED FLOW

- **LDV SYSTEM:**
 - 2-COMPONENT BACKSCATTER/COUNTER PROCESSORS
 - 1-COMPONENT FORWARD SCATTER/COUNTER PROCESSORS
 - 1-COMPONENT FORWARD SCATTER/FOURIER PROCESSORS

Figure 7

CONE INSTALLED IN AEDC/VKF TUNNEL A

Figure 8 shows the 7.0-degree half-angle cone installed in the AEDC/VKF Tunnel A.

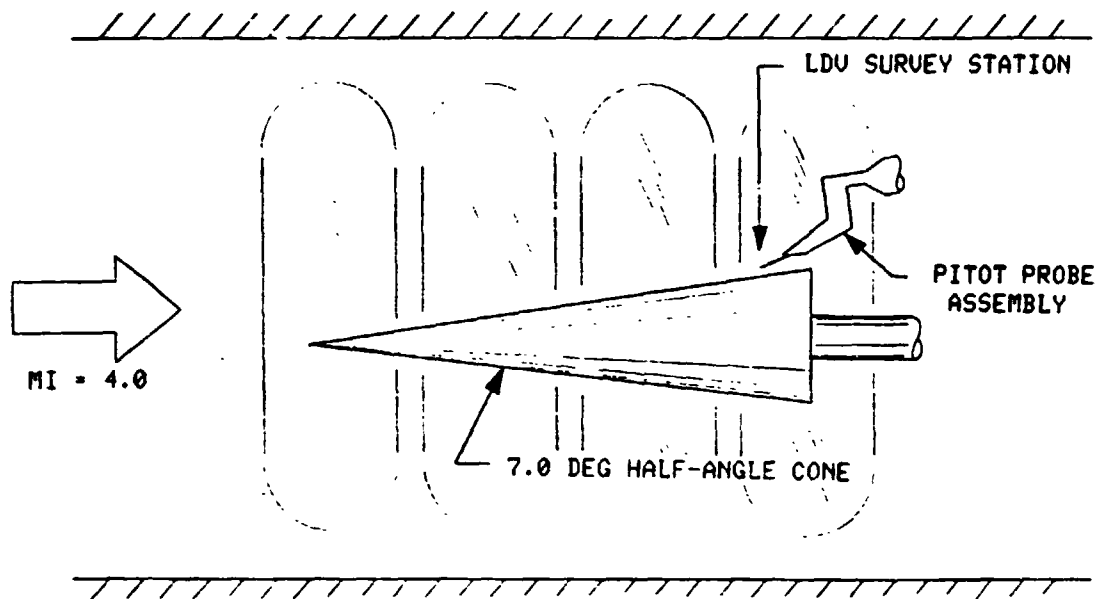

Figure 8

SEEDING

Figure 9 shows the types of seeding employed.

- **EXTERNAL FLOW (STREAM TUBE)**
 - **COLLISON NEBULIZER/OLIVE OIL**
 - **LASKIN NOZZLE/OLIVE OIL**

Figure 9

COMPARISON OF LDV MEASUREMENTS WITH THEORY AND PITOT PROBE RESULTS FOR THE CONE LAMINAR BOUNDARY LAYER

LDV measurements in the cone laminar boundary layer are compared with pitot probe data and theory in Figure 10. The polydisperse particle distribution and the high percentage of relatively large particles resulted in significant LDV measurement errors. The technique used for editing the LDV data is presented in Figures 11 and 12.

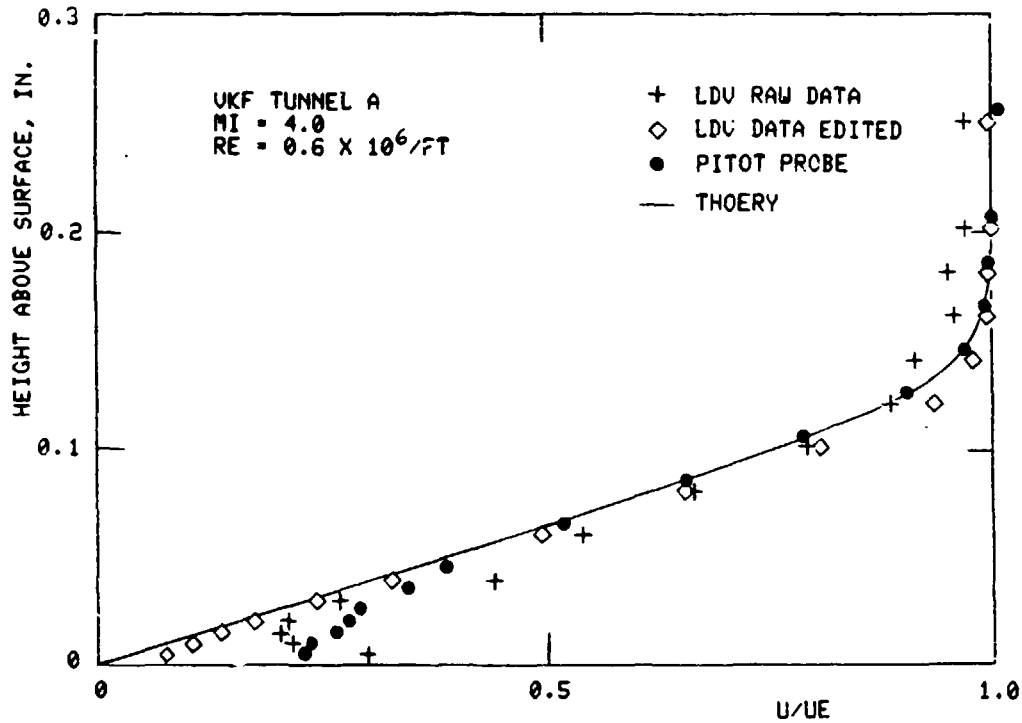

Figure 10

LDV SCATTER PLOT FOR LDV MEASUREMENT IN CONE BOUNDARY LAYER AND SUGGESTED TRAJECTORIES OF OBSERVED PARTICLES

A velocity scatter plot, typical of those observed in the lower portion of the cone laminar boundary layer, is presented in Figure 11 to provide additional insight. An observed high data rate near the model is evidence of the integrating effect of the forward facing surface. The number density of the large, fast particles appears to increase more rapidly than that of the smaller, slow, fluid following ones, causing a high bias.

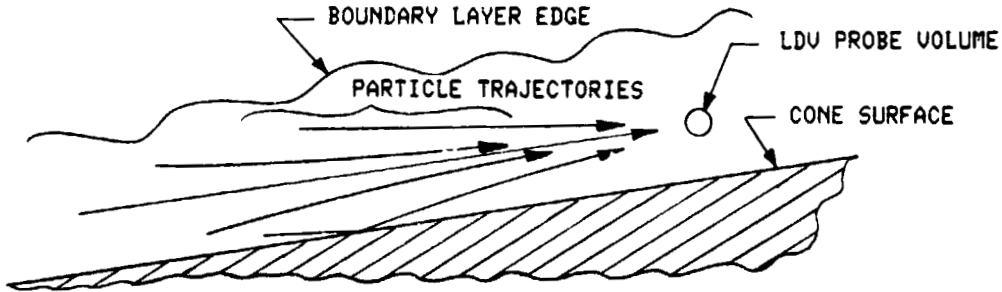
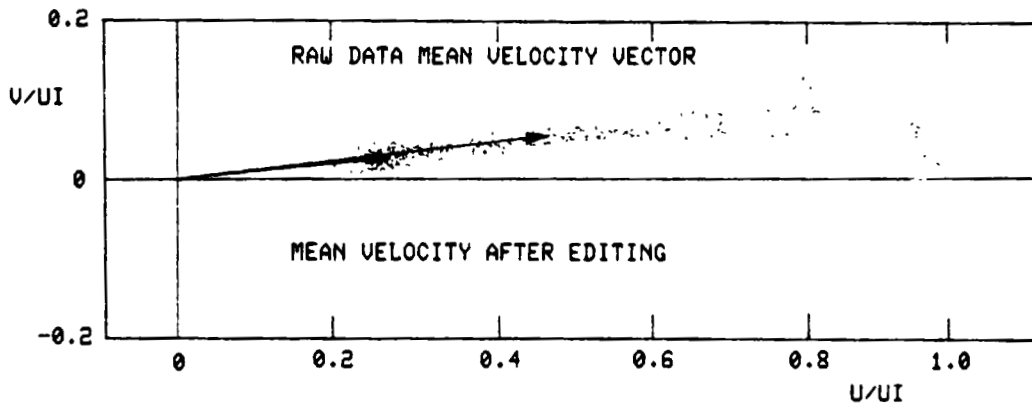

Figure 11

LDV VELOCITY PROBABILITY DISTRIBUTION IN THE CONE LAMINAR BOUNDARY LAYER

The typical axial velocity probability distribution is presented in Figure 12 to illustrate the results of rejecting the large particle bursts. Such editing required caution and cannot be done in situations where the large particles dominate the sample. A monodisperse sample not containing the larger particles could render such editing unnecessary.

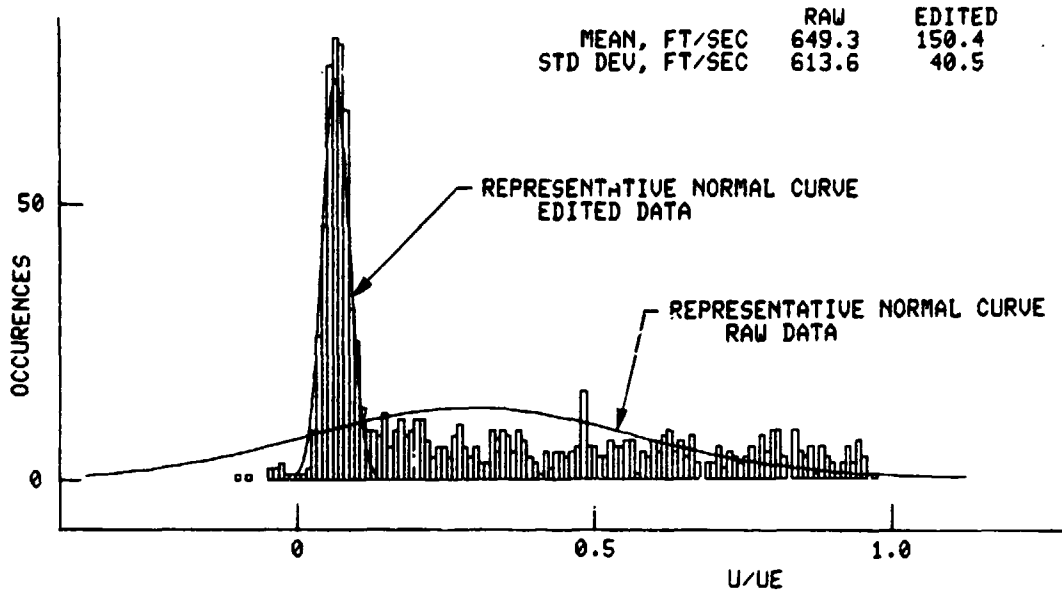

Figure 12

TWO-DIMENSIONAL CIRCULAR CYLINDER TEST

The 2-Dimensional cylinder configuration provided a strong, stable detached bow shock. Such an extreme velocity gradient is useful for the on-line "determination" of seed particle size. Horizontal LDV surveys were obtained through the shock on the model centerline for two Reynolds numbers (Figures 13 and 14). The aerosol generators and seed materials used are presented in Figure 15.

- **MODEL CONFIGURATION**
 - 2.0 IN DIA CIRCULAR CYLINDER,
ORIENTED NORMAL TO THE FREE STREAM

- **TEST CONDITIONS**
 - MI = 4.0
 - RE = 0.6×10^6 /FT and 3.0×10^6 /FT

- **CONFIGURATION CHARACTERISTICS:**
 - STRONG, STABLE SHOCK

- **LDV SYSTEM:**
 - 2-COMPONENT BACKSCATTER/COUNTER PROCESSORS
 - 1-COMPONENT FORWARD SCATTER/COUNTER PROCESSOR
 - 1-COMPONENT FORWARD SCATTER/FOURIER PROCESSOR

Figure 13

TWO-DIMENSIONAL CYLINDER MODEL IN MACH 4.0 STREAM

Figure 14 shows a sketch of the two-dimensional cylinder model in the Mach 4.0 stream.

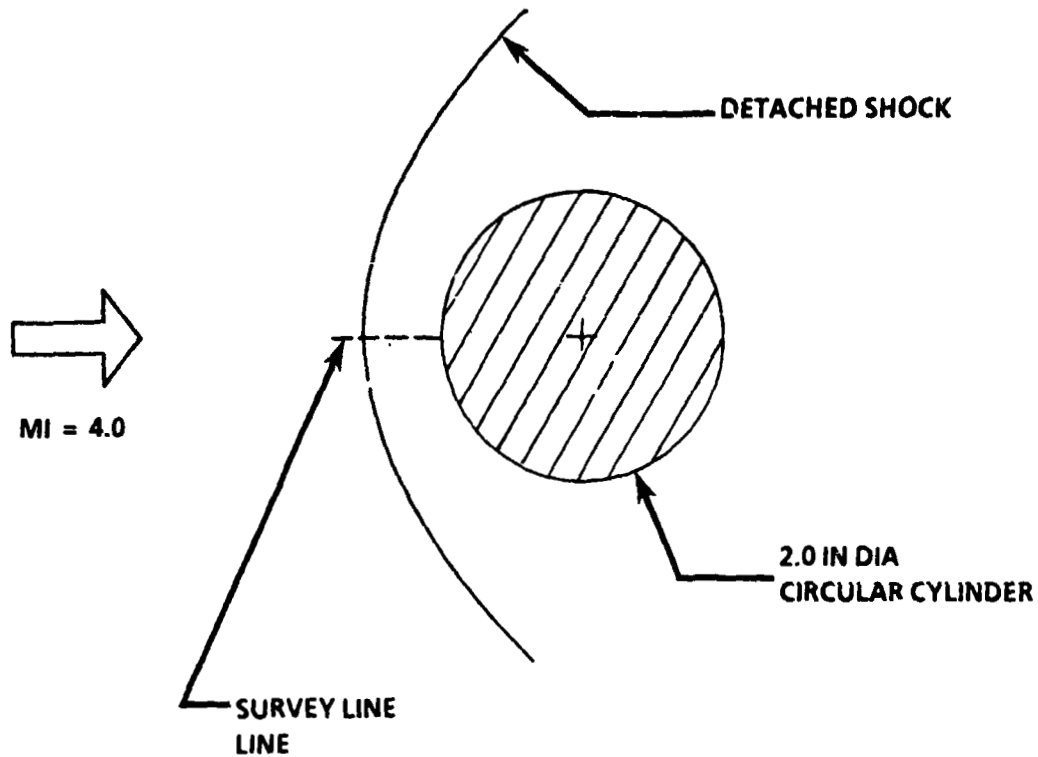

Figure 14

SEEDING

Figure 15 shows the types of seeding employed.

- **EXTERNAL FLOW (STREAM TUBE):**
 - COLLISON NEBULIZER/OLIVE OIL
 - COLLISON NEBULIZER/OLIVE OIL AND FREON
 - LASKIN NOZZLE/OLIVE OIL
 - AMBIENT PARTICLES

Figure 15

COMPUTED PARTICLE RESPONSE TO A NORMAL SHOCK

The computed responses of several sizes of oil droplets to the cylinder bow shock are presented in Figure 16. Based upon the computations, one would expect a polydisperse particle distribution to produce a rapid broadening and skewing of the velocity probability distribution immediately downstream of the shock, a gradual reversal in skewing direction, and finally, the formation of a low velocity mode as each successively larger particle size relaxed to the fluid velocity. This is, in fact, what was observed, indicating that the flow contained a wide range of particle sizes.

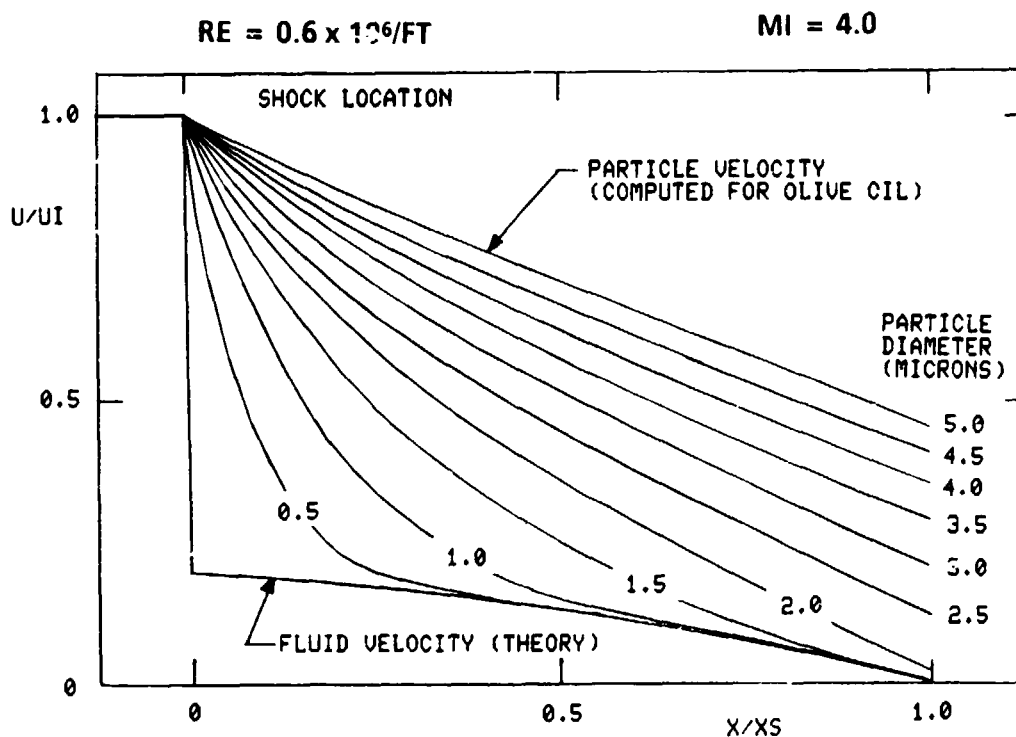

Figure 16

EFFECTS OF REYNOLDS NUMBER ON PARTICLE RESPONSE TO A SHOCK

Velocity probability distributions obtained upstream of the cylinder are presented in Figures 17 through 21 to illustrate the effects of several variables. Theoretical fluid velocity is represented by the solid line.

The particle response is strongly dependent upon Reynolds number as shown in the results presented in Figure 17. The particle relaxation distance was reduced significantly in the high Reynolds number case.

COUNTER PROCESSOR
FORWARD SCATTER

COLLISON NEBULIZER
OLIVE OIL

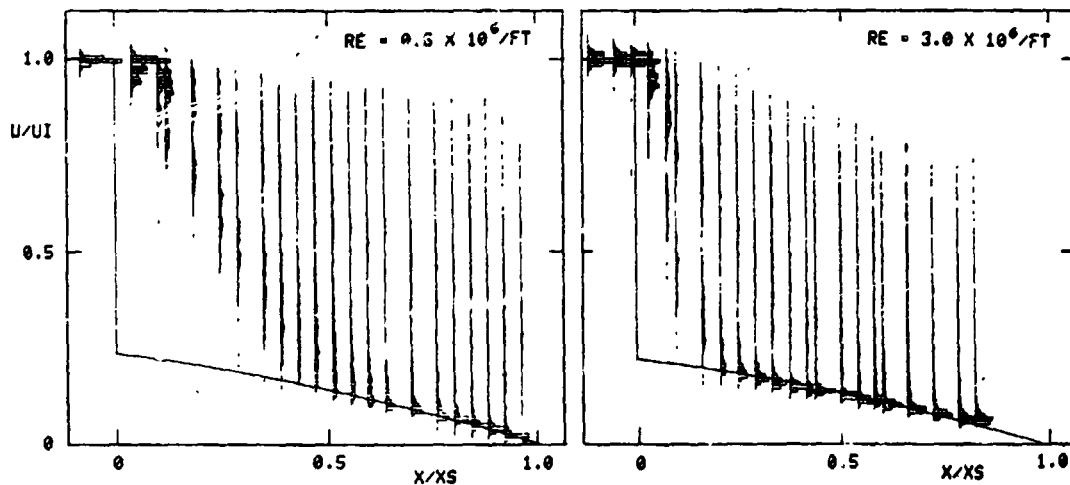

Figure 17

EFFECTS OF SEED GENERATOR ON LDV MEASUREMENTS

The 2-D cylinder flow was utilized to assess the performance of two types of liquid atomizers. The particle size distributions produced by the two devices were very similar, with the Laskin nozzle providing slightly smaller particles as well as fewer large ones. Both distributions were highly polydisperse as shown in Figure 18.

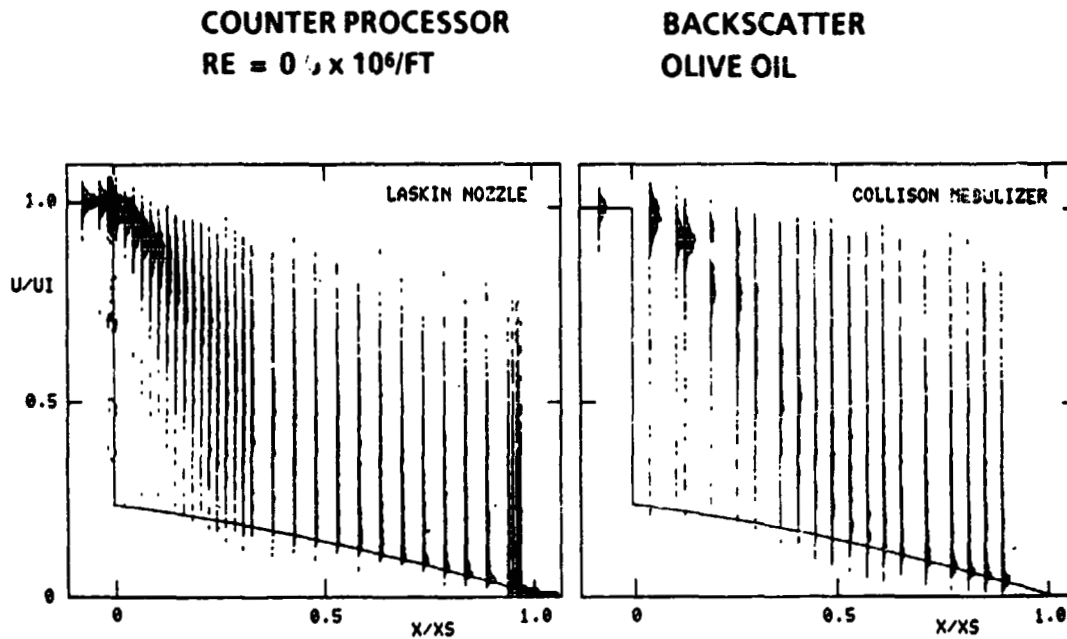

Figure 18

ORIGINAL PAGE IS
OF POOR QUALITY

COMPARISON OF LDV MEASUREMENTS IN SEEDED AND UNSEEDED FLOW

Figure 19 indicates that the most accurate mean velocity measurements and shortest relaxation distances were obtained using only the ambient aerosols in the Tunnel A flow. The data rate, however, was extremely slow. Backscatter signals from the particle were too weak for processing by the counter processor in the high velocity flow upstream of the shock.

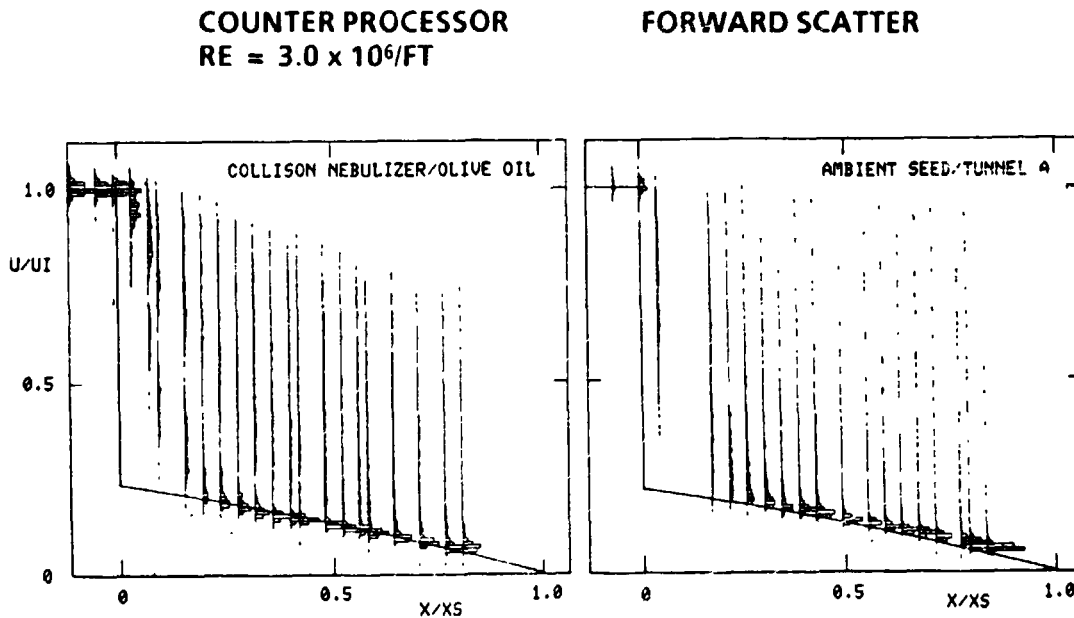

Figure 19

COMPARISON OF FORWARD SCATTER AND BACK SCATTER RESULTS

As would be expected, the forward scatter signal was significantly stronger than that available in backscatter. Thus, the signal from smaller particles could be processed by the forward scatter system as indicated by the earlier probability mode buildup at the fluid velocity shown in Figure 20.

COUNTER PROCESSOR
RE = $3.0 \times 10^6/FT$

COLLISON NEBULIZER
OLIVE OIL

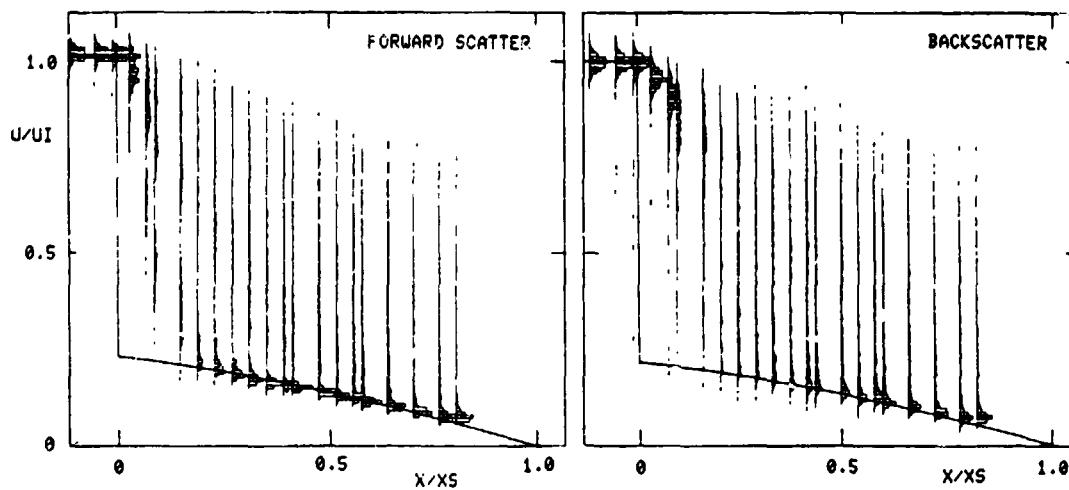
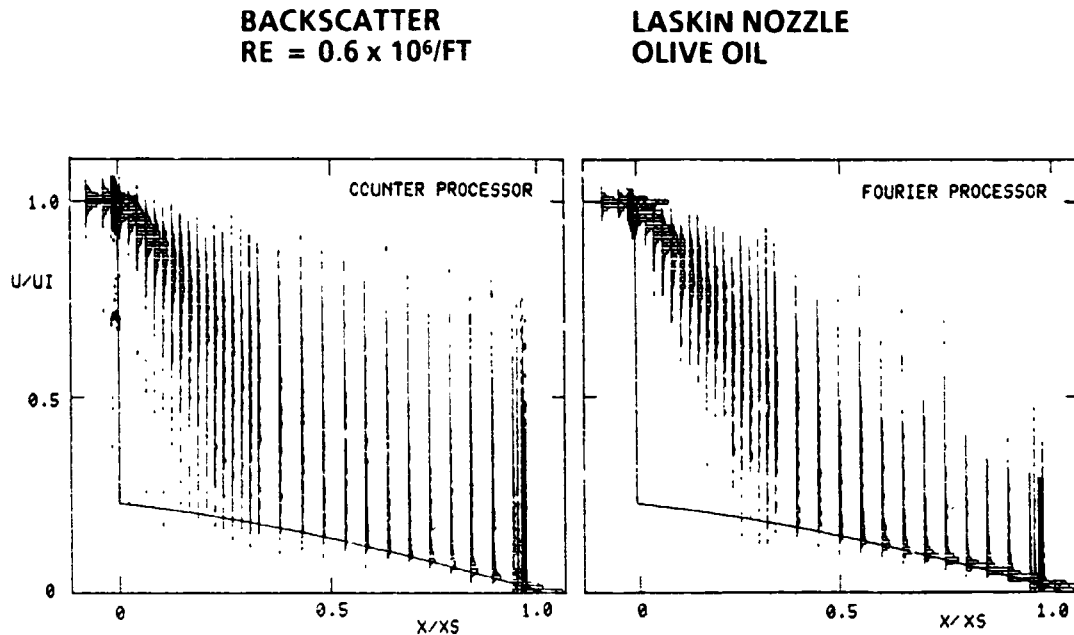

Figure 20

COMPARISON OF RESULTS FROM TWO LDV PROCESSORS

Figure 21 results from the cylinder shock also indicate that the Fourier processor can "see" smaller particles than the counter type. The primary differences appear to be the strength of the mode at the fluid velocity and the relative number of larger particles observed by the two instruments.



CONCLUSIONS

Conclusions are presented in Figure 22.

- **POLYDISPERSE PARTICLE DISTRIBUTIONS CAN YIELD MISLEADING LDV RESULTS WHICH ARE DIFFICULT, IF NOT IMPOSSIBLE, TO DEAL WITH OFF-LINE**
- **BACKSCATTER SIGNALS CAN PROVIDE ACCURATE MEASUREMENTS IN TRANSONIC FLOWS IF REYNOLDS NUMBER IS SUFFICIENTLY HIGH AND IF PARTICLES CAN BE KEPT SUFFICIENTLY SMALL**
- **FORWARD SCATTER SHOULD BE USED WHERE PRACTICAL**
- **SEEDING DEVICES ARE NEEDED WHICH CAN PROVIDE MONODISPERSE DISTRIBUTIONS OF SMALL PARTICLES IN LARGE ENOUGH QUANTITIES FOR PRODUCTION TESTING**
- **A TECHNIQUE FOR ON-LINE PARTICLE SIZE MONITORING IS NEEDED**
- **FOURIER PROCESSORS APPEAR TO BE A PROMISING ALTERNATIVE TO COUNTER PROCESSORS**

Figure 22

REFERENCES

1. Heltsley, F. L.; Walker, B. J.; and Nichols, R. H.: Transonic Nozzle-Afterbody Flow Field Measurements Using a Laser Doppler Velocimeter. Presented at 53rd meeting of Fluid Dynamics Panel Symposium on Wind Tunnels and Testing Techniques, Cesme, Turkey, Sept. 26-29, 1983.
2. Nichols, R. H.: Calculation of Particle Dynamics Effects in Laser Velocimeter Data. Wind Tunnel Seeding Systems for Laser Velocimeters, NASA CP-2393, 1985. pp. 1-12.
3. Crosswy, F. L.: Particle Size Distributions of Several Commonly Used Seeding Aerosols. Wind Tunnel Seeding Systems for Laser Velocimeters, NASA CP-2393, 1985, pp. 53-76.