

ADAPTATION OF A MODERN MEDIUM HELICOPTER (SIKORSKY S-76)
TO HIGHER HARMONIC CONTROL

James J. O'Leary
Chief, Aeromechanics Risk Reduction
and
Dr. Sesi B. R. Kottapalli
Dynamics Engineer

Sikorsky Aircraft Division
United Technologies Corporation
Stratford, Connecticut

and

Mark Davis
Associate Research Engineer
United Technologies Research Center
E. Hartford, Connecticut

Abstract

Sikorsky Aircraft has performed analytical studies, design analyses, and risk reduction tests for Higher Harmonic Control (HHC) on the S-76. The S-76 is an 8-10,000 lb helicopter which cruises at 145 kts. Flight test hardware has been assembled, main servo frequency response tested and upgraded, aircraft control system shake tested and verified, open loop controllers designed and fabricated, closed loop controllers defined and evaluated, and rotors turning ground and flight tests planned for the near future. Open loop analysis shows that about 2° of higher harmonic feathering at the blade 75% radius will be required to eliminate 4P vibration in the cockpit. Analytical computer simulations of a closed loop controller have been evaluated, relative to the theses of reducing vibration to low levels while maintaining good ride quality and aircraft structural stress attributes. The analytical results, design concepts, program approach, and risk reduction tests are reviewed herein, providing a status report on HHC for the S-76.

Introduction

As we move toward the end of this century, where the design and fielding of many thousands of new helicopters is a major objective, it is mandatory to develop weight-effective, high technology airframe vibration control. This is true for both high speed level flight (advance ratio $\mu = 0.40$) and low speed maneuvering

flight. The rotor speed may be varied by large percentages (10 to 30%) to optimize other aircraft characteristics such as acoustics, performance, load factor, and time on station. This could preclude the use of more conventional vibration treatment devices because of adverse frequency response characteristics and/or weight considerations. Over two decades of analytical studies, wind tunnel tests, and light aircraft flight tests ($\mu = 0.26$) have demonstrated HHC to be a viable concept for vibration control. Application of HHC to larger aircraft with the design requirements discussed above has not occurred.

The concept underlying HHC is that reductions in airframe vibrations and blade loads can be achieved by oscillating the rotor blade in pitch at $(N-1)\Omega$, $N\Omega$, $(N+1)\Omega$ frequencies where N is the number of blades and Ω is the rotor speed.

Vibration reduction using HHC was successfully demonstrated in full scale testing on an OH-6A helicopter in the early part of 1984 (Reference 1) after an eight year effort which included wind tunnel testing. In this effort a closed loop controller was employed to reduce vibration from 0.45 g's to 0.03 g's at 100 kts (advance ratio of 0.26) in a 2500 lb aircraft. This fifteen fold reduction is impressive for a steady state flight condition. Much smaller (3 to 1) reductions in vibrations were obtained in maneuvers. The next logical question is whether such high magnitudes of vibration reductions are attainable in a larger and heavier aircraft (8,000 - 10,000 lbs) flying at speeds typical of modern helicopters without significant reductions in the life of control and rotor system parts

Presented at the 2nd Decennial Specialists Meeting on Rotorcraft Dynamics, NASA, Ames Research Center, Moffett Field, California, November, 1984.

(e.g. Sikorsky S-76 at 145 knots flying at an advance ratio of about 0.36). This is important since the vibratory hub loads increase at least as $(\mu)^2$. This means that the loads at 145 knots are 2 1/4 times those at 100 knots. Also, at higher advance ratios, the potential for greater interharmonic coupling exists.

Sikorsky Aircraft is currently engaged in a comprehensive program for the prototype development of an HHC system for the S-76 which is more in the LHX weight category and speed regime than the aircraft in Reference 1. This program will reach major milestones of open loop flight testing in the fourth quarter of 1984 and closed loop testing in 1985. The extensive design analysis and risk reduction tests Sikorsky Aircraft has employed in the S-76 program will be discussed in this paper.

Sikorsky Aircraft has extensive interest and experience in HHC technology. References 2 and 3 present analytical HHC design studies on vibration reductions in the BLACK HAWK UH-60A and the Sikorsky ABC. These efforts are described next.

The BLACK HAWK study (by Sikorsky and the United Technologies Research Center (UTRC)) projected 80-90 percent reduction in fuselage vibrations. Implementation requirements for an HHC system were also explored in Reference 2. For example it was projected that an HHC system would weigh roughly 1 percent of the BLACK HAWK design gross weight, compared to the 2.2 percent weight of the rotorhead bifilar absorber and the three other conventional absorbers in the current BLACK HAWK.

The U.S. Army is funding a preliminary design investigation to define a production HHC system for Army inventory aircraft (such as the BLACK HAWK and APACHE). The HHC design and its impact on the aircraft systems will be defined and a production solution suggested. This will take HHC into the 16-20,000 lbs, 160 knot regime.

In Reference 3 Sikorsky Aircraft conducted a preliminary design study on the use of HHC for the ABC. This included the definition of the higher harmonic control required to reduce vibrations as well as the method and hardware to input this control. It was projected that a 90 percent reduction in vibration was feasible with relatively small amplitudes of HHC input ($\frac{1}{2}$ to 2 degrees) at flight speeds up to 300 knots. The design study considered blade and pushrod loads, as well as the actuation and control system capabilities and its

integration into the aircraft systems. A primary conclusion of this study was that blade and control loads could be accommodated in the detailed design phase and that no fatal flaw was obvious for system integration. This study provided information for applications of HHC to a counter-rotating aircraft at very high speed in the 12000 lb range of gross weight. The added mechanical challenge of the two coaxial rotors is perhaps a drawback, but the potential cancellation of upper and lower rotor forces in 3 of the 6 degrees of freedom is beneficial. In any event, the design experience and risk identification forthcoming from the HHC application to the ABC provided valuable training aspect to Sikorsky Aircraft in future HHC applications. A detailed program has been laid out for HHC on the ABC.

Vibration Characteristics of the S-76

The S-76 is a modern medium size helicopter used mostly in the commercial market for VIP transport and offshore oil missions. For both these missions the ride quality in the cockpit and cabin is extremely good. This four bladed rotor system is designed to minimize the 4P (19.5 Hz at 100% NR) vibration in conjunction with rotating system 3P and 5P inplane bifilar absorbers with cycloidal tuning bushings. The ride quality in the forward cockpit is further enhanced by the use of a variable tuned fixed system vibration absorber. Reference 4 discusses the details of the dynamic design. The self tuning nature of the bifilers and the nose absorber allow for rotor speed operation over a 11 percent range to optimize mission performance. While this system works well, it requires 2.75% of the design gross weight. The goal of 1% weight factor with an active self adaptive controller - lumped into a existing fly by wire (FBW) computer - is thus attractive. Additionally, while the self tuning features of the current system allow for rotor speed variations to optimize performance, a much larger range of operating speed changes can be accommodated with HHC. This is especially important for military applications.

Analytical Study

The analytical study was conducted for basically three reasons: 1) to demonstrate the effectiveness of HHC on the S-76 in cruise at an airspeed of 145 knots; 2) to define the design requirements of HHC; and 3) to support subsequent ground and flight tests. Both open and closed loop cases were considered in this study with emphasis on the open loop analysis so as to identify design require-

ments and provide response sensitivities to HHC inputs. While the closed loop study for the S-76 has been of a preliminary nature, analytical results in References 2 and 5 show that closed loop algorithms can be used to reduce vibration in an aircraft with gross weight in the 8000 - 16000 lbs range. All open and closed loop analytical results obtained to date indicate that HHC inputs of 2° or less are sufficient to reduce vibration in a helicopter at a cruise condition of 145 knots and 10000 lbs lift. Note that it is not necessary to completely eliminate 4P vibrations; what is required is excellent ride quality while maintaining acceptable blade loads. This implies that the vibrations need to be reduced only to a specified level. Open loop flight testing will establish this level and provide blade and control load derivatives coupled with performance and acoustic benefits (or detriments) to define the closed loop parameters.

The aeroelastic analysis used was G400 (Reference 6) a time history analysis. The S-76 fuselage was represented by modes derived from a NASTRAN analysis. The baseline absolute predicted values of the vibrations in the S-76 study are smaller than the flight results. Hence, the S-76 analytical results presented herein should be interpreted as representative of trends. The configuration studied was an S-76 operating at 145 knots and 10000 lbs lift. Vibration levels, pushrod loads, and blade bending moments were obtained from G400. It is possible that the analytical results can be improved by using fuselage modes derived from shake test results.

Open Loop

Open loop results were obtained from a parametric study involving 3P, 4P, and 5P blade pitch changes. The amplitude and phase of the HHC inputs were systematically varied to determine their effect on fuselage vibration, control loads, and blade vibratory moments.

Vibration The effect of the amplitude and phase of a pure 3P input on pilot vertical vibration is shown in Figure 1. The 3P input is expressed as a sine function $\phi_3 \sin(3\psi + \phi_3)$ where ϕ_3 is the amplitude, ϕ_3 is the phase, and ψ the blade azimuth. Two contours are given in Figure 1, one for a 3P amplitude of 1° and the other for an amplitude of 2°. Note that the phase difference between adjacent data points in this figure is 30°. Because of the shape of the closed contour it is evident that the pilot vertical vibration varies nonlinearly with the 3P input. The results in this figure indicate that a 3P input with an amplitude of

2° and a phase of 115° will eliminate pilot vertical vibration.

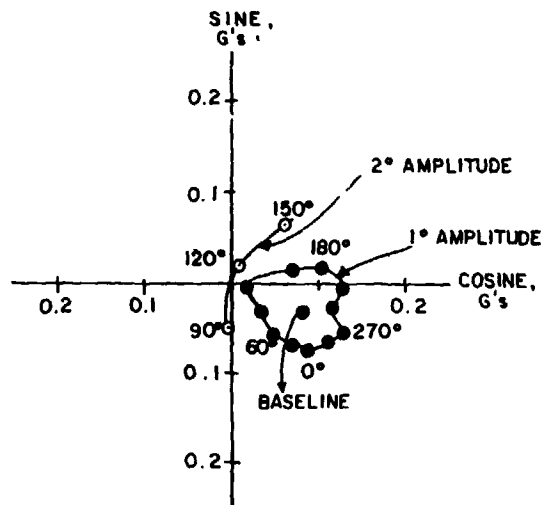

Figure 1. Pilot Vertical Vibration versus Phase and Amplitude of 3P Input

Figure 2 shows that a pure 4P open-loop input is less effective than the 3P input in reducing pilot vertical vibration. Even a properly phased 4P input would require more than 2° of amplitude to eliminate pilot vertical vibration. This suggests that the S-76 4P vibration is due more to 4P inplane loads that come from 3P and 5P rotating loads, and not the 4P vertical shear.

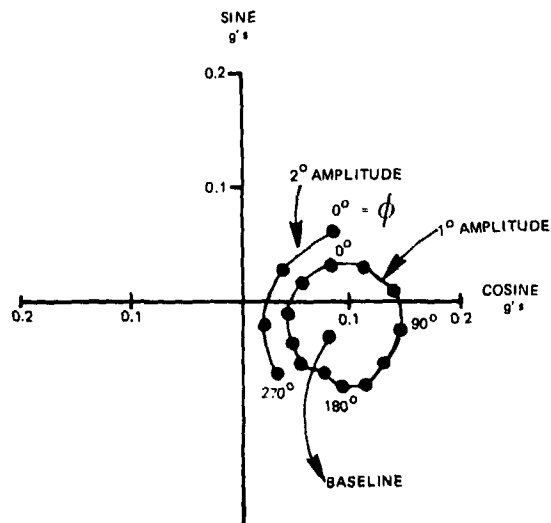

Figure 2. Pilot Vertical Vibration versus Phase and Amplitude of 4P Input

Note that the pilot vertical vibration variation with 4P HHC is less nonlinear than with 3P. Figure 3 shows the effect of a 4P input on cabin vertical vibration. A comparison of Figures 2 and 3 shows that a 4P input that reduces pilot vertical vibration increases cabin vertical vibration. This anomaly may be due to the phasing of rotor loads and fuselage modal cancellation and shows that pure 4P control would not be optimal. While these are open loop results with individual inputs, a closed loop controller would identify and implement the correct combinations of 3P, 4P, and 5P inputs and be able to accommodate such opposing trends by minimizing a specified performance index that includes vibration at several locations, if necessary.

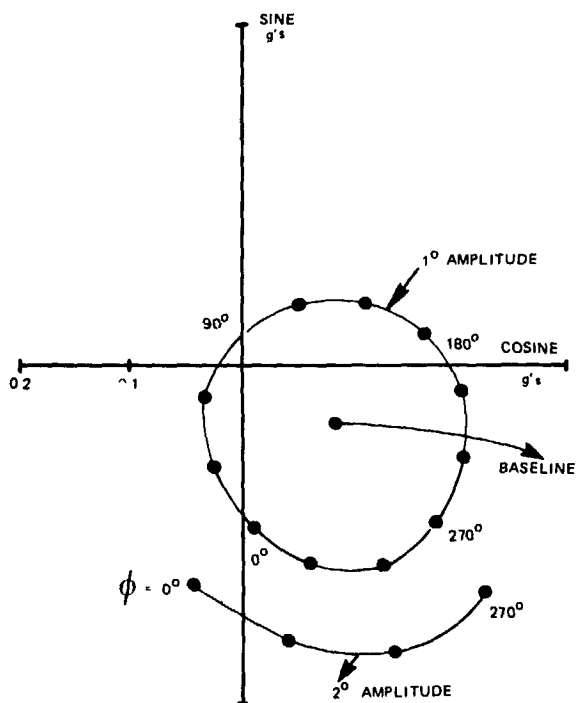

Figure 3. Cabin Vertical Vibration versus Phase and Amplitude of 4P Input

Figure 4 shows the effect of 5P control on pilot vertical vibration and indicates that the pilot vertical vibration variation with 5P control is not as nonlinear as with 3P. Further, a 5P input of 1.5° amplitude and 220° phase will virtually eliminate this vibration component.

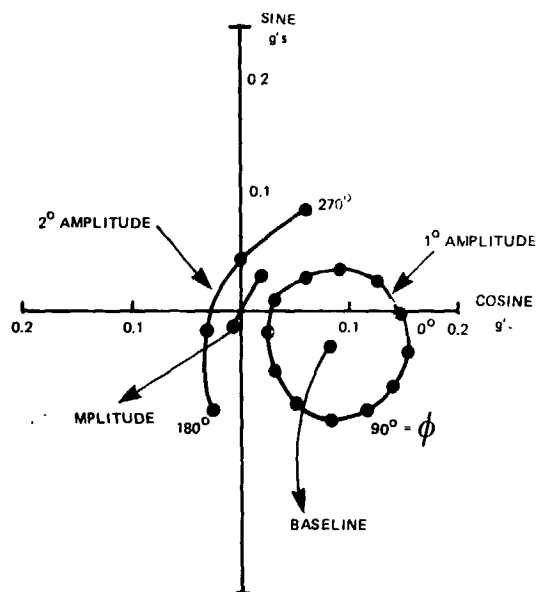

Figure 4. Pilot Vertical Vibration versus Phase and Amplitude of 5P Input

The above results indicate that an individual harmonic input can be used to reduce a particular component of vibration (e.g., pilot vertical) with various levels of effectiveness. The resultant vibration at other locations in the fuselage may or may not be lower due to the phasing of rotor loads and modal cancellation. In order to achieve overall vibration reduction throughout the fuselage, it may be necessary to prescribe multi-harmonic control inputs to reduce vibration at several sensor locations. Due to the interharmonic coupling effects between the three inputs and the intermodal cancellation effects in the airframe, the task of defining the amplitude and phase of each input to minimize overall vibration becomes complex. Therefore, this task will be accomplished by a self-adaptive controller algorithm used in a closed-loop system. However, open-loop flight testing will be used to verify trends as well as determine the sensitivity of vibration and loads to a matrix of inputs. Based upon the open-loop results presented herein it may be expected that for the S-76, 1.5° of 3P input will have a substantial effect on pilot vibration.

Pushrod Load and Bending Moments The maximum effect of a 1° open loop input on the pushrod load is shown in Figure 5. The figure shows that open loop higher harmonic control can increase the pushrod load. Though not shown here, a 2° 5P

input at a phase of 240° results in a half peak-to-peak pushrod load of 721 lbs which is close to the endurance limit of 755 lbs. Thus, the effect of control system fatigue damage due to HHC will have to be considered in the design stage.

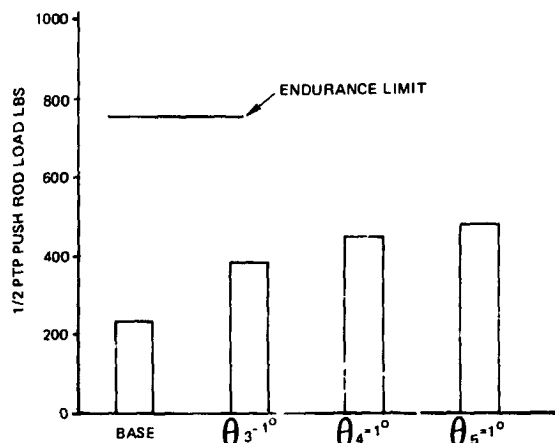

Figure 5. Increase in Pushrod Load due to 1° HHC Input

Figure 6 shows that the peak-to-peak flatwise and edgewise moments increase by about 20 percent due to 1° of higher harmonic input. A 2° 4P input causes approximately a 40% increase in the flatwise moment and a 2° 5P input results in a 55% increase in the edgewise moment (these increases were the maximum increases obtained for all the cases). Therefore, blade bending moment increases due to HHC are potentially significant for higher amplitude control angles and will need to be considered. Open-loop testing combined with fatigue life calculations will determine the importance of these increases. A plan to incorporate blade and control loads into the closed loop controller so that vibration may be reduced with a minimum increase in blade loads is under consideration.

Closed Loop

Vibration The self-adaptive deterministic controller algorithm documented in Reference 5 was used in a preliminary analytical study of closed-loop control for the S-76. The flight condition investigated was a cruise condition at 145 knots and 10000 lbs of lift. The results of vibration reduction achieved by the closed-loop controller, when using equally weighted 3P, 4P, and 5P inputs to reduce vibration of six equally weighted components, is shown in Table 1. Reductions of at least 20 percent were achieved at all locations. Even larger reductions of 50

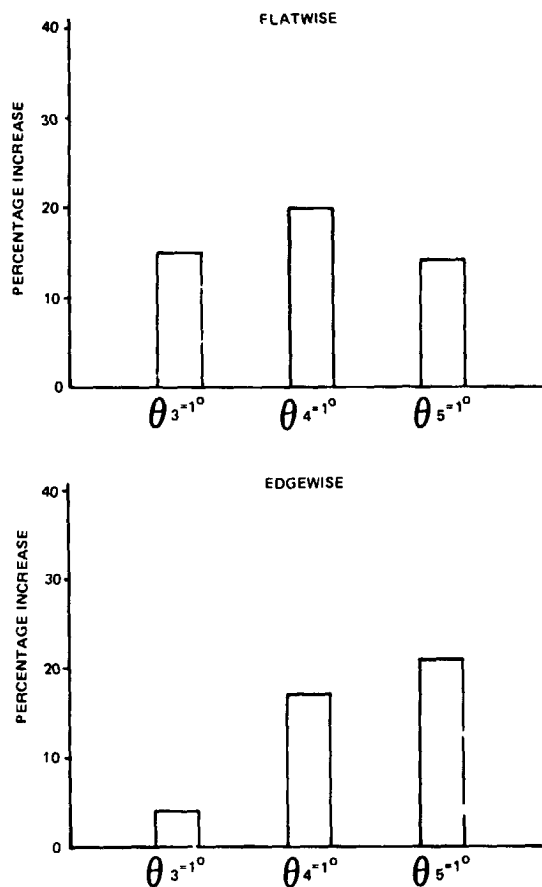

Figure 6. Percentage Increases in half Peak-to-Peak Blade Bending Moments due to 1° HHC Input

to 70 percent were achieved in the cabin vertical and pilot lateral components, respectively. These results can be improved by fine tuning the controller for the S-76. This involves weighting the importance of various vibration locations as well as the tailoring of the controller algorithm for identification and tracking.

Results from both References 2 and 5 suggest that very good controller performance can be achieved for the S-76 at forward flight speeds of 145 knots. In Reference 2, a similar deterministic control algorithm was evaluated in an analytical simulation of the BLACK HAWK at a speed of 150 knots and at gross weights of 13200 and 16500 lbs. Vibrations were calculated at components that directly correspond to those shown in Table 1 for the S-76. At both of these gross weights, reductions on the order of 30 percent were achieved in the pilot, copilot, and cabin

vertical components, while 50 percent reductions were obtained in the pilot lateral and longitudinal components. The vibration reductions and the HHC inputs for the 16500 lbs case are shown in Figure 7. In Reference 5, the closed-loop controller algorithm was evaluated in an analytical simulation of the H-34 rotor mounted on the NASA/Ames rotor test apparatus (RTA) in the 40 x 80 wind tunnel. Forward flight conditions at 150 knots and rotor thrust levels of about 8000 and 12000 lbs were investigated. Reductions of the order of 75 to 95 percent were achieved, in vertical and longitudinal vibration components calculated at the nose, tail, and a main structural member corresponding to the cabin. The vibration reductions are shown in Figure 8. In both studies, the required amplitudes of 3P, 4P, and 5P control increased with rotor thrust, but were less than 1.0° for all rotor thrusts.

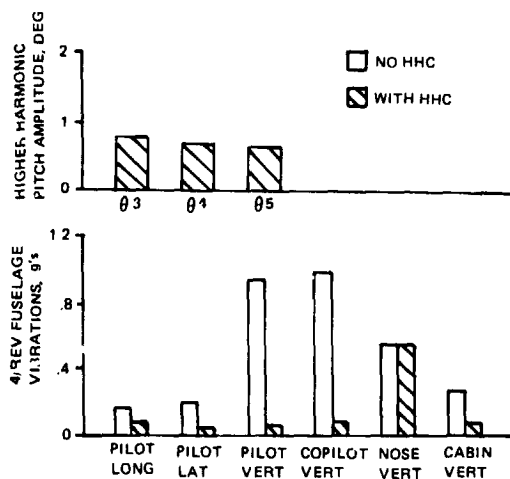

Figure 7. Effect of Closed Loop Control on Black Hawk Vibrations, 150 Kts, 16500 lbs.

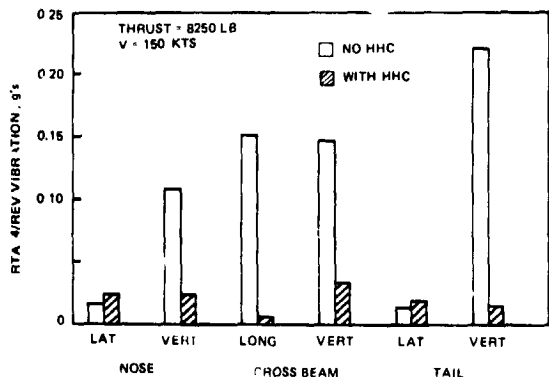

Figure 8. Effect of Active Control on Predicted 4P RTA Baseline Vibrations

The transient response of the deterministic controllers used in References 2 and 5 exhibited good behavior, since they were appropriately tuned for the particular aircraft investigated. For example, the time history of the performance index and higher harmonic control inputs for the H-34 study are shown in Figure 9, which is taken from Reference 5. The figure represents the transient behavior of the closed loop controller for an operating condition of 150 knots and 12000 lbs of thrust. Note that convergence to the final solution is smooth and the controller shows well-mannered behavior. The performance index is reduced by over 90 percent in only four rotor revolutions. This amounts to approximately one second in real time. Flight test results from Reference 1 indicate that such short time periods do not pose any problems to present state of the art controllers and computers which can operate within these time constraints.

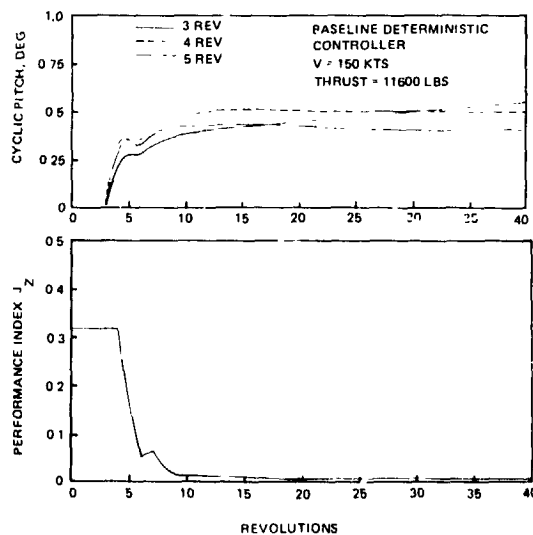

Figure 9. Time History of Vibration Controller

Pushrod Load and Bending Moments The half peak-to-peak S-76 pushrod loads for the closed loop cases are shown below:

Baseline	232 lbs
With HHC	486 lbs

Compared to the pushrod load, the bending moments were less sensitive to HHC inputs. The maximum change in the maximum bending moments, both flatwise and edge-wise, were less than 5%.

If these increases are found to be significant with respect to the fatigue endurance limit, it may be possible to

TABLE 1
REDUCTION IN VIBRATION WITH HHC
Vibration q's (after 24 revolutions)

	Pilot Long.	Pilot Lat.	Pilot Vert.	Co-Pilot Vert.	Nose Vert.	Cabin Vert.
Controller Off	0.078	0.053	0.082	0.029	0.033	0.116
Controller On	0.054	0.015	0.067	0.023	0.022	0.061
Percentage Reductions	30	70	20	20	30	50

achieve acceptable tradeoffs in vibration reduction and blade/control loads by incorporating parameters that are representative of these loads into the controller performance index. With appropriate weighting on vibration and load parameters, the controller would be guided to a better solution in terms of both considerations. Analytical results which indicate such an approach may be feasible are presented and discussed in Reference 5. For example, Figure 10 from Reference 5, shows the effect of arbitrarily eliminating 5P control, while reducing vibration at a 150 knot, 12000 lb thrust condition. When all three inputs are used, increases in blade moments result. When 5P control

is eliminated, both flatwise and torsion moments are about the same as those with no HHC, while the increase in the edgewise moment is only 20 percent. Both sets of HHC control inputs resulted in about the same vibration reductions. If the change in control mix of amplitude and phase were less arbitrary, it may be possible to achieve acceptable vibration levels with minimal detrimental effects on other considerations.

S-76 HHC Hardware Development Program

In 1981 an Independent Research and Development project was initiated to flight test an HHC system on the Sikorsky S-76. This effort is now in its final stages with open loop testing scheduled to take place in the last quarter of 1984 and closed loop testing planned for 1985. This project covers analytical studies, conceptual design, preliminary and detailed design, system risk reduction tests, system integration, and procurement and manufacture of HHC system components. Figure 11 shows an S-76 control system schematic with the HHC modifications added. Figure 12 shows the completed mechanical/electrical elements that are ready for flight.

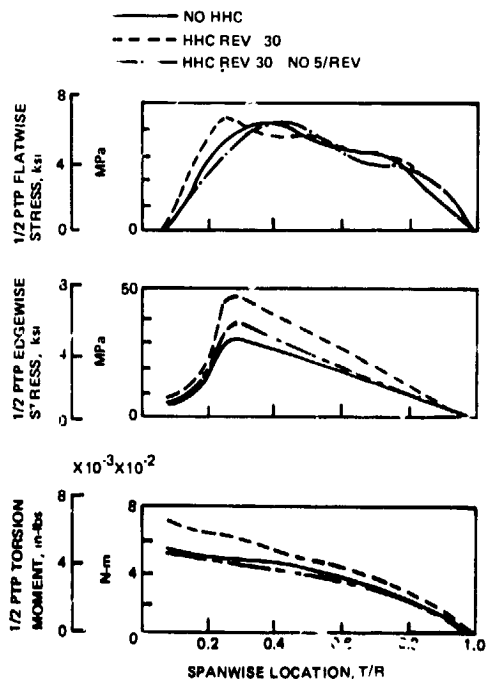

Figure 10. Effect of Active Vibration Control on Blade Vibratory Moments and Stresses, 150 Kts, 12000 lbs.



Figure 11. Modified Control System of the S-76

ORIGINAL PAGE IS
OF POOR QUALITY

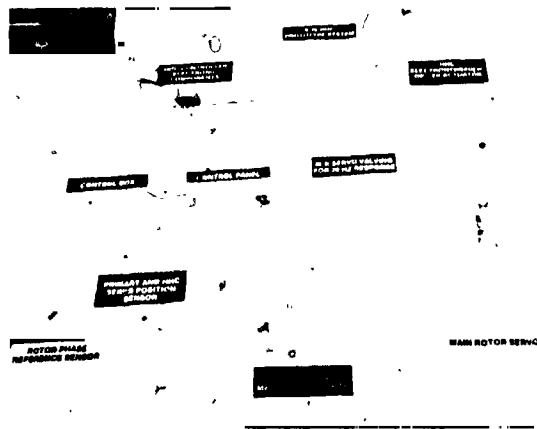

Figure 12. Mechanical and Electrical Elements of the HHC System

Philosophy

The principal design issues that have been identified include the frequency response of the main servos, frequency response of the HHC actuation system and controls, hydraulic power requirements, failure modes, rotor and control loads, and the hydraulic/mechanical implementation of the system on the S-76. The basic philosophy is to design and test a prototype system as "proof of concept" on an S-76 with minimum change to the aircraft. The program goal is to demonstrate HHC at 145 knots and 10000 lbs lift. The long term goal is to define design loads and issues for a production version of the HHC system. To accomplish these goals in a

safe and logical manner, a risk reduction plan has been established (Table 2) to eliminate uncertainties in structural issues (blade loads, control loads) prior to flying open and closed loop. This risk reduction program, extending over a four year period, was based upon lessons learned at Sikorsky and Government/Industry published results.

Risk Reduction

The first risk reduction test was conducted in 1981 on the main servo to define its gain at 20 Hz which is approximately the 4P frequency at 100% NR. Modifications were made to the valving, shown in Figure 12, to improve this gain. Figure 13 shows the old and new gains where a significant increase in the gain at 20 Hz is attained, going from 0.50 to 0.75.

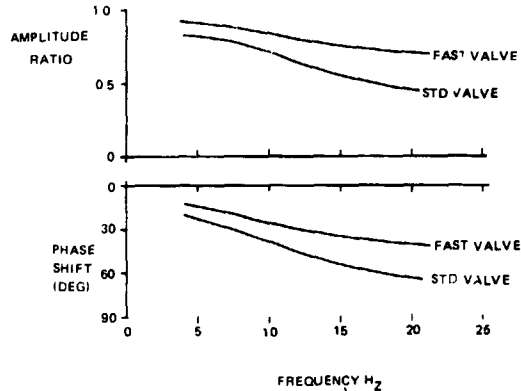

Figure 13. S-76 Primary Servo Frequency Response with higher Gain Valve

TABLE 2

RISK REDUCTION PLAN

	<u>ISSUE</u>	<u>ACTION</u>	<u>DATE</u>
1.	Adequate Servo Frequency Response	Change Valves and Test	1981
2.	Blade Pitch Response With Mechanical System	Conduct nonrotating Shake Test (Without Rotor Turning)	1982
3.	Analytical Vibration Reduction	Analyze System (Need 1.5 Degrees)	1983
4.	Adverse Rotor Impedance	Conduct Rotating Ground Test	1994
5.	A/C Hydraulics Capable of Inputting Desired HHC	Conduct Rotating Ground Test	1984
6.	Open Loop HHC (Loads, Slop, Effectiveness)	Conduct Flight Test	1984
7.	Closed Loop Controller Functional Adequacy	Conduct Flight Test	1985

A second risk reduction 4P frequency response test was performed in 1982 on the entire S-76 HHC control system to define its dynamic response. In this test the rotor was stationary and the blades were lifted out of their drooped position to better represent their torsional dynamics. The result of this nonrotating test was that blade angles of 2° to 3° at 4P could be obtained with the present controls, hydraulics, and the modified higher gain servo. It is projected that on the S-76 about 2° of 4P input is required at high flight speed. Figure 14 shows the schematic of the test setup. Figure 15 shows the test results for various levels of 4P frequency input to the main rotor servo. As much as ±3° were output at the blade 75% radius station without exceeding pushrod endurance limit, and no problems were discovered in the rest of the system shown in Figure 14. This was very encouraging and implied that there is beneficial dynamic amplification taking place within the S-76 pitch control system. This testing reduced a big risk seen in OH-6A testing where high frequency control system deflections were excessive and blade response in pitch was inadequate.

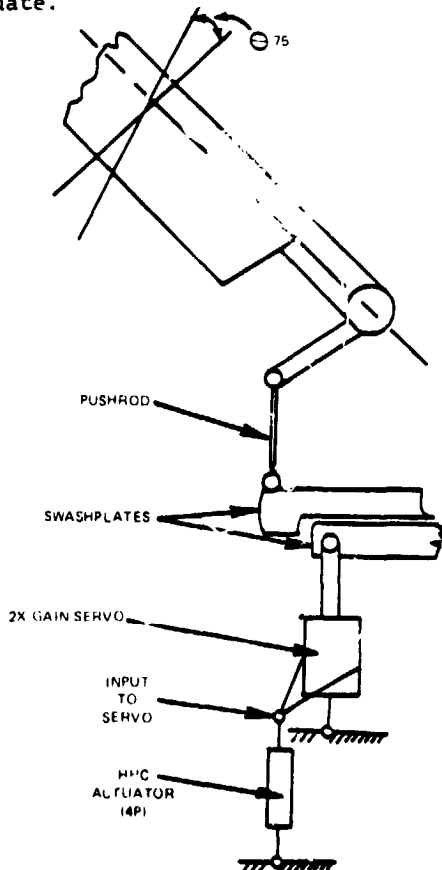

Figure 14. HHC Risk Reduction Test Setup

While this nonrotating frequency response test demonstrated that the S-76 control system bearing slop (free play) and flexibility do not attenuate the 4P input getting to the blade, the effect of rotation of the blades on rotor impedance is still a big question. The power and flow required to stroke the actuators, either collectively or cyclically, is obviously dependent on these "unknowns" which are difficult to calculate or simulate in a non-rotating test. Therefore as shown in Table 2 risk reduction tests will be performed prior to flight testing and include another ground test with the rotor turning so as to define pitch angles, flows, and hydraulic power required.

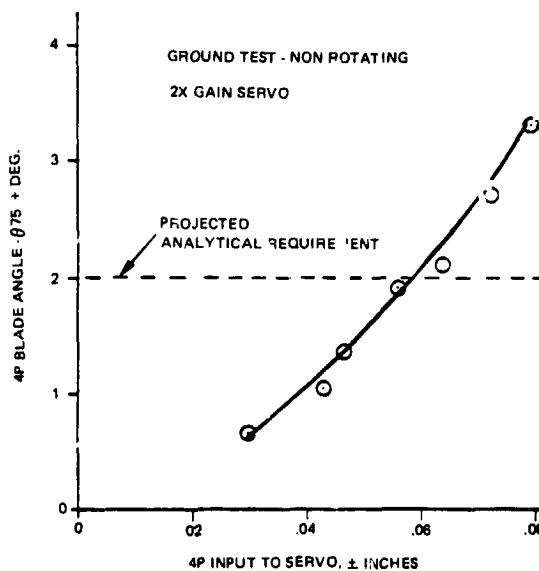

Figure 15. S-76 HHC Risk Reduction Test Results

Mechanical Design - Prototype

To perform this rotor turning ground test, inputs at 20 Hz would have to be made to the S-76 control system at an appropriate location. As shown in Figure 11 the HHC driver actuators are placed to excite the input side of the three main rotor servos. The HHC design is prototype in nature so that off the shelf driver actuators can be used. These are shown in Figure 12. Their stroke requirements are of the order of ±0.090" maximum at 20 Hz, and they are nominally limited in authority to ten percent of the main rotor servo stroke, which can be built-up incrementally to that value.

The placement of these driver actuators in the system as close as possible to the input of the main servo is to assure

ORIGINAL PAGE IS
OF POOR QUALITY

that the high frequency vibratory inputs feed toward the rotor and not toward the pilot (the ratio of impedance is estimated to be 80 to 1). Since the S-76 has no pilot boost, the mechanical design relies on this principle. Figure 16 is a drawing of the prototype mechanical installation for the S-76. The design basically replaces the last control rod to each main rotor servo input with a shorter control rod, an idler bracket, and the driver actuator. This mechanical design is critical since it had to be completed in order to perform the next risk reduction test which is the crucial rotating rotor ground test to assure that there is no adverse rotor impedance, no hydraulic flow anomalies, and no problems of fit and function. Figure 17 shows the HHC mechanical parts.

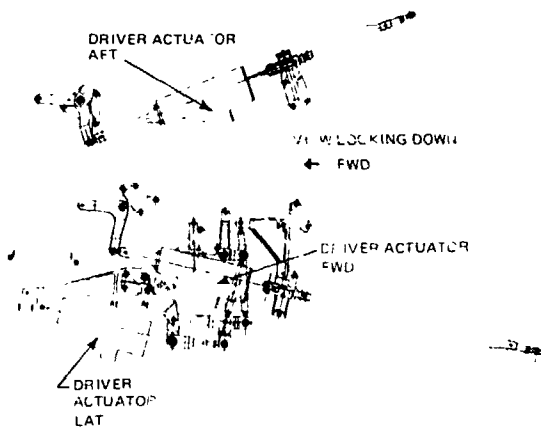

Figure 16. S-76 HHC Installation Drawing



Figure 17. S-76 Modified Mechanical Parts for HHC

Hydraulic Design - Prototype

In the S-76, hydraulic power is developed by the first and second stage hydraulic systems. These two hydraulically independent systems provide the power boost necessary to operate the flight controls. In addition, the second stage provides a utility system for operation of the landing gear and nose vibration absorber. The non-rotating test results in Figure 15 showed that flow requirements may be reduced by dynamic amplification within the pitch control system with the increased gain main rotor servo. With a maximum flow rate of 4 gpm for the S-76 and no dynamic amplification, vibratory amplitudes of ± 0.030 " are projected and this translates into about 1° of blade pitch at 4P. Since extensive modification would have been required to upgrade the hydraulic system in this "proof of concept HHC test" and because the non-rotating rotor ground test did show amplification through the system, it was decided to proceed to the next step in the risk reduction plan, i.e., a rotating rotor ground test with the existing S-76 hydraulics in order to get design information. The net weight increase due to the mechanical and hydraulic parts is approximately 35 lbs which is 2.35% of the design gross weight of the S-76. The total weight increase due to HHC is given in the subsection on open loop control in this paper.

Electronic Design - Prototype

The primary requirement of an HHC system is to improve ride quality by reducing vibration while maintaining acceptable loads during steady flight and maneuver conditions within the flight envelope. The HHC system is not flight critical and in case of failure, the system will be shut off.

The primary generic elements of a closed loop HHC system (Figure 18) can be identified as follows:

- i) Sensors. These could be accelerometers for monitoring and reducing vibrations and strain gages for monitoring and optimizing blade, control, and hub loads.
- ii) A flightworthy microcomputer programmed with stable mathematical algorithms that provides optimal control inputs to reduce vibrations and loads based upon the state of the helicopter. This system must also be capable of performing adaptive computations, providing NP feathering signals in response to changes in the flight conditions, and limited self testing.

iii) An electronic control unit (ECU) may also be required, depending upon the HHC system design. The ECU may interface with other elements of the HHC system and perform functions such as extracting NP components from the accelerometer signals (Reference 1).

Note that the ECU may not be required in some designs if its functions are performed by other devices. An alternative design of the controller may contain all hardware necessary to communicate with the sensors and actuators as well as the self-adaptive control algorithms, self test, and failure mode protection functions. However, for purposes of understanding it may be better to identify an ECU and its functions. One important design issue is that it may be better to unload the computer to let it do pure processing. Functions such as signal generation and signal conditioning are best performed by an ECU.

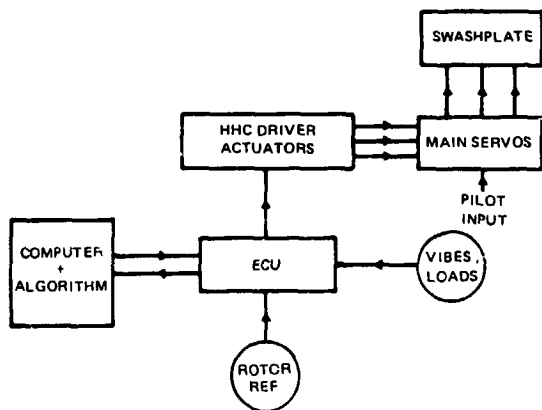

Figure 18. HHC Concept Diagram

Open Loop Control

Item 6 of Table 2 shows that open loop testing will follow the successful rotating ground test. This testing will allow an organized look at the effect of HHC amplitude and phase at several flight conditions to define the sensitivities of vibration, loads, performance, and acoustic changes. To this end a control and measuring system to define HHC inputs/outputs has been designed and fabricated and is shown in Figure 12. The net weight increase due to open loop electronic hardware is 40 lbs which is 0.40% of the S-76 design gross weight. This means that the total weight of the open loop HHC system is 75 lbs which is 0.75% of the design gross weight of the S-76 and is within the 1% target weight.

Production Issues

The present hydraulic and mechanical controls on the S-76 are designed and manufactured to MIL standards and FAA specifications. Any additional items due to HHC would be designed to the same standards with updated design loads derived from the prototype flight testing. Table 3 presents a list of the issues identified in past HHC designs and tests. Mechanical systems of future helicopters may be simplified by the use of FBW so that the potential of adverse vibratory effects in the control linkages may be minimized. The NP excitation to the blade pitch control system may be performed by one actuator with special provisions to preclude seal wear and leakage.

TABLE 3

HHC DESIGN ISSUES

1. Weight, Volume, and Overall Power
2. Hydraulic System Pressure and Flow Requirements
3. Modification of Existing Components
4. Actuator Placement and Frequency Response
5. Effects of Slop, Hysteresis and Control Flexibility
6. Mechanical Feedback to Pilot Stick
7. Structural Loads in Components
8. Fail Safety and Need for Redundancy
9. Available Travel in the Controls
10. Mission Effectiveness and Reliability
11. System Cost
12. Maintenance
13. Survivability
14. Development Risks

The electronic system reliability can be enhanced by embedding interface hardware and the microprocessor in a single line replaceable unit, interconnecting sensors with fiber optic links wherever possible, and incorporating self test features into the sensors.

Extensive self test capabilities will

ease maintenance of the HHC electronic system. Faults detected in flight could be allocated a specific code and could be stored in non-volatile memory for later recall by maintenance personnel via a built-in-test (BIT) code display and code advance switch. Preflight tests may be initiated by toggling a ground test switch. Detected faults will be stored and displayed in the same manner as flight BIT's. Maintenance can also be eased by breaking of electronic units into modules and bread boards.

Plans

At the time of writing this paper a major portion of the groundwork of analysis, testing and fabrication of system prototype parts, and bench testing has been accomplished. Detailed testing will be performed to address the following issues:

1. Reduction in cockpit and cabin NP vibrations for the following flight conditions:
 - steady state cruise
 - turns and maneuvers
 - low speed maneuvers
 - rotor speed changes
 - gusts
 - mission profiles for simulated LHX.
2. Effect of HHC on blade and control loads.
3. Trade off in loads/life and acceptable vibration reduction for good unintrusive ride quality for the crew and vibratory environment for weapons sensors, equipment, avionics, etc.
4. Hydraulic power, flow, fluid temperature.
5. Mechanical control function, wear, slop, and seal life.
6. Acoustics
7. Aerodynamic performance.
8. Reliability and maintainability of HHC parts and the aircraft system.
9. Electronic controller gains, time constants, update time, algorithm optimization, and potential preprogramming of the controller.

Concluding Remarks

Analytical evaluation of HHC for the S-76 aircraft (8-10,000 lb, 145 knots) indicates 1°-2° for HHC will be required.

It is expected that reasonable blade loads and control loads can be maintained by including them into the self adaptive controller algorithm.

Hardware test results to date demonstrate that the S-76 HHC system can provide the required one to two degrees input at the blades with a reasonable weight increase.

The S-76 will be ready for flight evaluation of HHC after successful risk reduction tests of the actuator and the control system. These tests are based on industry and government work and "lessons learned".

Production implementation efforts have been initiated at Sikorsky Aircraft on mechanical, hydraulic, electronic, and computer fronts to integrate HHC into designs from the beginning as mature systems. U.S. Army programs to install production HHC systems on its fleet of latest generation aircraft will make HHC successful in the long term when combined with prototype design/test programs such as those for the S-76 and OH-6A.

REFERENCES

1. Wood, E.R., Powers, R.W., Cline, J.H., and Hammond, C.E. "On Developing and Flight Testing A Higher Harmonic Control System," Presented at the 39th Annual Forum of the American Helicopter Society, St. Louis, Missouri, May 1983. Also, "HHC Program Review" by Hughes Helicopter, Inc., May 10, 1984, Mesa, Arizona.
2. Taylor, R.B., Zwicke, P.E., Gold, P. and Miao, W., "Analytical Design and Evaluation of an Active Control System for Helicopter Vibration Reduction and Gust Response Alleviation," NASA CR 152377, July 1980.
3. O'Leary, J. and Miao, W., "Design of Higher Harmonic Control for the ABC," Presented at the American Helicopter Society National Specialists' Meeting on "Rotor System Design", October 1980, Philadelphia, Pennsylvania.
4. Niebanck, C. Girvan, W., "Sikorsky S-76 Analysis, Design and Development for Successful Dynamic Characteristics" Presented at 34th Annual Forum of the American Helicopter Society, Washington, D.C., May 1973.
5. Davis, M.W. "Refinement and Evalua-

tion of Helicopter Real-Time Self-Adaptive Active Vibration Controller Algorithms," NASA CR 3821, September 1984.

6. Bielawa, R.L., "Aeroelastic Analysis for Helicopter Rotor Blades with Time-Variable, Nonlinear Structural Redundancy - Mathematical Derivation and User's Manual", NASA CR-2638, October 1976.

7. Molusis, J.A., Hammond, C.E., Cline, J.H., "A Unified Approach to the Optimal Design of Adaptive and Gain Scheduled Controllers to Achieve Minimum Helicopter Vibrations," Proceedings of the 37th Annual Forum of the American Helicopter Society, New Orleans, LA., May 1981.

8. Davis, M.W., "Documentation for a Generic Active Controller," United Technologies Research Center Report R83-95614917, November 1983.

DISCUSSION
Paper No. 23

ADAPTION OF A MODERN MEDIUM HELICOPTER (SIKORSKY S-76) TO HIGHER HARMONIC CONTROL

James J. O'Leary
Dr. Sesi B. R. Kottapalli
and
Mark Davis

Walter Gerstenberger, Consultant: Could you introduce this added control in the regular autopilot servo?

Kottapalli: It's a parallel arrangement. We did not introduce [it] in the autopilot system.

Gerstenberger: Why not put it in series?

Kottapalli: We did not want to affect the safety of the control system.

Gerstenberger: The autopilot doesn't, it's limited authority.

Kottapalli: That's right, but we did not want to tamper with anything in the primary control system. The autopilot is limited authority, but it's a very low frequency type of system, and what we're talking about here is 20 Hertz.

Gerstenberger: Okay, it's what you say, I'll have to listen to it.

Jing Yen, Bell Helicopter: I have two questions for you. Number one, I understand the higher harmonic control [is] for the 4 per rev. The magnitudes we've been talking about are 1/2 degree and 1/4 degree. Here you show 1 and 2 degrees.

Kottapalli: Yes.

Yen: So you are very confident that these would be the magnitude you would need?

Kottapalli: That's right. Actually we are talking about something like 1-1/2 degrees, and we are hoping that we could do with one degree only. We don't want to perturb the system too much. One philosophy that we have is that we need not reduce the vibration to zero level. What we want is a comfortable ride quality. So that's our outlook. We could live with some residual vibration. Let's say you go from .45 g's to .03 g's--you may not even perceive anything at .03 g's. You may be able to live with something higher than that.

Yen: Does your higher harmonic control requirement vary with the air speed? I understand that you are aiming at the high speed end.

Kottapalli: That's right; that's the primary condition we're looking for, and it does vary somewhat. In any case, all of them would be less than 2 degrees or 1-1/2 degrees.

Yen: How about the low speed transition?

Kottapalli: Low speed transition? We did not conduct any studies on that. I guess we're most interested in the cruise condition. The primary program goal was to have something that works at the cruise speed of the S-76, but I would expect that it would vary at low speeds.

Bob Wood, Hughes Helicopters: I was interested in your talk, Sesi, and of course we were following it with great interest. I just wrote down some numbers and thought you might be interested in them. When you go to doing your open loop testing, of course, HHC can make the ship rougher as well as smoother.

Kottapalli: Yes, we are aware of that.

Wood: I scaled up with our OH-6--we were .7 g's with a third of a degree, so if you went to 3 degrees we would have been at 6.3 g's. If you allow for the fact that you're four times our gross weight you will be at 1.7 g's, so just be careful with that amplitude when you are flying open loop.

Kottapalli: Yes. You are absolutely right. What we intend to do is conduct a phase sweep, let's say, with the lateral tilt of the swash plate and go from zero to 360 degrees. Most likely, for some values of the phase, we are going to increase the vibration. We are looking for the other values of the phase where we reduce the vibration. Yes, that is a very important point and we have had to tell our flight test people about that so that they don't get nervous.