

1985 Goddard Space Flight Centre
Battery Workshop

Goddard Spaceflight Centre
Greenbelt, Maryland
Nov. 19-21, 1985

TITLE: Investigation of Nickel Hydrogen Battery Technology for
the RADARSAT Spacecraft

D.A. McCoy
RADARSAT Spacecraft Engineer
Communications Research Centre
Dept. of Communications

J.L. Lackner
Energy Conversion
Systems Electrochemist
Defence Research
Establishment Ottawa
Dept. of National Defence

The Low Earth Orbit (LEO) operations of the RADARSAT spacecraft require high performance batteries to provide energy to the payload and platform during eclipse periods. Nickel Hydrogen cells are currently competing with the more traditional Nickel Cadmium cells for high performance spacecraft applications at GEO (Geostationary Earth Orbit) and LEO. Nickel Hydrogen cells appear better suited for high power applications where high currents and high Depths of Discharge are required. Although a number of GEO missions have flown with Nickel Hydrogen batteries it is not readily apparent that the LEO version of the Nickel Hydrogen cell is able to withstand the extended cycle lifetime (5 years) of the RADARSAT mission. The problems associated with Nickel Hydrogen cells are discussed in the context of the RADARSAT mission and a test program designed to characterize cell performance is presented.

Investigation of Nickel Hydrogen Battery Technology for the RADARSAT Spacecraft

The RADARSAT spacecraft is presently in the design definition phase of development for an expected launch in 1991 by the NASA Space Transportation System. The RADARSAT system will provide navigational information for marine operations in the Canadian Arctic, Atlantic and Pacific coastal regions as well as data on renewable and non-renewable resources over the Canadian land mass. The RADARSAT spacecraft will support four earth resources sensors in a sun synchronous polar orbit at an altitude of 1007 km. The sensor complement consists of a C-Band Synthetic Aperture Radar, a microwave Scatterometer and two optical imaging instruments. The on orbit configuration is depicted in Figure 1. The spacecraft is designed for five years of operations with an extension of the mission life to at least 8 years by on orbit servicing to upgrade equipment and instruments.

The RADARSAT mission requires the operation of sensors in sunlight and eclipse to provide the necessary coverage of the Canadian arctic and land mass. This requirement has influenced the design of the power supply system supporting the payload by requiring approximately 2 kW-hr of stored energy during eclipse. An example of a typical power consumption profile for the RADARSAT mission is shown in Figure 2.

A rough estimate of battery mass needed to supply this energy may be calculated by applying average power densities for battery systems as reported in the literature. Based on values of 40 W-Hr/kgm a Nickel Hydrogen battery system operating at 50% depth of discharge would have a mass of 75 kgm. while a Nickel Cadmium system would have a mass of 120 kgm. to supply the eclipse power requirement for RADARSAT. In the limited viewpoint of mass, Nickel Hydrogen batteries appear to be the best candidate for supplying the RADARSAT eclipse energy requirements. However, there are other factors of concern in comparing Nickel Hydrogen batteries to Nickel Cadmium batteries for the RADARSAT spacecraft. In particular, RADARSAT will have a design life of 5 years and will require a cycle lifetime of about 25,000 cycles. Based on data presently available it is not clear that Nickel Hydrogen cells are capable of providing the needs of RADARSAT for a 5 year mission while a data base for Nickel Cadmium cells in excess of the RADARSAT cycle life requirements does exist. Although the mass penalty associated with the use of Nickel Cadmium cells is undesirable to the RADARSAT spacecraft, the baseline design has adopted Nickel Cadmium over Nickel Hydrogen because of the issue of cycle lifetimes.

Notwithstanding the Nickel Cadmium baseline for the spacecraft a test program to evaluate Nickel Hydrogen battery technology has been initiated to develop a data base for a low earth orbit (LEO) RADARSAT type mission for future applications. The RADARSAT Nickel Hydrogen Battery Technology test program has been designed to address basic technology issues of concern to the project.

As mentioned previously, cycle lifetime is a prime concern in the use of Nickel Hydrogen cells. However, a number of other concerns are prominent and are often related to the cycle lifetime issue. The choice of separator material is an important decision that will affect the final performance of the cell as well as affecting a somewhat less observable phenomenon of electrolyte recirculation. This feature appears to be an important point in the higher current applications such as the RADARSAT mission and the test program will address the issue to some degree by comparison of cells with Asbestos separators to those with Zircar separators. Wicking has been incorporated in both types of cells to aid electrolyte recirculation. A schematic representation of the cell configuration for the RADARSAT NiH₂ test cells is given in Figure 3 along with the general shape of the separator materials used.

The operational use of Nickel Hydrogen cells for a LEO regime raises questions concerning charge strategies since the exothermic charge regime produces high power dissipations that influence the design of thermal radiators. A representative analysis of this effect is depicted in Figure 4 which is based on a RADARSAT battery thermal analysis by British Aerospace. To address this issue, tests will be performed to study this characteristic and to try to reduce the heating effect by limiting charging in the highly exothermic region. Charge control methods considered are rate of change of temperature, as well as rate of change of pressure differentials and the standard voltage and capacity C/D measurement. The RADARSAT cells are fitted with pressure transducers and other sensing elements to investigate these control methods.

Self discharge is also of concern from an operational point of view and tests will be performed to characterize the phenomenon for the RADARSAT cells.

A flowchart of the testing plan for the RADARSAT NiH₂ cells is shown in Figure 6. Two types of tests are identified in the charts, these being short term performance tests and long term life cycle tests.

The short term tests are performed in advance of cycle life tests to identify the performance characteristics of the NiH₂ cells for comparison to other designs. The issues discussed above will be addressed via these tests in addition to standard issues such as the nature of cell capacities in relation to discharge current, which are important parameters to a spacecraft such as RADARSAT where discharge currents can approach C values.

Following tests to establish baseline performance of the cells, cycling tests will be performed with an attempt at following the expected operating profile of the RADARSAT spacecraft. The test format for the eight cells is shown in Figure 7.

Four cycling tests will run simultaneously on 2 cells each. The use of 2 cells permits a premature failure of one cell without a complete loss of data since one cell will continue to cycle. Two of each type of separators will experience cycling regimes resulting in a depth of discharge of about 50% rated capacity to about 80% rated capacity. This will permit an evaluation of each separator over a range of DOD. The higher depth of discharge rate may also permit an evaluation of accelerated life cycle testing wherein cycle life is related to depth of discharge.

Summary

The RADARSAT mission will require batteries capable of operating under extended cycle lifetimes on the order of 25,000 cycles to satisfy mission requirements. At the same time the batteries must satisfy constraints with respect to mass and volume as well as the interrelationship between current, amp hour capacity and depth of discharge. At present, the state-of-the-art in battery technology suggests Nickel Hydrogen cells are not proven for LEO operations and the diversity of design and opinion in the industry attests to the need for detailed study of the technology in advance of a commitment to fly. Although a decision to baseline Nickel Cadmium cells has recently been made, the RADARSAT program recognizes the value of Nickel Hydrogen systems for future applications and is proceeding with a test program to assess the technology. Future missions may then take advantage of the benefits accruing from Nickel Hydrogen systems without the risk of limited data.

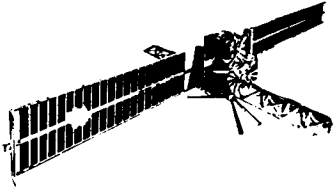

RADARSAT PROGRAM

MISSION OBJECTIVES

- **MONITOR ICE FORMATIONS IN CANADIAN COASTAL ZONES AND SHIPPING LANES, RENEWABLE LAND RESOURCES AND GEOLOGICAL EARTH FEATURES WITH C BAND SYNTHETIC APERTURE RADAR (SAR).**
- **OCEANS SEA STATE, WIND DIRECTION AND VELOCITY WITH A KU BAND SCATTEROMETER.**
- **REMOTE SENSING OF LAND MASSES FOR RENEWABLE AND NON-RENEWABLE RESOURCES, WITH OPTICAL SENSOR.**

COVERAGE FOR SAR

- **DAILY COVERAGE OF CANADIAN ARCTIC.**
- **16 DAY WORLD REPEAT CYCLE.**
- **3 DAY SUB CYCLE OVER CANADIAN LAND MASS.**

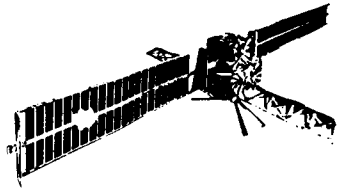

RADARSAT PROGRAM

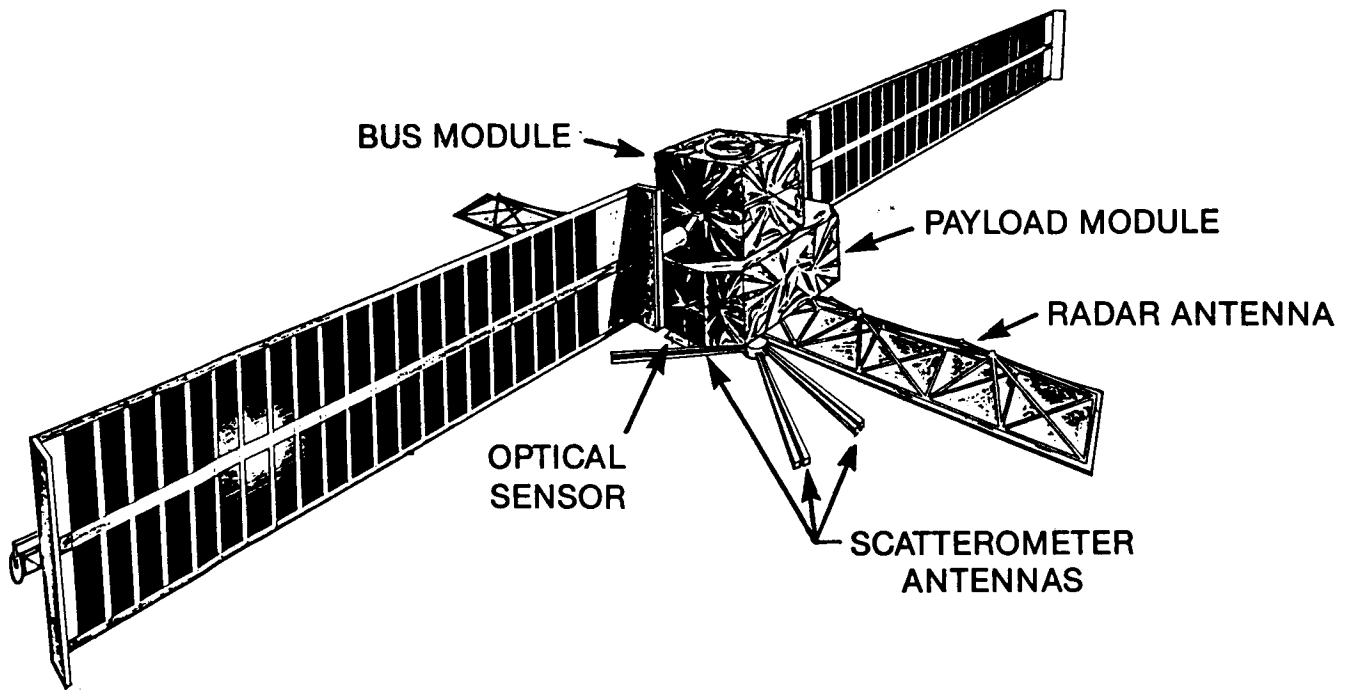

RADARSAT ON-ORBIT CONFIGURATION



RADARSAT PROGRAM

ORIGINAL PAGE IS
OF POOR QUALITY

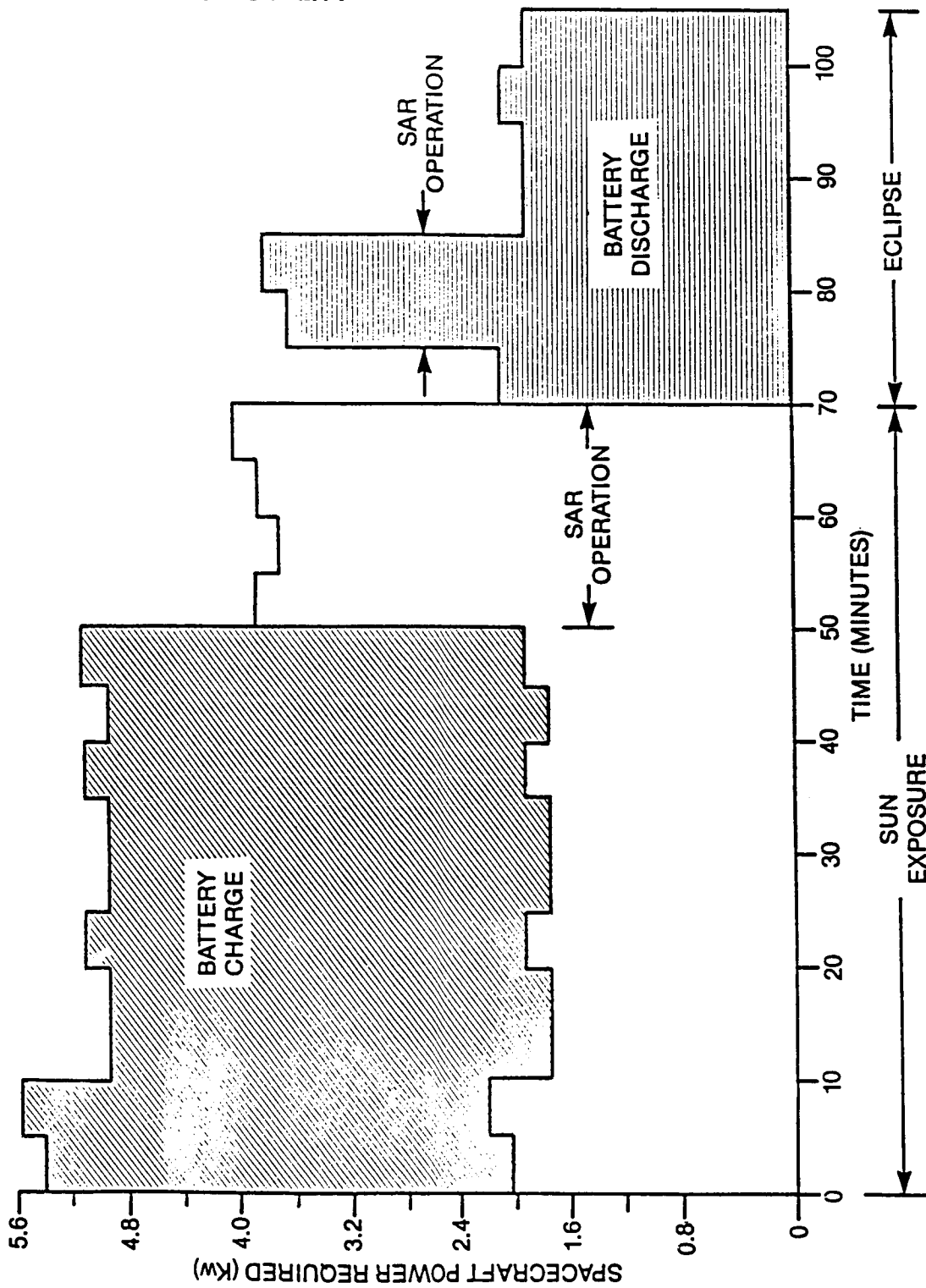

TYPICAL RADARSAT POWER TIMELINE (FOR DEMONSTRATION ONLY)

RADARSAT PROGRAM

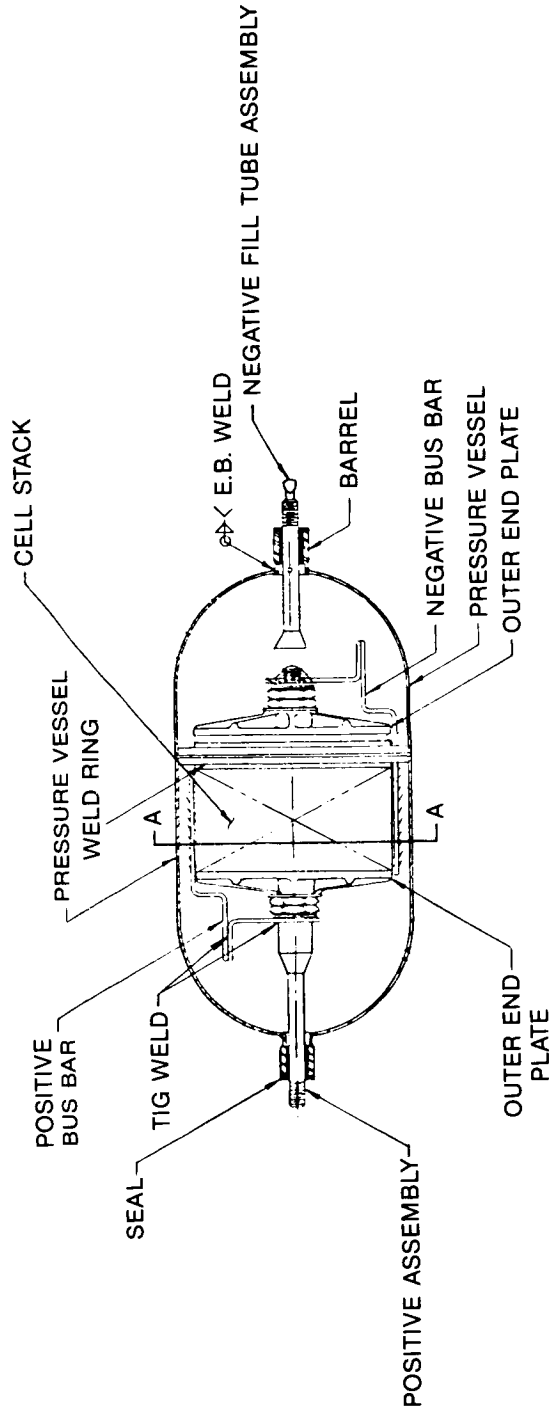

STANDARD INTELSAT CELL DESIGN

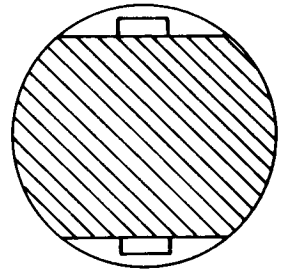

ZIRCAR SEPARATOR

SECTION VIEW

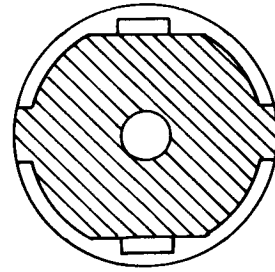

ASBESTOS SEPARATOR

RADARSAT NICKEL HYDROGEN CELL CONFIGURATIONS

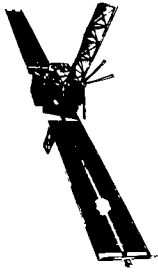

RADARSAT PROGRAM

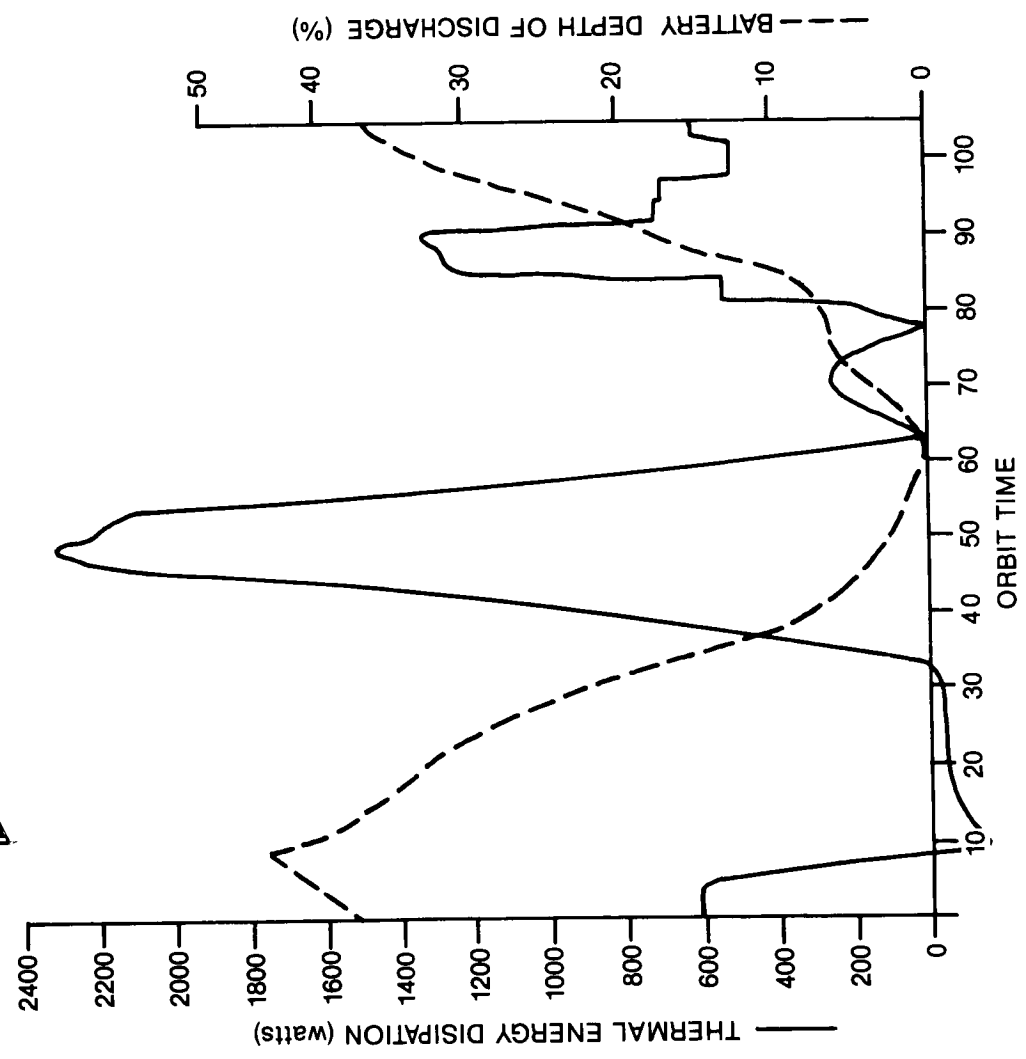

NICKEL HYDROGEN BATTERY THERMAL MODEL



RADARSAT PROGRAM

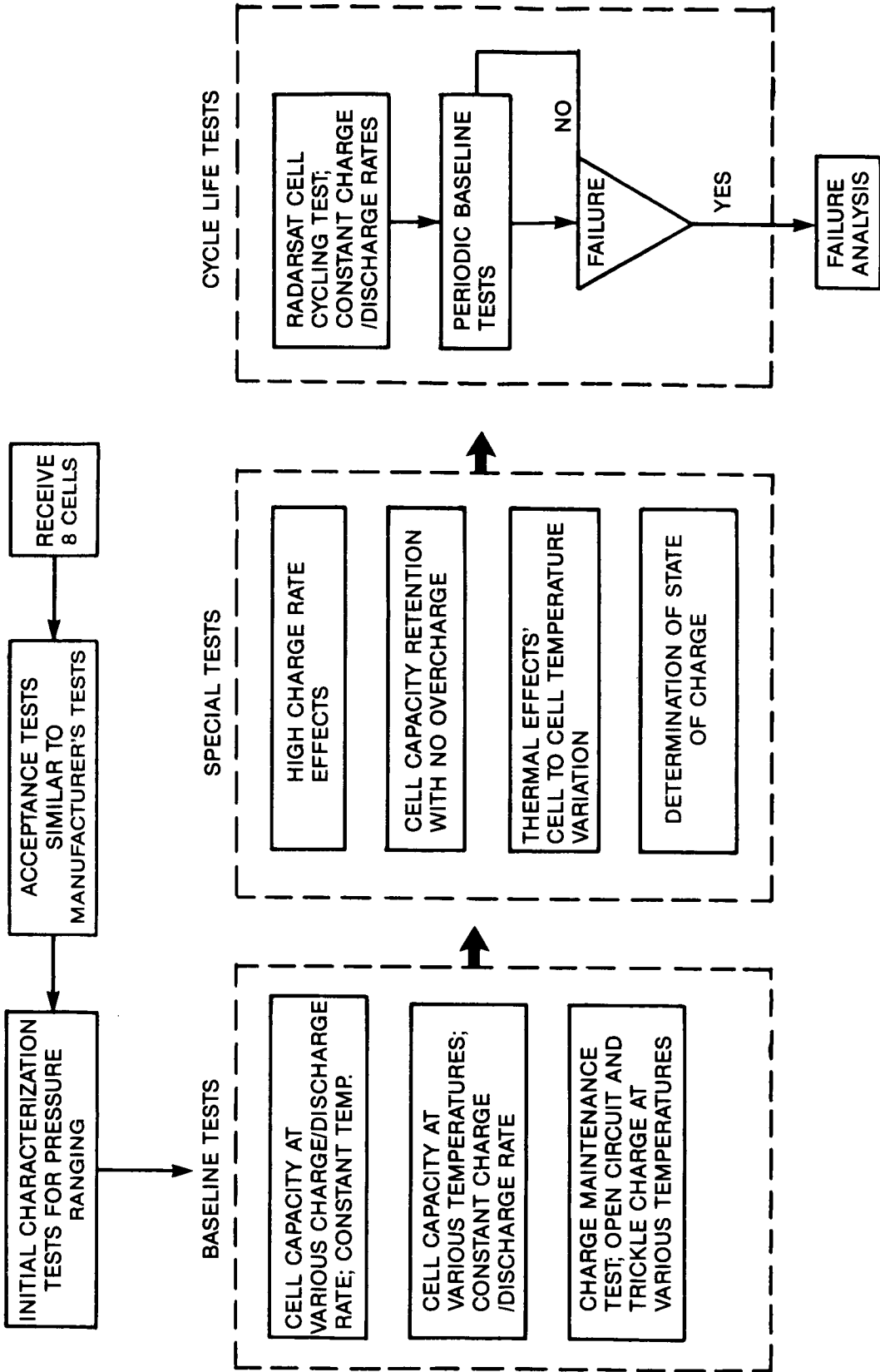

RADARSAT NICKEL HYDROGEN CELL TEST PROGRAM FLOW CHART

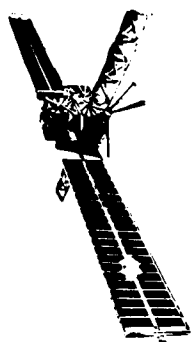

RADARSAT PROGRAM

	50% DOD	80% DOD	
50 AMP-HR CELLS WITH ASBESTOS SEPARATORS	2	2	ALL CELLS ON RADARSAT ORBIT TIMELINE
50 AMP-HR CELLS WITH ZIRCONIUM OXIDE SEPARATORS	2	2	

RADARSAT
NICKEL HYDROGEN CELL CYCLE TEST MATRIX



RADARSAT PROGRAM

SUMMARY

- THE RADARSAT SPACECRAFT IS CHALLENGING THE STATE-OF-THE-ART IN AEROSPACE BATTERY DESIGN.
- NICKEL HYDROGEN BATTERIES APPEAR TO BE THE BEST CHOICE BUT CYCLE LIFE IS UNKNOWN AT PRESENT.
- TESTS ARE UNDERWAY TO CHARACTERIZE NICKEL HYDROGEN CELLS FOR RADARSAT.
- PROBLEMS TO BE ADDRESSED BY THE RADARSAT NICKEL HYDROGEN CELL TEST PROGRAM ARE:
 - BASIC CELL CAPACITY AT VARIOUS CHARGE/DISCHARGE RATES AND VARIOUS TEMPERATURES.
 - CHARGE MAINTENANCE DURING CELL INACTIVE PERIODS.
 - STATE-OF-CHARGE MEASUREMENT METHODS AND OPERATIONS IN EN-DOTHERMIC REGIME FOR THERMAL CONTROL.
 - CYCLE LIFE OF NICKEL HYDROGEN CELLS IN SIMULATED RADARSAT OPERATIONAL SCENARIO.
 - RELATIVE PERFORMANCE OF ZIRCAR AND ASBESTOS SEPARATORS.
- GENERATE CONFIDENCE IN BATTERY DESIGN FOR RADARSAT SPACECRAFT FOR 5 YEARS OF OPERATIONS IN LOW EARTH ORBIT