

APPLICATION OF OPTIMIZATION TECHNIQUES  
TO VEHICLE DESIGN - A REVIEW

B. Prasad and C. L. Magee

Ford Motor Company  
Dearborn, Michigan

## ABSTRACT

This paper reviews the work that has been done in the last decade or so in the application of optimization techniques to vehicle design. Much of the work reviewed here deals with the design of body or suspension (chassis) components for reduced weight. Other papers dealing with system optimization problems for improved functional performance, such as ride or handling, are also reviewed. The paper is organized according to the types of application rather than constraints imposed or the objective function chosen for an optimization process.

In reviewing the work on the use of optimization techniques, one notes the transition from the rare mention of the methods in the 70's to an increased effort in the early 80's. Efficient and convenient optimization and analysis tools still need to be developed so that they can be regularly applied in the early design stage of the vehicle development cycle to be most effective. Based on the reported applications, the paper attempts to assess the potential for automotive application of optimization techniques. The major issue involved remains the creation of quantifiable means of analysis to be used in vehicle design. The conventional process of vehicle design still contains much experience-based input because it has not yet proven possible to quantify all important constraints. This restraint on the part of the analysis will continue to be a major limiting factor in application of optimization to vehicle design.

### 1. INTRODUCTION

In the past several years, significant mass reductions in the automotive fleet have resulted from downsizing, better design of structural components, improved configuration, and use of alternate materials. The role of optimization techniques in aiding in one or more of the above tasks and during proper estimation or selection of optimum parameters in vehicles can be seen to be slowly increasing. This is reflected in the number of papers now being published or submitted for publication in the SAE or other automotive journals.

The use of the computer as a possible design tool was well understood as early as 1965 by Dunseth (ref. 1) as a means of reducing problem-solving time. At that time, the use of optimization techniques was at its very infancy. Only a very few application papers employing this technique existed. The first few such potential applications in the automotive field were in the design of suspension and vibration isolators. Bender (refs. 2 and 3) was one of the first who proposed the use of the techniques for vehicle suspension design, and Wolkovitch (ref. 4) did the same for optimization of the mechanical system response under shock and vibration environments. However, it took several years for the optimization technique to make any significant debut in the structural areas relating to automotive design (refs. 5 and 6). During the early 1970's applications began to increase as the techniques were applied to a number of automotive structural components. Some of the suspension components were again the first to be studied due to previous familiarity with them (refs. 7 and 8). Significant growth in the use of the techniques for structures has only been found in the late 1970's and the early 1980's when quite a few general purpose finite element analysis and design programs were made publicly available. References 9 to 23 outline some of the design-oriented computer programs currently in use for structural design optimization.

Although the topic of optimization is still new to many workers in the automotive field, there are also expert users among the vehicle analysts and designers. In the last few years, a number of good general review papers have surfaced but none dealing specifically with automotive design. Past reviews on optimization have concentrated on such aspects as optimization techniques (refs. 24 to 28), constraints (refs. 25 to 32), elements used such as plates or beams (ref. 31) or design approaches (refs. 4, 26, 27, and 32). Most of the applications referred to either were standard benchmark problems (such as transmission towers) or were characteristic mainly of aerospace structures.

## 2. REVIEW OF CURRENT AUTOMOTIVE APPLICATIONS

In this section, various vehicle applications of optimization technology that are reported in the literature are reviewed. The topics are covered in five separate subheadings, namely, "Primary Structures," "Chassis and Suspension," "Engine and Powertrain," "Body Panels and Mechanisms," and "Vehicle Systems." The last topic covers those areas which deal with the vehicle as a whole or in which more than one vehicle subsystem is involved. The primary structures, which include most of the thin walled beams, the body joints, and some panels and bars, form the "skeleton" of the vehicle body structure and function as the main load-carrying structures to satisfy the "global load" requirements. The structural components included in this subset are the upper and lower front rails, all pillars, rockers, the roof rails and header, the floor tunnel, etc. (see fig. 1). The other subsystems such as "Chassis and Suspensions" or "Body Panels" and the corresponding reinforcements do not contribute significantly to meeting global load requirements. The design criteria for the body panels are generally governed by local or regional structural requirements such as strength, oil canning, denting, etc.

Fig. 2 shows a breakup for mass distribution of a typical vehicle curb weight (VCW = 2020 lb) in terms of the chosen subsystems. The total mass of the primary structures is about 400 lb (20% of VCW). The miscellaneous items such as fuel, battery, seats, etc. make up the total curb weight.

### 2.1 Primary Structures

The primary structure or skeleton frame is that portion of the body which is composed of beam-like members carrying the major loads. Most of the work on PS deals with the car body as a whole and has attempted to retain its significant (basic) characteristics (refs. 5, 6, and 33 to 35). Some have oversimplified the design problem by not considering the component's interactions or not including all the important design criteria such as frequencies, stresses, displacements, and buckling or side constraints which result from packaging or manufacturing. A few have estimated the total mass reduction potential for alternate materials based on the "equal stiffness" substitution rule (refs. 36 and 37). The latter approach ignores the fact that critical design criteria may change as new materials are introduced and that the interaction of components may alter the expected mass reduction.

Others who have attempted a more advanced approach have either considered multiple design criteria including stiffness, strength and frequency or have included several important service loads (refs. 5, 33, and 35). The scope of model fidelity and design variables in these studies was, however, limited. In particular, simplified beam models (see fig. 3) have been used which only approximately describe the complex real vehicle structures. In addition, in all the studies reported in references 34 and 38 only the beam gauges were varied; the heights, widths and section shapes of the beams were fixed. The sectional dimensions were relaxed in reference 5, but the locations of the joints and their stiffnesses were fixed. In reference 35, a more detailed beam and plate model (see fig. 3) was used for better stiffness and mass distributions, but only the gauges of beams and plate elements were employed as design variables. The local design constraints for the panels (plates) such as buckling, denting, etc. were ignored. This resulted in a design in which most of the panels were driven to minimum gage; the gauges of the beams remained the potent sizing variables.

## 2.2 Body Panels and Mechanisms

Double-layered panels are used in many car components, such as the deck lid, hood, floor pan, fender, and quarter panel. Finite element simulation for their analysis is not difficult since most of the outer panels can be idealized by an area element (a plate or shell element), and the inner panels can be idealized by line elements. However, the use of optimization for panel design is still very rare (refs. 39 to 48). Initial optimization attempts either did not consider all the important design constraints or simplified the problems. For example, reference 39 only considered the weight reduction potential by material substitution or design changes based on "equal" structural characteristics. Reference 40 used CONMIN for optimization but limited the constraints to overall bending and torsion and design variables to three parameters ( $t_0$ ,  $t_1$ , and  $b$ ). (See fig. 4(a).)

Another study (ref. 41) of alternate materials considered eight design variables (see fig. 4) and three stiffness criteria (including edge bending) (see fig. 5). A more complete set of design variables (13 to 16) based on inner reinforcements independence was considered in reference 44. (See fig. 6.) A more practical set of constraints (dent resistance, stiffness, buckling and springback) were considered in references 43 and 46; however, the equations used were mostly empirical and were difficult to extrapolate. Another alternate material study similar to that of reference 39 was reported in reference 47 for metal-to-composite substitution. Besides the dimensions of the inner and outer panels, the locations of the inner panels were chosen as design variables (ref. 48). (See fig. 7.) In reference 45 the shape parameters of sheet metal structures were considered for design against crush.

## 2.3 Chassis and Suspension

The design of a vehicle's suspension is generally a compromise among competing design requirements aimed at satisfying comfortable passenger ride and good vehicle road handling performance. Numerous optimization studies have been conducted on suspension design (refs. 3, 7, and 49 to 64), shock and vibration isolation (refs. 4 and 65 to 73), impact absorption (refs. 72 and 74), and wheels (refs. 75 and 76). In most studies, the main concern was that of selecting quantifiable measures of vibration which directly affect ride or handling performance. Examples of these measures of vibration include rms values of displacement, acceleration, rate of

change of acceleration (jerk), and absorbed power. Other measures, such as movement within the rattle space (without contacting bump stops (ref. 62)), low dynamic load between tire and road surface for good directional control and limitations on the allowable rolling angle (ref. 53), and tire life, have also been of some concern. In the time domain analysis (or experiment) the rms values, for example, can be obtained by

$$\text{rms (a)} = \left[ \int_0^t a^p (t) dt \right]^{1/p}$$

where "a" stands for any of the vibration parameters: displacement, velocity, acceleration or jerk. Several such criteria have been used (refs. 60 to 63, 72, 73, and 76) but the simulation models were often simplified for estimating "a" or like parameters.

Most investigators have considered the suspension design problem as an idealized lumped spring-mass and damper system (see figs. 8 and 9 for two such idealizations) and used multi-criterion optimization, nonlinear programming formulation or an optimal control theory, often with feedback capabilities. Bender (refs. 2 and 3) and several others used a weighted sum of the quantities describing ride comfort and subsequently minimized this single quantity. A few employed an approach where these performance criteria were treated as independent functionals of a multi-objective system (refs. 49 to 51). Optimal control theory was used in the synthesis of an active suspension by Bender and others (refs. 3, 8, 53, 55 to 57, 60, and 64) and for vehicle suspension models by Haug and others (refs. 61 and 71). Two recent publications are discussed here. Thompson (ref. 63) used a frequency locus method to develop formulas for the optimum spring and damper rates in conventional car suspensions. The analysis is based on a linear four-degree-of-freedom model shown in fig. 8. The front and rear spring and damper rates (with a constraint on overall static stiffness) are obtained using the conjugate direction method to minimize the weighted sum of the mean-squared tire forces on random roads.

Haug (ref. 61) used an adjoint variable method to minimize the driver-absorbed power on a nominal road, subject to bounds on absorbed power on a rough road, driver peak acceleration over a discrete obstacle, suspension jounce and rebound travel, wheel hop, and limits on design parameters. The analysis is based on a linear five-degree-of-freedom model shown in fig. 9. Spring stiffness and damping coefficients were chosen as design variables and optimal control theory was employed for numerical optimization. There are also some structural optimization studies on chassis components, as opposed to the suspension system optimization discussed above (refs. 75 and 76). Automobile wheels (refs. 75 and 76) and a rear suspension torque arms (ref. 77) are some of the new applications wherein the importance of shape optimization is explored for potential weight savings.

## 2.4 Engine and Powertrain

On the engine and powertrain side, the use of optimization started somewhat late (1975). Engine control optimization, fuel economy and emissions received the initial attention (refs. 78 to 84). Applications now exist in quite a few areas of engine control and components design. A number of papers have considered determining the necessary engine mount parameters (mount locations, rates and mount rate ratios) required to achieve a number of performance objectives (refs. 85 to 87). Reference 85 considered the ride improvement and reference 86 considered the limits

on vertical, pitch and fore/aft mode frequencies plus the decoupling of the modes of vibration as their performance objectives for engine mounts. Other engine applications include design for low noise (ref. 88), unbalances (ref. 89) and engine controls (ref. 90). The use of finite element analysis in component optimization is considered in reference 91 for gasoline engines, in reference 92 for diesel engines and in reference 93 for IC engine pistons. In reference 94 a continuously variable transmission was designed to control emission for a given fuel, whereas in reference 95 the emission efficiency and power of five automotive fuels were compared in one engine with standard transmission. Engine applications for fuel economy performance and emission optimization can be envisioned as useful but none have been reported in the literature.

## 2.5 Vehicle Systems

In this section we consider cases where the entire car is simulated using some sort of mathematical model for use in optimization. In reference 96 a computer simulation program, PROMETHEUS, developed by the National Highway Traffic Safety Administration (NHTSA), was used. A pedestrian hazard index, which is estimated as a function of forces and accelerations to which the pedestrian is exposed (called EPIC), is minimized. The design variables were selected from the hood/grille/bumper assembly, which was characterized using a skewed hyper ellipse

$$\left( \frac{x + y \tan\theta}{HL} \right)^N + \left( \frac{y}{HH \cos\theta} \right)^N = 1$$

where HL, HH,  $\theta$ , and N were chosen as design variables.

In reference 97, some important design constraints dictated by specifications were used; namely, the steering column displacement during crash was not to exceed five inches (ref. 98) and the occupant injury index was kept below the specified value (ref. 99). The weighted residual of the unsatisfied constraints was minimized by varying sheet metal thicknesses and geometry. Occupant injury, or the vehicle crash severity index (VCSI), was simulated as a simple function of the passenger compartment deceleration. In reference 100, vehicles were regarded as rigid bodies and model equations of impact were derived from impulse/momentum balances, equivalent coefficient of friction, and moment of restitution. The least-squares-fit approach (ref. 100) was employed to fit experimentally determined velocity components to the analytically derived equations of the vehicle collision model.

In reference 101, a methodology for optimizing design parameters for vehicle safety is described. The methodology, which is based upon a limiting performance design philosophy, characterizes changes in the structure and the restraint system of an image vehicle which lead to progressive improvements in vehicle crashworthiness.

Reference 102 proposes a preliminary design of front and rear body structures by analytical and experimental evaluation of the impact strength and crash energy capacity, followed by resizing of related members. Though the analysis may be reasonable and the result may appear mathematically accurate, often the "design criteria" used for the components in most of the studies (refs. 96, 97, and 100 to 102) fall short of practicality. References 103 and 104 are some of the earlier (1970) uses of optimization to the design of front end and restraint systems, respectively.

## 2.6 Other Components

In recent years, there has been noticeable interest in developing capability or methods to attack new or more difficult problems in automotive design, especially those relating to structural areas. References 77 and 105 to 108 outline some typical but diverse developments. They include shape optimization (ref. 77), general capability to obtain design sensitivity for any calculable response function (ref. 105), procedures to optimize solid components (ref. 106) and the capability to address multi-objective systems (those in which more than one design objective may be present at one time) (ref. 107). Naturally, only a few typical examples of automotive components, namely, rear suspension torque arm (ref. 77), composite wheel (ref. 105), engine bearing cap (ref. 106) and connecting rod (ref. 107), are included with each.

## 3. COMPLEXITY IN THE VEHICLE DESIGN PROCESS

The automotive design process is complex since it involves a number of constraints and design criteria which need to be considered for the design trade-off to be meaningful. The constraints on vehicle design are many and some have not received a quantitative underpinning (ref. 102). Cost is one of these and it is an important attribute because it often involves elements such as alternate materials fabrication, manufacturability (forming, welding, machining, casting), and assembly procedures, none of which is easily quantifiable but may lead to significant changes in the way the automobiles are currently built. In a second category, several important vehicle attributes such as ride, noise, handling, vibration, etc., can be included which do carry some analysis basis along with a vast experimental data base. Nonetheless, most of these attributes have subjective elements (human response is essential) and thus their design criteria are often questionable and also appear difficult to extrapolate. A third class of vehicle attributes---appearance, style and interior arrangement, etc.---contain irreducible subjective elements, which can only be quantified if accurate mathematical models for human behavior are developed. This is a long-term proposal at best. In addition, some areas relating to system behavior, such as occupant simulation in frontal and side impact, have not yielded to reliable analysis. In these areas optimization will remain underutilized.

On the structural side, however, there exist quite a few areas which have yielded to sound and reasonable analytical bases (either numerical or closed form). For such applications the design problem becomes a straightforward direct linking process with an optimization counterpart. Many problems (such as static and dynamic analysis for strength, stiffness, frequency and compliance) can easily be handled through this process since they can be modeled using finite elements, for which optimization linking may have been "generically" established. There are several FEM-based programs which have established design optimization capability on a general basis (refs. 11 to 13 and 18 to 20). Crashworthiness for automobiles is, however, an exception because it has not yet received an established viable and economical base for behavior characterization. The existing finite element theory of shells and plates does not prove to be economical. Some authors have used simplified system (rigid-body lumped mass) models for the simulation of a problem such as frontal crush or side impact. They have, in many instances, coupled their analysis models with the optimization programs for the purpose of obtaining their new design parameters (refs. 96 and 97). The question of validity for their so-called "optima," however, remains an issue. From the above discussion, it is

apparent that it may not be possible to come up with a reasonable set of constraints (all quantifiable) and a good set of criteria for problems such as vehicle crush which can lead to a meaningful optimal design at the end. Developments in these areas will be a key determinant in further progress in the utilization of optimization in vehicle design.

#### 4. STATUS/TREND IN OPTIMIZATION TECHNOLOGY

##### 4.1 Design Variables

Optimization studies in the automated design of structures can be classified into four groups of design variables:

- a. Size variables, which define the sizes (excluding lengths) of the structural members
- b. Geometrical variables, which are typically the spatial coordinates of the intersections of the structural members
- c. Materials variables, such as Young's modulus, density, etc.
- d. Topological variables, which define the configuration---e.g., which members are to be included in the structure and which ones are not

The overwhelming majority of the work in structural synthesis has involved only sizing types of variables, and several extensive programs have been developed to handle this general class of problem. Materials and geometrical variables have received less attention, although a number of programs which include these variables (refs. 13, 15, and 18 to 20) do exist. The difficulties with geometric variables arise due to the inherent problems associated with changing geometry and the need for looping the model generation algorithm within an optimization system. The latter difficulties also appear common or even more pronounced with topological variables but the topological variables differ with the rest of the above three in one important way.

Topological variables by nature are discrete variables and, unlike continuous variables, cannot be used with finite differencing. Therefore, one encounters mathematical barriers while attempting to use a well-developed technique or an optimization program based on a gradient technique with the rest of the variables. Some nongradient techniques may prove useful. However, the literature on topological optimization within the finite element framework is sparse, and for automotive-related problems it is almost nonexistent. Most of the topological optimization in real practice is performed using intuition and judgment, with computer analyses and engineering/graphics often acting as helpful tools.

##### 4.2 Generic Modeling

A recent technique called "generic modeling" (ref. 75) has been found to be quite useful and suitable for this type of application. It lends itself to incorporation as an integral part of an automated system, which is most critical for the efficient use of optimization and design programs. The generic modeling approach not only relieves the user of the burden of recreating the model, but also cuts down model modification time (topology, geometry, etc.) substantially.



Initially, generic modeling is slightly more expensive than the conventional graphics system approach. However, the cumulative cost of conventional modeling increases at a much faster rate as the number of modeling changes increases during the design process (fig. 10). Specific modeling cost comparisons for a wheel and vehicle body structure are provided in reference 75. For example, after the body structure model had been modified about ten times, the total cost of conventional modeling was about 100% more than the corresponding cost of generic modeling. (See fig. 10.) Although the generic modeling procedure has been applied to wheel and simple body models, the fuel potential will only be realized by applying it to the development of larger size models. Such a versatile generic modeling procedure will not be easy to develop because substantial efforts are necessary to model complex body parts with lengthy logic and procedures. Attainment of such a procedure promises a large potential payoff, not only in reduced cost and efficient structure, but also in providing a timely input to the vehicle design cycle.

#### 4.3 Computer Programs

Most of the current general purpose computer programs (GPCP) either are based on mathematical programming techniques (ref. 25) or use recursive design methods obtained from optimality criteria (ref. 24). These methods enable the designer to arrive directly at a solution that satisfies the provisions for strength, stiffness, vibration, ride, handling, harshness, noise, safety and/or serviceability (as the case may be) while making the most efficient use of materials. Much progress has been made during the past quarter century since the direct methods of mathematical programming were first applied to optimization problems of structural design (refs. 1 and 24 to 32). The effort has led to the appearance of several textbooks and useful developments (refs. 9 to 23) which provide a unified treatment of the topic. These references are not complete, merely indicative. Most programs are now equipped with schemes which may be approximate but minimize the number of calls to the required analysis system in order to reduce the overall cost of total optimization.

#### 4.4 Constraint Approximations

The constraint approximation concept is one such popular scheme which is commonly found in most present GPCP. The programs ODYSSEY (ref. 15), ACCESS (ref. 10), PROSSS (refs. 11 and 12) and PARS (refs. 18 to 22) use a Taylor series expansion, linear or reciprocal, in design variables (whenever appropriate) for the constraints. A more general power form of constraint approximation is used in EAL/PARS (ref. 22). This facilitates simulation of a number of constraints and structural types, if present. Reference 22 also includes a new method for collapsing a number of active constraints into a few representative equivalent constraints without losing the essential nature of the original problem. The major advantage of this approach is that design sensitivity vectors and constraint approximations need to be calculated for only a reduced number of equivalent constraints. For large problems, this often results in significant computational savings (ref. 21).

#### 4.5 Optimization Algorithms

Optimization algorithms in most of the efficient computer codes are often derived from first order methods, which require gradient information for the

constraints and objective function. A number of programs (ODYSSEY (ref. 15), OPUS (ref. 13), PARS (refs. 18 to 20), and PROSSS (refs. 11 and 12)) use CONMIN, which is a feasible directions algorithm (ref. 9), as an optimizer. EAL/PARS (refs. 18 to 20) has two optimizers, CONMIN and a second one based on a variable penalty method (VPM) which uses SUMT (Sequence of Unconstrained Minimization Technique) with a modified Newton method. The required information of the second derivatives in Newton's method is supplied approximately but explicitly as a function of first derivatives and their initial values (ref. 21). The method, therefore, is designed to provide a second-order convergence rate at a cost no higher than what is usually required for the first-order methods.

#### 4.6 Design Sensitivity

Design sensitivity computations are probably the most expensive ventures of any optimization technique. Most GPCP, therefore, tend to include this capability in one form or the other. The efficiency, of course, depends upon their mode of linking and the sensitivity technique used (ref. 105). It is now widely believed that the cost of gradient computations through analytical means is the most economical, though the procedure differs with the number of active constraints and design variable ratios. (See ref. 105.) Finite differencing is considered to be the most expensive method for calculating sensitivity.

### 5. POTENTIAL FUTURE AND PROSPECTS

From the foregoing discussion, it is indicative that progress in optimization and sensitivity capability (especially in structural areas) has improved significantly. With the ability to handle any design variable, as specified by "generic modelling" (ref. 75) and increased efficiency (ref. 21), the cost of optimization is becoming a "less serious" barrier to application. Adequate "quantification" of the associated constraints and "clear-cut" definition of the design criteria remain major stumbling blocks for the widespread use of optimization. Until it is possible to quantify (at least crudely) most of the important constraints that we encounter today in automotive design, the prospects for optimization as an integral part of the design process appear uncertain and may remain so for the foreseeable future.

Design sensitivity will perhaps remain a major mode of design iteration, with "analysts" serving as a major input source to decision making (refs. 105 and 108). This is because most of the important constraints are experience based (often subjective), and adequate quantification has not been well enough established to seek automation. An important near-term outgrowth of recent developments in optimization technology is that this process (i.e., sensitivity calculation) can now be accomplished much more efficiently. Thus, the input of analysis to design is becoming more timely and valuable. The capability to apply optimization to various systems will grow at a steady pace and the CAD/CAM interfaces to design will become more popular and automated. The availability of more efficient optimization systems and programs will grow commercially. In addition, with the exploding computer technology and cost of hardware declining, the computational cost for design and optimization will continue to be a less severe barrier to medium or moderately large size applications. Thus, we might expect more utilization of optimization with graphics and "man-in-the-loop" modes of operation.

Design with topological variables (such as configuration or appearance) will continue to be done on a "one-at-a-time" basis. A topology is first selected based on the understanding of the design requirements and packaging, and its shape, geometry or sectional parameters are then optimized. This may not be as efficient as one would find in a "simultaneous" design mode, but the process is likely to stay at least until the stage arrives when, through advances in the field of artificial intelligence, the designer will be able to put his thoughts into a computer language.

## 6. CONCLUSIONS

It has not proved possible to quantify all the important constraints, such as ride, NVH (noise, vibration, and harshness), and manufacturability, that need to be considered in the design of automotive vehicles for overall system goals. This limitation on the part of the analytical basis will apparently continue to set the pace for the use of optimization.

On the structural side, the trend in the use of advanced techniques in vehicle design is away from methods tailored to specific components and shapes and toward methods that can handle material and shape changes in design for a number of components. For modeling, this trend manifests itself with the use of generic modeling or similar methods which reduce the time requirement or eliminate user interfaces. For the analysis part, the trend is toward the use of finite element or similar discretization techniques. For the design part, the trend is away from costly trial and error modes of approach and more toward the use of design sensitivity and/or general numerical optimization algorithms.

## REFERENCES

1. Dunseth, J. H., "The Use of a Computer as a Design Tool," SAE Paper 65-986A, Int. Automotive Engineering Congress, Detroit, Jan. 1965.
2. Bender, E. K., Karnopp, D. C., and Paul, I. L., "On the Optimization of Vehicle Suspensions Using Random Process Theory," ASME-67-TRANS-12, Mech. Eng., Vol. 89, 1967.
3. Bender, E., "Optimum Linear Preview Control with Application to Vehicle Suspension," ASME J. Basic Engineering, Vol. 90, 1968, pp. 213-221.
4. Wolkovitch, J. "Techniques for Optimizing the Response of Mechanical Systems to Shock and Vibration," SAE Transactions, Vol. 77, 1969. (Also SAE Paper No. 680748, 1968.)
5. Bennett, J. A. and Nelson, M. F., "An Optimization Capability for Automotive Structures," SAE Paper No. 790972, 1979.
6. Hasselgren, A. and Svanberg, K., "Using Finite Element Methods and Optimization Techniques in Lightweight Car Design," presented at the International Conference on Modern Vehicle Design Analysis, England, June 22-24, 1983.
7. Thompson, A. G., "A Simple Formula for Optimum Damping in Suspensions," Automotive Engineering, 1972, Vol. 3, No. 4, Inst. of Mechanical Engineers, p. 20.

8. Hullender, D. A., "Minimum Vehicle-Guideway Clearances Based on a Contact Frequency Criterion," ASME Journal of Dynamic System, Measurement and Control, Vol. 96, 1974, pp. 213-217.
9. Vanderplaats, G. N., "CONMIN - A Fortran Program for Constrained Function Minimization," NASA TM X-62282, 1973.
10. Schmit, L. A. and Fleury, C., "An Improved Analysis Synthesis Capability Based on Dual Methods - ACCESS 3," AIAA/ASME/ASCE/AHS 20th Structures, Structural Dynamics and Materials Conference, St. Louis, Mo., April 1979, AIAA Paper No. 79-0721.
11. Sobieszczanski-Sobieski, J. and Bhat, R. B., "Adaptable Structural Synthesis Using Advanced Analysis and Optimization Coupled by a Computer Operating System," AIAA/ASME/ASCE/AHS 20th Structures, Structural Dynamics and Materials Conference, St. Louis, Mo., April 1979, pp. 20-71, AIAA Paper No. 79-0723.
12. Rogers, J. L., Sobieszczanski-Sobieski, J. and Bhat, R. B., "An Implementation of the Programming Structural Synthesis System (PROSSS)," NASA TM-83180, Dec. 1981.
13. Adelberg, M. L. and DeVries, R. I., "OPUS - A Programming System Approach to Structural Optimization," SAE Paper No. 811316, 4th Int. Conference on Vehicle Structural Mechanics, Nov. 18-20, 1981, pp. 151-160.
14. McCormick, C. W. (ed.), "MSC/NASTRAN User's Manual, MSC/NASTRAN Version 62," The MacNeal-Schwendler Corporation, Los Angeles, 1981.
15. Bennett, J. A. and Botkin, M. E., "Automated Design for Automotive Structures," ASME Paper No. 81-DET-91, presented at the Design Engineering Technical Conference, Hartford, CT, Sept. 1981.
16. Kecman, D., "Program WEST for Optimization of Rectangular and Square Section Tubes from the Safety Point of View," SAE Paper No. 811312, Proc. of 4th Int. Conference on Vehicle Structural Mechanics, 1981, pp. 99-112.
17. Osborn, J. and Thiel, L., "Optimal Design of Minimum Weight Structures," SAE Paper No. 810686, presented at the Earthmoving Industry Conference, Peoria, Illinois, April 1981.
18. Haftka, R. T. and Prasad, B., "Programs for Analysis and Resizing of Complex Structures - PARS," Computers and Structures, Vol. 10, Nos. 1-2, pp. 323-330, 1979.
19. Haftka, R. T., Prasad, B., and Tsach, U., "PARS: Programs for Analysis and Resizing of Structures - User Manual," NASA CR-159007, 1979.
20. Prasad, B. and Haftka, R. T., "Organization of PARS - A Structural Resizing System," Advances in Engineering Software Journal, Vol. 4, No. 1, 1982, pp. 9-19.
21. Prasad, B., "Approximation, Adaptation and Automation Concepts for Large-Scale Structural Optimization," Engineering Optimization, Vol. 6, 1983, pp. 129-140.

22. Prasad, B., "An Integrated System Approach to Structural Synthesis," Eighth Conference on Electronic Computations, James K. Nelson, Editor, American Society of Civil Engineers, New York, NY, Feb. 1983, pp. 155-171.
23. Whetstone, W. D., "EISI-EAL: Engineering Analysis Language," Proc. of the Second Conference on Computing in Civil Engineering, ASCE, 1980, pp. 276-285. (Also as "Reference Manual Vol. 2: Structural Analysis Primary Processors," System Level 209I, Engineering Information Systems, Inc., CA, July 1983.)
24. Khot, N. S., Venkayya, V. B. and Berke, L., "Experiences with Minimum Weight Design of Structures Using Optimality Criteria Methods," SAE Paper No. 770607, 1977.
25. Vanderplaats, G. N., "Automated Design Using Numerical Optimization," SAE Paper No. 791061, 1979.
26. Ragsdell, K. M., "Optimization as a Tool for Automotive Design," SAE Paper No. 800432, 1980.
27. Dill, J. C. and Bliss, F. W., "Computer Graphics - Assessment of State-of-the-Art, Parts I and II," SAE Paper No. 800010, 1980.
28. Kamal, M. M., "Impact of Computer Developments on Engineering Applications - Past, Present and Future," SAE Paper No. 800011, 1980.
29. Mayne, R. W., "Optimization Techniques for Shock and Vibration Isolator Development," The Shock and Vibration Digest, Vol. 8, No. 1, 1976, pp. 87-94.
30. Rao, S. S., "Structural Optimization Under Shock and Vibration Environment," Shock and Vibration Digest, Feb. 1979, Vol. 11, pp. 3-12.
31. Haftka, R. T. and Prasad, B. "Optimum Structural Design with Plate Bending Elements - A Survey," AIAA J., Vol. 19, No. 4, April 1981, pp. 517-522.
32. Barone, M. R., "Modeling and Computational Techniques in Automotive Structures," AMD Vol. 50, Computational Methods in Ground Transportation Vehicles, edited by M. M. Kamal and J. A. Wolf, 1982.
33. Haftka, R. T. and Prasad, B., "Lightweight Design of the Sides of a Typical 100 Ton High Side Gondola Car," SAE Paper No. 790973, 3rd Int. Conference on Vehicle Structural Mechanics, Oct. 1979, Troy, MI, pp. 11-18.
34. Fenyas, P. A., "Structural Optimization with Alternate Materials - Minimum Mass Design of the Primary Structure," SAE Paper No. 810228, 1981.
35. Miura, H., Lust, R. V., and Bennett, J. A., "Integrated Panel and Skeleton Automotive Structural Optimization," SAE Paper No. 811317, 4th International Conference on Vehicle Structural Mechanics, pp. 161-169, 1981.
36. Hsia, H. and Kidd, J. A., "Weight Reduction Potential of Passenger Cars and Light Trucks by Material Substitution," SAE Passenger Car Meeting, Dearborn, MI, SAE Paper No. 800803, June 1980.
37. Reid, D. and Stevenson, P., "Optimal Substitution of Lightweight Materials in Automobiles," SAE Paper No. 800828, 1980.

38. Bennett, J. A., "Minimum Weight Design of a Body-Beam Structure Made of Continuous Fiber Composites," Proceedings of XVIII FISITA Congress, Hamburg, Germany, May 1980.
39. Chang, D. C., and Justusson, J. W., "Structural Requirements in Material Substitution for Car-Weight Reduction," SAE Paper No. 760023, 1976.
40. Chang, D. C. and Barone, M. R., "Structural Optimization in Panel Design," SAE Paper No. 770610, 1977.
41. Chang, D. C., "Optimal Designs with Alternate Materials Suitable for High-Volume Production," SAE Paper No. 790975, 1979.
42. Rolf, R. L., Sharp, M. L. and Herbein, W. C., "Minimizing the Weight of Aluminum Body Panels," SAE Paper No. 790164, 1979.
43. Vadhavkar, A. V., Fecek, M. G., Shah, V. C. and Swenson, W. E., "Panel Optimization Program (POP)," SAE Paper No. 810230, 1981.
44. Prasad, B., "Some Considerations in Efficient Design of Lightweight Structures," SAE Paper No. 811315, 4th International Conference on Vehicle Structural Mechanics, Detroit, Michigan, Nov. 1981, pp. 141-149.
45. Akerstrom, T., Jernstrom, C. and Wierzbicki, T., "Shape Optimization of Sheet Metal Structures Against Crash," SAE Paper No. 811314, 1981.
46. Herbein, W. C., Wolf, N. P. and Bockhold, J. J., "Minimizing the Weight and Cost of an Aluminum Deck Lid," SAE Paper No. 810783, 1981.
47. Chang, D. C., Wu, K-M and Vella, J. R., "Potential Mass Reduction and Material Cost Penalties of Body Panels with Alternate Materials," SAE Paper No. 810229, 1981.
48. Du, H. A. and Tang, S. C., "Minimum Weight Design of a Car Trunk Deck-Lid Subject to Overall Stiffness Constraints," Journal of Mechanical Design, Vol. 104, pp. 831-836, 1982.
49. Esmailzadeh, E., "Design Synthesis of a Vehicle Suspension System Using Multi-Parameter Optimization," Vehicle System Dynamics, 7, 1972, pp. 83-96.
50. Metwalli, S. M., Afimiwala, K. A. and Mayne, R. W., "Optimum Design of Vehicle Suspension," ASME Paper No. 73-ICT-58, 1973.
51. Potter, R. A., and Willmert, K. D., "Optimum Design of a Vehicle Suspension System," ASME 73-DET-46, 1973.
52. Hedrick, J. K. "Some Optimal Control Techniques Applicable to Suspension System Design," ASME Paper No. 73-ICT-55, 1973.
53. Young, J. W., and Wormley, D. N., "Optimization of Linear Vehicle Suspensions Subjected to Simultaneous Guideway and External Force Disturbances," ASME Journal of Dynamic Systems, Measurement and Control, Series G, Vol. 95, No. 2, 1973, pp. 213-219.

54. Thompson, A. G., "Quadratic Performance Indices and Optimum Suspension Design," Proc. Inst. of Mechanical Engineers, 1973, Vol. 187, No. 9/73, pp. 129-139.
55. Thompson, A. G., "Design of Active Suspensions," Proc. Inst. of Mechanical Engineers, Vol. 185, No. 36, pp. 553-563, 1971.
56. Thompson, A. G., Davis, B. R. and Pearce, C. E. M., "Optimal Linear Active Suspension with Finite Road Preview, SAE Paper No. 800520, 1980.
57. Blazer, L. A., "Optimal Control with Partial Preview of Disturbances and Rate Penalties and its Application to Vehicle Suspension," International Journal of Control, Vol. 33, No. 2, 1981, pp. 323-345.
58. Johnson, R. N. and Fine, D. S., "Suspension Optimization for Better Vehicle Handling," Developments in Mechanics, Proc. of 17th Midwestern Mechanics Conference, Ann Arbor, Michigan, May 1981, pp. 135-136.
59. Egbert D. E. and Linlecki, A., "Computer Optimization of Trailer Suspensions," Mechanism and Machine Theory, Vol. 16, 1981, pp. 369-384.
60. Hrovat, D. and Hubbard, M., "Optimum Vehicle Suspensions: Minimizing RMS Rattlespace, Spring-Mass Acceleration, and Jerk," Trans. ASME, Journal of Dynamic Systems, Measurement and Control, Vol. 103, No. 3, 1981, pp. 228-236.
61. Haug, E. J., "Vehicle Suspension Dynamic Optimization," presented at the International Conference on Modern Vehicle Design Analysis, London, England, June 22-24, 1983.
62. Lu, X-P, Li, H-L and Papalambros, P., "A Design Procedure for Optimization of Vehicle Suspensions," paper presented at the International Conference on Modern Vehicle Suspensions," London, England, June 22-24, 1983.
63. Thompson, A. G., "Suspension Design for Optimum Road-Holding," SAE Paper No. 830663, 1983.
64. Ghoneim, H. and Metwalli, S. M., "Optimum Vehicle Suspension with a Damped Absorber," ASME Paper No. 83-DET-42, presented at the Design and Production Engineering Technical Conference, Dearborn, Mi., Sept. 11-14, 1983.
65. Karnopp, D. C., and Trikha, A. K., "Comparative Study of Optimization Techniques for Shock and Vibration Isolation," Journal of Eng. for Industry, Trans. ASME, Vol. 91, No. 4, 1969, pp. 1128-1132.
66. Van Deusen, B. D., "Truck Suspension System Optimization," SAE Paper No. 710222, 1971.
67. Sevin, E. and Pilkey, W. D., "Optimum Shock and Vibration Isolation," Monograph No. 6, The Shock and Vibration Information Center, Naval Research, U.S. Dept. of Defense, Washington, D.C., 1971.
68. Wilmert, K. D. and Fox, R. L., "Optimum Design of a Linear Multi-Degree-of-Freedom Shock Isolation System," Journal of Engineering for Industry, Vol. 94, May 1972, pp. 465-471.

69. Esmailzadeh, E., "Optimization of Pneumatic Vibration Isolation System for Vehicle Suspension," Trans. ASME, Journal of Mech. Design, 1977.
70. Hedrick, J. K., Billington, G. F. and Dreesbach, D. A., "Analysis, Design and Optimization of High Speed Vehicle Suspension Using State Variable Techniques," ASME Journal of Dynamic System, Measurement and Control, Vol. 96, 1974, pp. 193-203.
71. Hsiao, M. H., Haug, E. J. and Arora, J. S., "A State Space Method for Optimal Design of Vibration Isolators," Journal of Mechanical Design, Vol. 100, 1978.
72. Soom, A. and Lee, Ming-San, "Optimal Design of Linear and Nonlinear Vibration Absorbers for Damped Systems," Journal of Vibration, Acoustics, Stress and Reliability in Design," ASME, Vol. 105, Jan. 1983, pp. 112-119.
73. Hati, S. K. and Rao, S. S., "Cooperative Solutions in the Synthesis of Multi-Degree-of-Freedom Shock Isolation Systems," Journal of Vibration, Acoustics, Stress and Reliability in Design, ASME, Vol. 105, Jan. 1983, pp. 101-103.
74. Afimiwala, K. A. and Mayne, R. W., "Optimum Design of an Impact Absorber," Journal of Engineering for Industry, Vol. 96, Feb. 1974, pp. 124-130.
75. Kulkarni, H. T., Prasad, B. and Emerson, J. F., "Generic Modeling Procedure for Complex Component Design," SAE Paper No. 811320, 4th International Conference on Vehicle Structural Mechanics, Detroit, Michigan, 1981.
76. Riesner, M. and DeVries, R. I., "Finite Element Analysis and Structural Optimization of Vehicle Wheels," SAE Paper No. 830133, 1983.
77. Botkin, M. E., "Shape Optimization of Plate and Shell Structures," AIAA Paper No. 8100553, AIAA/ASME/ASCE, 22nd Structures, Structural Dynamics and Materials Conference, Atlanta, GA, April 1981.
78. Auiler, J. E., Zbrozek, J. D. and Blumberg, P. N., "Optimization of Automotive Engine Calibration for Better Fuel Economy - Methods and Applications," SAE Paper No. 770076, 1977.
79. Rishavy, E. A., Hamilton, S. C., Ayers, J. A. and Keane, M. A., "Engine Control Optimization for Best Fuel Economy with Emission Constraints," SAE Paper No. 77075, 1977.
80. Cassidy, J. F., "A Computerized On-Line Approach to Calculating Optimum Engine Calibrations," SAE Paper No. 770078, 1977.
81. Dohner, A. R., "Transient System Optimization of an Experimental Engine Control System Over the Federal Emissions Driving Schedule," SAE Paper No. 780286, 1978.
82. Matsumoto, K. et al., "Engine Control Optimization for Smaller Passenger Cars," SAE Paper No. 780590, 1978.
83. Prabhakar, R., Citron, S. J. and Goodson, R. E., "Optimization of Automotive Engine Fuel Economy and Emissions," ASME Publications 75 WA/Aut-19, 1975.



84. Rao, H. S., Cohen, A. I., Tennant, J. A. and VanVoorhies, K. L., "Engine Control Optimization Via Nonlinear Programming," SAE Paper No. 790177, 1979.
85. Baum, J. H., Bennett, J. A. and Crane, T. G., "Truck Ride Improvement Using Analytical and Optimization Methods," SAE Paper No. 770609, 1977.
86. Johnson, S. R. and Subhedar, J. W., "Computer Optimization of Engine Mounting Systems," SAE Paper No. 790974, 1979.
87. Bernard, J. E. and Starkey, J. M., "Engine Mount Optimization," SAE Paper No. 830257, 1983.
88. Lalor, N., "Computer Optimized Design of Engine Structures for Low Noise," SAE Paper No. 790364, 1979.
89. Nivi, H., Seth, B. B. and Field, N. L., "Optimum Phaser Tolerances for Machines with Designed Unbalance," Journal of Mechanisms, Transmissions and Automation in Design, ASME Paper No. 83-DET-36, presented at the Design and Production Engineering Technical Conference, Dearborn, Mi., Sept. 11-14, 1983.
90. Tennant, J. A., Cohen, A. I., Rao, H. S. and Powell, J. D., "Computer Aided Procedures for Optimization of Engine Controls," International Journal of Vehicle Design, Vol. 4, No. 3, 1983, pp. 258-269.
91. Fukuda, M., "Engine Component Design Through the NISSAN Structural Analysis System," SAE Paper No. 800320, 1980.
92. Lalor, N., "Finite Element Optimization Techniques of Diesel Engine Structures," SAE Paper No. 820437, 1982.
93. Rao, S. S. and Srinivasa Rao, S. S., "Optimum Design of I.C. Engine Pistons," ASME Paper No. 83-DET-31, presented at the Design and Production Engineering Conference, Dearborn, Mi., Sept. 11-14, 1983.
94. Radtke, R. R., Unnewehr, L. E. and Freedman, R. J., "Optimization of a Continuously Variable Transmission with Emission Constraints," SAE Paper No. 810107, 1981.
95. Watson, H. C. and Milkins, E. E., "Comparison and Optimization of Emission Efficiency and Power of Five Automotive Fuels in One Engine," International Journal of Vehicle Design, Vol. 3, No. 4, 1982, pp. 463-476.
96. Twigg, D. W., Tocher, J. L. and Eppinger, R. H., "Optimal Design of Automobiles for Pedestrian Protection," SAE Paper No. 770094, 1977.
97. Bennett, J. A., Lin, K. H. and Nelson, M. F., "The Application of Optimization Techniques to Problems of Automotive Crashworthiness," SAE Paper No. 770608, 1977.
98. Steering Control Rearward Displacement. Code of Federal Regulations, Title 49, Part 571, Section 204, Federal Motor Vehicle Safety Standard, Transportation Dept., 1977.

99. Occupant Crash Protection in Passenger Cars, Multipurpose Passenger Vehicles, Trucks, and Buses. Code of Federal Regulations, Title 49, Part 571, Section 208, Federal Motor Vehicle Safety Standard, Transportation Dept., 1972.
100. Brach, R., "Identification of Vehicle and Collision Impact Parameters from Crash Tests," ASME Paper No. 83-DET-13, presented at the Design and Production Engineering Technical Conference, Dearborn, Mi., Sept. 11-14, 1983.
101. White, K. P., Pilkey, W. D., Gabler, H. C. and Hollowell, T., "Optimizing Design Parameters for Highway Vehicle Safety," International Journal of Vehicle Design, Vol. 4, No. 6, 1983, pp. 618-632.
102. Augustitus, J. A., Kamal, M. M. and Howell, L. J. "Design Through Analysis of an Experimental Automobile Structure," SAE Paper No. 770597, 1978.
103. Moore, D. F., "Minimization of Occupant Injury by Optimum Front-End Design," SAE Paper No. 700416, International Automobile Safety Conference Compendium, Detroit, Michigan, May 13-15, 1970.
104. Searle, J., "Optimum Occupant Restraints," SAE Paper No. 700422, International Automobile Safety Conference Compendium, Detroit, Michigan, May 13-15, 1970.
105. Prasad, B. and Emerson, J. F., "A General Capability of Design Sensitivity for Finite Element Systems," AIAA Paper No. 82-0680-CP, pp. 175-186, AIAA/ASME/ASCE/AHS 23rd Structures, Structural Dynamics and Materials Conference, Atlanta, GA, May 1982.
106. Imam, M. H., "Minimum Weight Design of a 3-D Solid Components," Computers in Engineering, 1982, Vol. III, Edited by Hulbert, L. E., et al., ASME, New York, NY, pp. 119-126, 1982.
107. Prasad, B. and Emerson, J. F., "Optimal Structural Remodeling of Multi-Objective Systems," Computers in Engineering, 1982, Vol. III, Edited by Hulbert, L. E., et al., ASME, New York, NY, pp. 99-108, 1982. (Also in Computers and Structures, Vol. 18, No. 4, 1984, pp. 619-628.)
108. Chon, C. T. and Du, H. A., "An Alternative Approach to Design Sensitivity Analyses for Large-Scale Structures," Computers in Engineering, 1983, Vol. III, Edited by Dietrich, D. E., et al., ASME, New York, NY, pp. 233-237, 1983.

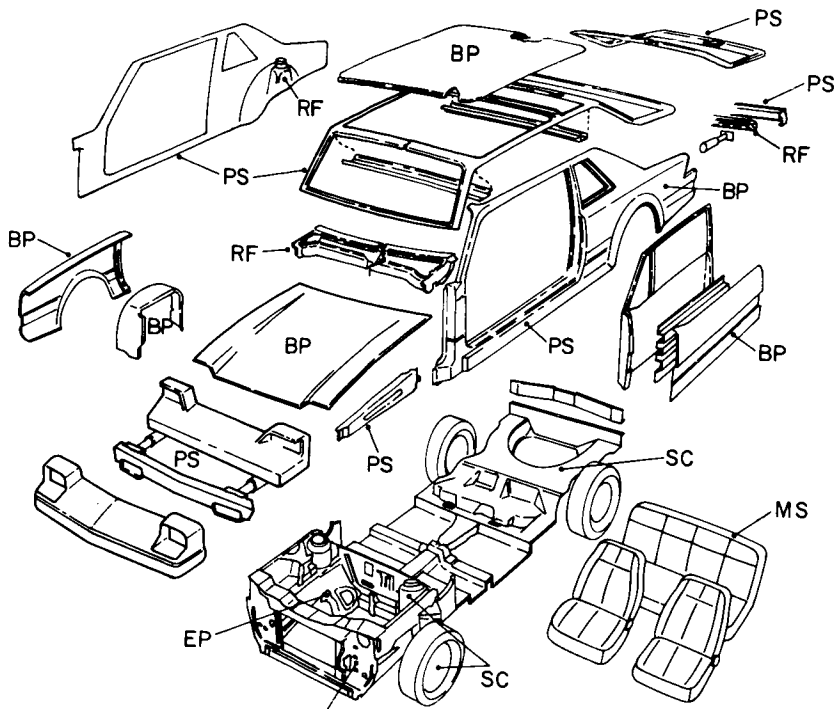

Figure 1. Division of vehicles into six subsystems: primary structures (PS), body panels (BP), engine and powertrain (EP), suspension and chassis (SC), reinforcement and fixtures (RF), and miscellaneous (fuels, seats, battery, etc.) (MS).

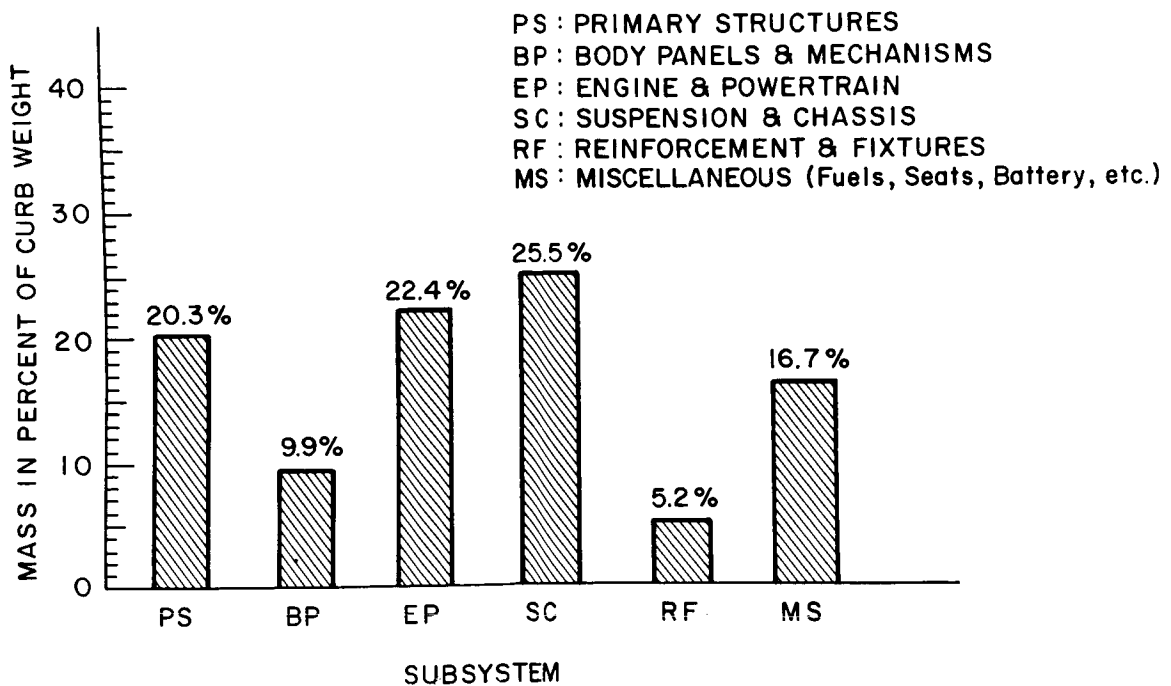
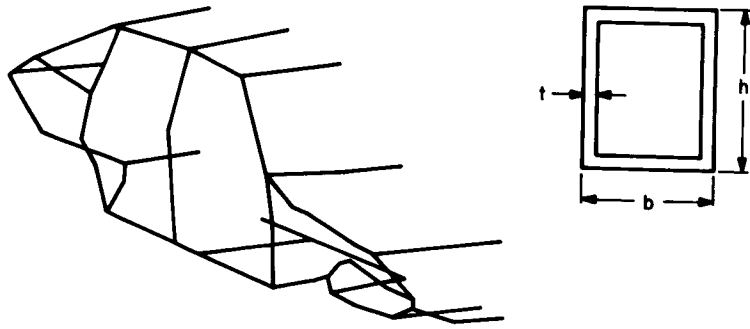
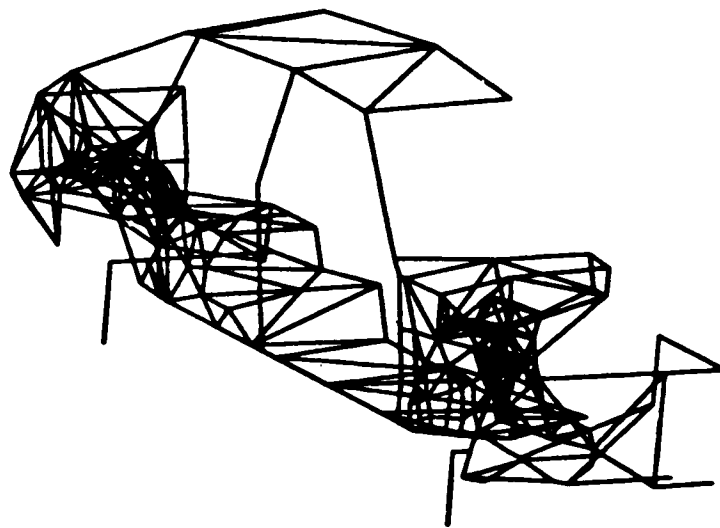

Figure 2. Mass distribution of subsystems in a typical car (curb weight = 2020 lb).



(a) Typical simplified beam model. (Adapted from refs. 5 and 15.)



(b) Typical beam/plate model. (Adapted from ref. 35.)

Figure 3. Beam models for optimization.

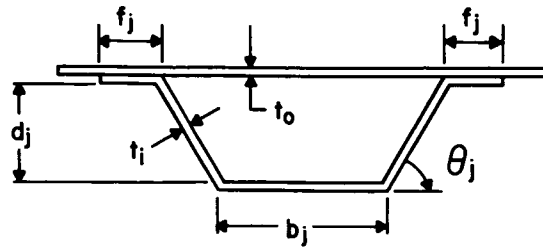
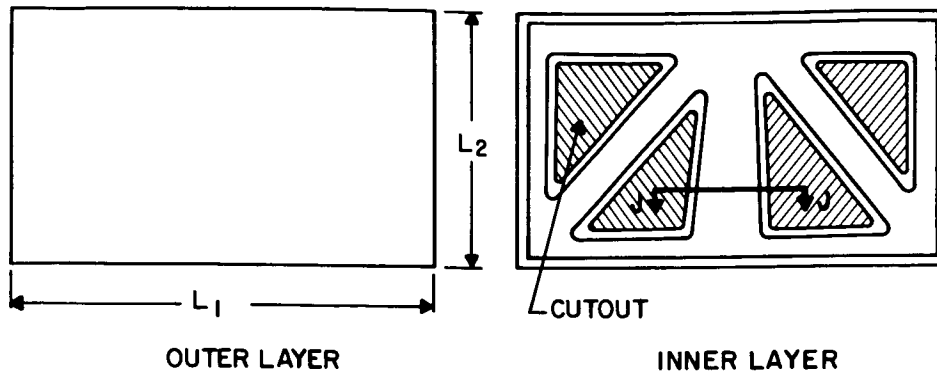

CROSS SECTION J-J

(a) Double-layer panel.

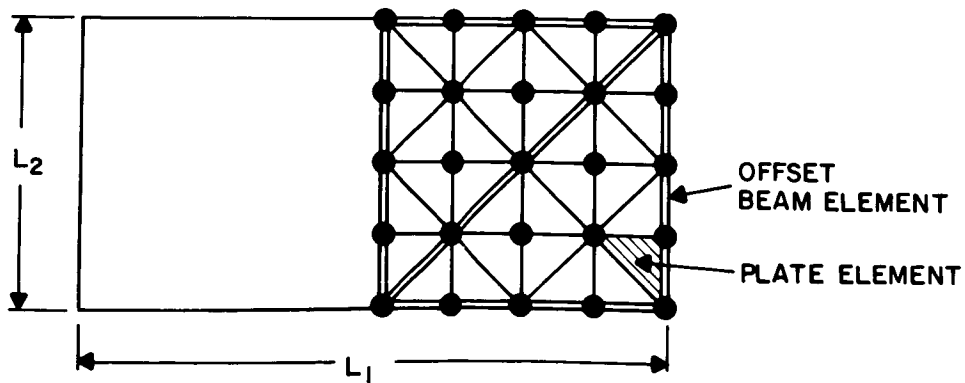

(b) Finite element model (32 plate elements, 20 offset beam elements, no. of design variables = 8) (ref. 41).

Figure 4. Mathematical models for optimization with alternate materials.

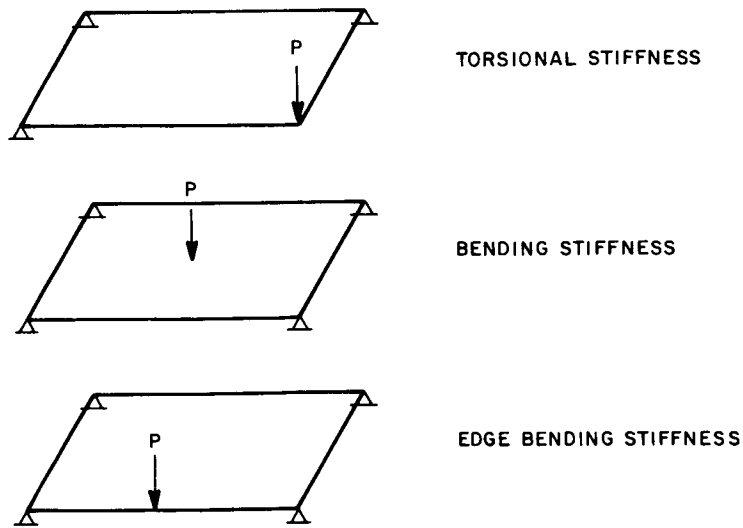
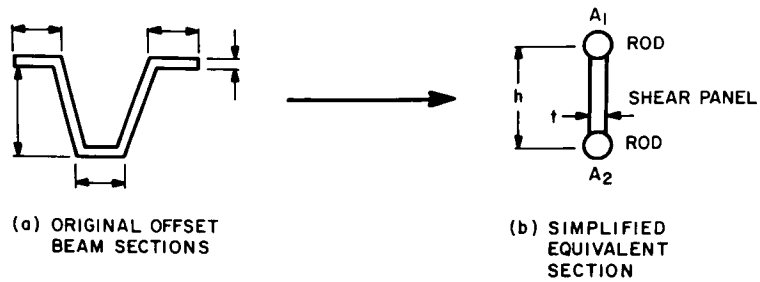
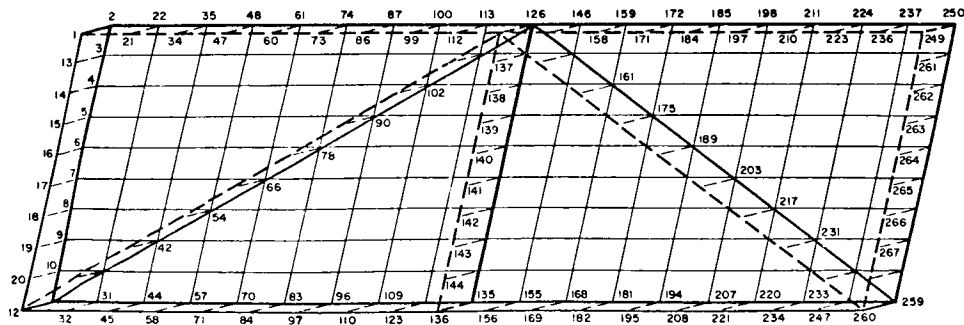

Figure 5. Frequently used stiffness design criteria for double panel.



(a) Cross sectional idealizations. (A maximum of 4 design variables per stiffener is allowed.)



(b) Detailed finite element model (number of design variables = 16.) (Adapted from ref. 44.)

Figure 6. Finite element model.

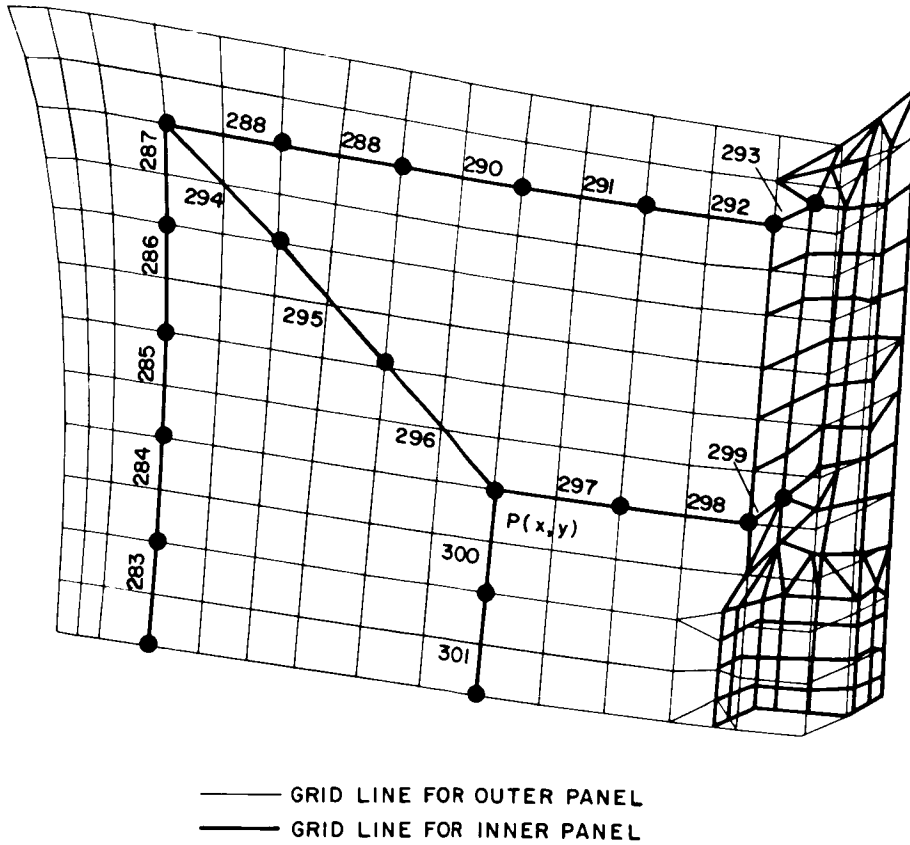

Figure 7. Half model of truck decklid (38 beams, 196 plates, number of design variables = 4) (ref. 48).

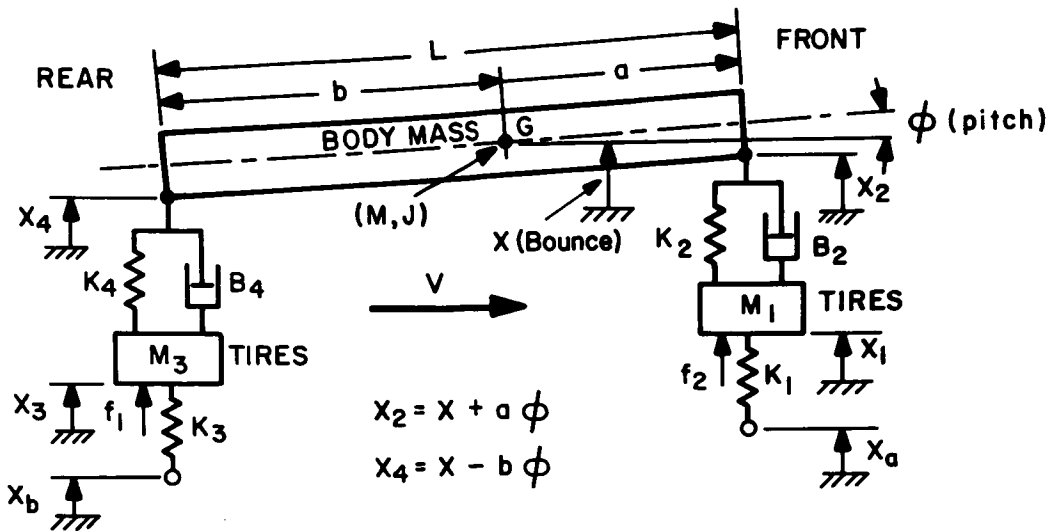

Figure 8. Linear half vehicle model (four degrees of freedom) (ref. 63).

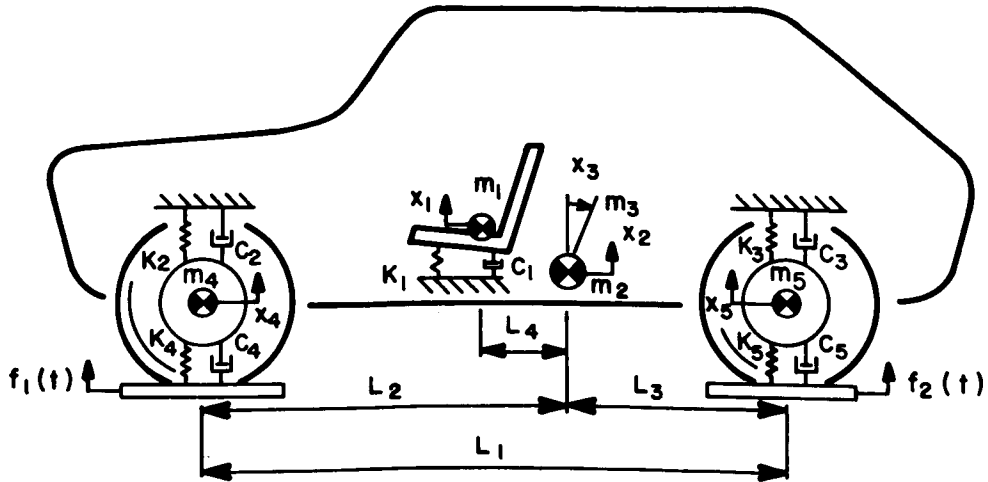
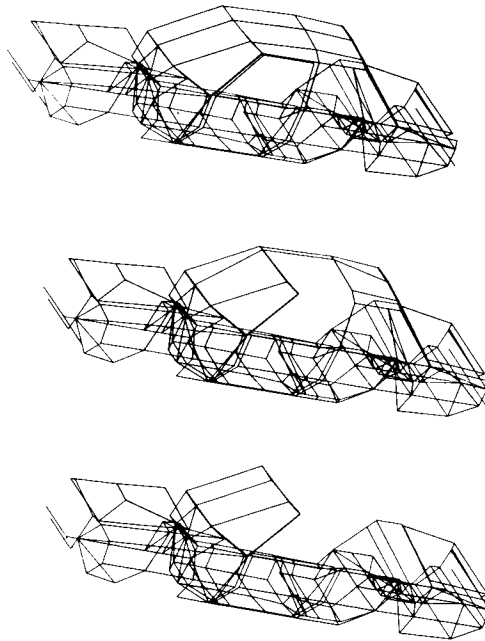

Figure 9. Linear half vehicle model (five degrees of freedom) (ref. 61).



(a) Vehicle body models derived using generic approach.

Figure 10. Generic modelling approach.



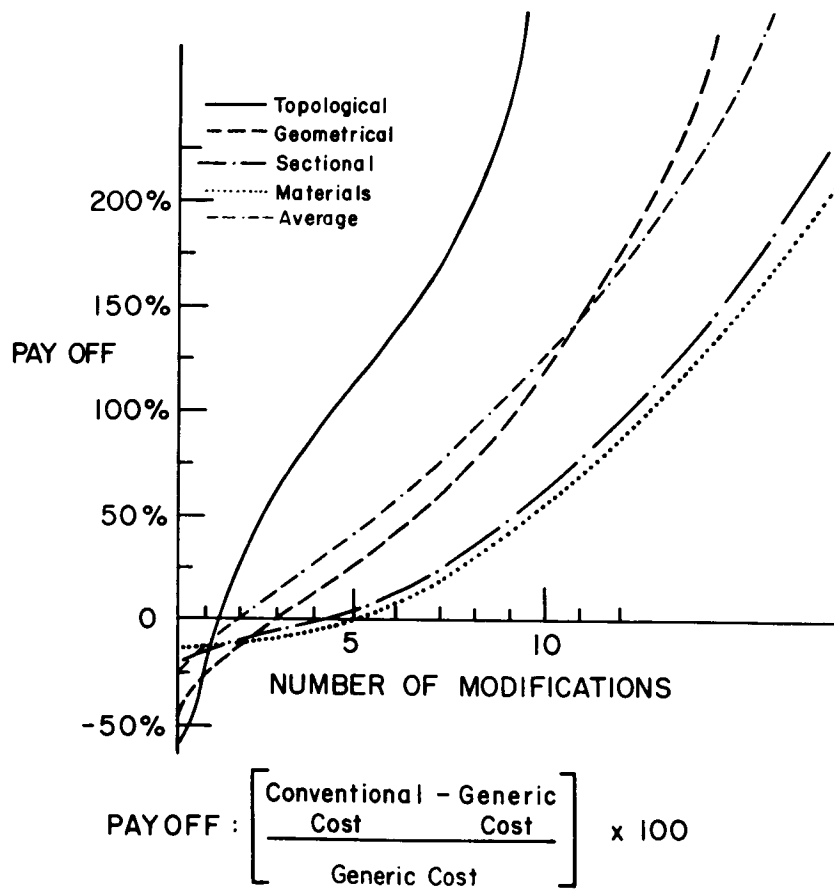

(b) Payoff from using generic modelling approach.

Figure 10. Concluded.