

NASA Contractor Report 172391

48p

# Window Acoustic Study for Advanced Turboprop Aircraft

R.A. Prydz, F.J. Balena

LOCKHEED-CALIFORNIA COMPANY  
BURBANK, CALIFORNIA

CONTRACT NAS1-16441  
August 1984

(NASA-CR-172391) WINECW ACOUSTIC STUDY FOR  
ADVANCED TURBOPROP AIRCRAFT Final Report  
(Lockheed-California Co., Burlak.) 48 p

N87-12322

CSSL 20A

Unclass

H1/71 44701

**NASA**

National Aeronautics and  
Space Administration

Langley Research Center  
Hampton, Virginia 23665

NASA Contractor Report 172391

# Window Acoustic Study for Advanced Turboprop Aircraft

R.A. Prydz, F.J. Balena

LOCKHEED-CALIFORNIA COMPANY  
BURBANK, CALIFORNIA

CONTRACT NAS1-16441  
August 1984

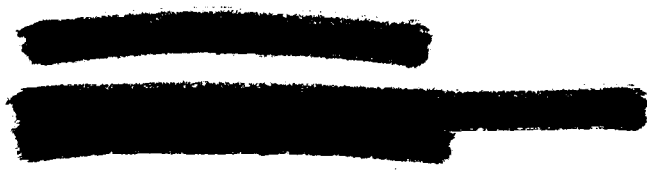

**NASA**

National Aeronautics and  
Space Administration

Langley Research Center  
Hampton, Virginia 23665

TABLE OF CONTENTS

| <u>Section</u> | <u>Title</u>  | <u>Page</u> |
|----------------|---|-------------|
|                | LIST OF ILLUSTRATIONS . . . . .   | v           |
|                | LIST OF TABLES. . . . .   | vii         |
|                | SUMMARY . . . . .   | 1           |
|                | INTRODUCTION . . . . .  | 1           |
|                | LIST OF SYMBOLS . . . . .   | 3           |
| 1.0            | ANALYSIS. . . . .   | 4           |
| 1.1            | Background. . . . .   | 4           |
| 1.2            | Theory. . . . .   | 5           |
| 1.2.1          | Panel characteristics . . . . .   | 5           |
| 1.2.2          | Airsaces and porous blankets . . . . .  | 7           |
| 1.2.3          | Multiple layered configurations . . . . .   | 8           |
| 1.2.4          | Theory versus experiment. . . . .   | 10          |
| 2.0            | WINDOW PARAMETER STUDY. . . . .   | 13          |
| 2.1            | Study Guideline . . . . .   | 13          |
| 2.2            | Single-Pane Design. . . . .   | 15          |
| 2.3            | Double-Pane Design. . . . .   | 18          |
| 2.4            | Configuration Selection . . . . .   | 22          |
| 3.0            | TEST ARTICLES . . . . .   | 22          |
| 4.0            | RECOMMENDATION FOR LABORATORY TEST PROGRAM TO EVALUATE<br>WINDOW DESIGNS. . . . . | 27          |
| 4.1            | Test Facility . . . . .   | 27          |
| 4.2            | Basic Test Configuration. . . . .   | 29          |
| 4.3            | Measurement Program . . . . .   | 29          |
| 4.4            | Instrumentation Requirements. . . . .   | 32          |
| 5.0            | CONCLUSIONS . . . . .   | 33          |
| APPENDIX       | ENGINEERING DRAWINGS OF THE WINDOW TEST ARTICLES. . . . .                         | 35          |
|                | REFERENCES. . . . .   | 36          |

PRECEDING PAGE BLANK NOT FILMED

LIST OF ILLUSTRATIONS

| <u>Figure</u> | <u>Title</u>   | <u>Page</u> |
|---------------|--|-------------|
| 1             | Estimate TL of window and wall (window area = 10% of total area) . . . . .   | 4           |
| 2             | Typical aircraft window configuration . . . . .  | 9           |
| 3(a)          | Frequency dependence of the transmission loss of a single-pane window for different angles of incidence from 0° to 80°, with 5° interval. . . . .    | 11          |
| (b)           | Frequency dependence of the corresponding random incidence average transmission loss . . . . .   | 11          |
| 4(a)          | Frequency dependence of the transmission loss of a double-pane window for different angles of incidence of 0° to 85° with 5° interval. . . . .       | 12          |
| (b)           | Frequency dependence of the corresponding random incidence average transmission loss . . . . .   | 12          |
| 5             | Two-engine aircraft exterior noise signature (directivity pattern symmetrical about propeller centerline for M = 0). . . . .                         | 16          |
| 6             | Single-pane glass window with scratch shield - 2.54 cm (1.0 in.) airspace. . . . .   | 16          |
| 7             | Single-pane glass window with scratch shield - 7.62 cm (3.0 in.) airspace. . . . .   | 17          |
| 8             | Single-pane glass window with scratch shield - 12.70 cm (5.0 in.) airspace. . . . .  | 17          |
| 9             | Single-pane lucite window with scratch shield - 12.70 cm (5.0 in.) airspace. . . . .   | 20          |
| 10            | Comparison of predicted TL for double-pane glass and lucite windows. . . . .   | 20          |
| 11            | Effect of scratch shield thickness on the predicted TL of a double-pane glass window. . . . .  | 21          |
| 12            | Comparison of predicted TL for single- and double-pane windows with the same total surface density of 26.9 kg/m <sup>2</sup> (5.5 psf) . . . . .     | 21          |
| 13            | Comparison of predicted TL for single- and double-pane glass windows with the same total surface density of 38.9 kg/m <sup>2</sup> (8 psf) . . . . . | 23          |

PRECEDING PAGE BLANK NOT FILMED

LIST OF ILLUSTRATIONS -- CONTINUED

| <u>Figure</u> |   | <u>Page</u> |
|---------------|---|-------------|
| 14            | Effect of scratch shield thickness on the predicted TL of a double-pane glass window representative of the L-1011 window design . . . . . | 23          |
| 15            | Effect of inner pane window thickness on the predicted TL of a double-pane glass window with a lucite scratch shield . . . . .            | 24          |
| 16            | Predicted TL results for triple-pane window designs without a scratch shield - 5.1 cm (2 in.) thick window . .                            | 24          |
| 17            | Predicted TL results for triple-pane window designs with a scratch shield - 7.62 cm (3 in.) thick window. . . . .                         | 25          |
| 18            | Predicted TL results for triple-pane window designs with a scratch shield - 15.24 cm (6 in.) thick window . . . . .                       | 25          |
| 19            | Window configurations. . . . .  | 26          |
| 20            | Window test articles - front and rear views . . . . .   | 28          |
| 21            | Sketch of window installation in double-wall structure . . .  | 28          |
| 22            | Schematic diagram of structural frequency response system . . . . .   | 33          |
| 23            | Schematic diagram of signal generation, data acquisition, and analysis system. . . . .  | 34          |

LIST OF TABLES

| <u>Table</u> | <u>Title</u>   | <u>Page</u> |
|--------------|--|-------------|
| 1            | Window Parameter Study . . . . .                                       | 14          |
| 2            | Material Properties for Glass and Lucite . . . . .                     | 15          |
| 3            | Pane Fundamental Resonances . . . . .                                  | 18          |
| 4            | Double-Pane, Double-Wall Resonances . . . . .                          | 19          |
| 5            | Proposed Test Configurations for Sound Transmission<br>Tests . . . . . | 31          |
| 6            | Experimental Program Outline for Window Evaluation . . . .             | 32          |

## WINDOW ACOUSTIC STUDY FOR ADVANCED TURBOPROP AIRCRAFT

R. A. Prydz and F. J. Balena

### SUMMARY

A theoretical parametric study was performed to establish acoustic window designs for advanced turboprop powered aircraft. The basic approach of the Cockburn and Jolly sound transmission method was used to analyze multipane window configurations. The results of the analysis showed that a triple-pane, high-surface-density window would meet both the acoustic and sidewall space requirements. Sidewall depths of 7.62 cm (3 inch) and 15.24 cm (6 inch) were assumed for the analysis and the window transmission loss requirements were based on interior noise levels of 80 and 75 dBA for estimated peak external surface levels of 140 and 150 dB. It was estimated that transmission loss values of 54 dB and 69 dB at a blade passage frequency of 164 Hz were required to achieve the goals of 80 and 75 dBA respectively.

Two window configurations were designed and fabricated, each consisting of two glass outer panes, a third inner pane made of lucite and a lightweight lucite scratch shield. The two window designs are identical except for the thicknesses of the inner glass pane and of the air space between the second and third panes. In addition, recommendations are made for a laboratory test program to evaluate the window test articles and verify the predicted TL.

### INTRODUCTION

Recent analytical and experimental studies (references 1, 2, 3, and 4) have shown that acceptable cabin noise levels for advanced turboprop powered aircraft can be achieved by using appropriate fuselage sidewall designs. The studies show that an interior noise level of 80 dBA with an assumed exterior level of 140 dB could be achieved with 1 to 2 percent of takeoff gross weight penalty using double wall sidewall designs. These findings are based on certain simplifying assumptions, one of which is the exclusion of window effects from the analysis. Clearly, if the transmission through the windows is not adequately controlled the double wall sidewall design can be compromised. An efficient sidewall design requires that the window and surrounding wall area have approximately the same transmission characteristics at the critical turboprop frequencies. For an 80 dBA interior noise level and 140 dB exterior level, the transmission loss (TL) of the window would have to be about 54 dB at the estimated full-scale blade passage frequency of 164 Hz. More recent studies indicate that the exterior level for an advanced turboprop may be as high as 150 dB and the interior level may need to be as low as 75 dBA to be subjectively comparable to modern turbofan aircraft. This would require about 69dB of TL at the blade passage frequency for the combined window and

sidewall. These transmission loss estimates were made without taking account of the flight effects which would tend to make the values conservative (reference 3).

In the present study, the basic approach of the Cockburn and Jolly method (reference 5) has been used to analyze multipane window configurations and establish window designs which would satisfy the specified noise criteria. Parametric studies have been performed at normal incidence conditions for single and multipane window configurations. Parameters that were varied included the thickness of window panes and scratch shields, the spacing between them and the window material (lucite and glass). The basic window size (21.6 cm by 29.2 cm) which is about the same as that of an L-1011 window was not varied for the analysis. These results showed that the acoustic and space requirements could be met if glass window panes are used. Final designs which have been selected for fabrication consist of two glass outer panes separated by a small air space, a third fail-safe inner pane made of lucite, and a lucite scratch shield. It was found that the more stringent noise criteria could be satisfied by simply increasing the thickness of the inner glass pane by about 40 percent. Two window test articles were fabricated for laboratory evaluation and verification of the predicted TL. Recommendations for a laboratory test program are also presented in this report.



## LIST OF SYMBOLS

| <u>English Symbols</u>          |   | <u>Units</u>                            |
|---------------------------------|---|---|
| a                               | Window height   | cm (in.)                                |
| b                               | Window width  | cm (in.)                                |
| c                               | Acoustic wave propagation speed   | m/sec (ft/sec)                          |
| d                               | Spacing between window panes  | cm (in.)                                |
| D                               | $Eh^3/12(1-\nu^2)$ plate modulus  | N-m (lb-ft)                             |
| E                               | Young's modulus of elasticity   | N/m <sup>2</sup> (psi)                  |
| f                               | Frequency of sound wave   | Hz                                      |
| j                               | $\sqrt{-1}$ imaginary number  |   |
| k                               | Volume coefficient of elasticity of air                                 | N/m <sup>2</sup> (psf)                  |
| m                               | Number of circumferential half wavelengths                              |   |
| m                               | Mass or surface density   | Kg/m <sup>2</sup> (psf)                 |
| n                               | Number of axial half wavelengths  |   |
| M                               | Mach number of flow   |   |
| NR                              | Noise reduction   | dB                                      |
| P                               | Fluid static pressure   | N/m <sup>2</sup> (psf)                  |
| $P_{ax}, P_{cir}$               | (Axial, circumferential) in plane stress due to internal pressurization |   |
| $P_i$                           | Amplitude of incident acoustic pressure wave                            | N/M <sup>2</sup> (psf)                  |
| TL                              | Transmission loss   | dB                                      |
| Y                               | Blanket porosity  |   |
| Z                               | Acoustical impedance  |   |
| <br>Greek Letters               |   |   |
| $\alpha$                        | Acoustical absorption coefficient                                       |   |
| $\eta$                          | Damping loss factor   |   |
| $\theta$                        | Angle of incident wave vector relative to normal to surface             |   |
| $\nu$                           | Poisson's ratio   |   |
| $\rho$                          | Bulk density  | Kg/M <sup>3</sup> (lb/ft <sup>3</sup> ) |
| $\tau$                          | Acoustic transmission coefficient                                       |   |
| <br>Subscripts and Superscripts |   |   |
| 1                               | Property of outer pane  |   |
| 2                               | Property of inner pane  |   |
| B                               | Refers to blanket   |   |

1. ANALYSIS

1.1 Background

During an earlier analytical study of interior noise for advanced turboprop aircraft (reference 1) the fuselage structure and interior trim were evaluated. As a result of this effort an optimized narrow-body fuselage configuration was identified and referred to as Design No. 8 (page 49, table 8, reference 1). This configuration was designed to provide an interior noise level of 80 dBA when subjected to a peak free-field level of 134 dB. An important feature of real aircraft, passenger cabin windows, was not considered in the analytic study. Window transmission loss or noise reduction will control the noise levels for passengers seated next to the window and may well impact the noise levels throughout the passenger cabin.

The design of passenger cabin windows for an advanced turboprop aircraft will be an important part of the fuselage sidewall design. Although windows may comprise only 5 to 10 percent of the sidewall area they can nevertheless have a significant impact on interior noise levels. An analysis of the effect of window transmission loss (TL) on total sidewall TL is presented in figure 1. Using these results it is logical to conclude that the window and the sidewall should have approximately the same TL. This is not an unexpected result since acoustic treatments would be required over a large surface area to

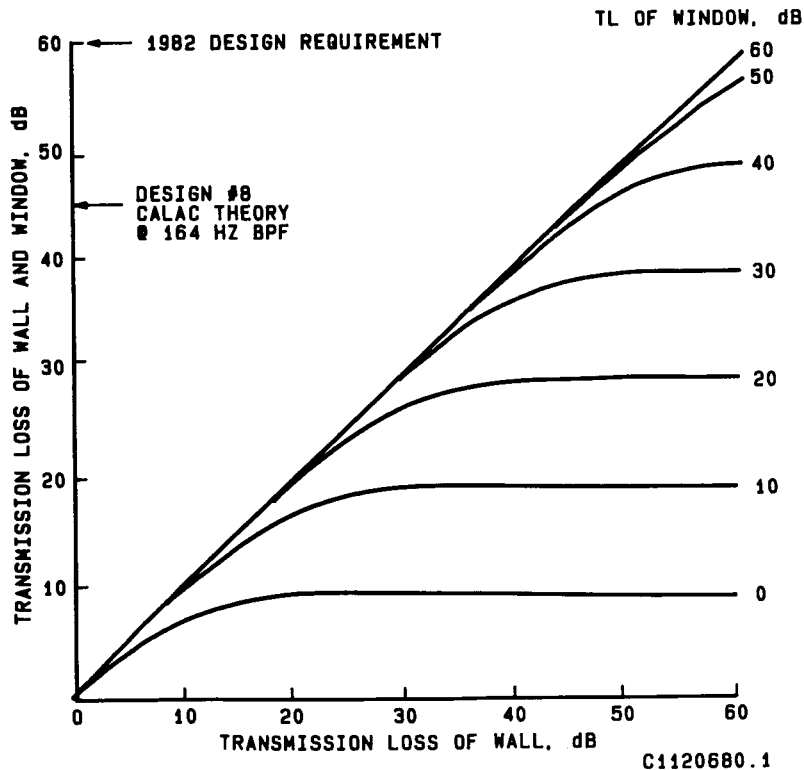

Figure 1. - Estimated TL of window and wall. (Window area = 10% of total area.)

compensate for excessive noise transmission through the windows. In addition, passengers seated next to the windows would be exposed to higher noise levels no matter how much treatment was applied to the sidewall.

The basic approach to the selection of a passenger cabin window configuration was guided by the design philosophy used in the design of the L-1011 windows. The L-1011 window assembly consists of lucite double panes separated by an airspace and an interior scratch shield to protect the inner window surface. The inboard pane provides protection from flying glass in the event that the outer pane is broken. It is designed to take the pressure load if the outer pane fails but the inner pane must be made from lucite or a laminate of lucite and glass for safety reasons. A single-pane window and scratch shield were also studied to determine if a simpler less sophisticated design would satisfy the noise reduction objectives of this program.

## 1.2 Theory

The analytical approach that was used for the small panel analyses of reference 1 is appropriate for this window study. Windows will be treated as simply supported flat panels without inplane stresses, and the airspaces between window panes will define multilayered configurations. Septa and fiberglass blankets are included in the theory for completeness but are not used. The equations used to define the impedance of and pressure ratio across individual layer types will be described below. For the following discussion,  $\theta$  denotes the classical incidence angle measured with reference to an axis normal to the surface and positive in the downstream direction. It should be noted that the analysis was performed for a normal incidence plane wave and no forward velocity ( $M = 0$ ). This was done to simulate the laboratory conditions for which the selected window configurations will be tested.

1.2.1 Panel characteristics.- For a panel subjected to an obliquely incident sound wave with an external airflow, the pressure ratio is obtained from

$$\frac{P_I}{P_T} = 1/2 \left[ 1 + \frac{Z_p \cos \theta_2}{Z_2} + \frac{\rho_1 c_1 \cos \theta_2}{\cos \theta_1 (1+M \sin \theta_1) Z_2} \right] \quad (1)$$

where

- $P_I$  = incident pressure
- $P_T$  = transmitted pressure
- $Z_p$  = characteristic impedance of skin panel

**ORIGINAL PAGE IS  
OF POOR QUALITY**

The characteristic impedance of a flat panel bounded by stiffeners and with inplane stresses to simulate pressurization is defined by

$$Z_p = \frac{\omega_o^2}{\omega} m \eta + \frac{\omega^3 D \eta}{C_1^4} \frac{\sin^4 \theta}{(1+M \sin \theta)^4} + j \left[ \omega m - \frac{\omega_o^2}{\omega} m - \frac{\omega_o^3 D}{C_1^4} \frac{\sin^4 \theta}{(1+M \sin \theta)^4} \right] \quad (2)$$

where

$\omega_o$  = fundamental frequency of skin panel

$$\omega_o = \frac{\pi}{(m)^{1/2}} \left[ \frac{P_{ax}}{a^2} + \frac{P_{cir}}{b^2} + D \pi^2 \left( \frac{1}{a^2} + \frac{1}{b^2} \right)^2 \right]^{1/2} \quad (3)$$

The corresponding pressure ratio equation from reference 3 is (eq. 6.4)

$$\frac{P_1}{P_2} = \frac{P_i + P_r}{P_t} = \left[ 1 + \frac{Z \cos \theta}{Z_2} \right]$$

The difference between the two expressions result from the definition of incident pressure. For this study the incident pressure did not include the reflected pressure, while in reference 5 the incident pressure was defined as the sum of the incident and reflected pressures. When free-field sound pressure levels are measured or calculated, equation (1) should be used to calculate the pressure ratio across the skin. The characteristic impedance equation from reference 5 is (eq. 6.5).

$$Z_p = \omega_o m \eta + \frac{\omega^3 D}{C^4} \sin^4 \theta + j \left[ \omega m - \frac{\omega_o^2 D}{\omega} - \frac{\omega^3 D}{C^4} \sin^4 \theta \right]$$

The difference in the first term of the equation is probably due to a typographical error in reference 5 and the denominator of the last term of equation (1) includes a flow effect. The inclusion of the flow effect in equations (1 and 2) was consistent with the flow effect described in Koval's cylindrical shell theory (reference 6).

When an internal layer is either a panel or a septum the following expression is used to determine the pressure ratio across the layer.

$$\frac{P_I}{P_T} = 1 + \frac{Z_p \cos \theta_2}{Z_2} \quad (4)$$

where

- $Z_p$  = characteristic impedance of layer
- $Z_p$  =  $j\omega m$  for a septum
- $Z_p$  = equation 2 (with  $M = 0$ ) for a panel
- $Z_2$  = termination impedance

Equation (4) is identical to equation (6.4) of reference 5.

1.2.2 Airspaces and porous blankets.- The pressure ratio across an airspace or a soft porous blanket subjected to an obliquely incident wave is given by

$$\frac{P_I}{P_T} = \frac{\cosh \left[ bd \cos \phi + \coth^{-1} \left( \frac{Z_2 \cos \phi}{Z_B} \right) \right]}{\cosh \left[ \coth^{-1} \left( \frac{Z_2 \cos \phi}{Z_B} \right) \right]} \quad (5)$$

where

$b$  = complex propagation constant (reference 5)

$$b = j\omega \left[ \left( \frac{\bar{\rho}_1 Y}{K} \right) \left( 1 - j \frac{\bar{R}_1}{\omega \rho_1} \right) \right]^{1/2} \quad \text{for blankets} \quad (6)$$

$$= J \frac{\omega}{c} \text{ for airspaces}$$

$Z_2$  = termination impedance

$$Z_B = -j \frac{KB}{\omega Y} \text{ for blankets}$$

$$Z_B = \rho C \text{ for airspaces}$$

The corresponding equation from reference 5 is (eq. 6.11)

$$\frac{P_1}{P_2} = \frac{\cosh \left[ \frac{bd}{\cos \phi} + \coth^{-1} \frac{Z_2}{Z_B} \right]}{\cosh \left[ \coth^{-1} \frac{Z_2}{Z_B} \right]}$$

The input impedance of panel or septum layers is simply the sum of the layer characteristic impedance and its termination impedance. This simple relationship does not hold for blankets and airspaces and their input impedance is

$$Z_{IN} = \frac{Z_B}{\cos \phi} \coth \left[ bd \cos \phi + \coth^{-1} \left( \frac{Z_2 \cos \phi}{Z_B} \right) \right] \quad (7)$$

This expression is a modification of equations 6.12 and 6.14 of reference 5.

1.2.3 Multiple layered configurations.- The procedure that is used to calculate the pressure ratio across a multilayered configuration will now be described. The pressure ratio across a single layer of a configuration can be calculated if both the characteristic and termination impedances of the layer are known by equations (1, 4, and 5).

The input impedance of each layer is calculated by starting at the innermost layer and working outward (figure 2). Thus, the input impedance of the scratch shield is equal to the sum of its characteristic impedance and its termination impedance.

$$Z_{ss} = Z_p \text{ (eq. 2) } + (\rho^c) \text{ cabin}$$

The input impedance of the scratch shield is also the termination impedance of the airgap and the input impedance of the airgap is then

$$Z_{AG} = \frac{Z_A}{\cos \phi} \coth \left[ bd \cos \phi + \coth^{-1} \left( \frac{Z_{ss} \cos \phi}{Z_A} \right) \right]$$

Finally, the input impedance of the outer pane is defined as

$$Z_{op} = Z_p \text{ (eq. 2) } + Z_{AG}$$

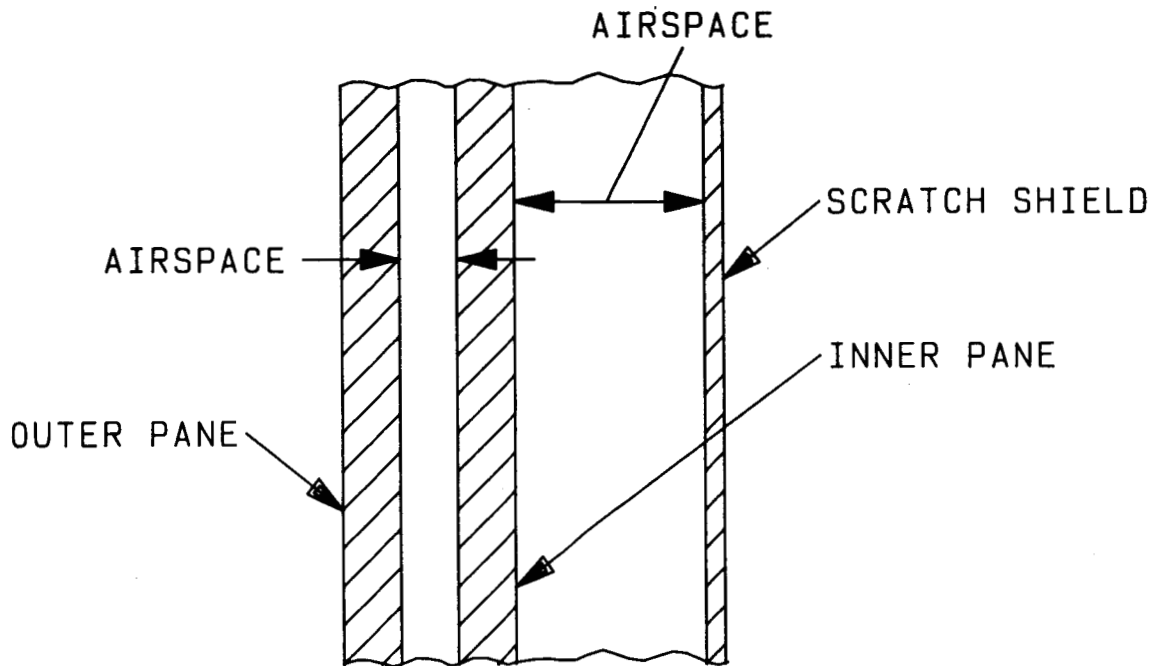

Figure 2. - Typical aircraft window installation.

With the characteristic and termination impedance defined for each layer of the configuration, the pressure ratio across each layer can now be calculated using equations (1, 4, and 5). The pressure ratio across a multilayered configuration can be expressed in terms of the pressure ratio across the individual layers.

$$\left[ \frac{P_I}{P_T} \right]^2 = \left[ \frac{P_I}{P_2} \cdot \frac{P_2}{P_3} \cdot \frac{P_3}{P_4} \cdots \frac{P_n}{P_T} \right]^2 \quad (8)$$

Therefore, the pressure ratio across an entire configuration of n layers is equal to the ratio of the pressure transmitted by the innermost layer to the pressure incident on the outermost layer.

Transmission is calculated from

$$TL = 10 \log \left| \frac{P_I}{P_T} \right|^2 \quad (9)$$

Laboratory verification tests are often performed in a free-field (anechoic) environment or a random incidence environment. The equations presented earlier are suitable for free-field plane waves at specific angles of incidence. In order to simulate the effect of random incidence or reverberant environment, the pressure ratio can be integrated over a range of incidence angles and averaged (reference ).

$$\bar{\tau} = \left[ \frac{P_T}{P_I} \right]^2 = \frac{2 \int_0^{\theta'} \tau(\theta) \sin 2\theta d\theta}{1 - \cos 2\theta'} \quad (10)$$

Where  $\bar{\tau}$  is the reverberant field transmission coefficient obtained by averaging  $\tau(\theta')$ . The  $\theta'$  is the limiting value of the incidence angle  $\theta$ . A value of 1.48 rad (87.5 deg) was selected for  $\theta'$  and the integration was approximated using Simpson's rule with a 5-degree step or increment. The denominator ( $1 - \cos 2\theta'$ ) is approximately equal to 2.0 ( $\theta' = 0.46$  rad (87.5 deg)) and the above expression for the averaged transmission coefficient is reduced to

$$\bar{\tau} = \int_0^{\theta'} \tau(\theta) \sin 2\theta d\theta \quad (11)$$

**1.2.4 Theory versus experiments.**- This effort was confined to an analytical investigation of window transmission loss. However, a test case was found in the literature (reference 7) to exercise the methodology used for the current study. Figures 3 and 4 show the measured and calculated transmission loss values from reference 7 and the Lockheed predictions. Figure 3 shows excellent agreement for the single-pane glass window. It should be noted that the window dimensions were 2.74 m (9 ft) by 2.13 m (7 ft) by 0.97 cm (0.38 in.) thick, and the data shown are well above the fundamental plate resonance. The transmission loss dip between 1 and 2 kHz is the grazing incidence coincidence frequency. Thus the comparisons are extremely good up to the coincidence frequency for both the discrete and random incidence cases. Figure 4 compares the measured and calculated transmission loss for a double-pane window. The dimensions for this configuration are 2.74 m (9 ft) by 2.13 m (7 ft) with 0.97 cm (0.38 in.) and 0.79 cm (0.31 in.) thick panes which are separated by a 20.32 cm (8 in.) airspace. Agreement between theory and experiment is very good for the discrete angles and fair for the random incidence case. This window size is not representative of the aircraft window configurations of interest but does provide a partial validation of the prediction methodology.



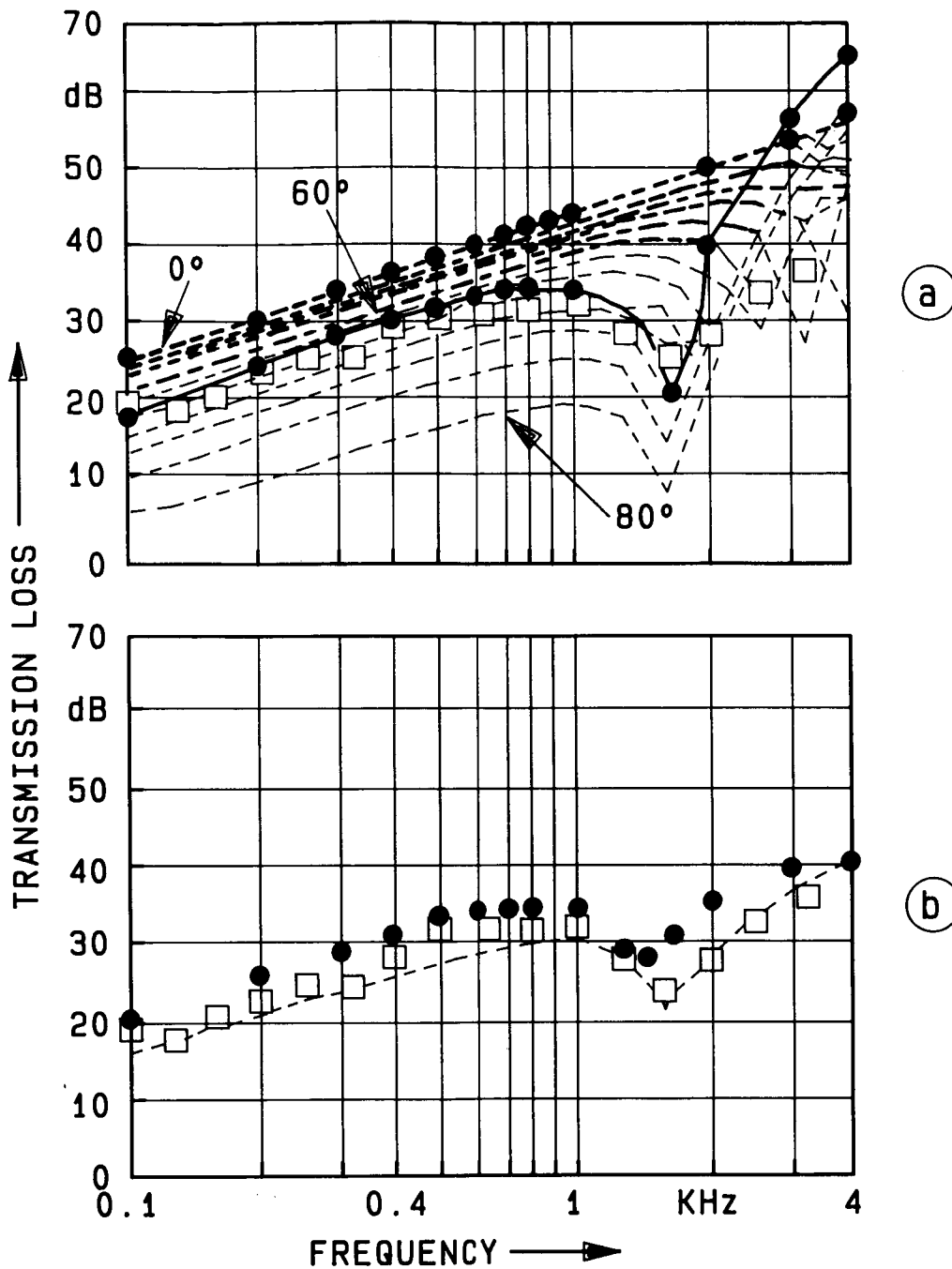

Figure 3-a). - Frequency dependence of the transmission loss of a single-pane window for different angles of incidence from  $0^{\circ}$  to  $80^{\circ}$ , with  $5^{\circ}$  interval.

- b). - Frequency dependence of the corresponding random incidence average transmission loss, - - - Calculated (reference 7);  $\square$  Measured (reference 7)  
 • Lockheed predicted results  
 Glass thickness = 0.97 cm (0.38 in.); loss factor = 0.05; mass = 2.1 g/cm<sup>2</sup>

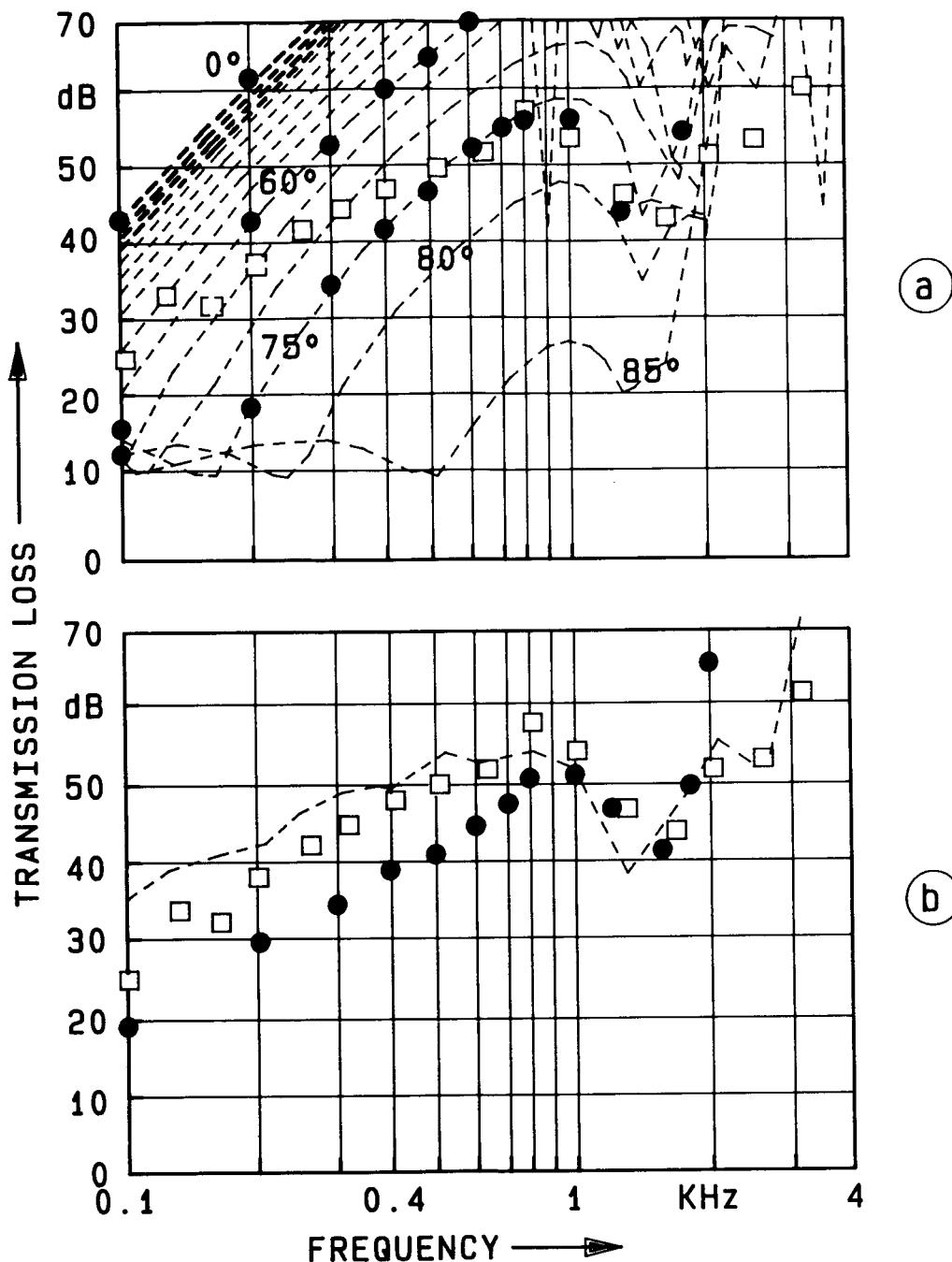

Figure 4-a). - Frequency dependence of the transmission loss of a double-pane window for different angles of incidence from  $0^{\circ}$  to  $85^{\circ}$  with  $5^{\circ}$  interval.

- b). - Frequency dependence of the corresponding random incidence average transmission loss, - - - Calculated (reference 7);  
 □ Measured (reference 7)  
 ● Lockheed predicted results  
 Glass thickness = 0.79 cm (0.31 in.), 0.97 cm (0.38 in.);  
 Separation: 20.3 cm (8 in.). Size of Window: 2.74 m x 2.13 m (9 x 7 ft.).

## 2. WINDOW PARAMETER STUDY

### 2.1 Study Guidelines

The window design is based on the following two noise criteria specified by NASA:

- (1) 80 dBA interior noise level for an estimated overall exterior level of 140 dB
- (2) 75 dBA interior noise level for an estimated overall exterior level of 150 dB

Narrowbody Design No. 8 of reference 1 is the configuration for which this window design study is being performed. This configuration had an outer-wall surface density of  $19.52 \text{ kg/m}^2$  (4.0 psf) and an inner wall density of  $13.42 \text{ kg/m}^2$  (2.75 psf). These surface densities would correspond to a 1.63 cm (0.64 in.) thick outer pane and a 1.12 cm (0.44 in.) scratch shield if Lucite windows are used, and approximately half these values if the heavier glass is used. Narrow body Design No. 8 has a 15.24 cm (6 in.) wall thickness and if necessary the full depth could be used.

The target interior noise level is 80 dBA and the amount of noise reduction required will be a function of the propfan blade passage frequency. At 164 Hz the A-weighting reduces the sound pressure level by about 13 dB. If the exterior overall sound pressure level is 140 dB, then a noise reduction of 47 dB would be required to achieve an 80 dBA interior level. If the exterior overall level were 150 dB and the desired interior level were 75 dBA, then a noise reduction of 62 dB would be required. Converting noise reduction to transmission loss would require a knowledge of the absorption present in the aircraft at the frequencies of interest. For an average absorption coefficient of 20 percent at the blade passage frequency the difference between noise reduction and transmission loss is approximately 7 dB. Therefore a window transmission loss of 54 dB is required to obtain a noise reduction of 47 dB at 164 Hz. A transmission loss of 69 dB is required to achieve a noise reduction of 62 dB at 164 Hz for an exterior overall level of 150 dB and an interior level of 75 dBA at 164 Hz. The relationship between noise reduction and transmission coefficient  $\tau$  is given below.

$$NR = 10 \log_{10} \left[ 1 + \frac{\bar{\alpha}}{\tau} \right]$$

Two basic window designs were studied for their ability to attenuate low frequency noise. The simpler single pane and scratch shield was investigated as a minimum cost configuration. The multiple-pane configuration is the most likely commercial aircraft window design and it has the potential for much larger noise attenuations. A total of 72 configurations were analyzed for the single-pane design and over 200 for the multiple-pane design as summarized in

table 1. For all of the analyses the Mach number was zero and internal pressurization was standard sea level. The source directivity used for the propfan interior noise study of reference 1 is highly directional, especially for the two-engine configuration (figure 5). The highest surface sound pressure levels are produced in or near the plane of the propeller - near normal incidence. The sharp roll-off in the axial direction of the propfan noise signature more than compensates for the reduction in transmission loss at larger angles of incidence. Normal incidence was found to provide the most demanding requirement for the acoustic performance of the window. Therefore a normal incidence analysis was used for the parameter studies. The materials used in the window analyses are summarized in table 2 below.

TABLE 1. - WINDOW PARAMETER STUDY

|  |  |
|--|--|
| <b>I - <u>Single Outer Pane With Scratch Shield</u></b>  |  |
| A. Outer pane thickness, cm (in.)                        | 0.51 (0.2), 1.02 (0.4), 1.52 (0.6)             |
| B. Scratch shield thickness, cm (in.)                    | 0.25 (0.1), 0.51 (0.2), 0.76 (0.3), 1.02 (0.4) |
| C. Airspace Thickness, cm (in.)                          | 2.54 (1.0), 7.62 (3.0), 12.7 (5.0)             |
| D. Window material                                       | Glass, lucite                                  |
| Total configurations = 72                                |  |
| <b>II - <u>Double Outer Pane With Scratch Shield</u></b> |  |
| A. Outer pane thickness, cm (in.)                        | 0.51 (0.2), 1.02 (0.4)                         |
| B. Pane spacing, cm (in.)                                | 0.64 (0.25), 1.27 (0.50)                       |
| C. Inner pane thickness, cm (in.)                        | 0.51 (0.2), 1.02 (0.4)                         |
| D. Airspace thickness, cm (in.)                          | 2.54 (1.0), 7.62 (3.0), 12.7 (5.0)             |
| E. Scratch shield thickness, cm (in.)                    | 0.25 (0.1), 0.51 (0.2), 0.76 (0.3), 1.02 (0.4) |
| F. Window material                                       | Glass, lucite                                  |
| Total configurations = 192                               |  |
| <b>III - <u>Selected Additional Configurations</u></b>   |  |
| A L-1011 window design                                   |  |
| B Modified L-1011 window design (triple-pane windows)    |  |

TABLE 2. - MATERIAL PROPERTIES FOR GLASS AND LUCITE

| Property   | Glass           | Lucite                   |
|--|-----------------|--------------------------|
| Density - $\text{kg/m}^3$ ( $\text{lb/in}^3$ )       | 2353.1 (0.085)  | 1190.3 (0.043)           |
| Youngs modulus - $\text{N/m}^2$ ( $\text{lb/in}^2$ ) | 68.9 ( $10^7$ ) | 4.13 ( $6 \times 10^5$ ) |
| Poisson's ratio                                      | 0.28            | 0.40                     |
| Loss factor  | 0.01            | 0.01                     |

## 2.2 Single-Pane Designs

The range and number of parameters studied for the single pane and scratch shield are shown in table 1. For a selected window material and thickness and an airspace thickness, the scratch shield thickness was varied from 0.254 cm (0.1 in.) to 1.02 cm (0.4 in.). Initially, the same material was used for both the window and the scratch shield. Combinations of glass and lucite were not investigated until later in the study. Predicted transmission loss values are shown for the 1.52 cm (0.6 in.) outer window pane for 2.54 (1 in.), 7.62 (3 in.) and 12.7 (5 in.) centimeter airspaces in figures 6, 7, and 8. For each combination of outer window thickness and airspace thickness the varying parameter was scratch shield thickness. Acoustic performance improves with larger airspaces but the absolute values are far less than is needed to meet the propfan interior noise requirement. The mechanisms which cause the variations in the window performance are:

- (a) Outer window plate resonance
- (b) Scratch shield plate resonance
- (c) Double wall resonance

These resonance frequencies were calculated for each configuration and are given in tables 3 and 4. Figure 6 through 8 indicate a notch in the transmission (TL) spectrum at 1200 Hz for different airspaces and scratch shield thicknesses. Table 3 identifies the plate resonance for a 1.52 cm (0.6 in.) thick lucite pane as 1161 Hz. A complicated picture emerges for a single outer pane, airspace and scratch shield. It is much more complicated with two or more panes plus scratch shield. Figure 8 gives the highest transmission loss values obtained for a single glass pane window with a glass scratch shield. While these transmission losses are high enough to meet the interior noise criteria for the propfan, the glass window assembly is extremely heavy and the scratch shield is thick enough to be an inner pane for a double pane configuration. In figure 9 the maximum TL values for the lucite configurations are seen to be much lower than required.

ORIGINAL PAGE IS  
OF POOR QUALITY

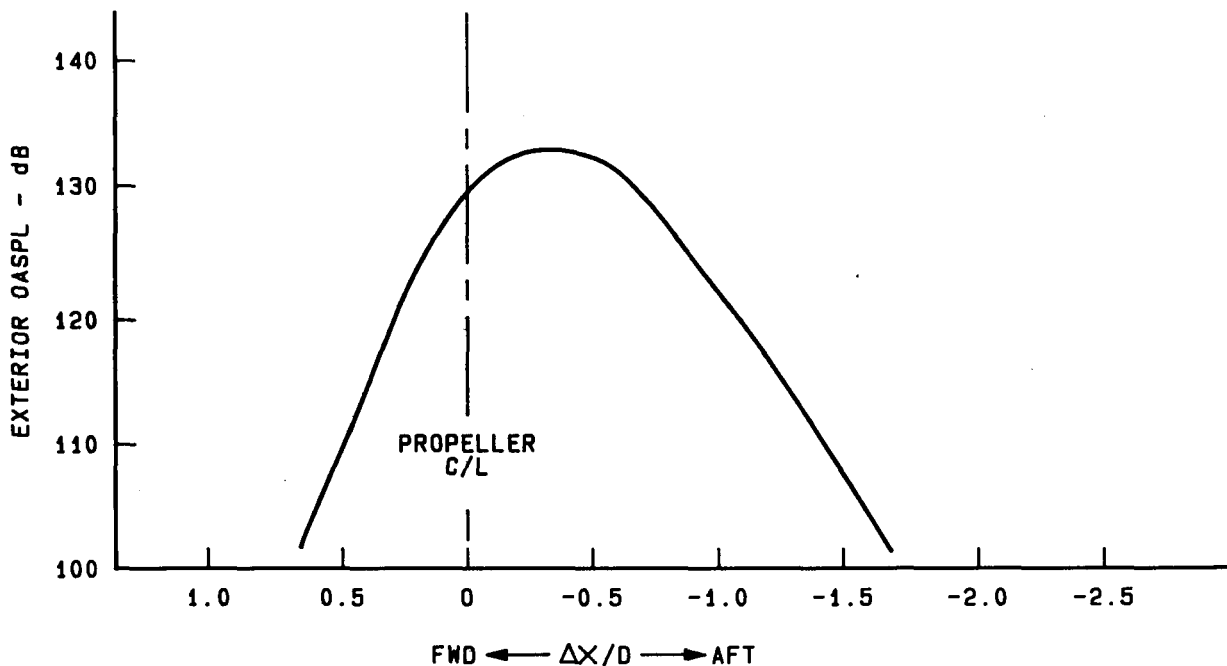

C112680.5

Figure 5. - Two engine aircraft exterior noise signature (directivity pattern symmetrical about propeller centerline for M = 0)

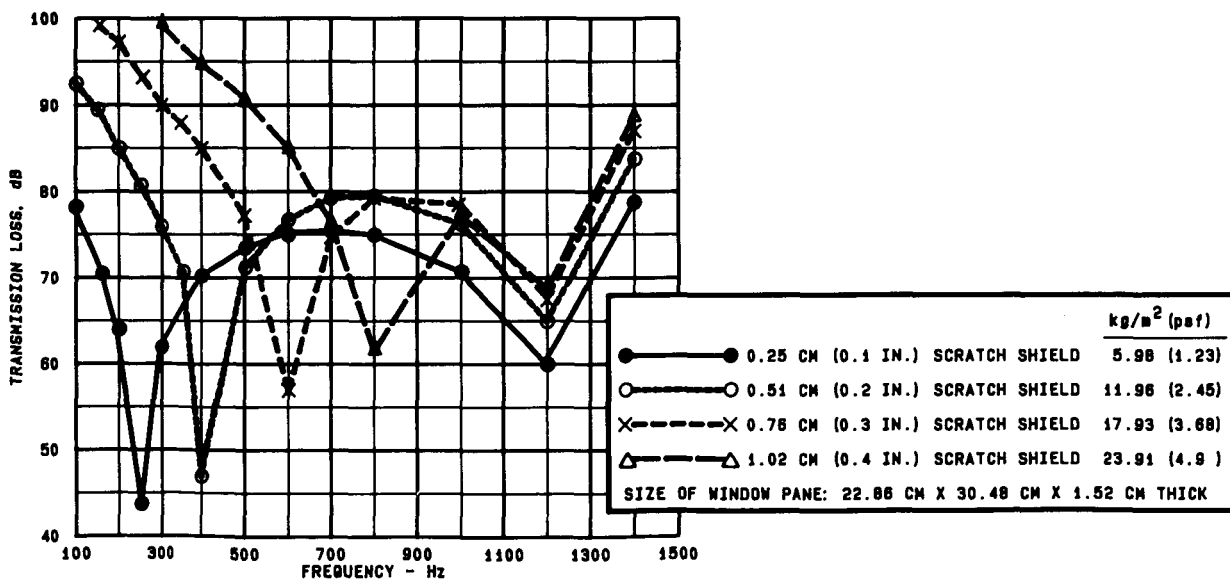

C112680.8

Figure 6. - Single-pane glass window with scratch shield - 2.54 cm (1.0 in.) airspace.

ORIGINAL PAGE IS  
OF POOR QUALITY

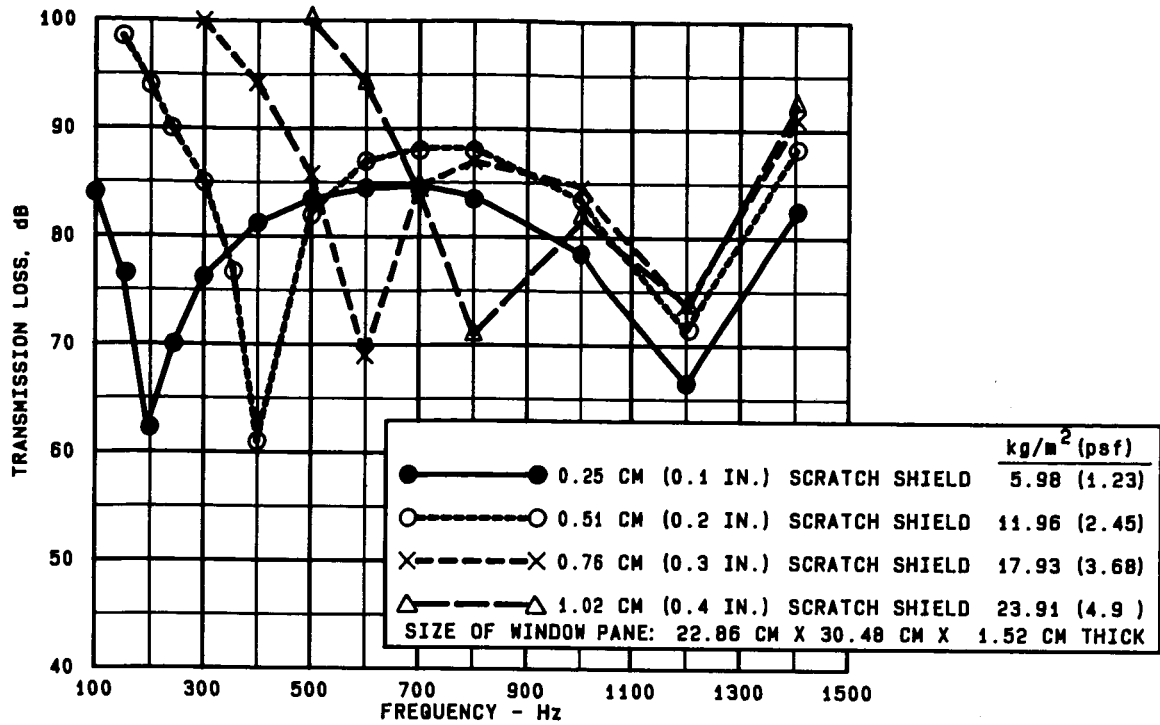

C112880.7

Figure 7. - Single-pane glass window with scratch shield -  
7.62 cm (3.0 in.) airspace.

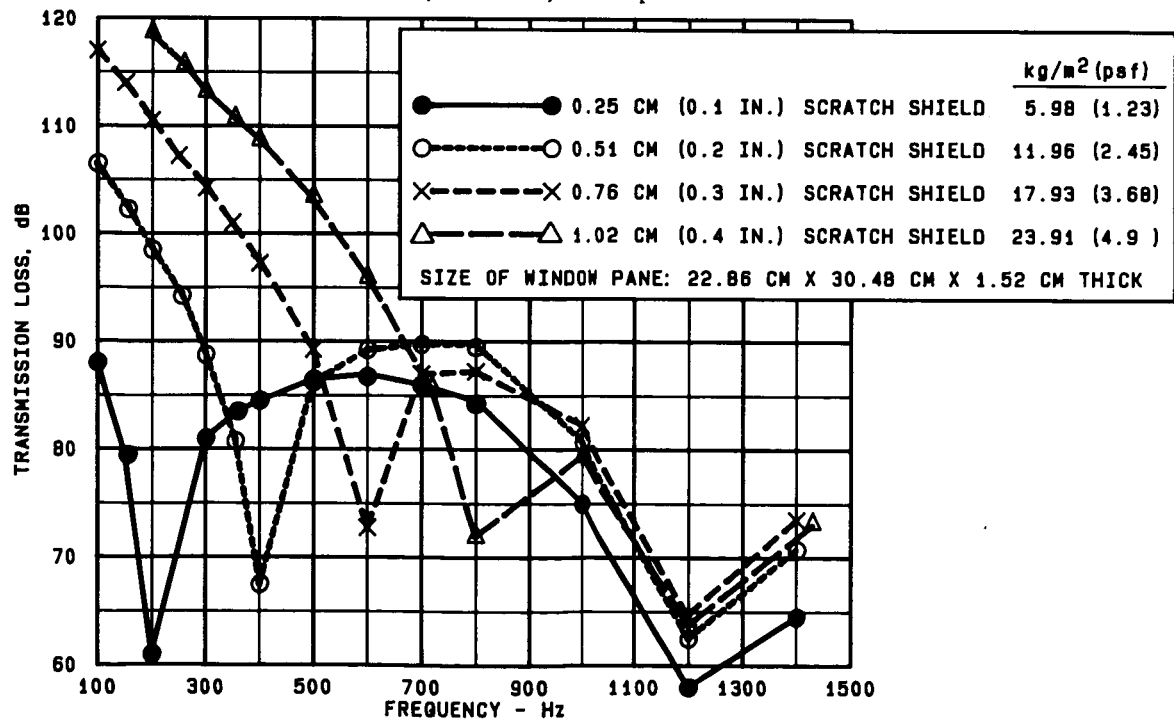

C112880.8

Figure 8. - Single-pane glass window with scratch shield -  
12.70 cm (5.0 in.) airspace.

TABLE 3. - PANE FUNDAMENTAL RESONANCES

| Pane Thickness<br>cm (in.) | Resonant Frequency - Size of Window (22.86 x 30.48 cm) |             |
|----------------------------|--|-------------|
|                            | Glass (Hz)   | Lucite (Hz) |
| 0.25 (0.1)                 | 194  | 70          |
| 0.51 (0.2)                 | 387  | 140         |
| 0.76 (0.3)                 | 581  | 210         |
| 1.02 (0.4)                 | 775  | 280         |
| 1.27 (0.5)                 | 969  | 350         |
| 1.52 (0.6)                 | 1161   | 420         |

### 2.3 Double-Pane Designs

When two or more window panes are combined, the number of possible configurations increases significantly. A total of 192 double-pane configurations were analyzed as itemized in table 1. From these analytical results several candidate designs were studied which were suitable for commercial aircraft. The results of the parameter study showed that the TL requirements could be met using glass panes and scratch shields of reasonable thicknesses. This was, however, not the case for an all lucite window which would require extremely thick window panes to meet the requirements. Figure 10 compares the results of double-pane glass window configurations with a double-pane window made of lucite. It is seen that below 400 Hz the TL of the lucite window having 1.02 cm (0.4 in.) thick panes is nearly 20 dB lower than a glass window with one half the pane thickness. In the vicinity of the estimated propfan blade passage frequency (154 Hz) the TL of the glass windows is considerable. For the 1.02 cm thick glass window panes the TL is about 88 dB at 160 Hz. Figure 11 shows the effect of the scratch shield thickness on the TL of a double-pane glass window. By doubling the scratch shield thickness, the TL increases by about 15 dB in the region below 300 Hz. (It is noted that use of glass scratch shields may be precluded for safety reasons.)

Figures 12 and 13 compare the TL data between single- and double-pane glass windows with the same total surface weight density. These results are better understood by referring to tables 3 and 4. The estimated plate resonance for a 1.02 cm (0.4 in.) thick glass pane is 775 Hz and it decreases to 387 Hz for a 0.51 cm (0.2 in.) thick pane. The higher resonance frequency for the single pane is advantageous for low frequency transmission loss. In addition, the double-wall resonance frequency for the single 1.02 cm glass pane with a 0.25 cm (0.1 in.) thick scratch shield is 172 Hz and the plate resonance for a 0.25 cm (0.1 in.) scratch shield is 194 Hz. The simplified method for estimating the double-wall resonance frequencies of table 4 does not include plate stiffness considerations and it is not accurate when the plate resonance occurs at a higher frequency than the double-wall resonance. In this instance the estimated plate resonance frequencies for 0.51 cm (0.2 in.) and 1.02 cm (0.4 in.) glass panes are 387 Hz and 775 Hz. Both of these frequencies are much higher than the associated double-wall resonant frequency estimates of



TABLE 4. - DOUBLE-PANE, DOUBLE-WALL RESONANCES

| Material Thickness, cm (in.) |            | Airspace, cm (in.) | Resonant Frequency (Hz) |        |
|------------------------------|------------|--------------------|-------------------------|--------|
| Pane #1                      | Pane #2    |                    | Glass                   | Lucite |
| 0.51 (0.2)                   | 0.25 (0.1) | 2.54 (1.0)         | 188                     | 264    |
|                              | 0.51 (0.2) |                    | 154                     | 215    |
|                              | 0.76 (0.3) |                    | 140                     | 197    |
|                              | 1.02 (0.4) |                    | 133                     | 186    |
| 0.51 (0.2)                   | 0.25 (0.1) | 7.62 (3.0)         | 109                     | 153    |
|                              | 0.51 (0.2) |                    | 89                      | 124    |
|                              | 0.76 (0.3) |                    | 81                      | 114    |
|                              | 1.02 (0.4) |                    | 77                      | 108    |
| 0.51 (0.2)                   | 0.25 (0.1) | 12.7 (5.0)         | 84                      | 118    |
|                              | 0.51 (0.2) |                    | 69                      | 96     |
|                              | 0.76 (0.3) |                    | 63                      | 88     |
|                              | 1.02 (0.4) |                    | 59                      | 83     |
| 1.02 (0.4)                   | 0.25 (0.1) | 2.54 (1.0)         | 172                     | 241    |
|                              | 0.51 (0.2) |                    | 133                     | 186    |
|                              | 0.76 (0.3) |                    | 117                     | 165    |
|                              | 1.02 (0.4) |                    | 109                     | 152    |
| 1.02 (0.4)                   | 0.25 (0.1) | 7.62 (3.0)         | 99                      | 139    |
|                              | 0.51 (0.2) |                    | 77                      | 108    |
|                              | 0.76 (0.3) |                    | 68                      | 95     |
|                              | 1.02 (0.4) |                    | 63                      | 88     |
| 1.02 (0.4)                   | 0.25 (0.1) | 12.7 (5.0)         | 77                      | 108    |
|                              | 0.51 (0.2) |                    | 59                      | 83     |
|                              | 0.76 (0.3) |                    | 52                      | 74     |
|                              | 1.02 (0.4) |                    | 49                      | 68     |
| 1.52 (0.6)                   | 0.25 (0.1) | 2.54 (1.0)         | 166                     | 233    |
|                              | 0.51 (0.2) |                    | 125                     | 176    |
|                              | 0.76 (0.3) |                    | 109                     | 152    |
|                              | 1.02 (0.4) |                    | 99                      | 139    |
| 1.52 (0.6)                   | 0.25 (0.1) | 7.62 (3.0)         | 96                      | 135    |
|                              | 0.51 (0.2) |                    | 72                      | 102    |
|                              | 0.76 (0.3) |                    | 63                      | 88     |
|                              | 1.02 (0.4) |                    | 57                      | 80     |
| 1.52 (0.6)                   | 0.25 (0.1) | 12.7 (5.0)         | 74                      | 104    |
|                              | 0.51 (0.2) |                    | 56                      | 79     |
|                              | 0.76 (0.3) |                    | 49                      | 68     |
|                              | 1.02 (0.4) |                    | 44                      | 62     |

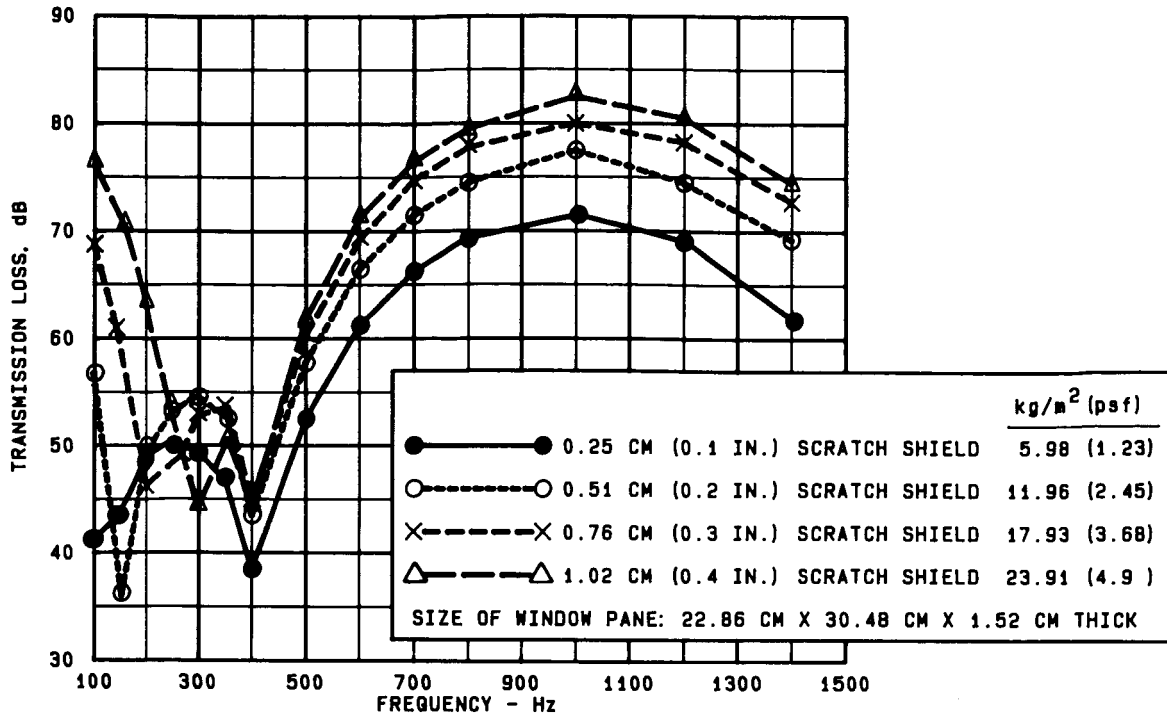

C112880.9

Figure 9. - Single-pane Lucite window with scratch shield - 12.70 (5.0 in.) airspace.

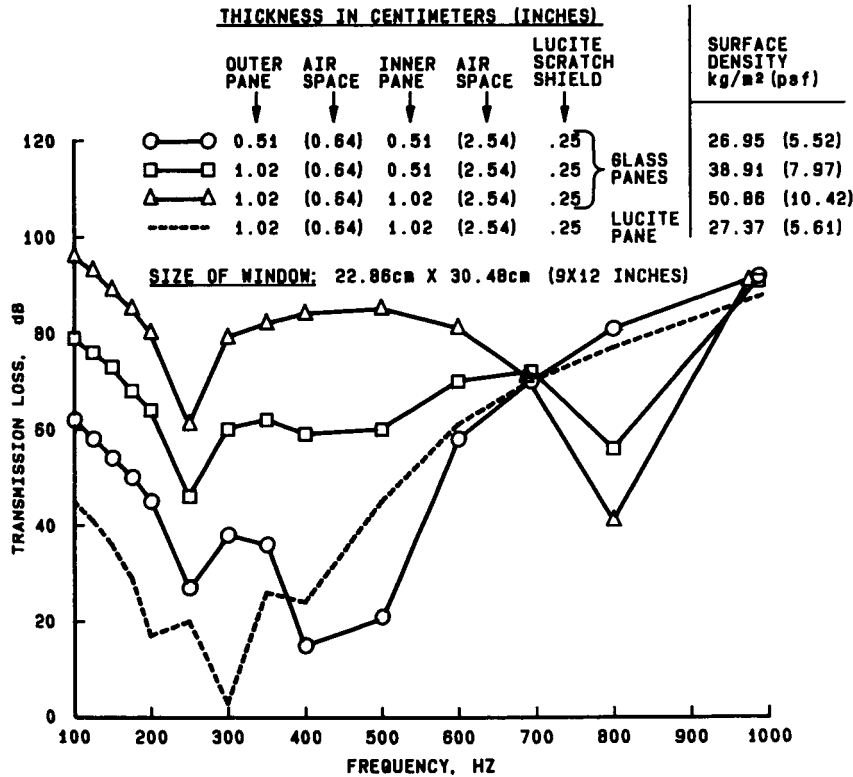

Figure 10. - Comparison of predicted TL for double-pane glass and Lucite windows.

ORIGINAL PAGE IS  
OF POOR QUALITY

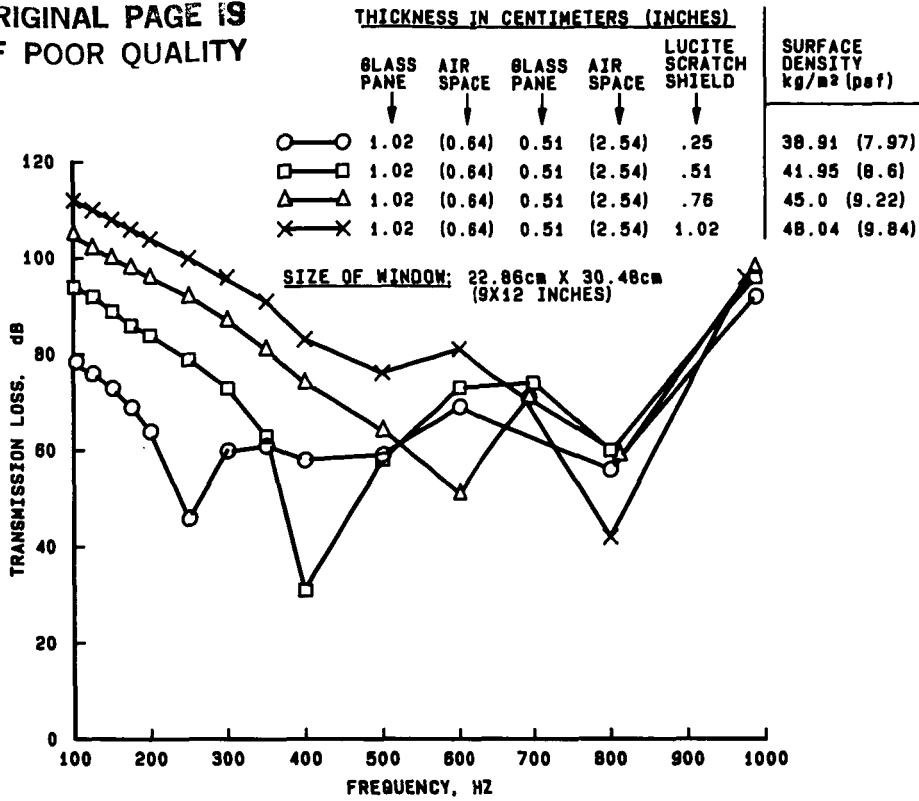

Figure 11. - Effect of scratch shield thickness on the predicted TL of a double-pane glass window.

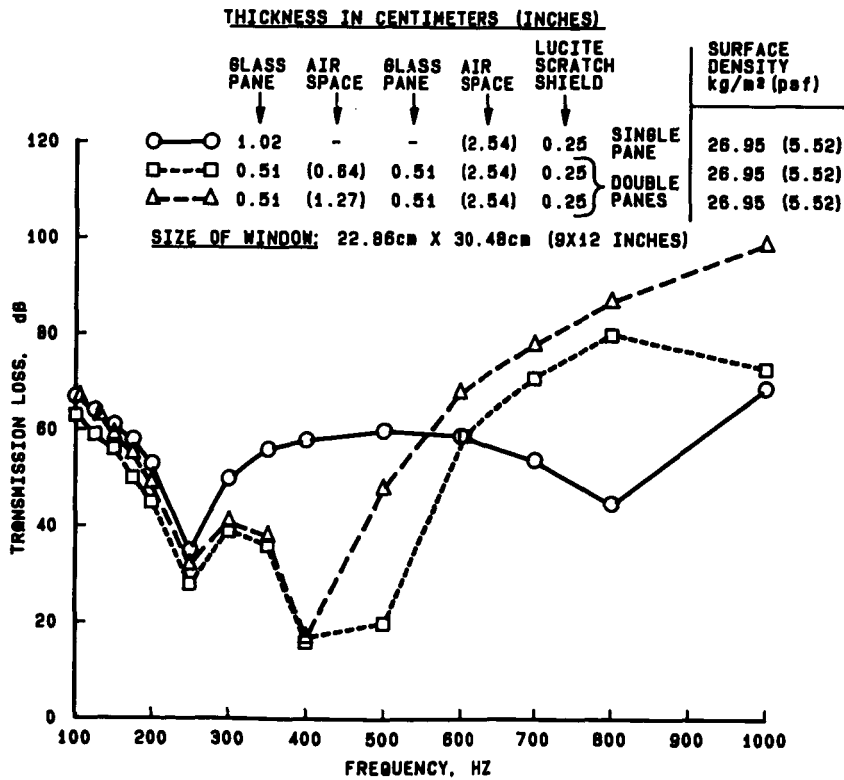

Figure 12. - Comparison of predicted TL for single- and double-pane windows with the same total surface density of 26.9 kg/m<sup>2</sup> (5.5 psf).

about 200 Hz. The predicted transmission loss minimum at 250 Hz in figure 12 is the double-wall frequency with plate stiffness effects which are not included in the approximate calculations for table 4. As expected, greater complexities are introduced for multi degree-of-freedom systems which include coupled structural/acoustic resonances.

#### 2.4 Configuration Selection

From the results of the parametric study it became clear that the propfan interior noise requirements could be met with a design similar to that of an L-1011 window by simply replacing the lucite panes with the heavier glass and retaining the lucite scratch shield. Consequently, additional transmission loss computations were performed whose results are presented in figures 14 and 15. Figure 14 shows the results for the L-1011 window design with the lucite scratch shield thickness as the varying parameter. It is observed that for scratch shield thicknesses of 0.76 cm (0.3 in.) and 1.02 cm (0.4 in.) the acoustic performance of the glass window is well within the required TL range. In figure 15 the effect of the inner glass pane thickness on the TL is shown. These data indicate that the minimum noise criterion (54 dB of TL at 164 Hz) could be met with the basic L-1011 window design, and by making the inner pane the same thickness as the outer pane, i.e., 0.94 cm (0.37 in.), the more stringent requirement (69 dB of TL) would be met.

Although such designs are shown by analysis to have the required acoustical characteristics they are not acceptable from a safety standpoint because the inner pane is made of glass. This additional requirement led to a final design from which the window test articles were fabricated. It consists of two glass outer panes separated by an air space and a third inner pane made of lucite. The results of the triple pane window study are shown in figures 16, 17, and 18. Figure 16 compares TL predictions for the two window designs without the presence of a scratch shield, and figures 17 and 18 contain data with the scratch shield included for total window depths of 7.62 cm (3 in.) and 15.24 cm (6 in.) respectively. The presence of a scratch shield has an adverse effect on the window acoustic performance below 200 Hz and in the region near the second propfan harmonic. However, above 400 Hz the contribution of the scratch shield to the window TL is significant. It is noted that the predicted transmission losses for the two high-surface-density designs are very large over a wide frequency range. The configuration represented by the solid curve consists of two glass panes of equal thickness (0.94 cm) and a 0.64 cm thick lucite pane. The configuration represented by the dotted line differs only in the thickness of the inner glass pane which is 0.64 cm compared to 0.94 cm.

### 3. TEST ARTICLES

Sketches of the two window assemblies are shown in figure 19 and a photograph of the actual test articles is shown in figure 20. The engineering drawings are given in the Appendix. The overall dimensions (width, height, and depth) of the two window assemblies are identical. What differs between them is the thickness of the inner glass pane and the thickness of the air

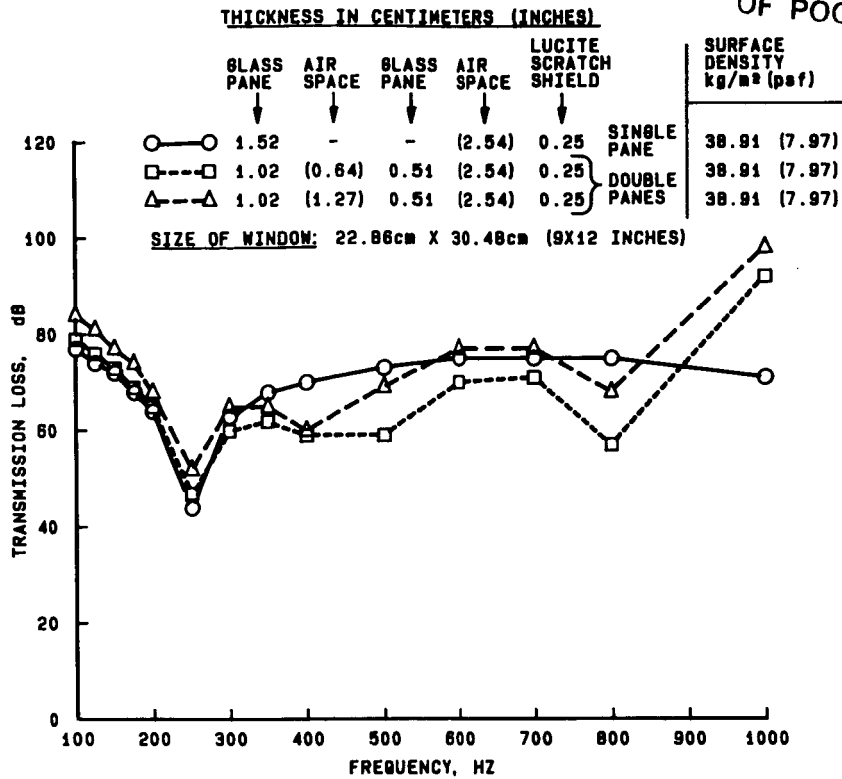

Figure 13. - Comparison of predicted TL for single- and double-pane glass windows with the same total surface weight density of 38.9 kg/m<sup>2</sup> (8 psf).

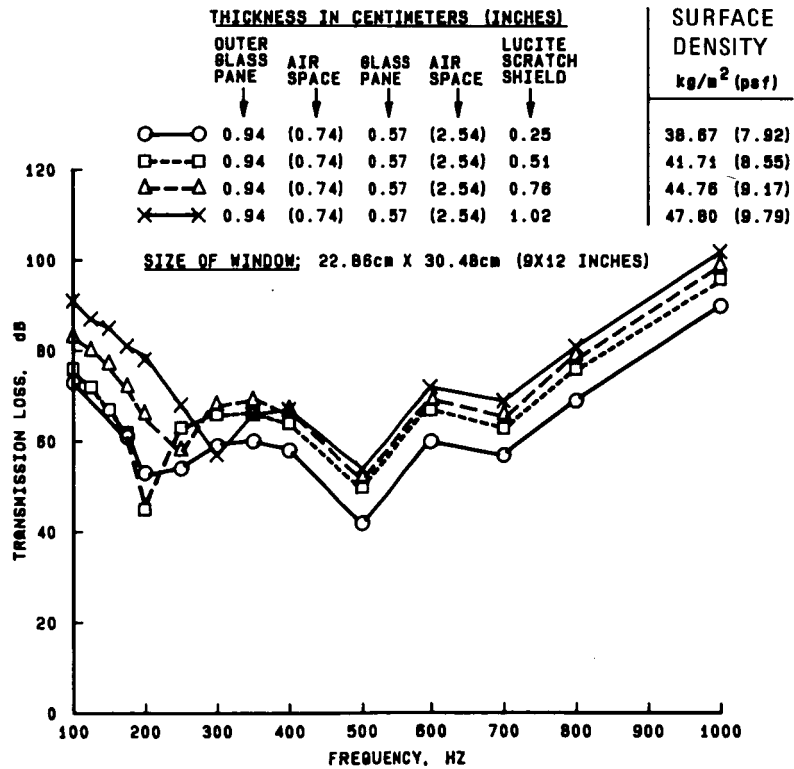

Figure 14. - Effect of scratch shield thickness on the predicted TL of a double-pane glass window representative of the L-1011 window design.

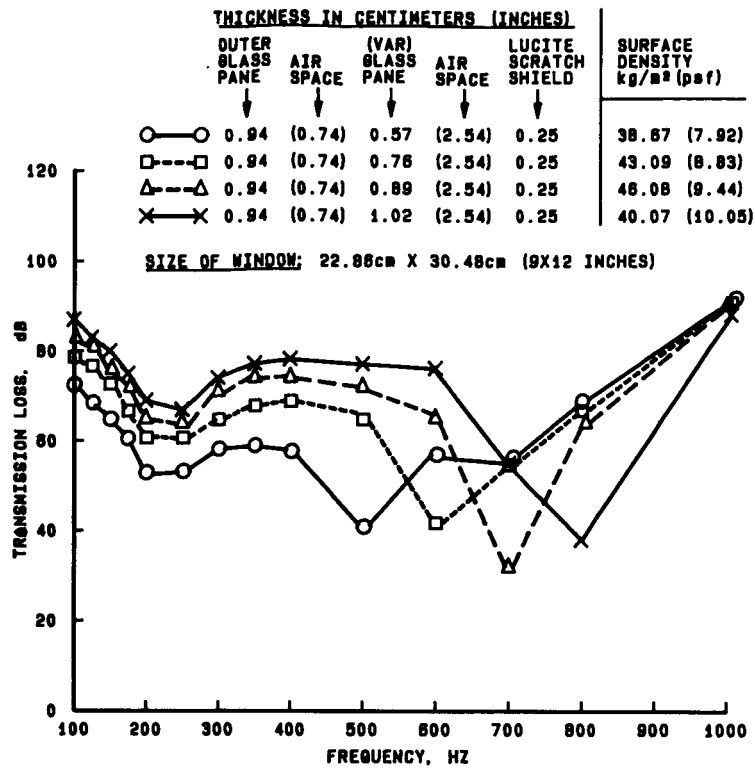

Figure 15. - Effect of inner pane window thickness on the predicted TL of a double-pane glass window with a Lucite scratch shield.

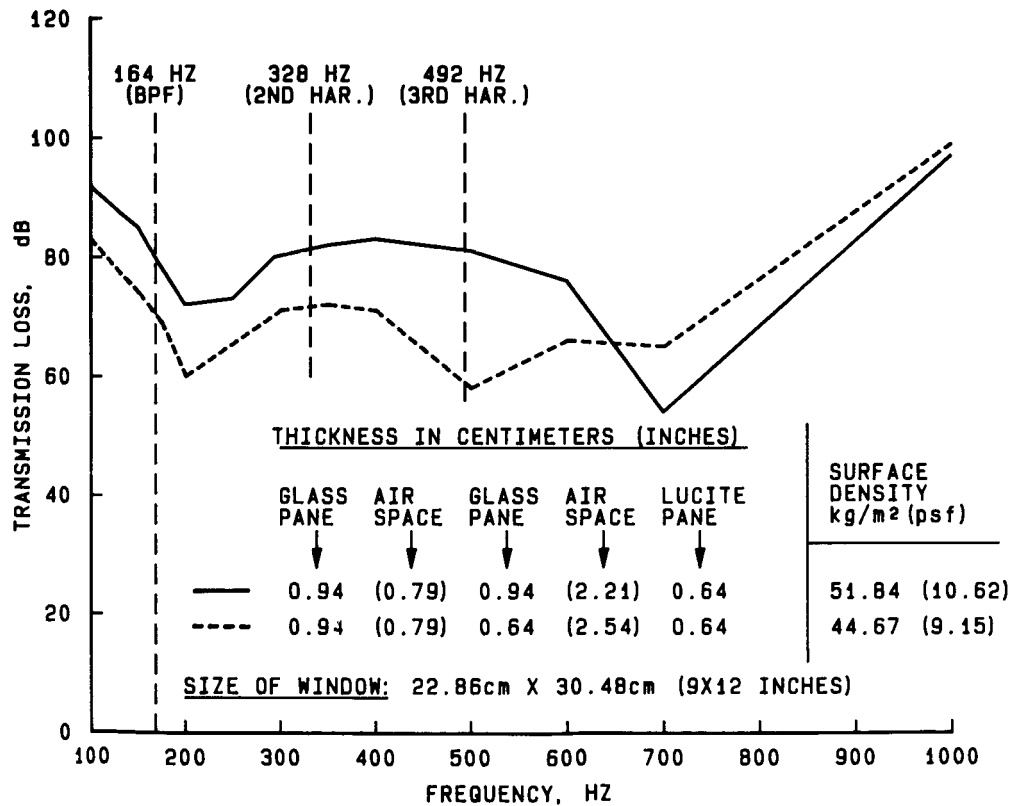

Figure 16. - Predicted TL results for triple-pane window designs without a scratch shield - 5.1 cm (2 in.) thick window.

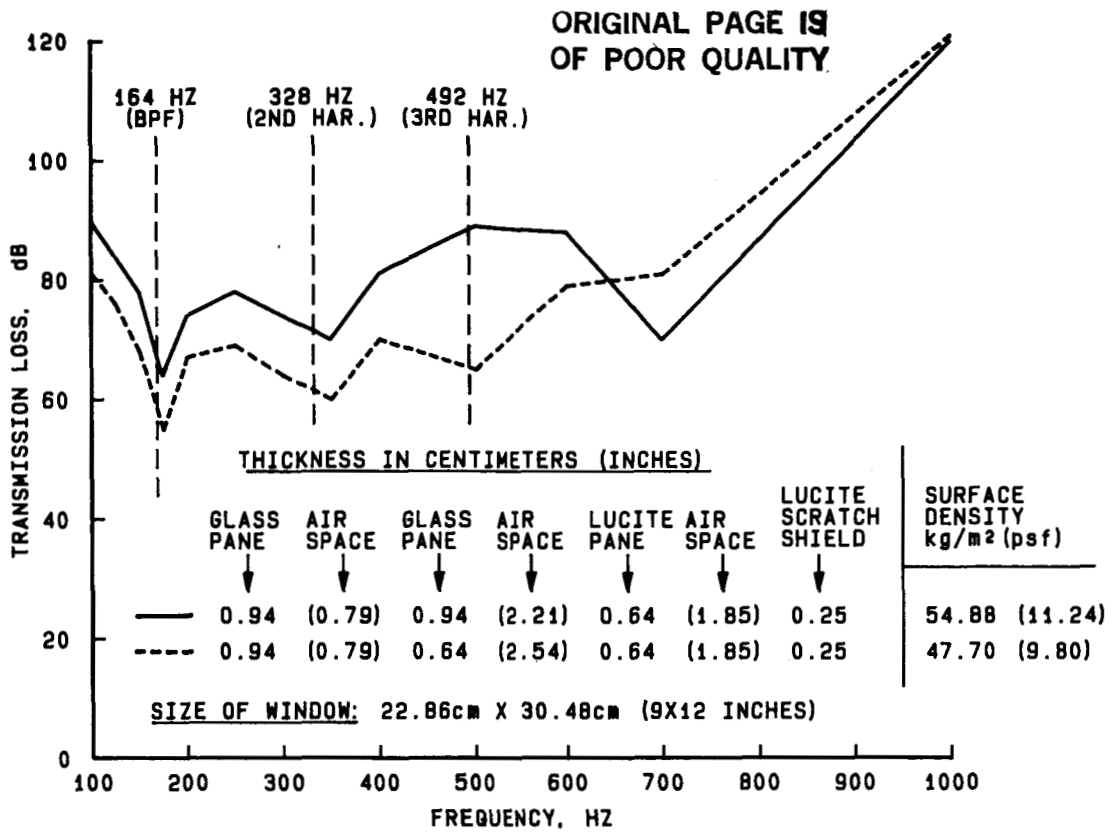

Figure 17. - Predicted TL results for triple-pane window designs with a scratch shield - 7.62 cm (3 in.) thick window.

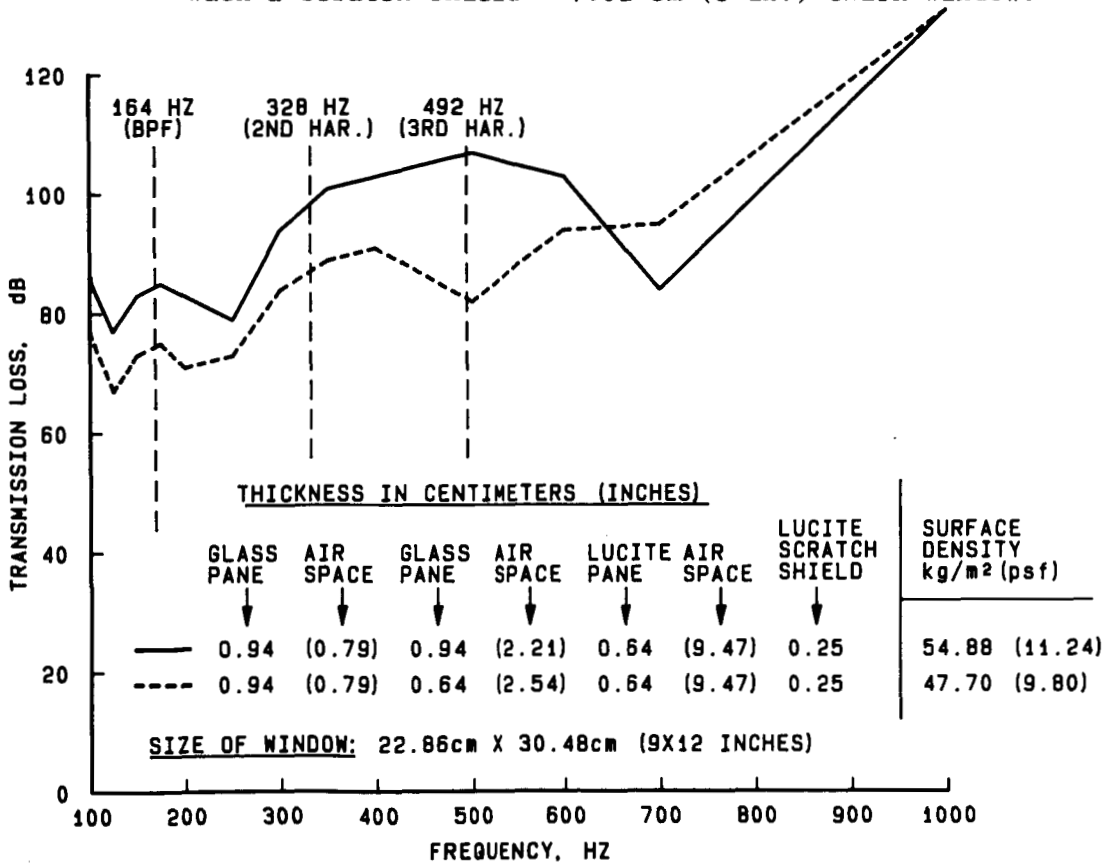
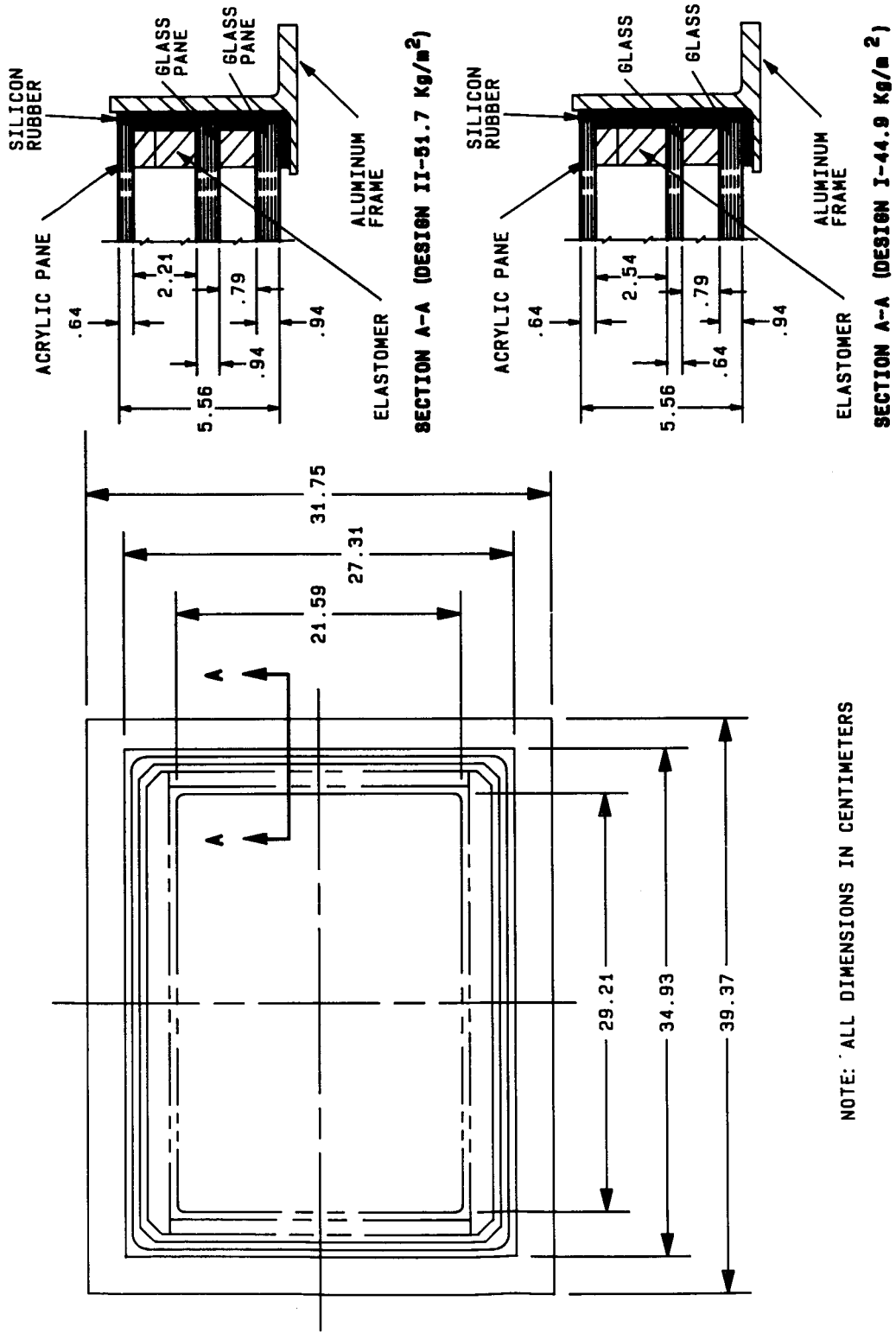

Figure 18. - Predicted TL results for triple-pane window designs with a scratch shield - 15.25 cm (6 in.) thick window.

ORIGINAL PAGE IS  
OF POOR QUALITY



NOTE: ALL DIMENSIONS IN CENTIMETERS

Figure 19. - Window configurations.



space between the second and third window panes. The window with the thicker pane has a surface density of  $51.7 \text{ kg/m}^2$  (10.6 psf) as compared to  $44.9 \text{ kg/m}^2$  (9.2 psf) for the one with the thinner pane. The aluminum window frames have overall dimensions of 31.8 cm by 39.4 cm (12.5 x 15.5 inches) and the window size is 21.6 cm by 29.6 cm (8.5 x 11.5 inches) which is about the same as that of an L-1011 window. The dimensions of the window panes are 25.4 cm by 33 cm (10 x 13 inches).

The triple panes were potted into a 6.4 cm (2.5 inch) deep aluminum frame with silicon rubber (RTV). Strips of elastomers were used to support the window panes in the frame and to provide the required air gap between the panes. A contact cement was used to hold the elastomer in place.

Figure 21 shows a sketch of the window assembly installed in a double-wall flat structure. The structure is representative of sidewall design No. 8 of CR 159222 (reference 1) which has about the same transmission loss (TL) as the window design with the lower surface density. The 0.25 cm (0.1 inch) thick scratch shield which is mounted on the trim panel is decoupled from the window assembly. This is to prevent structureborne sound transmission and minimize the effect of double-wall resonances on the TL. The visual shield which is mounted around the cavity formed by the scratch shield and inner window pane is primarily for aesthetic purposes. Interior noise reduction programs on the L-1011 have revealed that lower acoustic window radiation is achieved when there is no mechanical connection between the scratch shield and the window assembly.

#### 4. RECOMMENDATION FOR LABORATORY TEST PROGRAM TO EVALUATE WINDOW DESIGNS

In this section, recommendations are made for the experimental evaluation of two window configurations designed by analysis as described previously. Test and analysis requirements are discussed to determine the acoustic characteristics of the windows and verify the accuracy of the analytical model for predicting the transmission loss (TL) of multipane window designs. Measurements are proposed which would define the structural frequency response, acoustic transmission, and radiation properties of the test articles.

##### 4.1 Test Facility

The conventional approach for determining the sound transmission properties of a flat or curved structure is to mount the test article between two test chambers, introduce sound in one of them and then measure the sound pressure/power in each chamber. Although the traditional sound transmission loss method involves two reverberation chambers, approaches involving either one or two anechoic chambers are often used to determine the transmission properties of a structure. Generally, the type of method that one selects is dependent on the test objectives. For the window study, the anechoic-to-anechoic method is preferred because it allows a closer simulation of the angle of incidence and the determination of the sound radiation properties of the window. When evaluating a high-transmission loss structure at low frequencies, flanking

ORIGINAL PAGE IS  
OF POOR QUALITY

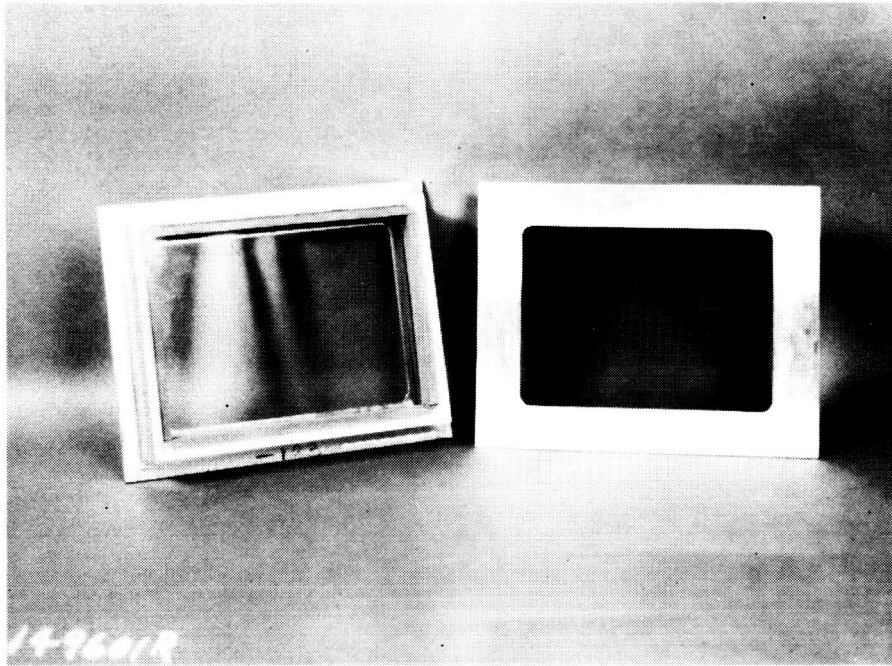

Figure 20. - Window test articles - front and rear views.

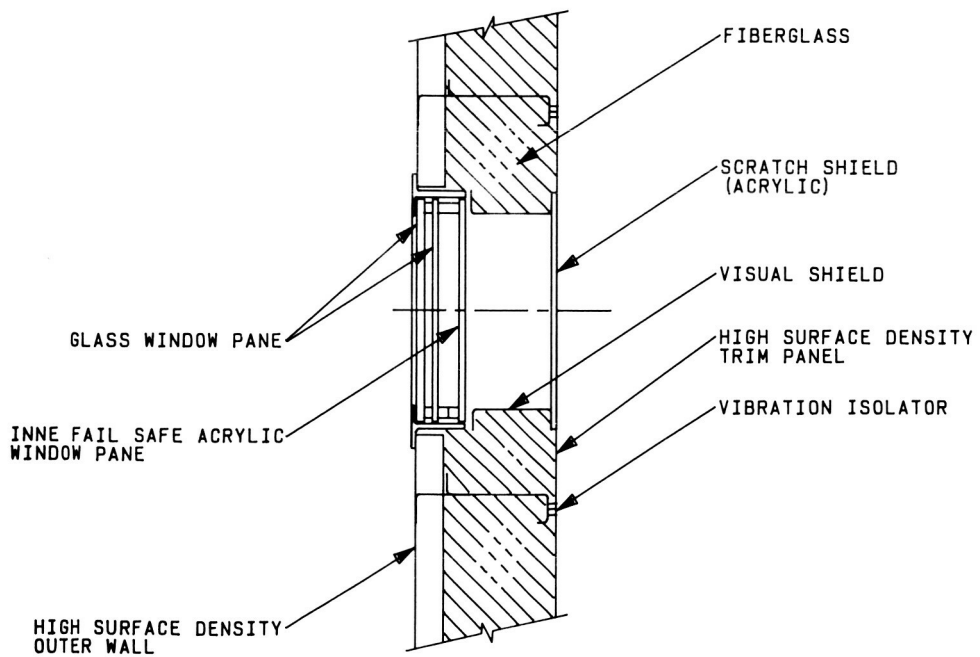

Figure 21. - Sketch of window installation in a double-wall structure.

transmission is often difficult to control. In this study the windows have been designed for very large transmission losses (55 to 70 dB), exceeding the TL capabilities of most existing acoustic facilities. For example, a 30.5 cm (12 in.) thick concrete wall provides only about 60 dB of TL at 200 Hz and every additional 5 dB increase of TL requires doubling of the mass. The flanking transmission problem, however, can be minimized to a large extent by making sound intensity rather than the conventional sound pressure measurements. In addition to the lower sensitivity to flanking, the two-microphone acoustic intensity method is less affected by the room characteristics than the conventional methods. Moreover, the newer method can discriminate between areas of high and low sound radiation which is important for a window evaluation. The disadvantages of the intensity method center on the need for a fairly high signal-to-noise ratio and the inherent phase inaccuracies at low frequencies. An adequate signal-to-noise ratio can usually be achieved by increasing the excitation level by an appropriate amount. For very high transmission loss structures, however, care must be taken not to exceed the linear region of the structural response of the test article. The phase problem is mostly of concern below 100 Hz which is outside the frequency range of interest. A phase-matched two microphone system should give accurate results at and above the estimated propfan blade passage frequency of 164 Hz.

Therefore, the experimental investigation should rely heavily on the sound intensity measurement method to evaluate the two window designs. It will provide a better understanding of the sound transmission mechanism as well as more accurate results.

#### 4.2 Basic Test Configuration

There are a number of test configurations that could be used to perform the experimental window evaluation in the laboratory. One approach would be to test the window assemblies, shown in figure 20, as separate structures in an opening of a thick concrete wall separating the two test chambers. For the purpose of merely verifying the predicted TL of the high surface density windows this would probably be the best method to use. A more representative approach would be to incorporate the window in an appropriate fuselage sidewall structure with trim panels and a scratch shield. Since one of the design objectives was to achieve a window transmission loss at least equivalent to that of sidewall design No. 8 of NASA CR 159222 (reference 1) it would be desirable to test the windows in a flat panel configuration which is representative of this design. Figure 21 and drawing No. X17003-5 in the Appendix show a single window installation in a double-wall test panel which is representative of design No. 8.

#### 4.3 Measurement Program

The main result that the measurement program should provide is the variation of the window sound transmission loss with narrowband frequencies over the range of about 100 to 1000 Hz. Based on the analysis, significant fluctuations in the spectrum levels are expected. Major changes in the

transmission loss curve should be well defined and understood if optimum window designs are to be achieved for advanced turboprop powered aircraft. Therefore two sets of measurements should be performed, one set that is diagnostic, the other set that defines the basic sound transmission properties of the two window configurations.

The diagnostic measurements would include a modal analysis to identify the major resonance frequencies of the window frame and inner and outer window panes, and determine the associated mode shapes and damping over the frequency range of about 100 to 600 Hz. The impact method is a quick and accurate method for defining the structural parameters. The technique is well documented in the literature (reference 8). Briefly, it consists of applying a transient force at a grid point and measuring the response at a fixed reference location. This procedure is then repeated for each of the selected grid points. To provide quality data, a number of impacts, at least five, should be averaged. Since the input energy spectrum of a hammer impact depends on its mass, head stiffness, and local structural stiffness at the impact point, care should be taken to ensure that the impacts will provide energy adequate to cover the desired frequency range. However, one needs to proceed with caution when applying the input force to the outer glass pane. A fairly soft hammer tip made of rubber or plastic is recommended. Prior to the investigation, preliminary checks should be made using different hammer configurations so that a suitable selection can be made.

Multiwall structures such as aircraft windows have been found deficient (see Section 1 on Analysis) because of resonances involving the wall masses coupled by the air space spring. These double-wall resonances and their effect on the sound radiation should be investigated and compared with theory. Using acoustic excitation at normal incidence the structural and acoustic window response should be measured. Acoustic measurements would be made in the air spaces between the window panes and between the inner window pane and scratch shield. The data would then be correlated with vibration measurements and the radiated sound. Data would be taken with the window assembly sealed and vented. The test article can be easily modified to a vented configuration by drilling holes through and around the frame at locations coinciding with the two air spaces of the triple-pane window. This would allow the air spring stiffness effect to be determined. It is suggested that when the air is allowed to move freely into the adjacent fiberglass as the panes are vibrating, tends to minimize the double-wall resonance effect. When the air is trapped in the cavity between the window panes, a more efficient coupled system is obtained resulting in more intense sound radiation. These measurements should be performed in a two-room, preferably anechoic, transmission loss facility where the basic sound transmission investigations would also be carried out.

A number of test configurations, shown in table 5 are recommended for the sound transmission study. These configurations are selected to provide a direct comparison between the transmission properties of the basic sidewall structure and the test windows, and to determine the effects of the window on the acoustic performance of the sidewall. Acoustic excitation would be provided at normal incidence by a low-frequency loudspeaker and the transmission properties of each configuration would be determined from sound pressure and intensity

TABLE 5. - PROPOSED TEST CONFIGURATIONS FOR SOUND TRANSMISSION TESTS

| Configuration No. | Test Panel Description   | Wall Spacing cm (in.) | Window Assembly | Objective                                      |
|-------------------|--|-----------------------|-----------------|--|
| 1                 | Sidewall design #8*  | 15.2 (6)              | --              | Measure TL of basic sidewall design            |
| 2                 | Sidewall design #8 with cutout for window installation covered lead vinyl and fiberglass | 15.2 (6)              | --              | Measure TL of modified sidewall structure      |
| 3                 | Sidewall design #8 with single window installation                                       | 15.2 (6)              | I               | Measure combined TL of sidewall and window     |
| 4                 | Sidewall design #8 with increased surface density walls (window installed)               | 15.2 (6)              | I               | Measure TL of window                           |
| 5,6               | Same as 3 and 4 with window II   | 15.2 (6)              | II              | Same as 3 and 4 above                          |
| 7, 10             | Sidewall design #8 with reduced wall spacing (repeat 1 - 4)                              | 7.6 (3)               | II              | Measure TL of modified design #8 configuration |

\* Design #8 (CR 159222, Table 8, Page 49)

|  |                                   |
|--|-----------------------------------|
| 1. Frame Spacing                           | 48.3 cm (19 in.)                  |
| 2. Stringer Spacing                        | 15.2 cm ( 6 in.)                  |
| 3. Wall Spacing                            | 15.2 cm ( 6 in.)                  |
| 4. Fiberglass Thickness                    | 7.62 cm (3 in.)                   |
| 5. Airgap Thickness                        | 6.65 cm (2.62 in.)                |
| 6. Skin Thickness                          | 0.114 cm (0.045 in.)              |
| 7. Surface Density of Outer Wall Structure | 6.25 kg/m <sup>2</sup> (1.28 psf) |
| 8. Surface Density of Add-On Material      | 13.3 kg/m <sup>2</sup> (2.72 psf) |
| 9. Surface Density of Trim Panel           | 13.4 kg/m <sup>2</sup> (2.75 psf) |

measurements. Measurements at discrete frequencies corresponding to the critical full-scale profan frequencies should be made, and over a broadband frequency range of about 100 to 1000 Hz using random noise excitation. A summary of the proposed experimental program is outlined in table 6. Three major tasks are proposed: (1) modal analysis to define the structural resonances, mode shapes and damping of the window frame and inner and outer panes, (2) multipane window resonance study to assess the effect of coupled system resonances on the radiation properties and (3) sound transmission tests to evaluate various panel-window configurations.

TABLE 6. - EXPERIMENTAL PROGRAM OUTLINE FOR WINDOW EVALUATION

| Major Tasks                     | Test Objectives   | Test Configurations   | Excitation  | Data  |
|---------------------------------|---|---|---|---|
| Modal analysis                  | Determine structural frequency response of window assemblies in the 100 to 600 Hz frequency range | <ul style="list-style-type: none"> <li>● Window assembly I</li> <li>● Window assembly II</li> </ul>                                     | Impact  | <ul style="list-style-type: none"> <li>● Acceleration</li> <li>● Force</li> </ul>                                     |
| Window acoustic resonance study | Identify double-wall window resonance and determine effect on window transmission                 | <ul style="list-style-type: none"> <li>● Config. 4 and 6 in table</li> <li>● Sealed and vented air gaps between window panes</li> </ul> | Normal incidence acoustic excitation at discrete frequencies          | <ul style="list-style-type: none"> <li>● Sound pressure</li> <li>● Acceleration</li> <li>● Sound intensity</li> </ul> |
| Sound transmission tests        | Determine sound transmission loss and radiation properties of various panel-window configurations | Test configurations as in table 5   | Discrete and broadband random acoustic excitation at normal incidence | <ul style="list-style-type: none"> <li>● Sound pressure</li> <li>● Acceleration</li> <li>● Sound intensity</li> </ul> |

#### 4.4 Instrumentation Requirements

From the previous discussions two separate types of instrumentation requirements can be defined, one which is associated with modal analysis, the other with sound transmission testing and analysis. Figure 22 shows a schematic diagram of a typical modal analysis system using the impact method. The force pulse is generated by a hammer, weighing about 100 grams, that is instrumented with a force gage. The response of the window panes is measured at a fixed reference location using a miniature accelerometer. An accelerometer having integral electronics is preferred because of its high sensitivity relative to its size. The impact and response signals are then processed in a Fourier analysis system with modal capability to form the force/acceleration transfer functions from which the resonant frequencies, mode shapes and damping of the various window components are defined. A measurement grid of at least nine points, as shown in figure 22, is required to determine the structural frequency response of the window panes. For these tests the window assembly need not be mounted into the test panel.

The signal generation, data acquisition, and analysis systems for the acoustic tests are shown diagrammatically in figure 23. An oscillator and a random noise generator would be used to provide the discrete frequency and broadband random signals to the loudspeaker. A spectrum shaper would be used for the broadband signal to optimize the spectrum for maximum signal-to-noise ratio over the frequency range of interest (100 - 1000 Hz). The discrete frequency excitation would be limited to frequencies at and near the estimated full-scale blade passage frequency and lower order harmonics, and to frequencies

ORIGINAL PAGE IS  
OF POOR QUALITY

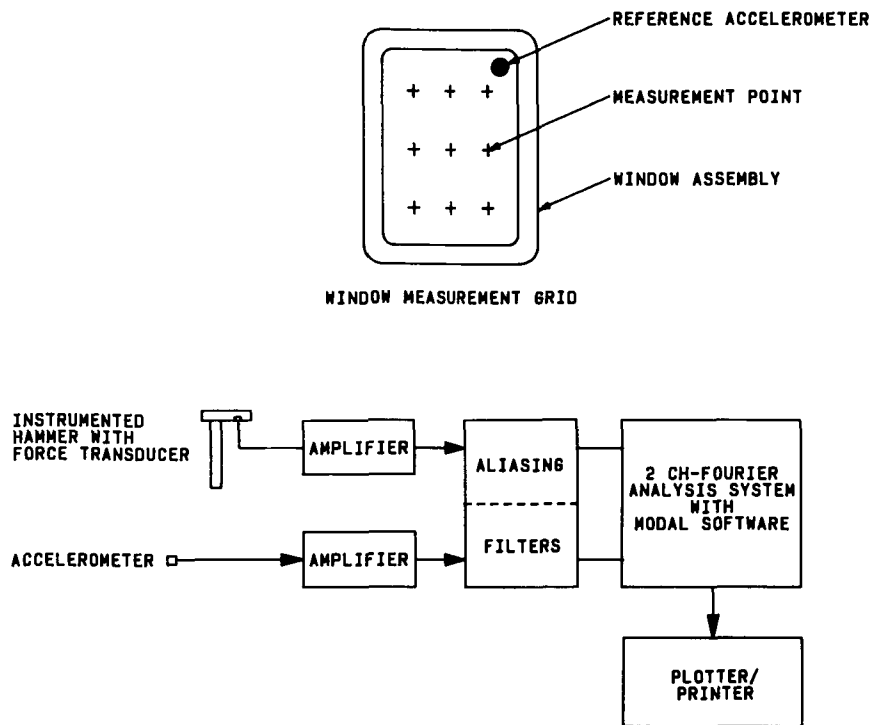

Figure 22. - Schematic diagram of structural frequency response system.

related to the coupled system resonances. During each test condition a reference microphone located close to the noise source would be used to monitor the excitation level. Also, the input voltage to the speaker should be monitored on a digital voltmeter and recorded on magnetic tape to ensure that the same sound level is obtained from test to test. The incident power would be determined from an array of microphones located in the free field (empty chamber) at the same distance from the noise source as when the panel is in place during the transmission tests. The microphone would be arranged in a uniform grid slightly less the size of the test panel. The radiated power would be measured with a two-microphone intensity probe by scanning the probe over the window and panel structure. The window should be instrumented with sufficient microphones and accelerometers to define the structural-acoustic response (see figure 23). All acoustic and vibration data should be recorded on magnetic tape for subsequent analysis.

## 5.0 CONCLUSIONS

An acoustic analysis has been performed to establish acoustic window designs for advanced turboprop powered aircraft. A fairly extensive parametric study revealed that the material of the window panes is one of the most important parameters affecting the transmission loss. For an L-1011 size window, very

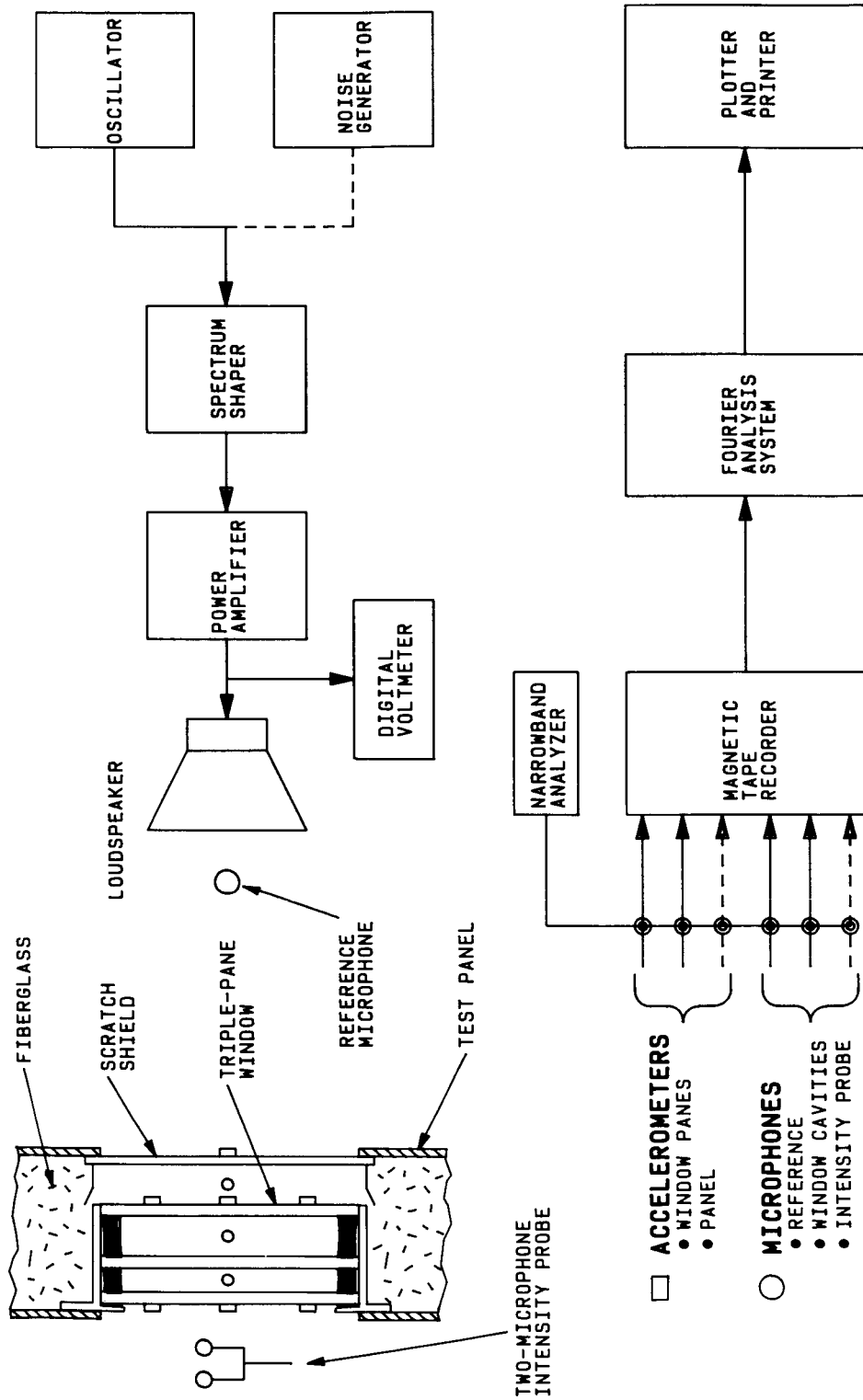

Figure 23. - Schematic diagram of signal generation, data acquisition and analysis systems.



large transmission losses can be achieved at low frequencies when glass is used for the window panes. It is shown that practical windows can be designed which would not compromise the acoustic performance of high transmission loss sidewalls designs.

The windows that have been identified are high-surface-density designs, consisting of two glass outer panes, separated by a small air gap, a third fail safe inner pane made of lucite and a light weight scratch shield. It is noted that a weight-optimization study was not performed. Some reduction in weight may be achieved by eliminating the third pane and making the inner glass pane fail safe using a laminate of lucite and glass.

Experimental evaluation of the window test articles and verification of the predicted transmission losses is an important part of the development of a window design for advanced turboprop aircraft. Procedures for performing laboratory tests are presented in this report.

#### APPENDIX

##### ENGINEERING DRAWINGS OF WINDOW TEST ARTICLES

| <u>DRAWING NO.</u> | <u>TITLE</u>                                 |
|--------------------|--|
| X 17003-1          | Window Assembly                              |
| X 17003-2          | Window Frame Detail                          |
| X 17003-3          | Window Pane Detail                           |
| X 17003-4          | Window Elastomer                             |
| X 17003-5          | Window Installation in Double-Wall Structure |

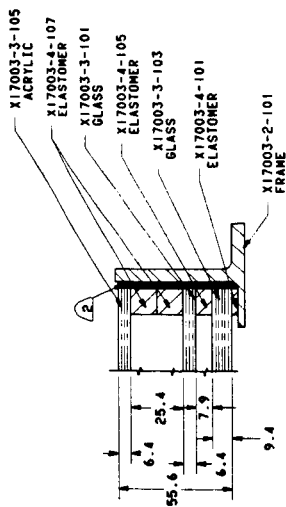
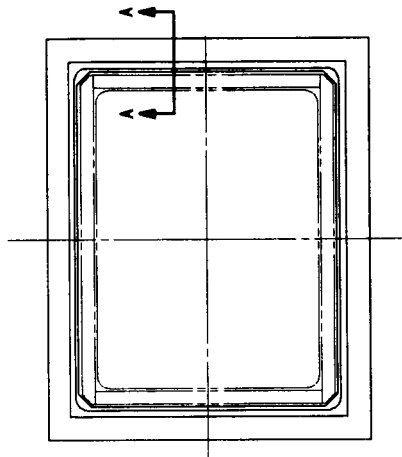

SECTION A - A  
FOR -101

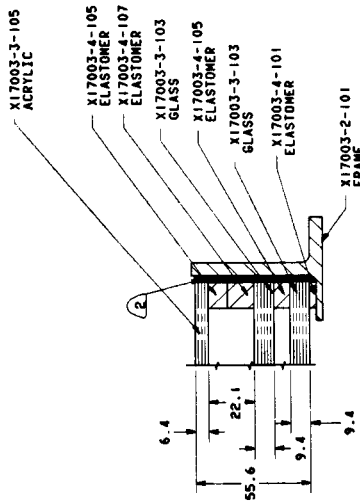

SECTION A - A  
FOR -103

NOTES

- ① USE A SUITABLE CONTACT CEMENT TO HOLD ELASTOMER IN PLACE
- ② POT IN PLACE WITH A SUITABLE STRIP OF ELASTOMER. THE POSITIONING OF ELASTOMER MUST BOND TO THE STRIP ELASTOMER
- ③ USE THE X17003-4-105 0.8 THICK ELASTOMER AS REQUIRED TO OVERCOME THE THICKNESS TOLERANCE OF THE ELASTOMER AND HOLD THE DIMENSIONED GAP BETWEEN THE GLASS TO PLUS OR MINUS 0.76
- ④ ALL DIMENSIONS ARE IN MILLIMETERS

TEST WINDOW ASSEMBLY -101  
TEST WINDOW ASSEMBLY -103

| QTY | DESCRIPTION                          | MATERIAL | SIZE |
|-----|--------------------------------------|----------|------|
| 1   | CASTABLE ELASTOMER                   |          |      |
| 1   | X17003-4-109 ELASTOMER (0.8 X 12.7)  |          |      |
| 1   | X17003-4-107 ELASTOMER (12.7 X 12.7) |          |      |
| 1   | X17003-4-105 ELASTOMER (9.5 X 12.7)  |          |      |
| 1   | X17003-4-103 ELASTOMER (7.9 X 12.7)  |          |      |
| 1   | X17003-4-101 ELASTOMER (3.2 X 12.7)  |          |      |
| 1   | X17003-3-105 ACRYLIC (6.4)           |          |      |
| 2   | X17003-3-103 GLASS (9.5)             |          |      |
| 1   | X17003-3-101 GLASS (6.4)             |          |      |
| 1   | X17003-2-101 FRAME                   |          |      |
| 1   | TEST WINDOW ASSEMBLY                 |          |      |
| 1   | TEST WINDOW ASSEMBLY                 |          |      |
| 1   | TEST WINDOW ASSEMBLY                 |          |      |
| 1   | TEST WINDOW ASSEMBLY                 |          |      |

|   |              |                 |
|---|--------------|-----------------|
| LOCKHEED-CALIFORNIA COMPANY<br>A DIVISION OF LOCKHEED CORPORATION | DATE: 5/1/84 | BY: [Signature] |
| TRANSMISSION LOSS<br>PROP-FAN WINDOW<br>ASSEMBLY                  | OVERPLOTS    | NO. 001         |
| FORM NO. X17003-1   | SCALE: FULL  | SHEET: 1 OF 1   |

ORIGINAL PAGE 19  
OF POOR QUALITY

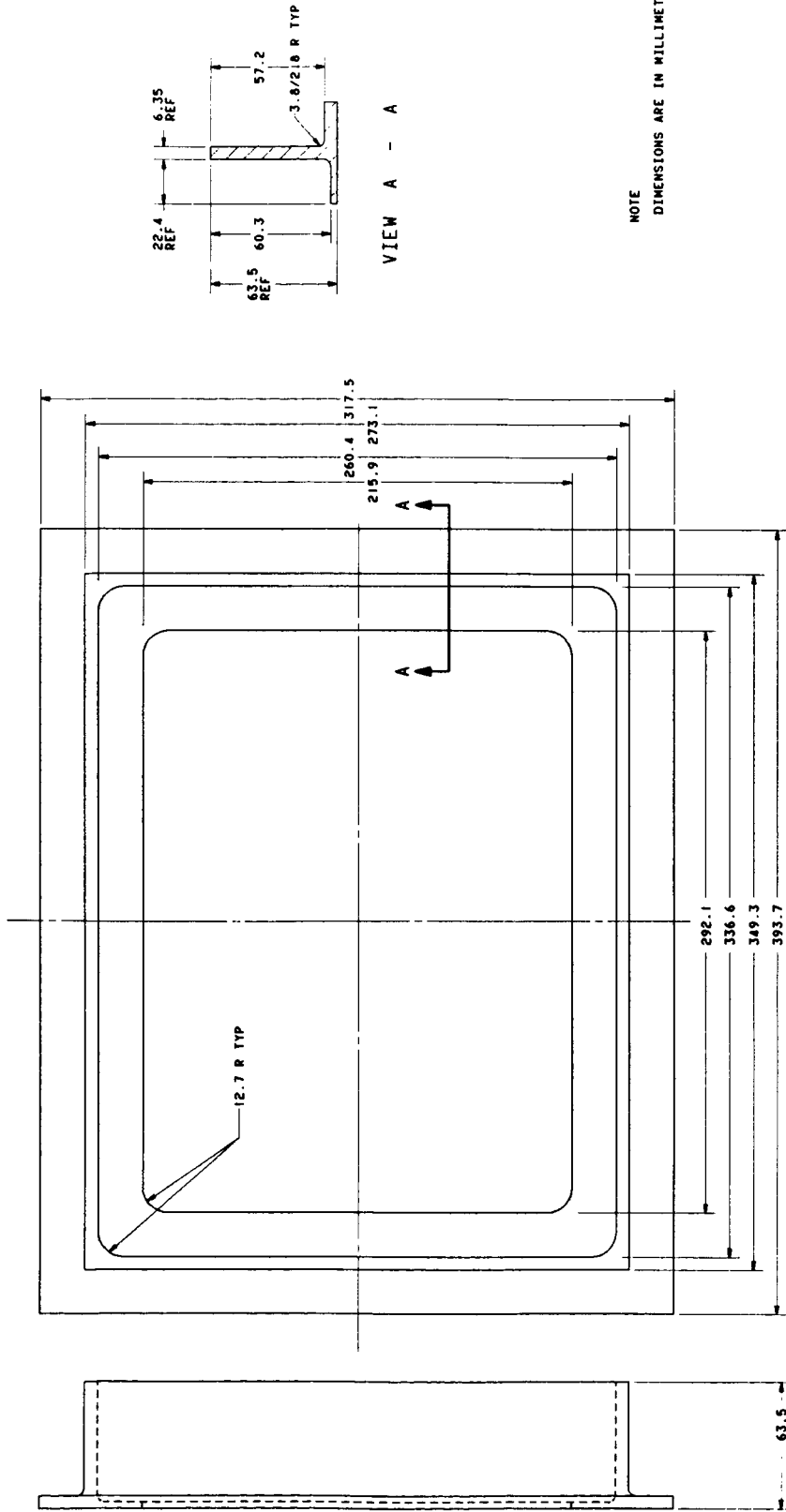

NOTE  
DIMENSIONS ARE IN MILLIMETERS

|         |  |                               |                      |      |
|---------|--|-------------------------------|----------------------|------|
| 101     | PLATE  | ANY ALUM                      | 63.5 X 317.5 X 393.7 | SIZE |
| DASH NO | DESC   | MATL                          |                      |      |
|         | LOCKHEED-CALIFORNIA COMPANY<br>4 DIVISIONS<br>TRANSMISSION LOSS<br>PROP-FAN WINDOW<br>FRAME DETAIL |                               |                      |      |
|         | DESIGNED BY: DON BLACK<br>DATE: 5/1/84<br>CHECKED BY: [blank]<br>APPROVED BY: [blank]              |                               |                      |      |
|         | OVERPLOTS: A001 C001   |                               |                      |      |
| 101     | DWG NO   | X17003-2                      |                      |      |
| 2       | RECD   | THIS IS A HALF SIZE REDUCTION |                      |      |
|         |  | SCALE FULL                    |                      |      |

Window Frame Detail

ORIGINAL PAGE 10  
OF POOR QUALITY

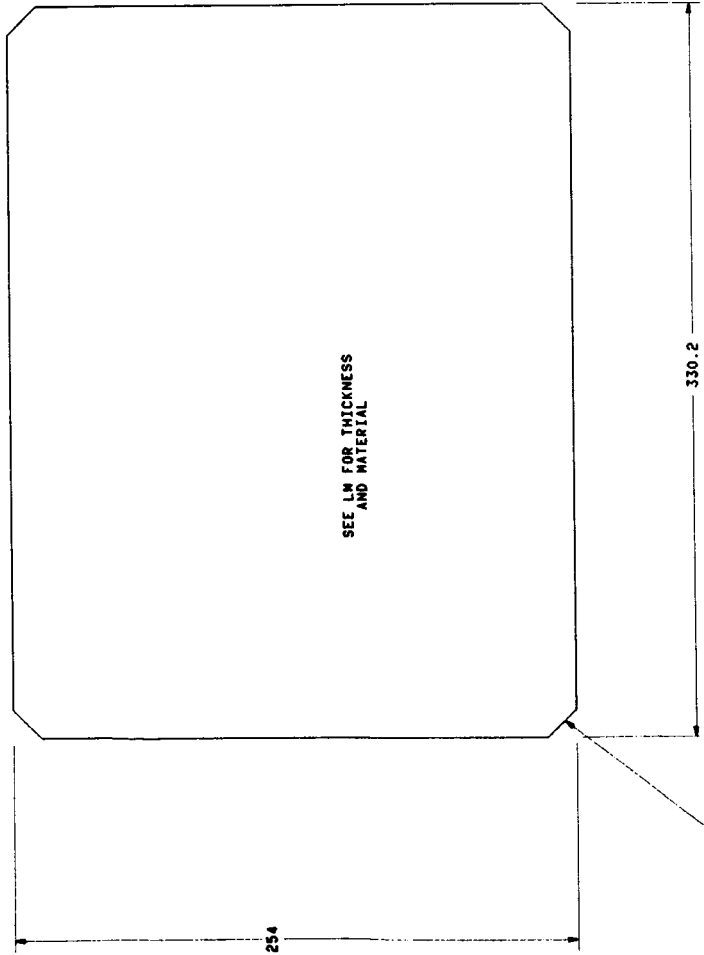

SEE LM FOR THICKNESS  
AND MATERIAL

CLIP 12.7 AT 45 DEG TYP

- 101
- 103
- 105

1 STANDARD ANNEALED PLATE

2 GENERAL PURPOSE CAST SHEET

3 DIM ARE IN MILLIMETERS

|          |              |   |  |
|----------|--------------|---|--|
| 105      | ACRYLIC      | (2)   | 6.35 X 254 X 330.2                                   |
| 103      | GLASS        | (1)   | 9.53 X 254 X 330.2                                   |
| 101      | GLASS        | (1)   | 6.35 X 254 X 330.2                                   |
| DASH NO. | DESC         | MATL  | SIZE   |
| 105 2    | OVERPLOTS    | LOCKHEED-CALIFORNIA COMPANY<br>EUREKA, CALIFORNIA<br>A DIVISION OF LOCKHEED CORPORATION | TRANSMISSION LOSS<br>PROP-FAN WINDOW<br>GLASS DETAIL |
| 103 2    | A001<br>CD01 | DESIGNED BY DON BLACK<br>CHECKED BY DON BLACK<br>DATE 5/1/84                            |  |
| 101 2    |              |   |  |
| DASH NO  | RECD         | THIS IS A HALF<br>SIZE REDUCTION  |  |
| USED ON  |              | DWG NO X17003-<br>SCALE FULL  |  |

Window Pane Detail

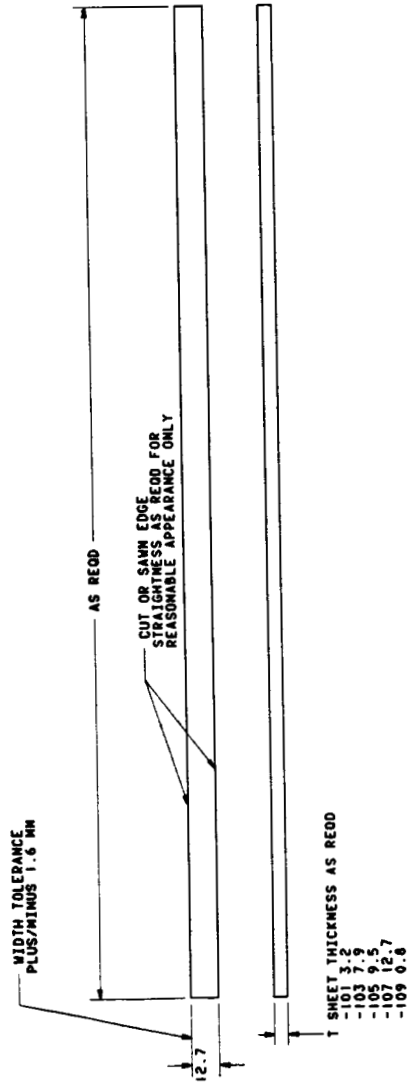

NOTES

1 CUT FROM SILICONE SHEET PACKING  
(IL A RUBBER COMPANY CAT 82 P 212)

2 DIM ARE IN MILLIMETERS

| NO      | ELASTOMER | QTY  | SIZE                  |
|---------|-----------|------|-----------------------|
| 109     | ELASTOMER | 1    | 0.82 X 12.7 X AS REOD |
| 107     | ELASTOMER | 1    | 12.7 X 12.7 X AS REOD |
| 105     | ELASTOMER | 1    | 9.5 X 12.7 X AS REOD  |
| 103     | ELASTOMER | 1    | 7.96 X 12.7 X AS REOD |
| 101     | ELASTOMER | 1    | 3.2 X 12.7 X AS REOD  |
| DASH NO | DESC      | MATL | SIZE                  |

  

|   |              |
|---|--------------|
| LOCKHEED-CALIFORNIA COMPANY<br>DIVISION OF LOCKHEED CORPORATION |              |
| DESIGNED BY: DON BLACK  | DATE: 5/1/84 |
| CHECKED BY: DON BLACK   | DATE: 5/1/84 |
| APPROVED BY: DON BLACK  | DATE: 5/1/84 |
| OVERPLOTS   | 4001<br>CDD1 |
| THIS IS A HALF<br>SIZE REDUCTION                                |              |

|          |          |            |              |
|----------|----------|------------|--------------|
| X17003-1 | ALL REOD | SCALE FULL | SHEET 1 OF 1 |
| USED ON  | DASH NO  |            |              |

Window Elastomer

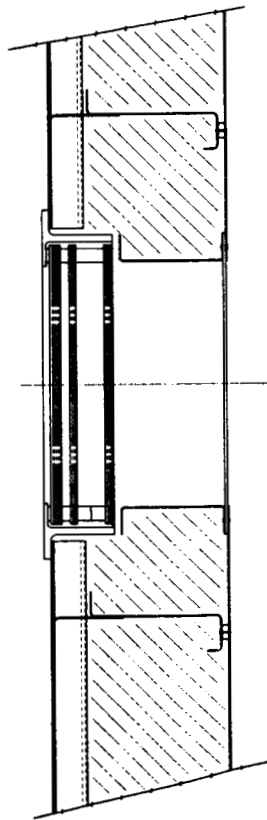
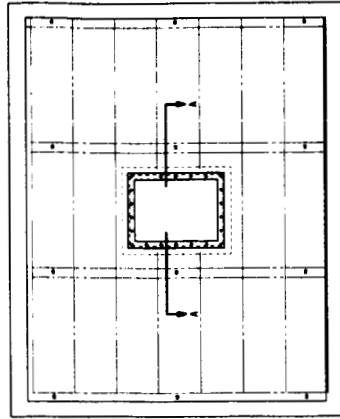

VIEW A - - A

ORIGINAL PAGE IS  
OF POOR QUALITY

|   |                                 |  |   |
|---|---------------------------------|--|---|
| DRAWING NO. 4001<br>REV. 0/01<br>02/05/01 | TITLE<br>WINDOW<br>INSTALLATION | PROJECT NO. X17003-5<br>DATE 1/01      | COMPANY<br>TRANSMISSION LOSS<br>INSTALLATION  |
| DRAWN BY<br>CHECKED BY                    | DESIGNED BY<br>APPROVED BY      | PROJECT NAME<br>WINDOW<br>TRANSMISSION | LOCATION<br>TRANSMISSION LOSS<br>INSTALLATION |

Window Installation in Double-Wall Structure

## REFERENCES

1. Revell, J. D.; Balena, F. J.; and Koval, L. R.: Interior Noise Control by Fuselage Design Techniques on High-Speed Propeller-Driven Aircraft. NASA CR 159222.
2. Prydz, R. A.; Revell, J. D.; Hayward, J. L.; and Balena, F. J.: Evaluation of Fuselage Design Concepts for Interior Noise Control on High-Speed Propeller-Driven Aircraft. NASA CR 165960, September 1982.
3. Revell, J. D.; Balena, F. J.; and Prydz, R. A.: Cabin Noise Weight Penalty Requirements for a High-Speed Propfan-Powered Aircraft: A Progress Report. SAE Paper 821360 presented at the SAE Aerospace Congress and Exposition, Anaheim, California, October 25-28, 1982.
4. Rennison, D. C.; Wilby, J. F.; March, A. H.; and Wilby, E. G.: Interior Noise Control Prediction Study for High-Speed, Propeller-Driven Aircraft. NASA CR 159200, September 1979.
5. Cockburn, J. A.; and Jolly, A. C.: Structural-Acoustic Response, Noise Transmission Losses and Interior Noise Levels of an Aircraft Fuselage Excited by Random Pressure Fields. USAF, AFFDL-TR-68-2, Wright Patterson Air Force Base, Ohio, August 1968.
6. Koval, L. R.: On Sound Transmission into a Thin Cylindrical Shell Under Flight Conditions. Journal of Sound and Vibration, Vol. 48, No. 2, pp 265-275, 1976.
7. Bazley, E. N.: The Airborne Sound Insulation of Partitions. National Physics Laboratory, Teddington, Middlesex, August 1978. (Data also referenced in "Acoustics in Physics and Engineering." by K. U., Ingard, Acustica, Vol. 52, No. 3, 1983.)
8. Halvorsen, W. G.; Brown, D. L.: Impulse Technique for Structural Frequency Response Testing. Sound and Vibration, pp 8-21, November 1977.

|   |  |  |  |  |            |
|---|--|--|--|--|------------|
| 1. Report No.<br>NASA CR-172391   |  | 2. Government Accession No.                          |  | 3. Recipient's Catalog No.<br>August 1984  |            |
| 4. Title and Subtitle<br>Window Acoustic Study for Advanced Turboprop Aircraft  |  |  |  | 5. Report Date   |            |
|   |  |  |  | 6. Performing Organization Code  |            |
| 7. Author(s)<br>R. A. Prydz,<br>F. J. Balena  |  |  |  | 8. Performing Organization Report No.<br>LR 30727  |            |
| 9. Performing Organization Name and Address<br>Lockheed-California Company<br>Burbank, CA 91520   |  |  |  | 10. Work Unit No.  |            |
|   |  |  |  | 11. Contract or Grant No.<br>NAS1-16441  |            |
| 12. Sponsoring Agency Name and Address<br>National Aeronautics and Space<br>Administration<br>Washington, DC 20546  |  |  |  | 13. Type of Report and Period Covered<br>Contractor Report   |            |
|   |  |  |  | 14. Sponsoring Agency Code   |            |
| 15. Supplementary Notes<br>Langley Technical Monitor: John S. Mixson<br>Final Report  |  |  |  |  |            |
| 16. Abstract<br><br>An acoustic analysis has been performed to establish window designs for advanced turboprop powered aircraft. The window transmission loss requirements were based on A-weighted interior noise goals of 80 and 75 dBA. The analytical results showed that a triple pane window consisting of two glass outer panes and an inner pane made of acrylic would provide the required transmission loss and meet the sidewall space limits. Two window test articles were fabricated for laboratory evaluation and verification of the predicted transmission loss. Procedures for performing laboratory tests are presented. |  |  |  |  |            |
| 17. Key Words (Suggested by Author(s))<br>Window Transmission Loss, Advanced Turboprop Aircraft, Analytical Study   |  |  |  | 18. Distribution Statement<br> |            |
| 19. Security Classif. (of this report)<br>Unclassified  |  | 20. Security Classif. (of this page)<br>Unclassified |  | 21. No. of Pages<br>48   | 22. Price* |