

NASA Contractor Report 4246

Space Station Wardroom Habitability and Equipment Study

David Nixon, Christopher Miller,
and Regis Fauquet
*Southern California Institute of Architecture
Santa Monica, California*

Prepared for
Ames Research Center
under Cooperative Agreement NCC2-356



National Aeronautics and
Space Administration
Office of Management
Scientific and Technical
Information Division

1989

CONTENTS

	EXECUTIVE SUMMARY	xi
1	INTRODUCTION	1
2	PHASE 1 : EXPERIMENTAL DESIGN STUDIES	
2.1	OBJECTIVES	4
2.2	WARDROOM EXPERIMENTAL CONCEPT 1	5
2.3	WARDROOM EXPERIMENTAL CONCEPT 2	12
2.4	WARDROOM EXPERIMENTAL CONCEPT 3	20
2.5	EVALUATION METHODOLOGY	26
2.6	EVALUATION RESULTS	44
3	PHASE 2 : FINAL DESIGN STUDY	
3.1	OBJECTIVES	47
3.2	WARDROOM DESIGN CRITERIA	48
3.3	WARDROOM DESIGN APPROACH	59
3.4	WARDROOM FINAL CONCEPT	70
4	WARDROOM EQUIPMENT STUDIES	
4.1	WARDROOM TABLE	88
4.2	PORTABLE/WEARABLE WORKSTATION	108
4.3	PASSIVE LEG RESTRAINT	117
5	CONCLUSIONS	120
6	RECOMMENDATIONS	124
7	APPENDICES	
7.1	APPENDIX A : ABBREVIATIONS	125
7.2	APPENDIX B : MOCK-UP INVENTORY	126
7.3	APPENDIX C : PROJECT TEAM	131
8	REFERENCES	132

LIST OF FIGURES

		PAGE
FIGURE 1	CONCEPT 1 - EXPLANATORY DRAWING [1 OF 2]	6
FIGURE 2	CONCEPT 1 - EXPLANATORY DRAWING [2 OF 2]	7
FIGURE 3	CONCEPT 1 - MOCK-UP [1 OF 2]	8
FIGURE 4	CONCEPT 1 - MOCK-UP [2 OF 2]	8
FIGURE 5	CONCEPT 1 - GENERAL VIEW OF MOCK-UP	9
FIGURE 6	CONCEPT 1 - ADAPTABLE WORKSTATION	10
FIGURE 7	CONCEPT 1 - WARDROOM TABLE	11
FIGURE 8	CONCEPT 2 - EXPLANATORY DRAWING [1 OF 2]	13
FIGURE 9	CONCEPT 2 - EXPLANATORY DRAWING [2 OF 2]	14
FIGURE 10	CONCEPT 2 - GENERAL VIEW OF MOCK-UP	15
FIGURE 11	CONCEPT 2 - VIEW ALONG CENTRAL PASSAGE	16
FIGURE 12	CONCEPT 2 - MOCK-UP [1 OF 4]	17
FIGURE 13	CONCEPT 2 - MOCK-UP [2 OF 4]	17
FIGURE 14	CONCEPT 2 - MOCK-UP [3 OF 4]	18
FIGURE 15	CONCEPT 2 - MOCK-UP [4 OF 4]	18
FIGURE 16	CONCEPT 2 - GREENHOUSE UNIT	19
FIGURE 17	CONCEPT 3 - EXPLANATORY DRAWING [1 OF 2]	21
FIGURE 18	CONCEPT 3 - EXPLANATORY DRAWING [2 OF 2]	22
FIGURE 19	CONCEPT 3 - GENERAL VIEW OF MOCK-UP	23
FIGURE 20	CONCEPT 3 - VIEW OF UTILITY CORE	24
FIGURE 21	CONCEPT 3 - MOCK-UP [1 OF 2]	25
FIGURE 22	CONCEPT 3 - MOCK-UP [2 OF 2]	25
FIGURE 23	SCHEMATIC STUDY A	52
FIGURE 24	SCHEMATIC STUDY B	53
FIGURE 25	SCHEMATIC STUDY C	54
FIGURE 26	MODULE CONCEPTUAL CONFIGURATION	60
FIGURE 27	FOUR STANDOFF CONFIGURATION - ACCOMMODATION	61
FIGURE 28	ROTATED SPINE CONFIGURATION - ACCOMMODATION	61
FIGURE 29	FOUR STANDOFF CONFIGURATION - UTILITIES SYSTEMS	62
FIGURE 30	ROTATED SPINE CONFIGURATION - UTILITIES SYSTEMS	62
FIGURE 31	FOUR STANDOFF CONFIGURATION - STRUCTURAL SPINES	64
FIGURE 32	ROTATED SPINE CONFIGURATION - STRUCTURAL SPINES	64
FIGURE 33	FOUR STANDOFF CONFIGURATION - RACK WIDTHS	65
FIGURE 34	ROTATED SPINE CONFIGURATION - RACK WIDTHS	65
FIGURE 35	FOUR STANDOFF CONFIGURATION - RACK GEOMETRY	66
FIGURE 36	ROTATED SPINE CONFIGURATION - RACK GEOMETRY	66
FIGURE 37	FOUR STANDOFF CONFIGURATION - ACCOMMODATION LAYOUT	68
FIGURE 38	ROTATED SPINE CONFIGURATION - ACCOMMODATION LAYOUT	69
FIGURE 39	EXTENT OF MOCK-UP CONSTRUCTION	70
FIGURE 40	GENERAL VIEW OF WARDROOM	71
FIGURE 41	STANDOFF SYSTEM STRUCTURAL ELEMENTS	72
FIGURE 42	STANDOFF AND RACK CONFIGURATION	73
FIGURE 43	STANDOFF SYSTEM UTILITY ELEMENTS	74
FIGURE 44	MEETING/MEAL FACILITY CONFIGURATION	75
FIGURE 45	CREW GROUP MEETING & MEAL FACILITY	76
FIGURE 46	STANDOFF RECESSED LIGHTING DETAIL	77
FIGURE 47	WINDOW WORKSTATIONS	79
FIGURE 48	STOWAGE BAG SYSTEM	80

FIGURE 49	EXERCISE COMPARTMENT CONFIGURATION	81
FIGURE 50	INTERIOR VIEW OF EXERCISE COMPARTMENT	82
FIGURE 51	EXTERIOR VIEW OF EXERCISE COMPARTMENT	83
FIGURE 52	BICYCLE ERGOMETER INSTALLATION	84
FIGURE 53	ROWING MACHINE IN OPERATION	85
FIGURE 54	COMMAND/CONTROL WORKSTATION [1 OF 2]	87
FIGURE 55	COMMAND/CONTROL WORKSTATION [2 OF 2]	87
FIGURE 56	WARDROOM TABLE INSTALLED IN MOCK-UP	88
FIGURE 57	WARDROOM TABLE PROTOTYPE SYSTEM CONCEPT	89
FIGURE 58	TABLE 8-PERSON/SHALLOW-ANGLE SET-UP	91
FIGURE 59	TABLE EXTENDED 4-PERSON/SHALLOW-ANGLE SET-UP	91
FIGURE 60	TABLE 8-PERSON/STEEP-ANGLE SET-UP	92
FIGURE 61	TABLE 4-PERSON/SHALLOW-ANGLE SET-UP	92
FIGURE 62	TABLE 4-PERSON/STEEP-ANGLE SET-UP	93
FIGURE 63	WARDROOM TABLE ACTIVITY APPLICATION [1 OF 12]	94
FIGURE 64	WARDROOM TABLE ACTIVITY APPLICATION [2 OF 12]	95
FIGURE 65	WARDROOM TABLE ACTIVITY APPLICATION [3 OF 12]	96
FIGURE 66	WARDROOM TABLE ACTIVITY APPLICATION [4 OF 12]	97
FIGURE 67	WARDROOM TABLE ACTIVITY APPLICATION [5 OF 12]	98
FIGURE 68	WARDROOM TABLE ACTIVITY APPLICATION [6 OF 12]	99
FIGURE 69	WARDROOM TABLE ACTIVITY APPLICATION [7 OF 12]	100
FIGURE 70	WARDROOM TABLE ACTIVITY APPLICATION [8 OF 12]	101
FIGURE 71	WARDROOM TABLE ACTIVITY APPLICATION [9 OF 12]	102
FIGURE 72	WARDROOM TABLE ACTIVITY APPLICATION [10 OF 12]	103
FIGURE 73	WARDROOM TABLE ACTIVITY APPLICATION [11 OF 12]	104
FIGURE 74	WARDROOM TABLE ACTIVITY APPLICATION [12 OF 12]	105
FIGURE 75	VIEW OF TABLE IN 4-STANDOFF CONFIGURATION [1 OF 2]	106
FIGURE 76	VIEW OF TABLE IN 4-STANDOFF CONFIGURATION [2 OF 2]	107
FIGURE 77	SIDE VIEW OF DEPLOYED PORTABLE/WEARABLE WORKSTATION	109
FIGURE 78	FACE VIEW OF DEPLOYED PORTABLE/WEARABLE WORKSTATION	110
FIGURE 79	SIDE VIEW OF STOWED PORTABLE/WEARABLE WORKSTATION	111
FIGURE 80	CLOSE-UP OF DEPLOYED PORTABLE/WEARABLE WORKSTATION	112
FIGURE 81	PORTABLE/WEARABLE WORKSTATION FLIGHT-TEST [1 OF 4]	114
FIGURE 82	PORTABLE/WEARABLE WORKSTATION FLIGHT-TEST [2 OF 4]	114
FIGURE 83	PORTABLE/WEARABLE WORKSTATION FLIGHT-TEST [3 OF 4]	115
FIGURE 84	PORTABLE/WEARABLE WORKSTATION FLIGHT-TEST [4 OF 4]	115
FIGURE 85	PASSIVE LEG RESTRAINT PROTOTYPE	117
FIGURE 86	PASSIVE LEG RESTRAINT USER OPERATION	118

LIST OF TABLES

		PAGE
TABLE 1	EVALUATION SHEET - MOCK-UP CONCEPT 1 [1 OF 9]	28
TABLE 2	EVALUATION SHEET - MOCK-UP CONCEPT 1 [2 OF 9]	28
TABLE 3	EVALUATION SHEET - MOCK-UP CONCEPT 1 [3 OF 9]	29
TABLE 4	EVALUATION SHEET - MOCK-UP CONCEPT 1 [4 OF 9]	29
TABLE 5	EVALUATION SHEET - MOCK-UP CONCEPT 1 [5 OF 9]	30
TABLE 6	EVALUATION SHEET - MOCK-UP CONCEPT 1 [6 OF 9]	30
TABLE 7	EVALUATION SHEET - MOCK-UP CONCEPT 1 [7 OF 9]	31
TABLE 8	EVALUATION SHEET - MOCK-UP CONCEPT 1 [8 OF 9]	31
TABLE 9	EVALUATION SHEET - MOCK-UP CONCEPT 1 [9 OF 9]	32
TABLE 10	EVALUATION SHEET - MOCK-UP CONCEPT 2 [1 OF 9]	33
TABLE 11	EVALUATION SHEET - MOCK-UP CONCEPT 2 [2 OF 9]	33
TABLE 12	EVALUATION SHEET - MOCK-UP CONCEPT 2 [3 OF 9]	34
TABLE 13	EVALUATION SHEET - MOCK-UP CONCEPT 2 [4 OF 9]	34
TABLE 14	EVALUATION SHEET - MOCK-UP CONCEPT 2 [5 OF 9]	35
TABLE 15	EVALUATION SHEET - MOCK-UP CONCEPT 2 [6 OF 9]	35
TABLE 16	EVALUATION SHEET - MOCK-UP CONCEPT 2 [7 OF 9]	36
TABLE 17	EVALUATION SHEET - MOCK-UP CONCEPT 2 [8 OF 9]	36
TABLE 18	EVALUATION SHEET - MOCK-UP CONCEPT 2 [9 OF 9]	37
TABLE 19	EVALUATION SHEET - MOCK-UP CONCEPT 3 [1 OF 9]	38
TABLE 20	EVALUATION SHEET - MOCK-UP CONCEPT 3 [2 OF 9]	38
TABLE 21	EVALUATION SHEET - MOCK-UP CONCEPT 3 [3 OF 9]	39
TABLE 22	EVALUATION SHEET - MOCK-UP CONCEPT 3 [4 OF 9]	39
TABLE 23	EVALUATION SHEET - MOCK-UP CONCEPT 3 [5 OF 9]	40
TABLE 24	EVALUATION SHEET - MOCK-UP CONCEPT 3 [6 OF 9]	40
TABLE 25	EVALUATION SHEET - MOCK-UP CONCEPT 3 [7 OF 9]	41
TABLE 26	EVALUATION SHEET - MOCK-UP CONCEPT 3 [8 OF 9]	41
TABLE 27	EVALUATION SHEET - MOCK-UP CONCEPT 3 [9 OF 9]	42
TABLE 28	MOCK-UP EVALUATION SUMMARY	43
TABLE 29	OUTLINE RACK & COMPARTMENT INVENTORY	58

PREFACE

This is the Final Report on a program of investigation into space habitability which began in 1985 with work on schematic design studies for the interior of the Space Station Habitability Module. These early studies were published in SPACE STATION GROUP ACTIVITIES HABITABILITY MODULE STUDY, NASA Contractor Report 4010, in 1986.

This report, which is entitled SPACE STATION WARDROOM HABITABILITY AND EQUIPMENT STUDY, is the sequel to the earlier report. In this study, certain design concepts and opportunities which emerged in the earlier study are explored and developed in mock-up and prototype form. Readers are recommended to obtain both reports for a complete picture of the direction of the work.

This report was prepared by David Nixon with assistance from Christopher Miller and Regis Fauquet of the Space Projects Group. The photographs were taken by Wade Sisler of NASA-Ames Research Center.

The full-size mock-up of the Wardroom described and illustrated in Section 3 of this report was delivered as a 'kit-of-parts' to NASA in June 1988 for demonstration and research purposes. For further information, please contact:

David Nixon
Future Systems Consultants
1103 South Hudson Avenue
Los Angeles
CA 90019

tel. 213-938-8528

EXECUTIVE SUMMARY

This report documents a project carried out between 1986 and 1988 by the Space Projects Group, a space architecture research unit affiliated to Southern California Institute of Architecture in Los Angeles, California.

The project was carried out for the Aerospace Human Factors Research Division of NASA-Ames Research Center, Mountain View, California under a NASA Cooperative Agreement. Technical Monitor for the project was Marc M. Cohen.

The objectives of the project were threefold. Firstly, to develop preliminary full-size mock-up concepts for the Wardroom and associated facilities in the Space Station Habitability Module. Secondly, to develop a single full-size mock-up concept for the Wardroom which embodies innovative accommodation features developed in the preliminary concepts. Thirdly, to select appropriate items of crew equipment and develop them as demonstration prototypes.

The project concentrated on the crew Wardroom as this is the largest and most significant group activity facility on the Space Station and, therefore, is an ideal candidate for advanced habitability studies.

The following points summarize the conclusions of the study.

- Space Station Module life-cycle reconfiguration and upgrading options are constrained by initial accommodation systems design.
- A dedicated buffer zone separating day and night accommodation increases noise attenuation and improves personal privacy.
- Dual-level configurations improve operational/translational efficiency and generate enhanced perceptual interest.
- Demountable standoff structure contributes to reduced physical obstruction and simpler on-orbit modification.
- Variable-depth standoff structure contributes to rationalized utilities distribution and improved systems accessibility.
- Variable-width racks and compartments contribute to improved organizational versatility and enhanced operational performance.
- Deployable/retractable compartments provide valuable additional free volume and improved occupant performance.
- Adaptable and conformable crew equipment features improve workstation ergonomics and facilitate routine tasks.

The following points summarize the recommendations of the study.

- **Assess the impact of IOC Habitability Module configuration design decisions on Space Station life-cycle scenarios.**
- **Ensure the inclusion of a dedicated buffer zone between day and night facilities in the IOC Space Station Habitability Module.**
- **Examine improved options for the design of the HM/Exercise Compartments in the IOC Space Station Habitability Module.**
- **Encourage the development of innovative equipment features which facilitate routine tasks throughout the Space Station.**
- **Determine the suitability and potential of dual-level accommodation configurations for Evolutionary Space Station Modules.**
- **Investigate the potential use of variable-depth structural standoff systems for Evolutionary Space Station Modules.**
- **Evaluate alternative approaches for the organization and rationalization of utilities systems in Evolutionary Space Station Modules.**
- **Determine the opportunities for introducing variable-width racks and compartments into Evolutionary Space Station Modules.**

1 INTRODUCTION

This report entitled "Space Station Wardroom Habitability & Equipment Study" documents a project carried out between 1986 and 1988 by the Space Projects Group, a space architecture research unit affiliated to Southern California Institute of Architecture in Los Angeles, California. The project was carried out for the Aerospace Human Factors Research Division of NASA-Ames Research Center, Mountain View, California under a NASA Cooperative Agreement. Technical Monitor for the project was Marc M. Cohen.

The objectives of the project were threefold. Firstly, to develop preliminary full-size mock-up concepts for the Wardroom and associated facilities in the Space Station Habitability Module. Secondly, to develop a single full-size mock-up concept for the Wardroom which embodies innovative accommodation equipment and systems features. Thirdly, to select appropriate items of crew equipment and develop them as demonstration prototypes. These three objectives correspond respectively with Sections 2, 3 and 4 of this report.

The project concentrated on the crew Wardroom as this is the largest and most significant group activity facility on the Space Station and, therefore, is an ideal candidate for habitability studies. NASA has defined crew activities in the vicinity of the Wardroom as food preparation and clean-up, recreation, meals, meetings, video presentations and discussions [ref. 1].

The project is set against the background of the Space Station program as it progressed from 1986 to 1988. During that time, NASA-appointed contractor teams were engaged in Phase B preliminary design and definition studies of Space Station major elements and systems which led to the award of Phases C/D development contracts by the beginning of 1988. Much of the reference material used in this project was drawn from progress documents prepared by the contractor teams during that period.

At the time that the Space Projects Group began the project, the designs of Space Station Module interior configurations were already substantially determined. During 1984 and 1985, the initial Space Station configuration had included two Habitability Modules - one for day facilities and one for night facilities. By the beginning of 1986, NASA had decided to combine day and night crew facilities in a single Habitability Module for program cost reasons. This generated a requirement for a Habitability Module configuration which provided maximum rack and compartment capacity. The result of this was the emergence of the Four Standoff Configuration as the preferred design candidate.

The preliminary phases of the formal Space Station design program identified several key criteria concerning the design of on-orbit crew facilities. These included: the division of the main accommodation between a Habitability Module and a Laboratory Module with secondary accommodation provided by connecting Nodes; the adoption of a horizontal linear orientation and organization for facilities in both modules; the incorporation of four structural and utility spines providing attachment points for internal racks and compartments and distribution routes for utilities systems. As the Space Station program proceeded through preliminary design and definition stages, these criteria led to definitive interior designs for the Habitability and Laboratory modules. The principal accommodation was organized into linear sequences of racks and compartments facing central square access corridors. This approach became known as the Four Standoff Configuration. It originated in the schematic designs of module interior configurations

outlined in the Space Station Reference Configuration Description defined by NASA in 1984 [ref. 2] which, in turn, were derived from the design configurations of Spacelab Modules built for NSTS missions by the European Space Agency.

Though the design of the Four Standoff Configuration selected by NASA resolved initial functional requirements very effectively, it was less desirable in terms of long-duration crew habitability and less successful in terms of optimum human factors potential. In the pursuit of maximum capacity, efficiency and economy, the feasibility and range of alternative architectural configuration options were not comprehensively investigated during Space Station Phase B and design opportunities aimed at improving the long-term quality of accommodation in orbit were not properly explored.

The importance of good habitability and human factors design for long-term space applications is sometimes underestimated. Crew facilities on the Space Station must 'look good and feel good' to use. The challenge, put simply, is to convert an alien and confined mechanical enclosure into a hospitable and humane living and working environment. Good habitability and human factors design is necessary to foster a positive relationship between crews and their surroundings. The quality of that relationship, or bond, will largely determine whether the Space Station will function effectively as a living and working facility during its lifetime. In an environment where every surface, panel or knob is almost an arm's reach away, the bond between humans and equipment is inextricable. Habitability and human factors issues become critical and are vital ingredients in the quest for human productivity in space.

A key objective for the Space Station will be to sustain a high level of crew productivity on a daily basis. To achieve this, the best possible conditions must be provided for environmental comfort, functional efficiency and facilities habitability. Given the planned 90-day crew tours and the pressure for intensive crew tasking and timelining, such conditions are essential to help to make routine activities as straightforward, comfortable and safe as possible. To ensure that these conditions are maintained during the life-cycle of the Space Station, operational flexibility must be provided. Operational flexibility is a key factor in sustaining human performance over time which contributes to the accepted definition of human productivity in space. It implies responsive design with integral capabilities ranging from short-term adaptability and modification to long-term growth and upgrading. This approach was explored by the project team in earlier schematic studies of Habitability Module architecture [ref. 3]. Operational flexibility will emerge as an important issue for the Space Station.

The changes which drive the need for operational flexibility will originate from crew or ground team initiation or intervention. Some typical examples include: revision and upgrading of an initial Space Station module from combined living/sleeping facilities to a single type of facility as permitted by addition of further accommodation modules; internal reconfiguration of a module caused by major changes in crew numbers, shifts or activities; on-orbit crew preferences for a modification of a rack or compartment arrangement for functional or cultural reasons; replacement of on-board equipment or systems influenced by improvements in technology or performance, or by existing equipment failure. In planning for operational flexibility, it will be vital to maintain the Space Station as an acceptable living and working environment for successive crews as conditions evolve and improve over time. However, whatever life-cycle improvements can be made will only partly alleviate problems of confinement which will face crews on long missions or tours of duty.

In situations of prolonged confinement, the quality of habitability and attitude towards interior surroundings becomes a real issue for the occupants, a fact which was recognized in space human factors evaluation studies as early as 1970 [ref. 4]. This fact has also been demonstrated by observing human behavior under analogous terrestrial conditions ranging from long submarine missions to Antarctic research stations [ref. 5]. For example, the visual character of internal module environments is now recognized as influencing human productivity [ref. 6], an observation which appears to have been confirmed by the Soviet Union with their Salyut spacecraft crews [ref. 7]. Clearly, there is a need to optimize living and working conditions in space within the volumetric constraints imposed by any particular manned space application or mission. This need supports the case for the study of advanced habitability concepts.

Crew productivity, operational flexibility and advanced habitability are therefore key issues in any project which seeks to explore new ideas for living and working in space. It was with these issues in mind that the Space Projects Group carried out the project described in this report.

Much opportunity exists to improve the design of future crew accommodation beyond Space Station standards. As manned missions lengthen, crews increase in numbers, and operations evolve in complexity, these issues will become not just desirable objectives but critical necessities. The task of providing well-designed accommodation is not necessarily a matter of making spacecraft larger, it is a matter of pursuing more innovative, sensitive and versatile design solutions. The planners of future space missions must address these issues more carefully if the conditions under which mankind ventures into space permanently are to evolve from being only marginally acceptable.

2 PHASE 1 : EXPERIMENTAL DESIGN STUDIES

2.1 OBJECTIVES

The central purpose of PHASE 1 has been to explore and evaluate alternative life-size architectural configurations for the Wardroom in experimental concept form, and to identify and evaluate features appropriate for application and study in PHASE 2.

PHASE 1 tasks comprise the design and fabrication of a life-size portion of a Space Station Module shell, and the design and fabrication of three alternative Wardroom design concepts as life-size mock-ups within the shell.

PHASE 1 comprises the following objectives:

- **To simulate and evaluate the physical form and environmental characteristics of the Wardroom and its constituent elements and equipment at a preliminary design level.**
- **To generate and experiment with innovative architectural/industrial design alternatives for potential incorporation in a high-fidelity mock-up to be constructed in PHASE 2.**
- **To obtain experience in the design and construction of life-size mock-ups in sufficient depth necessary for mock-up application and effective completion.**
- **To apply anthropometric and group ergonomic design criteria to an architectural configuration based on an explicit operational organization.**

The shell has been built to simulate the interior geometry of a portion of the Space Station Habitability Module to the extent necessary for the provision of physical enclosure and support for the three Wardroom research mock-ups.

The shell comprises twelve independent modular elements built with wood and aluminum frames and internally surfaced with curved plywood sheets. Each modular element is 1220 mm. [48 "] wide and describes a 90° arc of approximately 7315 mm. [84"] radius [thus four elements make up a complete cylindrical section of Module]. The elements are interconnected to form a horizontal shell 4880 mm. [288"] long which is open at each end for viewing and demonstration.

Three Experimental Mock-up Concepts have been developed. The three concepts represent a spectrum of possible design approaches. Experimental Concept 1 is a derivative of the Four Stand-Off configuration. Internal racks, compartments and equipment attach to structural and utility spines with hinged joints enabling elements to swing-out for Module wall access. Experimental Concept 2 is a variation of a Central Core/Central Beam configuration. Racks, compartments and equipment attach to central structural and utility spines leaving the Module wall unobstructed and free for crew activity applications. Experimental Concept 3 is a fully innovative configuration. A single utility route is formed as a crew-accessible tunnel and racks and compartments are asymmetrical with curvilinear, ergonomically-contoured profiles incorporating soft materials.

2.2 WARDROOM EXPERIMENTAL CONCEPT 1

2.2.1 BASIC CONCEPT

Four perimeter standoff spines which provide attachment and support for deployable and interchangeable modular racks and compartments and ergonomically adaptable crew stations.

2.2.2 DESCRIPTION

Four standoff spines run the length of the Module and are located at 90° intervals around the Module perimeter. Two opposite spines are designated as "wall" spines with reference to the horizontal configuration and are primary spines. The primary spines provide distribution of utilities including fluids, power, data and communications systems throughout the Module, as well as hinged structural retention for a range of modular elements and equipment which determine the architectural configuration. The other two opposite spines are designated as the "floor" and "ceiling" spines with reference to the horizontal configuration and are secondary spines. The secondary spines are used only for additional structural retention of elements and equipment. The location of two rack volumes, right and left, in the upper and lower portions of the Module affords an opportunity for two levels of activity within the cylindrical cross-section.

Modular design allows element and equipment positions relative to each other and to the Module shell to be rearranged on-orbit. This will assist reconfiguration or upgrading procedures. Elements and equipment are also adaptable and transformable in terms of their operation. Interchangeability and transformability are made possible by ensuring that hinged connections to spines are designed for optimum performance.

Adaptability is incorporated in the design of equipment using hinged/pivoted connections to allow adjustment in terms of size or geometry to suit various ergonomic body positions or crew group sizes. The mock-up incorporates an articulated, multi-panel workstation which can adapt in profile to conform to the full range of zero-g neutral body posture anthropometric sizes. Also included is an expandable Wardroom meeting table with 4 crew positions for single-shift use extending to 8 crew positions for full crew complement use. Transformability is incorporated in the design of elements using flexible/foldable screens to enable them to be deployed during periods of active use and stowed away at other times, thereby conserving valuable internal free volume. The mock-up demonstrates a 1 to 2 person library/study compartment which when deployed provides a maximum of 5.53 cu.m. of semi-private accommodation and when stowed occupies only 1.32 cu.m. Also included in the mock-up are 8 personalized sleeping compartments attached to the Module perimeter, each of which occupies 0.48 cu.m. in stowed form while providing 1.66 cu.m. of private crew accommodation in deployed form.

2.2.3 KEY FEATURES

• 2 crew workstations • 1 wardroom table • 2 personal hygiene units • 2 library/study compartments • 2 ECLSS units • 8 sleeping compartments

2.2.4 CONCEPT 1 DRAWINGS AND PHOTOGRAPHS

See FIGURE 1 and FIGURE 2 for explanatory drawings.
See FIGURE 3 through FIGURE 7 for mock-up photographs.

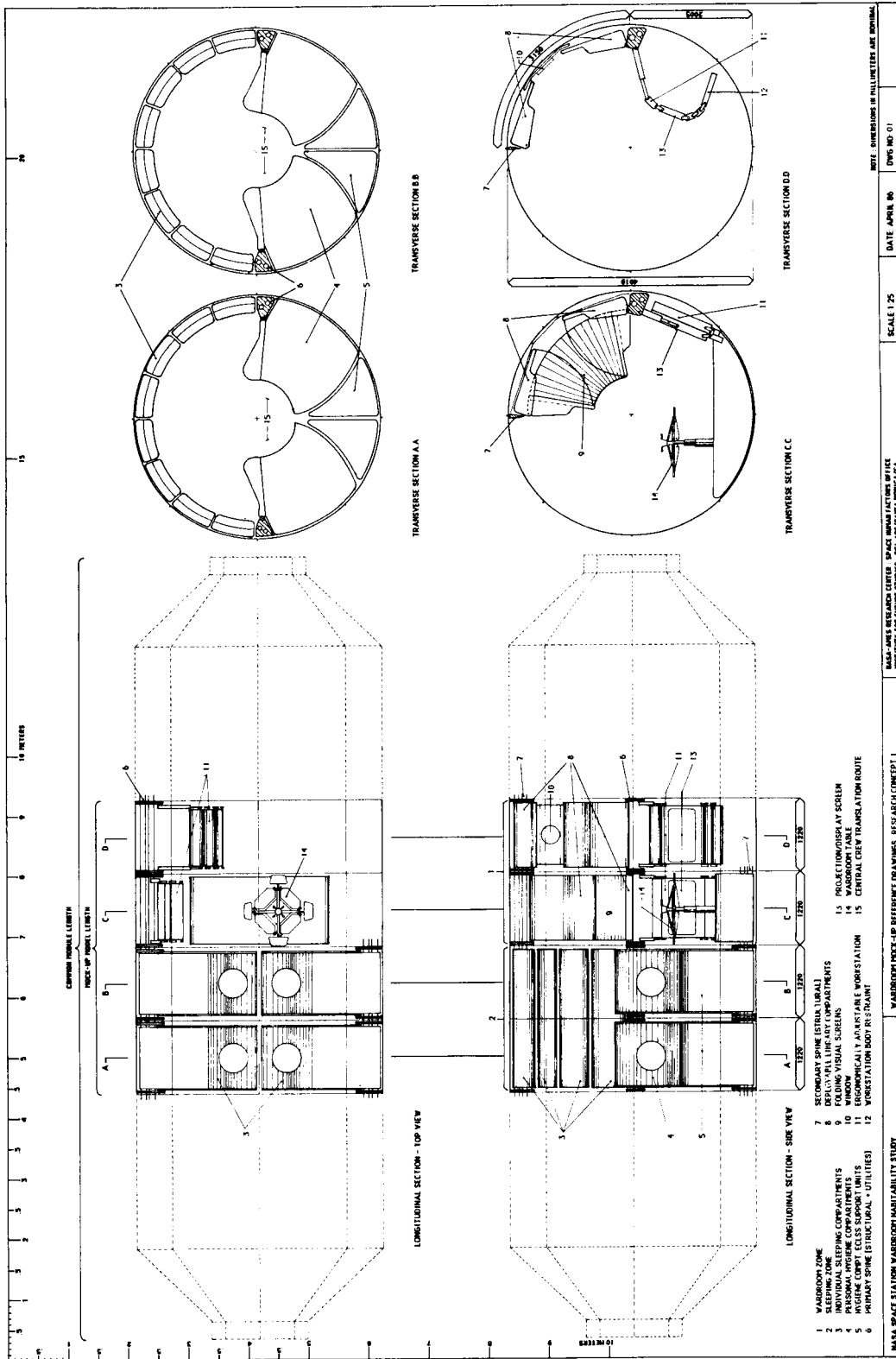

FIGURE 1 : CONCEPT 1 - EXPLANATORY DRAWING

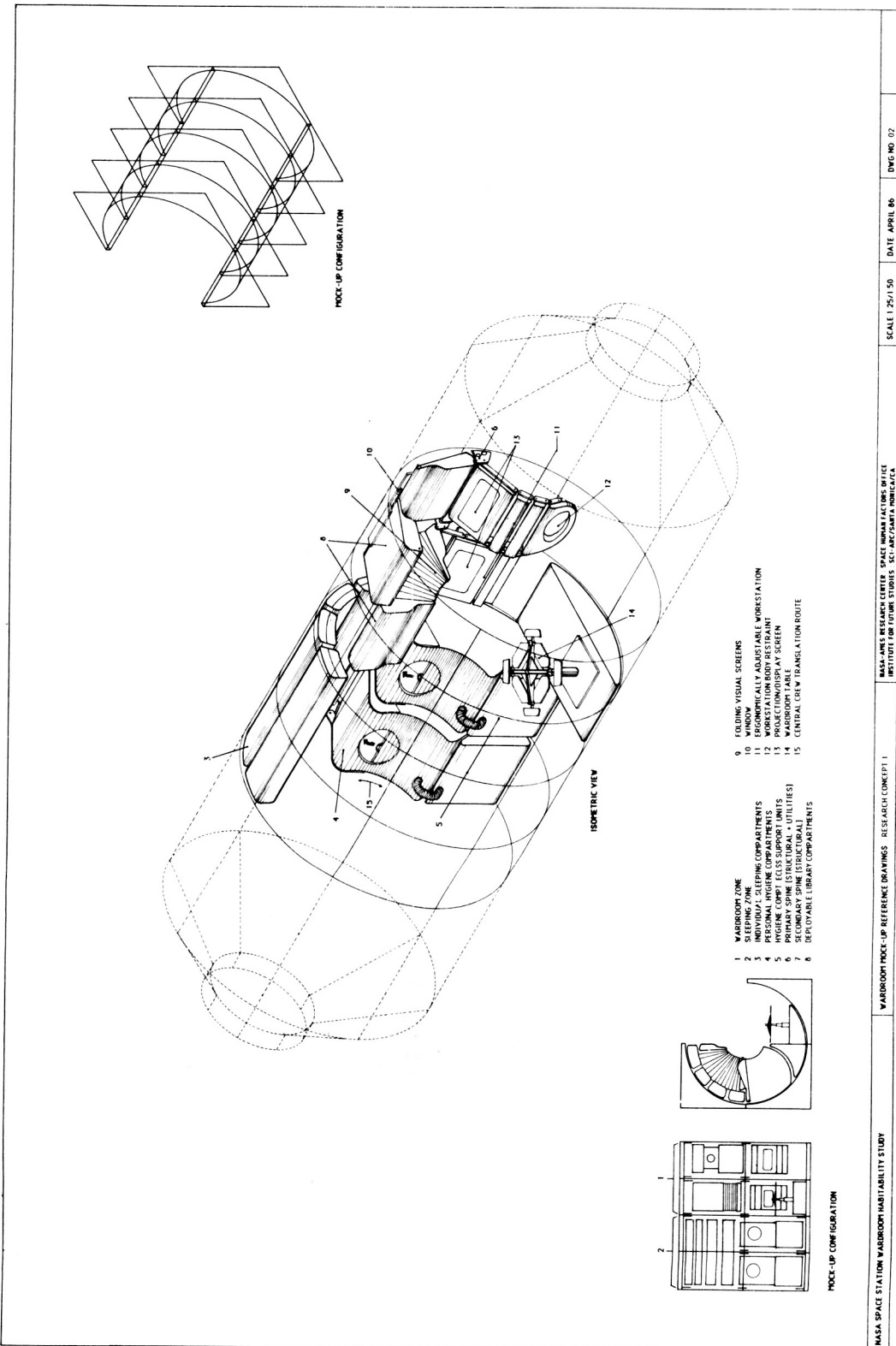

FIGURE 2 : CONCEPT 1 - EXPLANATORY DRAWING



FIGURE 3 : CONCEPT 1

FIGURE 3 on the left shows the adaptable crew workstation. This workstation is an assembly of articulated and interconnected display panels which are manually positioned by the user according to individual arm-reach or sightline preference. The circular waist restraint in the foreground would be padded and hinged to suit different physical crew sizes.

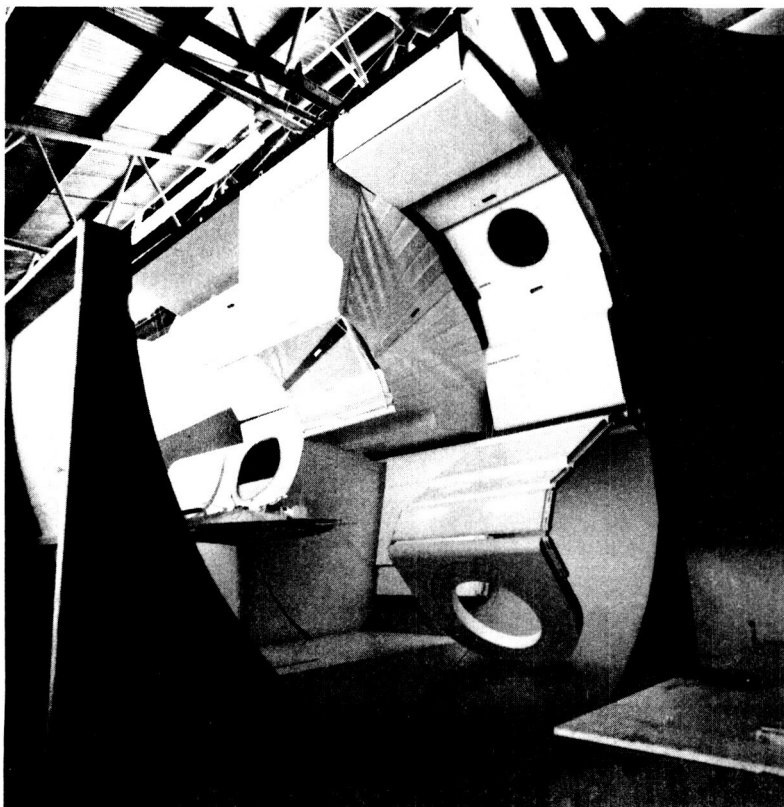

FIGURE 4 : CONCEPT 1

FIGURE 4 on the left shows the complete mock-up for the Four Stand-Off design concept. The various element and equipment items which comprise the configuration are attached to, and deploy from, the perimeter of the Module.

FIGURE 5 on the following page shows mock-up features in more detail. In the foreground is a meeting and meal table for up to 8 crew-members. The adaptable workstation is to the right and a deployable library compartment is in the top center. Two personal hygiene compartments are to the left.

ORIGINAL PAGE
BLACK AND WHITE PHOTOGRAPH

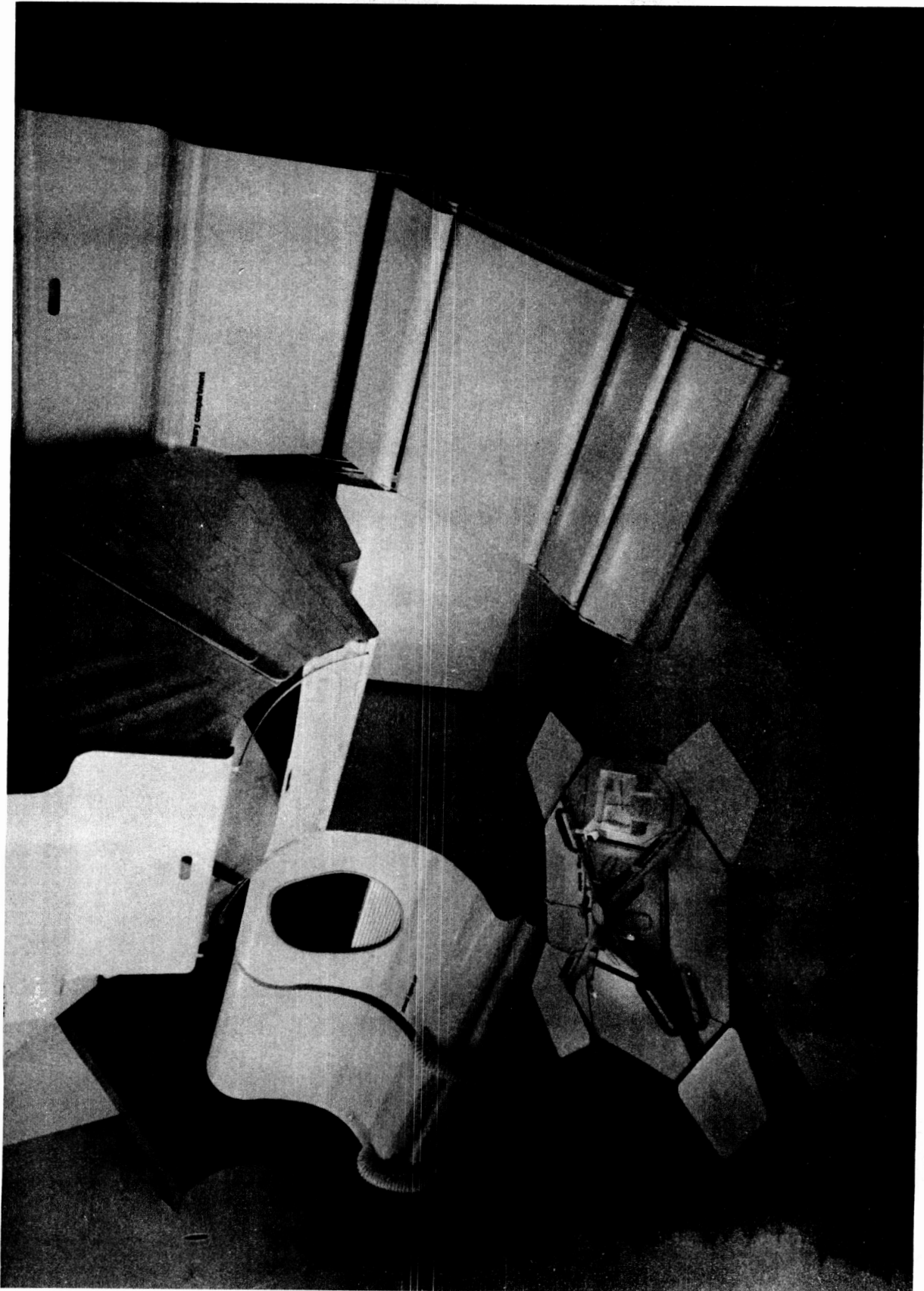

FIGURE 5 : CONCEPT 1 - GENERAL VIEW OF MOCK-UP



FIGURE 6 : CONCEPT 1 - ADAPTABLE WORKSTATION

FIGURE 6 above is a close-up view of the adaptable workstation. The design assumes that flat-screen display technology will have advanced sufficiently by the early 1990's to be suitable for use on-board the Space Station. This will enable workstations with electronic information display screens to be built from shallow panels with consequent volumetric savings.

FIGURE 7 on the following page is a close-up view of the Wardroom table. 4 inner positions are permanent and 4 outer positions are deployable/stowable. Up to 8 crewmembers can be "seated".

ORIGINAL PAGE
BLACK AND WHITE PHOTOGRAPH

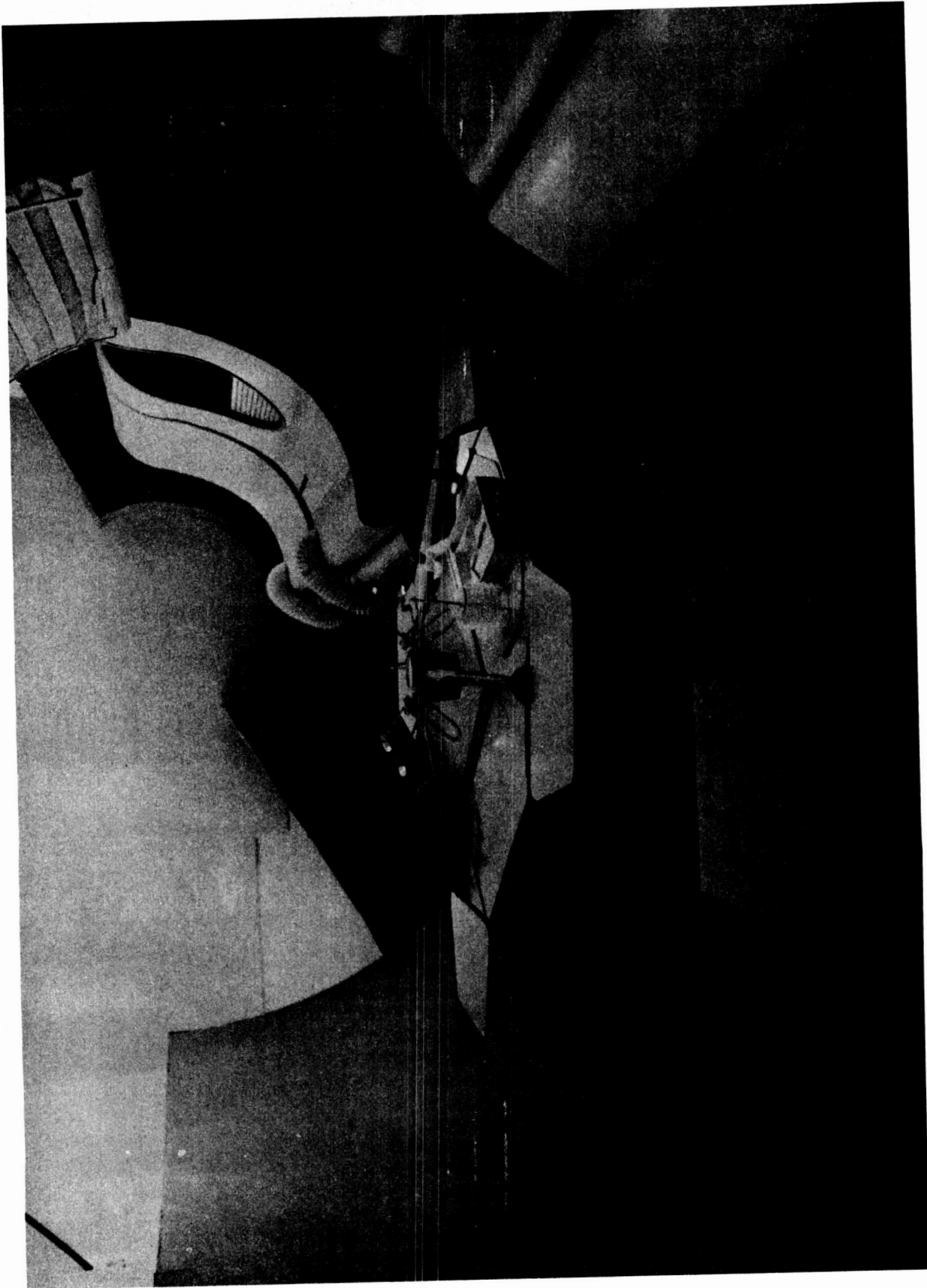

FIGURE 7 : CONCEPT 1 - WARDROOM TABLE

2.3 WARDROOM EXPERIMENTAL CONCEPT 2

2.3.1 BASIC CONCEPT

A triangulated core with a central access corridor and three structural/utility spines which provide support and attachment for dedicated and interchangeable modular elements or equipment.

2.3.2 DESCRIPTION

Three tubular spines run the length of the Module and are located at the apexes of a constant equilateral-triangle section core. The main crew inter-Module translation route occupies the core center. The spines are connected by triangular bulkheads at intervals, and core sides are fully open for continuous crew access and intra-Module translation. The three tubular spines provide structural retention for a range of elements and equipment which determine the architectural configuration. They also carry Module utilities including air, fluids, power, data and communications systems. Utility crossovers occur at bulkheads, and the design enables 100% duplication of all systems.

Modular elements and equipment attach to the core. Crewmembers can interchange these elements between their longitudinal positions by simple, manual procedures. These features aim to facilitate mission-related or life-cycle modification or reconfiguration and enhance crew/equipment interface efficiency and comfort.

A primary feature of this concept is the use of required equipment and storage elements as walls or barriers to help to define a variety of small, semi-private, functionally-specific areas. Two such elements are a 'greenhouse' rack and a soft 'storewall' rack. The former incorporates a glovebox growing chamber and open planter served by a tubular framework supplying environmental controls, nutrient systems and structural retention. The latter comprises an array of soft pocket storage containers tethered to a support framework. Both elements provide a degree of privacy between adjacent activity areas. The Module perimeter is kept free to maximize interior perceptual interest and sense of spaciousness, freedom of movement and wall surface accessibility for maintenance purposes.

The architectural internal organization of the Module is divided into three 120° segments as determined by the triangular core. Each segment provides ample anthropometric volume for crew activities and storage, workstation and equipment requirements. A constant horizontal reference is maintained throughout the Module which locates one 120° segment [the "loft" segment] along the upper portion of the Module. This segment is left as clear as possible to enhance visual contact between end caps and to maximize freedom of intra-Module crew movement. If necessary, this segment can be divided by demountable screens into self-contained crew activity areas according to crew routine requirements.

2.3.3 KEY FEATURES

• 2 galley food prep. stations • 2 Galley hygiene stations • 2 'greenhouse' units [glovebox/open] • 1 soft 'storewall' unit • 1 wardroom meeting table • radial storage compartments

2.3.4 CONCEPT 2 DRAWINGS AND PHOTOGRAPHS

See FIGURE 8 and FIGURE 9 for explanatory drawings.
See FIGURE 10 through FIGURE 16 for mock-up photographs.

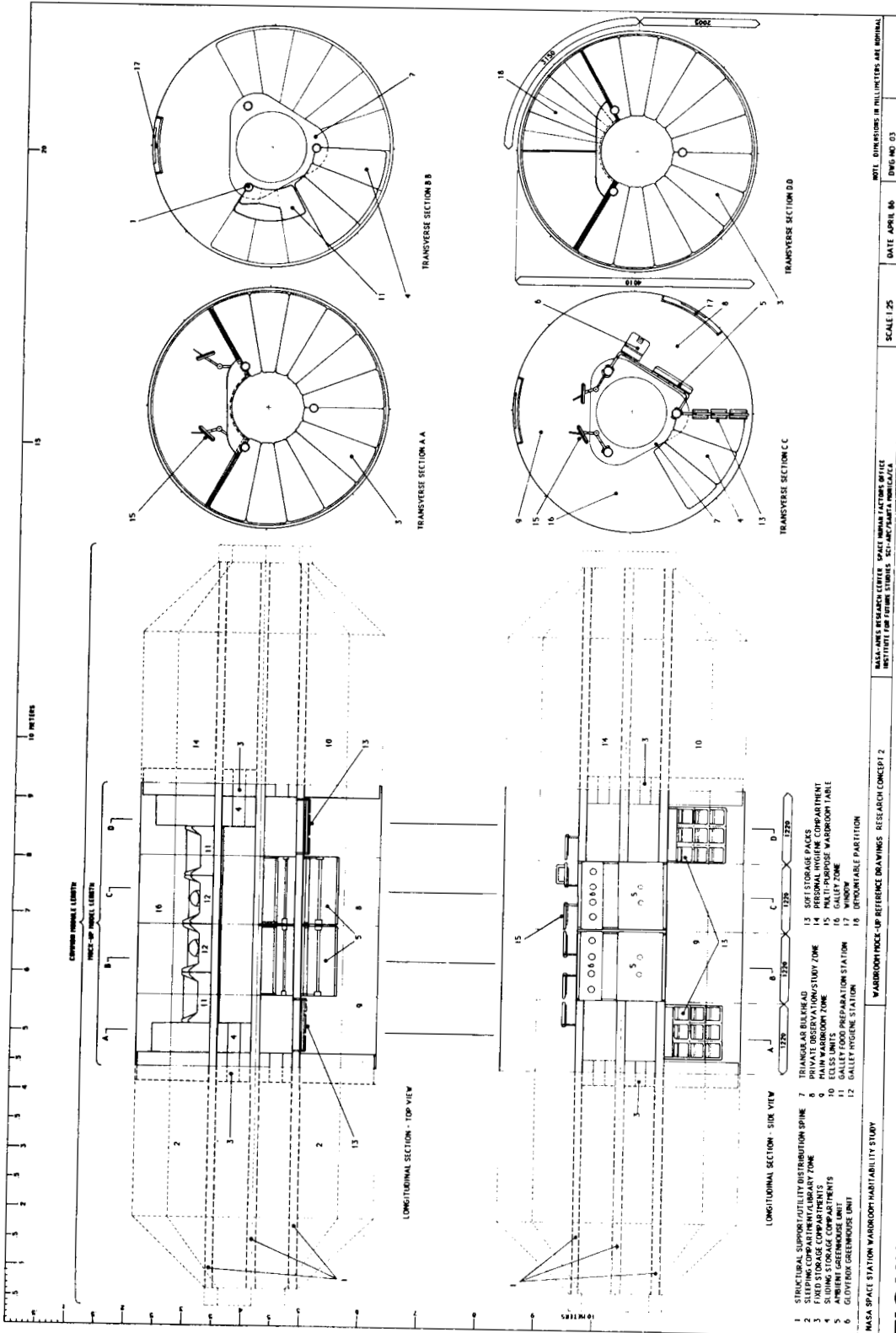

FIGURE 8 : CONCEPT 2 - EXPLANATORY DRAWING

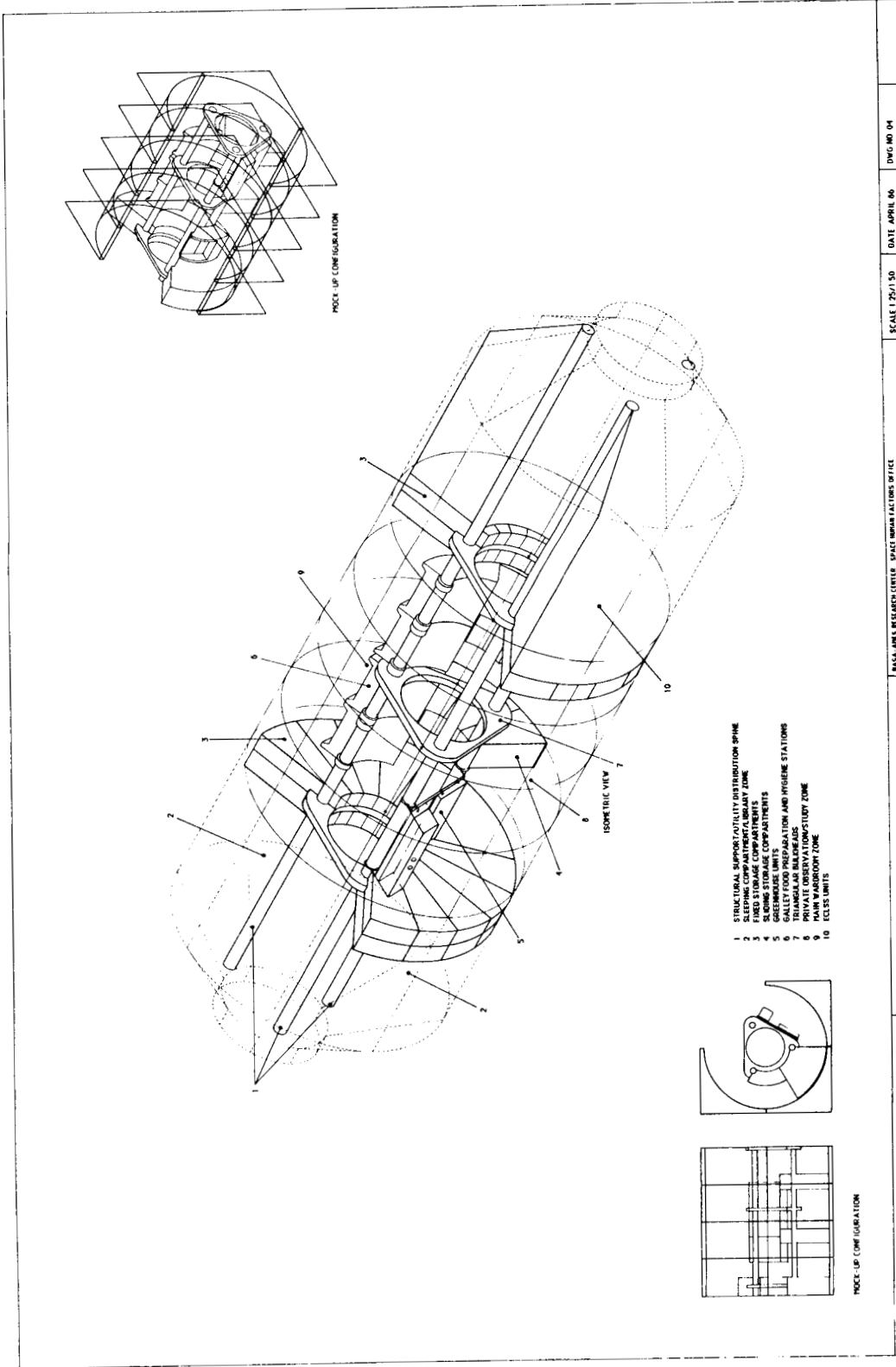

FIGURE 9 : CONCEPT 2 - EXPLANATORY DRAWING

NASA SPACE STATION W/ABROOD HABITABILITY STUDY W/ABROOD POCK-UP REFERENCE DRAWINGS - RESEARCH CONCEPT 2 SCALE 1/250150 DATE APRIL 06 DWG NO 04

ORIGINAL PAGE
BLACK AND WHITE PHOTOGRAPH

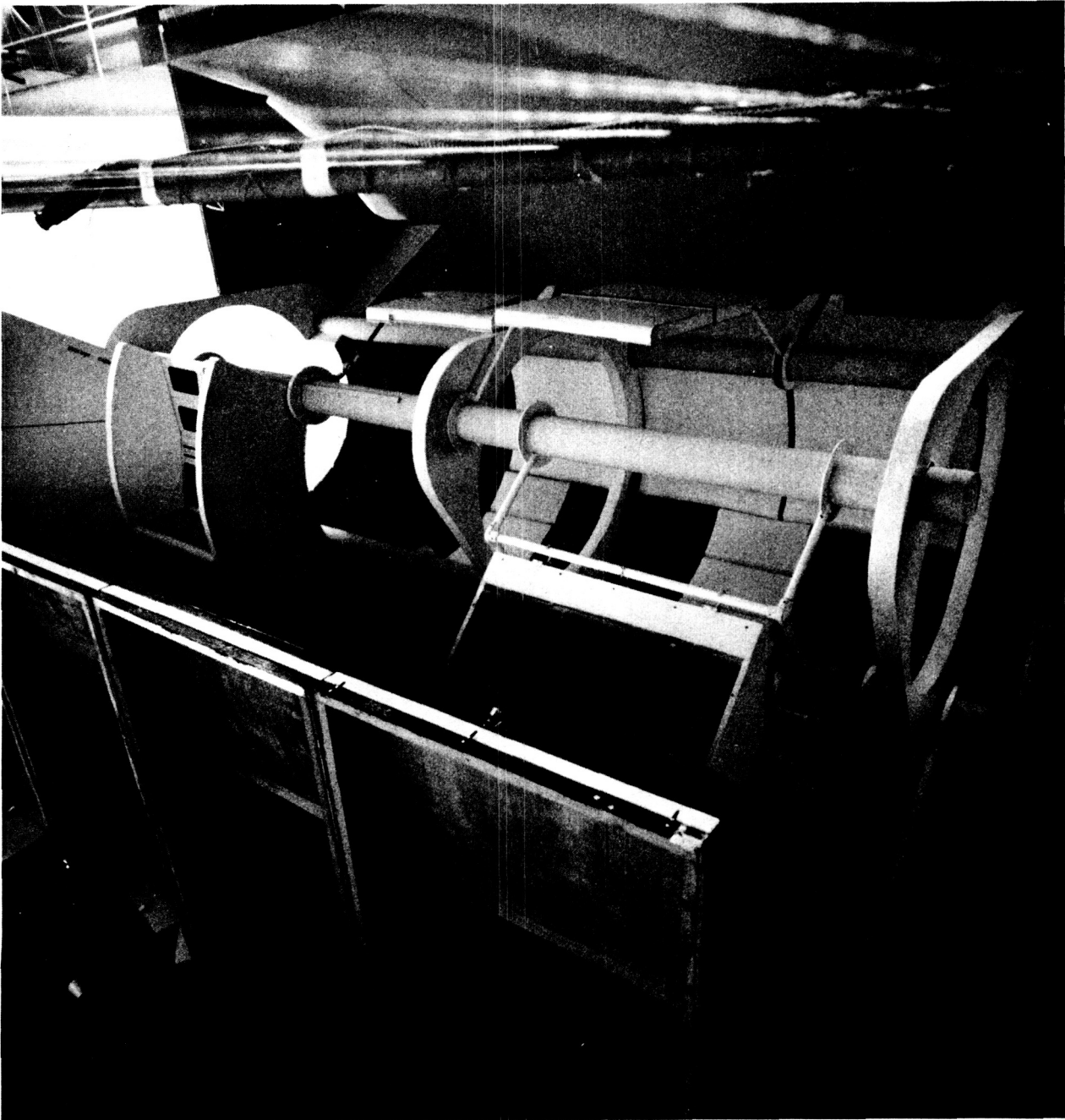

FIGURE 10 : CONCEPT 2 - GENERAL VIEW OF MOCK-UP

FIGURE 10 shows entire WARDROOM, GALLEY, and LIBRARY mockup. SLEEPING quarters are intended beyond mockup on left, beyond to the right would be EXERCISE area, and dense packed ECLSS. Equipment shown are (left to right): large storage units, folding acoustical screen, galley unit, soft storage unit, reversible wardroom table sections, galley and hygiene units, sliding storage units, and open and contained greenhouse units.



FIGURE 11 : CONCEPT 2 - VIEW ALONG CENTRAL PASSAGE

FIGURE 11 shows view down central circulation path looking from ECLSS area, through WARDROOM (top), GALLEY (right), and LIBRARY (left) areas, toward SLEEPING quarters. Three structural spines delineate path, carry utilities, and serve as attachment points for equipment and storage units. Triangular ring, in foreground, provides rigidity to spines and acts as attachment point for folding acoustical screens and other accessories. Design team poses for scale.

ORIGINAL PAGE
BLACK AND WHITE PHOTOGRAPH

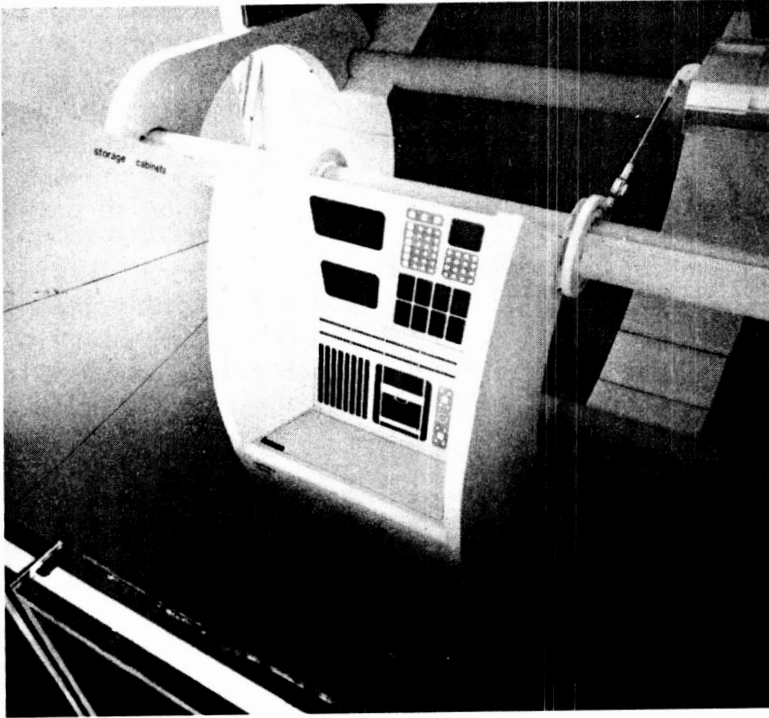

FIGURE 12 : CONCEPT 2

FIGURE 12 shows detail of galley unit. The unit is designed as an individual food preparation station and provides microwave and convection ovens, rehydrator, utensil and condiment storage, and quick access food storage. Food waste disposal and cleanup are provided in similarly designed hygiene units. The units have self-contained air filtering capabilities [through side wings] for containment of odors and floating food debris.

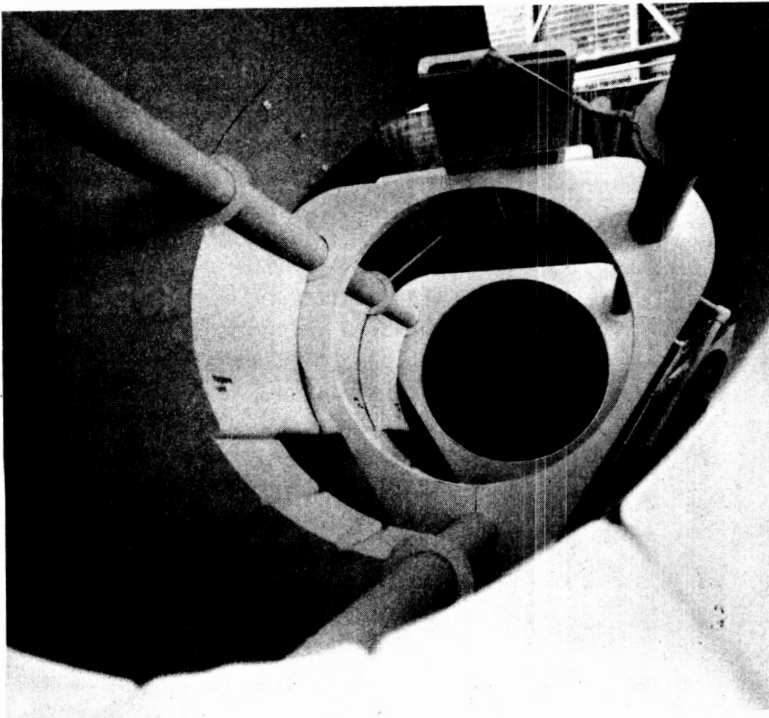

FIGURE 13 : CONCEPT 2

FIGURE 13 shows view of GALLEY area from SLEEPING quarters. Galley storage unit [lower left] is assembled from wedge-shaped modules and has sliding attachment to service spine. Galley and hygiene units [center left] are fixed but may be removed, replaced, or relocated at the crew's discretion. Placement of equipment and storage units provides variety of spaces within module volume.

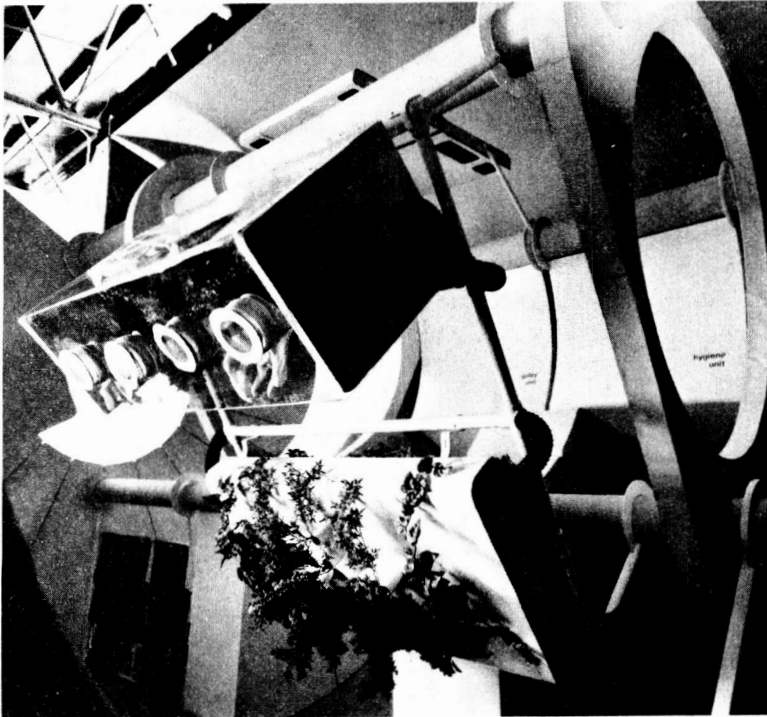

FIGURE 14 : CONCEPT 2

FIGURE 14 shows LIBRARY area with greenhouse units providing screen from circulation path. Open and closed units attach to framework which supplies nutrient solution for hydroponic growing techniques. The Framework may be attached between two central spines or may be rotated about one spine and fixed in any position desired.

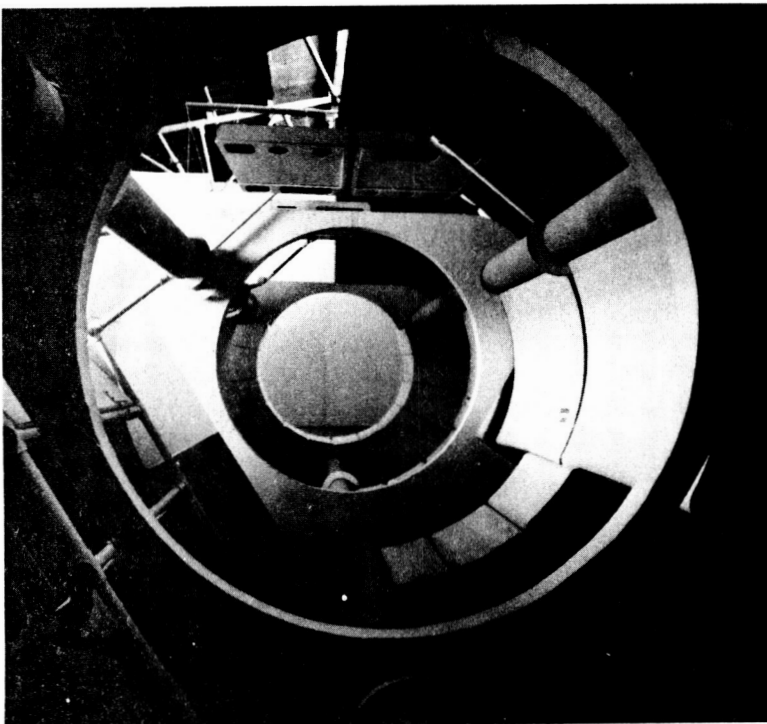

FIGURE 15 : CONCEPT 2

FIGURE 15 shows view down circulation path. In right foreground are galley units and sliding storage unit. In top center are articulated wardroom table elements. Table elements are sized for individual use and may be combined and attached for communal activities. Eating and recreational tasks are accommodated on one surface of an element, workstation tasks are accommodated on the reverse surface. Services are supplied through an adjustable arm which can be attached anywhere on the service spine.

ORIGINAL PAGE
BLACK AND WHITE PHOTOGRAPH



FIGURE 16 : CONCEPT 2 - GREENHOUSE UNIT

FIGURE 16 shows detail of greenhouse units. Glovebox unit allows controlled cultivation of experimental plants. Containment protects against accidental exposure to atmospheric poisons. Open unit allows recreational plant cultivation. Plants provide visual and tactile cues for an environment of relaxed social intercourse and are thus located to provide a visual screen for the LIBRARY area.

2.4 WARDROOM EXPERIMENTAL CONCEPT 3

2.4.1 BASIC CONCEPT

An accessible off-center utility route and modular, curved-geometry racks and compartments which provide anthropometrically-responsive, soft interior fascias for crew station functions.

2.4.2 DESCRIPTION

This interior configuration is the most innovative of the three concepts studied. It combines architecturally fixed and architecturally interchangeable elements which are integrated together to provide a total environment for crew efficiency and comfort.

The fixed element system comprises an eccentrically-located utility core of 20 cu.m. attached to the Module perimeter and two utility rings [bulkheads] of 10 cu.m. each. The core and rings provide distribution of air, fluids, power, data and communications systems throughout the Module. The utility core is crew-accessible for maintenance. The interchangeable element system comprises a series of modular, radially-organized elements whose positions relative to each other and to the Module can be modified during their life-cycle. Elements comprise storage, equipment and workstation functions. Each element is autonomous in terms of function, operation and structural/utility connections to facilitate life-cycle upgrading or on-orbit rearrangement. Individual elements are detachable from the Module shell for maintenance and inspection. Uniform element depth from inner surface to Module perimeter is nominally 1 meter which leaves a central crew translation volume of 2.1 meters in diameter. This diameter can vary from -50 mm. to +200 mm. depending on the specific dimensional requirements of individual elements.

The importance of ensuring comfortable zero-g body posture throughout the wide range of operational activities to be encountered within the Module places special emphasis on the ergonomic design of the elements themselves. To achieve this, conventional angular element geometry has evolved into an innovative concept of anthropomorphic element geometry which tailors the design of the physical man/machine interface to the performance requirements of each element. The contouring is applied to inner faces of each element with the sides standardized to simplify element interconnection and closure. Each element combines controllable internal lighting with translucent facing panels. This will provide low ambient background illumination of the Module interior combined with high localized integral [backlit] illumination of systems control/input consoles and visual image/data displays. Lighting pattern, intensity, level and color for each element is individually-controllable according to user comfort or preference. The key feature of this concept lies in the physical integration of crewmembers with their surroundings in an efficient and comfortable manner and which enhances long-term perceptual interest and psychological awareness.

2.4.3 KEY FEATURES

- radial contoured racks/elements • continuous modular utility spine

2.4.4 CONCEPT 3 DRAWINGS AND PHOTOGRAPHS

See FIGURE 17 and FIGURE 18 for explanatory drawings.
See FIGURE 19 through FIGURE 22 for mock-up photographs.

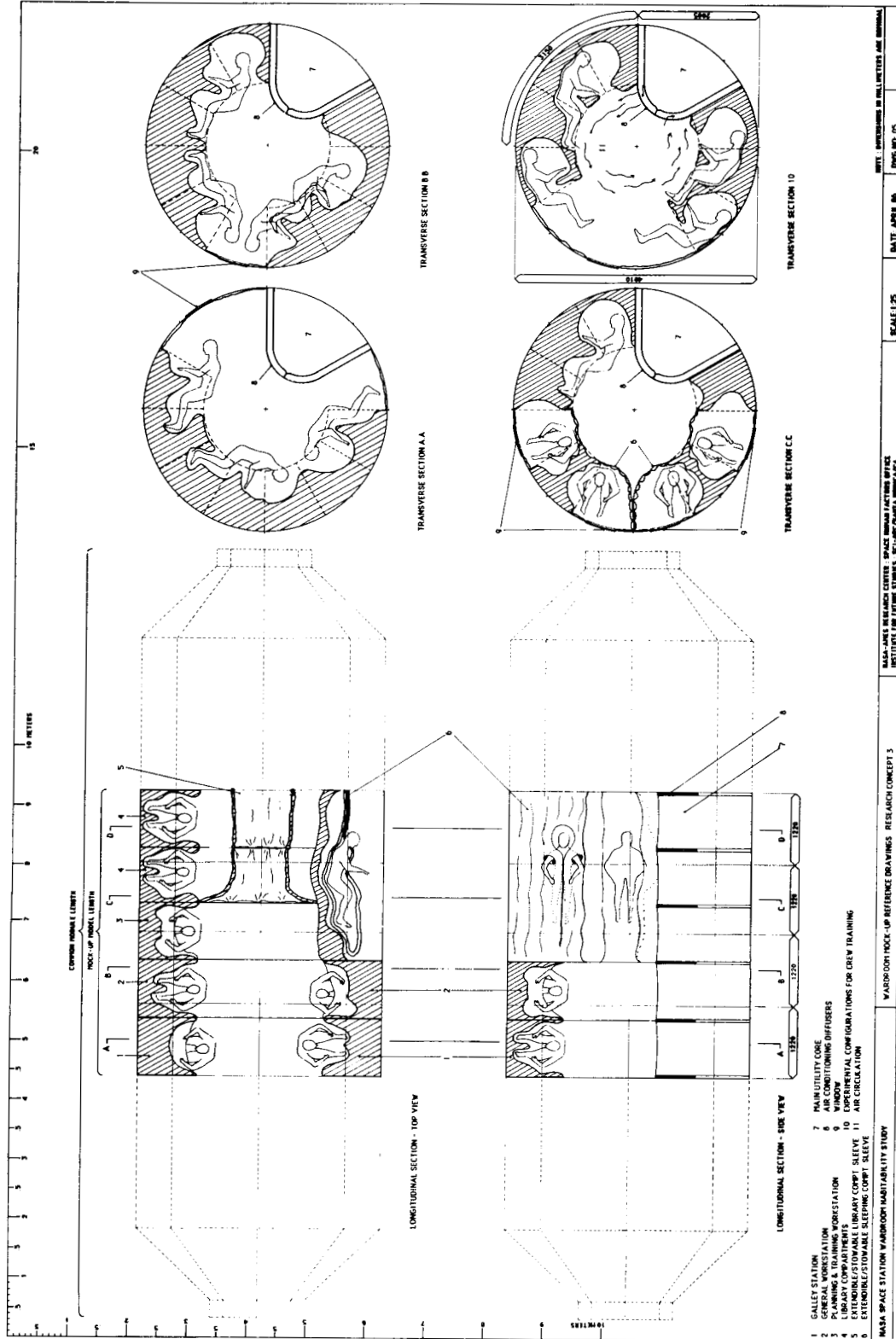

FIGURE 17 : CONCEPT 3 - EXPLANATORY DRAWING

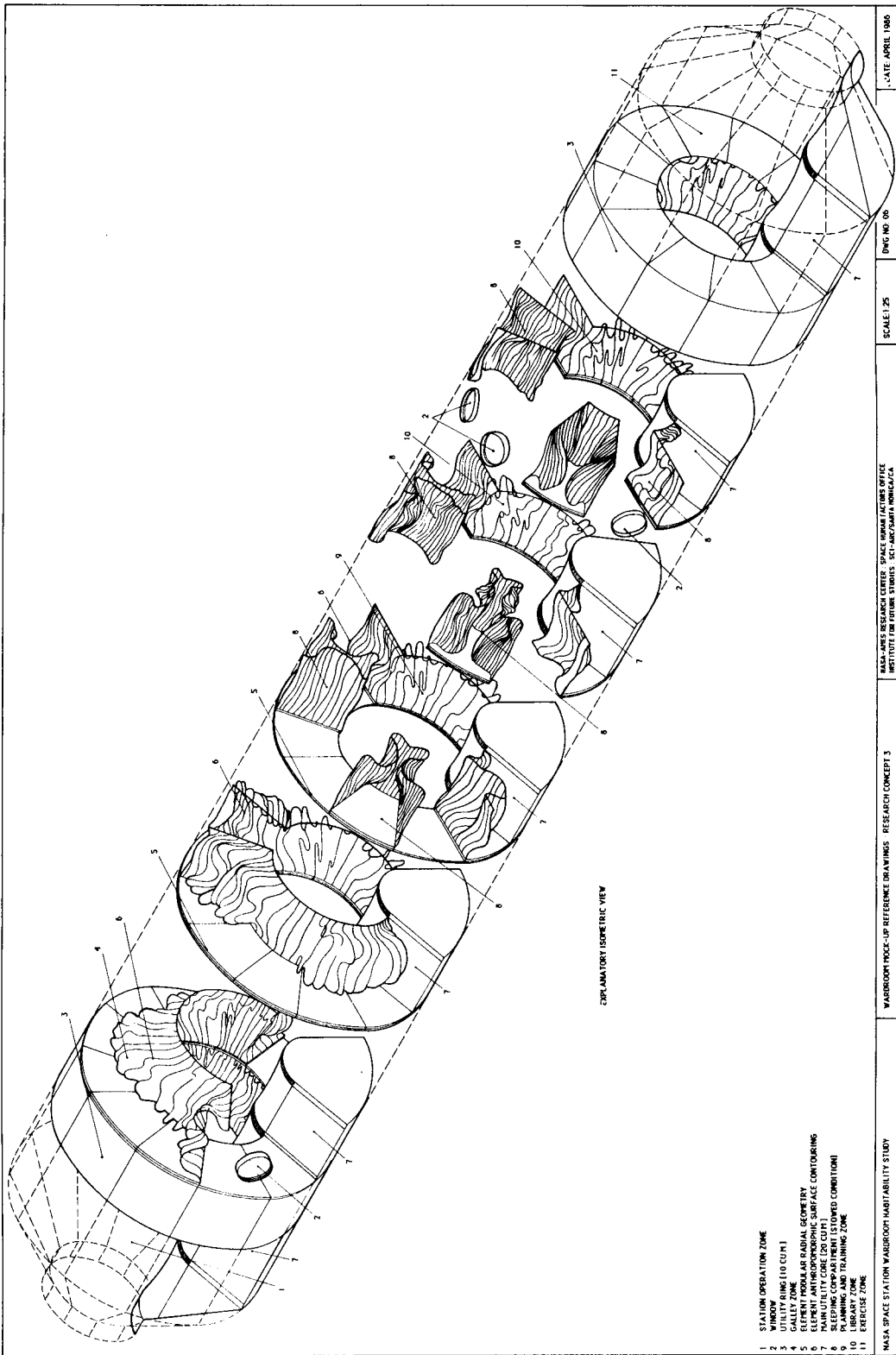

FIGURE 18 : CONCEPT 3 - EXPLANATORY DRAWING



FIGURE 19 : CONCEPT 3 - GENERAL VIEW OF MOCK-UP

FIGURE 19 The different rack and compartment elements which comprise the Wardroom area form an anthropomorphic environment along the center of which is a large free volume for crew movement and activity. The accessible utility core on the right provides a constant visual cue and reference within the Module. In the left foreground, a life-size mannequin is shown in position at a crew workstation. In the upper right, a series of racks and compartments represent training workstations and a library.

ORIGINAL PAGE
BLACK AND WHITE PHOTOGRAPH



FIGURE 20 : CONCEPT 3 - VIEW OF UTILITY CORE

FIGURE 20 The utility core shown on the left represents an important visual reference within the Module and provides the routing and major distribution of gas, fluid, air, power and communications systems throughout the interior. The flexible grab-handles are designed to be visually obvious and are located at frequent intervals on rack and compartment faces to facilitate crew use.

**ORIGINAL PAGE
BLACK AND WHITE PHOTOGRAPH**

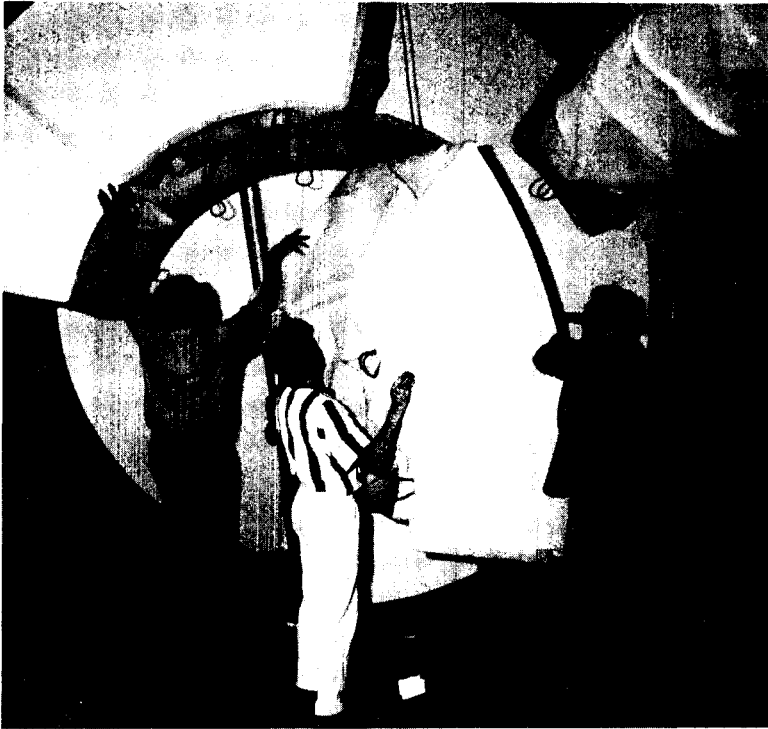

FIGURE 21 : CONCEPT 3

FIGURE 21 The racks and compartments are built in different sizes according to the size and type of systems they contain. This difference enables the crew to assemble different element configurations on-orbit according to operational requirements while ensuring that the visual quality of the interior is retained. The photograph shows elements being installed.



FIGURE 22 : CONCEPT 3

FIGURE 22 The modular concept allows on-orbit completion of the Wardroom interior. Flexible grab-handles on each element enable crewmembers to perform easy maneuvers in weightlessness. The addition of attachment mechanisms to the rear of elements would provide connections with the Module hull and enable elements to swing-out for wall access.

2.5 EVALUATION METHODOLOGY

2.5.1 PURPOSE

The three Experimental Concepts developed in Phase 1 have been evaluated by key members of the project team who are most familiar with aspects of the research effort. The team members comprise the project Technical Monitor from NASA, the project Principal Investigator and the two project Research Assistants. The purpose of the evaluation process is to identify and evaluate design features for development and application in further phases of work.

2.5.2 EVALUATION FACTORS

Each of the three Experimental Concepts is evaluated against a series of Design Factors which cover a full range of key design issues concerned with the definition and function of the Wardroom.

A total of fifty-seven Design Factors are identified for use in the evaluation process. These Design Factors are organized into nine Factor Groups. Each Factor Group deals with a major design aspect of the project.

The nine Factor Groups are

1. ARCHITECTURAL CONCEPT
2. UTILITY SYSTEMS
3. ARCHITECTURAL SUB-SYSTEMS
4. PERCEPTUAL QUALITY
5. ERGONOMICS
6. WARDROOM ACTIVITIES
7. ASSOCIATED FEATURES
8. ORIENTATION/TRANSLATION
9. CREW GROUP USES

2.5.3 EVALUATION TECHNIQUES

TABLES 1-27 contain the recorded information of the evaluation procedure. The evaluation of each of the three Experimental Concepts by Design Factor and Factor Group yields varying levels and qualities of design response. In TABLES 1-27, these levels of design response are represented in terms of scoring against a five-point rating scale ranging from 'optimal' with a value of 5, to 'inadequate' with a value of 1. For the purposes of evaluation, each of the ten Factor Groups and each of the fifty-seven Design Factors are given equal weighting respectively.

Resulting evaluation scores are recorded in the right-hand columns of TABLES 1-27. Firstly, cumulative values for each Design Factor are shown in column E1-E4. These are based on the horizontal addition of individual factors in the four individual columns E1, E2, E3 and E4 respectively. Secondly, these cumulative values are added together vertically to give a single total value in a box located the bottom of column E1-E4. This value is the total score achieved by particular Experimental Mock-up for a particular Factor Group.

The scores are compared according to four parameters of evaluation. Two parameters address high-scoring Design Factors and Factor Groups respectively, and two parameters address low-scoring Design Factors and Factor Groups respectively.

The parameters are defined below. Symbols [solid and hollow positive and negative signs] are used to identify appropriate scores in TABLES 1-27, and in summarized form in TABLE 28.

Highest scores for resolution of individual Design Factors by each Experimental Mock-up Concept. Any score of 16 or more per single factor is considered a high score, based on a score of '4 = preferable' for each of the 4 team evaluations [i.e. $4 \times 4 = 16$]. In TABLE 28, these are shown as percentiles of individual high-scoring Design Factors in their high-scoring Factor Group.

Highest scores for resolution of Factor Groups by each Experimental Mock-up Concept. Addition of all individual Design Factor scores to give a single value for a single Factor Group achieved by each Experimental Mock-up Concept.

Lowest scores for resolution of individual Design Factors by each Experimental Mock-up Concept. Any score of less than 12 per single factor is considered a low score, based on a score of '3 = acceptable' for each of the 4 team evaluations [i.e. $3 \times 4 = 12$]. In TABLE 28, these are shown as percentiles of individual low-scoring Design Factors in their low-scoring Factor Group.

Lowest scores for resolution of Factor Groups by each Experimental Mock-up Concept. Addition of all individual Design Factor scores to give a single value for a single Factor Group achieved by each Experimental Mock-up Concept.

TABLE 28 shows a summary of the results of the evaluation process. The four parameters of evaluation are shown as four vertical columns and the nine Factor Groups are shown as nine horizontal columns. Appropriate scores and symbols are located in individual boxes. In one instance, two Experimental Mock-up Concepts share high scores and in another instance, all three Experimental Concepts Mock-up share high scores. These instances occur where the scores are identical or extremely close.

The results of the evaluation process are summarized in Section 2.6 - EVALUATION RESULTS.

TABLE 1		EVALUATION SCORING 5 = OPTIMAL 3 = ACCEPTABLE 1 = INADEQUATE																4 = PREFERABLE 2 = MINIMAL		CUMULATIVE VALUES FOR INDIVIDUAL CRITERIA					
MOCK-UP CONCEPT 1		E1					E2					E3					E4					E1 - E4			
ARCHITECTURAL CONCEPT		5	4	3	2	1	5	4	3	2	1	5	4	3	2	1	5	4	3	2	1				
CREW TRANSLATION ROUTE				■				■					■					■						14	
RACK/COMP. CREW INTERFACE				■						■					■					■				12	
RACK/COMP. ATTACHMENTS			■							■					■					■				12	
ARCHITECTURAL DEFINITION				■						■					■					■				13	
VOLUMETRIC UTILIZATION		■						■					■					■						19	+
TOTAL VALUE FOR CRITERIA GROUP EVALUATION																		70	■						
GENERAL COMMENTS		Dual levels of crew activity combined with deployable/fold-away elements/equipt. achieves high volumetric efficiency. Wardroom table acts as focal point. Library is better located away from immediate wardroom vicinity.																							
TABLE 2		EVALUATION SCORING 5 = OPTIMAL 3 = ACCEPTABLE 1 = INADEQUATE																4 = PREFERABLE 2 = MINIMAL		CUMULATIVE VALUES FOR INDIVIDUAL CRITERIA					
MOCK-UP CONCEPT 1		E1					E2					E3					E4					E1 - E4			
UTILITY SYSTEMS		5	4	3	2	1	5	4	3	2	1	5	4	3	2	1	5	4	3	2	1				
PRIMARY UTILITY CORES			■					■					■								■			14	
UTILITY SYS. DISTRIBUTION			■							■					■					■				16	+
SECONDARY STRUCTURE				■						■					■					■				14	
UTILITY SYS. ATTACHMENTS				■						■					■					■				13	
PRESSURE WALL ACCESS			■					■					■					■						17	+
TOTAL VALUE FOR CRITERIA GROUP EVALUATION																		74							
GENERAL COMMENTS		Location of utility systems in opposite stand-offs potentially provides rationalized systems distribution to racks/compartments. Access to pressure hull achieved by hinged attachments enabling elements to swing-out.																							

TABLE 3	EVALUATION SCORING		5 = OPTIMAL		4 = PREFERABLE		3 = ACCEPTABLE		2 = MINIMAL		1 = INADEQUATE		CUMULATIVE VALUES FOR INDIVIDUAL CRITERIA								
MOCK-UP CONCEPT 1	E1					E2					E3					E4					E1 - E4
ARCH. SUB-SYSTEMS	5	4	3	2	1	5	4	3	2	1	5	4	3	2	1	5	4	3	2	1	
RACK/COMP. MODULARITY		4					4					4						4			15
RACK/COMP. CHANGE-OUT		4					4					4						4			18
MODULE LONGITUDINAL FIT		4					4					4						4			17
MODULE RADIAL FIT		4					4					4						4			15
CREW ACTIVITY SEPARATIONS		4					4					4						4			14
SUB-SYSTEMS INTEGRATION		4					4					4						4			10
TOTAL VALUE FOR CRITERIA GROUP EVALUATION																			89		

GENERAL COMMENTS Modularity of rack/compartments provides simple interchangeability and reconfiguration. Closure of inter-rack gaps needs consideration. Crew activity separations capable of further organization.

TABLE 4	EVALUATION SCORING		5 = OPTIMAL		4 = PREFERABLE		3 = ACCEPTABLE		2 = MINIMAL		1 = INADEQUATE		CUMULATIVE VALUES FOR INDIVIDUAL CRITERIA								
MOCK-UP CONCEPT 1	E1					E2					E3					E4					E1 - E4
PERCEPTUAL QUALITY	5	4	3	2	1	5	4	3	2	1	5	4	3	2	1	5	4	3	2	1	
PERCEIVED SPACIOUSNESS		4					4					4						4			16
GENERAL VISUAL COMPLEXITY		4					4					4						4			17
GENERAL VISUAL INTEREST		4					4					4						4			17
LIGHTING INTEGRATION ABILITY		4					4					4						4			12
LIGHTING QUALITY		4					4					4						4			12
LIGHTING EFFICIENCY		4					4					4						4			12
GENERAL VISUAL COMFORT		4					4					4						4			11
POTENTIAL TACTILE COMFORT		4					4					4						4			12
SENSE OF ORGANIZATION		4					4					4						4			12
TOTAL VALUE FOR CRITERIA GROUP EVALUATION																			121		

GENERAL COMMENTS Spaciousness enhanced by fold-away compartments, Kinetic functions of elements generates visual variety/interest. Lighting systems require development. Visual/tactile comfort can be improved by attention to colors/materials/surfaces.

TABLE 5 MOCK-UP CONCEPT 1	EVALUATION SCORING																				CUMULATIVE VALUES FOR INDIVIDUAL CRITERIA						
	5 = OPTIMAL					4 = PREFERABLE					3 = ACCEPTABLE					2 = MINIMAL						1 = INADEQUATE					
	E1					E2					E3					E4						E1 - E4					
ERGONOMICS	5	4	3	2	1	5	4	3	2	1	5	4	3	2	1	5	4	3	2	1							
INTRA-MODULE TRAFFIC		4					4					4					4									15	
GENERAL ANTHROPOMETRICS																										16	+
5%/95% ADJUSTABILITY																										18	+
ERGONOMIC INTERFACES																										19	+
NEUTRAL BODY POSTURE																										20	+
GROUP ERGONOMIC FUNCTIONS																										18	+
TOTAL VALUE FOR CRITERIA GROUP EVALUATION																									106	+	
GENERAL COMMENTS Ergonomic and anthropometric design clearly established and demonstrated for racks, compartments, workstation and table.																											

TABLE 6 MOCK-UP CONCEPT 1	EVALUATION SCORING																				CUMULATIVE VALUES FOR INDIVIDUAL CRITERIA						
	5 = OPTIMAL					4 = PREFERABLE					3 = ACCEPTABLE					2 = MINIMAL						1 = INADEQUATE					
	E1					E2					E3					E4						E1 - E4					
WARDROOM ACTIVITIES	5	4	3	2	1	5	4	3	2	1	5	4	3	2	1	5	4	3	2	1							
GENERAL RECREATION																										17	+
TELECONFERENCES																										17	+
PLANNING/TRAINING/MEETING																										13	
4 CREW MEALS																										20	+
8 CREW MEALS																										20	+
WORKSTATION APPLICATIONS																										13	
SHIFT CHANGE BRIEFING																										20	+
CREW CHANGE BRIEFING																										17	+
TOTAL VALUE FOR CRITERIA GROUP EVALUATION																									137	+	
GENERAL COMMENTS Design works well for range of wardroom activities and functions for various sizes of crew groups. Table to be designed to swing/stow to one side for large group gatherings.																											

TABLE 7		EVALUATION SCORING 5 = OPTIMAL 3 = ACCEPTABLE 1 = INADEQUATE				EVALUATION SCORING 4 = PREFERABLE 2 = MINIMAL				CUMULATIVE VALUES FOR INDIVIDUAL CRITERIA													
MOCK-UP CONCEPT 1																							
ASSOCIATED FEATURES		E1		E2		E3		E4		E1 - E4													
		5	4	3	2	1	5	4	3	2	1	5	4	3	2	1	5	4	3	2	1		
GALLEY LOCATION				3					3					3					3			12	
GALLEY DESIGN/OPERATION																						12	
LIBRARY LOCATION					3						3											9	
LIBRARY DESIGN/OPERATION			3					3					3					3				17 +	
WORKSTATION LOCATIONS			3					3					3					3				17 +	
WORKSTATION DESIGN			3					3					3					3				17 +	
WORKSTATION RESTRAINTS																						15	
WARDROOM TABLE																						19 +	
EQUIPMENT DEPLOYABILITY																						20 +	
COMPARTMENT DEPLOYABILITY																						20 +	
TOTAL VALUE FOR CRITERIA GROUP EVALUATION										158		+											
GENERAL COMMENTS		Library location require further study to enhance privacy. Compartment and equipment deployability and table and workstation adaptability are highly efficient and desirable design concepts.																					

TABLE 8		EVALUATION SCORING 5 = OPTIMAL 3 = ACCEPTABLE 1 = INADEQUATE				EVALUATION SCORING 4 = PREFERABLE 2 = MINIMAL				CUMULATIVE VALUES FOR INDIVIDUAL CRITERIA													
MOCK-UP CONCEPT 1																							
ORIENTATION/TRANSLAT'N		E1		E2		E3		E4		E1 - E4													
		5	4	3	2	1	5	4	3	2	1	5	4	3	2	1	5	4	3	2	1		
PERSONAL RESTRAINTS				3					3					3					3			12	
MOBILITY AIDS																						12	
LOCAL HORIZONTAL																						17 +	
GLOBAL HORIZONTAL																						16 +	
TOTAL VALUE FOR CRITERIA GROUP EVALUATION										57		+											
GENERAL COMMENTS		Horizontal reference is established without being dominant, assisted by table as focal point. Mobility aids and restraints require development.																					

TABLE 9 MOCK-UP CONCEPT 1	EVALUATION SCORING																				CUMULATIVE VALUES FOR INDIVIDUAL CRITERIA					
	5 = OPTIMAL					4 = PREFERABLE					3 = ACCEPTABLE					2 = MINIMAL						1 = INADEQUATE				
	E1					E2					E3					E4						E1 - E4				
CREW GROUP USES	5	4	3	2	1	5	4	3	2	1	5	4	3	2	1	5	4	3	2	1	E1 - E4					
INDIVIDUAL CREW USES																					14					
SMALL GROUP [2/4] USES																					14					
LARGE GROUP [5/8] USES																					15					
PRIVACY GRADIENT																					11					
TOTAL VALUE FOR CRITERIA GROUP EVALUATION																					54					
GENERAL COMMENTS	Sufficient size for various group uses up to 8 persons. Mixed activity potential and privacy gradients require further study. Proximity of library compartment to crew group activities is undesirable.																									

TABLE 10		EVALUATION SCORING		CUMULATIVE VALUES FOR INDIVIDUAL CRITERIA																		
MOCK-UP CONCEPT 2		5 = OPTIMAL 3 = ACCEPTABLE 1 = INADEQUATE		4 = PREFERABLE 2 = MINIMAL																		
ARCHITECTURAL CONCEPT	E1					E2					E3					E4					E1 - E4	
	5	4	3	2	1	5	4	3	2	1	5	4	3	2	1	5	4	3	2	1		
CREW TRANSLATION ROUTE	5					5					5					5					18	+
RACK/COMP. CREW INTERFACE		5					5					5					5				18	+
RACK/COMP. ATTACHMENTS			5					5					5					5			16	+
ARCHITECTURAL DEFINITION				5					5					5						5	13	
VOLUMETRIC UTILIZATION			5					5					5							5	13	
TOTAL VALUE FOR CRITERIA GROUP EVALUATION																				78	+	
GENERAL COMMENTS Central translation route and peripheral activity areas provides unique though complex architectural definition. Rack/compartment interfaces and attachments efficiently defined.																						

TABLE 11		EVALUATION SCORING		CUMULATIVE VALUES FOR INDIVIDUAL CRITERIA																		
MOCK-UP CONCEPT 2		5 = OPTIMAL 3 = ACCEPTABLE 1 = INADEQUATE		4 = PREFERABLE 2 = MINIMAL																		
UTILITY SYSTEMS	E1					E2					E3					E4					E1 - E4	
	5	4	3	2	1	5	4	3	2	1	5	4	3	2	1	5	4	3	2	1		
PRIMARY UTILITY CORES		5					5					5					5				18	+
UTILITY SYS. DISTRIBUTION†			5					5					5					5			16	+
SECONDARY STRUCTURE				5					5					5					5		14	
UTILITY SYS. ATTACHMENTS					5					5					5					5	11	-
PRESSURE WALL ACCESS	5					5					5					5					20	+
TOTAL VALUE FOR CRITERIA GROUP EVALUATION																				79	+	
GENERAL COMMENTS Triple utility cores and distribution system is well established and organized. Pressure wall accessibility is optimized with equipment elements detached from module wall.																						

TABLE 12		EVALUATION SCORING		5 = OPTIMAL		4 = PREFERABLE		3 = ACCEPTABLE		2 = MINIMAL		1 = INADEQUATE		CUMULATIVE VALUES FOR INDIVIDUAL CRITERIA									
MOCK-UP CONCEPT 2		E1		E2		E3		E4		E1 - E4													
ARCH. SUB-SYSTEMS		5	4	3	2	1	5	4	3	2	1	5	4	3	2	1	5	4	3	2	1		
RACK/COMP. MODULARITY																						16	+
RACK/COMP. CHANGE-OUT																						19	+
MODULE LONGITUDINAL FIT																						16	+
MODULE RADIAL FIT																						14	
CREW ACTIVITY SEPARATIONS																						16	+
SUB-SYSTEMS INTEGRATION																						13	
TOTAL VALUE FOR CRITERIA GROUP EVALUATION																				94	+		

GENERAL COMMENTS Rack/compartments modularity and change-out facilitated by triple-spine attachment freedom and large free volume. Radial and longitudinal fit of modular elements dependent on rack/compartments density required.

TABLE 13		EVALUATION SCORING		5 = OPTIMAL		4 = PREFERABLE		3 = ACCEPTABLE		2 = MINIMAL		1 = INADEQUATE		CUMULATIVE VALUES FOR INDIVIDUAL CRITERIA									
MOCK-UP CONCEPT 2		E1		E2		E3		E4		E1 - E4													
PERCEPTUAL QUALITY		5	4	3	2	1	5	4	3	2	1	5	4	3	2	1	5	4	3	2	1		
PERCEIVED SPACIOUSNESS																						17	+
GENERAL VISUAL COMPLEXITY																						18	+
GENERAL VISUAL INTEREST																						19	+
LIGHTING INTEGRATION ABILITY																						12	
LIGHTING QUALITY																						12	
LIGHTING EFFICIENCY																						12	
GENERAL VISUAL COMFORT																						13	
POTENTIAL TACTILE COMFORT																						13	
SENSE OF ORGANIZATION																						14	
TOTAL VALUE FOR CRITERIA GROUP EVALUATION																				130			

GENERAL COMMENTS Spaciousness, visual variety and interest well developed. Potential for various methods of lighting systems integration is substantial. Sense of organization established by utility/structural spines as references.

TABLE 14 MOCK-UP CONCEPT 2		EVALUATION SCORING 5 = OPTIMAL 3 = ACCEPTABLE 1 = INADEQUATE		4 = PREFERABLE 2 = MINIMAL		CUMULATIVE VALUES FOR INDIVIDUAL CRITERIA											
ERGONOMICS	E1		E2		E3		E4		E1 - E4								
	5	4	3	2	1	5	4	3	2	1	5	4	3	2	1		
INTRA-MODULE TRAFFIC																	
GENERAL ANTHROPOMETRICS																	
5%/95% ADJUSTABILITY																	
ERGONOMIC INTERFACES																	
NEUTRAL BODY POSTURE																	
GROUP ERGONOMIC FUNCTIONS																	
TOTAL VALUE FOR CRITERIA GROUP EVALUATION								74	■								
GENERAL COMMENTS Intra-module translation clearly defined by central route. Anthropometric and ergonomic design design requires further definition and study. Group activities and functions need consideration.																	

TABLE 15 MOCK-UP CONCEPT 2		EVALUATION SCORING 5 = OPTIMAL 3 = ACCEPTABLE 1 = INADEQUATE		4 = PREFERABLE 2 = MINIMAL		CUMULATIVE VALUES FOR INDIVIDUAL CRITERIA											
WARDROOM ACTIVITIES	E1		E2		E3		E4		E1 - E4								
	5	4	3	2	1	5	4	3	2	1	5	4	3	2	1		
GENERAL RECREATION																	
TELECONFERENCES																	
PLANNING/TRAINING/MEETING																	
4 CREW MEALS																	
8 CREW MEALS																	
WORKSTATION APPLICATIONS																	
SHIFT CHANGE BRIEFING																	
CREW CHANGE BRIEFING																	
TOTAL VALUE FOR CRITERIA GROUP EVALUATION								93									
GENERAL COMMENTS Range of crew wardroom activities can potentially be accommodated though group gatherings require further study in view of positions of spines. Some rack or compartment redeployment may improve volume available for large meetings.																	

TABLE 16 MOCK-UP CONCEPT 2	EVALUATION SCORING																				CUMULATIVE VALUES FOR INDIVIDUAL CRITERIA				
	5 = OPTIMAL					4 = PREFERABLE					3 = ACCEPTABLE					2 = MINIMAL						1 = INADEQUATE			
ASSOCIATED FEATURES	E1					E2					E3					E4					E1 - E4				
	5	4	3	2	1	5	4	3	2	1	5	4	3	2	1	5	4	3	2	1					
GALLEY LOCATION		■					■					■					■							■	13
GALLEY DESIGN/OPERATION		■					■					■					■							■	15
LIBRARY LOCATION			■					■					■					■						■	11
LIBRARY DESIGN/OPERATION			■					■					■					■						■	9
WORKSTATION LOCATIONS			■					■					■					■						■	12
WORKSTATION DESIGN			■					■					■					■						■	11
WORKSTATION RESTRAINTS				■					■					■					■					■	4
WARDROOM TABLE			■					■					■					■						■	14
EQUIPMENT DEPLOYABILITY			■					■					■					■						■	12
COMPARTMENT DEPLOYABILITY				■					■					■					■					■	6
TOTAL VALUE FOR CRITERIA GROUP EVALUATION																				107					

GENERAL COMMENTS Galley location requires further study. Workstation design and operation is potentially very flexible. Compartment adaptability/deployability requires further development. Restraint designs in large free volume may be difficult.

TABLE 17 MOCK-UP CONCEPT 2	EVALUATION SCORING																				CUMULATIVE VALUES FOR INDIVIDUAL CRITERIA				
	5 = OPTIMAL					4 = PREFERABLE					3 = ACCEPTABLE					2 = MINIMAL						1 = INADEQUATE			
ORIENTATION/TRANSLAT'N	E1					E2					E3					E4					E1 - E4				
	5	4	3	2	1	5	4	3	2	1	5	4	3	2	1	5	4	3	2	1					
PERSONAL RESTRAINTS			■					■					■					■						■	12
MOBILITY AIDS			■					■					■					■						■	12
LOCAL HORIZONTAL		■					■					■					■							■	16
GLOBAL HORIZONTAL		■					■					■					■							■	16
TOTAL VALUE FOR CRITERIA GROUP EVALUATION																				56					

GENERAL COMMENTS Restraints and mobility aids require development. Vertical orientation may be helped by emphasizing cueing in relation to spines [using the spines themselves or some other reference system].

TABLE 18		EVALUATION		5 = OPTIMAL		4 = PREFERABLE		CUMULATIVE															
MOCK-UP CONCEPT 2		SCORING		3 = ACCEPTABLE		2 = MINIMAL		VALUES FOR															
				1 = INADEQUATE				INDIVIDUAL															
CREW GROUP USES		E1					E2					E3					E4					E1 - E4	
		5	4	3	2	1	5	4	3	2	1	5	4	3	2	1	5	4	3	2	1		
INDIVIDUAL CREW USES			■					■					■					■				17	+
SMALL GROUP [2/4] USES			■					■					■	■				■				16	+
LARGE GROUP [5/8] USES				■					■					■					■			12	
PRIVACY GRADIENT				■					■					■					■			17	+
TOTAL VALUE FOR CRITERIA GROUP EVALUATION																						62	+
GENERAL COMMENTS		Good individual and small group use but potential difficulties accommodating large groups. Substantial opportunity for mixed activities. Effective privacy gradients are feasible.																					

TABLE 19 MOCK-UP CONCEPT 3		EVALUATION 5 = OPTIMAL 4 = PREFERABLE SCORING 3 = ACCEPTABLE 2 = MINIMAL 1 = INADEQUATE																				CUMULATIVE VALUES FOR INDIVIDUAL CRITERIA	
ARCHITECTURAL CONCEPT		E1					E2					E3					E4					E1 - E4	
		5	4	3	2	1	5	4	3	2	1	5	4	3	2	1	5	4	3	2	1		
CREW TRANSLATION ROUTE																						17	+
RACK/COMP. CREW INTERFACE																						15	
RACK/COMP. ATTACHMENTS																						6	-
ARCHITECTURAL DEFINITION																						20	+
VOLUMETRIC UTILIZATION																						19	+
TOTAL VALUE FOR CRITERIA GROUP EVALUATION																						77	+
GENERAL COMMENTS		Distinctive architectural definition and volumetric utilization with clear central translation route. Unique design of rack/compt. fascias. Attachment methods require definition.																					

TABLE 20 MOCK-UP CONCEPT 3		EVALUATION 5 = OPTIMAL 4 = PREFERABLE SCORING 3 = ACCEPTABLE 2 = MINIMAL 1 = INADEQUATE																				CUMULATIVE VALUES FOR INDIVIDUAL CRITERIA	
UTILITY SYSTEMS		E1					E2					E3					E4					E1 - E4	
		5	4	3	2	1	5	4	3	2	1	5	4	3	2	1	5	4	3	2	1		
PRIMARY UTILITY CORES																						19	+
UTILITY SYS. DISTRIBUTION																						16	+
SECONDARY STRUCTURE																						9	-
UTILITY SYS. ATTACHMENTS																						6	-
PRESSURE WALL ACCESS																						4	-
TOTAL VALUE FOR CRITERIA GROUP EVALUATION																						54	-
GENERAL COMMENTS		Utility core and distribution systems are clearly developed. Secondary structure attachments require study. Pressure wall accessibility a potential problem and requires some revision of rack/compt. geometries.																					

TABLE 21	EVALUATION	5 = OPTIMAL	4 = PREFERABLE	CUMULATIVE														
MOCK-UP CONCEPT 3	SCORING	3 = ACCEPTABLE	2 = MINIMAL	VALUES FOR														
	1 = INADEQUATE			INDIVIDUAL														
				CRITERIA														
ARCH. SUB-SYSTEMS	E1	E2	E3	E4	E1 - E4													
	5 4 3 2 1	5 4 3 2 1	5 4 3 2 1	5 4 3 2 1														
RACK/COMP. MODULARITY																		13
RACK/COMP. CHANGE-OUT																		15
MODULE LONGITUDINAL FIT																		16
MODULE RADIAL FIT																		9
CREW ACTIVITY SEPARATIONS																		10
SUB-SYSTEMS INTEGRATION																		10
TOTAL VALUE FOR CRITERIA GROUP EVALUATION																	73	

GENERAL COMMENTS Rack/compt. modularity and change-out are potentially feasible. Longitudinal and radial fit require development to achieve swing-out capability. Sub-systems integration requires substantial definition.

TABLE 22	EVALUATION	5 = OPTIMAL	4 = PREFERABLE	CUMULATIVE														
MOCK-UP CONCEPT 3	SCORING	3 = ACCEPTABLE	2 = MINIMAL	VALUES FOR														
	1 = INADEQUATE			INDIVIDUAL														
				CRITERIA														
PERCEPTUAL QUALITY	E1	E2	E3	E4	E1 - E4													
	5 4 3 2 1	5 4 3 2 1	5 4 3 2 1	5 4 3 2 1														
PERCEIVED SPACIOUSNESS																		16
GENERAL VISUAL COMPLEXITY																		18
GENERAL VISUAL INTEREST																		20
LIGHTING INTEGRATION ABILITY																		15
LIGHTING QUALITY																		17
LIGHTING EFFICIENCY																		14
GENERAL VISUAL COMFORT																		17
POTENTIAL TACTILE COMFORT																		20
SENSE OF ORGANIZATION																		9
TOTAL VALUE FOR CRITERIA GROUP EVALUATION																	146	

GENERAL COMMENTS Optimum demonstration of spaciousness and visual quality. Optimum potential for lighting systems integration and operation. Optimum potential for visual and tactile comfort.

TABLE 23		EVALUATION SCORING		5 = OPTIMAL		4 = PREFERABLE		3 = ACCEPTABLE		2 = MINIMAL		1 = INADEQUATE		CUMULATIVE VALUES FOR INDIVIDUAL CRITERIA									
MOCK-UP CONCEPT 3																							
ERGONOMICS		E1					E2					E3					E4					E1 - E4	
		5	4	3	2	1	5	4	3	2	1	5	4	3	2	1	5	4	3	2	1		
INTRA-MODULE TRAFFIC																						17	+
GENERAL ANTHROPOMETRICS																						16	+
5%/95% ADJUSTABILITY																						16	+
ERGONOMIC INTERFACES																						18	+
NEUTRAL BODY POSTURE																						16	+
GROUP ERGONOMIC FUNCTIONS																						8	-
TOTAL VALUE FOR CRITERIA GROUP EVALUATION																					91		
GENERAL COMMENTS		Intra-module traffic is clearly routed. Potential for optimum anthropometric and ergonomic design. Group activity functions require further study due to reduced diameter of internal available volume.																					
TABLE 24		EVALUATION SCORING		5 = OPTIMAL		4 = PREFERABLE		3 = ACCEPTABLE		2 = MINIMAL		1 = INADEQUATE		CUMULATIVE VALUES FOR INDIVIDUAL CRITERIA									
MOCK-UP CONCEPT 3																							
WARDROOM ACTIVITIES		E1					E2					E3					E4					E1 - E4	
		5	4	3	2	1	5	4	3	2	1	5	4	3	2	1	5	4	3	2	1		
GENERAL RECREATION																						15	
TELECONFERENCES																						8	□
PLANNING/TRAINING/MEETING																						8	□
4 CREW MEALS																						7	□
8 CREW MEALS																						7	□
WORKSTATION APPLICATIONS																						10	□
SHIFT CHANGE BRIEFING																						9	□
CREW CHANGE BRIEFING																						9	□
TOTAL VALUE FOR CRITERIA GROUP EVALUATION																					73	■	
GENERAL COMMENTS		Detailed consideration of wardroom activities is not fully developed. Specific and group activity rack/compt./equipt. requirements need further definition.																					

TABLE 25 MOCK-UP CONCEPT 3		EVALUATION SCORING 5 = OPTIMAL 4 = PREFERABLE 3 = ACCEPTABLE 2 = MINIMAL 1 = INADEQUATE																CUMULATIVE VALUES FOR INDIVIDUAL CRITERIA					
ASSOCIATED FEATURES		E1					E2					E3					E4					E1 - E4	
		5	4	3	2	1	5	4	3	2	1	5	4	3	2	1	5	4	3	2	1		
GALLEY LOCATION					■						■					■						8	▬
GALLEY DESIGN/OPERATION										■						■						9	▬
LIBRARY LOCATION											■					■					■	11	▬
LIBRARY DESIGN/OPERATION										■						■						13	
WORKSTATION LOCATIONS				■					■					■								10	▬
WORKSTATION DESIGN			■					■					■									15	
WORKSTATION RESTRAINTS			■					■					■									15	
WARDROOM TABLE				■						■					■						■	10	▬
EQUIPMENT DEPLOYABILITY						■					■					■					■	6	▬
COMPARTMENT DEPLOYABILITY						■					■					■					■	8	▬
TOTAL VALUE FOR CRITERIA GROUP EVALUATION																		105	■				

GENERAL COMMENTS Galley, library and workstation design and operation require detailed definition. Introduction of some deployability/adaptability features will improve equipment functions.

TABLE 26 MOCK-UP CONCEPT 3		EVALUATION SCORING 5 = OPTIMAL 4 = PREFERABLE 3 = ACCEPTABLE 2 = MINIMAL 1 = INADEQUATE																CUMULATIVE VALUES FOR INDIVIDUAL CRITERIA					
ORIENTATION/TRANSLAT'N		E1					E2					E3					E4					E1 - E4	
		5	4	3	2	1	5	4	3	2	1	5	4	3	2	1	5	4	3	2	1		
PERSONAL RESTRAINTS			■					■					■					■				19	+
MOBILITY AIDS			■					■					■					■				19	+
LOCAL HORIZONTAL				■					■					■							■	12	
GLOBAL HORIZONTAL				■						■					■						■	8	▬
TOTAL VALUE FOR CRITERIA GROUP EVALUATION																		58	+				

GENERAL COMMENTS Optimum concept and definition of restraints and mobility aids. Horizontal orientation and visual cues require further development.

TABLE 27	EVALUATION 5 = OPTIMAL 4 = PREFERABLE SCORING 3 = ACCEPTABLE 2 = MINIMAL 1 = INADEQUATE																CUMULATIVE VALUES FOR INDIVIDUAL CRITERIA					
MOCK-UP CONCEPT 3	E1				E2				E3				E4				E1 - E4					
CREW GROUP USES	5	4	3	2	1	5	4	3	2	1	5	4	3	2	1	5	4	3	2	1		
INDIVIDUAL CREW USES		■				■					■					■					17	+
SMALL GROUP [2/4] USES			■					■					■					■			13	
LARGE GROUP [5/8] USES				■					■					■					■		9	□
PRIVACY GRADIENT					■					■										■	4	□
TOTAL VALUE FOR CRITERIA GROUP EVALUATION																			43	■		
GENERAL COMMENTS	Crew group uses require further study. Substantial potential for mixed activity uses. Privacy gradient requires careful consideration.																					

TABLE 28 MOCK-UP EVALUATION SUMMARY	HIGHEST TOTAL SCORES FOR FACTOR GROUPS			% OF HIGH- SCORING SINGLE FACTORS PER HIGH-SCORING GROUP			LOWEST TOTAL SCORES FOR FACTOR GROUPS			% OF LOW- SCORING SINGLE FACTORS PER LOW-SCORING GROUP		
	MOCK-UP NO.			MOCK-UP NO.			MOCK-UP NO.			MOCK-UP NO.		
	1	2	3	1	2	3	1	2	3	1	2	3
ARCHITECTURAL CONCEPTS		+	+		+	+	—			□		
		78	77		60%	60%	70			0%		
		[CLOSE]			[EQUAL]							
UTILITY SYSTEMS		+			+				—			□
		79			60%				54			60%
ARCHITECTURAL SUB-SYSTEMS		+			+				—			□
		94			67%				73			50%
PERCEPTUAL QUALITY			+			+	—			□		
			146			67%	121			11%		
ERGONOMICS	+			+				—			□	
	106			83%			74			50%		
WARDROOM ACTIVITIES	+			+					—			□
	137			75%					73			87%
ASSOCIATED FEATURES	+			+					—			□
	158			60%					105			70%
ORIENTATION/ TRANSLATION	+	+	+	+	+	+						
	57	56	58	50%	50%	50%						
		[CLOSE]			[EQUAL]							
CREW GROUP USES		+			+				—			□
		62			75%				43			50%

2.6 EVALUATION RESULTS

2.6.1 USE OF RESULTS

PHASE 1 of the study has identified and evaluated design configurations and features which are suitable for application to further design definition phases. The results of the evaluation process, as summarized in TABLE 28, highlight those design features which are considered most successful and which offer the most potential for further development. These design features are carried forward to further phases of the study where they are used in the design development and definition of the Final Design Concept for the Wardroom configuration.

2.6.2 SUMMARIES OF KEY DESIGN FEATURES

The key design features are identified and briefly described below under each of the nine Factor Groups.

1. ARCHITECTURAL CONCEPT

The 4-meter diameter of a Space Station Common Module, combined with the freedom of crew movement and access obtainable in a microgravity environment, enables two levels of accommodation and crew activity to be incorporated within the Module cross-section. This opportunity is demonstrated in Mock-ups 1 and 2. Utilization of this opportunity assists the optimization of crew activities within, and functional layout of, the limited available volume. Volumetric organization within the Module can be functionally dynamic in operation as in Mock-up 1, or architecturally innovative in configuration as in Mock-up 3. Articulation of racks, compartments and equipment in Mock-up 2 is emphasized in the independent connection of these elements to the structural support and utility spines.

2. UTILITY SYSTEMS

Potential for general rationalization of utility systems and their primary distribution is explored in alternative ways by Mock-ups 1, 2 and 3. Mock-up 1 incorporates two opposite structural/utility routes running along the perimeter of the Module serving racks and compartments on each side. Mock-up 2 incorporates three symmetrically-located structural/utility spines surrounding a central circular translation corridor. Mock-up 3 incorporates a large, crew-accessible utility systems tunnel positioned against the Module wall. Rapid and effective Module pressure wall accessibility is demonstrated by Mock-up 1 with hinged swing-out attachments for racks and compartments, and by Module 2 which locates most configuration elements away from the cylindrical surface towards the center of the Module.

3. ARCHITECTURAL SUB-SYSTEMS

The longitudinal fit of racks and compartments within a Space Station Common Module is expressed in Mock-ups 1, 2 and 3 using various modular geometries for racks and compartments. Mock-ups 1 and 3 incorporate modular dimensions based on width increments determined by

crew activity compartment or crew workstation console sizes. Mock-up 2 introduces a greater range of modular dimensions with smaller increments made possible by the flexibility of attachment positions along the structural spines. This approach, in turn, expands the choice and range of crew activity organizational options within the Module. Mock-ups 1 and 2 also demonstrate potential for simple and efficient rack and compartment on-orbit change-out if combined with suitable manually-operable attachment mechanisms.

4. PERCEPTUAL QUALITY

A key objective of the interior design of the Habitability Module is to extend and enhance the quality of spaciousness, as far as possible, for the benefit of the crew. Mock-ups 1, 2 and 3 attempt to interpret and preserve spaciousness by various means. Mock-up 1 incorporates crew compartments which fold-away when not in use to provide internal volume for other uses. Mock-up 2 exposes the Module cylindrical wall as a means of enhancing interior visual scale. Module 3 applies contoured profiles to racks and compartments to generate visual variety and interest which are further enhanced by the use of innovative lighting and soft surfaces. In all three cases, the different approaches improve the physical environment within the confined volume beyond standards achieved by elementary configuration geometries.

5. ERGONOMICS

The issue of ergonomics is addressed in contrasting design proposals for crew/equipment interfaces demonstrated by Mock-ups 1 and 3. In Mock-up 1, the library compartment, crew workstation and wardroom table all explore the ergonomic relationship between a crewmember and his/her personal enclosure, console or surface. The library compartment provides a comfortable 'mini-environment' when deployed. The crew workstation and wardroom table provide optimum ergonomic performance with equipment components which adjust to anthropometric variables of percentile body size, field of vision, arm reach envelope or neutral body posture. Mock-up 3 utilizes curved, contoured surfaces which potentially conform to anthropometric variables by controlled deformation of their soft fascias.

6. WARDROOM ACTIVITIES

Crew activities which will take place within the wardroom vary in terms of size and type. The wardroom environment must be able to accommodate crew group sizes ranging from 1 to 4 persons for a regular Space Station crew shift group, 4 to 8 persons for an occasional Space Station crew complement group, and 8 to 16 persons for an infrequent Space Station crew exchange group. Mock-up 1 resolves these requirements using a versatile wardroom table located centrally within the wardroom facility and surrounded by sufficient free volume for large crew group gatherings or different activities occurring simultaneously. This arrangement is suitable for meals, meetings, teleconferences and large recreational activities. The table can swing-out of its central position to provide a large unobstructed volume.

7. ASSOCIATED FEATURES

Crew activity compartments with deployable/retractable operational characteristics are valuable volume savers in instances where compartment occupancy is intermittent. This is shown in the design of the library and sleeping compartments in Mock-up 1 where units are retracted and stowed against the wall of the Module when not in use. Crew workstations and tables with functions of adaptability to meet different tasks and extendability to meet different group sizes are explored in Mock-up 1. These features enable these equipment items to adjust to the fluctuating activity requirements of crew groups or individual crewmembers. The wardroom table provides a versatile meeting and mealtime resource with clustered separate table surfaces and accessories which fold away when not in use.

8. ORIENTATION AND TRANSLATION

Wardroom configurations with well-defined intra-Module and inter-Module crew translation routes are demonstrated in Mock-ups 2 and 3. In Mock-up 2, a narrow central translation corridor is surrounded by activity and facilities areas located around the Module cylindrical perimeter. In Mock-up 3, a large central translation volume of regular diameter is bordered by curved and profiled racks and compartments. Discernible horizontal orientation and cueing within the Module is evident in Mock-ups 1 and 2, assisted by the linear visual references provided by structural and utility spines. In some cases, individual workstations or compartments vary from strict horizontal alignment to make better use of the curvature of the Module wall. Mock-up 3 explores the role of hand and foot restraints as major cueing devices.

9. CREW GROUP USES

Combining multiple crew activities within a single Wardroom environment is an important design consideration. Mock-ups 2 and 3 suggest that it is possible to organize a range of activity areas in a linear and radial sequence simultaneously. Mock-up 2 locates activity areas in a sequence along the Module length and around the Module perimeter, affording considerable organizational flexibility and potential for an activity privacy gradient, Mock-up 3 locates activity areas in a sequence along the Module length and around the large central corridor, generating potential for organizational flexibility on a modular basis. Mock-up 1 indicates the possibility of stacking crew activities on two levels assuming that rack and compartment geometries can be designed to preserve clear translation and pressure-wall access.

3 PHASE 2 : FINAL DESIGN STUDY

3.1 OBJECTIVES

The central purpose of PHASE 2 is to develop a life-size, medium-high fidelity mock-up of the Space Station Wardroom which demonstrates a range of interior architectural and industrial design concepts based on criteria drawn from earlier studies, continuing studies and other additional sources.

An important task for architects and designers in the definition of the interior of the Habitability Module is to develop innovative ways of mitigating the adverse impact of on-board equipment inventory requirements on the free habitable volume for crew use. This is particularly significant for the Wardroom which is the focal point for interpersonal contact and communication for the entire crew and potentially the only relatively generous volume on the Space Station. The reduction of the Space Station initial configuration from two to one Habitability Module and the confirmation of an eight-person crew place exceptional pressures on free volume availability. The added possibility of crew tours as long as six months also heightens the habitability design problem. PHASE 2 comprises the following three objectives which focus on these critical issues.

- **To consolidate and continue research into Space Station Wardroom habitability based on relevant criteria drawn from previous or parallel programs and studies.**
- **To define and develop a feasible and innovative architectural/industrial design proposal for the configuration of the crew Wardroom in the Habitability Module.**
- **To contribute to the Space Station design effort by providing a life-size Wardroom mock-up for use by NASA as a research tool for continuing habitability studies.**

PHASE 2 concentrates on the design and development of a single configuration concept for the Wardroom constructed as a life-size, medium-high fidelity mock-up and based on a synthesis of criteria drawn from five sources which are summarized below and further described in SECTION 3.2.

- 1. Research program requirements determined by the Aerospace Human Factors Research Division at NASA-Ames Research Center.**
- 2. Appropriate recommendations of a previous study "Space Station Group Activities Habitability Module Study", NASA Contractor Report 4010.**
- 3. Selected architectural/industrial design features derived from the three Phase 1 Experimental Mock-up Concepts.**
- 4. Selected architectural/industrial design features drawn from additional schematic studies of Wardroom configurations.**
- 5. Appropriate data drawn from contractor team studies during Space Station Phase B/Definition and Preliminary Design Phase.**

3.2 WARDROOM DESIGN CRITERIA

3.2.1 RESEARCH PROGRAM REQUIREMENTS DETERMINED BY THE AEROSPACE HUMAN FACTORS RESEARCH DIVISION AT NASA-AMES RESEARCH CENTER

The following list comprises program requirements which are preferred constituents of the study as determined by the Aerospace Human Factors Research Division at NASA-Ames Research Center. The list specifies those items which have been incorporated in the Final Mock-up Concept.

- **Common Module Reference Dimensions**

Reference dimensions for a Space Station Common Module determined during Space Station Phase B include an internal diameter of 166" and a cylindrical length of 464".

- **Space Station Crew Size**

Crew size identified at Space Station Phase B for IOC Space Station operation is to be 8 persons divided into two alternating shifts of 4 persons each.

- **Exercise Compartments**

Exercise Compartments incorporating bicycle ergometer and rowing machine exercise equipment for 1 to 2 crewmembers. Compartment elements to be articulated to allow rear pressure wall access, demountable to allow on-orbit reconfiguration or change-out, and sized to allow passage through 50" square end hatches.

- **Planning/Station Operations Workstations**

Workstation/s for Planning/Station Operations activities for 1 to 2 crewmembers incorporating a dedicated workstation console, key equipment positions and body/foot restraints.

- **Window/Observation Workstations**

Workstation/s for Window/Observation activities for 1 to 2 crewmembers incorporating a dedicated workstation console, key equipment positions and body/foot restraints.

- **Galley Food Preparation/Storage Racks**

Galley Food Preparation and Storage Racks for 1 to 2 crewmembers incorporating dedicated galley console, key equipment positions and body/foot restraints. Galley rack elements to be articulated to allow rear pressure wall access, demountable to allow on-orbit reconfiguration or change-out, and sized to allow passage through 50" square end hatches.

- **Meeting/Meal Table**

Meeting/Meal Table for 4 to 8 crewmembers incorporating dedicated table positions, integral functions and body/foot restraints. Table to be hinged to enable it to swing away from a pedestal position during large group gatherings in the Wardroom.

3.2.2 RECOMMENDATIONS FROM THE PREVIOUS STUDY 'SPACE STATION GROUP ACTIVITIES HABITABILITY MODULE STUDY', NASA CONTRACTOR REPORT 4010

The following list outlines five areas of design performance considered important for further design research and potential application to Space Station habitability equipment. These areas are derived from recommendations in a previous report by the authors entitled 'Space Station Group Activities Habitability Module Study', Section 5 - Recommendations for Further Research', NASA Contractor Report 4010.

- **Element and Equipment Modularity and Demountability**

These design characteristics help to maximize life-cycle change-out/upgrading procedures and minimize configuration redundancy/systems obsolescence.

- **Element and Equipment Adaptability and Transformability**

These design characteristics help to maximize free volume availability/organizational efficiency and minimize functional inflexibility/performance deficiency.

- **Element and Equipment Stowability and Compactness**

These design characteristics help to maximize free volume availability/routine accessibility and minimize item inventory capacity/mass-weight properties.

- **Element and Equipment Ergonomics and User-Friendliness**

These design characteristics help to maximize anthropometric suitability/physical comfort and minimize operational difficulty/man-machine incompatibility.

- **Element and Equipment Self-Sufficiency and Reliability**

These design characteristics help to maximize individual maintainability/operational durability and minimize systems interdependence/failure propagation.

3.2.3 SELECTED ARCHITECTURAL/INDUSTRIAL DESIGN FEATURES DERIVED FROM THE THREE PHASE 1 EXPERIMENTAL MOCK-UP CONCEPTS

The following list summarizes certain design features developed in PHASE 1 of the study which are selected for further development and application in the Final Design Study. The evaluation carried out in PHASE 1 identifies these as the most successful design features which offer the most potential for further development.

- **Double-Height/Dual-Level Accommodation Configuration**

Two levels of crew accommodation, facilities and translation/access incorporated within the Module cross-section. This approach helps to optimize the arrangement of crew activities within, and the functional layout of, the limited available volume within the Module.

- **Rationalized and Organized Utility Systems Distribution**

Utility systems organized into primary utility routes running parallel to the Module longitudinal axis at predetermined positions at the perimeter. These routes serve racks and compartments on either side and are preferably combined with structural support spines.

- **Flexible/Modular Longitudinal Fit of Racks and Compartments**

Longitudinal fit of racks and compartments within the Module based on width increments determined by crew compartment or crew workstation size requirements. Incorporation of an incremental range of modular dimensions to improve choice of organizational layouts.

- **Distinctive Perceptual Quality/Variety of Interior Environment**

Enhancement of physical and perceptual qualities of interior spaciousness within the Module achieved by rack and compartment designs with advanced functional and geometrical characteristics. Use of curvilinear geometries and dynamic performance features.

- **Adaptable/Extendable Table and Workstation Equipment**

Application of advanced ergonomic criteria and concepts to the design of a wardroom table and crew workstation. Features include worksurface components which are adjustable to group activity variations, anthropometric size variations and body posture variations.

- **Adequate Free Wardroom Volume for Large Crew Group Gatherings**

Sufficient physical accommodation of a diversified range of crew group gatherings and activities within the immediate Wardroom area. Requirements include 1 to 4 person crew shift groups, 4 to 8 person crew complement groups and 8 to 16 person crew exchange groups.

- **Deployable/Retractable Dedicated Crew Activity Compartments**

Utilization of crew activity compartments with deployable/retractable operational features to save volume when compartment occupancy is intermittent. Compartments and incorporated equipment are designed to retract and stow against the Module wall when not in use.

- **Clear Translation Route and Horizontal Orientation/Cueing**

Unobstructed intra-Module and inter-Module translation route for crew movement efficiency and safety. Clearly defined horizontal orientation and cueing within the Module achieved by a notional 'floor' plane and visual references provided by linear structural elements.

- **Definitive Crew Activity and Configuration Layout Sequence**

Arrangement of crew activity areas and related racks, compartments and equipment into an appropriate sequence within the Module. Layout to be based on crew activity

proximities, life-cycle layout flexibility, dual-level facilities and buffer zone/privacy preferences.

3.2.4 SELECTED ARCHITECTURAL/INDUSTRIAL DESIGN FEATURES DRAWN FROM ADDITIONAL SCHEMATIC STUDIES OF WARDROOM CONFIGURATIONS

The following list summarizes key design considerations drawn from additional schematic design studies of alternative Wardroom configurations. These studies were carried out following completion of PHASE 1 with the aim of further developing selected element and equipment features to improve their design definition prior to application in the Final Mock-up Concept.

The studies are designated as Schematic Studies A, B and C and are illustrated in FIGURES 23, 24 and 25.

- **Dual-Level Organization Improved by Reduced Number of Standoffs**

The reduction of four standoffs [structural and utility spines] to three increases the unobstructed internal height within the Module and improves the organization of crew activities and facilities as a dual-height/double-level configuration.

Schematic Studies A and B in FIGURES 23 and 24 show Wardroom tables located close to the Module wall and, in one case, in a position previously occupied by a standoff. The low alignment of table surfaces and crew positions relative to the Module interior allows workstation activity compartments to be incorporated between standoffs above table locations while preserving a central unobstructed translation route.

- **Soft Storage System is an Effective Alternative to Rigid Locker Storage**

A soft/flexible storage system which functions as a lining to the Wardroom enclosure provides a lightweight, versatile and economical alternative to standard rigid locker stowage. While rigid lockers are suitable for sensitive items such as scientific equipment, soft storage containers/bags are suitable for small items associated with Wardroom meeting, working, meal and leisure activities.

Schematic Studies A and B in FIGURES 23 and 24 show storage systems comprising modular interchangeable bags enclosing the main Wardroom activity area. The system provides a comfortable restraining surface for crewmembers and contributes to the Wardroom decor.

- **Deployable Exercise Facility Contributes to Spaciousness and Efficiency**

An exercise facility can be developed using deployable/retractable flexible enclosures which define the exercise compartments containing the exercise machines and health monitoring equipment. The exercise machines can fold or pivot into position for use and stow in compact form inside the retracted compartment when not in use, providing a means of conserving valuable internal volume. This, in turn, contributes to improved spatial efficiency and enhanced spatial quality within the Module.

Schematic Study C in FIGURE 25 shows an exercise facility as a curved compartment lining the Module wall. The compartment comprises articulated/hinged elements which deploy inwards during operation and retract against the wall at other times.

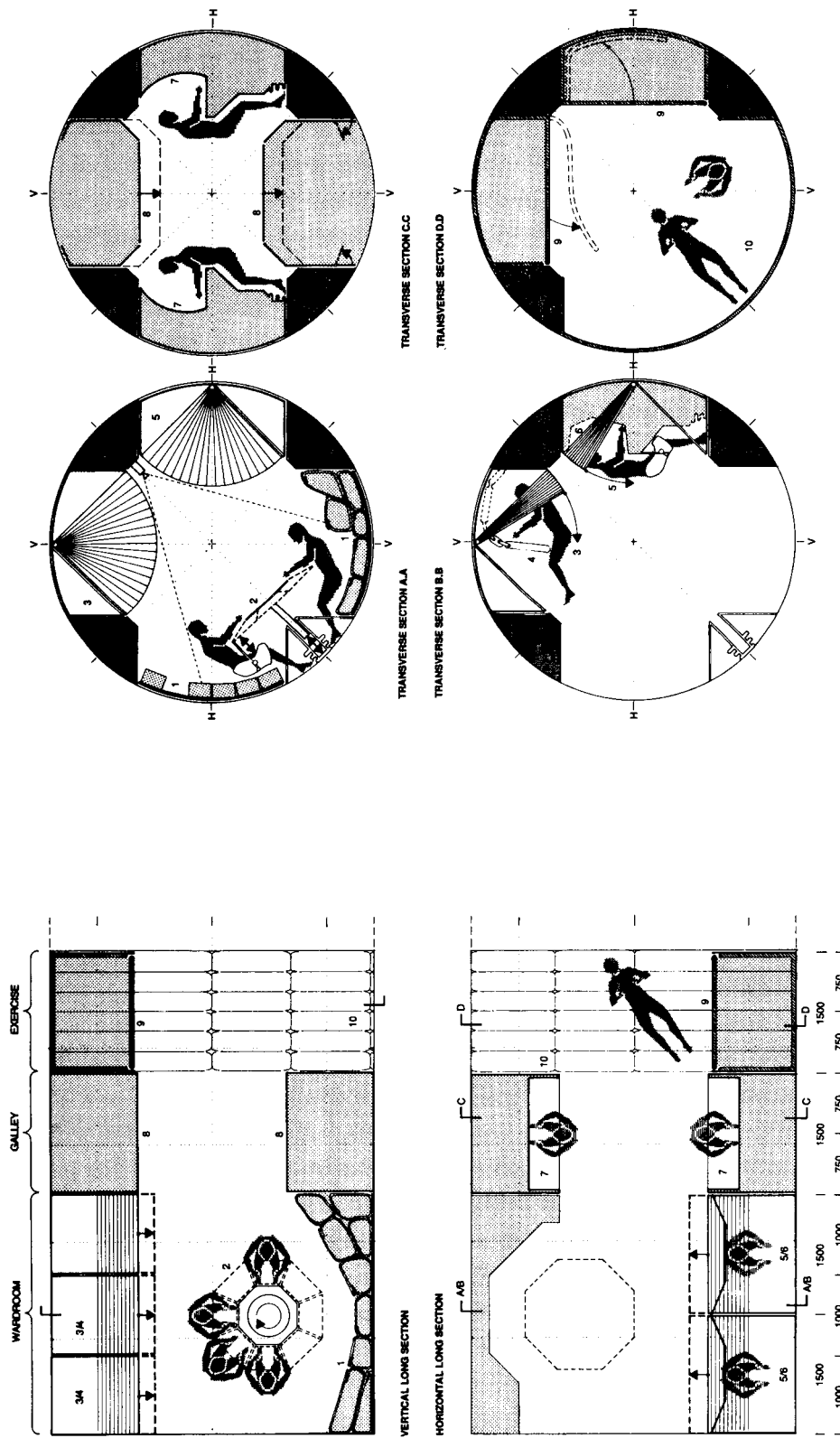

FIGURE 23 : SCHEMATIC STUDY A

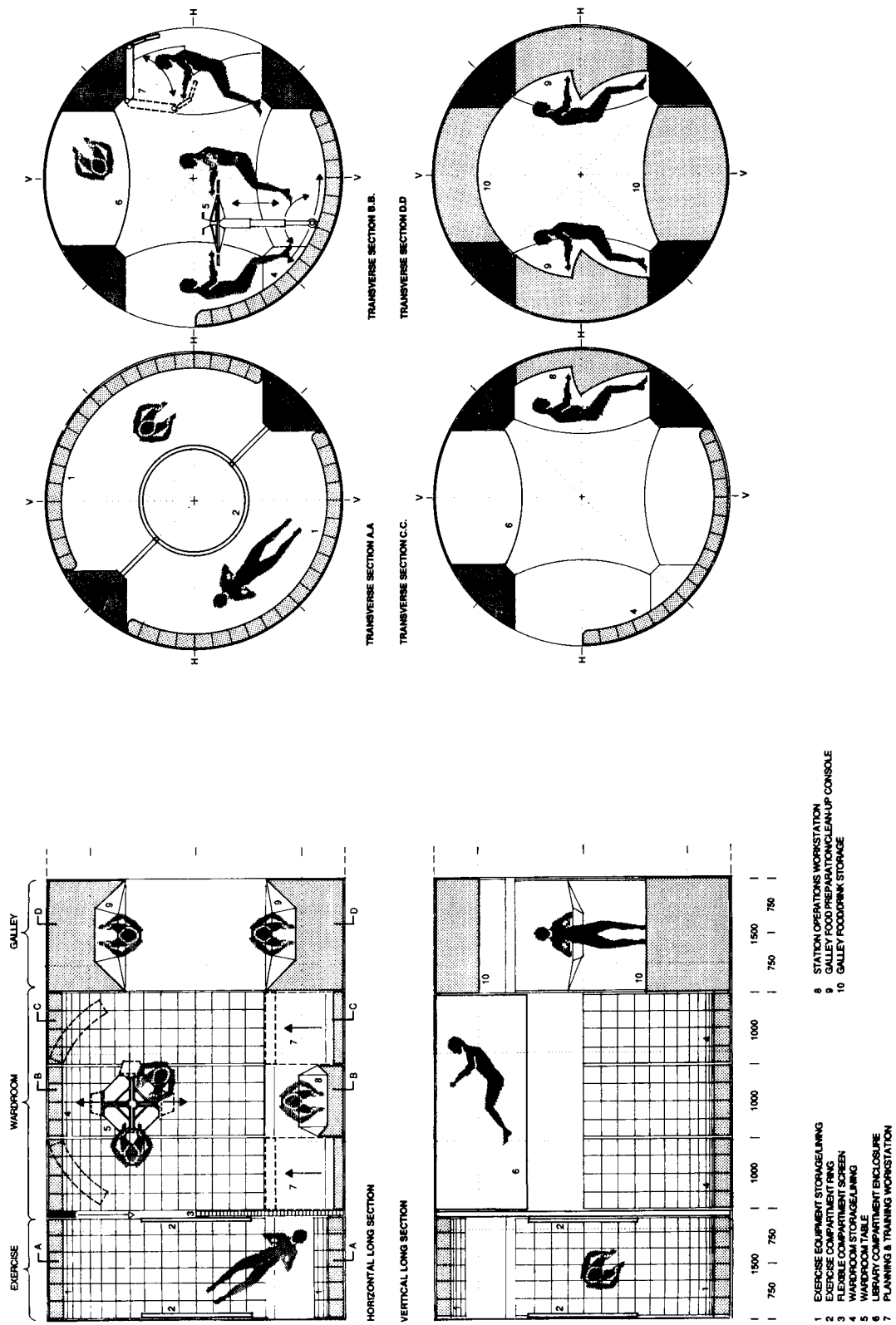
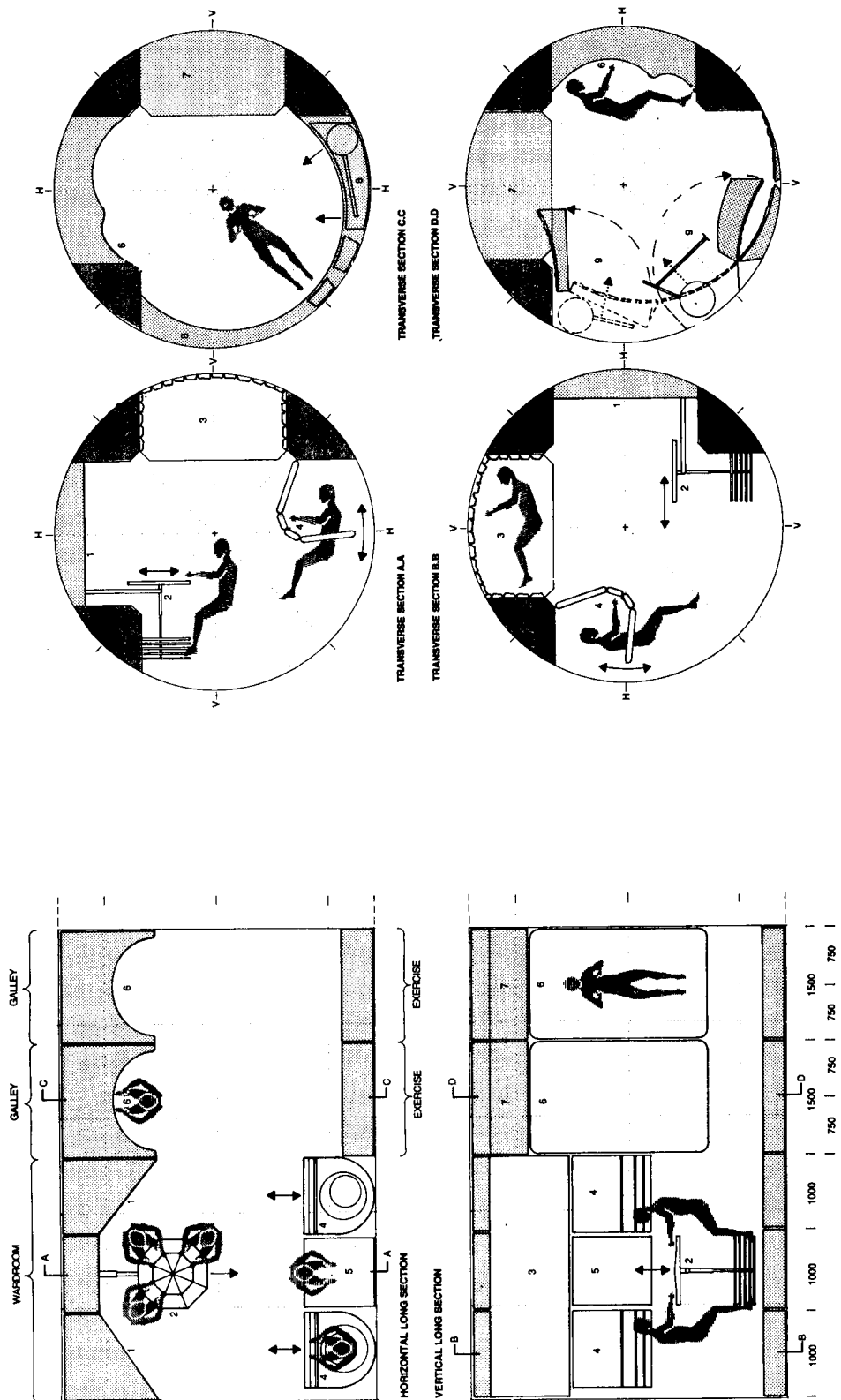

FIGURE 24 : SCHEMATIC STUDY B



- 1. WARDROOM STORAGE/LINING
- 2. WARDROOM TABLE
- 3. LIBRARY COMPARTMENT
- 4. PLANNING & TRAINING WORKSTATION
- 5. STATION OPERATIONS WORKSTATION
- 6. GALLEY FOOD PREPARATION/CLEAN-UP CONSOLE
- 7. GALLEY FOOD/DRINK STORAGE
- 8. EXERCISE EQUIPMENT (STOWED)
- 9. EXERCISE EQUIPMENT (DEPLOYED)

FIGURE 25 : SCHEMATIC STUDY C

- **Folding/Enclosing Workstations as Private/Semi-Private Facilities**

Crew workstations which incorporate performance features of transformability or adaptability can be designed and developed to provide partial privacy or full privacy for the operator.

Schematic Studies A and B in FIGURES 24 and 25 show folding workstations comprising a series of articulated/hinged panels which can be manually extended outwards from the Module wall as a semi-private enclosure in which the workstation itself provides visual screening. Full privacy can be achieved utilizing deployable screens to enclose the workstation when in use and fold away at other times. Schematic Study C in FIGURE 23 shows two workstations located between standoffs which can be fully enclosed by means of centrally-pivoted,'fan-fold' screens.

3.2.5 SELECTED DATA DRAWN FROM CONTRACTOR TEAM STUDIES DURING SPACE STATION DEFINITION AND PRELIMINARY DESIGN PHASE

The following list comprises observations drawn from Definition and Preliminary Design studies prepared by NASA-appointed contractor teams during Space Station Phase B in 1986. The observations are based on a review of Phase B contractor documents which followed receipt of document copies from NASA at the end of 1986.

Key document titles are: 'Space Station Definition and Preliminary Design, Preliminary Analysis and Design Document DR-02, Book 14 - Manned Systems, MDC H2028A' prepared by McDonnell Douglas Astronautics Company; and 'Space Station Work Package 2, Definition and Preliminary Design Phase, Volume 13 - Habitability/Man Systems, SSS 86-0073' prepared by Rockwell International.

The review identifies issues and criteria contained in the contractor studies which deserve further consideration and, where appropriate, incorporation as program criteria in the Final Mock-up Concept of the Wardroom.

- **Commonality of Configuration Racks, Compartments and Standoffs**

Commonality of racks, compartments and structural/utility standoff elements in the 4-standoff configuration selected for Space Station Modules is an important design issue. This implies that subsequent architectural studies of the Wardroom should comply with commonality requirements and constraints if they are to contribute to Space Station Development Phases C and D.

However, some contractor team studies show that a dual-level/double-height configuration offers several organizational and operational advantages over a single-level configuration. These are also shown in Experimental Concept 1 in Phase 1 of this report which demonstrates the alignment of standoffs with the cardinal points of the Module cross-section [i.e. rotating the 4-standoffs through 45°]. Therefore, double-height/dual-level configurations are worth further design investigation in the Final Mock-up Concept.

- **Standoff Design Concept, Definition and Operational Considerations**

The design and engineering concept of the standoffs can benefit from further study and investigation beyond Phase B level of detail and, if possible, before the design of these elements proceeds to a detailed development level in Phases C and D. Certain functional and operational characteristics of the standoffs may be capable of design improvement.

Particular design issues which deserve further consideration include: close-proximity utility routes accessibility; utility systems on-orbit operational safety; articulation/attachment methods for racks and compartments; pressure-wall accessibility through/around standoff structure; residual/redundant volume utilization; life-cycle reconfiguration/replacement of elements and components. These issues should be addressed in the Final Mock-up Concept for the Wardroom to the extent possible within the scope of the study.

- **Standardized Modular Width Dimension of Racks and Compartments**

Universal specification and application of the 42" modular width dimension for racks and compartments throughout all Space Station Modules deserves further investigation and evaluation. The proposed 42" dimension originates from the historical dimensions of experiment racks in Spacelab Modules. Though it is appropriate to apply this dimension to racks in the Space Station Laboratory Module to achieve commonality and coordination of experiment packages, it is questionable whether it should be extended *a priori* to all racks and compartments in the Habitability Module.

Studies carried out by the authors of this report suggest that the 42" dimension is not an ideal increment for crew workstations or activity compartments and, in some cases, is inappropriate and inefficient. Alternative modular dimensions for improved rack and compartment designs in the Final Mock-up Concept should be investigated.

- **Similarity of Phase B Definition and Preliminary Design Proposals**

Space Station Phase B contractor team design proposals for the interior of the Habitability Module are very similar in form and content. Both are based on the 4-standoff configuration and utilize a nearly identical set of program requirements resulting in nearly identical Module design definitions.

During the transition from preliminary design in Phase B to design development in Phases C and D, it is suggested that preservation and exploration of a wider range of design approaches and options is important in helping to ensure that an optimum design configuration is eventually chosen for Space Station application. Parallel configuration and equipment design studies which seek to identify potential design improvements to augment the 4-standoff configuration are worth pursuing and may generate useful contributions later in the design sequence.

- **Microgravity Human Factors and Crew Operations Considerations**

The inherently schematic nature of contractor team proposals at the Phase B level of design precludes any detailed design studies of crew equipment and corresponding investigation of human factors in a microgravity environment. Issues which require consideration include anthropometrics and ergonomics and their correct design interpretation to ensure that Space Station interior crew activities are performed as efficiently and comfortably as possible.

In-depth industrial design studies of racks, compartments and equipment within the Habitability Module are required to optimize their human factors performance and on-orbit operational potential. Such studies can be performed in parallel to the Phases C and D development sequence with the aim of contributing design proposals for selected items and at appropriate points in the development cycle.

- **Internal Accommodation Organization and Activities Adjacencies**

The Habitability Module architectural configurations proposed by Space Station Phase B contractor teams illustrate appropriate organizations for facilities within the Module and appropriate adjacencies of equipment racks and crew compartments. These are based on the program requirement for combining crew living and sleeping accommodation and facilities within a single Module.

The configurations are arranged to provide maximum separation of noise-generating daytime facilities such as the Wardroom from quiet night-time facilities such as the sleeping quarters. Separation is achieved by distance and augmented where possible by a 'buffer' zone utilizing screens or partitions which can be manually extended across the central corridor at suitable points. These design approaches to the Module internal organization should be utilized in continuing architectural studies.

- **Fitting-Out Inventory and Equipment Volumetric Requirements**

Phase B contractor team studies of the Habitability Module offer useful estimates of racks, compartments and equipment volumetric requirements within the Module. These estimates are based on initial assessments of on-orbit operational supply requirements for a proposed Space Station crew of eight persons, taking into account anticipated crew mission/tour durations of three to six months and infrequent NSTS/Orbiter visit and rendezvous intervals.

Rack and compartment types and quantities are shown with reference to the 4-standoff configuration. Equipment characteristics within rack and compartment envelopes are also indicated. Stowage volume requirements are also provided. Continuing architectural studies of the interior of the Habitability Module should adhere to these volumetric estimates in any studies of similar or alternative design configurations.

A summary of Habitability Module rack and compartment volumetric requirements prepared by Phase B contractor teams is shown in TABLE 29.

TABLE 29			
OUTLINE RACK & COMPARTMENT INVENTORY			
SPACE STATION PHASE B : HABITABILITY MODULE			
RACK OR COMPARTMENT TYPE [NOTE 1]	SIZE [NOTE 2]	QUANTITY [NOTE 3]	VOLUME CU.FT. [NOTE 4]
ECLSS - Air Revitalization	FULL	1	68
ECLSS - Temperature + Humidity Control	FULL	1	68
ECLSS - Hygiene Water	FULL	1	68
ECLSS - Water + Controls	FULL	1	68
ECLSS - Potable Water	FULL	1	68
ECLSS - Miscellaneous	FULL	1	68
PMAD	1/2	2	68
FMAD	1/2	2	68
GALLEY	FULL	4	272
WARDROOM	FULL	3	204
DMS	FULL	1	68
C&T	FULL	1	68
WORKSTATION - Command + Control	FULL	2	136
PHS - Lavatory	FULL	1	68
PHS - Shower	FULL	1	68
WASTE MANAGEMENT	FULL	1	68
HMF - Medical	FULL	2	136
HMF - Exercise	FULL	2	136
SAFE HAYEN	FULL	1	68
CREW QUARTERS	FULL+ 1/2	8	816
STOWAGE	FULL	3	204

NOTES: 1. RACK is defined as a STANDARD EQUIPMENT RACK and COMPARTMENT is defined as a FUNCTIONAL UNIT ENVELOPE in Phase B contractor studies.
2. FULL denotes a full-width rack or compartment. 1/2 denotes a half-width rack or compartment. FULL+ 1/2 denotes a one-and-a-half width rack or compartment.
3. Numbers denote quantity of racks or compartments required per category.
4. Figures are based on approximate volume [to nearest cu. ft.] per rack or compartment multiplied by the quantity required.

3.3 WARDROOM DESIGN APPROACH

3.3.1 SUMMARY OF MAJOR DESIGN GUIDELINES

The following list summarizes twenty major design guidelines for the Wardroom Design Approach and Wardroom Final Mock-Up. The list is derived from SECTION 3.2 which contains detailed lists of design criteria and requirements drawn from five sources which are identified in SUBSECTIONS 3.2.1 to 3.2.5 inclusive. The list is intended for use as an outline reference on major guidelines used in the design definition of the Wardroom described in SUBSECTIONS 3.3.2 to 3.3.7 and SECTION 3.4.

The Wardroom Design Approach and Wardroom Final Mock-Up will comply with, or incorporate elements, features or characteristics outlined below.

- 1. Common Module 166" Internal Diameter and 464" Effective Length**
- 2. IOC Space Station 8-Person/2-Shift Crew Complement**
- 3. Double-Height/Dual-Level Module Accommodation Configuration**
- 4. Compliance with Phase B Rack and Compartment Fitting-Out Inventory**
- 5. Definitive Configuration Organization and Activity Adjacencies**
- 6. Feasible Life-Cycle Modification and Reconfiguration**
- 7. Flexible/Modular Rack and Compartment Longitudinal Fit**
- 8. Adequate Free Wardroom Volume for Large Crew Group Uses**
- 9. Clear Module Translation Route and Horizontal Cueing**
- 10. Distinctive Perceptual Quality of Interior Environment**
- 11. Variable Decor/Finishes within Interior Environment**
- 12. Rationalized ECLS/Utilities/PH/DM/C&T/HM Systems Distribution**
- 13. Reduced Number of Full-Depth Structural Standoffs**
- 14. Improved Functional and Operational Structural Standoff Design**
- 15. Exercise Compartments and Galley Food Preparation/Storage Facilities**
- 16. Planning/Station Operations and Window/Observation Workstations**
- 17. Deployable/Retractable Dedicated Crew Activity Compartments**
- 18. Advanced Microgravity Anthropometrics and Ergonomics Features**
- 19. Adaptable/Extendable Wardroom Table and Adjunct Soft Storage System**
- 20. Folding/Enclosing Workstation Operations Techniques**

3.3.2 BASIC MODULE ORGANIZATION

The basic organization of a conceptual Habitability Module in which the Wardroom is located for the purposes of the Final Design Study is illustrated in FIGURE 26. Accommodation is divided into two generic zones notionally designated as day-time and night-time zones. These are separated by a buffer zone which provides visual and acoustic separation between day-time and night-time zones.

The day-time zone comprises the Wardroom and its associated facilities. A central Wardroom for group activities and gatherings incorporates facilities for meals, meetings, teleconferences, leisure activities and window workstations for observation. Galley facilities for Food Preparation and Storage are located on one side. Facilities for crew Exercise/Health Maintenance and Workstations for Station Operations and Planning are located on the other side adjacent to an end-cap.

The basic organizational arrangement has been selected for the Final Design Study for the following two reasons.

Firstly, crew translation between the Galley facilities and the Wardroom and the Exercise/HM and PSO Workstation facilities and the Wardroom, respectively, is likely to be frequent in terms of the number of movement events and the numbers of crewmembers involved. Given the need to avoid translation obstructions, crew activity conflicts and general 'bottlenecks' in the confined Module volume, it is preferable to locate these facilities on opposite sides of the main Wardroom facility.

Secondly, potential life-cycle scenarios for Habitability Module evolution and reconfiguration indicate a need for internal organizational flexibility in the arrangement of activities and facilities capable of responding to larger crew complements and expanded on-orbit IVA operations. In the conceptual configuration in FIGURE 26, a typical post-IOC reconfiguration objective involves relocating the entire night-time zone, including personal sleeping quarters and personal hygiene facilities, to a newly-delivered 'dormitory' Module which eliminates the inherent and inevitable conflicts caused by combining day-time and night-time crew facilities, shifts and operations in a single Module. This reconfiguration complies with the original NASA proposal for two separate day-time and night-time Habitability Modules which was dropped during Phase B for budgetary reasons. Then, the Exercise/HM facility relocates from the end-cap to the other end of the Module formerly occupied by the night-time zone. Next, the buffer zone, which is no longer needed after the removal of the personal sleeping quarters, is replaced by an extended Galley/Food Preparation and Storage facility. Finally, the Wardroom expands into the end-cap to take advantage of the architectural opportunity of the end-cap geometry.

This scenario for Habitability Module evolution and reconfiguration is one of several possible scenarios which reflect alternative ways in which a post-IOC Space Station might be developed.

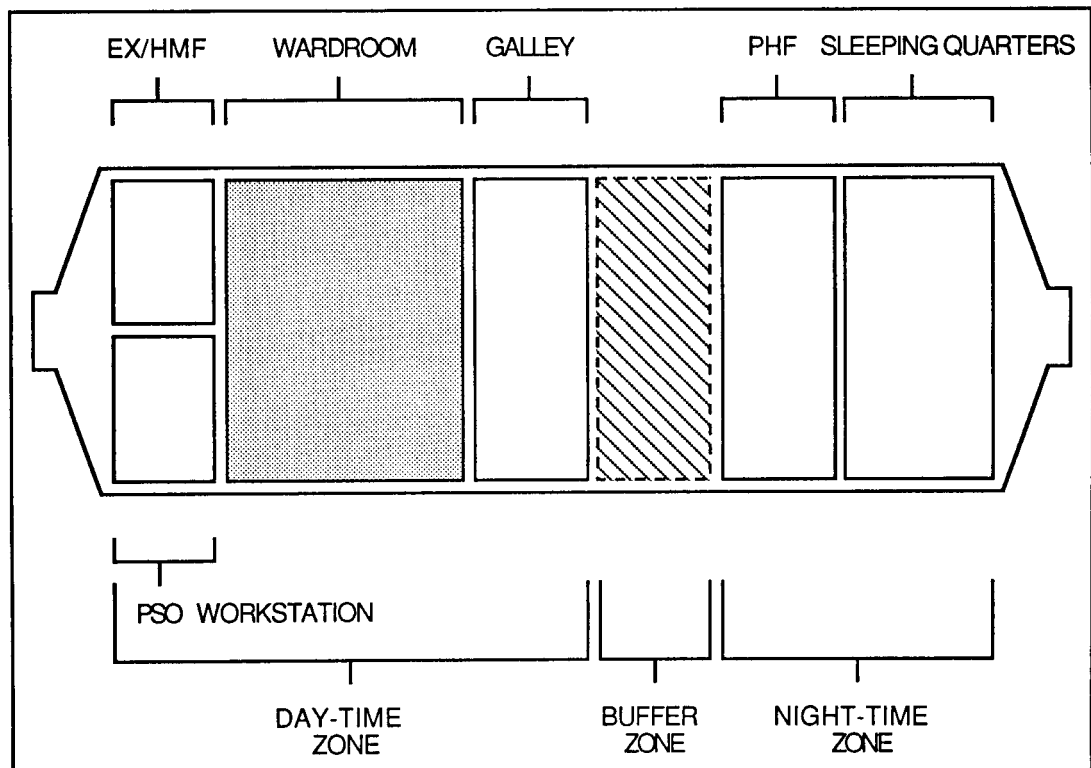

FIGURE 26 : MODULE CONCEPTUAL CONFIGURATION

3.3.3 GENERAL ACCOMMODATION CONFIGURATION

The accommodation design concept is essentially a rotated-standoff version of the 4-standoff configuration selected for Space Station Habitability and Laboratory Modules during the preliminary design stage of Phase B.

The basic interior configuration is shown in FIGURE 28 and the design changes can be seen by comparing this configuration to the 4-standoff configuration which is shown in FIGURE 27. The key feature of the concept is the rotation of the four linear structural and utility standoffs from the 45° radial alignments of the 4-standoff configuration to new alignments located at 90° radials or cross-section cardinal points. This creates a 'floor' standoff, a 'ceiling' standoff and two 'wall' standoffs.

The main advantage of this approach is that it reintroduces the possibility of an upper 'loft' level of accommodation while preserving the main structural system and utility distribution of the 4-standoff configuration. During earlier Space Station design and development phases, several contractor teams proposed alternative designs to the original NASA reference and 4-standoff configurations which included two levels of crew accommodation inside the Habitability Module. These options were subsequently terminated with the choice of the 4-standoff configuration design. The authors of this study consider that two levels of crew accommodation offer several advantages over a single level version and that further studies of this approach are worthwhile.

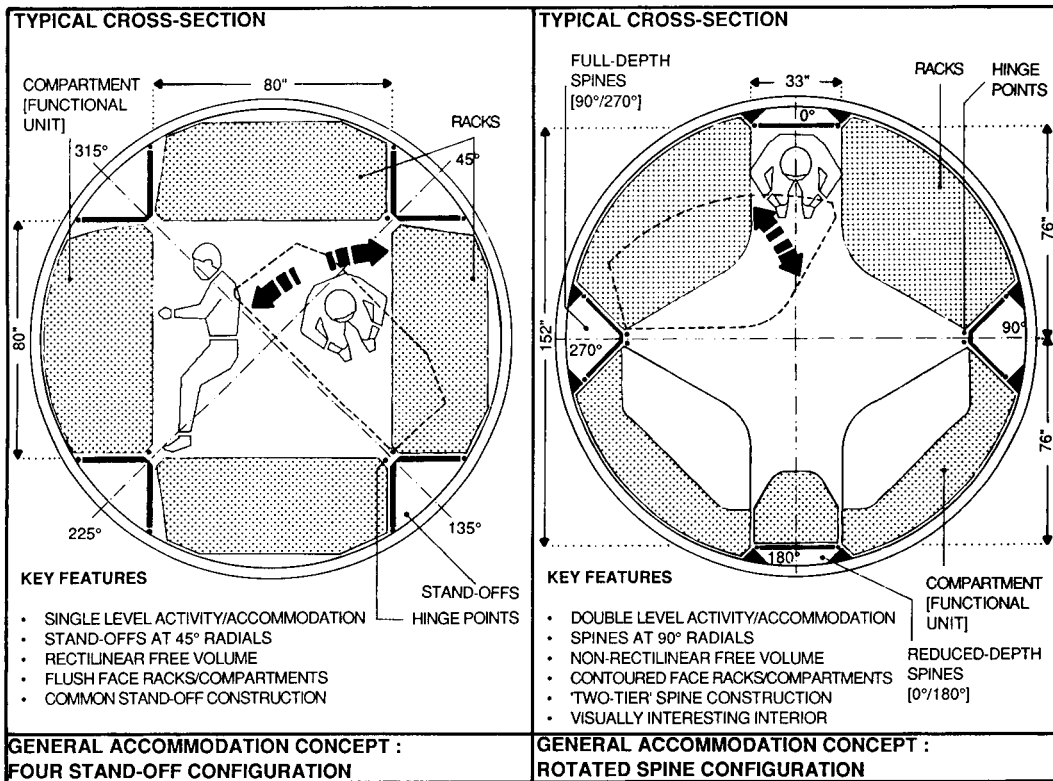

FIGURE 27

FIGURE 28

In the rotated-standoff configuration shown in FIGURE 28, two levels of crew activity are introduced. The two 'wall' standoffs are retained as full-depth primary spines for rack and compartment structural support and bulk utility systems distribution. The 'floor' and

'ceiling' standoffs are reduced in depth to provide increased internal height for two levels of accommodation and crew movement. This approach generates a potential internal configuration with broad advantages which include: a more generous Wardroom enclosure for large crew group utilization and occupation; a more effective use of available internal volume with a separate translation passage above a lower group meeting area; a visually stimulating architectural interior comprising different functional geometries for associated racks and compartments. These changes are achieved by replacing the rectilinear, symmetrical geometry of the 4-standoff configuration with a multi-faceted, asymmetrical geometry in which rack and compartment faces are 'profiled' where functionally and operationally appropriate.

3.3.4 ECLS/UTILITIES/PH/DM/C&T/HM SYSTEMS DISTRIBUTION

The four identical standoffs located at the 45° radial alignments in the 4-standoff configuration provide the primary means of distribution of Environmental Control and Life Support, Utilities, Personal Hygiene, Data Management, Communications and Tracking and Health Maintenance systems throughout the Habitability Module. The systems include: gas group [ambient air supply, thermal air supply and return, oxygen, nitrogen, carbon dioxide, methane, halon]; fluid group [potable water, hygiene water supply and return]; a vacuum line; cable group [high voltage power, low voltage power, multiple data management, communications and tracking, audio and video]. Additionally, the standoffs house air vents and data management system hardware boxes. In the 4-standoff configuration shown in FIGURE 29, the allocation of distributed systems within the standoffs is potentially identical in each standoff. Branches are fed through the sides of the standoffs and then through the end faces of the racks or compartments. Branches always occur at the hinged ends of racks or compartments to minimize the flexible linkages required to enable the racks or compartments to swing out with systems left connected.

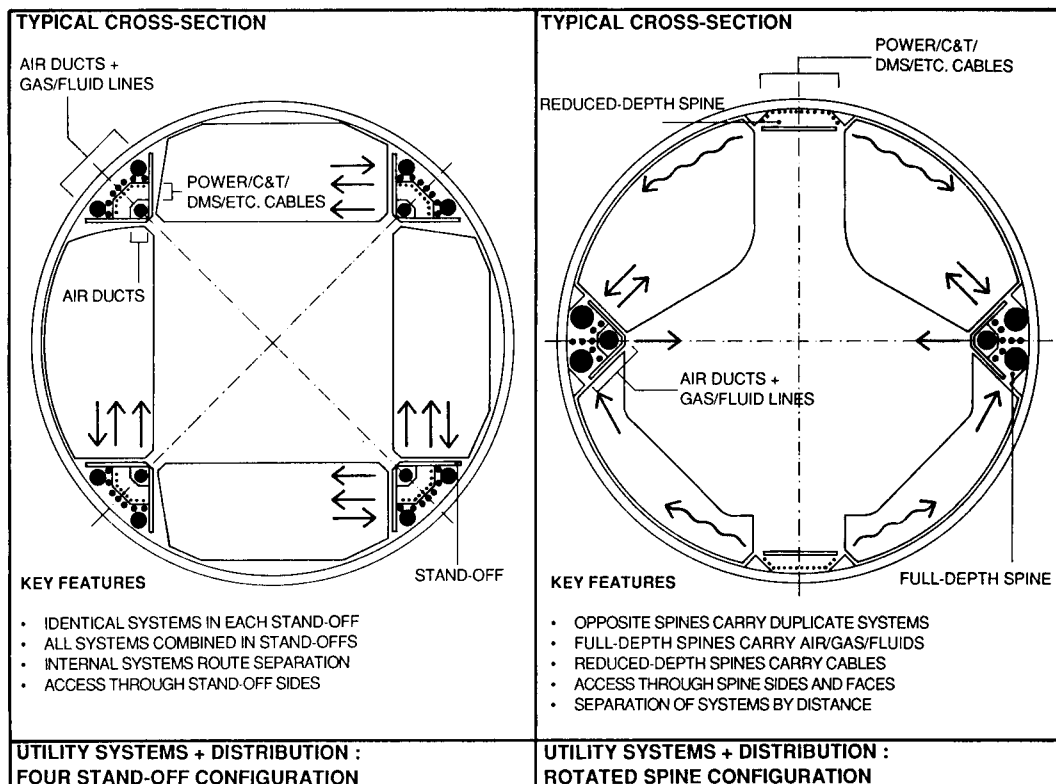

FIGURE 29

FIGURE 30

In the rotated-standoff configuration shown in FIGURE 30, the distribution of systems is revised and rationalized. Systems are divided between the full-depth primary standoffs and the reduced-depth secondary standoffs. Systems are grouped and duplicated in opposite standoffs according to the appropriateness of their cross-sectional size. Thus, the 'floor' and 'ceiling' standoffs, which are shallow, carry the duplicated cable group and the two 'wall' standoffs, which are deep, carry the duplicated fluid and air groups. The cable groups, which feed into the non-hinged ends of racks or compartments, will require additional coiled linkage lengths to comply with the longer extensions caused by the rack or compartment swing-outs.

The authors of this study believe that the distributed systems concept in the rotated-spine configuration has advantages over the method adopted in the 4-standoff configuration. In the latter, the proximity of gas [particularly oxygen] and fluid systems to power and communications systems is evident. In the former, this proximity is eliminated by virtue of the physical distance between any two adjacent standoffs. This potentially contributes to enhanced safety in an emergency and easier systems repair procedure in the event of a major failure occurring within the standoffs due to internal or external causes.

3.3.5 STRUCTURAL STANDOFFS AND ATTACHMENTS

The four identical standoffs located at the 45° radial alignments in the 4-standoff configuration provide the major design reference for the interior of the Habitability and Laboratory Modules. In all configurations, the standoffs provide the necessary means of rack and compartment tie-down and performance load distribution to the Module structure during NSTS lift-off and acceleration. Once in orbit, they provide the retention and pivot points for racks and compartments under microgravity conditions. In the 4-standoff configuration, all four standoffs are identical and triangular in section. The apex of each standoff is slightly truncated to form a continuous fascia strip along each standoff route. The edges of the fascia strips are defined by the hinge joints for rack and compartment attachments which occur at predetermined intervals. The strip itself is used for mounting a range of systems including: lighting panels; power, data, communications, audio and video system connections; ventilation inlets and outlets; crew and equipment restraints; emergency stowage access; and status information display. Several designs for the structural members comprising the standoff were considered by Space Station contractor teams including: single longitudinal center webs and lateral bracing arms; twin longitudinal face webs and lateral bracing arms; open longitudinal trusses of pinned-strut and node construction. The notional standoff design for Space Station Modules as shown in FIGURE 31 combines lateral L-shaped bar arms and longitudinal pinned-strut K-bracing panels in an alternated pattern based on rack and compartment attachment points.

In the rotated-standoff configuration, the standoffs are designed to be manually demountable and can be repositioned in a range of locations based on changing operational conditions or requirements. The standoffs are developed as a 'two-tier' structural system as shown in FIGURE 32. The reduced-depth structure comprises two projecting face webs which are angled inwards towards the apex. These webs are continuously attached to the Module inner surface along their outer edges and provide regularly-spaced attachment points for demountable structural arms along their inner edges. The demountable arms are double-elbow shaped and can be aligned and fixed in position over the reduced-depth standoff webs at frequent intervals. The arms are designed to be easily demountable and reattachable by crewmembers on-orbit using captive structural fasteners with simple release procedures. The apexes of the standoffs are truncated to provide pivot attachment points for racks and compartments and surface-mounted panels and interfaces for distributed systems and equipment described above.

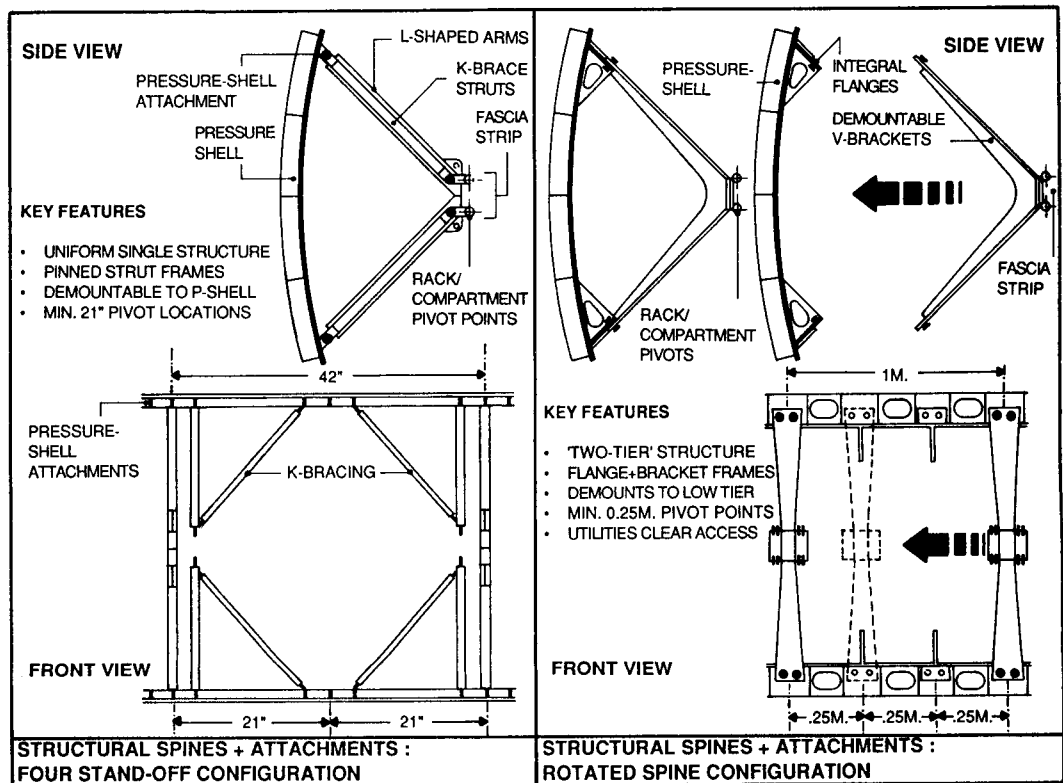

FIGURE 31

FIGURE 32

The proposed design for the standoffs is a flexible 'two-tier' concept which provides continuous capability for on-orbit modification, relocation or replacement of racks and compartments through a typical Module life-cycle. Given the impossibility of accurately predicting future on-orbit changes in Space Station activities, there is an evident need to design this type of versatility into future Modules.

3.3.6 RACK AND COMPARTMENT DIMENSIONS

The common width [42"] applied to racks and compartments in the 4-standoff configuration is based on the requirement for housing two adjacent items of standard experiment or laboratory equipment [19" wide each]. This requirement for double racks has its origins in the design of Spacelab Modules in which internal racks housed two standard experiment and laboratory equipment packages side by side. FIGURE 33 shows the effect of this common dimension on the layout of racks and compartments as they appear in a partial longitudinal section. In some circumstances, the common width is halved [to 21"] to allow two single racks to be combined within a double rack width [as with the fixed and portable workstations] or where an independent single rack is sufficient [as with stowage for the crew sleeping compartments].

The authors of this study consider that it is useful to identify and explore alternative dimensions for racks and compartments, and believe that the common dimension [42"] is insufficient for certain habitability functions such as crew exercise compartments and sleeping compartments. During earlier stages of this study, a small dimensional increment was identified for application in selected multiples to resolve the dissimilar volumetric requirements of racks and compartments within the Habitability Module.

A standard dimensional increment [250 millimeters] was selected for evaluation. This dimension enables compartments to be more efficiently and comfortably sized for crewmember activities [1.5 m. width based on full arm extension] and racks to be sized for appropriate Habitability Module stowage and equipment applications [1 m. width].

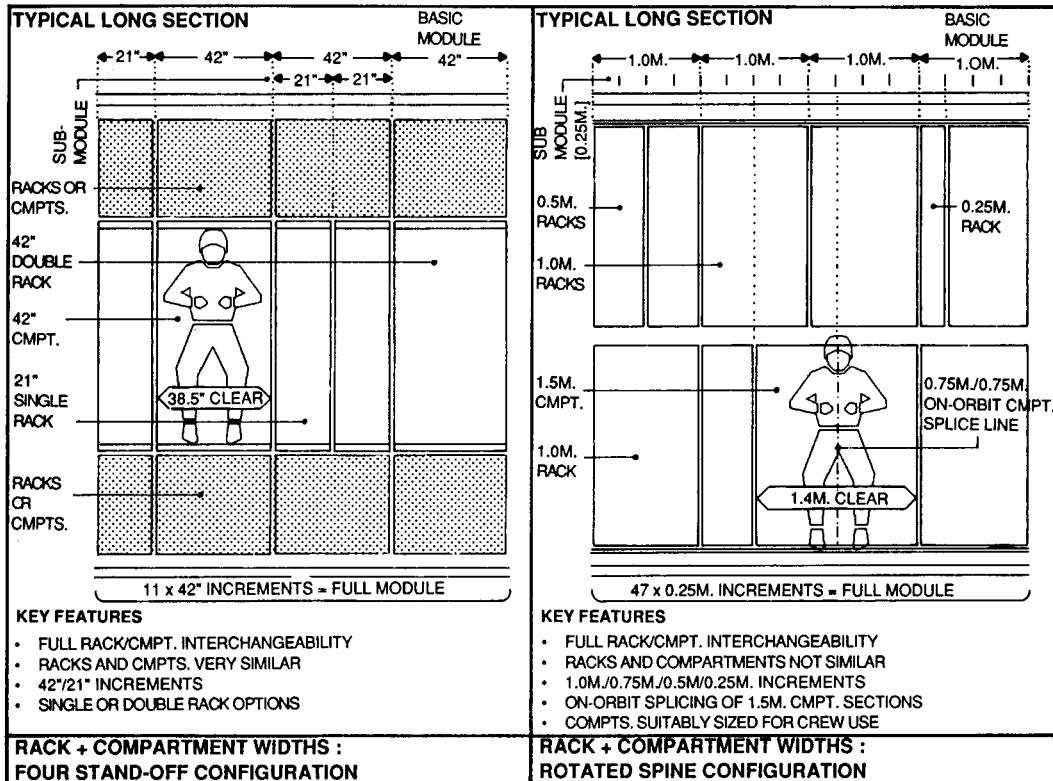

FIGURE 33

FIGURE 34

FIGURE 34 shows the application of the new increment [250 mm.] on the organization of racks and compartments in a partial longitudinal section. Compartments are constructed in two halves to enable them to pass easily through existing Module hatches. The two halves are connected in-situ along a splice line which occurs along the centerline or an offset line. Independent racks with smaller widths become feasible [750 mm. and 500 mm.].

Generally, the authors believe that utilizing a small reference dimension for rack and compartment widths improves long-term on-orbit flexibility and versatility. It allows racks and compartments to be configured more closely to specific performance requirements and it enables life-cycle integration, interchangeability or replacement of these elements to be based on a wider range of operational options.

3.3.7 RACK AND COMPARTMENT MORPHOLOGY

In the 4-standoff configuration, racks and compartments are generally developed with flat faces to optimize their volumetric capacity and rationalize their physical interface with integral elements or equipment. In certain circumstances, flat geometry for rack or compartment faces is functionally inefficient from the ergonomic or anthropometric viewpoint and the faces are profiled accordingly. FIGURE 35 shows typical examples of racks and compartments in the Habitability Module. The crew workstation is one of the few

elements that is profiled. Preliminary mock-up studies of Habitability Module interiors carried out by the authors indicate that design improvements can be made in the physical interface or 'bond' between crewmembers and elements or equipment. Anthropometric criteria are transformed into optimum ergonomic or 'user-friendly' design. This objective is particularly important for crew compartment, workstation and table design. Previous design studies of crew equipment by the authors maintain that the close relationship between humans and equipment in space is critical from the human factors standpoint. Innovative approaches to crew workstation design in microgravity can show that much potential exists for innovations and improvements.

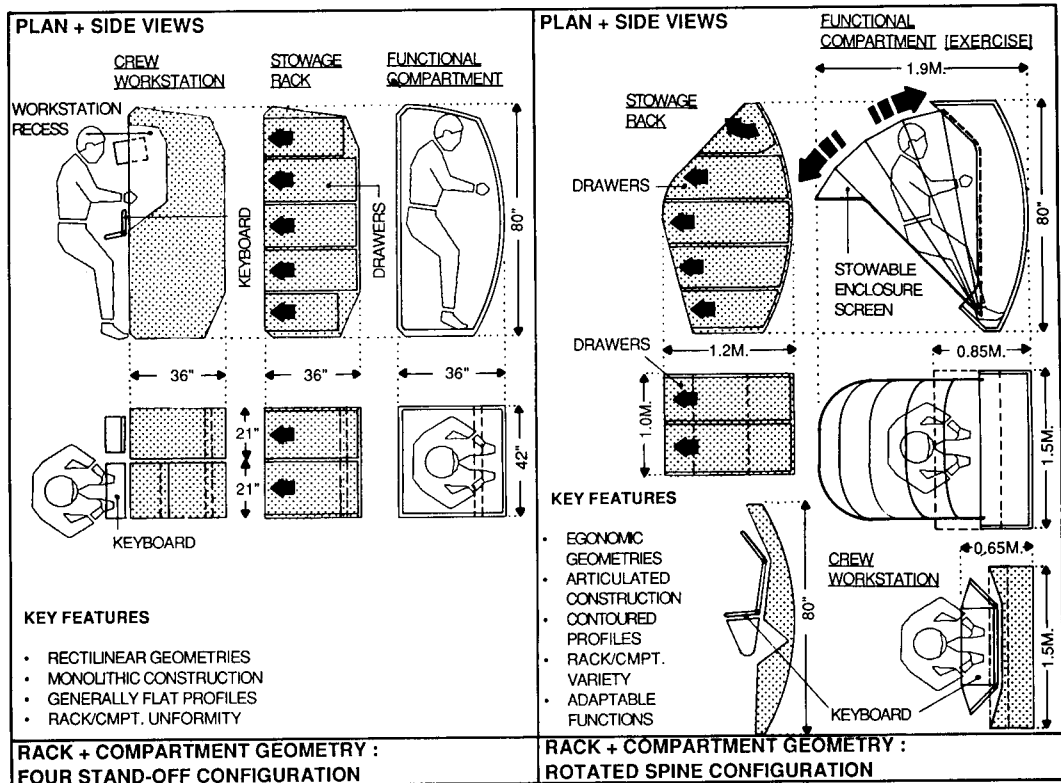

FIGURE 35

FIGURE 36

The importance of providing comfortable conditions for human body posture in microgravity throughout the wide range of crew activities to be encountered on the Space Station places special emphasis on the ergonomic design of the rack and compartment profiles. To achieve this, the standardized flat geometry of rack and compartment faces in the 4-standoff configuration has evolved in the rotated-standoff configuration into an innovative 'contoured' geometry which tailors the physical proportions of any particular rack or compartment more closely to its operational performance requirements. The contouring is applied to the inward faces while the sides remain flat to simplify standoff connections and closures. FIGURE 36 shows examples of contoured profiles applied to certain racks and compartments.

Another area of innovation in the rotated-standoff configuration deals with the introduction of adaptable or deployable performance capabilities into the design of certain rack, compartments and other items of equipment such as tables and workstations. FIGURE 36 shows examples of a workstation and an exercise compartment which utilize this technique. The workstation is of articulated, multiple panel construction with pivoted

panel connections which allow individual overall adjustment to suit various work task requirements or different ergonomic positions and body sizes. The exercise compartment incorporates fold-out exercise equipment and flexible screens which deploy during periods of crew use and stow away into a compartment shell at other times to conserve internal free volume.

3.3.8 INTERIOR ACCOMMODATION LAYOUTS

FIGURE 37 shows the interior accommodation layout of the 4-standoff configuration. This layout is taken from a study by a NASA-appointed contractor team during Space Station Phase B as explained in SECTION 3.2.5.

FIGURE 38 shows the interior accommodation layout of the rotated spine configuration. This layout has a similar Rack and Compartment inventory capacity to the 4-standoff configuration though the locations and types of Racks and Compartments are modified to reflect the architectural approach of the rotated-spine configuration described in SECTIONS 3.3.2 to 3.3.7.

Certain special features and facilities are also introduced.

Earlier research by the authors indicated that a quiet, semi-private area for two or three crewmembers to use occasionally would be useful for off-duty leisure and private study activities which would be difficult to undertake in the communal and noisier environment of the Wardroom. This facility is designated as a Library in FIGURE 38.

Three sets of screens separate the Wardroom from the Crew Quarters. These help to optimize acoustic separation by reducing airborne sound transmission along the central corridor. They also improve the quality of visual privacy for crewmembers entering or leaving Personal Hygiene Compartments and Crew Quarters.

Deployable/retractable Compartments are shown arrowed. These comprise Exercise and Crew Quarters Compartments. The Exercise Compartments incorporate flexible, fabric enclosures which deploy outwards during crew use and retract at other times to make additional volume available for crew translation and movement in the vicinity of the Wardroom. These elements are described in detail in SECTION 3.4. The same principle applies to the Crew Quarters though the design of these is beyond the scope of this study.

Portable stowage elements are introduced in the form of mobile logistics packs. These are retrieved from the Logistics Module, located in the Habitability Module where their contents are used, and then returned to the Logistics Module for use as trash containers. These elements provide stowage for consumables and supplies in corridor locations where their presence can be used to enhance local activities and operations without causing crew translation and movement obstructions. In the Galley area, the elements are used for storage of food and drink and are configured to assist Galley food preparation and clean-up operations. In the Personal Hygiene/Housekeeping area, the elements are used for storage of hygiene equipment and clothing supplies and are configured to assist in the design of the Library facility.

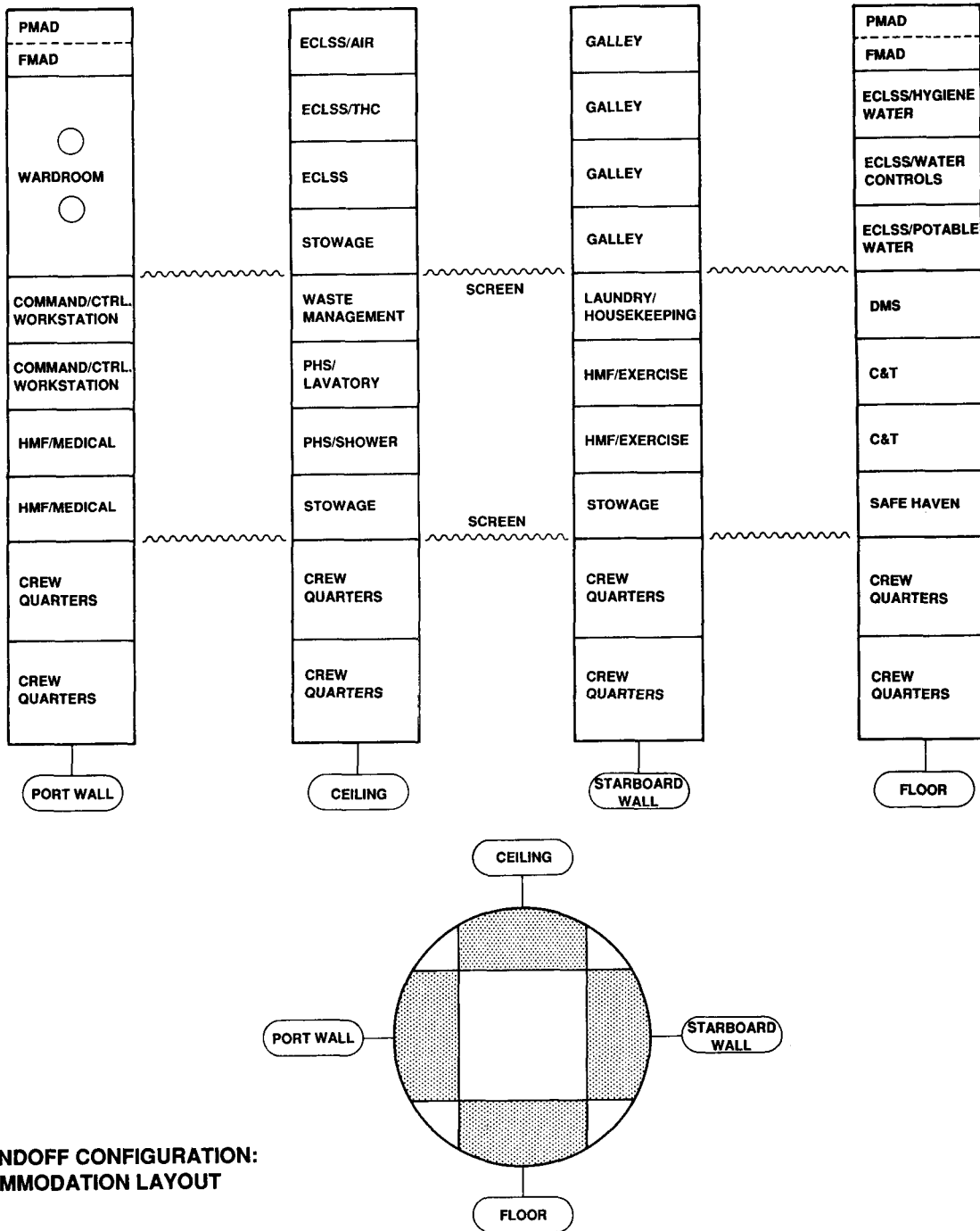
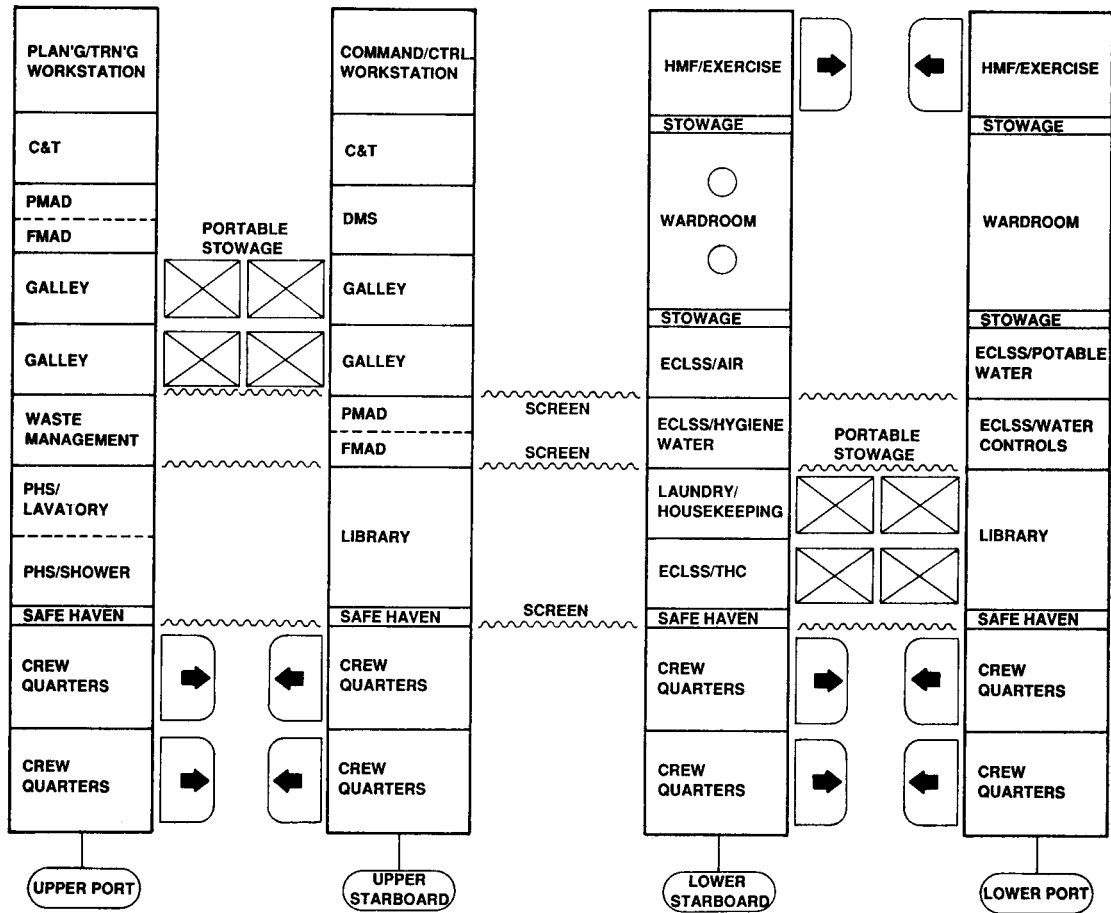

FIGURE 37



**ROTATED SPINE CONFIGURATION:
ACCOMMODATION LAYOUT**

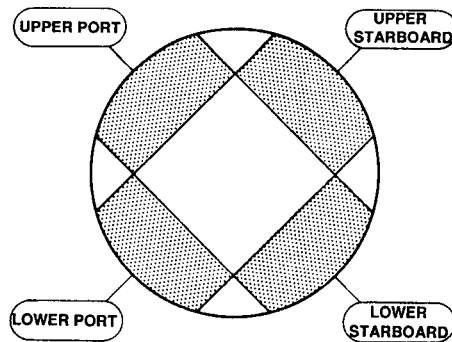

FIGURE 38

3.4 WARDROOM FINAL CONCEPT

3.4.1 FULL-SIZE WARDROOM MOCK-UP

FIGURE 39 shows the size of the full-size mock-up compared to the size of the complete Habitability Module. APPENDIX C contains a complete inventory of all elements and equipment comprising the mock-up described and illustrated in this report. The following list summarizes the main features.

- 2 HMF/Exercise Compartments
- 1 Command/Control Workstation
- 2 Window Workstations
- 1 Stowage Bag System
- 1 Wardroom Table
- 4 Passive Leg Restraints
- 6 Equipment Racks
- 4 Galley Racks

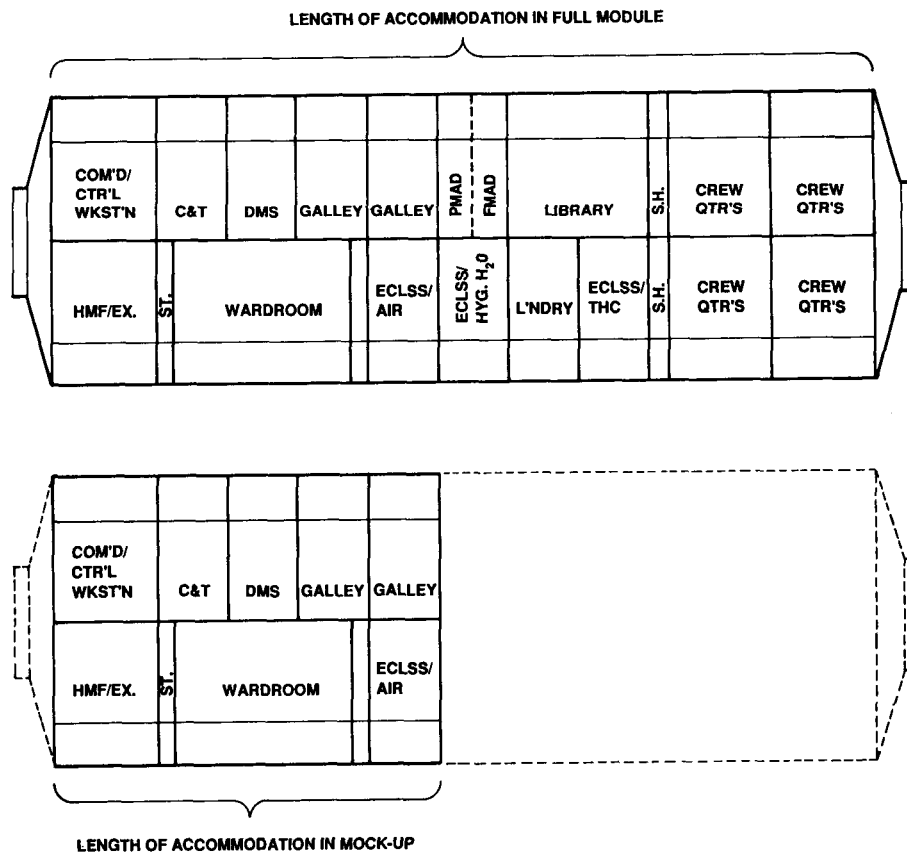

FIGURE 39 : EXTENT OF MOCK-UP CONSTRUCTION

FIGURE 40 shows a general view of the Wardroom in the mock-up. The view is looking down the center of the simulated Module towards the crew group meeting/meal facility at the lower level. At the upper level is a crew translation corridor bordered on each side by Equipment Racks with curved geometries. The Galley Racks at the upper level are partly visible in the top foreground. In the bottom foreground on each side are Equipment Racks.

ORIGINAL PAGE
BLACK AND WHITE PHOTOGRAPH

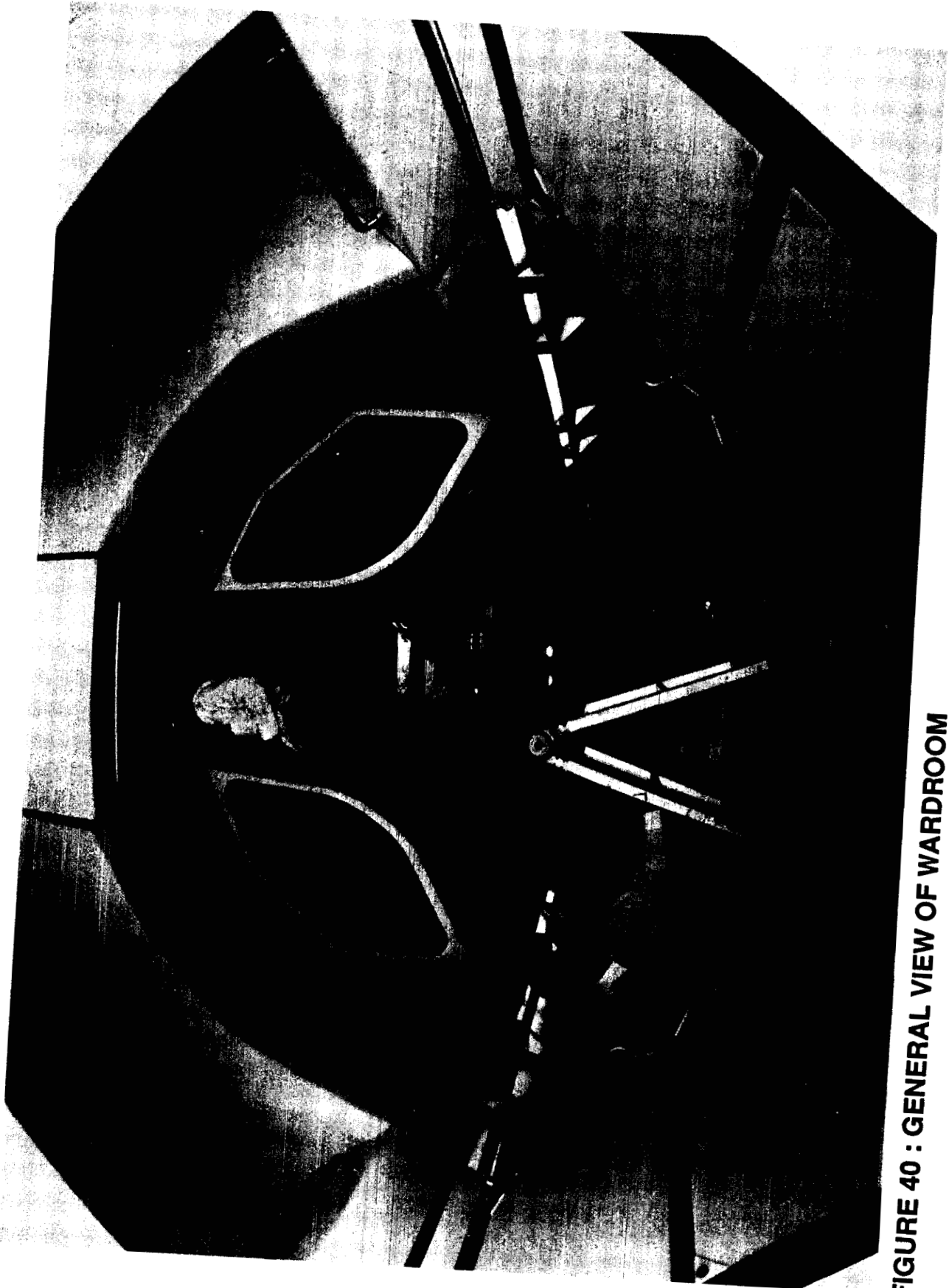
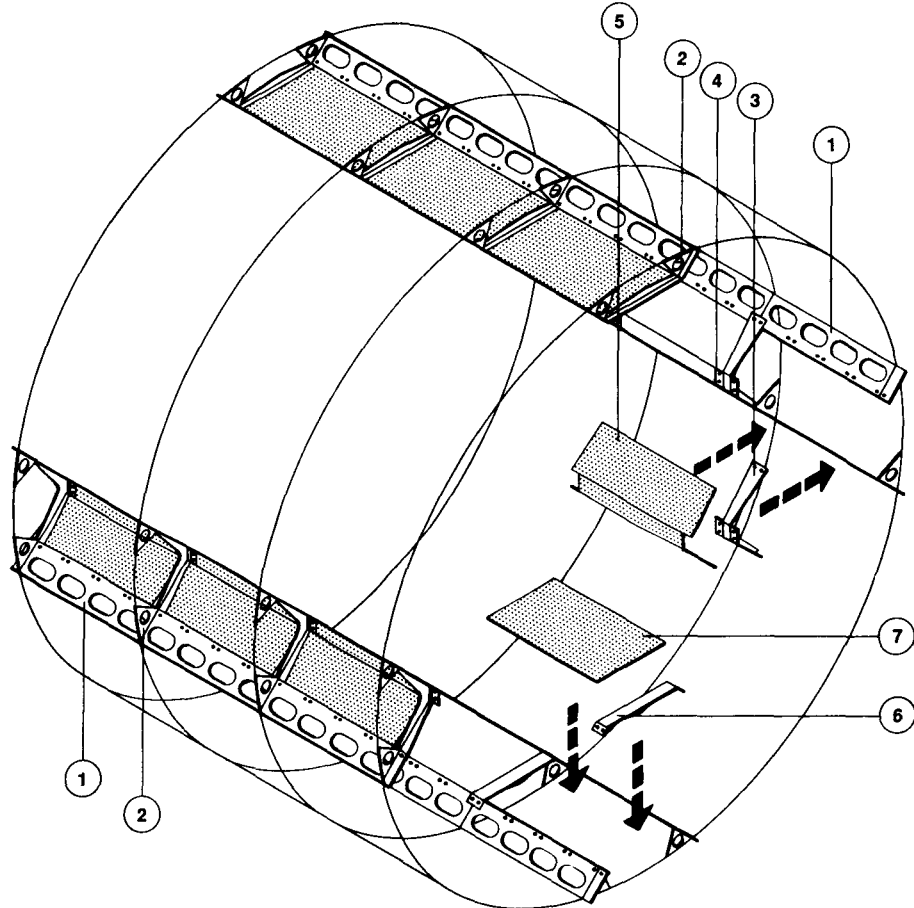

FIGURE 40 : GENERAL VIEW OF WARDROOM

FIGURE 41 is a diagram of the structural standoff elements and attachments of the rotated-spine configuration as envisaged for actual Module application. The approach to the design of the standoffs is described in SECTION 3.3.5.

FIGURE 41 : STANDOFF SYSTEM STRUCTURAL ELEMENTS



- 1 Continuous flanges attached to pressurized hull
- 2 Gussets connected to flanges and hull
- 3 Demountable primary standoff arms
- 4 Rack/Compartment element pivot/attachment points
- 5 Demountable primary standoff enclosure panels
- 6 Demountable secondary standoff arms
- 7 Demountable secondary standoff enclosure panels

FIGURE 42 shows the installation of structural standoffs and equipment elements in the mock-up. The fidelity of standoffs and elements has been simplified and standardized to facilitate project construction procedures and meet project budget constraints. At the upper left is a primary wall spine and at the lower right is a secondary floor spine. Triangular aluminum brackets are used to depict outer standoff arms and trapezoidal linear ducts are used to depict hull flange and gusset structures. The photograph shows a Rack hinged at the top to a primary bracket and fastened at the base to a secondary bracket. This Rack design has been developed specially for the rotated-spine configuration. In order to compensate for the loss of Rack volumetric capacity when converting from the standard 42" width dimension to the 1.0 meter dimension, certain Rack sizes in the rotated-spine

ORIGINAL PAGE
BLACK AND WHITE PHOTOGRAPH

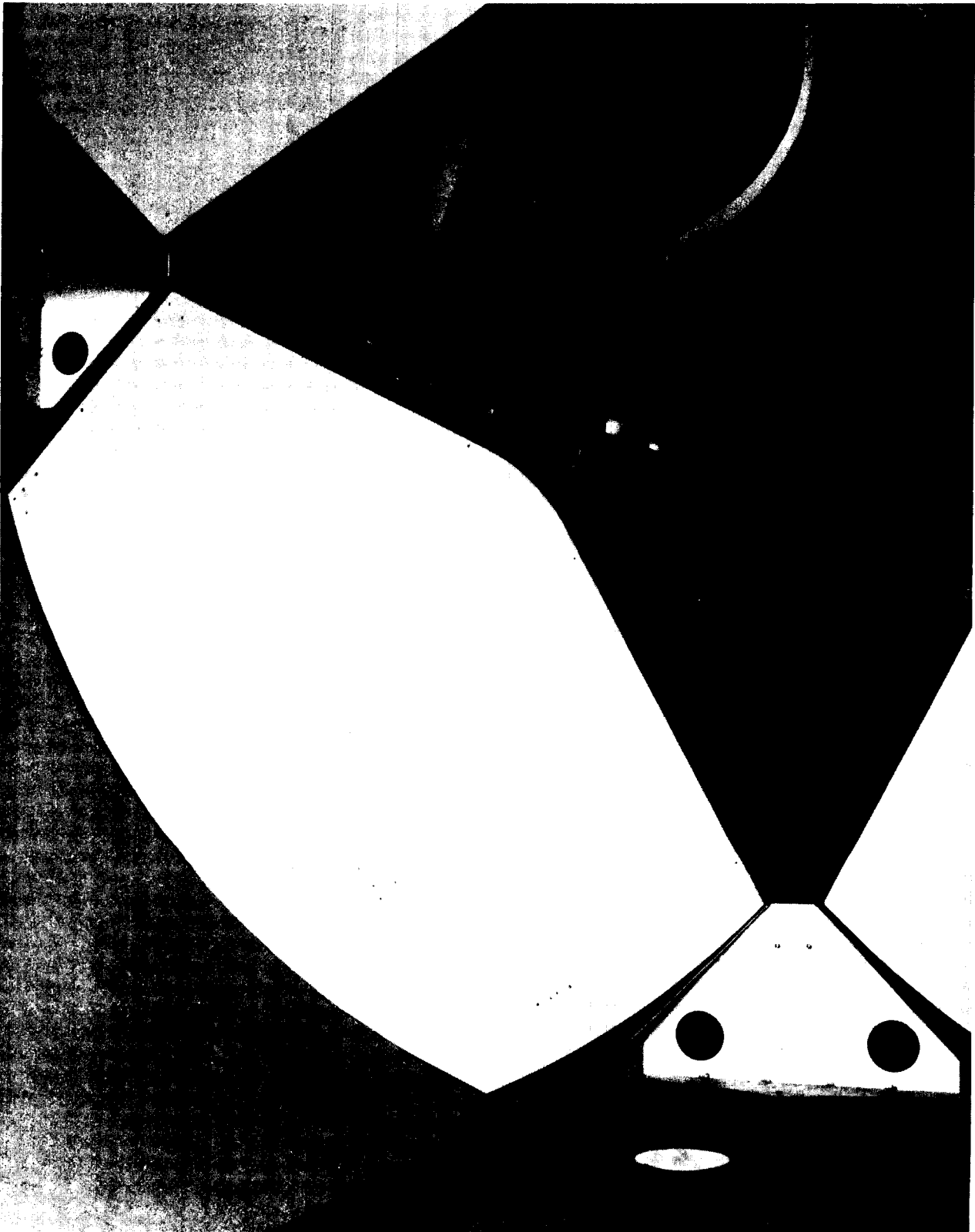
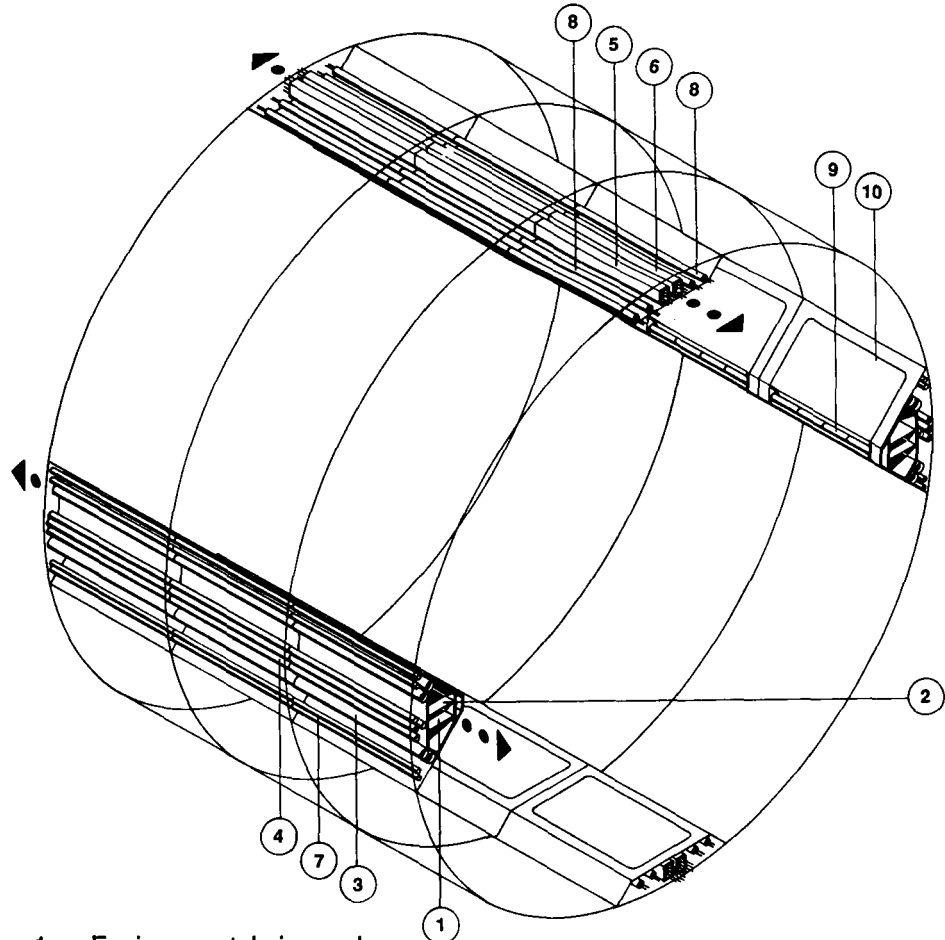

FIGURE 42 : STANDOFF AND RACK CONFIGURATION

configuration have been maximized. The internal volume of a standard 42" wide Rack is approximately 1.82 cubic meters in volume compared to the 1.0 meter wide Rack illustrated which is approximately 1.80 cubic meters in volume. The fascia profile of the Rack is generated by the swing-out clearances required. Due to their increased size, these Racks are only used in locations where regular crew activities are absent. In the rotated-spine configuration, they are used to advantage in the buffer zone between the Wardroom and the Crew Quarters where they provide a reduced passage to assist noise attenuation.

FIGURE 43 is a diagram of the utility systems and distribution of the rotated-spine configuration as envisaged for actual Module application. The approach to the design of the utility systems is described in SECTION 3.3.4.

FIGURE 43 : STANDOFF SYSTEM UTILITY ELEMENTS



- 1 Environmental air supply
- 2 Equipment thermal supply/return
- 3 Environmental thermal supply/return
- 4 Fluids [waste supply/return, potable water, halon, vacuum]
- 5 High-power electricity
- 6 Low-power electricity
- 7 Gases [oxygen and hydrogen]
- 8 Cables [C&T, DMS, A/V]
- 9 Recessed lighting units/grab-rails
- 10 Utilities access panels

3.4.2 CREW MEETING AND MEAL FACILITY

FIGURE 44 is a diagram showing the general architectural treatment of the Meeting and Meal Facility in the rotated-spine configuration. The approach to the architectural design of the accommodation is described in SECTION 3.3.3.

FIGURE 44 : MEETING/MEAL FACILITY CONFIGURATION

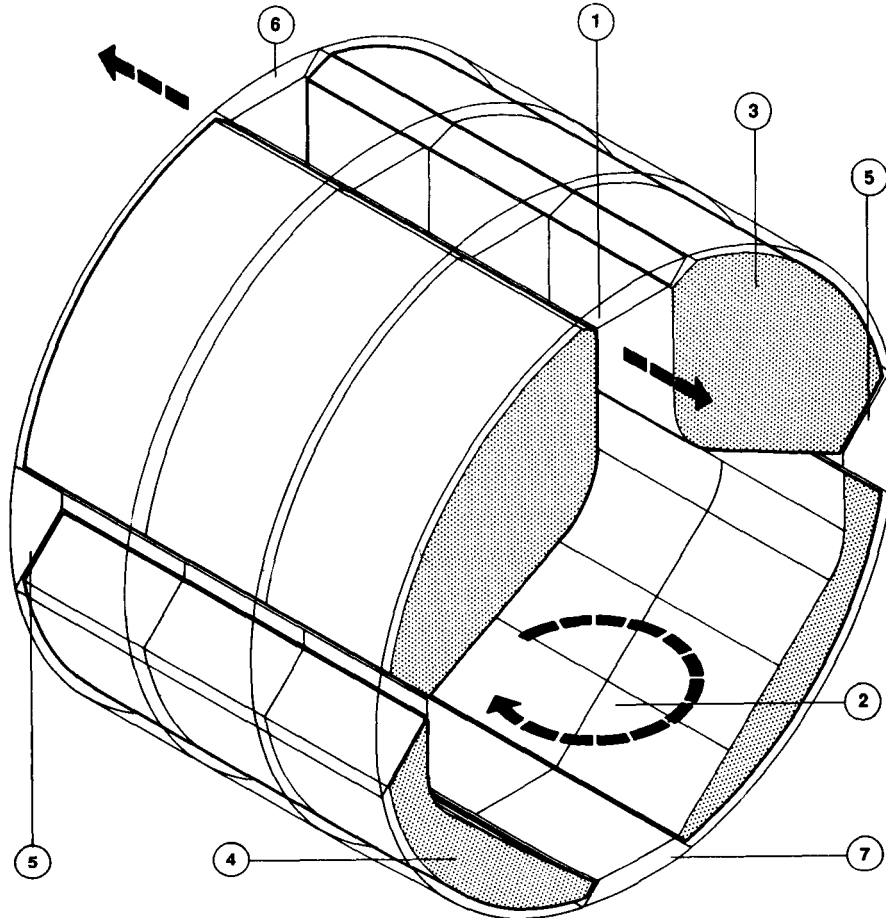

- 1 Upper level access corridor
- 2 Lower level group activity area
- 3 Rack containing equipment
- 4 Zones for soft stowage system and window workstations
- 5 Primary wall standoff route
- 6 Secondary ceiling standoff route
- 7 Secondary floor standoff route

FIGURE 45 shows a view of the Meeting and Meal facility in the mock-up. In the center is a Wardroom Table which provides positions for up to eight crewmembers engaged in mealtime, meeting, conference or planning activities. The Wardroom Table is described and illustrated in SECTION 4.1 of this report. To the left of the Wardroom Table is the soft Stowage Bag system and to the right are the two Window Workstations. The upper-level translation corridor is at top center. In the background can be seen the deployed fabric canopies of the two HMF/Exercise Compartments. The recessed lighting/grab-rail strips extend into the foreground on the left and right.

ORIGINAL PAGE
BLACK AND WHITE PHOTOGRAPH

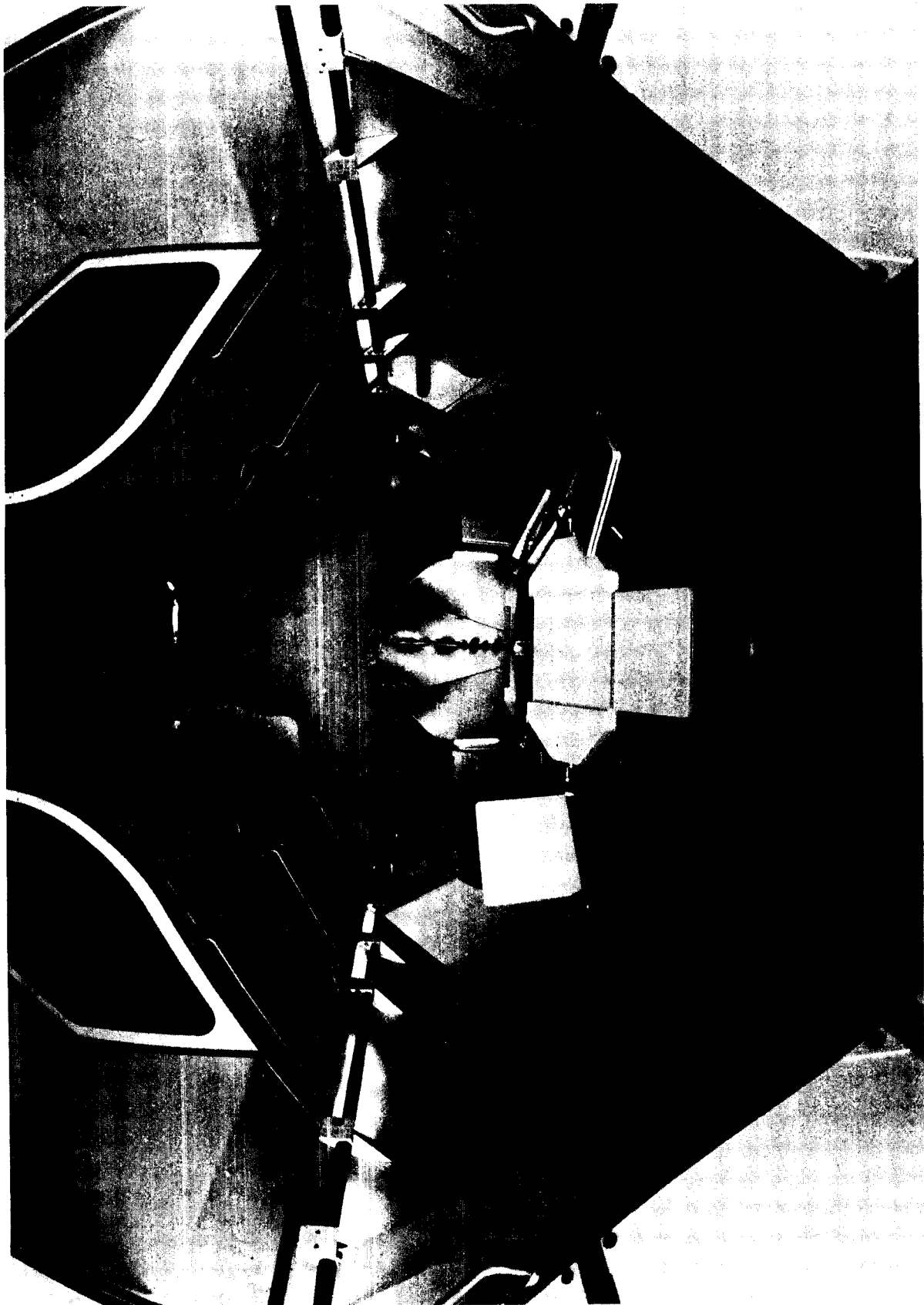

FIGURE 45 : CREW GROUP MEETING & MEAL FACILITY

ORIGINAL PAGE
BLACK AND WHITE PHOTOGRAPH



FIGURE 46 : STANDOFF RECESSED LIGHTING DETAIL

FIGURE 46 shows the detailed treatment of the primary structural standoffs facing the Wardroom meeting/meal facility. Fluorescent lighting tubes are incorporated within crew grab-rails. These are installed between standoff brackets with their lengths adjusted to the modular spacings of the brackets as determined by Rack widths. The standoff enclosure panels behind the lighting/grab-rail strips are shaped as parabolic reflectors to direct light from the grab-rail slots inwards into the Module for general illumination.

FIGURE 47 shows a preliminary layout for two Window Workstations located either side of a central control and display console. The Window Workstations are designed to be adapted for either real exterior viewing or virtual imaging techniques. Operations to be performed at the Window Workstations are likely to involve the following tasks.

- Earth and space observation
- EVA observation and control
- Data monitoring and communications
- Experiment monitoring
- Traffic operations and control
- Docking and berthing
- Maintenance and repair

The two Window Workstations are primarily designed for two crewmembers to use simultaneously for work operations, though up to four persons can be accommodated. During leisure periods, all crewmembers can view the screens. The central console and the fascias above and below the screens are designed to incorporate a range of controls, keyboards, displays and storage receptacles for photographic and scientific equipment. All Window Workstation elements are designed to pivot inwards to provide pressure-hull accessibility for inspection, maintenance or repair.

FIGURE 48 shows a modular Stowage Bag system used for the storage of a variety of small items used in connection with Wardroom activities. The following list gives examples of typical items likely to be included.

- Eating utensils
- Dry/wet wipes
- Writing implements
- Calculators
- Portable computers
- Log books
- Checklists
- Reference manuals
- Audio/video equipment
- Books and paper
- Hardcopy print-outs
- Cassettes and compact disks
- Videotapes

The concept encourages mission/crew personalization and introduces visual variety and color into the Wardroom environment. The entire Stowage Bag system can be designed to be mission/crew specific for this purpose. The surface of the Stowage Bag system also provides crewmembers with a soft back restraint while engaged in various work or leisure activities, as shown in the photograph. The Stowage Bag System is designed to be easily detachable for pressure-hull accessibility for inspection, maintenance or repair.

ORIGINAL PAGE
BLACK AND WHITE PHOTOGRAPH

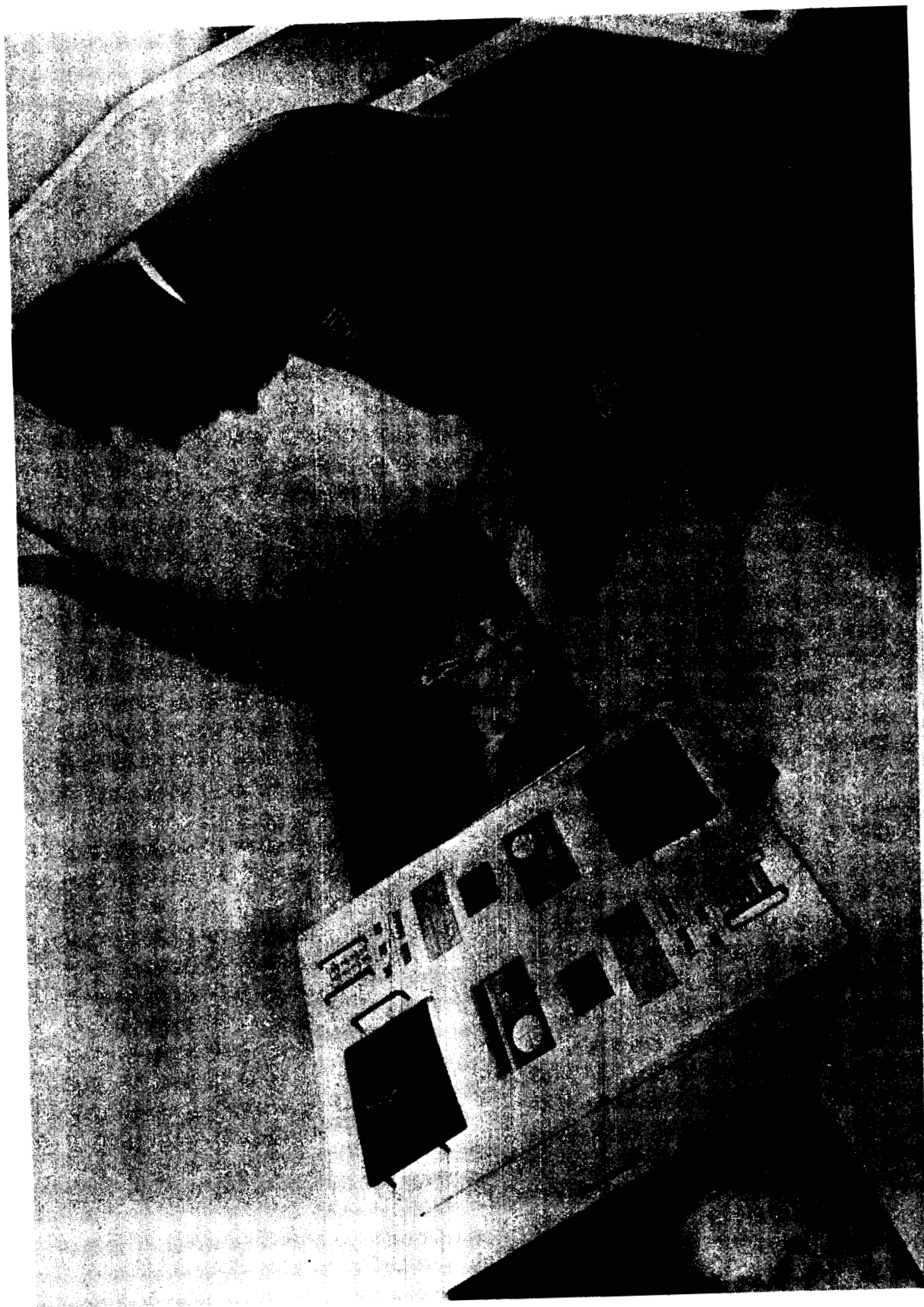

FIGURE 47 : WINDOW WORKSTATIONS

ORIGINAL PAGE
BLACK AND WHITE PHOTOGRAPH

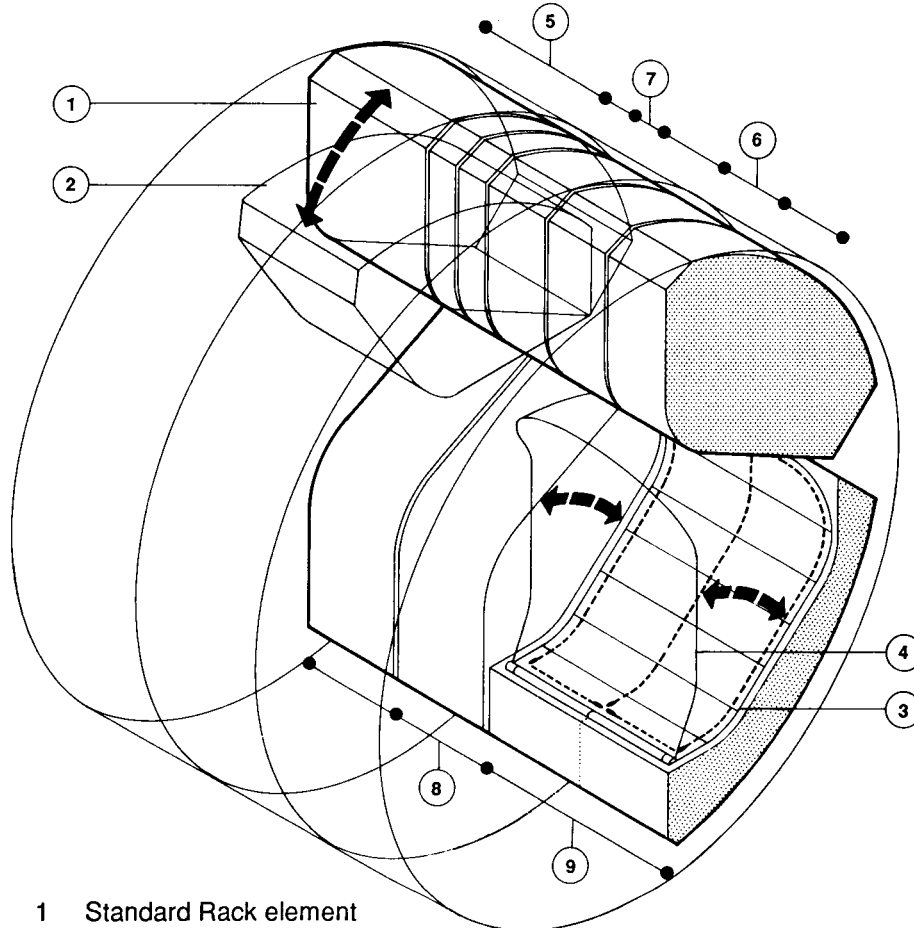

FIGURE 48 : STOWAGE BAG SYSTEM

3.4.3 HEALTH MAINTENANCE/EXERCISE COMPARTMENTS

The two Exercise Compartments incorporated in the mock-up provide exercise facilities and equipment for two crewmembers. One compartment incorporates a bicycle ergometer and the other compartment incorporates a rowing machine.

FIGURE 49 : EXERCISE COMPARTMENT CONFIGURATION



- 1 Standard Rack element
- 2 Rack swing-out for hull access
- 3 Exercise Compartment with enclosure frame in stowed position
- 4 Line of front of enclosure frame in deployed position
- 5 1.0 meter wide Rack
- 6 0.5 meter wide Racks
- 7 0.25 meter wide Racks
- 8 0.75 meter wide Racks
- 9 1.5 meter wide Exercise Compartments [2 x 0.75 meter elements]

FIGURE 49 shows the geometrical form of an Exercise Compartment in deployed and retracted positions compared to adjacent Racks and their range of width increments. Each compartment is configured as a 1.5 meter wide element with deployable fabric enclosure which folds outwards around the occupant when the compartment is in use. Two separate compartment elements, each 0.75 meters wide, are used to achieve the 1.5 meter width due to the constraints of the end hatch sizes in the Habitability Module. The two elements are designed to be connected together along a central 'splice' line once inside the Module.

ORIGINAL PAGE
BLACK AND WHITE PHOTOGRAPH

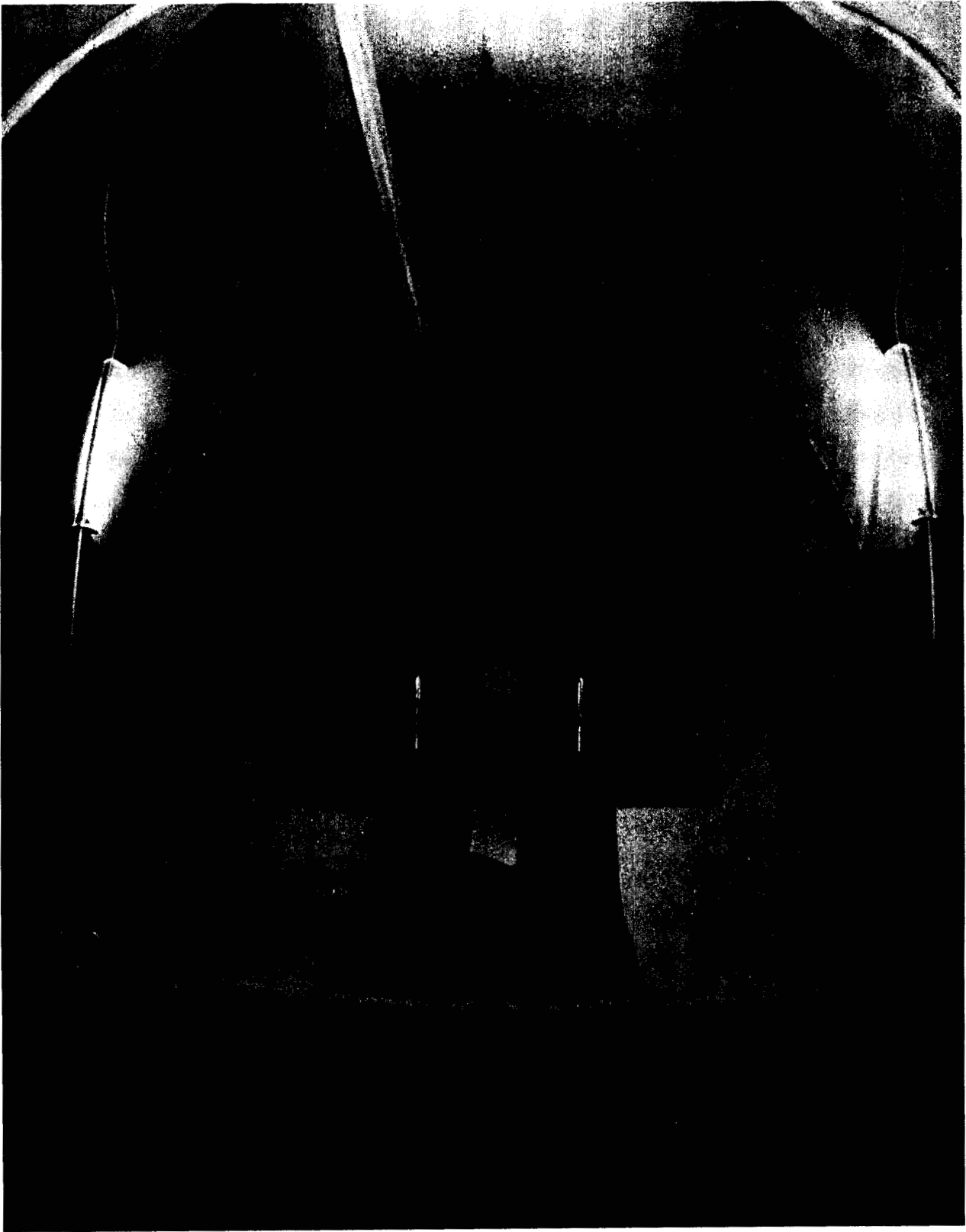

FIGURE 50 : INTERIOR VIEW OF EXERCISE COMPARTMENT

ORIGINAL PAGE
BLACK AND WHITE PHOTOGRAPH

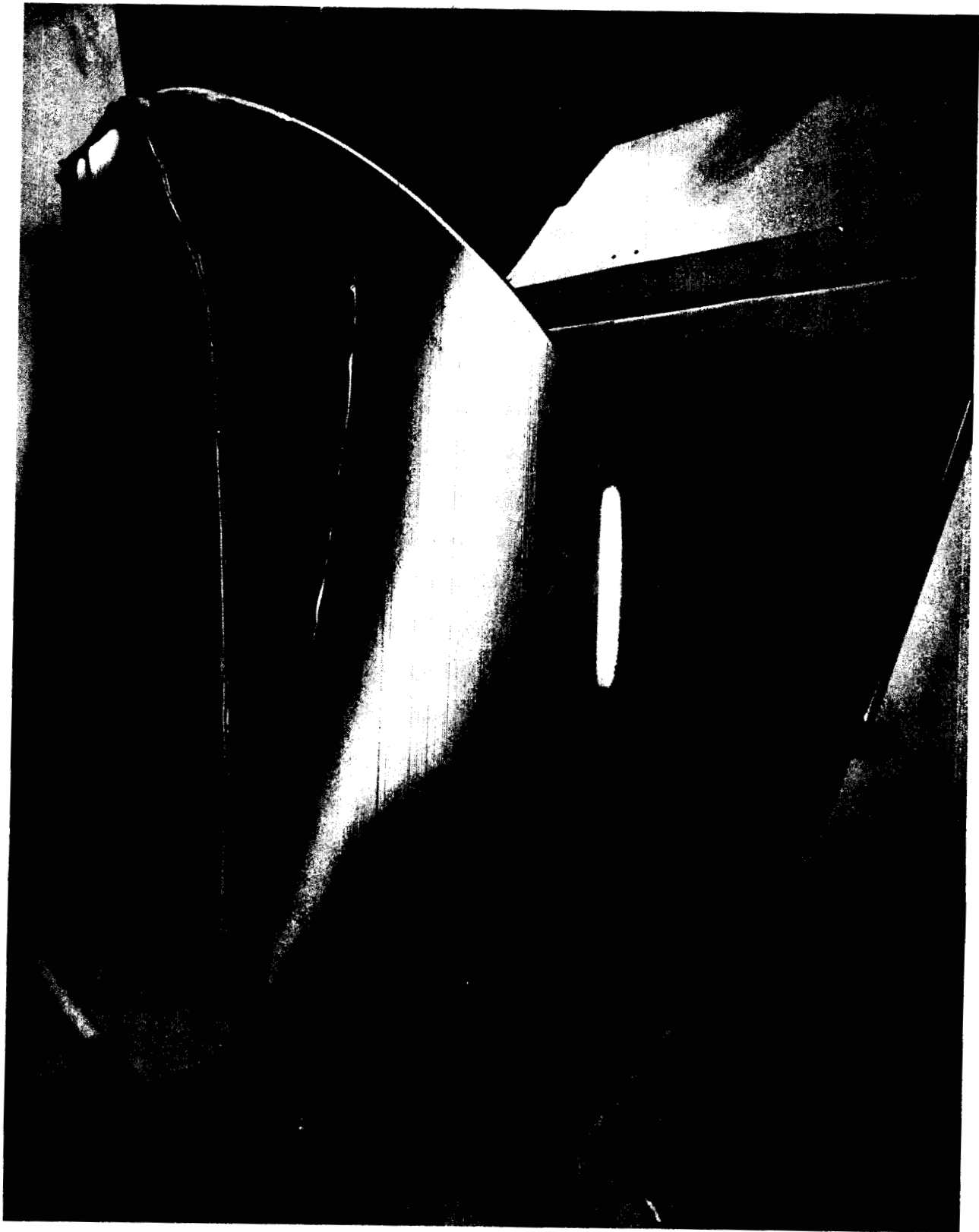

FIGURE 51 : EXTERIOR VIEW OF EXERCISE COMPARTMENT

ORIGINAL PAGE
BLACK AND WHITE PHOTOGRAPH



FIGURE 52 : BICYCLE ERGOMETER INSTALLATION

ORIGINAL PAGE
BLACK AND WHITE PHOTOGRAPH

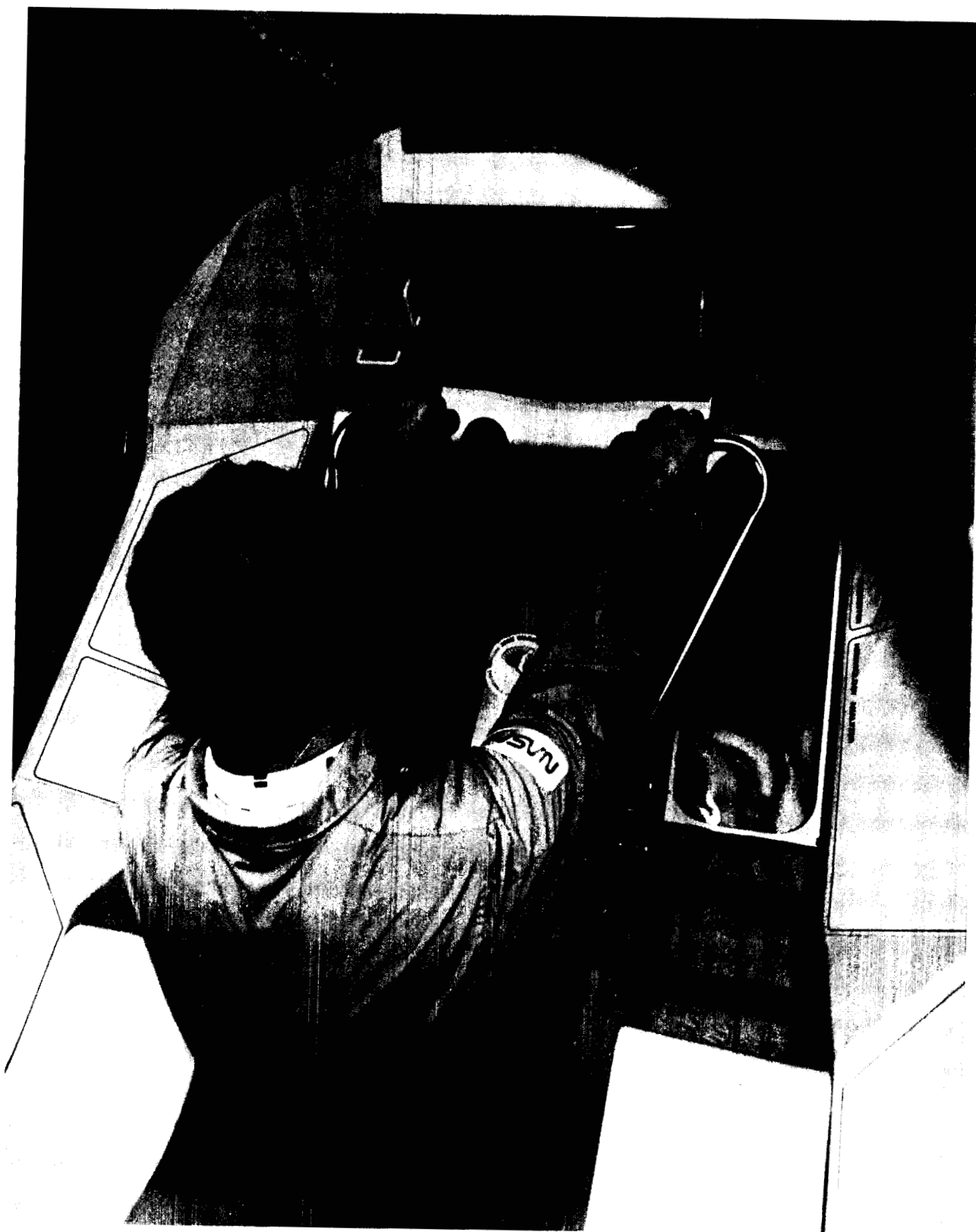

FIGURE 53 : ROWING MACHINE IN OPERATION

FIGURE 50 shows the interior of the Exercise Compartment with the rowing machine. The tensioned canopy is shown in the fully-deployed position. The deployable fabric enclosure ensures separation of air inside the Exercise Compartment from air outside it. This is necessary to prevent ambient perspiration and odors produced by exercising crew members from dispersing throughout the Habitability Module. Health Maintenance equipment panels are located on each side of the recessed rowing machine.

FIGURE 51 shows the exterior geometry of an Exercise Compartment with the fabric enclosure in the fully-deployed and tensioned position. The enclosures can be deployed by one person. Manual sealing and tensioning of the canopy edges is achieved using zips and fasteners. The enclosures also provide visual screening of the Exercise Compartments from crewmembers working in the adjoining meeting area who may be distracted by the visual movements of exercising crewmembers.

FIGURE 52 shows the Exercise Compartment with the bicycle ergometer. The canopy is shown in the partially-stowed position. When the compartment is not in use, the canopy is released, folded and stowed in compact form inside the compartment shell to release additional volume for crew group activities in the vicinity of the Wardroom. The enclosures can be deployed and used individually or combined together to form a single enclosure for two occupants to use simultaneously. Both Exercise Compartments are designed to pivot inwards to provide pressure-hull accessibility for inspection, maintenance or repair.

FIGURE 53 shows the interior of the Exercise Compartment with the rowing machine in use. The volumetric sizes of both compartments are designed to ensure sufficient and unobstructed volume for crew physical exercise routines involving full extension of legs and arms as well exercises on machines. An audio-visual entertainment system is located inside the compartment. Window panels are provided for real viewing or virtual imaging.

3.4.4. COMMAND/CONTROL WORKSTATION

FIGURE 54 and FIGURE 55 show the concept for the Command/Control Workstation. The design aims to provide an efficient, comfortable and versatile working facility for crewmembers.

The workstation is incorporated into a 1.5 meter wide rack element recess and complies with the anthropometric requirements of the 5th/95th percentile crew size range. All working surfaces are adjustable to optimize individual user field-of-vision and panel angle preferences and arm reach envelope requirements. The worksurface configuration comprises five panels in the center and four edge panels on each side of the center panels. The complete panel assembly is articulated and interconnected to enable it to fold back into the curved recess when not in use to provide additional volume for crew activities in the vicinity of the Wardroom. In this flattened configuration, all panels remain visible and accessible for monitoring, short duration operations or emergency procedures.

The design concept assumes the availability of thin-screen, high-fidelity display technology. Hardware and software specifications can be developed for individual panels and tailored to command/control tasks and operations. Each panel can be designed to function as an independent or interactive unit.

The crewmember restraint system comprises a twin padded-bar foot restraint located beneath the workstation and a flexible waist restraint attached to the leading edge of the lowest center panel.

ORIGINAL PAGE
BLACK AND WHITE PHOTOGRAPH



FIGURE 55 : COM'D/CONT'L WORKSTATION

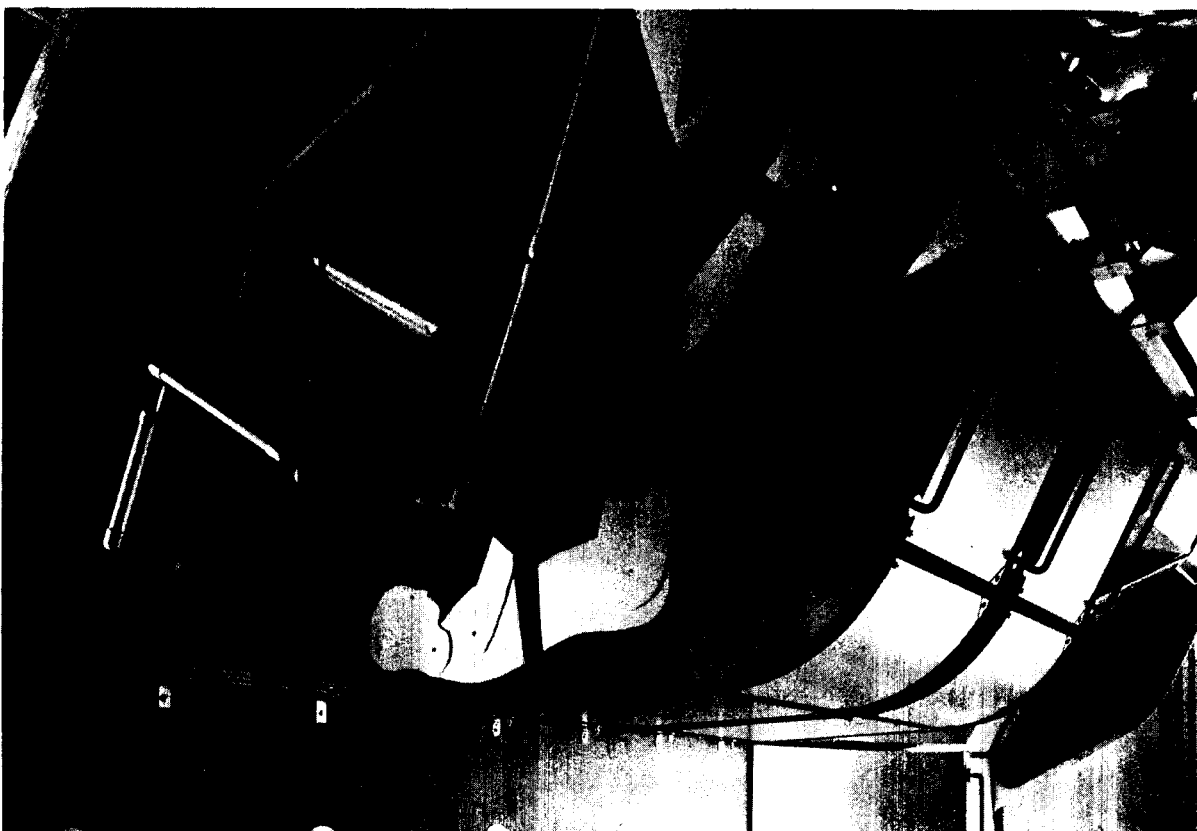

FIGURE 54 : COM'D/CONT'L WORKSTATION

4 WARDROOM EQUIPMENT STUDIES

4.1 WARDROOM TABLE

4.1.1 PURPOSE

A multi-purpose table is located in the center of the Meeting and Meal Facility in the mock-up. The table is intended for crew meetings, meals and work applications in the Wardroom in the Habitability Module. The table is designed for use in microgravity by a crew of up to eight persons. The table is dynamic in operation with individual work surfaces that can be manually unfolded and adjusted to suit various crew group sizes, types of operational use, and physical and visual comfort preferences.

FIGURE 56 shows the table installed in the mock-up in use by two persons.

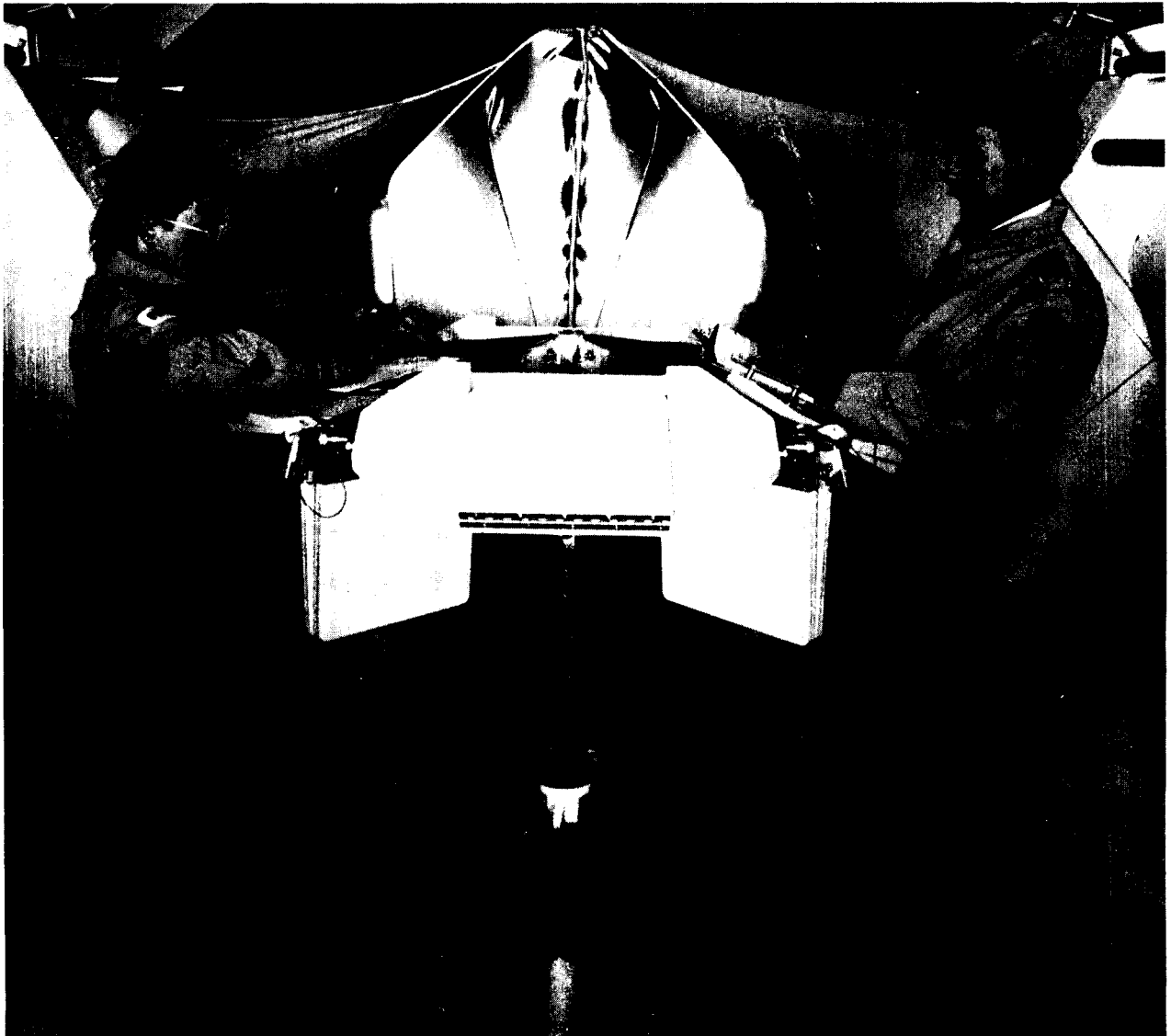
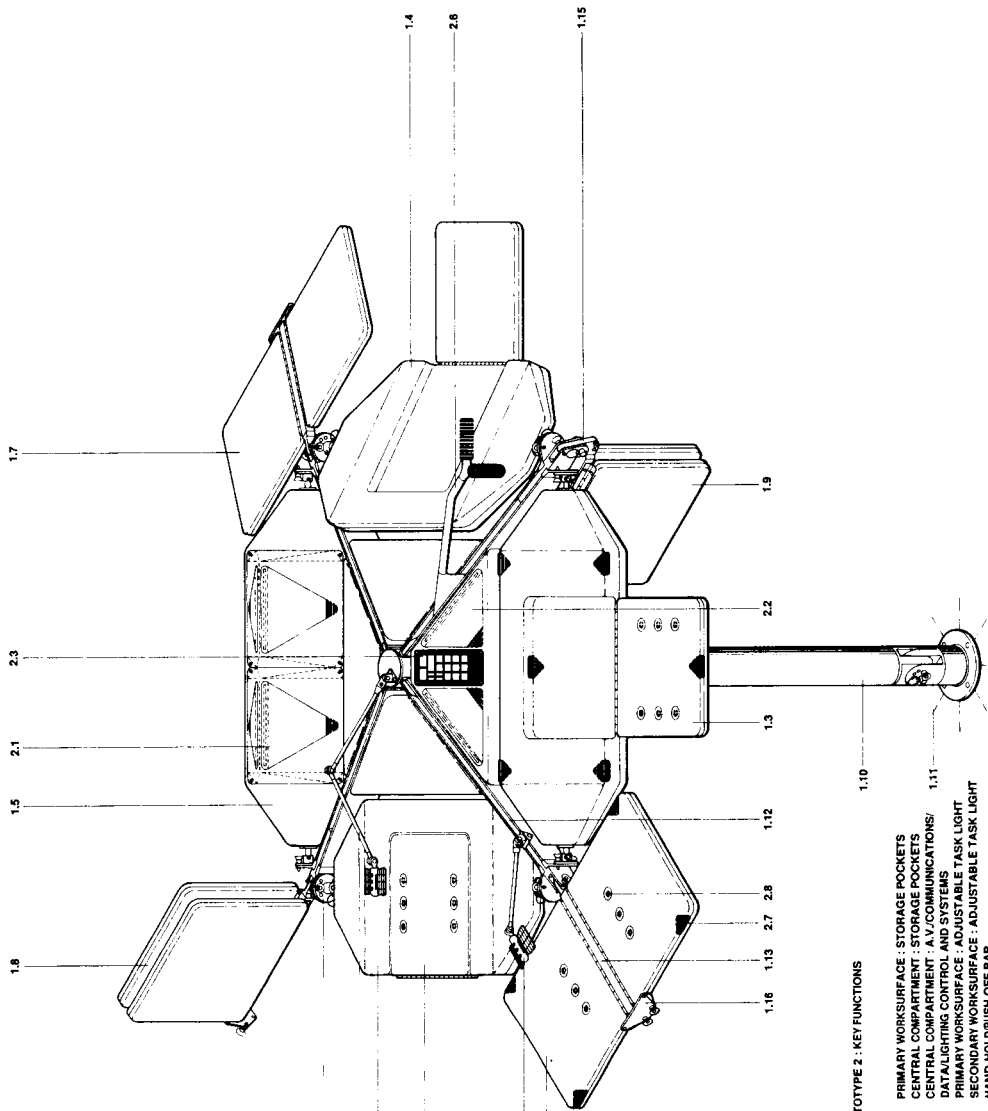

FIGURE 56 : WARDROOM TABLE INSTALLED IN MOCK-UP



1.14
2.4
1.1
1.2
2.5
1.6

PROTOTYPE 1 : KEY FUNCTIONS

- 1.1 PRIMARY WORKSURFACE : FLAT
- 1.2 WORKSURFACE : FLEXED
- 1.3 WORKSURFACE TRAY : EXTENDED
- 1.4 PRIMARY WORKSURFACE : SLOPED
- 1.5 PRIMARY WORKSURFACE : REVERSE SIDE
- 1.6 SECONDARY WORKSURFACE : EXTENDED FLAT
- 1.7 SECONDARY WORKSURFACE : EXTENDED SLOPED
- 1.8 SECONDARY WORKSURFACE : FOLDED
- 1.9 SECONDARY WORKSURFACE : STOWED
- 1.10 MAIN POST
- 1.11 BASE POST JOINT : VERTICAL
- 1.12 MAIN ARM
- 1.13 MAIN WORKSURFACE : SLOPE/REVERSE CONTROL
- 1.14 PRIMARY WORKSURFACE : SLOPE/STOW CONTROL
- 1.15 SECONDARY WORKSURFACE : SLOPE/STOW CONTROL
- 1.16 SECONDARY WORKSURFACE : FOLD/UNFOLD CONTROL

PROTOTYPE 2 : KEY FUNCTIONS

- 2.1 PRIMARY WORKSURFACE : STORAGE POCKETS
- 2.2 CENTRAL COMPARTMENT : STORAGE POCKETS
- 2.3 CENTRAL COMPARTMENT : A/V/COMMUNICATIONS/ DAYLIGHTING CONTROL AND SYSTEMS
- 2.4 PRIMARY WORKSURFACE : ADJUSTABLE TASK LIGHT
- 2.5 SECONDARY WORKSURFACE : ADJUSTABLE TASK LIGHT
- 2.6 HAND-HOLD/PUSH-OFF BAR
- 2.7 RESTRAINT TABS : MANUALS/LOGBOOKS/CHECKLISTS/ PRINT-OUTS/DOCUMENTS
- 2.8 RESTRAINT SOCKETS : MEAL TRAYS/FLAT MONITORS/ PORTABLE COMPUTERS

FIGURE 57 : WARDROOM TABLE PROTOTYPE SYSTEM CONCEPT

C-2

4.1.2 DESIGN CONCEPT

FIGURE 57 shows the prototype concept in diagrammatic form and the division of table elements and components into two prototype development stages to comply with an extended prototype development and testing schedule.

The design approach replaces the conventional concept of a unified table surface with a group of independent surface elements which can be rotated, unfolded and angled to suit a wide range and mixture of operational and ergonomic requirements. Primary design objectives are to provide a compact, efficient and safe design which is responsive to the fluctuating need for up to eight crew positions and which must function comfortably and easily in microgravity. Secondary design objectives are to integrate functional support features including task lighting, storage pockets, object/implement restraints, handholds/push-offs and data/communications controls and interfaces.

The table is intended to be comfortable, compact and easy to use by the crew. Comfort is achieved by the overall plan configuration which ensures good sightlines and vocal distances for all participants, and by the extending and angled surfaces which ensure compliance with the 5th/95th percentile anthropometric size range. Compactness is achieved by ensuring that the outer table surface positions fold away when not in use to free as much volume as possible around the table for crew activities and movement. Ease of use is achieved by ensuring that all mechanisms, controls and accessories are simple and obvious to use and that maintenance, repair and cleaning duties are as straightforward as possible.

4.1.3 FUNCTIONAL OPERATION

The key design capability of the concept lies in the structural and functional control and independence of each of the eight surfaces while maintaining the overall image and role of the table as a major social gathering point. Four octagonal surfaces provide 'inboard' positions. These are supported on end pivots which adjust and lock at different angles and rotate for storage pocket access on the reverse side. Four rectangular 'butterfly' surfaces provide additional 'outboard' positions. When not in use, these fold together and rotate to stow directly beneath the table arms. The center post is hinged at the top and the bottom with a locking pivot mechanism to enable the table to swing out of its vertical axis to one side to provide unobstructed access for large crew gatherings or emergency procedures.

FIGURE 58 shows the prototype set up for an eight-person crew group with all 'inboard' and 'outboard' positions in use and all worksurfaces trimmed to their shallowest angles.

FIGURE 59 shows the prototype set up for a four-person crew group with a combination of 'inboard' and 'outboard' positions in use and all worksurfaces trimmed to their shallowest angles.

FIGURE 60 shows the prototype set up for a full eight-person crew group with all worksurfaces trimmed to their steepest angles.

FIGURE 61 shows the prototype set up for a four-person crew group with all 'inboard' positions in use and worksurfaces trimmed to their shallowest angles. The 'outboard' worksurfaces can be seen stowed beneath the table arms.

FIGURE 62 shows the prototype set up for a four-person crew group with all worksurfaces trimmed to their steepest angles.

ORIGINAL PAGE
BLACK AND WHITE PHOTOGRAPH

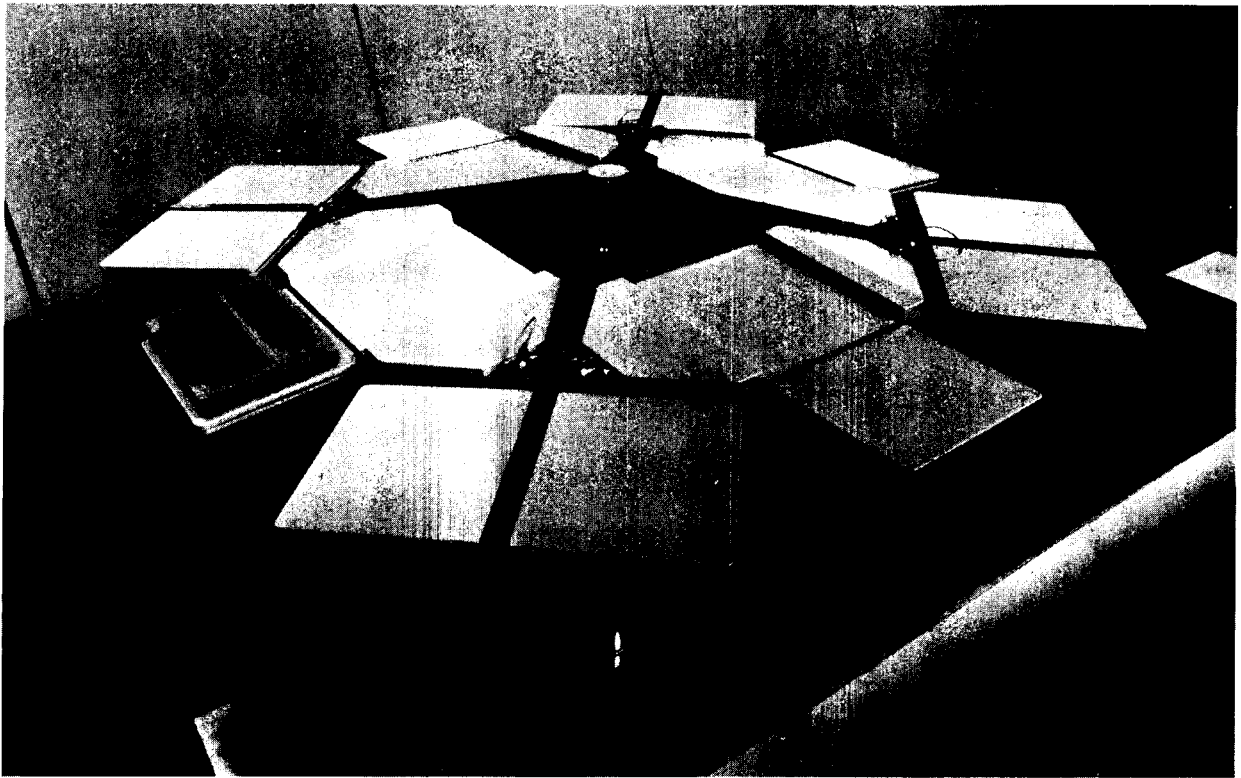

FIGURE 58 : TABLE 8-PERSON/SHALLOW-ANGLE SET-UP

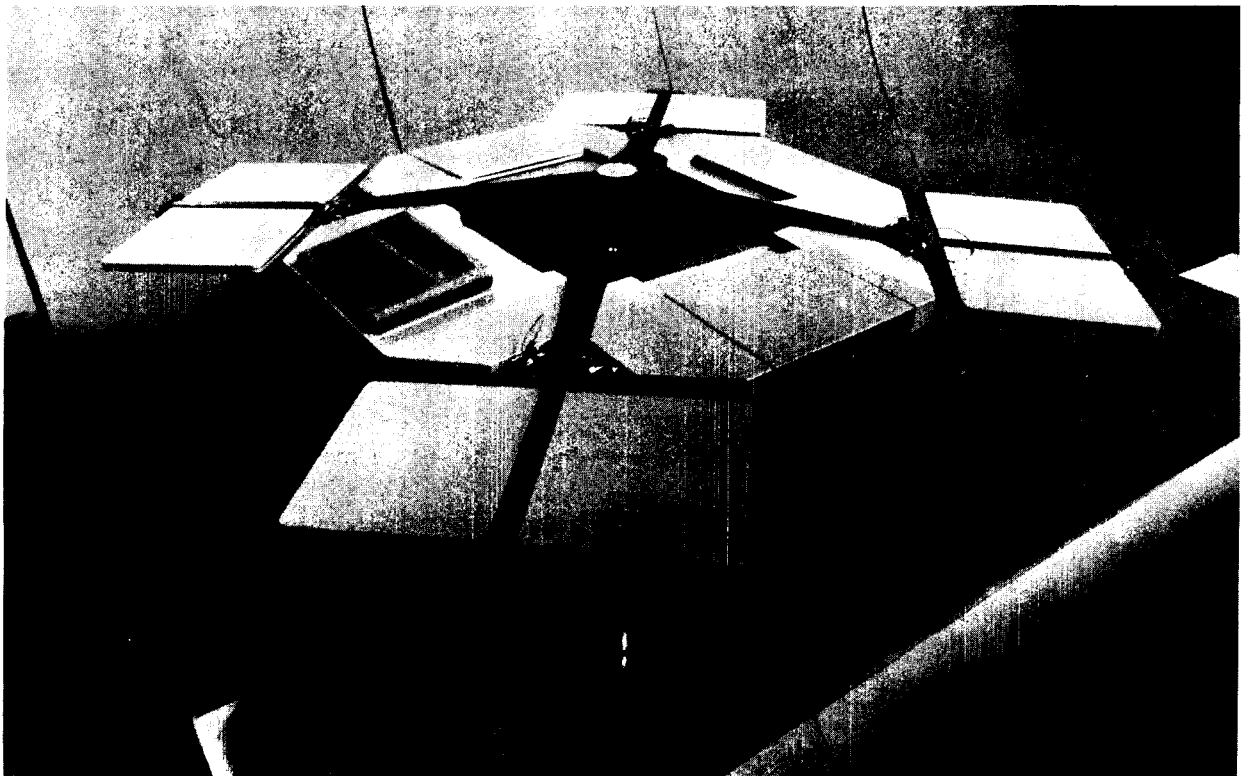

FIGURE 59 : TABLE EXT. 4-PERSON/SHALLOW-ANGLE SET-UP

ORIGINAL PAGE
BLACK AND WHITE PHOTOGRAPH

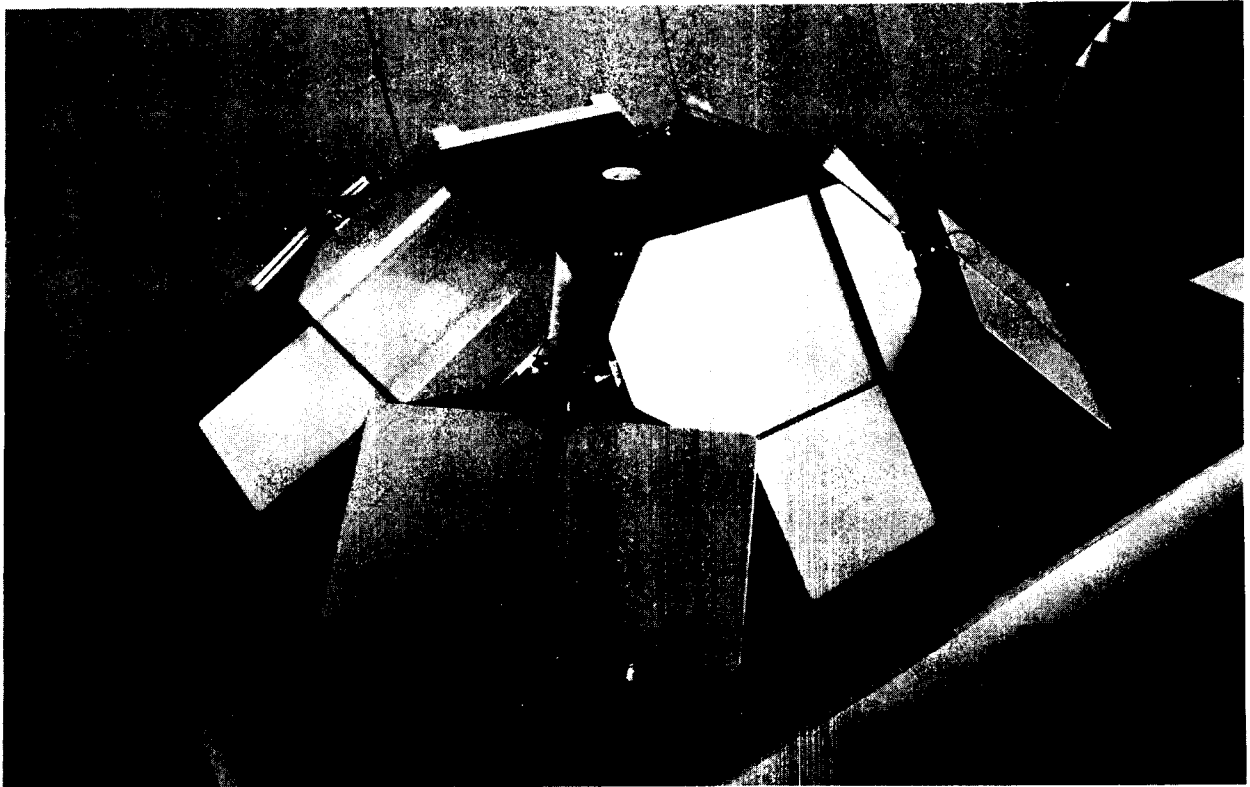

FIGURE 60 : TABLE 8-PERSON/STEEP-ANGLE SET-UP

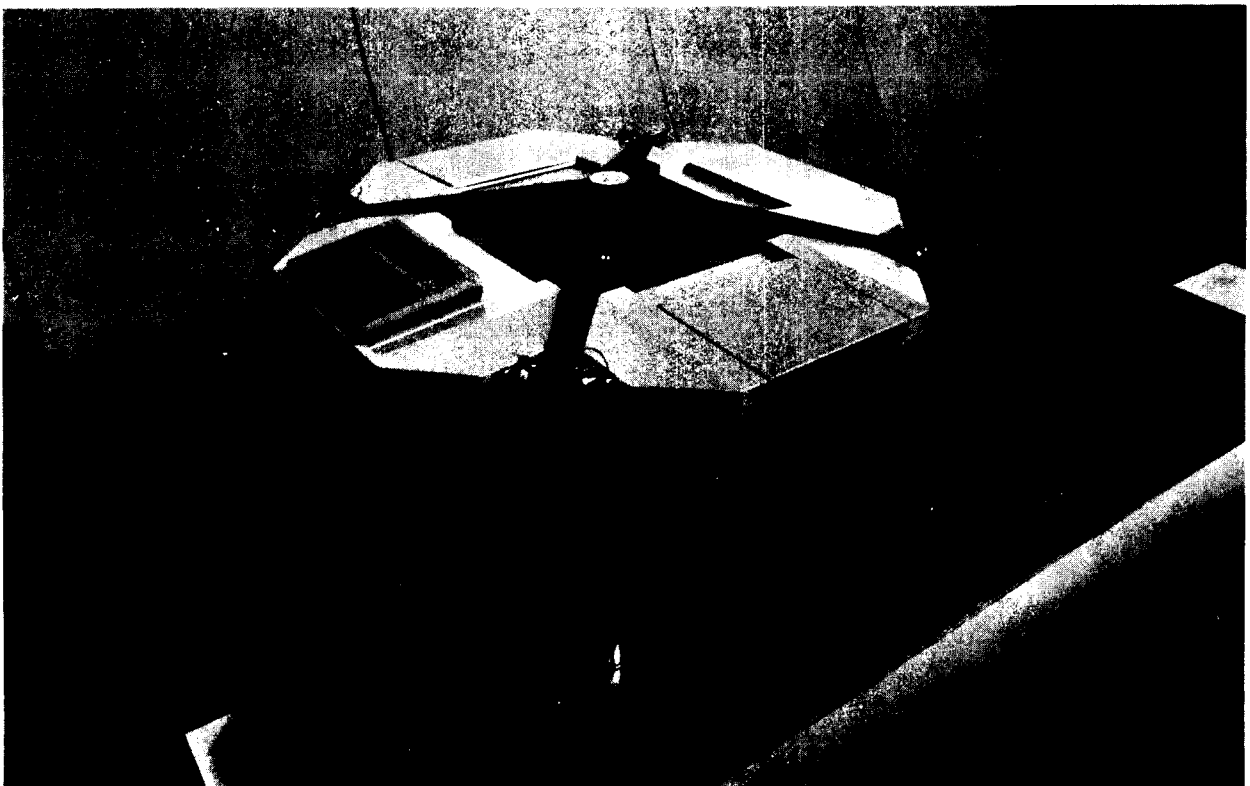

FIGURE 61 : TABLE 4-PERSON/SHALLOW-ANGLE SET-UP

ORIGINAL PAGE
BLACK AND WHITE PHOTOGRAPH

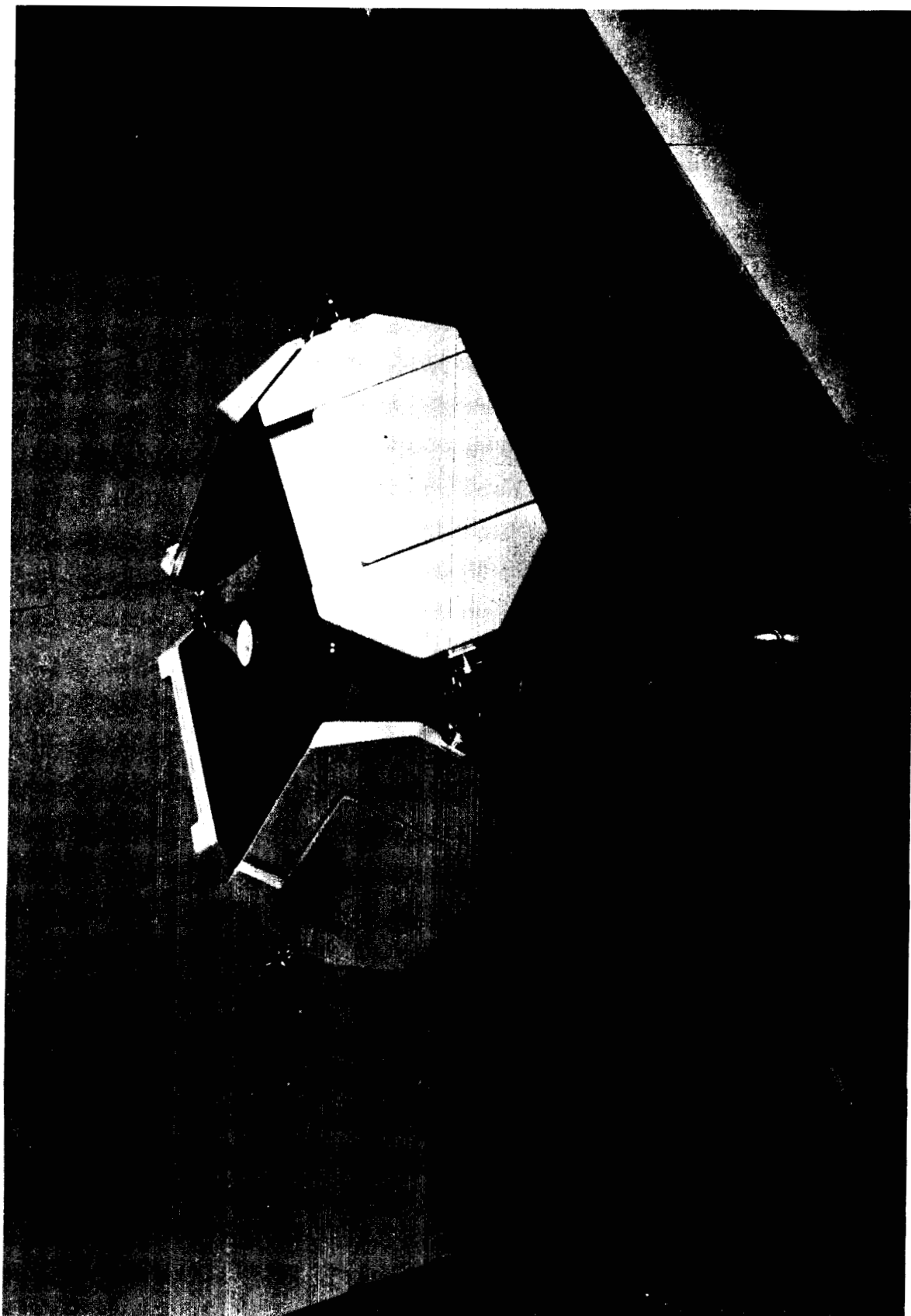

FIGURE 62 : TABLE 4-PERSON/STEEP-ANGLE SET-UP

4.1.4 WARDROOM TABLE ACTIVITY VARIATIONS

FIGURE 63 to FIGURE 74 inclusive show examples of crew activities which are likely to occur at the Wardroom Table in the Habitability Module. The examples are drawn from a series of diagrams developed during the study to illustrate the range of operational applications and crew combinations which are possible at the Wardroom Table.

Crew groups range from eight to two persons. At the Wardroom Table, crewmembers will engage in the activities below.

- Meetings and Conferences
- Planning, Training and Working Tasks
- Meals and Snacks
- Leisure Activities
- Combined/Mixed Activities

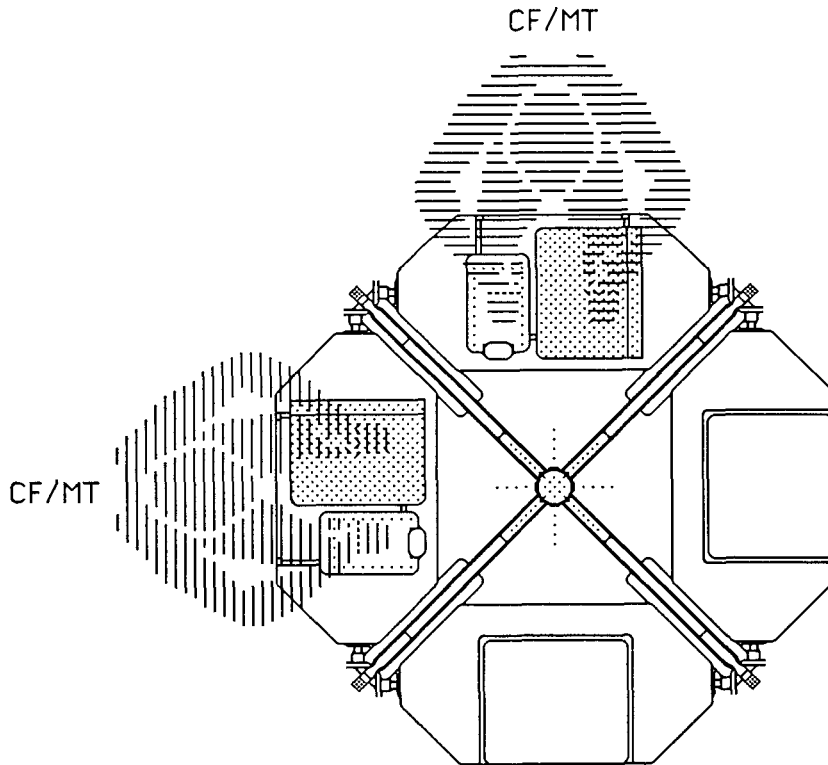

CREW ACTIVITY	CREW NUMBERS							
	1	2	3	4	5	6	7	8
MEETING/CONFERENCE [CF/MT]		■						
MEAL [ML]								
PLANNING/TRAINING/WORKING [PL/TR/WK]								
LEISURE [LS]								
TOTAL		■						

FIGURE 63 : WARDROOM TABLE ACTIVITY APPLICATION

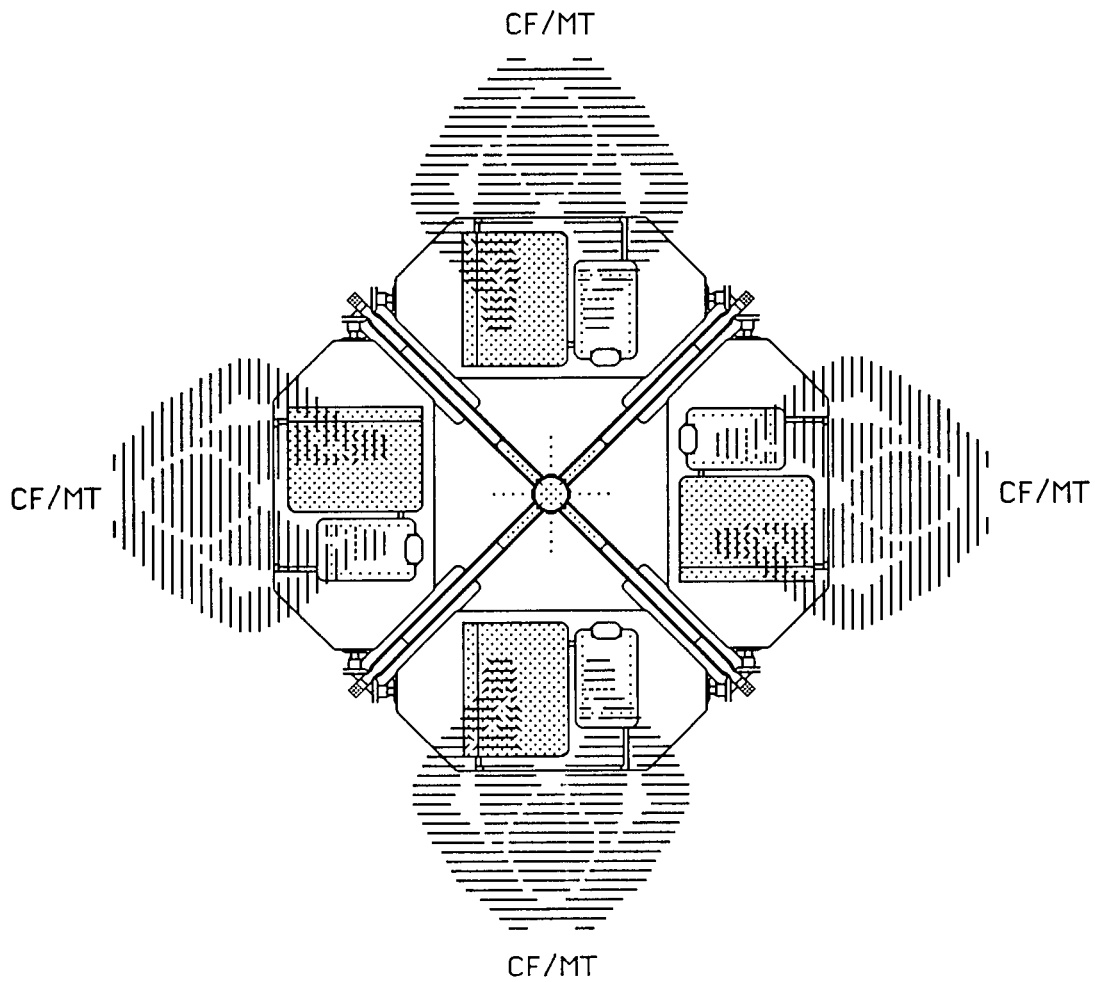

CREW ACTIVITY	CREW NUMBERS							
	1	2	3	4	5	6	7	8
MEETING/CONFERENCE[CF/MT]								
MEAL[ML]								
PLANNING/TRAINING/WORKING [PL/TR/WK]								
LEISURE[LS]								
TOTAL								

FIGURE 64 : WARDROOM TABLE ACTIVITY APPLICATION

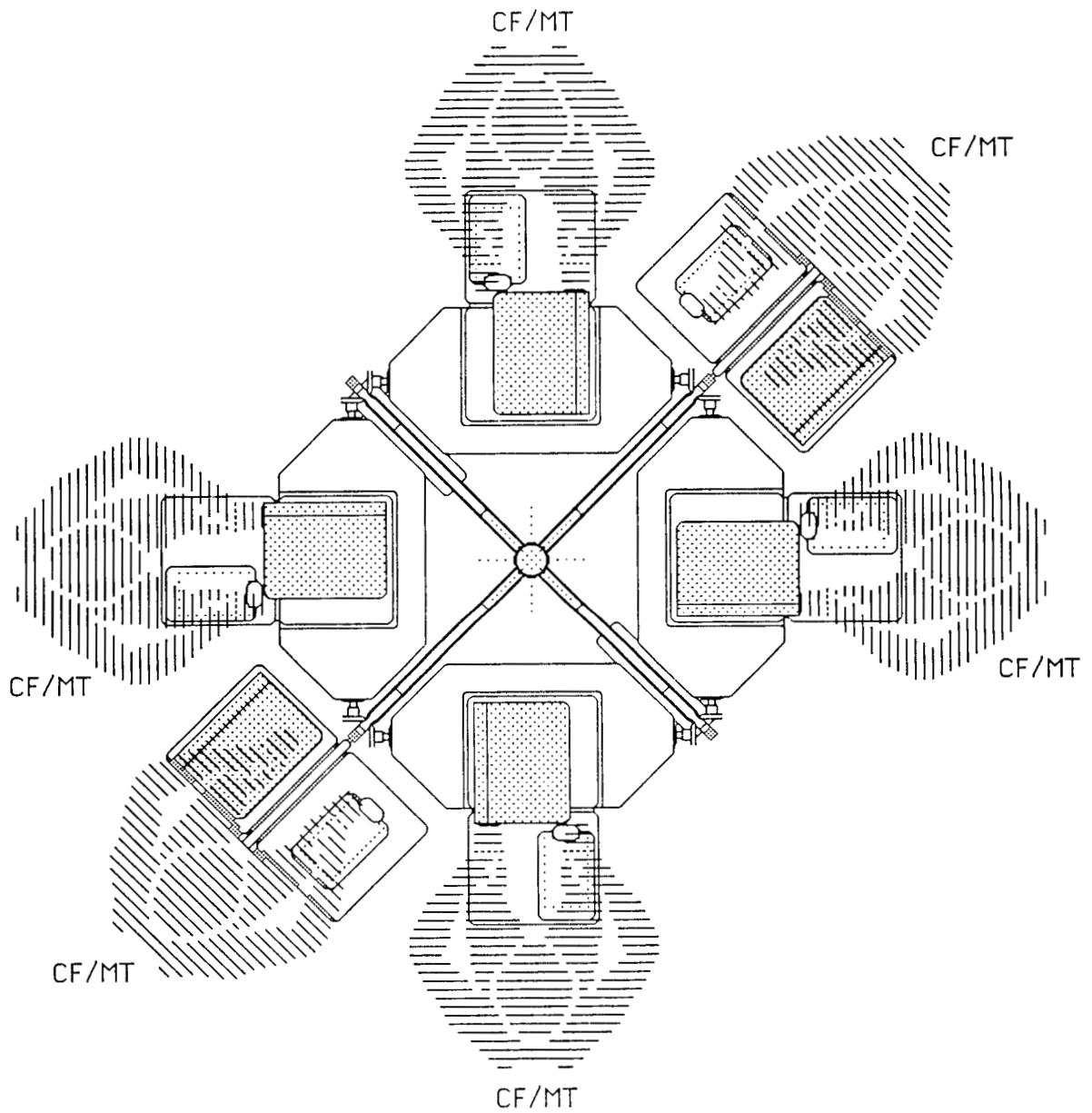

CREW ACTIVITY	CREW NUMBERS							
	1	2	3	4	5	6	7	8
MEETING/CONFERENCE [CF/MT]						■		
MEAL [ML]								
PLANNING/TRAINING/WORKING [PL/TR/WK]								
LEISURE [LS]								
TOTAL						■		

FIGURE 65 : WARDROOM TABLE ACTIVITY APPLICATION

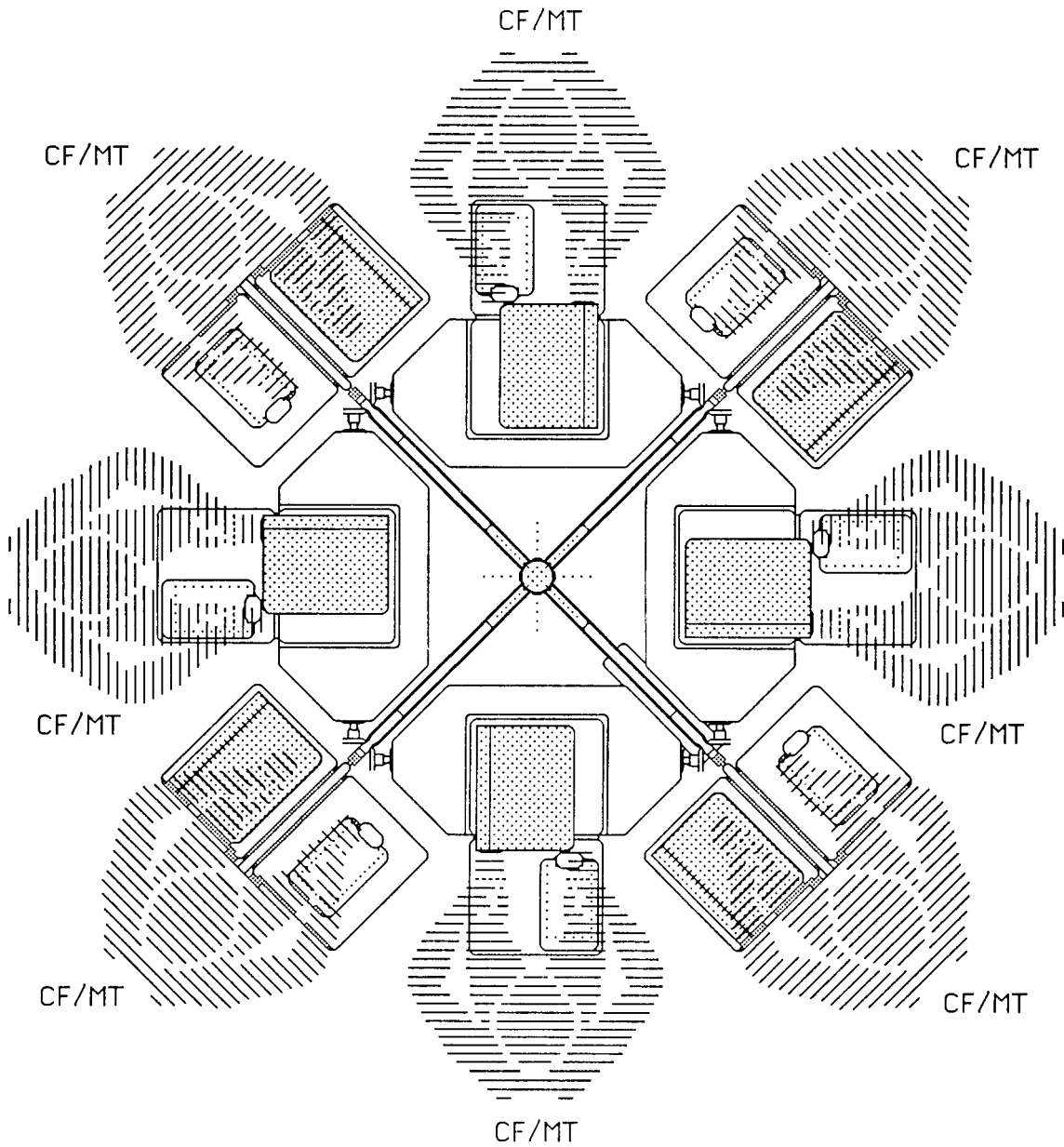

CREW ACTIVITY	CREW NUMBERS							
	1	2	3	4	5	6	7	8
MEETING/CONFERENCE [CF/MT]								
MEAL [ML]								
PLANNING/TRAINING/WORKING [PL/TR/WK]								
LEISURE [LS]								
TOTAL								

FIGURE 66 : WARDROOM TABLE ACTIVITY APPLICATION

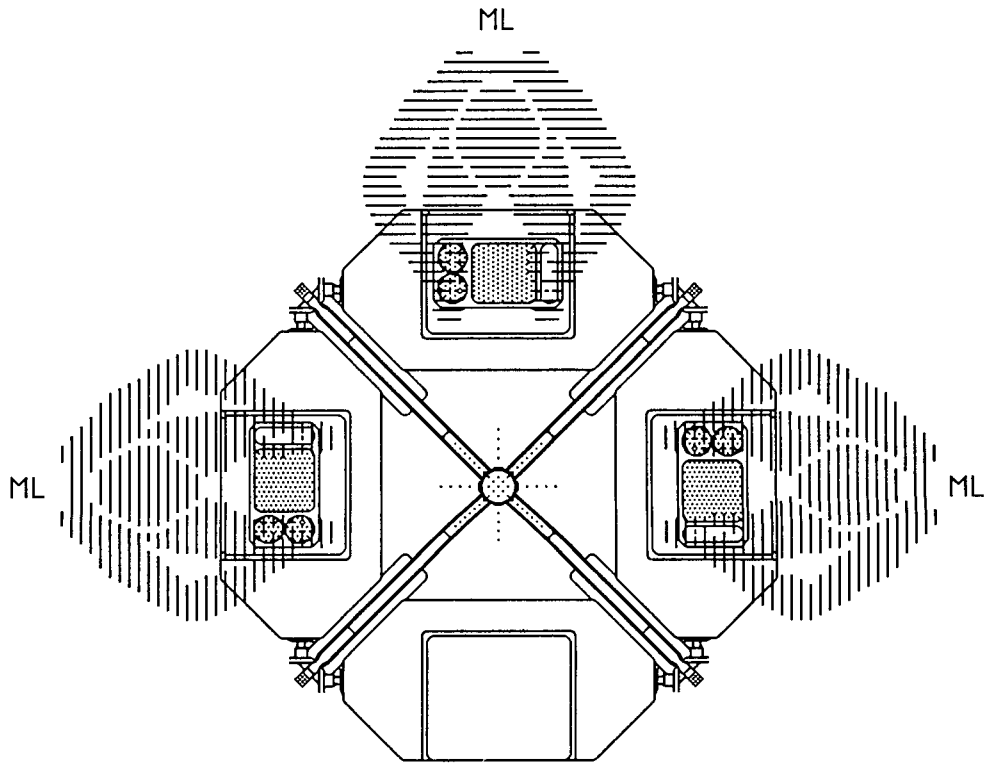

CREW ACTIVITY	CREW NUMBERS							
	1	2	3	4	5	6	7	8
MEETING/CONFERENCE[CF/MT]								
MEAL [ML]								
PLANNING/TRAINING/WORKING [PL/TR/WK]								
LEISURE [LS]								
TOTAL								

FIGURE 67 : WARDROOM TABLE ACTIVITY APPLICATION

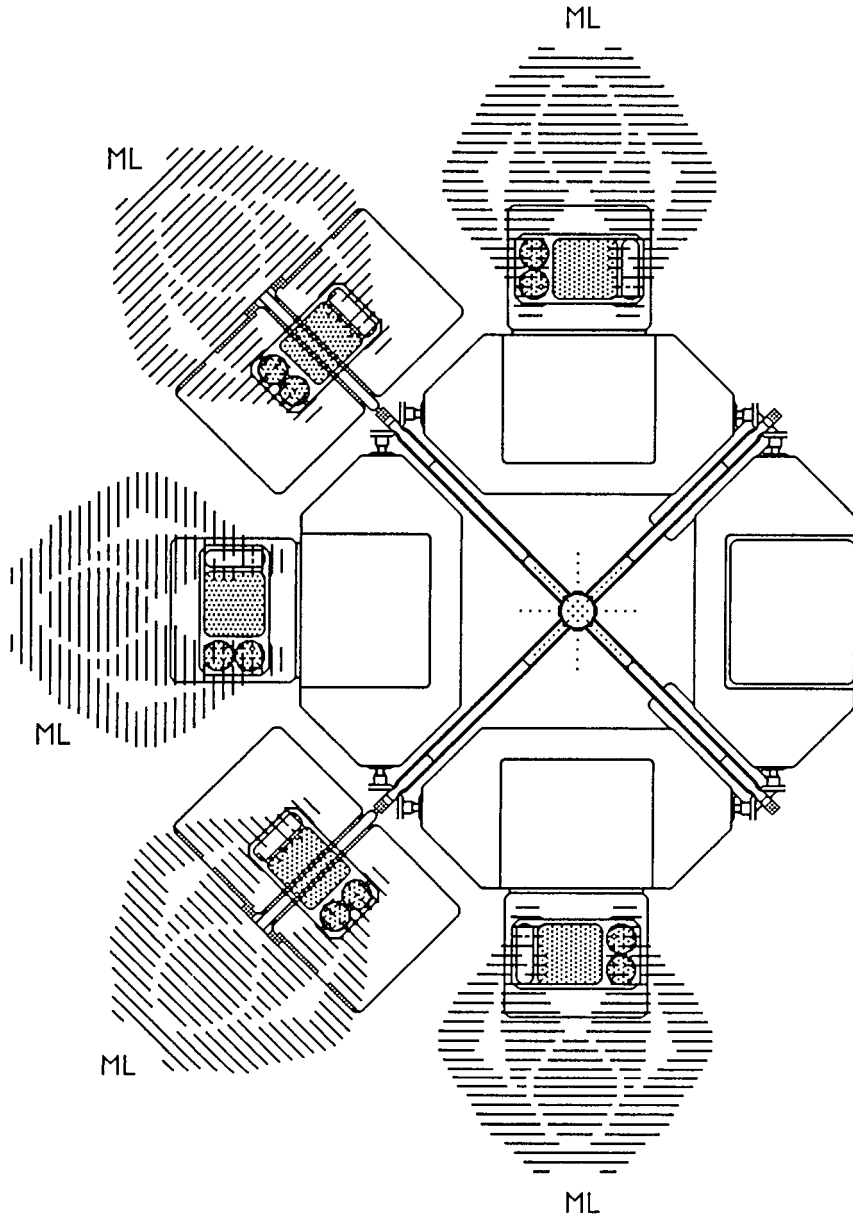

CREW ACTIVITY	CREW NUMBERS							
	1	2	3	4	5	6	7	8
MEETING/CONFERENCE[CF/MT]								
MEAL[ML]								
PLANNING/TRAINING/WORKING [PL/TR/WK]								
LEISURE[LS]								
TOTAL								

FIGURE 68 : WARDROOM TABLE ACTIVITY APPLICATION

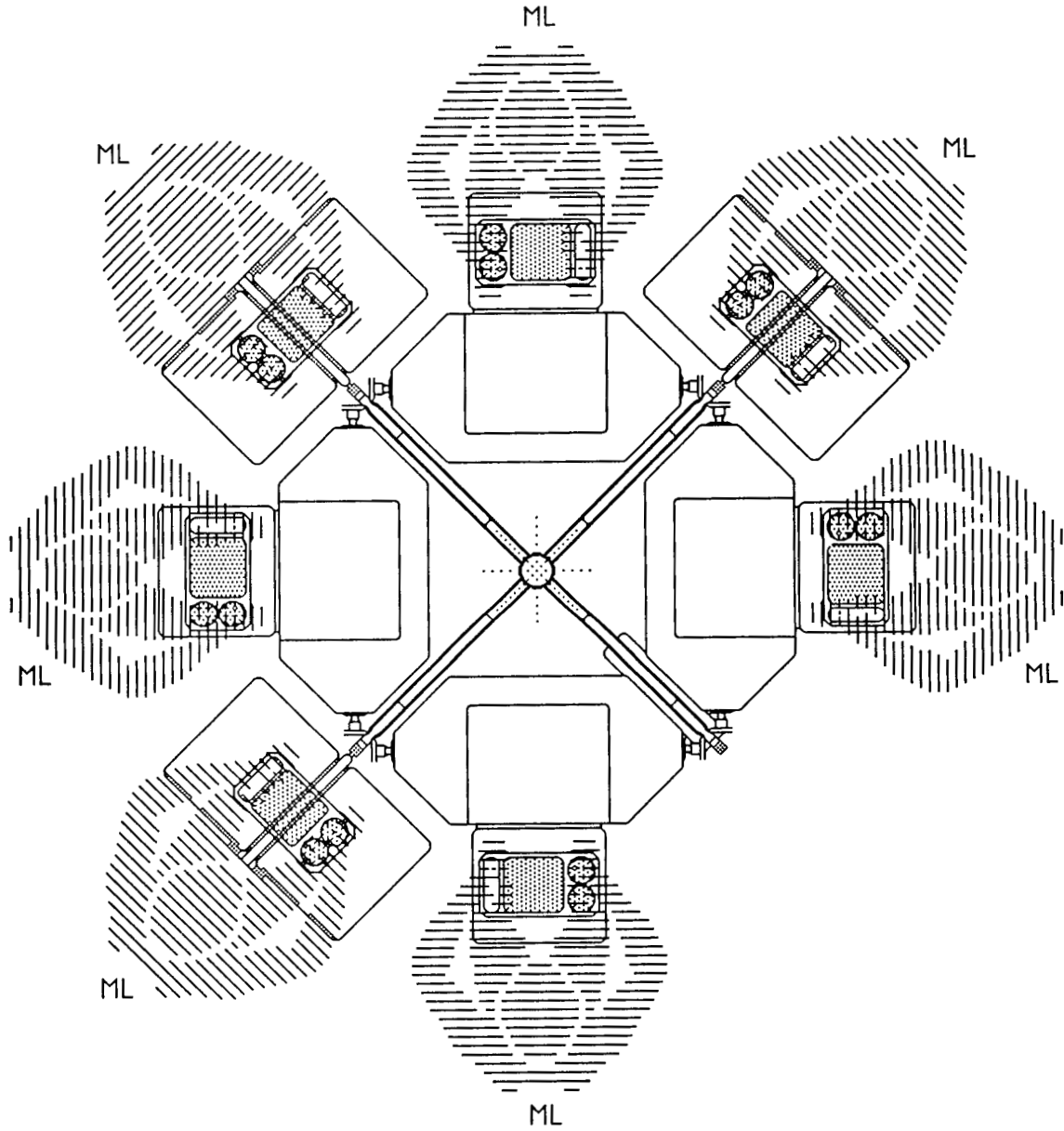

CREW ACTIVITY	CREW NUMBERS							
	1	2	3	4	5	6	7	8
MEETING/CONFERENCE [CF/MT]								
MEAL [ML]							■	
PLANNING/TRAINING/WORKING [PL/TR/WK]								
LEISURE [LS]								
TOTAL							■	

FIGURE 69 : WARDROOM TABLE ACTIVITY APPLICATION

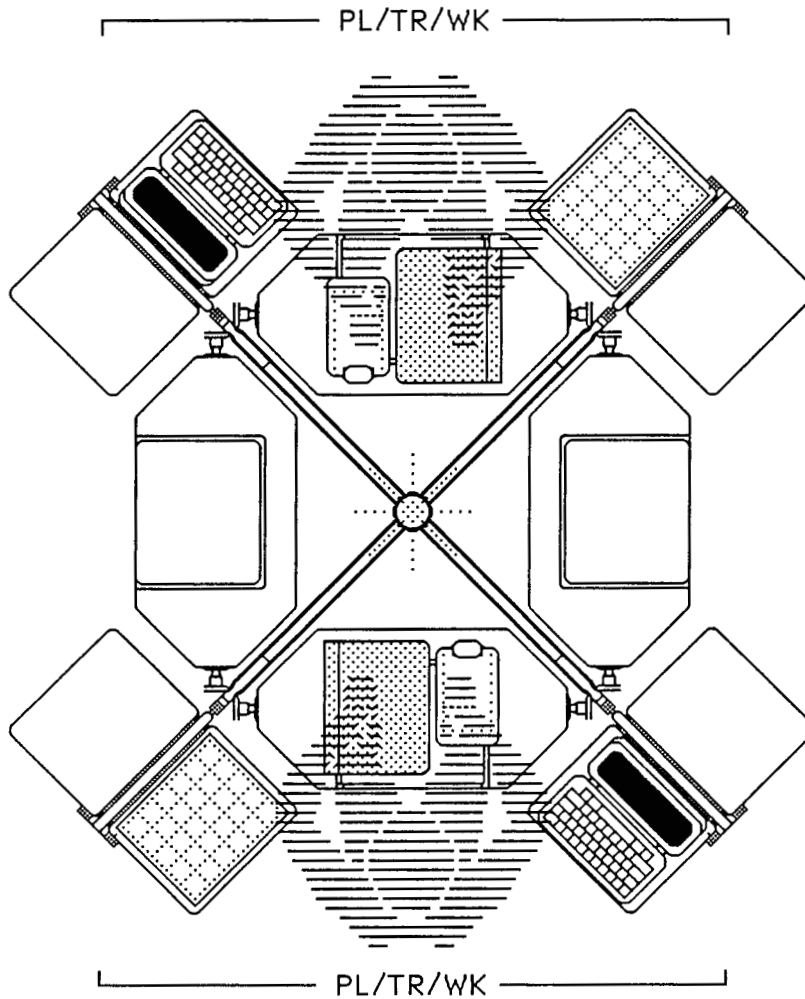

CREW ACTIVITY	CREW NUMBERS							
	1	2	3	4	5	6	7	8
MEETING/CONFERENCE[CF/MT]								
MEAL[ML]								
PLANNING/TRAINING/WORKING [PL/TR/WK]								
LEISURE[LS]								
TOTAL								

FIGURE 70 : WARDROOM TABLE ACTIVITY APPLICATION

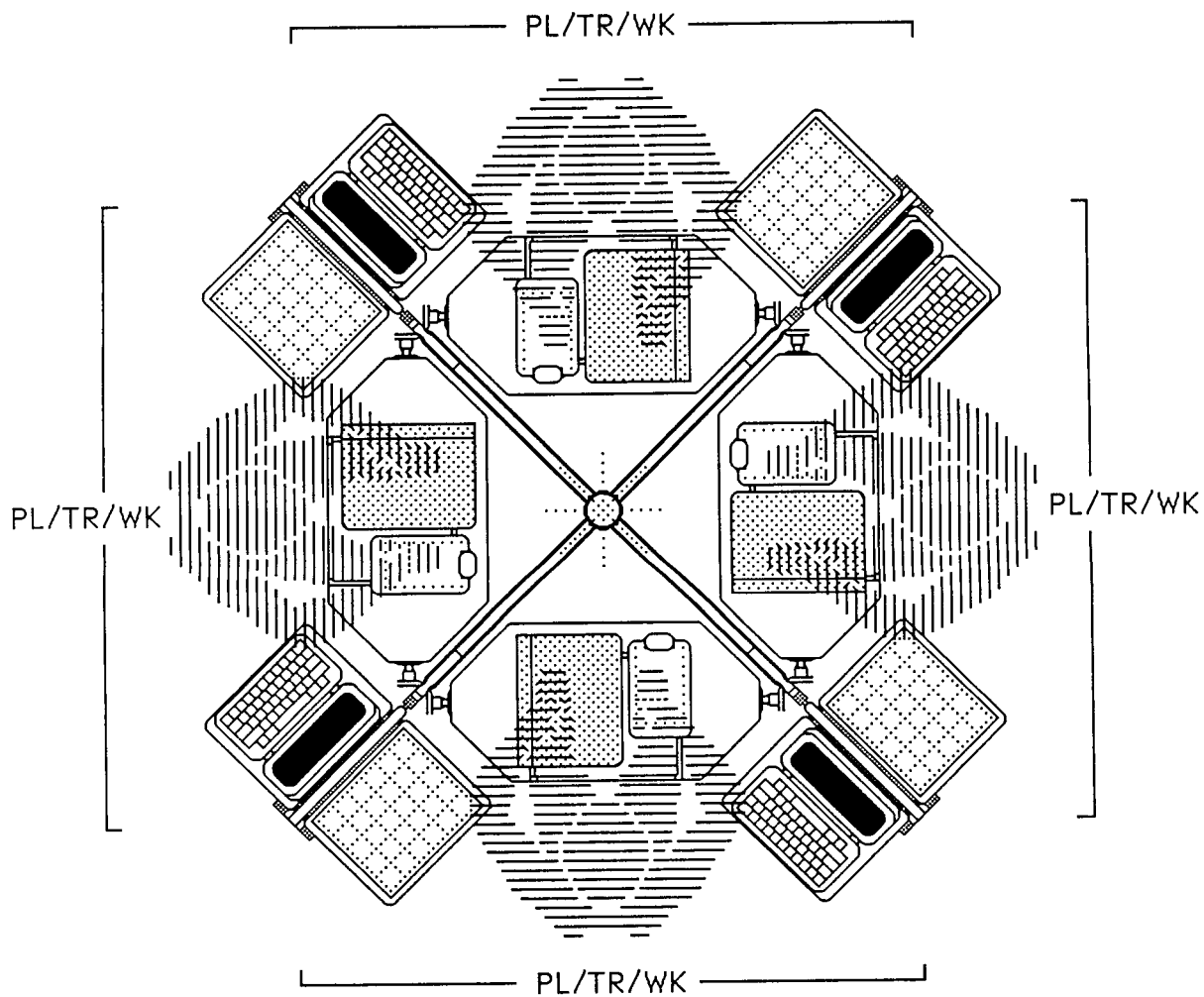

CREW ACTIVITY	CREW NUMBERS							
	1	2	3	4	5	6	7	8
MEETING/CONFERENCE[CF/MT]								
MEAL[ML]								
PLANNING/TRAINING/WORKING [PL/TR/WK]				■				
LEISURE[LS]								
TOTAL				■				

FIGURE 71 : WARDROOM TABLE ACTIVITY APPLICATION

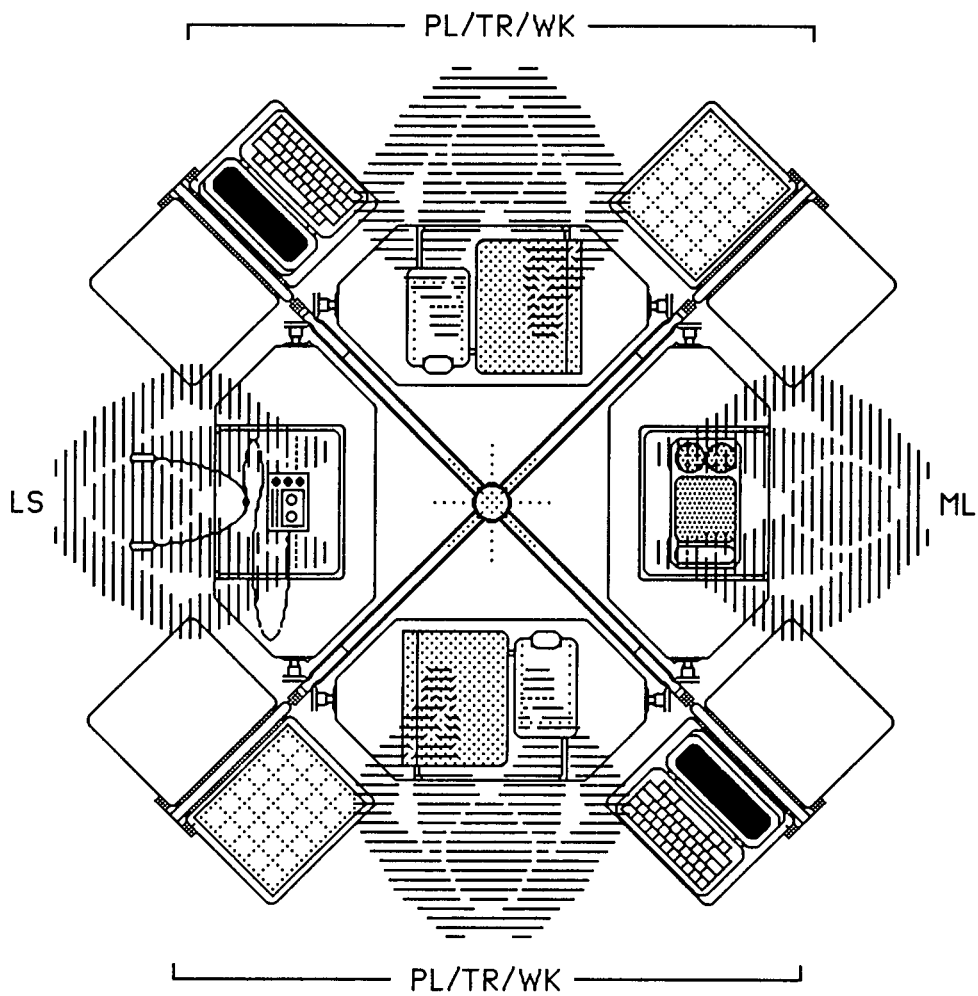

CREW ACTIVITY	CREW NUMBERS							
	1	2	3	4	5	6	7	8
MEETING/CONFERENCE[CF/MT]								
MEAL[ML]	■							
PLANNING/TRAINING/WORKING [PL/TR/WK]		■						
LEISURE[LS]	■							
TOTAL				■				

FIGURE 72 : WARDROOM TABLE ACTIVITY APPLICATION

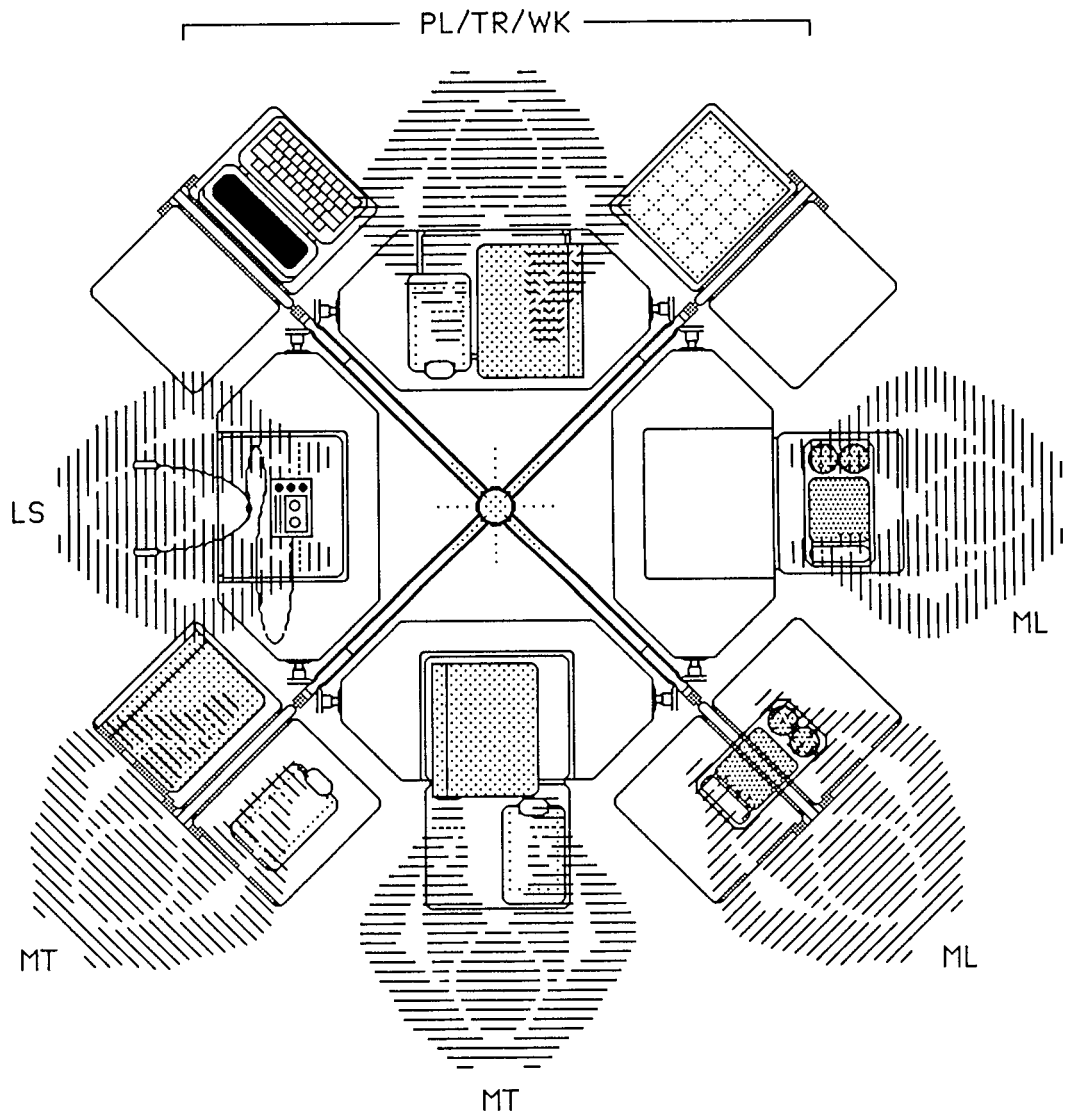

CREW ACTIVITY	CREW NUMBERS							
	1	2	3	4	5	6	7	8
MEETING/CONFERENCE[CF/MT]		■						
MEAL[ML]								
PLANNING/TRAINING/WORKING [PL/TR/WK]	■							
LEISURE[LS]								
TOTAL						■		

FIGURE 73 : WARDROOM TABLE ACTIVITY APPLICATION

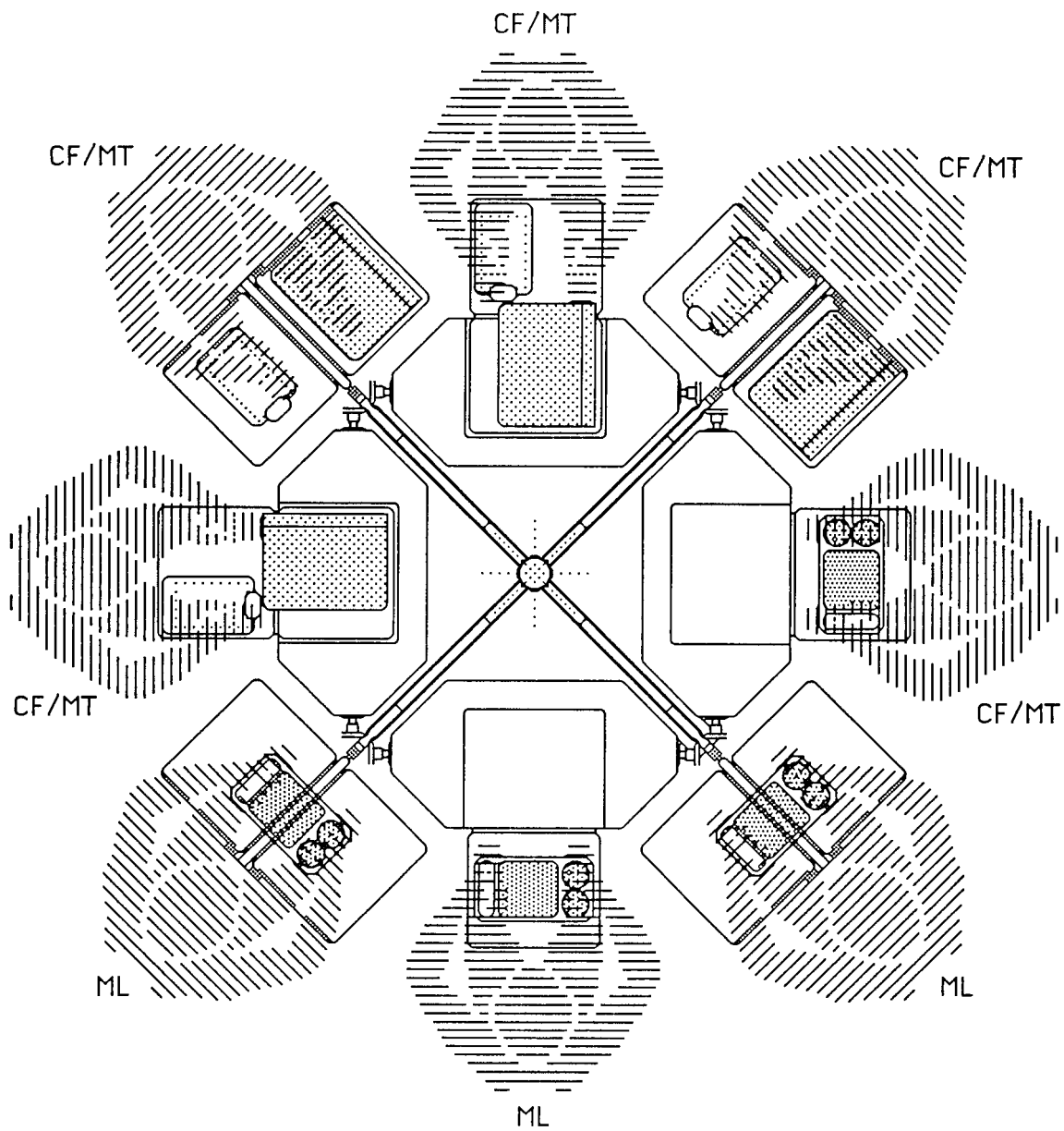

CREW ACTIVITY	CREW NUMBERS							
	1	2	3	4	5	6	7	8
MEETING/CONFERENCE[CF/MT]					■			
MEAL[ML]			■					
PLANNING/TRAINING/WORKING [PL/TR/WK]								
LEISURE[LS]								
TOTAL								■

FIGURE 74 : WARDROOM TABLE ACTIVITY APPLICATION

4.1.5 WARDROOM TABLE IN 4-STANDOFF CONFIGURATION

FIGURE 75 and FIGURE 76 show computer-generated views of the Wardroom Table as it would appear installed in the 4-standoff configuration in the Habitability Module. These views are included for comparison with the Wardroom Table as it appears in the rotated-standoff configuration in this study.

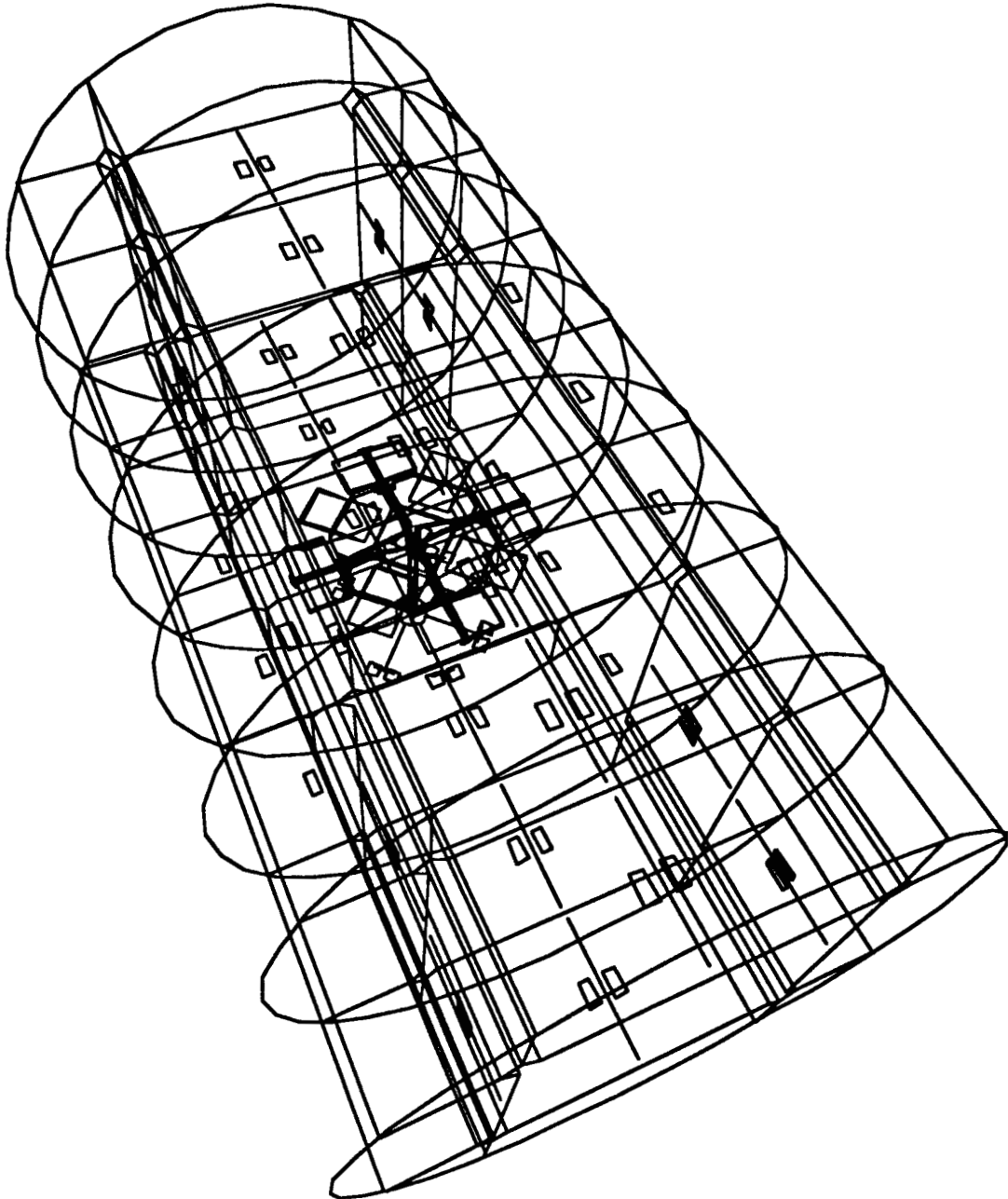

FIGURE 75 : VIEW OF TABLE IN 4-STANDOFF CONFIGURATION

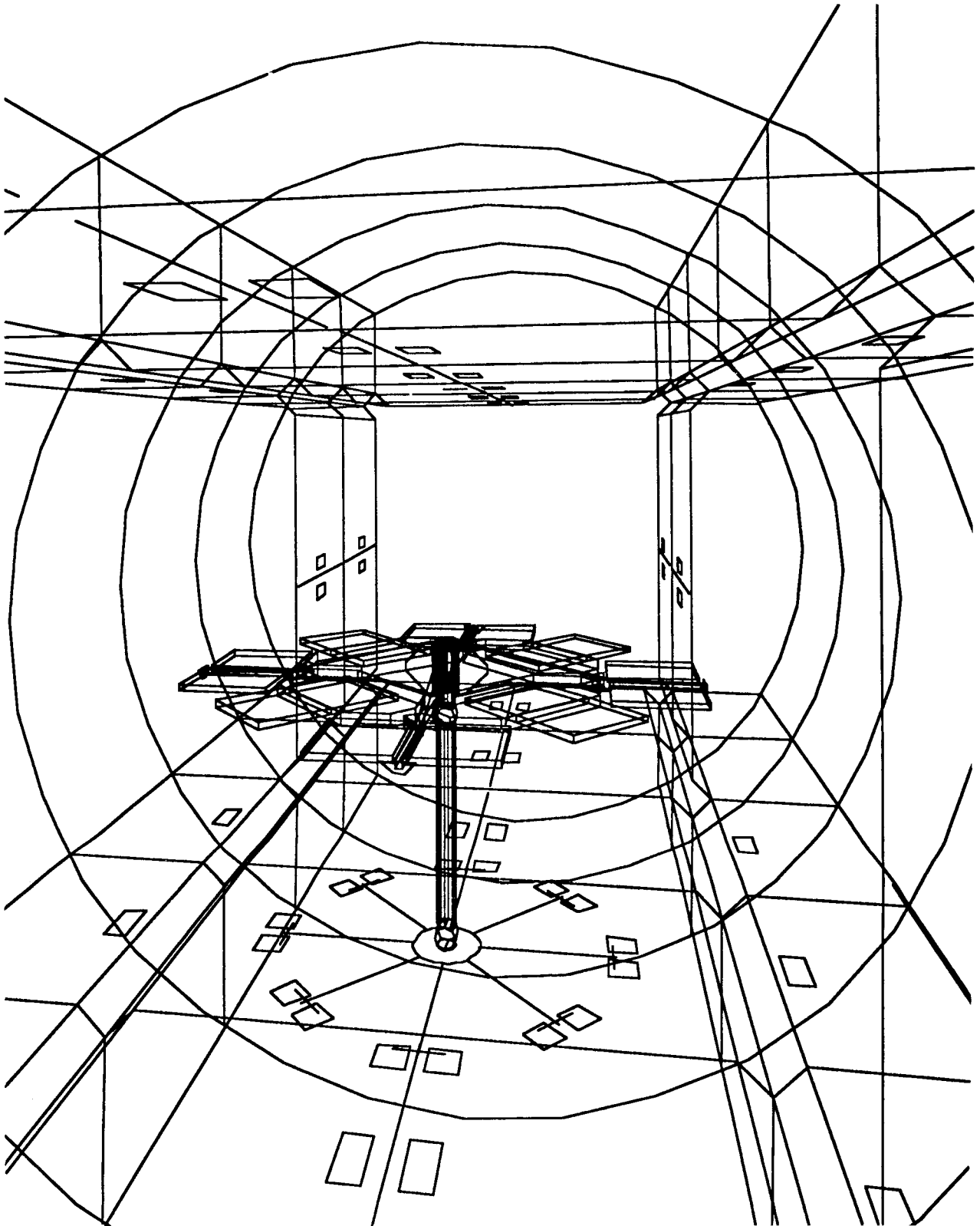

FIGURE 76 : VIEW OF TABLE IN 4-STANDOFF CONFIGURATION

4.2 PORTABLE/WEARABLE WORKSTATION

4.2.1 PURPOSE

The Portable/Wearable Workstation is designed to supplement fixed workstations in the Habitability Module. The purpose of the workstation is to provide a compact, portable and versatile facility with communications, data management and audio-visual capabilities.

The workstation is designed to deploy/extend outwards in front of the body during operation and fold/stow inwards when not in use and during translation by crewmembers. The workstation can be used in various Module, Node and Cupola work locations in a Space Station environment.

4.2.2 PRELIMINARY PROTOTYPE CONCEPT

The preliminary concept for the Portable/Wearable Workstation utilizes a series of interconnected shallow panel elements. A central panel incorporates a computer keyboard and small display screen. A top panel incorporates either a large computer display screen or a transparent screen for HUD. Two detachable side panels provide support for checklists and manuals. The design of the prototype anticipates the near-term commercial availability of thin-screen, high-fidelity display technology in compact and lightweight form. A commercially-available laptop computer was incorporated into the design for the purposes of preliminary prototype evaluation.

In deployed/extended mode, the panels form an ergonomically-shaped display directly in front of the user. The display is attached to a back support/harness with two adjustable, articulated arms which lock in position to provide rigidity and stability to counter imposed hand, arm or torso forces vectored onto the workstation panels when in use. The position and angle of the panels is adjustable to suit a full range of arm-reach and sight-line comfort preferences. In stowed mode, the workstation is designed for compact and rapid fold-up against the front body torso leaving the user with both hands free to facilitate translation in the microgravity environment. Further workstation prototype studies will develop a design which provides maximum wearer comfort and minimum physical projection during movement in microgravity.

FIGURE 77 shows a side view of the Portable/Wearable Workstation in the fully-deployed position. The back support/harness is shown with shoulder straps and two task lights mounted at head height. A notional HUD panel is shown extended vertically above the computer panel. The wearer is shown attaching a side panel to the center panel.

FIGURE 78 shows a front view of the Portable/Wearable Workstation in the fully-deployed position. The task lights are shown either side of the wearer's head. Both side panels are shown in their respective positions.

FIGURE 79 shows a side view of the Portable/Wearable Workstation in the fully-retracted position. The workstation harness frame and panels are folded backwards and stowed against the wearer's chest.

FIGURE 80 shows a close-up view of the Portable/Wearable Workstation panels. A laptop computer is incorporated into the center panel of the preliminary prototype and is shown in use by the wearer. The notional HUD panel is shown extended at an angle to the right. The two side panels are shown extended on either side of the center panel.

ORIGINAL PAGE
BLACK AND WHITE PHOTOGRAPH



FIGURE 77 : SIDE VIEW OF DEPLOYED P'BLE/W'BLE WORKST'N

ORIGINAL PAGE
BLACK AND WHITE PHOTOGRAPH



FIGURE 78 : FACE VIEW OF DEPLOYED P'BLE/W'BLE WORKST'N

ORIGINAL PAGE
BLACK AND WHITE PHOTOGRAPH



FIGURE 79 : SIDE VIEW OF STOWED P'BLE/W'BLE WORKST'N

ORIGINAL PAGE
BLACK AND WHITE PHOTOGRAPH

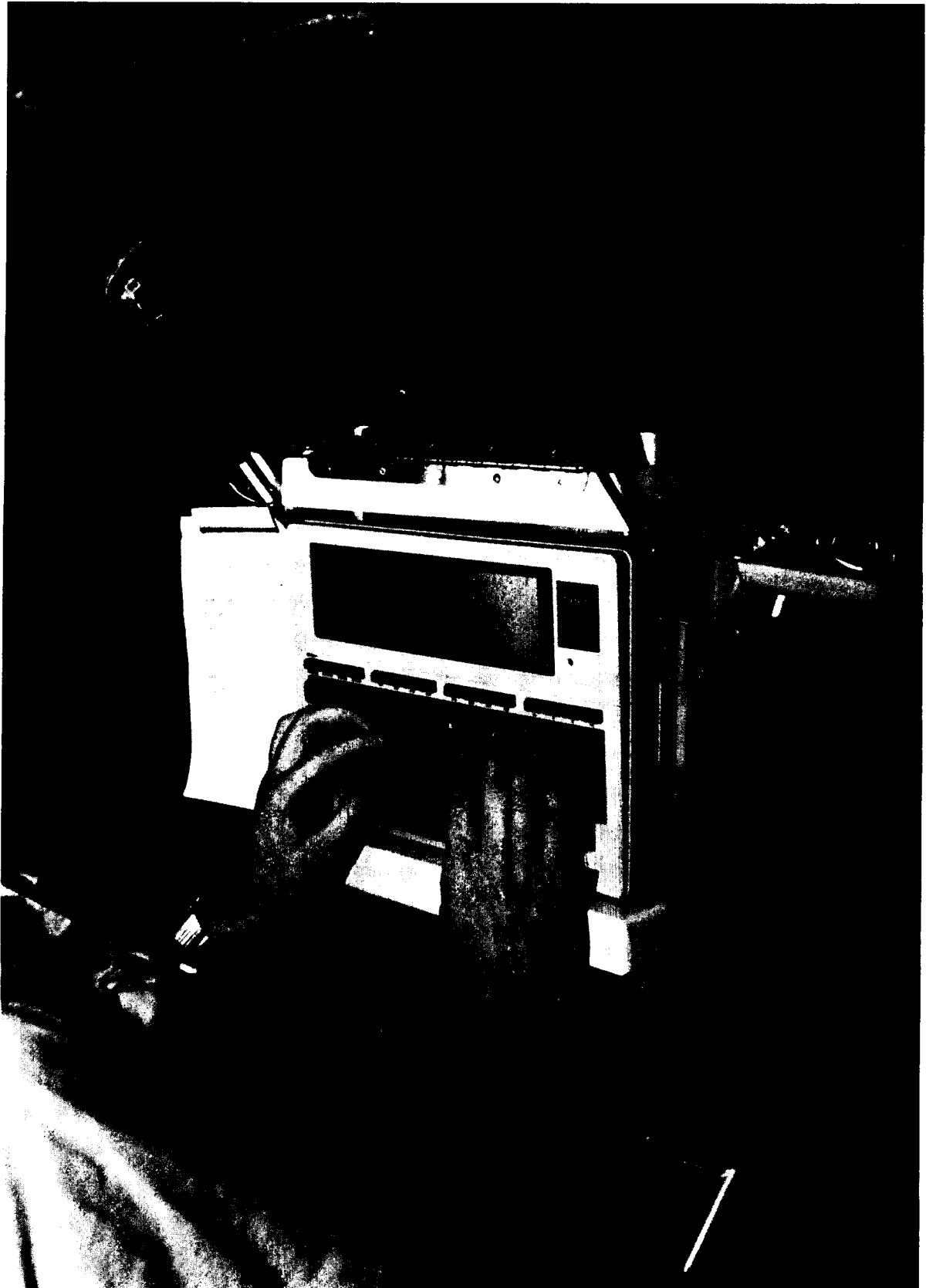

FIGURE 80 : CLOSE-UP OF DEPLOYED P'BLE/W'BLE WORKST'N

4.2.3 REDUCED GRAVITY KC-135 FLIGHT-TEST

The preliminary prototype was developed for testing on a NASA KC-135 reduced gravity flight-test. The aim of the flight-test was to conduct a preliminary evaluation of the performance of the Portable/Wearable Workstation in a simulated microgravity environment to establish the general feasibility of the concept.

Two series of parabolas were utilized for flight-testing the prototype. Each parabola series comprised twenty cycles of thirty-second intervals of simulated microgravity.

The first parabola series was dedicated to testing deployment and ergonomic aspects of the workstation.

The tests are summarized as follows:

- Ease of movement in microgravity with the workstation in non-deployed and deployed positions.
- Deployment characteristics of the workstation in restrained and unrestrained positions.
- Adjustment of accessory panels and lights in restrained and unrestrained positions.
- Examination of workstation physical comfort range in microgravity.
- Effects of finger and arm forces upon prototype keyboard, display, and accessory panels.

The second parabola series was designed to test the workstation while performing various tasks in microgravity.

The tests are summarized as follows:

- Writing upon clipboard panel attachment, and testing velcro-attached writing implement.
- Efficacy of the harness-mounted task lights.
- Computer operation in restrained and unrestrained positions.
- Effects of microgravity upon task concentration while using workstation in restrained and unrestrained positions.
- Ease of using miscellaneous equipment and accessories (e.g. video camera) while operating/wearing workstation.

FIGURE 81 shows a view of the interior of the NASA KC-135 aircraft during the flight-test. The Portable/Wearable Workstation and test subject are shown in the foreground.

FIGURE 82 shows the test subject operating the Portable/Wearable Workstation in the fully-deployed position. A leg restraint is used to enable the test subject to remain in a stationary position during part of the flight-test.

FIGURE 83 shows a side view of the test subject and the Portable/Wearable Workstation. Tension cords were connected from the top of the back support to the base of the center panel to provide additional strength and stability during the flight-test maneuvers.

FIGURE 84 shows a close-up view of the Portable/Wearable Workstation with the test subject operating the laptop computer.

ORIGINAL PAGE
BLACK AND WHITE PHOTOGRAPH

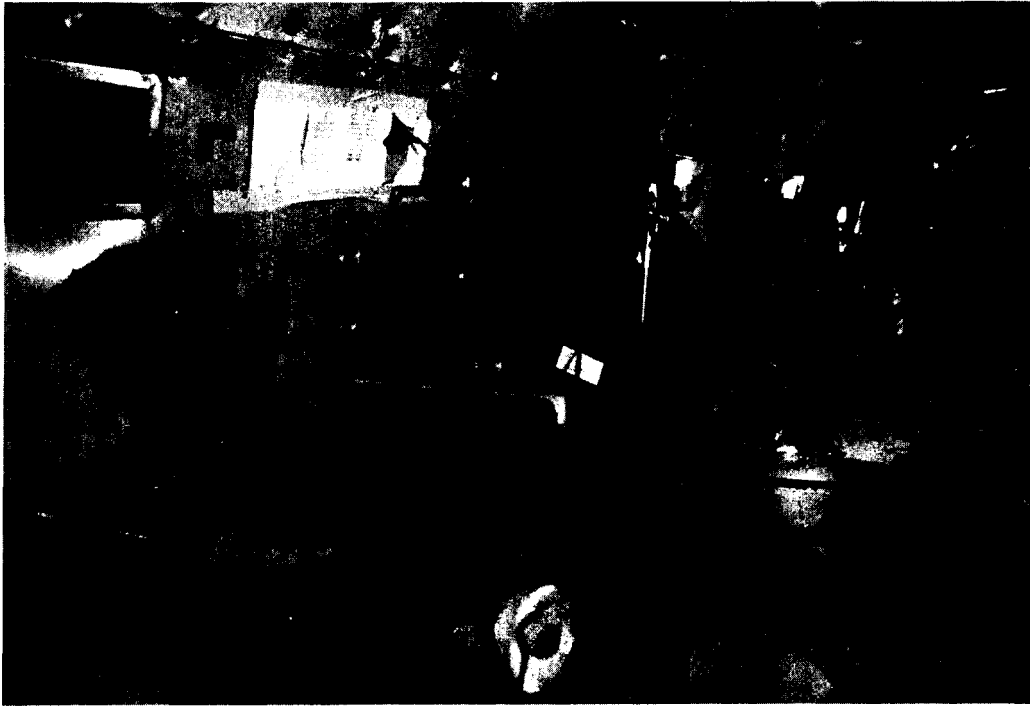

FIGURE 81 : PORTABLE/WEARABLE WORKST'N FLIGHT-TEST

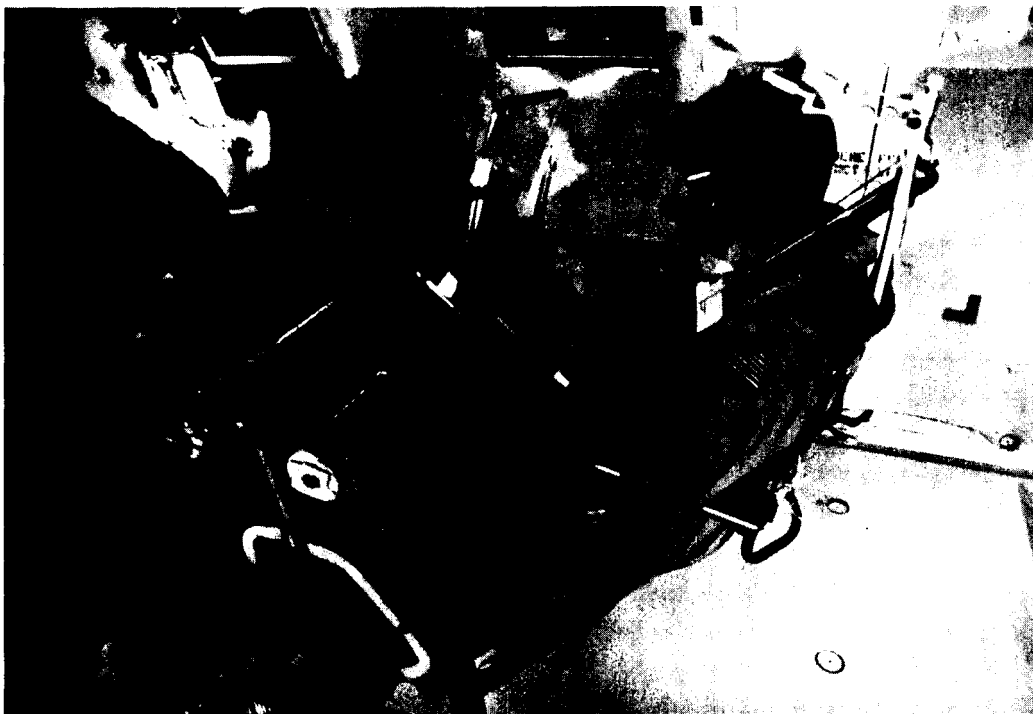

FIGURE 82 : PORTABLE/WEARABLE WORKST'N FLIGHT-TEST

ORIGINAL PAGE
BLACK AND WHITE PHOTOGRAPH



FIGURE 83 : PORTABLE/WEARABLE WORKST'N FLIGHT-TEST



FIGURE 84 : PORTABLE/WEARABLE WORKST'N FLIGHT-TEST

4.2.4 FLIGHT-TEST RESULTS AND RECOMMENDATIONS

The evaluation of the performance of the Portable/Wearable Workstation was assisted by analysis of a videotape that was taken during the flight. The results of the in-flight observations and post-flight analysis enabled several design modifications to be identified for application to further prototype studies.

The recommended modifications are summarized as follows:

- Reduction of the back support/harness to a smaller, more compact and less physically intrusive attachment.
- Potential integration of the body harness into a crew "shirt-sleeve" flightsuit as a removable belt or similar device.
- Re-location of workstation task lighting and its integration into the center panel.
- More compact and versatile frame for the entire workstation assembly.
- Further evaluation of appropriate computer hardware and software options for workstation integration.
- Further evaluation and testing of 5th/95th percentile anthropometric requirements, FOV requirements and arm-reach requirements.
- Easier and quicker workstation doffing/removal for improved safety in microgravity conditions.

4.3 PASSIVE LEG RESTRAINT

4.3.1 PURPOSE

A preliminary prototype of a Passive Leg Restraint was developed for incorporation in the Wardroom mock-up. The restraint is designed to stabilize the body without the use of attachments or muscular tension in a relaxed microgravity body posture.

4.3.2 PRELIMINARY PROTOTYPE CONCEPT

The preliminary concept for the Passive Leg Restraint is based on a simple and self-adjusting design without any active devices or mechanisms.

An initial version of the preliminary concept was constructed in prototype form and used in conjunction with the Portable/Wearable Workstation on the NASA KC-135 flight-test described in SECTION 4.2.3 of this report. This initial prototype is shown in FIGURE 82 in use by the test subject during the flight-test.

The evaluation results of the flight-test were used in the development of the preliminary prototype described below.

FIGURE 85 shows a sketch view of the preliminary prototype.

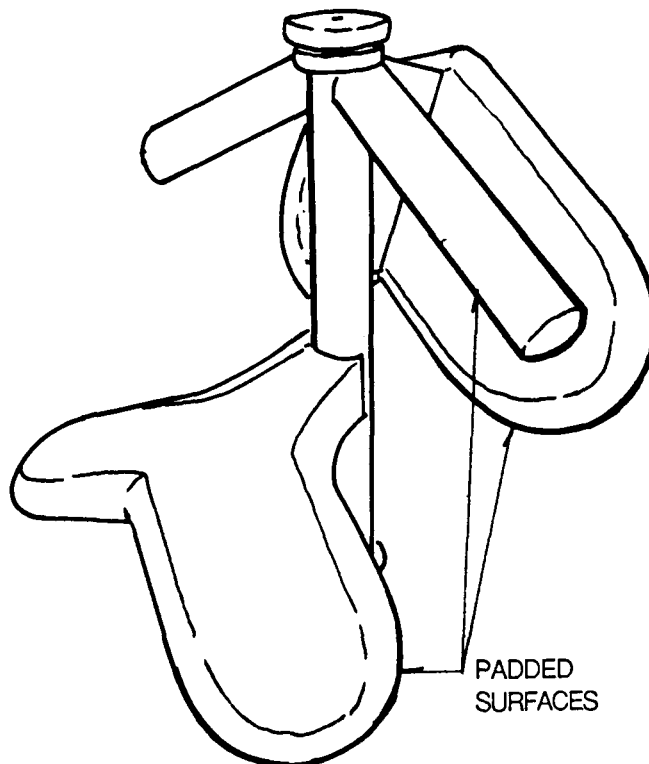

FIGURE 85 : PASSIVE LEG RESTRAINT PROTOTYPE

The concept employs a user-imposed, friction fit of the restraint against the lower leg and foot. This aims to provide comfortable long-duration usage by distributing the body forces through the lower and upper leg muscles. This is achieved by providing three contact points per lower limb as follows:

- The front of the leg at the knee.
- The top of the foot at the ankle.
- The back of the leg at the upper calf.

All forces from upper body movements are countered by the triangulation of these three points.

The restraint consists of three padded surfaces which provide support and comfort at the three contact points. To don the restraint, persons approach from above and wedge their legs into each side of the restraint with a scissors movement. The gaps between the padded surfaces are tapered to provide sufficient width for large legs towards the extremities of the restraint and sufficient width for small legs towards the center of the restraint. This configuration is in accordance with 5th/95th percentile anthropometric neutral-body posture requirements. The tapered leg openings are used in combination with inclined padded surface geometries to elevate low percentile [small] users to the same approximate arm and eye level as high percentile [large] users. This enables all restraint users to approach a common horizontal eye reference during crew meetings, work tasks and other group activities.

FIGURE 86 is a diagram showing the capability of the Passive Leg Restraint to achieve a close horizontal eye reference for users with different anthropometric percentile body sizes.

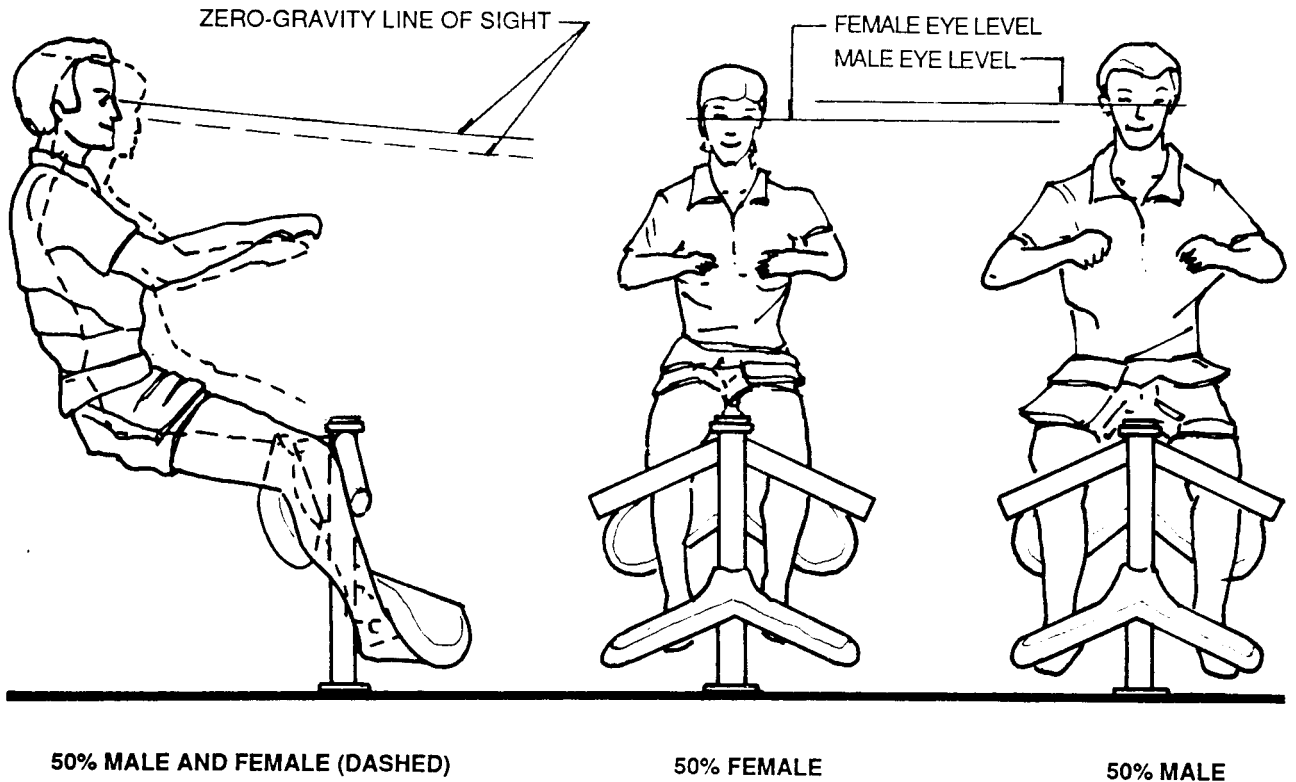

FIGURE 86 : PASSIVE LEG RESTRAINT USER OPERATION

In the preliminary prototype, the three padded contact surfaces are attached to a central support post. The post bolts to the floor surface at its base with a threaded internal rod attached to a circular knob at the top of the post. When the knob is turned, the base of the rod engages in a threaded recessed socket in the floor surface.

Further prototype studies of the Passive Leg Restraint will explore issues of demountability, portability and stowability with the aim of improving the performance of the initial design.

5 CONCLUSIONS

LIFE-CYCLE MODIFICATION

- LIFE-CYCLE RECONFIGURATION/UPGRADING OPTIONS ARE CONSTRAINED BY INITIAL ACCOMMODATION, STANDOFF AND UTILITIES DESIGN

Potential life-cycle scenarios for Space Station Module evolution and reconfiguration indicate a requirement for initial functional flexibility of organization, standoff structure and utility systems. This is necessary to ensure that all systems are able to respond to change-out, modification or upgrading procedures.

In the concept developed in this study, a typical post-IOC reconfiguration for the Habitability Module involves relocation of the entire 'night' zone including personal sleeping quarters and personal hygiene facilities to a post-IOC 'dormitory' Module, relocation of the HM/Exercise Facility, elimination of the 'buffer' zone and volumetric expansion of the Galley and the Wardroom. Many such life-cycle scenarios are possible. The extent to which it is possible to modify, reconfigure or upgrade a Module depends on the degree of ease or difficulty of decommissioning, detaching, relocating, reattaching and recommissioning of racks, compartments, standoff elements, utility systems and other accessories and items. These issues, in turn, depend on the quality of engineering provisions incorporated at the Module development stage designed to enable such changes to occur.

ORGANIZATION AND ZONING

- A DEDICATED BUFFER ZONE SEPARATING DAY AND NIGHT ACCOMMODATION INCREASES NOISE ATTENUATION AND IMPROVES PERSONAL PRIVACY

The Space Station will initially be occupied by an 8-person crew split into two shifts. The shifts will operate continuously throughout a 24-hour period with off-duty and on-duty shifts alternating approximately every 12 hours. Since day and night crew facilities are combined in a single Module, the proximity of both shifts raises problems of privacy and noise for the off-duty shift involved in personal hygiene tasks, leisure activities or asleep.

In the concept developed in this study, the internal accommodation in the Habitability Module is organized into a 'day' zone and a 'night' zone with the two zones separated by a dedicated 'buffer' zone to provide visual privacy and sound attenuation. The buffer zone comprises a small translation volume bordered by racks with operable screens at either end. The screens provide visual and acoustic separation of the two major activity zones. During translation by a crewmember, the screens consecutively fold or retract to the side of the passage to ensure continuity of visual privacy and acoustic attenuation. The buffer zone intentionally excludes racks or compartments requiring frequent crew access or utilization.

ARCHITECTURAL CONFIGURATION

- **DUAL-LEVEL CONFIGURATIONS IMPROVE OPERATIONAL/TRANSLATIONAL EFFICIENCY AND GENERATE ENHANCED PERCEPTUAL INTEREST**

The number, positions and geometry of standoffs within Space Station Modules determine the options and opportunities for the design of the interior configurations.

In the concept developed in this study, four standoffs are positioned at the cardinal points around the circular Module cross-section to create a 'floor' standoff, a 'ceiling' standoff and two 'wall' standoffs. The two wall standoffs incorporate full-depth, triangular profiles and the floor and ceiling standoffs incorporate shallow-depth, truncated profiles. The resulting increase in available vertical height inside the Module enables an upper or 'loft' level of accommodation to be introduced. In the Wardroom, this approach produces a spacious facility for large group activities at the lower level with a separate corridor for translation at the upper level. Next to the Wardroom, facilities such as Exercise Compartments and Workstations can be co-located on different levels. Dual-level configurations also generate visually interesting interiors with increased intra-Module view distances, a wider range of potential crew viewpoints and improved configuration overall architectural qualities.

STANDOFF STRUCTURAL SYSTEMS

- **DEMOUNTABLE STANDOFF STRUCTURE CONTRIBUTES TO REDUCED PHYSICAL OBSTRUCTION AND SIMPLER ON-ORBIT MODIFICATION**

Structural standoffs provide the major design reference for Space Station Module interior configurations. Their main structural function is to provide rack and compartment tie-down and load distribution to the Module hull during NSTS launch and acceleration, and corresponding restraint and pivoting once in orbit.

In the concept developed in this study, a 'two-tier' standoff design approach produces full-depth, triangular standoff profiles which can be manually modified to shallow-depth truncated standoff profiles, or vice versa, according to changing on-orbit conditions. This requires the removal or addition of demountable structural arms and closure panels using accessible structural fasteners. Both standoff profiles incorporate continuous flanges which project from the hull and provide regular attachment points for the structural arms. The arms are L-shaped for full-depth standoffs and I-shaped for shallow-depth standoffs. In post-IOC Space Station scenarios involving Module reconfigurations, shallow-profile standoffs can contribute to reduced interior physical obstruction where requirements determine a need for expanded and enhanced free volume.

UTILITIES DISTRIBUTION SYSTEMS

- **VARIABLE-DEPTH STANDOFF STRUCTURE CONTRIBUTES TO RATIONALIZED UTILITIES DISTRIBUTION AND IMPROVED SYSTEMS ACCESSIBILITY**

The four standoffs accommodate the primary distribution of utility systems throughout Space Station Modules and the secondary linkages of these systems into individual racks and compartments. The utility systems broadly include gas groups, fluid groups and cable groups.

In the concept developed in this study, utility groups are located in the variable-depth standoffs according to their volumetric distribution requirements. The gas and fluid groups, which require relatively large cross-sectional areas, are located and duplicated in the two full-depth wall standoffs. The cable groups, which require relatively small cross-sectional areas, are located and duplicated in the two shallow-depth floor and ceiling standoffs. This arrangement allows physical separation of the fluid and gas systems from power and communications systems by means of the distance between their standoffs. This contributes to enhanced systems safety and easier repair procedure. All standoffs incorporate removable panels for systems accessibility. The cable groups, which are likely to require the most frequent attention, are arranged in flat formations the shallow-depth standoffs to facilitate visual inspection and manual accessibility.

RACK AND COMPARTMENT SIZES

- **VARIABLE-WIDTH RACKS/COMPARTMENTS CONTRIBUTE TO IMPROVED ORGANIZATIONAL VERSATILITY AND OPERATIONAL PERFORMANCE**

Racks and compartments are traditionally conceived as modular elements of fixed volume and standardized width which are attached to the standoffs and pivot inwards to provide hull access for maintenance or repair. In the Space Station Modules, they are installed side-by-side to form continuous wall, floor or ceiling faces.

In the concept developed in this study, the standard Space Station element width increment of 42" is replaced by a basic modular increment of 250 millimeters. This is expanded in multiples to define the widths of racks and compartments throughout the Habitability Module. This increment enables a wide range of rack and compartment sizes and longitudinal fit layouts to be incorporated within the Module with consequent benefits in terms of on-orbit operational performance and evolutionary versatility. The increment also allows individual compartments to be sized for efficient and comfortable crew occupation or operation and individual racks to be sized for appropriate storage or equipment applications. All racks and compartments are capable of passage through Module end hatches either as whole or partly-disassembled units.

RACK AND COMPARTMENT FUNCTIONS

- **DEPLOYABLE/RETRACTABLE COMPARTMENTS PROVIDE VALUABLE ADDITIONAL FREE VOLUME AND IMPROVED OCCUPANT PERFORMANCE**

In Space Station Modules, crew compartments for specific activities are developed as fixed enclosures of predetermined volume to comply with longitudinal fit and central corridor architectural requirements.

In the concept developed in this study, innovative deployment capabilities are incorporated in the design of the some compartments, such as the Exercise Compartments, to enable them to fold away into compact units when not in use. This releases valuable additional volume for other crew activities. Sleep Compartments can be designed in a similar manner. These techniques result in a 40% free-volume/60% element-volume ratio for the design in this study compared to a 30% free-volume/70% equipment-volume ratio for Space Station designs. The importance of providing comfortable conditions for human body posture in weightlessness for all crew activities also places emphasis on the design of rack and compartment geometries. In this study, conventional rectilinear geometries are replaced by curvilinear or faceted geometries which match the physical proportions of rack and compartment faces more closely to anthropometric and ergonomic requirements.

CREW EQUIPMENT FEATURES

- **ADAPTABLE AND CONFORMABLE CREW EQUIPMENT FEATURES IMPROVE WORKSTATION ERGONOMICS AND FACILITATE ROUTINE TASKS**

Detailed consideration of human factors issues suggests that adaptable performance capabilities are incorporated into the design of items of Space Station equipment such as Tables and Workstations.

In the concept developed in this study, working prototypes of a Portable/Wearable Workstation and a Wardroom Table utilize and demonstrate these features. The Wardroom Table incorporates adaptable and deployable performance capabilities through manual control of independent worksurfaces. This provides positions for up to 8 crewmembers engaged in various group or individual activities. Unused worksurfaces can be retracted to provide more room for crew translation around the table, and all worksurfaces can be angled to suit individual anthropometric preferences. The Portable/Wearable Workstation provides a compact and portable crew workstation capability through 'user-friendly' design. The workstation unit is linked to the crew flightsuit with flexible attachments. During use, the user unfolds the workstation and deploys the keyboard and screen to desired operational angle. During translation, the user folds the workstation flat against the upper body to eliminate projections and leave both arms free to assist translation.

6 RECOMMENDATIONS

- **Assess the impact of IOC Habitability Module configuration design decisions and requirements on Space Station life-cycle scenarios. Rack and compartment topologies and standoff and utility systems methodologies should be evaluated to determine the scope and viability of future on-orbit modification, change-out or upgrading procedures.**
- **Ensure the inclusion of a dedicated buffer zone dividing day and night facilities in the IOC Habitability Module. The buffer zone should provide continuity of acoustic and visual separation during translation by crewmembers. This can be achieved with operable screens or partitions. Racks/compartments involving frequent crew visits should be excluded.**
- **Examine alternative options for the design of the Exercise Compartments in the IOC Habitability Module in order to provide crewmembers with expanded and enhanced internal volumes for regular physical exercise. Deployable lightweight canopies integrated into the compartment frames will provide safe, simple and efficient means of flexible enclosure.**
- **Encourage the design development of innovative crew equipment elements and features which aim to improve operational ergonomics and facilitate crew tasks throughout Space Station IOC Modules. Appropriate items should include: fixed workstations; portable workstations; meal tables; galley appliances; stowage systems; foot restraints; sleep restraints.**
- **Determine the suitability and potential of dual-level accommodation configurations for Evolutionary Habitability Module applications. Optimum configurations should be identified by studying and comparing dual-level design options based on three or four standoff linear routes aligned at cardinal or isometric points around the Module perimeter.**
- **Investigate the utilization of variable-depth structural standoff systems for Space Station Evolutionary Module applications. Standoff structural concepts should comprise demountable components and closure panels with variable-depth profiles designed to simplify on-orbit change-out operations and broaden post-IOC reconfiguration opportunities.**
- **Evaluate alternative approaches for the organization and rationalization of distributed utilities systems throughout Space Station Evolutionary Modules. Studies to be based on alternative standoff options and key issues should include: systems routing; systems accessibility; systems safety; systems linkages; systems upgrading; systems change-out.**
- **Determine the opportunities for introducing variable-width racks and compartments into Space Station Evolutionary Module architectural configurations. The study will identify ways of improving the efficiency and versatility of rack and compartment arrangements utilizing a range of interactive element widths based on small modular increments.**

APPENDIX A

ABBREVIATIONS

C&T	COMMUNICATIONS & TRACKING
DMS	DATA MANAGEMENT SYSTEM
ECLSS	ENVIRONMENTAL CONTROL & LIFE SUPPORT SYSTEM
EVA	EXTRA-VEHICULAR ACTIVITY
FMAD	FLUIDS MANAGEMENT & DISTRIBUTION
FOV	FIELD OF VIEW
HMF	HEALTH MAINTENANCE FACILITY
HUD	HEAD-UP DISPLAY
IOC	INITIAL OPERATIONAL CAPABILITY
IVA	INTRA-VEHICULAR ACTIVITY
NSTS	NATIONAL SPACE TRANSPORTATION SYSTEM
PHS	PERSONAL HYGIENE SYSTEM
PMAD	POWER MANAGEMENT & DISTRIBUTION
PSO	PLANNING & STATION OPERATIONS
SH	SAFE HAVEN
ST	STOWAGE
THC	TEMPERATURE & HUMIDITY CONTROL

APPENDIX B

MOCK-UP INVENTORY

SHEET 1 OF 5

ELEMENT	TYPE	QUANTITY	L.	W.	H.	PART NO.
<u>SHELL</u>	LOWER UNITS	12	7'6" x	4'0" x	7'6"	EACH 1-12 [TOP]
	UPPER UNITS	12	8'6" x	4'0" x	1'4"	EACH 1-12 [BOT]
	STAND-OFF PANELS [PAINTED GREY]	12	8'0" x	3'6" x	6"	EACH 13-24
	FLOOR EXTENSION PANELS [PAINTED GREY]	6	2'6" x	1'6" x	6"	EACH 25-26[X] [3 PIECES EACH SIDE = TOTAL OF 6 PIECES]
	BRACKETS [ALUMINUM]	20	2'6" x	1'3" x	9"	EACH 27-46 [SEE NOTE 2.]
	ASSEMBLY BOLTS	2 BAGS [PACKED IN BOX]	1'6" x	1'6" x	6"	47[X] [LARGE BAG CONTAINING BOLTS FOR MODULE SHELL ELEMENTS] 1'0" x 9" x 6" [SMALL BAG CONTAINING BOLTS FOR STAND-OFF PANELS]
	FLOOR FINISH [GREEN VINYL]	3 ROLLS	2'8" WIDE x 6" DIAMETER			48[X] [2 ROLLS] 1'6" WIDE x 6" DIAMETER [1 ROLL]
	STEP	1	3'0" x	4" x	2"	49 [COVERED IN FLOOR FINISH AND PRE-ATTACHED TO 2 BRACKETS]
FLOOR SUPPORTS	12	3'0" x	6" x	2"	EACH 50[X] [3 BUNDLES WITH 4 IN EACH BUNDLE]	
<u>EXERCISE AREA</u>	ROWING COMPT.	1 [PART A]	6'8" x	1'8" x	3'0"	51 [CONTAINS HINGED BOX, PADDING, PARTIAL TENT STRUCTURE/ CANOPY AND T.V. SCREEN]

MOCK-UP INVENTORY

SHEET 2 OF 5

ELEMENT	TYPE	QUANTITY	L.	W.	H.	PART NO.
<u>EXERCISE AREA</u> [CONT.]	ROWING COMPT.	1 [PART B]	6'8" x	3'4" x	3'0"	52
			[CONTAINS HINGED BOX, PADDING AND PARTIAL TENT STRUCTURE/CANOPY]			
	BICYCLE COMPT.	2	6'8" x	2'6" x	3'0" EACH	53-54
			[CONTAINS HINGED BOX, PADDING AND PARTIAL TENT STRUCTURE/CANOPY]			
	X-RAY CONSOLE	1	4'9" x	2'8" x	3'0"	55
	ROWING MACHINE	1	4'0" x	2'0" x	1'0"	56
	BICYCLE MACHINE	1	3'3" x	2'0" x	2'0"	57
			[PRE-ASSEMBLED INSIDE COMPARTMENT SECTION]			
EARTH PICTURES	1	3'0" x	2'6"		58	
		[EXTERIOR PHOTO VIEW]				
EARTH PICTURES	1	1'0" x	2'6"		59	
		[EXTERIOR PHOTO VIEW]				
END CANOPY FLAPS	2	9" x	9" x	3" EACH	60-61	
<u>WARDROOM AREA</u>	BULKHEADS	4	6'8" x	1'0" x	3'4" EACH	62-65
	WINDOW WORKST'N	2	7'0" x	2'0" x	1'0" EACH	66-67
			[UPPER AND LOWER SECTIONS]			
	WINDOW WORKST'N	1	2'0" x	1'0" x	1'0"	68
			[CENTER SECTION- PACKED IN BOX]			
	EARTH PICTURES	2	3'0" x	1'6"	EACH	69-70
	LEG RAILS	2	7'6" x	3" DIA.	EACH	71-72
LIGHTING INFILL STRIPS	8	1'8" x	1'3" x	2'4" EACH	73-80	
		[INCLUDES LIGHTING TUBES, INTERNAL LAMPS, EXTERNAL RUBBER COVER STRIPS, CONCEALED ELECTRICAL WIRING, COVER STRIPS AND SWITCHES]			[SEE NOTE 2.]	

MOCK-UP INVENTORY

SHEET 3 OF 5

ELEMENT	TYPE	QUANTITY	L.	W.	H.	PART NO.
<u>WARDROOM AREA</u> [CONT.]	LIGHTING INFILL STRIPS	2	3'4"	1'3"	2'4"	EACH 81-82 [INCLUDES LIGHTING TUBES, INTERNAL LAMPS, EXTERNAL RUBBER COVER STRIPS AND CONCEALED ELECTRICAL WIRING, COVER STRIPS AND SWITCHES] [SEE NOTE 2.]
	SOFT STOWAGE BAGS	20	1'9"	1'3"	8"	EACH 83[X] [PACKED IN 5 PLASTIC BAGS]
	BAG SUPPORT RAILS AND BRACKETS	6	5'6"	1'0"	3"	EACH 84-87[X] [4 RAILS AND 2 BRACKETS - BRACKETS ARE PACKED IN A BOX]
	TELESCOPIC WORKPADS	4	2'3"	9"	3"	EACH 88-91
	ECLSS RACKS	4	6'8"	4'0"	3'6"	EACH 92-95
<u>WORK-STATION</u>	WORKSTATION ASSEMBLY	1	6'0"	5'0"	3'0"	96 [ASSEMBLY COMPRISES A SERIES OF FLAT PANELS ATTACHED TO A HINGED, TUBULAR FRAME - ALL PACKED IN LARGE CARDBOARD BOX]
	LEG RESTRAINT ASSEMBLY	1	5'0"	2'3"	1'6"	97 [ASSEMBLY COMPRISES BASE PANEL, SIDE BRACKETS AND ADJUSTABLE LEG BARS]
	BACK PANELS	2	7'0"	2'7"		EACH 98-99 [UPPER SHELL UNITS 1 AND 2 - 1 PANEL PRE-ATTACHED TO UPPER SHELL UNIT 1]
	BACK PANELS	2	7'0"	2'7"		EACH 100-101 [UPPER SHELL UNITS 7 AND 8 - 1 PANEL PRE-ATTACHED TO UPPER SHELL UNIT 7]

MOCK-UP INVENTORY

SHEET 4 OF 5

ELEMENT	TYPE	QUANTITY	L.	W.	H.	PART NO.
<u>WORK-STATION</u> [CONT.]	STAND-OFF FASCIA STRIPS	2	5'0" x 4" x		1/8"	EACH 102-103
	STAND-OFF SLOPED FASCIA PANEL	1	5'0" x	2'0" x	1/8"	103A
<u>GALLEY AREA</u>	CENTER CONSOLE	1	6'6" x	2'9" x	2'3"	104
	GALLEY RACKS	4	6'8" x	3'6" x	2'6"	EACH 105-108
	ECLSS UNITS	2	6'8" x	4'0" x	3'6"	EACH 109-110
	END PANELS	2	6'8" x	4'0" x	1/8"	EACH 111-112 [PRE-ATTACHED TO GALLEY RACKS]
	STAND-OFF FASCIA STRIPS	2	3'3" x	4" x	1/8"	EACH 113-114
<u>MISCELL-ANEOUS</u>	MISC. BOLTS/ SCREWS/ FASTENERS	PACKED IN A BOX	LOOSE PACKETS/BAGS			115
	D-HANDLES	4 [PACKED IN A BOX]	2'0" x	3"		116[X] [SPARE D-HANDLES]
	LEG RESTRAINTS	4	2'6" x	1'0" x	2'6"	117-120
	TABLE	1 BOX	5'0" x	1'8" x	1'8"	121
	SPARE PARTS AND SUPPLIES	1 BOX	2'0" x	2'0" x	2'0"	122
	SPARE LIGHTING TUBE	1 [PACKED IN A BOX]	3'0" x	2" DIAMETER		123
	SPARE SHELL FABRIC LINING	1 ROLL	5'0" x 3" DIAMETER			124

MOCK-UP INVENTORY

SHEET 5 OF 5

- NOTES:**
1. ALL DIMENSIONS LISTED ABOVE ARE APPROXIMATE.
 2. PART NOS. 35-46, 73-80 AND 81-82 ARE SHIPPED IN TWO PRE-ASSEMBLED SECTIONS, EACH 10' 3" LONG.
 3. ALL PART NOS. MARKED WITH THE SUFFIX [X] INDICATE MULTIPLE PARTS LISTED UNDER ONE PART NO.

APPENDIX C

PROJECT TEAM

PHASE 1 : EXPERIMENTAL DESIGN STUDIES

SPACE PROJECTS GROUP

Bedros Darkjian
Regis Fauquet
Oussama Hamadani
Robert Kleis
John Lynch
Christopher Miller
David Nixon
Greg Salmi
Jeff Salmi
Aleco Simonian
Elia Susiloputro
John Wood

PHASE 2 : FINAL DESIGN STUDY

SPACE PROJECTS GROUP

Mike Avila
Gary Alzona
Jeff Deyoe
Regis Fauquet
Joe Kennedy
Yuc-hun Lin
John Lynch
Christopher Miller
David Nixon
Pat Scarlett
Manfred Schlosser
Karl Schurz
Kristy Skelton
Brad Skepner
Mike Whitby
Rod Woolner

WARDROOM EQUIPMENT STUDIES

SPACE PROJECTS GROUP

Joe Kennedy
Christopher Miller
Brad Skepner

SPACEHAB INC. [NASA KC-135 flight test]

Tom Taylor

FUTURE SYSTEMS CONSULTANTS [Wardroom Table design]

Jan Kaplicky
Kathryn Lim
David Nixon

REFERENCES

1. National Aeronautics and Space Administration: Man-Systems Integration Standards, Vol. 1, National Aeronautics and Space Administration, NASA-STD-3000, March 1987.
2. National Aeronautics and Space Administration: Space Station Reference Configuration Description, Space Station Program Office, Johnson Space Center, JSC-19989, NASA TM-87493, 1984.
3. Nixon, David: Space Station Group Activities Habitability Module Study, Institute for Future Studies, NASA-Ames Research Center, NASA-CR-4010, 1986.
4. National Academy of Sciences: Human Factors in Long-Duration Space Flight, Space Science Board, National Academy of Sciences, Washington D.C., NASA-CR-136960, 1972.
5. Stuster, J.W.: Space Station Habitability Recommendations based on a Systematic Comparative Analysis of Analogous Conditions, Anacapa Sciences Inc., Ames Research Center, NAS2-11690, NASA CR-3943, 1986.
6. Lockheed Missiles & Space Company: Space Station Human Productivity Study, Vol. 1, LMSC F060784/1, NASAA-Johnson Space Center NAS9-17272, DR SE-1093T, Man-Systems Division, 1985.
7. Bluth, B.J. and Helppie, Martha: Soviet Space Stations as Analogs, Boeing Aerospace Company, Second edition, D180-28182-1, 1983.



Report Documentation Page

1. Report No. NASA CR-4246		2. Government Accession No.		3. Recipient's Catalog No.	
4. Title and Subtitle Space Station Wardroom Habitability and Equipment Study			5. Report Date December 1989		
			6. Performing Organization Code		
7. Author(s) David Nixon, Christopher Miller, and Regis Fauquet			8. Performing Organization Report No.		
			10. Work Unit No. 482-52-21		
9. Performing Organization Name and Address Southern California Institute of Architecture 1800 Berkeley Street Santa Monica, CA 90404			11. Contract or Grant No. NCC2-356		
			13. Type of Report and Period Covered Contractor Report		
12. Sponsoring Agency Name and Address National Aeronautics and Space Administration Washington, DC 20546-0001			14. Sponsoring Agency Code		
			15. Supplementary Notes Point of Contact: Remus N. Bretoi, Ames Research Center, MS 239-15, Moffett Field, CA 94035 (415) 694-6149 or FTS 464-6149		
16. Abstract <p>This study explores and develops experimental designs in life-size mock-up form for the Wardroom facility for the Space Station Habitability Module. In Phase 1, three preliminary concepts for the Wardroom configuration are fabricated and evaluated. In Phase 2, the results of Phase 1 are combined with a specific range of program design requirements to provide the design criteria for the fabrication of an innovative medium-fidelity mock-up of a Wardroom configuration. The study also focuses on the design and preliminary prototyping of selected equipment items including crew exercise compartments, a meal/meeting table and a portable workstation. Design criteria and requirements are discussed and documented. Preliminary and final mock-ups and equipment prototypes are described and illustrated.</p>					
17. Key Words (Suggested by Author(s)) Space station, Human productivity, Wardroom, Exercise facility, Anthropometrics, Ergonomics, Workstations			18. Distribution Statement Unclassified-Unlimited Subject Category - 54		
19. Security Classif. (of this report) Unclassified		20. Security Classif. (of this page) Unclassified		21. No. of Pages 141	22. Price A07