

JPL D-4788

Mars Rover/Sample Return (MRSR) Mission  
Mars Rover Technology Workshop  
Proceedings

Chairman: John C. Mankins, Jet Propulsion Laboratory

April 28-30, 1987  
Pasadena, California

**JPL**  
Jet Propulsion Laboratory  
California Institute of Technology

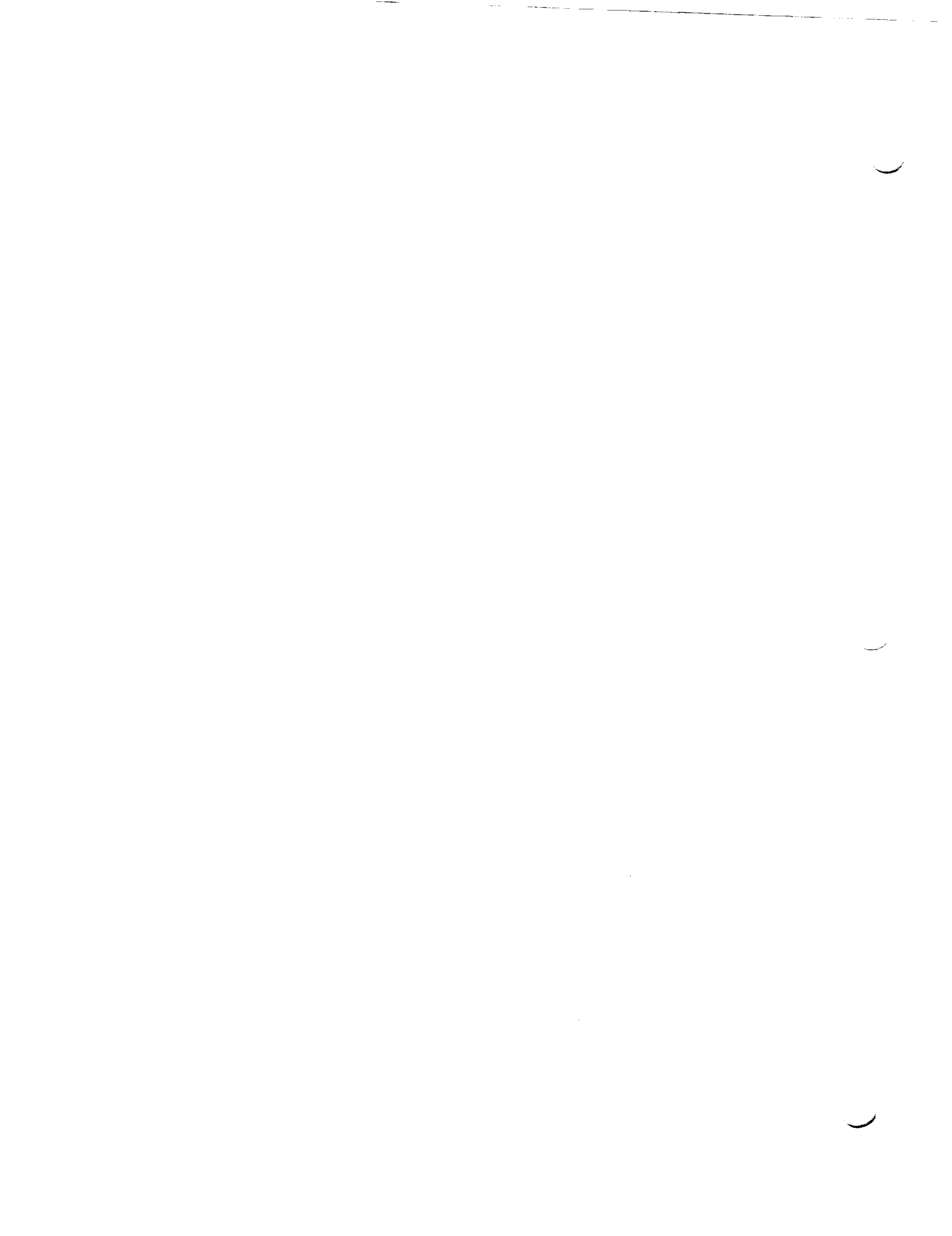



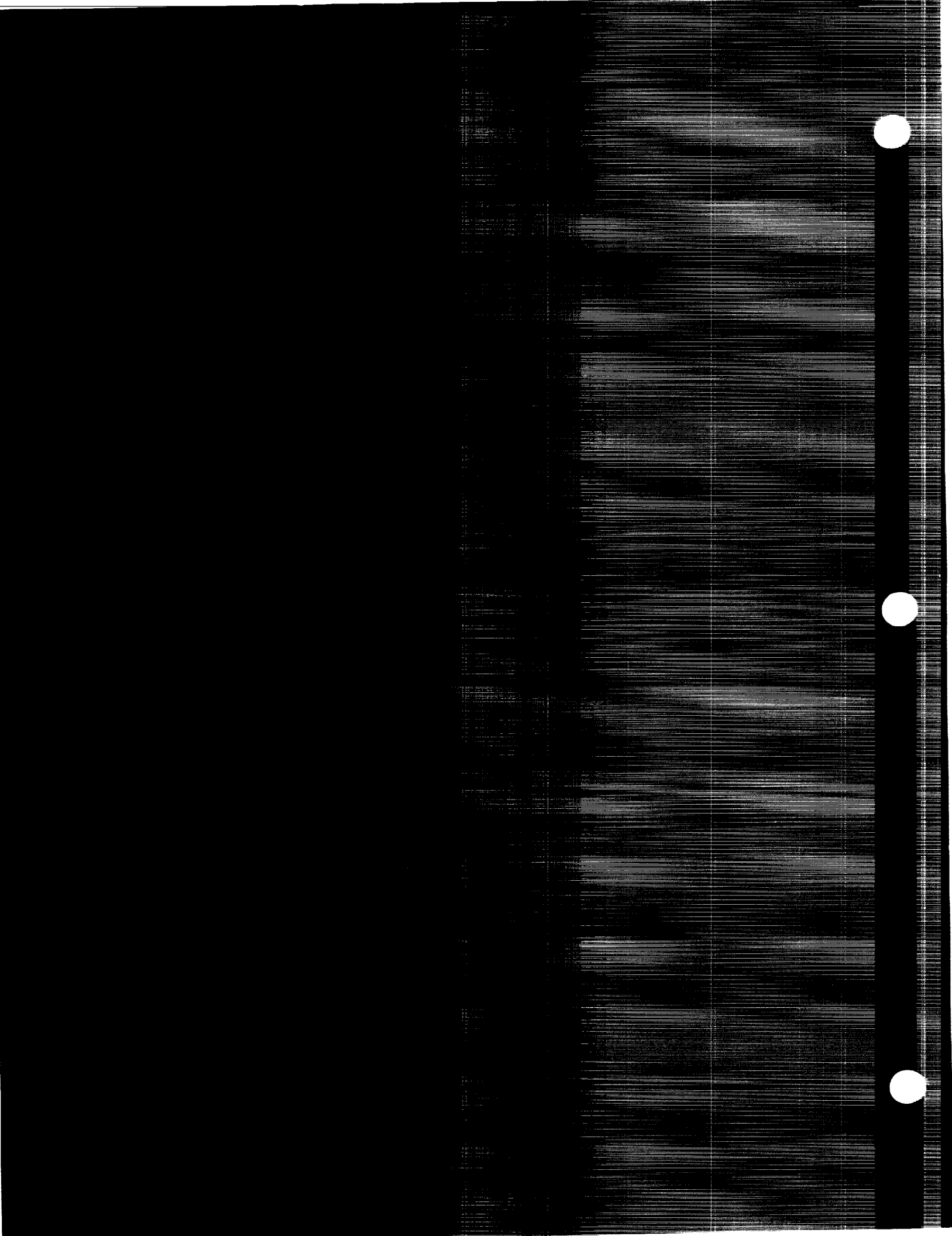



JPL D-4788, Vol. 1

Mars Rover/Sample Return (MRSR) Mission

# Mars Rover Technology Workshop Proceedings

Volume 1: Executive Summary and  
Mission/Systems Panel

Editor and Chairman: John C. Mankins, Jet Propulsion Laboratory

April 28-30, 1987  
Pasadena, California

**JPL**  
Jet Propulsion Laboratory  
California Institute of Technology

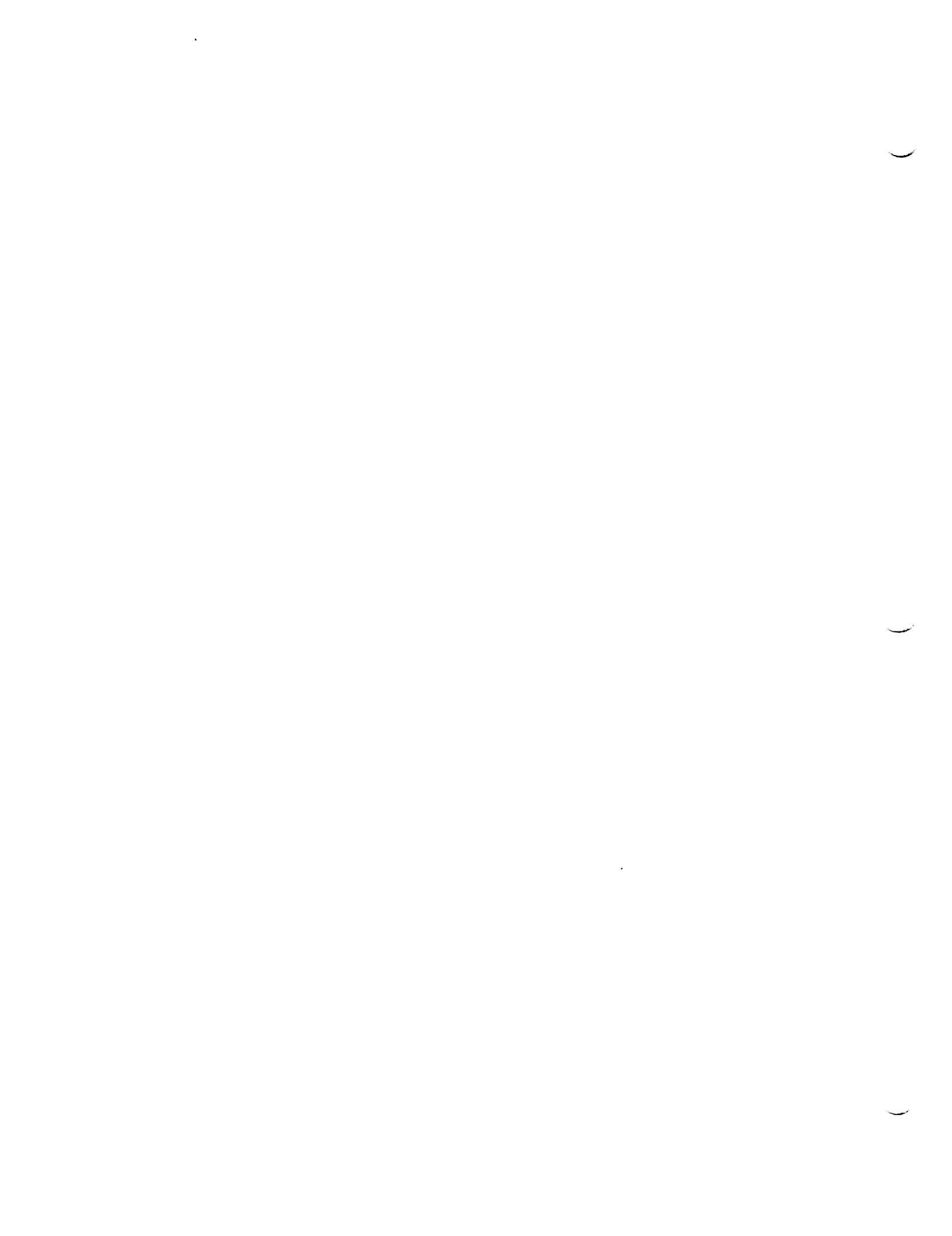

## GLOSSARY

### ACRONYMS AND ABBREVIATIONS

AMTEC	-	alkali metal thermoelectric converter
CCD	-	charge-coupled device
DOF	-	degrees of freedom
DSN	-	Deep Space Network
DoD	-	Department of Defense
FET	-	field effect transistor
GPHS	-	general purpose heat source
GPS	-	Global Positioning System
GaAs	-	gallium arsenide
GaP	-	gallium phosphide
Gb	-	gigabit(s)
HEMPT	-	high electron mobility pseudomorphic transistor
Hz	-	hertz
JPL	-	Jet Propulsion Laboratory
JSC	-	Johnson Space Center
K	-	Kelvin
kg	-	kilogram
km	-	kilometer
LeRC	-	Lewis Research Center
Li-FeS <sub>2</sub>	-	lithium-ferric sulfide
Li-TiS <sub>2</sub>	-	lithium-titanium sulfide
MIMIC	-	Microwave/Millimeterwave Monolithic Integrated Circuit
MMIC	-	microwave monolithic integrated circuit
MRSR	-	Mars Rover and Sample Return
MW	-	megawatt
Mb	-	megabit(s)
Mips	-	million instructions per second
NASA	-	National Aeronautics and Space Administration
NaS	-	sodium-sulfur
Nd	-	neodymium
OAST	-	Office of Aeronautics and Space Technology
PID	-	proportional-integral-derivative
RAM	-	random access memory
RF	-	radio frequency
RHU	-	radioisotope heater unit
RMS	-	root mean square
RTG	-	radioisotope thermoelectric generator
SSA	-	solid state amplifier
SiGe	-	silicon germanium
TWTA	-	traveling wave tube amplifier
VLSI	-	very large scale integration
YAG	-	yttrium aluminum garnet
bps	-	bits per second
cm	-	centimeter
kW	-	kilowatt
m	-	meter



## CONTENTS

	<u>Page</u>
1. INTRODUCTION . . . . .	1-1
2. OVERVIEW . . . . .	2-1
3. SAMPLE ACQUISITION, ANALYSIS, AND PRESERVATION WORKING GROUP . . . . .	3-1
4. MOBILITY WORKING GROUP. . . . .	4-1
5. COMMUNICATIONS WORKING GROUP. . . . .	5-1
6. GLOBAL NAVIGATION WORKING GROUP . . . . .	6-1
7. LOCAL GUIDANCE AND HAZARD AVOIDANCE WORKING GROUP . . . . .	7-1
8. COMPUTING AND TASK PLANNING WORKING GROUP . . . . .	8-1
9. POWER WORKING GROUP . . . . .	9-1
10. SYSTEM/MISSION WORKING GROUP . . . . .	10-1

## APPENDIXES

A. TECHNOLOGY PLANNING WORKSHEETS . . . . .	1-AA-1
B. PRESENTED MATERIALS . . . . .	1-AB-1
C. MARS ROVER CAPABILITY SCENARIOS . . . . .	1-AC-1
B. PLENARY SESSION NOTES . . . . .	1-AD-1

## FIGURES

<u>Figures</u>	<u>Page</u>
3-1. Rover Sampling Capability Options . . . . .	3-8
5-1. Rover K <sub>a</sub> -band Antenna Configurations . . . . .	5-5
7-1. Semi-autonomous Path Planning Architecture for a Mars Rover. . . . .	7-2

## TABLES

<u>Tables</u>	<u>Page</u>
1-1. Working Group Chairmen . . . . .	1-2
2-1. Summary of Rover Capability Options . . . . .	2-2
3-1. Rover Traverse/Sampling Scenarios . . . . .	3-2
3-2. Operational Characteristics for a Rover Designed by Geologists/Chemists . . . . .	3-5
4-1. Rover Locomotion Types and Characteristics . . . . .	4-2
4-2. Terrain Model Requirements . . . . .	4-3
5-1. DSN Long-range Plan Highlights . . . . .	5-2
5-2. Antenna Aperture Size and DSN Station Pairs for Mars-to-Earth Communications at 2.68 AU . . . . .	5-3
5-3. Optical Communication Systems Characteristics . . . . .	5-8
7-1. Rover Speed, Power and Computing Capabilities/ Requirements for a 1000-Kg, 500-W Vehicle . . . . .	7-5
9-1. Rover Power Requirement Estimates . . . . .	9-1
9-2. Baseline and Enhanced Power System Technologies . . . . .	9-2
10-1. System/Mission Working Group Participants . . . . .	10-2
10-2. Rover - Necessary Science Skills . . . . .	10-4

## SECTION 1

### INTRODUCTION

A return to the surface of Mars has long been an objective of NASA mission planners. The ongoing Mars Rover and Sample Return (MRSR) mission study represents the latest stage in that interest. As part of NASA's preparation for a possible MRSR mission, a technology planning workshop for the Mars rover was held on April 28-30, 1987, in Pasadena, California. The workshop, which was sponsored by the NASA Office of Aeronautics and Space Technology (OAST) Space Directorate and hosted by the Jet Propulsion Laboratory, attempted to define technology requirements, options, and preliminary plans for the principal areas of Mars rover technology. The overall objective was to bring together members from the various segments of the U.S. aerospace community (NASA centers, industry, and academia) to initiate coordinated planning of requirements for Mars rover technology development.

The workshop was organized into seven technology working groups: Sample Acquisition, Analysis, and Preservation; Mobility; Communications; Global Navigation; Local Guidance and Hazard Avoidance; Computing and Task Planning; and Power. There was also an Executive Panel composed of the chairmen of the individual working groups, and a cross-group Systems/Mission working group. Each technology working group presented a final report detailing the results of their efforts, including the objectives of the group, major capability or technology issues, technology forecasts and plans, and recommendations. This document constitutes a summary of these working group reports. The chairmen of the technology working groups are listed in Table 1-1.

Table 1-1. Working Group Chairmen

Working Group	Chairman
Systems/Mission	J. Mankins, JPL
Sample Acquisition, Analysis, and Preservation	D. Blanchard, NASA/JSC S. Hayati, JPL
Mobility	D. Bickler, JPL
Communications	R. Horttor, JPL
Global Navigation	L. Wood, JPL
Local Guidance and Hazard Avoidance	B. Wilcox, JPL T. Kanade, Carnegie Mellon University
Computing and Task Planning	D. Eisenman, JPL S. Grenander, JPL
Power	R. Detwiler, JPL C. P. Bankston, JPL



## SECTION 2

### OVERVIEW

The specific objectives of the Technology Planning Workshop for the Mars Rover were: to establish a set of preliminary options for Mars rover technologies, based upon strawman rover capability scenarios; to concisely identify increased rover system capability and mission performance due to each technology option; to establish initial roadmaps for research and development for the various technology options; and to formulate a preliminary long-range plan for the timely development of rover technologies. The workshop also aimed to establish a common basis of information and a network of relationships with the U.S. aerospace community to coordinate and focus further planning for rover technology development.

In preparation for the workshop, several alternative strawman rover capability scenarios were developed. These minimum, moderate, and maximum capability options were not intended to represent "point designs;" rather, they were intended to be considered individually, with interdependencies (such as between rover mass, instantaneous speed, and power) discussed and quantified if possible. Table 2-1 provides a summary of the various characteristics of each scenario. A copy of the material distributed at the workshop is provided in an appendix. All scenarios assume that 100 days out of every 400 are lost due to sand storms, and that the roundtrip Mars/Earth communications time varies from approximately 8 to 40 minutes. The program new start date was chosen to be 1993 or 1995, corresponding to launch opportunities in 1998 or 2000, respectively. The necessary technology must generally be at a sufficient level of maturity by these "technology cutoff" dates.

For a minimum capability mission, the landing site will be selected for minimum risk to the mission. The terrain will be a flat plain, with no major inclines in the traversed path. The maximum steady grade traversed will be 15-30%. For a moderate mission, the landing site selected will present a moderate risk to the mission. Substantial inclines will be included in the traversed path; steady grades of up to 30-60% will be traversed. A maximum capability mission will involve a landing site selected for maximum acceptable risk to the mission. Because this option allows for extended sampling operations (500 km traversed distance), the lander can descend either into rough country or into less risky country (in which case the rover would traverse to and from the rougher country for sampling at a wide variety of sites, such as the bottom of ravines).

A minimum capability rover will take samples of surface materials, with minimal drilling into rocks (to about 10 cm) and no coring. The moderate option would add moderate (2 m) subsurface coring. Maximum capability sampling would include deep (5 m) subsurface coring. Even deeper coring could be considered, as well as limited collection of the atmosphere. All three scenarios would utilize Earth-based selection of all collected samples. Limited autonomous pre-screening of samples could be considered for the maximum option.

Table 2-1. Summary of Rover Capability Options

	Alternative Scenarios		
	Minimum	Moderate	Maximum
Rover Mass (kg)	400	700	1000
Science Package Mass (kg)	60	100	140
Average Power Level (W)	200	300	400
Instantaneous Surface Speed (m/hr)	100	500	1000
Rover Mission Duration (yr)	1	3	5
Total Traversed Distance (km)	100	1000	5000
During Sampling (km)	100(1 yr)	100(1 yr)	500(1 yr)
During Extended Operations (km)	--	900(2 yrs)	4500(4 yrs)
Maximum Object Size Traversed (m)*	0.5	0.5	1.0
Global Navigation Accuracy (m)	1000	100	10
Autonomous Operations Duration (hr)	1	10	100
Total Data Transmitted (Mb/day)	100	250	1000
Sample Acquisition Rate (samples/day)	0.5	2	5
Total Mass of Collected Samples (kg)	5	5	10

\*Known surface object size (i.e., the maximum resolution of orbital mapping) is 1.5 m.

For the minimum and moderate scenarios, there would be no operations at night. The maximum option may involve operations, such as traversing, at night. Operations for a minimum mission would end with ascent vehicle departure. In the other two scenarios, an extended period of rover exploration would follow ascent vehicle departure.

The U.S. has never operated a roving vehicle on the surface of another planetary body, without the assistance of a human driver, as in the Apollo program. Thus, the remote control of the path of such a vehicle, whether the computations are performed on the vehicle or on Earth, involves entirely unproven technology. Not only are new sensing and processing capabilities required, the basic system concepts and architecture are not well-understood. The following paragraphs present brief summaries of the conclusions and recommendations of the working groups in each technical area.

The scientific operational usefulness of the rover is primarily determined by its level of capability for sample acquisition, analysis, and preservation. In this area, there is a need for technology development in various selected subsystems. A full-function imaging system for site and sample selection, documentation, and characterization will be required. For the sample acquisition system, the most important characteristic is reliability. Therefore, the emphasis will be to simplify the mechanical subsystems, and to provide redundant arm capability. Realistic testing of these devices will also be necessary. Deep subsurface coring may present a substantial technology challenge. The robotic arms must function in a highly autonomous, data-driven, sensory-controlled manner. Although there is no need for a new general program in robotics for rover applications, there is a need for specific development of slow, lightweight manipulators that can operate in an unstructured environment. Finally, the need for integrated rover system design and testing is a major technology development issue; a test-bed which integrates several critical rover functions (at least mobility, sample acquisition, and local guidance) is essential to the timely development, demonstration, and selection of optimal technology options.

In the area of mobility, a clear requirement for the early development of a detailed Martian terrain model was identified. A variety of potential configurations and technology options are possible for the rover locomotion system, including legs, wheels, or tracks. The working group determined that computer modeling and terrain/vehicle simulation should be used to select and optimize the vehicle configuration. The use of computer modeling is one of the vehicle industry's emerging techniques. It must, however, be coupled with experimental proof of the modeling assumptions. Specialized development of selected mobility systems must take place, accompanied by extended demonstrations and research in realistic terrain. Because prototype testing will undoubtedly reveal failure modes not anticipated, the overall process will be one of iteration.

In the area of communications, there are two potential system configurations: direct communications between the rover and Earth, and the use of a Mars synchronous orbiter for communications relay purposes. The latter option would enable continuous communications support from Earth, and reduce the communications resources required on the rover. For a direct rover link to Earth, although the mission could be performed using existing X-band technology, the availability of  $K_a$ -band communications would greatly enhance overall mission performance. Intensive development of space-qualified  $K_a$ -band components will be necessary, along with the expected expansion of the Deep Space Network to  $K_a$ -band. Further study and development of optical communications technology could also be pursued, although an operational system is not expected to be available for a mission occurring prior to the year 2000. Communications at optical frequencies would allow for a direct, high-rate link from the rover to Earth, and would consume fewer rover resources.

Global navigation of the rover involves the problem of accurately determining the location of the vehicle on Martian surface at any time. Global navigation is quite complex, and will require the use of several classes of navigational techniques. These alternative approaches include

inertial and dead-reckoning techniques, imaging-related techniques, and radiometric techniques. Inertial and dead-reckoning components include gyroscopes, accelerometers, odometers, and compasses. Imaging-related navigation involves image correlation and mapping, photogrammetry, and on-board data integration and topographic information extraction technologies. Radiometric techniques for rover position determination include the use of Doppler, ranging, or differential very-long-baseline interferometry (delta VLBI). Systems studies are required to select the appropriate ensemble of techniques. Advanced technology development for selected applications for the rover may also be required. In addition, high-resolution (meter-level) maps of possible landing areas and environs should be obtained prior to final site selection to allow routes to be planned in great detail and to enhance mission safety.

An autonomous local guidance and hazard avoidance capability is necessary for the rover to traverse substantial distances at a reasonable speed without complete dependence upon Earth-based path designation. Local guidance and hazard avoidance is highly dependent on the selected mix between mobility, computing/processing capability, and surface imaging resolution from orbit. As stated above, a high-resolution terrain data base of the exploration areas should be obtained, preferably prior to the arrival of the rover at Mars. Technology development is required in several areas, including sensors (such as laser scanners), perceptual and planning algorithms, reflex and error recovery algorithms, and special-purpose computing hardware (such as VLSI components). Because reliability is an essential characteristic, all of these technologies must be developed, integrated, and tested using realistic environments.

Technology for the area of computing and task planning revolves around the essential requirement for a dynamically reconfigurable, general-purpose processor to provide computing for a variety of rover functions, including mobility, local guidance, and sample acquisition. There is also a need for multi-megabyte, highly fault-tolerant random access memory (RAM) technology. Moreover, there is a requirement for extremely high-density on-board data storage technology (possibly through flight-qualified, erasable, optical disks). There may also be a need for the development of specific flight-qualified components for specialized processing. The integration of all of these elements will require the development of a fault-tolerant, distributed, real-time computing architecture for the rover.

Power technology for the rover will depend primarily upon the development of a specialized radioisotope thermoelectric generator (RTG) system for use on Mars. The development of a highly efficient thermal-to-electric energy conversion capability for RTG systems would greatly reduce the mass and volume of the rover power system. Thermal management of the vehicle in the cold Martian environment is a critical issue that may be best resolved by the use of multiple, modular RTGs. Further development of advanced high-energy batteries and regenerative fuel cells is necessary to provide a high-performance energy storage system. Power integrated circuit technology is required to reduce the mass of power conditioning and control hardware. Finally, two concepts can be considered as an alternative to an RTG-based rover power system: a central power station involving a nuclear

fission reactor or a solar power source utilized with a rechargeable rover; or a photovoltaic/battery-powered rover.

A variety of issues which crosscut technical considerations for a Mars rover were also identified. These include the need to address planetary quarantine and back-contamination issues early, and the need to pursue further technology planning for a MRSR mission in the context of the entire mission (rover, orbiter, and lander), rather than considering the individual mission elements in isolation.

The development needs and recommendations that were specified by the technology working groups are summarized below.

#### Sample Acquisition, Analysis, and Preservation

- Test-bed for realistic, integrated testing of autonomous sample acquisition tasks
- Full-function imaging system for site and sample selection, documentation, and characterization
- Highly autonomous, data-driven, sensory-controlled robotic arms
- Development and extensive testing of reliable, lightweight manipulators and other sampling devices

#### Mobility

- Early development of a detailed Martian terrain model to support mobility system selection and design
- Computer modeling and terrain/vehicle simulation to select and optimize the vehicle configuration
- Specialized development of selected mobility systems, accompanied by extensive testing in realistic terrain

#### Communications

- Development and space-qualification of  $K_a$ -band components, including phased-array antennas, solid-state power amplifiers, multimode tracking feeds, and beam waveguides
- Highly-reliable microwave monolithic integrated circuit (MMIC)  $K$ -band devices
- Expansion of the Deep Space Network (DSN) to  $K_a$ -band
- (Optional) Study, development, and space-qualification of optical communications technology, along with an Earth-orbiting or ground-based receiving system

### Global Navigation

- High-resolution maps of possible landing and exploration areas obtained prior to final site selection
- Systems studies to select the appropriate set of rover navigational techniques, including inertial and dead-reckoning techniques, imaging-related techniques, and radiometric techniques
- Image correlation and mapping, photogrammetry, and on-board data integration and topographic information extraction capabilities
- Advanced development of differential very-long-baseline interferometry tracking technology
- Coordinated acquisition capability for orbital tracking, orbital imaging, surface imaging, and rover inertial and radiometric guidance data

### Local Guidance and Hazard Avoidance

- High-resolution terrain data base of the exploration areas obtained prior to landing
- Advanced development of sensors for the rover, including an appropriate laser scanner and other range sensors.
- Advanced path planning and error recovery algorithms
- Extensive testing of local guidance and hazard avoidance subsystem integration approaches in realistic environments

### Computing and Task Planning

- Fault-tolerant, distributed, real-time computing architecture
- Dynamically reconfigurable, general-purpose flight processor for rover mobility, local guidance, and sample acquisition functions
- Special-purpose flight-qualified processors, such as very large scale integration (VLSI) components
- Multi-megabyte, fault-tolerant random-access memory
- Compact, reliable on-board data storage system

### Power

- Mars-capable RTG system with highly efficient thermal-to-electric energy conversion capability

- Multiple, modular RTGs or other approach that will allow thermal management of the rover
- Advanced high-energy batteries and regenerative fuel cells to provide a high-performance energy storage system
- Power integrated circuit technology to reduce the mass of power conditioning and control hardware

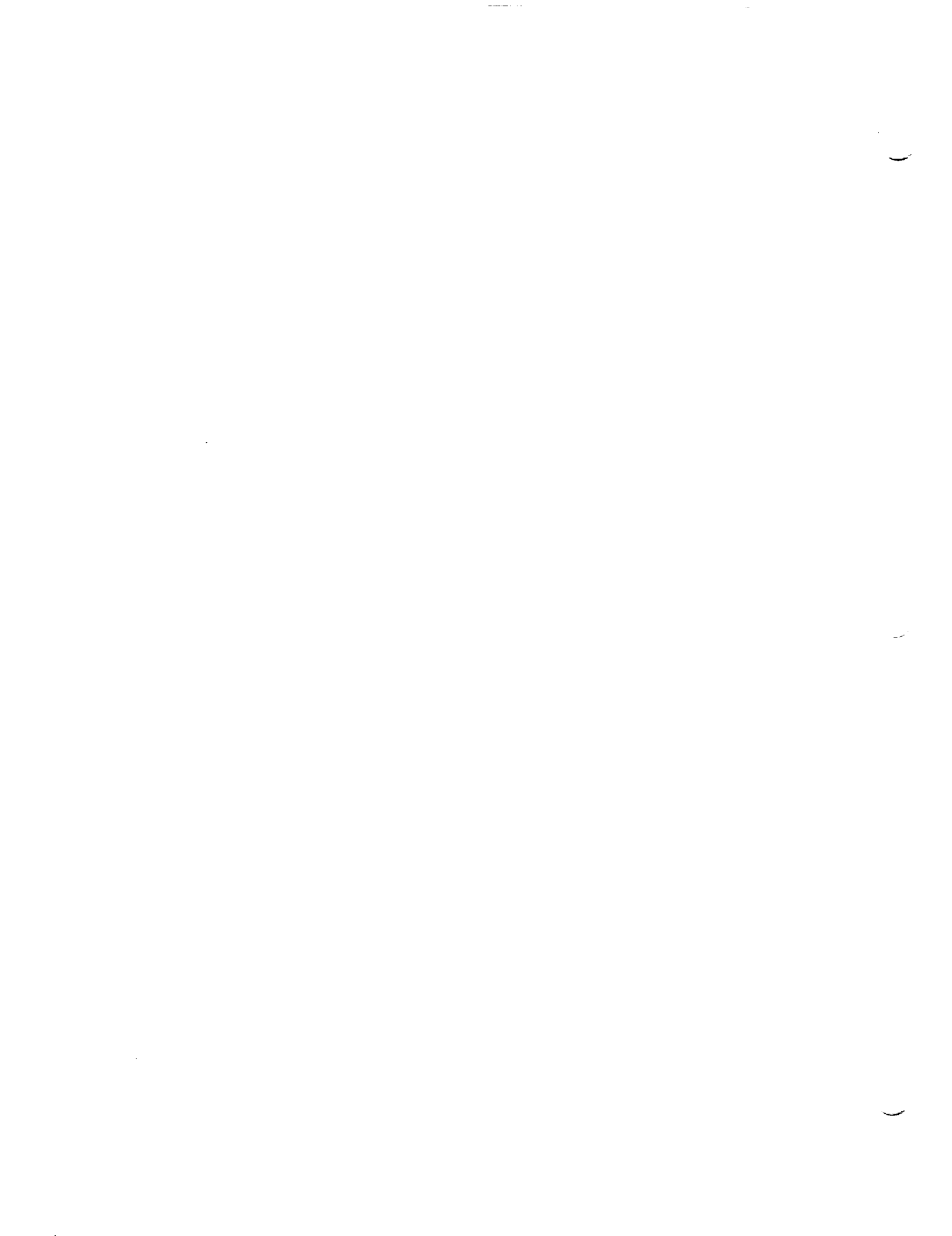



## SECTION 3

### SAMPLE ACQUISITION, ANALYSIS, AND PRESERVATION WORKING GROUP

The objectives of the working group were to establish a preliminary baseline for sample acquisition technology based on strawman mission capability scenarios. Emphasis was placed on the issues of science requirements, instrumentation, manipulation, analysis, and preservation. Mission capabilities were estimated for each of three levels of rover

sophistication (minimum, moderate, and maximum), as outlined in the **Overview** section of this document. The areas that were examined are: samples, tools, and preservation; science instrumentation; robotic autonomy; configuration (arms and capabilities); and vision, sensors, control, and coordination. Attempts were made to identify technology issues, to determine specific areas of required technology development, and to estimate the necessary development timelines for maturing the essential technologies in time to meet mission start requirements.

The first issue that arose was that of mission requirements for sample acquisition, analysis, and preservation. The mission requirements are scenario-dependent, and are influenced by the feasibility of various modes of operation. The group defined operational/traverse scenarios for each of the levels of rover capability using relatively simple assumptions about mission timelines and rover capabilities. The resulting general scenarios, outlined in Table 3-1, are useful for assessing the practical implications of assumed rover capabilities in terms of samples collected and the amount and quality of science conducted. In each case, the proposed rover mission would begin with a short 10-day, 0.5-km radius (maximum) reconnaissance trip around the lander for initial survey and checkout purposes. Subsequently, a number of planned traverses would take place. A typical rover traverse would conduct about 4 hours of work every 24 hours, visiting 8 sites on a 40 km trip taking 50 days, and returning to the lander with 3 kg of soil, rocks, and cores. Note that the sample acquisition totals listed in the table do not necessarily represent the number of specimens delivered to the lander; it is assumed that the rover will probably return with about half its collected samples to the lander for further analysis.

One of the conclusions reached by the group is that the scientific operational usefulness of the rover is primarily determined by the level of capability of its sample acquisition system and the frequency of uplink command interaction allowed during sampling station activities. Another important consideration is the role of the immobile station with respect to sharing the workload on the surface with the rover. Enhanced stationary lander capability simplifies the rover tasks and allows simultaneous work at the stationary lander. Stationary lander functions might include dust and atmospheric sample collection, subsampling and packaging functions, and scientific instrument platform both as a stand-alone science station (weather) and as a cooperative station with the rover (seismic thumping or electromagnetic sounding).

Table 3-1. Rover Traverse/Sampling Scenarios

	Minimum	Moderate	Maximum
Sample acquisition rate	1 per two days	1-2 per day	5 per day
Stops per traverse (planned)	4-6	8-12	15-20
Number of traverses			
Short	4	2	2
Medium	1	2	2
Long	1	1	1
Reconnaissance	1	1	1
Distance of traverses (round-trip)			
Short	20 km	20 km	10 km
Medium	40 km	40 km	40 km
Long	80 km	80 km	100 km
Reconnaissance	3 km	3 km	3 km
Duration of traverses (round-trip)			
Short	30 days	30 days	30 days
Medium	50 days	50 days	50 days
Long	100 days	100 days	120 days
Reconnaissance	10 days	10 days	10 days
Total sample acquisition	130 samples	250-500 samples	1200-1400 samples

Tools for sample collection fall into three general categories: (1) end effectors for the manipulator arms; (2) drills for soils and rocks; and (3) special-purpose, single-function "gizmos". For all these devices, the most important characteristic is reliability. The primary functions of arm-mounted tools are mostly "pick and place" functions, which are relatively simple operations. The group determined that arms for the tools should stay simple, and that extra degrees-of-freedom needed for specific tasks should be built into the end effector. The strategy of a universal mount between arm and tools with mechanical, power and signal connections incorporated appears to be feasible.

Drills can be body-mounted on the rover, or they can be arm-mounted tools. For shallow coring of rocks and small-diameter (0.5 cm) subsampling devices, arm-mounted drills are suggested. The feasibility of this approach and the limits on core depth and diameter are technical issues for the

robotics system. Deep soil-coring and robust rock-coring drills will probably be body-mounted tools with few degrees-of-freedom. Very deep soil-coring (5 m depth and greater) imposes a more complex drilling system. The interaction of the arms in support of drilling operations may be a significant source of requirements for the arms. While the general technology of drilling is well-understood, new designs and applications require extensive testing in realistic environments.

Single-function devices (gizmos) should be considered as complements to the robotic arm and tool system. Reliability concerns suggest the need for simplicity; some functions in the sampling system might be better assigned to fixed single-purpose equipment than to talented multi-purpose arms and tools. Some examples of gizmos are rock crushing apparatus for sample preparation for analysis, a drill press analog as a subsampling coring device, and spring-loaded drive tubes to sample duricrust (as in the minimum rover where no coring drill is anticipated). There is no particular technology impact resulting from these types of tools, except for specific gizmo development needs as they become identified.

A rover providing a moderate sampling capability should contain the following sampling devices:

- Manipulator arms with end-effector tools for collection of individual rocks and duricrust beds
- Coring drill, 2 m length x 2 cm diameter, for regolith sampling
- Manipulator-operated dual mini-drills (1 cm diameter x 10 cm length) for rock/bedrock sampling
- Scoop for sampling bulk regolith, fines, rocks, and duricrust
- Rake for collecting lithic fragments > 1 cm nominal dimension
- Impact drive tubes for near-surface regolith samples.

The stationary lander for a moderate-capability rover should include the following equipment:

- For primary samples
  - Atmospheric gas sampler
  - Airborne dust collector
- For contingency samples
  - Manipulator for bulk soil (scoop) and rock acquisition
  - 2 m coring drill

- For processing of samples
  - Core drill subsampler (mini-coring drill)
  - Rock subsampler (mini-coring drill)
  - Canister loading and reloading mechanisms

With this equipment, it should be possible to obtain a variety of the sample types required for a full investigation of: igneous and sedimentary rock-forming processes; soil-forming processes; regolith layering, with implications for climatic history; duricrust formation and salt migration; volatile inventory assessments (carbonates and nitrates); formation ages of major geologic units; volcanic history; etc.

A maximum capability rover would add several important capabilities, including more versatile sampling arms, and a 5-m coring drill which would allow improved chances for reaching buried ice. The latter is especially necessary at the lower latitudes of Mars because the depth to ice is expected to increase with decreasing distance to the equator. In addition, the deep hole will make feasible an experiment to measure heat flow, which is expected to provide important information on the thermal history of the planet. A soil penetrometer would also be added for systematic measurements of soil bearing strengths.

For a minimum capability rover, one-shot spring-driven impact drive tubes would be substituted for the coring drill. This would allow sampling of duricrust, soil, and a minimum of sampling of soil layers. It is extremely unlikely, however, that permafrost ice will be found at the depths that could be sampled in this manner. Core sampling of rock will be somewhat limited because of restrictions placed on the versatility of the manipulator arm and reduction of mini-drill capability.

For preservation purposes, each sample should be maintained in the environmental state in which it was collected, i.e., its "natural habitat" as defined by the lowest mean annual temperature. The most important intensive variable is temperature, although ambient gas pressure and atmospheric composition are also of importance. Therefore, samples will require a cold storage facility. Thermal control could be provided by passive means (buffering) or by active cooling (e.g., Stirling cycle or Peltier coolers could be considered). Necessary compromises might include greater emphasis on cooling regolith samples, with less emphasis on cooling rock samples. Containerization and preservation could be assigned to the stationary lander. No significant technological issues in this area were identified by the group.

Table 3-2 lists a number of rover operational characteristics desired by scientists. The basic envisioned operational scenario begins as the rover navigates itself to the directed area of interest, and parks. It surveys the area for "objects" of possible interest, and builds a local area map of object locations and extracted object features. These data along with the visual data are then transmitted to Earth. The scientists then select the "objects" of interest and specify the operations to be performed on them.

Table 3-2. Operational Characteristics for a Rover Designed by Geologists/Chemists

---

Cruise speed of rover	10 cm/sec
Time required to collect a rock or soil sample	30 min
Time required to collect a regolith core sample	45 min
Mass of a rock sample	76 g
Mass of a soil sample	50 g
Mass of a regolith core sample	600 g
Time required to collect a visual image	20 min
Time required to perform a preliminary examination of a sample	2 hr
One-way Mars/Earth communication time	20 min
Time required to make a decision on Earth regarding a rover operation	24 hr

---

This information is then transmitted to the rover, and the task execution is performed autonomously.

A full-function imaging system will be required for site geology assessment and sample selection, documentation, and characterization. There is significant functional overlap among this system, systems needed for local navigation, and systems needed for control and coordination of the arm and tool functions. The anticipated role of the imaging system in conjunction with the autonomous rover systems is largely one of documentation and monitoring. The imaging system needs no particular technology innovation. However, the concept is nascent, and technology issues may arise as the concept is refined and integrated with other non-science functional requirements.

In all, eight science instruments were identified as preliminary candidates for on-surface measurements. These candidate instruments for the rover are: stereo cameras; reflectance spectrometer; ultraviolet spectrometer; atmospheric pressure/temperature sensors; alpha-backscatter spectrometer; x-ray fluorescence spectrometer; passive seismometer; and soil water detector. Most of these instruments are in the preliminary stages of concept and development.

Robotics technology for a Mars rover mission was one of the primary areas assessed by the working group. Issues were addressed within three categories: (1) configuration (number of arms, number of joints, etc.), (2) control of arms, and (3) autonomy. These technology items were discussed within the context of the minimum, moderate, and maximum levels of rover sophistication. The general assessment was that robotics technology is relatively mature, and the required technology can be developed by a 1993 technology cutoff date. One possible exception is the area of autonomy, which is not very well developed. Considering that the sampling tasks even for the maximum mission are not very complex, less general but more robust autonomous motion planning and mechanization should be available by 1993, assuming that research and development starts in FY 1988.

In regard to sample acquisition system configuration, the principal requirement is high reliability. Reliability will be greatly enhanced by simplifying the mechanical subsystems, and by providing redundant arm capability. The advantages of having two arms for the rover are recovery from roll-over, the ability for one arm to service or repair the other, and redundancy, in case one arm stops functioning.

Based on the minimum sampling requirements (i.e., one sample every two days, minimal drilling, and no coring), the group agreed that two 3-degrees-of freedom (DOF) robotic arms would provide a simple functional manipulation capability for the mission. These robotic arms will obviously have limited orientation capability; hence, the spatial range of the operation will be very limited. The main reason for proposing a 3-DOF configuration for the arms is to have simple and reliable mechanical systems. These arms should be designed utilizing gear trains for mechanical power transmission, rather than direct-drive actuators. Gear technology is well-understood, and is essential to keep the mass and power down when using small motors. There should be a suite of tools that could be attached to the arms via a universal interface. The interface will accommodate power to the tool (if required), and also transmit sensory information to the arm controller. Tools should consist of items such as a servo-controlled parallel-jaw gripper with force sensing capability, a scoop, a rake, a simple multi-finger claw (as opposed to a complex multi-finger hand), a drill, etc.

For a moderate capability mission, the rover should have two 6-DOF arms. This configuration would provide a greater work volume with which the arms can be utilized to perform sampling and packaging tasks. The increased degrees-of-freedom would reduce the need to position the rover in an exact position and orientation for sample acquisition, and also will provide greater flexibility for the design of the packaging instrumentation and their particular position on the rover. Some elementary repair and maintenance could be performed as part of the moderate mission scenario. Modularity will be important for the rover design, so that parts can be easily replaced.

A maximum capability rover should have two 7-DOF arms for more sampling and analysis, as well as maintenance and repair, capabilities. The extra degree-of-freedom could be used to position the arm in hard-to-reach areas, as well as to avoid kinematic singularities. As with other mission options, one can always choose to utilize only a few of the degrees-of-freedom

for simpler operations. These arms could be used to assemble core drill bits for 2-5 m coring operations.

Figure 3-1 summarizes the differences in sampling configurations for the three levels of rover sophistication. Note that, for maintenance purposes, one of the arms should have more than 3 degrees-of-freedom. This arm should be able to reach every location on the rover; the length of the arm would be determined by this requirement. (Extra degrees-of-freedom could be provided by sophisticated end-effector tools.) In addition, the use of composite materials to make the arms lightweight and stiff should be researched.

Currently, most industrial robotic arms are controlled using simple proportional-integral-derivative (PID) control laws. Advanced research in robot control is mostly concerned with perfect trajectory tracking for fast robot movements. Because sampling operations will be performed with very moderate velocities, PID control laws can successfully be utilized for each joint without being concerned with non-linear dynamics coupling. PID control laws would be sufficient for the minimum and moderate capability mission scenarios. More complex control laws such as minimum energy solution should be used in conjunction with singularity and collision avoidance techniques for the maximum mission option.

Force control is also required for sample acquisition, drilling, and packaging operations. Force control is not as mature as position control; hence, further developments are required for all of the mission scenarios. At the present time, many universities and research institutions have developed force control capabilities for carefully staged demonstrations. It is envisioned, however, that force control techniques will mature in the next few years.

For the minimum capability option, position, velocity, joint torques, and/or end-point forces and torques must be sensed. The position, orientation, and shape of objects of interest must be provided to the controller by the Earth-based science team from the images transmitted by the rover. The required accuracy will be a function of the particular tool used for sample acquisition. Accuracies should be in the range of 1-5 mm for the position of the object, and 1-2° in its orientation. A small laser rangefinder could provide this capability. The moderate mission option would require proximity sensor feedback for enhanced autonomous operations. The maximum mission option would incorporate tactile sensors on some of the tools, in addition to the sensors discussed for the moderate scenario. Dual arm control will be required for more complex packaging, repair, and maintenance, as well as for acquiring heavy samples and for assembling core drills. Tactile sensor based control and dual arm control techniques are not mature, and would have to be developed in the next five years. In addition to the above-mentioned sensors, rover-mounted sensors such as accelerometers are needed to account for small rover movements during sampling operations.

The level of autonomy was determined to be an important factor in the operation of the rover in general and sample acquisition in particular. Due to the long communications time delay between the Earth and Mars,

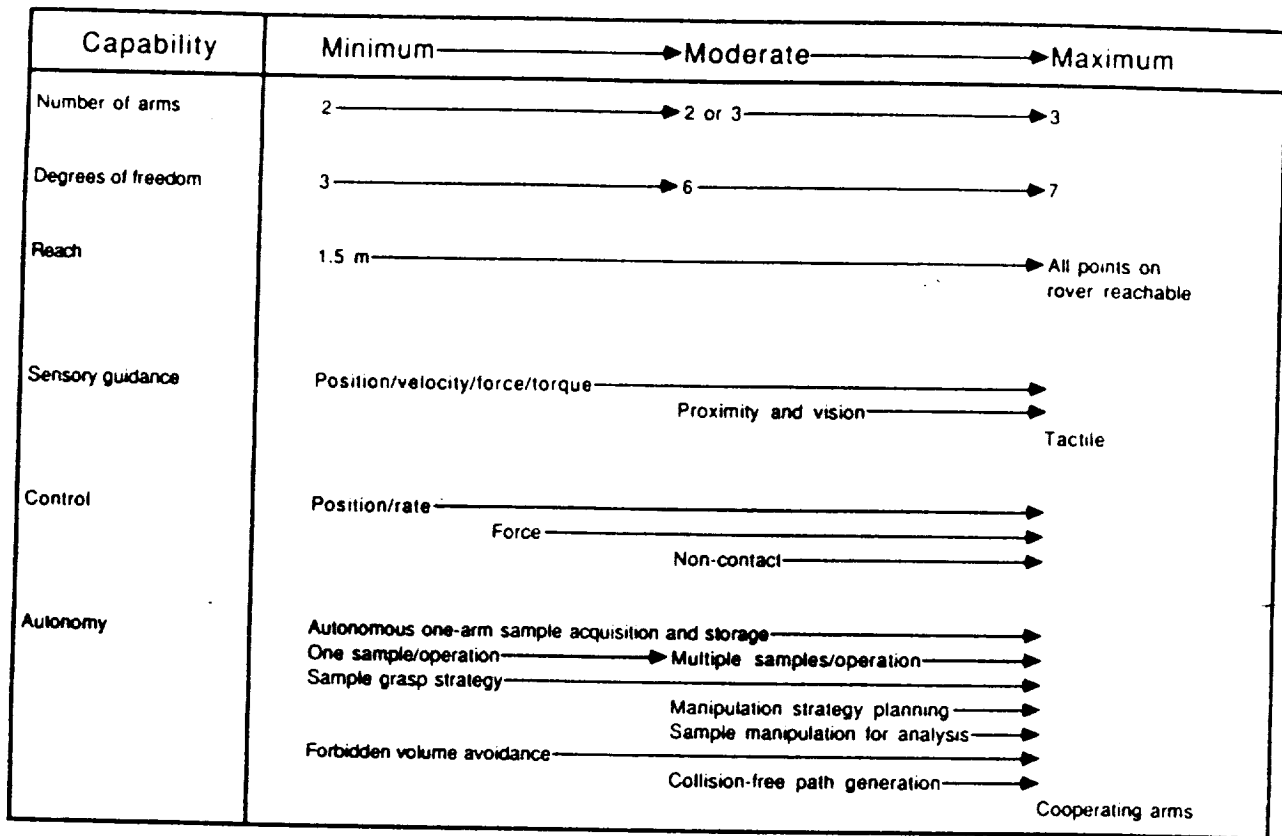

Figure 3-1. Rover Sampling Capability Options

autonomous operations must be relied upon heavily for sampling. In addition to this long time delay which rules out teleoperated movement of the robotic arms, mission operation complexities will restrict command uplink to the rover to at most once a day. Therefore, the arms must function in a highly autonomous, data-driven, sensory-controlled manner. It was felt that no new language is required for implementation of the low- and high-authority portions of the controller subsystem. However, the software architecture of such a system will require further study and development. Discussions on the predictability and safety aspects of autonomous operations suggested that a simulation tool must be available to make sure that appropriate plans would be generated by the task planner before the uplink command is sent.

The minimum mission option would require high-level task planning for simple "pick-and-place" operations of only one three-DOF arm at a time. The plan must generate a series of subtasks to pick up the designated tool, approach the object, grasp it, depart with the grasped object, and finally place it in a designated container. This basic level of autonomy has been demonstrated at research institutions and universities.

To achieve moderate or maximum levels of rover arm autonomy, additional technology must be developed in the next five years. In the moderate mission option, multiple sample acquisitions by simultaneously operating arms would be planned and executed from only one command uplink.



Also, modest sample manipulation would be performed by the arms for packaging and analysis purposes. The maximum mission scenario requires an extra degree of autonomy, since the rover might be moved by a small distance after acquiring the first sample to acquire additional specimens. The planning would include dual-arm cooperating task execution for more complex sampling, maintenance, and repair tasks. For this option, robust algorithms for collision-free path generation must be developed.

In conclusion, the working group unanimously agreed that the best strategy for developing the required technology for sample acquisition, analysis, and preservation is to build a test-bed. This test-bed can provide a realistic integrated system to experiment with and to verify various autonomous sample acquisition tasks. In fact, this idea can be broadened to include other technology areas outside of sample acquisition, such as mobility, communications, computing and task planning, and global navigation.

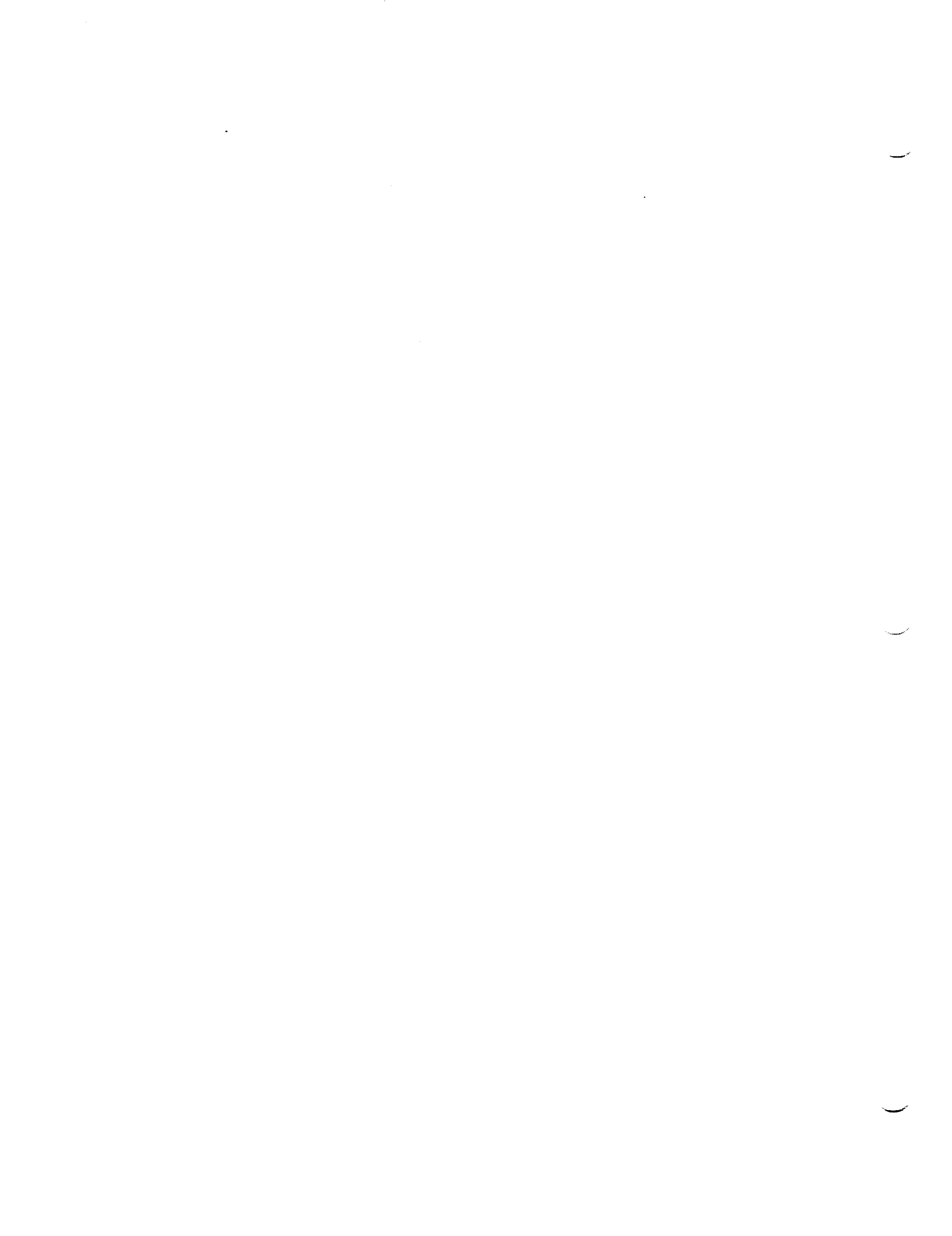

## SECTION 4

### MOBILITY WORKING GROUP

The Mobility working group primarily looked at the problem of terrain definition, and options for vehicle configurations. The lessons learned from lunar vehicle developments, the state-of-the-art in legged vehicles, and the experience of many military vehicle developments, were all discussed in ways that they relate to a Mars rover. The impact of the various rover capability scenarios (minimum, moderate, and maximum) on mobility technology requirements was considered. However, the group determined that while these scenarios influence future point designs, they are not drivers in the development of mobility technology.

The function of locomotion is the key consideration in rover design. The degree of severity of the terrain dictates the type of locomotion system used (rolling, crawling, walking, flying, etc.). Other considerations combine with locomotion to determine the vehicle configuration. For example, the limited volume available for storing the rover in transit to the Martian surface requires a combination of small parts and/or collapsible designs. In addition, to the extent that operations are performed while the vehicle is in motion, it serves as a dynamic instrument platform. For some static operations, it must function as a rigid base.

Because the rover vehicle must operate autonomously, it must be able to right itself and to withstand overturning. The value of the mission, coupled with the uncertainty of the hazards, dictates a self-righting vehicle. By ruggedizing the appropriate instruments and equipping the vehicle to turn upright again, the mission can be continued. The rover also requires the ability to recover from hazards and failures.

The spectrum of locomotion types is very broad. The working group determined that there are two major types of locomotion: legged and rolling. However, by incorporating a pair of robust manipulator arms to be used also as climbing arms/legs, a third type can be created which may have the speed and efficiency of wheels while adding self-recovery capability and the ability to climb out of crevices. Such a "hybrid" vehicle is expected to be the most efficient means of overcoming large obstacles and self-righting the vehicle. The arms might also be used to stabilize the vehicle during drilling operations. Table 4-1 lists the most significant aspects of the three locomotion types. The number of legs/wheels, degree of body articulation, and type of suspension are examples of configuration elements not yet resolved.

In the table, the option listed for wheels as "4, 5, 6, or more" is intended to point out the significance of the number of wheels. Four wheels could be the most efficient. Five is unconventional, but is still stable after losing one leg. Six is the most popular obstacle-climbing configuration. For soft soils, more wheels are advantageous, and provide improved maneuverability.

Table 4-1. Rover Locomotion Types and Characteristics

	Legs	Wheels/Tracks	Hybrid
TECHNOLOGY OPTIONS	-Various geometries	-4,5,6, or more -Chassis articulated -Various suspensions -"Active" suspension	-Wheels and legs
RATIONALE	-Fully terrain-adaptable -Foldable -Omnidirectional -Stable platform	-Proven technology -Potentially simple -Efficient on smooth surfaces	-Most versatile
COMMENTS	-Complex	-Trade-off of size with number of wheels -Needs stabilization	-May compromise sampling

The comment on the hybrid type is meant to call attention to the need to coordinate the vehicle designer and the sample acquisition engineer. In order to make the legs rugged, it is likely that only three degrees-of-freedom will be designed into the legs. However, as discussed in the preceding section, an additional three to four degrees-of-freedom can be added by the use of sophisticated end-effectors.

For the legged option, near-term research is necessary to provide a better understanding of the way a foot sinks into the soil. This understanding is a prerequisite to developing the computer software necessary for negotiating combinations of turns and hills on various soils and obstacles. For the wheels/tracks option, development should begin with determining the best configuration. This can be done by a combination of scale models of computer modeling. Similarly, the obstacle-climbing maneuvers of a hybrid arm-wheeled vehicle need to be analyzed to determine an optimal configuration. The configurations that result from each option should then be compared.

The working group also determined that a single body unit has significant advantages over several body units. Distributing the load, in the form of a separate body unit over each axle, is a proven way to gain obstacle climbing ability. However, a single body unit provides important advantages in regard to thermal control and instrument platform stability. Improved suspension schemes need to be developed for this type of vehicle.

The Martian terrain presents a unique problem for the vehicle designer. Vehicle design will involve more than simply selecting

characteristics from the experiences gained either on Earth or on the Moon. The Martian gravity is between that of the Earth and the Moon (1>.38>.17). Mars has enough atmosphere to burn up small meteorites and turn them to dust. Mars also has volcanoes which have likely made more dust. Indications are that Mars has much more dust in the particle size range of less than 10 microns than the Moon. Whereas the Earth forms clay from particles this fine, Mars has dust storms which circulate the dust and keep it loose. The deep ravines of Mars are likely to contain "soil" composed of dust, compacted and bound by frost and/or salt crystals to an unknown value of cohesive force.

Consequently, the early development of a detailed Martian terrain model is considered to be essential. For preliminary traverse planning, it will be necessary to understand the consequences of compromising the vehicle mobility at specific sites. The specter of deep soft dust, in particular, is the most threatening unknown (as it was at one point in the lunar experience). A requirements list for a terrain model is offered in Table 4-2.

In order to design a Mars rover, it is necessary to combine previous vehicle experience with what is known about the Martian environment and what is desired of the sample gathering mission. The recommended procedure for this task is to begin with computer simulation of the environment and promising vehicle configurations. Computer modeling is becoming the vehicle industry's most efficient means of selecting a design. It is expected that key generalizations will emerge that allow trade-offs to be performed. After a superficial computer optimization, laboratory experiments should be conducted to determine the validity of the interactions between elements used in the computer analysis. By combining and iterating computer optimization with laboratory experiments on specific elements, a preliminary design will emerge. The design needs to be modeled as hardware and tested extensively in order to expose any shortcomings.

Table 4-2. Terrain Model Requirements

Terrain Category	Characteristics
Soils (dust, crust, etc.)	Angle of internal friction Cohesion Size Depth
Profile (obstacles, etc.)	Roughness (RMS dimension) Size Shape Distribution
Slope	Distribution Angle

Although there is considerable experience in vehicle design, the rover designer still does not possess the knowledge necessary to configure a vehicle for the Martian landscape. It is not known how to trade off mobility capabilities over a variety of terrains against the other aspects of vehicle design such as reliability, efficiency, speed, etc. This situation is similar to that encountered in the 1960s, when a wide variety of vehicles were proposed for lunar exploration, including many innovative new vehicles which rolled, walked, crawled, and burrowed into and over sand and rocks. A few wheeled vehicle designs were selected which had been reasonably optimized for the surface of the Moon. These designs emphasized the practicable features of light weight and collapsibility. Even though it is likely that the chosen configuration for a Mars rover mission will emphasize the same characteristics, the vehicle research involved in developing special designs is of great value.

## SECTION 5

### COMMUNICATIONS WORKING GROUP

The Communications working group considered the technology requirements and options for the various communications links that will be necessary to support principally the rover part of a MRSR mission. Key assumptions included projected Deep Space Network (DSN) capabilities for the late 1990's, as well as constraints drawn from recent MRSR mission studies. Technology developments required for microwave and optical communications systems were identified, along with constraints or requirements imposed on other functions or subsystems.

Two major configurations are possible. In the first, the rover communicates directly to Earth, and all commanding and telemetry needs are performed without direct involvement of the orbiting mapping satellite. Because this configuration depends on Earth view periods, rover operations requiring Earth-based involvement necessarily are restricted to about 10 hours per day. The second configuration uses a Mars synchronous orbiter for communications relay purposes. This option would provide the dual benefits of allowing for substantive (Earth-interactive) operations during the Mars night, and of reducing the communications resources required on the rover. The relay satellite also could function as a base for computational support to mobility, hazard avoidance, and sample collection. A reduced capability direct-to-Earth mode would serve as a backup to the possibly limited lifetime of the relay satellite.

Another potential use of the relay satellite could be as a precursor mapping satellite, if sufficient orbital change energy can be provided. The satellite would provide high-resolution maps of the surface prior to final site selection and planning, thereby considerably improving the safety of the mission. Such a precursor should be launched one Mars opportunity sooner than the primary mission.

Daily data return for the MRSR mission was estimated by the Communications working group to be between a minimum of 100 Mb and a maximum of 1 Gb. Based upon an approximately 5% duty cycle for transmission, strawman downlink telemetry rates of 30 kbps and 150 kbps were selected. Both system configurations are capable of supporting these data rates. In addition, the 30 kbps and 150 kbps rates are keyed to DSN 34-m and 70-m single aperture performance, respectively. For a full Mars year, multiple DSN aperture needs should be restricted to short periods of high importance. A 1 Mbps link may also be required for high data rate dumps, science- or mobility-related needs, or high-interest public relations opportunities (real-time TV transmission). For this high-capacity link, using the orbiter as a relay satellite will be necessary if optical communications technology is not available.

The Earth-to-Mars uplink (command) data rate capability was set at 2 kbps by the working group. An emergency mode of about 8 bps was also selected. For these requirements, metric tracking performance is adequate to support navigation functions. Therefore, the tracking function does not appear to be a technology driver.

The DSN configuration available to support the MRSR mission by the late 1990's will be approximately that which will support the Voyager spacecraft at Neptune, plus technology advances as defined in the current DSN long-range plan. Planned implementations to the DSN are summarized in Table 5-1.

Today's DSN downlink system temperature capability at X-band is 25 K. Installation of beam waveguides in the early 1990's is a potential enhancement which would facilitate the installation of  $K_a$ -band (32 GHz) downlink capabilities and allow reduction of the working system temperature at X-band to the neighborhood of 15-18 K. This would require cryogenic cooling of feed components, and lowering of the operating low-noise amplifier temperature. The nominal  $K_a$ -band system working temperature is 40 K at 30° elevation. In addition, the uplink radio frequency (RF) power of today's DSN transmitters is 20 kW. The DSN long-range plan includes prospective enhancement of this capability to 400-1000 kW at X-band.

It is assumed that at least one 34-m antenna will be continuously available to support a link with Mars. Installation of multiple receiver channels and dual uplinks will allow contact with multiple Mars spacecraft via that single 34-m aperture. The 70-m DSN aperture will be made available as needed to support the higher data rate operation. Under an emergency or special-event situation, higher-power uplinks and arrays of receiving apertures could be mobilized to provide added capability.

Table 5-1. DSN Long-Range Plan Highlights

- 
- Increased performance of 64-m antennas by expansion to 70 m and improved microwave efficiency (1989)
  - Inter-agency arrays for telemetry and radio science enhancement (1989)
  - X-band uplink (by 1989-90)
  - Ranging capability for spacecraft that use X-band uplink (by 1989)
  - BLOCK II system VLBI terminals (1987)
  - Improved radar signal processing equipment (1987), and transmitter power increase to 1 MW (1993)
  - Replacement of "standard" 34-m antennas with new, high-efficiency 34-m antennas (1995)
  - $K_a$ -band downlink services (1995)
-



The working group utilized the assumption that, for a direct rover-to-Earth link, the rover power available to conduct downlink transmissions will be limited to the same 120 W (approximately) required to support locomotion. Downlink operation will, therefore, be available only from a stationary rover. This constraint was derived from previous studies on rover capabilities.

Another important limitation for a MRSR mission involves antenna aperture size for the space segment of the mission. For a direct rover link to Earth, aeroshell packaging restrictions will constrain the aperture diameter to less than 1.0 m, unless a deployable design is considered. An aperture size of 0.6 m or less would be ideal. For a relay satellite in orbit around Mars, a 3.6-m-diameter aperture is considered nominal. Table 5-2 lists the aperture sizes needed to support the data rates from Mars to Earth using various combinations of RF transmitter power and DSN stations, for  $K_a$ -band and X-band frequencies. The values in the table include allowance for uncertainties in design, manufacture, measurement error, etc. For an X-band system, the root sum square of the tolerances should be about 0.8 dB. A conservative sigma of about 1.0 dB is used for a  $K_a$ -band link, because this technology has little or no space flight history. For a 90% confidence link performance, a margin of 2 sigma should be adequate.

The table shows that, for a direct rover-to-Earth link, minimum rover communications needs can be accommodated by a mechanically steerable 0.6-m dish and a 40-W transmitter on the rover. This X-band system would require no major technological developments. However, based upon the constraints of aperture size on the rover,  $K_a$ -band links would make antenna packaging far easier. Moreover, for a given antenna size and transmitter power, a  $K_a$ -band system would permit an improvement in data transmission capability of approximately a factor of five, as compared to X-band.

Table 5-2. Antenna Aperture Size and DSN Station Pairs for Mars-to-Earth Communications at 2.68 AU (90% reliability, 2 sigma (1.6 dB X-band, 2.0 dB  $K_a$ -band))

	RF Power	Aperture Diameter (30 kbps, 34-m Stations)	Aperture Diameter (150 kbps, 70-m Stations)	Aperture Diameter (1 Mbps, 70-m Stations)
$K_a$ -Band	40 W	0.2 m	0.2 m	0.8 m
	20 W	0.3 m	0.3 m	1.2 m
	10 W	0.4 m	0.4 m	1.7 m
X-Band	40 W	0.6 m	0.6 m	1.8 m
	20 W	0.9 m	0.9 m	2.7 m
	10 W	1.3 m	1.3 m	3.8 m

For a Mars-orbiting relay satellite, a 1.3-m-diameter X-band antenna and a 10 W transmitter would be sufficient to meet the minimum communications needs. An antenna of the size utilized on the Voyager spacecraft should be sufficient, at 10 W RF power, to provide the 1 Mbps link. For the rover-to-orbiter,  $K_u$ -band is recommended. A transmitter power of less than 10 W and a relatively broad-beam antenna of more than  $10^\circ$  should be adequate. Note that in this scenario, the relay satellite would absorb much of the power, pointing, and computational constraints imposed on the rover communications subsystem.

The rover antenna can take the form of a fairly simple, low-gain antenna if a relay satellite in Mars orbit is implemented. For a direct link to Earth with aperture size on the order of 0.6 m, a number of  $K_a$ -band antenna configurations are possible. Some of these configurations are illustrated in Figure 5-1. Two array approaches, in particular, are attractive. One is a body-fixed phased array (labeled "phased array" in Figure 5-1) which relies completely on electronic beam steering. A second approach is to use a combination of mechanical and electronic beam steering (labeled "array with waveguide" in the figure). The body-fixed, electronically beam-steered array has the advantage of very compact packaging with no stowing required. The disadvantage, however, is its complexity; the array is required to scan over angles on the order of  $60^\circ$ , which implies that individually phase-controlled radiators must be spaced on the order of one-half wavelength (5 mm). Thus, approximately 6,000 elements are required. The alternatives are to reduce the range of the electronic beam-steering angle, which allows greater spacing between elements, or to use sub-arrays to substantially reduce the number of active elements. If the electronic beam steering range is less than  $10^\circ$ , the number of active elements can be reduced to the order of 200. To produce 40 W of radiated power, each element must radiate on the order of 200 mW.

These two array approaches offer several attractive benefits. One benefit is the capability of utilizing the array for electronic beam steering. This is an important consideration because, in order to keep pointing loss less than 1 dB, pointing accuracy must be maintained to less than  $0.13^\circ$ . Although a complete study of mechanical pointing systems for rover applications has not been carried out, it is anticipated that pointing to this level of accuracy will be difficult in the Martian environment. Coarse pointing information could be derived from rover on-board sensors, and fine pointing information could be obtained from a monopulse system incorporated into the Earth-to-rover uplink communications system. The most power-efficient approach to implementing the array is to utilize distributed solid-state amplifier and phase shifter components. The array would provide the additional benefit of low-loss power combining of solid-state amplifier outputs.

The technologies for  $K_a$ -band phased array antennas, solid-state power amplifiers, multimode tracking feeds, and beam waveguides are generally at the conceptual design level. In contrast, the technology for a mechanically steerable  $K_a$ -band antenna is currently at the breadboard level.

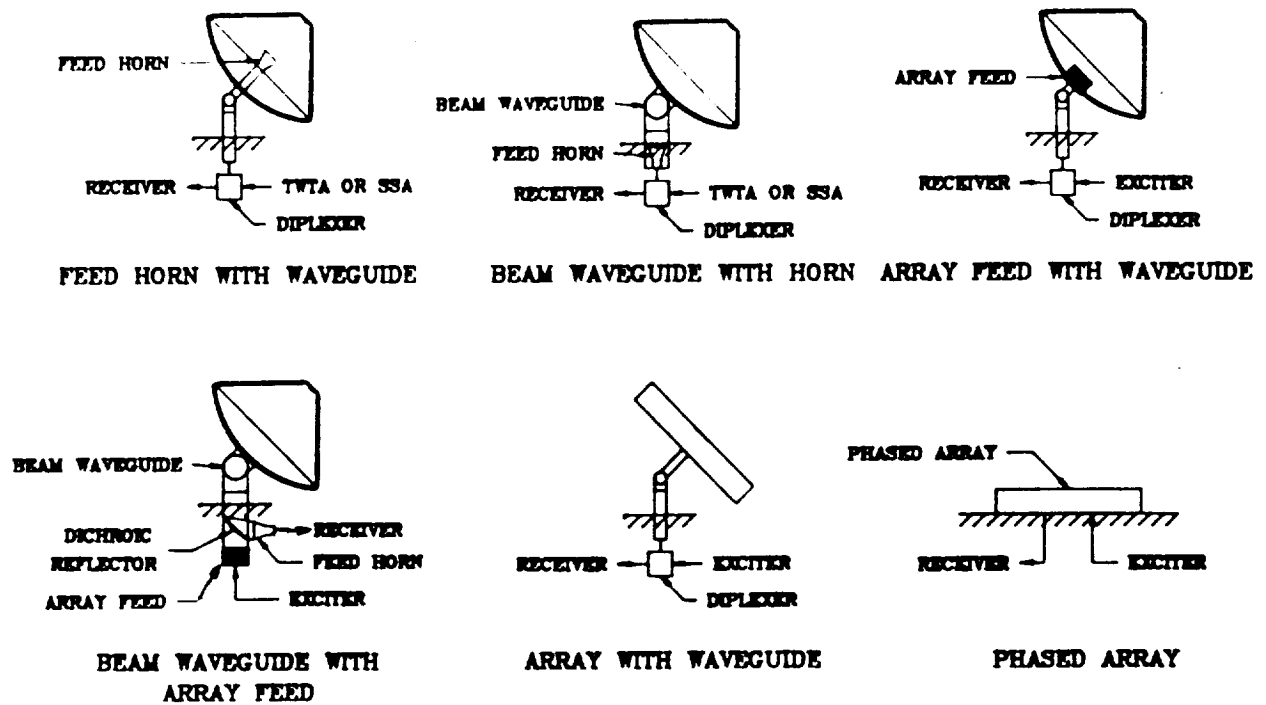

Figure 5-1. Rover  $K_a$ -Band Antenna Configurations

A key concern in development of electronically steered arrays is cost. Cost is driven by labor-intensive activities, including assembly and test of the large number of elements. The use of microwave monolithic integrated circuit (MMIC) technology, in which the majority of device interconnects are eliminated, will help bring about low phased-array cost. In addition, computer-aided test systems are being developed to reduce testing costs.

MMIC devices are presently being developed for use at  $K_a$ -band by NASA Lewis Research Center (LeRC). The DoD's Microwave/Millimeter-wave Monolithic Integrated Circuit (MIMIC) program will also contribute to rapid advances in MMIC technology. In addition, new device structures such as the pseudomorphic high electron mobility transistor (HEMPT) show great promise for improved performance such as high power efficiency. Within the last six months, for example, power-added efficiencies of the order of 35% have been demonstrated for discrete devices of this type.

JPL has recently initiated a  $K_a$ -band transmitter development program. This program utilizes devices being developed at the Lewis Research Center (LeRC). The initial objective is to demonstrate a one-dimensional electronically beam-steered array utilizing unpackaged MMIC amplifier and phase shifter devices. Initial tests of this test bed array are planned for later this year. Measurements of the MMIC devices are presently being carried out, and fabrication of components of the array is under way.

The state-of-the-art of K<sub>a</sub>-band solid-state technology is represented by gallium arsenide (GaAs) field effect transistor (FET) technology; IMPATT amplifier technology does not have the power efficiency capability of FET technology. GaAs FETs have been demonstrated with power levels of the order of 1 W at 30 GHz, but with low gain and efficiency. Power-added efficiencies of the order of 35% at 35 GHz have been obtained at 50 mW. Continued effort is required to produce both high power and efficiencies, and these devices need to be integrated into MMIC devices. LeRC is presently funding programs to move toward these goals, but enhanced and focused development is required. The present thrust of NASA-funded efforts does not include packaging, which is required for high-reliability space applications. Very little effort has been undertaken to assure reliability of MMIC devices.

To meet the needs of the rover communications system for a direct link to Earth, high-efficiency GaAs power FETs with power-added efficiencies of greater than 35% with 250 mW or more output power are required. These devices must be integrated into multistage MMICs to obtain gain levels of the order of 15-20 dB. In addition, low-loss phase shifters with losses of less than 6 dB are required. The phase shifters must be integrated with high-efficiency power amplifiers to compensate for the power loss. It is desirable to integrate digital components on the MMIC chip to minimize the number of interconnects to the phase shifter digital control system.

In order to apply these devices to the rover communications system, they must be encapsulated in impedance-matched packages to provide hermetic seals from the environment. This technology does not presently exist. In addition, the devices must be designed and tested to provide high-reliability operation. Automated testing procedures must be devised to provide low-cost devices. Lower costs will also be derived from the development of improved MMIC modeling techniques to allow more rapid convergence on a device design.

Transmit module and circuit technology development is required for the rover communications system. Areas of development include low-loss millimeter wave power combiners and power distribution networks to maintain high power efficiency. In addition, methods of optimal integration of radiating elements and MMIC devices need to be developed to minimize circuit losses and costs. Automated testing techniques for these modules require development. Other development areas for transmit modules include thermal control systems and power distribution methods.

Development is also required in the area of methodology for optimizing active array architecture. This methodology must consider a number of complex issues, including low-loss and highly-reliable interconnections of RF transmission lines and dc power and digital control lines. The optimum architecture must provide integration of millimeter wave active and passive transmission lines and radiating elements with thermal control systems packaged for ruggedness and allowing for replacement components. It must accommodate a modular construction technique to reduce cost and allow lower-level subelement testing.

Efficient design procedures require the development of improved active array analysis methods to allow more accurate predictions of performance to reduce the costs of development and improved performance. Related to this is the need for improved modeling array feed element analysis, particularly planar antenna element structures. Another important area is the development of beam waveguide technology to reduce signal loss from the antenna system to other elements of the millimeter wave system.

Development is required in several additional areas which support active array systems. These include digital electronic beam steering control systems, control system interconnections, power supplies, and thermal analysis methods. Digital beam-steering control systems will benefit from the development of custom VLSI circuits integrated with the microwave components and the application of optical interconnections for control of MMIC devices. The development of a  $K_a$ -band exciter and transponder subsystem is another critical development area. This subsystem should be designed to incorporate a high level of MMIC devices to minimize size and mass.

As stated earlier, communications at optical frequencies would allow for a direct 1 Mbps link from the rover to Earth. Critical development of most components for this application are required. Optical communications are more credible for a 1995 technology cutoff date than by 1993. An even more substantial obstacle is the questionable likelihood that NASA would be able to design and implement a complete network of ground or space-based terminals that could be made operational for a mission occurring prior to the year 2000. An Earth-orbiting receiver (possibly on the Space Station) would be necessary to avoid the interference from adverse weather conditions that ground-based receivers would experience. For ground-based reception, three spatially diverse sites in the vicinity of each DSN complex would be required in order to achieve a system weather availability of about 97%. Two telescopes, spaced several hundred miles apart, in each DSN region would achieve 91% availability, while only one per region would achieve 70% availability. Logistical considerations for maintenance and data handling imply that the ground-based receivers be in the vicinity of existing DSN resources.

The performance values for a MRSR optical communications system are summarized in Table 5-3. The system is estimated to weigh about 25 kg and have a deployed volume of  $0.054 \text{ m}^3$ , whereas an X-band microwave system would weigh about 40 kg and take up  $1.0 \text{ m}^3$  volume on the rover, or  $24.5 \text{ m}^3$  volume on the orbiter. In addition, an optical system on the rover would also consume 35 W of power, as compared to approximately 120 W for the microwave system, thereby permitting data transfer during roving on the Martian surface. Critical technology needs for optical communications include: detectors with  $\geq 30\%$  quantum efficiency at 0.532 micrometers; a 0.4-W Nd:YAG laser with  $\geq 10\%$  overall efficiency at 0.532 micrometers; a 10-m non-diffraction limited collector for ground-based reception; and detectors and techniques for sub-microradian acquisition, pointing, and tracking.

Table 5-3. Optical Communications System Characteristics

---

Package: 10 cm telescope  
400 mW doubled Nd:YAG laser  
35 W total power  
25 kg total mass (fully redundant except for telescope and gimbal)

Receiver: Ground-based 10-m collector (non-diffraction limited)

Downlink: 150 kbps, bit error rate =  $1 \times 10^{-3}$

Uplink: 2 kbps, bit error rate =  $1 \times 10^{-9}$

---

## SECTION 6

### GLOBAL NAVIGATION WORKING GROUP

The Global Navigation working group addressed the problem of accurately determining the location of the rover on the surface of Mars. This includes both the estimate of the vehicle's current position at any time and the knowledge of its positions at previous times. The group attempted to identify the most promising approaches to this complex problem, and to specify required advances in technology. The name "Global Navigation" was assigned to the group to distinguish its activities from those of the Local Guidance and Hazard Avoidance working group. The latter group was concerned with the detection and avoidance of nearby hazards, whereas the Global Navigation group was concerned with locating the vehicle on a larger scale with respect to a Mars-referenced coordinate system.

The rover navigation task will start before landing, with detailed mapping of the surface. This information is essential for determining and describing desirable landing sites in enough detail to assess landing safety and geological interest. The same information is used to plan rover traverses. Earth-based operations will define the transformation from inertial (orbit-based) coordinates to the local reference frames in the vicinity of the landing site.

The Mars Observer mission planned for 1992 would be an ideal opportunity to acquire meter-level resolution maps of possible landing areas and environs. This would enable a large number of rover excursions to be planned in great detail, and would minimize the number of surprises to be overcome during the mission. However, because of mission considerations, the Mars Observer may not be assigned this task. An alternative, discussed in the preceding section of this document, would be to launch the MRSR orbiter spacecraft one Mars opportunity sooner than the primary mission, so that it would provide high-resolution maps of the planet surface prior to final site selection and planning.

Once landed, the rover will use its inertial instruments to determine its attitude in the local reference frame. The rover imaging system will provide stereo views of the local terrain for Earth-based correlation with available maps, thus determining the location of the landing site. Earth-based Doppler measurements of the rover's communications downlink and orbiter-rover ranging can also be used to help locate the site.

Once initialized in local position coordinates on the map, the rover can autonomously navigate a traverse toward a target location identified in map coordinates. It will use standard inertial navigation techniques to maintain its knowledge of attitude, position, and velocity in the local reference frame, including propagation of the co-variance of this knowledge. Inputs to this computation include attitude changes from gyroscopes, accelerometers sensitive along all three axes, and integrated wheel rotation angle. If the rover is a walker, it may require an odometer wheel.

However, the accuracy of this inertially-determined position degrades rapidly with time, so that it is useful only as a short-term reference. By modeling its own navigational error, the rover will determine when it requires a position update. Periodically, it will stop and become re-initialized. Updating the rover navigation system can be accomplished in a number of ways. These include: Earth-based radiometric techniques; map matching and image correlation (landmark tracking); laser ranging of the rover from the lander or the orbiter (reflector tracking); radar ranging (including orbiter beacon tracking); and stellar updates of rover attitude (star tracking).

Earth-based radiometric techniques include the use of Doppler ranging, or differential very-long-baseline interferometry (delta-VLBI). These techniques can supply precise distances between lander and rover in Earth- or Mars-centered coordinates, which can be converted to local map coordinates through orbiter imaging. With the use of conventional Doppler tracking and ranging of the rover from the Earth, it might be possible to determine its longitude and its distance from the spin axis of Mars to an accuracy of tens to hundreds of meters, with the third position component somewhat more poorly determined. With the addition of advanced delta-VLBI techniques (not yet demonstrated), it might be possible to determine all three position components to an accuracy of meters to tens of meters. The data processing for this delta-VLBI approach could take place on the Earth (as has always been done to date) or, conceivably, on Mars.

Alternatively, a highly-autonomous position update can be obtained with an on-board expert system which can correlate the local scene with horizontal projections of orbiter imagery. The latter may require self-initiated traverses to add scene changes to the image-correlation process until solution confidence is high enough to proceed. If the orbiter were assisted by another orbiting craft, dual ranging to the rover could provide sufficient position information. Another possible technique for obtaining periodic position updates involves measurement by the rover of the changes in the Doppler shift in a radio signal from the orbiter, as the orbiter moves across the Martian sky. This technique is the basis for the Transit satellite navigation system, which has been used for more than 20 years on Earth. Its use on Mars, however, will require considerable modification.

The last navigation task will be to bring accumulated samples to the sample return vehicle, which will be either the lander that brought the rover, or an independent craft. If the lander is the sample return vehicle, then the traverse will be like any other traverse, because the lander is the origin for the rover local reference frame. However, if the sample return vehicle is an independent craft, it must first be described in the local reference frame through the same processes used to identify the initial rover landing site.

If high-resolution maps of the areas to be explored are not available, the rover navigation task changes considerably. Local guidance and hazard avoidance will be more dependent upon rover imaging and Earth-based supervision of path selection. Previously planned routes may be found traversable only with a fairly robust rover. Radiometric techniques (or a large number of stereo images) will be required to determine the location of



the rover and to update its position. Moreover, to assure a productive mission, the rover and its navigational capabilities would have to be designed for a wide range of possible extremes in traverse scenarios and conditions.

The working group identified technology needs for three general classes of navigational techniques: inertial and dead-reckoning techniques; imaging-related techniques; and radiometric techniques. These technology areas are discussed in the remainder of the section. Systems studies are required to select the appropriate set of techniques for the rover.

Inertial and dead-reckoning navigation components provide short-term information on the location of the rover relative to some initial reference point. An inertial system is likely to comprise an array of gyroscopes and accelerometers. Essentially, it measures the short-term movements of the vehicle and the slope of the local terrain. The on-board computer is utilized to keep track of the position and attitude of the rover with respect to the local vertical and with respect to the lander.

The inertial system will require periodic recalibration. Recalibration consists of stopping all rover motion for an interval sufficient to assess the rest outputs of the inertial sensors. The more frequently the inertial system is recalibrated, the lower are the errors due to doubly integrating accelerometer bias. A recalibration schedule for providing high performance might be once every five minutes, for a duration of one minute.

Deductive (dead) reckoning is the process of maintaining continuous knowledge of location relative to some starting point by keeping track of all motions. Dead reckoning is normally implemented by plotting motions on a map of the local terrain. Landmarks may also be plotted on the map, and may be used subsequently for correcting dead-reckoning errors.

Motions can be plotted either by doubly integrating accelerometer measurements or by measuring surface motion using an odometer. An odometer can use measurements of the rotation of a wheel. The wheel may be one of the rover's drive wheels or a coasting wheel. Unfortunately, errors in measuring wheel rotation can result from skidding and from highly sloping local terrain, such as boulders, walls, or other obstacles. Alternatively, stereoscopic measurements of distances to visible terrain features may provide greater accuracy.

A compass can also be used for dead reckoning, to determine rover latitude. Although applicable to navigation on Mars, the magnetic compass lacks accuracy even on Earth where the magnetic field is far stronger than on Mars, and it would suffer from interference by the magnetic field produced by the rover. An alternative is gyrocompassing, which involves measuring the planetary rotation vector. Any of a variety of gyroscopic sensors can be used, including spinning wheels or laser gyros.

A baseline inertial reference unit for a MRSR mission should measure three components of body angular rate and three components of acceleration. More than three accelerometers and more than three gyros should be used to provide redundancy. The inertial and dead-reckoning system should also include a wheel to function as an odometer. The wheel must be non-driven to

eliminate skidding. Optional additions and substitutions to enable a high-performance system include: a gravity gradiometer to determine contact acceleration with respect to the three components of position, and to measure the magnitude and location of gravity anomalies; a three-axis stabilized platform to replace the baseline inertial reference unit described above; and an optical odometer based on measuring surface motion using a charge-coupled device (CCD) sensor.

Advances in the state-of-the-art will enhance the performance of inertial and dead-reckoning navigation, but are not essential to enable the mission. Improved performance will result in higher accuracy in locating the rover, and will reduce the required frequency of position updates. However, although latitude can be computed directly from inertial measurements, the latitude deviations from predicted inertial performance that will result may be larger than permitted. Radiometric or other techniques may be necessary to provide the required accuracy. Radiometric or other techniques may also be needed to provide longitude and latitude to sufficient accuracy.

In the area of imaging-related navigational techniques, there are three fundamental technologies involved with solving the rover's navigation and positioning requirements: image correlation and mapping, photogrammetry, and on-board data integration and topographic information extraction. A very considerable development effort is required to coordinate the gathering of orbital tracking, orbital imaging, surface imaging, and rover inertial and radiometric guidance data. The primary objective of this capability is to maximize the rover's autonomy by minimizing Earth-based supervision of local path selection, time utilization, and resource (power) utilization.

An important issue is correlation of stereoscopic images taken by the lander with stereoscopic images taken by the orbiter. Images taken by the rover will be increasingly difficult to interpret as feature distance from the rover increases. Distinctive skyline profiles may be identifiable on images taken from orbit, but more gentle features in the "mid-field" (between about 10 m and 1 km from the rover) may be nearly impossible to correlate with orbiter images. On board the rover, automated correlation of an expected scene with the actual scene may be highly desirable to allow extension of the time or path intervals over which continuous rover travel can occur. Algorithms for automated scene correlation must be developed and rigorously verified.

It is important that the rover take stereoscopic images so that distances to landmarks (and their sizes) can be accurately measured. These images will also be essential for scientific interpretations and sample documentation. It is also important that stereoscopic images of the rover traverse be taken from orbit because stereoscopy increases interpretability and identification of landforms by at least an order of magnitude. It also allows accurate measurement of slopes that might affect traverse planning. The Mars Observer altimeter will provide the first comprehensive survey of Mars topography, and will provide a vital regional calibration to stereoscopic surveys of the actual landing site made by the MRSR orbiter.

The rover's cameras should have sufficient sensitivity to sense stars in daytime. Precise measurements of the directions to identifiable stars can be used to define a celestial coordinate system, and thereby provide

compass information. By relating compass and vertical information, latitude can be determined; by relating celestial, vertical, and chronometer data, longitude can be determined.

Experience with Surveyor, Apollo and Viking has demonstrated that image resolution of approximately one meter/pixel is required for adequate optical tracking of a surface traverse from orbit. Positive identification of surface vehicles can be provided by optical reflectors on the vehicles, oriented by a simple computer system to reflect the Sun into the lens of an orbiting spacecraft. The data processing techniques required to extract high-accuracy (1-m) topography from near-vertical orbiter imaging (also at the 1-m accuracy level) must be developed and automated and verified. Concepts for doing this exist, but the accuracies achievable must be ascertained from simulations. The total number of orbiter pictures required to cover a rover tour area may be large; hence, the process must be automated far beyond the analysis-intensive methods which are currently used.

The rover will require an on-board data integration and topographic information extraction system to provide information about where the rover is, what features are around it, and what features are between it and its destination. This system must integrate information from regional topographic maps with the rover photogrammetry system in real-time to produce local position and route planning information, continuously updating its data base. Such a system would likely be based on a "neural net" computer architecture operating within a parallel processing system. The DoD is actively funding research in this and related technology areas, with breadboard testing more likely by 1995 than 1993. Parallel NASA research will be necessary to address the rover's more specific requirements, and to examine alternative technologies. Related spatial data integration, correlation, and interrogation/query issues need further investigation.

As discussed earlier in this section, Earth-based radiometric techniques for rover position determination include the use of Doppler, ranging, or differential very-long-baseline interferometry (delta-VLBI). Delta-VLBI is a technique of radio astronomy that can be used to precisely measure the angular separation of two signal sources. Two (or more) widely-separated tracking stations are used at once to observe the sources. The signal delay in arriving at the two stations is measured for both signals. The measured difference between the delays gives the angular separation of the sources. The angular separation can be converted to linear separation using the known distance to Mars. Two Earth baselines can provide the two-dimensional plane-of-sky vector between the sources. The third dimension can be inferred from a model of the Mars surface or can be measured by direct ranging.

The Mars rover and lander could provide two radio signals which, when viewed from Earth, would have very small angular separations of less than 1 arc sec. These two signals (and that of the orbiter as well) will sit well within the mainbeam of a 70-m DSN tracking station at X-band. This will offer an unusual opportunity to perform delta-VLBI with extraordinary accuracy. For example, observing simultaneously from two 4,000-km baselines in North America, it will be possible to determine the two-dimensional vector between the rover and the lander with an accuracy of about 2 m, no matter what their separation, from an observation lasting less than 60 seconds.

Current VLBI tracking technology uses a wide bandwidth (40 MHz) to achieve accurate measurement of signal group delay between stations. Using this bandwidth, accuracy at Mars would be a few hundred meters. To achieve few-meter accuracy, it is proposed to extend the effective bandwidth to 8.4 GHz by resolving the cycle ambiguity of the X-band carrier. This will improve the precision by a factor of more than 200. To achieve this ambiguity resolution, it will be necessary to increase the transmitted signal bandwidth to several hundred megahertz.

In addition to directly measuring the rover-lander vector, delta-VLBI can indirectly aid rover navigation by establishing very precisely (on the order of 1 km) the absolute positions of the rover and the lander on Mars, and the Mars ephemeris in the inertial reference frame defined by very distant (extra-galactic) radio sources. This would require alternate observations of the vehicles and a distant source, typically a quasar. Delta-VLBI could also provide few-meter determination of the position of the rover with respect to the orbiter, and thereby improve orbiter tracking. It should be possible to produce a position measurement from the raw observation in less than 30 minutes.

To achieve these capabilities, several areas of current technology must be extended. A new wideband transponder, preferably with a maximum tone separation of 400 MHz, must be developed for each vehicle to be observed. The frequencies and signal structures to be used must be determined. A portable, real-time, high-precision phase extractor must be developed for installation at the tracking stations. This would be a straightforward adaptation of existing Global Positioning System (GPS) receivers which have the requisite performance characteristics. The data processing system for fast turnaround of the observations must also be developed.

Alternatively, the delta-VLBI scenarios could be inverted, so that a signal is transmitted from the Earth and received at the two landed vehicles on Mars. The accuracy of the angular measurement would be identical to the original scenarios. The advantage that this would provide is that the rover could acquire a measurement of two components of the lander-rover vector without the round-trip light time delay inherent in an Earth-based processing system. This would necessitate phase-extracting receivers on the rover and lander, and a communications link between the rover and lander. The processing (phase differencing) would have to be performed on the rover or lander prior to transmission to Earth.

Finally, to calibrate stereoscopic measurements made by the orbiter, accurate orbital determinations are required. These can be obtained with state-of-the-art techniques through VLBI ranging and other tracking methods. For example, the orbit of the Mars orbiter can be precisely determined by a combination of tracking from Earth and by tracking an orbiter beacon from the lander. In addition, the rover's location relative to the lander and the orbiter could be measured by tracking the orbiter beacon from the rover and comparing rover and lander measurements.

## SECTION 7

### LOCAL GUIDANCE AND HAZARD AVOIDANCE WORKING GROUP

Because of the long delay in round-trip telemetry from Mars to Earth, local navigation by conventional teleoperation is highly impractical. The Mars rover must be able to autonomously sense, perceive, and plan for safely navigating in the local environment toward a designated goal. This will allow for traverse distances substantially greater than those achievable with Earth-based path designation alone. The Local Guidance and Hazard Avoidance working group identified key components that are required for this capability, and produced concrete recommendations for developing such technologies. Detailed discussions on sensing, perception, planning, and control took place. The group's discussions, conclusions, and recommendations are summarized in this section.

The local guidance and hazard avoidance problem is characterized by the need to traverse through very rough terrain, with the requirement for extreme reliability, in spite of very constrained computing resources. Even with high-resolution a priori knowledge of the region being explored, extreme care will have to be taken. Figure 7-1 outlines one possible semi-autonomous path planning architecture for a Mars rover.

Local guidance and hazard avoidance involves the determination of commands (steering, speed, braking, etc.) to the rover mobility system which will enable the rover to safely follow global routes to the science sites and to the sample return vehicle. This requires the following: local terrain sensing by stereo cameras and/or by laser scanning; evaluation of range data, probably in light of an existing topographic map; determination of surface properties (e.g., slope, roughness, and estimated frictional coefficient); and selection of a suitable path which minimizes some combination of risk, power, and distance from the global route. The mobility commands for this desired path are then generated, as are expected sensor outputs. During the traverse, the expectations are compared to the actual sensor readings, and excessive variance will result in appropriate replanning (or even reflex action if necessary). After traversing a modest distance (perhaps 10 m, depending on the type of range sensing used), the process repeats.

The working group divided its discussions among the topical areas of: sensing and perception; planning; programming and computation; and vehicle control. Emphasis was placed upon identifying the capabilities that could be demonstrated by a 1993 technology cutoff date. In the area of sensing and perception, the consensus of the group was that several sensing modalities are needed on the rover to reliably determine the geometry of the terrain. These include stereo image correlation, at least one of three possible active sensors (laser scanner, sonar phased array, and millimeter wave radar), and some sort of mechanical probe (which could be used intermittently when conditions warrant). These sensors, together with an accurate heading reference unit, inclinometers, an odometer, and articulation sensors, will provide the raw data for planning a safe path for the vehicle.

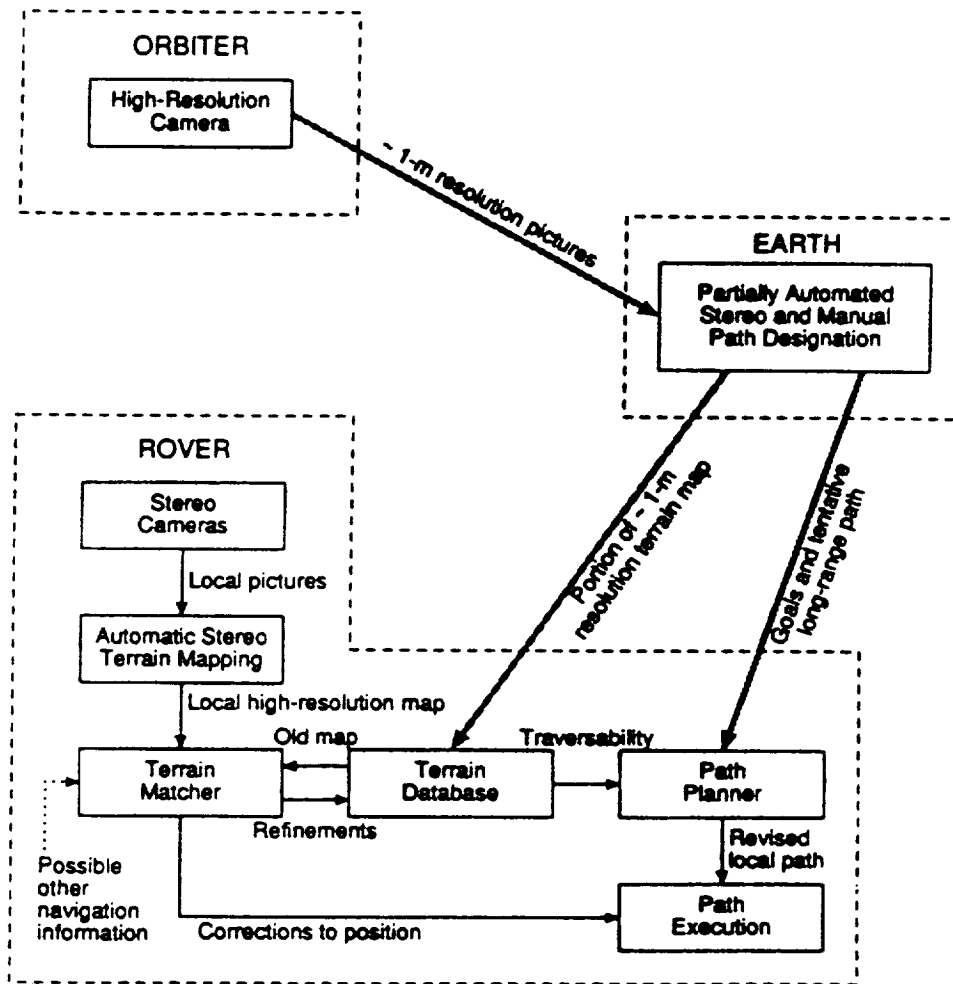

Figure 7-1. Semi-Autonomous Path-Planning Architecture for a Mars Rover

In regard to fusion of the sensor data, two approaches were suggested. One approach would use statistical techniques to combine the various data to produce an integrated "best estimate" range map of the terrain. It was suggested that a 100 x 100 range map, subtending about 1 radian and extending to some 30 m in range, would be about right. The other approach involves the use of the various sensor data by the terrain/vehicle interaction modeling and path-planning algorithms only at the appropriate points dictated by the particular algorithms. It was generally agreed that both approaches have merit and should be investigated further. In addition, it was felt that estimation of surface properties was probably too ambitious for a 1993 technology cutoff date, but might be provided by Earth-based computations on the ground as part of global route planning derived from orbital imagery.

It was estimated that the total processing requirements for sensing the terrain and perceiving hazards and obstacles from the rover range from a few million instructions per meter to 500 million instructions per meter of forward travel. A caveat in this estimate concerns sonar phased arrays. A

two-dimensional phased array might necessitate as many as a trillion instructions to form a range map. Moreover, the effect of the thin Martian atmosphere on sonic propagation and attenuation is not known; it is assumed that appropriate impedance-matching elements would allow sonar to work. However, it was generally agreed that special-purpose hardware might allow the processing of sonar maps, the correlation of stereo images, and other needed computations without excessive power consumption. It was also agreed that the development of an appropriate laser scanner is essential.

A strong majority of the group felt that it would be impossible to convince a project manager that long traversals could be performed with acceptable risk without first having a high-resolution (about 3 m resolution) terrain data base of the area of operations. As discussed in the Global Navigation section of this document, this would require an imaging orbiter in a low or highly elliptical orbit capable of acquiring stereo images. Due to the Viking experience of frequent ground fog, dust storms, and other atmospheric attenuation, this orbiter should be launched at some prior opportunity to avoid excessive delays in getting quality pictures of the operating area. It was also pointed out that it is an enormous task to prepare a high-quality terrain data base at the resolution desired for this mission, which is another reason for making the orbiter a precursor mission.

In general, several attractive planning approaches and algorithms exist, and there is little risk in demonstrating these elements of the local guidance and hazard avoidance subsystem by 1993 following an appropriate research and integration effort. A number of unresolved issues were identified in planning. These include: replanning after local failure; backtracking; risk assessment of a tentative planned path; reactive planning in the event of slippage; opportunism; optimality (or acceptability) criteria - risk, power, speed, etc.; representing and dealing with uncertainty; the level of task specifications from Earth; and to what degree the local guidance and hazard avoidance subsystem will be involved in planning sample retrievals.

The computing requirements for planning were felt to lie perhaps an order of magnitude down from the high end of the estimated sensing and perception requirements. Thus, a few tens of millions of operations per meter should be adequate for path planning. It was suggested that, like sensing and perception, some major computationally-intensive aspects of planning could benefit from the use of custom VLSI or other special hardware.

In the area of programming and computation, a discussion of languages, operating systems, and development environments revealed that the dominant development languages are C and LISP, and dominant operating system is Unix, and the most popular development environment is the 68020/VME-bus-based Sun workstation. However, there are significant differences among today's various mobile-robot software development environments, to the point where there is little software portability at the object code level.

The software system will have to be reliable, exhibit the characteristics of graceful degradation, error protection and fault recovery, and be reprogrammable at all levels. The group addressed a variety of

additional topics as well, including software verification, software development and debugging tools, the usefulness of simulations, and the requirements imposed on the on-board operation system. Some members of the group felt that the technology of software verification is advanced to the point where it can make a significant contribution over normal software development procedures. Others felt its applicability to a complex system like this is very limited.

The vehicle control technology area can be partitioned into three sensor/perception systems: visual perception, vestibular perception (orientation, acceleration, etc.) and proprioceptive perception (articulation sensing and vehicle three-dimensional modeling of itself). The degree of proprioceptive sensing that will be needed depends on the type of vehicle locomotion selected, as well as its maneuverability requirements. The group agreed that, at a minimum, the rover will need: a three-dimensional representation of the local environment; estimates of the surface friction, load bearing capacity, etc.; a stability model of the vehicle; and some way to generate and verify expectations about path execution. Additional issues in this area include reflex responses and error detection, diagnosis, and recovery.

The total test experience to date with control of autonomous mobile robots in natural terrain is estimated to be on the order of 5 km. However, extensive simulations of vehicles on rough terrain have been conducted, and the results appear promising. Consequently, it was generally agreed that, with the exception of vehicle reflex action to unexpected dynamic factors (e.g., slipping on a sand dune), several approaches and algorithms exist which could be integrated relatively quickly in a technology demonstration. As with planning, it was felt that a processing capability of a few tens of millions of operations per meter would be adequate to model the terrain/vehicle interaction for use by the path planner.

Based upon the discussions summarized above, the total computing requirements for safe travel by the rover were estimated to be between 50 and 500 million instructions per meter. The lower figure is roughly equally split between sensing and perception, planning, and terrain/vehicle interaction modeling, while the upper figure is dominated by sensing and perception, principally stereo correlation. It was also generally agreed that additional computation could be used almost without limit, but that these estimated values would permit sufficiently low risk that the mission would not be compromised.

Power requirements are closely tied to these computing requirements. The basis for concern over power is the low estimated power budget for the vehicle - between 250 and 500 W for all vehicle functions, including mobility. This can be compared to a typical autonomous military vehicle test-bed, which has a few tens of kilowatts for computing alone. Consequently, requests were issued to the Mobility and Computing and Task Planning working groups for estimates of the power requirements for mobility and computing, respectively. The Mobility group arrived at an estimate of 0.6 to 8 watts per kg of rover mass per m/sec of forward travel (corresponding to an effective frictional coefficient of 0.15 to 2). The Computing and Task Planning group estimated



that a radiation-hardened, flight-qualified, general-purpose multiprocessor could be configured with 3-5 million instructions per second (Mips) performance for 20-25 W power consumption, complete with its necessary I/O and memory. This translates into a performance level of 4 to 8 watts per Mips.

Given a rover mass and power budget, these estimates for computing and power requirements can be used to determine the vehicle speed capability, the needed performance of the on-board computer, and the distribution of power between the computing and mobility subsystems. These values are shown in Table 7-1 for a 1000-kg rover with a 500-W power supply. The "worst" and "best" cases correspond to the extremes of the range estimates for computing and power requirements. The "moderate" case uses the logarithmic mean for the range estimates.

For all three cases, the power distribution and computer performance requirements are disturbingly high. In each case, as would normally be expected, most of the power would go to the mobility subsystem during long traverses. However, in the historically-justified case of conservative estimates for computer and software performance, and with a moderate mobility power requirement, up to 75% of the power would be available for computing, as in the fourth case portrayed in the table. For this case, it is envisioned that a computer with up to 40 Mips performance would be

Table 7-1. Rover Speed, Power, and Computing Capabilities/ Requirements for a 1000-kg, 500-W Vehicle

Case (local guidance and hazard avoidance computing requirement; mobility power requirement; computing power requirement)	Average Rover Speed	Power Distribution	Computer Performance
Worst ( $5 \times 10^8$ instructions per meter; 8 W/kg per m/sec; 8 W/Mips)	4 cm/sec	67% mobility, 33% computing	20 Mips
Moderate ( $1.5 \times 10^8$ instructions per meter; 2 W/kg per m/sec; 6 W/Mips)	17 cm/sec	69% mobility, 31% computing	25 Mips
Best ( $5 \times 10^7$ instructions per meter; 0.6 W/kg per m/sec; 4 W/Mips)	62 cm/sec	75% mobility, 25% computing	30 Mips
Worst/moderate mobility ( $5 \times 10^8$ instructions per meter; 2 W/kg per m/sec; 8 W/Mips)	8 cm/sec	33% mobility, 67% computing	40 Mips

required. This is at least 100 times the performance of any computer that has heretofore been used on a planetary spacecraft. Therefore, the use of custom VLSI or special computational hardware (such as a single-instruction, multiple data processor array) may be required to perform the necessary computations using significantly less power.

It was the general consensus of the working group that Earth-based path designation alone, where an operator views wide-baseline stereo images and designates an extended path for the rover, would not be safe for designated paths in excess of about 30 m. Given the roughly 1-hour turnaround for these commands due to the long speed-of-light delay, this results in a rover speed of just under 1 cm/sec. Thus, even the worst-case estimates for computing and power requirements allow for an average rover speed of more than 4 times that which can be achieved through Earth-based path designations alone, as indicated in the table. Autonomous local guidance and hazard avoidance also greatly simplifies the mission ground operations.

The group made four recommendations based upon its discussions and conclusions. The first recommendation is for a 3-m-resolution terrain data base to be developed for the areas to be explored, preferably prior to the arrival of the rover at Mars. A 30-cm aperture camera in a low or highly-elliptical orbit around Mars could achieve this objective. This camera, smaller than the one on Mars Observer, need not require a highly expensive spacecraft.

The second recommendation is that local guidance and hazard avoidance subsystem elements and integration approaches should be tested in realistic environments starting as soon as possible. Thousands of kilometers of testing are needed by 1993. Because multiple plausible approaches exist, several integration efforts must proceed in parallel. It was noted that a number of test-bed vehicles exist today, and that the creation of a Mars-like terrain of sand and boulders could be accomplished very quickly. However, at the speeds at which these vehicles operate testing over great distances will take a long time.

The group recommended that research and development in the following areas is crucial and should begin immediately: sensors; perceptual and planning algorithms; reflex and error recovery algorithms; and special-purpose computing hardware (e.g., custom VLSI) for higher performance per watt. A small majority of the group agreed that the single most attractive sensing modality for the rover is laser scanning. Scanners adequate for immediate research are manufactured by several companies, but the specific character of these devices is not optimized for the needs of a Mars rover. Ultimately, a low-power, compact, and rugged unit with few-centimeter accuracy over ranges from 0-30 m, and able to scan about 0.5 x 1.0 radian with a few tens of thousands of measurements in a few seconds or less, is needed. Current devices have greater performance (such as speed) than is needed, but resolution, range, and power are not optimal for this application. It would also be desirable for the scanner to be capable of focusing on a distant (a few kilometers) site for a longer time in order to determine point ranges, but this may not be feasible. Finally, it was generally agreed that the rover must have more than one way of sensing range of terrain features. Most members of the group favored stereo correlation, while a significant minority felt sonar phased

arrays or millimeter wave radars have attractive properties. All of these can benefit greatly from custom hardware developments.

The fourth recommendation states that because unmanned rovers are essential to solar system exploration, a long-term research and development program should be supported. It is clear that Mercury, the moons of Jupiter and Saturn, and the other solid bodies of the Solar System will have surface rovers long before humans set foot on them. Therefore, it makes sense to develop the technology for highly capable rovers that can operate effectively even with speed-of-light time delays of many hours, or with communications blackouts of days or weeks.

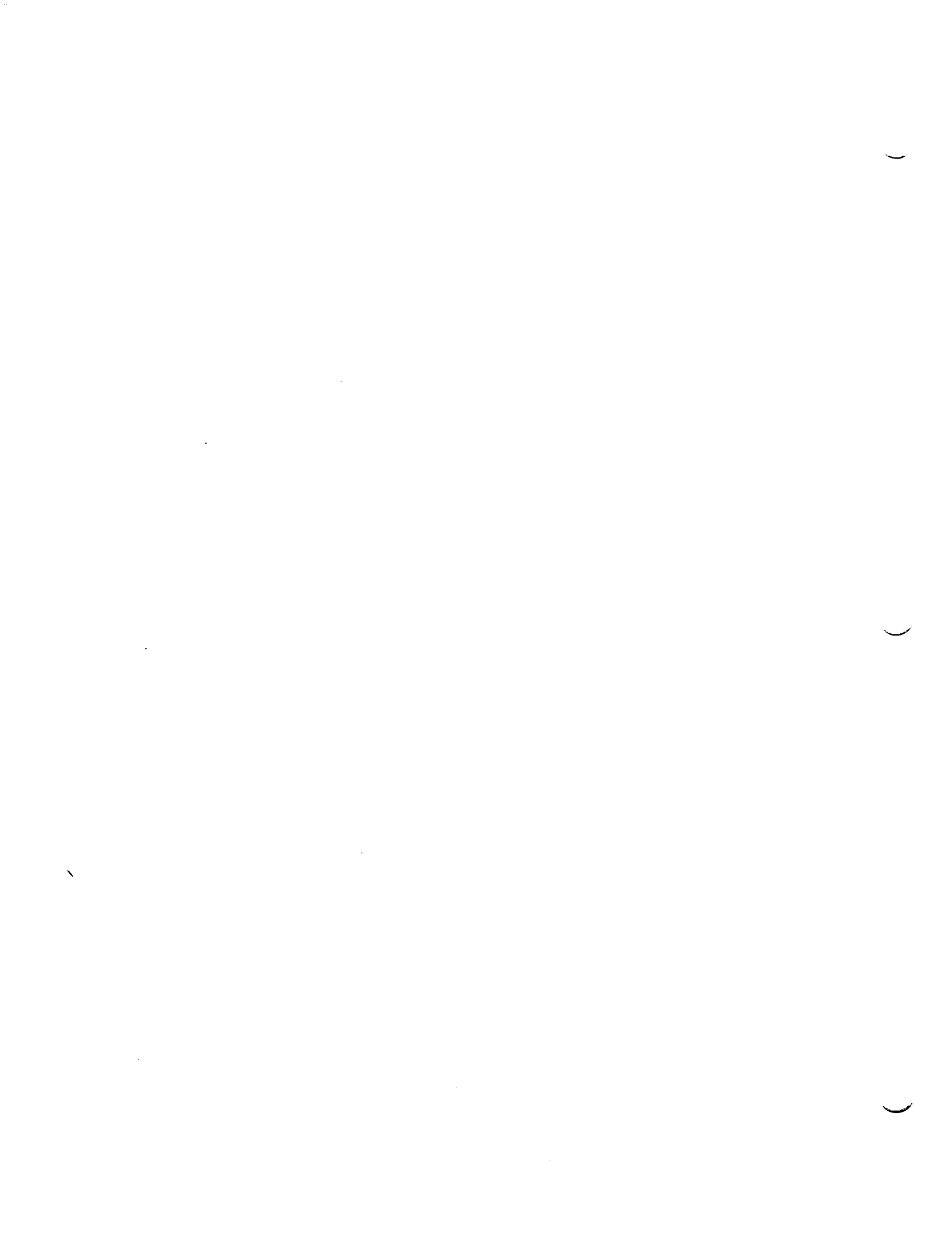

## SECTION 8

### COMPUTING AND TASK PLANNING WORKING GROUP

The Computing and Task Planning working group consisted of members from various space technology disciplines, including spacecraft sequence planners, artificial intelligence system developers, and autonomous vehicle technologists. The diversity of the participants illustrates the strong interdisciplinary nature of this technology area. The requirements placed on the computing and task planning functions for the rover are largely secondary; i.e., they are driven by the capabilities of the on-board subsystems and the expected mode of rover operation. In particular, rover computing technology must satisfy performance requirements for (1) local guidance and hazard avoidance, (2) science and sample acquisition operations, and (3) mobility (depending upon the configuration selected).

Up to a point, more capable and autonomous subsystems will increase requirements for both general-purpose computing capability and task planning. Because specific rover capabilities and modes of operation have not yet been determined, the computing and task planning requirements are largely unknown. Therefore, most of the group's discussions centered on bringing up issues, rather than arriving at conclusions and detailed recommendations.

The rover will require a distributed, real-time computing architecture with the following characteristics:

- Highly reprogrammable
- Dynamically reconfigurable
- Hosts and coordinates procedural and symbolic processing
- Highly adaptive to environment
- Fault-tolerant
- Provides system safety
- Provides diagnostic and recovery planning

Advanced development of general-purpose computing hardware, special-purpose processing hardware, and software will be necessary to realize this goal. Integrated testing will be needed to develop computing and task planning technology for all rover systems.

An on-board general-purpose processor capable of performance on the order of 1-10 million instructions per second (Mips) will be required for the rover. This estimate assumes that the task planning and navigation systems will time-share the general-purpose computing resources. Current state-of-the-art radiation-hardened, flight-qualified hardware cannot satisfy the requirement for 1-10 Mips performance. The group agreed that current NASA programs in this area should be strengthened.

There may also be a requirement for the development of specific flight-qualified components, such as custom VLSI, for specialized processing. This is expected to be particularly important for local guidance and hazard avoidance. Computing requirements for this function are discussed at length in the preceding section.

It was determined that random-access memory (RAM) requirements for the rover will be in the range of  $10^7$ - $10^8$  bits. This estimate was based upon expected task planning computing requirements. A high degree of fault tolerance will also be necessary. Although this RAM requirement exceeds those of previous planetary missions, it is not expected to present an insurmountable problem.

For mass storage, roughly  $10^6$ - $10^7$  bits capacity will be needed. High reliability will be an essential characteristic. This requirement represents a major concern, as it may limit the ultimate capability of the rover. Magnetic bubble memory technology is a possibility, as is erasable magneto-optical disk technology. Advanced bubble memory technology would offer substantial advantages in terms of power consumption, mass, volume, nonvolatility, and resistance to harsh environments. For an optical disk data storage system, emphasis should be placed on developing a compact, space-qualified system.

It is expected that a key constraint on rover computing capabilities will be the need to limit the power consumption of on-board computing. However, no specific conclusions were reached by the group regarding requirements in this area. Similarly, mass and radiation hardening requirements may impose constraints, but no specific recommendations were determined in these areas.

A variety of issues were considered that involve software concerns, including: rover activity planning, both on-board and on Earth; simulation for Earth-based planning; on-board monitoring; and on-board diagnosis. It is not clear what the specific needs will be in these areas. The group agreed that the rover, with its highly capable subsystems, will present a more complicated planning problem than has yet been addressed in planetary exploration.

In addition, development of software validation and verification technology will be necessary to assure the MRSR project and its sponsors that every reasonable precaution will have been taken in this area. Currently, it is not possible to validate and verify any large software system (such as that used by the Shuttle).

## SECTION 9

### POWER WORKING GROUP

The Power working group identified power and thermal control requirements, constraints, and technology issues for a Mars rover. High-level system trade-offs and comparisons of power source/component technology options and thermal control options were studied that support the strawman rover capability scenarios. Assessments were made of the technology readiness of power and thermal control system elements for a baseline technology cutoff date of 1993, and for an enhanced technology cutoff date of 1995. In addition, recommendations were made for a non-RTG option to address concerns related to safety issues.

Rover power requirements for various modes of operation are estimated in Table 9-1. Minimum, moderate, and maximum scenarios, which roughly correspond to those presented in the Overview section of this document, are offered. The rover must not only satisfy these requirements, but it must function in the Martian environment, with the threats of surface dust, dust storms, and a temperature range of  $-113^{\circ}$  to  $-13^{\circ}\text{C}$ . Shock and vibration from vehicle travel must also be withstood. In addition, severe mass and volume constraints are imposed on the power system, to allow for a maximized science payload.

Table 9-1. Rover Power Requirement Estimates

Mission Operations	Rover Power Estimates (Average/Peak Power, Watts)		
	Minimum	Moderate	Maximum
Traverse mode <sup>1</sup>			
Flat terrain	140/500 <sup>2</sup>	170/600 <sup>2</sup>	360/700 <sup>2</sup>
Sloped terrain	175/500 <sup>2</sup>	220/600 <sup>2</sup>	380/700 <sup>2</sup>
Data transmission mode	200	240	260
Science mode <sup>3</sup>	170/450 <sup>4</sup>	320/700 <sup>4</sup>	340/800 <sup>4</sup>
Standby mode	120	170	190

<sup>1</sup>Assumes 1-m wheel diameter (25 cm width).

<sup>2</sup>Motor stall power, 1-sec duration.

<sup>3</sup>Assumes arm movement or science at high power.

<sup>4</sup>Core drilling, 0.5-hr duration.

The working group determined that there is no difference among the power/thermal control component technologies that are required to satisfy these preliminary power requirements for any of the three mission scenarios. The requirements all fit within the bounds of RTG output capability. Only a scaling of component size is needed to support each scenario. Table 9-2 lists a baseline selection of components which could support a technology cutoff date of 1993. Enhanced mission component options (technology cutoff date of 1995), which would provide the possibility for reduced mass or increased power capabilities for the mission, are also shown.

For the power levels that the rover will require, the General Purpose Heat Source (GPHS) RTG is the most suitable primary power source. The current state-of-the-art GPHS RTG offers a specific power of approximately 5 W/kg. A new modular RTG that uses GaP-doped SiGe thermoelectric material in a multicouple concept is under development. The modular RTG is expected to provide a specific power on the order of 9 W/kg. Continued development of this technology at an adequate funding level is necessary to meet a 1993 readiness date. For an enhanced power system, thermal-to-electric energy conversion could be provided by improved thermoelectric multicouples offering 12 W/kg specific power, or by the Alkali Metal Thermoelectric Converter (AMTEC) concept. AMTEC is a thermally regenerative electrochemical device which could permit power levels of 1 kW per unit by achieving a specific power of as much as 20 W/kg. However, in order to bring AMTEC to readiness level for space application in 1995, accelerated funding for development will be required.

Table 9-2. Baseline and Enhanced Power System Technologies

Function	Baseline Technology Selected	Enhanced Technology Selected
Heat source	GPHS	GPHS
Power conversion	GaP-doped SiGe multicouples (modular RTG)	AMTEC Improved thermoelectric multicouples (modular RTG)
Energy storage	NaS or Li-TiS <sub>2</sub> batteries	Li high-energy cathode batteries Bi-polar battery systems Regenerative fuel cells
Power control and distribution	Unregulated 28 V Cascaded power control at 200 kHz Dedicated processor	Power integrated circuits High-frequency power electronics Dedicated processor



During the Earth-to-Mars cruise and aerobraking operations, heat from the RTGs must be rejected. In contrast, during surface operations, heat must be conserved and distributed throughout the rover to maintain thermal control. Therefore, the radioisotope heater units (RHUs) must produce sufficient heat to achieve this capability. The development of the GPHS into a new and higher thermal-power RHU would provide a satisfactory heat source; however, radiative flux would be a problem. It may be possible to distribute segments of a modular RTG system around the vehicle so that the waste heat can be used for thermal control. Although the engineering/integration problem will be more difficult for multiple sealed RTGs, there may be a beneficial mass trade-off for thermal control.

For energy storage, sodium-sulfur (NaS) or Li-TiS<sub>2</sub> secondary batteries are candidates for a baseline power system. These technologies could provide energy storage densities of as much as 75-100 W-h/kg. Advanced development of 1 kW (600 W-h) NaS cells, and of a long-life electrolyte for Li-TiS<sub>2</sub> batteries, is recommended. For an enhanced system, the options include Li-FeS<sub>2</sub>, Li-S, and bi-polar batteries, as well as regenerative fuel cells. The lithium high-energy cathode battery types may achieve energy storage densities of double the value projected for the baseline system. Bi-polar batteries could provide the surge power capability required for motor stall current demands in a very small package. Regenerative fuel cells could offer a specific power of greater than 200 W-h/kg. Accelerated development of the enhanced battery options will be necessary. In addition, establishment of an advanced regenerative fuel cell program is recommended.

Power conditioning and control for a baseline system will involve unregulated 28 V distribution at 200 kHz, and a dedicated processor, as shown in Table 9-2. Attention must be paid to electronic integration issues and instrumentation needs. An enhanced system will include the features of power integrated circuits, high-frequency power electronics, and a dedicated processor. In particular, power integrated circuit technology should be developed to reduce the mass and volume of power electronics by 40-50%, as compared to the baseline system.

If radioisotope heat sources are not available for an MRSR mission for political or fiscal reasons, then a central power station concept, involving an alternative source of power along with a "rechargeable" rover, could be utilized. The central station could be a nuclear fission reactor coupled to any one of a number of different conversion systems (thermoelectric, thermionic, dynamic Brayton or organic Rankine), or it could even be a photovoltaic array or a solar dynamic system. The central station would electrolyze water to obtain hydrogen and oxygen for use by the rover, which would carry a fuel cell system. The central station would also include an electrolyzer "filling station" with hydrogen/oxygen storage.

When the rover for this type of system required a "recharge", it would return to the central station and physically pick up tanks of hydrogen and oxygen. At this point, the rover would also unload the water that was generated in the reverse (power) process. Recent studies have showed that regenerative fuel cells are competitive in mass with advanced batteries for energy storage, but do not have the lifetime limitations with respect to depth

of discharge and cycling that batteries possess. The main feature of this concept is that it clearly limits rover travel to within a radius dependent upon rover fuel tank or battery mass or size. It also will likely be heavier in mass than an RTG-based rover power system. Moreover, an additional separate launch and lander package may be required for a nuclear reactor. However, it does provide an ancillary benefit in that the central power station can be left on the surface of Mars to be utilized by a possible manned mission a few years thereafter.

In this concept, the central station would not need to operate continuously. Therefore, in spite of the threat of dust storms, the photovoltaic and solar dynamic options appear feasible. However, if a solar system is used, then thermal control of the central station during dust storms may present a problem, as the station would go into a dormant state until the dust storms subside, and would then require "thawing out". This would not be an issue for a central station based upon a nuclear fission reactor, since heat would be available all of the time. In either case, the dormancy and thaw-out problem would apply to the rover because it has limited storage.

A photovoltaic/battery-powered rover is another alternative to RTG power. This option would allow more extended travel, but may limit operations to non-dust storm areas such as the top of the northern hemisphere. An extended dust storm (greater than 1 to 2 days) could end the mission when stored electrical energy is depleted and science/subsystems are exposed to Mars surface temperature extremes. For a minimum capability rover, a 10-15 m<sup>2</sup> area array weighing approximately 30 kg would be required to support electrical loads alone. The array must be rugged, and have protection against the dust environment (encapsulation) and/or surface cleaning. Sun tracking will allow for a smaller (10 m<sup>2</sup>) array. In addition, the array must have a single or multiple deployment/retraction capability.

These alternatives to RTG power may impose severe impacts on vehicle operations and science/engineering subsystems. In particular, rover thermal heat would have to be supplied by electrical power. It has been estimated that this power demand may exceed the power needed to support engineering and science electrical loads. For a photovoltaic/battery-powered rover, the required array area may double when heater electrical power needs are considered.

## SECTION 10

### SYSTEM/MISSION WORKING GROUP

The objective of the System/Mission Working Group was to provide cross-coordination and interchanges between discipline groups during the course of the Workshop. The System/Mission Working Group also provided a central forum for discussion of across-discipline issues and/or requirements for Mars Rover technologies. Participants in the working group are listed in Table 10-1.

This section provides a top-level perspective of the mission and science capabilities required; it also provides a discussion of planetary quarantine issues which affect the Rover and the MRSR mission as a whole.

A number of "technology planning worksheets" were generated as part of the System/Mission Working Group's efforts. In addition, a variety of discipline-oriented planning worksheets was generated and submitted to the System/Mission Working Group for inclusion in the proceedings; these discipline-oriented data were either inappropriate for any of the defined working groups, or were provided shortly after the close of the workshop. All of these inputs are provided in Appendix A of this volume.

#### 10.1 MISSION & SCIENCE OVERVIEW

There is a widespread feeling that the time is right for a major program of Mars exploration, including a mission to return a geologically varied suite of samples collected by a rover. The Soviets have announced an ambitious, exciting Mars program which includes landing a "hopper" type of spacecraft on, and a powered flyby of Phobos; and rovers, penetrators, and balloons on Mars, plus a sample return from Mars. The western Europeans are eager to participate both with the Soviets and with any such program on our part. In the U.S., in addition to the science community wanting MRSR on its own merits, many see it as an ideal technology-driving mission which could reestablish NASA/U.S. leadership in space, while others see it as an ideal mission for international cooperation.

In response to these feelings, Geoff Briggs, Director of the NASA Office of Space Science and Application's Solar System Exploration Division, has set up an 18-month program to prepare the infrastructure and a database of mission technology requirements, options, and trades. Then, if the U.S.A. decides to go with a 1993 new start and a 1998 launch, the basic foundation will be ready.

Institutionally, the Jet Propulsion Laboratory and the Johnson Space Center have the largest roles (with both in-house studies and contracts to manage), and major support comes from Space Applications International Corporation (SAIC) and NASA HQ. Organizationally, three groups have been set up to coordinate the program. The steering group, chaired by Geoff Briggs, provides overall direction and concentrates on programmatic issues, meeting on an ad hoc basis. The science working group, chaired by Mike Carr, determines

Table 10-1. System/Mission Working Group Participants

Individual/Paper	Working Group Role /Paper Topic	Phone, Address
John C. Mankins	Chairman	(818) 354-4116 JPL/301-165
Dr. Arden Albee	participant	(818) 356-6367 California Institute of Technology Pasadena, CA
Sheryl Bergstrom	participant	(818) 354-2496 JPL/125-112
Donald Davis	participant	Not Available Lockheed Missiles and Space Company Palo Alto, CA
Austin Fehr	participant	Not Available Martin Marietta Denver Aerospace Denver, CO 80201
Charles Gartrell	participant	(703) 893-5900 General Research Corp. 7655 Old Springhouse Rd. McLean, VA 22102
Gordon Johnston	participant	(FTS) 453-2755 NASA, OAST/RS Washington, DC 20546
Dr. Neville Marzwell	participant	(818) 354-6543 JPL/198-330
Gerald Olivieri	participant	(818) 354-1186 JPL/301-285
Gerald C. Snyder	participant	(202) 479-2609 NASA Code EL
P. Richard Turner	participant	(818) 354-5643 JPL/233-306
Marty Valgora	participant	Not Available NASA/Lewis Research Center Cleveland, OH

both the science requirements on the mission and the environments in which the mission will have to operate. It meets every other month. The mission analysis and systems engineering working group includes members of both the other groups plus people from the in-house and contractor studies. It meets monthly to build mission data bases, consider trades, etc.

The mission set to be considered includes a simple launch with a heavy-lift launch vehicle and two dual-launch options: one with the rover and return vehicles launched separately, allowing an international mission without technology transfer, and the other with the payload balanced in terms of mass.

A guideline of the effort is to work toward a U.S. mission, but do nothing to preclude international cooperation. The study will look at five point designs for the mission, but even more important will be the partial deviations of science and cost with respect to mission parameters such as traverse distance and rover mass. The partials will then be used to make trades between and among the point designs.

Among the major tradeoffs to be made are:

- Lander - dumb/robust vs smart/fragile
- Aerobrake vs propulsive orbit insertion (Mars and Earth)
- Mobility - autonomous vs CARD
- Rover size - small, moderate, large, or 2 moderate
- Sample handling - how pristine?
- Where is intelligence? - rover, lander, orbiter, Earth

All of these factors will be focused on one primary goal: to return an intelligently selected suite of Martian materials for detailed study in terrestrial laboratories. The return of Martian surface and subsurface samples to Earth laboratories (unsterilized) will allow a full range of the most sophisticated analytical techniques to be applied for the study of chronology, elemental and isotopic chemistry, mineralogy and petrology, and for the search for current and fossil life.

To achieve that goal, many necessary science skills must be incorporated into the Rover itself. Potential science capabilities that have been previously identified are listed in Table 10-2.

## 10.2 PLANETARY PROTECTION REQUIREMENTS FOR A MARS ROVER SAMPLE RETURN MISSION

The current NASA Planetary Protection (PP) policy requirements are no longer realistic in light of the enormous advances in our knowledge of the planets in the past 15 years. Reassessments by the Space Science Board Committee on Planetary Biology and Chemical Evolution, and the obvious need to relieve unnecessary burdens on flight projects led NASA/JPL to draft a new policy in 1981. To date this proposed policy has not been approved by NASA.

Table 10-2. Rover - Necessary Science Skills

---

Quantitative imaging	<ul style="list-style-type: none"> <li>• long range to close up</li> <li>• multi-spectral</li> <li>• stereoscopic</li> </ul>
Sample procurement	<ul style="list-style-type: none"> <li>• selective rock or soil</li> <li>• preprogrammed rock or soil</li> <li>• unweathered rock - 10 cm (?)</li> <li>• deep soil - 1 m (?)</li> <li>• scoop/rake/sieve/drill/hammer/lever/wedge/cracker/chipper</li> </ul>
Sample processing	<ul style="list-style-type: none"> <li>• fractionate sample by physical properties-crusher/magnetic separator/sieves/heat/leach/dust/splitter/holder</li> <li>• flexible sequencing of preparation and distribution</li> </ul>
Elemental analysis	<ul style="list-style-type: none"> <li>• accurate and precise</li> <li>• major and critical minor elements</li> </ul>
Mineral phase analysis	<ul style="list-style-type: none"> <li>• positive identification</li> <li>• abundance in mixtures</li> </ul>
"Molecular" analysis	<ul style="list-style-type: none"> <li>• volatiles/organics/anion complexes</li> <li>• atmosphere analysis</li> <li>• soil and rock analysis</li> <li>• stepwise heating</li> <li>• gas reactions</li> </ul>
Microscopy	<ul style="list-style-type: none"> <li>• multi-spectral</li> <li>• fabric and texture</li> <li>• composition, size, shape of particulates</li> <li>• surface features and coatings on grains</li> <li>• grain surface reactivity</li> <li>• biological activity</li> </ul>
Sample return study	<ul style="list-style-type: none"> <li>• test reactivity of soil with packaging materials</li> <li>• test for gas release and pressure buildup</li> </ul>
Traverse geophysics	<ul style="list-style-type: none"> <li>• seismic profile - regolith thickness</li> <li>• electrical conductivity - permafrost thickness</li> <li>• magnetic profile - near-surface structure</li> <li>• gravity profile</li> <li>• topographic mapping</li> <li>• biological activity</li> </ul>

---

Table 10-2. Rover - Necessary Science Skills (Contd)

---

Transport deployable packages	<ul style="list-style-type: none"><li>• seismometer</li><li>• magnetometer</li><li>• meteorology-pressure/temperature/wind velocity and direction</li><li>• heat flow/near-surface temperature profile</li><li>• u.v.-visible photometer</li></ul>
-------------------------------	--

---

It is assumed that the planetary protection program applied to the Mars Rover/Sample Return (MRSR) Mission will be implemented under a new policy with yet-to-be-defined constraints and implementation procedures, especially as pertains to the protection of the Earth against back contamination. To detail the potential requirements and assess their implications for and impact on a MRSR mission, the mission is divided into three phases; a) outbound, b) sample acquisition and delivery, and c) science and quarantine investigations.

- a. Outbound. Requirements for this phase provide for protecting Mars from terrestrial contamination. These requirements are similar to those imposed on and implemented by the Viking Project with one notable exception. The requirement for sterilization of the complete lander/probe would be replaced by a requirement for sterilization of selected subsystems.
- b. Sample Acquisition and Delivery. Included in this phase are all near-Mars activities, the Mars-to-Earth transit, Earth entry, recovery, and transport to the Mars Receiving Laboratory (MRL) on Earth or in Earth orbit. Although requirements have not been developed it is anticipated that the major thrust of the requirements will address the sealing of the sample; verification, maintenance and monitoring of the seal; and the means to prevent any accidental release of extraterrestrial material at Earth. Specific requirements will also address issues concerned with sample acquisition, transfer and storage, and active safety features to be used in non-nominal conditions. Furthermore, there will be guidelines for pre-project studies and research to validate approaches toward meeting requirements; multiple certifications will be required at key mission milestones to assure that requirements have been met.
- c. Science and Quarantine Investigations. This phase of an MRSR mission begins with the receipt of the sealed Mars sample in the MRL. Requirements for this phase will be aimed at assuring Earth safety when the sample is released from its container and throughout the study of the sample. There will be explicit requirements for the construction, management, and containment capabilities of the MRL, extensive PP protocol

for studying the sample; guidelines for handling the sample during scientific investigations; and strict conditions and requirements concerning the ultimate release of the sample for scientific investigation outside the MRL.

In summary, the outbound phase of an MRSR mission will be favorably impacted by the new PP policy. Requirements will be somewhat relaxed from those imposed on Viking under the old policy and implementation. The other two phases of the mission will be seriously impacted by the new policy, not in relative terms, since there never was a formal policy addressing those phases, but in terms of the anticipated range of requirements deemed essential for affording Earth the same protection, at the very least, as is provided for planets of interest. The extent of this impact on an MRSR project will depend on the severity of specific requirements to be developed in the near future.

Initially, a revised Planetary Protection policy which incorporates the Earth-return phase of the mission must be accepted and implementing documents drafted. The real constraints on the mission will not be known until this first step is completed. There are also some critical management issues which should be resolved early in the mission planning phase of the Mars Rover Sample Return Mission. Experience from the Apollo Project has shown that:

- 1) Management systems committed to absolute containment with minimum mission impact are needed.
- 2) The location of responsibility for prevention of back contamination must be determined.

### 10.3 OTHER INFORMATION

In addition to the data above, a variety of other information relating to Mars Rover technology and requirements was presented at the workshop. In particular, a presentation to several Working Groups was made by S. Squyres of Cornell University. This presentation is provided in Appendix B of this volume.

As has been noted elsewhere, a set of levels of rover capability was devised by the working chairmen (meeting before the workshop); these levels establish a common context for technology planning in the separate groups. A copy of the capability scenarios as distributed at the workshop is provided in Appendix C.



## Galileo Analog - Architecture

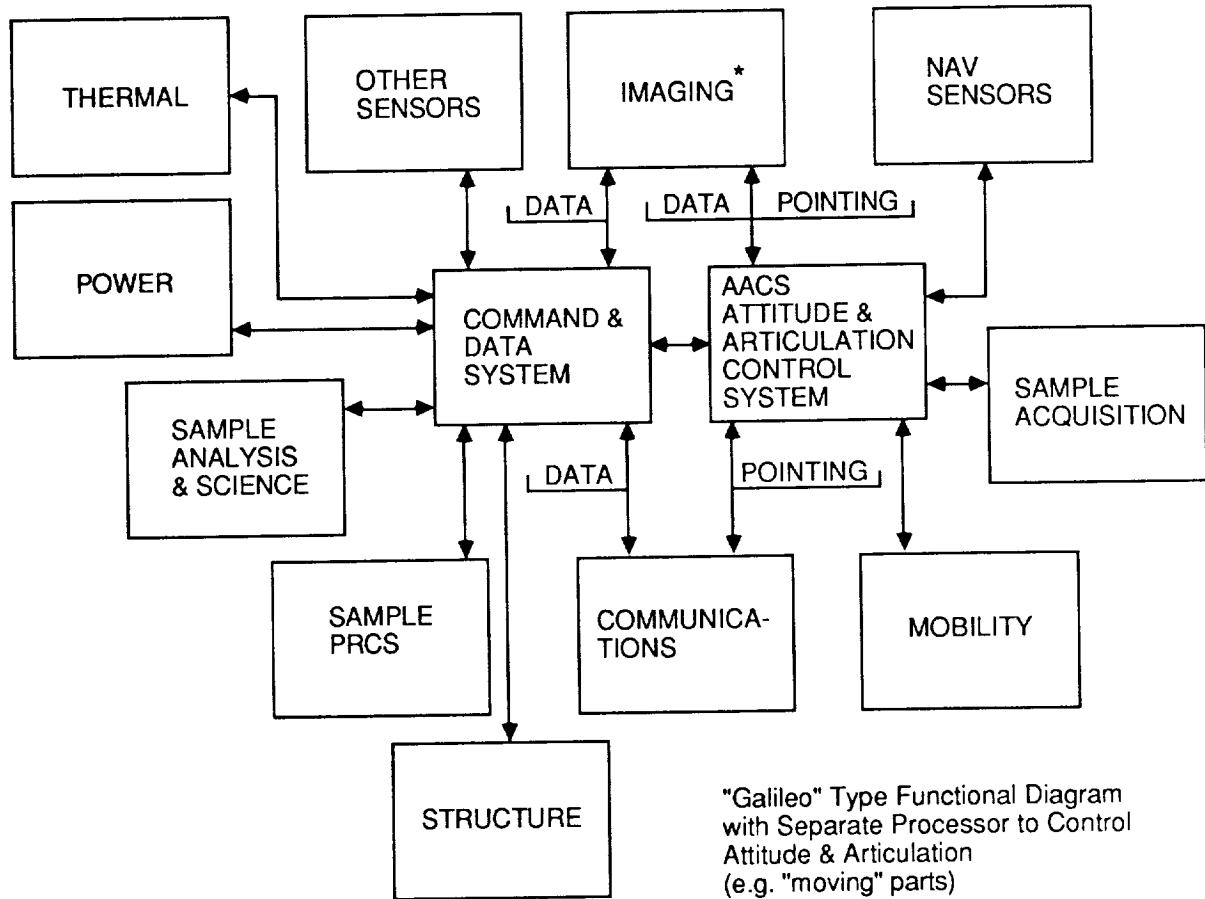

\* Imaging (& other remote sensing data) used both for local guidance and control (by the AACS) and for relay to earth (by the cmd & data syst.)

Galileo got into trouble with this architecture by dividing fault protection responsibility between command & data system and the attitude and articulation control system. This allowed the situation in which the two systems got into a fault protection "race", making analysis impossible.

The objectives of this architecture included management/programmatic factors and the desire to incorporate distributed processing capabilities.

Lesson learned: Fault-tolerance should go in the command and data system only.

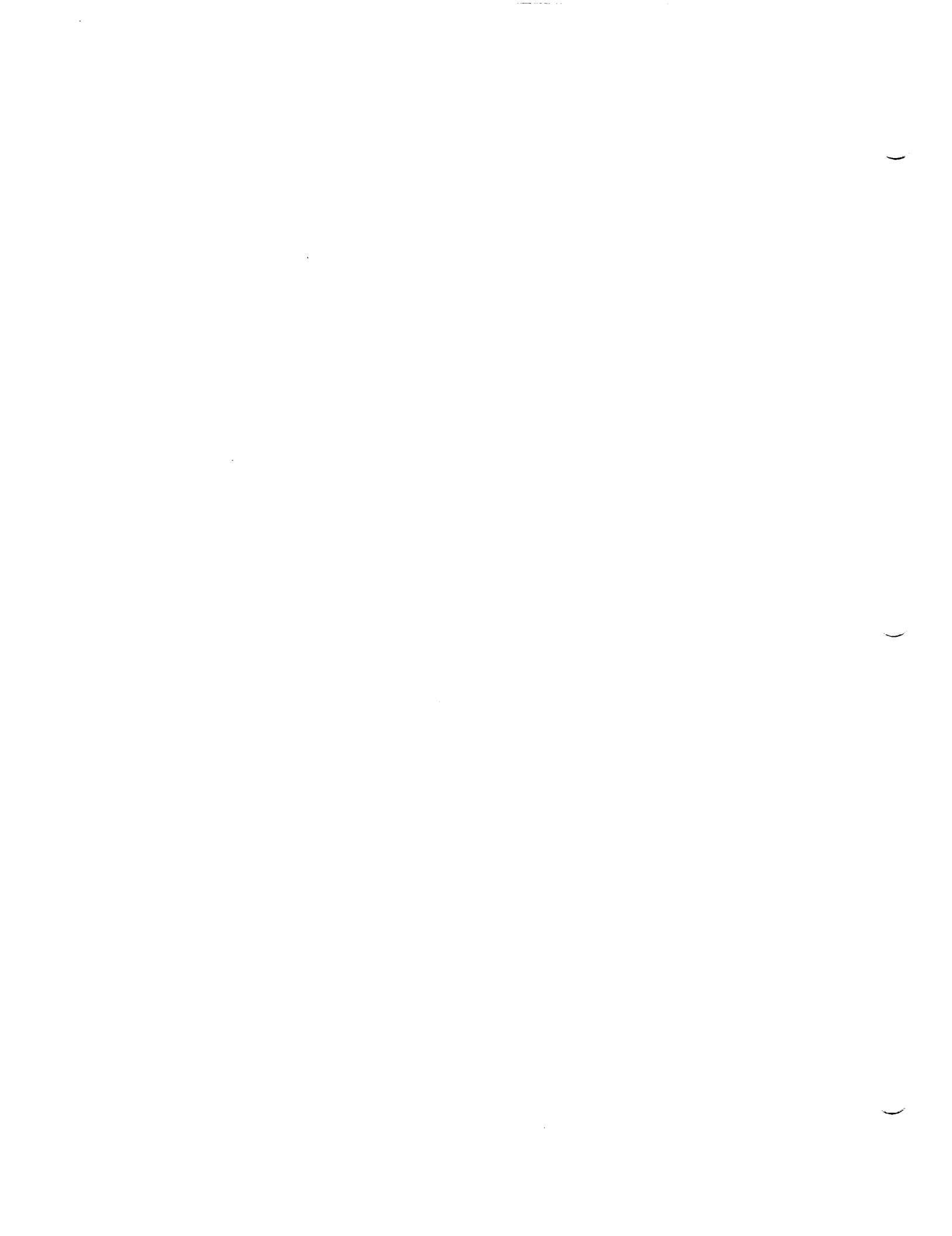

APPENDIX A

TECHNOLOGY PLANNING WORKSHEETS

TECHNOLOGY PLANNING WORKSHEET

WORKING GROUP: System/Mission REFERENCE(S): \_\_\_\_\_  
DATE: 1/30/87 TIME: \_\_\_\_\_

TECHNOLOGY: (Mars) environmental interactions

KEYWORDS: materials, design, surface coating, desert environment

RELATED TECHNOLOGIES: surface materials, thermal control,

DESCRIPTION: The known characteristics of the Martian <sup>surface</sup> environment include small (opt 10micron) particles present in the atmosphere with sufficient wind velocities (opt. 10 m/s) to cause surface scouring. Furthermore, these particles tend to be magnetic and can pose a hazard in certain situations.

STATUS: Surface erosion rates, even in the space environment, are relatively unknown.

PROGRAMS/EXPERTISE: Viking

MRSR MISSION DRIVERS: surface erosion; material compatibility; rover design features

MRSR APPLICATION ISSUES: imaging systems (optics) drive motor, and other magnetic ~~sources~~ sources, thermal control, etc.

TECHNOLOGY PLANNING WORKSHEET

WORKING GROUP: System/mission REFERENCE(S): \_\_\_\_\_  
 DATE: 4/30 TIME: \_\_\_\_\_  
 TECHNOLOGY: (Mars) environmental interactions

DEVELOPMENT FORECAST:

DATE	MILESTONE/COMMENTS	1998-LAUNCH			2000-LAUNCH		
		\$,K FUND.	TECH. LEVEL	DATE ERROR	\$,K FUND.	TECH. LEVEL	DATE ERROR
1988	Mars surface environment characterization	\$50K	1	0			
1989	surface erosion lab tests completed	\$150K	3	±1			
1990							
1991	sealing/buffing/chieling options & tests	\$1,500K	5	±1			
1992							
1993	thermal control system effects	\$150K	4	0*			
1994							
1995							**
1996							
1997							

\* NOTE: Technology selection cut-off date for a 1998-launch mission.  
 \*\* NOTE: Technology selection cut-off date for a 2000-launch mission.

TECHNOLOGY PLANNING WORKSHEET

WORKING GROUP: \_\_\_\_\_ REFERENCE(S): \_\_\_\_\_

DATE: \_\_\_\_\_ TIME: \_\_\_\_\_

TECHNOLOGY: \_\_\_\_\_

=====

ADDITIONAL WORKSPACE:

DATE: 4/30 TIME: \_\_\_\_\_ NOTES: \_\_\_\_\_  
 GROUP: System/ Mission

TECHNOLOGY PROGRAM	DEVELOPMENT SCHEDULE							TOTAL: 2,450					
	1988	1989	1990	1991	1992	'93	'94		'95	'96	'97-'00		
Mars environmental interactions Dust environment interaction Surface test lab simulator Neutral buoyancy Soils/soil-like/simulating systems " " " Test Thermal control/subsystem effects								TOTAL: 18					
PROGRAM SCOPE • \$, K • WY	300	1000	650	400	100								
MRSR PROGRAM REFERENCES	TECHNOLOGY DEVELOPMENT TECHNOLOGY SELECTION ▼ 1988 LAUNCH ▼ 2000 LAUNCH MRSR DESIGN & DEV. → LAUNCH ▼												

1987 TECHNOLOGY PLANNING WORKSHOP  
FOR THE MARS ROVER

TECHNOLOGY PLANNING WORKSHEET

WORKING GROUP: SYSTEM/MISSION REFERENCE(S): \_\_\_\_\_  
DATE: \_\_\_\_\_ TIME: \_\_\_\_\_

TECHNOLOGY: GEOPHYSICAL DATA SYSTEMS

KEYWORDS: SPATIAL DATA, GEOPHYSICAL DATA, DIGITAL TERRAIN MODELS, VISUALIZATION

RELATED TECHNOLOGIES: DIGITAL STEREO PHOTOGRAMMETRY, GEOGRAPHIC INFORMATION SYSTEMS, AUTONOMOUS SYSTEMS, KNOWLEDGE ENGINEERING, COMPUTER GRAPHICS, REAL TIME IMAGE CORRELATION

DESCRIPTION: \_\_\_\_\_

A Technology Assessment program is needed to assure the technological capability exists and can be acquired to be able to create, manage, and display terrain and other spatial geophysical data of Mars for ~~the~~ operations, engineering design and scientific utilization purposes.

STATUS: Many of the basic technologies exist but major questions are: 1) access to D-D technology; 2) handling large data sets rapidly; 3) creation of 1 meter resolution terrain models without a precision control net; and 4) data quality needed for safety margin requirements.

PROGRAMS/EXPERTISE: Expertise resides with DoD, NASA, Dept of Interior, and the surveying and mapping industry. No

MRSR MISSION DRIVERS: LANDING, ROVER ROUTE PLANNING, ROVER AND LANDER DESIGN, SCIENCE PLANNING, SURFACE OPERATIONS, SCIENCE ANALYSIS,

MRSR APPLICATION ISSUES: \_\_\_\_\_

ORIGINAL PAGE IS  
OF POOR QUALITY



1987 TECHNOLOGY PLANNING WORKSHOP  
FOR THE MARS ROVER

TECHNOLOGY PLANNING WORKSHEET

WORKING GROUP: System/ Mission REFERENCE(S): \_\_\_\_\_  
DATE: \_\_\_\_\_ TIME: \_\_\_\_\_

TECHNOLOGY: \_\_\_\_\_

DEVELOPMENT FORECAST:

DATE	MILESTONE/COMMENTS	1998-LAUNCH			2000-LAUNCH		
		\$,K	TECH. DATE	ERROR	\$,K	TECH. DATE	ERROR
1988	Technology Assessment	300 K					
1989	Controlled 1 meter Terrain Model Demo	1,000 K					
1990	Knowledge Base Requirements for Autonomous Exploration, Adaptive Landing & Rover Planning	1,000 K					
1991	Rover Planning Demo Adaptive Landing Demo	1,800 K					
1992	Uncontrolled 1 meter Terrain Model Demo	2,000 K					
1993	Autonomous Exploration Demo	2,000 K		*			
1994							
1995							**
1996							
1997							

\* NOTE: Technology selection cut-off date for a 1998-launch mission.  
\*\* NOTE: Technology selection cut-off date for a 2000-launch mission.

TECHNOLOGY PLANNING WORKSHEET

WORKING GROUP: \_\_\_\_\_ REFERENCE(S): \_\_\_\_\_

DATE: \_\_\_\_\_ TIME: \_\_\_\_\_

TECHNOLOGY: \_\_\_\_\_

=====

ADDITIONAL WORKSPACE:

Dave Nichols  
JPL  
Info Systems Program

180-703 x48912

A number of scenarios for a Mars Rover Sample Return mission have been discussed which assume the existence of a high resolution (1-3 meter) terrain elevation data base. The qualitative and operational requirements for such a data base are not well enough understood to determine if technology exists which is capable of creating and managing that data base for Mars exploration. Other spatial geophysical data may be required to complement the elevation data, which are just as difficult to acquire and manage. It is critical to understand the computational, management, quality and display requirements for Mars spatial data to aid in both mission and technology planning.

Terrain and associated geophysical data are useful (if not critical) in more than a single application. In terms of this workshop, detailed knowledge of terrain is required for global navigation, task planning, local navigation, sample acquisition and mobility. Therefore, it is important to take a broad view of the terrain data base requirements for all applications of a Mars Rover Sample Return mission, at least until the problem is clearly delineated into unique requirements for specific applications. Terrain data base knowledge is potentially applicable in the following areas:

**LANDING** - The descent vehicle will presumably be capable of landing somewhere within an error ellipse of approximately 7x3 Km. which has been pre-determined to be in a region of maximum scientific interest. Final descent will likely be guided to a precise safe landing point via real time image correlation. The lander will acquire imagery and in real time correlate it with stored terrain feature data so as to pin-point final landing.

**ROVER ROUTE PLANNING** - Planning overall rover routes (as opposed to local hazard avoidance) will require detailed terrain data displayed and correlated with other geophysical data such that safety and scientific objectives are maximized.

**ROVER AND LANDER DESIGN** - Detailed models of the morphological and surface composition characteristics for candidate roving regions and landing sites are needed in order to develop design requirements for the rover mobility systems and the lander.

**SCIENCE PLANNING** - Sampling and sensing strategies will require developing (as the mission proceeds) increasingly detailed models of the crustal geophysical characteristics to be used for correlative analysis and visualization. These data will need to be readily accessible in a computational environment sufficient to support daily planning cycles.

**SCIENCE OPERATIONS** - In order to maximize scientific return, the

rover and its payload complement may employ a certain amount of autonomy. This may be as simple as creating alarms in response to pre-established observational criteria; or more complex by managing overall resources based upon ~~real-time observations~~, disciplinary and spatial knowledge bases, and real-time observations.

SCIENCE ANALYSIS - The data bases which are created for the above applications will also be useful in conducting the scientific analysis associated with the mission. A highly flexible, interactive spatial information system, capable of supporting 3 dimensional correlative analysis and data management, will be required to build up a planetary geophysical model based on the observational data.

There are many questions which need to be addressed in order to assess the technological readiness for terrain data support of a Mars Rover mission. Some of the questions are:

1.0 What are the characteristic requirements of the digital elevation models?

1.1 What horizontal and vertical resolution is required?

1.2 What horizontal and vertical accuracy is required?

1.3 What absolute or relative positional accuracy is required?

1.4 What is the required data quality?

1.5 What is the areal extent of pre-defined terrain models?

2.0 What are the operational requirements?

2.1 What kind of safety margins are required and how does that impact the terrain data requirements

2.2 How much terrain elevation or other data must be managed on board a rover or synchronous orbiting platform?

2.3 What is the ground-to-space terrain data update cycle?

2.4 Are there any novel or unique visualization and display requirements for operations personnel or science users?

2.5 What role does terrain learning play in supporting operations?

2.6 What terrain knowledge is required to support autonomous scientific operations?

3.0 What geophysical and geomorphological data are required other than terrain elevation, such as surface material composition, slope characteristics, surface roughness, sub-surface structure, and geomagnetic and gravitational data? What are the size, accuracy, quality, and operational support requirements for the data?

TECHNOLOGY PLANNING WORKSHEET

WORKING GROUP: System/Mission REFERENCE(S): \_\_\_\_\_

DATE: 4/30 TIME: \_\_\_\_\_

TECHNOLOGY: Integrated <sup>rover</sup> system simulator and tested

KEYWORDS: \_\_\_\_\_

RELATED TECHNOLOGIES: software tools

DESCRIPTION: Complete understanding of a rover functioning in a Martian environment would benefit to a large degree by developing an ~~integrated~~ integrated ~~the~~ functional simulator and system tested.

STATUS: \_\_\_\_\_

PROGRAMS/EXPERTISE: RL/industry rover related experience

MRSR MISSION DRIVERS: all

MRSR APPLICATION ISSUES: all rover functions

1987 TECHNOLOGY PLANNING WORKSHOP  
FOR THE MARS ROVER

TECHNOLOGY PLANNING WORKSHEET

WORKING GROUP: System Mission REFERENCE(S): \_\_\_\_\_  
 DATE: 4/30 TIME: \_\_\_\_\_  
 TECHNOLOGY: Integrated system simulator and test bed

DEVELOPMENT FORECAST:

DATE	MILESTONE/COMMENTS	1998-LAUNCH			2000-LAUNCH		
		\$,K FUND.	TECH. LEVEL	DATE ERROR	\$,K FUND.	TECH. LEVEL	DATE ERROR
1988							
1989	subsystem simulators	\$2,000	5	±1			
1990							
1991	Integrated system simulator	\$3,000	5	±1			
1992							
1993	Test bed demo.	\$5,000	5	±1*			±2
1994							
1995							**
1996							
1997							

↓  
5 years

\* NOTE: Technology selection cut-off date for a 1998-launch mission.  
 \*\* NOTE: Technology selection cut-off date for a 2000-launch mission.

TECHNOLOGY PLANNING WORKSHEET

WORKING GROUP: \_\_\_\_\_ REFERENCE(S): \_\_\_\_\_  
DATE: \_\_\_\_\_ TIME: \_\_\_\_\_

TECHNOLOGY: \_\_\_\_\_  
=====

ADDITIONAL WORKSPACE:



DATE: 4/30 TIME: \_\_\_\_\_ NOTES: \_\_\_\_\_  
 GROUP: System Support

TECHNOLOGY PROGRAM	DEVELOPMENT SCHEDULE							TOTAL: \$/000	TOTAL: FY
	1988	1989	1990	1991	1992	'93	'94		
Integrated Power System Simulator & Test-bed Subsystem Functional description & data base Subsystem Simulators Integrated System simulator Test-bed development & Test-bed administration exercises									
• \$, K • WY	1000	250	350	950	1000				
	8	10	10	10	8				
MRSR PROGRAM REFERENCES	TECHNOLOGY DEVELOPMENT TECHNOLOGY SELECTION ▼ 1998 LAUNCH ▼ 2000 LAUNCH MRSR DESIGN & DEV. → LAUNCH ▼								

TECHNOLOGY PLANNING WORKSHEET

WORKING GROUP: \_\_\_\_\_ REFERENCE(S): \_\_\_\_\_  
DATE: \_\_\_\_\_ TIME: \_\_\_\_\_

TECHNOLOGY: STRUCTURES

KEYWORDS: MOBILITY, ADAPTIVE STRUCTURES

RELATED TECHNOLOGIES: MECHANISMS

DESCRIPTION: DEVELOPMENT OF VEHICLE SUSPENSION AND ARTICULATION SYSTEM FOR AUTONOMOUS OPERATION, APPLICATION OF INTELLIGENT STRUCTURAL SYSTEMS TO THE DESIGN OF THE WHEEL AND SUSPENSION SYSTEM SUCH THAT THE VEHICLE CAN ENHANCE MOBILITY AND EXTRICATE ITSELF FROM AN IMPASSE

STATUS: MANNED LUNAR ROVER TECHNOLOGY DEMONSTRATED CRITICAL FUNCTIONS DEMONSTRATED ON SIMILAR PROGRAMS, LEVEL 2.

PROGRAMS/EXPERTISE: CURRENTLY DEVELOPING ADAPTIVE STRUCTURAL CONCEPTS FOR THE CONTROL OF LARGE FLEXIBLE STRUCTURES

MRSR MISSION DRIVERS: AUTONOMOUS ROVING VEHICLE

MRSR APPLICATION ISSUES: \_\_\_\_\_

1987 TECHNOLOGY PLANNING WORKSHOP  
FOR THE MARS ROVER

TECHNOLOGY PLANNING WORKSHEET

WORKING GROUP: \_\_\_\_\_ REFERENCE(S): \_\_\_\_\_

DATE: \_\_\_\_\_ TIME: \_\_\_\_\_

TECHNOLOGY: STRUCTURES

DEVELOPMENT FORECAST:

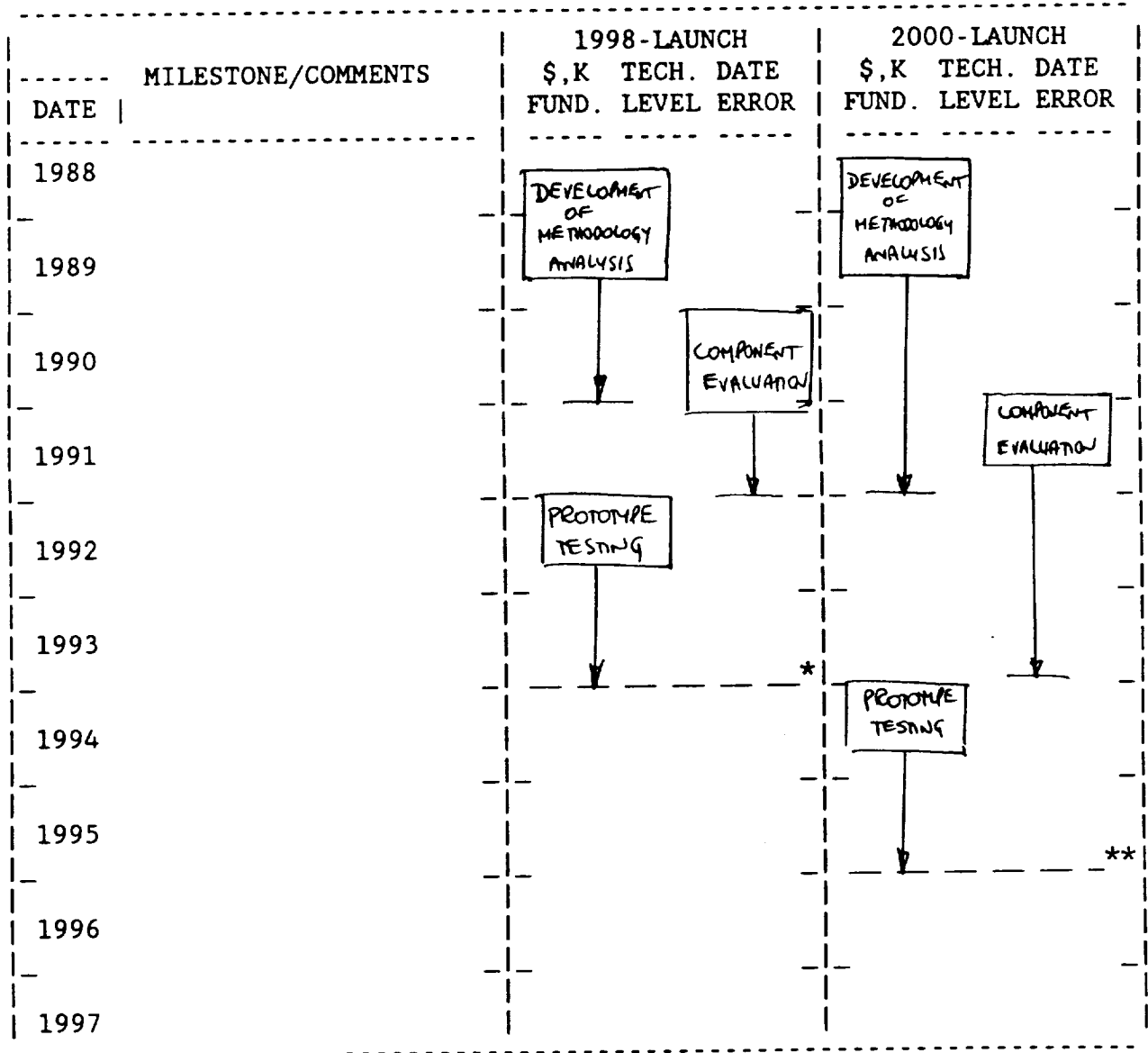

\* NOTE: Technology selection cut-off date for a 1998-launch mission.

\*\* NOTE: Technology selection cut-off date for a 2000-launch mission.

TECHNOLOGY PLANNING WORKSHEET

WORKING GROUP: \_\_\_\_\_ REFERENCE(S): \_\_\_\_\_  
DATE: \_\_\_\_\_ TIME: \_\_\_\_\_

TECHNOLOGY: STRUCTURES

ADDITIONAL WORKSPACE:

• TECHNOLOGY NEED:

DEMONSTRATION OF ROVER MOBILITY OVER ANTICIPATED MARTIAN TERRAIN FOR AUTONOMOUS OPERATION.

• CANDIDATE TECHNOLOGY APPROACH:

DEVELOP ANALYTICAL TOOLS AND CANDIDATE DESIGNS AND DEMONSTRATE THESE ON PROTOTYPE HARDWARE FOR

1. VEHICLE SUSPENSION AND ARTICULATION SYSTEM
2. WHEEL DESIGN FOR ADAPTABILITY TO TERRAIN VARIATIONS

THE APPROACH WILL BE TO UTILIZE TECHNOLOGY BEING DEVELOPED FOR THE CONTROL OF LARGE FLEXIBLE STRUCTURES TO THE DESIGN OF THE ROVER. APPLICATION OF ACTIVE STRUCTURAL MEMBERS TO THE ROVER SUSPENSION SYSTEM.

DATE: \_\_\_\_\_ TIME: \_\_\_\_\_  
 GROUP: STRUCTURES

NOTES: \_\_\_\_\_

		DEVELOPMENT SCHEDULE									
		1988	1989	1990	1991	1992	'93	'94	'95	'96	'97-'00
TECHNOLOGY PROGRAM	DEVELOPMENT OF METHODOLOGY	[Timeline with arrows from 1988 to 1992]									
	COMPONENT EVALUATION	[Timeline with arrows from 1991 to 1995]									
	PROTOTYPE TESTING	[Timeline with arrows from 1992 to 1996]									
PROGRAM SCOPE	• \$, K	200	200	300	400	600	600	300	200		TOTAL: 2800
	• WY	1.5	1.5	2.0	2.0	2.0	2.0	1.5	1.0		TOTAL: 13.5
MRSR PROGRAM REFERENCES		TECHNOLOGY DEVELOPMENT TECHNOLOGY SELECTION ▼ 1998 LAUNCH ▼ 2000 LAUNCH MRSR DESIGN & DEV. → LAUNCH ▼									

TECHNOLOGY PLANNING WORKSHEET

WORKING GROUP: Systems/Mission REFERENCE(S): \_\_\_\_\_  
DATE: 4/30 TIME: \_\_\_\_\_

TECHNOLOGY: PLANETARY QUARANTINE TECHNOLOGY

KEYWORDS: \_\_\_\_\_

RELATED TECHNOLOGIES: MATERIALS, STERILIZATION, SAMPLE CONTAINMENT, CONTAMINATION CONTROL

DESCRIPTION: PLANETARY QUARANTINE TECHNOLOGY IS A KEY PROGRAMMATIC CONSTRAINT IN A MARS MISSION AND A PLANET PROTECT. THE TECHNOLOGY REQUIRED TO IMPLEMENT THESE POLICIES WILL IMPACT THE DESIGN OF THE ROVER FROM THE CONCEPTION TO THE SYSTEM LEVEL.

STATUS: LEVEL 4 - WITH THE EXCEPTION OF STERILIZATION TECHNIQUES IT IS ANTICIPATED THAT ALL OF THE SCIENTIFIC EQUIPMENT TECHNICAL AREAS ARE DEVELOPED TO LEVEL 4 OR HIGHER.

PROGRAMS/EXPERTISE: SOME LEVEL OF EXPERTISE EXISTS WITHIN NASA (JPL, JSC), ACADEMIA, AND POSSIBLY INDUSTRY. SINCE THE TECHNOLOGISTS HAVE NOT BEEN TRAINED WITH REGARD TO THE AVAILABLE EXPERTISE MAY HAVE DIMINISHED.

MRSR MISSION DRIVERS: THE U.S. IS SIGNATORY TO THE U.N. SPACE TREATY WHICH REQUIRES THE DEVELOPMENT AND USE OF QUANTITATIVE QUARANTINE STANDARDS.

MRSR APPLICATION ISSUES: ABILITY OF SYSTEM COMPONENTS TO WITHSTAND CURRENTLY ACCEPTED OR PROSAL VULNERATION TECHNIQUES (I.E. "DRY HEAT") IS THE KEY ISSUE. THIS RELATES TO THE NEED TO REVIEW AND REVISE CURRENT POLICY AND IMPLEMENTATION.

1987 TECHNOLOGY PLANNING WORKSHOP  
FOR THE MARS ROVER

TECHNOLOGY PLANNING WORKSHEET

WORKING GROUP: Systems/Maneuver REFERENCE(S): \_\_\_\_\_

DATE: 4/2 TIME: \_\_\_\_\_

TECHNOLOGY: Low Power Systems and Technology

DEVELOPMENT FORECAST:

DATE	MILESTONE/COMMENTS	1998-LAUNCH			2000-LAUNCH		
		\$,K FUND.	TECH. LEVEL	DATE ERROR	\$,K FUND.	TECH. LEVEL	DATE ERROR
1988							
1989	PP CONSTRAINTS IDENTIFIED	350	N/A	±1	350	N/A	±1
1990							
1991	STARTED THE INITIAL COLLECTION AND RECOMMENDATION TECHNOLOGICAL						
1992	MARKET RECOGNITION METHODS DEFINED TO MEET PP REQUIS	900	4	±2	1500	6	+3
1993	PP PLAN APPROVED FOR MROB DESIGN	100	N/A	+1			
1994							
1995							**
1996							
1997							

\* NOTE: Technology selection cut-off date for a 1998-launch mission.

\*\* NOTE: Technology selection cut-off date for a 2000-launch mission.

ORIGINAL PAGE IS  
OF POOR QUALITY





## REFERENCES

- Alexander M., "Quarantine for Samples from Mars," pp. 121-146 in A.II. Schwartz, Theory and Experiment in Exobiology, Wolters-Noordhoff Publishing, The Netherlands (1972).
- Anon., "Recombinant DNA-how public?", Nature, Vol. 278, p. 383 (1979).
- Arnold, J.P., and R.S. Young, "Mars Surface Sample Return Mission Workshop" (Report), NASA Headquarters, 22p (1974).
- Bagby, J.P., "Back Contamination: Lessons Learned During the Apollo Lunar Quarantine Program," Report to JPL (1975).
- Bagby, J.P., "Planetary Protection Study/Discussion Group," (Report), Colorado State University, 19pp (1979).
- Pazelon, D. L., "Risk and Responsibility," Science, Vol. 205, pp. 277-280 (1979).
- Christensen, M. P., et al., "Mars Surface Sample Return Quarantine Planning Study," JPL 760-158 (1976).
- Davis, R.D., "The Recombinant DNA Scenarios: Andromeda Strain, Chimera, and Golem," American Scientist, Vol. 65, pp. 547-555 (1977).
- Department of Health, Education, and Welfare, National Institutes of Health, "Recombinant DNA Research: Guidelines," Federal Register, Vol. 41, No. 131, pp. 27902-27943 (July 7, 1976).
- Fox, D. G., L. R. Hall and E. J. Pacon, "Development of Planetary Quarantine in the United States," pp. 1-9 in W. Vishniac, Life Sciences and Space Research X, Akademie-Verlag, Berlin (1972).
- Hobby, G., "Back-Contamination Contingency Planning for an Earth Orbiting Laboratory," JPL Report (1978).
- Michaelson, G.S., and T.A. Mahoney, "Organizational Strategies for Protection Against Back Contamination," Final Report, NGL-24-005-160 (1976).
- Miller, L. W., "Background for Terrestrial Quarantine Constraint for Unmanned Sample Return Missions," JPL Document.
- Miller, L.W., W. Stavro and D.M. Taylor, "Planetary Quarantine Constraints for Unmanned Planetary Sample Return Missions," JPL Document (1972).
- NASA, Interagency Agreement Between the National Aeronautics and Space Administration, the Department of Agriculture, the Department of Health, Education and Welfare, the Department of the Interior, and the National Academy of Sciences, "Protection of the Earth's Biosphere from Lunar Sources of Contamination," (1967).

- NASA, "Extraterrestrial Exposure," NPD 8020.14 (1969).
- NASA, "Outbound Planetary Biological and Organic Contamination Control: Policy and Responsibility," NPD 8020.10A (1972).
- NASA, "Quarantine Provisions for Unmanned Extraterrestrial Missions," NHB 8020.12A (1976).
- NASA, Interagency Committee on Back Contamination, "Excerpts of Federal Regulations Pertinent to Contamination Control for Lunar Sample Return Missions."
- Phillips, G.B., "Back Contamination," Environmental Biology and Medicine, Vol. 1, pp. 121-160 (1971).
- Robinson, G.S., "Earth Exposure to Extraterrestrial Matter; NASA's Quarantine Regulations," International Lawyer, Vol. 5, No. 2, pp. 219-248 (1969).
- Robinson, G.S., "Earth Exposure to Martian Matter - Back Contamination Procedures and International Quarantine Regulations," in Colloquium on the Law of Outer Space, 18th, Lisbon, Portugal, Sept. 21-27 (1975).
- Space Science Board, National Academy of Sciences, "Potential Hazards of Back Contamination from the Planets," Conference (1965).
- Vinogradov, S., "Outer Space Activities and Environmental Protection," Interagency Astronautical Federation, International Astronautical Congress, 30th, Munich, West Germany, 79-115L-32 (1979).
- Young, R.S., "Post-Viking Exobiology," Biosciences, Vol. 28, No. 8, pp. 502-505 (1978).
- Young, R.S., and D.L. DeVincenzi, "From Mars with Love," Science, Vol. 186, pp. 495-501 (1974).

DATE: 4/30 TIME: \_\_\_\_\_ NOTES: \_\_\_\_\_

GROUP: PLANETARY PROTECTION

TECHNOLOGY PROGRAM	DEVELOPMENT SCHEDULE									
	1988	1989	1990	1991	1992	'93	'94	'95	'96	'97-'00
<p><i>SPACE PROTECTION</i></p> <ul style="list-style-type: none"> <li>• COMMUNICATIONS CONTROL</li> <li>• MARS SURVEILLANCE &amp; TRACKING</li> </ul> <p><i>PLANETARY PROTECTION</i></p> <ul style="list-style-type: none"> <li>• SAMPLE RETURN CONTAINMENT</li> <li>• SPACE CONTAMINATION CONTROL</li> <li>• ENVIRONMENTAL CONTROL</li> </ul> <p><i>ROVER PROBES</i></p> <ul style="list-style-type: none"> <li>• PROBES</li> <li>• REQUIREMENTS DEFINED</li> <li>• TESTS CONSIDERED</li> <li>• PROGRAM CERTIFIED</li> </ul>										
<p>PROGRAM SCOPE</p> <ul style="list-style-type: none"> <li>• \$, K</li> <li>• WY</li> </ul>										
<p>MRSR PROGRAM REFERENCES</p>										

*Handwritten notes in the schedule column:*  
 1988-1991: *Space Protection*  
 1992-1993: *Planetary Protection*  
 1994-1995: *Rover Probes*  
 1996-1997: *Probes*

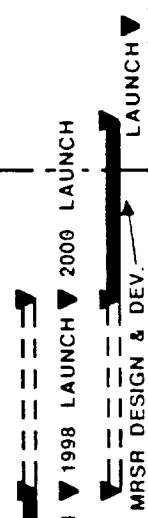

TECHNOLOGY PLANNING WORKSHEET

WORKING GROUP: M. REFERENCE(S): \_\_\_\_\_

DATE: 5/14/87 TIME: \_\_\_\_\_

TECHNOLOGY: Ultra High Temp. / UV Hard / Low Temp. Polymers and Composites

KEYWORDS: \_\_\_\_\_

RELATED TECHNOLOGIES: elastomers, spring steel

DESCRIPTION: The Mars rover will need to operate over a five year period in an environment at 150K - Temp, Spine, Drive Belts etc. will need to perform in this environment and retain their resilient properties.

STATUS: technology needs to be brought

PROGRAMS/EXPERTISE: Galileo / Flat Plate

MRSR MISSION DRIVERS: \_\_\_\_\_

MRSR APPLICATION ISSUES: \_\_\_\_\_

ORIGINAL PAGE IS  
OF POOR QUALITY

TECHNOLOGY PLANNING WORKSHEET

WORKING GROUP: Mars REFERENCE(S): \_\_\_\_\_

DATE: 5/1/87 TIME: \_\_\_\_\_

TECHNOLOGY: Abandon [unclear] / [unclear] / [unclear]  
Coatings

KEYWORDS: \_\_\_\_\_

RELATED TECHNOLOGIES: paint

DESCRIPTION: The Mars Rover will be expected to go above soil which is in the ground and airborne. The rover will use a protective cover to avoid any chemical contamination of science instruments.

STATUS: Technology not yet developed

PROGRAMS/EXPERTISE: Flet Plate [unclear] / Wide Field [unclear]

MRSR MISSION DRIVERS: \_\_\_\_\_

MRSR APPLICATION ISSUES: \_\_\_\_\_



1987 TECHNOLOGY PLANNING WORKSHOP  
FOR THE MARS ROVER

TECHNOLOGY PLANNING WORKSHEET

WORKING GROUP: \_\_\_\_\_ REFERENCE(S): \_\_\_\_\_

DATE: \_\_\_\_\_ TIME: \_\_\_\_\_

TECHNOLOGY: Chemistry

KEYWORDS: \_\_\_\_\_

RELATED TECHNOLOGIES: \_\_\_\_\_

DESCRIPTION: The rover will have to operate in a non-neutral environment for 5 years. Chemically inert materials will be used.

STATUS: Further work to be further defined

PROGRAMS/EXPERTISE: Geology / Flat Plate solar Array / V. King

MRSR MISSION DRIVERS: \_\_\_\_\_

MRSR APPLICATION ISSUES: \_\_\_\_\_

ORIGINAL PAGE IS  
OF POOR QUALITY

TECHNOLOGY PLANNING WORKSHEET

WORKING GROUP: Mars Rover Team REFERENCE(S): \_\_\_\_\_  
DATE: 5-4-87 TIME: \_\_\_\_\_

TECHNOLOGY: High Temperature / Abrasion Resistant / Low Temp  
Tool ~~Material~~ Material

KEYWORDS: Impact resistant / Abrasion resistant / Low temp

RELATED TECHNOLOGIES: High Temp / Abrasion Resistant

DESCRIPTION: \_\_\_\_\_  
\_\_\_\_\_  
\_\_\_\_\_  
\_\_\_\_\_  
\_\_\_\_\_

STATUS: These are well-established materials with a long history of use in space applications.

PROGRAMS/EXPERTISE: We worked extensively with Ford. Also I've had a program control group in the past with employees from management staff.

MRSR MISSION DRIVERS: It is necessary to have a good design collection and a good design process.

MRSR APPLICATION ISSUES: Properties of cryogenic temperatures. Failure of materials.

ORIGINAL PAGE IS  
OF POOR QUALITY



(PREPARED BY)	C. Hsieh	(DATE)	5/3/87	(REPORT NO.)	
(CHECKED BY)		(DATE)		(PROJECT)	
TITLE					

Keywords: Light weight materials, metal matrix composites.

Related Technologies: Aluminum-Lithium alloys, powder metallurgy.

Description: Metal matrix composites combine the ~~strength~~ <sup>advantages</sup> of the matrix metals and the reinforcing materials such as particulates, whiskers, and fibers to obtain properties far exceeding that of the component materials. The <sup>density,</sup> strength, stiffness, thermal expansion coefficient and thermal conductivity can all be tailored to the ~~type~~ specific requirements. Usual reinforcement materials are ceramic such as silicon carbide and alumina and graphite fibers. The ~~usable~~ <sup>usable</sup> temperature of metal matrix composites is higher than the matrix alloys. Also metal matrix composites do not have problems of <sup>moisture</sup> outgassing ~~out~~ of organic matrix composites. ~~Metal~~

(PREPARED BY)

(DATE)

(REPORT NO.)

(CHECKED BY)

(DATE)

(PROJECT)

TITLE

matrix composites have better radiation resistance than organic matrix composites.  
Status: Industry is gaining experience on metal matrix composites.

Programs / Expertise: JPL has conducted material evaluation of metal matrix composites for Air Force Rocket Propulsion Lab. including mechanical properties, fracture toughness testing at RT and at HTE temperature. The effects of thermal cycling was studied.

MRSR MISSION DRIVERS: Continuously ~~reinforced~~ fiber reinforced metal matrix composites have the highest specific modulus and specific strength of than conventional materials.

(PREPARED BY)

(DATE)

(REPORT NO.)

(CHECKED BY)

(DATE)

(PROJECT)

TITLE

MRSR Application Issues: Long term dimensional stability (such as micro creep) has to be evaluation. Fabrication technique, mechanical fastening schemes ~~are~~ <sup>will be</sup> different from the conventional metal structures and have to be investigated. Thermal hysteresis of thermal expansion coefficient has to be addressed such as cross-plying and/or thermal treatment of the metal matrix composites.

(PREPARED BY)

C. Hsieh

(DATE)

5/3/87

(REPORT NO.)

(CHECKED BY)

(DATE)

(PROJECT)

TITLE

Keywords: Light weight materials, Aluminum-lithium alloys, ~~etc~~

Related Technologies: Metal Matrix composites, Surface treatment, fracture mechanics.

Description: Aluminum-lithium alloys has a density about 9% lower than the conventional aluminum alloy and 13% higher in elastic modulus. These alloys have the strengths as high as the high strength alloy 7075 while have better fatigue crack growth resistance and better fracture toughness. Some of these materials are weldable. They can be fabricated using the conventional manufacturing techniques.

Status: These materials are in the stage of being incorporated in some newer commercial and military aircrafts. Aerospace industry is conducting intensive research on these material

(PREPARED BY)	(DATE)	(REPORT NO.)
(CHECKED BY)	(DATE)	(PROJECT)
TITLE		

Programs/Expertise: JPL has conducted material evaluation of Aluminum-Lithium alloy for Air Force Rocket Propulsion Lab. including mechanical properties, fracture toughness testing at RT and at LHe temperature.

MRSR Mission DRIVERS: High specific stiffness and specific strength than the backbone materials for aerospace applications, i.e., conventional aluminum alloys.

MRSR Application Issues: Stress corrosion cracking resistance has to be evaluated. Surface finishes such as conversion coating and anodizing treatment have to be investigated.

OR

TECHNOLOGY PLANNING WORKSHEET

WORKING GROUP: Power Panel REFERENCE(S): \_\_\_\_\_

DATE: 4/29/87 TIME: 9AM-NOON

TECHNOLOGY: Rover Cab Temperature Control

KEYWORDS: Rover Cab, Temperature Control, Thermal

RELATED TECHNOLOGIES: Mobility, Radioactive Heating Units (RHU's), Thermal Science

DESCRIPTION: If multiple cabs are used on a Mars roving vehicle, very large amounts of heat (at least 200w) will be necessary to heat each cab. During the cold Martian nights (-150°C) the most reliable, lightest way to supply this is to modify present RTG heat sources (62.5w each) to supply the heat. This eliminates the need for fluid pumps and lines to the trailing RTG cab, and greatly reduces overall rover electrical needs. Variable conductance heat pipes (SOA) connected to radiators can cool the cabs during the day.

STATUS: Present radioactive heating units (RHU's) are available in a one watt size only. RTG heating sources (presently 62.5w) can be modified, however to provide instrument heating for the cabs.

PROGRAMS/EXPERTISE: Thermal Science and Engineering, RTG power design, Heat Pipe Technology

MRSR MISSION DRIVERS: This technology must be developed if separate rover cabs are used and high reliability is to be ensured. Flexible heat pipes and fluid pumped loops are highly undesirable from a reliability standpoint

MRSR APPLICATION ISSUES: RTGs, Science Instrument Heating, Mobility

1987 TECHNOLOGY PLANNING WORKSHOP  
FOR THE MARS ROVER

TECHNOLOGY PLANNING WORKSHEET

WORKING GROUP: Power Panel REFERENCE(S): \_\_\_\_\_  
 DATE: 4/29/87 TIME: 9AM-Noon \_\_\_\_\_  
 TECHNOLOGY: Rover Cab Temperature Control

DEVELOPMENT FORECAST:

DATE	MILESTONE/COMMENTS	1998-LAUNCH		2000-LAUNCH	
		\$,K FUND.	TECH. LEVEL DATE ERROR	\$,K FUND.	TECH. LEVEL DATE ERROR
1988	Develop Thermal Models of large RHU (LRHU) systems	125 K			
1989	LRHU design	225 K			
1990	LRHU fabrication	500 K			
1991	LRHU testing	500 K			
1992	LRHU flight and safety qualification	1100 K			
1993	LRHU System Integration studies	500 K			*
1994	Flight Design	800 K			
1995	Flight Fab	2500 K			**
1996	Flight Test	1500 K			
1997	Flight Integration	900 K			

\* NOTE: Technology selection cut-off date for a 1998-launch mission.

\*\* NOTE: Technology selection cut-off date for a 2000-launch mission.

1987 TECHNOLOGY PLANNING WORKSHOP  
FOR THE MARS ROVER

PAGE 3

TECHNOLOGY PLANNING WORKSHEET

WORKING GROUP: \_\_\_\_\_ REFERENCE(S): \_\_\_\_\_

DATE: \_\_\_\_\_ TIME: \_\_\_\_\_

TECHNOLOGY: \_\_\_\_\_

\_\_\_\_\_

ADDITIONAL WORKSPACE:



DATE: 4/29/87 TIME: 9 AM - Noon NOTES: Rover Cab Temperature Control

GROUP: Power Panel

TECHNOLOGY PROGRAM	DEVELOPMENT SCHEDULE									
	1988	1989	1990	1991	1992	'93	'94	'95	'96	'97-'00
Develop thermal models of Large Radiative Heating Units (LRHU)										
LRHU Design										
LRHU Fabrication										
LRHU Testing										
LRHU Flight & Safety Eval										
LRHU System Intg Studies										
Flight Design										
Flight Fab										
Flight Test										
Flight Integration										
PROGRAM SCOPE	• \$, K	125	225	500	500	500	800	2500	2400	TOTAL: 8650
	• WY	1.0	1.8	3.0	3.5	3.0	8.0	10.5	12.0	TOTAL: 44.8
MRSR PROGRAM REFERENCES	TECHNOLOGY DEVELOPMENT TECHNOLOGY SELECTION ▼ 1998 LAUNCH ▼ 2000 LAUNCH MRSR DESIGN & DEV. → LAUNCH ▼									

TECHNOLOGY PLANNING WORKSHEET

WORKING GROUP: Power Panel REFERENCE(S): \_\_\_\_\_

DATE: 4/29/87 TIME: 9AM-NOON

TECHNOLOGY: RTG Heat Rejection

KEYWORDS: RTG, Temperature Control, Thermal, Heat Pipe

RELATED TECHNOLOGIES: RTG, Aeroshell, Aerobrake, Heat Pipes

DESCRIPTION: During Mars atmosphere aerobraking, the aeroshell will heat greatly, thus preventing RTG heat rejection. ① Diode heat pipes must be developed for the RTG to prevent aeroshell heat from further heating the RTG's and ② some type of phase change heat rejection system must be developed for the RTG's

STATUS: ① Diode heat pipes have functioned on spacecraft but not at the required heat rejection levels and temperatures for RTG use (approx 250°C)  
② Phase change heat rejection systems have not been used for RTG's

PROGRAMS/EXPERTISE: Thermal Science and Engineering, Heat Pipe Technology, RTG Cooling Technology

MRSR MISSION DRIVERS: This technology must be developed if radioactive power sources, eg RTG's are used and if Aerobraking is utilized.

MRSR APPLICATION ISSUES: RTG's, Aerobraking

1987 TECHNOLOGY PLANNING WORKSHOP  
FOR THE MARS ROVER

TECHNOLOGY PLANNING WORKSHEET

WORKING GROUP: Power Panel REFERENCE(S): \_\_\_\_\_  
DATE: 4/29/87 TIME: 9AM-NOON

TECHNOLOGY: RTG Heat Rejection

DEVELOPMENT FORECAST:

DATE	MILESTONE/COMMENTS	1998-LAUNCH		2000-LAUNCH	
		\$,K FUND.	TECH. DATE LEVEL ERROR	\$,K FUND.	TECH. DATE LEVEL ERROR
1988	Develop Thermal Models of RTG/Aeroshell	150K			
1989	Model Multi-Phase-Change Heat Sinks/Heat Pipes	250K			
1990	Diode Heat Pipe and Phase Change Material Thermal Tests	350K			
1991	Fabricate Ancillary Components, Conformal Radiator, Etc	400K			
1992	Fabricate Phase Change Heat Sink	750K			
1993	Full Thermal Verification Testing of Heat Pipes and Heat Sinks	1200K			
			*		
1994	Flight Design	600K			
1995	Flight Fab	1500K			
					**
1996	Flight Test	1200K			
1997	Flight Integration	900K			

\* NOTE: Technology selection cut-off date for a 1998-launch mission.

\*\* NOTE: Technology selection cut-off date for a 2000-launch mission.

TECHNOLOGY PLANNING WORKSHEET

WORKING GROUP: \_\_\_\_\_ REFERENCE(S): \_\_\_\_\_  
DATE: \_\_\_\_\_ TIME: \_\_\_\_\_

TECHNOLOGY: \_\_\_\_\_

ADDITIONAL WORKSPACE:

DATE: 4/29/87 TIME: 9 AM - Noon

NOTES: RTG Heat Rejection

GROUP: Power Panel

TECHNOLOGY PROGRAM	DEVELOPMENT SCHEDULE							TOTAL: 7300					
	1988	1989	1990	1991	1992	'93	'94		'95	'96	'97-'00		
RTG/Aeroshell Thermal Models													
Phase Change Mat'l Thermal Models													
Heat Pipe and Phase Change Material Tests													
Fab Ancillary Components													
Fab Phase Change Heat Sink													
Full Thermal Verification Testing													
Flight Design													
Flight Fab													
Flight Test													
Flight Integration													
PROGRAM SCOPE	• \$, K	150	250	350	400	750	1200	600	1500	2100	TOTAL: 7300		
	• WY	1.0	2.0	2.7	3.0	5.0	7.0	3.0	9.0	12.0	TOTAL: 44.7		
MRSR PROGRAM REFERENCES	TECHNOLOGY DEVELOPMENT TECHNOLOGY SELECTION ▼ 1988 LAUNCH ▼ 2000 LAUNCH MRSR DESIGN & DEV. → LAUNCH ▼												

~~2547 JSE 88-138~~~~JANUARY 8, 1987~~

May 1, 1987

TO: ~~Jim Randolph~~ John Mankins

FROM: Jack A. Jones *Jack A. Jones*

SUBJECT: Mars Rover Mission - Primary Temperature Control Concerns

- REFERENCES:
1. Ron Salazar, Thermal Control input to JPL Aerocapture FY'82 Final Report and Presentation, June, 1982.
  2. P. Dunn, Heat Pipes, 3rd Ed, Oxford, New York, Pergamon, 1982.
  3. G. L. Fleischman, G. F. Pasley, R. J. McGrath, and L. D. Loudon back, "A High Reliability Variable Conductance Heat Pipe Space Radiator," AIAA 3rd International Heat Pipe Conference, Palo Alto, California, May 22-24, 1978.
  4. Robert Campbell, Private Communication, JPL Section 343, October, 1986.
  5. Roy McIntosh, Private Communication, GSFC Thermal Control, Noted NASA Flight Heat Pipe Authority, October, 1986.

### Introduction

For the projected Mars Rover mission, there will be a wide variety of thermal environments with which to contend. A summary of the major thermal environments is shown in Table 1 and includes those for launch, earth orbit, planetary cruise, atmospheric entry, Martian orbit, and Martian surface. Past JPL interplanetary spacecraft have dealt quite successfully with all but two of these problems. Specifically, they are the problems associated with aerocapture (include heat transfer through the aeroshell) and mobility on the Martian surface.

A summary is shown in Figure 1 (Ref.1) of the various ways in which temperature control has been maintained on various spacecraft from the 1960's to the present and beyond. Due to the complicated nature of maintaining temperature control both within the aeroshell and while mobile on the Martian surface, both areas are addressed separately in the following sections.

### Temperature Control Through The Aeroshell

The aeroshell is a large shell which must protect the spacecraft during the atmospheric heating of aerobraking and/or aeromaneuvering in the Martian atmosphere. It is important to transfer the heat of both the electronics science packages and the RTG during the long interplanetary cruise, and yet find a way to stop the heat due to atmospheric entry from overheating these

internal spacecraft components. Although controllable fluid-pumped cooling loops would suffice for this problem, this type of cooling system requires very long life fluid pumps and thus has serious reliability implications.

An alternative means of temperature control is to provide cooling by means of diode heat pipes. A diode heat pipe consists of a hollow, enclosed tube that is partially filled with a liquid that can flow only in one direction. As the vapor is boiled at one end, providing cooling, it travels to the other end of the tube (radiator end) where it condenses and returns by capillary action to the original end. Although the diode heat pipe is relatively new in inception, this type of device has been used quite successfully on a number of space flights (Ref. 2). Separate heat pipes for both the electronics and RTG (Figure 2) should be able to safely maintain temperatures during cruise, and shut-off during aerocapture. An additional phase change material, e.g., vented water vapor, may then be used to absorb the anticipated 5kw+/- RTG heat during aerocapture.

Segmented Rover Electronics Compartments

On the previous Viking landers, both the RTG and the science experiments were in the same single spacecraft unit. The heat necessary to heat the science instruments was thus readily available as required by means of a movable conduction joint to the RTG. For the present Mars Rover design, however, the science instruments are separate from the RTG, and alternative heating methods must be used. If electrical waste heat or dedicated heaters are used, the two science modular compartments would require 150 watts each of power and still be covered with 20 cm of insulation (30kg total) to survive the 150K (-123°C) Martian nights.

Also, heat pipes are gravity sensitive and would likely cease to function if the forward cabs are below the RTG level, i.e. going downhill.

Although a fluid pumped loop to the RTG would suffice to provide heat to the other segments, this would again require long life pumps and lead to serious reliability problems. Similarly, flexible heat pipes would be a serious reliability problem, especially when the rover is moving over difficult terrain. In addition to possible mechanical failure, vibrations can dislodge the fluid from the heat pipe capillaries, thus potentially "turning off" the heat pipe. An alternative manner of heating is to adapt a number of small power packages (about 62.5w heat each) from an RTG heating unit, and place these shielded heat sources appropriately in the compartments. Although flight-qualified radioactive heating units (RHU's) are presently available only in one watt sizes, these larger 62.5 watt RHU's should be relatively easy to get flight-qualified (Ref.4), since they would be identical to those already in the Galileo RTG. Alternatively, cab heating could be provided by placing smaller, multiple RTG's in each cab instead of one large trailing RTG unit. Cooling of the modules could then be accomplished by internal louvers (to avoid Martian dust) or by variable conduction heat pipes (VCHP). The VCHP method is now relatively commonly used for spacecraft (Ref.3,5) and can automatically maintain a spacecraft temperature to about +/- 5°C. A description of a typical VCHP is shown in Figure 3.

modular cabs

ORIGINAL PAGE IS OF POOR QUALITY

This may result in lower overall cab weight and reduce the need for flexible power cables between the cabs

Summary and Conclusions

The two areas of temperature control that are unique to the Martian Rover Mission, and thus of considerable concern are the spacecraft (RTG plus electronics) temperature control through the aeroshell and the temperature control of the segmented, modular rover. Cooling through the aeroshell can be maintained by diode heat pipes, which will also act to prevent internal heating up during aerobraking. A phase change material, e.g., pressurized water vapor may help to cool the RTG during actual aeromaneuvers.

Heating of the modular electronics compartments can be accomplished by adapting Galileo-type RTG radioactive heating sources (62.5w each) to form a large size radioactive heating unit (RHU). Cooling of the compartments can be accomplished by means of variable conductance heat pipes connected to external radiators. Although all these temperature control systems are generally feasible, specific attention must be given to producing and flight-qualifying the 62.5w RHU's, as well as to designing the proposed RTG/aeroshell temperature control systems.

*or smaller, multiple RTG's*

*or by using smaller multiple RTG's such that at least one is located in each cab*

JAJ:cj

Distribution

- G. Klein
- W. Menard/B. Wada
- H. Norton
- W. Petrick
- J. Roschke
- P. Salazar



**TABLE 1. MARS ROVER MISSION THERMAL CONTROL  
THERMAL ENVIRONMENTS**

**LAUNCH**

- o RTG HEAT REJECTION TO STS
- o EJECTION FROM SHUTTLE BAY

**EARTH ORBIT**

- o RTG AND SPACECRAFT HEAT REJECTION TO SPACE
- o SOLAR AND EARTH HEATING

**PLANETARY CRUISE**

- o RTG AND SPACECRAFT HEAT REJECTION TO SPACE
- o VARYING SOLAR HEATING

**ATMOSPHERIC ENTRY**

- o AEROSHELL HEATING
- o SPACECRAFT AND SCIENCE INSTRUMENT THERMAL CONTROL
- o RTG HEAT REMOVAL/STORAGE

**PLANETARY ORBIT**

- o AEROSHELL EJECTION
- o SOLAR AND PLANETARY HEATING
- o MULTIPLE MISSIONS

**PLANETARY SURFACE**

- o EXTREMES OF WARM (-23°C) AND COLD (-123°C)
- o ROVER MOBILITY/ORIENTATION/VIBRATION

# Aerocapture Spacecraft Thermal Control

## Thermal Control System Technology Development History

FIGURE 1

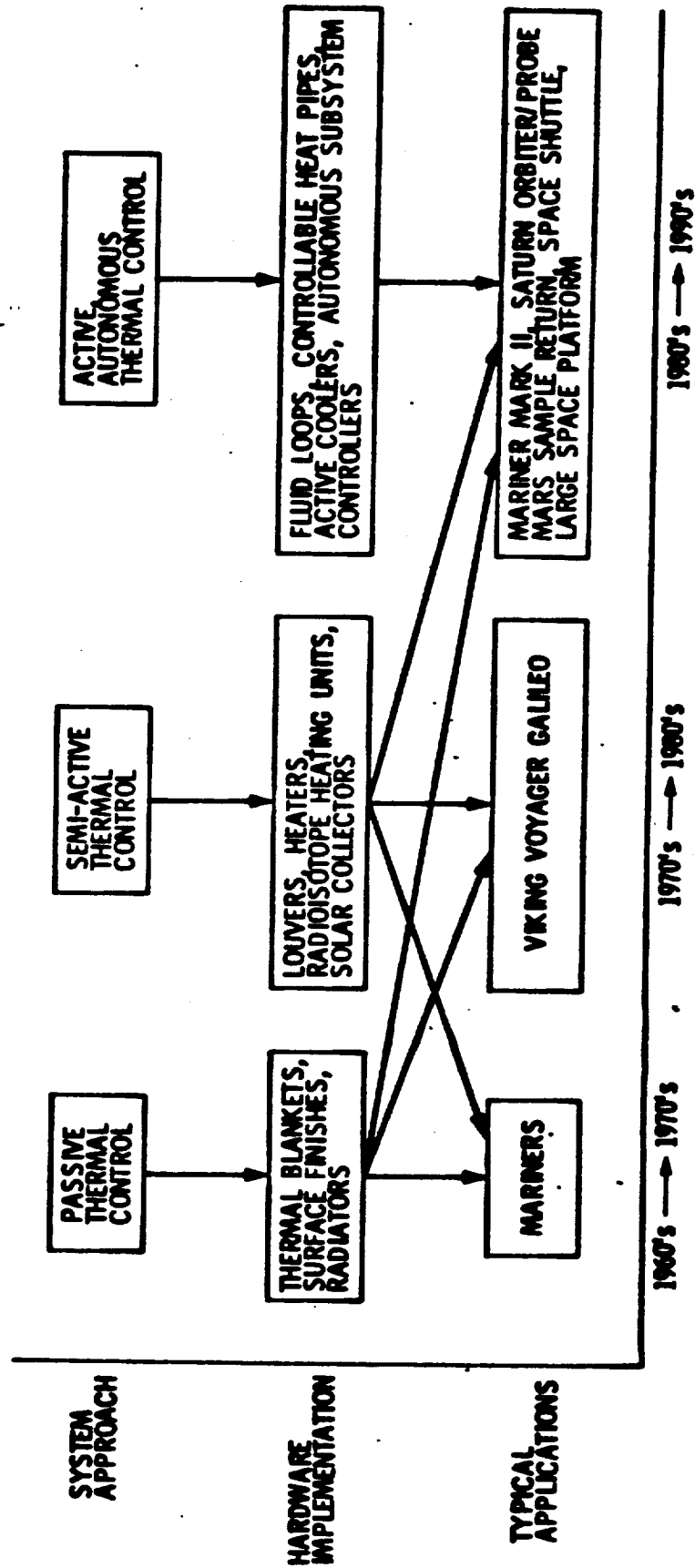

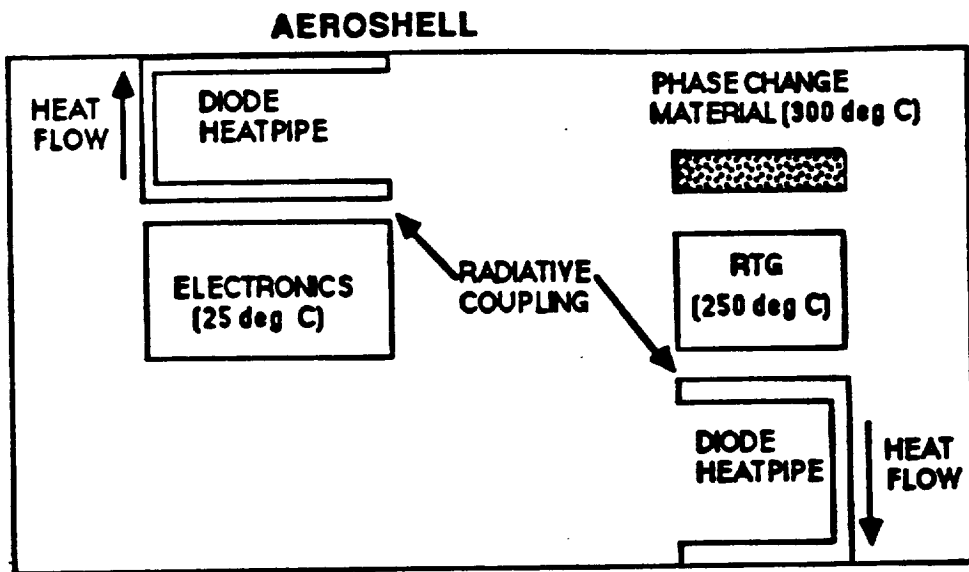
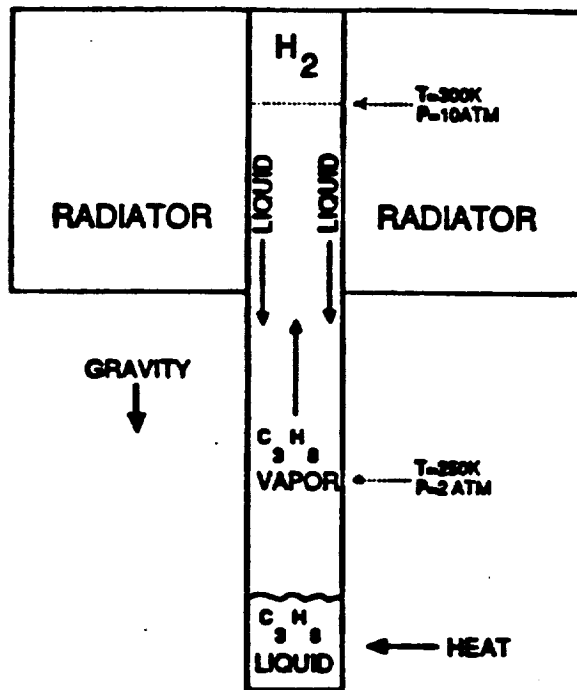

FIGURE 2. AEROCAPTURE SPACECRAFT THERMAL CONTROL



When the propane temperature rises from  $250^{\circ}C$  to  $300^{\circ}C$ , its pressure increases from 2 ATM to 10 ATM. This compresses a hydrogen "non-condensable" gas slug so that the propane vapor can condense on the colder radiator. The condensed liquid then falls and provides cooling when it is re-boiled.

FIGURE 3. VARIABLE CONDUCTANCE HEAT PIPES

TECHNOLOGY PLANNING WORKSHEET

WORKING GROUP: System & Mission REFERENCE(S): \_\_\_\_\_

DATE: 30 Apr 87 TIME: \_\_\_\_\_

TECHNOLOGY: System Fault Protection Design and Analysis

KEYWORDS: Fault Protection, Verification, Diagnosis

RELATED TECHNOLOGIES: AI / System Autonomy

DESCRIPTION: System level Fault protection design consists of developing control sequences which detect faults, assess them, and recover by reconfiguring the system to an alternate safe operating state. This involves understanding the inter-related operating behavior of the system for specific faults and analyzing the resulting sequences to verify that they accomplish their objectives in a variety of nominal and non-nominal operating conditions.

STATUS: level 3 manually developed process, has been demonstrated for Gemini shows that better system incorporating automation is needed.

PROGRAMS/EXPERTISE: Section 313 has understanding of problem, responsibility for implementation in project environment.

MRSR MISSION DRIVERS: Design and validation of fault protection has been a system consisting of traditional and new subsystems in an unfamiliar environment.

MRSR APPLICATION ISSUES: Must develop and prove integrated methodology by start of Rover system design.

1987 TECHNOLOGY PLANNING WORKSHOP  
FOR THE MARS ROVER

TECHNOLOGY PLANNING WORKSHEET

WORKING GROUP: System Fault Protection REFERENCE(S): \_\_\_\_\_

DATE: 2 Apr 87 TIME: \_\_\_\_\_

TECHNOLOGY: System Fault Protection

DEVELOPMENT FORECAST:

DATE	MILESTONE/COMMENTS	1998-LAUNCH			2000-LAUNCH		
		\$,K FUND.	TECH. LEVEL	DATE ERROR	\$,K FUND.	TECH. LEVEL	DATE ERROR
1988	Develop concept for automated fault protection	75K		± 25K			
1989	Produce requirements, start exploratory prototyping	200K		± 50K			Spread development over 2 more years (90 to 93 years) 90-95
1990	Continue prototyping development	350K		± 50K			
1991	Develop prototyping test environment	350K		± 50K			
1992	Design of critical systems begin development	500K		± 50K			
1993	Design test environment software	300K		± 50K			
1994				*			
1995							**
1996							
1997							

\* NOTE: Technology selection cut-off date for a 1998-launch mission.

\*\* NOTE: Technology selection cut-off date for a 2000-launch mission.

1987 TECHNOLOGY PLANNING WORKSHOP  
FOR THE MARS ROVER

PAGE 3

TECHNOLOGY PLANNING WORKSHEET

WORKING GROUP: \_\_\_\_\_ REFERENCE(S): \_\_\_\_\_  
DATE: \_\_\_\_\_ TIME: \_\_\_\_\_

TECHNOLOGY: \_\_\_\_\_

=====

ADDITIONAL WORKSPACE:

DATE: \_\_\_\_\_ TIME: \_\_\_\_\_

NOTES: Purchase of potential AE systems took 4 1/2 yrs including in early 89 - 90 costs. Significant purchase of new concepts H/W not included. Estimates are success-oriented.

GROUP: System Fault Protection Design & Analysis

TECHNOLOGY PROGRAM	DEVELOPMENT SCHEDULE									
	1988	1989	1990	1991	1992	'93	'94	'95	'96	'97-'00
1. Concept Development, Requirements Draft	A									
2. Requirements Development		A								
3. Exploratory Prototyping			A							
4. Prototype testing, fix, learn				A						
5. Spentimed system design					A					
6. Structural system development						A				
7. Spentimed system test							A			
PROGRAM SCOPE	\$, K	25	200	250	200	250	200	200	200	TOTAL:
	WY	15	25	35	30	35	30	30	30	TOTAL:
MRSR PROGRAM REFERENCES	TECHNOLOGY DEVELOPMENT TECHNOLOGY SELECTION ▼ 1998 LAUNCH ▼ 2000 LAUNCH MRSR DESIGN & DEV. → LAUNCH ▼									



TECHNOLOGY PLANNING WORKSHEET

WORKING GROUP: System & Mission REFERENCE(S): \_\_\_\_\_

DATE: 30 Apr 87 TIME: \_\_\_\_\_

TECHNOLOGY: System Modeling / Simulation Methodology and Tools

KEYWORDS: System Analysis, Modeling, Simulation, Data base, AI

RELATED TECHNOLOGIES: Data base Design/management,

DESCRIPTION: A methodology and tools to support the creation of system design information and its incorporation in modeling and simulation. Data and knowledge bases developed in the design phase of system development are used in models and simulations to verify design performance. Refinement of the data/knowledge bases during system implementation allows support for system integration/test. Incorporation of information learned in integration/test allows a mature version of the data/knowledge base to support AI-based monitoring, planning, and sequence generation applications for operation.

STATUS: level 4 - Simulation and modeling tools are available for specific applications - i.e. dynamic system modeling, system functional modeling, etc. Study of methodology to integrate modeling & simulation with design, integration/test process hasn't progressed beyond level 2.

PROGRAMS/EXPERTISE: JPL is not good at this.

MRSR MISSION DRIVERS: Complex system of traditional SKI subsystems and untried technologies requires simulation/modeling to verify many design and operating features.

MRSR APPLICATION ISSUES: Need an understanding of the design/development process that will be applied to the rover to develop understanding of what must be modeled, simulated and identify products of design/IT process which must be delivered to use tools

1987 TECHNOLOGY PLANNING WORKSHOP  
FOR THE MARS ROVER

PAGE 2

TECHNOLOGY PLANNING WORKSHEET

WORKING GROUP: System & Mission REFERENCE(S): \_\_\_\_\_

DATE: 30 Apr 87 TIME: \_\_\_\_\_

TECHNOLOGY: System Modeling/Simulation Methodology/Tools

DEVELOPMENT FORECAST:

DATE	MILESTONE/COMMENTS	1998-LAUNCH		2000-LAUNCH	
		\$,K FUND.	TECH. DATE LEVEL ERROR	\$,K FUND.	TECH. DATE LEVEL ERROR
1988	Develop methodology, define products, issue program	185K	± 25K		
1989	Start building test tools, conduct off studies	350K	+100K		
1990	Develop methodology, conduct test, selected tool/application to be used in test	500K	+100K		
1991	Develop test methodology, conduct test, develop test	500K	± 50K		
1992	Develop test methodology, conduct test, develop test	400K	+ 25K		
1993	Test in production environment	250K	± 25K		
1994			*		
1995					**
1996					
1997					

↑ slip 1998 schedule by 2 yrs.

} ie' need look more

\* NOTE: Technology selection cut-off date for a 1998-launch mission.

\*\* NOTE: Technology selection cut-off date for a 2000-launch mission.

1987 TECHNOLOGY PLANNING WORKSHOP  
FOR THE MARS ROVER

PAGE 3

TECHNOLOGY PLANNING WORKSHEET

WORKING GROUP: \_\_\_\_\_ REFERENCE(S): \_\_\_\_\_

DATE: \_\_\_\_\_ TIME: \_\_\_\_\_

TECHNOLOGY: \_\_\_\_\_

=====

ADDITIONAL WORKSPACE:

DATE: 30 Apr 87 TIME:

NOTES: Equipment Procurement account to fall in FY 89-90 to the force, reflected by T-look mentioned in FY 89-90. Estimate by contractor in terms of underestimation of cost.

GROUP: Naval Systems

TECHNOLOGY PROGRAM	DEVELOPMENT SCHEDULE									
	1988	1989	1990	1991	1992	'93	'94	'95	'96	'97-'00
1.0 Develop technology Requirements Procedure Development Product description Implementation Plan Requirements Document	Δ Δ Δ Δ Δ									
2.0 Select hardware/Software approach Evaluate Tools Select Commercial S/W, HW Procure external Tools, HW Design prototype, I/F to interface		Δ Δ Δ Δ								
3.0 Prototype Development Reconstitute prototype				Δ Δ						
4.0 Design of Operational System					Δ					
5.0 Implementation of Operational System Test										
6.0 Test program development										
PROGRAM SCOPE	• \$, K	175 + 1.5	150 + 200	500	500	400	1.5	255 + 1.5		TOTAL:
	• WY	1.5	5.0	4.5	4.5	4.0		2.0		TOTAL:
MRSR PROGRAM REFERENCES	<p>TECHNOLOGY DEVELOPMENT</p> <p>TECHNOLOGY SELECTION ▼ 1998 LAUNCH ▼ 2000 LAUNCH</p> <p>MRSR DESIGN &amp; DEV. → LAUNCH ▼</p>									

APPENDIX B  
PRESENTED MATERIALS

# Rover Imaging Requirements for a Mars Rover/Sample Return Mission

## S.W. Squyres

### Introduction

One of the most important types of instruments to be considered for a Mars rover is an imaging system. The rover imaging system (or systems) will play a critical role in virtually all phases of the rover mission: regional and local scale navigation, geologic characterization of sites, sample selection, and preliminary sample analysis. The purpose of this brief document is to present a very preliminary attempt at outlining the basic functional requirements for rover imaging, based on scientific criteria. I begin from the assumption that the primary purpose of rover imaging is to assure the optimum selection of samples for return to Earth. Other scientific goals are considered secondary. Of course, specification of the imaging capabilities that a rover should possess is a complex task involving many compromises, and is one that will eventually have to be done by a group of individuals with specialties ranging from martian geology to optics and detector design.

A number of different bases of experience may be drawn upon to help specify imaging capabilities for a Mars rover. These include the Viking Lander imaging experiment, more recent work with a number of more sophisticated sensors that have been developed for laboratory and remote sensing use, and field experience in Mars-like terrestrial environments such as the Antarctic Dry Valleys. All of these are considered briefly here.

### Imaging Objectives

First, we must state the objectives of the imaging system(s). There are at least four: (1) *rover navigation*, (2) *sample selection*, (3) *sample acquisition*, and (4) *"supplemental" science* not directly related to samples.

*Rover navigation* must be conducted over a range of scales, all of which may involve rover imaging to some degree. At the largest scale, it will be necessary to find the location of the rover in a regional context; that is, its general position relative to known landmarks and geologic units. At an intermediate scale, it will be necessary for the rover to navigate "from point A to point B", where point B is some feature of interest (*e.g.*, a rock of unusual color) that is observed in an image taken at point A. This point to point navigation must be performed with sufficient accuracy to guarantee that the object of interest can be found reliably once the rover arrives in its vicinity. Finally, at a scale comparable to the size of the rover itself, it will be necessary to avoid obstacles that could present a hazard. Regional-scale navigation will almost certainly involve radio tracking from an orbiter, and presumably will not rely heavily on "dead reckoning" from images except as a last resort. Small-scale (hazard avoidance) navigation may well utilize highly specialized sensors coupled with some form of artificial intelligence. It is the imaging requirements for intermediate (~10 - 100 m) scale navigation, then, that are of primary interest here.

*Sample selection* will probably be the most challenging objective. It will be necessary to choose, from the huge number of possibilities presented to the rover, the few kilograms

of samples that will produce the highest science return. The process of narrowing down the many possible choices will involve three levels of detail, each with its own unique imaging requirements:

- *Level 1 — Reconnaissance:* At the coarsest level, it will be necessary to survey the basic geologic characteristics of a site, noting the location and general morphology of features such as lava flows, aeolian deposits, block fields, etc. At some level of detail this will have already been accomplished from orbit; to be useful, rover reconnaissance imaging must improve significantly on existing orbital images.
- *Level 2 — Prospective sample identification:* Once a site has undergone an initial survey, it will be necessary to identify the materials in the field of view that are worth a closer look. For some geologic units, especially in the early phases of the rover mission, this may simply mean selecting samples that are representative of the unit and easily handled by the sample acquisition system. In other cases, it may mean identifying a unique outcrop, boulder, or other exposure that differs, perhaps subtly, from those around it.
- *Level 3 — Detailed sample investigation:* After a prospective sample has been identified, perhaps from some distance, it will be desirable to move the rover to it and examine it in some detail so that a decision can be made whether to return it (or part of it) to Earth. At this point, a number of instruments onboard the rover might be put to use. Imaging could contribute in two ways. First, it could be used to characterize the appearance of the sample at a variety of scales, perhaps including microscopic. This information would include gross sample shape (including indicators of weathering style), grain size distribution, vesicularity, fabric, grain texture, etc. Second, it could be used to characterize the spectral reflectance properties of the sample, perhaps allowing a preliminary determination of mineralogy.

*Sample acquisition* will also involve imaging. Some of this involvement will be purely operational; images of the sampling process will be useful to precisely document sample location and orientation, and may be needed for troubleshooting if a problem arises. Other uses of imaging in the sampling process might include examination of soil under a rock that has been lifted, description of the wall geometry of trenches that have been dug, etc.

*Supplemental science* is considered here to be any scientific objective of the imaging experiment that is not directly related to sample acquisition. Many could be considered, and such science may be a major part of an extended rover mission that takes place after all samples have been collected. A partial list of possible supplemental imaging science objectives is included in an appendix to this document.

## Field of View and Resolution

Perhaps the most fundamental characteristics of an imaging system are its field of view and resolution. In practice, the two are tightly coupled, and are major drivers for the imaging data rate. Field of view is simply the angular size of an area imaged. Image resolution can

be defined in a number of ways, and can be limited by either the angular size of the pixels in the image or the modulation transfer function of the optics. Data rate considerations generally make pixel size the controlling factor. Denoting the focal length of the camera as  $f$  and the absolute size of pixels on the focal plane detector as  $S$ , the angular size  $s$  of pixels in the image scene is given by  $\tan(s/2) = S/2f$ .

As a first step, the field of view and resolution requirements can be broken into two categories: *wide field, low resolution* imaging, and *narrow field, high resolution* imaging. *Wide field, low resolution* imaging would be similar in some respects to Viking Lander imaging. Its primary purposes would be rover navigation and Level 1 sample selection imaging (i.e., reconnaissance of the basic geologic characteristics of sites). A desirable pixel size might be  $\sim 1$  mrad. This would be about a factor of two improvement over the survey mode of the Viking Lander cameras. It would translate to a spatial resolution of 2 mm/pixel at a distance of 2 m, and 10 cm/pixel at 100 m. This angular resolution would provide imaging better than that achievable from orbit to a distance on the order of 1 km from the rover. The field of view requirement in azimuth would clearly be  $360^\circ$ . In elevation, the field of view of the Viking Lander cameras was  $100^\circ$ ;  $60^\circ$  below the horizon and  $40^\circ$  above it. Comparable values would probably suffice for a rover. With such capabilities, wide field, low resolution imaging would also be useful for limited Level 2 (prospective sample identification) imaging in the near field.

*Narrow field, high resolution* imaging would have to take several forms. One of these would be telescopic. Terrestrial field experience shows that a telescopic capability is crucial in any geologic traverse over poorly-known terrain that involves limited mobility. In order to be truly useful, telescopic imaging should probably have a spatial resolution of no worse than 0.5 cm/pixel at a distance of 100 m, corresponding to an angular pixel size  $s$  of  $\leq 0.05$  mrad/pixel. For reference, this requirement would translate to a focal length of  $\geq 200$  mm for a CCD detector with a pixel spacing of  $10 \mu\text{m}$ . The primary use for a telescopic capability would be Level 2 sample identification imaging in the far field. In principle, inclusion of this capability would increase the number of prospective samples that could be investigated in a given scene by a factor of  $\geq 400\times$  over what could be done with wide field, low resolution imaging alone. It should be possible to point the telescopic imaging anywhere in the  $360 \times 100^\circ$  envelope of the wide field imaging.

A second type of narrow field, high resolution imaging would be at what could be termed "hand sample" scale. This would be used for Level 3 imaging aimed at detailed characterization of rock morphology. The goal would be to provide a resolution comparable to that of the unaided human eye examining a hand-held sample. This is roughly equivalent to 0.125 mm/pixel at a focus distance of 0.5 m, or a pixel size  $s$  of 0.25 mrad/pixel. For a CCD array of  $10 \mu\text{m}$  pixels, this resolution would mean a focal length of 40 mm. Because Level 3 imaging place would probably take place in conjunction with use of other instruments, it would have to involve samples whose positions relative to the rover were known and controlled. The necessary pointing envelope could therefore be considerably smaller than for telescopic imaging.

A final type of narrow field, high resolution imaging that could be used for Level 3 sample characterization would be some type of microscopic capability. The easiest one to implement, and perhaps the only one desirable, would be a capability similar to that of a field geologist's hand lens. Such imaging would be used to characterize the detailed



grain morphology of prospective samples. A desirable spatial resolution might be  $\sim 0.01$  mm/pixel at a focus distance of 4 cm, again translating to an angular resolution of 0.25 mrad/pixel.

## Stereoscopic Capability

Stereophotogrammetry is a powerful technique for establishing the three-dimensional shape of planetary surfaces. However, when applied from highly oblique surface-based images, some serious limitations can be caused by the unconventional image geometry. First, the situation can be complicated by the extreme foreshortening and large scale variations in a single image scene. Second, surface topography can block out features of interest. Third, stereo convergence angles vary widely from the near field to the far field, and only permit useful distance determinations over a limited range. Figure 1 summarizes the minimum stereoscopic uncertainty achievable with the Viking Lander cameras in their high resolution mode. The values given are theoretical limits achievable with ideal image geometry. These cameras had a horizontal separation of 82 cm, and in high resolution mode had an angular resolution of 0.7 mrad/pixel. At a distance of 10 m the range uncertainty was about 20 cm; at 100 m it was 20 m. These values can be improved with higher angular resolution and greater stereo separation (although the latter will lead to larger convergence angles and corresponding loss of useful stereo capability in the very near field). However, it may be difficult to improve on Viking stereo performance substantially, since there are practical restrictions on camera separation and spatial resolution for wide field images. It will be shown below that range uncertainties of only a few percent over tens of meters can lead to severe operational difficulties when attempting to locate samples that have been imaged from a distance. The intrinsic limitations of surface-based stereophotogrammetry will have important implications for the strategy chosen for point-to-point navigation.

## Multispectral Capability

In order for imaging to be truly useful for intelligent sample selection, some type of multispectral capability must be available. At visible to near infrared wavelengths, rock-forming minerals have reflectance spectra consisting of a continuum upon which may be superimposed absorption bands. These spectra, and particularly the positions, shapes, and depths of absorption features, can be distinctive indicators of mineralogy. The absorption features tend to be concentrated in the near infrared portion of the spectrum. It is known from Earth-based reflectance spectra of the martian surface that there is spectral variability on the planet. Such data have very poor spatial resolution, however, and the spectra involve mixing of materials with varying spectral properties over a wide range of length scales. At the very high spatial resolution possible in rover images, however, it should be possible in many cases to separate out mineral phases and make tentative identifications of minerals present in prospective samples. Multispectral capability will therefore be crucial both for obtaining samples that are truly representative of units of interest and for locating samples that differ from those around them.

For Level 1 imaging aimed at simply characterizing the general appearance of the scene around the rover, 3-color visible wavelength imaging should suffice. For Level 2

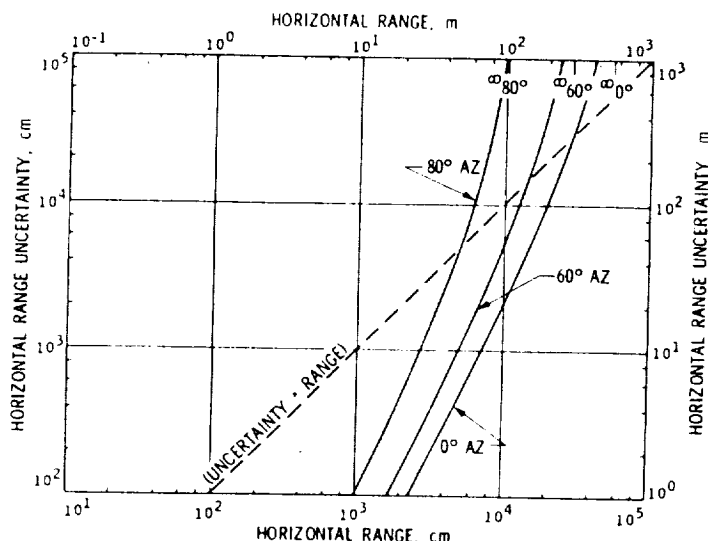

Figure 1: Ranging accuracy *vs.* range for the Viking Lander cameras. Azimuth angles are relative to perpendicular to stereo baseline. From Liebes and Schwartz, *J. Geophys. Res.* **82**, 4421 (1977).

imaging, however, it will be necessary to incorporate a number of channels in the near infrared that will enable preliminary recognition of potentially interesting spectral features in prospective samples remote from the rover. Considerable study will be required to select the optimum number, positions, and widths of infrared channels; something like 5 to 10 channels extending out to  $\sim 2.5 \mu\text{m}$  might be a reasonable first approximation. For Level 3 imaging, the goal would be to aid in preliminary determination of sample mineralogy. At a minimum, this goal would require a spectral capability like that needed for Level 2 (of course, it would be used at much higher spatial resolution, enabling much better separation of mixed phases). A more ambitious, but potentially very valuable approach might be to include a capability like that of the Mars Observer Mission VIMS experiment, which is specifically designed to enable identification of martian minerals from their reflectance spectra. This approach would entail a true imaging spectrometer, with a wavelength range of  $\sim 0.3$  to  $5 \mu\text{m}$ , sampled at intervals of 10–20 nm. The challenges of editing and processing such data would be helped greatly by the experience that will be gained from VIMS.

### Other Characteristics

A number of other characteristics also need to be considered for any rover imaging system:

*Polarization* — Images acquired through polarizing filters can under certain circumstances provide useful information about the textural properties of surfaces. If it could be implemented simply, a capability to acquire images with vertical and horizontal polarization might be desirable.

*Radiometric calibration* — Radiometric calibration is only moderately important for Level 1 imaging aimed primarily at characterizing the gross morphology of the scene around

the rover. Very good calibration (errors of  $< 5\%$  absolute,  $1\%$  relative) is very important, however, for Level 2 and Level 3 multispectral imaging aimed at extracting mineralogical information.

*Positioning* — As discussed above, the horizontal separation of stereo imagers has a major impact on stereo ranging capability. The height of imagers above the ground will also be important. Terrestrial experience suggests that navigation and reconnaissance is best accomplished with imagers that are at least twice as high above the ground as the height of typical obstacles. In contrast, Level 3 hand sample imaging may require positioning the imager tens of cm from the sample; Level 3 microscopic imaging might require a separation of only a few cm.

## **A Terrestrial Analog for Mars Rover Imaging: A Traverse Through the Antarctic Dry Valleys**

Some useful constraints may be placed on the requirements for a Mars rover imaging system from terrestrial experience in Mars-like environments. The Dry Valleys of Antarctica constitute perhaps the most Mars-like environment on Earth. They lie in a cold polar desert at a latitude of approximately  $-77$  to  $-78^\circ$ . The valleys are unglaciated, separated from the main Antarctic Ice Sheet by the Transantarctic Mountains. The mean annual temperature in the valleys is  $\sim 250$  K. Winds are high, and precipitation, plant life, and animal life are negligible. Lithology is variable, and includes Precambrian to Cambrian metasedimentary and plutonic rocks, Devonian to Triassic non-marine sandstones, and more recent mafic dikes.

During the austral summer field season of 1986-1987, I performed a very preliminary experiment to stimulate thinking on the requirements for Mars rover imaging. In one afternoon, I walked a 5 km traverse through Pearse Valley in the upper portion of Taylor Valley. At twelve irregularly spaced stations along the traverse, image mosaics were acquired with a hand-held 35-mm SLR camera. The photographic coverage included  $360^\circ$  far field mosaics acquired 1 meter above ground level,  $180^\circ$  far and near field mosaics acquired 2 meters above ground level, and limited telephoto coverage with a field of view of  $\sim 10^\circ$ .

Figures 2 and 3 show typical images of the Viking lander sites and the Antarctic Dry Valleys. The similarities are striking. The most significant differences are that there is substantial distant relief in the Antarctic images only (note, however, that most of Mars is much more rugged than the Viking sites), and that the more effective eolian transport in Antarctica has selectively removed silt and clay-sized particles, leaving sand as the finest material present. Besides the obvious similarities in block sizes and distributions, more detailed similarities extend to the presence of wind-blown drifts (Figures 4 and 5), and the presence of shallow polygonal trough patterns (Figures 6 and 7).

Several findings became very clear from the execution of the traverse itself and the subsequent examination of the photos. First, telephoto coverage is of critical importance when moving through poorly-known terrain. Field geologists recognize the importance of binoculars in reconnaissance mapping, even when good air photos are available. Such was certainly the case in Antarctica, and the same will probably hold for a Mars rover. Many distant features of prospective interest can be tentatively identified in low to moderate

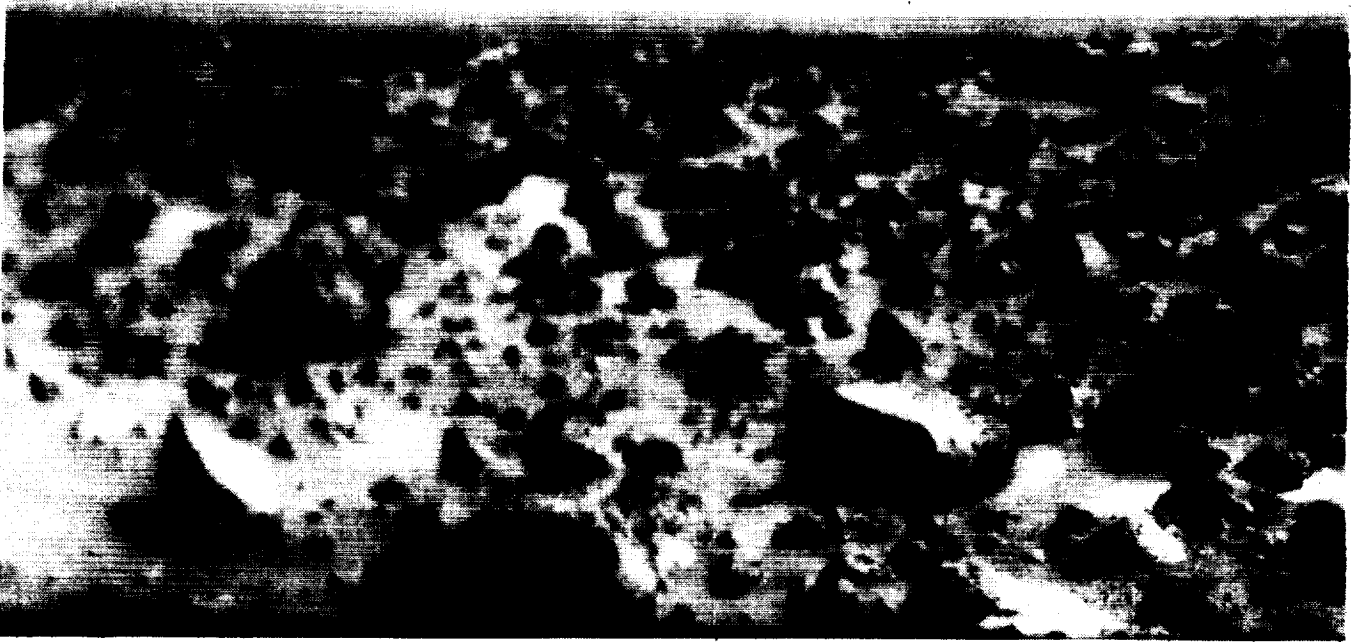

Figure 2: A typical Viking Lander image of the martian surface



Figure 3: A typical image in the Antarctic Dry Valleys



Figure 4: A Viking Lander image showing wind-blown drift deposits



Figure 5: An Antarctic image showing wind-blown drift deposits

ORIGINAL PAGE  
BLACK AND WHITE PHOTOGRAPH

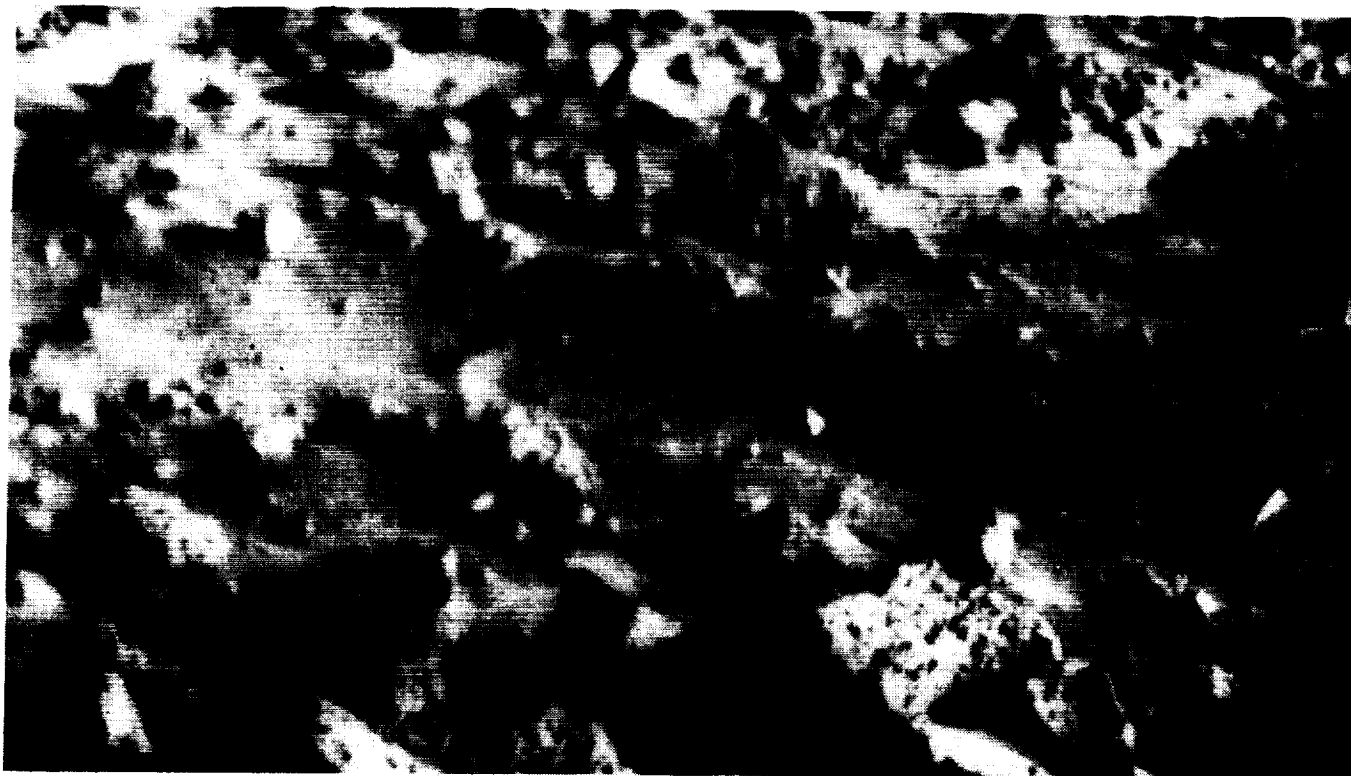

Figure 6: A Viking Lander image showing a shallow trough that forms part of a polygonal pattern

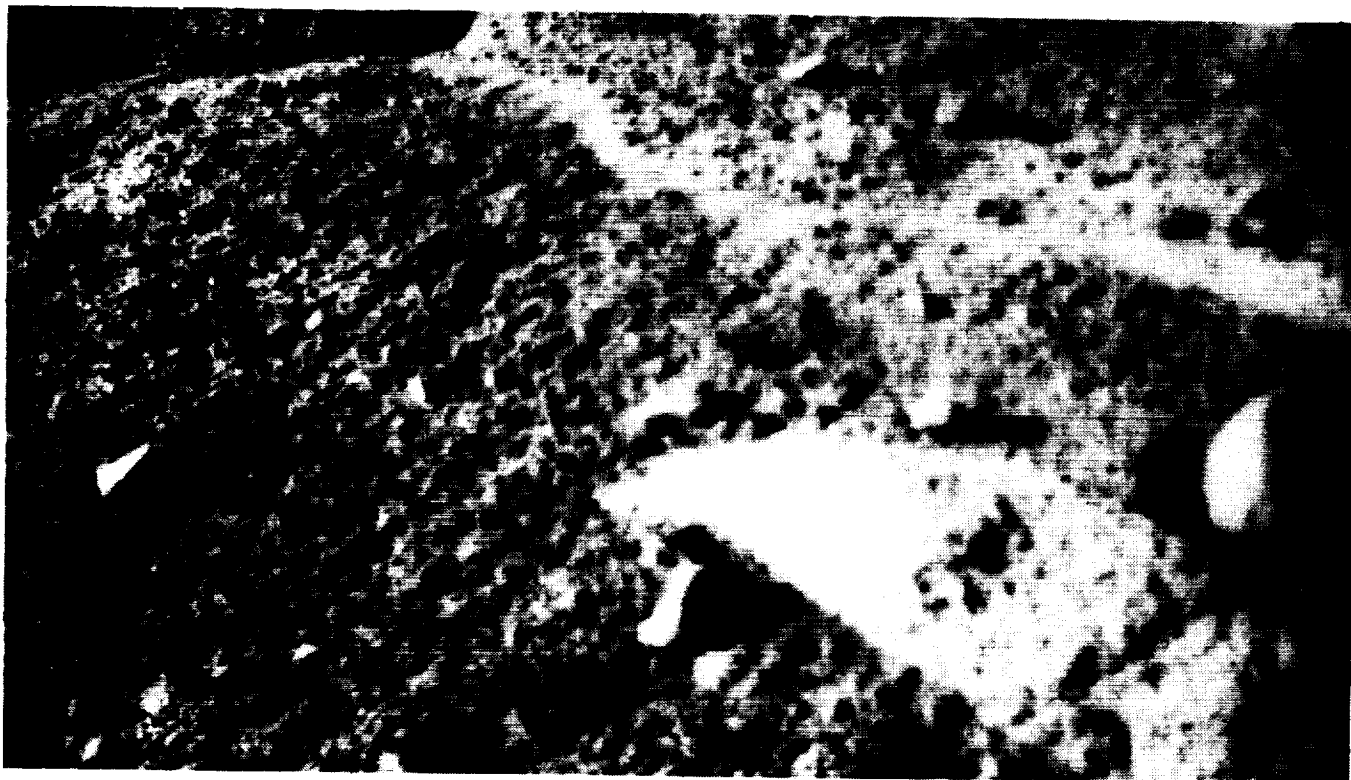

Figure 7: An Antarctic image showing shallow troughs that form part of a polygonal pattern

ORIGINAL PAGE  
BLACK AND WHITE PHOTOGRAPH

resolution images, but only confirmed with high resolution telescopic imaging. This was found to be particularly important in locating bedrock outcrops. As will probably be the case in many areas on Mars, bedrock outcrops in the Dry Valleys are few and far between in easily navigable terrain. Moreover, many outcrops are short vertical faces that would not be visible in orbital images. It is likely that telescopic imaging will play a very important role in sample selection on the martian surface.

Another fairly obvious observation was the importance of the height of the imaging system above the ground. While the impression was not quantified in any sense, it appeared that images acquired at a height less than roughly twice that of typical boulders can be difficult to interpret for navigational purposes. In areas where most rocks and other forms of relief were tens of cm high, 1-meter and 2-meter images were equally valuable. Where the local relief was up to 1 meter, however, the 2-meter images contained substantially more useful information than the 1-meter images.

Perhaps the most striking observation was the importance of positional accuracy in locating distant samples. At two different stations, hypothetical prospective samples were located at distances of  $\sim 100$  m. It was assumed that the rover would then move directly toward these samples, stopping to acquire the next set of images when it had arrived at the expected point with a range accuracy of at worst 10%. In one case the desired point was intentionally undershot by 10 m. This placed me in a depression, from which 1-meter images were completely inadequate to locate the desired sample, the position of the last station, or even useful landmarks on the horizon. In the other case, a telephoto image was taken of the desired sample from a distance of roughly 100 m (Figure 8. The prospective sample is a low, dark, triangular rock just slightly to the left of center.) In this case, the desired location was overshoot by a small amount, and a wide angle image was taken back in the direction of the previous station (Figure 9). The identification of any of the rocks in the first image in the field of view of the second image is left as an exercise for the reader. They are there, but they are difficult to recognize. The important point is that irregularly shaped rocks can look very different when viewed from different angles. If the rover were expected to travel distances on the order of 100 m between images, based solely on stereo images taken at the starting point, it would in many cases be very difficult to locate the object of the traverse once the rover arrives near it. Very high positional accuracies are required. One possible solution might be to do continuous positional updates with onboard processing of images taken during a  $\sim 100$  m traverse; another might be to improve range determinations by using extremely high resolution orbital images.





Figure 8: Telephoto image of a hypothetical prospective sample area.



Figure 9: Same area as imaged in the previous figure, but near field, wide angle, and in the opposite direction.

ORIGINAL PAGE  
BLACK AND WHITE PHOTOGRAPH



## Appendix: Supplemental Rover Imaging Science Objectives

- Recognize ancient sediments deposited in standing water bodies (*e.g.*, look for fine-scale layering, graded bedding, deltaic forms, *etc.*)
- Evaluate small valley system morphology to determine the true channel (as opposed to valley) dimensions.
- Search for ancient small-scale runoff features indicative of former precipitation.
- Search for unambiguous indicators of liquid water flow in large outflow channels (*e.g.*, gravel or cobble mega-ripples) to settle doubts about a catastrophic flood origin.
- Search for morphologic evidence of recent fluvial activity in young materials.
- Study small-scale eolian depositional forms (dunes, sand ripples) and their implications for wind directions and efficiency of eolian transport.
- Study small-scale eolian erosional forms and their implications for the importance of eolian erosion as a function of geologic material.
- Search for terrestrial-scale “periglacial” features (*e.g.*, patterned ground with scales of meters to tens of meters) that might be indicative of ground ice processes.
- Search at middle latitudes for small-scale downslope creep features that might indicate substantial ground ice content.
- Characterize the small-scale morphology of lava flows (pahoehoe, aa, *etc.*) and implications for lava emplacement, rheology, and composition.
- Examine putative explosive volcanic deposits (*e.g.*, in Amazonis Planitia) and determine whether their small-scale morphology is indeed consistent with such an origin.
- Examine regions of suspected volcano-ground ice interaction for morphologic evidence of móberg formation, lahar flow, and palagonitization.
- Examine rock morphology to evaluate weathering processes, degree of vespication, crystal size, *etc.*
- Search for the presence and distribution of exposed duricrust.
- Look for small-scale layering in polar layered deposits indicative of short-term climate changes.
- Determine the small-scale morphology of lobate ejecta deposits, with the goal of determining the mode of emplacement (*e.g.*, establish geometry of flow-field indicators, search for small peripheral channels formed by release of entrained water after ejecta emplacement).
- Examine the detailed morphology of wrinkle ridges, with the goal of choosing among hypotheses for their formation and evaluating their usefulness as an indicator of the presence of flood lavas.
- Characterize the near-surface wind field and its relationship to topography and surface roughness.
- Characterize the distribution of atmospheric dust.
- Characterize the small-scale distribution of surface and atmospheric condensates as a function of elevation, local topography, geologic material, latitude, time of day *etc.*

CORNELL UNIVERSITY  
*Center for Radiophysics and Space Research*

SPACE SCIENCES BUILDING  
ITHACA, N. Y. 14853-6801

*Telephone (607) 255-5284*

May 13, 1987

John C. Mankins  
Mail Stop 301-285  
Jet Propulsion Laboratory  
4800 Oak Grove Drive  
Pasadena, CA 91109

Dear John:

Enclosed is a copy of the writeup that I promised on Mars rover imaging requirements, including the Antarctic work that I talked about at the workshop. As we agreed, I have included a number of the slides I showed, and have left room in the manuscript to include them as printed figures. The figure numbers are indicated in red on each of the slides. Please return the slides to me when you have finished with them, as they are my only copies.

Note also that this writeup includes the material that I presented to the Sample Acquisition group, but in a bit more detail, and so can supersede any of my workshop viewgraphs you might have been planning to put in the workshop report. Please let me know if I can provide any further help in this area.

Sincerely,

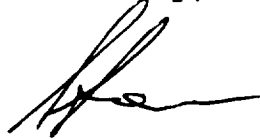

Steven W. Squyres

cc: Doug Blanchard  
Jim Randolph

APPENDIX C

MARS ROVER CAPABILITY SCENARIOS

# TECHNOLOGY PLANNING WORKSHOP FOR THE MARS ROVER

## APPENDIX C

1987 MARS ROVER WORKSHOP:

### STRAWMAN MARS ROVER CAPABILITY SCENARIOS

The following appendix provides several alternative MRSR Rover capability scenarios, based upon options for Rover mission operations; these are directed at (1) minimum capabilities scenarios, (2) moderate capability scenarios, and (3) maximum capability scenarios. Please note that these alternatives do not represent monolithic "point designs" for three different rovers; rather they are intended to be considered individually, with interdependencies (such as between rover mass, instantaneous speed, and power) discussed and quantified if possible.

THIS IS THE CORNERSTONE UNDERLYING THE APPROACH TO TECHNOLOGY PLANNING BEING PURSUED AT THIS WORKSHOP: KEYING TECHNOLOGY PLANNING SYSTEMATICALLY TO ENHANCEMENTS/OPTIONS IN ROVER CAPABILITIES.

Appendix C.1 provides a summary table of the rover functional capability options which should be considered as drivers for alternative technology options and technology development planning forecasts.

There are alternatives in programmatic parameters and the roles of non-Rover MRSR systems (particularly, the orbiter and ground-based mission operations) which will interact heavily with on-board Rover technologies. These options are incorporated as sub-choices within the narratives provided in Appendices C.2-C.4 (for example, two launch date alternatives are shown for all other capability options).

TECHNOLOGY PLANNING WORKSHOP FOR THE MARS ROVER

APPENDIX C

APPENDIX C.1: SUMMARY TABLE OF CAPABILITY OPTIONS

FUNCTIONAL CAPABILITY	ALTERNATIVE SCENARIOS:		
	MINIMUM	MODERATE	MAXIMUM
Rover Mass (kg)	400	700	1000
Rover Mission Duration (days)*	300	300 + 500	300 + 1000
Total Traversed Distance (km)*	100	1000	5000
Instantaneous Rover Surface Speed (m/hr)	100	500	1000
Power Level (average) (Watts)	200	300	400
Autonomous Operations Duration (hrs)	1	10	100
Total Data Transmitted (Mbits/day)	100	250	1000
Global Navigation Accuracy (meters)	1000	100	10
Sampling Rate (per day)	0.5	2.0	5.0
Known Surface Object Size (meters)	1.5	1.5	1.5

\* NOTE: See the narrative discussion of each capability option for details regarding these values.

TECHNOLOGY PLANNING WORKSHOP FOR THE MARS ROVER

APPENDIX C

C.2 MARS ROVER TECHNOLOGY PLANNING WORKSHOP:  
STRAWMAN - MINIMUM CAPABILITY SCENARIOS

The following parameters approximately characterize "minimum" Mars Rover capability scenarios. All scenarios assume (1) that 100 days out of every 400 are lost due to sand storms, and (2) that the Round Trip Light Time for communications with Earth varies approx. from 8 min. to 40 min.

- 
1. Mission launch date: 1998 or 2000
  2. Technology Selection Cut-off: 1992/3 or 1994/5
  3. MINIMUM TOTAL ROVER MASS: 400.00 kg.  
- Science Package Mass: approx. 57 kg.
  4. MINIMUM CAPABILITY SITE & TERRAIN FACTORS:  
Total Rover Traversed Distance: 100.00 km/over 1 yr.  
During Sampling 100.00 km/over 1 yr.  
During Extended Operations n/a  
Maximum size Object traversed: 0.50 m  
Maximum Resolution of Orbital Mapping: 1.50 m  
General Terrain Description:  
Landing site selected for minimum risk to the mission.  
Flat plain, no major inclines in traversed path (no mountains, valleys, ravines, etc.), small boulders as noted; maximum steady grade traversed of 15-30%. For a conservative landing site, and a low total traverse rover, it is assumed that the rover covers the terrain noted.
  5. MINIMUM CAPABILITY SAMPLING APPROACH:

## TECHNOLOGY PLANNING WORKSHOP FOR THE MARS ROVER

Surface materials, minimal drilling into rocks (perhaps about 10 cm). Assume the rover does no coring.

Human selection of all collected samples; no autonomous pre-screening.

Total Collected Mass: 5 kg

### 6. MINIMUM CAPABILITY ROVER OPERATIONS:

Total duration of Rover Operations: 1 year.

Assume no operations at night; consider technology impact of both Orbiter communications link & non-link on operations. The baseline communications approach is a direct Rover-to-ground link.

Operations baselined to end with ascent vehicle departure.

MARS ROVER TECHNOLOGY PLANNING WORKSHOP:  
STRAWMAN - MODERATE CAPABILITY SCENARIOS

The following parameters approximately characterize "moderate" Mars Rover capability scenarios. All scenarios assume (1) that 100 days out of every 400 are lost due to sand storms, and (2) that the Round Trip Light Time for communications with Earth varies approx. from 8 min. to 40 min.

- 
1. Mission launch date: 1998 or 2000
  2. Technology Selection Cut-off: 1992/3 or 1994/5
  3. MODERATE CAPABILITY TOTAL MASS: 700 kg  
- Science Package Mass: approx. 100 kg
  4. MODERATE CAPABILITY SITE & TERRAIN FACTORS:  

Total Rover Traversed Distance:	1000.00 km/over 3 yrs.
During Sampling	100.00 km/over 1 yr.
During Extended Operations	1000.00 km/over 2 yrs.

Maximum size Object traversed:	0.50 m
Maximum Resolution of Orbital Mapping:	1.50 m

  
General Terrain Description:  

Landing site selected for moderate risk to the mission. Substantive inclines included in traversed path (valleys, ravines, etc.), boulders as noted; maximum steady grade traversed of 30-60 %. For the rover capability noted (i.e., only a minimum traverse during sampling), it is assumed that the lander vehicle descends into rougher territory and then deploys the rover for operations there.
  5. MODERATE CAPABILITY SAMPLING APPROACH:



TECHNOLOGY PLANNING WORKSHOP FOR THE MARS ROVER

Surface materials, minimal drilling into rocks (10 cm), plus moderate subsurface coring (2 m).

Human selection of all collected samples; no pre-screening.

Total Collected Mass: 5 kg

6. MODERATE CAPABILITY ROVER OPERATIONS:

Total duration of Rover operations: 3 yrs

Assume no operations at night; consider technology impact of both Orbiter communications link & non-link on operations. The baseline communications approach is a direct Rover-to-ground link.

Operations baselined to extend beyond ascent vehicle departure; approx. 400 days sampling, then approx. 1 1/2 years of exploration.

TECHNOLOGY PLANNING WORKSHOP FOR THE MARS ROVER

APPENDIX C

C.4 MARS ROVER TECHNOLOGY PLANNING WORKSHOP:  
STRAWMAN - MAXIMUM CAPABILITY SCENARIOS

The following parameters approximately characterize "maximum" Mars Rover capability scenarios. All scenarios assume (1) that 100 days out of every 400 are lost due to sand storms, and (2) that the Round Trip Light Time for communications with Earth varies approx. from 8 min. to 40 min.

- 
1. Mission launch date: 1998 or 2000
  2. Technology Selection Cut-off: 1992/93 or 1995/6
  3. MAXIMUM CAPABILITY TOTAL MASS: 1000 kg.

- Science Package Mass: approx. 140 kg

Options or benefits for still greater maximum rover mass could/should be considered.

4. MAXIMUM CAPABILITY SITE & TERRAIN FACTORS:

Total Rover Traversed Distance: 5000.0 km  
During Sampling 500.00 km/over 1 yr.  
During Extended Operations 4500.00 km/over 4 yrs.

Maximum size Object traversed: 1.00 m

Maximum Resolution of Orbital Mapping: 1.50 m

General Terrain Description:

Landing site selected for maximum acceptable risk to the mission. Substantive inclines included in traversed path (hills, valleys, ravines, etc.), boulders as noted. For the rover capability noted during sampling (500 km) it can be assumed either that the lander descends into rough country, or that the lander descends into less risky country and the rover traverses to and from the rougher country for sampling at more interesting sites (such as the bottoms of ravines).

TECHNOLOGY PLANNING WORKSHOP FOR THE MARS ROVER

5. MAXIMUM CAPABILITY SAMPLING APPROACH:

Surface materials, minimal drilling into rocks (10 cm), plus deep subsurface coring (5 m). Requirements and capabilities for still deeper coring could/should be considered. Limited collection of atmosphere could be considered.

Human selection of all collected samples; limited autonomous pre-screening of samples could be considered.

Total Collected Mass: 10 kg.

6. MAXIMUM CAPABILITY ROVER OPERATIONS:

Total duration of Rover operations: 5 years

Consider operations at night (for example, traversing at night is clearly an option); consider technology impact of both Orbiter communications link & non-link on operations. The baseline communications approach is a direct Rover-to-ground link.

Operations baselined to extend beyond ascent vehicle departure; approx. 400 days sampling, then approx. 3 1/2 years of exploration.

# MARS ROVER SAMPLE RETURN: ROVER FUNCTIONAL BLOCK DIAGRAM

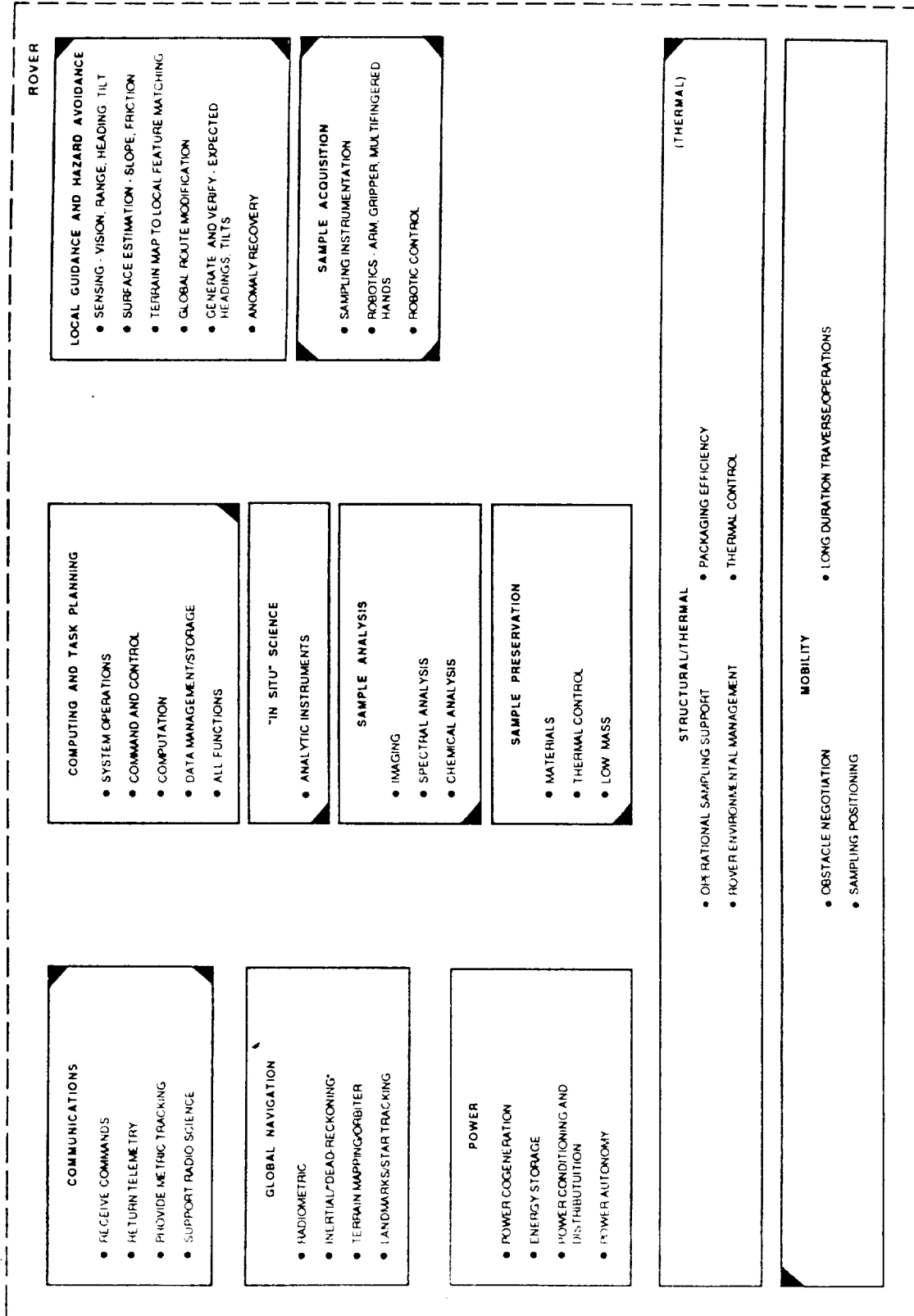

APPENDIX D

PLENARY SESSION NOTES

**JPL**

TECHNOLOGY  
PLANNING WORKSHOP  
FOR THE  
MARS ROVER

DAY 2

PLENARY SESSION

# JPL DAY 2 - PLENARY SESSION

---

## OVERVIEW

- "So far, so good..."
- Working groups proceeding apace.
  - No major revision as yet of "C".
  - No substantive re:egg. or re-direction.
- Some issues to consider.

# JPL DAY 2 - PLENARY SESSION

---

## ISSUES

- NEED TO IDENTIFY TECHNOLOGY IMPACTS OF EXTENDED MISSION CAPABILITY  
[MOBILITY, POWER, ?]
- OVERALL QUESTION OF FUNCTIONAL ALLOCATION OF ROVER RESOURCES (POWER, ETC.)  
FOR NOW: MAKE 'WAGS' IN GROUPS.
- COMPUTING QUESTIONS. (1) FLIGHT QUALIFICATION;  
(2) 'ARCHITECTURE'; (3) RAISE Q'S RE: ORBITER;  
"WHAT'S THE JOB"



# JPL DAY 2 - PLENARY SESSION

---

## ISSUES (CONTINUED)

- NEED FOR MOBILITY TO PROVIDE "STABLE" PLATFORM CONFIGURATION.
- NEED TO CONSIDER / IDENTIFY THERMAL ISSUES.
- OTHERS ?

## JPL DAY 2 - PLENARY SESSION

---

SAMPLE Acquisition, Analysis, Preservation

- Surface exploration, general sampling plan discussed
- Robotics, Automation & degrees of autonomy to be discussed today
- No sample acquisition task found to be impossible ... yet.

# JPL Power Technologies Panel

## GOALS

---

- IDENTIFY COMPONENT TECHNOLOGIES & CONCEPTS
- IDENTIFY MOST CONSERVATIVE STRAINMAN & ISSUES
- IDENTIFY (ADVANCED) TECHNOLOGY OPTIONS AND ISSUES
- IDENTIFY KEY DRIVERS IN POWER SYSTEM DESIGN.  
HOW IS THE POWER SYSTEM AFFECTED BY 3 SCENARIOS?
- WHAT ARE INTEGRATION ISSUES?
- ESTABLISH PERFORMANCE SENSITIVITY TO COMPONENT TRADEOFFS
- PROVIDE RECOMMENDATIONS
- ADDRESS QUESTION: WHAT IF NO RTG?

# Power Technologies Panel

Power Source Issue

MARS Rover RTG MAY BE A UNIQUE DESIGN DUE TO:

- MARS ATMOSPHERE / DUST (RTG NORMALLY VENTED AFTER LAUNCH)
- THERMAL DESIGN ISSUES RELATED TO RTG WASTE HEAT / TEMP. CONTROL OF OTHER SUBS

## Global Navigation Panel - Tuesday PM

- Presentations on and extensive discussion of
- Inertial and dead reckoning navigation techniques
- Orbiter-based optical techniques for rover navigation
- Rover-based optical navigation techniques

# JPL DAY 2 - PLENARY SESSION

---

## TODAY

- MORNING -
  - TECHNOLOGY PLANNING
    - OPTIONS VS. CAPABILITY REQ'TS.
    - DEVELOPMENT (1998)
    - KEY ISSUES
- AFTERNOON -
  - ONCE MORE! (2000)

## TECHNOLOGY READINESS LEVELS

- LEVEL 1 BASIC PRINCIPLES OBSERVED AND REPORTED
- LEVEL 2 CONCEPTUAL DESIGN FORMULATED
- LEVEL 3 CONCEPTUAL DESIGN TESTED ANALYTICALLY OR EXPERIMENTALLY
- LEVEL 4 CRITICAL FUNCTION/CHARACTERISTIC DEMONSTRATION
- LEVEL 5 COMPONENT/BREADBOARD TESTED IN RELEVANT ENVIRONMENT
- LEVEL 6 PROTOTYPE/ENGINEERING MODEL TESTED IN RELEVANT ENVIRONMENT
- LEVEL 7 ENGINEERING MODEL TESTED IN SPACE

# JPL DAY 2 - PLENARY SESSION

---

## THURSDAY

- NO MORNING PLENARY
- "TO DO'S"
  - EXISTING ~~AND~~ PLAYERS/TECHNOLOGY
  - SUMMARY TEXT/CHARTS
  - KEY ISSUES/RECOMMENDATIONS
- SEE THE "RED BOOK".



**S/M W.G.**

**ROLES:**

- 1. TROUBLE-SHOOTING**
- 2. TRANSFER OF IDEAS ACROSS W.G.'S**
- 3. RAISE & DOCUMENT SYSTEM-LEVEL ISSUES**
- 4. PERIODICALLY CHECK ON THE PROGRESS OF THE  
W.G.'S - /MRSR**
- 5. TOP-LEVEL ROVER/MRSR ARCHITECTURE**
  - 0 INTERFACES (?)**
  - 0 SUBSYSTEMS (?)**
- 6. SUMMARIZE "OPTIONS CHART"**

MISSION REQUIREMENTS/OBJECTIVES

SCIENCE

1. RETURN NON-STERILIZED, SELECTED SAMPLES IN TERRESTRIAL LABORATORIES
  - 1.1 SURFACE WEATHERED/UNWEATHERED (0-20 MIN DRILL)
  - 1.2 SUB-SURFACE (0-5 M) (PERMAFROST)
  - 1.3 MULTIPLE GEOLOGIC SITES
    - 1.3.1 EQUATORIAL
    - 1.3.2 POLAR ("ICE")
  - 1.4 IN SITES SCIENCE (SAMPLING) REQUIREMENTS.
  - 1.5. "EXTENDED MISSION" IS NOT A REQUIREMENT".

PROGRAMMATIC

2. MANNED MARS PRECURSOR  
[NOTE: IMPACT ON CAPABILITY?  
IMPACT ON TECHNOLOGY?  
IMPACT ON SITE SELECTION?

OTHER

3. "PLANETARY QUARANTINE" AND "BACK-CONTAMINATE"  
DETAILS TBD

# S/M APPROACH

MISSION REQUIREMENTS



SYSTEM-LEVEL  
ISSUES

ARCHITECTURAL  
OPTIONS

TECHNOLOGY  
ISSUES  
+  
PLANS

"SUB-SYSTEM"  
&  
"MISSION MODEL (S)"

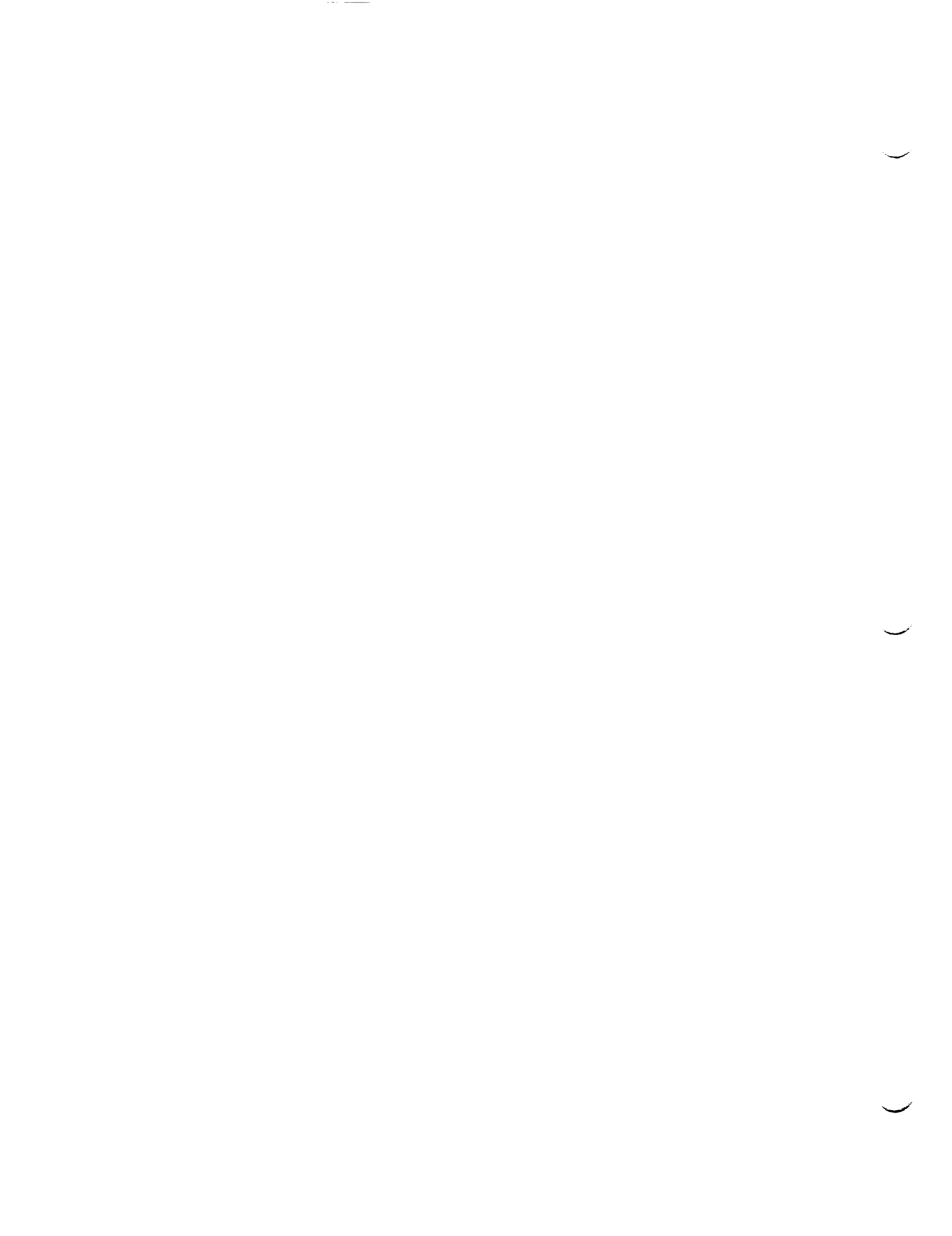





JPL D-4788, Vol. 3

Mars Rover/Sample Return (MRSR) Mission  
Mars Rover Technology Workshop  
Proceedings  
Volume 3: Mobility

Chairman: Donald Bickler, Jet Propulsion Laboratory

April 28-30, 1987  
Pasadena, California

**JPL**  
Jet Propulsion Laboratory  
California Institute of Technology

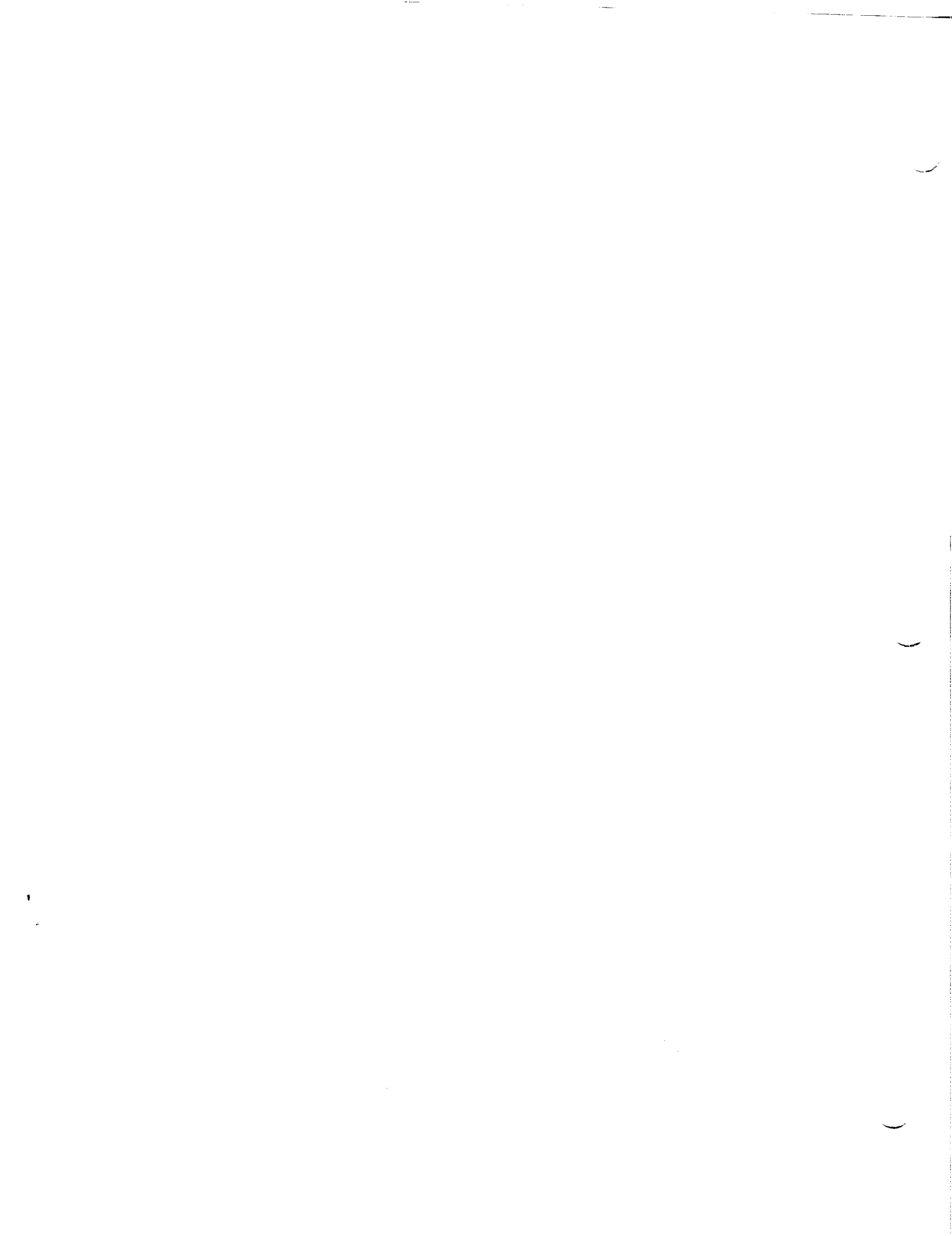



GLOSSARY

ACRONYMS AND ABBREVIATIONS

GM	General Motors
JPL	Jet Propulsion Laboratory
MRSR	Mars Rover and Sample Return
NASA	National Aeronautics and Space Administration
OAST	Office of Aeronautics and Space Technology
OSU	Ohio State University
SSEC	Solar System Exploration Committee

PRECEDING PAGE BLANK NOT FILMED

1

2

3

CONTENTS

1. EXECUTIVE SUMMARY . . . . . 3-1-1

2. INTRODUCTION . . . . . 3-2-1

    2.1 WORKING GROUP OBJECTIVES/GOALS . . . . . 3-2-1

    2.2 BACKGROUND . . . . . 3-2-3

3. DISCUSSION . . . . . 3-3-1

4. SUMMARY AND CONCLUSIONS . . . . . 3-4-1

5. PRESENTED MATERIALS . . . . . 3-5-1

    5.1 GRUMMAN AIRCRAFT ENGINEERING CORP. . . . . 3-5-1

    5.2 BOEING AEROSPACE COMPANY . . . . . 3-5-1

    5.3 ODETICS . . . . . 3-5-5

    5.4 U.S. ARMY TANK AUTOMOTIVE COMMAND . . . . . 3-5-5

    5.5 JPL MARS ROVER MODELING . . . . . 3-5-8

    5.6 FMC . . . . . 3-5-13

    5.7 GENERAL MOTORS . . . . . 3-5-17

    5.8 OHIO STATE UNIVERSITY . . . . . 3-5-21

Figures

3-1. Significant Aspects of Three Candidate Locomotion Types . . 3-3-2

3-2. Mobility Session Requirements for Terrain Model . . . . . 3-3-4

3-3. Funding Level Estimates to Develop Three Mobility  
Configuration Options . . . . . 3-3-5

5-1. Grumman Model Tests . . . . . 3-5-2

5-2. Grumman Model Tests . . . . . 3-5-3

5-3. Boeing Lunar Rover General Configuration . . . . . 3-5-4

5-4. Lunar Rover Wheel/Tire Configuration . . . . . 3-5-6

CONTENTS (Contd)

Figures

5-5. Lunar Rover Traction Drive . . . . .	3-5-7
5-6. NATO Reference Mobility Model (NRMM) . . . . .	3-5-9
5-7. Gross Structure of NATO Reference Mobility Model . . . . .	3-5-10
5-8. General Flow of Information in NRMM Computer Model . . . . .	3-5-11
5-9. JPL Mars Rover Modeling Process . . . . .	3-5-12
5-10. Wire Frame of JPL Rover Baseline With Cube as Obstacle . . . . .	3-5-14
5-11. FMC Mobility Matrix . . . . .	3-5-15
5-12. Mobility Subsystem Parameters . . . . .	3-5-16
5-13. Three Types of Lunar Roving Vehicles . . . . .	3-5-18
5-14. Elastic Frame Wheeled Lunar Vehicle With 3-Foot Diameter Wheels Operating in Sand Dunes . . . . .	3-5-19
5-15. Folding Sequence for Lunar Roving Vehicle . . . . .	3-5-20
5-16. A Successive Gait Pattern . . . . .	3-5-22
5-17. The Adaptive Suspension Vehicle in the Laboratory . . . . .	3-5-23
5-18. Components for Two Legs Rotating Vehicle About Point "C" . . . . .	3-5-24
5-19. Active Suspension System To Be Studied . . . . .	3-5-25
5-20. Proposed Sequence for Uprighting Maneuver . . . . .	3-5-26

Table

2-1. List of Attendees . . . . .	3-2-2
----------------------------------	-------

## SECTION 1

### EXECUTIVE SUMMARY

The Mobility Session was well represented with experienced leaders in the art of vehicle mobility. The lessons learned from the lunar vehicle developments, the state-of-the-art in legged vehicles, and the experience of many military vehicle developments, were all discussed in ways that they relate to a Mars rover.

While the session remained open-minded to novel vehicle configurations, it was agreed that the exotic configurations were weeded out in the 1960's for good reasons. The three leading contenders today are legged, wheeled, and tracked. The number of legs/wheels, degree of body articulation, and type of suspension are examples of configuration elements not yet resolved.

The problem of terrain definition was pointed out as most significant. The people planning the rover excursions need to understand the consequences of compromising the vehicle at specific sites. The specter of deep soft dust has been brought forward as the most threatening unknown (as it was at one point in the lunar experience). A requirement list was generated for terrain specification categories.

There is little doubt that the vehicle must be able to withstand overturning and be able to right itself. The value of the mission coupled with the uncertainty of the hazards dictates a self-uprighting vehicle. Discussion of the use of the robotic arms, intended only for sampling, for assisting the mobility under severe conditions, led to the concept of a "hybrid" vehicle. By making the arms robust, they can be used to supplement the locomotion system, allowing the overall vehicle to be simpler, more efficient on "normal" terrain, and lighter weight. The arms might also be used to stabilize the vehicle during drilling operations.

A conclusion was reached that computer modeling, and vehicle and terrain simulation should be used to select and optimize the vehicle configuration. The use of computer modeling is one of the vehicle industry's emerging techniques. It must be coupled, however, with experimental proof of the modeling assumptions. It is also known that prototype testing will undoubtedly reveal failure modes not anticipated, and hence, not modeled. The overall process is one of iteration which cannot be accurately scheduled until the full scope of the problem is known.

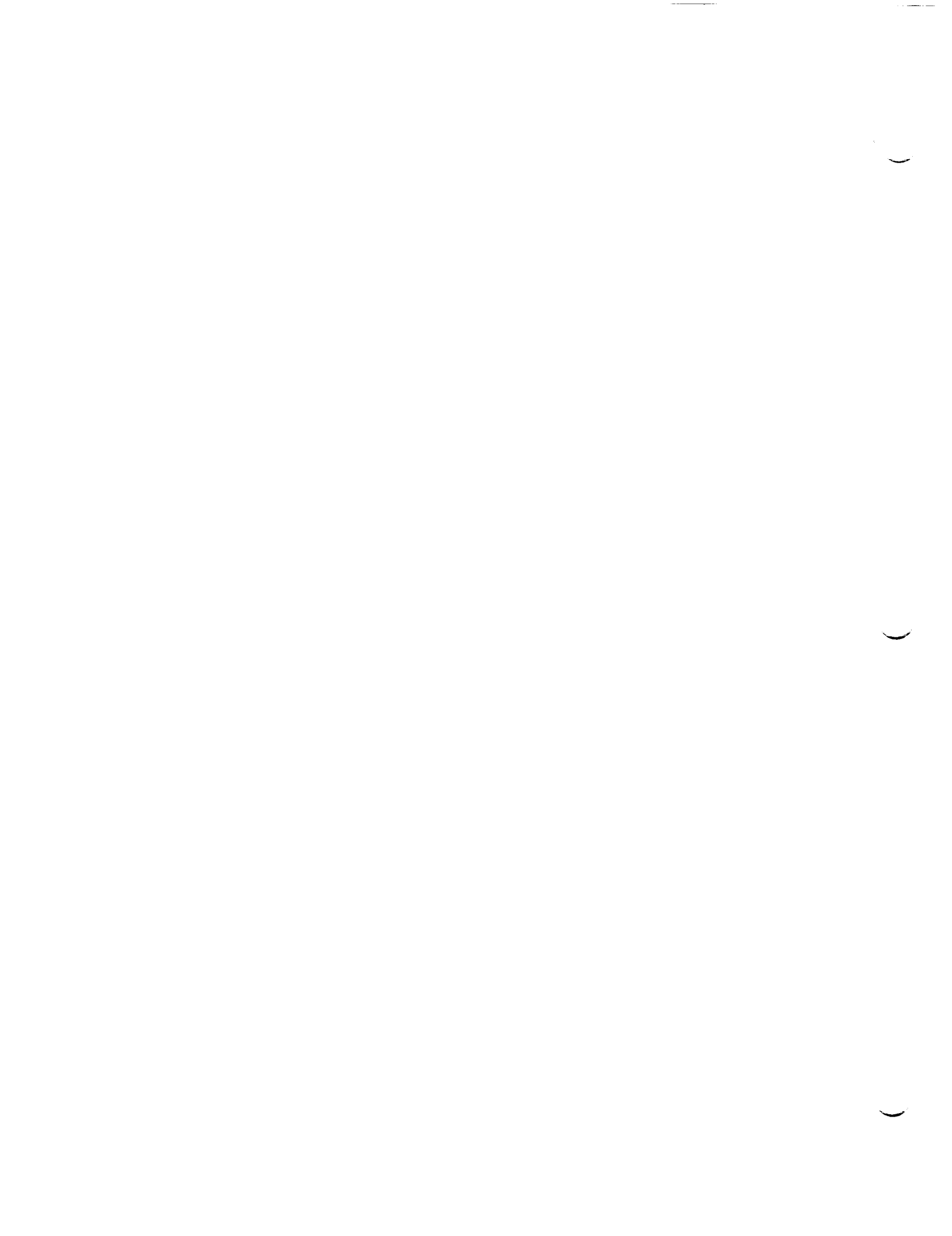

## SECTION 2

### INTRODUCTION

The Mars Rover and Sample Return (MRSR) mission is being studied by the National Aeronautics and Space Administration (NASA) as a potential augmentation of the core planetary exploration program outlined by the Solar System Exploration Committee (SSEC). The "Mars Rover" is a major element of the planned MRSR mission; the Rover will provide the capability to collect diverse samples of materials from a wide area of the Martian surface.

The Mobility Working Group of the Technology Planning Workshop for the Mars Rover was supported by a mix of experienced U.S. industrial, academic, and NASA vehicle designers and researchers in mobility technology. The participants of the working group are listed in Table 2-1. (Note: Not all of the participants attended all three days of the workshop; also, in addition to the participants, several observers whose names are not listed in Table 2-1 attended the Mobility Working Group.)

#### 2.1 WORKING GROUP OBJECTIVES/GOALS

The initial objectives of the Mobility Working Group included:

(1) To establish a set of preliminary options for mobility technologies, based upon a set of three strawman scenarios: minimum, medium, maximum. (Note: It was discussed and concluded that while these scenarios definitely influence future point designs, they are not seen as drivers in the development of mobility technology.)

(2) To identify performance due to each technology option.

(3) To establish an initial roadmap for research and development for Mars Rover mobility technology.

(4) To formulate a long-range plan for the minimum, moderate, and maximum performance technologies.

(5) To establish a common basis of information to help coordinate relationships between the U.S. aerospace community and the science community designing the Mars Rover mission.

(6) To record the appropriate information to facilitate a proceedings document.

At the start, Mobility Session discussed goals appropriate to the extent of the workshop. The following goals emerged:

(1) Assess vehicle options.

(2) Define requirements for an engineering terrain model.

(3) Assess field experience.

Table 2-1. List of Attendees

Individual	Working Group Role /Paper Topic	Phone, Address
Don Bickler	Chairman "Introduction"	(818) 354-5488 JPL/157-205
Alex Alexandrovich	participant	(516) 575-3402 Grumman Aircraft Mail Stop A22-025 Bethpage, NY 11714-3582
Richard F. Bonsack	"Boeing Experience with Lunar Rover"	(206) 773-9208 Boeing Aerospace Co. P.O. Box 3707 Seattle, WA 98124 Mail Stop 82-11
Kevin Daly (c/o Nadine Dinger)	"Odetics Walking Machines"	(714) 758-0300 Odetics - Aim Division 1515 S. Manchester Ave. Anaheim, CA 92802
Zoltan Janosi	"NATO Reference Mobility Model"	(313) 574-6015 U.S. Army Tank- Automotive Command AMSTA-RYA Warren, MI 48397-5000
John Marinshaw	"Mobility Specifications"	(408) 289-3409 FMC 1105 Coleman Ave. Santa Clara, CA 95052
Ferenc Pavlics	"GM Experience Developing Rover Vehicles"	(805) 961-5251 General Motors P-201 6767 Hollister Ave. Goleta, CA 93117
Alan Ratliff	(coordinating)	<del>(###) ###-####</del> Lockheed Missiles and Space Company Huntsville Engineering Center 4800 Bradford Blvd. Huntsville, Alabama 35805



Table 2-1. List of Attendees (Contd)

Individual	Working Group Role /Paper Topic	Phone, Address
Ronald Thompson	participant	(608) 262-3437 (University of Wisconsin at Madison) 1415 Johnson Dr. Madison, WI 53706
Ken Waldron (Stanford U.)	"Walking Vehicles and Wheels using active suspension"	(415) 723-0960 943 Mears Court Stanford, CA 94305

- (4) Define subsystems required for analytical design modeling.
- (5) Define interface requirements.

## 2.2 BACKGROUND

While vehicle design is a mature science, there are unique characteristics involved in a Mars rover mission.

The efforts being expended in vehicle design are primarily the following:

- (1) Improvements in passenger vehicle speed, efficiency, reliability, and riding comfort.
- (2) Improvements in farm and construction vehicles which are, for the most part, special-purpose machines and, as such, allow maximization of some aspects of vehicle configuration while sacrificing others.
- (3) Improvements in military vehicles. Some military vehicles may come the closest to configurations applicable to a Mars rover. The combination of high reliability, suitability for a variety of off-road conditions, minimum weight, and good efficiency is sought by both. The military, of course, makes significant vehicle configuration sacrifices in order to carry weapons and repel the effects of enemy weapons.
- (4) Experiments with recreational vehicles and toys. This is by far the most inventive forum for vehicle configuration. For the most part, the inventor/designer/builder makes his own rules and judges his own success in terms that he negotiates with the natural elements. In spite of overwhelming R&D efforts by the professional community, these amateurs have succeeded in building sling shot drag racers which demonstrate tire coefficients of friction greater than unity, dune buggies which climb loose sand at the maximum angle attainable by the sand itself, and a variety of toys which climb and tumble and keep going.

With these four reservoirs of experience, the rover designer still does not have what he needs to configure a vehicle for the Martian landscape. It is not known how to trade off mobility over a variety of terrains against the other aspects of vehicle design such as reliability, efficiency, speed, etc. One needs only to remember the wide variety of proposed vehicles for lunar exploration. The 1960's gave us exciting (often weird) new vehicles which rolled, walked, crawled, and burrowed into and over sand and rocks. These were condensed into a few wheeled vehicle designs which had been reasonably optimized for the surface of another planet (Earth's moon). When it came down to the actual vehicle used on the moon, it was a disappointment to admirers of weird and exotic vehicles. It was, however, the best known configuration for the specific mission. It would be a tremendous mistake to conclude that all the research on special designs was wasted because light weight and collapsibility dominated the final design of the lunar vehicle.

## SECTION 3

### DISCUSSION

The mobility system can be discussed in terms of the following functions: stowage, providing an apparatus platform, self-recovery, and locomotion.

The limited volume available for storing the rover in transit to the Martian surface requires a combination of small parts and/or collapsible designs. To the extent that operations are performed while the vehicle is in motion, it is a dynamic platform. For some static operations it must function as a rigid base. The probability of overturning the vehicle on Mars must be considered. In more hazardous terrain the probability increases. By ruggedizing the appropriate instruments and equipping the vehicles to enable them to turn upright again, the mission can be continued.

The function of locomotion is primary to the rover design. The degree of severity of the terrain dictates the type of locomotion used (rolling, crawling, walking, flying, etc.). Other functions combine with locomotion to determine the vehicle configuration.

The spectrum of locomotion types is very broad. All the types considered in the 1960's as candidates for a lunar rover need not be reconsidered. After sorting, however, there are still several candidates applicable to a Mars mission. After considerable discussion, it was decided that there are two major types of locomotion; legged and rolling. By combining a pair of beefed-up manipulator arms (to be used also as climbing arms/legs) a third type is created which may have the speed and efficiency of wheels while adding self-righting capability and the ability to climb out of crevices, etc. Figure 3-1 lists only the most significant aspects of the three types.

The options listed for wheels as "4, 5, 6, more" are there to point out the significance of the number of wheels. Four wheels should be the most efficient. Five is unconventional but is still stable after losing one leg. Six is the most popular obstacle-climbing configuration. For soft soils more wheels are advantageous.

The comment on the hybrid is meant to call attention to the need to coordinate the vehicle designer and the sample acquisition engineer. Only three degrees of freedom are needed for a leg, and it should be pointed out that making these legs rugged still allows three to four more degrees of freedom to be added at the end. These additional degrees of freedom can be precise in order to manipulate delicate samples.

One of the first steps in designing a vehicle is knowing what terrain features are to be involved. In general, a vehicle configured to travel over loose sand and dust is poorly configured to climb large blocky obstacles.

The specter of deep, loose dust which can envelop a vehicle was of great concern before lunar missions. This issue arises again because of the different conditions on Mars. Indications are that there is much wind-blown

T Y P E	T E C H N O L O G Y O P T I O N S	R A T I O N A L E	C O M M E N T S
LEGS	VARIOUS GEOMETRIES	FULLY TERRAIN ADAPTABLE FOLDABLE OMNIDIRECTIONAL STABLE PLATFORM	COMPLEX
WHEELS/TRACKS	4, 5, 6, MORE CHASSIS ARTICULATED VARIOUS SUSPENSIONS "ACTIVE" SUSPENSION	PROVEN TECHNOLOGY POTENTIALLY SIMPLE EFFICIENT ON SMOOTH SURFACES	TRADE OFF SIZE with NUMBER WHEELS NEEDS STABILIZATION
HYBRID	WHEELS AND LEGS	MOST VERSATILE	MAY COMPROMISE SAMPLING

Figure 3-1. Significant Aspects of Three Candidate Locomotion Types

dust on Mars with particles less than 10 microns in size. (Diatomaceous earth particles are about 3 microns in size.) The degree of compaction makes a tremendous difference to a vehicle. On Earth, wind-blown sand favors a particle size of about 0.5 mm and it is expected that it is similar on Mars. There are publications to indicate that the sand on Mars is agglomerated dust particles which easily crush back into dust. While the Viking Landers I and II show a crust on the surface, it is not likely that freshly formed dunes have crust.

As one of its goals, the Mobility session tabulated the key requirements for a terrain model. These are listed in Figure 3-2.

Rough-cut estimates were made of funding levels required to develop three options for mobility configuration. These are shown in Figure 3-3. The legged option involves a better understanding of the way a foot sinks into the soil. This understanding is prerequisite to developing the computer software necessary for negotiating combinations of turns and hills on various soils and obstacles. The wheels/track option begins with determining the best configuration. This is done by a combination of scale models of computer modeling. The hybrid option overlaps the other options. It involves the optimization of configurations using arms as mobility elements. It is expected to be the most efficient means of overcoming large obstacles and self-righting the vehicle.

**SOIL**

**A N G L E O F  
I N T E R N A L  
F R I C T I O N**

**COHESION**

**DUST**

**SIZE**

**DEPTH**

**CRUST**

**PROFILE**

**ROUGHNESS (RMS  
DIMENSION)**

**OBSTACLES**

**SIZE**

**SHAPE**

**DISTRIBUTION**

**HIDDEN OBSTACLES**

**SLOPE**

**DISTRIBUTION**

**ANGLE**

3-2. Mobility Session Requirements for Terrain Model

DATE \_\_\_\_\_ TIME \_\_\_\_\_ NOTES \_\_\_\_\_  
 GROUP MOBILITY

TECHNOLOGY PROGRAM	DEVELOPMENT SCHEDULE									
	1988	1989	1990	1991	1992	'93	'94	'95	'96	'97-'00
<b>LEGGED OPTION</b>										
Foot to Ground R&D										
Software Development										
Configuration Modeling										
Materials Development										
Motors and Transmissions										
Integration Thermal Control Fault Tolerance Self Repair										
	Programs	1000	2000	2000	4000	3000				13000
PROGRAM SCOPE	*S.K	2000	4000	6000	6500	4500				TOTAL 23000
	*WY	10	20	30	25	15				TOTAL 100
<b>WHEELS/TRACKS OPTION</b>										
Configuration Modeling										
Motors and Transmissions										
Thermal Control										
Materials Development										
Self Repair										
Integration										
	Programs	500	1000	1000	500					3000
PROGRAM SCOPE	*S.K	2000	4000	3500	2500					TOTAL 12000
	*WY	15	30	25	20					TOTAL 90
<b>HYBRID OPTION (DELTA COST)</b>										
Configuration Modeling										
Software Development										
Motors and Transmissions										
Integration										
	Programs	500	500	1000						2000
PROGRAM SCOPE	*S.K	1000	1500	1500						TOTAL 4000
	*WY	5	10	5						TOTAL 20
MRSR PROGRAM REFERENCES	TECHNOLOGY DEVELOPMENT      TECHNOLOGY SELECTION      1998 LAUNCH      2000 LAUNCH MICHIGAN & ILL.      LAUNCH									

Figure 3-3. Funding Level Estimates to Develop Three Mobility Configuration Options

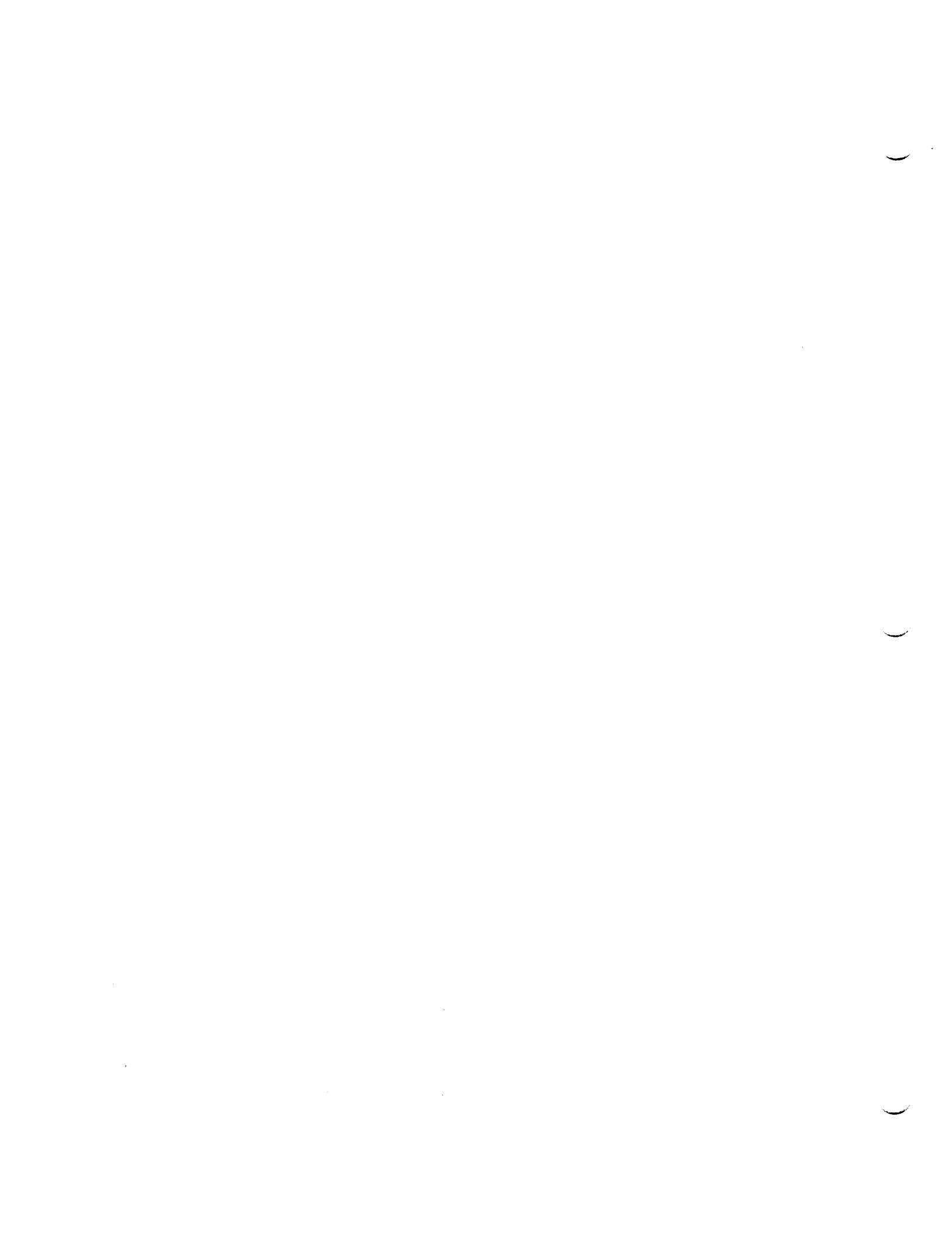



## SECTION 4

### SUMMARY AND CONCLUSIONS

The Martian terrain is a unique problem for the vehicle designer. There is more to it than simply selecting characteristics from the experiences gained either on Earth or on the Moon. The Martian gravity is between that of the Earth and the Moon (1>.38>.17). Mars has enough atmosphere to burn up small meteorites and turn them to dust. Mars has volcanoes which have likely made more dust. Indications are that Mars has much more dust in the particle size range less than 10 microns than the Moon. The Earth forms clay from particles this fine. Mars has dust storms which circulate the dust and keep it loose. The deep ravines of Mars are likely to be cut into "soil" composed of dust, compacted and bound by frost and/or salt crystals to an unknown value of cohesive force.

The Mars rover vehicle must operate autonomously. It must resist overturning and/or bogging down. It must recover when it does. The more severe conditions will stop the vehicle. The fact that severe conditions are statistically rare must be combined with the extent of the rover's wandering. For this reason, it is concluded that the rover needs more than a means of locomotion. It needs the ability to upright itself and to recover from hazards and failures.

It was concluded that a single body unit has significant advantages over several body units. Distributing the load, in the form of a body unit over each axle, is a proven way to gain obstacle-climbing ability. However, the advantages of thermal control and instrument platform stability are important enough to consider better suspension schemes.

It was concluded that computer modeling the terrain and the candidate vehicles is emerging in the industry as the most efficient means of selecting a design.

In order to design a Mars rover, it is necessary to combine previous vehicle experience with what is known about the Martian environment and what is desired of the sample-gathering mission. The recommended procedure for this task is to begin with computer simulation of the environment and promising vehicle configurations. It is expected that key generalizations will emerge that allow trade-offs to be performed. A superficial computer optimization should be followed by laboratory experiments to determine the validity of the interactions between elements used in the computer analysis. By combining and iterating computer optimization with laboratory experiments on specific elements a preliminary design will emerge. The design needs to be modeled as hardware and tested extensively in order to flush out its shortcomings. Unique combinations of terrain features and vehicle geometries will undoubtedly be discovered. Failure modes will be discovered as well. This process should be repeated through the prototype stage in order to evolve a meaningful design. Throughout this process, innovation will contribute. It is not a simple matter of innovation at the initial concept phase.

It is reasonable to conclude that inasmuch as one or more manipulator "arms" will be on the rover, these arms can be made to augment the vehicle mobility. By having two arms, the sample acquisition (their primary purpose) system is redundant against failure. We need to analyze the obstacle-climbing maneuvers of a hybrid arm-wheeled vehicle and trade off the configuration. (Should the arms be in front, at the corners, on the top, or ?) The resulting hybrid would then be compared to a baseline configuration.

## SECTION 5

### PRESENTED MATERIALS

The following section provides the materials that were presented by various participants at the Mobility Working Group.

#### 5.1 GRUMMAN AIRCRAFT ENGINEERING CORPORATION (PRESENTED BY JOHN NORRIS)

The Grumman lunar vehicle design experience was presented, showing a variety of vehicle and wheel designs. The Grumman design for the lunar rover was a four-wheeled vehicle. They also experimented extensively with six-wheeled vehicles. A key feature of their "flexible cone" wheel design is that the ground contact "footprint" is very long for a given wheel diameter. They employ a footprint equivalent to that of a wheel many times larger in diameter. One version of cone wheels was designed for use on military jeeps used in Vietnam for 16,000-mile service. Figures 5-1 and 5-2 show some of the Grumman model tests.

#### 5.2 BOEING AEROSPACE COMPANY (PRESENTED BY RICHARD BONSAK)

The actual lunar rovers used were contracted from Boeing. Figure 5-3 shows the general configuration. Eight were built and three are on the Moon. Some of the statistics of their performance are:

##### MISSION SUMMARY

	APOLLO 15	APOLLO 16	APOLLO 17
Number of sorties	3	3	3
Total distance traveled	27.5 km	27.1 km	36.1 km
Average speed	9.2 kph	7.9 kph	8.1 kph
Maximum speed	14 kph	17 kph	18 kph

##### PERFORMANCE SUMMARY

SPEED:	16 kph; smooth, hard surface
TURN RADIUS:	3.0 meters
GRADE:	25 degrees; ascend and descend
ROLL STABILITY:	14 degrees
ENDURANCE:	92 km (limited by non-rechargeable battery power)
OBSTACLES:	Objects - 30.5 cm step Depressions - 71.0 cm breach

The reasons given for the actual rovers having four wheels rather than six were: 1) it was of paramount importance that the vehicle fold into a compact space, 2) the vehicle was steered by a man and could avoid excessive obstacles, and 3) it was light weight enough (on the Moon) that a man could lift it out of a good number of possible accidents.

ORIGINAL PAGE  
BLACK AND WHITE PHOTOGRAPH

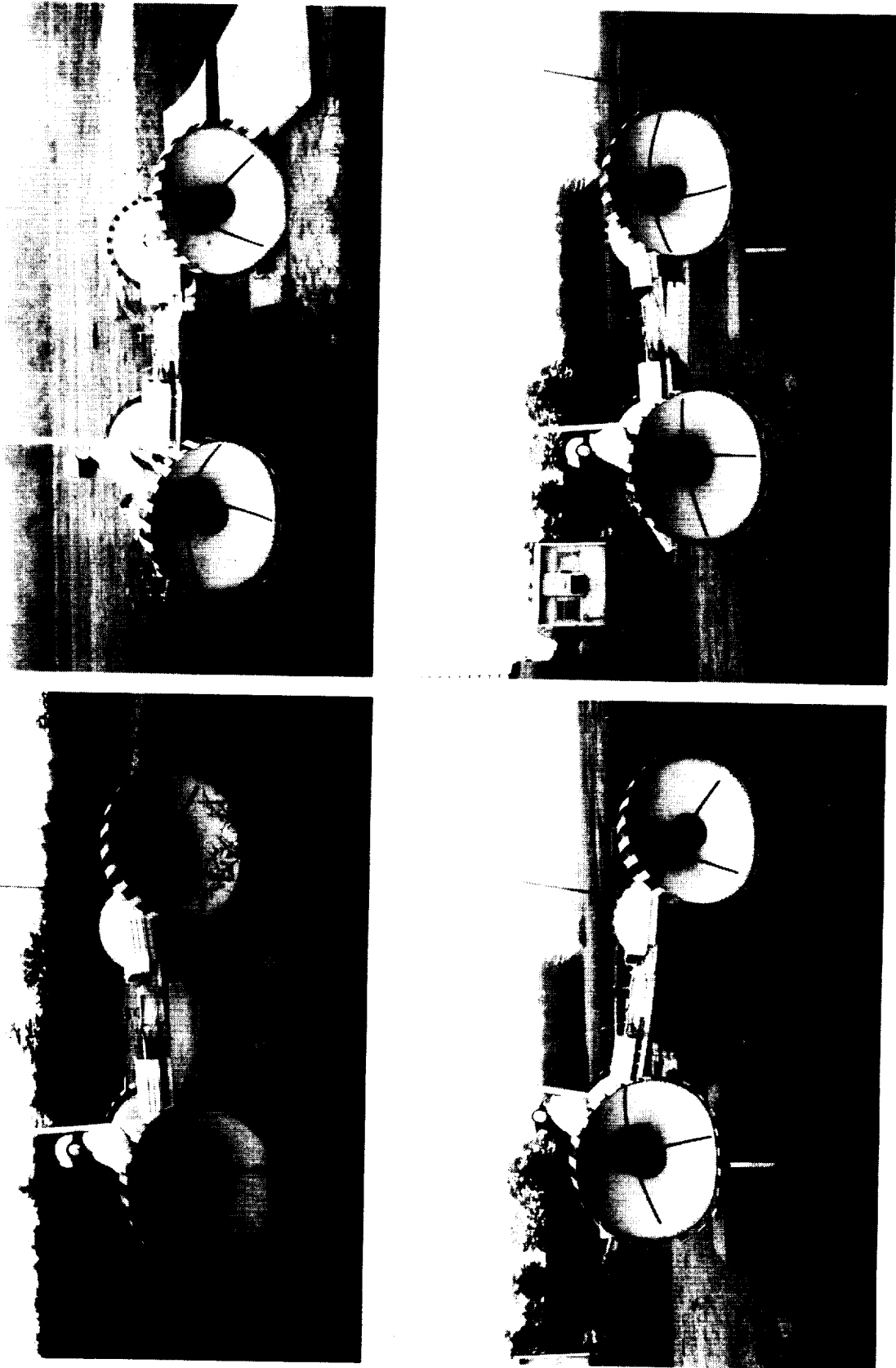

Figure 5-1. Grumman Model Tests

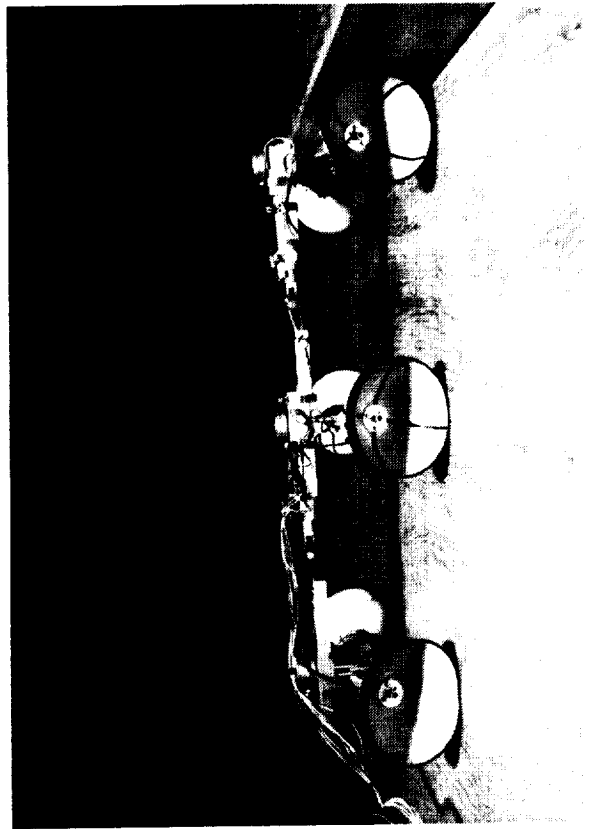
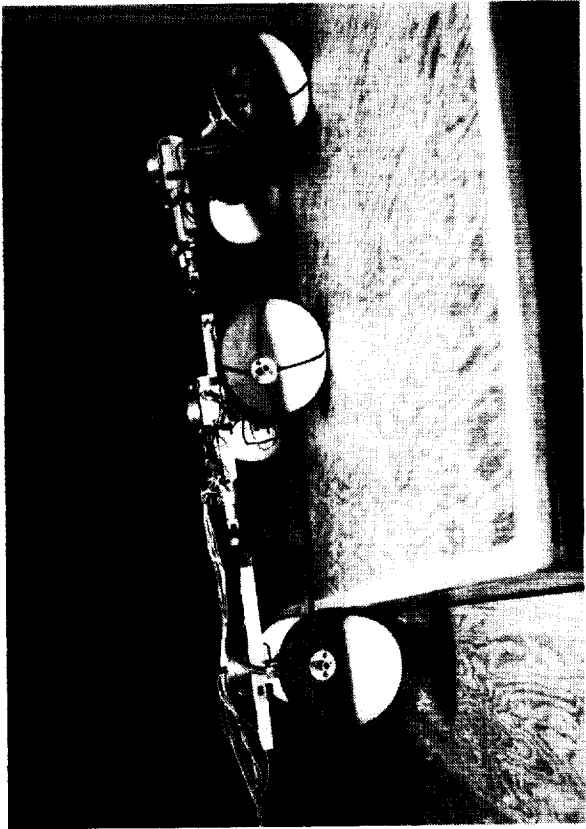

Figure 5-2. Gruman Model Tests

ORIGINAL PAGE  
BLACK AND WHITE PHOTOGRAPH

**DIMENSIONS**

Length: 3.1 m  
Width: 1.8 m  
Wheel base: 2.3 m  
Clearance: 0.35 m

**EARTH WEIGHT**

Vehicle only: 210 kg  
Fully loaded: 517 kg

**PROPULSION**

Electric motor: one per wheel  
Battery: 2 - 36v silver-zinc,  
non-rechargeable

**CONTROL**

"Stick" type hand controller  
Two axle Ackerman steering

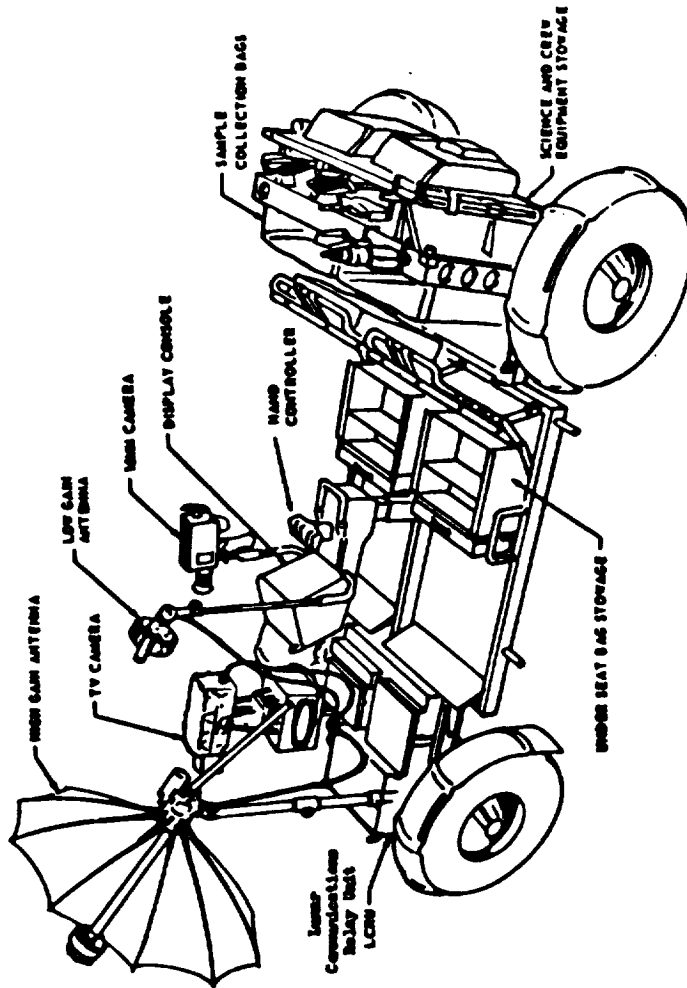

Figure 5-3. Boeing Lunar Rover General Configuration

ORIGINAL PAGE IS  
OF POOR QUALITY

The wire wheel design shown in Figure 5-4 could be altered to be optimum when used on a Mars rover mission. By designing to a low-stress level, fatigue failure can be virtually eliminated.

The drive motors used on each of the rover wheels are shown in Figure 5-5. The gear case is liquid lubricated. It is sealed without the use of rotating seals. A harmonic drive is used which seals by way of an elastically deformed metal tube. The motors used are series-wound 1/4 horsepower, with a gear reduction of 80 to 1. In the event of a motor/drive failure, the astronaut could decouple the drive to allow freewheeling.

### 5.3 ODETICS [PRESENTED BY NEVILLE MARZWELL (JPL)]

Odetics did not have a representative at the Mobility session. Dr. Neville Marzwell of JPL presented information on the Odetics walking machine, gained through a previous development contract with JPL and other experience. The Odetics machines have six legs mounted circumferentially rather than in-line. As such they have a spider-like appearance.

ODETICS I was a blind, "feeler" machine. It navigated by sensing surfaces ahead of it and then placing weight on the leg being moved. Software was developed to the extent that the machine successfully climbed stairs. It could lower itself in order to crawl under things and it could narrow its configuration in order to pass through a 1.5-foot-wide opening.

ODETICS II has a stereo vision system. It estimates step height, width, and distance. It has been successfully demonstrated traveling through a field of roof-shaped obstacles. Its stability has been demonstrated as well. The machine can lift 5 to 7 times its weight. A 700 kg robot has lifted a 5 ton truck. NASA technology level 5 has been accomplished.

The power required is influenced by the shape of the terrain, with rough terrain requiring more power. There are sensors on each foot for determining contact. There are vision sensors, and force feedback is used to sense forces applied. As the terrain becomes very rough, significantly more computational time is required, slowing the vehicle down. In the case of retracing a "memorized" trip (stored in the computer memory) the vehicle speed is quite rapid.

The actual mechanisms in use are not qualified (space, military, etc.) but nothing is seen to indicate that qualified mechanisms cannot be developed. The vehicle can walk with one leg disabled.

A comment was made that adding grippers at the end of the legs should improve the climbing ability considerably.

### 5.4 U.S. ARMY TANK AUTOMOTIVE COMMAND (PRESENTED BY ZOLTON JANOSE)

The NATO Reference Mobility Model (NRMM) was presented and discussed. This model is a detailed system for classification of terrain units which can be related to actual areas. It is used for prediction of performance of various vehicles over the modeled terrain. Prospective users

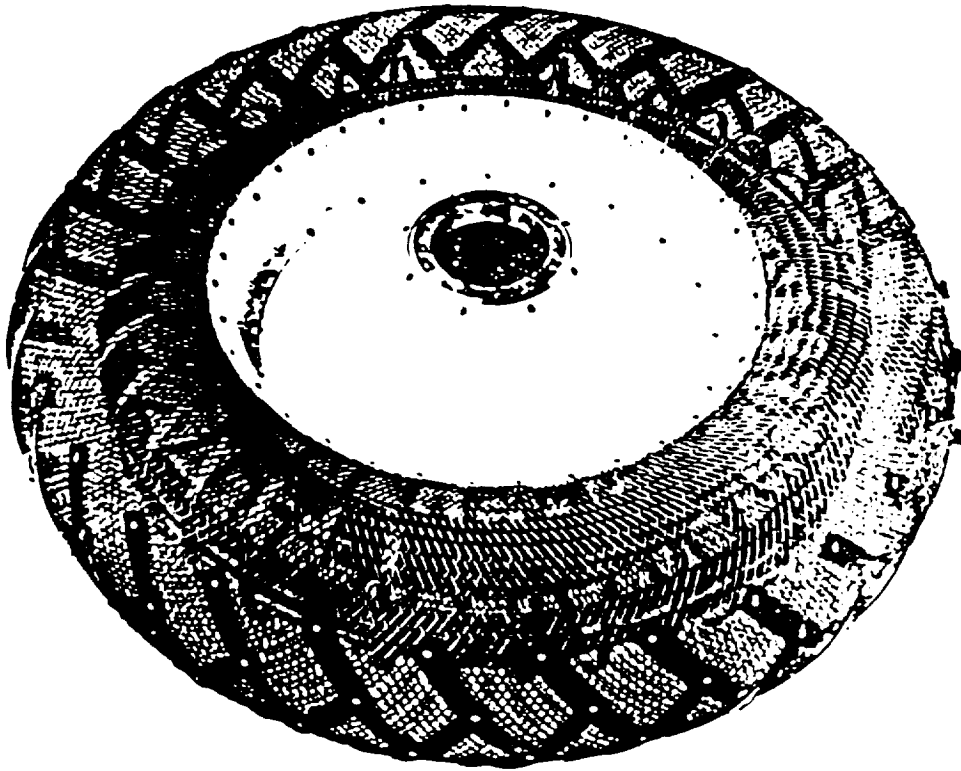

**TIRE**

Woven wire -

- Zinc coated piano wire
- Titanium bump stop
- Titanium chevron tread

**HUB**

Spun aluminum

**DIMENSIONS**

Diameter: 0.85 m (approx.)

Width: 0.22 m (approx.)

**EARTH WEIGHT**

Each wheel: 5.4 kg

Figure 5-4. Lunar Rover Wheel/Tire Configuration



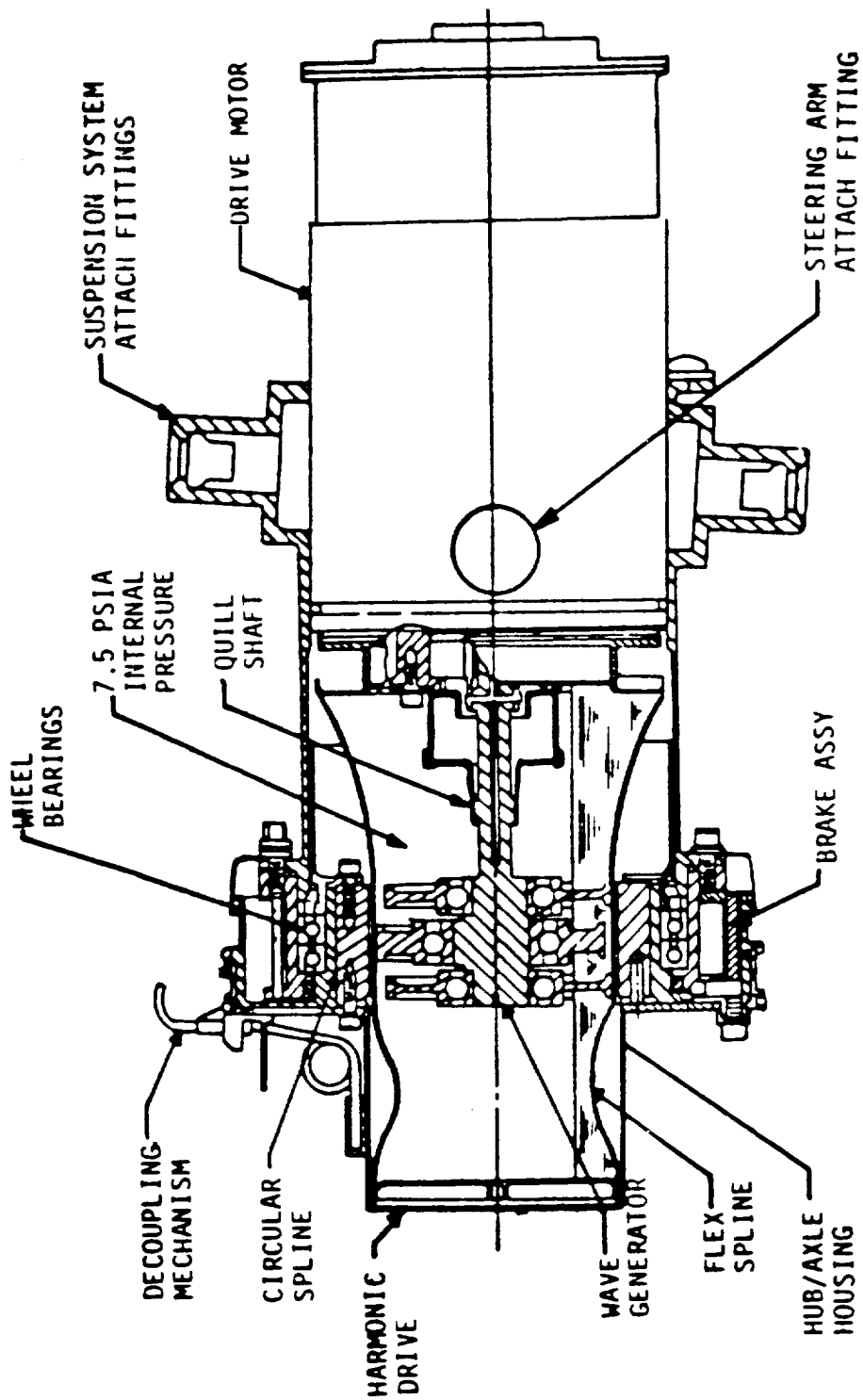

Figure 5-5. Lunar Rover Traction Drive

of this performance prediction methodology are: vehicle designers, the vehicle procurement community, and the military planning community. Figure 5-6 shows the sub-models involved. The terrain factors are surface composition, type and strength; vegetation, stem (tree trunk) size and spacing and visibility; surface geometry, slope, obstacles, roughness; and linear geometry, stream size and spacing, water velocity, and depth. There are 21 factors in all, and from a combination of these factors and 78 classes of terrain data, maps are constructed with coded zones of classification. Typically there are 10 to 20 changes in a zone for a nautical mile in Europe. For vehicle performance predictions, data is gathered for vehicle running gear, power train, geometry, water characteristics, highway characteristics, mobility-assist systems, ride and obstacle data, and obstacle interference data. These data are put into the computer model. Figure 5-7 shows the gross structure of this model. Figure 5-8 shows the general flow of information. (AC/DC means acceleration/deceleration.)

There has been generally good agreement between predicted and measured performance. As a result, there has been a shift away from building and testing expensive prototypes until they are shown by computer modeling to be promising.

#### 5.5 JPL MARS ROVER MODELING (PRESENTED BY GERALD LILIENTHAL)

Mobility computer analysis at JPL has the present objective:

To develop a variety of different rover configurations and evaluate them for degree of mobility by computer simulation.

The scope has been broken down into input and output.

##### INPUT SCOPE:

- Will require application of surface study data
  - Macro scale: Site selection and important surface hazard data
  - Micro scale: Definition of important surface morphology
- Takes off from existing work of Wilcox (JPL) and Pavlics (GM)

##### OUTPUT SCOPE

- Optimizes existing 6-wheel rover
- Develops other configurations for maximum mobility
- Provides foundation for study of rover interaction with sample acquisition devices.

Two phases of simulation will be undertaken. The first phase unites the vehicle with hazards for correlating with existing test data to either validate or refine the model. Several geometries will be optimized and the results reported. The second phase will add sample acquisition inputs and the control algorithms in order to optimize the complete system. The modeling process is shown in Figure 5-9.

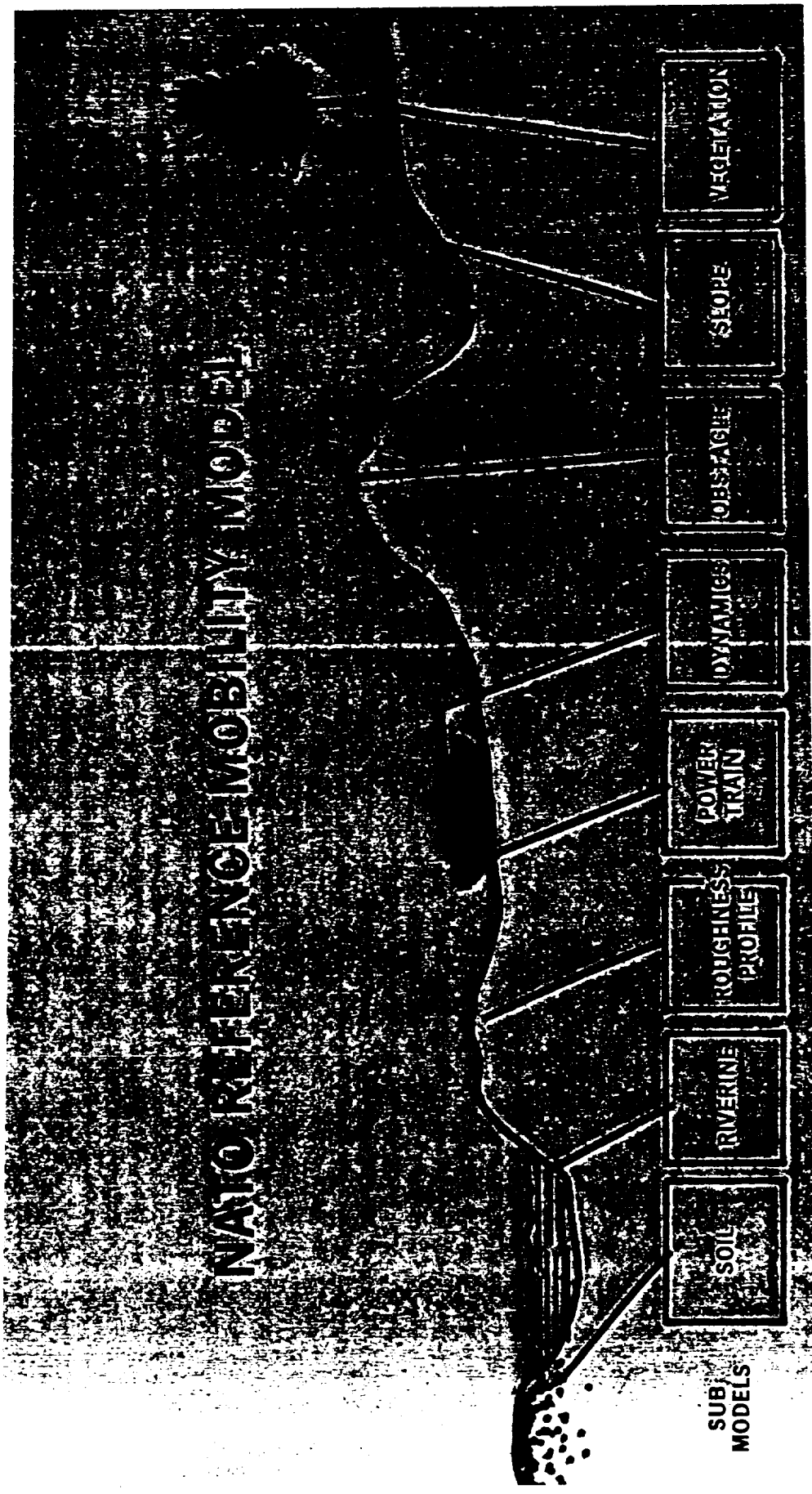

SUB  
MODELS

Figure 5-6. NATO Reference Mobility Model (NRMM)

ORIGINAL PAGE IS  
OF POOR QUALITY

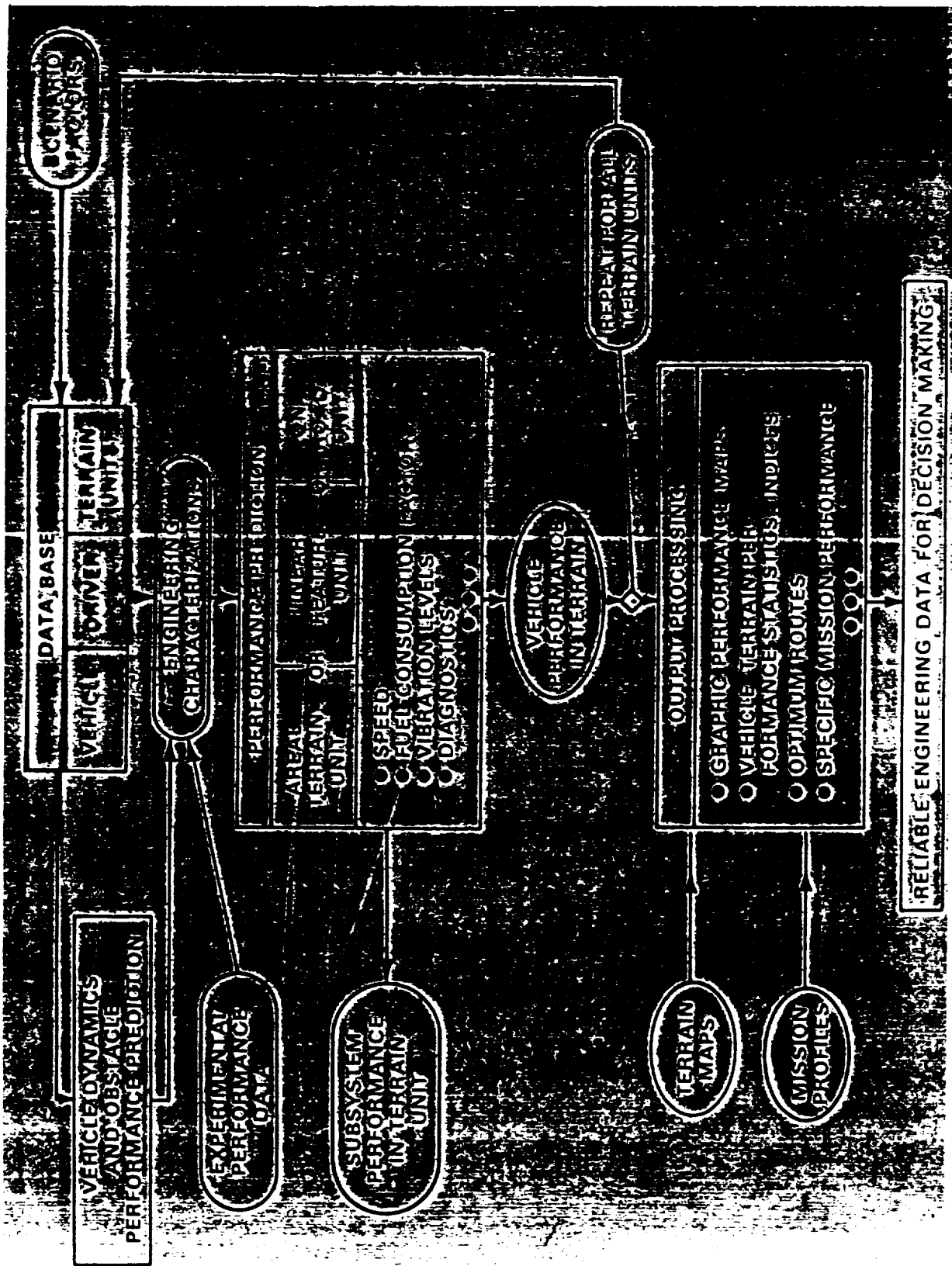

Figure 5-7. Gross Structure of NATO Reference Mobility Model

ORIGINAL PAGE IS OF POOR QUALITY

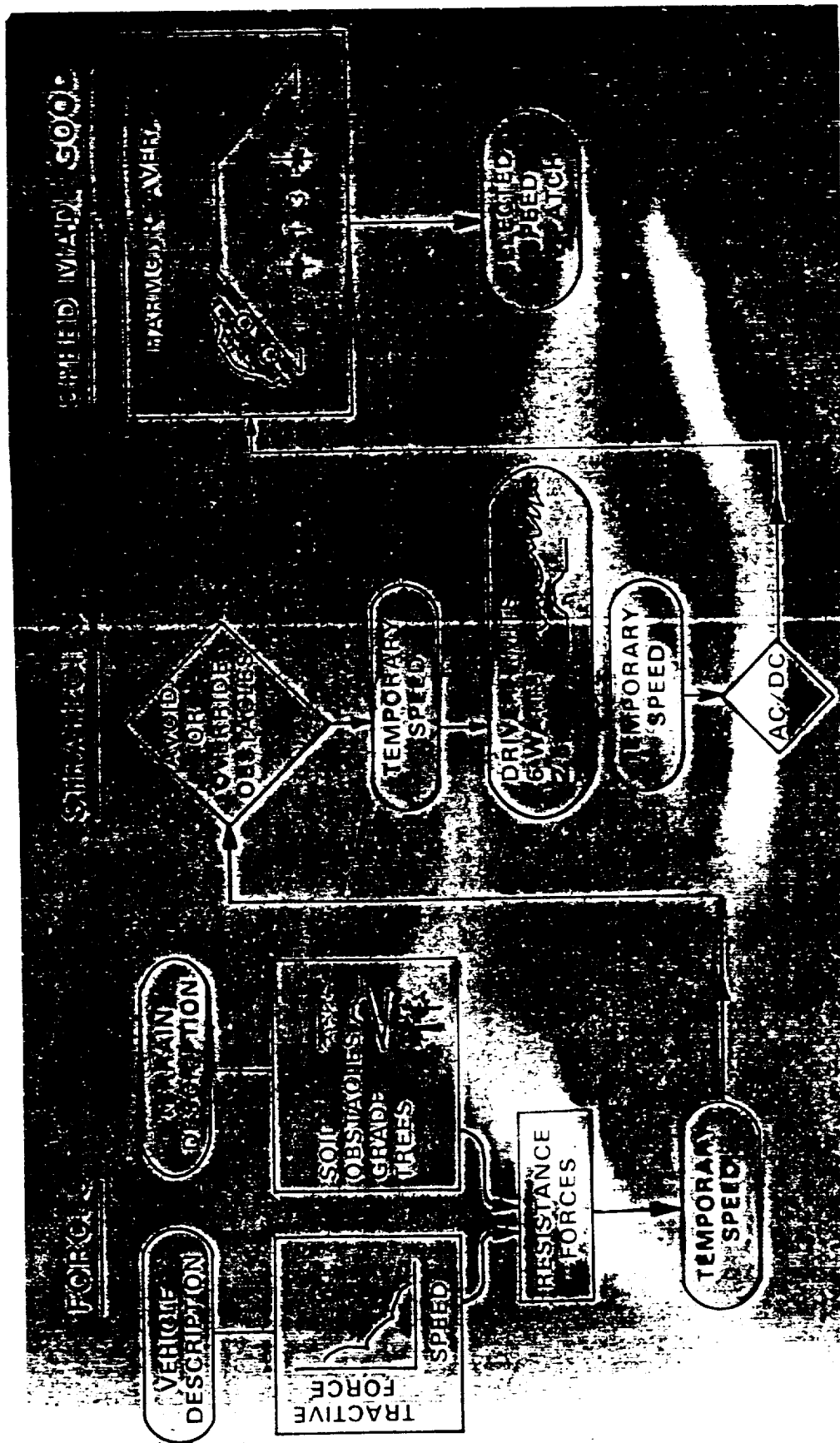
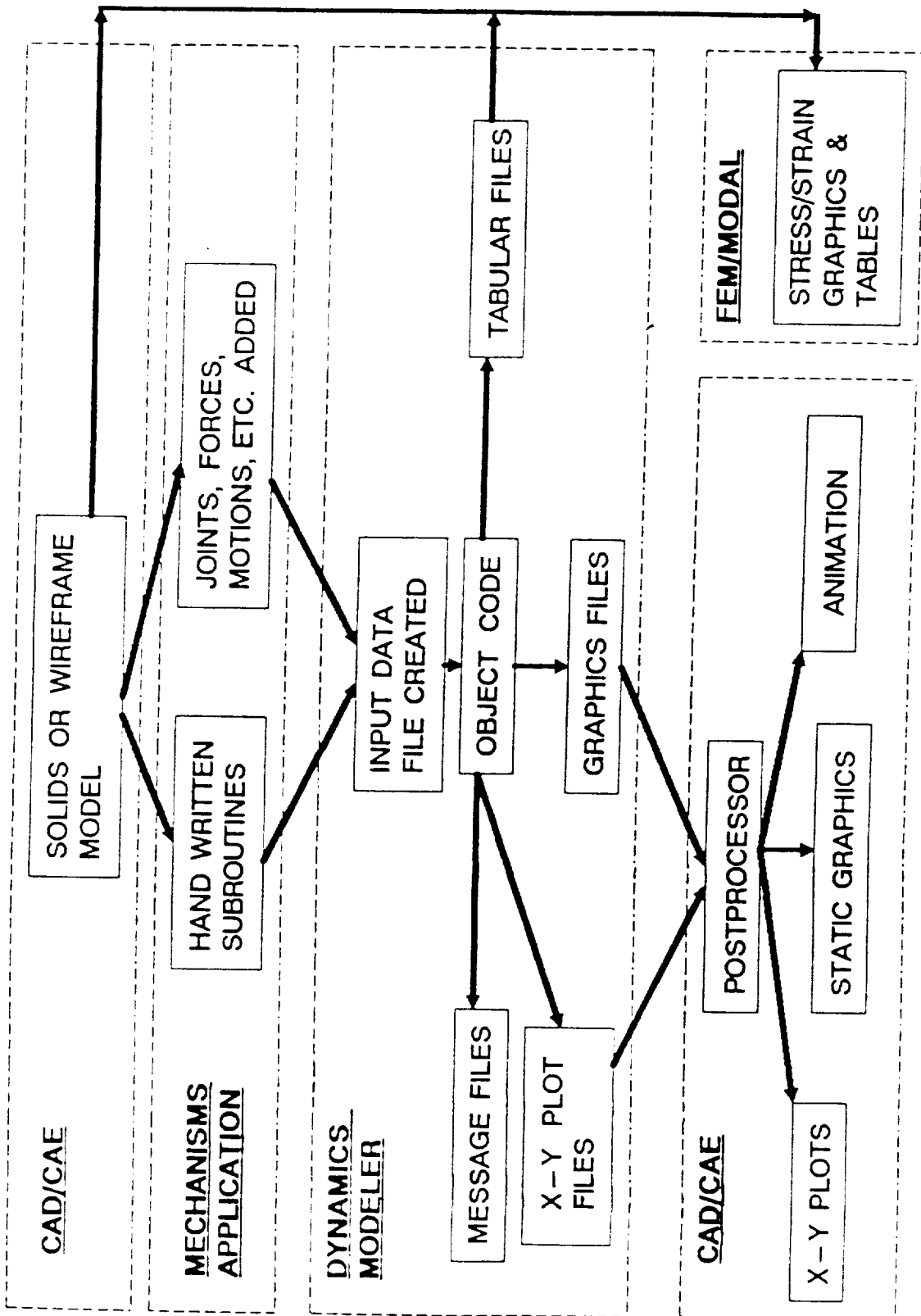

Figure 5-8. General Flow of Information in NRRM Computer Model



ENTIRE ANALYSIS DONE WITH ONE DATABASE

Figure 5-9. JPL Mars Rover Modeling Process

Figure 5-10 shows a wire frame of the existing rover baseline configuration with a simple cube as an obstacle. The features of this modeling effort are:

**PARTS:**

3-dimensional rigid bodies possessing mass, inertia, and geometry

**FLEXIBILITY:**

Structural elasticity included directly in the model

**CONNECTIVITY:**

Part motion constraints modeled from the extensive collection of standard joints and joint components

**FORCES:**

Library of linear and nonlinear force components that include springs, dampers, bushings, etc.

**MOTIONS:**

Time-dependent translations and rotations

**FUNCTION LIBRARY:**

Predefined algorithms such as Fourier, sine, step, and polynomial forces and motions

**DIFFERENTIAL EQUATIONS:**

Expressions for describing controls, hydraulics, electrical system effects

**SPLINES:**

Can include experimental test data of discrete functions in the data set to describe forces and motions

## 5.6 FMC (PRESENTED BY JOHN MARINSHAW)

FMC uses a systematic approach to achieving mobility, breaking it into four parts:

- Singular mobility entity (Mobility matrix)
- Relate to engineering design process
- Specify mobility subsystem parameters in hardware terms
- Conduct subsystem mobility analysis and trade studies

The matrix used is shown in Figure 5-11. Mobility subsystem parameters are shown in hardware terms in an attribute tree (Figure 5-12). A typical subsystem is the suspension. A sample suspension arrangement is:

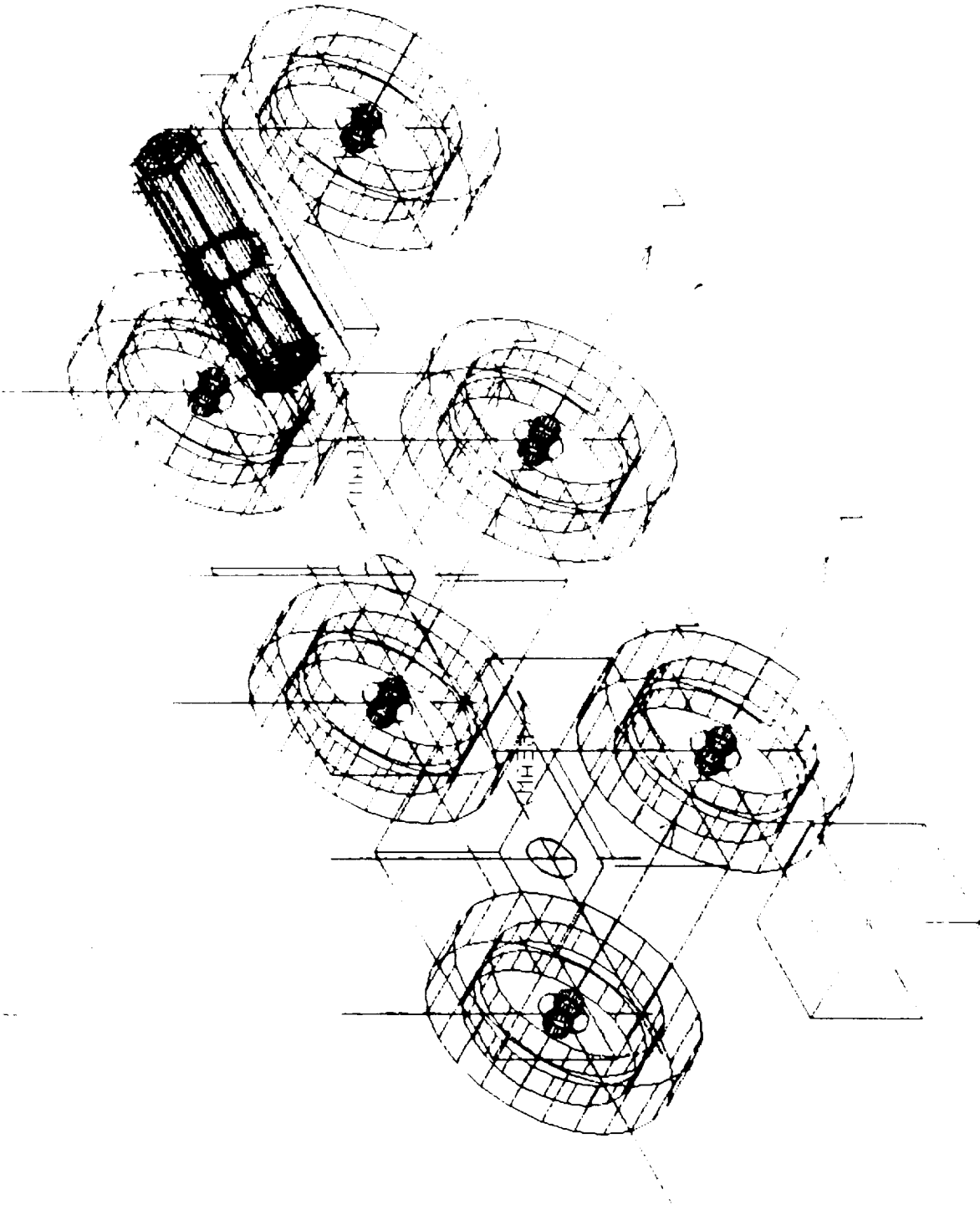

Figure 5-10. Wire Frame of JPL Rover Baseline With Cube as Obstacle

ORIGINAL PAGE IS  
OF POOR QUALITY



MOBILITY PARAMETERS	WEIGHT	VEHICLE CONCEPTS ALTERNATIVES					
		A		B		C	
		RATING	SCORE	RATING	SCORE	RATING	SCORE
PROPULSION • POWER • SPEED • BRAKING • STEERING/CONTROL	20						
	10	9	90	10	100	8	80
	3	9	27	8	24	6	24
	2	8	16	6	12	5	10
	5	7	35	6	30	4	20
SUSPENSION • RIDE PERFORMANCE • STABILITY • OBSTACLE PERFORMANCE	40						
	30	10	300	9	270	8	240
	5	9	45	6	30	7	35
	5	8	40	9	40	3	15
TRACK • GROUND PRESSURE • MOBILITY INDEX/ VEHICLE COME INDEX • NOMINAL VMD SPEED • PERCENT NO-GO	30						
	10	10	100	9	90	7	70
	15	10	150	9	135	6	90
	5	9	45	8	40	6	30
VEHICLE/SYSTEM CONSTRAINTS • VISION • VEHICLE SIZE & WT • SEAT DESIGN • GROUND TRANSPORT • AIR TRANSPORT • WATER PERFORMANCE	10						
	3	9	27	10	30	9	27
	2	10	20	8	16	7	14
	1	6	6	9	9	10	10
	2	8	16	9	18	10	20
	1	7	7	8	8	5	5
1	6	6	10	10	5	5	
WEIGHTED TOTAL SCORE	100	—	930	—	862	—	605
BANK ORDER	—	1	2	3			

Figure 5-11. FMC Mobility Matrix

ORIGINAL PAGE IS  
OF POOR QUALITY

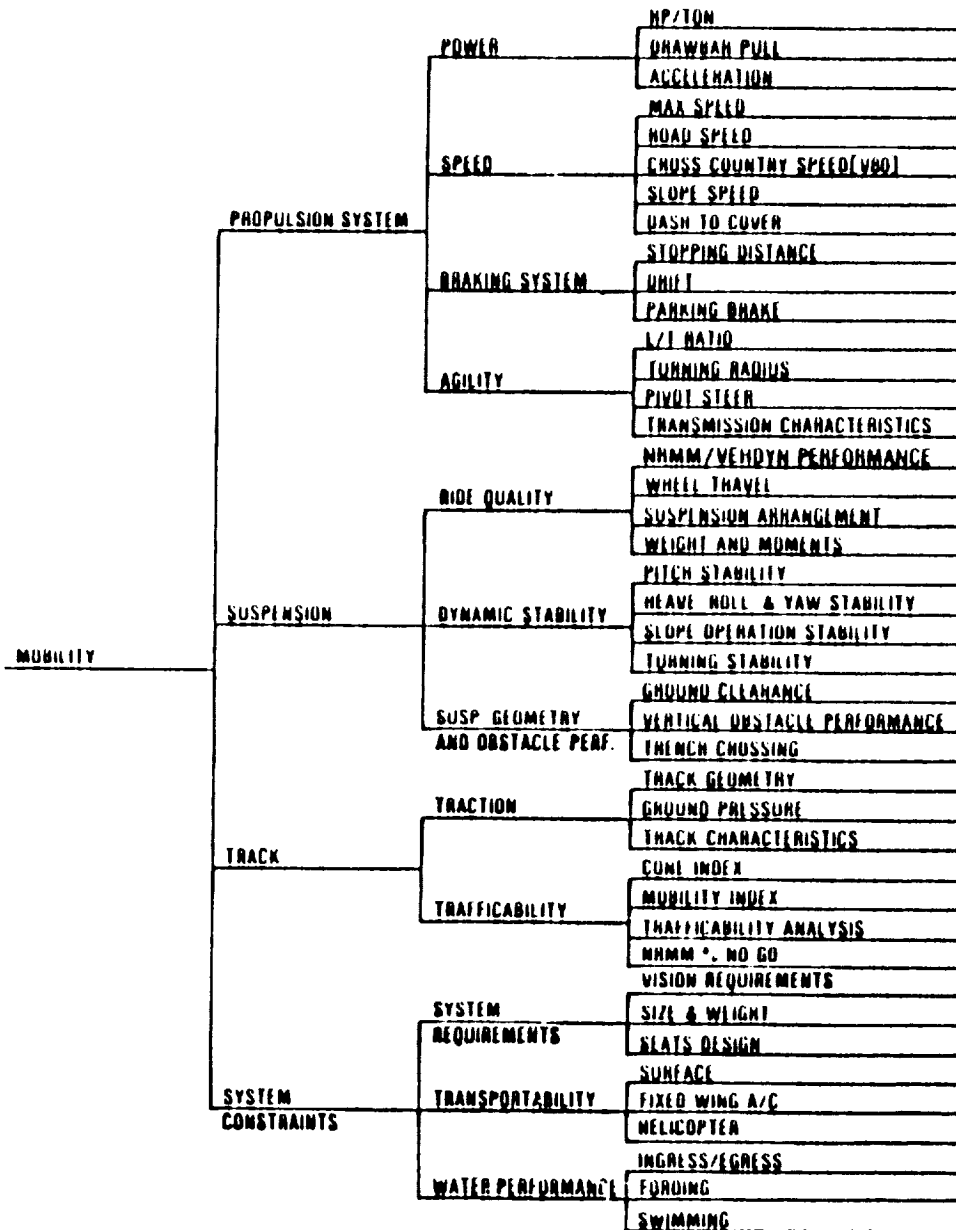

Figure 5-12. Mobility Subsystem Parameters

ORIGINAL PAGE IS  
OF POOR QUALITY

- Minimum ground clearance = Wheel travel + 4 to 6 inches  
(16 to 20 inches)
- Obstacle crossing
  - Vertical Wall: 30 to 36 inches
    - Approach angle -- 60° with 90° preferred
    - Departure angle -- 40° with 90° preferred
  - Trench crossing: 6 to 9 feet

In a cooperative effort between government and industry, FMC has had success using their mobility matrix approach.

#### 5.7 GENERAL MOTORS (PRESENTED BY FERENC PAVLICS)

General Motors (GM) has considerable experience in lunar vehicle design. They began with various types (configurations) of experimental vehicles modeled and tested in soil bins. Figure 5-13 shows three of these types. The tracked vehicle and the screw-driven vehicle are very good in loose fluffy soil. The six-wheeled vehicle is one of the earliest versions of the elastic frame concept. By having three body sections, one on each axle, connected by elastic frame members, the result is a vehicle with fantastic climbing ability. It climbs vertical steps 1 1/2 wheel diameters high. The last two axles push (every wheel is power driven) the front axle against the vertical rise with sufficient force (if the coefficient of friction is greater than 2/2 to send it crawling vertically. Once on top it pulls the center axle while the last axle pushes. With the first two axles on top they pull the last one up. A four wheeled configuration cannot compete unless its wheels are very large.

Figure 5-14 shows a 12-foot-long version of this configuration using 3-foot diameter wheels. It has climbed 4 1/2-foot vertical steps and has crossed 4 1/2-foot wide crevices. The bottom photo shows the vehicle traversing the lee side of a sand dune where the soil is at the "angle of repose" (as steep as the soil will pile). Notice the indication of minor landslides following in the wake of the vehicle. The vehicle is in the act of turning uphill and subsequently climbing up and over the dune. It is recognized in the mobility community as the ultimate in traction to climb a hill of soil at its angle of repose. As the vehicle climbs, the wheels slip at about 50%, essentially digging into the hill and placing the soil behind.

GM has built several vehicles with this basic configuration (wheel-bases 1 1/2 wheel diameters long, two wheel diameters wide, three axles with three bodies). Full-scale engineering models were tested for the Surveyor mission. The tests included sand dunes and lava craters.

The manned lunar mission vehicles were also built by GM. After all the six-wheel development, the actual vehicles sent to the Moon had four wheels. Some of the reasons given for this are: as a manned vehicle it could be steered around obstacles, weight was very important, and the vehicle had to fold up into a compact storage space. Figure 5-15 shows the steering diagram and the folding sequence for the vehicle.

ORIGINAL PAGE  
BLACK AND WHITE PHOTOGRAPH

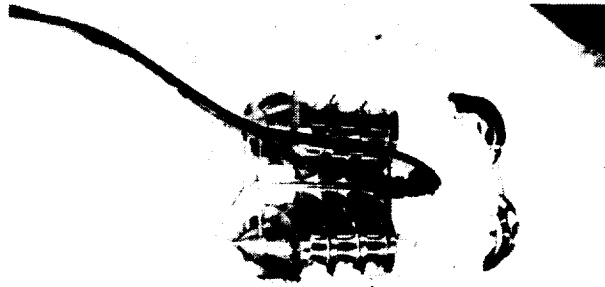
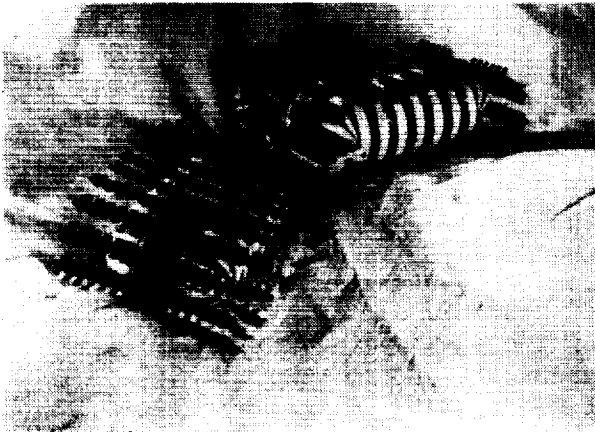

ORIGINAL PAGE IS  
OF POOR QUALITY

Figure 5-13. Three Types of Lunar Roving Vehicles

ORIGINAL PAGE  
BLACK AND WHITE PHOTOGRAPH

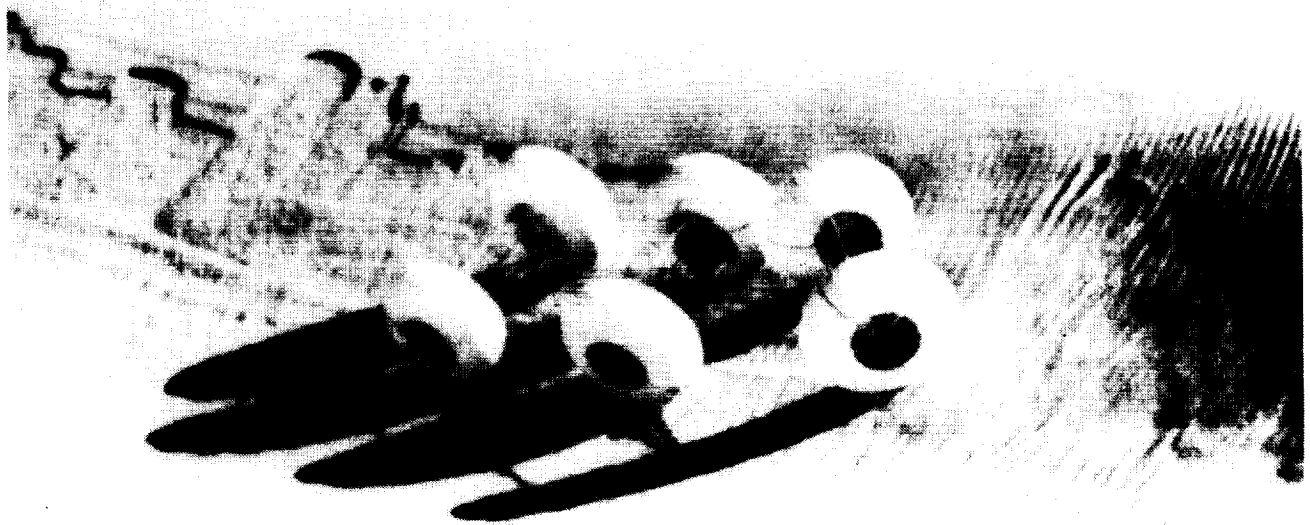
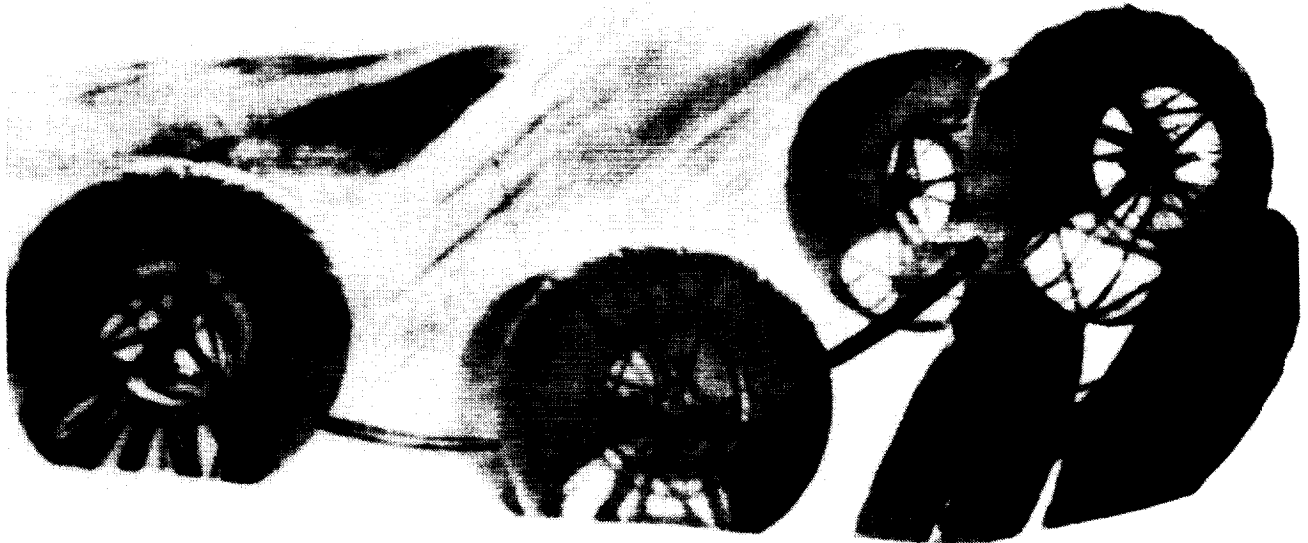
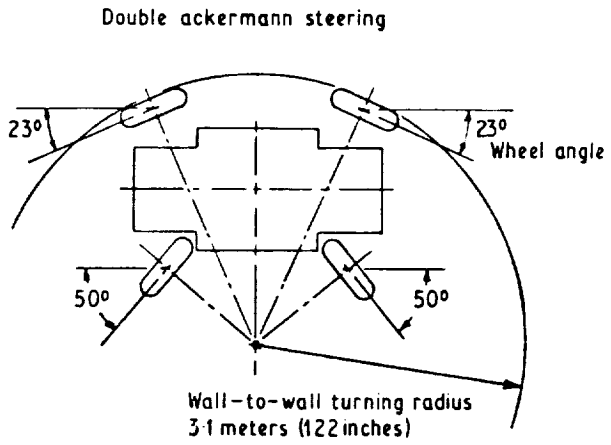
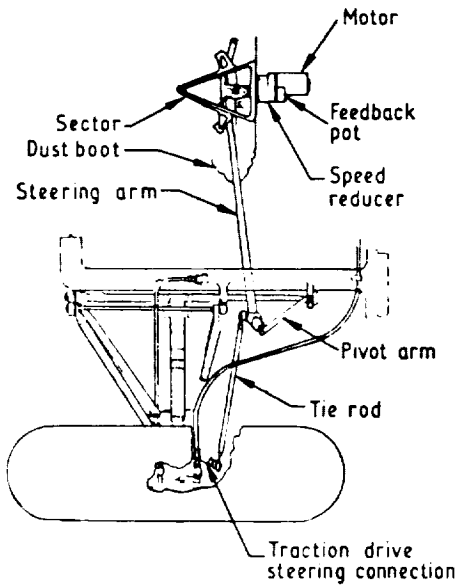

Figure 5-14. Elastic Frame Wheeled Lunar Vehicle With 3-Foot Diameter Wheels Operating in Sand Dunes

3-5-19

C-3

ORIGINAL PAGE IS  
OF POOR QUALITY



Capability verified by actual measurement on qual and flight no. 1 vehicles

Steering diagram

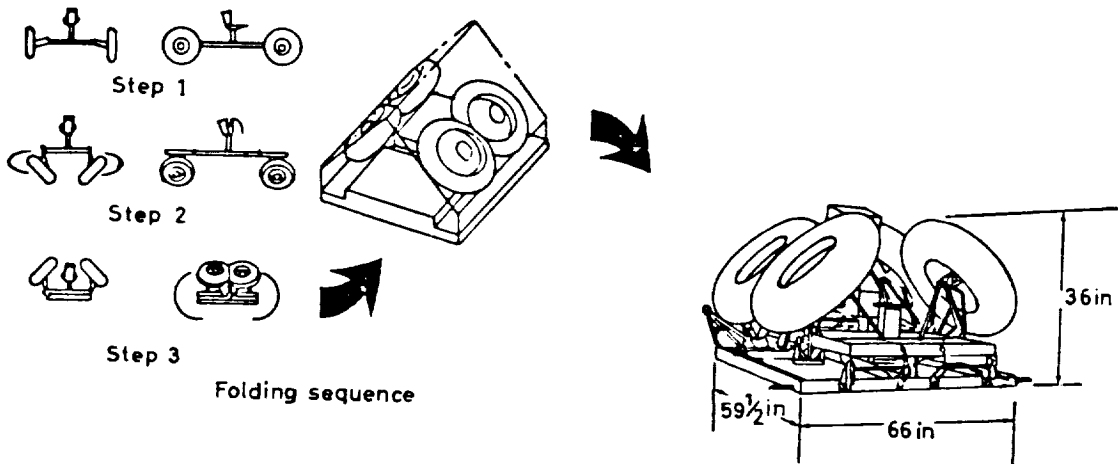

Figure 5-15. Folding Sequence for Lunar Roving Vehicle

Two topics were discussed, the six-legged walking vehicle built by Ohio State University (OSU), and a proposed six-wheeled vehicle using an actively suspended articulated chassis.

A gait is fundamental to walking, with machines as with animals. A gait is a leg sequencing rule. Walking, running, trotting, galloping are gaits. A variety of gaits may be used by a walking vehicle such as the Adaptive Suspension Vehicle. On reasonably smooth and level ground, the symmetric wave gaits are optimal. These are gaits in which the legs of each bilateral pair operate exactly  $180^\circ$  out of phase. The legs on each side of the vehicle operate at equal phase intervals in a rear-to-front side of the vehicle operate at equal phase intervals in a rear-to-front sequence. For crossing large obstacles, a paired gait is used in which the legs of each bilateral pair operate in phase. The leg pairs are operated in the same rear-to-front sequence as in a wave gait.

Figure 5-16 shows a time sequence for a six-step gait, which the OSU vehicle uses as its primary gait. Other gaits are used for stepping over crevices and for climbing. The machine is quite large, at least twelve feet long and perhaps a ton in weight. At present it walks at 2 mph. By the end of the summer it will be up to 5 mph. At that speed it will be limited by the computer. The mechanical equipment is capable of 8 mph. Figure 5-18 shows the machine in the laboratory.

The business of turning corners is quite complex. To avoid scuffing, the computer must optimize normal to tangential foot forces. The present system uses sub-optimal solutions which resolve the motions into components. Figure 5-18 shows the components for two legs rotating the vehicle about point "C." In order to accomplish this, the machine has 18 actuator degrees of freedom resulting in 6 output degrees of freedom.

The active suspension system to be studied is shown in Figure 5-19. Coordination of wheeled locomotion systems presents some problems which are similar to those of legged systems, and some which are different. Of course, there is no equivalent of gait in a wheeled system. However, the problem of distributing force among the actuators is important. It is complicated by the wheel action, and by suspension and steering geometry. In conventional vehicles, the force distribution problem is solved approximately by passive mechanisms: differentials. This approach is likely to be unsatisfactory for agile vehicles with long effective suspension travel to minimize suspension saturation.

One of the features of this design is the ability to upright itself from a position lying on its side. The proposed sequence for this maneuver is shown in Figure 5-20. The primary advantage of such an active suspension system is to improve traction and climbing ability.

Time Sequence

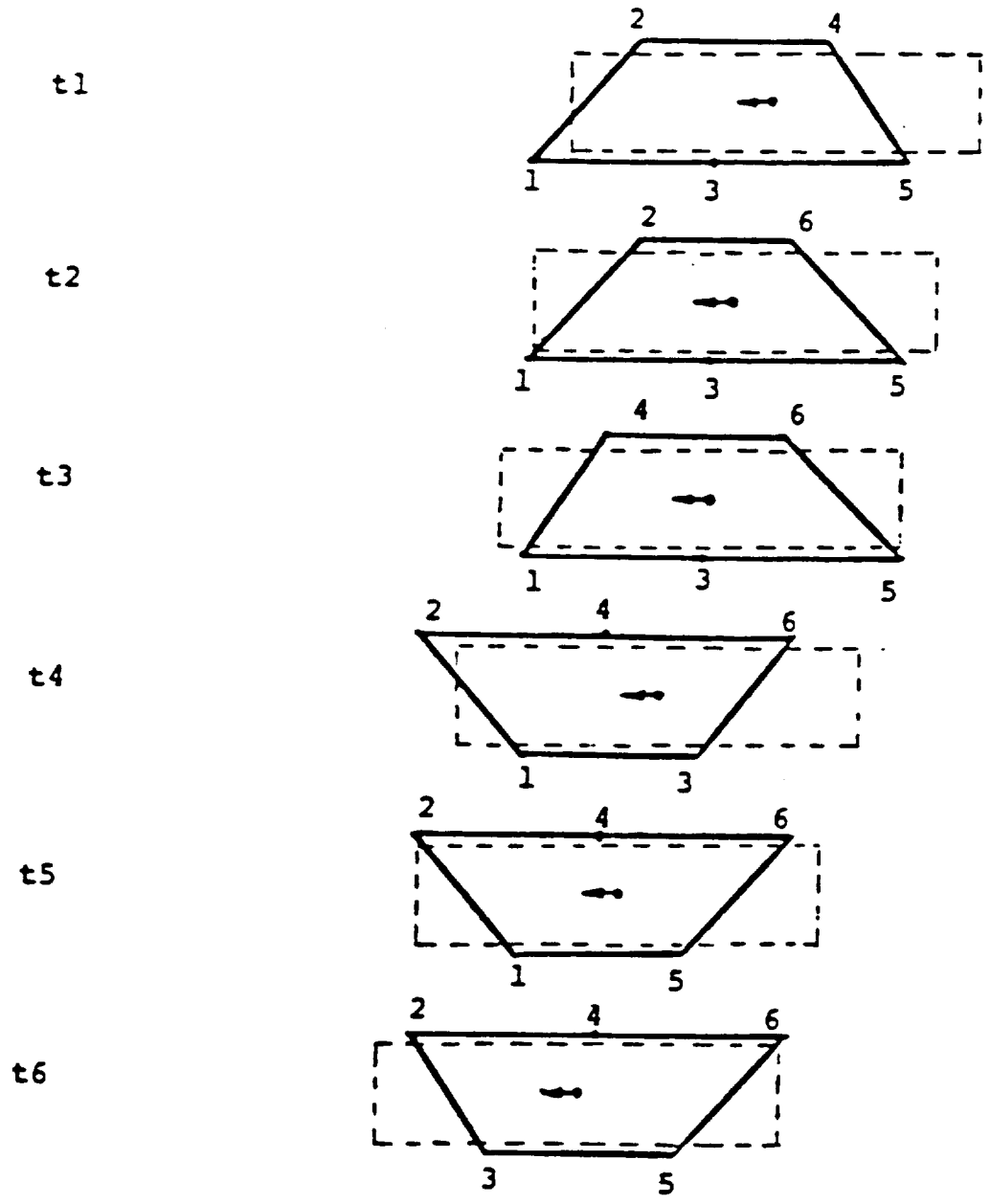
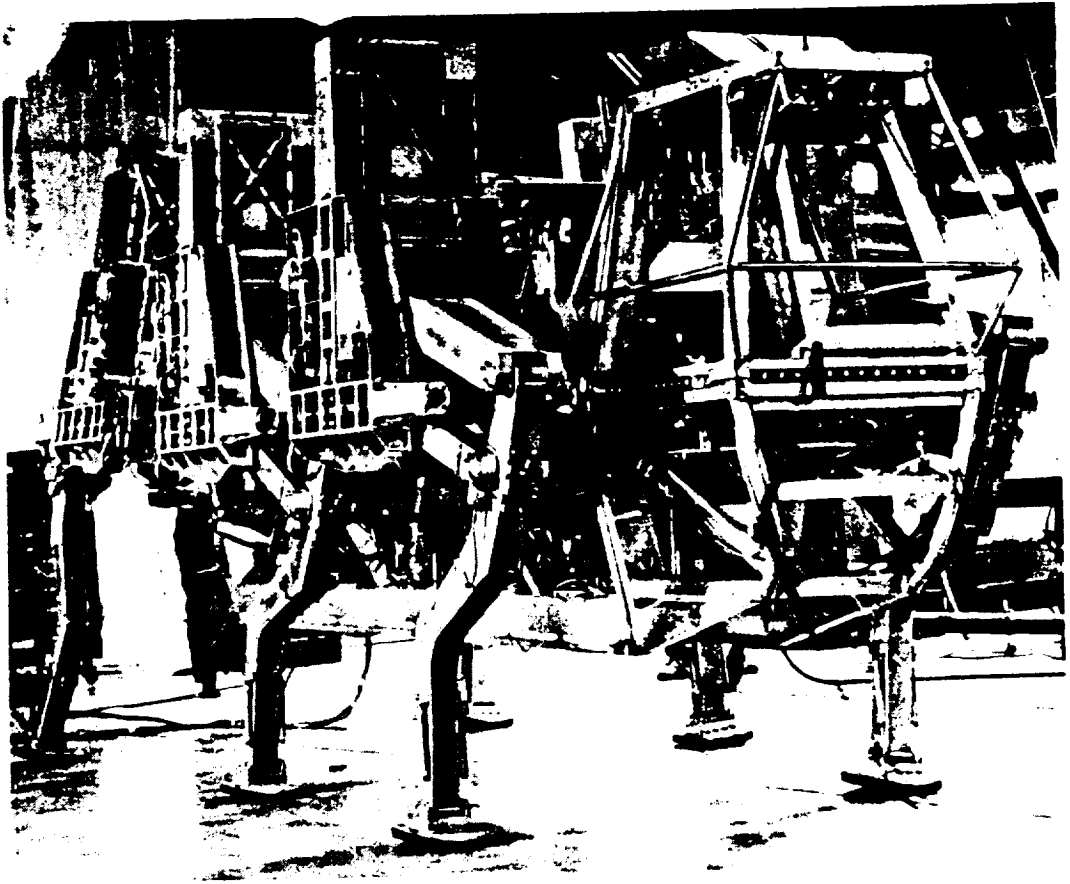

Figure 5-16. A Successive Gait Pattern





This machine exemplifies the legged system technology. The Adaptive Suspension Vehicle system software installation is in progress. The vehicle has been operated in both manual and automated coordination modes.

Figure 5-17. The Adaptive Suspension Vehicle in the Laboratory

**ORIGINAL PAGE IS  
OF POOR QUALITY**

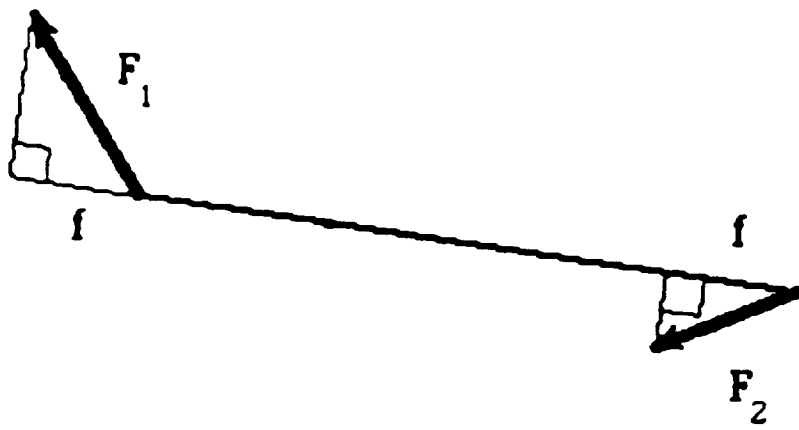

(a)

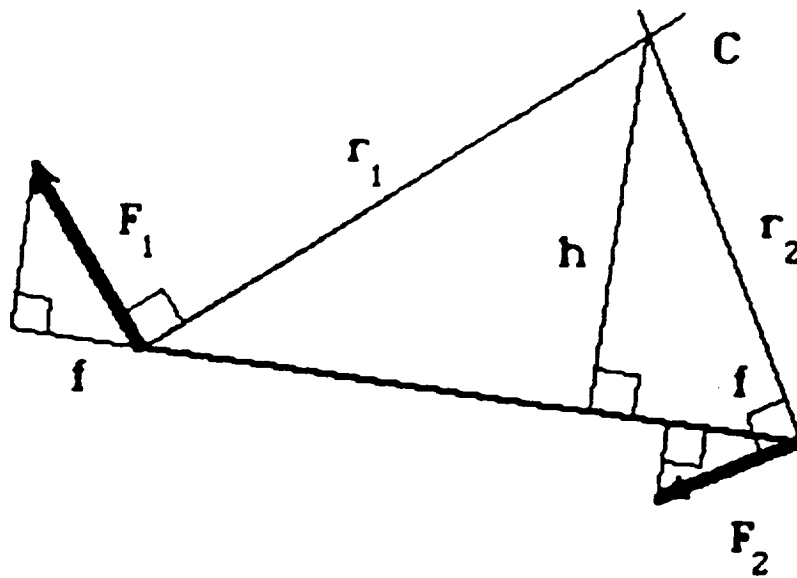

(b)

$$\frac{r_1}{h} = \frac{F_1}{a}, \quad \frac{r_2}{h} = \frac{F_2}{a}, \quad \frac{r_1}{r_2} = \frac{F_1}{F_2}$$

Figure 5-18. Components for Two Legs Rotating Vehicle About Point "C"

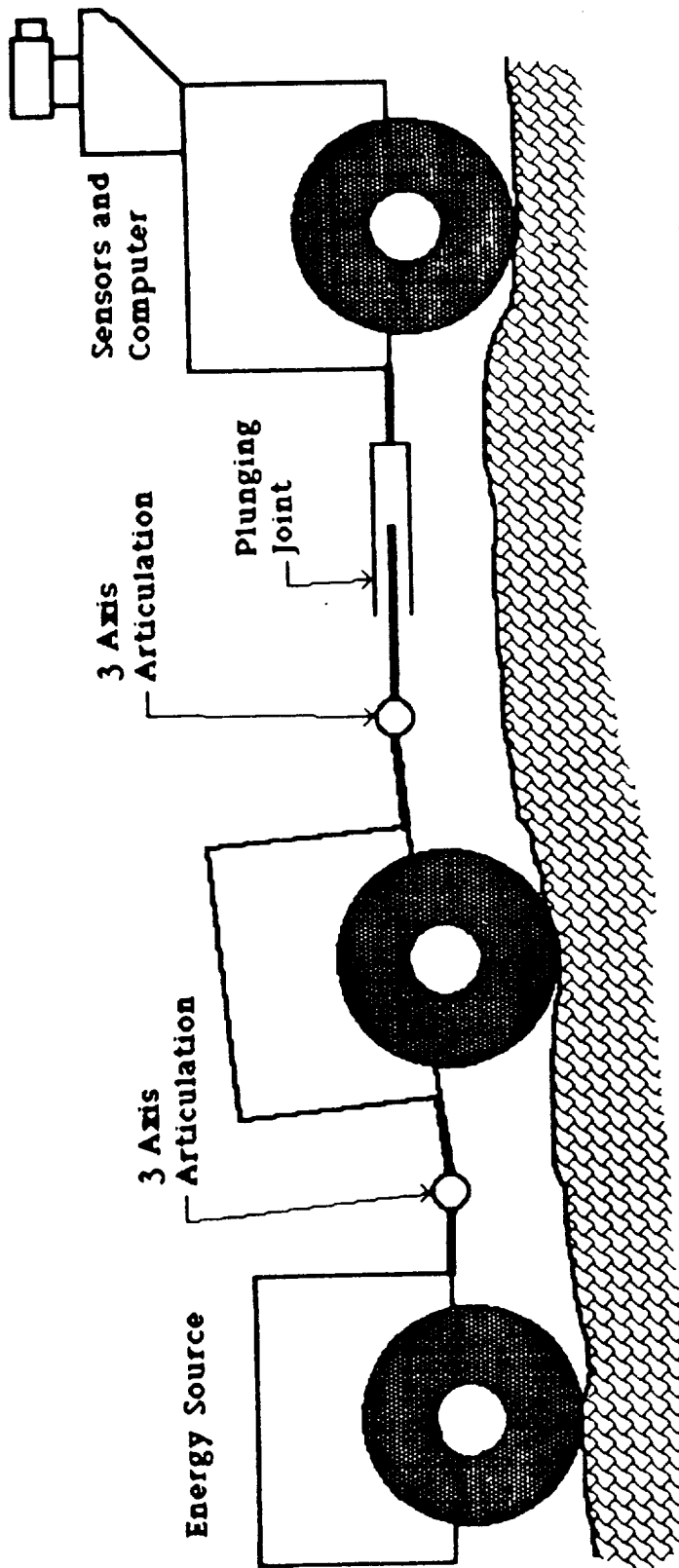

It is assumed that the vehicle center of mass power supply module is above the middle is heavier than the axle line when the other 2 modules. The plunging joint is at axle distances are mid-stroke. arranged so that the

All articulation axes, and the plunging joint, are actuated.

Figure 5-19. Active Suspension System To Be Studied

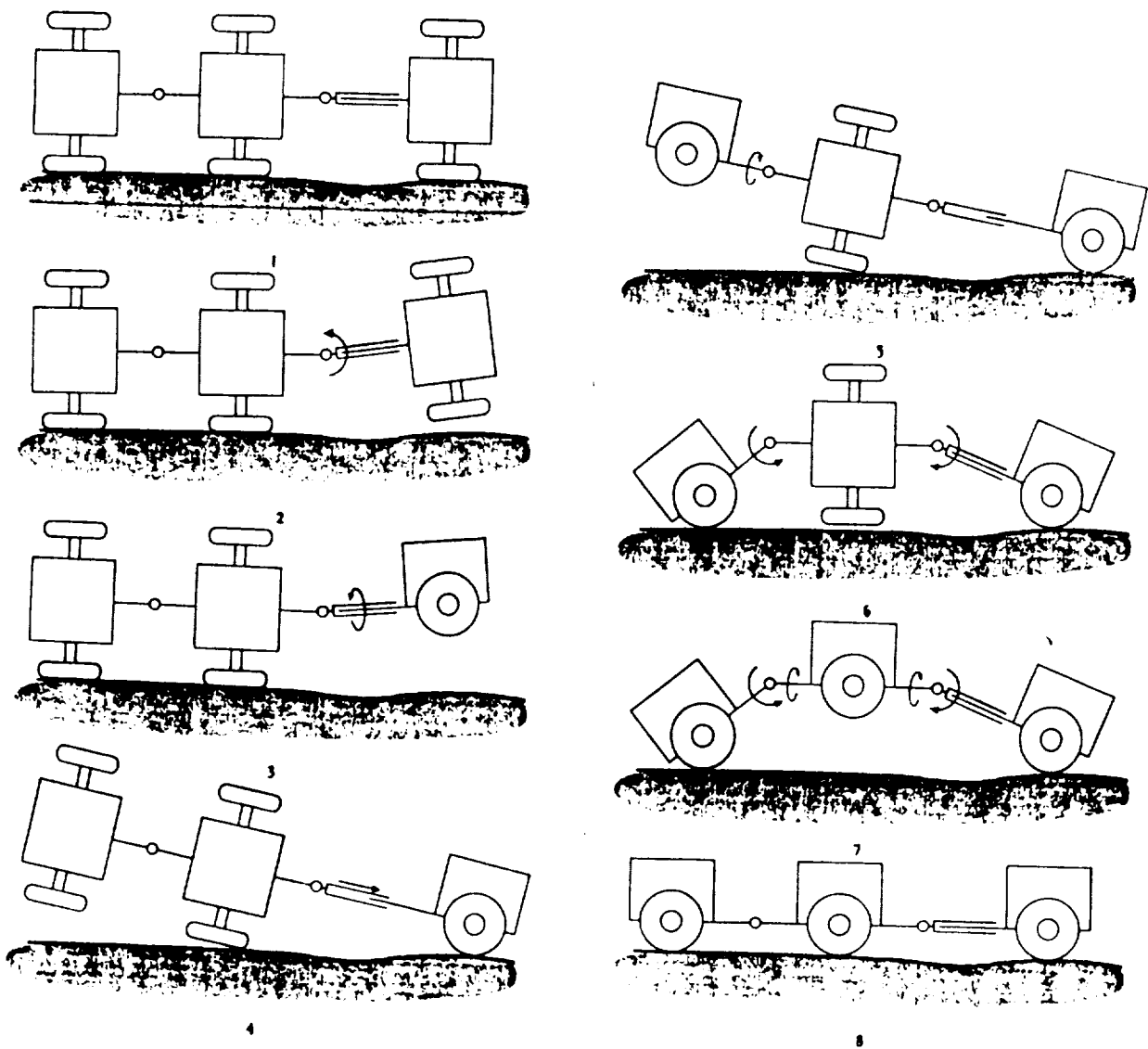

Figure 5-20. Proposed Sequence for Uprighting Maneuver

**The Mechanics of Mobile**

**Robotic Platforms**

by

**Kenneth J. Waldron**

**Nordholt Professor**

**Department of Mechanical Engineering**

**The Ohio State University**

**Columbus, Ohio 43210**

# **Major Configuration Design Issues for Mobile Platforms**

- \* Mobility
- \* Power Consumption
- \* Coordination
- \* Sensing Requirements

## Coordination

Coordination is the determination of the command variables to be sent to the actuator servos in order to produce the desired motion of the vehicle body. Most robotic platforms are **overconstrained**, that is, the number of actuators is larger than the number of body degrees of freedom to be controlled. Therefore, the system is redundant. Overconstrained systems which have closed loops require that their actuators be **force controlled**. That is, actuator force must be sensed and must be the primary feedback variable.

## **Platform Degrees of Freedom**

Vehicles move over a surface. Surface motion allows, at most, three degrees of freedom. Of course, real vehicle bodies move with six degrees of freedom. However, it is convenient to regard the additional three degrees of freedom as being provided by the vehicle's suspension.



Controlled Degrees of Freedom  
of Different Types of Mobile Platform

	Articulated Steering	Skid Steering	Omni-Directional
Longitudinal displacement	position	position	position
Lateral displacement	---	---	position
Heading	rate	position	position

## Gait

A gait is a leg sequencing rule. Walking, running, trotting, galloping are gaits. A variety of gaits may be used by a walking vehicle, such as the Adaptive Suspension Vehicle. On reasonably smooth and level ground, the symmetric wave gaits are optimal. These are gaits in which the legs of each bilateral pair operate exactly  $180^{\circ}$  out of phase. The legs on each side of the vehicle operate at equal phase intervals in a rear-to-front sequence. For crossing large obstacles, a paired gait is used in which the legs of each bilateral pair operate in phase. The leg pairs are operated in the same rear-to-front sequence as in a wave gait.

Time Sequence

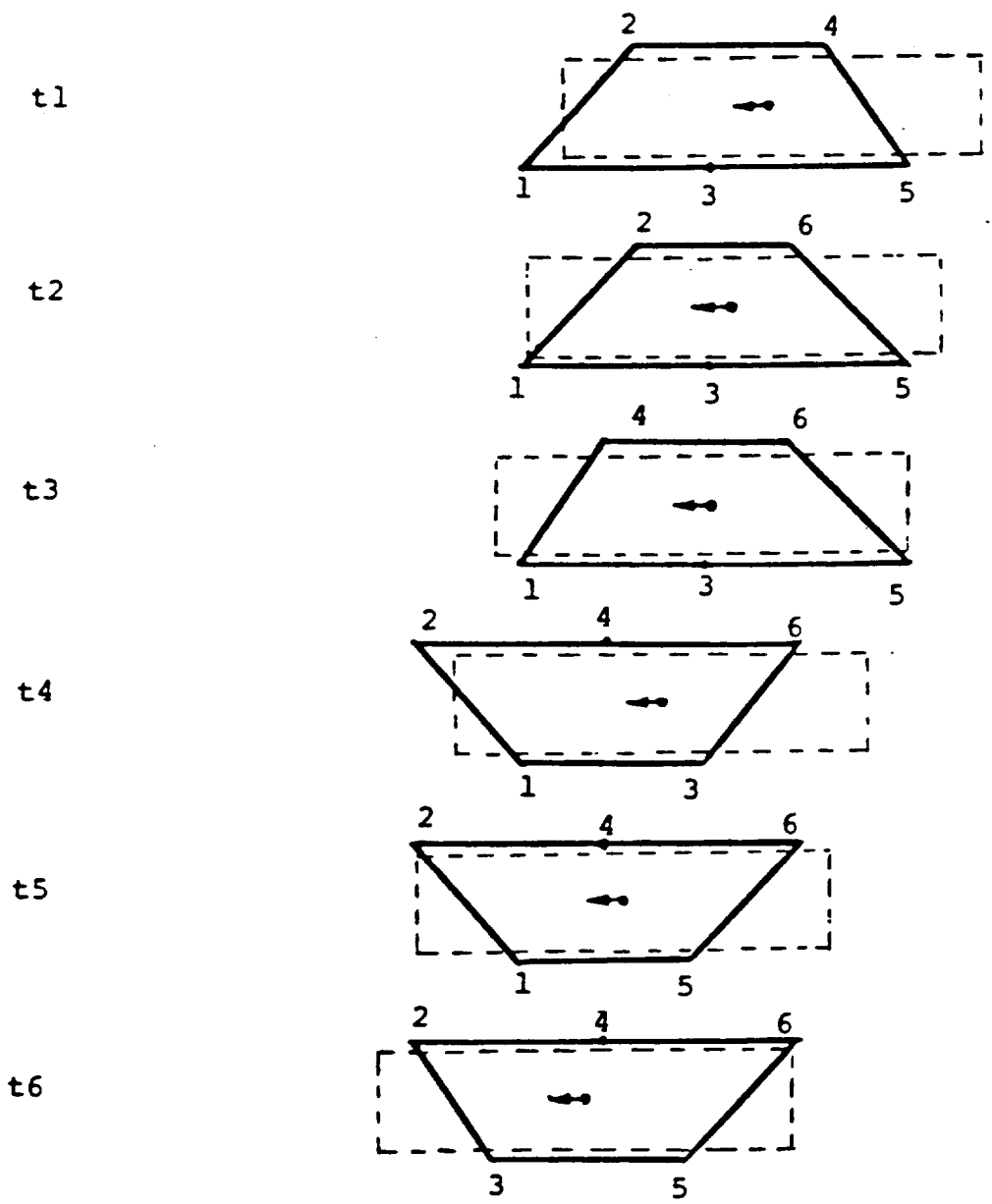

A successive gait pattern.

ORIGINAL PAGE IS  
OF POOR QUALITY

$$S = (n/2 - 1) \cdot P + (1 - 3/(4\beta)) \cdot R \quad R \leq P, \quad \frac{1}{2} \leq \beta < 1$$

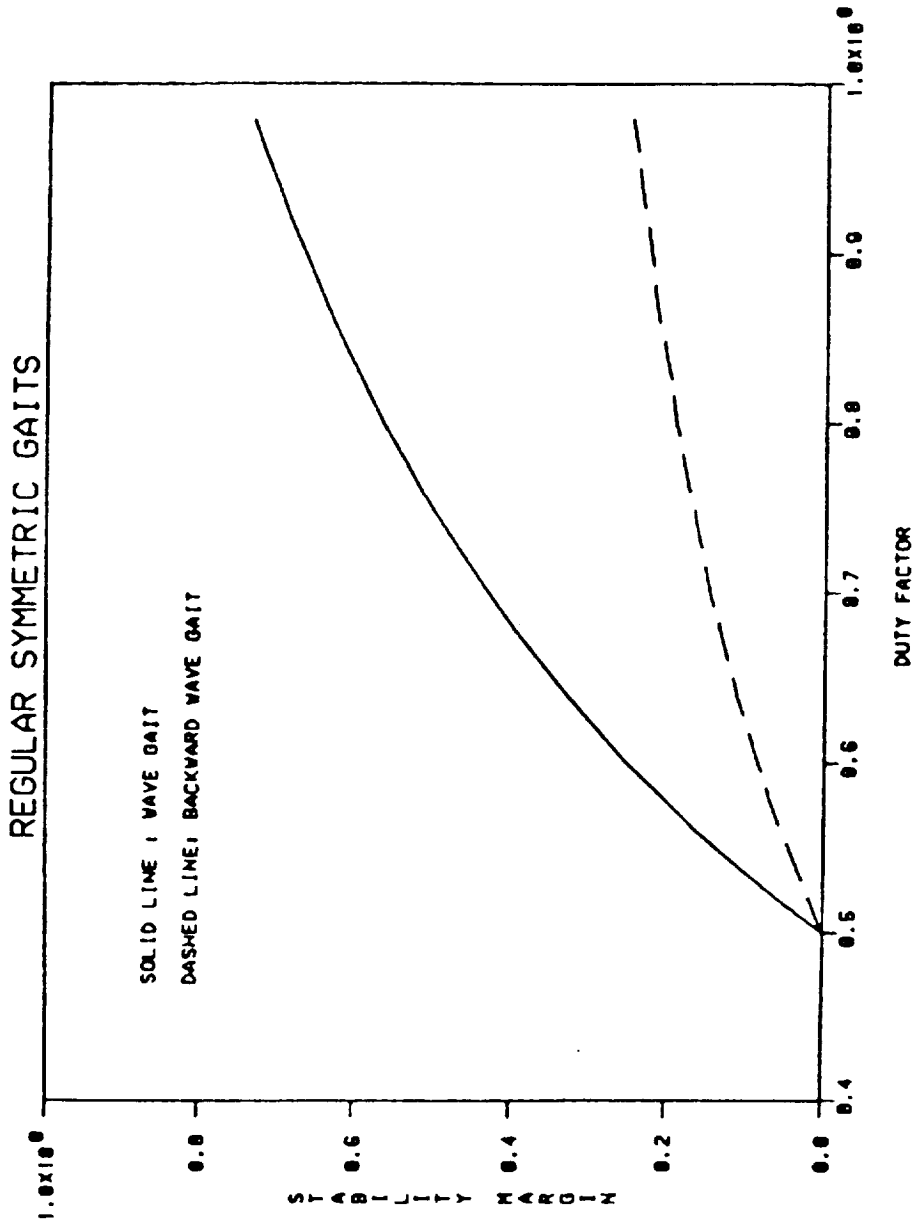
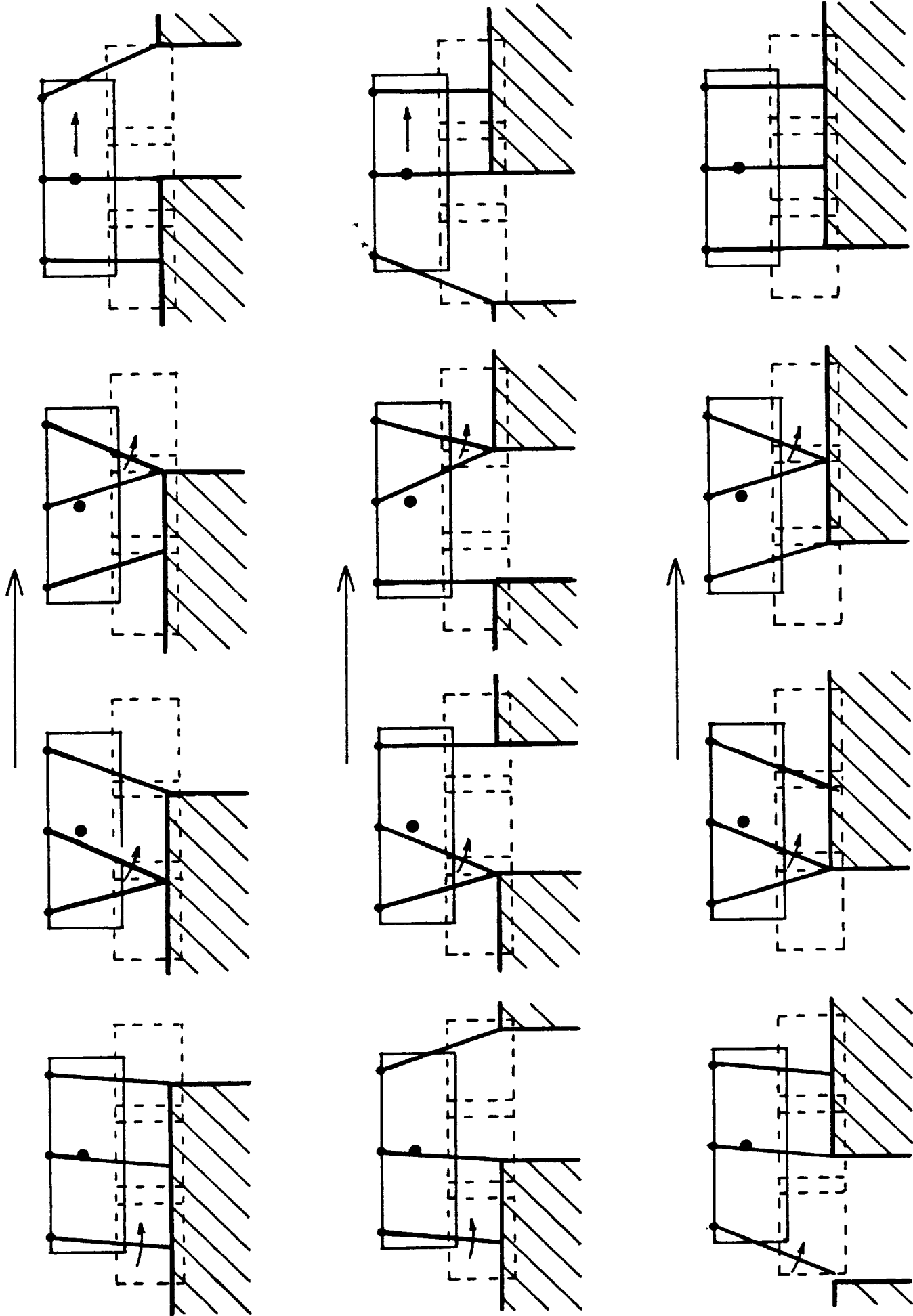

Figure 3.13: Gait stability margin of wave gaits and backward wave gaits.



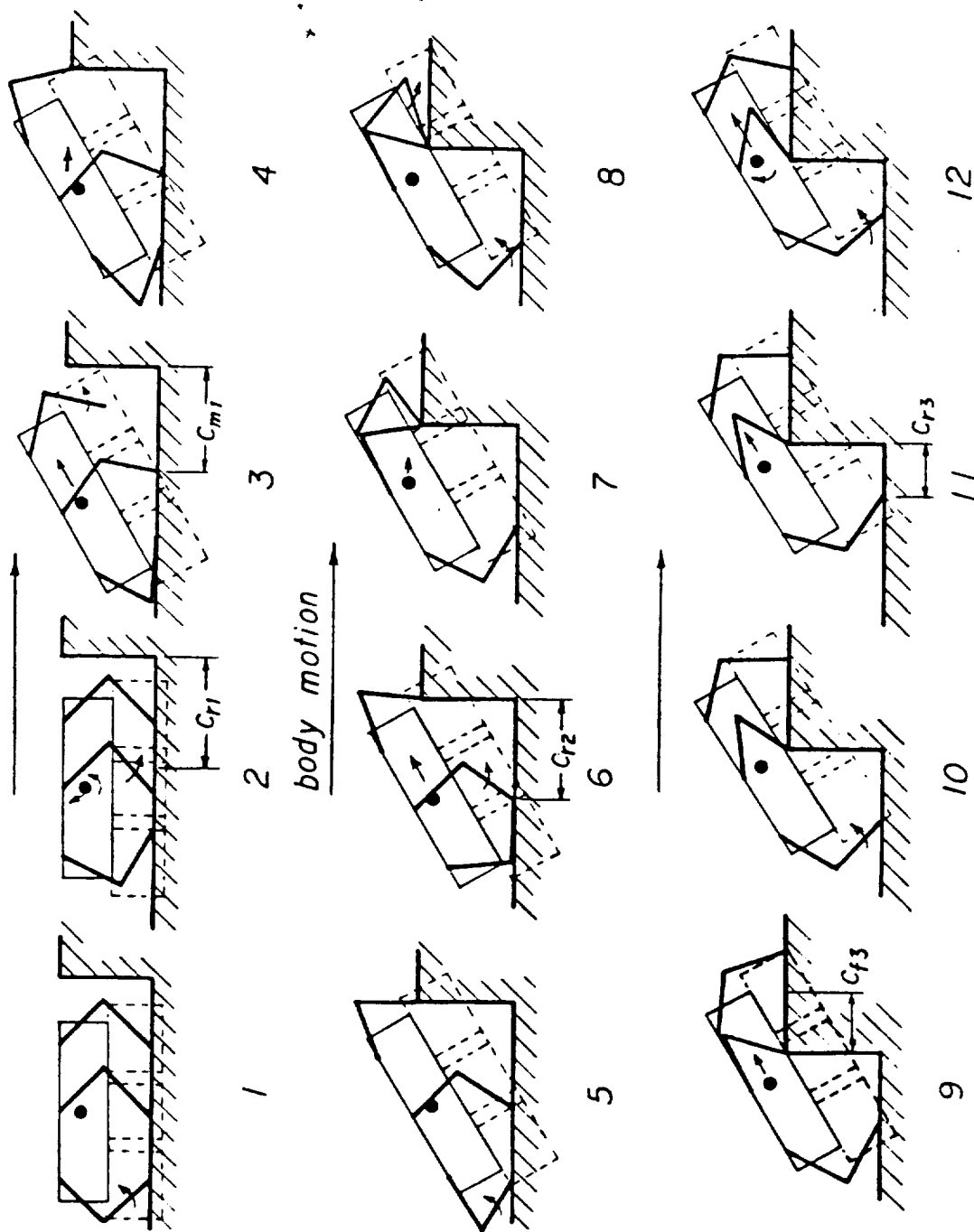
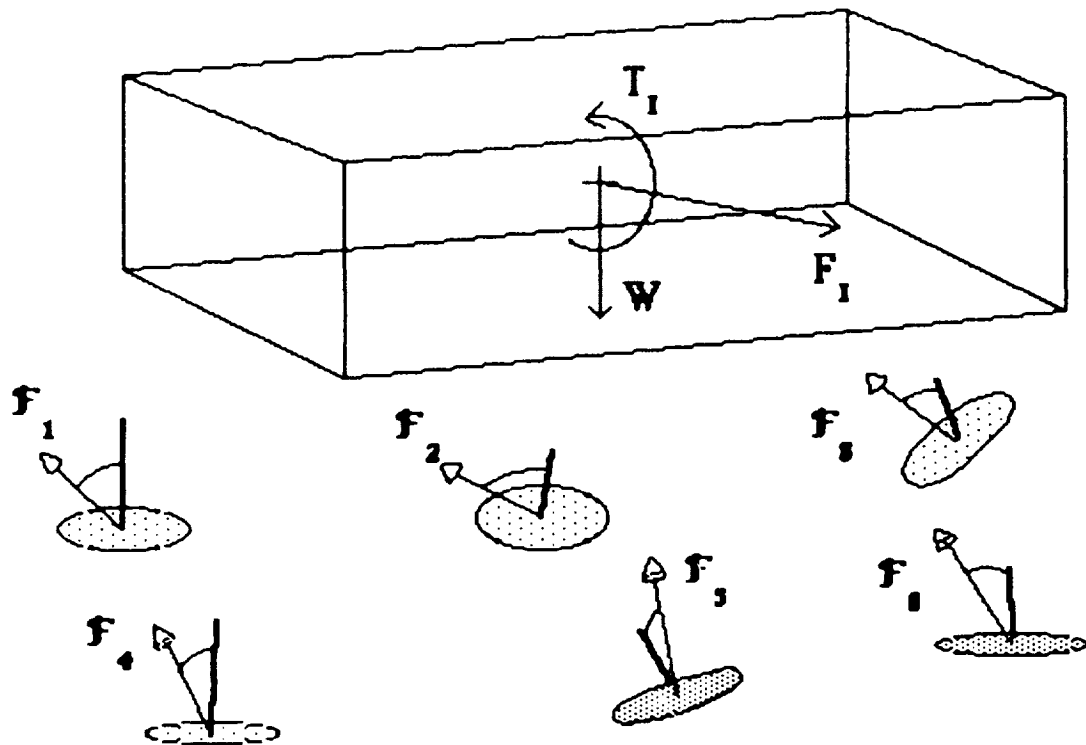
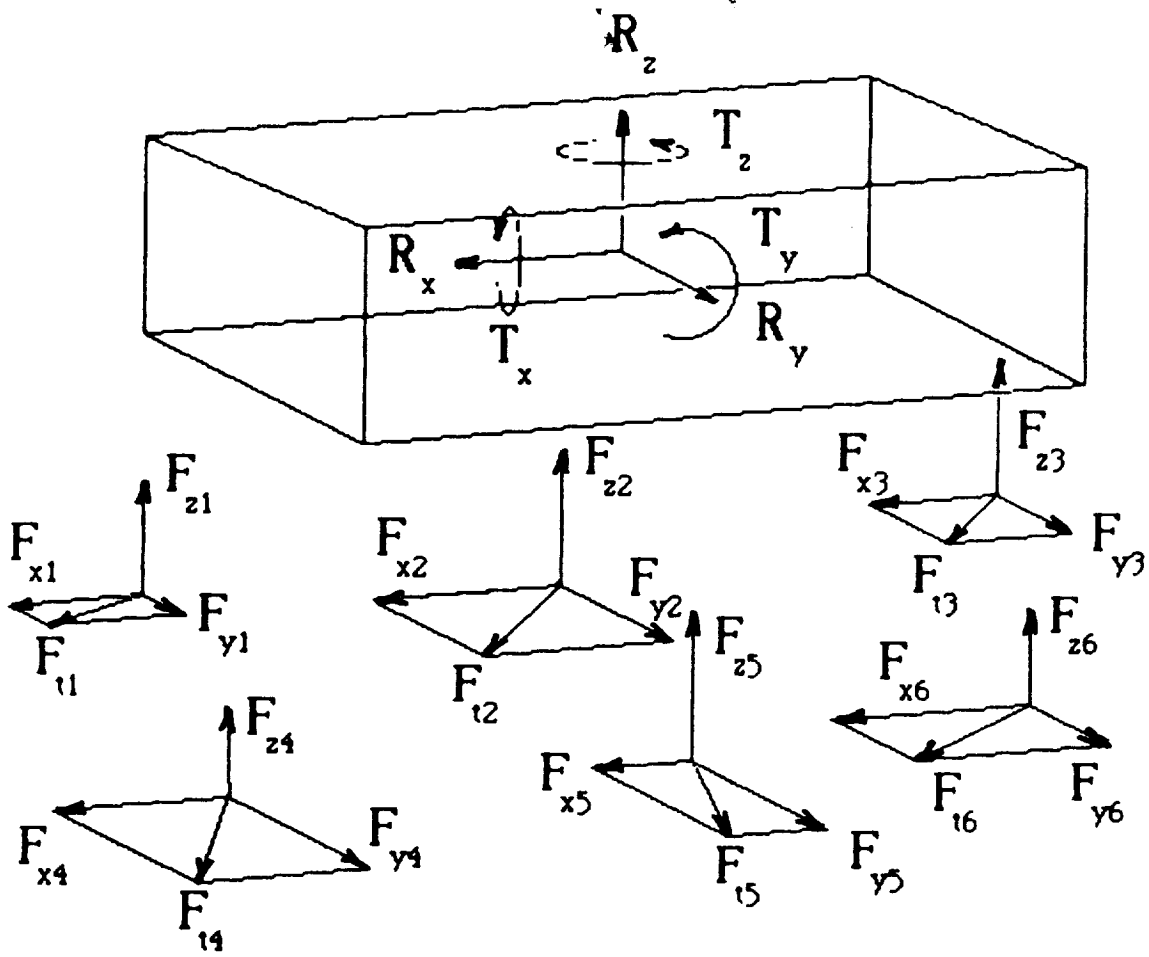

Figure 4.19: Lateral motion sequence of a stepping up.



**Force System Acting on Legged Vehicle**

ORIGINAL PAGE IS  
OF POOR QUALITY





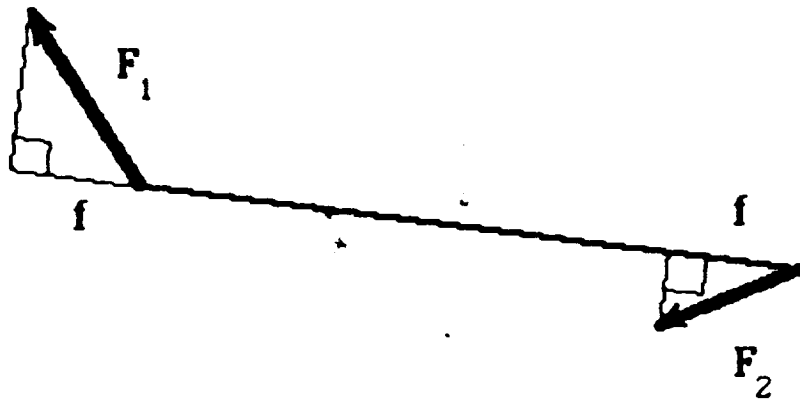

(a)

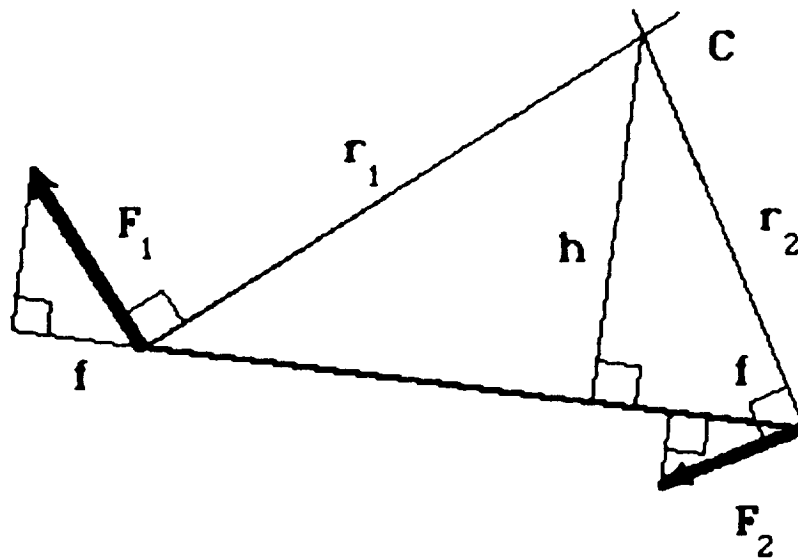

(b)

$$\frac{r_1}{h} = \frac{F_1}{a} \quad , \quad \frac{r_2}{h} = \frac{F_2}{a} \quad , \quad \frac{r_1}{r_2} = \frac{F_1}{F_2}$$

ORIGINAL PAGE IS  
OF POOR QUALITY

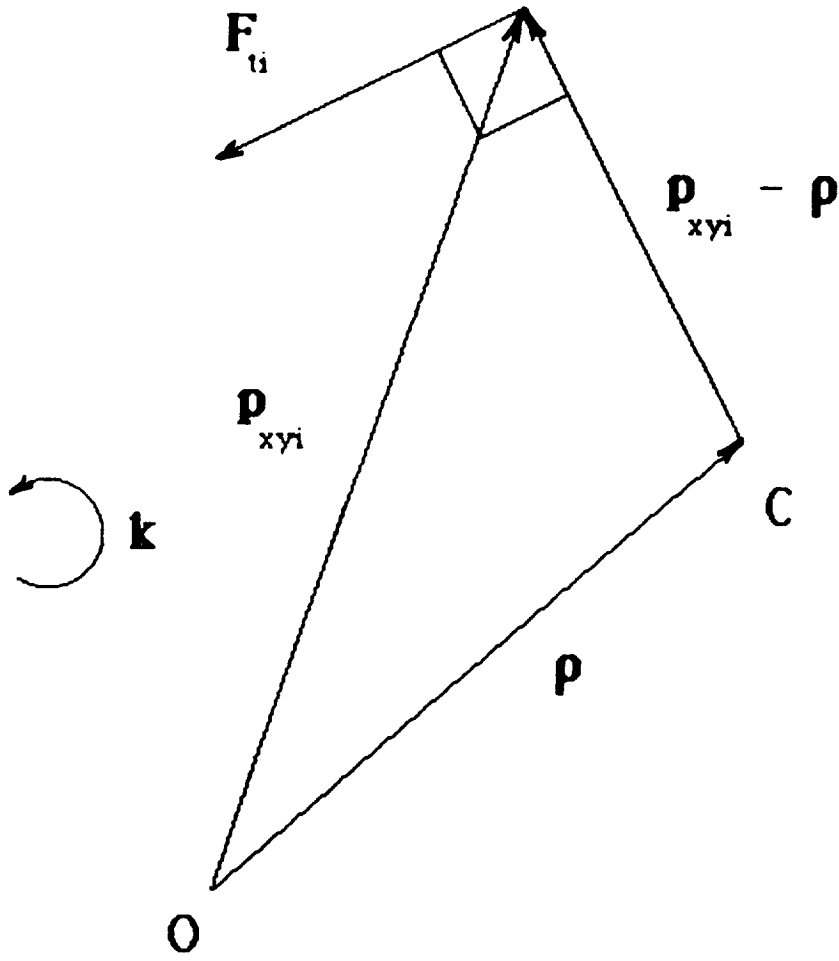

## **Coordination of Wheeled Locomotion Systems**

Coordination of wheeled locomotion systems presents some problems which are similar to those of legged systems, and some which are different. Of course, there is no equivalent of gait in a wheeled system. However, the problem of distributing force among the actuators is important. It is complicated by the wheel action, and by suspension and steering geometry. In conventional vehicles, the force distribution problem is solved approximately by passive mechanisms: differentials. This approach is likely to be unsatisfactory for agile vehicles with long effective suspension travel to minimize suspension saturation.

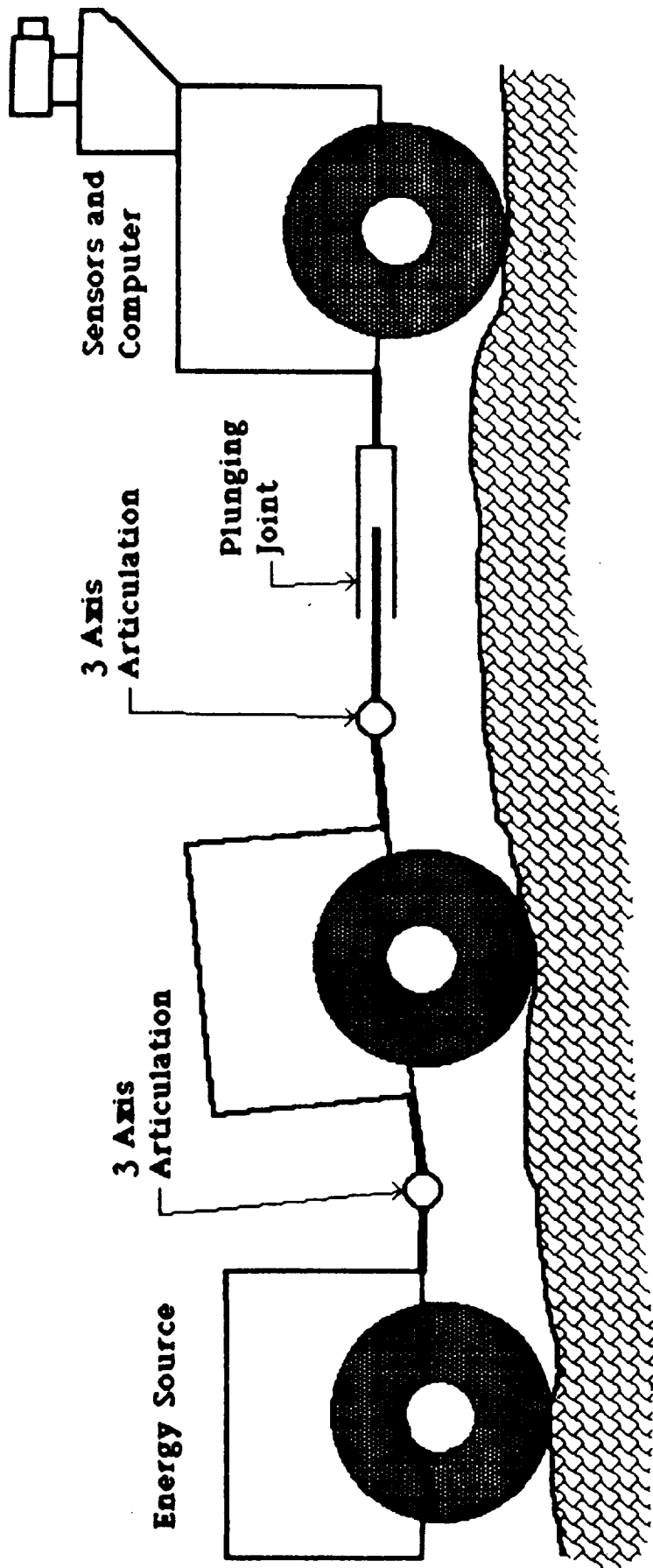

It is assumed that the vehicle center of mass power supply module is above the middle is heavier than the axle line when the other 2 modules. The plunging joint is at axle distances are mid-stroke. arranged so that the

All articulation axes, and the plunging joint, are actuated.

1

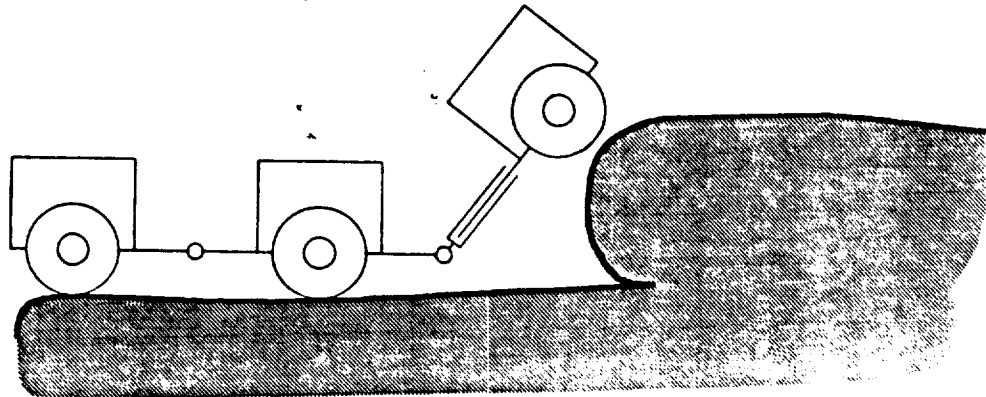

2

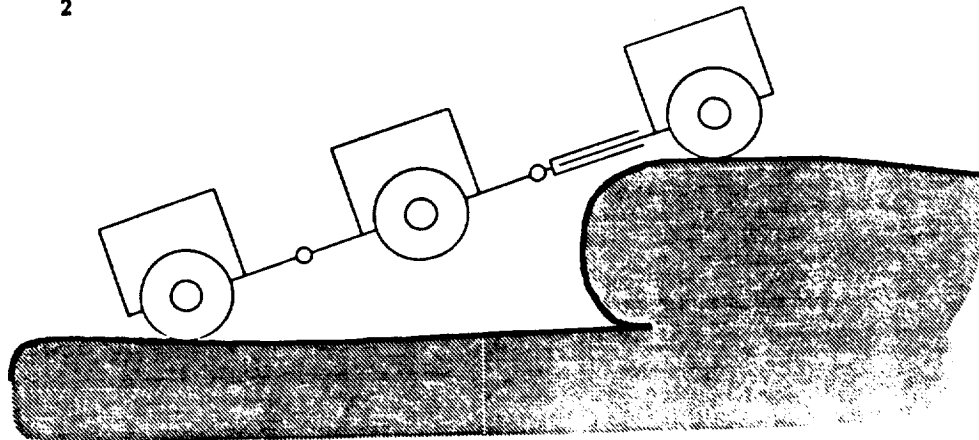

3

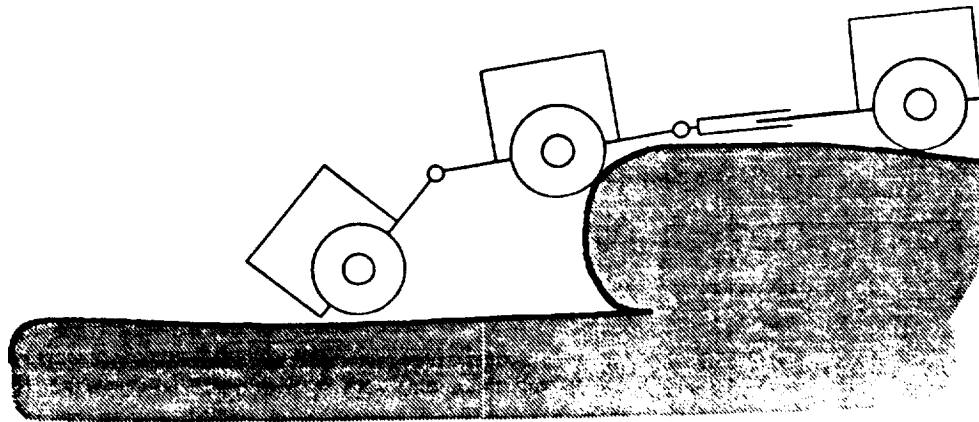

ORIGINAL PAGE IS  
OF POOR QUALITY

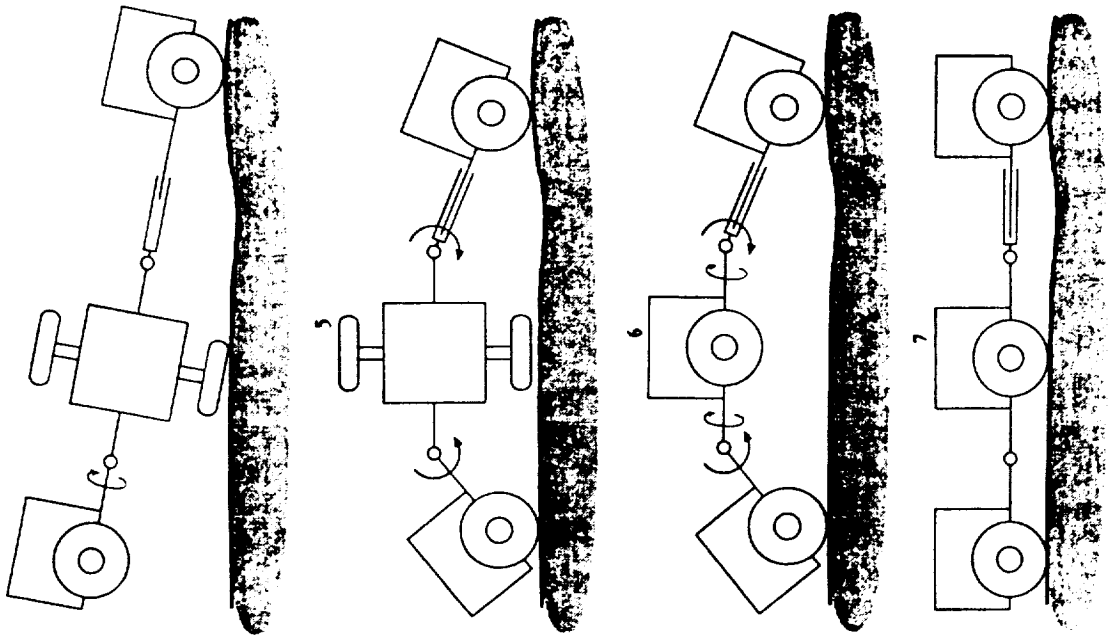
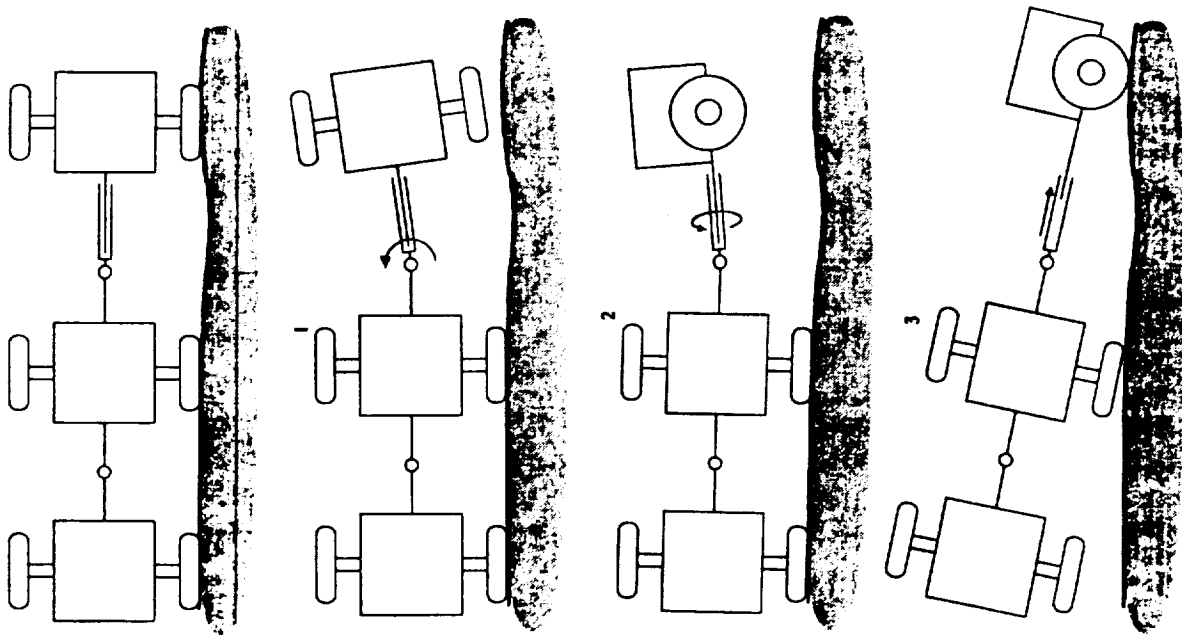

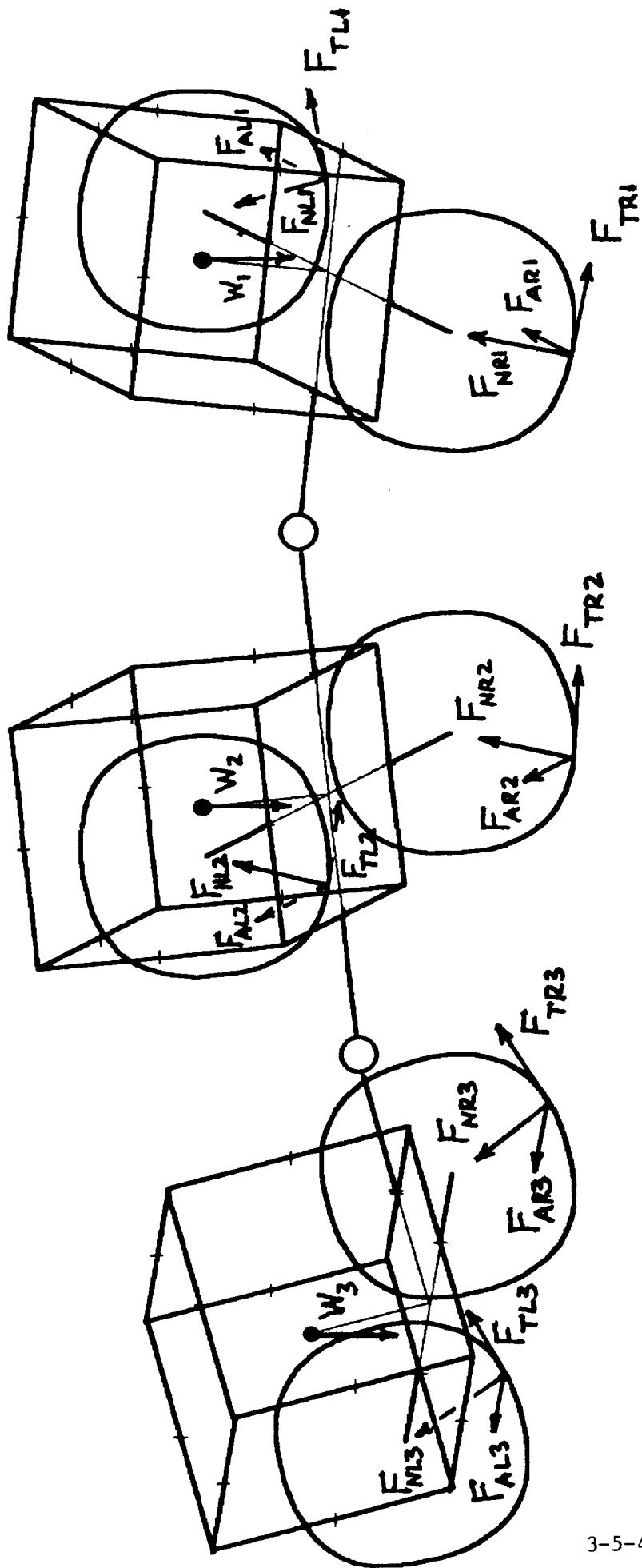

## **Mobility**

May be characterized by considering performance with respect to two terrain regimes:

Small amplitude terrain variations

Large obstacles



## **Available Terrain Characterization Data**

- \* Power spectral densities for graded terrain. Used to drive analyses of conventional vehicle dynamics.**
  
- \* Some "random walk" amplitude probability type data available (Fort Eustis Study).**

## **Small Amplitude Terrain Variations**

Suspension behaves as low-pass filter removing high frequency components of terrain variation. Performance can be characterized by attenuation of power spectral density of terrain "signal". Yields good comparison between rolling and legged systems. Rolling suspensions behave as analog systems. Legged locomotion systems behave as sampled data systems. The filtering effects can be directly compared.

Terrain data is most usefully presented in the form of power spectral density versus wavelength plots.

# Terrain Smoothing

## Terrain Modification

- \* Grading removes high frequency irregularities. Allows use of vehicles with short characteristic length.

## Locomotion System Smoothing

- \* Tracked, and multiple, load-sharing wheeled vehicles average the terrain, effectively filtering out high frequency irregularities.
- \* Legged vehicles sample the terrain at discrete intervals, and so do not see irregularities of wavelength less than twice the stroke.

## Power Spectral Density of Body Motion

For continuous system:

$$W_y(\omega) = |H(\omega)|^2 W_x(\omega)$$

where  $W_y$  is power spectral density of resultant motion,  $W_x$  is power spectral density of terrain,  $H$  is impulse response of suspension.

For legged system:

$$W_y(z) = H(z^{-1}) H(z) W_x(z).$$

In this case  $H(z)$  is determined by the algorithm used to control body displacement and attitude.

POWER SPECTRAL DENSITY

Attenuation vs. Wavelength

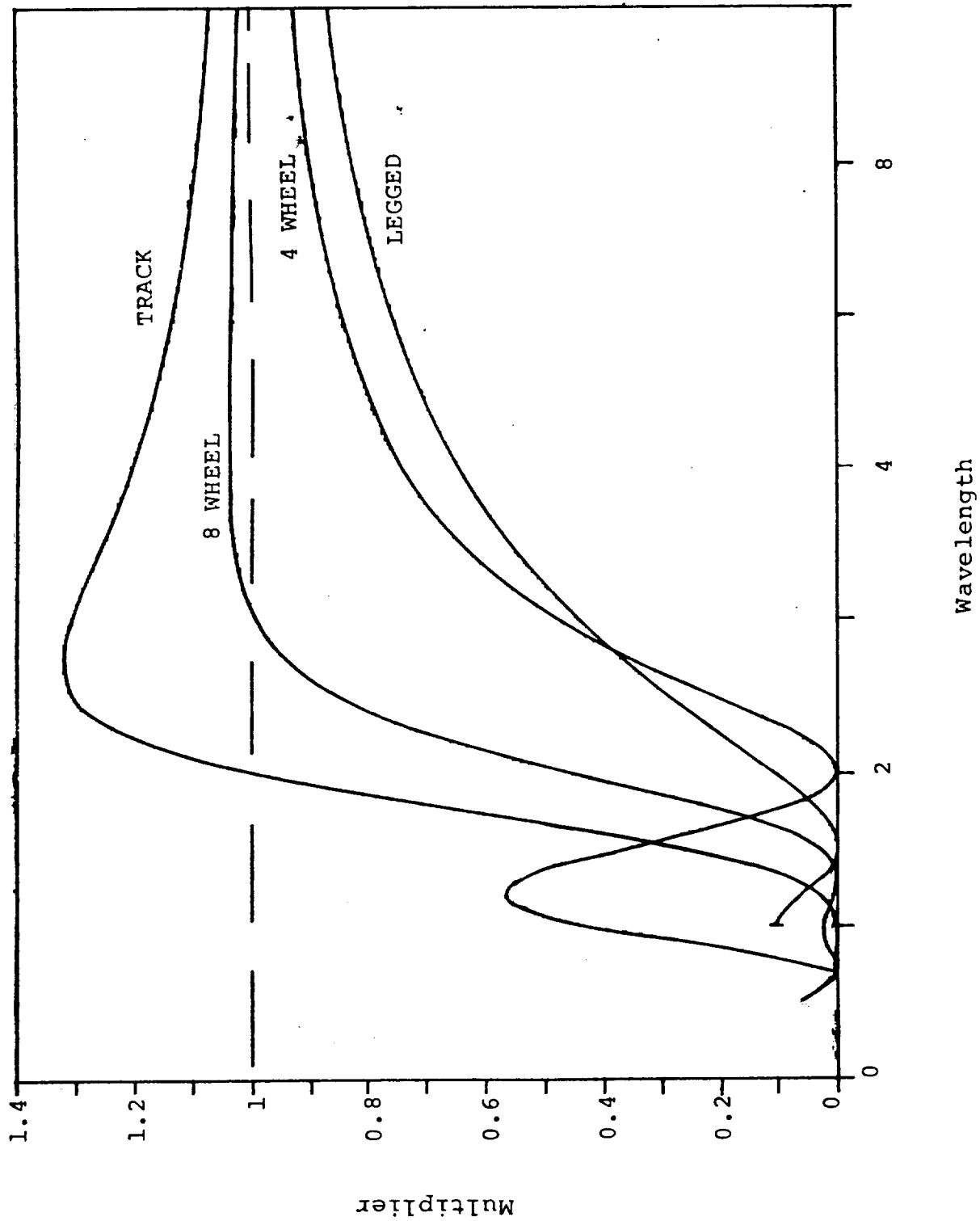

## Large Obstacles

Passive suspensions saturate after relatively modest suspension travel. Encounters with terrain variations beyond saturation amplitude will usually result in damage to vehicle. Hence, such "obstacles" must be actively avoided. Saturation amplitudes of legged systems are an order of magnitude larger than those of passive suspensions.

Past practice has been to characterize large obstacle performance either in terms of one parameter obstacles, or by performance envelopes requiring specification of the complete vehicle geometry. The former is too limited for good description of performance. The latter requires too much extraneous detail to be useful in comparative studies. A two parameter obstacle characterization is a compromise. It is a natural characterization for a legged system, but is less so for passive suspension systems. Adequate characterization of the latter requires use of several sub-types of obstacle.

Terrain data is most useful in the form of probabilities of encounter of obstacles of given amplitude in a random traverse of specified length.

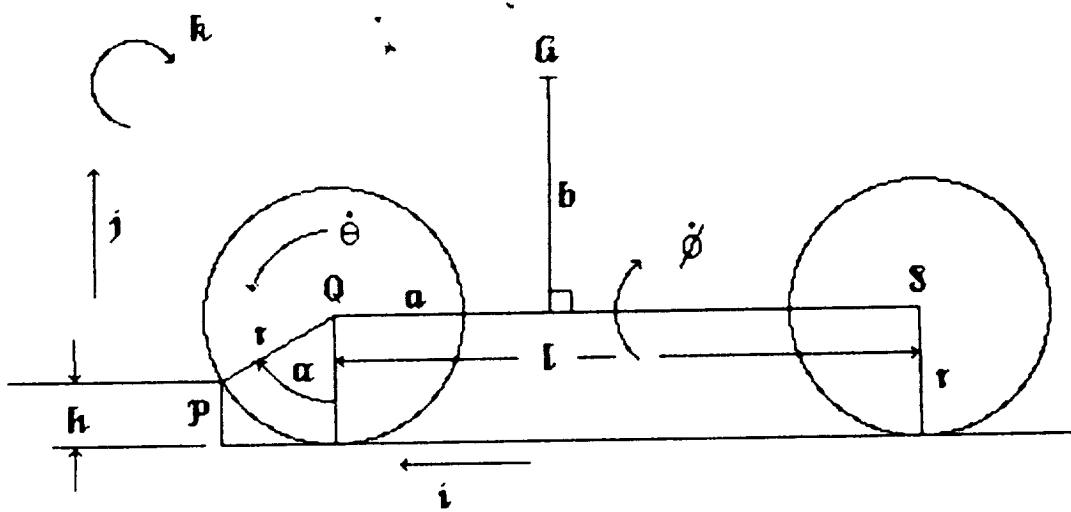

EFFECT OF STEP ON PLATFORM VELOCITY

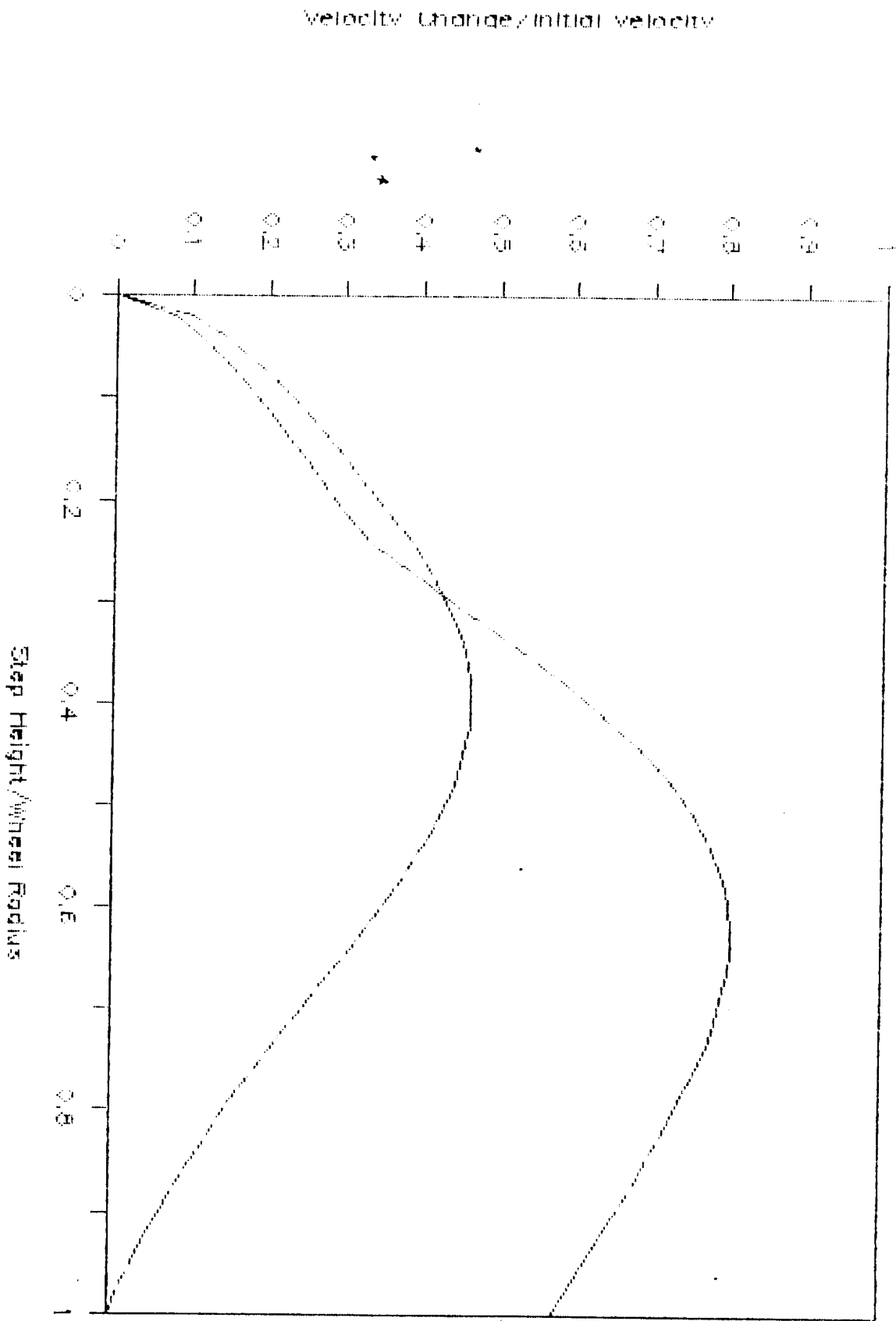



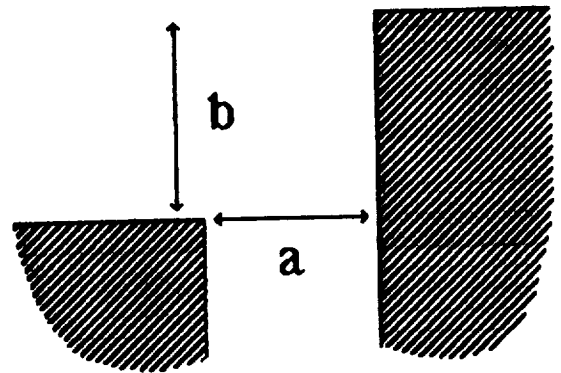
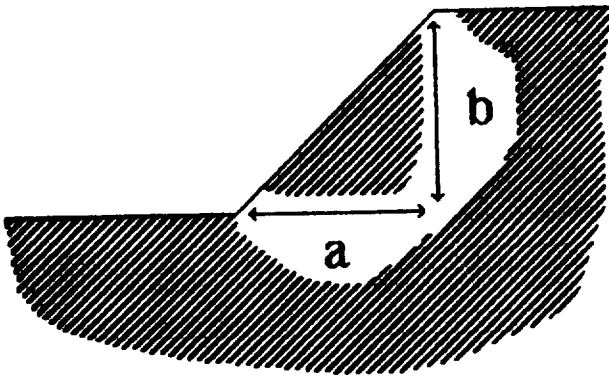
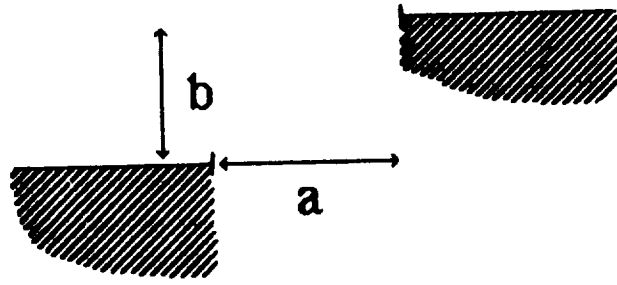

## Two Parameter Obstacles

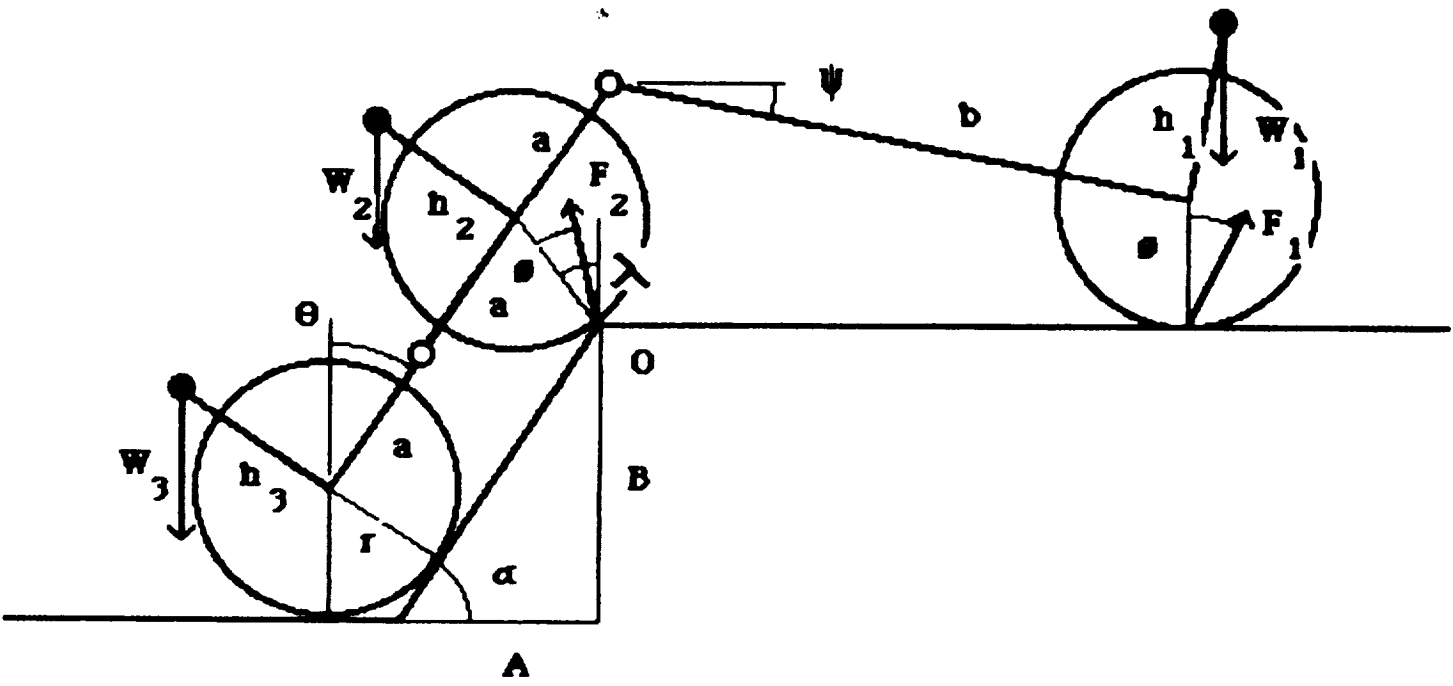

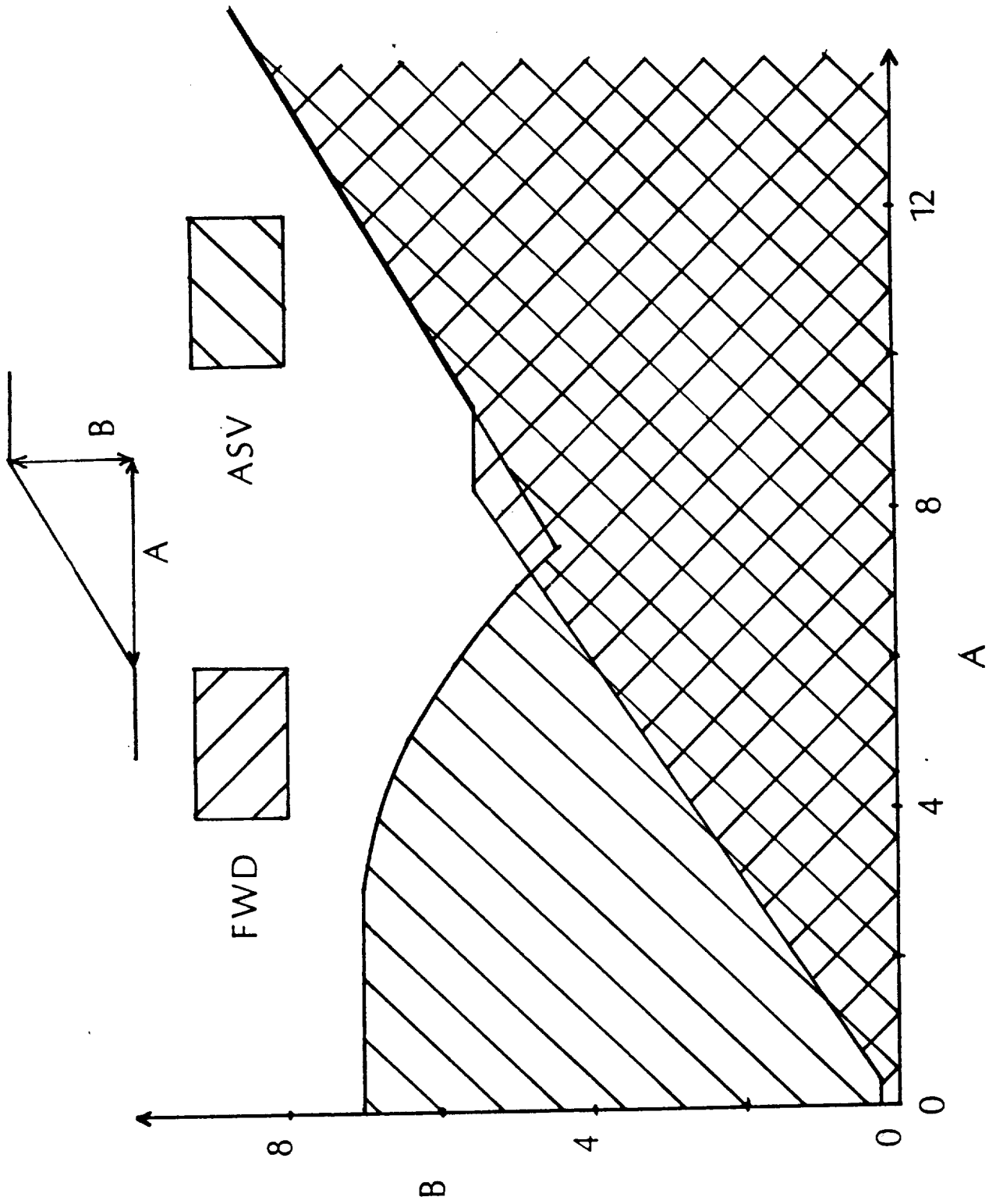

# PERCENTAGE OF AREA NOT SUITABLE FOR CONVENTIONAL TRACKED VEHICLES\*

## EUROPE (50%)

30% — TOO STEEP, RUGGED  
12% — DENSE FOREST  
3% — WET, MARSHY  
5% — COMBINATION OF ABOVE, OTHER

## AFRICA (25%)

12% — TOO STEEP, RUGGED  
2% — WET, MARSHY  
6% — DENSE FOREST  
5% — COMBINATION OF ABOVE, OTHER

## USSR (55%)

20% — TOO STEEP, RUGGED 3% —  
3% — DENSE FOREST  
5% — WET, MARSHY  
5% — COMBINATION

## SOUTH AMERICA (60%)

## ASIS (45%)

33% — TOO STEEP, RUGGED  
10% — DENSE FOREST  
2% — WET, MARSHY  
5% — COMBINATION, OTHER

## NORTH AMERICA (55%)

25% — TOO STEEP, RUGGED  
20% — DENSE FOREST  
2% — WET, MARSHY  
8% — ICE CAP

\*LOGISTICAL VEHICLE OFF-ROAD MOBILITY, PROJECT TCCO 62-6, FEBRUARY, 1967. U.S. ARMY TRANSPORTATION  
COMBAT DEVELOPMENTS AGENCY, FORT EUSTIS, VIRGINIA.

4376/81W

# PROBABILITY OF VERTICAL OBSTACLE HEIGHT

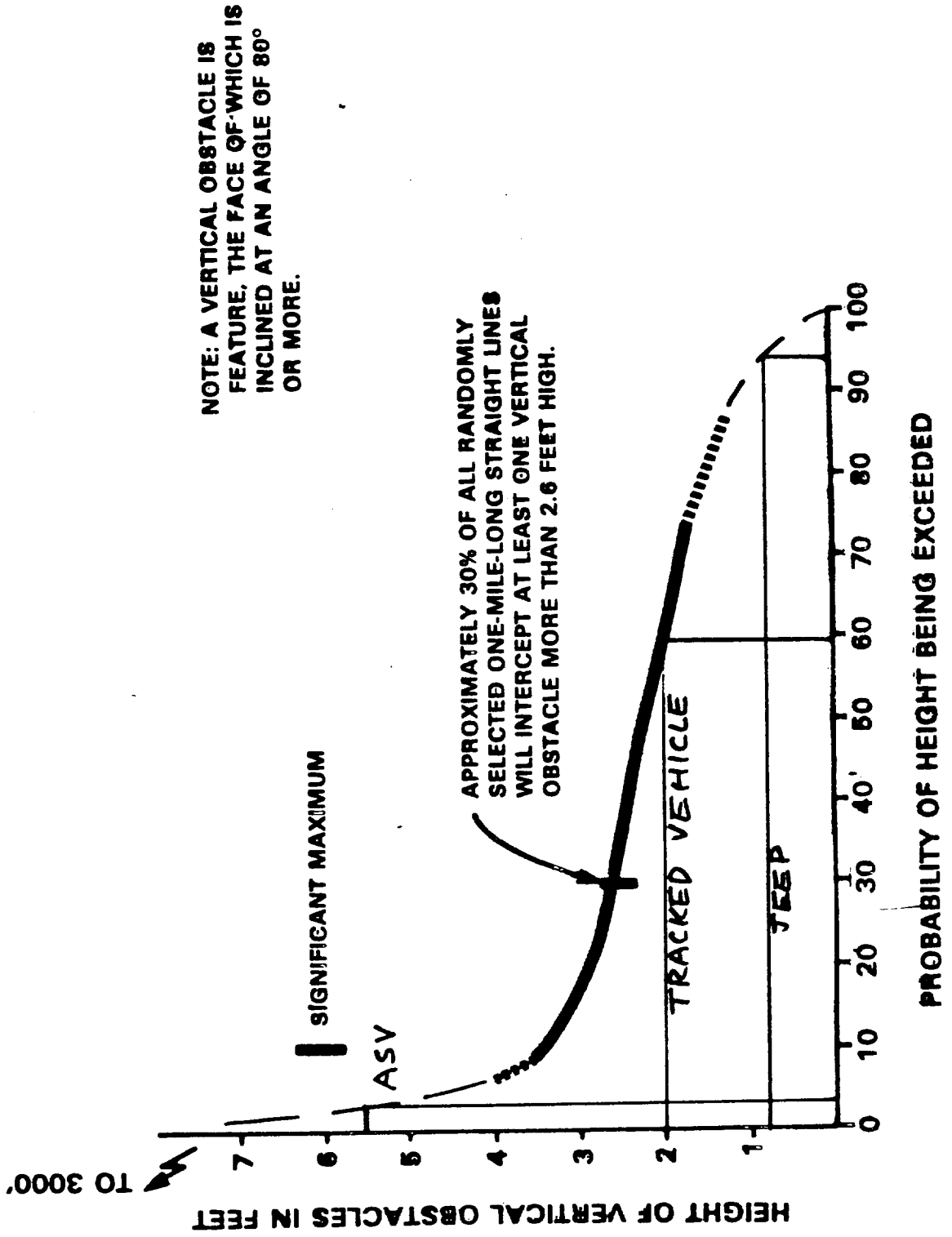

## **Power Consumption Mechanisms**

- 1 Soil Work
- 2 Passive Suspension Damping
- 3 Active Suspension Dynamic Power Consumption
- 4 Power Transmission and Control Losses
- 5 System Overhead

## Specific Resistance

$$\epsilon = \frac{P}{W v}$$

where:  $\epsilon$  is specific resistance,  $P$  is power consumed,  $W$  is weight,  $v$  is velocity.

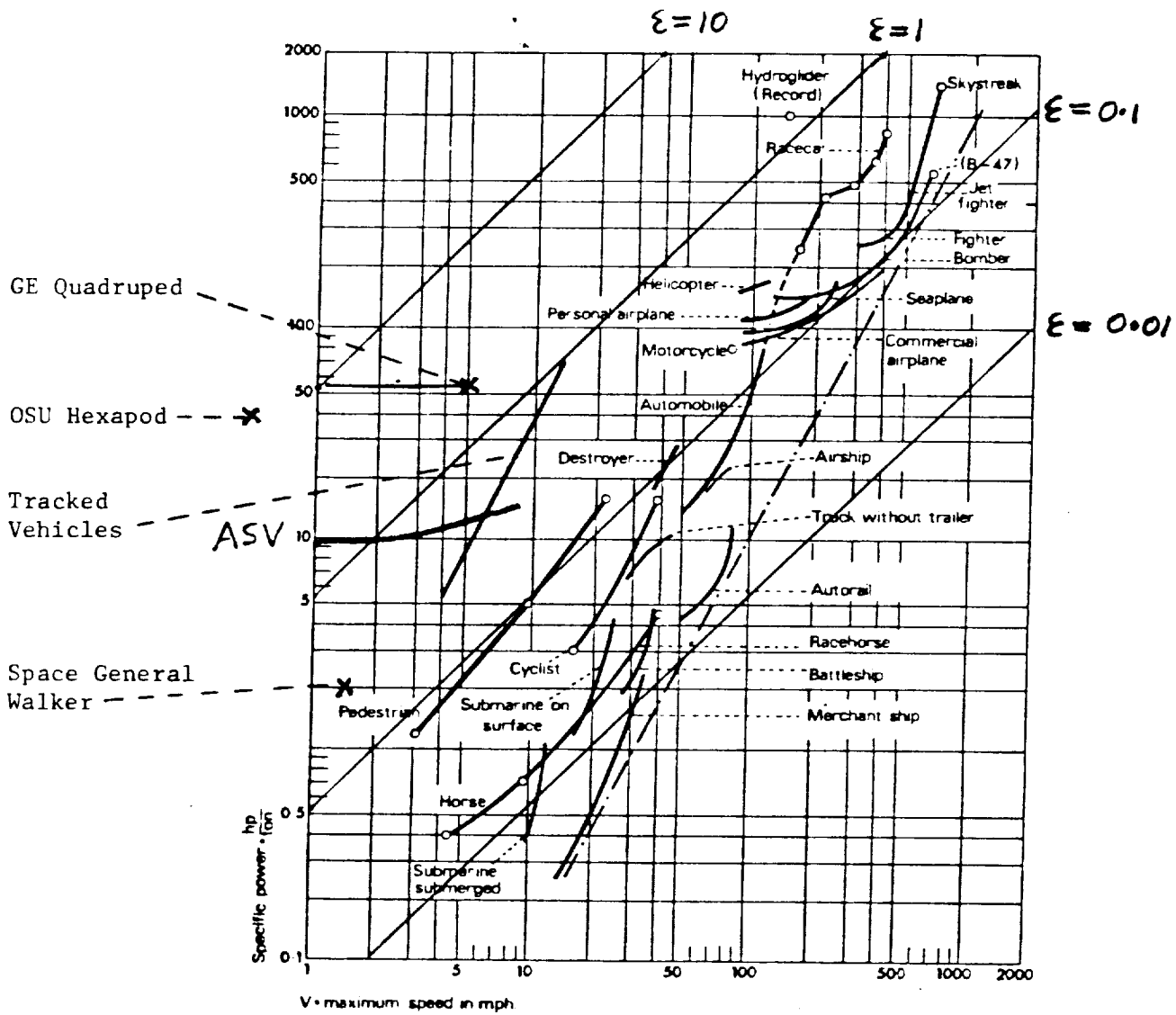

Figure 1.9. Specific power, defined as the ratio of the maximum power available to the gross weight of the vehicle, plotted as a function of its maximum speed (from Gabrielli and von Karman 1954)

ORIGINAL PAGE IS  
OF POOR QUALITY



# Soil Work

## 1 Legged System

Model using flat plate sinkage equation:

$$p = kz^n$$

## 2 Wheeled System

Model using Bekker's rigid wheel model:

$$R = \frac{1}{n+1} \left( \frac{1}{bk} \left( \frac{3W}{(3-n)\sqrt{D}} \right)^{2n+2} \right)^{\frac{1}{2n+1}}$$

ORIGINAL PAGE IS  
OF POOR QUALITY

# SOIL WORK SPECIFIC RESISTANCE

LEGGED SF / WHEEL SF

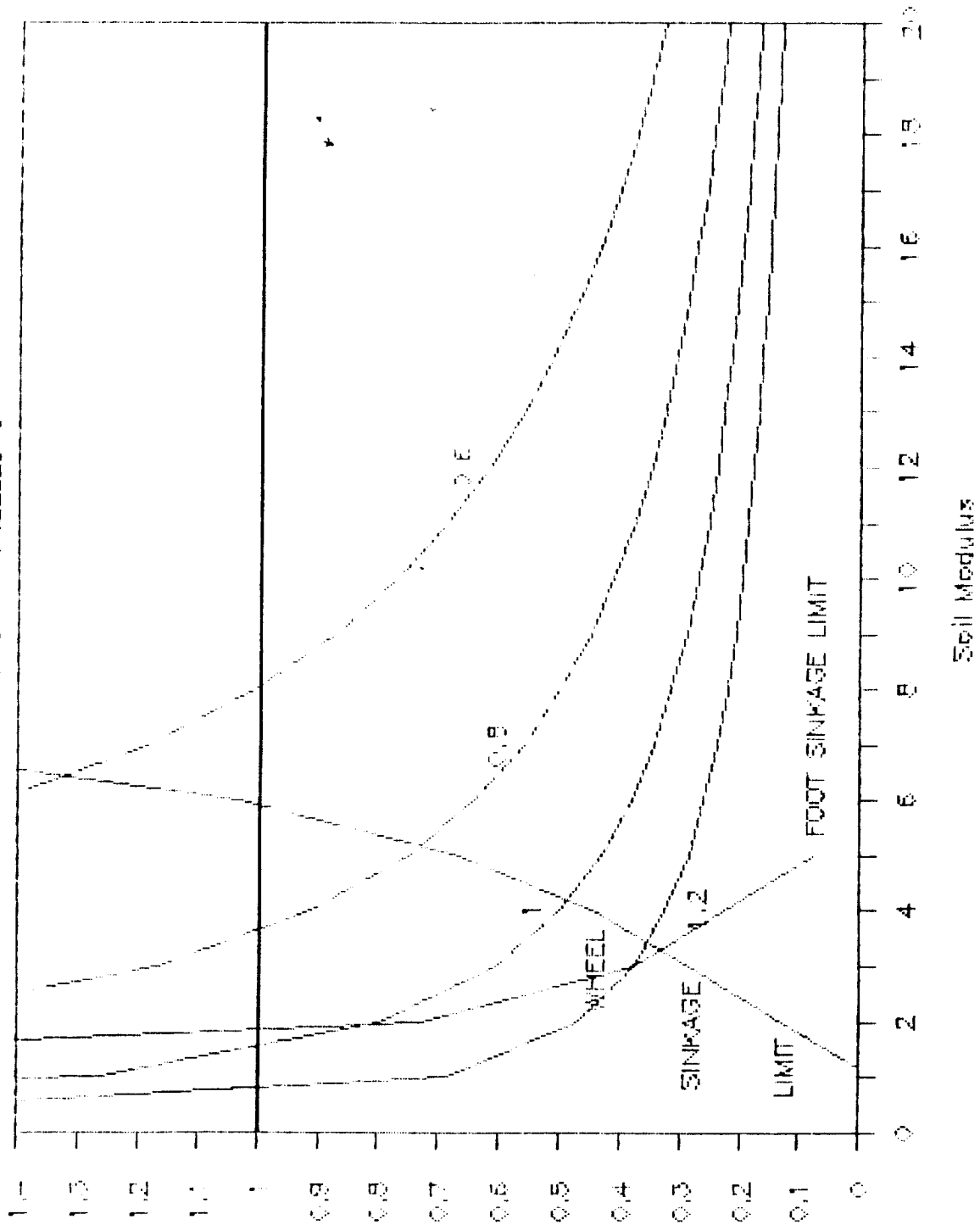

Specific Resistance Ratio

ORIGINAL PAGE IS  
OF POOR QUALITY

P = SOIL WORK POWER

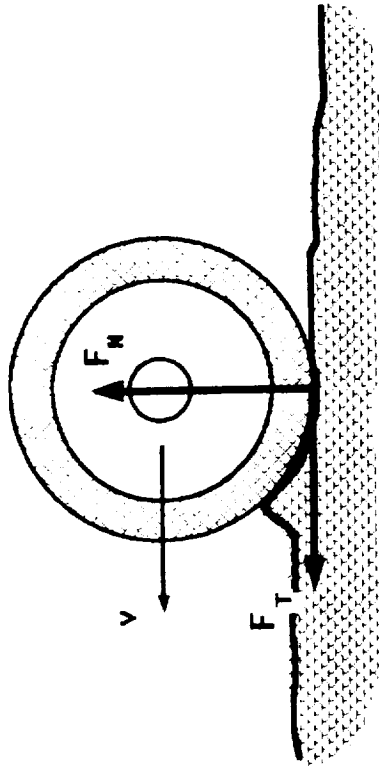

ORIGINAL PAGE IS  
OF POOR QUALITY

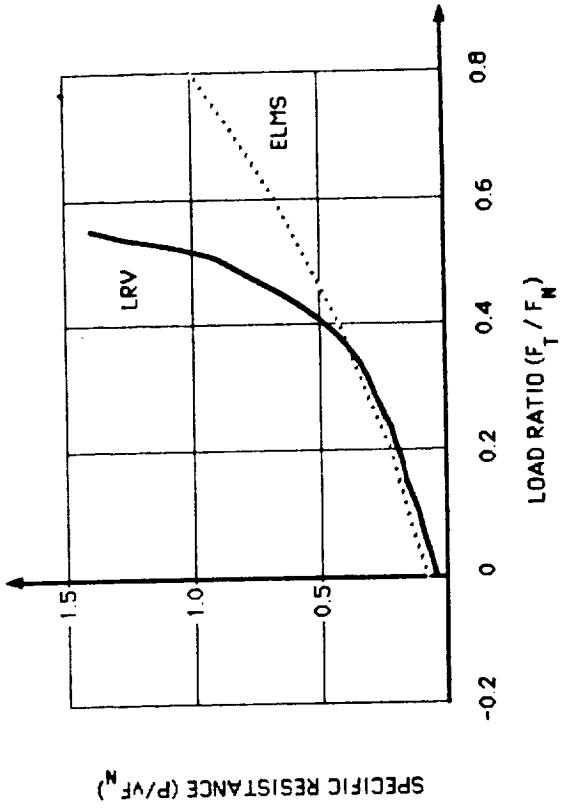

Simulated Dense Lunar Soil

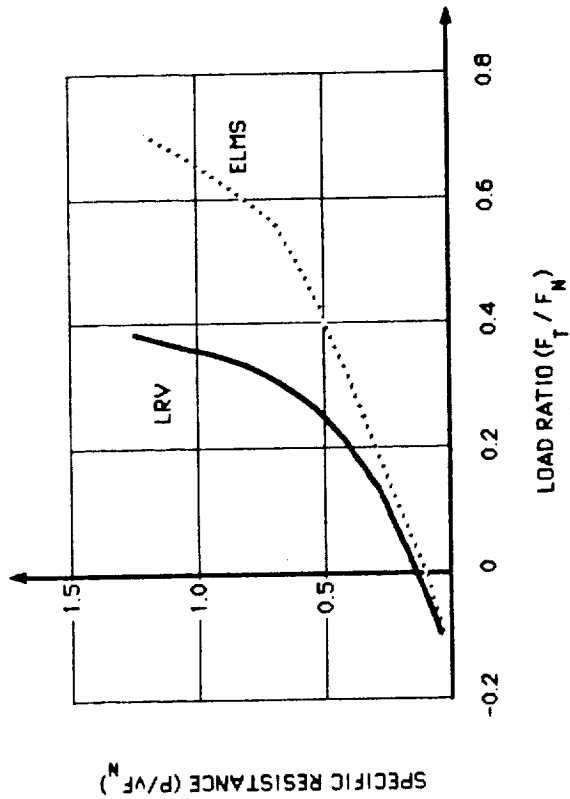

Simulated Loose Lunar Soil

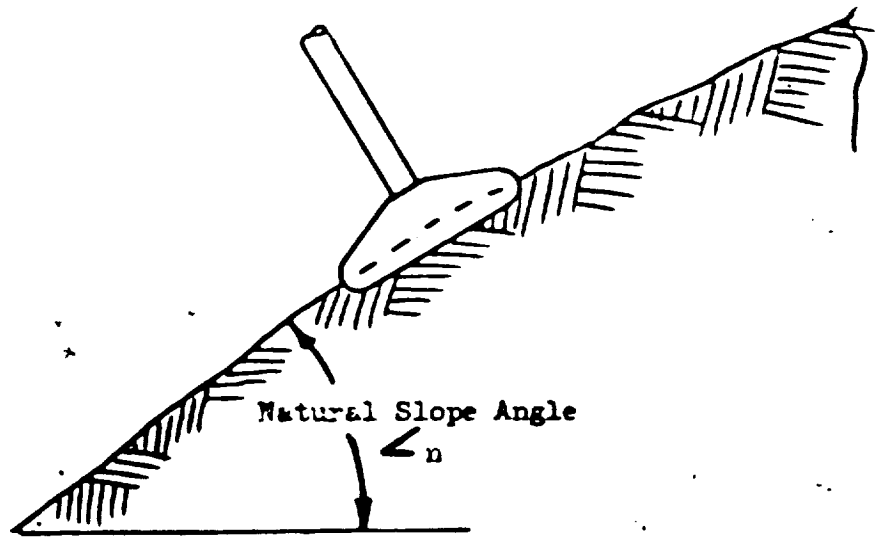

FIG. 1-2 Walking Climb

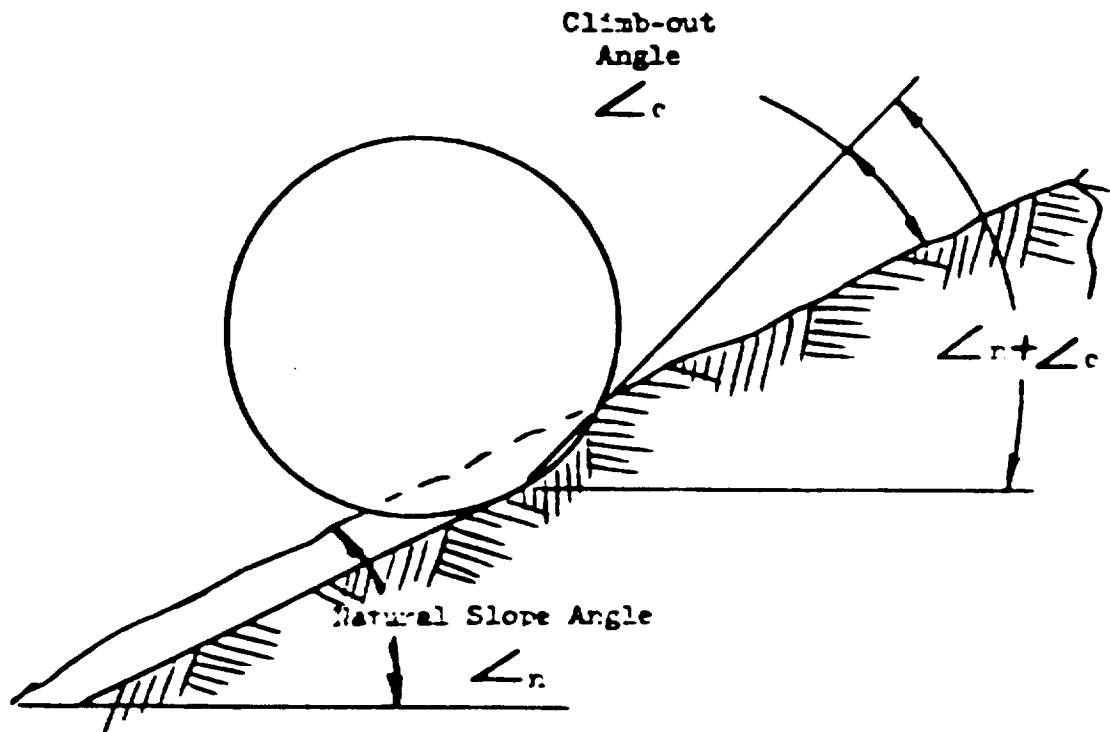

FIG. 1-3 Rolling Climb

## **Passive Suspension Damping**

Increases inversely as square of wavelength for given amplitude. If, more realistically, amplitude is assumed to be approximately proportional to wavelength at small wavelengths, dissipated power is inversely proportional to wavelength.

This power consumption mechanism is important in passive and hybrid suspension systems. It is not applicable to legged systems.

# Active Suspension Dynamic Power

## Consumption

### Actively Suspended Wheeled System

Power to drive active suspension. At small wavelengths, increases inversely as the cube of wavelength, for constant amplitude, or inversely as the square of wavelength if amplitude is assumed to be proportional to wavelength.

### Legged System

Power to oscillate legs. Can be minimized by designing legs as pendula with appropriate natural frequencies. Increases as square of leg frequency at frequencies substantially above pendulating frequency.

## KINETIC ENERGY LOSSES

CAUSED BY FLUCTUATING LEG VELOCITY

ARMATURE K.E. CAN BE LARGE FRACTION OF  
LEG K.E. IN ELECTRIC SYSTEM

TO RECOVER LEG K.E. ARRANGE FOR IT TO  
BE STORED AS P.E. THAT IS, CREATE  
GRAVITATIONAL OR SPRING OSCILLATOR.

## GEOMETRIC WORK

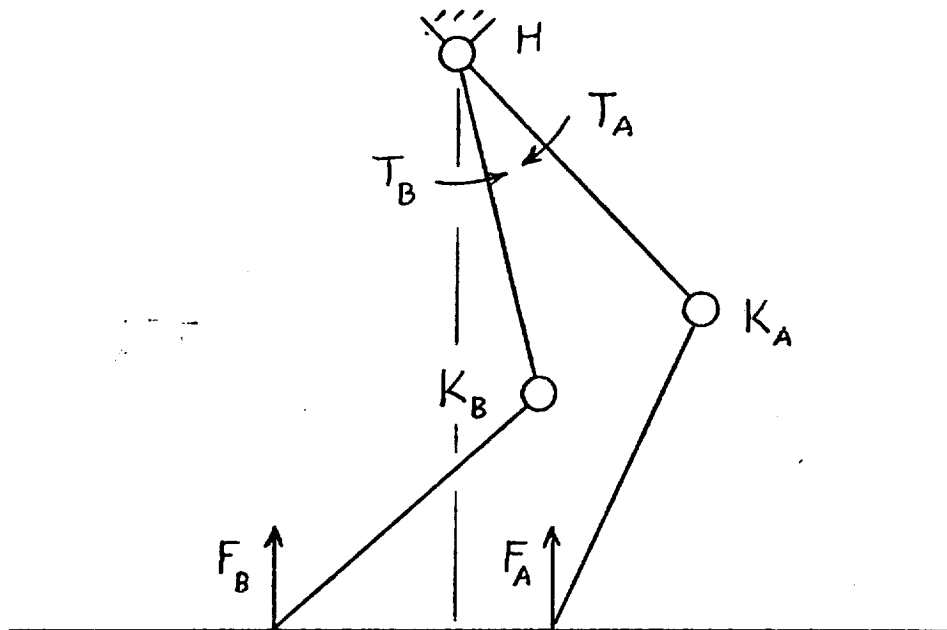

IN A GENERAL LEG CONFIGURATION, EACH ACTUATOR DOES POSITIVE MECHANICAL WORK FOR ONLY PART OF THE MOTION CYCLE. FOR THE REMAINDER OF THE CYCLE, THE LOADS DO WORK ON THE ACTUATOR. THAT IS, THE ACTUATOR IS "BACK - DRIVEN" BY THE LOADS.



SCHEMATIC LEG ARRANGEMENT

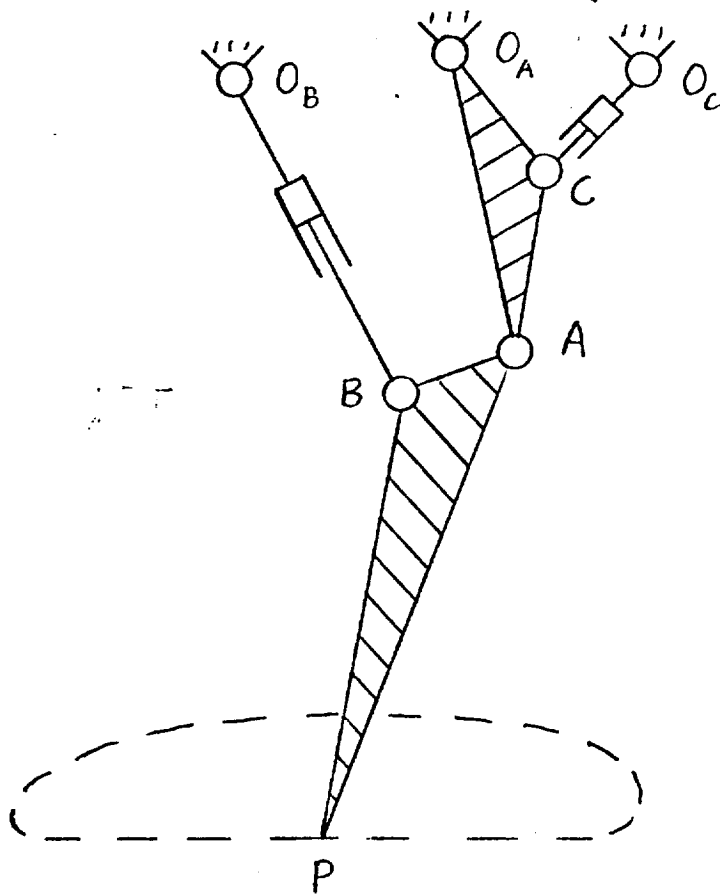

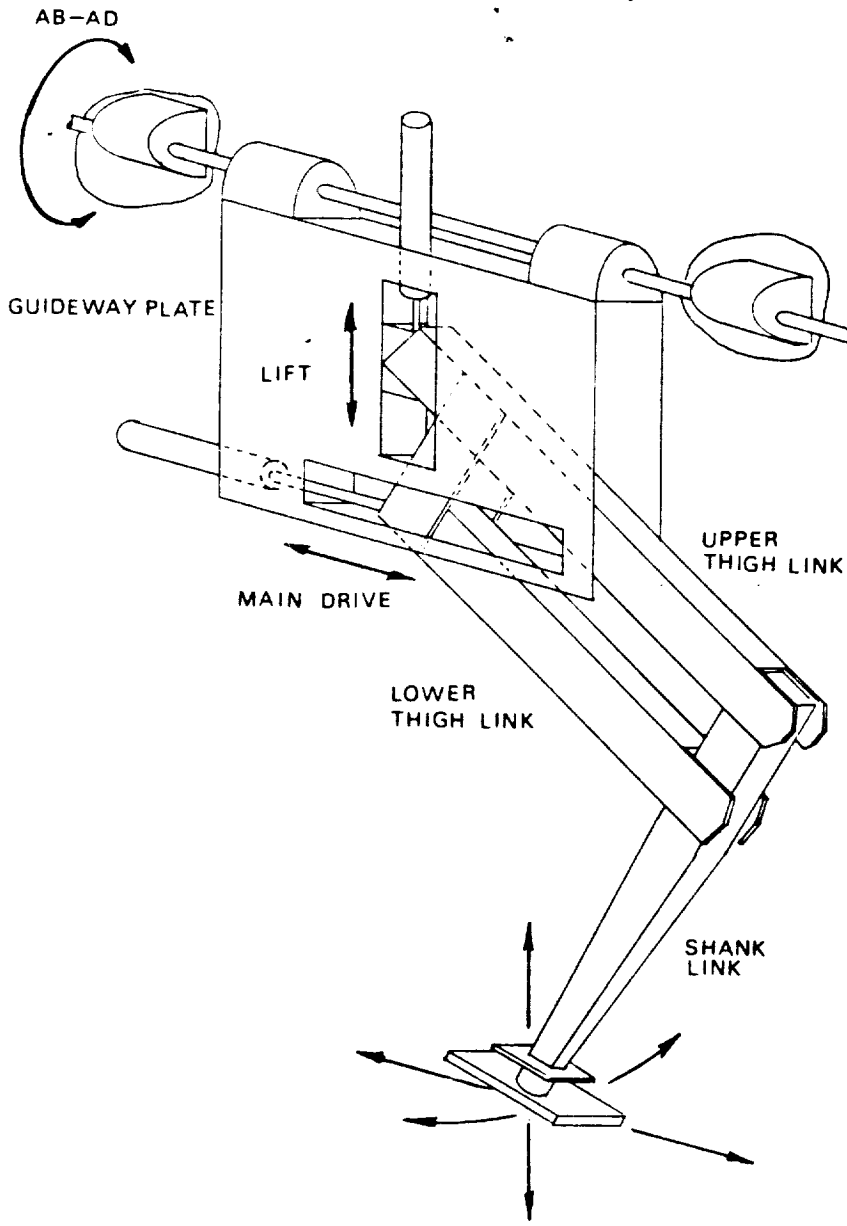

## **Power Transmission and Control Losses**

Increase linearly with number of actively controlled actuators. Magnitude depends on type of power transmission and actuation system used.

In electric systems, in particular, there is a component proportional to the power output of the actuation system. This is primarily due to resistive losses in the actuators, and associated circuitry.

## **System Overhead**

Power required to run computer, sensors, and other equipment not associated with the actuation system. There is also usually an overhead associated with the actuation system. For a given system, this is a power loss term which does not vary with the degree of activity.

REFERENCE TITLY M

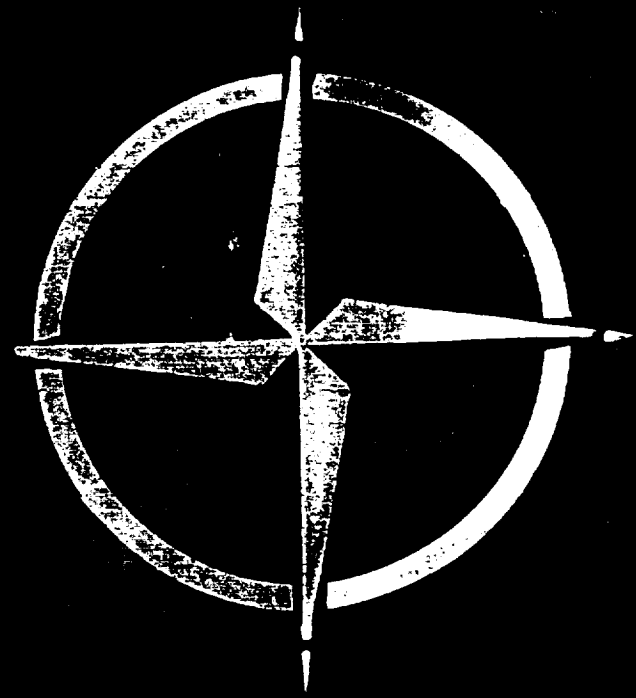

VISUAL  
EDUCATION  
PRODUCTS

**GEMLINE**  
Transparency Mounts  
KEUFFEL & EBBER  
A KODAK Company

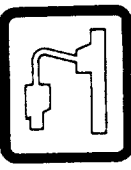

3-5-75

ORIGINAL PAGE IS  
OF POOR QUALITY

# NATO REFERENCE MOBILITY MODEL

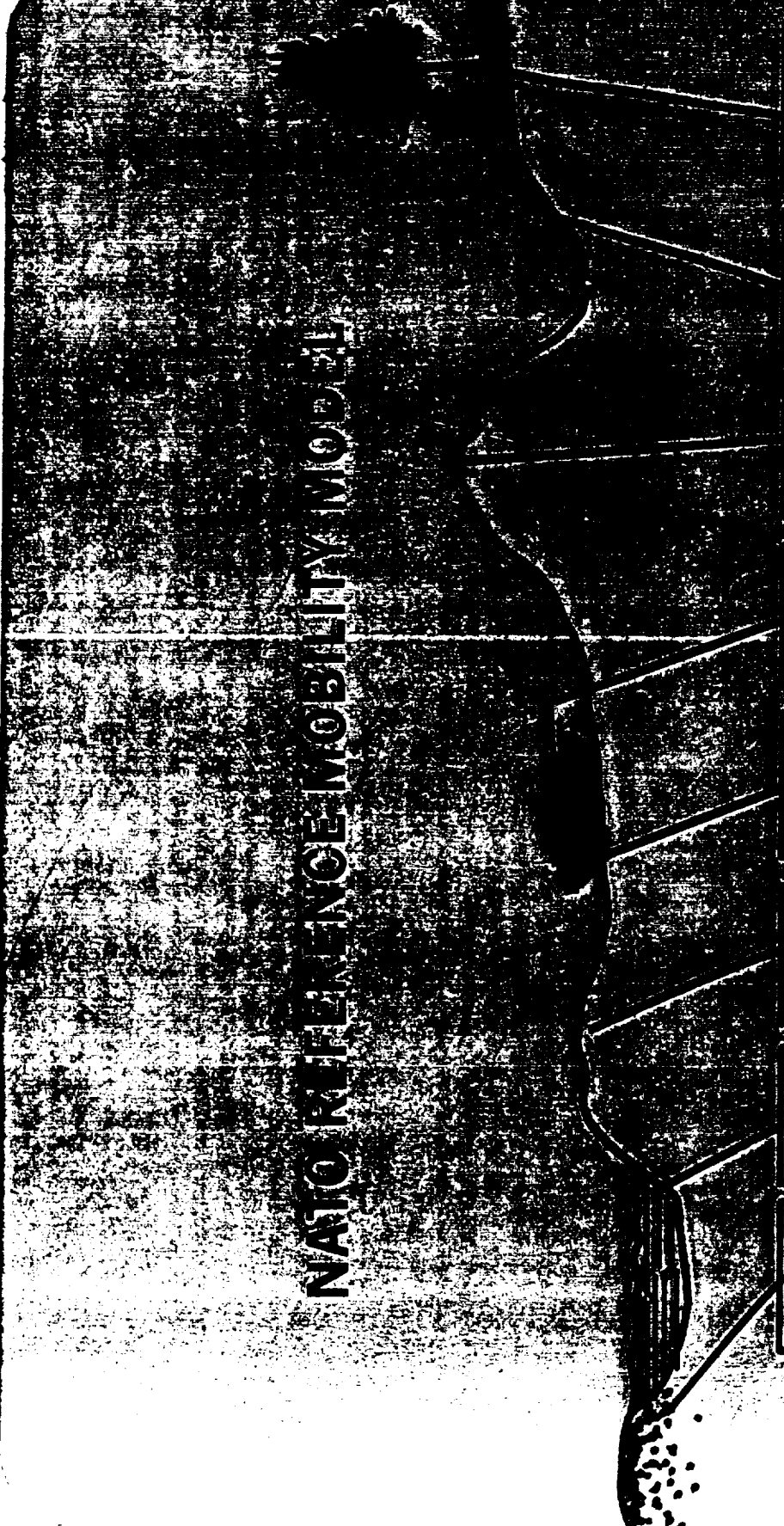

- SOIL
- RIVERINE
- ROUGHNESS PROFILE
- POWER TRAIN
- DYNAMICS
- OBSTACLE
- SLOPE
- VEGETATION

SUB MODELS

# HISTORICAL BACKGROUND

## CORPS OF ENGINEERS

WATERWAYS  
EXPERIMENT  
STATION

(WES) — 1949

TRAFFICABILITY  
RESEARCH

## AMC

ATAC  
LAND LOCOMOTION  
LABORATORY

(LLL) — 1955

LAND LOCOMOTION  
MECHANICS RESEARCH

COMMON  
GOAL — 1969

MOBILITY  
MODEL

ORIGINAL PAGE IS  
OF POOR QUALITY

# TERRAIN FACTORS

- Surface Composition
  - Type
  - Strength
  - Surface Geometry
  - Slope
  - Discrete Obstacles
  - Roughness
  - Vegetation
  - Stem Size and Spacing
  - Visibility
  - Linear Geometry
  - Stem Size and Spacing
  - Water Velocity and Depth
- 21 Factors in All



TERRAIN DATA

CLASSES

11 8 4 7 7 9 8 9 9

STRENGTH CI OR CI

SLOPE %

OBSTACLE

APPROACH

VERT. MAGN. CM

LENGTH M

WIDTH CM

SPACING M

ROUGHNESS (RIMS)

STEM DIA CM } 8 PAIRS

STEM SPACING M

VISIBILITY M

PORTION OF AREAL TERRAIN UNIT MAP OF EASTERN SECTION OF WEST GERMANY TRANSECT





**WE HAVE TERRAIN MAPS FROM:**

**WEST GERMANY**

**JORDAN**

**IRAN**

**KOREA**

**21 QUADS**

**3**

**2**

**2**

**PLUS TRANSECTIONS IN:**

**YUMA**

**FT. KNOX**

**APG**

AT131-83



# VEHICLE FACTORS

- Geometric Characteristics
- Inertial Characteristics
- Mechanical Characteristics

ORIGINAL PAGE IS  
OF POOR QUALITY

**VEHICLE DATA**

- RUNNING GEAR**
- POWERED/UNPOWERED**
- TIRE SIZE**
- POWER TRAIN**
- TORQUE RATIO/SPEED RATIO CURVE**
- ACCESSORY LOSS CURVE**
- VEHICLE GEOMETRY**
- ANGLE OF DEPARTURE**
- ROAD WHEEL TRAVEL**
- WATER CHARACTERISTICS**
- FORDING DEPTH**
- FLOATER (YES/NO)**
- HIGHWAY CHARACTERISTICS**
- AERODYNAMIC DRAG COEFFICIENT**
- CORNERING STIFFNESS OF TIRES**
- MOBILITY ASSIST SYSTEMS**
- WING CAPACITY/SPEED**
- RIDE AND OBSTACLE DATA**
- CALCULATED OR MEASURED**
- OBSTACLE INTERFERENCE DATA**
- MINIMUM CLEARANCE**
- MAXIMUM TRACTION REQUIRED**

ORIGINAL PAGE IS OF POOR QUALITY

# SCENARIO OPTIONS

## A. ENVIRONMENTAL

SEASON

SNOW

RAINFALL

TRAVERSE

OPERATING INFLATION PRESSURE

AIR TEMPERATURE

ROAD SURFACE CONDITION

HEAD WIND SPEED

## B. DRIVER

CRITICAL VEGETATION SPEED

MINIMUM VISIBILITY SPEED

ROUGHNESS ACCEPTANCE LEVEL

HORIZONTAL IMPACT ACCELERATION

MAXIMUM DECELERATION USED

PERCENT MAXIMUM DECELERATION

AVAILABLE

REACTION TIME



# GROSS STRUCTURE OF NATO REFERENCE MOBILITY MODEL

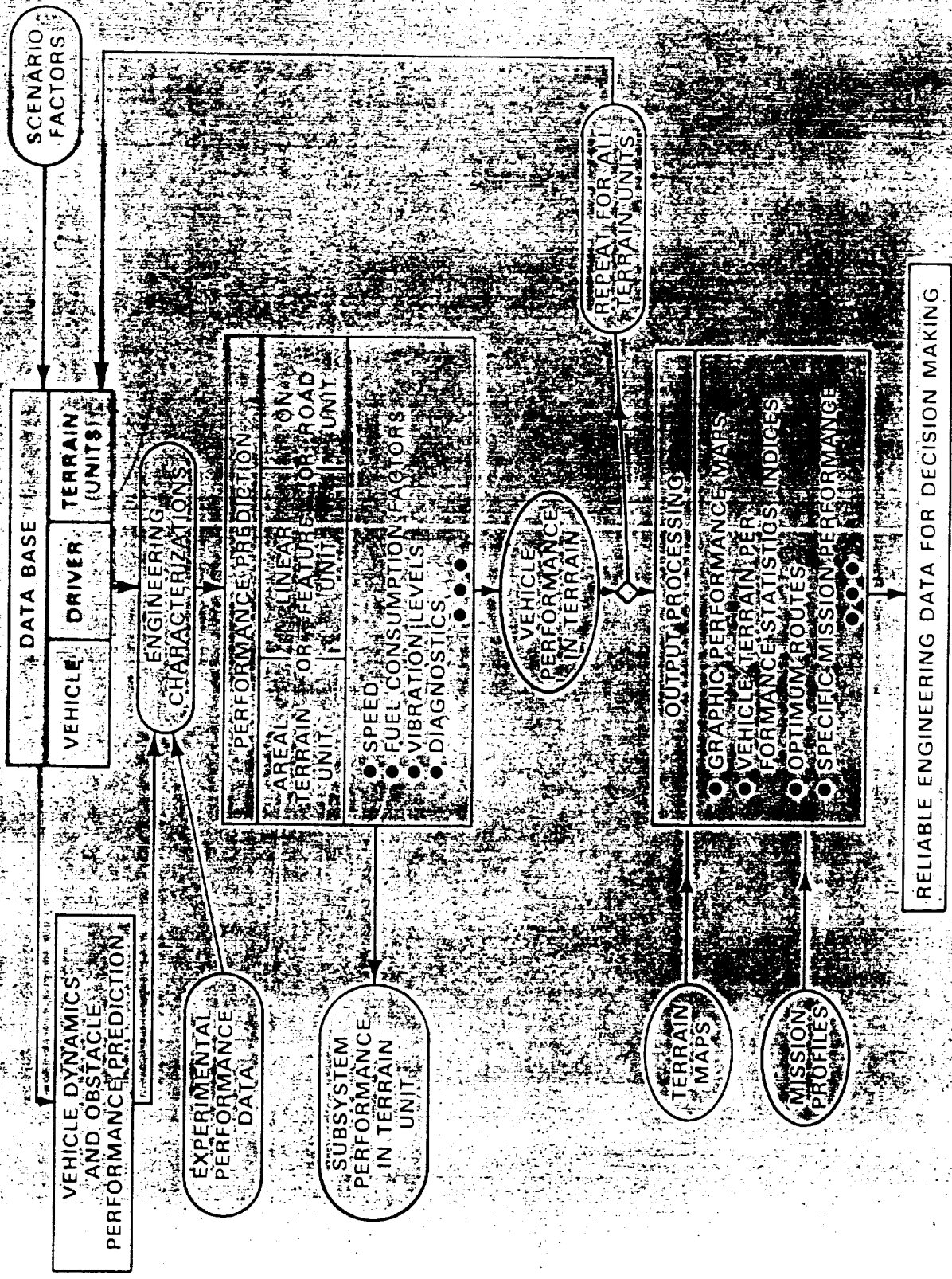

11131-83

ORIGINAL PAGE IS OF POOR QUALITY

GENERAL FLOW STRATEGIES

SPEED MADE GOOD

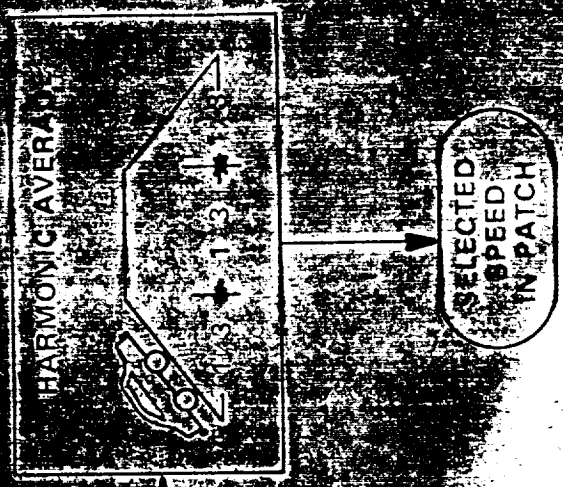

STRATEGIES

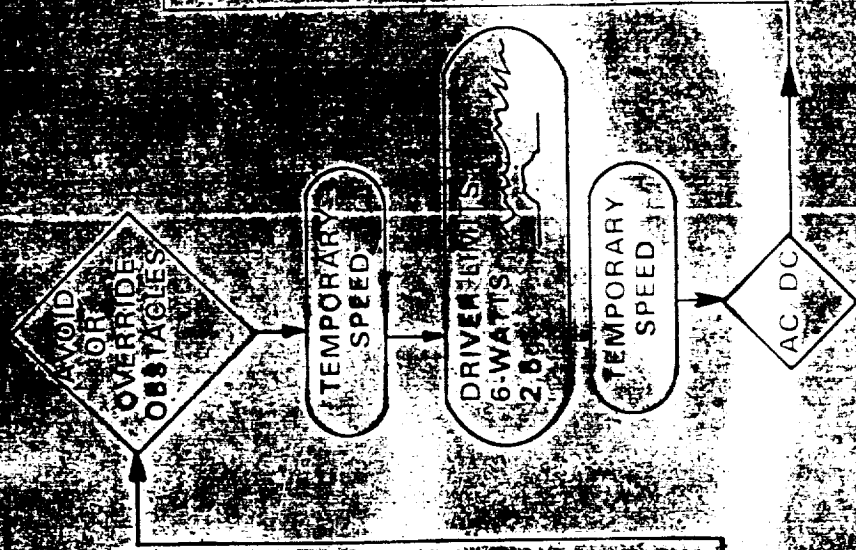

FORCES

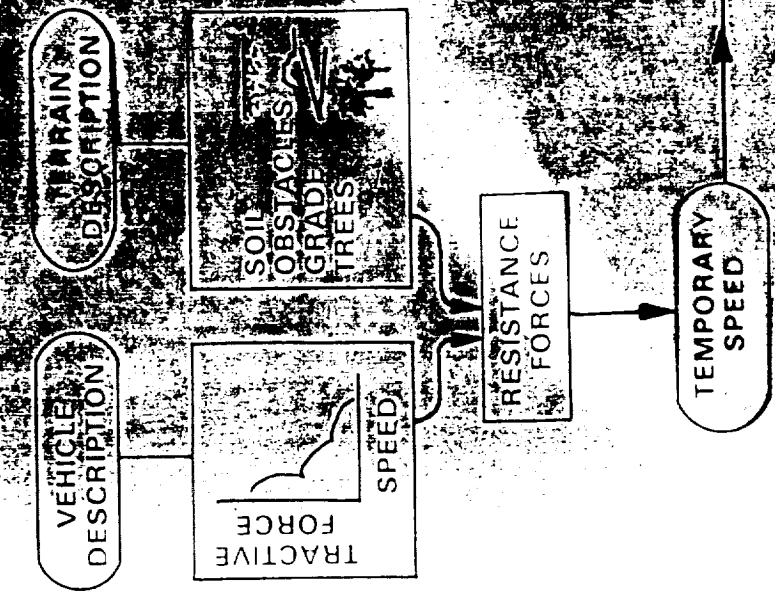

ORIGINAL PAGE IS OF POOR QUALITY



SPEED PROFILE (FIRST INTRODUCED FOR  
THE WHEELS STUDY).

CUMULATIVE AVERAGE SPEED OBTAINED  
BY ALLOWING THE VEHICLE TO NEGOTIATE

EACH TERRAIN UNIT IN AN ORDER OF  
INCREASING DIFFICULTY

ORIGINAL PAGE IS  
OF POOR QUALITY

# SPEED PROFILE

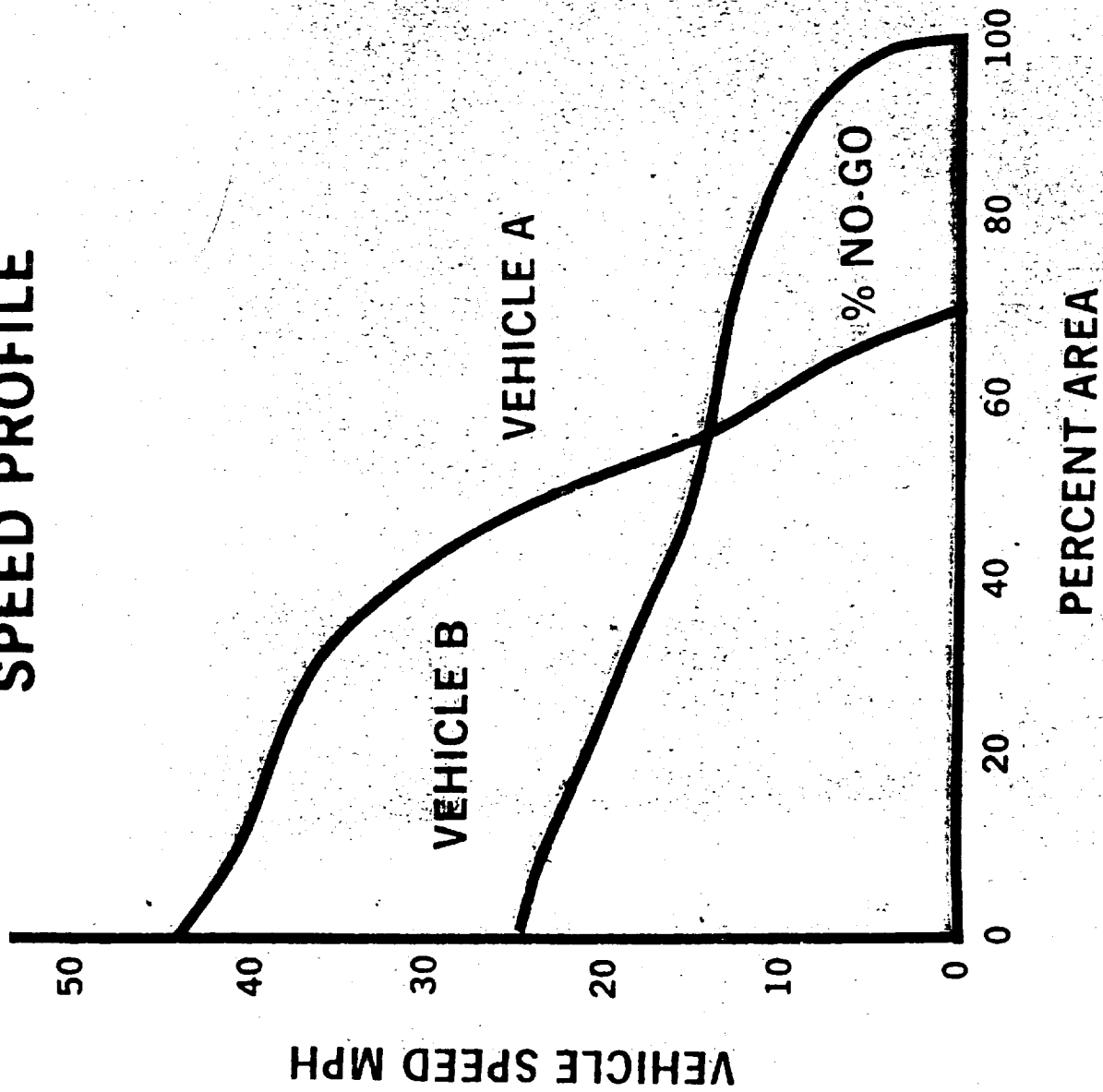

VEHICLE SPEED VERSUS PERCENT OF TOTAL TRANSECT AREA

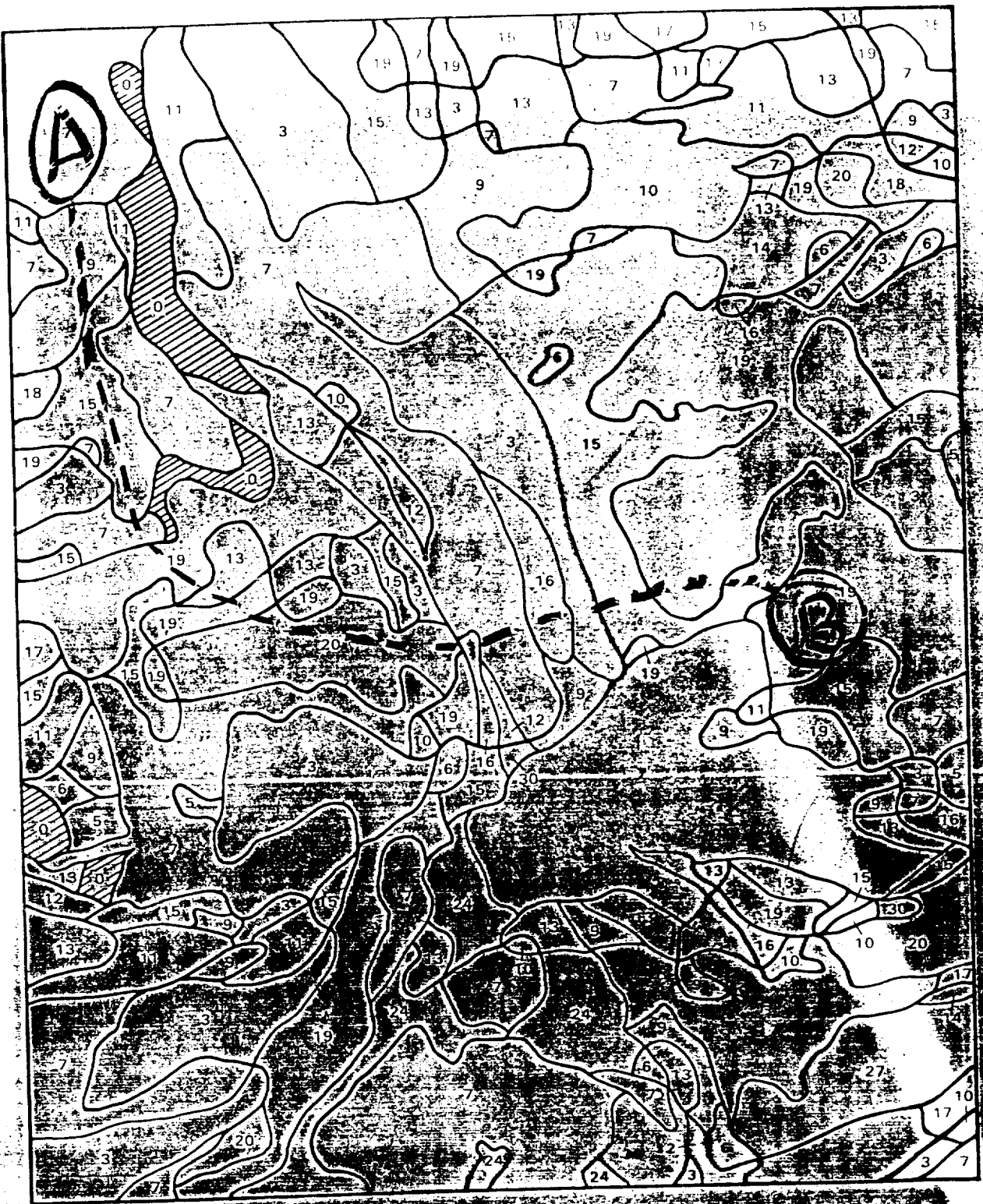

MOBILITY MAP OFF-ROAD PERFORMANCE OF A 2 1/2 TON TRUCK OVER A 2 x 1 1/2 MILE TERRAIN AREA IN WEST GERMANY. NUMBERS DESIGNATE MAXIMUM ACHIEVABLE SPEED TO NEAREST MPH. CROSS-HATCHED AREA IS NO GO.

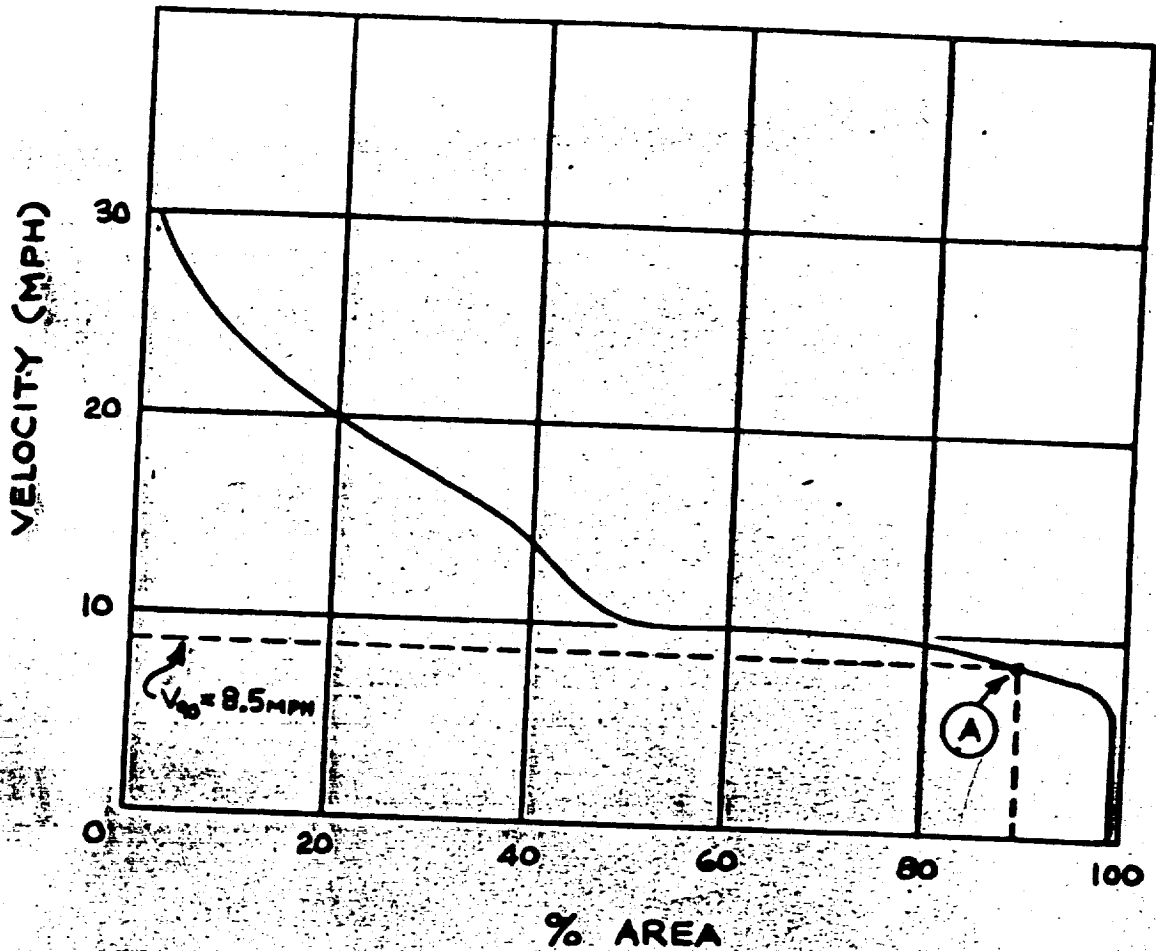

FIGURE 4. Mobility Profile. Off-Road Performance of 2-1/2 Ton Truck in West German Terrain per Map in Figure 3.

ORIGINAL PAGE IS OF POOR QUALITY

DIAGNOSTICS

GO TERRAIN UNITS

- RIDE
- TIRE CONSTRUCTION
- POWER/RESISTANCE
- VISIBILITY
- MANEUVER (AVOID OBSTACLES)
- MANEUVER (OVERRIDE OBSTACLES)
- OBSTACLE IMPACT
- OBSTACLE FORCE
- DRIVER PRODUCED

NO-GO TERRAIN UNITS

- NO BRAKING
- SOIL/SLOPE
- OBSTACLE INTERFERENCE
- AXLE HANGUP ROUND OBSTACLES
- VEGETATION
- OBSTACLE FORCE

ORIGINAL PAGE IS  
OF POOR QUALITY

**AMC 71 MOBILITY MODEL  
VALIDATION TESTS**

**FT. SILL (PRAIRIE)**

**YUMA PROVING GROUND (SAND, DESERT,  
GRAVEL)**

**EGLIN AIR FORCE BASE (WOODED)**

**HOUGHTON (ROUGH, OPEN, FORESTED,  
HILLY)**

**FT. KNOX (HILLY, FORESTS)**



Ride Dynamics

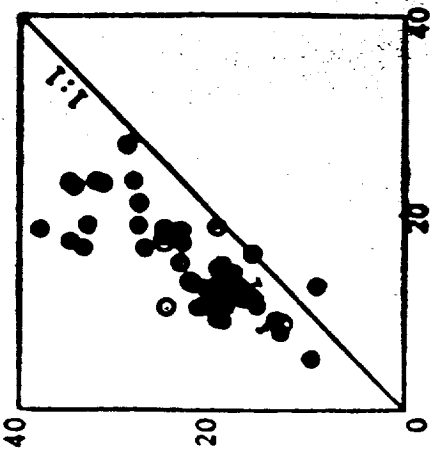

Surface and Slope Resistances

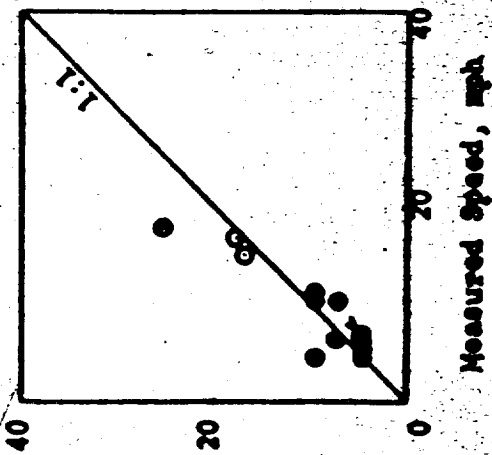

Visibility

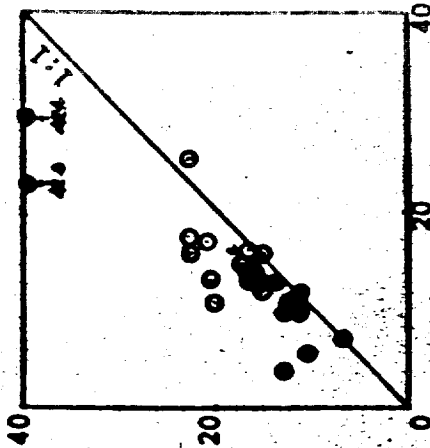

Maneuver

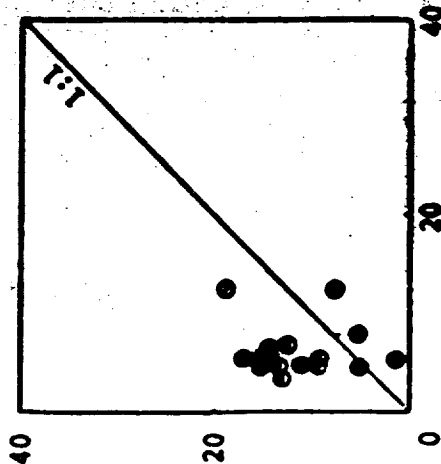

Force from Obstacles and Vegetation

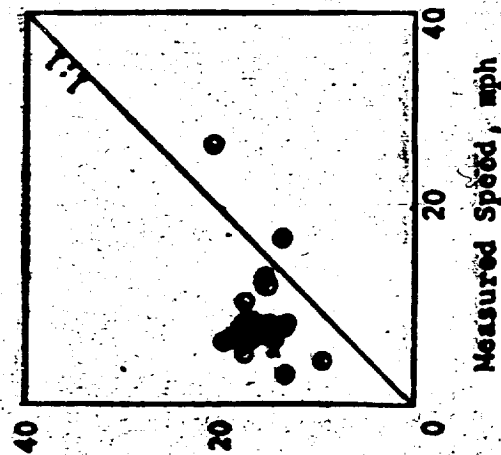

Acceleration-Deceleration Between Obstacles

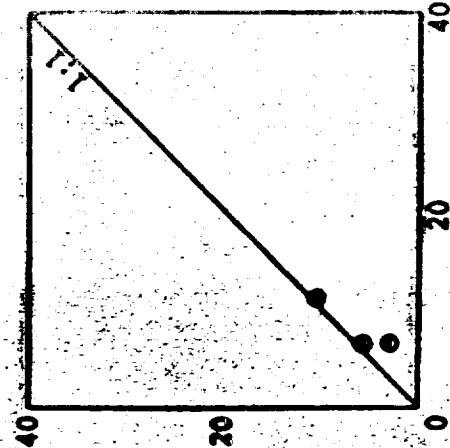

LEGEND

- Ft. Sill
- Heughton
- Yuma
- Ft. Knox
- Hightn

COMPARISON OF MEASURED AND PREDICTED SPEEDS FOR FACTORS CONTROLLING SPEED

M35A2

Plate

A. M151

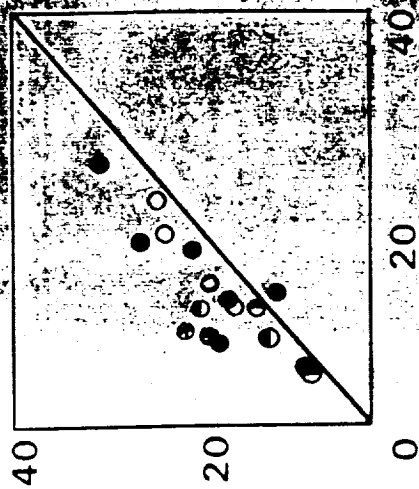

B. M35A2 (MOD)

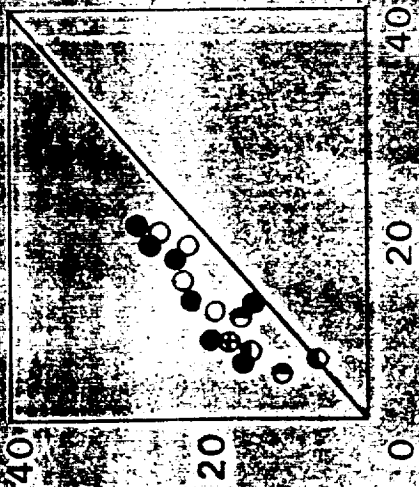

C. M113A1

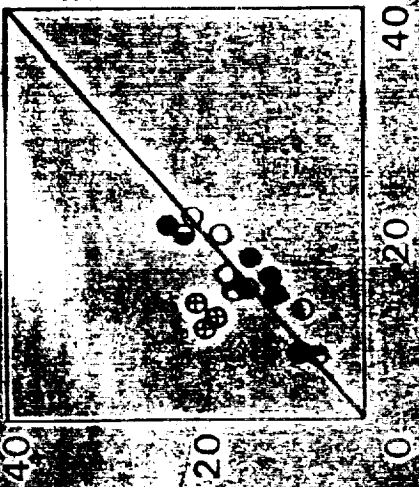

D. M48

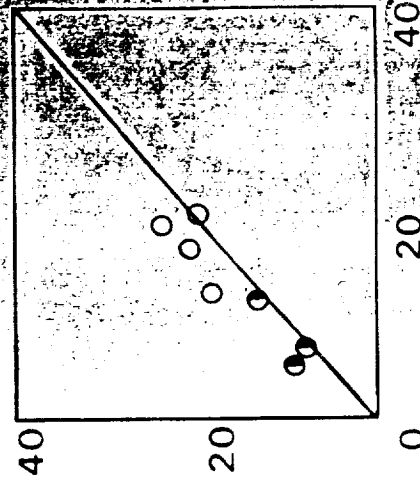

E. M60

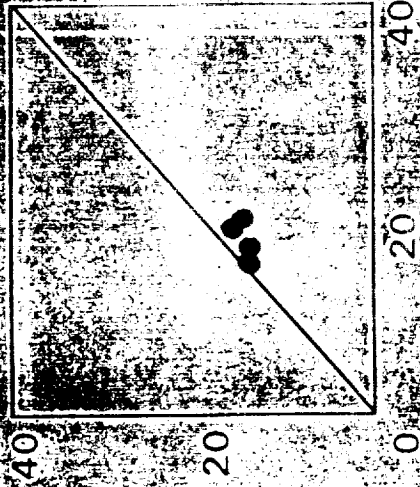

MEASURED SPEED, MPH

MEASURED SPEED, MPH

LEGEND

- FT. SILL TESTS
- YUMA TESTS
- ⊕ EGLIN TESTS
- HOUGHTON TESTS
- FT. KNOX TESTS

COMPARISON OF MEASURED  
AND PREDICTED SPEEDS MADE  
GOOD FOR VALIDATION  
VEHICLES ON TRAVERSES  
CLASSES





# PROSPECTIVE USERS OF VEHICLE PERFORMANCE PREDICTION METHODOLOGY

Vehicle Design and  
Development  
Community

Military  
Planning  
Community

Vehicle  
Procurement  
Community

Preparation of  
Specifications  
ROC's etc.

Vehicle Design  
and  
Development

Vehicle Test  
and  
Evaluation

Evaluation of  
Competitive  
Designs

Strategic  
Selection of  
Mix

Tactical  
1. Route  
Selection  
2. Estimation  
of Engineer  
Support

**NRMM HAS BEEN USED FOR THE FOLLOWING VEHICLES/PROGRAMS:**

**ACVT**

**M-I**

**HEMTT**

**MPWS**

**LAV**

**HMMWV**

**MTT**

**CONCEPTS**

A1131-83

ORIGINAL PAGE IS  
OF POOR QUALITY

**JPL**

**MARS ROVER DYNAMIC  
MODELING**

**JET PROPUSION LABORATORY  
ADVANCED SPACECRAFT DEVELOPMENT  
4800 OAK GROVE  
PASADENA, CA 91109**

**GERALD LILIENTHAL  
818 - 354 - 9082**

**APRIL 28, 1987**

**W5**



## MOBILITY COMPUTER ANALYSIS

**OBJECTIVE:** TO DEVELOP A VARIETY OF DIFFERENT ROVER CONFIGURATIONS AND EVALUATE THEM FOR DEGREE OF MOBILITY BY COMPUTER SIMULATION

**DEFINITION:** MOBILITY IS THE RELATIVE EASE OF MOVING BETWEEN DESIRED SURFACE LOCATIONS OVER OR AROUND A SET OF DEFINED SURFACE HAZARDS

**CRITERIA (LISTED IN ORDER OF PRIORITY):**

- o HIGH RELIABILITY
  - oo MINIMUM NUMBER OF FAILURE POINTS
  - oo SAMPLING ACTIVITIES AIDED
- o LOW OVERTURNING OR BOGDOWN SUSEPTIBILITY
- o LOW POWER CONSUMPTION (ABOUT 200 WATTS AVAILABLE)
- o LOW MASS
- o COMPACT DESIGN (SHOULD FIT INTO AEROSHELL)



## SCOPE OF STUDY

### INPUT SCOPE:

- WILL REQUIRE APPLICATION OF SURFACE STUDY DATA
  - MACRO SCALE: SITE SELECTION AND SURFACE HAZARD DATA IMPORTANT
  - MICRO SCALE: DEFINITION OF SURFACE MORPHOLOGY IMPORTANT
- TAKES OFF FROM EXISTING WORK OF WILCOX (JPL), PAVLICS (GM), BEKKER AND OTHERS

### OUTPUT SCOPE:

- OPTIMIZES EXISTING 6-WHEEL ROVER
- DEVELOPS OTHER CONFIGURATIONS FOR MAXIMUM MOBILITY
- PROVIDES FOUNDATION FOR STUDY OF ROVER INTERACTION WITH SAMPLE ACQUISITION DEVICES



# SIMULATION -- PHASE 1

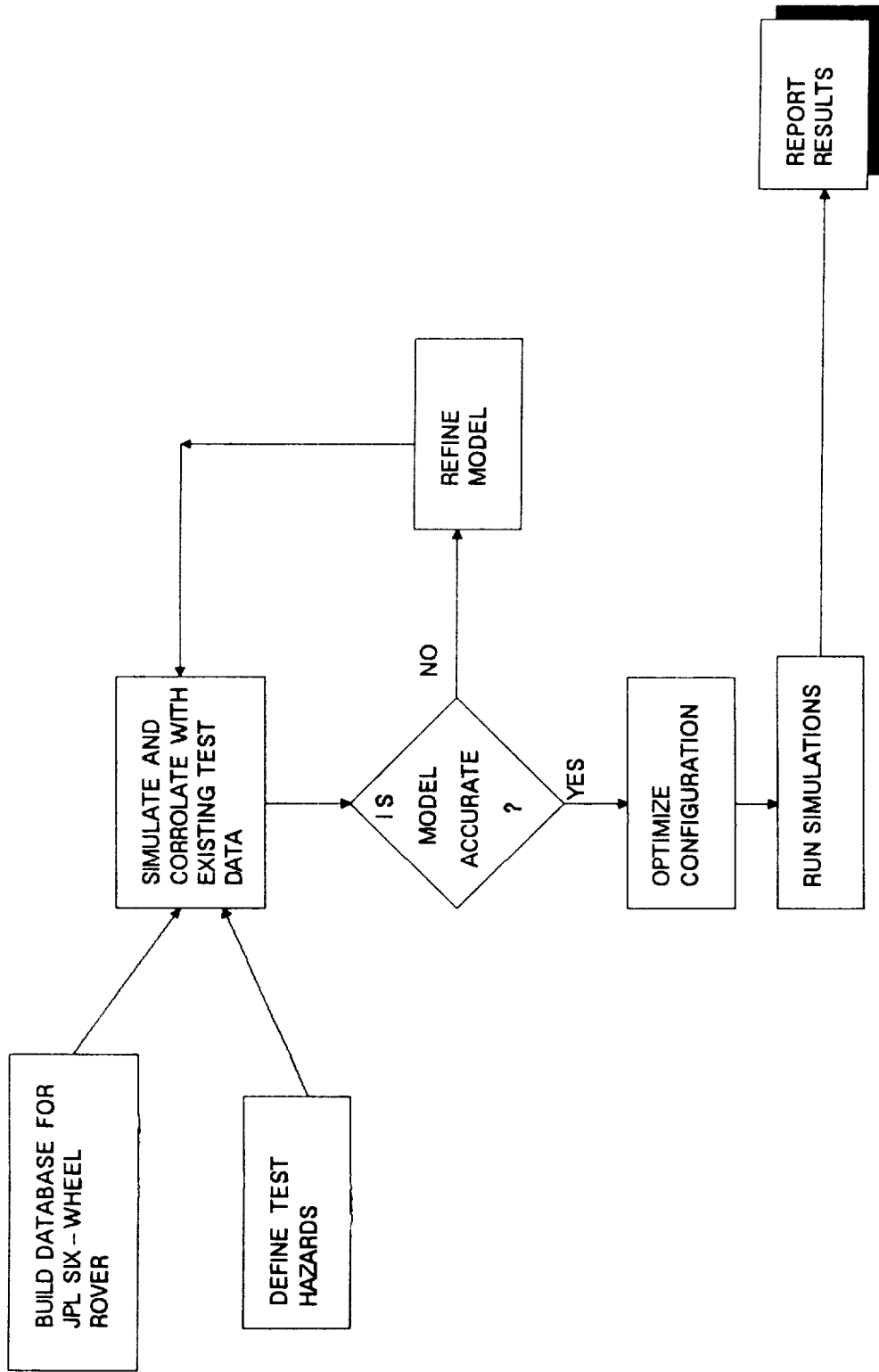

G. LILIENTHAL 4/27/87 W1



# SIMULATION -- PHASE 2

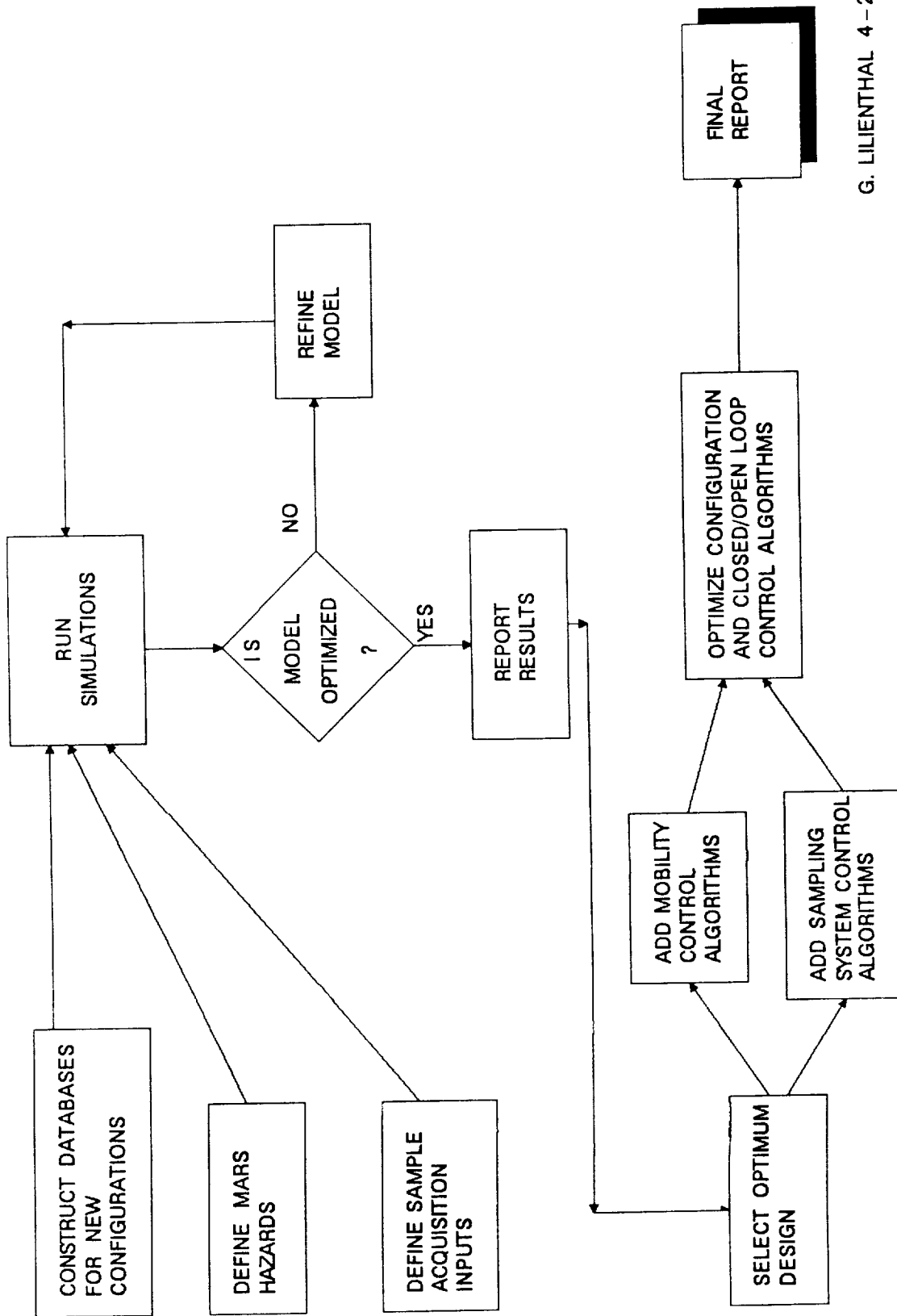

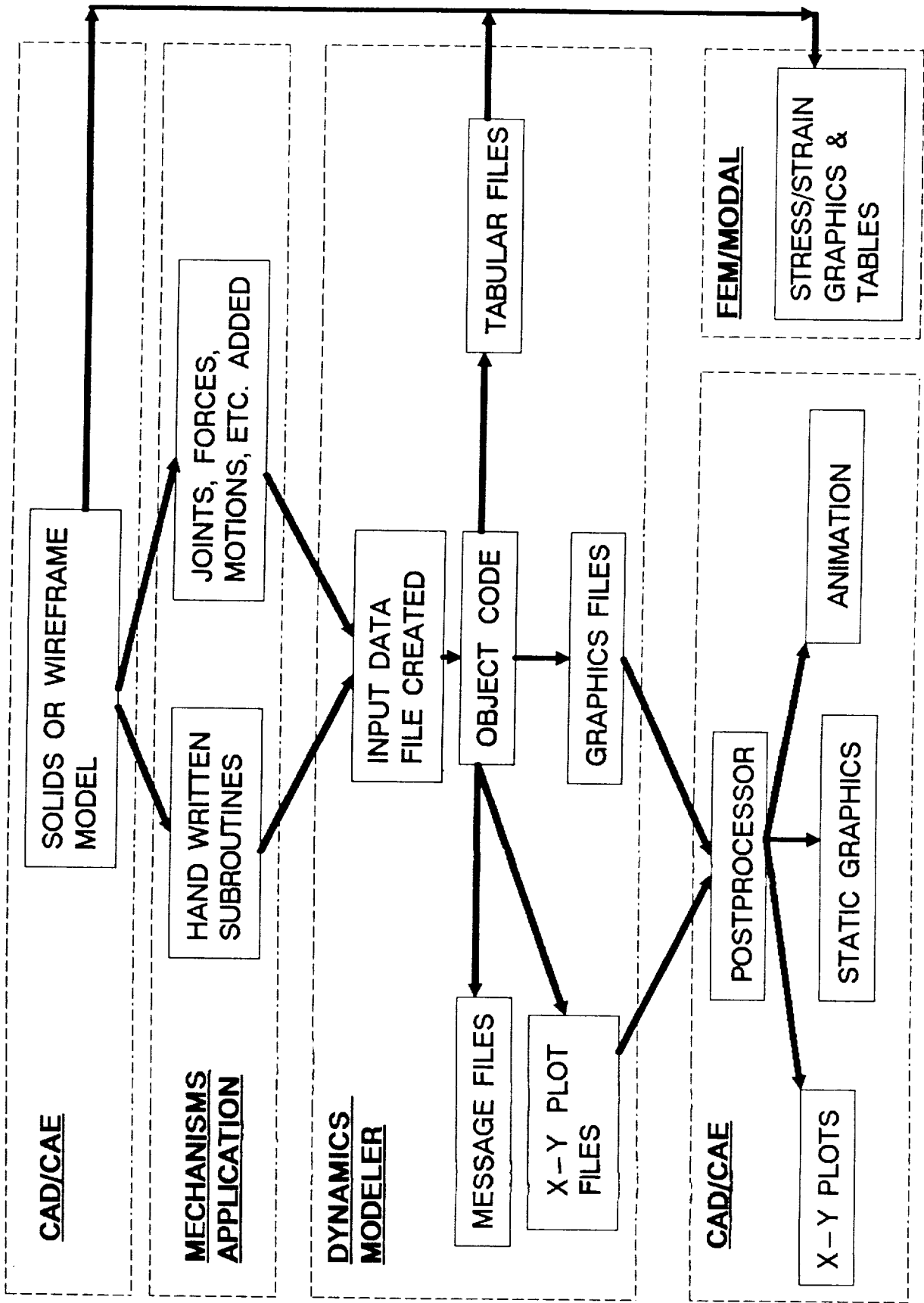

W6

ENTIRE ANALYSIS DONE WITH ONE DATABASE

GERALD LILIENTHAL 4/26/87



*Order: site relocation availability from v. 1*

**AEROCAPTURE**  
**PROPULSIVE CAPTURE**

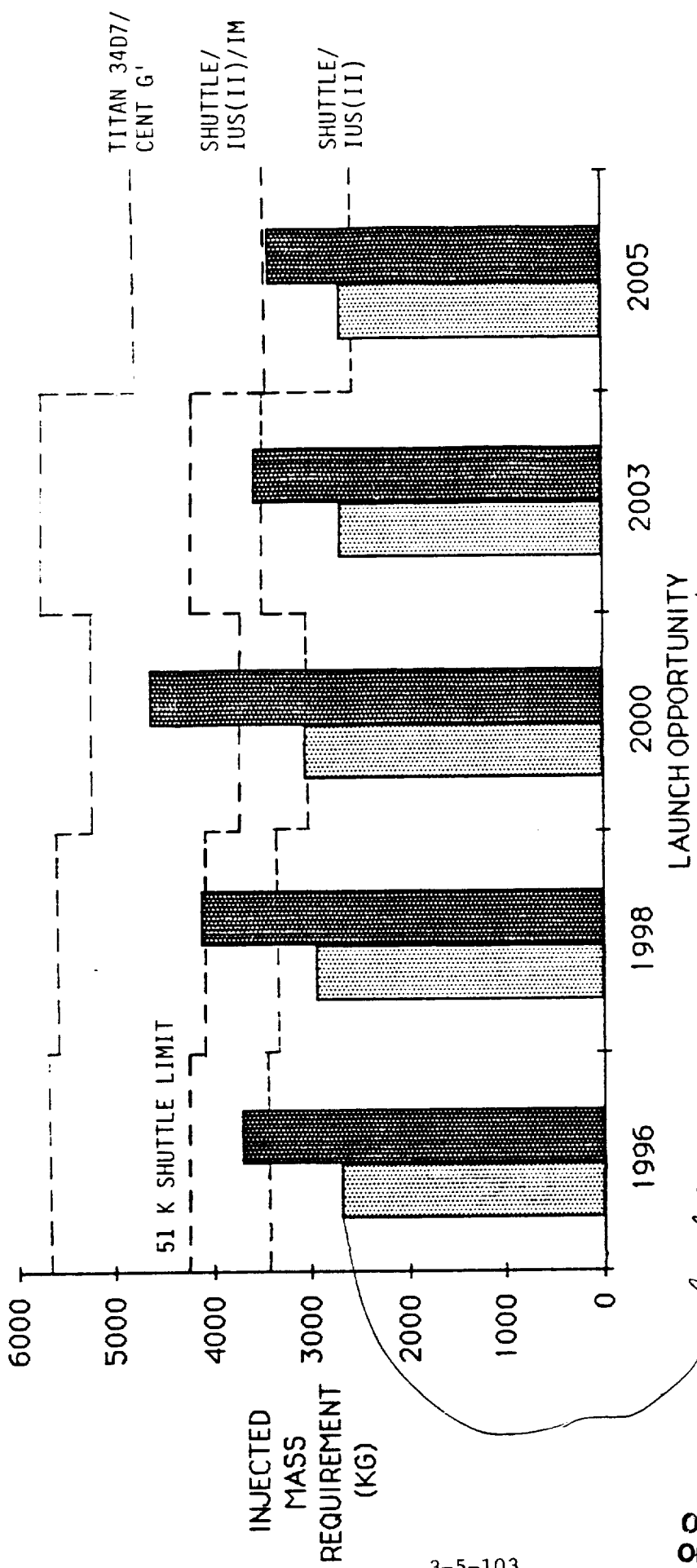

*slightly larger than G.U.*

**MARS ROVER MISSION MASS PERFORMANCE**

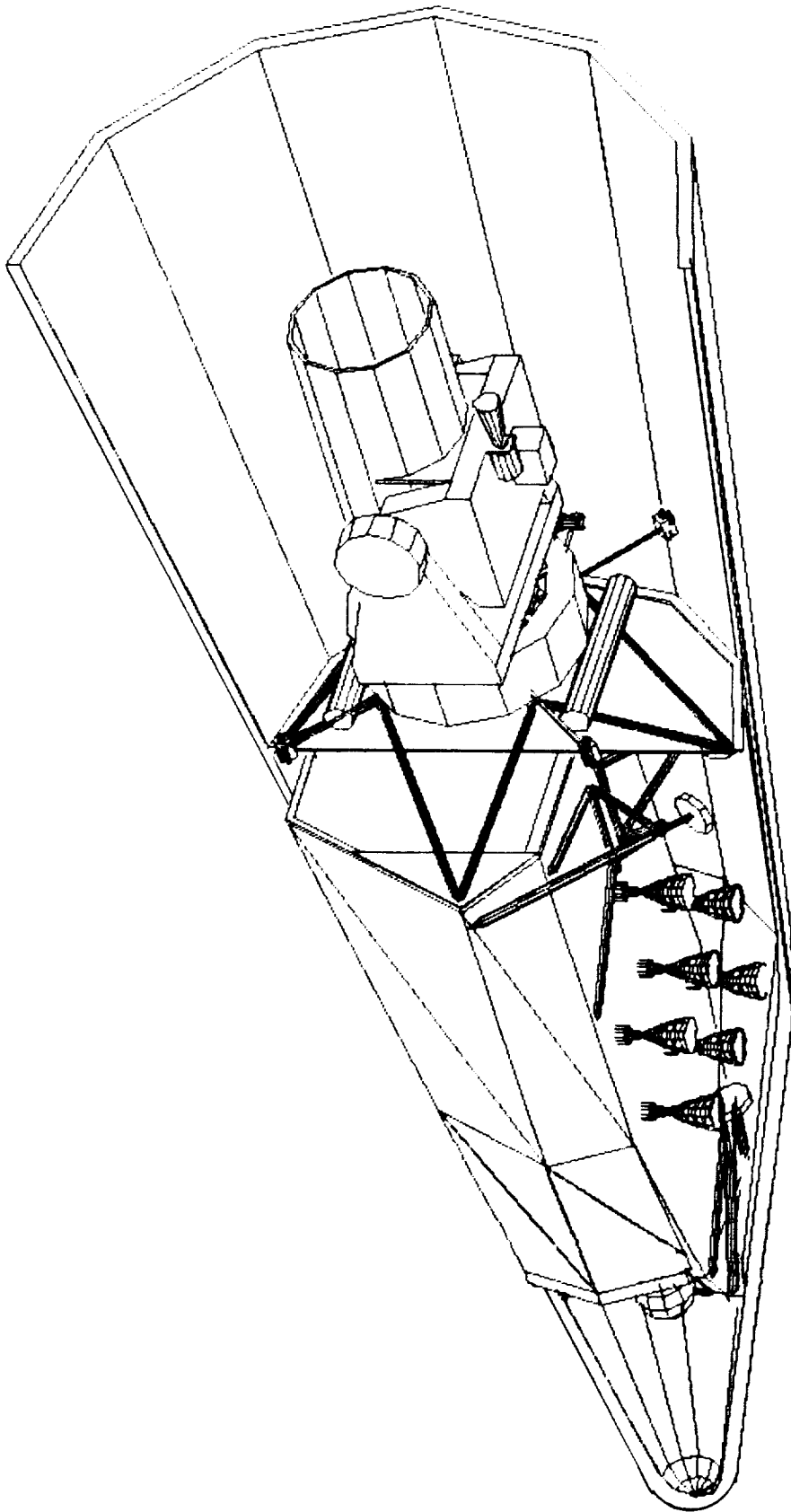

3-5-104

3-5-105

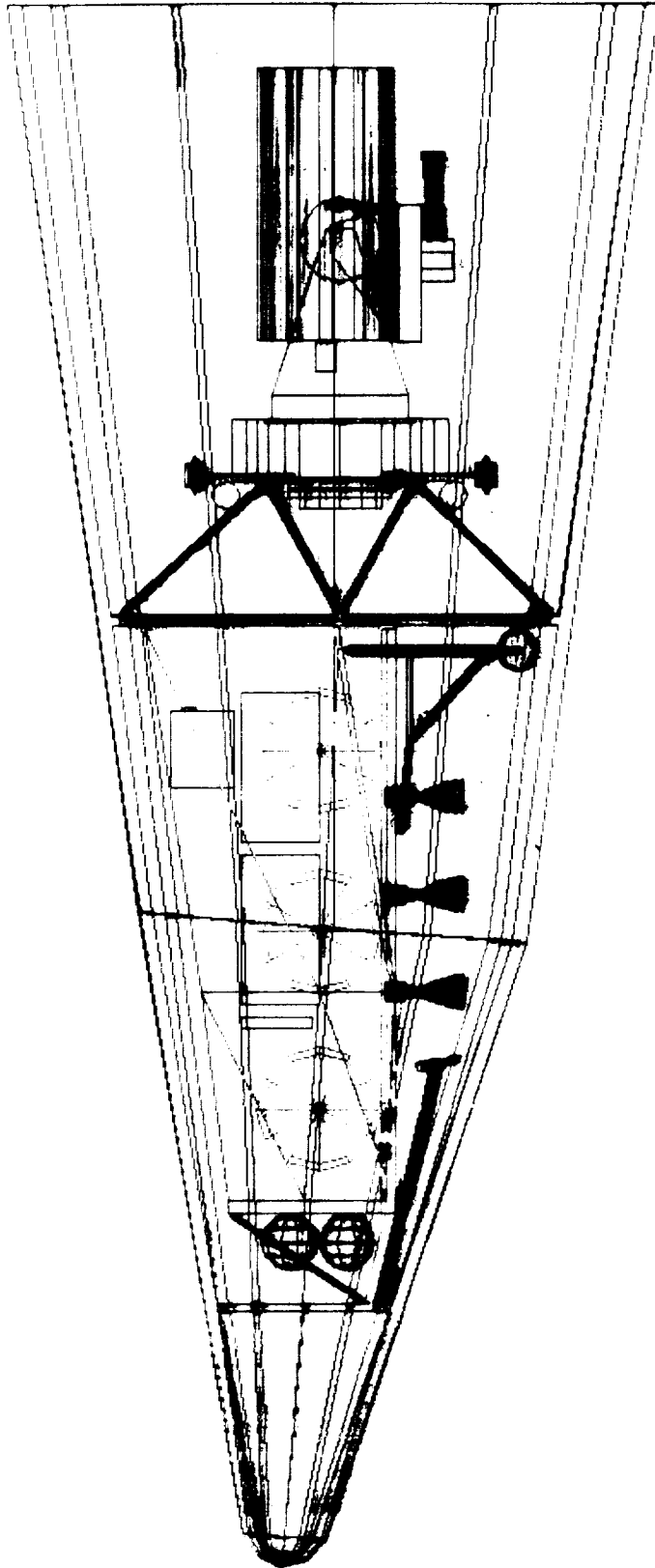

3-5-105

ORIGINAL PAGE IS  
OF POOR QUALITY

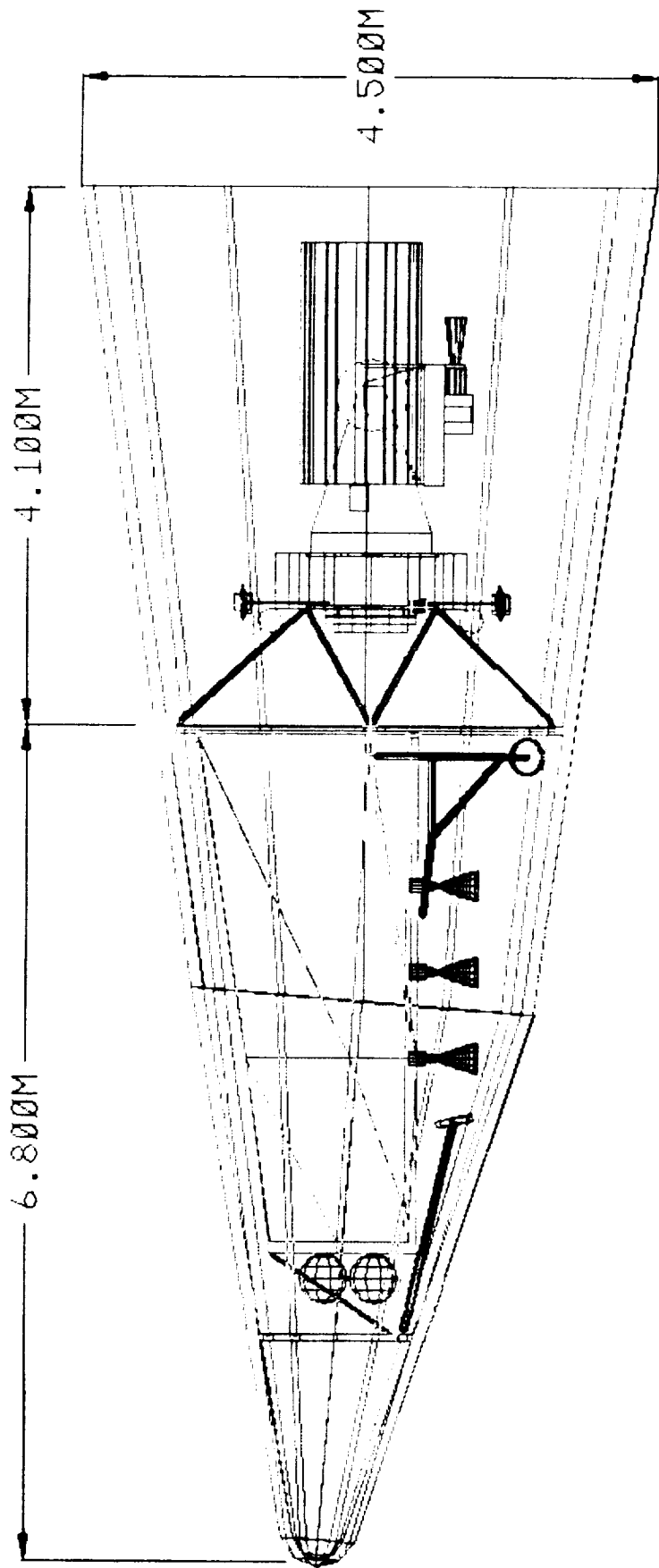

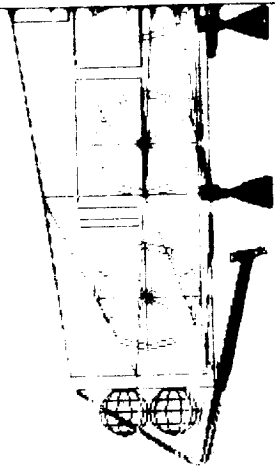

T\_WIND

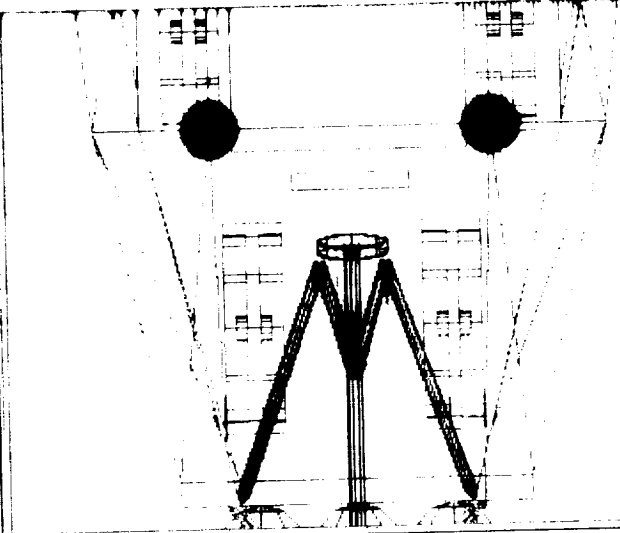

B\_WIND

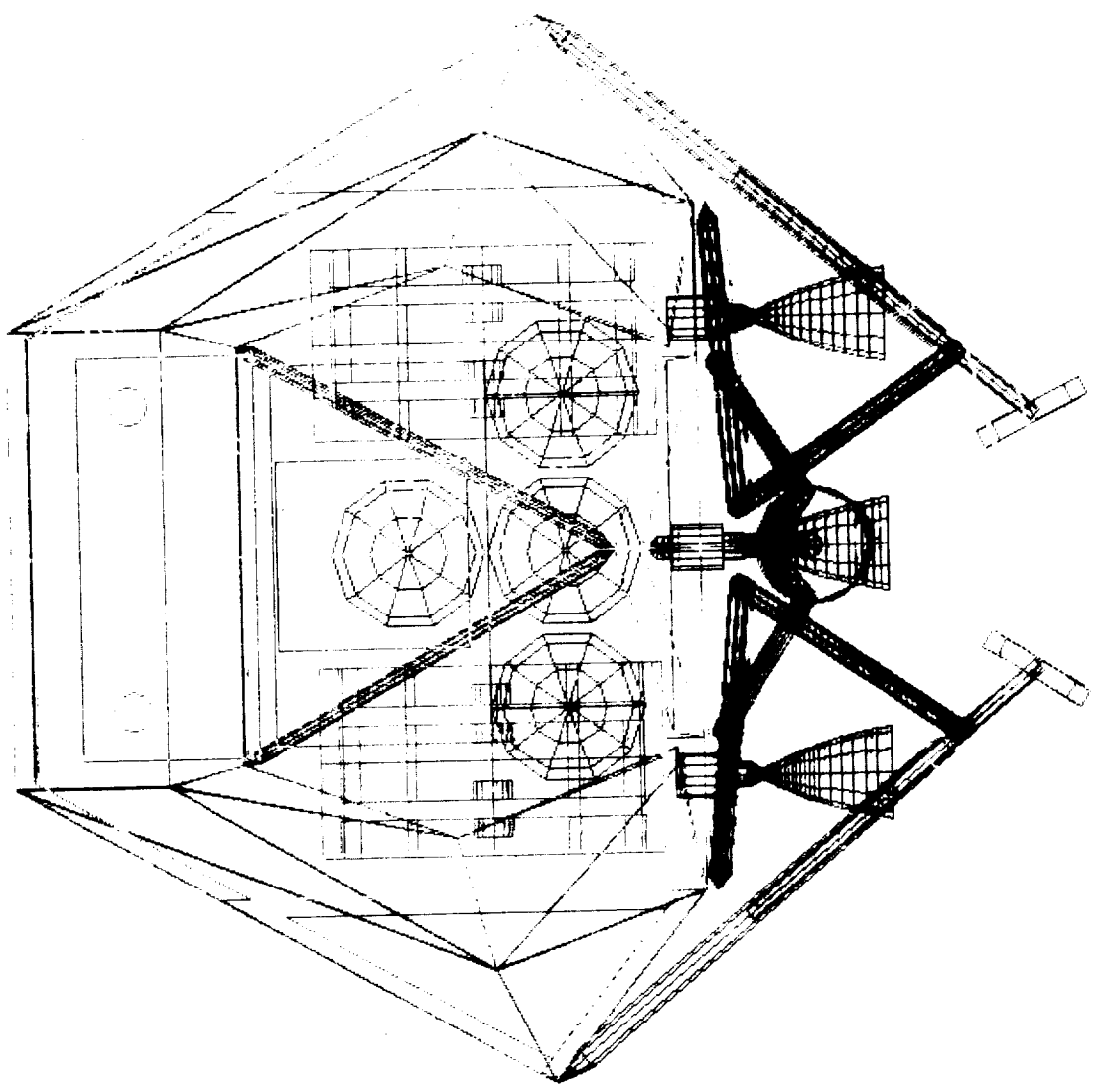

IN

3-5-107

ORIGINAL PAGE IS  
OF POOR QUALITY

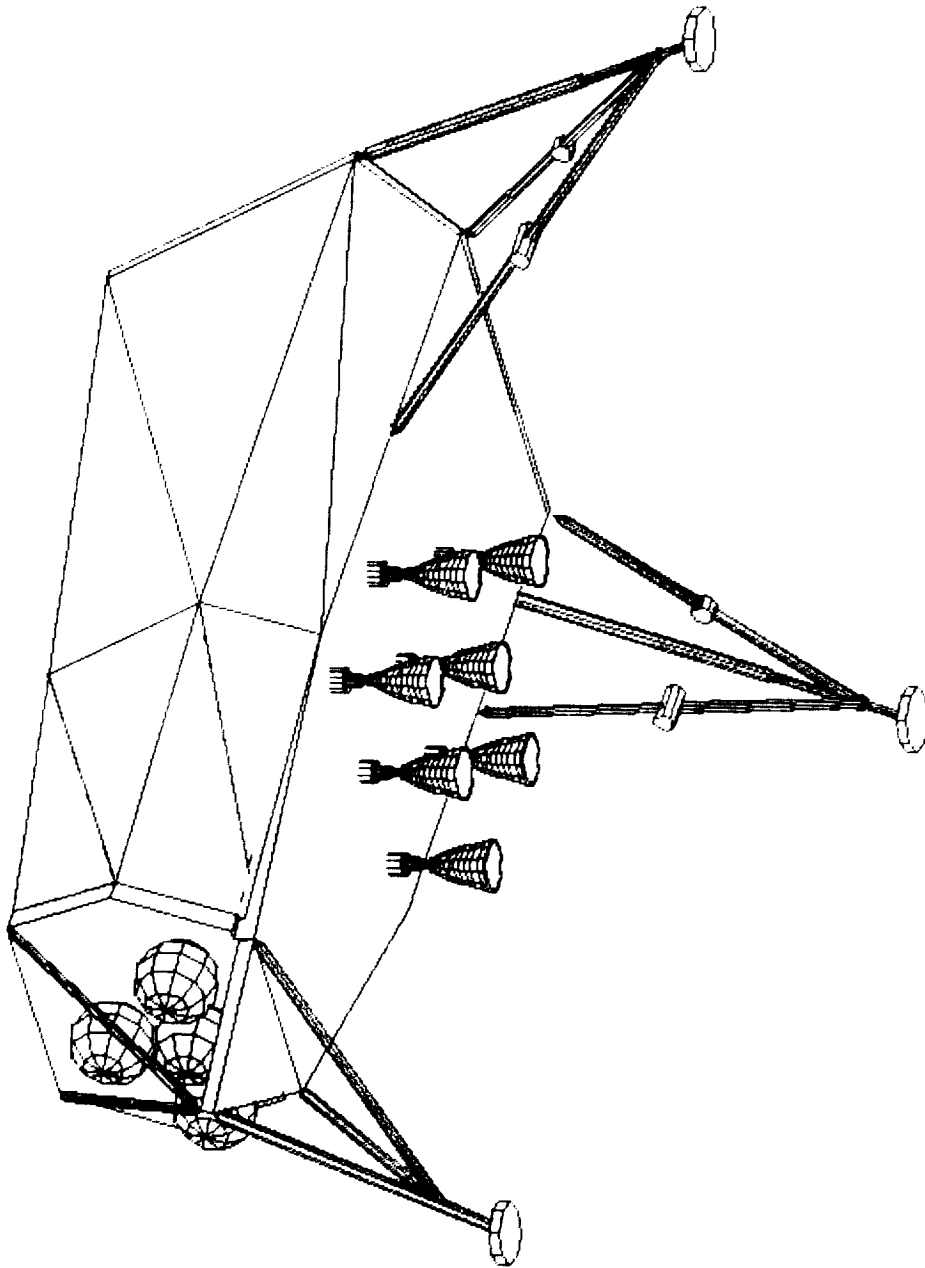

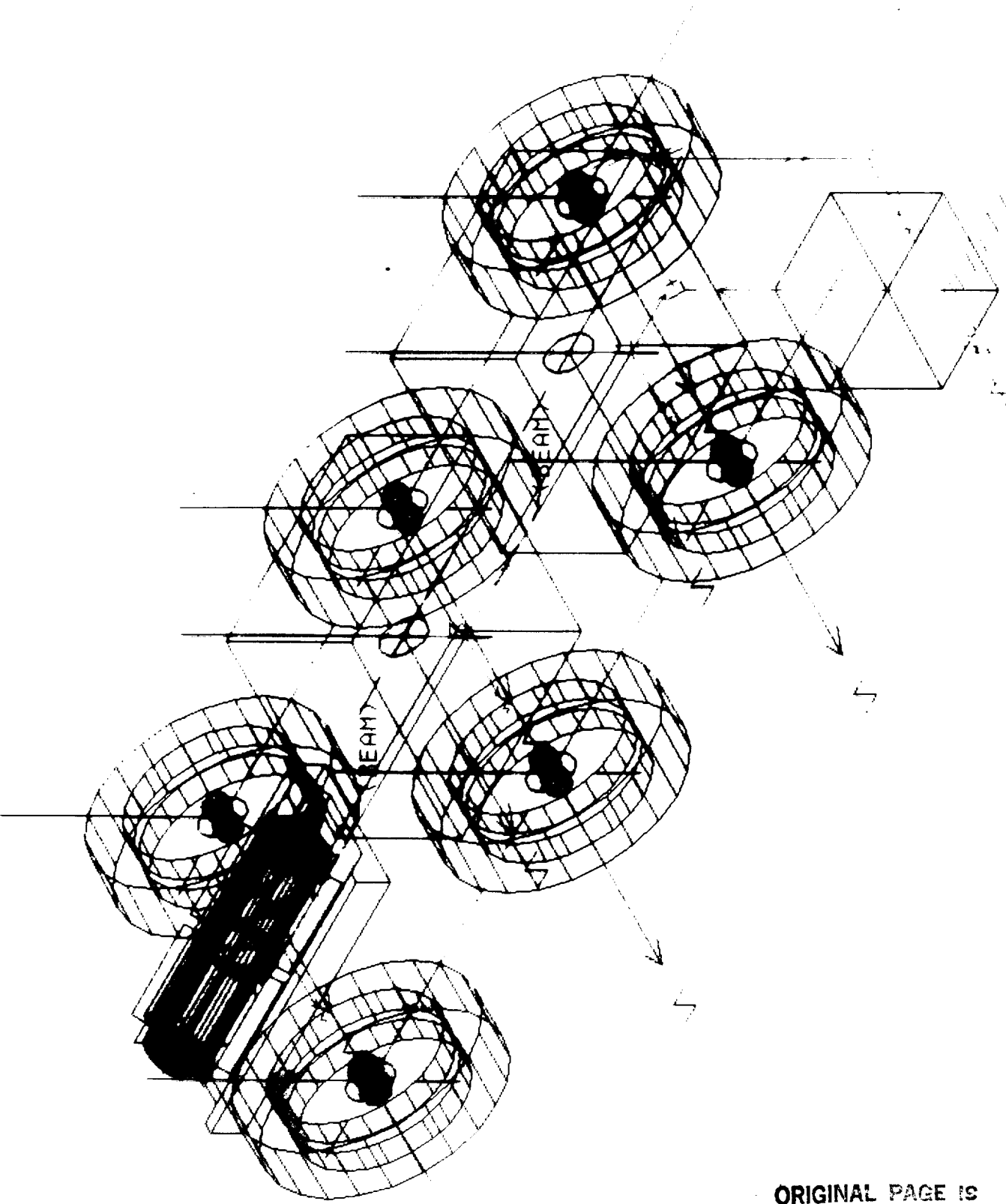

ORIGINAL PAGE IS  
OF POOR QUALITY

## MODELING FEATURES

**PARTS:** 3-DIMENSIONAL RIGID BODIES POSSESSING MASS, INERTIA, AND GEOMETRY

**FLEXIBILITY:** STRUCTURAL ELASTICITY INCLUDED DIRECTLY IN THE MODEL.

**CONNECTIVITY:** PART MOTION CONSTRAINTS MODELED FROM THE EXTENSIVE COLLECTION OF STANDARD JOINTS AND JOINT COMPONENTS

**FORCES:** LIBRARY OF LINEAR AND NONLINEAR FORCE COMPONENTS THAT INCLUDE SPRINGS, DAMPERS, BUSHINGS, ETC.

**MOTIONS:** TIME-DEPENDENT TRANSLATIONS AND ROTATIONS

**FUNCTION LIBRARY:** PREDEFINED ALGORITHMS SUCH AS FOURIER, SINE, STEP, AND POLYNOMIAL FORCES AND MOTIONS.

**DIFFERENTIAL EQUATIONS:** EXPRESSIONS FOR DESCRIBING CONTROLS, HYDRAULICS, ELECTRICAL SYSTEM EFFECTS.

**SPLINES:** CAN INCLUDE EXPERIMENTAL TEST DATA OF DISCRETE FUNCTIONS IN THE DATA SET TO DESCRIBE FORCES AND MOTIONS.



# **Implementing Tracked Vehicle Mobility Specifications**

# Agenda

- **Developing mobility specifications**
- **Systematic approach to achieving mobility**
  - **Mobility matrix**
  - **Converting specifications to hardware terms**
  - **Specification short comings**
- **Summary**

## **Elements of Mobility**

- **Soft soil performance**
- **Rough terrain performance**
- **Obstacle performance**
- **Slope performance**
- **Agility**
- **Water performance**
- **Transportability**

## **Systematic Approach to Achieving Mobility**

- **Singular mobility entity**
  - **Mobility matrix**
- **Relate to engineering design process**
- **Specify Mobility subsystem parameters in hardware terms**
- **Conduct subsystem mobility analysis and trade studies**

(6)

# Mobility Matrix

MOBILITY PARAMETERS	WEIGHT	VEHICLE CONCEPTS ALTERNATIVES									
		A			B			C			
		RATING	SCORE	RATING	SCORE	RATING	SCORE	RATING	SCORE		
PROPULSION	20	6	90	10	100	8	80	9	27	8	24
• POWER	10										
• SPEED	3										
• BRAKING	2										
• STEERING/CONTROL	5										
SUSPENSION	40	10	300	9	270	8	240	2	45	7	35
• RIDE PERFORMANCE	30										
• STABILITY	5										
• OBSTACLE PERFORMANCE	5										
TRACK	30	10	100	9	90	7	70	10	150	6	90
• GROUND PRESSURE	10										
• MOBILITY INDEX/ VEHICLE CONE INDEX	15										
• MRRM V80 SPEED & PERCENT NO-GO	5										
VEHICLE/SYSTEM CONSTRAINTS	10	6	45	8	40	6	30	9	27	9	27
• VISION	3										
• VEHICLE SIZE & WT	2										
• SEAT DESIGN	1										
• GROUND TRANSPORT	2										
• AIR TRANSPORT	1										
• WATER PERFORMANCE	1										
WEIGHTED TOTAL SCORE	100	—	930	—	862	—	695	—	862	—	695
RANK ORDER	—	1	1	2	2	3	3	1	2	3	3

# Sample Mobility Attribute Tree

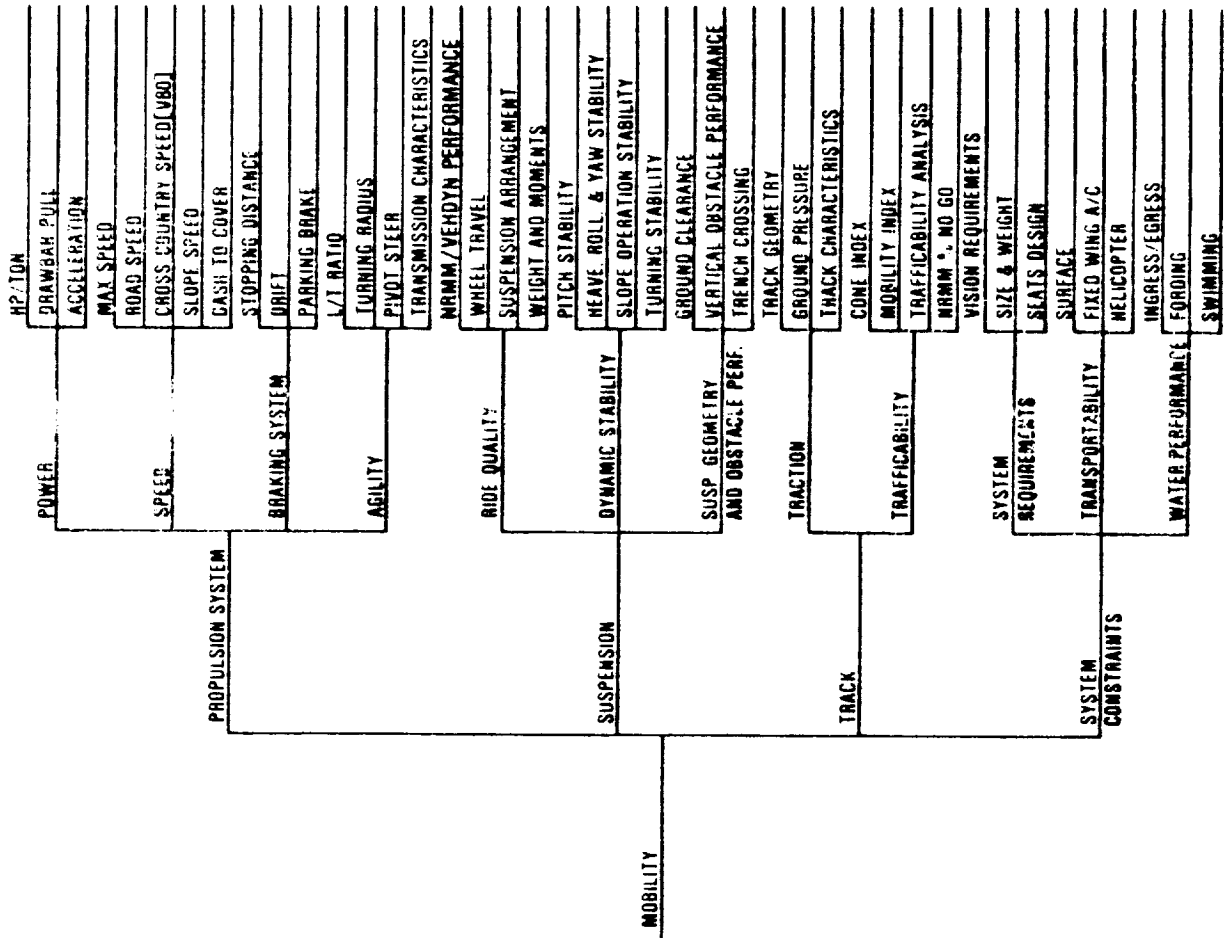

C-4

ORIGINAL PAGE IS  
OF POOR QUALITY

(LB)

# Vehicle Effectiveness Matrix

VEHICLE PARAMETERS	WEIGHT	VEHICLE CONCEPTS ALTERNATIVES								
		A			B			C		
		RATING	SCORE		RATING	SCORE		RATING	SCORE	
MOBILITY	20	10	200		5	100		4	80	
SURVIVABILITY	30	8	240		10	300		4	120	
FIREPOWER	30	7	210		7	210		10	300	
SYSTEM REQUIREMENTS	10	6	60		3	60		10	100	
SUPPORTABILITY	5	8	40		2	10		4	20	
COST	5	9	45		4	20		2	10	
WEIGHTED TOTAL SCORE	100	—	795		—	700		—	630	
RANK ORDER	—		1			2			3	

# Relating Mobility to the Engineering Process and Hardware Terms

- Power train
- Suspension
- Track
- Vehicle/system Constraints



## Propulsion System Mobility Parameters

- Power
  - Acceleration
  - Power to weight ratio
- Speed
  - Top speed
  - Speed on grade/slopes
  - Dash to cover
- Braking
  - Stopping distance
  - Drift
- Steering and control (agility)
  - L/T ratio
  - Turning radius/pivot steer
  - Transmission characteristics
    - Shift points & speed range spread
  - Steering type
  - Power train stall torque

**Power Train  
Engine Selection Mobility Parameters**

- **Acceleration**  
 $P_e = P_1 + K_1 \text{ MVA}$
- **Speed on grade**  
 $P_e = P_2 + K_2 V \cdot (W \sin \theta - R_f)$
- **Dash-to-cover time**

# Engine Selection Dash to Cover Speed

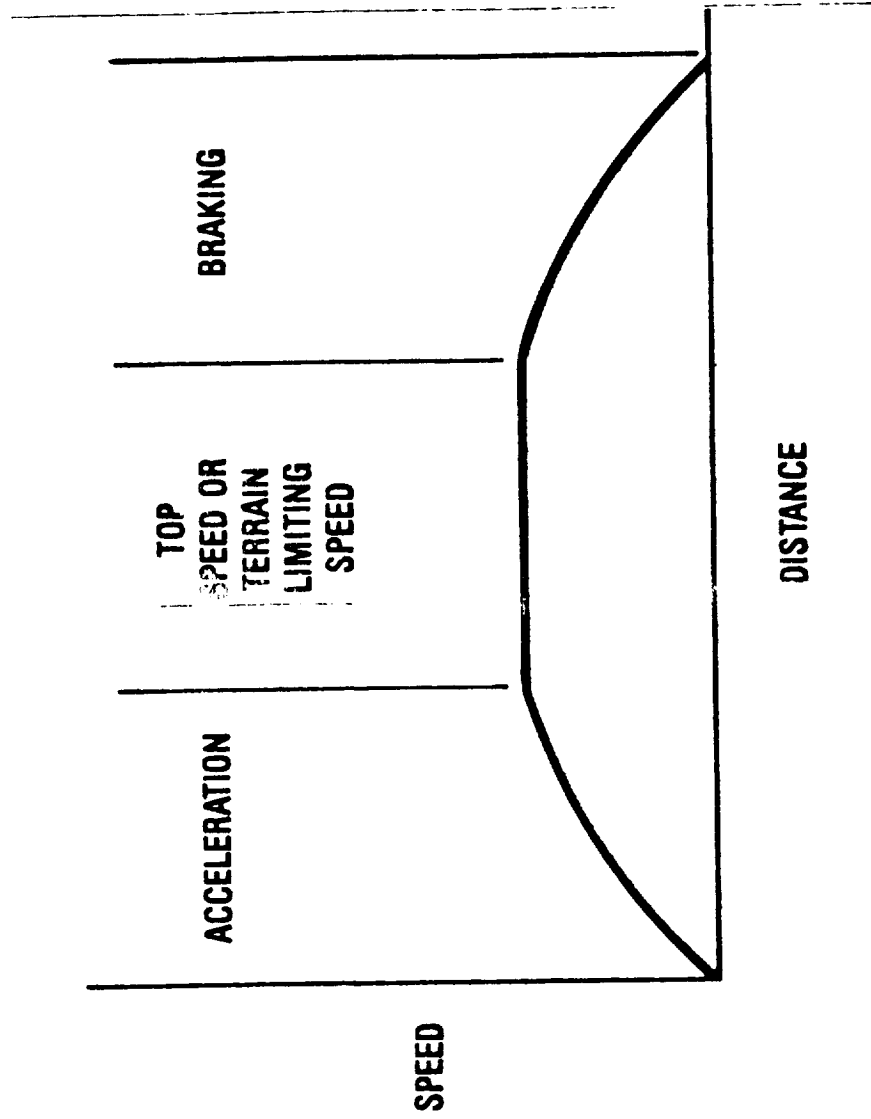

18-31-84

# Engine Selection 250-m Dash Time vs SHP/T

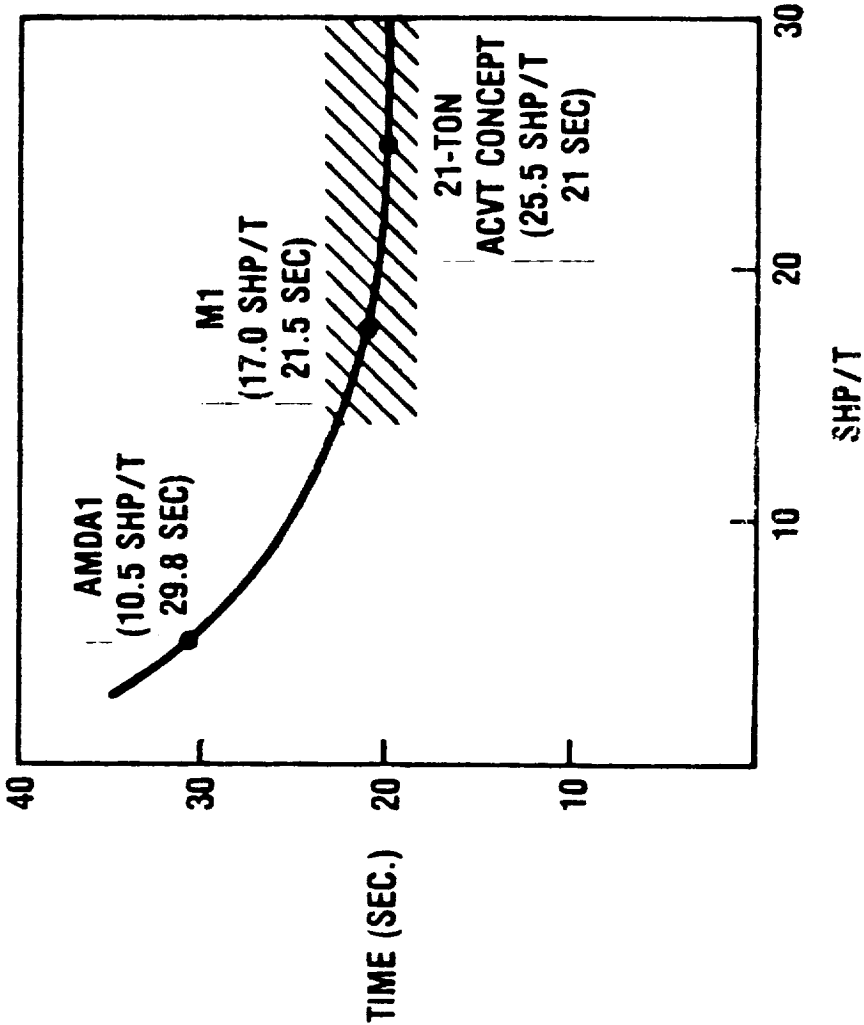

19-31-84

14

**Power Train  
Transmission Selection Mobility Parameters**

- **Speed on grade**
- **Speed ratio spread**
- **Turning radius**
- **L/T ratio**
- **Braking**
- **Final drive**

# Transmission Selection Vehicle Performance Comparison Speed on Grade/Speed Ratio Spread

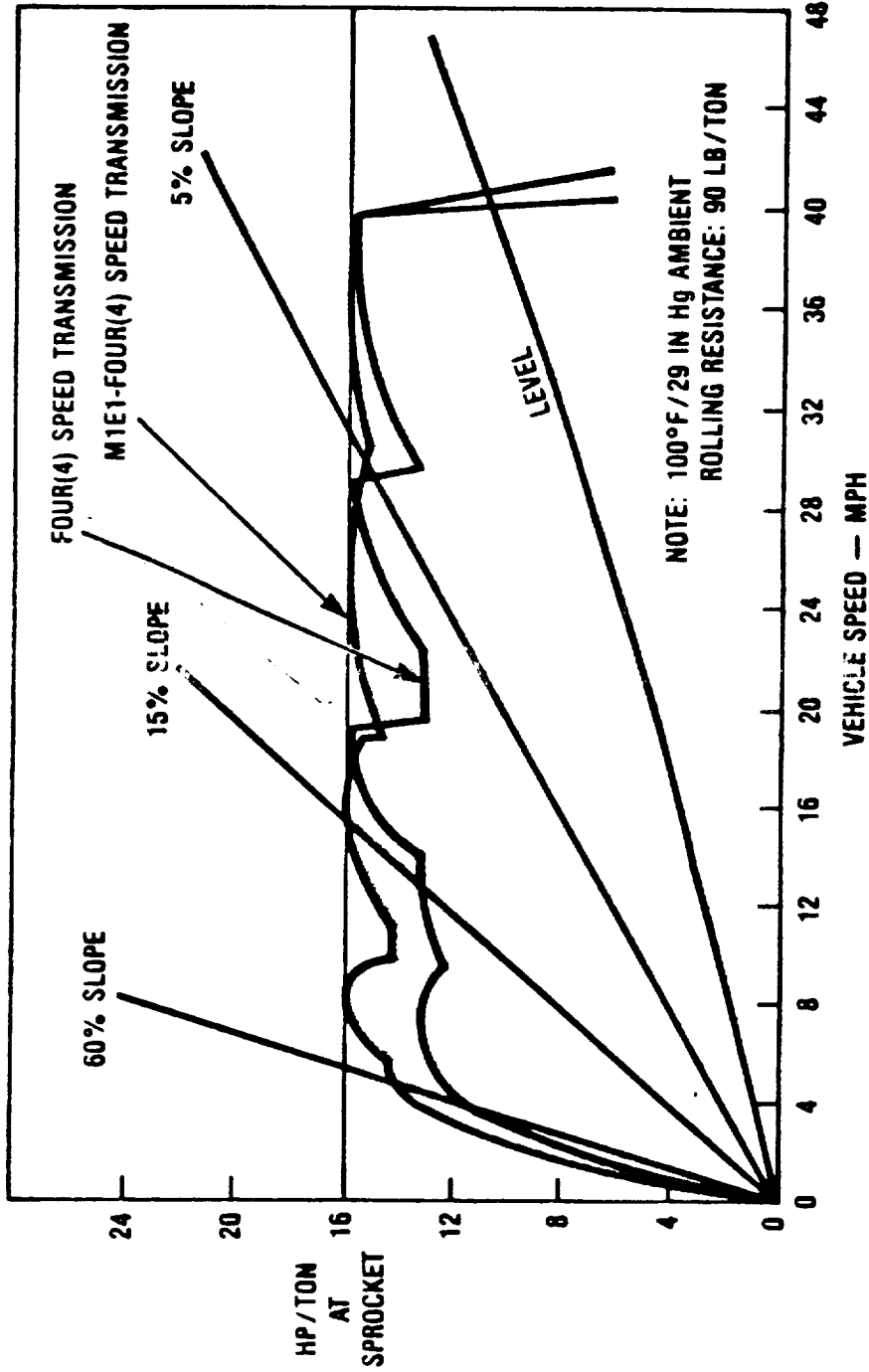

19-31-44

# Transmission Selection Turning Stability

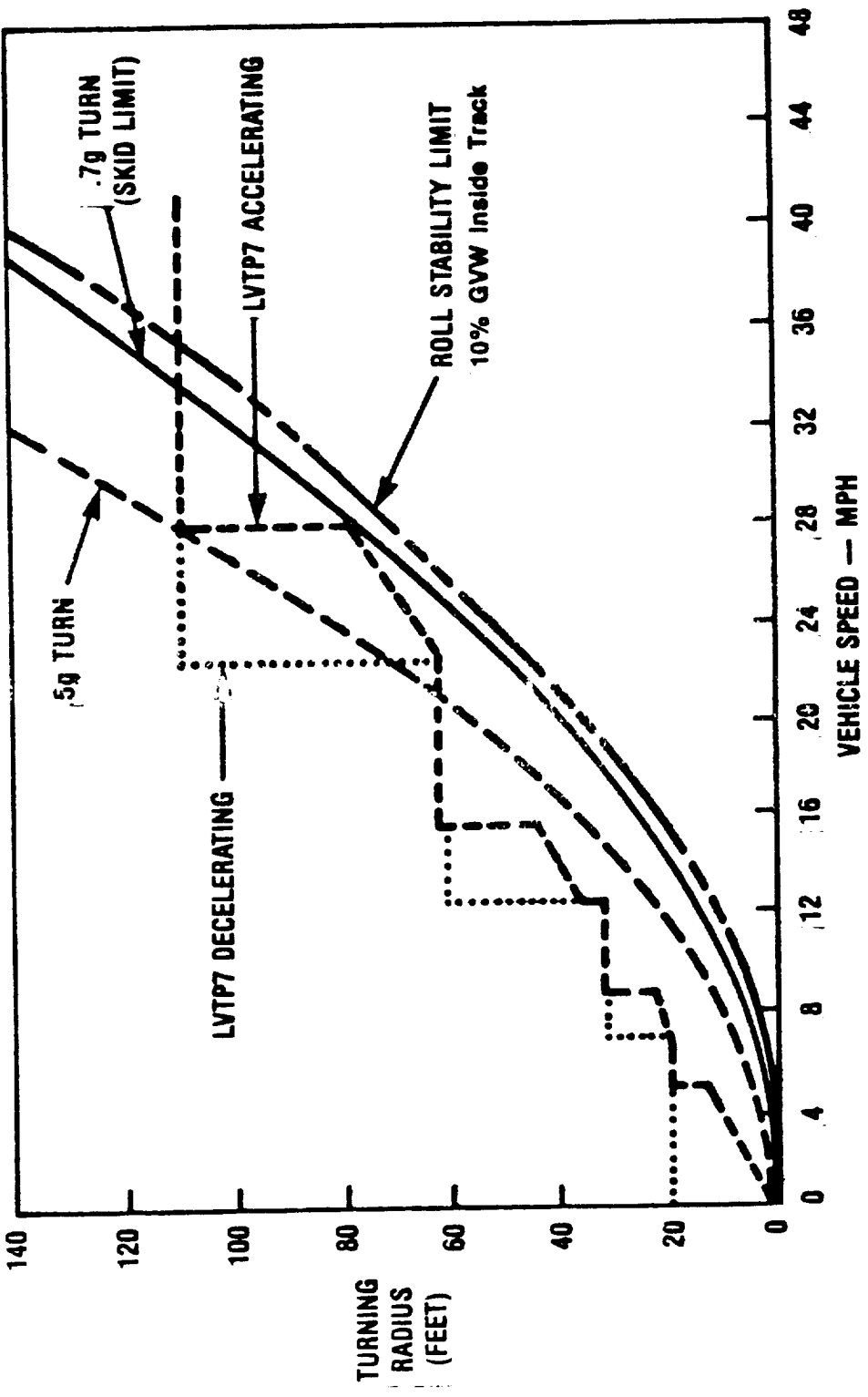

# Suspension System Mobility Parameters

- Ride performance and gun platform stability
  - Vehicle ride dynamics analysis model criteria
  - NATO reference mobility model criteria
  - Vehicle test course and speed criteria
  
- Stability
  - Pitch stability
  - Turning stability
  - Slope operation
  
- Obstacle performance
  - Ground clearance
  - Vertical obstacle
  - Trench crossing
  - Approach and departure angles



## **Suspension Arrangement**

- **Minimum ground clearance = Wheel travel +  
4 to 6 inches  
(16 to 20 inches)**
- **Obstacle crossing**
  - **Vertical Wall: 30 to 36 inches**
    - Approach angle — 60° with  
90° preferred**
    - Departure angle — 40° with  
90° preferred**
  - **Trench crossing: 6 to 9 feet**

# **Analytical Performance Measurement Criteria**

## **VEHDYN Model**

- Acceleration magnitude and comparison**
- Pitch and Heave displacement magnitude and comparison**

## **NRMM**

- 6 watts absorbed power**
- 2.5g Acceleration**
- Alternative limits exceeding the above for special applications**

# SUPPORT ASSEMBLY SELECTION Performance Comparison

ORIGINAL PAGE IS  
OF POOR QUALITY

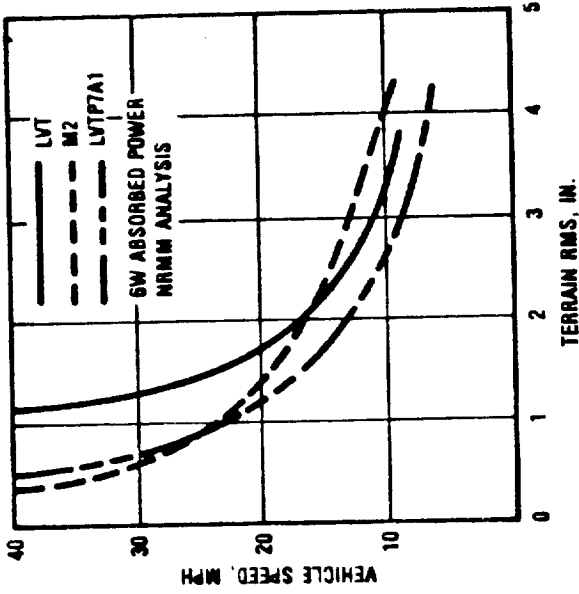
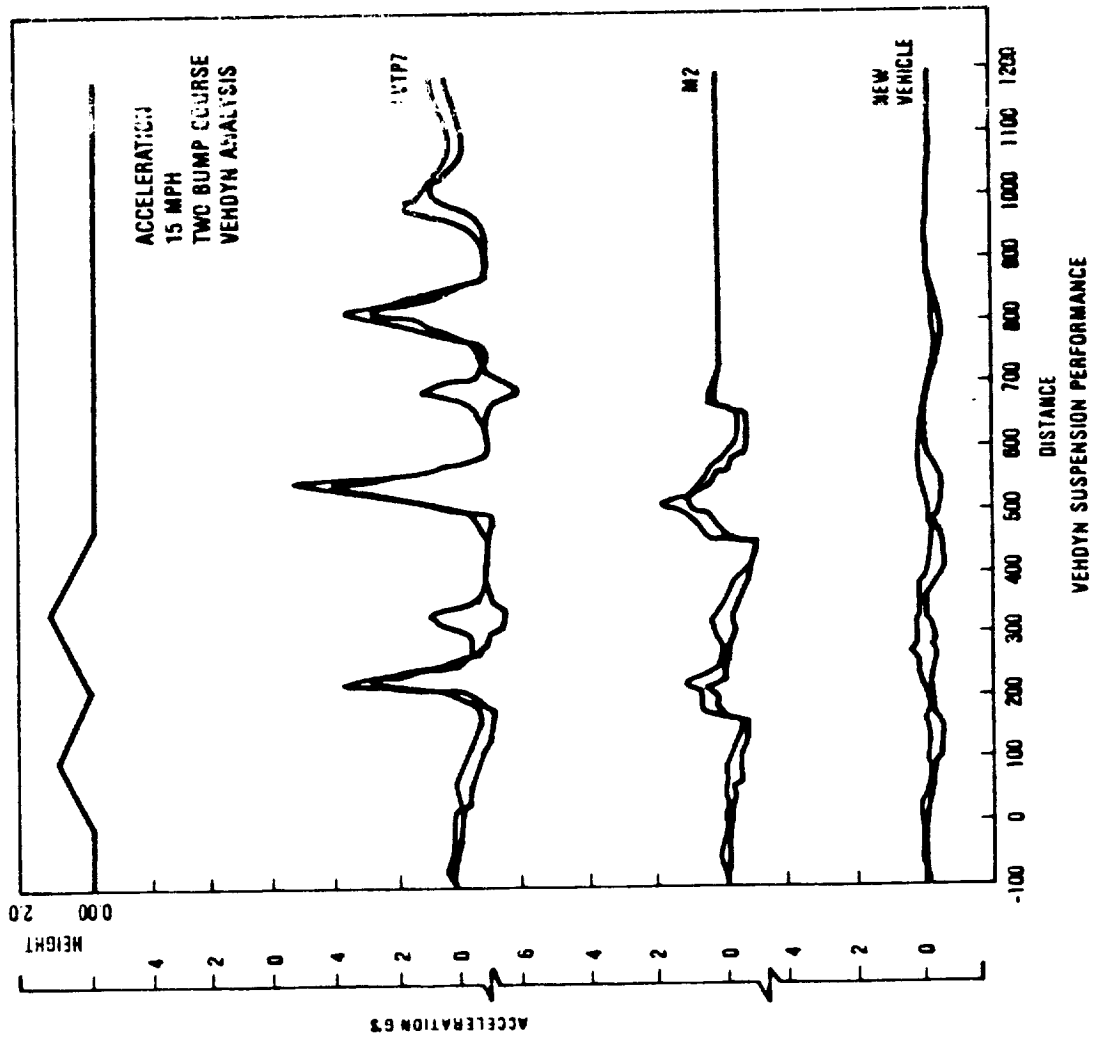

## **Suspension Support Assembly Selection**

- **Spring rate**
  - **Ride performance**
  - **Turning and slope stability**
- **Damping Rate**
  - **Ride performance**
  - **Gun platform stability**
- **Wheel travel**
  - **Ride performance**

**SUPPORT ASSEMBLY SELECTION**  
**Percent Side Slope vs Percent GW**  
**on Uphill Track**

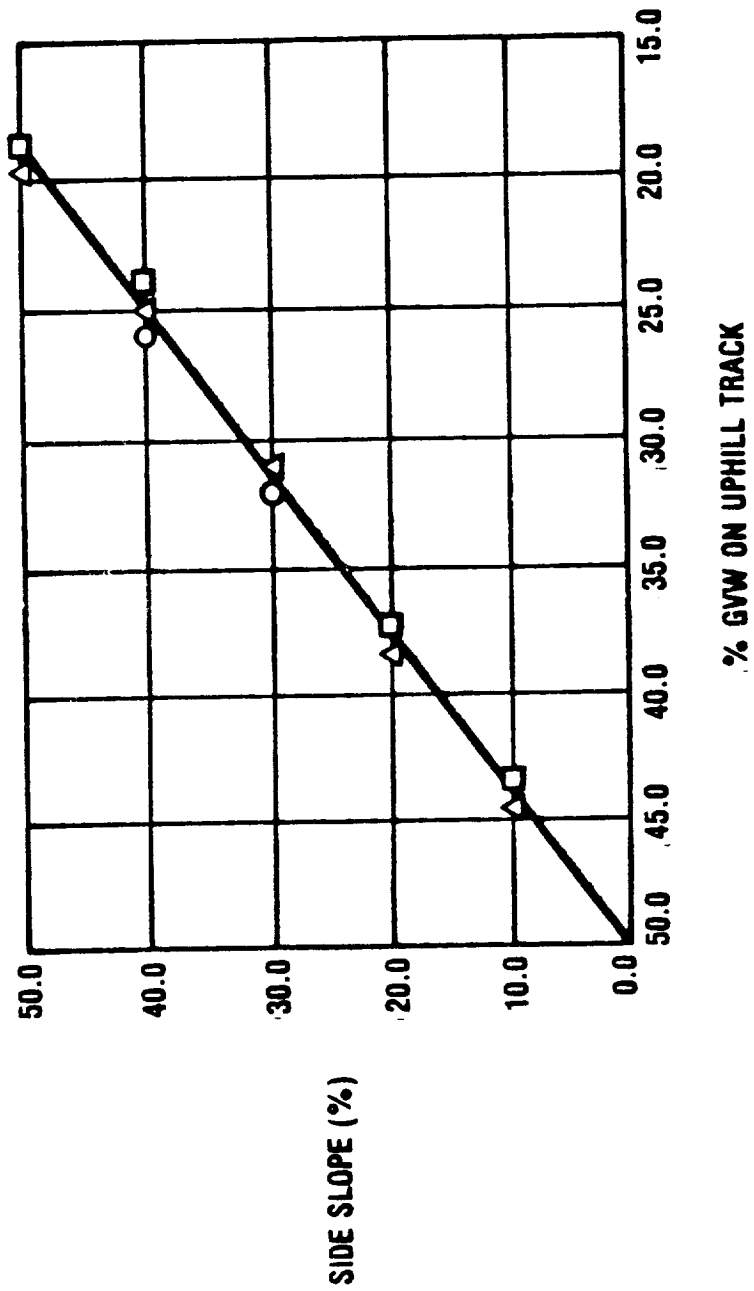

25A

# SUPPORT ASSEMBLY SELECTION

## Vehicle Dynamics Response Increased Shock Absorber Damping

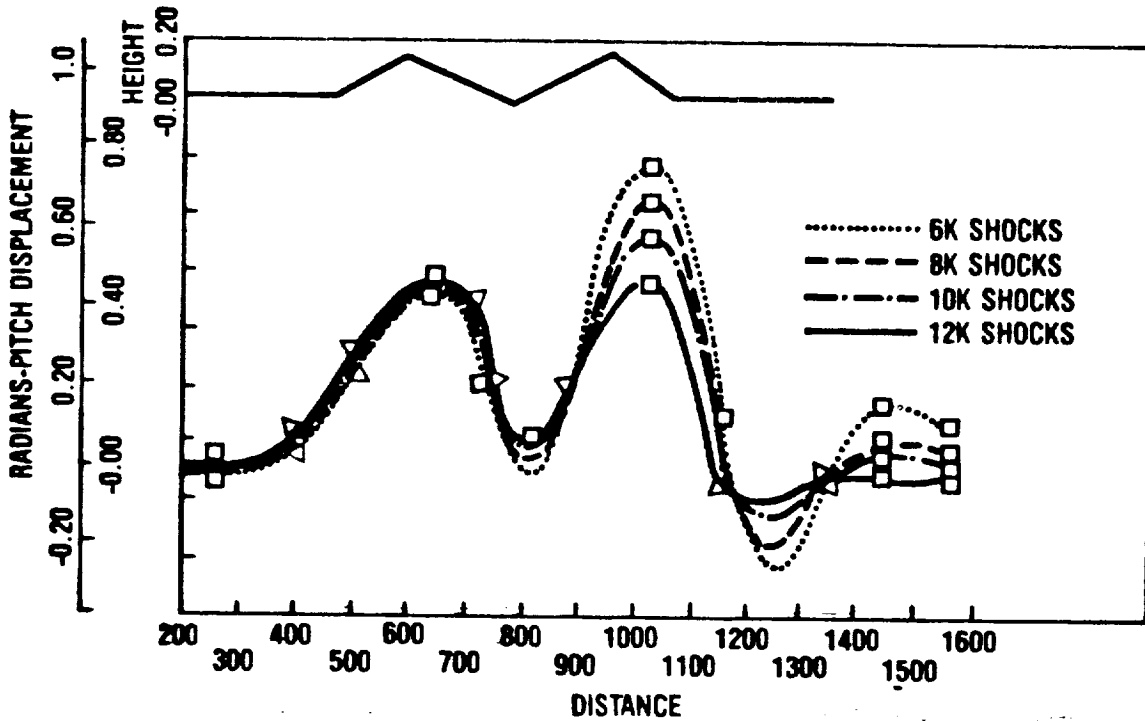
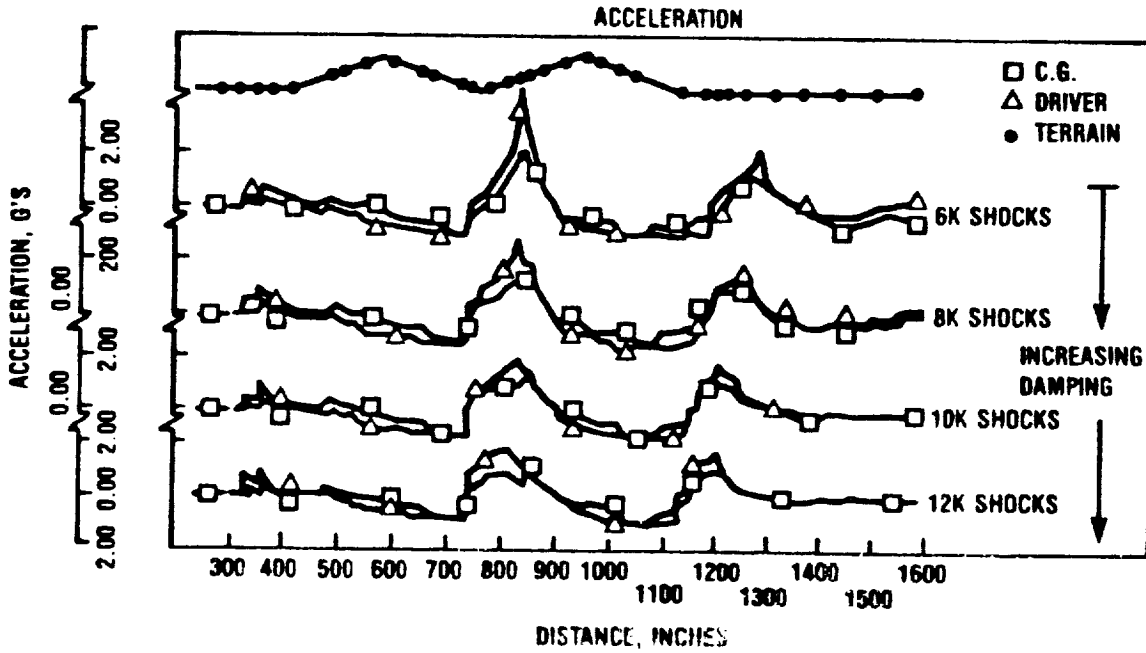

26

# SUPPORT ASSEMBLY SELECTION NRMM Damping Capacity Analysis

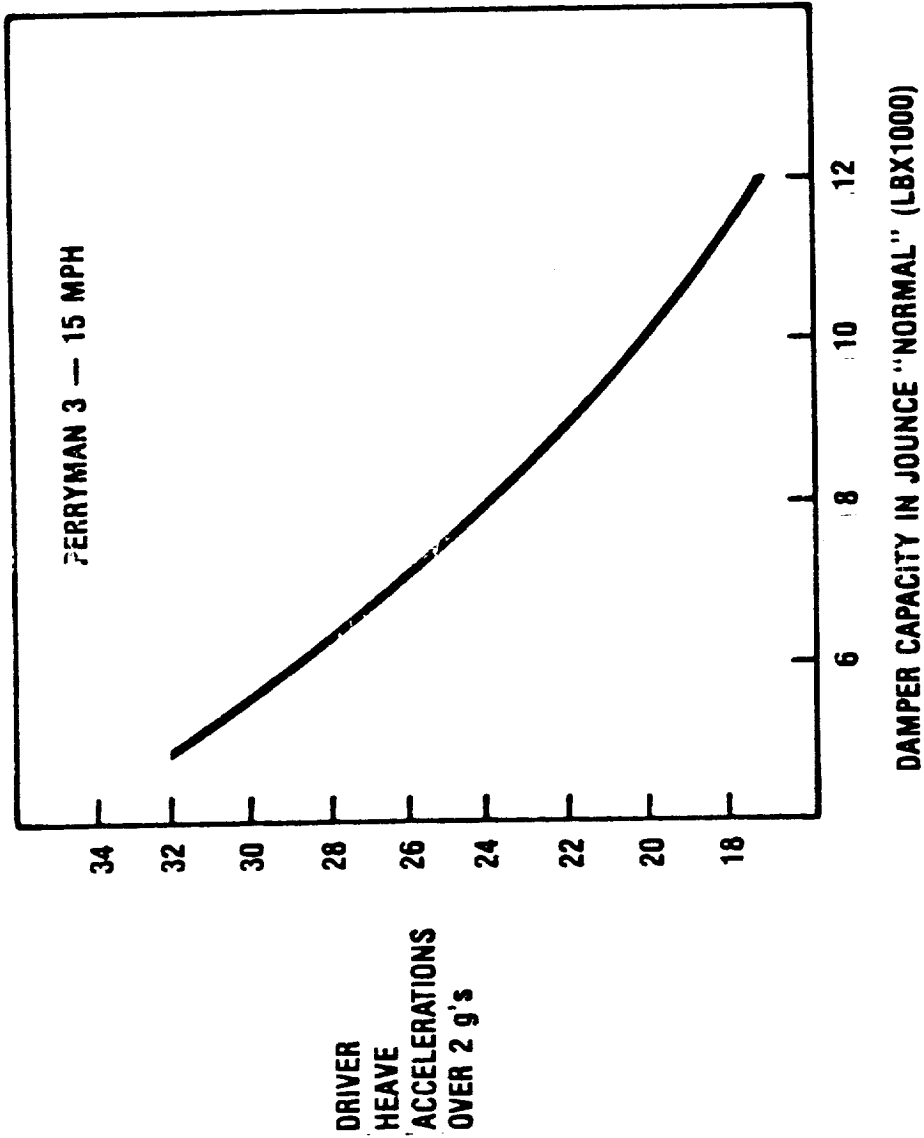

19-31-84

27

**SUPPORT ASSEMBLY SELECTION  
VEHDYN Wheel Travel Analysis**

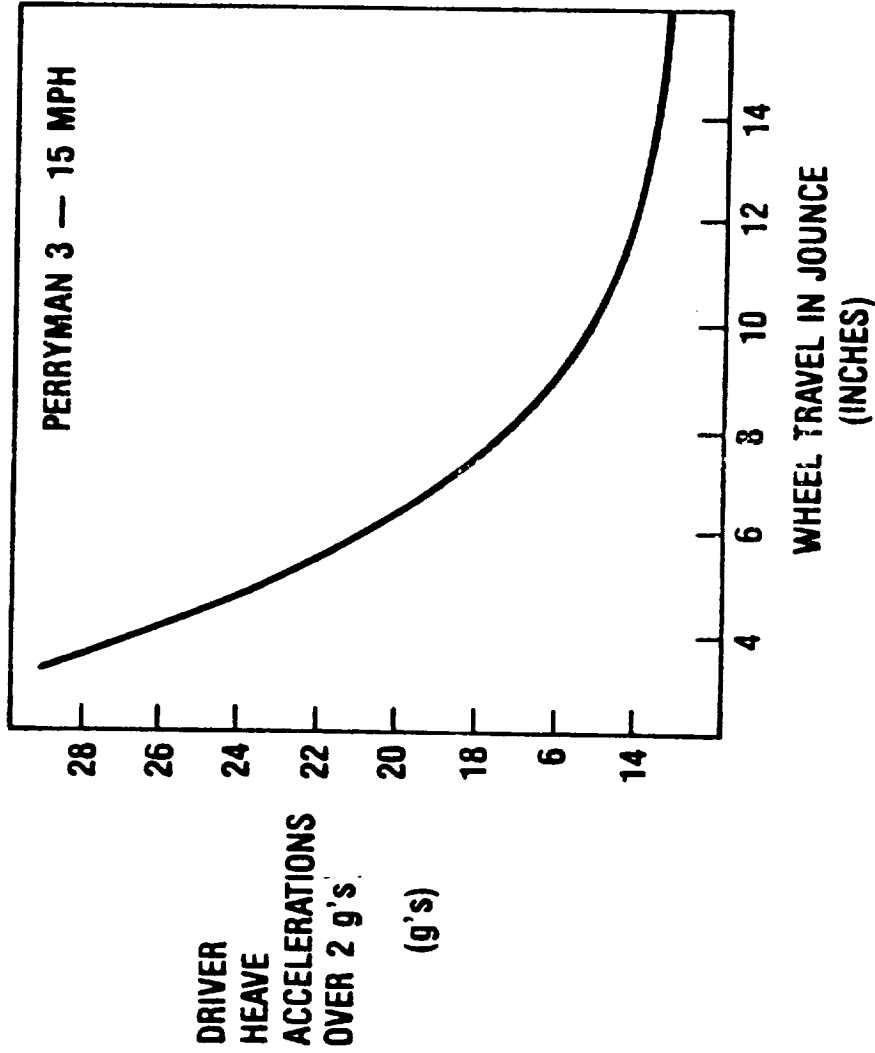

19-31-84



## **Track System Mobility Parameters**

- **Ground Pressure**
- **Mobility Index (MI) or Vehicle Cone Index (VCI)**
- **NRMM V80 Speed and Percent No-Go**

# TRACK SELECTION Soft Soil Mobility Assessment Utilizing VCI

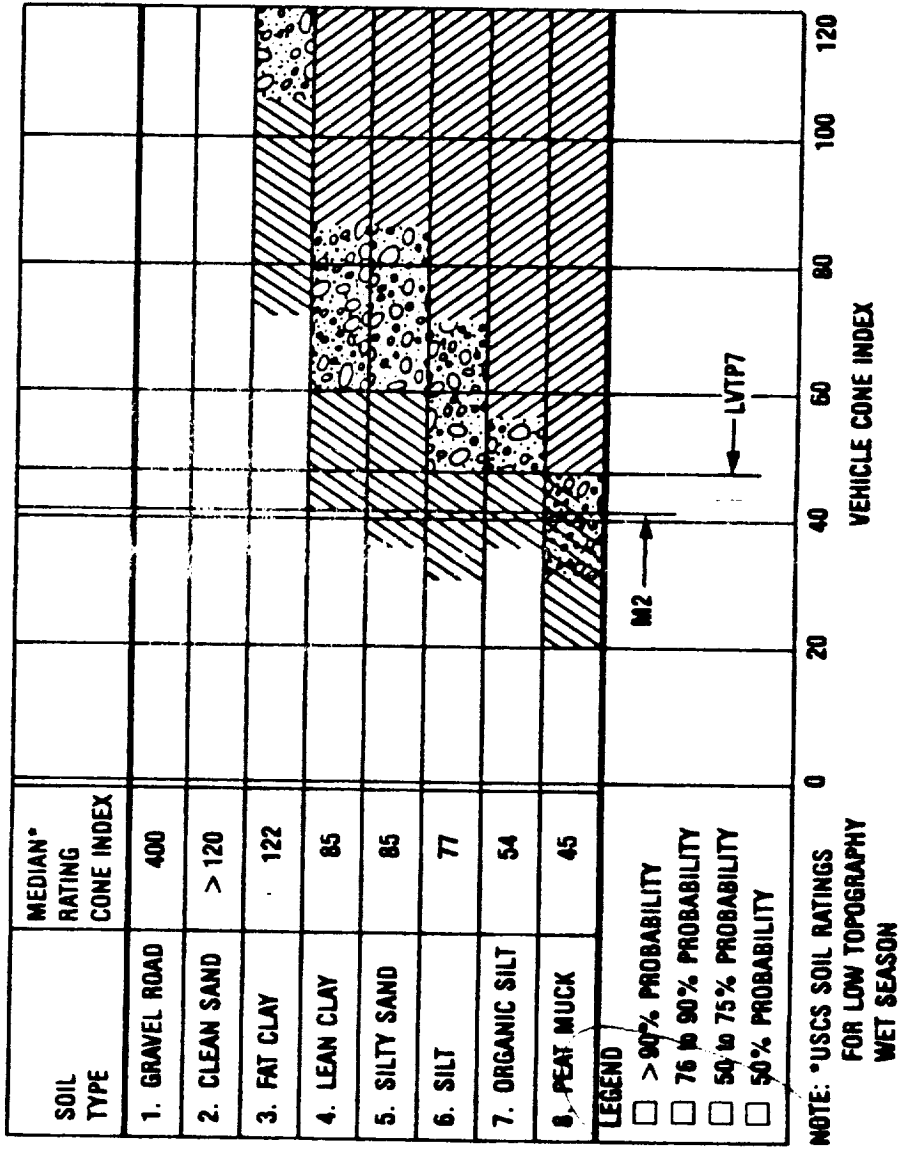

19-31-84

30

## Vehicle/System Constraint Parameters

- Driver Vision
- Seat Design
- Ground Transportability
  - Rail
  - Highway
  - Ship
- Air Transportability
  - Fixed Wing Aircraft
  - LAPES
  - Helicopter
- Water Performance
  - Fording
  - Water Ingress/Egress
  - Swimming

**VEHICLE MOBILITY CONSTRAINT  
Driver's Vision  
(Open Hatch)**

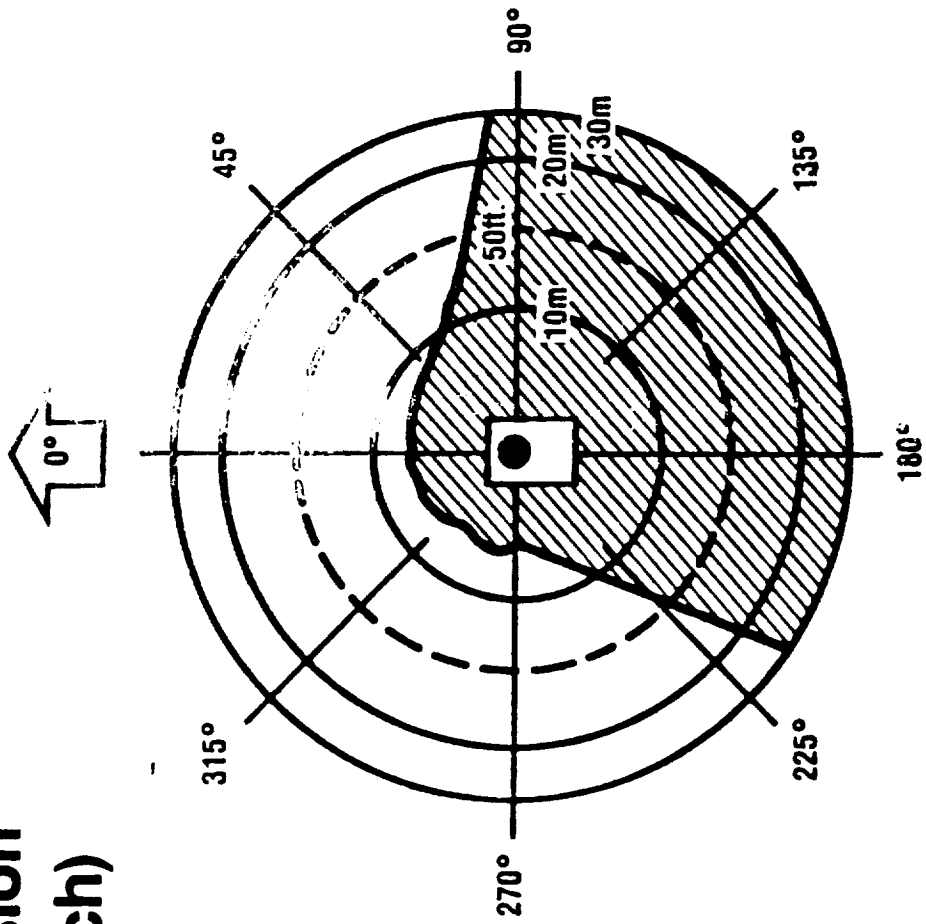

18-31-84

33

**VEHICLE MOBILITY CONSTRAINT**  
**Highway Transport**

- **GVW < 160,000 lbs.**
- **Height < 132 in.**
- **Width < 12 ft, ≤ 8 ft. desirable**
- **Ground Pressure ≤ 12.5 psi**
- **Load per Linear Foot**  
**≤ 3000 + .06 (GVW · 8000)**

**(no permit required)**

**for GVW < 60,000 lbs.**

$$\leq \frac{20,000 \times \text{GVW}}{160,000 + \text{GVW}}$$

**for GVW > 60,000 lbs.**

# Air Transport Imposed Vehicle Constraints

CONSTRAINT	C-13C	C-141	C-5	C-17 (PRELIMINARY)
HEIGHT	102"	103"	FRONT/REAR 155"/156	141"
HEIGHT (LAPES)	96"			
WIDTH	111" (105" @ FLOOR)	111"	216"	203"
WIDTH (AIIRDROP)	108 (PLATFORM)	108"		
LENGTH	480"	834"	1160"	1056"
FLOOR				
LOADING LB/FT	6000	3020	10,800	
LOAD				
LIMITATION (TONS)	22.3 MAX	35 MAX	102 MAX	86.1 MAX
TYPE III AIRFIELD				
100 NM	19.8			
500 NM	17.4			
1000 NM	13.9			
1500 NM	10.4			
TYPE II AIRFIELD				
100 NM	9.8		-	-
500 NM	7.4	-	-	-
1000 NM	3.9	-	-	-
1500 NM	4	-	-	-
TYPE I AIRFIELD				
100 NM	4.8	-	-	-
500 NM	2.4	-	-	-
1000 NM	-	-	-	-
1500 NM	-	-	-	-
DROP				
100 NM		-	-	-
500 NM	23.9	32.1	-	-
1000 NM	17.0	32.1	-	-
1500 NM	9.9	29.7	-	-

19-21-84

38

ORIGINAL PAGE IS  
OF POOR QUALITY

**VEHICLE MOBILITY CONSTRAINT**

**Water Performance**

- **Fording**
  - **40 inch depth unaided**
  - **9 inch minimum grill freeboard**
- **Water ingress/egress**
- **Swimming**

## Summary

- Cooperative Government and industry specification development
- Mobility matrix approach
- Suggested implementation means and parameters



# **A BRIEF LOOK AT LUNAR ROVER**

**RICHARD F. BONSACK  
MANAGER,  
ROBOTIC SYSTEMS TECHNOLOGY**

**BOEING AEROSPACE COMPANY  
SEATTLE, WASHINGTON**

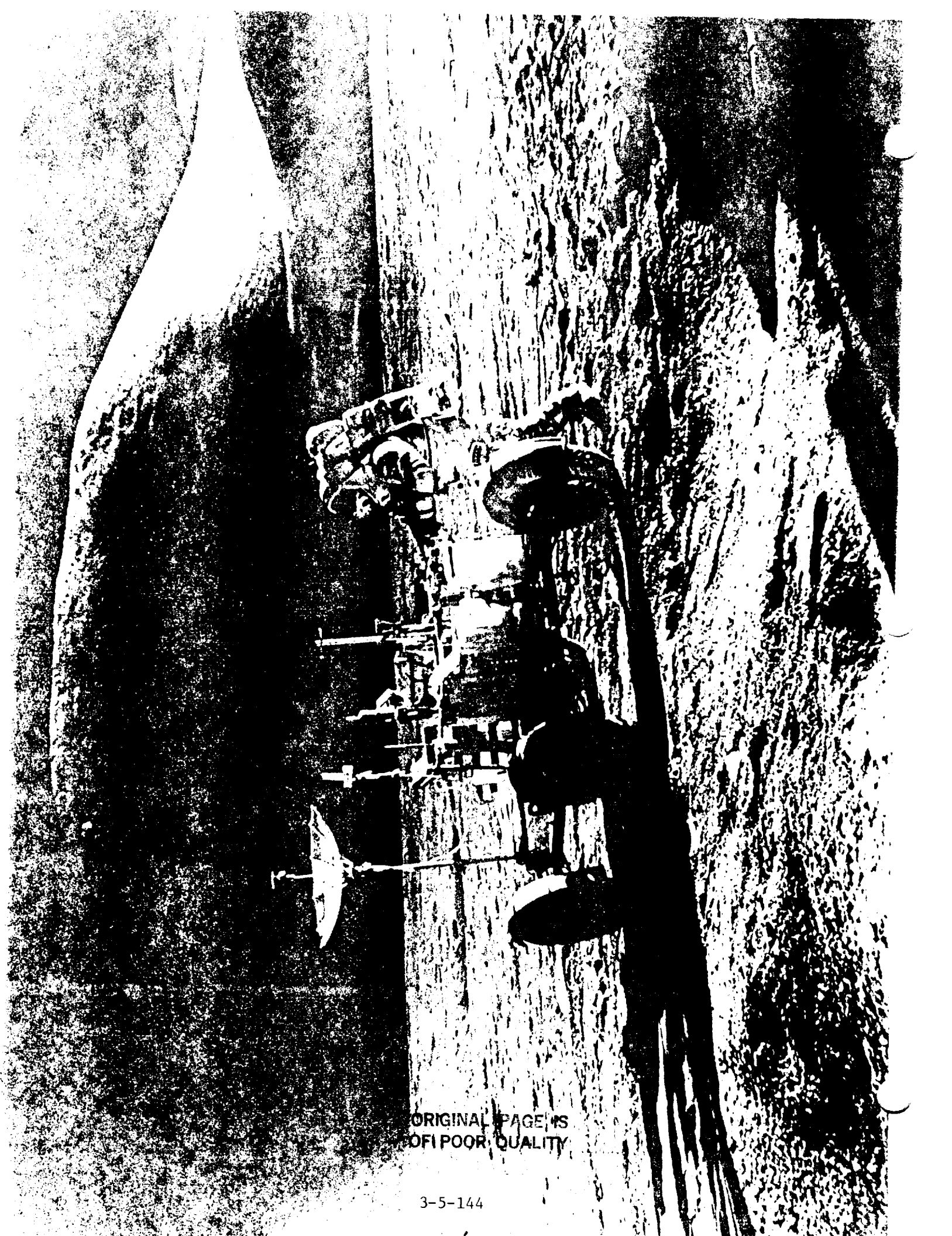

ORIGINAL PAGE IS  
OF POOR QUALITY

# LUNAR ROVER - MISSION/PERFORMANCE SUMMARY

Boeing Aerospace Company

## MISSIONS SUMMARY

	APOLLO 15	APOLLO 16	APOLLO 17
Number of sorties	3	3	3
Total distance traveled	27.9 km	27.1 km	36.1 km
Average speed	9.2 kph	7.9 kph	8.1 kph
Maximum speed	14 kph	17 kph	18 kph

## PERFORMANCE SUMMARY

<b>SPEED:</b>	16 kph; smooth, hard surface
<b>TURN RADIUS:</b>	3.0 meters
<b>GRADE:</b>	25 degrees; ascend and descend
<b>ROLL STABILITY:</b>	45 degrees
<b>ENDURANCE:</b>	92 km (limited by non-rechargeable battery power)
<b>OBSTACLES:</b>	Objects - 30.5 cm step Depressions - 71.0 cm breach

# LUNAR ROVER - GENERAL CONFIGURATION

Boeing Aerospace Company

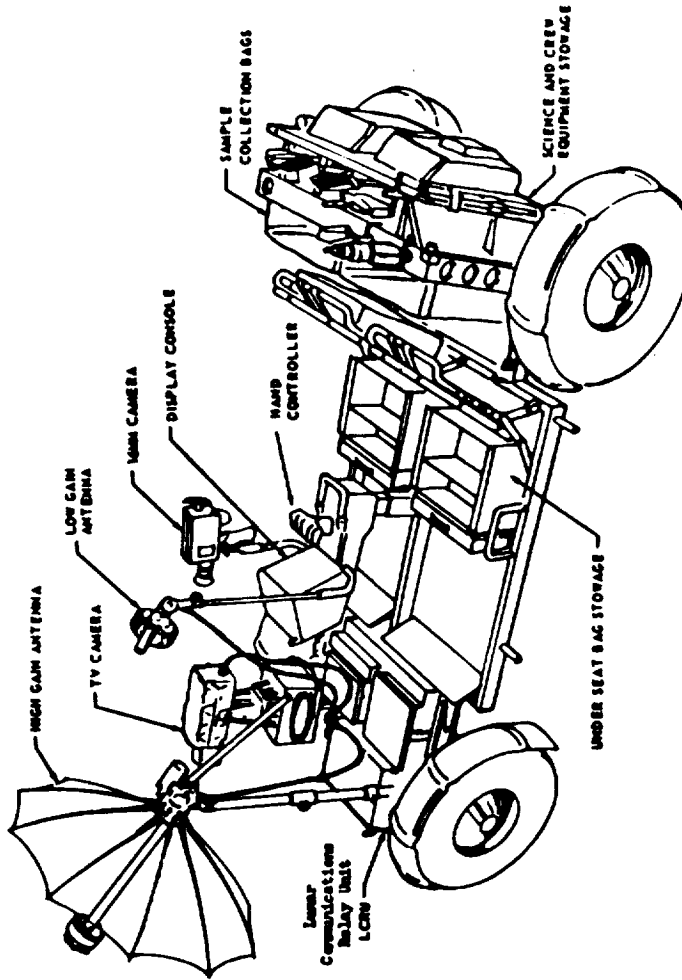

## DIMENSIONS

Length: 3.1 m  
 Width: 1.8 m  
 Wheel base: 2.3 m  
 Clearance: 0.35 m

## EARTH WEIGHT

Vehicle only: 210 kg  
 Fully loaded: 517 kg

## PROPULSION

Electric motor: one per wheel  
 Battery: 2 - 36v silver-zinc,  
 non-rechargeable

## CONTROL

"Stick" type hand controller  
 Two axel Ackerman steering

# LUNAR ROVER- MOBILITY SUBSYSTEM

Boeing Aerospace Company

- WHEELS
- TRACTION DRIVE ELEMENTS
  - MOTOR
  - TRANSMISSION
  - BRAKE
- DRIVE CONTROL ELECTRONICS (DCE)
- HAND CONTROLLER
- SUSPENSION
- STEERING
- LUBRICATION AND DUST CONTROL

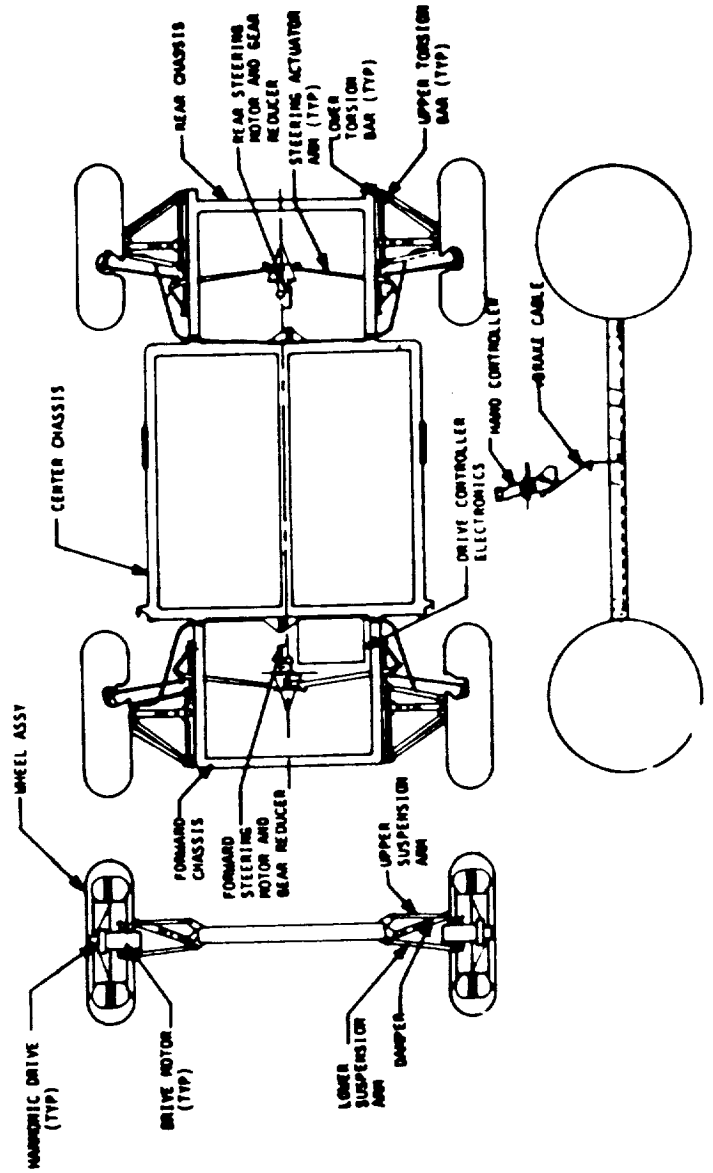

# LUNAR ROVER - WHEEL/TIRE CONFIGURATION

Boeing Aerospace Company

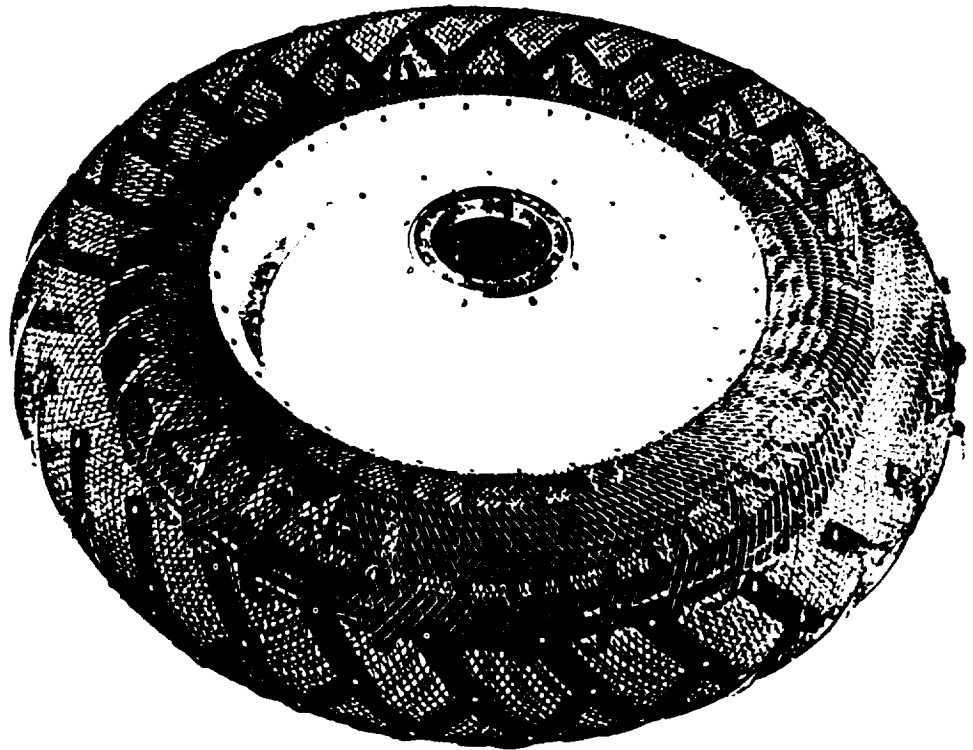

## TIRE

Woven wire -

- Zinc coated piano wire
- Titanium bump stop
- Titanium chevron tread

## HUB

Spun aluminum

## DIMENSIONS

Diameter: 0.85 m (approx.)

Width: 0.22 m (approx.)

## EARTH WEIGHT

Each wheel: 5.4 kg

# LUNAR ROVER- WHEEL CROSS-SECTION

Boeing Aerospace Company

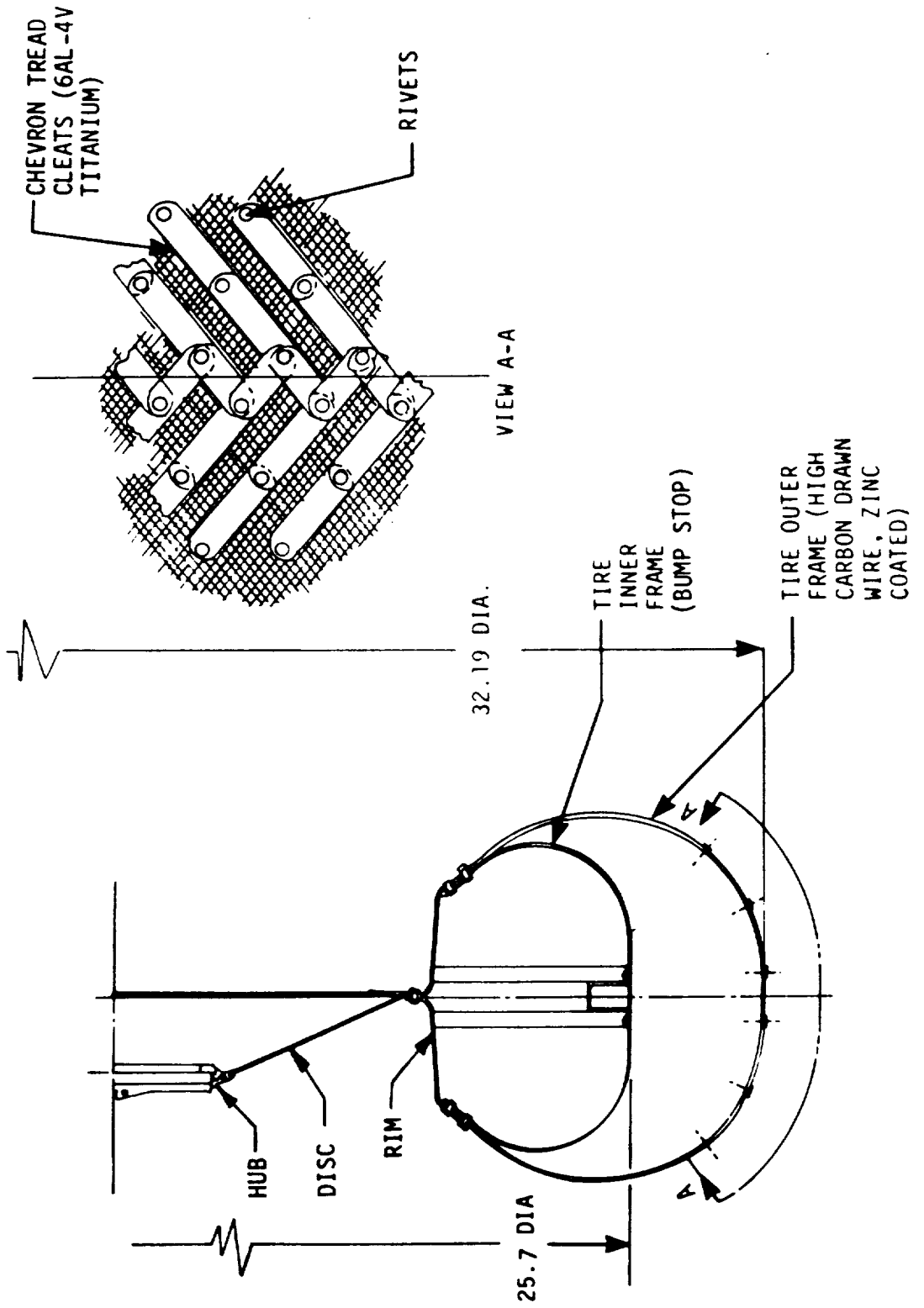

# LUNAR ROVER - CHASSIS CONFIGURATION

Boeing Aerospace Company

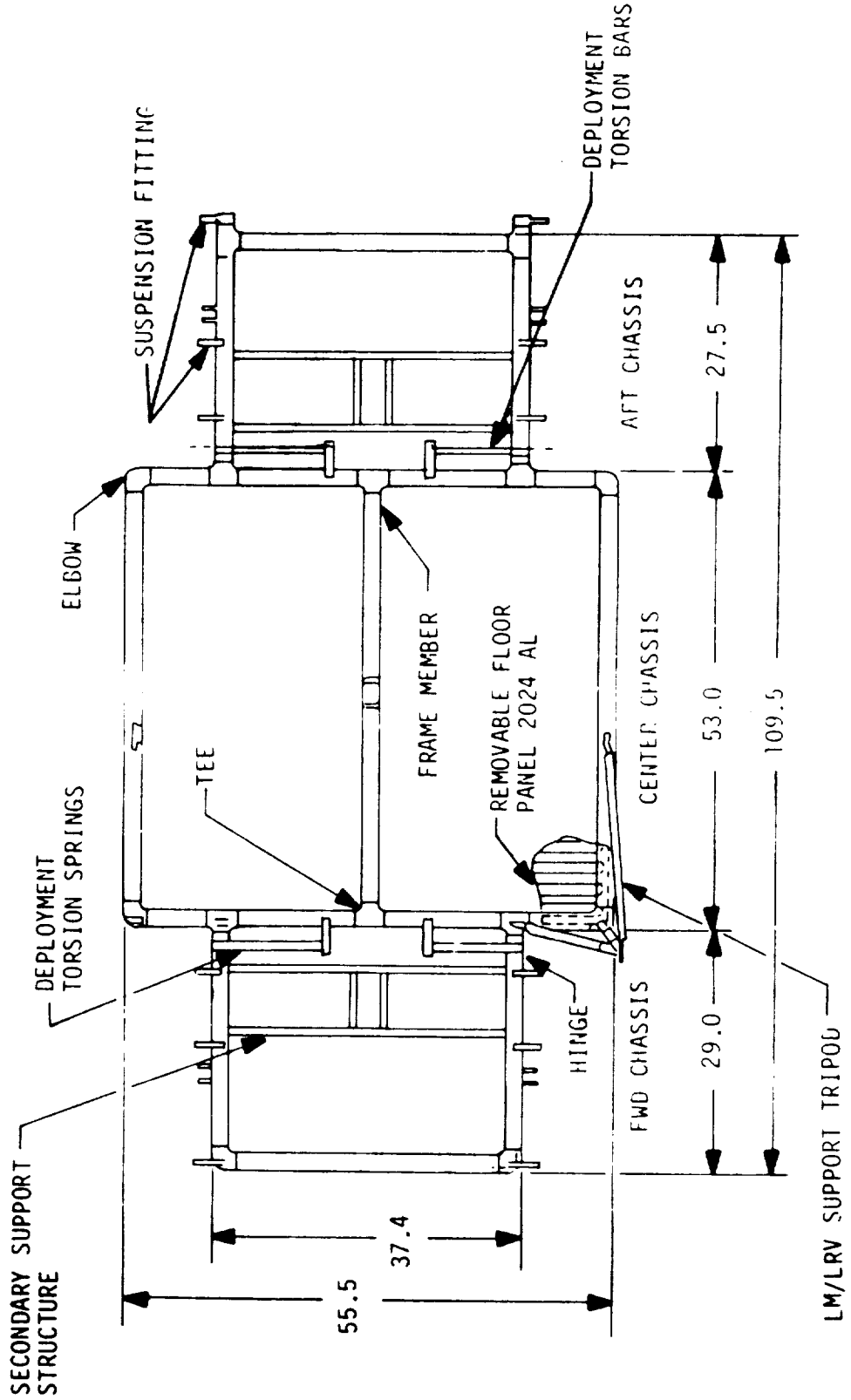



# LUNAR ROVER- SUSPENSION ASSEMBLY

Boeing Aerospace Company

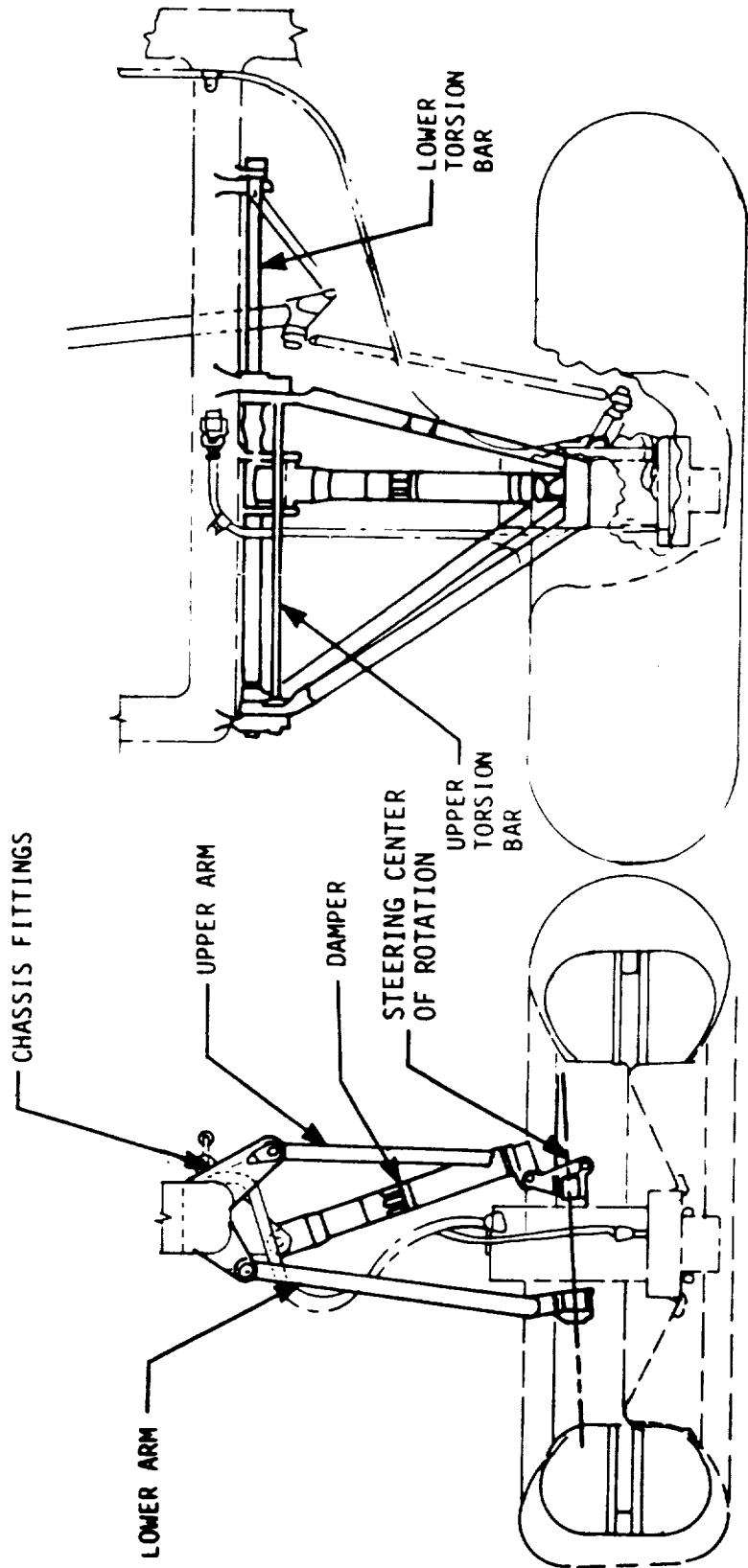

# LUNAR ROVER- SUSPENSION SPECIFICATIONS

Boeing Aerospace Company

- 0 SPECIFICATIONS
  - JOUNCE 6 INCHES
  - REBOUND 4 INCHES
  - SPRING RATE 14 LB/INCH
  - DAMPING RATE 3 LB-SEC/INCH
- 0 MATERIALS
  - PARALLEL ARMS: 2219-T81, T87 ALUMINUM
  - TORSION BARS: 5 CR-MO-V STEEL, 260 KPSI HEAT TREAT
  - DAMPER CYLINDER: 2024-T851 ALUMINUM
  - DAMPER PISTON: 4400 STEEL

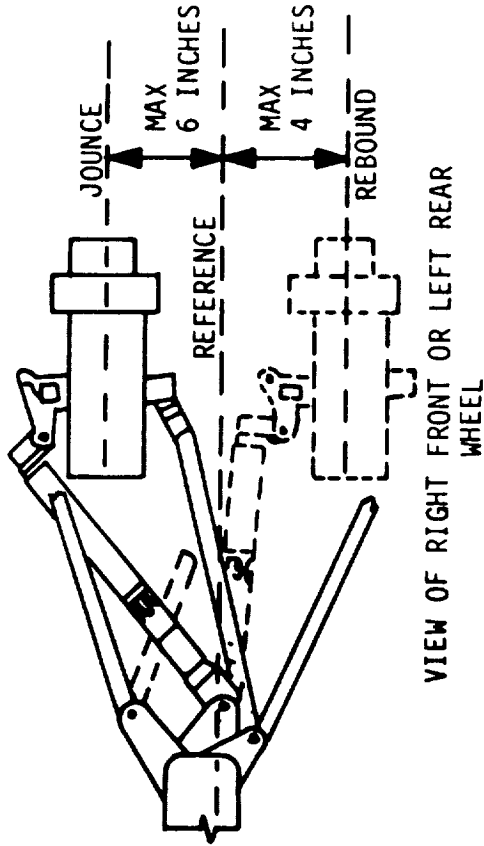

- 0 DAMPER LENGTHS
  - MINIMUM 8.74
  - STOWED 9.00
  - REBOUND 10.16
  - STATIC 11.25
  - JOUNCE 13.06

# LUNAR ROVER- TRACTION DRIVE



Boeing Aerospace Company

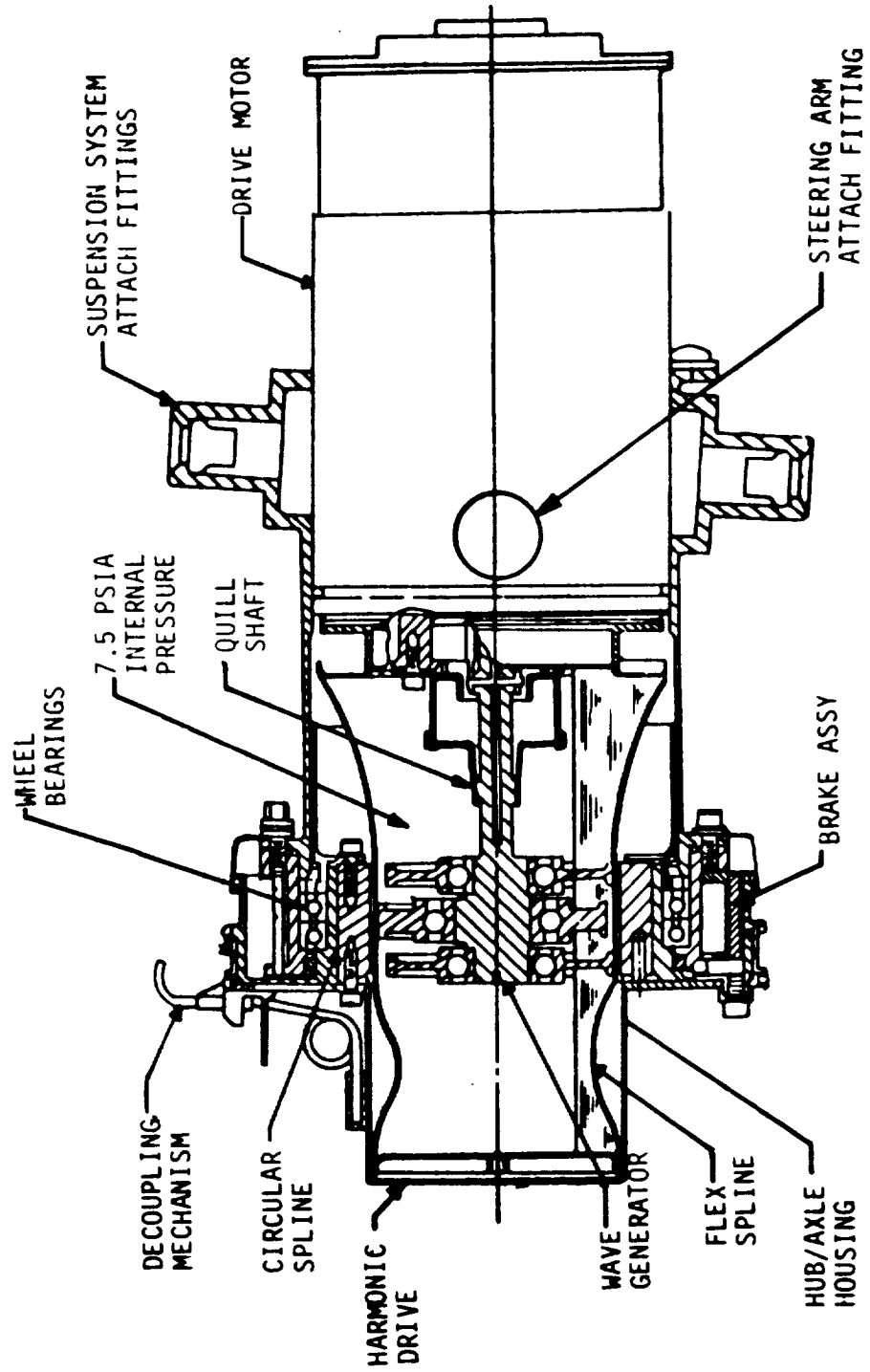

# LUNAR ROVER - TRACTION DRIVE INSTALLATION

Boeing Aerospace Company

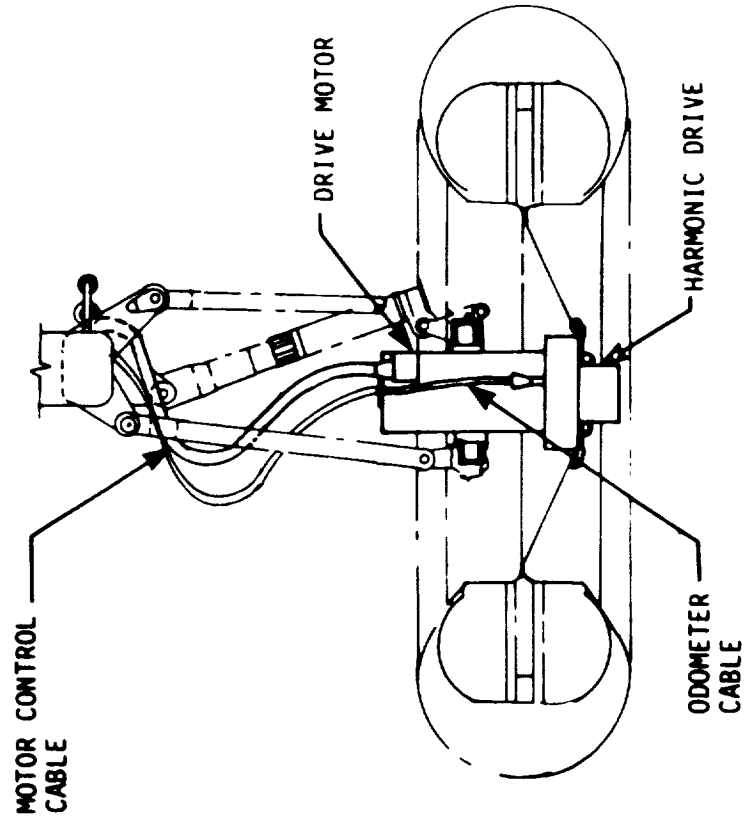
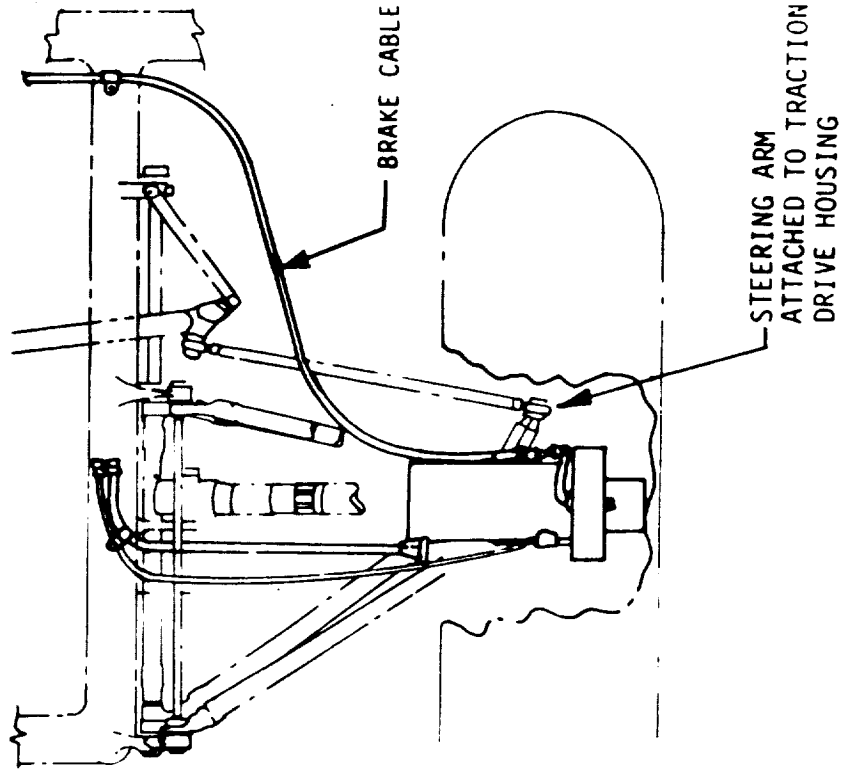

# LUNAR ROVER- STEERING CONFIGURATION

Boeing Aerospace Company

- o 4 WHEEL STEERING, IDENTICAL FRONT AND REAR SYSTEMS
- o 6 BAR LINKAGE DRIVEN BY SERVO MOTOR
- o EACH SYSTEM INDEPENDENT WITH MANUAL DISCONNECT

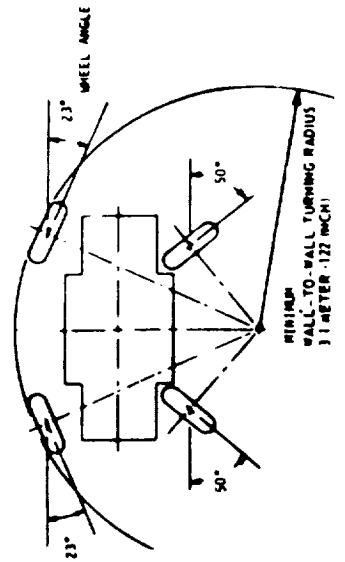
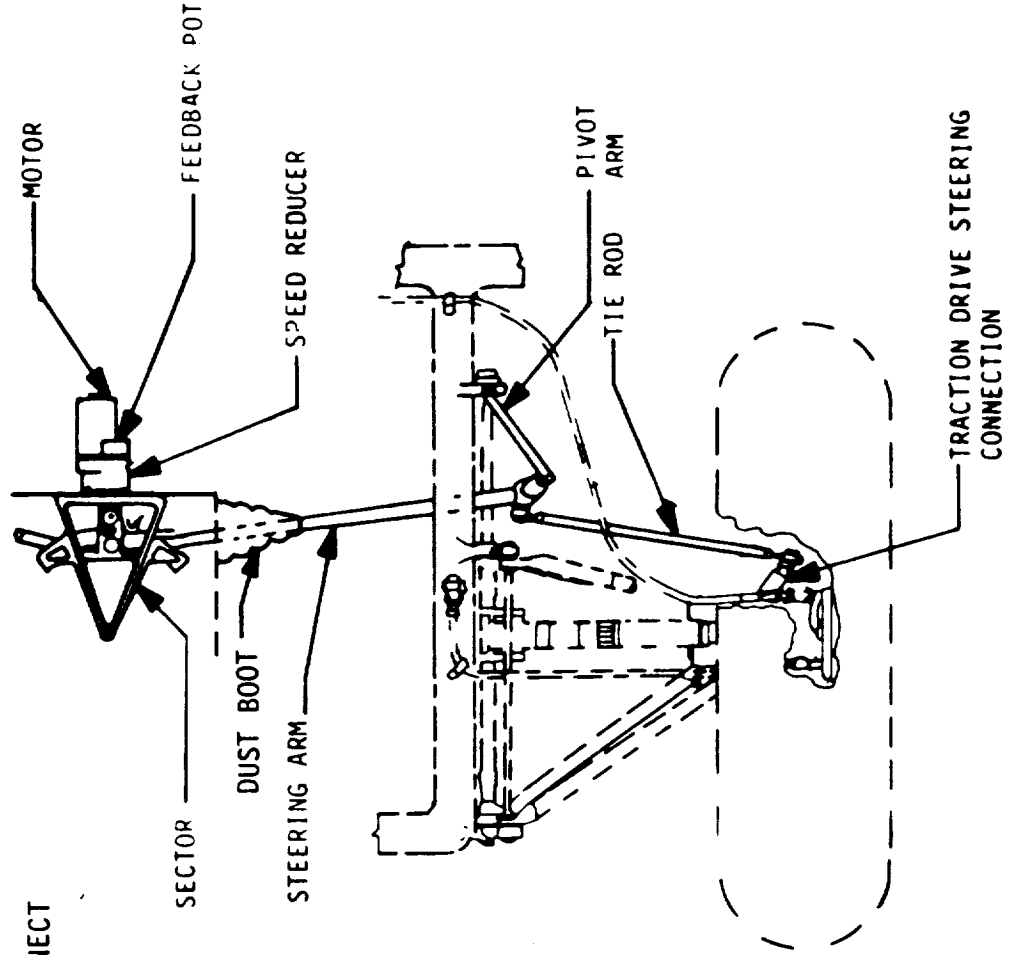
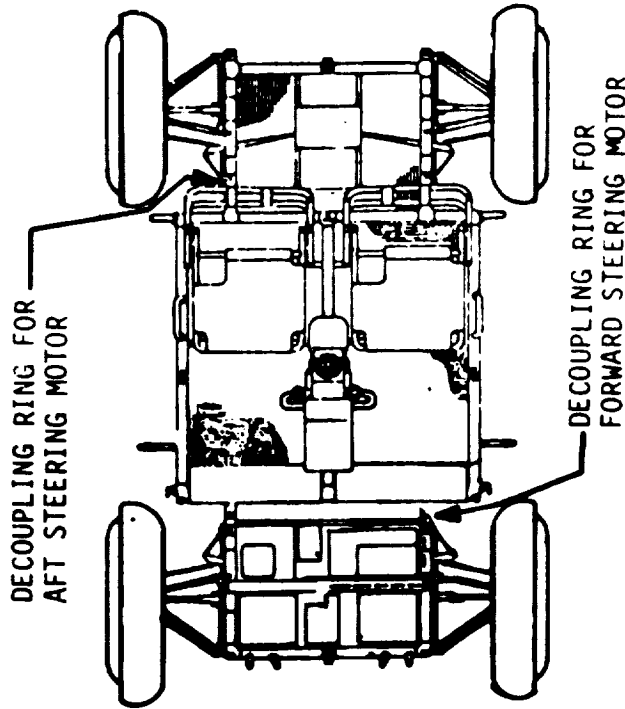

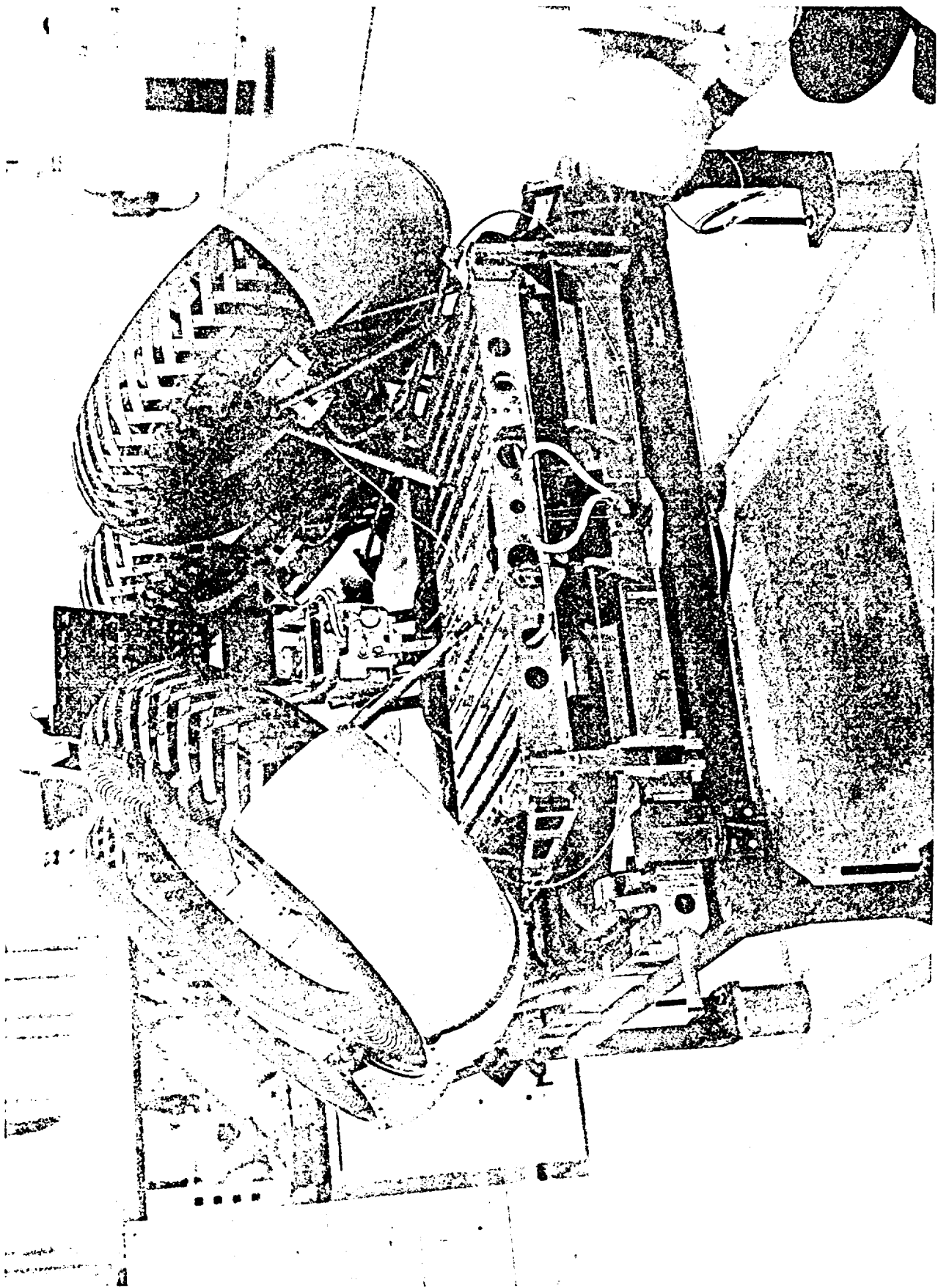

LRV FLIGHT UNIT #1 FOLDED IN MSOB

ORIGINAL PAGE IS  
OF POOR QUALITY



LRV FLIGHT UNIT #1 UNCRATING AT KSC

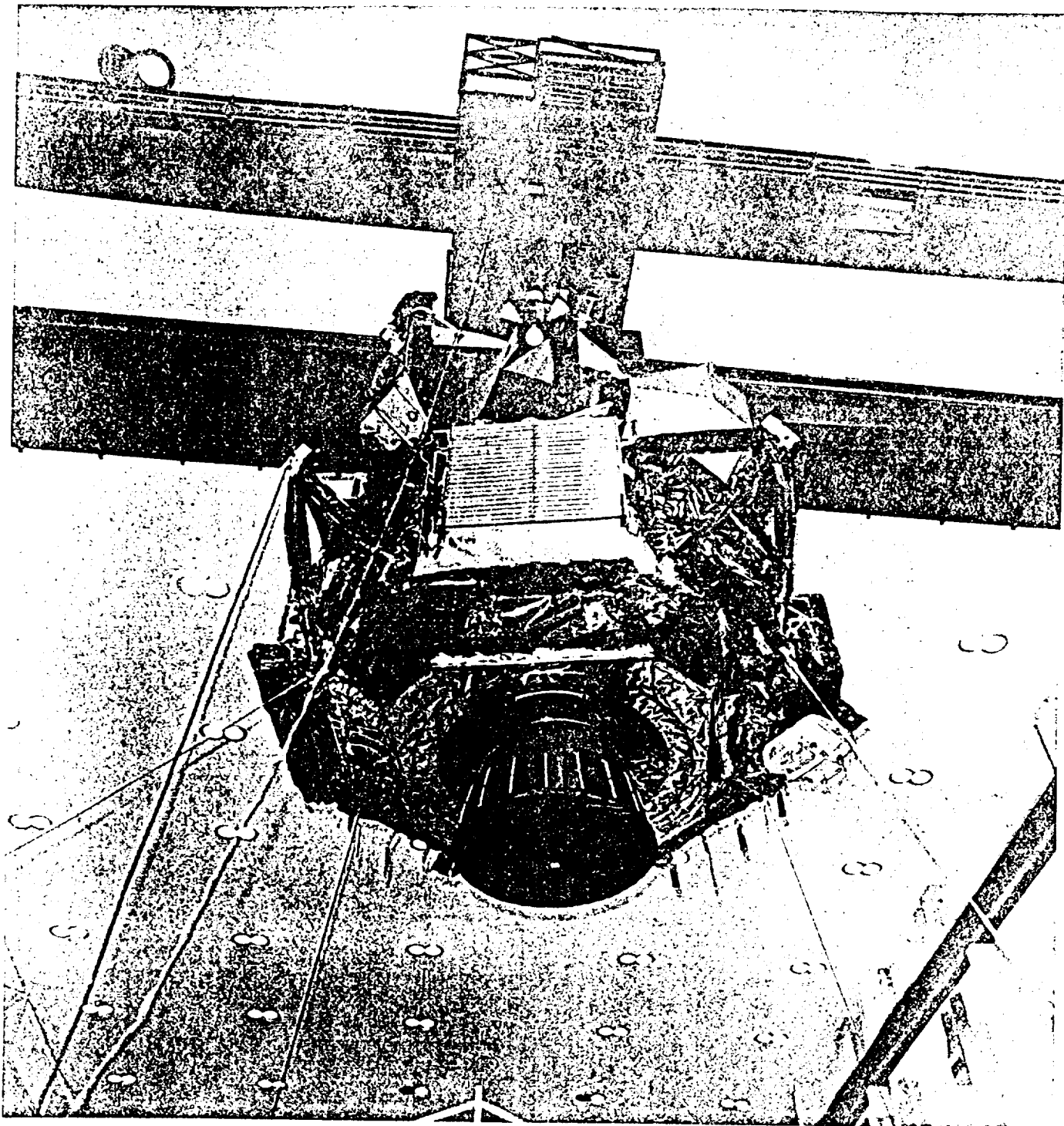

ORIGINAL PAGE IS  
OF POOR QUALITY

LRV FLIGHT UNIT #1 FINAL INSTALLATION INTO LM-10

3-5-158







JPL D-4788, Vol. 4

Mars Rover/Sample Return (MRSR) Mission

# Mars Rover Technology Workshop Proceedings

Volume 4: Local Guidance and Hazard Avoidance

Chairmen: Brian Wilcox, Jet Propulsion Laboratory  
Takeo Kanade, Carnegie Mellon University

April 28-30, 1987  
Pasadena, California

**JPL**  
Jet Propulsion Laboratory  
California Institute of Technology

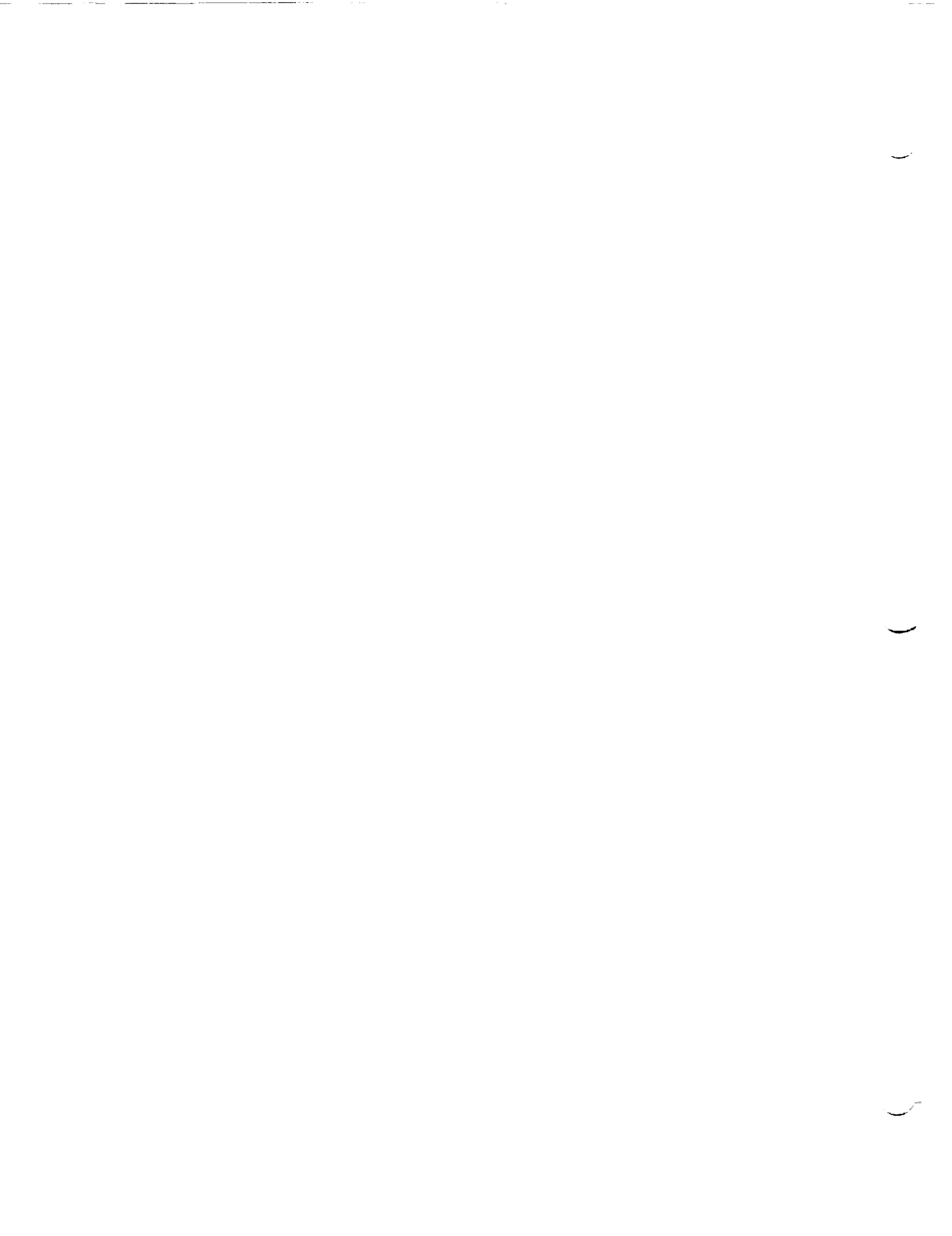

## GLOSSARY

### ACRONYMS AND ABBREVIATIONS

AI	artificial intelligence
cg	center-of-gravity
CMU	Carnegie Mellon University
CW	continuous wave
DARPA	Defense Advanced Research Projects Agency
DoD	Department of Defense
DoE	Department of Energy
FM	frequency modulation
JPL	Jet Propulsion Laboratory
LG&HA	Local Guidance and Hazard Avoidance
m	meter
MIPS	million instructions per second
MIT	Massachusetts Institute of Technology
MRSR	Mars Rover Sample Return
NASA	National Aeronautics and Space Administration
VLSI	very large scale integration

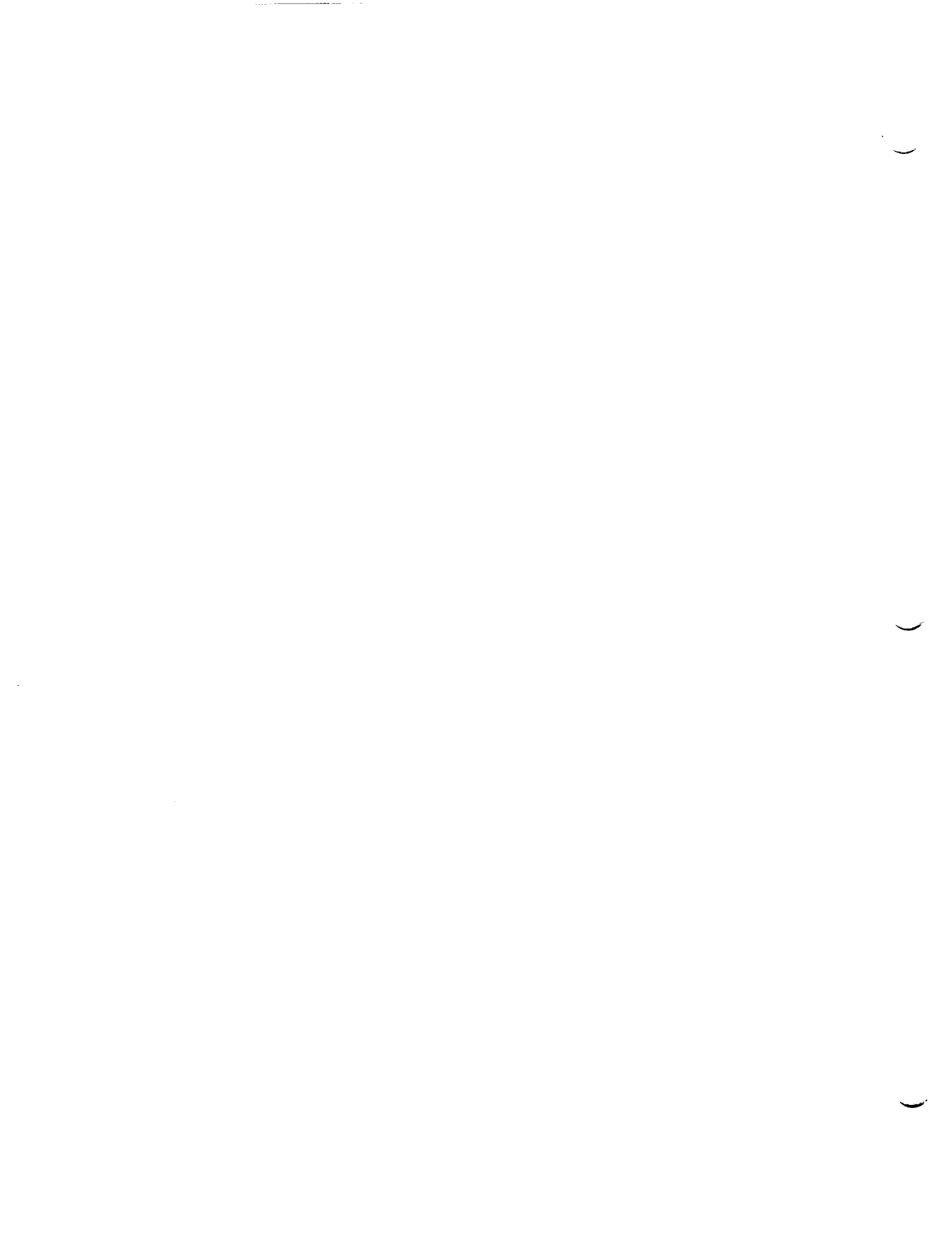

CONTENTS

1.0 EXECUTIVE SUMMARY . . . . . 4-1-1

2.0 INTRODUCTION . . . . . 4-2-1

    2.1 OBJECTIVES . . . . . 4-2-1

    2.2 APPROACH . . . . . 4-2-1

3.0 DISCUSSION . . . . . 4-3-1

    3.1 SENSING AND PERCEPTION . . . . . 4-3-1

    3.2 PLANNING . . . . . 4-3-2

    3.3 PROGRAMMING AND COMPUTATION . . . . . 4-3-2

    3.4 VEHICLE CONTROL . . . . . 4-3-4

4.0 SUMMARY AND CONCLUSIONS . . . . . 4-4-1

5.0 PRESENTED MATERIALS . . . . . 4-5-1

APPENDIXES

A TECHNOLOGY PLANNING WORKSHEETS . . . . . 4-AA-1

B SUMMARY FORMS . . . . . 4-AB-1

C INDIVIDUAL CONTRIBUTIONS . . . . . 4-AC-1

D PROJECTED SCHEDULES . . . . . 4-AD-1

Table

2-1 LG&HA Working Group Members 4-2-2

1

2

3



## SECTION 1

### EXECUTIVE SUMMARY

The Local Guidance and Hazard Avoidance (LG&HA) working group consisted of representatives from academia (Carnegie-Mellon and MIT), industry (Martin Marietta, General Dynamics, FMC, General Motors, Hughes, and Advanced Decision Systems) and NASA (JPL, Ames, and Langley). All major mobile robot programs in the U.S. were represented, including both the research and implementation elements of the DARPA Autonomous Land Vehicle program and the Army's Automated Ground Vehicle Technology program. A private consultant and noted mobile robot research, Scott Harmon, coordinated discussion topics and arranged keynote speakers on each of the significant research issues: Sensing and Perception, Planning, and Terrain/Vehicle Modeling and Control. Session co-chairmen were Takeo Kanade of Carnegie Mellon University and Brian Wilcox of JPL.

### SUMMARY OF DISCUSSIONS

In the opening remarks to the working group, it was suggested that three numbers are key to the design of the Mars Rover:

- 1) Power requirements of computing in watts per million instructions per second (MIPS)
- 2) Power requirements of mobility in watts per kilogram over mass per meter/sec of forward travel
- 3) Computer instructions needed to sense the terrain, perceive hazards and obstacles, model the terrain/vehicle interaction and plan a safe course for the vehicle, expressed in million instructions per meter of forward travel.

The basis for the concern over power was the extremely low estimated power budget for the vehicle given in the strawman scenarios provided at the beginning of the workshop--between 250 and 500 watts for all vehicle functions, including mobility. This is to be compared to a typical autonomous military vehicle testbed, which has a few tens of kilowatts for computing alone.

These three key numbers, plus the vehicle mass and power budget, can be combined using very simple algebra to give the vehicle speed, the needed capacity of the on-board computer (in MIPS), and the distribution of power between the computing and mobility subsystems. Requests were immediately issued to the Mobility and Computing working groups for estimates of the first two of these three numbers. A major goal of the Local Guidance and Hazard Avoidance working group was to estimate the third number and scope a research program that would demonstrate it in a realistic environment by 1993.

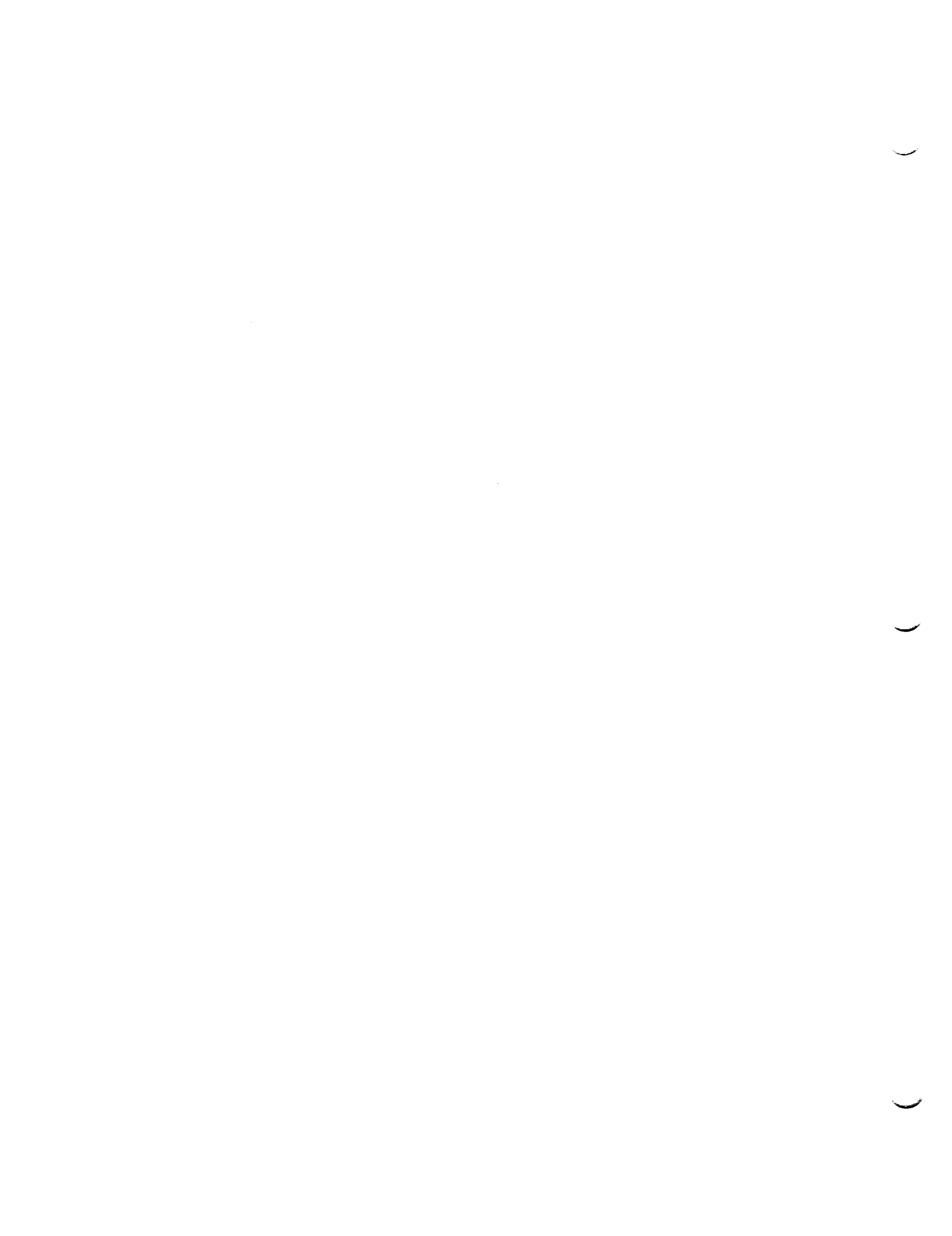

## SECTION 2

### INTRODUCTION

The Local Guidance and Hazard Avoidance working group represent prominent autonomous mobile robot projects in academia, industry, and NASA. Members of the group are listed in Table 2-1. Issues addressed include sensing, perception, vehicle/terrain interaction modeling, planning, and expectation generation and verification.

#### 2.1 OBJECTIVES

The objective is the Local Guidance and Hazard Avoidance working group were to identify the technology requirements allowing the determination of commands (e.g., steering, speed, braking, etc.) to the rover mobility system which will enable the rover to safely follow global routes to the science sites and to the sample return vehicle. This requires that the local terrain be sensed, such as by stereo cameras or by laser scanning, that the range data be evaluated (probably in light of an existing topographic map), that surface properties be determined (slope, roughness, estimated frictional coefficient, etc.), and that a suitable path be chosen which minimizes vehicle some combination of risk, power, distance from global route and so on. From this desired path the mobility commands are generated, as are expectations for the profiles of various sensors (inclinometers, accelerometers, slip sensors, etc.).

During the traverse, the expectations are compared to the actual sensor readings, and excessive variance will result in appropriate replanning (or even reflex action if necessary). After traversing a modest distance (depending on the type of range sensing used—approximately 10 meters) the process repeats. The working group evaluated the sensor types, processing and architectural requirements, development issues, and likely capabilities that could be expected by 1993 or 1995. A strawman technology development plan was produced.

#### 2.2 APPROACH

The available time (2 days) was divided into sessions on Sensing and Perception, Planning, Programming and Computation, and Vehicle Control. Introductory presentations were solicited from selected contributors, and discussion leaders were similarly solicited. A goal statement was distributed to working group members prior to the workshop, as was a list of possible discussion topics. These are also attached.

Table 2-1. Local Guidance and Hazard Control Working Group Members

---

Dave Atkinson Jet Propulsion Laboratory Mail Stop 301-490 4800 Oak Grove Drive Pasadena, CA 91109	818-354-2555
Professor Rodney Brooks MIT Artificial Intelligence Laboratory 545 Technology Square Cambridge, MA 02139	617-253-5223
Andy Chang FMC Corporation-Central Engineering Labs 1205 Coleman Ave, Box 580 Santa Clara, CA 95052	408-289-3757
Peter Cheeseman AAI Research Branch, MS 244-17 NASA Ames Research Center Moffett Field, CA 94035	FTS 464-6544
Dave Collier c/o Ferenc Pavlics Department Head-Vehicle Systems General Motors Corporation 6767 Hollister Avenue Goleta, CA 93117	805-961-5251
Robert Douglass c/o Roger Schappell Martin Marietta Denver Aerospace P.O. Box 179 Denver, CO 80201	303-977-4474
Donald B. Gennery Jet Propulsion Laboratory M/S 23 4800 Oak Grove Drive Pasadena, CA 91109	818-354-9794
Mike Goode c/o Al Meintel Mail Stop 152D NASA Langley Research Center Hampton, VA 23665-5225	FTS 928-2489
Scott Harmon Robot Intelligence International P.O. Box 7890 San Diego, CA 92107	619-225-0712

---

Table 2-1. Local Guidance and Hazard Control Working Group Members  
(Continued)

---

Professor Takeo Kanade Department of Computer Science Carnegie Mellon University Pittsburg, PA 15213-3890	412-268-3016
Francis (Skip) Lunsford General Dynamics Land Systems Warren, MI 48090	313-362-8088
Hans Moravec Department of Computer Science Carnegie Mellon University Pittsburg, PA 15213	412-268-3829
Dave Payton Hughes AI Center Suite 2010 23901 Calabasas Road Calabasas, CA 91302	818-702-5276
Doug Schapiro Advanced Decision Systems	

---

Issues to discuss:

Sensing

- o Stereo vision vs. laser ranging vs. other (will have stereo vision for controllers and scientists anyway).
- o Proximity-sensor-based overrides if higher-level process goes haywire.
- o Inclometers, accelerometers, heading reference, slip sensors, motor speed/torque/power/temperature, etc.

Perception/Understanding

- o Stereo correlation
- o 2½-d range map to 3-d inference
- o Surface reflection models, shape-from-shading
- o Inference of surface properties (e.g., tractive coefficient, sand vs. rock vs. dust, etc.)
- o What resolution is needed at what range?

#### Relation to Terrain Map

- o Perspective to plan view transformation
- o Estimation of obstacle sizes, surface slopes
- o Matching major features to terrain map

#### Vehicle Mobility Model

- o Obstacle climbing vs. estimated tractive coefficient
- o Grade climbing vs. estimated tractive coefficient
- o Transverse slope (overturning)
- o Obstacle climbing--non-square approach angle
- o Speed control as rover approaches obstacles, crevasses, etc.
- o CG modifications by picking up in-situ materials

#### Path Planning

- o Planning boundary conditions
  - How to stay near global route plan
  - How to know what is "safe," e.g., how to vary the "timidity" of the vehicle
  - What to optimize--power, stability, speed, accelerations, "wear and tear"

#### Planning algorithms

- Go/no-go vs. scalar vs. vector-valued optimization
- A\* and its successors
- Heuristic vs. algorithmic planning
- How far to plan before re-sense and re-plan?

#### Expectation Verification and Execution Monitoring

- o How to predict heading, inclination, acceleration, and proximity sensor profiles?
- o How much deviation is acceptable? How much resolution is needed?
- o Sensor fusion--when are a few small anomalies equal to one major mistake?

Anomaly Recovery

- o Reaction time
- o Reaction modes--always a "stop" or sometimes more sophisticated?

Required Computational Resources

- o 10 Megaflop shared resource OK?
- o Custom VLSI for stereo correlation, perspective transformation, path planning, etc.
- o Special sensors (laser scanner, light striper, etc.)

SENSORS

Power	Ops/Meter A			VLSI?
	Low	Medium	High	
*Stereo	$10^6, 10^4$ pix, C ?	$5 \times 10^8$	$10^{??}/\text{pix}$	Y
*20 watts: 1 ea				
Laser Scan	0	0	$10^{12}$ <sup>0</sup>	Y
Sonar		$10^7$		Y
MM Wave	0	$10^2$		Y
*Motion		$5 \times 10^6$	$5 \times 10^7$	Y
*Probe		0		N
Odometer		0		N
Inertial Nav		0		N
*Sensor Fusion	$10^5$		$10^7$	N
Goal - produce reliable 100x100 range map				

Disclaimer: Sensor fusion to be one at other levels also. Numbers may be way off--especially sonar. Sensor fusion issue is controversial.





## SECTION 3

### DISCUSSION

#### 3.1 SENSING AND PERCEPTION

Takeo Kanade of CMU gave the introductory presentation on sensing and perception, and Don Gennery of JPL led the discussion. The consensus of the group was that several sensing modalities were needed to reliably determine the geometry of the terrain, including stereo correlation (since it is assumed there will be stereo cameras for the benefit of scientists on Earth in any event); at least one of three possible active sensors (laser scanner, sonar phased array, and millimeter wave radar); and some sort of mechanical probe (which could be used intermittently when conditions warrant). These sensors, together with an accurate heading reference unit, inclinometers, odometer, and articulation sensors (particularly on the pointing platform where the vision and ranging sensors are located) provide the raw data for planning a safe path for the vehicle.

A vigorous discussion of sensor fusion took place. One group (Rod Brooks of MIT and Takeo Kanade of CMU) maintained that it was not appropriate to fuse the various sensor data into a single range map which would then be used by the vehicle/terrain interaction modeling and path planning algorithms. Rather, the various sensor data should be used by those algorithms only at the appropriate points dictated by the particular algorithms. Another group (Peter Cheeseman of NAS Ames, Hans Moravec of CMU, and Don Gennery of JPL) felt that it was entirely reasonable to use statistical techniques to combine the various data at this point to produce an integrated "best estimate" range map of the terrain. It was suggested that a 100x100 range map, subtending about 1 radian and extending to some 30 m in range could be about right. No resolution of this issue resulted, and it was generally agreed that both approaches had merit and should be investigated further. It was felt that estimation of surface properties (frictional coefficient, sand vs. rock, etc.) was probably too ambitious for a '92 technology freeze, but might be provided by humans on the ground as part of the global route plan derived from orbital imagery.

It was estimated that the total processing requirements for sensing and perception on the Mars Rover ranged from a few million instructions per m to 500 million instructions per m. A caveat in this estimate concerns sonar phased arrays. A two-dimensional phased array might require as many as a trillion instructions to form a range map. (Members of the working group had experience only with one-dimensional phased arrays, which were not deemed adequate for the complex Martian terrain). Also the effect of the thin Martian atmosphere on sonic propagation and attenuation as not known by members of the group--it was assumed that appropriate impedance-matching elements would allow sonar to work. However, it was generally agreed that special-purpose hardware might allow the processing of sonar maps, the correlation of stereo images, and other needed computations without excessive power consumption. It was also agreed that the development of an appropriate laser scanner was essential (although suitable scanners for research purposes are manufactured by at least three vendors, some with flight qualification experience).

### 3.2 PLANNING

Hans Moravec of CMU gave the introductory presentation on Planning, and Peter Cheeseman of NAS Ames led the discussion.

There was general agreement that several attractive planning approaches and algorithms exist, and that there is little risk in demonstrating these elements of the LG&HA subsystem by late '92 following an appropriate research and integration effort.

There was general agreement that the possibility of acquiring a terrain data base of the areas of Mars that are to be explored should be exercised if at all possible. This would require an imaging orbiter in a low or highly elliptical orbit capable of acquiring stereo images at a few meters resolution. Due to the Viking experience of frequent ground fog, dust storms, and other atmospheric attenuation, it was also generally agreed that this orbiter should be launched at some prior opportunity to avoid excessive delays in getting quality pictures of the operating area. It was also pointed out that it is an enormous task to prepare a high-quality terrain data base at the resolution desired for this mission, which is another reason for making the orbiter a precursor mission. A strong majority of the group felt that it would be impossible to convince a project manager that long traversals could be performed with acceptable risk without first having a high-resolution (about 3 m) terrain data base of the area of operations.

A number of open issues were identified in planning. These include replanning after local failure, backtracking, risk assessment of a tentative planned path, reactive planning in the event of slippage, opportunism, planning representation, optimality (or acceptability) criteria--risk, power, speed, etc., representing and dealing with uncertainty, hybrid planning (global and local), the level of task specifications from Earth, and to what degree the Local Guidance and Hazard Avoidance subsystem will be involved in planning sample retrievals.

Total computer instructions per meter for planning were felt to lie perhaps an order of magnitude down from the high end of the Sensing and Perception subsystem requirements. Thus a few tens of millions of operations per meter would be adequate for path planning. It was suggested that, like sensing and perception, some major computationally-intensive aspects of planning could benefit from the use of custom VLSI or other special hardware.

### 3.3 PROGRAMMING AND COMPUTATION

Scott Harmon of Robot Intelligence International gave the introductory presentation on Programming and Computation, and Rod Brooks of MIT led the discussion.

A discussion of languages, operating systems, and development environments revealed that the dominant development languages are C and LISP, the dominant operating system is Unix, and the most popular development environment is the 68020/VME-bus-based Sun workstation. However, there were

significant differences between all the mobile robot development environments represented, to the point where there is little software portability at the object code level, even where two organizations are working on the same project (e.g., DARPA ALV). It was generally agreed that no language or development environment standard be imposed during the development of a breadboard demonstration of a Local Guidance and Hazard Avoidance system.

There was also a vigorous discussion of the issue of software verification. Some members of the group felt that the technology of software verification (a verification that a particular code in fact represents the desired algorithm) is to the point where it can make a significant contribution over normal software development procedures. Others felt its applicability to a complex system like this were very limited.

Other topics addressed during this portion of the discussion were fault tolerance, software development and debugging tools, the usefulness of simulations, the requirements imposed on the on-board operating system, and graceful degradation.

The Mobility working group apparently had heated discussions estimating the typical power requirements for the vehicle mobility system on Martian terrain. A first estimate of 2 to 20 watts per kg per meter per second was provided, later reduced to 1 to 10, and finally revised to be .6 to 8 (corresponding to an effective frictional coefficient of 0.15 to 2).

These three sets of estimates for the three key numbers give the results below (where the logarithmic mean for the high and low estimates is used for the moderate value: 6 for Computing, 2 for Mobility, and 150 for LG&HA).

1000 Kg Rover with 500 Watt Power Supply

Case	Average Rover Speed	Power Distribution	Computer Performance
Worst Case	4 cm/sec	67% Mobility 33% Computation	20 MIPS
Moderate Case	17 cm/sec	69% Mobility 31% Computation	25 MIPS
Best Case	62 cm/sec	75% Mobility 25% Computation	30 MIPS
Nominal Mobility Worst Computing Worst LG&HA	8 cm/sec	33% Mobility 67% Computation	40 MIPS

It was the general consensus of the group that the alternative to autonomous local guidance and hazard avoidance (Earth-based path designation, where a human on Earth views wide-baseline stereo images and designates an extended path for the rover) would not be safe for designated paths in excess of about 30 m. Given the roughly 1-hour turnaround for these commands due to the long speed-of-light delay, this results in a rover speed of just under 1 cm/sec. Thus even the worst-case estimates for all three of the key numbers results in an average rover speed about 6 times that which can be achieved through Earth-based path designation (and in addition a greatly simplifies the mission operations).

All of the power distribution and computer performance numbers are disturbing. One would normally expect most of the power to go to the mobility subsystem during long traverses. However, in the historically justified case of conservative estimates for computer and software performance, and with a nominal mobility figure, up to 75% of the power goes to computing, and it is envisioned that a computer with up to 40 MIPS performance would be used. This is at least 100 times the performance of any computer that has heretofore been used on a planetary spacecraft. These figures make the use of custom VLSI or special computational hardware (such as a Single-Instruction, Multiple Data processor array) very attractive in performing the necessary computations using significantly less power.

#### 3.4 VEHICLE CONTROL

Bob Douglass of Martin Marietta gave the introductory presentation on Vehicle Control, and Andy Chang of FMC led the discussion.

Bob Douglass partitioned the problem into three sensor/perception systems: visual perception, vestibular perception (orientation, acceleration, etc.) and proprioceptive perception (articulation sensing and vehicle 3-D modeling of itself). There was some discussion of how much proprioceptive sensing will be needed--it depends a lot on the type of vehicle selected (legged vs. wheeled, rigid chassis vs. articulated) but also depends on how tightly one is going to try to maneuver the vehicle. It was generally agreed that the vehicle needs, at a minimum, a 3-D representation of the local environment, some estimates (perhaps constant, perhaps given from Earth as part of the global route plan, and perhaps sensed by the vehicle) of the surface friction, load-bearing capability, etc., some stability model of the vehicle, and some way to generate and verify expectations about the path execution. Also discussed as part of this session were reflex responses and error detection, diagnosis, and recovery.

It was estimated that the total experience with autonomous mobile robots in natural terrain was on the order of 5 km. However, extensive simulations of vehicles on rough terrain have been conducted and results are very promising. As a result, it was generally agreed that, with the exception of vehicle reflex action to unexpected dynamic factors (e.g., slipping on a sand dune), that several approaches and algorithms exist which could be integrated relatively quickly in a technology demonstration. As with planning, it was felt that a few tens of millions of operations per meter would be adequate to model the terrain/vehicle interaction for use by the path planner.

## SECTION 4

### SUMMARY AND CONCLUSIONS

Based on the Vehicle Control (3.4) discussion, it was generally agreed that between 50 and 500 million computer instructions will need to be performed for each meter of safe travel by the Mars Rover. The lower figure is roughly equally divided among Sensing and Perception, Planning, and Terrain/Vehicle Interaction Modeling, while the upper figure is dominated by Sensing and Perception, principally stereo correlation. (It was also generally agreed that additional computation could be used almost without limit, but that these estimated values would permit sufficiently low risk that the mission would not be compromised.)

The Computation and Task Planning working group estimated that a radiation-hardened, flight-qualified, general-purpose multiprocessor could be configured with 3 to 5 MIPS performance for 20 to 25 watts power consumption, complete with its necessary I/O and memory. This translates into 4 to 8 W per MIPS.

The Local Guidance and Hazard Avoidance working group adopt the following two conclusions:

#### Conclusion #1:

A local guidance and hazard avoidance subsystem can be developed which will allow traverse distances substantially greater than earth-based path designation.

It was mentioned at various points in the deliberations that, although the cost of such a development is not insignificant, the risk of being able to accomplish this objective is not overly large. A huge base of past work, primarily funded by the Department of Defense, together with the existence of several vehicle test beds, has uncovered the major deficiencies that plagued the wildly optimistic efforts of the past. It was generally agreed that this effort could be undertaken with the expectation of success.

#### Conclusion #2:

The local guidance and hazard avoidance problem is characterized by:

1. Very rough terrain
2. The possibility of strong a priori knowledge (e.g., 3-m terrain data base)
3. A requirement for extreme reliability
4. Computing resources which are very constrained.

Recommendations:

The above conclusions led to the following recommendations being accepted by the group:

Recommendation #1:

A 3-m terrain data base should be developed for the exploration areas, preferably prior to the rover arrival at Mars.

It was noted in the discussion of this recommendation that a 30 cm aperture camera in a low or highly elliptical orbit around Mars could achieve this objective (with an appropriate pointing platform, focal plane sensor, data and communication subsystems). This camera, smaller than the one on Mars Observer, need not require a highly expensive spacecraft.

Recommendation #2:

Local guidance and hazard avoidance subsystem elements and integration approaches should be tested in realistic environments starting as soon as possible (Oct '87):

- o Thousands of km of testing are needed by '93
- o Multiple plausible approaches exist; several integration efforts must proceed in parallel.

During the discussion of this recommendation, it was mentioned that a number of test bed vehicles exist today, and that the creation of Mars-like terrain of sand and boulders could be accomplished very quickly were there a will to do so. Furthermore, these vehicles in most cases represent very different, but also very credible, approaches to the safe guidance of a mobile robot. Lastly, if the vehicle is to traverse safely many tens or hundreds of km on Mars, it seems appropriate that an order of magnitude or two of additional testing should occur on Earth. At the speeds these vehicles operate, that will take a long time.

Recommendation #3:

Research and development in the following areas are crucial and should begin immediately.

- o Sensors (e.g., laser scanner)
- o Perceptual and planning algorithms
- o Reflex and error recovery algorithms
- o Special-purpose computing hardware (e.g., custom VLSI) for higher performance per watt).

It was agreed by a (small) majority that the single most attractive sensing modality for Mars Rover is laser scanning. Scanners adequate for immediate research are manufactured by several companies (and a number of the mobile robot research efforts represented in the working group already have them), but the specific character of these devices is not optimized for the needs of Mars Rover. Ultimately, a low-power, compact, and rugged unit with few-centimeter accuracy over ranges from 0 to 30 m, able to scan about .5x1 radian with a few tens of thousands of measurements in a few seconds or less is needed. Current devices have more performance than needed (such as speed) but resolution, range, and power are not optimal for this application. It is generally agreed that it would also be desirable if this scanner could be focused on a distant (few km) site for a longer time to get point ranges, but this may not be feasible.

It was also generally agreed that the rover must have more than one way of sensing range to the terrain--a large group favored stereo correlation and a significant minority felt sonar phased arrays or millimeter wave radars have attractive properties. All of these can benefit greatly from custom hardware developments.

#### Recommendation #4:

Unmanned rovers are essential to solar system exploration: a long-term research and development program should be supported.

It was mentioned, particularly by the academic participants, that an on-again, off-again program of near-term demonstration-oriented research was very shortsighted as well as disruptive to the nation's system of graduate education. Although this mode of operation has become the norm, not the exception, in government-funded research, there was a strong feeling that the case of planetary rovers might be a way to break out of the mold. It had been pointed out in the opening plenary session that the Sally Ride commission had proposed four "bold new initiatives," three of which began with unmanned surface rovers. It was self-evident that Mercury, the moons of Jupiter and Saturn, and the other solid bodies of the solar system will have surface rovers long before humans set foot on them. Thus it makes sense to develop the technology for highly capable rovers that can operate effectively even with speed-of-light time delays of many hours, or with communication obscurations of days or weeks.

#### Schedule and Budget Recommendations

In the schedule and budget recommendations of the working group, four activities are called out:

1. Use existing autonomous vehicle test beds in Mars-like terrain to understand the problem
2. Develop new sensors and computing hardware

3. Develop algorithms
4. Develop and integrate the test bed vehicle

In the first year (FY '88), task 1 begins as soon as possible. This will allow the elucidation of the problems particular to the Mars Rover. Much of the current work is on terrestrial-unique problems such as vegetation typing, hydrology recognition (water or mud), etc. There is little concentration concerning the safe guidance of real autonomous vehicle test beds in rough terrain littered with boulders.

It is assumed that the funding level for FY '88 represents a modest ramp-up for this program, since it would be FY '89 before Congress and NASA are able to allocate significant preproject funds. It is felt, however, that \$5M would allow a significant head start in defining the key sensor, algorithm, and integration issues through the use of existing testbeds in simulated Martian terrain.

The remaining tasks begin in FY '89, when a significant preproject research budget is assumed to be available. The second task, to define what portions of the sensing and processing can be embodied in special hardware, will begin working with some of the more well-established sensor modalities (such as laser scanners) and algorithms (such as stereo correlation). Later work will incorporate other sensor modalities and algorithms as they mature. The third task, algorithm development, will use the existing test bed vehicles to define, enhance, integrate, and optimize algorithms for all phases of sensing, perception, vehicle/terrain interaction modeling, and planning. Later, these algorithms will be delivered and integrated into the more realistic test bed vehicles developed under task 4. This task will design and fabricate vehicles with the mobility and size characteristics of the real Mars Rover that can be dedicated to thousands of km of testing in desert terrain, and later in the dry valleys of Antarctica.

There was considerable frank discussion over the scale of the effort required to accomplish the goal of demonstrating, to the satisfaction of a highly conservative flight management team, an adequate local guidance and hazard avoidance capability that would convince. The final program recommended is \$120M between 1988 and 1992, with an ongoing program of \$25M per year after that for unmanned planetary rover research. Some felt that this figure would be assumed to have padding in it, and that the activity would go forward with lesser funding and the same goals. There was virtually unanimous agreement that this would fail. Represented in the group were several senior managers of autonomous vehicle programs for military contractors, and they felt that the \$120M figure was realistic without any contingency. There was general agreement that contingency would not be added to the final estimates of the group (so as to give NASA planners our "best estimate") but that the lack thereof should be clearly stated.

In summary, the group consensus was that this was a do-able job on the proposed schedule, given the resources identified. There was agreement on the need to make proper use of FY '88 if a FY '93 technology freeze is to be achieved. Lastly, there was agreement that a precursor orbiter with the appropriate (and even modest) imaging system on board be planned as part of the mission.



SECTION 5  
PRESENTED MATERIALS

# Sensing & Perception

TAKEO KANADE  
Carnegie-Mellon



4-5-3

4-5-3

ORIGINAL PAGE IS  
OF POOR QUALITY

## CHARACTERISTICS

Very Rough Terrain

Active Sensing (Lighting, Finding by doing)

Less Need for Real Time  
(except reflex)

# FUNCTIONS for WHAT

Terrain Mapping/  
Modeling/  
Matching

MOBILITY

Terrain Typing/  
Ground Condition

REMEDICATION/  
EXCAVATION

Sample Finding/  
Sample Condition  
(Geological Understanding)

SAMPLING

"Interst"/"Surprise"  
Detection

MAN-MACHINE

# Sensors for Terrain Understanding

Color camera : Stereo (Mainly for Man-Machine Interface)

Multispectral (Surface Reflectance)

Active Scanning Range Finder :

Programmable Time-of-Flight (inc. Phase Shift) Range Sensor

Camera & Sensor Platform : Controllable for View Selection

Lighting

Calibration Target

Probe for Ground Condition → Manipulation

Vehicle Motion (Inclinometer, Accelerometer, Slip, etc...)

# Major Sources of Terrain Information

Range Sensor — Depth, Shape, Location  
3D Texture, Vehicle Track

Camera — Color, Texture, Vehicle Track

Probe/Cane — Softness, Ground Condition

Vehicle Motion (Slip, Slide) — Ground Condition



# ISSUES

## Representation

- (At least) Two-levels : Local ( $\sim 10m$ )  
and Global ( $\sim 10km$ )

Iconic (eg. elevation) and Symbolic  
(Terrain Features)

- Incremental Acquisition

Shapeless shape of objects (rocks, dunes, ...)

Explicit Rep of Known/Unknown  
Certainty



# ISSUES

## Recognition

Major Obstacles (Shape, Size, Property)

Ground Condition

Terrain Primitives (hill, valley  
Roughness ...)

Matching Terrain Primitives

- Change Detection & Description

→ Remediation

- Functional (Manipulative) Property of  
Sample Candidates

- Learning Ground Condition

vs. Rover Track  
Rover Motion  
Appearances

# ISSUES

## Strategy

### - Fusion

- For coverage ( View → Local Map → Global Map )
- For scope ( shape, appearance, surface property )
- For Improvement ( resolution, accuracy, certainty )

Known Map



## Active Lighting

### - View Point Selection

# "Initial" Plan

## Scanning Range Finder

10 x "ERIM"

~ 200 ~ 300 m

~ 2 / cm

~ 0.05° IFOV

~ 500K sample/sec

~ Programmable

## Overlooking Stereo from Orbiter

(Partially Manual?)

## Terrain Map Integration

Range data Sequence

Overlooking Stereo

← when the data is unreliable?

## Obstacle / Navigable Region Classification and Update by Terrain Data

## Ground Condition Recognition.

# Getting Depth Map

	Complex Acc		(data) Reliability	Power	(devia) Reliability	VLSI
Stereo	$10^9$	$\sim 10^6$	H M	$\frac{1}{2}$ M-L	H	Y
Laser Scan	-	H	H	H	$H_{20^{\text{th}}}$ M?	Y
Sonar	$10^7$	L	L	M-L	?	Y
Motion	$10^8$	H	L	L	H	
MM Wave	-					

Kanade

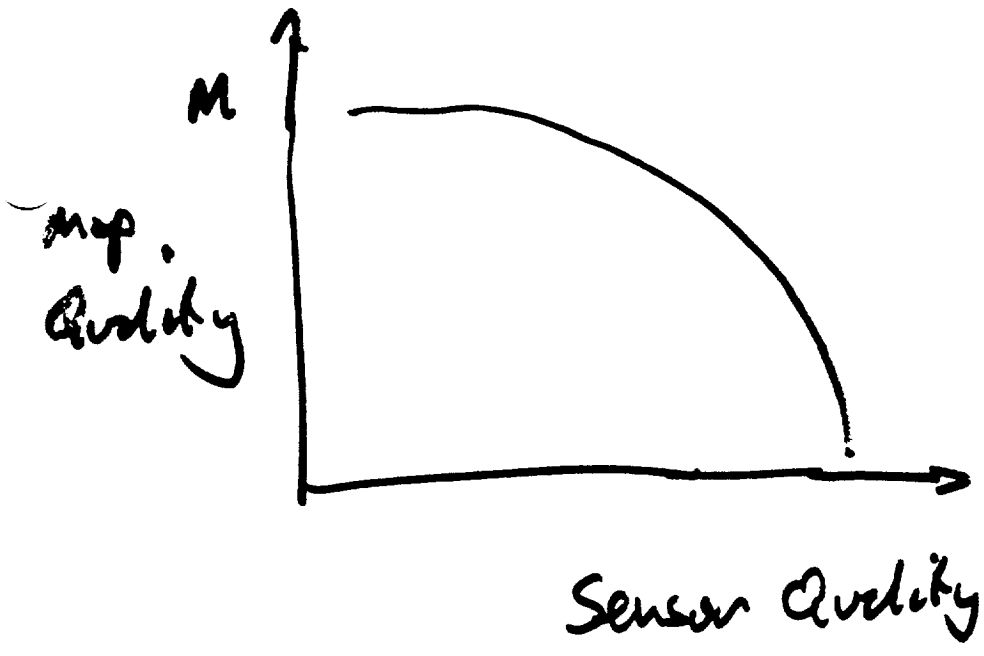



SEMIAUTONOMOUS OPERATION OF MARS ROVER  
USING ORBITAL IMAGERY

Donald B. Gennery

# MARS ROVER

## SEMI-AUTONOMOUS MOBILITY

**JPL**

ORBITER TAKES PICTURES

TRANSMIT PICTURES TO EARTH (~2 hr)



OPERATOR DESIGNATES APPROXIMATE PATH



ROVER CAMERAS TAKE STEREO PAIR OF PICTURES



DESIGNATED PATH (~10 km)

~ ONCE/DAY



TRANSMIT PATH AND SURROUNDING MAP TO MARS (~2 hr)

ROVER DRIVES ~10 m IN ~30 sec



~10 m every 90 sec (11 cm/sec average)

ANALYZE PICTURES AND COMPUTE REVISED PATH (~60 sec)

# SEMI-AUTONOMOUS OPERATION OF MARS ROVER

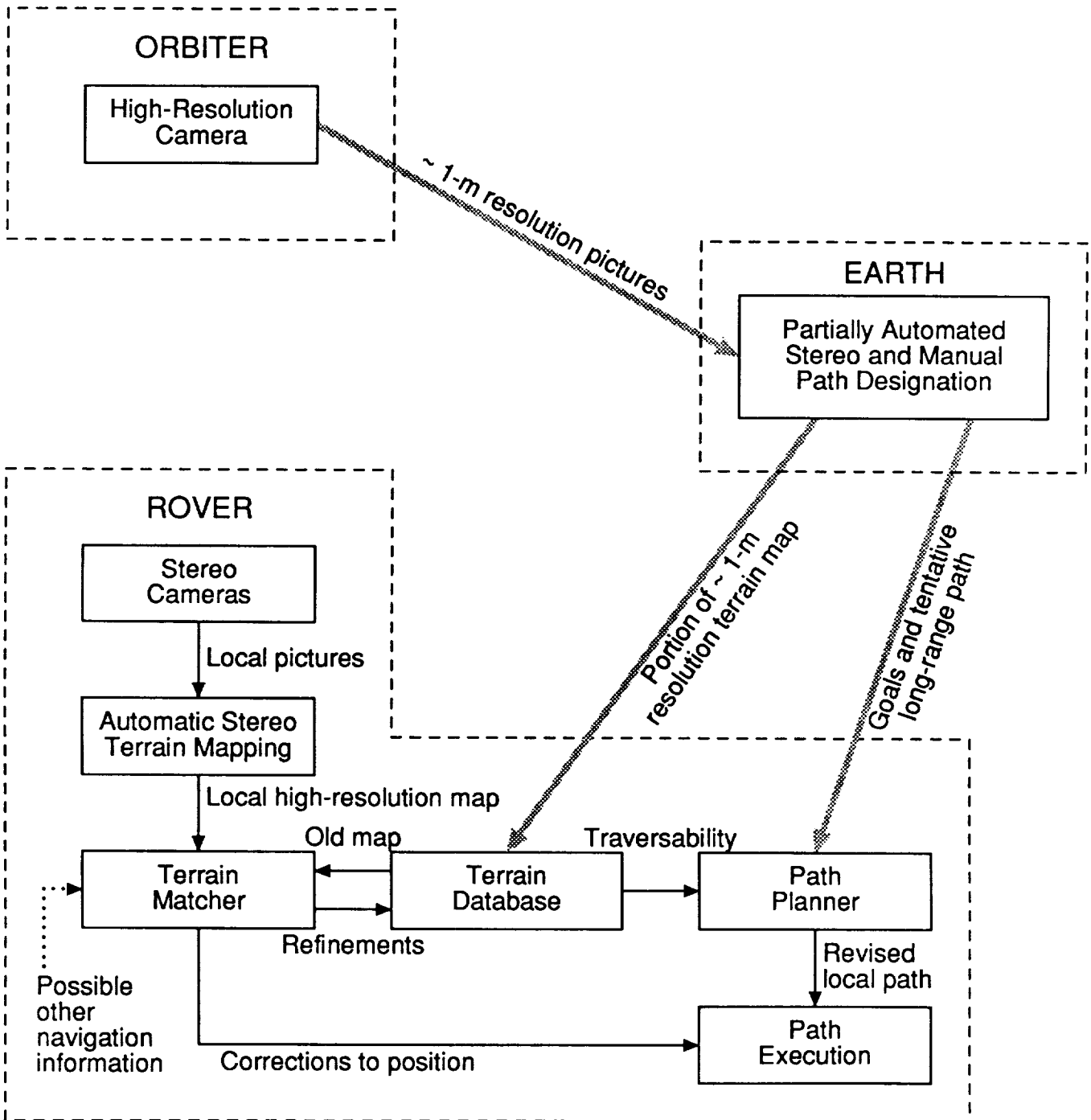



# EXAMPLE OF SEMIAUTONOMOUS OPERATION OF MARS ROVER

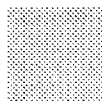
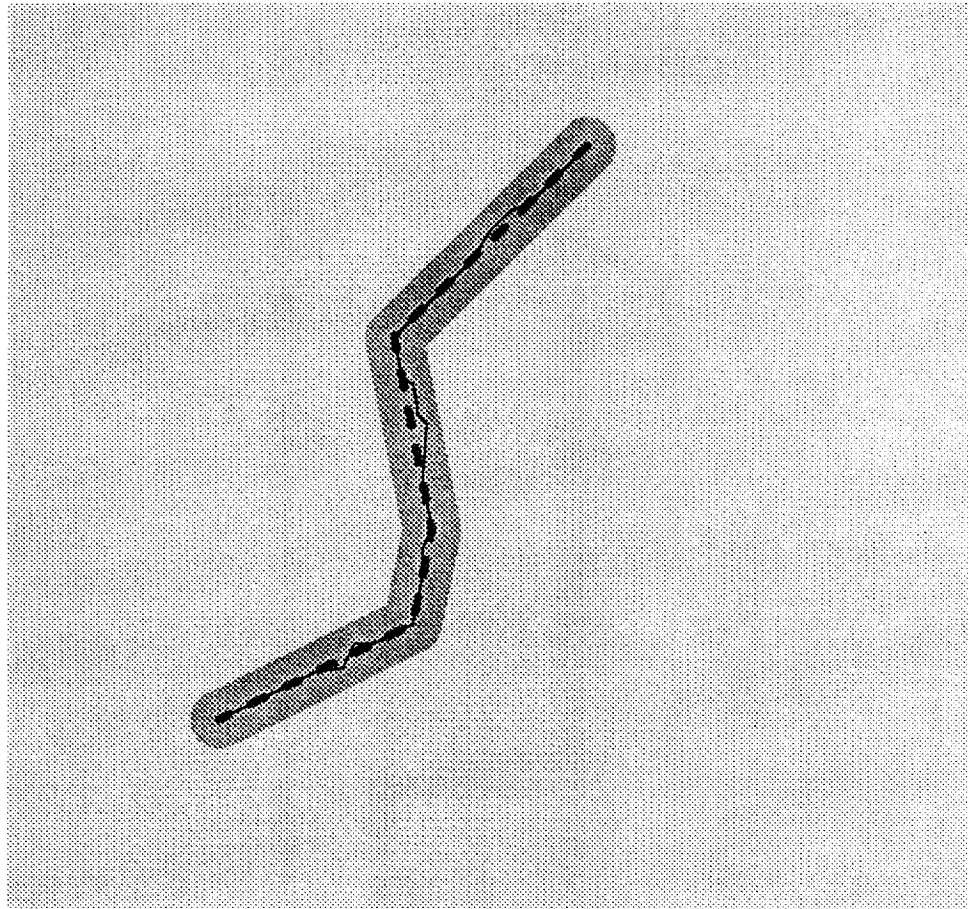

Area mapped from orbiter



Portion of map sent to rover



Path designated manually

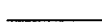

Revised path used by rover



Approximate area accurately visible to rover at one time

## ADVANTAGES

- Higher average speed than Earth-based path designation
- All-night traversal without communications satellite
- Reduced use of Deep Space Network
- Reliable operation because of human planning and orbital data

## DATA TRANSMISSION REQUIREMENTS FOR PLANNING ONE-DAY TRAVERSAL

Orbiter to Earth, for two pictures of 10-km by 10-km area with 1-m resolution and gray values compressed to 4 bits/pixel on average:

800,000,000 bits (1.9 hr @ 117,000 bits/sec)

Earth to rover, for 10-km by 400-m strip with 1-m resolution and heights compressed to 4 bits/point on average:

16,000,000 bits (2.2 hr @ 2000 bits/sec)

## RANGES FOR ACCURATE STEREO AND PLANNING

If the rover cameras are 0.5 m apart and 2 m above the ground and each pixel subtends 1 mrad, the following holds in the ground plane:

Distance	Transverse pixel size	Longitudinal horiz. pixel size	Stereo distance pixel resolution	Distance resolution in vertical plane
10 m	0.01 m	0.05 m	0.2 m	0.04 m
20 m	0.02 m	0.20 m	0.8 m	0.08 m
30 m	0.03 m	0.45 m	1.8 m	0.12 m
40 m	0.04 m	0.80 m	3.2 m	0.16 m
50 m	0.05 m	1.25 m	5.0 m	0.20 m

From the above, if the orbital cameras have a resolution of 1 m, the rover cameras produce better data out to about 30 m.

Therefore, each route should be planned locally to at least 30 m, but for accuracy new pictures should be taken and the route replanned about every 10 m.

Power	SENSORS Ops/Meter A			VLSI?
	Low	Med	High	
* Stereo	10 <sup>6</sup> , 10 <sup>4</sup> pix, C ?		5x10 <sup>8</sup> 10 <sup>???</sup> /pix	Y
*20 watts: 1 ea				
Laser Scan	0		0	Y
Sonar			10 <sup>7</sup>	Y
MM wave	0		10 <sup>2</sup>	Y
* Motion			5x10 <sup>6</sup>	Y
* Probe			0	N
Odometer			0	N
Inertial Nav			0	N
* Sensor Fusion	10 <sup>5</sup>		10 <sup>7</sup>	N

Goal - produce reliable 100x100 range map

Disclaimer -Sensor fusion to be done at other levels also.  
 Numbers may be way off - esp. sonar. Sensor  
 fusion issue controversial.

## PLANNING ISSUES

Replanning after local failure  
Degree of backtracking allowed  
Risk assessment  
Reactive planning: slippage, comms shadowing, rock tracking (keep  
in view)  
Opportunism: go back & take opportunity, see area unknown  
Planning Representation  
Optimality (acceptability) criteria risk, power, speed, etc. .  
Dealing w/ uncertainty  
Hybrid planning (local & global)  
Level of task specifications from Earth  
Planning for sample retrieval  
Do we have to backtrack, if so, how far?

- Is a terrain data base needed  
to allow the rover to navigate  
safely beyond the local  
horizon (as approved by humans)  
(Except in emergencies)

$\frac{Y}{15}$   $\frac{N}{0}$

Should the rover have long-range  
autonomous capabilities in event  
of some subsystem failures

$\frac{Y}{15}$   $\frac{N}{0}$

Question from Local Guidance for Mobility

How much power does mobility require  
(in watts/kg/(m/s))?

relayed by G. Snyder



From 2 to 20



# Path Planning

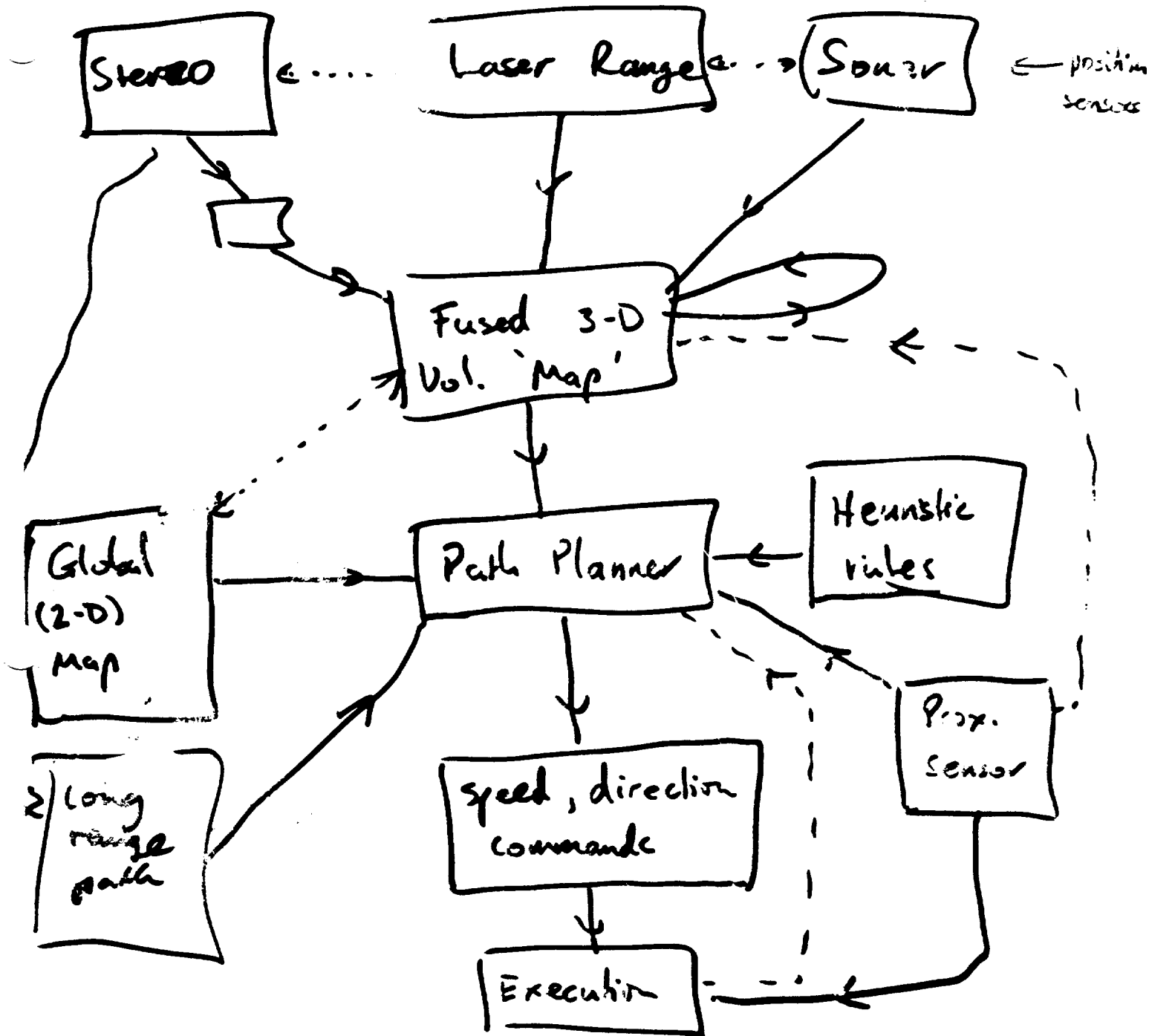

\* 1-10 cycles/sec. [map update]

\* Problem interrupts/replanning

\* Bootstrapping of robot's local position using local features

4-5-25

[10m<sup>3</sup> ... .. => 10<sup>3</sup> "voxels"]

ORIGINAL PAGE IS OF POOR QUALITY

Computing:

$$C \sim .1 - 10 \frac{\text{watts}}{\text{MIPS}}$$

Mobility:

$$M \sim .1 - 10 \frac{\text{watts}}{\text{kg} \cdot \text{m}/\text{sec}}$$

Autonomy:

$$A \sim 10 - 1000 \text{ MJ/meter}$$

$$P = VmM + ACV$$
$$= V(mM + AC)$$

$$V = \frac{P}{mM + AC}$$

conserv

$$@ C = .10, M = 10, A \sim 1000, m = 1000, P = 300$$

$$V = \frac{300}{10 \cdot 1000 + 10 \cdot 1000} = 1.5 \text{ cm/sec}$$

best case

$$V = \frac{300}{(.1)(1000) + (10)(.1)} = \frac{300}{101} = 3 \text{ m/sec}$$

# GENERAL DESIGN ISSUES

## SYSTEM QUESTIONS -

How should LG&HA interact with the other system components?

What LG&HA subsystem coordination model is best?

What major system demonstrations are realistic & useful?

# **GENERAL DESIGN ISSUES**

## **TECHNOLOGY REQUIREMENTS -**

**Reliable Autonomous Subsystems**

**Techniques for Evaluating  
Tradeoffs**

**Effective Human-Machine  
Interfaces**

**Load Shifting Procedures &  
Protocols**

**Complex System Design &  
Verification**

# **PROGRAMMING, VERIFICATION & DEBUGGING**

## **MAJOR TECHNOLOGY AREAS**

**programming languages (both for  
development and patching)**

**efficient debugging techniques  
& tools**

**fault tolerant software**

**software verification & testing  
techniques**

**bulletproofing for autonomous  
systems**

**Event-based simulation for  
concept testing**

## **COMPUTATION QUESTIONS -**

**How much computing is required?  
(Is 10 MFLOP enough?)**

**What are the computational com-  
plexity limitations?**

**What special purpose hardware is  
required (e.g., stereo corr.)?**

**What processing is needed for  
special sensors, reflexes?**

**How can data fusion error be  
contained?**

**Is onboard prog. support needed?**

# **NEEDED COMPUTING CAPABILITIES**

**workload distribution & control**

**data distribution & control**

**onboard computing support  
(e.g., operation system)**

**error detection & containment**

**failure recovery**

**enough computing to meet the  
peak demand**

# NEEDED PROGRAMMING CAPABILITIES

implement a complex hardware & software system

implement a reliable system with graceful degradation, error detection & fault recovery

implement a system which can be reprogrammed at all levels



# PROGRAMMING, VERIFICATION & DEBUGGING

## MAJOR TECHNOLOGY DEFICIENCIES

integrated software development  
environment for robots  
effective debugging techniques  
& tools for integrated computing  
& mechanical systems  
fault tolerant software develop-  
ment techniques & tools  
software verification & testing  
techniques & tools

# MAJOR TECHNOLOGY DEFICIENCIES

distributed operating systems  
for robots

distributed databases for robots

robot multisensor integration

robot computational theory

special purpose computing  
architectures

integration of multiple dispa-  
rate computing architectures

robot computing system design  
theory

error control in robots

**LOCAL GUIDANCE & HAZARD AVOIDANCE  
FOR A MARTIAN ROVER**

**Bob Douglass  
Advanced Automation Technology  
Martin Marietta Denver Aerospace**

## REQUIRED CAPABILITIES

- Plan & Execute Local Path  
(5m - 50m - area seen in one image)
- Detect and Avoid Hazards (obstacles)

## **PATH PLANNING & EXECUTION REQUIREMENTS**

- Description of terrain
- Local path planner
- Local Surface Typing (?)
- Movement Feedback
- Local Orientation & Position of Sensors, Vehicle

## **LOCAL GUIDANCE: DESCRIBING THE TERRAIN**

- Description as 3-D Surfaces
- Algorithm or Sensor to Extract Range
- Algorithm to Process Range Image
- Processing Power
- Real Power & Packaging

## **DESCRIPTION AS 3-D SURFACES**

- Full 3-D Surface Model
  - polygonal surface patches
  - solids
- Grid of Elevations (local)
- Grid of Local Slopes
- Grid of Surface Normals
- Unobservable Areas
- Alternative: Treat Surface as Flat

## EXTRACTING RANGE IMAGES

- **Passive**
  - stereo
  - motion stereo
  - shape from X (texture, shading)
- **Passive Problem**
  - at mercy of environmental variables (night, dust, sun angle)
  - needs algorithm breakthroughs/validation
  - mighty processing power
- **Active**
  - laser radar
  - millimeter wave radar
  - sonic or ultrasonic arrays
- **Active Problems**
  - electromechanical
  - slower, lower resolution
  - power requirements
  - areas of no return



## PROCESSING POWER

- General Purpose Serial
  - slow speeds & resolution only
- Custom Pipelines (VICOM, DATACUBE) - maybe
- Parallel
  - low level pixel manipulation
  - 2-D, 3-D grid connected
  - reasonable amount of arithmetic
  - SIMD probably sufficient
- SIMD grid + 2nd interconnect
  - connection machine
  - pyramid for packaging
- Custom VLSI
- Close Coupling Between Custom, Parallel, General

## LOCAL PATH PLANNER

- Generates Sequence of Moves over terrain model
- Want to Minimize/Optimize Distance travelled, fuel used, etc.
- Graph Search
  - A\*
  - Dynamic Programming
- Coordinated with Global Route Planner
  - general direction
- May Need to Move to Observe

## **Surface Typing**

- Distinguish Gravel, Rock, Sand
- Spectral Information
- Texture
- Shape
- May Not Need Mars-depends on surface & vehicle

## MOTION FEEDBACK - PATH EXECUTION

- Control Equations Must Know
  - where vehicle is
  - how moving
  - how pointed
  - locally (image to image) & globally
- Inertial Systems
  - good globally
  - locally - coarse resolution & error buildup
- Odometers (or legged equivalents)
  - wheel slip - real problem off-road
  - getting stuck - accelerometers
- Visual Motion Feedback
  - landmark recognition --- needs maps
  - motion monitoring - interest features

## LOCAL ORIENTATION & POSITION

- Sensor Position
  - to ground for slopes
  - to last image to correlate
- Vehicle Position
  - know where wheels, feet, body are
- Difficult Problem
  - initially stabilize
  - must still understand vehicle to sensor orientation to intelligently position sensors
  - must anticipate vehicle movement

## **HAZARD DETECTION & AVOIDANCE REQUIREMENTS**

- Detect Potential Hazard
- Describe Obstacle or Hazard  
(size, slope, location)
- Path Planner to Avoid
- Control Strategy

## DETECTING HAZARDS/OBSTACLES

- obstacle = can't be negotiated or  
can't tell if it can
- sticksup > 1.5m
- sticksdown < 1.5m?
- absolute slope > roll/tilt/traction limit
- in path of travel
- object moving into path

## DESCRIBING HAZARDS

- Must Extract 3-D Discontinuity of Sufficient
  - size
  - shape
  - slope or elevation
- Absolute Slope Must Be Assessed
- Must Understand Sensor Position & Orientation to Ground
- Must Locate Obstacle
- Can Be Same Elevation/Slope Description as for Local Guidance



## HAZARD DETECTION

- Quick & Simple Methods
  - sonics, ultrasonics
  - may work for fast detection
  - cat whiskers - what about holes?
- Need 3-D Range Info for Hazard Description,  
Probably Detection
  - passive - stereo, etc. + algorithm
  - active - laser radar, mmw

## HAZARD AVOIDANCE

- Can Use Same Path Planner as for Local Guidance
- Could Place Obstacles on Path & Use Potential Fields to Avoid
- Model of Vehicle Required to
  - define what is a hazard
  - manuver all parts of the vehicle around the hazard
- Control Strategy: Couple Synchronous Real-Time Control with Asynchronous Event Driven Planning and Monitoring

## CONCLUSIONS

1. Rough Outline of Solution is in Hand
  - mixed autonomous/teleoperated demonstrated
  - basic sensor, processor, algorithm suite exists for earth environment
2. Need to Determine if Active Range Sensor Is Feasible
3. Processing Architecture will be Hybrid
  - custom VLSI, parallel, general
  - high band width network between
4. Synchronous/Asynchronous System Architecture

# Animal Model

- mobility sensing/perception •  
vs object perception
- 

## 3 Sensor/Perception Systems

### 1. Visual Perception

- modeling world (3-D) & location w/in world

### 2. Vestibular

- orientation, acceleration of sensor platform

### 3. Proprioceptive

- model of yourself & where your parts are

# Vehicle Control

---

- Sensing

- Perception

(processing sense data → model of world)

- Planning for Action

- Action & Monitoring Action

↓  
sensing, perception, replanning

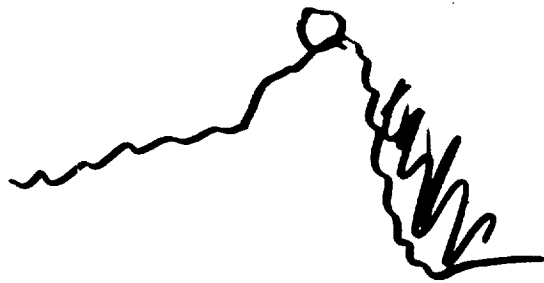

## Requirements for Vehicle Control

1. Model of environment:  
3-D, surface typing (?), unknowns
2. Model of where your parts are  
& location & orientation & movement  
w/respect to environment model
- > 3. Need stability model of vehicle
4. Need to know where parts are  
going
5. Need to plan for & move (allocate)  
sensors/perception based on above

# INTELLIGENT VEHICLE CONTROL.

- MOTION CONTROL
- EXECUTION & MONITORING
- ERROR DETECTION & RECOVERY
- ETC. (eg. Safety)
- !
- !

# MOTION CONTROLS

## ROVER TRANSIT

## STABILIZATION

Stable  
Disrupt-  
tion

Linear

Turning

Climbing  
mechanisms

\* Difficult

Traction \* Articulation

- wheels
- tracks

- wheels/arms
- tracks/arms

etc.

\* C.G. Modification

\* Articulation

- Arms/legs
- Vehicle sections

- Sample
- Sensors

- Tools
- Shafts
- Manipulators



# Execution & Monitoring

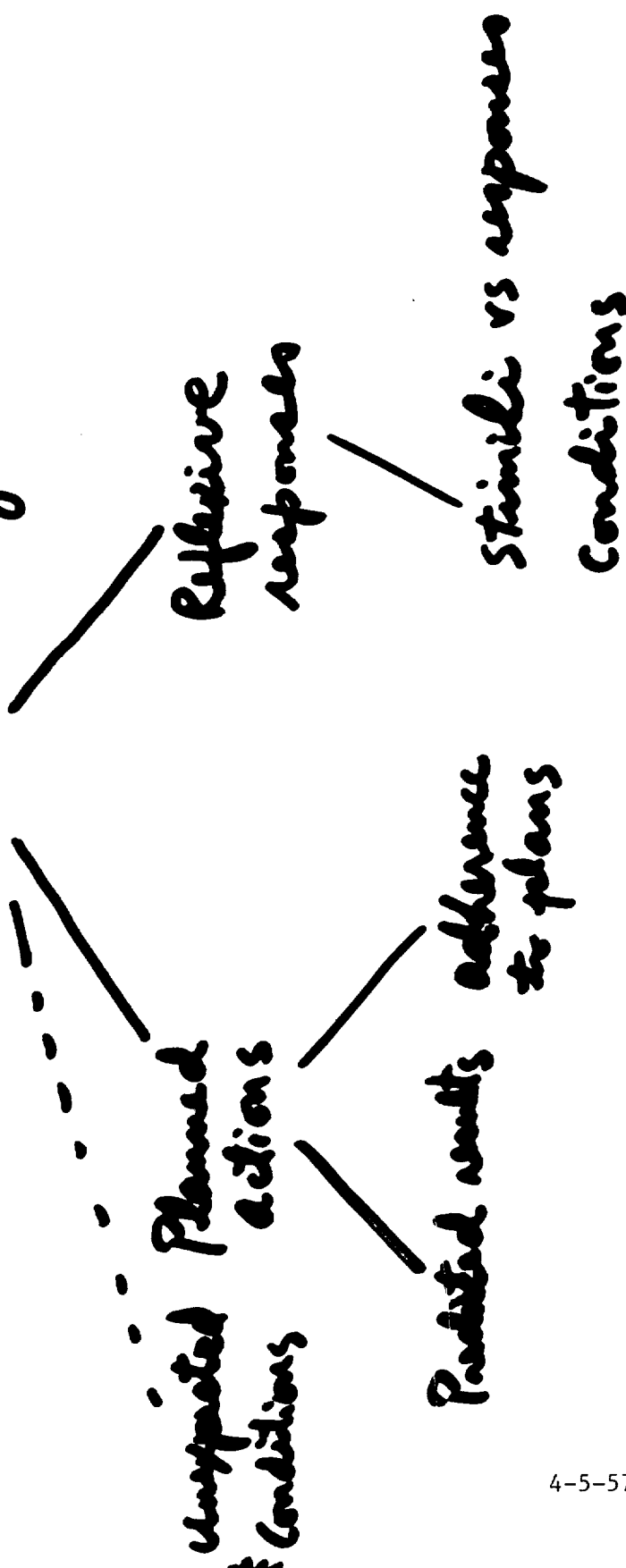

unexpected conditions

\* Difficult

# ERROR DETECTION, RECOVERY

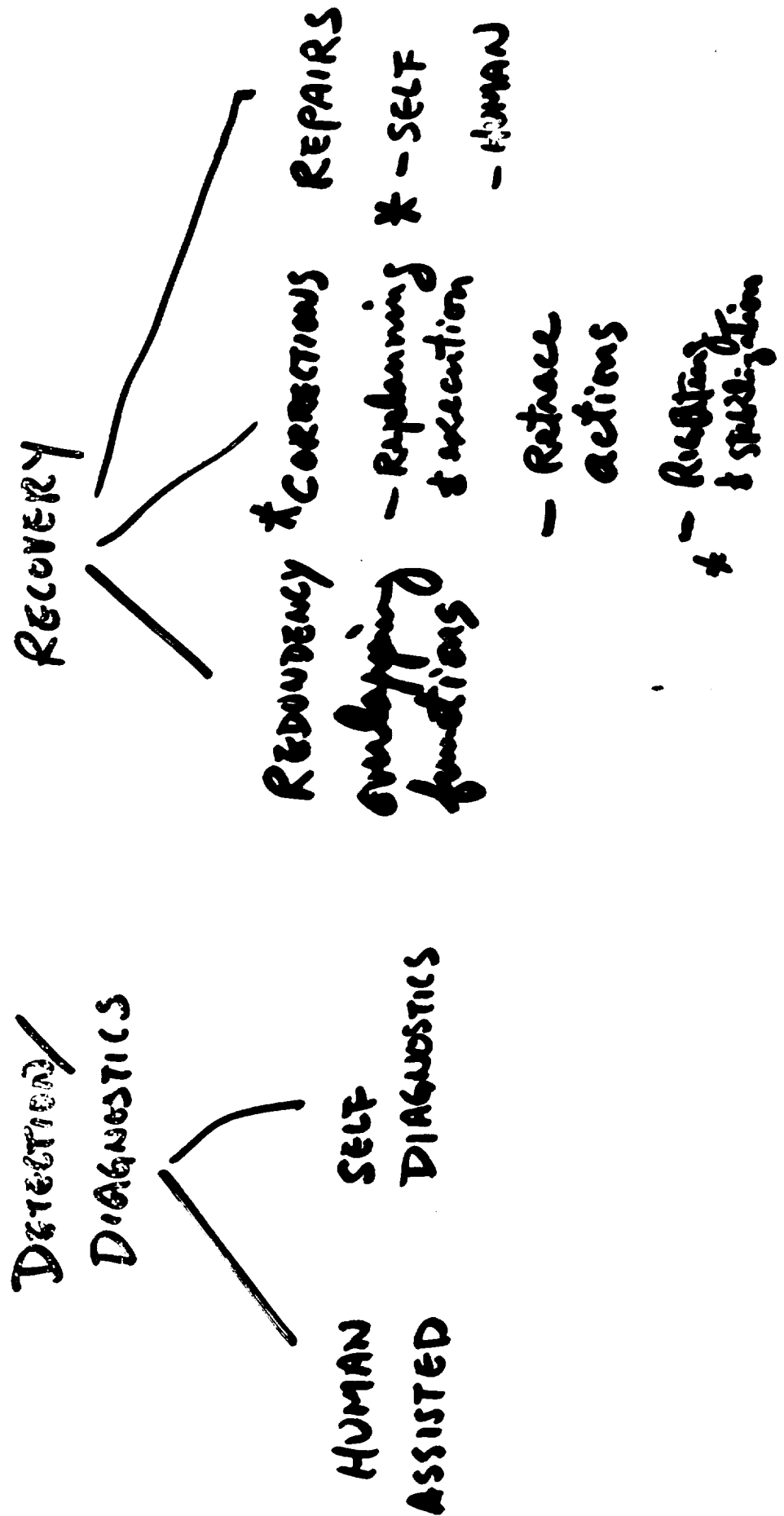

\* Difficult

# LOCAL GUIDANCE & HAZARD AVOIDANCE

## POWER ALLOCATION - COMPUTING VS MOBILITY

NOM			WATTS (GENERAL PURPOSE CPU)
6	COMPUTING	4-8	$\frac{\text{WATTS}}{\text{MIPS}}$
6	MOBILITY	2-20	$\frac{\text{WATTS}}{\text{KG}(\text{m/sec})}$
150	LG+HA	50-500	$\frac{\text{MINSTR}}{\text{meter}}$

THEREFORE (w/ 1000 Kg Rover and 500 watts)

TRAVERSE SPEED (AVERAGE)

POWER DISTRIBUTION

MIN

2  $\frac{\text{cm}}{\text{sec}}$

80% MOBILITY  
20% COMPUTING

NOM

7  $\frac{\text{cm}}{\text{sec}}$

85% MOBILITY  
15% COMPUTING

MAX

23  $\frac{\text{cm}}{\text{sec}}$

90% MOBILITY  
10% COMPUTING

BEST MOBILITY  
WORST COMPUTING  
WORST LG+HA

9  $\frac{\text{cm}}{\text{sec}}$

30% MOBILITY  
70% COMPUTING

# LOCAL GUIDANCE & HAZARD AVOIDANCE

## CONCLUSIONS

- 1) An LG&HA subsystem can be developed which will allow traverse distances substantially greater than Earth-based path designation.
- 2) The LG&HA problem is characterized by:
  - a) Very rough terrain.
  - b) Strong a priori knowledge is possible (e.g. 3 meter terrain data base)
  - c) Extreme reliability is required
  - d) Very constrained computing resources

# LOCAL GUIDANCE & HAZARD AVOIDANCE

## RECOMMENDATIONS

- 1) A 3-meter terrain data base should be developed for the exploration areas, preferably prior to the rover arrival at Mars.
- 2) LG&HA subsystem elements and integration approaches should be tested in realistic environments starting as soon as possible (Oct '87).
  - Thousands of Km of testing are needed by '93.
  - Multiple plausible approaches exist; several integration efforts must proceed in parallel.
- 3) R&D in the following areas are crucial and should begin immediately:
  - Sensors (e.g. laser scanner)
  - Perceptual and planning algorithms
  - Reflex and error recovery algorithms
  - Special-purpose computing hardware (e.g. custom VLSI) for higher performance AI work.
- 4) Unmanned rovers are essential to solar system exploration: a long-term R&D program should be supported.

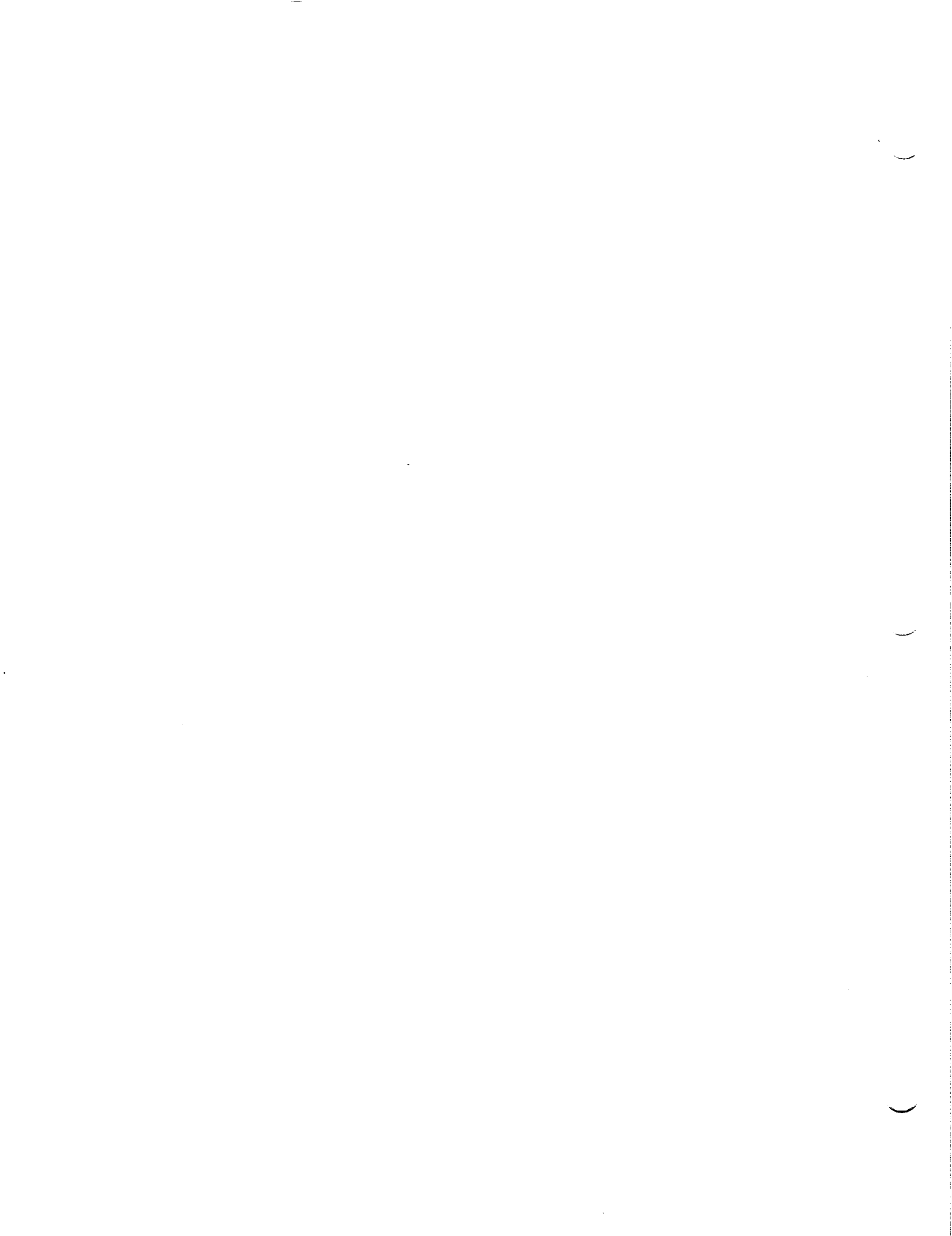

## APPENDIX A

### TECH PLANNING WORKSHEETS

#### Sensors for Local Guidance

##### A. Chang

###### Description:

1. Multiple sensors: camera plus sonar or camera and laser range sensor.
2. Electronically scannable laser range sensor.

##### D. Gennery

###### Description:

Vehicle should have stereo cameras and scanning 3D range finder (laser or sonar).

##### Anonymous

###### Description:

Should investigate (i.e., fund) millimeter scale radar for local navigation and for geological information inside rocks (ground). Note that with radar seeing through objects, will not have the occlusion problem.

#### Planning Tech

##### Anonymous

###### Description:

Reactive mechanisms for navigation (moving so as to keep 2 rocks in view track, landmark following). Highly reactive control from proprioceptors (steering into skids). "Reactions" for supporting occasional complete autonomy (in terrain shadowing of common - moving to acquire comm while not interfering with path. Less efficient strategies for negotiating all obstacles.)

#### Certainty Grids for Sensor Fusion

##### Hans Moravec

###### Keywords:

Sensor Fusion, Spatial Modeling, Sensing, Planning

Related Technologies:

Stereo Vision, Sonar, Laser Range Finding, Proximity Detection

Description:

Certainty grids are a finite-element representation of spatial knowledge, incorporating data from various sensors, explicitly representing error distributions in measurements, and combining multiple measurements for precise inferences. The representation is good for collecting data and for planning.

Status:

Single sensor versions have been demonstrated since 1982 at the CMU Mobile Robot Lab, with sonar and stereo vision.

Programs/Expertise:

CMU Mobile Robot Lab/Stereo Navigation, Sonar Navigation, Grid representations.

MRSR Mission Drivers:

Local navigation and hazard avoidance.

MRSR Application Issues:

Calculation in certainty grids are well suited for array processors.

Milestones/Comments

- 1988: First demonstration of dual sensor grid maps - stereo/sonar.
- 1989: Simple environment. Navigation with two or more sensors.
- 1990: First rough terrain experiments.
- 1991: Additional rough terrain experience.

Autonomous Navigation (cross country)

A. Chang

Description:

Need to demonstrate autonomous navigation cross-country on earth before Mars launch of rover. This allows for a thorough checkout of the entire MRSR for the rover.

Status:

FMC has already demonstrated (in 1985) cross-country autonomous navigation at Camp Roberts, CA. This was done in very benign(?) terrain.



## Sonar Study for Mars Rover Applications

A. Chang

### Description:

- Determine Mars atmospheric effects on sonar
- Determine specification for sonar
  - Design sonar
  - Develop computing algorithms
- Develop VLSI computing hardware for sonar image processing
- Verify, test and demonstrate design.

### Status:

Two sonar imaging sensors have already been developed at FMC for autonomous navigation.

## Sensor Fusion

A. Chang

### Description:

1. Fuse vision and sonar for autonomous navigation, e.g., sonar has no problem differentiating a rock from its shadow, while vision has problems in dealing with shadows.
2. Fuse vision with flexible probes.
3. Fuse vision with laser ranger.

## Planning Algorithms

A. Chang

### Description:

Implement planning algorithms in VLSI. These should be the (??) generic and general purpose algorithms (e.g., dynamic programming).

### Status:

This effort has been initiated at FMC and it is expected that gate array version of specialized hardware will be available by year end (1987).

## Vision/Image Understanding

A. Chang

### Description:

Demonstrate on a real vehicle, e.g., FMC's autonomous M113, landmark recognition and location to verify position of autonomous vehicle (INS accuracy, etc.) for autonomous navigation.

### Status:

Demonstration of landmark recognition and terrain typing have already been performed in the lab at FMC.

## Scanning Laser Radar (non-mechanical scanner)

Anonymous

### Keywords:

Range Map, Scanning laser radar, Non-mechanical scanner

### Related Technologies:

Stereo vision, millimeter wave radar, structured light.

### Description:

State of the art scanning laser radar allows realtime (4 Hz) acquisition of 256x256 range maps with each pixel containing absolute range data at a resolution of 4 mm. The maximum range capability can be as high as 30 m with depths of range of 10 m, including the near contact to 10 m range. The primary advantage of using scanning laser radar is that the acquired range map is inherently three dimensional, thereby alleviating the need for extensive 3D derivation computations. A major disadvantage of laser radars is the amount of power required to operate them. A large proportion of this power is consumed by mechanical scanners. Currently, there are no non-mechanical scanners capable of delineating frames subtended by 50° x 50° scans rapidly (4 to 30 Hz).

### Status:

Non-mechanical scanners are essentially non-existent. Their development is essential to the full realization of scanning laser radar's contribution to range mapping.

### Programs/Expertise:

CMU, Martin Marietta Denver, NASA Johnson, NASA Langley, ERIM, Odetics, Digital Signal

Milestone Comments:

1989 - 150, 1990 - 150, 991 - 100.

Don Gennery:

For reasonably robust operation, the local guidance and hazard avoidance system probably needs a computing power of at least  $10^8$  operations per meter traveled. More computing power, almost without limit, could be used by better algorithms. Another factor of 10 (i.e.,  $10^9$  operations per meter) could be utilized easily.

Hazard Avoidance and Local Guidance - Demonstrations and Testing of Ideas for Local Guidance

Rodney A. Brooks - MIT AI Lab

We have been able to identify only two outdoor mobile robots which have been operated autonomously off the road. The total distance traveled by these two projects (FMC under Andy Chang, and CMU under Takeo Kanade) amounts to less than 3 km. Both projects used relatively benign off-road conditions; grass-covered smooth terrain with trees as the only obstacles. Some further experiments may be done late in '87 on ALV by Martin Marietta, and by FMC and General Dynamics.

Most vision and laser scanner algorithms have been tested only in laboratories under very controlled conditions. Very few projects have connected vision to an autonomous vehicle - in all cases the algorithms have been at the simple end of the algorithm complexity spectrum.

We need to connect vision and laser scanner algorithms to vehicles and run them in "outdoor environments." A three-phase approach to this is:

1. In fiscal '88 (or '89) fund a number (>3) sites (with experience with autonomous mobile robots, and with a number of algorithms ready to test to run autonomous mobile robots (most probably with umbilicals to off-board processors) most probably in simulated Martian environments. For instance, the vehicles could be quite small (tens of cm on a side), with motors and sensors on board but no onboard computing. The environment would be indoors with controlled lighting, to simulate different sun angles. A simulated Martian terrain with rocks and dust would provide the terrain. The small scale work should be focused on algorithm design.
2. One to two years later there should be some number of demonstrations in an outdoor desert (Mojave?) of one or more of the earlier indoor demonstrations. These will require more robust test vehicles.
3. By technology out of date, there should be a test of the most promising system(s) on a specifically constructed vehicle.

## Alternate Power Concepts

Rodney A. Brooks

The workshop has concentrated on a rover concept of a very reliable single rover of roughly 1000 kg.

There are other concepts which may be worth considering in relatively low budget parallel efforts.

Rather than one 1000 kg rover, perhaps we could have ten 100 kg rovers, or one hundred 10 kg rovers, or one thousand 1 kg rovers. The tradeoff we can make is that with multiple rovers we can live with less reliability on any given rover and perhaps achieve more ambitious results. Of course we may not need to spend 1000 kg total.

Very small rovers might not have communications onboard. They might use solar power (solar power goes down with the square of the rover size whereas mass goes down with the cube). Different rovers might have specialized tools (core sampler, rock picker-upper). They would travel off in different directions from the lander. Some would operate on small traverses and use a beacon on the lander to find their way back. Others would go on longer traverses, leaving small solar powered beacons to find their way back. The beacons might also act as low bandwidth communication relays.

Complete 10 kg rovers on Earth are already feasible. Current development in micromachines suggest 1 kg Earth rovers may soon be feasible.

Fifty 10 kg Mars rovers could halve the mass requirements of the mission. They might significantly expand the amount of territory that can be covered by the mission.

## Alternate Rover Concepts

D. Shapiro, Advanced Design Systems

The approach pursued by the LG&HA working group has focused on the availability of high quality map data, accurate navigation, as well as high quality and potentially computer-intensive perception. With some changes in mission capabilities, substantially simpler approaches may become possible (with attendant large-cost benefits).

In specific, I believe we can support surface exploration and provide vehicle safety in the absence of 3-m resolution map data obtained from orbital imagery. The consequence will be a decreased confidence that an Earth-designated path can be executed by the rover with the expectation that some paths can be safely explored. For example, given 8 to 10-m data, a poor sense of own movement and no global position registration (map based), landmark based steering with local obstacle avoidance is sufficient to negotiate approximate paths. In this scenario, the character of movement on the surface is different: medium range planning

might be earth-based, requiring the vehicle to climb and observe from hills. Returning to previous locations, e.g., specific rocks, would be more tedious. Tropisms, or reactive planning mechanism, might be indicated for autonomous movement at both local and global scales. The recommendation is that these approaches should be explored.

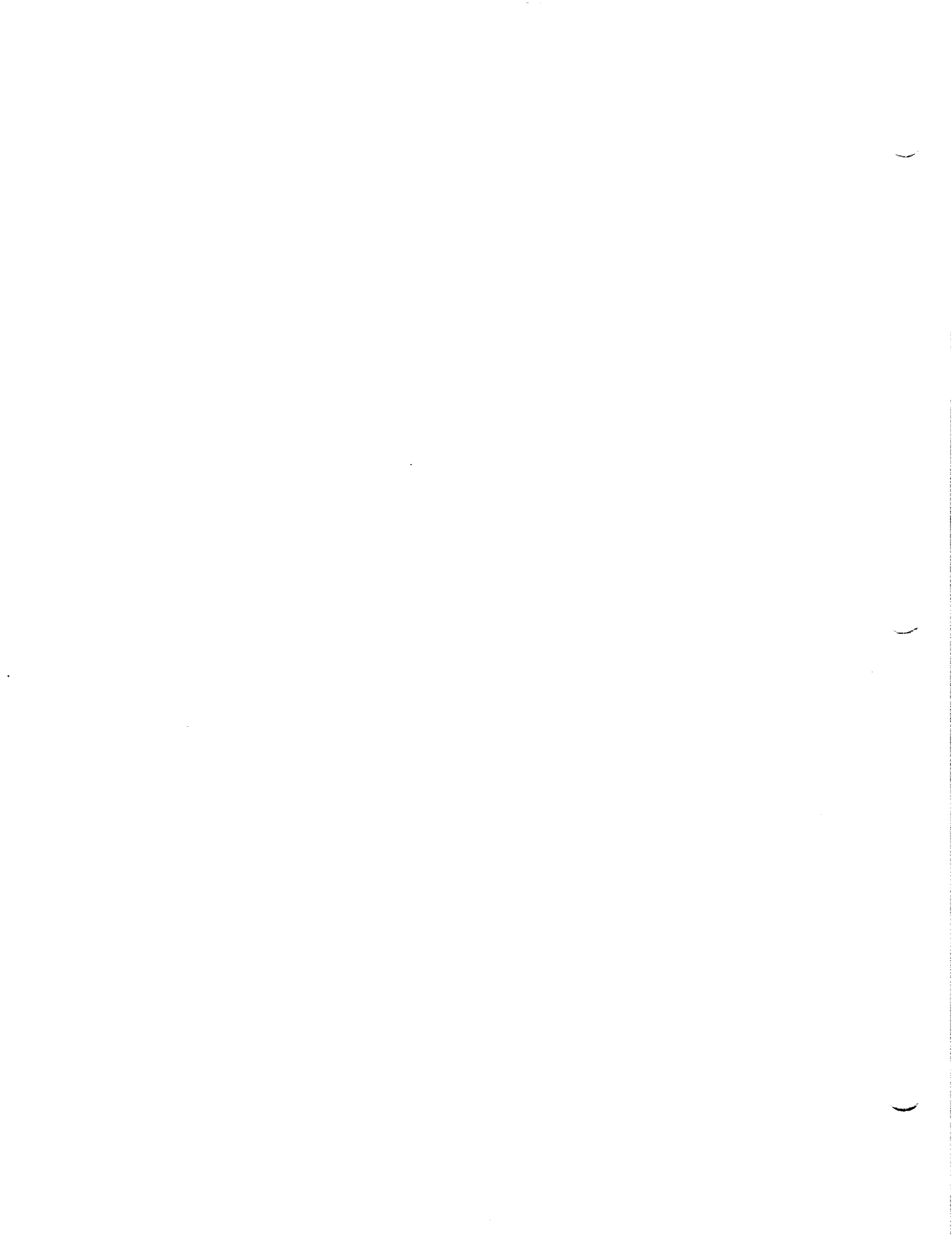

APPENDIX B  
SUMMARY FORMS

SUMMARY FORM - Anonymous

I. Function - Range Map

Technology Options

FM/CW Scanning Laser Radar

Rationale

Real-time (4 Hz) mm resolution (range) over 10-30-m range with a depth of range from near 0 to max range. Dynamic reflectance range of 8 dB. To allow continuous position information relative to (a) selected target(s) during the 10 to 10-m lurch. Prevents periods of open loop operation.

Capability Set

Power requirement 20W or less; 256x256 spatial designation. 50 degree scan H & V should have non-mechanical scanning capability.

II. Function - Proportional Proximity Sense

Technology Options

FM/CW Laser Radar

Rationale

To provide continuous data about hazards within close proximity (0.5 m) of the rover.

Capability Set

Real-time (30 Hz), submillimeter range resolution over a range of 0 to 0.5 m. Power requirement 3W or less.

SUMMARY FORM - D. Atkinson

I. Functions - Terrain Representation for Path Planning

Technology Options

"Low level" space subdivision (grid)

- Potential field
- Hierarchical space - subdivision
- Semantic segmentation

Rationale

Level and kind of representation chosen enables different kinds of path generation and selection approaches. One or more approaches will be important for different capabilities. Representation is an open issue.

Capability Set

- Path optimality
- Risk assessment
- Vehicle modeling
- Processing efficiency

II. Function - Rover Mobility Modeling

Technology Options

- Heuristic
- Qualitative
- Quantitative
- Hybrid Qualitative, Quantitative

Rationale

Important for path risk assessment; vehicle "health" sensing; using sensors (planning) to acquire information about the terrain.

Capability Set

Selection of technical option is dependent on risk/computation tradeoff.

III. Function - Dynamic Replanning, Reactive Planning

Technology Options

- Knowledge based system
- A priori response to situation



#### Rationale

Ability to respond autonomously to unforeseen situations is required to reduce risk and fail-safe or fail operational for the rover. Implications are real-time (e.g., slippages) and "offline" (e.g., box canyon)

#### Capability Set

- Flexible response to local failures, versus canned response occasionally requiring human control

#### IV. Function - Goal Management

##### Technology Options

Knowledge-based system

#### Rationale

Rover must be able to evaluate unforeseen situations and autonomously determine path feasibility without vehicle risk.

#### Capability Set

- Greater autonomy
- Could contribute to opportunism in science objectives.

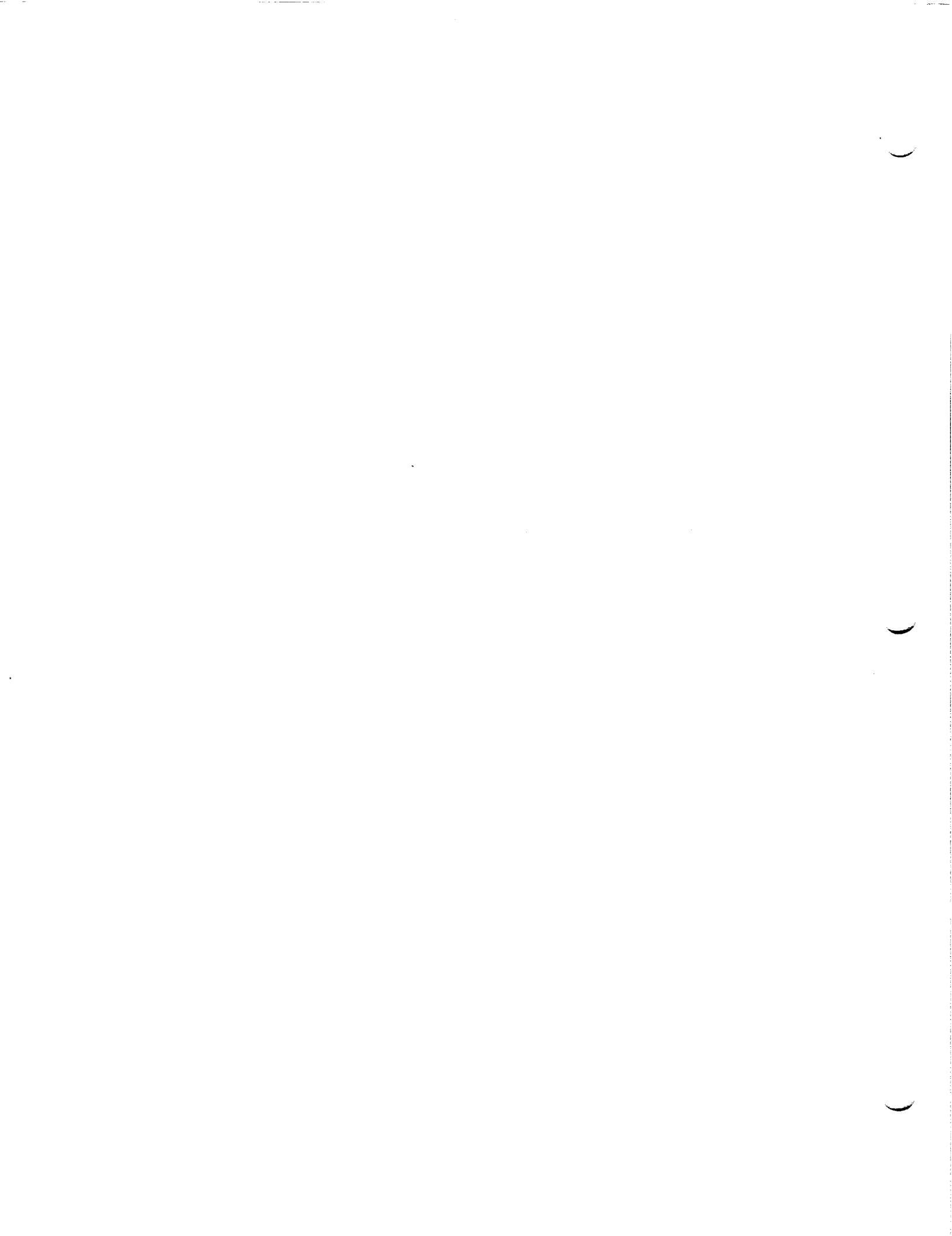

APPENDIX C  
INDIVIDUAL CONTRIBUTIONS

Local Guidance and Hazard Avoidance (LG & HA) is an essential capability for the Mars Rover to successfully accomplish its mission. Because of the long delay in round-trip telemetry from Mars to Earth, local navigation by conventional teleoperation is highly impractical. The Mars Rover must autonomously sense, perceive, and plan for navigating in the local environment safely toward the designated goal. Our panel has concluded that an autonomous LG&HA subsystem can be developed, has identified key technical components for it, and produced concrete recommendations for developing such technologies. Detailed discussions on sensing, perception, planning, and control are presented in the summary and reports from the panel. I believe that the most important point to be made is that the technologies for an autonomous LG&HA subsystem must be developed, integrated, and tested within the context of the total Rover system using realistic environments. Developing capabilities of intelligent autonomous navigation will be crucial not only to the Mars Rover and Sample Return mission but also to unmanned exploration of other planets.

Takeo Kanade, Co-Chairman  
Carnegie-Mellon University

# Certainty Grids for Mobile Robots

Hans P. Moravec

Robotics Institute  
Carnegie-Mellon University  
Pittsburgh, PA 15213

## 1 Abstract

A numerical representation of uncertain and incomplete sensor knowledge we call Certainty Grids has been used successfully in several of our past mobile robot control programs, and has proven itself to be a powerful and efficient unifying solution for sensor fusion, motion planning, landmark identification, and many other central problems. We propose to build a software framework running on processors onboard our new Uranus mobile robot that will maintain a probabilistic, geometric map of the robot's surroundings as it moves. The "certainty grid" representation will allow this map to be incrementally updated in a uniform way from various sources including sonar, stereo vision, proximity and contact sensors. The approach can correctly model the fuzziness of each reading, while at the same time combining multiple measurements to produce sharper map features, and it can deal correctly with uncertainties in the robot's motion. The map will be used by planning programs to choose clear paths, identify locations (by correlating maps), identify well known and insufficiently sensed terrain, and perhaps identify objects by shape. The certainty grid representation can be extended in the time dimension and used to detect and track moving objects. Even the simplest versions of the idea will allow us fairly straightforwardly to program the robot for tasks that have hitherto been out of reach. We look forward to a program that can explore a region and return to its starting place, using map "snapshots" from its outbound journey to find its way back, even in the presence of disturbances of its motion and occasional changes in the terrain.

## 2 Introduction

Robot motion planning systems have used many space and object representations. Objects have been modelled by polygons and polyhedra, or bounded by curved surfaces. Free space has been partitioned into Voronoi regions or, more heuristically, free corridors. Traditionally the models have been hard edged - positional uncertainty, if considered at all, was used in just a few special places in the algorithms, expressed as a gaussian spread. Partly this is the result of analytical difficulty in manipulating interacting uncertainties, especially if the distributions are not gaussian. Incomplete error modelling reduces positional accuracy. More seriously, it can produce entirely faulty conclusions: a false determination of an edge in a certain location, for instance, may derail an entire train of inference about the location or existence of an object. Because

they neglect uncertainties and alternative interpretations, such programs are brittle. When they jump to the right conclusions, they do well, but a small error early in the algorithm can be amplified to produce a ridiculous action. Most artificial intelligence based robot controllers have suffered from this weakness.

We've built our share of brittle controllers. Occasionally, however, we stumble across numerical (as opposed to analytic) representations that seem to escape this fate. One is deep inside the program that drove the Stanford Cart in 1979 [6]. Each of 36 pairings of nine images from a sliding camera produced a stereo depth measurement of a given feature, identified by a correlator, in the nine images. Some pairings were from short baselines, and had large distance uncertainty, others were from widely separated viewpoints, with small spread. The probability distributions from the 36 readings were combined numerically in a 1000 cell array, each cell representing a small range interval (Figure 1). Correlator matching errors often produced a multi-peaked resultant distribution, but the largest peak almost always gave the correct range. The procedure was the most error tolerant step in the Cart navigator, but it alone did not protect the whole program from brittleness.

A descendant of the Cart program by Thorpe and Matthies contained a path planner [5] that modelled floor space as a grid of cells containing numbers representing the suitability of each region to be on a path. Regions near obstacles had low suitability while empty space was high. A relaxation algorithm found locally optimum paths (Figure 2). The program represented uncertainty in the location, or even existence, of obstacles by having the suitability numbers for them vary according to extended, overlapping, probability distributions. The method dealt very reliably and completely with uncertainty, but also suffered from being embedded in an otherwise brittle program.

Our most thorough use of a numerical model of position uncertainty is a sonar mapper, map matcher and path planner developed initially for navigating the Denning Sentry [4, 2, 3]. Space is represented as a grid of cells, each mapping an area 30 (in some versions 15) centimeters on a side and containing two numbers, one the estimated probability that the area is empty, the other that it is occupied. Cells whose state of occupancy is completely unknown have both probabilities zero, and inconsistent data is indicated if both numbers are high. Many of the algorithms work with the difference of the numbers. Each wide angle sonar reading adds a thirty degree swath of emptiness, and a thirty degree

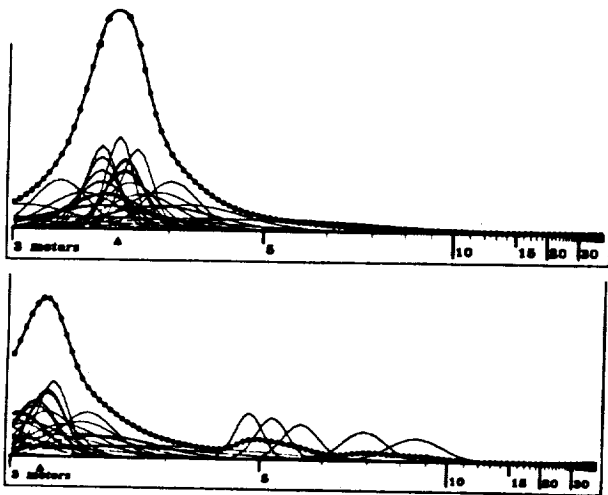

Figure 1: Nine Eyed Stereo - Identifications of a point on an object seen in nine different images taken as a camera traversed a track at right angles to its direction of view. Each pairing of images gives a stereo baseline, some short some long. Long baselines have less uncertainty in the calculated distance. The distributions for all 36 possible pairings are added in a one dimensional "certainty grid", and the peak of the resultant sum taken as the actual distance to the object. The top graph is for a case where are nine identifications of the point in the images are correct. The bottom is a case where one image is in error. The error produces eight small peaks at incorrect locations, but these are no match for the accumulation of the correct values.

arc of occupancy, by itself a very fuzzy image of the world. Several hundred readings together produce an image with a resolution often better than 15 centimeters, despite many aberrations in individual readings (Figure 3). The resiliency of the method has been demonstrated in successful multi-hour long runs of Denning robots around and around long trajectories, using three second map building and three second map matching pauses at key intersections to repeatedly correct their position. These runs work well in clutter, and survive disturbances such as people milling around the running robot.

Ken Stuart of MIT and Woods Hole has implemented a three dimensional version of the sonar mapper for use with small submersible craft. Tested so far only in simulation, but in the presence of large simulated errors, Stuart's program provides extremely good reconstructions, in a  $128 \times 128 \times 64$  array, of large scale terrain, working with about 60,000 readings from a sonar transducer with a seven degree beam. Running on a Sun computer, his program can process sonar data fast enough to keep up with the approximately one second pulse rate of the transducers on the two candidate submersibles at Woods Hole.

Recently Serey and Matthies demonstrated the utility of the grid representation in a stereo vision based navigator [1]. Edges crossing a particular scanline in the two stereo images are matched by a dynamic programming method, to produce a range profile. The wedge shaped space from the camera to the range profile is marked empty, cells along the profile itself are marked occupied. The resulting map is then used to plan obstacle avoiding paths as with the stereo and sonar programs mentioned above (Figure 4).

Despite its effectiveness, in each instance we adopted the grid representation of space reluctantly. This may reflect habits from a recent time when analytic approaches were more feasible and seemed more elegant because computer memories were too small to easily handle numerical arrays of a few thousand to a million cells. I think the reluctance is no longer appropriate. The straightforwardness, generality and uniformity of the grid representation has

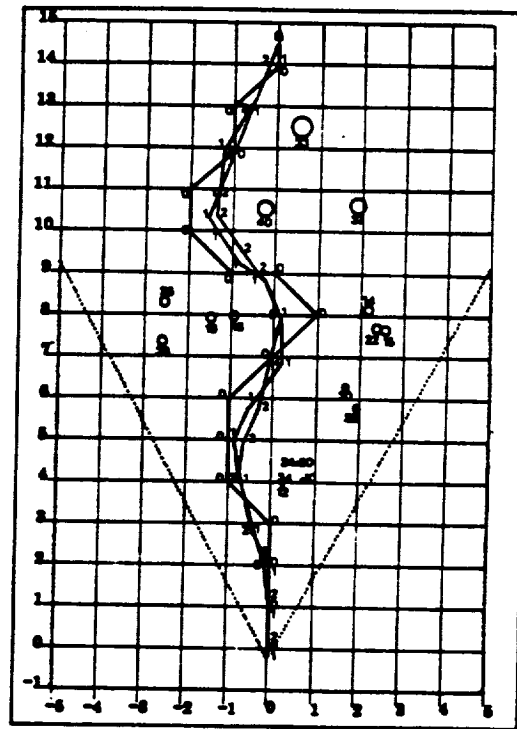

Figure 2: Relaxation Path Planner - A path is chosen that minimizes a given cost function in a Certainty Grid. Small perturbations are made in the vertices of the path in directions that reduce the cost.

proven itself in finite element approaches to problems in physics, in raster based approaches to computer graphics, and has the same promise in robotic spatial representations. At first glance a grid's finite resolution seems inherently to limit positioning accuracy. This impression is false. Cameras, sonar transducers, laser scanners and other long range sensors have intrinsic uncertainties and resolution limits that can be matched by grids no larger than a few hundred cells on a side, giving a few thousand cells in two dimensions, or a few million in three dimensions. Since the accuracy of most transducers drops with range, even greater economy is possible by using a hierarchy of scales, covering the near field at high resolution, and successively larger ranges with increasingly coarser grids. Besides this, the implicit accuracy of a certainty grid can be better than the size of its cell. The grid can be thought of as a discrete sampling of a continuous function. Extended features such as lines (perhaps representing walls) may be located to high precision by examining the parameters of surfaces of best fit. The Denning robot navigator mentioned above convolves two maps to find the displacement and rotation between them. In the final stages of the matching correlation values are obtained for a number of positions and angles in the vicinity of the best match. A quadratic least squares polynomial is fitted to the correlation values, and its peak is located analytically. Controlled tests of the procedure usually give positions accurate to better than one quarter of a cell width.

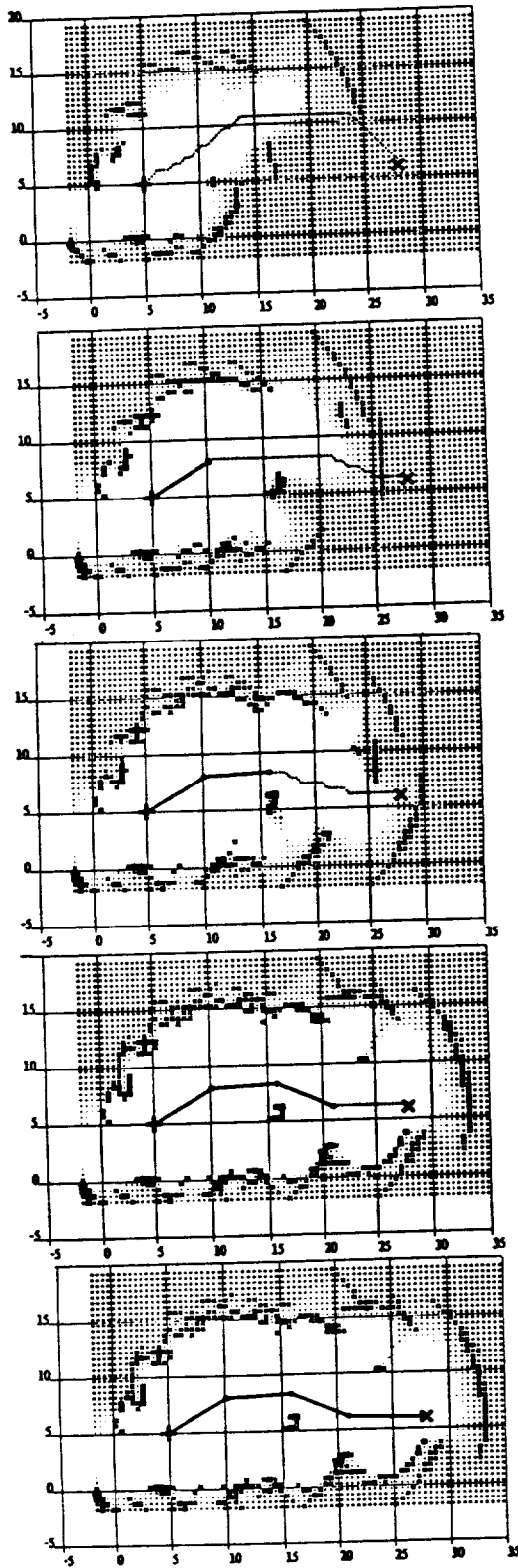

Figure 3: Sonar Mapping and Navigation - Plan view of the certainty grid built by a sonar guided robot traversing our laboratory. The scale marks are in feet. Each point on the dark trajectory is a stop that allowed the onboard sonar ring to collect twenty four new readings. The grid cells are white if the occupancy probability is low, dots if unknown, and x if high. The forward paths were planned by a relaxation path planner working in the grid as it was incrementally generated.

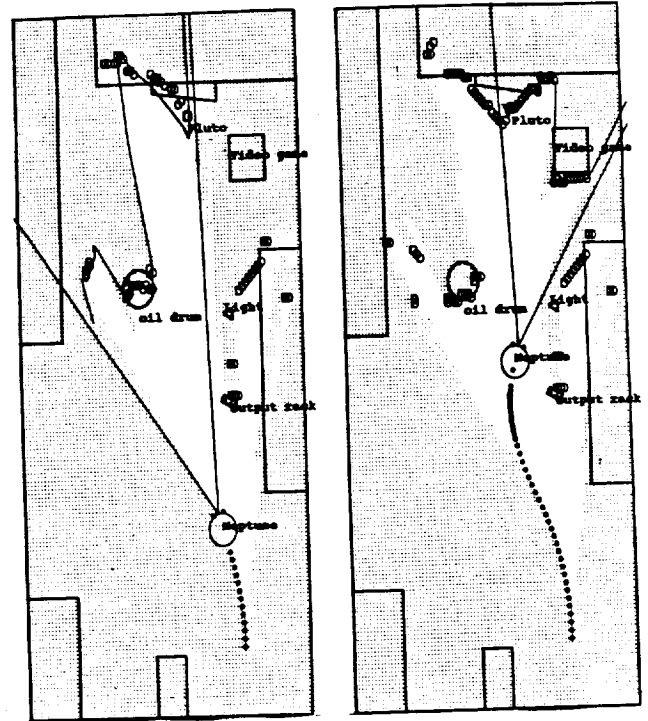

Figure 4: Stereo Mapping and Navigation - Plan view of the certainty grid built by a stereo guided robot traversing our laboratory. The situation is analogous to the sonar case of Figure 3, but the range profiles were gathered from a scanline stereo method using two TV cameras rather than a sonar ring.

Our results to date suggest that many mobile robot tasks can be solved with this unified, sensor independent, approach to space modelling. The key ingredients are a robot centered, multi resolution, map of the robot's surroundings, procedures for efficiently inserting data from sonar, stereo vision, proximity and other sensors into the map, other procedures for updating the map to reflect the uncertainties introduced by imprecise robot motion, and yet others to extract conclusions from the maps. We've already demonstrated procedures that produce local and global navigational fixes and obstacle avoiding paths from such maps. Other tasks, such as tracking corridors, finding vantage points with good views of unseen regions, and identification of larger features such as doors and desks by general shape seem within reach.

### 3 The Representation

The sonar mappers mentioned above are our most thorough use to date of the certainty grid idea. Although our original implementations used two grids to represent occupancy knowledge (labelled  $P_{occupied}$  and  $P_{empty}$ ), Stuart's 3D system uses only one. An analysis of the steps in our code reveals that one grid will indeed suffice, and this simplification makes clear several puzzling issues in the original formulation.

Before any measurements are made, the grid is initialized to a background occupancy certainty value,  $C_b$ . This number represents the average occupancy certainty we expect in a mature map, and encodes a (very) little bit of a-priori information we have about the world. In our lab a good  $C_b$  seems to be about the number of cells in the perimeter of the grid divided by the total cells ( $4 \times 32 / (32 \times 32) = 1/8$ ) in the case of the Denning code. If the space is very cluttered,  $C_b$  should be larger. As the map is used, values near  $C_b$  will stand for regions whose occupancy state is essentially unknown, while those much nearer zero will

represent empty places, and those much nearer unity are likely to be occupied. Most of the planning algorithms that use the grid will be better off if they do not make sharp distinctions, but instead numerically combine the certainty values from various cells to produce "goodness of fit" numbers for their various hypotheses. In this way the essential uncertainties in the measurements are not masked, and the algorithms do not jump to unnecessary, possibly false, conclusions.

#### 4 Inserting Measurements

The readings of almost any kind of sensor can be incorporated into a certainty grid, if they can be expressed in geometric terms. The information from a reading can be as minimal as a proximity detector's report that there is probably something in a certain region of space, or as detailed as a stereo depth profiler's precise numbers on the countours of a surface.

The first step, in general, is to express the sensor's measurement as a numerical spatial certainty distribution commensurate with the grid's geometry. For an infrared proximity detector this may take the form of set of numbers  $P_x$  in an elliptical envelope with high certainty values in a central axis (meaning detection is likely there) tapering to zero at the edges of the illumination envelope. Let's suppose the sensor returns a binary indication that there is or is not something in its field of view. If the sensor reports a hit, cells in the certainty grid  $C_x$  falling under the sensor's envelope can be updated with the formula

$$C_x := C_x + P_x - C_x \times P_x$$

which will increase the  $C$  values. In this case the  $P$  values should be scaled so their sum is one, since the measurement describes a situation where there is something somewhere in the field of view, probably not everywhere. If the reliability of the sensor is less than perfect, the normalization may be to a sum less than unity. If, on the other hand, the detector registers no hit, the formula might be

$$C_x := C_x \times (1 - P_x)$$

and the  $C$ s will be reduced. In this case the measurement states that there is nothing anywhere in the field of view, and the  $P$  values should reflect only the chance that an object has been overlooked at each particular position; i.e. they should not be normalized. If the sensor returns a continuous value rather than a binary one, perhaps expressing some kind of rough range estimate, a mixed strategy similar to the one described below for sonar is called for.

A Polaroid sonar measurement is a number giving the range of the nearest object within an approximately thirty degree cone in front of the sonar transducer. Because of the wide angle, the object position is known only to be somewhere on a certain surface. This range surface can be handled in the same manner as the sensitivity distribution of a proximity detector "hit" above. The sonar measurement has something else to say, however. The volume of the cone up to the range reading is probably empty, else a smaller range would have been returned. The empty volume is like the "no hit" proximity detector case, and can be handled in the same fashion. So a sonar reading is like a proximity detector hit at some locations, and increases the occupancy probability there, and like a miss at others, where it decreases the probability. If we have a large number of sonar readings taken from different vantage points (say as the robot moves), the gradual accumulation of such certainty numbers will build a respectable map. We can, in fact, do a little better than that. Imagine two sonar readings whose volumes intersect. And suppose the "empty" region of the second overlaps part of the range surface of the first. Now the range surface says

"somewhere along here there is an object", while the empty volume says "there is no object here". The second reading can be used to reduce the uncertainty in the position of the object located by the first reading by decreasing the probability in the area of the overlap, and correspondingly increasing it in the rest of the range surface. This can be accomplished by reducing the range surface certainties  $R_x$  with the formula  $R_x := R_x \times (1 - E_x)$  where  $E_x$  is the "empty" certainty at each point from the second reading, then normalizing the  $R$ s. This method is used to good effect in the existing sonar navigation programs, with the elaboration that the  $E$ s of many readings are first accumulated, and then used to condense the  $R$ s of the same readings. (It is this two stage process that led us to use two grids in our original programs. In fact, the grid in which the  $E$ s are accumulated need merely be temporary working space.)

The stereo method of Serey and Matthies provides a depth profile of visible surfaces. Although, like a sonar reading, it describes a volume of emptiness bounded by a surface whose distance has been measured, it differs by providing a high certainty that there is matter at each point along the range surface. The processing of the "empty" volume is the same, but the certainty reduction and normalization steps we apply to sonar range surfaces are thus not appropriate. The grid cells along a very tight distribution around the range surface should simply be increased in value according to the "hit" formula. The magnitude and spread of the distribution should vary according to the confidence of the stereo match at each point. The method used by Serey and Matthies matches edge crossing along corresponding scanlines of two images, and is likely to be accurate at those points. Elsewhere it interpolates, and the expected accuracy declines.

If the robot has proximity or contact sensors, its own motion can contribute to a certainty grid. Areas traversed by the robot are almost certainly empty, and their cells can be reduced by the "no hit" formula, applied over a confident sharp edged distribution in the shape of the robot. This approach becomes more interesting if the robot's motion has inherent uncertainties and inaccuracies. If the certainty grid is maintained so it is accurate with respect to the robot's present position (so called robot co-ordinates), then the past positions of the robot will be uncertain in this co-ordinate system. This can be expressed by *blurring* the certainty grid accumulated from previous readings in a certain way after each move, to reflect the uncertainty in that move. New readings are inserted without blur (essentially the robot is saying "I know *exactly* where I am now; I'm just not sure where I was before). The track in the certainty grid of a moving robot's path in this system will resemble the vapor trail of a high flying jet - tight and dense in the vicinity of the robot, diffusing eventually to nothing with time and distance.

#### 5 Extracting Deductions

The purpose of maintaining a certainty grid in the robot is to plan and monitor actions. Thorpe and Elfes showed one way to plan obstacle avoiding paths. Conceptually the grid can be considered an array of topographic values - high occupancy certainties are hills while low certainties are valleys. A safe path follows valleys, like running water. A relaxation algorithm can perturb portions of a trial path to bring each part to a local minimum. In principle a decision need never be made as to which locations are actually empty and which are occupied, though perhaps the program should stop if the best path climbs beyond some threshold "altitude". If the robot's sensors continue to operate and update the grid as the path is executed, impasses will become obvious as proximity and contact sensors raise the occupancy certainty of locations where they make contact with solid matter.



As indicated in the introduction, we have already demonstrated effective navigation by convolving certainty grids of given locations built at different times, allowing the robot to determine its location with respect to previously constructed maps. This technique can be extended to subparts of maps, and may be suitable for recognizing particular landmarks and objects. For instance, we are presently developing a wall tracker that fits a least squares line to points that are weighted by the product of the occupancy certainty value and a gaussian of the distance of the grid points from an a-priori guess of the wall location. The parameters of the least squares line are the found wall location, and serve, after being transformed for robot motion, as the initial guess for the next iteration of the process.

For tasks that would benefit from an opportunistic exploration of unknown terrain, the certainty grid can be examined to find interesting places to go next. Unknown regions are those whose certainty values are near the background certainty  $C_b$ . By applying an operator that computes a function such as

$$\sum(C_x - C_b)^2$$

over a weighted window of suitable size, a program can find regions whose contents are relatively unknown, and head for them. Other operators similar in spirit can measure other properties of the space and the robot's state of knowledge about it. Hard edged characterizations of the stuff in the space can be left to the last possible moment by this approach, or avoided altogether.

## 6 A Plan: Awareness for a Robot

Uranus is the CMU Mobile Robot Lab's latest and best robot and the third and last one we intend to construct for the foreseeable future. About 60 cm square, with an omnidirectional drive system intended primarily for indoor work, Uranus carries two racks wired for the industry standard VME computer bus, and can be upgraded with off the shelf processors, memory and input output boards. In the last few years the speed and memory available on single boards has begun to match that available in our mainframe computers. This removes the main arguments for operating the

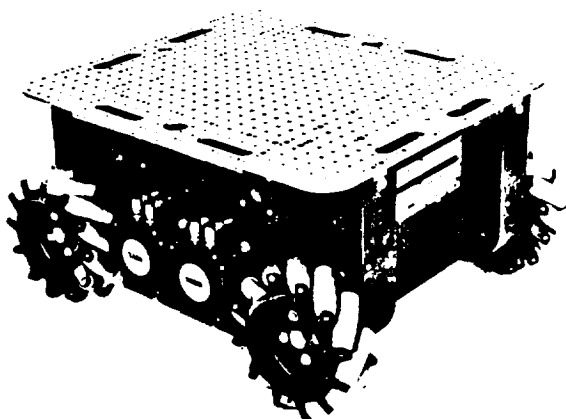

Figure 5: The Uranus Mobile Robot - A bouncing baby, full of promise.

machine primarily by remote control. With most computing done on board by dedicated processors, enabling very high bandwidth and reliable connection of processors to sensors and effectors, real time control is much easier. Also favoring this change in approach is a realization by us, growing from our experience with robot control programs from the very complex to the relatively simple, that the most complicated programs are probably not the most effective way to learn about programming robots. Very complex programs are slow, limiting the number of experiments possible in any given time, and they involve too many simultaneous variables, whose effects can be hard to separate. A manageable intermediate complexity seems likely to get us to our long term goals fastest. The most exciting element in our current plans is a realization that certainty grids are a powerful and efficient unifying solution for sensor fusion, motion planning, landmark identification, and many other central problems.

As the core of the robot and the research we will prepare a kind of operating system based on the "certainty grid" idea. Software running continuously on processors onboard Uranus will maintain a probabilistic, geometric map of the robot's surroundings as it moves. The certainty grid representation will allow this map to be incrementally updated in a uniform way from various sources including sonar, stereo vision, proximity and contact sensors. The approach can correctly model the fuzziness of each reading, while at the same time combining multiple measurements to produce sharper map features, and it can deal correctly with uncertainties in the robot's motion. The map will be used by planning programs to choose clear paths, identify locations (by correlating maps), identify well known and insufficiently sensed terrain, and perhaps identify objects by shape. To obtain both adequate resolution of nearby areas and sufficient coverage for longer range planning, without excessive cost, a hierarchy of maps will be kept, the smallest covering a 2 meter area at 6.25 cm resolution, the largest 16 meters at 50 cm resolution (Figure 6). This map will be "scrolled" to keep the robot centered as it moves, but rotations of the robot will be handled by changing elements of a matrix the represents the robot's orientation in the grid. The map forms a kind of consciousness of the world surrounding the robot - reasoning about the world would actually be done by computations in the map. It might be interesting to take one more step in the hierarchy, to a one meter grid that simply covers the robot's own extent. It would be natural to keep this final grid oriented with respect to robot chassis itself, rather than approximately to the compass as with the other grids. This change of co-ordinate system would provide a natural distinction between "world" awareness and "body" or "self" awareness. Such encoding of a sense of self might even be useful if the robot were covered with many sensors, or perhaps were equipped with manipulators. We have no immediate plans in that direction, and so will pass by this interesting idea for now.

Our initial version will contain a pair of two dimensional grid sets, one mapping the presence of objects at the robots operating height of a few feet above ground level. The other will map the less complex idea of presence of passable floor at various locations. The object map will be updated from all sensors, the floor map primarily from downward looking proximity detectors, though possibly also from long range data from vision and sonar. The robot will navigate by dead reckoning, integrating the motion of its wheels. This method accumulates error rapidly, and this uncertainty will be reflected in the maps by a repeated blurring operation. Old readings, whose location relative to the robot's present position and orientation are known with decreasing precision, will have their effect gradually diffused by this operation, until they eventually evaporate to the background certainty value.

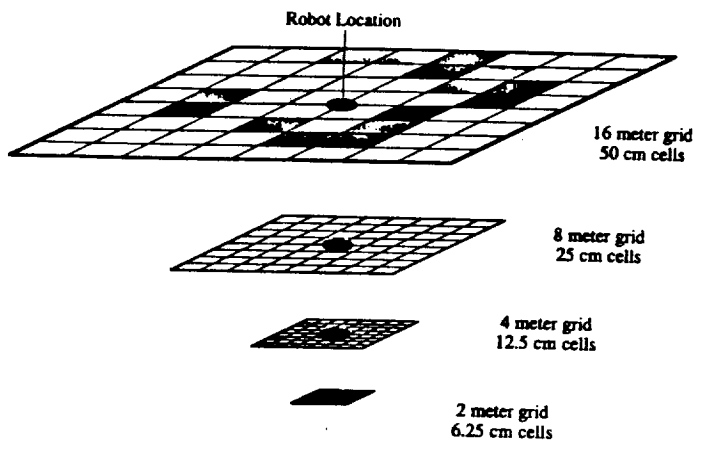

Figure 6: Map Resolution Hierarchy - Coarse maps for the big picture, fine ones for the fiddly details in the immediate environment. All the maps are scrolled to keep the robot in the center cells.

It would be natural to extend the two-grid system to many grids, each mapping a particular vertical slice, until we have a true three dimensional grid. We will do this as our research results, and processing power permit. The availability of single board array processors that can be installed on the robot would help this, as the certainty grid operations are very amenable to vectorizing. The certainty grid representation can also be extended in the time dimension, with past certainty grids being saved at regular intervals, like frames in a movie film, and registered to the robot's current co-ordinates (and blurred for motion uncertainties). Line operators applied across the time dimension could detect and track moving objects, and give the robot a sense of time as well as space. This has some very thrilling conceptual (and perceptual) consequences, but we may not get to it for a while.

Even the simplest versions of the idea will allow us fairly straightforwardly to program the robot for tasks that have hitherto been out of reach. We look forward to a program that can explore a region and return to its starting place, using map "snapshots" from its outbound journey to find its way back, even in the presence of disturbances of its motion and occasional changes in the terrain. By funneling the sensor readings through a certainty grid, which collects and preserves all the essential data, and indications of uncertainties, and makes it available in a uniform way, we avoid the problem we've had, that for each combination of sensor and task a different program is required. Now the task execution is decoupled from the sensing, and thus becomes simpler.

## 7 References

1. Serey, B. and L. H. Matthies, **Obstacle Avoidance using 1-D Stereo Vision**, CMU Robotics Institute Report, November, 1986.
2. Elfes, A. E, **A Sonar-Based Mapping and Navigation System**, Workshop on Robotics, Oak Ridge National Lab, Oak Ridge, TN, August, 1985. (invited presentation), in the proceedings of the 1986 IEEE International Conference on Robotics and Automation, San Francisco, April 7-10 1986 also to appear as an invited paper in IEEE Transactions on Robotics and Automation.
3. Kadonoff, M., F. Benayad-Cherif, A. Franklin, J. Maddox, L. Muller, B. Sert and H. Moravec, **Arbitration of Multiple Control Strategies for Mobile Robots**, SPIE conference on Advances in Intelligent Robotics Systems, Cambridge, Massachusetts, October 26-31, 1986. In SPIE Proceedings Vol 727, paper 727-10.
4. Moravec, H. P. and A. E. Elfes, **High Resolution Maps from Wide Angle Sonar**, proceeding of the 1985 IEEE International Conference on Robotics and Automation, St. Louis, March, 1985, pp 116-121, and proceedings of the 1985 ASME conference on Computers in Engineering, Boston, August, 1985.
5. Thorpe, C. E., **Path Relaxation: Path Planning for a Mobile Robot**, CMU-RI-TR-84-5, Robotics Institute, Carnegie-Mellon University, April, 1984. also in proceedings of IEEE Oceans 84, Washington, D.C., August, 1984 and Proceedings of AAAI-84, Austin, Texas, August 6-10, 1984, pp. 318-321.
6. Moravec, H. P., **Robot Rover Visual Navigation**, UMI Research Press, Ann Arbor, Michigan, 1981. also available as **Obstacle Avoidance and Navigation in the Real World by a Seeing Robot Rover**, Stanford AIM-340, CS-80-813 and CMU-RI-TR-3.

This work has been supported since 1981 by the Office of Naval Research under contract N00014-81-K-503

APPENDIX D  
PROJECTED SCHEDULES







JPL D-4788, Vol. 5

Mars Rover/Sample Return (MRSR) Mission

# Mars Rover Technology Workshop Proceedings

Volume 5: Global Navigation

Chairman: Lincoln Wood, Jet Propulsion Laboratory

April 28-30, 1987  
Pasadena, California

**JPL**  
Jet Propulsion Laboratory  
California Institute of Technology

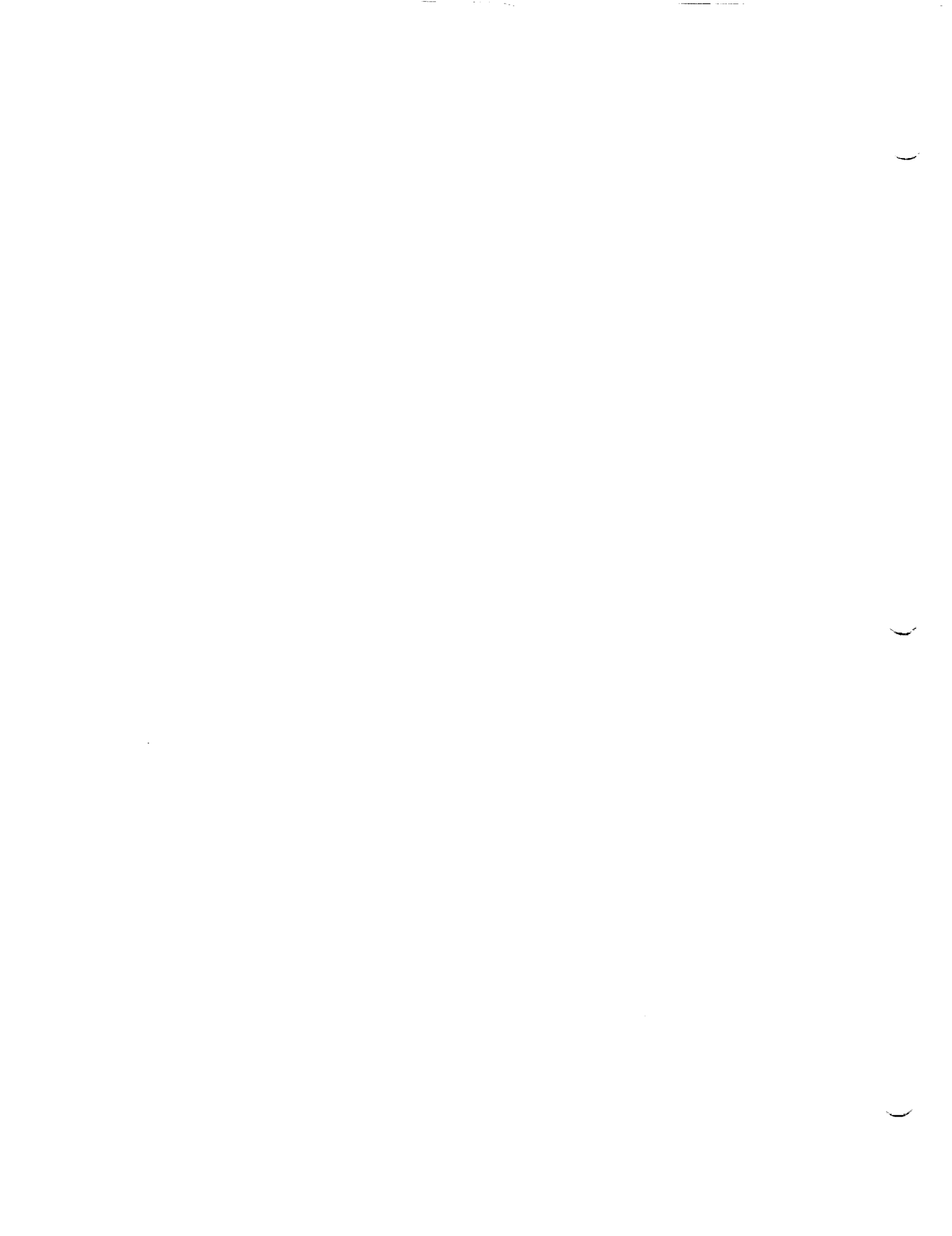



## GLOSSARY

### ACRONYMS AND ABBREVIATIONS

CCD	charge-coupled device
DoD	Department of Defense
DSN	Deep Space Network
GPS	Global Positioning System
MO	Mars Observer
MRSR	Mars Rover Sample Return
ODIIE	onboard data integration and topographic information extraction
NASA	National Aeronautics and Space Administration
PRN	pseudo random noise
USGS	United States Geological Survey
VLBI	very long baseline interferometry

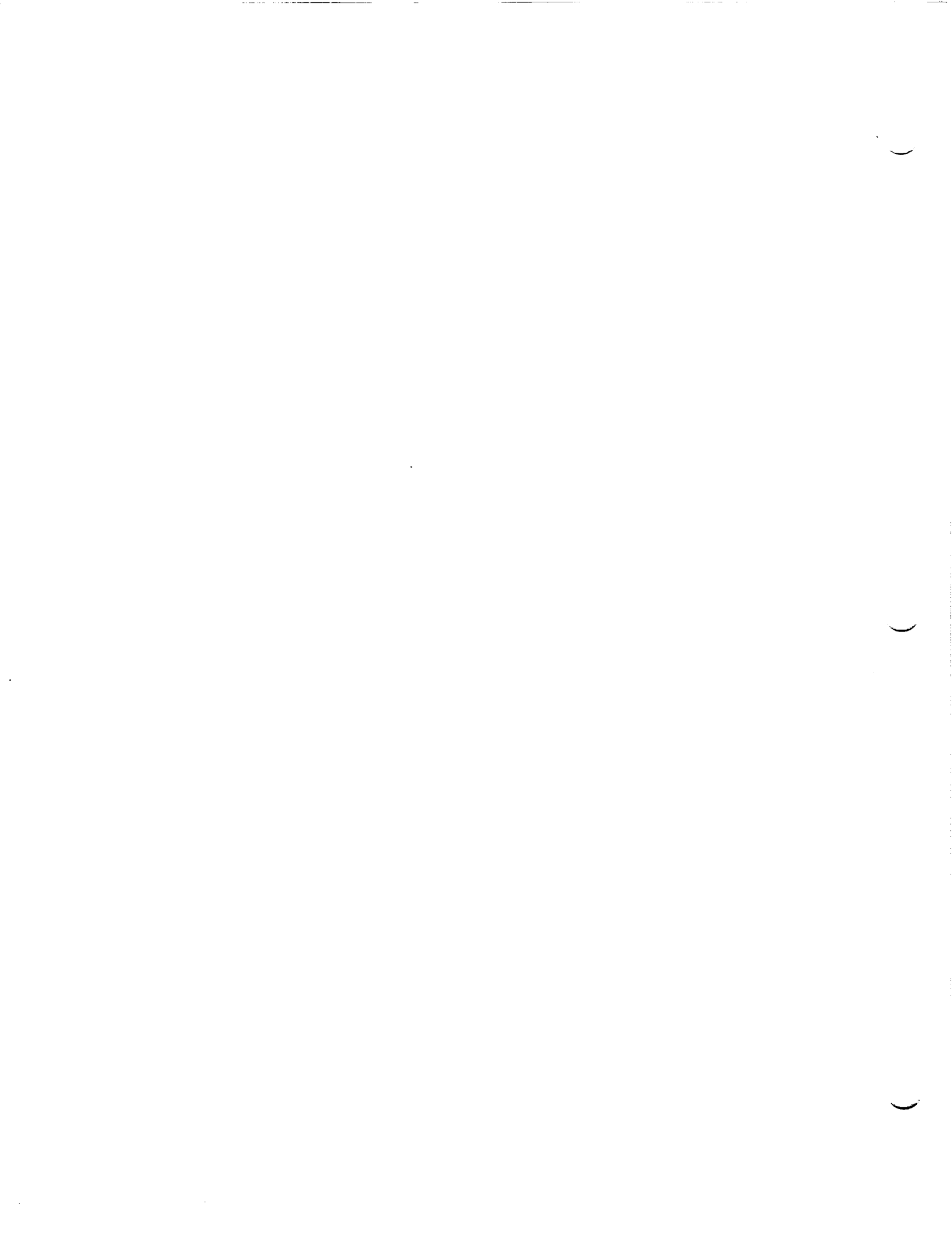

CONTENTS

	<u>Page</u>
1. EXECUTIVE SUMMARY . . . . .	5-1-1
1.1 Definition . . . . .	5-1-1
1.2 Inertial and Dead Reckoning Techniques. . . . .	5-1-1
1.3 Imaging-related Navigation Techniques . . . . .	5-1-2
1.4 Radiometric Techniques . . . . .	5-1-3
1.5 Synthesis of a Navigation System . . . . .	5-1-4
2. INTRODUCTION . . . . .	5-2-1
3. DISCUSSION . . . . .	5-3-1
3.1 Inertial and Dead Reckoning Techniques . . . . .	5-3-1
3.2 Imaging-Related Navigational Techniques . . . . .	5-3-5
3.3 VLBI for Mars Rover Navigation. . . . .	5-3-9
4. SUMMARY AND CONCLUSIONS . . . . .	5-4-1
4.1 Global Navigation . . . . .	5-4-1
5. PRESENTED MATERIALS . . . . .	5-5-1
 APPENDIXES	
A TECHNOLOGY PLANNING WORKSHEETS . . . . .	5-AA-1
B SUMMARY FORMS . . . . .	5-AB-1
C INDIVIDUAL CONTRIBUTIONS . . . . .	5-AC-1
D PROJECTED SCHEDULES . . . . .	5-AD-1

Table

2-1. List of Panel Members . . . . .	5-2-2
--------------------------------------	-------

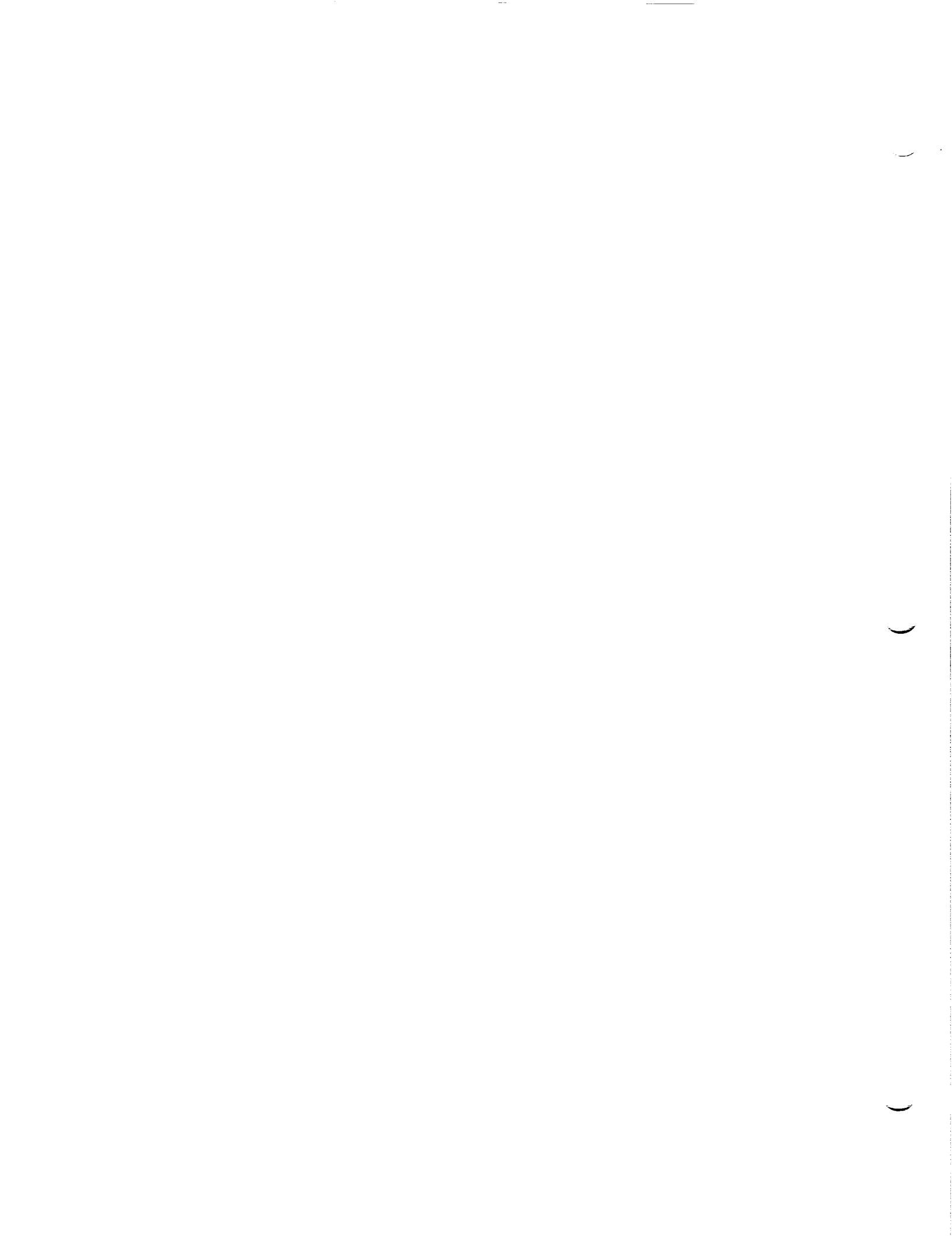

## SECTION 1

### EXECUTIVE SUMMARY

#### 1.1 DEFINITION

The Global Navigation Panel met to address the problem of accurately determining the location of the Mars Rover on the surface of Mars. Both the knowledge of the vehicle's current position at any time and the (more accurate) reconstruction of its positions at previous times were of interest. The name "Global Navigation" was assigned to the panel to distinguish its activities from those of the Local Guidance and Hazard Avoidance Panel. The latter panel was concerned with the detection and avoidance of nearby hazards, whereas the Global Navigation Panel was concerned with locating the vehicle on a larger scale with respect to some sort of Mars-referenced coordinate system.

The problem of accurately locating the rover on the surface of Mars is quite complex and will require the use of several classes of navigational techniques for its achievement. Accordingly, the deliberations of the workshop and the documentation of the conclusions have been divided into four parts, three dealing with general classes of navigational techniques and one dealing with how these various techniques can be synthesized to form an overall navigation system:

1. Inertial and dead-reckoning techniques
2. Imaging-related techniques
3. Radiometric techniques
4. Synthesis of a navigation system

#### 1.2 INERTIAL AND DEAD RECKONING TECHNIQUES

Inertial and dead reckoning navigation components (gyroscopes, accelerometers, odometers, compasses, etc.) provide short-term information on the location of the rover relative to some initial reference point. They depend on inertial and noninertial sources for initialization and periodic updating during the course of the roving mission. Advances in the state of the art will enhance the performance of inertial and dead-reckoning navigation, but are not mission enabling. Benefits of improved technology are:

- Higher accuracy in locating the rover
- Lower frequency in updating the inertial components
- Lower volume and mass
- Improved data processing
- Improved science output

No other component of the navigation system can be eliminated as a consequence of technological advances in inertial and dead-reckoning techniques. This is because:

- Degradation in position knowledge derived from inertial and dead-reckoning components is progressive. Knowledge must be updated periodically from external sources. Improved performance reduces the frequency of updates but does not eliminate them.
- Although latitude can be computed directly from inertial measurements, the errors that will result from predicted inertial performance may be larger than permitted. Current radiometric or other techniques can provide the needed accuracy. It is improbable that inertial technology can be improved enough to match current radiometric performance.
- Inertial and dead reckoning techniques provide no absolute measure of longitude or latitude. Radiometric or other techniques can provide longitude and latitude information to a sufficient degree of accuracy.

### 1.3 IMAGING-RELATED NAVIGATIONAL TECHNIQUES

Imaging systems on board both the rover and an orbiter can play key roles in rover navigation. The orbiter imaging system can be used to produce, in advance, high-resolution maps of the general area to be traversed by the rover. Stereo image pairs (coupled with altimetry data, if available) would be used to produce these maps. In addition, orbiter images taken during the course of the rover mission might include the rover or tracks made by the rover as identifiable objects. Positive identification of the rover in these imaging frames can be improved by including optical reflectors on the vehicle.

The images obtained by the orbiter looking down at the surface of Mars will have to be projected along a variety of horizontal boresight directions to match what the rover will see using its own stereo imaging system. These projected orbiter images can then be correlated with images taken with the rover imaging system to locate the rover.

In general, the work that needs to be done to provide a satisfactory state of technology readiness for these techniques involves computational advances, rather than advances in optical hardware. The data processing techniques required to extract high-accuracy (1-m) topography from near-vertical orbiter imaging must be developed, automated, and verified. Concepts for doing this exist, but the accuracies achievable must be ascertained from simulations. The total number of orbiter pictures required to cover a rover tour may be large, so that the process must be automated far beyond the methods that are currently used, which are very analyst-intensive.

Automated correlation, on board the rover, of an expected scene with the actual scene may be highly desirable, to allow extension of the time or path intervals over which the rover motion can be left unattended. Algorithms for automated scene correlation must be developed and rigorously verified.

In the area of spacecraft hardware, the number of pictures required from the orbiter may be fairly large, to allow 1-m resolution maps to be made. Therefore, the highest possible bit rates from the orbiter are desirable to allow acquisition of the required data in a period of perhaps a few weeks.

#### 1.4 RADIOMETRIC TECHNIQUES

The Mars rover and lander will provide two radio signals that, when viewed from the Earth, will have very small angular separations--less than one milliarcsecond. These two signals (and that of the orbiter as well) will fit well within the main beam of a 70-m Deep Space Network (DSN) tracking station operating at X-band. This will offer an unusual opportunity to perform differential very-long-baseline interferometry (delta-VLBI) with extraordinary accuracy. Observing simultaneously from two 4000-km baselines, it will be possible to determine the two-dimensional plane-of-sky projection of the rover-lander position vector to an accuracy of about two meters, with an observation lasting less than 60 seconds. The third dimension can be measured by Earth-based ranging or inferred from a model of the shape of the Martian surface.

Current VLBI tracking technology uses a wide bandwidth (40 MHz) to achieve accurate measurement of signal group delay between stations. To achieve few-meter accuracy, it is proposed to extend the effective bandwidth to 8.4 GHz by resolving the cycle ambiguity of the X-band carrier. To achieve this ambiguity resolution it will be necessary to increase the bandwidth of the transmitted signal to several hundred megahertz, by means of a new wideband transponder. A portable, real-time, high-precision phase extractor must be developed for installation at the tracking stations. A data processing system for fast turnaround of observations must be developed. The feasibility of resolving the X-band cycle ambiguity must be demonstrated with experiments on existing sources.

The delta-VLBI scenario can be inverted; that is, signals can be transmitted from Earth with reception at the two landed vehicles on Mars. This requires phase-extracting receivers on the rover and the lander and a communication link between the two. This Mars-based approach avoids the round-trip light-time delay inherent in an Earth-based processing system.

Related to the inverted delta-VLBI approach is the use of Global Positioning System (GPS) technology. Multiple-channel GPS receivers could be placed on the rover, lander, and return vehicle. Large existing Earth-based antennas could be equipped to transmit dual-frequency L-band signals, modulated by pseudorandom noise, at suitable power levels for reception at Mars. Existing time synchronization at the nanosecond level would be used to

control the transmitted signals from Earth. The GPS receivers on Mars would not require modification, except for changes in the local data processing in the equipment: instead of GPS satellite ephemerides, the celestial mechanics of the Earth-Mars system would be used.

#### 1.5 SYNTHESIS OF A NAVIGATION SYSTEM

The overall rover navigation system will most likely make use of all three navigational approaches described above: inertial and dead reckoning, imaging-related, and radiometric.

Starting from the landing point, or some other reference point, inertial navigation techniques will most likely be used in the short term to provide estimates of vehicle attitude, position, and velocity in a locally level frame. Inputs to these computations will include attitude changes from gyros, three-dimensional accelerations, and integrated wheel rotation angle. (The odometer is desirable for stabilization of the position estimate, but may be obviated by frequent full stops to dump accumulated velocity and attitude error.) By modeling its own navigational error, the rover will recognize when it requires a position update. It will then stop to be reinitialized.

Updating the rover navigation system can be accomplished in several ways. Radiometric data, including Doppler, ranging, and delta-VLBI, can supply precise distances between the lander and the rover in Earth- or Mars-centered coordinates, which can be converted to local map coordinates through orbiter imaging. A highly autonomous update can be obtained with an onboard expert system that can correlate the local scene with a horizontal projection of orbiter imagery.

#### Acknowledgment

I would like to thank the following panel members for taking the time to participate in the workshop and for contributing many clever ideas and stimulating discussions: Raymond Batson, Carl S. Christensen, Merton E. Davies, Pasquale B. Esposito, William W. Kellogg, Allan R. Klumpp, John E. Prussing, David C. Redding, Stephen P. Synnott, Alfred J. Treder, and Thomas P. Yunck. I would also like to thank the following guests who were invited to participate in the deliberations of the panel for their equally substantial contributions: Charles E. Bell, James S. Border, Nevin A. Bryant, Robert W. Gaskell, Thomas L. Logan, and James P. McDanell.



## SECTION 2

### INTRODUCTION

This section of the proceedings of the Global Navigation Panel contains the following introductory material:

- Viewgraphs presented at the opening plenary session
- List of panel members

The Navigation Panel will address the problem of accurately determining the location of the rover on the surface of Mars. Both the knowledge of the vehicle's current position at any time and the (more accurate) reconstruction of its positions at previous times are of interest. The panel will explore various techniques (and combinations thereof) that can be used for position determination, including

1. Earth-based radiometric techniques (Doppler, ranging, and differential very-long-baseline interferometry)
2. Landmark and star sighting using the camera on board the rover
3. High-resolution terrain mapping using the camera on board the orbiter, with vertically observed images projected horizontally for use by the rover
4. Mars-based radiometric techniques (such as observation by the rover of a signal generated by the orbiter or lander)
5. Inertial and other dead-reckoning techniques

The panel will seek to identify those techniques that are most promising and will recommend technology development schedules and funding levels appropriate to the various mission scenarios.

Table 2-1  
 1987 Mars Rover Workshop  
 Navigation Technologies Panel

<u>Chairman</u>	<u>Phone</u>	<u>Address</u>
Dr. Lincoln J. Wood	818-354-3137	JPL 301-125J
<u>Panelists</u>	<u>Phone</u>	<u>Address</u>
Dr. Raymond Batson	FTS 765-7260	U.S. Geological Survey 2255 N. Gemini Drive Flagstaff, AZ 86001
Dr. Hans Baussus von Luetzow <sup>1</sup>	703-355-2663	U.S. Army Engineering Topographic Laboratory Fort Belvoir, VA 22060
Dr. Carl S. Christensen	818-354-7408	JPL 301-125J
Dr. Merton E. Davies	213-393-0411 ext 7692	The Rand Corporation 1700 Main Street Santa Monica, CA 90406
Dr. Pasquale B. Esposito	818-354-3885	JPL 301-150
Dr. William W. Kellogg	415-723-3389	Department of Aeronautics and Astronautics Durand Building Stanford University Stanford, CA 94305
Mr. Allan R. Klumpp	818-354-3892	JPL 301-125L
Mr. Thomas E. Moore <sup>2</sup>	FTS 525-8298	Johnson Space Center EH2 Houston, TX 77058
Dr. John E. Prussing	217-333-8231	Professor Aeronautical and Astronautical Engineering 101 Transportation Building University of Illinois Urbana, IL 61801

<sup>1</sup>Unable to attend

<sup>2</sup>Unable to attend

<u>Panelists</u>	<u>Phone</u>	<u>Address</u>
Dr. David C. Redding	818-354-3696	Charles Stark Draper Laboratory, Inc. 555 Technology Square Cambridge, MA 02139
Dr. Stephen P. Synnott	818-354-6933	JPL 301-125L
Mr. Alfred J. Treder	206-773-5177	Boeing Aerospace Company M/S 82-26 P.O. Box 3707 Seattle, WA 98124
Professor Roy Welch <sup>3</sup>	404-542-2359	Laboratory for Remote Sensing and Mapping Science Department of Geography University of Georgia Athens, GA 30602
Dr. Thomas P. Yunck	818-354-3369	JPL 238-640

<u>Invited Guests</u>	<u>Phone</u>	<u>Address</u>
Dr. Charles E. Bell	818-354-8976	JPL 198-140
Dr. James S. Border	818-354-8338	JPL 238-640
Dr. Nevin A. Bryant	818-354-7236	JPL 168-522
Dr. Robert W. Gaskell	818-354-2116	JPL 301-125L
Dr. Thomas L. Logan	818-354-4032	JPL 168-522
Dr. James P. McDanell	818-354-3288	JPL 301-125L

<sup>3</sup>Unable to attend

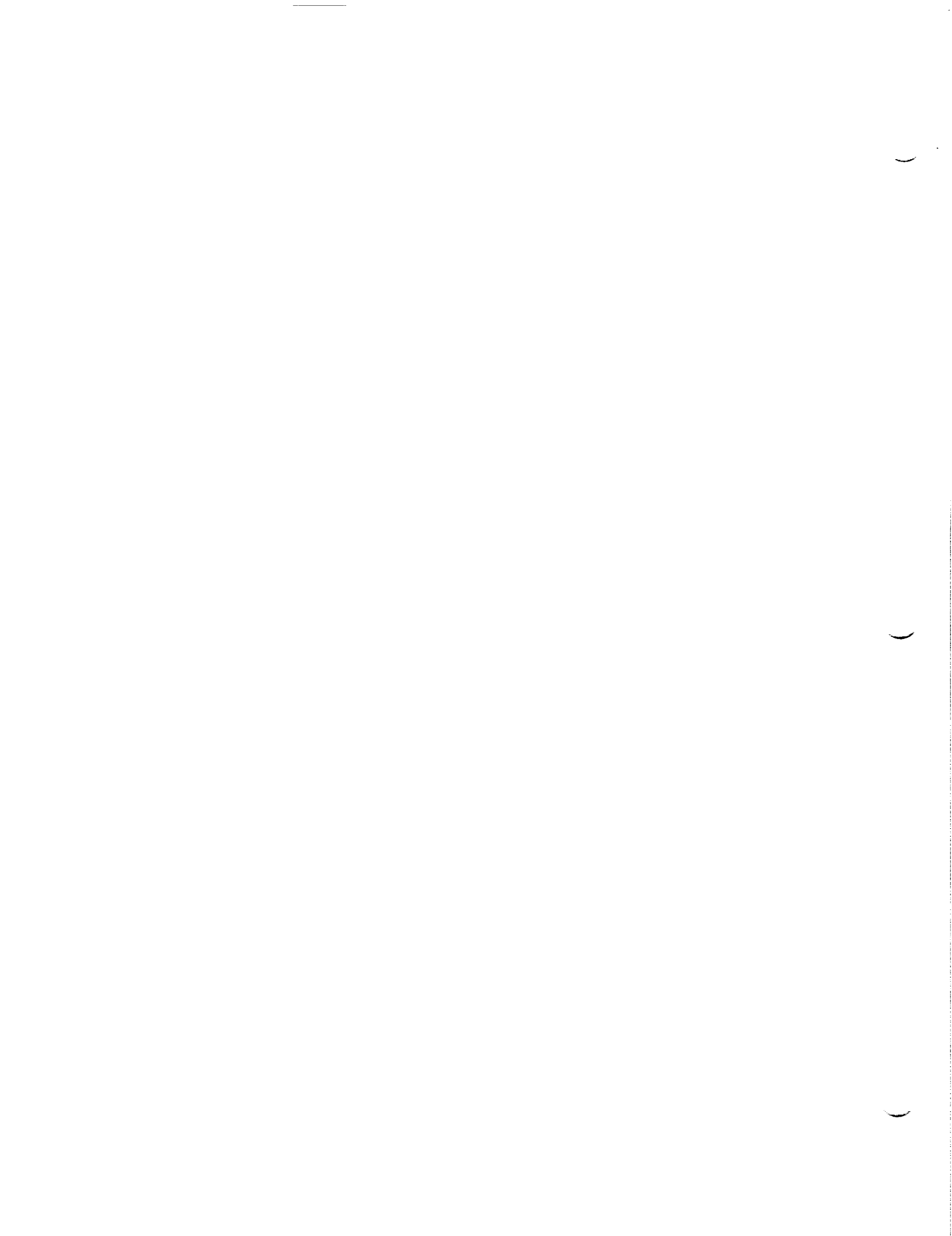

## SECTION 3

### DISCUSSION

#### 3.1 INERTIAL AND DEAD RECKONING TECHNIQUES

Inertial and dead reckoning navigation components are members of a larger navigation system. These components provide short-term information on the location of the rover relative to some initial or updated point. They depend upon inertial and noninertial sources for initialization and periodic updating during the course of the roving mission.

Advances in the state of the art will enhance the performance of inertial and dead reckoning navigation, but are not mission enabling. Benefits of improved technology are:

- Higher accuracy in locating the rover
- Lower frequency in updating the inertial components. This is important because updating involves stopping all rover motion while inertial components are recalibrated.
- Lower volume and mass
- Improved data processing
- Improved science output

No other component of the navigation system can be eliminated as a consequence of technology advances in inertial and dead reckoning techniques. This is because:

- Degradation in position knowledge derived from inertial and dead reckoning components is progressive. Knowledge must be updated periodically from external sources. Improved performance reduces the frequency of updates but does not eliminate them.
- Although latitude can be computed directly from inertial measurements, the errors that will result from predicted inertial performance may be larger than permitted (see performance section below). Current radiometric or other techniques can provide the needed accuracy. It is very improbable that inertial technology can be improved enough to match current radiometric performance.
- Inertial and dead reckoning techniques provide no absolute measure of longitude or latitude. Radiometric techniques can provide both longitude and latitude to sufficient accuracy.

### 3.1.1 Inertial and Dead-reckoning Components

A wide variety of instruments could be selected. A baseline system described below, using just two of the candidates, is likely to meet the most stringent performance requirements while staying within the most stringent mass budget. High- and low-performance systems add or substitute other components.

#### Baseline System Components

- A strap-down inertial reference unit which measures three components of body angular rate and three components of contact acceleration is required. More than three accelerometers and more than three gyros should be used to provide redundancy. Optical technology should meet all requirements while being free of moving parts. The gravity measurements are important for both science and navigation.
- An odometer is needed, on which consist of a wheel whose rotation is measured to determine incremental motion relative to the surface. The wheel must be nondriven to eliminate skidding.

#### High-performance System Components

- A gravity gradiometer is added to provide the 3x3 matrix of the partials of contact acceleration with respect to the three components of position. This instrument is useful for measuring the magnitude and location of gravity anomalies. Knowledge of gravity anomalies is important scientifically and can be used to correct other inertial measurements.
- A three-axis stabilized platform could be substituted for the strap-down inertial reference system of the baseline system above. This approach would require mechanical components and greater mass.
- An optical odometer could be developed based on plotting the motion of the surface on a charge-coupled device (CCD) sensor. This is a new technology item being proposed by this workshop.

#### Low-Performance System Components

- A single pendulous gyrocompass could substitute for the three-axis strap-down gyroscopes. Performance in an Earth environment is at least  $0.1^\circ$  at the equator. This cannot provide azimuth in a polar mission.

### 3.1.2 Techniques and Performance

The subsections below describe the functions performed using the inertial and dead-reckoning components. Performance computations are based on worst-case predictions of the performance of inertial components on a Mars sample return mission in 1995. The predictions, provided by Jerold Gilmore of the C.S. Draper Laboratory in a personal communication on June 10, 1985 are:

- Accelerometer bias: 300 micro Earth g =  $2.94E-3 \text{ m/s}^2$
- Gyro bias: 0.1 degree/hour

#### Locating the Vertical Axis

The vertical axis is measured as the direction of the contact acceleration vector when the rover is at rest. The error is

$$\text{VERTICAL ERROR} = 2.94E-3 / 3.73 = 7.88E-4 \text{ RADIAN,}$$

where the numerator is the accelerometer bias error and the denominator is Mars surface gravity.

#### Locating the Polar Axis

The polar axis is measured as the direction of the rover angular rotation vector when it is at rest. The error is

$$\text{POLAR ERROR} = 0.1 / 14.621 = 6.84E-3 \text{ RADIAN,}$$

where the numerator is the gyro bias error and the denominator is the Mars rotation rate.

#### Measuring North

North is the projection of the pole into the plane normal to the vertical. The error is

$$\text{NORTH ERROR} = 6.84E-3 / \text{COS(LATITUDE)} \text{ RADIAN,}$$

where the numerator is the polar error.

#### Measuring Latitude

Latitude is the complement of the angle between the vertical and polar axes. The error is

$$\begin{aligned} \text{LATITUDE ERROR} &= \text{RSS}(7.88E-4, 6.84E-3) = 6.88E-3 \text{ RADIAN} \\ &= 23.3 \text{ km (Mars radius} = 3.3884E+6 \text{ m),} \end{aligned}$$

where the components are the vertical and polar errors.

### Dead Reckoning

Deductive (dead) reckoning is the process of maintaining continuous knowledge of location relative to some starting point by keeping track of all motions. Dead reckoning is normally implemented by plotting motions on a map of the local terrain. Landmarks may also be plotted on the map and may be used subsequently for correcting dead reckoning errors.

Motions can be plotted either by doubly integrating accelerometer measurements or by measuring surface motion using the odometer.

Errors are due to errors in the direction of north, accelerometer errors, and errors in the odometer.

North (or azimuth) errors were estimated in a previous subsection.

Accelerometer errors are accumulated during intervals between recalibration.

Odometer errors can result from slipping and from slopes and steps in the path of the wheel. Errors due to knowledge of the wheel diameter should be negligible.

Dead-reckoning errors are highly dependent upon updating frequency and strategy, as described in the next section.

#### 3.1.3 Updating and Recalibration

Periodically the inertial system must be updated and recalibrated. Updating consists of replacing the state derived inertially with a more accurate measurement from noninertial sources. Recalibration consists of stopping all rover motion for an interval sufficient to assess the rest outputs of the inertial sensors. The more frequently the inertial system is recalibrated the smaller the errors due to doubly integrating accelerometer bias.

The more frequently the inertial system is recalibrated the lower are the resulting errors. A recalibration schedule for providing high performance might be once every five minutes, for a duration of one minute. The resulting performance remains to be determined.

Measurement sources for updating the inertial system include:

- Radiometric
- Map matching and image correlation
- Optical ranging from the mother craft or the orbiter
- Radar ranging



- Stellar updates of platform attitude
- Gravity measurements

### 3.2 IMAGING-RELATED NAVIGATIONAL TECHNIQUES

#### 3.2.1 On-board Computer Data Integration and Topographic Information Extraction (ODIIE)

The rover has the problem of knowing its x,y position, the position of topographic features around it, and the position of its desired destination. In addition, the rover must know its elevation (z value), the elevation of features around it, and the elevation gradients involved in reaching its desired destination. This data should be derivable from vision-based stereo imaging and correlation with Viking Orbiter and Mars Observer (MO) image maps, and near-time-real processing with Mars Orbiter data. The data must also correlate with the rover's inertial and radio-based guidance systems. The primary mission driver for this capability is to maximize the rover's autonomy by minimizing earth-based supervision of local path selection, time utilization, and resource (power) utilization. Topographic science objectives are also maximized.

There are three fundamental technologies involved in solving the rover's local and regional navigation and positioning requirements: image correlation and mapping, terrestrial (horizontal) photogrammetry, and on-board data integration and topographic information extraction (ODIIE). The image correlation and mapping component contains several subtechnologies separately addressed by Batson, Bryant, and Synnott. Assuming these technologies are achieved, then prior to landing, a large integrated Mars database should exist containing:

1. An 800-m resolution United States Geological Survey (USGS) Viking Orbiter photomosaic of Mars with local positional accuracy of 800 m in a zone  $\pm 40$  degrees of the equator and  $\pm 3$  km elsewhere, regional positional accuracy of  $\pm 3$  km, and an elevational accuracy of  $\pm 50$  m.
2. A 230-m resolution USGS Viking Orbiter photomosaic of the equatorial regions with local positional accuracy of 230 m and regional positional accuracy of  $\pm 3$  km.
3. Local detail maps of 8- to 20-m resolution and accuracy (where Viking Orbiter data permit).
4. Local Mars Observer photomosaics of 1- to 2-m resolution and accuracy, with point elevation values (altimeter data) of 1- to 2-m resolution and  $\pm 500$  m positional accuracy.

After landing, Mars Orbiter photomosaics similar to item 4 above would become available on a near-real-time basis, assuming resolution of the technology issues raised by Batson, Bryant, and Synnott.

The second fundamental technology issue, terrestrial (horizontal) photogrammetry, involves the use of stereo imaging cameras on board the rover to calculate the x,y position and z value (elevation) of local features in its field of view. This technology is fairly mature, but requires rigorous verification and testing for accuracy assessment, given the rover's unique situation and requirements.

The third fundamental technology issue is the onboard data integration and topographic information extraction (ODIIE) system. ODIIE is a massive, spatial database system which integrates the local and regional x,y,z data to provide the rover with information about where it is, what topographic features are around it, and what topographic features are between it and its destination. With this information, the rover can extend its autonomy to move about rapidly with minimal earth-based guidance. ODIIE prepares regional information (point A to B position and route planning) from its database of precorrelated Viking Orbiter and Mars Observer photomosaics, updated with Mars (MRSR) Orbiter photomosaic data. This regional information is integrated with the terrestrial photogrammetry system to produce local position and route planning information. ODIIE integrates the local and regional information in real time, continuously updating its database to produce an increasingly more detailed "map" of its current and destination topographic environment.

The basic subtechnology for ODIIE is a real-time, query, self-learning, problem-solving, spatial (geographic) computer processing system. Such a system would likely be based on a "neural net" computer architecture operating within a concurrent (parallel) processing system. The system concept is to operate in a manner similar to that of neurons in the human brain. Preliminary (non-spatial) neural net systems are currently at the technology readiness of Levels 1 through 3. Spatial systems are at Level 1. The DoD is actively funding research in this and related technology areas, with Level 5 technology readiness more likely in 1995 than in 1993. The DoD research should be watched carefully, with parallel NASA research to address the rover's more specific requirements, and to examine alternative technologies. Related spatial data integration, correlation, and interrogation/query subtechnologies are fairly advanced, but need further investigation.

The ODIIE concept also contains an implicit capability for assisting in general science analysis, development of science models and hypotheses, and identification of interesting anomaly sites for potential visitation and investigation.

### 3.2.2 Computation and Hardware Advances

Primarily, advances are needed in computation rather than in optical hardware.

As discussed in the workshop, the data processing techniques required to extract high accuracy (1-m) topography from near-vertical orbiter imaging (also at the 1-m accuracy level) must be developed, automated, and

verified. Concepts for doing this exist, but the accuracies achievable must be ascertained from simulations. The total number of orbiter pictures required to cover a rover tour area may be large and so the process must be automated far beyond the current methodology, which is very analyst-intensive.

Onboard the rover, automated correlation of an expected scene with the actual scene may be highly desirable to allow extension of the time or path intervals over which the rover motion can be left unattended. Algorithms for automated scene correlation must be developed and rigorously verified.

In the spacecraft hardware area, the number of pictures required from the Mars Rover orbiter may be fairly large (in the thousands) to allow 1-m maps to be made. Therefore the highest possible bit rates from the orbiter are desirable to allow acquisition of the required data in only a few weeks at most.

### 3.2.3 Optical (Global) Navigation

Optical navigation includes correlation of stereoscopic images taken by the lander with stereoscopic images taken by the orbiter. Images taken by the rover will be excessively foreshortened and difficult to interpret as distance from the rover increases. Distinctive skyline profiles may be identifiable on images taken from orbit, but more gentle features in the "mid-field" (between about 10 m and 1 km from the rover) may be nearly impossible to correlate with orbiter images.

Distinctive features (sharp craters, large rocks, etc.) imaged by the rover within about 10 m of the rover, if they are large enough to be recognized on orbiter images, will provide the most accurate possible verification of the relative position of the traverse. This accuracy can only be exceeded by locating the image of the rover and/or its tracks on images taken from orbit.

It is important that the rover take stereoscopic images so that distances to landmarks (and their sizes) can be accurately measured. These stereoscopic images will also be essential for scientific interpretations and sample documentation. It is important that stereoscopic images of the rover traverse be taken from orbit because stereoscopy increases interpretability and identification of landforms by at least an order of magnitude. It also allows accurate measurement of slopes that might affect traverse planning.

Experience with Surveyor, Apollo and Viking has demonstrated that image resolution of approximately one m/pixel is required for adequate optical tracking of a surface traverse from orbit. Viking did not have this resolution, and several months of intensive examination of images and other data were required to provide a rather tenuous identification of the Viking 1 landing site. Viking 2 was never located. Identification of landed vehicles (and under proper illumination their tracks), was demonstrated on Apollo, with 1-m resolution panoramic camera pictures taken from orbit. Positive identification of landed vehicles can be provided by optical reflectors on the vehicles, oriented by a simple computer system to reflect the sun into the lens of an orbiting spacecraft.

There is a continuing problem with absolute locations on Mars. An image with one m/pixel shows the dimensions and spacing of features within that frame to an accuracy of about one meter. There is no guarantee, however, that these features can be located within 3 to 5 km with respect to the Martian prime meridian, because this is the standard error of current mapping done with Viking data. Accurate determination of the Mars Observer orbits and of the MRSR orbit would allow the Viking horizontal datum to be improved to one km or less. This can be accomplished with state-of-the-art techniques through VLBI ranging and other radio tracking methods.

Stereoscopic imaging from orbit can be done by aiming the camera at the landing site from two or more points in space. These can be "fore" and "aft" views from two points in the same orbital track, or they can be taken from different orbital revolutions. It is important that the lines of sight from the two stations converge at an angle of 10° to 60°. The larger the convergence, the greater the potential accuracy of stereoscopic measurement of local topography.

Accurate orbital determinations are required to calibrate stereoscopic measurement.

It is conceivable that the Mars Observer (MO) spacecraft (1992 launch) could be used to make stereoscopic surveys of MRSR sites by tilting the imaging system as described above. Comprehensive stereoscopic surveys of several potential MRSR sites could very well overtax the observer mission profile, however, and jeopardize its goal of comprehensive Mars global surveys.

The MO altimeter will provide the first comprehensive survey of Mars topography, and will provide a vital regional calibration to stereoscopic surveys of the actual landing site made by the MRSR orbiter.

No new technology is required for optical navigation of the MRSR lander. A very considerable development effort is required, however, to coordinate the gathering of orbital tracking data, MRSR orbital imaging, MRSR surface imaging, and MRSR inertial guidance data. Each of these systems has strengths and weaknesses. Properly combined, they can provide the most precise scientific survey of part of another planet that has yet been accomplished.

#### Navigation required

- To drive to preplanned stations
- To avoid hazards of regional extent not visible to rover
- To drive rover to sample return vehicle

#### Optical Navigation

- Stereoscopic images from orbit (1 m/pixel)
- Stereoscopic images from rover (<.1 m resolution)
- Accurate orbital determinations vital to control optical navigation (VLBI, etc.)
- Active reflectors on landed spacecraft provide unambiguous identification from orbit

Development Required  
Methods For:

- Efficient and timely correlation of optical navigation with VLBI and inertial
- Improvement of topographic datum of Mars
- Improvement of planimetric datum (i.e., location with respect to prime meridian) of Mars
- Mars observer mission data important to MRSR mission planning

Accurate navigation of the rover is required in order to insure:

1. That the rover reaches pre-planned stations at which intensive scientific observation and sampling will be done.
2. That the rover does not travel to some location from which it cannot return to the sample-return shuttle (e.g., that it does not travel downhill, over what might be a long but gentle slope, and not have enough power to climb back up that slope).
3. That the rover can find the sample-return shuttle after its sampling traverse is completed.
4. That the rover can continue to follow specified traverses during an extended mission after the sample-return shuttle has departed.

### 3.3 VLBI FOR MARS ROVER NAVIGATION

The Mars Rover and Lander will provide two radio signals which, when viewed from earth, will have very small angular separations:  $<1$  marcsec. These two signals (and that of the orbiter as well) will sit well within the main beam of a 70-m tracking station at X-band. This will offer an unusual opportunity to perform differential very-long-baseline interferometry (delta VLBI) with extraordinary accuracy. Observing simultaneously from two 4,000 km baselines in (for example) North America, it will be possible to determine the two-dimensional (2-d) vector between the rover and the lander with an accuracy of about 2 m, no matter what their separation, with an observation lasting less than 60 seconds.

Delta VLBI is a technique of radio astronomy that can be used to precisely measure the angular separation of two signal sources. Two (or more) widely separated tracking stations are used at once to observe the sources. The signal delay in arriving at the two stations is measured for both signals. The measured difference between the delays gives the angular separation of the sources. The angular separation can be converted to linear separation from the known distance to Mars. Two earth baselines can provide the 2-d plane-of-sky vector between the sources. The third dimension can be inferred from a model of the Mars surface or can be measured by direct ranging.

Current VLBI tracking technology uses a wide bandwidth (40 MHz) to achieve accurate measurement of signal group delay between stations. Using this bandwidth, accuracy at Mars would be a few hundred meters. To achieve few-meter accuracy it is proposed to extend the effective bandwidth to 8.4 GHz by resolving the cycle ambiguity of the X-band carrier. This will improve the precision by a factor of more than 200. To achieve this ambiguity resolution it will be necessary to increase the transmitted signal bandwidth to several hundred megahertz.

In addition to directly measuring the rover-lander vector, delta VLBI can indirectly aid rover navigation by establishing very precisely (about 1 km) the absolute positions of the rover and lander on Mars and the Mars ephemeris in the inertial reference frame defined by very distant (extra-galactic) radio sources. This requires alternate observations of the vehicles and a distant source, typically a quasar. Finally, delta VLBI can provide few-meter determination of the rover with respect to the orbiter, and thereby improve orbiter tracking. It should be possible to turn around an observation, that is, produce a position measurement from the raw observation, in less than 30 minutes.

To achieve these capabilities, several areas of current technology must be extended. A new wideband transponder, preferably with a maximum tone separation of 400 MHz, must be developed for each vehicle to be observed. Details of the frequencies and signal structures to be used must be determined. (It is most feasible to place the widest bandwidth signal at Ka-band and to use that signal for X-band ambiguity resolution.) A portable, real-time, high-precision phase extractor must be developed for installation at the tracking stations. This would be a straightforward adaptation of existing GPS receivers which have the requisite performance characteristics. The data processing system for fast turnaround of the observations must be developed. Finally, the feasibility of resolving the X-band cycle ambiguity must be demonstrated with experiments on existing sources.

The delta VLBI scenarios can be inverted, i.e., transmitted from the Earth and received at the two landed vehicles on Mars. The accuracy of the angular measurement is identical to the original scenarios. This requires phase extracting receivers on the rover and lander, and a communications link between the rover and lander. The processing (phase differencing) would be done on Mars rather than the Earth. Advantage: The rover can have a measurement of two components of the lander-rover vector without the round trip light time delay inherent in an earth-based processing system.

**Technologies required:**

Receivers: flight-hardened, GPS-type receivers able to receive three frequencies simultaneously, extract phase differences, and resolve ambiguities.

Communication Link: A lone data rate link is needed between the lander and rover to transmit the differenced phase from the lander to the rover (or vice versa).

Onboard Processing: The rover (or lander) needs the capability to update the estimate of the position vector (relative rover-lander) and transmit this information to earth.

### 3.3.1 Description

The technique of obtaining differential Global Positioning System (GPS) measurements has been developed for precise geodetic surveying, and was field tested in Western Europe and the U.S. using the existing satellite constellation. In the presence of an adequate constellation, three-dimensional surveys have been generated which are competitive with the more conventional techniques. Plans are proceeding to accommodate the technique into national surveys. The technique is a modification of VLBI procedures. The observables available are functions of instantaneous ranges between satellites and ground stations and their time derivatives; these quantities reflect the relative geometry of the ground stations and the satellites. GPS receivers separated from one another use selected observables along with their observational errors to define the baseline between them to a high level of precision; the technique permits common uncertainties to be removed by subtraction or differencing. From the geometrical view, all differential GPS measurements may be classified either as differential ranges or differential range differences; mathematically, differential ranges have more geometrical strength than differential range differences.

Utilizing VLBI nets in an active (transmitting) mode as a substitute for the GPS satellite's constellation, it is proposed to modify three GPS multiple-channel receivers for use on the surface of Mars; the receivers will be mounted on the return vehicle, the landing vehicle, and the rover. It is proposed that the three modified receivers be used in the differential range mode. Two rather significant modifications must be contemplated. The VLBI observatories must be equipped to transmit dual L-band pseudo random noise (PRN) modulated signals at a suitable power level for Mars GPS receivers. Existing time synchronization at the nanosecond level will be utilized to control the transmitted signals from Earth. The GPS receivers on Mars will not require modification but the local data processing included in the equipment must be modified: instead of satellite ephemerides, the celestial mechanics of the Earth-Mars system must be provided. The exploitation of the existing time-coded GPS signals from a synchronized-time source of VLBI oscillators permits the existing GPS techniques to be used even at interplanetary ranges. TOPEX has developed a highly refined GPS multichannel receiver which should be considered as a model for use on Mars. Metric positioning precision should be available on Mars.

It should also be realized that the electromagnetic transmission of rigidly controlled frequency and time signals between Earth and Mars for periods greater than a year will be in the plane of the ecliptic and must include solar conjunction. Such ingredients provide an ideal recipe for refining one or more of the tests of the general theory of relativity.

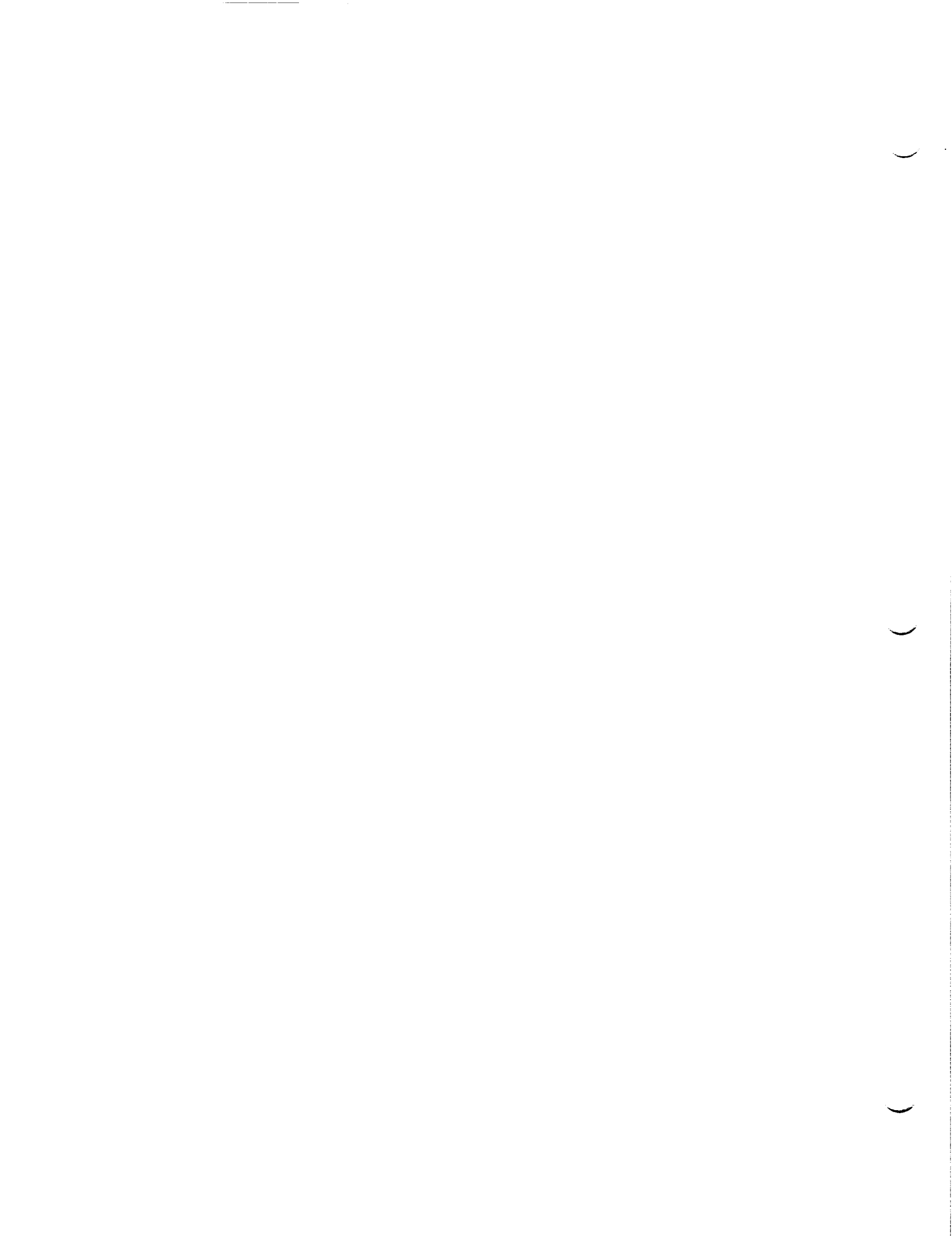



## SECTION 4

### SUMMARY AND CONCLUSIONS

#### 4.1 GLOBAL NAVIGATION

The rover navigation task starts before landing, with detailed mapping of the surface. This information is essential for determining and describing desirable landing sites in enough detail to quantify landing safety and geological interest. The same information is used to define rover traverses (surface map coordinates, landmarks). Earth-based operations will define the transformation from inertial (orbit-based) coordinates to the local level in the vicinity of the landing site.

Once landed, the rover will use its inertial instruments to determine its attitude in the local level frame (gravity and rotational pole directions). The rover imaging system will provide stereo views of the local terrain for Earth-based correlation with available maps, thus determining the location of the landing site. Earth-based Doppler measurements of the rover COMM carrier and orbiter-rover ranging can also be used to help locate the site (the latter requires that orbiter ephemeris be constantly updated through landmark navigation).

Once initialized in local level position coordinates on the map, the rover can autonomously navigate a traverse toward a target location identified in map coordinates. In the short term it will use standard inertial navigation techniques to maintain its knowledge of attitude, position, and velocity in the local level frame, including propagation of the covariance of this knowledge. Inputs to this computation include attitude changes from gyros, three-dimensional accelerations, and integrated wheel rotation angle (if the rover is a walker it may require an odometer wheel). The odometer is desirable for stabilization of the position estimate, but this may be obviated by frequent full stops to dump accumulated velocity and attitude error. By modeling its own navigational error, the rover will recognize when it requires a position update. It will then stop to be re-initialized.

Updating the rover navigation system can be accomplished in several ways. Earth-based radiometric techniques (including ranging, Doppler, and differential VLBI) can supply precise distances between lander and rover in Earth- or Mars-centered coordinates, which can be converted to local map coordinates through orbiter imaging. A highly autonomous update can be obtained with an onboard expert system which can correlate the local scene with horizontal projection of orbiter imagery. The latter may require self-initiated traverses to add scene changes to the correlation process until solution confidence is high enough to proceed. If the orbiter were assisted by another orbiting craft, dual ranging to the rover could provide sufficient position information.

The last navigation task will be to bring accumulated samples to the sample return vehicle. This will be either the lander that brought the rover, or an independent craft. If the former, it is the reference point for the rover local map reference frame, and is approached like any other traverse, since they are all described in that frame. If an independent craft, it must first be described in the local map frame through the same processes used to identify the initial rover landing site. Thus, rover navigation is the same for either case.

SECTION 5

PRESENTED MATERIALS

1987 TECHNOLOGY PLANNING WORKSHOP FOR THE MARS  
ROVER

GLOBAL NAVIGATION PANEL

LINCOLN J. WOOD

28 APRIL 1987

OBJECTIVES OF PANEL

- INVESTIGATE PROBLEM OF LOCATING ROVER ON SURFACE OF MARS
  - REAL-TIME POSITION ESTIMATION
  - AFTER-THE-FACT PATH RECONSTRUCTION
- IDENTIFY MOST PROMISING APPROACHES AND REQUIRED ADVANCES IN TECHNOLOGY
- DEVELOP SCHEDULES AND COST ESTIMATES FOR TECHNOLOGY DEVELOPMENT
- DO ABOVE FOR RANGE OF MISSION OPTIONS

ORIGINAL PAGE IS  
OF POOR QUALITY

TECHNIQUES FOR ROVER POSITION DETERMINATION

- O EARTH-BASED RADIO METRIC
  - O DOPPLER
  - O RANGING
  - O DIFFERENTIAL VERY-LONG-BASELINE INTERFEROMETRY (DELTA-VLBI)
- O ROVER-BASED OPTICAL
  - O LANDMARK SIGHTING
  - O STAR SIGHTING
- O ORBITER-BASED OPTICAL
  - O HIGH-RESOLUTION TERRAIN MAPPING
  - O VERTICALLY OBSERVED IMAGES PROJECTED HORIZONTALLY FOR ROVER USE
  - O DIRECT OBSERVATION OF ROVER?
- O MARS-BASED RADIO METRIC
  - O INTERVEHICLE LINKS
  - O INVERTED DELTA-VLBI
- O INERTIAL AND OTHER DEAD-RECKONING
  - O GYROS AND ACCELEROMETERS
  - O ODOMETERS, COMPASSES, ETC.

LJW-2  
4/28/87

PANEL MEMBERS

NAME	ORGANIZATION
RAYMOND BATSON	U.S. GEOLOGICAL SURVEY
HANS BAUSSUS & LUETZOW	U.S. ARMY ENGINEERING TOPOGRAPHIC LABORATORY
CARL S. CHRISTENSEN	JPL
MERTON E. DAVIES	RAND CORPORATION
PASQUALE B. ESPOSITO	JPL
WILLIAM W. KELLOGG	STANFORD UNIVERSITY
ALLAN R. KLUMPP	JPL
THOMAS E. MOORE	JOHNSON SPACE CENTER
JOHN E. PRUSSING	UNIVERSITY OF ILLINOIS
DAVID C. REDDING	CHARLES STARK DRAPER LABORATORY, INC.
STEPHEN P. SYNNOTT	JPL
ALFRED J. TREDER	BOEING AEROSPACE COMPANY
ROY WELCH	UNIVERSITY OF GEORGIA
LINCOLN J. WOOD (chair)	JPL
THOMAS P. YUNCK	JPL

1987 TECHNOLOGY PLANNING WORKSHOP FOR THE MARS ROVER

GLOBAL NAVIGATION PANEL

LINCOLN J. WOOD

30 APRIL 1987

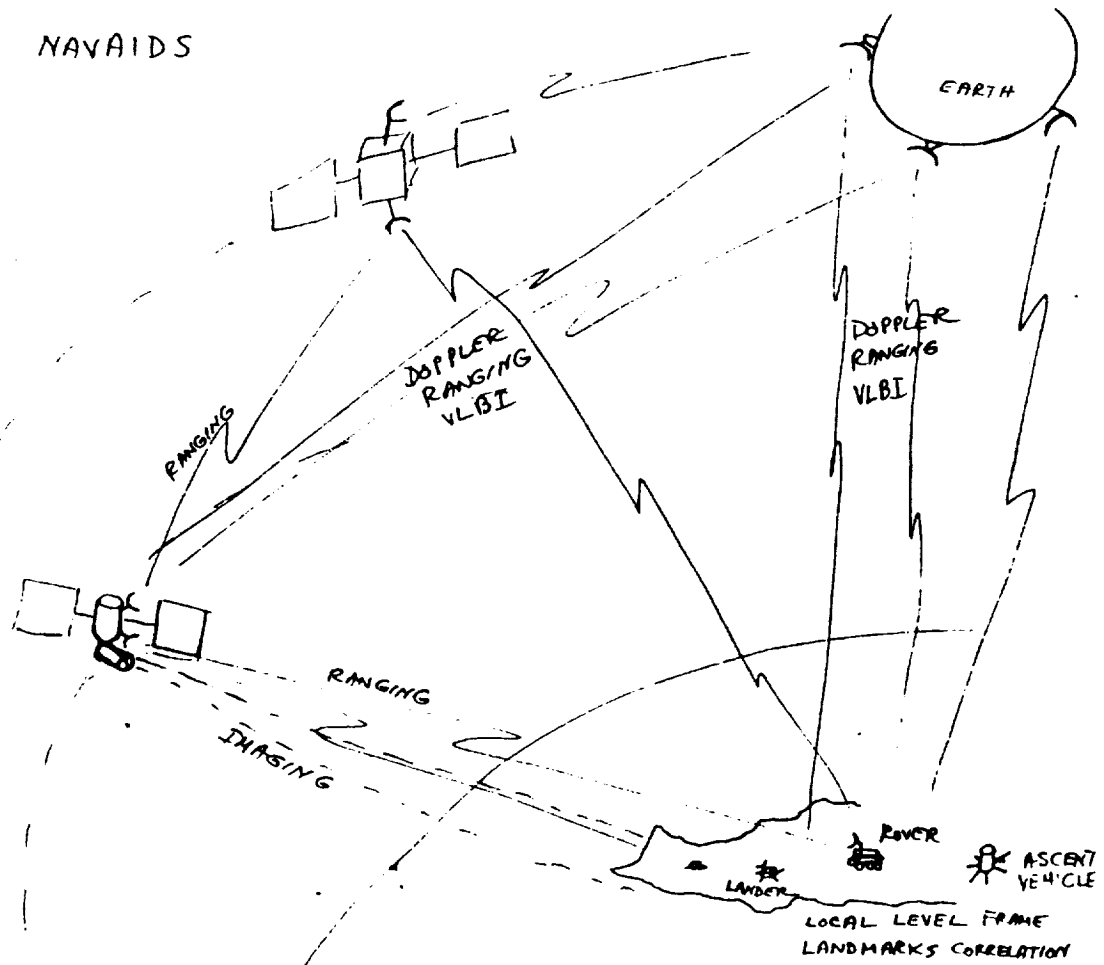

## INERTIAL/DEAD RECKONING SYSTEM

- 0 ARCHITECTURE DEPENDS ON ACCURACY REQUIREMENT (1000M, 100M, 10M)
- 0 ACCURACY DEPENDS ON INSTRUMENT QUALITY AND UPDATE STRATEGY
- 0 THREE EXAMPLE SYSTEMS (LOW, MID, HIGH ACCURACY)
- 0 ALL SYSTEMS REQUIRE
  - o CLOCK
  - o ODOMETER/VELOCITY METER
  
- 0 LOW-LEVEL SYSTEM (20M/KM → 2M/KM ACCURACY)
  - o GYRO COMPASS
    - o PENDULOUS GYRO OR SIMPLE 3-AXIS IMU
  - o UPDATES
    - o ZERO-VELOCITY UPDATES
    - o RADIOMETRIC/MAP TECHNIQUES/OPTICAL RANGING/RADAR RANGING

- 0 MID-LEVEL SYSTEM (5M/KM → 0.1M/KM ACCURACY)
  - o STRAP DOWN IMU
    - o IRON OR LASER GYROS
    - o GRAVIMETER QUALITY ACCELEROMETERS
  - o UPDATES TECHNIQUES AS ABOVE
    - o VECTOR GRAVITY SCIENCE

- 0 HIGH-LEVEL SYSTEM (< 0.2M/KM ACCURACY)
  - o LOCAL-LEVEL STABILIZED IMU
    - o EXCELLENT QUALITY INSTRUMENTS
    - o GRAVITY GRADIOMETER
  - o UPDATE TECHNIQUES AS FOR MID-LEVEL SYSTEM
    - o STAR TRACKER
  - o TENSOR GRAVITY SCIENCE



GOOD INERTIAL NAVIGATION CAN CONTRIBUTE A  
GRAVITY SCIENCE CAPABILITY

- 0 IMU SENSITIVE TO GRAVITY ANOMALIES
- 0 GRAVIMETER PROVIDES  $|\dot{g}|$
- 0 GRADIOMETER PROVIDES  $\left[\frac{\partial \dot{g}}{\partial r}\right]$
- 0 INSTRUMENTS PROVIDE INDICATION OF SUBSURFACE GEOLOGY AS WELL AS GOOD NAVIGATION

TECHNOLOGY GOALS

- 0 ODOMETER IN-HAND
- 0 VELOCITY METER IF WHEEL NOT APPROPRIATE
  - o OPTICAL, SONAR, EM TECHNIQUES?
  - o ACCELEROMETERS
- 0 PENDULOUS GYRO
  - o MINIATURIZATION
- 0 STRAPDOWN/LOCAL LEVEL IMUs
  - o IRON GYROS IN-HAND
  - o LASER/FIBER OPTIC GYROS
    - o SOME POSSIBLY GOOD DEVICES NEED FURTHER DEVELOPMENT
  - o ACCELEROMETERS IN-HAND
- 0 GRAVIMETER
  - o USED ON LUNAR ROVER
- 0 GRAVITY GRADIOMETER
  - o NEEDS FURTHER DEVELOPMENT, MINIATURIZATION

## TECHNOLOGY GOALS (CONT.)

- 0 STELLAR UPDATE CAPABILITY
  - o POINTABLE MULTI-FUNCTION STAR TRACKER
- 0 LASER RANGING
- 0 SYSTEM TRADES

## OPTICAL (VISION) NAVIGATION

### PROBLEMS

- 0 KNOWLEDGE OF CURRENT X, Y, Z ROVER POSITION
- 0 KNOWLEDGE OF SURROUNDING TOPOGRAPHIC FEATURE POSITIONS AND RELATIVE ELEVATION
  
- 0 KNOWLEDGE OF ELEVATION GRADIENTS AND FEATURES BETWEEN CURRENT AND DESTINATION LOCATIONS
  
- 0 INTEGRATION OF OPTICAL AND INERTIAL GUIDANCE

OPTICAL (VISION) NAVIGATION  
REQUIREMENTS

- 0 ORBITAL STEREOSCOPIIC IMAGING OF 1M/PXL
- 0 ROVER STEREOSCOPIIC IMAGERY OF  $<.1\text{MR/PXL}$   
FROM ALTITUDE
- 0 ACCURATE ORBITAL DETERMINATIONS (E.G. VLBI)
- 0 ACTIVE REFLECTORS ON ROVER FOR ENHANCED ORBITAL  
IDENTIFICATION

OPTICAL (VISION) NAVIGATION  
FUNDAMENTAL TECHNOLOGY ISSUES

- 0 IMAGE CORRELATION AND MAPPING
  - 0 CONTROL OF MARS TOPOGRAPHIC & PLANIMETRIC DATUM
  - 0 CONTROL OF INSTABILITIES IN OBSERVER/ORBITER  
VIA:
    - . COMBINATION OF WIDE AND NAROW FIELD CAMERAS
    - . IMAGE MIRROR SPLITTING FOR SIMULTANEOUS FORE  
AND AFT VIEWING
    - . PRECISION ALTITUDE TRACKING
  - 0 SCENE "CHIP" CORRELATION/MATCHING

## FUNDAMENTAL TECHNOLOGY ISSUES (CON'T.)

- 0 TERRESTRIAL STEREOGRAMMETRY
  - 0 ERECTABLE ROVER MAST WITH TV CAMERAS
  
- 0 ON-BOARD DATA INTEGRATION
  - 0 INTEGRATE OBSERVER/ORBITER TOPOGRAPHIC DATA WITH GROUND STEREOGRAMMETRY
  - 0 LOCAL AND REGIONAL POSITION/ELEVATION
  - 0 NEURAL NET COMPUTING ARCHITECTURE
    - . SELF LEARNING
    - . PROBLEM SOLVES
    - . INTELLIGENCE
  - 0 INTEGRATE OPTICAL AND INERTIAL GUIDANCE

## RADIO METRIC ROVER NAV

- USE EARTH-BASED VLBI FOR:
  - ROVER-LANDER 2-D VECTOR WITH METER-LEVEL ACCURACY
  - ROVER & LANDER ABSOLUTE POSITION WITH 1km ACCURACY
  - ROVER-ORBITER POSITION WITH METER-LEVEL ACCURACY
  
- PRECISE RANGING FOR THIRD COMPONENT OF ROVER-LANDER VECTOR
  
- POSSIBLE VARIATIONS
  - INVERTED VLBI - TRANSMITTING FROM EARTH, RECEIVING & PROCESSING ON MARS; SAVES R.T. LIGHT TIME
  - QUASI-GPS SIGNALS BROADCAST FROM EARTH; SIMILAR TO INVERTED VLBI
  - MARS SURFACE MODEL FOR THIRD POSITION COMPONENT

## ROVER LOCATION USING DOPPLER AND RANGING MEASUREMENTS

---

- REFERENCES: VIKING LANDER  
LUNAR STATION
- TECHNOLOGY: MICROWAVE LINK BETWEEN  
EARTH AND ROVER, LANDER & SIC  
X-BAND OR DUAL FREQUENCY
- TECHNIQUE:  
MEASUREMENTS - DOPPLER AND RANGE  
DATA ANALYSIS: LOCATION OF  
ROVER AND LANDER
- LOCATION ACCURACY  
VIKING 1 LANDER LOCATION  $\sim 20m$   
(INERTIAL REF. FRAME)  
SIMULATION ANALYSIS NEEDS TO BE  
PERFORMED - EXPECTATION: AS  
ABOVE OR BETTER

## TECHNOLOGY ITEMS FOR EARTH-BASED VLBI

- PORTABLE REAL TIME TONE PHASE EXTRACTOR  
FOR INSTALLATION AT TEMPORARY STATIONS
- WIDEBAND VLBI TRANSPONDER FOR ROVER &  
LANDER. DESIRED TONE SPACING: 300-400 MHz (Ka-Band)
- RAPID TURNAROUND (FEW-MINUTE) VLBI  
DATA PROCESSOR

Note: DEMONSTRATION OF X-BAND CYCLE AMBIGUITY  
RESOLUTION WITH EXISTING SOURCES SHOULD  
BE PURSUED.

## Additional Technology Items for Mars-Based AYLDI

---

- Space Qualified Real Time Tone Phase Extractor  
On Board
- Automated Navigation Data Processing System

## ROVER NAVIGATION SYSTEM CONCEPTS AND ARCHITECTURE

- CONTINUE SYSTEM LEVEL ANALYSIS BEGUN AT WORKSHOP
- IN-DEPTH ANALYSIS OF ALTERNATIVE APPROACHES TO GLOBAL NAVIGATION
- DETERMINE RANGE OF APPLICABILITY OF ALTERNATIVE SYSTEM CONCEPTS IN TERMS OF PERFORMANCE PARAMETERS
  - ACCURACY
  - DEGREE OF AUTONOMY
  - FUNCTIONAL REDUNDANCY
  - RESPONSE TIME
  - RELIABILITY
  - COST
  - POWER AND MASS REQUIREMENTS
  - TECHNOLOGY READINESS

INERTIAL NAVIGATION  
AND  
DEAD RECKONING  
FOR  
MARS SURFACE ROVER

ALLAN KLUMPP

TECHNOLOGY PLANNING WORKSHOP  
ON THE MARS ROVER

1987 APRIL 28 - 30

GYROCOMPASSING TO DETERMINE  
ROVER ATTITUDE

- o Inertial measurements taken while rover is at rest on the Mars surface.
- o Rover attitude is determined by erecting Mars local-vertical coordinate axes with respect to the rover body.
- o Inertial sensors measure contact acceleration  $A$  and angular rate  $W$  in a body-fixed coordinate frame.
- o Mars local-vertical coordinate axes are computed as:  
UP := UNIT(A);  
(UNIT YIELDS COLLINEAR UNIT-LENGTH VECTOR)  
EAST := UNIT(W \*\* A);  
(\*\*\* => VECTOR CROSS PRODUCT)  
NORTH := UP \*\* EAST;

### GYROCOMPASSING TO DETERMINE ROVER LATITUDE

- o Inertial measurements taken while rover is at rest on the Mars surface.
- o Latitude is the complement of the angle between between the POLE and UP axes. The POLE axis is computed as:

POLE := UNIT(W);

- o For maximum precision at any latitude, latitude is computed using the two-argument ARCTAN function of the SIN and COS of the angle:

LATITUDE := ARCTAN(UP \* POLE,  
ABVAL(UP \*\* POLE));  
("\*\*" => VECTOR DOT PRODUCT,  
ABVAL YIELDS VECTOR LENGTH)

2

### INERTIAL DETERMINATION OF LONGITUDE AND ALTITUDE

- o No way to directly measure longitude inertially.
- o Longitude can be initialized from a noninertial source.
- o Longitude changes can be measured by doubly integrating the east component of sensed acceleration.
- o Measurement of altitude in terms of the vertical component of sensed acceleration may be unreliable because of local variations in surface density.

ORIGINAL PAGE IS  
OF POOR QUALITY



### DEDUCTIVE (DEAD) RECKONING

**Concept:** Maintain continuous knowledge of location relative to some starting point (the mother craft) by keeping track of all motions.

**Implementation:** Plot motions and landmarks on a map of the local terrain.

4

### DEAD RECKONING MEASUREMENT SOURCES

- o Inertial instruments
- o Odometers
- o Optical sensors

ORIGINAL DOCUMENTS  
OF POOR QUALITY

### CHARACTERISTICS OF INERTIAL INSTRUMENTS

- o Calibrate to null drift when vehicle at rest.
- o Bias errors cause drift acceleration whenever cover is moving.
- o Although latitude is measured directly, measurement error is large compared to dimensions of craft and local terrain (see performance estimates below).

6

### CHARACTERISTICS OF ODOMETERS

- o Odometers use measurements of rotation of wheel(s) in contact with surface.
- o Dependent on an outside source for direction of motion.
- o Subject to errors due to skidding and wheel size uncertainty. Using a nonpropulsive "fifth" wheel can minimize skidding errors.

ORIGINAL PAGE IS  
OF POOR QUALITY

## CHARACTERISTICS OF OPTICAL SENSORS

- o Using laser ranging to corner-cube reflectors, position and attitude of the rover relative to the mother craft can be determined precisely.
- o Using laser ranging and gyrocompassing, position relative to natural landmarks can be determined imprecisely.

8

### GYROCOMPASSING ERROR

MASS ACQUISITION RATE	14.621°/HR
GYRO BIAS*	0.1°/HR

$$\begin{aligned} \Delta \text{ AZIMUTH ERROR} &= \frac{0.1}{14.621 \cos(\text{LATITUDE})} \\ &= 6.84 / \cos(\text{LATITUDE}) \text{ MILLIADIANS} \\ &\approx 0.4^\circ / \cos(\text{LATITUDE}) \end{aligned}$$

\* WORST CASE NUMBERS FROM JEROLD GILMORE, C.S. DRAPER LAB, 1985 JUNE 10

ORIGINAL PAGE IS  
OF POOR QUALITY

# LATITUDE ERROR

MARS SURFACE GRAVITY

3.73 m/s<sup>2</sup>

ACCEL BIAS ERROR 300 μg (EARTH) \*

2.94 E-3 m/s<sup>2</sup>

$$\text{VERTICAL ERROR} = \frac{2.94 \text{ E-3}}{3.73} = 7.88 \text{ E-4 RAD}$$

POLAR ERROR (FROM PREV VUMAPH) 6.84 E-3 RAD

$$\text{LATITUDE ERROR} = \text{RSS}(7.88 \text{ E-4}, 6.84 \text{ E-3}) = 6.88 \text{ E-3 RAD}$$

$$\text{TRANSLATIONAL ERROR} = 6.88 \text{ E-3 RAD} \cdot 3.3874 \text{ EG M RADIUS}$$

$$= 2.33 \text{ E4 M}$$

$$= 23.3 \text{ Km}$$

\* WORST CASE FROM JEROLD GILMORE, C.S. DRAPER LAB, 1985 JUNE 10

KLUMP 87 04 23

## LASER RANGING FOR DETERMINING RELATIVE POSITION AND ATTITUDE (SIX COMPONENTS TOTAL)

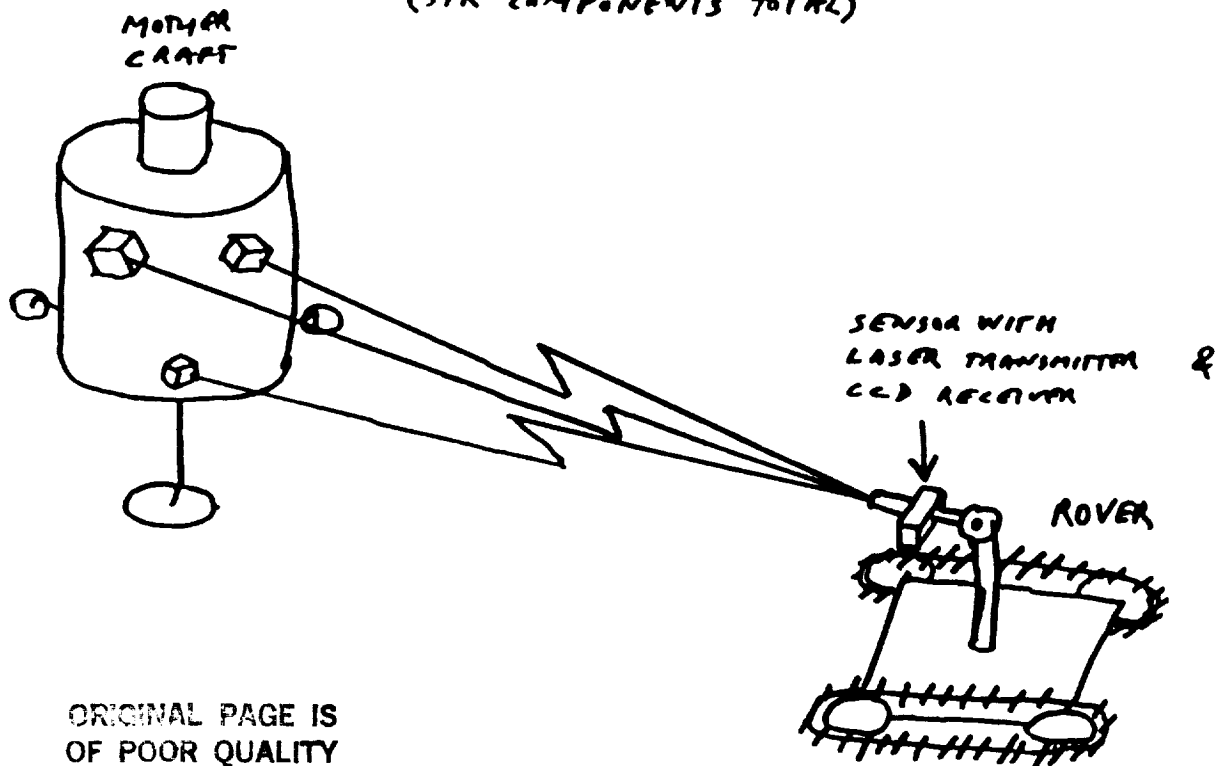

ORIGINAL PAGE IS OF POOR QUALITY

# LASER RANGING PERFORMANCE

SENSOR RANGE PRECISION < 1 mm  
ASSUME BASELINE BETWEEN REFLECTORS 1 m  
AZIMUTH ERROR  $\text{ASS}(1 \text{ mm}, 1 \text{ mm}) / 1 \text{ m} = 1.414 \text{ mrad}$   
 $= 0.08^\circ$

AZIMUTH POSITION ERROR @ 10 km RANGE = 14.14 m

MAX RANGE: 10'S OF KILOMETERS, FOR REASONABLE MASS, POWER  
MASS AND/OR POWER INCREASE RAPIDLY WITH MAX RANGE

\* DATA FROM NOBLE WORKSHOP (ELMER TUBBS),  
JPL SHAPES PROGRAM

KLUMPP 87 04 23

TECHNOLOGY PLANNING WORKSHOP  
FOR THE MARS ROVER

GLOBAL NAVIGATION PANEL  
PRECISION GLOBAL MAPPING ISSUES

N. A. BRYANT , JPL

● APPLICATIONS:

- A. HIGH-RESOLUTION TERRAIN MAPPING X,Y,Z
- B. HORIZONTALLY PROJECT IMAGES FOR USE BY THE ROVER
- C. LANDMARK RECOGNITION FOR THE ROVER

NOTE: [A] REQUIRED TO IMPLEMENT [B] OR [C]

---

CONSTRAINTS TO HIGH RESOLUTION TERRAIN MAPPING

● DESIGN TRADEOFFS:

- A. FOR A GIVEN FOCAL PLANE AT A GIVEN ALTITUDE, THE HIGHER THE RESOLUTION, THE LOWER THE AREAL COVERAGE PER FRAME
  - IMPACTS NUMBER OF ORBITS REQUIRED TO COVER AN AREA
- B. LARGER AREAL COVERAGE FOR A GIVEN CAMERA SACRIFICES RESOLUTION AT A GIVEN ALTITUDE
  - IMPACTS PRECISION OF INFORMATION AVAILABLE FOR ROVER TERRAIN ROUTING
- C. LARGER AREA COVERAGE AT HIGH RESOLUTION REQUIRES HEAVIER CAMERA SYSTEM
  - IMPACTS ORBITER WEIGHT AND AFFECTS COMMUNICATIONS DATA RATE REQUIRED

## CONSTRAINTS TO HIGH RESOLUTION TERRAIN MAPPING (CONT)

- FUNDAMENTAL RELATIONSHIPS BETWEEN RESOLUTION (IFOV) AND CONTROL
    - A. HORIZONTAL CONTROL
      - SCENE TO SCENE MATCHING AFFECTED BY LIGHTING PROBLEMS AND SHADOW EFFECTS
      - 5m RESOLUTION GIVES COMPLETENESS OF DETAIL FOR 1:50,000 SCALE MAP, IE RMSE=15m
    - B. VERTICAL CONTROL
      - MULTIPLE PIXELS REQUIRED TO IDENTIFY PARALLAX, 32x32
      - 5m RESOLUTION GIVES CONTOUR INTERVAL OF 50m, +/- 15m
      - NO DIGITAL ELEVATION MODEL IS BASED SOLELY ON STEREOIMAGERY, IE ALTIMETER DATA REQUIRED
    - C. ORBIT EPHEMERIS IMPACTS X,Y,Z, POSITIONING, BOTH RELATIVE AND ABSOLUTE, FOR ADJACENT FRAMES
      - VIKING ORBITER ADJACENT ORBITS DIFFERED 3-5 km AFTER BEST A POSTERIORI EPHEMERIS CALCULATION
      - EPHEMERIS POSITIONAL ACCURACY MORE IMPORTANT WITH LESS SIDE-LAP BETWEEN PASSES
- 

## POTENTIAL STRATEGY

- VIKING ORBITER CONTROLLED PHOTOMOSAICS FOR HORIZONTAL POSITIONING: 200m, 100m, 50m, 10m
  - NOTE: GLOBAL COVERAGE ONLY AT 200m
- VIKING ORBITER CONTROLLED ELEVATION MODELS FOR SELECTED AND AVAILABLE AREAS USING 20-8m IMAGERY
- MARS OBSERVER WITH SIMULTANEOUS VIMS, ALTIMETER, & NAVIGATION TRACKING
  - IMPROVES PLANETARY CONTROL NET
  - ADDS TO VERTICAL TOPOGRAPHY RESOLUTION
  - VALIDATES SITE SELECTION OPTIONS
- MRSE ORBITER IMAGER FOR FINAL CONTROLLED MOSAIC OF LANDING SITE
  - NOTE: MAY NOT REQUIRE COMPLETE 100km COVERAGE IF VIKING & MO IMAGERY CAN BE INTEGRATED

PRECISION GLOBAL MAPPING  
TECHNOLOGICAL ISSUES

- WE CANNOT DESIGN ROVER ROBUSTNESS REQUIRED UNTIL WE UNDERSTAND THE ORBITER IMAGER RESOLUTION REQUIRED
  - 1m RESOLUTION USING 1000x1000 CAMERA REQUIRES 20,000 IMAGES TO PROVIDE MINIMAL STEREO COVERAGE (2/3 VO IMAGES)
  - WILL THE ROVER HAVE STEREOVISION COMPUTER SUPPORT ADEQUATE FOR TERRAIN AVOIDANCE GUIDANCE? IF SO, MAY RELAX ORBITER RESOLUTION REQUIREMENTS
- SYSTEMATIC APPROACHES TO STEREOGRAMMETRY PRECISION IMPROVEMENT FROM "UNSTABLE " PLATFORMS
  - OPTION: A. COMBINATION WIDE AND NARROW FIELD CAMERAS
  - B. SPLIT IMAGES WITH MIRRORS, FORWARD & SIDE LOOKS
  - C. ADAPTIVE CHIP MATCHING FOR CO-REGISTRATION
- ASSUMING THAT HORIZONTAL VIEWS ARE TO BE USED TO ORIENT THE ROVER:
  - HOW FREQUENTLY WILL THEY BE NEEDED? (COMPUTATION AND COMMUNICATIONS IMPACT)
  - WHAT IS RANGING RESOLUTION ON ROVER CAMERAS VS ORBITER IMAGER DATA REPROJECTED TO HORIZONTAL VIEW?
- USE OF FRACTAL GEOMETRY TO PROVIDE ENHANCED HORIZONTAL VIEWS FOR STEREO COMPARISON ON ROVER AND LANDMARK RECOGNITION FROM ROVER
  - MAY RELAX VERTICAL AND HORIZONTAL RESOLUTION REQUIREMENTS
- USE OF ADAPTIVE/ASSOCIATIVE PATTERN RECOGNITION TECHNOLOGY TO CO-REGISTER ROVER-OBSERVED SCENE TO HORIZONTAL VIEWS PROJECTED FROM ORBITER IMAGES





5-5-23A



ORIGINAL PAGE  
BLACK AND WHITE PHOTOGRAPH

5-5-23

ORIGINAL PAGE IS  
OF POOR QUALITY

ALL VIKING IMAGES OF MARS

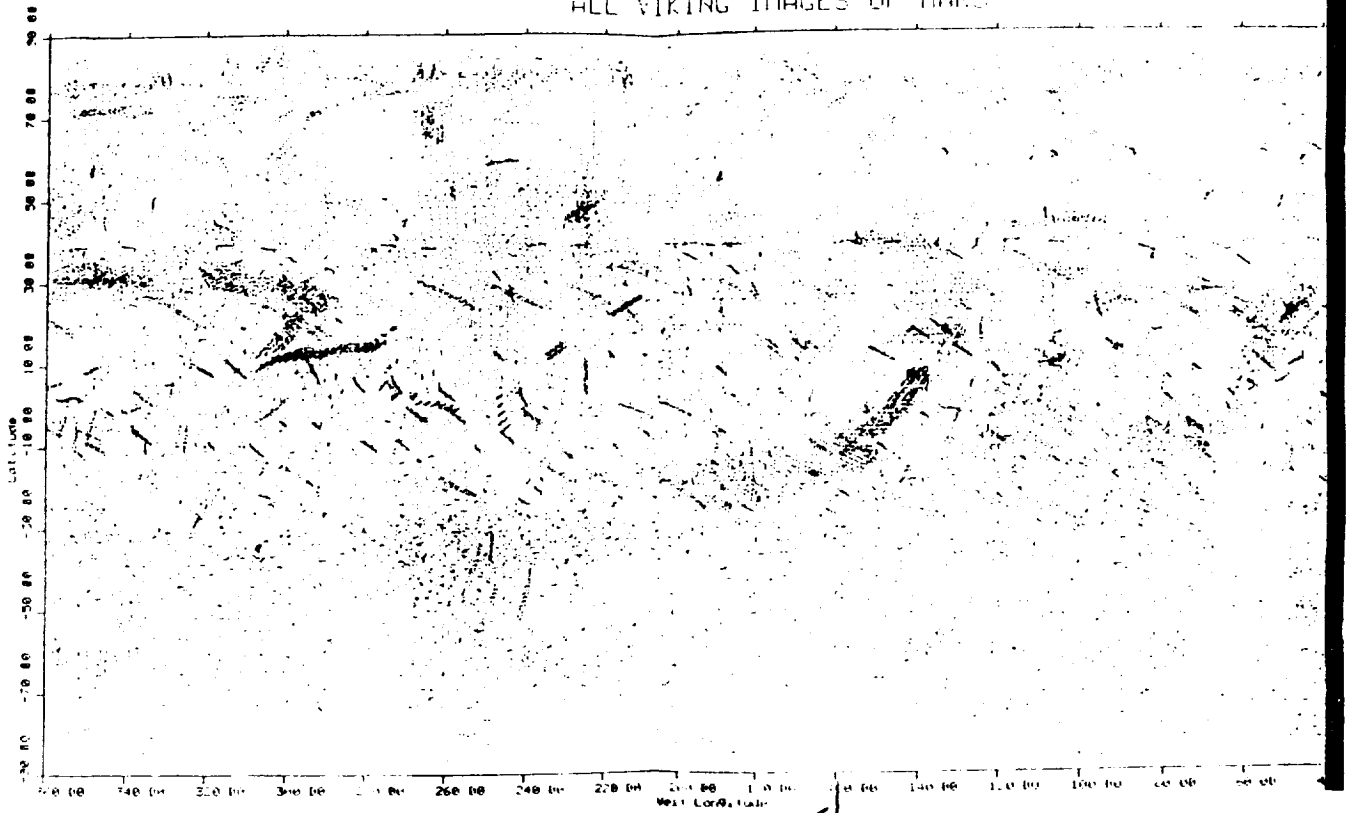

ORIGINAL PAGE IS  
OF POOR QUALITY

5-5-24

TYPICAL TOUR

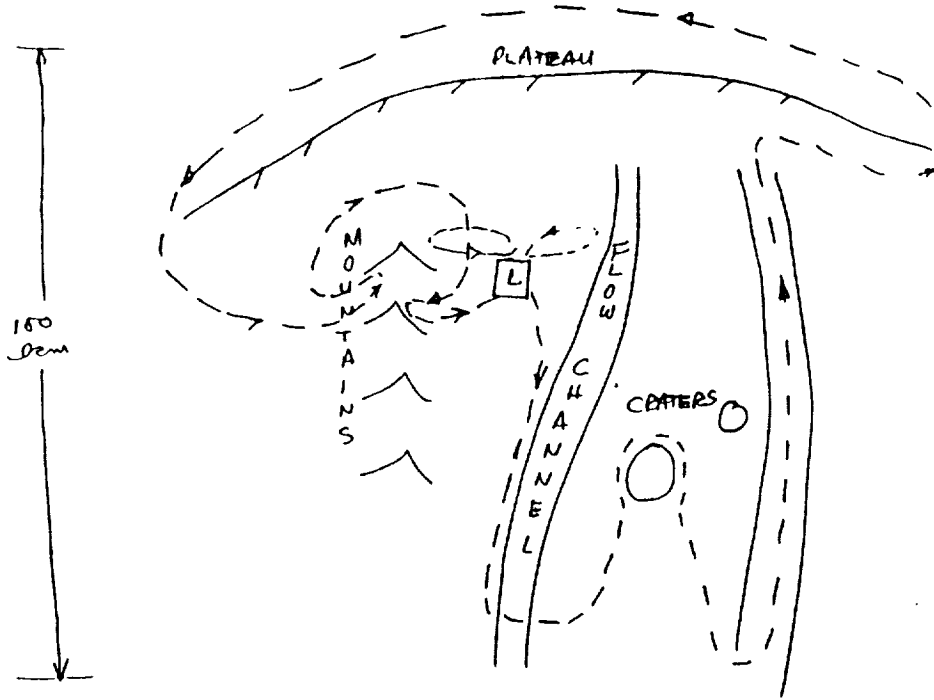

ROVER NAVIGATION  
DEAD RECKONING

SPS-1

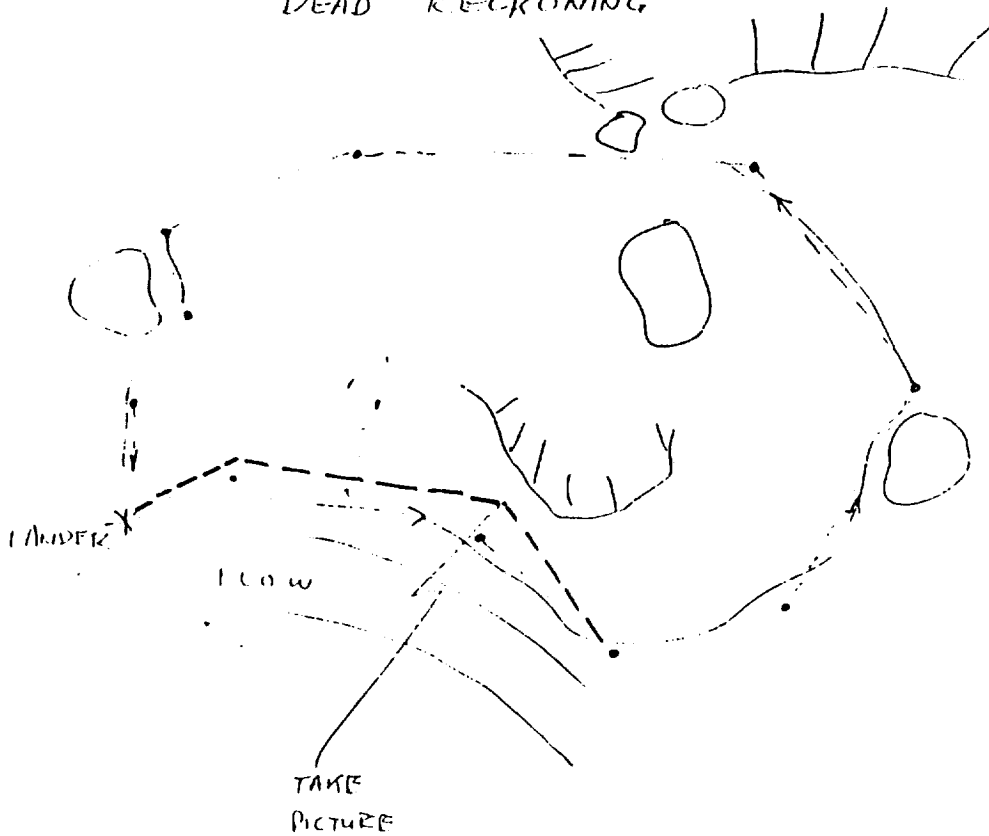

SPS-2

# MARS ROVER

## TWO MODES OF OPERATION

- TRAVEL
- DETAILED SITE EXAMINATION
  - COMPLETELY COVER AREA WITH INSTRUMENT SCANS
  - SAMPLE ROCKS ETC

- ASSUMPTION - 1m IMAGING MAPS PROVIDED BY MO AND/OR ORBITER, COVERING 100 km x 100 km AREA TO BE LANDED IN / ROVER SPS-3

## ROVER NAVIGATION

### TRAVEL MODE

- ESTIMATE LIKELY ERRORS IN PATH DRIFT
  - ACCELEROMETER ERRORS
  - ODOMETER "
  - STAR TRACKER / CAMERA ERRORS
- SET TIME / PATH LENGTHS FOR UNATTENDED MOTION
- SET PICTURE TAKING FREQUENCY REQUIREMENTS

## ROVER NAVIGATION

### TRAVEL MODE

- SMOOTHING MAY ALLOW CALIBRATION OF SYSTEMATIC ERRORS
  - RECONSTRUCTION OF MICRO PATH FROM
    - FEW TIEPOINTS (PICTURES)
    - INTEGRATED ACCELEROMETER OUTPUT ETC
- A PICTURE PLANNING FUNCTION WILL BE IMPORTANT TO FIND "MAXIMUM-INFORMATION" PICTURES ALONG ROUTE

SPS-5

## ROVER NAVIGATION

### IMAGING SYSTEM CHARACTERISTICS

- FIELD OF VIEW - TENS OF DEGREES
- PIXEL ACCURACY -  $10^{-3}$  TO  $10^{-4}$  radians
  - GET 10 TO 1 m RANGING AT 100 m FROM PARALLAX
  - SEE DETAIL TO CM'S AT 100m

ORIGINAL PAGE IS  
OF POOR QUALITY

- SHOULD HAVE HIGH DEGREE OF FLEXIBILITY IN CHOOSING COMPRESSIONS, SUBFIELD SELECTION ETC (ALA MOC)

- POINTING KNOWLEDGE RELATIVE TO ROVER VEHICLE COORDINATE SYSTEM OF L.O.S. SPS-6

## ROVER NAVIGATION

### IMAGING SYSTEM CHARACTERISTICS

- POINTABLE
- ZOOMABLE ?
- MULTIPLE CAMERA SYSTEMS ?
  - FOCUSING AT 1, 2 m
  - THEN AT  $\infty$
- ASSOCIATED MICROPROCESSORS / MEMORY TO ALLOW ONBOARD CORRELATIONS ETC

SPS-7

ORIGINAL PAGE IS  
OF POOR QUALITY

# TOPOGRAPHIC MODEL:

- DEFINE GEOID AS EQUIPOTENTIAL SURFACE:

$$\Phi(\vec{R}) = 1$$

- POTENTIAL IS SUM OF TRIAXIAL ELLIPSOID TERM

$$\Phi_0(\vec{R}) = \vec{R} \cdot \underline{A} \cdot \vec{R}$$

AND LOCAL PERTURBATIONS.

- BUMP MODEL. QUADRATIC POLES LOCATED BELOW SURFACE:

$$\Phi_i(\vec{R}) = S_i / (\vec{R} - \vec{R}_i)^2$$

WIDTH  $\approx$  DEPTH OF POLE ( $D_i$ )  
HEIGHT APPROXIMATELY

$$h_i \approx R_i S_i / 2 D_i^2$$

MODEL IS LOCAL,  
UNLIKE SPHERICAL  
HARMONICS. IDEAL  
FOR FITTING WITH  
LOCAL DATA.

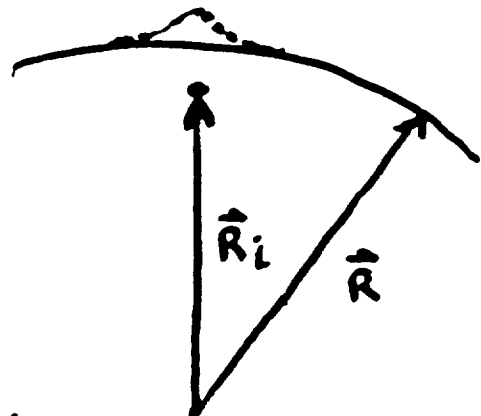

- SURFACE NORMAL PROPORTIONAL TO GRADIENT OF POTENTIAL

$$\hat{n} = \vec{\nabla} \Phi / |\nabla \Phi|$$



## GOALS:

- INITIAL LOCATION OF ROVER
- PLANNING OF EXCURSIONS
- MINIMIZE NUMBER OF PICTURES NEEDED FOR EXCURSIONS
- ACCURATE LOCAL TOPOGRAPHY

## STRATEGY:

- CONSTRUCT TOPOGRAPHIC MODEL FROM ORBITER IMAGES.
- COMPARE ROVER IMAGES WITH THOSE PREDICTED FROM TOPOGRAPHIC MODEL.
- SIMULTANEOUSLY UPDATE BOTH TOPO MODEL AND ROVER POSITION.

## OBSERVABLES:

- VIKING PICTURES ( $\approx 100$  m) (20 m)
- MARS ORBITER PICTURES ( $\approx 1$  m) (.2 m)
- ORBITER STARS (OD)
- ORBITER TERRAIN ( $\approx 1$  m, OD, MAPPING)
- ROVER STARS (ROUGH POSITION  $\approx 10-100$ )
- ROVER TERRAIN (FINE POSITION)

## SCALING:

- LARGE SCALE TOPOGRAPHY FIT WITH ORBITAL STEREO DATA.
- PRECISE HEIGHTS FIXED BY USING SMALLER SCALE LANDMARKS (TOPO OR ALBEDO)
- REPEAT PROCEDURE ON SMALLER SCALE.

## LANDMARKS:

- DEFINED AS SMALL SURFACE PATCH IN PARTICULAR PICTURE.
- FIT LOCAL TOPO OR ALBEDO MODEL IN PATCH OVER ALL PICTURES. SOLVE FOR LOCATIONS IN OTHER PICTURES.
- USE LOCATIONS IN IMAGE SPACE TO DETERMINE LAT, LONG AND HEIGHT OF PATCH
- TYPICAL RESULTS FROM IO INDICATE 0.1 PIXEL ACCURACY FOR  $\approx 20$  PIXEL DIAMETER LANDMARKS.
- VIKING DATA ( $\approx 100$  m) SHOULD GIVE HEIGHTS + LOCATIONS TO  $\approx 20$  m
- ORBITER DATA ( $\approx 1$  m) SHOULD GIVE HEIGHTS + LOCATIONS TO  $\approx 20$  cm.

# GROUND VIEW POSSIBILITIES:

- EXAMINE HORIZON (LINE FIT)

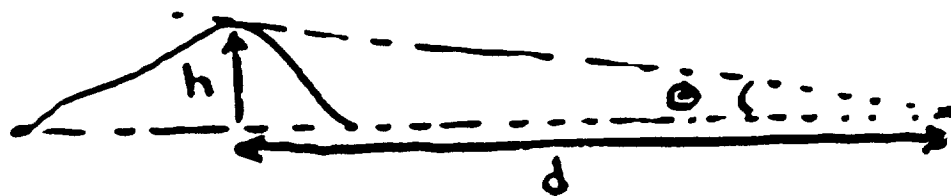

$$d \approx h / \theta$$

FOR  $\theta \approx .3$ ,  $\delta h = 1\text{m} \Rightarrow \delta d = 3\text{m}$ .  
IF  $d \approx 100\text{m}$ ,  $\delta d = 1\text{m} \Rightarrow \delta \theta \approx .003$   
ANGULAR RESOLUTION OF  $10^{-3}$  OK.

- STEREO. TWO CAMERAS SEP BY  $\sim 1\text{m}$ . MEASURE POSITIONS OF METER SIZED RUBBLE WITHIN  $\sim 100\text{m}$ . COMPARE WITH ORBITER VIEW
- ACTIVE STEREO. MOVE ROVER AROUND. OBSERVE RELATIVE MOTIONS OF NEARBY + DISTANT FEATURES.
- STAR OBSERVATIONS, SATELLITE OBSERVATIONS. DIRECT OR OBS OF RISING + SETTING.
- STATISTICS: IF REGION HAS MANY FEATURES, MUCH TERRAIN, ERRORS DRIVEN DOWN BY MULTIPLE MEASUREMENTS. (IF NOT, LEAVE)

RWG-4



ORIGINAL PAGE  
BLACK AND WHITE PHOTOGRAPH

5-5-33

ORIGINAL PAGE IS  
OF POOR QUALITY

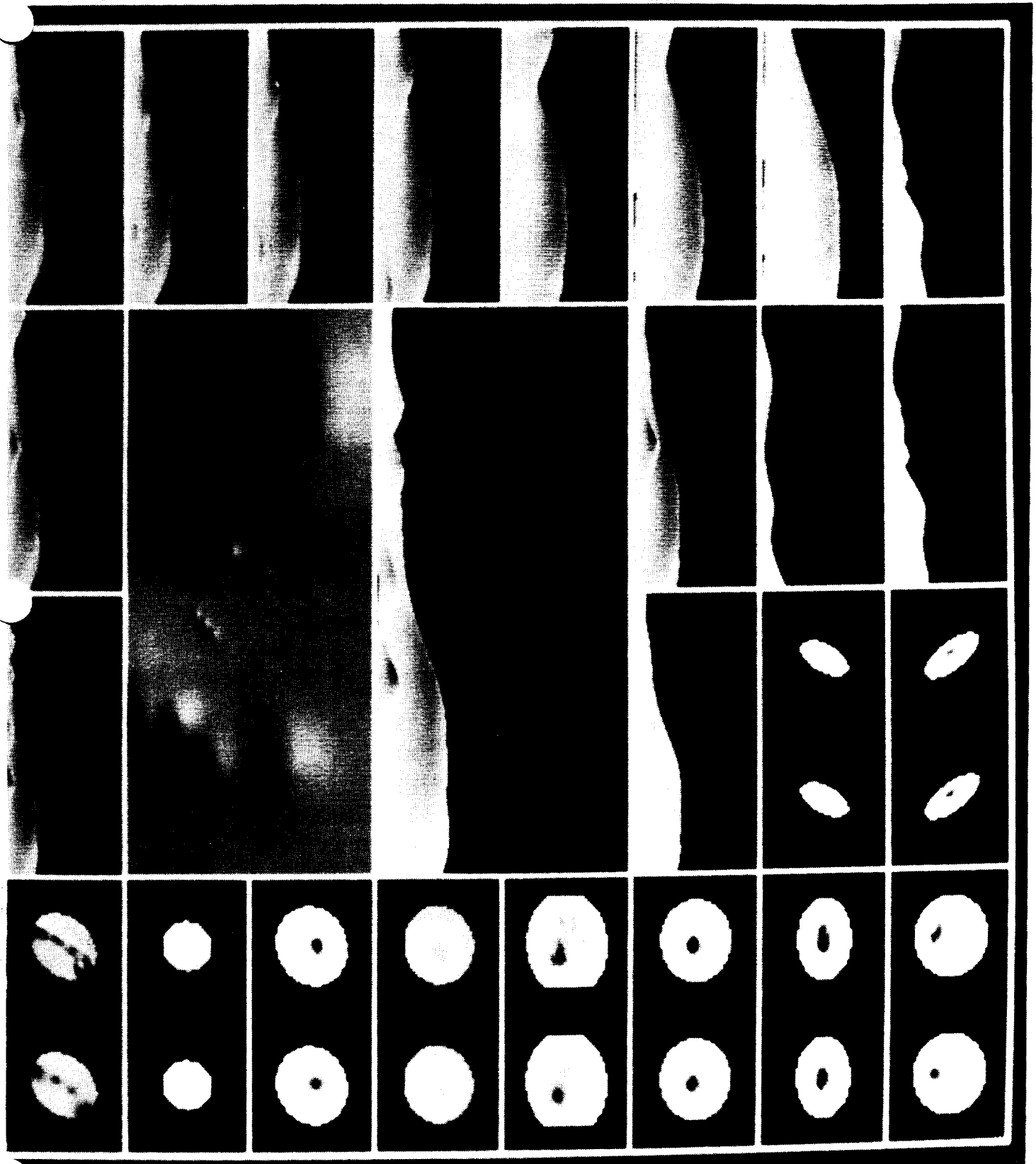

ORIGINAL PAGE  
BLACK AND WHITE PHOTOGRAPH

5-5-34

ORIGINAL PAGE IS  
OF POOR QUALITY

MARS OBSERVER ORBIT DETERMINATION  
P. B. ESPOSITO  
4-29-87

## MARS OBSERVER MISSION DESCRIPTION

- LAUNCH ON STS IN AUGUST 1990
  - 20 DAY LAUNCH WINDOW, DEPLOY FROM CARGO BAY IN LOW EARTH ORBIT
- ONE YEAR IN ERPLANETARY TRANSIT
  - TRAJECTORY CORRECTION MANEUVERS, INSTRUMENT CALIBRATIONS
- ORBIT INSERTION AT MARS INTO 4100 KM PERIAPSIS, 24 HR ORBIT
- INSERTION ORBIT DRIFTS (60 - 80 DAYS) TO SUN-SYNCHRONOUS ORIENTATION
- PROPULSIVE MANEUVERS TO ATTAIN CIRCULAR, FROZEN GEOMETRY MAPPING ORBIT
  - 361 KM AVERAGE ALTITUDE, 116 MIN PERIOD, 93 DEG INCLINATION
  - SUN-SYNCHRONOUS WITH 2:00 AM/PM EQUATOR CROSSINGS
- SCIENCE MISSION DURATION IS ONE MARTIAN YEAR (687 DAYS) IN MAPPING ORBIT
- REPEATING GROUND TRACK STRATEGY MAPS ENTIRE PLANET IN 59 DAYS
- ORBIT ALTITUDE RAISED AT END OF MISSION TO MEET PLANETARY PROTECTION REQUIREMENT

PBE-1

**JPL** MISSION SYSTEM PDR  
**ORBIT DETERMINATION DURING DRIFT PHASE**

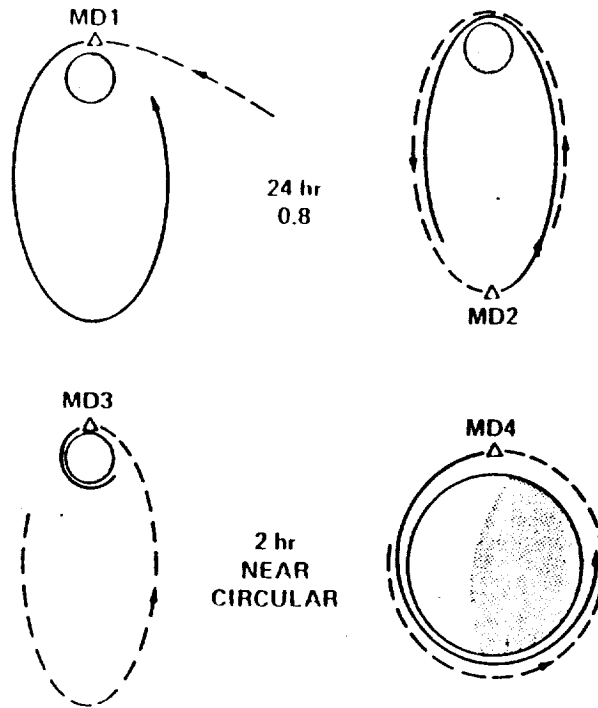

- OD ANALYSIS
- VIKING-TYPE ORBIT
- GRAVITY FIELD (POLAR REGION)
- FIRST NEAR CIRCULAR ORBIT:  
 SHORT PERIOD  
 SMALL ALTITUDE
- NEAR SOLAR CONJUNCTION
- GCO

PBE-2  
 NOV 6

**JPL** MISSION SYSTEM PDR  
**ORBIT GEOMETRY AND ANALYSIS STRATEGY**

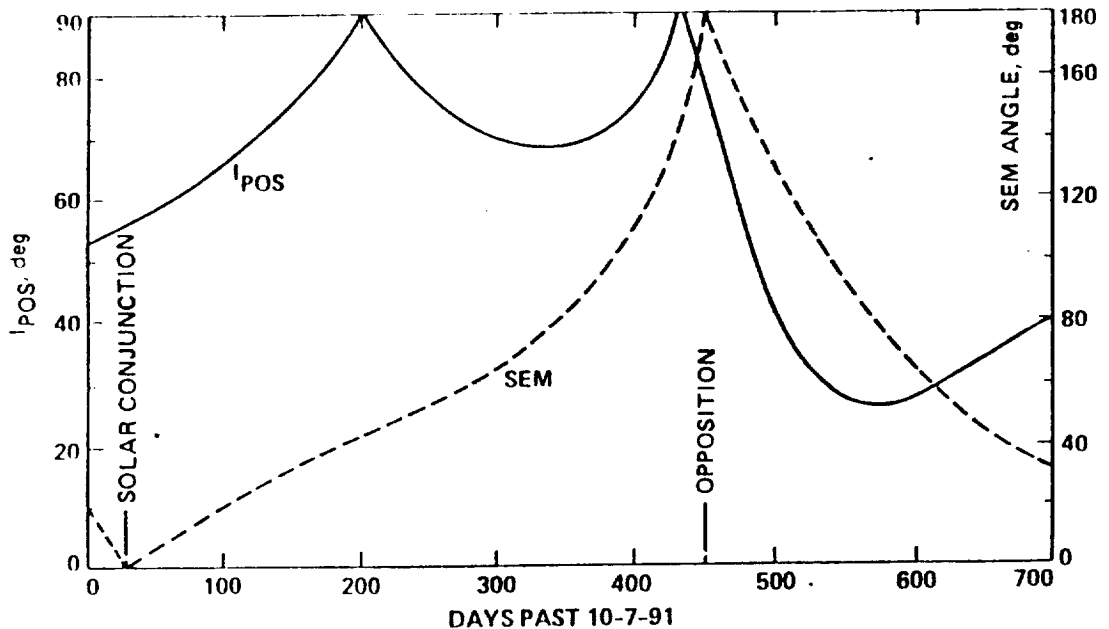

PBE-3  
 NOV 7



# MISSION SYSTEM PDR MO GROUND TRACE WITH GRAVITY ANOMALIES

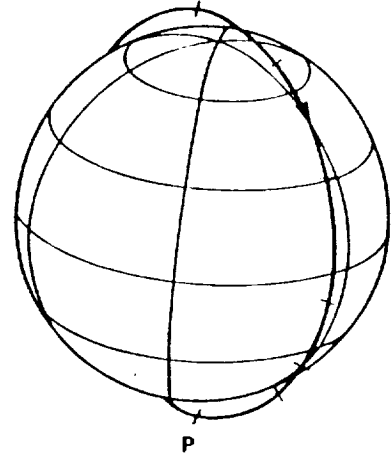
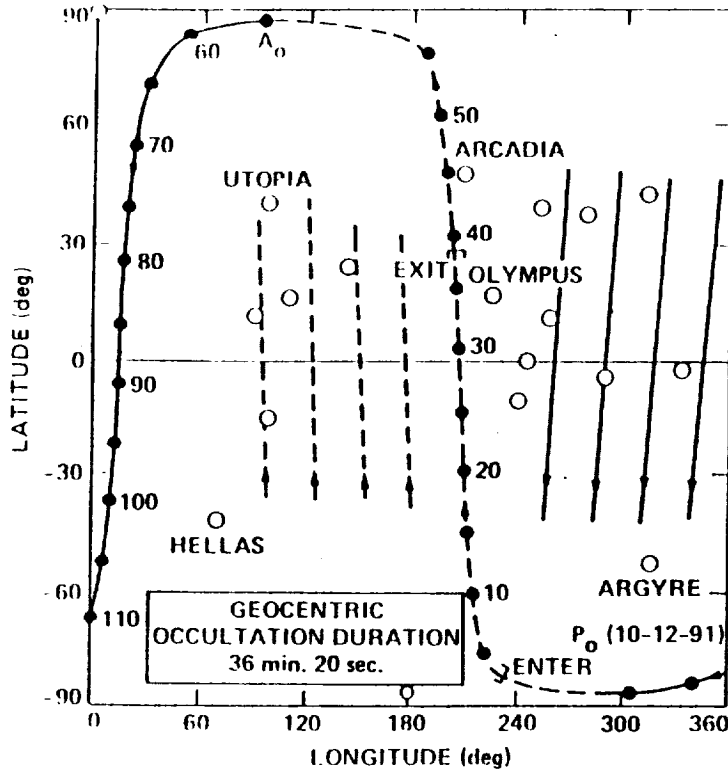

PBE-4

1101 B



# MISSION SYSTEM PDR GRAVITY FIELD ERROR MODEL (ONE SIGMA FORMAL-UNNORMALIZED)

COEFFICIENT		ERROR ( $\times 10^{-7}$ )		
J2	} 21, 22	.439		
C		-	.0571	
S		-	.0613	
J3	} 31, ...33	1.28		
C		.237	.0670	.0182
S		.230	.0630	.0160
		.		
		.		

6 x 6 FIELD:  $\sigma = [6 - 10] \sigma$  (FORMAL)

GRAVITY ANOMALIES

PBE-5

1101 B



# MISSION SYSTEM PDR JPL GRAVITY ANOMALY AND ERROR MODEL

SOURCE	EAST LONGITUDE (deg)	LATITUDE (deg)	RADIUS (km)	Gm (km <sup>3</sup> /s <sup>2</sup> )	
HELLAS PLANITIA	69.7	-42	900*	-0.4	} 30%
ISIDIS PLANITIA	89.0	12	240	0.1	
UTOPIA PLANITIA	95.0	42	700*	0.25	
ELYSIUM MONS	146.5	25	300	0.15	
OLYMPUS MONS	226.5	18	300	0.6	
ARSIA MONS	239.5	-9	180	0.15	
PAVONIS MONS	247.5	0	180	0.15	
ALBA PATERA	251.0	40.5	450	0.2	
ASCRAEUS MONS	256.0	11	200	0.15	
ARGYRE PLANITIA	317.0	-51	400	-0.1	
HESPERIDA	98.0	-15	900*	0.1	} 70%
ELYSIUM, WEST	110.0	18	600	-0.1	
ARCADIA	209.0	49	600	0.05	
ALBA PATERA, EAST	276.0	39	660*	0.1	
VALLES MARINERIS	289.0	-4	540	-0.03	
ACIDALTA, WEST	310.0	45	720	-0.07	
VALLES MARINERIS	332.0	-2	600	-0.04	
NORTH POLAR CAP	0.0	87.5	540	0.14	100%
SOUTH POLAR CAP	180.0	-85	600	0.0	± .14

PBE-6

# MISSION SYSTEM PDR JPL POSITION ERROR DURING MAPPING

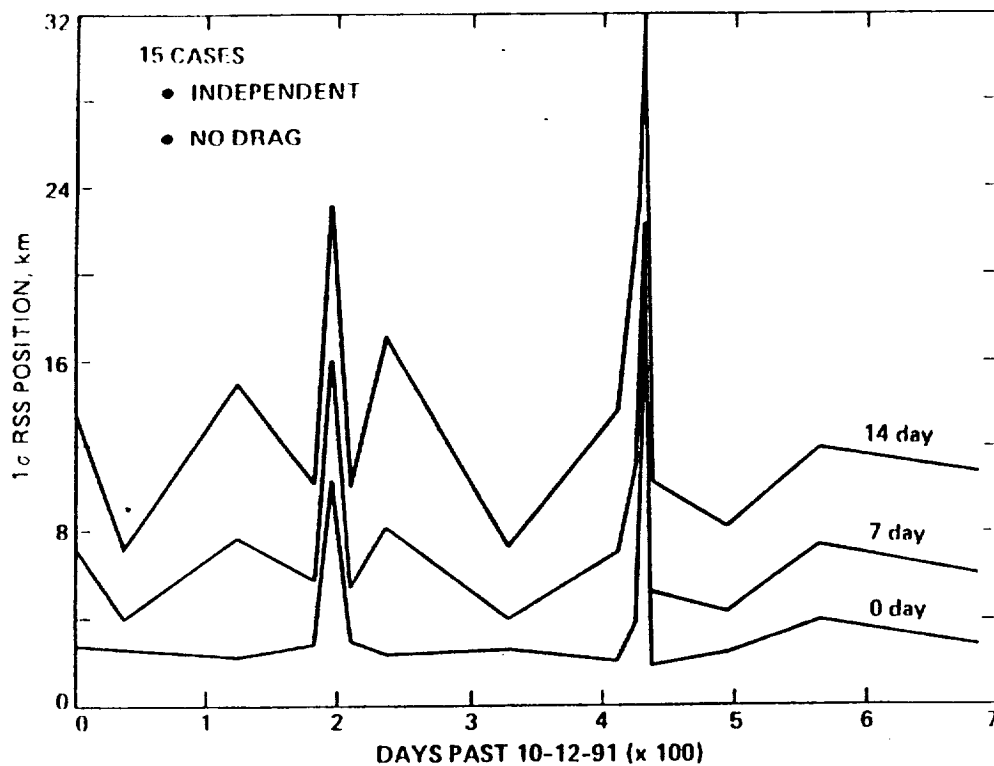

5-5-38

PBE-7

FIG 12

ORIGINAL PAGE IS  
OF POOR QUALITY

GRAVITY FIELD: CURRENT ERROR VS GCO EXPECTATION (ATHENA/SOLN6A)

10-12-91

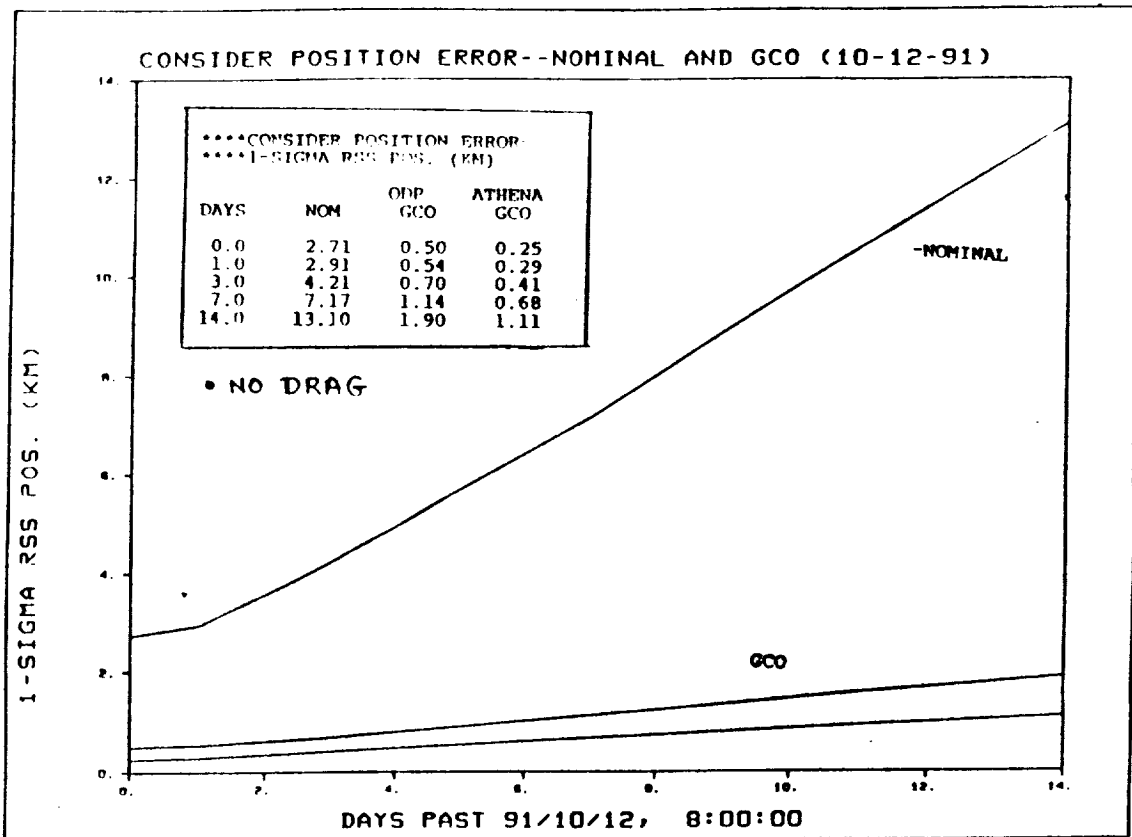
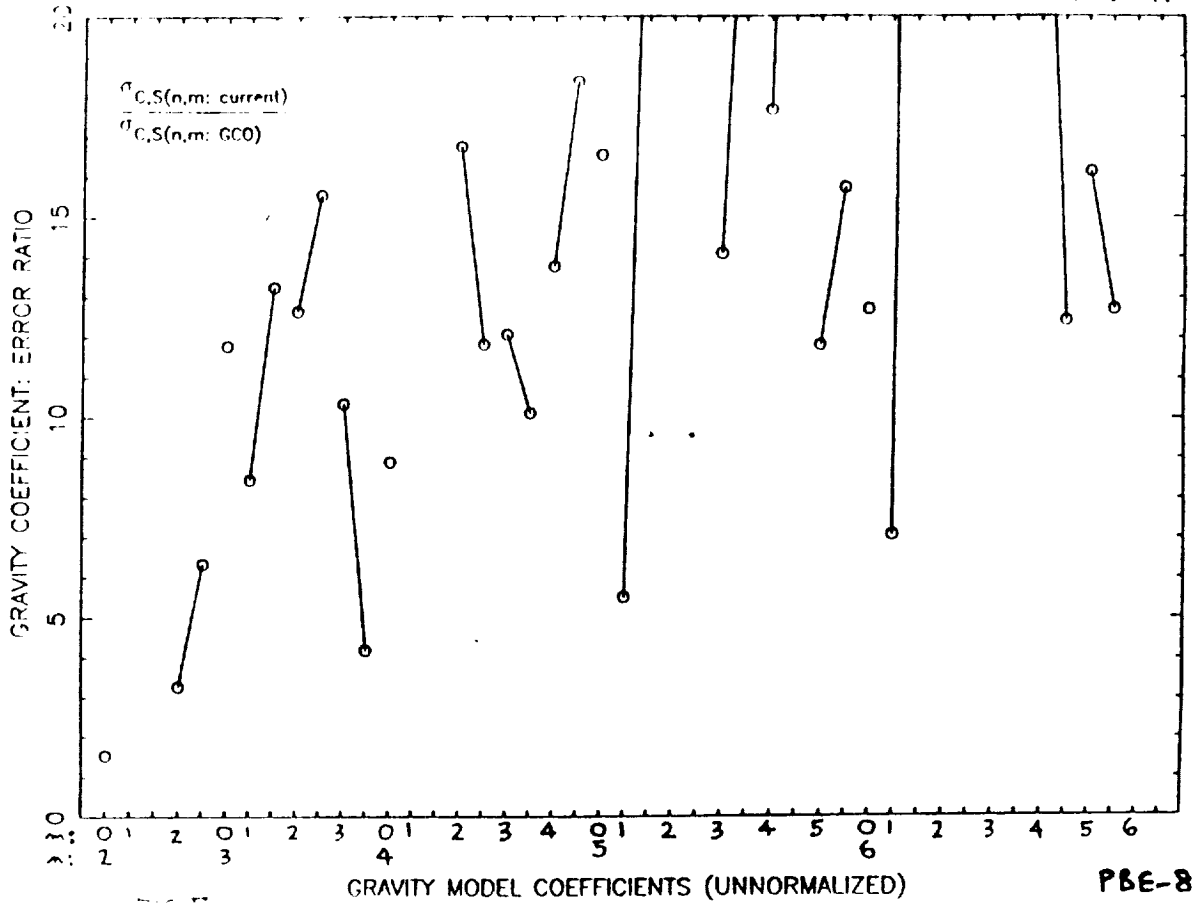
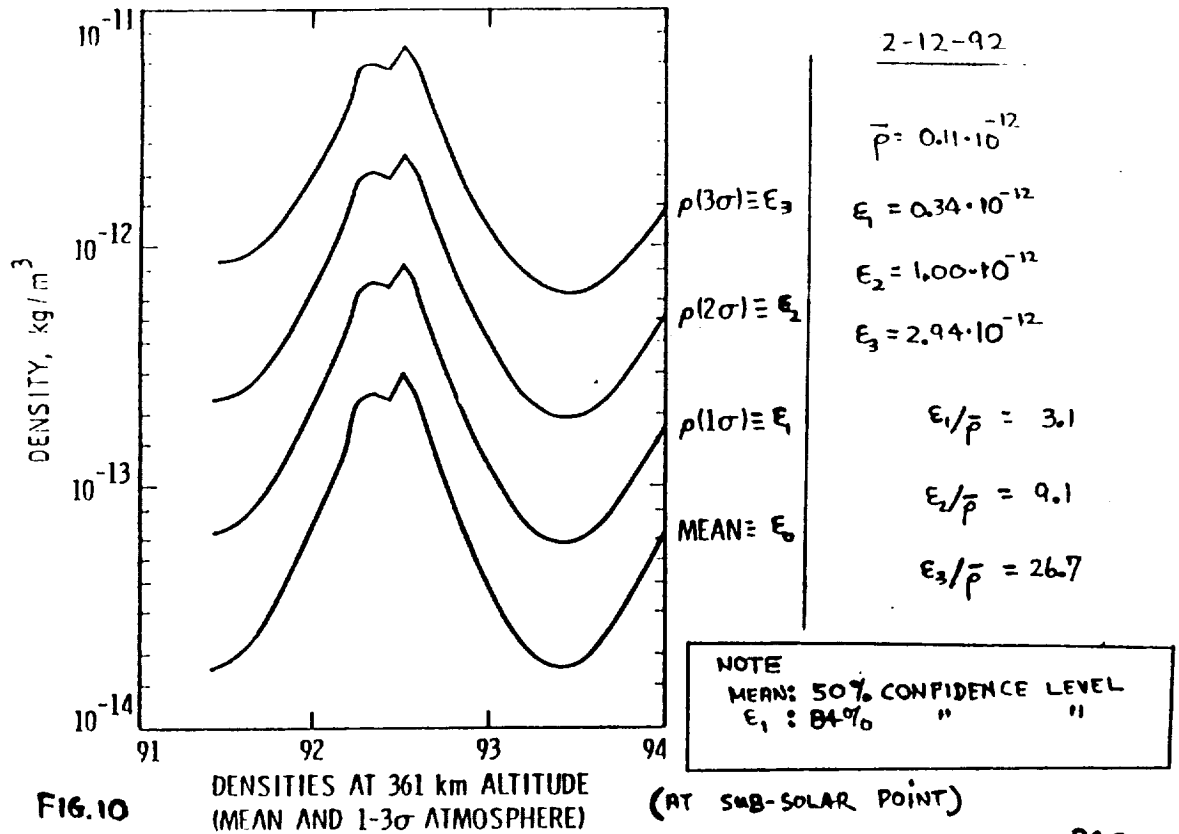

Fig. 8

# MARTIAN ATMOSPHERE DENSITY



## Very Long Baseline Interferometry

Measurement of Difference in Signal Arrival Time (Dahy) at two Stations

### AVLBI

Measurement of Differential Delay or Dahy Rate Between two radio sources

### Information Content

Precise Plane-of-Sky Position + Velocity in Direction of Baseline Projection

Common Errors Diminished by Differencing Station and Spacecraft Clocks

Troposphere and Ionosphere

Station Location and Earth Orientation

Instrumental Delays

JSB-1

### AVLBI Applications

Voyager - Cruise Trajectory O. D.

Venus Rallies - Balloon Motion Reconstruction

Magellan - Orbiter O. D.

Mars Observer - Mars Ephemeris Improvement  
Tying Mars to EGRS Frame

Galileo - Probe Trajectory Reconstruction

ORIGINAL PAGE IS  
OF POOR QUALITY

# SPACECRAFT VLBI DELAY OBSERVABLE

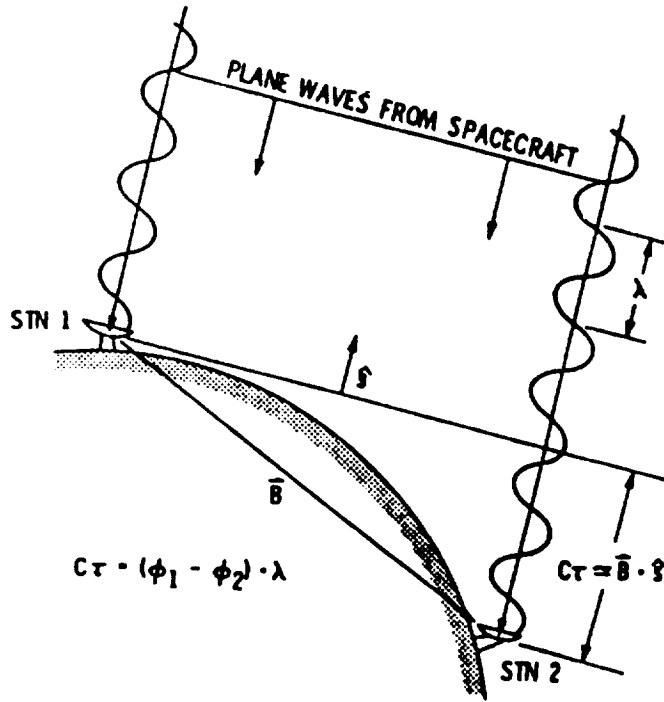
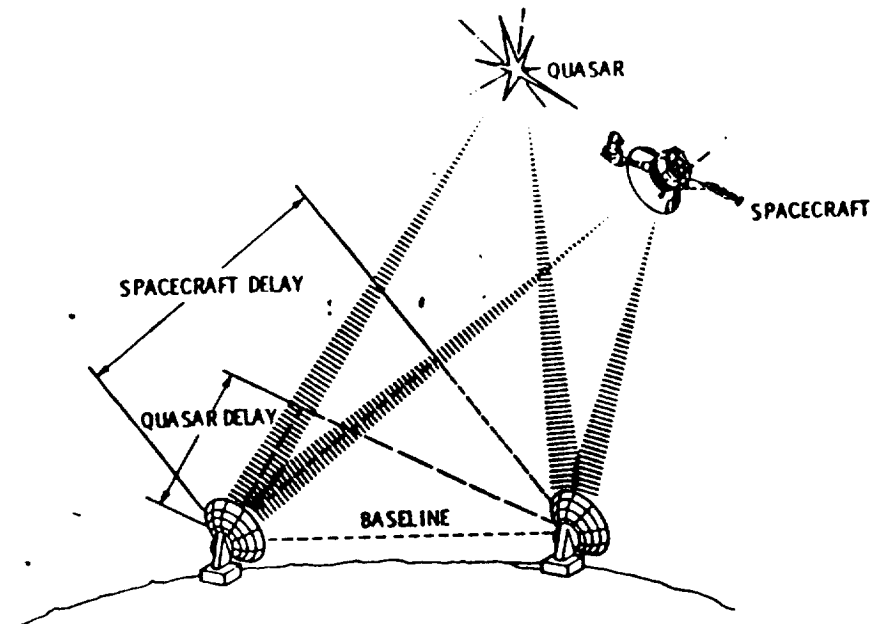

Figure A-1

JSB-3

# CONVENTIONAL $\Delta$ VLBI GEOMETRY



- WIDEBAND  $\Delta$ VLBI ( $\Delta$ DOR) MEASURES DIFFERENTIAL DELAY
- NARROWBAND  $\Delta$ VLBI MEASURES DIFFERENTIAL DELAY RATE

Figure A-2

JSB-4

M R Δ R Δ V L B I

Improved Mars Eph + Absolute Lander Location

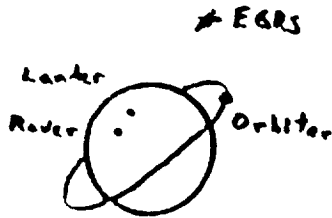

Lander/EGRS ΔVLBI

Lander Doppler + Range

Orbiter Position Relative to Mars

Lander/Orbiter ΔVLBI

Orbiter Doppler

Rover Position Relative to Lander

Rover/Lander ΔVLBI

[Mars Surface Model or Range for 3-D]

JSB-5

MARS ROVER ΔVLBI GEOMETRY

- TWO SOURCES WITHIN ONE BEAM
- ANGULAR SEPARATION < 1 arcsec
- OBSERVING TIME < 1 min
- PERFORMANCE: 1-3 m RELATIVE POSITION

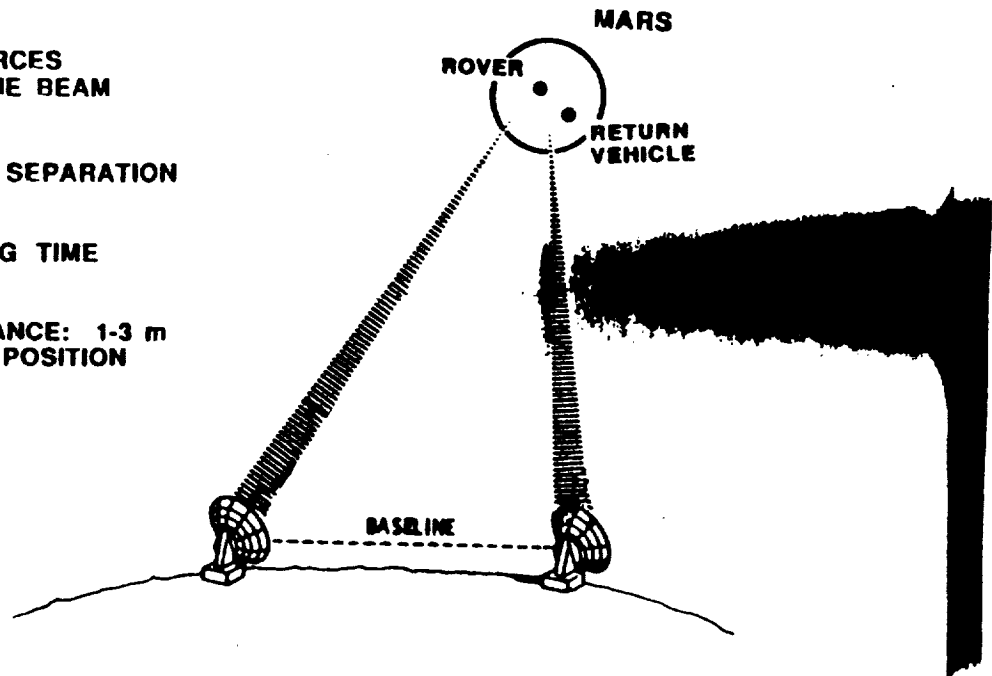

Figure A-3

JSB-6

## Accuracy vs. Wavelength

Signal	$\lambda$	Meas Error ( $\lambda/\mu\text{sec}$ )	Angular Error (1000 km) (baseline)	Position Error (1.5 AU)
120 MHz res. tone	250 cm	0.25 cm	625 prad	141 m
900 MHz res. tone	75	.075	189	42
X-band carrier	3.6	.0036	9	2
Ka-band carrier	0.9	.0009	2	1/2

JSB-7

## $\Delta$ VLBI PERFORMANCE SUMMARY

### TWO SOURCES WIDELY SEPARATED ( $\sim 10^\circ$ )

	ANGLE UNITS	AT MARS	AT JUPITER
ANGULAR POSITION	5-15 nrad*	1-4 km	7-22 km
ANGULAR VELOCITY	5 prad/sec	1.5 m/s	7.5 m/s

### TWO SOURCES ON SAME PLANET (<10 arcsec)

ANGULAR POSITION	3-10 prad	1-3 m	5-15 m
ANGULAR VELOCITY	0.1 prad/s	3 cm/s	15 cm/s

\*Projected, 1990

ORIGINAL PAGE IS  
OF POOR QUALITY

JSB-8

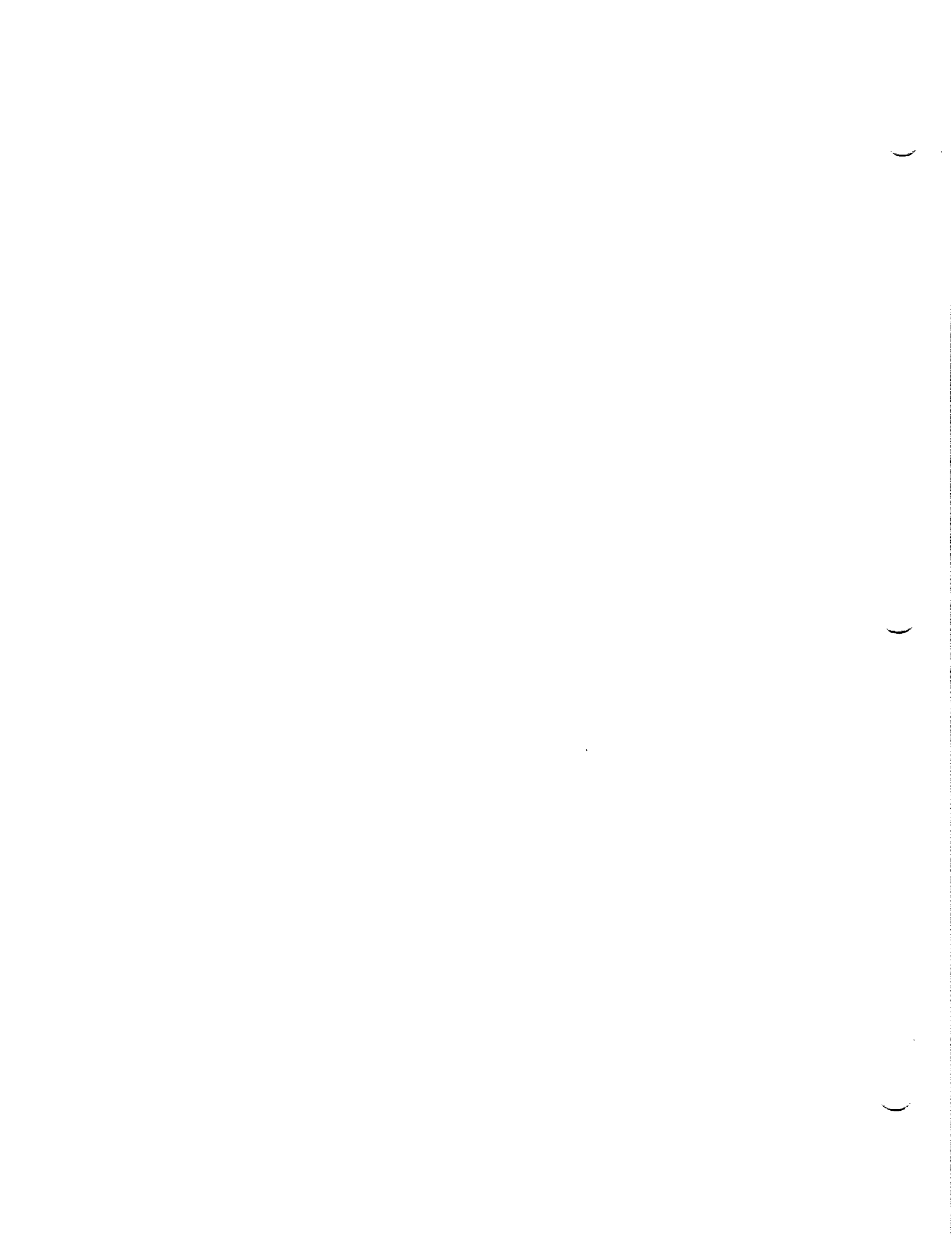



APPENDIX A

TECHNOLOGY PLANNING WORKSHEETS

TECHNOLOGY PLANNING WORKSHEET

WORKING GROUP: Global Navigation REFERENCE(S): \_\_\_\_\_  
DATE: 4/30/87 TIME: 12:00 Noon

TECHNOLOGY: Gravimetry

KEYWORDS: Gravimetry Gradiometer

RELATED TECHNOLOGIES: \_\_\_\_\_

DESCRIPTION: Very accurate measurements of a <sup>vector</sup> gravity magnitude are provided by the gravimeter. A gradiometer provides a very accurate measure of the ~~tensor~~ 3x3 Gravity gradient matrix.

STATUS: Gravimeter is in-hand; was used on Apollo Lunar Rover. Gradiometer needs further development including miniaturization.

PROGRAMS/EXPERTISE: \_\_\_\_\_

MRSR MISSION DRIVERS: \_\_\_\_\_

MRSR APPLICATION ISSUES: \_\_\_\_\_

ORIGINAL SOURCE  
OF POOR QUALITY

TECHNOLOGY PLANNING WORKSHEET

WORKING GROUP: GLOBAL NAV REFERENCE(S): \_\_\_\_\_

DATE: \_\_\_\_\_ TIME: \_\_\_\_\_

TECHNOLOGY: GRAVITY GRADIOMETER

KEYWORDS: GRAVIMETRY, INERTIAL NAVIGATION

RELATED TECHNOLOGIES: gyroscopes, accelerometers

DESCRIPTION: Device to measure gradient of gravity. Currently too large - needs miniaturization. Several approaches (Draper Lab, Bell Aerospace, others).

STATUS: 4 yrs development, 2 yrs implementation

PROGRAMS/EXPERTISE: Navy inertial navigation of submarines

MRSR MISSION DRIVERS: Not enabling - can enhance navigation, can provide gravity science

MRSR APPLICATION ISSUES: weight, expense, schedule

ORIGINAL PAGE IS  
OF POOR QUALITY

TECHNOLOGY PLANNING WORKSHEET

WORKING GROUP: Global Navigation REFERENCE(S): \_\_\_\_\_  
DATE: 4/30 TIME: 12:00

TECHNOLOGY: High performance Accelerometer

KEYWORDS: Tunneling Electron, Accelerometer

RELATED TECHNOLOGIES: Tunneling electron microscope

DESCRIPTION: Miniature accelerometer based on tunneling current sensing of micro deflections of calibrated sensor element!

STATUS: Funding needed to demonstrate accuracies

PROGRAMS/EXPERTISE: \_\_\_\_\_

MRSR MISSION DRIVERS: Mass, Lifetime, Accuracy  
Not needed - current technology good enough

MRSR APPLICATION ISSUES: \_\_\_\_\_

1987 TECHNOLOGY PLANNING WORKSHOP  
FOR THE MARS ROVER

TECHNOLOGY PLANNING WORKSHEET

WORKING GROUP: \_\_\_\_\_ REFERENCE(S): \_\_\_\_\_

DATE: \_\_\_\_\_ TIME: \_\_\_\_\_

TECHNOLOGY: High performance accelerometer

DEVELOPMENT FORECAST:

DATE	MILESTONE/COMMENTS	1998-LAUNCH			2000-LAUNCH		
		\$.K FUND.	TECH. LEVEL	DATE ERROR	\$.K FUND.	TECH. LEVEL	DATE ERROR
1988			100				
1989	Feasibility/Design study		150				
1990			200				
1991	Breadboard		200				
1992			200				
1993	Brassboard		250				
1994							
1995							**
1996							
1997							

\* NOTE: Technology selection cut-off date for a 1998-launch mission.

\*\* NOTE: Technology selection cut-off date for a 2000-launch mission.

TECHNOLOGY PLANNING WORKSHEET

WORKING GROUP: Global Navigation REFERENCE(S): \_\_\_\_\_  
DATE: 4/30/87 TIME: 11:20

TECHNOLOGY: Multi-Function Tracker

KEYWORDS: Star tracker, Target tracker

RELATED TECHNOLOGIES: CCD imagers

DESCRIPTION: Tracker (stabilized, pointable) for  
obtaining star fixes, moons position, Earth  
relative pointing for communication (optical comm),  
orbiter location, terrain/star scenes, etc

STATUS: Flight ready CCD Tracker, 1 arcsec accuracy.

PROGRAMS/EXPERTISE: ASTROS I, Planetary ASTROS II

MRSR MISSION DRIVERS: Surface navigation support,  
optical communication

MRSR APPLICATION ISSUES: \_\_\_\_\_

TECHNOLOGY PLANNING WORKSHEET

WORKING GROUP: \_\_\_\_\_ REFERENCE(S): \_\_\_\_\_

DATE: \_\_\_\_\_ TIME: \_\_\_\_\_

TECHNOLOGY: Multi-Function Tracker

DEVELOPMENT FORECAST:

DATE	MILESTONE/COMMENTS	1998-LAUNCH			2000-LAUNCH		
		\$,K FUND.	TECH. LEVEL	DATE ERROR	\$,K FUND.	TECH. LEVEL	DATE ERROR
1988			200 k				
1989	Low mass tracker design		200 k				
1990			250 k				
1991	multifunction Tracking s/w		250 k				
1992			300 k				
1993	Critical Function Demo		300 k			*	
1994							
1995						**	
1996							
1997							

\* NOTE: Technology selection cut-off date for a 1998-launch mission.

\*\* NOTE: Technology selection cut-off date for a 2000-launch mission.

TECHNOLOGY PLANNING WORKSHEET

WORKING GROUP: Global Navigation REFERENCE(S): \_\_\_\_\_  
DATE: 4/30/87 TIME: 10:50 Am

TECHNOLOGY: Non-contacting odometer

KEYWORDS: Surface rate sensor, scene correlation

RELATED TECHNOLOGIES: Trailing wheel odometer,

DESCRIPTION: Electromagnetic, sonic, optical, or other method of high accuracy ground motion measurement without the use of wheels.

STATUS: Industrial process rate sensors, scene correlators, dopplar rate sensors.

PROGRAMS/EXPERTISE: potentially a special case of correlation scene tracking

MRSR MISSION DRIVERS: Need for high accuracy ground relative traverse knowledge.

MRSR APPLICATION ISSUES: \_\_\_\_\_



1987 TECHNOLOGY PLANNING WORKSHOP  
FOR THE MARS ROVER

TECHNOLOGY PLANNING WORKSHEET

WORKING GROUP: Global Navigation REFERENCE(S): \_\_\_\_\_  
DATE: \_\_\_\_\_ TIME: \_\_\_\_\_

TECHNOLOGY: Non-contacting odometer

DEVELOPMENT FORECAST:

DATE	MILESTONE/COMMENTS	1998-LAUNCH		2000-LAUNCH	
		\$,K FUND.	TECH. DATE LEVEL ERROR	\$,K FUND.	TECH. DATE LEVEL ERROR
1988	Literature Search	50 k			
1989	Related Technology Survey	100 k			
1990	Sensor design concept	100 k			
1991	Breadboard	200 k			
1992	Brassboard	250 k			
1993	Critical Function Demo	250 k			
1994			*		
1995					**
1996					
1997					

\* NOTE: Technology selection cut-off date for a 1998-launch mission.

\*\* NOTE: Technology selection cut-off date for a 2000-launch mission.

TECHNOLOGY PLANNING WORKSHEET

WORKING GROUP: \_\_\_\_\_ REFERENCE(S): \_\_\_\_\_  
DATE: \_\_\_\_\_ TIME: \_\_\_\_\_

TECHNOLOGY: Non-contacting odometer

ADDITIONAL WORKSPACE:

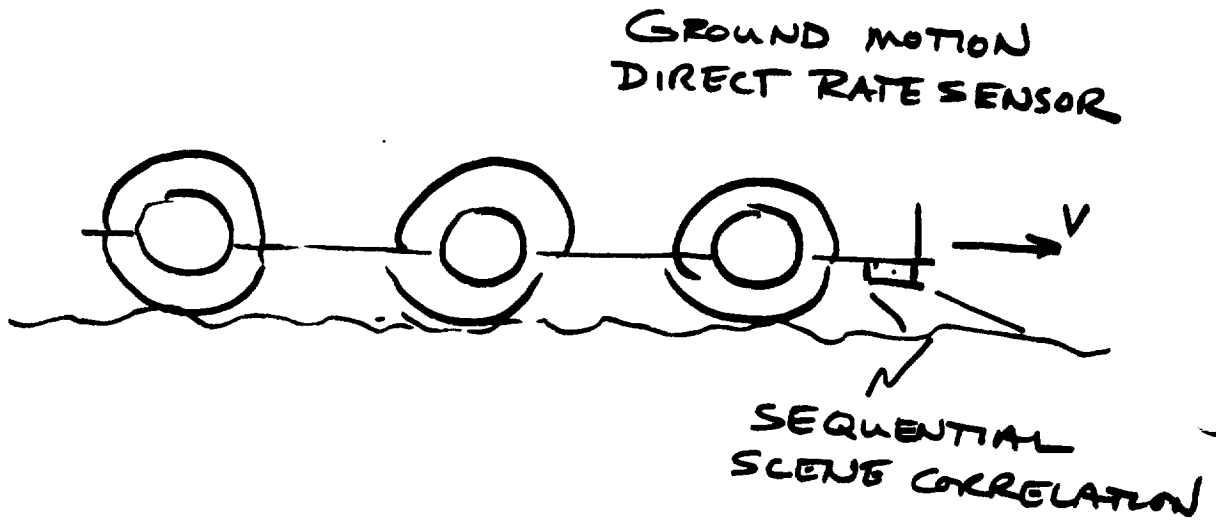

TECHNOLOGY PLANNING WORKSHEET

WORKING GROUP: Global Navigation REFERENCE(S): \_\_\_\_\_  
DATE: 4/30/87 TIME: 12:00N

TECHNOLOGY: Pendulous Gyro

KEYWORDS: Vertical gyro, local vertical, pendulous gyro

RELATED TECHNOLOGIES: Inertial Nav systems - Aircraft

DESCRIPTION: Low mass, rugged miniature pendulous gyro to provide local vertical sensing.

STATUS: existing technology - miniaturize

PROGRAMS/EXPERTISE: Adapt/qualify existing systems.  
miniaturize

MRSR MISSION DRIVERS: lifetime, accuracy

MRSR APPLICATION ISSUES: \_\_\_\_\_

TECHNOLOGY PLANNING WORKSHEET

WORKING GROUP: \_\_\_\_\_ REFERENCE(S): \_\_\_\_\_  
DATE: \_\_\_\_\_ TIME: \_\_\_\_\_

TECHNOLOGY: Pendulous Gyro

DEVELOPMENT FORECAST:

DATE	MILESTONE/COMMENTS	1998-LAUNCH			2000-LAUNCH		
		\$,K FUND.	TECH. LEVEL	DATE ERROR	\$,K FUND.	TECH. LEVEL	DATE ERROR
1988		200					
1989	Design	250					
1990		250					
1991	Brassboard	250					
1992		300					
1993	Critical Function	300		*			
1994							
1995							
1996							**
1997							

\* NOTE: Technology selection cut-off date for a 1998-launch mission.

\*\* NOTE: Technology selection cut-off date for a 2000-launch mission.

TECHNOLOGY PLANNING WORKSHEET

WORKING GROUP: GLOBAL NAVIGATION REFERENCE(S): \_\_\_\_\_

DATE: 4/30/87 TIME: 10:00 AM

TECHNOLOGY: ERECTABLE MAST WITH TV CAMERAS FOR ROVER

KEYWORDS: STEREOGRAMMETRY, CONTROL, PHOTOGRAMMETRY

RELATED TECHNOLOGIES: IMAGING SENSORS, FOLDING AND ERECTABLE STRUCTURE

DESCRIPTION: THE ROVER WILL REQUIRE A MAP OF THE AREA TO BE EXPLORED WITH A RESOLUTION OF ABOUT 1M. A FOLDED STRUCTURE RIGIDLY MOUNTED ON THE ROVER COULD BE ERECTED TO A HEIGHT OF ABOUT 6m. 4 TO 8 TV CAMERAS WOULD BE MOUNTED ON THE MAST AND POSITIONED TO VIEW THE TERRAIN IN FRONT OF AND AROUND THE ROVER. STEREO PICTURES WOULD BE TAKEN AND PROJECTED TO PORTRAY A THREE DIMENSIONAL VIEW OF THE AND <sup>VERTICAL</sup> VIEW OF THE SURFACE. THESE DATA WOULD ~~PERMIT~~ PERMIT PRECISELY LOCATE THE PATH OF THE ROVER ON THE MAP.

STATUS: MOST OF THE REQUIRED TECHNOLOGY IS <sup>WELL</sup> ADVANCED, HOWEVER RAPID STEREO PROCESSING AND CORRELATING IMAGES DOES REQUIRE ADDITIONAL DEVELOPMENT.

PROGRAMS/EXPERTISE: \_\_\_\_\_

MRSR MISSION DRIVERS: \_\_\_\_\_

MRSR APPLICATION ISSUES: \_\_\_\_\_

TECHNOLOGY PLANNING WORKSHEET

WORKING GROUP: \_\_\_\_\_ REFERENCE(S): \_\_\_\_\_  
DATE: \_\_\_\_\_ TIME: \_\_\_\_\_

TECHNOLOGY: Erectable Mast with TV Cameras for Rover

DEVELOPMENT FORECAST:

DATE	MILESTONE/COMMENTS	1998-LAUNCH			2000-LAUNCH		
		\$,K FUND.	TECH. LEVEL	DATE ERROR	\$,K FUND.	TECH. LEVEL	DATE ERROR
1988	DESIGN & DEFINITION	100k					
1989		100k					
1990	PROTOTYPE DEVELOPMENT TEST	150k					
1991		150k					
1992	FLIGHT HARDWARE	200k					
1993		200k		*			
1994							
1995							
1996							**
1997							

\* NOTE: Technology selection cut-off date for a 1998-launch mission.  
\*\* NOTE: Technology selection cut-off date for a 2000-launch mission.

TECHNOLOGY PLANNING WORKSHEET

WORKING GROUP: GLOBAL NAVIGATION REFERENCE(S): \_\_\_\_\_

DATE: 4/22/87 TIME: \_\_\_\_\_

TECHNOLOGY: Erectable Mast with TV Cameras for Rover

ADDITIONAL WORKSPACE:

EXPERIENCE WITH THE SURVEYOR AND VIKING LANDERS AND THE SOVIET  
LUJAKHOD ROVERS HAVE INDICATED THE DIFFICULTY OF CORRELATING PICTURES  
TAKEN FROM BODY MOUNTED CAMERAS WITH ~~PRO~~ VERTICAL PICTURES TAKEN  
FROM ORBIT. IN ORDER TO NAVIGATE RAPIDLY IT <sup>is important that</sup> ~~WOULD HELP IF~~ THE  
ROVER PICTURES ~~SHOULD~~ BE TAKEN FROM ALTITUDE TO MINIMIZE THE  
DISTORTION THAT MUST BE REMOVED TO CORRELATE THE ROVER IMAGES  
WITH THE ORBITER PICTURES. THUS, IF THE CAMERAS ARE MOUNTED  
ON A MAST THE PICTURES WOULD BE EASILY AND RAPIDLY RECTIFIED.

ORIGINAL PAGE IS  
OF POOR QUALITY

TECHNOLOGY PLANNING WORKSHEET

(SYNONYM)

WORKING GROUP: GLOBAL NAVIGATION REFERENCE(S): \_\_\_\_\_  
DATE: \_\_\_\_\_ TIME: \_\_\_\_\_

TECHNOLOGY: HIGH RESOLUTION TOPOGRAPHIC DIGITAL MAPS  
FROM ORBITER IMAGING

KEYWORDS: IMAGE PROCESSING, TOPOGRAPHIC MAPS

RELATED TECHNOLOGIES: ONBOARD COMPUTER SYSTEMS

DESCRIPTION: METHODS TO EXTRACT INFORMATION  
ON THE TOPOGRAPHY FROM STEREO VERTICAL  
IMAGING AND ASSOCIATED AUTOMATED  
PROCESSING

STATUS: SOME CONCEPTS AND PROTOTYPES  
EXIST - CONCEPTS MUST BE  
VERIFIED, TESTED ETC.

PROGRAMS/EXPERTISE: \_\_\_\_\_  
\_\_\_\_\_  
\_\_\_\_\_

MRSR MISSION DRIVERS: 1m MAPS WILL GREATLY  
SIMPLIFY ROVER TOUR PLANNING, NAVIGATION,  
HAZARD AVOIDANCE ETC.

MRSR APPLICATION ISSUES: \_\_\_\_\_  
\_\_\_\_\_  
\_\_\_\_\_



1987 TECHNOLOGY PLANNING WORKSHOP  
FOR THE MARS ROVER

TECHNOLOGY PLANNING WORKSHEET

WORKING GROUP: GLOBAL NAV REFERENCE(S): \_\_\_\_\_  
DATE: \_\_\_\_\_ TIME: \_\_\_\_\_

TECHNOLOGY: HIGH RESOLUTION TOPOGRAPHIC MAPS FROM  
FROM ORBITER IMAGING

DEVELOPMENT FORECAST:

DATE	MILESTONE/COMMENTS	1998-LAUNCH		2000-LAUNCH	
		\$,K FUND.	TECH. DATE LEVEL ERROR	\$,K FUND.	TECH. DATE LEVEL ERROR
1988	CONCEPTS/I.D. OF CURRENT APPROACHES		200K		
1989	DEVELOPMENT OF NEW TECHNIQUES				
1990					
1991	SIMULATIONS, ERROR ASSESSMENTS				
1992					
	FAULT TOLERANCING				
1993				*	
1994	TRANSFER TO OPERATIONAL				
1995					
	CAPABILITY				**
1996					
1997					

\* NOTE: Technology selection cut-off date for a 1998-launch mission.  
\*\* NOTE: Technology selection cut-off date for a 2000-launch mission.

1987 TECHNOLOGY PLANNING WORKSHOP  
FOR THE MARS ROVER

PAGE 1

T. LOGAN

TECHNOLOGY PLANNING WORKSHEET

WORKING GROUP: Global Navigation REFERENCE(S): Optical (Visual) Processing

DATE: 4/29/87 TIME: \_\_\_\_\_

TECHNOLOGY: On-board computer Data Integration and topographic  
Information Extraction (CDIIE)

KEYWORDS: Image Processing, Photogrammetry, Neural Net Computer, database, topography

RELATED TECHNOLOGIES: Image Processing, Photogrammetry, Neural Net Computers,  
Spatial data integration and fusion

DESCRIPTION: CDIIE is a massive spatial database system which uses an  
advanced neural net computing architecture to integrate local and regional topographic  
position and elevation data (X, Y, Z values) in real time, continuously updating its  
topographic database, producing increasingly higher detailed maps of its environment.

STATUS: Active D&D work in this area. Need parallel NASA work to  
address the rover's specific requirements. Neural Net technology readiness  
of level 5 more likely in 1995 than 1993.

PROGRAMS/EXPERTISE: \_\_\_\_\_

MRSR MISSION DRIVERS: Maximize the rover's autonomy by minimizing  
earth-base supervision of local path selection, time utilization, and resource  
(power) utilization. Topographic science objectives also maximized

MRSR APPLICATION ISSUES: \_\_\_\_\_

1987 TECHNOLOGY PLANNING WORKSHOP  
FOR THE MARS ROVER

TECHNOLOGY PLANNING WORKSHEET

WORKING GROUP: Global Navigation REFERENCE(S): Optical (visual)  
 DATE: 4/29/87 TIME: \_\_\_\_\_  
 TECHNOLOGY: CDIFF

DEVELOPMENT FORECAST:

DATE	MILESTONE/COMMENTS	1998-LAUNCH		2000-LAUNCH	
		\$,K FUND.	TECH. DATE LEVEL ERROR	\$,K FUND.	TECH. DATE LEVEL ERROR
1988	Requirements Definition & Technology Identification	200			
1989	System Design & Preliminary Testings	200			
1990		200			
1991	Experimental Design & Demonstration	300			
1992		300			
1993	Implementation of Technology, Readiness	200			*
1994		200			
1995		200			**
1996					
1997					

\* NOTE: Technology selection cut-off date for a 1998-launch mission.  
 \*\* NOTE: Technology selection cut-off date for a 2000-launch mission.

TECHNOLOGY PLANNING WORKSHEET

WORKING GROUP: Global Navigation REFERENCE(S): Billingsley, Colvocoresses  
DATE: 4/30/87 TIME: 9 am

TECHNOLOGY: Precision Stereogrammetry for ~~MRSR~~ Mars Rover Sites

KEYWORDS: Vertical Control, Stereogrammetry, Photogrammetry, ~~Attitude, Ephemeris~~ Orthophotomosaic, Digital Elevation Models

RELATED TECHNOLOGIES: Imaging Sensors, On-board processing, Optics Design, Automated Stereoplotters, Geodetic Control

DESCRIPTION: The Mars Rover site needs to be mapped to 1m horizontal and  $\pm 3m$  vertical control via imagery taken from an orbiting camera prior to landing for site certification/ descent guidance and route planning. Earth based and orbital ~~systems~~ platforms have precise ephemeris and ground control points to adjust imagery control nets for 6 degrees of freedom. MRSR orbiter would not have this. Therefore, accurate pointing data required for useful ~~and~~ elevation models must utilize alternative techniques to independently (page 3)

STATUS: Predominantly paper studies, some computer studies. Lack of technologists available to address problem, however this has not been a specific issue within earth oriented photogrammetry.

PROGRAMS/EXPERTISE: Stereogrammetry has not been of interest to NASA since Apollo mission. Expertise lies with USGS, DMA. NASA has funded some ~~not~~ relevant studies 5-10 years ago. viz Attitude Tracker.

MRSR MISSION DRIVERS: (1) High resolution imagery controlled horizontally and able to derive a digital elevation model to sufficient accuracy required for Rover traverse planning. (2) Communication data rate could be exceedingly high if on-board processing not done to high enough precision.

MRSR APPLICATION ISSUES: No high resolution map base would severely limit Rover traverse planning & require very robust rover design. Overall mission would need to be constrained if not available.

1987 TECHNOLOGY PLANNING WORKSHOP  
FOR THE MARS ROVER

TECHNOLOGY PLANNING WORKSHEET

WORKING GROUP: Global Navigation REFERENCE(S): \_\_\_\_\_

DATE: 4/30/87 TIME: 9 am

TECHNOLOGY: Precision Stereogrammetry for Mars Rover Sites

DEVELOPMENT FORECAST:

DATE	MILESTONE/COMMENTS	1998-LAUNCH			2000-LAUNCH		
		\$,K FUND.	TECH. LEVEL	DATE ERROR	\$,K FUND.	TECH. LEVEL	DATE ERROR
1988	Requirements Analysis & Feasibility/Tradeoffs of Design Alternatives	200k/yr			200k/yr		
1989		"			"		
1990	Breadboard tests on Airborne platforms	400k/yr			400k/yr		
1991	On Board Processing	"			"		
1991	Ground Processing of Orthophotomosaic	"			"		
1992	Detailed Design/Precision Analysis	"			"		
1993	Data compression, Associative Memory Chips Applied to Problem	"			"		
1994				*	"		
1995					"		**
1996							
1997							

\* NOTE: Technology selection cut-off date for a 1998-launch mission.

\*\* NOTE: Technology selection cut-off date for a 2000-launch mission.

TECHNOLOGY PLANNING WORKSHEET

WORKING GROUP: Global Navigation REFERENCE(S): \_\_\_\_\_

DATE: 4/30/87 TIME: 9 am \_\_\_\_\_

TECHNOLOGY: Precision Stereogrammetry for Mars Rover Site

=====

ADDITIONAL WORKSPACE:

Description cont.: compensate for an "unstable" platform. Technologies that should adequately address this problem have been ~~addressed~~ implemented primarily at paper study and computer simulation levels.

These include: (1) combination wide and narrow field cameras base sighted, with use of wide field images to ~~locate~~ position high resolution images. This approach was rejected as too costly for Galileo mission.

- (2) Splitting the image with mirrors to achieve a simultaneous fore and aft image on the same focal plane to obtain stereo effect. (see Colvaresseses article)
- (3) Use of an attitude tracker (see article by F.C. Billingsley) to dynamically compute attitude relative to planetary surface.
- (4) Use of adaptive chip ~~and~~ segment matching to co-register images along side-lap between orbital passes. This would be done on Earth, not in Mars orbit.

1987 TECHNOLOGY PLANNING WORKSHOP  
FOR THE MARS ROVER

PAGE 1

TECHNOLOGY PLANNING WORKSHEET

WORKING GROUP: GLOBAL NAV (SYNNOH) REFERENCE(S): \_\_\_\_\_  
DATE: \_\_\_\_\_ TIME: \_\_\_\_\_

TECHNOLOGY: ROVER CAMERA SCENE CORRELATION

KEYWORDS: IMAGE PROCESSING, ONBOARD COMPUTERS, AI

RELATED TECHNOLOGIES: \_\_\_\_\_

DESCRIPTION: DEVELOP THE ~~SCENE~~ SCENE  
CORRELATING OR MATCHING TECHNIQUES  
OR ALGORITHMS TO ALLOW THE  
ROVER TO MEASURE ITS POSITION  
~~WITH~~ FROM ONE OR A FEW PICTURES,  
AND DO IT AUTONOMOUSLY

STATUS: SOME DOD WORK MAY EXIST. THE  
FIELD MUST BE REVIEWED.

PROGRAMS/EXPERTISE: \_\_\_\_\_

MRSR MISSION DRIVERS: UNATTENDED PATH/TIME INTERVALS  
FOR ROVER MOTION MAY BE SIGNIFICANTLY  
EXTENDED IF PICTURE BASED VERIFICATIONS  
OF INERTIAL NAVIGATION ESTIMATES IS POSSIBLE

MRSR APPLICATION ISSUES: \_\_\_\_\_

1987 TECHNOLOGY PLANNING WORKSHOP  
FOR THE MARS ROVER

TECHNOLOGY PLANNING WORKSHEET

WORKING GROUP: GLOBAL NAV REFERENCE(S): \_\_\_\_\_  
DATE: \_\_\_\_\_ TIME: \_\_\_\_\_

TECHNOLOGY: Rover Camera Scene Correlation

DEVELOPMENT FORECAST:

DATE	MILESTONE/COMMENTS	1998-LAUNCH			2000-LAUNCH		
		\$,K FUND.	TECH. LEVEL	DATE ERROR	\$,K FUND.	TECH. LEVEL	DATE ERROR
1988	CONCEPTS DEVELOPED AND/OR GATHERED;		200				
1989			200				
1990	NECESSARY NEW TECHNIQUES DEVELOPED, CODED ETC						
1991							
1992							
1993	SIMULATIONS VERIFICATION;						
1994				*			
1995	TRANSFER TO ONBOARD COMPUTER ETC						**
1996							
1997							

\* NOTE: Technology selection cut-off date for a 1998-launch mission.  
\*\* NOTE: Technology selection cut-off date for a 2000-launch mission.



1987 TECHNOLOGY PLANNING WORKSHOP  
FOR THE MARS ROVER

PAGE 1

## TECHNOLOGY PLANNING WORKSHEET

WORKING GROUP: Global Navigation REFERENCE(S): 1) VIKING LANDER STATION LOCATION  
 DATE: 4-24-87 TIME: 3:30 PM 2) LUNAR STATION LOCATION BY LUNAR LASER RANGING,

TECHNOLOGY: ROVER LOCATION AND NAVIGATION USING  
DOPPLER AND RANGE MEASUREMENTS

KEYWORDS: ROVER NAVIGATION; DOPPLER; RANGING

RELATED TECHNOLOGIES: SIX TRANSPONDER - TELECOMMUNICATIONS -

DESCRIPTION: USE DSN TO DIRECTLY COMMUNICATE WITH THE LANDER  
AND ROVER (AS WELL AS SIC) AND MEASURE TWO-WAY OR  
ONE-WAY DOPPLER. MEASUREMENTS MAY BE REQUIRED  
FROM SEVERAL STATIONS SIMULTANEOUSLY AND DIFFERENCED  
DATA TYPES MAY BE NECESSARY. THE PRECISION OF THE ROVER  
LOCATION SHOULD BE IN THE 10-1000 METER RANGE BUT NUMERICAL  
STUDIES WILL BE NECESSARY TO CONFIRM THIS. BASIC TECHNOLOGY  
ALREADY EXISTS BUT ENHANCEMENTS MAY BE NECESSARY TO  
SATISFY PRECISION REQUIREMENTS.

STATUS: (1) LOCATION OF FIXED STATION ON MARS' SURFACE ACCOMPLISHED  
DURING VIKING MISSION. (2) LOCATION OF CORNER REFLECTORS ON  
MOON BY LUNAR-LASER RANGING ON-GOING AND ALREADY  
DEMONSTRATED

PROGRAMS/EXPERTISE: \_\_\_\_\_

MRSR MISSION DRIVERS: 1- This proposal or concept is driven by the need to determine  
the absolute or relative position of the rover.

2- TECHNOLOGY NEEDS ENHANCEMENTS NOT OVERALL  
DEVELOPMENT — TECHNOLOGY: X-BAND TRANSPONDER  
(POSSIBLY KA BAND?)

MRSR APPLICATION ISSUES: 1- LOCATION OF SURFACE ROVER AND FIXED LANDER  
2- SCIENCE APPLICATION FOR LONG-TERM (YRS.) DATA ACQUISITION FROM  
A BEACON (ROVER OR FIXED LANDER) (i.e. MONITOR MARS' ROTATION AND  
VARIATION, OTHER GEOPHYSICS, LONG TERM MONITOR OF PLANETARY  
MOTION (HAS MANY IMPLICATIONS).

1987 TECHNOLOGY PLANNING WORKSHOP  
FOR THE MARS ROVER

TECHNOLOGY PLANNING WORKSHEET

WORKING GROUP: GLOBAL NAV REFERENCE(S): \_\_\_\_\_  
DATE: 4-30-87 TIME: \_\_\_\_\_

TECHNOLOGY: ROVER NAVIGATION ...

DEVELOPMENT FORECAST:

DATE   MILESTONE/COMMENTS	1998-LAUNCH		2000-LAUNCH	
	\$,K FUND.	TECH. DATE LEVEL ERROR	\$,K FUND.	TECH. DATE LEVEL ERROR
1988 1) TRANSPONDER DEVEL (NEED INPUT OF TELECOM ENG.) 2) SIMULATION AND ANALYSIS →	200K			(same as 1998 LAUNCH)
1989 COMPLETE ANALYTICAL/NUMERICAL STUDY (ACCURACY ASSESSMENT)	200K			
1990 EXAM ENHANCEMENTS TO BASIC APPROACH (i.e. diff. track data, better quality ...)	200K			
1991				
1992				
1993				
1994				
1995				
1996				**
1997				

\* NOTE: Technology selection cut-off date for a 1998-launch mission.

\*\* NOTE: Technology selection cut-off date for a 2000-launch mission.

1987 TECHNOLOGY PLANNING WORKSHOP  
FOR THE MARS ROVER

PAGE 3

## TECHNOLOGY PLANNING WORKSHEET

WORKING GROUP: GLOBAL- NAV REFERENCE(S): \_\_\_\_\_  
DATE: 4-30-87 TIME: \_\_\_\_\_TECHNOLOGY: ROVER LOCATION AND NAVIGATION USING  
DOPPLER AND RANGE MEASUREMENTS

## ADDITIONAL WORKSPACE:

Other related Rover Nav. Concepts are possible but must be studied or simulated to determine Rover location accuracies:

- a) S/C -to- Rover (& BACK) TRANSMISSION. This assumes that the S/C orbit is very well known (of the order of tens of meters) and the rover location is determined relative to the orbiter (possibly by on-board processing of the S/C to rover data and also on earth)

Although this concept stresses doppler <sup>and</sup> range <sup>^</sup> differences data types may also be important. Simulations and analytical analysis will determine the relative importance of various data types.

TECHNOLOGY PLANNING WORKSHEET

WORKING GROUP: Global Navigation REFERENCE(S): \_\_\_\_\_  
DATE: 4-30-87 TIME: 9:46

TECHNOLOGY: Wideband VLBI Transponder for Rover and Lander

KEYWORDS: AVLBI, Wideband Transponder, Cycle ambiguity resolution

RELATED TECHNOLOGIES: Real Time Phase Extractor, Near Real Time VLBI Data Processor

DESCRIPTION: To enable X-band VLBI cycle ambiguity resolution, which is crucial to few-meter relative navigation of the Rover, an intermediate signal bandwidth of several hundred MHz is required. This could consist simply of two monochromatic tones separated by 300-400 MHz. That bandwidth should be available at Ka-band. Resolving the ambiguity in differential phase (between tones) will be straightforward and will then allow X-band ambiguity resolution. Precise ranging capability should be incorporated for determining quickly the third position component.

STATUS: No X/Ka-band transponder is yet under development. This will require considerable extension of current transponder technology

PROGRAMS/EXPERTISE: \_\_\_\_\_

MRSR MISSION DRIVERS: Accurate determination of Rover position with respect to the Lander

MRSR APPLICATION ISSUES: \_\_\_\_\_

1987 TECHNOLOGY PLANNING WORKSHOP  
FOR THE MARS ROVER

TECHNOLOGY PLANNING WORKSHEET

WORKING GROUP: Global Navigation REFERENCE(S): \_\_\_\_\_

DATE: 4-30-87 TIME: \_\_\_\_\_

TECHNOLOGY: Wideband UHF Transponder for Rover and Lander

DEVELOPMENT FORECAST:

DATE	MILESTONE/COMMENTS	1998-LAUNCH		2000-LAUNCH	
		\$,K FUND.	TECH. DATE LEVEL ERROR	\$,K FUND.	TECH. DATE LEVEL ERROR
1988	Transponder design	200	(3)		Same
1989	Transponder design	200	(3)		Same
1990	Eng'g model dev't. and test	600	(5)		Same
1991	Eng'g model dev't. and test	600	(5)		Same
1992	Flight unit dev't	1,500	(7)		Same
1993	Flight unit dev't	1,500	(7)		Same
1994				*	
1995					**
1996					
1997					

\* NOTE: Technology selection cut-off date for a 1998-launch mission.

\*\* NOTE: Technology selection cut-off date for a 2000-launch mission.

TECHNOLOGY PLANNING WORKSHEET

WORKING GROUP: Global Navigation REFERENCE(S): \_\_\_\_\_  
DATE: 4-30-87 TIME: 9:00

TECHNOLOGY: Real Time Phase Extractor for  
Rover Navigation with Earth-Based  $\Delta$ VLBI

KEYWORDS:  $\Delta$ VLBI, Cycle ambiguity resolution, real time phase extraction

RELATED TECHNOLOGIES: wideband transponder, near real time  
VLBI Data processor

DESCRIPTION: To make the  $\Delta$ VLBI concept for Rover navigation work  
in near real time (few minute turnaround) it will be necessary to extract  
phase from multiple broadcast tones with high precision (.001 cycle)  
in real time. The extracted phases can then be sent in real time  
to a central site for final ambiguity resolution, which should take  
no more than a few minutes.

STATUS: There are existing Global Positioning System (GPS) receivers which  
perform similar functions at L-band with the required performance  
characteristics. The adaptation should be straightforward.

PROGRAMS/EXPERTISE: \_\_\_\_\_  
\_\_\_\_\_  
\_\_\_\_\_

MRSR MISSION DRIVERS: Accurate determination of Rover position with  
respect to the Lander

MRSR APPLICATION ISSUES: \_\_\_\_\_  
\_\_\_\_\_  
\_\_\_\_\_

1987 TECHNOLOGY PLANNING WORKSHOP  
FOR THE MARS ROVER

TECHNOLOGY PLANNING WORKSHEET

WORKING GROUP: Global Navigation REFERENCE(S): \_\_\_\_\_  
DATE: 4-30-87 TIME: 9:00

TECHNOLOGY: Real Time Phase Extractor for Rover Navigation with Earth-Based AULBI

DEVELOPMENT FORECAST:

DATE	MILESTONE/COMMENTS	1998-LAUNCH		2000-LAUNCH	
		\$,K FUND.	TECH. DATE LEVEL ERROR	\$,K FUND.	TECH. DATE LEVEL ERROR
1988	GPS receiver design mod.	50	(3)	Same	
1989	Receiver fab + <del>test</del> Proof of concept demo	300	(3)	Same	
1990	Final design	300	(5)	Same	
1991	} Fab & installation	800	(7)	Same	
1992					
1993				*	
1994					
1995					**
1996					
1997					

\* NOTE: Technology selection cut-off date for a 1998-launch mission.  
\*\* NOTE: Technology selection cut-off date for a 2000-launch mission.

TECHNOLOGY PLANNING WORKSHEET

WORKING GROUP: Global Navigation REFERENCE(S): \_\_\_\_\_

DATE: 4-30-87 TIME: \_\_\_\_\_

TECHNOLOGY: Rapid Turnaround Rover  $\Delta$ VLBI Processor  
=====

KEYWORDS:  $\Delta$ VLBI, Cycle Ambiguity Resolution

RELATED TECHNOLOGIES: Real Time Phase Extractor, Wideband VLBI Transponder

DESCRIPTION: To provide timely production of Rover position fixes (within a few minutes of the observations) with  $\Delta$ VLBI, the current VLBI processing system must be streamlined and automated  
\_\_\_\_\_  
\_\_\_\_\_  
\_\_\_\_\_

STATUS: Current procedures work well but are designed for 12-24 hr. turnaround. Substantial upgrading will be required to reduce this to a few minutes but the steps are well understood.

PROGRAMS/EXPERTISE: \_\_\_\_\_  
\_\_\_\_\_  
\_\_\_\_\_

MRSR MISSION DRIVERS: Short Turnaround determination of Rover position with respect to the lander  
\_\_\_\_\_  
\_\_\_\_\_

MRSR APPLICATION ISSUES: \_\_\_\_\_  
\_\_\_\_\_  
\_\_\_\_\_



1987 TECHNOLOGY PLANNING WORKSHOP  
FOR THE MARS ROVER

TECHNOLOGY PLANNING WORKSHEET

WORKING GROUP: Global Navigation REFERENCE(S): \_\_\_\_\_

DATE: 4-30-87 TIME: \_\_\_\_\_

TECHNOLOGY: Rapid Turnaround Rover AULBI Processor

DEVELOPMENT FORECAST:

DATE   MILESTONE/COMMENTS	1998-LAUNCH		2000-LAUNCH	
	\$,K FUND.	TECH. DATE LEVEL ERROR	\$,K FUND.	TECH. DATE LEVEL ERROR
1988				
1989 Processor Design	150	(3)	Same	
1990 Processor Design	150	(3)	Same	
1991 Implementation	400	(4)	Same	
1992 Implementation	400	(5)	Same	
1993 Testing & Validation	600	(7)	Same	
1994				
1995				**
1996				
1997				

\* NOTE: Technology selection cut-off date for a 1998-launch mission.  
\*\* NOTE: Technology selection cut-off date for a 2000-launch mission.

TECHNOLOGY PLANNING WORKSHEET

WORKING GROUP: Global Navigation REFERENCE(S): \_\_\_\_\_  
DATE: 30 IV 87 TIME: \_\_\_\_\_

TECHNOLOGY: Inverted VLBI and Mars GPS Navigation System

KEYWORDS: \_\_\_\_\_

RELATED TECHNOLOGIES: VLBI, GPS, TOPEX

DESCRIPTION: Utilize existing technical differential developments to provide components ~~of~~ for a Martian surface GPS utilizing GPS/PRN modulated coded L-band signals from VLBI observatories based upon Earth with antennas greater than 20 m. GPS receivers will be mounted in the return vehicle, the landing vehicle, and the Martian rover. The computer portion of the GPS receiver must be based upon the celestial mechanics of Earth-Mars system instead of the GPS satellite ephemerides. The GPS-PRN code permits transmission of system's status updates.

STATUS: Component techniques have been used operationally but in different system contexts. Level 5 or higher

PROGRAMS/EXPERTISE: \_\_\_\_\_

MRSR MISSION DRIVERS: Necessity to control motion of rover on surface with respect to the surface map used for the mission reference frames

MRSR APPLICATION ISSUES: \_\_\_\_\_

1987 TECHNOLOGY PLANNING WORKSHOP  
FOR THE MARS ROVER

TECHNOLOGY PLANNING WORKSHEET

WORKING GROUP: \_\_\_\_\_ REFERENCE(S): \_\_\_\_\_  
DATE: \_\_\_\_\_ TIME: \_\_\_\_\_

TECHNOLOGY: \_\_\_\_\_

DEVELOPMENT FORECAST:

DATE	MILESTONE/COMMENTS	1998-LAUNCH		2000-LAUNCH	
		\$,K FUND.	TECH. DATE LEVEL ERROR	\$,K FUND.	TECH. DATE LEVEL ERROR
1988	<del>This</del> Design L-band transmitter for VLBI observatory		$8 \times 10^6$		
1989	Build and test dual L-band xmitter with VLBI observatory		$5 \times 10^6$		
1990	Provide Earth-Mars Ephemeris data and reprogram Mult. channel GPS receiver prepared for TOPEX		$2 \times 10^6$		
1991	Field test VLBI-GPS Receiver system with STS		$10 \times 10^6$		
1992	Space qualify and build GPS receivers for Mars Mission		$10 \times 10^6$		
1993				*	
1994					
1995					**
1996					
1997					

\* NOTE: Technology selection cut-off date for a 1998-launch mission.

\*\* NOTE: Technology selection cut-off date for a 2000-launch mission.



1987 TECHNOLOGY PLANNING WORKSHOP  
FOR THE MARS ROVER

TECHNOLOGY PLANNING WORKSHEET

WORKING GROUP: Global Navigation REFERENCE(S): \_\_\_\_\_  
DATE: 4/30 TIME: 10:30

TECHNOLOGY: Space Qualified Real Time Phase Extractor for 'inerted VLSI'

DEVELOPMENT FORECAST:

DATE	MILESTONE/COMMENTS	1998-LAUNCH		2000-LAUNCH	
		\$,K FUND.	TECH. DATE LEVEL ERROR	\$,K FUND.	TECH. DATE LEVEL ERROR
1988					
1989	(see schedule for Earth-based ΔV LBI - add 3 years and multiply \$ by 10)				
1990					
1991					
1992					
1993			*		
1994					
1995					**
1996					
1997					

\* NOTE: Technology selection cut-off date for a 1998-launch mission.  
\*\* NOTE: Technology selection cut-off date for a 2000-launch mission.

TECHNOLOGY PLANNING WORKSHEET

WORKING GROUP: Global Navigation REFERENCE(S): \_\_\_\_\_  
DATE: 4/30 TIME: 9:30

TECHNOLOGY: Automated on board navigation processing for 'inverted AVLBI'  
=====

KEYWORDS: AVLBI, Inverted AVLBI, navigation, estimation

RELATED TECHNOLOGIES: AVLBI phase extractor,  
\_\_\_\_\_

DESCRIPTION: For 'inverted AVLBI' (Earth transmit, Mars receive) a phase difference is received from <sup>simultaneous</sup> ~~the~~ same earth based signal source at the rover and the lander. These phase measurements are then differenced to obtain a measurement of the lander-rover position vector. An on-board estimator is required to incorporate these measurements and update the estimate of the vector.  
\_\_\_\_\_  
\_\_\_\_\_

STATUS: Level 3  
\_\_\_\_\_  
\_\_\_\_\_

PROGRAMS/EXPERTISE: \_\_\_\_\_  
\_\_\_\_\_  
=====

MRSR MISSION DRIVERS: Obtain accurate relative rover lander position  
\_\_\_\_\_  
\_\_\_\_\_

MRSR APPLICATION ISSUES: \_\_\_\_\_  
\_\_\_\_\_  
=====

TECHNOLOGY PLANNING WORKSHEET

WORKING GROUP: Global Navigation REFERENCE(S): \_\_\_\_\_  
DATE: 4/30 TIME: 9:30

TECHNOLOGY: Automated on board navigational processing for inertial VLBI

DEVELOPMENT FORECAST:

DATE	MILESTONE/COMMENTS	1998-LAUNCH		2000-LAUNCH	
		\$,K FUND.	TECH. DATE LEVEL ERROR	\$,K FUND.	TECH. DATE LEVEL ERROR
1988	Functional Design	50K	(2)	Same	
1989	Detailed Design	150K	(3)	↓	
1990	(computer) Hardware selection for prototype	150K	(3)		
1991	Coding prototype	250K	(3)		
1992	Software complete	250K	(5)		
1993	Testing of prototype	250K	(6)	*	
1994	II Coding for flight computer		(6)		
1995					
1996	Test				
1997	System Test I				

\* NOTE: Technology selection cut-off date for a 1998-launch mission.

\*\* NOTE: Technology selection cut-off date for a 2000-launch mission.

TECHNOLOGY PLANNING WORKSHEET

WORKING GROUP: GLOBAL NAVIGATION REFERENCE(S): \_\_\_\_\_

DATE: 4/30 TIME: \_\_\_\_\_

TECHNOLOGY: ROVER NAVIGATION SYSTEM CONCEPTS AND ARCHITECTURE

KEYWORDS: NAVIGATION SYSTEMS

RELATED TECHNOLOGIES: INERTIAL NAVIGATION, CARTOGRAPHY, VLBI, RADIO METRICS, IMAGE CORRELATION, OPTICAL NAVIGATION, SENSORS

DESCRIPTION: There is a clear need to examine in depth the system-level issues and alternative approaches to global navigation that were discussed in the rover workshop. The range of applicability of alternative navigation concepts must be evaluated in terms of accuracy, reliability, response time, functional redundancy, operational complexity, degree of autonomy, cost effectiveness, power and mass requirements, and technology readiness. This system-level task would identify specific combinations of technologies that provide full navigation functionality, quantify the tradeoffs among them, and parameterize the range of applicability.

STATUS: LEVEL 1, INDIVIDUAL TECHNOLOGIES AT VARIOUS DEGREES OF MATURITY. INTEGRATION INTO ROVER SYSTEM CONCEPT NOT DONE.

PROGRAMS/EXPERTISE: SYSTEM ENGINEERING APPROACHES WELL DEVELOPED

MRSR MISSION DRIVERS: GLOBAL NAVIGATION ACCURACY, COST, RATE OF INFORMATION RETURN

MRSR APPLICATION ISSUES: EARTH-BASED VERSUS ONBOARD PROCESSING, DEGREE OF AUTONOMY REQUIRED/FEASIBLE, OPTICAL VERSUS RADIO METRIC METHODS FOR UPDATING INERTIAL NAVIGATION SYSTEM, INTEGRATION OF GLOBAL AND LOCAL NAVIGATION.



1987 TECHNOLOGY PLANNING WORKSHOP  
FOR THE MARS ROVER

TECHNOLOGY PLANNING WORKSHEET

WORKING GROUP: GLOBAL NAV REFERENCE(S): \_\_\_\_\_

DATE: 4/30 TIME: \_\_\_\_\_

TECHNOLOGY: ROVER NAVIGATION SYSTEM CONCEPTS AND ARCHITECTURE

DEVELOPMENT FORECAST:

DATE	MILESTONE/COMMENTS	1998-LAUNCH		2000-LAUNCH	
		\$,K FUND.	TECH. DATE LEVEL ERROR	\$,K FUND.	TECH. DATE LEVEL ERROR
1988	DEFINE ALTERNATIVE SYSTEM CONCEPTS	200		100	
1989	ASSESS APPLICABLE TECHNOLOGY CAPABILITIES	210		105	
1990	CONDUCT TRADE STUDIES	220		220	
1991	PARAMETERIZE SYSTEM APPLICABILITY	230		230	
1992				240	
1993			*		
1994					
1995					
1996					**
1997					

\* NOTE: Technology selection cut-off date for a 1998-launch mission.  
\*\* NOTE: Technology selection cut-off date for a 2000-launch mission.

TECHNOLOGY PLANNING WORKSHEET

WORKING GROUP: GLOBAL NAV REFERENCE(S): \_\_\_\_\_  
DATE: 4/30 TIME: \_\_\_\_\_

TECHNOLOGY: ROVER NAVIGATION SYSTEM CONCEPTS AND ARCHITECTURE

---

ADDITIONAL WORKSPACE:

The United States has never operated a roving vehicle on the surface of another planetary body, without the assistance of a human driver, as in the Apollo program. Thus, the remote control of the path of such a vehicle, whether the computations are performed on the vehicle or on the earth, is entirely new technology. Not only are new measurement and processing technologies required, the basic system concepts and architecture are not well understood.

With regard to the global navigation problem, the position of the rover can be kept track of by means of an onboard inertial navigation system, consisting of gyroscopes and accelerometers sensitive along all three axes, as in the case of many terrestrial vehicles. However, the accuracy of this inertially-determined position degrades rapidly with time, so that it is useful only as a short-term reference. Various radio metric techniques can be used to periodically update the inertially-determined position. With the use of conventional Doppler tracking and ranging of the rover from the Earth, it might be possible to determine its longitude and its distance from the spin axis of Mars to an accuracy of tens to hundreds of meters, with the third position component somewhat more poorly determined. With the addition of advanced Delta-VLBI techniques (not yet demonstrated), it might be possible to determine all three position components to an accuracy of meters to tens of meters. The data processing for this Delta-VLBI approach could take place on the Earth (as has always been done to date) or, conceivably, on Mars. Other possible techniques for obtaining periodic position fixes for the lander include the siting of surface landmarks with the onboard camera (the landmark locations must then be solved for as part of the determination process) and the measurement of the changes in the Doppler shift in a radio signal from the orbiter, as the orbiter moves across the Martian sky. The latter technique is the basis for the Transit satellite navigation system, which has been used for more than 20 years on the Earth. Its use on Mars, however, will require considerable modification. These and other system level issues will be addressed by the proposed task.

TECHNOLOGY PLANNING WORKSHEET

WORKING GROUP: GLOBAL NAV REFERENCE(S): \_\_\_\_\_

DATE: 4/30/87 TIME: \_\_\_\_\_

TECHNOLOGY: NAVIGATION AVIONICS OPTIMIZATION

KEYWORDS: Inertial sensors, radio-metric techniques, autonomous image correlation

RELATED TECHNOLOGIES: \_\_\_\_\_

DESCRIPTION: Determine sensitivity of landed science intensity (rate of useful new scientific data acquisition) to the several parameters of Rover navigation, such as position error growth rate vs time and space, rate and quality of update information available from various external sources, and the quality of onboard landmark recognition. Evaluate the landed mass penalty for each combination of navigation technologies to determine a cost function for technology selection versus science intensity.

STATUS: Relevant inertial sensors require qualification for space use. Radio-metric techniques have been tested experimentally. Autonomous image correlation is in conceptual design evolution.

PROGRAMS/EXPERTISE: \_\_\_\_\_

MRSR MISSION DRIVERS: Landed science package mass, total mass of Rover, diversity of landed science, efficiency and robustness of mission operations

MRSR APPLICATION ISSUES: \_\_\_\_\_

1987 TECHNOLOGY PLANNING WORKSHOP  
FOR THE MARS ROVER

TECHNOLOGY PLANNING WORKSHEET

WORKING GROUP: Global Nav. REFERENCE(S): \_\_\_\_\_  
DATE: 4/30/87 TIME: \_\_\_\_\_

TECHNOLOGY: Navigation Avionics Optimization

DEVELOPMENT FORECAST:

DATE	MILESTONE/COMMENTS	1998-LAUNCH			2000-LAUNCH		
		\$,K	TECH. DATE	FUND. LEVEL ERROR	\$,K	TECH. DATE	FUND. LEVEL ERROR
1988	Sensitivity Study Report	\$200K			\$200K		
1989							
1990	Review/Update	\$80K			\$80K		
1991							
1992	Review/Update	\$80K			\$80K		
1993							
1994	Review/Update			*	\$80K		
1995							**
1996							
1997							

\* NOTE: Technology selection cut-off date for a 1998-launch mission.

\*\* NOTE: Technology selection cut-off date for a 2000-launch mission.

APPENDIX B

SUMMARY FORMS

FUNCTION	TECHNOLOGY OPTIONS	RATIONALE	CAPABILITY "SET"
<p>Gravity <del>Gradiometry</del></p>		<p><del>More accurate inertial navigation</del> Gravity Science</p>	<p>high</p>
<p>Gravimetry</p>	<p>Gravimeter Gradiometer</p>	<p>More accurate inertial navigation &amp; Gravity science Very accurate inertial nav and gravity science</p>	<p>medium high</p>

FUNCTION	TECHNOLOGY OPTIONS	RATIONALE	CAPABILITY "SET"
Odometry	Non-driven wheel Non-contacting scanner/ground translation sensor	known technology simplicity, accuracy	Low medium/high
Star fix, Earth, moons tracking	CCD, lightweight optics	Celestial update of inertial sys. Surface location support Optical communication Earth track/point	medium/high (1 arcsec)
Inertial rate sensor	Mechanical < rotor Optical < ring laser fiber optic	Low mass/power wide dynamic range solid state - long life	all
Accelerometer	Existing Technology Potential new developments Tunneling electron sensor	Applicable Technology in place low mass, high accuracy	all medium/high
Local vertical sensing	pendulous gyro	simplicity	low/medium

FUNCTION	TECHNOLOGY OPTIONS	RATIONALE	CAPABILITY "SET"
<p>Laser ranging</p> <p>Stabilized platform/image for multifunction tracker</p> <p>Autonomous fault detection and recovery</p>	<ul style="list-style-type: none"> <li>• gimbal</li> <li>• mirror steering</li> </ul> <p>on-board knowledge based system</p>	<p>high accuracy, proximity navigation</p> <p>high accuracy star fix, Earth tracking</p> <p>rover safety</p>	<p>high</p> <p>medium/high</p> <p>medium/high</p>





FUNCTION	TECHNOLOGY OPTIONS	RATIONALE	CAPABILITY "SET"
<p>(6) Erectable Mast with TV Cameras for Recon</p>	<p>Image Sensors, Folding &amp; Erectable Structures, Control, Stereogrammetry, Photogrammetry</p>	<p>Experiences with previous reconns indicates the need to have <del>an</del> <sup>at</sup> the camera mounted as high as possible to permit correlation of ground images with observation/terrain images</p>	<p>ALL</p>

FUNCTION	TECHNOLOGY OPTIONS	RATIONALE	CAPABILITY "SET"
<p>Location And Navigation Of Mars Rover and Lander</p>	<p>Equip to rover and lander range and depth measurements</p>	<p>Will provide rover and lander position determination to tens of meter accuracy (wrt inertial reference frame)</p>	<p>ALL</p>

FUNCTION	TECHNOLOGY OPTIONS	RATIONALE	CAPABILITY "SET"
Meter-level position determination of Rover w.r.t. Lander	$\Delta$ VLBI between Rover and Lander supplemented with precise ranging.	Can provide few-meter determination of 3-dim vector from Rover to Lander	All

APPENDIX C

INDIVIDUAL CONTRIBUTIONS

1987 Mar 02

TO: Mars Rover Navigation Development Team  
FROM: Allan Klumpp  
SUBJECT: Thoughts on Rover Navigation

### INTRODUCTION

This document describes a spectrum of approaches for navigating a Mars rover. Rather than proposing a point design, the document sketches a variety of design components from which the components of a point design may one day be selected. The selection should be based on feasibility studies, not yet undertaken, to evaluate the components in terms of cost, performance, and other criteria to be established.

Some of the components are well known, having been used for interplanetary spacecraft navigation for many years. Others are extrapolations of existing capabilities. Some are based on previous studies. A few are new concepts.

### PROBLEM STATEMENT

Rover navigation must enable the rover to explore the Mars surface to a range of <?> km from the mother spacecraft for a period of <?> days with little chance of getting lost, stuck, or destroyed. Specific objectives are:

- o Maintain at all times knowledge of the location and attitude of the rover. Location and attitude are with respect to both the mother and Mars centered coordinates.
- o Map the region around the mother to a radius of <?> km. The map must define landmarks, hazards, terrain features, and topography. Mapping specifications are described in Section <?>. The map is transmitted to Earth (directly or via the orbiter) and is used for navigating the rover.
- o Return Mars surface samples from nearby and remote locations to the mother for local analysis and/or for return to Earth.

## COMPONENTS OF ROVER NAVIGATION

### Dead Reckoning

One of the earliest ways to navigate is using deductive reckoning, misnamed "dead" reckoning. Dead reckoning is the process of keeping track of one's location relative to some starting point by mapping each step as one proceeds from the starting point.

The rover can employ dead reckoning by means of a compass and an odometer. Possible compasses and odometers are discussed in the following sections.

### Compasses

One of the earliest and simplest navigation instruments is the magnetic compass. Although applicable to navigation on Mars, the magnetic compass lacks accuracy even on Earth where the magnetic field is far stronger than on Mars, and it suffers from interference by the magnetic field produced by the rover.

Gyrocompassing is the process of determining the direction of the planetary pole as the direction of the measured planetary rotation vector. Any of a variety of gyroscopic sensors can be used, including spinning wheels or laser gyros. Latitude can be measured as the angle between the sensed vertical and the pole, minus  $\pi/2$ .

### Odometers

An odometer can use measurements of the rotation of a wheel. The wheel may be one of the rover's drive wheels or a coasting or "fifth" wheel. Errors in measuring wheel rotation can result from skidding and from highly sloping local terrain, such as boulders, walls, or other obstacles.

Odometers based on stereoscopic measurements of distances to visible terrain features (see below) may provide greater accuracy. Errors result from the finite dimensions of the features as they are viewed from a variety of directions.

### Inertial Navigation

Inertial navigation is essential measuring the short-term movements and the slope of the local terrain. The inertial system is likely to comprise an array of gyroscopes and accelerometers. With today's technology, the cumbersome gimbaled systems should not be necessary. Instead, a strapdown system should utilize the onboard computer to keep track of the position and attitude of the rover with respect to the local vertical and with respect to the mother.

### Stereoscopic Triangulation

Stereoscopic cameras mounted to provide the largest possible baseline can be used to measure the distance to reference landmarks by measuring the parallax.

### Star Tracking

The cameras must have sufficient sensitivity to sense stars in daytime. Precise measurements of the directions to identifiable stars can be used for many purposes, including:

- o The directions to two known stars define a celestial coordinate system. Relating celestial and Mars-centered provides compass information.
- o By relating compass and vertical information, latitude is determined.
- o By relating celestial, vertical, and chronometer data, longitude is determined.

### Orbiter Beacon Tracking

The orbit of the Mars orbiter can be precisely known by a combination of tracking from Earth and by tracking an orbiter beacon from the mother. The rover's location relative to the mother and the orbiter can be measured by tracking the orbiter beacon from the rover and comparing rover and mother measurements.

### Landmark Tracking

Once a map of the terrain is generated, the rover can track known landmarks to navigate relative to the mother. Although this navigation is no more accurate than the mapped landmarks, landmark tracking can be used for homing in while returning to the mother.

### Reflector Tracking

A pattern of reflectors on the mother can be used in much the same way as it is for rendezvous and docking in space. A laser sensor measures the range to individual reflectors by measuring the round-trip light time, and the direction by measuring the location of the reflector image on a CCD. Range can be measured to submillimeter precision.

Measurements of the range and direction to the individual reflectors determines the position and attitude of the rover with respect to the mother. Preliminary studies by Noble Nerheim and others at JPL show that these data can be measured to great accuracy at a range of tens of kilometers, using lasers and reflectors of reasonable power and size.



Each reflector is a corner cube. Individual reflectors can be identified in a number of ways. One way is to place the reflectors in a pattern whose geometry variations define individual reflectors. Another way is to place each reflector behind a spectrally coded filter.

## SOME THOUGHTS ON ROVER NAVIGATION REQUIREMENTS

S. Symonett

To try to get a feel for how the scientists would look at the problem of specifying navigation requirements for a roving mission I called Hal Masursky, who really could only confirm a few general thoughts I'm sure we all have had on the subject. The scientists would like the vehicle to be capable of traversing a certain total distance in the prime mission, and also be capable of local detailed probing into interesting terrain: climbing some distance up into mountain canyons and of course back down again, circling around craters with complex debris environments, sampling at a range of radial distances from such craters, meandering up flow channels, etc. Masursky thought that the only sensible approach at the outset was to attempt to get NASA to acquire meter level maps of possible landing areas and environs so that the planning and Nav jobs could be done completely optically, very few surprises would have to be overcome during the roving mission by the hardware and a large number of intricate rover excursions could be planned in excruciating detail.

The MO mission of course would have to be the data gathering precursor, a role MO is currently resisting because of budget considerations of course. Clearly the planning and nav jobs are greatly different, as is the science achievable, in the two extreme scenarios for a priori data--- complete lm maps, or the current state with Viking maps and resolutions of 50m to 150m or worse. Obviously the rover and its capabilities would be considerably different in the two cases as well. Another possibility is that MO will be able to do only a partial job of imaging coverage. In this case even if the new orbiter fills in the high res imaging gaps, previously planned routes may be found traversable only with a fairly robust rover. The point is that at this stage the rover mission scenarios are very poorly constrained, and the possible nav scenarios and requirements also span a comparably wide space. Under these circumstances, our best bet would be to identify all possible navigation issues for the extreme mission types and list the solutions we would propose to solve all the nav problems, that is, write a comprehensive nav document (perhaps notable only for its lack of detailed quantitative content!).

In either case two different modes of roving are likely: a travel mode to go the next interesting place, probably taking pictures etc along the way but not stopping to sample; and the detailed exploration mode in which the vehicle intentionally gets into tight spots, picks up stuff, images the area completely, gets to the edges of abysses etc. These exploration periods may require a lot of earth interaction because the rover is in tough spots and even with lm knowledge of the area, extreme care will have to be taken. Even in the travel mode over supposedly reasonable terrain care must be taken that all hazards which could be misinterpreted in vertical imaging are assessed as the vehicle approaches them.

With high res data available a priori you can never really get lost and a few pictures will serve to reestablish the rover's location after a travel leg. But the length of long travel legs will be set by the ability to force the vehicle's path to conform to the desired path. Using inertial systems or whatever the vehicle will wander off the desired path, and the likely error buildup, caused either by hardware errors or terrain effects, will limit the allowable length of a completely blind traverse. We don't want the vehicle to wind up on the dangerous side of a feature from which it will take half a day to extricate it, etc. The reconstruction of the micropath actually traversed in this blind way may require using the rover telemetry data and the pictures acquired along the way (but not used for control). The micropath reconstruction will be desired if science data is being taken continuously. Since bit rates will be low pictures for science or recon will be few, and the detailed micro path knowledge may depend on integrating accelerometer data etc, perhaps not a 314 type of job. The pictures will of course tie the vehicle to the high res map.



DRAFT

Mars Rover Navigation Techniques

1. Rover Relative to Mother; Mother Absolute

- 1) Radio from either earth or the orbiter or both, received and used differentially at both the mother (M) and the rover (R).

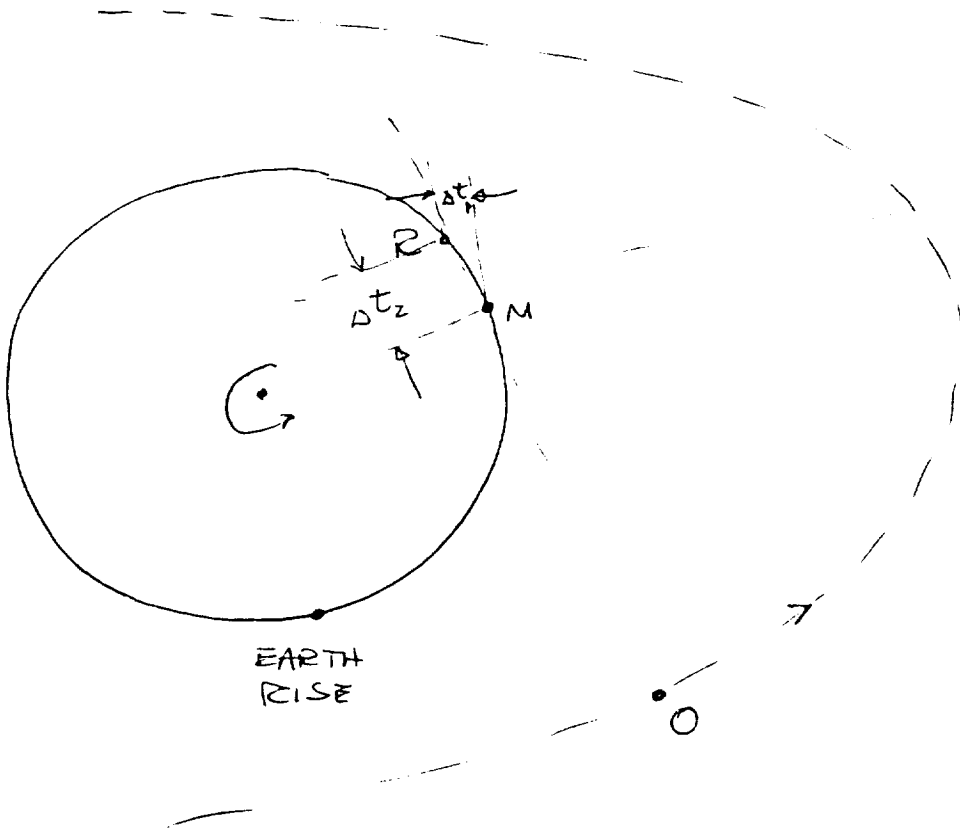
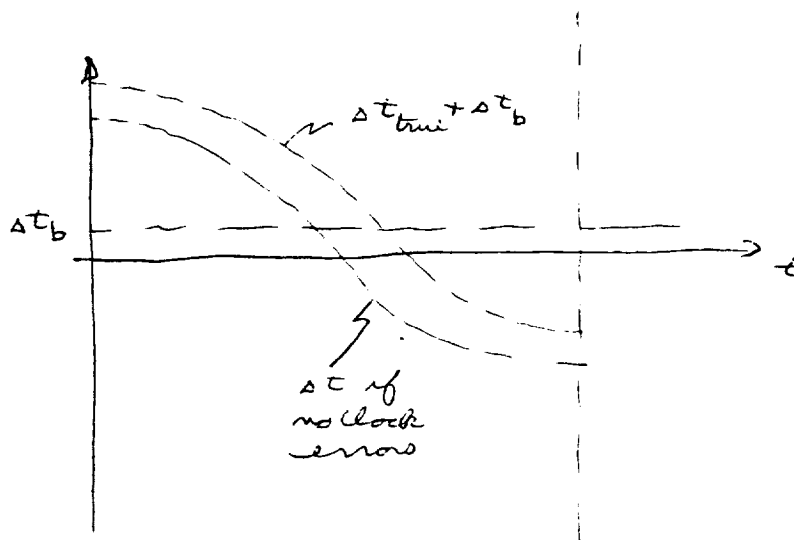

Figure (1)

ORIGINAL FILED IN  
OF POOR QUALITY

Suppose a complex code (i.e., train of well defined variations in the radio stream) were sent from earth and merely recorded, time tagged and returned to earth by both the Mother and Rover. The correlation of the two signals will give the time delay shown in Figure (1). The Mother and lander need clocks or perhaps only need to receive "beeps" from an orbiter clock. But the arrival times of the beeps will depend on the locations so an independent way of synching the clocks is needed.

The  $\Delta t$  observed from the earth data consists of a cosine term plus the clock bias  $\Delta t_b$



ORIGINAL PAGE IS  
OF POOR QUALITY

At the earth rise for example the rover clock may be advanced slightly from the mother vehicle's clock so it sees the earth pulse earlier, causing an interpretation that  $\Delta t$  and hence distance is larger than it really is. But now suppose that we can also illuminate the landers from the orbiter with a series of complex signals. The bias in the rover clock now seems to shorten the distance between them when they are at orbiter set. We should therefore be able to eliminate  $\Delta t_D$ ,

The earth or orbiter illumination should probably carry timing pulses as pictured.

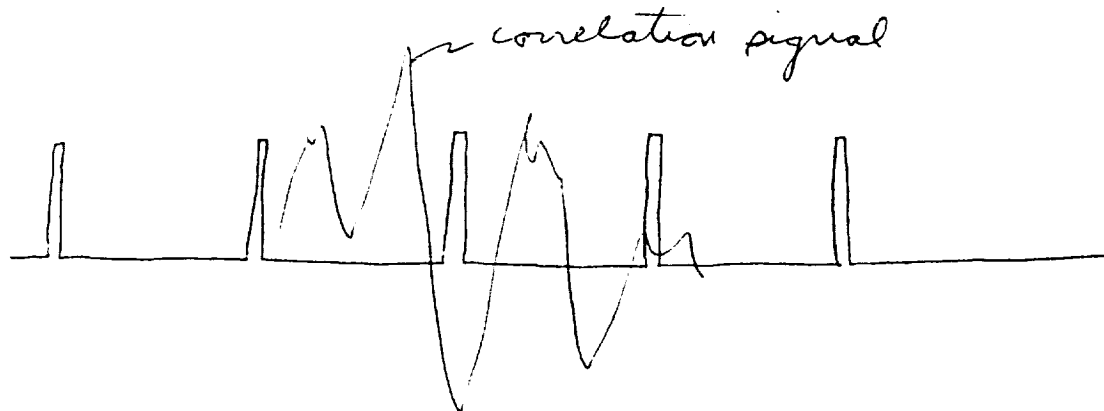

The lander clocks then can be made just smart enough to bridge a few pulse periods without drift. They need be no better.

But accuracies achievable with this approach have to be investigated.

The mother lander's position can probably be determined by earth based tracking to a few meters in a "Mars radio" frame. The orbiter's position will probably only be good to a few kilometers. But these relative locations can be tied together using pictures obtained by a combination of the orbiter and landers.

The rover can map out an area a few 10's of meters around the mother, and this large patch can then be identified in orbiter pictures good to perhaps a few to 10 meters. The optical and radio locations of the mother can then be compared to achieve at least one point in a frame tie - i.e. a tie of the picture frame to the dynamical frame.

#### 11. Rover Navigation

The method described above will give mother-relative tiepoints at a few places. The trick of mapping a local patch with the rover will also allow tiepoints to be determined in the orbiter picture data. So two of the functions of rover nav - reconstruction and safely returning to the mother - will be "anchored" considerably by these previous techniques. The problems now remaining are those of local safe route finding and reconstruction of the detailed path - i.e. control and then knowledge of the path microstructure. Here the rover onboard cameras provide the critical data.

In gross terms, the distances traveled in short bursts by the rover will be in straight lines or nearly so, and the actual direction traversed will be observed in picture data by keeping track of the locations of rocks, etc., in a series of pictures. Parallax will provide distances (although to date no detailed analyses on accuracies achievable have been attempted). But a significant problem appears to be the determination by the rover of bearing or azimuth and in fact the

specification of bearing to the rover by the controllers. How is the rover to understand or sense bearing? The rover will not have a long distance view to allow it to target itself to a distant objective. The magnetic field possibility may not be satisfactory.

Stars are an obvious possibility if a useful number of them can be detected through the daytime atmosphere. The field-of-view and the detector would have to be designed to allow orientation about the local "up" to within a few degrees.

The deviation of the actual motion from that desired is, as mentioned above, to some extent measurable by watching the cross-position of objects in the field.

The knowledge of the microstructure of the path can be refined or smoothed after the global tiepoints are nailed down, as described above.

A picture planning type of function also will be required to assess the types and volumes of pictures required to both measure the motion as it happens, and for reconstruction, perhaps including using backward looking frames.

Copy to:

AR Klumpp  
JP McDanel  
KD Mease  
D Sonnabend  
LJ Wood



## 8.7 ATTITUDE TRACKER

Fred C. Billingsley  
Jet Propulsion Laboratory, California Institute of Technology  
Pasadena, California 91109

Line array sensors produce data which has no inherent geometrical continuity. Hence, any platform attitude variation will be evidenced as a distortion when the data lines are displayed in the normal Cartesian raster. Ancillary sensing is required to establish the platform attitude to allow geometric rectification. This is normally provided by inertial or star reference attitude sensors. However, in the absence of such sensors or if performance of them is degraded, the required attitude information is lost.

A strawman sensor design is proposed which utilizes small image areas on the ground to provide a series of motion vectors with which the platform attitude can be tracked; this allows the distorted image received by the normal image line sensor to be rectified.

### THE PROBLEM

Future sensors of the linear array type will return lines of data which are independent in the sense that there is no data tie between them. It is essential for mapping and stereo work that the data lines used for analysis be in precisely the correct geometrical position. If the sensed image lines are not in the correct positions, interpolation or other compensation must be used before analysis. But there is no information in the data as planned to measure the correctness of position; position accuracy depends on platform attitude accuracy for a sufficiently long period. Anticipated spacecraft control parameters will be (marginally) adequate if all is perfect, but there is not much tolerance for degradation, nor any planned way to work around degradations. The use of ground control points will be necessary for precise tie to the ground, but will be clumsy for continued use for the stereo tracking, and, in any event, surveyed ground control points will not be available for many areas. The problem is exacerbated with an aircraft platform due to the ubiquitous attitude instability.

### WHAT IS NEEDED

What is needed is a system for analyzing the platform motion as reflected in the ground distortions, which may be used to 1) verify platform stability and 2) provide the data for correcting the geometric aspects of the image lines, either in parallel with the expected good performance of a spacecraft platform or to compensate for degraded performance. Ideally, the system would be useful on board, but ground calculations and correction would be acceptable. Maximum use should be made of the GCPs and the Global Positioning System, but the system should allow (perhaps degraded) use without these.

STRAWMAN SOLUTION

A system for providing the data for self-tracking could be designed as follows: As part of a separate sensor boresighted to the imaging sensor, a set of small square image areas of, say 64 x 64 or 128 x 128 pixels, arranged as sketched (Figure 1) is imaged on to a set of area array detectors. All are read out simultaneously into a set of memories. For each area, the displacement between it and a previous image, taken a few image lines previously is determined. The sequential set of displacement vectors may be used to model the platform attitude variations, and to generate the geometric correction parameters. The related software will have to bridge gaps in the displacement vector sequence due to clouds or other noncorrelation, and to operate in areas of terrain relief.

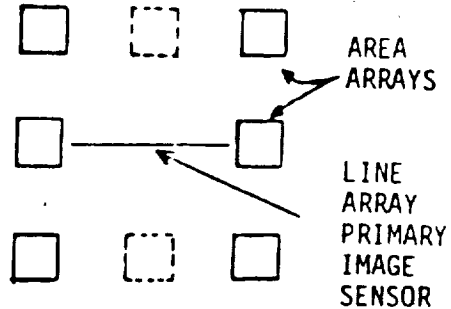
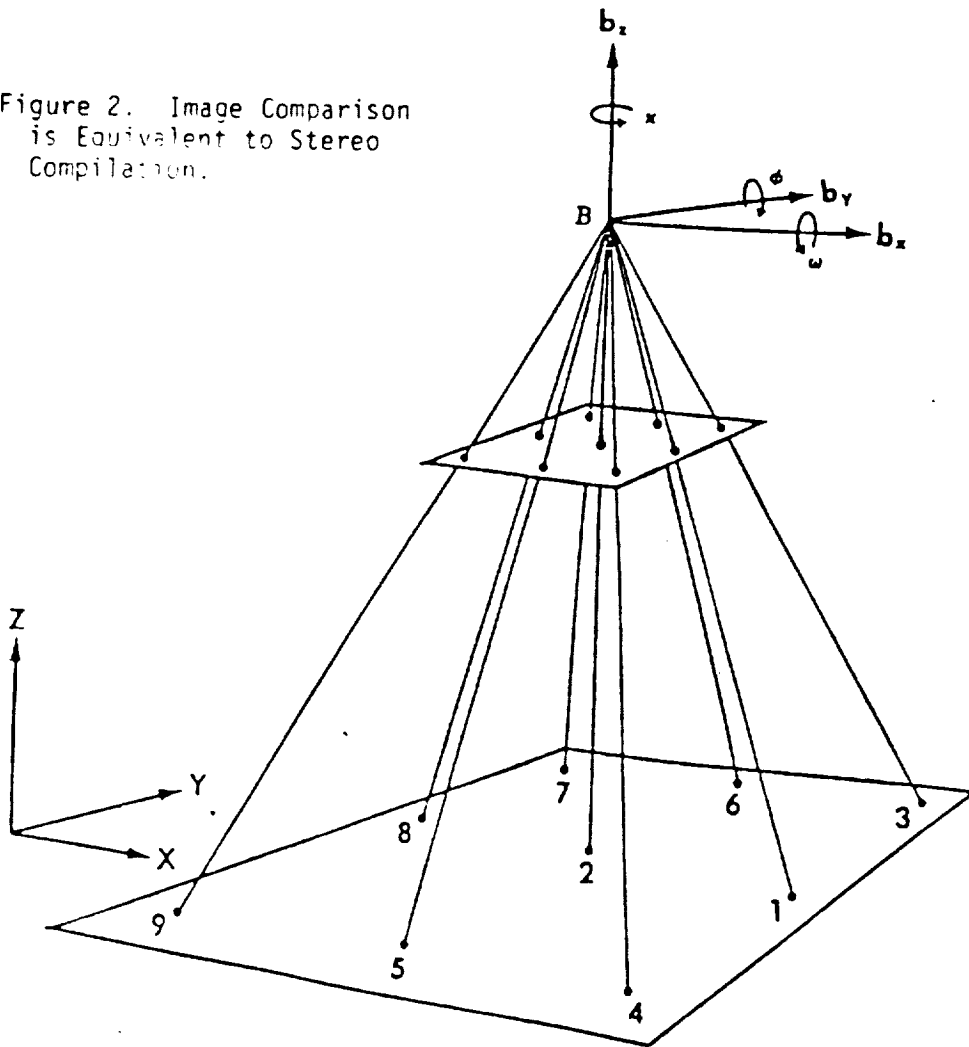

Figure 1.  
Possible  
Arrangement  
of Area  
Array Sensors

Data analysis follows the well known stereo compilation principles. The effects as seen in normal stereo compilation practice are given in Figures 2 and 3 (from D. H. Alspaugh, "Stereo Compilation and Digitizing," Proc. Latin American Technology Exchange Week, Panama City, May 1979, p. 314).

Figure 2. Image Comparison is Equivalent to Stereo Compilation.



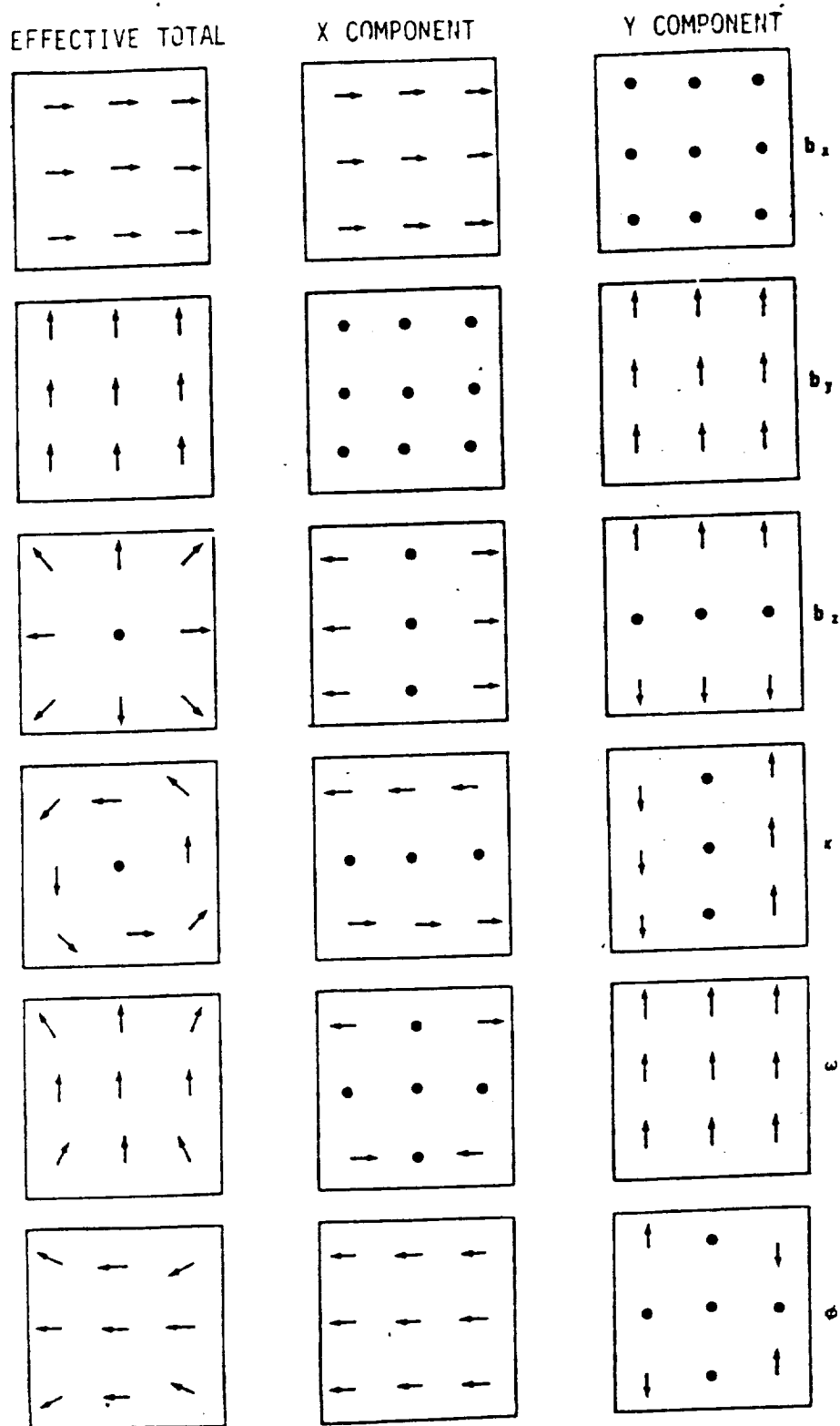

Figure 3. The Image Motion Vector Set as it Reflects Platform Motion

ORIGINAL PAGE IS  
OF POOR QUALITY

In the eventual instrument, the data processing would be self-contained (Figure 4), so that only the derived attitude parameters would be transmitted or utilized.

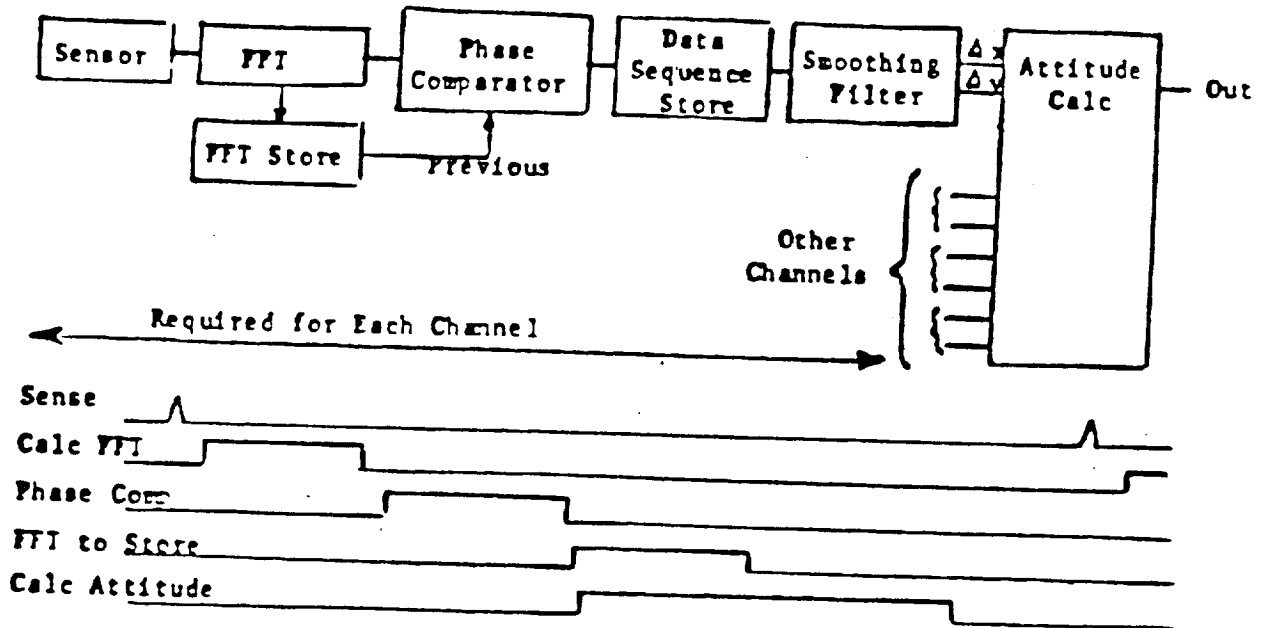

Figure 4. Data Processing Block Diagram and Timing

Lockheed<sup>(1 & 2)</sup> has built a phase plane comparator, including the FFT, which operates in 1/30 second. Incorporation of this approach could allow this part of the processing to be time-multiplexed.

1. Kuglin, C. D., Hines, D. C., "The Phase Correlation Image Alignment Method," Proc. IEEE 1975 International Conference on Cybernetics and Society, pp. 163-165.
2. Pearson, J. J., Hines D. C., Golosman, S., "Video Rate Image Correlation Processor," SPIE Vol. 119, Applications of Digital Image Processing, IOCC 1977, pp. 197-205.

It may be necessary to incorporate a LIDAR or equivalent sensor to determine the instantaneous altitude.

## 8.5 AN AUTOMATED MAPPING SATELLITE SYSTEM\*

Alden P. Colvocoresses  
U.S. Geological Survey  
National Center, Mail Stop #520  
Reston, Virginia 22092

### Abstract

Throughout the world, topographic maps are compiled by manually operated stereoplotters that recreate the geometry of two wide-angle overlapping stereo frame photographs. Continuous imaging systems such as strip cameras, electro-optical scanners, or linear arrays of detectors (push brooms) can also create stereo coverage from which, in theory, topography can be compiled. However, the instability of an aircraft in the atmosphere makes this approach impractical. The benign environment of space permits a satellite to orbit the Earth with very high stability as long as no local perturbing forces are involved. Solid-state linear-array sensors have no moving parts and create no perturbing force on the satellite. Digital data from highly stabilized stereo linear arrays are amenable to simplified processing to produce both planimetric imagery and elevation data. A satellite, called Mapsat, including this concept has been proposed to accomplish automated mapping in near real time. Image maps as large as 1:50,000 scale with contours as close as 20-m interval may be produced from Mapsat data.

### Background

The geometry of stereo mapping photographs, whether taken from aircraft or satellite, is well known and documented. Transforming such photographs into topographic maps is a relatively slow and expensive process that for many critical steps defies automation. Compared to an aircraft, a satellite offers the unique advantages of much greater stability and uniform velocity.

Utilizing these advantages, a sensing system in space can now provide imagery of mapping quality, even though a continuous electro-optical imaging system is used instead of a mapping camera with its inherent high geometric fidelity. The next generation of space sensors will include solid-state linear arrays (fig. 1) that involve no moving parts. By continuous imaging with very high geometric fidelity they will permit, at least in part, the automated mapping of the Earth from space in three as well as two dimensions. The fundamental difference between conventional and continuous stereo methods is illustrated by figure 2.

---

\* Approved for publication by Director, U.S.G.S.

At least four papers have been published that relate directly to automated three-dimensional mapping. In 1952, Katz (1) showed how height measurements could be made with a stereoscopic continuous-strip camera. The geometry of such a strip camera and stereo linear arrays is basically the same. In 1962, Elms (2) elaborated on the strip camera concept and indicated its advantages over frame cameras as a possible component of an automated mapping system. In 1972, Helava and Chapelle (3) described the development of instrumentation by which a conventional stereomodel can be scanned using the epipolar-plane\* principle, and thus reducing image correlation from a two-dimensional to a basically one-dimensional task.

In 1976 Scarano and Brumm (4) described the automated stereo-mapper AS-11B-X which utilizes the epipolar-scan concept and one-dimensional digital image correlation described by Helava and Chapelle. Thus the concept of reducing photogrammetric data stereo correlation from two to one dimension is well established. The cited literature, however does not describe the possibility of imaging the Earth directly in stereoscopic digital form suitable for one-dimensional processing.

Beginning in 1977 a serious effort to define a stereo satellite or Stereosat (5) was undertaken by NASA. The Stereosat concept calls for linear-array sensors, looking fore, vertical and aft, but its principal objective is to provide a stereoscopic view of the Earth rather than to map it in automated mode. There are other ways of obtaining stereo imagery with linear arrays. The French SPOT (6) satellite can look left or right of the track and thus achieves stereo by combining imagery from nearby passes of the the satellite. NASA's Multispectral Linear Array (MLA) concept (7), as so far defined, calls for fore and aft looks through the same set of optics by use of a rotating mirror. However, neither the SPOT nor NASA's MLA approach are considered optimum for stereo mapping of the Earth, as neither is designed to acquire data in continuous form.

#### Mansat Geometric Concept

Linear arrays represent a relatively new remote sensing concept. Five papers on this subject were presented at the ASP/ACSM annual convention during March 1978 (8,9,10,11,12). These papers concentrated on detector

\*An epipolar plane is defined by two air or space exposure (imaging) stations and one point on the ground.

technology and the application of linear array sensors in a vertical imaging mode. Welsh (13) recently described the geometry of linear arrays in stereo mode, although his error analysis for such a system is based on measurements made from images rather than computations based on the digital data.

By combining the technology of linear arrays, the concept of epipolar-plane scanning, and the experience gained from Landsat and other space sensing systems, Mapsat was defined (14), and its proposed parameters are listed in Table 1. The Mapsat concept was the work of several individuals, but perhaps the single most important contribution was that of Donald Light (verbal communication), then of the Defense Mapping Agency, who first suggested that epipolar planes, as described by Helava (3) and used in the AS-11B-X plotter, could be achieved directly from space and that topographic data might then be extracted in real time. There are several feasible configurations by which linear array sensors can continuously acquire stereo data. It was decided that the system must permit selection from the three spectral bands, provide for two base-to-height ratios of 0.5 and 1.0 and be compatible with the epipolar concept. Figure 3 illustrates the configuration selected to accomplish the stereoscopic as well as monoscopic functions.

Acquiring stereo data of the Earth in epipolar form directly from space is the fundamental geometric concept of Mapsat. The epipolar conditions shown in Figure 4 implies that five points--the observed ground point P, the two exposure stations S and S', and the two image detectors f and a--lie in a single plane. If this epipolar condition is maintained as the satellite moves along its orbit, every point P observed by detector f in the forward looking array will also be observed subsequently by detector a in the aft looking array. Thus image correlation can be obtained by matching the data stream from detector f with that from a--a one-dimensional correlation scheme. This description applies equally to the use of the vertical with either the fore-or aft-looking array but involves a weaker (0.5) base-to-height ratio than the described use of the fore and aft arrays (base-to-height ratio of 1.0). In practice the data streams from more than one detector may be involved since there will normally be some offset in the path of a given pair of detectors. Moreover under certain conditions, correlation may be improved by a limited expansion of the correlation function to two dimensions.

ORIGINAL PAGE IS  
OF POOR QUALITY

Because each detector array is looking at a different portion of the Earth at any given time, Earth rotation complicates the epipolar condition. As shown in figure 5, this complication can be overcome by controlling the spacecraft attitude. This description is obviously simplified; further complications involve such factors as the ellipsoidal shape of the Earth, variations in the orbit, spacecraft stability, and even very large elevation differences. The spacecraft position and attitude must be precisely determined by such systems as the Global Positioning System (GPS or NAVSTAR) and frequent stellar referencing. Satellite attitude control involves gyros and inertial wheels, and, when a satellite is free of perturbing forces created by moving (actuated) parts, attitude can be maintained for reasonable periods to the arc-second.

Of course, the sensing system must retain precise geometric relationship to the attitude control system. Defining the correct satellite attitude and the rates in yaw, pitch, and roll to maintain the epipolar condition requires precise mathematical analysis. Two independent analyses, one by Howell of ITEK (15) and the other by Snyder (16) of U.S. Geological Survey, confirm Mapsat's geometric feasibility, and a U.S. patent has been allowed on the concept. Table 2 indicates the maximum deviations from the epipolar condition caused by the various expected error sources. This table is based on a half orbit (50 minutes) which covers the daylight portion to which imagery is basically limited. Attitude rate errors would be considerable if only corrected once every 50 minutes but, as the table indicates, 10-minute intervals based on stellar reference reduce the errors to a reasonable amount. Ten-minute stellar referencing using star sensors as described by Junkins et al., (17), is considered reasonable. Computer programs have been developed that result in the epipolar plane condition being maintained as long as adequate positional and attitude reference data are available and properly utilized. Figure 6 illustrates the simplicity of elevation determination in an epipolar plane which is the key element of Mapsat.

Obviously, the Mapsat concept can be effectively implemented only if stringent specifications regarding orbit, stability, reference, and sensor systems are met. Table 3 lists the Mapsat geometric requirements as defined to date, and each is considered to be within the state of the art.

#### Mapping Accuracy

By meeting the geometric requirements indicated and achieving stereo correlation, the resulting map accuracy is compatible with scales as large as 1:50,000 and contours as close as 20 m interval based on U.S. National Map Accuracy Standards. Reference 15 covers this analysis in some detail. Such accuracies result from the indicated geometric requirements and the following factors:



- o Linear array detectors are positioned with sub-micron accuracy.
- o Optical distortion effects, when accounted for by calibration, are negligible.
- o Atmospheric refraction, because of the steep look angles, is of a very low order and is reasonably well known; air-to-water refraction is also known where underwater depth determination is involved.
- o Relative timing, which is referenced to data acquisition, is accurate to within the microsecond.
- o Digital stereo correlation, where uniquely achieved, provides three dimensional root-mean-square (rms) positional accuracy to within half the pixel dimension.

These considerations result in relative positional errors for defined points of only 6 to 7m (rms) both horizontally and vertically. This vertical accuracy requires the 1.0 base-to-height ratio. Such accuracy is adequate for the mapping indicated but assumes that control is available for reference to the Earth's figure. As indicated by ITEK (15) and the author (19), control points of 1,000 km spacing along on orbital path will be adequate for such a purpose. Where no control exists the absolute accuracy of the resultant maps, with respect to the Earth's figure, may be in rms error by 50 to 100 m although their internal (relative) accuracy remains at the 6 to 7 m rms level.

#### Stereocorrelation

The determination of elevations from stereo data requires the correlation of the spectral response from the same point or group of points as recorded from two different positions. In the aerial photography case these two positions are the camera stations, whereas with linear arrays in space the two recording positions are constantly moving with the satellite. In the photography case, correlation is achieved by orienting the two photographs to model the acquisition geometry. Once this is done, correlation can be achieved by the human operator, or the image stereomodel can be scanned and correlated by automated comparison of the signal patterns from the two photographs. A system such as the AS-11B-X (3,4) generates one-dimensional digital data in epipolar planes from the model. In theory, epipolar data should be correlated much faster than that from a system that must search in two dimensions to establish correlation. In practice, the automated correlation of digital data has been only partially successful; and, as Mahoney (18) has recently pointed out, correlation by either manual or automated systems is still a slow and costly process. To date, no one has acquired original sensor data in epipolar form. Thus, no one can really say how well such data can be

ORIGINAL PAGE IS  
OF POOR QUALITY

automatically correlated, until a satellite such as Mapsat is flown. Simulation using digitized aerial photographs or linear-array stereo-sensing of a terrain model are relevant experiments worth conducting. However, they will provide only partial answers, since the degree of correlation will depend on the area involved. The characteristics of the Earth's surface, coupled with related conditions, such as the atmosphere and Sun angles, are highly varied; which means that the degree of correlation will also be highly varied. This problem does not imply that the Mapsat concept has not been validated. Having stereo data organized in linear digital form is of obvious advantage to create the three-dimensional model of the Earth's surface. Many areas will correlate in one-dimensional mode, others will require two-dimensional treatment, and still other areas may not correlate at all. By properly defining the satellite parameters and data processing, the correlation function can be optimized and raised well above that obtainable from wide-angle photography systems. For example, digital data can readily be modulated to enhance contrast or edges that make up the patterns on which correlation depends. Photography can also be modulated, but it is far more difficult (and less effective) than digital-data modulation, as film lacks the dynamic range and sensitivity of solid-state detectors. Mapsat will acquire data in an optimum form for automated correlation, which will expedite the precise determination of elevations and create digital elevation data that are becoming a basic tool for many disciplines.

#### Acquisition Modes and Products

As previously described (14), Mapsat is designed to be operated in a wide variety of modes. These include variation in resolution (10-m elements on up), spectral bands, swath width, and stereo modes. Such flexibility permits optimum data acquisition without exceeding a specified data-transmission rate that is now defined at 48 megabits per second (Mb/s).

The Earth's surface is highly varied, and data product requirements are likewise highly varied. By varying the acquisition modes and, in turn, producing a variety of products, the data management problem becomes complicated as compared to existing systems such as Landsat which produces only two basic types of data. However, solving this data management problem is a small price to pay for a system that can meet a wide variety of requirements for remotely sensed data of the Earth. Only four primary products are expected from Mapsat as follows:

- (a) Raw-data digital tapes from which quick-look images can be displayed in near real time.
- (b) Processed digital image tapes calibrated both radiometrically and geometrically to a defined map projection. Such data will be two-dimensional (planimetric) but describe the Earth's radiance (brightness) in multispectral form as is now accomplished by Landsat Multispectral Scanner tapes.

- (c) Processed digital tapes, again calibrated both radiometrically and geometrically, but which now describe the Earth's surface in three dimensions (topographically) with an associated radiance value. Such tapes are, in effect, digital elevation data sets of the Earth's surface.
- (d) Standardized images, both black-and-white and in color, which include geometric corrections and radiometric enhancements. Such corrections and enhancements will be of recognized general value and of a type that can be performed without undue delay or excessive cost. The images would also be of standardized scale.

From these four basic products, a wide variety of derivatives can be made which include the following:

- (a) Black-and-white and multicolor image maps and mosaics at scales as large as 1:50,000, or even 1:25,000 (1:24,000) where map accuracy standards are not required.
- (b) Thematic displays and maps involving such subjects as land cover and land use classification.
- (c) Maps which depict the Earth's topography by such means as contours (as close as 20-m interval), slopes, elevation zones, shaded relief, and perspective display.

#### Conclusion

Mapsat will not meet all anticipated remote sensing requirements, and it will in no way replace those air-photo surveys required to meet mapping requirements for scales larger than 1:50,000 and contour intervals of less than 20 m. What it will do, is provide a precise three-dimensional multispectral model of the Earth at reasonable resolution and in digital form. Moreover, the satellite will record the changing responses of the Earth's surface as long as it is in operation.

Mapsat can be built today at what is considered to be a reasonable cost (15) as it is based on available components and technology. Moreover, it is designed for simplified operation and data processing. Assuming that an operational Earth-sensing system will be flown, surely Mapsat is a deserving candidate for such a job.

### Mapsat Parameters

- o Orbit--Same as Landsat 1, 2 and 3 (919 km alt).
- o Sensor--Linear Arrays--Three optics looking 23° forward, vertical and 23° aft. Three spectral bands:
  - blue green 0.47 - 0.57 um
  - red 0.57 - 0.70 um
  - near IR 0.76 - 1.05 um
- o Swath--180 km or portion thereof.
- o Resolution--Variable--Down to 10 m element.
- o Transmission--S (or X) band, compatible with Landsat receivers but with rates up to 48 Mb/s.
- o Processing--One dimensional, including stereo.

Table 1

Magsat Epipolar Condition  
 Maximum Deviation (+) in Half Orbit--(50 Minutes)  
 (Meters on the Ground)

Case 1. Vertical plus Case 2. Fore and  
 For or Aft--B/H = 0.5 Aft--B/H = 1.0

o Optimum condition:	1.3 m	0.3 m
o Attitude errors (yaw and pitch) of:		
10 arc seconds	0.7	1.6
100 arc seconds	5.0	12
o Attitude rate errors of:		
10 <sup>-6</sup> deg./sec.	11 (2)*	22 (4)*
10 <sup>-5</sup> deg./sec.	110 (22)*	230 (46)*
o Elevation differences of:		
1,000 m	2.3	0.5
10,000 m	22	1.8

\* ( ) Values obtained by 10 minute rather than 50 minute stellar reference intervals.

Mapsat Geometric Requirements

- o Positional Determination of Satellite--10 to 20 m<sup>1/</sup> in all three axes.
- o Pointing Accuracy--Within<sup>2/</sup> 0.1 of vertical.
- o Pointing Determination--Within<sup>2/</sup> 5 to 10 arc seconds
- o Stability of Satellite--Rotational rates within<sup>2/</sup> 10<sup>-6</sup> degrees/second.

---

1/ rms (1σ)

2/ very high probability (3σ)

Table 3

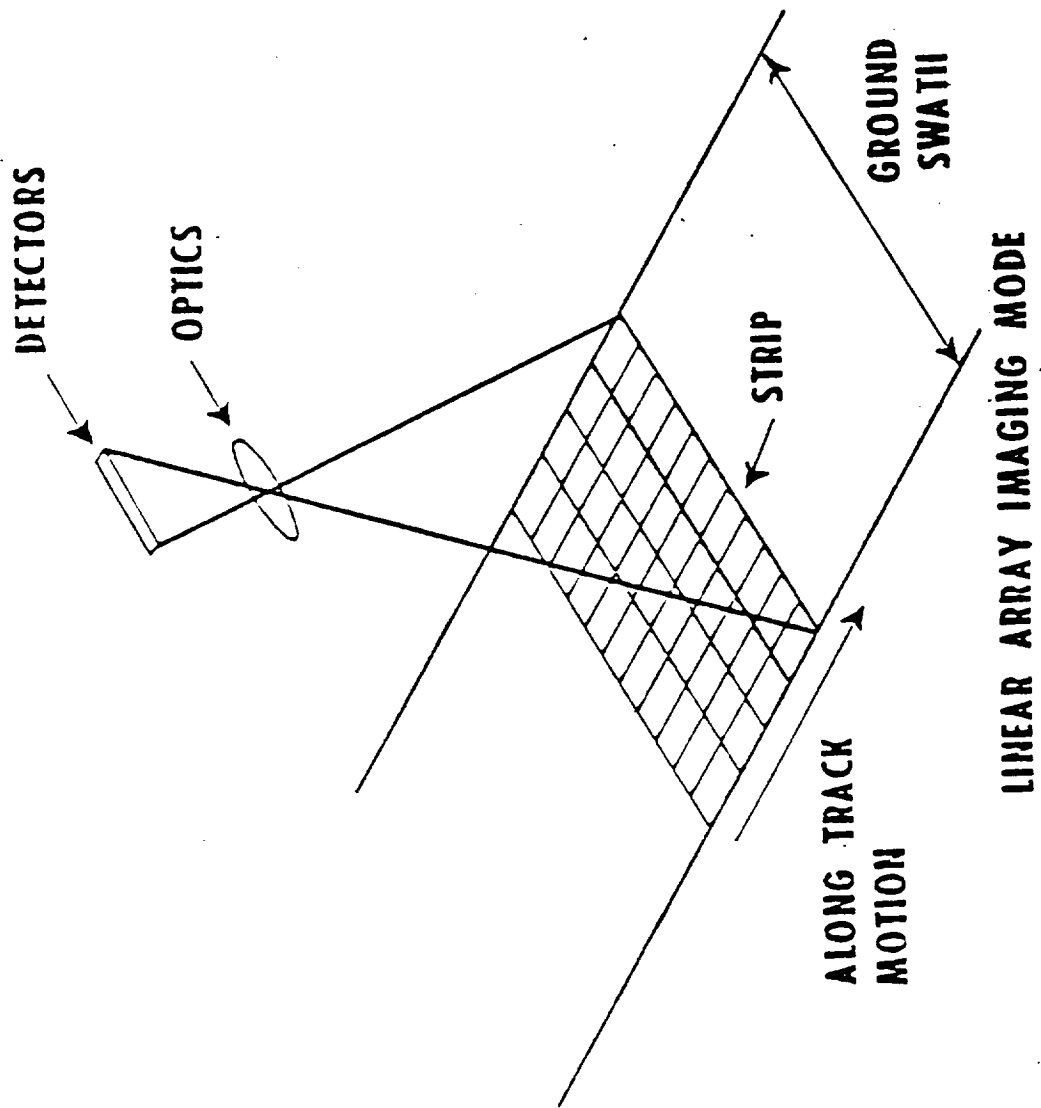
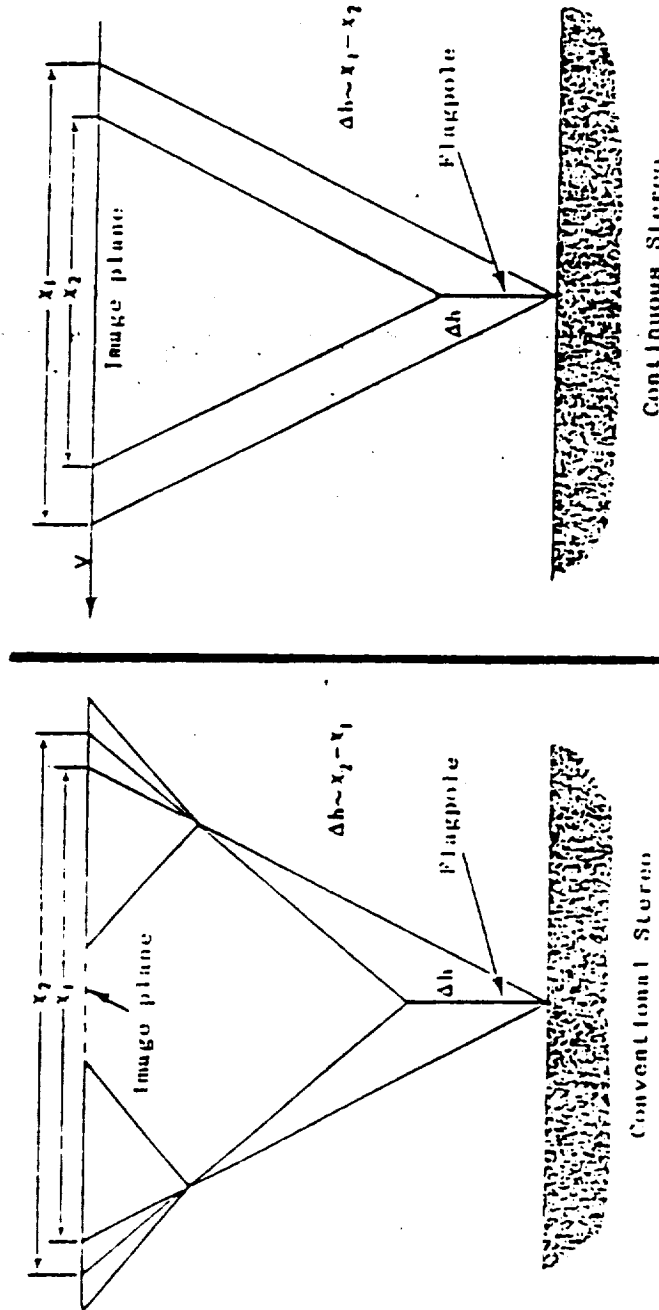

Figure 1

# CONVENTIONAL VS. CONTINUOUS STEREO IMAGING MODES



- Both modes resolve elevation differences
- Conventional mode involves discontinuities based on each stereo pair
- Continuous mode involves no discontinuities but requires very stable platform of known uniform velocity (V)
- Conventional mode involves 2 dimensional data processing
- Continuous mode permits 1 dimensional data processing from 2 data sets

Figure 2



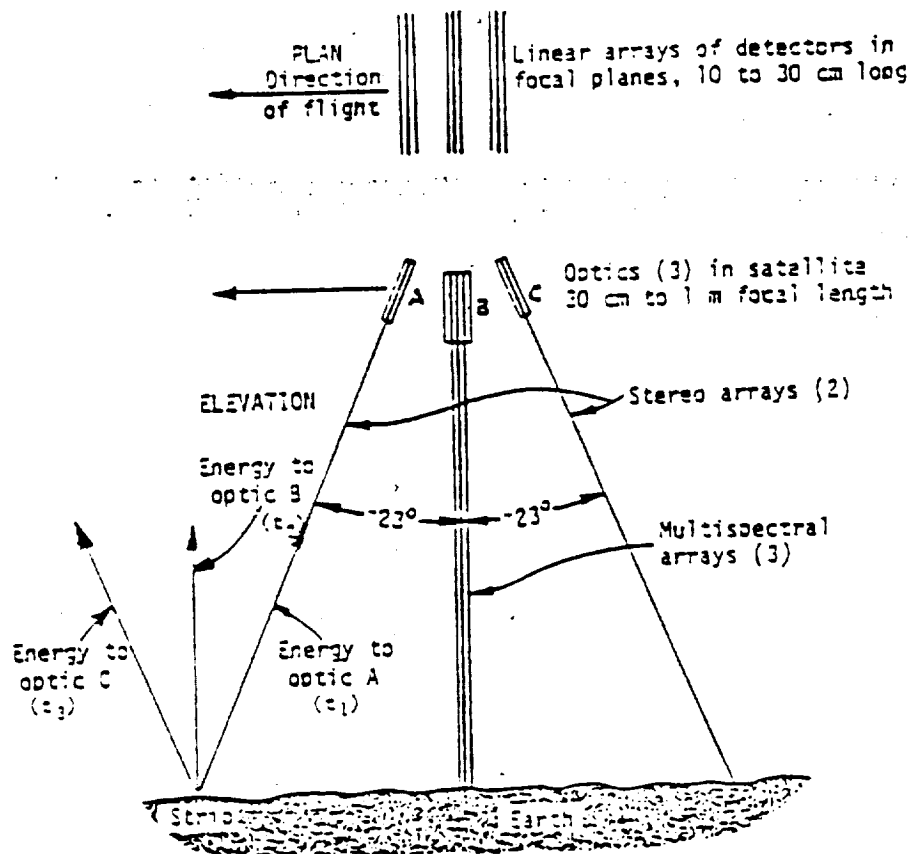

Marsat Sensor Configuration (not to scale).

Optics A, B, and C are a rigid part of satellite. Optic B senses the same strip 50 seconds after A; optic C, 120 seconds after A. Any combination of A, B, and C produces stereo. Optics A and C are of about 10% longer focal length to provide resolution compatible with optic B.

Figure 1

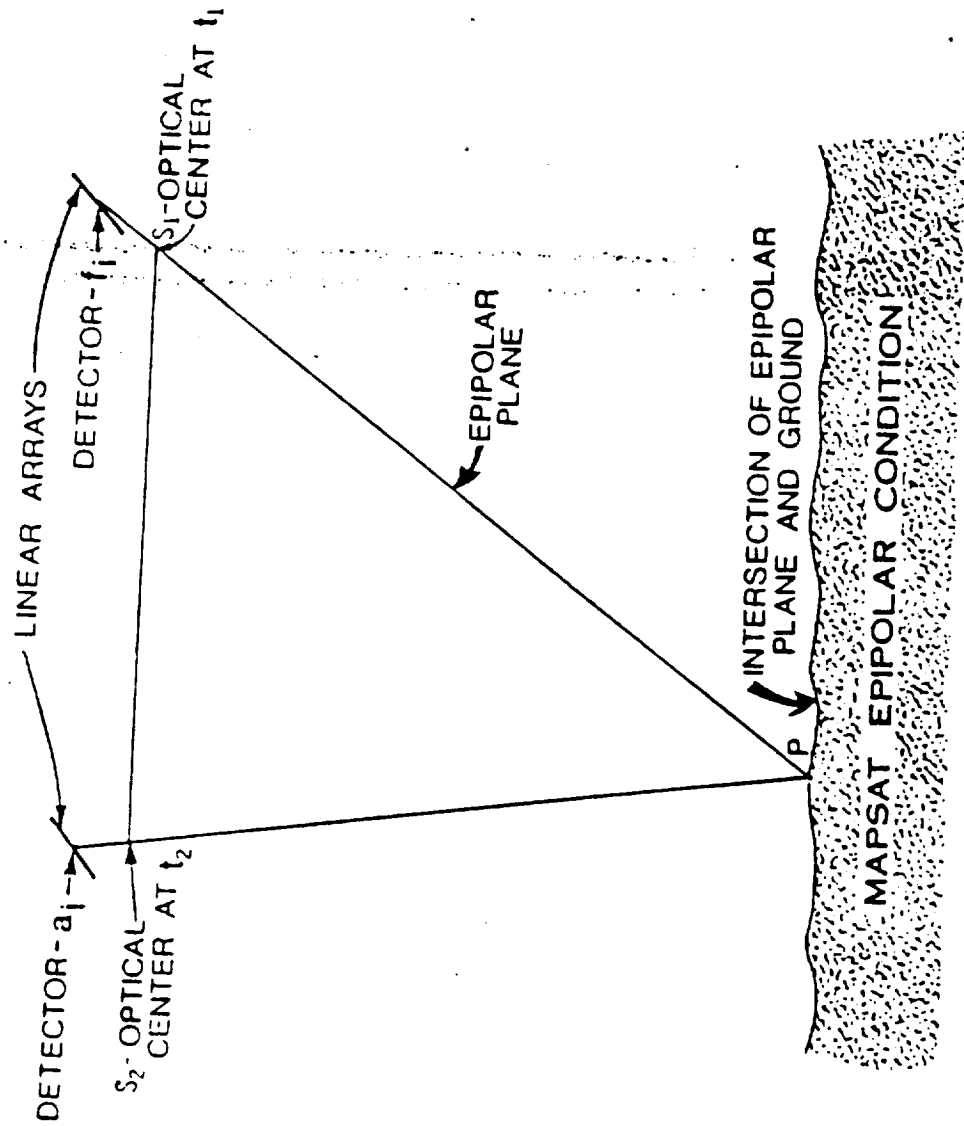
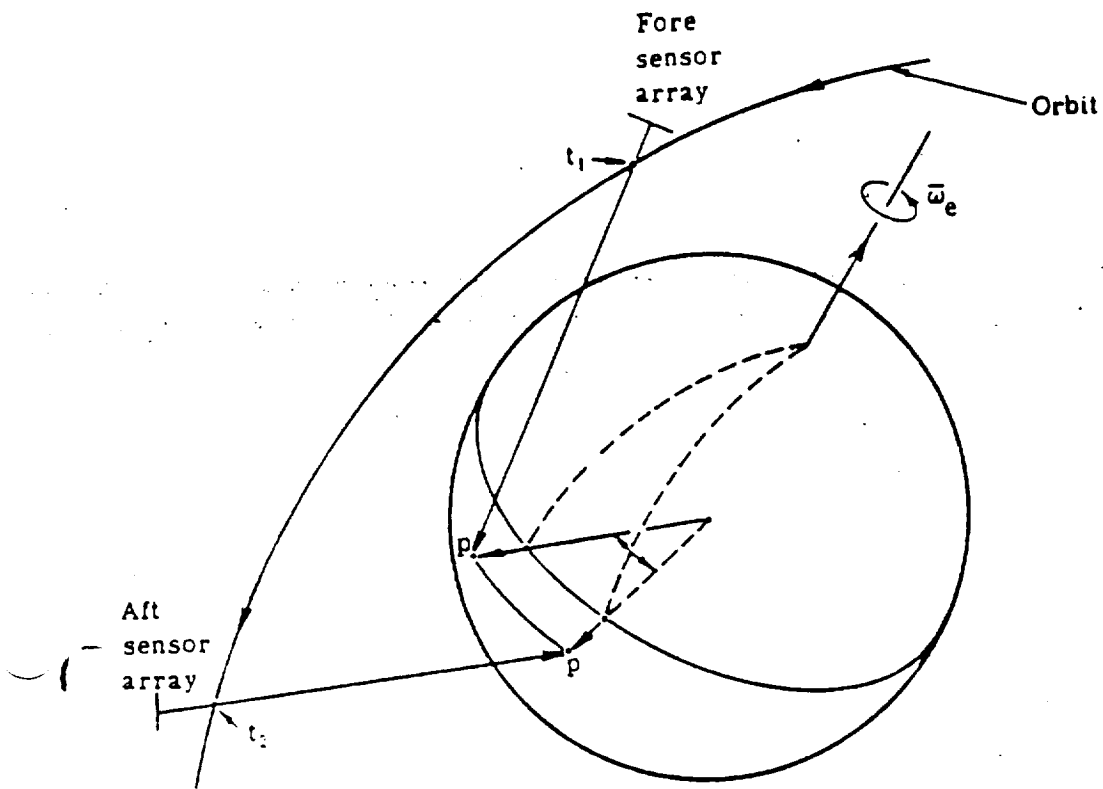

Figure 4



Mapsats Epipolar Acquisition Geometry

Mapsat Epipolar Plane Geometry

Elevation difference as a function of time

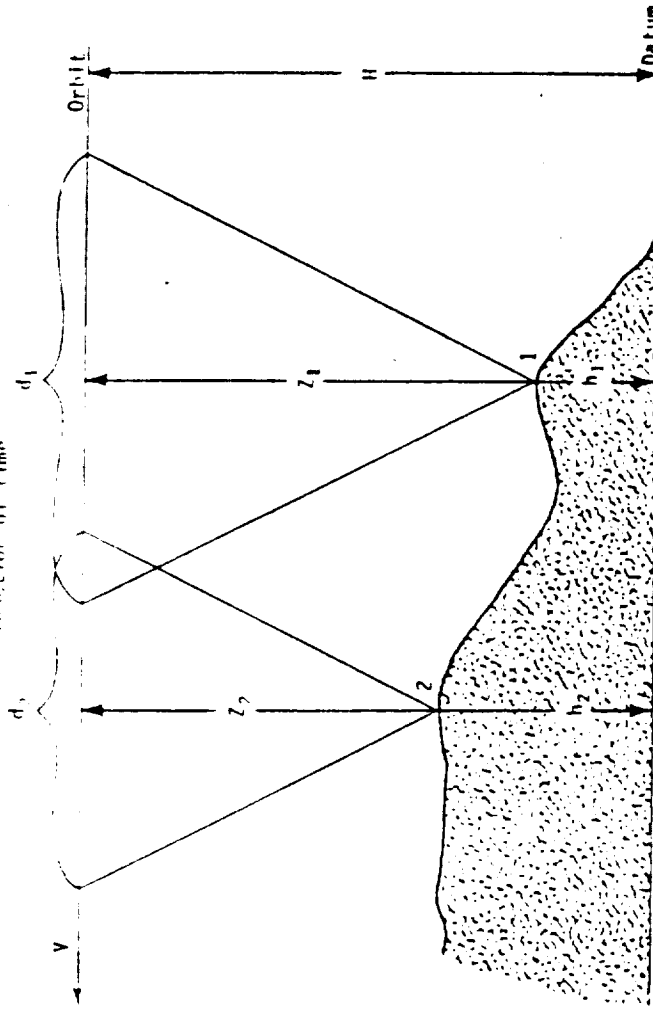

- $V$  = satellite velocity (constant)
- $t_1, t_2$  = time to stereo image points 1 and 2
- $d_1 = V \cdot t_1$  dist. moved to acquire stereo
- $d_2 = V \cdot t_2$  dist. moved to acquire stereo
- $H$  = satellite altitude above datum (constant)
- $h_1, h_2$  = elevation of points 1 and 2 above datum
- $Z_1, Z_2$  = distance from orbit to points 1 and 2
- $k, K$  = constants
- $h_1 = H - Z_1 = H - k \cdot d_1 = H - k \cdot V \cdot t_1$
- $h_2 = H - Z_2 = H - k \cdot d_2 = H - k \cdot V \cdot t_2$
- $h_2 - h_1 = K \cdot (t_2 - t_1)$
- $\Delta h, \Delta t$  = elevation and time differences, points 1 and 2
- $\Delta h = K \cdot \Delta t$

Figure 6

APPENDIX D

PROJECTED SCHEDULES



DATE: 4/30/87 TIME: \_\_\_\_\_

NOTES: \_\_\_\_\_

GROUP: Global Technology Navigation

		DEVELOPMENT SCHEDULE									
		1988	1989	1990	1991	1992	'93	'94	'95	'96	'97-'00
TECHNOLOGY PROGRAM	Aeronics Optimization Study Review & Update	Report									
PROGRAM SCOPE	• \$, K	200		80		80		20			
	• WY	1		1		1		1			
MRSR PROGRAM REFERENCES		TECHNOLOGY DEVELOPMENT TECHNOLOGY SELECTION 1988 LAUNCH 2000 LAUNCH MRSR DESIGN & DEV. LAUNCH									

DATE: 4/30/87 TIME: \_\_\_\_\_

NOTES: \_\_\_\_\_

GROUP: GLOBAL NAVIGATION

TECHNOLOGY PROGRAM	DEVELOPMENT SCHEDULE									
	1988	1989	1990	1991	1992	'93	'94	'95	'96	'97-'00
<b>ROVER NAVIGATION SYSTEM CONCEPTS AND ARCHITECTURE</b> DEFINE ALTERNATIVE SYSTEM CONCEPTS ASSESS APPLICABLE TECHNOLOGY CAPABILITIES AND STATUS CONDUCT TRADE STUDIES PARAMATERIZE SYSTEM PERFORMANCE AND APPLICABILITY										
PROGRAM SCOPE	2.00	2.10	2.20	2.30						TOTAL: 8.60
MRSR PROGRAM REFERENCES	2.0	2.0	2.0	2.0						TOTAL: 8.0
TECHNOLOGY DEVELOPMENT TECHNOLOGY SELECTION ▼ 1998 LAUNCH ▼ 2000 LAUNCH MRSR DESIGN & DEV. → LAUNCH ▼										



DATE: 4/29/87 TIME: \_\_\_\_\_ NOTES: \_\_\_\_\_

GROUP: Global Navigation (Leyen)

TECHNOLOGY PROGRAM	DEVELOPMENT SCHEDULE										TOTAL: \$	TOTAL: %	
	1988	1989	1990	1991	1992	'93	'94	'95	'96	'97-'00			
<b>ODIIE</b> 1) Requirements Definition & Technology Identification 2) System Design & Preliminary Testers 3) Experimental Design & Demonstration 4) Implementation & Technology Readiness													
PROGRAM SCOPE													
MRSR PROGRAM REFERENCES													

DATE: 4/29/87 TIME:

NOTES:

GROUP: Global Navigation

TECHNOLOGY PROGRAM	DEVELOPMENT SCHEDULE									
	1988	1989	1990	1991	1992	'93	'94	'95	'96	'97-'00
<p>Precision Stereogrammetry for Mars Rover Sites</p> <p>1) Requirements Analysis &amp; Feasibility/Tradeoffs of Design Alternatives</p> <p>2) Breadboard Tests on Airborne platforms            A. On Board Processing            B. Ground Processing of Orthorectified</p> <p>3) Detailed Design/Precision Analysis</p> <p>4) Data Compression, Ascentric Memory Chips Applied to Problem</p>										
PROGRAM SCOPE	200	200	400	400	400	400	400	400	400	TOTAL:
• \$, K	2	2	3	3	3	3	3	3	3	TOTAL:
• WY										
MRSR PROGRAM REFERENCES	<p>TECHNOLOGY DEVELOPMENT</p> <p>TECHNOLOGY SELECTION ▼ 1988 LAUNCH ▼ 1998 LAUNCH ▼ 2000 LAUNCH</p> <p>MRSR DESIGN &amp; DEV. → LAUNCH ▼</p>									

DATE: 4/29/87 TIME: \_\_\_\_\_

NOTES: \_\_\_\_\_

GROUP: GLOBAL NAVIGATION (SYNNOT)

TECHNOLOGY PROGRAM	DEVELOPMENT SCHEDULE										
	1988	1989	1990	1991	1992	'93	'94	'95	'96	'97-'00	
HIGH RESOLUTION TOPOGRAPHY FROM ORBITER IMAGING											
1) CONCEPTS & ASSES'S CURRENT STATE											
2) DEVELOPMENT			V								
3) TESTS, SIMULATIONS											
4) TRANSFER TO OPS											
POWER ONBOARD SCIENCE DETECTION											
1) CONCEPTS + SCOPE ONBOARD COMPUTE POWER REQ'D											
2) DEVELOP NEW TECHNIQUES											
3) SIMULATIONS, VERIFICATIONS, TRANSFER TO POWER COMPUTER											
PROGRAM SCOPE	• \$, K										TOTAL:
	• WY										TOTAL:
MRSR PROGRAM REFERENCES	TECHNOLOGY DEVELOPMENT										
	TECHNOLOGY SELECTION ▼ 1998 LAUNCH ▼ 2000 LAUNCH MRSR DESIGN & DEV. → LAUNCH ▼										

DATE: 4/30/87 TIME: 17:52 GMT

NOTES: Space Qualified Show Extractor development

GROUP: Global Navigation

Follow Earth based Show Extractor - development schedule through 1992 is identical (not included in that schedule)

TECHNOLOGY PROGRAM	DEVELOPMENT SCHEDULE									
	1988	1989	1990	1991	1992	'93	'94	'95	'96	'97-'00
Automated On Board Navigation Processing for 'inertial A/GI'										
Functional Design Detailed Design Coding Prototype Testing Flight Computing software Testing										
Space Qualified Show Extractor Proof of concept demo Fabrication & installation										
PROGRAM SCOPE	\$, K	50	150	250	250		40M			TOTAL:
	WY	.5	1	1.5	1.5					TOTAL:
MRSR PROGRAM REFERENCES	TECHNOLOGY DEVELOPMENT TECHNOLOGY SELECTION ▼ 1998 LAUNCH ▼ 2000 LAUNCH MRSR DESIGN & DEV. → LAUNCH ▼									

DATE: 4-30-87 TIME: \_\_\_\_\_ NOTES: \_\_\_\_\_

GROUP: Global Navigation

TECHNOLOGY PROGRAM	DEVELOPMENT SCHEDULE									
	1988	1989	1990	1991	1992	'93	'94	'95	'96	'97-'00
<u>Real Time Phase Extractor for Rover AVLBI</u> GPS Receiver Design Mod Fab & Proof of Concept Demo Final Design Fab & Installation	→	→	→	→	→	→	→	→	→	→
<u>Wideband Transponder for Rover AVLBI</u> Transponder design Eng Model Dev't. & Test Flight Unit Dev't & Test				→	→	→	→	→	→	→
<u>Rapid Turnaround AVLBI Processor</u> Processor Design Implementation Testing & Validation				→	→	→	→	→	→	→
PROGRAM SCOPE	\$, K	250	650	1,050	2,300	2,100				TOTAL:
	WY	2.0	4.0	7.0	15.0	15.0				TOTAL:
MRSR PROGRAM REFERENCES	TECHNOLOGY DEVELOPMENT TECHNOLOGY SELECTION ▼ 1988 LAUNCH ▼ 1998 LAUNCH ▼ 2000 LAUNCH MRSR DESIGN & DEV. → LAUNCH ▼									

DATE: 4-30-87

TIME:

P. Esposito

NOTES:

Known location & Navigation using Doppler  
and Range Measurements

GROUP: GLOBAL NAVIGATION

TECHNOLOGY PROGRAM	DEVELOPMENT SCHEDULE									
	1988	1989	1990	1991	1992	'93	'94	'95	'96	'97-'00
Rover Navigation/Location a) TRANSPONDER DEVEL. b) SIMULATION - Study to determine Rover Position Accuracy and to define Data Requirements										
	Need input from Telecommunications Engineers to assess technology package (may be 500k/yr for 3 yrs of research (?)) simulation and SW development 1 Full-time person for 3 yrs at 200k per year									
PROGRAM SCOPE										
	• \$, K									TOTAL:
	• WY									TOTAL:
MRSR PROGRAM REFERENCES	TECHNOLOGY DEVELOPMENT TECHNOLOGY SELECTION ▼ 1998 LAUNCH ▼ 2000 LAUNCH MRSR DESIGN & DEV. → LAUNCH ▼									







JPL D-4788, Vol. 6

Mars Rover/Sample Return (MRSR) Mission

# Mars Rover Technology Workshop Proceedings

Volume 6: Communications

Chairman: Richard Horttor, Jet Propulsion Laboratory

April 28-30, 1987  
Pasadena, California

**JPL**  
Jet Propulsion Laboratory  
California Institute of Technology

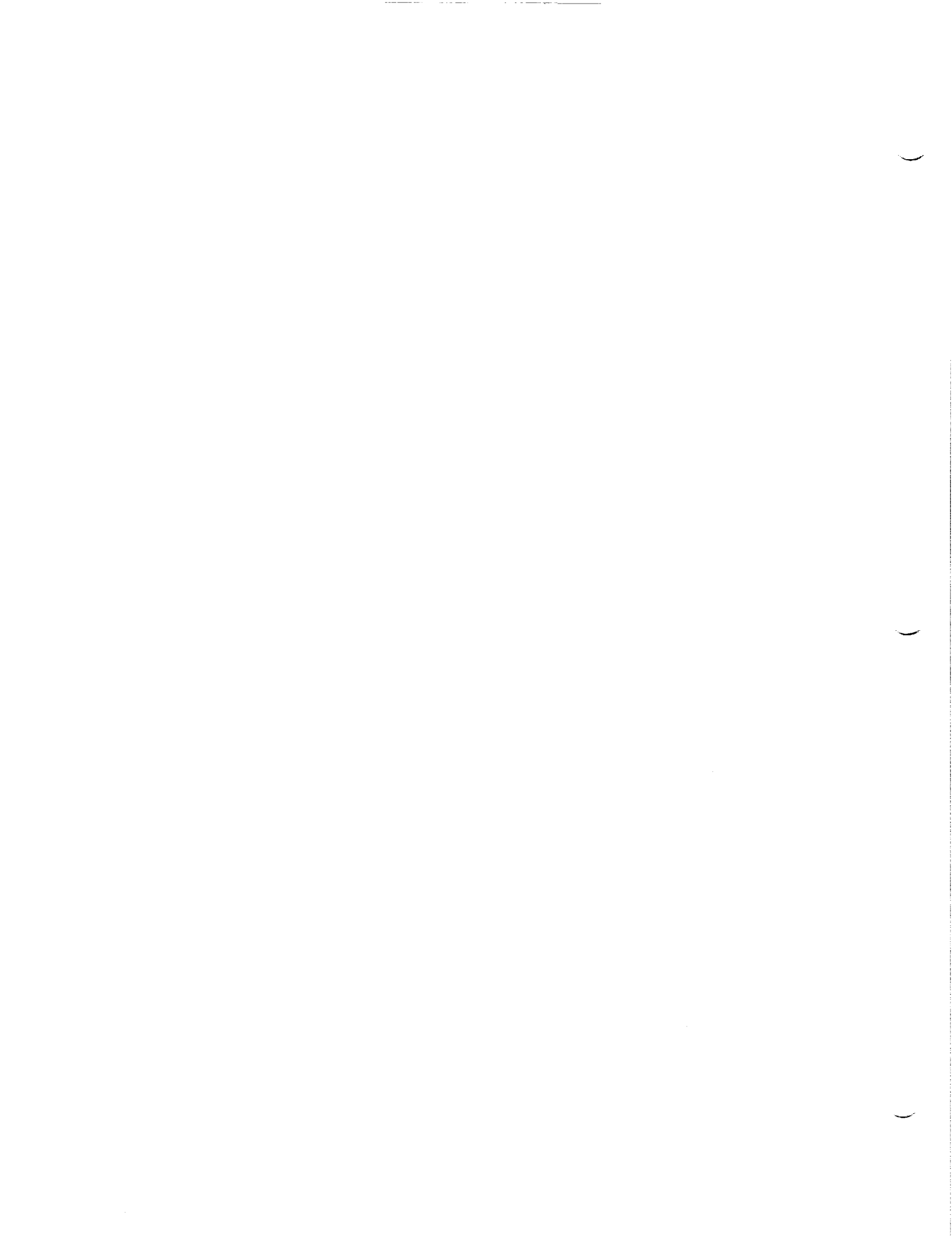

## GLOSSARY OF ACRONYMS

AU	-	Astronomical Unit (Mean Earth-Sun Distance)
BER	-	bit error rate
bps	-	bits per second
CARD	-	computer aided remote driving
CCD	-	charge coupled device
CID	-	charge injection device
DoD	-	Department of Defense
DSN	-	deep space network
ELV	-	expendable launch vehicle
FET	-	field effect transistor
FOV	-	field of view
GaAs	-	gallium arsenide
GEO	-	geosynchronous orbit
Gnd	-	ground
HEMPT	-	high electron mobility pseudomorphic transistor
kbps	-	kilobits per second
LEO	-	low earth orbit
LeRC	-	(NASA) Lewis Research Center
LNA	-	low noise amplifier
LRP	-	long range plan
Mbps	-	megabits per second
MIMIC	-	microwave and millimeter wave integrated circuit
MMIC	-	microwave monolithic integrated circuit
MRSR	-	Mars Rover and Sample Return
NASA	-	National Aeronautics and Space Administration
Nd	-	neodymium

- SSPA - solid state power amplifier
- TDA - Telecommunications and Data Acquisition (JPL Office of)
- TDRSS - Tracking and Data Relay Satellite System
- TWT - traveling wave tube
- TWTA - traveling wave tube amplifier
- VLSI - very large scale integration; very large scale integrated (circuits)
- YAG - yttrium aluminum garnet

## CONTENTS

	<u>Page</u>
1. EXECUTIVE SUMMARY . . . . .	6-1-1
2. INTRODUCTION . . . . .	6-2-1
2.1 WORKING GROUP APPROACH . . . . .	6-2-1
2.2 CONSTRAINTS . . . . .	6-2-2
3. DISCUSSION . . . . .	6-3-1
3.1 DSN ASSUMPTIONS - 1995 . . . . .	6-3-1
3.2 SYSTEM CONFIGURATIONS . . . . .	6-3-10
3.3 MICROWAVE COMMUNICATIONS TECHNOLOGY . . . . .	6-3-12
3.3.1 K <sub>a</sub> -Band Technology Requirements . . . . .	6-3-12
3.3.2 Technology Development Programs and Needs . . . . .	6-3-20
3.4 OPTICAL COMMUNICATIONS TECHNOLOGY . . . . .	6-3-34
4. SUMMARY AND CONCLUSIONS . . . . .	6-4-1
5. PRESENTED MATERIALS . . . . .	6-5-1

### Figures

3-1. DSN Long-Range Plan: Network Configuration, 1990-1995 . . . . .	6-3-2
3-2. DSN Long-Range Plan: Summary of Major Network Developments . . . . .	6-3-3
3-3. Cost-Performance Improvement Comparison Graph . . . . .	6-3-9
3-4. Possible System Configurations. . . . .	6-3-11

## CONTENTS (Contd)

Page

### Figures

3-5. Data Rate Versus Aperture Size: 34-m DSN Station . . . . .	6-3-13
3-6. Data Rate Versus Aperture Size: 70-m DSN Station . . . . .	6-3-14
3-7. Some MRSR Antenna Configurations . . . . .	6-3-18
3-8. 32-GHz Transmitter Module . . . . .	6-3-21
3-9. 21-Element Array Feed . . . . .	6-3-22
3-10. MRSR Array Concept . . . . .	6-3-23
3-11. One Dimensional Steered Array Test Bed . . . . .	6-3-26
3-12. Optical Telecom Configurations . . . . .	6-3-35
3-13. Far Field Antenna Diffraction . . . . .	6-3-36
3-14. Multi-Bit/Photon Communication . . . . .	6-3-37
3-15. System Configuration, Performance Values . . . . .	6-3-38
3-16. Optical Communications Package . . . . .	6-3-39
3-17. Target Acquisition . . . . .	6-3-40
3-18. Mars Rover Telecommunications Lasercom Pointing . . . . .	6-3-41
3-19. Optical Communications Technology Development . . . . .	6-3-42
4-1. Conclusions and Recommendations . . . . .	6-4-3
4-2. System Configurations . . . . .	6-4-4
4-3. X-Band Direct . . . . .	6-4-5
4-4. $K_a$ Band Direct . . . . .	6-4-6
4-5. Optical Direct . . . . .	6-4-7
4-6. Power/Relay at Aerosync . . . . .	6-4-8
4-7. Communications Assessment . . . . .	6-4-9

CONTENTS (Contd)

	<u>Page</u>
<u>Tables</u>	
2-1. Working Group Participants . . . . .	6-2-2
3-1. Parameters used in Calculating Data Rates: 34-m . . . . .	6-3-15
3-2. Parameters Used in Calculating Data Rates: 70-m . . . . .	6-3-16
3-3. Aperture Sizes Needed to Support Data Rates . . . . .	6-3-17
3-4. JPL K <sub>a</sub> -Band Spacecraft Transmitter Program . . . . .	6-3-24
3-5. K <sub>a</sub> Band Solid State Technology Status . . . . .	6-3-27
3-6. SSA Technology Development Needs . . . . .	6-3-28
3-7. K <sub>u</sub> Band Uplink . . . . .	6-3-33
3-8. K <sub>u</sub> Band Downlink . . . . .	6-3-33
 <u>APPENDIXES</u>	
A. TECHNOLOGY PROGRAM SCHEDULES . . . . .	6-AA-1
B. SUMMARY FORMS (not supplied) . . . . .	
C. DIARIES OF KEY THOUGHTS . . . . .	6-AC-1
D. OTHER MATERIALS . . . . .	6-AD-1

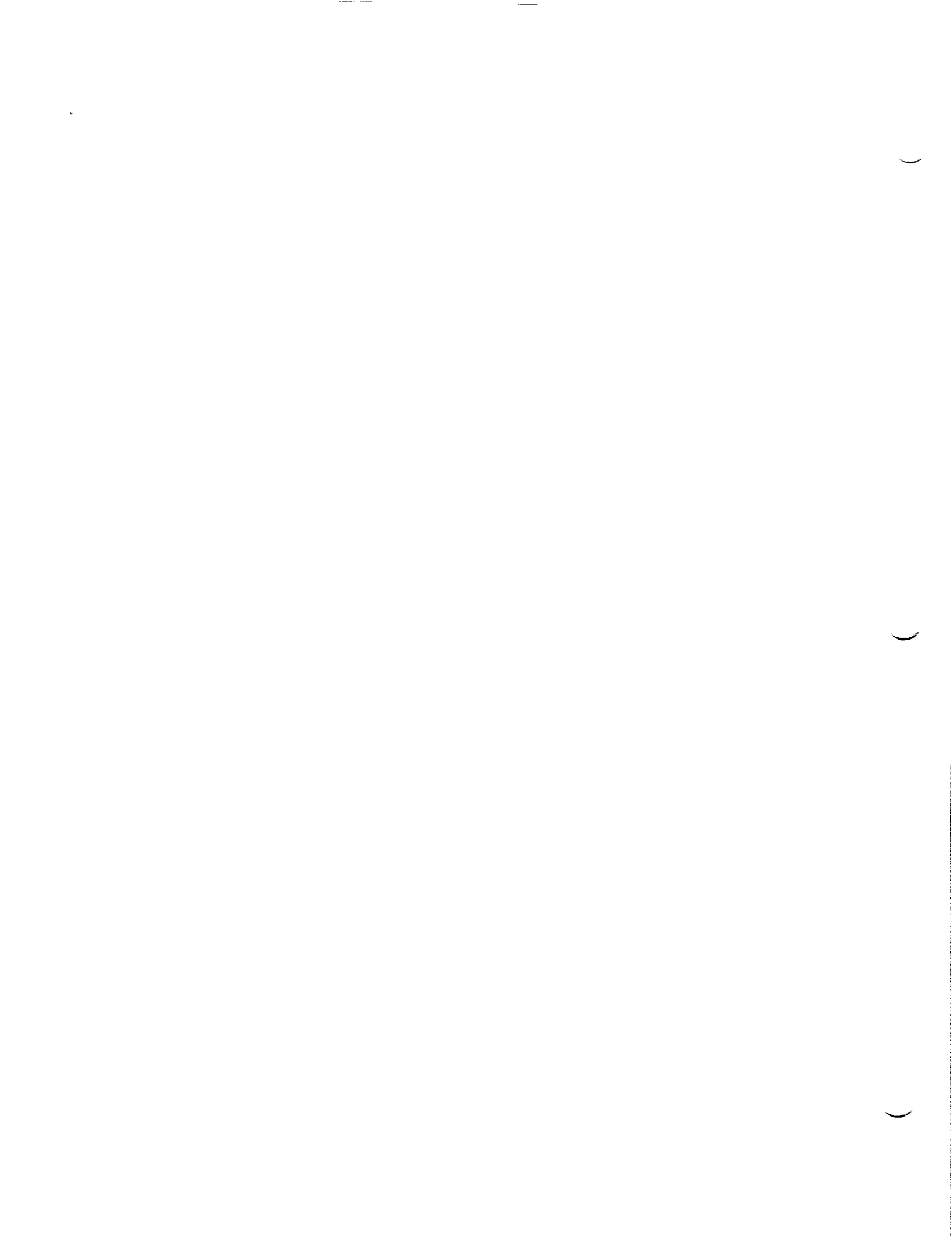



## SECTION 1

### EXECUTIVE SUMMARY

Improvements in both K<sub>a</sub>-band and optical-frequency, Mars-environment-qualified technology are required to support Mars Rover/Sample Return (MRSR) missions for launches in 1998 or 2000. Existing X-band technology requires antennas that are too large to conveniently package into the restricted space of an aeroshell, without a deployable design.

The availability of an operational Deep Space Network (DSN) optical network will probably preclude optical links for the early launch.

A dedicated aerosynchronous circular orbit relay would provide nearly continuous communications support to the rover while also providing a computing base for hazard avoidance. The same relay satellite, given sufficient energy, could also serve as a precursor to map Martian surface to 10 m resolution. The Mobility panel believes the high resolution maps are necessary and that adequate computing resources may be difficult to place on the rover.

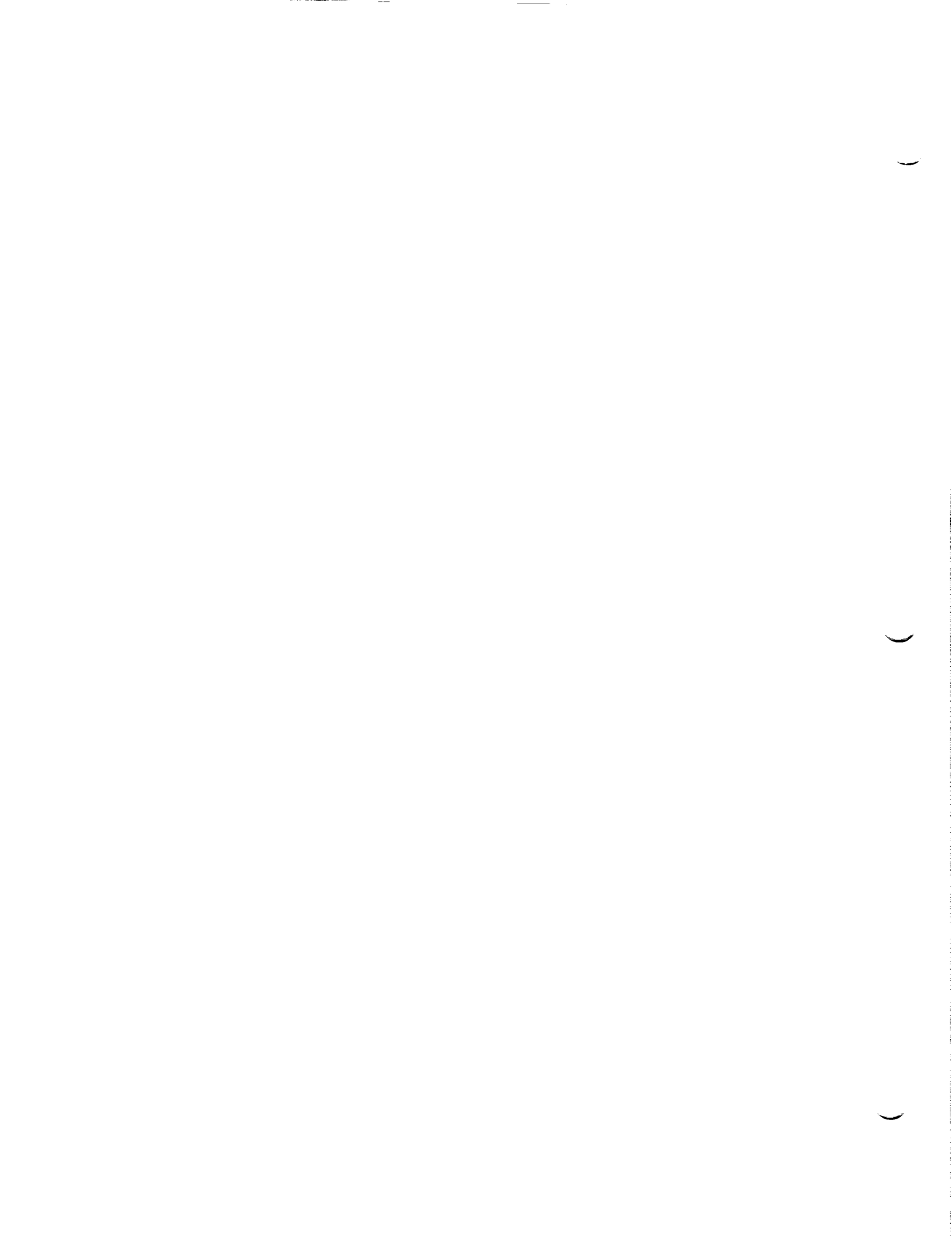

## SECTION 2

### INTRODUCTION

#### 2.1 WORKING GROUP APPROACH

The panel primarily considered the data requirements and technologies for the various communications links principally supporting the rover part of the Mars Rover/Sample Return (MRSR) Mission. The command link capability of 2 kbps was not a driver for normal operation over directive apertures; an emergency mode of some 8 bps is also included. For these conditions, metric tracking performance is adequate to support navigation requirements. The tracking function does not appear to be a technology driver and therefore did not receive great attention. Quantitative characterizations must be added at another time.

Radio science utilization of the communications links also was not considered. Therefore, the need for ultra-stable oscillators has not been addressed. A good case can be made later for such devices in the  $10^{-13}$  to  $10^{-14}$  fractional frequency domain as measured by Allan Variance with 1000 second averaging.

There are two major system configurations in this report. One is for a rover with direct communication to Earth providing all support requirements. (The satellite providing 0.5 m surface mapping for traveling support is not addressed here.) The other configuration uses a Mars-synchronous orbiter for communications relay purposes. Such capability reduces the communications resources needed on the rover, provides a base for computational support to mobility, hazard avoidance and sample collection, and could be the precursor satellite providing 5-m to 10-m resolution of the surface. It is recognized that significant orbital change energy will be needed to do both the precursor and relay functions with the same spacecraft.

Downlink telemetry rates include 30 kbps and 150 kbps keyed to 34-m and 70-m single aperture performance, respectively. For a full Mars year, multiple DSN aperture needs should be restricted to short periods of high importance. A 1 Mbps link is offered for high data rate dumps, science- or mobility-related, or high-interest public relations opportunities.

Key assumptions include the projected DSN capabilities in the late 1990's as well as constraints drawn from recent MRSR Mission studies. Technology developments for microwave and optical implementation are identified along with constraints or requirements imposed on other functions or subsystems.

Finally, the conclusions and recommendations cover preferred technology options and the desirability of the relay satellite.

Table 2-1 provides a list of working group participants.

Table 2-1. Workshop Participants

Richard L. Horttor	(818) 354-2462 JPL/161-228
Robert C. Clauss	(FTS) 782-7536 JPL/264-801
Richard M. Dickinson	(818) 354-2759 JPL/238-540
Peter Garriga	Hughes Aircraft Co. 862 Penn St. El Segundo, CA 90245
Kumar Krishen	(FTS) 525-0207 Mail Code EE NASA/Johnson Space Center Houston, TX 77058
Dr. James W. Layland	(818) 354-3166 JPL/264-801
Dr. Marc D. Rayman	(818) 354-2544 JPL/200-122
A. Landis Riley	(818) 354-0401 JPL/161-213
Grady Stevens	(216) 433-3503 Space Communications Div. Mail Stop 54-1 NASA/Lewis Research Center Cleveland, OH 44135
James H. Wilcher	(818) 354-2669 JPL/264-801
Raul Rey	TRW

## 2.2 CONSTRAINTS

There are two principal constraints derived from previous studies on MRSR Rover. One was that the power available to conduct downlink transmissions was the same 120 watts dc required to support locomotion. Hence, downlink operation would be available only from a stationary rover. The other was aperture size. Aeroshell space constrained aperture area such that 1 m or more was "impossible" and 0.5 m or less was "easy".

Data return capabilities are keyed to Deep Space Network (DSN) aperture sizes in nonarrayed modes. The rationale is that arrayed support should be restricted to short periods of high importance, not long-term use such as a Mars year, hence, 30 kbps to a 34-m station and 150 kbps to a 70-m station. A 1 Mbps capability is postulated for data dumps or high-interest public relations. The relay satellite greatly aids this mode.

A constraint on the early utilization of optical telecommunications is the questionable likelihood that NASA would be able to design and implement a complete network of ground- or space-based terminals that could be committed in an operational sense by the early time frame (1998).

Minimum data quantities per day were assumed to be 100 Mbits and maximum daily data return was 1 Gbit. An approximately 5% duty cycle for transmission was assumed and thus data rates of 30 kbps, 150 kbps, and 1 Mbps were deemed appropriate. These constraints are part of the "transmit while stationary" scenario.

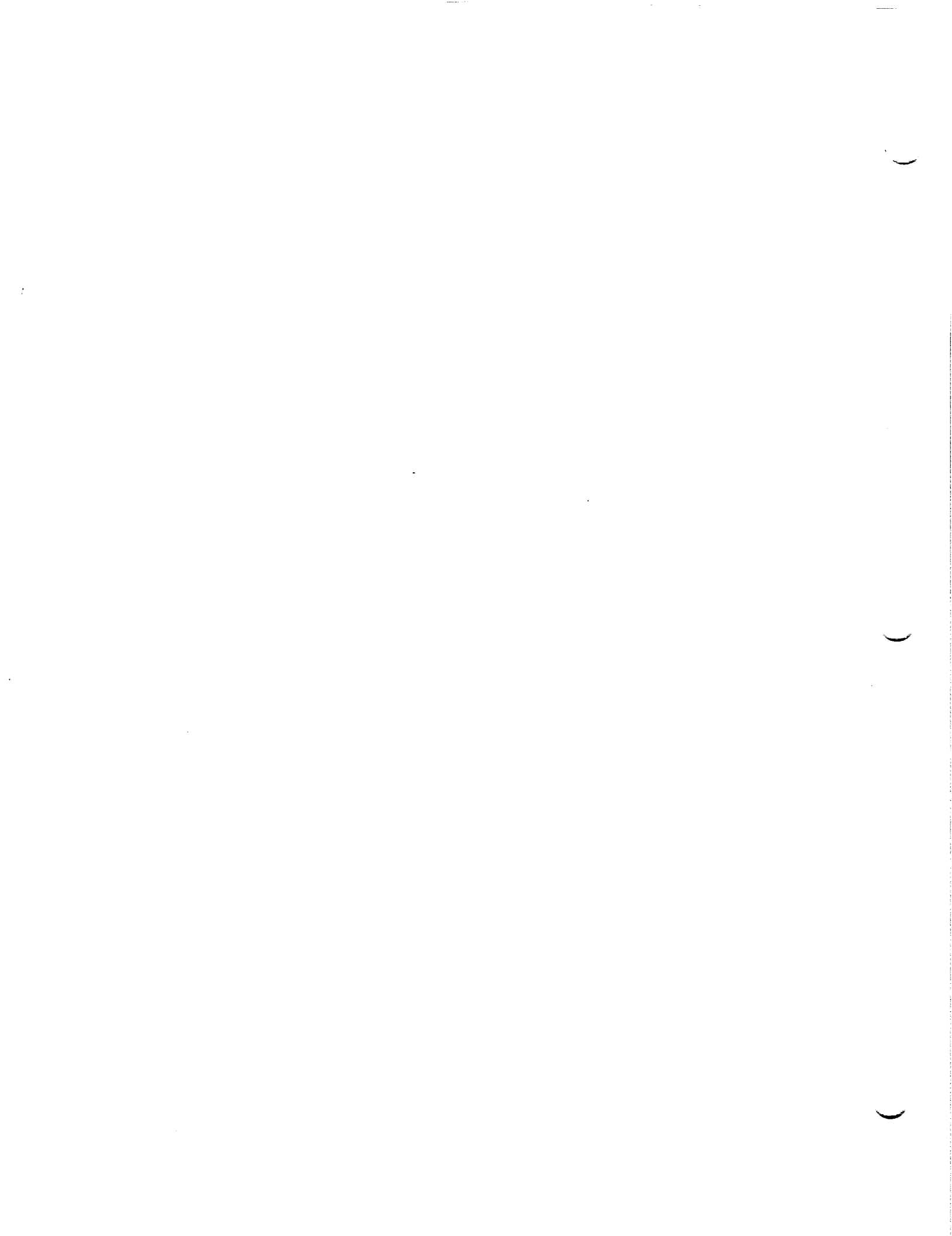

## SECTION 3

### DISCUSSION

#### 3.1 DSN ASSUMPTION - 1995

The DSN configuration available to support the MRSR by the late 1990's will be approximately that which will support the Voyager at Neptune, plus technology advances as defined in the current DSN Long-Range Plan (LRP). Referring to the accompanying figure which represents the DSN-LRP, the map of the 1990's DSN is shown as Figure 3-1. A trace of the evolution of capabilities appears as Figures 3-2a thru 3-2f. All DSN antennas are on the order of 68% aperture efficient at X-band.

Uplink powers are 20 kW where available, and downlink system temperature of 25 K at X-band exist today as specified in DSN Interface Document 810-5. Installation of a beam wave guide in the early 1990's is a potential enhancement which will facilitate installation of  $K_a$ -band and allow reduction of the working system temperature at X-band to the neighborhood of 15-18 K. This requires cryogenic cooling of the feed components and lowering the operating low-noise amplifier (LNA) temperature. The nominal  $K_a$ -band system working temperature is 40 K at 30° elevation. It is assumed that at least one 34-m antenna will be continuously available to support a link with the spacecraft in the vicinity of Mars. Installation of multiple-receiver channels and dual uplinks will allow contact with multiple Mars spacecraft via that single 34-m aperture. The 70-m DSN aperture will be made available as needed to support the higher frequency rate of operation. In an emergency or special event situation, higher power uplinks and arrays of receiving apertures can be mobilized to provide added capability.

A cost-performance improvement comparison graph is shown in Figure 3-3 for enhancing X-band capability or going to  $K_a$ -band microwave links or optical frequency links.

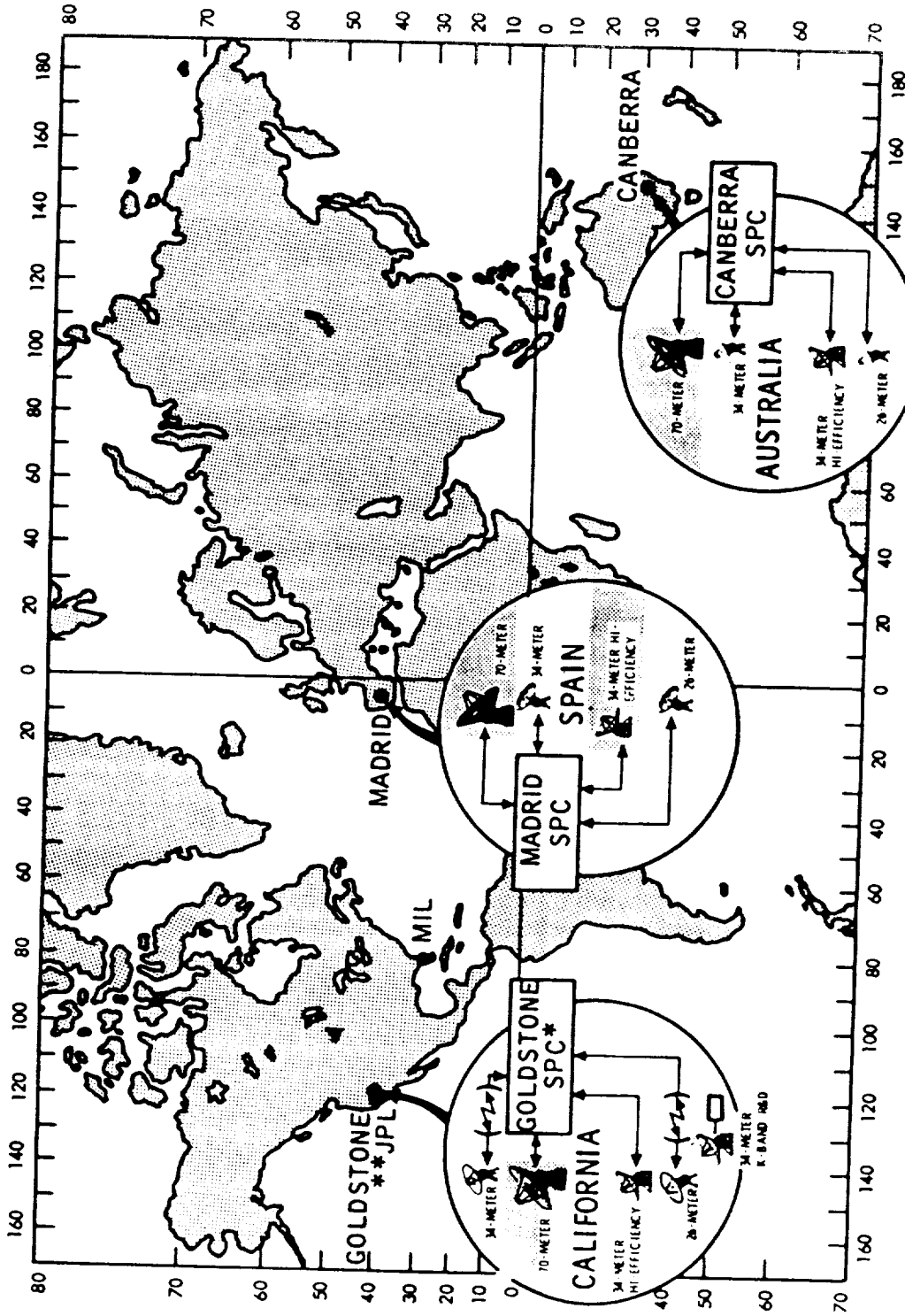

SHADING INDICATES CHANGES FROM 1985

\*\* JPL INCLUDES THE NETWORK OPERATIONS CONTROL CENTER, THE CENTRAL COMMUNICATIONS TERMINAL, A COMPATIBILITY TEST AREA, A MOBILE COMPATIBILITY TEST FACILITY, AND OFFICES AND LABORATORIES OF THE DEEP SPACE NETWORK

\* SPC: SIGNAL PROCESSING CENTER

COMMUNICATION BETWEEN JPL AND THE SIGNAL PROCESSING CENTERS OR MERRITT ISLAND (MIL) IS PROVIDED BY THE NASA COMMUNICATIONS NETWORK (NASCOM)

6483-A116

Figure 3-1. DSN Long-Range Plan: Network Configuration, 1990-1995



- |   |  |
|---|--|
| <u>AUGUST 1985</u>                        | <u>CIRCA 2000</u>  |
| 1. ONE STANDARD 64-METER ANTENNA.....     | ONE HIGH-EFFICIENCY 70-METER ANTENNA SUBNET (SX/LSXK <sub>a</sub> )                      |
| 2. ONE STANDARD 34-METER ANTENNA.....     | ONE HIGH EFFICIENCY 34-METER ANTENNA SUBNET #1 (SX/SXK <sub>a</sub> )                    |
| 3. HIGH EFFICIENCY 34-METER ANTENNAS..... | ONE HIGH EFFICIENCY 34-METER ANTENNA SUBNET #2 (X/SX) AT GOLDSTONE AND TIDBINILLA (-/SX) |
| 4. ONE 26-METER ANTENNA SUBNET (S/S)..... | ONE 26-METER ANTENNA SUBNET (SX/SX)  |
| 5. CTA 21, MIL 71 (S/SX).....             | CTA 21, MIL 71, (SX/SXK <sub>a</sub> )   |

ADDITIONAL CAPABILITIES TO BE AVAILABLE BY 2000

1. INTERNATIONAL CROSS-SUPPORT VIA GLOBAL STANDARDS
2. S-, X-, AND K<sub>a</sub>-BAND SOLAR SYSTEM RADAR AT GOLDSTONE
3. EARTH-ORBITER LOCATIONS USING THE GLOBAL POSITIONING SYSTEM
4. K<sub>a</sub>-BAND AND FOLLOW-ON OPTICAL-BAND FIELD DEVELOPMENT STATION

JWL-3  
1-15-87

\* (A/BC) DENOTES (UPLINK/DOWNLINK) FREQUENCY BANDS

6483-A1603

Figure 3-2a. DSN Long-Range Plan: Summary of Major Network Developments

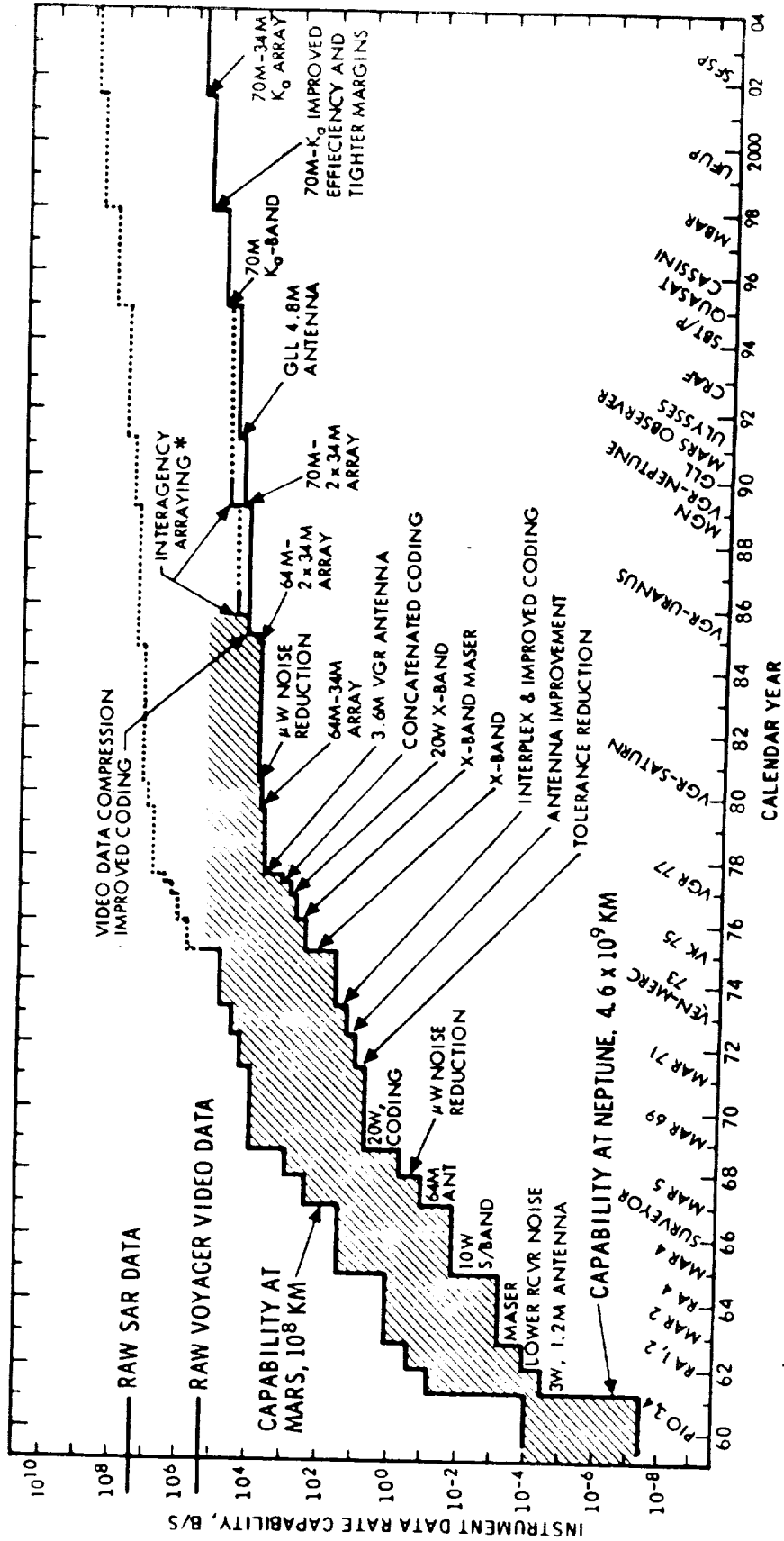

\* INTER-AGENCY ARRAYING IS USED ONLY FOR SPECIAL EVENTS (e.g. VOYAGER AT URANUS AND AT NEPTUNE)

Figure 3-2b. DSN Long-Range Plan - Profile of Telemetry Reception Capability

**- HIGHLIGHTS -**

1. **INCREASED PERFORMANCE OF 64-METER ANTENNAS BY EXPANSION TO 70-METERS AND IMPROVED MICROWAVE EFFICIENCY (1989) [VGR-2/Y]**
2. **INTER-AGENCY ARRAYS FOR TELEMETRY AND RADIO SCIENCE ENHANCEMENT (1989) [VGR-2/Y]**
3. **X-BAND UPLINK (BY 1989-90) [MGN, MO]**
4. **RANGING MACHINES FOR SPACECRAFT THAT USE X-BAND UPLINK (BY 1989) [MO]**
5. **GLOBAL POSITIONING SATELLITE SYSTEM (GPS) APPLICATIONS (1989 ff) [TOPEX]**

Figure 3-2c. DSN Long-Range Plan - Planned Implementations

**- HIGHLIGHTS -**

- 6. BLOCK II SYSTEM VLBI TERMINALS (1987)**
- 7. IMPROVED RADAR SIGNAL PROCESSING EQUIPMENT (1987),  
AND TRANSMITTER POWER INCREASE TO 1 MW (1993)**
- 8. REPLACEMENT OF "STANDARD" 34-METER ANTENNAS WITH NEW  
HIGH EFFICIENCY 34-METER ANTENNAS (1995)**
- 9. 1.5 MBIT/SEC GCF CAPABILITIES (1990)**
- 10. K<sub>a</sub>-BAND DOWNLINK SERVICES (1995)**

Figure 3-2d. DSN Long-Range Plan - Planned Implementations (contd)

**- HIGHLIGHTS -**

- 1. BEAM WAVEGUIDES**
- 2. 400 KW TO 1000 KW X-BAND TRANSMITTER**
- 3. STATION FREQUENCY STABILITY FOR ONE PART IN  $10^{15}$   
(FLIGHT RADIO SCIENCE)**
- 4. RECEPTION IN VARIOUS FREQUENCY BANDS FROM 1 TO 10 GHz  
WITH 300 MHz INSTANTANEOUS BANDWIDTHS (SETI)**
- 5. COMPUTER-AIDED SCHEDULING AND CONFLICT RESOLUTION,  
FAULT DIAGNOSIS, AND SERVICE RESTORATION**

Figure 3-2e. DSN Long-Range Plan - Prospective Implementations

**- HIGHLIGHTS -**

- 1. NEW RESEARCH AND DEVELOPMENT ANTENNA CAPABLE OF K<sub>a</sub>-BAND FREQUENCIES, AND FOR USE IN MARS OBSERVER K<sub>a</sub> BAND LINK EXPERIMENT**
- 2. ADVANCED CODING DEMONSTRATION**
- 3. 400 KW K<sub>a</sub>-BAND GYROKLYSTRON FOR EMERGENCY COMMANDING AND SOLAR SYSTEM RADAR**
- 4. REAL-TIME CONNECTED ELEMENT INTERFEROMETRY FOR NAVIGATION**
- 5. "EXPERT SYSTEMS" TECHNOLOGY FOR FAULT DIAGNOSIS**

Figure 3-2f. DSN Long-Range Plan - Research and Development

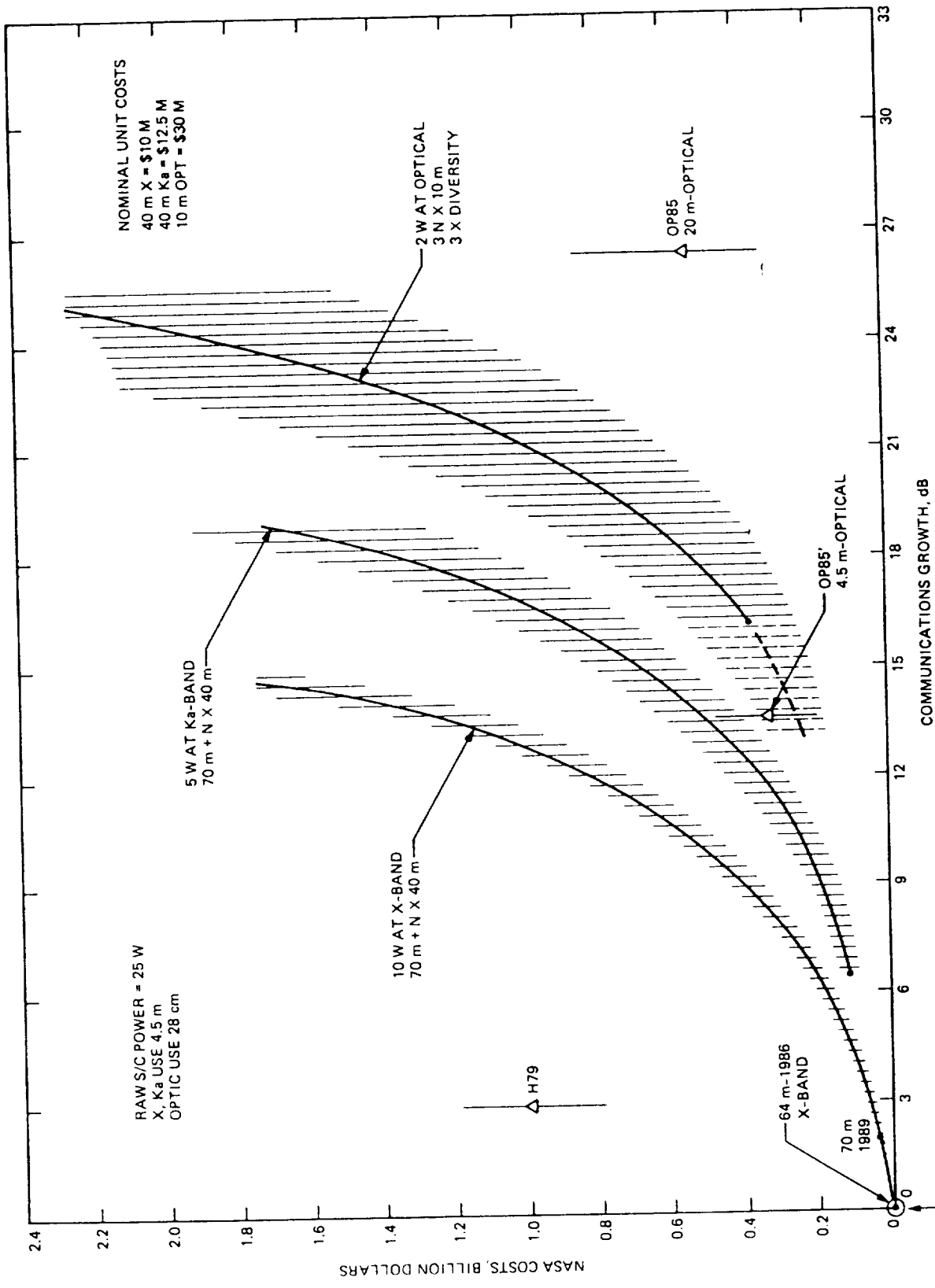

Figure 3-3. Cost-Performance Improvement Comparison Graph

### 3.2 SYSTEM CONFIGURATIONS

Two possible system configurations are addressed here. (See Figure 3-4). The first configuration considers only rover-direct-with-Earth communications; all commanding and telemetry needs are performed without direct involvement of the mapping satellite. The latter has its own communications links, which are not considered here.

For this configuration, the rover can provide sufficient consumables to support the 30 kbps/150 kbps communications at microwave frequencies (8.4 GHz and 32 GHz). Because this configuration depends on Earth-view periods, rover operations requiring Earth-based involvement necessarily are restricted to about 10 hours per day.

The data rates are derived from the Randolph Study, which postulated a fairly heavy, Earth-based involvement with a "move a little, send pictures, wait, move a little..." type of operation. For purposes of this workshop, these data rates were chosen, even though the "correct" or "new" operations scenario might well imply a change. For flexibility a 1 Mbps capability is offered as either an enhancement or the opportunity for a stronger mission plan.

The second configuration derives from two considerations. One is the scientific desire for substantive operations during the Mars night. Earth-based observation is deemed prudent during such operations. The other consideration is that a relay satellite does reduce the communications assets required on a rover.

For this configuration, primary data return and command traffic is directed through the relay. A reduced-capability, direct-to-Earth mode exists as a backup to the possibly limited lifetime of the relay satellite.

Another potential use of the relay satellite could be as a precursor mapping satellite, if sufficient orbit change energy can be provided. There is reason to believe that the mission can be executed with much-improved safety if 5- to 10-m resolution maps are available prior to final site selection and planning. Such a precursor would be sent one Mars opportunity sooner than the primary mission.

Both configurations support all the telemetry and command rates. However, if optical communication is not available, the relay is needed in order to do the 1 Mbps rate. Therefore a relay or no relay decision is coupled with the technology choice.



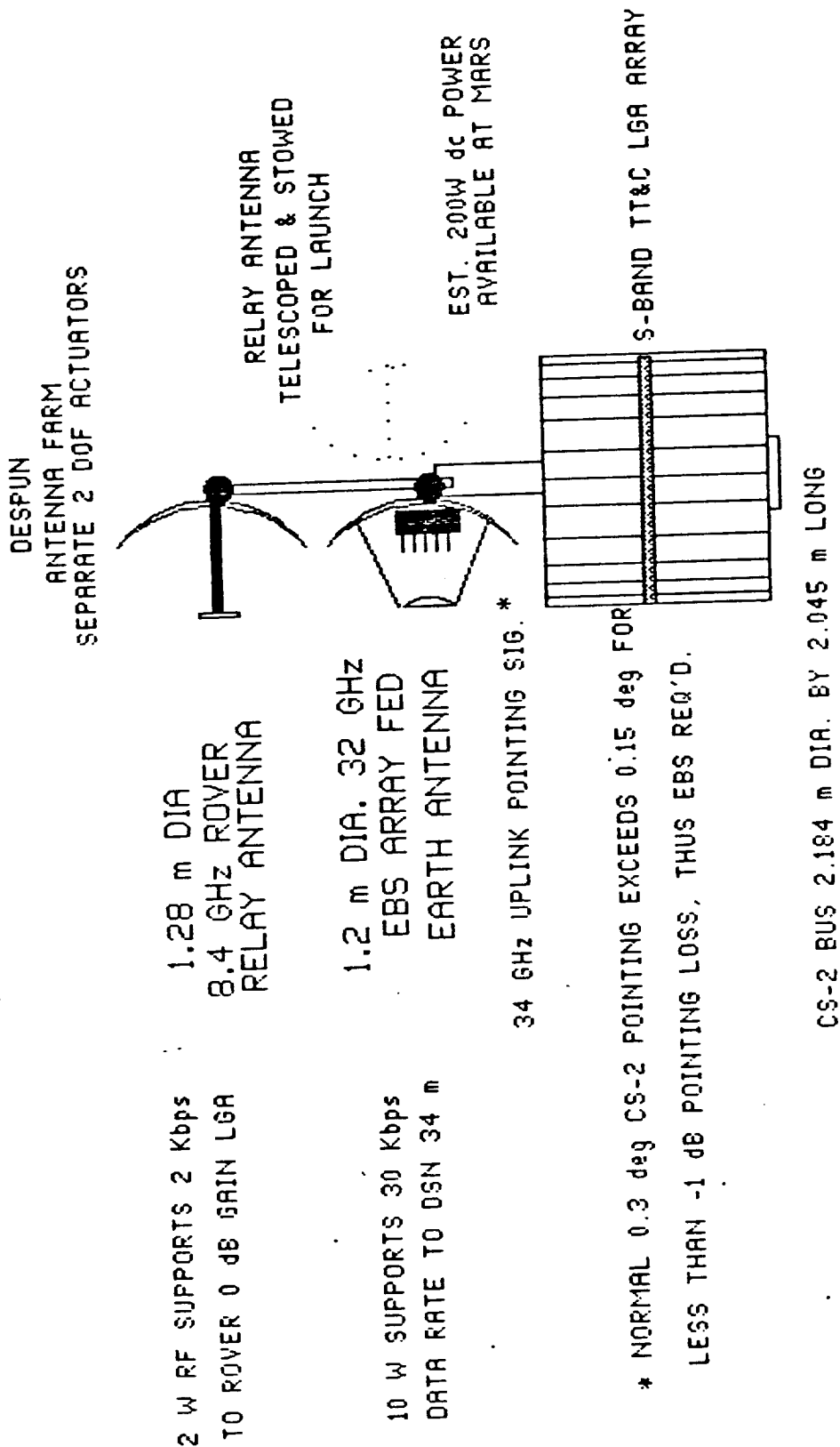

2 W RF SUPPORTS 2 Kbps  
TO ROVER 0 dB GAIN LGA

10 W SUPPORTS 30 Kbps  
DATA RATE TO DSN 34 m

\* NORMAL 0.3 deg CS-2 POINTING EXCEEDS 0.15 deg FOR  
LESS THAN -1 dB POINTING LOSS, THUS EBS REQ'D.

CS-2 BUS 2.184 m DIA. BY 2.045 m LONG

Figure 3-4. Possible System Configurations

### 3.3 MICROWAVE COMMUNICATIONS TECHNOLOGY

#### 3.3.1 $K_a$ -Band Technology Requirements

3.3.1.1.  $K_a$ - Versus X-band Trade-offs. Figures 3-5 and 3-6 show plots of supported data rate as a function of antenna aperture size with power as a parameter at  $K_a$ - and X-bands for a downlink from Mars to Earth. Figure 3-5 was computed for a 34-m DSN station, and Figure 3-6 was computed for a 70-m DSN station. Tables 3-1 and 3-2 contain the parameters used in these calculations for particular cases of transmitter power and aperture size. These represent the predicted performance of DSN stations in the 1993 time frame. Two particular aperture sizes are of interest. The first case considered is a 0.5-m aperture, which represents a strawman size considered for a downlink antenna located on the rover with a direct link to the earth. The second case is a 3.6-m aperture which represents an antenna that may be mounted on a relay satellite in orbit around Mars. Strawman data rates examined for the MRSR mission were 30 kbps, 150 kbps, and 1 Mbps.

The plots in Figures 3-5 and 3-6 include an allowance for uncertainties in design, manufacture, measurement error and the like. For an X-band system, the root sum square of the tolerances should be about 0.8 dB. For a 90% confidence link performance, a margin of 2 sigma or 1.6 dB should be adequate.

Because a  $K_a$ -band system has little or no space-flight history, a more conservative margin should be chosen. A link sigma of 1.0 dB seems reasonable. Thus, a margin of 2 sigma becomes 2 dB.

Link designs for  $K_a$ -band and X-band to 34-m and 70-m stations are given in Tables 3-1 and 3-2. They define the reference points in Figures 3-5 and 3-6.

Table 3-3 lists the aperture sizes needed to support the data rates from Mars conjunction to Earth using various combinations of RF transmitter power and DSN stations. Based on the constraints of aperture size on the rover, the  $K_a$ -band links are clearly far easier to package. Also, since the postulated relay requires directive antennas for both the Mars-to-relay and Relay-to-Earth links, operations size will also be important. Hence, for both applications,  $K_a$ -band communications capability has significant advantages over X-band.

3.3.1.2 Rover Antenna Configurations. The rover antenna can take the form of a fairly simple, low-gain antenna if a relay satellite in Mars orbit is implemented. Considerations are discussed elsewhere in this volume. We will focus on the configuration of a  $K_a$ -band antenna for a direct link to Earth with aperture size on the order of 0.5 m.

A number of  $K_a$ -band antenna configurations are available for the rover-to-Earth downlink. Some of these configurations are illustrated in Figure 3-7.

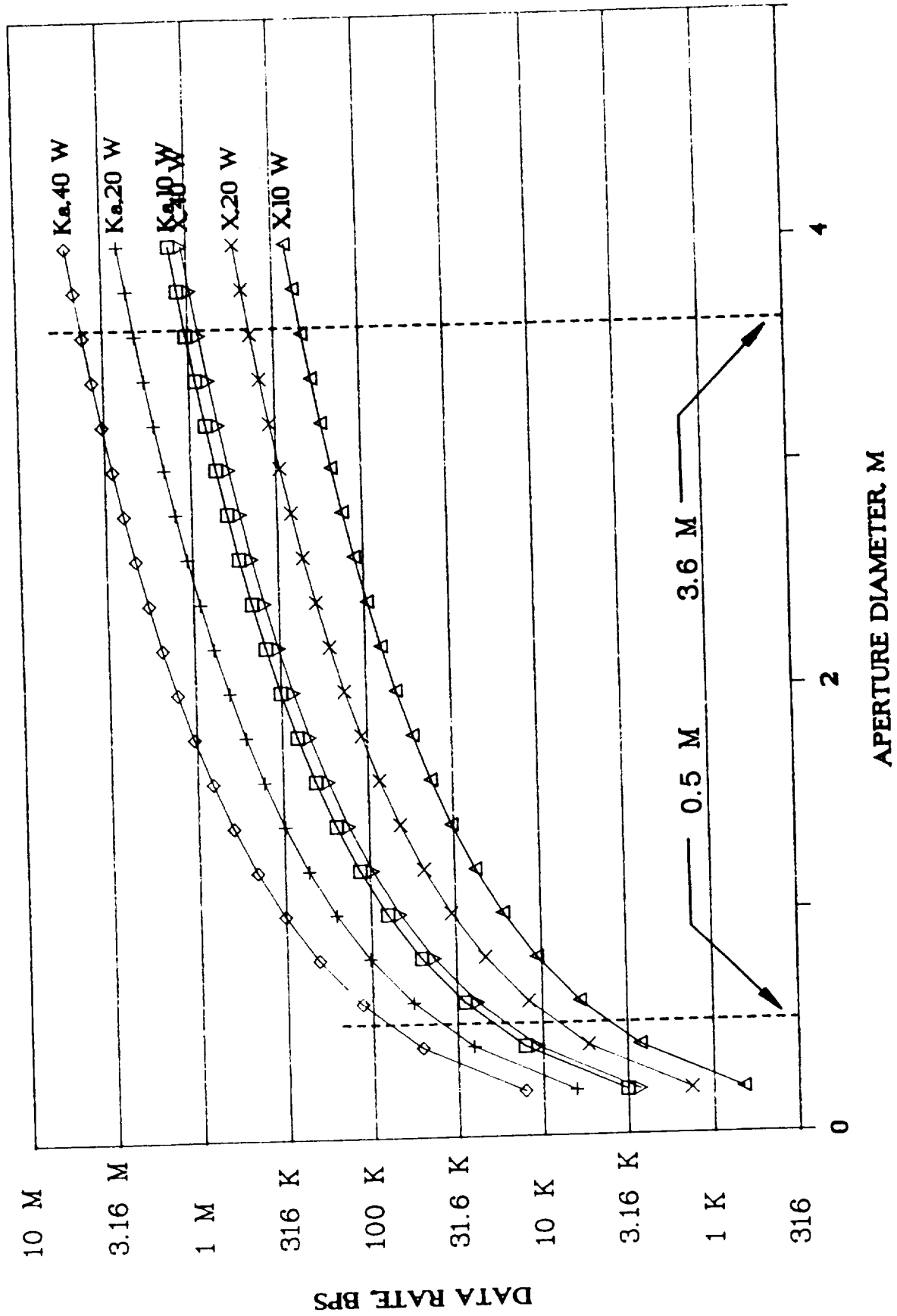

Figure 3-5. Data Rate Versus Aperture Size: 34-m DSN Station

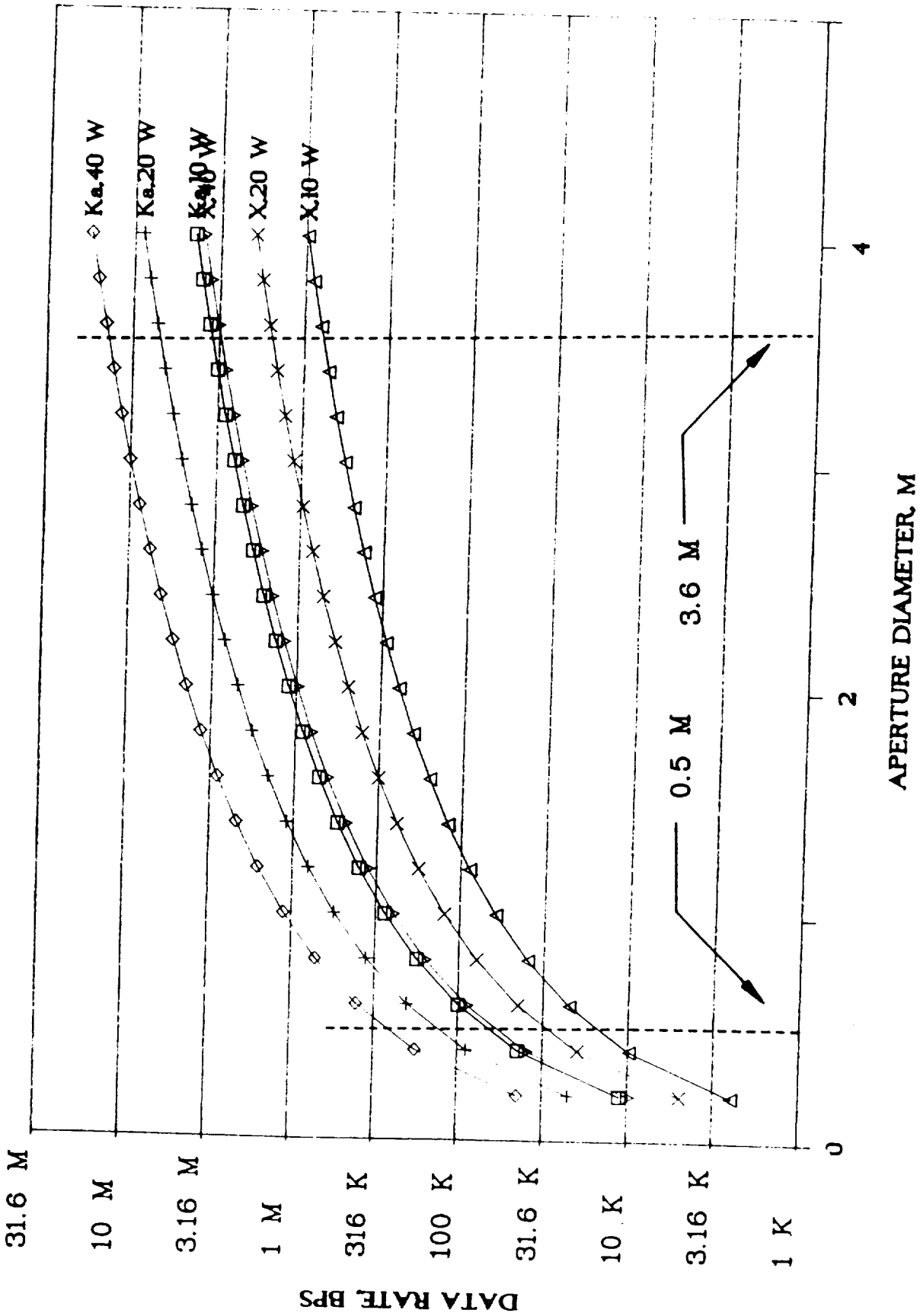

Figure 3-6. Data Rate Versus Aperture Size: 70-m DSN Station

Table 3-1. Parameters Used in Calculating Data Rates: 34-m

DSN LINK ELEMENTS	34 M DSN STATION	
	Ka-BRAND	X-BRAND
	INPUT PARAMETERS	LINK BUDGET
TRANSMITTING SYSTEM PARAMETERS		
1. RF POWER OUTPUT	20 W	43.0 DBM
2. TRANSMITTER CIRCUIT LOSS	0 DB	0.0 DB
3. ANTENNA CIRCUIT LOSS	0 DB	0.0 DB
4. ANTENNA GAIN		42.3 DB
5. ANTENNA POINTING LOSS	0.5 M	
ANTENNA EFFICIENCY	0.6	
	0.34 DEG	-1.0 DB
6. PATH PARAMETERS		
7. RANGE	2.683 AU	-294.6 DB
8. FREQUENCY	32 GHZ	
RECEIVING SYSTEM PARAMETERS		
9. POLARIZATION LOSS	-0.01 DB	.0 DB
10. ANTENNA GAIN	34 M	78.9 DB
ANTENNA EFFICIENCY	0.6	
11. ANTENNA POINTING LOSS	-0.15 DB	-0.2 DB
12. SYSTEM NOISE TEMP.	40 K	-182.6 DBM/HZ
ZENITH NOISE TEMP.	25 K	
ADD. FOR ELEVATION ANGLE	15 K	
ELEVATION ANGLE	30 DEG.	51.0 DB
13. AVAILABLE PT/NO		
TELEMETRY PERFORMANCE ESTIMATE		
14. RANGING CARRIER SUPPRESSION	0 DB	0.0 DB
15. REQUIRED PT/NO		49.0 DB-HZ
DATA RATE	40000 BPS	
REQUIRED EB/NO	3 DB	
REQUIRED CARRIER MARGIN	20.51 DB	
MODULATION LEVEL (RMS)	80 DEG	
16. PERFORMANCE MARGIN		2.0 DB
17. LINK RELIABILITY		
	20 M	43.9 DBM
	0 DB	0.0 DB
	0 DB	0.0 DB
	0.5 M	
	0.6	
	1.3 DEG	-1.0 DB
	2.683 AU	-283.0 DB
	8.415 GHZ	
	-0.01 DB	.0 DB
	34 M	68.0 DB
	0.7	
	-0.3 DB	-0.3 DB
	16 K	-196.6 DBM/HZ
	13 K	
	3 K	
	30 DEG.	43.9 DB
	0 DB	0.0 DB
	8400 BPS	42.2 DB-HZ
	3 DB	
	20.51 DB	
	80 DEG	
		1.6 DB

Table 3-2. Parameters Used in Calculating Data Rates: 70-m

USN LINK ELEMENTS	70 M DSN STATION	
	Ka-BAND	X-BAND
TRANSMITTING SYSTEM PARAMETERS	INPUT PARAMETERS	LINK BUDGET
1. RF POWER OUTPUT	20 W	43.0 DBM
2. TRANSMITTER CIRCUIT LOSS	0 DB	0.0 DB
3. ANTENNA CIRCUIT LOSS	0 DB	0.0 DB
4. ANTENNA GAIN	0.5 M	30.7 DB
ANTENNA DIAMETER	0.6	
ANTENNA EFFICIENCY	0.34 DEG	-1.0 DB
5. ANTENNA POINTING LOSS		
PATH PARAMETERS		
6. SPACE LOSS	2.683 RU	-294.6 DB
RANGE	32 GHZ	
FREQUENCY		
RECEIVING SYSTEM PARAMETERS	INPUT PARAMETERS	LINK BUDGET
7. POLARIZATION LOSS	-0.01 DB	0.0 DB
8. ANTENNA GAIN	70 M	84.4 DB
ANTENNA DIAMETER	0.5	
ANTENNA EFFICIENCY	0.16 DB	-0.2 DB
9. ANTENNA POINTING LOSS		-182.6 DBM/HZ
10. NOISE SPECTRAL DENSITY	40 K	
SYSTEM NOISE TEMP.	25 K	
ZENITH NOISE TEMP.	15 K	
ADD. FOR ELEVATION ANGLE	30 DEG.	56.5 DB
ELEVATION ANGLE		
11. AVAILABLE PT/NO		
TELEMETRY PERFORMANCE ESTIMATE		
12. RANGING CARRIER SUPPRESSION	0 DB	0.0 DB
13. REQUIRED PT/NO	140000 BPS	54.5 DB-HZ
DATA RATE	3 DB	
REQUIRED EB/NO	20.51 DB	
REQUIRED CARRIER MARGIN	80 DEG	
MODULATION LEVEL (RMS)		
14. PERFORMANCE MARGIN		2.0 DB
15. LINK RELIABILITY		
	31000 BPS	43.0 DBM
	3 DB	0.0 DB
	20.51 DB	0.0 DB
	80 DEG	30.7 DB
		-1.0 DB
		-283.0 DB
	2.683 RU	
	8.415 GHZ	
	-0.01 DB	
	70 M	
	0.6	
	-0.3 DB	
	16 K	
	13 K	
	3 K	
	30 DEG.	
		43.5 DB
	0 DB	0.0 DB
		47.9 DB-HZ
		1.6 DB

Table 3-3.

	<u>30 kbps/34M Stations</u>	<u>15 kbps/70M</u>	<u>1 Mbps/70M</u>
	<u>RF Power</u>	<u>Aperture Diameter</u>	<u>Aperture Diameter</u>
K <sub>a</sub> -Band	40W	.2M	.2M
	20W	.3M	.3M
	10W	.4M	.4M
X-Band	40W	.6M	.6M
	20W	.9M	.9M
	10W	1.3M	1.3M

Aperture size and DSN Station Pairs are for Mars to Earth at 2.68 AU (90% reliability, 2 $\sigma$ ; 1.6 dB X-band, 2.0 dB K<sub>a</sub>-band)

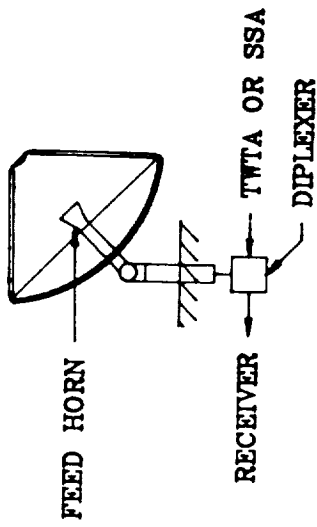

FEED HORN WITH WAVEGUIDE

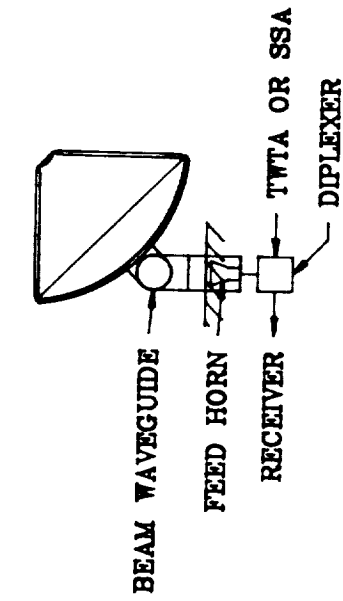

BEAM WAVEGUIDE WITH HORN ARRAY FEED WITH WAVEGUIDE

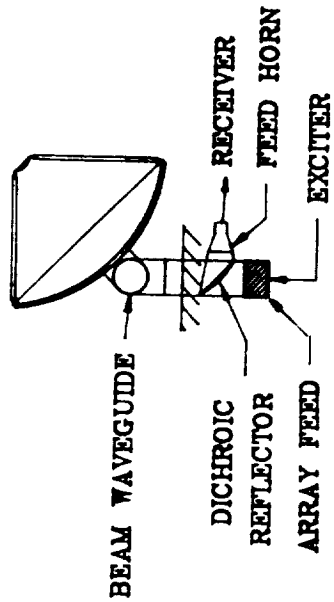
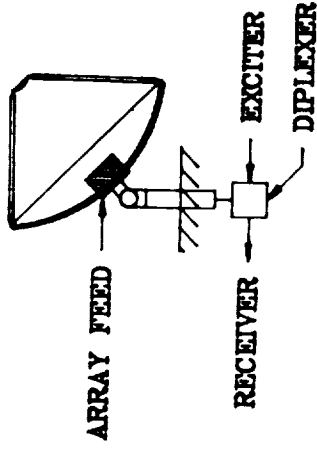

BEAM WAVEGUIDE WITH ARRAY FEED

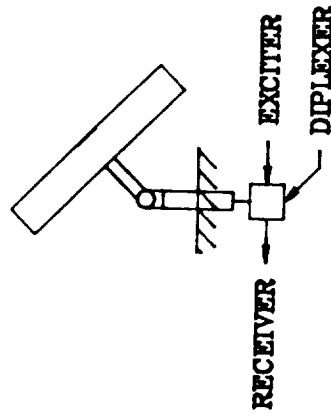

ARRAY WITH WAVEGUIDE

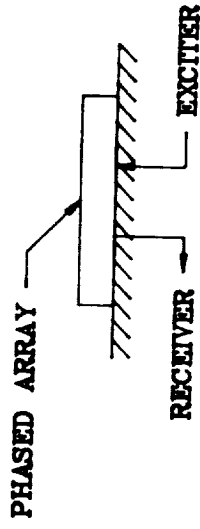

PHASED ARRAY

Figure 3-7. Some RSR Antenna Configurations



Of these configurations, two array approaches have several attractive benefits. One benefit is the capability of utilizing the array for electronic beam steering. This is an important consideration because in order to keep pointing loss less than 1 dB, pointing accuracy must be maintained to less than  $\sim 0.13$ . Although a complete study of mechanical pointing systems for rover applications has not been carried out, it is anticipated that pointing to this level of accuracy will be difficult in the Martian environment. Coarse pointing information could be derived from rover onboard sensors, and fine pointing information could be obtained from a monopulse system incorporated into the earth-to-rover uplink telecommunications system. The most power-efficient approach to implementing the array is to utilize distributed solid-state amplifier and phase-shifter components. The array provides the additional benefit of low-loss power combing of solid-state amplifier outputs. Thus, it appears that an active array is the most promising approach for implementing a  $K_a$ -band rover-to-Earth downlink.

Two approaches to the implementation of the array have been considered. One is a body-fixed phased-array (labeled "PHASED ARRAY" in Figure 3-7) which relies completely on electronic beam steering. A second approach is to use a combination of mechanical and electronic beam steering (labeled "ARRAY WITH WAVEGUIDE" in Figure 3-7). The body-fixed electronically beam steered array has the advantage of very compact packaging with no stowing required. The disadvantage, however, is its complexity; the array is required to scan over angles of the order of 60° which implies that individually phase-controlled radiators must be spaced on the order of one-half wavelength (5 mm). Thus approximately 6,000 elements are required. The alternative is to reduce the range of the electronic beam steering angle which allows greater spacing between elements or the use of subarrays to substantially reduce the number of active elements. If the electronic beam steering range is less than 10° the number of active elements can be reduced to the order of 200. To produce 40 W of radiated power each element must radiate on the order of 200 mW.

A key concern in development of electronically steered arrays is cost. Cost is driven by labor-intensive activities including assembly and test of the large number of elements. The promise of low phased-array cost, however, exists in the form of microwave monolithic integrated circuits (MMIC), in which the majority of the device interconnects are fabricated and, thus, labor-intensive interconnecting tasks are reduced. In addition, computer-aided test systems are being developed to reduce testing costs.

MMIC devices are presently being developed at 32 GHz by NASA Lewis Research Center (LeRC). In addition, the DoD recently initiated the Microwave and Millimeter Wave Integrated Circuit (MIMIC) Program which will result in an investment of the order of \$500M over the next five years in MMIC technology. It is anticipated that these programs will result in rapid advances in this technology which will result in substantially reduced costs and increased performance. In addition, new device structures such as the pseudomorphic high electron mobility transistor (HEMPT) show great promise for improved performance such as high power efficiency. Within the last six months, for example, power-added efficiencies of the order of 35% have been demonstrated for discrete devices of this type.

MMIC devices consisting of integrated phase shifters and power amplifiers will be mounted in hermetically sealed packages and integrated into

transmitter modules containing radiating elements. One such concept is shown in Figure 3-8. The modules will then be integrated into arrays such as that shown in Figure 3-9 for an array feed for the Cassini mission or the larger array required for MRSR as shown in Figure 3-10.

### 3.3.2 TECHNOLOGY DEVELOPMENT PROGRAMS AND NEEDS

JPL has initiated a 32-GHz spacecraft transmitter development program under funding from TBD (OSO). This program utilizes devices being developed at LeRC. The objectives, approach, and present status are summarized in Tables 3-4a and 4b. The initial objective is to demonstrate a one-dimensional electronically beam-steered array utilizing unpackaged MMIC amplifier and phase-shifter devices. A diagram of this array is shown in Figure 3-11. Initial tests of this test bed array are planned for later this year (1987). Measurements of the MMIC devices are presently being carried out, and fabrication of components of the array is under way. In addition to MRSR, this technology is applicable to other NASA missions, such as Cassini.

Table 3-5 summarizes the present status of Ka-band solid-state technology. The focus of this table is on gallium arsenide (GaAs) field effect transistor (FET) technology and does not include IMPATT amplifier technology since this technology does not have the power efficiency capability of FET technology. GaAs FETs have been demonstrated with power levels of the order of one watt at 30 GHz but with low gain and efficiency. Power-added efficiencies of the order of 35% at 35 GHz have been obtained at 50 mW. Continued effort is required to produce both high power and efficiencies, and these devices need to be integrated into MMIC devices. LeRC is presently funding programs to move toward these goals, but enhanced and focused development effort is required. The present thrust of NASA-funded efforts does not include packaging, which is required for high-reliability space applications. Very little effort has been undertaken in the area of assuring reliability of MMIC devices. Tables 3-6a through 3-6c summarize the areas in which technology development is required to meet the needs of a rover communications system, and these points are elaborated on below.

#### Device Technology Needs

High-efficiency GaAs power FETs with power-added efficiencies of greater than 35% with 250 mW or more output power are required. These devices must be integrated into multistage MMICs to obtain gain levels of the order of 15-20 dB. In addition, low-loss phase shifters with losses less than 6 dB are required, with integrated amplifiers to compensate for the power loss. These amplifiers are required to operate with high efficiency. Integration of phase shifters and high-efficiency power amplifiers is required. It is desirable to integrate digital components on the MMIC chip to minimize the number of interconnects to the phase shifter digital control system. These digital components will function to decode data from a serial bus input and provide sampling and hold functions to maintain phase-shift states. In addition, interconnections could be further reduced if serial data bus data interfaces are made by optical interconnections to the MMIC chips. These optical interconnections can be made either by optical fibers or by direct illumination of the MMIC chips.

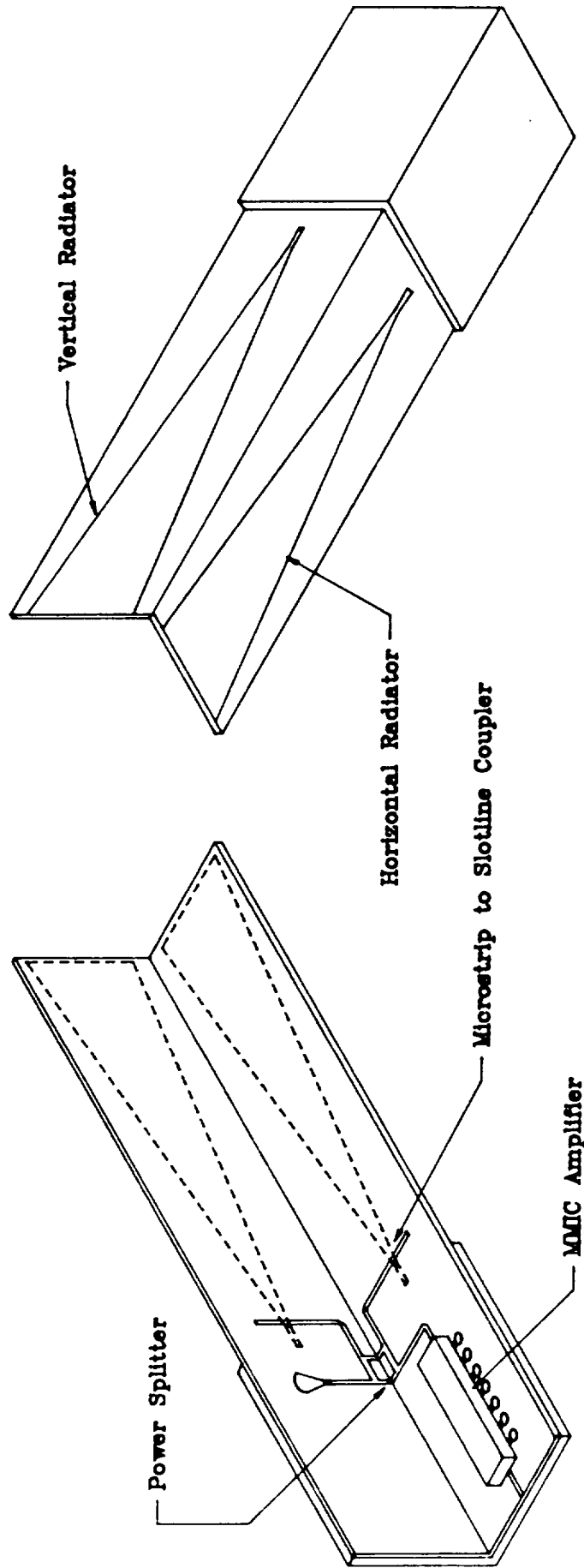

Figure 3-8. 32-GHz Transmitter Module

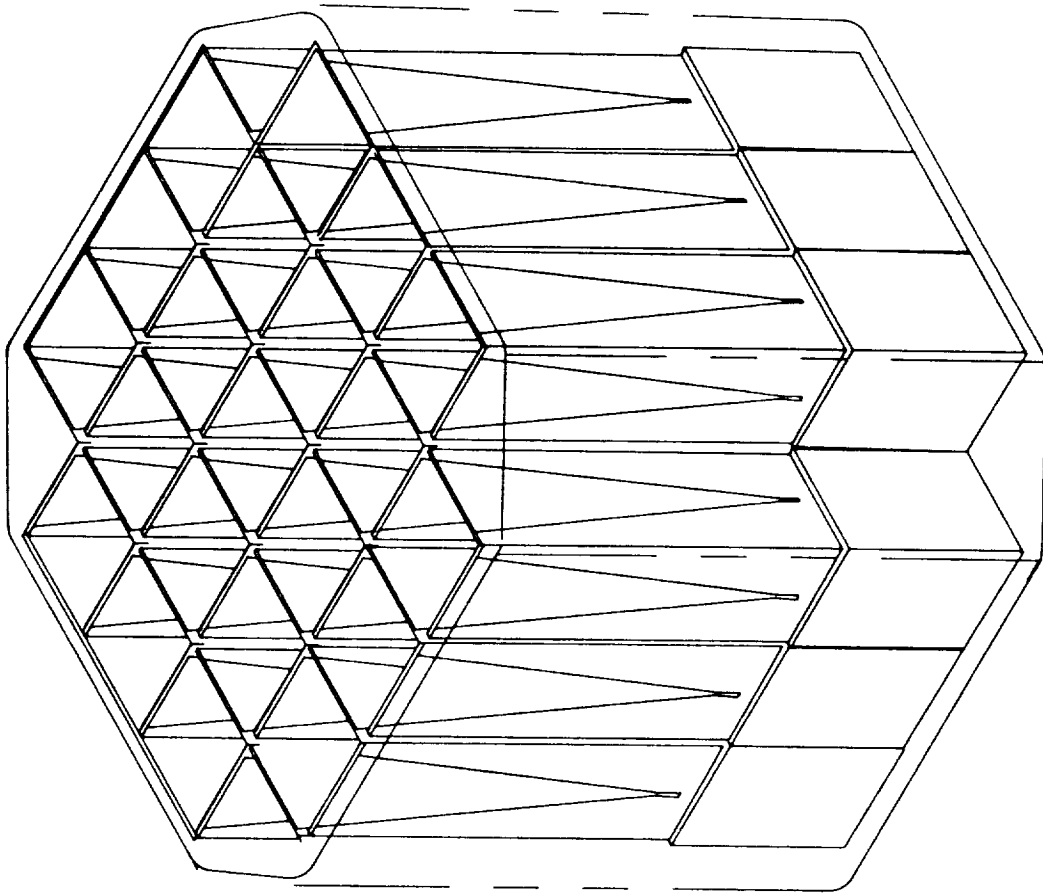

Figure 3-9. 21-Element Array Feed

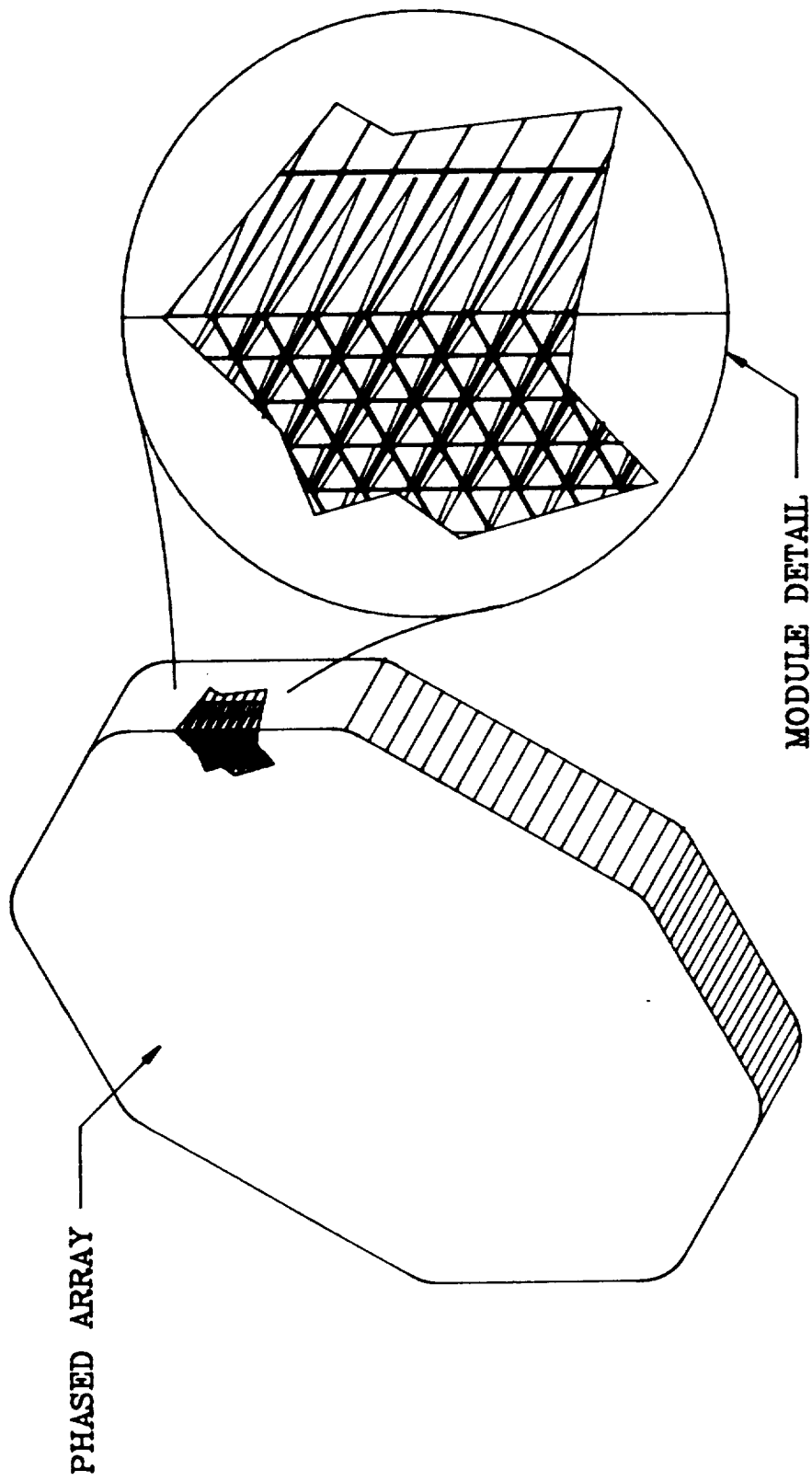

Figure 3-10. MRSR Array Concept

Table 3-4a. JPL Ka-band Spacecraft Transmitter Program

\* OBJECTIVES

- DEVELOP TECHNOLOGY REQUIRED FOR SPACEBORNE TRANSMITTERS AT 32 GHZ FOR DEEP SPACE MISSIONS

\* APPROACH

- DEFINE TECHNOLOGY TO SUPPORT MISSIONS WITH LOW RF POWER AND HIGH RF POWER REQUIREMENTS
- EVALUATE 32 GH COMPONENTS TO DEFINE TECHNOLOGY DEVELOPMENTS REQUIRED
- DEVELOP TRANSMITTER COMPONENTS JOINTLY WITH LERC
- DEVELOP SPACE QUALIFIED 32 GHZ TRANSMITTER SUBSYSTEMS

Table 3-4b. JPL K<sub>a</sub>-band Spacecraft Transmitter Program (contd)

\* PRESENT STATUS

- PROGRAM INITIATED IN OCTOBER 1986

- SSA ACTIVE ARRAY BEING STUDIED INITIALLY

- AMPLIFIER AND PHASE SHIFTER MMIC'S FROM LERC ARE UNDER TEST AT JPL

- ONE DIMENSIONAL ELECTRONICALLY BEAM STEERED ARRAY FEED BEING DESIGNED

- SYSTEM STUDIES UNDERWAY

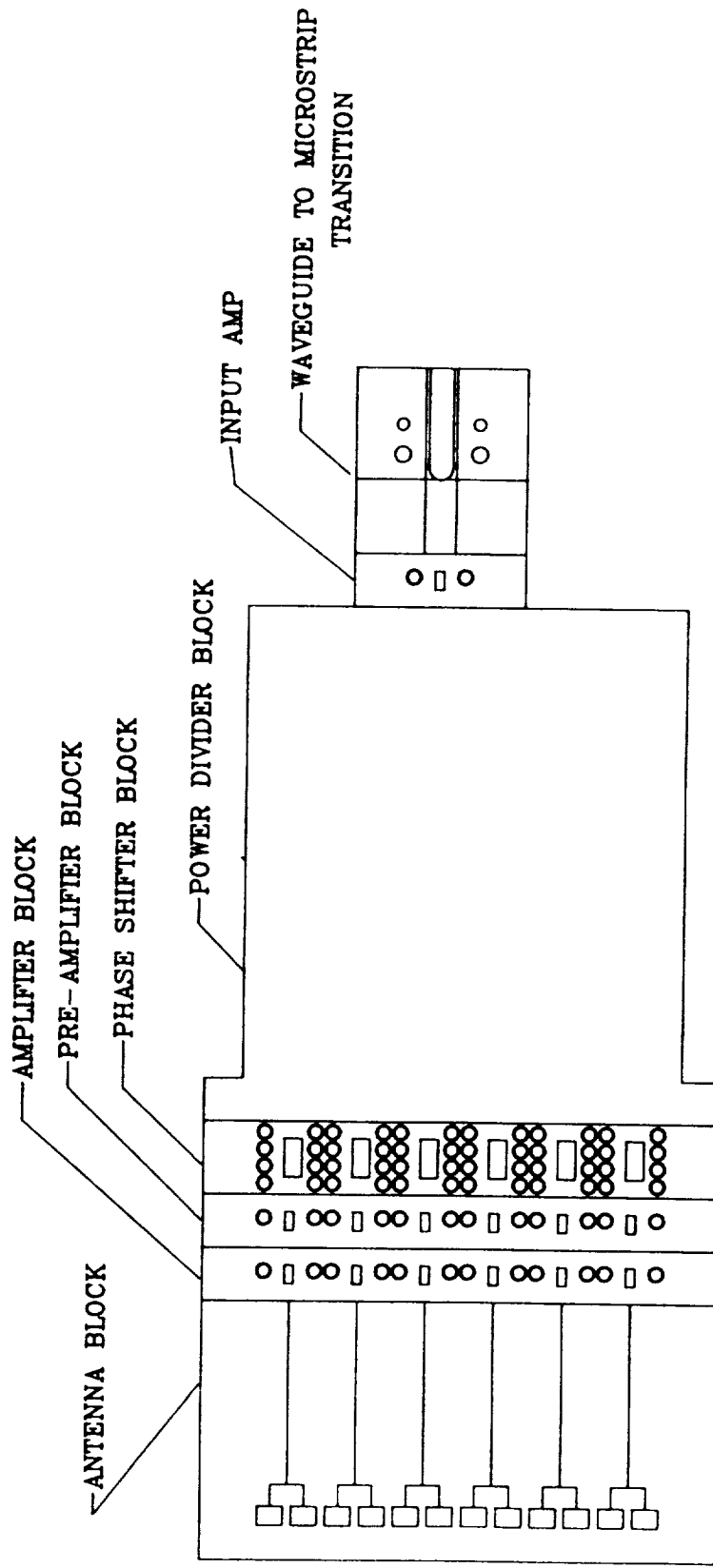

Figure 3-11. One Dimensional Steered Array Test Bed



Table 3-5. K<sub>a</sub> Band Solid State Technology Status

- \* SOLID STATE
  - HIGHEST POWER GAAS FET 1W WITH LOW GAIN AND EFFICIENCY AT 30 GHZ
  - EFFICIENCIES OF 35% DEMONSTRATED AT 50MW
  - MMIC POWER AMPLIFIER DEVELOPMENT INITIATED AT 35 GHZ BY LERC BUT PERFORMANCE IS FAR FROM GOALS
  - PACKAGED DISCRETE AND MMIC DEVICES NOT AVAILABLE
  - RELIABILITY ISSUES HAVE NOT BEEN ADDRESSED
  - LOW LOSS POWER COMBINING TECHNIQUES REQUIRED

Table 3-6a. SSA Technology Development Needs

- \* **DEVICES**
- **HIGH EFFICIENCY POWER FET'S (>35% @ 250 MW)**
- **HIGH EFFICIENCY MMIC POWER AMPLIFIERS (>35% @ 250 MW)**
- **LOW LOSS PHASE SHIFTERS (<6DB)**
- **PACKAGED 32 GHZ MMIC'S**
- **HI-REL DEVICES**
- **LOW COST 32 GHZ MMIC'S**
- **IMPROVED MMIC MODELING TECHNIQUES**

Table 3-6b. SSA Technology Development Needs (contd)

- \* **CIRCUITS**
  - **LOW LOSS POWER COMBINERS**
  - **INTEGRATED MMIC AND RADIATORS**
  - **T/R MODULES**
  - **LOW LOSS RF DISTRIBUTION NETWORKS**
  
- \* **ARRAYS**
  - **IMPROVED ACTIVE ARRAY ARCHITECTURE**
  - **IMPROVED ACTIVE ARRAY ANALYSIS**
  - **IMPROVED ARRAY FEED ANALYSIS**
  - **BEAM WAVEGUIDE DEVELOPMENT**

Table 3-6c. SSA Technology Development Needs (contd)

- \* **POWER AND CONTROL**
- **OPTICALLY CONTROLLED MMIC'S**
- **CUSTOM VLSI FOR ARRAY CONTROL**
- **MMIC AND ACTIVE ARRAY THERMAL ANALYSIS TECHNIQUES**
  
- \* **OTHER**
- **KA-BAND EXCITER**

In order to apply these devices to the MRSR communications, they must be encapsulated in impedance-matched packages to provide hermetic seals from the environment. This technology does not presently exist. In addition, the devices must be designed and tested to provide high-reliability operation. Automated testing procedures must be devised to provide low-cost devices. Lower costs will also be derived from the development of improved MMIC modeling techniques to allow more rapid convergence on a device design.

#### Circuit and Transmit Module Technology Needs

Transmit module and circuit technology development is required in a number of areas to implement the MRSR communication system. Areas of development include low-loss millimeter wave power combiners and power distribution networks to maintain high power efficiency. In addition, methods of optimally integrating the radiating elements and MMIC devices need to be developed to minimize circuit losses and costs. Automated testing techniques for these modules require development. Other development areas for transmit modules include thermal control systems and signal and dc power distribution methods.

#### Array Technology Needs

Development is required in the area of methodology for optimizing active array architecture. This methodology must consider a number of complex issues including low-loss and highly reliable interconnections of RF transmission lines and dc power and digital control lines. The optimum architecture must provide integration of millimeter-wave active and passive transmission lines and radiating elements with thermal control systems packaged for ruggedness and allowing for replacement of components. It must accommodate a modular construction technique to reduce cost and allow lower level subelement testing.

Efficient design procedures require the development of improved active array analysis methods to allow more accurate predictions of performance to reduce cost of development and to improve performance. Related to this is the need for improved modeling array feed element analysis, particularly planar antenna element structures.

Another important area is the development of beam waveguide technology to reduce signal loss from the antenna system to other elements of the millimeter wave system.

#### Power and Control Technology Needs

Development is required in several areas which support active array systems. These include digital electronic beam steering control systems, control system interconnections, power supplies and thermal analysis methods. Digital beam steering control systems will benefit from the development of custom VLSI circuits integrated with the microwave components and the application of optical interconnections for control of MMIC devices.

### Other Technology Needs

The development of a  $K_a$ -band exciter and transponder subsystem is another critical development area. This subsystem should be designed to incorporate a high level of MMIC devices to minimize size and mass.

### $K_u$ -Band Rover-to-Relay Link

The design of this link is based on existing development capabilities as demonstrated on the NASA Tracking and Data Relay Satellite System. The key link is the 1 Mbps  $K_u$ -band uplink (rover to relay satellite). Performance parameters for this link are presented in Tables 3-7 and 3-8. The 1-Mbps link will be used to transmit video from the rover to the Earth (or processed on the relay satellite) via the relay satellite. To maintain adequate video quality a bit error rate (BER) of  $10^{-5}$  is assumed. To obtain this, an  $E_b/N_0 = 11$  dB (9.6 dB plus 1.4 dB for channel degradation) is required. The rover can use a 0.08-m diameter horn antenna which has a gain of 18 dB with  $20^\circ$  angle broad coverage of the relay satellite. With this broad coverage, pointing requirements on the rover are substantially reduced; however a simple autotrack system is needed if rover motion is  $\pm 30$ . Similarly, the 2-meter antenna on the relay covers a 500 km diameter on the surface of Mars, reducing spacecraft antenna pointing requirements.

The rover transmitter power of 2 W with a 2-MHz bandwidth (to support 1 Mbps) is easily achievable with present technology. Both traveling wave tube amplifiers (TWTAs) and solid state power amplifiers (SSPAs) are available and space qualified. They must, however, be qualified for the Mars surface environment.

### $K_u$ -Band Relay-to-Relay Link

The 2-kbps link with a 15 dB  $E_b/N_0$  poses no problem for closing the link, given the 2-m spacecraft antenna and a 0.08-m rover horn. However, the electronic equipment LNAs and the receiver/transponder must be qualified for operation on the surface of Mars.

Also, the required  $K_u$ -band-to-X-band isolation must be thoroughly investigated.

Table 3-7.  $K_u$  Band Uplink

Parameter	Value
Frequency	12 Ghz
1 Mbps at $E_b/N_0$	11 dB <sup>(1)</sup>
Rover Antenna Gain	18 dB <sup>(2)</sup>
Rover Transmitter Power	2W
EIRP	21 dBW
G/T at Spacecraft	20 dB/°K <sup>(3)</sup>
Spacecraft Antenna Gain	47 dB <sup>(4)</sup>
Spacecraft Antenna Diameter	2 meters

(1) 9.6 dB for  $10^{-5}$  dB without coding; coding gives 6 dB additional gain.

(2) 0.08-m horn, 20° angle.

(3)  $T = 500K$ ; requires A/T or a pointing subsystem, and assumes rover motion of  $\pm 30^\circ$ .

(4) at a 0.7° angle. 1.7° coverage is required for a 500 km rover traverse.

Table 3-8.  $K_u$  Band Downlink

Parameter	Value
Frequency	15 Ghz
2 kbps at $E_b/N_0$	15 dB <sup>(1)</sup>
Spacecraft Antenna Gain	48 dB
Transmitter Power	14 W
EIRP Spacecraft	59 dBW
G/T Rover	1 dB

(1) 11 dB required for  $10^{-9}$ .

#### $K_a$ -Band TWTA

A TWTA of the following characteristics is desired for rover/Earth data transmission:

Frequency - 32 GHz  
 RF Power Output - 30 to 50 W  
 Bandwidth - 10 MHz

Tubes of these characteristics are available at present for missile/ELV applications. Required is a tube development for space/planetary surface application. Development issues for MRSR are breakdown voltage, storage, and turn-on temperature and efficiency. Present tube temperatures are -50°C storage and -30°C turn-on. Potting materials crystallize below -50°C. RF/dc TWTA efficiency of 30 to 35% is typical. Efficiency up to 50% may be possible with improvements in collector design and by taking advantage of the narrow band requirements of the tube. Tube development milestones and funding are:

Go-Ahead	1/91
Engineering Model Completion	1/93
Qualification Test Model Completion	1/94
Life Test Start	1/94

Cost of this effort is estimated at \$4.5M.

### 3.4 OPTICAL COMMUNICATIONS TECHNOLOGY

Viewgraphs are attached that were presented for describing the optical frequency telecommunication systems (see Figures 3-12 through 3-19). System configurations for orbiting or earth-based triplicated spatial diversity sites are shown. System parameters, telescope concept, and acquisition and pointing techniques, etc., are illustrated. The final viewgraph lists the desired technology requiring developments.



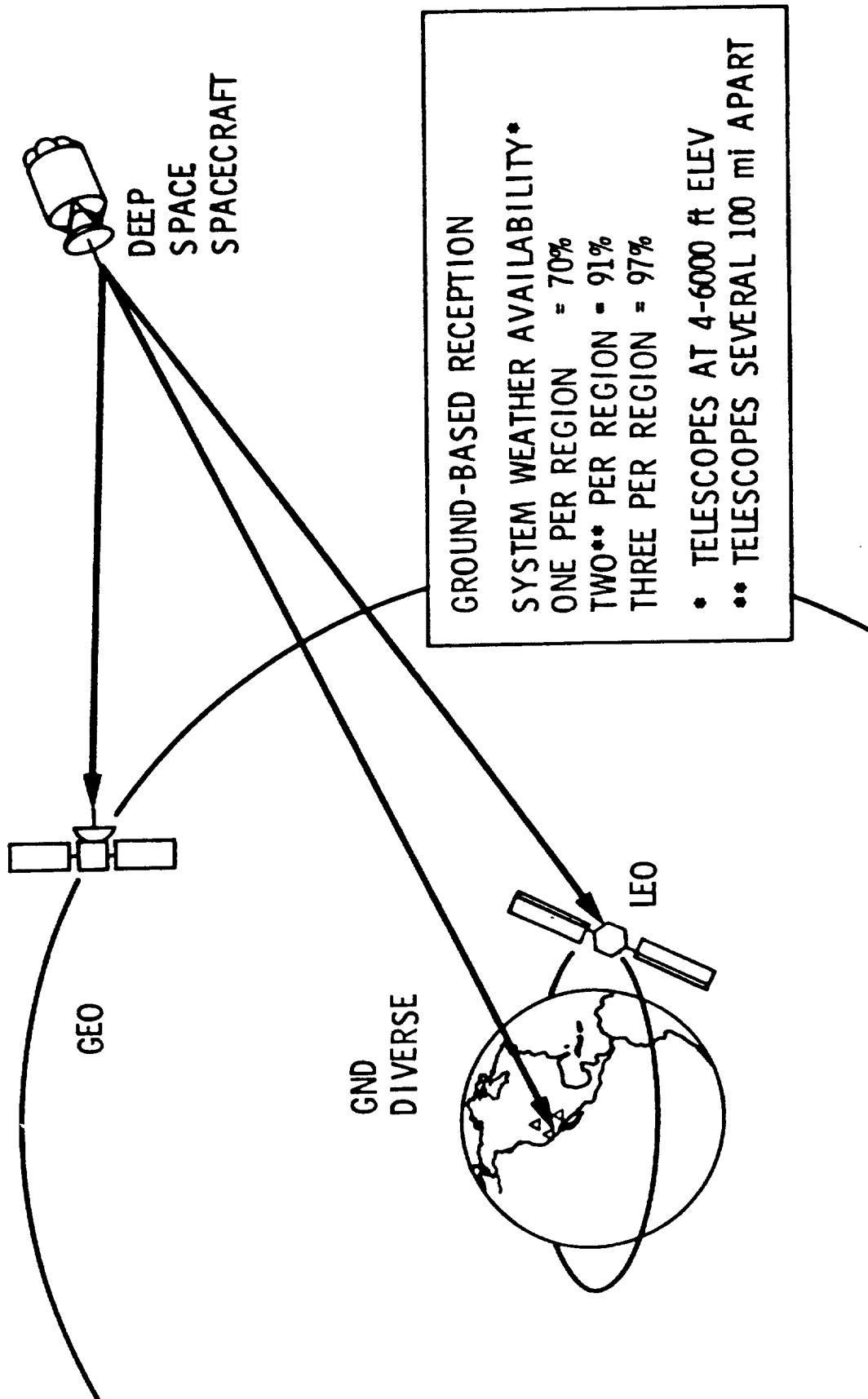

Figure 3-12. Optical Telecom Configurations



$$\theta \approx 2.4 \lambda / D$$

$\lambda$  = wavelength

SPOT DIAMETER AT RECEIVER =  $\theta R$  ( $R$  = range)

POWER DENSITY AT RECEIVER  $\propto \frac{P_{\text{TRANSMIT}}}{(\theta R)^2}$

$$\left. \begin{array}{l} \text{RF (Ka Band)} \\ \lambda \approx 0.94 \text{ cm} \\ D = 1.0 \text{ m} \end{array} \right\} \Rightarrow \theta_{\text{RF}} \approx 23 \text{ mrad}$$

$$\left. \begin{array}{l} \text{Optical (Green)} \\ \lambda = 0.53 \mu \\ D = 0.1 \text{ m} \end{array} \right\} \Rightarrow \theta_{\text{OPT}} \approx 13 \mu\text{rad}$$

For the same  $P_{\text{TRANSMIT}}$ , the relative power density at the receiver =  $\frac{(\theta_{\text{OPT}})^2}{(\theta_{\text{RF}})^2} \approx 3 \cdot 10^6$

Figure 3-13. Far Field Antenna Diffraction

# PULSE POSITION MODULATION

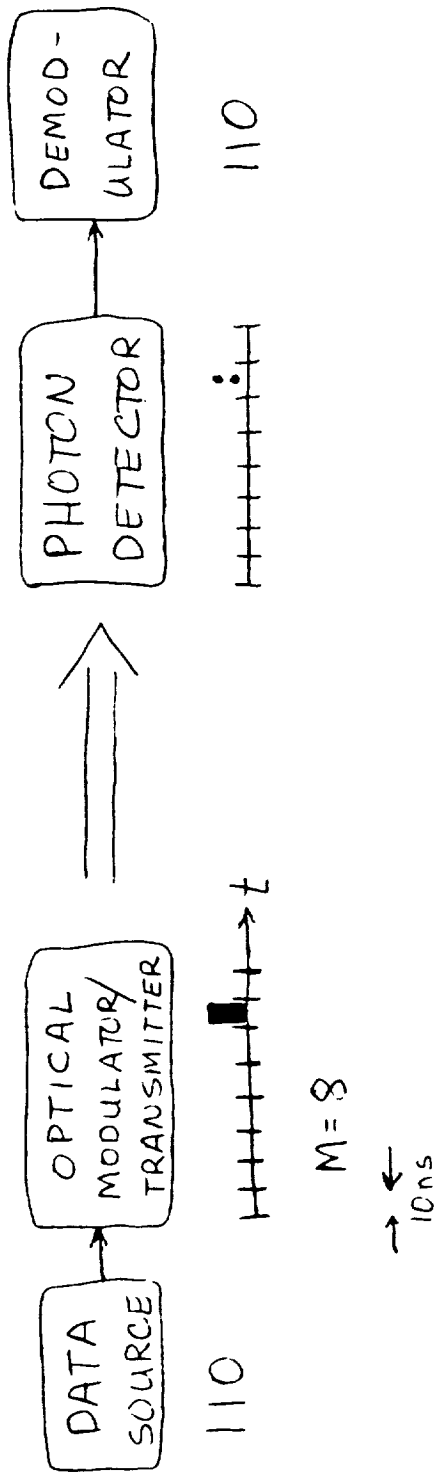

2 detected photons, 3 bits  $\Rightarrow$

1.5 bits/detected photon.

2.5 bits/detected photon demonstrated at JPL

Figure 3-14. Multi-Bit/Photon Communication

Package: 10 cm telescope

400mW doubled Nd:YAG laser

35 W total power

25 kg total mass (fully redundant except telescope and gimbal)

Receiver: Ground-based 10-meter solar collector  
(non-diffraction limited)

For worst case  $R = 2.6 \text{ AU}$  ( $\therefore$  daytime reception), optical depth of Martian atmosphere = 1

Downlink: 150 kbps, BER =  $10^{-3}$  ( $M = 256$ , R-S rate  $7/8$ )

Uplink: 2 Kbps, BER =  $10^{-9}$

Figure 3-15. System Configuration, Performance Values

# GIMBALED TELESCOPE CONFIGURATION

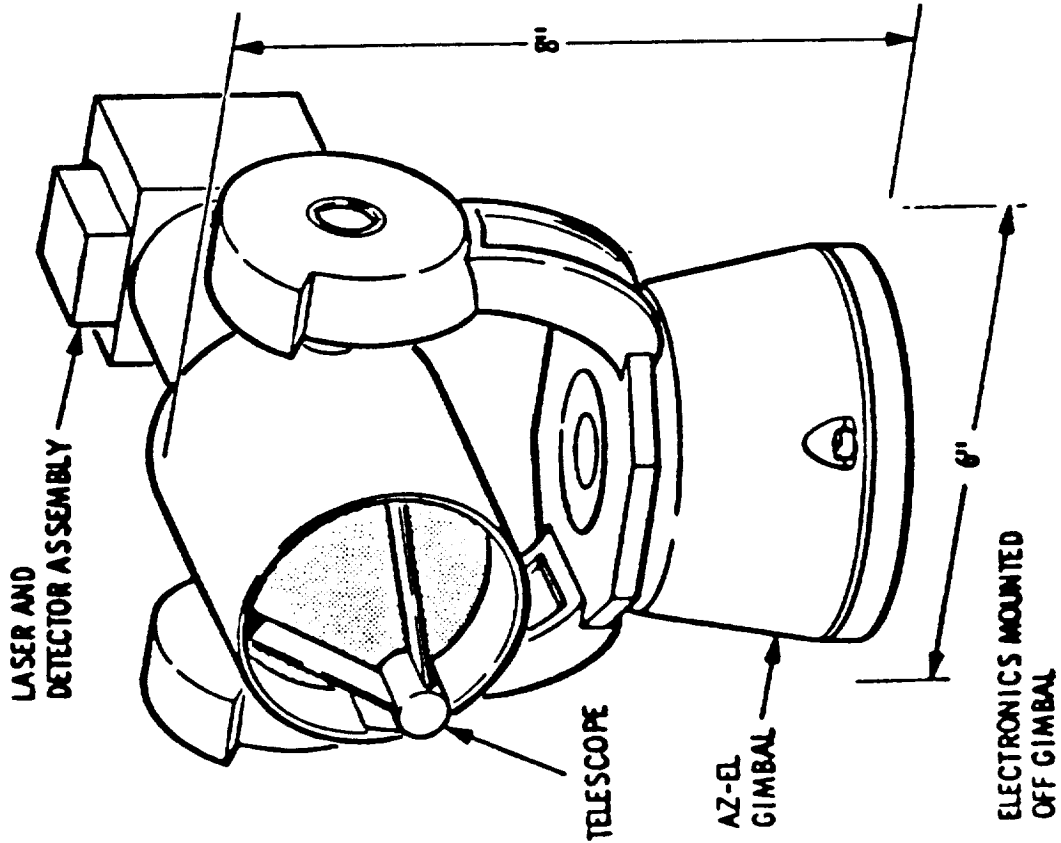

# OPTICAL AND ELECTRICAL SCHEMATIC

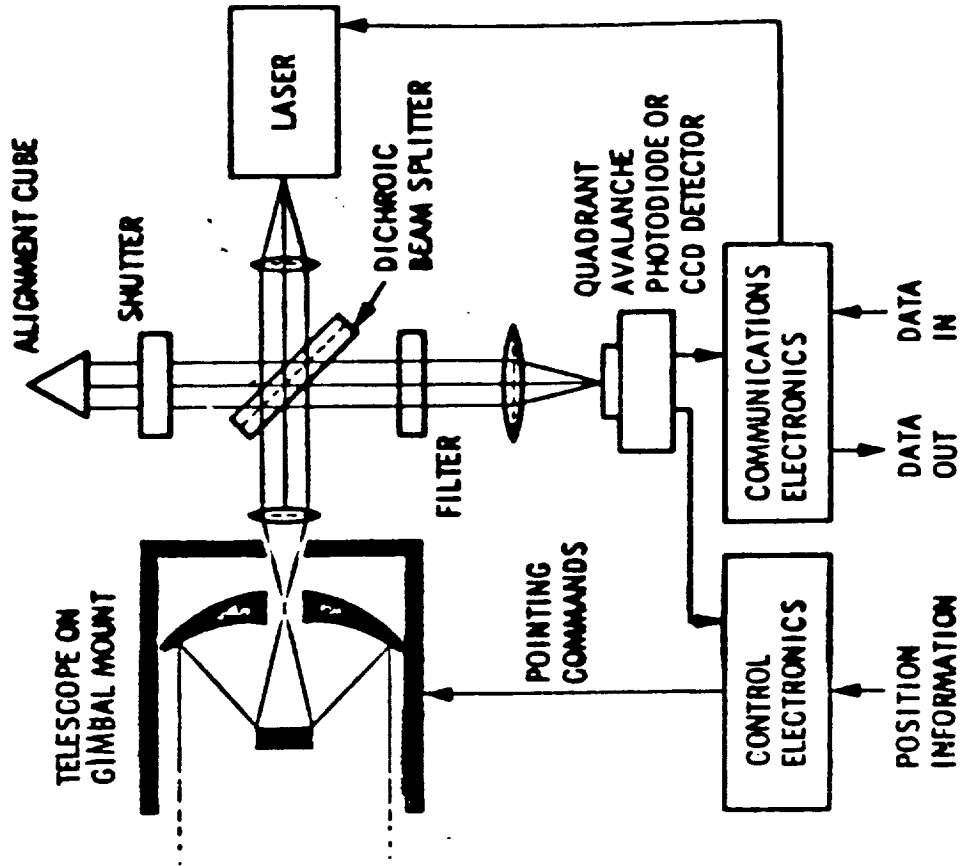
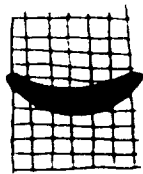

Figure 3-16. Optical Communications Package

WHEN  $R=0.4$  A.U., FOOTPRINT AT EARTH IS ONLY  $\sim 800$ KM.  
CRESCENT EARTH SPANS  $\sim 15$  PIXELS.



SCAN THE IMAGE WITH RESPECT TO THE DETECTOR  
ARRAY. WHEN A PRE-SET THRESHOLD FOR PIXEL  
ILLUMINATION IS CROSSED, EDGE IS LOCATED.

RESOLUTION  $\sim 1$  PIXEL EXPECTED.

20

WITH KNOWLEDGE OF RECEIVER POSITION RELATIVE TO EDGE,  
RECEIVER CAN BE LOCATED.

Figure 3-17. Target Acquisition

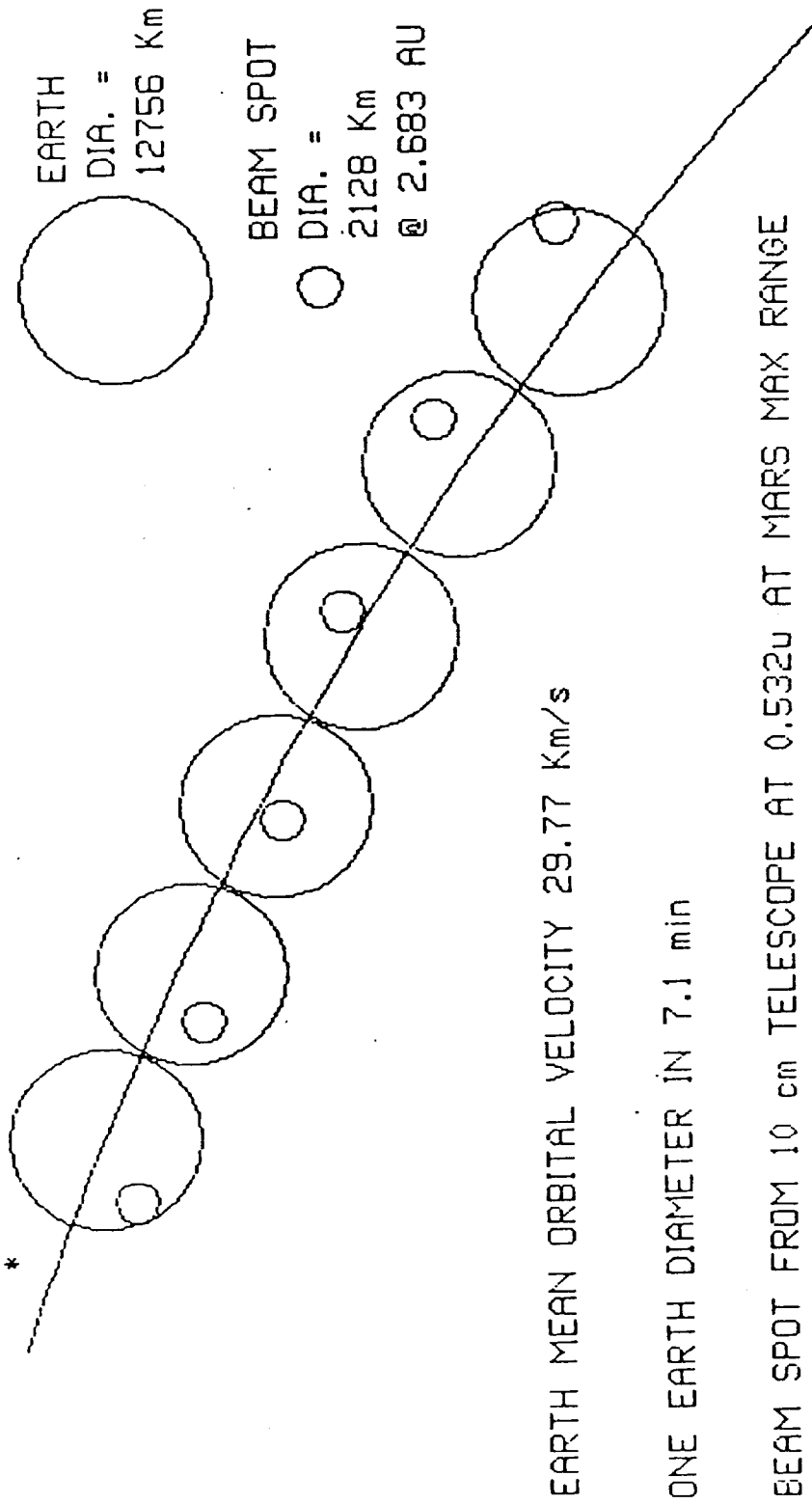

Figure 3-18. Mars Rover Telecommunications Lasercom Pointing

- DETECTORS WITH  $\geq 30\%$  QUANTUM EFFICIENCY  
AT  $0.532\mu\text{m}$
- 0.4 W Nd:YAG WITH  $\geq 10\%$  OVERALL EFFICIENCY  
AT  $0.532\mu\text{m}$
- 10-meter non-diffraction limited solar collector  
(for ground-based reception)
- Detectors (CCD, CID) and techniques for fine ( $< 1\mu\text{rad}$ )  
acquisition, pointing, and tracking

Figure 3-19. Optical Communications Technology Development



## SECTION 4

### CONCLUSIONS AND RECOMMENDATIONS

A Mars-synchronous orbiting satellite would pay off significantly by providing both nearly continuous communications support, as well as the possible opportunity to serve as the precursor surface-mapping satellite. It is recognized that significant orbital change energy will be required to perform this dual function. If the 1 Mbps data link is required, then optical communications provides the only realistic rover-direct-to-Earth capability. A relay is a must if 1 Mbps is to be available by microwave means.

The development times for microwave implementation are all compatible with a 1993 decision date. The range of currently available technologies varies from current space-qualified hardware that must be modified for Mars environments to 32-GHz components which now exist as primitive devices that need to be assembled to system-level performance entities in a Mars environment.

Optical communications are more credible by a 1995 technology cutoff than by 1993. A possibly greater constraint is the ground reception capability implied, that is, three or four spatially diverse sites in the vicinity of each DSN complex. Logistical considerations for maintenance and data handling imply that they be in the vicinity of existing DSN ground resources.

Minimum Mars rover communication needs can be accommodated with an X-band system requiring no major technological developments or improvements in the present DSN system. This assumes a mechanically steerable 0.5-meter dish and a 40-watt transmitter on the rover with a 30 kbps data transmission rate. The minimum data transmission of 100 M bits/day are attained with one hour daily transmission to the 70-meter DSN facility.

Taking advantage of the expected DSN expansion to  $K_a$ -band permits significant improvements in communication service. In this case, a 0.5-meter mechanically steerable dish and 40 watt transmitter permit an improvement factor of ten in data transmission. All major components of this  $K_a$ -band are at level 4 to 5 in technological readiness.

Improvements in  $K_a$ -band technology can reduce communications subsystem payload size, mass, and power requirements by 40 to 60 percent. Technology areas to focus on are the phased-array, solid-state power amplifier, multimode tracking feed, and beam waveguide. These technologies are at level 2 to 3 readiness.

Communication at optical wavelengths offers the possibility of real-time TV transmission to earth (1 Mbps). No show-stoppers have been identified to allow this technology to be available for the 1995 effort. However, critical development of most components at both ends of the link are required. Additional, more detailed information is given in Figures 4-1 through 4-7.

Alternately, 1 Mbps data transmission is possible with existing technology by using a communications relay satellite placed in synchronous altitude to relay rover data. In this case, a  $K_u$ -band rover uplink is recommended. A transmitter power of less than ten watts and a relatively broad beam antenna of more than ten degrees should be adequate. In this manner, the relay satellite would absorb much of the power, pointing, and computational constraints imposed on the communications subsystem.

0 MICROWAVE TECHNOLOGY DEVELOPMENTS ARE  
REASONABLE BY 1993

0 OPTICAL TECHNOLOGY DEVELOPMENTS ARE MORE  
REASONABLE BY 1995 AND GROUND INVESTMENT BY  
2000 (PROGRESS DEPENDS ON FUNDING)

0 MARS SYNCHRONOUS SATELLITE IS A SIGNIFICANT  
BENEFIT

NEARLY CONTINUOUS COMMUNICATIONS  
"LOCAL" COMPUTING SUPPORT  
POSSIBLE MAPPING PRECURSOR (LOWER ORBIT)

Figure 4-1. Conclusions and Recommendations

**TWO PATHWAYS**

**ROVER DIRECT TO EARTH**

**CONTACT WHILE IN VIEW (HALF TIME)  
ROVER TO SYNCHRONOUS RELAY**

**CONTINUOUS COVERAGE**

**THREE DATA RATES**

**30 KBPS - ROUTINE CONTINUOUS COVERAGE**

**-ALLOWS 100MB/DAY WITH 5% DUTY CYCLE  
150 KGPS - SURVEY AND ROUTE PLANNING IMAGING**

**-GIVES 500 MG/DAY USING 5% DUTY CYCLE  
1000 KGPS - HIGH VOLUME**

**-GIVES 3500 MB/DAY USING 5 DUTY CYCLE  
THREE TECHNOLOGIES FOR MARS TO EACH PATH**

**X-BAND MICROWAVE (8.4 GH3)**

**KA-BAND MICROWAVE (32 GH3)**

**OPTICAL - BAND (564 TH3)**

	30 KBPS	150 KBPS	1000 KBPS
<b>ROVER</b>			
<b>RF POWER AVAILABLE</b>	40 W	SAME AS 30K	NOT
<b>ANTENNA</b>	1.0M		
<b>DC POWER</b>	130 W		
<b>VOLUME</b>			
<b>MASS</b>	20KG		
<b>POINTING</b>	1		
<b>DSN</b>			
<b>SYSTEMP</b>	25K	25K	
<b>ANTENNA</b>	34M	70M	

Figure 4-3. X-Band Direct

	30 KB/S	150KB/S	1000KB/S
<b>ROVER</b>			
RF POWER	24 W	SAME AS 30K	40 W
ANTENNA	.5M		.75 M
DC POWER	120W		200 W
VOL.			
MASS	L0KG		20KG
POINTING	.3		.1
<b>DSN</b>			
SYSTEMP	40K	40K	40K
ANTENNA	34M	70M	70M

Figure 4-4. K<sub>a</sub> Band Direct

	30KBPS	150KBPS	1000KBPS
ROVER			
RAD POWER	.4W		2.0W
TELESCOPE	D.10CM		15 CM.
DC POWER	35W		50W
VOL.			
MASS	25KG		30KG
POINTING	10		.7
GROUND			
SYSTEM	DAYLIGHT	DAYLIGHT	DAYLIGHT
TELESCOPE	5 M	10 M	10 M

Figure 4-5. Optical Direct

SOURCE	ROVER	RELAY	KEY TECHNOLOGIES
FREQ.	8GH3	32GH3	DUAL ARTICULATED
HGA'S			
RF PWR	12W	20W	EBS VERNIER
POINTING			
ANT.	30CM	3.0M	
DC PWR	35W/60W TOTAL	120W	M I C R O W A V E
DEVICES			
MASS	15KG		
POINTING	.75	.025	
RECEIVER			
SYSTEMP	500K	45K	
ANTENNA	3.6M	34M	

Figure 4-6. Rover/Relay at Aerosync, 1,000 Mbps





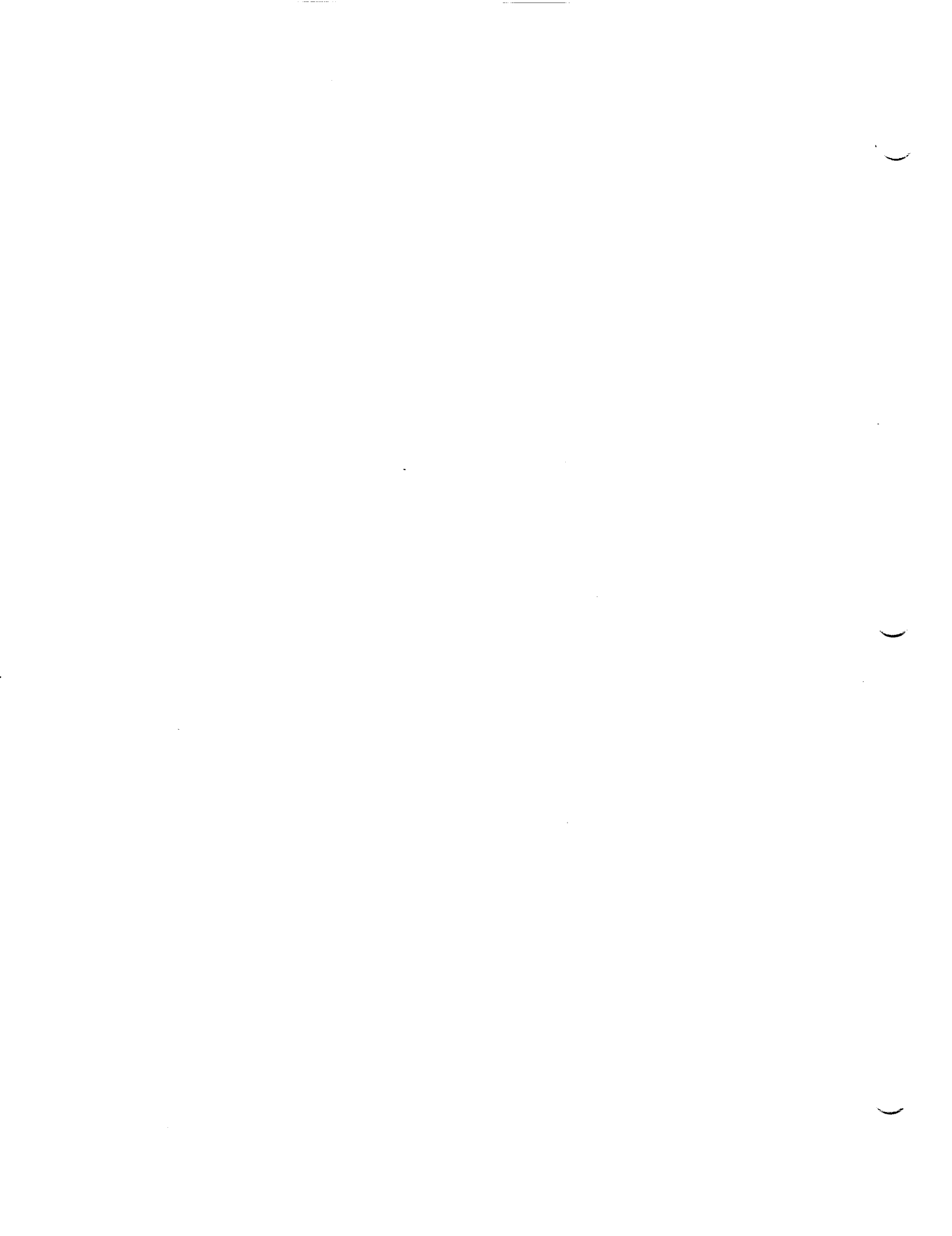

## SECTION 5

### PRESENTED MATERIALS

#### Estimated Mars Rover Scenario Daily Data Quantities

##### A. Terrain Navigation Only:

1. Computer Aided Remote Driving (CARD) = 40 Mb downlink data per 10 hr day.

2. CARD uplink = 10 Kb per day.

##### B. Imaging Science at a Station (Specified Examination Location).

1. 500x500 pixels/ 4:1 compression, X 2 for Stereo, X 2 for before and after, X 8 total including multispectral, X 8 bits per pixel = 16 Mb from the deployable close up camera. Plus Sampling Operations Support for Two X 1000X1000X8b/2:1 = 8Mb. Sum = 24Mb.

2. Uplink Sampling Operations Commands = 1 Kb. (Manipulator and Effector trajectories.)

##### C. Imaging Science While Otherwise Stopped or "Along-the-Way".

1. 1000X1000 pixels/ 4:1 compression, X3 ea. 45 deg FOV overlapped frames for a quadrant, X 2 for Stereo, X 2 in the am and X2 in the pm, sum: 1-Thermal, plus 1-IR, and 2-visual, X 8 b per pixel = 192 Mb.

2. Uplink Science Commands and Data = ?

SUMMARY TOTAL

I. DOWNLINK:

CASE	#PIXELS	b/PX	COMP.	STEREO	#SCENES	VIS'L	IR	THERM.	FREQ.	=Mb
A.	1000X1000	8	4:1	2	1	1	0	0	10	40
B.	500X500	8	4:1	2	2	2	1	1	2	16
	1000X1000	8	2:1	2	1	1	0	0	1	8
C.	1000X1000	8	4:1	2	3	2	1	1	4	<u>192</u>
One Science Station, Total Mb per 10 hr day =										256

II. UPLINK:

CASE	Quan.
A.	10 Kb
B.	1 Kb
C.	?

Total Kb per 10 hr day =

DATA RATES

I. DOWNLINK

A. AVERAGE -  $256 \text{ Mb} / 10 \text{ hr} \times 3600 \text{ sec} / \text{hr} = 7 \text{ Kbps}$ .

B. PERIODIC - 10 min each hour =  $256 \text{ Mb} / 10 \text{ hr} \times 600 \text{ s} = 43 \text{ Kbps}$

- 15 min each hour =  $256 \text{ Mb} / 10 \text{ hr} \times 900 \text{ s} = 28 \text{ Kbps}$

- 30 min each hour =  $256 \text{ Mb} / 10 \text{ hr} \times 1800 \text{ s} = 14 \text{ Kbps}$

C. MAX SUM STOP = 4Mb CARD Support + 24 Mb Specified Exam. Locat. + an "Along-the-Way" data load of  $192/4 = 76 \text{ Mb}$  Total.

- in 10 min =  $76 \text{ Mb} / 600 \text{ sec} = 127 \text{ Kbps}$

- in 15 min =  $76 \text{ Mb} / 900 \text{ sec} = 84 \text{ Kbps}$

- in 30 min =  $76 \text{ Mb} / 1800 \text{ s} = 42 \text{ Kbps}$

MARS ROVER WORKSHOP  
COMMUNICATIONS PANEL  
QUESTIONS

- 0 USE OF CONTINUOUS COMMUNICATIONS SUPPORT THROUGH SYNCHRONOUS RELAY SATELLITE
- 0 PLACE COMPLEXITY ON ORBITER: COMPUTING, RECORDING, PROCESSING
- 0 SHARING ORBITING IMAGING VERSUS ROVER IMAGING
- 0 ROVER CONSUMABLES AVAILABLE FOR COMMUNICATIONS POWER, MASS, VOLUME
- 0 USE OF HIGH RATE TELEMETRY: "R/T TV"
- 0 USE 30 KBPS/150KBPS BASELINE, MICROWAVE 32 GHZ
- 0 USE OF OPTICAL RANGING CAPABILITY ON ROVER
- 0 COMMAND RATE FROM EARTH 2000 BPS NORMAL  
8 BPS EMERGENCY

RLH  
4/29/87

**MARS ROVER WORKSHOP  
COMMUNICATIONS PANEL  
RESULTS**

- 0 EVALUATED TWO SYSTEM CONFIGS.  
ROVER-EARTH ONLY  
ROVER-RELAY EARTH**
- 0 TELEMETRY CAPABILITY DOMINANT  
30KBPS/150KBPS BASELINE  
1 MPBS ENHANCED**
- 0 MICROWAVE BASED SYSTEMS BY 1993**
- 0 OPTICAL SYSTEMS BY 1995**
- 0 COMMAND RATES 2000/8 BPS**
- 0 METRIC TRACKING-ADEQUATE**

**MARS ROVER WORKSHOP  
COMMUNICATIONS**

- 0 NEED CONSIDERABLE MISSION INTERACTION TO ITERATE  
CAPABILITY CHOICES**
- 0 RELAY SATELLITE ORBIT (17,097 KM ALT) NOT  
COMPATIBLE WITH SCIENCE OR MAPPING**
- 0 RELAY SATELLITE PROVIDES NEAR CONTINUOUS  
COMMUNICATION, ALSO, LOCATION FOR COMPUTING,  
STORAGE..**
- 0 RELAY SATELLITE NECESSARY FOR IMBPS BY 1993  
TECHNOLOGY CUT OFF**

MARS ROVER WORKSHOP  
COMMUNICATIONS PANEL  
TECHNOLOGY STATUS

8.4 GHZ (X-BAND) INADEQUATE FUNDING  
COMPONENTS AND ELEMENTS EXIST  
NEED DEVELOPMENT TO MARS  
ENVIRONMENT (LEVEL 4 TO 5)

32 GHZ (KA BAND) MORE INADEQUATE FUNDING  
EMERGING TECHNOLOGY DEVICES EXIST  
FULL TRANSITION FROM (1 OR 2 TO 5)  
GROUND ELEMENTS ARE PLANNED

OPTICAL INADEQUACY PROPORTIONAL TO FREQUENCY  
NEED FULL TRANSITION FROM 1 TO 5  
NEED GROUND RECEPTION - CAPITAL INVEST.



## COMMUNICATION CAPABILITIES

- 0 ASSUMING MODEST POWER/VOLUME LIMITS; AND 5% DUTY CYCLE
- 0 DIRECT COMMUNICATION AT MAX RANGE
  - 0 X-BAND INTO 34M GIVES 30 BPS OR 100 MB/DAY
  - 0 X-BAND INTO 70M GIVES 150 KBPS OR 500 MB/DAY
  - 0 K-BAND (> 40 W RF POWER), 70 M 1000 KBPS OR 3000 MB/DAY
- LOWER POWER, SMALLER APERTURE MEET LOWER RATES
- 0 OPTICAL INTO 10M PHOTON COLLECTOR IN DAYLIGHT GIVES 1000 KBPS
- 0 RELAY VIA AEROSYNC ORBITER ALLOWS 1000 KBPS FROM SMALL, LOW-POWER ROVER (EG. 12W @ 30 CM)



PENDULOUS  
X-BAND LGA

# MSR ROVER TELECOM SUBSYSTEM

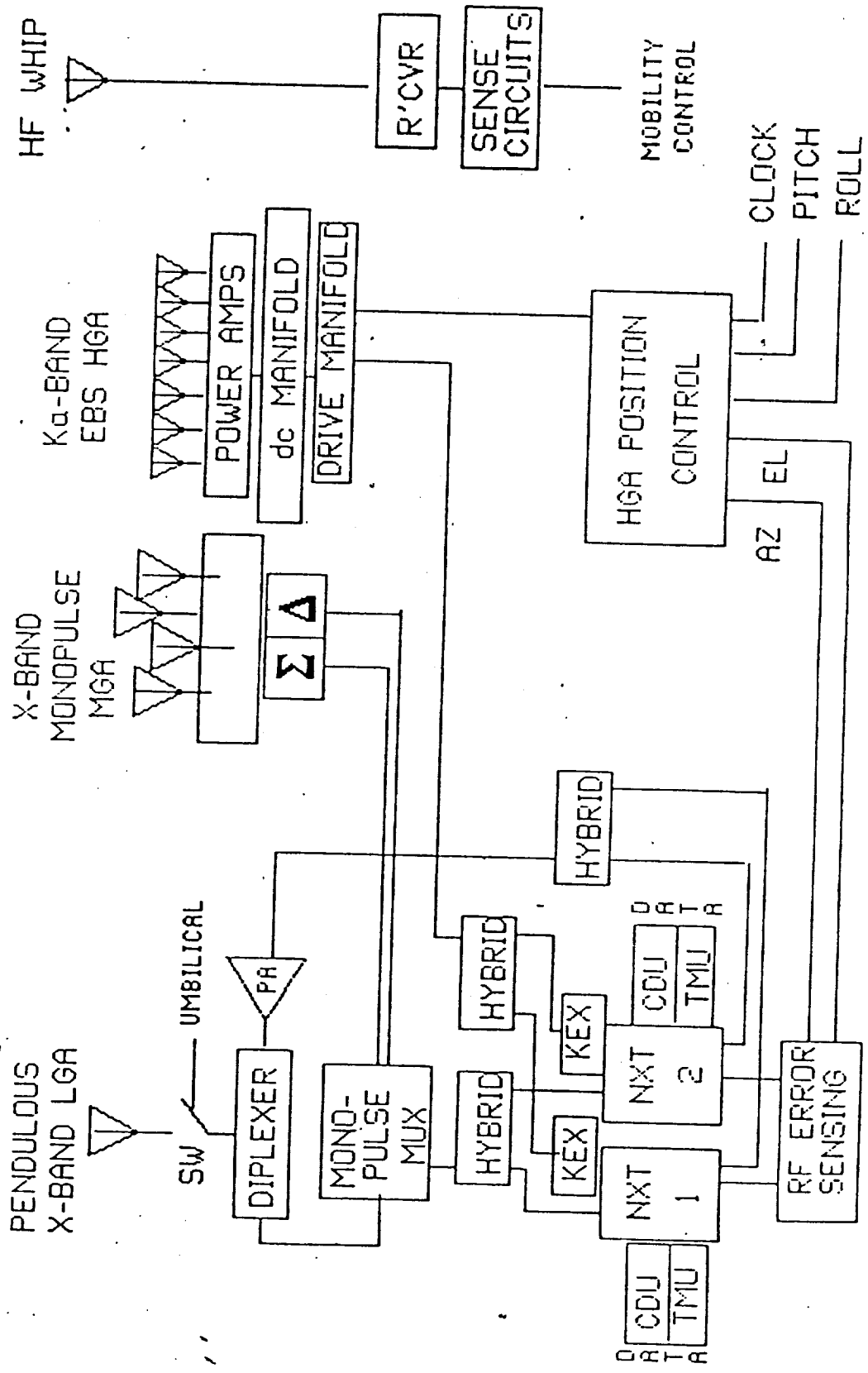

ROVERBLK 55091E RMD

# JPL

## MARS ROVER MECH. BEAM STEERING

FLUSH FOLDING  
**COLLIMATOR**  
 3-5 SEGMENT DOUBLY CURVED  
 SURFACE WITH DEPLOYMENT  
 ACTUATORS & INSTRUMENTAT.  
 STOW-ERECT ACTUATOR,  
 LATCH & INDICATORS

FLAT STOWED  
**ELEVATION  
 TILT PLATE**  
 ELEVATION DRIVE ACTUATOR  
 CTRL ELECT & STOW-LATCH.

FEED

## SLIP RINGS AZIMUTH TURNTABLE

**BEARING**  
 AZIMUTH DRIVE ACTUATORS  
 CONTROL ELECTRONICS &  
 POSITION ENCODERS.  
 STOW LATCH & INDICATORS.

## BEAM TUNNEL

DIAMETER SIZED FOR X-U/L  
 IOR MO'PULSE ON ROTATOR

## CORNER TURNER

AND FINE POINTING PAIRED  
 MIRRORS WITH ACTUATORS,  
 CTRL ELECT & ENCOD, LATCHES

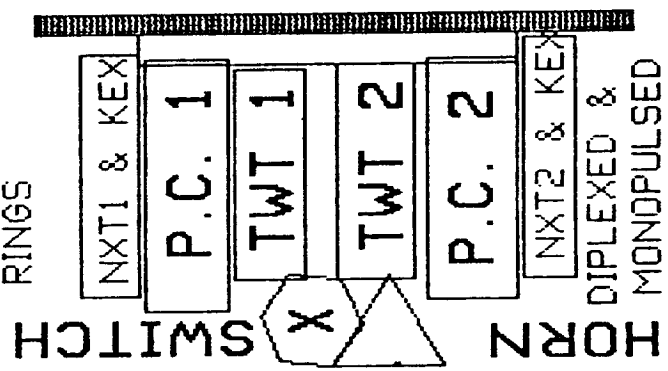

WASTE HEAT  
RADIATOR

MARSMECH 870220 RMD

# JPL MARS ROVER CONFIGURATION CONCEPTS

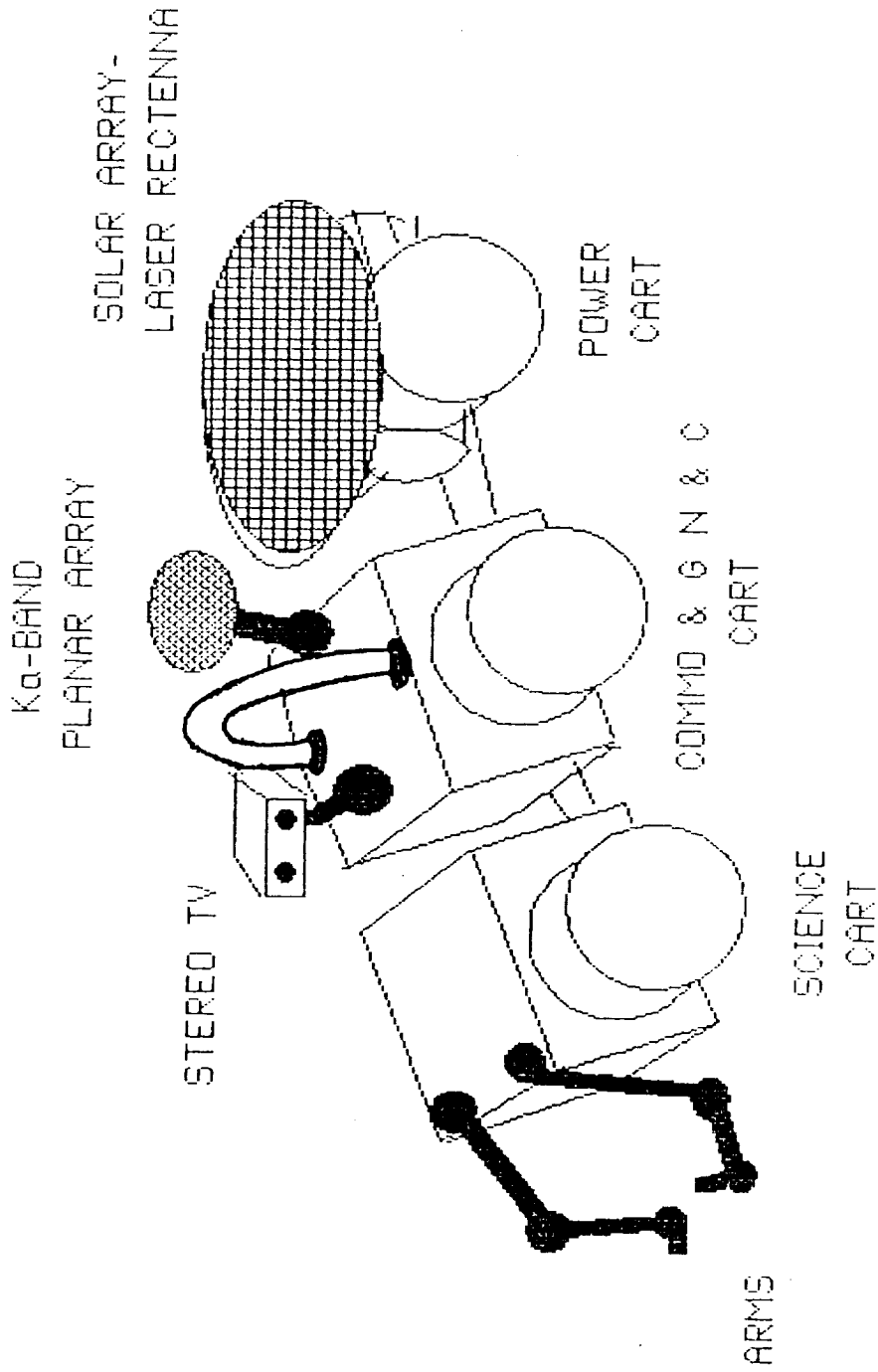

GDSHCART 870408 RMD

**JPL**

# DEEP SPACE EXPLORATION

## MSR ROVER COMMUNICATIONS PACKAGING CONSIDERATIONS

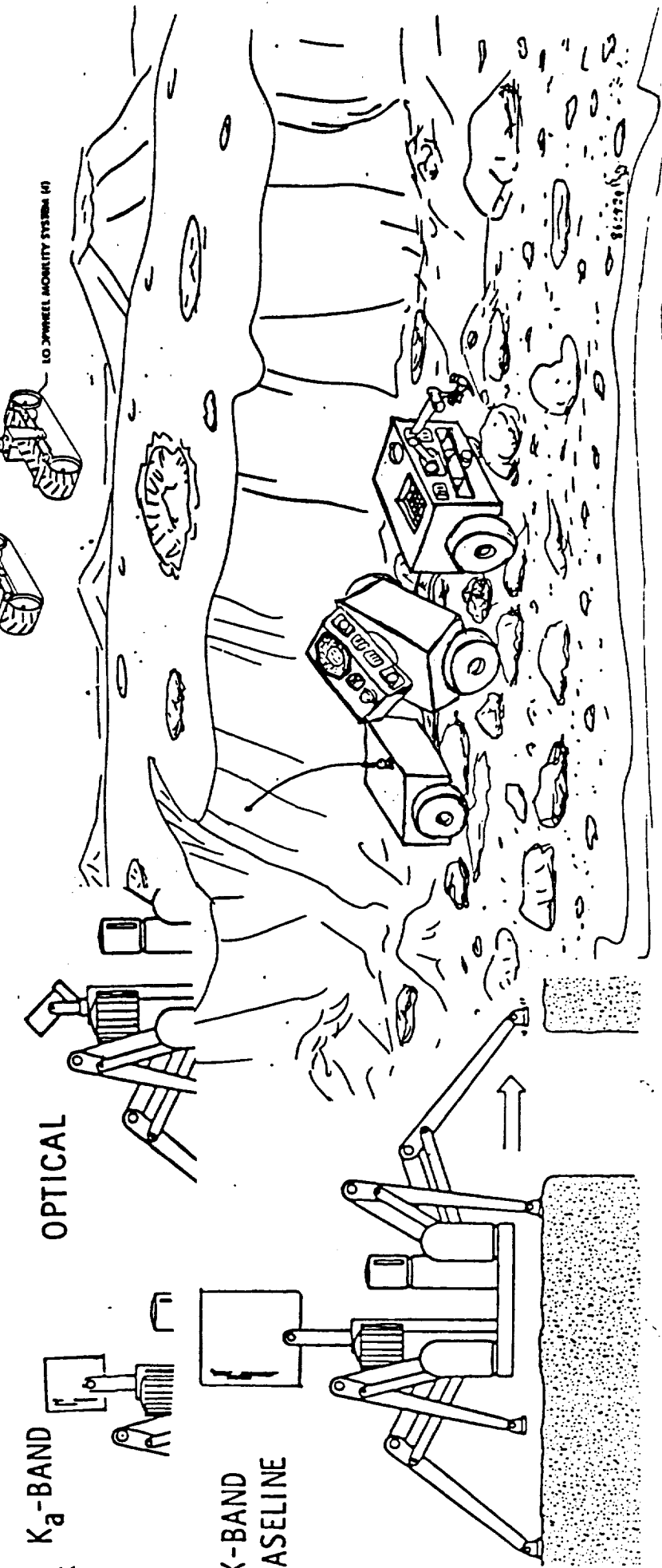
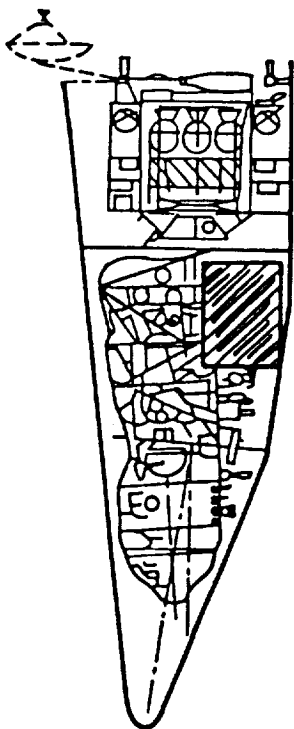
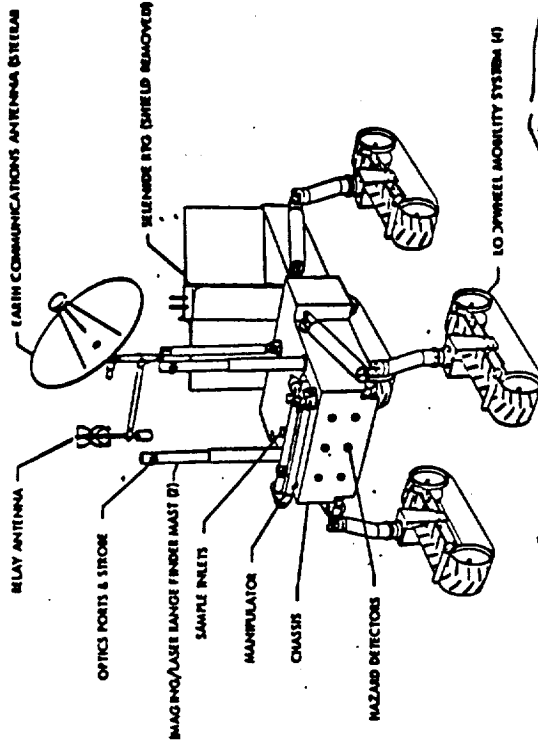

6-5-11

ORIGINAL PAGE IS OF POOR QUALITY

Mars Rover Sampling (MRS) Mission Study  
**MARS ENTRY CAPSULE (MEC)**  
 (CONCEPTUAL DESIGN)

LEGEND :

- 1 - AEROSHIELD
- 2 - BIOSHIELD
- 3 - DEORBIT/ROLL CTL.PROP.
- 4 - MLM RETRO-PROP.
- 5 - RTG HEAT REJ. DEVICE
- 6 - ROVER AFT MODULE
- 7 - ROVER CENTER MODULE
- 8 - VERT.PHASE PARA.SUPT.
- 9 - ROVER FWD. MODULE
- 10 - VERT.PHASE PARA.CABLE
- 11 - HORIZ.PHASE SUPT.STRUC
- 12 - PARACHUTE SYSTEM
- 13 - MEC RELAY SYSTEM
- 14 - MEC-NOV ADAPTER
- 15 - BIOSHIELD END CAP
- 16 - NOV BUS (REF.)
- 17 - THRUSTER CLUSTER (4)
- 18 - ANTENNA ANTENNA
- 19 - FLAP (2)
- 20 - FLAP ACTUATOR (3)
- 21 - ACTR. DRIVE ELECTRON.
- 22 - LANDING LEG ASSY. (4)
- 23 - RETROPROP. ENGINE (3)
- 24 - ELECTRONICS BOX
- 25 - TDLRR ANTENNA
- 26 - TV/RES BOX VERTICAL DEPLOYMT.ACTR. (2)
- 27 - FLEX. LINK (2)(STOWED)
- 28 - MLM MAIN SUPPORT PLA

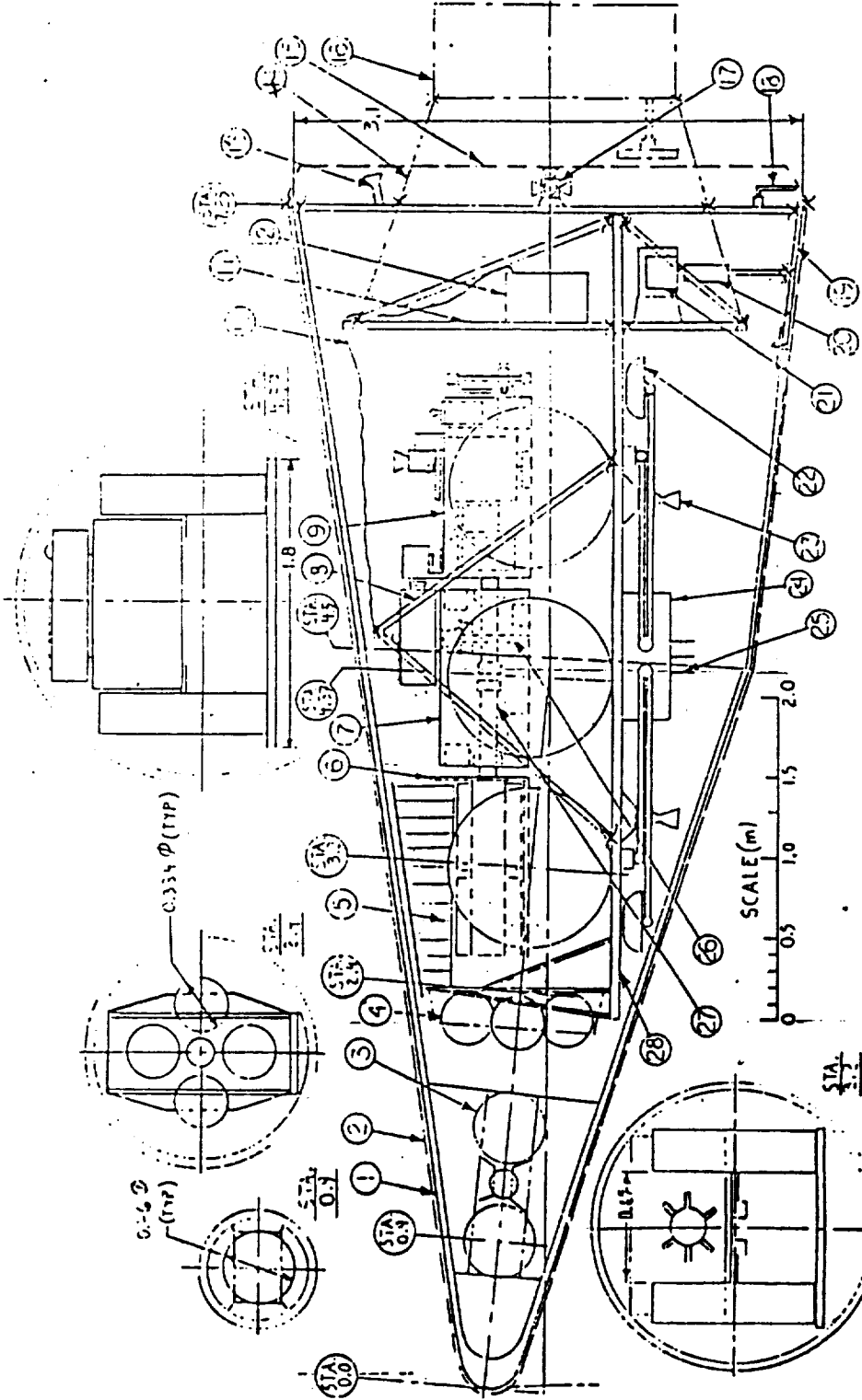

H.N.Norton  
 28 Oct.1986

$W/L = 82 \text{ Kg} @ 276 \text{ W}$   
 DRY BUS = 229 Kg  
 RCS PUMP = 37Y  
 ← AKM GRP. = 317.6 Kg  
 TOTAL S = 670 Kg

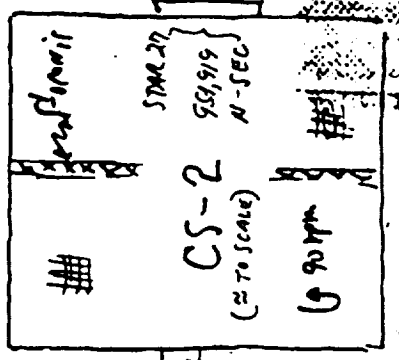

TTC SEC-BAND  
 TCM - 250bps  
 CMO - 128bps  
 DRE RANGE - 100KHz

ORIGINAL PAGE IS  
 OF POOR QUALITY

APPENDIX A

TECHNOLOGY PLANNING WORKSHEETS

TECHNOLOGY PLANNING WORKSHEET

WORKING GROUP: COMMUNICATIONS REFERENCE(S): \_\_\_\_\_  
DATE: 04/29/87 TIME: \_\_\_\_\_

TECHNOLOGY: Ka-BAND ELECTRONICALLY BEAM STEERED COMMUNICATIONS SYSTEM

KEYWORDS: MMIC, PHASED ARRAY, Ka-BAND, ELECTRONIC BEAM STEERING

RELATED TECHNOLOGIES: POWER, THERMAL, CONTROL/DATA

DESCRIPTION: MRSR COMMUNICATIONS TO EARTH AT 32 GHz (Ka-band) HAS BEEN IDENTIFIED AS AN ENABLING TECHNOLOGY TO PROVIDE A HIGH DATA RATE (30 Kbps). THIS BAND PROVIDES BENEFITS FOR A SYSTEM UTILIZING A DIRECT LINK FROM THE ROVER TO EARTH OR FROM A MARS ORBITING RELAY SATELLITE. THE NARROW BEAM WIDTHS ASSOCIATED WITH THESE SYSTEMS REQUIRES ELECTRONIC BEAM STEERING FOR FINE POINTING ( 1°) TO AUGMENT A COURSE MECHANICAL STEERING SYSTEM. ELEMENTS OF THE SYSTEM WHICH REQUIRE DEVELOPMENT INCLUDE HIGH EFFICIENCY MMIC POWER AMPLIFIERS ( 30%) AND PHASE SHIFTERS, TRANSMIT MODULES, ARRAY ANTENNAE AND BEAM STEERING ELECTRONICS.

STATUS: INITIAL DEVELOPMENT EFFORT IS UNDERWAY TO DEVELOP THE REQUIRED MMIC DEVICES BUT ACCELERATED FOCUSED EFFORT IS REQUIRED. Ka-band TRANSMIT ARRAYS ARE UNDER DEVELOPMENT AT JPL UTILIZING DEVICES BEING DEVELOPED BY LeRC.

PROGRAMS/EXPERTISE: AT PRESENT OSO IS SUPPORTING INITIAL DEVELOPMENT AT JPL WITH COOPERATIVE EFFORTS AT LeRC BEING SUPPORTED BY OAST.

MRSR MISSION DRIVERS: Ka-band TECHNOLOGY DEVELOPMENT IS REQUIRED TO ENABLE HIGH DATA RATE COMMUNICATIONS FROM MARS TO EARTH WITH PRACTICAL POWER AND ANTENNAE APERTURE SIZE ACCOMODATIONS.

MRSR APPLICATION ISSUES: APPLICATION ISSUES RELATED TO Ka-band COMMUNICATIONS ARE VOLUME/PACKAGING TRADE-OFFS, POWER TRADE-OFFS AND MARS TO EARTH DATA RATE TRADE-OFFS.



1987 TECHNOLOGY PLANNING WORKSHOP  
FOR THE MARS ROVER

TECHNOLOGY PLANNING WORKSHEET

WORKING GROUP: COMMUNICATIONS REFERENCE(S): \_\_\_\_\_  
DATE: 04/30/87 TIME: \_\_\_\_\_

TECHNOLOGY: Ka-band ELECTRONICALLY BEAM STEERED COMMUNICATIONS

DEVELOPMENT FORECAST:

DATE	MILESTONE/COMMENTS	1998-LAUNCH		2000-LAUNCH	
		\$,K FUND.	TECH. DATE LEVEL ERROR	\$,K FUND.	TECH. DATE LEVEL ERROR
1988	PRELIMINARY ARRAY TRANSMIT MODULE	\$1,500K		\$1,500K	
1989	DEVELOP PRELIMINARY TRANSMIT MODULE	\$1,800K		\$1,800K	
1990	DESIGN AND FABRICATE EBS	\$2,000K		\$2,000K	
1991	COMPLETE EBS ARRAY TEST BED	\$3,500K		\$2,500K	
1992	DESIGN AND FAB EBS ARRAY BREADBOARD	\$2,500K		\$2,500K	
1993	COMPLETE EBS ARRAY BREADBOARD	\$2,500K		\$2,500K	
1994	DEVELOP IMPROVED EFFICIENCY EBS ARRAY BREADBOARD			\$2,500K	
1995	COMPLETE IMPROVED EFFICIENCY EBS ARRAY BREADBOARD			\$2,500K	**
1996	DEVELOP FLIGHT MODEL EBS ARRAY				
1997	COMPLETE FLIGHT MODEL EBS ARRAY				

\* NOTE: Technology selection cut-off date for a 1998-launch mission.

\*\* NOTE: Technology selection cut-off date for a 2000-launch mission.

1987 TECHNOLOGY PLANNING WORKSHOP  
FOR THE MARS ROVER

PAGE 3

TECHNOLOGY PLANNING WORKSHEET

WORKING GROUP: COMMUNICATIONS REFERENCE(S): \_\_\_\_\_

DATE: 4/30/87 TIME: \_\_\_\_\_

TECHNOLOGY: Ka-Band Electronically Beam Steered Communications

=====

ADDITIONAL WORKSPACE:

It is planned that the early phases of the MMIC development effort will be carried out by LeRC with close cooperative support of JPL. It is further assumed that the present LeRC effort is augmented and that this augmented effort is focused toward support of the MRSR project. JPL is assumed to have responsibility for design and development of transmit modules, the active array system and the electronic beam steering control system. JPL is also assumed to have responsibility for development of flight qualified MMIC devices.

1987 TECHNOLOGY PLANNING WORKSHOP  
FOR THE MARS ROVER

TECHNOLOGY PLANNING WORKSHEET

WORKING GROUP: COMMUNICATIONS REFERENCE(S): \_\_\_\_\_

DATE: 4/30/87 TIME: 11:25 AM

TECHNOLOGY: TELEMETRY/CODING

KEYWORDS: CODING, REED-SOLOMON, VITERBI

RELATED TECHNOLOGIES: \_\_\_\_\_

DESCRIPTION: CODING IMPROVEMENTS HAVE BEEN IDENTIFIED THAT COULD GIVE A 1dB TO 2dB IMPROVEMENT IN TELEMETRY CAPABILITY OVER THE BASELINE USED IN LINK CALCULATIONS DURING THIS WORKSHOP (REED-SOLOMON/VITERBI CHANNEL CONVOLUTIONAL  $k = 7$ ,  $r = 2$ , 8-BIT REED-SOLOMON INTERLEAVED). HARDWARE NEEDS TO BE BUILT. CODING IMPROVEMENT SHOULD BE DEMONSTRATED. ENCODERS NEED TO BE SPACE QUALIFIED.

STATUS: COMPUTER SIMULATIONS HAVE DEMONSTRATED FEASIBILITY AND VERIFIED THE IMPROVEMENT POTENTIAL FOR LONGER CONSTRAINT/LENGTH AND LARGER RS CODES)

PROGRAMS/EXPERTISE: DSN ADVANCED SYSTEMS PROGRAMS, RTOP-71

MRSR MISSION DRIVERS: IMPROVE TELEMETRY LINK BY 1 TO 2 dB

MRSR APPLICATION ISSUES: DATA RATE VS. POWER, MASS, AND STATIONERY COMMUNICATIONS TIME REQUIRED FOR TRANSMISSIONS FROM ROVER TO EARTH.

TECHNOLOGY PLANNING WORKSHEET

WORKING GROUP: COMMUNICATIONS

REFERENCE(S): \_\_\_\_\_

DATE: 4/30/87 TIME: 11:30

TECHNOLOGY: TELEMETRY/CODING

DEVELOPMENT FORECAST:

DATE	MILESTONE/COMMENTS	1998-LAUNCH		2000-LAUNCH	
		\$,K FUND.	TECH. DATE LEVEL ERROR	\$,K FUND.	TECH. DATE LEVEL ERROR
1988	DEVELOP ENCODERS AND DECODERS				
1989					
1990	DEMONSTRATE CODING IMPROVEMENT OF 1 dB TO 2 dB				
1991					
1992					
1993					
1994			*		
1995					
1996					**
1997					

\* NOTE: Technology selection cut-off date for a 1998-launch mission.

\*\* NOTE: Technology selection cut-off date for a 2000-launch mission.

TECHNOLOGY PLANNING WORKSHEET

WORKING GROUP: COMMUNICATIONS REFERENCE(S): \_\_\_\_\_

DATE: 4/30/87 TIME: 9:00 AM

TECHNOLOGY: OPTICAL COMMUNICATIONS

KEYWORDS: LASER, DIRECT DETECTION, DETECTOR ARRAY COLLECTOR

RELATED TECHNOLOGIES: POINTING, TRACKING, ACQUISITION

DESCRIPTION: TWO OPTIONS FOR OPTICAL COMMUNICATION HAVE BEEN IDENTIFIED; DIRECT ROVER TO EARTH (DRE), AND ORBITER/RELAY TO EARTH (OE). THE DATA RATES FOR DRE RANGE FROM A MINIMUM OF 150 KBPS TO SEVERAL MBPS DEPENDING ON THE EARTH SKY BRIGHTNESS DURING RECEPTION AND THE RANGE BETWEEN THE TWO PLANETS. FOR THE OE OPTION THE DATA RATES ARE APPROXIMATELY THREE TIMES THAT OF THE DR. THE BIT ERROR RATE (BER) FOR THESE CALCULATIONS WAS ASSUMED TO BE  $10^{-3}$ .

STATUS: THE COMPONENTS EXIST AND PERFORMANCE HAS BEEN DEMONSTRATED IN LABORATORY ENVIRONMENT. THE DETECTOR AND LASER TRANSMITTER EFFICIENCIES ASSUMED HAVE NOT BEEN DEMONSTRATED. HOWEVER, NO IMPEDIMENTS ARE SEEN FOR SYSTEM DEVELOPMENT

PROGRAMS/EXPERTISE: THE TECHNOLOGY IS EVOLVING. ACTS WILL BE CARRYING A LASER COMMUNICATION SYSTEM. INDUSTRIES HAVE MAJOR INVESTMENTS IN THIS TECHNOLOGY AREA. JPL HAS A GROUP RECOGNIZED NATIONALLY IN THIS SPECIFIC AREA OF WORK

MRSR MISSION DRIVERS: COARSE POINTING  $1^\circ$  REQUIRED. THIS HAS IMPLEMENTATION CONSEQUENCES FOR THE ACQUISITION, POINTING, AND TRACKING FOR THE OPTICAL COMMUNICATIONS SYSTEM.

MRSR APPLICATION ISSUES: OPTICAL COMMUNICATION HAS NOT BEEN DEMONSTRATED IN THE EXPECTED MARS ENVIRONMENT BUT THE VISIBILITY DATA HAS BEEN USED FOR BASELINE CALCULATIONS.

1987 TECHNOLOGY PLANNING WORKSHOP  
FOR THE MARS ROVER

TECHNOLOGY PLANNING WORKSHEET

WORKING GROUP: COMMUNICATION REFERENCE(S): RAYMAN/KRISHEN  
DATE: 4/30/87 TIME: 11:00 AM

TECHNOLOGY: OPTICAL COMMUNICATONS

DEVELOPMENT FORECAST:

DATE	MILESTONE/COMMENTS	1998-LAUNCH		2000-LAUNCH	
		\$,K FUND.	TECH. DATE LEVEL ERROR	\$,K FUND.	TECH. DATE LEVEL ERROR
1988	DETECTOR DEVELOPMENT (EFF. ≤ 30%)			2000	
1989	DETECTOR DEVELOPMENT TRANSMITTER DEVELOPMENT (EFF. ≤ 10%)			3000	
1990	TRANSMITTER DEVELOPMENT ACQUISITION, POINTING, TRACKING (APT) (<1 mrad)			4000	
1991	APT LAB. SYSTEM DEMO.			4000	
1992	LAB SYSTEM DEMO. SPACE SYSTEM DESIGN			5000	
1993	SPACE SYSTEM DEMO.			5000	
1994	SPACE SYSTEM DEMO.		*	2000	
1995	DATA ANALYSIS			1000	**
1996					
1997					

\* NOTE: Technology selection cut-off date for a 1998-launch mission.  
\*\* NOTE: Technology selection cut-off date for a 2000-launch mission.

1987 TECHNOLOGY PLANNING WORKSHOP  
FOR THE MARS ROVER

TECHNOLOGY PLANNING WORKSHEET

WORKING GROUP: COMMUNICATIONS REFERENCE(S): RAYMAN/KRISHEN  
DATE: 4/30/87 TIME: 10:00 AM

TECHNOLOGY: OPTICAL COMMUNICATIONS

DEVELOPMENT FORECAST:

DATE	MILESTONE/COMMENTS	1998-LAUNCH		2000-LAUNCH	
		\$,K FUND.	TECH. DATE LEVEL ERROR	\$,K FUND.	TECH. DATE LEVEL ERROR
1988	DETECTOR DEVELOP. (EFF. $\leq 30\%$ ) TRANSMITTER DEVELOP. (EFF. $\leq 10\%$ )	2500			
1989	DETECTOR DEVELOP. TRANSMITTER DEVELOP.	3000			
1990	ACQUISITION, POINTING AND TRACKING ( $< 1\text{mrad}$ ) LABORATORY SYSTEM DEVELOP.	4000			
1991	LABORATORY SYSTEM DEMONS. SPACE SYSTEM DEVELOPMENT	5000			
1992	SPACE SYSTEM DEMONSTRATION	8000			
1993	DATA ANALYSIS	500	*		
1994					
1995					**
1996					
1997					

\* NOTE: Technology selection cut-off date for a 1998-launch mission.  
\*\* NOTE: Technology selection cut-off date for a 2000-launch mission.

TECHNOLOGY PLANNING WORKSHEET

WORKING GROUP: COMMUNICATIONS REFERENCE(S): RAYMAN/KRISHEN  
DATE: 4/30/87 TIME: 9:30 AM

TECHNOLOGY: OPTICAL COMMUNICATIONS

ADDITIONAL WORKSPACE:

ADVANTAGES OF OPTICAL COMMUNICATIONS

- O LIGHT WEIGHT COMPARED TO MICROWAVE SYSTEMS. SYSTEM WEIGHT ESTIMATED IS 25 KGS FOR FULL REDUNDANCY (EXCEPT TELESCOPE AND GIMBAL) COMPARED TO 40 KGS FOR THE X-BAND MICROWAVE SYSTEM.
- O SMALLER DEPLOYED VOLUME THAN MICROWAVE. FOR OPTICAL TRANSMITTER IT COULD BE 30 CM x 30 CM x 60 CM COMPARED TO 100 CM x 100 CM x 100 CM (ON ROVER), 350 CM x 200 CM x 350 CM (ON ORBIT) FOR THE MICROWAVE SYSTEM.
- O SMALLER POWER CONSUMPTION: 35 WATTS COMPARED TO 125 WATTS FOR THE MICROWAVE SYSTEM. THIS ALLOWS DATA TRANSFER DURING ROVING ON THE MARS SURFACE.

A SLIGHT CHANGE IN CONFIGURATION PERMITS AN IMAGING MODE WHICH ALLOWS COLLECTION OF UNIQUE DATA IN OPTICAL BANDS.

CAPABILITY FOR HIGH DATA RATES EXISTS COMPARED TO MICROWAVE BANDS.



1987 TECHNOLOGY PLANNING WORKSHOP  
FOR THE MARS ROVER

TECHNOLOGY PLANNING WORKSHEET

WORKING GROUP: COMMUNICATIONS REFERENCE(S): \_\_\_\_\_  
DATE: 4/30/87 TIME: \_\_\_\_\_

TECHNOLOGY: X-BAND SOLID STATE POWER AMPLIFIER AND ARRAY ANTENNA

KEYWORDS: MMIC, HEMT

RELATED TECHNOLOGIES: \_\_\_\_\_

DESCRIPTION: DEVELOP 8.4 GHZ HIGH ELECTRON MOBILITY POWER TRANSISTORS WITH  
HIGH EFFICIENCY AND MMIC DEVICES FOR ARRAY ANTENNA NEEDED FOR ROVER X-BAND  
COMMUNICATIONS TO AND FROM EARTH.

STATUS: INDUSTRY INVOLVED IN DEVELOPMENT OF HEMTS AT THIS TIME MMIC WORK GOING  
ON IN INDUSTRY

PROGRAMS/EXPERTISE: OAST FUNDED X-BAND POWER AMPLIFIER WORK FOR CRAF

MRSR MISSION DRIVERS: ROVER MUST RECEIVE X-BAND FROM EARTH (7.2 GHz).  
ANTENNA ARRAY SHOULD AUTO-TRACK 7.2 GHz SIGNAL AND TRANSMIT BACK TO EARTH  
AT 8.4 GHz or 32 GHz

MRSR APPLICATION ISSUES: RECEIVE COMMANDS FORM EARTH AND SEND TELEMETRY  
TO EARTH

1987 TECHNOLOGY PLANNING WORKSHOP  
FOR THE MARS ROVER

TECHNOLOGY PLANNING WORKSHEET

WORKING GROUP: COMMUNICATIONS REFERENCE(S): \_\_\_\_\_  
DATE: 4/30/87 TIME: 1:10 PM

TECHNOLOGY: X-BAND SOLID STATE POWER AMPLIFIERS AND ANTENNA ARRAY

DEVELOPMENT FORECAST:

DATE	MILESTONE/COMMENTS	1998-LAUNCH		2000-LAUNCH	
		\$,K FUND.	TECH. DATE LEVEL ERROR	\$,K FUND.	TECH. DATE LEVEL ERROR
1988	CONCEPTUAL DESIGN PRELIMINARY DESIGN	\$800/YEAR (FY'88 \$)			
1989	COMPONENT DEVELOPMENT EVALUATION		NEEDED FROM 1988 THROUGH 1992		
1990	TRADE-OFF STUDIES				
1991	BREADBOARD DEVELOPMENT AND TESTS				
1992	ENGINEERING MODEL DESIGN FAB AND TESTS				
1993			*		
1994					
1995					
1996					**
1997					

\* NOTE: Technology selection cut-off date for a 1998-launch mission.  
\*\* NOTE: Technology selection cut-off date for a 2000-launch mission.

1987 TECHNOLOGY PLANNING WORKSHOP  
FOR THE MARS ROVER

PAGE 1

TECHNOLOGY PLANNING WORKSHEET

WORKING GROUP: COMMUNICATIONS REFERENCE(S): \_\_\_\_\_  
DATE: 4/30/87 TIME: 11:45 \_\_\_\_\_

TECHNOLOGY: DEEP SPACE 32 GHz TRANSPONDER  
=====

KEYWORDS: \_\_\_\_\_

RELATED TECHNOLOGIES: DEEP SPACE X-BAND TRANSPONDER  
\_\_\_\_\_

DESCRIPTION: DEVELOPMENT OF A DEEP SPACE K<sub>A</sub>-BAND TRANSPONDER IS NEEDED.  
\_\_\_\_\_  
\_\_\_\_\_  
\_\_\_\_\_  
\_\_\_\_\_  
\_\_\_\_\_

STATUS: CONCEPTUAL DESIGN FOR K<sub>A</sub>-BAND EXCITER DONE DURING DESIGN EFFORT FOR THE  
NASA DEEP SPACE X-BAND TRANSPONDER DEVELOPMENT EFFORT  
\_\_\_\_\_

PROGRAMS/EXPERTISE: NASA X-BAND TRANSPONDER DEVELOPMENT PROGRAM UNDERWAY  
AT PRESENT TIME  
\_\_\_\_\_  
\_\_\_\_\_

MRSR MISSION DRIVERS: REQUIRED FOR K<sub>A</sub>-BAND COMMUNICATIONS LINK  
\_\_\_\_\_  
\_\_\_\_\_

MRSR APPLICATION ISSUES: ROVER TO EARTH COMMUNICATIONS  
\_\_\_\_\_  
\_\_\_\_\_

1987 TECHNOLOGY PLANNING WORKSHOP  
FOR THE MARS ROVER

TECHNOLOGY PLANNING WORKSHEET

WORKING GROUP: COMMUNICATIONS REFERENCE(S): \_\_\_\_\_  
DATE: 4/30/87 TIME: 11:55 AM

TECHNOLOGY: DEEP SPACE 32 GHz TRANSPONDER

DEVELOPMENT FORECAST:

DATE	MILESTONE/COMMENTS	1998-LAUNCH		2000-LAUNCH	
		\$,K FUND.	TECH. DATE LEVEL ERROR	\$,K FUND.	TECH. DATE LEVEL ERROR
1988	PRELIMINARY DESIGN COMPONENT DEVELOPMENT		QAST FUNDING		
1989	BREADBOARD DESIGN		REQUIRED AT 600K PER YEAR LEVEL		
1990	BREADBOARD FABRICATION		FROM 1988 THROUGH 1992. (IN FY'88 DOLLARS)		
1991	BREADBOARD TESTS				
1992	DEVELOPMENT ENGINEERING MODEL				
1993					
1994			*		
1995					
1996					**
1997					

\* NOTE: Technology selection cut-off date for a 1998-launch mission.  
\*\* NOTE: Technology selection cut-off date for a 2000-launch mission.

C.S

1987 TECHNOLOGY PLANNING WORKSHOP  
FOR THE MARS ROVER

PAGE 1

TECHNOLOGY PLANNING WORKSHEET

WORKING GROUP: COMMUNICATIONS REFERENCE(S): \_\_\_\_\_  
DATE: 4/30/87 TIME: 10:50 AM

TECHNOLOGY: MICROWAVE, 32 GHZ BEAM WAVEGUIDE FOR SPACECRAFT

KEYWORDS: BEAM WAVEGUIDES, TWTs, ANTENNAS, POINTING

RELATED TECHNOLOGIES: ANTENNA CONTROL, BEAM SCANNING, LOW-LOSS MICROWAVE  
POWER TRANSMISSION

DESCRIPTION: DEVELOPE A BEAM WAVEGUIDE SYSTEM FOR SPACECRAFT ANTENNAS AT 32 GHZ  
TO REDUCE LOSSES, ENABLE VERNIER BEAM STEERING, AND PROVIDE A STABLE ENVIRON-  
MENT FOR POWER AMPLIFIERS WITHIN THE SPACECRAFT BUS RATHER THAN ON THE ANTENNA  
WHERE THE ENVIRONMENT CAN BE SEVERE.

STATUS: THIS WORK IS PROPOSED FOR DEVELOPMENT IN THE SYSTEMS DEVELOPMENT EFFORT  
FUNDED BY OSO THROUGH THE TDA OFFICE AT JPL

PROGRAMS/EXPERTISE: TECHNOLOGY HAS SIMILARITY TO BEAM WAVEGUIDE BEING DEVE-  
LOPED FOR DSN ANTENNAS IN DSN ADVANCED SYSTEMS PROGRAM

MRSR MISSION DRIVERS: ENABLES USE OF EITHER TWT OR SOLID STATE POWER AMPLIFIERS  
WITH VERNIER BEAM STEERING TO REDUCE POINTING LOSS AND TRANSMISSION LINE LOSS

MRSR APPLICATION ISSUES: REDUCES TRANSMITTER POWER NEEDED TO ACHIEVE REQUIRED  
EIRP AND PROTECTS POWER AMPLIFIER FROM SEVERE ENVIRONMENT THAT THE ROVER WILL  
EXPERIENCE.

1987 TECHNOLOGY PLANNING WORKSHOP  
FOR THE MARS ROVER

TECHNOLOGY PLANNING WORKSHEET

WORKING GROUP: COMMUNICATIONS REFERENCE(S): \_\_\_\_\_  
DATE: 4/30/87 TIME: 11:00 AM

TECHNOLOGY: MICROWAVE, 32 GHz BWG FOR SPACECRAFT

DEVELOPMENT FORECAST:

DATE	MILESTONE/COMMENTS	1998-LAUNCH		2000-LAUNCH	
		\$,K FUND.	TECH. DATE LEVEL ERROR	\$,K FUND.	TECH. DATE LEVEL ERROR
1988	COMPLETE SYNTHESIS AND ANALYSIS OF DESIGNS.				
1989	COMPLETE TRADE-OFF STUDY				
1990	BUILD AND TEST MODEL BY AND OF 1989,				
1991					
1992					
1993					
1994			*		
1995					
1996					**
1997					

\* NOTE: Technology selection cut-off date for a 1998-launch mission.  
\*\* NOTE: Technology selection cut-off date for a 2000-launch mission.

1987 TECHNOLOGY PLANNING WORKSHOP  
FOR THE MARS ROVER

PAGE 1

TECHNOLOGY PLANNING WORKSHEET

WORKING GROUP: COMMUNICATIONS REFERENCE(S): TDA PROGRESS  
DATE: 4/30/87 TIME: 9:50 AM REPORT 42-88

TECHNOLOGY: MICROWAVE (8.4 GHz AND 32 GHz DSN)

KEYWORDS: BEAM WAVEGUIDES, CRYOGENICS,, MASERS

RELATED TECHNOLOGIES: WEATHER EFFECTS ON TELEMETRY PERFORMANCE

DESCRIPTION: DSN PERFORMANCE AT 8.4 GHz AND 32 GHz WILL BE ENHANCED BY USE OF BEAM WAVEGUIDE (BWG) FEED SYSTEMS. BWG ENABLES THE USE OF 1.5 KELVIN CRYOGENIC SYSTEMS FOR COOLING MASERS AND FEED COMPONENTS. THE RESULTING SENSITIVITY (G/T) IMPROVEMENT CAN BE 2dB TO 3dB AT 8.4 GHz FOR A 95% WEATHER CONFIDENCE FACTORS AS COMPARED TO PRESENT PROJECTIONS FOR THE 1990 DSN (THE 32 GHz IMPROVEMENT IS ABOUT 1dB).

STATUS: BWG DEMONSTRATED IN SATELLITE COMMUNICATIONS STATIONS, THE USUDA DEEP SPACE STATION AND NOBEYAMA RADIO OBSERVATORY (JAPAN).

PROGRAMS/EXPERTISE: DSN ADVANCED SYSTEMS PROGRAM IS SUPPORTING DEVELOPMENT OF BWG AND 1.5K CRYOGENIC SYSTEM SCHEDULED FOR FIELD DEMO AT GOLDSTONE IN 1990.

MRSR MISSION DRIVERS: REDUCES SPACECRAFT (ROVER) TRANSMITTER EIRP REQUIREMENTS BY 1 TO 3dB FOR REQUIRED DATA RATE OR ENABLES HIGHER DATA RATE.

MRSR APPLICATION ISSUES: DATA RATE VS. POWER AND MASS OR ROVER STATIONARY TIME FOR TRANSMISSION TO EARTH.

1987 TECHNOLOGY PLANNING WORKSHOP  
FOR THE MARS ROVER

TECHNOLOGY PLANNING WORKSHEET

WORKING GROUP: COMMUNICATIONS REFERENCE(S): TDA PROGRESS  
DATE: 4/30/87 TIME: 10:40 AM REPORT 42-88

TECHNOLOGY: MICROWAVE (8.4 GHz AND 32 GHz DSN)

DEVELOPMENT FORECAST:

DATE	MILESTONE/COMMENTS	1998-LAUNCH		2000-LAUNCH	
		\$,K FUND.	TECH. DATE LEVEL ERROR	\$,K FUND.	TECH. DATE LEVEL ERROR
1988					
1989	ADVANCED CRYO, FEED AND MASER TECH.		CONTINUING EFFORT AT \$1 M PER YEAR IN DSN ADVANCED SYSTEMS PROGRAM		
1990	BWG RESEARCH ANTENNA AT GOLDSTONE		\$6.4M IN COFF PLAN		
1991					
1992	NEW DSN 34M BWG SUBNET		FUNDS IN COFF PLAN		
1993	BWG CONVERSION FOR 34M HEF DSN SUBNET		FUNDS IN COFF PLAN*		
1994					
1995	BWG CONVERSION FOR DSN 70M SUBNET		FUNDS IN COFF PLAN)		
1996					**
1997					

\* NOTE: Technology selection cut-off date for a 1998-launch mission.  
\*\* NOTE: Technology selection cut-off date for a 2000-launch mission.



1987 TECHNOLOGY PLANNING WORKSHOP  
FOR THE MARS ROVER

PAGE 1

TECHNOLOGY PLANNING WORKSHEET

WORKING GROUP: COMMUNICATIONS REFERENCE(S): \_\_\_\_\_  
DATE: 4/30/87 TIME: \_\_\_\_\_

TECHNOLOGY: KA BAND TWTA

KEYWORDS: ROVER TRANSMITTER, KA-BAND, TWTA, COMMUNICATIONS

RELATED TECHNOLOGIES: \_\_\_\_\_

DESCRIPTION: 32 GHz, 30 TO 50 WATT, BW < 100 MHz, DISPENSER CATHODE, HELIX TWTA,  
EFFICIENCY 40%, STORAGE TEMP. -50°C, TURN ON TEMP. -30°C.

STATUS: SIMILAR TWTA PRESENTLY AVAILABLE FOR MISSILE APPLICATIONS.

PROGRAMS/EXPERTISE: \_\_\_\_\_

MRSR MISSION DRIVERS: \_\_\_\_\_

MRSR APPLICATION ISSUES: ROVER TO EARTH 150 KBPS DATA LINK. TURN ON  
TEMPERATURE (<30°C) EFFICIENCY (>35%)

1987 TECHNOLOGY PLANNING WORKSHOP  
FOR THE MARS ROVER

TECHNOLOGY PLANNING WORKSHEET

WORKING GROUP: COMMUNICATION REFERENCE(S): \_\_\_\_\_  
DATE: 4/30/87 TIME: \_\_\_\_\_

TECHNOLOGY: KA BAND TWTA

DEVELOPMENT FORECAST:

DATE	MILESTONE/COMMENTS	1998-LAUNCH		2000-LAUNCH	
		\$,K FUND.	TECH. DATE LEVEL ERROR	\$,K FUND.	TECH. DATE LEVEL ERROR
1988					
1989					
1990					
1991	TWTA DEVELOPMENT START 1/91	\$1000K,	10%		
1992	ENGINEERING MODEL COMPLETION 12/92	\$2000K,	20%		
1993	DUAL MODEL COMPLETION 12/92	\$1500K,	20%		
1994	INITIATE LIFE TESTING 1/93	\$100K			
1995		\$100K			
1996		\$100K			**
1997		\$100K			

\* NOTE: Technology selection cut-off date for a 1998-launch mission.  
\*\* NOTE: Technology selection cut-off date for a 2000-launch mission.

APPENDIX B

SUMMARY FORMS

(NOT SUPPLIED)

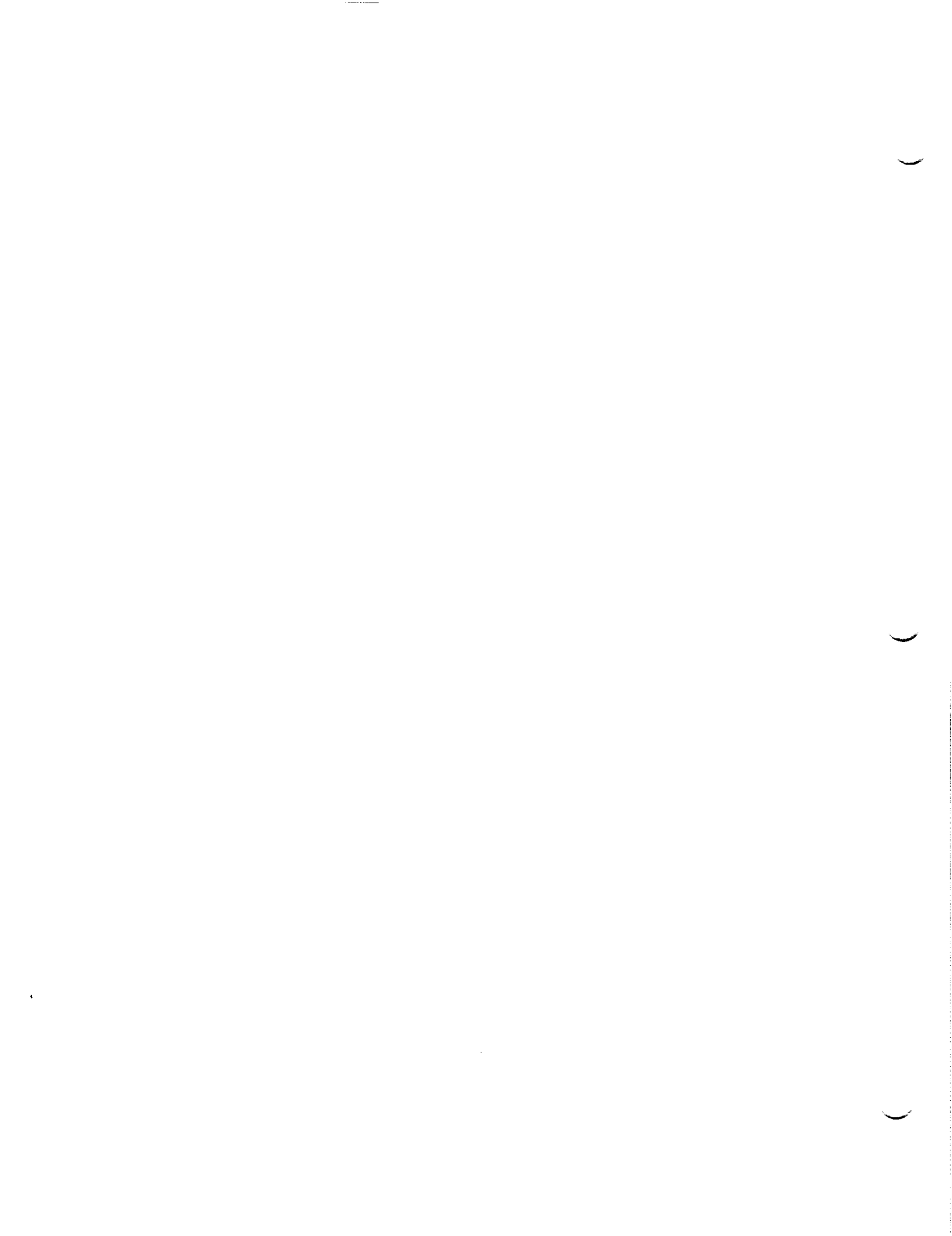

APPENDIX C

DIARIES OF KEY THOUGHTS

R. Hunter

# MARS ROVER WORKSHOP

## Diary of Key Thoughts

(Please enter worthy ideas, thoughts, needed actions or observations as they occur and are discussed.)

1. Use of Rover Ascent vehicle to Orbiter Relay links to Earth depends on Orbital parameters and role of link. i.e. principal return path or night side support only.
2. Having seen the DSN \$vs. DB improvements for 32 GHz and Optical over 8.45 Hz we need to produce the equivalent behavior at the Rover end. Can they do \$ trades across both ends of the lengths.
3. Optical example got questions on surface quality of "photon bucket" and cost. Also spot size at Earth (opposition) is 800 km. Implies sub-earth pointing. Need "Road map."
4. Define data types. Define data paths. Find limits before a technology gap.
5. What power is available to communications for downlink?
6. Should downlink be active only while Rover is stationary.
7. Consider applicability of a Mars Synchronous Orbiter relay communications link as a continuous data path. Keep Rover simple. Is this orbit compatible with Earth return orbit? Or does it imply a 2nd orbiter.
8. Relay Link Mode could allow greater complexity on Orbiter:
  - Processing
  - Recording
  - Control
9. Imaging of Terrain from Orbiter.
  - How many at .5m resolution?
  - How many images from Rover?
  - What is interaction between them?
10. What may communications assume for Rover consumables?
  - DC Power
  - Mass
  - Volume

## MARS ROVER WORKSHOP

### Diary of Key Thoughts

(Please enter worthy ideas, thoughts, needed actions or observations as they occur and are discussed.)

11. How about real High Rate Telemetry?

Assume 30kps/150 kps microwave  
Allow Optical experiment at 1 Mbps

12. Can Thermal Control maintain a 0°C Baseplots for planar array.

(-23° to -120°C)

13. Programmable Image Compression. What is the computing load?

14. For X-Band Receive for autotrack. There is a trade of between 4 "horn" array at edges of planar array and a single over mode horn at center.

15. Does Communications have a functional need for Data Storage?

16. Want X-Band Analogs of the 1 MBPS link to compare to 32 GHz.

17. For Rover, how about TWTA and slotted waveguide phased array? More pointing demand, harder to incorporate X-Band receive into this 32 GHz idea. Needs work.

18. Dickinson showed the cartoon with 32 GHz Beam Waveguide implementation: (Lots of single point failures, in series)

19. Optical Point ahead. At conjunction, Earth moves 7 D<sub>E</sub> in a two-way light time. Hence, angle that subtended by 7 D<sub>E</sub> plus Earth rotation or 600km.

20. What about Facilities support for Optical Reflector. 10 M anything needs more than a 1 M something.

21. Slide show demonstration of value of a few "enroute" pictures. That helps rover avoid getting lost.

22. What about Homing Beacon on Ascent vehicle for benefit of Rover to rendezvous?

23. Operation in Mars Atmosphere means RF breakdown and multipaction in 7 MB?

MARS ROVER WORKSHOP

Diary of Key Thoughts

(Please enter worthy ideas, thoughts, needed actions or observations as they occur and are discussed.)

1.

2.

3.

4.

5.

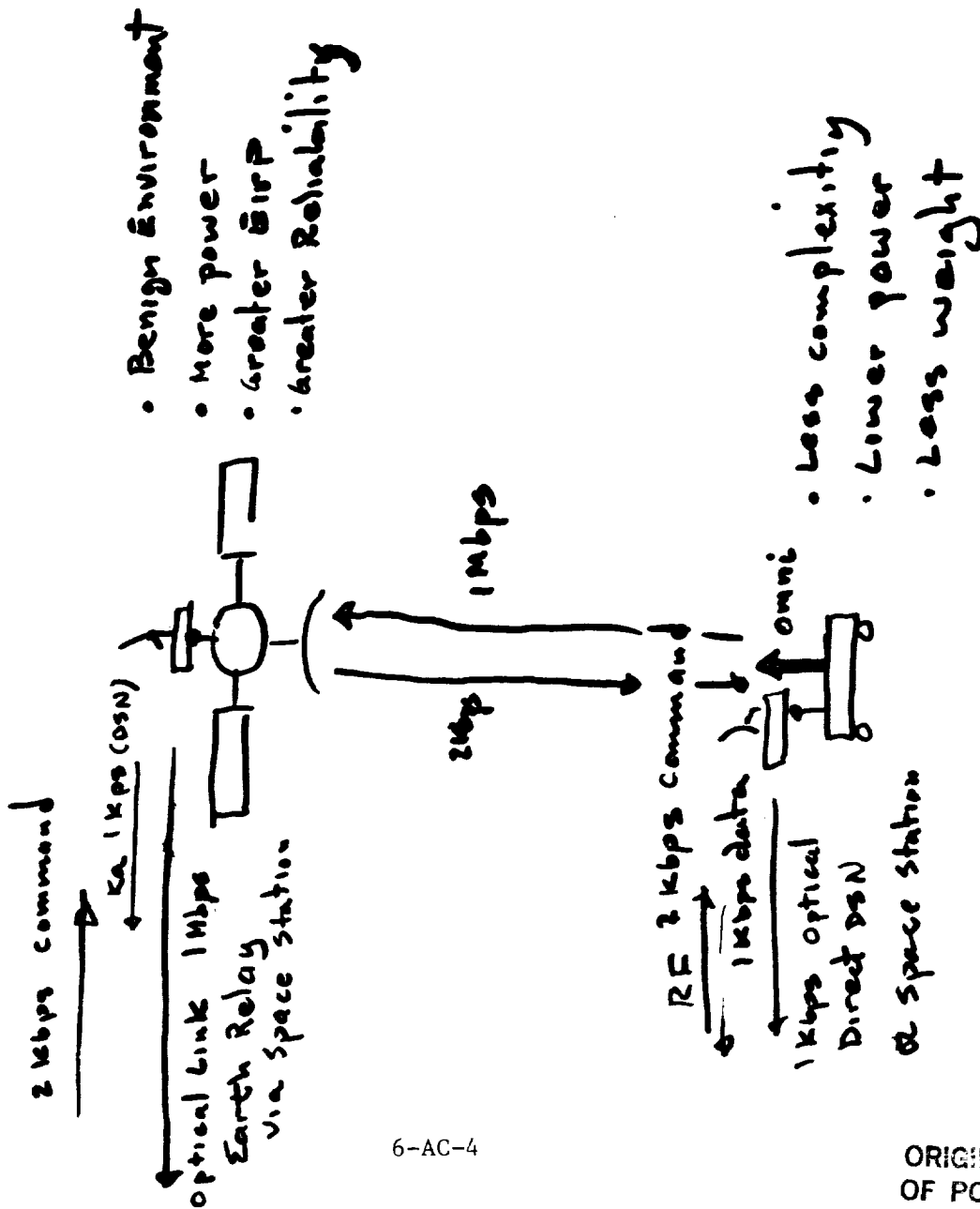



1. 2. 3.

# MARS ROVER WORKSHOP

## Diary of Key Thoughts

(Please enter worthy ideas, thoughts, needed actions or observations as they occur and are discussed.)

### 1. TECHNOLOGIES

- 0 KA SSAPAs
- 0 Laser Power Sources
- 0 Telescope Design
- 0 Video Compression
- 0 Coding

2.

3.

4.

5.

*P. M. Dickerson*

MARS ROVER WORKSHOP

Diary of Key Thoughts

(Please enter worthy ideas, thoughts, needed actions or observations as they occur and are discussed.)

1. Under worst case (2.6 AU, daytime reception on Earth with 10-meter collector) orbiter can do 1 Mbps with same 35W, 25 kg full redundancy except for telescope.
2. Earth-target pointing using 10-15 cm telescope (which can support all scenarios) seems to be no problem using scanning technique to locate Earth limb with subpixel resolution.
- 3.
- 4.
- 5.

MARS ROVER WORKSHOP

Diary of Key Thoughts

(Please enter worthy ideas, thoughts, needed actions or observations as they occur and are discussed.)

1. Off-Peak hrs data return link.
2. Cost chart for: Values to mission of changes in available or required  $\Delta$ Comm,  $\Delta$  Power,  $\Delta$  Data etc.
3. Value of  $K_a$ -34 GHz U/L Quick S/C Data Load?
4. Value of telecommunicating with Rover while underway?
5. How much can the telecommunications subsystem depend upon other Rover Systems in finding Earth, and their ACQ time and accuracy?
6. What would be the value to the project of having a slow but continuous data return rate for returning a few pictures while in transit?
7. NASA's Research Technology Budget vs. its Application Technology Budget.
8. Viking shut down telecommunications within  $5^\circ$  of line of sight to the sun. What would be the obscuration angular range for 32GHz and optical links?

MARS ROVER WORKSHOP

Diary of Key Thoughts

(Please enter worthy ideas, thoughts, needed actions or observations  
as they occur and are discussed.)

1. Imaging while moving?
  
2. 30/150 kbps - 1 Mbps D/L  
8/2000 bps U/L
  
- 3.
  
- 4.
  
- 5.

MARS ROVER WORKSHOP

*Handwritten notes:*  
L. ...  
M. ...

Diary of Key Thoughts

(Please enter worthy ideas, thoughts, needed actions or observations as they occur and are discussed.)

1. 1/2 M Dia. transmitting array  $\approx$  80 W dc rejection.
2. Application Technology Budget vs. Research Technology Budget.
3. Phobos is within 5° of the sun from September 1 thru October 30.  
(Viking Lander shut down within 5° of the sun)
4. Martian fog propagation effects.
5. Value of both microwave and optical.

MARS ROVER WORKSHOP

*H. J. ...*  
*G. M. Dickstein*

Diary of Key Thoughts

(Please enter worthy ideas, thoughts, needed actions or observations as they occur and are discussed.)

1. Value of different paths (direct to earth or relay via orbiter with storage) for various data?
2. Value of having big computer on orbit instead of on Rover (approximately a constant benign environment vs. Rover environment).
3. What are the effects of martian fog on 32GHz or optical frequency links propagation performance?
- 4.
5. Is there value in having simultaneous optical and microwave links?

*Collection*

# MARS ROVER WORKSHOP

## Diary of Key Thoughts

(Please enter worthy ideas, thoughts, needed actions or observations as they occur and are discussed.)

1. Rover Direct - X-only  
30 kbps/150 kbps/I MB -  $K_a$ -Available  
Optical Also

2. Rover and Relay S/C - X-only  
30 kbps/150 kbps/I MB -  $K_a$ -Available  
Optical Also

3.

4.

5.

## MARS ROVER WORKSHOP

### Diary of Key Thoughts

(Please enter worthy ideas, thoughts, needed actions or observations as they occur and are discussed.)

1. Nobody's addressing issue of cooling of rf amplifiers and thermal dissipation problem.
  
2. We need to describe what we can offer and what we need to achieve it. What are some reasonable scenarios (data rates, distances, power, mass, volume, etc)?
  
3. As long as optical can support 60 kbps under worst case with 4.0 dB margin and has modest rover needs (35W, 25 kg) it should be offered.
  
4. 30 kbps should be considered absolute minimum: that's just enough to do stereo imaging for rover motion. Need some data for science, too, and it could be comparable.
  
5. 0.5 m K<sub>a</sub> 90% eff. 10W planar array only does 30 Kbps to DSN 34m @ 2.6 A.U. That doesn't<sup>a</sup> allow for science.



APPENDIX D

OTHER MATERIALS

DATE: 4/30/82 TIME: \_\_\_\_\_

NOTES: ENHANCED K<sub>a</sub>-BAND ELECTRONICALLY BEAM  
STEEERED ELECTRONICS

GROUP: COMMUNICATIONS

TECHNOLOGY PROGRAM	DEVELOPMENT SCHEDULE									
	1988	1989	1990	1991	1992	'93	'94	'95	'96	'97-'00
o HIGH EFFICIENCY 32 GHZ MMIC TECHNOLOGY	[Timeline bar from 1988 to 1991]									
o EBS ARRAY DESIGN	[Timeline bar from 1988 to 1992]									
o BREADBOARD TRANSMIT MODULE DEVELOPMENT	[Timeline bar from 1988 to 1992]									
o EBS ARRAY TEST BED	[Timeline bar from 1989 to 1992]									
o ENHANCED EFFICIENCY 32 GHZ MMIC TECHNOLOGY	[Timeline bar from 1991 to 1993]									
o HI-REL MMIC DEVELOPMENT	[Timeline bar from 1992 to 1994]									
o ENHANCED EFFICIENCY ARRAY DEVELOPMENT	[Timeline bar from 1992 to 1994]									
o EBS ARRAY BREADBOARD DEVELOPMENT	[Timeline bar from 1993 to 1994]									
o EBS CONTROL SYSTEM DEVELOPMENT	[Timeline bar from 1993 to 1994]									
<b>PROGRAM SCOPE</b>	1,500	1,800	2,000	2,500	2,500	2,500	2,500	2,500	2,500	TOTAL: 15,300
<b>WY</b>	3.5	4.0	4.5	5.5	5.5	5.5	5.5	5.5	5.5	TOTAL: 34
<b>MRSR PROGRAM REFERENCES</b>	TECHNOLOGY DEVELOPMENT TECHNOLOGY SELECTION ▼ 1988 LAUNCH ▼ 2000 LAUNCH MRSR DESIGN & DEV. → LAUNCH ▼									

DATE: 4/30/87 TIME: 1:15 PM NOTES:

GROUP: COMMUNICATIONS

TECHNOLOGY PROGRAM	DEVELOPMENT SCHEDULE									
	1988	1989	1990	1991	1992	'93	'94	'95	'96	'97-'00
MICROWAVE (8.4 GHz AND 32 GHz, DSH); NOTE: OSO/TDA FUNDED (NOT SHOWN BELOW). NO OAST FUNDS NEEDED										
MICROWAVE (32 GHz BEAM WAVEGUIDE FOR S.C.)		2 WY \$300 K								
TELEVISION CODING										
32 GHz EXCITER										
X-BAND POWER AMP., ARRAY ANTENNA										
		1 WY/YR, \$125 K/YR								
		4 WY/YR, \$600 K/YR								
		4 WY/YR \$800 K/YR								
PROGRAM SCOPE	1825	1825	1525	1525	1400					TOTAL:
	11	11	9	9	8					TOTAL:
MRSR PROGRAM REFERENCES	TECHNOLOGY DEVELOPMENT TECHNOLOGY SELECTION ▼ 1988 LAUNCH ▼ 2000 LAUNCH MRSR DESIGN & DEV. → LAUNCH ▼									

DATE: 4/29/87 TIME:

NOTES: OPTICAL COMMUNICATIONS

GROUP: COMMUNICATIONS

TECHNOLOGY PROGRAM	DEVELOPMENT SCHEDULE									
	1988	1989	1990	1991	1992	'93	'94	'95	'96	'97-'00
DETECTOR DEVELOPMENT										
TRANSMITTER DEVELOPMENT										
ACQ./POINTING/TRACKING GROUND-BASED RECEIVER										
LAB. SYSTEM DEVELOPMENT										
SPACE SYSTEM DEVELOPMENT										
SPACE BREADBOARD SYSTEM DEMO.										
DATA ANALYSIS										
<b>PROGRAM SCOPE</b>	2500	3000	4000	5000	8000	500				TOTAL: 23,000
• \$, K	5	10	10	15	20	2				TOTAL: 62
• WY	<p style="text-align: center;"> </p>									
MRSR PROGRAM REFERENCES	<p style="text-align: center;"> </p>									





JPL D-4788, Vol. 7

Mars Rover/Sample Return (MRSR) Mission

# Mars Rover Technology Workshop Proceedings

Volume 7: Computing and Task Planning

Chairmen: David Eisenman, Jet Propulsion Laboratory  
Sven Grenander, Jet Propulsion Laboratory

April 28-30, 1987  
Pasadena, California

**JPL**  
Jet Propulsion Laboratory  
California Institute of Technology

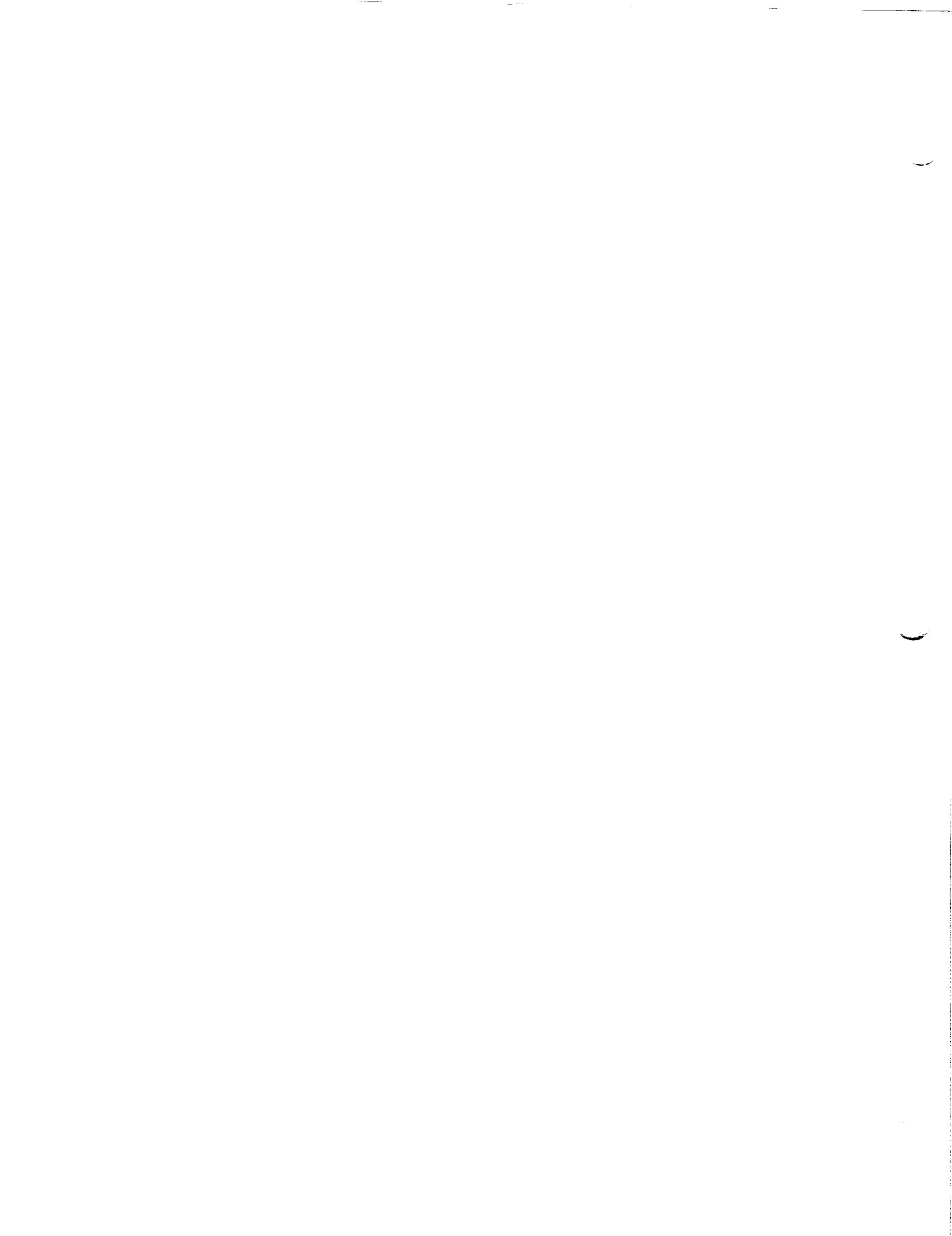



## GLOSSARY

### ABBREVIATIONS AND ACRONYMS

AI	artificial intelligence
CMOS	complementary metal oxide semiconductor
CPU	Central Processing Unit
DoD	Department of Defense
Eos	Earth orbiting satellite
G&C	guidance and control
GaAs	gallium arsenide
I/O	Input/Output
MIPS	Million instructions per second
Mbytes	Megabytes
MeV	mega electron volts
NASA	National Aeronautics and Space Administration
NAV	navigation
PERT	program evaluation and review technique
RAM	Random Access Memory
ROM	read only memory
SAR	synthetic aperture radar
SEU	single event upset
TCU	Thermal Control Unit
VHSIC	very high speed integrated circuit
VLSI	very large scale integration

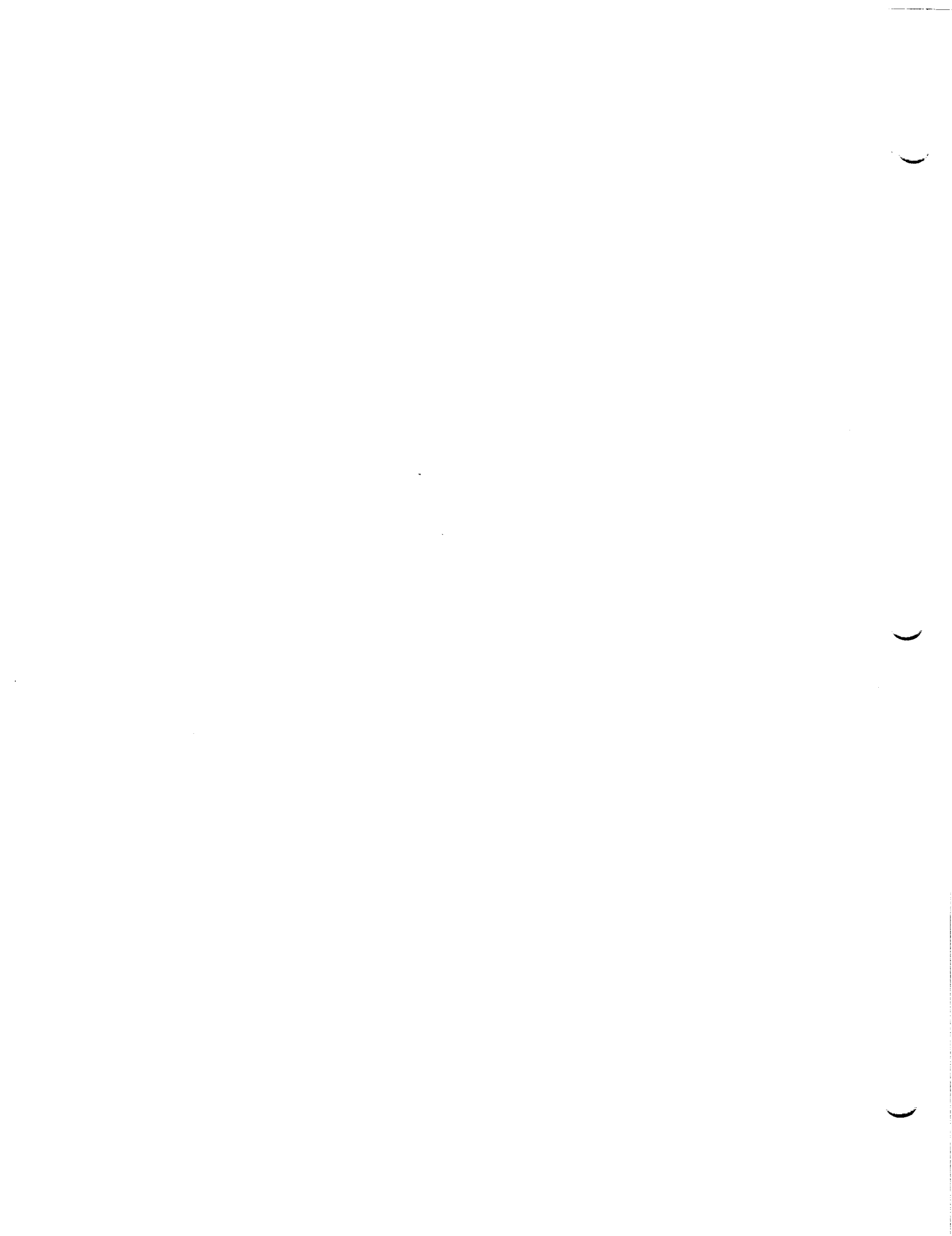

CONTENTS

1.	EXECUTIVE SUMMARY . . . . .	7-1-1
2.	INTRODUCTION . . . . .	7-2-1
3.	DISCUSSION . . . . .	7-3-1
	3.1 Hardware . . . . .	7-3-1
	3.2 Software . . . . .	7-3-1
4.	SUMMARY AND CONCLUSIONS . . . . .	7-4-1
	4.1 Hardware . . . . .	7-4-1
	4.2 Software . . . . .	7-4-1
5.	PRESENTED MATERIALS. . . . .	7-5-1

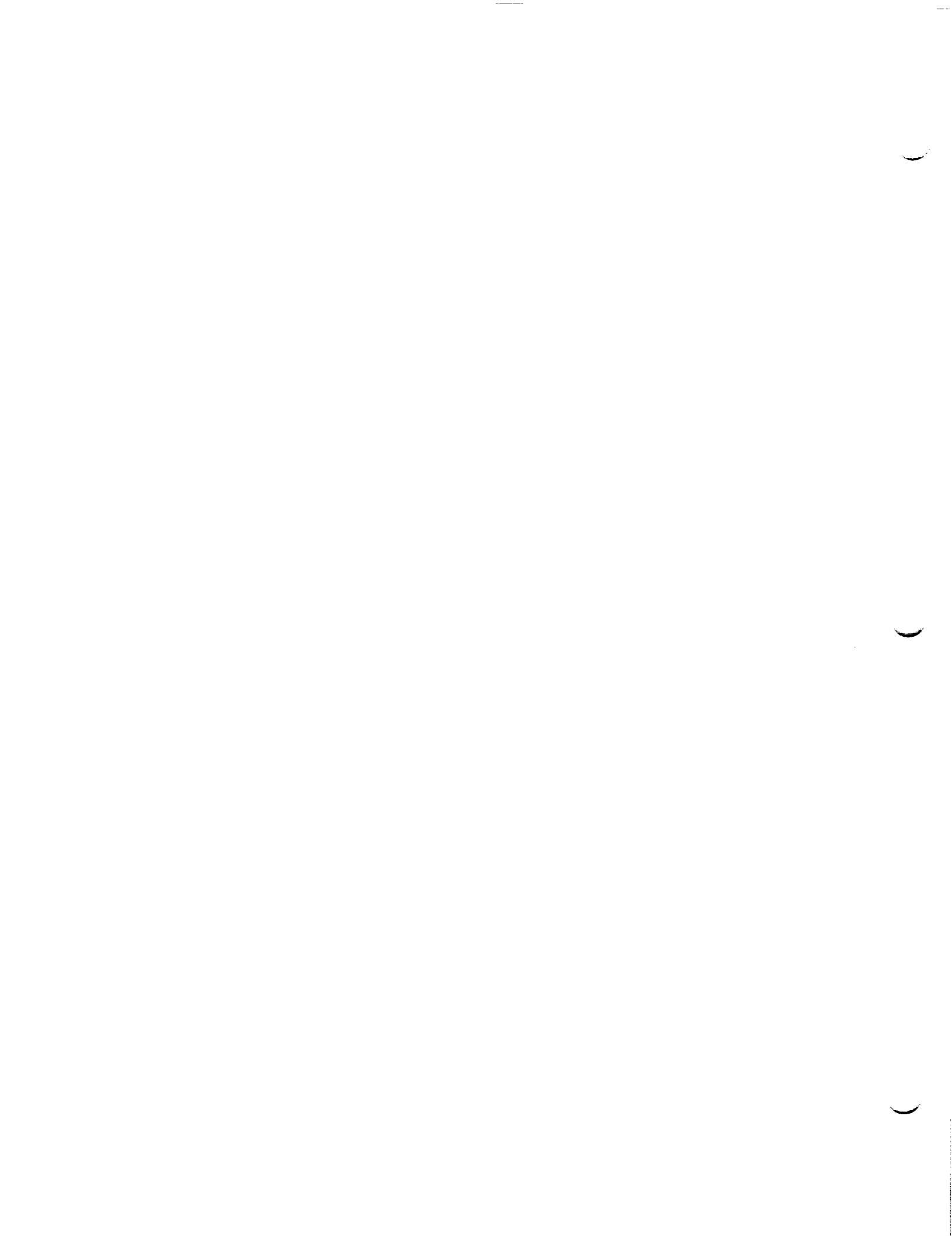

## SECTION 1

### EXECUTIVE SUMMARY

The requirements placed on computing and task planning functions for the rover are driven by the capabilities of the on-board subsystems and the expected mode of rover operation. Rover computing and task planning technology must satisfy performance requirements for local guidance and hazard avoidance, science and sample acquisition, and rover mobility.

To accomplish the computing operations expected in rover task planning activities, a multi-megabyte, highly fault-tolerant random access memory, with storage requirements in the range of  $10^7$  to  $10^8$  bits, will be required. Also, a highly reliable mass storage system with a capacity of about  $10^6$  to  $10^7$  bits will be needed. This is a major concern, but magnetic bubble memory or magneto-optical disc technology may offer possible solutions.

A key constraint on rover computing capabilities may be the need to limit the power consumption of on-board computing. Mass and radiation hardening requirements may also impose constraints, but no specific conclusions or recommendations were made in these areas.

Software issues were also considered. Although no specific needs were defined, areas of concern were: rover planning activity, both on-board and on Earth; simulation for Earth-based planning; on-board monitoring; and on-board diagnosis. There was general agreement within the working group that the rover, with its highly capable subsystems, will present a planning problem more complex than any previously encountered in planetary exploration.

A final issue, software validation and verification technology development, must be resolved in order to assure the Mars Rover Sample Return project and its sponsors that every reasonable precaution has been taken in this area. It is not currently possible to validate and verify any large-scale software system, such as the one used on the Space Shuttle.

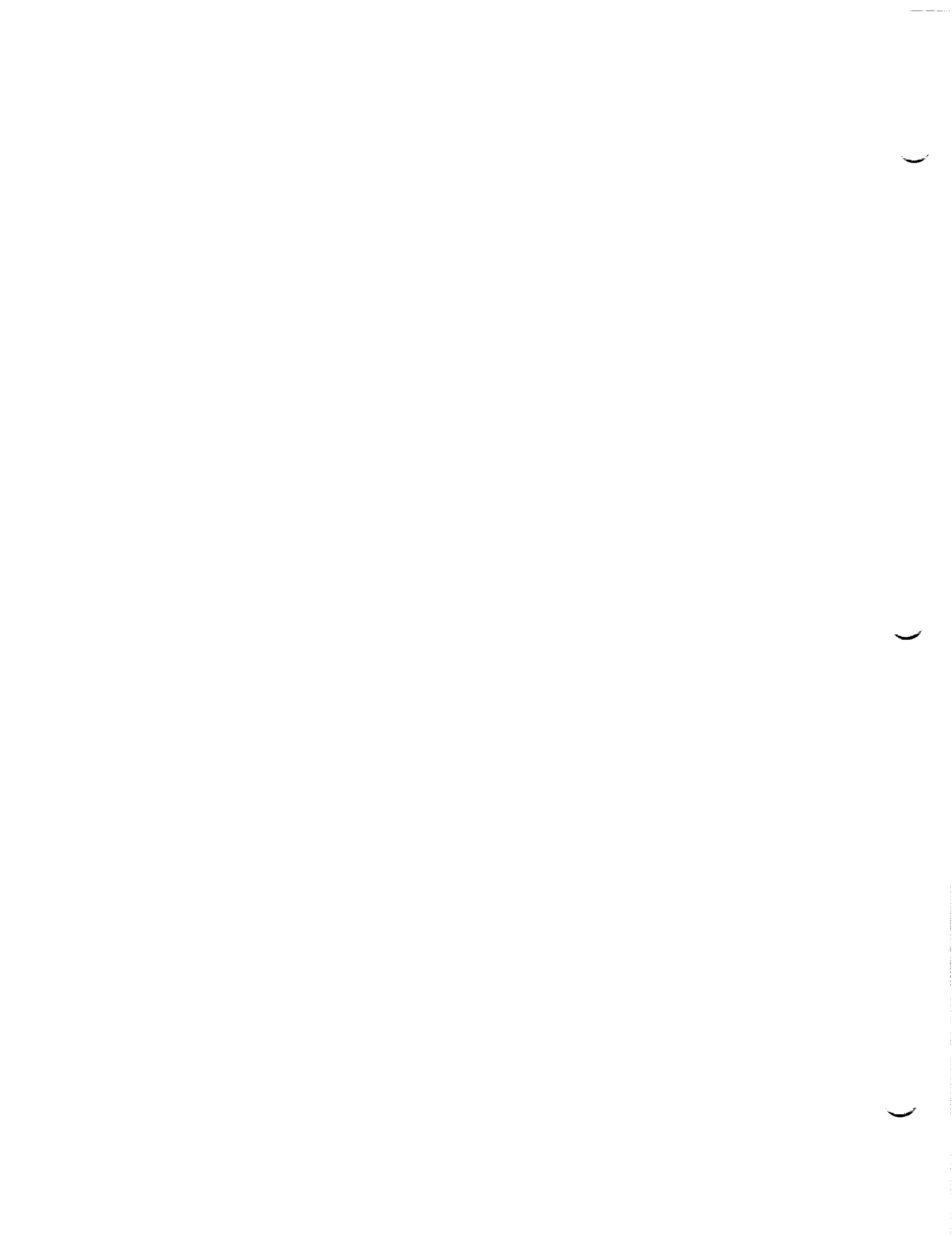

## SECTION 2

### INTRODUCTION

The Computing and Task Planning working group consisted of members from various disciplines. Among these disciplines were spacecraft sequence planners, Artificial Intelligence (AI) system developers, and Autonomous Vehicle technologists.

While these disciplines overlap, the differences in background caused the first couple of days to be devoted to a familiarization across discipline boundaries. Many of the participants had prepared presentations for the workshop and these presentations served as the catalyst for discussions which helped in the familiarization process. The material used in the presentations is included at the back of this section and constitutes the bulk of this volume of the proceedings.

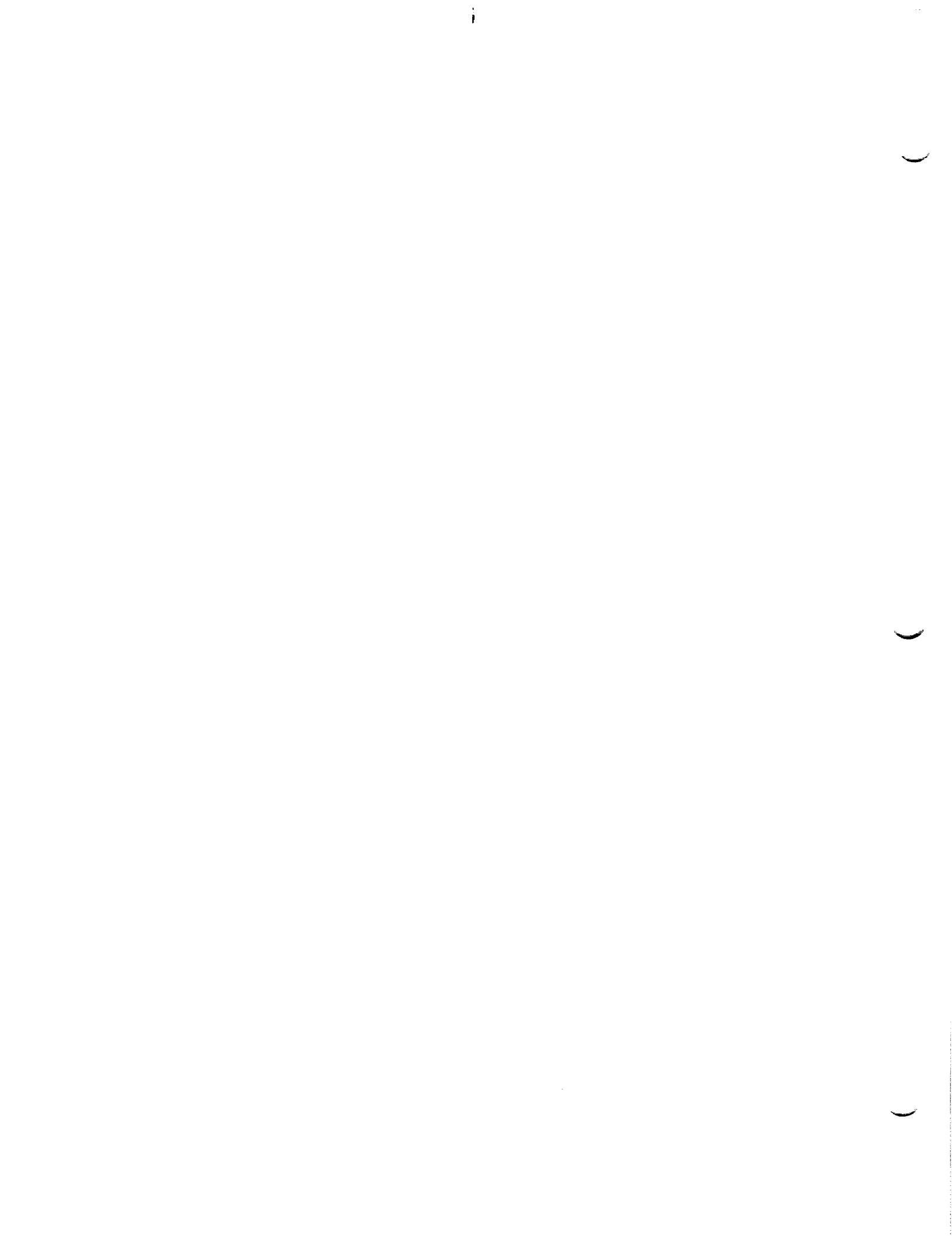



## SECTION 3

### DISCUSSION

The requirements placed on the computing and task planning functions are driven by the capabilities of the onboard subsystems and the expected mode of rover operation. Up to a point, more capable and autonomous subsystems will increase requirements on both the general-purpose computing capability and the task planning function. Similarly, sprint versus graze modes (adaptive versus highly adaptive) will have a significant impact upon the general-purpose computing capability and the task planning function. As neither the subsystem capabilities nor modes of operation have yet been determined, the computing and task planning requirements are largely unknown and most of the discussions centered on bringing up issues rather than arriving at answers or conclusions.

The main issues which were discussed during this group's sessions are divided into two sections. In the first section are issues (questions) concerning general-purpose computer hardware. In the second section, the questions deal with the software to be hosted in the hardware.

#### 3.1 HARDWARE

- What is the probable required range for instructions per second (Million Instructions Per Second or MIPS) out of the general-purpose onboard computers?
- How does the state-of-the-art in flight hardware compare to the MIPS requirement?
- How much random access memory (RAM) could reasonably be required?
- How does the state-of-the-art in-flight hardware compare to the RAM requirement?
- How much mass storage can we expect to require (megabytes)?
- How does the state-of-the-art in-flight hardware compare to the mass storage requirement?
- What is the implication on power and mass from these hardware requirements?
- What degree of radiation hardening is going to be required?

#### 3.2 SOFTWARE

- Rover activity planning: how much can be done on board and how much will be required on board?

- Rover activity planning: how much can be done on the ground and how much will be required on the ground?
- Simulation: to what extent will simulation be required for ground-based planning, and what is the state-of-the-art in simulation of non-deterministic systems and environments?
- Monitoring: how sophisticated will the onboard monitoring have to be?
- Diagnosis: how sophisticated will the onboard diagnosis capability have to be?
- Software validation and verification: is it possible, is it practical?

## SECTION 4

### SUMMARY AND CONCLUSIONS

#### 4.1 HARDWARE

- It was concluded that on the order of 1 to 10 MIPS would be required for the onboard general-purpose computer. This number assumed that the task planning and navigation systems could time share the general-purpose computer resources.
- Current state-of-the-art flight hardware can not satisfy the 1 to 10 MIPS range. It was deemed unlikely that NASA could undertake the expense of development of the hardware, and the NASA should rely upon Department of Defense (DoD) sources for the development. NASA should devote some effort to staying abreast of these DoD developments.
- RAM requirements ranged from 1 to 10 Mbytes. This range was driven by the expected task planning computation speed requirement.
- The RAM requirement was certainly higher than for previous planetary missions but was not deemed an insurmountable problem.
- The mass storage requirement ranged from 0.1 to 1.0 Gbyte.
- The mass storage requirement was a major concern. No space-qualified mass storage capabilities are anywhere near the expected needs. Bubble memories were mentioned as a possibility, as were rewritable optical disks. However, it is clear that this storage requirement will have to be seriously investigated as it may limit the ultimate capability of the rover.
- No conclusions were reached regarding either mass or power requirements.
- No conclusions were reached regarding radiation hardening requirements.

#### 4.2 SOFTWARE

- It is clear that the rover, with its highly capable subsystems, will present a more complicated planning problem than has been addressed before in planetary exploration. The problem lies in planning for a system which is not as smart as an astronaut, but too smart to be predictable.
- It was not clear how much diagnosis will be required on board.

- Software validation and verification evoked the normal response. It cannot currently be done with any large software system (for example, the Shuttle). However, it was agreed that work would have to be done to assure the project, as well as sponsors, that every reasonable precaution had been taken until a method of validation and verification could be developed.

SECTION 5  
PRESENTED MATERIALS

COMPUTING  
AND  
TASK PLANNING  
VIEWGRAPHS

**JPL**

# *MAX*

A High Speed, General Purpose  
Multicomputer for Space Applications

MAX Users Workshop

March 16, 1987

Bob Rasmussen

**JPL**

## Computational Requirements Summary

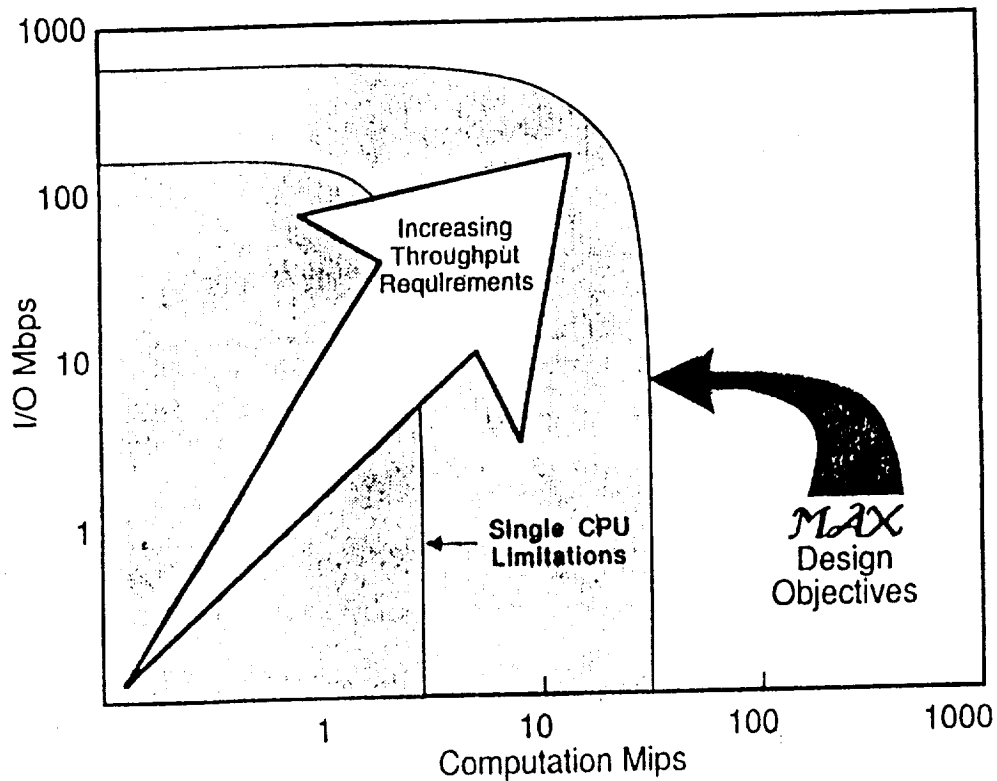

7-5-3

ORIGINAL PAGE IS  
OF POOR QUALITY

## Principle MAX Objectives

- New Device Technology
  - Faster, lower power, higher density
  - Radiation and Single Event Upset hard
- Powerful Software Methodology
  - High modularity
  - Sophisticated concurrency support
  - Configuration transparency
- Flexible Concurrent Architecture
  - Wide application range through modularity
  - Realizable in a variety of device technologies
- Fault Tolerance
  - Efficiently tailorable to application needs
  - Distributable for damage tolerance
  - On line repairability

## *MAX* Technology Roadmap

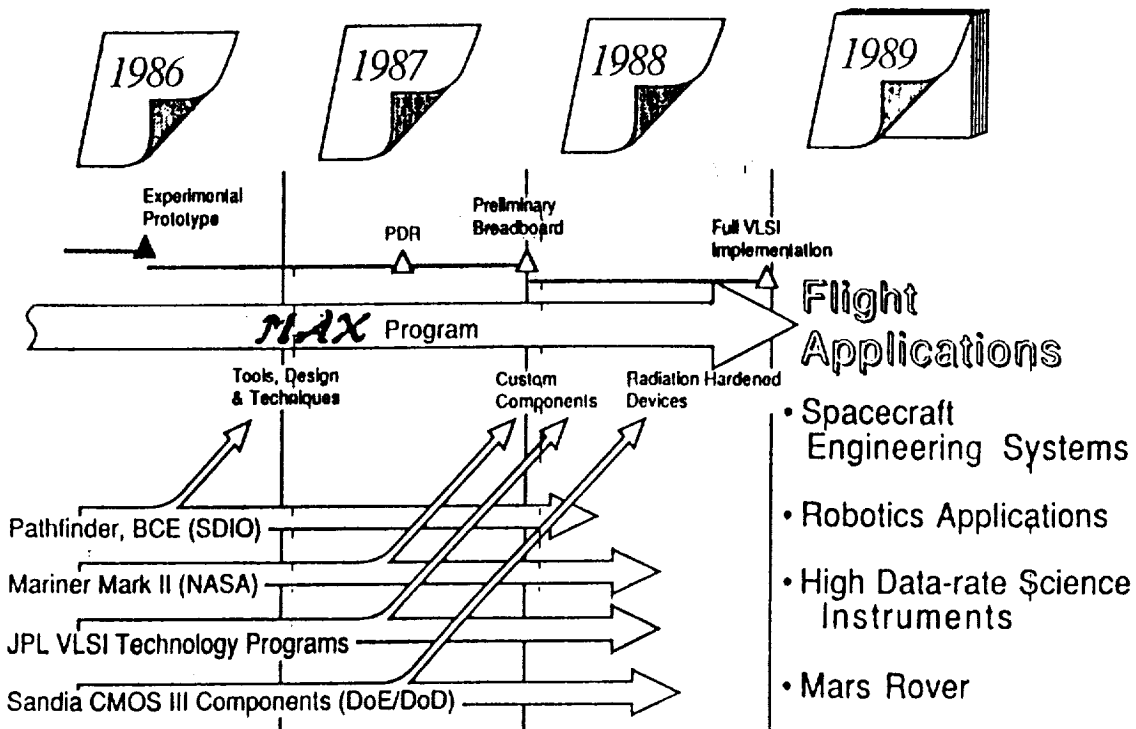





## Flexible Concurrent Architecture



## Device Technology

- Ultimate goal is a VHSIC realization
  - Near term space qualifiability is an open issue
- Current implementation in Sandia National Laboratory components
  - Previous flight qualification history.
  - 2 micron, 10-15 MHz CMOS.
  - Hard to >100 krad.
  - SEU immune ( $>37 \text{ MeV} / \text{mg} / \text{cm}^2$ ).
  - Emulation of NS32000 series components.
    - 32 bit  $\mu$ -processor family.
    - Well suited to high level languages.
  - Additional memory and glue components.
  - Support for custom VLSI components.

## Device Technology

### MAX Module Configuration

- DUAL PROCESSOR DESIGN
- SEPARATE LOCAL BUS & MEMORY FOR EACH CPU
- COMMUNICATION THROUGH SHARED MEMORY
- DMA I/O SUPPORT
- FPU CO-PROCESSOR
- OFF BOARD BUS
- SINGLE BOARD DESIGN

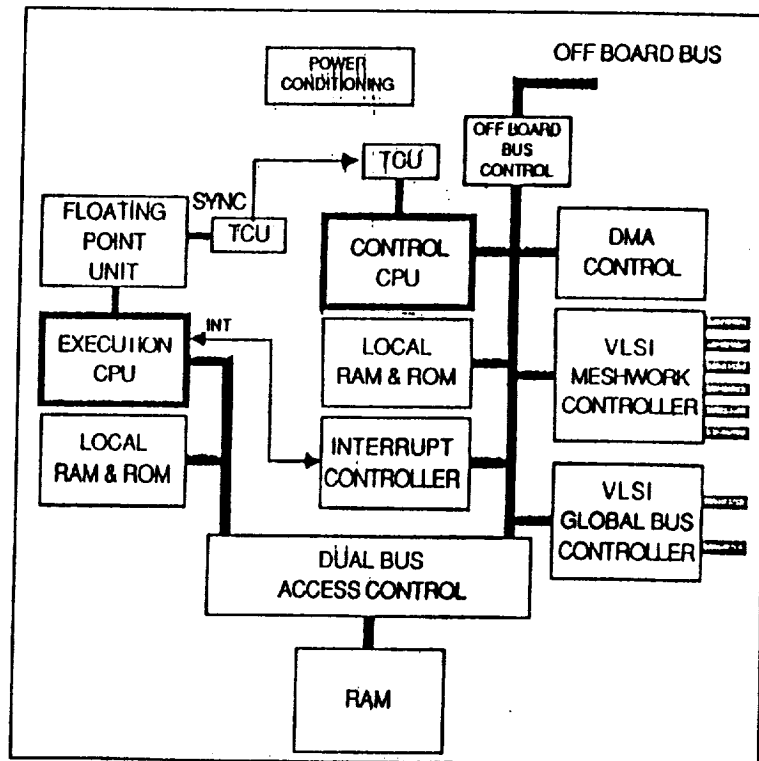

# MAX Hardware Architecture

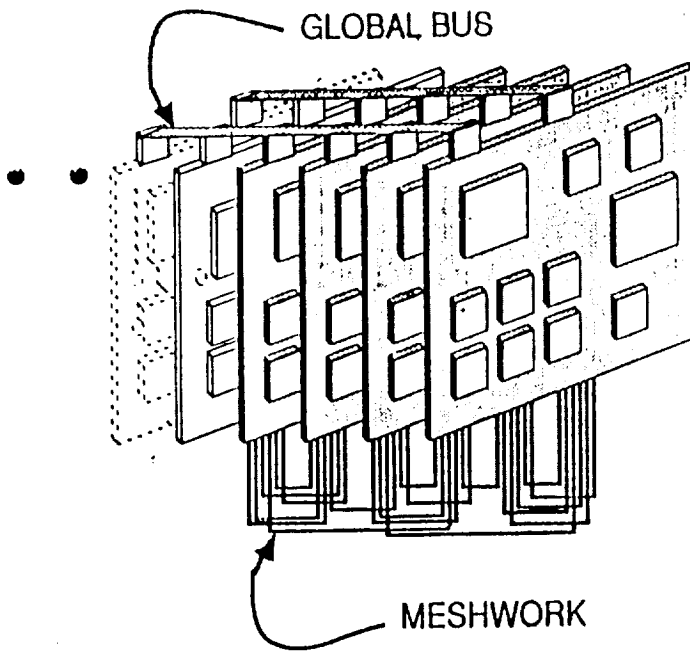

- FULLY DECENTRALIZED
- ANY NUMBER OF IDENTICAL PROCESSING MODULES
- NO SHARED MEMORY BETWEEN MODULES

## Topology examples

- Fully connected

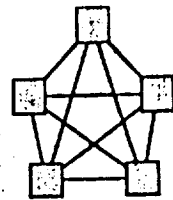

- Augmented Trees/rings

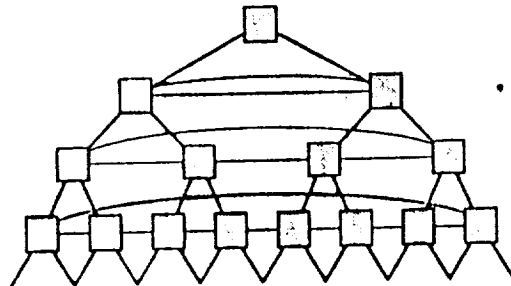

- Hypercube

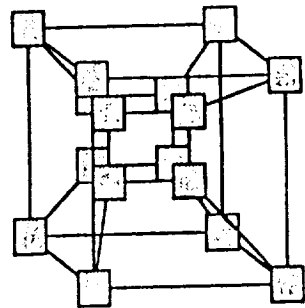

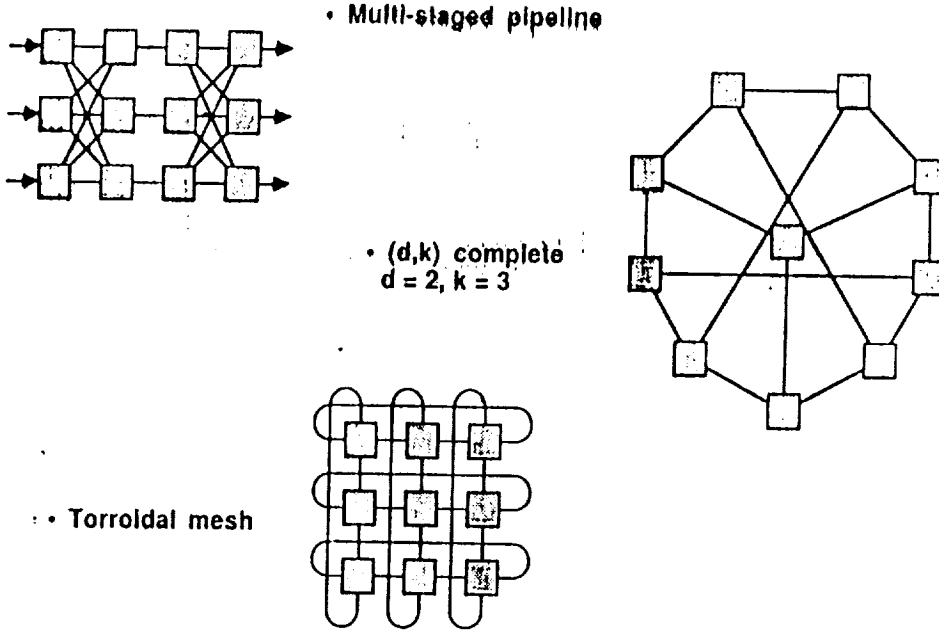

VLSI Global Bus Controller

Features:

- 0.5 to 10 Mhz programmable baud rate
- Broadcast mode
- Fully distributed operation
- Deterministic (worst case) access delay
- Round robin access during heavy loading
- Multiple access during light loading
- Minimal data traffic, only control information
- Global system time synchronization

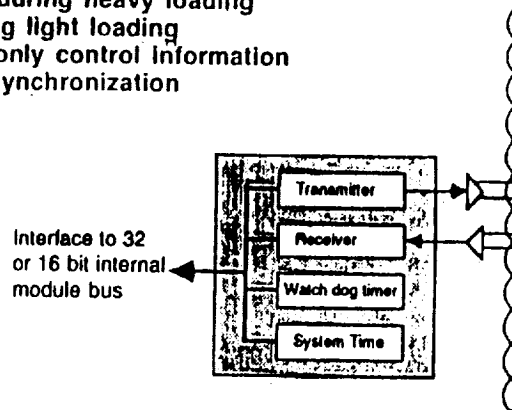

# Powerful Software Methodology

## The Data Flow Concept

- System functions activated by the flow of information
- Relationships often represented by Data Flow Graphs
- Familiar models...

- Spreadsheet programs
- PERT charts
- Signal flow diagrams
- DeMarco structured analysis diagrams

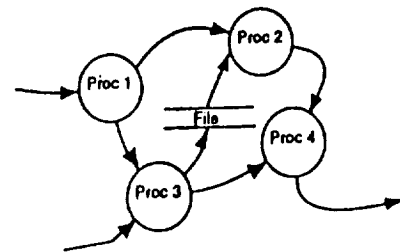
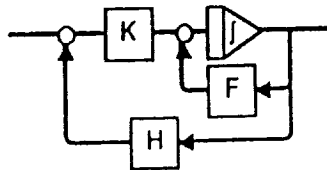
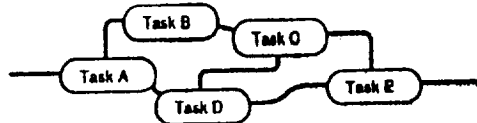
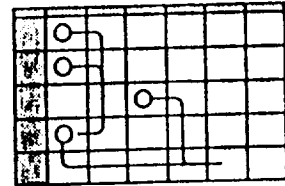

JPL

## HALIOS The MAX Operating System

- Fully distributed
  - One copy on each module
  - Cooperation via global bus
- Layered design
  - Conventional multi-tasking and I/O at lower level
  - Data flow programming model at high level
- Tailored for real time applications
  - Time / event operations
  - Prioritization of responses
- Transparently implements fault tolerance

JPL

## Data Flow Software Design

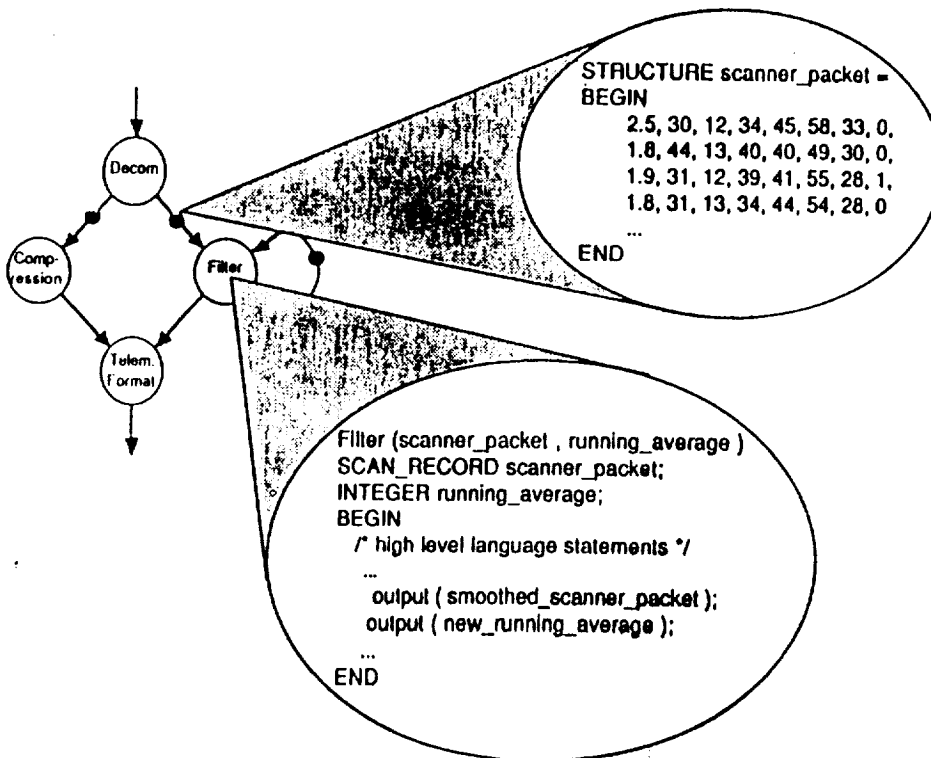

## Data Flow Formalities

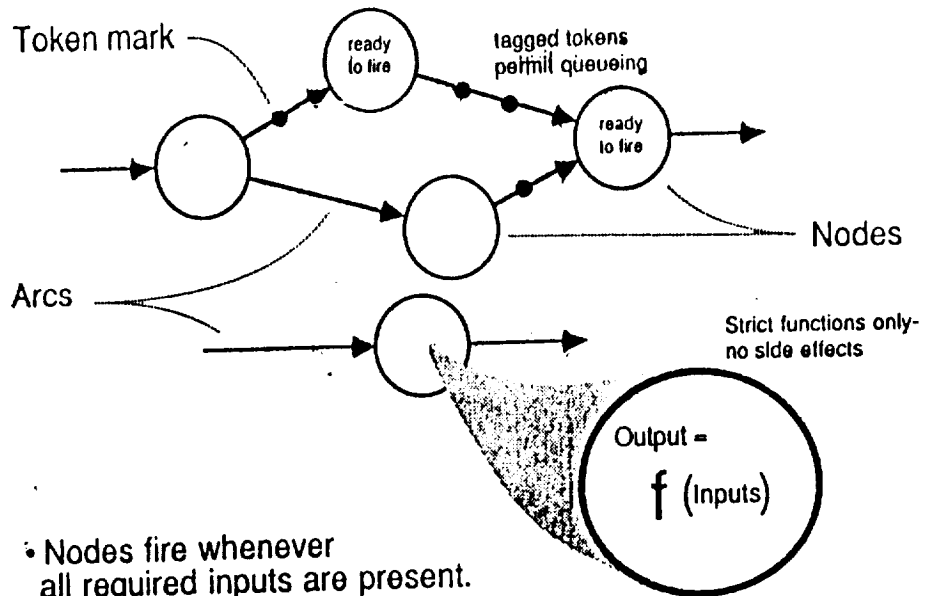

- Nodes fire whenever all required inputs are present.
- Tokens can be created or destroyed, but never changed
- Strict functions only, no side effects

## Low Resolution Data Flow Advantages

- Concurrency specification facilitated
- Highly modular code
  - Details of code hidden at system level
  - Design specification, coding, test, and maintenance in small, decoupled pieces
- System state completely embodied in tokens
  - No other context to preserve through faults or interruptions
  - Need compare or checkpoint only tokens
- Unified approach to data & control lowers overhead
  - Token data
  - Meshwork packets
  - Memory blocks
  - Code segments

} *common structure*

**JPL**

## **Fault Tolerance**

**JPL**

## **Fault Tolerance**

- **Software**
  - Transparent redundancy
  - Distributed operating system
  - Multiple copies of application software
  - Triplicate and vote option for data-flow graph functions
- **Hardware**
  - Meshwork can route around failed boards
  - Dual global bus design



# Rover Applications for Max

March 16, 1987

Jet Propulsion Laboratory  
California Institute of Technology  
Pasadena, California

## JPL SPACE COMPUTATIONAL REQUIREMENTS SUMMARY

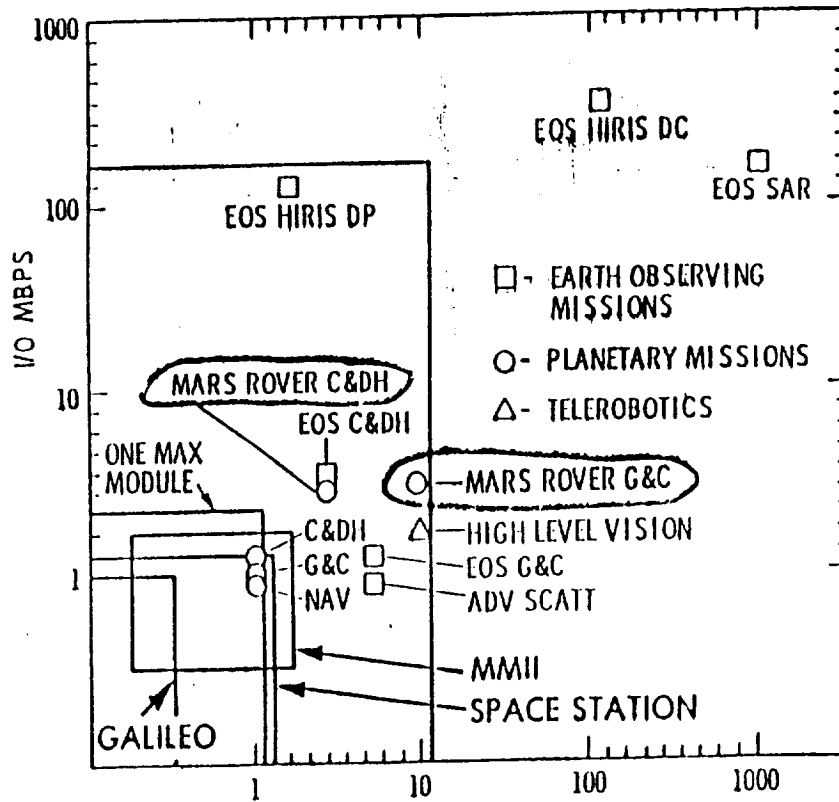

# MARS ROVER ARCHITECTURE

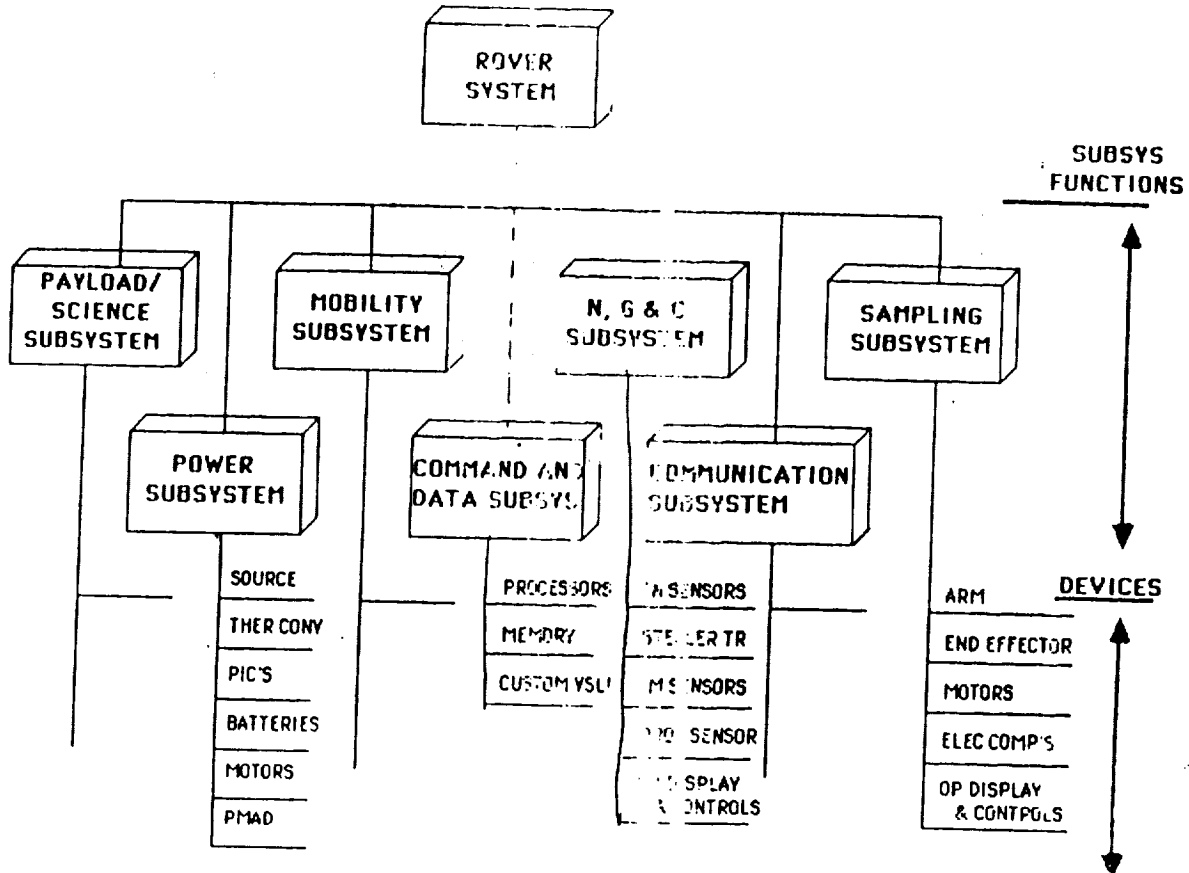

## Hover Highlights

	<u>1990</u>	<u>1992</u>	<u>1995</u>
Peak speed	1 km/hr	5 km/hr	10 km/hr
Traverse rate	1 km/day	10 km/day	15 km/day
Samples / day	5	50	500
Autonomous path length	.1 km	10 km	100 km
Operator support	continuous		Once a day supervision

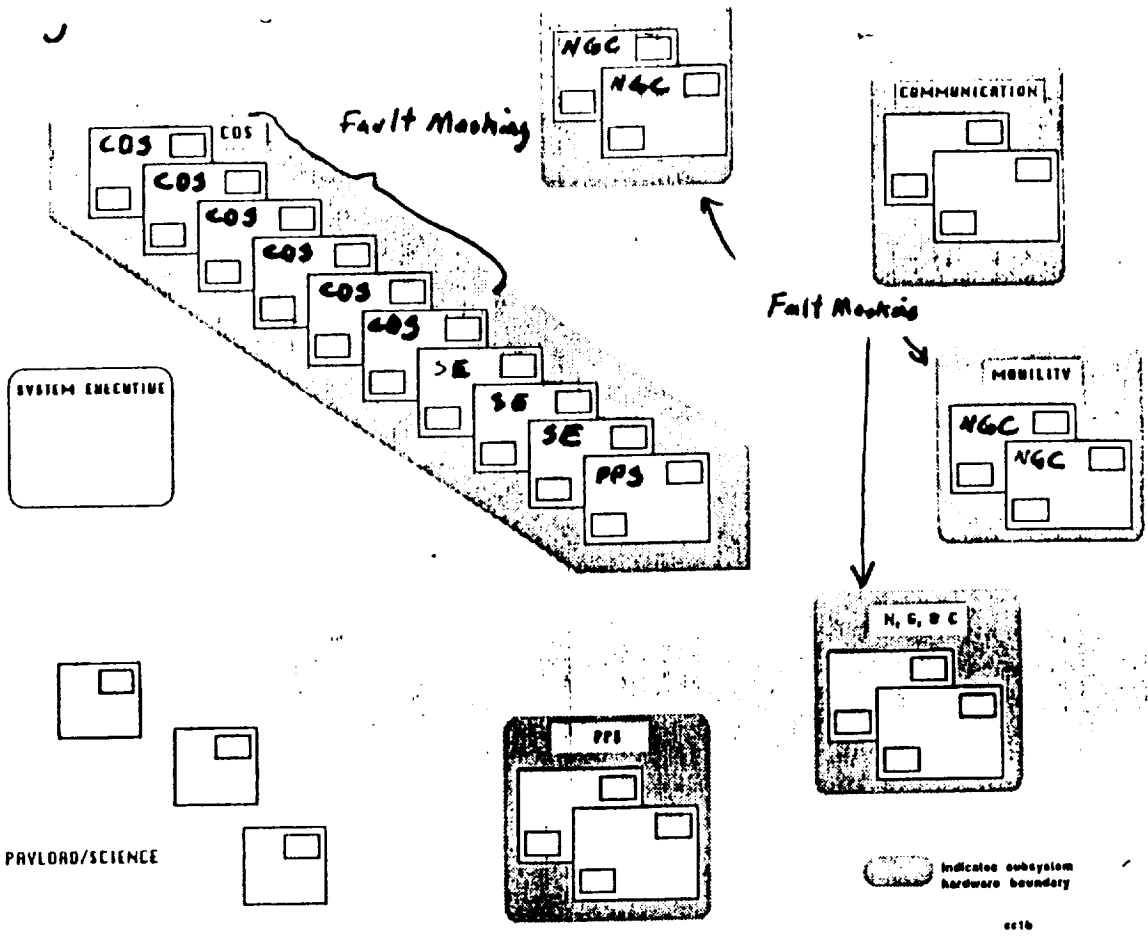

Explore

Configuration

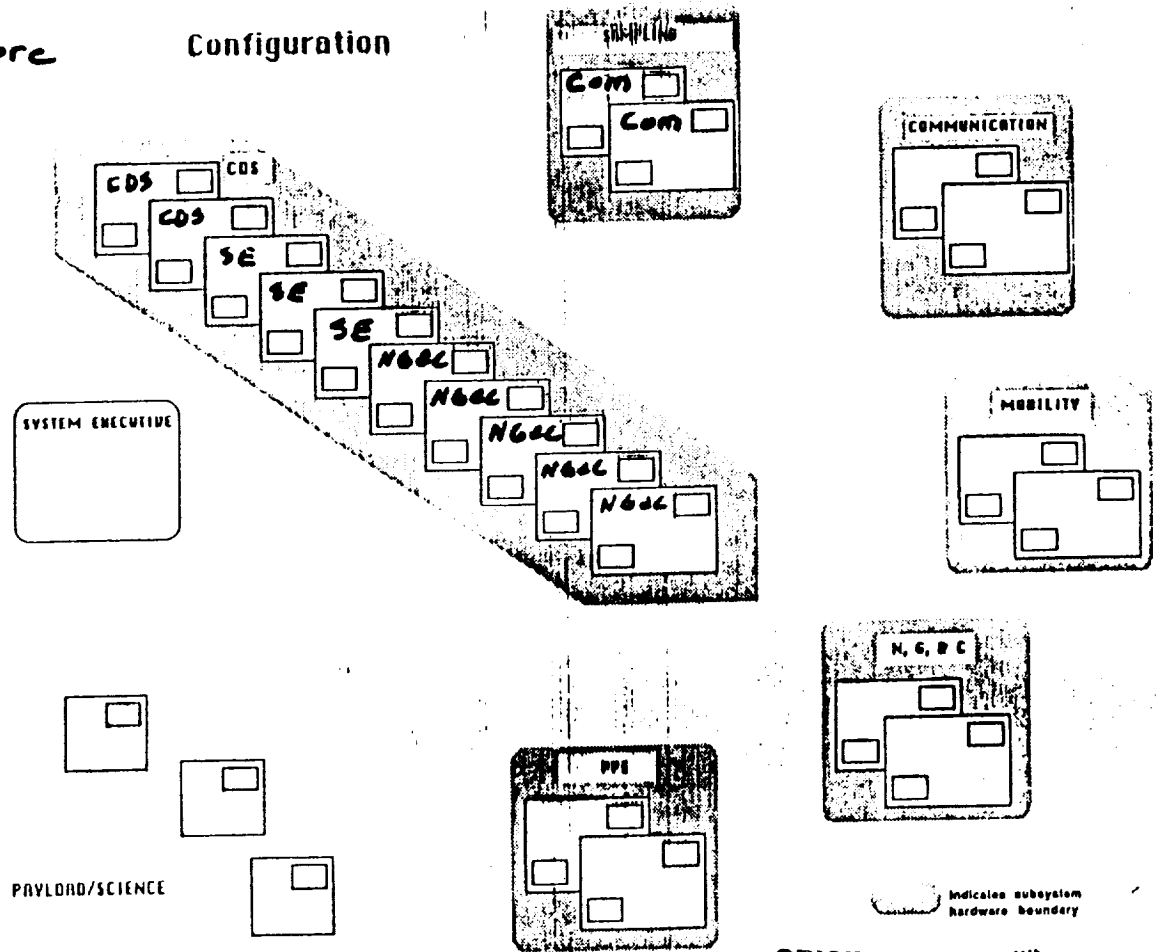

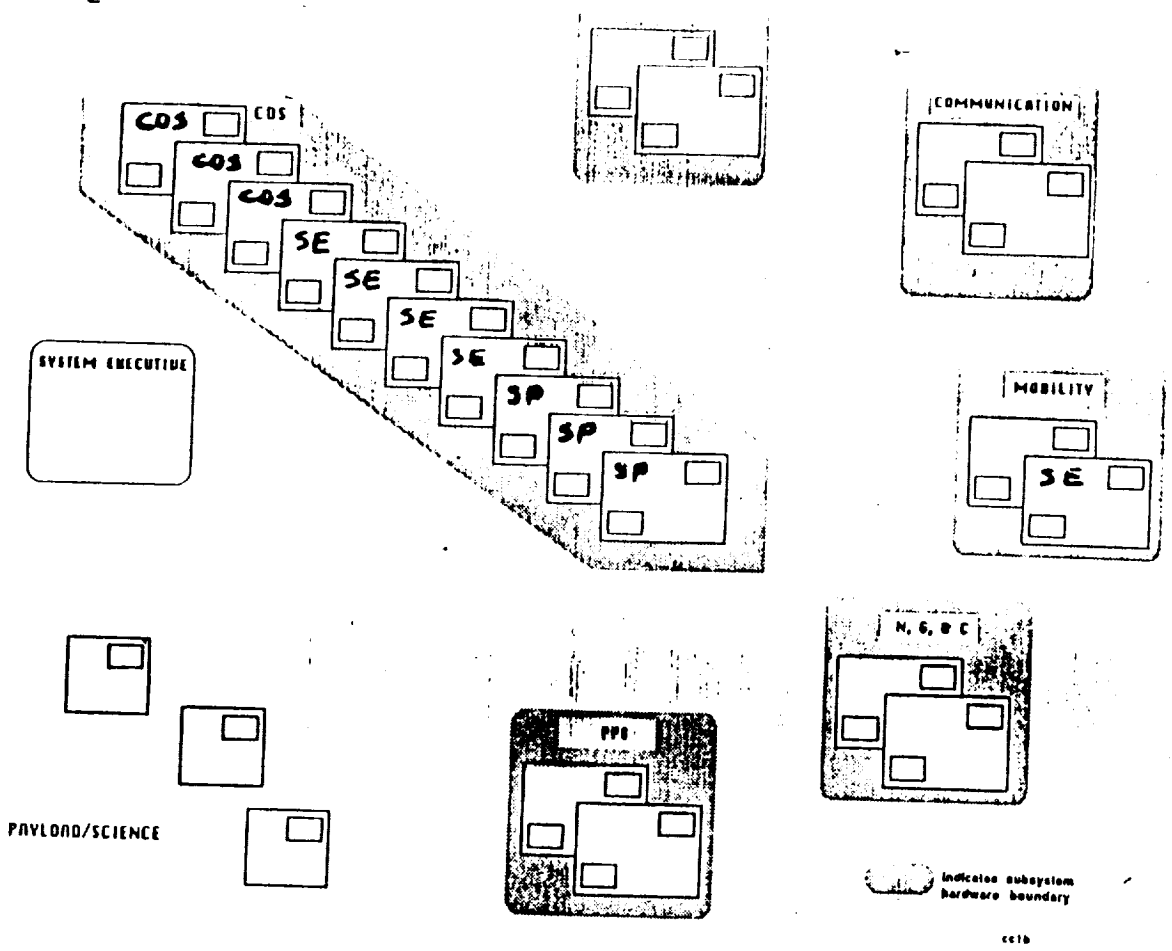

**Max Power Efficiency Advantage**

Specific power in multiprocessor systems ( MIPS/watt) is primarily determined at the chip level, not by the architecture.

All architectures that load processors efficiently have about the same MIPS/watt as the basic chips in the individual processors.

The power advantage of MAX comes from ability to reconfigure.

- Software implemented reliability
- Software implemented synchronization

Total number of processors = min number to meet max demand

- This is driven by need to save weight
- Standby redundancy is not appropriate for Rover computer

For less demanding times

- Assign computational load for min power
- Run only processes needed
  - minimize redundant processes
- Run some processors at slow process rate

## Power and Weight

1992 Semi autonomous

- Needs approximately 15 total individual processors
  - @ 5 watt/board P=75 watts
  - THATS A LARGE FRACTION OF AVAILABLE POWER
- Weight will also be dear
  - tens of ~~watts~~<sup>lbs</sup>, a large fraction of available power

## Conclusion

Rover range = f (MIPS/watt, MIPS/#)

## Better Processors

Improved processors will help, but not much very soon

- GaAs targeted at rad/hard DOD applications at sacrifice of power.
  - May not be useful on Rover
- 1 1/4 micron CMOS some hope
  - May improve MIPS/# and MIPS/watt by factor of 2 or so
  - Primarily DOD development
  - 3 to 5 years away

Summary

Rover should use 320xx processor technology

- Switch when successor processor appears (3 to 5 years)

Max is especially appropriate for Rover

- Flexible processor assignment during normal program execution can save weight and power.
  - for Reliability
  - for Synchronization of processors
- Permits mix of processing speeds
  - Can mix various process speeds
- Max advantage will become more apparent when system weight and power are addressed more seriously.

nrsp

7-5-18

ORIGINAL VALUE IS  
OF POOR QUALITY

POWER SYSTEM AUTONOMY

MARS ROVER TECHNOLOGY WORKSHOP  
4/28 - 4/30/87

Bill Miller  
303 971-5569

Martin Marietta  
P.O. Box 179  
Denver CO 80201  
Mail Stop S-0550

DEFINITIONS - AUTOMATION & AUTONOMY

AUTOMATION IS THE USE OF MACHINES TO CONTROL AND/OR CARRY OUT PROCESSES IN A PREDEFINED OR MODELED SET OF CIRCUMSTANCES WITHOUT HUMAN INTERVENTION.

AUTONOMY IS THE ABILITY OF A SYSTEM, SUBSYSTEM OR ELEMENT TO OPERATE MEETING ITS SPECIFIED OBJECTIVE WHILE BEING NON-DEPENDENT ON A HIGHER LEVEL FOR ANY LOCAL ACTION REQUIRED IN RESPONSE TO EXTERNAL INPUT AND/OR STIMULI PRODUCED BY INTERNALLY CONTAINED SENSORS.

# LEVEL OF AUTONOMY - CATEGORIZATION

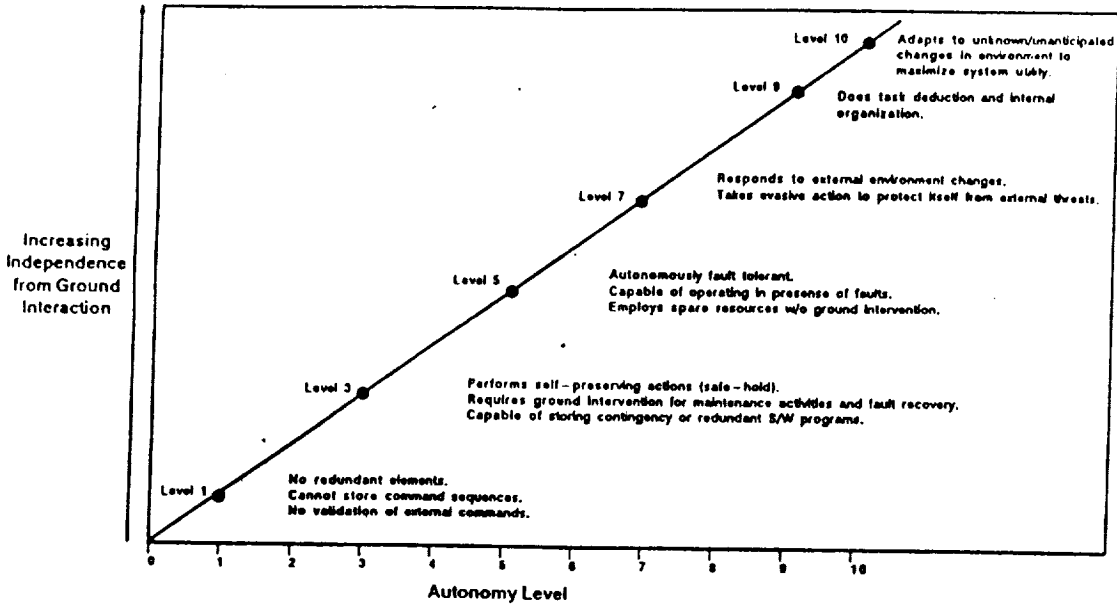

## TOP LEVEL FUNCTIONAL DECOMPOSITION

NOTES ON P.S. AUTONOMY

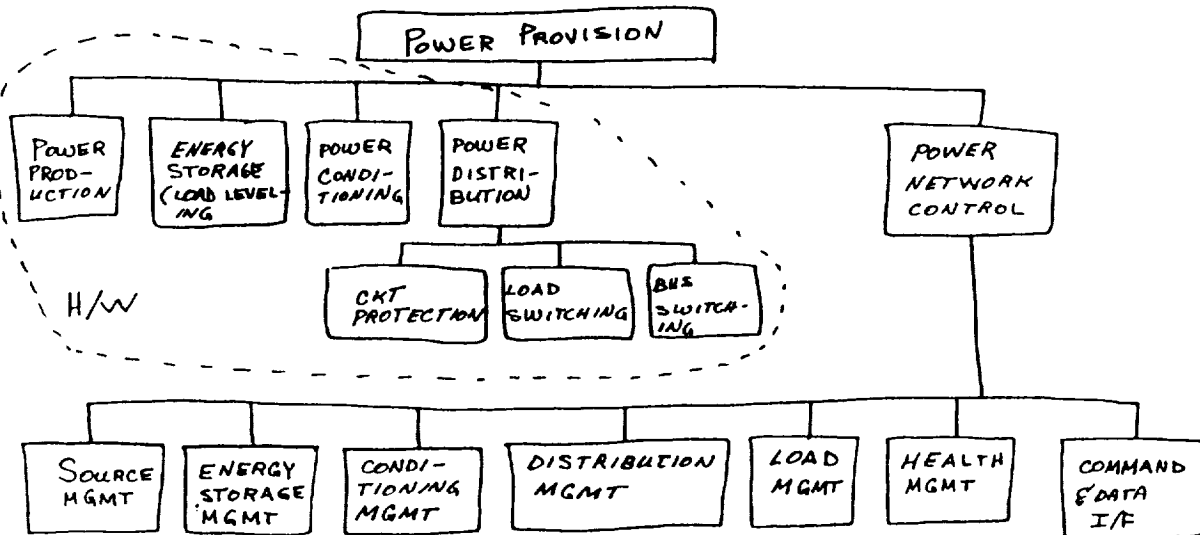

4/29/17  
12m



## POWER SYSTEM AUTONOMY - ROVER AUTONOMY

- POWER SYSTEM NON-DEPENDENCE
- ENERGY STORAGE MGMT - KNOWLEDGE BASED SYSTEM
- SWITCHGEAR PROVIDES LOWER REQUIRED REACTION TIMES  
(DATA BUS RATES AND COMPUTATIONAL PERFORMANCE)
- HEALTH MGMT - FAULT DETECTION
  - FAULT ISOLATION
  - INTELLIGENT RECONFIGURATION
  - FAULT LOGGING
  - NEAR TRENDS

} KNOWLEDGE  
BASED  
SYSTEM

- POWER Subsystem IMPACTS VS ROVER LEVELS
- KNOWLEDGE BASE DEVELOPMENT
- THERMAL SUBSYSTEM AID

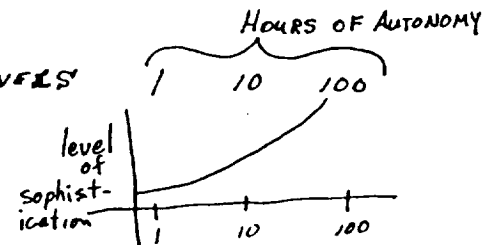

4/29/97  
RPM

**New Generation  
Vision Technology  
for  
Autonomous Navigation**

Chuck Thorpe  
Robotics Institute  
Carnegie Mellon

**Goals of the  
NAVLAB Project**

Map-guided and exploratory missions

Landmark recognition and tracking

On- and off-road navigation

Obstacle avoidance

## NavLab

Room for onboard:

- computers (5 racks), including Warp, controller, Suns
- researchers (4, including watchdog)
- power (2 \* 5500 Watt generators)
- sensors (pan/tilt + pan)

Roadable

Fixable

Comfortable

Controllable

Testbed for data fusion and for variety of terrain

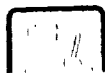
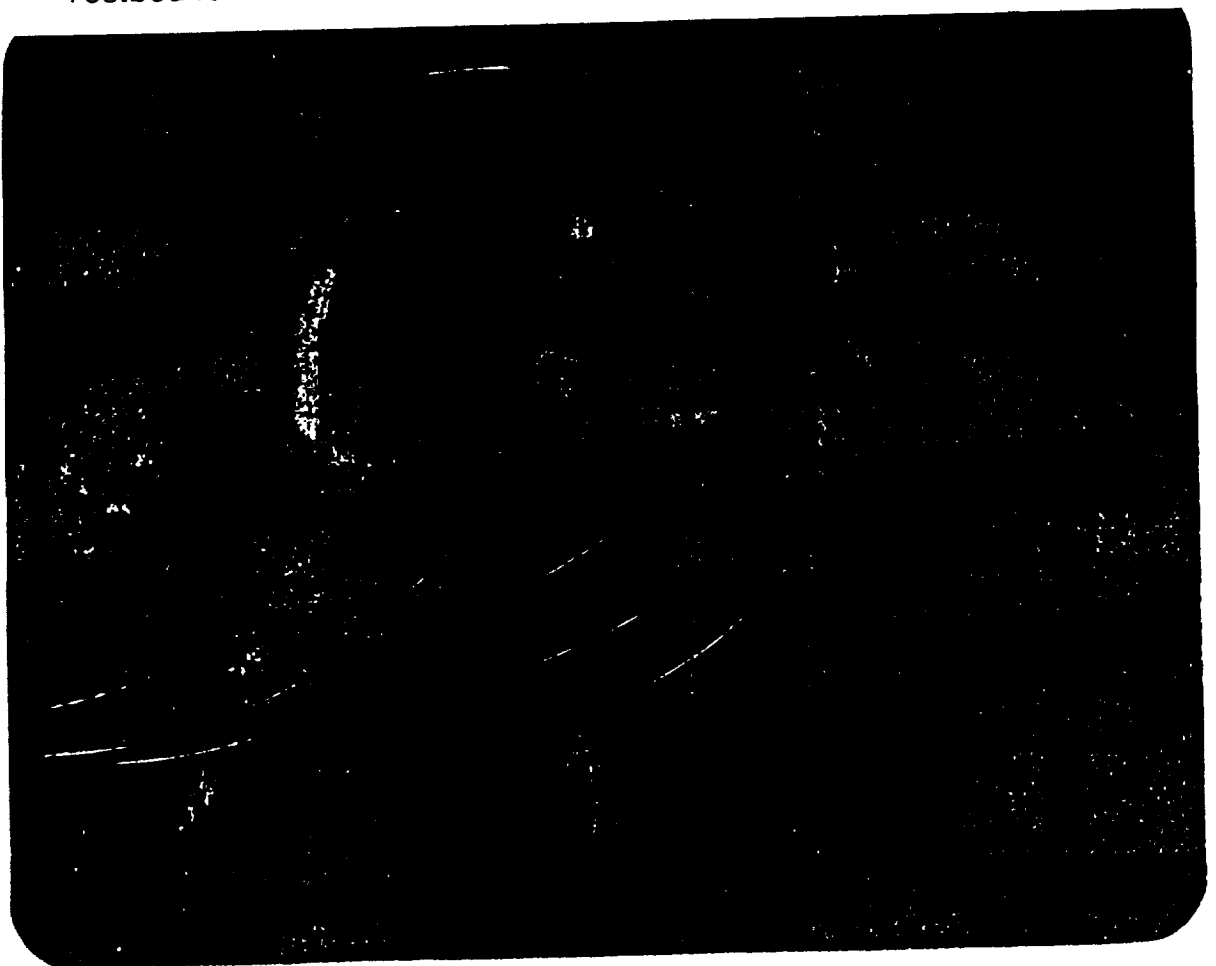

**GEMINI**

Transparency Mounts

7-5-23



ORIGINAL PAGE IS  
OF POOR QUALITY

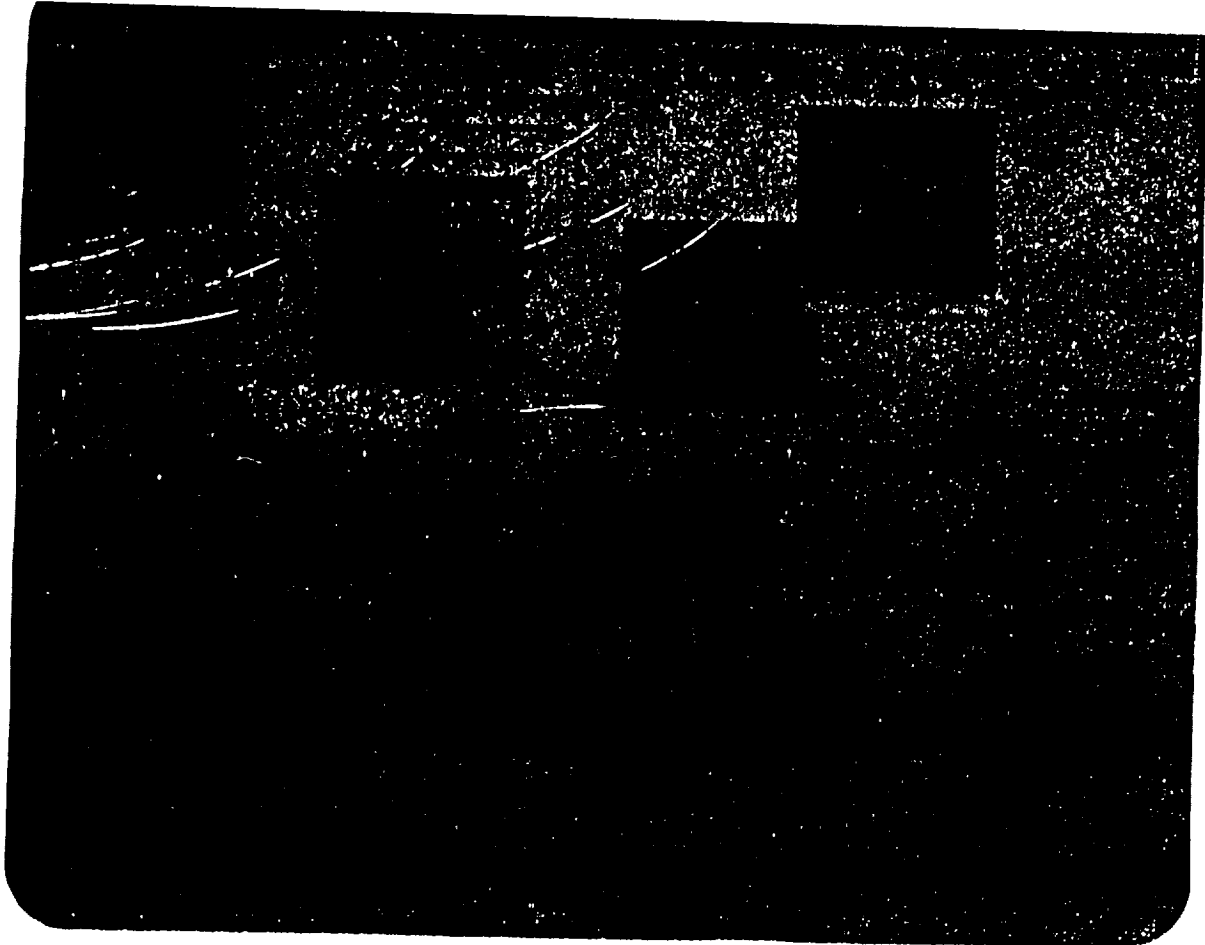
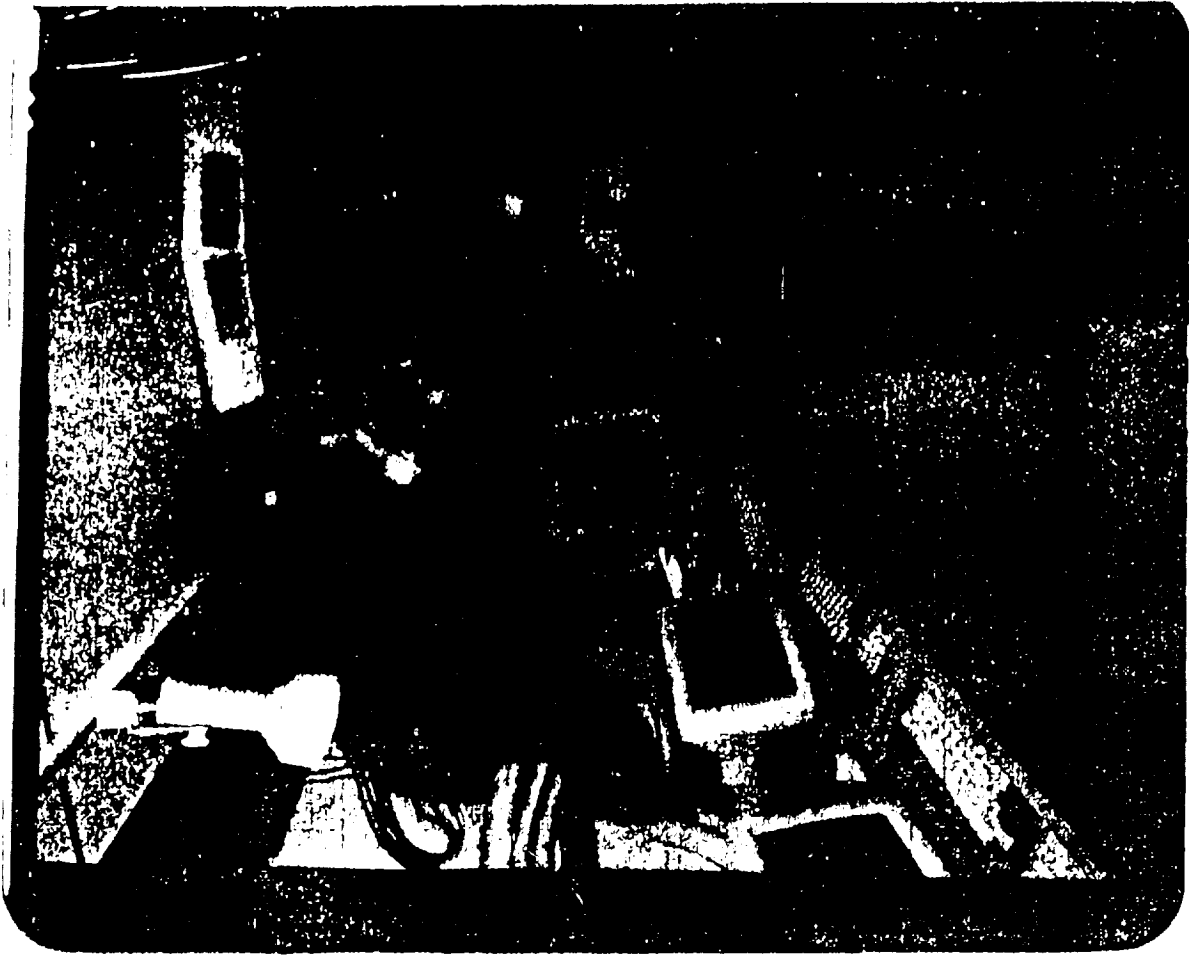

**GEMINI**  
7-5-24  
Transparency Mounts



ORIGINAL PAGE IS  
OF POOR QUALITY

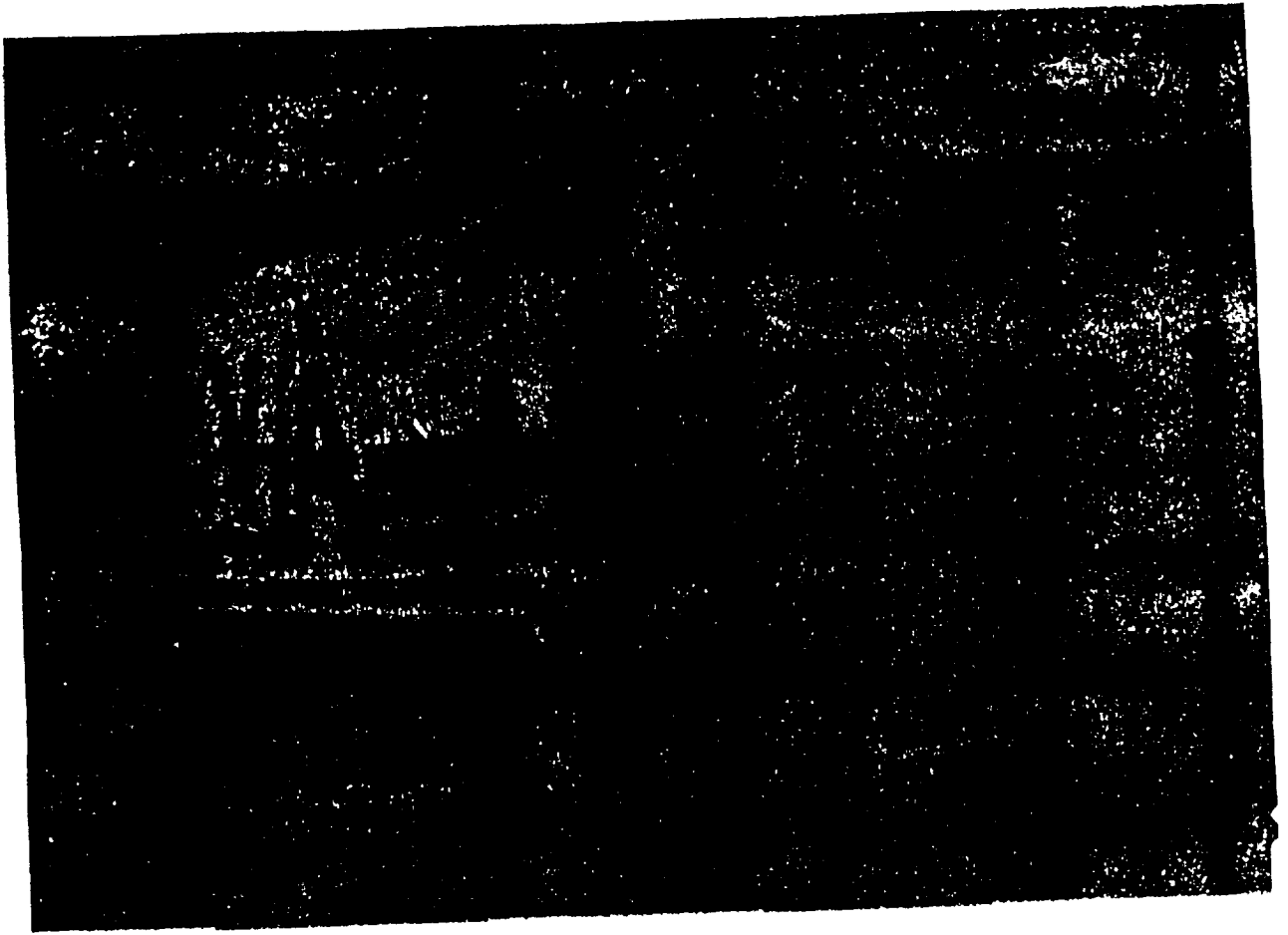

Park Demo Site

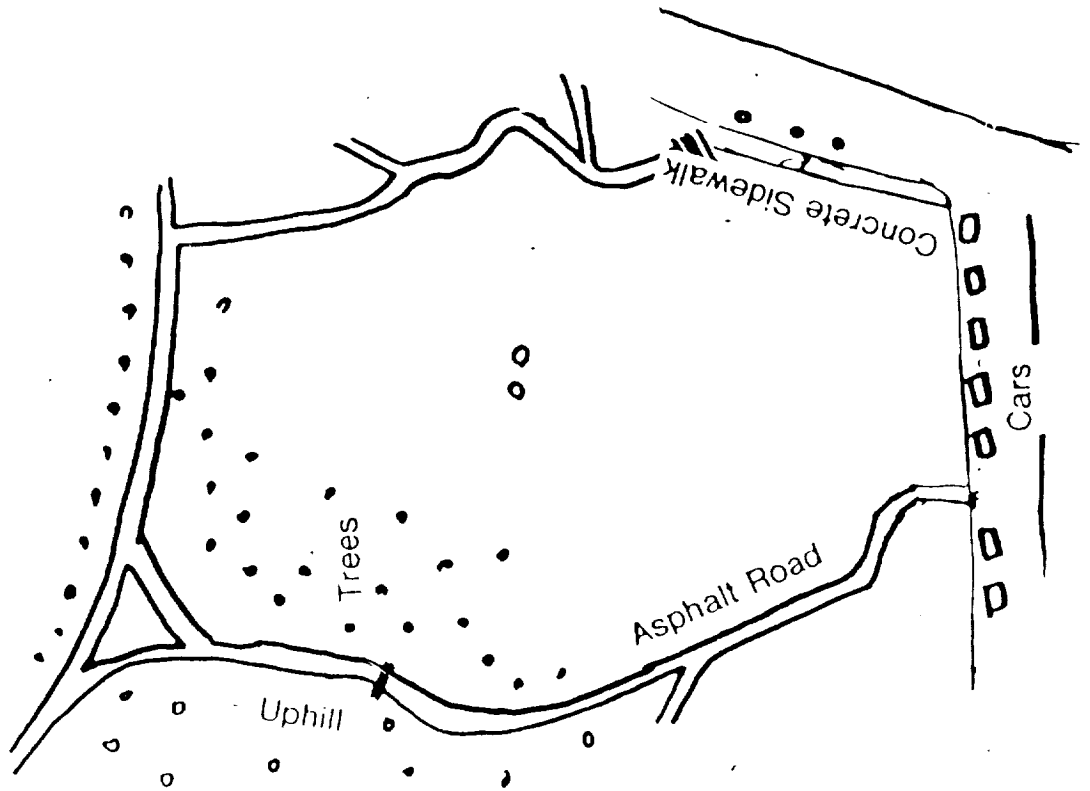

7-5-25

CONCRETE SIDEWALK  
ASPHALT ROAD

# Vision Principles for the Real World

Assume variation and change

Use few geometric parameters

Work in the image

Calibrate directly

Use outside constraints

Test with real data

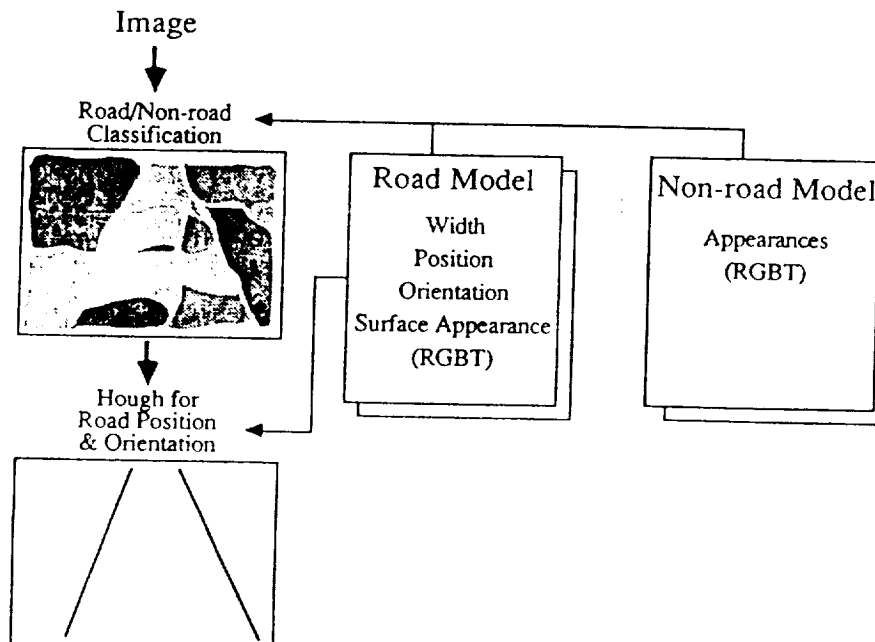

## Implementation

### Image reduction

- 2 x 2 averaging from 480 x 512 to 30 x 32

### Color classification

- 2 road classes and 2 nonroad classes
- Standard maximum likelihood
- Uses R, G, and B

### Texture calculation

- High resolution Robert's operator
- Normalize for shadow edges with low resolution Robert's
- Normalize for shadow interiors with mean value
- Threshold and count edges
- Classify with fixed means and variances

### Combine color and texture results

- Produce classification and "confidence"

### Vote for best road position

- Hough transform

P: Road direction relative to vehicle  
 $\Theta$ : Vehicle position relative to road center

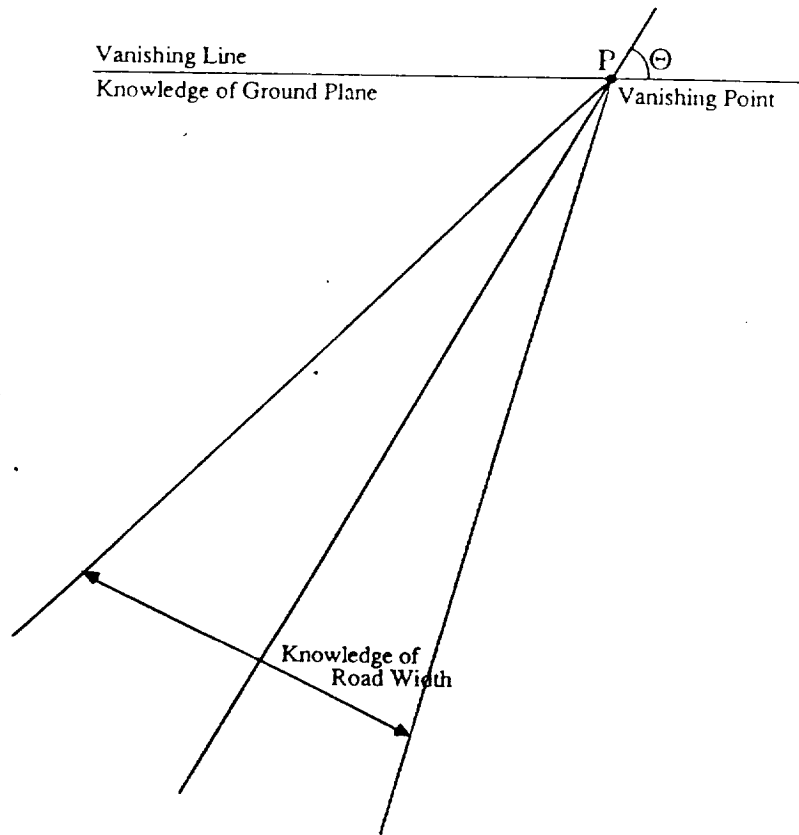

Find a good combination of (P,  $\Theta$ )

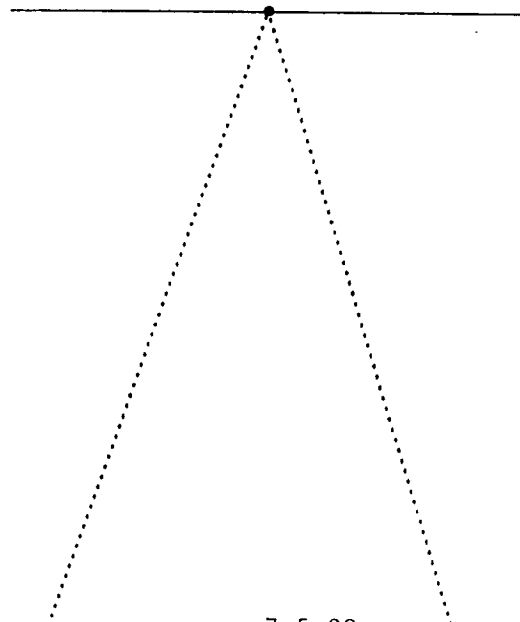



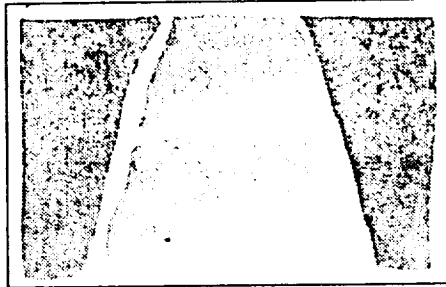

P: Road direction relative to vehicle  
 $\Theta$ : Vehicle position relative to road center

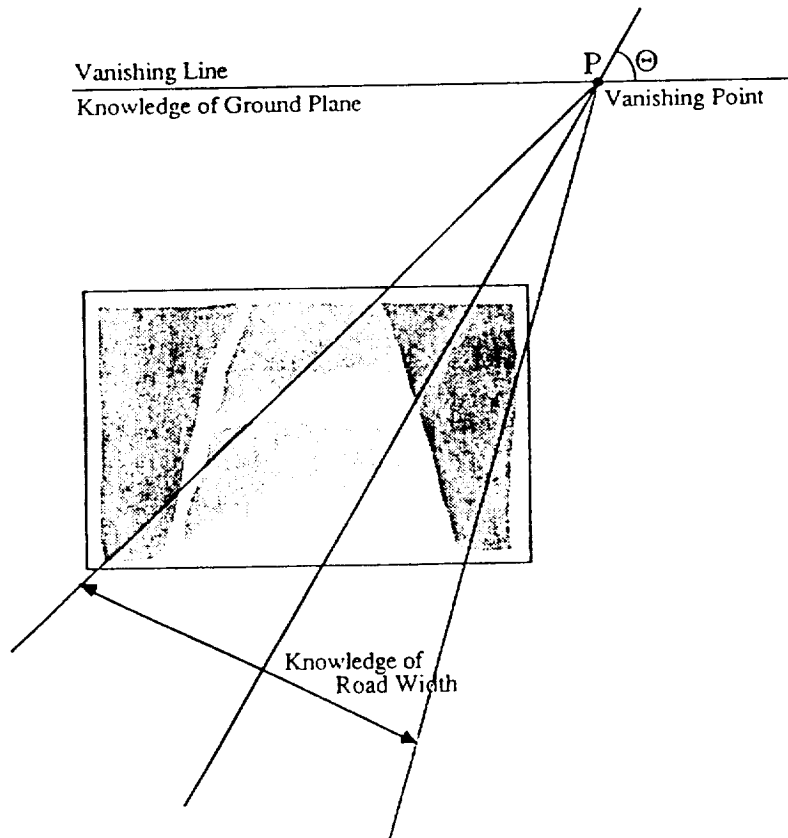

Find a good combination of  $(P, \Theta)$   
7-5-29

ORIGINAL PAGE IS  
OF POOR QUALITY

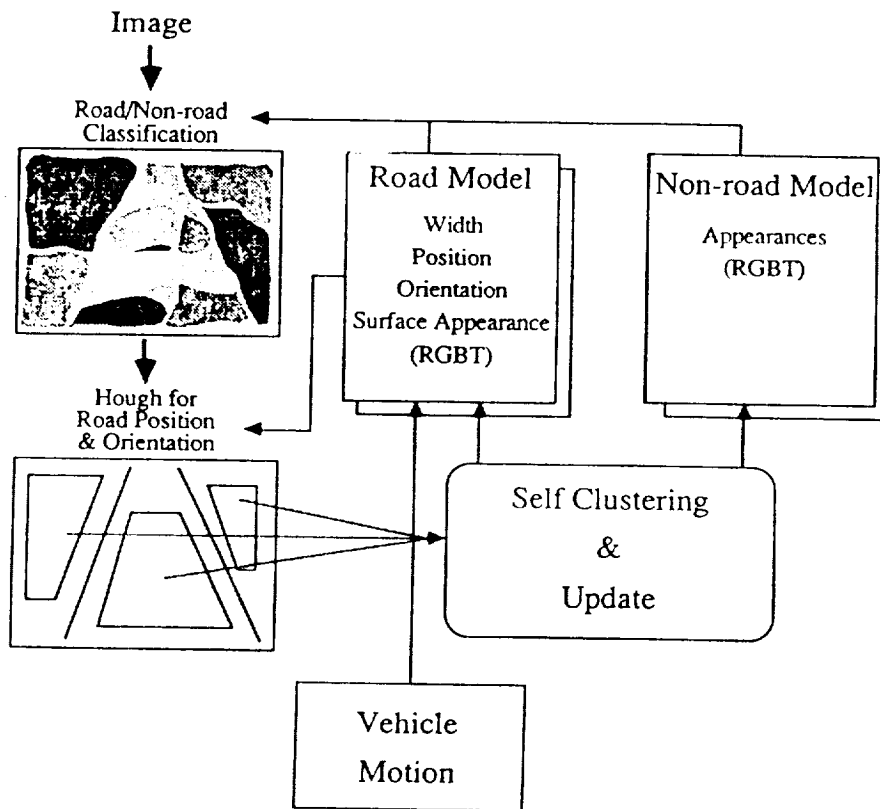
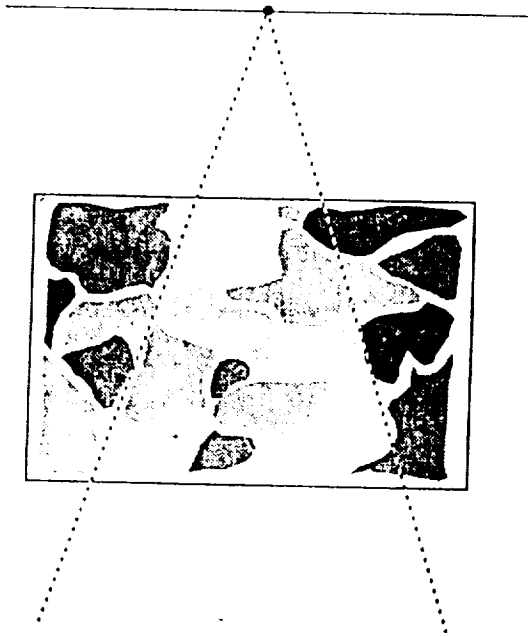

### Update colors

- Four areas plus safety zones
- Calculate statistics / reclassify
- Use distance to means

### Initialization

- Geometry calibration with two meter sticks
- Color and road shape calibration with training image

### Performance

- 10 second loop time on Sun 3 /180
- Almost all good enough for navigation
- Remaining problems:
  - Road covered with snow or leaves
  - Drastic illumination changes
  - Saturation

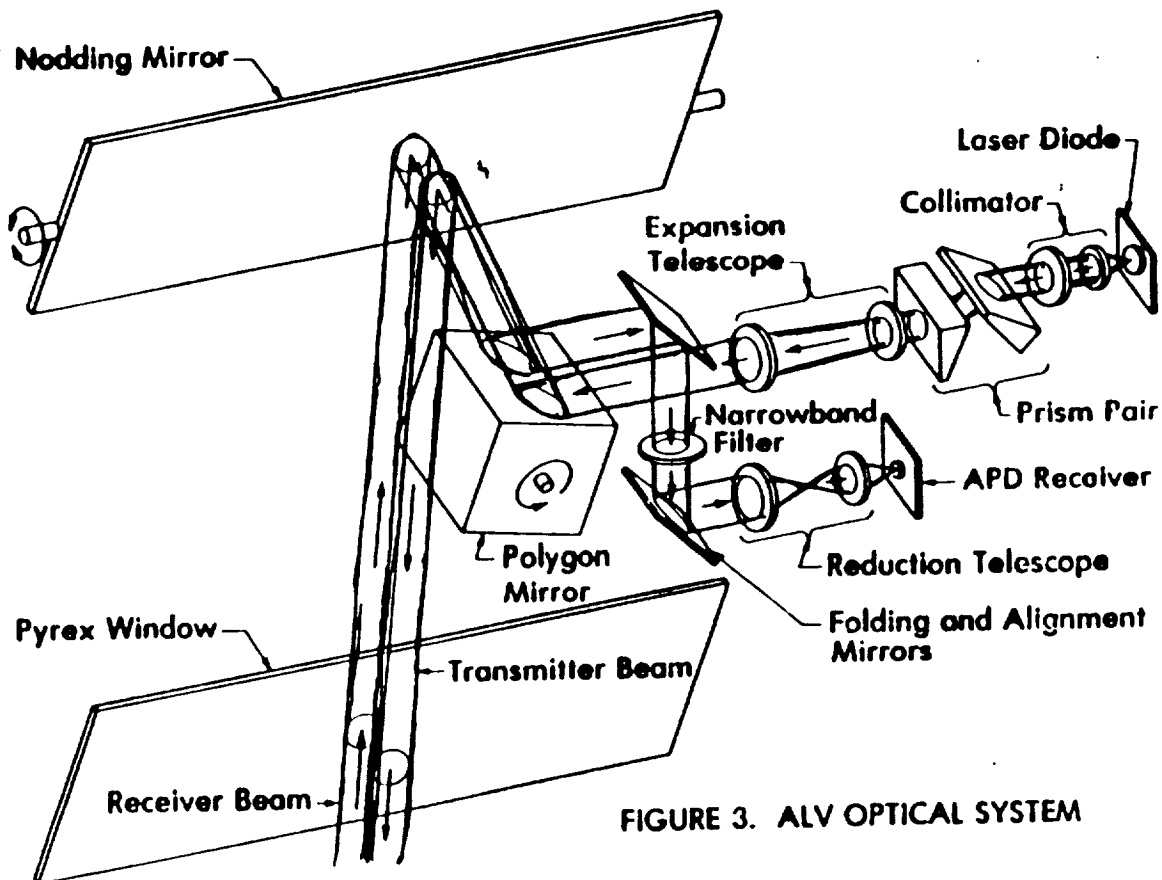
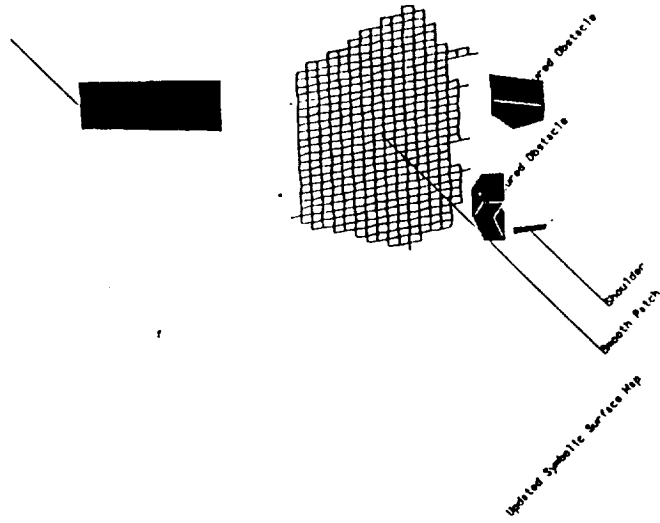
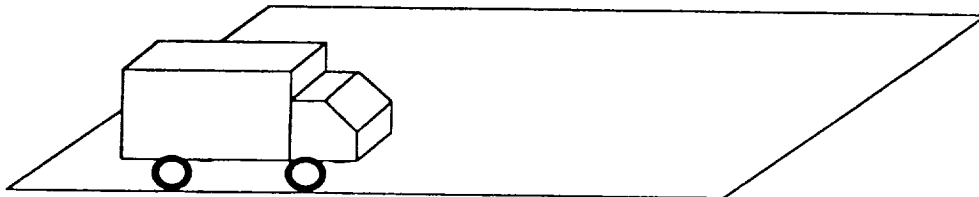

FIGURE 3. ALV OPTICAL SYSTEM



Motion  
Sensor



$Z_w$   
 $Y_w$   
 $X_w$

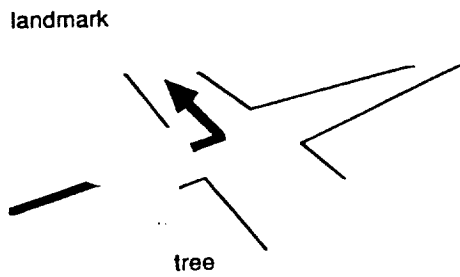
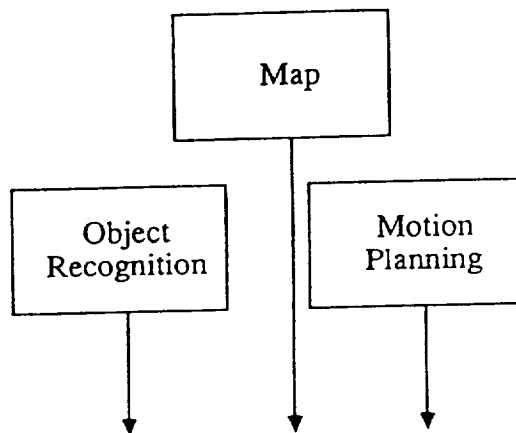
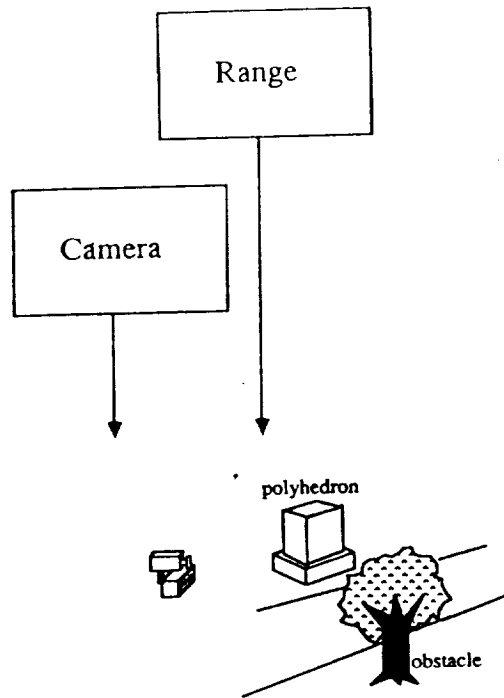

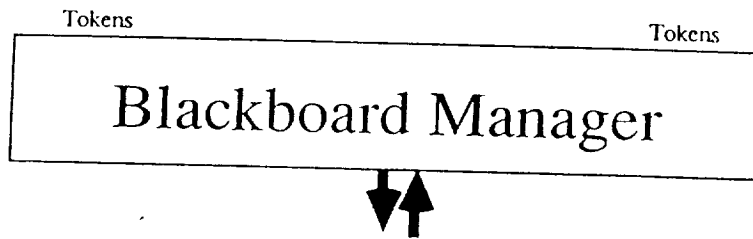

Local  
Map

- Moving Coordinates
- Time
- Distributed Processing

### **Artificial Intelligence for Mobile Robots**

Standard AI applications:

- Fault diagnosis
- Signal interpretation
- Threat analysis

Unique applications:

- Mission planning and execution
- Image understanding and fusion

Intelligent mobile robots need more than standard expert system tools.

# History of AI

Inference → Knowledge

Logic Theorist:

- all inference
- solved Towers of Hanoi, Missionaries and Cannibals
- "If P then Q" (no knowledge)

Mycin:

- rule-based "expert system"
- medical diagnosis
- "If P then Q with confidence 0.7" (shallow knowledge)

Aladdin:

- deep reasoning
- Aluminum alloy design
- "examine crystal structure, electrical structure" (deep knowledge)

## Expert Systems for Mobile Robots

Design tenets:

- Use separate modules
- Provide tools for geometry and time
- Provide tools for synchronization
- Handle real-time vs symbolic interface
- Provide a "virtual vehicle"
- Plan for big systems

Avoid:

- Do not throw away geometric precision
- Do not concentrate on explanations
- Do not build an omniscient master process

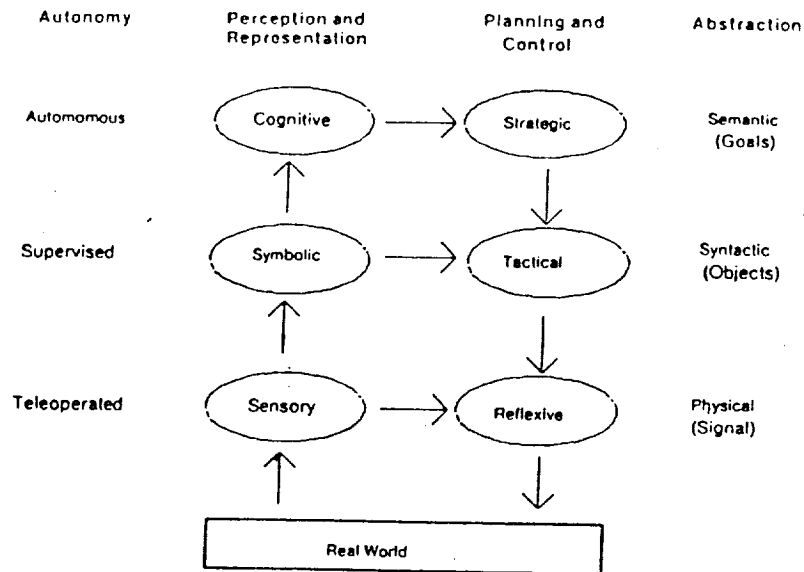

## Blackboard Features

Multiple independent processes

Multiple processors & processor types (Sun, Vax, IEEE  
Standard floating point, byte swapping, ...)

Multiple coordinate frames and history

Multiple languages (C, Common Lisp)

Multiple interaction modes (immediate, one-shot,  
continuous)

Geometric queries (point, line, polygon, point set, ...)

Time and position server

No master process



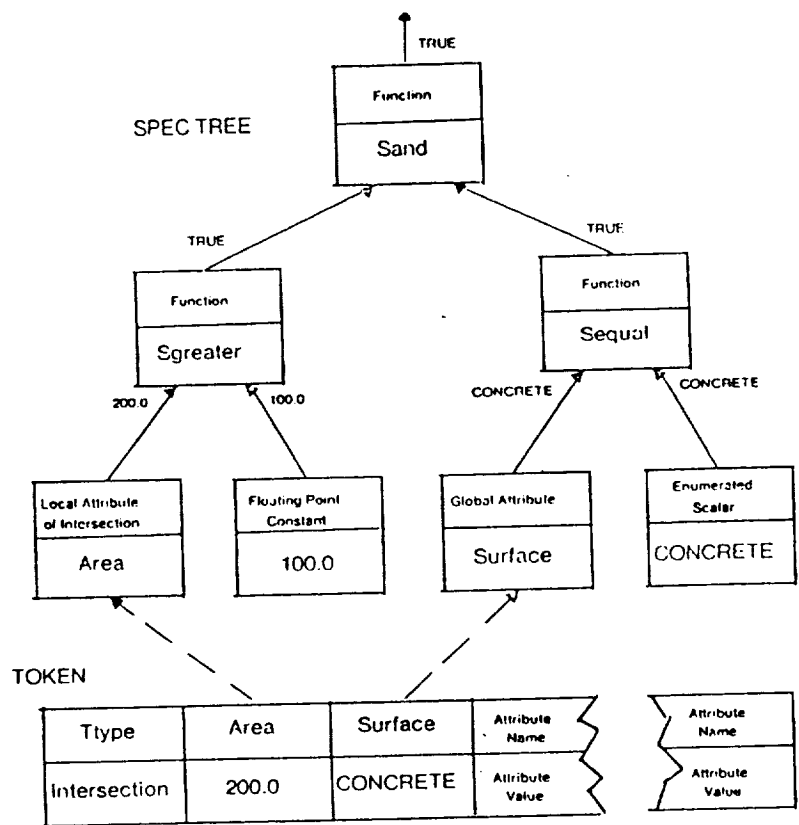
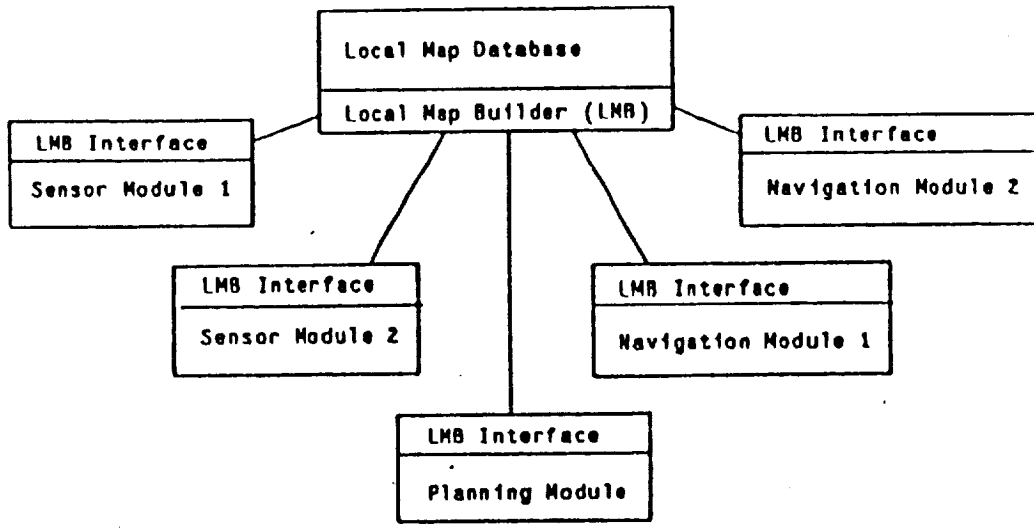

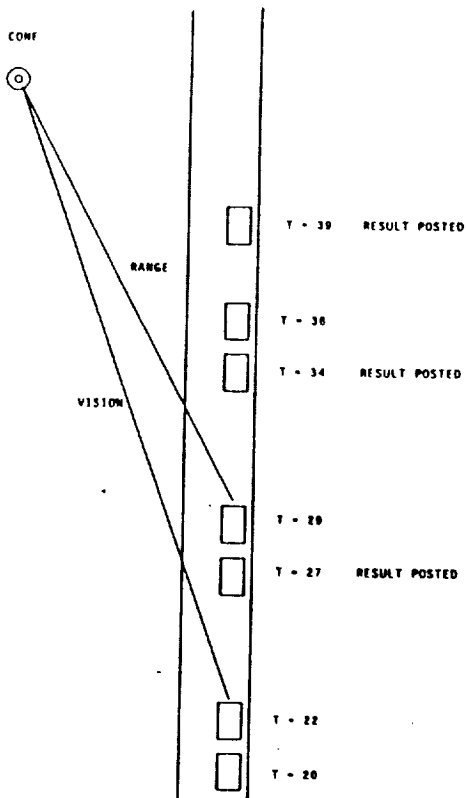

## Module Architecture

- Implemented for Terregator map following system
- Adapted for Navlab

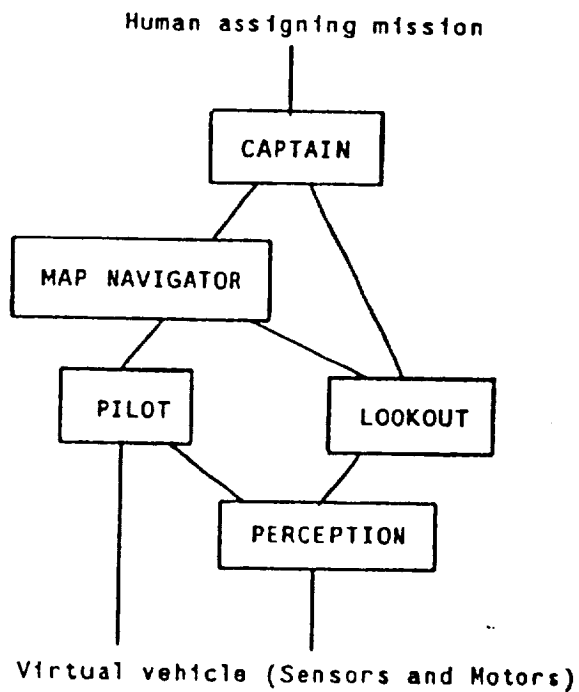

## **Coming Attractions**

From other institutions:

- UMass segmentation from motion
- ADS planning
- SRI object recognition
- USC moving object detection

From CMU:

- Warp implementations
- HET interface
- Interface to manipulators

## **So What?**

Contributions to National Space Program:

- Not road following, but vision tenets
- 3D perception
- Blackboard and geometry

All experimental, generic, and limited, need major effort for space qualification.

Right ideas, right testbeds, right start, and freely available.

# Driving Pipeline

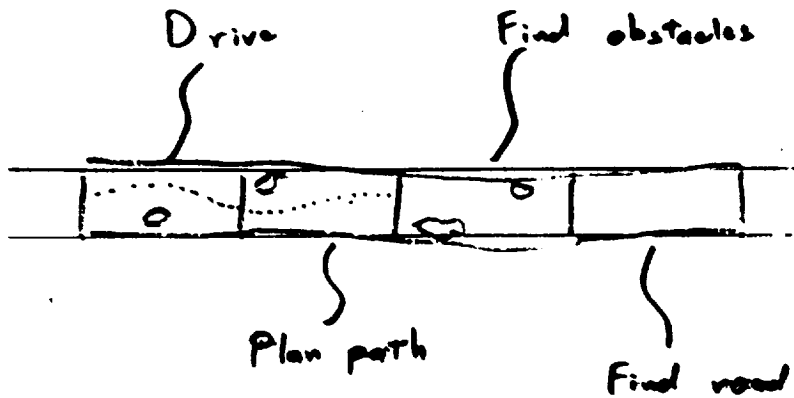

## CMU Blackboard Shortcomings

Topless and bottomless

Do driving units really work? (perception vs path planning)

Unfinished error models

Unfinished real-time (multiprocessor?)

Restricted assumptions about maps

Unfinished pipeline

Extensible to manipulation?

# Map/sensor fusion

Three forthcoming PhD theses in this area:

1. Improve vehicle and object position accuracy from multiple readings by modeling the shape of the error distributions
2. Project video data onto range images and do segmentation in the 6-vector space (Red, Green, Blue, X, Y, Z)
3. Keep track of dead reckoning errors and automatically update the trajectory history when landmarks are recognized, handling errors in transforms between objects seen at different times from different vehicle locations by different sensors

## **Lessons & surprises**

Easy stuff is so easy

Hard stuff is so hard

Communications (TV, radio, audio) are a major headache

Sensor limitations (TV, ERIM, sonar)

Camera calibration (hard to do right, may not be needed)

Blackboard is so large

Funding works (within 1K)

## Three Levels of Path Planning

Long range

Obstacle avoidance

Servoing

Importance of interfaces between levels

NO DATA	10000
POND	10000
BARREN EARTH	10
BUILDING	10000
DISTURBED SURFACE	100
GRASS	20
MIXED-MED/DENSE SPACE	100
PARKING LOT	5
SHRUB-MED/DENSE SPACE	200
SHRUB-OPEN/MED SPACE	100
TREES-MED/DENSE SPACE	400
TREES-OPEN/MED SPACE	200
UNPAVED ROAD	10
ASPHALT ROAD<18FT	2
ASPHALT ROAD>18FT	1
DIRT ROAD<18FT	4
DIRT ROAD>18FT	3
JEEP TRAIL<18FT	6
JEEP TRAIL>18FT	5
PAVED ROAD	5
PLANNED PATH	5
GULLY	1000



## Obstacle Avoidance

Multiple "costs":

- distance
- proximity to obstacles
- sharpness of turns
- travel through unknown areas

Added dimensions for moving obstacles

Alternatives

ORIGINAL PAGE IS  
OF POOR QUALITY

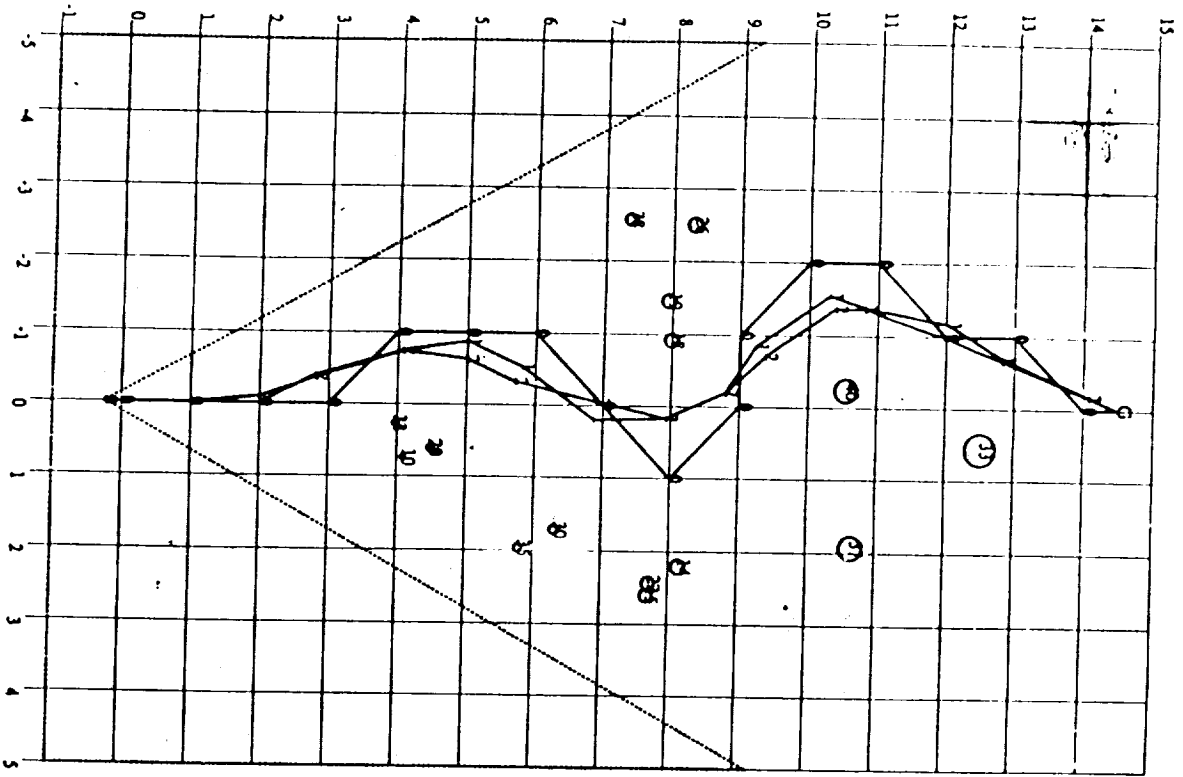
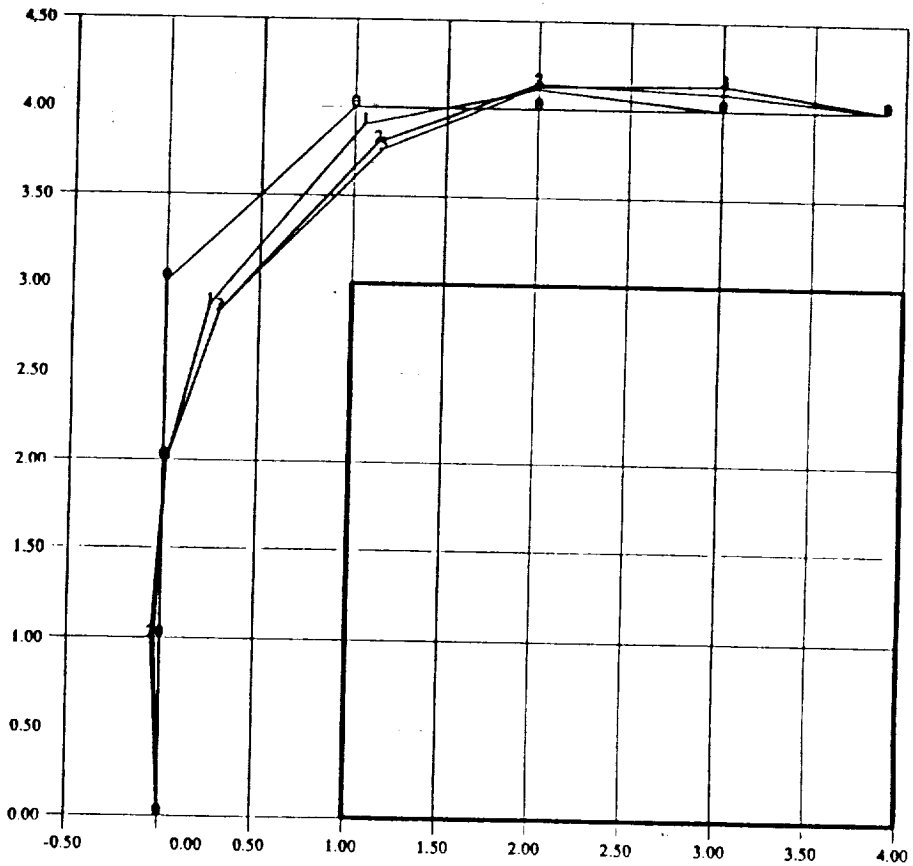

Figure 3





---

PROTOTYPE GLOBAL PATH PLANNER (PGPP)  
FOR ROBOTIC VEHICLES

TACOM contract DAAE07 - C - 86 - R090

Patrick J. McNally

April 28, 1987

---

AGENDA

KMS FUSION - Who we are

Robotic Vehicle and Path Planner concepts

The Prototype Global Path Planner Program

- system architecture

- terrain data

- mobility models

- etc

Issues for the Global Path Planner

Issues for the Mars Rover

1) *Fusion energy research*

DOE contract provided 92% of corporate revenue in 1983.  
Fusion is a promising long-term source of energy.

2) *Aerospace Technology*

Laser technology and Aerospace Instrumentation.  
Dept. of Defense and NASA are customers.  
Provides most rapid immediate growth.

3) *Bio-Technology*

Products are diagnostic reagents and cell culture materials.  
Bio-tech subsidiary—CTC.  
Explosive growth forecast in the late 1980's.

PJM-3  
4/28/87

**We play a unique role  
in the national fusion program**

- In 1985, KMS Fusion will receive \$140 M from DOE for Laser Fusion Research
- We operate one of the most powerful lasers in the world — Chroma
  - 800 Joules in 1 nsec (Infrared)
  - 500 Joules in 1 nsec (visible)
- We maintain a flexible experimental facility
- We provide targets and target components to the other program participants.

PJM-4  
4/28/87

## KMSF Aerospace Staff — What is our past experience?



Apollo Lunar Science Stations	15 Scientific Experiments, Astronaut Deployed
Landsat Ground Processing Systems	Landsat Receiving Station Located at NASA GSFC
Laser Retroreflector Ranging Satellites	2 Laser Ranging Satellites with 456 Reflectors
Viking Scientific Instruments	3 Instruments for 2 Mars Missions
Mass Spectrometer Instrumentation	Space, Ground & Submarine Based Mass Spectrometers
IR Airborne Radiometer Systems	Several High Sensitivity 4 $\mu$ m & 10 $\mu$ m Systems
ASW Surveillance and Oceanographic Sensors	Low Light Level and Meteorological Sensors
Shuttle Inertial & Mass Spectrometer Instruments	Current Space Shuttle Flight Hardware
X-Ray Inspection Systems	Airport Security Systems
Multispectral Airborne Sensing Instruments	NASA and DOD Infrared Scanners
Digital Data Processing & Display Systems	High Speed Airborne and Ground Data Processing Systems

PJM - 6  
4/28/87

## ROBOTIC VEHICLE CONCEPT



### ARCHITECTURE:

HIGH LEVEL PATH PLANNER  
LOW LEVEL ROUTE FOLLOWER  
NAVIGATION SYSTEM

### IMPLEMENTATION:

Path planner uses terrain database, vehicle mobility information, and mission information  
— computation intensive and data storage/retrieval intensive

Route follower uses terrain recognition and vehicle control  
— sensor intensive and computation intensive

Path Planner is re-activated when Route Follower encounters major obstacles

Route Follower is expected to find locations to turn with aid from Navigation system

PJM - 6  
4/28/87



# PGPP SYSTEM ARCHITECTURE

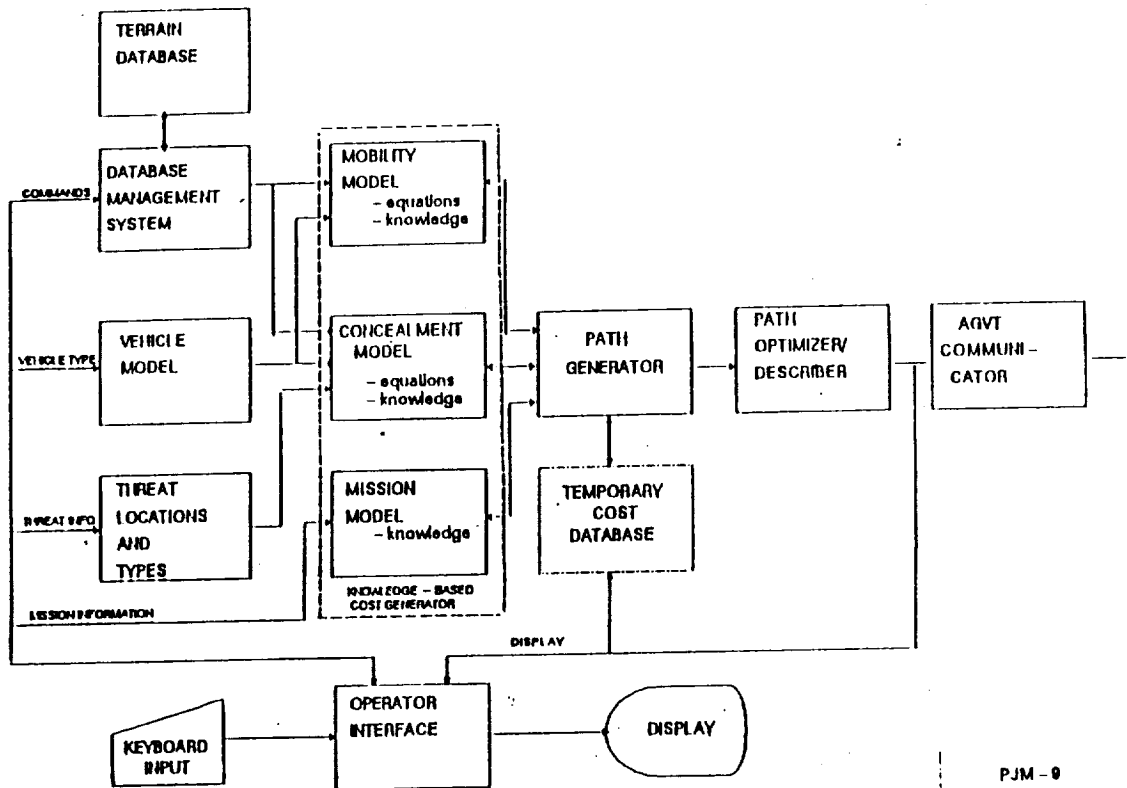

PJM-9  
4/28/87

# Symbolics Computer in KMSF Development Environment

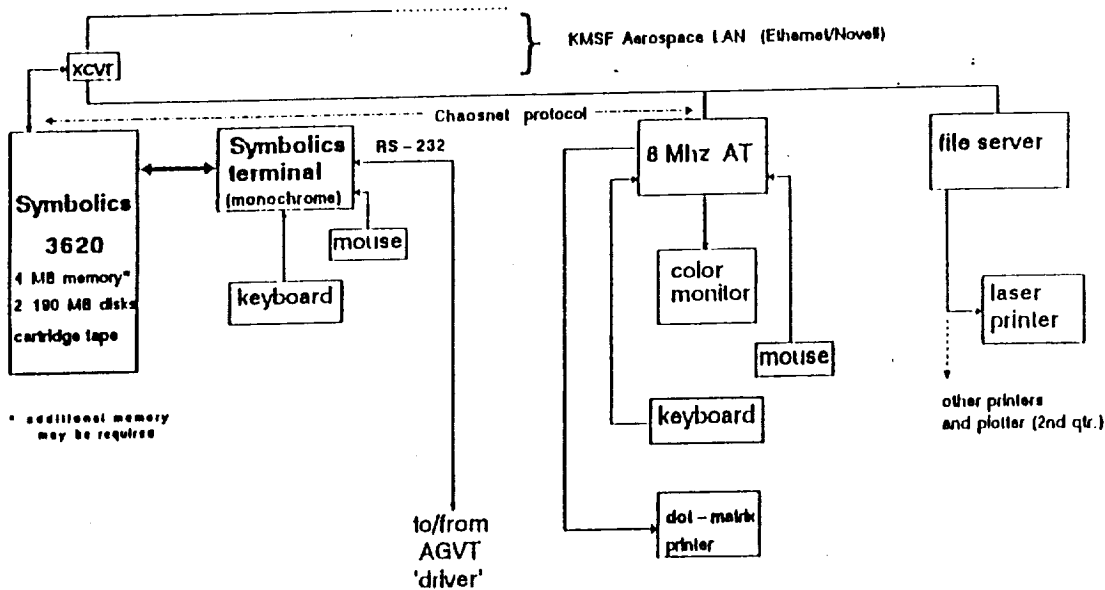

\* additional memory may be required

to/from  
AGVT  
'driver'

other printers  
and plotter (2nd qtr.)

PJM-10  
4/28/87

# FORT KNOX TERRAIN DATA DERIVATION

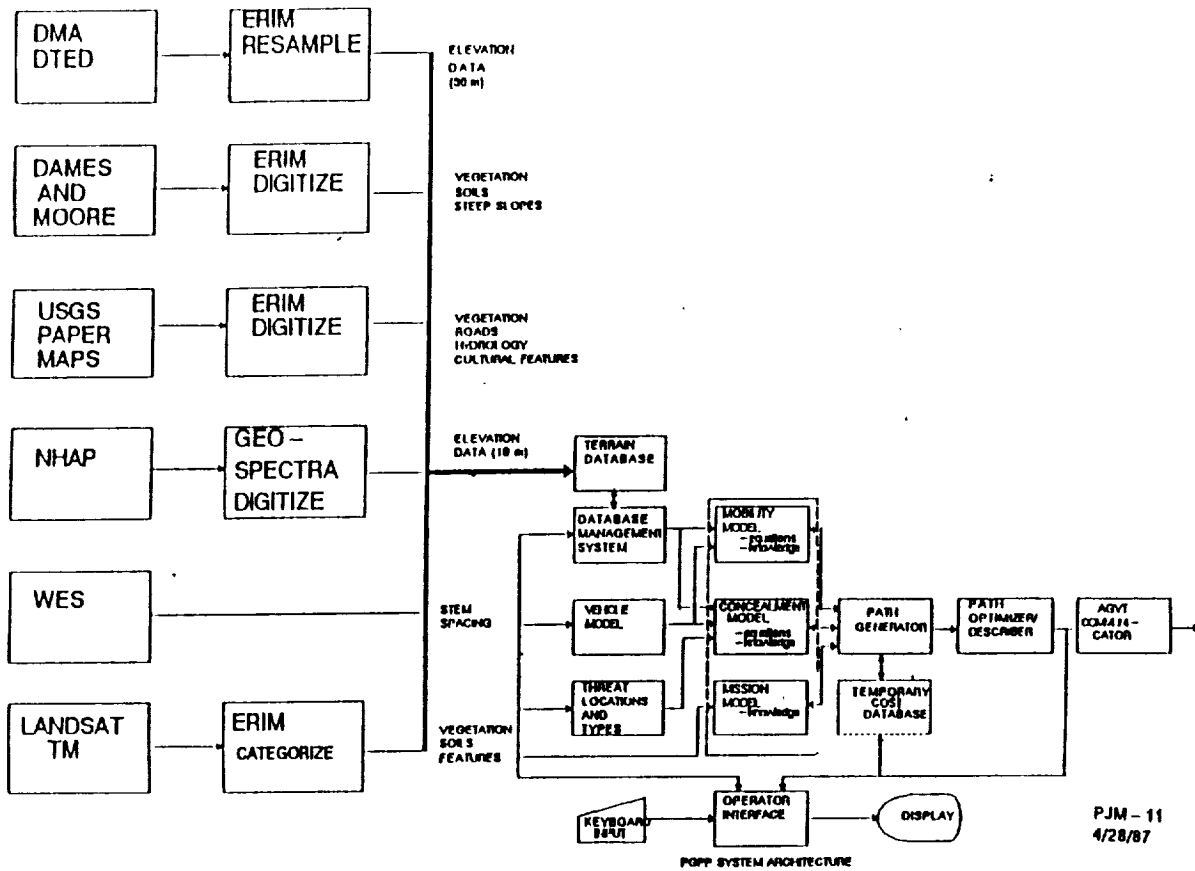

# DATA RESOLUTION LEVELS

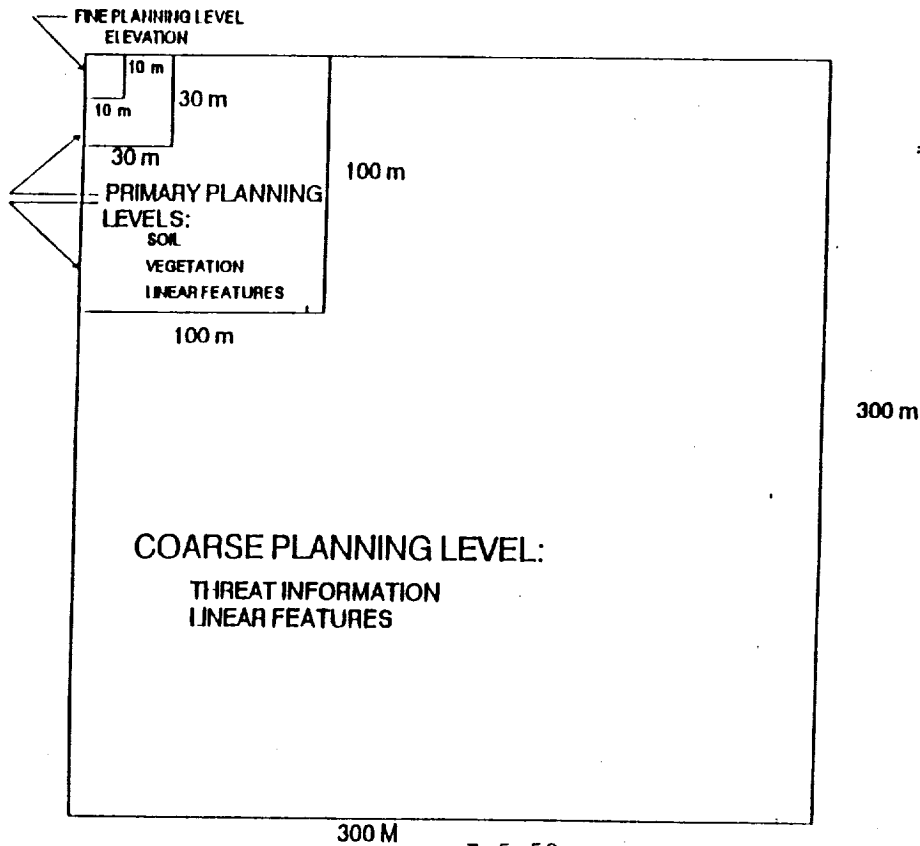

ORIGINAL PAGE IS  
OF POOR QUALITY

# MOBILITY MODELS

## MOBILITY MODELS FOR USE IN PGPP

### 1) NATO REFERENCE MOBILITY MODEL (URMI):

LARGE FORTRAN PROGRAM USED FOR PREDICTING VEHICLE MOBILITY CHARACTERISTICS GIVEN VEHICLE GEOMETRIC, INERTIAL, AND MECHANICAL CHARACTERISTICS

CAN BE USED IN "TRAVERSE MODE" IN COMBINATION WITH TERRAIN INFORMATION FOR SURFACE COMPOSITION, GEOMETRY, AND VEGETATION TO OBTAIN CROSS-COUNTRY SPEED ESTIMATES

SPEED REDUCTION FACTORS DUE TO SOIL, SLOPE, AND STEEP OVERRIDE AS WELL AS STEEP AVOIDANCE AND OBSTACLE OVERRIDE/AVOIDANCE ARE CALCULATED

SIDE SLOPE NOT CURRENTLY MODELLED

MODEL IS LARGE, COMPLEX, AND WRITTEN FOR SPECIFIC MAINFRAME HARDWARE USING NON-STANDARD FORTRAN

### 2) ETI CROSS-COUNTRY MOVEMENT MODEL (CCH):

EQUATIONS AND TABLES USED BY TERRAIN ANALYSTS FOR DRAWING CROSS-COUNTRY MOVEMENT MAP OVERLAYS

CAN BE USED IN COMBINATION WITH TERRAIN INFORMATION FOR SURFACE COMPOSITION, SLOPE, AND VEGETATION TO OBTAIN CROSS-COUNTRY SPEED ESTIMATES

SPEED REDUCTION FACTORS DUE TO SOIL, SLOPE, AND VEGETATION OVERRIDE/AVOIDANCE, (NO OBSTACLE CAPABILITY). ALSO CONSIDERS "SLOPE INTERCEPT FREQUENCY" SPEED DEGRADATION

SIDE SLOPE NOT CURRENTLY MODELLED

MODEL EQUATIONS ARE EASILY RUN ON A PC

PJM - 13  
4/28/87

## PGPP Major Software Components

- Operator Interface
- Terrain Database Management System
- Knowledge Based Cost Generator
- Path Generator
- Path Optimizer/Describer
- AGVT Communicator

PJM - 14  
4/28/87

## Potential FY 88 Additional Tasks

kms  
fusion  
Inc.

- 1 Support integration of PGPP S/W with AGVTs for Ft. Knox tests.
- 2 Expand PGPP to compute est. fuel consumption and allow route plan to minimize.
- 3 Standardize Robotic vehicle system architecture wrt path planning and define interface control points; e.g. terrain data bases and I/O messages.
- 4 Standardize terrain data bases for Robotic vehicle applications.
- 5 Standardize I/O message content and format.
- 6 Conduct additional field tests at distinctively different sites.
- 7 Expand PGPP to support planning/re-planning for multiple vehicles.
- 8 Conduct systematic sensitivity studies of PGPP performance vs. terrain and mobility model level of detail.
- 9 Select computer & language for field implementation of GPP.

PJM - 15  
4/28/87

## OTHER ISSUES FOR MARS ROVER

kms  
fusion  
Inc.

### Terrain Data Interaction with Navigation function:

- inertial sensors
- external positioning
- feature recognition

### Terrain data resolution vs. feature recognition for obstacle avoidance

### "Missions" for a Mars Rover - Maintenance vs. Scientific

### Teleoperator / Autonomy division of functions and time

### Rover / Mars Base / Orbiter / Mission Operations Architecture

### Terrain Database content for Mars

PJM - 16  
4/28/87



Estimated Mars Rover Scenario Daily Data Quantities

A. Terrain Navigation Only:

1. Computer Aided Remote Driving (CARD) = 40 Mb downlink per 10 hr day.
2. CARD uplink = 10 Kb per day.

B. Imaging Science at a Station (Specified Examination Location).

1. 500X500 pixels/ 4:1 compression, X 2 for Stereo, X 2 for before and after, X 8 total including multispectral, X 8 bits per pixel = 16 Mb from the deployable close up camera. Plus Sampling Operations Support for Two X 1000X1000X8b/2:1 = 8Mb. Sum = 24Mb.
2. Uplink Sampling Operations Commands = 1 Kb.  
(Manipulator and Effector trajectories.)

C. Imaging Science While Otherwise Stopped or "Along-the-Way".

1. 1000X1000 pixels/ 4:1 compression, X3 ea. 45 deg FOV overlapped frames for a quadrant, X 2 for Stereo, X 2 in the am & X2 in the pm, sum: 1-Thermal, plus 1-IR, and 2-visual, X 8 b per pixel = 192 Mb.
2. Uplink Science Commands and Data = ?

SUMMARY TOTAL

I. DOWNLINK:

CASE	#PIXELS	b/PX	COMP.	STEREO	#SCENES	VIS'L	IR	THERM.	FREQ.	=Mb
A.	1000X1000	8	4:1	2	1	1	0	0	10	40
B.	500X500	8	4:1	2	2	2	1	1	2	16
	1000X1000	8	2:1	2	1	1	0	0	1	8
C.	1000X1000	8	4:1	2	3	2	1	1	4	192
One Science Station, Total Mb per 10 hr day =										256

II. UPLINK:

CASE Quan.

- A. 10 Kb
- B. 1Kb
- C. ?

Total Kb per 10 hr day = -----

DATA RATES

I. DOWNLINK

- A. AVERAGE - 256 Mb/ 10 hr X 3600 sec/ hr = 7 Kbps.
- B. PERIODIC- 10 min each hour = 256Mb/10 hr X 600s = 43 Kbps
  - 15 min each hour = 256Mb/10 hr X 900s = 28 Kbps
  - 30 min each hr = 256Mb/10 hr X 1800 s = 14 Kbps
- C. MAX SUM STOP = 4Mb CARD Support + 24 Mb Specified Exam. Locat. + an "Along-the-Way" data load of 192/4 = 76 Mb Total.
  - in 10 min = 76 Mb/600 sec = 127 Kbps
  - in 15 min = 76 Mb/900 sec = 84 Kbps
  - in 30 min = 76 Mb/1800 s = 42 Kbps

# TELEROBOT FLIGHT COMPUTATIONAL PROBLEM

D. B. SMITH  
SECTION 348

FEBRUARY 18, 1987

## 1987 TELEROBOT TESTBED FUNCTIONAL BLOCK DIAGRAM

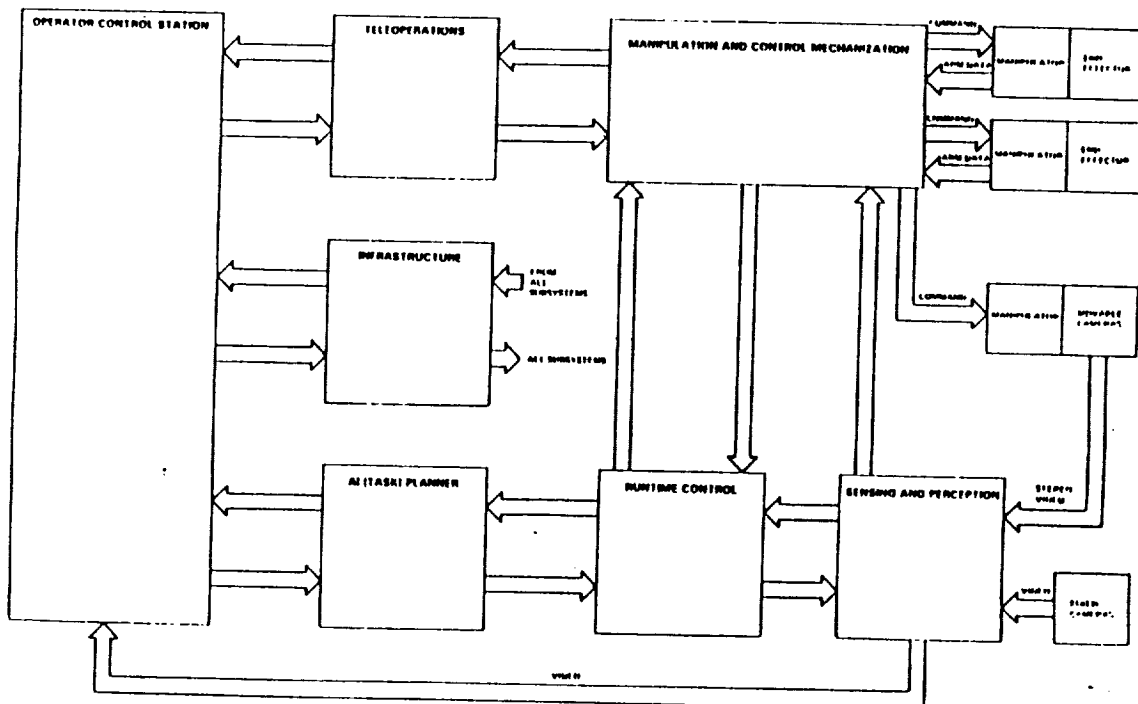

# 1987 TELEROBOT TESTBED FUNCTIONAL ARCHITECTURE

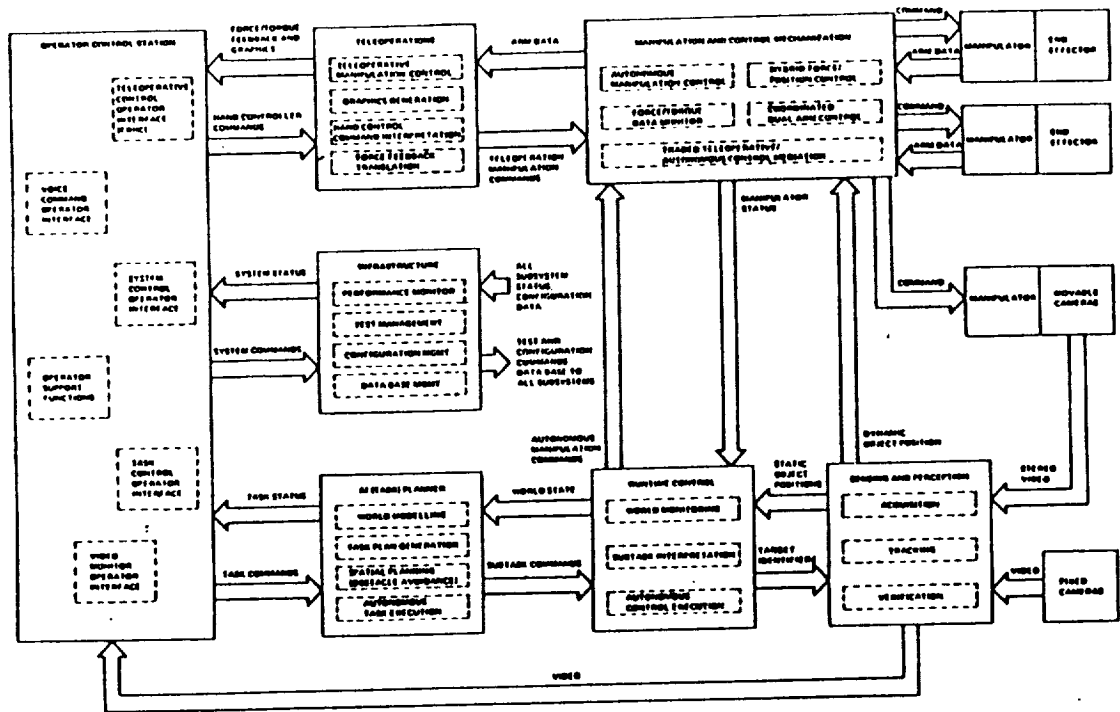

DBS 348  
02/18/87  
ROBFT.3

## TELEROBOTIC DEMONSTRATION MANIPULATOR CONTROL & MECHANIZATION

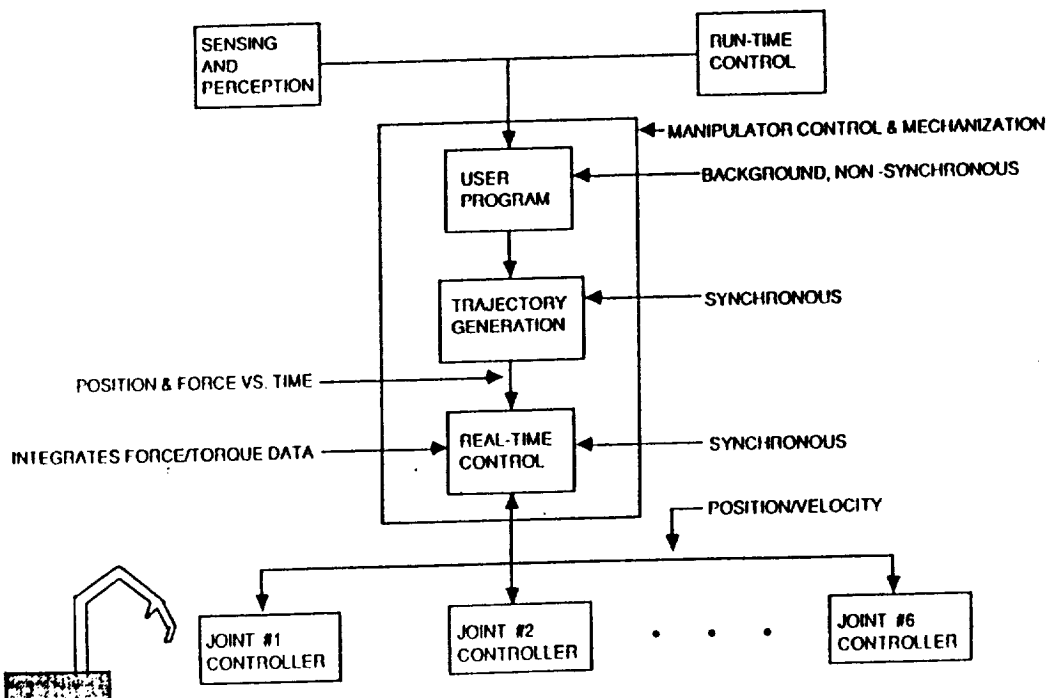

**RUN-TIME CONTROL CALCULATIONS**

- DETERMINE END-EFFECTOR POSITION AND VELOCITY FROM MATRIX DIFFERENTIAL EQUATION.

$$M(\theta)\ddot{\theta} + C(\theta, \dot{\theta}) + g(\theta) = \tau$$

WHERE  $M(\theta) = (12 \times 12)$  MATRIX FOR TWO ARMS AND  $\theta_i, \dot{\theta}_i, \ddot{\theta}_i$  ARE  $12 \times 1$  VECTORS,  $i = 1, \dots, 12$ .

- DETERMINE POSITION AND VELOCITY MOVEMENTS OF EACH JOINT USING INVERSE (KINEMATIC) JACOBIANS FOR EACH CONTROL LOOP.
- REAL-TIME CONTROL TAKES 8000 FLOATING - POINT COMPUTATIONS PER CYCLE FOR DUAL ARMS. RUNS @ 200 - 300 Hz.

DRS 348  
02/18/87  
ROBFLT.5

**IMPLICATIONS OF THESE COMPUTATIONS**

- 300Hz TIMES 8000 FLOPS  $\longrightarrow$  2.4 MFLOPS FOR ONE PART OF DUAL ARM CONTROLLER.
- A SINGLE 32032 NATIONAL FLIGHT MICROPROCESSOR CAN EXECUTE 100,000 FLOPS.
- THEREFORE NEED 24.



## ROBOTICS SUMMARY

- HIGH THROUGHPUT, 2.4 MFLOPS JUST FOR ONE PART. NEED CONCURRENCY.
- LARGE, HIGHLY DIVERSE REAL-TIME TASKS WHICH ARE VERY INTERRELATED.
- MANY DIFFERENT I/O'S , SOME OF WHICH ARE HIGH RATE.
- WILL WANT TO EXPAND MONOTONICALLY WITH CAPABILITY.
- MUST BE FLIGHT QUALIFIABLE.

DRS 348  
02/18/87  
ROBELT.7

**JPL**

# **ON-BOARD INFORMATION PROCESSING DATA COMPRESSION**

ROBERT F. RICE / JPL



## **WHAT IS DATA COMPRESSION**

- **MORE EFFICIENT REPRESENTATION OF INFORMATION**
  - **FEWER BITS FOR SAME INFORMATION**
  - **SAME BITS FOR MORE INFORMATION**

N BITS/IMAGE

N BITS/IMAGE

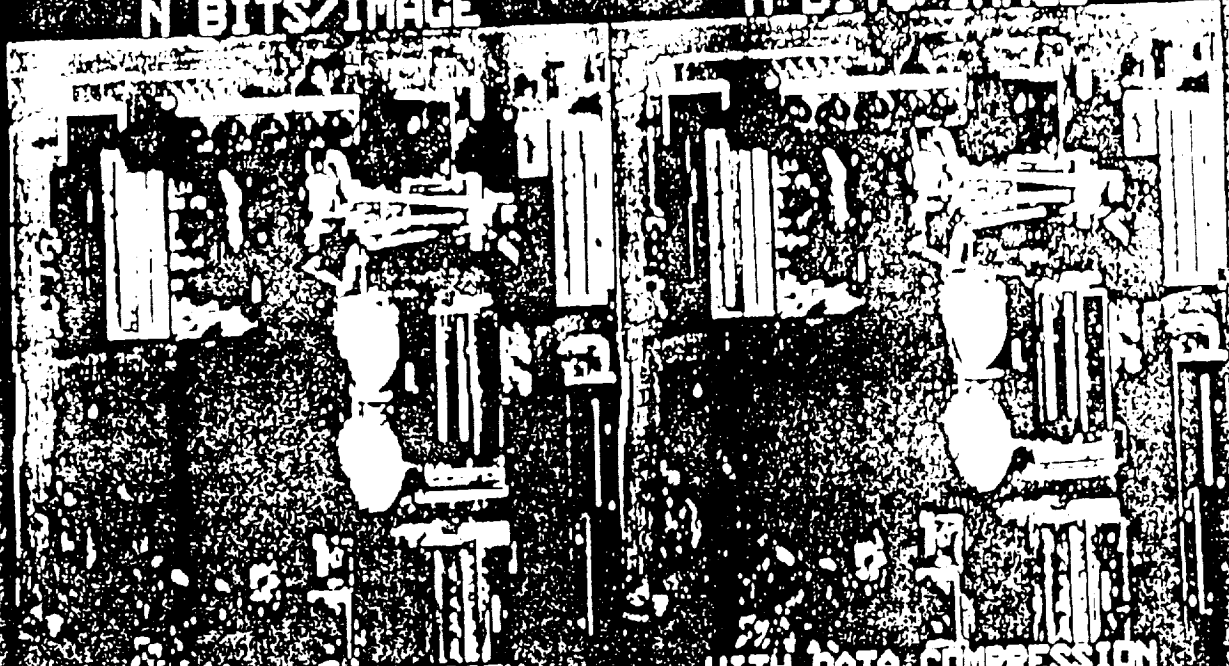

NO DATA COMPRESSION

WITH DATA COMPRESSION

INFORMATION PROCESSING RESEARCH LAB

JUN 1980

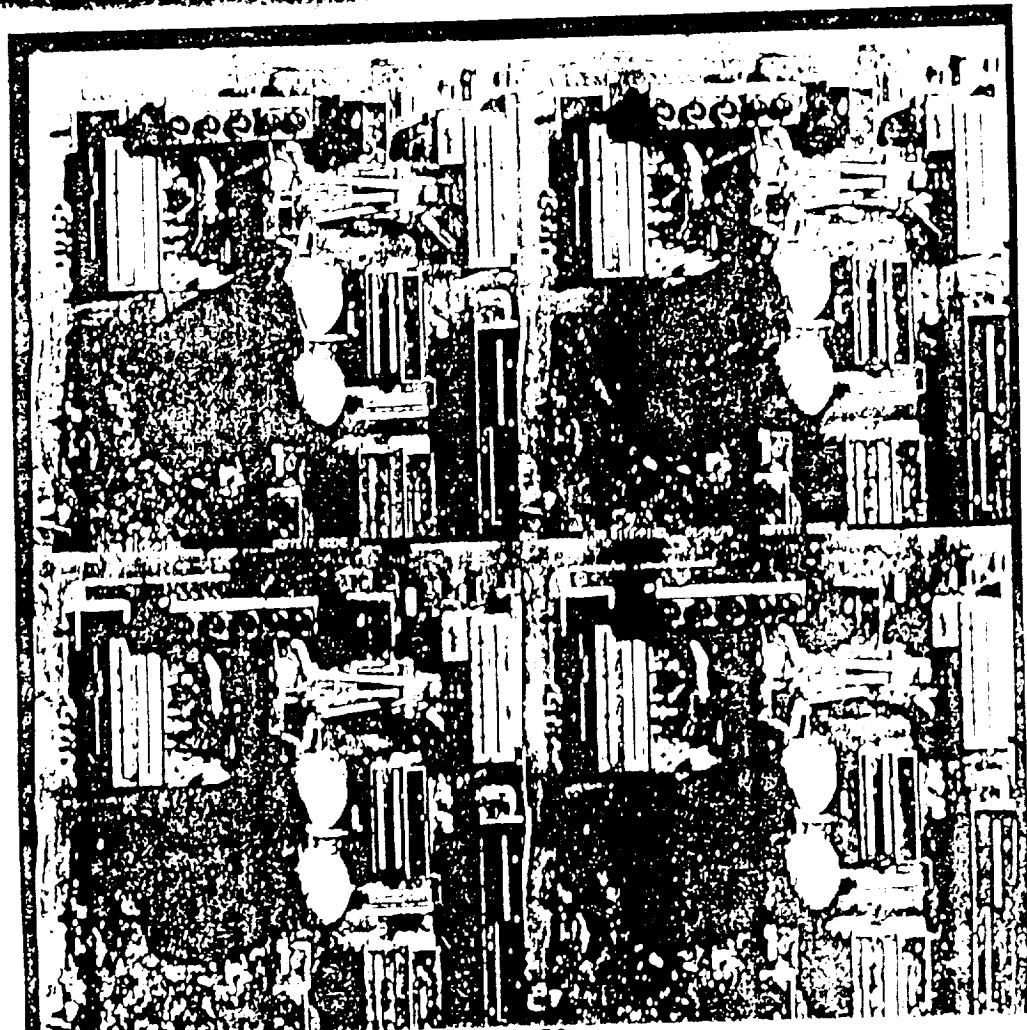

ORIGINAL PAGE IS OF POOR QUALITY

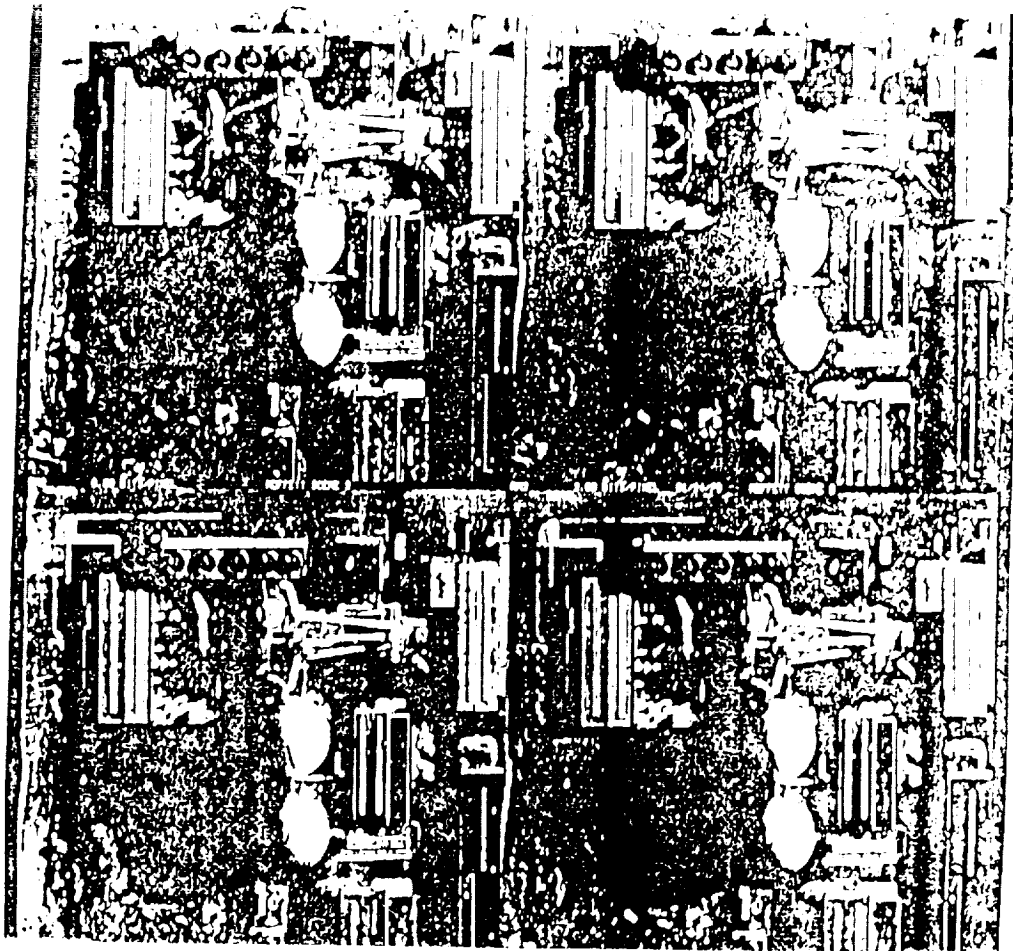

ORIGINAL PAGE IS  
OF POOR QUALITY

RH2 DATA COMPRESSION

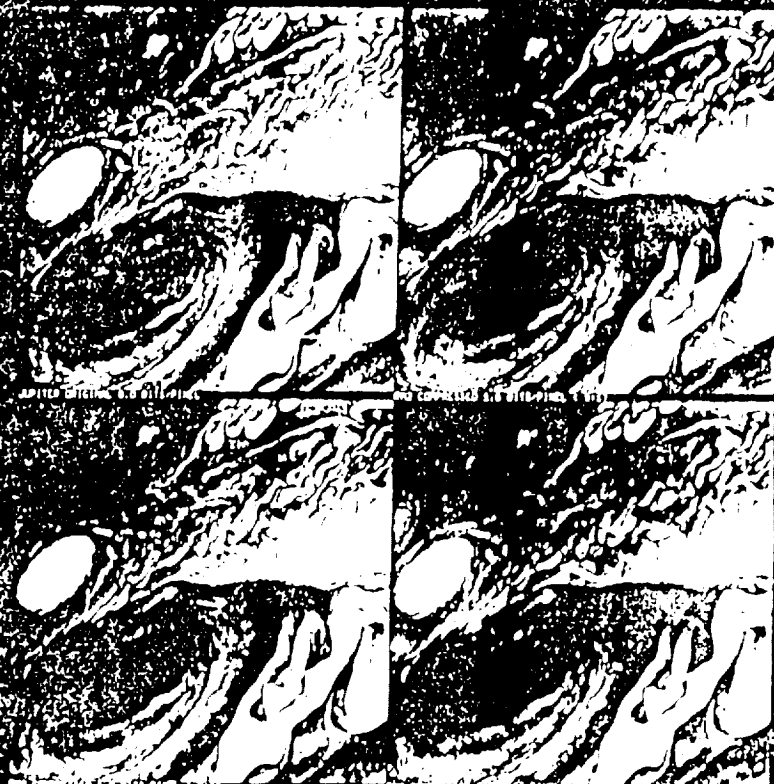

JET PROPULSION LABORATORY  
INFORMATION PROCESSING RESEARCH LAB.  
PASADENA, CALIF. 91109



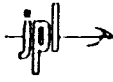

# CAN ALSO OBTAIN HIGHER QUALITY, IMAGES AT SAME DATA RATE |

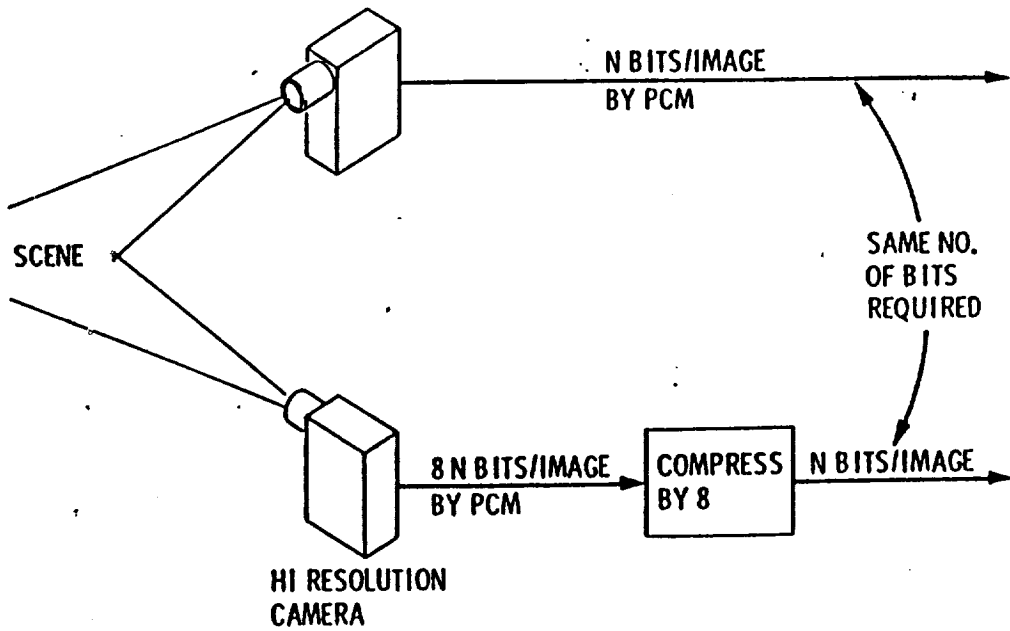

# DATA COMPRESSION INTO THE 1990'S

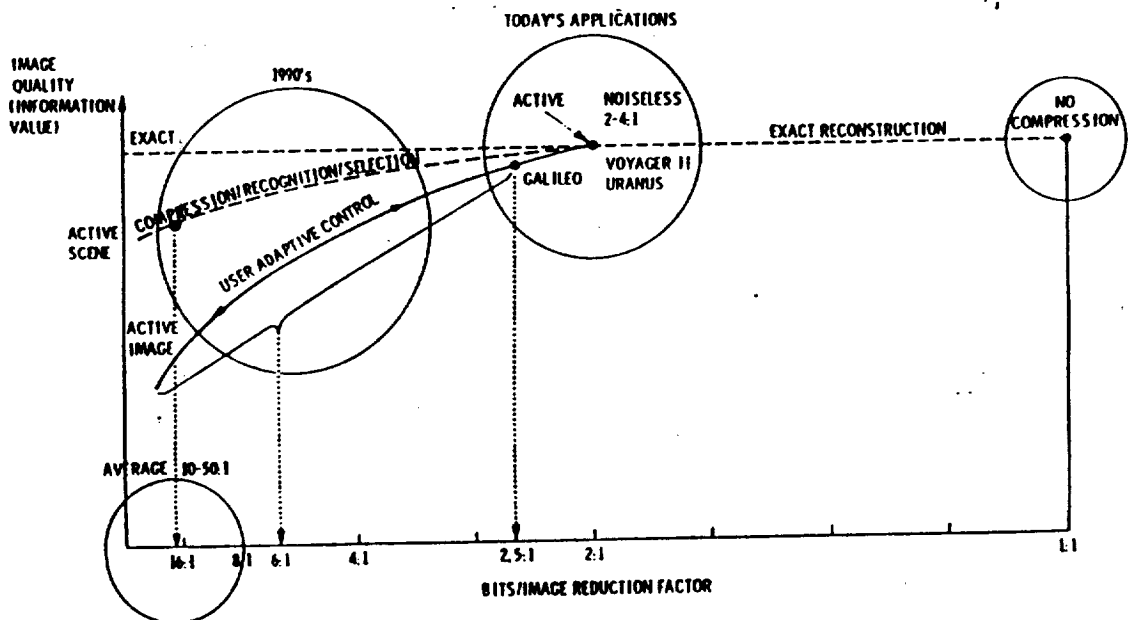

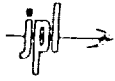

## BENEFITS TO FLIGHT PROJECTS

- 10-50:1 END-TO-END INFORMATION RATE ADVANTAGE
  - DEEP SPACE COMMUNICATION
  - GROUND DISTRIBUTION
- 10-50:1 REDUCTION IN DATA STORAGE REQUIREMENTS



## CHALLENGES

- HIGH RATE IMPLEMENTATIONS (> 1 MEGABIT/SEC)
- MISSION DESIGN AND CONTROL UTILIZING INFORMATION ADAPTIVE CAPABILITIES
- SPECIFYING COMBINED COMPRESSION/EXTRACTION/SELECTION ALGORITHMS

# MSI REQUIREMENTS

A single Noiseless Image Compressor

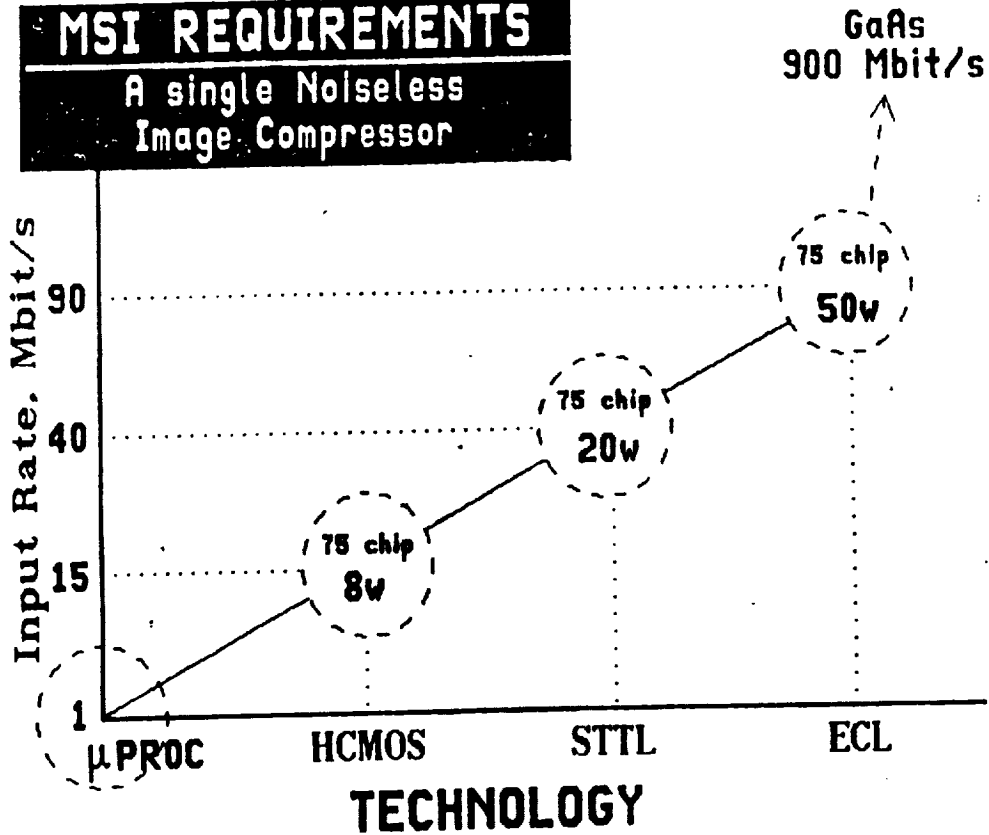

# VLSI REQUIREMENTS

A single Noiseless Image Compressor

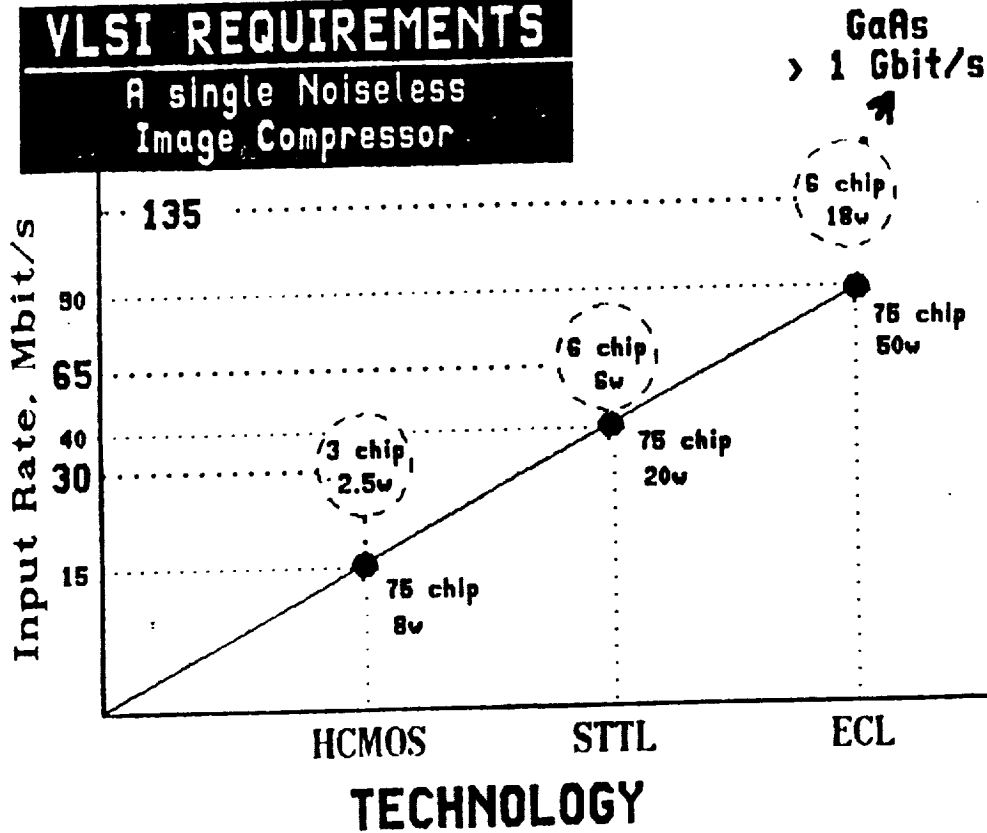

---

TELEPRESENCE/HUMAN FACTORS OVERVIEW

DR. BARBARA LINDAUER

ORIGINAL PAGE  
BLACK AND WHITE PHOTOGRAPH

**MARTIN MARIETTA**

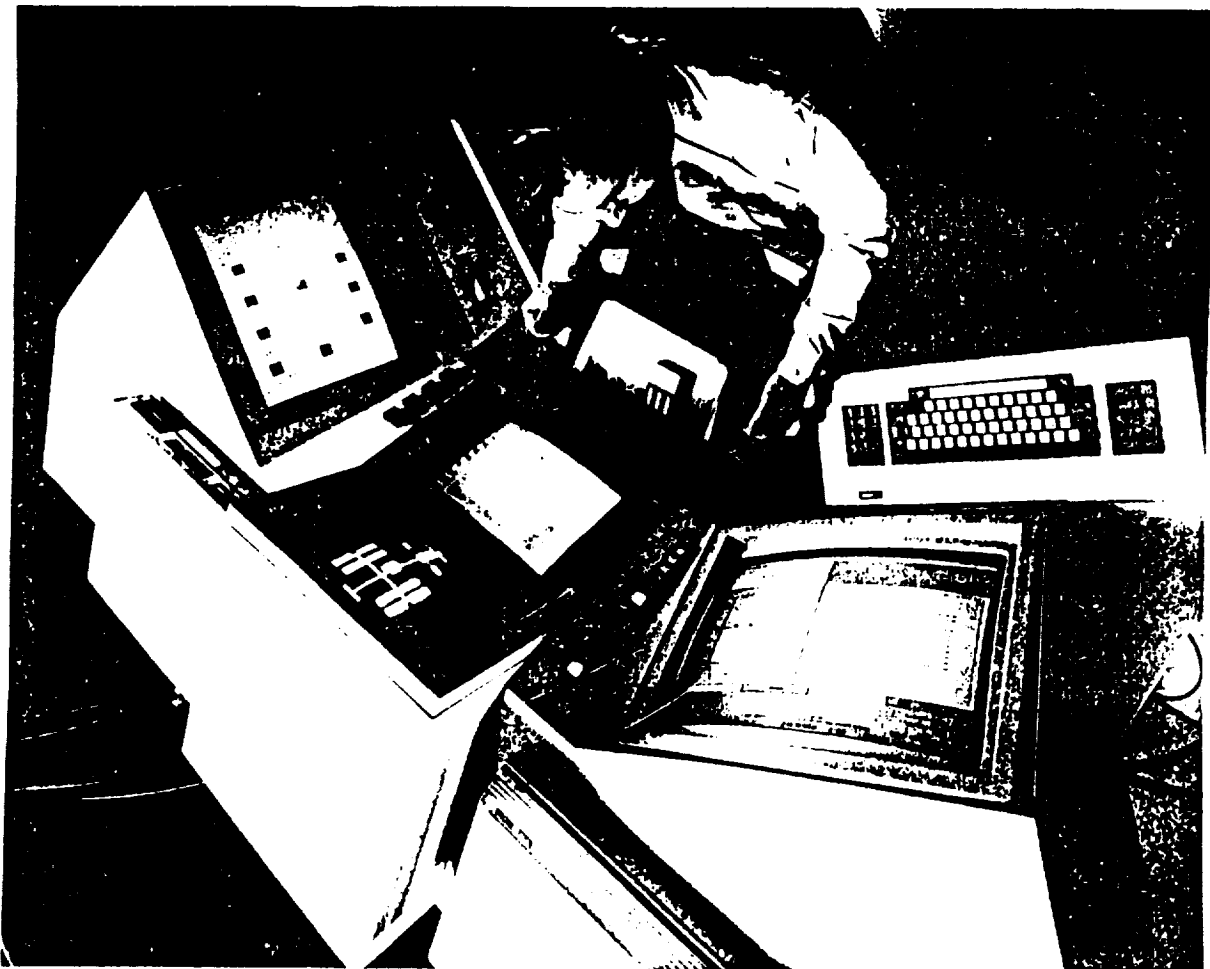

7-5-64

ORIGINAL PAGE IS  
OF POOR QUALITY

TELEPRESENCE/HUMAN FACTORS OVERVIEW

---

APPROACH: TO DEVELOP FLEXIBLE TESTBED WORKSTATIONS/CONTROL CONSOLES  
FOR EVALUATING HUMAN INTERFACE/CONTROL STRATEGIES

ACCOMPLISHMENTS:

HUMAN FACTORS ENGINEERING TESTBED (HML)  
PILOT'S CONSOLE SIMULATOR (OMV)  
REMOTE OPERATOR'S CONSOLE (ALV)  
RECONFIGURABLE CONTROL STATION (ITA)

PROJECTED 1987 ACTIVITY: D-03R - ADVANCED WORKSTATION DESIGN (RCC)

**MARTIN MARIETTA**

HUMAN FACTORS ENGINEERING TESTBED - 1986 IRAD \$1.3M  
CER \$1.5M

---

APPROACH: RESEARCH AND DEFINE HUMAN FACTORS ENGINEERING ISSUES USING  
CREW CAB SIMULATOR

- SEAT DESIGN
- CREW CAB TECHNOLOGIES FOR TACTICAL WARNING SCENARIO
- VEHICLE CONTROLLABILITY
- HABITABILITY/CONFINEMENT

OBJECTIVES: BUILD A SIMULATOR AND DISPLAY SYSTEM TO EVALUATE CONTROLS AND  
DISPLAYS FOR DRIVING AND VEHICLE CONTROLLABILITY, NAVIGATIONAL  
AIDS, FAULT DETECTION/FAULT ISOLATION, CONTROL AND DISPLAY  
PLACEMENT AND VISIBILITY

**MARTIN MARIETTA**

C-9  
7-5-65

ORIGINAL PAGE IS  
OF POOR QUALITY

HFE TESTBED VEHICLE CONTROLLABILITY STUDY RESULTS:

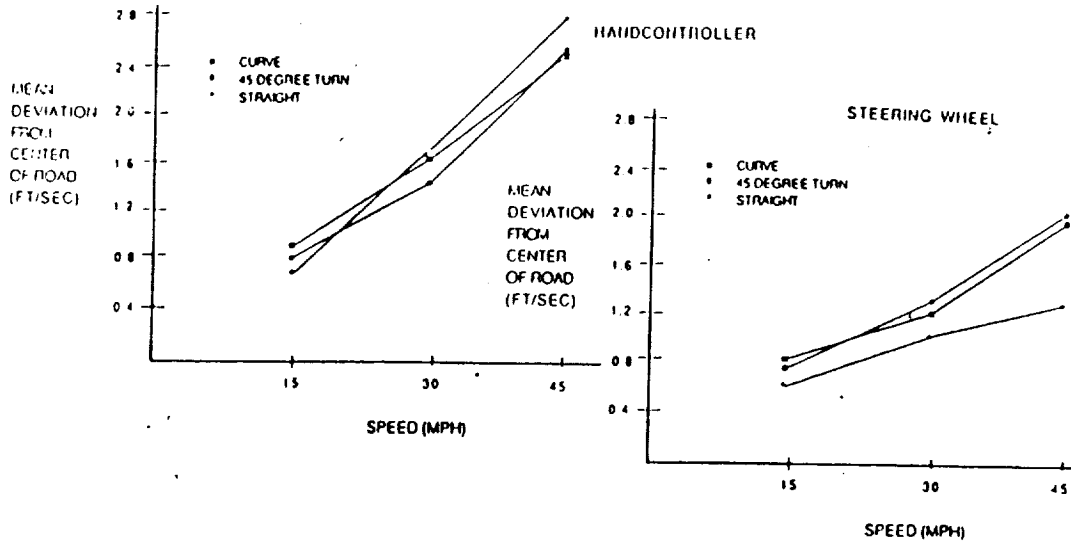

**MARTIN MARIETTA**

RECONFIGURABLE CONTROL STATION - 1985 CER \$128K

APPROACH: PROVIDE A TESTBED WORKSTATION FOR CONTROLS RESEARCH AND THE STUDY OF SYSTEM/SUBSYSTEM INTERACTIONS

OBJECTIVES: PROVIDE A FLEXIBLE INTERFACE FOR ROBOTIC SYSTEM USERS

- DISPLAY UP TO FOUR VIEWS SIMULTANEOUSLY
- STEREO VIDEO DISPLAY
- DATA RECORDING

RESULTS - CURRENTLY OPERATIONAL IN ROBOTICS LABORATORY

**MARTIN MARIETTA**

# Reconfigurable Control Station

---

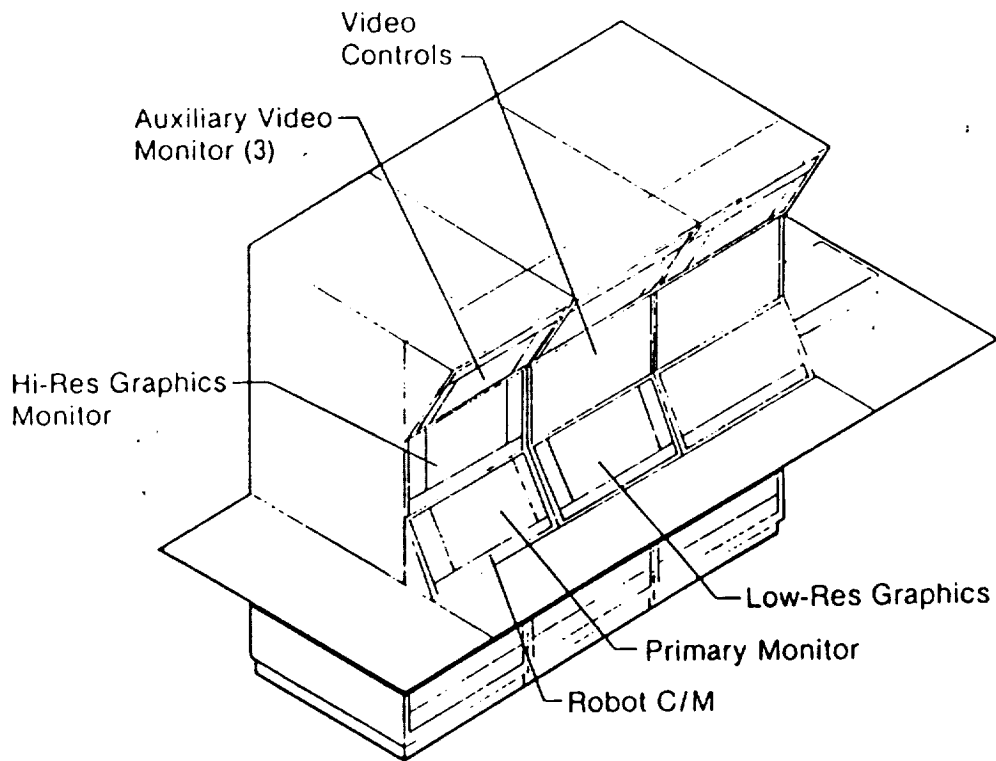

NOSC - MMMA HUMAN FACTORS LABORATORY - UNIVERSITY OF HAWAII  
1985-1987 IRAD \$135K

---

APPROACH: TO JOINTLY DEVELOP A LABORATORY UNDER THE DIRECTION OF  
DR. ROBERT E. COLE FOR EVALUATION OF REMOTE STEREO VIEWING SYSTEMS.

OBJECTIVES: USING THE EXISTING LABORATORY, DETERMINE

- EXTENT OF PERCEPTUAL ERROR FOR TARGETS AT MID AND EXTREME LOCATIONS
- ATTENUATION OF PERCEPTUAL ERROR THROUGH HYPERSTEREOSCOPIC CAMERA POSITIONS, PANNING CAMERAS TO CENTER PERIPHERAL IMAGES, OR PROVIDING FEEDBACK TO SUBJECTS REGARDING DEGREE OF ERROR
- ADAPTATION OF RESULTS TO MONITORING OF AUTONOMOUS AND MULTIPLE VEHICLE SYSTEMS

**MARTIN MARIETTA**

1986 RESULTS:

---

- o ACCURACY OF DEPTH PERCEPTION FOR STEREO VIEWING SYSTEM DECREASES SIGNIFICANTLY FOR IMAGES LOCATED PERIPHERALLY TO CENTRAL CAMERA AXIS FOR PERIPHERAL DISTANCES OF 15.25cm, 21.5cm AND 30.48cm AND AT CAMERA-OBJECT DISTANCES OF BOTH 3.5m AND 2m.
- o ACCURACY CAN BE REGAINED BY:
  - INCREASING INTERCAMERA SEPARATION TO 2x OR 4x
  - PANNING THE CAMERA BASE TO CENTER THE OBJECTS IN CAMERA FOVs AND MONITOR SCREENS
  - PRACTICE OVER TRIALS AND VERBAL FEEDBACK

**MARTIN MARIETTA**

REMOTE OPERATOR'S CONSOLE - 1985 CER - \$325K  
- IRAD - \$ 50K

---

APPROACH: DESIGN AND BUILD A RECONFIGURABLE REMOTE OPERATOR'S CONSOLE FOR EVALUATING HUMAN OPERATOR/TELEOPERATION TECHNIQUES FOR SUPERVISORY CONTROL OF AN AUTONOMOUS LAND VEHICLE.

OBJECTIVES: INTEGRATE STEREO DISPLAY SYSTEM FOR REMOTE MANAGEMENT OF VEHICLES. INTERACTIVE MAP DISPLAY FOR VEHICLE NAVIGATION.

- UTILIZATION OF RAMTECH MAP DISPLAY
- EVALUATION AND DATA COLLECTION FOR VEHICLE SUBSYSTEMS FOR TELEOPERATION
- GAUGES, DISPLAYS FOR HEALTH & STATUS INFORMATION. OPERATOR ASSISTANCE
- KEYBOARD FOR OPERATOR INPUT
- RECONFIGURABLE PUSH BUTTONS AND JOYSTICK CONTROL

RESULTS: CURRENTLY OPERATIONAL; AWAITING RF HOOK-UP TO ALV

**MARTIN MARIETTA**



PILOT'S CONSOLE SIMULATOR - 1985-1987 IRAD & CER \$500K

---

APPROACH: BUILD A GENERAL CONSOLE TO PROVIDE A MEANS FOR EVALUATING ALTERNATIVE HUMAN FACTORS INTERFACE TECHNIQUES AND DESIGN FEATURES THAT A REMOTE PILOT MIGHT USE TO CONTROL ORBITAL VEHICLES.

OBJECTIVES:

- MAXIMIZE CONSISTENCY OF DATA ENTRY TRANSACTIONS, DATA DISPLAY, CONTROL ACTIONS, AND OPERATIONAL PROCEDURES;
- MAXIMIZE OPERATOR EFFICIENCY BY MINIMIZING THE NUMBER AND COMPLEXITY OF ENTRY AND CONTROL ACTIONS REQUIRED;
- MAXIMIZE COMPATABILITY OF THE SYSTEM WITH USER NEEDS;
- PROVIDE THE USER WITH CHOICES IN HOW HE OR SHE CONTROLS DATA ENTRY AND DISPLAY.
- INVOLVED UTILIZATION OF ADVANCED SCREEN DESIGN (MISSION INFORMATION AND ADVISORY AREAS, EXPERT SYSTEM DISPLAY, CAUTION AND WARNING DISPLAY AREA, REAL TIME DATA SELECTION, MESSAGE AREA SYSTEM, REAL TIME DATA PLOT) GRAPHIC OVERLAYS, TOUCHSCREENS, SPEECH RECOGNITION AND SYNTHESIS SYSTEM, HAND CONTROLLERS, AND PROGRAMMABLE ICONS.

RESULTS: SIMULATIONS USED IN SUPPORT OF OMV PROPOSAL.

**MARTIN MARIETTA**

ADVANCED WORKSTATION DESIGN - 1987 IRAD(D-03R) \$100K  
1987 CER(SOS) \$316K

---

APPROACH:

ADDRESS THE NEED FOR EVALUATING ADVANCED WORKSTATION DESIGN FOR ENHANCING OPERATOR CONTROL OF AUTONOMOUS SYSTEMS IN MISSION SCENARIOS. PREVIOUS WORK HAS ADDRESSED PRIMARILY TELEOPERATION OF ROBOTIC SYSTEMS USING SINGLE OPERATOR/SINGLE SYSTEM CONTROL CONSOLES. MISSION EMANATING FROM DOD AND NASA NOW INCORPORATE SYSTEMS WITH AUTONOMOUS CAPABILITIES AND REQUIRE SINGLE OPERATOR CONTROL OF MULTIPLE SYSTEMS. THERE IS A NEED FOR A FLEXIBLE WORKSTATION TESTBED FOR EVALUATING NEW TECHNOLOGIES THAT CAN ENHANCE THE MAN-MACHINE INTERFACE.

**MARTIN MARIETTA**

ORIGINAL PAGE IS  
OF POOR QUALITY

OBJECTIVES:

- o CREATE A STATE-OF-THE-ART FLEXIBLE WORKSTATION FROM PRIMARILY EXISTING REMOTE OPERATOR CONSOLE COMPONENTS CAPABLE OF SERVING AS A FLEXIBLE TESTBED FOR EVALUATING SINGLE OPERATOR/MULTIPLE SYSTEM OPERATIONAL REQUIREMENTS.
- o DEVELOP AND INCORPORATE INTO THE WORKSTATION, TESTBED SOFTWARE CAPABLE OF ASSISTING OPERATOR IN REMOTE MANAGEMENT TASKS AND REDUCING OPERATOR WORKLOAD DURING CRITICAL MISSION PHASES.
- o CONDUCT A SERIES OF EXPERIMENTAL STUDIES EMPLOYING ADVANCED CONTROL AND DISPLAY TECHNOLOGIES INCLUDING AN INTELLIGENT OPERATOR ASSISTANT EXPERT SYSTEM TO ASSESS THE RELATIVE EFFECTIVENESS OF VARIOUS TECHNOLOGIES, SUCH AS VARIOUS VISUAL DISPLAYS, IN ASSISTING A SINGLE HUMAN OPERATOR IN MULTIPLE SYSTEM MANAGEMENT (IN CONJUNCTION WITH THE UNIVERSITY OF HAWAII).

**MARTIN MARIETTA**

ROBOTIC COMMAND CENTER CONSOLE DESIGN CONCEPT

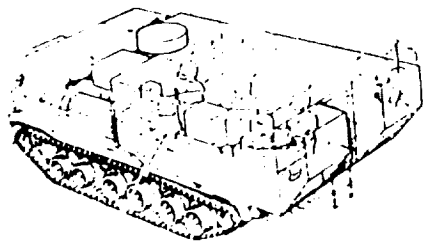

MLRS CHASSIS

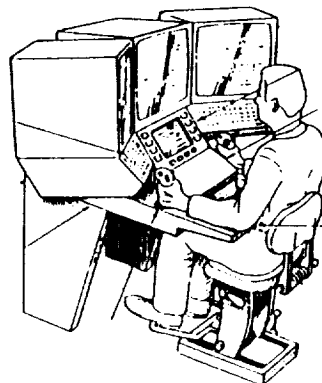

CONSOLE LAYOUT

MARS ROVER TECHNOLOGY WORKSHOP

COMPUTING & TASK PLANNING

WORKING GROUP SUMMARY

D. EISENMAN  
S. GRENANDER

APRIL 28-30, 1987

# COMPUTING

- GENERAL PURPOSE PROCESSING NEEDS FOR MOD. SCENARIO
  - 10 MIPS/10 MBYTES AT LEAST
  - ASSUMED RESOURCE SHARING
  - < 50 MIPS/50 MBYTES WITH SIMULTANEOUS OPS
- HIGHLY RECONFIGURABLE - DYNAMICALLY GENERAL PURPOSE PROCESSOR
  - STRONG IMPERATIVE FOR A MARS ROVER
  - CURRENT NASA PROGRAMS SHOULD BE STRENGTHENED

- RANDOM ACCESS NON-VOLATILE MASS STORAGE FOR MOD. SCENARIO

- < 10 GBytes.

- SPACE-QUALIFIED OPTICAL DISK (ERASEABLE)

- CURRENT NASA EFFORT SHOULD PLACE MORE EMPHASIS ON GETTING A SMALLER SPACE QUAL'D SYSTEM

- ADVANCED MAGNETIC BUBBLE TECHNOLOGY (VBL) WHICH OFFER FANTASTIC POWER/WEIGHT/VOL GAINS SHOULD BE PURSUED MORE VIGOROUSLY

- HOPFIELD

- ROVER WILL NEED MULTI-MEGA BYTES OF RAM

- NASA NEEDS TO PUSH RAD/SEU IMMUNE MEMORY COMPONENT DEVELOPMENT

- NASA NEEDS TO DEVELOP FAULT-TOLERANT DESIGNS FOR LARGE RAM SUBSYSTEMS

- DISTRIBUTED REAL-TIME COMPUTING ROVER ARCHITECTURE

- HIGHLY REPROGRAMMABLE
- DYNAMICALLY RECONFIGURABLE
- HOSTS & COORDINATES PROCEDURAL AND SYMBOLIC PROCESSING
- HIGHLY ADAPTIVE TO ENVIRONMENT
- FAULT TOLERANT
- PROVIDES SYSTEM ~~SAFETY~~ WITH SUBSYSTEM UNCERTAINTY
- PROVIDES DIAGNOSTIC & RECOVERY PLANNING

- DEVELOP A SYSTEM LEVEL DESIGN/ DEVELOPMENT ENVIRONMENT (H/W & S/W)

- DESIGN/REQUIREMENTS KNOWLEDGE CAPTURE AIDS TO MAINTAIN "CORPORATE MEMORY" OVER LONG LIFE CYCLE
- LANGUAGE TOOLS/METHODS FOR HIGH-LEVEL DESIGN AND INTERFACE DESIGN
- APPROACH TO EASE ADAPTATION TO ~~PROGRAM~~ <sup>REQUIREMENT</sup> CHANGES AND TECHNOLOGY ~~AND~~ ADVANCES

- TEST BEDS

- NEEDED FOR COMPUTING & TASK PLANNING,  
LOGAL GUIDANCE & HAZARD AVOIDANCE,  
AND THE SYSTEM

- THEY ARE NEEDED TO SOLVE THE ROVER  
SYSTEM TECHNOLOGY QUESTIONS

- SPECIAL PURPOSE PROCESSING

- NASA NEEDS TO DEVELOP METHODS & IMPLEMENTATIONS  
TO COMPRESS IMAGING (VISUAL & IR) DATA  
AT RATIOS  $\geq 10:1$  AND STILL MAINTAIN  
ACCEPTABLE INFORMATION CONTENT

- NASA NEEDS TO DEVELOP METHOD & IMPLEMENTATIONS  
FOR IMAGE/VISION PROCESSING SUCH AS  
DEFINING EXTENT OF A FEATURE, FIND  
OBSTACLES, SEPARATE FEATURES SPECTRALLY

- DEVELOP ALG'S & CHIPS  $\rightarrow$  SPACE QUAL.

- ADAPT CURRENT VISION PROCESSORS

• ESTABLISH A WORKING GROUP TO  
CONTINUE REFINING THE COMPUTER  
& TASK PLANNING TECHNOLOGY  
DEVELOPMENT PLAN



# TASK PLANNING

## TASK PLANNING

- PARTICIPANTS
  - PLANNERS
  - AI SYSTEM DEVELOPERS
  - AUTONOMOUS VEHICLE TECHNOLOGISTS
  
- FUNCTIONS
  - ROVER ACTIVITY PLANNING
    - EARTHBASED
    - ON BOARD
  - SIMULATION
  - MONITERING
  - DIAGNOSIS

# Computing & TASK PLANNING

GROUND

REQUEST LANGUAGE

SCIENCE PLANNING

PLAN EXPANSION & CHECKING

PLAN EXPANSION } & CHECKING  
PLAN ADAPTATION }

ROVER

GOAL DIRECTED PLANNING  
RESOURCE ALLOCATION

MULTIAGENT PLANNING  
CONTINGENCY PLANNING

## SIMULATION

H/W

TEST BED

S/W

PLAN GENERATION (RESOURCE ALLOCATION)

ANOMALY PREDICTION (LIMITS)

INTERNAL MODEL (WORLD STATE)

(2)

## MONITORING FUNC.

DATA FUSION: TEMP, INCL, . . . .

STATE CORRELATION: "SAME ROCK?"

WORLD MODELLING:

## DIAGNOSIS

EXPERT SYSTEM CAPABILITY REQUIRED

DEEP REASONING RQT. ⇒ OPEN ISSUE

---

STATE OF THE ART

S/W: CONSIDERABLE DEVELOPMENT REQ, WITHIN REASON

H/W: MEMORY AND MASS STORAGE CRITICAL ISSUES

OPEN ISSUES

REPLANNING ROBUSTNESS

SIW VALIDATION & VERIFICATION