

11/14/91  
E6601

NASA Technical Memorandum 105278

# Development of a Ninety String Solar Array Simulator

Thomas E. Vasek and Arthur G. Birchenough  
*Lewis Research Center*  
*Cleveland, Ohio*

October 1991

**NASA**

# DEVELOPMENT OF A NINETY STRING SOLAR ARRAY SIMULATOR

Thomas E. Vasek and Arthur G. Birchenough  
National Aeronautics and Space Administration  
Lewis Research Center  
Cleveland, Ohio 44135

## ABSTRACT

A power source was developed to support testing for the Space Station Freedom Power Management and Distribution (PMAD) DC Testbed. The intent was to simulate as closely as possible the steady-state and transient responses of a solar array. The solar array string simulator design is comprised of ninety strings of power MOSFETs driven by an external power supply. The devices were operated as constant current linear regulators. Circuit component values were chosen to provide the desired voltage and current slopes in the respective constant voltage and current regions of the I-V curves. These parameters were used along with predetermined open circuit voltage and short circuit current values. Resistor-capacitor networks were placed across the string outputs to simulate a transient response similar to a solar array. The flexibility of operating in either a negative or positive ground configuration was also factored into the design.

Several breadboards and one thermal prototype were built and tested. Responses were successfully verified and improved upon during successive breadboards. Thermocouple instrumentation was installed to verify that adequate cooling techniques had been employed on the thermal prototype.

The completed ninety string simulator consists of four power MOSFETs, four twenty-five watt source resistors, and four 250 watt drain-source bypass resistors per string in addition to the control circuitry. Therefore, considerable wiring interconnect and cooling devices were required to sufficiently implement the large scale design. Two ninety string solar array simulators were fabricated and functionally checked out in the testbed. This permitted the analysis of all strings operating in parallel on a much larger scale than the breadboards.

## INTRODUCTION

A power source was developed to support testing for the Space Station Freedom Power Management and Distribution (PMAD) DC Testbed located in the Power Systems Facility (PSF) at the NASA Lewis Research Center in Cleveland, Ohio. The intent was to simulate as closely as possible the individual string steady-state and transient responses of a solar array. The steady-state response was modelled from the characteristic current-voltage (I-V) curves obtained from an actual solar array field located adjacent to the test facility. Transient tests that were conducted on another solar array panel at another facility at Lewis were used for the determination of the array capacitance to be designed into the simulator to achieve similar results. The string simulator was also designed to complement the existing solar array field. This was necessary since the number of days providing adequate sunlight to test at high power levels is limited in this region. Having a good solar array simulator in the testbed would prevent frequent disruptions in the test schedule due to uncooperative weather conditions.

## DESIGN DESCRIPTION AND PARAMETERS

### Major Simulator Elements

The major components of the solar array string simulator are a large, external power supply and ninety series regulators, with one regulator simulating one string. Figure 1 is a basic block diagram of this configuration. The supply chosen was a Dynapower SA42-2250401-STVCRF, rated 225 volts at 400 amps. Four of these units had been previously installed at the facility to support daily testing activities. The supply provides the input

power to the simulator and is adjusted to the open circuit voltage of the array. The power supply is remotely located in another test cell and controlled via a remote panel near the simulator.

Each of the ninety series regulators functions as a constant current linear regulator that is adjusted to the desired short circuit current of the array. The individual string circuit consists of four IRF #743 HEXFETs in parallel with bypass resistors across each drain and source terminal. Figure 2 is a schematic diagram of one solar string. This particular semiconductor was chosen because of its high voltage and power rating suitable for meeting the design specifications of the simulator. [1] Also, the small size of the component and its ease of mounting made this the desirable choice. Four stages in parallel were chosen to reduce the power dissipation per stage and handle an even distribution of short circuit current should the disabling of stages be required to serve as an additional means of current regulation.

A transistor current source using MJE #350 transistors is dedicated for each solar array string. The circuit drives the HEXFET string electronics to provide the proper level of current during operation. Resistors in this circuit also determine the current slope during the constant current mode of operation. The transistors and associated resistors are shown in the upper right corner of Figure 2.

The final design consideration was grounding configuration. Both positive and negative grounding schemes were considered. To achieve maximum flexibility, the simulator was designed to accommodate either scheme. Normal operation is conducted as negative ground, with the HEXFET drains tied together and the source outputs isolated from one another. By removing jumper blocks in each string circuit and reconfiguring the input/output wiring, positive grounding is obtained. The jumper blocks allow resistors to be removed without major rework to the printed circuit board. This becomes important in a repetitive, large scale ninety-string design. For positive grounding, the sources are tied together and the drains are used as the outputs. Figure 3 is a block diagram of the simulator employing the positive grounding configuration. The control wire routing also must be changed to reflect the different grounding scheme. The I-V curves and transient responses for both

configurations met the original simulator requirements. These procedures were intended to lessen the downtime between testing should any grounding reconfiguration be required.

### Design Parameters

Modelling the steady-state I-V curves centered around two main parameters, open circuit voltage and short circuit current. Open circuit voltage was defined to be the voltage input to the simulator. Short circuit current was set by resistive components in the individual string circuits, specifically the bypass resistors and source resistors. Based upon values that the space station solar arrays would provide, these parameters were chosen to be 210 volts and 2.6 amps respectively. Slopes in both the constant voltage and constant current portions of the I-V curves were selected as approximately ten percent. Decreasing the open circuit voltage effectively reduces the current and proportionally shifts the curve to the left. The solar array field was used as a basis for determining the general shape of the curves. The solar panels in the array field are configured for nominally 160 volts at 2.4 amps per string, with a total field power output of approximately 30 kW. Figure 4 is a typical curve obtained from the adjacent solar array field. In this case, the open circuit voltage was set for 210 volts. The short circuit current only reached two amps, possibly because the solar panels had not been cleaned for a long period of time. Figure 5 shows the simulator responses, with several different current adjust settings. The operational description section of this report will briefly describe these curves.

Transient tests that were conducted on a space station prototype solar array in another facility at Lewis were used to define the simulator response. Transient tests were also performed on the solar array field adjacent to the facility, however the data showed considerable oscillations in the load current before settling out to the short circuit values. This was believed to be a result of the long cable lengths interconnecting the solar panels with the termination cabinets. No further effort was expended on the field since the prototype results were determined to be a good representation of the actual solar arrays.

To implement the transient characteristics, a

series resistor-capacitor network of 100 ohms and .01 microfarads was connected across each string output. Figure 6 shows oscilloscope traces of the simulator transient response through these components. Both the load voltage and current waveforms are detailed.

### Operational Description

This section briefly describes the operation of the simulator. When operating in the constant voltage section of the curve, supplying a load, the HEXFETs are conducting and current flows through the four paralleled stages. The "on" resistance of the semiconductors is very small and power dissipation is minimal. [3] A resistor placed in series with each of the source leads provides the desired slope during this mode of operation.

To reduce the power dissipation in the HEXFETs when turning from on to off, and to provide the desired level of short circuit current, a bypass resistor was placed across each drain and source terminal. When operating in the constant current portion of the curve or when a short is applied to the string outputs, the bypass resistor effectively takes the current flow. The current setting for the simulator can be reduced several ways. First, by adjusting a ten-turn precision potentiometer in the current source circuit, the I-V curve can be lowered. However, at the lower potentiometer settings, the constant current portion of the curve becomes a linear slope since the HEXFET bypass resistors are the main contributors. Figure 5 shows the response at the maximum potentiometer setting, full short circuit current, and at a reduced setting, which is the lower of the two curves. The linear portion is evident here. By reducing the open circuit voltage, the I-V curve will shift left as previously discussed. Finally, removing fuses in each source leg of the string circuits will reduce the short circuit current in twenty-five percent increments. The fuses were intended to allow for some protection of each stage as well as offer some degree of control. For clarity, reference figure 2 for the schematic diagram and component layout.

### BREADBOARDS AND PROTOTYPES

The initial solar array string breadboard consisted

of a single string with three paralleled HEXFET stages. The packaging technique was of no importance; the main goal was to verify responses. Semiconductors were mounted on finned aluminum heat sinks and the source power and bypass resistors were all secured to an aluminum chassis which was also used as a heat sink. The control electronics were mounted inside of the aluminum chassis.

The test set used to generate the I-V curves was merely a power rheostat instrumented with digital panel meters indicating load voltage and current. Data points were taken by hand. To record the transient response, a variable power load-switching circuit was employed. This consisted of several heavy-duty resistors having a power MOSFET shunting the specified load at a 20 kHz rate. The following instrumentation was used during both types of testing:

1. Hewlett-Packard #5183 digitizing oscilloscope and waveform recorder
2. Hewlett-Packard #7475A six-pen plotter
3. Gould #1604 digitizing oscilloscope
4. Tektronix #AM503 current probe amplifier
5. Tektronix #6302 current probes
6. Tektronix #6902B oscilloscope isolator

The responses were successfully achieved with the initial breadboard, however a second breadboard was later built. The purpose was to dissipate less power per stage by adding a fourth HEXFET and fine-tune the current slope for the I-V curve. The power and bypass resistors were not adequately cooled with this type of configuration, however.

With the design parameters and responses successfully met, the next step was to find a way to sufficiently cool the various components. An off-the-shelf extruded aluminum cold plate with copper tubing serpentine within the plate length was chosen. A twelve-inch section was purchased, representative of the size required for three solar array strings based on the component footprints. Facility cooling tower water was run through the cold plate at approximately seventy-nine degrees F. The HEXFETs were mounted over Kapton isolator pads to ensure good thermal conductivity while maintaining electrical isolation. Source resistors were also mounted on the cold plate. Associated string electronics were placed on printed circuit boards with three-terminal connectors to slip over the HEXFET leads. Thermocouples were installed

on various areas of the cold plate surface, on several HEXFET cases, and on the water supply and return lines.

After running the thermal prototype for nearly two months, sufficient cooling of the semiconductors and resistors was demonstrated. Various load conditions were imposed upon the system, with the test set-up running eight hours a day. Stainless steel immersion heaters were used as the HEXFET drain-source bypass resistors and placed in a tank of water. Cold plate and component case temperatures were maintained well below their thermal limits with only slight increases in cooling tower water temperature of several degrees F observed. HEXFET case temperatures were observed as high as 200 degrees F, however this was with the bypass resistors removed from the circuit. The power dissipation in the semiconductors was kept to an acceptable level with the bypass resistors as the original design intended.

## DEVELOPMENT AND IMPLEMENTATION

### String Electronics

Developing and integrating the required hardware for a full-scale simulator proved to be a very detailed and involved process. The requirements specified eighty-two solar strings and several spares were added to lessen the downtime during testing should any failures occur. It was arbitrarily decided to include eight spares. This resulted in the total number of components needed to comprise a ninety string simulator to be 360 HEXFETs, 360 drain-source bypass resistors, 360 source resistors, and ninety R-C networks. Reference figures 7 and 8 for photographs of the completed simulator.

Since each HEXFET stage is designed to handle one-quarter of the total string short circuit current, each bypass resistor dissipates approximately 122 watts maximum. The decision was made to use the stainless steel immersion heaters used in the thermal prototype. They were available as off-the-shelf items since they were chosen to have resistive values close to what the string required. By working the series combination of the heaters and the source resistors, the short circuit current and voltage slope were obtained without having to special order any components. The heaters were the screw plug type,

having a three-quarter-inch pipe thread to facilitate easy installation into a water tank. Twist-lock electrical connectors were provided along with the heaters to allow for the wiring terminations. Four immersion heaters were required for each solar array string.

A four-foot square aluminum tank was fabricated in-house to cool all 360 heaters. Facility cooling tower water lines were run to the tank and mounted within a support stand for the tank. Valves were installed in the tank lines to regulate the flow should any changes need to be made for insufficient cooling.

The same basic cold plate configuration used for the thermal prototype was retained with the exception of increasing the length of the aluminum plate. A four-inch section of the plate was reserved for one string, which incorporated four thirty-five ohm, twenty-five watt source resistors, and the four HEXFETs. Along with mounting the HEXFETs on Kapton pads to ensure the electrical isolation and thermal conductivity between the drain-case and cold plates, nylon shoulder washers were placed in the mounting through-holes. This prevents the mounting screws from electrically contacting the plate. Twelve solar strings were assigned per cold plate to match the total footprint as set by the immersion heater tank. This made the cold plate length an even forty-eight inches long. Eight plates were needed to cool ninety strings, with some extra plate surface left on the last plate.

Each of the eight plates was mounted horizontally, standing on edge above the water tank. The space between adjacent cold plates was six inches to allow sufficient room for the string circuit cards. The plates were supported with stand-offs mounted on the water tank angle iron rails. A manifold having separate shut-off valves in all eight sets of supply and return cooling tower water lines was also mounted on the rail. This allows each cold plate to be isolated from the cooling system should removal be required. Flexible hose was routed from the manifold to each inlet and outlet port of the cold plates.

The string circuit cards consisted of three-by-five inch printed circuit boards with four, three-terminal connectors soldered to one edge. They were spaced so as to slip over the HEXFET leads. The contact insertion resistance provided adequate force to hold the cards securely in place. Other components on

the card are zener diodes, assorted resistors, fuses, and a sixteen-pole screw terminal connector. The zener diodes are connected across each gate-to-source circuit to suppress any transient voltage spikes caused by switching. One-hundred ohm resistors were placed in series with each gate to prevent oscillations in the HEXFET stages. Initially, in the first breadboard, these resistors were not included and oscilloscope traces revealed high frequency oscillations every so often. The circuit layout, as well as the external string wiring was kept as symmetrical as possible to maintain the balanced current in the paralleled stages. [2] In addition to several 10K ohm resistors per stage for control, one programming jumper per stage was also mounted. Removing these jumpers changes the configuration to positive ground. There is also one subminiature one-amp fuse per source output lead. Its function was previously mentioned under the operational description section. They are held by 2AG fuse clips so that replacement does not require desoldering. Finally, a sixteen-pole screw mount PC connector was mounted on each board to provide orderly interfacing to the immersion heaters and source resistors, and also to the control and input/output sections of the simulator.

#### Control and Input/Output Electronics

Mounted above the cold plates on stand-offs was a four-foot square sheet of quarter-inch bakelite that contained the short circuit adjust control, input/output connectors, R-C networks for transient response, and instrumentation. A clear, ventilated plexiglass cover enclosed the bakelite top to guard against shock hazards. Two 120 cfm muffin fans mounted near the back of the unit circulated air across the control circuit boards and R-C networks.

A quick-disconnect connector system was incorporated into the simulator to permit easy removal of the cold plates should this become necessary to replace any failed components. All control signals and wiring from the string circuit cards to the immersion heaters pass through these connectors which are mounted on the right side of the simulator. Figure 8 is a side view showing these connectors and cold plates.

Four printed circuit boards mounted vertically on the bakelite contained the MJE #350 transistors and

associated resistors to provide the desired current slope and drive for all ninety strings. Clip-on heat sinks were placed on each transistor to cool the devices along with the muffin fan airflow. Several thirty volt, 350 mA encapsulated power supplies connected in parallel powered these circuits. A ten-turn precision power potentiometer served as the control to set the short circuit current to the desired level. Changing the configuration to positive ground requires bypassing the transistor circuits and wiring the potentiometer directly to the string electronics.

Input connectors for the solar array string simulator were chosen to be 250 amp pin receptacles. They are mounted on a panel at the rear of the bakelite top section. Heavy-duty 250 amp socket plugs attached to #4/0 welding cable serve as the interconnect to the Dynapower power supplies. Each individual string output is brought to a pin on one of four Amphenol thirty-seven pin MS-series box connectors. Paralleled off each connector pin is the respective R-C network.

Mounted on a panel at the front of the bakelite are several digital panel meters and a thermocouple digital readout. Open circuit voltage and short circuit current are displayed on the panel meters. A temperature selector switch allows the monitoring of eleven type K thermocouples. One is mounted on each cold plate, near the return water line, inside the immersion heater water tank, and on the cooling tower inlet and outlet lines to the simulator. A console in the testbed contains the remote power supply controls and emergency disconnect functions. The simulator is configured so that it cannot be energized unless the cooling system is operating. This guards against inadvertent overheating of the system components.

To gauge the approximate level of short circuit current that the solar simulator is operating at, a small panel meter gives a single string current value that is obtained from the MJE #350 transistor circuit. The current flow in milliamps through the collector leg is converted to a proportional voltage and displayed via the meter.

#### CONCLUSION

Two solar array string simulators have been fabricated and functionally tested. Results have been favorable with the exception of one instability

problem being uncovered. The anomaly appeared during testing within the simulator operating range of 120 to 100 volts on the I-V curve. At these conditions, many of the individual string circuit currents became oscillatory, however not all circuits were affected. A similar problem was noticed during initial breadboard testing. It was solved by inserting a resistor in series with the gate and further by relocating the zener diode. It seemed that the capacitance of the zener diode was causing the circuit to become unstable. Further analysis has shown that the four .01 microfarad capacitors on each string circuit board were also adding to the problem. One simulator has had these components removed and the oscillations were eliminated. If the problem does not reappear, the other simulator will be similarly modified.

## REFERENCES

- [1] Brian R. Pelly, "Applying International Rectifier's Power MOSFETs," International Rectifier HEXFET Databook, Chapter 1, Application Note 930, pp. A8-A18: 1982-83.
- [2] Brian R. Pelly, "The Do's and Don't's of Using Power HEXFETs," International Rectifier HEXFET Databook, Chapter 2, Application Note 936, pp. A19-A24: 1982-83.
- [3] S. Clemente, B.R. Pelly, R. Ruttonsha, "Current Ratings, Safe Operating Area, and High Frequency Switching Performance of Power HEXFETs," International Rectifier Databook, Chapter 3, Application Note 949, pp. A25-A35: 1982-83.

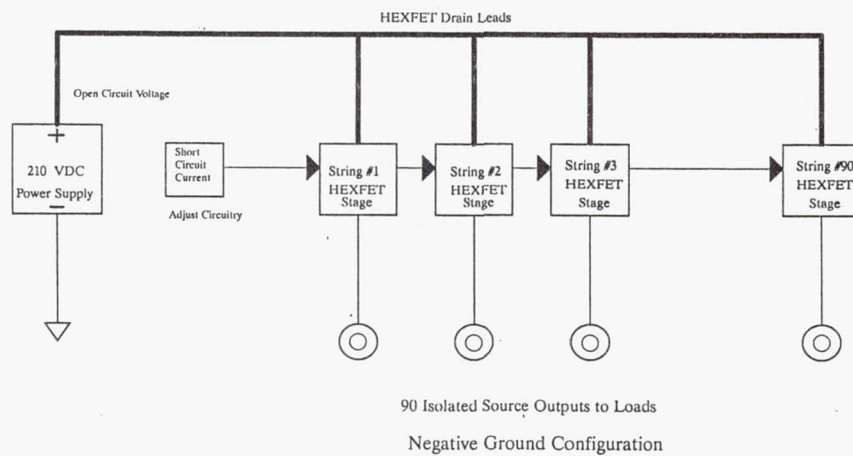

Figure 1 Solar Array String Simulator Block Diagram

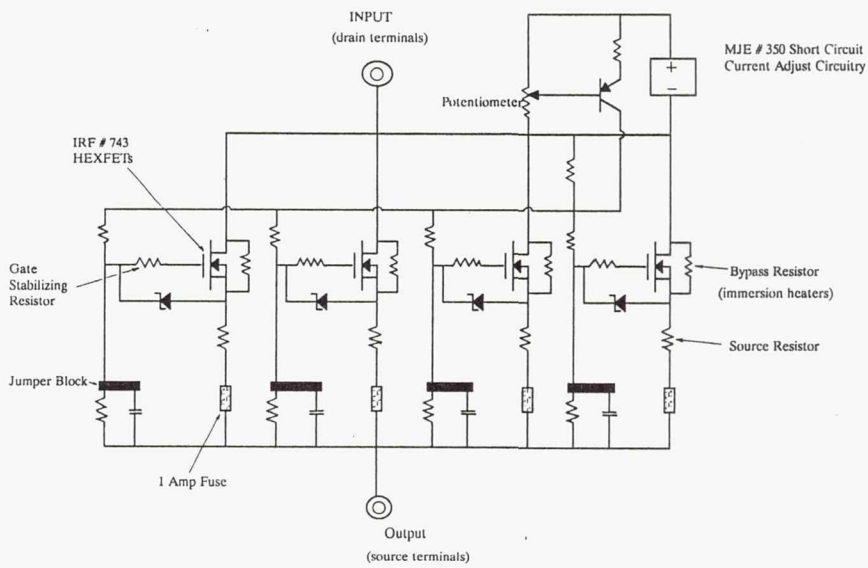
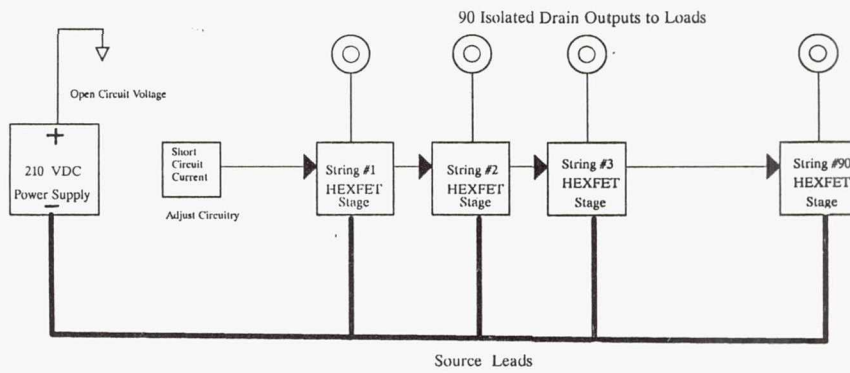
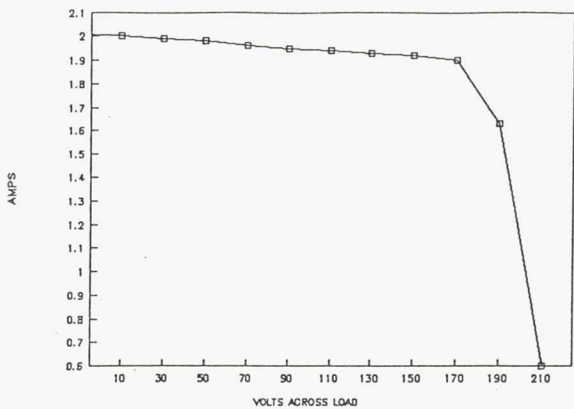

Figure 2 Solar Array String Simulator Schematic



Positive Ground Configuration

Figure 3 Solar Array String Simulator Block Diagram



Voc = 210 vdc

Figure 4 Solar Array Field I-V Curve

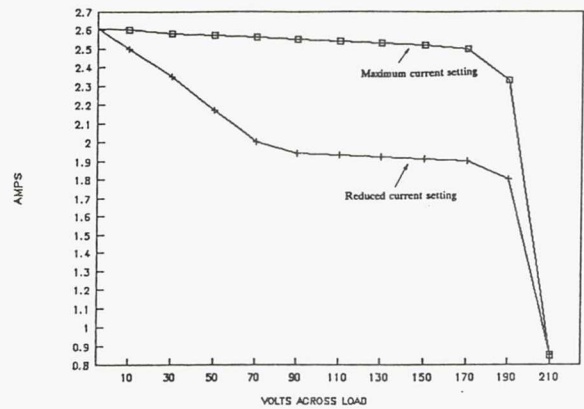

Voc = 210 vdc

Figure 5 Solar Array String Simulator I-V Curve



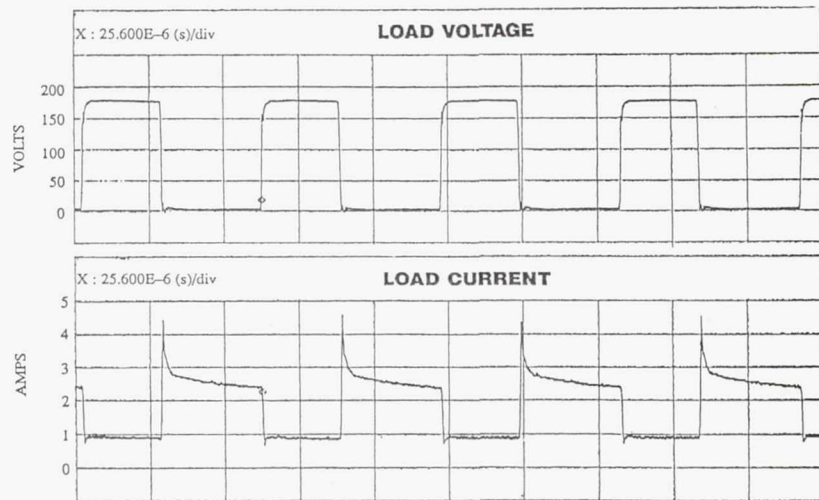

Figure 6 Solar Array String Simulator Transient Response

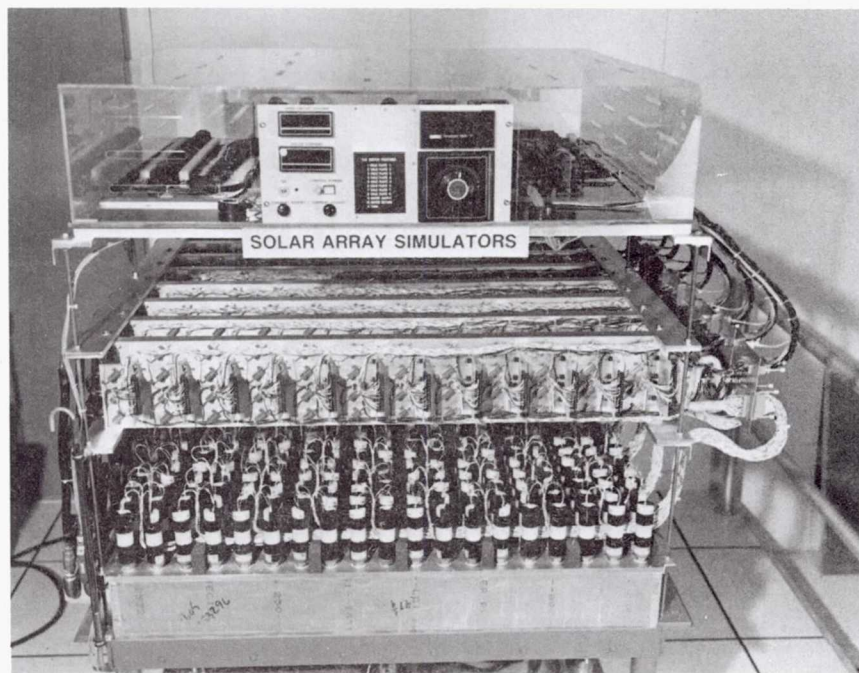

Figure 7 Solar Array String Simulator - Front View

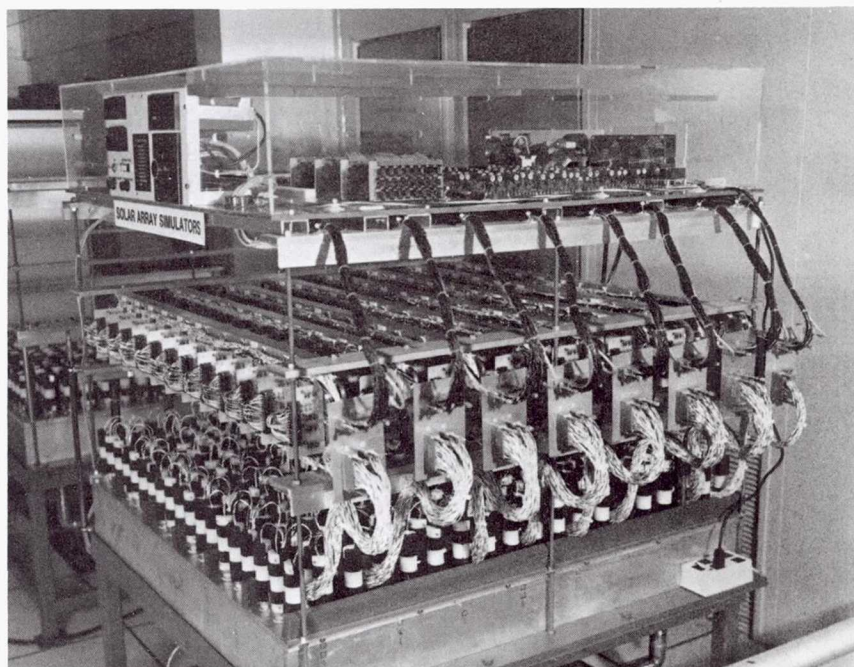

Figure 8 Solar Array String Simulator - Side View

# REPORT DOCUMENTATION PAGE

Form Approved  
OMB No. 0704-0188

Public reporting burden for this collection of information is estimated to average 1 hour per response, including the time for reviewing instructions, searching existing data sources, gathering and maintaining the data needed, and completing and reviewing the collection of information. Send comments regarding this burden estimate or any other aspect of this collection of information, including suggestions for reducing this burden, to Washington Headquarters Services, Directorate for Information Operations and Reports, 1215 Jefferson Davis Highway, Suite 1204, Arlington, VA 22202-4302, and to the Office of Management and Budget, Paperwork Reduction Project (0704-0188), Washington, DC 20503.

<b>1. AGENCY USE ONLY</b> <i>(Leave blank)</i>	<b>2. REPORT DATE</b> October 1991	<b>3. REPORT TYPE AND DATES COVERED</b> Technical Memorandum	
<b>4. TITLE AND SUBTITLE</b> Development of a Ninety String Solar Array Simulator		<b>5. FUNDING NUMBERS</b>  WU - 474 - 74 - 10	
<b>6. AUTHOR(S)</b> Thomas E. Vasek and Arthur G. Birchenough			
<b>7. PERFORMING ORGANIZATION NAME(S) AND ADDRESS(ES)</b>  National Aeronautics and Space Administration Lewis Research Center Cleveland, Ohio 44135 - 3191		<b>8. PERFORMING ORGANIZATION REPORT NUMBER</b>  E - 6601	
<b>9. SPONSORING/MONITORING AGENCY NAMES(S) AND ADDRESS(ES)</b>  National Aeronautics and Space Administration Washington, D.C. 20546 - 0001		<b>10. SPONSORING/MONITORING AGENCY REPORT NUMBER</b>  NASA TM - 105278	
<b>11. SUPPLEMENTARY NOTES</b> Responsible person, Thomas E. Vasek, (216) 433 - 2672.			
<b>12a. DISTRIBUTION/AVAILABILITY STATEMENT</b>  Unclassified - Unlimited Subject Category 18		<b>12b. DISTRIBUTION CODE</b>	
<b>13. ABSTRACT</b> <i>(Maximum 200 words)</i> A power source was developed to support testing for the Space Station Freedom Power Management and Distribution (PMAD) DC Testbed. The intent was to simulate as closely as possible the steady-state and transient responses of a solar array. The solar array string simulator design is comprised of ninety strings of power MOSFETs driven by an external power supply. The devices were operated as constant current linear regulators. Circuit component values were chosen to provide the desired voltage and current slopes in the respective constant voltage and current regions of the I-V curves. These parameters were used along with predetermined open circuit voltage and short circuit current values. Resistor-capacitor networks were placed across the string outputs to simulate a transient response similar to a solar array. The flexibility of operating in either a negative or positive ground configuration was also factored into the design. Several breadboards and one thermal prototype were built and tested. Responses were successfully verified and improved upon during successive breadboards. Thermocouple instrumentation was installed to verify that adequate cooling techniques had been employed on the thermal prototype. The completed ninety string simulator consists of four power MOSFETs, four twenty-five watt source resistors, and four 250 watt drain-source bypass resistors per string in addition to the control circuitry. Therefore, considerable wiring interconnect and cooling devices were required to sufficiently implement the large scale design. Two ninety string solar array simulators were fabricated and functionally checked out in the testbed. This permitted the analysis of all strings operating in parallel on a much larger scale than the breadboards.			
<b>14. SUBJECT TERMS</b> Power Management and Distribution; Power System Facility; HEXFET; Current-voltage characteristics; Solar array			<b>15. NUMBER OF PAGES</b> 10
			<b>16. PRICE CODE</b> A03
<b>17. SECURITY CLASSIFICATION OF REPORT</b> Unclassified	<b>18. SECURITY CLASSIFICATION OF THIS PAGE</b> Unclassified	<b>19. SECURITY CLASSIFICATION OF ABSTRACT</b> Unclassified	<b>20. LIMITATION OF ABSTRACT</b>