

NASA Technical Memorandum 104744

Space Shuttle Entry Terminal Area Energy Management

Thomas E. Moore

November 1991

(NASA-TM-104744) SPACE SHUTTLE ENTRY
TERMINAL AREA ENERGY MANAGEMENT (NASA)
50 p CSCL 01B

N92-19930

G3/01 Unclas
0057115



NASA Technical Memorandum 104744

Space Shuttle Entry Terminal Area Energy Management

Thomas E. Moore
Lyndon B. Johnson Space Center
Houston, Texas

National Aeronautics and Space Administration
Lyndon B. Johnson Space Center
Houston, Texas

November 1991

CONTENTS

Section		Page
1.0	Introduction	1
1.1	Guidance Modifications	1
1.2	Entry to Landing Guidance Functions	1
2.0	Development History	2
2.1	Energy to Attitude Control	4
2.2	Optional TAEM Targeting (OTT)	6
2.3	Bailout Modes	9
2.4	Smart Speedbrake and Bank Limit for OI22	10
2.5	Theta Limits	11
3.0	Detailed Description of Algorithms	12
3.1	Technique of Constraints Limits	12
3.2	Overview	13
3.3	TAEM and GRTLS Executives - TGEXEC & GREYEC	14
3.4	Initialization - TG/INIT & GRINIT	15
3.5	Heading Alignment - TGXHAC	15
3.6	Navigation User Parameter Processor - HAC Control	16
3.7	Ground Track Predictor - GTP	17
3.8	Computations - TGCOMP	20
3.9	TAEM Transitions - TGTRAN	23
3.10	TAEM Body Vertical Acceleration - TGNZC	28
3.11	TAEM Speedbrake - TGSBC	36
3.12	TAEM Bank - TGPHIC	36
3.13	Overview of GRTLS Open Loop Guidance Phases 6 to 4	41
3.14	GRTLS Transitions - GRTRN	42
3.15	GRTLS Body Vertical Acceleration - GRNZC	44
3.16	GRTLS Alpha Recovery - GRALPC	44
3.17	GRTLS Speedbrake - GRSBC	45
3.18	GRTLS Bank - GRPHIC	46

ORIGINAL PAGE IS
OF POOR QUALITY

1.0 INTRODUCTION

An historical account of the development for Shuttle's Terminal Area Energy Management (TAEM), is presented. A derivation and explanation of logic and equations is provided as a supplement to the well documented guidance computation requirements contained within the official Functional Subsystem Software Requirements (FSSR) published by Rockwell for NASA. This FSSR contains the full set of equations and logic, whereas this document will address just certain areas for amplification.

1.1 GUIDANCE MODIFICATIONS

The abort Glide Return to Launch Site (GRTLs) is a high altitude extension of TAEM.

TAEM was initially developed to do its primary function of energy management with an energy controller, but has since been modified to an altitude controller for better energy management in the presence of unknown winds.

Optional TAEM Targeting (OTT) provides greater flexibility for pilot control of the ground track by providing the option for an overhead approach to the runway in addition to a straight-in approach. This modification has been in use since STS-5.

A bailout guidance mode was added to implement one of the recommendations of the Rogers Commission Report for crew capability to escape from an Orbiter in controlled subsonic gliding flight. The software changes to both TAEM and GRTLs, along with the associated escape pole, were the means of implementing this recommendation starting with STS-26.

A pending modification, Change Request 89979, involves a smarter speedbrake for energy control and a smarter vehicle vertical acceleration (NZ) limiter that limits total NZ by limiting bank attitude.

A potential modification, previously considered and still a potential change, is Theta Limits which would compute pitch attitude limits to constrain airspeed in the presence of degraded airdata.

1.2 ENTRY TO LANDING GUIDANCE FUNCTIONS

The Entry guidance flies the low lift-to-drag (L/D) and high angle-of-attack (α) lifting body vehicle from atmospheric entry to the higher L/D and low α aeroplane flight region of TAEM. The Entry vertical component command of the aero lift vector commands the bank angle magnitude to control the downrange component relative to the runway landing site. The lateral component command of the aero lift vector, commands the bank angle direction (roll reversals) to control the crossrange component relative to the runway landing site, whenever the lateral deviation from the target exceeds a deadband level. As the TAEM target altitude is approached, entry guidance transitions from the high α of about 40° to the TAEM level of about 10°. Speedbrake during entry is to a preprogrammed profile to assist attitude control and is not used for guidance.

TAEM starts at a mach level of 2.5 at about 85,000 ft altitude. The lateral component command of the aero lift vector commands bank angle magnitude and sign to control crossrange relative to a prescribed or calculated (direct route) ground track toward the runway. The vertical channel basically controls energy and altitude with α . Speedbrake control during TAEM continues from entry to a preprogrammed profile until subsonic and then controls airspeed indirectly through dynamic pressure.

TAEM delivers the vehicle into the final approach plane of the runway and then delivers control to the approach and landing guidance at from 5000 to 10000 feet altitude. The approach guidance continues to fly the reference glide slope with α , the lateral track with bank, and the airspeed with speedbrakes. The landing guidance then flares from the steep reference to a shallow glide slope and then flares to the runway for touchdown.

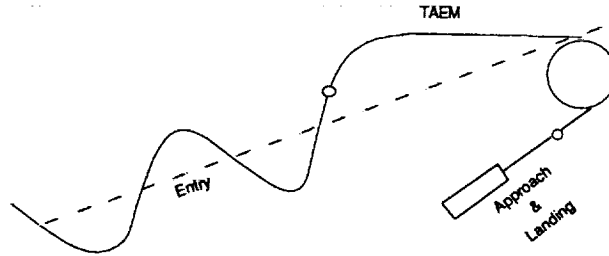

Entry to Landing Ground Track Sketch

The GRTLS guidance is identical to TAEM, except that it starts its TAEM phase at mach 3.2 and has three guidance open loop phases with closed loop flight control of either angle-of-attack or acceleration in the region between external tank separation (about mach 6) and mach 3.2.

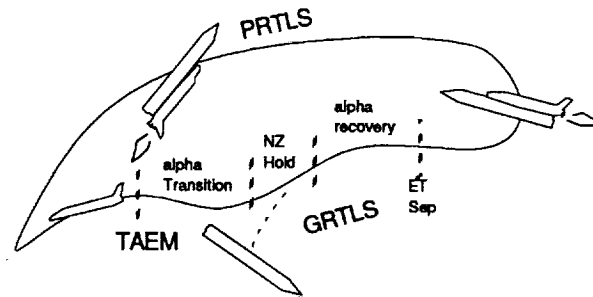

GRTLS Vertical Plane Sketch

2.0 DEVELOPMENT HISTORY

The three flight control variables given for the development of TAEM are speedbrake for drag modulation below mach .95, normal acceleration along the body axis Z (NZ) for longitudinal state control, commanded from the guidance to the flight control which controls α to get NZ, and vehicle bank angle or roll about the velocity vector for lateral state control or direction of flight.

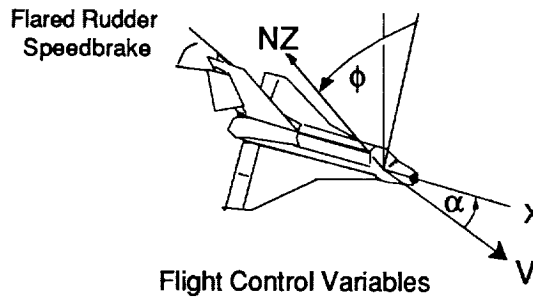

Energy is the longitudinal variable to be controlled.

$$E = wh + mV^2/2$$

$$E/W = h + V^2/(2g) = h + qbar/(pg)$$

During the early 1970's, many organizations were involved in the development of the TAEM guidance. This author, in JSC's Avionics System Division, produced a Variable Entry Point guidance. Candidates from others were the Race Track from JSC's MPAD Division, the VORTAC from Charles Stark Draper Labs, the Cylinder from McDonnell Douglas, and the Spiral from Rockwell International. A study contract was given to MDAC/St. Louis to pick, or blend into another form, the final guidance. The result was a "Hybrid" that incorporated good features from all the candidates.

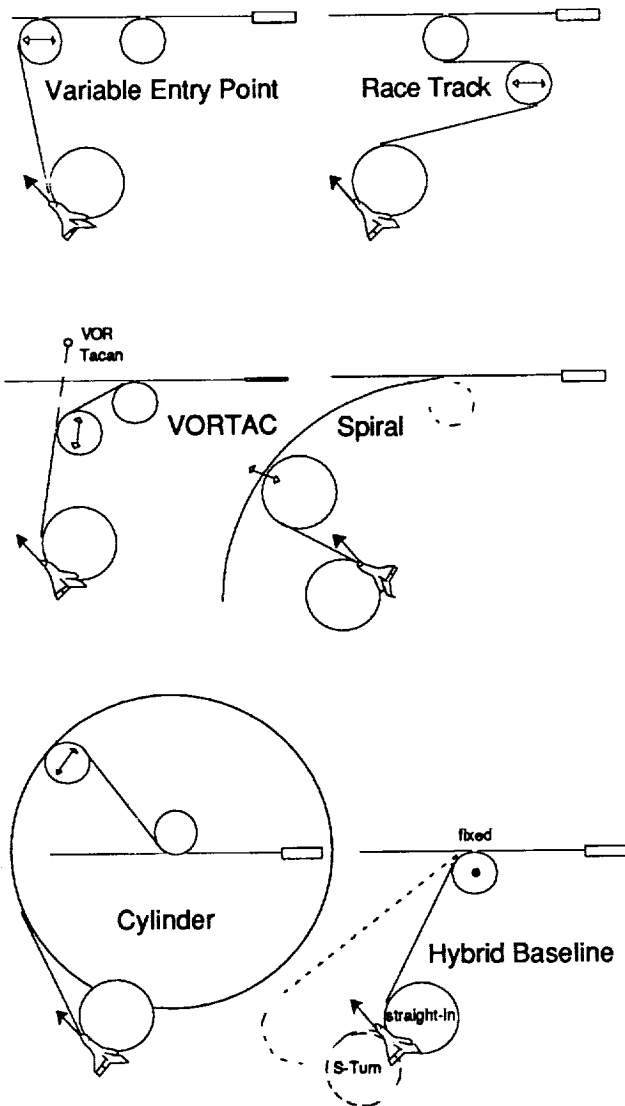

Candidate Guidance Schemes

Simplicity was a major emphasis in the formulation of the Hybrid guidance. Instead of computing a ground track to satisfy the energy dissipation required from any initial condition to a runway landing, as was done with the VEP and Racetrack, the Hybrid would use a prescribed direct path to a cylinder fixed on the same side of the runway as the vehicle. Instead of using an offset target to provide an acceptable ground track in case of a high energy overshooting approach, as was done with the VORTAC and Cylinder, the Hybrid would just turn away (S-Turn) from the target cylinder (Heading Alignment Cylinder-HAC) for extreme high energy cases, until the energy entered an acceptable level to head for the HAC. Instead of a complex coordination of both vertical and lateral channels, as was done with the Spiral, the Hybrid would separate the channels: α for vertical, and bank for lateral control.

2.1 ENERGY TO ATTITUDE CONTROL

This baseline guidance, established in 1975, was then subjected to additional testing that found some poor performance and response characteristics. This baseline performed the major task for TAEM of energy control, by controlling the energy with speedbrakes, and by controlling the dynamic pressure with normal acceleration NZ. The first problem was that a firm control of energy is not desirable for a situation where the vehicle flies toward the HAC in a tailwind, and then turns 180° into a headwind. Energy control will bias altitude (h) below nominal and dynamic pressure (qbar) above nominal so that energy remains nominal. At the end of the turn, the low h and high qbar are the reverse of what is required to fly into a headwind.

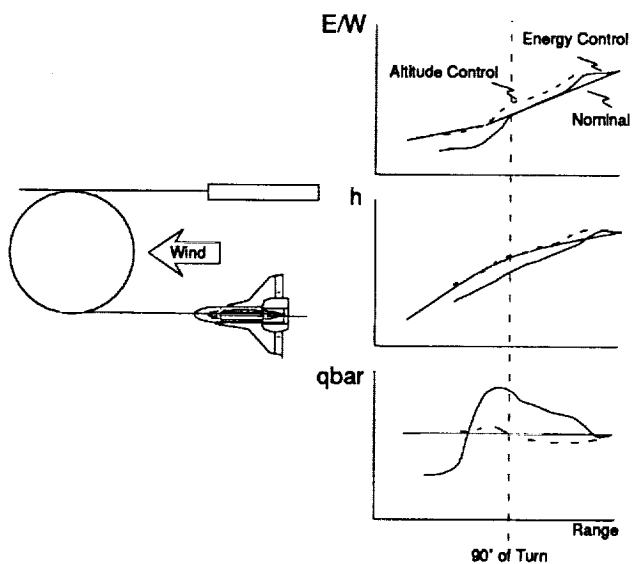

Energy Loss Turning into a Headwind

The second problem was the oscillatory response characteristics of controlling qbar with just NZ caused by qbar being a function also of drag in addition to lift (NZ).

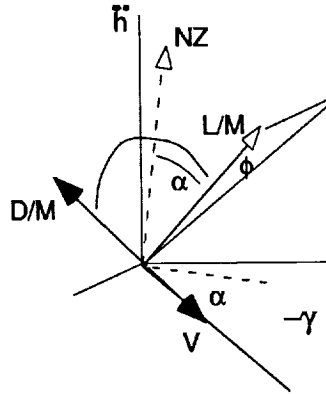

NZ Control of Altitude or Qbar

The vertical acceleration component shows close correlation with NZ,

$$g \cdot NZ = L/M \cos(\alpha) + D/M \sin(\alpha) - g \cos\theta \cos\phi$$

$$h\ddot{b} = L/M \cos(\phi) \cos(\gamma) - D/M \sin(\gamma) - g$$

i.e., exactly equal when $\alpha = -\gamma$ and $\phi = 0$, and therefore good predictable quadratic response can be expected from:

$$NZC = k_1 (hc - h) - k_2 \dot{h}$$

but, looking at qbar,

$$qbar = \rho V^2 / 2$$

where,

$$\begin{aligned} \rho &= \rho_0 e^{-Kh} \\ \dot{\rho} / \rho &= -K \dot{h} \\ \dot{V} &= -g \sin(\gamma) - D/M \end{aligned}$$

and the derivative of qbar,

$$\begin{aligned} \dot{qbar} &= 2 qbar \dot{V} / V + qbar \dot{\rho} / \rho \\ &= -2 qbar (g \sin(\gamma) + D/M) / V - qbar K \dot{h} \end{aligned}$$

shows a good correlation with \dot{h} , which by itself, would give a good correlation to NZ by the above argument. But it also has a predominant drag term, where the representative numeric example;

$$g = -12, \quad g = 32, \quad D/M = 2 \cdot 32 / 4 = 16, \quad K = 5E-5, \\ qbar = 200, \quad \dot{h} = -150$$

$$\dot{qbar} = +3 - 8 + 1.5$$

shows the -8 drag term to be larger and opposite in direction, and therefore poor unpredictable response can be expected from:

$$NZC = -k_3 (qbar_c - qbar) + k_4 \dot{qbar}$$

The change to controlling just the altitude component of energy with NZ solved both of these problems. Maintaining reference h eliminates erroneous altitude biasing of energy control, and the close relationship of NZ to altitude acceleration produces predictable and smooth response. For simplicity sake, the speedbrake was changed to the other component of energy which is velocity or $qbar$, and for the sake of approximately matching the controller of the Approach & Landing guidance, which is based on airspeed.

This altitude controller also maintains control over both energy and dynamic pressure by the utilization of midvalue limits that are calculated. This will be discussed in more detail later.

2.2 OPTIONAL TAEM TARGETING (OTT)

The Shuttle flight crew in 1976 expressed an interest in an overhead (OH) type approach as an option to the straight-in (SI) approach to the HAC. The objective is to conserve energy for subsonic dissipation in the vicinity of the runway. Another reason which became the real selling point for making the change was thunderstorm avoidance at the Cape. The altitude difference between SI and OH increases the probability for successfully flying either under or over a weather disturbance along the landing site approach.

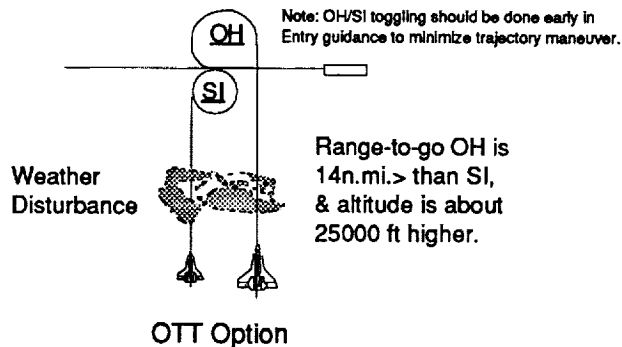

The development of this guidance modification started in 1976 as the Reverse Targeting Scheme and later became known as Optional TAEM Targeting (OTT). The initial developers and testers were the author of this paper, Vance Brand/Astronaut, Bob McNenny/MDAC, Gil Carman/JSC-MPAD, Chuck Bowser/JSC-Crew Systems, and Ellis Henry/JSC-MPAD. The initial development was on an off-line Univac batch computer, and then evolved to more detailed testing and development on the Crew Procedures Simulator-Bldg 5, Shuttle Procedures Simulator-Bldg 35, Shuttle Engineering Simulator-Bldg 16, and the Shuttle Avionics Integration Lab-Bldg 16. The first flight of OTT was on STS-5 in 1982.

In addition to the option of SI or OH, OTT added or modified the following features: 1. The Heading Alignment Circle-HAC was changed to a spiral. In three dimensions the circle is a cylinder, and the spiral a cone, and therefore the HAC is now a Heading Alignment Cone.

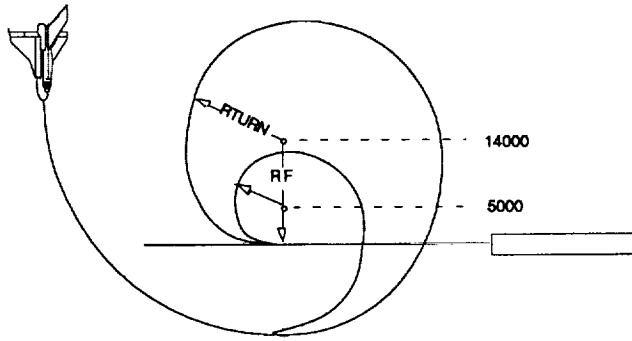

Spiral HAC

$$RTURN = RF + R_1\Psi + R_2\Psi^2$$

$$Range = (RF + R_1\Psi/2 + R_2\Psi^2/3)\Psi/57.$$

$$RF = 5K \text{ to } 14K, R_1 = 0., R_2 = .093$$

2. The HAC radius is now adjustable after the HAC turn phase starts. A low energy condition of sufficient magnitude will start shrinking the radius.

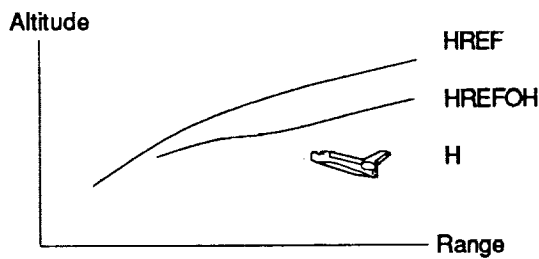

Spiral Adjustment

$$RF = RF - 0.8 (HREFOH - H) / (\partial H / \partial R \cdot \partial R / \partial RF)$$

where,

$$\partial H / \partial R = \text{Tan}(15^\circ)$$

$$\partial R / \partial RF = \Psi^\circ / 57.3$$

3. Provisions for HAC turns greater than 360° were made because Entry guidance roll reversals can wrap an OH which starts less than 360° to greater than 360° .

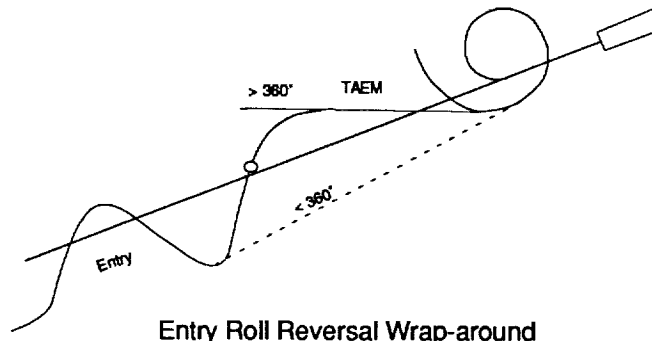

4. An energy dump phase on approach to the HAC was added to alleviate the ground track overshoot that results from large turn, supersonic HAC starts. Supersonic bank is limited to keep sonic boom overpressure low. This procedure biases the target energy lower than nominal for large turn angles, which produces a dive to dump energy, and then just prior to transonic, a pull-up maneuver targets for subsonic q_{barmin} . This converts kinetic to potential energy, allowing the HAC to be followed more closely; because the subsonic region starts sooner, the higher subsonic bank is used, and the velocity to be turned is smaller.

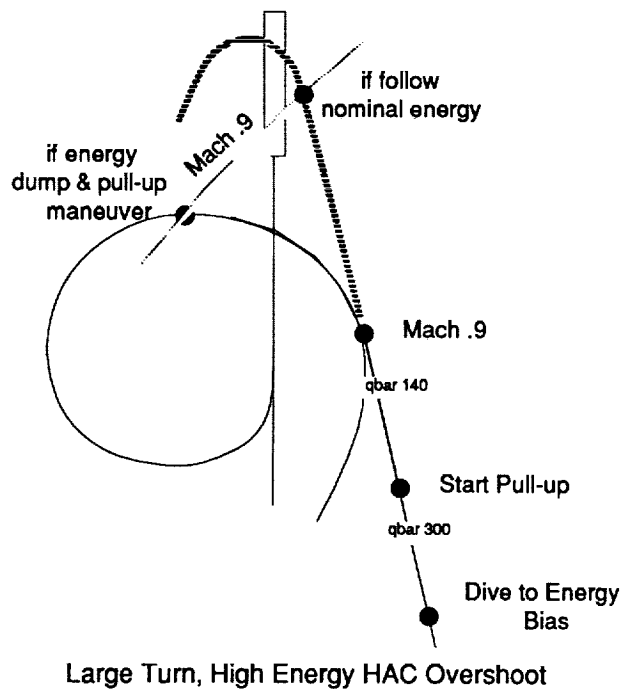

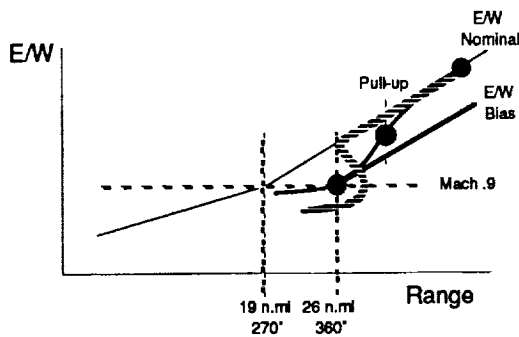

Energy Dump for High Speed Turn

5. Also this low supersonic bank limit could, with default airdata, produce a serious HAC overshoot and loss of vehicle because of delayed transonic indication from AD. The solution implemented is that the low bank limit is increased if airdata is default.

2.3 BAILOUT MODES

The bailout mode was developed to provide an automatic flight system to maintain the Orbiter in controlled flight to allow time for the crew to escape using the newly developed parachute/ pole escape system. The design requirements:

- Airloads minimized by minimizing airspeed.
- Two fault tolerance on mode engagement resulting from either crew action or hardware failure.
- Nominal manual flight operations maintained.
- Angle-of-attack constrained to airdata maximum of 20°.
- Minimize software to fit within the AP101B flight computer.

The level B changes were to set a bailout flag if mach <.95 and the pilot had both moved the abort selection switch to the Abort to Orbit position and pushed the abort PBI. The bailout flag would then force GRTLS to re-initialize to the acquisition phase.

The TAEM/GRTLS guidances monitor the bailout flag and the manual/auto status of both pitch and roll, so that command values are obtained at the point that the pilot has selected those values by going from manual to auto, individually in each axis. The pitch command selected is dynamic pressure, which is controlled with the standard logic, by making the minimum and maximum values the same as the command value. Also a new angle-of-attack pitch axis constraint is added for both TAEM and GRTLS. The roll command is simply the bank angle selected at the above snapshot. The speedbrake command is simply zero when the bailout flag is on.

2.4 SMART SPEEDBRAKE AND BANK LIMIT FOR OI22

The baseline speedbrake controller has gone from energy to qbar and now eventually back to energy although with a different formulation from the original. The change request CR89979 is scheduled for OI22, Jan 1993.

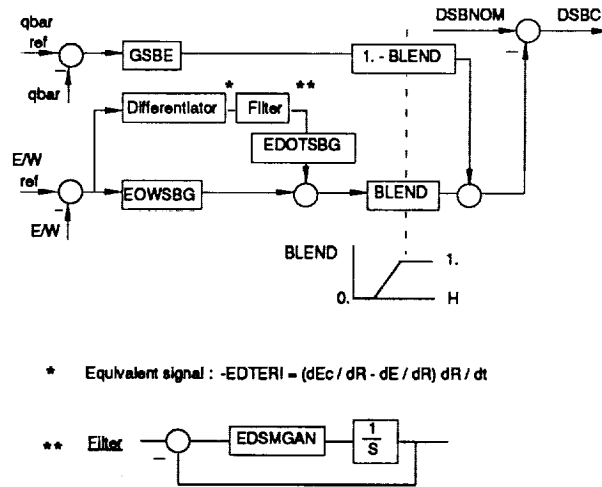

Smart Speedbrake

The present qbar algorithm generally moves the brakes in the proper direction, except in transient conditions such as a vehicle (energy & altitude) high, qbar low case. Energy will put them out, whereas θ bar will tuck them erroneously in, until the altitude channel drives the speed up.

The NZ and bank limit coordination are also included in CR89979. This will produce a cooperative coupling, such as for a vehicle high condition during a turn maneuver in a crosswind.

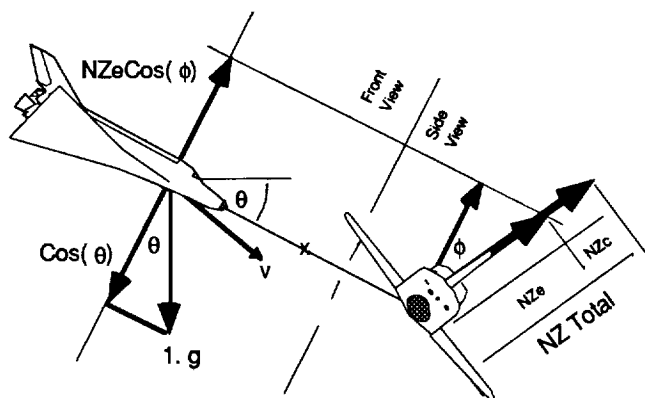

Equilibrium component of normal acceleration,
 $NZC \cos \phi = \text{Gravity } (1.0) \cos \theta$

Total normal acceleration,
 Desired limit ± 2.2 [NZ total] = $\cos \theta / \cos \phi + [NZC]$ limit $\pm .5$

To constrain NZ total to NZmax
 then solve for bank limit,
 $NZ_{max} = \cos \theta / \cos \phi_{lim} + NZC$
 $\cos \phi_{lim} = \cos \theta / (NZ_{max} - NZC)$
 $\phi_{lim} = \cos^{-1}(\cos \phi_{lim})$

Smart NZ - Bank Limiter

The new computed bank limit will provide more lateral acceleration to counter the crosswind as the vehicle pitches down toward the reference altitude. The NZ is limited for structural reasons, and now if the vertical channel does not require much lift, then the lateral channel can get more force up to the NZ limit. The reverse situation can also be found where the vertical channel can get the maximum from NZ if the lateral does not require much force.

2.5 THETA LIMITS

Erroneous airdata to TAEM could result in the NZ(qbar) control laws either overspeed overloading the vehicle, or underspeed stalling, or losing energy on the backside of the L/D curve. This can be prevented with additional constraints on NZC of upper and lower pitch limits (θ).

$$\theta_{max} = f(V, q_{barmin}, \text{Speedbrake}, \text{Bank})$$

$$\theta_{min} = f(V, q_{barmax}, \text{Speedbrake}, \text{Bank})$$

These limits can be determined empirically by flying an open loop entry simulation to the min or max qbar for various setting on speedbrake and bank. This has been done and the results were applied to the pilot displays to allow a manual override of the guidance. This could be applied to the guidance utilizing another midval limiter added to the present NZC.

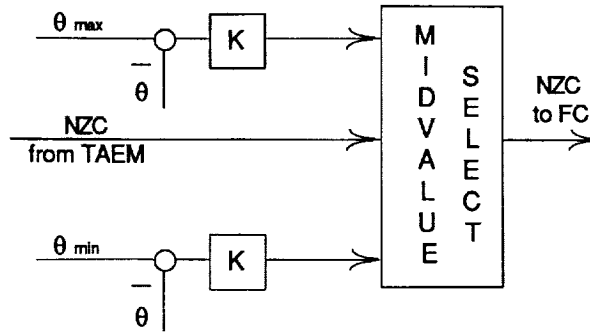

Potential Theta (θ) Limits for TAEM

An open issue though is where to place this logic. It is a guidance function, but it may require the higher computation frequency of the flight control loops.

3.0 DETAILED DESCRIPTION OF ALGORITHMS

3.1 TECHNIQUE OF CONSTRAINTS LIMITS

A utility routine MIDVAL is used throughout the guidance that selects the middle value of three inputs that can be mixtures of variables and constants or all variables. A cascade of these software devices has the effect of prioritizing constraints. For example

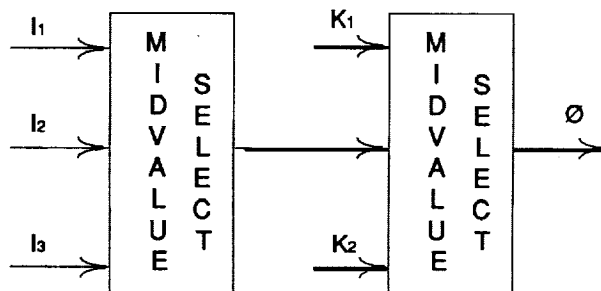

Cascaded Midval Functions

The lowest level constraints say that I_2 will never exceed I_1 , nor go below I_3 , assuming $I_1 > I_3$. The highest priority constraints say that no matter what I_1, I_2 or I_3 do, \emptyset will never go above K_1 , nor below K_2 , assuming $K_1 > K_2$.

The most detailed application of this technique is seen in the TGNZC routine of TAEM where three midvals are cascaded.

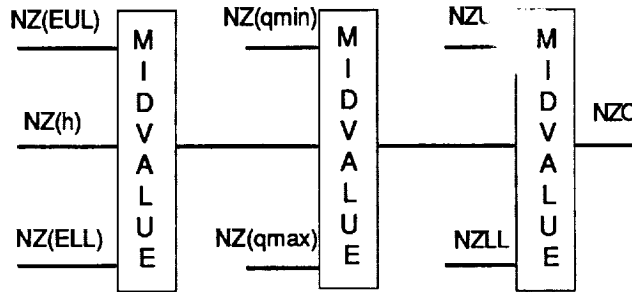

TGNZC Constraint Priorities

with the result:

1. NZ(h) is the nominal driver, so that usually $NZC = NZ(H)$
 2. But if energy goes too far beyond energy nominal then the dynamic commands $NZ(E/W_{nom}+8000)$ or $NZ(E/W_{nom}-4000)$ take over. For example, a simple straight-in approach to the runway in a headwind, could possibly not make it to the runway if the vehicle starts pitching down to a less efficient L/D as soon as h is satisfied.
- At $V = 2000$, where

$$E/W = h + V^2 / (2g) = h + qbar / (\rho * g)$$

$$\Delta E/W = \Delta h + \Delta qbar / (\rho * g) = \Delta h + V^2 * \Delta qbar / (2g * qbar)$$

$$\Delta E/W = \Delta h + 500 \Delta qbar$$

$\Delta qbar$ can be about 80 low(140) from the nominal(220) for a L/Dmax case, which then at mach 2 would be equivalent to 40,000 ft of altitude. That is E/Wnom is not achieved until h goes 40000 higher than its nominal.

3. But regardless of the h or E/W situation, a higher priority is NZ(qbar), i.e., 140 min for max L/D or 300 max for max dive. If energy were low, it would only go lower if qbar were allowed to go below qbarmin.
4. And the highest priority is vertical acceleration which prevents the wings from being pulled off trying to get to an optimum qbar.

3.2 OVERVIEW

The remaining discussion will follow the format of the FSSR's for both TAEM and GRTLS. There are unique routines for GRTLS which are given names that start with GR____. The basically common routines used by both TAEM and CRTLS are given names that start with TG____. The basic functions of TG routines between TAEM and GRTLS are the same, although they may not be exactly identical. For example, TGCOMP has more linear reference profile segments for GRTLS than TAEM.

Any I-Load constants values should be considered approximate where exact values should be obtained from the I-Load database.

The logic flow:

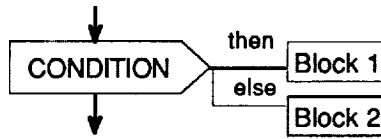

means IF (CONDITION) is true, then do Block 1, else, if false, do Block 2. Return and continue past CONDITION when finished either.

3.3 TAEM AND GRTLS EXECUTIVES - TGEEXEC & GREEXEC

The flow chart of all TAEM subroutines also shows the interface with the pilot for OTT, the various phases of TAEM, and a brief description of changes to SB & Bank with CR89979.

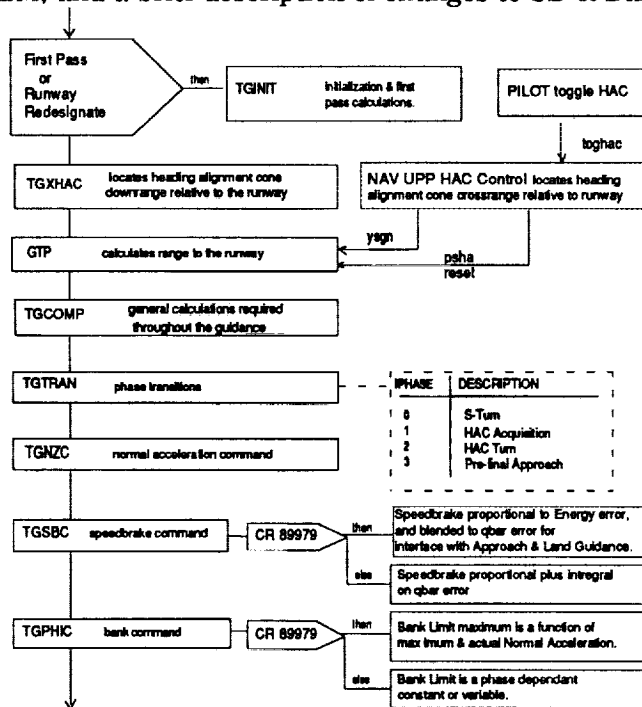

TAEM Executive Flow Logic - TGEEXEC

The flow chart of all GRTLS subroutines also shows the interface with the pilot for OTT, and the various phases of GRTLS.

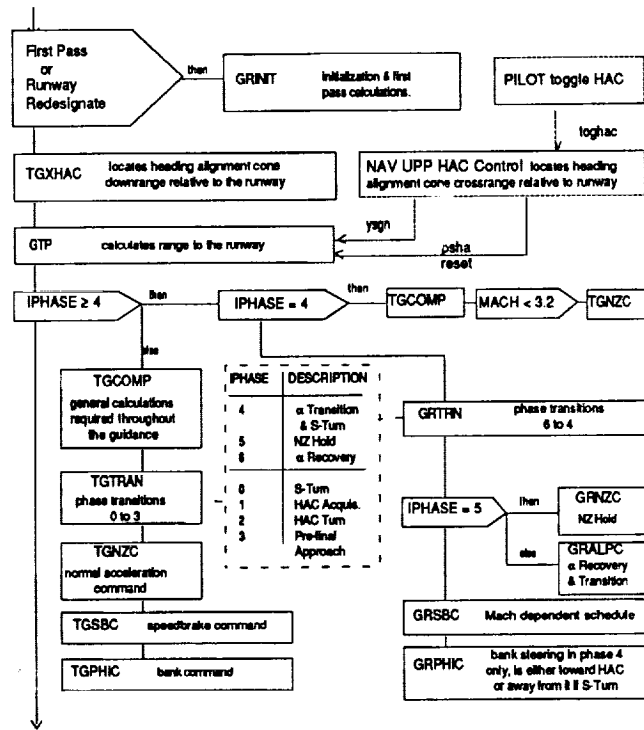

GRTLS Executive Flow Logic - GREXEC

3.4 INITIALIZATION - TGINIT & GRINIT

All variables that require initialization are done here, for either the first pass through TAEM or GRTLS, or whenever during these guidances, the opposite end of the runway or a new runway is selected.

3.5 HEADING ALIGNMENT- TGXHAC

The inplane X coordinate points of the Heading Alignment Cone are computed from the corresponding pre-flight trajectory design input (I-Load) altitude points.

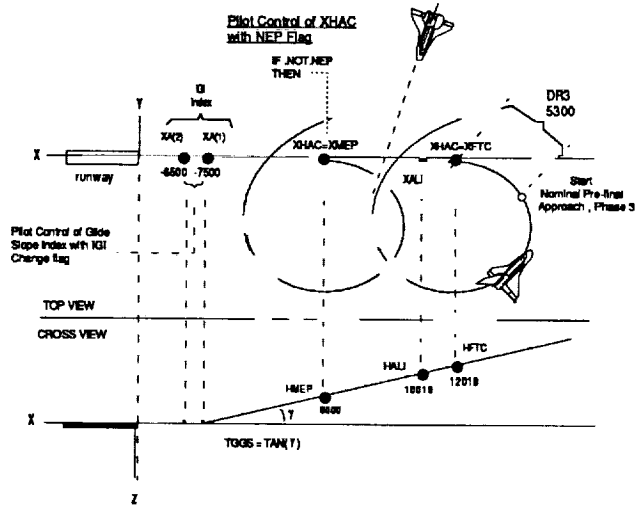

Geometry calculations of the Heading Alignment Cone
- TGXHAC

The vehicle nominally arrives in the final approach plane on the steep glide slope at HFTC prior to the Approach & Landing Guidance at HALI, but if an energy low condition were encountered and the pilot assesses that HALI will not be achieved, then the pilot can move the HAC to XMEP to shorten the range to the runway.

The adjustment of the glideslope intersect point XA (IGI) is an autoland adjustment for headwind. The adjustment should be made in TAEM, to allow time to settle on the new trajectory, but it is not intended to be a TAEM energy control variable.

3.6 NAVIGATION USER PARAMETER PROCESSOR - HAC CONTROL

The pilot can toggle the HAC between overhead (OH) and straight-in (SI) with a keyboard item entry. The software is outside the guidance and documented in the Navigation FSSR 6/30/85, pages 4-207 to 210.

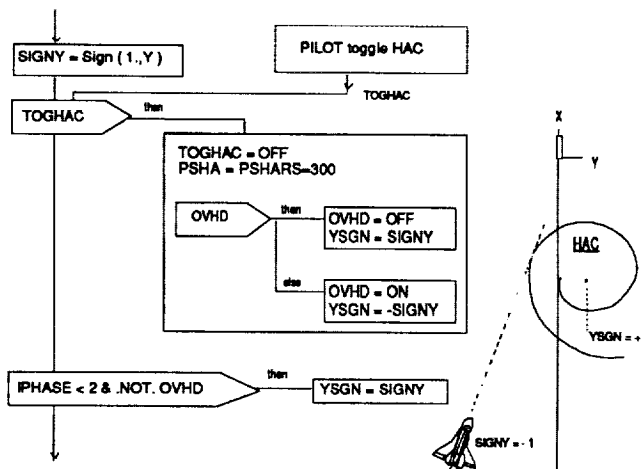

NAV UPP HAC Control

The HAC information sent to the guidance specifies the side of the runway for the HA and the targeting for either OH or SI. The HAC turn angle PSHA is reset to PSHARS at a toggle to restart properly from a potential wrap around condition where $PSHA > 360^\circ$.

3.7 GROUND TRACK PREDICTOR - GTP

The ground track, or trajectory component in the ground plane, is predicted for three major phases by calculating the turn geometry of the acquisition phase by rotating the present velocity vector toward the final turn spiral HAC, and then wings level flight to the HAC. The HAC phase distance is calculated from the acquisition point around the HAC and into the final approach plane, and then to the runway for the pre-final phase.

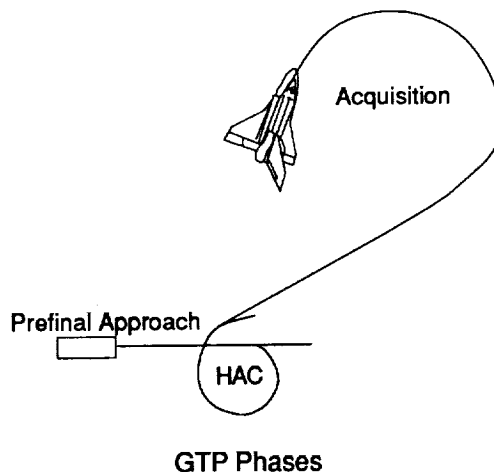

The GTP is not concerned with energy state at the present or end conditions. Other elements, to be discussed later, will guide the vehicle energy to a reference at the predicted range.

The navigation state of the vehicle and the state of the HAC are specified relative to the runway from which the GTP computes the state of the vehicle relative to the HAC and the vehicle range from the runway.

Working backwards along a trajectory, the last part of GTP is simply the direct range vector to the runway.

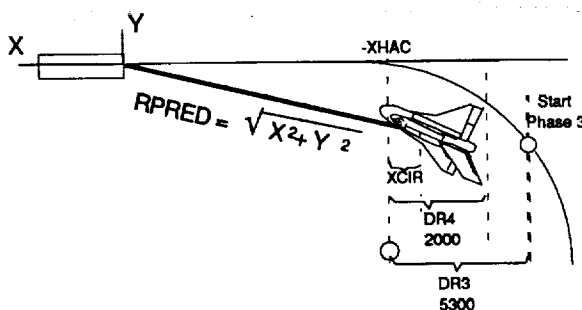

Prefinal Approach Range Prediction

This direct range algorithm used to start with the last guidance phase (3), but as part of the OTT modifications, this start was delayed until XCIR < DR4(2000) to provide a smooth range calculation transition. A smooth bank calculation transition occurs with the phase 3 point at DR3(5300 ft).

The next part of GTP is the analytical range around the HAC. For the spiral HAC,

$$RTURN = RF + R_1 \text{ PSHA(deg)} + R_2 \text{ PSHA}^2$$

(14K) (0) (0.093)

The range around the spiral,

$$RPRED2 = \int \text{Tan Vel} \cdot dt = \int (\text{RTURN} \cdot \text{PSHA} \cdot dt / 57.3) \cdot dt$$

$$\text{PSHA} = \int_0^{\text{PSHA}} \text{RTURN} / 57.3 \cdot d\text{PSHA}$$

$$= (\text{RF} \cdot \text{PSHA} + R_1 \cdot \text{PSHA}^2 / 2 + R_2 \cdot \text{PSHA}^3 / 3) / 57.3$$

and to the runway,

$$RPRED2 = RPRED2 + \text{XHAC}$$

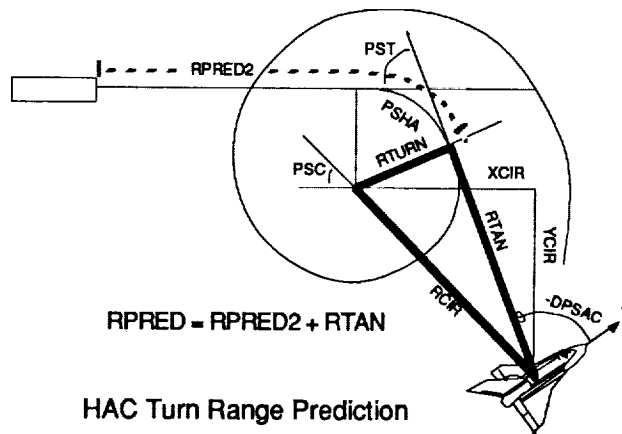

The acquisition phase establishes RTAN the same as the HAC phase. The velocity vector is then projected through a circular turn until parallel to RTAN. From that point the RC vector is projected to the HAC intersect.

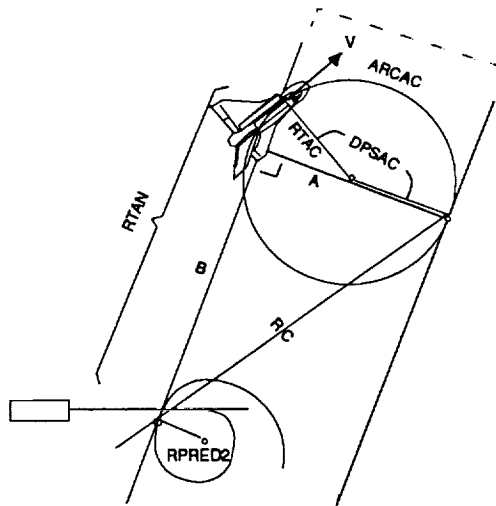

$$\text{ARCAC} = \text{RTAC} \cdot |\text{DPSAC}|$$

$$\text{RPREd} = \text{ARCAC} + \text{RC} + \text{RPREd2}$$

Acquisition Range Prediction

The circular turn radius is calculated from the present velocity and an average bank of mach.

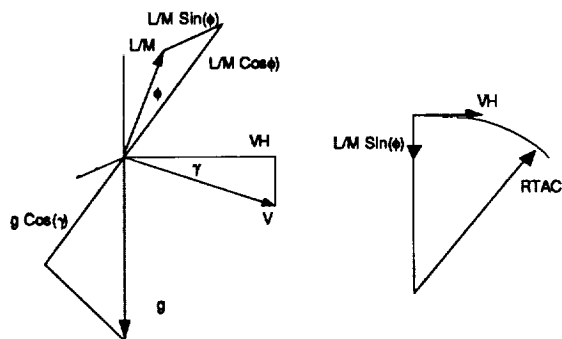
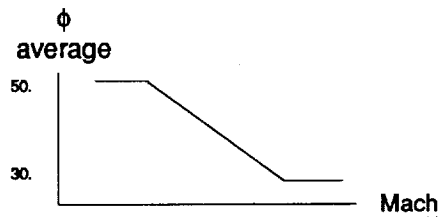

For $\dot{\gamma} = 0$,

$$L/M \cos(\phi) = g \cos(\gamma)$$

$$\begin{aligned} RTAC &= VH^2 / (L/M \sin(\phi)) = VH^2 / (g \cos(\gamma) \tan(\phi)) \\ &= VH \cdot V / (g \tan(\phi)) \end{aligned}$$

Acquisition Turn

An additional term is added for GRTLS because of the early S-Turn at high velocity with a low bank rate of only 5 deg/sec.

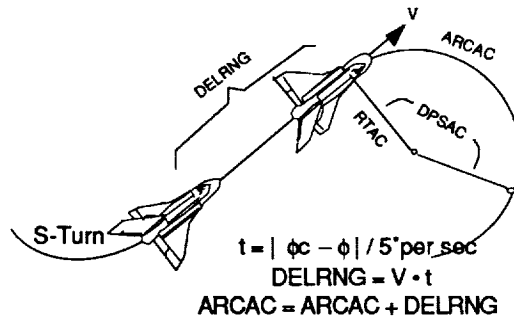

Acquisition Range Prediction
Additional Term for GRTLS

3.8 COMPUTATIONS - TGCOMP

General calculations that will be used elsewhere are basically done here, such as energy, reference values for energy, altitude and dynamic pressure, and boundary values for energy. A few exceptions, though, are that the action of filtering q_{bar} and the control of the HAC final turn radius are done here.

There are three variable indexing parameters for TAEM.: 1. IGI, which was discussed in TGHAC, has two settings for glide slope intersect for final approach; 2. IGS has two settings to allow reshaping of profiles for an optional heavy payload return from orbit. GRTLS does not have this index, because the weight is known before lift-off; 3. IEL allows two segments for TAEM and four segments for GRTLS to generate reference profiles.

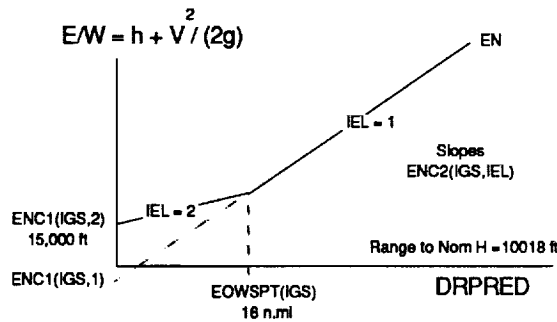

Energy Reference (Nominal) Profile

GRTLS also does additional indexing with IES, IEST and IEM to generate S-Turn and minimum energy profiles. These indexing differences are the main reason that the TGCOMP software, used by both TAEM and GRTLS, are not identical, although the functions are the same.

The objective of the Energy Dump Maneuver, in cooperation with the Pull-up Maneuver in the TGNZC, is to target for subsonic conditions at HAC initiation, to facilitate tracking the HAC.

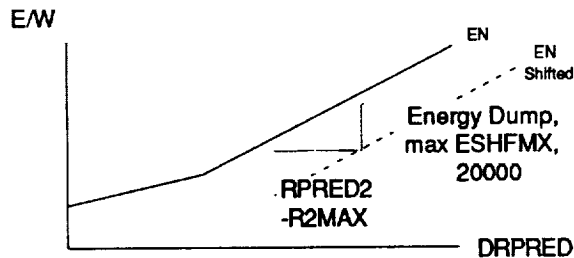
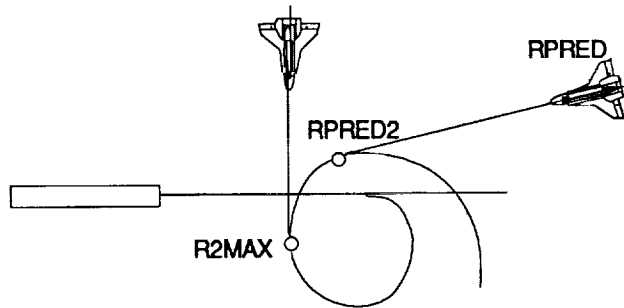

Energy Dump

The empirically determined R2MAX is the maximum value of RPRED2 to start the turn phase at the nominal energy and be at a low enough speed to track the HAC. The empirically determined ESHFMX is set to minimize energy loss for large turns > 400°.

The energy profiles are computed here and used for decisions in TGTRAN, or constraints in TGNZC. One exception is that EMOH for TAEM, but not GRTLS, is computed in TGTRAN.

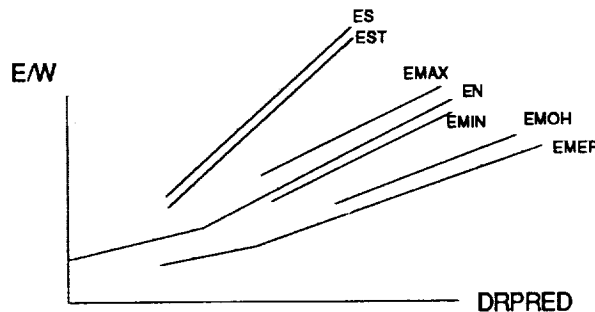

Energy Profiles

The energy boundary lines of ES and EMEP represent the limits of wings level dive or range stretch respectively. The max stretch for an overhead approach, EMOH, is less than EMEP because higher energy dissipation during the HAC turn. The EMAX & EMIN are used to constrain the altitude controller in TGNZC. Energy is a better control parameter for a straight in approach with either a wind condition where energy will bias altitude to compensate velocity, or a navigation altitude error. But altitude is a better control parameter for non-straight in wind conditions. The energy constraint on altitude tends to capture the advantages of each. The bias values from EN are empirically determined from 180° turns into either a head or tail wind on final approach.

The altitude reference is computed from linear and cubic function segments.

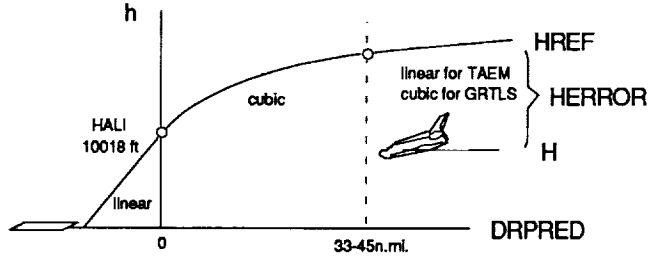

Altitude Reference Profile

The equations for the Tan of the flight path angle reference, DHDRRF, is obtained by differentiating the href equations.

The dynamic pressure reference is generated from two limited linear segments.

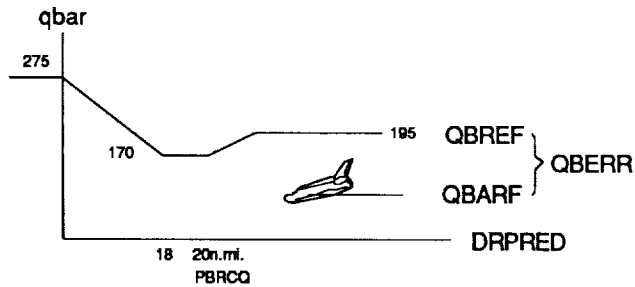

Dynamic Pressure Reference Profile

The radius of the HAC spiral at the final approach, RF, is adjusted if the altitude goes below HREFOH during the turn phase if the turn angle > 90°.

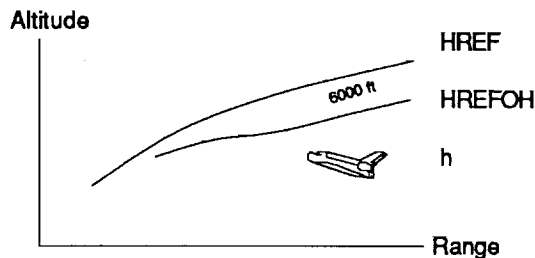

Spiral Adjustment

The adjustment utilizes a filter,

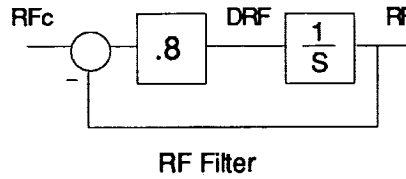

Assuming the HAC flight path angle is about 15°, then

$$h = R \tan 15, hc = Rc \tan 15$$

$$R = RF \cdot \Psi, Rc = RFc \cdot \Psi$$

Solving for command values,

$$RFc - RF = (h - hc) / (\Psi \tan 15)$$

and substituting HREFOH for command altitude for the rate of change of RF,

$$DRF = (-.8 / \tan 15) (HREFOH - h) / (\Psi \tan 15)$$

The input dynamic pressure to the qbar filter,

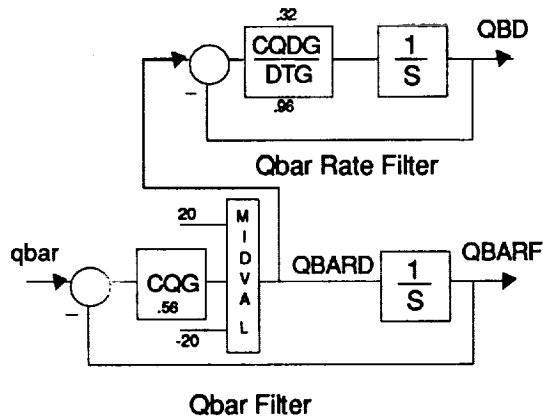

is selected from either measured airdata, if it is good and $V \leq 1500$, or from navigation derived qbar.

3.9 TAEM TRANSITIONS - TGTRAN

This routine, used by both TAEM and GRTLS, performs transition of guidance phases and issuance of alert conditions. There are additional GRTLS phase transitions in GRTRN.

IPHASE	Description	
0	S-Turn	TGTRAN
1	HAC Acquisition	
2	HAC Turn	
3	Pre-final Approach	
4	Alpha Transition	GRTRN
5	NZ Hold	
6	Alpha Recovery	
End TAEM	Start Approach & Landing Guidance	

In addition, the bailout mode is managed. When the bailout flag has been set then individually the pitch and bank flags are set for bailout control of each axis whenever auto mode of that axis has been selected after having been in manual mode. The manual mode drives to the conditions that will be held by the auto mode.

The transition out of TAEM and into AL guidance for normal non-bailout operation is a function of four error functions on h , Y , γ and $qbar$, or it is forced at h of 5000 ft. The transition criteria was provided for TAEM implementation by the AL development group.

The transition to phase 3 usually occurs at a range of $RPRED3$, but will be forced to phase 3 at $h < HMIN3(7000)$ to enable the AL transition for a low energy approach which can occur only from phase 3.

The transition to phase 2 occurs when the vehicle gets to within 10% of the turn radius.

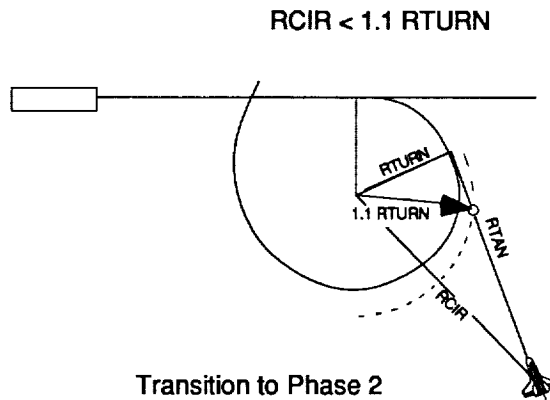

This empirical transition point provides good bank transition by avoiding the HAC overshoot of a later transition and a bank command sign reversal of an earlier transition. This earlier start problem results from the radial rate damping term for phase 2 bank command. The ideal RCIR start produces an initial bank command equal to the steady state value required for the turn.

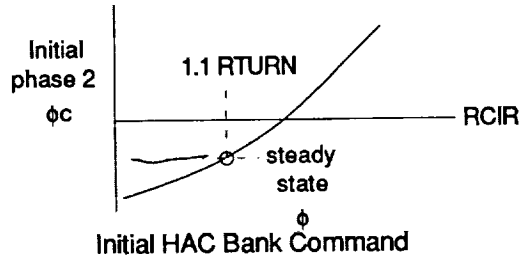

The transition to an S-Turn is done if E/W exceeds the profile line ES. The transition from the S-Turn to phase 1 occurs in TAEM when the energy returns below ES by a bias amount ENBIAS, and in GRILS when energy goes below the profile EST(see TGCOMP). The objective of the S-Turn is to do an open loop maneuver turning away from the straight-in solution until energy gets to an acceptable value(EST) for straight-in. Attention is also given to the direction of turn because a turn which intersects the HAC in the wrong direction is undesirable.

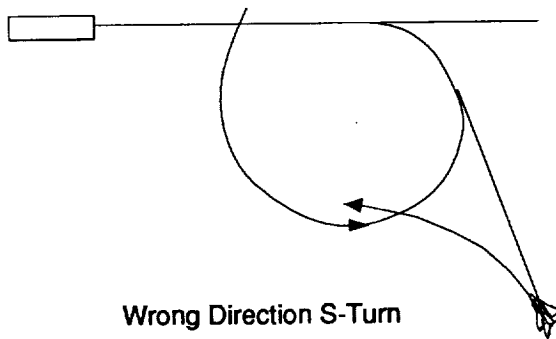

The direction of turn logic that unwraps the HAC during an S-Turn prevents this problem,

$$S \text{ (Sign of Bank, + right) } = - \text{YSGN}$$

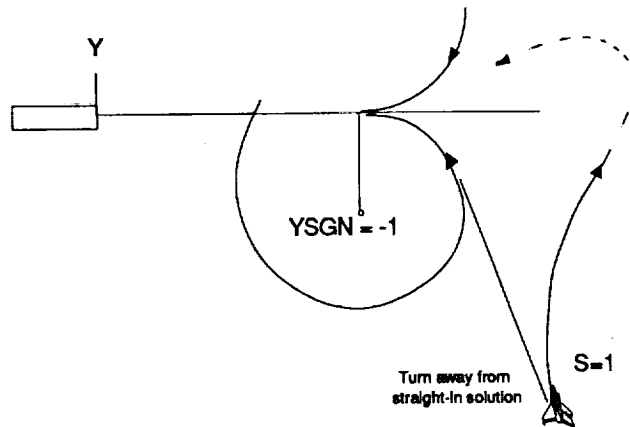

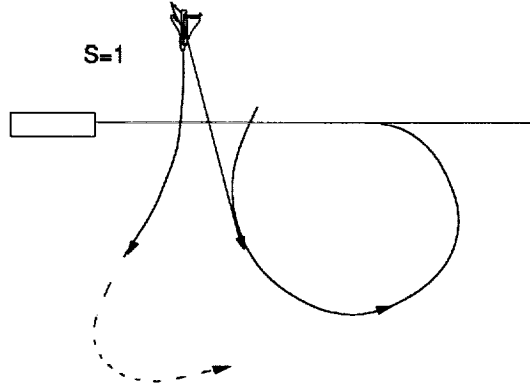

Right Direction S-Turns

Additional turn direction considerations are given for turns $< 90^\circ$.

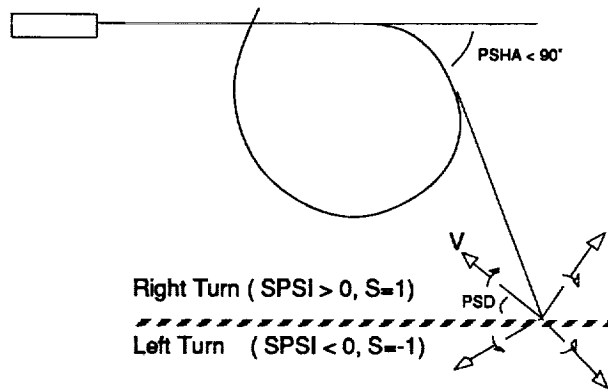

Additional Turn Direction Logic

To avoid an S-Turn geometry problem for low range condition where an acquisition solution is not achieved after the S-Turn,

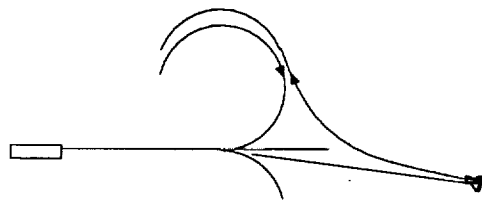

Low Range S-Turn

S-Turns are inhibited if $DRPRED < RMINST$ (20n.mi.). At this minimum range S-Turn,

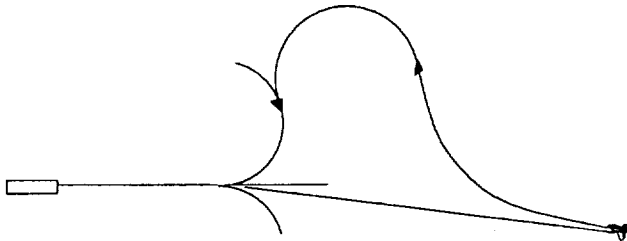

Minimum Range S-Turn

there is sufficient room to turn and acquire the HAC.

The S-Turn is also inhibited in TAEM for turn angles $> PSSTRN(200^\circ)$,

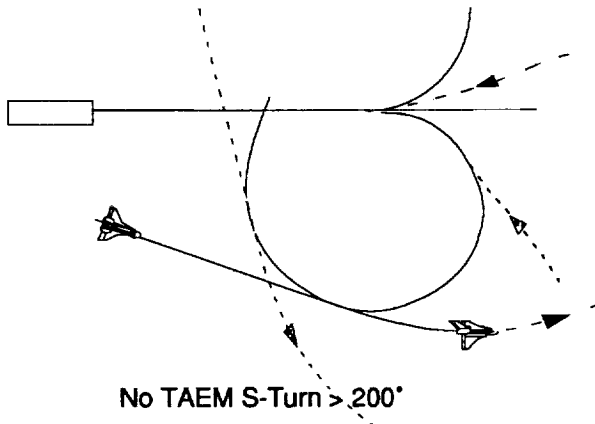

because the high energy HAC overshoot will gain enough range and transition to a satisfactory energy-range state without encountering a geometry problem.

But for GRTLS that nominally require S-Turns in phase 4, PSSTRN is set at 1000' to enable S-Turns.

Low energy alerts are issued to the pilot for his action. An energy lower than EMOH during overhead approach is suggesting to the pilot that he consider downmoding to straight in.

ORIGINAL PAGE
OF POOR QUALITY

is simply a second order controller, with the assumption that DNZC produces \dot{h} without time delay or error. The stability and response characteristics are specified by design to be at

a natural frequency ω_n , and a damping ratio ζ , determined by the products of gains and the ratios of gains.

$$\omega_n = \text{GDH} \sqrt{(\text{HDREQG} \cdot .322)} \\ = .054 \text{ to } .179$$

The gain ratio is held constant as frequency varies with altitude and therefore the damping ratio is slightly under critical damping.

$$4\zeta^2 = .322 \text{ GDH} / (\text{HDREQG} \cdot \text{GDH}) = 3.22 \\ \zeta = .9$$

A more rigorous evaluation of the altitude controller transfer function involves NZc to \dot{h} transfer.

$$\text{NZc} = \dot{h} / g$$

Assuming that Az converges to the command state, i.e., flight control gains \gg guidance gains then

$$\text{Az} = \text{NZc} + \text{Cos } \theta / \text{Cos } \phi$$

The measured acceleration is given by,

$$\text{Az} = L (\text{Cos } \alpha + \text{Sin } \alpha / (L/D)) / (Mg)$$

and altitude acceleration is given by,

$$\dot{h} = L (\text{Cos } \phi \text{ Cos } \gamma - \text{Sin } \gamma / (L/D)) / M - g$$

Solving from the above,

$$\dot{h} = Q (\dot{h} + g \text{ Cos } \theta / \text{Cos } \phi) - g$$

where,

$$Q = (\text{Cos } \phi \text{ Cos } \gamma - \text{Sin } \gamma / (L/D)) / (\text{Cos } \alpha + \text{Sin } \alpha / (L/D))$$

Substituting $\dot{h} = (\omega_n / (2\zeta)) (h_c - h) - \dot{h}$ and transforming to LaPlace, with the linearizing assumption that Q is constant,

$$h(S) = (Q \omega_n^2 h_c(S) + L(g(Q \text{Cos } \theta / \text{Cos } \phi - 1))) \\ / (S^2 + Q 2\zeta \omega_n S + Q \omega_n^2)$$

Numerical evaluation with $L/D=4$, $\alpha=10$, $\gamma=-10$, $\theta=0$, and $\phi=0$ gives,

$$Q = 1 \\ h \text{ converges to } h_c \text{ without error}$$

With $\phi = 45$, and $\omega_n = .179$,

$$Q = .72$$

h converges to $h_c + h_e$

$$h_e = g (Q \cos\theta / \cos\phi - 1) / (Q \omega_n^2) = 26\text{ft}$$

and the actual damping decreases

$$\zeta_{\text{actual}} = \sqrt{Q} \cdot \zeta_{\text{design}} (.9) = .76$$

A modification that divided $h_{dbldotc}$ by $\cos \phi$ would change this damping decrease to a small increase, .92.

The guidance has been formulated without this $\cos\phi$ division and, so far, no justification has been found for a change.

Stability analyses of Gain and Phase Margin, Root Locus, and mainly integrated simulation were conducted for the total G&C system where flight control gain is not \gg guidance gain. The next lowest gain ($q_c / \Delta\alpha$) in the flight control NZ is .47 at q_{bar} of 200 which is not much higher than the highest guidance gain of .322. The stability analyses, though, have all verified satisfactory response characteristics and control margin.

The secondary vertical controller is for the dynamic constraints of dynamic pressure and energy with NZ.

The maximum dynamic pressure constraint Q_{BMXNZ} is determined from hinge moment constraints. The minimum Q_{BMNZN} is the results from a flight at maximum L/D and is a function of weight and bank. The profiles are generated as a function of mach.

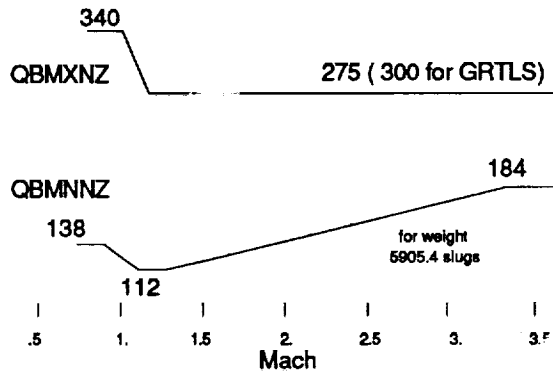

Dynamic Pressure Constraints

To facilitate trajectory tracking of the HAC, a pull-up maneuver that lowers Q_{BMXNZ} acts in cooperation with the energy dump of TGCMP to target for subsonic initial conditions for a large turn HAC. The maximum turn angle at which the HAC initiation is subsonic, with a nominal energy approach, is approximately 270° at a range-to-go RPRED2 of R2MAX. At higher turn angles the supersonic low L/D and low sonic boom bank limit can cause the range to increase at HAC initiation as the vehicle flies past the HAC.

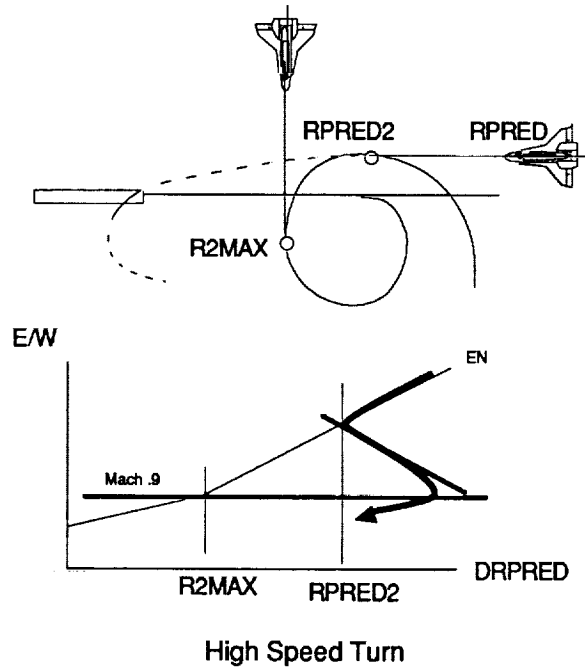

The energy dump shifts the reference energy profile to target the same energy state of R2MAX at RPRED2. The pull-up starts at an energy state EQLOWU 85,000ft, by lowering QBMXNZ by an amount depending on the range error term and any flight deviation from the shifted energy reference.

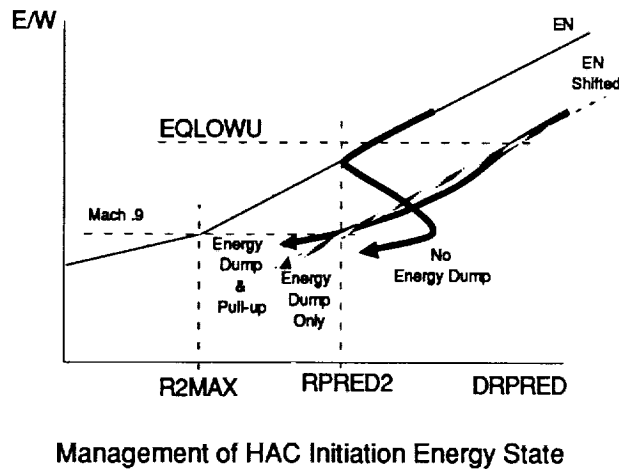

This energy dump & pull-up maneuver lowers the energy deficit that must be made up subsonically.

The secondary guidance vertical controllers for minimum and maximum dynamic pressure constraints each use the same flow diagram.

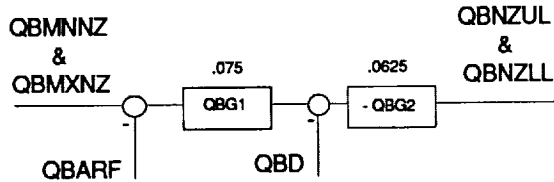

Dynamic Pressure Controller

An added feature in GRTLS is that QBG2 is a function of mach.

Analytical stability analysis of qbar is not as clean as with altitude because there is no simple relationship with NZ, but is a function of many variables and derivatives. Also, it is non-linear.

$$q\dot{b} = \rho V V\dot{b} + \rho V \dot{V}^2 + 2\rho \dot{V} V \dot{b} + \rho b \dot{V}^2 / 2$$

The alternative approach used was to determine gains and stability empirically. The response at the flight boundaries of either qbar min or max, is satisfactory. The unpredictable and oscillatory response, though when used as a primary controller, was a part of the reason for selecting altitude as previously discussed under "Energy to Altitude Control."

The secondary guidance vertical controllers for upper and lower energy constraints each use basically the same controller as altitude, except that energy error replaces altitude error, and altitude rate damping remains the same. The gains were given new names, but to date, the values have been the same.

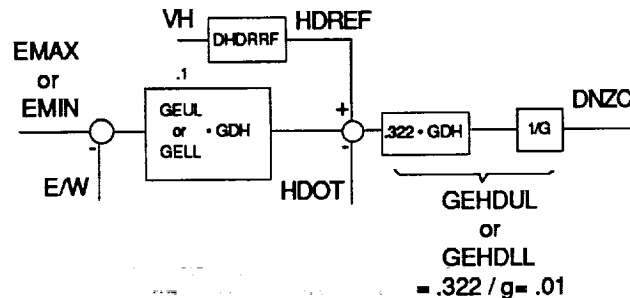

Energy Controller

This controller assigns all of the energy change to the potential component. The final energy will converge to the appropriate potential (initially unknown because the integral of drag*time is the only thing that changes energy) and kinetic components. The stability is approximately that of the altitude controller, but is mainly verified by simulation to be satisfactory.

Constraints on angle-of-attack are imposed for GRTLS only.

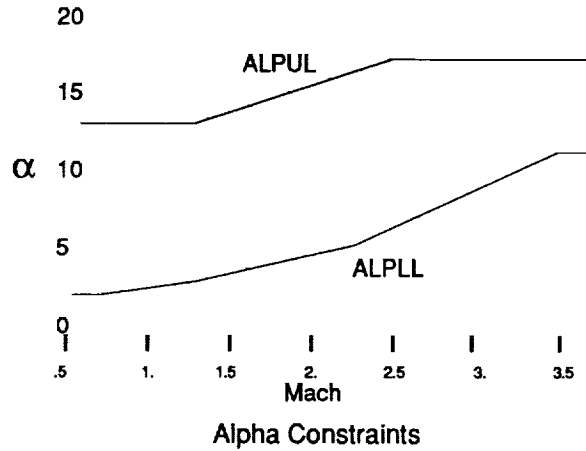

The controller for α constraints,

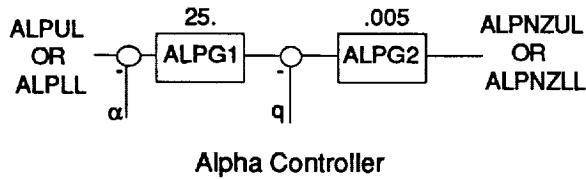

The convergence to a steady state will occur when $\dot{\gamma} = 0$.

$$\dot{\gamma} = (L/M \cos \phi - g \cos \gamma) / V = 0.$$

$$NZ = (\cos \alpha + \sin \alpha / (L/D)) L / (Mg) = DNZC + \cos \theta / \cos \phi$$

Solving for DNZC and $\alpha \varepsilon = \alpha_c - \alpha$,

$$DNZC = (C\alpha + S\alpha / (L/D)) C\gamma / C\phi - C\theta / C\phi = \alpha \varepsilon 25 \cdot .005$$

Numerical evaluation with

$$L/D=4, \alpha=10, \gamma=-10, \theta=0, \text{ and } \phi=0, \text{ and}$$

$$1.5 \quad 20 \quad 0 \quad 20 \quad 0, \text{ gives,}$$

$$\alpha \varepsilon = .1 \text{ to } 1.8^\circ$$

and therefore α converges closely to α_c .

The baseline altitude and the six other dynamic constraint signals that have been generated above are now combined using the "Technique of Constraints Limits" that was previously discussed.

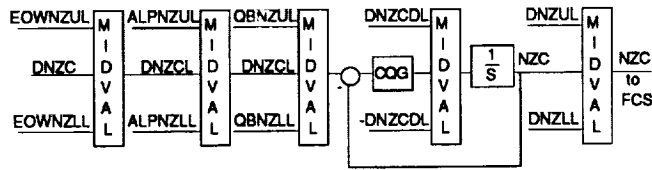

Vertical Controller Constraints and Filter

where the alpha constraints are for GRTLS only.

The bailout mode takes a snapshot of dynamic pressure Q_{BARS} whenever $bailout_pitch$ goes from false to true. The upper and lower qbar constraints are then set to Q_{BARS} so that $NZ(Q_{BARS})$ will be midvalue selected, regardless of $NZ(h, E/W \text{ or } \alpha)$, to go to the CQG filter. An additional angle-of-attack constraint is added for both TAEM and GRTLS (which replaces $ALPNZUL$ previously computed in GRTLS).

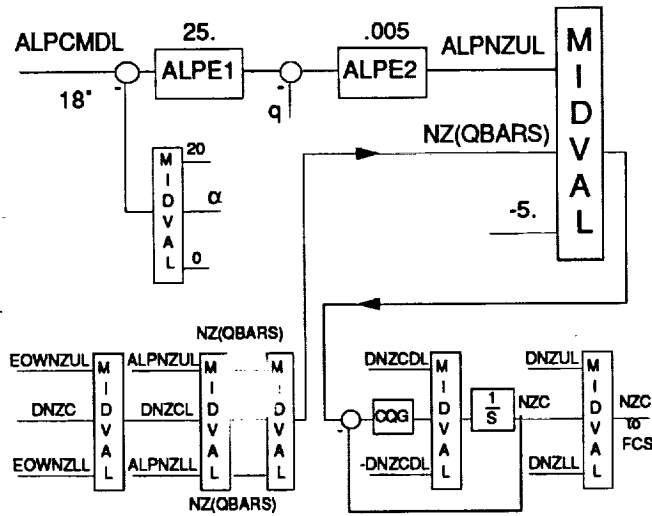

Vertical Controller Constraints for Bailout

In the pre-final approach phase 3 (and not bailout), when it is too late to do anything about energy and maximum control tightness is desired, the filter is removed and just qbar constraints are used.

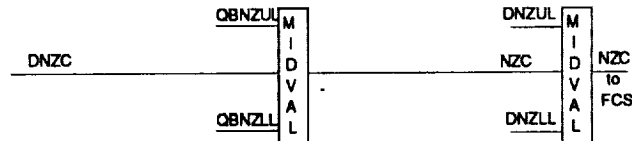

Vertical Controller Constraints for pre-final

The S-Turn bank command is simply at the bank limit, in the direction of "S", as determined in TGTRAN.

$$PHIC = S \cdot PHILIMIT$$

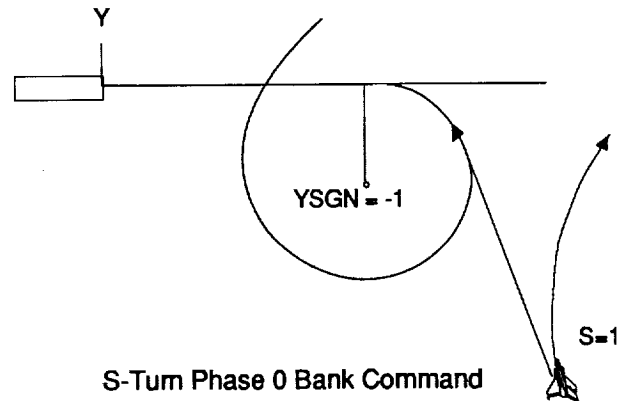

The acquisition bank command is proportional to heading error.

$$PHIC = GPHI (2.5) \cdot DPSAC$$

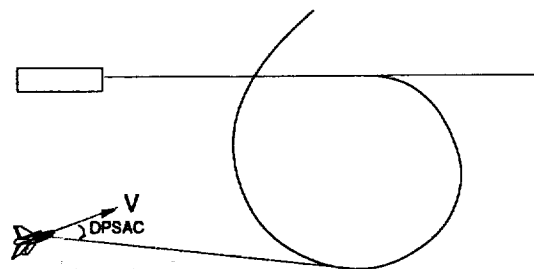

Acquisition Phase 1 Bank Command
or Phase 2 with RERRC > RERRLM (7000)

The relationship of lateral acceleration and bank with steady state vertical conditions,

$$\begin{aligned} L/M \cos \phi &= g \cos \gamma \\ L/M \sin \phi &= a \\ \tan \phi &= a / (g \cos \gamma) \\ \phi^{\circ} &\sim 57.3 \tan \phi \end{aligned}$$

The rotation rate of the velocity in degrees per second,

$$\begin{aligned} \omega &= a/V = g \cos \gamma \tan \phi 57.3 / V \\ \phi^{\circ} &\sim \omega V 57.3 / (g \cos \gamma 57.3) \end{aligned}$$

Substituting command values,

$$\begin{aligned} \phi^{\circ} &\sim \omega c V / (g \cos \gamma) \\ &= 2.5 \text{ DPSAC} \end{aligned}$$

Solving for the control gain,

$$\omega_c / \text{DPSAC} = 2.5 g \cos \gamma / V$$

This lateral controller gain is small compared to the next inner loop gain(.5 to 1.2) in the flight control,

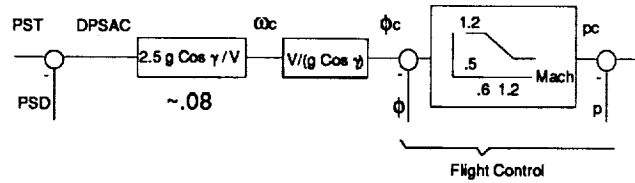

Lateral Acquisition Controller

and therefore the response is exponential at about $1/.08 = 12$ second time constant.

The HAC turn bank command is proportional to position and rate errors relative to the HAC, and includes a feed forward centrifugal force acceleration term.

$$\text{PHIC} = -\text{YSGN}(\text{Rdbldotref} + \text{GR} \cdot \Delta R + \text{GRDOT} \cdot \Delta \text{Rdot})$$

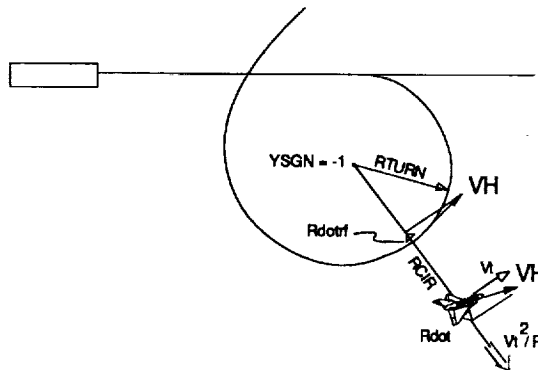

HAC Turn Phase 2 Bank Command

The relationship of lateral acceleration and bank with steady state vertical conditions,

$$\tan \phi_c = \text{Rdbldot} / (g \cos \gamma)$$

and the partial derivative,

$$\partial \phi^* / \partial \text{Rdbldot} = 57.3 \cos^2 \phi / (g \cos \gamma)$$

are used to derive the lateral controller,

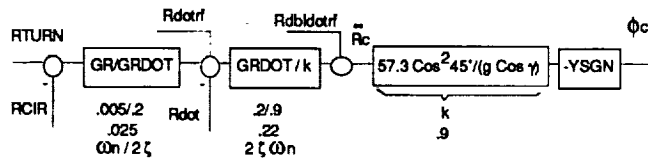

Lateral HAC Turn Controller

which has response characteristics for a natural frequency of .074, and is overdamped with damping ratio ζ of 1.5.

The reference radial rate is derived by differentiating the spiral radial command.

$$\begin{aligned}
 RTURN &= RF + R1 \cdot PSHA + R2 \cdot PSHA^2 \\
 RDOT &= (R1 + 2 R2 \cdot PSHA) \cdot PSHAdot \\
 PSHAdot &= -VH \cdot 57.3 / RTURN \\
 RDOTRF &= -VH \cdot (R1 + 2 R2 \cdot PSHA) \cdot 57.3 / RTURN
 \end{aligned}$$

The reference radial acceleration counter balances centrifugal force,

$$Rdbldotf = -Vt^2 / RTURN$$

The implementation of this term involves the conversion to ϕ_c .

$$PHIP2C = Rdbldotf \cdot 57.3 / g$$

and then a quadratic curve fit from $\tan \phi_c$ to ϕ_c .

$$\begin{aligned}
 \tan \phi_c &= PHIP2C \\
 PHIP2C &= \frac{PHI2C1 \cdot \tan \phi_c - PHI2C2 \cdot \tan^2 \phi_c}{1.13 - .0055}
 \end{aligned}$$

ϕ_c	PHIP2C
30	31.4
45	46.7
60	58.0

The pre-final bank command is proportional to lateral position and rate errors relative to the runway.

$$PHIC = -GY \cdot Y - GYDOT \cdot Ydot$$



Pre-final Phase 3 Bank Command

The relationship of lateral acceleration and bank with steady state vertical conditions,

$$\begin{aligned} \tan \phi_c &= Y_{dbldotc} / (g \cos \gamma) \\ \phi_c &\sim 57.3 Y_{dbldotc} / (g \cos \gamma) \end{aligned}$$

The lateral controller,

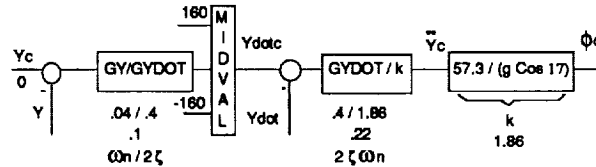

Lateral Pre-final Controller

has response characteristics for a natural frequency of .15, and a damping ratio ζ of .73.

A fader which starts at the first pre-final pass with ISR=5 allows the bank command to change by only 1/5 the difference between old and new command. On the second pass 1/4 is dumped in, and so on, until at ISR=1 the system fully uses the phase 3 PHIC.

Simulation testing revealed two oscillation problems. A case of high energy with HAC overshoot and spiral shrink can produce both situations.

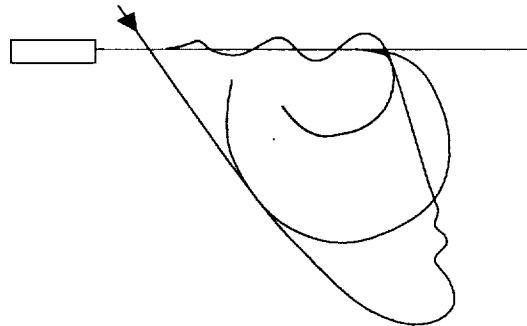

A Previous Bank Oscillation Case

For the HAC phase the oscillation was eliminated by reverting back to the acquisition bank command and its lower limits when $RERRC > RERRLM(7000ft)$. For the pre-final phase the oscillation was eliminated by allowing the bank limit to increase from 30° to 60° as the command increases to 100°.

$$PHILIMIT = MIDVAL(30,60, .43(ABS(PHIC)) + 17.)$$

The bailout mode takes a snapshot of bank, PHIC_ATS, whenever bailout_bank goes from false to true, and outputs PHIC_ATS as the bank command.

3.13 OVERVIEW OF GRTLS OPEN LOOP GUIDANCE PHASES 6 TO 4

GRTLS phases 6 and 4 use the angle-of-attack command mode of the flight control system(FCS) that is not otherwise used in TAEM. The regular normal acceleration command NZC/TAEM/FCS mode is used in phase 5.

The open loop feature of these phases is that guidance does not close the loop with longitudinal state commands to drive α or NZc, although α and NZ are of course closed loop within the FCS. An exception is that phase 4 lateral control is a guidance closed loop direction command that is either toward the HAC, or away from it for a high energy S-Turn.

The objective of this part of GRTLS is to aerodynamically reduce altitude rate after falling into the atmosphere, and to transition to front side L/D flight at mach 3.2 for normal TAEM closed loop guidance energy management. Typical GRTLS atmosphere re-entry profiles show the angle-of-attack going from about 10° at ET/SEP to, and holding, 50° for the phase 6 Alpha Recovery.

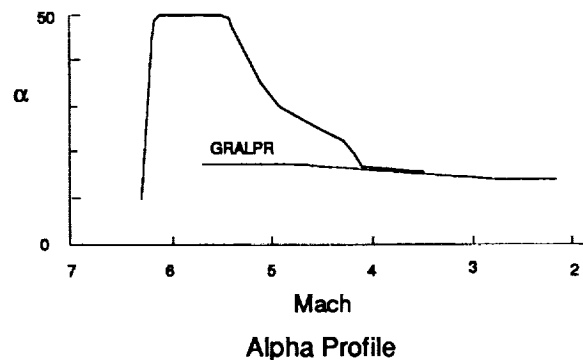

After the rate-of-descent peaks, a calculation is made for the NZ level to transition to phase 5 NZ Hold at which point a constant NZ near 2 is held to reduce the rate-of-descent.

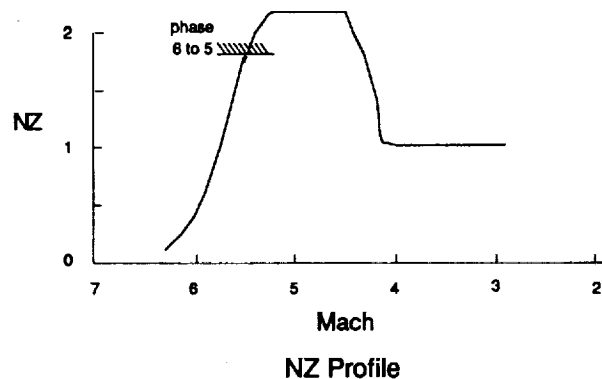

At a rate-of-descent of $-HDTRN$,

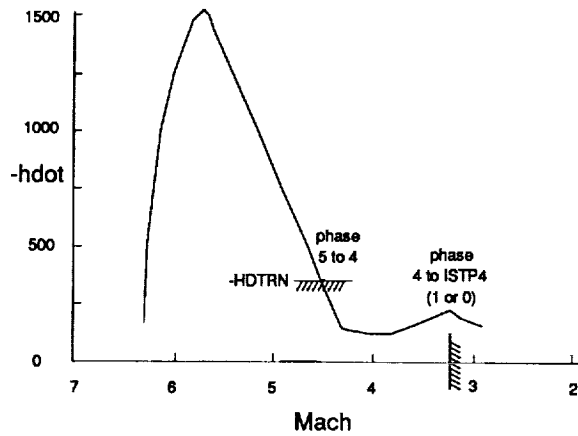

Rate of Descent Profile

the transition to phase 4 Alpha Transition, then commands alpha to a profile GRALPR, until TAEM phase 1 (or 0) starts at mach 3.2.

3.14 GRTLS TRANSITIONS - GRTRN

The transition to phase 5 occurs when NZ builds to a computed value, $NZ + DGRNZ$.

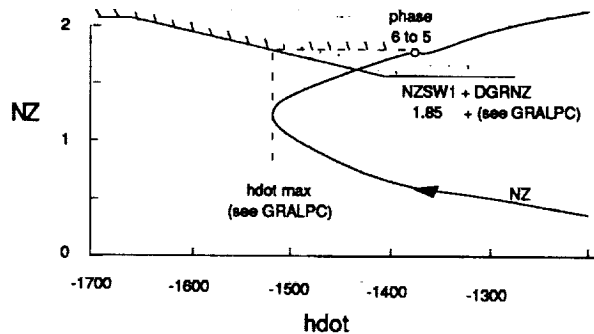

Transition Phase 6 to 5

The alpha profile to be flown in phase 4 is computed in GRTRN, so that a test with it can also be used in the transition to phase 4. The transition is mainly on $hdot > HDTRN$, but also alpha must be $> GRALPR$.

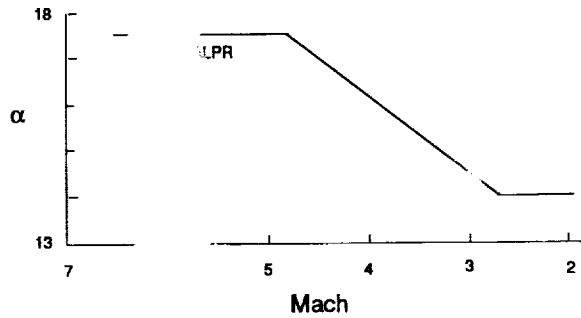

Phase 4 Alpha Transition Profile

This α is increased for phase 4 - Turns, up to the limit of AMAXLD.

$$GRALPR = \text{Min}(GRALPR / |\text{Cos } \phi|, AMAXLD)$$

A correction to NZ,

$$CORNZ = NZ - \text{Cos}\theta / \text{Cos}\phi (TAS/(TAS+VCO))$$

involves subtracting the $C\theta/C\phi$ term from the total NZ to get an initial NZC reset of the filter used in TGNZC. This replaces the level of NZC last used in phase 5 which would produce a big transient at phase 1 initiate if left alone.

The logic for transition to phase 1 (1 or 0) involves energy, NZ, and mach, but the I-Load usage of EOWL1=0, and MSW2=MSW1=3.2 produces a transition based only on mach of 3.2.

Low energy alerts are issued during phase 4 to the pilot for his action. An energy lower than EMOH during overhead approach is suggesting to the pilot that he consider downmoding to straight in.

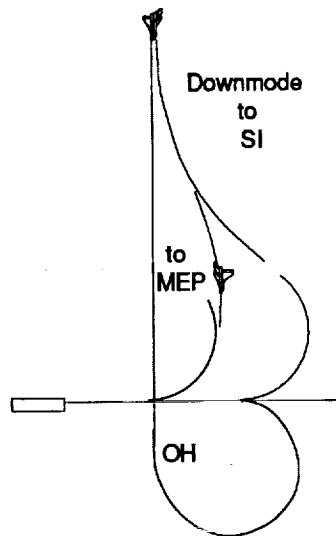

Energy Alerts

An energy lower than EMEP is advising that the HAC be moved closer to the runway.

3.15 GRTLS BODY VERTICAL ACCELERATION - GRNZC

The NZC for phase 5 is generated as a function of a linear and an exponential term to go from the initial to the final constant command value.

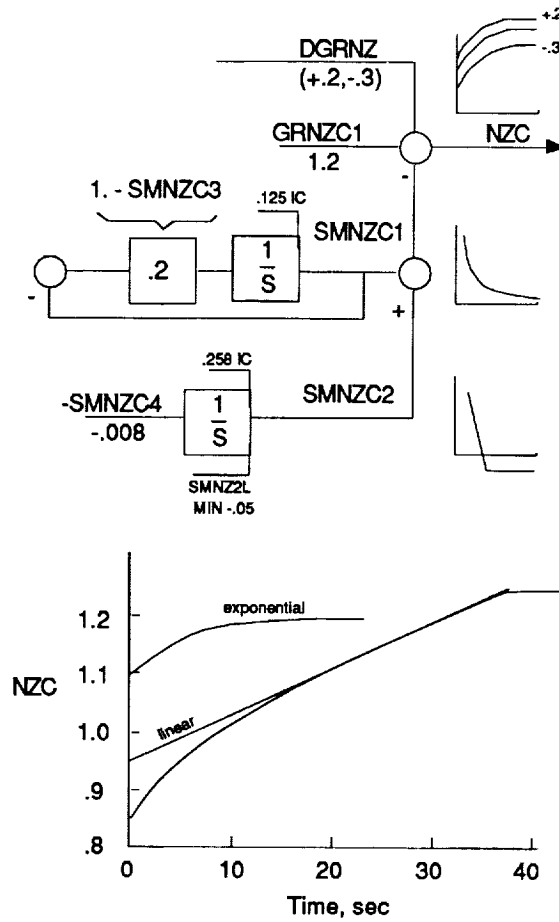

Phase 5 NZC

3.16 GRTLS ALPHA RECOVERY - GRALPC

The angle-of-attack command for phase 6 is ALPREC 50°.

The maximum descent rate is captured here, and the $DGRNZ$ used in $GRTRN$ & $GRNZC$ are calculated.

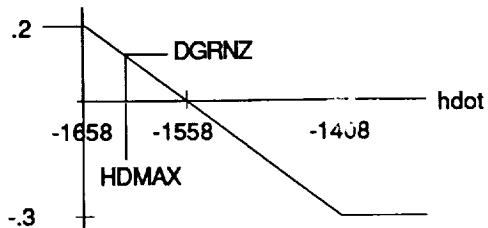

DGRNZ Calculation

$$DGRNZ = \text{MIDVAL} \left(\frac{(HDNOM - HDMAX) DHDNZ, DHDLL, DHDUL}{-1558 \quad .002 \quad .2 \quad -3} \right)$$

The angle-of-attack command for phase 4 is initialized at the α at the start of phase 4. The command is then ramped down toward GRALPR at a limit change of GRAL, $\pm 1^\circ$. When α falls below GRALPR, then α is clamped to GRALPR.

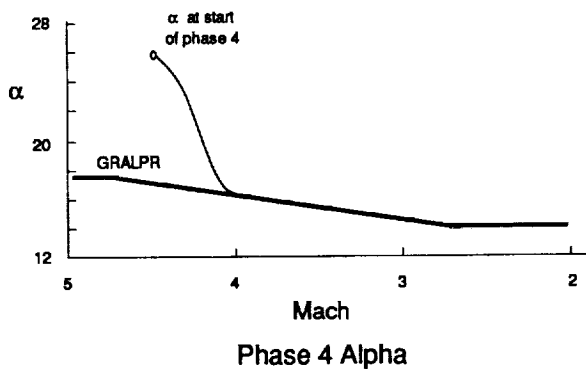

3.17 GRTLS SPEEDBRAKE - GRSBC

The speedbrakes stay tucked in at zero until pitch jets are shut off at qbar of 20.

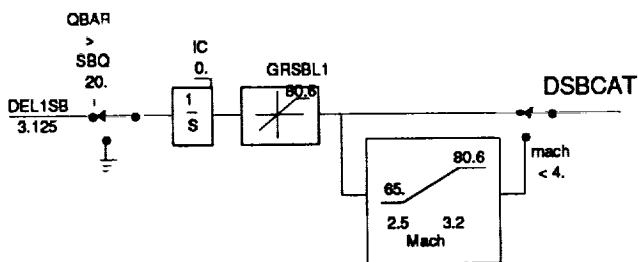

GRTLS Speedbrake

The command then ramps up to 80.6 and, then at mach 4, ramps back down to 65. for TAEM interface.

3.18 GRTLS BANK - GRPHIC

The bank command is zero until phase 4 at which point the command is the same as phase 1 in TGPHIC to acquire the HAC, and the same as phase 0 in TGTRAN for high energy S-Turns. The flag ISTEP4 tracks the S-Turn status so that the transition in GRTRN to TAEM will be either to S-Turn phase 0, or acquisition phase 1.

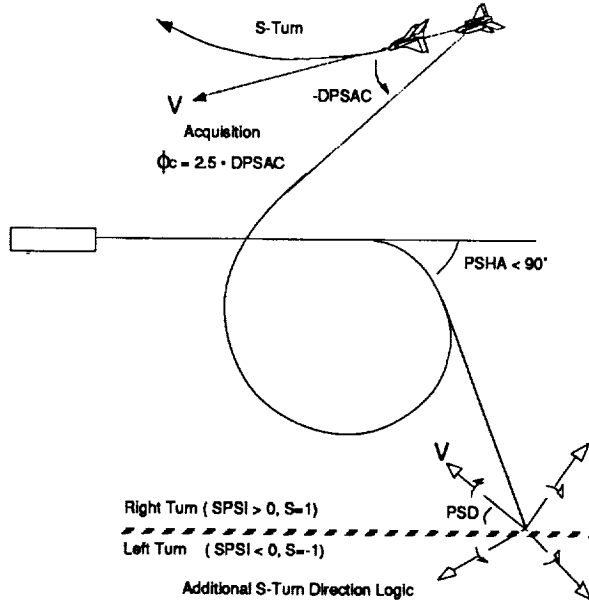

Bank Directions

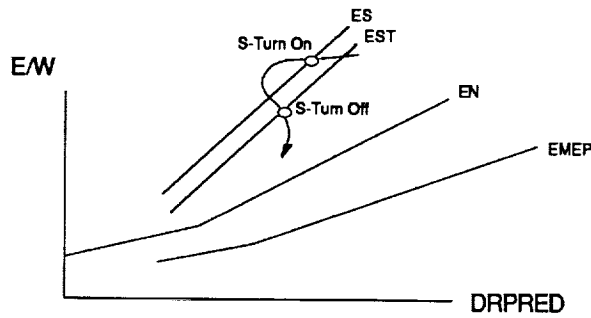

S-Turn Energy Profiles

GRTLS Phase 4 BankCommands

The only exceptions from normal TAEM operation are that mach must be less than MSW3(7.0), and the I-Load PSSTRN is set high at 1000. to enable S-Turns for all overhead approaches.

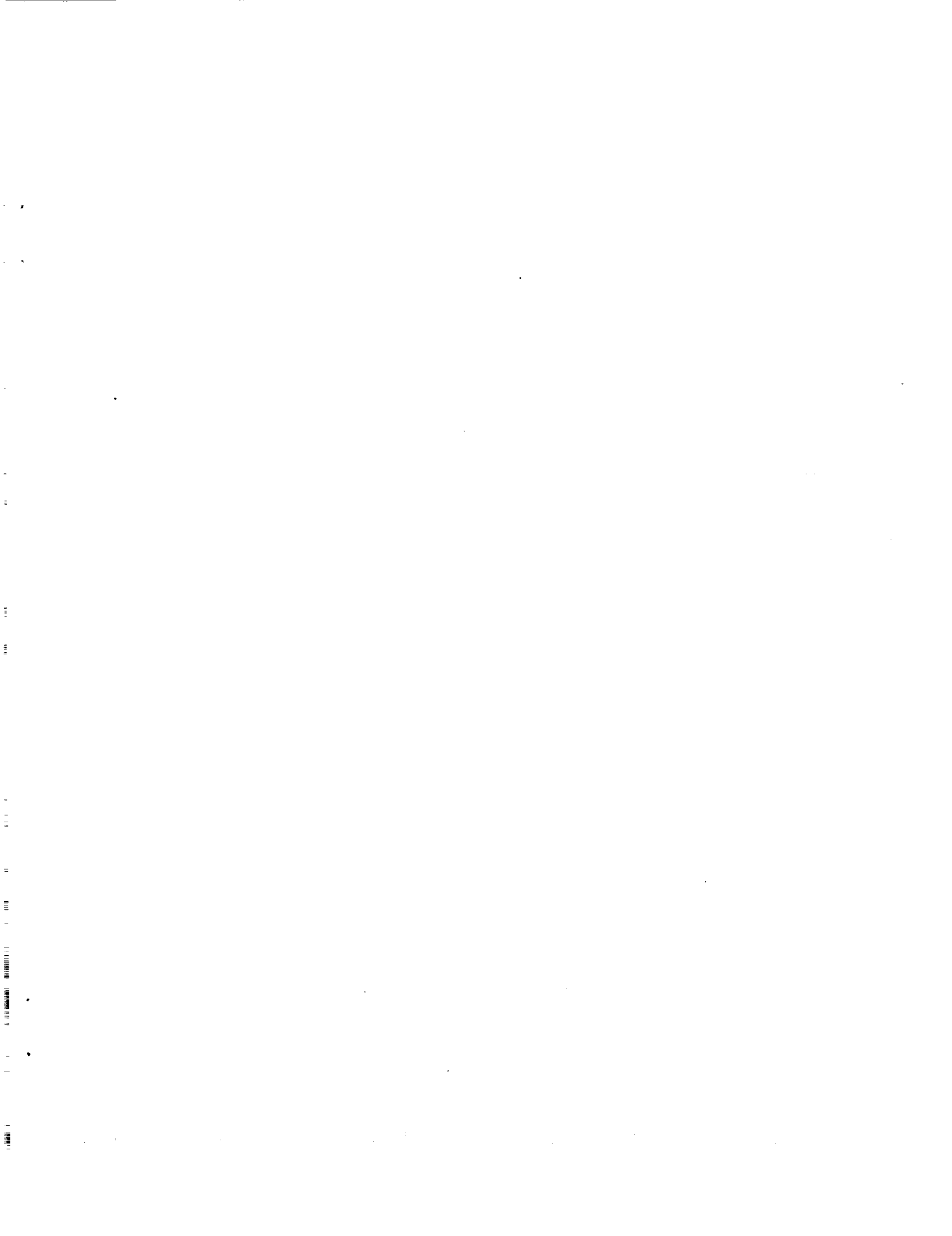

REPORT DOCUMENTATION PAGE

Form Approved
OMB No. 0704-0188

Public reporting burden for this collection of information is estimated to average 1 hour per response, including the time for reviewing instructions, searching existing data sources, gathering and maintaining the data needed, and completing and reviewing the collection of information. Send comments regarding this burden estimate or any other aspect of this collection of information, including suggestions for reducing this burden, to Washington Headquarters Services, Directorate for Information Operations and Reports, 1215 Jefferson Davis Highway, Suite 1204, Arlington, VA 22202-4302, and to the Office of Management and Budget, Paperwork Reduction Project (0704-0188), Washington, DC 20503.

1. AGENCY USE ONLY (Leave blank)	2. REPORT DATE November 1991	3. REPORT TYPE AND DATES COVERED Technical Memorandum	
4. TITLE AND SUBTITLE Space Shuttle Entry Terminal Area Energy Management		5. FUNDING NUMBERS 551-15-1216	
6. AUTHOR(S) Thomas E. Moore (NASA)			
7. PERFORMING ORGANIZATION NAME(S) AND ADDRESS(ES) Guidance and Control Branch/EG2 Ascent/Entry Section Navigation, Control, and Aeronautics Division Johnson Space Center Houston, Texas 77058		8. PERFORMING ORGANIZATION REPORT NUMBER S-661	
9. SPONSORING / MONITORING AGENCY NAME(S) AND ADDRESS(ES) National Aeronautic and Space Administration Washington, D.C. 20546-001		10. SPONSORING / MONITORING AGENCY REPORT NUMBER TM 104744	
11. SUPPLEMENTARY NOTES			
12a. DISTRIBUTION / AVAILABILITY STATEMENT Unclassified/Unlimited Subject Category 01		12b. DISTRIBUTION CODE	
13. ABSTRACT (<i>Maximum 200 words</i>) A historical account of the development for Shuttle's Terminal Area Energy Management (TAEM) is presented. A derivation and explanation of logic and equations are provided as a supplement to the well documented guidance computation requirements contained within the official Functional Subsystem Software Requirements (FSSR) published by Rockwell for NASA. The FSSR contains the full set of equations and logic, whereas this document will address just certain areas for amplification.			
14. SUBJECT TERMS Shuttle Guidance TAEM		15. NUMBER OF PAGES	
		16. PRICE CODE	
17. SECURITY CLASSIFICATION OF REPORT Unclassified	18. SECURITY CLASSIFICATION OF THIS PAGE Unclassified	19. SECURITY CLASSIFICATION OF ABSTRACT Unclassified	20. LIMITATION OF ABSTRACT Unlimited