

DESIGN, EVALUATION AND EXPERIMENTAL EFFORT TOWARD
DEVELOPMENT OF A HIGH STRAIN COMPOSITE WING
FOR NAVY AIRCRAFT

p 25

P. 25



Joseph Bruno
Grumman Aerospace Corporation
Bethpage, NY

N92-32514

Mark Libeskind
Naval Air Development Center
Warminster, PA

SUMMARY

This design development effort, sponsored by the Naval Air Development Center, addressed significant technical issues concerning the use and benefits of high strain composite wing structures ($\epsilon_{ult} = 6000$ micro-in/in) for future Navy aircraft.

These issues were concerned primarily with the structural integrity and durability of the novel/innovative design concepts and manufacturing techniques which permitted a 50 percent increase in design ultimate strain level (while maintaining the same fiber/resin system) as well as damage tolerance and survivability requirements. An extensive test effort consisting of a progressive series of coupon and major element tests was an integral part of this development effort, and culminated in the design, fabrication and test of a major full-scale wing box component. The successful completion of the tests demonstrated the structural integrity, durability and benefits of the design. Low energy impact testing followed by fatigue cycling verified the damage tolerance concepts incorporated within the structure. Finally, live fire ballistic testing confirmed the survivability of the design.

The potential benefits of combining newer/emerging composite materials and new or previously developed high strain wing design to maximize structural efficiency and reduce fabrication costs, was the subject of subsequent preliminary design and experimental evaluation effort.

INTRODUCTION

Polymer matrix composite (PMC) materials have found increasing application in the aerospace industry because of their high strength and stiffness-to-weight ratios and potentially lower unit costs. While weight savings on the order of 15-30 percent have been realized (on a component basis) in first generation applications, PMC structures have not yet met their full potential in terms of weight savings. This has been due in part to conservatism in design as a result of which strain levels have been suppressed to account for reduced performance under hot/wet conditions and the presence of notches and/or damage.

This paper reviews the technology that can lead to improved composite wing structures and associated structural efficiency by increasing design ultimate strain levels beyond their current limit of 3500-4000 micro-in/in to 6000 micro-in/in, through the development of novel and innovative design concepts and manufacturing techniques, while maintaining the same fiber/resin system and without sacrificing structural integrity, durability, damage tolerance, survivability, or repairability. A subsonic patrol multi-mission aircraft was selected as the baseline for this study.

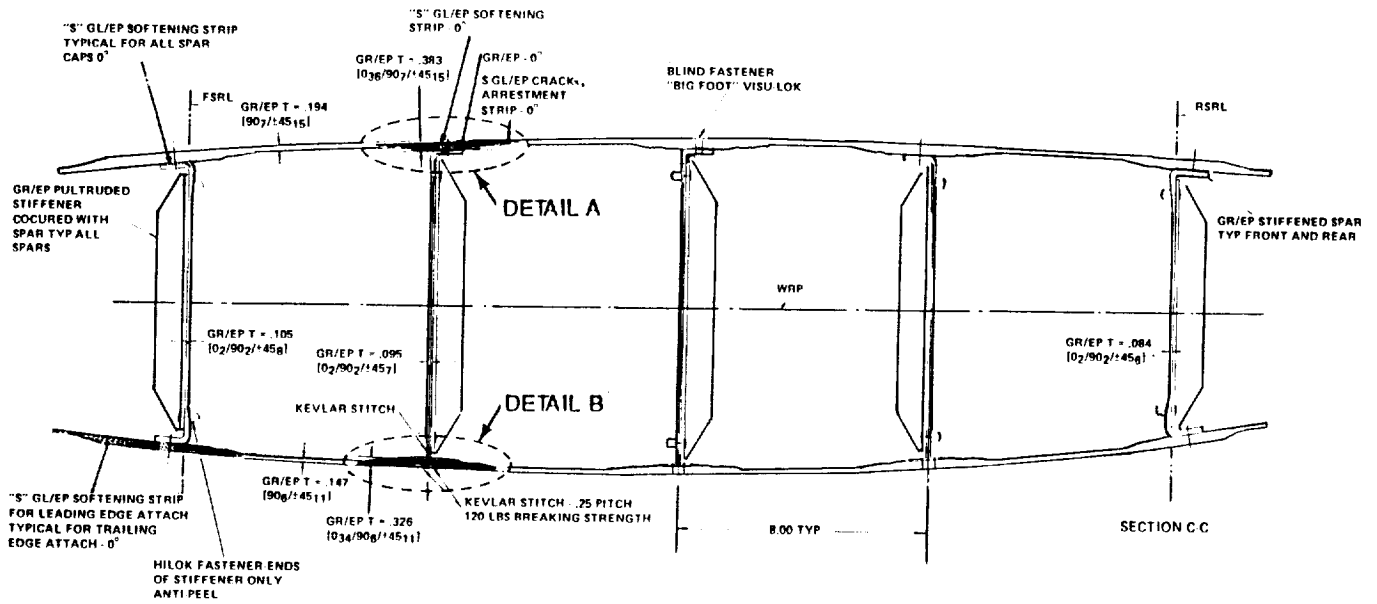
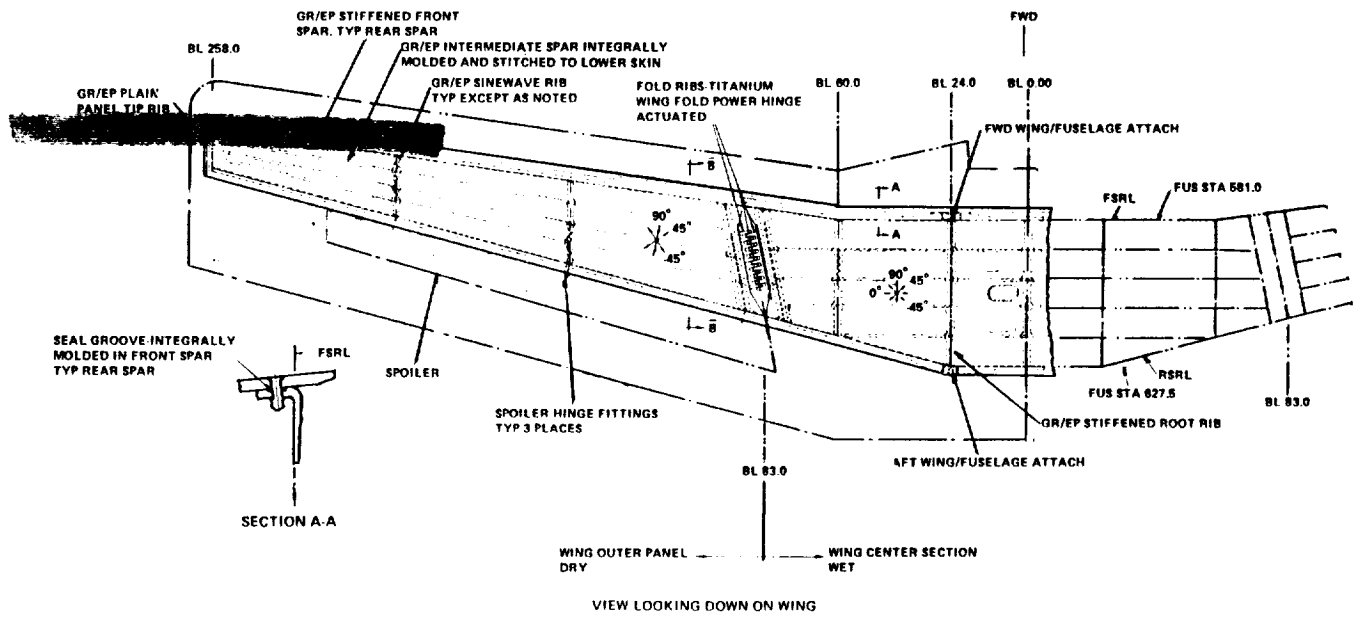

• DETAIL A

• DETAIL B

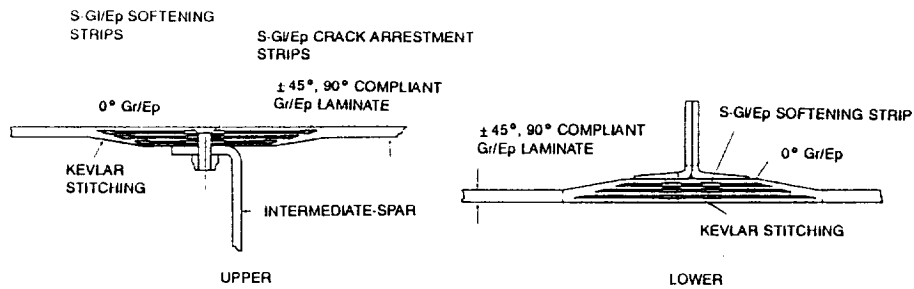

R89-0547-068

Fig. 1 High Strain Wing Planform & Structural Arrangement

Recently, a number of new PMC material systems with improved fibers and toughened resin systems have been introduced by material suppliers. Compared to existing composite material systems used on operational aircraft, the emerging new/improved composite fibers offer increased strength, stiffness, and higher strain-to-failure in the presence of a notch, while new emerging resin systems (both toughened thermosets and engineered thermoplastics) have increased toughness and improved elevated temperature/wet retention of properties. This paper also covers the potential benefits that can be realized through the combination of newer/emerging fiber composite materials with tougher resin systems and a new and/or previously developed high strain wing design in terms of maximized composite wing structural efficiency and reduced production costs.

The subject design evaluation and experimental effort provided the design data base and "know-how" needed to achieve significant improvement in structural efficiency for weight-critical structures, through exploitation of the maximum capability of existing composite materials and the introduction and use of new and improved composite materials.

HIGH STRAIN WING DESIGN DEVELOPMENT

The planform and basic geometry for a Navy subsonic multi-mission type aircraft wing baselined for this effort are shown in Fig. 1. The wing has a span of approximately 44 ft and a fold span of 16 ft, and is sized to allow installation of a conformal radar in the leading and trailing edges. The thickness-to-chord ratio (T/C) is 14 percent at the root and 12 percent at the tip with a maximum depth of 14.4 in. at the centerline. Fuel is carried in the wing box center section from fold-joint to fold-joint. Roll control in conventional flight is provided by spoilers mounted off the rear beam. The vehicle performance goals indicated a need for significant structural weight reductions over the state-of-the-art (SOA) level of composite structural design technology. A 50 percent increase in design ultimate strain level ($\epsilon_{ult} = 6000$ micro-in/in) to achieve a 20 percent weight reduction goal over a SOA composite wing was needed in part to achieve the vehicle performance goals.

Design criteria established for this effort are presented in Fig. 2. The environmental conditions were established based upon aircraft operating temperatures, mission profiles and typical deployment areas. Damage tolerance requirements are similar to current design requirements, i.e., ultimate load

WEIGHT:	20% WEIGHT REDUCTION FROM CURRENT SOA COMPOSITE DESIGN
STRAIN LEVEL:	6000 MICRO-IN/IN. DESIGN ULTIMATE STRAIN FOR TENSION AND COMPRESSION COVERS
ENVIRONMENTAL CONDITIONS:	160 DEG F AND 1.3% MOISTURE
DAMAGE TOLERANCE:	SUSTAIN DUL AFTER LOW ENERGY IMPACT
SURVIVABILITY:	EXPERIENCE SINGLE HIT BY 23MM HEI PROJECTILE AND RETAIN CAPABILITY TO CARRY DESIGN LIMIT LOAD
MAINTENANCE:	ONE COVER REMOVABLE FOR INSPECTION & REPAIR
FUEL CONTAINMENT:	DESIGNED TO WITHSTAND MAX FUEL PRESSURES; HYDRODYNAMIC RAM EFFECTS CONSIDERED

R89-0547-069

Fig. 2 High Strain Wing Design Criteria

capability with the presence of low energy impact damage (LEID). Survivability considerations required the structure to carry limit load following a single hit from a ballistic projectile and to tolerate hydrodynamic ram effects due to high energy impact. Supportability requirements dictated that one cover be removable for maintenance and repair. This requirement eliminated the use of blind or interference type fasteners from the design. In addition, removable access panels for maintenance of internal wing systems were included in the design. Finally, the wing box is an integral fuel containing structure and was therefore designed to withstand maximum fuel pressures encountered during refueling or flight conditions.

During the initial phase of the program, numerous design concepts and structural configurations with the capability to operate at significantly higher strain levels were generated to identify the maximum weight savings. Design studies were performed on two levels: structural arrangement and structural component geometry. Typical variations in structural arrangement (the quality and location of structural members) included both multi-spar and multi-rib designs as shown in Fig. 3. Certain structural geometries (the physical shapes and proportions of structural system elements) are more efficient than others for a particular type of loading. The various structural geometric configurations investigated for the cover and substructure components are illustrated in Fig. 4 and 5. The optimum cross-sectional area (i.e., least weight, height/width/thickness combination) for each structural configuration was determined so that the various geometric shapes could be compared on a common basis.

The major thrust of the design and trade study effort, however, was the definition of notch strain concentration reduction techniques in the highly strained 0-deg. Gr/Ep plies. Since fastener holes are the most common form of notches in the composite wing design (and therefore one of the major limitations in achieving increased design allowable strains) several design approaches were studied to eliminate the notch sensitivity effects of the fastener holes in the 0-deg Gr/Ep. These techniques, also shown in Fig. 4 and 5, include the utilization of compliant high strain-to-failure laminates with concentrated and unnotched 0-deg plies; use of S-Gl/Ep softening strips to locally replace highly strained 0-deg Gr/Ep plies in those areas affected by a bolt hole; use of Kevlar/epoxy (K/Ep) stitches for cover-to-substructure attachment to reduce significantly the notch concentration effect over that of a standard attachment bolt; integral construction techniques whereby cover and stiffener/substructure elements are integrally cured in a single autoclave operation eliminating bolt holes and their associated notch concentration effects entirely; and cover-to-substructure attachment at reduced box chordal height where strains are lower.

The configuration selected for detail development was a multi-spar wing consisting of five spars outboard of the wingfold, six inboard, and 15 ribs. The basic upper and lower covers are compliant high strain-to-failure Gr/Ep (AS1/3501-5A) laminates consisting of 90 and ± 45 -deg plies only. The required axial load carrying 0-deg plies are concentrated and banded in discrete caps over the spar supports. The upper cover is attached to the substructure with mechanical fasteners through nut-plates, which satisfies the requirement for cover removal for maintenance and repair. O-rings are used under the heads of the fasteners in the fuel tank area. An S-glass/epoxy (S-Gl/Ep) softening strip locally replaces the 0-deg Gr/Ep plies in the vicinity of the discrete cap affected by the fastener holes, thereby eliminating the resulting strain concentration in the 0-deg Gr/Ep. The lower cover is integrally co-cured and stitched to the intermediate spars, which eliminates mechanical fasteners and associated strain concentrations caused by the holes to accommodate fastener installation. The high tensile strength K/Ep stitches

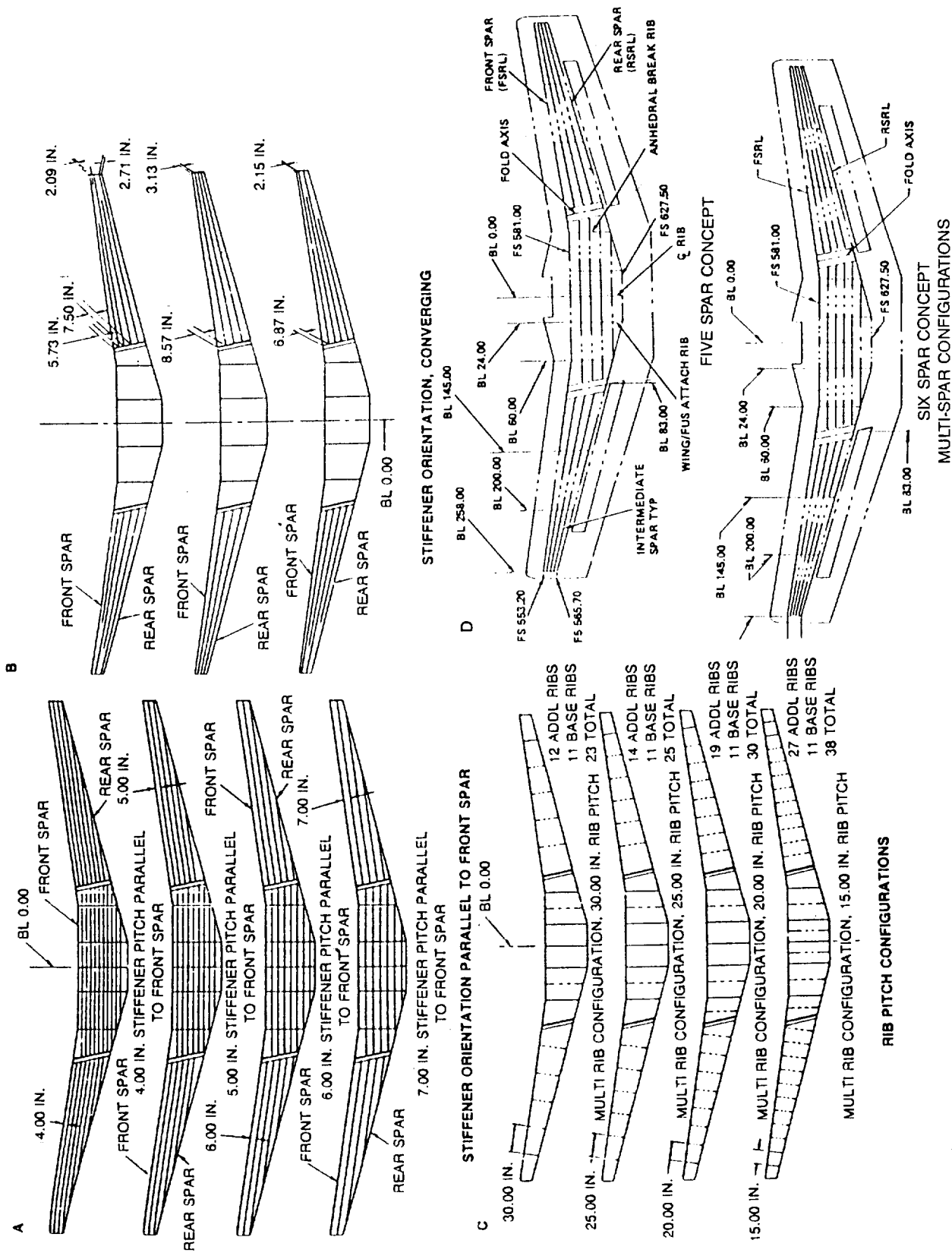

R89-0547-070

Fig. 3 Typical Structural Arrangement Trades

ORIGINAL PAGE IS
OF POOR QUALITY

Multi-Spar Cover Concepts

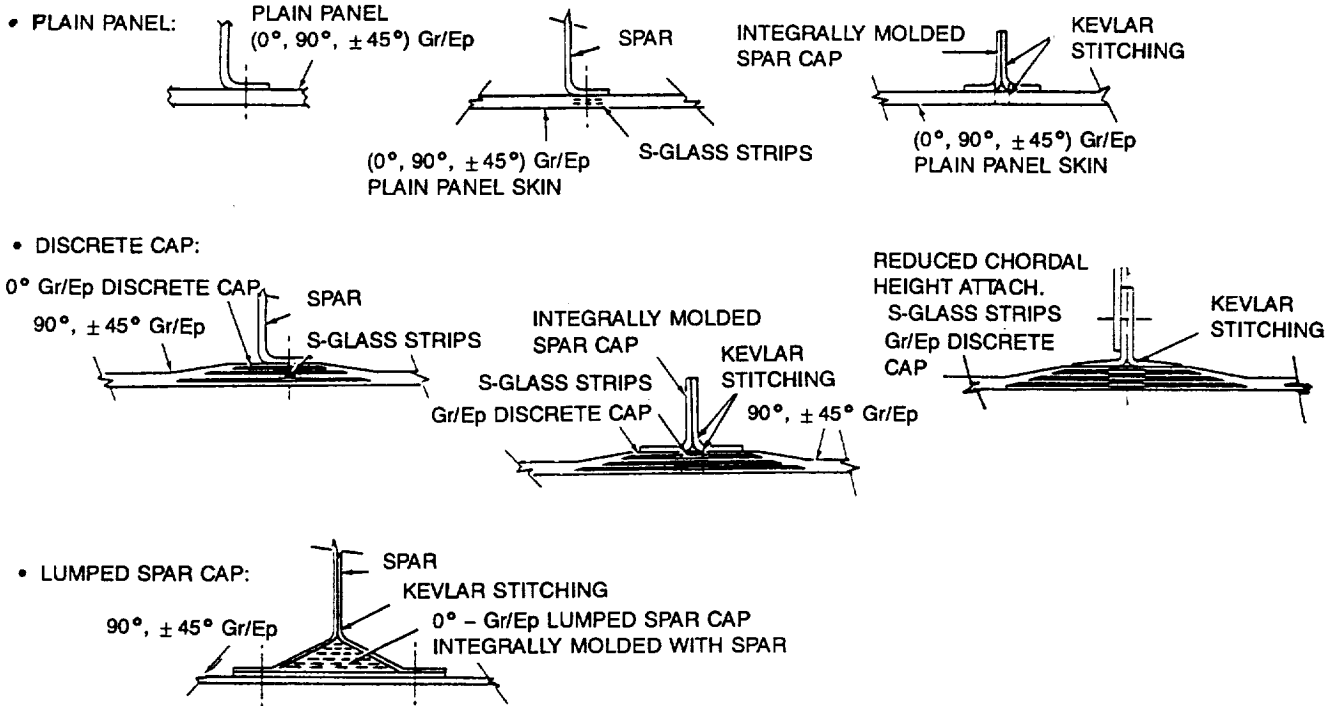

Multi-Rib Stiffened Cover Concepts

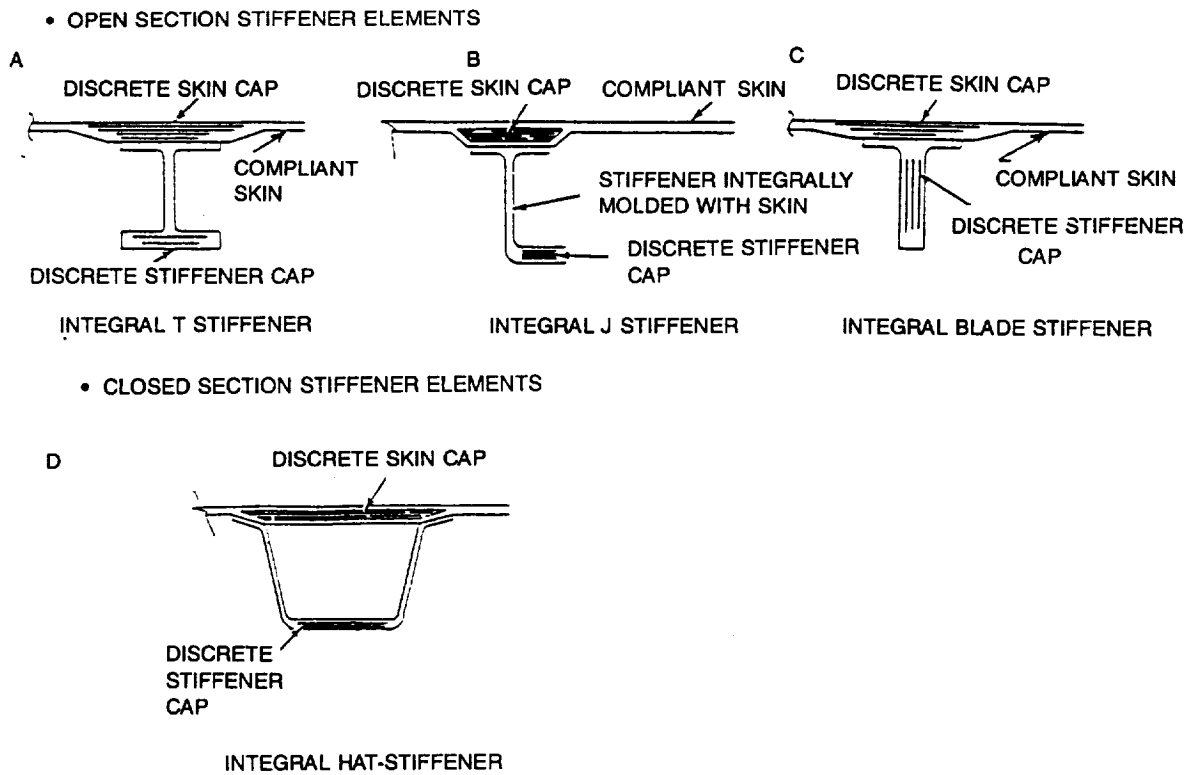

R89-0547-071

Fig. 4 Typical Cover & Notch Strain Reduction Concept Trades

Spar Concepts (Multi-Spar & Multi-Rib Designs)

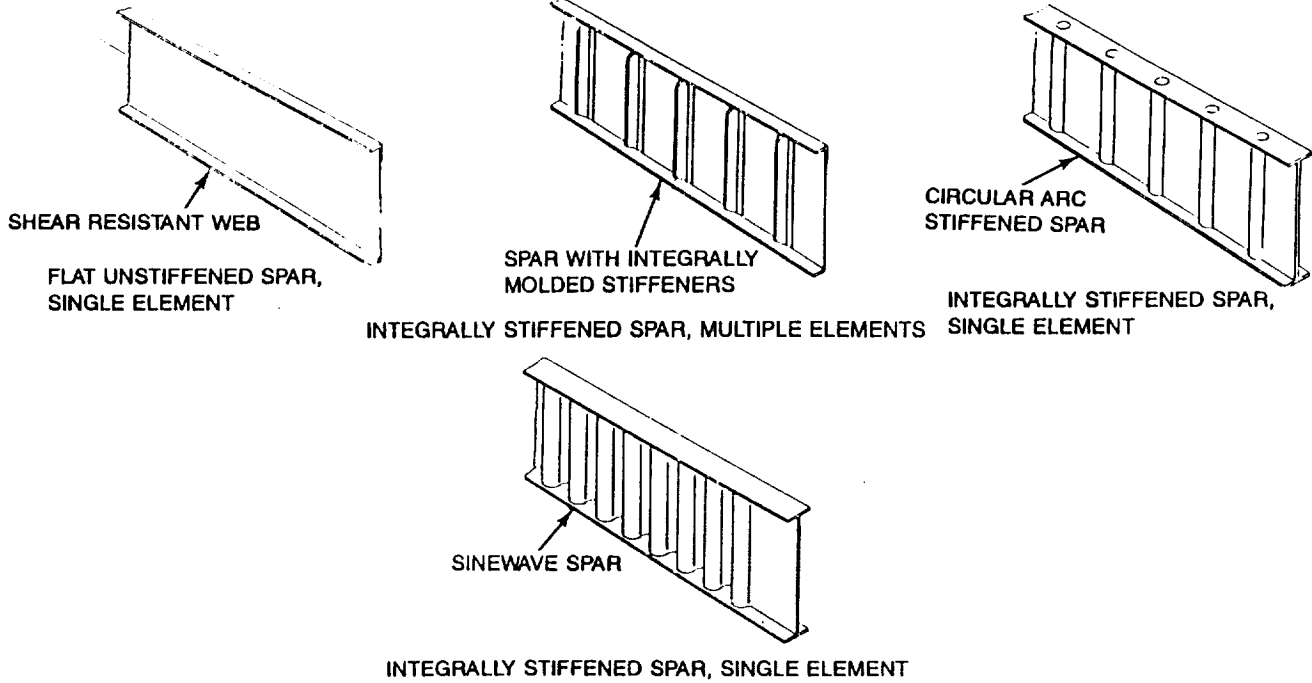

Rib Concepts (Stiffened Cover Types)

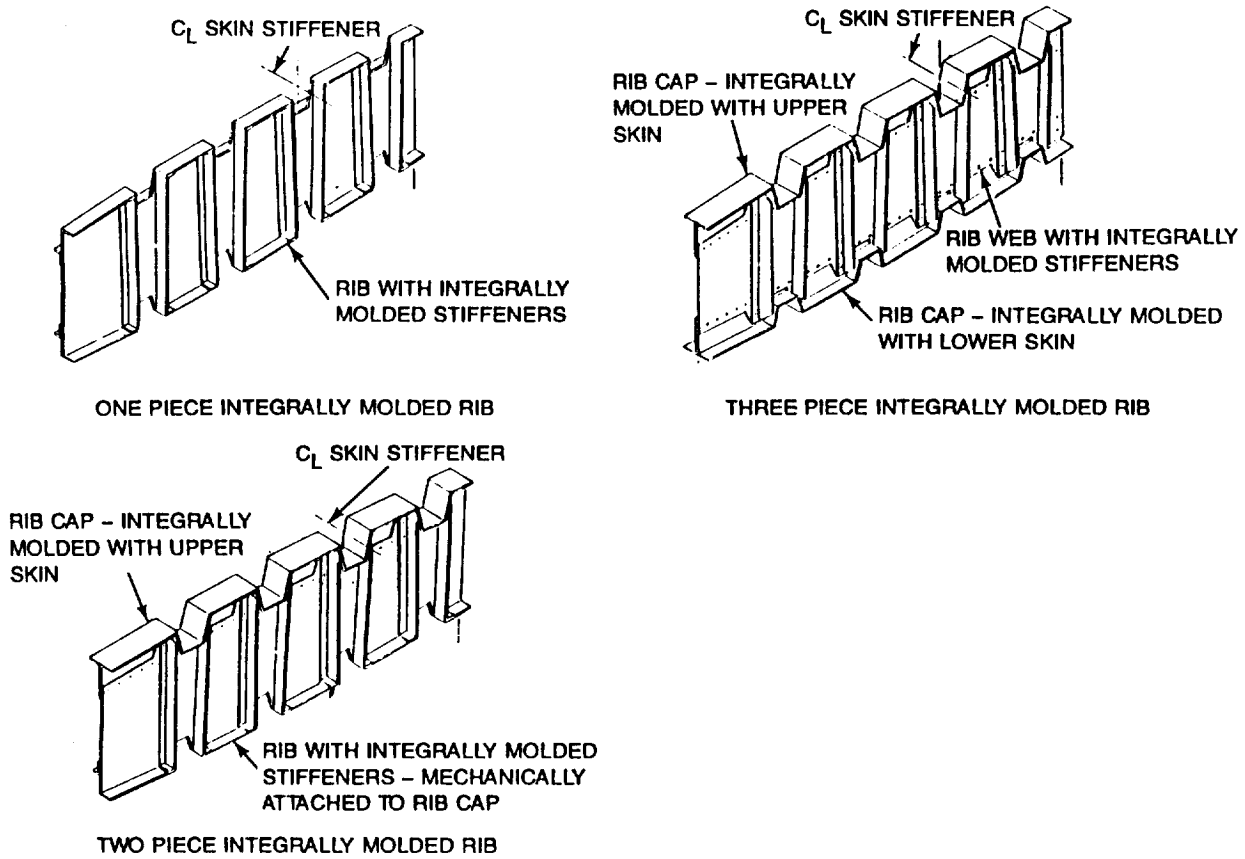

R89-0547-072

Fig. 5 Typical Substructure Configuration Trades

incorporated through the thickness prior to cure provide reinforcement for out-of-plane loads. To reduce the strain concentration effect caused by the stitching operation in the cover and spar caps the 0-deg Gr/Ep plies are locally replaced by S-GI/Ep softening strips.

Damage tolerance is achieved through the inherent survivability features of the high strain wing multi-spar design which provides multiple load paths around damage, and the incorporation of crack-arrestment strips (to each side of the discrete caps) made of a compliant material to contain damage and prevent the damage from growing to catastrophic failure under design loads. S-GI/Ep strips were selected as the crack-arrestment medium because of their high strain-to-failure. In addition K/Ep stitches were incorporated through the crack-arrestment strips to provide translaminal reinforcement to arrest delamination growth and to provide a controlled tear path in the basic lightly loaded region of the cover for hydrodynamic ram survivability requirements.

An extensive design development and verification test effort has been an integral part of this development program. Design development testing consisted of over 140 coupons and 32 major elements prior to final design of a full-scale wing box subcomponent. The development test objectives were to

- Derive material allowables for notched high strain laminates with S-GI/Ep softening strips
- Correlate and confirm the adequacy of the analytical procedures used to define and analyze the design concept
- Demonstrate the structural integrity of critical design areas
- Demonstrate the ability of the high strain wing to sustain cyclic loading consistent with the aircraft's design life
- Demonstrate the effectiveness of the stitched S-GI/Ep crack-arrestment strips for LEID and battle damage
- Establish the confidence to proceed to the fabrication and test of the full-scale representative subcomponent aimed at
 - Verification of the high strain wing design under combined loading and fuel pressure
 - Demonstration of the manufacturing approach.

The coupon and element tests successfully met their objectives by establishing and confirming the design criteria utilized in satisfying the structural requirements high strain structural integrity, durability, damage tolerance and survivability. More details of the development test data relative to these areas are presented in the following section.

SUBCOMPONENT SELECTION AND DEFINITION

To demonstrate the features and structural adequacy of the design on a larger scale, a section of the wing was selected to be represented by a large component test article. The basic criteria used to identify and select this design verification component were that it be of a generic nature and contain a broad range of structural features. In addition, it should be subjected to a complex state of loading and should address the critical design areas so that analytic techniques may be verified and extended. Finally, the selected component must be capable of demonstrating the fabrication techniques applicable to full scale high strain wing production.

Using these criteria, the wing center section was selected as the demonstration article because this portion of the wing contains the highest load intensities and strain levels, as well as the greatest weight savings. It also contains all the major design areas of concern generic to wings for a future Navy multi-mission aircraft. The component, shown in Fig. 6, is a 95-in. long, 38-in. wide and 13-in. deep three-cell box structure consisting of two intermediate spars integrally molded and stitched to the lower cover; and mechanically attached to the discrete cap upper cover. The front and rear spars are mechanically attached to both the upper and lower covers. A typical access door, located in the center bay, is incorporated into the component's upper cover.

Fabrication of the subcomponent consisted of 12 major composite details and numerous metal details. All metal details and machine parts were fabricated at Grumman's Bethpage, NY facility. Composite details, which include the front spar, rear spar, six intermediate spar segments, upper cover, lower cover and two BL12.0 ribs were laid-up and cured at Grumman's Milledgeville, GA composite fabrication facility. Upon completion of NDI the composite details, and the integrally co-cured/stitched lower cover and intermediate spars sub-assembly were shipped to Bethpage for final assembly and instrumentation. Fuel sealing around the tank periphery was accomplished by injecting a fluorosilicone compound into a wide channel incorporated in the flanges of the substructure, through which the box assembly hardware passes. O-rings were used under the heads of the box assembly hardware at the intermediate spar and BL±12 rib location.

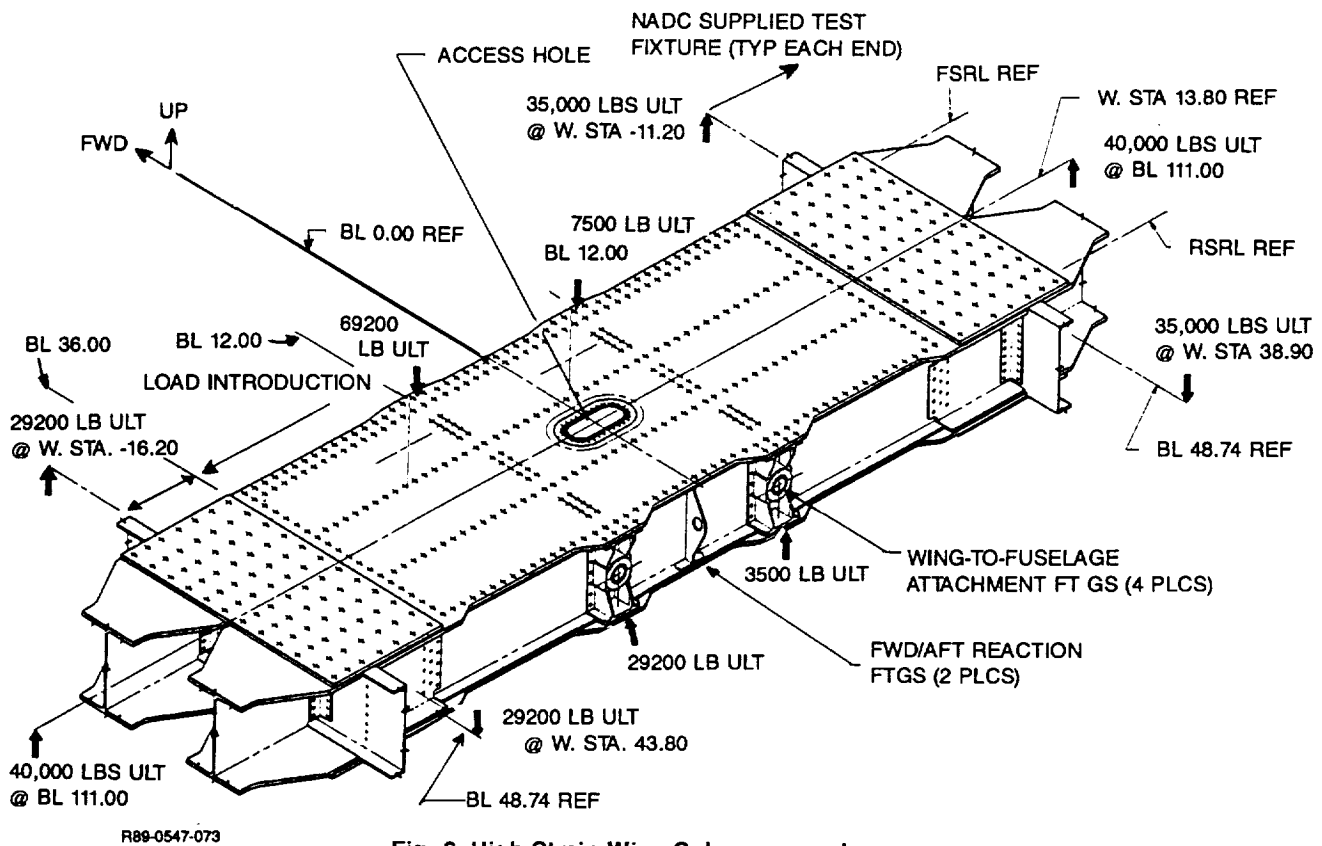

Fig. 6 High Strain Wing Subcomponent

INSTRUMENTATION

Prior to final attachment of the upper cover during manufacturing, strain gages were applied to internal surfaces of the box. Wiring from internal instrumentation was routed to the outside of the box through a bulkhead fitting installed through the rear spar. Following completion of the box assembly, external gages were applied to the specimen. A total of 42 axial, 10 shear and 30 rosette gages were installed. In addition to the strain gages, the subcomponent was monitored with 14 deflection transducers. These strain and deflection measurements permitted the confirmation of stress analysis predictions and were used as a means of monitoring the specimen during test.

Applied mechanical loads were measured by calibrated load cells installed in line with the load applying hydraulic cylinders. Pressure measurements were monitored via a pressure gage attached to the subcomponent at one of the two pressure bulkhead fittings.

TEST SET-UP

The subcomponent was tested as a through box indicative of the actual aircraft. Load introduction simulating actual flight conditions was accomplished through non-test structure attached to both ends of the box at BL±49. The moment connection was accomplished by a set of steel plates which spliced two reinforced steel "I" beams extending from BL49 to BL111. Both the plate and beams were attached to the subcomponent with multiple rows of fasteners into the steel transition plates on the Gr/Ep covers, and steel angles attached to the spars. Torsion loads were applied to a 1.5 in. thick steel plate extending forward and aft and attached at BL49. The subcomponent was attached to steel fixture frames for test, with four wing-to-fuselage titanium attachment fittings to the test frames. Reactions at the four wing-to-fuselage attachment points were shear only, with the bending moment carried across the subcomponent. Figure 7 is a photograph of the subcomponent set-up for test. All loads were applied through self-aligning bearings to eliminate out-of-plane loading due to specimen deflections and fixed actuator locations.

TEST PROCEDURE

The sequence of structural tests performed to demonstrate the capability of the design is presented in Fig. 8. Test numbers 1 through 4 were functional runs to check out the test specimen, test fixturing, test control equipment and instrumentation. Test number 5 demonstrated the ability of the subcomponent to withstand static application of the critical loads to 114% DLL. Test 8 subjected the specimen to two lifetimes of combined mechanical and internal pressure fatigue loading. During the fatigue test the internal pressure of the subcomponent was maintained at a constant 5.3 psig which is equivalent to design limit pressure. Test 7 demonstrated the design ultimate strength capability of the component by loading the specimen to 150% design limit load. Tests 8 through 10 were damage tolerance tests which demonstrated the capability of the design to sustain low energy impact damage and continue to carry the required design loads.

DESIGN ULTIMATE TEST

Following the preliminary pressurization and system checkout tests, the test box was incrementally loaded to design ultimate load. Strain gage and deflection transducer readings were recorded at each load increment and critical readings were compared with predictions to ensure proper loading and test specimen response. Nondestructive inspection performed following the ultimate load test did not disclose any anomalies.

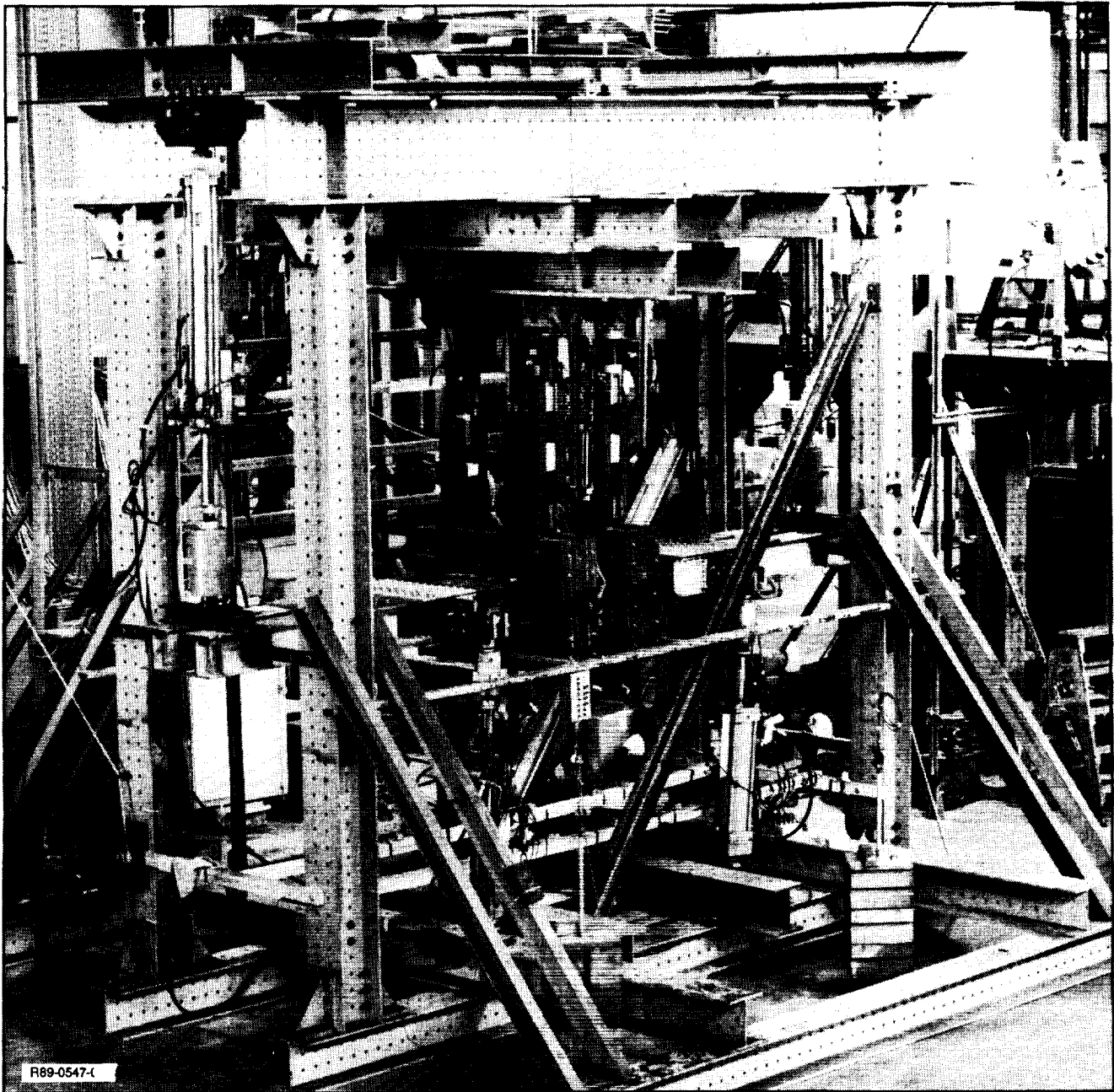

Fig. 7 High Strain Wing Subcomponent Set-up for Test at NADC

ORIGINAL PAGE
BLACK AND WHITE PHOTOGRAPH

TEST NUMBER	DESCRIPTION OF TESTS
1	MECHANICAL LOADS SURVEY TO 50% DLL
2	MECHANICAL LOADS SURVEY TO -25% DLL
3	DESIGN LIMIT PRESSURE
4	COMBINED MECHANICAL LOADS TO 50% DLL WITH INTERNAL LIMIT PRESSURE
5	COMBINED MECHANICAL LOAD AND PRESSURE TEST TO 114% DLL
6	TWO LIFETIME SPECTRUM FATIGUE TEST WITH INTERNAL LIMIT PRESSURE
7	COMBINED MECHANICAL LOAD AND PRESSURE TEST TO 150% DLL
8	COMBINED MECHANICAL LOAD AND PRESSURE TEST TO 114% DLL
9	ONE LIFETIME SPECTRUM FATIGUE TEST
10	MECHANICAL LOAD TEST TO 114% DLL

R89-0547-075

Fig. 8 High Strain Wing Subcomponent Sequence of Tests

DURABILITY AND DAMAGE TOLERANCE TESTS

The subcomponent was tested to the equivalent of 12,000 flight hours of fatigue testing. The spectrum used for this testing was an AV-8B flight by flight spectrum which consists of seven flights encompassing a total of six flight hours. This seven flight sequence was repeated 2000 times to obtain the required two lifetimes of testing. As can be seen from the plot of the load peaks of this spectrum (Fig. 9) applied loads ranged from a maximum of 114% DLL to a minimum of -25% DLL. Strain surveys at the maximum spectrum load were performed every 1/4 lifetime, and nondestructive inspections were performed every 1/2 lifetime. No anomalies were detected upon evaluation of the strain data nor from the results of the inspections.

Upon completion of the fatigue testing, damage tolerance testing was performed to demonstrate the capability of the incorporated design features to arrest delamination growth under combined loading. Specifically, the intent of this testing was to show that the Kevlar stitching provided a positive boundary at which the delamination would be arrested. An instrumented drop tower was positioned over the specimen and used to impart visible low energy impact damage at two selected locations on the component upper cover. These locations were mid-bay (between spars) and thus centered between the rows of Kevlar stitching. Based upon previous survey results, 40 ft-lb was the energy level selected for use in producing the desired level of damage. Figure 10 shows the delaminated area following the two drops as determined by ultrasonic inspection. As shown in the photograph, the first delamination was circular and did not reach the stitch lines, while the second delamination extended to and was partially arrested by the stitch line. The component was then fatigue tested for one additional spectrum life in an attempt to determine whether the delaminations would propagate and be arrested by the stitch lines. Following this cycling, however, ultrasonic inspection did not reveal any growth in the original delaminated area.

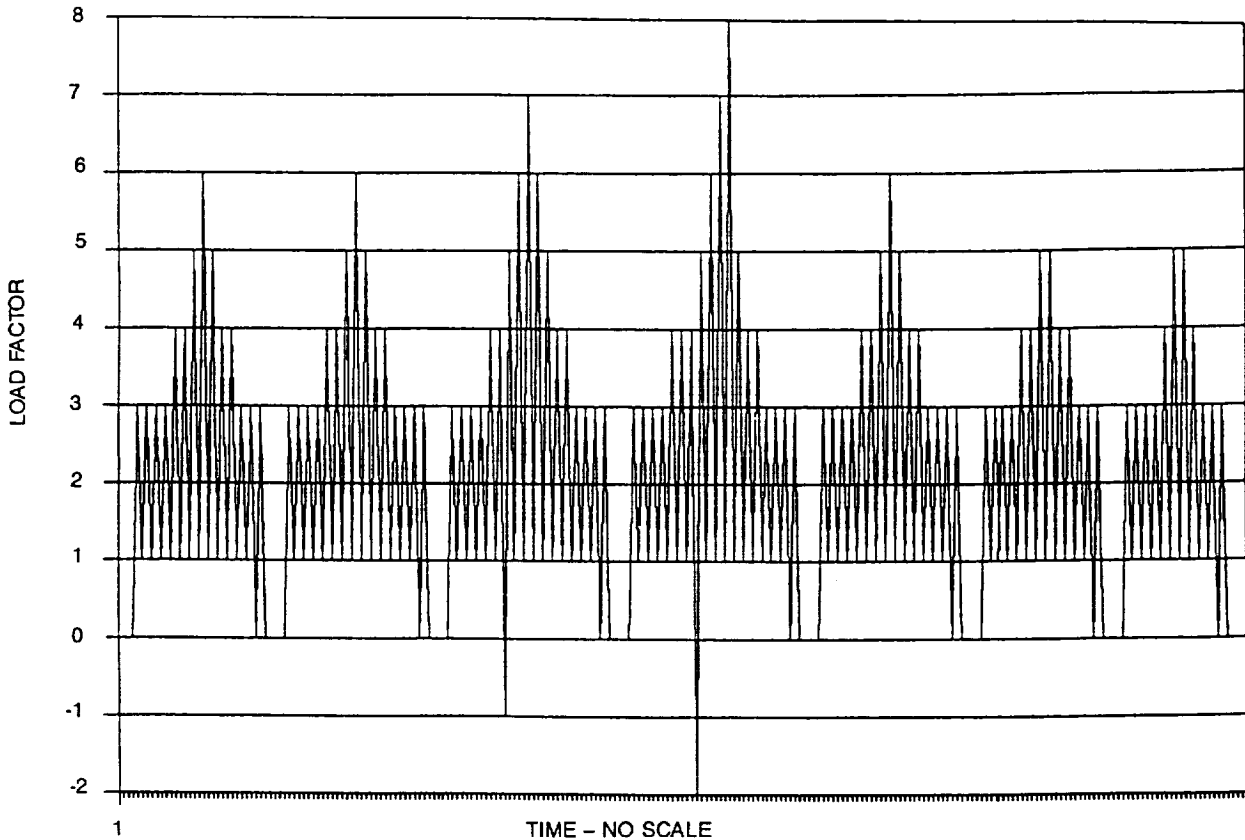

R89-0547-076

TIME - NO SCALE
Fig. 9 Fatigue Spectrum

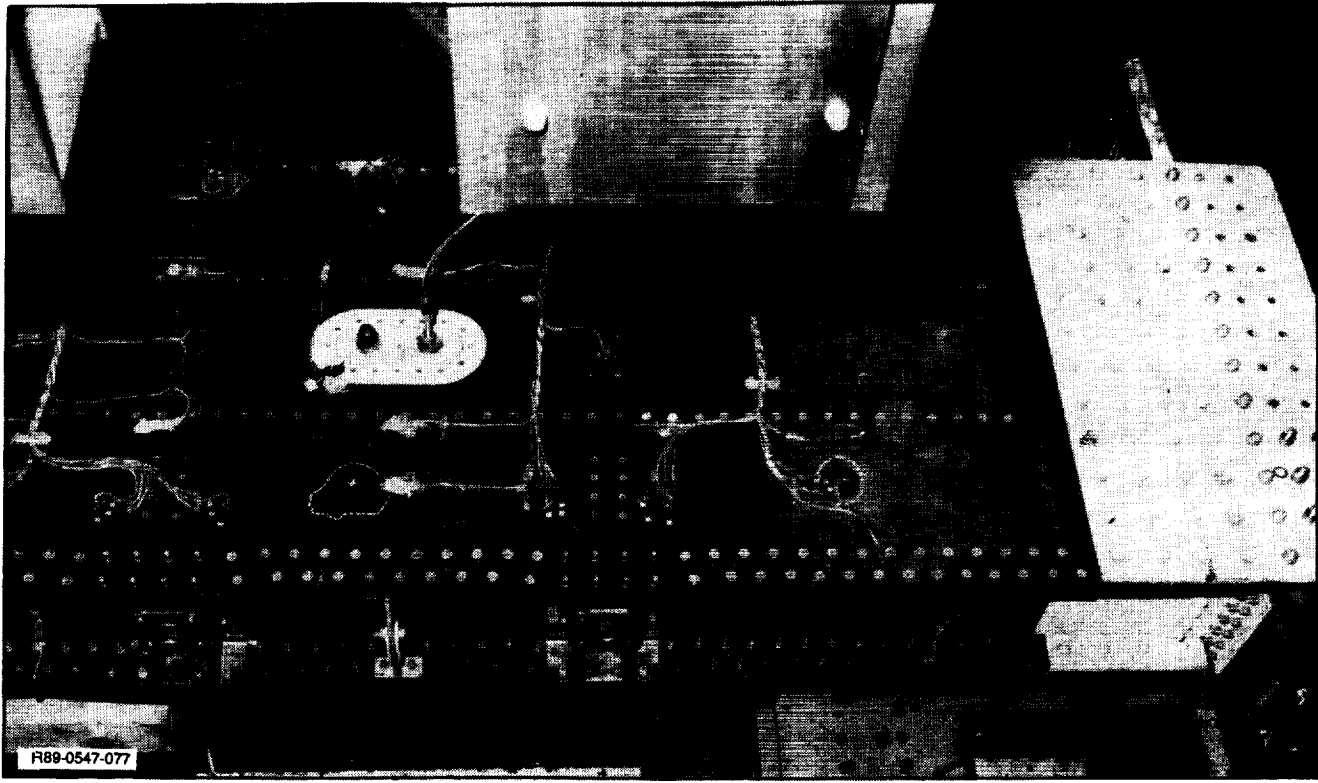

Fig. 10 Subcomponent Impact Locations Damage

ORIGINAL PAGE
 BLACK AND WHITE PHOTOGRAPH

SURVIVABILITY TEST

Upon completion of the structural testing, the component was removed from the test fixture and shipped to the Naval Weapons Center (NWC) for ballistic testing. The intent of this testing was to demonstrate the survivability of the design to the impact of 30 mm high explosive incendiary (HEI) rounds and the accompanying hydraulic ram loading. Three concepts were incorporated into the design to contain ballistic damage. These concepts, controlled tear paths in the basic cover panels formed through the use of Kevlar stitching, fiberglass crack arrestment strips and a discrete cap configuration, were to be evaluated through this testing.

Although the wing box was originally designed to be tested in four-point bending, testing facilities and fabrication restrictions at NWC required that the box be tested as a cantilevered beam. The box was mounted in a test fixture, clamped at one end and loaded at the other end with load applying air bags. Pressure in the air bags was increased until 55% DLL was obtained at the fixed end of the specimen. The 30 mm gun mount was placed on the ground beneath the test pad at a distance of 25 feet from the box. Fluid level in the box was set at 75% full and ullage pressurization was set at the design limit level of 5.3 psig. Figure 11 is a photograph of the test set-up.

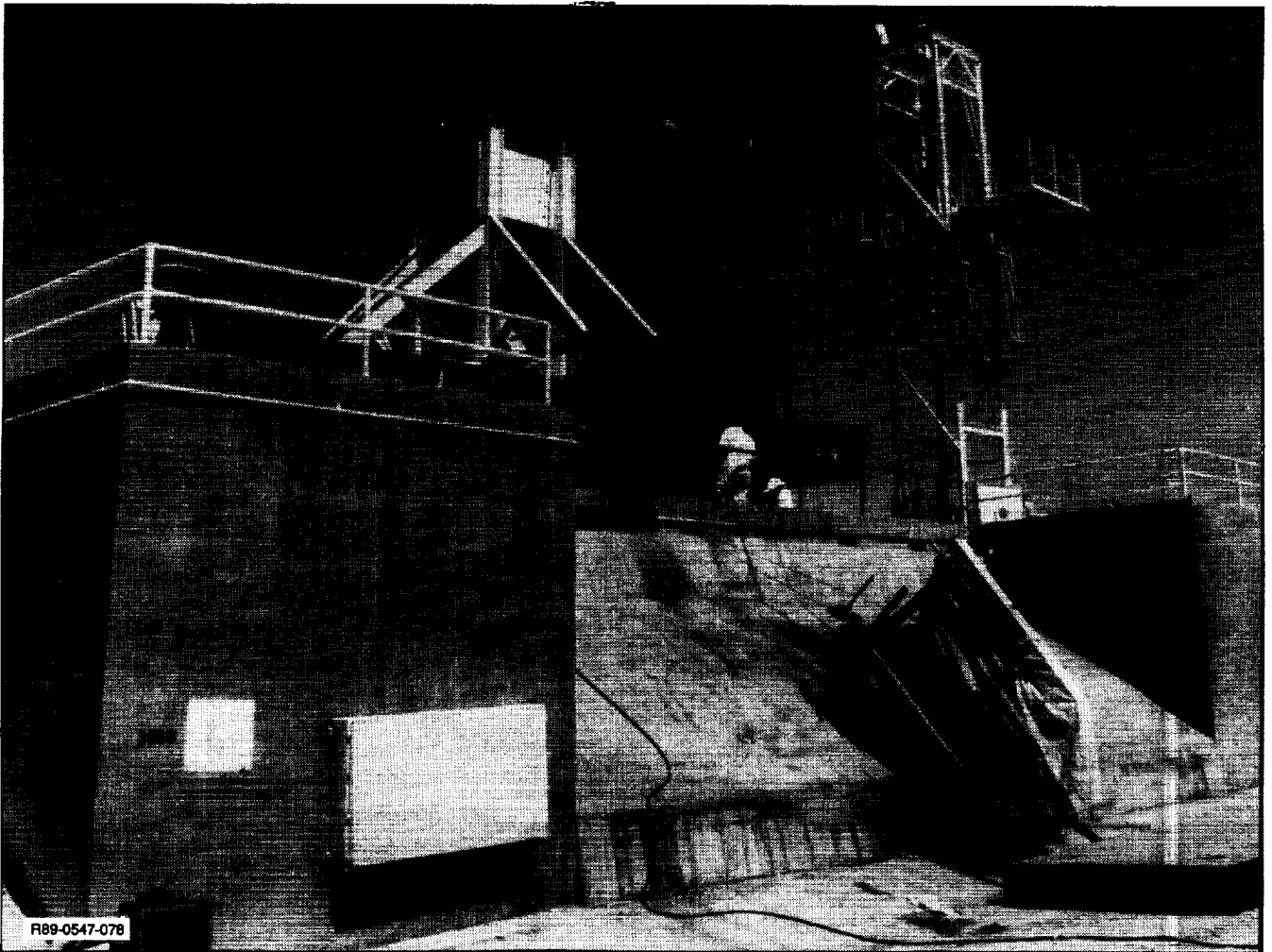

Fig. 11 Subcomponent Survivability Test Set-up at Naval Weapons Center

Upon firing, the round entered the cover at the lower aft bay and 1.25 inches to the left of the box centerline. The round detonated inside the box, probably while passing through the aft intermediate spar. Figure 12 is a photograph of the component taken approximately 3 milliseconds after impact of the round.

Post-test examination of the lower cover (Fig. 13) revealed ripping along the stitch lines crossing into the right bay. The aft center portion of the lower cover failed along the chordwise stitching as planned, but some damage did extend forward of the aft bay. As seen in the photograph of the upper cover, Fig. 14, almost all of the visible damage is confined to the middle and aft central bays with failures along both the stitch lines and the fastener rows. Damage to the spars and ribs ranged from no visible damage to the front and rear spars to destruction of the intermediate spars. Damage to the right rib was not apparent and damage to the left rib was localized to the lower cap.

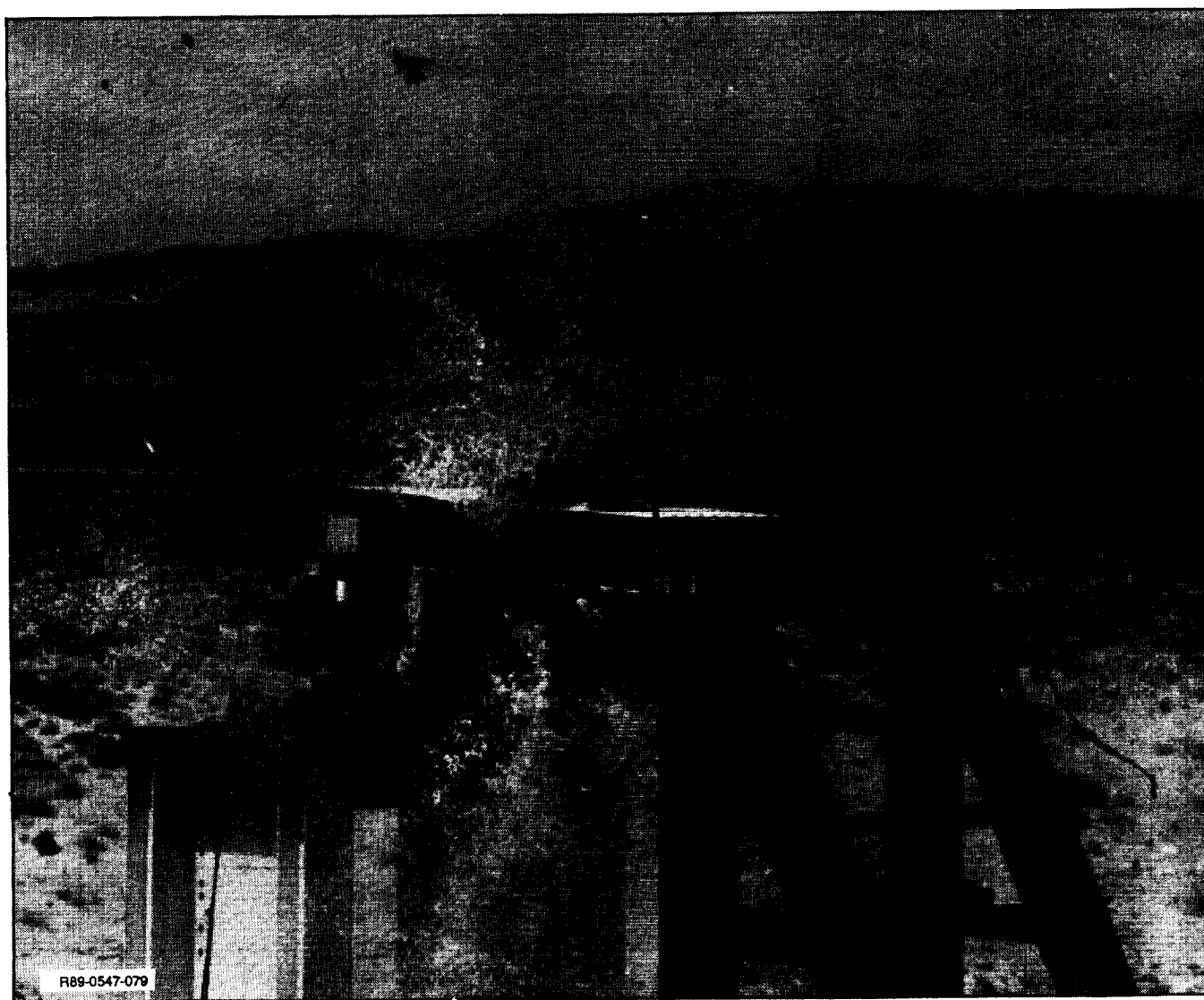

Fig. 12 30-mm HEI 3 Milliseconds After Impact

ORIGINAL PAGE
BLACK AND WHITE PHOTOGRAPH

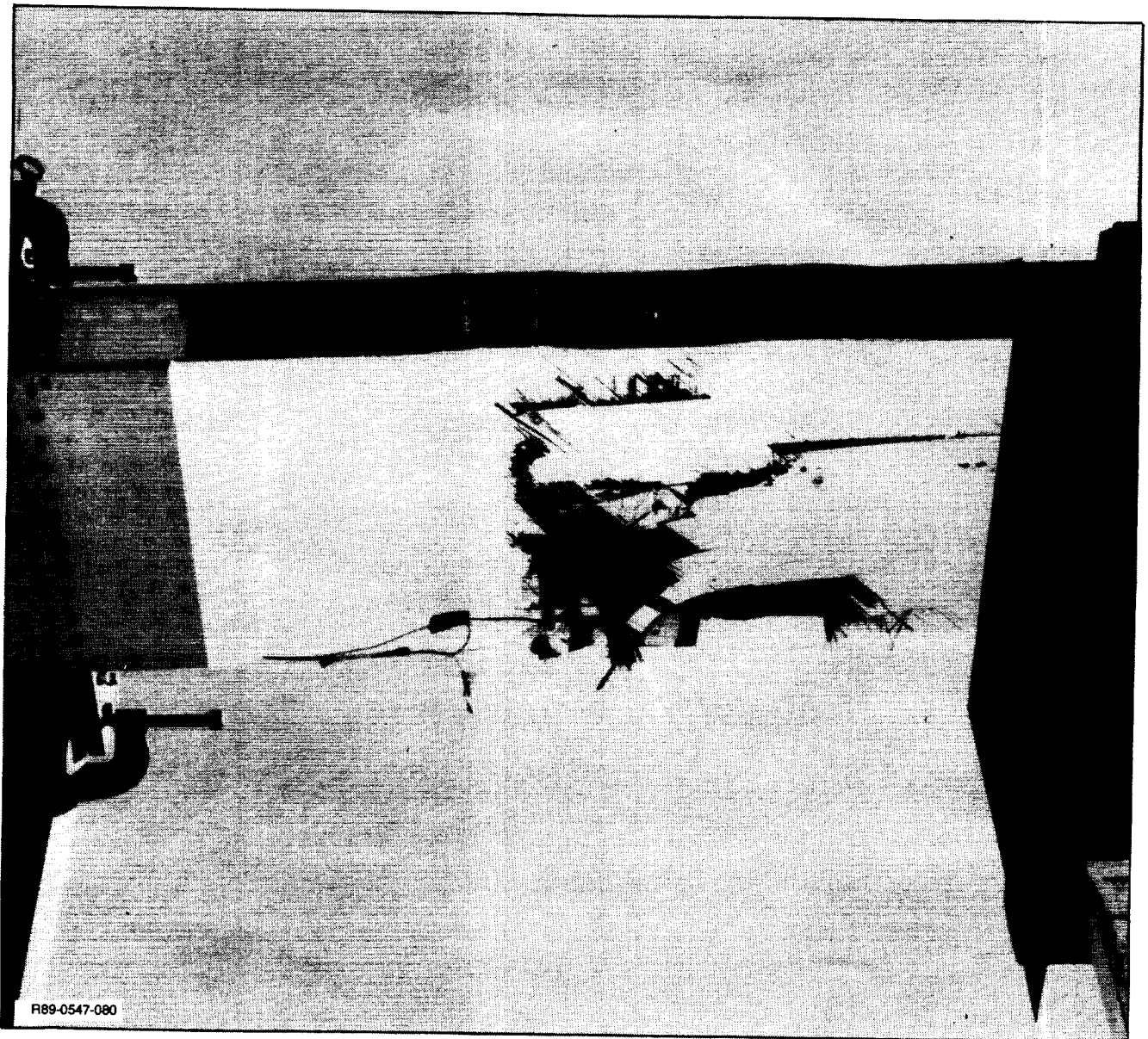

Fig. 13 Damaged Lower Cover

In summary, although extensive skin and substructure damage was incurred, the structure was capable of supporting the applied loading both during and after the test. The lines of Kevlar stitching, although inconsistent, did provide tear paths which appeared to control and limit the damage area. Finally, fiberglass softening and crack arrestment strips increased the overall bolted joint strength enough to permit bolt failure in tension, rather than bolt pull-through.

TECHNICAL ISSUES

The program has addressed significant technical issues affecting the use of high strain advanced composite wing structures. These issues concerned primarily

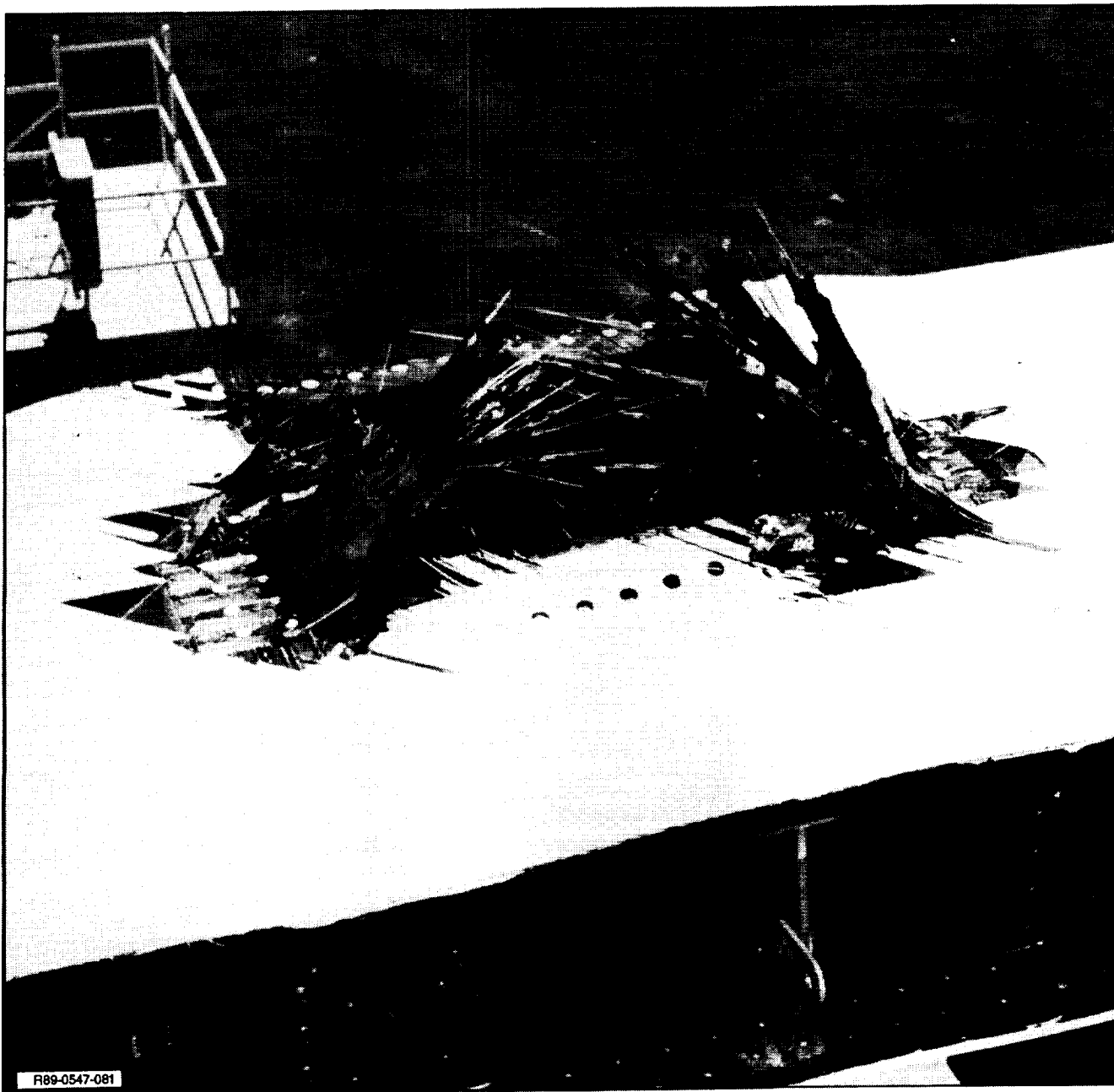

Fig. 14 Damaged Upper Cover

structural integrity and durability of a high strain Gr/Ep wing and ability of this type of structure to satisfy vehicle damage tolerance and ballistic survivability requirements. The feasibility of satisfying these requirements while achieving a 21.5 percent weight savings over a standard strain wing has been demonstrated.

Coupon test results were used to provide basic materials data on the unique hybrid configuration and to provide a better analysis basis for the design. Coupon type specimens included simple tension and compression specimens with loaded holes

to develop bearing/bypass load interaction curves, like that illustrated in Fig. 15, for the softened laminate. The effectiveness of the softening strip concept is vividly depicted in Fig. 15. This figure illustrates that the softening strip approach permitted attainment of the full unnotched strength of the Gr/Ep, and that this strain level can be sustained at design bearing stress levels in excess of 55 ksi. In contrast, the all-Gr/Ep laminates were capable of sustaining slightly more than half that value with no bolt load, and displayed a pronounced sensitivity to increased bearing stress. Coupon tests also included bolt-pull through and integral cover-to-substructure flatwise tension specimens. Various element type specimens representative of critical areas of the design were tested to ensure the structural integrity of the design concept and subcomponent. Element tests performed included combined longitudinal tension and flatwise tension beams of the wing integral lower cover and spar attachment; spar termination elements demonstrated the ability of the spar/rib intersection to sustain high tension and compression longitudinal strains, access hole elements verified the ability of the upper cover to sustain high compressive strains in the presence of a large access hole, and shear elements demonstrated the shear/buckling strength of the covers and spars. The durability of the design was demonstrated by fatigue testing of coupons and elements in excess of two lifetimes, followed by a residual static strength test to failure above 6000 micro-in/in.

To demonstrate that the high strain wing design concept/features can provide the degree of damage tolerance and survivability previously mentioned, a series of elements representative of the high strain wing covers was tested to verify that

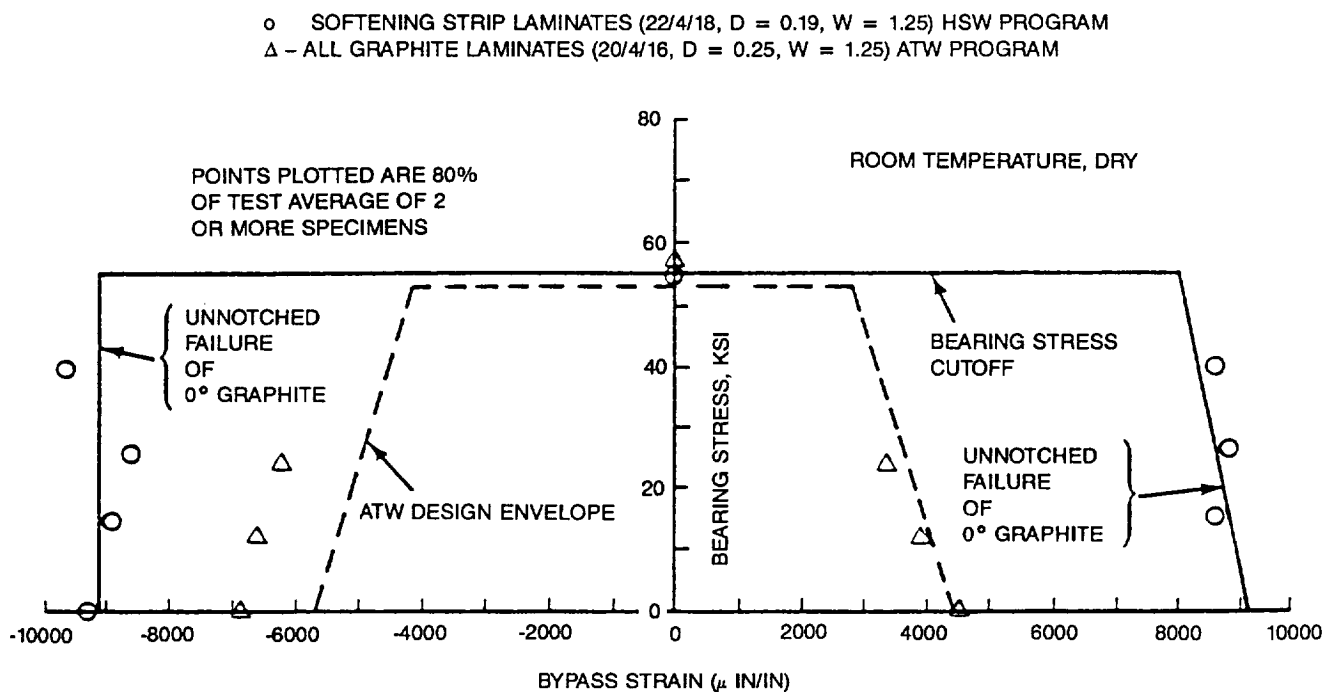

Fig. 15 Comparison of Softening Strip Laminates & All-Graphite Laminates

LEID, which has grown to a significantly larger size due to the high operating strain level, is arrested by the stitched S-GI/Ep crack-arrestment strips, while damage from high energy impact is also arrested at the crack-arrestment strips. Three distinct locations of the wing covers were of particular interest: the basic cover between spars, the discrete cap cover spars, and near the edge but not on the discrete cap/spar. Tests indicated that the stitches were effective in stopping initial delamination growth caused by impact. Spectrum fatigue and static testing to design ultimate levels of elements containing LEID and penetrations (representative of small ballistic threats) produced no significant propagation. The static testing of a major element representing a three cap/spar segment of the lower cover, with an 8-in. dia. hole incorporated through the center cap simulating a 23 mm hit, demonstrated the effectiveness of the stitched crack-arrestment strips in arresting the propagation of a combined crack/delamination which had started from the edge of the hole at a strain level of 4200 micro-in/in and permitting the panel to sustain the higher load in the fatigue spectrum (Pxx - 4700 micro-in/in) without subsequent growth or catastrophic failure. A single cell test box filled with JP-4 fuel, pressurized to 5.3 psi and ballistically impacted with a 5/8-in dia. steel ball at 4500 ft/sec demonstrated the feasibility of the lines of stitches through the crack-arrestment strips to provide a "controlled tear path," thereby isolating/containing the damage resulting from the hydrodynamic ram effects on one basic cover bay.

Finally, the subcomponent provided a full scale demonstration of the structural integrity and durability of the most critical portion of the wing under combined loading and fuel pressure, as well as satisfaction of the damage tolerance and survivability requirements of the baselined vehicle.

ADVANCED WING DESIGN DEVELOPMENT

Coincident with this development effort, the trend toward increased structural efficiency and damage tolerant structures has emphasized the need for and vigorous development of newer/emerging composite materials consisting of improved graphite fibers in combination with toughened resin systems. Compared with composite material systems used on operational aircraft these newer/emerging graphite fibers offer increased strength, stiffness and strain-to-failure in the presence of a notch. New/emerging resin systems, both toughened thermoset and engineered thermoplastic, have increased toughness and improved elevated temperature/wet retention of properties. The potential benefits that can be realized through the combination of these newer/emerging fibers and tougher resin systems with new and/or previously developed high strain wing designs (to maximize structural efficiency and reduce fabrication costs while maintaining to the greatest extent possible the weight savings, durability, damage tolerance and survivability, demonstrated by the high strain wing) was assessed in a subsequent design and experimental evaluation effort also sponsored by NADC.

Two categories of new and/or improved graphite fibers - high strain (1.8 percent or greater elongation) and higher modulus (40 MSI or greater with at least 1.5 percent elongation) - were considered in conjunction with two categories of resin

systems: toughened thermosets and "engineered" thermoplastics. A total of 28 toughened thermoset and nine thermoplastic material systems, summarized in matrix format in Fig. 16 and 17, have been evaluated for screening purposes. Grumman's extensive data base and material supplier data were used, in part, to perform the screening. In addition, industry standardized coupon tests were performed to obtain sufficient data where lacking, and to characterize the candidate material systems to allow comparison on a common basis. Standardized coupon tests consisted of unidirectional tension, compression, horizontal shear, and double cantilever beam (DCB). DCB tests measured critical Mode I interlaminar fracture toughness (G_{IC}) which provided a timely experimental indication of the relative damage tolerance of the numerous material systems. Coupons consisting of a 6/2/8 laminate (number of plies in the 0/90/ \pm 45-deg orientations) were tested in compression to correlate 0-deg compressive layer strength with the unidirectional test results. Five replicates of each specimen type were tested to determine a coefficient of variation and evaluate material properties variability, thereby providing a better indication of average material properties. Four toughened thermoset (IM8/8551-7A, G40-800/F584, HITEX 46/E7T1-2 and T800/F3900) and two thermoplastic material systems (IM7/APC-II and T650-42/RADEL-X) exhibited an overall balanced improvement in mechanical properties and were selected for characterization testing and further consideration for the preliminary design and trade study effort. In addition, the IM8/8551-7A material system had the highest compression after impact (CAI) strength, G40-800/F584 exhibited excellent handling characteristics and was considered one of the best systems for adaptability to automated processing techniques deemed essential to achieving high strain wing structures with lower production, and both the HITEX-46/E7T1-2 and T800/F3900 exhibited high compression strength/stiffness with good CAI strength.

Material characterization testing consisted of a series of simple tension and compression unnotched specimens and notched specimens with filled and loaded holes to determine the notch sensitivity of the material, develop allowable bearing/passing load interaction envelope curves, and establish a data base of design values for use during the advanced wing preliminary design and trade study effort. Based on the comparative coupon test results it was concluded generally that these newer/emerging composite materials provided advantages that could increase structural performance of future Navy aircraft wing primary structures. Specifically, compression after impact strength was increased by approximately 100 percent, notched tensile strength was improved approximately 50 percent, and notched design ultimate strain levels in excess of 6000 micro-in/in for tension-dominated structures were developed without the use of S-GI/Ep softening strips. Notched compression failure strains, however, were comparable to non-toughened Gr/Ep materials (without S-GI/Ep softening strips) used on current operational aircraft.

Preliminary design and trade studies performed were aimed at identifying the optimum balance between maximum structural efficiency and low fabrication cost by combining the most promising candidate material systems with design concepts that permit maximum translation of their unique properties to achieving the 50 percent increase in design ultimate strain level without the use of S-GI/Ep softening strips and crack-arrestment strips, while maintaining to the greatest extent possible the weight savings, durability, damage tolerance and survivability of the original high strain wing design.

Two categories of design concepts emphasizing both material and configuration orientation concepts were generated. The first category, materials oriented concepts, relied ostensibly on improved material properties to achieve program

Fiber Manufacturer	Fiber Type	Fiber Tensile Strength (KSI)	Fiber Tensile Modulus (MSI)											Availability		
				R6376/CIBA	CYCOM 1827/CYAN	XU71787/DOW	F584/HEXCEL	8551/HERCULES	HG9105-2/HYSOL	5745C/NARMCO	E7K8/US POLY	974/FIBERITE	ERLIX 1928/AMOCO		E111-2/US POLY	T3900/HEXCEL
BASF/CELION	G-40 -600	600	43.5	✓			✓			✓	✓					Developmental
BASF/CELION	G-40 -700	690	49				-									Developmental
BASF/CELION	G-40 -800	820	43.5				✓									Developmental
BASF/CELION	CELION-ST	580	35	✓												Full Production
HERCULES	IM6	635	40		✓		✓	✓		✓						Full Production
HERCULES	IM7	680	41			✓		✓								Full Production
HERCULES	IM8	750	45					✓								Full Production
HERCULES	AS6	650	35					✓								Full Production
HITCO	HITEX-42	600	42							✓	✓					Full Production
HITCO	HITEX-46	900	46								✓			✓		Full Production
AMOCO	T-650	650	42										✓			Full Production
AMOCO	T-40X	820	41	✓			✓			✓			✓			Full Production
HYSOL	IM-S	820	43							✓						Limited Production Quant
HYSOL	APPOLLO-M	820	53				✓		✓							Limited Production Quant
HEXCEL	T800	850	42											✓		Limited Production Quant

R89-0547-083

Fig. 16 Toughened Thermoset Prepregs

Fiber Manufacturer	Fiber Type	Fiber Tensile Strength (KSI)	Fiber Tensile Modulus (MSI)							Availability	
				APC-2(PEEK)/ICI	PPS(RYTON)/PHILLIPS	KII(AVIMID)/DUPONT	PAI(TORLON)/AMOCO	KIII(AVIMID)/DUPONT	RADEL-X/AMOCO		
BASF/CELION	G-40 -600	600	43.5		✓						Developmental
HERCULES	IM6	635	40		✓	✓	✓		✓		Full Production
HERCULES	AS6	650	35				✓		✓		Full Production
HYSOL	APPOLLO-M	820	53		✓						Limited Production Quant

R89-0547-084

Fig. 17 Engineered thermoplastic Prepregs

objectives. Using a metals-like approach the application of the optimum material system to a specific component was based on matching the superior/unique material properties with critical design requirements/parameters of that component in order to satisfy them in an optimum manner. For example, a material system with high tensile strength/stiffness, strain-to-failure in the presence of a notch, and high through-the-thickness toughness was considered for application to the tension cover, while a material system with high compression strength/stiffness, strain-to-failure in the presence of a notch, and high fracture toughness against delamination was more desirable for application to the compression cover. This category of concepts permitted maximum design flexibility at minimum fabrication cost by permitting mechanical attachments through regions of the covers containing high concentrations of 0-deg Gr/Ep plies without the need for S-GI/Ep softening strips or other strain concentration reduction techniques (in the 0-deg Gr/Ep). Concepts investigated under the second category, configuration oriented concepts, did not rely as heavily on improved material properties to achieve their goal. Concepts in this category emphasized compliant high strain-to-failure laminates and other softening techniques at substructure attachment areas, thereby minimizing strain concentration effects due to notches and isolating high concentrations of unnotched 0-deg. plies. Here again, the use of S-GI/Ep softening strips and crack-arrestment strips was eliminated to simplify the design and reduce fabrication costs. The material and configuration oriented concepts investigated are illustrated in Fig. 18 and 19, respectively.

MATERIAL/DESIGN TEST EVALUATION

Material/design validation testing, an integral part of this design and experimental effort, also addressed technical issues concerning structural integrity, durability, damage tolerance and survivability of the selected material system/design concept combination. The capability of the material/design concept to achieve the degree of durability, damage tolerance and survivability exhibited by the original high strain wing, was experimentally evaluated through a series of point design oriented major element representative of the compression critical upper cover.

The durability/damage tolerance element is a three cap cover segment, made of sufficient size to permit the independent experimental evaluation of LEID in three separate and distinct areas of the cover element in one test: directly over the discrete cap/spar support, the basic cover between spar supports, adjacent to but not over the discrete cap/spar support. The specimens were subjected both to static and cyclic loading to demonstrate the capability of the combined material toughness/design concept to prevent the delamination damage from growing to catastrophic proportions under the high working strain level.

The survivability specimens being set up for test at the time of writing are identical to the durability/damage tolerance specimens tested under the previous high strain wing program. They will be ballistically impacted in the center cap with a 23 mm HEI round while the specimen is loaded in tension to approximately 55% of DLL (2500 micro-in/in). A series of smaller single bay cover specimens ballistically impacted with a 23 mm HEI round while mounted to a tank test fixture filled with water demonstrated the ability of toughened material/design concepts to isolate/contain the damage from the hydrodynamic ram effects to one basic cover panel leaving the discrete cover and spar cap with their axial load carrying material intact.

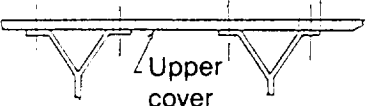
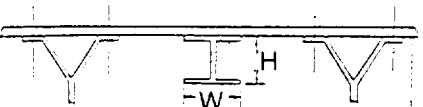
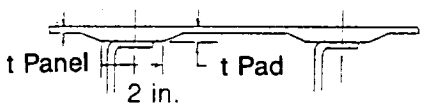
Materials Oriented Concepts	Advantages	Disadvantages
Spread zero upper cover (with "Y" intermediate spars) 	<ul style="list-style-type: none"> • Least cover fab cost • Very efficient comp cover when combined with Y spar • Easily repaired • Good battle damage tolerance due to multiple load paths 	<ul style="list-style-type: none"> • Max rows of fasteners – assy cost impact • High strain concentration – fasteners through laminate with high % of 0-deg plies • Damage tolerance totally material dependent • Excessive S/S shear carrying material
Spread zero upper cover with integral "I" stiffener 	<ul style="list-style-type: none"> • Minimizes number of spars • Reduced assembly costs • Good battle damage tolerance due to multiple load paths 	<ul style="list-style-type: none"> • High strain concentrations – fasteners through laminate with high % of 0-deg plies • Damage tolerance totally material dependent • Difficult to repair
Discrete cap upper cover 	<ul style="list-style-type: none"> • Most efficient comp cover design for multi-spar configuration • Min number of substructure attachments • Excellent damage tolerance due to multiple load paths & compliant laminates 	<ul style="list-style-type: none"> • Increased laminate tailoring • High strain concentration factor – fasteners through laminate with high % 0-deg plies • Difficult to repair

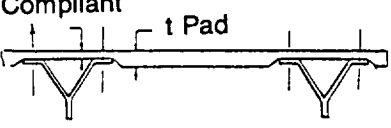
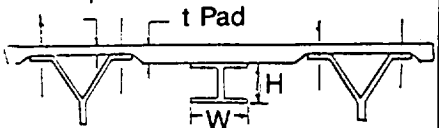
Configuration Oriented Concepts	Advantages	Disadvantages
Isolated spread zero 	<ul style="list-style-type: none"> • Efficient comp cover when combined with Y spar • Min strain-concentration factor-fasteners through compliant laminate • Good battle damage tolerance-multiple load paths 	<ul style="list-style-type: none"> • Increased cover laminate tailoring-manuf cost impact • Max number of substructure attachment fasteners – assy cost impact • Excessive substructure shear carrying material
Isolated spread zero w/integral "I" stiffener 	<ul style="list-style-type: none"> • Minimizes number of spars • Good overall damage tolerance due to multiple load paths & compliant laminates • Min strain concentration factor-fasteners through compliant laminate 	<ul style="list-style-type: none"> • Not most efficient comp cover • Difficult to repair • High cover complexity due to laminate tailoring & integrally molded stiffener

R89-0547-085

Fig. 18 Upper Cover Structural Configurations

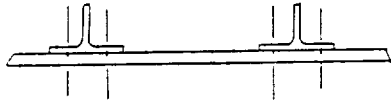
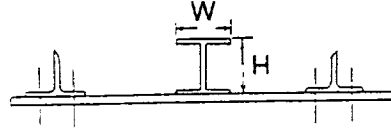
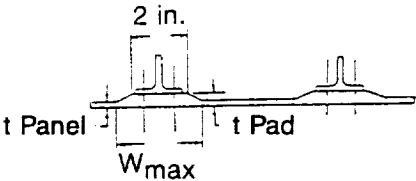
Materials Oriented Concepts	Advantages	Disadvantages
Spread zero lower cover - Tee & angle spar support 	<ul style="list-style-type: none"> • Least cover fab cost • Very efficient comp cover when combined with Y spar • Easily repaired • Good battle damage tolerance to multiple load paths 	<ul style="list-style-type: none"> • Max rows of fasteners – assy cost impact • High strain concentration – fasteners through laminate with high % of 0-deg plies • Damage tolerance totally material dependent • Excessive S/S shear carrying material
Lower cover with integral "I" stiffener 	<ul style="list-style-type: none"> • Minimizes number of spars • Reduced assembly costs • Good battle damage tolerance due to multiple load paths 	<ul style="list-style-type: none"> • High strain concentrations – fasteners through laminate with high percent of 0-deg plies • Damage tolerance totally material dependent • Difficult to repair
Discrete cap lower cover 	<ul style="list-style-type: none"> • Most efficient comp cover design for multi-spar configuration • Min number of substructure attachments • Excellent damage tolerance due to multiple load paths & compliant laminates 	<ul style="list-style-type: none"> • Increased laminate tailoring • High strain concentration factor-fasteners through laminate with high % 0-deg plies • Difficult to repair

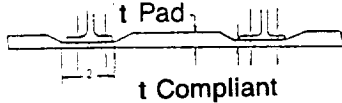
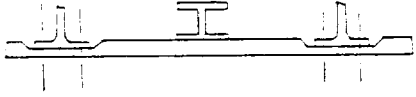
Configuration Oriented Concepts	Advantages	Disadvantages
Discrete cap lower cover (un-notched zeros) 	<ul style="list-style-type: none"> • Efficient comp cover when combined with Y spar • Min strain-concentration factor-fasteners through compliant laminate • Good battle damage tolerance – multiple load paths 	<ul style="list-style-type: none"> • Increased cover laminate tailoring – manuf cost impact • Max number of substructure attachment fasteners – assy cost impact • Excessive substructure shear carrying material
Discrete cap lower cover w/integral "I" stiffener (un-notched zeros) 	<ul style="list-style-type: none"> • Minimizes number of spars • Good overall damage tolerance due to multiple load paths & compliant laminates • Min strain concentration factor-fasteners through compliant laminate 	<ul style="list-style-type: none"> • Not most efficient comp cover • Difficult to repair • High cover complexity due to laminate tailoring & integrally molded stiffener

R69-0547-086

Fig. 19 Lower Cover Structural Configurations

CONCLUSIONS

Conclusions reached as a result of the described efforts have been encouraging and have met overall project objectives.

Specifically, the incorporation of composite design improvements to achieve high strains at design ultimate load resulted in a wing structure that is

- Lighter than composite baseline
 - Multi-spar design: 22%
 - Multi-rib design: 30%
- Lower in cost than composite baseline
 - 10% via: Reduced laminate ply count, reduced part count (integral construction), with fewer fasteners, holes and less assembly time
- Durable/damage tolerant
 - K-Ep stitches through S-GI/Ep crack-arrestment strips were effective in stopping initial delamination growth resulting from impact
 - Major wing cover elements and wing box subcomponent sustained cyclic loading consistent with twice the airframe design life and ultimate load with impact damage
- Survivable
 - Incorporation of S-GI/Ep crack-arrestment strips within the Gr/Ep laminate can blunt the growth of a through crack
 - High strain design concepts and features can sustain a 30-mm HEI ballistic penetration while carrying design limit load
 - K/Ep stitches through the crack-arrestment strips were effective in isolating and containing damage resulting from hydrodynamic ram effects.

Newer/emerging composite materials appear to provide improvements that can be utilized on high strain wing structures for future Navy aircraft in order to reduce fabrication cost and increase structural efficiency and supportability

- Toughened thermoset and thermoplastic material systems provided almost 100 percent increase in compression after impact strength
- Notched static tensile strengths were improved by approximately 50 percent
- Developed design ultimate strain levels in excess of 6000 micro-in/in for notched tension dominated structures without use of S-GI/Ep softening strips
- Developed design ultimate strain levels notched for compression dominated structures (without softening strips) were comparable to current non-toughened Gr/Ep materials. However, the increased stiffness of the newer intermediate modulus fibers provides increased load carrying capability which also can be translated into increased structural efficiency and weight savings, without increase in design ultimate strain level.