

**APPLICATION OF COMPUTATIONAL FLUID DYNAMICS
AND LAMINAR FLOW TECHNOLOGY FOR IMPROVED
PERFORMANCE AND SONIC BOOM REDUCTION**

**Percy J. Bobbitt
Eagle Engineering, Inc.
Hampton Division**

ABSTRACT

A discussion is given of the many factors that affect sonic booms with particular emphasis on the application and development of improved CFD codes. The benefits that accrue from interference (induced) lift, distributing lift using canard configurations, the use of wings with dihedral or anhedral and hybrid laminar flow control for drag reduction are detailed. The application of the most advanced codes to a wider variety of configurations along with improved ray-tracing codes to arrive at more accurate and, hopefully, lower sonic booms is advocated. Finally, it is speculated that when all of the latest technology is applied to the design of a supersonic transport it will be found environmentally acceptable.

INTRODUCTION

Supersonic transport configurations have changed considerably over the years starting with variable sweep and clipped delta concepts and evolving to arrow wings and cranked deltas. Fuselages and wings could easily be identified as separate components in the early 70's but in more recent concepts the two are blended to the point that one cannot tell when one stops and the other starts. The inboard portion of the wing of many configurations employ exaggerated strakes with high sweeps ($\approx 75^\circ$) which extend forward to the apex of the configuration. As a result of these changes, sonic boom overpressures have decreased from slightly above 2 psf to values nearing 1.0 psf. Still further reductions appear feasible, perhaps to around 0.75 psf as conjectured in figure 1. L/D values have also seen steady improvement (see fig. 2), the cruise L/D of the Concorde is about 7.0, SCAR concepts had cruise L/D 's of about 9 and recent cranked deltas 10.0. Similar improvements in transonic and takeoff/landing L/D 's have been made (see fig. 2). It is generally conceded that additional improvements are possible in L/D in all the flight regimes.

One of the technologies thought to have the potential to make a significant improvement in L/D through the reduction in viscous drag is hybrid laminar flow control (HLFC). This technology, which has proven successful in the wind tunnel and in flight at transonic speeds, is now being developed for transport application at supersonic speeds. Its utilization will clearly impact wing design and thus aircraft weight, performance and sonic boom.

Improvements in structural weight fraction and engine efficiencies are equally important technology advances in the attainment of an environmentally sound supersonic transport. A lighter weight airplane will have a smaller wing and lower thrust engines, yielding lower sonic booms and fuel consumption and emissions. A discussion of weight concerns is given in the paper by C. Driver in reference 1

In the present paper we will discuss how HLFC technology impacts wing geometry as well as other configuration variables thought to be beneficial from an L/D and/or sonic boom perspective. Among the configuration variables are wings and canards arranged to increase interference lift and improve lift distribution and wing dihedral to improve propagation characteristics. The improvement of state of the art aerodynamics and ray-tracing CFD codes to explore and perhaps optimize these concepts will also be discussed.

SYMBOLS

$$B = \sqrt{M_\infty^2 - 1}$$

c chord

C_D	drag coefficient	$\left(= \frac{D}{1/2 \rho_\infty V_\infty^2 S_{ref}} \right)$
C_L	lift coefficient	$\left(= \frac{L}{1/2 \rho_\infty V_\infty^2 S_{ref}} \right)$
D	drag force	
L	lift force	
h	airplane altitude	
l	equivalent length of airplane	
M_∞	free stream Mach number	
p	local static pressure	
Δp	static pressure jump ($= p - p_\infty$)	
r	radial distance	
Re_l	Reynolds number based on length of configuration	
T	maximum thickness of airfoil	
V_∞	free stream velocity	
x	distance from leading edge in streamwise direction	
y	distance from centerline in spanwise direction	
α	angle of attack	
Γ	dihedral angle	
Λ	sweep angle	
ρ_∞	free stream density	

Subscripts:

max	maximum value
trans	value at transition
1	value of the canard
2	value for the main wing

Abbreviations:

CFD	computational fluid dynamics
HLFC	hybrid laminar flow control
HSCT	High Speed Civil Transport
LEFT	Leading Edge Flight Test
N.F.	normal flow
NLF	natural laminar flow
SCAR	Supersonic Cruise Aircraft Research
S.F.	spanwise flow

SONIC BOOM REDUCTION

Sonic booms, in addition to NO_x emissions and engine noise, were the primary environmental concerns for supersonic transport designers during the 1960's and they remain so today. There is confidence, nevertheless, that these concerns can be treated successfully through continued research and the diligent application of state-of-the-art technologies. More efficient engines, lighter weight structural concepts and materials, and more accurate and capable aerodynamic codes will all contribute to lower sonic booms. Concepts not previously treatable using linear methods, and not producible using the 1960's structures technology, may now be explored.

The most difficult aspect of this systems-engineering challenge is the effect that these technologies have upon one another. One parameter cannot be changed without impacting the others unless the specific problem formulation or design permits the application of various constraints.

The primary factors affecting sonic boom and, hence, the design for a supersonic transport are:

- Mach number
- Aircraft weight
- Altitude/Atmosphere
- Aircraft size and shape
- Deceleration/Acceleration
- Engine position and exhaust
- Lift distribution/generation
- Dihedral/Anhedral
- Viscous effects
- Aircraft performance

A few remarks will be made about each of these factors with special emphasis on the last four.

Mach Number

Mach number affects the dynamic pressure which, in turn, influences the angle of attack that a given configuration must fly to maintain altitude. It can also have a major impact on interference effects such as induced lift and drag. Mach number determines whether a shock is attached or detached and whether for a given wing the leading-edge normal Mach number is subsonic or supersonic. Mach number is a factor in all viscous phenomena including shock boundary layer interactions.

Weight

Weight, of course, determines the amount of lift required to maintain straight and level flight. As lift increases for a given configuration and flight condition, so does the intensity of the boom. Due to the boom sensitivity to weight, it is perhaps more important to reduce the weight of a supersonic transport for given payload than any other type of aircraft. The aerodynamic efficiency and size of a given configuration along with the structures, materials, and systems required to fabricate it are all critical factors in the weight and, hence, the sonic boom intensity.

Altitude/Atmosphere

Altitude is a known critical factor in NO_x emissions and a factor in the character and intensity of the sonic boom signature. Nontrivial differences can occur in the sonic boom signature depending on the altitude of flight and whether a real or simplified atmosphere is used in the prediction (see ref. 2). Ideally, several "real" atmospheric models should be used to evaluate the boom for HSCT configurations including seasonal variations and atmospheric inversions. Since the variations in atmospheric properties must be discretized when employing ray tracing programs, the resolution employed can also affect the boom pressure signature calculated.

Aircraft Shape

Many configurations produce an N-shaped pressure signature long before the wave impacts the ground. There are configuration shapes and lengths, however, whose pressure signatures do not reach this terminal state as discussed in NASA SP's 180 and 255, AIAA preprint 89-1105, NASA TP 1348, as well as many other papers. Generally one attempts to shape the effective area distribution of a configuration such that a "plateau" wave and/or finite rise time wave are propagated. The attributes of these signatures (see later discussion on optimum shape) were discovered in the mid-60's and further refined in the 70's and still provide the primary targets for configuration design.

Aircraft Size

Aircraft size has many of the implications of "weight" since larger size usually means a heavier airplane. Increases in length normally have a beneficial effect on the sonic boom; however, one must be careful how the length is increased and the associated boom affected before making any judgement on its value. When size can be increased and the ratio of aircraft weight to wing area maintained or decreased, then size will be beneficial.

Attitude, Deceleration and Acceleration

The attitude a vehicle has with respect to the ground has a first order effect on the boom signature. Consequently, the climb and descent phases of flight must be tailored to minimize the sonic boom. Since one is usually accelerating during climb the possibility of a focused boom must be considered.

Engine Position and Exhaust

Normally, engines will be placed, and sometimes configured to maintain as smooth an area distribution as possible. When this is done, the wave drag will usually be at or near its minimum value for the configuration being evaluated. In addition, the engines will create a disturbance that must be allowed for in the sonic boom calculations. An important aspect of the engine as far as sonic boom is concerned is the exhaust, hence in a proper evaluation of an aircraft's sonic boom, whether theoretical or experimental, the exhaust must be modeled. In summary, the selection of an engine location and whether or not the engines should be paired (two pods of two engines) or located singly has important implications for the boom.

Lift Distributions

As noted by Ferri (ref. 3), "In order to reduce the sonic boom, interference effects must be utilized. The introduction of lift in the *front* of an airplane makes the equivalent area distribution similar to the cross-sectional area distribution of a blunt body." Figure 3 from Ferri's paper shows a simplified two-surface configuration. With 1/3 of the lift carried by the canard, a significant decrease in the maximum Δp_{shock} was realized. The potential of two-surface, canard wing configurations was not thoroughly explored in the 60's nor has it been explored in recent times. The application of current CFD codes to two-surface configurations, using a more accurate minimum boom area distribution as a guide, is clearly needed.

Interference Lift

Interference effects can be both beneficial and harmful. They can affect drag and lift and in the 60's were difficult to assess. With the advent of the new full potential, Euler and Navier-Stokes CFD codes and improved grid schemes, interference assessments can be made in a much more straightforward and accurate manner. Where interference lift is a nontrivial component of the total lift the near field signatures must be accurately portrayed by a higher order code to determine if there are any attendant sonic boom reductions. Equivalent axisymmetric bodies cannot be used for boom prediction

Ferri and Ismail (ref. 3) examined the use of the body compression field on the wing underside and the expansion field on the top to increase lift without proportional drag increases. Figure 4 from that same reference shows, however, that the compression field increases lift and drag in the same proportion for a semi circular body located on the lower side of the wing. As a consequence, no increase in L/D over a symmetrically located circular body is realized. However, the expansion field of an afterbody on the top of a wing should not experience such a cancellation. The important thing to remember is that as long as L/D is not decreased, interference lift will yield a lower sonic boom. An example of four "induced lift" configurations embodying a canard are shown in figure 5. There are many variations on this "induced lift" scheme, including fuselage shaping, but they require optimization. The application of 3-D Navier-Stokes and 3-D ray propagation codes to this problem should be a high priority.

Dihedral and Anhedral

We have just discussed induced lift as a means of reducing sonic boom. Another configuration variable thought to be worth additional study is wing dihedral or anhedral. Data from references 4 and 5 give a few clues of the potential. Near field spanwise $(\Delta p/p)_{\max}$ variations indicate reduced levels for dihedral (see fig. 6a from ref. 4) and increased levels for Anhedral relative to a flat wing. Sonic boom calculations based on the propagation of the centerline pressure signatures for the three wings are shown in figure 6b. There is a problem, however, with the wave propagation calculations in that they do not fully account for the radial and circumferential variations of the near field. It is clear from the physics of acoustics propagation that all gradients as well as magnitudes should be matched at the interface of the pressure field and ray tracing code. In the case of dihedral there is a divergence of the pressure field and for anhedral a convergence followed by divergence of the pressure field that is not represented by the "cylindrical" propagation of most ray propagation codes (see sketch).

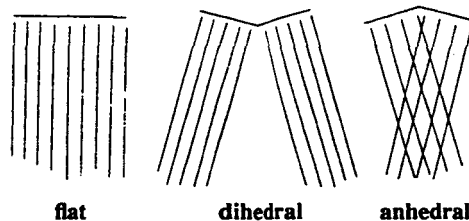

Sketch of Idealized Ray Propagation Patterns For a Flat Wing and Wings with Dihedral and Anhedral

The fact that the anhedral $(\Delta p/p)_{\max}$ curve is above the flat wing curve in figure 6b is an artifact of the position ($h/l = 4.5$) where the pressures were measured (see sketch). The contention here is that the benefits of dihedral and anhedral is underestimated and the underestimate increases with increasing Mach number. The latter is true since the wing pressure fields becomes more planar, or two dimensional like. The equivalent axisymmetric source distributions used for lift in linear theory provide the highest pressures on the centerline; dihedral and anhedral should reduce the level and move the maximum off the centerline. At the very least they should spread the energy more evenly over the ground. As a consequence, one would expect that more of the pressure field to be expended above and beyond the lateral cutoff leaving less for impact with the ground (see sketch).

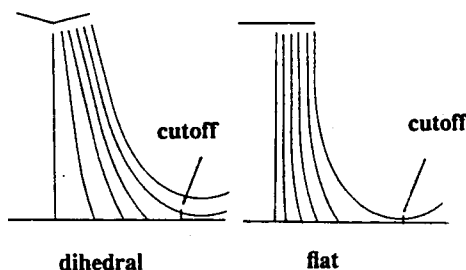

Sketch of Idealized Ray Propagation Patterns Relative to the Lateral Cutoff

In summary, then we have to:

- Propagate the real 3-D pressure field and not an idealized one.
- Solve the 3-D ray propagation equations.
- Adopt a new attitude with respect to what represents an optimum 3-D configuration.
- Measure radial and lateral gradients in wing tunnel flow fields for use in ray tracing codes.

A further contention is when advantage is taken of dihedral (anhedral), induced lifts, canards and 3-D minimization that moderate sweeps, more amenable to laminar flow, will look more attractive. CFD practitioners have an opportunity, to push sonic boom technology to the next level and perhaps reduce sonic booms to sonic "boomlets."

Viscous Effects

It has been shown in a number of papers that the boundary layer thickness and its contributions to the configurations effective shape cannot be ignored in the prediction of sonic booms (ref. 6). If an inviscid code is used for minimization purposes then boundary layer displacement thickness must be subtracted from the input geometry to arrive at the actual shape that will produce the minimum. It is important then to have some idea at the displacement thicknesses on the body and wing if one uses an inviscid code in boom minimization. In the analysis of a given configuration, boundary layers on the various aircraft components must be

taken into account, hence local Reynolds numbers, Mach numbers and pressure gradients become important. Clearly, a thick boundary layer will result in a higher sonic boom than a thin one (ref. 6). Consequently, the sonic boom associated with an aircraft will be favorably affected by HLFC.

Low Supersonic and Transonic Performance

While one has his principal focus on cruise L/D, sonic boom, weight, etc., there must also be some consideration given to the performance of the various designs at off design speeds. The efficiency of flight at low supersonic and transonic speeds as well as at landing and take-off must be considered. The lowest boom configuration may, for example, have poor transonic performance and the highest landing speed. If overland supersonic flight is not possible for whatever reason, then efficient transonic flight could be a very large "plus."

SUPERSONIC LAMINAR FLOW CONTROL

The use of suction for Laminar Flow Control (LFC) to facilitate drag reduction goes back to the early 1900's and was vigorously pursued in the 50's and 60's. Around 1970 LFC received a "new lease on life" from NASA's Aircraft Energy Efficient Program (ACEE). This program was formulated to provide the technology to increase the efficiency of large transports beyond that of the transport aircraft then flying. One of the components of this program was the Langley LFC Program carried out in the Langley 8-foot TPT on a 7-foot chord model. It had both slotted and perforated surfaces and was designed for a Mach number of 0.82. The extent of suction was variable so that both full chord and partial chord suction could be examined. Finally, and more pertinent to the present discussion, a Hybrid Laminar Flow Control (HLFC) concept was tested where suction was applied in the leading edge region and a favorable pressure gradient beyond the suction cutoff enabled laminar flow back to the 90 percent chord under some conditions.

Also sponsored by the ACEE Program was a series of flight tests focusing on Natural Laminar Flow (NLF) and LFC. The latter program had the acronym LEFT (Leading Edge Flight Test) and was aimed at the practical problems that arise at or near the leading edge of laminar flow wings. Insect contamination and deicing are two of the major ones. Also of interest in this program were the problems of contamination in an airport environment and flight through clouds, rain and ice crystals. A Lockheed Jetstar was equipped with two LFC gloves, one designed by Lockheed and the other by McDonnell Douglas. The Douglas glove had a perforated titanium surface and the Lockheed glove had a slotted aluminum surface. Test flights spanned about one year, much of it in simulated airline service, and found no significant adverse effects.

Since the completion of the ACEE Program, several other successful flight tests have been completed as part of NASA Langley's drag reduction program including a B-757 glove to evaluate the effect of engine noise on transition and, more recently, a B-757 test of a large HLFC glove.

At supersonic speeds some relevant wind tunnel tests have been carried out, many in the 1950's and 1960's, some of more recent vintage in NASA Langley's Supersonic Quiet Tunnel. Flight tests of a laminar flow glove at supersonic speeds are rare if nonexistent. A flight test program is, however, in progress utilizing an F-16XL which has approximately 65 degrees of

sweep and sufficient sustained supersonic flight capability for diagnostic experimentation. More flight experiments, perhaps using a different aircraft, should be carried out after further wing optimization studies are completed and, consequently, configuration options better understood. CFD and experimental wing studies should be undertaken including airfoil research to better understand the utility of both sharp and rounded leading edges and the types of pressure distributions required to minimize the extent and level of suction for a given extent of laminar flow. Investigations such as that carried out in the 60's based on the linear theory design of turbulent wings should be instituted using CFD codes for HLFC concepts and concurrent sonic boom calculations. Wing planform studies to provide an understanding of the effect of sweep on wave drag, sonic boom, L/D , suction-mass-flow requirements and transition are also required. In addition both diamond and arrow type planforms should be examined to determine if low chord Reynolds numbers (arrow wings) are more conducive to large extents of laminar flow than a wing with low sweep in the mid-chord region.

Some clues are provided in reference 7 where calculations of transition location as a function of sweep and Mach number are compared to data obtained by S. Pate in 1963 and documented in reference 8 (see fig. 7). It shows that beyond a sweep of 55 degrees only a trivial amount of NLF exists and suction must be used to obtain significant runs of laminar flow. Figure 8 from the same reference shows the small effect of sweep on wave drag for a fixed C_L leading one to believe that the real "trade off" on sweep is between sonic boom and friction drag. It is easy, when one looks at the data in reference 7, to come to the conclusion that the optimum sweep from a performance standpoint, for a laminar-flow wing is substantially less than for a turbulent flow wing. Optimum sweep in this context is one that yields the maximum drag reduction per unit suction system weight.

Figure 9 shows a sketch of a diamond wing of moderate sweep and a cranked delta planform with high inboard sweep. Also depicted is what the isobars of the two wing shapes might look like. The lower sweep of the isobars in the mid-chord region of the diamond wing would be more conducive to an HLFC concept than wings, such as the cranked delta where the isobars on average have higher sweeps.

If moderate sweeps are found to be advantageous for HLFC and low drag, then the wing leading edges will probably be supersonic (shock sweep $>$ leading sweep) with small radii or sharp leading edges. At off design (lower) Mach numbers, these leading edges will be a handicap - particularly at transonic Mach numbers. To overcome this problem, an articulated multifunction leading edge is proposed. It is deployed from the lower surface in order to keep the top surface free from hinges, steps and gaps. There are several versions of this device, one is shown schematically in figure 10. This type of leading edge can carry out the same functions as a vortex flap during landing and takeoff and increase L/D during transonic cruise. At low supersonic speeds, it might also decrease drag by obtaining a larger fraction of the available leading edge suction.

Another possible by-product of the application of LFC to supersonic transports is the use of the suction compressors to blow the flaps during landing and takeoff. Two dimensional tests of an airfoil with a blown trailing edge flap and deflected leading edge achieved a C_{Lmax} equivalent to that obtained using a leading edge Krueger flap with a triple-slotted trailing edge flap. The thin

sections appropriate to supersonic aircraft will not achieve this level but should provide 3-D L/D and C_{Lmax} values much higher than any conventional flap system. If this turns out to be an accurate projection, then landing speeds comparable to those of subsonic transports can be achieved.

The possible advantages of lower sweep, sharp-leading-edge, HLFC wings are summarized below:

- Lower drag, higher L/D
 - 60 percent top surface laminar flow should yield 7-10 percent decrease in aircraft drag
- Less suction mass flow for given area of laminar flow
 - Lower suction-system weight
- Higher transonic L/D
- More efficient high lift system
 - Lower landing and takeoff velocities
 - Smaller engine
- Possibly lower structural weight or lower T/C 's
- Lower leading-edge shock vorticity (leading edge shocks more planar)
- Lift more evenly distributed
- Lower sonic booms

BOOM PREDICTION

Sonic boom technology was developed to an advanced state during the 50's and 60's using the types of methods and computers that were state-of-the-art at that time. Most analytical methods were based on the Whitham F-function approach and the ARAP ray-propagation methodology. A few second order methods were formulated to account for nonlinear shock and non-axisymmetric effects (see NASA SP-255 and AIAA 89-1105) but none ever became "validated" codes.

While lifting-surface and axisymmetric body disturbances do not propagate in exactly the same manner, in the Whitham approach they are combined and represented as an equivalent axisymmetric body. For the shapes of interest in the 60's and the level of technology, adequate predictions were possible. Since that time, full potential, Euler and Navier Stokes codes have been developed which obviate the need for the Whitham assumptions. Theoretical or experimental near-field pressure signatures can be used for boom predictions with the aid of the Hicks/Mendoza or the C. L. Thomas methods (see NASA TN D-4214). As a consequence, a better accounting of real aircraft geometries and the contributions of lift and thickness have been made. Even so the full three dimensional disturbance field of an aircraft and the associated peripheral and radial gradients are not properly accounted for the propagation codes commonly used. With today's numerical techniques and computers the gradients at the interface of the near field pressures should be routinely accounted for. It was noted earlier that these gradients are not ordinarily measured in a wind tunnel boom-signature test.

On the CFD side most aircraft codes/grids are optimized to obtain the flow near the body with accuracy. When used to obtain pressure signatures for sonic boom calculations, new requirements arise. First, the shock up to the radial location at which the pressure signature is sought must be

resolved with high accuracy. Second, the calculation must be made well beyond the base of the body to insure that the rearmost point of the pressure signature "sees" the entire configuration and the near wake. To cater to these requirements means more grid points, more storage, and perhaps some modification of the grid scheme.

Optimum radius distributions from, a sonic boom standpoint, of power-law bodies ($r \propto x^n$) based on linear theory, yield n values which vary from 1/4 to 3/4 depending on the altitude and Mach number (see paper by L. B. Jones, D. S. Hague, and R. T. Jones). Since this type of area distribution is provided by a "blunt" equivalent axisymmetric shape which leads to a detached shock, the linear attached shock solution must be viewed as an approximate one. Note that the equivalent area distribution can be composed of both thickness and lift components and that the "blunt body" can be provided by a lifting surface or fuselage. Now with the application of modern CFD codes, a true optimum can be determined for various types of aircraft geometries. The computer resources required will be large but so will the reward.

An indication of the capabilities of current CFD technology to predict the aerodynamics of supersonic cruise vehicles can be obtained from a number of recent papers. One of particular note is that of V. Vatsa (ref. 9) which compares calculated pressures, forces and moments for a cranked delta configuration. Figure 11a from this paper shows the configuration; figure 11b shows the agreement of the predicted lift and drag coefficients with data at a Mach number of 3.0. Pressure distribution comparisons show similar agreement. The addition of suction boundary conditions and transition criteria are needed to estimate the performance of HLFC wings with the same degree of precision, i.e., with Navier-Stokes codes. Euler equations plus boundary layer codes can also be used to advantage. Some calculations of this type have already been accomplished in connection with F-16XL glove experiment.

A summary of the areas that CFD can contribute to supersonic aircraft design is given below:

- Configuration design and analysis
- Sonic boom
- Engine placement
 - performance
 - boom, including engine exhaust
 - flutter
- Buffet
- Inlet and exhaust flows
- Loads
- High lift
- Transition and suction requirements for HLFC
- 3-D ray tracing

CONCLUDING REMARKS

The two barrier environmental problems in supersonic commercial transport design are sonic booms and engine NO_x emissions. The former, which is the subject of the present workshop, has many technical facets as well as economical implications. If the boom of a supersonic transport

cannot be reduced to acceptable levels for overland flight, substantial losses in productivity will result. In the present paper an attempt has been made to show that there are technologies and configuration options that, if fully explored, will lead to reduced sonic booms and perhaps increase performance as well. With the increased application of CFD and experimental tools to supersonic HLFC, induced lift, canard configurations, dihedral/anedral and ray tracing one can look forward to the reduction of sonic booms to sonic "whooshes."

REFERENCES

1. Driver, Cornelius: What Gross Weight and Range for an Advanced HSCT. Proceedings of NASA Sonic Boom Workshop, Feb. 25-27, 1992.
2. Darden, Christine M.: Minimization of Sonic-Boom Parameters in Real and Isothermal Atmospheres. NASA TN D-7842, March 1975.
3. Ferri, Antonio and Ismail Ahmed: Report on Sonic Boom Studies. Second Conference on Sonic Boom Research held at NASA Washington, DC, NASA SP-180. May 9-10, 1968.
4. Hunton, Lynn W.: Current Research in Sonic Boom. Second Conference on Sonic Boom Research held at NASA Washington, DC, NASA SP-180. May 9-10, 1968.
5. Carlson, Harry W., Barger, Raymond L., and Mach, Robert J.: Application of Sonic-Boom Minimization Concepts in Supersonic Transport Design. NASA TN D-7218, June 1973.
6. Mack, Robert J., and Darden, Christine M.: Wind-Tunnel Investigation of the Validity of a Sonic-Boom-Minimization Concept. NASA TP 1421, October 1979.
7. Goradia, S. H. and Bobbitt P. J.: Theoretical Investigation for the Effects of Sweep, Leading-Edge Geometry, and Spanwise Pressure Gradients on Transition and Wave Drag at Transonic and Supersonic Speed with Experimental Correlations. SAE Technical Paper Series 881484, Aerospace Technology Conference and Exposition, Anaheim, CA, October 3-6, 1988.
8. Pate, S. R., and Brillhart, R. E.: Investigation of Boundary Layer Transition on Swept Wings at March Numbers 2.5 to 5. AEDC-TDR-65-10, July 1963.
9. Vatsa, Veer N., Turkel, Eli, and Abolhassani, J. S.: Extension of Multigrid Methodology to Supersonic/Hypersonic 3-D Viscous Flows. Fifth Copper Mountain Conference on Multigrid Methods, March 31-April 5, 1991.

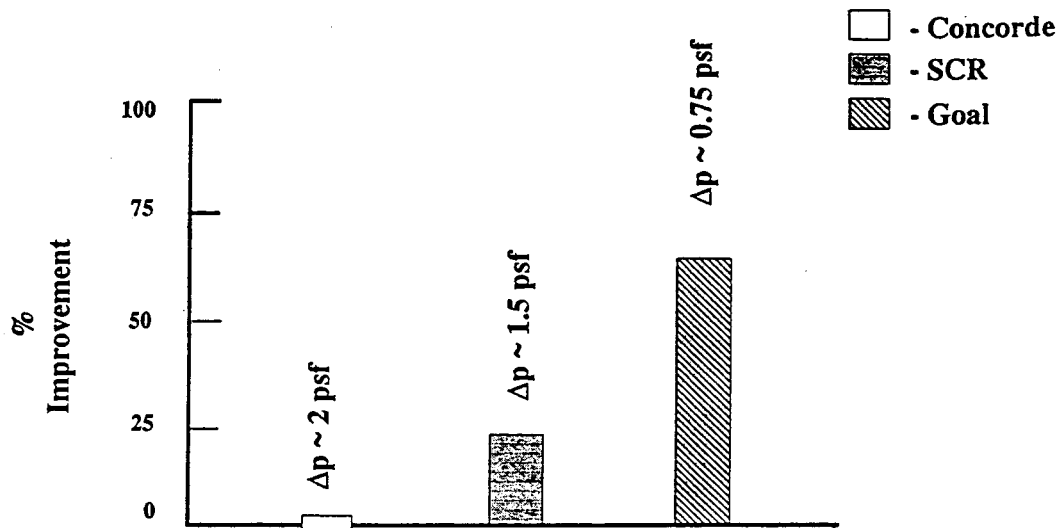

Figure 1. - Improvements in sonic boom overpressures relative to Concorde.

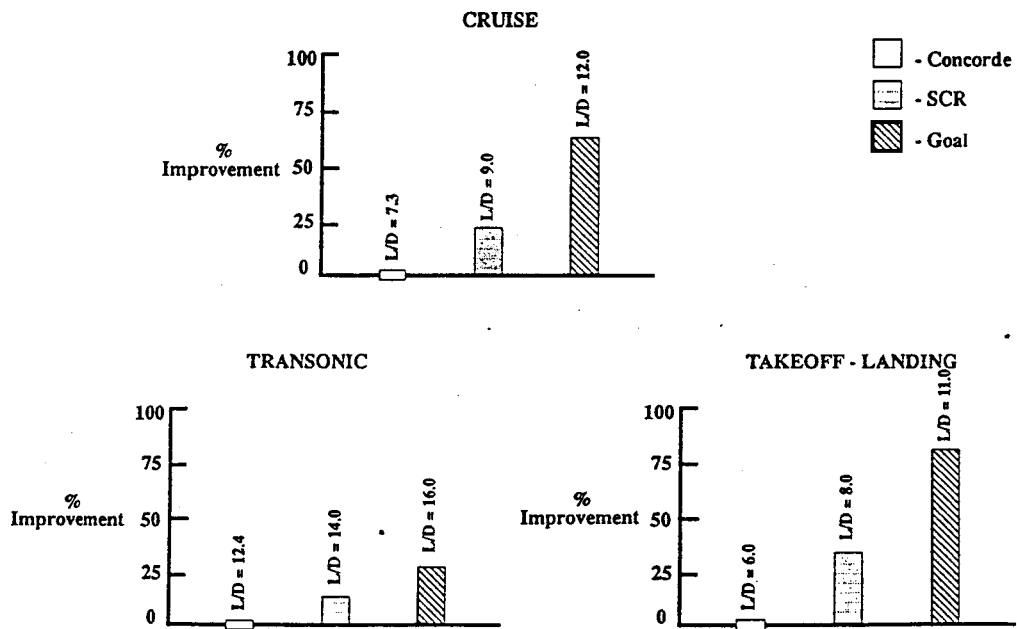

Figure 2. - L/D improvements in cruise, landing/takeoff and transonic flight regimes of supersonic transport designs since the Concorde.

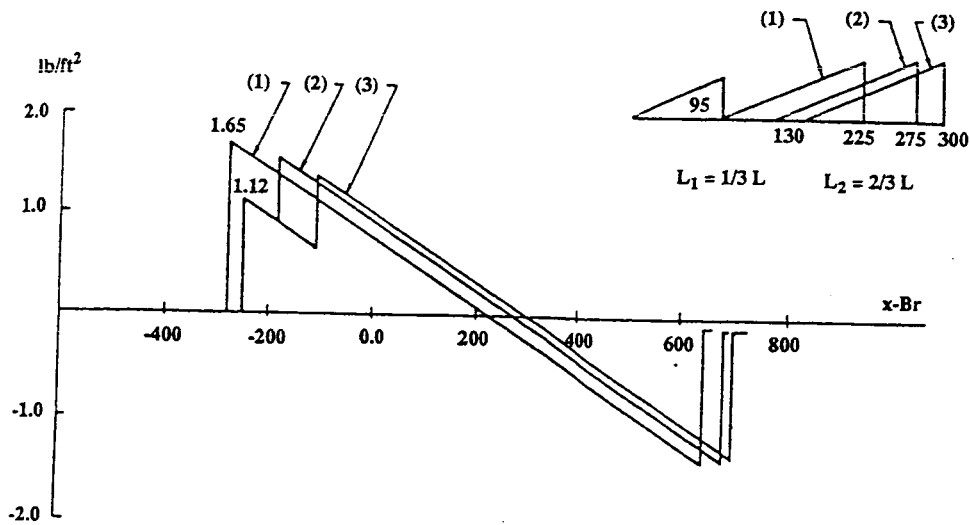

Figure 3. - Sonic boom signatures of simple canard/wing configurations.

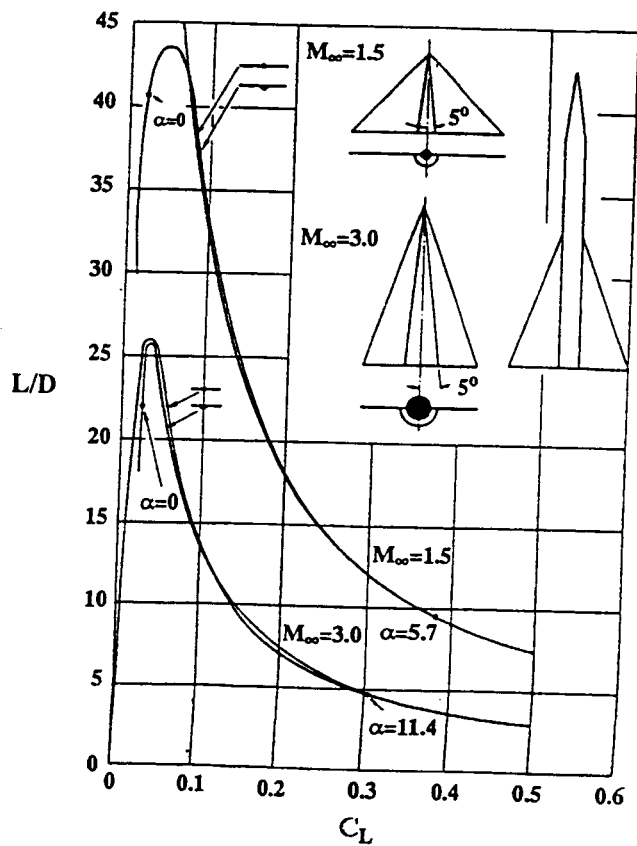

Figure 4. - L/D variations with C_L for two conical wing-body configurations at Mach numbers of 1.5 and 3.0.

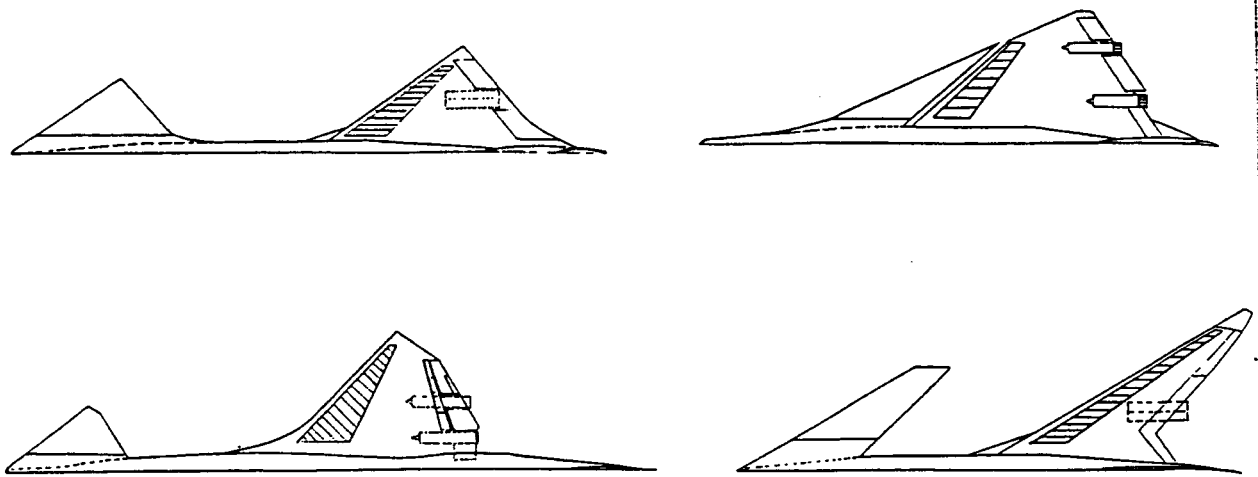

Figure 5. - Sketches of various types of induced-lift canard configurations.

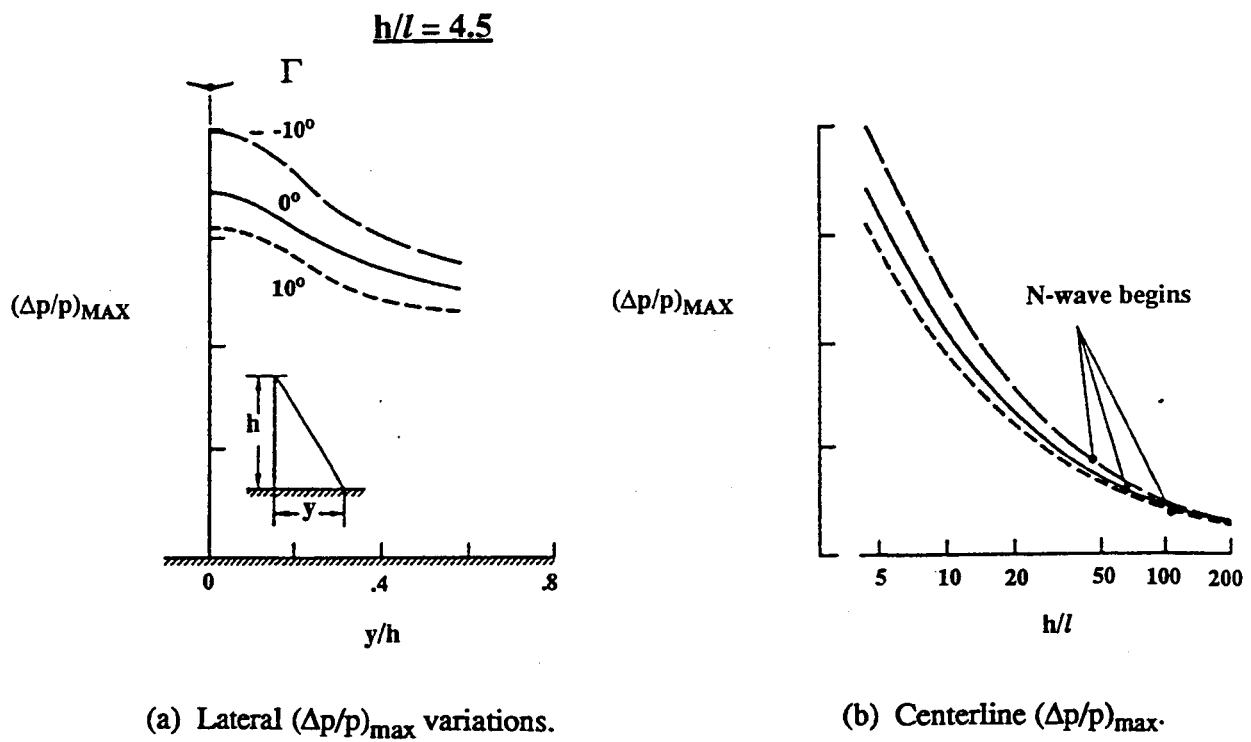
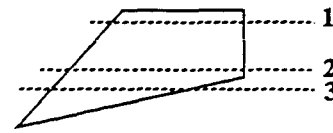

Figure 6. - Dihedral wing characteristics. $M_{\infty} = 1.7$; $C_L = 0.2$.

Circular Arc Section
 $T/C = .03, M_\infty = 3.0,$
 Chord Reynolds No. $= 6 \times 10^6, \alpha = 0^\circ$

Probe Location Station



- Theoretical computations for external disturbance level in tunnel
- - - Theoretical computations for negligible external disturbance level for free air conditions
- Experimental transition by sublimation technique @ Station #2

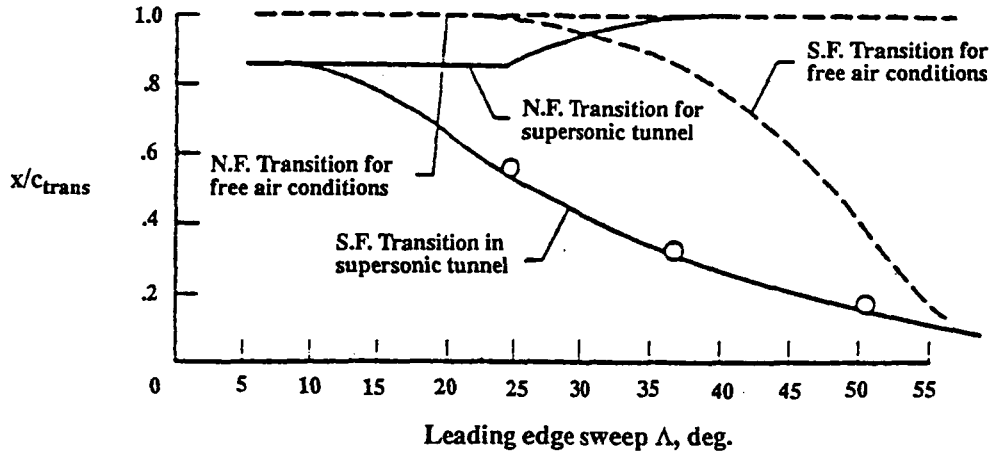

Figure 7. - Comparison of transition locations in wind tunnel conditions and in free air.

Biconvex Airfoil Section
 $T/C = 0.0465, M_\infty = 2.5$
 Free stream chord Reynolds no. $= 0.6 \times 10^6$
 Infinitely swept wing conditions
 $L/D_{max} = 9.15$ occurs @ $C_L = .12$

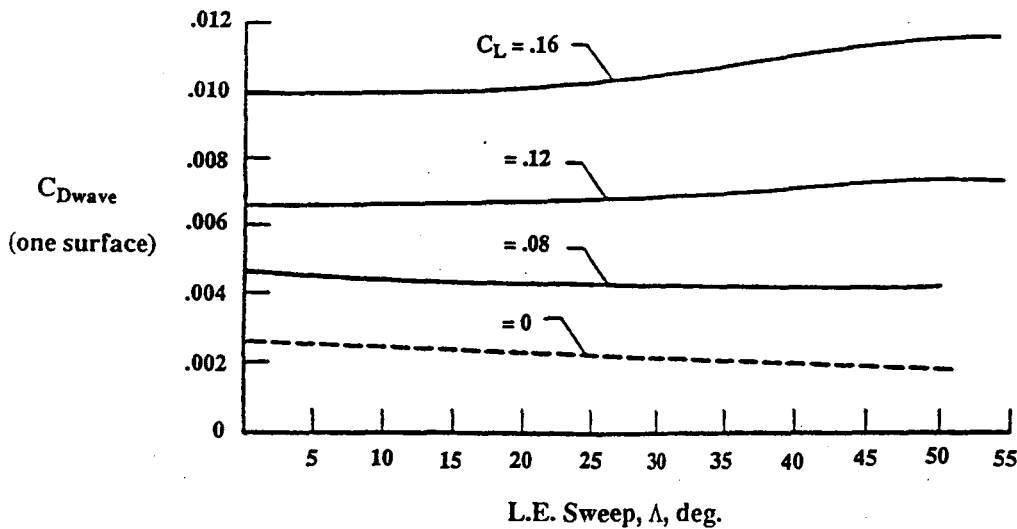

Figure 8. - Effect of C_L on the variation of supersonic wave drag with sweep.

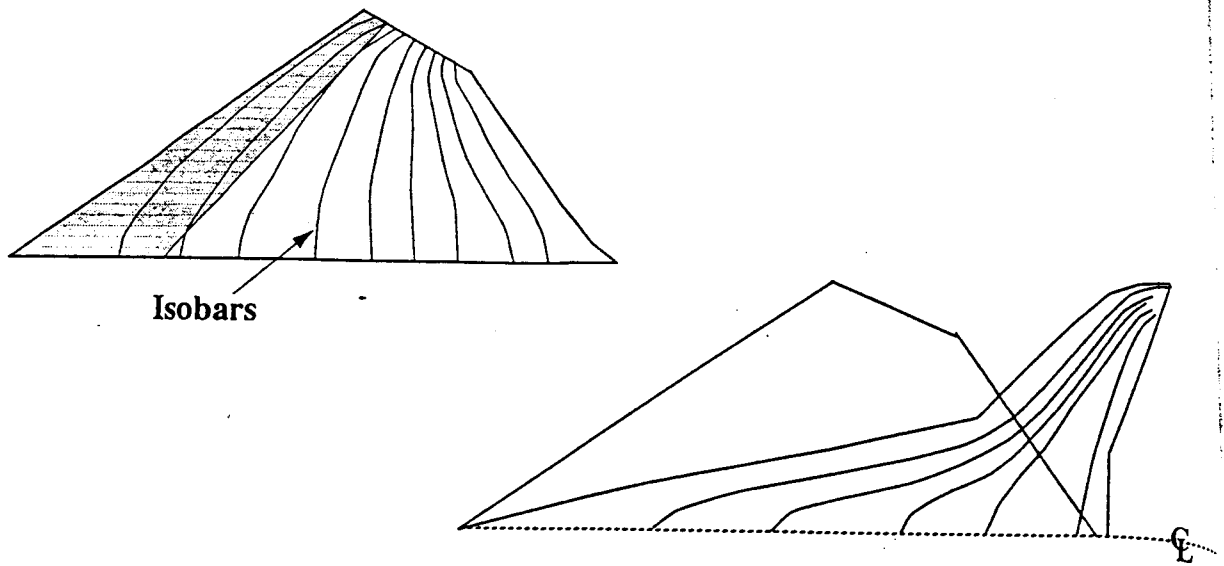

Figure 9. - Comparison of isobars for diamond and cranked delta wings.

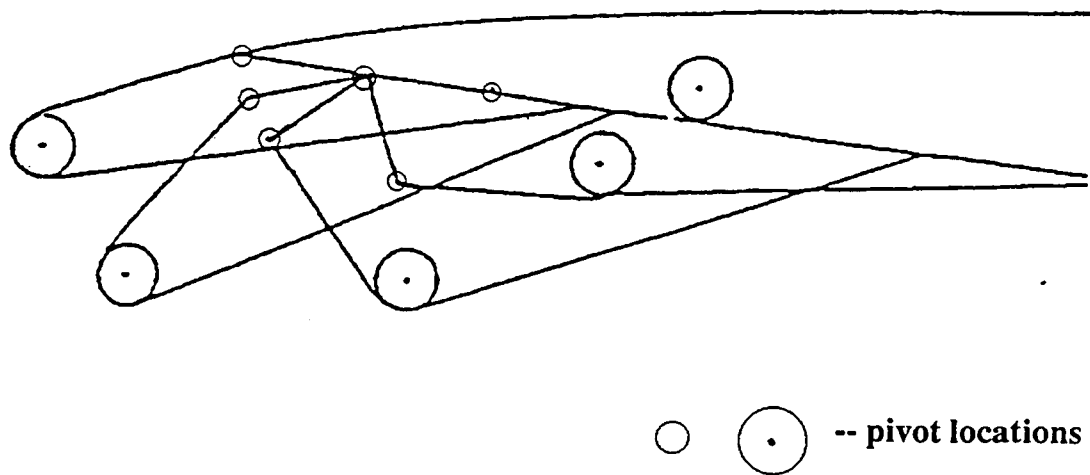
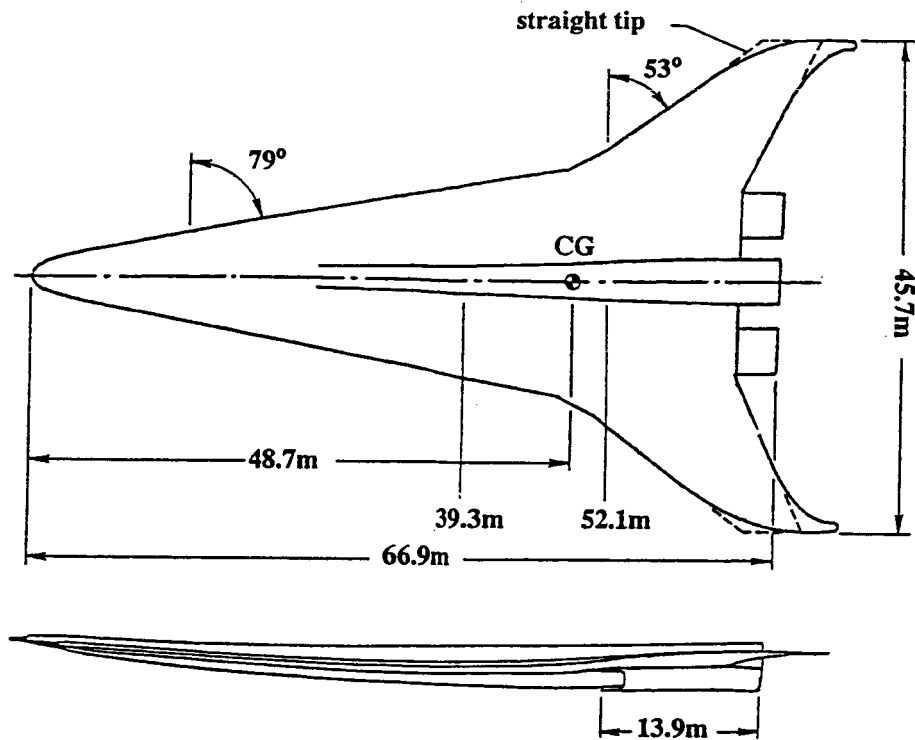
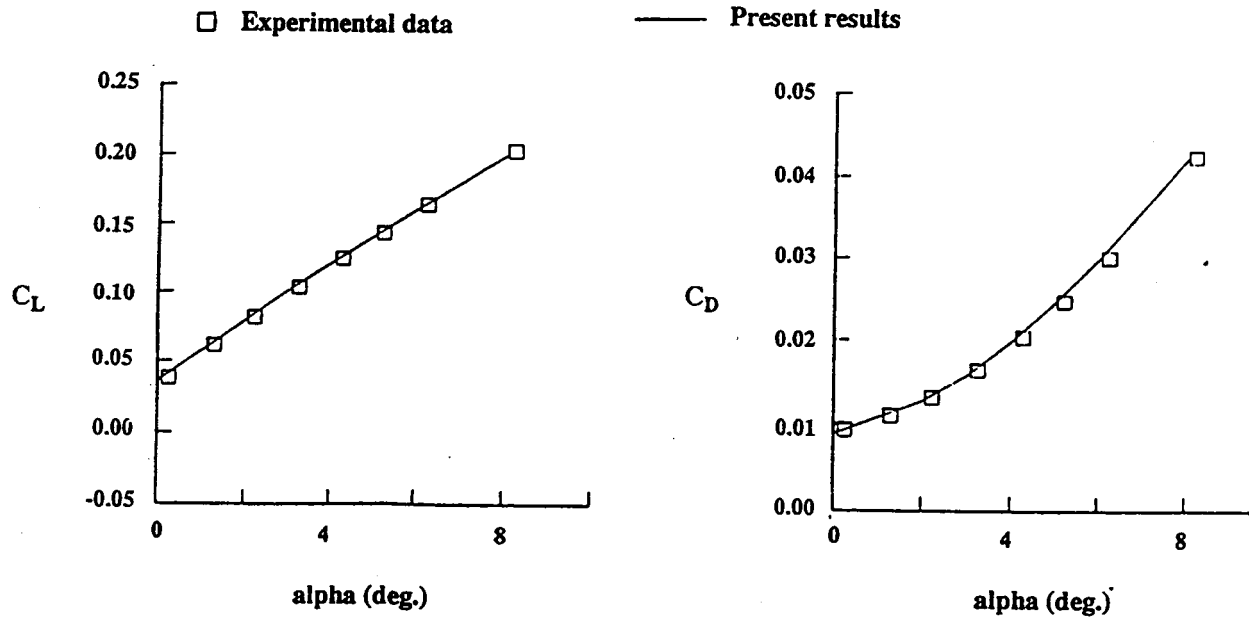

Figure 10. - Sketch of a leading edge device for sharp-edged supersonic wings.



(a) Generic supersonic transport.



(b) C_L and C_D comparisons.

Figure 11. - Geometry of a supersonic transport configuration and the predicted lift and drag coefficients compared to experiment. $M_\infty = 3.0$, $Re_l = 6.3 \times 10^6$